



58700

216 pieces VOREL tool set in a handy case.
Designed for assembly, workshop and household works.

- tools made of CrV 6140, CrV 50BV30 and carbon steel
- As-drive system increases the maximum torque by 25% and protects the screw against damage
- wide range sizes of spanners, sockets and bits

Zestaw 216 narzędzi VOREL w poręcznej walizce.

Przeznaczony do prac montażowych, warsztatowych i w gospodarstwie domowym.

- narzędzia wykonane ze stali węglowej, CrV 6140 i CrV 50BV30
- system As-drive zwiększa maksymalny moment o 25% i zabezpiecza śrubę przed uszkodzeniem
- szeroki przekrój rozmiarów kluczy, nasadek i bitów



www.toya.pl

**AS-DRIVE
SYSTEM**

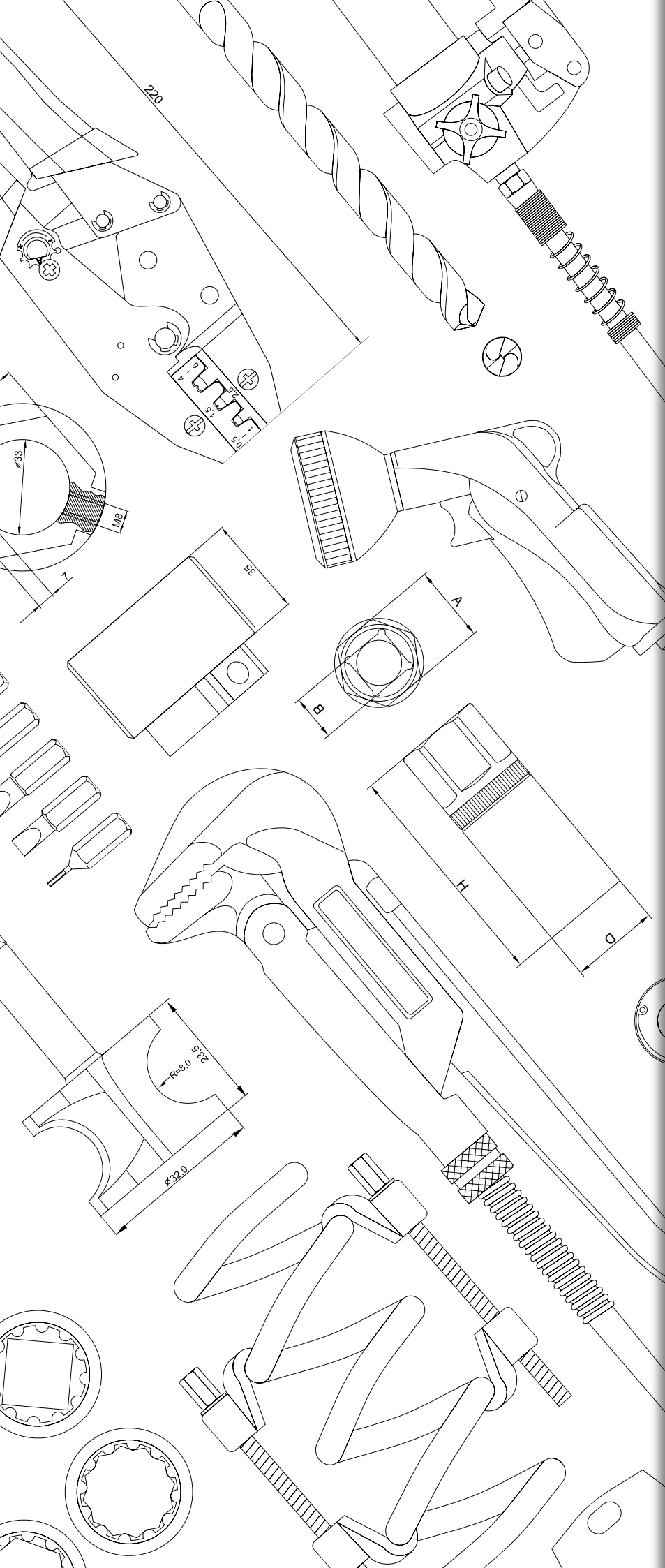

TOYA SA
ul. Sołtysowicka 13-15
51-168 Wrocław
☎ (+48 71) 32 46 200
fax: (+48 71) 32 46 370

sales@yato.pl (sale)
export@yato.pl (export)
import@yato.pl (import)

ODDZIAŁ WARSZAWSKI
Teren ProLogis Park Nadarzyn
al. Kasztanowa 160
05-831 Młochów k. Warszawy

☎ (+48 22) 73 82 800
☎ (+48 22) 73 82 828
sales@yato.pl (sale)
export@yato.pl (export)

1 **Spanners**
Klucze

6-13



2 **Sockets, accessories & sets**
Klucze nasadowe, akcesoria i zestawy

14-23



3 **Screwdrivers & screwdriver bits**
Wkrętaki i końcówki wkrętakowe

24-41



4 **Pliers & pipe wrenches**
Szczypce i klucze do rur

42-51



5 **Electrician tools**
Narzędzia dla elektryków

52-57



6 **Hammers, chisels, punches & axes**
Młotki, dłuta, przecinaki i siekiery

58-69



7 **Clamps & vices**
Ściski i imadła

70-75



8 Cutting tools Narzędzia tnące

76-119



9 Plumbing tools Narzędzia hydrauliczne

120-127



10 Fastening tools Narzędzia do łączenia

128-145

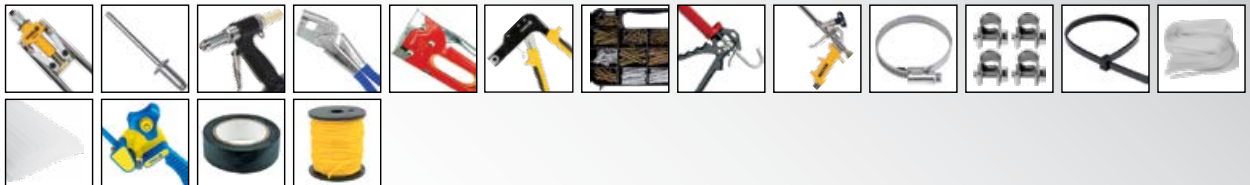

11 Plastering & bricklaying tools Narzędzia budowlane i malarskie

146-189



12 Measuring tools Narzędzia miernicze

190-207

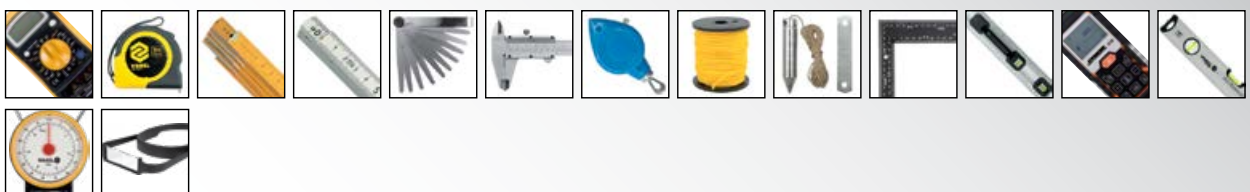

13 Pneumatic tools Narzędzia pneumatyczne

208-219



14 Special automotive tools & equipment Narzędzia i wyposażenie warsztatu samochodowego

220-255



15 Power tools & accessories 256-283
Elektronarzędzia i akcesoria



16 Welding equipment 284-291
Sprzęt spawalniczy



17 Safes, padlocks & locks 292-301
Sejfy, kłódki i zamki



18 Accessories 302-307
Akcesoria



19 Bicycle accessories 308-313
Akcesoria rowerowe



20 Kitchen and home appliance 314-347
Sprzęt AGD



21 Household equipment 348-377
Gospodarstwo domowe



22 Health & safety products Artykuły BHP

378-393



23 Electric products Artykuły elektryczne

394-407



24 Garden tools & power tools Narzędzia i elektronarzędzia ogrodowe

408-487



25 Sanitary ware & hydraulics Armatura sanitarna i hydraulika

488-531



Memo

1

Spanners Klucze



Combination spanners Klucze płasko-oczkowe

8-10



Combination spanners & sets, polished head

Klucze płasko-oczkowe i zestawy,
polerowana główka.....

8

Combination spanners & sets, satin finish CrV

Klucze płasko-oczkowe i zestawy,
wykończenie satynowe CrV.....

9

Combination ratchet wrenches Klucze płasko-oczkowe z grzechotką

10



Combination ratchet wrenches

Klucze płasko-oczkowe z grzechotką.....

10

Combination ratchet wrench sets

Zestawy kluczy płasko-oczkowych z grzechotką.....

10

Double open end spanners Klucze płaskie

10-11



Double open end spanners & sets, polished head

Klucze płaskie i zestawy, polerowana główka.....

10

Double open end spanner sets, satin finish CrV

Zestawy kluczy płaskich,
wykończenie satynowe CrV.....

11

Bi-hexagonal ring spanners Klucze oczkowe odgięte

11



Bi-hexagonal ring spanner sets, polished head

Zestawy kluczy oczkowych odgiętych, polerowana główka.....

11

Open end swivel socket spanners Klucze płasko-nasadowe

11



T-type deep socket wrenches Klucze nasadowe typu „T”

11

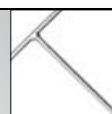

Box end wrenches Klucze rurowe

11



L-type wrenches

Klucze nasadowe typu „L”

12



Multipipe wrenches

Klucze uniwersalne

12



Double ratchet wrenches

Klucze nasadkowe z grzechotką

12



Adjustable wrenches

Klucze nastawne

12-13



Torque wrenches

Klucze dynamometryczne

13



1

EN Combination spanner
 PL Klucz płasko-oczkowy
 DE Maulringschlüssel
 RU Ключ комбинированный

CZ Plochý a očkový klíč
 RO Cheie combinată
 HU Kulcs villás-csillag
 ES Combinada con llave de estrella



No.	Size / Rozmiar [mm]	
51060	6	200/1200
51070	7	200/1000
51080	8	60/600
51090	9	60/600
51100	10	50/600
51110	11	50/400
51120	12	50/400
51130	13	50/400
51140	14	50/300
51150	15	50/300
51160	16	50/200
51170	17	20/200
51180	18	25/200
51190	19	30/120
51200	20	20/160
51210	21	20/120
51220	22	30/120
51240	24	15/90
51270	27	15/60
51300	30	10/40
51320	32	10/40

EN Combination spanner set
 PL Komplet kluczy płasko-oczkowych
 DE Maulringschlüsselsatz
 RU Набор ключей комбинированных
 CZ Souprava plochých a očkových klíčů
 RO Set chei combinate rasucite
 HU Kulcskészlet, villás-csillag
 ES Juego de combinadas con llave de estrella



No.	Size / Rozmiar [mm]	pcs / szt.	
51580	6, 8, 10, 11, 13, 14, 17, 19	8	5/50
51620	6, 7, 8, 9, 10, 11, 12, 13, 14, 17, 19, 22	12	5/20
51650	6, 7, 8, 9, 10, 11, 12, 13, 14, 15, 16, 17, 18, 19, 20, 21, 22, 23, 24, 25, 26, 27, 28, 30, 32	25	1/4

EN Combination spanner
 PL Klucz płasko-oczkowy
 DE Maulringschlüssel
 RU Ключ комбинированный
 CZ Plochý a očkový klíč
 RO Cheie combinată
 HU Kulcs villás-csillag
 ES Combinada con llave de estrella



STHOR

No.	Size / Rozmiar [mm]	
51040	6	200/1200
51042	8	100/600
51044	10	50/600
51046	12	50/400
51047	13	50/400
51048	14	50/300
51049	15	50/300
51051	17	20/200

EN Combination spanner set
 PL Komplet kluczy płasko-oczkowych
 DE Maulringschlüsselsatz
 RU Набор ключей комбинированных
 CZ Souprava plochých a očkových klíčů
 RO Set chei combinate rasucite
 HU Kulcskészlet, villás-csillag
 ES Juego de combinadas con llave de estrella



No.	Size / Rozmiar [mm]	pcs / szt.	
51560	8, 10, 12, 13, 14, 17	6	15/60
51590	6, 8, 10, 12, 13, 14, 17, 19	8	10/40
51630	6, 7, 8, 9, 10, 11, 12, 13, 14, 17, 19, 22	12	5/20
51640	6, 7, 8, 9, 10, 11, 12, 13, 14, 17, 19, 21, 24, 27, 32	15	2/12
51645	6, 7, 8, 9, 10, 11, 12, 13, 14, 15, 16, 17, 18, 19, 21, 22, 24, 27, 30, 32	20	2/8

EN Combination spanner set
 PL Komplet kluczy płasko-oczkowych
 DE Maulringschlüsselsatz
 RU Набор ключей комбинированных
 CZ Souprava plochých a očkových klíčů
 RO Set chei combinate rasucite
 HU Kulcskészlet, villás-csillag
 ES Juego de combinadas con llave de estrella



VOREL

No.	Size / Rozmiar [mm]	pcs / szt.	
50850	8, 10, 12, 13, 14, 17	6	4/40
50861	6, 8, 10, 13, 14, 17, 19, 22	8	4/32
50871	6, 7, 8, 9, 10, 11, 12, 13, 14, 17, 19, 22	12	2/20

EN Combination spanner set
 PL Komplet kluczy plasko-oczkowych
 DE Maulringschlüsselsatz
 RU Набор ключей комбинированных

CZ Souprava plochých a očkových klíčů
 RO Set chei combinate rasucite
 HU Kulcskészlet, villás-csillag
 ES Juego de combinadas con llave de estrella

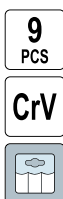

VOREL

No.	Size / Rozmiar	pcs / szt.	
50880	1/4" (6.3 mm), 5/16" (7.9 mm), 3/8" (9.5 mm), 7/16" (11.1 mm), 1/2" (12.7 mm), 9/16" (14.3 mm), 5/8" (15.9 mm), 1/16" (17.5 mm), 3/4" (19.0 mm)	9	10

EN Combination spanner set
 PL Komplet kluczy plasko-oczkowych
 DE Maulringschlüsselsatz
 RU Набор ключей комбинированных

CZ Souprava plochých a očkových klíčů
 RO Set chei combinate rasucite
 HU Kulcskészlet, villás-csillag
 ES Juego de combinadas con llave de estrella



VOREL

No.	Size / Rozmiar [mm]	pcs / szt.	
51720	8, 10, 12, 13, 14, 17	6	4/40
51721	6, 8, 10, 12, 13, 14, 17, 19	8	4/32
51722	6, 7, 8, 9, 10, 11, 12, 13, 14, 17, 19, 22	12	2/20

EN Combination spanner set
 PL Komplet kluczy plasko-oczkowych
 DE Maulringschlüsselsatz
 RU Набор ключей комбинированных

CZ Souprava plochých a očkových klíčů
 RO Set chei combinate rasucite
 HU Kulcskészlet, villás-csillag
 ES Juego de combinadas con llave de estrella



VOREL

No.	Size / Rozmiar [mm]	pcs / szt.	
51705	8, 10, 12, 13, 14, 15, 17, 19	8	30

EN Combination spanner
 PL Klucz plasko-oczkowy
 DE Maulringschlüssel
 RU Ключ комбинированный
 CZ Plochý a očkový klíč
 RO Cheie combinată
 HU Kulcs villás-csillag
 ES Combinada con llave de estrella



1



VOREL

No.	Size / Rozmiar [mm]	
51671	6	20/400
51672	7	20/400
51673	8	20/400
51674	9	20/400
51675	10	20/320
51676	11	20/240
51677	12	20/240
51678	13	20/200
51679	14	20/200
51680	15	20/200
51681	16	20/200
51682	17	20/160
51683	18	20/160
51684	19	20/160
51685	20	20/120
51686	21	20/120
51687	22	20/120
51688	23	10/80
51689	24	10/80
51690	25	10/60
51691	26	10/40
51692	27	10/40
51693	28	10/40
51694	29	10/40
51695	30	10/40
51696	32	10/40

EN Combination spanner set
 PL Komplet kluczy plasko-oczkowych
 DE Maulringschlüsselsatz
 RU Набор ключей комбинированных

CZ Souprava plochých a očkových klíčů
 RO Set chei combinate rasucite
 HU Kulcskészlet, villás-csillag
 ES Juego de combinadas con llave de estrella



VOREL

No.	Size / Rozmiar [mm]	pcs / szt.	
51710	6, 8, 10, 11, 12, 13, 14, 15, 17, 18, 19, 22	12	20

1

- EN Combination spanner set
- PL Komplet kluczy płasko-oczkowych
- DE Maulringschlüsselsatz
- RU Набор ключей комбинированных
- CZ Souprava plochých a očkových klíčů
- RO Set chei combinate rasucite
- HU Kulcskészlet, villás-csillag
- ES Juego de combinadas con llave de estrella

25 PCS CrV



VOREL

No.	Size / Rozmiar [mm]	pcs / szt.	
51715	6, 7, 8, 9, 10, 11, 12, 13, 14, 15, 16, 17, 18, 19, 20, 21, 22, 23, 24, 25, 26, 27, 28, 30, 32	25	4

- EN Combination ratchet wrench set
- PL Zestaw kluczy płasko-oczkowych z grzechotką
- DE Ratschenringmaulschlüssel-Satz
- RU Набор комбинированных ключей с трещоткой
- CZ Klíče ráčnové sada
- RO Set chei combinate
- HU Racsnis csillag-villás kulcs készlet
- ES Juego de llaves planas con matraca

4 PCS 72T 60Si2Mn CrV



VOREL

No.	Size / Rozmiar [mm]	pcs / szt.	
52661	10, 13, 17, 19	4	10/20

- EN Double open end spanner set
- PL Komplet kluczy płaskich
- DE Doppelmaulschlüsselsatz
- RU Набор рожковых ключей
- CZ Souprava plochých klíčů
- RO Set chei fixe
- HU Villás kulcskészlet
- ES Juego de llaves fijas

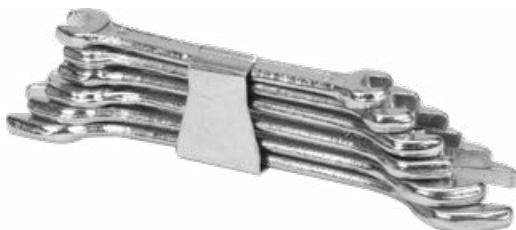

No.	Size / Rozmiar [mm]	pcs / szt.	
50560	6x7, 8x9, 10x11, 12x13, 14x15, 16x17	6	20/80
50590	6x7, 8x9, 10x11, 12x13, 14x15, 16x17, 18x19, 20x22	8	10/40
50610	6x7, 8x9, 10x11, 12x13, 14x15, 16x17, 18x19, 20x22, 24x27, 30x32	10	5/20
50630	6x7, 8x9, 10x11, 12x13, 14x15, 16x17, 18x19, 20x22, 21x23, 24x26, 25x28, 27x32	12	5/15

- EN Combination ratchet wrench
- PL Klucz płasko-oczkowy z grzechotką
- DE Ratschenringmaulschlüssel
- RU Ключ комбинированный с трещоткой
- CZ Klíč očkoplochý ráčnový
- RO Cheie combinata cu crichet
- HU Csillag-villás kulcs racsnis
- ES Llave combinada fija abierta y carraca

72T 60Si2Mn CrV



VOREL

No.	Size / Rozmiar [mm]	
52652	10	10/100
52653	11	10/100
52654	12	10/100
52655	13	10/100
52656	14	10/100
52657	15	10/100
52658	17	10/50
52659	19	10/50
52660	22	10/40

- EN Double open end spanner
- PL Klucz płaski
- DE Doppelmaulschlüssel
- RU Ключ рожковый
- CZ Plochý klíč
- RO Cheie fixă
- HU Villáskulcs
- ES Llave fija



No.	Size / Rozmiar [mm]	
50070	6x7	100/1000
50090	8x9	60/600
50100	8x10	60/600
50110	10x11	60/600
50120	10x13	50/500
50130	12x13	50/500
50150	14x15	50/300
50170	13x17	50/300
50190	17x19	30/180
50220	19x22	30/180
50270	24x27	25/100
50330	30x32	15/60

- EN Double open end spanner set
- PL Komplet kluczy płaskich
- DE Doppelmaulschlüsselsatz
- RU Набор ключей рожковых
- CZ Souprava plochých klíčů
- RO Set chei fixe
- HU Kulcskészlet, villás
- ES Juego de llaves fijas



No.	Size / Rozmiar [mm]	pcs / szt.	
50580	6x7, 8x9, 10x11, 12x13, 14x15, 16x17, 18x19, 20x22	8	10/40

EN Double open end spanner set
 PL Komplet kluczy płaskich
 DE Doppelmaulschlüsselsatz
 RU Набор рожковых ключей
 CZ Souprava plochých klíčů
 RO Set chei fixe
 HU Villás kulcskészlet
 ES Juego de llaves fijas



VOREL

No.	Size / Rozmiar [mm]	pcs / szt.	
51740	6x7, 8x9, 10x11, 12x13, 14x15, 16x17	6	4/40
51741	6x7, 8x9, 10x11, 12x13, 14x15, 16x17, 18x19, 20x22	8	4/24

EN Bi-hexagonal ring spanner set
 PL Komplet kluczy oczkowych odgiętych
 DE Doppelringschlüsselsatz
 RU Набор ключей накидных изогнутых
 CZ Klíče očkové vyhnuté sada
 RO Set chei inelare cu cot
 HU Csillagkulcs készlet
 ES Juego de llaves de estrella acodadas

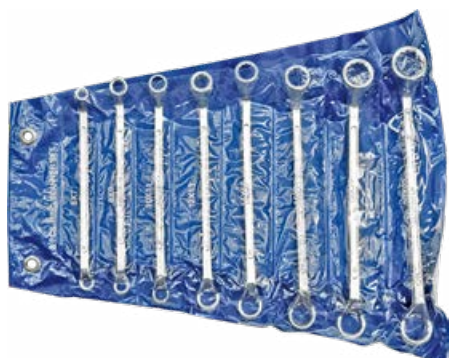

No.	Size / Rozmiar [mm]	pcs / szt.	
52580	6x7, 8x9, 10x11, 12x13, 14x15, 16x17, 18x19, 20x22	8	5/20

EN T-type socket wrench
 PL Klucz nasadowy typu „T”
 DE T-Griff-Steckschlüssel
 RU Ключ торцевой Т-образный
 CZ Šerový a nastrčný kľúč
 RO Cheie tubulara tip „T”
 HU Kulcs, csap-dugó
 ES Llave mandril vaso



No.	Socket size / Rozmiar nasadki [mm]	L [mm]	
56770	8	190	50
56710	8	380	50
56780	10	190	50
56720	10	380	50
56790	13	190	50
56730	13	380	50

EN Bi-hexagonal ring spanner set
 PL Komplet kluczy oczkowych odgiętych
 DE Doppelringschlüsselsatz
 RU Набор ключей накидных изогнутых



No.	Size / Rozmiar [mm]	pcs / szt.	
52630	6x7, 8x9, 10x11, 12x13, 14x15, 16x17, 18x19, 20x21, 22x23, 24x25, 26x27, 28x32	12	2/8

EN Open end swivel head socket wrench
 PL Klucz płasko-nasadowy, przegubowy
 DE Maul-Steckschlüssel
 RU Ключ рожково-торцевой с шарниром



No.	Size / Rozmiar [mm]	
52680	8	20/200
52700	10	20/200
52730	13	20/200
52740	14	20/200
52750	15	25/100
52770	17	25/100
52790	19	25/50
52820	22	25/50

EN Tubular socket wrench set
 PL Komplet kluczy rurowych
 DE Rohrsteckschlüsselsatz
 RU Набор ключей трубчатых
 CZ Klíče trubkové
 RO Chei pt. țevi
 HU Csőkulcs
 ES Llaves de tubería



No.	Size / Rozmiar [mm]	pcs / szt.	
52900	6x7, 8x9, 10x11, 12x13, 14x15, 16x17, 18x19, 20x22	10	6/24



1

10
PCS

1

- EN L-type socket wrench
 PL Klucz nasadowy typu „L”
 DE Steckschlüssel gebogen
 RU Ключ торцевой „L” типа
- CZ Nástrčný kľúč fajtkový
 RO Cheie tubulara cu cot tip „L”
 HU Kulcs, dugó-pipa
 ES Llave de vaso „L”



No.	Size / Rozmiar [mm]	
54600	6	80/320
54610	7	80/320
54620	8	50/200
54630	9	40/160
54640	10	40/160
54650	11	25/100
54660	12	25/100
54670	13	25/100
54680	14	20/80
54690	15	20/80
54700	16	12/48
54710	17	12/48
54720	18	10/40
54730	19	10/40
54750	21	6/24
54760	22	6/24
54780	24	6/24

- EN Adjustable wrench
 PL Klucz nastawny
 DE Rollgabelschlüssel
 RU Ключ разводной
- CZ Nastavitelný kľúč
 RO Cheie reglabilă
 HU Állítható svédkulcs
 ES Llave ajustable tipo inglesa



No.	L [mm]	
54061	200	6/60
54062	250	6/36
54063	300	6/24

- EN Multipipe wrenches
 PL Klucze uniwersalne
 DE Universalschlüssel
 RU Ключи универсальные
 CZ Univerzální kľúče
 RO Chei universale
 HU Univerzális kulcs
 ES Juego de llaves universales



No.	☰ [mm]	pcs / szt.	
54000	9-22, 23-32	2	20/40

- EN Double ratchet wrench
 PL Klucz nasadkowy z grzechotką
 DE Gerüstratsche
 RU Ключ торцевой с трещоткой
 CZ Ráčnový kľúč prúchozí dvostranný
 RO Cheie tubulara dubla cu cichet
 HU Kettős racsnis kulcs
 ES Llave de vaso con carraca



32T



No.	Size / Rozmiar [mm]	
52935	17x19	2/40
52936	19x22	2/40

- EN Adjustable wrench
 PL Klucz nastawny
 DE Rollgabelschlüssel
 RU Ключ разводной
- CZ Nastavitelný kľúč
 RO Cheie reglabilă
 HU Állítható svédkulcs
 ES Llave ajustable tipo inglesa



No.	L [mm]	
54065	150	6/120
54066	200	6/60
54067	250	6/36
54068	300	6/24

EN Adjustable wrench
 PL Klucz nastawny
 DE Rollgabelschlüssel
 RU Ключ разводной
 CZ Nastavitelný klíč
 RO Cheie reglabilă
 HU Állítható svédkulcs
 ES Llave ajustable tipo inglesa



VOREL

No.	L [mm]	
54080	375	2/12
54081	450	2/6

EN Torque wrench
 PL Klucz dynamometryczny wychylny
 DE Drehmomentschlüssel
 RU Ключ динамометрический стрелочный
 CZ Dynamometrický klíč
 RO Cheie cu dinamometru
 HU Nyomatékkulcs
 ES Llave dinamométrico inclin.

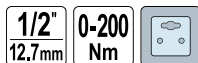

VOREL

No.	Ø	
57450	1/2" (12.7 mm)	6/24

EN Torque wrench
 PL Klucz dynamometryczny
 DE Drehmomentschlüssel
 RU Ключ динамометрический
 CZ Dynamometrický klíč
 RO Cheie cu dinamometru
 HU Nyomatékkulcs
 ES Llave dinamométrica



VOREL

No.	Ø	L [mm]	Torque / Moment obrotowy [Nm]	
57300	3/8" (9.5 mm)	270	13.6-108	20
57350	1/2" (12.7 mm)	465	28.0-210	10

EN Adjustable wrench
 PL Klucz nastawny
 DE Rollgabelschlüssel
 RU Ключ разводной

CZ Nastavitelný klíč
 RO Cheie reglabilă
 HU Állítható svédkulcs
 ES Llave ajustable tipo inglesa



1



VOREL

No.	L [mm]	
54070	150	6/120
54071	200	6/60
54072	250	6/36
54073	300	6/24

EN Torque wrench
 PL Klucz dynamometryczny wychylny
 DE Drehmomentschlüssel
 RU Ключ динамометрический стрелочный
 CZ Dynamometrický klíč
 RO Cheie cu dinamometru
 HU Nyomatékkulcs
 ES Llave dinamométrico inclin.

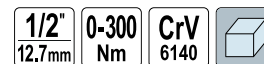

VOREL

No.	Ø	
57451	1/2" (12.7 mm)	16

EN Torque wrench
 PL Klucz dynamometryczny
 DE Drehmomentschlüssel
 RU Ключ динамометрический
 CZ Dynamometrický klíč
 RO Cheie cu dinamometru
 HU Nyomatékkulcs
 ES Llave dinamométrica



VOREL

No.	Ø	L [mm]	Torque / Moment obrotowy [Nm]	
57400	3/4" (19.0 mm)	625	68-406	10

2

Sockets, accessories & sets Klucze nasadowe, akcesoria i zestawy



Sockets
Klucze nasadowe



16

Hexagonal sockets 1/2" Klucze nasadowe sześciokątne 1/2"	16
Hexagonal sockets 3/4" Klucze nasadowe sześciokątne 3/4"	16
Universal wrench sockets Nasadki uniwersalne	16

Accessories
Akcesoria



16-17

Extension bars Przedłużki	16
Universal joints Przeguby Cardana	16
Sliding T-bars Pokręta typu „T”	17
Speed braces Rękojeści wygięte	17

Ratchet handles
Grzechotki



17-18

Socket & tool sets
Zestawy kluczy nasadowych
i narzędziowych



18-23

Socket sets 1/4" Zestawy kluczy nasadowych 1/4"	18
Socket sets 3/8" Zestawy kluczy nasadowych 3/8"	18
Socket sets 1/2" Zestawy kluczy nasadowych 1/2"	18
Socket sets 3/4" Zestawy kluczy nasadowych 3/4"	19
Tool sets Zestawy narzędziowe	19

2

EN Hexagonal socket
 PL Nasadka sześciokątna
 DE Sechskantenschlüssel
 RU Торцевая головка 6-гранная

CZ Šestihřanný nástavec
 RO Cheie tubulară hexagonală
 HU Hatszögű rátét
 ES Boquilla hexagonal corta

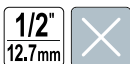

No.	Socket size / Rozmiar nasadki [mm]	Ø	
53100	10	1/2" (12.7 mm)	150/300
53120	12	1/2" (12.7 mm)	150/300
53130	13	1/2" (12.7 mm)	150/300
53140	14	1/2" (12.7 mm)	150/300
53150	15	1/2" (12.7 mm)	150/300
53160	16	1/2" (12.7 mm)	150/300
53170	17	1/2" (12.7 mm)	125/250
53180	18	1/2" (12.7 mm)	100/200
53190	19	1/2" (12.7 mm)	100/200
53220	22	1/2" (12.7 mm)	150/150
53240	24	1/2" (12.7 mm)	50/100
53270	27	1/2" (12.7 mm)	50/100
53300	30	1/2" (12.7 mm)	40/80
53320	32	1/2" (12.7 mm)	40/80

EN Universal wrench socket
 PL Nasadka uniwersalna
 DE Universal Steckschlüssel
 RU Головка универсальная

CZ Univerzální šroubovací nástavec
 RO Cheie tubulară universală
 HU Univerzális dugókulcs
 ES Universal llave de cubo



No.	Socket size / Rozmiar nasadki [mm]	Ø	
53002	7-19	3/8" (9.5 mm)	8/48
53003	11-32	1/2" (12.7 mm)	6/24

EN Extension bar
 PL Przedłużka
 DE Verlängerung
 RU Удлинитель для воротка

CZ Prodlužovací přípravek
 RO Prelungitor
 HU Toldalék
 ES Tubo de prolongación



No.	Ø	L [mm]	
53610	1/2" (12.7 mm)	125	50/100
53630	1/2" (12.7 mm)	250	25/50

EN Extension bar
 PL Przedłużka
 DE Verlängerung
 RU Удлинитель для воротка

CZ Prodlužovací přípravek
 RO Prelungitor
 HU Toldalék
 ES Tubo de prolongación



No.	Ø	L [mm]	
53650	3/4" (19.0 mm)	100	60
53670	3/4" (19.0 mm)	200	25

EN Hexagonal socket
 PL Nasadka sześciokątna
 DE Sechskantenschlüssel
 RU Торцевая головка 6-гранная

CZ Šestihřanný nástavec
 RO Cheie tubulară hexagonală
 HU Hatszögű rátét
 ES Boquilla hexagonal corta

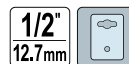

No.	Socket size / Rozmiar nasadki [mm]	Ø	
53332	10	1/2" (12.7 mm)	10/300
53335	13	1/2" (12.7 mm)	10/300
53336	14	1/2" (12.7 mm)	5/300
53337	15	1/2" (12.7 mm)	5/300
53338	16	1/2" (12.7 mm)	5/300
53339	17	1/2" (12.7 mm)	5/250
53340	18	1/2" (12.7 mm)	10/200
53341	19	1/2" (12.7 mm)	10/200

EN Hexagonal socket
 PL Nasadka sześciokątna
 DE Sechskantenschlüssel
 RU Торцевая головка 6-гранная

CZ Šestihřanný nástavec
 RO Cheie tubulară hexagonală
 HU Hatszögű rátét
 ES Boquilla hexagonal corta

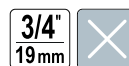

No.	Socket size / Rozmiar nasadki [mm]	Ø	
53400	22	3/4" (19.0 mm)	50
53410	24	3/4" (19.0 mm)	50
53420	27	3/4" (19.0 mm)	50
53430	30	3/4" (19.0 mm)	50
53440	32	3/4" (19.0 mm)	50
53450	36	3/4" (19.0 mm)	50
53460	38	3/4" (19.0 mm)	40
53470	41	3/4" (19.0 mm)	25
53480	46	3/4" (19.0 mm)	20
53490	50	3/4" (19.0 mm)	20

EN Universal joint
 PL Przegub Cardana
 DE Kardangelenk
 RU Карданный шарнир
 CZ Kardanový kloub
 RO Articulație Cardanică
 HU Kárdán csukló
 ES Articulación Cardan



No.	Ø	
53600	1/2" (12.7 mm)	60/120

EN Sliding T-bar
PL Pokrętko typu „T”
DE Handgriff mit Gleitstück
RU Вороток Т-образный

CZ Otočná račka typ „T”
RO Măner clupă tipul „T”
HU „T” alakú hajtókar
ES Mango tipo „T”



No.	Ø	L [mm]	
53700	1/2" (12.7 mm)	250	25/50

EN Speed brace
PL Rękojeść wygięta
DE Kurbelverlängerung
RU Вороток-коловорот

CZ Ohnutá rukojeť
RO Măner clupă (manivelă)
HU Hajlított markolat
ES Mango encorvado



No.	Ø	L [mm]	
53730	1/2" (12.7 mm)	400	40

EN Ratchet handle
PL Grzechotka
DE Hebelumschaltknarre
RU Трещотка

CZ Ráčna
RO Dispozitiv de prindere cu clichet
HU Racsnis hajtókar
ES Carraca



No.	Ø	L [mm]	
53561	1/4" (6.3 mm)	135	40/80
53562	3/8" (9.5 mm)	190	25/50
53563	1/2" (12.7 mm)	240	20/40

EN Ratchet handle
PL Grzechotka
DE Hebelumschaltknarre
RU Трещотка

CZ Ráčna
RO Dispozitiv de prindere cu clichet
HU Racsnis hajtókar
ES Carraca



No.	Ø	L [mm]	Number of teeth / Liczba zębów	
53571	1/4" (6.3 mm)	150	72	6/36
53572	3/8" (9.5 mm)	200	72	6/36
53573	1/2" (12.7 mm)	260	72	6/36

EN Sliding T-bar
PL Pokrętko typu „T”
DE Handgriff mit Gleitstück
RU Вороток Т-образный

CZ Otočná račka typ „T”
RO Măner clupă tipul „T”
HU „T” alakú hajtókar
ES Mango tipo „T”



No.	Ø	L [mm]	
53710	3/4" (19.0 mm)	450	20

EN Ratchet handle
PL Grzechotka
DE Gelenk-Hebelumschaltknarre
RU Трещотка

CZ Ráčna
RO Dispozitiv de prindere cu clichet
HU Racsnis hajtókar
ES Carraca



No.	Ø	L [mm]	
53500	1/4" (6.3 mm)	125	40/80
53520	3/8" (9.5 mm)	195	25/50
53540	1/2" (12.7 mm)	250	20/40

EN Flexible ratchet handle
PL Grzechotka przegubowa
DE Gelenk-Hebelumschaltknarre
RU Трещотка шарнирная

CZ Kloubová řehtačka
RO Antrenor cu clichet, flexibil
HU Csuklós racsnis
ES Llave de carraca articulada

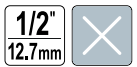

No.	Ø	L [mm]	
53560	1/2" (12.7 mm)	250	25/50

EN Ratchet handle
PL Grzechotka
DE Hebelumschaltknarre
RU Трещотка

CZ Ráčna
RO Dispozitiv de prindere cu clichet
HU Racsnis hajtókar
ES Carraca



No.	Ø	L [mm]	Number of teeth / Liczba zębów	
53575	1/4" (6.3 mm)	155	72	12/72
53576	3/8" (9.5 mm)	200	72	6/48
53577	1/2" (12.7 mm)	250	72	6/36

- EN Ratchet handle
- PL Grzechotka
- DE Hebelumschaltknarre
- RU Трещотка
- CZ Ráčna
- RO Dispozitiv de prindere cu clichet
- HU Racsnis hajtókar
- ES Carraca



No.	Ø	L [mm]	pcs / szt.	Icon
53580	3/4" (19.0 mm)	500	10	Icon

- EN Socket set
- PL Komplet nasadek z akcesoriami
- DE Sechskantenschlüssel-Einsatz
- RU Набор торцевых головок
- CZ Sada nástrčných klíčů a ráčny
- RO Trusă de scule
- HU Dugókulcs készlet racsnis hajtókarral
- ES Juego de boquillas con accesorios



1/4" (6.3 mm): 4, 4.5, 5, 5.5, 6, 7, 8, 9, 10, 11, 12 mm; 3/8" (9.5 mm): 13, 14, 17 mm; 3/8" (9.5 mm) x 21 mm; 3/8" (9.5 mm) x 70 mm; 1/4" (6.3 mm) x 3/8" (9.5 mm); 1/4" (6.3 mm) x 50 mm; 3/8" (9.5 mm) x 190 mm; 3/8" (9.5 mm)

No.	Ø	pcs / szt.	Icon
58210	1/4" (6.3 mm), 3/8" (9.5 mm)	20	Icon

- EN Socket set
- PL Komplet nasadek z akcesoriami
- DE Sechskantenschlüssel-Einsatz
- RU Набор торцевых головок
- CZ Sada nástrčných klíčů a ráčny
- RO Trusă de scule
- HU Dugókulcs készlet racsnis hajtókarral
- ES Juego de boquillas con accesorios



1/2" (12.7 mm): 10, 11, 12, 13, 14, 15, 16, 17, 18, 19, 20, 21, 22, 23, 24, 27, 30, 32 mm; 1/2" (12.7 mm) x 21 mm; 1/2" (12.7 mm) x 125 mm; 1/2" (12.7 mm) x 250 mm; 1/2" (12.7 mm) x 250 mm; 1/2" (12.7 mm) x 240 mm; 1/2" (12.7 mm) x 390 mm

No.	Ø	pcs / szt.	Icon
58260	1/2" (12.7 mm)	24	Icon

- EN Socket set
- PL Komplet nasadek z akcesoriami
- DE Sechskantenschlüssel-Einsatz
- RU Набор торцевых головок
- CZ Sada nástrčných klíčů a ráčny
- RO Trusă de scule
- HU Dugókulcs készlet racsnis hajtókarral
- ES Juego de boquillas con accesorios



1/4" (6.3 mm): 4, 4.5, 5, 5.5, 6, 6.5, 7, 8, 9, 10, 11, 12, 13 mm; 1/4" (6.3 mm) x 50 mm; 1/4" (6.3 mm) x 120 mm; 1/4" (6.3 mm)

No.	Ø	pcs / szt.	Icon
58160	1/4" (6.3 mm)	16	Icon

- EN Socket set
- PL Komplet nasadek z akcesoriami
- DE Sechskantenschlüssel-Einsatz
- RU Набор торцевых головок
- CZ Sada nástrčných klíčů a ráčny
- RO Trusă de scule
- HU Dugókulcs készlet racsnis hajtókarral
- ES Juego de boquillas con accesorios



1/2" (12.7 mm): 8, 9, 10, 11, 12, 13, 14, 15, 16, 17, 18, 19, 20, 21, 22, 23, 24, 27, 30 mm; 1/2" (12.7 mm) x 125 mm; 1/2" (12.7 mm) x 250 mm; 1/2" (12.7 mm) x 240 mm; 1/2" (12.7 mm)

No.	Ø	pcs / szt.	Icon
58240	1/2" (12.7 mm)	24	Icon

- EN Ratchet handle with socket set
- PL Komplet nasadek z grzechotką
- DE Sechskant-Steckschlüssel-Satz
- RU Трещотка с насадками
- CZ Sada nástrčných klíčů a ráčny
- RO Trusă de scule
- HU Dugókulcs készlet racsnis hajtókarral
- ES Matraca con boquillas

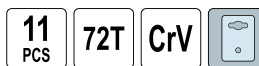

No.	Socket size / Rozmiar nasadki [mm]	L [mm]	Ø	Icon
58600	5, 6, 7, 8, 9, 10, 11, 12, 13, 14	150	1/4" (6.3 mm)	Icon
58602	10, 11, 12, 13, 14, 15, 17, 19, 22, 24	260	1/2" (12.7 mm)	Icon

EN Socket set
 PL Komplet nasadek z akcesoriami
 DE Sechskantenschlüssel-Einsatz
 RU Набор торцевых головок
 CZ Sada nástrčných klíčů a ráčny
 RO Trusă de scule
 HU Dugókulcs készlet racsnis hajtókarral
 ES Juego de boquillas con accesorios

12 PCS **1/2"** 12.7mm **45T** AS-DRIVE



1/2" (12.7 mm): 10, 11, 12, 13, 14, 15, 17, 19, 21, 24 mm;
 1/2" (12.7 mm);
 1/2" (12.7 mm); 45T

No.	Ø	pcs / szt.	📦
58633	1/2" (12.7 mm)	12	5/10

EN Socket set
 PL Komplet nasadek z akcesoriami
 DE Sechskantenschlüssel-Einsatz
 RU Набор торцевых головок

CZ Sada nástrčných klíčů a ráčny
 RO Trusă de scule
 HU Dugókulcs készlet racsnis hajtókarral
 ES Juego de boquillas con accesorios

14 PCS **3/4"** 19mm



3/4" (19.0 mm): 22, 24, 27, 30, 32, 36, 38, 41, 46, 50 mm;
 3/4" (19.0 mm) x 100; 200 mm;
 3/4" (19.0 mm) x 456 mm; 3/4" (19.0 mm) x 495 mm

No.	Ø	pcs / szt.	📦
58140	3/4" (19.0 mm)	14	2

EN Tool set
 PL Zestaw narzędziowy
 DE Sechskant-Steckschlüssel-Satz
 RU Набор торцевых головок

CZ Sada nástrčných klíčů a ráčny
 RO Trusă de scule
 HU Dugókulcs készlet racsnis hajtókarral
 ES Juego de herramientas

38 PCS **1/4"** 6.3mm

45T AS-DRIVE



1/4" (6.3 mm): 3.5, 4, 4.5, 5, 5.5, 6, 7, 8, 9, 10, 11, 12, 13, 14 mm;
 1/4" (6.3 mm); 1/4" (6.3 mm); 1/4" (6.3 mm);
 1/4" (6.3 mm); 1/4" (6.3 mm); 1/4" (6.3 mm); 45T; 1/4" (6.3 mm); 1/4" (6.3 mm);
 1/4" (6.3 mm); 4, 5.5, 6.5 mm; 1/4" (6.3 mm); PH1, PH2; 1/4" (6.3 mm); PZ1, PZ2;
 1/4" (6.3 mm); T10, T15, T20, T25, T30, T40; 1/4" (6.3 mm); 3, 4, 5, 6, 8 mm

No.	Ø	pcs / szt.	📦
58640	1/4" (6.3 mm)	38	10

EN Ratchet handle with socket set
 PL Komplet nasadek z grzechotką
 DE Sechskant-Steckschlüssel-Satz
 RU Трещотка с насадками
 CZ Sada nástrčných klíčů a ráčny
 RO Trusă de scule
 HU Dugókulcs készlet racsnis hajtókarral
 ES Matraca con boquillas

19 PCS **1/2"** 12.7mm **45T**

AS-DRIVE



1/2" (12.7 mm): 8, 9, 10, 11, 12, 13, 14, 15, 16, 17, 19, 21, 22, 23, 24, 27, 30, 32 mm;
 1/2" (12.7 mm); 45T

No.	Ø	pcs / szt.	📦
58634	1/2" (12.7 mm)	19	4/8

EN Socket set
 PL Komplet nasadek z akcesoriami
 DE Sechskantenschlüssel-Einsatz
 RU Набор торцевых головок

CZ Sada nástrčných klíčů a ráčny
 RO Trusă de scule
 HU Dugókulcs készlet racsnis hajtókarral
 ES Juego de boquillas con accesorios

20 PCS

3/4" 19mm



3/4" (19.0 mm): 22, 24, 26, 27, 28, 30, 32, 34, 36, 38, 41, 42, 45, 46, 48, 50 mm;
 3/4" (19.0 mm) x 100; 200 mm;
 3/4" (19.0 mm) x 456 mm;
 3/4" (19.0 mm) x 495 mm

No.	Ø	pcs / szt.	📦
58150	3/4" (19.0 mm)	20	2

EN Tool set
 PL Zestaw narzędziowy
 DE Sechskant-Steckschlüssel-Satz
 RU Набор торцевых головок

CZ Sada nástrčných klíčů a ráčny
 RO Trusă de scule
 HU Dugókulcs készlet racsnis hajtókarral
 ES Juego de herramientas

42 PCS **1/4"** 6.3mm

45T AS-DRIVE



1/4" (6.3 mm): 4, 4.5, 5, 5.5, 6, 7, 8, 9, 10, 11, 12, 13, 14 mm; 1/4" (6.3 mm); 8, 9, 10, 11, 12, 13 mm;
 1/4" (6.3 mm); 2 PCS; 1/4" (6.3 mm); 1/4" (6.3 mm); 1/4" (6.3 mm); 1/4" (6.3 mm);
 1/4" (6.3 mm); 45T; 1/4" (6.3 mm); 1/4" (6.3 mm); 1/4" (6.3 mm) x 1/4" (6.3 mm);
 1/4" (6.3 mm); 3, 4, 5 mm; 1/4" (6.3 mm); PH0, PH1, PH2; 1/4" (6.3 mm); PZ0, PZ1, PZ2;
 1/4" (6.3 mm); 6, 7, 8 mm; 1.5, 2, 2.5 mm

No.	Ø	pcs / szt.	📦
58641	1/4" (6.3 mm)	42	10

EN Tool set
 PL Zestaw narzędziowy
 DE Sechskant-Steckschlüssel-Satz
 RU Набор торцевых головок
 CZ Sada nástrčných klíčů a ráčny
 RO Trusă de scule
 HU Dugókulcs készlet racsnis hajtókarral
 ES Juego de herramientas

56 PCS
 1/4" 6.3mm
 CrV 50BV30
 45T
 AS-DRIVE



1/4" (6.3 mm): 4, 4.5, 5, 5.5, 6, 7, 8, 9, 10, 11, 12, 13 mm; 1/4" (6.3 mm): 6, 7, 8, 9, 10, 11, 12, 13 mm; 1/4" (6.3 mm): E4, E5, E6, E7, E8, E10; CrV 50BV30; 1/4" (6.3 mm); 2 PCS; 1/4" (6.3 mm); 1/4" (6.3 mm); 1/4" (6.3 mm); 1/4" (6.3 mm); 45T; 1/4" (6.3 mm); 1/4" (6.3 mm) (F) x 3/8" (9.5 mm) (M); 1/4" (6.3 mm): 4, 5, 5.5, 6.5 mm; 1/4" (6.3 mm): PH1, PH2, PH3; 1/4" (6.3 mm): PZ1, PZ2, PZ3; 1/4" (6.3 mm): T8, T10, T15, T20, T25, T30, T40; 1/4" (6.3 mm): 3, 4, 5, 7, 6, 8 mm

No.	Ø	pcs / szt.	Icon
58643	1/4" (6.3 mm)	56	10

EN Tool set
 PL Zestaw narzędziowy
 DE Sechskant-Steckschlüssel-Satz
 RU Набор торцевых головок
 CZ Sada nástrčných klíčů a ráčny
 RO Trusă de scule
 HU Dugókulcs készlet racsnis hajtókarral
 ES Juego de herramientas

94 PCS
 1/2" 12.7mm
 1/4" 6.3mm
 45T
 AS-DRIVE



1/2" (12.7 mm): 10, 11, 12, 13, 14, 15, 16, 17, 18, 19, 20, 21, 22, 23, 24, 27, 30, 32; 1/4" (6.3 mm): 4, 4.5, 5, 5.5, 6, 7, 8, 9, 10, 11, 12, 13, 14 mm; 1/2" (12.7 mm): 14, 15, 17, 19 mm; 1/4" (6.3 mm): 6, 7, 8, 9, 10, 11, 12, 13 mm; 1/2" (12.7 mm); 2 PCS; 1/4" (6.3 mm); 2 PCS; 3/8" (9.5 mm) (F) x 1/2" (12.7 mm) (M); 1/4" (6.3 mm); 1/2" (12.7 mm); 1/4" (6.3 mm); 1/2" (12.7 mm); 16, 21 mm; 1/4" (6.3 mm); 1/2" (12.7 mm); 1/4" (6.3 mm); 45T; 1/4" (6.3 mm); 1/4" (6.3 mm); 1/2" (12.7 mm) x 5/16" (7.9 mm); 1/4" (6.3 mm) x 1/4" (6.3 mm); 5/16" (7.9 mm): 8, 10, 12 mm; 5/16" (7.9 mm): PH3, PH4; 5/16" (7.9 mm): PZ3, PZ4; 5/16" (7.9 mm): T40, T45, T50, T55; 5/16" (7.9 mm): 8, 10, 12, 14 mm; 1/4" (6.3 mm): 4, 5, 5.5, 7 mm; 1/4" (6.3 mm): PH1, PH2; 1/4" (6.3 mm): PZ1, PZ2; 1/4" (6.3 mm): T8, T10, T15, T20, T25, T30; 1/4" (6.3 mm): 3, 4, 5, 6 mm; 1.5, 2, 2.5 mm

No.	Ø	pcs / szt.	Icon
58687	1/4" (6.3 mm), 1/2" (12.7 mm)	94	3

EN Tool set
 PL Zestaw narzędziowy
 DE Sechskant-Steckschlüssel-Satz
 RU Набор торцевых головок
 CZ Sada nástrčných klíčů a ráčny
 RO Trusă de scule
 HU Dugókulcs készlet racsnis hajtókarral
 ES Juego de herramientas

22 PCS
 3/8" 9.5mm
 45T
 AS-DRIVE



3/8" (9.5 mm): 6, 7, 8, 9, 10, 11, 12, 13, 14, 15, 16, 17, 18, 19, 20, 21, 22 mm; 3/8" (9.5 mm); 3/8" (9.5 mm); 45T

No.	Ø	pcs / szt.	Icon
58661	3/8" (9.5 mm)	22	10

EN Tool set
 PL Zestaw narzędziowy
 DE Sechskant-Steckschlüssel-Satz
 RU Набор торцевых головок
 CZ Sada nástrčných klíčů a ráčny
 RO Trusă de scule
 HU Dugókulcs készlet racsnis hajtókarral
 ES Juego de herramientas

108 PCS
 1/2" 12.7mm
 1/4" 6.3mm
 CrV 50BV30
 45T
 AS-DRIVE



1/2" (12.7 mm): 10, 11, 12, 13, 14, 15, 16, 17, 18, 19, 20, 21, 22, 24, 27, 30, 32 mm; 1/4" (6.3 mm): 4, 4.5, 5, 5.5, 6, 7, 8, 9, 10, 11, 12, 13, 14 mm; 1/2" (12.7 mm): 14, 15, 17, 19, 22 mm; 1/4" (6.3 mm): 6, 7, 8, 9, 10, 11, 12, 13 mm; 1/2" (12.7 mm): E10, E11, E12, E14, E16, E18, E20, E24; 1/4" (6.3 mm): E4, E5, E6, E7, E8; CrV 50BV30; 1/2" (12.7 mm); 2 PCS; 1/4" (6.3 mm); 2 PCS; 3/8" (9.5 mm) (F) x 1/2" (12.7 mm) (M); 1/2" (12.7 mm); 1/4" (6.3 mm); 1/2" (12.7 mm); 16, 21 mm; 1/4" (6.3 mm); 1/2" (12.7 mm); 1/4" (6.3 mm); 45T; 1/4" (6.3 mm); 1/2" (12.7 mm) (F) x 5/16" (7.9 mm) (F); 5/16" (7.9 mm): 8, 10, 12 mm; 5/16" (7.9 mm): PH3, PH4; 5/16" (7.9 mm): PZ3, PZ4; 5/16" (7.9 mm): T40, T45, T50, T55, T60; 5/16" (7.9 mm): 7, 8, 10, 12, 14 mm; 1/4" (6.3 mm): 4, 5, 5.5, 6.5 mm; 1/4" (6.3 mm): PH1, PH2; 1/4" (6.3 mm): PZ1, PZ2; 1/4" (6.3 mm): T8, T10, T15, T20, T25, T27, T30; 1/4" (6.3 mm): 3, 4, 5, 6 mm; 1.5, 2, 2.5 mm

No.	Ø	pcs / szt.	Icon
58685	1/4" (6.3 mm), 1/2" (12.7 mm)	108	3

EN Tool set
 PL Zestaw narzędziowy
 DE Sechskant-Steckschlüssel-Satz
 RU Набор торцовых головок
 CZ Sada nástrčných klíčů a ráčny
 RO Trusă de scule
 HU Dugókulcs készlet racsnis hajtókarral
 ES Juego de herramientas

122 PCS 1/2" 12.7mm 1/4" 6.3mm CrV 50BV30
 CrV 6150 45T AS-DRIVE

2



1/2" (12.7 mm): 12, 13, 14, 15, 16, 17, 18, 19, 20, 21, 22, 24, 27, 30, 32 mm; 1/4" (6.3 mm): 4, 4.5, 5, 5.5, 6, 7, 8, 9, 10, 11, 12, 13, 14 mm; 1/2" (12.7 mm): 10, 12, 13, 14, 17, 19 mm; 1/4" (6.3 mm): 4, 5, 6, 7, 8, 9 mm; 1/2" (12.7 mm): E10, E12, E14, E16, E18, E20, E22, E24; CrV 50BV30: 1/2" (12.7 mm), 1/4" (6.3 mm); 3/8" (9.5 mm) (F) x 1/2" (12.7 mm) (M); 3/8" (9.5 mm) (F) x 1/4" (6.3 mm) (M); 1/2" (12.7 mm), 1/4" (6.3 mm); 1/2" (12.7 mm): 16, 21 mm; 1/2" (12.7 mm), 1/4" (6.3 mm); 45T; 1/4" (6.3 mm); 1/4" (6.3 mm) x 1/4" (6.3 mm); 1/4" (6.3 mm): 3, 4, 5, 6 mm; 1/4" (6.3 mm): PH0, PH1, PH2; 1/4" (6.3 mm): PZ0, PZ1, PZ2; 1/4" (6.3 mm): 4.0, 5.5, 6.5 mm; 1/4" (6.3 mm): PH1, PH2, PH3; 1/4" (6.3 mm): PZ2, PZ3; 1/4" (6.3 mm): T8, T10, T15, T20, T25; 1/4" (6.3 mm): T10, T15, T20, T25, T40; 1/4" (6.3 mm): 3, 4, 5, 6 mm; 8, 9, 10, 11, 12, 13, 14, 15, 16, 17, 18, 19 mm; 4x100, 6.5x150, PH2x100, PH3x150 mm; CrV 6150: 160 mm; 160 mm; 180 mm; 250 mm; 300 g; 2, 2.5, 3, 4, 5, 6, 7, 8, 10 mm



No.	Ø	pcs / szt.	☐
58690	1/4" (6.3 mm), 1/2" (12.7 mm)	122	2

EN Tool set
 PL Zestaw narzędziowy
 DE Sechskant-Steckschlüssel-Satz
 RU Набор торцовых головок
 CZ Sada nástrčných klíčů a ráčny
 RO Trusă de scule
 HU Dugókulcs készlet racsnis hajtókarral
 ES Juego de herramientas

173 PCS 1/2" 12.7mm 3/8" 9.5mm 1/4" 6.3mm
 CrV 50BV30 45T AS-DRIVE



1/2" (12.7 mm): 10, 11, 12, 13, 14, 15, 16, 17, 18, 19, 20, 21, 22, 23, 24, 27, 30, 32 mm; 3/8" (9.5 mm): 10, 11, 12, 13, 14, 15, 16, 17, 18, 19 mm; 1/4" (6.3 mm): 4, 4.5, 5, 5.5, 6, 7, 8, 9, 10, 11, 12, 13, 14 mm; 1/2" (12.7 mm): 16, 17, 18, 19, 22 mm; 3/8" (9.5 mm): 10, 11, 12, 13, 14, 15 mm; 1/4" (6.3 mm): 4, 5, 6, 7, 8, 9, 10 mm; 1/2" (12.7 mm): E18, E20, E24; 3/8" (9.5 mm): E10, E11, E12, E14, E16; 1/4" (6.3 mm): E4, E5, E6, E7, E8; CrV 50BV30: 1/2" (12.7 mm; 2 PCS), 3/8" (9.5 mm), 1/4" (6.3 mm; 2 PCS); 3/8" (9.5 mm) (F) x 1/2" (12.7 mm) (M); 1/2" (12.7 mm), 3/8" (9.5 mm), 1/4" (6.3 mm); 1/2" (12.7 mm): 16, 21 mm; 3/8" (9.5 mm): 18 mm; 1/4" (6.3 mm); 1/2" (12.7 mm), 3/8" (9.5 mm), 1/4" (6.3 mm); 45T; 1/4" (6.3 mm); 1/2" (12.7 mm) x 5/16" (7.9 mm), 3/8" (9.5 mm) x 5/16" (7.9 mm); 1/4" (6.3 mm) x 1/4" (6.3 mm); 5/16" (7.9 mm): 8, 10, 12 mm; 5/16" (7.9 mm): PH3, PH4; 5/16" (7.9 mm): PZ3, PZ4; 5/16" (7.9 mm): T40, T45, T50, T55, T60, T70; 5/16" (7.9 mm): T40, T45, T50, T55, T60, T70; 1/4" (6.3 mm): 7, 8, 10, 12, 14 mm; 1/4" (6.3 mm): T5, T6, T7; 1/4" (6.3 mm): T7, T10, T15, T20, T25, T27, T30, T40, T45; 1/4" (6.3 mm): M5, M6, M8; 1/4" (6.3 mm): RM5, RM6, RM7, RM8, RM9; 1/4" (6.3 mm): 4, 5.5, 6.5, 7 mm; 1/4" (6.3 mm): PH0, PH1, PH2; 1/4" (6.3 mm): PZ0, PZ1, PZ2; 1/4" (6.3 mm): T8, T9, T10, T15, T20, T25, T27, T30; 1/4" (6.3 mm): T8, T9, T10, T15, T20, T25, T27, T30; 1/4" (6.3 mm): 3, 4, 5, 6 mm; 1.25, 1.5, 2, 2.5, 3, 4, 5 mm



No.	Ø	pcs / szt.	☐
58688	1/4" (6.3 mm), 3/8" (9.5 mm), 1/2" (12.7 mm)	173	1

EN Tool set
 PL Zestaw narzędziowy
 DE Sechskant-Steckschlüssel-Satz
 RU Набор торцовых головок
 CZ Sada nástrčných klíčů a ráčny
 RO Trusă de scule
 HU Dugókulcs készlet racsnis hajtókarral
 ES Juego de herramientas

2

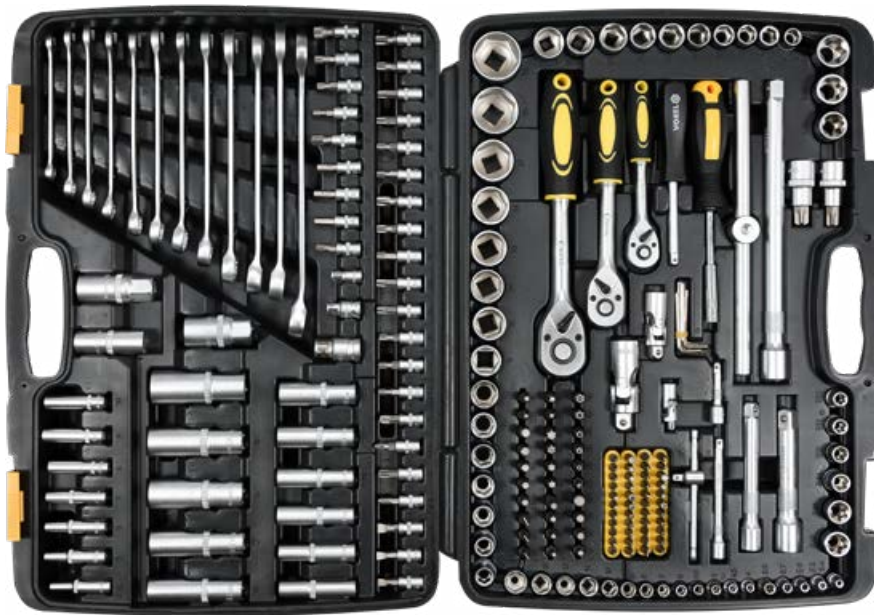

No.	Ø	pcs / szt.	
58700	1/4" (6.3 mm), 3/8" (9.5 mm), 1/2" (12.7 mm)	216	1

EN Tool set
 PL Zestaw narzędziowy
 DE Sechskant-Steckschlüssel-Satz
 RU Набор торцовых головок
 CZ Sada nástrčných klíčů a ráčny
 RO Trusă de scule
 HU Dugókulcs készlet racsnis hajtókarral
 ES Juego de herramientas

216 PCS 1/2" 12.7mm 3/8" 9.5mm 1/4" 6.3mm CrV 50BV30
 CrV 6140 45T AS-DRIVE

1/2" (12.7 mm): 10, 11, 12, 13, 14, 15, 17, 19, 20, 21, 22, 24, 27, 30, 32 mm; 3/8" (9.5 mm): 10, 11, 12, 13, 14, 15, 16, 17, 18, 19 mm; 1/4" (6.3 mm): 4, 4.5, 5, 5.5, 6, 7, 8, 9, 10, 11, 12, 13, 14 mm; 1/2" (12.7 mm): 16, 17, 18, 19, 22 mm; 3/8" (9.5 mm): 10, 11, 12, 13, 14, 15 mm; 1/4" (6.3 mm): 4, 5, 6, 7, 8, 9, 10 mm; 1/2" (12.7 mm): E20, E22, E24; 3/8" (9.5 mm): E10, E11, E12, E14, E16, E18; 1/4" (6.3 mm): E4, E5, E6, E7, E8; CrV 50BV30; 1/2" (12.7 mm): 2 PCS; 3/8" (9.5 mm): 1/4" (6.3 mm); 2 PCS; 1/2" (12.7 mm): 3/8" (9.5 mm), 1/4" (6.3 mm); 1/2" (12.7 mm): 16, 21 mm; 3/8" (9.5 mm): 18 mm; 1/2" (12.7 mm): 1/4" (6.3 mm); 1/2" (12.7 mm), 3/8" (9.5 mm), 1/4" (6.3 mm); 45T; 1/4" (6.3 mm); 1/4" (6.3 mm); 1/2" (12.7 mm) x 5/16" (7.9 mm), 3/8" (9.5 mm) x 5/16" (7.9 mm), 1/4" (6.3 mm) x 1/4" (6.3 mm); 5/16" (7.9 mm): 6, 6.5, 8 mm; 1/4" (6.3 mm): 4, 5.5, 6.5 mm; CrV 6140; 5/16" (7.9 mm): PH3, PH4; 1/4" (6.3 mm): PH1, PH2; CrV 6140; 5/16" (7.9 mm): P23, P24; 1/4" (6.3 mm): PZ1, PZ2; CrV 6140; 5/16" (7.9 mm): T25, T27, T30, T35, 2xT40, T45, T50; 1/4" (6.3 mm): T8, T10, T15, T20, T25; CrV 6140; 5/16" (7.9 mm): T27, T30, T35, T40, T45, T50; 1/4" (6.3 mm): T8, 2xT10, 2xT15, 2xT20, 2xT25, T40; CrV 6140; 5/16" (7.9 mm): T55, T60; 1/4" (6.3 mm): 5.5, 6, 6.5, 7, 8 mm; 1/4" (6.3 mm): 3, 4, 5, 6 mm; CrV 6140; 1/4" (6.3 mm): 3, 4, 5, 6 mm; CrV 6140; 5/16" (7.9 mm): M5, M6, M8, M10; 1/4" (6.3 mm): M5, M6, M8; CrV 6140; 1/4" (6.3 mm): S1, S2; CrV 6140; 1/4" (6.3 mm): 1, 2, 3 mm; CrV 6140; 1/4" (6.3 mm): 6, 8, 10 mm; CrV 6140; 1/4" (6.3 mm): 6, 6.5, 8 mm; CrV 6140; 1/4" (6.3 mm): PH3, PH4; CrV 6140; 1/4" (6.3 mm): PZ3, PZ4; CrV 6140; 1/2" (12.7 mm): T55, T60; 1/4" (6.3 mm): T25, T27, T30, T35, T40 (2 PCS), T45, T50; CrV 6140; 1/4" (6.3 mm): T27, T30, T35, T40, T45, T50; CrV 6140; 1/4" (6.3 mm): 5.5, 6, 6.5, 7, 8 mm; CrV 6140; 1/4" (6.3 mm): M5, M6, M8, M10; CrV 6140; 8, 10, 11, 12, 13, 14, 15, 16, 17, 18, 19, 22 mm; 1.27, 1.5, 2, 2.5, 3, 4, 5 mm

216 PCS 1/2" 12.7mm 3/8" 9.5mm 1/4" 6.3mm CrV 50BV30 45T AS-DRIVE

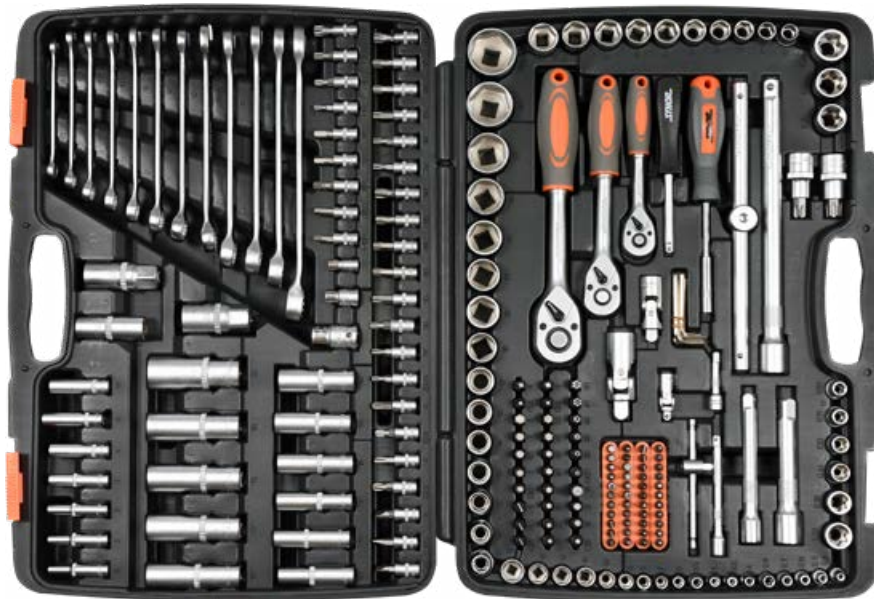

No.	Ø	pcs / szt.	
58691	1/4" (6.3 mm), 3/8" (9.5 mm), 1/2" (12.7 mm)	216	1

1/2" (12.7 mm): 10, 11, 12, 13, 14, 15, 17, 19, 20, 21, 22, 24, 27, 30, 32 mm; 3/8" (9.5 mm): 10, 11, 12, 13, 14, 15, 16, 17, 18, 19 mm; 1/4" (6.3 mm): 4, 4.5, 5, 5.5, 6, 7, 8, 9, 10, 11, 12, 13, 14 mm; 1/2" (12.7 mm): 16, 17, 18, 19, 22 mm; 3/8" (9.5 mm): 10, 11, 12, 13, 14, 15 mm; 1/4" (6.3 mm): 4, 5, 6, 7, 8, 9, 10 mm; 1/2" (12.7 mm): E20, E22, E24; 3/8" (9.5 mm): E10, E11, E12, E14, E16, E18; 1/4" (6.3 mm): E4, E5, E6, E7, E8; CrV 50BV30; 1/2" (12.7 mm): 2 PCS; 3/8" (9.5 mm): 1/4" (6.3 mm); 2 PCS; 1/2" (12.7 mm): 3/8" (9.5 mm), 1/4" (6.3 mm); 1/2" (12.7 mm): 16, 21 mm; 3/8" (9.5 mm): 18 mm; 1/2" (12.7 mm): 1/4" (6.3 mm); 1/2" (12.7 mm), 3/8" (9.5 mm), 1/4" (6.3 mm); 45T; 1/4" (6.3 mm); 1/4" (6.3 mm); 1/2" (12.7 mm) x 5/16" (7.9 mm), 3/8" (9.5 mm) x 5/16" (7.9 mm), 1/4" (6.3 mm) x 1/4" (6.3 mm); 5/16" (7.9 mm): 6, 6.5, 8 mm; 1/4" (6.3 mm): 4, 5.5, 6.5 mm; 5/16" (7.9 mm): PH3, PH4; 1/4" (6.3 mm): PH1, PH2; 5/16" (7.9 mm): P23, P24; 1/4" (6.3 mm): PZ1, PZ2; 5/16" (7.9 mm): T25, T27, T30, T35, T40 (2 PCS), T45, T50; 1/4" (6.3 mm): T8, T10, T15, T20, T25; 5/16" (7.9 mm): T27, T30, T35, T40, T45, T50; 1/4" (6.3 mm): T8, 2xT10, 2xT15, 2xT20, 2xT25, T40; 5/16" (7.9 mm): 5.5, 6, 6.5, 7, 8 mm; 1/4" (6.3 mm): 3, 4, 5, 6 mm; 1/4" (6.3 mm): 3, 4, 5, 6 mm; CrV 6140; 5/16" (7.9 mm): M5, M6, M8, M10; 1/4" (6.3 mm): M5, M6, M8; CrV 6140; 1/4" (6.3 mm): S1, S2; CrV 6140; 1/4" (6.3 mm): 1, 2, 3 mm; 1/4" (6.3 mm): 6, 8, 10 mm; 1/4" (6.3 mm): 6, 6.5, 8 mm; 1/4" (6.3 mm): PH3, PH4; 1/4" (6.3 mm): PZ3, PZ4; 1/2" (12.7 mm): T55, T60; 1/4" (6.3 mm): T25, T27, T30, T35, 2xT40, T45, T50; 1/4" (6.3 mm): 5.5, 6, 6.5, 7, 8 mm; CrV 6140; 1/4" (6.3 mm): M5, M6, M8, M10; 8, 10, 11, 12, 13, 14, 15, 16, 17, 18, 19, 22 mm; 1.27, 1.5, 2, 2.5, 3, 4, 5 mm

EN Tool set
 PL Zestaw narzędziowy
 DE Sechskant-Steckschlüssel-Satz
 RU Набор торцовых головок

CZ Sada nástrčných klíčů a ráčny
 RO Trusă de scule
 HU Dugókulcs készlet racsnis hajtókarral
 ES Juego de herramientas

225 PCS | 1/2" 12.7mm | 3/8" 9.5mm | 1/4" 6.3mm | CrV 6140 | 45T | AS-DRIVE | METRIC SAE |

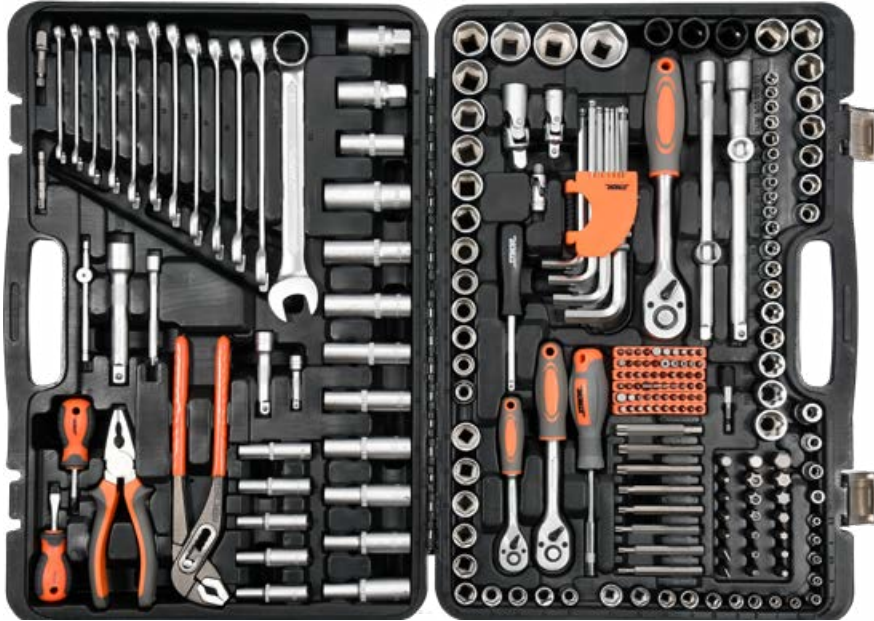

1/2" (12.7 mm): 10, 13, 15, 16, 17, 18, 19, 20, 21, 22, 23, 24, 27, 30, 32 mm; 3/8" (9.5 mm): 10, 11, 12, 13, 14, 15, 16, 17, 18, 19 mm; 1/4" (6.3 mm): 3.5, 4, 4.5, 5, 5.5, 6, 7, 8, 9, 10, 11, 12, 13, 14 mm; 1/2" (12.7 mm): 10, 11, 12, 13, 14, 15, 17, 19, 21 mm; 3/8" (9.5 mm): 6, 7, 8, 9, 10 mm;

1/2" (12.7 mm): 7/16" (11.1 mm), 1/2" (12.7 mm), 9/16" (14.3 mm), 5/8" (15.9 mm), 11/16" (17.5 mm), 3/4" (19.0 mm), 13/16" (20.6 mm), 7/8" (22.2 mm); 1/4" (6.3 mm): 1/4" (6.3 mm), 9/32" (7.1 mm), 5/16" (7.9 mm), 11/32" (8.7 mm), 3/8" (9.5 mm); 1/2" (12.7 mm): 17, 19, 21 mm; 1/2" (12.7 mm): E16, E18, E20, E22, E24; 3/8" (9.5 mm): E10, E11, E12, E14; 1/4" (6.3 mm): E4, E5, E6, E7, E8; 1/2" (12.7 mm): 2 PCS; 3/8" (9.5 mm): 2 PCS; 1/4" (6.3 mm): 2 PCS; 3/8" (9.5 mm) (F) x 1/2" (12.7 mm) (M), 1/2" (12.7 mm) (F) x 3/8" (9.5 mm) (M), 1/2" (12.7 mm), 3/8" (9.5 mm), 1/4" (6.3 mm); 1/2" (12.7 mm): 16, 21 mm; 3/8" (9.5 mm): 18 mm; 1/4" (6.3 mm); 1/2" (12.7 mm), 3/8" (9.5 mm), 1/4" (6.3 mm); 45T; 1/4" (6.3 mm); 1/4" (6.3 mm); 1/4" (6.3 mm); 1/2" (12.7 mm) x 5/16" (7.9 mm), 3/8" (9.5 mm) x 5/16" (7.9 mm), 3/8" (9.5 mm) x 1/4" (6.3 mm), 1/4" (6.3 mm) x 1/4" (6.3 mm); 3/8" (9.5 mm) x 1/4" (6.3 mm), 1/4" (6.3 mm) x 1/4" (6.3 mm) (2 PCS); 1/4" (6.3 mm) x 1/4" (6.3 mm); 5/16" (7.9 mm): 8, 10 mm; 1/4" (6.3 mm): 3, 4, 5.5, 6.5, 7, 8, 9 mm; CrV 6140; 5/16" (7.9 mm): PH3, PH4; 1/4" (6.3 mm): PH0, PH1, PH2, PH3; CrV 6140; 5/16" (7.9 mm): PZ3, PZ4; 1/4" (6.3 mm): PZ0, PZ1, PZ2, PZ3; CrV 6140; 5/16" (7.9 mm): T20, T25, T27, T30, T40, T45, T50, T55 (L=75 mm); T40, T45, T50, T55, T60, T70 (L=30 mm); 1/4" (6.3 mm): T8, T9, T10, T15, T20, T25, T27, T30; 5/16" (7.9 mm): T40, T45, T50, T55, T60, T70; 1/4" (6.3 mm): T8, T9, T10, T15, T20, T25, T27, T30; CrV 6140; 5/16" (7.9 mm): 10, 12, 14 mm; 1/4" (6.3 mm): 3, 4, 5, 6, 7, 8 mm; CrV 6140; 1/4" (6.3 mm): 4, 5, 6, 7, 8 mm; CrV 6140; 1/4" (6.3 mm): M5, M6, M8, M10; CrV 6140; 1/4" (6.3 mm): S1, S2; CrV 6140; 1/4" (6.3 mm): 1, 2, 3, 4; CrV 6140; 1/4" (6.3 mm): 6, 8, 10; CrV 6140; 1/4" (6.3 mm): 4, 6, 8, 10 mm; CrV 6140; 8, 9, 10, 11, 12, 13, 14, 15, 16, 17, 19, 22 mm; 6x38, PH2x38; 180 mm; 250 mm; 2, 2.5, 3, 4, 5, 6, 7, 8, 10, 12 mm



No.	⊙	pcs / szt.	
58693	1/4" (6.3 mm), 3/8" (9.5 mm), 1/2" (12.7 mm)	225	1

Memo

3

Screwdrivers & screwdriver bits Wkrętaki i końcówki wkrętakowe

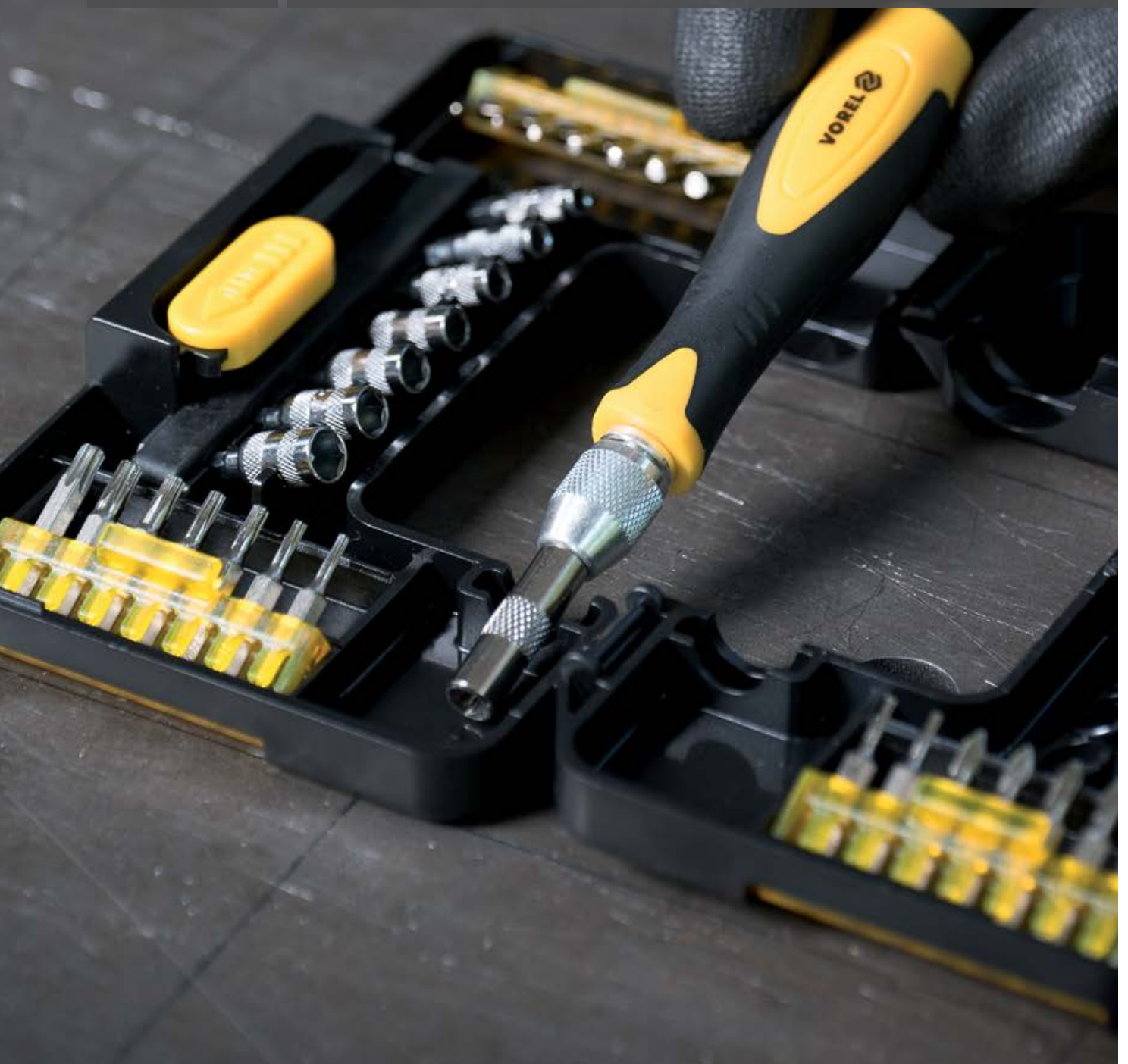

Screwdrivers, 3 colour handle
Wkrętaki, trójkolorowa rączka

26-28

Slotted screwdrivers

Wkrętaki płaskie..... 26

Phillips screwdrivers

Wkrętaki krzyżakowe..... 26

Pozidrive screwdrivers

Wkrętaki „Pozidrive”..... 26

Torx screwdrivers

Wkrętaki „Torx”..... 26

Screwdriver sets

Komplety wkrętaków..... 26

Ratchet screwdrivers

Wkrętaki z grzechotką..... 28

Go-through screwdrivers
Wkrętaki do pobijania

28

Slotted screwdrivers

Wkrętaki płaskie..... 28

Phillips screwdrivers

Wkrętaki krzyżakowe..... 28

Screwdrivers HI-TEC & sets
Wkrętaki HI-TEC i zestawy

28-30

Slotted screwdrivers

Wkrętaki płaskie..... 28

Phillips screwdrivers

Wkrętaki krzyżakowe..... 29

Screwdriver sets

Komplety wkrętaków..... 30

Special & impact screwdrivers
Wkrętaki specjalne i udarowe

30-33

Two way screwdrivers

Wkrętaki dwustronne..... 30

Ratchet screwdriver sets with bits

Zestawy wkrętaków z grzechotką i bitami..... 30

Impact screwdrivers

Wkrętaki udarowe..... 32

Telescopic screwdrivers

Wkrętaki teleskopowe..... 32

T-bar screwdrivers

Wkrętaki T-gryf..... 32

Screwdriver sets
Zestawy wkrętaków

33-34

Precision screwdrivers sets
Zestawy wkrętaków precyzyjnych

34-35

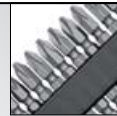
Screwdriver bits
Kończówki wkrętakowe

35-38

Screwdriver bit sets

Zestawy końcówek wkrętakowych..... 35

Screwdriver bit holders

Uchwyty do końcówek wkrętakowych..... 38

Nut setter sets

Zestawy nasadek magnetycznych do wkrętarek..... 38

Hex & Torx keys & sets
Klucze imbusowe i zestawy

39-41

T-handle keys & sets

Klucze imbusowe typu „T” i zestawy..... 39

Hex keys

Klucze imbusowe „Hex”..... 40

Hex key sets

Zestawy kluczy imbusowych „Hex”..... 40

Torx & Torx Tamperproof key setsZestawy kluczy imbusowych „Torx”
i „Torx Tamperproof”..... 41

EN Slotted screwdriver
 PL Wkrętek płaski
 DE Schraubendreher
 RU Отвёртка

CZ Šroubovák
 RO Şurubelniţă
 HU Csavarhúzó
 ES Destornillador



3



VOREL

No.	⊖ [mm]	L [mm]	PCS RO/DE	📦
60912	2	75	12	96/384
60950	3	75	12	96/384
60951	3	100	12	96/384
60952	4	100	12	96/384
60913	4	150	12	96/384
60914	4	200	12	60/240
60915	5	38	12	60/240
60953	5	75	12	60/240
60954	5	100	12	60/240
60955	5	150	12	60/240
60916	5	200	12	36/144
60917	6	38	12	60/240
60956	6	100	12	36/144
60957	6	150	12	36/144
60958	6	200	12	36/144
60959	8	150	6	24/96
60918	8	250	6	24/96

EN Screwdriver
 PL Wkrętek
 DE Schraubendreher
 RU Отвёртка

CZ Šroubovák
 RO Şurubelniţă
 HU Csavarhúzó
 ES Destornillador



VOREL

No.	⊕	L [mm]	PCS RO/DE	📦
60931	PZ0	75	12	96/384
60932	PZ0	100	12	96/384
60933	PZ1	75	12	60/240
60934	PZ1	100	12	60/240
60935	PZ1	200	12	36/144
60936	PZ2	100	12	36/144
60937	PZ2	150	12	36/144
60938	PZ2	200	12	36/144
60939	PZ3	150	8	24/96

EN Screwdriver set
 PL Komplet wkręteków
 DE Schraubendrehersatz
 RU Набор отвёрток
 CZ Zámečnické šroubováky
 RO Şurubelnițe de lăcătușerie
 HU Lakatos csavarhúzó
 ES Juego de destornilladores



VOREL

No.	pcs / szt.	📦
60970	10	6/24

EN Screwdriver
 PL Wkrętek
 DE Schraubendreher
 RU Отвёртка
 CZ Šroubovák
 RO Şurubelniţă
 HU Csavarhúzó
 ES Destornillador



VOREL

No.	⊕	L [mm]	PCS RO/DE	📦
60920	PH00	65	12	96/384
60961	PH0	75	12	96/384
60962	PH0	100	12	96/384
60921	PH1	38	12	60/240
60963	PH1	75	12	60/240
60964	PH1	100	12	60/240
60965	PH1	150	12	60/240
60922	PH1	250	12	36/144
60923	PH2	38	12	60/240
60966	PH2	100	12	36/144
60967	PH2	150	12	36/144
60968	PH2	200	12	36/144
60924	PH2	250	12	36/144
60969	PH3	150	6	24/96

EN Screwdriver
 PL Wkrętek
 DE Schraubendreher
 RU Отвёртка

CZ Šroubovák
 RO Şurubelniţă
 HU Csavarhúzó
 ES Destornillador



VOREL

No.	⊗	L [mm]	PCS RO/DE	📦
60880	T5	75	12	96/384
60881	T6	75	12	96/384
60882	T7	75	12	96/384
60883	T8	75	12	96/384
60884	T9	75	12	96/384
60885	T10	100	12	60/240
60886	T15	100	12	60/240
60887	T20	100	12	60/240
60888	T25	100	12	36/144
60889	T27	100	12	36/144
60890	T30	100	12	36/144
60891	T40	100	6	24/96



⊖ 3x7.5, 5x100, 6x100, 6x150, 8x150 mm; CrV 6150;
 ⊕ PH0x7.5, PH1x7.5, PH2x100, PH2x150, PH3x150 mm; CrV 6150

EN Screwdriver set
 PL Komplet długich wkrętaków
 DE Schraubendrehersatz
 RU Набор отвёрток
 CZ Zámečnické šroubováky
 RO Şurubelnițe de lăcătușerie
 HU Lakatos csavarhőző
 ES Juego de destornilladores

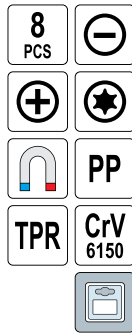
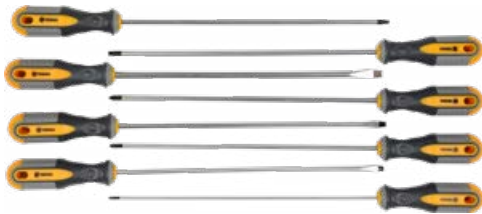

⊖ 5.5, 6.5, 8.0 mm (L=325 mm); CrV 6150;
 ⊕ PH0, PH1, PH2 (L=325 mm); CrV 6150;
 ⊗ T25, T30 (L=325 mm); CrV 6150



No.	pcs / szt.	
60990	8	10

EN Screwdriver set
 PL Komplet wkrętaków
 DE Schraubendrehersatz
 RU Набор отвёрток
 CZ Zámečnické šroubováky
 RO Şurubelnițe de lăcătușerie
 HU Lakatos csavarhőző
 ES Juego de destornilladores

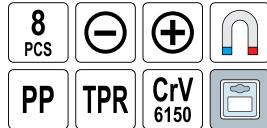

⊖ 3.0x75, 5.5x75, 6.5x38, 6.5x100 mm; CrV 6150;
 ⊕ PH0x75, PH1x75, PH2x38, PH2x100 mm; CrV 6150



No.	pcs / szt.	
60782	8	12/24

EN Screwdriver set
 PL Komplet wkrętaków
 DE Schraubendrehersatz
 RU Набор отвёрток
 CZ Zámečnické šroubováky
 RO Şurubelnițe de lăcătușerie
 HU Lakatos csavarhőző
 ES Juego de destornilladores

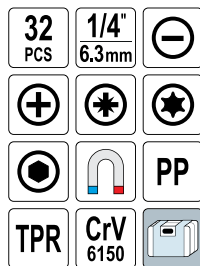

⊖ 4.0x75, 6.5x100, 8.0x150 mm; CrV 6150; ⊕ PH1x75, PH2x100 mm; CrV 6150; ⊗ PZ1x75, PZ2x100 mm; CrV 6150;
 ⊖ 2.0x50, 2.5x50, 3.0x50 mm; CrV 6150; ⊕ PH00x50, PH0x50, PH1x50 mm; CrV 6150; ⊕ 1/4\"/>



No.	pcs / szt.	
60785	32	10

EN Screwdriver set
 PL Komplet wkrętaków
 DE Schraubendrehersatz
 RU Набор отвёрток
 CZ Zámečnické šroubováky
 RO Şurubelnițe de lăcătușerie
 HU Lakatos csavarhőző
 ES Juego de destornilladores

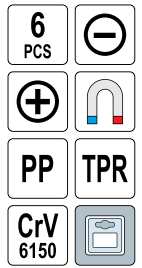

⊖ 5.5x75, 6.5x38, 6.5x100 mm; CrV 6150;
 ⊕ PH1x75, PH2x38, PH2x100 mm; CrV 6150



No.	pcs / szt.	
60783	6	10/20

EN Screwdriver set
 PL Komplet wkrętaków
 DE Schraubendrehersatz
 RU Набор отвёрток
 CZ Zámečnické šroubováky
 RO Şurubelnițe de lăcătușerie
 HU Lakatos csavarhőző
 ES Juego de destornilladores

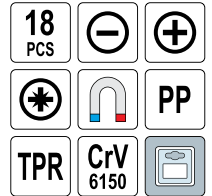

⊖ 5.5x75, 6.5x38, 6.5x100, 8.0x150 mm; CrV 6150; ⊕ PH1x75, PH2x38, PH2x100, PH3x150 mm; CrV 6150;
 ⊖ 2.5x50, 3.0x50 mm; CrV 6150; ⊕ PH00x50, PH0x50 mm; CrV 6150; ⊗ T5x50, T6x50, T7x50, T8x50, T9x50, T10x50 mm; CrV 6150



No.	pcs / szt.	
60781	18	10

EN Screwdriver set
 PL Komplet wkrętaków
 DE Schraubendrehersatz
 RU Набор отвёрток
 CZ Zámečnické šroubováky
 RO Şurubelnițe de lăcătușerie
 HU Lakatos csavarhőző
 ES Juego de destornilladores

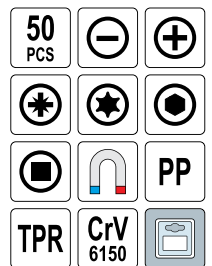

⊖ 4.0x75, 6.5x68, 6.5x100, 8.0x150 mm; CrV 6150; ⊕ PH1x75, PH2x38, PH2x100, PH3x150 mm; CrV 6150;
 ⊖ 2.0x50, 2.5x50, 3.0x50 mm; CrV 6150; ⊕ PH00x50, PH0x50 mm; CrV 6150; ⊗ T6x50, T8x50, T10x50 mm; CrV 6150; □ 1/4\"/>



No.	pcs / szt.	
60780	50	6

EN Screwdriver set
 PL Komplet wkręteków
 DE Schraubendrehersatz
 RU Набор отвёрток
 CZ Zámečnické šroubováky
 RO Șurubelnițe de lăcătușerie
 HU Lakatos csavarhúzó
 ES Juego de destornilladores



VOREL

No.	pcs / szt.	
60750	100	3

EN Ratchet screwdriver set
 PL Zestaw wkrętek z grzechotką
 DE Ratschenschraubendreher-Satz mit Einsätzen
 RU Отвёртка реверсивная с набором бит и торцевых головок
 CZ Ráčňový kloubový šroubovák
 RO Set surubelniță
 HU Dugókulcs és bit készlet csukló
 ES Juego con destornillador y carraca



1/4" (6.3 mm): 5, 6, 7 mm (L=25 mm); 1/4" (6.3 mm): PH1, PH1, PH2, PH2, PH3 (L=52 mm); 1/4" (6.3 mm): T10, T15, T20, T25, T30 (L=52 mm); 1/4" (6.3 mm): 4, 6 mm (L=52 mm); 1/4" (6.3 mm): 5, 6, 7, 8, 9, 10 mm; 1/4" (6.3 mm), 5/16" (7.9 mm), 11/32" (8.7 mm), 3/8" (9.5 mm), 7/16" (11.1 mm), 1/2" (12.7 mm); 1/4" (6.3 mm)

VOREL

No.	pcs / szt.	
60975	29	6/24

EN Go-through screwdriver
 PL Wkrętek do pobijania
 DE Schlagschrauber
 RU Отвёртка-било

CZ Šroubovák s úderným koncem
 RO Șurubelniță pt. fixare
 HU Beütő csavarhúzó
 ES Destornillador para dar golpes



VOREL

No.		L [mm]		
62170	PH1	75	8	12/96
62171	PH1	100	8	12/96
62172	PH2	100	10	12/72
62173	PH2	150	10	12/72
62174	PH2	200	10	12/72
62175	PH2	250	10	12/72
62176	PH3	150	13	12/72
62177	PH3	200	13	12/72
62178	PH3	250	13	12/72

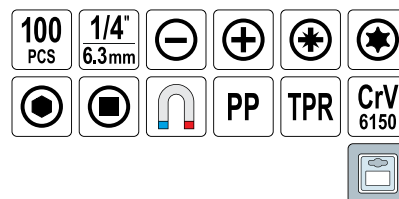

1/4" (6.3 mm): 6, 7, 8, 9, 10, 11 mm (L=35 mm); CrV 6150; 3.0x75, 4.0x100, 5.5x75, 5.5x100, 6.5x100, 6.5x150, 8.0x150 mm; CrV 6150; PH0x75, PH1x75, PH1x100, PH1x150, PH2x100, PH2x150 mm; CrV 6150; PZ0x75, PZ1x75, PZ2x100 mm; CrV 6150; T10x75, T20x75, T25x100, T30x100 mm; CrV 6150; S0x75, S1x75, S2x100 mm; CrV 6150; 2.5x50, 3.0x50 mm; CrV 6150; PH00x50, PH0x50 mm; CrV 6150; T6x50, T7x50, T8x50, T10x50 mm; CrV 6150; 1/4" (6.3 mm): 3, 3.5, 4, 4.5, 5, 5.5, 6, 6.5, 7, 8 mm (L=25 mm); CrV 6150; 1/4" (6.3 mm): PH0 (2 PCS), PH1 (2 PCS), PH2 (3 PCS), PH3 (3 PCS) (L=25 mm); CrV 6150; 1/4" (6.3 mm): PZ0 (2 PCS), PZ1 (2 PCS), PZ2 (3 PCS), PZ3 (3 PCS) (L=25 mm); CrV 6150; 1/4" (6.3 mm): T6, T8, T10, T15, T20, T25, T27, T30, T35, T40 (L=25 mm); CrV 6150; 1/4" (6.3 mm): 2, 2.5, 3, 3.5, 4, 4.5, 5, 5.5, 6, 7 mm (L=25 mm); CrV 6150; 1/4" (6.3 mm): 1/8", 9/64", 5/32", 3/16", 7/32", 1/4" (L=25 mm); CrV 6150; 1/4" (6.3 mm): S0, S1, S2, S3 (L=25 mm); CrV 6150; 1/4" (6.3 mm); SL5-PH1, SL6-PH2; CrV 6150

EN Go-through screwdriver
 PL Wkrętek do pobijania
 DE Schlagschrauber
 RU Отвёртка-било

CZ Šroubovák s úderným koncem
 RO Șurubelniță pt. fixare
 HU Beütő csavarhúzó
 ES Destornillador para dar golpes

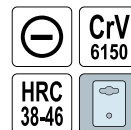

VOREL

No.		L [mm]		
62160	5	75	8	12/96
62161	5	100	8	12/96
62162	6	100	10	12/72
62163	6	150	10	12/72
62164	6	200	10	12/72
62165	6	250	10	12/72
62166	8	150	13	12/72
62167	8	200	13	12/72

EN Screwdriver
 PL Wkrętek
 DE Schraubendreher
 RU Отвёртка

CZ Šroubovák
 RO Șurubelniță
 HU Csavarhúzó
 ES Destornillador



VOREL

No.		L [mm]	
61010	2.5	63	12/240
61020	3.2	75	12/240
61030	3.2	100	12/240
61040	3.2	150	12/240
61050	5.0	75	12/240
61060	5.0	100	12/240
61070	5.0	150	12/240
61080	5.0	200	12/240

EN Screwdriver
PL Wkrętkak
DE Schraubendreher
RU Отвёртка

CZ Šroubovák
RO Şurubelniţă
HU Csavarhúzó
ES Destornillador

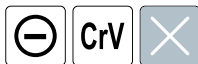

VOREL

No.	⊖ [mm]	L [mm]	☐
61090	6	38	12/192

EN Screwdriver
PL Wkrętkak
DE Schraubendreher
RU Отвёртка
CZ Šroubovák
RO Şurubelniţă
HU Csavarhúzó
ES Destornillador



VOREL

No.	⊕	L [mm]	☐
61290	PH2	38	12/288

EN Screwdriver
PL Wkrętkak
DE Schraubendreher
RU Отвёртка

CZ Šroubovák
RO Şurubelniţă
HU Csavarhúzó
ES Destornillador

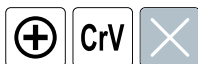

VOREL

No.	⊕	L [mm]	☐
61250	PH1	75	12/240
61260	PH1	100	12/240
61270	PH1	150	12/240
61280	PH1	200	12/240

EN Screwdriver
PL Wkrętkak
DE Schraubendreher
RU Отвёртка

CZ Šroubovák
RO Şurubelniţă
HU Csavarhúzó
ES Destornillador

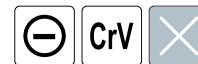

VOREL

No.	⊖ [mm]	L [mm]	Driver / Zaberak	☐
61110	6	100	tak	12/144
61120	6	150	nie	12/144
61140	6	200	nie	12/144
61150	6	250	nie	12/144
61160	8	150	nie	6/72

EN Screwdriver
PL Wkrętkak
DE Schraubendreher
RU Отвёртка

CZ Šroubovák
RO Şurubelniţă
HU Csavarhúzó
ES Destornillador



VOREL

No.	⊕	L [mm]	☐
61210	PH0	63	12/240
61220	PH0	75	12/240
61230	PH0	100	12/240
61240	PH0	150	12/240

EN Screwdriver
PL Wkrętkak
DE Schraubendreher
RU Отвёртка
CZ Šroubovák
RO Şurubelniţă
HU Csavarhúzó
ES Destornillador



VOREL

No.	⊕	L [mm]	Driver / Zaberak	☐
61300	PH2	100	nie	12/144
61320	PH2	150	nie	12/144
61340	PH2	200	nie	12/144
61350	PH2	250	nie	12/144

- EN Screwdriver set
- PL Komplet wkrętek
- DE Schraubendrehersatz
- RU Набор отвёрток
- CZ Zámečnické šroubováky
- RO Şurubelniţe de lăcătuşerie
- HU Lakatos csavarhúzó
- ES Juego de destornilladores



No.	pcs / szt.	
61550	5	5/20

- EN Two-way screwdriver
- PL Wkrętek dwustronny
- DE Umsteckschraubendreher
- RU Отвёртка двухсторонняя
- CZ Dvoustranný šroubovák
- RO Şurubelniţă dublu capăt
- HU Kétoldalal csavarhúzó
- ES Destornillador de dos caras



|| 6 mm-PH2 (L=115 mm); CrV 6150



No.	pcs / szt.	
64952	6/120	

- EN Screwdriver
- PL Wkrętek
- DE Schraubendreher
- RU Отвёртка
- CZ Šroubovák
- RO Şurubelniţă
- HU Csavarhúzó
- ES Destornillador



No.	pcs / szt.	
65041	7	25/100

- EN Two-way screwdriver
- PL Wkrętek dwustronny
- DE Umsteckschraubendreher
- RU Отвёртка двухсторонняя
- CZ Dvoustranný šroubovák
- RO Şurubelniţă dublu capăt
- HU Kétoldalal csavarhúzó
- ES Destornillador de dos caras

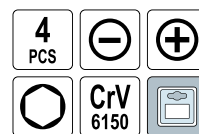

|| 5 mm-PH1; CrV 6150;
|| 6 mm-PH2; CrV 6150;
○ 6-8 mm; CrV 6150



No.	pcs / szt.	
64654	4	12/72

- EN Precision screwdriver bits
- PL Zestaw końcówek śrubokrętowych
- DE Schraubendreherbitsatz
- RU Набор специальных бит
- CZ Sada bitov
- RO Truse bit
- HU Bitkészlet
- ES Juego de llaves especiales

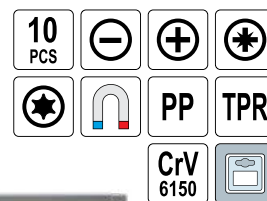

|| 5-6 mm (L=150 mm); CrV 6150; || PH1-PH2 (L=150 mm); CrV 6150; || PZ1-PZ2 (L=150 mm); CrV 6150; || T20-T25 (L=150 mm); CrV 6150; ○ 5-6 mm (L=150 mm); CrV 6150



No.	pcs / szt.	
64960	6	12/48

- EN Ratchet screwdriver set with bits
- PL Zestaw wkrętek z grzechotką i bitami
- DE Schraubendreher mit Ratche
- RU Отвёртка реверсивная с набором бит
- CZ Šroubovák z řehačkou
- RO Şurubelniţă cu clichet
- HU Racsnis csavarbehajtó
- ES Juego con destornillador y carraca



|| 1/4" (6.3 mm): 3.5, 4, 5.5 mm (L=25 mm);
|| 1/4" (6.3 mm): PH0, PH1, PH2 (L=25 mm);
|| 1/4" (6.3 mm): PZ0, PZ1, PZ2 (L=25 mm);
|| 1/4" (6.3 mm): T20, T25 (L=25 mm)



No.	pcs / szt.	
64658	12	12/72

EN Ratchet screwdriver set with bits
 PL Zestaw wkrętek z grzechotką i bitami
 DE Schraubendreher mit Ratche
 RU Отвёртка реверсивная с набором бит
 CZ Šroubovák z fehtačkou
 RO Şurubelniţă cu clichet
 HU Racsnis csavarbehajtó
 ES Juego con destornillador y carraca



25 PCS 1/4" 6.3mm

Icons: Minus, Plus, Torx, Torx+, Phillips, Torx, Torx+, Phillips, Torx

PP TPR

CrV 6150

1/4" (6.3 mm): 4, 5, 6, 7, 6, 9, 10, 11, 12 mm; 1/4" (6.3 mm): (L=25 mm); CrV 6150; 1/4" (6.3 mm): 4, 5, 6 mm (L=25 mm); CrV 6150; 1/4" (6.3 mm): PH0, PH1, PH2, PH3 (L=25 mm); CrV 6150; 1/4" (6.3 mm): PZ0, PZ1, PZ2, PZ3 (L=25 mm); CrV 6150; 1/4" (6.3 mm): T10, T15, T20 (L=25 mm); CrV 6150



No.	pcs / szt.	Icon
65105	25	6/36

EN Ratchet screwdriver set with bits
 PL Zestaw wkrętek z grzechotką i bitami
 DE Schraubendreher mit Ratche
 RU Отвёртка реверсивная с набором бит
 CZ Šroubovák z fehtačkou
 RO Şurubelniţă cu clichet
 HU Racsnis csavarbehajtó
 ES Juego con destornillador y carraca

31 PCS 4 mm

Icons: Minus, Plus, Torx, Torx+, Phillips, Torx, Torx+, Phillips, Torx

CrV



1/4" (6.3 mm): 1.0, 1.5, 2.0, 2.5, 3.0 mm; CrV; PH000, PH00, PH0, PH1, PH2; CrV; PZ0, PZ1; CrV; T4, T5, T6, T7, T8, T10; CrV; 0.7, 0.9, 1.3, 1.5, 2.0, 3.0 mm; CrV; 3.0 mm; CrV; 3.0 mm; CrV; 2.6 mm; CrV; 115 mm; CrV



No.	pcs / szt.	Icon
65025	31	6/24

EN Ratchet screwdriver set with bits
 PL Zestaw wkrętek z grzechotką i bitami
 DE Schraubendreher mit Ratche
 RU Отвёртка реверсивная с набором бит
 CZ Šroubovák z fehtačkou
 RO Şurubelniţă cu clichet
 HU Racsnis csavarbehajtó
 ES Juego con destornillador y carraca



1/4" (6.3 mm): 5, 6, 7, 8, 9, 10 mm (L=20 mm); CrV; 3.0, 4.0, 5.0, 6.0 mm, 1/8" (3.2 mm), 5/32" (4.0 mm), 3/16" (4.8 mm), 1/4" (6.3 mm); CrV; PH0, PH1, PH2, PH3; CrV; PZ0, PZ1, PZ2, PZ3; CrV; T15, T20, T25, T30; CrV; 3.0, 4.0, 5.0, 6.0 mm, 1/8" (3.2 mm), 5/32" (4.0 mm), 3/16" (4.8 mm), 1/4" (6.3 mm); CrV; S0, S1, S2, S3 mm, CrV; 1/4" (6.3 mm); (L=25 mm); CrV; 1/4" (6.3 mm); (L=60 mm); CrV

EN Ratchet screwdriver set with bits
 PL Wkrętek z grzechotką i wymiennymi końcówkami
 DE Schraubendreher mit Ratche
 RU Отвёртки с набором бит
 CZ Šroubovák z fehtačkou
 RO Şurubelniţă cu clichet
 HU Racsnis csavarbehajtó
 ES Juego con destornillador y carraca



31 PCS

Icons: Minus, Plus, Torx, Torx+, Phillips, Torx, Torx+, Phillips, Torx

CrV 6150

HRC 50-54

1/4" (6.3 mm): 3, 3.5, 4, 5, 5.5, 6 mm (L=25 mm); 1/4" (6.3 mm): PH0, PH1, PH2, PH3 (L=25 mm); 1/4" (6.3 mm): PZ0, PZ1, PZ2, PZ3 (L=25 mm); 1/4" (6.3 mm): T10, T15, T20, T25, T27, T30 (L=25 mm); 1/4" (6.3 mm): 2, 2.5, 3, 4, 5, 6 mm (L=25 mm); 1/4" (6.3 mm): S0, S1 (L=25 mm); 2.0x50 mm; PH00 x 50 mm



No.	pcs / szt.	Icon
64655	31	6/36

EN Ratchet screwdriver set with bits
 PL Wkrętek z grzechotką i wymiennymi końcówkami
 DE Schraubendreher mit Ratche
 RU Отвёртки с набором бит
 CZ Šroubovák z fehtačkou
 RO Şurubelniţă cu clichet
 HU Racsnis csavarbehajtó
 ES Juego con destornillador y carraca

36 PCS

Icons: Minus, Plus, Torx, Torx+, Phillips, Torx, Torx+, Phillips, Torx

CrV 6150



1/4" (6.3 mm): 4, 4.5, 5, 6, 7, 8, 9, 10, 11, 12, 13 mm; 1/4" (6.3 mm): 3, 3.5, 4, 5.5 mm (L=25 mm); 1/4" (6.3 mm): PH0, PH1, PH2, PH3 (L=25 mm); 1/4" (6.3 mm): PZ0, PZ1, PZ2, PZ3 (L=25 mm); 1/4" (6.3 mm): T10, T15, T20, T25, T27, T30 (L=25 mm); 1/4" (6.3 mm): 3, 4 mm (L=25 mm); 50 mm



No.	pcs / szt.	Icon
64660	36	6/24

41 PCS 1/4" 6.3mm

Icons: Minus, Plus, Torx, Torx+, Phillips, Torx, Torx+, Phillips, Torx

CrV



No.	pcs / szt.	Icon
64385	41	6/24

EN Impact screwdriver
 PL Wkrętak udarowy
 DE Schlagschrauber
 RU Отвёртка ударная
 CZ Narazový šroubovák kovový
 RO Şurubelniţă metalică cu percutor
 HU Kézi ütvecsavarhúzó
 ES Destornillador de percusión



No.	pcs / szt.	Box
65120	5	25

EN Impact screwdriver
 PL Wkrętak udarowy
 DE Schlagschrauber
 RU Отвёртка ударная
 CZ Narazový šroubovák kovový
 RO Şurubelniţă metalică cu percutor
 HU Kézi ütvecsavarhúzó
 ES Destornillador de percusión

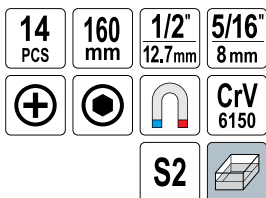

5/16" (7.9 mm) x 1/2" (12.7 mm);
 4, 5, 6, 8, 9 mm (L=35 mm); S2;
 PH1, PH2, PH3 (L=35 mm); S2;
 4, 5, 6, 8 mm (L=35 mm)



No.	pcs / szt.	Box
65124	14	20

EN Screwdriver with magnetic telescopic pick-up tool
 PL Wkrętak z teleskopowym chwytakiem magnetycznym
 DE Schraubendreher mit auschiebbaren magnetischem Halter
 RU Отвёртка магнитная с битами
 CZ Magnetický ťoubovák-teleskop
 RO Şurubelniţă cu magnet-teleskop
 HU Mágneses csavarbehajtó-teleszkop
 ES Destornillador magnético-telescop

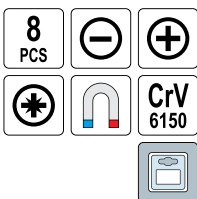

1/4" (6.3 mm): 3, 4, 5.5 mm (L=25 mm);
 1/4" (6.3 mm): PH1, PH2 (L=25 mm);
 1/4" (6.3 mm): PZ1, PZ2 (L=25 mm)



No.	pcs / szt.	Box
64650	8	12/72

EN Ratchet screwdriver set with bits
 PL Zestaw wkrętak z grzechotką i bitami
 DE Schraubendreher mit Ratche
 RU Отвёртка реверсивная с набором бит
 CZ Šroubovák z fehtačkou
 RO Şurubelniţă cu cichet
 HU Racsnis csavarbehajtó
 ES Juego con destornillador y carraca

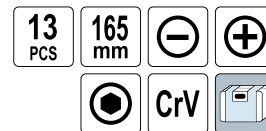

5/16" (7.9 mm) x 1/2" (12.7 mm);
 5, 6, 8, 9 mm (L=35 mm);
 PH1, PH2, PH3, PH4 (L=35 mm);
 4, 5, 6, 8 mm (L=35 mm)



No.	pcs / szt.	Box
65123	13	20

EN Telescopic screwdriver, magnetic
 PL Wkrętak magnetyczny, teleskopowy
 DE Schraubendreher
 RU Отвёртка магнитная с битами
 CZ Magnetický ťoubovák-teleskop
 RO Şurubelniţă telescopică cu magnet
 HU Mágneses csavarbehajtó-teleszkop
 ES Destornillador magnético-telescop

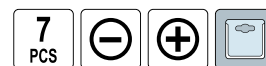

No.	pcs / szt.	Box
65045	7	25/100

EN T-bar screwdriver
 PL Wkrętak T-gryf
 DE T-griff Schraubendrehersatz
 RU Отвёртка с Т-образной ручкой и насадками
 CZ Šroubovák T-gryf
 RO Set surubelniţa tip „T”
 HU Csavarbehajtó, T-gryf
 ES Destornillador T-grifo



No.	pcs / szt.	Box
65100	21	10/80

EN T-bar screwdriver
 PL Wkrętak T-gryf
 DE T-griff Schraubendrehersatz
 RU Отвертка с Т-образной ручкой и насадками
 CZ Šroubovák T-gryf
 RO Set șurubelniță tip „T”
 HU Csavarbehajtó, T-gryf
 ES Destornillador T-grifo

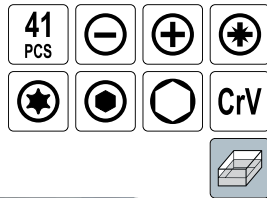

□ 1/4" (6.3 mm): 4, 5, 6, 7 mm (L=25 mm); ⚙ 1/4" (6.3 mm): PH1, PH2, PH3 (L=25 mm);
 ⚙ 1/4" (6.3 mm): T10, T15, T20, T25, T30, T40 (L=25 mm); ⚙ 1/4" (6.3 mm): PZ1, PZ2, PZ3
 (L=25 mm); ○ 1/4" (6.3 mm): 4, 5, 6 mm (L=25 mm); ⚙ 1/4" (6.3 mm): 5, 6, 7, 8, 9, 10, 11, 12, 13 mm; CrV;
 ⚙ 1/4" (6.3 mm): 3/16" (4.8 mm), 7/32" (5.6 mm), 1/4" (6.3 mm), 9/32" (7.1 mm), 5/16" (7.9 mm), 11/32" (8.7 mm), 3/8"
 (9.5 mm), 7/16" (11.1 mm), 1/2" (12.7 mm); CrV; ⚙ 1/4" (6.3 mm) x 6 mm; ⚙ 1/4" (6.3 mm)



No.	pcs / szt.	📦
65150	41	24

EN Screwdriver set
 PL Komplet wkrętaków
 DE Schraubendrehersatz
 RU Набор отвёрток
 CZ Zámečnické šroubováky
 RO Șurubelnițe de lăcătușerie
 HU Lakatos csavarhózó
 ES Juego de destornilladores

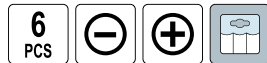

No.	pcs / szt.	📦
64050	6	20/80

EN Screwdriver set
 PL Komplet wkrętaków
 DE Schraubendrehersatz
 RU Набор отвёрток
 CZ Zámečnické šroubováky
 RO Șurubelnițe de lăcătușerie
 HU Lakatos csavarhózó
 ES Juego de destornilladores



No.	pcs / szt.	📦
64090	6	10/60

EN Screwdriver set
 PL Komplet wkrętaków
 DE Schraubendrehersatz
 RU Набор отвёрток
 CZ Zámečnické šroubováky
 RO Șurubelnițe de lăcătușerie
 HU Lakatos csavarhózó
 ES Juego de destornilladores

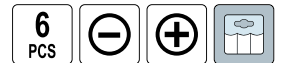

No.	pcs / szt.	📦
64060	6	20/60

EN Screwdriver set
 PL Komplet wkrętaków
 DE Schraubendrehersatz
 RU Набор отвёрток
 CZ Zámečnické šroubováky
 RO Șurubelnițe de lăcătușerie
 HU Lakatos csavarhózó
 ES Juego de destornilladores



No.	pcs / szt.	📦
64070	7	20/80

EN Ratchet screwdriver set with bits
 PL Zestaw wkrętak z grzechotką i bitami
 DE Schraubendreher mit Ratche
 RU Отвертка реверсивная с набором бит
 CZ Šroubovák z řehlačkou
 RO Șurubelniță cu clichet
 HU Racsnis csavarbehajtó
 ES Juego con destornillador y carraca

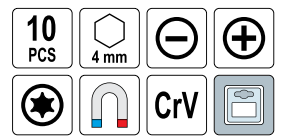

□ 1.0, 1.5, 2.0 mm; CrV;
 ⚙ PH00, PH0, PH1; CrV;
 ⚙ T6, T7, T8; CrV



No.	pcs / szt.	📦
64400	10	8/144

EN Precision screwdriver bits and holder
 PL Zestaw końcówek śrubokrętowych z uchwytem
 DE Schraubendreherbitsatz mit Bithalter
 RU Отвертка с набором специальных бит
 CZ Sada bitů s držákem
 RO Truse bit + capete șurubel niță
 HU Csavarhúzó bit készlet
 ES Juego de destornillador con puntas

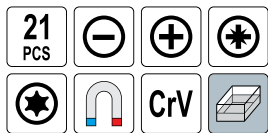

No.	pcs / szt.	
64370	21	10/60

EN Precision screwdriver bits and holder
 PL Zestaw końcówek śrubokrętowych z uchwytem
 DE Schraubendreherbitsatz mit Bithalter
 RU Отвертка с набором специальных бит
 CZ Sada bitů s držákem
 RO Truse bit + capete șurubel niță
 HU Csavarhúzó bit készlet
 ES Juego de destornillador con puntas

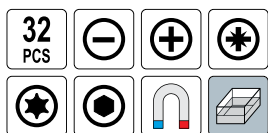

|| 1/4" (6.3 mm): 1.0, 1.5, 2.0, 2.5, 3.0, 3.5, 4.0 mm;
 ⊕ 1/4" (6.3 mm): PH000, PH00, PH0, PH1;
 ⊕ 1/4" (6.3 mm): PZ0, PZ1;
 ⊕ 1/4" (6.3 mm): T4, T5, T6, T7, T8, T9, T10, T15, T20;
 ○ 1/4" (6.3 mm): 0.7, 0.9, 1.3, 1.5, 2.0, 2.5, 3.0, 4.0 mm



No.	pcs / szt.	
64371	32	10/20

EN Precision screwdriver set
 PL Zestaw wkrętek precyzyjnych
 DE Präzisions-Feinmechanikersatz
 RU Набор прецизионных отверток

CZ Šroubováky sada pro jemnou mechaniku
 RO Set șurubelnite
 HU Órás csavarhúzó készlet
 ES Destornilladores precisos

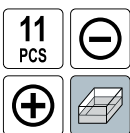

⊖ 0.9, 1.2, 1.4, 1.8, 2.4, 3.0 mm;
 ⊕ PH00, PH0, PH1

No.	pcs / szt.	
64330	11	25/100

EN Ratchet screwdriver set with bits
 PL Zestaw wkrętek z grzechotką i bitami
 DE Schraubendreher mit Ratche
 RU Отвертка реверсивная с набором бит
 CZ Šroubovák z fehtačkou
 RO Șurubelniță cu clichet
 HU Racsnis csavarbehajtó
 ES Juego con destornillador y carraca

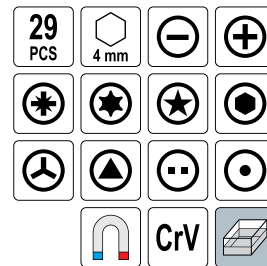

|| 0.7, 1.0, 1.2, 1.5, 1.8 mm; CrV; ⊕ PH000, PH00, PH0, PH1; CrV; ⊕ PZ000, PZ00, PZ0, PZ1; CrV; ○ 0.7, 0.9, 1.3, 1.5, 2.0 mm; CrV; ⊕ T4, T5, T6, T7, T8; CrV; △ 3.0 mm; CrV; ▽ 3.0 mm; CrV; ▾ 2.6 mm; CrV; ☆ 2.0 mm; CrV; ° 1.0 mm; CrV



No.	pcs / szt.	
64401	29	12/48

EN Precision screwdriver set
 PL Zestaw wkrętek precyzyjnych
 DE Präzisions-Feinmechanikersatz
 RU Набор прецизионных отверток

CZ Šroubováky sada pro jemnou mechaniku
 RO Set șurubelnite
 HU Órás csavarhúzó készlet
 ES Destornilladores precisos

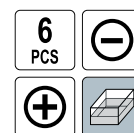

⊖ 1.4, 2.0, 2.4, 3.0 mm;
 ⊕ PH0, PH1

No.	pcs / szt.	
64310	6	20/100

EN Precision screwdriver and hook set
 PL Zestaw precyzyjnych wkrętek i haczyków
 DE Präzisions-Schraubendreher- und Haken-Satz
 RU Набор точных отверток и крючков
 CZ Sada přesných šroubováků a háčků
 RO Set șurubelnite de precizie
 HU Precíziós csavarhúzó és kampó készlet
 ES Set de destornilladores precisos y ganchos



⊖ 2.5, 3.5 mm; ⊕ PH00, PH0; ⊕ T6, T7, T8, T10; ⤵ 45°, 90°, 135°, 180°



No.	pcs / szt.	
64555	12	10/40

EN Precision screwdriver bits and holder
 PL Zestaw końcówek śrubokrętowych z uchwytem
 DE Schraubendreherbitsatz mit Bithalter
 RU Отвёртка с набором специальных бит
 CZ Sada bitů s držákem
 RO Truse bit + capete șurubel niță
 HU Csavarhúzó bit készlet
 ES Juego de destornillador con puntas

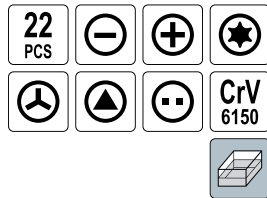

□ 1/16" (1.6 mm), 5/64" (2.0 mm), 3/32" (2.4 mm), 1/8" (3.2 mm), 5/32" (4.0 mm); ⚙ PH000, PH00, PH0, PH1 ⚙ T5, T6, T7, T8, T9, T10, T15, T20; △ 3.0 mm; ⚙ 3.0 mm; ⚙ 2.6 mm;



No.	pcs / szt.	📦
64395	22	10/50

EN Mobile phone repair tools set
 PL Zestaw do naprawy telefonów komórkowych
 DE Mobiletelefon Reparatur Satz
 RU Набор инструмента для ремонта мобильных телефонов
 CZ Nástroje na opravu mobilních telefonů
 RO Set șurubelnițe service telefoane mobile
 HU Mobiltelefon-javítás szerszámkészlet
 ES Herramientas de la reparación del teléfono móvil fijadas

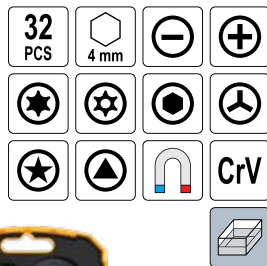

□ 1.0, 2.0 mm; CrV; ⚙ PH000, PH00, PH0, PH1; CrV; ⚙ T2, T3, T4, T5, T6, T8, T10; CrV; ⚙ T7; CrV; ⚙ 1.5, 2.0 mm; CrV; ⚙ Y000, Y00, Y0; CrV; ⚙ 0.8 (2 PCS), 1.2, 1.5 mm; CrV; △ 3.0 mm; CrV; ⚙ 4x75 mm; CrV



No.	pcs / szt.	📦
64384	32	6/48

EN Screwdriver bit set
 PL Zestaw końcówek śrubokrętowych
 DE Schraubendreherbitsatz
 RU Набор битов
 CZ Sada bitů
 RO Truse bit
 HU Bitkészlet
 ES Puntas de destornilladora

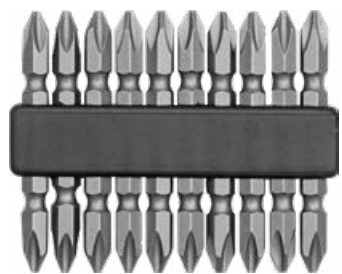

No.	+	L [mm]	pcs / szt.	📦
65700	PH2	60	10	25/100

EN Precision screwdriver bits and holder
 PL Zestaw końcówek śrubokrętowych z uchwytem
 DE Schraubendreherbitsatz mit Bithalter
 RU Отвёртка с набором специальных бит
 CZ Sada bitů s držákem
 RO Truse bit + capete șurubel niță
 HU Csavarhúzó bit készlet
 ES Juego de destornillador con puntas

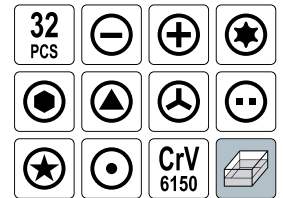

□ 1/16" (1.6 mm), 5/64" (2.0 mm), 3/32" (2.4 mm), 1/8" (3.2 mm), 9/64" (3.6 mm), 5/32" (4.0 mm); ⚙ PH000, PH00, PH0, PH1, PH2; ⚙ 0.035" (0.9 mm), 1/16" (1.6 mm), 0.05" (1.8 mm), 5/64" (2.0 mm), 3/32" (2.4 mm), 1/8" (3.2 mm), 5/32" (4.0 mm); ⚙ T4, T5, T6, T7, T8, T10, T15, T20; ☆ 5/64" (2.0 mm); ○ 0.035" (0.9 mm); △ 1/8" (3.2 mm); ⚙ 1/8" (3.2 mm); ⚙ 7/64" (2.8 mm)



No.	pcs / szt.	📦
64396	32	10/50

EN Precision screwdriver set
 PL Wkrętaki precyzyjne
 DE Präzisions-Schraubendrehersatz
 RU Набор отвёрток для точных работ
 CZ Precizní šroubováky
 RO Șurubelnițe precise
 HU Precíziós csavarhúzó
 ES Destornilladores precisos



No.	Tip size / Rozmiar grotu	pcs / szt.	📦
64553	1.4, 2.4, 3.0, PH00, PH0, PH1	6	10/60
64554	T5, T6, T7, T8, T9, T10	6	10/60

EN Screwdriver bit set
 PL Zestaw końcówek śrubokrętowych
 DE Schraubendreherbitsatz
 RU Набор битов
 CZ Sada bitů
 RO Truse bit
 HU Bitkészlet
 ES Puntas de destornilladora



□ 1/4" (6.3 mm); 5, 6 mm (L=25 mm); CrV; ⚙ 1/4" (6.3 mm); PH0, PH1, PH2 (L=25 mm); CrV; ⚙ 1/4" (6.3 mm); PZ1, PZ2 (L=25 mm); CrV; ⚙ 1/4" (6.3 mm); T15, T20 (L=25 mm); CrV; ⚙ 1/4" (6.3 mm); (L=60 mm); CrV



No.	pcs / szt.	📦
65705	10	5/80

- EN Screwdriver bit set
- PL Zestaw końcówek śrubokrętowych
- DE Schraubendreherbitsatz
- RU Набор битов
- CZ Sada bitů
- RO Truse bit
- HU Bitkészlet
- ES Puntas de destornilladora



1/4" (6.3 mm): 3, 4, 5, 5.5, 6, 7 mm (L=25 mm); CrV; 1/4" (6.3 mm): PH0, PH1 (2 PCS), PH2 (2 PCS), PH3 (L=25 mm); CrV; 1/4" (6.3 mm): PZ0, PZ1 (2 PCS), PZ2 (2 PCS), PZ3 (L=25 mm); CrV; 1/4" (6.3 mm): T10, T15, T20, T25, T27, T30 (L=25 mm); CrV; 1/4" (6.3 mm): 2, 3, 4, 5, 5.5, 6 mm (L=25 mm); CrV; 1/4" (6.3 mm): (L=60 mm); CrV



No.	pcs / szt.	
66302	31	10/30

- EN Screwdriver bit set
- PL Zestaw końcówek śrubokrętowych
- DE Schraubendreherbitsatz
- RU Набор битов
- CZ Sada bitů
- RO Truse bit
- HU Bitkészlet
- ES Puntas de destornilladora

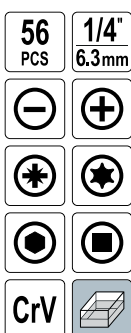

1/4" (6.3 mm): 3, 4, 5, 5.5, 6, 7 mm (L=25 mm); 4, 6 mm (L=50 mm); CrV; 1/4" (6.3 mm): PH0, PH1 (2 PCS), PH2 (5 PCS), PH3 (L=25 mm); PH1, PH2, PH3 (L=50 mm); CrV; 1/4" (6.3 mm): PZ0, PZ1 (2 PCS), PZ2 (5 PCS), PZ3 (L=25 mm), PZ1, PZ2, PZ3 (L=50 mm); CrV; 1/4" (6.3 mm): T10, T15, T20, T25, T27, T30, T40 (L=25 mm); T15, T20, T25 (L=50 mm); CrV; 1/4" (6.3 mm): 2, 2.5, 3, 4, 5, 5.5, 6 mm (L=25 mm); 4, 5, 6 mm (L=50 mm); CrV; 1/4" (6.3 mm): S0, S1, S2, S3 (L=25 mm); CrV



No.	pcs / szt.	
66310	56	8/16

- EN Screwdriver bit set
- PL Zestaw końcówek śrubokrętowych
- DE Schraubendreherbitsatz
- RU Набор битов
- CZ Sada bitů
- RO Truse bit
- HU Bitkészlet
- ES Puntas de destornilladora

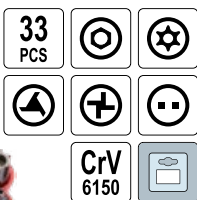

1/4" (6.3 mm): T8, T10, T15, T20, T25, T27, T30, T35, T40 (L=25 mm); 1/4" (6.3 mm): 5/64" (2.0 mm), 3/32" (2.4 mm), 7/64" (2.8 mm), 1/8" (3.2 mm), 9/64" (3.6 mm), 5/32" (4.0 mm) (L=25 mm); 1/4" (6.3 mm): 2, 2.5, 3, 4, 5, 6 mm (L=25 mm); 1/4" (6.3 mm): 1, 2, 3, 4 (L=25 mm); 1/4" (6.3 mm): 6, 8, 10 (L=25 mm); 1/4" (6.3 mm): 4, 6, 8, 10 (L=25 mm); 1/4" (6.3 mm): (L=60 mm)



No.	pcs / szt.	
66330	33	12/60

- EN Screwdriver bit set
- PL Zestaw końcówek śrubokrętowych
- DE Schraubendreherbitsatz
- RU Набор битов
- CZ Sada bitů
- RO Truse bit
- HU Bitkészlet
- ES Puntas de destornilladora



1/4" (6.3 mm): 3, 4, 5, 5.5, 6, 7 mm (L=25 mm); CrV; 1/4" (6.3 mm): PH0, PH1 (2 PCS), PH2 (4 PCS), PH3 (L=25 mm); CrV; 1/4" (6.3 mm): PZ0, PZ1 (2 PCS), PZ2 (4 PCS), PZ3 (L=25 mm); CrV; 1/4" (6.3 mm): T10, T15, T20, T25, T27, T30, T40 (L=25 mm); CrV; 1/4" (6.3 mm): 2, 2.5, 3, 4, 5, 5.5, 6 mm (L=25 mm); CrV; 1/4" (6.3 mm): S0, S1, S2, S3 (L=25 mm); CrV; 1/4" (6.3 mm): (L=60 mm); CrV



No.	pcs / szt.	
66301	41	10/40

- EN Screwdriver bit set
- PL Końcówki śrubokrętowe do gipsów
- DE Schraubendreherbitsatz
- RU Насадки для быстрого завинчивания саморезов по гипсокартону
- CZ Koncovky šroubovokové na sádku
- RO Capete pt. ghips pt. șurubelniță
- HU Csavarhúzóvégék gipszhez
- ES Puntas con limitador



1/4" (6.3 mm): PH2 (L=25 mm)



No.	pcs / szt.	
65800	2	12/144

- EN Screwdriver bit set
- PL Zestaw końcówek śrubokrętowych
- DE Schraubendreherbitsatz
- RU Набор битов
- CZ Sada bitů
- RO Truse bit
- HU Bitkészlet
- ES Puntas de destornilladora

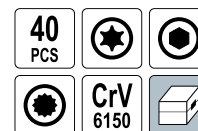

3/8" (9.5 mm): T20, T25, T30, T40, T45, T50, T55 (L=30 mm); 3/8" (9.5 mm): T20, T25, T30, T40, T45, T50, T55 (L=75 mm); 3/8" (9.5 mm): 4, 5, 6, 7, 8, 10, 12 mm (L=30 mm); 3/8" (9.5 mm): 4, 5, 6, 7, 8, 10, 12 mm (L=75 mm); 3/8" (9.5 mm): M5, M6, M8, M10, M12 (L=30 mm); 3/8" (9.5 mm): M5, M6, M8, M10, M12 (L=75 mm); 1/2" (12.7 mm) x 3/8" (9.5 mm), 3/8" (9.5 mm) x 3/8" (9.5 mm)



No.	pcs / szt.	
66400	40	10

EN Screwdriver bit set
 PL Zestaw końcówek śrubokrętowych
 DE Schraubendreherbitsatz
 RU Набор битов
 CZ Sada bitů
 RO Truse bit
 HU Bitkészlet
 ES Puntas de destornilladora



⚙️ T20, T25, T30, T40, T45, T50, T55 (L=30 mm); T20, T25, T30, T40, T45, T50, T55 (L=75 mm);
 ○ 4, 5, 6, 7, 8, 10, 12 mm (L=30 mm); 4, 5, 6, 7, 8, 10, 12 mm (L=75 mm); ○ M5, M6, M8, M10, M12 (L=30 mm); M5, M6, M8, M10, M12 (L=75 mm)



No.	pcs / szt.	📦
66410	40	10

EN Screwdriver bit set
 PL Zestaw końcówek śrubokrętowych
 DE Schraubendreherbitsatz
 RU Набор битов
 CZ Sada bitů
 RO Truse bit
 HU Bitkészlet
 ES Puntas de destornilladora



⚙️ 3/8" (9.5 mm): T20, T25, T30, T40, T45, T50, T55 (L=30 mm); 3/8" (9.5 mm): T20, T25, T30, T40, T45, T50, T55 (L=75 mm);
 📏 1/2" (12.7 mm) x 3/8" (9.5 mm)



No.	pcs / szt.	📦
66580	15	20

EN Screwdriver bit set
 PL Zestaw końcówek śrubokrętowych
 DE Schraubendreherbitsatz
 RU Набор битов

CZ Sada bitů
 RO Truse bit
 HU Bitkészlet
 ES Puntas de destornilladora

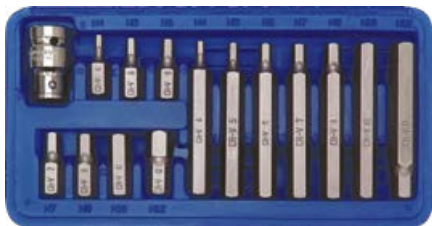

○ 3/8" (9.5 mm): 4, 5, 6, 7, 8, 10, 12 (L=30 mm); 3/8" (9.5 mm): 4, 5, 6, 7, 8, 10, 12 (L=75 mm); 📏 1/2" (12.7 mm) x 3/8" (9.5 mm)



No.	pcs / szt.	📦
66720	15	20

EN Screwdriver bit set
 PL Zestaw końcówek śrubokrętowych
 DE Schraubendreherbitsatz
 RU Набор битов

CZ Sada bitů
 RO Truse bit
 HU Bitkészlet
 ES Puntas de destornilladora

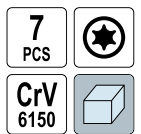

⚙️ 3/8" (9.5 mm): T25, T30, T40, T45, T50, T55 (L=30 mm);
 📏 1/2" (12.7 mm) x 3/8" (9.5 mm)



No.	pcs / szt.	📦
66570	7	24/72

EN Screwdriver bit set
 PL Zestaw końcówek śrubokrętowych
 DE Schraubendreherbitsatz
 RU Набор битов

CZ Sada bitů
 RO Truse bit
 HU Bitkészlet
 ES Puntas de destornilladora



○ 3/8" (9.5 mm): 4, 5, 6, 8, 10, 12 mm (L=30 mm); 📏 1/2" (12.7 mm) x 3/8" (9.5 mm)



No.	pcs / szt.	📦
66710	7	24/72

EN Screwdriver bit set
 PL Zestaw końcówek śrubokrętowych
 DE Schraubendreherbitsatz
 RU Набор битов

CZ Sada bitů
 RO Truse bit
 HU Bitkészlet
 ES Puntas de destornilladora



○ 3/8" (9.5 mm): M5, M6, M8, M10, M12 (L=30 mm); 📏 1/2" (12.7 mm) x 3/8" (9.5 mm)



No.	pcs / szt.	📦
66760	6	24/72

EN Screwdriver bit set
 PL Zestaw końcówek śrubokrętowych
 DE Schraubendreherbitsatz
 RU Набор битов

CZ Sada bitů
 RO Truse bit
 HU Bitkészlet
 ES Puntas de destornilladora

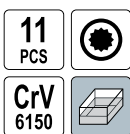

3/8" (9.5 mm): M5, M6, M8, M10, M12 (L=30 mm); 3/8" (9.5 mm): M5, M6, M8, M10, M12 (L=75 mm);
 1/2" (12.7 mm) x 3/8" (9.5 mm)



No.	pcs / szt.	Box
66770	11	20

EN Screwdriver bit set
 PL Zestaw końcówek śrubokrętowych
 DE Schraubendreherbitsatz
 RU Набор битов

CZ Sada bitů
 RO Truse bit
 HU Bitkészlet
 ES Puntas de destornilladora



No.	pcs / szt.	Box
66112	10	25/100

EN Screwdriver bit set
 PL Zestaw końcówek śrubokrętowych
 DE Schraubendreherbitsatz
 RU Набор битов

CZ Sada bitů
 RO Truse bit
 HU Bitkészlet
 ES Puntas de destornilladora



No.	pcs / szt.	Box
66200	20	12/48

EN Screwdriver bit set
 PL Komplet końcówek nasadowych
 DE Bit-Steckschlüsselsatz
 RU Набор торцевых головок

CZ Sada nastrčných koncoviek
 RO Set de capete tubulare
 HU Csökulcskészlet
 ES Juego de puntas de calar



1/4" (6.3 mm): 5, 6, 7, 8, 9, 10, 11, 13 mm; CrV 6150



No.	pcs / szt.	Box
66113	8	25/50

EN Screwdriver bit set
 PL Zestaw końcówek śrubokrętowych
 DE Schraubendreherbitsatz
 RU Набор битов
 CZ Sada bitů
 RO Truse bit
 HU Bitkészlet
 ES Puntas de destornilladora

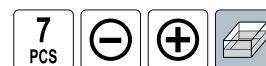

No.	pcs / szt.	Box
66080	7	20/200

EN Screwdriver bit set
 PL Zestaw końcówek śrubokrętowych
 DE Schraubendreherbitsatz
 RU Набор битов

CZ Sada bitů
 RO Truse bit
 HU Bitkészlet
 ES Puntas de destornilladora



No.	pcs / szt.	Box
66210	20	12/48

EN Screwdriver bit holder
 PL Uchwyt do końcówek śrubokrętowych
 DE Bithalter
 RU Магнитный держатель

CZ Držák na šroubovavokóncovky
 RO Capete șurubelniță
 HU Szár a csavarhúzóvégekhez
 ES Mandril para puntas



No.	Box
65850	30/300

EN Angle adapter
 PL Adapter kątowy
 DE Winkelschrauber
 RU Адаптер угловой для бит

CZ Úhel elektrická vrtačka přípojení adaptéru
 RO Dispozitiv unghiular de insurubat
 HU Sarokcsavarozó adapter
 ES Ángulo magnético bit driver adaptador



No.	Box	L [mm]	Box
65840	1/4" (6.3 mm)	130	60

EN T-handle hex key
 PL Klucz sześciokątny typu "T"
 DE T-Griff Sechskant Stiftschlüssel
 RU Ключ Hex T-образный с рукояткой
 CZ Imbusový klíč s T-rukojetí
 RO Cheie hexagonală tip "T"
 HU Imbuskulcs T-markolattal
 ES Llave Allen con mango en "T"

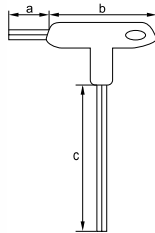

No.	⊙ [mm]	a [mm]	b [mm]	c [mm]	📦
56640	2.0	10	59	100	24/240
56641	2.5	12	59	100	24/240
56642	3.0	13	59	100	24/240
56643	4.0	13	76	150	24/192
56644	5.0	14	76	150	24/192
56645	6.0	14	76	150	24/192
56646	7.0	16	95	200	12/72
56647	8.0	18	95	200	12/72
56648	10.0	20	95	200	12/72

EN T-handle hex key with ball
 PL Klucz sześciokątny typu "T" z kulką
 DE T-Griff Sechskant Stiftschlüssel mit Kugel
 RU Ключ Hex T-образный с шаровой головкой
 CZ T-yp imbusového klíče s kulovou hlavou
 RO Cheie hexagonală cu bila tip "T"
 HU Imbuskulcs T-markolattal gömbfej
 ES Llave Allen con el tipo de pelota "T"

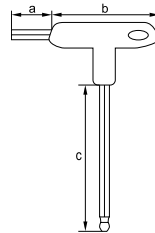

No.	⊙ [mm]	a [mm]	b [mm]	c [mm]	📦
56620	2.0	10	59	100	24/240
56621	2.5	12	59	100	24/240
56622	3.0	13	59	100	24/240
56623	4.0	13	76	150	24/192
56624	5.0	14	76	150	24/192
56625	6.0	14	76	150	24/192
56626	7.0	16	95	200	12/72
56627	8.0	18	95	200	12/72
56628	10.0	20	95	200	12/72

EN T-handle Torx key
 PL Klucz Torx typu "T"
 DE T-Griff Torx-Schlüssel
 RU Ключ Torx T-образный с рукояткой
 CZ Torx klíč s T-rukojetí
 RO Cheie Torx tip "T"
 HU Torx kulcs T-markolattal
 ES Torx llave en forma de "T" con un mango

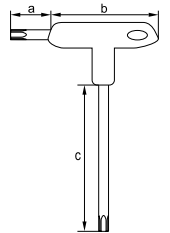

No.	⊙ [mm]	a [mm]	b [mm]	c [mm]	📦
56630	T10	10	59	100	24/240
56631	T15	12	59	100	24/240
56632	T20	13	59	100	24/192
56633	T25	13	76	150	24/192
56634	T27	14	76	150	24/192
56635	T30	14	76	150	24/192
56636	T40	16	95	200	12/72
56637	T45	18	95	200	12/72
56638	T50	20	95	200	12/72

EN T-handle hex key set
 PL Zestaw kluczy sześciokątnych typu "T"
 DE T-Griff Sechskant Stiftschlüsselsatz
 RU Набор ключей Hex с T-образной рукояткой
 CZ Sada imbusů "T" rukojetí
 RO Set chei hexagonale tip "T"
 HU Imbuskulcs T-markolattal készlet
 ES Juego de llaves Allen con mango en "T"

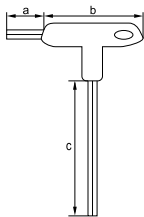

No.	⊙ [mm]	a [mm]	b [mm]	c [mm]	pcs / szt.	📦
56649	2.5, 3, 4, 5, 6, 7, 8, 10	12, 13, 14, 16, 18, 20	59, 59, 76, 76, 95, 95	100, 100, 150, 150, 200, 200	8	12/24

EN T-handle hex key set with ball
 PL Zestaw kluczy sześciokątnych typu "T" z kulką
 DE T-Griff Sechskant Stiftschlüsselsatz mit Kugel
 RU Набор ключей Hex с T-образной рукояткой
 CZ Sada imbusů s kulíčkou a "T" rukojetí
 RO Set chei hexagonale cu bila Tip "T"
 HU Imbuskulcs T-markolattal készlet
 ES Juego de llaves Allen con mango en "T"

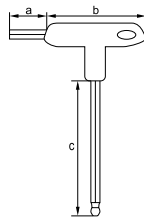

No.	⊙ [mm]	a [mm]	b [mm]	c [mm]	pcs / szt.	📦
56629	2.5, 3, 4, 5, 6, 7, 8, 10	12, 13, 13, 14, 14, 16, 18, 20	59, 59, 76, 76, 95, 95	100, 100, 150, 150, 200, 200	8	12/24

EN T-handle Torx key set
 PL Zestaw kluczy Torx typu "T"
 DE T-Griff Torx-Schlüssel-Satz
 RU Набор ключей Torx с T-образной рукояткой
 CZ Klíče typ "T" Torx sada
 RO Set chei Torx tip "T"
 HU T-nyelű Torx kulcs készlet
 ES T-tipo llave Torx set

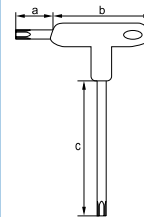

No.	⊙ [mm]	a [mm]	b [mm]	c [mm]	pcs / szt.	📦
56639	T10, T15, T20, T25, T27, T30, T40, T45, T50	10, 12, 13, 14, 16, 18, 20	59, 59, 76, 76, 95, 95	100, 100, 150, 150, 200, 200	9	12/24

EN Hex key
 PL Klucz sześciokątny
 DE Sechskant-Stiftschlüssel
 RU Шестигранник
 CZ Imbusový klíč
 RO Cheie imbus
 HU Imbisz kulcs
 ES Llave hexagonal



3



No.	⌀ [mm]	
56040	4	1000/2000
56050	5	400/800
56060	6	400/800
56070	7	300/600
56080	8	200/400
56100	10	100/200
56120	12	50/100
56130	13	50/100
56140	14	50/100
56170	17	25/50

EN Hex key set
 PL Zestaw kluczy imbusowych
 DE Sechskant-Stiftschlüsselsatz
 RU Набор шестигранников
 CZ Imbusové klíče
 RO Cheie imbus
 HU Imbisz kulcs
 ES Juego de llaves Hex

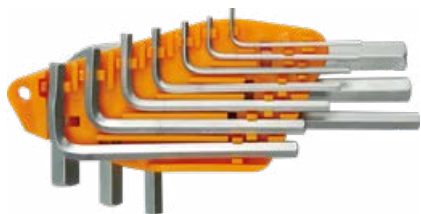

No.	⌀ [mm]	pcs / szt.	
56393	1.5, 2, 2.5, 3, 4, 5, 5.5, 6, 8, 10	10	10/60

EN Hex key set
 PL Zestaw kluczy imbusowych
 DE Sechskant-Stiftschlüsselsatz
 RU Набор шестигранников
 CZ Imbusové klíče
 RO Cheie imbus
 HU Imbisz kulcs
 ES Juego de llaves Hex



No.	⌀ [mm]	pcs / szt.	
56470	2.5, 3, 4, 5, 6, 8, 10	7	20/40

EN Hex key set
 PL Zestaw kluczy imbusowych
 DE Sechskant-Stiftschlüsselsatz
 RU Набор шестигранников
 CZ Imbusové klíče
 RO Cheie imbus
 HU Imbisz kulcs
 ES Juego de llaves Hex



No.	⌀ [mm]	pcs / szt.	
56380	2, 2.5, 3, 4, 5, 6, 8, 10	8	20/100
56390	1.5, 2, 2.5, 3, 4, 5, 6, 7, 8, 10	10	20/100

EN Hex key set
 PL Zestaw kluczy imbusowych
 DE Sechskant-Stiftschlüsselsatz
 RU Набор шестигранников
 CZ Imbusové klíče
 RO Cheie imbus
 HU Imbisz kulcs
 ES Juego de llaves Hex

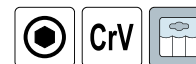

No.	⌀ [mm]	pcs / szt.	
56391	1.5, 2, 2.5, 3, 3.5, 4, 5, 6, 8, 10	10	20/100
56392	2, 2.5, 3, 4, 5, 6, 8, 10	8	20/100

EN Hex key set
 PL Zestaw kluczy imbusowych
 DE Sechskant-Stiftschlüsselsatz
 RU Набор шестигранников
 CZ Imbusové klíče
 RO Cheie imbus
 HU Imbisz kulcs
 ES Juego de llaves Hex



No.	⌀ [mm]	pcs / szt.	
56400	2, 2.5, 3, 4, 5, 6, 8, 10, 12, 14	10	20/40

EN Hex key set
 PL Zestaw kluczy imbusowych
 DE Sechskant-Stiftschlüsselsatz
 RU Набор шестигранников
 CZ Imbusové klíče
 RO Cheie imbus
 HU Imbisz kulcs
 ES Juego de llaves Hex



No.	⌀ [mm]	pcs / szt.	
56473	1.5, 2, 2.5, 3, 4, 5, 6, 8	8	10/60

EN Hex key set
 PL Zestaw kluczy imbusowych
 DE Sechskant-Stiftschlüsselsatz
 RU Набор шестигранников
 CZ Imbusové klíče
 RO Chei imbus
 HU Imbisz kulcs
 ES Juego de llaves Hex

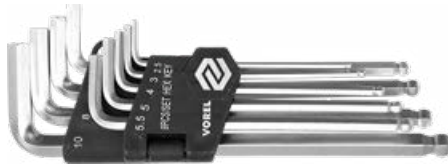
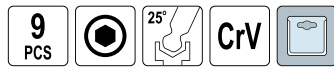

No.	⌀ [mm]	pcs / szt.	📦
56475	2.5, 3, 4, 5, 5.5, 6, 7, 8, 10	9	10/60

EN Hex key set
 PL Zestaw kluczy imbusowych
 DE Sechskant-Stiftschlüsselsatz
 RU Набор шестигранников
 CZ Imbusové klíče
 RO Chei imbus
 HU Imbisz kulcs
 ES Juego de llaves Hex

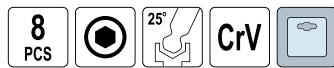

No.	⌀ [mm]	pcs / szt.	📦
56505	1.5, 2, 2.5, 3, 4, 5, 6, 8	8	25/100

EN Torx key set
 PL Zestaw kluczy Torx
 DE Torx Schlüsselsatz
 RU Набор ключи Torx
 CZ Souprava klíčů Torx
 RO Set de chei Torx
 HU Kulcskészlet Torx
 ES Juego de llaves Torx

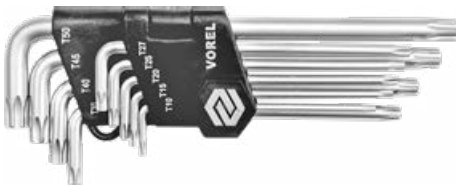

No.	⌀	pcs / szt.	📦
56478	T10, T15, T20, T25, T27, T30, T40, T45, T50	9	20/40

EN Torx key set
 PL Zestaw kluczy Torx
 DE Torx Schlüsselsatz
 RU Набор ключи Torx
 CZ Souprava klíčů Torx
 RO Set de chei Torx
 HU Kulcskészlet Torx
 ES Juego de llaves Torx



No.	⌀	pcs / szt.	📦
56507	T9, T10, T15, T20, T25, T27, T30, T40	8	25/100

EN Hex key set
 PL Zestaw kluczy imbusowych
 DE Sechskant-Stiftschlüsselsatz
 RU Набор шестигранников
 CZ Imbusové klíče
 RO Chei imbus
 HU Imbisz kulcs
 ES Juego de llaves Hex



No.	⌀ [mm]	pcs / szt.	📦
56477	2, 2.5, 3, 4, 5, 5.5, 6, 8, 10	9	10/60

EN Hex key set
 PL Zestaw kluczy imbusowych
 DE Sechskant-Stiftschlüsselsatz
 RU Набор шестигранников
 CZ Imbusové klíče
 RO Chei imbus
 HU Imbisz kulcs
 ES Juego de llaves Hex



No.	⌀ [mm]	pcs / szt.	📦
56506	1.5, 2, 2.5, 3, 4, 5, 6, 8	8	25/100

EN Torx key set
 PL Zestaw kluczy Torx
 DE Torx Schlüsselsatz
 RU Набор ключи Torx
 CZ Souprava klíčů Torx
 RO Set de chei Torx
 HU Kulcskészlet Torx
 ES Juego de llaves Torx



No.	⌀	pcs / szt.	📦
56600	T10, T15, T20, T25, T27, T30, T40	8	50/100



4

Pliers & pipe wrenches Szczypce i klucze do rur

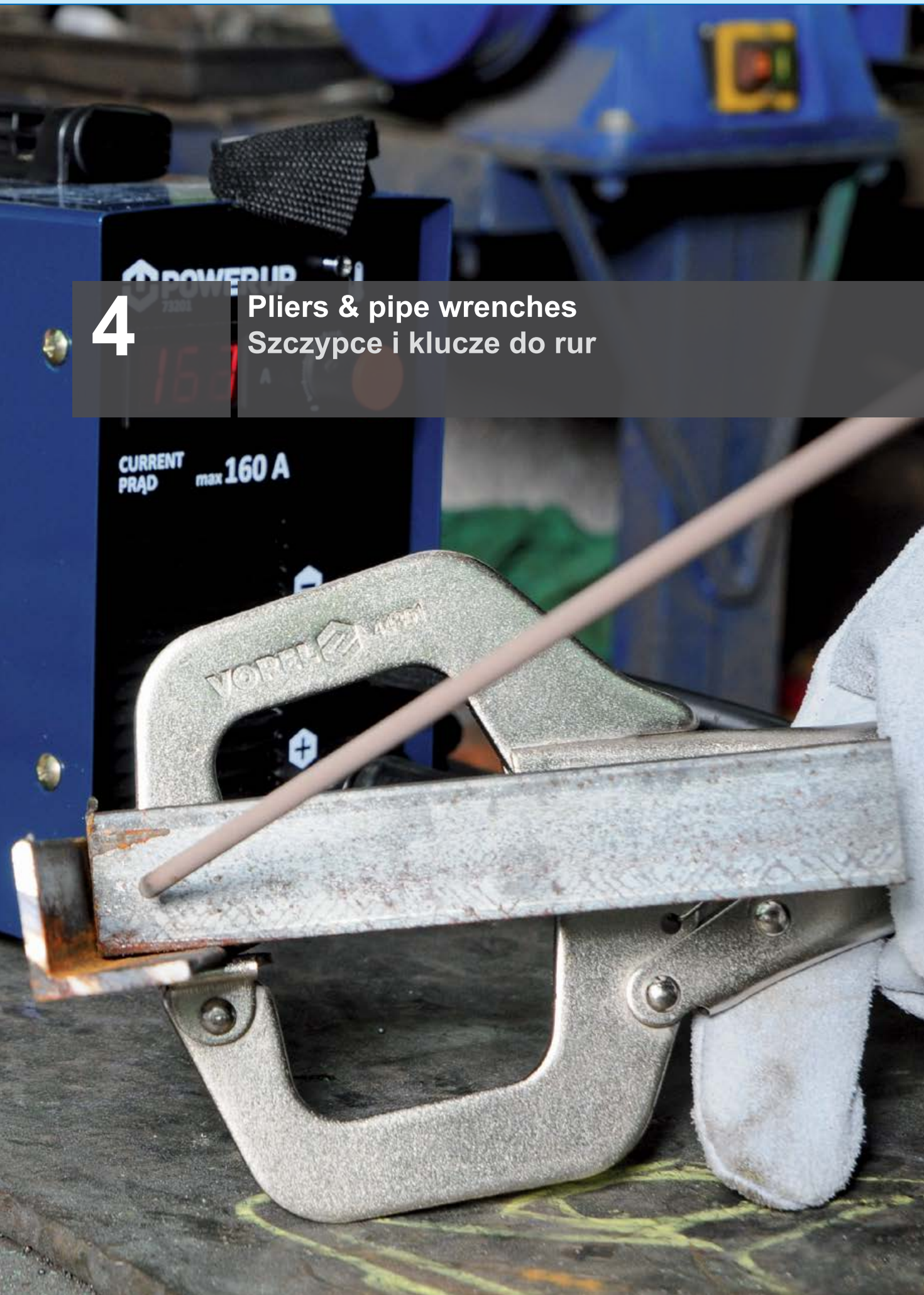

Pliers, heavy duty blue handle Szczypce, uchwyt niebieski

44



Combination pliers

Szczypce uniwersalne..... 44

Side cutting pliers

Szczypce tnące, boczne..... 44

Long nose pliers

Szczypce wydłużone, proste..... 44

Bent nose pliers

Szczypce wydłużone, wygięte..... 44

Pliers, 2 colour handle Szczypce, dwukolorowa rączka

44-45

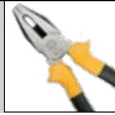

Combination pliers

Szczypce uniwersalne..... 44

Side cutting pliers

Szczypce tnące, boczne..... 44

Long nose pliers

Szczypce wydłużone, proste..... 44

Bent nose pliers

Szczypce wydłużone, wygięte..... 44

Round nose pliers

Szczypce okrągłe..... 45

Wire stripping pliers

Szczypce do ściągania izolacji..... 45

End cutting pliers

Szczypce tnące, czołowe..... 45

Water pump pliers

Szczypce nastawne..... 45

Chrome plated pliers Szczypce chromowane

45



Water pump pliers

Szczypce nastawne..... 45

Pincers & pliers Szczypce i obcęgi

45



End cutting pliers

Szczypce tnące, czołowe..... 45

Carpenter's pincers

Obcęgi..... 45

Tower pincers

Szczypce tynkarskie..... 45

Profile connection pliers Szczypce do łączenia profili

46



Pliers „Juco” Szczypce „Juco”

46



Combination pliers

Szczypce uniwersalne..... 46

Side cutting pliers

Szczypce tnące, boczne..... 46

Mini pliers

Szczypce „Mini”

46-47



Combination pliers

Szczypce uniwersalne..... 46

Side cutting pliers

Szczypce tnące, boczne..... 46

Long nose pliers

Szczypce wydłużone, proste..... 46

Bent nose pliers

Szczypce wydłużone, wygięte..... 47

Flat nose pliers

Szczypce płaskie..... 47

Round nose pliers

Szczypce okrągłe..... 47

End cutting pliers

Szczypce tnące, czołowe..... 47

Mini pliers sets

Zestawy szczypiec „Mini”..... 47

Circlip pliers Szczypce Segera

47-48



Lock grip pliers & sets Szczypce zaciskowe i zestawy

48-49



Water pump pliers Szczypce nastawne

49



Pipe wrenches Klucze do rur

50-51



Pipe wrenches Stillson type

Klucze do rur typu Stillson..... 50

Adjustable pipe wrenches

Klucze do rur nastawne..... 50

Adjustable wrenches

Klucze nastawne francuskie..... 51

Chain pipe wrenches Klucze do rur łańcuchowe

51



EN Combination pliers
 PL Szczypce uniwersalne
 DE Kombinationszange
 RU Плоскогубцы универсальные
 CZ Univerzální kleště
 RO Patent universal
 HU Kombináltfogó
 ES Alicates universal



VOREL

No.	L [mm]	
40010	160	6/60
40011	180	6/60
40012	200	6/60

EN Long nose pliers
 PL Szczypce wydłużone proste
 DE Radiozange
 RU Тонкогубцы
 CZ Prodloužené kleště rovné
 RO Patent drept alungit
 HU Rádiófogó, egyenes
 ES Alicates de punta



VOREL

No.	L [mm]	
40013	160	6/120
40014	200	6/60

EN Combination pliers
 PL Szczypce uniwersalne
 DE Kombinationszange
 RU Плоскогубцы универсальные
 CZ Univerzální kleště
 RO Patent universal
 HU Kombináltfogó
 ES Alicates universal



VOREL

No.	L [mm]	
40041	160	6/60
40042	180	6/60
40043	200	6/60

EN Long nose pliers
 PL Szczypce wydłużone proste
 DE Radiozange
 RU Тонкогубцы
 CZ Prodloužené kleště rovné
 RO Patent drept alungit
 HU Rádiófogó, egyenes
 ES Alicates de punta



VOREL

No.	L [mm]	
40044	160	6/120
40045	180	6/60

EN Diagonal side cutting pliers
 PL Szczypce tnące boczne
 DE Seitenschneider
 RU Бокорезы
 CZ Řezací kleště boční
 RO Patent de tăiat lateral
 HU Oldal csípőfogó
 ES Alicates corte lateral



VOREL

No.	L [mm]	
40017	160	6/60
40018	180	6/60

EN Bent nose pliers
 PL Szczypce wydłużone wygięte
 DE Telefonzange
 RU Тонкогубцы изогнутые
 CZ Prodloužené kleště ohnuté
 RO Patent curbat alungit
 HU Rádió- és telefonfogó, hajlított
 ES Alicates curvos



VOREL

No.	L [mm]	
40015	160	6/120
40016	200	6/60

EN Diagonal side cutting pliers
 PL Szczypce tnące boczne
 DE Seitenschneider
 RU Бокорезы
 CZ Řezací kleště boční
 RO Patent de tăiat lateral
 HU Oldal csípőfogó
 ES Alicates corte lateral



VOREL

No.	L [mm]	
40047	160	6/120
40048	180	6/60

EN Bent nose pliers
 PL Szczypce wydłużone wygięte
 DE Telefonzange
 RU Тонкогубцы изогнутые
 CZ Prodloužené kleště ohnuté
 RO Patent curbat alungit
 HU Rádió- és telefonfogó, hajlított
 ES Alicates curvos



VOREL

No.	L [mm]	
40050	160	6/120
40051	180	6/60

EN Round nose pliers
 PL Szczypce okrągłe
 DE Rundzange
 RU Крупнорыбы
 CZ Kruhové kleště
 RO Patent rotund
 HU Kerekcsőrű fogó
 ES Alicates redondos

160 mm



VOREL

No.	L [mm]	
40054	160	6/120

EN End cutting pliers
 PL Szczypce tnące czolowe
 DE Vornschnneider
 RU Кусачки торцевые
 CZ Kleště štípačí čelní
 RO Cleste retezat
 HU Homlokcsípő fogó
 ES Cortacables frontales

160 mm



VOREL

No.	L [mm]	
40055	160	6/60

EN Water pump pliers
 PL Szczypce nastawne
 DE Wasserpumpenzange
 RU Клещи переставные
 CZ Hydraulické kleště nastavitelné
 RO Cleste instalator tip papagal
 HU Állítható csőfogó
 ES Alicates de fontanero

250 mm

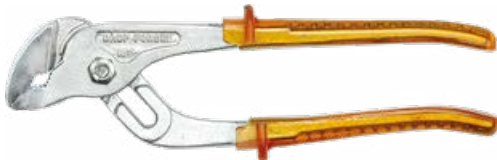

No.	L [mm]	
41500	250	6/60

EN Carpenter's pincers
 PL Obcegi
 DE Kneifzange
 RU Клещи строительные
 CZ Kleště
 RO Cleste cuie
 HU Harapófogó
 ES Tenazas



VOREL

No.	L [mm]	
41151	180	6/60
41152	200	6/60

EN Wire stripping pliers
 PL Szczypce do ściągania izolacji
 DE Abisolierzange
 RU Клещи для снятия изоляции
 CZ Kleště na sundávání izolace
 RO Patent pt. decablat
 HU Szigeteléseltávolító fogó
 ES Pinzas pelacables

160 mm



VOREL

No.	L [mm]	
40056	160	6/60

EN Water pump pliers
 PL Szczypce nastawne
 DE Wasserpumpenzange
 RU Клещи переставные
 CZ Hydraulické kleště nastavitelné
 RO Cleste instalator tip papagal
 HU Állítható csőfogó
 ES Alicates de fontanero

250 mm



VOREL

No.	L [mm]	
40057	250	6/60

EN End cutting pliers
 PL Szczypce tnące czolowe
 DE Vornschnneider
 RU Кусачки торцевые
 CZ Kleště štípačí čelní
 RO Cleste retezat
 HU Homlokcsípő fogó
 ES Cortacables frontales

180 mm



VOREL

No.	L [mm]	
41121	180	6/60

EN Tower pincers
 PL Obcegi tynkarskie
 DE Beisszange
 RU Клещи штукатурные
 CZ Kleště štípačí čelní
 RO Cleste pt. cuie
 HU Rabitzfogó
 ES Tenazas de enlucido

250 mm



VOREL

No.	L [mm]	
41381	250	6/60

EN Profile connection pliers
 PL Szczypce do łączenia profili
 DE Profil Verbundzange
 RU Клещи для соединения профилей
 CZ Kleště do spojování profilů
 RO Clește sertizat profile rigips
 HU Profilösszekítő fogó
 ES Alicates para unir perfiles

280 mm 65Mn



VOREL

No.	L [mm]	
04300	280	6/36

EN Combination pliers
 PL Szczypce uniwersalne
 DE Kombinationszange
 RU Плоскогубцы универсальные
 CZ Univerzální kleště
 RO Patent universal
 HU Kombináltfogó
 ES Alicates universal

1000 V



JUKO

No.	L [mm]	Voltage / Napiecie [V]	
40160	160	1000	10/50
40180	180	1000	10/50
40200	200	1000	10/50

EN Combination pliers
 PL Szczypce uniwersalne
 DE Kombinationszange
 RU Плоскогубцы универсальные
 CZ Univerzální kleště
 RO Patent universal
 HU Kombináltfogó
 ES Alicates universal

120 mm



VOREL

No.	L [mm]	
42300	120	12/120

EN Long nose pliers
 PL Szczypce wydłużone proste
 DE Radiozange
 RU Тонкогубцы
 CZ Prodloužené kleště rovné
 RO Patent drept alungit
 HU Rádiófogó, egyenes
 ES Alicates de punta

125 mm



VOREL

No.	L [mm]	
42303	125	12/120

EN Profile connection pliers
 PL Szczypce do łączenia profili
 DE Profil Verbundzange
 RU Клещи для соединения профилей
 CZ Kleště do spojování profilů
 RO Clește sertizat profile rigips
 HU Profilösszekítő fogó
 ES Alicates para unir perfiles

300 mm



VOREL

No.	L [mm]	
04301	300	6/24

EN Diagonal side cutting pliers
 PL Szczypce tnące boczne
 DE Seitenschneider
 RU Бокорезы
 CZ Řezací kleště boční
 RO Patent de tăiat lateral
 HU Oldal cspófogó
 ES Alicates corte lateral

160 mm 1000 V



JUKO

No.	L [mm]	Voltage / Napiecie [V]	
40700	160	1000	10/50

EN Diagonal side cutting pliers
 PL Szczypce tnące boczne
 DE Seitenschneider
 RU Бокорезы
 CZ Řezací kleště boční
 RO Patent de tăiat lateral
 HU Oldal cspófogó
 ES Alicates corte lateral

110 mm



VOREL

No.	L [mm]	
42301	110	12/120

EN Long nose pliers
 PL Szczypce wydłużone proste
 DE Radiozange
 RU Тонкогубцы
 CZ Prodloužené kleště rovné
 RO Patent drept alungit
 HU Rádiófogó, egyenes
 ES Alicates de punta

150 mm

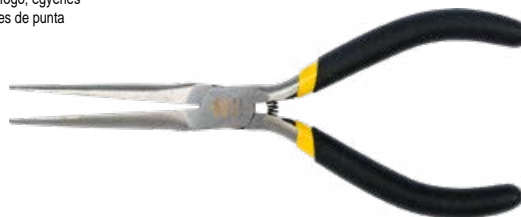

VOREL

No.	L [mm]	
42305	150	12/120

EN Long nose pliers
 PL Szczypce wydłużone proste
 DE Radiozange
 RU Тонкогубцы
 CZ Prodloužené kleště rovné
 RO Patent drept alungit
 HU Rádiófogó, egyenes
 ES Alicates de punta



No.	L [mm]	
42305	150	12/120

EN Flat nose pliers
 PL Szczypce płaskie
 DE Flachzange
 RU Плоскогубцы удлиненные
 CZ Kleště ploché
 RO Clește cu vârf ascuțit
 HU Rádiófogó, egyenes
 ES Alicates de bocas planas



No.	L [mm]	
42306	120	12/120

EN End cutting pliers
 PL Szczypce tnące czołowe
 DE Vornscheider
 RU Кусачки торцевые
 CZ Kleště štípací čelní
 RO Clește retezat
 HU Homlokcsípő fogó
 ES Cortacables frontales



No.	L [mm]	
42302	110	12/120

EN Mini pliers set
 PL Zestaw miniszczypiec
 DE Mini-Zangensatz
 RU Пассатижи в наборе
 CZ Elektronické kleště
 RO Set mini patenti
 HU Elektronikai fogó
 ES Alicates electronicas



No.	pcs / szt.	
42309	6	4/40

EN Bent nose pliers
 PL Szczypce wydłużone wygięte
 DE Telefonzange
 RU Тонкогубцы изогнутые
 CZ Prodloužené kleště ohnuté
 RO Patent curbat alungit
 HU Rádió- és telefonfogó hajlítót
 ES Alicates curvos



No.	L [mm]	
42304	125	12/120

EN Round nose pliers
 PL Szczypce okrągłe
 DE Rundzange
 RU Круглогубцы
 CZ Kruhové kleště
 RO Patent rotund
 HU Kerekcsőrű fogó
 ES Alicates redondos



No.	L [mm]	
42307	125	12/120

EN Mini pliers set
 PL Zestaw miniszczypiec
 DE Mini-Zangensatz
 RU Пассатижи в наборе
 CZ Elektronické kleště
 RO Set mini patenti
 HU Elektronikai fogó
 ES Alicates electronicas



No.	pcs / szt.	
42308	4	25/50

EN Circclip pliers, external straight
 PL Szczypce Segera zewnętrzne proste
 DE Seegeringzange aussen gerade
 RU Съемник стопорных колец (разжим)
 CZ Kleště Segera vnější rovné
 RO Clește Seger exterior drept
 HU Segerfogó külső, egyenes
 ES Alicates Seger exteriores de punta



No.	L [mm]	
43050	160	6/60
43055	180	6/60
43060	200	6/60

EN Circlip pliers, external bent
 PL Szczypce Segera zewnętrzne wygięte
 DE Seegeringzange aussen gebogen
 RU Съёмник стопорных колец (разжим)

CZ Kleště Segera vnější ohnuté
 RO Clește Seger exterior curbat
 HU Segerfogó külső, hajlítot
 ES Alicates Seger exteriores curvos



No.	L [mm]	
43051	160	6/60
43056	180	6/60
43061	200	6/60

EN Circlip pliers, internal bent
 PL Szczypce Segera wewnętrzne wygięte
 DE Seegeringzange innen gebogen
 RU Съёмник стопорных колец (сжим)

CZ Kleště Segera vnitřní ohnuté
 RO Patent Seger interior curbat
 HU Segerfogó belső, hajlítot
 ES Alicates Seger interiores curvos



No.	L [mm]	
43053	160	6/60
43058	180	6/60
43063	200	6/60

EN Lock grip pliers
 PL Szczypce Morse'a
 DE Gripzange
 RU Зажим ручной

CZ Kleště Morse'a
 RO Clește Morse
 HU Morse fogó
 ES Alicates Morse

250 mm



No.	L [mm]	
44100	250	6/60

EN Locking pliers set
 PL Zestaw szczypiec Morse'a
 DE Gripzangen-Set
 RU Набор клещей Морса
 CZ Sada kleští siko
 RO Set clești autoblocanti
 HU Morse fogókészlet
 ES Juego de pinzas morsa



No.	L [mm]	pcs / szt.	
44110	140, 165, 185, 225	4	5/20

EN Circlip pliers, internal straight
 PL Szczypce Segera wewnętrzne proste
 DE Seegeringzange innen gerade
 RU Съёмник стопорных колец (сжим)

CZ Kleště Segera vnitřní rovné
 RO Clește Seger interior drept
 HU Segerfogó belső, egyenes
 ES Alicates Seger interiores de punta



No.	L [mm]	
43052	160	6/60
43057	180	6/60
43062	200	6/60

EN Circlip pliers set
 PL Szczypce Segera
 DE Seegeringzange
 RU Съёмник стопорных колец
 CZ Kleště Segera
 RO Clește pt. inele de siguranța
 HU Segerfogó
 ES Alicates Seger

5 PCS

150 mm



No.	L [mm]	pcs / szt.	
43510	150	5	12/60

EN Lock grip pliers
 PL Szczypce Morse'a
 DE Gripzange
 RU Зажим ручной

CZ Kleště Morse'a
 RO Clește Morse
 HU Morse fogó
 ES Alicates Morse

250 mm



No.	L [mm]	
44102	250	6/60

4 PCS HRC 45-48



L=140, 165, 225 mm,
 L=180 mm

EN Lock grip pliers
 PL Szczypce spawalnicze
 DE Schweisserzange
 RU Клещи зажимные сварочные
 CZ Svářečské kleště
 RO Clește autoblocant pt. sudura
 HU Hegesztő fogó
 ES Alicates de soldar

0-70 mm 275 mm
 C TYPE



No.	L [mm]	Type / Typ	Box
44300	275	C	6/36

EN Lock grip pliers
 PL Szczypce spawalnicze
 DE Schweisserzange
 RU Клещи зажимные сварочные
 CZ Svářečské kleště
 RO Clește autoblocant pt. sudura
 HU Hegesztő fogó
 ES Alicates de soldar

0-60 mm 225 mm
 U TYPE



No.	L [mm]	Type / Typ	Box
44400	225	U	6/36

EN Mini locking pliers set
 PL Zestaw szczypiec spawalniczych mini
 DE Mini-Schweißzangen-Satz
 RU Набор сварочных мини-клещей
 CZ Sada svařovacích kleští mini
 RO Set mini clești autoblocanți
 HU Mini testcsipesz készlet
 ES Juego de mini pinzas para soldar

4 PCS HRC 45-48

L=110 mm;
 L=125 mm;
 L=130 mm (2 PCS)



VOREL

No.	L [mm]	pcs / szt.	Box
44330	110, 125, 130, 130	4	6/24

EN Welding locking pliers „C” type
 PL Szczypce zaciskowe klamrowe typu „C”
 DE Klemm- und Klammerzange vom Typ „C”
 RU Клещи зажимные сварочные
 CZ Kleště samosvorné upínací typu „C”
 RO Clește de strângere cu clemă tip „C”
 HU „C” fogó
 ES Pinzas de tornillo (de apriete) de grapa tipo „C”

0-70 mm 280 mm
 C TYPE



VOREL

No.	L [mm]	Type / Typ	Box
44301	280	C	5/30

EN Lock grip pliers
 PL Szczypce spawalnicze
 DE Schweisserzange
 RU Клещи зажимные сварочные
 CZ Svářečské kleště
 RO Clește autoblocant pt. sudura
 HU Hegesztő fogó
 ES Alicates de soldar

0-65 mm 250 mm 95 mm
 SM TYPE



No.	L [mm]	Type / Typ	Box
44500	250	SM	6/36

EN Water pump pliers
 PL Szczypce hydrauliczne nastawne
 DE Wasserpumpenzange
 RU Клещи переставные
 CZ Kelešťe siko
 RO Clește papagal
 HU Vízpumpafogó
 ES Alicates de fontanero ajustables

250 mm 7 POSITIONS POSICIONES



VOREL

No.	L [mm]	Box
41510	250	10/50

EN Pipe wrench
 PL Klucz do rur
 DE Rohrschlüssel
 RU Ключ трубный
 CZ Klíč součásti na trubky
 RO Cheie reglabila pt. tevi
 HU Csőkulcs
 ES Llave para tubos



4



No.	L [mm]	
55250	250	6/48
55300	300	6/36
55350	350	6/24

EN Adjustable pipe wrench
 PL Klucz nastawny do rur
 DE Rohrschlüssel
 RU Ключ трубный переставной

CZ Nastavitelný klíč na trubky
 RO Cheie reglabila pt. tevi
 HU Állítható csőkulcs
 ES Llave para tubos tipo Inglesa

45°



No.	Max. pipe diameter / Maks. średnica rury	L [mm]	
55100	1" (25 mm)	330	12/36
55150	1-1/2" (38 mm)	390	10/20
55200	2" (50 mm)	540	6/12

EN Adjustable pipe wrench
 PL Klucz nastawny do rur
 DE Rohrschlüssel
 RU Ключ трубный переставной

CZ Nastavitelný klíč na trubky
 RO Cheie reglabila pt. tevi
 HU Állítható csőkulcs
 ES Llave para tubos tipo Inglesa

90°



VOREL

No.	Max. pipe diameter / Maks. średnica rury	L [mm]	
55215	1" (25 mm)	310	24
55216	1-1/2" (38 mm)	420	1/16
55217	2" (50 mm)	560	1/8

EN Pipe wrench
 PL Klucz do rur
 DE Rohrschlüssel
 RU Ключ трубный

CZ Klíč součásti na trubky
 RO Cheie reglabila pt. tevi
 HU Csőkulcs
 ES Llave para tubos



VOREL

No.	L [mm]	
55620	195	6/36
55625	245	6/30
55630	275	6/24
55635	310	6/18
55645	395	4/12
55660	490	2/6
55690	750	2/4

EN Adjustable pipe wrench
 PL Klucz nastawny do rur
 DE Rohrschlüssel
 RU Ключ трубный переставной
 CZ Nastavitelný klíč na trubky
 RO Cheie reglabila pt. tevi
 HU Állítható csőkulcs
 ES Llave para tubos tipo Inglesa

45°



VOREL

No.	Max. pipe diameter / Maks. średnica rury	L [mm]	
55210	1" (25 mm)	320	1/24
55211	1-1/2" (38 mm)	425	1/16
55212	2" (50 mm)	560	1/8

EN Adjustable pipe wrench
 PL Klucz nastawny do rur
 DE Rohrschlüssel
 RU Ключ трубный переставной

CZ Nastavitelný klíč na trubky
 RO Cheie reglabila pt. tevi
 HU Állítható csőkulcs
 ES Llave para tubos tipo Inglesa

S



VOREL

No.	Max. pipe diameter / Maks. średnica rury	L [mm]	
55220	1" (25 mm)	315	1/24
55221	1-1/2" (38 mm)	425	1/16
55222	2" (50 mm)	560	1/8

EN Adjustable wrench
 PL Klucz nastawny francuski
 DE Stahlschraubenschlüssel (Franzose)
 RU Ключ разводной

CZ Nastavitelný klíč francouz
 RO Cheie reglabilă franceză
 HU Állítható franciakułcs
 ES Llave ajustable inglesa



No.	Jaws opening capacity / Zakres rozwarcia szczęk [mm]	Jaws width / Szerokość szczęk [mm]	
54497	0-25	60	10
54498	0-35	70	10
54499	0-45	80	10
54500	0-55	90	5
54510	0-65	100	5

EN Chain pipe wrench
 PL Klucz łańcuchowy do rur
 DE Kettenrohrzange
 RU Ключ цепной для труб
 CZ Klíč řetězový na trubky
 RO Cheie reglabilă pt. tevi cu lanț
 HU Lánccs csőfogó
 ES Llave de cadena

300 mm

485 mm

4" 100 mm

INDUCTION HARDENED TEETH ZĘBY HARTOWANE INDUKCYJNIE



4



No.	Max. pipe diameter / Maks. średnica rury	L [mm]	
55792	4" (100.0 mm)	300	10/30

Memo	

5

Electrician tools Narzędzia dla elektryków

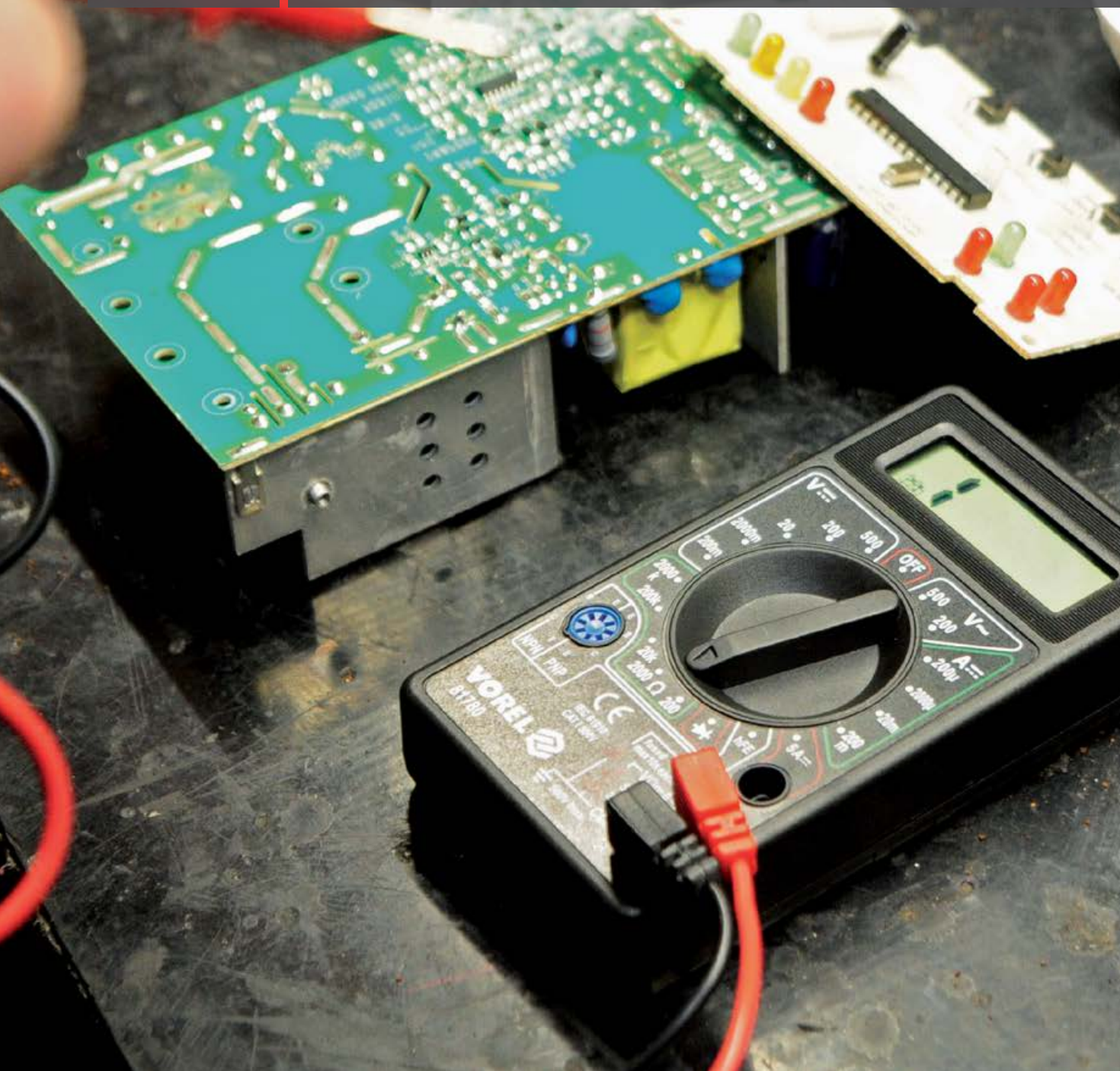

Crimping pliers
 Szczypce do zaciskania
 konektorów

.....54



Voltage testers
 Próbniki napięcia

.....56



Wire strippers
 Ściągacze izolacji

.....54-55



Digital universal meters
 Cyfrowe mierniki uniwersalne

.....56-57



Electrical cutters
 Obcinaki elektryczne

.....55-56



- EN Ratchet crimping pliers
- PL Szczypce do zaciskania konektorów
- DE Kabelschuhzange
- RU Клещи для опрессовки наконечников
- CZ Kleště pro svěření zaciskania konektorů
- RO Clește sertizat conectori
- HU Krimpelő fogó
- ES Pinzas de apretar de conectores



No.	mm2	AWG	
45500	0.5-2.5	20-14	12/36

- EN Ratchet crimping pliers
- PL Szczypce do zaciskania konektorów
- DE Kabelschuhzange
- RU Клещи для опрессовки наконечников
- CZ Kleště pro svěření zaciskania konektorů
- RO Clește sertizat conectori
- HU Krimpelő fogó
- ES Pinzas de apretar de conectores



No.	RJ	
45504	RJ45, RJ10, RJ11, 8P, 6P, 4P	10/50

- EN Solderless terminal kit
- PL Zaciskacz z konektorami w kasecie
- DE Kabelschuhzange u. Kabelschuhe
- RU Клещи для бжима + изолированные наконечники
- CZ Svěrka z konektorama v kasetě
- RO Set cleste mufare plus conectori
- HU Présszerszám csatlakozókkal egy dobozban
- ES Apretador con conectores en caja



No.	mm2	AWG	mm2	AWG	pcs / szl.	
45050	1.5-6.0	22-10	1.5-6.0	22-10	100	25/50

- EN Ratchet crimping pliers
- PL Szczypce do zaciskania konektorów
- DE Kabelschuhzange
- RU Клещи для опрессовки наконечников
- CZ Kleště pro svěření zaciskania konektorů
- RO Clește sertizat conectori
- HU Krimpelő fogó
- ES Pinzas de apretar de conectores

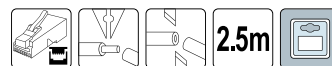

No.	RJ	
45503	RJ45, RJ11	10/40

- EN Wire stripper
- PL Ściągacz izolacji
- DE Abisolierzange
- RU Съёмник изоляции
- CZ Odizolovací klejte
- RO Decablator
- HU Blankolo fogó
- ES Extractor de aislado

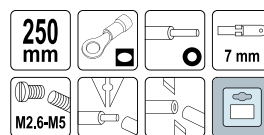

No.	mm2	AWG	mm2	AWG	
45000	1.5-6.0	22-10	0.75-6.0	22-10	12/120

- EN Wire stripper
- PL Ściągacz izolacji
- DE Abisolierzange
- RU Съёмник изоляции
- CZ Odizolovací klejte
- RO Decablator
- HU Blankolo fogó
- ES Extractor de aislado

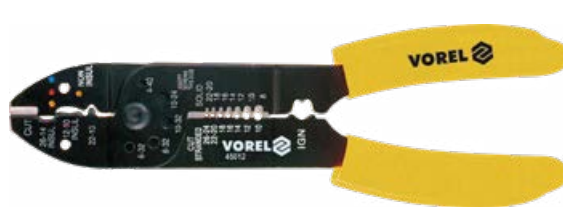
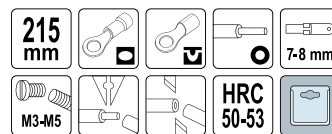

No.	mm2	AWG	mm2	AWG	mm2	AWG	
45012	0.64-2.6	26-10	0.8-2.6	22-10	0.64-2.6	26-10	12/72

EN Wire stripper
 PL Ściągacz izolacji
 DE Abisolierzange
 RU Съёмник изоляции
 CZ Odizolovací klejše
 RO Decablator
 HU Blankolo fogo
 ES Extractor de aislado

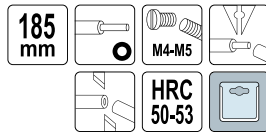

No.	mm ²	AWG	Box
4510	0.8-2.6	22-10	12/120

EN Wire stripper / crimper
 PL Automacyjny ściągacz izolacji
 DE Automatische Abisolierzange
 RU Клещи для удаления изоляции
 CZ Automatický stahovač izolace
 RO Clește automat desizolat
 HU Automatikus szigeteléselhúzó
 ES Pelacables automatico

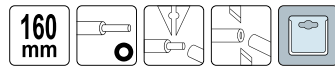

No.	mm ²	AWG	Box
4511	1.0-3.2	17-12	10/40

EN Automatic wire stripper with cutter
 PL Automacyjny ściągacz z obcinakiem
 DE Automatische Abisolierzange + Schneider
 RU Клещи-автомат для снятия изоляции
 CZ Automatický stahovač izolace
 RO Decablator automat
 HU Automatikus szigeteléselhúzó
 ES Pelacables automatico

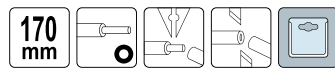

No.	mm ²	AWG	Box
4520	0.5-4.0	20-13	10/50

EN Wire stripper / crimper
 PL Automacyjny ściągacz izolacji
 DE Automatische Abisolierzange
 RU Клещи для удаления изоляции
 CZ Automatický stahovač izolace
 RO Clește automat desizolat
 HU Automatikus szigeteléselhúzó
 ES Pelacables automatico

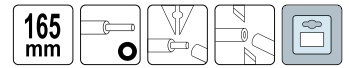

No.	mm ²	AWG	Box
45100	0.5-6.0	20-10	20/100

EN Universal wire stripper
 PL Uniwersalny ściągacz izolacji
 DE Universal Abisolierzange
 RU Универсальный съёмник изоляции
 CZ Univerzální odizolovací kleště
 RO Decablator universal
 HU Blankolo fogo
 ES Extractor de aislado universal

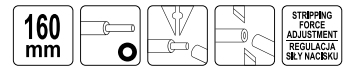

No.	mm ²	AWG	Box
45160	0.25	30	10/40

EN Electrical cutter
 PL Obcinak elektryczny
 DE Seitenschneider
 RU Щипцы для резки проводов
 CZ Elektrické upichovky ze stahovadlem
 RO Clește tăietor electrician
 HU Kábelvágó
 ES Cortacables eléctricos

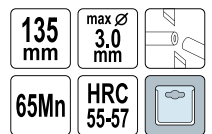

No.	L [mm]	Box
45020	135	12/120

- EN Electrician scissors
- PL Nożyczki dla elektryków
- DE Elektrische Schere
- RU Ножницы универсальные
- CZ Elektrické nůžky
- RO Foarfece - electrician
- HU Univerzális olló
- ES Tijeras eléctricos

140 mm SS2Cr13 PP



No.	L [mm]	
76320	140	12/120

- EN Voltage tester
- PL Próbnik napięcia
- DE Spannungsprüfer
- RU Отвёртка индикаторная
- CZ Zkoušeč napětí
- RO Creion de tensiune
- HU Fáziskereső
- ES Comprobador de corriente

190 mm 125-250 V~



No.	L [mm]	
65235	190	12/600

- EN Digital universal multimeter
- PL Cyfrowy miernik uniwersalny
- DE Digital-Multimeter
- RU Универсальный цифровой измеритель
- CZ Digitální multimetr univerzální
- RO Multimetru digital universal
- HU Digitális multiméter
- ES Manómetro digital universal

LCD 1999 0-600V A.C. 0-600V D.C. 0-10 A A.C. 0-10 A D.C. 0-200 MΩ 0-20 μF 0-20 kHz hFE PNP NPN DATA HOLD AUTO POWER OFF AUTOMATYCZNE WYŁĄCZANIE 9 V



No.	Digit height / Wysokość cyfr [mm]	
81783	25	20

- EN Voltage tester
- PL Próbnik napięcia
- DE Spannungsprüfer
- RU Отвёртка индикаторная
- CZ Zkoušeč napětí
- RO Creion de tensiune
- HU Fáziskereső
- ES Comprobador de corriente

140 mm 125-250 V~



No.	L [mm]	
65233	140	12/1200

- EN Digital universal multimeter
- PL Cyfrowy miernik uniwersalny
- DE Digital-Multimeter
- RU Универсальный цифровой измеритель
- CZ Digitální multimetr univerzální
- RO Multimetru digital universal
- HU Digitális multiméter
- ES Manómetro digital universal

LCD 1999 0-500V A.C. 0-500V D.C. 0-5 A D.C. 0-2 MΩ hFE PNP NPN 9 V



No.		
81780		12/72

- EN Digital universal multimeter
- PL Cyfrowy miernik uniwersalny
- DE Digital-Multimeter
- RU Универсальный цифровой измеритель
- CZ Digitální multimetr univerzální
- RO Multimetru digital universal
- HU Digitális multiméter
- ES Manómetro digital universal

LCD 1999 0-600V A.C. 0-600V D.C. 0-10 A A.C. 0-10 A D.C. 0-200 MΩ 0-20 μF 0-20 kHz °C -40 +400 hFE PNP NPN DATA HOLD AUTO POWER OFF AUTOMATYCZNE WYŁĄCZANIE 9 V



No.	Digit height / Wysokość cyfr [mm]	
81784	25	20

EN Digital universal multimeter
 PL Cyfrowy miernik uniwersalny
 DE Digital-Multimeter
 RU Универсальный цифровой измеритель
 CZ Digitální multimetr univerzální
 RO Multimetru digital universal
 HU Digitális multiméter
 ES Manómetro digital universal

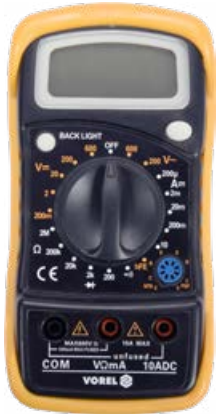

LCD 1999	0-600V A.C.	0-600V D.C.
0-10 A D.C.	0-2 MΩ	h _{FE} PNP NPN
⚡	📶	DATA HOLD
LED BACKLIGHT PODSWIETLONE	9 V 6F22I	📦



No.	📦
81773	50

EN Digital universal multimeter
 PL Cyfrowy miernik uniwersalny
 DE Digital-Multimeter
 RU Универсальный цифровой измеритель
 CZ Digitální multimetr univerzální
 RO Multimetru digital universal
 HU Digitális multiméter
 ES Manómetro digital universal

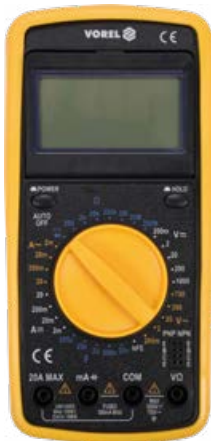

LCD 1999	0-750V A.C.	0-1000V D.C.
0-20 A A.C.	0-20 A D.C.	0-200 MΩ
0-200 µF	h _{FE} PNP NPN	⚡
📶	DATA HOLD	ADJUSTABLE DISPLAY REGULOWANY WYŚWIETLACZ
AUTO POWER OFF AUTOMATYCZNE WYŁĄCZANIE	9 V 6F22I	📦



No.	📦
81775	40

EN Digital universal multimeter
 PL Cyfrowy miernik uniwersalny
 DE Digital-Multimeter
 RU Универсальный цифровой измеритель
 CZ Digitální multimetr univerzální
 RO Multimetru digital universal
 HU Digitális multiméter
 ES Manómetro digital universal



LCD 1999	0-500V A.C.	0-500V D.C.
0-10 A D.C.	0-20 MΩ	⚡
📶	1.5V 9V 12V BATTERY TEST TEST BATERII	DATA HOLD
LED BACKLIGHT PODSWIETLONE	9 V 6F22I	📦



No.	📦
81774	50

EN Clamp universal multimeter
 PL Cęgowy miernik uniwersalny
 DE Universal Zangenamperemeter
 RU Универсальный цифровой измеритель
 CZ Digitální multimetr univerzální
 RO Multimetru digital universal
 HU Digitális multiméter
 ES Manómetro digital universal



LCD 1999	0-450V A.C.
0-600V D.C.	0-400A A.C.
0-200 KΩ	⚡
📶	DATA HOLD
2x AAA	📦



No.	📦
81801	5/60

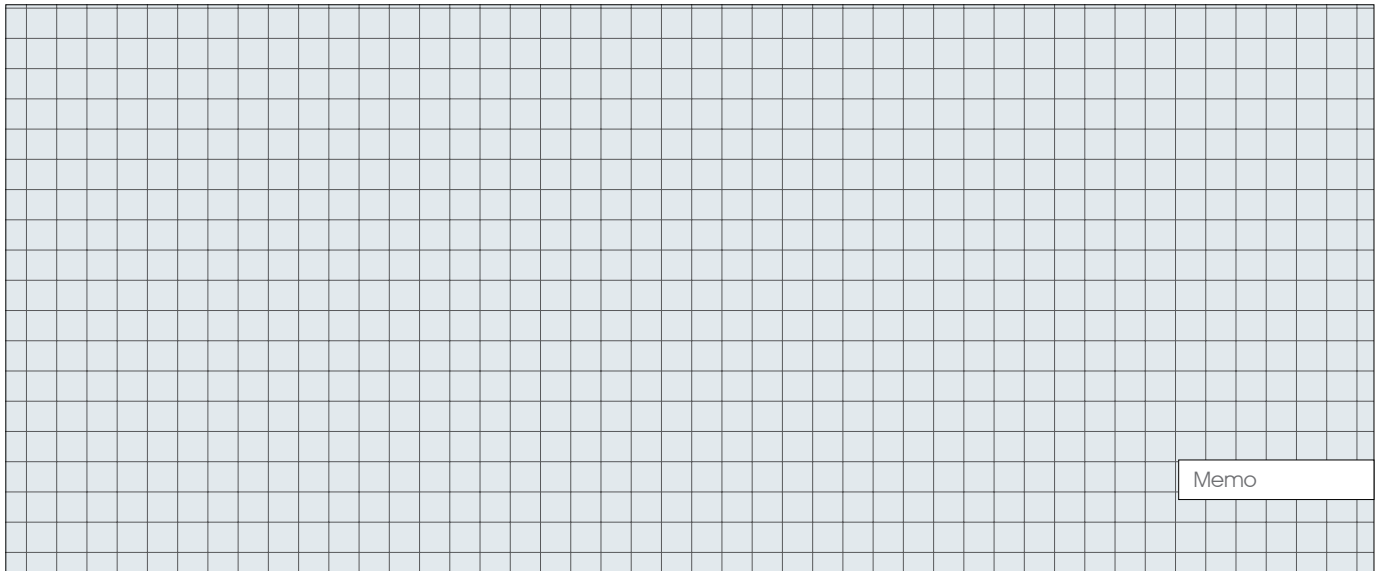

Memo

6

Hammers, chisels, punches & axes Młotki, dłuta, przecinaki i siekiery



Machinist hammers Młotki ślusarskie



60-61

Machinist hammers with wooden handle

Młotki ślusarskie z rączką drewnianą..... 60

Machinist hammers with fibreglass handle

Młotki ślusarskie z rączką z włókna szklanego..... 60

Machinist hammers „Juco”

Młotki ślusarskie „Juco”..... 60

Brick hammers „Juco”

Młotki murarskie „Juco”..... 61

Welder's hammers „Juco”

Młotki spawalnicze „Juco”..... 61

Stoning hammers Młotki kamieniarskie



61

Stoning hammers „Juco”

Młotki kamieniarskie „Juco”..... 61

Hammers with tubular steel handle Młotki z trzonkiem rurowym



61-62

Claw hammers

Młotki szewskie..... 61

Roofing hammers

Młotki ciesielskie..... 62

Mason's hammers

Młotki murarskie..... 62

Hammers with fibreglass handle Młotki z rączką z włókna szklanego



62

Claw hammers

Młotki szewskie..... 62

Roofing hammers

Młotki ciesielskie..... 62

Rubber mallets Młotki gumowe



62-63

Rubber mallets with wooden handle

Młotki gumowe z rączką drewnianą..... 62

Rubber mallets with tubular steel handle

Młotki gumowe z rączką stalową..... 62

Rubber mallets with fibreglass handle

Młotki gumowe z rączką z włókna szklanego..... 63

Soft faced mallets

Młotki blacharskie gumowo-plastykowe..... 63

Wooden mallets Młotki drewniane



63

Chisels, cold chisels, punches & wrecking bars

Dłuta, przecinaki, przebijaki i łomy



63-65

Wood chisels with wooden handle

Dłuta stolarskie z rączką drewnianą..... 63

Wood chisels with plastic handle

Dłuta stolarskie z rączką z tworzywa..... 63

Curving chisels

Dłuta snycerskie..... 64

Cold chisels

Przecinaki..... 64

Cold chisels „Juco”

Przecinaki „Juco”..... 64

Punches

Przebijaki..... 64

Wrecking bars

Łomy..... 65

Wrecking bars „Juco”

Łomy „Juco”..... 65

Axes Siekiery



66-67

Axes with wooden handle

Siekiery z trzonkiem drewnianym..... 66

Axes with fibreglass handle

Siekiery z trzonkiem z włókna szklanego..... 66

Axes „Juco”

Siekiery „Juco”..... 66

Hammer and axe wedges

Zestawy klinujące do młotków i siekier..... 67

Picaxes Kilofy



68

Pickaxes

Kilofy..... 68

Wood splitters „Juco”

Kliny do rozłupywania drewna „Juco”..... 68

EN Machinist hammer
 PL Młotek ślusarski
 DE Schlosserhammer
 RU Молоток слесарный

CZ Zámečnické kladívko
 RO Ciocan de lăcătușerie
 HU Vaskalapács
 ES Martillo



No.	m [g]	
30010	100	12/120
30020	200	12/72
30030	300	12/60
30040	400	6/48
30050	500	6/36
30060	600	6/36
30080	800	6/24
30100	1000	6/24
30150	1500	6/12
30200	2000	6/12

EN Machinist hammer
 PL Młotek ślusarski
 DE Schlosserhammer
 RU Молоток слесарный

CZ Zámečnické kladívko
 RO Ciocan de lăcătușerie
 HU Vaskalapács
 ES Martillo

DIN 1042



No.	m [kg]	
30531	3	1
30532	4	1
30533	5	1
30534	6	1
30535	8	1
30536	10	1

EN Machinist hammer with tubular steel handle
 PL Młotek ślusarski ze stalowym trzonkiem
 DE Schlosserhammer
 RU Молоток с металлической обрезиненной рукояткой
 CZ Zámečnické kladívko
 RO Ciocan de lăcătușerie
 HU Vaskalapács
 ES Martillo, mango de acero



JUCO

No.	m [g]	
30220	300	5
30222	500	5
30224	800	5

EN Machinist hammer
 PL Młotek ślusarski
 DE Schlosserhammer
 RU Молоток слесарный

CZ Zámečnické kladívko
 RO Ciocan de lăcătușerie
 HU Vaskalapács
 ES Martillo



VOREL

No.	m [g]	
30410	100	6/120
30420	200	6/60
30430	300	6/60
30440	400	6/48
30450	500	6/36
30460	600	6/36
30480	800	6/24
30500	1000	6/24
30510	1500	6/12
30520	2000	6/12

EN Machinist hammer with fibreglass + PVC handle
 PL Młotek ślusarski, rączka z włókna szklanego
 DE Schlosserhammer Fiberglasstiel
 RU Молоток со стеклопластиковой ручкой
 CZ Zámečnické kladívko
 RO Ciocan de lăcătușerie
 HU Vaskalapács
 ES Martillo



VOREL

No.	m [g]	
30310	100	6/120
30320	200	6/36
30330	300	6/36
30340	400	6/36
30350	500	6/36
30360	600	6/36
30380	800	6/24
30390	1000	6/24
30395	1500	6/12
30400	2000	6/12

EN Machinist hammer
 PL Młotek ślusarski
 DE Schlosserhammer
 RU Молоток слесарный

CZ Zámečnické kladívko
 RO Ciocan de lăcătușerie
 HU Vaskalapács
 ES Martillo

DIN 1041



JUCO

No.	m [g]	
31010	100	10
31030	300	10
31050	500	10
31070	700	10
31100	1000	10
31150	1500	6
31200	2000	6

EN Machinist hammer
 PL Młotek ślusarski
 DE Schlosserhammer
 RU Молоток слесарный

CZ Zámečnické kladívko
 RO Ciocan de lăcătușerie
 HU Vaskalapács
 ES Martillo

DIN 1042



JUCO

No.	m [g]	
31300	3000	1
31400	4000	1
31500	5000	1
31600	6000	1
31800	8000	1
32000	10000	1

EN Brick hammer
 PL Młotek murarski
 DE Maurerhammer
 RU Молоток каменщика
 CZ Zednické kladívko
 RO Ciocan de zidărie
 HU Kőműves kalapács
 ES Martillo albañil



JUCO

No.	m [g]	
32720	700	5

EN Safety stoning hammer
 PL Młotek kamieniarski
 DE Fäustel
 RU Кувалда двухобуховая

CZ Palička kovová
 RO Ciocan pt. zidărie
 HU Kőtörő kalapács
 ES Martillo

DIN 6475



JUCO

No.	m [g]	
32201	1500	6
32202	2000	6
32203	3000	1
32204	4000	1
32205	5000	1
32206	6000	1
32207	8000	1
32208	10000	1

EN Machinist hammer
 PL Młotek ślusarski
 DE Schlosserhammer
 RU Молоток слесарный

CZ Zámečnické kladívko
 RO Ciocan de lăcătușerie
 HU Vaskalapács
 ES Martillo

DIN 1041



JUCO

No.	m [g]	
29992	300	5
29993	500	5
29994	700	5
29995	1000	5
29996	1500	5
29997	2000	5

EN Welder's hammer
 PL Młotek spawalniczy
 DE Schweisserhammer
 RU Молоток сварщика

CZ Svářečské kladívko
 RO Ciocan de sudură
 HU Hegesztő kalapács
 ES Martillo para soldar



JUCO

No.	m [g]	
32110	350	5

EN Claw hammer with tubular steel handle
 PL Młotek szwowski, rączka ze stali
 DE Klauenhammer
 RU Молоток-гвоздодер с металлической обрезиненной рукояткой
 CZ Ševcovské kladívko
 RO Ciocan de cizmărie
 HU Cipész kalapács
 ES Martillo sacador mango de acero



VOREL

No.	m [g]	
32625	600	6/24

EN Roofing hammer with tubular steel handle
 PL Młotek ciesielski, rączka ze stali
 DE Lattenhammer
 RU Молоток кровельщика
 CZ Tesařské kladívko
 RO Ciocan de dulgherie
 HU Ácskalapács
 ES Martillo sacador mango de acero



VOREL

6

No.	m [g]	
32685	600	6/24

EN Mason's hammer type „R” with tubular steel handle
 PL Młotek murarski reński, rączka ze stali
 DE Maurerhammer rheinische Form
 RU Молоток каменщика

CZ Zednické kladívko renské
 RO Ciocan de zidărie
 HU Kőműves kalapács, rajnai típus
 ES Martillo rin mango de acero



VOREL

No.	m [g]	
32715	600	6/24

EN Roofing hammer with fibreglass + PVC handle
 PL Młotek ciesielski, rączka z włókna szklanego
 DE Lattenhammer Fiberglasstiel
 RU Молоток кровельщика
 CZ Kladivo tesařské, ručka ze skleněných vláken
 RO Ciocan de dulgherie
 HU Ácskalapács
 ES Martillo de carpintero con mango de fibra de vidrio



VOREL

No.	m [g]	
32687	600	6/24

EN Rubber mallet with steel handle
 PL Młotek gumowy z rączką stalową
 DE Gummihammer Stahlstiel
 RU Киянка резиновая

CZ Pryžové kladívko
 RO Ciocan de cauciuc
 HU Gumikalapács
 ES Mazo de goma



VOREL

No.	Head diameter / Średnica obucha [mm]	
33557	50	12/60
33657	56	12/48
33907	66	6/24

EN Mason's hammer type „B” with tubular steel handle
 PL Młotek murarski berliński, rączka ze stali
 DE Berliner Mauerhammer
 RU Молоток каменщика

CZ Zednické kladívko berlinské
 RO Ciocan de zidărie tip Berlin
 HU Kőműves kalapács, berlini típus
 ES Martillo berlin mango de acero



VOREL

No.	m [g]	
32705	600	6/24

EN Claw hammer
 PL Młotek szewski
 DE Klauenhammer
 RU Молоток-гвоздодеп
 CZ Kladivo ševcovské
 RO Cican pt. cismani
 HU Cipész kalapács
 ES Martillo sacador



VOREL

No.	m [g]	
32627	600	6/24

EN Rubber mallet
 PL Młotek gumowy
 DE Gummihammer
 RU Киянка резиновая

CZ Pryžové kladívko
 RO Ciocan de cauciuc
 HU Gumikalapács
 ES Mazo de goma



No.	Head diameter / Średnica obucha [mm]	
33550	45	36/72
33650	55	12/60
33900	70	12/24



EN Rubber mallet with fibreglass + PVC handle
 PL Młotek gumowy, rączka z włókna szklanego
 DE Gummihammer Fiberglasstiel
 RU Киянка резиновая с фиберглассовой ручкой

CZ Pryžové kladívko
 RO Ciocan de cauciuc
 HU Gumikalapács
 ES Mazo de goma



No.	Head diameter / Šířka obucha [mm]	
33535	45	12/48
33555	50	12/48
33655	56	6/30
33905	66	6/24
33925	76	6/18

EN Carpenter's wooden mallet
 PL Młotek drewniany stolarski
 DE Tischlerhammer aus Holz
 RU Молоток деревянный столярный

CZ Palice dřevěná stolařská
 RO Ciocan din lemn de tâmplar
 HU Asztalos fakalapács
 ES Martillo de madera de carpintero



No.	L [mm]	
33530	320	20

EN Chisel
 PL Dłuto
 DE Stechbeitel
 RU Стамеска с ударной головкой
 CZ Řezbářské dláto
 RO Dalte de tâmplărie
 HU Asztalos véső
 ES Cíncel con mango transparente



No.	Size / Rozmiar [mm]	
25510	6	5/60
25511	8	5/60
25512	10	5/60
25513	12	5/60
25514	14	5/60
25515	15	5/60
25516	18	5/60
25517	20	5/60
25518	22	5/60
25519	25	5/60
25520	32	5/60
25521	38	5/60

EN Soft faced mallet
 PL Młotek blacharski, guma - plastik
 DE Ausbeulhammer
 RU Молоток рихтовочный комбинированный с деревянной ручкой

CZ Klempířské kladívko
 RO Ciocan pt. tabla
 HU Bádógos kalapács
 ES Mazo goma-plástico

35 mm



No.	Head diameter / Šířka obucha [mm]	
33950	35	30/60

EN Wooden mallet
 PL Młotek drewniany blacharski
 DE Holzhammer für Bleche
 RU Молоток жестящика, деревянный

CZ Palice dřevěná klempířská
 RO Ciocan din lemn de tinichigiu
 HU Bádógos fakalapács
 ES Martillo de madera de hojalatero



No.	L [mm]	
33532	285	20

EN Wood chisel set
 PL Zestaw dłut stolarskich
 DE Stech-Beitelsatz
 RU Набор стамесок

CZ Zámečnické dláta
 RO Dalte de tâmplărie
 HU Asztalos véső
 ES Cinceles de carpintero

4 PCS



No.	pcs / szt.	
25500	4	10/40

EN Wood chisel set
 PL Zestaw dłut do drewna
 DE Stechbeitelsatz
 RU Набор стамесок по дереву

CZ Zámečnické dláta
 RO Set dalii
 HU Asztalos véső
 ES Juego de cinceles

4 PCS



No.	Size / Rozmiar [mm]	pcs / szt.	
25530	6, 12, 18, 24	4	10/40

EN Curving chisel set
 PL Zestaw dłut snyocerskich
 DE Holzschnittwerkzeugsatz
 RU Набор фигурных стамесок для резьбы по дереву
 CZ Řezbářské dláta
 RO Dalte curbate cu mâner din lemn
 HU Finom véső
 ES Cinceles mango de madera

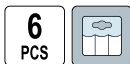

6

No.	pcs / szt.	Icon
25700	6	15/60

EN Cold chisel with protection
 PL Przecinak z osłoną
 DE Schlitzmeißel mit Handschutz
 RU Зубило с протектором

CZ Plochý sekáč (z krytem)
 RO Daltă - tăietor plată (cu apărătoare)
 HU Hidegvágó, lapos (védőfejjel)
 ES Cincel plano (con protector)



VOREL

No.	W [mm]	L [mm]	Icon
35351	25	300	12/36
35352	25	350	10/30
35353	25	400	12/24
35355	25	500	5/20

EN Forged cold chisel
 PL Przecinak ślusarski
 DE Flachmeißel
 RU Зубило слесарное

CZ Zámečnický sekáč
 RO Dalta forjată pt. metal
 HU Lakatos hidegvágó
 ES Cincel de cerrajería



JUCO

No.	Thickness / Grubość [mm]	W [mm]	L [mm]	m [kg]	Icon
35372	10	20	200	0.25	10
35373	12	23	250	0.46	10
35374	12	23	300	0.53	10
35376	10	30	400	0.90	10

EN Forged cold chisel with protection
 PL Przecinak murarski z osłoną
 DE Meißel mit Handschutz
 RU Зубило с протектором

CZ Zámečnický sekáč (z krytem)
 RO Dalta forjată cu protecție
 HU Fém hidegvágó, kézvédővel
 ES Cincel de cerrajería mm con protector

JUCO

No.	Thickness / Grubość [mm]	L [mm]	m [kg]	Icon
35359	17	250	0.56	5
35360	17	300	0.65	5
35362	17	350	0.76	5
35364	19	400	1.00	5
35366	19	450	1.13	5
35368	19	500	1.22	5

EN Cold chisel with protection
 PL Przecinak z osłoną
 DE Schlitzmeißel mit Handschutz
 RU Зубило с протектором

CZ Plochý sekáč (z krytem)
 RO Daltă - tăietor plată (cu apărătoare)
 HU Hidegvágó, lapos (védőfejjel)
 ES Cincel plano (con protector)



No.	W [mm]	L [mm]	Icon
35250	20	250	12/72
35300	25	300	12/48

EN Cold chisel with protection
 PL Przecinak z osłoną
 DE Schlitzmeißel mit Handschutz
 RU Зубило с протектором

CZ Plochý sekáč (z krytem)
 RO Daltă - tăietor plată (cu apărătoare)
 HU Hidegvágó, lapos (védőfejjel)
 ES Cincel plano (con protector)



VOREL

No.	Thickness / Grubość [mm]	W [mm]	L [mm]	Icon
35450	18	50	215	6/36
35451	19	75	215	6/36
35452	25	100	215	6/36

EN Octagonal point chisel with protection
 PL Przebijak murarski z osłoną
 DE Spitzmeißel mit Handschutz
 RU Керн с протектором

CZ Sekáč zednický s ochranným
 RO Dorn cu protecție pt. construcții
 HU Falvéső kézvédővel
 ES Cincel de cerrajería con protector



No.	L [mm]	Icon
35430	300	12/48



EN Wrecking bar
 PL Łom
 DE Nageleisen
 RU Лом

CZ Páčidlo
 RO Ranga
 HU Szögkihúzó
 ES Palanca



VOREL

No.	W [mm]	L [mm]	
34243	18	500	5/10
34245	18	700	10
34247	18	1000	10

EN Square type wrecking bar
 PL Łom kwadratowy, hartowane końcówki
 DE Nageleisen gehärtete Spitze
 RU Лом квадратный с закаленными концами
 CZ Páčidlo hranaté, kalené konce
 RO Ranga patrata
 HU Négyyszög keresztmetszetű feszítővas, edzett véggel
 ES Palanca



VOREL

No.	Thickness / Grubość [mm]	W [mm]	L [mm]	
34254	12	22	400	12/24
34256	16	30	600	6/12

EN Wrecking bar
 PL Łom
 DE Nageleisen
 RU Лом-гвоздодёр

CZ Páčidlo
 RO Ranga pt. scos cuie
 HU Szögkihúzó
 ES Palanca



No.	L [mm]	
34600	600	24
34750	750	24
34900	900	24

EN Wrecking bar
 PL Łom budowlany
 DE Baubrechstange
 RU Лом круглый

CZ Stavební páčidlo
 RO Ranga
 HU Szögkihúzó
 ES Palanca



JUCO

No.	Ø [mm]	L [mm]	m [kg]	
34220	27	1000	3.6	1
34222	27	1200	4.8	1
34225	27	1500	5.7	1

EN Flat wrecking bar
 PL Łom płaski hartowany
 DE Nageleisen gehärtete Spitze
 RU Лом плоский закаленный

CZ Páčidlo ploché kalené
 RO Ranga plata
 HU Lapos feszítővas
 ES Palanca plana



VOREL

No.	Thickness / Grubość [mm]	W [mm]	L [mm]	
34251	6	35	450	6/24

EN Wrecking bar
 PL Łom
 DE Nageleisen
 RU Лом-гвоздодёр

CZ Páčidlo
 RO Ranga pt. scos cuie
 HU Szögkihúzó
 ES Palanca



No.	L [mm]	
34300	300	60

EN Wrecking bar
 PL Łom sześciokątny
 DE Brechstange
 RU Лом-гвоздодёр шестигранный

CZ Šestiúhľé páčidlo
 RO Ranga pt. scos cuie
 HU Hatszögű feszítővas
 ES Palanca hexagonal



JUCO

No.	Thickness / Grubość [mm]	L [mm]	m [kg]	
34204	17	400	0.82	5
34205	17	500	1.1	5
34206	17	600	1.2	5
34207	17	700	1.4	5
34208	17	800	1.6	5
34210	19	1000	2.5	5
34212	19	1200	3	5

EN Drop forged hatchet
 PL Siekiera ze stali kutej
 DE Handbeil
 RU Топор кованый

CZ Sekera ocelová kovaná
 RO Toporisca lama forjata
 HU Kovácsolt acél fejű
 ES Hacha de metal forjado



FLO

No.	m [g]	
33080	800	12/24

EN Axe
 PL Siekiera
 DE Handbeil
 RU Топор

CZ Sekera
 RO Secure
 HU Szekerce
 ES Hacha



FLO

No.	m [g]	
33067	600	24
33087	800	20
33107	1000	12
33127	1250	12
33147	1400	12
33177	1600	12

EN Axe
 PL Siekiera
 DE Handbeil
 RU Топор

CZ Sekera
 RO Secure
 HU Szekerce
 ES Hacha

DIN
 5131
 7294



JUCO

No.	m [g]	DIN	
33024	400	5131	5
33026	600	5131	5
33028	800	5131	5
33030	1000	5131	5
33032	1250	7294	5
33035	1500	7294	5
33038	1800	7294	5
33039	2000	7294	5
33040	2500	7294	5

EN Axe
 PL Siekiera
 DE Handbeil
 RU Топор

CZ Sekera
 RO Secure
 HU Szekerce
 ES Hacha



FLO

No.	m [g]	
32930	1000	10

EN Axe with fibreglass + PVC handle
 PL Siekiera, rączka z włókna szklanego
 DE Handbeil Fiberglasstiel
 RU Топор с фибреглассовой ручкой

CZ Sekyrka
 RO Toporisca cu coada din fibra de sticla
 HU Szekerce
 ES Hacha con mango de fibra de vidrio



VOREL

No.	m [g]	
33065	600	20
33085	800	20
33105	1000	12
33125	1250	6

EN Axe
 PL Siekiera
 DE Handbeil
 RU Топор

CZ Sekera
 RO Secure
 HU Szekerce
 ES Hacha

DIN
 5131
 7294



JUCO

No.	m [g]	DIN	
33000	400	5131	5
33001	600	5131	5
33002	800	5131	5
33003	1000	5131	5
33004	1250	7294	5
33005	1500	7294	5
33006	1800	7294	5
33007	2000	7294	5
33008	2500	7294	5

EN Axe set
PL Zestaw siekier tradycyjnych
DE Satz traditioneller Äxte
RU Набор традиционных топоров

CZ Sada klasických seker
RO Set topoare
HU Hagymányos balta készlet
ES Set de hechas tradicionales



JUKO

No.	m [kg]	
32999	0.4, 1.5	5

EN Hammer-axe for wood splitting
PL Siekiero-młot
DE Spaltaxt
RU Топор-колун

CZ Sekera-kladivo
RO Secure-ciocan
HU Szekerce-kalapács
ES Hacha martillo para partir madera



JUKO

No.	m [g]	
32927	2100	1
32928	3200	1

EN Canadian axe
PL Siekiera kanadyjska
DE Handbeil „Kanadische Form“
RU Топор канадского типа

CZ Sekera kanadská
RO Topor canadian
HU Hosszú nyelű, hasító fejsze
ES Hacha canada

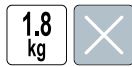

JUKO

No.	m [g]	
33022	1800	5

EN Hammer wedges
PL Zestaw klinujących
DE Keilesatz
RU Набор клинов
CZ Sada klínků
RO Set cultivator
HU Ékelő készlet
ES Juego de sujeción



JUKO

No.	For hammer / Do młotka [kg]	For axe / Do siekiery	
99460	0.1-0.5	-	50
99461	0.7-2.0	-	50
99462	3.0-4.0	0.4	50

EN Axe
PL Siekiera z klinem
DE Handbeil
RU Топор

CZ Sekera
RO Secure
HU Szekerce
ES Hacha



JUKO

No.	m [g]	
32924	2000	5

EN Hammer-axe for wood splitting
PL Siekiero-młot
DE Spaltaxt
RU Топор-колун

CZ Sekera-kladivo
RO Secure-ciocan
HU Szekerce-kalapács
ES Hacha martillo para partir madera



JUKO

No.	m [g]	
32925	2500	1
32926	4000	1

EN Hammer wedges
PL Zestaw klinujących
DE Keilesatz
RU Набор клинов

CZ Sada klínků
RO Set cultivator
HU Ékelő készlet
ES Juego de sujeción

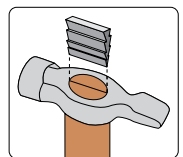

VOREL

No.	pcs / szt.	
99472	10	6/72

EN Hammer wedges
PL Zestaw klinujących
DE Keilesatz
RU Набор клинов
CZ Sada klínků
RO Set cultivator
HU Ékelő készlet
ES Juego de sujeción



JUKO

No.	For hammer / Do młotka [kg]	For axe / Do siekiery [kg]	
99463	5-6	0.6-1.0	50
99464	8-10	1.2-2.5	50

EN Pick axe
 PL Kilof bez trzonka
 DE Spitzhacke ohne Stiel
 RU Кирка двухсторонняя без черенка

CZ Násada na krumpáč
 RO Coadă tarnacop
 HU Csákánynyél
 ES Palo para pico

2.5
kg



VOREL

No.	m [kg]	
32901	2.5	8

6

EN Pick axe
 PL Kilof oprawiony
 DE Spitzhacke
 RU Кирка двухсторонняя с черенком

CZ Krumpáč osazený
 RO Târâncop cu coadă
 HU Ékelt csákány
 ES Piqueta

2.5
kg



VOREL

No.	m [kg]	
32900	2.5	6

EN Wooden handle for pick axe
 PL Trzonek do kilofa
 DE Stiel für Spitzhacke
 RU Черенок для кирки

CZ Násada na krumpáč
 RO Coadă tarnacop
 HU Csákánynyél
 ES Palo para pico

90
cm



No.	L [cm]	For / Dla	
32902	90	32901	10

EN Wood splitter
 PL Klin do rozłupywania drewna
 DE Spaltkeil
 RU Клин для раскалывания бревен

CZ Klín na štípání polen
 RO Pana pt. lemn
 HU Fahasító ék
 ES Cuña para partir madera



JUCO

No.	m [kg]	
32922	2	1
32923	3	1

Memo	
------	--

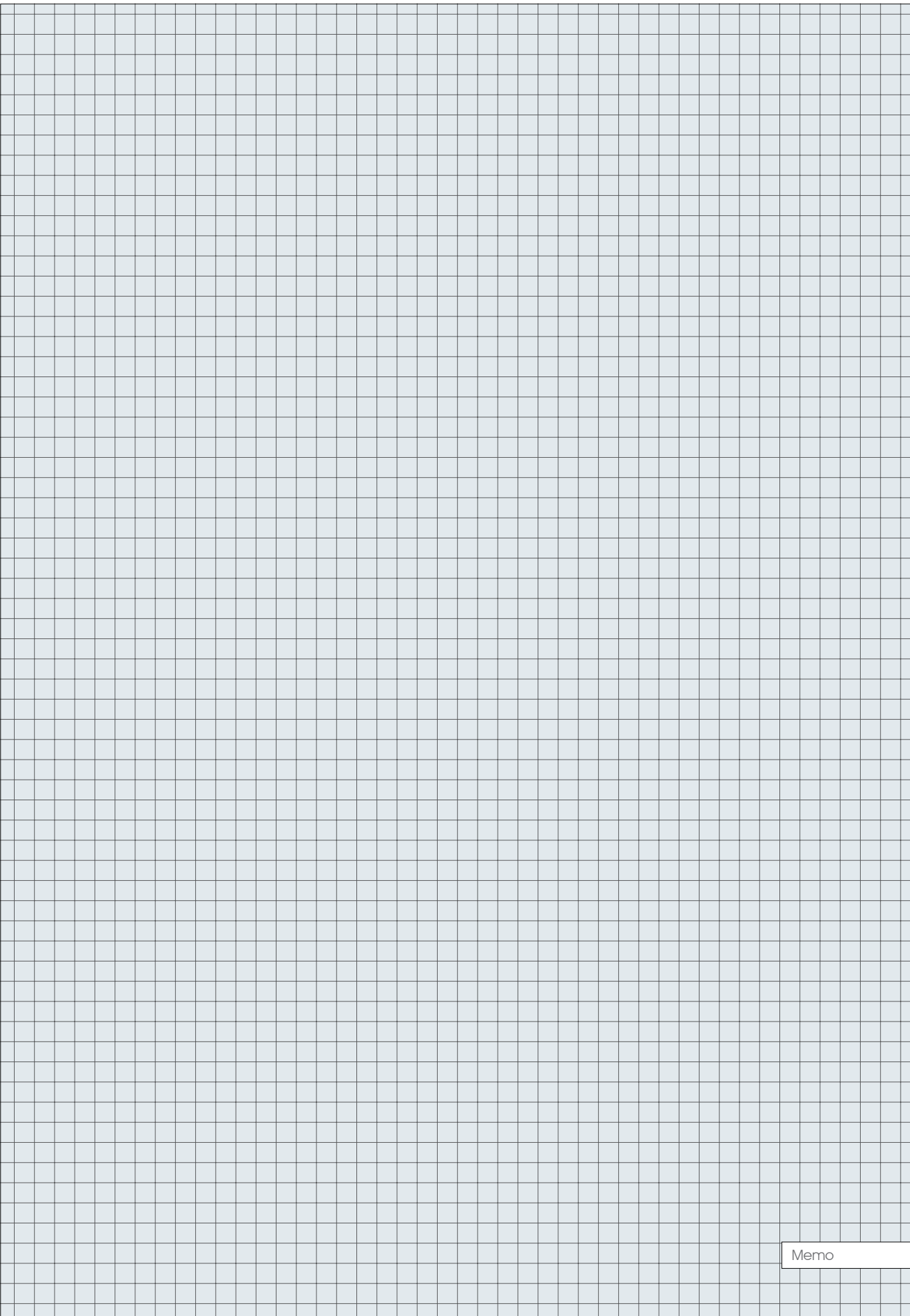

Memo

7

Clamps & vices Ściski i imadła

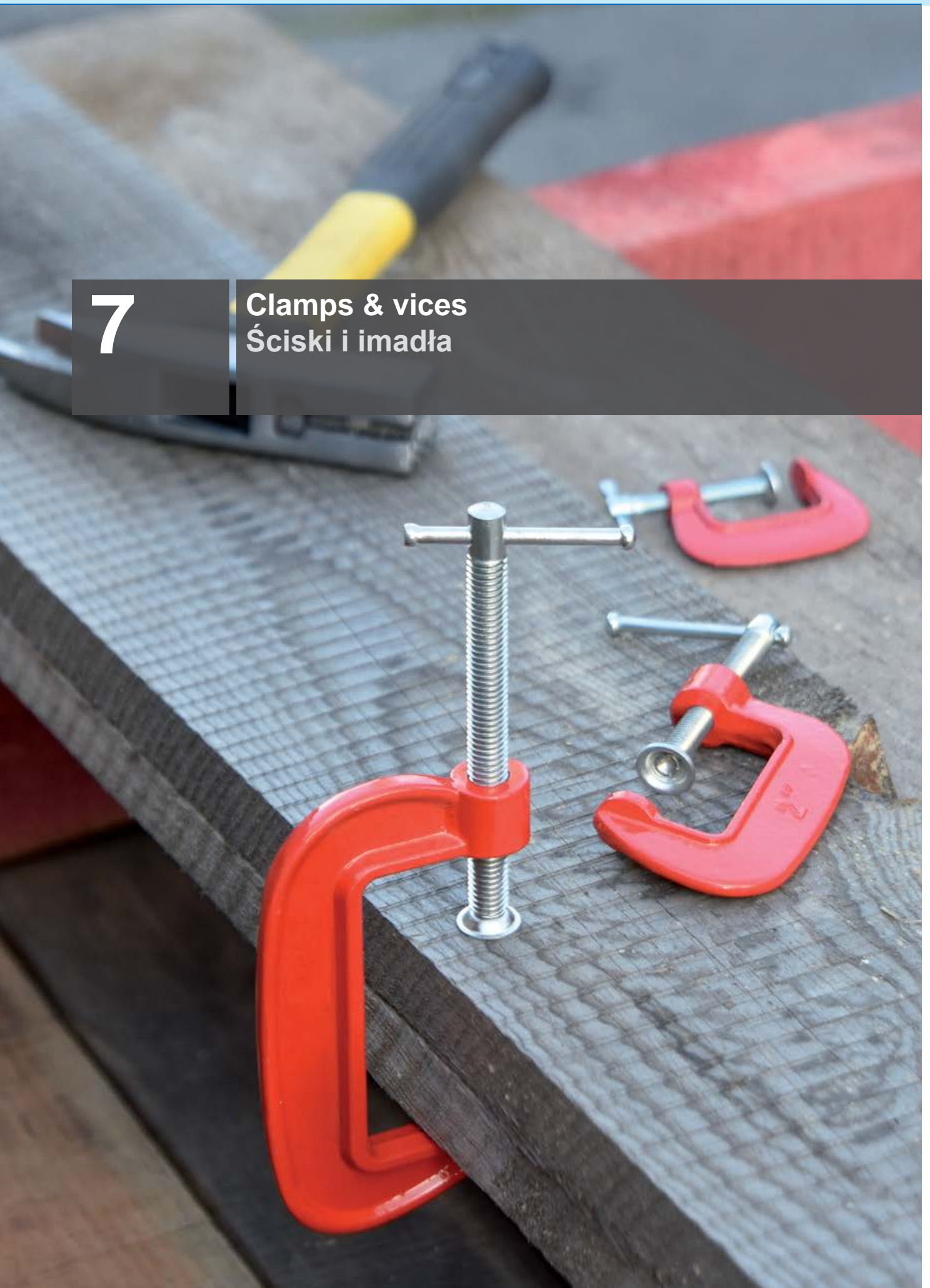

Clamps Ściski



72-74

F-clamps & sets

Ściski stolarskie i zestawy..... 72

Quick release clamps

Ściski szybkozaciskowe..... 72

Battenboard clamps

Ściski do klejenia płyt stolarskich..... 73

Spring clamps

Ściski sprężynowe..... 73

Corner clamps

Ściski kątowe..... 73

Frame clamps

Ściski taśmowe..... 73

C-clamps

Ściski typu „C”..... 74

Ratchet floor clamps

Pasy ściągające do paneli podłogowych..... 74

Vices Imadła



74-75

Baby vices

Imadła stołowe..... 74

Bench vices

Imadła ślusarskie..... 75

Hinged pipe vices

Imadła zaciskowe do rur..... 75

EN F-clamp
 PL Ścisk stolarski
 DE Schraubzwinge
 RU Струбцина
 CZ Truhlářské upínadlo
 RO Presa lemn
 HU Asztalos szorító
 ES Tornillo de apriete



7 VOREL

No.	Size / Rozmiar [mm]	
37100	50x100	12/60
37101	50x150	12/60
37102	50x200	12/60
37103	50x250	12/60
37104	50x300	12/60
37106	80x200	10/30
37107	80x250	10/30
37108	80x300	10/20
37109	80x500	10/20
37110	120x300	10/20
37111	120x500	10
37112	120x800	10
37113	120x1000	6
37114	120x1200	6
37115	120x1500	6

EN F-clamp
 PL Ścisk stolarski
 DE Schraubzwinge
 RU Струбцина
 CZ Truhlářské upínadlo
 RO Presa lemn
 HU Asztalos szorító
 ES Tornillo de apriete



No.	Size / Rozmiar [mm]	pcs / szt.	
38150	50x150	2	10/30
38200	50x200	2	10/30

EN F-clamp
 PL Ścisk stolarski
 DE Schraubzwinge
 RU Струбцина
 CZ Truhlářské upínadlo
 RO Presa lemn
 HU Asztalos szorító
 ES Tornillo de apriete

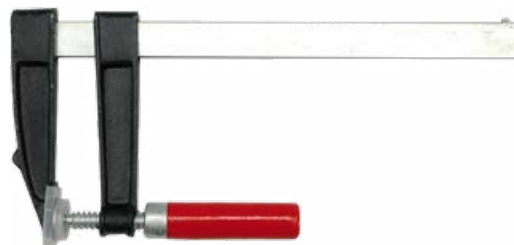

No.	Size / Rozmiar [mm]	
37150	50x150	12/60
37200	50x200	12/60
37250	50x250	12/60
37300	50x300	12/60
37380	80x300	15/30
37400	80x500	15/30
37430	120x300	10/20
37500	120x500	10/20
37800	120x800	10
37900	120x1000	10

EN Quick release clamp
 PL Ścisk szybkozaciskowy
 DE Schnellklemme
 RU Быстрозажимная струбцина
 CZ Svěrák rychloupínací
 RO Clemă cu prindere rapidă
 HU Gyors asztalos szorító
 ES Apretador rápido



VOREL

No.	L [mm]	Max. expand range / Maks. zasięg rozpięcia [mm]	Max. clamping range / Maks. zasięg ściskania [mm]	Max. jaws depth / Maks. głębokość szczęk [mm]	
38401	150	141-312	0-152	63	12/36
38402	200	141-355	0-203	63	6/36
38403	250	141-405	0-254	63	6/30
38404	300	141-464	0-304	63	6/30
38406	350	141-555	0-355	63	6/24
38407	450	141-617	0-457	63	6/24
38408	600	141-769	0-609	63	6/18
38409	750	141-922	0-762	63	6/12

EN Squeezing clamp
 PL Ścisik z prowadnicą aluminiową do klejenia płyt
 DE Aluminium-Fugzwinge
 RU Струбцина-вайма
 CZ Dverový upínač
 RO Menghina pt. tamplarie
 HU Táblásító szorító
 ES Prensa sargento de aluminio



VOREL

No.	L [mm]	
38642	900	10
38641	1500	10
38643	2400	3/10

EN Spring clamp
 PL Ścisik sprężynowy
 DE Federklemme
 RU Струбцина с пружинным зажимом
 CZ Pružinová svěrka
 RO Cleste presa pt. lemn
 HU Rugós szorító
 ES Pinza de resorte



No.	L [mm]	
38500	100	24/240
38515	150	12/120
38525	200	10/100

EN Corner clamp
 PL Ścisik stolarski kątowy
 DE Gehrungszwinge
 RU Струбцина угловая
 CZ Truhlářské upínadlo úhlové
 RO Cleste presa colt
 HU Asztalos szorító, sarok
 ES Tornillo de angulo



VOREL

No.	Size / Rozmiar [mm]	
38751	65x70	6/12

EN Pipe clamps
 PL Ścisik do klejenia płyt mocowanie na rurę
 DE Holz kleben Rohrschelle
 RU Струбцина трубная
 CZ Trubková zvierka
 RO Menghina tamplarie pt. tevi
 HU Végtelen csavaros fém szorító
 ES Prensa sargento para carpintería

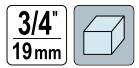

VOREL

No.	
38620	12

EN Corner clamp
 PL Ścisik stolarski kątowy
 DE Gehrungszwinge
 RU Струбцина угловая
 CZ Truhlářské upínadlo úhlové
 RO Cleste presa colt
 HU Asztalos szorító, sarok
 ES Tornillo de angulo



No.	Size / Rozmiar [mm]	
38750	75	10/100

EN Frame clamp
 PL Ścisik taśmowy
 DE Bandzwinge
 RU Ленточный зажим
 CZ Pásová svorka
 RO Clema pt. cadru
 HU Szalagos szorító
 ES Tensor de cinta



VOREL

No.	Tape length / Długość taśmy [m]	
38531	4	20

- EN "C" clamp
 PL Ścisk typu „C”
 DE C-Schraubzwinge
 RU Струбцина тип „С”
- CZ Sverka tvaru „C”
 RO Menghina tip „C”
 HU Pillanatszorító
 ES Tornillo tipo „C”



No.	Jaws range / Rozstaw szczęk [mm]	Force pressure / Siła nacisku [kg]	
38430	50	140	50
38431	75	190	50
38432	100	270	30
38433	125	320	20
38434	150	360	18
38435	200	390	10
38436	250	420	6

- EN Ratchet floor clamp
 PL Pas ściągający do paneli podłogowych
 DE Spanngürt für Laminatpannele
 RU Ремень для стяжки напольных панелей
 CZ Stahovací pás na podlahní panele
 RO Curea elastică strâns plăci parchet
 HU Padlópanelhez rögzítő pánt
 ES Cinta tirante para placas de suelo



No.	Tape length / Długość taśmy [m]	
82355	5	10/20

- EN Baby vice - swivel base
 PL Imadło stolowe obrotowe
 DE Bankschraubstock drehbar
 RU Тиски настольные поворотные
 CZ Stolní svěrák otáčivý
 RO Menghină rotativă de masă
 HU Satu, asztali, forgó
 ES Tornillo de apriete giratorio



No.	Jaws width / Szerokość szczęk [mm]	
36014	40	12/24
36015	50	10/20
36016	60	9/18
36018	75	6/12

- EN C-clamp set
 PL Ścisaki modelarskie
 DE Mini-Schraubzwingensatz
 RU Набор струбцин С-типа
- CZ Modelářské upínadlo
 RO Presa lemni tip „C” set
 HU Modellező szorítók
 ES Tornillos tipo „C”



No.	Jaws range / Rozstaw szczęk [mm]	
38830	25, 50, 75	12/48

- EN Baby vice - fixed base
 PL Imadło stolowe
 DE Bankschraubstock
 RU Тиски настольные неповоротные
 CZ Stolní svěrák
 RO Menghină de masă
 HU Satu, asztali
 ES Tornillo de apriete



No.	Jaws width / Szerokość szczęk [mm]	
36000	25	15/60
36004	40	12/48
36005	50	18/36
36006	60	12/24
36008	70	10/20

- EN Baby vice - fixed base
 PL Imadło stolowe
 DE Bankschraubstock
 RU Тиски настольные поворотные
 CZ Stolní svěrák
 RO Menghină de masă
 HU Satu, asztali
 ES Tornillo de apriete



No.	Jaws width / Szerokość szczęk [mm]	
36650	65	10

EN Bench vice - fixed base
 PL Imadło ślusarskie
 DE Schlosserschraubstock
 RU Тиски слесарные с наковальней

CZ Zámečnický svérák
 RO Menghină de lăcătușerie
 HU Satu, lakatos
 ES Tornillo de apriete



No.	Jaws width / Szerokość szczęk [mm]	
36032	100	1
36033	125	1
36034	150	1/1

EN Hinged pipe vice
 PL Imadło zaciskowe do rur
 DE Rohrschraubstock
 RU Тиски для труб
 CZ Uprínací svérák na trubky
 RO Menghină pt. țevi
 HU Satu, csőszorító
 ES Tornillo de apriete para tubos



No.	Mounting element diameter / Średnica mocowanego elementu [mm]	
36570	13-50	6

EN Bench vice - swivel base
 PL Imadło ślusarskie obrotowe
 DE Schlosserschraubstock drehbar
 RU Тиски слесарные поворотные

CZ Zámečnický svérák otáčivé
 RO Menghină de lăcătușerie rotativă
 HU Satu, lakatos forgó
 ES Tornillo de apriete giratorio



No.	Jaws width / Szerokość szczęk [mm]	
36037	100	1
36038	125	1
36039	150	1

7



Memo

8

Cutting tools Narzędzia tnące



Drill bits Wiertła

79-87



Twist drill bits HSS & sets

Wiertła do metalu HSS i zestawy..... 79

Twist drill bits HSS-G & sets

Wiertła do metalu HSS-G i zestawy..... 80

Step drills & sets

Wiertła stopniowe i zestawy..... 80

Universal drills & sets

Wiertła uniwersalne i zestawy..... 81

Masonry drill bits & sets

Wiertła do betonu i zestawy..... 82

Wood drill bits

Wiertła do drewna..... 82

SDS Masonry drill bits & sets

Wiertła do betonu SDS i zestawy..... 83

SDS Chisels

Przecinaki i dłuta SDS..... 84

Hollow drill sets

Wiertła koronowe do betonu..... 86

Hole saw kits

Zestawy otwornic..... 86

Tungsten carbide hole saws

Otwornice z węglikiem wolframu..... 87

Drills for glass, ceramic tiles & sets

Wiertła do szkła, ceramiki, gresu i zestawy..... 87

Jigs & patterns

Wzorniki i szablony..... 87

Tools for dowel joints

Narzędzia do połączeń kołkowych

88

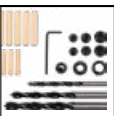

Taps & dies

Narzędzia do gwintowania

88-90



Hand taps CZ TOOLS

Gwintowniki CZ TOOLS..... 88

Machine taps CZ TOOLS

Gwintowniki maszynowe CZ TOOLS..... 89

Circular dies CZ TOOLS

Narzynki CZ TOOLS..... 89

Tap & die sets CZ TOOLS

Zestawy gwintowników i narzynek CZ TOOLS..... 89

Tap wrenches & die holders

Pokręta do gwintowników i narzynek..... 89

Tap & die sets

Zestawy gwintowników i narzynek..... 90

Screw extractor sets

Wykrętaki do zerwanych śrub..... 90

Router bits, rotary rasps & sets

Frezy do drewna, metalu i zestawy

90



Diamond tools

Narzędzia diamentowe

91-92



Diamond blades for cutting construction materials

Tarcze diamentowe do cięcia materiałów budowlanych..... 91

Diamond rod saws

Brzeszczoty diamentowe..... 92

Tungsten carbide tipped tools

Narzędzia z ostrzem z węglika wolframu

92



Tungsten carbide saws for wood

Tarcze z węglikiem do drewna..... 92

Tungsten carbide saws for aluminium

Tarcze z węglikiem do aluminium..... 92

Cutting & grinding discs

Tarcze do cięcia i szlifowania

92-93



Metal cutting discs

Tarcze do cięcia metalu..... 92

Metal grinding discs

Tarcze do szlifowania metalu..... 93

Stone cutting discs

Tarcze do cięcia kamienia..... 93

Stone grinding discs

Tarcze do szlifowania kamienia..... 93

Flap discs

Ściernice listkowe talerzowe

93



Grinding discs

Tarcze do szlifierek stołowych

93-94



Shears

Nożyce

94-96



Tin snips

Nożyce do blachy..... 94

Bolt cutters

Nożyce do prętów..... 95

Saws & blades

Piły i brzeszczoty

96-102



Hand saws

Piły do drewna..... 96

Bow saws

Piły kabłąkowe..... 97

Bow saw blades

Brzeszczoty do pił kabłąkowych..... 97

Compass saws

Piły otwornice..... 97

Saws for gas concrete

Piły do gazobetonu..... 97

Hacksaw frames

Piły do metalu..... 97

Cross cut saws

Piły poprzeczne..... 99

Miter saws Piły kątowe.....	99
Miter boxes Skrzynki uciosowe.....	99
Blades Brzeszczoty.....	100
Jig saw blades Brzeszczoty do wyrzynarek.....	102
Brushes, knives & files Szczotki, noże i pilniki	102-115
Wire brushes Szczotki druciane.....	102
Cup brushes Szczotki tarczowe.....	103
Rubber discs Tarcze gumowe do elektronarzędzi.....	104
Pocket knives Noże składane.....	106
Window scrapers Skrobaki do szyb.....	109
Glass cutters Nożyki do cięcia szkła.....	109
Marking out tools Narzędzia traserskie.....	109
Scrapers Cykliny.....	110
Wood carving knife sets Zestawy nożyków precyzyjnych.....	110
Scissors Nożyczki.....	110
Leatherwork accessories Akcesoria kaletnicze.....	110
Wood planes Strugi.....	111
Steel files Pilniki do metalu.....	112
Diamond whetstones & sets Oselki diamentowe i zestawy.....	113
Rasps Tarniki do drewna.....	113
Rasps for plaster Tarniki do gipsu.....	114



Abrasive products Artykuły ściernie

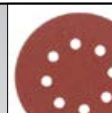

.....	115-118
Sharpening stones Oselki.....	115
Waterproof sand papers Papiery ściernie wodoodporne.....	115
Abrasive clothes Piłna ściernie.....	116
Abrasive meshes Siatki ściernie.....	116
No end abrasive bands Taśmy ściernie bezkońcowe.....	116
Abrasive sponges Kostki ściernie.....	116
Abrasive sheets and discs Arkusze i krążki ściernie.....	117
Sanding blocks Błoki ściernie.....	117
Polishing sets Zestawy polerskie.....	118

EN Twist drill bit
 PL Wiertło do metalu
 DE Metallspiralbohrer
 RU Сверло по металлу
 CZ Vrták na kov
 RO Burghiu pt. metal
 HU Fúrószárkészlet fémhez
 ES Broca para metal



STHOR

No.	Ø [mm]	pcs / szt.	
20100	1.0	10	200/10000
20150	1.5	10	200/8000
20200	2.0	10	200/8000
20250	2.5	10	200/4000
20280	2.8	10	200/4000
20300	3.0	10	200/4000
20320	3.2	10	100/4000
20350	3.5	10	100/4000
20400	4.0	10	100/4000
20420	4.2	10	100/2500
20450	4.5	10	100/2500
20500	5.0	10	100/2500
20550	5.5	10	100/2000
20600	6.0	10	50/1200
20650	6.5	10	50/1200
20700	7.0	10	50/1200
20800	8.0	5	50/600
20850	8.5	5	50/600
20900	9.0	5	50/600
21000	10.0	5	50/250
21100	11.0	5	50/250
21200	12.0	5	50/250
21250	12.5	5	50/250
21300	13.0	5	50/250
21400	14.0	5	50/200
21600	16.0	5	10/100

EN Twist drill set
 PL Zestaw wiertel do metalu
 DE Metallspiralbohrersatz
 RU Набор сверл по металлу
 CZ Souprava vrtáků na kov
 RO Set de burghie pt. metal
 HU Fúrószárkészlet fémhez
 ES Juego de brocas para metal



STHOR

No.	Ø [mm]	pcs / szt.	
22330	1, 1.5, 2, 2.5, 3, 3.5, 4, 4.5, 5, 5.5, 6, 6.5, 7, 7.5, 8, 8.5, 9, 9.5, 10	19	30
22340	1, 1.5, 2.0, 2.5, 3.0, 3.5, 4.0, 4.5, 5, 5.5, 6, 6.5, 7, 7.5, 8, 8.5, 9, 9.5, 10, 10.5, 11, 11.5, 12, 12.5, 13	25	20

EN Twist drill set
 PL Zestaw wiertel do metalu
 DE Metallspiralbohrersatz
 RU Набор сверл по металлу
 CZ Souprava vrtáků na kov
 RO Set de burghie pt. metal
 HU Fúrószárkészlet fémhez
 ES Juego de brocas para metal



STHOR

No.	Ø [mm]	pcs / szt.	
22130	1.5, 2, 2.5, 3, 3.2, 3.5, 4, 4.5, 4.8, 5, 5.5, 6, 6.5	13	25/100
22180	2, 2.5, 3, 3.5, 4, 4.5, 5, 5.5, 6, 6.5, 7, 7.5, 8	13	25/50

EN Twist drill set
 PL Zestaw wiertel do metalu
 DE Metallspiralbohrersatz
 RU Набор сверл по металлу
 CZ Souprava vrtáků na kov
 RO Set de burghie pt. metal
 HU Fúrószárkészlet fémhez
 ES Juego de brocas para metal

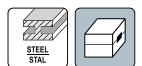

STHOR

No.	Ø [mm]	pcs / szt.	
22190	1, 1.5, 2, 2.5, 3, 3.5, 4, 4.5, 5, 5.5, 6, 6.5, 7, 7.5, 8, 8.5, 9, 9.5, 10	19	30
22250	1, 1.5, 2, 2.5, 3, 3.5, 4, 4.5, 5, 5.5, 6, 6.5, 7, 7.5, 8, 8.5, 9, 9.5, 10, 10.5, 11, 11.5, 12, 12.5, 13	25	20

EN Twist drill set
 PL Zestaw wiertel do metalu
 DE Metallspiralbohrersatz
 RU Набор сверл по металлу
 CZ Souprava vrtáků na kov
 RO Set de burghie pt. metal
 HU Fúrószárkészlet fémhez
 ES Juego de brocas para metal

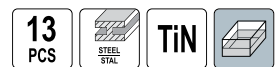

STHOR

No.	Ø [mm]	pcs / szt.	
22300	1.5, 2.0, 2.5, 3.0, 3.2, 3.5, 4.0, 4.5, 4.8, 5.0, 5.5, 6.0, 6.5	13	25/100
22310	2.0, 2.5, 3.0, 3.5, 4.0, 4.5, 5.0, 5.5, 6.0, 6.5, 7.0, 7.5, 8.0	13	25/50

EN HSS twist drill bit
 PL Wiertło do metalu HSS
 DE Metallspiralbohrer HSS
 RU Сверло по металлу HSS
 CZ Vrták na kov HSS
 RO Burghiu pt. metal HSS
 HU Fúrószár fémhez HSS
 ES Broca para metal HSS

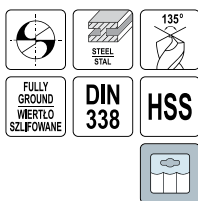

STHOR

No.	Ø [mm]	pcs / szt.	Box
21900	1.0	10	20/1000
21905	1.5	10	20/1000
21910	2.0	10	20/800
21915	2.5	10	20/800
21919	3.0	10	20/500
21921	3.2	10	20/400
21924	3.5	10	20/400
21927	4.0	10	10/400
21929	4.2	10	10/250
21932	4.5	10	10/250
21934	4.8	10	10/250
21936	5.0	10	10/250
21941	5.5	10	10/200
21944	6.0	10	10/120
21948	6.5	10	5/120
21950	7.0	5	10/120
21951	7.5	5	10/120
21952	8.0	5	10/120
21955	8.5	5	10/120
21956	9.0	5	10/120
21958	10.0	5	10/50
21961	11.0	5	10/50
21963	12.0	5	10/50
21966	13.0	3	16/48

EN Step drill
 PL Wiertło stopniowe
 DE Stufenbohrer
 RU Сверло ступенчатое
 CZ Stupňovitý vrták
 RO Burghiu din titan cu gaurire in trepte
 HU Lépcsős fúró
 ES Broca cónica escalonada

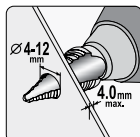
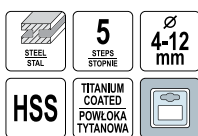

STHOR

No.	Ø [mm]	Box
22610	4, 6, 8, 10, 12	25/200

EN Twist drill set
 PL Zestaw wiertel do metalu
 DE Metallspiralbohrersatz
 RU Набор сверл по металлу
 CZ Souprava vrtáků na kov
 RO Set de burghie pt. metal
 HU Fúrószárkészlet fémhez
 ES Juego de brocas para metal

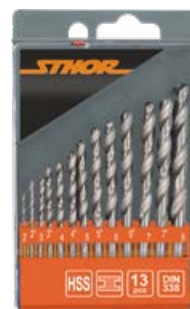
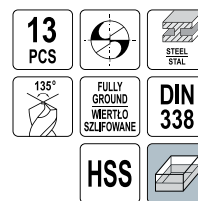

STHOR

No.	Ø [mm]	pcs / szt.	Box
21998	2, 2.5, 3, 3.5, 4, 4.5, 5, 5.5, 6, 6.5, 7, 7.5, 8	13	10/50

EN Twist drill set
 PL Zestaw wiertel do metalu
 DE Metallspiralbohrersatz
 RU Набор сверл по металлу
 CZ Souprava vrtáků na kov
 RO Set de burghie pt. metal
 HU Fúrószárkészlet fémhez
 ES Juego de brocas para metal

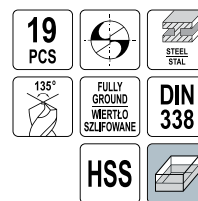

STHOR

No.	Ø [mm]	pcs / szt.	Box
21999	1, 1.5, 2, 2.5, 3, 3.5, 4, 4.5, 5, 5.5, 6, 6.5, 7, 7.5, 8, 8.5, 9, 9.5, 10	19	5/30

EN Twist drill set
 PL Komplet wiertel do metalu
 DE Metallspiralbohrersatz
 RU Набор сверл по металлу
 CZ Souprava vrtáků na kov
 RO Set de burghie pt. metal
 HU Fúrószárkészlet fémhez
 ES Juego de brocas para metal

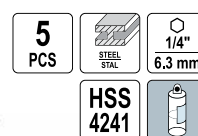

STHOR

No.	Ø [mm]	pcs / szt.	Box
21650	4, 5, 6, 8, 10	5	30/60

EN Step drill
 PL Wiertło stopniowe
 DE Stufenbohrer
 RU Сверло ступенчатое
 CZ Stupňovitý vrták
 RO Burghiu din titan cu gaurire in trepte
 HU Lépcsős fúró
 ES Broca cónica escalonada

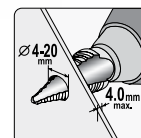

STHOR

No.	Ø [mm]	Box
22611	4, 6, 8, 10, 12, 14, 16, 18, 20	25/100

EN Step drill
 PL Wiertło stopniowe
 DE Stufenbohrer
 RU Свёрло ступенчатое
 CZ Stupňovitý vrták
 RO Burghiu din titan cu gaurire in trepte
 HU Lépcsős fúró
 ES Broca cónica escalonada

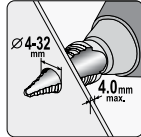
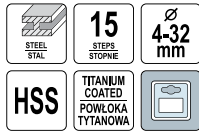

No.	Ø [mm]	
22612	4, 6, 8, 10, 12, 14, 16, 18, 20, 22, 24, 26, 28, 30, 32	10/80

EN Step drills
 PL Zestaw wiertel stopniowych
 DE Stufenbohrer Set
 RU Свёрло ступенчатое шулки

CZ Stupňovité vrtáky sada
 RO Set burghie in trepte
 HU Lépcsős fúró készlet
 ES Juego de brocas cónicas escalonadas

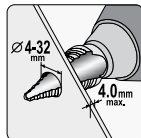
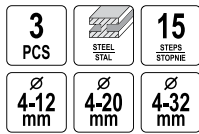

No.	Ø [mm]	
22616	4-12 (4, 6, 8, 10, 12 mm), 4-20 (4, 6, 8, 10, 12, 14, 16, 18, 20, 22, 24, 26, 28, 30, 32 mm), 4-32 (4, 6, 8, 10, 12, 14, 16, 18, 20, 22, 24, 26, 28, 30, 32 mm)	20

EN Universal drills
 PL Komplet wiertel uniwersalnych
 DE Universalbohrer-Set
 RU Набор универсальных сверл
 CZ Sada viceúčelový vrták
 RO Set burghie universal
 HU Keményfém többcélu fúró készlet
 ES Sets de brocas multimaterial



No.	Ø [mm]	pcs / szt.	
21695	4, 5, 6, 8, 10	5	25/100

EN Universal drill
 PL Wiertło uniwersalne
 DE Universalbohrer
 RU Универсальное сверло

CZ Víceúčelový vrták
 RO Burghiu universal
 HU Kőzet és többcélu fúró
 ES Broca multimaterial

No.	Ø [mm]	L [mm]	
21680	3	75	150/600
21682	4	80	150/600
21684	5	85	100/400
21686	6	110	100/400
21688	7	110	100/400
21690	8	120	100/400
21691	10	120	50/200
21692	12	150	50/200

EN Step drill
 PL Wiertło stopniowe
 DE Stufenbohrer
 RU Свёрло ступенчатое
 CZ Stupňovitý vrták
 RO Burghiu din titan cu gaurire in trepte
 HU Lépcsős fúró
 ES Broca cónica escalonada

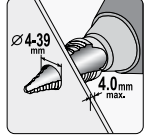

No.	Ø [mm]	
22613	4, 6, 9, 12, 15, 18, 21, 24, 27, 30, 33, 36, 39	10/40

EN Step drills
 PL Zestaw wiertel stopniowych
 DE Stufenbohrer Set
 RU Свёрло ступенчатое шулки
 CZ Stupňovité vrtáky sada
 RO Set burghie in trepte
 HU Lépcsős fúró készlet
 ES Juego de brocas cónicas escalonadas

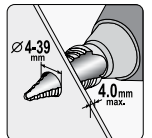

No.	Ø [mm]	
22617	4-12 (4, 6, 8, 10, 12 mm), 4-20 (4, 6, 8, 10, 12, 14, 16, 18, 20 mm), 4-32 (4, 6, 8, 10, 12, 14, 16, 18, 20, 22, 24, 26, 28, 30, 32 mm), 4-39 (4, 6, 9, 12, 15, 18, 21, 24, 27, 30, 33, 36, 39 mm)	20

EN Universal drills
 PL Komplet wiertel uniwersalnych
 DE Universalbohrer-Set
 RU Набор универсальных сверл
 CZ Sada viceúčelový vrták
 RO Set burghie cu coada hexagonala
 HU Keményfém többcélu fúró készlet
 ES Sets de brocas multimaterial



No.	pcs / szt.	
22640	4	25/100



- EN Masonry drill set
- PL Wiertła do betonu
- DE Betonspiralbohrersatz
- RU Сверла по бетону в наборе
- CZ Souprava vrtáků do betonu
- RO Set de burghie pt. beton
- HU Fúrószárkészlet betonhoz
- ES Brocas para hormigon

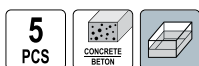

STHOR

No.	Ø [mm]	pcs / szt.	
23331	4, 5, 6, 8, 10	5	50/100

- EN Wood drill set
- PL Wiertła do drewna
- DE Holzbohrersatz
- RU Набор сверел по дереву
- CZ Vrtáky do dřeva
- RO Burghie pt. lemn
- HU Fafúroszár készlet
- ES Brocas para madera



No.	Ø [mm]	pcs / szt.	
22350	4, 5, 6, 8, 10	5	25/200

- EN Wood drill set
- PL Wiertła do drewna
- DE Holzbohrersatz
- RU Набор сверел по дереву
- CZ Vrtáky do dřeva
- RO Burghie pt. lemn
- HU Fafúroszár készlet
- ES Brocas para madera



STHOR

No.	Ø [mm]	pcs / szt.	
22381	3, 4, 5, 6, 7, 8, 9, 10	8	10/80

- EN Masonry drill bit
- PL Wierćko do betonu
- DE Betonbohrer
- RU Сверло по бетону
- CZ Vrták na beton
- RO Burghiu pt. beton
- HU Fúrószár betonhoz
- ES Broca para hormigon

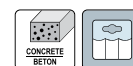

STHOR

No.	Ø [mm]	L [mm]	
23311	4	75	200/1600
23312	5	85	200/1600
23313	6	100	200/1000
23315	8	120	100/500
23325	8	400	50/200
23316	10	120	100/500
23326	10	400	50/100
23317	12	150	50/250
23327	12	400	50/100
23318	14	150	50/150
23329	16	400	25/50

- EN Wood drill set
- PL Wiertła do drewna
- DE Holzbohrersatz
- RU Набор сверел по дереву
- CZ Vrtáky do dřeva
- RO Burghie pt. lemn
- HU Fafúroszár készlet
- ES Brocas para madera



STHOR

No.	Ø [mm]	pcs / szt.	
22380	3, 4, 5, 6, 7, 8, 9, 10	8	20/100

- EN Wood drill set
- PL Wiertła do drewna
- DE Holzbohrersatz
- RU Набор сверел по дереву
- CZ Vrtáky do dřeva
- RO Burghie pt. lemn
- HU Fafúroszár készlet
- ES Brocas para madera



STHOR

No.	Ø [mm]	L [mm]	pcs / szt.	
22460	6, 8, 10, 12, 13, 14	300	6	25

EN Wood drill set
 PL Wiertła do drewna
 DE Holzbohrersatz
 RU Набор сверел по дереву
 CZ Vrtáky do dřeva
 RO Burghie pt. lemn
 HU Fafúrószár készlet
 ES Brocas para madera



6
PCS

WOOD
DREHWIG

230
mm

STHOR

No.	Ø [mm]	L [mm]	pcs / szt.	
22465	10, 12, 14, 16, 18, 20	230	6	10

EN Flat wood bits
 PL Wiertła do drewna, topatkowe
 DE Holz-Flachfräsbohrersatz
 RU Набор сверел по дереву
 CZ Vrtáky do dřeva
 RO Burghie pt. lemn
 HU Fafúrószár készlet
 ES Brocas para madera



6
PCS

WOOD
DREHWIG

No.	Ø [mm]	pcs / szt.	
22500	10, 12, 16, 18, 20, 25	6	10/100

EN Hand gimlet set
 PL Zestaw świderków ręcznych
 DE Handbohrer
 RU Бурав по дереву
 CZ Nebožez kovový
 RO Burghiu de palma
 HU Kézi fúró
 ES Broca manual



3
PCS

VOREL

No.	Ø [mm]	pcs / szt.	
22430	1,5, 2, 3	3	15/360

EN Hand gimlet set
 PL Zestaw świderków ręcznych
 DE Handbohrer
 RU Бурав по дереву
 CZ Nebožez kovový
 RO Burghiu de palma
 HU Kézi fúró
 ES Broca manual



4
PCS

VOREL

No.	Ø [mm]	pcs / szt.	
22431	2, 3, 4, 5	4	20/200

EN Wood drill set
 PL Wiertła do drewna
 DE Holzbohrersatz
 RU Набор сверел по дереву
 CZ Vrtáky do dřeva
 RO Burghie pt. lemn
 HU Fafúrószár készlet
 ES Brocas para madera



6
PCS

WOOD
DREHWIG

460
mm

STHOR

No.	Ø [mm]	L [mm]	pcs / szt.	
22466	10, 12, 14, 16, 18, 20	460	6	10

EN Masonry drill bit
 PL Wiertło do betonu
 DE Betonbohrer
 RU Бур по бетону
 CZ Vrták na beton
 RO Burghiu pt. beton
 HU Fúrószár betonhoz
 ES Broca para hormigón

CONCRETE
BETON

SDS
PLUS



STHOR

No.	Ø [mm]	L [mm]	
23620	5	110	10/500
23640	6	110	10/500
23650	6	160	10/500
23660	6	210	10/300
23670	8	110	10/500
23680	8	160	10/400
23690	8	210	10/250
23692	8	300	10/200
23693	8	460	10/100
23694	8	600	10/100
23710	10	160	10/300
23720	10	210	10/250
23722	10	300	10/150
23723	10	460	10/100
23724	10	600	10/100
23730	12	160	10/300
23740	12	460	10/100
23750	12	266	10/150
23752	12	600	10/60
23800	14	166	10/200
23820	14	460	10/80
23830	14	266	10/150
23832	14	600	10/50
23840	16	200	10/160
23850	16	300	8/96
23860	16	460	8/48
23862	16	600	8/48
23880	18	300	8/72
23882	18	460	6/48
23883	18	600	6/48
23920	20	300	5/50
23930	20	460	5/50
23932	20	600	5/30
23960	22	460	5/25
23962	22	600	5/25
23980	25	300	5/50
23982	25	600	5/15
23990	25	460	5/25
23992	28	600	2/10
23999	30	600	5/10

EN Masonry drill bit
 PL Wiertło do betonu
 DE Betonspiralbohrer
 RU Сверло по бетону

CZ Vrták na beton
 RO Burghiu pt. beton
 HU Fúrészár betonhoz
 ES Broca para hormigón



STHOR

No.	Ø [mm]	L [mm]	Box
23371	16	300	10/50
23390	16	600	5/30
23411	16	900	4/20
23372	18	300	10/50
23391	18	600	5/30
23412	18	900	4/20
23373	20	300	8/40
23392	20	600	4/20
23413	20	900	2/10
23374	22	300	6/30
23393	22	600	4/20
23414	22	900	2/10
23375	24	300	6/30
23394	24	600	4/20
23415	24	900	2/10
23376	25	300	6/30
23395	25	600	4/20
23416	25	900	2/10
23377	26	300	6/30
23396	26	600	2/10
23417	26	900	2/10
23397	28	600	2/10
23418	28	900	5
23379	30	300	4/20
23398	30	600	2/10
23419	30	900	5
23380	32	300	4/20
23399	32	600	2/10
23420	32	900	5
23381	35	300	4/20
23400	35	600	2/10
23421	35	900	5
23382	37	300	4/20
23422	37	900	5
23402	38	600	1/5
23423	38	900	5
23403	40	600	5
23424	40	900	5

EN Flat chisel
 PL Dłuto wąskie
 DE Flachmeißel
 RU Зубило узкое

CZ Sekáč
 RO Daltă spatulată
 HU Lapos véső
 ES Cincel plano



STHOR

No.	Ø [mm]	Working width / Szerokość robocza [mm]	L [mm]	Box
23591	14	20	250	25/50

EN Masonry drill set
 PL Komplet wiertel do betonu
 DE Betonbohrersatz
 RU Набор буров по бетону
 CZ Souprava vrtáků do betonu
 RO Set de burghie pt. beton
 HU Fúrészárkészlet betonhoz
 ES Juego de brocas



STHOR

No.	Ø [mm]	pcs / szt.	Box
23988	5, 6, 8, 10, 12	5	15/60

EN Point chisel
 PL Szpicak
 DE Spitzmeißel
 RU Зубило пиковое

CZ Špičák
 RO Dorn
 HU Hegyes véső
 ES Cincel punta



STHOR

No.	Ø [mm]	Working width / Szerokość robocza [mm]	L [mm]	Box
23590	14	1.5	250	25/50

EN Point chisel
 PL Szpicak
 DE Spitzmeißel
 RU Зубило пиковое

CZ Špičák
 RO Dorn
 HU Hegyes véső
 ES Cincel punta



STHOR

No.	Ø [mm]	Working width / Szerokość robocza [mm]	L [mm]	Box
23601	18	1.5	280	20/40
23602	18	1.5	400	10/20

EN Flat chisel
 PL Dłuto wąskie
 DE Flachmeißel
 RU Зубило узкое

CZ Sekáč
 RO Daltă spatulată
 HU Lapos véső
 ES Cincel plano



STHOR

No.	Ø [mm]	Working width / Szerokość robocza [mm]	L [mm]	Box
23603	18	25	280	20/40
23604	18	25	400	10/20

EN Spade chisel
 PL Dłuto szerokie
 DE Spatmeißel
 RU Зубило плоское широкое
 CZ Sekáč plochý
 RO Dalta
 HU Széles véső
 ES Cíncel pala



STHOR

No.	Ø [mm]	Working width / Szerokość robocza [mm]	L [mm]	
23592	14	40	250	25/50

EN Spade chisel
 PL Dłuto szerokie
 DE Spatmeißel
 RU Зубило плоское широкое
 CZ Sekáč plochý
 RO Dalta
 HU Széles véső
 ES Cíncel pala



STHOR

No.	Ø [mm]	Working width / Szerokość robocza [mm]	L [mm]	
23605	18	40	280	20/40
23606	18	50	400	10/20

EN Groove chisel
 PL Bruzdownik
 DE Nutenmeißel
 RU Зубило-штробер

CZ Sekáč drážkovací
 RO Dalta canal
 HU Horonyvéső
 ES Cíncel acanalado



STHOR

No.	Ø [mm]	Working width / Szerokość robocza [mm]	L [mm]	
23608	18	25	400	20/20

EN Adapter
 PL Adapter
 DE Adapter
 RU Адаптер

CZ Adaptér
 RO Adaptor
 HU Adapter
 ES Adaptador



STHOR

No.	L [mm]	
23460	60	100/200

EN Flat chisel
 PL Dłuto płaskie
 DE Spatmeißel
 RU Долото плоское
 CZ Sekáč plochý
 RO Punctator tip dalta
 HU Széles lapos véső
 ES Cíncel plano



STHOR

No.	Ø [mm]	Working width / Szerokość robocza [mm]	L [mm]	
23594	14	60	250	25/50

EN Groove chisel
 PL Bruzdownik
 DE Nutenmeißel
 RU Зубило-штробер
 CZ Sekáč drážkovací
 RO Dalta canal
 HU Horonyvéső
 ES Cíncel acanalado



STHOR

No.	Ø [mm]	Working width / Szerokość robocza [mm]	L [mm]	
23593	14	22	250	25/50

EN Hammer drill & chisel set
 PL Komplet wiertel i przecinaków do betonu
 DE Bohrer und Meißel Satz
 RU Набор буров и зубил

CZ Souprava vrtáků + sekáče
 RO Set de burghie + dalte tăietor
 HU Fúrészárkészlet + hidegvágó
 ES Juego de cinceles y brocas

12
PCS



SDS
PLUS



VOREL

No.	pcs / szt.	
23585	12	8



EN Hollow drill set
 PL Wiertło koronowe do muru
 DE Bohrkronen
 RU Коронка по бетону
 CZ Korunový vrták na zed'
 RO Burghiu cu coroaană pt. beton
 HU Koronafúró falhoz
 ES Broca widia para muro

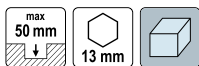

VOREL

No.	Ø [mm]	
03240	65	24
03241	80	20

EN Drywall circle cutter
 PL Wycinarka do płyt gipsowych
 DE Schnittzirkel für Gipsplatten
 RU Резак круговой по гипскартону
 CZ Vytíňovačka pro sádrové desky
 RO Tăietor pt. plăci de ghips
 HU Gipszalkívágó
 ES Compas cortador para planchas de escayola



VOREL

No.	Ø [mm]	
03990	30-400	12/48

EN Hole saw set
 PL Wycinarka otworów do drewna
 DE Lochsägensatz
 RU Пилы кольцевые по дереву в наборе
 CZ Vytínač otvorů
 RO Tăietor (ferăstrău rotund) pt. orificii
 HU Lyukasztó
 ES Sierra de corona para madera

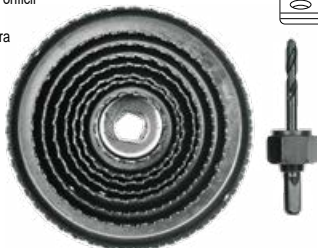
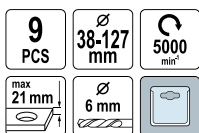

VOREL

No.	Ø [mm]	pcs / szt.	
22572	38, 51, 57, 67, 76, 89, 102, 127	9	6/24

EN Hole saw set
 PL Zestaw wycinarek do otworów w drewnie
 DE Lochsägensatz
 RU Пилы кольцевые по дереву в наборе
 CZ Vytínač otvorů
 RO Set freze circulare cu dinti caliti
 HU Szűrőfűrész edzett
 ES Sierra de corona curtido



VOREL

No.	Ø [mm]	pcs / szt.	
22571	64, 76, 87, 102, 127	8	6/24

EN Hollow drill set
 PL Wiertło koronowe do muru
 DE Bohrkronen
 RU Коронка по бетону
 CZ Korunový vrták na zed' - pouzdro šestiúhelník
 RO Burghiu cu coroaană pt. beton - mandrină hexagonală
 HU Koronafúró falhoz - hatszögletű szárral
 ES Broca widia para muro



VOREL

No.	Ø [mm]	
03245	65	24
03246	80	20

EN Hole saw set
 PL Wycinarka otworów do drewna
 DE Lochsägensatz
 RU Пилы кольцевые по дереву в наборе
 CZ Vytínač otvorů
 RO Tăietor (ferăstrău rotund) pt. orificii
 HU Lyukasztó
 ES Sierra de corona para madera

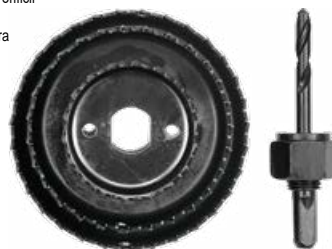
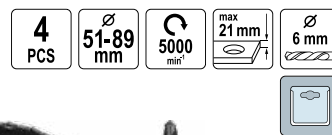

VOREL

No.	Ø [mm]	pcs / szt.	
22565	51, 76, 89	4	12/48

EN Hole saw set
 PL Zestaw wycinarek do otworów w drewnie
 DE Lochsägensatz
 RU Пилы кольцевые по дереву в наборе
 CZ Vytínač otvorů
 RO Tăietor (ferăstrău rotund) pt. orificii
 HU Lyukasztó
 ES Juego de sierras de corona

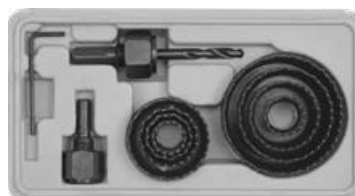
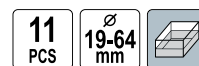

VOREL

No.	Ø [mm]	pcs / szt.	
22570	19, 21, 28, 31, 37, 43, 51, 64	11	12/36

EN Hole saw for wood with hardened teeth
 PL Wyrzynarka do drewna, hartowane zęby
 DE Lochsägensatz
 RU Пилы кольцевые по дереву закаленные зубья
 CZ Vyřezávací pila kalená
 RO Set freze circulare cu dinti caliti
 HU Szűrőfűrész edzett
 ES Sierra de corona curtido

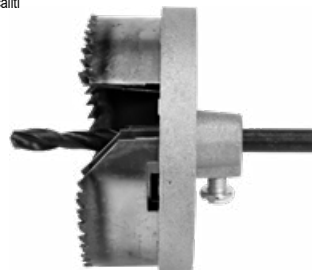
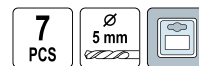

No.	Ø [mm]	Max. drilling depth / Maks. głębokość wiercenia [mm]	
28680	26, 32, 38, 45, 50, 56, 63	17	10/100
28690	26, 32, 38, 45, 50, 56, 63	43	10/80

EN Hole saw for wood
 PL Wyrzynarka do drewna
 DE Lochsägensatz
 RU Пилы кольцевые по дереву
 CZ Vyřezávací pila
 RO Set freze decupat lemn
 HU Szűrőfűrész
 ES Sierra de corona

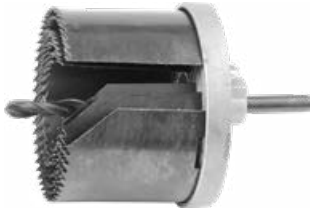
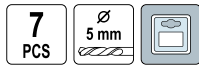

No.	Ø [mm]	Max. drilling depth / Maks. głębokość wiercenia [mm]	Box icon
28710	26, 32, 38, 45, 50, 56, 63	20	10/100
28720	26, 32, 38, 45, 50, 56, 63	43	10/80

EN Tungsten carbide coated hole saw set
 PL Zestaw wycinarek wolframowych
 DE Lochbohrersatz
 RU Коронки вольфрамовые

CZ Sada děrovacích vrtáků pro keramiku
 RO Set freze + maner
 HU Körkivógó készlet wolfram borítással
 ES Juego de punzones de wolframio



No.	Ø [mm]	Box icon
03300	33, 53, 67, 73	20
03301	33, 53, 67, 83	20

EN Drill for glass
 PL Wiertło do szkła i ceramiki
 DE Bohrer für Glas
 RU Сверло по стеклу

CZ Vrták do skla
 RO Burghiu pt. sticlă
 HU Üvegfúró
 ES Broca para vidrio



No.	Ø [mm]	L [mm]	Box icon
21700	3	60	125/500
21701	4	60	125/500
21702	5	70	125/500
21703	6	75	125/500
21704	8	80	125/500
21705	10	100	125/500
21706	12	100	100/400

EN Tool drill guide
 PL Szablono do wyznaczania otworów
 DE Schablone zur Markierung von Löchern
 RU Шаблон для разметки отверстий
 CZ Šablona pro značení otvorů
 RO Instrument ghidare pt. gaurire
 HU Nyílászablón
 ES Plantilla para determinar perforaciones



No.	L [mm]	Box icon
18180	200 (ramię poziome), 250 (listwa pionowa)	40

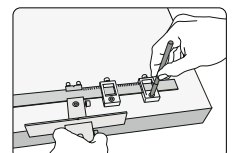
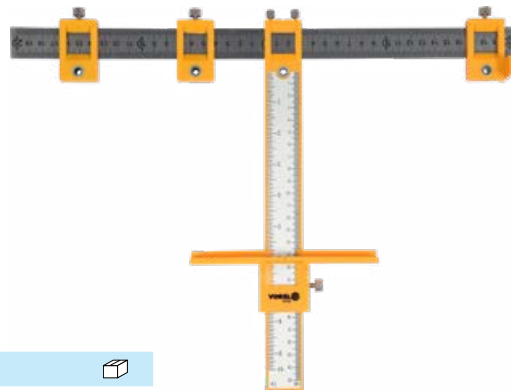

EN Hole saw set
 PL Zestaw wycinarek do otworów
 DE Lochsägensatz
 RU Пилы кольцевые по дереву
 CZ Vyřezávací otvory
 RO Set freze
 HU Lyukasztó
 ES Cortador de agujeros



No.	Ø [mm]	pcs / szt.	Box icon
28725	60, 67, 74, 81, 95	8	6/24

EN Tile and glass drill
 PL Wiertło do szkła i glazury
 DE Glass- und Fliesbohrer
 RU Сверло по плитке и стеклу

CZ Vrták do skla a glazury
 RO Burghiu pt. sticlă și glazură
 HU Üveg- és csempefúró
 ES Broca para cristal y azulejos



No.	Ø [mm]	L [mm]	Box icon
05540	4	80	50/100
05560	6	90	50/100
05580	8	95	50/100
05600	10	100	50/100

EN Glass and tile drills
 PL Zestaw wiertel do szkła i ceramiki
 DE Glas- und Fliesenbohrer
 RU Набор сверл по стеклу и керамике
 CZ Vrtáky do skla a keramiky
 RO Set burghie pt. sticla si ceramica
 HU Üveg és kerámi fúrók
 ES Juego de brocas, ceramica



No.	Ø [mm]	pcs / szt.	Box icon
21709	4, 5, 6, 8, 10	5	25/100

EN Depth collars for drills
 PL Ograniczniki głębokości wiercenia
 DE Bohrtiefenbegrenzersatz
 RU Ограничители глубины сверления
 CZ Omezovače hloubky vrtání
 RO Limitator adancime pt. burghiu
 HU Mélységűtközők
 ES Topes de profundidad para brocas

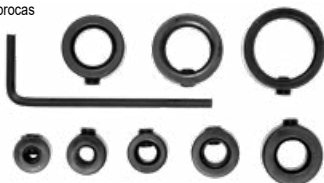

VOREL

No.	Ø [mm]	pcs / szt.	
24070	3, 4, 5, 6, 8, 10, 12, 16	8	20/120

EN Dowel set
 PL Zestaw narzędzi do połączeń kołkowych
 DE Werkzeugsatz für Dübelverbindungen
 RU Набор инструментов для дюбельных соединений
 CZ Sada nářadí pro kolikové spoje
 RO Set burghiu + cepi de lemn
 HU Készlet fatiplis rögzítésekhez
 ES Kit de herramientas para clavijas



INCLUDED:
 - 30 pcs of wood dowel pins: 6 x 30 mm, 8 x 40 mm, 10 x 40 mm
 - 6 pcs of dowelling centre points: 6, 8, 10 mm
 - 3 pcs of drill stops: 6, 8, 10 mm
 - 3 pcs of brad point drill bits: 6, 8, 10 mm
 - Hex key

W ZESTAWIE:
 - 30 kołków drewnianych rowkowanych: 6 x 30 mm, 8 x 40 mm, 10 x 40 mm
 - 6 znaczników: 6, 8, 10 mm
 - 3 ograniczniki głębokości wiercenia: 6, 8, 10 mm
 - 3 wiertła do drewna: 6, 8, 10 mm
 - Klucz imbusowy



VOREL

No.	Ø [mm]	pcs / szt.	
24080	6, 8, 10	43	6/24

EN Woodworking doweling jig
 PL Szablon do połączeń kołkowych
 DE Dübel Bohrschablone
 RU Кондуктор для сверления отверстий
 CZ Kolikovací přípravek
 RO Sablon pt. dibluri lemn
 HU Tipliző fúrósablon
 ES Guía de perforación



VOREL

No.	Ø [mm]	
24090	6, 8, 10	50

EN Hand taps
 PL Gwintowniki
 DE Handgewindebohrer
 RU Метчик

CZ Závítníky
 RO Tarozi
 HU Menetfúró
 ES Machos de roscar



EN Dowelling centre points
 PL Znaczniki do wyznaczania otworów
 DE Holzdübel-Markierspitzen
 RU Набор кернов для мебельных шкантов
 CZ Značičí hroty pro kolikování
 RO Cep pt. centrare
 HU Tipli jelölő
 ES Centradores

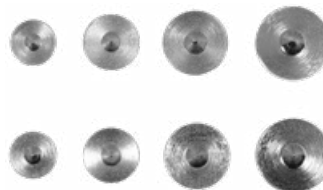

VOREL

No.	Ø [mm]	pcs / szt.	
24060	6 x2, 8 x2, 10 x2, 12 x2	8	20/120

EN Pocket hole cutter set
 PL Zestaw do połączeń kieszeniowych
 DE Taschenbohrlehre Satz
 RU Комплекты для карманного соединения
 CZ Šikmý otvor lokátor
 RO Set pt. cepuri lemn
 HU Zsebfurat-szűrő készlet
 ES Juego para agujeros de bolsillo



Ø9.5x3.5 mm;
 115x25x25 mm; 9.5 mm;

VOREL

No.	
24091	10/40

EN Pocket hole plugs
 PL Zasklepki do otworów kieszeniowych
 DE Stöpsel zum Verschließen von Taschenlochbohrungen
 RU Заглушки для карманных отверстий
 CZ Zátky do šikmých otvorů
 RO Cepuri lemn
 HU Zsebfurat kitöltő
 ES Tapones para agujeros de bolsillo

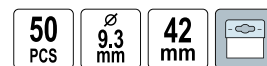

VOREL

No.	Ø [mm]	L [mm]	pcs / szt.	
24095	9.3	42	50	100



No.	Size / Rozmiar	pcs / szt.	
24300	M3	3	25/100
24310	M4	3	25/100
24320	M5	3	25/100
24330	M6	3	25/100
24340	M7	3	25/100
24350	M8	3	25/100

No.	Size / Rozmiar	pcs / szt.	
24370	M10	3	25/100
24390	M12	3	25/100
24410	M14	3	20
24430	M16	3	20
24450	M18	3	20
24470	M20	3	20

EN Machine tap
 PL Gwintownik maszynowy
 DE Maschinengewindebohrer
 RU Метчик машинный

CZ Strojní závitník
 RO Tarod de mașină
 HU Gépi menetfűrő
 ES Macho mecanico



No.	Size / Rozmiar	
24960	M3	25/100
24961	M4	25/100
24962	M5	25/100
24963	M6	25/100
24964	M8	25/100
24965	M10	25/100
24966	M12	25/100

EN Hand tap set
 PL Komplet gwintowników
 DE Innengewindebohrersatz
 RU Набор метчиков
 CZ Souprava závitníků
 RO Set de tarozi
 HU Menetfűrő készlet
 ES Juego de machos de roscar



No.	Size / Rozmiar	pcs / szt.	
24940	M3, M4, M5, M6, M7, M8, M10, M12	25	60

EN Ratchet tap wrench
 PL Grzechotka do gwintownika
 DE Gewindebohrerratsche
 RU Вороток для метчиков с трещоткой
 CZ Řečtačka na závitník
 RO Cheie cu clichet pt. tarod
 HU Racsnis hajtászár menetfűrőhoz
 ES Carraca para macho de roscar



No.	Size / Rozmiar	
24700	M3-M8	25/100
24710	M5-M12	25/100

EN Circular die
 PL Narzynka
 DE Schneideisen
 RU Плашка
 CZ Kruhová závitová čelist
 RO Filieră
 HU Menetvágó
 ES Cojinete de roscar



cztool

No.	Size / Rozmiar	
24500	M3	25/100
24510	M4	25/100
24520	M5	25/100
24530	M6	25/100
24550	M8	25/100
24570	M10	25/100
24590	M12	25/100
24610	M14	25/100
24630	M16	15/60
24650	M18	30/60
24670	M20	15/60

EN Tap and die set
 PL Komplet gwintowników i narzynek
 DE Gewindeschneidwerkzeugsatz
 RU Набор плашек и метчиков
 CZ Souprava závitníků a kruhových závitových čelistí
 RO Set de tarozi și filiere
 HU Menetfűrő és menetvágó készlet
 ES Juego de machos de roscar y cojinetes



No.	Size / Rozmiar	pcs / szt.	
24900	M3, M4, M5, M6, M8, M10, M12	32	10

EN Tap wrench
 PL Pokrętko do gwintownika
 DE Windeisen
 RU Вороток для метчиков
 CZ Ovládací kolečko na závitník
 RO Cheie (măner) pt. tarod
 HU Hajtászár menetfűrőhoz
 ES Llave giramachos



No.	Size / Rozmiar	
24730	M4-M8	30
24740	M9-M12	25
24750	M13-M18	20

EN Die holder
 PL Oprawka do narzynek
 DE Schneisenhalter
 RU Плашкодержатель
 CZ Závítová objímka
 RO Portfilieră
 HU Menetvágó tartó
 ES Portacojinele



No.	Size / Rozmiar	
24800	M3-M6	30
24810	M7-M9	25
24813	M10-M11	25
24820	M12-M14	30
24823	M15-M16	20

EN Screw extractor set
 PL Wykrętki do zerwanych śrub
 DE Schraubenausdrehersatz
 RU Набор для извлечения обломанных болтов
 CZ Vrtáky do přetržených šroubu
 RO Capete pt. deșurubat șuruburi rupte
 HU Törtcsavar kiszedő készlet
 ES Destornillador para tornillos arrancados



No.	Size / Rozmiar	pcs / szt.	
24000	1/8" (3.2 mm) - 1/4" (6.3 mm), 1/4" (6.3 mm) - 5/16" (7.9 mm), 5/16" (7.9 mm) - 7/16" (11.1 mm), 7/16" (11.1 mm) - 9/16" (14.3 mm), 9/16" (14.3 mm) - 3/4" (19.0 mm)	5	12/120

EN Router bit set
 PL Zestaw frezów do drewna
 DE Oberfräsersatz
 RU Набор фрез по дереву
 CZ Souprava frézů do dřeva
 RO Set de freze pt. lemn
 HU Medőjofrezf komplektas
 ES Juego de frezas para madera



No.	Toolholder size / Rozmiar uchwyty narzędziowego [mm]	pcs / szt.	
22550	8	12	5/20

EN Router bit set
 PL Zestaw frezów do drewna
 DE Oberfräsersatz
 RU Набор фрез по дереву
 CZ Souprava frézů do dřeva
 RO Set de freze pt. lemn
 HU Medőjofrezf komplektas
 ES Juego de frezas para madera

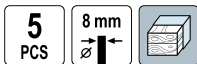

No.	Ø [mm]	Toolholder size / Rozmiar uchwyty narzędziowego [mm]	pcs / szt.	
22551	15, 20, 25, 30, 35	8	5	5/20

EN Tap and die set
 PL Komplet gwintowników i narzynek
 DE Gewindeschneidwerkzeugsatz
 RU Набор плашек и метчиков
 CZ Souprava závitníků a kruhových závitových čelistí
 RO Set de tarozi și filiere
 HU Menetfúró és menetvágó készlet
 ES Juego de machos de roscar y cojinetes



No.	Size / Rozmiar	
24295	M3, M4, M5, M6, M8, M10, M12, M3-M12, M3-M12	10/20

EN Router bit set
 PL Zestaw frezów do drewna
 DE Oberfräsersatz
 RU Набор фрез по дереву
 CZ Souprava frézů do dřeva
 RO Set de freze pt. lemn
 HU Medőjofrezf komplektas
 ES Juego de frezas para madera

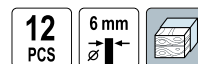

No.	Ø [mm]	Toolholder size / Rozmiar uchwyty narzędziowego [mm]	pcs / szt.	
22552	6, 12, 12.7, 16, 22, 25.4, 28.6, 32	6	12	20

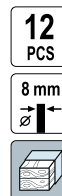

EN Rotary file set
 PL Tarniki trzpieniowe
 DE Profil-Fräser Satz
 RU Набор фрез
 CZ Hrotové rašple
 RO Răspeluri cu coadă
 HU Fareszelőkészlet, csapszáras
 ES Rotatorio archivos



No.	pcs / szt.	
25405	6	50/300

EN Diamond blade segmented
 PL Tarcza diamentowa "segment"
 DE Diamantrennscheibe
 RU Диск алмазный сегментированный

CZ Diamantový kotouč segmentový
 RO Disc diamantat segmentat
 HU Szegegens gyémántkorong
 ES Disco de diamante de segmentos



No.	Ø [mm]	max C [min ⁻¹]	
08711	115	12000	20/200
08712	125	11000	20/160
08714	180	8000	15/60
08715	230	6500	10/40

EN Diamond blade continuous rim
 PL Tarcza diamentowa pełna
 DE Diamantrennscheibe
 RU Диск алмазный сплошной

CZ Diamantový kotouč plyný
 RO Disc diamantat margine continua
 HU Gyémántkorong (teljes)
 ES Disco de diamante



No.	Ø [mm]	max C [min ⁻¹]	
08731	115	12000	20/200
08732	125	11000	20/160
08734	180	8000	15/60
08735	230	6500	10/40

EN Diamond blade turbo
 PL Tarcza diamentowa turbo
 DE Diamantrennscheibe Turbo
 RU Отрезной алмазный диск турбо

CZ Diamantový kotouč turbo
 RO Disc diamantat turbo
 HU Gyémántkorong turbo
 ES Disco de diamante turbo



No.	Ø [mm]	max C [min ⁻¹]	
08751	115	12000	20/200
08752	125	11000	20/160
08754	180	8000	15/60
08755	230	6500	10/40

EN Diamond blade segmented
 PL Tarcza diamentowa "segment"
 DE Diamantrennscheibe
 RU Диск алмазный сегментированный

CZ Diamantový kotouč segmentový
 RO Disc diamantat segmentat
 HU Szegegens gyémántkorong
 ES Disco de diamante de segmentos



No.	Ø [mm]	Mounting hole diameter / Średnica mocowania [mm]	Cutting segment thickness / Grubość segmentu tnącego [mm]	Cutting segment height / Wysokość segmentu tnącego [mm]	max C [min ⁻¹]	
08780	115	22.2	1.9	7	13200	20/120
08781	125	22.2	2.0	7	12000	20/120
08782	180	22.2	2.3	7	8400	15/45
08783	230	22.2	2.4	7	6600	10/30

EN Diamond blade continuous rim
 PL Tarcza diamentowa pełna
 DE Diamantrennscheibe
 RU Диск алмазный сплошной
 CZ Diamantový kotouč plyný
 RO Disc diamantat margine continua
 HU Gyémántkorong teljes
 ES Disco de diamante



No.	Ø [mm]	Mounting hole diameter / Średnica mocowania [mm]	Cutting segment thickness / Grubość segmentu tnącego [mm]	Cutting segment height / Wysokość segmentu tnącego [mm]	max C [min ⁻¹]	
08785	115	22.2	1.9	5	13200	20/120
08786	125	22.2	2.0	5	12000	20/120
08787	180	22.2	2.3	5	8400	15/45
08788	230	22.2	2.4	5	6600	10/30

EN Diamond blade turbo
 PL Tarcza diamentowa turbo
 DE Diamantrennscheibe Turbo
 RU Отрезной алмазный диск турбо
 CZ Diamantový kotouč turbo
 RO Disc diamantat turbo
 HU Gyémántkorong turbo
 ES Disco de diamante turbo



No.	Ø [mm]	Mounting hole diameter / Średnica mocowania [mm]	Cutting segment thickness / Grubość segmentu tnącego [mm]	Cutting segment height / Wysokość segmentu tnącego [mm]	max C [min ⁻¹]	
08790	115	22.2	2.0	7.0	13200	20/120
08791	125	22.2	2.1	7.0	12000	20/120
08792	180	22.2	2.4	7.5	8400	15/45
08793	230	22.2	2.6	7.5	6600	10/30

- EN Diamond rod saw
- PL Brzeszczot diamentowy
- DE Diamantsägekordel
- RU Полотно алмазное
- CZ Lanko pivoľe diamentowe
- RO Panze diamentate
- HU Fűrészlap-pálca, gyémántbevonatú
- ES Hoja de sierra de diamante



No.	L [mm]	
27575	300	20/100

- EN TCT circular saw blade for aluminium
- PL Pila tarczowa do aluminium z węglikiem wolframu
- DE Hartmetallbestückt Kreissägeblatt für Aluminium
- RU Диск пильный по алюминию
- CZ Kotočová pila na hliník s karbidem wolframu
- RO Disc circular pt. aluminiu
- HU Wolframkarbidos körfűrészlap, alumíniumhoz
- ES Disco de sierra con carbono



No.	Ø [mm]	Ød [mm]	max C [min ⁻¹]	Cutting segment thickness / Grubość segmentu tnącego [mm]	Metal disc thickness / Grubość tarczy [mm]	T	
08853	210	30	6500	2.2	1.6	72	10/20
08854	250	30	5400	3.0	1.8	100	10/20
08855	300	30	4500	3.2	2.0	100	10

- EN Metal cutting disc
- PL Tarcza do cięcia metalu
- DE Trennscheibe für Metall
- RU Диск отрезной по металлу
- CZ Kotoč pro řezání kovu
- RO Disc debitat metale
- HU Vágókorong fémhez
- ES Disco cortador para metal



No.	Ø [mm]	Mounting hole diameter / Średnica mocowania [mm]	Cutting segment thickness / Grubość segmentu tnącego [mm]	max C [min ⁻¹]	
08630	115	22	1.0	12000	25/200
08633	115	22	2.5	13300	25/200
08631	125	22	1.0	11000	25/200
08635	125	22	2.5	12200	25/200
08639	230	22	1.6	6600	25/50
08640	230	22	3.2	6600	25/50
08641	230	22	2.5	6600	25/50
08642	300	32	3.2	5100	10/20
08644	350	32	3.5	4400	10/20
08646	400	32	4.0	3800	10/20

- EN TCT circular saw blade for wood
- PL Pila tarczowa do drewna z węglikiem wolframu
- DE Kreissägeblatt HM-Bestückt
- RU Диск пильный с карбидом вольфрама
- CZ Kotočová pila na dřevo z karbidem wolframu
- RO Ferăstrău circular cu dinți din wolfram pt. lemn
- HU Wolframkarbidos körfűrész fához
- ES Disco de sierra con carbono de tungsteno



No.	Ø [mm]	Ød [mm]	max C [min ⁻¹]	Cutting segment thickness / Grubość segmentu tnącego [mm]	Metal disc thickness / Grubość tarczy [mm]	T	
08811	140	20	9600	2.0	1.3	16	25/50
08819	160	20	8300	2.0	1.4	18	25/50
08820	160	30	8300	2.0	1.4	24	25/50
08821	160	30	8300	2.0	1.4	36	25/50
08822	160	20	8300	2.0	1.4	48	25/50
08825	184	30	7400	2.2	1.4	24	10/20
08827	184	30	7400	2.2	1.4	40	10/20
08828	185	20	7400	2.2	1.4	18	10/20
08829	200	30	6500	2.2	1.6	24	10/20
08831	210	30	6500	2.2	1.6	40	10/20
08832	210	30	6500	2.2	1.6	60	10/20
08833	250	30	5400	3.0	1.8	24	10/20
08834	250	30	5400	3.0	1.8	40	10/20
08835	250	30	5400	3.0	1.8	60	10/20
08837	300	30	4500	3.2	2.0	40	10
08838	300	30	4500	3.2	2.0	60	10
08845	350	30	3800	3.2	2.2	40	10
08851	400	30	3300	3.2	2.2	60	10

- EN Metal cutting disc
- PL Tarcza do cięcia metalu
- DE Trennscheibe für Metall
- RU Диск отрезной по металлу
- CZ Kotoč pro řezání kovu
- RO Disc debitat metale
- HU Vágókorong fémhez
- ES Disco cortador para metal



No.	Ø [mm]	Mounting hole diameter / Średnica mocowania [mm]	Cutting segment thickness / Grubość segmentu tnącego [mm]	max C [min ⁻¹]	
08170	115	22	1.0	13200	25/200
08174	115	22	3.0	13200	25/200
08171	125	22	1.0	12200	25/200
08175	125	22	3.0	12200	25/200

EN Metal grinding disc - depressed centre
 PL Tarcza do szlifowania metalu wypukła
 DE Metall-Schleifscheibe gewölbt
 RU Диск шлифовальный по металлу

CZ Kotouč pro broušení kovu
 RO Disc pt. șlefuit metal
 HU Vágókorong fémhez
 ES Disco de pulir de metalo



VOREL

No.	Ø [mm]	Mounting hole diameter / Średnica mocowania [mm]	Cutting segment thickness / Grubość segmentu tnącego [mm]	max. C [min ⁻¹]	
08663	115	22	6.0	13300	25/100
08665	125	22	6.8	11000	25/100
08669	230	22	6.8	6600	25/50

EN Stone cutting disc
 PL Tarcza do cięcia kamienia
 DE Stein-Trennscheibe
 RU Диск отрезной по камню
 CZ Kotouč pro řezání kamene
 RO Disc pt. tăiat piatră
 HU Vágókorong kőhöz
 ES Disco cortador de piedra



VOREL

No.	Ø [mm]	Mounting hole diameter / Średnica mocowania [mm]	Cutting segment thickness / Grubość segmentu tnącego [mm]	max. C [min ⁻¹]	
08671	115	22	3.2	13200	25/200
08672	125	22	3.2	12200	25/200
08674	230	22	3.2	6600	25/50

EN Abrasive disc
 PL Ścierniaka listkowa talerzowa
 DE Lameller
 RU Диск лепестковый

CZ Kotouč brusný lamelový
 RO Disc abraziv
 HU Lamellás csiszoló
 ES Disco abrasivo



VOREL

No.	Grit / Ziamistość	Ø [mm]	max. C [min ⁻¹]	
07974	P40	115	13300	50/200
07984	P40	125	12300	50/200
07975	P60	115	13300	50/200
07985	P60	125	12300	50/200
07976	P80	115	13300	50/200
07986	P80	125	12300	50/200
07977	P100	115	13300	50/200
07987	P100	125	12300	50/200
07978	P120	115	13300	50/200
07988	P120	125	12300	50/200

EN Metal grinding disc - depressed centre
 PL Tarcza do szlifowania metalu wypukła
 DE Metall-Schleifscheibe gewölbt
 RU Диск шлифовальный по металлу выпуклый
 CZ Kotouč pro broušení kovu
 RO Disc pt. șlefuit metal
 HU Vágókorong fémhez
 ES Disco de pulir de metalo



STHÖR

No.	Ø [mm]	Mounting hole diameter / Średnica mocowania [mm]	Cutting segment thickness / Grubość segmentu tnącego [mm]	max. C [min ⁻¹]	
08190	115	22	6	13200	25/100
08191	125	22	6	12200	25/100

EN Stone grinding disc - depressed centre
 PL Tarcza do szlifowania kamienia wypukła
 DE Stein-Schleifscheibe gewölbt
 RU Диск шлифовальный по камню
 CZ Kotouč pro broušení kamene
 RO Disc pt. șlefuit piatră
 HU Csiszolókorong kőhöz
 ES Disco de pulir de piedra



VOREL

No.	Ø [mm]	Mounting hole diameter / Średnica mocowania [mm]	Cutting segment thickness / Grubość segmentu tnącego [mm]	max. C [min ⁻¹]	
08683	125	22	6.8	11000	25/100

EN Grinding disc
 PL Tarcza do szlifierki stolowej
 DE Schleifscheibe
 RU Круг для настольного точильного станка
 CZ Brusný kotouč
 RO Discul abraziv
 HU Kőszűrűkő
 ES Disco abrasivo



VOREL

No.	Ø [mm]	Mounting hole diameter / Średnica mocowania [mm]	Thickness / Grubość [mm]	max. C [min ⁻¹]	
08876	200	20	40	3850	5

- EN Grinding disc
- PL Tarcza do szlifierki stolowej
- DE Schleifscheibe
- RU Круг для настольного точильного станка
- CZ Brusný kotouč
- RO Discul abraziv
- HU Kőszűrű
- ES Disco abrasivo



No.	Ø [mm]	Mounting hole diameter / Średnica mocowania [mm]	Thickness / Grubość [mm]	max. ω [min ⁻¹]	Grit / Ziarnistość	
08860	125	12.7	17	5850	gruboziairny	10
08861	125	12.7	17	5850	drobnoziairny	10
08864	150	12.7	16	5350	gruboziairny	10
08865	150	12.7	17	5350	drobnoziairny	10
08868	150	31.8	25	5350	gruboziairny	10
08869	150	31.8	25	5350	drobnoziairny	10
08873	200	15.9	20	3850	drobnoziairny	10
08875	200	31.8	30	3850	drobnoziairny	10

- EN Figure tin snips
- PL Nożyce do blachy
- DE Blechscherer
- RU Ножницы по металлу
- CZ Nůžky na plech
- RO Foarfece pt. tablă
- HU Lemezvágó olló
- ES Tijeras para hojalata



No.	L [mm]	Max. cutting capacity in cold-rolled steel / Maks. grubość cięcia w stali walcowanej na zimno [mm]	
48000	250	1.5	6/36

- EN Figure tin snips
- PL Nożyce do blachy
- DE Blechscherer
- RU Ножницы по металлу
- CZ Nůžky na plech
- RO Foarfece pt. tablă
- HU Lemezvágó olló
- ES Tijeras para hojalata



No.	L [mm]	Max. cutting capacity in cold-rolled steel / Maks. grubość cięcia w stali walcowanej na zimno [mm]	
48080	250	1	6/36

- EN Grinding wheel dresser
- PL Przyrząd do wyrównywania tarcz szlifierskich
- DE Schleifscheiben-Abrichter
- RU Шарошка для выравнивания абразивных дисков
- CZ Zařízení pro vyrovnávání brusných kotoučů
- RO Dresser cu roată de șlefuit
- HU Csiszolókorong szabályzó
- ES Rectificador de muelas abrasivas

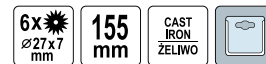

No.	L [mm]	
08900	155	12/48

- EN Figure tin snips
- PL Nożyce do blachy
- DE Blechscherer
- RU Ножницы по металлу
- CZ Nůžky na plech
- RO Foarfece pt. tablă
- HU Lemezvágó olló
- ES Tijeras para hojalata



No.	L [mm]	Max. cutting capacity in cold-rolled steel / Maks. grubość cięcia w stali walcowanej na zimno [mm]	
48060	250	1.2	6/48

- EN Figure tin snips
- PL Nożyce do blachy
- DE Blechscherer
- RU Ножницы по металлу
- CZ Nůžky na plech
- RO Foarfece pt. tablă
- HU Lemezvágó olló
- ES Tijeras para hojalata



No.	L [mm]	
48100	250	6/60

EN Figure tin snips
 PL Nożyce do blachy
 DE Blechscherer
 RU Ножницы по металлу
 CZ Nůžky na plech
 RO Foarfece pt. tablă
 HU Lemezvágó olló
 ES Tijeras para hojalata



VOREL

No.	L [mm]	Max. cutting capacity in cold-rolled steel / Maks. grubość cięcia w stali walcowanej na zimno [mm]	
48082	250	1	6/36

EN Figure tin snips
 PL Nożyce do blachy
 DE Blechscherer
 RU Ножницы по металлу
 CZ Nůžky na plech
 RO Foarfece pt. tablă
 HU Lemezvágó olló
 ES Tijeras para hojalata

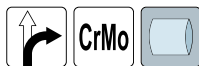

VOREL

No.	L [mm]	Max. cutting capacity in cold-rolled steel / Maks. grubość cięcia w stali walcowanej na zimno [mm]	
48050	250	1.5	6/36

EN Figure tin snips
 PL Nożyce do blachy
 DE Blechscherer
 RU Ножницы по металлу
 CZ Nůžky na plech
 RO Foarfece pt. tablă
 HU Lemezvágó olló
 ES Tijeras para hojalata



VOREL

No.	L [mm]	Max. cutting capacity in cold-rolled steel / Maks. grubość cięcia w stali walcowanej na zimno [mm]	
48081	250	1	6/36

EN Figure tin snips
 PL Nożyce do blachy
 DE Blechscherer
 RU Ножницы по металлу
 CZ Nůžky na plech
 RO Foarfece pt. tablă
 HU Lemezvágó olló
 ES Tijeras para hojalata



No.	L [mm]	pcs / szt.	
48330	250	3	5/20

EN Figure tin snips
 PL Nożyce do blachy
 DE Blechscherer
 RU Ножницы по металлу
 CZ Nůžky na plech
 RO Foarfece pt. tablă
 HU Lemezvágó olló
 ES Tijeras para hojalata

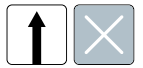

No.	L [mm]	
48200	250	6/60

EN Figure tin snips
 PL Nożyce do blachy
 DE Blechscherer
 RU Ножницы по металлу
 CZ Nůžky na plech
 RO Foarfece pt. tablă
 HU Lemezvágó olló
 ES Tijeras para hojalata



VOREL

No.	L [mm]	Max. cutting capacity in cold-rolled steel / Maks. grubość cięcia w stali walcowanej na zimno [mm]	
48070	250	1.2	6/48

EN Figure tin snips
 PL Nożyce do blachy
 DE Blechscherer
 RU Ножницы по металлу

CZ Nůžky na plech
 RO Foarfece pt. tablă
 HU Lemezvágó olló
 ES Tijeras para hojalata



No.	L [mm]	
48150	250	6/60

EN Bolt cutter
 PL Nożyce do drutu
 DE Drahtschere
 RU Болторез

CZ Nůžky na drát
 RO Clește pt. buloane
 HU Drótvágó olló
 ES Tijeras para alambre



No.	L [mm]	
49200	200	15/60

EN Bolt cutter
 PL Nożyce do prętów
 DE Bolzenschneider
 RU Болторез

CZ Nůžky na tyče
 RO Clește pt. buloane
 HU Kábelvágó olló
 ES Tijeras para barras



No.	L [mm]	
49450	450	20
49600	600	1/10

EN Miter shears
 PL Nożyce wielofunkcyjne do węży, rurek, listew
 DE Mitre Scheren
 RU Ножницы угловые для пластмассовых и резиновых профилей
 CZ Úhlové nůžky
 RO Foarfeca de mana pt. taiat garnituri
 HU Gérvágó olló
 ES Tijeras multifuncionales para mangueras, tubos, molduras

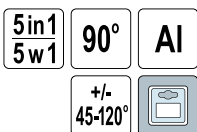

8



No.	Hose diameter / Srednica węża [mm]	
48350	17, 20, 27	6/24

EN Hand saw for wood
 PL Pila do drewna
 DE Handsäge
 RU Пила по дереву

CZ Pila na dřevo
 RO Fierastrău „coada de vulpe” pt. lemn
 HU Fafűrész, egyenes
 ES Sierra de mano



No.	L [mm]	
28380	400	10/40
28381	450	10/40
28382	500	10/40

EN Hand saw for wood
 PL Pila do drewna
 DE Handsäge
 RU Пила по дереву

CZ Pila na dřevo
 RO Fierastrău „coada de vulpe” pt. lemn
 HU Fafűrész, egyenes
 ES Sierra de mano

No.	L [mm]	
28394	400	12/60
28395	450	12/60

EN Bolt cutter
 PL Nożyce do prętów profesjonalne
 DE Bolzenschneider
 RU Болторез „ПРОФИ”
 CZ Nůžky na tyče
 RO Clește pt. buloane
 HU Kábelvágó olló
 ES Tijeras para barras



No.	L [mm]	Max. cutting diameter / Maks. średnica cięcia [mm]	
49770	350	6	1/24
49771	450	8	1/12
49772	600	10	1/12
49773	750	12	6
49774	900	14	4
49775	1050	16	2

EN Hand saw for wood
 PL Pila płatnica
 DE Handsäge
 RU Пила по дереву
 CZ Pila na dřevo
 RO Fierastrău „coada de vulpe” pt. lemn
 HU Fafűrész, egyenes
 ES Sierra de mano

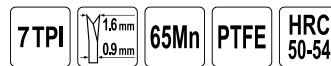

No.	L [mm]	
28385	400	12/48
28386	450	10/40
28387	500	10/40



EN Bow saw
PL Pila kabląkowa
DE Bügelsäge
RU Лучковая пила по дереву

CZ Oblouková pila
RO Ferăstrău de curbură
HU Keretes fűrész
ES Sierra de arco



No.	L [mm]	
28740	525	24
28750	750	24

EN Bow saw
PL Pila kabląkowa
DE Bügelsäge
RU Лучковая пила по дереву

CZ Oblouková pila
RO Ferăstrău de curbură
HU Keretes fűrész
ES Sierra de arco



FLO

No.	L [mm]	
28746	610	12/24
28755	760	12/24

EN Compass saw
PL Pila otwornica
DE Astsäge
RU Пила выкружная

CZ Pila otvornice
RO Ferăstrău coadă de șoarece
HU Lyukfűrész
ES Sierra compas

300
mm



No.	L [mm]	
28650	300	30/120

EN Saw for gas concrete
PL Pila do gazobetonu
DE Gasbetonsäge
RU Пила по газобетону с твердосплавным зубом
CZ Pila na plynobeton
RO Fierastrau cu placute vidia pt. BCA
HU Fűrész gázbetonhoz
ES Sierra para gas hormigon



VOREL

No.	L [mm]	T	
28011	600	15	6/12
28012	660	34	6/12

EN Bow saw
PL Pila kabląkowa
DE Bügelsäge
RU Лучковая пила по дереву
CZ Oblouková pila
RO Ferăstrău de curbură
HU Keretes fűrész
ES Sierra de arco



FLO

No.	L [mm]	
28745	530	12/24

EN Spare blade for bow saw
PL Brzeszczot
DE Bügelsägeblatt
RU Полотно для лучковой пилы по сырому дереву
CZ Ostří na dřevo
RO Panza fierastrau tip arc
HU Fűrészlap fához
ES Hoja de sierra



FLO

No.	L [mm]	W [mm]	
28771	530	20	60/240
28772	610	20	60/240
28773	760	20	60/240

EN Saw for gas concrete
PL Pila do gazobetonu
DE Gasbetonsäge
RU Пила по газобетону с твердосплавным зубом
CZ Pila na plynobeton
RO Fierastrau cu placute vidia pt. BCA
HU Fűrész gázbetonhoz
ES Sierra para gas hormigon

600
mm



No.	L [mm]	T	
28000	600	33	5
28010	600	17	5

EN Hacksaw frame
PL Pila do metalu
DE Metallsägebogen
RU Ножовка по металлу
CZ Pila na kov
RO Ferăstrău pt. metal
HU Fémfűrész
ES Sierra de metalo

300
mm



No.	L [mm]	
27000	300	12/48

EN Hacksaw frame
 PL Pila do metalu
 DE Metallsägebogen
 RU Ножовка по металлу
 CZ Pila na kov
 RO Ferăstrău pt. metal
 HU Fémfűrész
 ES Sierra de metalo



No.	L [mm]	
27100	250-300	12/60

EN Hacksaw frame
 PL Pila do metalu
 DE Metallsägebogen
 RU Ножовка по металлу
 CZ Pila na kov
 RO Ferăstrău pt. metal
 HU Fémfűrész
 ES Sierra de metalo

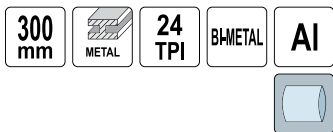

VOREL

No.	L [mm]	
27322	300	6/36

EN Hacksaw frame
 PL Pila do metalu
 DE Metallsägebogen
 RU Ножовка по металлу
 CZ Pila na kov
 RO Ferăstrău pt. metal
 HU Fémfűrész
 ES Sierra de metalo



No.	L [mm]	
27600	150	30/150

EN Multi-functional hand saw with multiple blades
 PL Pila wielofunkcyjna z zestawem akcesoriów
 DE Multifunktionale magische Säge
 RU Многофункциональная волшебная пила

CZ Multifunkční ruční dřevěná pila
 RO Fierastrau multifunctional cu lame de rezerva
 HU Varázs fűrész
 ES Sierra mágica multifuncional

INCLUDED:

- Multi-functional hand saw
- 6 universal blades 150 mm for wood, metal and plastics
- 2 diamond blades: round blade for glass and tiles, flat blade 6 mm
- 2 tile cutters
- Frame with round blade for cutting glass and with teeth for breaking glass or tiles
- Wing bolt
- Flat blade 175 x 20 mm for wood and plastics

W ZESTAWIE:

- Pila modelarska
- 6 uniwersalnych brzeszczotów 150 mm do drewna, metalu i tworzyw
- 2 brzeszczoty diamentowe: okrągły do ceramiki i szkła oraz płaski 6 mm
- 2 rysiki do ceramiki
- Rama z okrągłym nożem do cięcia szkła oraz wycięciami do łamania szkła lub ceramiki
- Nakrętka skrzydełkowa
- Brzeszczot płaski 175 x 20 mm do agresywnego cięcia drewna i tworzyw

VOREL

No.		
27610		30

EN Hacksaw frame
 PL Pila do metalu
 DE Metallsägebogen
 RU Ножовка по металлу
 CZ Pila na kov
 RO Ferăstrău pt. metal
 HU Fémfűrész
 ES Sierra de metalo

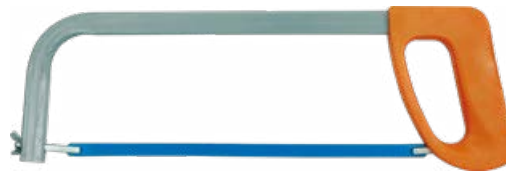

No.	L [mm]	
27200	300	20/60

EN Hacksaw frame
 PL Pila do metalu
 DE Metallsägebogen
 RU Ножовка по металлу
 CZ Pila na kov
 RO Ferăstrău pt. metal
 HU Fémfűrész
 ES Sierra de metalo



JUCO

No.	L [mm]	
27495	300	5

EN Hack saw set
 PL Zestaw pil do metalu
 DE Metallsägen
 RU Набор пил по металлу
 CZ Sada pil na kov
 RO Set bomfaiere
 HU Fémfűrész készlet
 ES Sierras de metal, juego

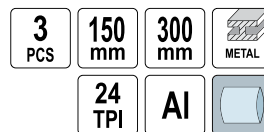

VOREL

No.	L [mm]	pcs / szt.	
27333	150, 300, 300	3	6/36



EN Cross - cut saw CZ Pila bříchatka
 PL Pila poprzeczna RO Joagar
 DE Bauchsäge HU Keresztvágó fűrész
 RU Пила двуручная ES Sierra para corte cruzado



No.	L [cm]	Type / Typ	
28790	100	L-1000	10

EN Precision miter saw – 2 angles
 PL Pila kątowa uchylna - 2 kąty cięcia
 DE Präzisionsgehrungssäge kipptbar
 RU Стусло металлическое наклонное „ПРОФИ”
 CZ Úhlová pila sklápěcí
 RO Fierastru de taiat la unghi in doua plane
 HU Kézifűrész, döntött
 ES Sierra de angulo desviable 2 angulos de corte



No.	Saw blade length / Długość brzoźczotu [mm]	Horizontal cutting angle / Kąt cięcia w płaszczyźnie poziomej [°]	
29050	550	45, 55, 60, 72, 90	1

EN Plastic miter box CZ Ustřihací skřítka z umělé hmoty
 PL Skrzynka uciosowa RO Cutie din plastic pt. taiat oblic
 DE Schneidlade HU Vágósablon műanyag
 RU Стусло пластмассовое ES Gría de ingletar de plástico



No.	Dimensions / Wymiary [mm]	
29311	250x45	70
29312	285x60	50

EN Precision miter saw
 PL Pila kątowa
 DE Präzisions-Gehrungssäge
 RU Стусло металлическое „ПРОФИ”
 CZ Úhlová pila
 RO Fierastru pt. taiat la unghi
 HU Kézifűrész
 ES Sierra de angulo

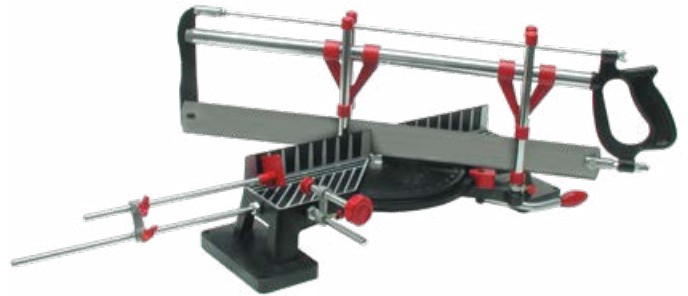
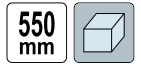

No.	Saw blade length / Długość brzoźczotu [mm]	Horizontal cutting angle / Kąt cięcia w płaszczyźnie poziomej [°]	
29000	550	22.5, 30, 36, 45, 90	1

EN Wooden miter box
 PL Drewniana skrzynka uciosowa
 DE Gehrungsschneidlade
 RU Стусло деревянное
 CZ Ustřihací skřítka dřevená
 RO Cutie din lemn pt. taiat oblic
 HU Vágósablon fa
 ES Gría de ingletar de madera

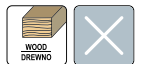

No.	Dimensions / Wymiary [mm]	
29210	300x80	10
29220	450x105	12

EN Plastic miter box CZ Ustřihací skřítka z umělé hmoty
 PL Skrzynka uciosowa RO Cutie din plastic pt. taiat oblic
 DE Schneidlade HU Vágósablon műanyag
 RU Стусло пластмассовое ES Gría de ingletar de plástico



No.	Dimensions / Wymiary [mm]	
29313	280x90	30

EN Plastic miter box
 PL Skrzynka uciósowa
 DE Schneidlade
 RU Ступно пластмассовое

CZ Ustřihací skříňka z umělé hmoty
 RO Cutie din plastic pt. tăiat oblic
 HU Vágósablon műanyag
 ES Gria de ingletar de plástico



No.	Dimensions / Wymiary [mm]	
29317	230x50	50
29318	250x65	50
29319	290x85	30

8

EN Sabre saw blades
 PL Brzeszczy do pily szablastej
 DE Säbelsägeblatt
 RU Пильное полотно
 CZ Pilový plátek do pily ocasky
 RO Pânză de ferăstrău sabie
 HU Szablyafűrészlap
 ES Hoja de sierra sable



No.	pcs / szt.	
27850	7	10/100

EN Hacksaw spare blades
 PL Brzeszczy
 DE Metallsägeblatt
 RU Полотно двустороннее

CZ Čepele
 RO Pânze
 HU Fémfűrészlap
 ES Hojas

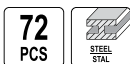

No.	Type / Typ	L [mm]	W [mm]	pcs / szt.	
27500	RAMb	300	25	72	10



No.	Type / Typ	L [mm]	W [mm]	pcs / szt.	
27501	RAMc	300	12	144	10



No.	Type / Typ	L [mm]	W [mm]	pcs / szt.	
27502	RAMa	300	12	144	10



No.	Type / Typ	L [mm]	W [mm]	pcs / szt.	
27505	RAMe	300	20	72	10

EN Plastic miter box
 PL Skrzynka uciósowa
 DE Schneidlade
 RU Ступно пластмассовое
 CZ Ustřihací skříňka z umělé hmoty
 RO Cutie din plastic pt. tăiat oblic
 HU Vágósablon műanyag
 ES Gria de ingletar de plástico



No.	Dimensions / Wymiary [mm]	
29323	325x125	18

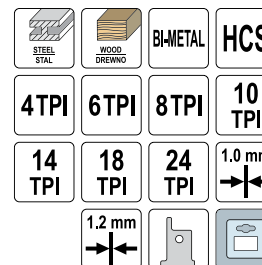

EN Hacksaw spare blades
 PL Brzeszczy
 DE Metallsägeblatt
 RU Полотно двустороннее
 CZ Čepele
 RO Pânze
 HU Fémfűrészlap
 ES Hojas

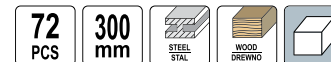

No.	Type / Typ	L [mm]	W [mm]	pcs / szt.	
27506	RAMf	300	20	72	10



No.	Type / Typ	L [mm]	W [mm]	pcs / szt.	
27510	RAMd	300	25	72	10

EN Hacksaw spare blade for metal
 PL Brzeszczot do metalu
 DE Metallsägeblatt
 RU Полотно по металлу
 CZ Pílový list na kov
 RO Panza fierastrau pt. metal
 HU Fémfűrészlap
 ES Hoja de sierra para metal

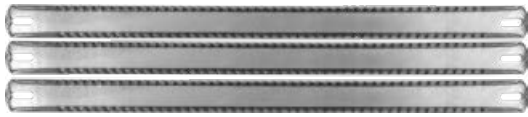
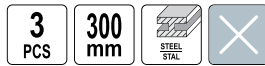

No.	Type / Typ	L [mm]	W [mm]	pcs / szt.	
27511	RAMb	300	25	3	50

EN Hacksaw spare blade for wood and metal
 PL Brzeszczot do drewna i metalu
 DE Sägeblatt für Holz und Metall
 RU Полотно по дереву и металлу
 CZ Pílový list na dřevo a kov
 RO Panza fierastrau pt. lemn si metal
 HU Fűrészlap fához és fémhez
 ES Hoja de sierra para madera y metal

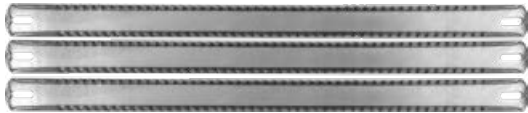
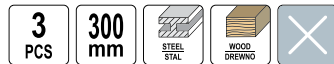

No.	Type / Typ	L [mm]	W [mm]	pcs / szt.	
27513	RAMd	300	25	3	50

EN Hacksaw spare blade for metal
 PL Brzeszczot do metalu
 DE Metallsägeblatt
 RU Полотно по металлу
 CZ Pílový list na kov
 RO Panza fierastrau pt. metal
 HU Fémfűrészlap
 ES Hoja de sierra para metal



No.	L [mm]	pcs / szt.	
27520	300	12	20/120

EN Hacksaw spare blade for wood and PVC
 PL Brzeszczot do drewna i PVC
 DE Sägeblatt für Holz und PVC
 RU Полотно по дереву и ПВХ
 CZ Pílový list na dřevo a PVC
 RO Panza fierastrau pt. lemn si PVC
 HU Fűrészlap fához és PVC-hez
 ES Hoja de sierra para madera y PVC



No.	L [mm]	W [mm]	Thickness / Grubość [mm]	TPI	
29090	550	45	0.7	18	50

EN Hacksaw spare blade for metal
 PL Brzeszczot do metalu
 DE Metallsägeblatt
 RU Полотно по металлу
 CZ Pílový list na kov
 RO Panza fierastrau pt. metal
 HU Fémfűrészlap
 ES Hoja de sierra para metal

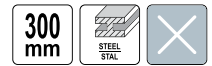

No.	Type / Typ	L [mm]	W [mm]	
27530	RAMb	300	25	70/700

EN Hacksaw spare blade for wood and metal
 PL Brzeszczot do drewna i metalu
 DE Sägeblatt für Holz und Metall
 RU Полотно по дереву и металлу
 CZ Pílový list na dřevo a kov
 RO Panza fierastrau pt. lemn si metal
 HU Fűrészlap fához és fémhez
 ES Hoja de sierra para madera y metal



No.	Type / Typ	L [mm]	W [mm]	
27533	RAMf	300	20	70/700

EN Hacksaw spare blade for metal
 PL Brzeszczot do metalu
 DE Metallsägeblatt
 RU Полотно по металлу
 CZ Pílový list na kov
 RO Panza fierastrau pt. metal
 HU Fémfűrészlap
 ES Hoja de sierra para metal



No.	L [mm]	pcs / szt.	
27800	150	10	8/120

EN Hacksaw spare blade for metal
 PL Brzeszczot do metalu
 DE Metallsägeblatt
 RU Полотно по металлу
 CZ Pílový list na kov
 RO Panza fierastrau pt. metal
 HU Fémfűrészlap
 ES Hoja de sierra para metal



No.	L [mm]	W [mm]	Thickness / Grubość [mm]	TPI	
29100	550	45	0.7	32	50

- GB Jig saw blades
 PL Brzeszczyty do wyrzynarki elektrycznej
 DE Stichsägeblätter
 RU Полотно для электролобика
- CZ Pilový list do přímočaré pily
 RO Panza fierastrau circular
 HU Dekopírlap
 ES Recambio sierra de calar

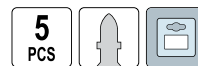

VOREL

6 TPI 1.5 mm

WOOD DREWNO PLYWOOD SKLEJKA PVC HCS 65Mn

No.	L [mm]	Working length / Długość robocza [mm]	pcs / szt.	
27811	100	75	5	100/400

VOREL

6 TPI 1.2 mm

WOOD DREWNO HCS 65Mn

No.	L [mm]	Working length / Długość robocza [mm]	pcs / szt.	
27813	100	75	5	100/400

VOREL

10 TPI 1.5 mm

WOOD DREWNO CHIPBOARD PLYTA WIDORWA HCS 65Mn

No.	L [mm]	Working length / Długość robocza [mm]	pcs / szt.	
27815	100	75	5	100/400

GB Jig saw blades
 PL Brzeszczyty do wyrzynarki elektrycznej
 DE Stichsägeblätter
 RU Полотно для электролобика
 CZ Pilový list do přímočaré pily
 RO Panza fierastrau circular
 HU Dekopírlap
 ES Recambio sierra de calar

5 PCS

VOREL

6 TPI 1.2 mm

WOOD DREWNO CHIPBOARD PLYTA WIDORWA HCS 65Mn

No.	L [mm]	Working length / Długość robocza [mm]	pcs / szt.	
27830	100	75	5	100/400

VOREL

6 TPI 1.5 mm

WOOD DREWNO PVC HCS 65Mn

No.	L [mm]	Working length / Długość robocza [mm]	pcs / szt.	
27831	100	75	5	100/400

VOREL

21 TPI 1.0 mm

STEEL STAL HSS M2

No.	L [mm]	Working length / Długość robocza [mm]	pcs / szt.	
27832	76	50	5	100/400

VOREL

10 TPI 1.5 mm

WOOD DREWNO PLYWOOD SKLEJKA HCS 65Mn

No.	L [mm]	Working length / Długość robocza [mm]	pcs / szt.	
27833	100	75	5	100/400

VOREL

STEEL STAL WOOD DREWNO PLYWOOD SKLEJKA PVC

No.	L [mm]	Working length / Długość robocza [mm]	pcs / szt.	
27834	100, 100, 76, 100, 70	75, 75, 50, 75, 45	5	100/400

VOREL

10 TPI 1.5 mm

WOOD DREWNO PLYWOOD SKLEJKA PVC HCS 65Mn

No.	L [mm]	Working length / Długość robocza [mm]	pcs / szt.	
27810	100	75	5	100/400

VOREL

8 TPI 1.2 mm

WOOD DREWNO CHIPBOARD PLYTA WIDORWA PVC HCS 65Mn

No.	L [mm]	Working length / Długość robocza [mm]	pcs / szt.	
27812	100	75	5	100/400

VOREL

21 TPI 1.0 mm

STEEL STAL HSS M2

No.	L [mm]	Working length / Długość robocza [mm]	pcs / szt.	
27814	76	50	5	100/400

VOREL

STEEL STAL CHIPBOARD PLYTA WIDORWA PLYWOOD SKLEJKA PVC

No.	L [mm]	Working length / Długość robocza [mm]	pcs / szt.	
27820	100, 100, 100, 76, 100	75, 75, 75, 50, 75	5	100/400

- EN Steel wire brush
 PL Szczotka drucziana
 DE Stahdrahtbürste
 RU Щетка стальная
 CZ Drátěný kartáč
 RO Perie de sarmă
 HU Drótkéfe
 ES Cepillo de acero



VOREL

No.	Row quantity / Liczba rzędów	
06930	3	12/120
06940	4	12/120
06950	5	12/120
06960	6	12/120

- EN Plastic handle wire brush set
 PL Komplet szczotek druczianych
 DE Bürstensatz
 RU Набор стальных щеток
 CZ Drátěný kartáče
 RO Set perii de sarma
 HU Kefekészlet
 ES Juego de cepillos
- 3 PCS BRASS MOSIADZ STEEL STAL NYLON



VOREL

No.	L [mm]	
06963	170	24/240
06964	220	24/72

EN Brass wire brush
 PL Szczotka druciana mosiężna
 DE Messingdrahtbürste
 RU Щетка проволочная латунная
 CZ Drátěný kartáč mosazný
 RO Perie de sârmă din alamă
 HU Réz drótkefe
 ES Cepillo de laton



VOREL

No.	Ø [mm]	max. ω [min ⁻¹]	Icon
06965			25/100

EN Circular brush - crimped wire
 PL Szczotka tarczowa, drut karbowany
 DE Stahldraht - Kegelfbürste
 RU Щетка-крацевка с гайкой

CZ Kotoučový kartáč, rýhovaný drát
 RO Perie rotundă, sârmă ondulată
 HU Tarcás drótkefe, sodrott dróttal
 ES Cepillo redondo de alambre ondulado



VOREL

No.	Ø [mm]	max. ω [min ⁻¹]	Icon
06972	100	12500	12/72
06973	115	12500	12/72

EN Circular brush - twisted wire
 PL Szczotka tarczowa z gwintem, drut splatany
 DE Stahldraht - Zopf - Kegelfbürste
 RU Щетка-крацевка-усиленная

CZ Kotoučový kartáč, pletený drát
 RO Perie rotativă, sârmă împletită
 HU Tarcás drótkefe, egyenes dróttal
 ES Cepillo redondo de alambre conico



VOREL

No.	Ø [mm]	max. ω [min ⁻¹]	Icon
06977	100	12500	12/48

EN Circular brush - twisted wire
 PL Szczotka tarczowa, drut splatany
 DE Stahldraht - Zopfscheibenbürste
 RU Дисковая щетка витая

CZ Kotoučový kartáč
 RO Perie rotativă
 HU Tarcás drótkefe
 ES Cepillo redondo de alambre conico

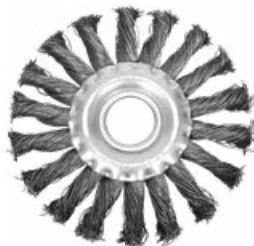

VOREL

No.	Ø [mm]	max. ω [min ⁻¹]	Icon
06981	100	11000	12/72
06982	115	11000	12/48
06983	150	9000	12/36

EN Cup brush - crimped wire
 PL Szczotka czolowa z gwintem, drut karbowany
 DE Stahldraht - Topfbürste
 RU Щетка-крацевка чашка с гайкой

CZ Čelní kartáč, rýhovaný drát
 RO Perie frontală, sârmă ondulată
 HU Homlok drótkefe, sodrott dróttal
 ES Cepillo de copa de alambre ondulado



VOREL

No.	Ø [mm]	max. ω [min ⁻¹]	Icon
06970	75	1200	12/72
06971	100	8500	6/24

EN Cup brush - twisted wire
 PL Szczotka czolowa z gwintem, drut splatany
 DE Stahldraht - Zopfopfbürste
 RU Щетка - крацевка круговая
 крученная щетка крацевка (чашка)

CZ Čelní kartáč, pletený drát
 RO Perie frontală, sârmă împletită
 HU Homlok drótkefe, sodrott dróttal
 ES Cepillo de copa de alambre conico



VOREL

No.	Ø [mm]	max. ω [min ⁻¹]	Icon
06974	65	12500	12/36
06975	80	8500	12/36
06976	100	8500	6/24

EN Circular brush - crimped wire
 PL Szczotka tarczowa, drut karbowany
 DE Stahldraht - Scheibenbürste
 RU Щетка-крацевка латунированная сталь

CZ Kotoučový kartáč
 RO Perie rotativă
 HU Tarcás drótkefe
 ES Cepillo redondo de alambre ondulado



VOREL

No.	Ø [mm]	max. ω [min ⁻¹]	Icon
06978	125	6000	12/72
06979	150	6000	12/36
06980	200	4500	12/24

EN Circular brush - crimped wire
 PL Szczotka tarczowa z trzpieniem, drut karbowany
 DE Stahldraht-Scheibenbürste
 RU Щетка круговая со стержнем

CZ Okružní kartáč drátěný se stopkou
 RO Perie rotundă pt. bormasina
 HU Tarcás drótkefe, nyéllel
 ES Cepillo redondo



VOREL

No.	Ø [mm]	max. ω [min ⁻¹]	Icon
06985	75	4500	10/120
06986	100	4500	12/120

- EN Cup brush – crimped wire
- PL Szczotka czolowa z trzpieniem, drut karbowany
- DE Stahldraht - Topfbürste
- RU Щетка-крацовка со стержнем чашка
- CZ Čelní kartáč, z hrotem, rýhovaný drát
- RO Perie frontală cu coadă, sârmă ondulată
- HU Homlok drótkefe, nyéllal, sodrott dróttal
- ES Cepillo de copa con mandril, de alambre ondulado



No.	Ø [mm]	max Ω [min ⁻¹]	
06987	50	4500	10/180
06988	75	4500	12/96

- EN Steel wire brush set
- PL Szczotki druciane okrągłe
- DE Stahldraht - Bürstensatz
- RU Набор щеток
- CZ Drátěné kartáče kulaté
- RO Perii de sârmă rotunde
- HU Kerek drótkefe
- ES Cepillos de alambre redontos



No.	max Ω [min ⁻¹]	
06990	4500	20/120

- EN Circular brush - twisted wire
- PL Szczotka tarczowa z trzpieniem, drut splatany
- DE Stahldraht - Scheibenbürste
- RU Щетка круговая со стержнем
- CZ Okružní kartáč drátěný se stopkou
- RO Perie rotundă pt. bormasina
- HU Tarcás drótkefe, nyéllal
- ES Cepillo redondo



No.	Ø [mm]	max Ω [min ⁻¹]	
06993	75	12500	30/180

- EN Rubber disc with velcro
- PL Przystawka z rzepem
- DE Klett - Haftstützleiler mit Dorn
- RU Насадка резиновая с шестигранным хвостовиком, для дрели
- CZ Přídavné zařízení ze zipem
- RO Disc-Suport cu scai pt. hârtie abrazivă rotundă
- HU Kistál tapadókoronggal
- ES Disco de goma con velcro



No.	Ø [mm]	max Ω [min ⁻¹]	
08312	125	2000	12/120

- EN Wire brush set
- PL Szczotki druciane z trzpieniem, drut karbowany
- DE Stahldraht-Bürstensatz
- RU Набор щеток-крацовок со стержнем
- CZ Okružní kartáč drátěný se stopkou
- RO Set perii sarma ondulata
- HU Tarcás drótkefe, nyéllal, sodrott dróttal
- ES Cepillos de alambre con mandril



No.	Ø [mm]	max Ω [min ⁻¹]	
06989	25, 50, 50	4500	12/60

- EN Cup brush – crimped wire
- PL Szczotka czolowa z trzpieniem, drut karbowany
- DE Stahldraht - Topfbürste
- RU Щетка-крацовка „КИСТЬ” со стержнем
- CZ Čelní kartáč, z hrotem, rýhovaný drát
- RO Perie frontală cu coadă, sârmă ondulată
- HU Homlok drótkefe, nyéllal, sodrott dróttal
- ES Cepillo de copa con mandril, de alambre ondulado



No.	Ø [mm]	max Ω [min ⁻¹]	
06992	24	4500	12/96

- EN Cup brush - twisted wire
- PL Szczotka czolowa z trzpieniem, drut splatany
- DE Stahldraht - Zopfrundbürste
- RU Щетка-крацовка витая со стержнем
- CZ Čelní kartáč, z hrotem, pletený drát
- RO Perie frontală cu coadă, sârmă împletită
- HU Homlok drótkefe, nyéllal, egyenes dróttal
- ES Cepillo de copa con mandril de alambre conico



No.	Ø [mm]	max Ω [min ⁻¹]	
06995	22	4500	24/192
06994	75	12500	12/96

- EN Rubber disc with arbor
- PL Przystawka-dysk z trzpieniem
- DE Klett - Haftteller + Ersatzdorn
- RU Насадка резиновая с шестигранным хвостовиком, для дрели
- CZ Nástavec-kotouč s upínacím trnem
- RO Disc cu știft, ajutăj
- HU Csiszoló korong nyéllal
- ES Disco de goma con mandril



No.	Ø [mm]	max Ω [min ⁻¹]	
08314	125	3250	20/120

EN Rubber disc for angle grinder with velcro
 PL Euro dysk do kątowniki z rzepem
 DE Klett - Haftsteller + Gewindeflansch
 RU Насадка пластиковая жесткая под круг на липучке
 CZ Euro disk do úhelníků ze zipem
 RO Suport disc abraziv, fixare scai
 HU Euro lemez élhez, tapadókoronggal
 ES Disco de goma para angul con velcro

Ø
125
mm

M14

HOOK
FASTENER
RZEP

VOREL

No.	Ø [mm]	max. ω [min ⁻¹]	
08315	125	12200	30/120

EN Rubber disc for angle grinder and drill machine
 PL Przystawka do szlifierek kątowych i wiertarek
 DE Klett - Haftstützteller mit Gewindeflansch und Ersatzdorn
 RU Насадка шлифовальная, гайка M14 с липучкой+ переход
 CZ Kotouč do úhelníků ze zipem
 RO Suport disc abraziv, fixare scai
 HU Euro lemez élhez, tapadókoronggal
 ES Disco de goma para ancul con mandril

Ø
125
mm

M14

HOOK
FASTENER
RZEP

VOREL

No.	Ø [mm]	max. ω [min ⁻¹]	
08316	125	12200	30/120

EN „Multi-disk“ rubber disc with velcro
 PL Tarcza gumowa „multi-dysk“ z rzepem
 DE Gummihafststützteller
 RU Насадка резиновая поворотная с липучкой, для дрели
 CZ Terč multi-dysk ze zipem
 RO Suport disc abraziv, fixare scai
 HU Multidisk tárcsa tapadókorong
 ES Multi-disco con velcro

Ø
125
mmHOOK
FASTENER
RZEP

PRO

No.	Ø [mm]	max. ω [min ⁻¹]	
08350	125	2000	20

EN Rubber disc for angle grinder with velcro
 PL Euro dysk do kątowniki z rzepem
 DE Klett - Haftstützteller mit Gewindeflansch
 RU Насадка пластиковая жесткая под круг на липучке
 CZ Euro disk do úhelníků ze zipem
 RO Euro disc cu scai pt. polizor unghiular
 HU Euro lemez élhez, tapadókoronggal
 ES Disco de goma para angul con velcro

HOOK
FASTENER
RZEP

PRO

No.	Ø [mm]	max. ω [min ⁻¹]	
08500	125	10000	20
08510	150	8500	20

EN Rubber disc for angle grinder with velcro
 PL Tarcza do kątowniki z rzepem
 DE Klett - Gummihafststützteller mit Gewindeflansch
 RU Насадка шлифовальная под круг на липучке
 CZ otouč do úhelníků ze zipem
 RO Suport disc abraziv, fixare scai
 HU Euro lemez élhez, tapadókoronggal
 ES Disco para el pulidor angular con sujetador velcro

Ø
125
mm

M14

HOOK
FASTENER
RZEP

VOREL

No.	Ø [mm]	max. ω [min ⁻¹]	
08318	125	12500	25/100

EN Rubber disc with velcro
 PL Przystawka z rzepem
 DE Klett - Haftstützteller mit Dorn
 RU Насадка резиновая с хвостовиком и липучкой для дрели
 CZ Přídavné zařízení ze zipem
 RO Suport disc abraziv, fixare scai
 HU Kistál tapadókoronggal
 ES Disco de goma con velcro

HOOK
FASTENER
RZEP

PRO

No.	Ø [mm]	max. ω [min ⁻¹]	
08400	125	2000	20

EN Rubber disc for angle grinder
 PL Euro dysk do kątowniki z trzpieniem
 DE Klett - Haftstützteller mit Gewindeflansch und Ersatzdorn
 RU Насадка шлифовальная, гайка M14 с липучкой + переход
 CZ Euro disk do úhelníků
 RO Euro disc cu scai pt. polizor unghiular
 HU Euro lemez élhez, tapadókoronggal
 ES Disco de goma para ancul con mandril

Ø
125
mmHOOK
FASTENER
RZEP

PRO

No.	Ø [mm]	max. ω [min ⁻¹]	
08501	125	10000	20

- EN Rubber disc for angle grinder with velcro
 PL Tarcza do kątówki z rzepem nr 2
 DE Klett - Gummihafstüttzeller mit Gewindeflansch
 RU Насадка шлифовальная под круг на липучке
 CZ Kotouč do úhelníků ze zipem číslo 2
 RO Disc de pásă la scai nr. 2 pt. polizor unghiular
 HU Euro lemez élhez, tapadókoronggal, 2 sz.
 ES Disco de goma para angul con velcro



PRO
EKO

No.	Ø [mm]	max. ω [min ⁻¹]	
08511	125	10000	20

- EN Polishing felt disc
 PL Filc polerski na rzep
 DE Filzpolierdisc
 RU Полировальная насадка из фетра на липучке
 CZ Leštící plstěnek na zip
 RO Disc pasla de lustruit cu scai
 HU Polirozó filc tapadókoronggal
 ES Fieltro de pulir con velcro



PRO
EKO

No.	Ø [mm]	max. ω [min ⁻¹]	
08522	125	10000	100

- EN Lock knife
 PL Nóż składany sierpak
 DE Klappmesser
 RU Нож складной
 CZ Dřevěný nůž srpek
 RO Cutit secera manier lemn
 HU Hajlított pengéjű kés, fanyelű
 ES Cuchillo falciforme de madera



VOREL

No.	Blade length / Długość ostrza [mm]	
76621	75	10/100

- EN Cable knife
 PL Nóż monterski
 DE Montagemesser
 RU Нож электрика
 CZ Montážní nůž
 RO Cutit pt. decablat
 HU Szerelőkés
 ES Cuchillo de montaje



No.	
76640	50

- EN Polishing felt disc
 PL Rzep do tarczy gumowej (przylepiec)
 DE Klettdisk für Gummistüttzeller
 RU Круг с липучкой
 CZ Zip do pryžového kotouče (suchý zip)
 RO Disc pasla de lustruit cu scai
 HU Tapadókorong gumitárcsához
 ES Velcro para disco de goma

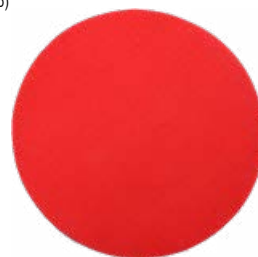

VOREL

No.	Ø [mm]	
08520	150	10/100
08521	125	10/100

- EN Folding knife
 PL Nóż składany
 DE Klappmesser
 RU Нож складной
 CZ Kapesní nůž
 RO Briceag
 HU Zsebkés
 ES Navaja



VOREL

No.	Blade size / Rozmiar ostrza [mm]	
76526	61x33x0.5	12/72

- EN Electrician's knife
 PL Nóż monterski składany
 DE Montagemesser
 RU Нож складной
 CZ Montážní nůž
 RO Cutit pt. decablat
 HU Szerelőkés
 ES Cuchillo de montaje



VOREL

No.	Blade length / Długość ostrza [mm]	
76622	85	10/100

- EN Cable knife
 PL Nóż monterski
 DE Montagemesser
 RU Нож электрика
 CZ Montážní nůž
 RO Cutit pt. decablat
 HU Szerelőkés
 ES Cuchillo de montaje



No.	
76650	50

EN Cable knife
 PL Nóż sierpak
 DE Klappmesser
 RU Нож садовый
 CZ Dřevěný nůž srpek
 RO Cutit secera maner lemn
 HU Hajlított pengéjű kés, fanyelű
 ES Cuchillo falciforme de madera



No.

76660



50

EN Spare blades for utility knife
 PL Ostrza zapasowe do nożyka
 DE Ersatz-Kurzklingen für Cuttermesser
 RU Запасные лезвия для ножа
 CZ Lomené ostrí náhradní
 RO Lame rezerva pt. cutter metallic
 HU Törhető tartalékpenge
 ES Filos de recambio para cuchillo

5
PCS

No.

76010

Blade size / Rozmiar ostrza [mm]

61x19

For / Dia

76000, 76011, 76015



100/600

EN Utility knife
 PL Nożyk z ostrzem trapezowym
 DE Cuttermesser
 RU Нож универсальный
 CZ Univerzální nůž s lichoběžníkovou čepelí
 RO Cuțit cu lamă trapezoidală retractabilă
 HU Univerzális kés
 ES Cuchillo con hoja trapezoidal



No.

76015

Blade size / Rozmiar ostrza [mm]

61x19



12/72

EN Metal utility knife
 PL Nożyk z łamanym ostrzem
 DE Abbrechklingen-Messer
 RU Нож строительный
 CZ Nůž ulamovací
 RO Cuțit universal (cutter)
 HU Univerzális kés
 ES Cuchillo de papelería



No.

76160

Blade width / Szerokość ostrza [mm]

9



24/288

EN Utility knife
 PL Nożyk z ostrzem trapezowym
 DE Cuttermesser
 RU Нож универсальный

CZ Univerzální nůž s lichoběžníkovou čepelí
 RO Cuțit cu lamă trapezoidală retractabilă
 HU Univerzális kés
 ES Cuchillo con hoja trapezoidal



No.

76000

Blade size / Rozmiar ostrza [mm]

61x19



25/200

EN Cutting knife with blade compartment
 PL Nóż instalacyjny z magazynkiem
 DE Universalmesser
 RU Нож обрешителный
 CZ Univerzální nůž
 RO Cutter cu maner metallic si compartiment pt. rezerva
 HU Univerzális kés
 ES Cutter con cargador



No.

76011

Blade size / Rozmiar ostrza [mm]

61x19



12/48

EN Metal utility knife
 PL Nożyk z łamanym ostrzem
 DE Abbrechklingen-Messer
 RU Нож строительный
 CZ Nůž ulamovací
 RO Cuțit universal (cutter)
 HU Univerzális kés
 ES Cuchillo de papelería



No.

76101

Blade width / Szerokość ostrza [mm]

9



60/360

EN Metal utility knife
 PL Nożyk z łamanym ostrzem
 DE Abbrechklingen-Messer
 RU Нож строительный
 CZ Nůž ulamovací
 RO Cuțit universal (cutter)
 HU Univerzális kés
 ES Cuchillo de papelería



No.

76184

Blade width / Szerokość ostrza [mm]

18



12/120

EN Metal utility knife
 PL Nożyk z łamanym ostrzem
 DE Abbrechklingen-Messer
 RU Нож строительный
 CZ Nůž ulamovací
 RO Cuijít universal (cutter)
 HU Univerzális kés
 ES Cuchillo de papelería



No.	Blade width / Szerokość ostrza [mm]	
76180	18	40/400

EN Metal utility knife
 PL Nożyk z łamanym ostrzem
 DE Abbrechklingen-Messer
 RU Нож строительный
 CZ Nůž ulamovací
 RO Cuijít universal (cutter)
 HU Univerzális kés
 ES Cuchillo de papelería



No.	Blade width / Szerokość ostrza [mm]	
76181	18	50/400

EN Metal utility knife
 PL Nożyk z łamanym ostrzem
 DE Abbrechklingen-Messer
 RU Нож строительный
 CZ Nůž ulamovací
 RO Cuijít universal (cutter)
 HU Univerzális kés
 ES Cuchillo de papelería



No.	Blade width / Szerokość ostrza [mm]	
76183	18	24/144

EN Metal utility knife
 PL Nożyk z łamanym ostrzem
 DE Abbrechklingen-Messer
 RU Нож строительный
 CZ Nůž ulamovací
 RO Cuijít universal (cutter)
 HU Univerzális kés
 ES Cuchillo de papelería



No.	Blade width / Szerokość ostrza [mm]	
76190	25	12/72

EN Metal utility knife
 PL Nożyk z łamanym ostrzem
 DE Abbrechklingen-Messer
 RU Нож строительный
 CZ Nůž ulamovací
 RO Cuijít universal (cutter)
 HU Univerzális kés
 ES Cuchillo de papelería



No.	Blade width / Szerokość ostrza [mm]	
76185	18	60/600

EN Metal utility knife
 PL Nożyk z łamanym ostrzem
 DE Abbrechklingen-Messer
 RU Нож строительный
 CZ Nůž ulamovací
 RO Cuijít universal (cutter)
 HU Univerzális kés
 ES Cuchillo de papelería



No.	Blade width / Szerokość ostrza [mm]	
76182	18	24/240

EN Metal utility knife
 PL Nożyk z łamanym ostrzem
 DE Abbrechklingen-Messer
 RU Нож строительный
 CZ Nůž ulamovací
 RO Cuijít universal (cutter)
 HU Univerzális kés
 ES Cuchillo de papelería



No.	Blade width / Szerokość ostrza [mm]	
76186	18	12/144

EN Spare blades
 PL Ostrza zapasowe do nożyka
 DE Abbrechklingen
 RU Лезвия для универсальных ножей
 CZ Lomené ostří náhradní
 RO Lame de rezervă rupte
 HU Törhető tartalékpenge
 ES Filo partido de recambio



No.	Blade width / Szerokość ostrza [mm]	pcs / szt.	
76214	25	5	36/288

EN Spare blades
 PL Ostrza zapasowe do nożyka
 DE Abbrechklingen
 RU Лезвия для универсальных ножей
 CZ Lomené ostří náhradní
 RO Lame de rezervă rupte
 HU Törhető tartalékpenge
 ES Filo partido de recambio



No.	Blade width / Szerokość ostrza [mm]	pcs / szt.	
76210	9	5	100/600
76220	18	5	100/600

EN Utility knife set
 PL Komplet nożyków
 DE Universal-Messersatz
 RU Набор ножей pistolетных

CZ Sada ulamovacích noží
 RO Set cuttere
 HU Univerzális kés és műanyag kaparó készlet
 ES Cuchillos de papelería



No.	pcs / szt.	
76250	5	30/150

EN Glass cutter
 PL Nóż do szkła
 DE Glasschneider
 RU Стеклопёз
 CZ Nůž do skla
 RO Diamant pt. sticlă
 HU Kés üveghez
 ES Cuchillo para cristal



No.	
05100	12/240

EN Glass cutting tool
 PL Nóż do płytek ceramicznych i szkła
 DE Fliesen- und Glasschneider
 RU Резак для керамической плитки и стекла
 CZ Nůž na řezání keramických dlaždic a skla
 RO Instrument de tăiat sticlă
 HU Csempé- és üvegvágó kés
 ES Cuchillo para cortar baldosas cerámicas y vidrio



VOREL

No.	L [mm]	
04060	120	6/240

EN Utility knife set
 PL Komplet nożyków
 DE Universal-Messersatz
 RU Набор ножей pistolетных
 CZ Sada ulamovacích noží
 RO Set cuttere
 HU Univerzális kés készlet
 ES Cuchillos de papelería

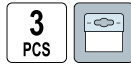

No.	pcs / szt.	
76230	3	50/200

EN Window scraper
 PL Skrobak do szyb
 DE Fensterabstreicher
 RU Скребок для стекла
 CZ Škrabák na skla
 RO Răzuitor pt. geamuri
 HU Kaparó üveghez
 ES Rascador de cristales



No.	Blade width / Szerokość ostrza [mm]	
06820	60	50/200

EN Oil glass cutter
 PL Nóż olejowy do szkła
 DE Ölglasschneider
 RU Стеклопёз масляный
 CZ Rezák na sklo
 RO Diamant pt. taiat sticlă cu ulei
 HU Olajkés üveghez
 ES Cuchillo de aceite para cristales



No.	
05050	6/120

EN Scriber
 PL Rysik traserski
 DE Reißnadel
 RU Чертилка по металлу
 CZ Rysovací jehla
 RO Ac detrasat
 HU Karcu
 ES Trazador



VOREL

No.	L [mm]	
35210	140	12/72

- EN Automatic center punch
- PL Punktak automatyczny
- DE Automatischer Körner
- RU Автоматический кернер
- CZ Automatické důlčikem
- RO Punctator automat
- HU Automatikus központ punci
- ES Centro automático punch



No.	L [mm]	
35240	140	12/72

- EN Wood carving knife set
- PL Komplet nożyków precyzyjnych z ostrzami
- DE Präzisionsmessersatz
- RU Набор ножей для резбы по дереву
- CZ Sada přesných noží s bity
- RO Set cutite prelucrare lemn
- HU Modellező készlet pengékkel
- ES Juego de cutters precisos con cuchillos



No.	pcs / szt.	
76305	16	25/100

- EN Scissors
- PL Nożyczki
- DE Haushaltsschere
- RU Ножницы
- CZ Nůžky
- RO Foarfece
- HU Olló
- ES Tijeras



No.	L [mm]	
76312	220	12/144

- EN Leather hole punch
- PL Dziurkacz nastawny
- DE Einstellbarer Locher
- RU Дырокол pistolетный
- CZ Děrovači kleště nastavitelné
- RO Perforator ajustabil
- HU Állítható lyukasztó
- ES Pinza perforadora ajustable

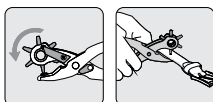

No.	L [mm]	
43600	220	6/36

- EN Double edge scraper
- PL Cyklina ręczna
- DE Ziehklingschaber
- RU Ручная цикля
- CZ Ruční škrabka
- RO Rascheta dubla
- HU Kézi kaparó
- ES Rasqueta manual



No.	Blade size / Rozmiar ostrza [mm]	
06840	40	10
06860	60	10

- EN Scissors
- PL Nożyczki
- DE Haushaltsschere
- RU Ножницы
- CZ Nůžky
- RO Foarfece
- HU Olló
- ES Tijeras



No.	L [mm]	
76311	170	12/144

- EN Scissors set
- PL Komplet nożyczek
- DE Haushaltsscherensatz
- RU Ножницы бытовые в наборе
- CZ Nůžky
- RO Foarfece
- HU Olló
- ES Tijeras



No.	L [mm]	pcs / szt.	
76314	140, 170, 190, 220, 250	5	12/24

- EN Leather hole punch & grommet setting tool kit
- PL Zestaw kaletniczy
- DE Taschenr Satz
- RU Набор для установки кнопок и люверсов
- CZ Děrovačka na pásky
- RO Set clesți prelucrare piele
- HU Szegecselő és lyukasztó készlet
- ES Kit de cuero herramientas neumáticas de perforación y ojal

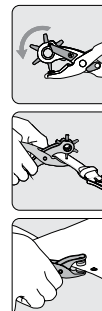

No.		
43603		5/20

EN Pliers for plastic snaps
 PL Praska do zaciskania nap
 DE Zange für Plastic Moschettoni
 RU Клещи для пластиковых защелками
 CZ Pliers pro plastovou nezapadne
 RO Plastic pliers pt. sporturi
 HU Fogó műanyag pattan
 ES Alicates para la snaps de plástico



VOREL

No.	Hole diameter / Średnica otworu [mm]	
76710	10, 12, 14	30/60

EN Punch set
 PL Komplet przebijaaków do skóry
 DE Lederlochereset
 RU Набор пробойников для кожи
 CZ Sada průbojníků na kůži
 RO Set preducele
 HU Bőryukasztó készlet
 ES Juego de perforar en piel

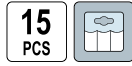

No.	Hole diameter / Średnica otworu [mm]	
76700	2, 2.5, 3.2, 4, 4.8, 5.5, 6.4, 8, 9.5, 11.1, 12.7, 14, 15.8, 19, 22	5/20

EN Mini block plane
 PL Metalowy strug modelarski
 DE Metallhobel für Modellbau
 RU Металлический рубанок для моделирования
 CZ Kovový modelářský hoblík
 RO Mini rindea
 HU Mini fémgyalu
 ES Cepillo mini



VOREL

No.	Blade width / Szerokość ostrza [mm]	
25881	26	10/50

EN Block plane
 PL Metalowy strug do drewna
 DE Metallhobel für Holz
 RU Металлический рубанок по дереву
 CZ Kovový hoblík do dřeva
 RO Rindea
 HU Fémgyalu
 ES Cepillo metálico para madera



VOREL

No.	Blade width / Szerokość ostrza [mm]	
25886	42	36

EN Punch set
 PL Komplet przebijaaków do skóry
 DE Lederlochereset
 RU Набор пробойников для кожи
 CZ Sada průbojníků na kůži
 RO Set preducele
 HU Bőryukasztó készlet
 ES Juego de perforar en piel



No.	Hole diameter / Średnica otworu [mm]	
76705	2.5, 3, 4, 5, 6, 7, 8, 9, 10	10/60

EN Rabbet plane
 PL Strug kątnik czolowy
 DE Simshobel
 RU Фальцгебель двойной деревянный
 CZ Hoblík čelní drážkovník
 RO Rindea frontală unghiulară
 HU Párkánygyalu, homlok
 ES Cepillo de ranura



No.	Blade width / Szerokość ostrza [mm]	L [mm]	
25830	30	245	20

EN Block plane
 PL Metalowy strug do drewna
 DE Metallhobel für Holz
 RU Металлический рубанок по дереву
 CZ Kovový hoblík do dřeva
 RO Rindea
 HU Fémgyalu
 ES Cepillo metálico para madera



VOREL

No.	Blade width / Szerokość ostrza [mm]	
25885	42	50

EN Block plane
 PL Metalowy strug do drewna
 DE Metallhobel für Holz
 RU Металлический рубанок по дереву
 CZ Kovový hoblík do dřeva
 RO Rindea
 HU Fémgyalu
 ES Cepillo metálico para madera



VOREL

No.	Blade width / Szerokość ostrza [mm]	
25887	44	30

EN Steel file
 PL Piłnik do metalu
 DE Werkstatt-Feile
 RU Напильник слесарный
 CZ Piłnik na kov
 RO Pila de lăcătușerie
 HU Lakatos reszelő
 ES Lima para metal

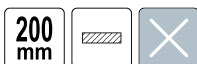

No.	L [mm]	
25160	200	25/100

EN Steel file
 PL Piłnik do metalu
 DE Werkstatt-Feile
 RU Напильник слесарный
 CZ Piłnik na kov
 RO Pila de lăcătușerie
 HU Lakatos reszelő
 ES Lima para metal



No.	L [mm]	
25162	200	25/100

EN Steel file
 PL Piłnik do metalu
 DE Werkstatt-Feile
 RU Напильник слесарный
 CZ Piłnik na kov
 RO Pila de lăcătușerie
 HU Lakatos reszelő
 ES Lima para metal



No.	L [mm]	
25164	200	25/100

EN Steel file set
 PL Zestaw piłników do metalu
 DE Feilensatz
 RU Набор напильников
 CZ Piłniky na kov
 RO Pile de lăcătușerie
 HU Lakatos reszelő készlet
 ES Juego de limas para metal



No.	L [mm]	pcs / szt.	
25166	200	5	10/20

EN Steel file
 PL Piłnik do metalu
 DE Werkstatt-Feile
 RU Напильник слесарный
 CZ Piłnik na kov
 RO Pila de lăcătușerie
 HU Lakatos reszelő
 ES Lima para metal

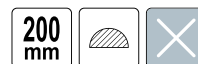

No.	L [mm]	
25161	200	25/100

EN Steel file
 PL Piłnik do metalu
 DE Werkstatt-Feile
 RU Напильник слесарный
 CZ Piłnik na kov
 RO Pila de lăcătușerie
 HU Lakatos reszelő
 ES Lima para metal



No.	L [mm]	
25163	200	25/100

EN Steel file set
 PL Zestaw piłników do metalu
 DE Feilensatz
 RU Набор напильников
 CZ Piłniky na kov
 RO Pile de lăcătușerie
 HU Lakatos reszelő készlet
 ES Juego de limas para metal

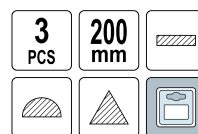

No.	L [mm]	pcs / szt.	
25165	200	3	10/20

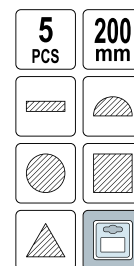

EN Needle file set
 PL Zestaw pilników iglaków
 DE Nadelfeilsatz
 RU Набор напильников надфили

CZ Sada jehlových pilníků
 RO Set pile conice
 HU Tűreszelő készlet
 ES Juego de limas de aguja



No.	L [mm]	Toolholder size / Rozmiar uchwyty narzędziowego [mm]	pcs / szt.	
25370	150	4	5	20/200
25380	150	4	10	25/100
25390	150	4	12	25/100

EN Needle file set
 PL Zestaw pilników iglaków
 DE Nadelfeilsatz
 RU Набор напильников надфили
 CZ Sada jehlových pilníků
 RO Set pile conice
 HU Tűreszelő készlet
 ES Juego de limas de aguja



VOREL

No.	L [mm]	pcs / szt.	
25351	140	6	20/160
25352	160	6	20/160
25353	180	6	20/120

EN Diamond whetstone
 PL Osełka diamentowa
 DE Diamant Schleifstein
 RU Алмазный брусок

CZ Diamond brousek
 RO Piatra abraziva diamantata
 HU Kétoldalas gyémánt fenőkő
 ES Piedra de afilar diamantada

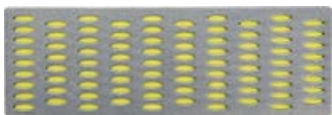

VOREL

No.	Grit / Ziamistość	W [mm]	L [mm]	
26131	G400	50	150	20/100

EN Diamond whetstone set
 PL Zestaw oselek diamentowych
 DE Diamant Schleifstein
 RU Алмазный брусок
 CZ Diamond brousek
 RO Piatra abraziva diamantata
 HU Kétoldalas gyémánt fenőkő
 ES Piedra de afilar diamantada



VOREL

No.	Grit / Ziamistość	W [mm]	L [mm]	
26140	G180, G260, G360	25	75	25/100

EN Needle file set
 PL Zestaw pilników iglaków
 DE Nadelfeilsatz
 RU Набор напильников надфили
 CZ Sada jehlových pilníků
 RO Set pile conice
 HU Tűreszelő készlet
 ES Juego de limas de aguja



No.	pcs / szt.	
25360	6	20/200

EN Diamond whetstone
 PL Osełka diamentowa
 DE Diamant Schleifstein
 RU Алмазный брусок

CZ Diamond brousek
 RO Piatra abraziva diamantata
 HU Kétoldalas gyémánt fenőkő
 ES Piedra de afilar diamantada



VOREL

No.	Grit / Ziamistość	W [mm]	L [mm]	
26130	G600	50	150	20/100

EN Diamond whetstone
 PL Osełka diamentowa
 DE Diamant Schleifstein
 RU Алмазный брусок

CZ Diamond brousek
 RO Piatra abraziva diamantata
 HU Kétoldalas gyémánt fenőkő
 ES Piedra de afilar diamantada

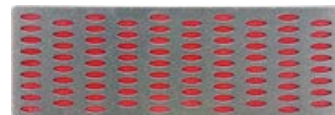

VOREL

No.	Grit / Ziamistość	W [mm]	L [mm]	
26132	G300	50	150	20/100

EN Wood rasp
 PL Tamnik do drewna
 DE Holzraspel
 RU Рашпиль по дереву
 CZ Rašple do dřeva
 RO Raspe
 HU Fareszelő
 ES Escarpelo para madera



VOREL

No.	L [mm]	
25170	200	25/100

EN Wood rasp
 PL Tarnik do drewna
 DE Holzraspel
 RU Рашиль по дереву
 CZ Rašple do dřeva
 RO Raspe
 HU Fareszelő
 ES Escarpelo para madera



No.	L [mm]	
25171	200	25/100

EN Wood rasp set
 PL Komplet tarników do drewna
 DE Holzraspelsatz
 RU Рашили для дерева

CZ Sada rašplí do dřeva
 RO Set raspe
 HU Fareszelő készlet
 ES Juego de escarpelos para madera



No.	L [mm]	pcs / szt.	
25173	200	3	10/20

EN Rasp for plaster
 PL Tarnik do gipsu
 DE Gipskartonplatten Rasp
 RU Рашиль для гипсокартона
 CZ Rašple pro omítky
 RO Rindea
 HU Reszelt vakolat
 ES Eliminador de yeso



No.	Working width / Szerokość robocza [mm]	L [mm]	
25300	40	60	10/60

EN Rasp for plaster
 PL Tarnik do gipsu
 DE Gipskartonplatten Rasp
 RU Рашиль для гипсокартона
 CZ Rašple pro omítky
 RO Rindea
 HU Reszelt vakolat
 ES Eliminador de yeso

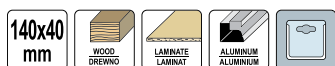

No.	Working width / Szerokość robocza [mm]	L [mm]	
25307	40	140	15/60

EN Wood rasp
 PL Tarnik do drewna
 DE Holzraspel
 RU Рашиль по дереву
 CZ Rašple do dřeva
 RO Raspe
 HU Fareszelő
 ES Escarpelo para madera

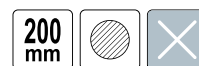

No.	L [mm]	
25172	200	25/100

EN Wood rasp set
 PL Komplet tarników do drewna
 DE Holzraspelsatz
 RU Рашили для дерева

CZ Sada rašplí do dřeva
 RO Set raspe
 HU Fareszelő készlet
 ES Juego de escarpelos para madera



No.	L [mm]	pcs / szt.	
25230	200	3	15/60

EN Blade for rasp
 PL Tarka zapasowa do tarnika
 DE Sägeblatraspel
 RU Лезвие для рашиля по гипсокартону
 CZ Čepel do škrabacích
 RO Lama pt. rasp
 HU Penge reszelő
 ES Hoja para raspar

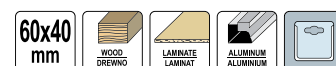

No.	Working width / Szerokość robocza [mm]	L [mm]	For / Dla	
25301	40	60	25300	10/120

EN Rasp for plaster
 PL Tarnik do gipsu
 DE Gipskartonplatten Rasp
 RU Рашиль для гипсокартона
 CZ Rašple pro omítky
 RO Rindea
 HU Reszelt vakolat
 ES Eliminador de yeso



No.	Working width / Szerokość robocza [mm]	L [mm]	
07930	50	140	6/36

EN Rasp for plaster
 PL Tarnik do gipsu
 DE Gipskartonplatten Rasp
 RU Рашиль для гипсокартона
 CZ Rašple pro omítky
 RO Rindea
 HU Reszelt vakolat
 ES Eliminador de yeso

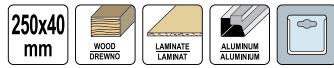

No.	Working width / Szerokość robocza [mm]	L [mm]	
25310	40	250	15/60

EN Sharpening stone
 PL Osełka owalna
 DE Abziehstein
 RU Брусок
 CZ Oblahovací brousek
 RO Pila abraziva pt. ascuțit
 HU Fenőkő
 ES Piedra de afilar



No.	L [mm]	
26210	225	50/100

EN Rotary sharpener
 PL Ostrzarka do wiertarki
 DE Bohrschärfer-Bohrmaschinenaufsatz
 RU Точило для ножей и ножниц

CZ Brousek na nože a nůžky
 RO Rezerva pt dispozitiv de ascuțit burghie
 HU Élezőkő fúrógéphe fogható
 ES Muela afilar cuchillos y tijeras



No.	
26225	80/240

EN Waterproof sand paper
 PL Papier ścierny wodoodporny
 DE Schleifpapier wasserfest
 RU Водостойкая наждачная бумага

CZ Smirkový papír-vodní
 RO Hârtie abrazivă rezistentă la apa
 HU Csiszolópapír vizes
 ES Papel de lija resistente al agua

No.	Grit / Ziarnistość	Size / Rozmiar [mm]	pcs / szt.	
07060	P60	230x280	50	1000
07080	P80	230x280	50	1000
07100	P100	230x280	50	1000
07120	P120	230x280	50	1000
07180	P180	230x280	50	1000
07240	P240	230x280	50	1000
07320	P320	230x280	50	1000
07400	P400	230x280	50	1000
07506	P600	230x280	50	1000
07508	P800	230x280	50	1000
07510	P1000	230x280	50	1000
07512	P1200	230x280	50	1000

EN Sharpening stone
 PL Osełka
 DE Wetzstein
 RU Брусок точильный
 CZ Brusný kámen
 RO Piatra pt. ascuțit
 HU Fenőkő
 ES Piedra de afilar

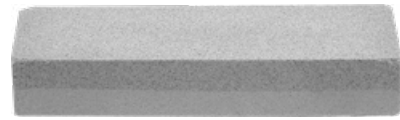

No.	L [mm]	
26150	150	25/50
26200	200	25/50

EN Knife sharpener
 PL Ostrzarka do noży
 DE Messerschärfer
 RU Точилка для ножей
 CZ Brousek na nože
 RO Cuiti ascuțitoare
 HU Késélező
 ES Afilador de cuchillos



No.	
26220	12/96

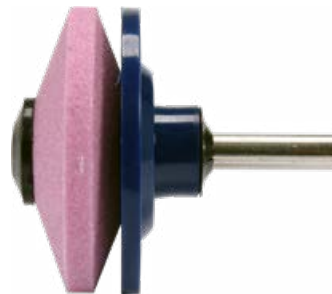

- EN Abrasive cloth
 PL Piótno ściernie
 DE Schleifgewebe
 RU Бумага наждачная на тканевой основе
 CZ Brusné platno
 RO Pânză abrazivă
 HU Csiszolóvászon
 ES Paño abrasivo

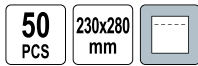

No.	Grit / Ziarnistość	Size / Rozmiar [mm]	pcs / szt.	
07530	P36	230x280	50	500
07540	P46	230x280	50	500
07560	P60	230x280	50	500
07580	P80	230x280	50	500
07610	P100	230x280	50	500
07620	P120	230x280	50	500
07630	P150	230x280	50	500

- EN No end abrasive band
 PL Taśma ścierna bezkońcowa
 DE Schleifband
 RU Лента шлифовальная бесконечная
 CZ Pás brusný nekonečný
 RO Banda abrazivă
 HU Végtelenített csiszolószalag
 ES Banda abrasiva sin extremos

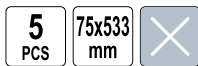

No.	Grit / Ziarnistość	Size / Rozmiar [mm]	pcs / szt.	
07664	P40	75x533	5	20/60
07665	P60	75x533	5	20/60
07666	P80	75x533	5	20/60
07667	P100	75x533	5	20/60
07668	P120	75x533	5	20/60

- EN Abrasive sponge
 PL Gąbka ścierna
 DE Schleifschwamm
 RU Губка для шлифования
 CZ Hubka brusná
 RO Burete abrazivă
 HU Dörzsszivacs
 ES Esponja abrasiva



No.	Grit / Ziarnistość	Size / Rozmiar [mm]	
07910	P46	124x98x12	100
07911	P60	124x98x12	100
07912	P80	124x98x12	100
07913	P100	124x98x12	100
07914	P120	124x98x12	100
07915	P150	124x98x12	100
07916	P180	124x98x12	100

- EN Abrasive mesh
 PL Siatka ścierna
 DE Schleifgitter
 RU Шлифовальная сетка
 CZ Brusné pletivo
 RO Plasă abrazivă
 HU Csiszolóháló
 ES Red abrasiva nacional

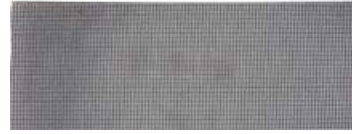
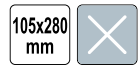

No.	Grit / Ziarnistość	Size / Rozmiar [mm]	
07879	P40	105x280	50
07880	P60	105x280	50
07881	P80	105x280	50
07882	P100	105x280	50
07883	P120	105x280	50
07884	P150	105x280	50
07885	P180	105x280	50
07886	P220	105x280	50

- EN Abrasive sponge
 PL Kostka ścierna
 DE Schleifschwamm
 RU Губка для шлифования
 CZ Hubka brusná
 RO Burete abrazivă
 HU Dörzsszivacs
 ES Esponja abrasiva



No.	Grit / Ziarnistość	Size / Rozmiar [mm]	
08288	P60	68x100x25	100
08289	P80	68x100x25	100
08290	P100	68x100x25	100
08291	P120	68x100x25	100
08292	P150	68x100x25	100
08293	P180	68x100x25	100

- EN Abrasive sponge
 PL Kostka ścierna
 DE Schleifschwamm
 RU Губка для шлифования
 CZ Hubka brusná
 RO Burete abrazivă
 HU Dörzsszivacs
 ES Esponja abrasiva



No.	Grit / Ziarnistość	Size / Rozmiar [mm]	
08301	P60	125x90x65x25	100
08302	P80	125x90x65x25	100
08303	P100	125x90x65x25	100
08304	P120	125x90x65x25	100
08306	P150	125x90x65x25	100
08307	P180	125x90x65x25	100
08308	P220	125x90x65x25	100

EN Abrasive disc with velcro
 PL Krażek ścierny z rzepem
 DE Fiberschleifscheiben ungelocht
 RU Круг шлифовальный на липучке
 CZ Brusný kotouč na suchý zip
 RO Disc abraziv (scai)
 HU Csiszolóártárcsa (tapadókoronggal)
 ES Juego de discos abrasivos (velcro)



No.	Grit / Ziarnistość	Ø [mm]	pcs / szt.	
08553	P36	125	5	50/200
08554	P40	125	5	50/200
08556	P60	125	5	50/200
08558	P80	125	5	50/200
08560	P100	125	5	50/200
08562	P120	125	5	50/200
08565	P150	125	5	50/200

EN Abrasive sheets with holes
 PL Arkusze ścierny z otworami
 DE Schleifbogen gelocht
 RU Шлифовальная бумага перфорированная
 CZ Brusné listy s otvory
 RO Hartie abraziva cu orificii
 HU Csiszolópapír lyukakkal
 ES Ojas abrasivas con agujero

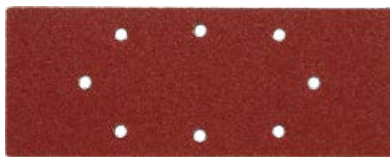
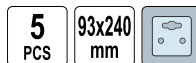

No.	Grit / Ziarnistość	Size / Rozmiar [mm]	pcs / szt.	
08534	P40	93x240	5	50/200
08536	P60	93x240	5	50/200
08538	P80	93x240	5	50/200
08540	P100	93x240	5	50/200
08542	P120	93x240	5	50/200
08545	P150	93x240	5	50/200

EN Sanding block
 PL Blok ścierny
 DE Handschleifer
 RU Брусок для шлифования
 CZ Brusný blok
 RO Suport smirghel
 HU Csiszolóblokk
 ES Bloque abrasivo



No.	Size / Rozmiar [mm]	
07970	210x100	20/80

EN Abrasive disc with holes with velcro
 PL Krażek ścierny z otworami
 DE Fiberschleifscheiben gelocht
 RU Круг шлифовальный перфорированный для липучки
 CZ Brusný kotouč z otvorami
 RO Disc abraziv cu orificii
 HU Csiszolóártárcsa (tapadókoronggal-lyukakkal)
 ES Juego de discos abrasivos con agujeros

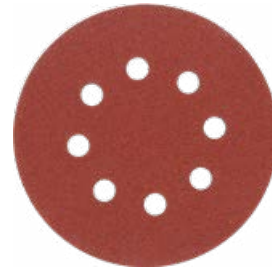
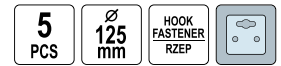

No.	Grit / Ziarnistość	Ø [mm]	pcs / szt.	
08573	P36	125	5	50/200
08574	P40	125	5	50/200
08576	P60	125	5	50/200
08578	P80	125	5	50/200
08580	P100	125	5	50/200
08582	P120	125	5	50/200
08585	P150	125	5	50/200

EN Sanding block
 PL Blok ścierny
 DE Handschleifer
 RU Брусок для шлифования
 CZ Brusný blok
 RO Suport smirghel
 HU Csiszolóblokk
 ES Bloque abrasivo



No.	Size / Rozmiar [mm]	
07950	160x85	20/100

EN Hand grinding block
 PL Blok ścierny z rzepem
 DE Schleifblock mit Klett
 RU Абразивный блок с липучкой
 CZ Brusná kostka se suchým zipem
 RO Suport de slefuire manual
 HU Csiszolóblokk, tépózáras
 ES Bloque abrasivo con velcro



No.	Ø [mm]	
07955	125	10/60

EN Hand grinding block
 PL Blok ścierny z rzepem
 DE Schleifblock mit Klett
 RU Абразивный блок с липучкой
 CZ Brusná kostka se suchým zipem
 RO Suport de slefuire manual
 HU Csiszolóblokk, tépőzáras
 ES Bloque abrasivo con velcro



No.	Ø [mm]	
07956	150	10/60

8

EN Sanding block
 PL Blok ścierny skręcany
 DE Handschleifer
 RU Тёрка для шлифования
 CZ Brusný blok
 RO Suport smirghel
 HU Csiszolóblokk
 ES Bloque abrasivo



No.	Size / Rozmiar [mm]	
07960	220x100	30

EN Polishing set
 PL Zestaw polerski
 DE Polierset
 RU Полировальный набор

CZ Čistící a leštící souprava
 RO Set pt. lustruit
 HU Tisztító és polírozó készlet
 ES Conjunto de limpieza e polimento



No.		
25420		30/60

EN Hand grinding block
 PL Blok ścierny z rzepem
 DE Schleifblock mit Klett
 RU Абразивный блок с липучкой
 CZ Brusná kostka se suchým zipem
 RO Suport de slefuire manual
 HU Csiszolóblokk, tépőzáras
 ES Bloque abrasivo con velcro



No.	Ø [mm]	
07957	150	10/120

EN Sanding block
 PL Blok ścierny zatrask
 DE Handschleifer
 RU Тёрка для шлифования
 CZ Brusný blok
 RO Suport smirghel
 HU Csiszolóblokk
 ES Bloque abrasivo



No.	Size / Rozmiar [mm]	
07962	210x100	30

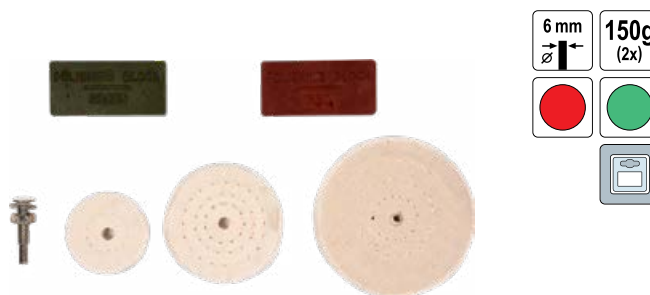

Memo	
------	--

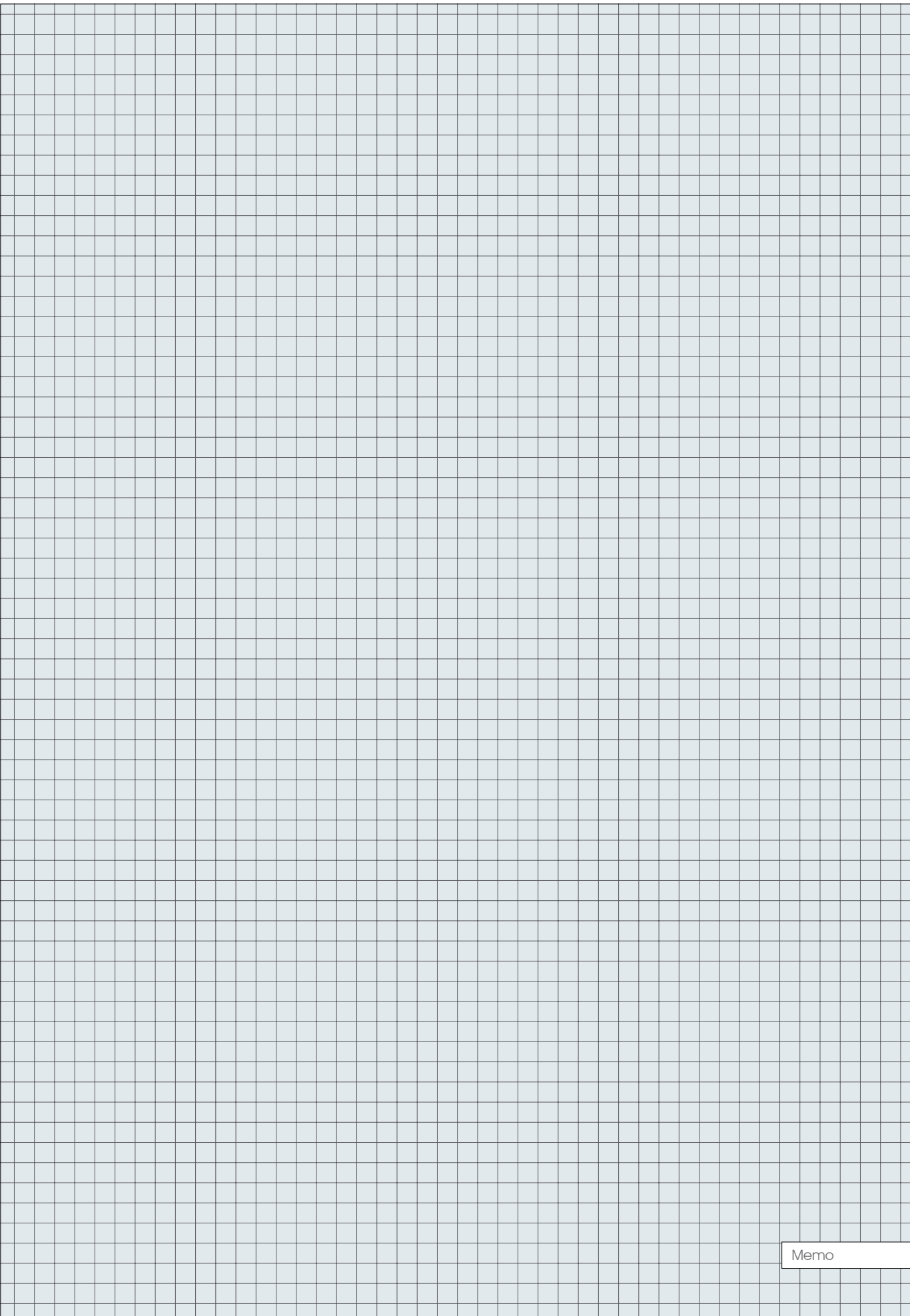

Memo



9

Plumbing tools Narzędzia hydrauliczne

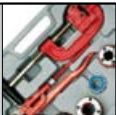

Ratchet die stocks
Komplety gwintownic ręcznych

..... 122 

Hinged pipe vices
Imadła zaciskowe do rur

..... 122 

Water pump pliers
Szczypce nastawne

..... 122 

Pipe wrenches
Klucze do rur

..... 122-123 

Pipe wrenches Stillson type
Klucze do rur typu Stillson..... 122

Adjustable pipe wrenches
Klucze do rur nastawne..... 123

Adjustable wrenches
Klucze nastawne francuskie..... 123

Chain pipe wrenches
Klucze do rur łańcuchowe

..... 123 

Pipe cutters
Obcinaki do rur

..... 124 

Calibrators
Kalibratory

..... 124 

Pipe welders
Zgrzewarki do rur

..... 124-125 

Burners & soldering tools
Palniki i lutownice

..... 125-126 

Hydraulic accessories
Akcesoria hydrauliczne

..... 126-127 

- EN Ratchet die stock
- PL Zestaw gwintownic
- DE Schneidkluppensatz
- RU Набор резьбонарезной сантехнический
- CZ Sada závitníků
- RO Set de filiere
- HU Menetfúró készlet
- ES Tarrajas para tubo



No.	Size / Rozmiar	pcs / szt.	
55820	3/8" (10.0 mm), 1/2" (12.5 mm), 3/4" (19.0 mm), 1" (25.0 mm), 1-1/4" (32.0 mm)	7	4

9

- EN Hinged pipe vice
- PL Imadło zaciskowe do rur
- DE Rohrschraubstock
- RU Тиски для труб
- CZ Uprinačí svěrák na trubky
- RO Menghină pt. țevi
- HU Satu, csőszorító
- ES Tornillo de apriete para tubos

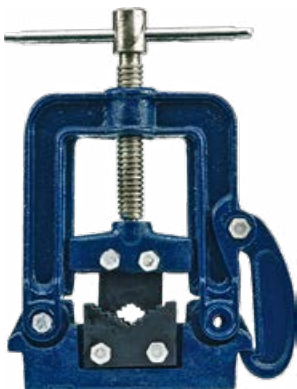

No.	Mounting element diameter / Średnica mocowanego elementu [mm]	
36570	13-50	6

- EN Pipe wrench
- PL Klucz do rur
- DE Rohrschlüssel
- RU Ключ трубный
- CZ Klič součásti na trubky
- RO Cheie reglabila pt. tevi
- HU Csőkulcs
- ES Llave para tubos



No.	L [mm]	
55250	250	6/48
55300	300	6/36
55350	350	6/24

- EN Ratchet die stock
- PL Zestaw gwintownic
- DE Schneidkluppensatz
- RU Набор резьбонарезной сантехнический
- CZ Sada závitníků
- RO Set de filiere
- HU Menetfúró készlet
- ES Tarrajas para tubo



No.	Size / Rozmiar	pcs / szt.	
55830	1-1/2" (38.0 mm), 2" (50.0 mm)	6	2

- EN Water pump pliers
- PL Szczypce hydrauliczne nastawne
- DE Wasserpumpenzange
- RU Клещи переставные
- CZ Keleště siko
- RO Clieste papagal
- HU Vízpumpafogó
- ES Alicates de fontanero ajustables

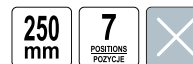

No.	L [mm]	
41510	250	10/50

- EN Pipe wrench
- PL Klucz do rur
- DE Rohrschlüssel
- RU Ключ трубный
- CZ Klič součásti na trubky
- RO Cheie reglabila pt. tevi
- HU Csőkulcs
- ES Llave para tubos



No.	L [mm]	
55620	195	6/36
55625	245	6/30
55630	275	6/24
55635	310	6/18
55645	395	4/12
55660	490	2/6
55690	750	2/4

EN Adjustable pipe wrench
 PL Klucz nastawny do rur
 DE Rohrschlüssel
 RU Ключ трубный переставной

CZ Nastavitelný klíč na trubky
 RO Cheie reglabilă pt. țevi
 HU Állítható csőkulcs
 ES Llave para tubos tipo Inglesa



No.	Max. pipe diameter / Maks. średnica rury	L [mm]	
55100	1" (25 mm)	330	12/36
55150	1-1/2" (38 mm)	390	10/20
55200	2" (50 mm)	540	6/12

EN Adjustable pipe wrench
 PL Klucz nastawny do rur
 DE Rohrschlüssel
 RU Ключ трубный переставной

CZ Nastavitelný klíč na trubky
 RO Cheie reglabilă pt. țevi
 HU Állítható csőkulcs
 ES Llave para tubos tipo Inglesa



VOREL

No.	Max. pipe diameter / Maks. średnica rury	L [mm]	
55215	1" (25 mm)	310	24
55216	1-1/2" (38 mm)	420	1/16
55217	2" (50 mm)	560	1/8

EN Adjustable wrench
 PL Klucz nastawny francuski
 DE Stahlschraubenschlüssel (Franzose)
 RU Ключ разводной

CZ Nastavitelný klíč francouz
 RO Cheie reglabilă franceză
 HU Állítható franciákulcs
 ES Llave ajustable inglesa



VOREL

No.	Jaws opening capacity / Zakres rozwarcia szczęk [mm]	Jaws width / Szerokość szczęk [mm]	
54497	0-25	60	10
54498	0-35	70	10
54499	0-45	80	10
54500	0-55	90	5
54510	0-65	100	5

EN Adjustable pipe wrench
 PL Klucz nastawny do rur
 DE Rohrschlüssel
 RU Ключ трубный переставной
 CZ Nastavitelný klíč na trubky
 RO Cheie reglabilă pt. țevi
 HU Állítható csőkulcs
 ES Llave para tubos tipo Inglesa



VOREL

No.	Max. pipe diameter / Maks. średnica rury	L [mm]	
55210	1" (25 mm)	320	1/24
55211	1-1/2" (38 mm)	425	1/16
55212	2" (50 mm)	560	1/8

EN Adjustable pipe wrench
 PL Klucz nastawny do rur
 DE Rohrschlüssel
 RU Ключ трубный переставной

CZ Nastavitelný klíč na trubky
 RO Cheie reglabilă pt. țevi
 HU Állítható csőkulcs
 ES Llave para tubos tipo Inglesa



VOREL

No.	Max. pipe diameter / Maks. średnica rury	L [mm]	
55220	1" (25 mm)	315	1/24
55221	1-1/2" (38 mm)	425	1/16
55222	2" (50 mm)	560	1/8

EN Chain pipe wrench
 PL Klucz łańcuchowy do rur
 DE Kettenrohrzange
 RU Ключ цепной для труб
 CZ Klíč řetězový na trubky
 RO Cheie reglabilă pt. țevi cu lanț
 HU Láncos csőfogó
 ES Llave de cadena



VOREL

No.	Max. pipe diameter / Maks. średnica rury	L [mm]	
55792	4" (100.0 mm)	300	10/30

9

EN Pipe cutter
 PL Obcinak do rur
 DE Rohrabschneider
 RU Труборез для труб
 CZ Rezač trubek
 RO Clește pt. tăiat țevi
 HU Csővágó olló csövekhez
 ES Cortatubos



No.	Cutting diameter / Średnica cięcia	Box icon
78381	1/10" - 1-1/4" (3-32 mm)	60

9

EN Pipe chamfering tool
 PL Gratownik do rur
 DE Rohrentgrater
 RU Гратосниматель
 CZ Odhrotovač trubek
 RO Dispozitiv bordurare țevi
 HU Külső-belső sorjázó
 ES Desbarbador de tubo



No.	Cutting diameter / Średnica cięcia [mm]	Box icon
78385	6-36	25/50

EN Pipe calibration tool
 PL Kalibrator do rur
 DE Kalibrierer für Mehrschichtverbundrohr
 RU Калибратор пластиковый

CZ Kalibrátor pro trubku
 RO Calibrator teava multistrat
 HU Csőkalibráló
 ES Calibrador para tubos multicapa



No.	Box icon
55740	300

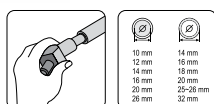

EN Universal quick deburrer
 PL Gratownik
 DE Universal-Schnell-Entgrater
 RU Универсальный быстро гратосниматель
 CZ Univerzální odhrotovač
 RO Debavurator rapid universal
 HU Univerzális gyors sorjázó
 ES Desbarbador rápido universal

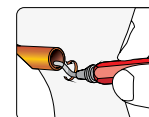
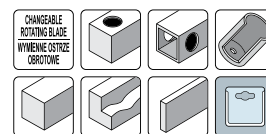

No.	Box icon
78388	50/150

EN PVC pipe cutter
 PL Obcinak do rur PVC
 DE PVC Rohrabschneider
 RU Труборез для труб из ПВХ
 CZ Rezač PVC trubek
 RO Clește pt. tăiat țevi din PVC
 HU Csővágó olló PVC csövekhez
 ES Cortatubos para PVC

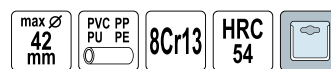

No.	Max. cutting diameter / Maks. średnica cięcia [mm]	Box icon
78341	42	12/48

EN PVC plastic pipe welder
 PL Zgrzewarka do rur termoplastycznych
 DE Schweissgerät für thermoplastische Rohre
 RU Аппарат для сварки пластиковых труб
 CZ Svářečka na termoplastické trubky
 RO Masina de sudat țevi termoplastice
 HU Hegesztő berendezés termoplasztikus csövekhez
 ES Máquina de soldar las tubos termoplásticos

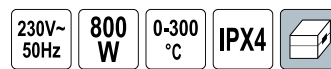

No.	Power / Moc [W]	Box icon
78911	800	5



EN PVC plastic pipe welder
 PL Zgrzewarka do rur termoplastycznych
 DE Schweissgerät für thermoplastische Rohre
 RU Аппарат для сварки пластиковых труб
 CZ Svářečka na termoplastické trubky
 RO Masina de sudat tevi termoplastice
 HU Hegesztő berendezés termoplasztikus csövekhez
 ES Máquina de soldar las tubos termoplásticos

230V~
50Hz

750
W

1500
W

0-300
°C

IPX0



No.	Power / Moc [W]	Icon
78912	750, 1500	4

EN PVC plastic pipe welder
 PL Zgrzewarka do rur termoplastycznych
 DE Schweissgerät für thermoplastische Rohre
 RU Аппарат для сварки пластиковых труб
 CZ Svářečka na termoplastické trubky
 RO Masina de sudat tevi termoplastice
 HU Hegesztő berendezés termoplasztikus csövekhez
 ES Máquina de soldar las tubos termoplásticos

230V~
50Hz

800
W

1500
W

0-300
°C

IP24



No.	Power / Moc [W]	Icon
78910	800, 1500	5

EN Gas torch
 PL Palnik gazowy
 DE Gasbrenner
 RU Газовая горелка
 CZ Plynový hořák
 RO Arzător de gaz
 HU Gázégő
 ES Soplete de gas



0.22
kW

PIEZO

max °C
1300

GAS
GAZ

BUTANE
BUTAN

LIGHTER
GAS
GAZ DO
ZAPALNICZEK

10
g

LOCK
BLOKADA

CHILDREN
PROTECTION
ZABEZPECZENIE
PRZED DZIECIAMI

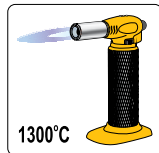
No.	Power / Moc [kW]	Icon
73420	0.22	10/60

EN Gas blow torch
 PL Palnik gazowy
 DE Lötbrenner
 RU Газовая горелка
 CZ Plynový hořák
 RO Arzător de gaz
 HU Gázégő
 ES Soplete de gas

1.3
kW

PIEZO

max °C
1300

GAS
GAZ

BUTANE
BUTAN



No.	Power / Moc [kW]	Icon
73412	1.3	10/60

EN Soldering tool 3 in 1
 PL Lutownica gazowa 3 w 1
 DE 3 in 1 Gaslötkolben
 RU Газовый паяльник 3 в 1
 CZ Plynová rajka 3 v 1
 RO Ciocan de lipit cu gaz 3 in 1
 HU Gaz-forrasztópaka 3 az 1
 ES Soldador de gas 3 en 1

25-80
W

GAS
GAZ

PROPANE
BUTANE
PROPAN
BUTAN

LIGHTER
GAS
GAZ DO
ZAPALNICZEK

15
ml

60 min

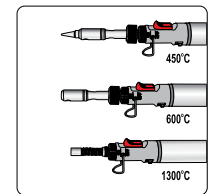
No.	Power / Moc [W]	Icon
73410	25-80	12/48

EN Gas blow torch
 PL Palnik gazowy
 DE Lötbrenner
 RU Газовая горелка
 CZ Plynový hořák
 RO Arzător de gaz
 HU Gázégő
 ES Soplete de gas

1.3
kW

PIEZO

max °C
1300

GAS
GAZ

BUTANE
BUTAN



No.	Power / Moc [kW]	Icon
73413	1.3	10/60

- EN Gas soldering lamp
- PL Gazowa lampa lutownicza
- DE Gaslötlampe
- RU Газовая паяльная лампа
- CZ Plynová pájecí lampa
- RO Lampă de lipit pe gaz
- HU Gázos forrasztólámpa
- ES Lampa de gas para soldar

1.7 kW	max °C 1200	123 g/h	BUTANE BUTAN
COMPOSITE BODY KOMPOZYTOVY KORPUS		190 g	



No.	Power / Moc [kW]	
73400	1.7	12

- EN Gas soldering lamp
- PL Gazowa lampa lutownicza
- DE Gaslötlampe
- RU Газовая паяльная лампа
- CZ Plynová pájecí lampa
- RO Lampă de lipit pe gaz
- HU Gázos forrasztólámpa
- ES Lampa de gas para soldar

1.7 kW	PIEZO	max °C 850	123 g/h
GAS GAZ	BUTANE BUTAN	METAL BODY METALOWY KORPUS	190 g



No.	Power / Moc [kW]	
73404	1.7	20

- EN Thread sealing paste
- PL Pasta uszczelniająca do gwintów
- DE Paste zum Abdichten der Gewinde
- RU Паста для герметизации резьбы
- CZ Těsnící pasta na závity
- RO Pastă etanșantă pt. filet
- HU Menettömítő paszta
- ES Pasta selladora para roscas



No.	m [g]	
86752	360	24

- EN Hydraulic repair kit
- PL Hydraulyczny zestaw naprawczy
- DE Hydraulischer Reparatursatz
- RU Комплект для уплотнения резьбы
- CZ Hydraulická opravářská souprava
- RO Set de reparații pt. instalatori
- HU Vízvezeték javító készlet
- ES Juego para reparaciones hidráulicas



No.	m [g]	
86761	100, 65	40

- EN Gas soldering lamp
- PL Gazowa lampa lutownicza
- DE Gaslötlampe
- RU Газовая паяльная лампа
- CZ Plynová pájecí lampa
- RO Lampă de lipit pe gaz
- HU Gázos forrasztólámpa
- ES Lampa de gas para soldar

1.7 kW	PIEZO	max °C 1200	123 g/h
BUTANE BUTAN	METAL BODY METALOWY KORPUS	190 g	



No.	Power / Moc [kW]	
73403	1.7	12

- EN PTFE tape
- PL Taśma PTFE
- DE Teflonband
- RU Фулмент
- CZ Teflonová páska
- RO Bandă de teflon
- HU Teflon szalag
- ES Cinta de teflón



No.	W [mm]	Thickness / Grubość [mm]	L [m]	
75201	12	0.1	12	250/1000
75202	19	0.2	15	200

- EN Thread sealing paste
- PL Pasta uszczelniająca do gwintów
- DE Paste zum Abdichten der Gewinde
- RU Паста для герметизации резьбы
- CZ Těsnící pasta na závity
- RO Pastă etanșantă pt. filet
- HU Menettömítő paszta
- ES Pasta selladora para roscas



No.	m [g]	
86750	65	48
86751	250	24

- EN Oakum
- PL Pakuły lniane
- DE Leinenwerg
- RU Лен сантехнический
- CZ Lněná koudel
- RO Căiți de lin
- HU Len kóc
- ES Estopa de lino



No.	m [g]	
86760	100	50

- EN Lubricant for PVC pipes
- PL Pasta poślizgowa do rur PCV
- DE Gleitpaste für PVC-Rohre
- RU Силиконовая смазка для ПВХ труб
- CZ Kluzná pasta na PVC trubky
- RO Pastă glisantă pt. țevi PVC
- HU Sikosító paszta PVC csövekhez
- ES Pasta de deslizamiento para tubos de PCV



No.	m [g]	
86770	250	18
86771	500	15

- EN Drain suction pump
- PL Pompa do udrażniania kanalizacji
- DE Rohrreinigungspumpe
- RU Пневматический вантуз для прочистки труб
- CZ Čerpadlo na čištění trubek
- RO Pompă pt. curățarea țevelor
- HU Lefolyótisztító pumpa
- ES Desatascador bomba de vacío





No.	Ø [mm]	
55505	65, 155	24

- EN Drain auger
- PL Spirala kanalizacyjna
- DE Hand-Rohrreinigungsspirale
- RU Трос для прочистки канализационных труб и каналов
- CZ Spirála na čištění trubek
- RO Dedeman cablu pt. desfundat canale
- HU Csőtisztító spirál
- ES Varilla para limpiar drenajes

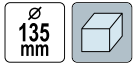

- EN Drain cleaner
- PL Pistolet do udrażniania rur
- DE Pistole zum Reinigen von Rohren
- RU Пневматический пистолет для прочистки труб
- CZ Pistoľ na čištění trubek
- RO Pistol pt. curățarea țevelor
- HU Csőtisztító pisztoly
- ES Pistola destapacaños



No.	Ø [mm]	
55500	63, 135	10

- EN Drain auger
- PL Spirala kanalizacyjna
- DE Hand-Rohrreinigungsspirale
- RU Трос для прочистки канализационных труб и каналов
- CZ Spirála na čištění trubek
- RO Dedeman cablu pt. desfundat canale
- HU Csőtisztító spirál
- ES Varilla para limpiar drenajes



No.	Ø [mm]	L [m]	
55541	5	1.5	20/80
55542	6	3.0	18/36

- EN Drain auger
- PL Spirala kanalizacyjna
- DE Hand-Rohrreinigungsspirale
- RU Трос для прочистки канализационных труб и каналов
- CZ Spirála na čištění trubek
- RO Dedeman cablu pt. desfundat canale
- HU Csőtisztító spirál
- ES Varilla para limpiar drenajes



No.	Ø [mm]	L [m]	
55544	9	5	5/10
55545	9	10	4/8

Memo

10

Fastening tools Narzędzia do łączenia

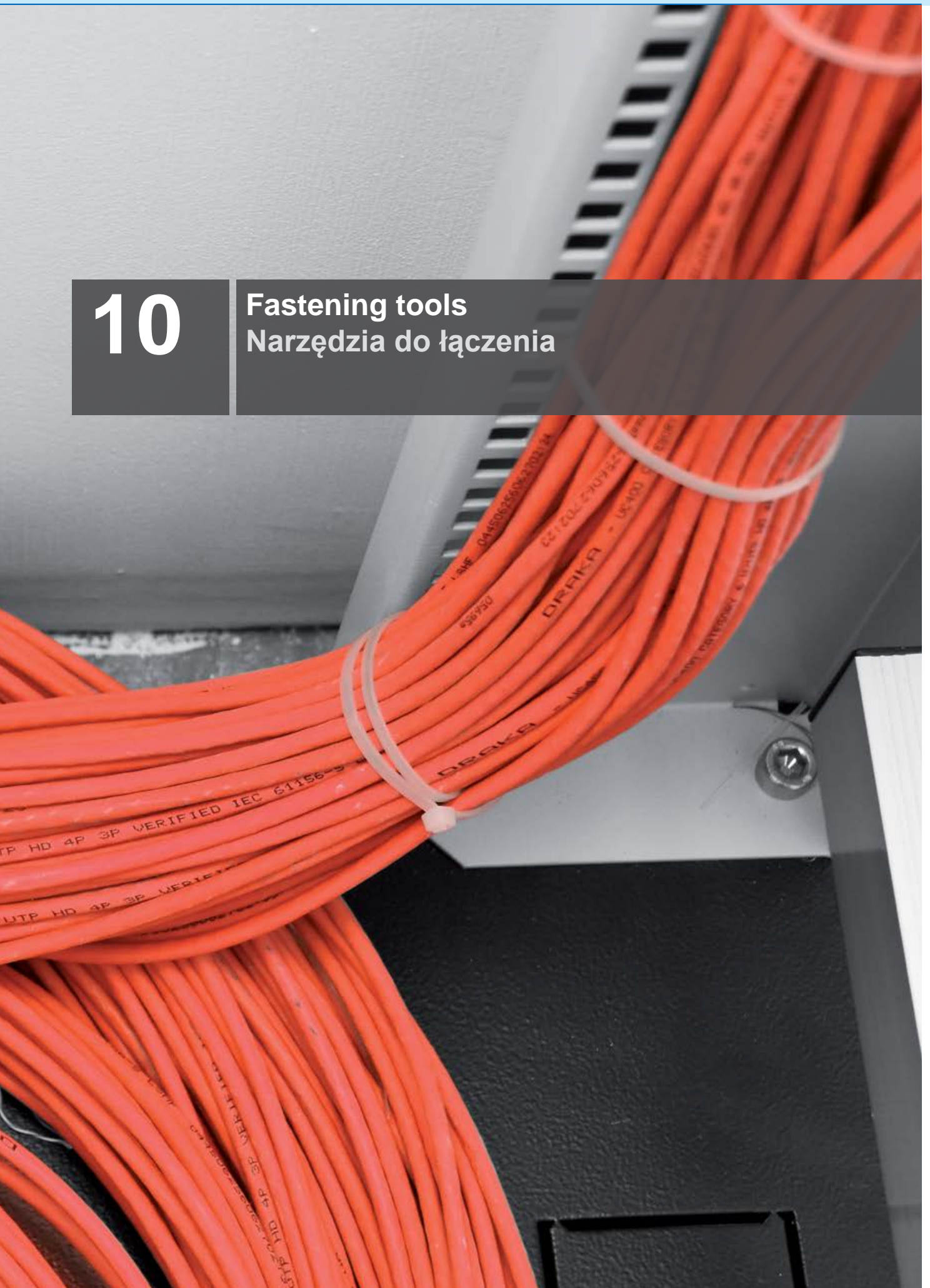

Hand riveters
 Nitownice ręczne

130-131

Hand riveters
 Nitownice ręczne..... 130

Hand riveting tool
 Nitownice ręczne, dźwigniowe..... 131

Rivets
 Nity

131

Aluminium blind rivets
 Nity aluminiowe..... 131

Pneumatic riveters
 Nitownice pneumatyczne

132

Profile connection pliers
 Szczypce do łączenia profili

132

Staple guns, staples & nails
 Zszywacze, zszywki i gwoździe

132-134

Staple guns
 Zszywacze..... 132

Staple removers
 Rozszywacze..... 133

Staples
 Zszywki..... 133

Brad nails
 Szyty..... 134

Nails
 Gwoździe..... 134

Pliers for hollow expansion bolts
 Zaciskarki do kołków typu molly

134

Screw, plug & hook sets
 Zestawy wkrętów, kołków i haków

135

Caulking guns
 Wyciskacze do mas

135-137

Foam guns
 Pistolety do pianki montażowej

137-138

Hose clips
 Opaski ślimakowe

138-139

Screw clamps
 Obejmy śrubowe

139

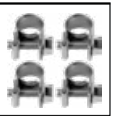
Cable ties
 Opaski plastikowe

139

Hook & loop cable ties
 Opaski z rzepem

140

Glue sticks & glue applicators
 Wkłady klejowe i dozowniki do kleju

140

Packing tape dispensers
 Podajniki taśmy pakowej

140

Tapes
 Taśmy

140-143

Ropes & lines
 Sznury i linki

143-145



EN Hand riveter
 PL Nitownica ręczna
 DE Hand-Nietzange
 RU Ручной заклепочник
 CZ Ruční nýtovačka
 RO Presă de nituit manuală
 HU Kézi popszegecshúzó
 ES Remachadora de mano



No.	L [mm]	Ø [mm]	
70000	250	2,4, 3,2, 4, 4,8	12/24

EN Hand riveter
 PL Nitownica ręczna
 DE Hand-Nietzange
 RU Ручной заклепочник
 CZ Ruční nýtovačka
 RO Presă de nituit manuală
 HU Kézi popszegecshúzó
 ES Remachadora de mano



No.	L [mm]	Ø [mm]	
70023	250	2,4, 3,2, 4, 4,8	12/24

EN Hand riveter
 PL Nitownica ręczna
 DE Hand-Nietzange
 RU Ручной заклепочник
 CZ Ruční nýtovačka
 RO Presă de nituit manuală
 HU Kézi popszegecshúzó
 ES Remachadora de mano

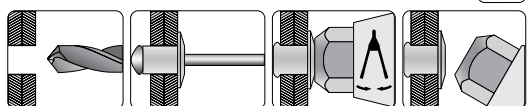
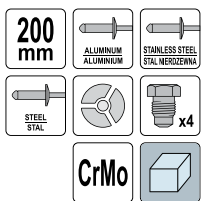

No.	L [mm]	Ø [mm]	
70035	200	2,4, 3,2, 4, 4,8	30

EN Hand riveter
 PL Nitownica ręczna
 DE Hand-Nietzange
 RU Ручной заклепочник
 CZ Ruční nýtovačka
 RO Presă de nituit manuală
 HU Kézi popszegecshúzó
 ES Remachadora de mano



No.	L [mm]	Ø [mm]	
70020	240	2,4, 3,2, 4, 4,8	12/24

EN Hand riveter
 PL Nitownica ręczna
 DE Hand-Nietzange
 RU Ручной заклепочник
 CZ Ruční nýtovačka
 RO Presă de nituit manuală
 HU Kézi popszegecshúzó
 ES Remachadora de mano

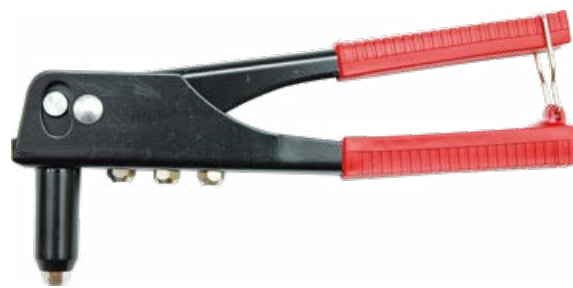
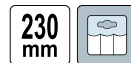

No.	L [mm]	Ø [mm]	
70030	230	2,4, 3,2, 4, 4,8	15/30

EN Hand riveter
 PL Nitownica ręczna
 DE Hand-Nietzange
 RU Ручной заклепочник
 CZ Ruční nýtovačka
 RO Presă de nituit manuală
 HU Kézi popszegecshúzó
 ES Remachadora de mano

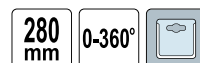

No.	L [mm]	Ø [mm]	
70100	280	2,4, 3,2, 4, 4,8	6/24

EN Hand riveter
 PL Nitownica ręczna
 DE Hand-Nietzange
 RU Ручной заклпочник
 CZ Ruční nýtovačka
 RO Presă de nituit manuală
 HU Kézi pöpszegecsűző
 ES Remachadora de mano

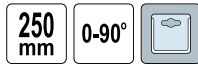

VOREL

No.	L [mm]	Ø [mm]	
70160	250	2,4, 3,2, 4, 4,8	12/24

EN Hand riveting tool
 PL Nitownica dźwigniowa
 DE Blindnietzange
 RU Заклпочник рычажный
 CZ Nýtovačka páková
 RO Nituire părghie
 HU Pöpszegecsűző
 ES Remachadora de palanca

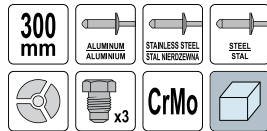

VOREL

No.	L [mm]	Ø [mm]	
70201	300	3,2, 4, 4,8	20

EN Hand riveting tool
 PL Nity aluminiumowa
 DE Aluminiumblindnietzange
 RU Заключник алюминевый
 CZ Nýtovačka alu
 RO Nituire alu
 HU Alu pöpszegecsűző
 ES Remachadora de aluminio



VOREL

No.	L [mm]	Ø [mm]	
70210	400	3,4, 4, 4,8	10/20

EN Hand nut tool
 PL Nitownica ręczna do nitonakrętek
 DE Nietmutternzange
 RU Ручной заклпочник для резьбовых заклпочек

CZ Nýtovací kleště na matici
 RO Clește pt. piulițe nituibile
 HU Emeltyűs pöpszegecsűző
 ES Remachadora de tuercas

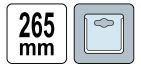

VOREL

No.	L [mm]	Nuts diameter / Średnica nitonakrętek	
70270	265	M3, M4, M5, M6	5/20

EN Hand riveter
 PL Nitownica ręczna
 DE Hand-Nietzange
 RU Ручной заклпочник

CZ Ruční nýtovačka
 RO Presă de nituit manuală
 HU Kézi pöpszegecsűző
 ES Remachadora de mano

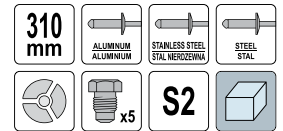

VOREL

No.	L [mm]	Ø [mm]	
70202	310	2,4, 3,2, 4, 4,8, 6,4	16

EN Aluminium blind rivets
 PL Nity aluminiumowe
 DE Aluminiumblindnieten
 RU Заключки алюминевые

CZ Hliníkové nýty
 RO Nituri din aluminiu
 HU Alu pöpszegecs
 ES Remaches de aluminio



VOREL

No.	L [mm]	Ø [mm]	pcs / szt.	
70320	6.4	3.2	50	150/300
70330	9.6	3.2	50	150/300
70340	12.7	3.2	50	150/300
70400	6.4	4.0	50	100/200
70410	9.6	4.0	50	100/200
70420	12.7	4.0	50	100/200
70430	19.0	4.0	50	100/200
70480	6.4	4.8	50	100/200
70490	9.6	4.8	50	100/200
70500	12.7	4.8	50	100/200
70510	19.0	4.8	50	75/150

EN Pneumatic riveting machine
 PL Nitownica pneumatyczna
 DE Druckluft Nietzange
 RU Пневматический заклепочник
 CZ Pneumatická nýtovačka
 RO Presa pneumatica pt. nituit
 HU Pneumatikus popszegecshűző
 ES Máquina remachadora



$L_{pa} = 76,1 \pm 3 \text{ dB}$; $L_{wa} = 87,1 \pm 3 \text{ dB}$; $a_s = 0,85 \pm 0,59 \text{ m/s}^2$

No.	Ø [mm]	Max. piston stroke / Maks. skok tłoka siłownika [mm]	F [kg]	F [N]	
70280	2,4, 3,2, 4, 4,8	14	720	7060	10

EN Staple gun
 PL Zszywacz tapicerski
 DE Tacker
 RU Стенлеп
 CZ Čalounická sešivačka
 RO Capsator tapiterie
 HU Kárpitos tűzőgép
 ES Grapadora de tapicero



No.	Staple length / Długość zszywki [mm]	
71000	4-8	10/60

EN Staple gun
 PL Zszywacz tapicerski
 DE Tacker
 RU Стенлеп
 CZ Čalounická sešivačka
 RO Capsator tapiterie
 HU Kárpitos tűzőgép
 ES Grapadora de tapicero

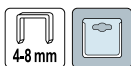

No.	Staple length / Długość zszywki [mm]	
71040	4-8	10/40

EN Profile connection pliers
 PL Szczypce do łączenia profili
 DE Profil Verbundzange
 RU Клещи для соединения профилей
 CZ Kleště do spojování profilů
 RO Cleste sertizat profile rigips
 HU Profilösszekítő fogó
 ES Alicates para unir perfiles

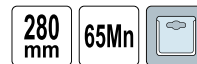

No.	L [mm]	
04300	280	6/36

EN Profile connection pliers
 PL Szczypce do łączenia profili
 DE Profil Verbundzange
 RU Клещи для соединения профилей
 CZ Kleště do spojování profilů
 RO Cleste sertizat profile rigips
 HU Profilösszekítő fogó
 ES Alicates para unir perfiles



No.	L [mm]	
04301	300	6/24

EN Staple gun
 PL Zszywacz tapicerski
 DE Tacker
 RU Стенлеп
 CZ Čalounická sešivačka
 RO Capsator tapiterie
 HU Kárpitos tűzőgép
 ES Grapadora de tapicero

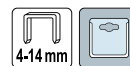

No.	Staple length / Długość zszywki [mm]	
71050	4-8	10/40

EN Staple gun
 PL Zszywacz tapicerski
 DE Tacker
 RU Стенлеп
 CZ Čalounická sešivačka
 RO Capsator tapiterie
 HU Kárpitos tűzőgép
 ES Grapadora de tapicero

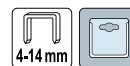

No.	Staple length / Długość zszywki [mm]	
71052	4-14	10/20

EN Staple gun
 PL Zszywacz tapicerski
 DE Tacker
 RU Стенпеп
 CZ Čalounická sešíváčka
 RO Capsator tapiterie
 HU Kárpitos tűzőgép
 ES Grapadora de tapicero

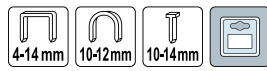

VOREL

No.		
71060		6/24

EN Staple remover
 PL Rozszywacz
 DE Entkammerer
 RU Расшиватель
 CZ Rozešíváč
 RO Extractor capse
 HU Kapocskiszedo
 ES Quitagrapas

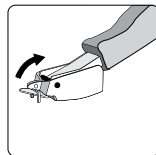

VOREL

No.		
71160		10/40

EN Staples type „E” for mesh pliers
 PL Zszywki typu „E” do mocowania siatki
 DE Zaunringe
 RU Скобы для обжима сетки
 CZ Svorky pro montáž pletiva
 RO Capse pt. făcut cuști
 HU Kapcsok madárháló rögzítéséhez
 ES Grapas omega



VOREL

No.	For / Dia	
49841	49840	10/60

EN Hammer tacker
 PL Zszywacz młotkowy
 DE Hammer Tacker
 RU Молотковый степлер
 CZ Sponkovač kladivový
 RO Capsator ciocan
 HU Kalapács tűzőgép
 ES Grapadora de martillo

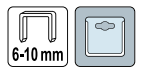

VOREL

No.	Staple length / Długość zszywki [mm]	
71080	6-10	6/24

EN Mesh pliers
 PL Szczypce do mocowania siatki ogrodzeniowej
 DE Zaunklammerzange
 RU Стенпеп-сшиватель для металлической сетки и сетки-рабицы
 CZ Kleště pro spojování a montáž pletiv
 RO Clește de capsat pt. fixarea gardurilor
 HU Fogó kerítéskapocshoz
 ES Hog anillo alicates



VOREL

No.		
49840		50

EN Staples
 PL Zszywki
 DE Heftklammern
 RU Скобы
 CZ Sponky
 RO Capse tapiterie
 HU Tűzőkapocs
 ES Grapas

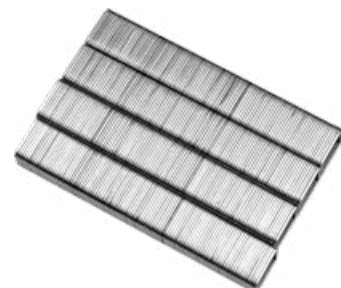

VOREL

No.	Staple length / Długość zszywki [mm]	Staple thickness / Grubość zszywki [mm]	Staple width / Szerokość zszywki [mm]	pcs / szt.	
72040	4	0.7	11.3	1000	60/480
72060	6	0.7	11.3	1000	60/360
72080	8	0.7	11.3	1000	60/300
72100	10	0.7	11.3	1000	60/240
72120	12	0.7	11.3	1000	50/200
72140	14	0.7	11.3	1000	40/160

EN Staples
 PL Zszywki
 DE Heftklammern
 RU Скобы
 CZ Sponky
 RO Capse tapiterie
 HU Tűzőkapocs
 ES Grapas



VOREL

No.	Staple length / Długość zszywki [mm]	Staple thickness / Grubość zszywki [mm]	Staple width / Szerokość zszywki [mm]	pcs / szt.	
71970	6	0.9	12.7	12000	10
71971	10	0.9	12.7	7500	10
71972	16	0.9	12.7	4500	10

EN Staples
 PL Zszywki
 DE Heftklammern
 RU Скобы
 CZ Sponky
 RO Capse tapiterie
 HU Tűzőkapocs
 ES Grapas

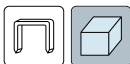

VOREL

No.	Staple length / Długość zszywki [mm]	Staple thickness / Grubość zszywki [mm]	Staple width / Szerokość zszywki [mm]	pcs / szt.	
71975	16	1.2	5.5	2000	27
71976	21	1.2	5.5	2200	18
71977	25	1.2	5.5	2000	18
71978	38	1.2	5.5	1600	15

EN Coil nails
 PL Gwoździe bębnowe
 DE Spulennägel
 RU Гвозди барабанные для пневмопистолета

CZ Hřebíky spojené drátem
 RO Cuie in rola
 HU Dobtáras szeg
 ES Clavos de tambor para filtros para tejados

VOREL

No.	Nail length / Długość gwoździa [mm]	Nail diameter / Średnica gwoździa [mm]	pcs / szt.	
72000	19	3.1	4200	1
72001	22	3.1	4200	1

EN Nails on paper tape
 PL Gwoździe taśmowe
 DE Streifennägel
 RU Гвозди отделочные для пневмопистолета
 CZ Hřebík nastřelovací
 RO Cuie
 HU Siktáras szeg
 ES Clavos de tira de papel

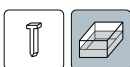

VOREL

No.	Nail length / Długość gwoździa [mm]	Nail diameter / Średnica gwoździa [mm]	pcs / szt.	
72010	50	2.8	3000	1
72011	65	2.8	3000	1
72012	75	2.8	3000	1
72013	90	3.1	2000	1

EN Brad nails
 PL Szyfity
 DE Stauchkopfnägel
 RU Шпилька для степлера
 CZ Kolářské hřebíky
 RO Cuie fara cap
 HU Műanyag spakli
 ES Palos

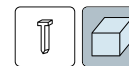

VOREL

No.	Staple length / Długość zszywki [mm]	Staple thickness / Grubość zszywki [mm]	Staple width / Szerokość zszywki [mm]	pcs / szt.	
71980	16	1.3	1.8	5000	27
71981	30	1.3	1.8	5000	18
71982	35	1.3	1.8	5000	15
71983	50	1.3	1.8	5000	15

EN Coil nails
 PL Gwoździe bębnowe
 DE Spulennägel
 RU Гвозди барабанные для пневмопистолета
 CZ Hřebíky spojené drátem
 RO Cuie in rola
 HU Dobtáras szeg
 ES Clavos de tambor



VOREL

No.	Nail length / Długość gwoździa [mm]	Nail diameter / Średnica gwoździa [mm]	pcs / szt.	
71990	32	2.1	7200	1
71991	38	2.1	7200	1
71992	50	2.1	5400	1
71993	64	2.5	3000	1
71994	70	2.5	3000	1
71995	75	2.5	3000	1
71996	80	2.8	3000	1
71997	90	2.8	3000	1

EN Coil nails
 PL Gwoździe bębnowe
 DE Spulennägel
 RU Гвозди барабанные для пневмопистолета

CZ Hřebíky spojené drátem
 RO Cuie in rola
 HU Dobtáras szeg
 ES Clavos de tambor para filtros para tejados

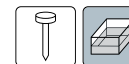

EN Pliers for hollow expansion bolts
 PL Zaciskarka do kołków „Molly”
 DE Maueranker-Einsatzwerkzeug
 RU Клещи для дюбелей „Молли”
 CZ Kleště kotvičky pro Molly hmoždinky
 RO Ceste dibluri
 HU Molly fogó üreges bővítőcsavarokhoz
 ES Alicata para tacos „Molly”

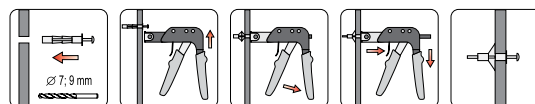

VOREL

No.	
04320	10/40

EN Screw & plug set
 PL Zestaw wkrętów i kołków rozporowych
 DE Dübel- und Schrauben Sortiment
 RU Набор крепежа шурупы и дюбеля
 CZ Set šroubů a hmoždinek
 RO Set dibluri + holsuruburi
 HU Csavar és tiplí készlet
 ES Juego de tornillos y pernos de expansión



3.5 x 30 mm (35 PCS), 4 x 40 mm (35 PCS), 4.5 x 50 mm (30 PCS); 2.8 x 30 mm (35 PCS), 3.0 x 40 mm (40 PCS), 3.8 x 50 mm (35 PCS); 5 x 30 mm (30 PCS), 6 x 35 mm (30 PCS), 8 x 50 mm (20 PCS)



No.	pcs / szt.	Tray
24112	290	5/20

EN Screw assortment
 PL Zestaw wkrętów
 DE Spanplatten-schrauben Sortiment
 RU Набор винтов

CZ Šrouby
 RO Set holsuruburi
 HU Csavar készlet
 ES Juego de tornillos



4 x 20 mm (50 PCS), 5 x 30 mm (15 PCS); 3.5 x 19 mm (50 PCS), 4.2 x 25 mm (30 PCS); 1.5 x 25 mm (120 PCS), 2.0 x 40 mm (50 PCS), 3.0 x 60 mm (25 PCS); M4 x 20 mm (25 PCS), M5 x 25 (15 PCS); M4 (25 PCS), M5 (15 PCS); M4 (50 PCS), M5 (30 PCS); M4 (25 PCS), M5 (15 PCS)



No.	pcs / szt.	Tray
24122	580	6/24

EN Cable manager set
 PL Zestaw do mocowania kabli
 DE Kabelhalter-Set
 RU Набор для крепления проводов

CZ Sada na uspořádání kabelů
 RO Set organizare cabluri
 HU Kábelkezelő készlet
 ES Juego de elementos de fijación de cables



No.	pcs / szt.	Tray
24140	124	6/60

EN Drill bit and plug set
 PL Komplet wiertel z kołkami rozporowymi
 DE Dübel- und Schrauben Sortiment
 RU Набор крепежа шурупы и дюбеля
 CZ Set šroubů a hmoždinek
 RO Set dibluri + holsuruburi
 HU Csavar és tiplí készlet
 ES Juego de brocas con pernos de expansión

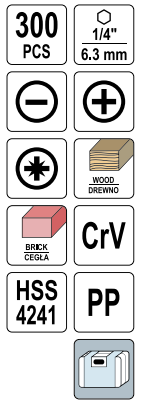

Ø 2, 3, 4, 5, 6, 8, 10 mm; HSS 4241; Ø 4, 5, 6, 8, 10 mm; Ø 5 mm (100 PCS), Ø 6 mm (100 PCS), Ø 8 mm (50 PCS), Ø 10 mm (25 PCS); PP; 1/4" (6.3 mm): 4.5, 6 mm (L=25 mm); CrV; 1/4" (6.3 mm): PH1, PH2 mm (L=25 mm); CrV; 1/4" (6.3 mm): PZ1, PZ2 (L=25 mm); CrV; 1/4" (6.3 mm): (L=60 mm); 1/4" (6.3 mm): (L=12 mm)



No.	pcs / szt.	Tray
24100	300	20

EN Picture hook assortment
 PL Zestaw haków na obrazy
 DE Bilderhaken-Set
 RU Набор крючков для картин

CZ Sada háčků na obrazy
 RO Set cârlige rame
 HU Résztes képekasztó készlet
 ES Juego de ganchos para cuadros



No.	pcs / szt.	Tray
24130	121	6/60

EN Caulking gun
 PL Wyciskacz do mas
 DE Kartuschenpistole
 RU Пистолет для герметика

CZ Ruční výtlačná pistole
 RO Pistol silicon
 HU Extrudáló pisztoly
 ES Pistola para masilla



No.	Tube length / Długość tuby [mm]	Tray
09100	230	20/40

EN Caulking gun
 PL Wyciskacz do mas
 DE Kartuschenpistole
 RU Пистолет для герметика
 CZ Ruční výtlačná pistole
 RO Pistol silicon
 HU Extrudáló pisztoly
 ES Pistola para masilla

230 mm



No.	Tube length / Długość tuby [mm]	
09130	230	10/20

EN Caulking gun
 PL Wyciskacz do mas
 DE Kartuschenpistole
 RU Пистолет для герметика

CZ Ruční výtlačná pistole
 RO Pistol silicon
 HU Extrudáló pisztoly
 ES Pistola para masilla



10



No.	Tube length / Długość tuby [mm]	
09120	245	24

EN Building and construction cement grouting gun
 PL Aplikator do zapraw, mas szpachlowych i fugowania
 DE Spritze für Mörtel-, Spachtel- und Fugenmaßen
 RU Аппликатор для строительных растворов, шпатлевок и затирки
 CZ Aplikátor malt, plniv a spojiování
 RO Pompa injectat beton
 HU Habarcs, spatulázó massa és fuga kinyomó
 ES Aplicador de mortero, masilla y para juntas

660 mm 80x20 mm PP
 ABS

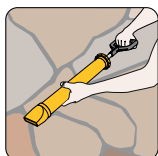

No.	L [mm]	
04450	660	24

EN Caulking gun
 PL Wyciskacz do mas
 DE Kartuschenpistole
 RU Пистолет для герметика
 CZ Ruční výtlačná pistole
 RO Pistol silicon
 HU Extrudáló pisztoly
 ES Pistola para masilla

230 mm



No.	Tube length / Długość tuby [mm]	
09150	230	20/40

EN Caulking gun
 PL Wyciskacz do mas
 DE Kartuschenpistole
 RU Пистолет для герметика

CZ Ruční výtlačná pistole
 RO Pistol silicon
 HU Extrudáló pisztoly
 ES Pistola para masilla

230 mm



No.	Tube length / Długość tuby [mm]	
09160	230	6/12

EN Building and construction cement grouting gun
 PL Aplikator do zapraw, mas szpachlowych i fugowania
 DE Spritze für Mörtel-, Spachtel- und Fugenmaßen
 RU Аппликатор для строительных растворов, шпатлевок и затирки
 CZ Aplikátor malt, plniv a spojiování
 RO Pompa injectat beton
 HU Habarcs, spatulázó massa és fuga kinyomó
 ES Aplicador de mortero, masilla y para juntas

660 mm 10 mm PP
 ABS

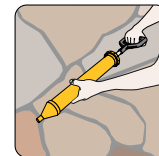

No.	L [mm]	
04451	660	24

EN Building and construction cement grouting gun
 PL Aplikator do zapraw, mas szpachlowych i fugowania
 DE Spritze für Mörtel-, Spachtel- und Fugenmaßen
 RU Аппликатор для строительных растворов, шпатлевок и затирки
 CZ Aplikátor malt, plniv a spojivování
 RO Pompa injectat beton
 HU Habarcs, spatulázó massa és fuga kinyomó
 ES Aplicador de mortero, masilla y para juntas

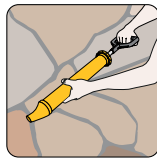
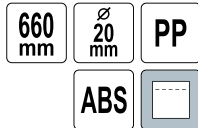

VOREL

No.	L [mm]	
04452	660	24

EN Foam gun
 PL Pistolet do pianki montażowej
 DE Schaumpistole
 RU Пистолет для нанесения полиуретановой пены
 CZ Pistolet na montážní pěnu
 RO Pistol pt. spumă
 HU Felrakó pisztoly, poliurethán habhoz
 ES Pistola para espuma de poliuretano



VOREL

No.	
09171	10/20

EN Foam gun
 PL Pistolet do pianki montażowej
 DE Schaumpistole
 RU Пистолет для нанесения полиуретановой пены
 CZ Pistolet na montážní pěnu
 RO Pistol pt. spumă
 HU Felrakó pisztoly, poliurethán habhoz
 ES Pistola para espuma de poliuretano



VOREL

No.	
09174	20

EN Foam gun
 PL Pistolet do pianki montażowej
 DE Schaumpistole
 RU Пистолет для нанесения полиуретановой пены
 CZ Pistolet na montážní pěnu
 RO Pistol pt. spumă
 HU Felrakó pisztoly, poliurethán habhoz
 ES Pistola para espuma de poliuretano



VOREL

No.	
09170	20

EN Foam gun
 PL Pistolet do pianki montażowej
 DE Schaumpistole
 RU Пистолет для нанесения полиуретановой пены
 CZ Pistolet na montážní pěnu
 RO Pistol pt. spumă
 HU Felrakó pisztoly, poliurethán habhoz
 ES Pistola para espuma de poliuretano



VOREL

No.	
09172	20

EN Foam gun
 PL Pistolet do pianki montażowej
 DE Schaumpistole
 RU Пистолет для нанесения полиуретановой пены
 CZ Pistolet na montážní pěnu
 RO Pistol pt. spumă
 HU Felrakó pisztoly, poliurethán habhoz
 ES Pistola para espuma de poliuretano



VOREL

No.	
09177	20

- EN Foam gun
- PL Pistolet do pianki montażowej
- DE Schaumpistole
- RU Пистолет для нанесения полиуретановой пены
- CZ Pistolet na montážní pěnu
- RO Pistol pt. spumă
- HU Felrakó pisztoly, poliurethán habhoz
- ES Pistola para espuma de poliuretano



No.	20
09173	

- EN Foam gun
- PL Pistolet do pianki montażowej
- DE Schaumpistole
- RU Пистолет для нанесения полиуретановой пены
- CZ Pistolet na montážní pěnu
- RO Pistol pt. spumă
- HU Felrakó pisztoly, poliurethán habhoz
- ES Pistola para espuma de poliuretano

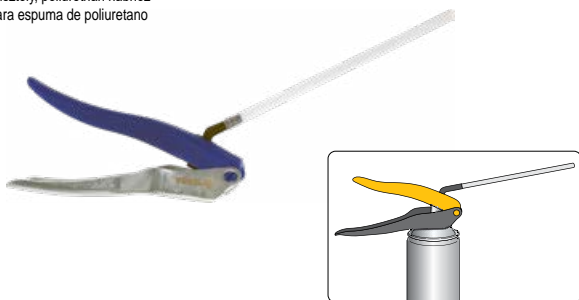

No.	100
09163	

- EN Hose clip
- PL Opaska ślimakowa
- DE Schlauchklemme
- RU Хомут стальной
- CZ Šneková páska
- RO Colier metalic
- HU Csigapánt
- ES Abrazadera sin fin



No.	Ø [mm]	W [mm]	100
73561	8-12	9	100
73562	10-16	9	100
73563	12-22	9	100
73565	16-27	9	100
73567	20-32	9	100
73568	25-40	9	100
73569	35-50	9	50
73570	40-60	9	50
73571	50-70	9	50
73572	60-80	9	25
73573	70-90	9	25
73574	80-100	9	25
73575	90-110	9	25



- EN Foam gun
- PL Pistolet do pianki montażowej
- DE Schaumpistole
- RU Пистолет для нанесения полиуретановой пены
- CZ Pistolet na montážní pěnu
- RO Pistol pt. spumă
- HU Felrakó pisztoly, poliurethán habhoz
- ES Pistola para espuma de poliuretano



No.	20
09165	

- EN Hose clip set
- PL Komplet opasek ślimakowych
- DE Schlauchklemmensatz
- RU Набор хомутов
- CZ Sada šnekových pásek
- RO Set coliere metalice
- HU Csigapántkészlet
- ES Juego de abrazaderas sin fin



No.	pcs / szt.	25
73590	8	

- EN Hose clip set
- PL Komplet opasek ślimakowych
- DE Schlauchklemmensatz
- RU Набор хомутов
- CZ Sada šnekových pásek
- RO Set coliere metalice
- HU Csigapántkészlet
- ES Juego de abrazaderas sin fin



No.	Ø [mm]	W [mm]	pcs / szt.	4/40
73831	8-12	9	4	4/40
73833	12-22	9	4	40
73835	20-32	9	4	40

EN Hose clip set
 PL Komplet serwisowy
 DE Schlauchklemmensatz
 RU Набор хомутов
 CZ Dělnická sada
 RO Set coliere metalice
 HU Szervizkészlet
 ES Juego de mantenimiento



No.	pcs / szt.	📦
73598	365	1

EN Screw clamp
 PL Obejma śrubowa
 DE Schraubklemme
 RU Винтовой зажим
 CZ Šroubová svorka
 RO Colier metalic
 HU Csavaros csőbillincs
 ES Abrazadera de tornillo



No.	Ø [mm]	W [mm]	pcs / szt.	📦
73787	19-21	18	4	100
73788	21-23	18	4	75
73789	23-25	18	4	75
73790	25-27	18	4	75
73791	27-29	18	3	75
73792	29-31	20	3	75
73793	32-35	20	3	75
73794	35-38	20	2	100
73795	38-41	20	2	100
73796	40-43	20	1	100
73797	44-47	22	1	100
73798	48-51	22	1	100
73799	52-55	22	1	100
73800	56-59	22	1	100
73801	60-63	22	1	100
73802	64-67	22	1	100
73803	68-73	24	1	100
73804	74-79	24	1	100
73805	80-85	24	1	100
73806	86-91	24	1	100
73807	92-97	24	1	100
73808	98-103	24	1	100

EN Cable ties
 PL Opaski plastikowe
 DE Kabelbinder
 RU Хомуты-стяжки пластиковые
 CZ Plastiková páska
 RO Set coliere din plastic
 HU Műanyag pánt
 ES Abrazaderas de plástico



No.	Size / Rozmiar [mm]	Max. tensile strength / Maks. odporność na zrywanie [kg]	Max. wire bundle diameter / Maks. średnica wiązki kabli [mm]	pcs / szt.	📦
73881	80x2.5	8	15	100	250/500
73882	100x2.5	8	20	100	250/500
73883	150x2.5	8	40	100	250/500
73884	200x2.5	8	50	100	125/250
73885	300x3.6	18	80	100	75/150

EN Screw clamp
 PL Obejma śrubowa
 DE Schraubklemme
 RU Винтовой зажим
 CZ Šroubová svorka
 RO Colier metalic
 HU Csavaros csőbillincs
 ES Abrazadera de tornillo



No.	Ø [mm]	W [mm]	pcs / szt.	📦
73780	8-10	9	4	100
73781	10-12	9	4	100
73782	12-14	9	4	100
73783	14-16	9	4	100
73784	16-18	9	4	100
73785	18-20	9	4	100
73786	20-22	9	4	100

EN Cable ties
 PL Opaski plastikowe
 DE Kabelbinder
 RU Хомуты-стяжки пластиковые
 CZ Plastiková páska
 RO Set coliere din plastic
 HU Műanyag pánt
 ES Abrazaderas de plástico

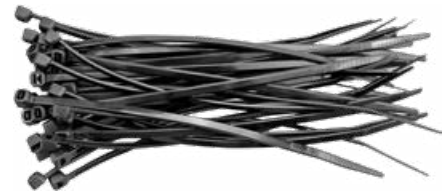

No.	Size / Rozmiar [mm]	Max. tensile strength / Maks. odporność na zrywanie [kg]	Max. wire bundle diameter / Maks. średnica wiązki kabli [mm]	pcs / szt.	📦
73892	100x2.5	8	20	100	250/500
73893	150x2.5	8	40	100	250/500
73894	200x2.5	8	50	100	125/250
73895	300x3.6	18	80	100	75/150
73929	280x4.8	22	80	100	50/100
73896	370x4.8	22	100	100	50/100
73897	430x4.8	22	120	100	35/70
73898	500x8.0	54	130	50	30/60



No.	Size / Rozmiar [mm]	Max. tensile strength / Maks. odporność na zrywanie [kg]	Max. wire bundle diameter / Maks. średnica wiązki kabli [mm]	pcs / szt.	📦
73906	200x4.8	22	50	100	75/150
73909	280x4.8	22	80	100	50/100
73886	370x4.8	22	100	100	50/100
73887	430x4.8	22	120	100	35/70
73888	500x8.0	54	130	50	30/60

EN Hook and loop cable ties
 PL Opaska rzepowa
 DE Klettkegelbinder
 RU Хомут на липучке
 CZ Opaska na suchý zip
 RO Chinga cu bucla
 HU Tépözárás szalag
 ES Cinta con velcro



No.	Size / Rozmiar [mm]	pcs / szt.	
73840	150x25	10	50/100
73843	300x25	10	50/100
73845	450x25	10	50/100

EN Nylon cable tie gun
 PL Zaciskacz do opasek kablowych
 DE Kabelbinder Verschluss Werkzeug
 RU Пистолет для кабельных стяжек
 CZ Kliešte viazacie káblové
 RO Cieste pt. strans coliere plastic
 HU Kábelkötégető fogó
 ES Pistola de amarre de cables

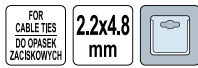

No.	
73875	10/40

EN Glue sticks
 PL Wkłady klejowe
 DE Heisskleberpatronen
 RU Стержин для горячей склейки
 CZ Lepicí vložky
 RO Mine cu clei
 HU Ragasztóbetét
 ES Cartucho de cola



APPLICATION: - Cardboard, wood, plastic, leather, fabrics
 ZASTOSOWANIE: - Tektura, drewno, plastik, skóra, tkaniny



No.	Ø [mm]	L [mm]	pcs / szt.	
73260	7	100	12	50/200
73270	11	100	6	20/120
73271	11	150	12	20/60

EN Packing tape dispenser
 PL Podajnik taśmy pakowej
 DE Verpackungsband-Abroller
 RU Диспенсер для клейких лент
 CZ Páskovačka
 RO Pistol cu banda de impachetare
 HU Csomagolószalag tépő
 ES Alimentador de la cinta de embalaje

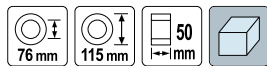

No.	W [mm]	
75295	50	12/24

EN Hook and loop cable ties
 PL Opaska rzepowa
 DE Klettkegelbinder
 RU Хомут на липучке
 CZ Opaska na suchý zip
 RO Chinga cu bucla
 HU Tépözárás szalag
 ES Cinta con velcro



No.	Size / Rozmiar [mm]	pcs / szt.	
73850	150x25	10	50/100
73853	300x25	10	50/100
73855	450x25	10	50/100

EN Glue sticks
 PL Wkłady klejowe
 DE Heisskleberpatronen
 RU Стержин для горячей склейки
 CZ Lepicí vložky
 RO Mine cu clei
 HU Ragasztóbetét
 ES Cartucho de cola



APPLICATION: - Cardboard, wood, plastic, leather, fabrics
 ZASTOSOWANIE: - Tektura, drewno, plastik, skóra, tkaniny



No.	Ø [mm]	L [mm]	m [kg]	
73300	11	200	1	10

EN Glue applicator - bottle kit
 PL Dozownik kleju
 DE Applikator-Flasche für Flüssigklebstoffe
 RU Анпликатор клея
 CZ Aplikátor lepidla
 RO Kit aplicator lipici
 HU Lamellarasztó
 ES Dispensador de pegamento

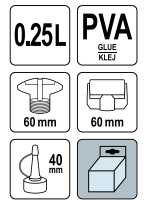

No.	
78027	50

EN Packing tape, brown
 PL Taśma pakowa brązowa
 DE Verpackungsband aus PP, braun
 RU Упаковочная клейкая лента
 CZ Balící páska PP hnědá
 RO Bandă ambalare PP maro
 HU PP barna ragasztószalag
 ES Cinta de embalaje marrón



No.	W [mm]	L [m]	
75301	48	40	36
75302	48	66	36

EN Packing tape, transparent
 PL Taśma pakowa przezroczysta
 DE Verpackungsband aus PP, durchsichtig
 RU Упаковочная клейкая лента

CZ Balící páska PP průhledná
 RO Bandă ambalare PP transparentă
 HU Átlátszó ragasztószalag
 ES Cinta de embalaje transparente



VOREL

No.	W [mm]	L [m]	
75303	48	40	36
75304	48	66	36

EN Self adhesive paper tape
 PL Taśma papierowa samoprzylepna
 DE Papierband selbstklebend
 RU Лента малярная бумажная

CZ Páska papírová samolepící
 RO Banda adeziva hartie
 HU Öntapadó papírszalag
 ES Cinta de papel autoadhesiva



VOREL

No.	W [mm]	L [m]	
75270	19	25	12/48
75271	25	25	9/36
75272	30	25	10/40
75273	38	25	6/24
75274	48	25	6/24
75285	25	50	9/36
75286	30	50	10/40
75287	38	50	6/24
75288	48	50	6/24

EN Double-sided carpet tape
 PL Taśma dwustronna do wykładzin
 DE Doppelseitiges Klebeband für Auslegware
 RU Двухсторонняя клейкая лента для укладки ковровых покрытий
 CZ Obojstranná lepicí páska (na podlahové krytiny)
 RO Bandă cu două părți adezive pt. mochetă
 HU Kétoldalas szalag szőnyegpadlókhöz
 ES Cinta de doble cara para revestimientos

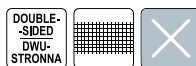

VOREL

No.	W [mm]	L [m]	
75260	50	5	48
75261	50	10	36
75262	50	25	24

EN Packing tape
 PL Taśma pakowa
 DE Band
 RU Упаковочная клейкая лента
 CZ Balící páska
 RO Banda scotch
 HU Csomagolószalag
 ES Cinta de embalaje



No.	W [mm]	L [m]	
75300	48	45	12/36

EN Blue masking tape
 PL Taśma maskująca, niebieska
 DE Malerei blau Tape
 RU Малярна стрічка

CZ Maskovací páska
 RO Bandă de mascare
 HU Fedőszalag
 ES Cinta adhesiva azul



VOREL

No.	W [mm]	L [m]	
75120	30	25	40
75121	38	25	24
75122	48	25	24
75123	30	50	40
75124	38	50	24
75125	48	50	24

EN Plastering tape
 PL Taśma tynkarska elewacyjna
 DE Putzband
 RU Штукатурные лента
 CZ Fasádní omítková páska
 RO Banda mascare pt. tencuieii
 HU Homlokzati festő szalag
 ES Cinta de enlucido de fachada



VOREL

No.	W [mm]	L [m]	
75130	38	20	24
75131	48	20	24
75132	38	50	28
75133	48	50	24

EN Double-sided tape
 PL Taśma dwustronna na folii
 DE Doppelseitiges Band auf PP-Folie
 RU Клейкая лента двухсторонняя на полипропиленовой основе
 CZ Obojstranná páska na PP folii
 RO Bandă cu două fețe pt. folii
 HU Kétoldalas
 ES Cinta de doble cara en film



VOREL

No.	W [mm]	L [m]	
75245	50	5	72
75246	50	10	72
75247	50	25	36

- EN Mounting tape
- PL Taśma samoprzylepna dwustronna
- DE Doppelseitiges Montageband
- RU Двухсторонняя монтажная лента
- CZ Páska montážní dvouvrstvá
- RO Scotch cu banda dubla
- HU Kétfoldalás ragasztószalag
- ES Cinta adhesiva de doble cara

2 PCS 2.25m 19mm 5m 19mm



No.	W [mm]	L [m]	
75100	19	2.25, 5	12/96

- EN Warning tape
- PL Taśma ostrzegawcza
- DE Warnband, kleband
- RU Лента сигнальная
- CZ Lepicí páska výstražná
- RO Bandă adevizivă avertizare
- HU Figyelmeztető ragasztó szalag
- ES Cinta de advertencia

SELF-ADHESIVE SAMO-PRZYLEPNA PVC



No.	W [mm]	L [m]	
75231	48	33	24

- EN Two-colour warning tape
- PL Taśma ostrzegawcza dwukolorowa
- DE Zweifarbiges Warnband
- RU Лента сигнальная
- CZ Páska výstražná dvojbarevná
- RO Banda de avertizare bicolora
- HU Kétszínű jelzőszalag
- ES Cinta de advertencia bicolor



No.	W [mm]	L [m]	
75233	75	100	24

- EN PVC Tape
- PL Taśma PCV
- DE PVC Band
- RU Изолента ПВХ
- CZ Páska PVC
- RO Banda izolatoare PVC
- HU PVC szalag
- ES Cinta PVC



No.	W [mm]	Thickness / Grubość [mm]	L [mm]	pcs / szt.	
75000	19	0.13	10	10	50
75050	50	0.13	10	1	25/100

- EN „DUCT” tape
- PL Taśma tekstylna „DUCT”
- DE Textilband „DUCT”
- RU Лента армированная на тканевой основе
- CZ Textilní páska „DUCT”
- RO Bandă textilă „DUCT”
- HU „DUCT” textil szalag
- ES Cinta textil “DUCT”

DUCT



No.	W [mm]	L [m]	
75238	48	10	24
75239	38	50	28
75240	48	50	24

- EN Warning tape
- PL Taśma ostrzegawcza
- DE Warnband, kleband
- RU Лента сигнальная
- CZ Lepicí páska výstražná
- RO Bandă adevizivă avertizare
- HU Figyelmeztető ragasztó szalag
- ES Cinta de advertencia

SELF-ADHESIVE SAMO-PRZYLEPNA PVC



No.	W [mm]	L [m]	
75230	48	33	24

- EN Aluminium tape
- PL Taśma aluminiowa
- DE Aluminiumband
- RU Алюминиевая клейкая лента
- CZ Hliníková páska
- RO Bandă aluminiu
- HU Alumínium szalag
- ES Cinta de aluminio

Al



No.	W [mm]	L [m]	
75140	48	10	36
75141	48	50	24

- EN PVC Tape
- PL Taśma PCV
- DE PVC Band
- RU Изолента ПВХ
- CZ Páska PVC
- RO Banda izolatoare PVC
- HU PVC szalag
- ES Cinta PVC

6 PCS



No.	W [mm]	Thickness / Grubość [mm]	L [mm]	pcs / szt.	
75060	19	0.13	3	6	10/100

EN PVC tape
 PL Taśma PCV do użytku zewnętrznego
 DE PVC Band
 RU Лента ПВХ для внешних работ
 CZ Páska PVC
 RO Bandă PVC
 HU Kétoldalas PVC
 ES Cinta de PVC para exteriores



VOREL

No.	W [mm]	L [m]	
75031	48	33	50

EN Builders line
 PL Sznurek murarski
 DE Maurerschnur
 RU Шнур - причалка
 CZ Šňůra zednická
 RO Sfoară pt. zidari
 HU Kőműves zsinór
 ES Cuerda de albañil



VOREL

No.	Ø [mm]	L [m]	
17497	1.2	75	12/48

EN Builders line
 PL Sznurek murarski
 DE Maurerschnur
 RU Шнур - причалка
 CZ Šňůra zednická
 RO Sfoară pt. zidari
 HU Kőműves zsinór
 ES Cuerda de albañil



No.	L [m]	Color / Kolor	
17488	50	zółty	60
17489	100	zółty	60

EN Polypropylene sennit line
 PL Linka pleciona polipropylenowa
 DE Geflochtenes Seil aus Polypropylen
 RU Канат полипропиленовый плетеный

CZ Lano pletené polypropylenové
 RO Coarda împletită din polipropilena
 HU Polipropilén fonott kötél
 ES Cuerda trenzada de polipropileno

VOREL

No.	Ø [mm]	L [m]	
69502	4	400	1
69503	5	250	1
69504	6	250	1
69505	8	300	1
69506	10	200	1
69507	12	180	1
69508	14	110	1
69509	16	80	1
69510	18	70	1

EN Builders line
 PL Sznurek murarski
 DE Maurerschnur
 RU Шнур - причалка
 CZ Šňůra zednická
 RO Sfoară pt. zidari
 HU Kőműves zsinór
 ES Cuerda de albañil



VOREL

No.	L [m]	
17495	75	12/48

EN Builders line
 PL Sznurek murarski
 DE Maurerschnur
 RU Шнур - причалка
 CZ Šňůra zednická
 RO Sfoară pt. zidari
 HU Kőműves zsinór
 ES Cuerda de albañil



VOREL

No.	Ø [mm]	L [m]	
17498	1.2	200	12/48

EN Builders line
 PL Sznurek murarski
 DE Maurerschnur
 RU Шнур - причалка
 CZ Šňůra zednická
 RO Sfoară pt. zidari
 HU Kőműves zsinór
 ES Cuerda de albañil



No.	L [m]	
17490	40	80



EN Polypropylene bricklayer's string
 PL Sznurek murarski polipropylenowy
 DE Maurerschnur aus Polypropylen
 RU Шнур каменщика
 CZ Šňúra zednická polypropylenová
 RO Șnur de zidărie din polietilena
 HU Kőműves zsinór polipropilén
 ES Cordel de albañilería



No.	Ø [mm]	L [m]	
17470	1.7	50	60/240
17471	1.7	100	30/120
17473	2.0	50	60/240
17474	2.0	100	30/120

EN Universal PP sennit string
 PL Sznurek PP pleciony, uniwersalny
 DE PP-Schnur, geflochten, universell
 RU Шнур полипропиленовый

CZ Šňúra PP pletená univerzální
 RO Șnur PP împletit, universal
 HU PP fonott kötél, univerzális
 ES Cordel trenzado universal PP



No.	Ø [mm]	L [m]	
69620	3	10	50
69621	3	20	40

EN Packing jute string
 PL Sznurek pakowy, jutowy
 DE Packschnur, aus Jute
 RU Шнур джутовый

CZ Šňúra ucpávková jutová
 RO Șnur de împachetat, de iuta
 HU Csomagkötöző spárga, juta
 ES Cordel de yute para embalaje



No.	m [g]	
69630	50	112
69631	100	100

EN Needle rope
 PL Lina igłowa
 DE Nadelseil
 RU Канат полипропиленовый, плетеный

CZ Lano s jádrem opletené
 RO Cablu ac
 HU Tűfonatos kötél
 ES Cable acalabrotado



No.	Ø [mm]	L [m]	
69539	8	10	30
69540	8	20	20
69542	10	10	25
69543	10	20	15
69546	12	20	10



EN Polyethylene bricklayer's string
 PL Sznurek murarski polietylenowy
 DE Maurerschnur aus Polyäthylen
 RU Полиэтиленовый шнур каменщика
 CZ Šňúra zednická polyetylenová
 RO Șnur de zidărie din polietilena
 HU Kőműves zsinór polietilén
 ES Cordel de albañilería de polietileno



No.	Ø [mm]	L [m]	
17480	1.7	50	60/240
17481	1.7	100	30/120
17483	2.0	50	60/240
17484	2.0	100	30/120

EN String jute rope
 PL Lina jutowa skręcana
 DE Verdrillt Seil aus Jute
 RU Канат джутовый

CZ Lano jutová kroucená
 RO Cablu răsucit de iuta
 HU Juta sodrott kötél
 ES Cable de yute torcido



No.	Ø [mm]	L [m]	
69572	10	10	20

EN Flax thread, twine
 PL Nici lniane, dratwa
 DE Leinenfaden, Pechfaden
 RU Нить (дратва) льняная

CZ Nítě lněné, dratev
 RO Fire de in, fire
 HU Len cérna, fonál
 ES Hilo de lino, cabo de zapatero



No.	m [g]	
69635	100	28
69637	250	18

11

Plastering & bricklaying tools Narzędzia budowlane i malarskie



Floor laminate cutters Gilotyny do cięcia paneli podłogowych	
.....	148

Tile cutters & accessories Przyrządy do cięcia glazury i akcesoria	
.....	148-157

Tile cutters Przyrządy do glazury.....	148
--	-----

Tile cutting pliers Szczypce do glazury.....	149
--	-----

Grout removers & finishers Skrobaki i szpachelki do fug.....	149
--	-----

Accessories for tiles Akcesoria do glazury.....	150
---	-----

Burners & soldering tools Palniki i lutownice	
.....	157-158

Gas burners & accessories Palniki gazowe i akcesoria	
.....	158-160

Ladders & supports Drabiny i podpory	
.....	160-162

Masonry tools Narzędzia budowlane	
.....	162-189

Floats Pace.....	162
----------------------------	-----

Trowels Kielnie.....	165
--------------------------------	-----

Plaster & stucco spray guns Tynkownice pneumatyczne.....	165
--	-----

Tools for areated blocks Narzędzia do betonu komórkowego.....	166
---	-----

Tools for drywalls Narzędzia do płyt gipsowo-kartonowych.....	167
---	-----

Putty knives Szpachelki.....	168
--	-----

Scrapers Skrobaki.....	170
----------------------------------	-----

Mason's pans Czerpaki murarskie.....	172
--	-----

Building strainers Sita budowlane.....	173
--	-----

Paint mixers & grout mixers Mieszadła do farb i do zaprawy.....	173
---	-----

Wallpapering tools Narzędzia do tapetowania.....	175
--	-----

Paint rollers & accessories Wałki do malowania i akcesoria.....	176
---	-----

Paint brushes & accessories Pędzle malarskie i akcesoria.....	178
---	-----

Multipurpose trays Podstawki gospodarcze.....	180
---	-----

Painting sheets Folie malarskie.....	180
--	-----

Tapes Taśmy.....	181
----------------------------	-----

Plastic buckets & tubs Wiadra i kasty budowlane.....	183
--	-----

Suction lifters Uchwyty do szyb.....	184
--	-----

Hooks „Juco” Haki budowlane „Juco”.....	185
---	-----

Carpenter's pencils & accessories Ołówki stolarskie i akcesoria.....	185
--	-----

Benders Giętareki.....	185
----------------------------------	-----

Paving tools Narzędzia brukarskie.....	186
--	-----

EN Floor laminate cutter
 PL Gilotyna do cięcia paneli podłogowych
 DE Laminat-Schneider
 RU Гильотина для ламината
 CZ Nůžky na laminátové plošcové podlahy
 RO Aparat de tăiat parchet laminat
 HU Laminált padló vágógép
 ES Guillotina cortapaneles



No.	Cutting length / Długość cięcia [mm]	Guide bar diameter / Średnica prowadnicy [mm]	Quantity
28880			2

EN Tile cutting machine
 PL Przyrząd do cięcia glazury
 DE Fliesenschneidmaschine
 RU Плиткорез
 CZ Přístroj na řezání glazury
 RO Mașină pt. tăiat gresie și faianță
 HU Csempevágó
 ES Cortadora de gres

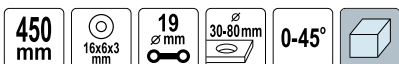

No.	Cutting length / Długość cięcia [mm]	Guide bar diameter / Średnica prowadnicy [mm]	Quantity
00320	450	19	1

EN Tile cutting machine
 PL Przyrząd do cięcia glazury
 DE Fliesenschneidmaschine
 RU Плиткорез
 CZ Přístroj na řezání glazury
 RO Mașină pt. tăiat gresie și faianță
 HU Csempevágó
 ES Cortadora de gres

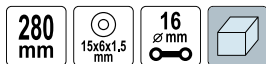

No.	Cutting length / Długość cięcia [mm]	Guide bar diameter / Średnica prowadnicy [mm]	Quantity
02300	280	16	6

EN Tile cutting machine
 PL Przyrząd do cięcia glazury
 DE Fliesenschneidmaschine
 RU Плиткорез
 CZ Přístroj na řezání glazury
 RO Mașină pt. tăiat gresie și faianță
 HU Csempevágó
 ES Cortadora de gres



No.	Cutting length / Długość cięcia [mm]	Guide bar diameter / Średnica prowadnicy [mm]	Quantity
02400	400	14	6

EN Tile cutting machine
 PL Przyrząd do cięcia glazury
 DE Fliesenschneidmaschine
 RU Плиткорез
 CZ Přístroj na řezání glazury
 RO Mașină pt. tăiat gresie și faianță
 HU Csempevágó
 ES Cortadora de gres

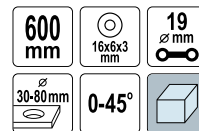

No.	Cutting length / Długość cięcia [mm]	Guide bar diameter / Średnica prowadnicy [mm]	Quantity
00300	600	19	1

EN Tile cutting machine
 PL Przyrząd do cięcia glazury
 DE Fliesenschneidmaschine
 RU Плиткорез
 CZ Přístroj na řezání glazury
 RO Mașină pt. tăiat gresie și faianță
 HU Csempevágó
 ES Cortadora de gres



No.	Cutting length / Długość cięcia [mm]	Guide bar diameter / Średnica prowadnicy [mm]	Quantity
00510	500	16	1
00610	590	16	1

EN Tile cutting machine
 PL Przyrząd do cięcia glazury
 DE Fliesenschneidmaschine
 RU Плиткорез
 CZ Přístroj na řezání glazury
 RO Mașină pt. tăiat gresie și faianță
 HU Csempevágó
 ES Cortadora de gres



No.	Cutting length / Długość cięcia [mm]	Guide bar diameter / Średnica prowadnicy [mm]	Quantity
01060	600	15	1

EN Tile cutting wheel
 PL Kółko wymienne ze śrubą
 DE Schneidrad mit Schraube
 RU Запасной ролик для плиткореза

CZ Výměnné kolečko se šroubem
 RO Cutit rola
 HU Cseregörgő csavarral
 ES Recambio de cuchillo redondo



No.	Dimensions / Wymiary [mm]	For / Dla	Quantity
03150	15x6x1.5	02300, 02400	50/200
03160	16x6x3	00300, 00320	50/200
03220	22x6x2	00510, 00600, 00610, 01060	50/200

EN Tile cutting wheel
 PL Kółko tnące wymienne
 DE Schneiderrad
 RU Запасной ролик для плиткореза
 CZ Výměnné kolečko
 RO Cuițt rolă
 HU Cseregörgő csavarral
 ES Recambio de cuchillo redondo



No.	Dimensions / Wymiary [mm]	For / Dla	
03221	22x10.5x2	00703	50/200

EN Tile cutting pliers
 PL Szczypce do glazury
 DE Glasurzange
 RU Кусачки для плитки

CZ Kleště do glazury
 RO Clește rupt faianta
 HU Csempefogó
 ES Tenazas para azulejos



No.	L [mm]	
04000	200	10/60

EN Tile cutting pliers
 PL Szczypce do łamania glazury
 DE Glasurzange
 RU Кусачки для плитки
 CZ Kleště do glazury
 RO Clește rupt faianta
 HU Csempefogó
 ES Tenazas para azulejos



No.	L [mm]	
04022	200	6/60

EN Tile cutting nipper
 PL Obcegi do glazury wygięte
 DE Glasurzange
 RU Клещи для плитки твердосплавные
 CZ Kleště do glazury ohnuté
 RO Clește curbă pt. glazură
 HU Hajlított csempé harapófogó
 ES Tenazas para azulecos curvo



No.	L [mm]	
04210	200	12/60

EN Tile cutting wheel
 PL Kółko tnące wymienne
 DE Schneiderrad
 RU Ролик для плиткореза
 CZ Výměnné kolečko
 RO Cuițt rolă
 HU Cseregörgő csavarral
 ES Recambio de cuchillo redondo



No.	Dimensions / Wymiary [mm]	
03225	22x6x6	500

EN Tile cutting pliers
 PL Szczypce do cięcia glazury
 DE Glasurzange
 RU Кусачки для плитки
 CZ Kleště do glazury
 RO Clește rupt faianta
 HU Csempefogó
 ES Tenazas para azulejos



No.	L [mm]	
04020	200	6/36

EN Tile cutting nipper
 PL Szczypce do glazury
 DE Glasurzange
 RU Кусачки для плитки
 CZ Kleště do glazury
 RO Clește rupt faianta
 HU Csempefogó
 ES Tenazas para azulejos



No.	L [mm]	
04200	200	12/60

EN Grout remover
 PL Skrobak do fug
 DE Fugenreiniger
 RU Скребок для швов плитки

CZ Škrabák na spáry
 RO Spaclu pt. rosturi
 HU Fugakihűző
 ES Rascador para juntas



No.	
04400	40/400

- EN Grout finisher
 PL Szpachelka do fugi
 DE Fugenreiniger
 RU Шпатель для затирки межплиточных швов
 CZ Šúves skrēpers
 RO Rázuitoare pt. rosturi
 HU Fugakihúzó
 ES Rascador para juntas



No.		
04410		450

- EN Grout remover
 PL Skrobak do fugi
 DE Fugenreiniger
 RU Скребок для швов плитки
 CZ Škrabák na spáry
 RO Spaclu pt. rosturi
 HU Fugakihúzó
 ES Rascador para juntas



No.	Blade size / Rozmiar ostrza [mm]	
04405	50x2	12/60

- EN Circular tile cutter
 PL Wycinarka do otworów w glazurze
 DE Fliesenbohrzeug
 RU Резак по плитке
 CZ Výseč otvorů v glazuře
 RO Cuitit rotativ taiat faianta
 HU Lyukkivágó csempéhez
 ES Ruleta de corte para azulejos

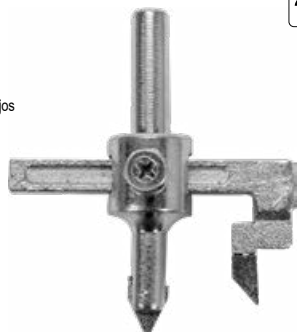

No.	Cutting diameter / Šrednica ciecia [mm]	
03900	20-90	20/80

- EN Spare blades for tile cutter
 PL Ostrze zapasowe do wycinarki
 DE Schneide für Fliesenlocher
 RU Запасные элементы для резака
 CZ Náhradní soustava na vystřihovačku
 RO Lame rezerva pt. cuitit
 HU Tartalékészlet a kivágóhoz
 ES Juego de recambios para ruleta



No.	For / Dla	
03950	03940	20/200

- EN Grout bag
 PL Worek do aplikacji fugi
 DE Fugenfüller-beutel
 RU Мешок для нанесения расшивки
 CZ Rukáv do spárování
 RO Punga umplere rosturi
 HU Fugázó zsák
 ES Saco para la aplicación de juntas



No.		
04440		36/108

- EN Tile laser
 PL Laser glazurmiczy
 DE Fliesenlaser
 RU Лазерный уровень для плитин
 CZ Laserová vodováha
 RO Nivel laser pt. plăci
 HU Csempelézer
 ES Láser de baldosas



No.	Vials / Libelle	
16030	2	20

- EN Circular tile cutter
 PL Wycinarka do otworów w glazurze
 DE Fliesenlocherbohrer mit Handschutz
 RU Резак по плитке „Балеринка” с защитной решеткой
 CZ Výseč otvorů v glazuře
 RO Cuitit rotativ taiat faianta
 HU Lyukkivágó csempéhez
 ES Ruleta de corte para azulejos



No.	Cutting diameter / Šrednica ciecia [mm]	
03940	20-94	24

- EN Adjustable plastic drill guide
 PL Prowadnica do wiercenia w płytkach ceramicznych
 DE Führungsschiene zum Bohren in Keramikfliesen
 RU Направляющая для сверления керамической плитки
 CZ Vodičko pro vrtání keramických obkladaček
 RO Ghidaj gaurire ajustabil
 HU Fúrászár vezető kerámia-csempéhez
 ES Guía para taladrar en azulejos cerámicos

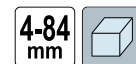

No.	Cutting diameter / Šrednica ciecia [mm]	
03960	4-24, 25-84	40

EN Tile drilling guide
 PL Prowadnica do wiercenia w płytkach
 DE Führungsschiene zum Bohren in Fliesen
 RU Направляющая для сверления плитки
 CZ Vodítko pro vrtání v dlaždicích
 RO Ghidaj pt. gaurit gresie
 HU Csempé fúró vezetô
 ES Guía de brocas para baldosas



VOREL

No.	Cutting diameter / Średnica cięcia [mm]	
03963	4, 5, 6, 8, 10, 12	12/36

EN TC tile cutter and breaker
 PL Rysik do cięcia i łamania glazury
 DE Fliesengriffel und Brecher
 RU Плиткорез-карандаш с отламывателем

CZ Rýsovací jehla na řezání a lámání glazury
 RO Cutit taiat / rupt faianta
 HU Karctól csempévágáshoz és töréshez
 ES Cortador y rompedor de azulejos



No.	L [mm]	
04100	200	5/100

EN Tile leveling set
 PL Przyrząd do poziomowania płytek
 DE Schlagschnurgerät
 RU Уровень для укладки кафеля
 CZ Přístroj pro regulaci úrovně dlaždiček
 RO Fir pt. trasat
 HU Padlólapszintező eszköz
 ES Nivelador de cuerda para azulejos

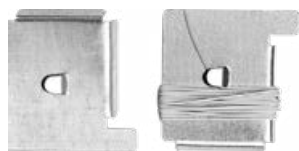

No.		
04500		60

EN Tile magnetic fittings
 PL Uchwyty magnetyczne do płytek
 DE Fliesen Magnete
 RU Магнитные фитинги для плитки

CZ Magnety pod obklady
 RO Balamale magnetice pt. imbinarea placilor
 HU Csempemágnés
 ES Trampilla magnética para la escotilla de inspección

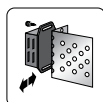
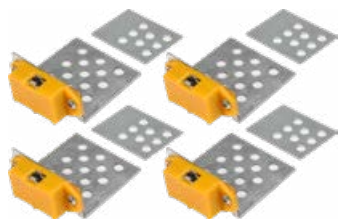

VOREL

No.	pcs / szt.	
04490	4	50/100

EN Hand tile cutter and breaker
 PL Rysik do cięcia glazury
 DE Fliesengriffel
 RU Резак для плитки
 CZ Rýsovací jehla na řezání glazury
 RO Cutit taiat / rupt faianta
 HU Karctól csempévágáshoz
 ES Cortador de azulejos



VOREL

No.	L [mm]	
04050	130	50/400

EN Glass cutting tool
 PL Nóż do płytek ceramicznych i szkła
 DE Fliesen- und Glasschneider
 RU Резак для керамической плитки и стекла
 CZ Nůz na řezání keramických dlaždic a skla
 RO Instrument de tăiat sticlă
 HU Csempé- és üvegvágó kés
 ES Cuchillo para cortar baldosas cerámicas y vidrio



VOREL

No.	L [mm]	
04060	120	6/240

EN Magnetic lock
 PL Maskownica uniwersalna
 DE Universal verdeckung mit Magnet
 RU Замок магнитный для кафеля
 CZ Maskovací rám univerzální do glazury
 RO Opritor magnetic
 HU Univerzális maszkoló csempéhez
 ES Cierre magnético universal

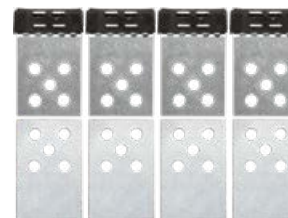
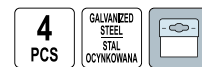

VOREL

No.		
04510		40

EN Glazing sponge
 PL Gąbka glazurnicza
 DE Fliesenschwamm
 RU Губка для затирки плитки
 CZ Houbka na spárování obkladů
 RO Burete pt. plăci ceramice
 HU Csempézó szivacs
 ES Esponja para esmalter



VOREL

No.	Dimensions / Wymiary [mm]	
04540	165x100x60	74

- EN Hygroscopic glazing sponge
- PL Gąbka glazurująca hydrochlonna
- DE Wasseraufsaugender Fliesenschwamm
- RU Губка для затирки плитки
- CZ Houba na spárování obkladů nasáková
- RO Burete pt. plăci ceramice hidroabsorbant
- HU Nedvszívó csempézó szivacs
- ES Esponja para esmalter higroscópica



No.	Dimensions / Wymiary [mm]	
04542	170x110x60	56

- EN Double glazing sponge
- PL Gąbka glazurująca dwuwarstwowa
- DE Doppelter Fliesenschwamm
- RU Губка для затирки плитки
- CZ Houba na spárování obkladů dvoustranná
- RO Burete pt. plăci ceramice dublu
- HU Dupla csempézó szivacs
- ES Esponja para esmalter doble



No.	Dimensions / Wymiary [mm]	
04544	165x100x80	18

- EN Glaze bucket
- PL Wiadro glazurujące
- DE Fliesenwaschset Rolleneimer
- RU Ведро с роликом для затирки швов
- CZ Malířské vědro
- RO Galeata pt. zugravit
- HU Fugázó vödör
- ES Cubo de pintura



No.	Capacity / Pojemność [l]	
00250	10	2

- EN Tile leveling system (clips)
- PL System poziomowania płytek (klipsy)
- DE Fliesen Nivelliersystem (Clips)
- RU Система выравнивания плитки (зажимы)
- CZ Systém vyrovnávání dlaždic (spony)
- RO Sistem nivelare plăci (cleme)
- HU Csempeszintező rendszer (talpak)
- ES Sistema de nivelación de baldosas (clips)

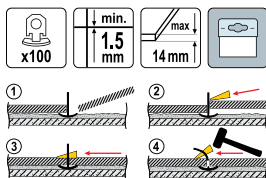

FEATURES:

- Useful when laying tiles on floors and walls
- Work great for large tiles
- Use with tiles of different thickness
- For use with 04718 wedges
- Save time and make work easy and efficient

CECHY:

- Ułatwia układanie płytek na ścianach i podłodze
- Szczególnie przydatny do płytek o większych rozmiarach
- Umożliwia poziomowanie płytek o różnych grubościach
- Do użytku z klinami 04718
- Ułatwia i przyspiesza pracę



30x30	33x33	40x40	45x45	50x50	60x60	80x80	60x30	100x50	120x60
42	36	20	28	24	10	10	22	16	10

NUMBER OF CLIPS FOR VARIOUS DIMENSIONS TILES PER 1 M³
LICZBA KLIPSÓW NA M³ W ZALEŻNOŚCI OD ROZMIARU PŁYTKI



No.	pcs / szt.	
04690	100	15

- EN Rubber glazing sponge
- PL Gąbka glazurująca gumowa
- DE Gummi-Fliesenschwamm
- RU Губка для затирки плитки
- CZ Houba na spárování obkladů gumová
- RO Burete pt. plăci ceramice de cauciuc
- HU Gumi csempézó szivacs
- ES Esponja para esmalter de goma



No.	Dimensions / Wymiary [mm]	
04546	150x100x50	10

- EN Tile leveling floor pliers
- PL Szczypce do poziomowania płytek
- DE Nivelliersystem Zange
- RU Щипцы до системы нивелировки
- CZ Kleště pro dlaždice vyrovnání
- RO Cieste de nivelat gresie reglabil
- HU Lapszintező speciális fogó
- ES Tenaza para sistema de nivelación



No.		
04699		5/30

- EN Tile leveling system (clips and wedges)
- PL System poziomowania płytek (klipsy i kliny)
- DE Fliesen Nivelliersystem (Clips und Keile)
- RU Система выравнивания плитки (зажимы и клинья)
- CZ Systém vyrovnávání dlaždic (spony a klíny)
- RO Sistem nivelare plăci (cleme si pene)
- HU Csempeszintező rendszer (talpak és ékek)
- ES Sistema de nivelación de baldosas (clips y cuñas)

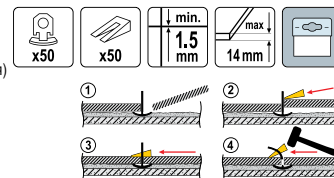

FEATURES:

- Useful when laying tiles on floors and walls
- Work great for large tiles
- Use with tiles of different thickness
- Wedges are reusable
- Save time and make work easy and efficient

CECHY:

- Ułatwia układanie płytek na ścianach i podłodze
- Szczególnie przydatny do płytek o większych rozmiarach
- Umożliwia poziomowanie płytek o różnych grubościach
- Kliny wielokrotnego użytku
- Ułatwia i przyspiesza pracę



30x30	33x33	40x40	45x45	50x50	60x60	80x80	60x30	100x50	120x60
42	36	20	28	24	10	10	22	16	10

NUMBER OF CLIPS FOR VARIOUS DIMENSIONS TILES PER 1 M³
LICZBA KLIPSÓW NA M³ W ZALEŻNOŚCI OD ROZMIARU PŁYTKI



No.	pcs / szt.	
04691	50+50	15

EN Tile leveling system (clips and wedges)
 PL System poziomowania płytek (klipsy i kliny)
 DE Fliesen Nivelliersystem (Clips und Keile)
 RU Система выравнивания плитки (зажимы и клинья)
 CZ Systém vyrovnávání dlaždic (spony a kliny)
 RO Sistem nivelare plăci (cleme și pene)
 HU Csempezintező rendszer (talpak és ékekek)
 ES Sistema de nivelación de baldosas (clips y cuñas)

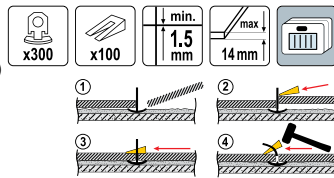

FEATURES:

- Useful when laying tiles on floors and walls
- Work great for large tiles
- Use with tiles of different thickness
- Wedges are reusable
- Save time and make work easy and efficient

CECHY:

- Ułatwia układanie płytek na ścianach i podłodze
- Szczególnie przydatny do płytek o większych rozmiarach
- Umożliwia poziomowanie płytek o różnych grubościach
- Kliny wielokrotnego użytku
- Ułatwia i przyspiesza pracę

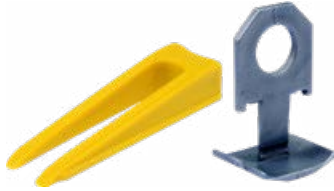

30x30	33x33	40x40	45x45	50x50	60x60	80x80	60x30	100x50	120x60
42	36	20	28	24	10	10	22	16	10

NUMBER OF CLIPS FOR VARIOUS DIMENSIONS TILES PER 1 M³
 LICZBA KLIPSÓW NA M³ W ZALEŻNOŚCI OD ROZMIARU PŁYTKI



No.	pcs / szt.	
04692	300+100	1

EN Tile leveling system (clips and wedges)
 PL System poziomowania płytek (klipsy i kliny)
 DE Fliesen Nivelliersystem (Clips und Keile)
 RU Система выравнивания плитки (зажимы и клинья)
 CZ Systém vyrovnávání dlaždic (spony a kliny)
 RO Sistem nivelare plăci (cleme și pene)
 HU Csempezintező rendszer (talpak és ékekek)
 ES Sistema de nivelación de baldosas (clips y cuñas)

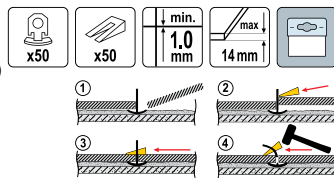

FEATURES:

- Useful when laying tiles on floors and walls
- Work great for large tiles
- Use with tiles of different thickness
- Wedges are reusable
- Save time and make work easy and efficient

CECHY:

- Ułatwia układanie płytek na ścianach i podłodze
- Szczególnie przydatny do płytek o większych rozmiarach
- Umożliwia poziomowanie płytek o różnych grubościach
- Kliny wielokrotnego użytku
- Ułatwia i przyspiesza pracę



30x30	33x33	40x40	45x45	50x50	60x60	80x80	60x30	100x50	120x60
42	36	20	28	24	10	10	22	16	10

NUMBER OF CLIPS FOR VARIOUS DIMENSIONS TILES PER 1 M³
 LICZBA KLIPSÓW NA M³ W ZALEŻNOŚCI OD ROZMIARU PŁYTKI



No.	pcs / szt.	
04714	50+50	15

EN Tile leveling system (clips)
 PL System poziomowania płytek (klipsy)
 DE Fliesen Nivelliersystem (Clips)
 RU Система выравнивания плитки (зажимы)
 CZ Systém vyrovnávání dlaždic (spony)
 RO Sistem nivelare plăci (cleme)
 HU Csempezintező rendszer (talpak)
 ES Sistema de nivelación de baldosas (clips)

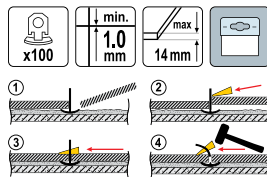

FEATURES:

- Useful when laying tiles on floors and walls
- Work great for large tiles
- Use with tiles of different thickness
- For use with 04718 wedges
- Save time and make work easy and efficient

CECHY:

- Ułatwia układanie płytek na ścianach i podłodze
- Szczególnie przydatny do płytek o większych rozmiarach
- Umożliwia poziomowanie płytek o różnych grubościach
- Do użytku z klinami 04718
- Ułatwia i przyspiesza pracę



30x30	33x33	40x40	45x45	50x50	60x60	80x80	60x30	100x50	120x60
42	36	20	28	24	10	10	22	16	10

NUMBER OF CLIPS FOR VARIOUS DIMENSIONS TILES PER 1 M³
 LICZBA KLIPSÓW NA M³ W ZALEŻNOŚCI OD ROZMIARU PŁYTKI



No.	pcs / szt.	
04716	100	15

EN Tile leveling system (clips)
 PL System poziomowania płytek (klipsy)
 DE Fliesen Nivelliersystem (Clips)
 RU Система выравнивания плитки (зажимы)
 CZ Systém vyrovnávání dlaždic (spony)
 RO Sistem nivelare plăci (cleme)
 HU Csempezintező rendszer (talpak)
 ES Sistema de nivelación de baldosas (clips)

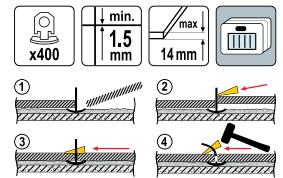

FEATURES:

- Useful when laying tiles on floors and walls
- Work great for large tiles
- Use with tiles of different thickness
- For use with 04718 wedges
- Save time and make work easy and efficient

CECHY:

- Ułatwia układanie płytek na ścianach i podłodze
- Szczególnie przydatny do płytek o większych rozmiarach
- Umożliwia poziomowanie płytek o różnych grubościach
- Do użytku z klinami 04718
- Ułatwia i przyspiesza pracę



30x30	33x33	40x40	45x45	50x50	60x60	80x80	60x30	100x50	120x60
42	36	20	28	24	10	10	22	16	10

NUMBER OF CLIPS FOR VARIOUS DIMENSIONS TILES PER 1 M³
 LICZBA KLIPSÓW NA M³ W ZALEŻNOŚCI OD ROZMIARU PŁYTKI



No.	pcs / szt.	
04693	400	1

EN Tile leveling system (clips and wedges)
 PL System poziomowania płytek (klipsy i kliny)
 DE Fliesen Nivelliersystem (Clips und Keile)
 RU Система выравнивания плитки (зажимы и клинья)
 CZ Systém vyrovnávání dlaždic (spony a kliny)
 RO Sistem nivelare plăci (cleme și pene)
 HU Csempezintező rendszer (talpak és ékekek)
 ES Sistema de nivelación de baldosas (clips y cuñas)

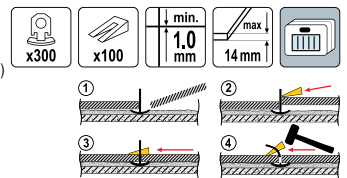

FEATURES:

- Useful when laying tiles on floors and walls
- Work great for large tiles
- Use with tiles of different thickness
- Wedges are reusable
- Save time and make work easy and efficient

CECHY:

- Ułatwia układanie płytek na ścianach i podłodze
- Szczególnie przydatny do płytek o większych rozmiarach
- Umożliwia poziomowanie płytek o różnych grubościach
- Kliny wielokrotnego użytku
- Ułatwia i przyspiesza pracę



30x30	33x33	40x40	45x45	50x50	60x60	80x80	60x30	100x50	120x60
42	36	20	28	24	10	10	22	16	10

NUMBER OF CLIPS FOR VARIOUS DIMENSIONS TILES PER 1 M³
 LICZBA KLIPSÓW NA M³ W ZALEŻNOŚCI OD ROZMIARU PŁYTKI



No.	pcs / szt.	
04715	300+100	1

EN Tile leveling system (clips)
 PL System poziomowania płytek (klipsy)
 DE Fliesen Nivelliersystem (Clips)
 RU Система выравнивания плитки (зажимы)
 CZ Systém vyrovnávání dlaždic (spony)
 RO Sistem nivelare plăci (cleme)
 HU Csempezintező rendszer (talpak)
 ES Sistema de nivelación de baldosas (clips)

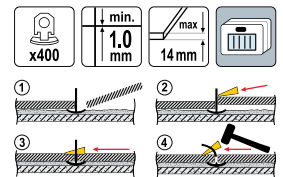

FEATURES:

- Useful when laying tiles on floors and walls
- Work great for large tiles
- Use with tiles of different thickness
- For use with 04718 wedges
- Save time and make work easy and efficient

CECHY:

- Ułatwia układanie płytek na ścianach i podłodze
- Szczególnie przydatny do płytek o większych rozmiarach
- Umożliwia poziomowanie płytek o różnych grubościach
- Do użytku z klinami 04718
- Ułatwia i przyspiesza pracę



30x30	33x33	40x40	45x45	50x50	60x60	80x80	60x30	100x50	120x60
42	36	20	28	24	10	10	22	16	10

NUMBER OF CLIPS FOR VARIOUS DIMENSIONS TILES PER 1 M³
 LICZBA KLIPSÓW NA M³ W ZALEŻNOŚCI OD ROZMIARU PŁYTKI



No.	pcs / szt.	
04717	400	1

EN Tile leveling system (wedges)
 PL System poziomowania płytek (kliny)
 DE Fliesen Nivelliersystem (Keile)
 RU Система выравнивания плитки (клинья)
 CZ Systém vyrovnávání dlaždic (kliny)
 RO Sistem nivelare placi (pene)
 HU Csemeszintező rendszer (ékek)
 ES Sistema de nivelación de baldosas (cuñas)

FEATURES:

- Useful when layed tiles on floors and walls
- Work great for large tiles
- Use with tiles of different thickness
- Wedges are reusable
- Save time and make work easy and efficient

CECHY:

- Ułatwia układanie płytek na ścianach i podłodze
- Szczególnie przydatny do płytek o większych rozmiarach
- Umożliwia poziomowanie płytek o różnych grubościach
- Kliny wielokrotnego użytku
- Ułatwia i przyspiesza prace

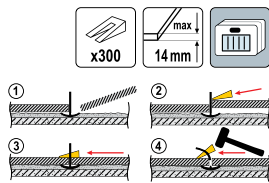

30x30	33x33	40x40	45x45	50x50	60x60	80x80	60x30	100x50	120x60
42	36	20	28	24	10	10	22	16	10

NUMBER OF CLIPS FOR VARIOUS DIMENSIONS TILES PER 1 M³
 LICZBA KLIPSÓW NA M³ W ZALEŻNOŚCI OD ROZMIARU PŁYTKI



No.	pcs / szt.	For / Dla	
04718	300	04690, 04693, 04716, 04717	1

11

EN Tile leveling system (clips and wedges)
 PL System poziomowania płytek (klipsy i kliny)
 DE Fliesen Nivelliersystem (Clips und Keile)
 RU Система выравнивания плитки (зажимы и клинья)
 CZ Systém vyrovnávání dlaždic (spony a kliny)
 RO Sistem nivelare placi (cleme si pene)
 HU Csemeszintező rendszer (talpak és ékek)
 ES Sistema de nivelación de baldosas (clips y cuñas)

FEATURES:

- Useful when layed tiles on floors and walls
- Work great for large tiles
- Use with tiles of different thickness
- Wedges are reusable
- Save time and make work easy and efficient

CECHY:

- Ułatwia układanie płytek na ścianach i podłodze
- Szczególnie przydatny do płytek o większych rozmiarach
- Umożliwia poziomowanie płytek o różnych grubościach
- Kliny wielokrotnego użytku
- Ułatwia i przyspiesza prace

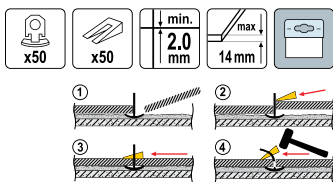

30x30	33x33	40x40	45x45	50x50	60x60	80x80	60x30	100x50	120x60
42	36	20	28	24	10	10	22	16	10

NUMBER OF CLIPS FOR VARIOUS DIMENSIONS TILES PER 1 M³
 LICZBA KLIPSÓW NA M³ W ZALEŻNOŚCI OD ROZMIARU PŁYTKI



No.	pcs / szt.	
04731	50+50	15

EN Tile leveling system (clips)
 PL System poziomowania płytek (klipsy)
 DE Fliesen Nivelliersystem (Clips)
 RU Система выравнивания плитки (зажимы)
 CZ Systém vyrovnávání dlaždic (spony)
 RO Sistem nivelare placi (cleme)
 HU Csemeszintező rendszer (talpak)
 ES Sistema de nivelación de baldosas (clips)

FEATURES:

- Useful when layed tiles on floors and walls
- Work great for large tiles
- Use with tiles of different thickness
- For use with 04718 wedges
- Save time and make work easy and efficient

CECHY:

- Ułatwia układanie płytek na ścianach i podłodze
- Szczególnie przydatny do płytek o większych rozmiarach
- Umożliwia poziomowanie płytek o różnych grubościach
- Do użytku z klinami 04718
- Ułatwia i przyspiesza prace

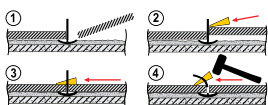

No.	pcs / szt.	
04734	400	1

EN Tile leveling system (clips)
 PL System poziomowania płytek (klipsy)
 DE Fliesen Nivelliersystem (Clips)
 RU Система выравнивания плитки (зажимы)
 CZ Systém vyrovnávání dlaždic (spony)
 RO Sistem nivelare placi (cleme)
 HU Csemeszintező rendszer (talpak)
 ES Sistema de nivelación de baldosas (clips)

FEATURES:

- Useful when layed tiles on floors and walls
- Work great for large tiles
- Use with tiles of different thickness
- For use with 04718 wedges
- Save time and make work easy and efficient

CECHY:

- Ułatwia układanie płytek na ścianach i podłodze
- Szczególnie przydatny do płytek o większych rozmiarach
- Umożliwia poziomowanie płytek o różnych grubościach
- Do użytku z klinami 04718
- Ułatwia i przyspiesza prace

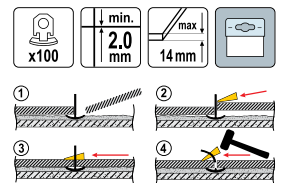

30x30	33x33	40x40	45x45	50x50	60x60	80x80	60x30	100x50	120x60
42	36	20	28	24	10	10	22	16	10

NUMBER OF CLIPS FOR VARIOUS DIMENSIONS TILES PER 1 M³
 LICZBA KLIPSÓW NA M³ W ZALEŻNOŚCI OD ROZMIARU PŁYTKI



No.	pcs / szt.	
04730	100	15

EN Tile leveling system (clips and wedges)
 PL System poziomowania płytek (klipsy i kliny)
 DE Fliesen Nivelliersystem (Clips und Keile)
 RU Система выравнивания плитки (зажимы и клинья)
 CZ Systém vyrovnávání dlaždic (spony a kliny)
 RO Sistem nivelare placi (cleme si pene)
 HU Csemeszintező rendszer (talpak és ékek)
 ES Sistema de nivelación de baldosas (clips y cuñas)

FEATURES:

- Useful when layed tiles on floors and walls
- Work great for large tiles
- Use with tiles of different thickness
- Wedges are reusable
- Save time and make work easy and efficient

CECHY:

- Ułatwia układanie płytek na ścianach i podłodze
- Szczególnie przydatny do płytek o większych rozmiarach
- Umożliwia poziomowanie płytek o różnych grubościach
- Kliny wielokrotnego użytku
- Ułatwia i przyspiesza prace

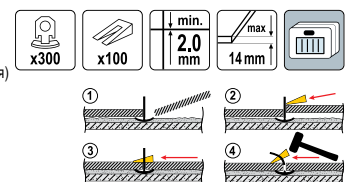

30x30	33x33	40x40	45x45	50x50	60x60	80x80	60x30	100x50	120x60
42	36	20	28	24	10	10	22	16	10

NUMBER OF CLIPS FOR VARIOUS DIMENSIONS TILES PER 1 M³
 LICZBA KLIPSÓW NA M³ W ZALEŻNOŚCI OD ROZMIARU PŁYTKI



No.	pcs / szt.	
04732	300+100	1



30x30	33x33	40x40	45x45	50x50	60x60	80x80	60x30	100x50	120x60
42	36	20	28	24	10	10	22	16	10

NUMBER OF CLIPS FOR VARIOUS DIMENSIONS TILES PER 1 M³
 LICZBA KLIPSÓW NA M³ W ZALEŻNOŚCI OD ROZMIARU PŁYTKI

EN Tile leveling system (clips)
 PL System poziomowania płytek (klipsy)
 DE Fliesen Nivelliersystem (Clips)
 RU Система выравнивания плитки (зажимы)
 CZ Systém vyrovnávání dlaždic (spony)
 RO Sistem nivelare plăci (cleme)
 HU Csempezsintező rendszer (talpak)
 ES Sistema de nivelación de baldosas (clips)

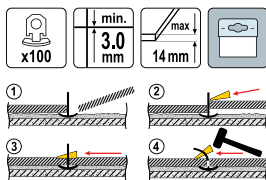

30x30	33x33	40x40	45x45	50x50	60x60	80x80	60x30	100x50	120x60
42	36	20	28	24	10	10	22	16	10

NUMBER OF CLIPS FOR VARIOUS DIMENSIONS TILES PER 1 M³
 LICZBA KLIPSÓW NA M³ W ZALEŻNOŚCI OD ROZMIARU PŁYTKI

FEATURES:

- Useful when layed tiles on floors and walls
- Work great for large tiles
- Use with tiles of different thickness
- For use with 04718 wedges
- Save time and make work easy and efficient



No.	pcs / szt.	
04735	100	15

EN Tile leveling system (clips and wedges)
 PL System poziomowania płytek (klipsy i kliny)
 DE Fliesen Nivelliersystem (Clips und Kelle)
 RU Система выравнивания плитки (зажимы и клинья)
 CZ Systém vyrovnávání dlaždic (spony a klíny)
 RO Sistem nivelare plăci (cleme si pene)
 HU Csempezsintező rendszer (talpak és ékek)
 ES Sistema de nivelación de baldosas (clips y cuñas)

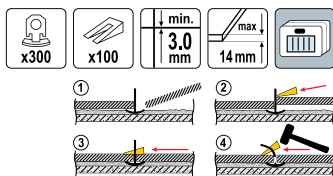

30x30	33x33	40x40	45x45	50x50	60x60	80x80	60x30	100x50	120x60
42	36	20	28	24	10	10	22	16	10

NUMBER OF CLIPS FOR VARIOUS DIMENSIONS TILES PER 1 M³
 LICZBA KLIPSÓW NA M³ W ZALEŻNOŚCI OD ROZMIARU PŁYTKI

FEATURES:

- Useful when layed tiles on floors and walls
- Work great for large tiles
- Use with tiles of different thickness
- Wedges are reusable
- Save time and make work easy and efficient



No.	pcs / szt.	
04737	300+100	1

EN Tile leveling system
 PL Klipsy poziomujące płytki
 DE Fliesen-Ausgleichssystem
 RU Система выравнивания плитки-зажим СВП
 CZ Dlaždice nivelační systém
 RO Sistemul de nivelare plăci
 HU Csempe szintező rendszer
 ES Sistema de nivelación del azulejo

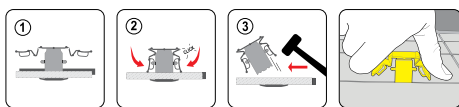

30x30	33x33	40x40	45x45	50x50	60x60	80x80	60x30	100x50	120x60
42	36	20	28	24	10	10	22	16	10

NUMBER OF CLIPS FOR VARIOUS DIMENSIONS TILES PER 1 M³
 LICZBA KLIPSÓW NA M³ W ZALEŻNOŚCI OD ROZMIARU PŁYTKI



No.	pcs / szt.	
04677	100	1

EN Tile leveling system (clips and wedges)
 PL System poziomowania płytek (klipsy i kliny)
 DE Fliesen Nivelliersystem (Clips und Kelle)
 RU Система выравнивания плитки (зажимы и клинья)
 CZ Systém vyrovnávání dlaždic (spony a klíny)
 RO Sistem nivelare plăci (cleme si pene)
 HU Csempezsintező rendszer (talpak és ékek)
 ES Sistema de nivelación de baldosas (clips y cuñas)

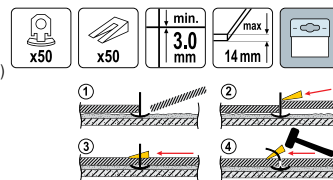

30x30	33x33	40x40	45x45	50x50	60x60	80x80	60x30	100x50	120x60
42	36	20	28	24	10	10	22	16	10

NUMBER OF CLIPS FOR VARIOUS DIMENSIONS TILES PER 1 M³
 LICZBA KLIPSÓW NA M³ W ZALEŻNOŚCI OD ROZMIARU PŁYTKI

FEATURES:

- Useful when layed tiles on floors and walls
- Work great for large tiles
- Use with tiles of different thickness
- Wedges are reusable
- Save time and make work easy and efficient



No.	pcs / szt.	
04736	50+50	15

EN Tile leveling system (clips)
 PL System poziomowania płytek (klipsy)
 DE Fliesen Nivelliersystem (Clips)
 RU Система выравнивания плитки (зажимы)
 CZ Systém vyrovnávání dlaždic (spony)
 RO Sistem nivelare plăci (cleme)
 HU Csempezsintező rendszer (talpak)
 ES Sistema de nivelación de baldosas (clips)

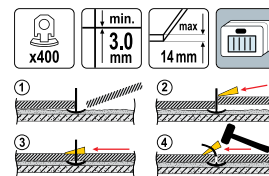

30x30	33x33	40x40	45x45	50x50	60x60	80x80	60x30	100x50	120x60
42	36	20	28	24	10	10	22	16	10

NUMBER OF CLIPS FOR VARIOUS DIMENSIONS TILES PER 1 M³
 LICZBA KLIPSÓW NA M³ W ZALEŻNOŚCI OD ROZMIARU PŁYTKI

FEATURES:

- Useful when layed tiles on floors and walls
- Work great for large tiles
- Use with tiles of different thickness
- For use with 04718 wedges
- Save time and make work easy and efficient



No.	pcs / szt.	
04739	400	1

EN Starter kit for levelling ceramic tiles
 PL Zestaw startowy do poziomowania płytek
 DE Startset für Nivellierung der Fliesen
 RU Базовый комплект для выравнивания плитки
 CZ Startovací sada pro vyrovnávání dlaždic
 RO Kit pt. nivelat plăci ceramice
 HU Csempezsintező kezdőkészlet
 ES Kit inicial de nivelación de azulejos



FEATURES:

- Useful when layed tiles on floors and walls
- Work great for large tiles
- Use with tiles of different thickness
- Save time and make work easy and efficient

CECHY:

- Ułatwiają układanie płytek na ścianach i podłodze
- Szczególnie przydatny do płytek o większych rozmiarach
- Umożliwiają poziomowanie płytek o różnych grubościach
- Ułatwiają i przyspieszają prace



No.	pcs / szt.	
04680	201	6/12

- EN Additional tile levelling straps
 PL Paski dodatkowe do zestawu do poziomowania płytek
 DE Zusätzliche Stifte zum Set für Nivellierung der Fliesen
 RU Дополнительные полоски для комплекта для выравнивания плитки
 CZ Dodatkové pásky k sadě pro vyrovnávání dlaždic
 RO Benzi pt. nivelat placii
 HU Plusz szjakk csempeszintező készlethez
 ES Tiras auxiliares para el kit de nivelación de azulejos



No.	pcs / szt.	
04681	100	18

- EN Additional tile levelling cups and straps
 PL Paski i kubki dodatkowe do zestawu do poziomowania płytek
 DE Zusätzliche Stifte und Kappen zum Set für Nivellierung der Fliesen
 RU Дополнительные полоски и колпачки для комплекта для выравнивания плитки
 CZ Dodatkové pásky a pohárky k sadě pro vyrovnávání dlaždic
 RO Benzi si cupe pt. nivelat placii ceramice
 HU Plusz szjakk és feltétek csempeszintező készlethez
 ES Tiras y cuñas auxiliares para el kit de nivelación de azulejos

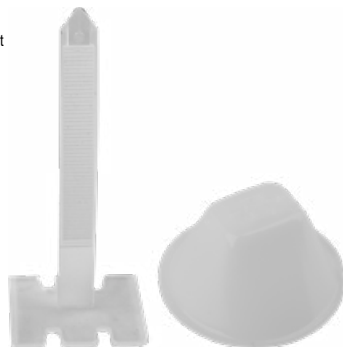

No.	pcs / szt.	
04683	100	24

- EN Cross shape tile spacers
 PL Krzyżyki dystansowe
 DE Fliesenkreuze
 RU Крестики для плитки
 CZ Distanční křížky
 RO Distanțiere în cruce
 HU Hézagoló kereszt
 ES Crucetas para juntas



No.	Thickness / Grubość [mm]	pcs / szt.	
04600	1.5	200	100
04610	2.0	200	100
04620	2.5	200	100
04630	3.0	150	100
04640	4.0	100	100
04650	5.0	100	100
04660	6.0	75	12/100
04668	8.0	30	100
04670	10.0	30	100

- EN Additional tile levelling cups
 PL Kubki dodatkowe do zestawu do poziomowania płytek
 DE Zusätzliche Kappen zum Set für Nivellierung der Fliesen
 RU Дополнительные колпачки для комплекта для выравнивания плитки
 CZ Dodatkové pohárky k sadě pro vyrovnávání dlaždic
 RO Cupe pt. nivelat placii ceramice
 HU Plusz feltétek csempeszintező készlethez
 ES Cuñas auxiliares para el kit de nivelación de azulejos



No.	pcs / szt.	
04682	100	30

- EN Levelling tongs for precision levelling straps
 PL Szczypce do zaciągania pasków poziomujących
 DE Spannange für Nivellierstifte
 RU Щипцы для затягивания выравнивающих полосок
 CZ Kleště do utahování vyrovnávacích pásků
 RO Dispozitiv pt. nivelare
 HU Szintezőszij húzó fogó
 ES Pinzas para tensar tiras de nivelación

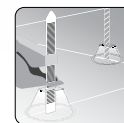

No.		
04684		12/48

- EN Wedges for wall and floor tiles
 PL Klíny do glazury
 DE Keile für Wand und Bodenfliesen
 RU Клинья для плитки
 CZ Klíny do glazury
 RO Distanțiere faianța
 HU Ék csempéhez
 ES Cuñas para juntas de azulejos



No.	Thickness / Grubość [mm]	pcs / szt.	
04700	4	100	100
04710	7	50	100

EN Cross shape tile spacers
 PL Krzyżyki dystansowe
 DE Fliesenkreuze
 RU Крестики для плитки
 CZ Distanční křížky
 RO Distanțiere in cruce
 HU Hézagoló kereszt
 ES Crucetas para juntas

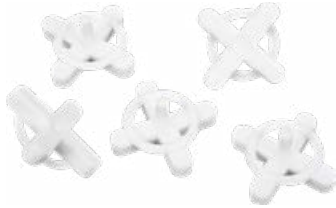

No.	Thickness / Grubość [mm]	pcs / szt.	
04581	1.0	100	100
04582	1.5	100	100
04583	2.0	100	100
04584	2.5	100	100
04585	3.0	100	100
04586	4.0	75	100

EN Panel clamps
 PL Klamry do paneli ściennych
 DE Klammern für Paneele
 RU Крепеж для панелей
 CZ Přichytky do panelů
 RO Cleme (bride) pt. panouri
 HU Kapcsok c panelekhez
 ES Abrazaderas para paneles de paredes

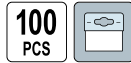

No.	Type / Typ	pcs / szt.	
04720	C-3	100	50
04721	C-1	100	50

EN Gas soldering lamp
 PL Gazowa lampa lutownicza
 DE Gaslötlampe
 RU Газовая паяльная лампа

CZ Plynová pájecí lamp
 RO Lampă de lipit pe gaz
 HU Gázos forrasztólámpa
 ES Lampa de gas para soldar



No.	Power / Moc [kW]	
73403	1.7	12

EN Cross shape tile spacers
 PL Krzyżyki dystansowe
 DE Fliesenkreuze
 RU Крестики для плитки
 CZ Distanční křížky
 RO Distanțiere in cruce
 HU Hézagoló kereszt
 ES Crucetas para juntas



No.	Thickness / Grubość [mm]	pcs / szt.	
04591	5	50	100
04592	6	50	100
04593	8	30	100
04594	10	30	100

EN Gas soldering lamp
 PL Gazowa lampa lutownicza
 DE Gaslötlampe
 RU Газовая паяльная лампа
 CZ Plynová pájecí lamp
 RO Lampă de lipit pe gaz
 HU Gázos forrasztólámpa
 ES Lampa de gas para soldar



No.	Power / Moc [kW]	
73404	1.7	12

EN Gas soldering lamp
 PL Gazowa lampa lutownicza
 DE Gaslötlampe
 RU Газовая паяльная лампа

CZ Plynová pájecí lamp
 RO Lampă de lipit pe gaz
 HU Gázos forrasztólámpa
 ES Lampa de gas para soldar

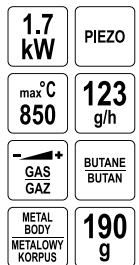

No.	Power / Moc [kW]	
73404	1.7	20



EN Gas torch
 PL Palnik gazowy
 DE Gasbrenner
 RU Газовая горелка
 CZ Plynový hořák
 RO Arzător de gaz
 HU Gázégő
 ES Soplete de gas



0.22 kW
 PIEZO
 max °C 1300
 GAS GAZ
 BUTANE BUTAN
 LIGHTER GAS GAZ DO ZAPALNICZEK
 10 g
 LOCK BLOKADA
 CHILDREN PROTECTION ZABEZPECZENIE PRZED DZIECIAMI
 30 min

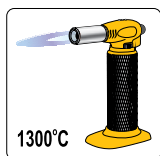

No.	Power / Moc [kW]	
73420	0.22	10/60

EN Gas blow torch
 PL Palnik gazowy
 DE Lötbrenner
 RU Газовая горелка
 CZ Plynový hořák
 RO Arzător de gaz
 HU Gázégő
 ES Soplete de gas

1.3 kW
 PIEZO
 max °C 1300
 GAS GAZ
 BUTANE BUTAN



No.	Power / Moc [kW]	
73412	1.3	10/60

EN Plumbers torch set with burners
 PL Zestaw do lutowania z dyszami
 DE Lötsatz
 RU Набор для пайки
 CZ Souprava k letování
 RO Set pt. lipit
 HU Forrasztó készlet
 ES Juego para soldadura

0.4 MPa (max.)
 BUTANE BUTAN
 290 g/h
 4.0 kW
 800-1200 °C
 360 mm
 x3
 17/22/40 mm
 2 m



No.	Max. pressure / Maks. ciśnienie [MPa]	Power / Moc [kW]	L [mm]	
73325	0.4	4	360	20

EN Soldering tool 3 in 1
 PL Lutownica gazowa 3 w 1
 DE 3 in 1 Gaslötkolben
 RU Газовый паяльник 3 в 1
 CZ Plynová rajka 3 v 1
 RO Ciocan de lipit cu gaz 3 in 1
 HU Gaz-forrasztópaka 3 az 1
 ES Soldador de gas 3 en 1

25-80 W
 GAS GAZ
 PROPANE BUTANE PROPAN BUTAN
 LIGHTER GAS GAZ DO ZAPALNICZEK
 15 ml
 60 min

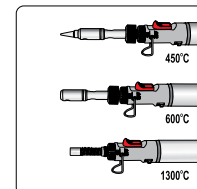

No.	Power / Moc [W]	
73410	25-80	12/48

EN Gas blow torch
 PL Palnik gazowy
 DE Lötbrenner
 RU Газовая горелка
 CZ Plynový hořák
 RO Arzător de gaz
 HU Gázégő
 ES Soplete de gas

1.3 kW
 PIEZO
 max °C 1300
 GAS GAZ
 BUTANE BUTAN



No.	Power / Moc [kW]	
73413	1.3	10/60

EN Point nozzle
 PL Dysza do lutowania, płomień punktowy
 DE Düse zum Löten, Punktflamme
 RU Сопло паяльника
 CZ Dyza na letování, bodový plamen
 RO Duză pt. lipit, flacăără punct
 HU Forrasztó égő, szűrő láng
 ES Tobera para soldadura, llama de punta

17 mm



No.	Size / Rozmiar [mm]	
73330	17	50/250

EN Flat nozzle
 PL Dysza do lutowania, płomień płaski
 DE Düse zum Löten, flache Flamme
 RU Conno плоское
 CZ Dyža na letování, plochy plamen
 RO Duză pt. lipit, flacăra plată
 HU Forrasztó égő, lapos láng
 ES Tobera para soldadura, llama plana



VOREL

No.	Size / Rozmiar [mm]	
73331	40	50/250

EN Roof heating torch with burners
 PL Palnik dekarski z dyszami
 DE Dachdeckerbrenner
 RU Кровельная горелка
 CZ Hořák pro pokrývače
 RO Arzător pt. acoperiș
 HU Bádogos forrasztó készülék
 ES Soplete de techado

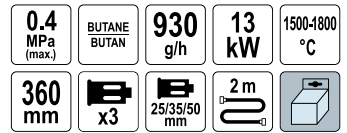

VOREL

No.	Max. pressure / Maks. ciśnienie [MPa]	Power / Moc [kW]	L [mm]	
73340	0.4	13	360	10

EN Roof heating torch with burners
 PL Palnik dekarski z dyszą i lancą
 DE Dachdeckerbrenner
 RU Кровельная горелка
 CZ Hořák pro pokrývače
 RO Arzător pt. acoperiș
 HU Bádogos forrasztó készülék
 ES Soplete de techado



VOREL

No.	Max. pressure / Maks. ciśnienie [MPa]	Power / Moc [kW]	L [mm]	
73341	0.4	47	745	20

EN Roof heating torch with burners
 PL Palnik dekarski z dyszą i lancą
 DE Dachdeckerbrenner
 RU Кровельная горелка
 CZ Hořák pro pokrývače
 RO Arzător pt. acoperiș
 HU Bádogos forrasztó készülék
 ES Soplete de techado



VOREL

No.	Max. pressure / Maks. ciśnienie [MPa]	Power / Moc [kW]	L [mm]	
73342	0.25	62	1315	8

EN Roof heating torch with burners
 PL Palnik dekarski z dyszami i lancą
 DE Dachdeckerbrenner
 RU Кровельная горелка
 CZ Hořák pro pokrývače
 RO Arzător pt. acoperiș
 HU Bádogos forrasztó készülék
 ES Soplete de techado



VOREL

No.	Max. pressure / Maks. ciśnienie [MPa]	Power / Moc [kW]	L [mm]	
73343	0.25	82	1385	8

EN Weed burner
 PL Palnik do wypalania chwastów
 DE Unkrautbrenner
 RU Горелка для выжигания сорняков
 CZ Hořák na pleveľ
 RO Arzător pt. buruieni
 HU Gyomégétő
 ES Quemador de malezas

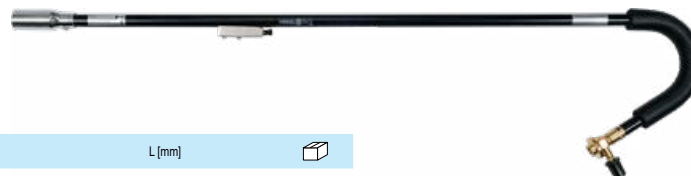

FLO

No.	Power / Moc [kW]	L [mm]	
73430	3	850	12



EN Nozzle
 PL Dysza
 DE Düse
 RU Сопло
 CZ Dýza
 RO Duză
 HU Fúvóka
 ES Tobera



EN Hose
 PL Wąż przyłączeniowy do gazu
 DE Anschluss Schlauch für Gas
 RU Шланг газоподводящий

CZ Hadice k připojení plynu
 RO Furtun de conectare pt. gaz
 HU Csatlakozó gáztömlő
 ES Manguera de conexión de gas



No.	Ø [mm]	
73350	25	50
73351	35	50
73352	50	50
73353	60	50



No.	L [m]	Ø [mm]	
73360	2	8	20
73362	5	8	10

EN Aluminium telescopic ladder
 PL Aluminiowa drabina teleskopowa
 DE Teleskopleiter aus Aluminium
 RU Многофункциональная стремянка
 CZ Hliníkový teleskopický žebřík
 RO Scară telesopică din aluminiu
 HU Alumínium kihúzható létra
 ES Escalera telescópica de aluminio

max 3.8 m
 13 STEPS STOPNE
 max 150 kg
 AI NYLON

max 3.8 m
 13 STEPS STOPNE
 max 150 kg
 AI NYLON

FEATURES:

- Safe folding system according to newpest EN 131-6 standard
- Safety lock

CECHY:

- Bezpieczny system składania zgodny z normą EN 131-6
- Blokada zabezpieczająca

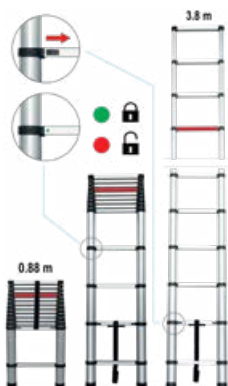

No.	Max. height / Maks. wysokość [m]	Rung quantity / Liczba stopni	
17701	3.8	13	1

EN Aluminium telescopic ladder
 PL Aluminiowa drabina teleskopowa
 DE Teleskopleiter aus Aluminium
 RU Многофункциональная стремянка
 CZ Hliníkový teleskopický žebřík
 RO Scară telesopică din aluminiu
 HU Alumínium kihúzható létra
 ES Escalera telescópica de aluminio



No.	Max. height / Maks. wysokość [m]	Rung quantity / Liczba stopni	
17702	3.8	13	1

EN Multifold ladder
 PL Drabina wielofunkcyjna
 DE Mehrzweckleiter
 RU Лестница многофункциональная
 CZ Multifunkční žebřík
 RO Scară multifuncțională
 HU Többcélú létra
 ES Escalera multipropósito

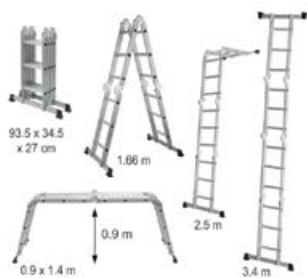

No.	Max. height / Maks. wysokość [m]	Rung quantity / Liczba stopni	
17704	3.4	4x3	1



max 3.4 m
 4x3 STEPS STOPNE
 16 kg
 max 150 kg



EN 2-step ladder
 PL Drabina 2-stopniowa rozkładana
 DE 2-Stufen-Leiter
 RU 2-ступенчатая лестница
 CZ Schůdky 2 stupně
 RO Scări cu 2 trepte
 HU 2 fokos lépcsők
 ES 2 pasos escaleras

90x47,5 x49 cm	h 99 cm FOLDED ZŁOŻONA	2 STEPS STOPNIE	38x26 cm
	max 150kg	SOFT GRIP MIEKKI UCHWYT	PROTECTION RAIL WSPORNIK OCHRONNY



No.	Height / Wysokość [m]	Rung quantity / Liczba stopni	
17730	0.9	2	4

EN Multifold ladder platform
 PL Podest do drabiny wielofunkcyjnej
 DE Podest für die Multifunktionale Leiter
 RU Подставки для стремянки
 CZ Pošišna pro víceúčelový žebřík
 RO Platformă pt. scară multifuncțională
 HU Palló a multifunkciós létrához
 ES Descansillos para la escala multifuncional

830x295 mm	560x295 mm	ZINC PLATED OCYNKO- WANA
	max 150kg	



No.	For / Dla	
17705	17704	5

EN Saw horse
 PL Podstawa robocza z metalu
 DE Stahl-Arbeitsbock
 RU Опорный штатив
 CZ Opěrný kozlík
 RO Capre de lucru
 HU Munkabak
 ES Caballete de apoyo

2 PCS	100x10 x75 cm	max 200kg	NON SLIP WORKTOP BLAT ANTY- POŚLIZGOWY
GALVANIZED STEEL STAL OCYNKOWANA	HOLDER FOR CARRYING UCHWYT DO PRZENOSZENIA		



No.	
29401	1

EN 3-step ladder
 PL Drabina 3-stopniowa rozkładana
 DE 3-Stufen-Leiter
 RU 3-ступенчатая лестница
 CZ Schůdky 3 stupně
 RO Scări cu 3 trepte
 HU 3 fokos lépcsők
 ES 3 pasos escaleras

115x47,5 x65 cm	h 125 cm FOLDED ZŁOŻONA	3 STEPS STOPNIE	
38x26 cm		max 150kg	PROTECTION RAIL WSPORNIK OCHRONNY



No.	Height / Wysokość [m]	Rung quantity / Liczba stopni	
17733	1.15	3	2

EN Saw horse
 PL Podstawa robocza z tworzywa
 DE Stahl-Arbeitsbock
 RU Опорный штатив
 CZ Opěrný kozlík
 RO Capre de lucru
 HU Munkabak
 ES Caballete de apoyo

2 PCS	PP	ABS	TPR	
----------	----	-----	-----	--



No.	
29400	3

EN Saw horse
 PL Podstawa robocza z regulowaną wysokością
 DE Stahl-Arbeitsbock
 RU Опорный штатив
 CZ Opěrný kozlík
 RO Capre de lucru
 HU Munkabak
 ES Caballete de apoyo

130 79 mm	max 200kg	GALVANIZED STEEL STAL OCYNKOWANA	HOLDER FOR CARRYING UCHWYT DO PRZENOSZENIA	
-----------------	-----------	---	---	--



No.	
29404	1

EN Adjustable roller stand
 PL Podpora z rolką
 DE Rollenbock
 RU Роликовая опора
 CZ Opěrný stojan
 RO Stand cu role si suport
 HU Felsőgörgős-bak
 ES Caballete de apoyo con rodillo



105 68 mm	60cm ROLLER ROLKA	max 60 kg
GALVANIZED STEEL STAL OCYNKOWANA	CHROME ROLLER CHROMOWANA ROLKA	



No.	
29410	1

EN Telescopic support bar
 PL Podpora teleskopowa
 DE Baustütze-Schnellspannstütze
 RU Подъемник-распорка для гипсокартона
 CZ Tuč teleskopická rozpěrná
 RO Suport sustinere telescopic
 HU Teleszkópos támasztórúd
 ES Puntal expansion



115 50 cm	max 30 kg	
-----------------	--------------	--



No.	
29440	2/10

EN Telescopic support bar
 PL Podpora teleskopowa
 DE Baustütze-Schnellspannstütze
 RU Подъемник-распорка для гипсокартона
 CZ Tuč teleskopická rozpěrná
 RO Suport sustinere telescopic
 HU Teleszkópos támasztórúd
 ES Puntal expansion



290 115 cm	max 30 kg	
------------------	--------------	--



No.	
29444	2/10

EN Telescopic support bar
 PL Podpora teleskopowa
 DE Baustütze-Schnellspannstütze
 RU Подъемник-распорка для гипсокартона
 CZ Tuč teleskopická rozpěrná
 RO Suport sustinere telescopic
 HU Teleszkópos támasztórúd
 ES Puntal expansion



290 160 cm	max 60 kg	
------------------	--------------	--



No.	
29445	4/8

EN Polystyrene plastering trowel
 PL Paca styropianowa
 DE Styropor-Reibebrett
 RU Тёрка пенопластовая
 CZ Polystyrénové hladítko
 RO Gletiera poliuretán
 HU Habszivacs simító
 ES Lana de polietileno



No.	Size / Rozmiar [mm]	
06400	130x270	10
06410	140x500	10
06440	170x320	10

EN Polystyrene plastering trowel
 PL Paca styropianowa
 DE Styropor-Reibebrett
 RU Тёрка пенопластовая
 CZ Polystyrénové hladítko
 RO Gletiera poliuretán
 HU Habszivacs simító
 ES Lana de polietileno



No.	Size / Rozmiar [mm]	
06420	140x700	10
06430	140x1000	10

EN Polystyrene plastering trowel
 PL Paca styropianowa
 DE Styropor-Reibebrett
 RU Тёрка пенопластовая
 CZ Polystyrénové hladítko
 RO Gletiera poliuretan
 HU Habszivacs simító
 ES Llana de polietileno

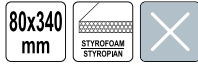

No.	Size / Rozmiar [mm]	
06401	80x340	10

EN Plastic plastering trowel
 PL Paca tynkarska plastikowa
 DE Glättekelle
 RU Гладилка пластиковая
 CZ Umělohmotné hladítko omítkářské
 RO Gletiera PVC
 HU Műanyag simító vakoláshoz
 ES Llana de plástico para enlucido



No.	Size / Rozmiar [mm]	
06500	270x130	24

EN Soft rubber plastering trowel
 PL Paca tynkarska miękka guma
 DE Gummireibebrett
 RU Тёрка пластмассовая с резиновым покрытием
 CZ Umělohmotné hladítko omítkářské z měkkou gumou
 RO Gletiera PVC cu cauciuc
 HU Műanyag simító vakoláshoz, lágy gumival
 ES Llana de plástico para enlucido con goma suave



No.	Size / Rozmiar [mm]	Rubber thickness / Grubość gumy [mm]	
06520	270x130	4	30

EN Plastering trowel
 PL Paca tynkarska rzadka gąbka
 DE Schwambrett
 RU Тёрка штукатурная с поролоновым покрытием (пластмассовая)
 CZ Umělohmotné hladítko omítkářské z řídkou houbou
 RO Gletiera PVC cu burete rar
 HU Műanyag simító vakoláshoz, lágy szivaccsal
 ES Llana de plástico para enlucido con esponja poco densa



No.	Size / Rozmiar [mm]	Sponge thickness / Grubość gąbki [mm]	
06540	270x130	25	20

EN Steel plastering trowel
 PL Tarka do styropianu
 DE Reibebrett für Styropor
 RU Тёрка стальная нержавеющая
 CZ Ohnutá špachtle nerezavějící
 RO Gletiera oțel
 HU Spatula hajlított, rozsdamentes
 ES Espátula de acero inox curvo



No.	Size / Rozmiar [mm]	
06470	270x130	20
06472	400x180	10

EN Plastering trowel
 PL Paca tynkarska filc
 DE Filzglätter
 RU Тёрка пластмассовая с войлочным покрытием
 CZ Umělohmotné hladítko omítkářské z filcem
 RO Gletiera PVC cu pasta
 HU Műanyag simító vakoláshoz, filccel
 ES Llana de plástico para enlucido con fieltro



No.	Size / Rozmiar [mm]	
06510	270x130	20

EN Plastering trowel
 PL Paca tynkarska gęsta gąbka
 DE Schwambrett
 RU Тёрка штукатурная с поролоновым покрытием (пластмассовая)
 CZ Umělohmotné hladítko omítkářské z hustou houbou
 RO Gletiera PVC cu burete dens
 HU Műanyag simító vakoláshoz, tömör szivaccsal
 ES Llana de plástico para enlucido con esponja densa



No.	Size / Rozmiar [mm]	Sponge thickness / Grubość gąbki [mm]	
06530	270x130	25	20



EN Stainless steel plastering trowel
 PL Paca tynkarska metalowa nierdzewna
 DE Schweizer Glätte
 RU Гладилка нержавеющей гладкая
 CZ Hladitko omltkáfské nerezavějící
 RO Gletiera inox
 HU Rozsdamentes simító vakoláshoz
 ES Llana de enlucido de acero inoxidable



No.	Size / Rozmiar [mm]	
06640	380x128	10
06660	480x128	10
06680	580x128	18

EN Stainless steel plastering trowel
 PL Paca tynkarska metalowa nierdzewna
 DE Glättekelle
 RU Гладилка нержавеющей с пластмассовой ручкой
 CZ Hladitko omltkáfské nerezavějící
 RO Gletiera inox maner plastic
 HU Rozsdamentes simító vakoláshoz
 ES Llana de enlucido de acero inoxidable



No.	Size / Rozmiar [mm]	
06700	270x125	24

EN Stainless steel plastering trowel
 PL Paca tynkarska metalowa nierdzewna
 DE Glättekelle gezahnt
 RU Гладилка нержавеющей зубчатая
 CZ Hladitko omltkáfské nerezavějící
 RO Gletiera inox
 HU Rozsdamentes simító vakoláshoz
 ES Llana de enlucido de acero inoxidable



No.	Size / Rozmiar [mm]	Teeth size / Rozmiar zębów [mm]	
06740	270x125	4x4	24
06760	270x125	6x6	24
06780	270x125	8x8	24
06781	270x125	10x10	24

EN Float with soft rubber
 PL Paca miękka z gumą do fugowania
 DE Weiches Reibebrett mit Gummi zum Verfugen
 RU Терка для затирки швов
 CZ Hladitko měkké s gumou na spárování
 RO Pac moale cu cauciuc pt. cimentare
 HU Fugázó simító puha gumival
 ES Llana suave con goma para rejuntar



No.	Size / Rozmiar [mm]	
06512	260x95	12

EN Stainless steel plastering trowel
 PL Paca tynkarska metalowa nierdzewna
 DE Schweizer Glätte gezahnt
 RU Гладилка металлическая зубчатая

CZ Hladitko omltkáfské nerezavějící
 RO Gletiera inox
 HU Rozsdamentes simító vakoláshoz
 ES Llana de enlucido de acero inoxidable



No.	Size / Rozmiar [mm]	Teeth size / Rozmiar zębów [mm]	
06650	380x128	8x8	10
06670	480x128	8x8	10
06690	580x128	8x8	18

EN Stainless steel plastering trowel
 PL Paca tynkarska metalowa nierdzewna, podstawa aluminium
 DE Glättekelle
 RU Гладилка стальная нержавеющей гладкая
 CZ Hladitko omltkáfské nerezavějící
 RO Gletiera inox
 HU Rozsdamentes simító vakoláshoz
 ES Llana de enlucido de acero inoxidable



No.	Size / Rozmiar [mm]	
06701	270x130	24

EN Plastic float with incised sponge
 PL Paca plastikowa z gąbką nacinaną
 DE Reibebrett aus Kunststoff, mit aufgeschnittenem Schwamm
 RU Пластиковый шпатель с надрезной губкой
 CZ Plastové hladitko s narezanou houbou
 RO Netezitoare din plastic cu burete taiat
 HU Műanyag simító, szivacsos
 ES Llana de plástico con esponja entallada



No.	Size / Rozmiar [mm]	Sponge thickness / Grubość gąbki [mm]	
06532	270x130	30	20

- EN Plastic float with hydroubber
- PL Paca plastikowa z hydrogumą
- DE Reibebrett aus Kunststoff, mit Hydrogummi
- RU Терка шлифовальная с мягкой губчатой накладкой
- CZ Plastové hladítko s rėnovou gumou
- RO Netezitoare din plastic cu hidrocauciu
- HU Mőanyag simító, durva szivaccsal
- ES Llana de plástico con hidrocaucho



No.	Size / Rozmiar [mm]	Rubber thickness / Grubość gumy [mm]	
06537	270x130	9	20
06538	270x130	18	20

- EN Stainless steel brick trowel
- PL Kielnia trójkątna nierdzewna
- DE Spitzkelle
- RU Кельма треугольная нержавеющей
- CZ Zednická lžice trojúhelníková nerezavějící
- RO Mistrie triunghiulară inoxidabilă
- HU Háromszög vakolókanál, rozsdamentes
- ES Paleta triangular de acero inoxidable



No.	Size / Rozmiar [mm]	
06341	180	50
06351	200	30

- EN Stucco trowel
- PL Kielnia sztukatorska podkowa
- DE Tiroler Stukkateurkelle
- RU Кельма штукатурная подкова
- CZ Lžice štukatérská podkova
- RO Mistrie
- HU Gipszkanál
- ES Espátula de estuco



No.	Size / Rozmiar [mm]	
06109	40x110	50
06110	60x110	50
06120	80x120	50
06121	100x120	50

- EN Plaster / stucco spray gun
- PL Tynkownica pneumatyczna do ścian
- DE Spritzpistole für Mörtel
- RU Пневмоковш для штукатурки стен
- CZ Střikací pistole pro maltu
- RO Spray pistol pt. mortar
- HU Habarcs szórópisztoly
- ES Pistola pulverizadora para mortero

0.4-0.6 MPa 400 l/min 4L max 50 m/h STANDARD



$L_{pA} = 91,8 \pm 2,5 \text{ dB}$; $L_{wA} = 102,8 \pm 2,5 \text{ dB}$; $a_n = <2,5 \text{ m/s}^2$

No.	Required air flow / Wymagany przepływ powietrza [l/min]	
09900	350-400	4

- EN Brick trowel
- PL Kielnia trójkątna
- DE Spitzkelle
- RU Кельма треугольная
- CZ Zednická lžice trojúhelníková
- RO Mistrie triunghiulară
- HU Háromszög vakolókanál
- ES Paleta triangular



No.	Size / Rozmiar [mm]	
06340	180	50
06350	200	50
06360	220	50

- EN Stainless steel brick trowel
- PL Kielnia trapezowa nierdzewna
- DE Stukkaturkelle
- RU Кельма шпательная нержавеющей
- CZ Lichoběžníková zednická lžice nerezavějící
- RO Mistrie trapezoidală inoxidabilă
- HU Trapéz vakolókanál, rozsdamentes
- ES Paleta trapezoidal de acero inoxidable



No.	Size / Rozmiar [mm]	
06370	130	50
06380	180	30



- EN Ceiling plaster / stucco spray gun
- PL Tynkownica pneumatyczna do sufitów
- DE Deckenplatte / Stucco Spritzpistole
- RU Пневмоковш для штукатурки потолков
- CZ Střikací pistole pro maltu
- RO Spray pistol pt. mortar
- HU Habarcs szórópisztoly
- ES Pistola pulverizadora para mortero

0.4-0.6 MPa 400 l/min 4L max 50 m/h STANDARD



$L_{pA} = 94,9 \pm 2,5 \text{ dB}$; $L_{wA} = 105,9 \pm 2,5 \text{ dB}$; $a_n = <2,5 \text{ m/s}^2$

No.	Required air flow / Wymagany przepływ powietrza [l/min]	
09903	350-400	4

- EN Hand wall coating sprayer
- PL Narzutnica tynku
- DE Verputzmaschine
- RU Метатель штукатурки
- CZ Omítačka
- RO Pulverizator manual pt. pereti
- HU Vakolatszóró
- ES Máquina de revestimiento de yeso



No.	Size / Rozmiar [mm]	
09910	210x170	12

- EN Borrer for aerated blocks
- PL Wiertło do bloczków
- DE Bohrer für Porenbeton
- RU Сверло по газобетону
- CZ Vrták do kvádrů
- RO Sfredel pt. bca
- HU Falfúró
- ES Taladro para bloques



No.	Working width / Szerokość robocza [mm]	
05821	60	20
05822	80	20
05823	120	20

- EN Scraper with teeth for plaster and aerated blocks
- PL Zdzierak wyrównujący z ząbkami
- DE Gipsobel mit Stahlklängen gezahnt
- RU Рубанок для газобетона зубчатый
- CZ Vyrovnávací škrabák se zoubky
- RO Raspel cu dinți
- HU Fogas, kiegyenlítő dörzsölő
- ES Raspador con dientes



No.	Size / Rozmiar [mm]	
05831	80x400	10

- EN Trowel for aerated blocks
- PL Kielnia do betonu komórkowego
- DE Kelle für Porenbeton
- RU Кельма для газобетона
- CZ Zednická lžice na pórobeton
- RO Mistrie pt. bca
- HU Habarcszterítő kanál sejtbetonhoz
- ES Allanadora para hormigón celular



No.	Size / Rozmiar [mm]	
05801	100	10
05802	115	10
05803	125	10
05804	200	10
05805	240	10
05806	300	10
05807	365	10

- EN Scraper for plaster and aerated blocks
- PL Zdzierak wyrównujący
- DE Gipsobel mit Stahlklängen
- RU Рубанок для газобетона
- CZ Vyrovnávací škrabák
- RO Raspel de nivelare
- HU Kiegyenlítő dörzsölő
- ES Raspador



No.	Size / Rozmiar [mm]	
05830	80x400	10

- EN Template tool for aerated blocks cut
- PL Przymiar do cięcia pod kątem
- DE Werkzeug für Porenbeton schneiden
- RU Угольник для резки газобетона
- CZ Právítko k fezáni pod úhlem
- RO Dispozitiv pt. taiat bca
- HU Gérvágó tok
- ES Calibre de comprobación para cortes angulares



No.	
05840	4

- EN Grooving device for aerated concrete
 PL Rylec do betonu komórkowego
 DE Werkzeug für Porenbeton bohruug
 RU Штроборез по газобетону
- CZ Drážkovač na pórobeton
 RO Dispozitiv canelat bca
 HU Horonymaró sejtbetonhoz
 ES Cincel para hormigón celular



VOREL

No.		
05850		10

- EN Panel carry
 PL Nosidło do płyt gipsowo-kartonowych
 DE Plattenträger mit Tragegriff
 RU Приспособление для переноски плит
 CZ Držák pro přenášení desek s rukojetí
 RO Dispozitiv pt. transportat plac de gips-carton
 HU Gipszkarton hordó
 ES Porta-paneles

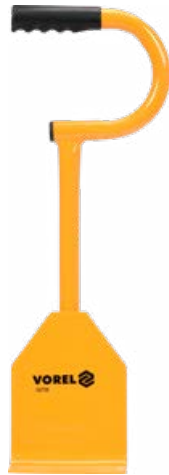

VOREL

No.	Dimensions / Wymiary [mm]	
04756	560x140x190	10

- EN Pliers for hollow expansion bolts
 PL Zaciskarka do kołków „Molly”
 DE Maueranker-Einsetzwerkzeug
 RU Клещи для дюбелей „Молли”
 CZ Kleště kotvící pro Molly hmoždinky
 RO Clește dibluri
 HU Molly fogó üreges bővítőcsavarokhoz
 ES Alicata para tacos „Molly”

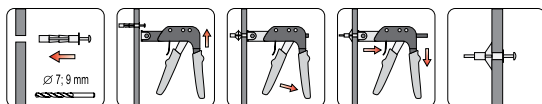

VOREL

No.		
04320		10/40

- EN Drywall panel carrier
 PL Uchwyt do przenoszenia płyt gipsowo-kartonowych
 DE Plattenträger mit Tragegriff
 RU Приспособление для переноски плит
 CZ Držák pro přenášení desek s rukojetí
 RO Dispozitiv pt. transportat plac de gips-carton
 HU Jellemzők és előnyök
 ES Empunadura porta-placas

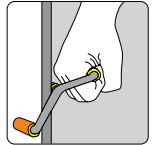

VOREL

No.		
04755		6/12

- EN Drywall stripper
 PL Obcinak dwustronny do płyt gipsowo-kartonowych
 DE Streifenschneider
 RU Рейсмус-резаk для гипсокартона
 CZ Řezák na sádkarton
 RO Dispozitiv reglabil de taiere a placilor de gips-carton
 HU Gipszkarton-vágó
 ES Cortador de tiras para tablaroca

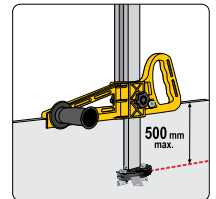
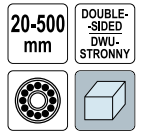

VOREL

No.	Cutting width / Szerokość cięcia [mm]	
04770	20-500	10

- EN Saw for gas concrete
 PL Pila do gazobetonu
 DE Gasbetonsäge
 RU Пила по газобетону с твердосплавным зубом
 CZ Pila na plynobeton
 RO Fierastrau cu placute vidia pt. BCA
 HU Fűrész gázbetonhoz
 ES Sierra para gas hormigón



No.	L [mm]	T	
28000	600	33	5
28010	600	17	5

- EN Saw for gas concrete
- PL Pila do gazobetonu
- DE Gasbetonsäge
- RU Пила по газобетону с твердосплавным зубом
- CZ Pila na plynobeton
- RO Fierastrau cu placute vidia pt. BCA
- HU Fűrész gázbetonhoz
- ES Sierra para gas hormigon



No.	L [mm]	T	
28011	600	15	6/12
28012	660	34	6/12

- EN Scraper set
- PL Komplet szpachelek
- DE Malerspachtelset
- RU Набор шпателей
- CZ Špachtle
- RO Șpacluri
- HU Spatula
- ES Espatulas



No.	Working width / Szerokość robocza [mm]	pcs / szt.	
06130	30, 50, 80	3	25/100

- EN Plastic japanese putty knife
- PL Szpachle japońskie plastikowe
- DE Japanspachtelsatz Kunststoff
- RU Пластиковые шпатели „ЯПОНКИ”
- CZ Japonské špachtle
- RO Set șpacluri plastic
- HU Spakli készlet
- ES Triuso espátula japonesa



No.	Working width / Szerokość robocza [mm]	pcs / szt.	
05950	50, 80, 100, 120	4	10

- EN Scraper
- PL Szpachelka
- DE Malerspachtel
- RU Шпатель
- CZ Špachtle
- RO Șpaclu
- HU Spatula
- ES Espatula



No.	Working width / Szerokość robocza [mm]	
06030	30	12/240
06040	40	12/240
06050	50	12/240
06060	60	12/240
06080	80	12/240
06100	100	12/240

- EN Stainless steel scraper
- PL Szpachelka kątowa wewnętrzna
- DE Kelle für Innenecken
- RU Кельма для внутренних углов
- CZ Úhlová špachtle vnitřní
- RO Șpaclu unghiular interior
- HU Belsőélí kanál
- ES Paleta en angulo



No.	Dimensions / Wymiary [mm]	
06150	80x60x60	50

- EN Stainless steel scraper set
- PL Szpachelki nierdzewne „japonki”
- DE Aufstreichspachtel
- RU Набор шпателей тип „Японский”
- CZ Špachtle japonské nerezavějící
- RO Șpacluri japoneze inoxidabile
- HU Spatula rozsdamentes
- ES Espatulas „japonesas” de acero

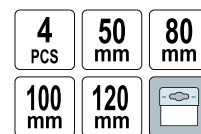

No.	Working width / Szerokość robocza [mm]	pcs / szt.	
06290	50, 80, 100, 120	4	12/120

EN Stainless steel putty knife
 PL Szpachla nierdzewna
 DE Edelstahl-Kleberspachtel
 RU Шпатель фасадный нержавеющей
 CZ Nerezová špachtle
 RO Spaclu inox pt. chituit
 HU Rozsdamentes spakli
 ES Espátula de acero inoxidable



No.	Working width / Szerokość robocza [mm]	
06294	40	100
06295	60	80
06296	80	60
06297	100	50
06298	150	80
06301	200	60
06304	250	50
06307	350	25
06308	450	25
06309	600	10

EN Finishing spatula
 PL Szpachla wykończeniowa
 DE Flächenspachtel
 RU Финишный шпатель

CZ Špachtle fasádní
 RO Spatula pt. finisare
 HU Glett lehéző
 ES Espátula de acabado



No.	Working width / Szerokość robocza [mm]	
06001	250	24
06002	400	12
06003	600	12
06004	800	12
06005	1000	8
06006	1200	8

EN Plastic putty knives for glue
 PL Pace plastikowe do kleju
 DE Kunststoffspachtel gezahnt
 RU Пластиковые шпатели для плиточного клея
 CZ Zubová stěrka plastová
 RO Spatula zîmtata
 HU Műanyag spakli
 ES Espátula de plástico

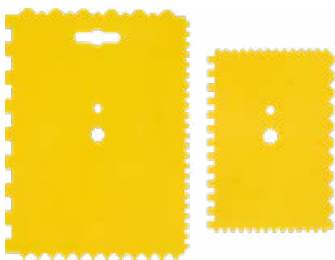
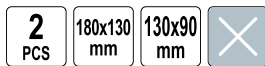

No.	Dimensions / Wymiary [mm]	pcs / szt.	
05960	180x130, 130x90	2	10

EN Stainless steel putty knife
 PL Szpachla nierdzewna
 DE Edelstahl-Kleberspachtel
 RU Шпатель фасадный нержавеющей
 CZ Nerezová špachtle
 RO Spaclu inox pt. chituit
 HU Rozsdamentes spakli
 ES Espátula de acero inoxidable

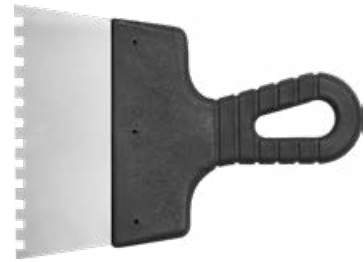

No.	Working width / Szerokość robocza [mm]	Teeth size / Rozmiar zębów [mm]	
06299	150	6x6	80
06300	150	8x8	80
06302	200	6x6	60
06303	200	8x8	60
06305	250	6x6	50
06306	250	8x8	50

EN Replaceable blade for finishing spatula
 PL Ostrze do szpachli wykończeniowej
 DE Spachtelklinge
 RU Лезвие для шпателя
 CZ Čepel do špachtle
 RO Lama de schimb pt. spatula finisare
 HU Glett lehéző él
 ES Hoja para espátula



No.	W [mm]	For / Dla	
06010	250	06001	160
06011	400	06002	160
06012	600	06003	160
06013	800	06004	80
06014	1000	06005	80
06015	1200	06006	80

EN Plastic smooth putty knife
 PL Szpachla plastikowa gładka
 DE Spachtel Kunststoff
 RU Шпатель прямой пластмассовый
 CZ Plastové rovné
 RO Spatula dintata
 HU Műanyag spakli
 ES Espátula de plástico



No.	Working width / Szerokość robocza [mm]	
05971	225	50

- EN Plastic putty knife with teeth
- PL Szpachla plastikowa z zębami
- DE Spachtel Kunststoff
- RU Шпатель пластмассовый, зубчатый
- CZ Plastové čtyřhranné zuby
- RO Spatula dintata
- HU Fogazott műanyag spatulya
- ES Espátula de plástico con dientes

225 mm 



No.	Working width / Szerokość robocza [mm]	Teeth size / Rozmiar zębów [mm]	
05972	225	6x6	50

- EN Plastic putty knife set
- PL Zestaw szpachli plastikowych
- DE Kunststoffspatel
- RU Шпатели пластиковые
- CZ Sada univerzálních stěrek
- RO Set spaclu plastic
- HU Spakli készlet
- ES Set espátula de plástico

4 PCS **40 mm** **60 mm**
80 mm **100 mm** 



No.	Working width / Szerokość robocza [mm]	pcs / szt.	
05980	40, 60, 80, 100	4	30

- EN Flexible silicone and sealant smother
- PL Gładzik do silikonu
- DE Silikonglätter
- RU Шпатель для затирки силикона
- CZ Hladitko do silikonu
- RO Dispozitiv pt. silicon si mastic
- HU Szilikon lehúzó
- ES Alisador de juntas de silicona

150 mm  



No.	L [mm]	
04360	150	24/240

- EN Plastic putty knife with truncated teeth
- PL Szpachla plastikowa z zębami trójkątnymi
- DE Spachtel Kunststoff
- RU Шпатель пластмассовый, зубчатый
- CZ Plastové trojúhelníkové zuby
- RO Spatula dintata
- HU Fogazott műanyag spatulya
- ES Espátula de plástico con dientes

225 mm 



No.	Working width / Szerokość robocza [mm]	Teeth size / Rozmiar zębów [mm]	
05973	225	7	50

- EN Rubber grout spreader
- PL Szpachla gumowa do fugowania
- DE Gummispatel
- RU Шпатель резиновый для фуговки
- CZ Pryžová špachtle na fugování
- RO Spaclu cauciucat pt. rosturi
- HU Fugázógumi
- ES Espátula de goma para rejuntar





No.	Working width / Szerokość robocza [mm]	
06310	150	30
06320	200	30
06330	250	30
06331	300	30

- EN Stainless steel scraper
- PL Szpachelka nierdzewna
- DE Rostfrei Spachtel
- RU Шпатель нержавеющей
- CZ Špachtle
- RO Șpaclu
- HU Spatula
- ES Espatula de acero inox

SS  



No.	Working width / Szerokość robocza [mm]	
05901	30	6/72
05902	40	6/72
05903	50	6/72
05904	60	6/72
05905	80	6/72
05906	100	6/72

EN Stainless steel scraper
 PL Szpachelka nierdzewna
 DE Rostfrei Spachtel
 RU Шпатель нержавеющей
 CZ Špachtle
 RO Șpaclu
 HU Spatula
 ES Espatula de acero inox



VOREL

No.	Working width / Szerokość robocza [mm]	
05911	30	6/72
05912	40	6/72
05913	50	6/72
05914	60	6/72
05915	80	6/72
05916	100	6/72

EN Painting scraper
 PL Skrobak malarski
 DE Malerabkratzer
 RU Скребок для краски со сменным лезвием
 CZ Škrabka malářská
 RO Răzuitor pt. zugrăvi
 HU Festékvakaró
 ES Rascador de pintor



No.	Blade working width / Szerokość robocza ostrza [mm]	
06795	100	60

EN Spare blades for painting scraper
 PL Ostrze do skrobaka
 DE Schneide für Malerabkratzer
 RU Сменные лезвия для скребка
 CZ Ostrůvky do škrabky
 RO Taiș pt. răzuitor
 HU Festékvakaró-pengék
 ES Filo para rascador



No.	For / Dla	
06796	06795	10/100

EN Stainless steel scraper
 PL Szpachelka nierdzewna wygięta
 DE Rostfrei Spachtel
 RU Шпатель нержавеющей изогнутый
 CZ Špachtle
 RO Șpaclu
 HU Spatula
 ES Espatula de acero inox curvo



VOREL

No.	Working width / Szerokość robocza [mm]	
05921	30	6/72
05922	40	6/72
05923	50	6/72
05924	60	6/72
05925	80	6/72
05926	100	6/72

EN Painting scraper
 PL Skrobak malarski
 DE Malerabkratzer
 RU Скребок для краски
 CZ Škrabka malářská
 RO Răzuitor pt. zugrăvi
 HU Festékvakaró
 ES Rascador de pintor



No.	Working width / Szerokość robocza [mm]	
06797	115	50

EN Telescopic scraper
 PL Skrobak teleskopowy
 DE Teleskop Schaber
 RU Скребок телескопический
 CZ Teleskopický stěrač
 RO Răzuitor flexibil
 HU Teleszkópos jégkaparó
 ES Telescopicos raspador



VOREL

No.		
06799		16/96

- EN Scraper for glass and gaskets
 PL Skrobak do szyb i uszczeliek
 DE Schaber für Glas und Dichtungen
 RU Скребок для стекла и прокладки
 CZ Škrabky na sklo
 RO Răzuitor
 HU Kaparó eszköz
 ES Rasqueta

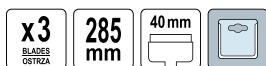

No.		
06790		6/36

- EN Scraper for concrete floor
 PL Skrobak do betonu bez trzonka
 DE Betonschaber
 RU Скребок напольный для бетона
 CZ Škrabka
 RO Răzuitor
 HU Kaparó
 ES Raspador obra suel



No.	Blade size / Rozmiar ostrza [mm]	
05760	120x350	12/24
05761	120x250	12/24

- EN Blade for scraper
 PL Wymienne ostrze do skrobaka do betonu
 DE Klinge für Betonschaber
 RU Лезвие к скребку для бетонного пола
 CZ Škrabka vyměnitelná čepel
 RO Lamă de schimb
 HU Kaparó cserélhető penge
 ES Răzuitor lamă de schimb



No.	Blade size / Rozmiar ostrza [mm]	
05773	150x250	25/50
05774	150x350	25/50

- EN Scraper for concrete floor
 PL Skrobak do betonu z trzonkiem
 DE Betonschaber
 RU Скребок напольный для бетона
 CZ Škrabka
 RO Răzuitor
 HU Kaparó
 ES Raspador obra suel



No.	Blade size / Rozmiar ostrza [mm]	L [mm]	
05750	75x200	1300	10
05751	75x300	1300	10
05752	75x400	1300	10

- EN Blade for scraper
 PL Wymienne ostrze do skrobaka do betonu
 DE Klinge für Betonschaber
 RU Лезвие к скребку для бетонного пола
 CZ Škrabka vyměnitelná čepel
 RO Lamă de schimb
 HU Kaparó cserélhető penge
 ES Răzuitor lamă de schimb



No.	Blade size / Rozmiar ostrza [mm]	
05770	100x200	25/50
05771	100x300	25/50
05772	100x400	25/50

- EN Mason's pan
 PL Czerpak murarski
 DE Gipspfänchen
 RU Ковш штукатурный
 CZ Zednický koreček
 RO Cancioc
 HU Kőműveskanál
 ES Achicador de albanil

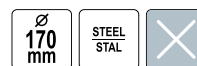

No.		
06335		50

EN Building strainer
 PL Sito budowlane
 DE Bau Sieb
 RU Сито строительное
 CZ Prohazovací sito stavební
 RO Sită construcții
 HU Építőipari rosta
 ES Cedazo para construcción



VOREL

No.	Dimensions / Wymiary [cm]	Eyelet size / Rozmiar oczka [mm]	
34944	60x100	4	30
34945	60x100	6	5/30
34946	60x100	8	5/30
34947	60x100	10	30

EN Mixer for compound and glue
 PL Mieszadło do zapraw i klejów
 DE Mörtelrührer
 RU Мешалка для клеевой массы и цемента

CZ Míchadlo na malty a lepidla
 RO Agitator pt. mortar și cleiuri
 HU Habarcs és ragasztó keverő
 ES Mezcladora para morteros y pegamientos



VOREL

No.	Ø [mm]	L [mm]	
09010	90	510	40

EN Mixer for gypsum and coat
 PL Mieszadło do gipsu i gładzi
 DE Gips- und Wachsührer
 RU Мешалка для гипса

CZ Míchadlo na sádku a stěrku
 RO Agitator pt. ipsos și honuituri
 HU Gipsz és glett keverő
 ES Mezcladora para yeso



No.	Ø [mm]	L [mm]	Type / Typ	
09025	75	370	C-75	20

EN Paint mixer
 PL Mieszadło do farbu
 DE Farbmischer
 RU Мешалка для краски

CZ Míchadlo na hmoty
 RO Mixer vopsea / var
 HU Keverő festékekhez
 ES Mezclador para pinturas



VOREL

No.	Ø [mm]	L [mm]	
09060	60	400	40/80
09080	85	400	40/80
09090	100	600	30

EN Mixer for compound and glue
 PL Mieszadło do zapraw i klejów
 DE Mörtelrührer
 RU Мешалка для клеевой массы и цемента
 CZ Míchadlo na malty a lepidla
 RO Agitator pt. mortar și cleiuri
 HU Habarcs és ragasztó keverő
 ES Mezcladora para morteros y pegamientos



VOREL

No.	Ø [mm]	L [mm]	
09005	65	410	40
09006	80	410	40

EN Mixer for gypsum and coat
 PL Mieszadło do gipsu i gładzi
 DE Gips- und Wachsührer
 RU Мешалка для гипса

CZ Míchadlo na sádku a stěrku
 RO Agitator pt. ipsos și honuituri
 HU Gipsz és glett keverő
 ES Mezcladora para yeso



VOREL

No.	Ø [mm]	L [mm]	
09015	85	400	40
09017	100	500	20

EN Grout mixer
 PL Mieszadło do fug
 DE Mörtelrührer
 RU Миксер для расшивочных растворов

CZ Míchadlo do spárovací hmoty
 RO Malaxor pt. ciment
 HU Fugakeverő szár
 ES Mezclador para mechada del azulejo



VOREL

No.	Ø [mm]	L [mm]	
09031	75	300	10

EN Grout double mixer
 PL Mieszadło do fugi podwójne
 DE Doppel-Mörtelrührer
 RU Миксер для расшивочных растворов двойной
 CZ Míchadlo do spárovací hmoty dvojité
 RO Malaxor dublu pt. ciment
 HU Dupla fugakeverő szár
 ES Mezclador doble para lechada del azulejo



No.	Ø [mm]	L [mm]	
09032	75	500	10

EN Mixer for compound
 PL Mieszadło do mas
 DE Rührer für Materialien auf Bitumenbasis
 RU Мешалка для штукатурки

CZ Míchadlo na stavební hmoty
 RO Agitator pt. mase
 HU Keverő masszához
 ES Mezcladora para masas



No.	Ø [mm]	L [mm]	Type / Typ	
09048	75	400	C-75	20
09049	85	450	C-85	20
09050	100	500	C-100	20
09051	110	550	C-110	20

EN Mixer for compound
 PL Mieszadło do mas
 DE Rührer für Materialien auf Bitumenbasis
 RU Мешалка для штукатурки

CZ Míchadlo na stavební hmoty
 RO Agitator pt. mase
 HU Keverő masszához
 ES Mezcladora para masas



No.	Ø [mm]	L [mm]	
09054	80	400	25
09056	100	600	25

EN Mixer for compound
 PL Mieszadło do mas
 DE Rührer für Materialien auf Bitumenbasis
 RU Мешалка для штукатурки

CZ Míchadlo na stavební hmoty
 RO Agitator pt. mase
 HU Keverő masszához
 ES Mezcladora para masas



No.	Ø [mm]	L [mm]	
09036	60	400	60
09038	80	400	35
09040	100	600	30

EN Mixer for compound
 PL Mieszadło do mas
 DE Rührer für Materialien auf Bitumenbasis
 RU Мешалка для штукатурки
 CZ Míchadlo na stavební hmoty
 RO Agitator pt. mase
 HU Keverő masszához
 ES Mezcladora para masas



No.	Ø [mm]	L [mm]	
09044	80	400	25
09046	100	600	25

EN Turbo mixer
 PL Mieszadło turbo
 DE Turborührer
 RU Миксер турбо

CZ Turbo míchadlo
 RO Malaxor turbo
 HU Turbó keverő szár
 ES Mezclador turbo



No.	Ø [mm]	L [mm]	Type / Typ	
09052	120	550	C-120	10

EN Mixer for loose materials
 PL Mieszadło do materiałów sypkich
 DE Mischer
 RU Миксер для сыпучих материалов

CZ Míchadlo na sypké materiály
 RO Agitator pt. materiale vărsătoare
 HU Keverő szóródó anyagokhoz
 ES Mezcladora para materiales sueltos



No.	Ø [mm]	L [mm]	
09028	80	400	35

EN Spiral mixer
 PL Mieszadło spiralne
 DE Spiralarührer
 RU Миксер спиральный

CZ Spirálové míchadlo
 RO Malaxor spirală
 HU Spirális keverő
 ES Mezclador espiral



No.	Ø [mm]	L [mm]	Type / Typ	
09094	120	600	C-120	10

EN Spiral mixer
 PL Mieszadło spiralne
 DE Spiralrührer
 RU Миксер спиральный

CZ Spirálové míchadlo
 RO Malaxor spirală
 HU Spirális keverő
 ES Mezclador espiral



VOREL

No.	Ø [mm]	L [mm]	
09096	80	400	20
09097	100	500	20

EN Turbo threaded stirrer
 PL Mieszadło turbo z gwintem
 DE Turborührer mit Gewinde
 RU Миксер турбо с резьбой

CZ Turbo míchadlo se závitem
 RO Malaxor cu filet, turbo
 HU Meneles turbó keverő szár
 ES Mezclador turbo con rosca



No.	Ø [mm]	L [mm]	
09063	115	580	10
09065	135	580	10

EN Wallpaper perforator
 PL Walek do perforacji tapet
 DE Tapetenperforierwalze
 RU Валик для перфорации обоев
 CZ Perforační váleček na tapety
 RO Perforator de tapet
 HU Tapétaperforáló henger
 ES Rodillo para perforación de papel de pared

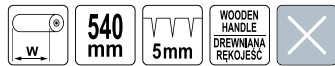

VOREL

No.	W [mm]	
06457	150	6/36



EN Deaeration roller
 PL Walek do odpowietrzania
 DE Entlüftungsrolle
 RU Валик азрационный
 CZ Váleček na odvzdušňování
 RO Rola pt. modelare sapa
 HU Levegőkinyomó henger
 ES Rodillo para hacer el vacío



VOREL

No.	Size / Rozmiar [mm]	
06450	75x230	15
06452	123x230	10

EN Plastic paint mixer
 PL Mieszadło z tworzywa do farb
 DE Farbrührstab aus Kunststoff
 RU Пластиковый миксер для лакокрасочных материалов
 CZ Plastové míchadlo do barev
 RO Mixer vopsea, plastic
 HU Műanyag festékeverő szár
 ES Mezclador de plástico para pintura



VOREL

No.	Ø [mm]	L [mm]	
09077	80	500	10

EN Turbo threaded mixer
 PL Mieszadło turbo z gwintem
 DE Turborührer mit Gewinde
 RU Миксер турбо с резьбой

CZ Turbo míchadlo se závitem
 RO Malaxor cu filet, turbo
 HU Meneles turbó keverő szár
 ES Mezclador turbo con rosca



VOREL

No.	Ø [mm]	L [mm]	
09062	100	500	20

EN Squeegee for wallpapers
 PL Rakiel do tapet
 DE Tapetenrakel
 RU Ракель для обоев
 CZ Škrabka na tapety
 RO Racleta pt. tapet
 HU Tapétalenyomó
 ES Rasqueta para papel de pared



VOREL

No.	Size / Rozmiar [mm]	
06460	280x165	12/120

EN Deaeration roller
 PL Walek do odpowietrzania
 DE Entlüftungsrolle
 RU Валик азрационный

CZ Váleček na odvzdušňování
 RO Rola pt. modelare sapa
 HU Levegőkinyomó henger
 ES Rodillo para hacer el vacío



VOREL

No.	Size / Rozmiar [mm]	
06453	110x500	2

EN Plaster roller
 PL Walek do gładzi gipsowych
 DE Rollspachtel-Walze
 RU Валик для шпаклевки
 CZ Váleček na sádrovou omítku
 RO Trafalet
 HU Glettelő henger
 ES Rodillo para masillar

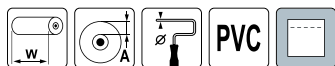

VOREL

No.	W [mm]	A [mm]	Ø [mm]	
09445	230	55	6	48

EN Handy paint roller
 PL Walek malarski ze zbiornikiem na farbę
 DE Malerrolle mit Farbbehälter
 RU Малярный валик с емкостью для краски
 CZ Malířský váleček s nádobou na barvu
 RO Trafalet cu rezervor
 HU Festőhenger festékadagoló tartállyal
 ES Rodillo de pintura con depósito

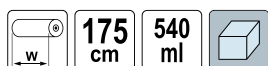

VOREL

No.	W [mm]	L [mm]	
09397	230	1750	6

EN Paint roller Syntex
 PL Walek malarski Syntex
 DE Malerroller Syntex
 RU Валик в сборе полиакрил
 CZ Malířský váleček
 RO Trafalet Syntex
 HU Festőhenger Syntex
 ES Rodilli de pintura Syntex

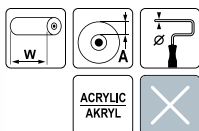

VOREL

No.	W [mm]	A [mm]	Ø [mm]	
09307	180	20	6	55
09308	250	20	6	50

EN Paint roller Vestan
 PL Walek malarski Vestan
 DE Malerroller
 RU Валик в сборе, полиакрил
 CZ Malířský váleček
 RO Trafalet lana artificiala
 HU Festőhenger
 ES Rodilli de pintura

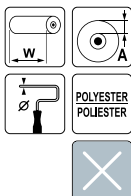

VOREL

No.	W [mm]	A [mm]	Ø [mm]	
09345	180	15	6	55
09346	250	15	6	50

EN Plaster roller replacement
 PL Zapasowy walek do gładzi gipsowych
 DE Rollspachtel-Ersatzwalze
 RU Запасной валик для шпаклевки
 CZ Náhradní váleček na sádrovou omítku
 RO Rezerva trafalet
 HU Glettelő henger fej
 ES Recambio rodillo para masillar

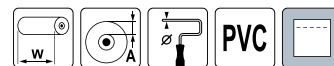

VOREL

No.	W [mm]	A [mm]	Ø [mm]	For / Dla	
09446	230	55	6	09445	50

EN Spare paint roller
 PL Zapasowy walek malarski
 DE Ersatz-Farbroller
 RU Запасной малярный валик
 CZ Náhradní malířský váleček
 RO Rezerva trafalet
 HU Pót festőhenger
 ES Rodillo de pintura de repuesto



VOREL

No.	W [mm]	For / Dla	
09398	230	09397	100

EN Paint roller Girpaint
 PL Walek malarski Girpaint
 DE Malerroller Girpaint
 RU Валик полиакрил в сборе
 CZ Malířský váleček Girpaint
 RO Trafalet cu fir galben
 HU Festőhenger Girpaint
 ES Rodilli de pintura Girpaint

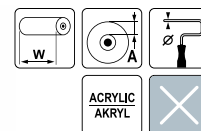

VOREL

No.	W [mm]	A [mm]	Ø [mm]	
09334	100	9	6	40
09336	180	18	6	60

EN Paint roller Flok
 PL Walek malarski Flok
 DE Malerroller Flok
 RU Валик в сборе мольтопрен
 CZ Malířský váleček
 RO Trafalet burete fin
 HU Festőhenger
 ES Rodilli de pintura

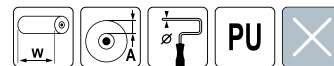

VOREL

No.	W [mm]	A [mm]	Ø [mm]	
09359	150	50	6	50

EN Paint roller Moltopren
 PL Walek malarski Moltopren
 DE Malerroller Moltopren
 RU Валик в сборе поролон

CZ Malířský váleček
 RO Trafalet burete cu tija plastic
 HU Festőhenger
 ES Rodilli de pintura

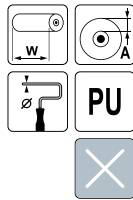

VOREL

No.	W [mm]	A [mm]	Ø [mm]	
09370	50	35	6	70

EN Paint roller refill Multicolor
 PL Zapas do walka Multicolor
 DE Maler-Ersatzwalzen Multicolor
 RU Шубка полиамидовая для валика

CZ Náhradní váleček Multicolor
 RO Rezerva trafalet fir Multicolor
 HU Csere festőhenger Multicolor
 ES Llana de polietileno Multicolor

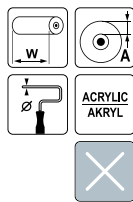

VOREL

No.	W [mm]	A [mm]	Ø [mm]	
09302	180	15	6	40
09303	250	15	8	25

EN Paint roller refill
 PL Zapas do walka
 DE Maler-Ersatzwalzen
 RU Шубка нейлоновая для валика

CZ Náhradní váleček
 RO Rezerva trafalet acril rosu
 HU Csere festőhenger
 ES Repuesto para el cilindro

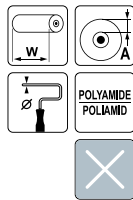

VOREL

No.	W [mm]	A [mm]	Ø [mm]	
09331	180	6	6	10/50
09332	250	6	8	10/40

EN Paint roller refill Flok
 PL Zapas do walka Flok
 DE Maler-Ersatzwalzen Flok
 RU Шубка мольтопрен

CZ Náhradní váleček Flok
 RO Rezerve trafalet burete fin
 HU Csere festőhenger Flok
 ES Esponja de recambio

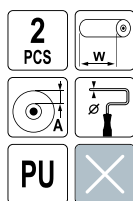

VOREL

No.	W [mm]	A [mm]	Ø [mm]	
09363	50	35	6	75
09365	100	35	6	80

EN Paint roller Moltopren
 PL Walek malarski Moltopren
 DE Malerroller Moltopren
 RU Валик в сборе поролон
 CZ Malířský váleček
 RO Trafalet burete cu tija plastic
 HU Festőhenger
 ES Rodilli de pintura



VOREL

No.	W [mm]	A [mm]	Ø [mm]	
09371	70	35	6	80
09372	100	35	6	70
09373	150	50	6	50

EN Paint roller refill Syntex
 PL Zapas do walka Syntex
 DE Maler-Ersatzwalzen Syntex
 RU Шубка полиакриловая для валика

CZ Náhradní váleček Syntex
 RO Rezerva trafalet Syntex
 HU Csere Syntex hengerhez
 ES Repuesto para el cilindro Syntex

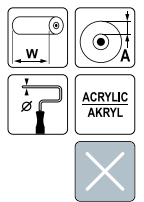

VOREL

No.	W [mm]	A [mm]	Ø [mm]	
09310	180	20	6	10/40
09311	250	20	6	40

EN Paint roller refill Girpaint
 PL Zapas do walka Girpaint
 DE Maler-Ersatzwalzen Girpaint
 RU Шубка полиамидная для валика

CZ Náhradní váleček Girpaint
 RO Rezerva trafalet fir galben
 HU Csere festőhenger Girpaint
 ES Repuesto para el cilindro Girpaint

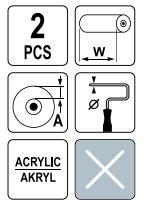

VOREL

No.	W [mm]	A [mm]	Ø [mm]	
09338	100	9	6	150

EN Paint roller refill Moltopren
 PL Zapas do walka Moltopren
 DE Maler-Ersatzwalzen Moltopren
 RU Шубка мольтопрен

CZ Náhradní váleček Moltopren
 RO Rezerve trafalet burete
 HU Csere festőhenger Moltopren
 ES Esponja de recambio

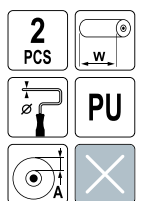

VOREL

No.	W [mm]	A [mm]	Ø [mm]	
09375	50	35	6	200
09377	100	35	6	90
09378	150	50	6	45

- EN Painting bowl
- PL Kucheta malarska
- DE Malerschale
- RU Ванночка малярная
- CZ Malířská kůveta
- RO Tava-suport trafalet
- HU Kűvetta
- ES Cuveta



No.	[mm]	
09406	150x245	75
09408	330x350	50

- EN Paint roller set Vestan
- PL Walek malarski Vestan z kratką
- DE Malerroller Vestan mit Abtropfgitter
- RU Валик с решёткой
- CZ Malířský váleček + mřížka
- RO Trafalet cu gratar
- HU Festőhenger + rács
- ES Rodillo de pintura + rejilla

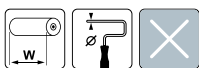

No.	W [mm]	Ø [mm]	
09385	180	6	25

- EN Paint roller set Moltopren
- PL Walek malarski Moltopren z kuchetą
- DE Malerroller Moltopren mit Malerschale
- RU Набор для покраски: ванночка, валик
- CZ Malířský váleček + kůveta
- RO Trafalet cu tava
- HU Festőhenger + kűvetta
- ES Rodillo esponja + cuveta

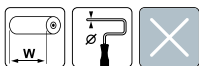

No.	W [mm]	Ø [mm]	
09395	50	6	60

- EN Flat paint brush
- PL Pędzel angielski
- DE Flachpinsel
- RU Кисть флейцевая тип Английский
- CZ Štětce anglický
- RO Pensulă englezească
- HU Laposécset
- ES Brocha plana

No.	W [mm]	H [mm]	
09521	25	44/39	50
09522	36	51/46	50
09523	50	51/46	50
09524	63	51/46	50
09525	76	51/46	50

- EN Painting grid
- PL Kratka malarska
- DE Farbenabrollgitter
- RU Решетка малярная
- CZ Malířská mřížka
- RO Gratar pt. zugrăvit
- HU Festőrács
- ES Rejilla para pintar

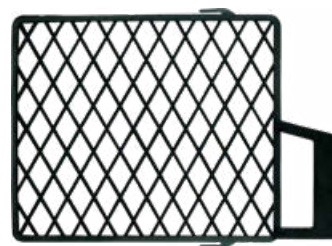

No.	[mm]	
09413	265x285	100

- EN Paint roller set Vestan
- PL Walek malarski Vestan z kuchetą
- DE Malerroller Vestan mit Malerschale
- RU Набор для покраски: ванночка, валик
- CZ Malířský váleček
- RO Trafalet cu tava
- HU Festőhenger + kűvetta
- ES Rodillo de pelo + cuveta

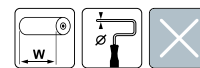

No.	W [mm]	Ø [mm]	
09390	180	6	12

- EN Paint roller handle
- PL Uchwyt do walika
- DE Malerroller-Griff
- RU Ручка для валика
- CZ Držák válečku
- RO Maner trafalet
- HU Festőhenger nyél
- ES Mango del cilindro

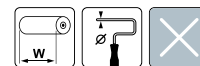

No.	W [mm]	Ø [mm]	
09421	50/70	6	90
09422	100	6	90
09425	150	6	150
09427	180	6	110
09429	250	6	110
09430	250	8	80

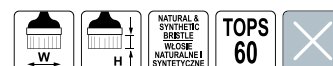

- EN Flat paint brush profi
- PL Pędzel angielski profesjonalny
- DE Professional Flachpinsel
- RU Профессиональная кисть флейцевая тип Английский
- CZ Anglický štětec profesionální
- RO Pensulă englezască profesională
- HU Profeszionalis lapsecset
- ES Brocha plana profesional



No.	W [mm]	H [mm]	
09531	25	51/46	50
09532	36	51/46	50
09533	50	57/52	50
09534	62	57/52	50
09535	75	57/52	50
09536	87	64/59	50
09537	102	64/59	50

- EN Round paint brush
- PL Pędzel okrągły
- DE Ringpinsel
- RU Кисть круглая
- CZ Kulatý štětec
- RO Pensula rotundă
- HU Marokecset
- ES Brocha redonda



No.	W [mm]	H [mm]	
09581	20	44/39	50
09583	30	51/46	50
09585	40	51/46	50
09587	50	57/52	50
09589	60	57/52	50

- EN Paint brush
- PL Ławkowiec
- DE Malerbürste
- RU Кисть-макловица деревянная ручка
- CZ Natírací kartáč profesionální
- RO Bidinea profesională
- HU Profeszionalis kenőkefe
- ES Brocha prof.



No.	W [mm]	H [mm]	
09647	170x85	64/58	10
09648	180x75	70/64	10
09649	190x85	76/68	10

- EN Angled paint brush
- PL Pędzel kaloryferowy
- DE Heizkörperpinsel
- RU Кисть радиаторная
- CZ Štětec na topná tělesa
- RO Pensulă pt. calorifere
- HU Radiátorecset
- ES Broca angulada de radiadores



No.	W [mm]	H [mm]	
09560	25	44/39	50
09561	36	51/46	50
09562	50	51/46	50

- EN Brush for wallpapers
- PL Pędzel do tapet
- DE Flächenstreicher
- RU Кисть-макловица деревянная ручка

- CZ Štětec na tapety dřevěný
- RO Bidinea prof.pt. tapet
- HU Ecset fa tapétákhoz
- ES Brocha de empapelar madera

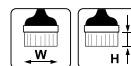

No.	W [mm]	H [mm]	
09636	110x30	51/46	30
09638	130x30	51/46	30
09640	140x40	57/52	30
09642	150x50	64/59	30

- EN Paint brush
- PL Chłapacz PCV
- DE Deckenbürste
- RU Кисть-макловица ПВХ
- CZ Smeták PVC
- RO Bidinea PVC
- HU PVC meszelő
- ES Brocha de PVC



No.	W [mm]	
09651	170x60	30

EN Paint brushes
 PL Pędzle malarskie
 DE Pinselset
 RU Набор кистей
 CZ Sada malířských štětců
 RO Set pensule
 HU Festőecset készlet
 ES Brochas de pintar



No.	W [mm]	pcs / szt.	
09920	25, 36, 50	3	25/200
09930	36, 50, 63	3	40/160
09950	15, 25, 36, 50, 63	5	25/100

EN Brush for pitch
 PL Smołowiec
 DE Pechstein
 RU Кисть для смолы

CZ Kartáč asfaltěrský
 RO Perie pt. asfalt
 HU Kátránykenő kefe
 ES Brocha para alquitrán



No.	W [mm]	
09653	170	30

EN All purpose boot tray
 PL Wielofunkcyjna podstawa gospodarcza
 DE Garten- und Haushalt-Unterlage
 RU Многофункциональный поднос

CZ Multifunkční podložka
 RO Tava multifunctionala
 HU Többfunkciós tálcá
 ES Bandeja de arranque universal

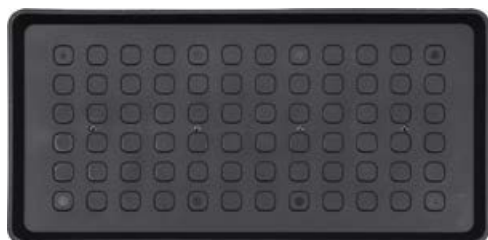

No.	Dimensions / Wymiary [mm]	
67260	780x384x32	30

EN Paint brush
 PL Ławkowiec PET
 DE Malerbürste
 RU Кисть-макловица PET
 CZ Natřací kartáč
 RO Bidinea
 HU Kenőkefe
 ES Brocha



No.	W [mm]	
09655	150x70	12
09650	170x70	12
09656	180x80	10

EN Magnetic paint brush holder
 PL Uchwyt magnetyczny do pędzli
 DE Magnethalter für Pinsel
 RU Магнитный патрон для кистей
 CZ Magnetický držák štětců
 RO Suport magnetic pt. pensule zugravit
 HU Mágneses ecsettartó
 ES Soporte magnético para pinceles

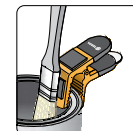

No.	L [mm]	
09590	90	24/96

EN Sheet for construction works
 PL Folia ochronna malarska
 DE Abdeckplane
 RU Пленка защитная
 CZ Stavební fólie
 RO Folie pt. construcții
 HU Építési fólia
 ES Lona protectora



No.	[m]	Thickness / Grubość [µm]	Material / Material	
09462	4x5	5	HDPE	40
09463	4x5	15	LDPE	20

EN Sheet for construction works
 PL Folia budowlana mocna
 DE Abdeckplane
 RU Плёнка защитная строительная повышенной прочности
 CZ Stavební folie
 RO Folie pt. constructii
 HU Építési fólia
 ES Lona protectora



VOREL

No.	[m]	Thickness / Grubość [µm]	pcs / szt.	
09457	4x5	20	15	
09459	4x5	30	10	

EN Construction waste bags
 PL Worki na odpady budowlane
 DE Müllsäcke
 RU Мешки для строительного мусора
 CZ Pytle na stavební odpad
 RO Saci gunoi pt. santier
 HU Zsák építési törmelékekhez
 ES Bolsas para desperdicios de construcción



VOREL

No.	Capacity / Pojemność [l]	Thickness / Grubość [µm]	pcs / szt.	
09470	80	40	10	30
09471	120	60	15	10

EN Self adhesive paper tape
 PL Taśma papierowa samoprzylepna
 DE Papierband selbstklebend
 RU Лента малярная бумажная

CZ Páska papírová samolepicí
 RO Banda adeziva hartie
 HU Öntapadó papírszalag
 ES Cinta de papel autoadhesiva



VOREL

No.	W [mm]	L [m]	
75270	19	25	12/48
75271	25	25	9/36
75272	30	25	10/40
75273	38	25	6/24
75274	48	25	6/24
75285	25	50	9/36
75286	30	50	10/40
75287	38	50	6/24
75288	48	50	6/24

EN Debris bags
 PL Worki na gruz, mocne
 DE Müllsäcke stabil
 RU Мешки для строительного мусора
 CZ Pytle na suť
 RO Saci pt. demolari
 HU Sittes zsák
 ES Bolsas para escombros



VOREL

No.	Capacity / Pojemność [l]	Thickness / Grubość [µm]	pcs / szt.	
09475	80	142	10	10
09476	80	142	3	10
09477	120	142	10	10
09478	120	142	3	10

EN Waste bags for styrofoam
 PL Worki na styropian
 DE Styropor Entsorgungssäcke
 RU Пакеты для мусора строительные материалы

CZ Pytle na polystyren
 RO Saci gunoi
 HU Szemeteszsák
 ES Sacos de poliestireno



VOREL

No.	Capacity / Pojemność [l]	Thickness / Grubość [µm]	pcs / szt.	
09472	240	40	10	10

EN Blue masking tape
 PL Taśma maskująca, niebieska
 DE Malerei blau Tape
 RU Малярна стрічка

CZ Maskovací páska
 RO Bandă de mascare
 HU Fedőszalag
 ES Cinta adhesiva azul



VOREL

No.	W [mm]	L [m]	
75120	30	25	40
75121	38	25	24
75122	48	25	24
75123	30	50	40
75124	38	50	24
75125	48	50	24

EN Plastering tape
 PL Taśma tynkarska elewacyjna
 DE Putzband
 RU Штукатурные лента
 CZ Fasádní omítková páska
 RO Banda mascare pt. tencuieli
 HU Homlokzati festő szalag
 ES Cinta de enlucido de fachada

20m 50m



VOREL

No.	W [mm]	L [m]	
75130	38	20	24
75131	48	20	24
75132	38	50	28
75133	48	50	24

EN Double-sided carpet tape
 PL Taśma dwustronna do wykładzin
 DE Doppelseitiges Klebeband für Auslegware
 RU Двухсторонняя клейкая лента для укладки ковровых покрытий
 CZ Obojstranná lepicí páska (na podlahové krytiny)
 RO Bandă cu două părți adezive pt. mochete
 HU Kétoldalas szalag szőnyegpadlókhöz
 ES Cinta de doble cara para revestimientos

DOUBLE-SIDED DWU-STRONNA



VOREL

No.	W [mm]	L [m]	
75260	50	5	48
75261	50	10	36
75262	50	25	24

EN Double-sided tape
 PL Taśma dwustronna na folii
 DE Doppelseitiges Band auf PP-Folie
 RU Клейкая лента двухсторонняя на полипропиленовой основе
 CZ Obojstranná páska na PP folii
 RO Bandă cu două fețe pt. folii
 HU Kétoldalas ragasztószalag
 ES Cinta de doble cara en film

DOUBLE-SIDED DWU-STRONNA **PP**



VOREL

No.	W [mm]	L [m]	
75245	50	5	72
75246	50	10	72
75247	50	25	36

EN Packing tape, brown
 PL Taśma pakowa brązowa
 DE Verpackungsband aus PP, braun
 RU Упаковочная клейкая лента
 CZ Balící páska PP hnědá
 RO Bandă ambalare PP maro
 HU PP barna ragasztószalag
 ES Cinta de embalaje marrón

VOREL

No.	W [mm]	L [m]	
75301	48	40	36
75302	48	66	36

EN Aluminium tape
 PL Taśma aluminiowa
 DE Aluminiumband
 RU Алюминиевая клейкая лента
 CZ Hliníková páska
 RO Bandă aluminiu
 HU Alumínium szalag
 ES Cinta de aluminio

Al



VOREL

No.	W [mm]	L [m]	
75140	48	10	36
75141	48	50	24

EN „DUCT” tape
 PL Taśma tekstylna „DUCT”
 DE Textilband „DUCT”
 RU Лента армированная на тканевой основе
 CZ Textilní páska „DUCT”
 RO Bandă textilă „DUCT”
 HU „DUCT” textil szalag
 ES Cinta textil „DUCT”

DUCT



VOREL

No.	W [mm]	L [m]	
75238	48	10	24
75239	38	50	28
75240	48	50	24

EN Mounting tape
 PL Taśma samoprzylepna dwustronna
 DE Doppelseitiges montageband
 RU Двухсторонняя монтажная лента
 CZ Páska montážní dvouvrstvá
 RO Scotch cu banda dubla
 HU Kétoldalas ragasztószalag
 ES Cinta adhesiva de doble cara

2 PCS 2.25m 19mm 5m 19mm



VOREL

No.	W [mm]	L [m]	
75100	19	2.25, 5	12/96

OPP



EN Packing tape, transparent
 PL Taśma pakowa przezroczysta
 DE Verpackungsband aus PP, durchsichtig
 RU Упаковочная клейкая лента
 CZ Balící páska PP průhledná
 RO Bandă ambalare PP transparentă
 HU Átlátszó ragasztószalag
 ES Cinta de embalaje transparente



No.	W [mm]	L [m]	
75303	48	40	36
75304	48	66	36

EN Packing tape
 PL Taśma pakowa
 DE Band
 RU Упаковочная клейкая лента
 CZ Balící páska
 RO Banda scotch
 HU Csomagolószalag
 ES Cinta de embalaje



No.	W [mm]	L [m]	
75300	48	45	12/36

EN Plastic bucket
 PL Wiadro budowlane
 DE Baueimer
 RU Ведро строительное
 CZ Stavební vědro
 RO Găleată pt. construcții
 HU Kőműves vödör
 ES Cubo de obra



No.	Capacity / Pojemność [l]	
06388	10	900
06390	12	680
06383	13	800
06393	16	450
06392	20	390
06384	21	400

EN Painting bucket
 PL Wiadro malarskie
 DE Malereimer
 RU Ведро малярное пластмассовое
 CZ Vědro malířské
 RO Găleată zidar
 HU Festővödör
 ES Cubo para pintar



No.	Capacity / Pojemność [l]	Dimensions / Wymiary [mm]	
09400	14	360x250x225	315



OPP



EN PVC tape
 PL Taśma PCV do użytku zewnętrznego
 DE PVC Band
 RU Лента ПВХ для внешних работ
 CZ Páska PVC
 RO Bandă PVC
 HU Kétoldalas PVC
 ES Cinta de PVC para exteriores



PVC



No.	W [mm]	L [m]	
75031	48	33	50

EN Plastic bucket
 PL Wiadro budowlane z wylewką
 DE Baueimer
 RU Ведро строительное со сливом
 CZ Stavební vědro
 RO Găleată pt. construcții
 HU Kőműves vödör
 ES Cubo de obra con pico



No.	Capacity / Pojemność [l]	
06391	12	720
06381	16	420
06382	20	500

EN Tub for mass mixing
 PL Kastrta budowlana
 DE Mörtelkasten
 RU Таз строительный круглый
 CZ Stavební vědro
 RO Vas plastic constructii
 HU Kőműves vödör
 ES Caba de obra



No.	Capacity / Pojemność [l]	
06397	40	110
06398	65	100
06399	90	160

EN Tub for mass mixing
 PL Kastrta osynkowana
 DE Mörtekkasten
 RU Кювета для перемешивания раствора

CZ Slavební vědro
 RO Vas plastic constructii
 HU Kőműves vödör
 ES Caba de obra



No.	Capacity / Pojemność [l]	
06394	40	210
06395	60	210
06396	90	120

EN Galvanized bucket
 PL Wiadro ocynkowane
 DE Baueimer
 RU Ведро оцинкованное
 CZ Vědro
 RO Găleată
 HU Kőműves vödör
 ES Cubo



VOREL

No.	Capacity / Pojemność [l]	
89560	5	900
89561	7	750
89562	10	600
89563	12	500
89564	15	350

EN Suction lifter
 PL Uchwyt-przysawka do szyb
 DE Glas-Gummissauger
 RU Держатель-присоска для стекол двойная
 CZ Podtlakový držák na sklo
 RO Ventuze
 HU Szélvédő kiemelő
 ES Elevador tipo ventosa

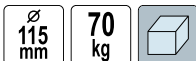

VOREL

No.	Ø [mm]	Max. lifting capacity / Maks. udźwig [kg]	
05301	115	70	24

EN Suction lifter
 PL Uchwyt-przysawka do szyb
 DE Glas-Gummissauger
 RU Держатель-присоска для стекол
 CZ Podtlakový držák na sklo
 RO Ventuza
 HU Szélvédő kiemelő
 ES Elevador tipo ventosa

VOREL

No.	Ø [mm]	Max. lifting capacity / Maks. udźwig [kg]	
05311	115	40	50

EN Garden bucket
 PL Wiadro ogrodnicze
 DE Garten Eimer
 RU Ведро огородное

CZ Zahradní vědro
 RO Găleată de grădină
 HU Kerti vödör
 ES Cubo de jardín



FLO

No.	Capacity / Pojemność [l]	
35600	15	500

EN Suction lifter
 PL Uchwyt-przysawka do szyb
 DE Glas-Gummissauger
 RU Держатель-присоска для стекол
 CZ Podtlakový držák na sklo
 RO Ventuza
 HU Szélvédő kiemelő
 ES Elevador tipo ventosa

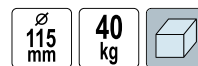

VOREL

No.	Ø [mm]	Max. lifting capacity / Maks. udźwig [kg]	
05300	115	40	48

EN Suction lifter
 PL Uchwyt-przysawka do szyb
 DE Glas-Gummissauger
 RU Держатель-присоска для стекол тройная
 CZ Podtlakový držák na sklo
 RO Ventuze
 HU Szélvédő kiemelő
 ES Elevador tipo ventosa

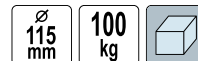

VOREL

No.	Ø [mm]	Max. lifting capacity / Maks. udźwig [kg]	
05302	115	100	12

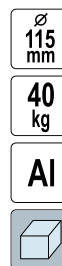

EN Suction lifter
 PL Uchwyt-przysawka do szyb
 DE Glas-Gummissauger
 RU Держатель-присоска для стекол двойная
 CZ Podtlakový držák na sklo
 RO Ventuze
 HU Szélvédő kiemelő
 ES Elevador tipo ventosa

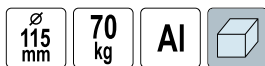

VOREL

No.	Ø [mm]	Max. lifting capacity / Maks. udźwig [kg]	
05312	115	70	10

EN Pump suction cup
 PL Uchwyt-przysawka
 DE Saugheber
 RU Держатель-присоска
 CZ Vakuový držák
 RO Ventuza cu pompa
 HU Vákuumos tapadókorong
 ES Ventosa bomba de vacío

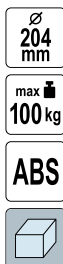

VOREL

No.	Ø [mm]	Max. lifting capacity / Maks. udźwig [kg]	
05325	204	100	10

EN Carpenter's pencil
 PL Ołówek stolarski
 DE Zimmermannsbleistift
 RU Карандаш столярный
 CZ Tesařská tužka
 RO Creion de tâmplărie
 HU Asztalos ceruza
 ES Lapiz de carpintero



No.	L [mm]	pcs / szt.	
09180	180	12	60/240

EN Wire tying twister hook
 PL Klucz do wiązania drutu zbrojeniowego
 DE Rödeldraht-Drillkurbel
 RU Крючок для вязки арматуры
 CZ Radlovačka
 RO Dispozitiv pt. legat fier beton
 HU Huzalsodró
 ES Gancho para amarrar alambre



VOREL

No.	L [mm]	
49830	240	20

EN Pump suction cup
 PL Uchwyt-przysawka
 DE Saugheber
 RU Держатель-присоска
 CZ Vakuový držák
 RO Ventuza cu pompa
 HU Vákuumos tapadókorong
 ES Ventosa bomba de vacío

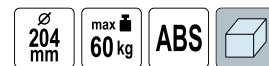

VOREL

No.	Ø [mm]	Max. lifting capacity / Maks. udźwig [kg]	
05319	204	60	10

EN Hook
 PL Hak budowlany
 DE Mauerhaken
 RU Крюк строительный
 CZ Stavební hák
 RO Cârlig de construcții
 HU Építőipari horog
 ES Gancho de obra



JUCO

No.	
34950	25

EN Carpenter's pencil sharpener
 PL Temperówka do ołówek stolarskich
 DE Zimmermann-Bleistift-Anspitzer
 RU Точилка для столярных карандашей
 CZ Ořezávkó na tesařskou tužku
 RO Ascuzitoare pt. creioane de tamplărie
 HU Ceruzahegyező
 ES Sacapuntas para lápiz de carpintero



VOREL

No.	
09190	40/240

EN Hand bar bender
 PL Klucz do gięcia prętów
 DE Metallbieger
 RU Рычажный трубогиб
 CZ Ruční ohýbačka
 RO Dispozitiv de indoit
 HU Kézi betonacél hajlító
 ES Curvador de tubos



VOREL

No.	L [mm]	
49810	930	4

- EN Bearing bender for bar
 PL Giętarka łożyskowa do drutu
 DE Drahtbiegevorrichtung, mit Lager
 RU Ручной станок для гибки арматуры
- CZ Ohybačka drátu s ložiskem
 RO Dispozitiv pt. îndoit suport sârmă
 HU Csapágyas dróthajlító
 ES Dobladora de alambre con rodamiento

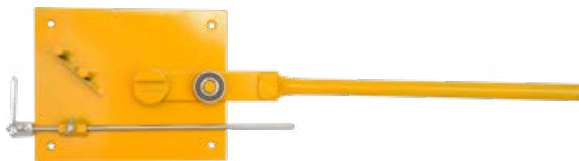

VOREL

No.	Ø [mm]	Dimensions / Wymiary [mm]	Bearing / Łożysko [mm]	
49805	6-8	17x17x5	35x15	2
49806	10-14	25x20x5	45x20	2

- EN Hand tamper
 PL Ubijak brukarski
 DE Pflasterstampfer
 RU Ручная трамбовка для уплотнения грунта
 CZ Pěchovadlo na pokládku dlažby
 RO Tamper de mână
 HU Kézi dőngölő
 ES Compactador manual de adoquines



VOREL

No.	
35000	1

- EN Longitudinal clamp
 PL Chwytnak brukarski wzdużny regulowany
 DE Bordstein-Verlegezange
 RU Захват-клевщи для бордюра продольные
- CZ Kleště na obrubníky podélné
 RO Cleste pt. borduri
 HU Hosszirányúszegélykő emelő fogó
 ES Pinza de colocación de rebordes mecánica



VOREL

No.	Grip range / Zakres chwytu [mm]	
35010	980-1170	2

- EN Rubber for lateral clamp
 PL Zapasowe końcówki do chwytaka
 DE Ersatzgummi für Bordsteinverlegezange
 RU Запасные наконечники
 CZ Náhradní gumový úchyt
 RO Mânere de cauciuc de rezervă
 HU Gumi alkatrészek
 ES Punta de repuesto

VOREL

No.	For / Dla	pcs / szt.	
35013	35012	4	10

- EN Bender for reinforcement bar
 PL Giętarka do drutu zbrojeniowego
 DE Biegevorrichtung für Bewehrungsdraht
 RU Ручной станок для гибки арматуры
- CZ Ohybačka armovacího drátu
 RO Dispozitiv pt. îndoit sârmă de armare
 HU Betonvas hajlító
 ES Dobladora de alambre de reforzamiento



VOREL

No.	Ø [mm]	Dimensions / Wymiary [mm]	
49800	6-8	16x12x5	4
49801	10-12	25x16x6	4
49802	14-16	25x16x6	2

- EN Rod extractor
 PL Wyciągacz do prętów
 DE Stangenauzieher
 RU Ручной вытягиватель прутка
 CZ Vytahovač tyčí
 RO Extractor tije
 HU Rúdkihúzó
 ES Extractor de varillas



VOREL

No.	Rod diameter / Średnica pręta [mm]	
35007	8-28	6

- EN Lateral clamp
 PL Chwytnak poprzeczny, podwójny
 DE Bordsteinverlegezange
 RU Захват-клевщи для бордюра поперечные
- CZ Kleště na obrubníky příčné
 RO Cleste pt. borduri
 HU Keresztirányúszegélykő emelő fogó
 ES Pavimentación pinza doble



VOREL

No.	Grip range / Zakres chwytu [mm]	
35012	200-510	2

4 PCS



EN Paving slab lifter
 PL Chwytnak brukarski wysoki
 DE Hoher Pflastergreifer
 RU Захват для бордюра
 CZ Držák na dlažební kostky
 RO Dispozitiv pt. ridicat dale de pavaj
 HU Magas térkőkiemelő
 ES Pinza para adoquines alta

VOREL

No.	Grip range / Zakres chwytu [mm]	
35014	220-500	5

EN Grapple for cobblestones
 PL Chwytnak zbiorczy do kostki brukowej
 DE Pflastersteineträger
 RU Захват ручной для переноса бордюрного камня и блоков

CZ Nosič na cihly
 RO Cleste pt. borduri
 HU Emelő fogó
 ES Pinza para bordillos longitudinal



VOREL

No.	Grip range / Zakres chwytu [mm]	
35015	700-1100	4

EN Brick tongs
 PL Chwytnak do podnoszenia płyt lub cegieł
 DE Greifer zum Heben von Platten oder Ziegeln
 RU Захват для подъема плит или кирпича
 CZ Nástroj pro přenášení desek a cihel
 RO Cleste caramida
 HU Csempé- és téglafogó
 ES Pinzas para transportar placas o ladrillos

410-680
mm



VOREL

No.	Grip range / Zakres chwytu [mm]	
35018	410-680	12

EN Blades for paver puller
 PL Zapasowe ostrza do imaka
 DE Ersatzklingen für Steinzieher-Steinheber
 RU Запасные лезвия
 CZ Náhradní čepele
 RO Tartalék penge
 HU Lame de rezerva
 ES Cuchillas de repuesto

2
PCS



VOREL

No.	For / Dla	pcs / szt.	
35021	35020	2	20



EN Slabgrabber
 PL Chwytnak brukarski jednoręczny regulowany
 DE Pflasterstein- und Klinker-Träger
 RU Захваты для тротуарной плитки кирпича, блоков
 CZ Kleště na dlažbu a cihly
 RO Cleste pt. caramizi
 HU Burkolólap fogó
 ES Pinza de colocación de losas



VOREL

No.	Grip range / Zakres chwytu [mm]	
35017	255-400	4

EN Paver puller
 PL Imak brukarski regulowany
 DE Steinzieher-Steinheber
 RU Захват для камня

CZ Kleště na vytahování dlažby
 RO Ridicator de pavele
 HU Térkőkiemelő szerszám
 ES Extractor de adoquines



VOREL

No.	Grip range / Zakres chwytu [mm]	
35020	80-275	4

EN Paver adjuster
 PL Łom wyważak brukarski
 DE Richteisen für Pflasterbau
 RU Лом с упором для демонтажа тротуарной плитки
 CZ Tuč pro opravu dlažby
 RO Bara de aliniere pavaj
 HU Tékő sorrendező
 ES Barra alineadora de adoquines

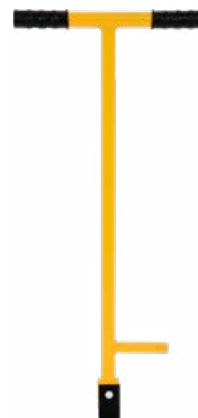

VOREL

No.	
35025	4

- EN Blade for paver adjuster
- PL Ostrze do łomu brukarskiego
- DE Ersatzklingen für Richtleisen
- RU запасные лезвия
- CZ Náhradní čepele
- RO Lama de rezervă
- HU Tartalék penge
- ES Cuchillas de repuesto



No.	For / Dla	
35026	35025	20

- EN Paver lifter
- PL Zgarniacz brukarski do podsypki
- DE Plan-Abzieher für Pflasterbau
- RU Правило для выравнивания основания под тротуарную плитку
- CZ Stahovací lišta
- RO Sistem de nivelare manuală
- HU Ágyazat lehúzó rendszer
- ES Sistema de enrasado manual

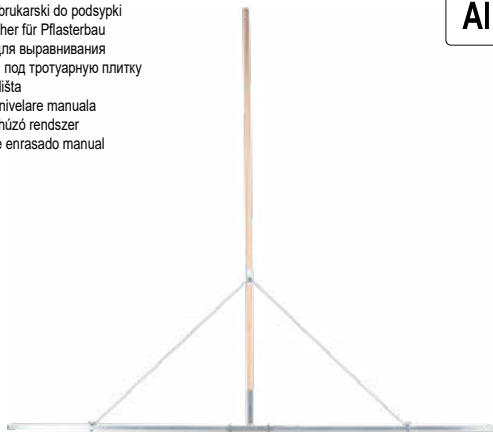

No.	L [cm]	
35031	150	1
35030	200	1

- EN Garden paving stone mould
- PL Forma do kostki brukowej
- DE Pflasterform
- RU Форма для брусчатки
- CZ Forma pro dlažební kostky
- RO Matrita pt. pavaje
- HU Térkő-minta sablon
- ES Plantilla para adoquines

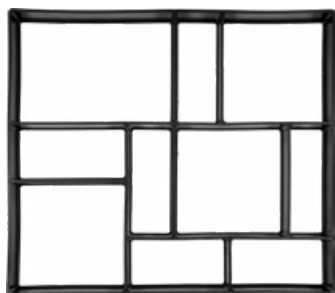

No.	Dimensions / Wymiary [mm]	
35061	450x400x40	10

- EN Paver lifter
- PL Zgarniacz brukarski do podsypki
- DE Plan-Abzieher für Pflasterbau
- RU Правило для выравнивания основания под тротуарную плитку
- CZ Stahovací lišta
- RO Sistem de nivelare manuală
- HU Ágyazat lehúzó rendszer
- ES Sistema de enrasado manual

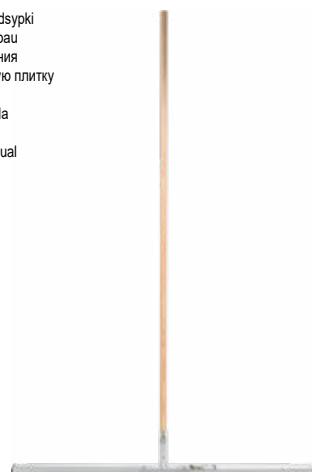

No.	L [cm]	
35033	75	1
35032	120	1

- EN Garden paving stone mould
- PL Forma do kostki brukowej
- DE Pflasterform
- RU Форма для брусчатки
- CZ Forma pro dlažební kostky
- RO Matrita pt. pavaje
- HU Térkő-minta sablon
- ES Plantilla para adoquines

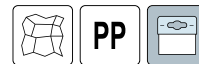

No.	Dimensions / Wymiary [mm]	
35060	430x425x40	10

- EN Garden paving stone mould
- PL Forma do kostki brukowej
- DE Pflasterform
- RU Форма для брусчатки
- CZ Forma pro dlažební kostky
- RO Matrita pt. pavaje
- HU Térkő-minta sablon
- ES Plantilla para adoquines

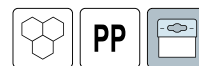

No.	Dimensions / Wymiary [mm]	
35062	360x360x40	10

EN Garden paving stone mould
 PL Forma do kostki brukowej
 DE Pflasterform
 RU Форма для брусчатки
 CZ Forma pro dlažební kostky
 RO Matrita pt. pavaje
 HU Térkö-minta sablon
 ES Plantilla para adoquines

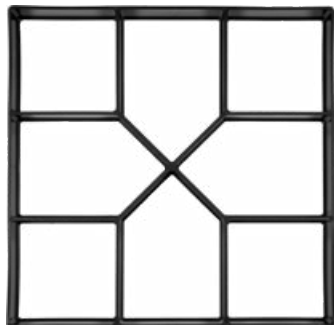

No.	Dimensions / Wymiary [mm]	
35063	400x400x40	10

EN Garden paving stone mould
 PL Forma do kostki brukowej
 DE Pflasterform
 RU Форма для брусчатки
 CZ Forma pro dlažební kostky
 RO Matrita pt. pavaje
 HU Térkö-minta sablon
 ES Plantilla para adoquines

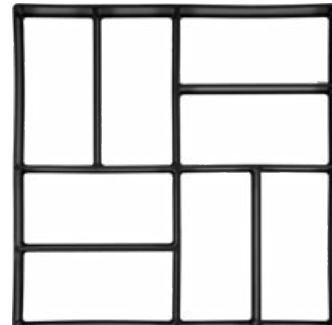

No.	Dimensions / Wymiary [mm]	
35064	400x400x40	10

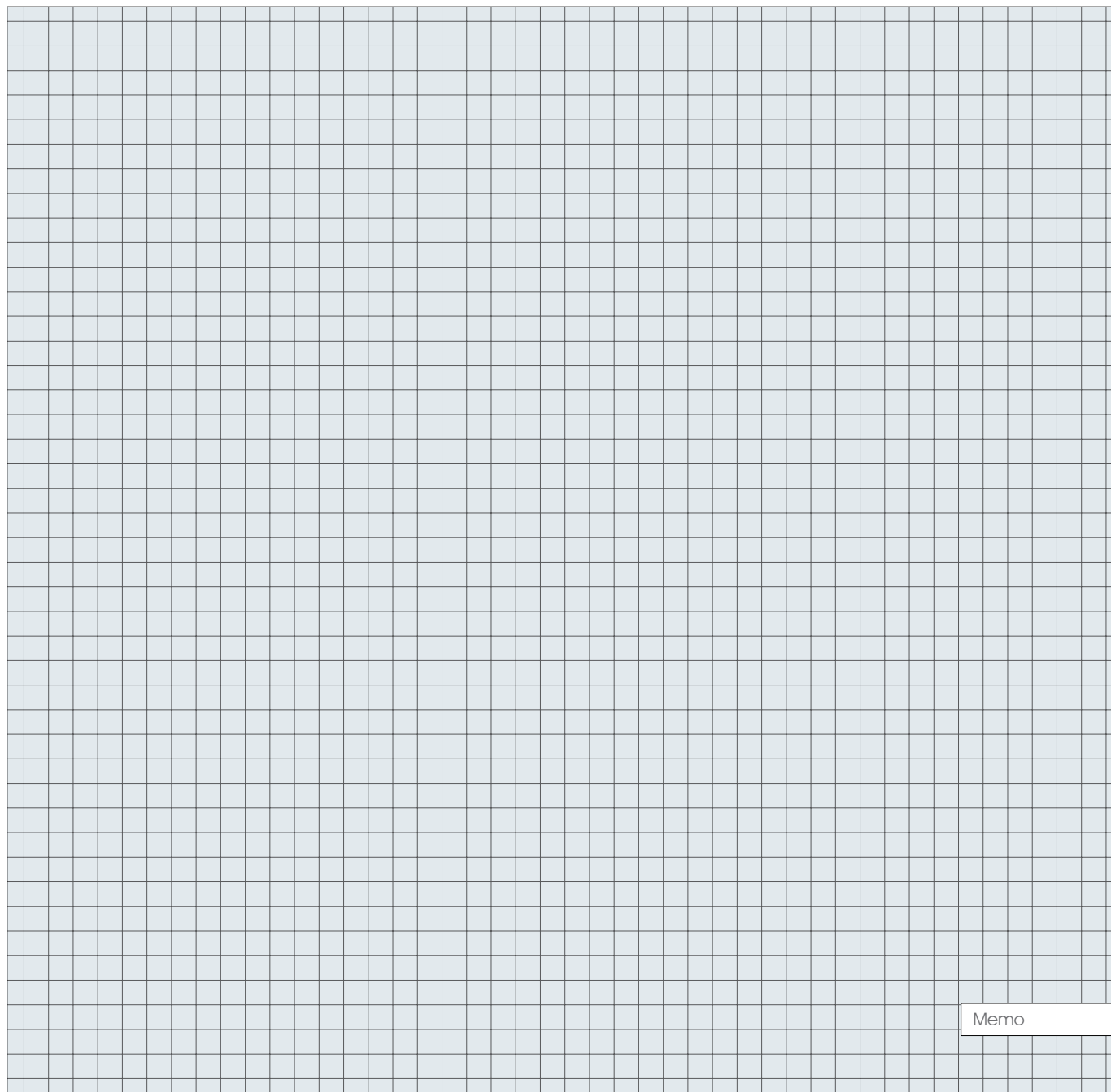







12

Measuring tools Narzędzia miernicze



Digital universal meters Cyfrowe mierniki uniwersalne	
.....
.....192-193	
Measuring tapes Miary zwijane	
.....
.....193-194	
Wooden folding rules Miary składane drewniane	
.....
.....194	
Plastic folding rules Miary składane z tworzywa	
.....
.....195	
Feeler gauges Szczelinomierze	
.....
.....195	
Vernier calipers Suwmiarki	
.....
.....195-196	
Chalk lines Sznury traserskie	
.....
.....196	

Ropes & lines Sznury i linki	
.....
.....196-199	
Plumb bobs Piony murarskie	
.....
.....199-200	
Try squares Kątowniki stolarskie	
.....
.....200-202	
Rulers Przymiary	
.....
.....203	
Electronic measuring tools Elektroniczne urządzenia pomiarowe	
.....
.....203-205	
Levels Poziomnice	
.....
.....205-206	
Scales Wagi	
.....
.....207	
Magnifiers Lupy	
.....
.....207	

EN Digital universal multimeter
 PL Cyfrowy miernik uniwersalny
 DE Digital-Multimeter
 RU Универсальный цифровой измеритель
 CZ Digitální multimetr univerzální
 RO Multimetru digital universal
 HU Digitális multiméter
 ES Manómetro digital universal

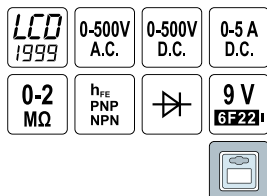

No.	Digit height / Wysokość cyfr [mm]	Icon
81780	25	12/72

EN Digital universal multimeter
 PL Cyfrowy miernik uniwersalny
 DE Digital-Multimeter
 RU Универсальный цифровой измеритель
 CZ Digitální multimetr univerzální
 RO Multimetru digital universal
 HU Digitális multiméter
 ES Manómetro digital universal

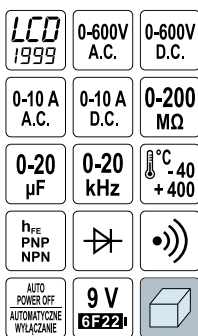

No.	Digit height / Wysokość cyfr [mm]	Icon
81784	25	20

EN Digital universal multimeter
 PL Cyfrowy miernik uniwersalny
 DE Digital-Multimeter
 RU Универсальный цифровой измеритель
 CZ Digitální multimetr univerzální
 RO Multimetru digital universal
 HU Digitális multiméter
 ES Manómetro digital universal

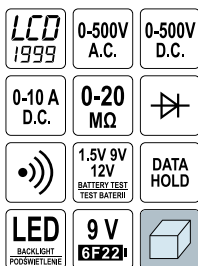

No.	Digit height / Wysokość cyfr [mm]	Icon
81774	50	50

EN Digital universal multimeter
 PL Cyfrowy miernik uniwersalny
 DE Digital-Multimeter
 RU Универсальный цифровой измеритель
 CZ Digitální multimetr univerzální
 RO Multimetru digital universal
 HU Digitális multiméter
 ES Manómetro digital universal

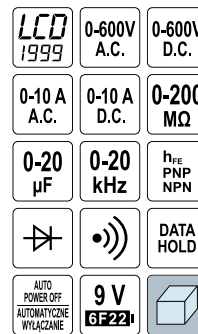

No.	Digit height / Wysokość cyfr [mm]	Icon
81783	25	20

EN Digital universal multimeter
 PL Cyfrowy miernik uniwersalny
 DE Digital-Multimeter
 RU Универсальный цифровой измеритель
 CZ Digitální multimetr univerzální
 RO Multimetru digital universal
 HU Digitális multiméter
 ES Manómetro digital universal

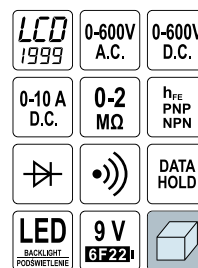

No.	Digit height / Wysokość cyfr [mm]	Icon
81773	50	50

EN Digital universal multimeter
 PL Cyfrowy miernik uniwersalny
 DE Digital-Multimeter
 RU Универсальный цифровой измеритель
 CZ Digitální multimetr univerzální
 RO Multimetru digital universal
 HU Digitális multiméter
 ES Manómetro digital universal

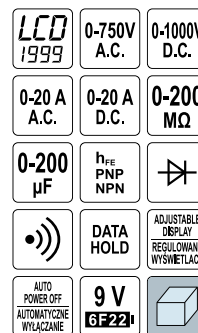

No.	Digit height / Wysokość cyfr [mm]	Icon
81775	40	40

EN Clamp universal multimeter
 PL Cęgowy miernik uniwersalny
 DE Universal Zangenamperemeter
 RU Универсальный цифровой измеритель
 CZ Digitální multimetr univerzální
 RO Multimetru digital universal
 HU Digitális multiméter
 ES Manómetro digital universal

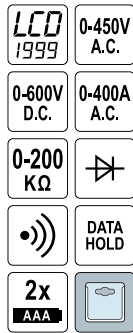

VOREL

No.	
81801	5/60

EN Measuring tape
 PL Miara zwijana
 DE Rollbandmass
 RU Рулетка
 CZ Měřicí pásmo
 RO Rulete din pinza
 HU Mérőszalag
 ES Flexómetro



VOREL

No.	L [m]	W [mm]	
10061	3.0	16	12/120
10062	5.0	19	12/120
10063	5.0	25	12/96
10064	7.5	25	6/72
10065	10.0	25	6/60

EN Measuring tape
 PL Miara zwijana
 DE Rollbandmass
 RU Рулетка
 CZ Měřicí pásmo
 RO Rulete din
 HU Mérőszalag
 ES Flexómetro



VOREL

No.	L [m]	W [mm]	
10130	2.0	16	12/120
10133	3.0	16	12/120
10135	5.0	16	12/120
10138	8.0	25	6/60
10139	10.0	25	6/60

EN Measuring tape
 PL Miara zwijana
 DE Rollbandmass
 RU Рулетка
 CZ Měřicí pásmo
 RO Rulete din
 HU Mérőszalag
 ES Flexómetro



VOREL

No.	L [m]	W [mm]	
10101	2.0	16	12/120
10104	3.0	16	12/120
10106	5.0	16	12/120
10109	7.5	19	6/60
10111	10.0	25	6/60

EN Measuring tape
 PL Miara zwijana
 DE Rollbandmass
 RU Рулетка
 CZ Měřicí pásmo
 RO Rulete din
 HU Mérőszalag
 ES Flexómetro



VOREL

No.	L [m]	W [mm]	
10122	2.0	16	12/120
10123	3.0	16	12/120
10125	5.0	19	12/120
10128	7.5	25	6/60
10129	10.0	25	6/60

EN Steel measuring tape
 PL Taśma miernicza stalowa
 DE Rollbandmass
 RU Мерная лента стальная
 CZ Měřicí pásmo ocelové
 RO Ruleta din oțel
 HU Acél mérőszalag
 ES Cinta de medir de acero



No.	L [m]	W [mm]	
12100	10	10	25/50
12200	20	10	25/50
12300	30	10	10/30
12500	50	10	10/30

EN Steel measuring tape
 PL Taśma miernicza stalowa, geodezyjna
 DE Rollbandmass
 RU Мерная лента стальная геодезийная

CZ Měřicí pásmo ocelové
 RO Ruleta cu picior
 HU Acél mérőszalag
 ES Cinta de medir de acero geodésico



No.	L [m]	
13200	20	10/20
13300	30	10/20
13500	50	10/20

EN Fibreglass measuring tape
 PL Taśma miernicza z włókna szklanego
 DE Rollbandmass
 RU Мерная лента фиберглассовая
 CZ Měřicí pásmo /skleněné vlákno/
 RO Ruleta fibra sticla
 HU Mérőszalag /üvegszál/
 ES Cinta de medir /fibra cristal/



No.	L [m]	
14300	30	12/60
14500	50	10/30

EN Wooden folding rule
 PL Miara drewniana, składana, okuta
 DE Gliedemasstab
 RU Метр складной деревянный
 CZ Měřicí pásmo dřevěné skladané /okované/
 RO Metru tamplar lemn
 HU Fa colstok /vasalt/
 ES Metro de madera, plegable /articulado/



No.	L [m]	Series / Seria	
15004	1	PERFECT B-Z	20/200
15006	2	PERFECT B-Z	10/100

EN Fibreglass measuring tape
 PL Taśma miernicza z włókna szklanego
 DE Rollbandmass
 RU Мерная лента фиберглассовая

CZ Měřicí pásmo /skleněné vlákno/
 RO Ruleta fibra sticla
 HU Mérőszalag /üvegszál/
 ES Cinta de medir /fibra cristal/



No.	L [m]	
14100	10	20/100
14200	20	12/60

EN Wooden folding rule
 PL Miara drewniana, składana, okuta
 DE Gliedemasstab
 RU Метр складной деревянный

CZ Měřicí pásmo dřevěné skladané /okované/
 RO Metru tamplar lemn
 HU Fa colstok /vasalt/
 ES Metro de madera, plegable /articulado/



No.	L [m]	
15010	1	24/480
15020	2	12/240

EN Wooden folding rule
 PL Miara drewniana, składana, okuta
 DE Gliedemasstab
 RU Метр складной деревянный
 CZ Měřicí pásmo dřevěné skladané /okované/
 RO Metru tamplar lemn
 HU Fa colstok /vasalt/
 ES Metro de madera, plegable /articulado/

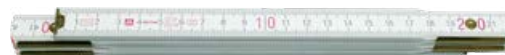

No.	L [m]	Series / Seria	
15005	1	PERFECT B	20/200
15007	2	PERFECT B	10/100

EN Plastic folding rule
 PL Miara plastikowa
 DE Kunststoffgliedmasstab
 RU Метр складной пластмассовый
 CZ Měřicí pásmo plastové skladané
 RO Metru de plastic
 HU Műanyag, összecusukható mérce
 ES Metro de plástico, plegable



No.	L [m]	
15050	1	20/200
15070	2	12/120

EN Plastic caliper
 PL Suwmiarka plastikowa
 DE Kunststoff-Bremssattel
 RU Штангенциркуль пластиковый
 CZ Plastové posuvné měřítko
 RO Subler masurat sprancene
 HU Műanyag tolómérő
 ES Calibre vernier regla, plástico

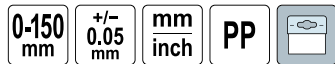

No.	Measuring range / Zakres pomiaru [mm]	Measurement accuracy / Dokładność pomiarowa [mm]	
15120	0-150	± 0.05	50/500

EN Vernier caliper
 PL Suwmiarka
 DE Messschieber
 RU Штангенциркуль
 CZ Posuvné měřítko
 RO Şubler
 HU Tolómérő
 ES Calibre

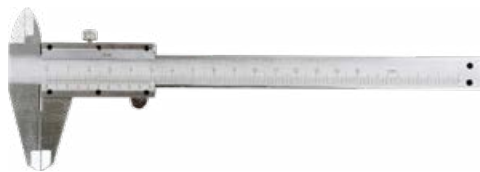

No.	Measuring range / Zakres pomiaru [mm]	Measurement accuracy / Dokładność pomiarowa [mm]	
15100	0-150	± 0.05	40

EN Dial caliper
 PL Suwmiarka zegarowa
 DE Präzisions-Uhrmessschieber
 RU Штангенциркуль стрелочный
 CZ Posuvné měřítko hodinové
 RO Subler cu cadran
 HU Órás tolómérő
 ES Calibre dial



No.	Measuring range / Zakres pomiaru [mm]	Measurement accuracy / Dokładność pomiarowa [mm]	
15220	0-150	± 0.02	10/50

EN Feeler
 PL Szczelinomierz
 DE Fühlerlehre
 RU Щупы
 CZ Spároměr
 RO Lere
 HU Hézagmérő
 ES Calibre de fisuras



No.	Gauge thickness / Grubość listka [mm]	Gauge quantity / Liczba listków	
15130	0.05, 0.10, 0.15, 0.20, 0.25, 0.30, 0.40, 0.50, 0.60, 0.70, 0.80, 0.90, 1.0	13	15/300
15200	0.05, 0.10, 0.15, 0.20, 0.25, 0.30, 0.35, 0.40, 0.45, 0.50, 0.55, 0.60, 0.65, 0.70, 0.75, 0.80, 0.85, 0.90, 0.95, 1.0	20	10/200

EN Vernier caliper
 PL Suwmiarka
 DE Messschieber
 RU Штангенциркуль
 CZ Posuvné měřítko
 RO Şubler
 HU Tolómérő
 ES Calibre

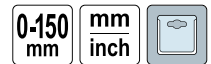

No.	Measuring range / Zakres pomiaru [mm]	Measurement accuracy / Dokładność pomiarowa [mm]	
15115	0-150	± 0.02	10/100

EN Vernier caliper
 PL Suwmiarka
 DE Messschieber
 RU Штангенциркуль
 CZ Posuvné měřítko
 RO Şubler
 HU Tolómérő
 ES Calibre



No.	Measuring range / Zakres pomiaru [mm]	Measurement accuracy / Dokładność pomiarowa [mm]	
15110	0-150	± 0.02	10/100

EN Digital caliper
 PL Suwmiarka elektroniczna
 DE Digital Messschieber
 RU Штангенциркуль электронный
 CZ Posuvné měřítko elektronické
 RO Şubler electronic
 HU Elektronikus tolómérő
 ES Calibre electrónico



No.	Measuring range / Zakres pomiaru [mm]	Measurement accuracy / Dokładność pomiarowa [mm]	
15240	0-150	± 0.03	10/40

EN Carbon fibre vernier caliper
 PL Suwmiarka elektroniczna z włókna węglowego
 DE Elektronischer Messschieber aus Kohlefaser
 RU Электронный штангенциркуль из углеродного волокна
 CZ Elektronické posuvné měřidlo z uhlíkového vlákna
 RO Șubler din carbon
 HU Elektromos szénszálas tolómérő
 ES Calibre electrónico de fibra de carbono

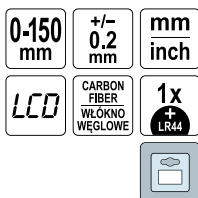

VOREL

No.	Measuring range / Zakres pomiaru [mm]	Measurement accuracy / Dokładność pomiarowa [mm]	
15113	0-150	± 0.2	25/100

EN Chalk line
 PL Sznur traserski
 DE Schnurlot
 RU Шнур-отвес малярный
 CZ Orysovací šňůra
 RO Șnur de trasat
 HU Kicsapózsínor
 ES Cordel tizador



VOREL

No.	L [m]	
17501	15	10/100

EN Chalk line
 PL Sznur traserski w pojemniku
 DE Schlagschnurroller
 RU Шнур для разметки в контейнере
 CZ Značkovací provázek v obalu
 RO Fir trasat cu creta
 HU Jelölőzsinór dobozban
 ES Tiralíneas para marcar

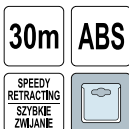

VOREL

No.	L [m]	
17506	30	12/48

EN Builders line
 PL Sznurek murarski
 DE Maurerschnur
 RU Шнур - причалка
 CZ Šňůra zednická
 RO Șfoară pt. zidari
 HU Kőműves zsinór
 ES Cuerda de albañil



No.	L [m]	
17490	40	80

EN Chalk line
 PL Sznur traserski
 DE Schnurlot
 RU Шнур-отвес малярный
 CZ Orysovací šňůra
 RO Șnur de trasat
 HU Kicsapózsínor
 ES Cordel tizador



No.	L [m]	
17500	15	10/100

EN Chalk line & blue chalk
 PL Sznur traserski z kredą niebieską
 DE Schlagschnur mit Kreide
 RU Шнур-отвес малярный + краска
 CZ Orysovací šňůra
 RO Fir trasare si praf de creta albastra
 HU Kicsapózsínór
 ES Cordel tizador con tiza azul

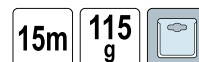

VOREL

No.	L [m]	m [g]	
17505	15	115	10/60

EN Blue/red chalk
 PL Kreda traserska
 DE Kreide blau/rot
 RU Краска для шнура
 CZ Křída trasovací
 RO Praf de creta pt. trasat
 HU Jelölő krétapor
 ES Tiza azul/rojo



VOREL

No.	m [g]	Color / Kolor	
17507	115	niebieski	20/80
17508	115	czerwony	20/80

EN Builders line
 PL Sznurek murarski
 DE Maurerschnur
 RU Шнур - причалка
 CZ Šňůra zednická
 RO Șfoară pt. zidari
 HU Kőműves zsinór
 ES Cuerda de albañil



VOREL

No.	L [m]	
17495	75	12/48

EN Builders line
 PL Sznurek murarski
 DE Maurerschnur
 RU Шнур - причалка
 CZ Šňůra zednická
 RO Sfoară pt. zidari
 HU Kőműves zsinór
 ES Cuerda de albañil

EASY
 ROLL-UP
 ŁATWE
 ZWIJANIE

PP



No.	Ø [mm]	L [m]	
17497	1.2	75	12/48

EN Builders line
 PL Sznurek murarski
 DE Maurerschnur
 RU Шнур - причалка
 CZ Šňůra zednická
 RO Sfoară pt. zidari
 HU Kőműves zsinór
 ES Cuerda de albañil



No.	L [m]	Color / Kolor	
17488	50	zółty	60
17489	100	zółty	60

EN Polyethylene bricklayer's string
 PL Sznurek murarski polietylenowy
 DE Maurerschnur aus Polyäthylen
 RU Полиэтиленовый шнур каменщика
 CZ Šňůra zednická polyetylenová
 RO Șnur de zidărie din polietilena
 HU Kőműves zsinór polietilén
 ES Cordel de albañilería de polietileno

PE



No.	Ø [mm]	L [m]	
17480	1.7	50	60/240
17481	1.7	100	30/120
17483	2.0	50	60/240
17484	2.0	100	30/120

EN Builders line
 PL Sznurek murarski
 DE Maurerschnur
 RU Шнур - причалка
 CZ Šňůra zednická
 RO Sfoară pt. zidari
 HU Kőműves zsinór
 ES Cuerda de albañil

EASY
 ROLL-UP
 ŁATWE
 ZWIJANIE

PP



No.	Ø [mm]	L [m]	
17498	1.2	200	12/48

EN Polypropylene bricklayer's string
 PL Sznurek murarski polipropylenowy
 DE Maurerschnur aus Polypropylen
 RU Шнур каменщика
 CZ Šňůra zednická polypropylenová
 RO Șnur de zidărie din polietilena
 HU Kőműves zsinór polipropilén
 ES Cordel de albañilería

PP



No.	Ø [mm]	L [m]	
17470	1.7	50	60/240
17471	1.7	100	30/120
17473	2.0	50	60/240
17474	2.0	100	30/120

EN Polypropylene sennit line
 PL Linka pleciona polipropylenowa
 DE Geflochtenes Seil aus Polypropylen
 RU Канат полипропиленовый плетеный

CZ Lano pletené polypropylenové
 RO Coarda împletită din polipropilena
 HU Polipropilén fonott kötél
 ES Cuerda trenzada de polipropileno

PP



No.	Ø [mm]	L [m]	
69502	4	400	1
69503	5	250	1
69504	6	250	1
69505	8	300	1
69506	10	200	1
69507	12	180	1
69508	14	110	1
69509	16	80	1
69510	18	70	1

- EN Line blocks with brick lines
 PL Uchwyty kątowe do linki murarskiej
 DE Maurerschnur Spannklotze mit Richtschnur
 RU Строительные уголки для причального шнура
 CZ Stavební rožky pro zednické provázky
 RO Dispozitiv pt. aliniere caramizi
 HU Építési rudak falazott húrokhoz
 ES Pareja de angulares para cuerda de albañil acha

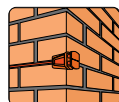

No.	L [m]	
17430	18	48/96

- EN String jute rope
 PL Lina jutowa skręciana
 DE Verdrillt Seil aus Jute
 RU Канат джутовый
- CZ Lano jutová kroucená
 RO Cablu răsucit de iuta
 HU Juta sodrott kötél
 ES Cable de yute torcido



No.	Ø [mm]	L [m]	
69572	10	10	20

- EN Flax thread, twine
 PL Nici lniane, dratwa
 DE Leinenfaden, Pechfaden
 RU Нить (дратва) льняная
- CZ Nítě lněné, dratev
 RO Fire de in, fire
 HU Len cérna, fonál
 ES Hilo de lino, cabo de zapatero



No.	m [g]	
69635	100	28
69637	250	18

- EN Needle rope
 PL Lina igłowa
 DE Nadelseil
 RU Канат полипропиленовый, плетеный
- CZ Lano s jádrem opletené
 RO Cablu ac
 HU Tűfonatos kötél
 ES Cable acalabrotado



No.	Ø [mm]	L [m]	
69539	8	10	30
69540	8	20	20
69542	10	10	25
69543	10	20	15
69546	12	20	10

- EN Steel pins for fixing masonry lines / hd line pin
 PL Szpilki murarskie stalowe
 DE Maurerliffe aus Stahl
 RU Стальные шпильки для кладки
 CZ Zednické hřebíky ocelové
 RO Cuie pt. fixare sfoara de trasat
 HU Falazósínór rögzítő szeg
 ES Pasadores de acero para mampostería

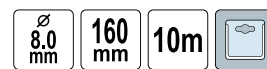

No.	Ø [mm]	L	
17435	8	160 mm (szpilki), 10 m (linka)	10/40

- EN Universal PP sennit string
 PL Sznurek PP pleciony, uniwersalny
 DE PP-Schnur, geflochten, universell
 RU Шнур полипропиленовый
- CZ Šňůra PP pletená univerzální
 RO Șnur PP împletit, universal
 HU PP fonott kötél, univerzális
 ES Cordel trenzado universal PP



No.	Ø [mm]	L [m]	
69620	3	10	50
69621	3	20	40

- EN Packing jute string
 PL Sznurek pakowy, jutowy
 DE Packschnur, aus Jute
 RU Шнур джутовый
- CZ Šňůra ucpávková jutová
 RO Șnur de împachetat, de iuta
 HU Csomagkötöző spárga, juta
 ES Cordel de yute para embalaje



No.	m [g]	
69630	50	112
69631	100	100



EN Spliced wire polypropylene string
 PL Sznurek PP do podwiązania wełny izolacyjnej
 DE Polypropylen Erntegar
 RU Шнур полипропиленовый

CZ Provázek polypropylenový
 RO Șnur din polipropilena
 HU Špagát polypropylénový
 ES Cuerda



No.	Ø [mm]	L [m]	
69608	2.5	200	100
69609	2.5	300	80
69610	2.5	450	50
69612	2.5	1000	24
69613	2.5	2000	12

EN Elastic sennit line
 PL Linka pleciona, elastyczna
 DE Geflochtenes Seil, elastisch
 RU Канат плетеный эластичный
 CZ Lano pletené elastické
 RO Coarda împletita, elastica
 HU Fonott kôtél, rugalmas
 ES Cuerda trenzada elástica



RUBBER
CORE
GUMOWY
RDZEN

PP



No.	Ø [mm]	L [m]	
69550	6	150	1
69551	8	100	1
69552	10	100	1

EN Brass plumb bob
 PL Pion murarski
 DE Senklot
 RU Отвес строительный
 CZ Zednická olovnice
 RO Fir pt. trasat cu greutate din alama
 HU Fűggőn
 ES Plomada

5m 50g BRASS MOSIADZ



No.	Size / Rozmiar [mm]	L [m]	
17301	12x62	5	10/150

EN Brass plumb bob
 PL Pion murarski
 DE Senklot
 RU Отвес строительный
 CZ Zednická olovnice
 RO Fir pt. trasat cu greutate din alama
 HU Fűggőn
 ES Plomada

6m 200g

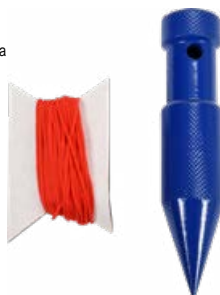

No.	Size / Rozmiar [mm]	L [m]	
17303	22x115	6	10/60

EN Plumb bob
 PL Pion murarski
 DE Senklot
 RU Отвес со шнуром
 CZ Murařská centrace
 RO Fir cu plumb
 HU Kőműves függőn
 ES Plomada albañil



No.	Size / Rozmiar [mm]	
17300	15x70	100

12

EN Brass plumb bob
 PL Pion murarski
 DE Senklot
 RU Отвес строительный
 CZ Zednická olovnice
 RO Fir pt. trasat cu greutate din alama
 HU Fűggőn
 ES Plomada

4.5m 140g



No.	Size / Rozmiar [mm]	L [m]	
17302	19x88	4.5	25/100

EN Brass plumb bob
 PL Pion murarski
 DE Senklot
 RU Отвес строительный
 CZ Zednická olovnice
 RO Fir pt. trasat cu greutate din alama
 HU Fűggőn
 ES Plomada

4.5m 300g



No.	Size / Rozmiar [mm]	L [m]	
17304	27x88	4.5	9/36

- EN Magnetic plumb
- PL Pion murarski z mocowaniem magnetycznym
- DE Senklot mit Haltemagnet
- RU Магнитный строительный отвес
- CZ Olovnice se magnetu
- RO Fir cu plumb magnetic
- HU Fűggőn
- ES Fios de prumo com íman

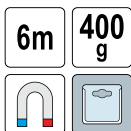

No.	L [m]	
17310	6	6/36

- EN Try square
- PL Kątownik stolarski
- DE Zimmermannswinkel
- RU Угольник столярный
- CZ Truhlářský úhelník
- RO Echer (unghi drept) de tâmplărie
- HU Asztalos derékszög
- ES Escuadra de metal



No.	Size / Rozmiar [mm]	
18201	200x300	24/48
18200	400x600	12/24

- EN Try square
- PL Kątownik metalowy ze stopką i libellą
- DE Metall-Anschlagwinkel mit Fuß und Libelle
- RU Металлический угольник с опорой и ампулой
- CZ Kovový úhelník s nohou a vodováhou
- RO Echer
- HU Fém asztalos derékszög talppal és libellával
- ES Escuadra metálica con pie y nivel

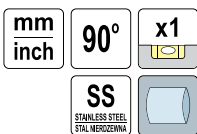

No.	L [mm]	
18380	150	10/60
18381	400	10/60
18382	700	10/60

- EN Try square
- PL Kątownik stolarski
- DE Zimmermannswinkel
- RU Угольник столярный
- CZ Truhlářský úhelník
- RO Echer (unghi drept) de tâmplărie
- HU Asztalos derékszög
- ES Escuadra de metal

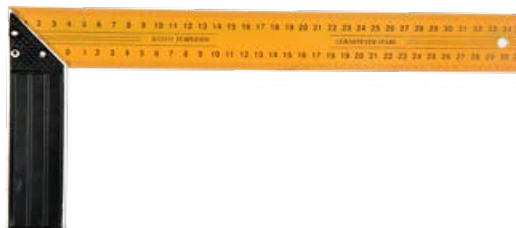

No.	L [mm]	
18250	250	12/120
18300	300	12/120
18350	350	12/120

- EN Aluminium try square
- PL Kątownik aluminiowy
- DE Alu-Zimmermannswinkel
- RU Угольник столярный алюминиевый
- CZ Truhlářský úhelník
- RO Echer (unghi drept) de tâmplărie
- HU Asztalos derékszög
- ES Escuadra



No.	L [mm]	
18360	250	10/60
18361	300	10/60
18362	350	10/60

- EN Try square set
- PL Zestaw kątowników metalowych ze stopką i libellą
- DE Metall-Anschlagwinkel-Set mit Fuß und Libelle
- RU Комплект металлических уголков с опорой и пузырьком
- CZ Sada kovových úhelníků s nohou a vodováhou
- RO Set 3 echere
- HU Fém asztalos derékszög készlet talppal és libellával
- ES Juego de escuadras metálicas con pie y nivel

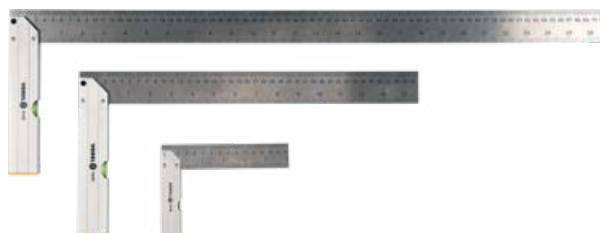
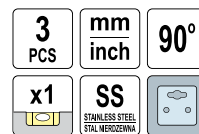

No.	L [mm]	
18390	150, 400, 700	25

EN Angle bar with a support
 PL Kątownik z podpórką
 DE Winkel mit Stütze
 RU Угольник столярный с откидным упором

CZ Úhelník s dorazem
 RO Cornier cu stand
 HU Támaszos derékszögelő
 ES Escuadra con soporte



No.	L [mm]	
18501	350	30
18502	500	30
18503	750	20
18504	1000	10

EN Aluminium try square
 PL Kątownik aluminiowy
 DE Alu-Zimmermannswinkel
 RU Угольник столярный алюминиевый
 CZ Truhlářský úhelník
 RO Echer (unghi drept) de tâmplărie
 HU Asztalos derékszög
 ES Escuadra de aluminio



No.	Size / Rozmiar [mm]	
18374	600x320	6/12
18375	1200x600	6/12

EN Bevel protractor
 PL Kątomierz nastawny
 DE Winkelmesser
 RU Угломер регулируемый со шкалой
 CZ Nastavitelný úhloměr
 RO Echer reglabil
 HU Állítható szögmérő
 ES Calibrador de biseles



No.	L [mm]	
18797	350	10
18798	500	10
18799	750	10

EN Aluminium try square
 PL Kątownik aluminiowy
 DE Alu-Zimmermannswinkel
 RU Угольник столярный алюминиевый
 CZ Truhlářský úhelník
 RO Echer (unghi drept) de tâmplărie
 HU Asztalos derékszög
 ES Escuadra de aluminio

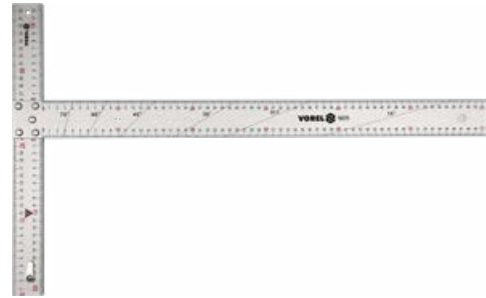

No.	Size / Rozmiar [mm]	
18370	600x390	2/10
18372	1200x390	2/10

EN Aluminium try square
 PL Kątownik aluminiowy
 DE Alu-Zimmermannswinkel
 RU Угольник столярный алюминиевый
 CZ Truhlářský úhelník
 RO Echer de tâmplărie
 HU Asztalos derékszög
 ES Escuadra de aluminio



12



No.	Size / Rozmiar [mm]	
18355	400x210	100
18356	600x210	60
18357	1000x210	60

EN Protractor with level
 PL Kątomierz z libellą i ruchomym ramieniem
 DE Winkelmesser
 RU Транспортир
 CZ Protractor
 RO Mușchi extensor
 HU Szögmerő
 ES Transportador

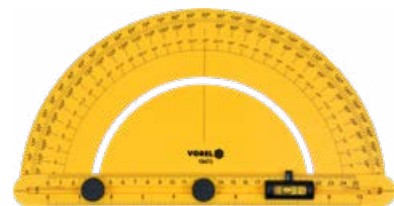

No.	L [mm]	Vials / Libelle	
18473	250	1	10/60

EN Protractor electronic with spirit level
 PL Kątomierz elektroniczny z poziomnicą
 DE Digital Winkelmesser mit Wasserwaage
 RU Транспортёр электронный с уровнем
 CZ Protractor electronic s urovni
 RO Protractor electronic level cu
 HU Szögmérő elektronikusak szint
 ES Con el nivel electrónico transportador

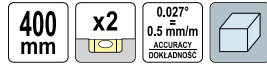

No.	L [mm]	Vials / Libelle	
17570	400	2	20

EN Bevel protractor
 PL Skośnica drewniana
 DE Schmiege
 RU Угольник регулируемый деревянный
 CZ Nastavitelný úhloměr
 RO Echer reglabil
 HU Állítható szögmérő
 ES Calibrador de biseles



No.	L [mm]	
18800	270	80
18810	400	60

EN Triangle ruler
 PL Kątownik ciesielski do krokwi
 DE Lineal Winkelmesser
 RU Угольник для плотника и столяра
 CZ Tesařský úhelník
 RO Echer pt. dulgherie
 HU Fém derékszög
 ES Escuadra



No.	L [mm]	
18530	180	100

EN Multipurpose angle finder
 PL Kątomierz budowlany
 DE Bauwinkelmesser
 RU Строительный угломер
 CZ Stavební úhloměr
 RO Raportor multifuncțional
 HU Építési szögmérő
 ES Escuadra de construcción

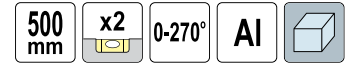

No.	L [mm]	Vials / Libelle	
18790	500	2	10

EN Adjustable ruler
 PL Kątownik nastawny do przenoszenia wymiarów
 DE Multifunktionales Messlineal
 RU Разметочный инструмент линейка-шаблон

CZ Pokosník nastavitelný
 RO Echer reglabil
 HU Szögmérték
 ES Medición del ángulo



No.	
18470	20/60

EN Aluminium triangle ruler with foot
 PL Kątownik aluminiowy ze stopką
 DE Aluminiumwinkel mit Fuß
 RU Алюминиевый угольник с основанием
 CZ Hliníkový úhelník s patkou
 RO Echer aluminiu cu talpa
 HU Talpas alumínium derékszög
 ES Escuadra de aluminio con pie



No.	Dimensions / Wymiary [mm]	
18377	180x180x250	12/120

EN Carpenter's ruler
 PL Przymiar do tapet
 DE Zeichen-Masstab
 RU Линейка стальная с деревянной ручкой

CZ Měřidlo stavební
 RO Rigla de taplariie
 HU Kőműves vonalzó
 ES Regla de obra



No.	L [mm]	
19750	750	10/40

EN Aluminium ruler, 2 vials
 PL Przymiar aluminiowy, uchwyt, 2 libelki
 DE Alu Zeichen-Masstab 2-lib
 RU Линейка столярная алюминиевая 2 глазка с ручкой
 CZ Měřidlo hliníkové
 RO Rigla de aluminiu cu 2 bule
 HU Alumínium vonalzó
 ES Regla de aluminio, mango, division 2-burbujas

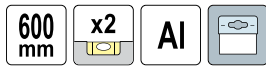

No.	L [mm]	Vials / Libelle	
19770	600	2	12/24

EN Laser distance meter
 PL Dalmierz laserowy
 DE Laserentfernungsmesser
 RU Лазерный дальномер
 CZ Laserový měřič vzdálenosti
 RO Telemetru cu laser
 HU Lézeres távolságmérő
 ES Medidores láser de distancias

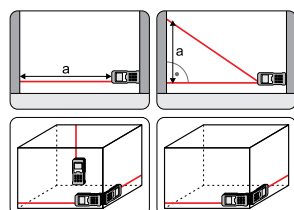
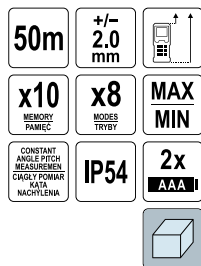

No.	
81791	10/50

EN Aluminium ruler, 2 vials
 PL Przymiar aluminiowy, uchwyt, 2 libelki
 DE Alu Zeichen-Masstab 2-lib
 RU Линейка столярная алюминиевая 2 глазка с ручкой
 CZ Měřidlo hliníkové
 RO Rigla de aluminiu cu 2 bule
 HU Alumínium vonalzó
 ES Regla de aluminio, mango, division 2-burbujas

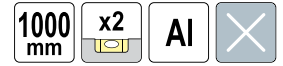

No.	L [mm]	Vials / Libelle	
19755	1000	2	24

EN Aluminium ruler
 PL Liniat aluminiowy
 DE Aluminium-Gliedemaß
 RU Алюминиевая линейка
 CZ Hliníkové pravítko
 RO Rigla aluminiu
 HU Alumínium vonalzó
 ES Regla de aluminio



12



No.	Dimensions / Wymiary [mm]	
19763	150x28x1.8	20/120
19765	300x28x1.8	20/120
19766	600x28x1.8	20/120
19767	1000x28x1.8	10/100

EN Laser distance meter
 PL Dalmierz laserowy
 DE Laserentfernungsmesser
 RU Лазерный дальномер
 CZ Laserový měřič vzdálenosti
 RO Telemetru cu laser
 HU Lézeres távolságmérő
 ES Medidores láser de distancias

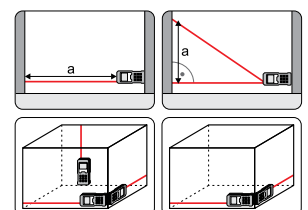
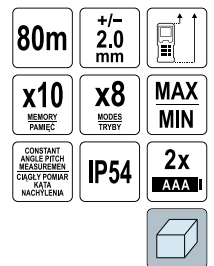

No.	
81794	10/50

EN Laser distance meter
 PL Dalmierz laserowy
 DE Laserentfernungsmesser
 RU Лазерный дальномер
 CZ Laserový měřič vzdálenosti
 RO Telemetru cu laser
 HU Lézeres távolságmérő
 ES Medidores láser de distancias



100 m	+/- 2.0 mm	
x10 MEMORY PAMIEC	x8 MODES TRYBY	MAX MIN
CONSTANT ANGLE PITCH MEASUREMENT CIEGLY POMIAR KĄTA NACHYLENIA	IP54	2x AAA

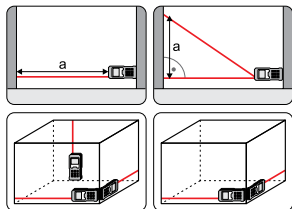

No.	
81795	10/50

EN Aluminium tripod
 PL Statyw aluminiowy
 DE Aluminium-Stativ
 RU Алюминиевый штатив
 CZ Hliníkový stativ
 RO Trepied aluminiu
 HU Alumínium állvány
 ES Trípode de aluminio



250x500 mm	AI	
------------	----	--



No.	H [mm]	
18021	250-500	12

EN Metal and voltage detector
 PL Wykrywacz metalu i przewodów
 DE Ortungsgerät für Metal und Leitungen
 RU Детектор металла и токоведущих проводов
 CZ Detektor kovu a elektrických vodičů
 RO Detector metale si electricitate
 HU Fém- és feszültség detektor
 ES Detector de metalo y cables



2in1 2w1	
LED LIGHT DIODE	
	6h
3x LR44	

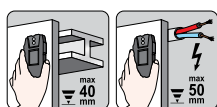

No.	
81786	10/80

EN Cross line green laser
 PL Laser zielony krzyżowy
 DE Laser mit grünem Kreuz
 RU Лазерный уровень зеленый крест
 CZ Laser zelený křížový
 RO Nivelă cu laser transversală
 HU Zöld keresztlézér
 ES Láser en cruz verde



±3.0mm /10m	±4°	510-530 nm
1/4" (6.3 mm) TRIPOD THREAD (SWINT STATIV)	8h	°C -10 +50
≤1 mW	II CLASS /KLASA	IP54
3V	2x AA	



No.	
18002	30

EN Aluminium tripod
 PL Statyw aluminiowy
 DE Aluminium-Stativ
 RU Алюминиевый штатив
 CZ Hliníkový stativ
 RO Trepied aluminiu
 HU Alumínium állvány
 ES Trípode de aluminio



500x1500 mm	AI	
-------------	----	--



No.	H [mm]	
18020	500-1500	12

EN Metal and voltage detector
 PL Wykrywacz metalu i przewodów
 DE Ortungsgerät für Metal und Leitungen
 RU Детектор металла и токоведущих проводов
 CZ Detektor kovu a elektrických vodičů
 RO Detector metale si electricitate
 HU Fém- és feszültség detektor
 ES Detector de metalo y cables



3in1 3w1	
WOOD /DREWNIO	LED
9V 6F22	



No.	
81785	20

EN Hygrometer
 PL Higrometr
 DE Hygrometer
 RU Гигрометр
 CZ Hygrometr
 RO Higrometru
 HU Higrométer
 ES Higrómetro



1.5-33%	6-60%
±2% ACCURACY DOKŁADNOŚĆ	0-40 °C
LCD	2x AAA



No.	
81751	72

EN Paint thickness tester
 PL Tester grubości lakieru
 DE Lackdickenmessgerät
 RU Толщиномер лакокрасочного покрытия
 CZ Tester tloušťky laku
 RO Tester de buzunar grosime vopsea
 HU Rétegvastagság mérő
 ES Medidor de espesor de recubrimiento



0-2.0 mm	±2% ACCURACY DOKŁADNOŚĆ	ALUMINIUM ALUMINIUM
	STEEL STAL	



No.	
81731	40/80

EN Torpedo level
 PL Poziomnica torpeda
 DE Wasserwaage torpeda
 RU Уровень духа торпедо

CZ Přesná vodováha torpédo
 RO Nivelă torpilă
 HU Vízmerék torpedó
 ES Nivel torpedo

230 mm	x3	0.027° 0.5 mm/m ACCURACY DOKŁADNOŚĆ



No.	L [mm]	Vials / Libelle	
16300	230	3	100

EN Infrared thermometer
 PL Pomiernik
 DE Pyrometer
 RU Пирометр
 CZ Pyrometr
 RO Termometru cu infraroșu
 HU Pírométer
 ES Pirómetro



°C -50 +380	∅1 -12+	MAX MIN
°C °F	LCD BACKLIGHT POŚWIETLENIE	
AUTO POWER OFF AUTOMATYCZNE WYŁĄCZANIE	2x AAA	



No.	
84400	20/80

EN Trapezoidal spirit level
 PL Poziomnica trapezowa
 DE Trapezförmige Wasserwaage
 RU Трапецидальный уровень

CZ Vodováha trapezová
 RO Nivelă trapezoidală
 HU Vízmerék trapéz
 ES Trapezoides nivel

500 mm	x2	0.027° 0.5 mm/m ACCURACY DOKŁADNOŚĆ



No.	L [mm]	Vials / Libelle	
16280	500	2	50

EN Torpedo level
 PL Poziomnica torpeda
 DE Wasserwaage torpeda
 RU Уровень духа торпедо

CZ Přesná vodováha torpédo
 RO Nivelă torpilă
 HU Vízmerék torpedó
 ES Nivel torpedo

230 mm	x3	0.027° 0.5 mm/m ACCURACY DOKŁADNOŚĆ



No.	L [mm]	Vials / Libelle	
16301	230	3	100

- EN Laser level mini
- PL Poziomnica laserowa mini
- DE Laser Wasserwaage mini
- RU Уровни лазерные мини
- CZ Úrovně laserové mini
- RO Niveluri mini cu laser
- HU Szintek lézer mini
- ES Niveles láser mini



No.		
17560		20

- EN Aluminium level
- PL Poziomnica aluminiowa
- DE Wasserwaage
- RU Уровень
- CZ Vodováha
- RO Cumpănă
- HU Vizmértek
- ES Nivel



No.	L [mm]	Vials / Libelle	
16340	400	3	20/60
16360	600	3	20/60
16380	800	3	20/60
16400	1000	3	20/60

- EN Aluminium level
- PL Poziomnica aluminiowa
- DE Wasserwaage
- RU Уровень
- CZ Vodováha
- RO Cumpănă
- HU Vizmértek
- ES Nivel



No.	L [mm]	Vials / Libelle	
17606	600	3	20/60
17608	800	3	20/60
17610	1000	3	20/60
17612	1200	3	15/30
17615	1500	3	15/30
17620	2000	3	10/20

- EN Post level
- PL Poziomnica do słupków
- DE Pfostenwasserwaage
- RU Уровни на столбности
- CZ Hladyň do míst
- RO Niveluri de cãtre posturile
- HU Szintek tőzetenek
- ES Los niveles a los mensajes



No.	Vials / Libelle	
16012	3	25/100

- EN Aluminium level
- PL Poziomnica aluminiowa
- DE Wasserwaage
- RU Уровень
- CZ Vodováha
- RO Cumpănă
- HU Vizmértek
- ES Nivel



No.	L [mm]	Vials / Libelle	
16551	400	3	25/50
16552	600	3	25/50
16553	800	3	25/50
16554	1000	3	25/50
16555	1200	3	15/30
16556	1500	3	15/30
16557	2000	3	10/20

- EN Water level
- PL Poziomnica wodna z węzłem
- DE Schlauchwaage
- RU Гидроуровень
- CZ Vodná vodováha
- RO Furtun de nivel
- HU Vizes vizmértek
- ES Nivel de agua



No.	L [mm]	Ø [mm]	
16000	15	10	15
16001	20	10	15
16002	25	10	15

EN Spring weight measurer
 PL Waga sprężynowa
 DE Federwaage
 RU Ручные пружинные весы
 CZ Váha péřová
 RO Cântar cu arc și cârlig
 HU Akasztós mérleg
 ES Balanza de resorte



No.	Max. lifting capacity / Maks. udźwig [kg]	
15291	25	72
15292	50	48

EN Head magnifier
 PL Lupa z opaską na głowę
 DE Lupe mit Stirband
 RU Лупа бинокулярная налобная
 CZ Lupa s hlavou
 RO Lupă cu cap
 HU Fejpántos nagyító szett
 ES Lupa con cabeza



No.	
73503	24

EN Spring weight measurer
 PL Waga sprężynowa z miarką zwięzaną
 DE Federwaage
 RU Ручные пружинные весы
 CZ Váha péřová
 RO Cântar cu arc și cârlig
 HU Akasztós mérleg
 ES Balanza de resorte



max
32 kg

1m
6mm



No.	Max. lifting capacity / Maks. udźwig [kg]	
15301	32	36



13

Pneumatic tools Narzędzia pneumatyczne



Air tools Narzędzia pneumatyczne

210-213



Impact wrenches Klucze udarowe.....	210
Pneumatic grinders Szlifierki pneumatyczne.....	210
Pneumatic ratchets Grzechotki pneumatyczne.....	211
Pneumatic hammers Młotki pneumatyczne.....	212
Pneumatic cut-off tools Przecinarki pneumatyczne.....	212
Pneumatic shears Nożyce pneumatyczne.....	212
Pneumatic drills Wiertarki pneumatyczne.....	213
Multi-purpose air tools Wielofunkcyjne narzędzia pneumatyczne.....	213

Tire inflating guns & heads Pistolety do pompowania kół i głowice

213-214



Pneumatic painting equipment Narzędzia do malowania

214-216



Spray guns Pistolety lakiernicze.....	214
Blow guns Pistolety do przedmuchiwania.....	215
Washing guns Pistolety do ropowania.....	216

Pneumatic accessories Akcesoria instalacji pneumatycznej

216-218



Air filters, regulators & lubricators Filtry, reduktory i smarownice.....	216
Spiral hoses Węże spiralne.....	217
Reinforced hoses Węże zbrojone.....	217
Couplers Złącza.....	217

Pneumatic riveters Nitownice pneumatyczne

218



EN Impact wrench
 PL Klucz pneumatyczny
 DE Druckluft-Schlagschrauber
 RU Ударный пневматический гайковерт
 CZ Klíč pneumatický
 RO Pistol pneumatic
 HU Pneumatikus ütvecsavarozó
 ES Llave neumática de percusión

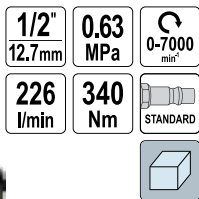

$L_{pa} = 92,6$ dB; $L_{wa} = 103,6$ dB; $a_n = 2,8$ m/s²

No.	Ø	Required air flow / Wymagany przepływ powietrza [l/min]	Max. torque / Maks. moment obrotowy [Nm]	Box
81100	1/2" (12.7 mm)	226	340	10

EN Air grinder
 PL Szlifierka pneumatyczna prosta
 DE Druckluftfeinhandschleifer
 RU Шлифмашинка пневматическая
 CZ Bruska přímá pneumatická
 RO Polizor pneumatic
 HU Pneumatikus egyenescsiszoló
 ES Lijadora neumática recta

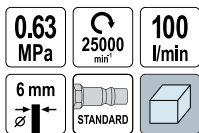

$L_{pa} = 88,0 \pm 3,0$ dB; $L_{wa} = 99,0 \pm 3,0$ dB; $a_n = 2,9 \pm 1,5$ m/s²

No.	Toolholder size / Rozmiar uchwyty narzędziowego	Required air flow / Wymagany przepływ powietrza [l/min]	Ø [min ⁻¹]	Box
81107	1/4" (6.3 mm)	100	25000	20

EN Air angle grinder
 PL Szlifierka pneumatyczna kątowa
 DE Ruckluft-Winkelschleifer
 RU Пневматическая угловая шлифовальная машина
 CZ Pneumatické úhlovou brusku
 RO Polizor unghiular pneumatic
 HU Pneumatikus sarokcsiszoló
 ES Amoladora angular neumática

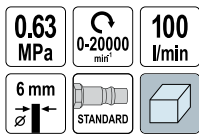

$L_{pa} = 90,1$ dB; $L_{wa} = 101,1$ dB; $a_n = 0,7$ m/s²

No.	Toolholder size / Rozmiar uchwyty narzędziowego	Required air flow / Wymagany przepływ powietrza [l/min]	Ø [min ⁻¹]	Box
81110	1/4" (6.3 mm)	100	0-20000	16

EN Air impact kit
 PL Klucz pneumatyczny z nasadkami
 DE Druckluft-Schlagschrauber mit Kräfteinsätzen
 RU Гайковерт пневматический с набором головок
 CZ Klíč pneumatický s nástavci
 RO Pistol pneumatic cu accesorii
 HU Pneumatikus ütvecsavarozó készlet
 ES Llave neumático de percusión



$L_{pa} = 95,0 \pm 3,0$ dB; $L_{wa} = 106,0 \pm 3,0$ dB; $a_n = 9,1 \pm 1,5$ m/s²

No.	Ø	Required air flow / Wymagany przepływ powietrza [l/min]	Max. torque / Maks. moment obrotowy [Nm]	Box
81101	1/2" (12.7 mm)	226	340	5

EN Air grinder
 PL Szlifierka pneumatyczna prosta
 DE Druckluftfeinhandschleifer
 RU Шлифмашинка пневматическая
 CZ Bruska přímá pneumatická
 RO Polizor pneumatic
 HU Pneumatikus egyenescsiszoló
 ES Lijadora neumática recta

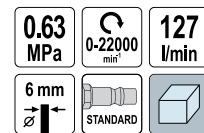

$L_{pa} = 82,8$ dB; $L_{wa} = 93,8$ dB; $a_n = 0,9$ m/s²

No.	Toolholder size / Rozmiar uchwyty narzędziowego	Required air flow / Wymagany przepływ powietrza [l/min]	Ø [min ⁻¹]	Box
81108	1/4" (6.3 mm)	127	0-22000	20

EN Die grinder kit
 PL Szlifierka pneumatyczna prosta z akcesoriami
 DE Druckluft-Schrauber mit Schleifaufsätzen
 RU Прямая пневматическая шлифмашинка и принадлежности
 CZ Bruska přímá pneumatická s příslušenstvím
 RO Masina de polizat pneumatică
 HU Pneumatikus kőszőrű készlet
 ES Lijadora neumática recta

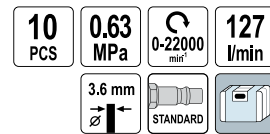

$L_{pa} = 88,0 \pm 3,0$ dB; $L_{wa} = 99,0 \pm 3,0$ dB; $a_n = 2,9 \pm 1,5$ m/s²

No.	Toolholder size / Rozmiar uchwyty narzędziowego	Required air flow / Wymagany przepływ powietrza [l/min]	Ø [min ⁻¹]	Box
81109	3 mm, 1/4" (6.3 mm)	127	0-22000	8

- EN Air micro die grinder kit
- PL Zestaw pneumatyczny szlifierka mini
- DE Luft Sterben Schleifer Kit
- RU Пневмошлифмашина мини в наборе
- CZ Pneumatická bruska mini
- RO Biax pneumatic tip stilou
- HU Pneumatikus mini-csiszoló
- ES Amoladora biax recta neumatica

16 PCS 0.63 MPa 0-54000 min⁻¹ 3 mm STANDARD

MIN OILER SMAROWNICA OIL POT OLIVMARKA



VOREL $L_{pa} = 79,0 \pm 3,0$ dB; $L_{wa} = 90,0 \pm 3,0$ dB; $a_p = <2,5$ m/s²

No.	Toolholder size / Rozmiar uchwyty narzędziowego [mm]	Ω [min ⁻¹]	
80970	3	0-54000	10

- EN Air sander
- PL Szlifierka pneumatyczna mimośrodowa
- DE Druckluft- Excenterschleifer
- RU Эксцентриковая шлифмашина
- CZ Bruska pneumatická
- RO Masina de slefuit pneumatica
- HU Pneumatikus sarokcsiszológép
- ES Lijadora neumática excéntrica

0.63 MPa 0-10000 min⁻¹ 113 l/min 150 mm STANDARD



VOREL $L_{pa} = 72,7$ dB; $L_{wa} = 83,7$ dB; $a_p = 1,44$ m/s²

No.	Disc diameter / Średnica tarczy [mm]	Ω [min ⁻¹]	
81114	150	0-10000	10

- EN Ratchet air wrench
- PL Grzechotka pneumatyczna
- DE Druckluft-Ratschenschrauber
- RU Пневмотрещотка
- CZ Pneumatická ráčna
- RO Antrenor pneumatic
- HU Préslevegős behajtó szerszám
- ES Carraca neumática

1/4" 6.3mm 0.65 MPa (max) 150 min⁻¹ 113 l/min 33 Nm STANDARD



VOREL $L_{pa} = 95,0 \pm 3,0$ dB; $L_{wa} = 106,0 \pm 3,0$ dB; $a_p = 9,2 \pm 1,5$ m/s²

No.	Ω	Required air flow / Wymagany przepływ powietrza [l/min]	Max. torque / Maks. moment obrotowy [Nm]	
81137	1/4" (6.3 mm)	113	33	20

- EN Straight line air sander
- PL Szlifierka pneumatyczna liniolowa
- DE Druckluft-Linearschleifer
- RU Пневматическая прямошлифовальная машина
- CZ Pneumatická bruska přímočará
- RO Slefuitor pneumatic
- HU Egyenes vonalú pneumatikus csiszoló
- ES Amoladora neumática lineal

0.63 MPa (max.) 170 l/min 2500 min⁻¹ 70x395 mm STANDARD



VOREL $L_{pa} = 79,1 \pm 3,0$ dB; $L_{wa} = 90,1 \pm 3,0$ dB; $a_p = 4,721 \pm 1,5$ m/s²

No.	Required air flow / Wymagany przepływ powietrza [l/min]	Work speed without load / Predkość pracy bez obciążenia [min ⁻¹]	
81150	170	2500	6

- EN Disc for air sander
- PL Tarcza polerska do szlifierki pneumatycznej
- DE Stützteller für Druckluftexcenterschleifer
- RU Диск для эксцентриковой шлифмашины
- CZ Disk pro pneumatickou brusku
- RO Masina disc pt. slefuit
- HU Csiszolókorong pneumatikus gépekhez
- ES Recambio disco lijadora orbital neumatica

150 mm 0-10000 min⁻¹ M8



VOREL

No.	Ω [mm]	Ω [min ⁻¹]	
81115	150	0-10000	10/100

- EN Ratchet air wrench
- PL Grzechotka pneumatyczna
- DE Druckluft-Ratschenschrauber
- RU Пневмотрещотка
- CZ Pneumatická ráčna
- RO Antrenor pneumatic
- HU Préslevegős behajtó szerszám
- ES Carraca neumática

1/2" 12.7mm 0.63 MPa 0-150 min⁻¹ 141 l/min 61 Nm STANDARD



VOREL $L_{pa} = 92,1$ dB; $L_{wa} = 103,1$ dB; $a_p = 0,8$ m/s²

No.	Ω	Required air flow / Wymagany przepływ powietrza [l/min]	Max. torque / Maks. moment obrotowy [Nm]	
81117	1/2" (12.7 mm)	141	61	20

EN Ratchet air wrench
 PL Grzechotka pneumatyczna
 DE Druckluft-Ratschenschrauber
 RU Пневмотрещотка
 CZ Pneumatická ráčna
 RO Antrenor pneumatic
 HU Préslevegős behajtó szerszám
 ES Carraca neumática

1/2"
12.7mm

0.63
MPa

0-160
min⁻¹

141
l/min

68
Nm

STANDARD



$L_{pA} = 91,0 \pm 3,0$ dB; $L_{wA} = 102,0 \pm 3,0$ dB; $a_n = 3,27 \pm 1,5$ m/s²

No.	Ø	Required air flow / Wymagany przepływ powietrza [l/min]	Max. torque / Maks. moment obrotowy [Nm]	Icon
81118	1/2" (12.7 mm)	141	68	10

EN Air hammer
 PL Młotek pneumatyczny
 DE Druckluft-Schlaghammer
 RU Пневматический молоток
 CZ Sekáč vzduchový
 RO Pneumatikus vésőkészlet pisztollyal
 HU Kládívo pneumatiké
 ES Marteau burineur

0.63
MPa

113
l/min

T
4500
min⁻¹

STANDARD



$L_{pA} = 85,0 \pm 3,0$ dB; $L_{wA} = 96,0 \pm 3,0$ dB; $a_n = 9,4 \pm 1,5$ m/s²

No.	Required air flow / Wymagany przepływ powietrza [l/min]	Icon
81133	113	8

EN Air nibbler
 PL Nożyce pneumatyczne matrycowe
 DE Pneumatische Schere
 RU Вырубные ножницы пневматические
 CZ Pneumatické nůžky na plech
 RO Foarfeca pneumatică
 HU Pneumatikus folyamatos lyukasztó
 ES Roedora neumática

0.62
MPa

113
l/min

3500
min⁻¹

5.5
mm

max
1.5mm
STEEL
STAL

STANDARD



$L_{pA} = 77,0 \pm 3,0$ dB; $L_{wA} = 88,0 \pm 3,0$ dB; $a_n = 4,42 \pm 1,5$ m/s²

No.	Required air flow / Wymagany przepływ powietrza [l/min]	Cutting speed / Prędkość cięcia [min ⁻¹]	Icon
81070	113	3500	20

EN Ratchet air wrench
 PL Grzechotka pneumatyczna
 DE Druckluft-Ratschenschrauber
 RU Пневмотрещотка
 CZ Pneumatická ráčna
 RO Antrenor pneumatic
 HU Préslevegős behajtó szerszám
 ES Carraca neumática

1/2"
12.7mm

0.63
MPa

160
min⁻¹

113
l/min

69
Nm

STANDARD



$L_{pA} = 94,0 \pm 3,0$ dB; $L_{wA} = 105,0 \pm 3,0$ dB; $a_n = 9,0 \pm 1,5$ m/s²

No.	Ø	Required air flow / Wymagany przepływ powietrza [l/min]	Max. torque / Maks. moment obrotowy [Nm]	Icon
81119	1/2" (12.7 mm)	113	69	10

EN Air cut-off tool
 PL Przecinararka pneumatyczna
 DE Druckluft-Schneidmaschine
 RU Резак пневматический
 CZ Pfičná bruska pneumatická
 RO Masina de taiat cu aer comprimat
 HU Pneumatikus sarokcsiszoló
 ES Cortadora neumática

0.62
MPa

113
l/min

75x9.5
mm

20000
min⁻¹

STANDARD



$L_{pA} = 84,5 \pm 3,0$ dB; $L_{wA} = 95,5 \pm 3,0$ dB; $a_n = 2,45 \pm 1,5$ m/s²

No.	Required air flow / Wymagany przepływ powietrza [l/min]	Icon
81080	113	20

EN Air shears pistol type
 PL Nożyce pneumatyczne kątowe
 DE Pneumatische Schere
 RU Пневматические ножницы угловые
 CZ Pneumatické nůžky na plech
 RO Foarfeca pneumatică
 HU Pneumatikus ollók
 ES Tijera neumática

0.62
MPa

184
l/min

3000
min⁻¹

5.5
mm

max
1.2mm
STEEL
STAL

max
1.4mm
Al

STANDARD



$L_{pA} = 77,0 \pm 3,0$ dB; $L_{wA} = 88,0 \pm 3,0$ dB; $a_n = 4,42 \pm 1,5$ m/s²

No.	Required air flow / Wymagany przepływ powietrza [l/min]	Cutting speed / Prędkość cięcia [min ⁻¹]	Icon
81072	184	3000	12

EN Air shears pistol type
 PL Nożyce pneumatyczne kątowe
 DE Pneumatische Schere
 RU Пневматические ножницы угловые
 CZ Pneumatické nůžky na plech
 RO Foarfeca pneumatica
 HU Pneumatikus ollók
 ES Tijera neumática

0.62 MPa	184 l/min	2100 min⁻¹	5.5 mm
max 1.2 mm STEEL STAL	max 1.4 mm Al	STANDARD	



$L_{pa} = 77,0 \pm 3,0$ dB; $L_{wa} = 88,0 \pm 3,0$ dB; $a_p = 4,42 \pm 1,5$ m/s²

No.	Required air flow / Wymagany przepływ powietrza [l/min]	Cutting speed / Prędkość cięcia [min ⁻¹]	
81073	184	2100	10

EN Multi-purpose oscillating air tool
 PL Wielofunkcyjne narzędzie oscylacyjne pneumatyczne
 DE Druckluft-Multifunktionswerkzeuge
 RU Пневматический многофункциональный инструмент
 CZ Pneumatická oscilační multifunkční bruska
 RO Multifuncțional oscilant pneumatic
 HU Pneumatikus oszcilláló multifunkciós csiszoló
 ES Estuche herramienta neumática multifunción

0.62 MPa	170 l/min	18000 min⁻¹
STANDARD		



$L_{pa} = 87,5 \pm 3,0$ dB; $L_{wa} = 98,5 \pm 3,0$ dB; $a_p = 4,511 \pm 1,5$ m/s²

No.	Required air flow / Wymagany przepływ powietrza [l/min]	Ω [min ⁻¹]	
81060	170	18000	10

EN Inflating gun
 PL Pistolet do pompowania
 DE Inflatorpistole
 RU Пистолет для накачивания
 CZ Pistolet na čerpání z manometrem
 RO Pistol cu manometru
 HU Pumpáló pisztoly nyomásmérővel
 ES Pistola de bombeo con manometro

1.2 MPa (max.)
STANDARD



$L_{wa} < 70$ dB; $a_p < 2,5$ m/s²

No.	
81650	10/40

EN Reversible air drill
 PL Wiertarka pneumatyczna
 DE Druckluft-Bohrmaschine
 RU Пневматическая дрель
 CZ Vrtačka ruční vzduchová
 RO Masina de gaurit pneumatica mandrina
 HU Pneumatikus fúró
 ES Taladradora neumática

0.62 MPa	113 l/min	1800 min⁻¹
10 mm max Ø	STANDARD	



$L_{pa} = 94,2 \pm 3,0$ dB; $L_{wa} = 105,2 \pm 3,0$ dB; $a_p = 2,14 \pm 1,5$ m/s²

No.	Required air flow / Wymagany przepływ powietrza [l/min]	Ω [min ⁻¹]	
81122	113	1800	10

EN Pneumatic tool set
 PL Zestaw narzędzi pneumatycznych z akcesoriami
 DE Druckluftwerkzeugsatz mit Zubehör
 RU Пневматический ударный инструмент в наборе
 CZ Sada pneumatického nářadí
 RO Set pistol cu accesorii pneumatice
 HU Légszerszámok készlet
 ES Juego de herramientas neumáticas con accesorios

1/2" 12.7 mm	0.63 MPa	CrV	6 mm
STANDARD		MIN. OILER SMAROWNICA	



No.	Ø	Toolholder size / Rozmiar uchwytu narzędziowego	pcs / szt.	
81142	1/2" (12.7 mm)	1/4" (6.3 mm)	33	2

EN Inflating gun
 PL Pistolet do pompowania
 DE Inflatorpistole
 RU Пистолет для накачивания
 CZ Pistolet na čerpání z manometrem
 RO Pistol cu manometru
 HU Pumpáló pisztoly nyomásmérővel
 ES Pistola de bombeo con manometro

0.6 MPa (max.)	35 cm	STANDARD	
-----------------------	--------------	----------	--



$L_{pa} = 88,0 \pm 3,0$ dB; $L_{wa} = 99,0 \pm 3,0$ dB; $a_p < 2,5$ m/s²

No.	
81651	30

EN Inflating head
 PL Glowica do pompowania
 DE Klemmnippel (universal)
 RU Насадка на насос под шланг

CZ Hlava na čerpání
 RO Cap pt. pompat
 HU Pumpafej
 ES Cabeza de bombeo



No.	Connector diameter / Šrednica krócca [mm]	
81653	8	50/300
81661	6	50/300

EN Spray gun with fluid cup
 PL Pistolet natryskowy
 DE Lackierpistole mit Fliessbecher
 RU Пистолет-распылитель с бачком
 CZ Pistole na lakování z nádrží
 RO Pistol de vopsit cu rezervor
 HU Festékszóró pisztoly
 ES Pistola de barniz



$L_{pa} = 58,2 \text{ dB}$; $L_{wa} = 69,2 \text{ dB}$

No.	Nozzle diameter / Šrednica dyszy [mm]	
80902	1.4	10

EN Spray gun with fluid cup
 PL Pistolet natryskowy
 DE Lackierpistole mit Fliessbecher
 RU Краскораспылитель верхний бак
 CZ Pistole na lakování z nádrží
 RO Pistol de vopsit cu rezervor inferior
 HU Festőpisztoly alsó tartállyal
 ES Pistola de barniz



$L_{pa} < 70 \text{ dB}$; $a_n < 2,5 \text{ m/s}^2$

No.	Nozzle diameter / Šrednica dyszy [mm]	
81617	1.5	20

EN Spray gun with fluid cup
 PL Pistolet natryskowy
 DE Lackierpistole mit Fliessbecher
 RU Пистолет-распылитель с бачком
 CZ Pistole na lakování z nádrží
 RO Pistol de vopsit cu rezervor
 HU Festékszóró pisztoly
 ES Pistola de barniz

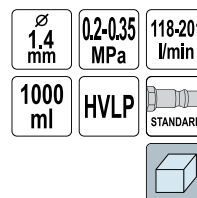

$L_{pa} = 61,2 \text{ dB}$; $L_{wa} = 72,2 \text{ dB}$

No.	Nozzle diameter / Šrednica dyszy [mm]	
80901	1.4	10

EN Spray gun with fluid cup
 PL Pistolet natryskowy
 DE Lackierpistole mit Fliessbecher
 RU Пистолет-распылитель с бачком
 CZ Pistole na lakování z nádrží
 RO Pistol de vopsit cu rezervor
 HU Festékszóró pisztoly
 ES Pistola de barniz

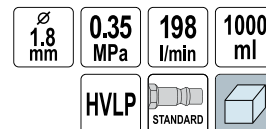

$L_{pa} = 85,0 \pm 2,5 \text{ dB}$; $L_{wa} = 98,9 \pm 2,5 \text{ dB}$

No.	Nozzle diameter / Šrednica dyszy [mm]	
80903	1.8	10

EN Spray gun with fluid cup
 PL Pistolet natryskowy
 DE Lackierpistole mit Fliessbecher
 RU Краскораспылитель верхний бак
 CZ Pistole na lakování z nádrží
 RO Pistol de vopsit cu rezervor inferior
 HU Festőpisztoly alsó tartállyal
 ES Pistola de barniz

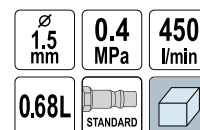

$L_{pa} < 70 \text{ dB}$; $a_n < 2,5 \text{ m/s}^2$

No.	Nozzle diameter / Šrednica dyszy [mm]	
81618	1.5	20

EN Spray gun kit
 PL Zestaw lakierniczy
 DE Lackierspritzsatz
 RU Набор покрасочный пневматический
 CZ Laková souprava
 RO Set de lacuit
 HU Részés fényezőkészlet
 ES Juego de barniz

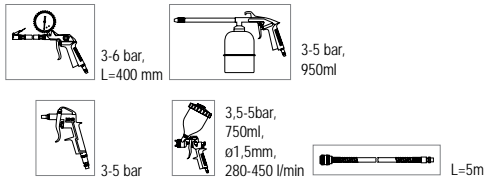
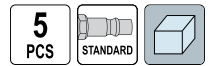

No.	pcs / szt.	Box icon
81638	5	10



EN Blow gun
 PL Pistolet do przedmuchiwania
 DE Ausblaspistole
 RU Пистолет для продувки короткий
 CZ Pistolet na profukování kratká
 RO Pistol scurt pt. suflat
 HU Pövid előléfűvő pisztoly
 ES Pistola de soplado

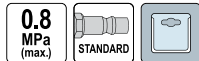

$L_{pa} = 91,0 \pm 3,0$ dB; $L_{wa} = 102,0 \pm 3,0$ dB; $a_h = <2,5$ m/s²

No.	Nozzle pipe length / Długość dyszy [mm]	Box icon
81631	100	10/40

EN Blow gun
 PL Pistolet do przedmuchiwania
 DE Ausblaspistole
 RU Пистолет для продувки короткий
 CZ Pistolet na profukování kratká
 RO Pistol scurt pt. suflat
 HU Pövid előléfűvő pisztoly
 ES Pistola de soplado

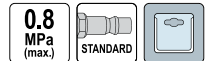

$L_{pa} = 91,0 \pm 3,0$ dB; $L_{wa} = 102,0 \pm 3,0$ dB; $a_h = <2,5$ m/s²

No.	Nozzle pipe length / Długość dyszy [mm]	Box icon
81632	200	10/40

EN Blow gun
 PL Pistolet do przedmuchiwania
 DE Ausblaspistole
 RU Пистолет для продувки короткий
 CZ Pistolet na profukování kratká
 RO Pistol scurt pt. suflat
 HU Pövid előléfűvő pisztoly
 ES Pistola de soplado

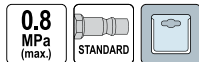

$L_{pa} = 91,0 \pm 3,0$ dB; $L_{wa} = 102,0 \pm 3,0$ dB; $a_h = <2,5$ m/s²

No.	Nozzle pipe length / Długość dyszy [mm]	Box icon
81633	300	10/40

EN Blow gun
 PL Pistolet do przedmuchiwania
 DE Ausblaspistole
 RU Пистолет для продувки короткий
 CZ Pistolet na profukování kratká
 RO Pistol scurt pt. suflat
 HU Pövid előléfűvő pisztoly
 ES Pistola de soplado

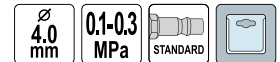

$L_{wa} = <70$ dB; $a_h = <2,5$ m/s²

No.	Box icon
81640	20/40

EN Blow gun
 PL Pistolet do przedmuchiwania
 DE Ausblaspistole
 RU Пистолет для продувки короткий
 CZ Pistolet na profukování kratká
 RO Pistol scurt pt. suflat
 HU Pövid előléfűvő pisztoly
 ES Pistola de soplado

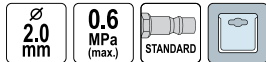

$L_{wa} = <70$ dB; $a_h = <2,5$ m/s²

No.	Box icon
81643	100

EN Blow gun with extension
 PL Pistolet do przedmuchiwania z przedłużką
 DE Gebläsepistole mit Verlängerung
 RU Пистолет для продувки длинный
 CZ Pistolet na profukování dlouhá
 RO Pistol lung pt. suflat
 HU Rövid előléfűvő pisztoly
 ES Pistola de soplado



$L_{wa} = <70$ dB; $a_h = <2,5$ m/s²

No.	Box icon
81644	20/40

- EN Air blow gun kit
- PL Zestaw do przedmuchiwania
- DE Ausblaspistole Druckluft Set
- RU Набор для продувки
- CZ Pneumatická čistící pistole sada
- RO Pistol aer curatat praful cu furtun
- HU Fuvató pistoly szett
- ES Kit pistola de aire aire bobina



$L_{pA} = 90,0 \text{ dB}$; $L_{wA} = 101,0 \text{ dB}$; $a_h = <2,5 \text{ m/s}^2$

No.	
81634	10/20

- EN Filter
- PL Filtr
- DE Filter
- RU Минифильтр
- CZ Filtr
- RO Minifiltru
- HU Szűrő
- ES Filtro



No.	Thread size / Rozmiar gwintu
81560	G1/4 10/50

- EN Pressure reducing valve with manometer
- PL Reduktor ciśnienia z manometrem
- DE Druckminderer mit Manometer
- RU Клапан уменьшения давления с манометром
- CZ Redukční ventil s manometrem
- RO Valva cu reductiepresiune + manometru
- HU Nyomáscsökkentő szelep nyomásmérővel
- ES Reductor + manometro



No.	Thread size / Rozmiar gwintu
81562	G3/8 50

- EN Air filter regulator and lubricator
- PL Zespół filtrujący, reduktor + smarownica
- DE Druckfilter - Druckminderer + Entöler
- RU Фильтр-редуктор + смазочный прибор
- CZ Redukční ventil s odlučovačem oleje
- RO Filtru cu reductor
- HU Levegőelőkészítő
- ES Juego de filtro, reductor + engrasador



No.	Thread size / Rozmiar gwintu
81556	G1/2 20

- EN Washing gun
- PL Pistolet do ropowania
- DE Waschpistole
- RU Пистолет для нефтянина
- CZ Pistole na ropování
- RO Pistol (dozator) pt. motorină
- HU Olajpisztoly
- ES Pistola de petrolear

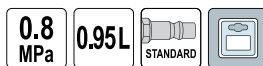

$L_{wA} = <70 \text{ dB}$; $a_h = <2,5 \text{ m/s}^2$

No.	
81647	10/20

- EN In-line air tool oiler
- PL Naolejacz do narzędzi pneumatycznych
- DE Ölter für Druckluftwerkzeuge
- RU Масленка для пневматического инструмента
- CZ Olejníčka do pneumatických nářadí
- RO Gresor scule pneumatice
- HU Pneumatikus szerszám olajozó
- ES Lubricador para herramientas neumáticas

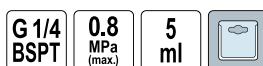

No.	
81570	20/100

- EN Filter - reductor
- PL Filtr - reduktor
- DE Druckfilter - Druckminderer
- RU Фильтр - редуктор
- CZ Filtr derukční ventil
- RO Filtru cu reductor
- HU Szűrő - nyomáscsökkentő
- ES Reductor - filtro

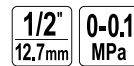

No.	Thread size / Rozmiar gwintu
81553	G1/2 20

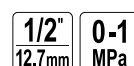

EN PE spiral tubes with rapid couplings
 PL Wąż spiralny PE z szybkozłączami
 DE Spiralschlauch mit Schnellkupplung
 RU Шланг спиральный с быстроразъемным соединением
 CZ Spirální hadice
 RO Furtun în spirală
 HU Spiráltömlő
 ES Manguera espiral

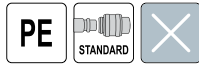

No.	Internal diameter / Średnica wewnętrzna [mm]	External diameter / Średnica zewnętrzna [mm]	L [m]	
81490	5	8	5	50
81491	5	8	10	25
81492	5	8	15	25

EN Armoured hose
 PL Wąż zbrojony
 DE Schlauch, verstärkt durch Bewehrung
 RU Шланг армированный для подачи воздуха

CZ Hadice vyztužená
 RO Furtun armat
 HU Fémbetétes tömlő
 ES Manguera armada

No.	Internal diameter / Średnica wewnętrzna [mm]	L [m]	Wall thickness / Grubość ścianki [mm]	ATM	
81519	6	50	2.5	10/40	1
81520	8	50	2.5	10/40	1
81521	10	50	2.5	10/40	1
81522	12	50	2.5	10/40	1
81523	14	50	3.0	10/40	1
81524	16	50	3.0	10/40	1
81525	19	50	3.5	10/40	1
81527	25	50	4.0	10/40	1

EN Quick coupler
 PL Szybkozłącze
 DE Schnellkupplung
 RU Быстрое соединение
 CZ Rychlospojka
 RO Mufa rapida pt. pistol pneumatic
 HU Gyorscsatlakozó
 ES Conexión de la entrada de aire

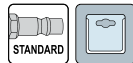

No.	Thread size / Rozmiar gwintu	
81370	G1/4	20/120
81371	G3/8	20/120
81372	G1/2	20/120

EN Quick coupler
 PL Szybkozłącze
 DE Schnellkupplung
 RU Быстрое соединение
 CZ Rychlospojka
 RO Mufa rapida pt. pistol pneumatic
 HU Gyorscsatlakozó
 ES Conexión de la entrada de aire

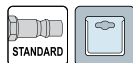

No.	Connector diameter / Średnica króćca [mm]	
81378	6	20/120
81379	8	20/120
81380	10	20/120

EN PU spiral tubes with rapid couplings
 PL Wąż spiralny PU z szybkozłączami
 DE Spiralschlauch mit Schnellkupplung
 RU Шланг спиральный с быстроразъемным соединением
 CZ Spirální hadice
 RO Furtun în spirală
 HU Spiráltömlő
 ES Manguera espiral



No.	Internal diameter / Średnica wewnętrzna [mm]	External diameter / Średnica zewnętrzna [mm]	L [m]	
81500	5	8	5	50
81501	5	8	10	25
81502	5	8	15	25



EN Quick coupler
 PL Szybkozłącze
 DE Schnellkupplung
 RU Быстрое соединение
 CZ Rychlospojka
 RO Mufa rapida pt. pistol pneumatic
 HU Gyorscsatlakozó
 ES Conexión de la entrada de aire

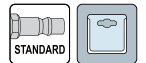

No.	Thread size / Rozmiar gwintu	
81373	G1/4	20/120
81374	G3/8	20/120

EN Quick coupler
 PL Szybkozłącze
 DE Schnellkupplung
 RU Быстрое соединение
 CZ Rychlospojka
 RO Mufa rapida pt. pistol pneumatic
 HU Gyorscsatlakozó
 ES Conexión de la entrada de aire



No.	Thread size / Rozmiar gwintu	
81390	G1/4	50/250
81391	G3/8	50/250

- EN Quick coupler
- PL Szybkozłącze
- DE Schnellkupplung
- RU Быстрое соединение
- CZ Rychlospojka
- RO Mufa rapida pt. pistol pneumatic
- HU Gyorscsatlakozó
- ES Conexión de la entrada de aire

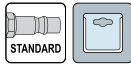

No.	Thread size / Rozmiar gwintu	
81387	G1/4	50/250

- EN Pneumatic riveting machine
- PL Nitownica pneumatyczna
- DE Druckluft Nietzange
- RU Пневматический заклепочник
- CZ Pneumatická nýťovačka
- RO Presa pneumatica pt. nituit
- HU Pneumatikus popszegecsőhúzó
- ES Máquina remachadora



$L_{pA} = 76,1 \pm 3 \text{ dB}$; $L_{wA} = 87,1 \pm 3 \text{ dB}$; $a_h = 0,85 \pm 0,59 \text{ m/s}^2$

No.	Ø [mm]	Max. piston stroke / Maks. skok tłoka siłownika [mm]	F [kg]	F [N]	
70280	2,4, 3,2, 4, 4,8	14	720	7060	10

- EN Quick coupler
- PL Szybkozłącze
- DE Schnellkupplung
- RU Быстрое соединение
- CZ Rychlospojka
- RO Mufa rapida pt. pistol pneumatic
- HU Gyorscsatlakozó
- ES Conexión de la entrada de aire

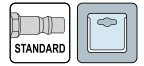

No.	Connector diameter / Średnica króćca [mm]	
81399	6	50/250
81400	8	50/250
81401	10	50/250



14 mm	85 l/min
0.63 MPa	720 kg / 7060 N
STANDARD	x4



Memo

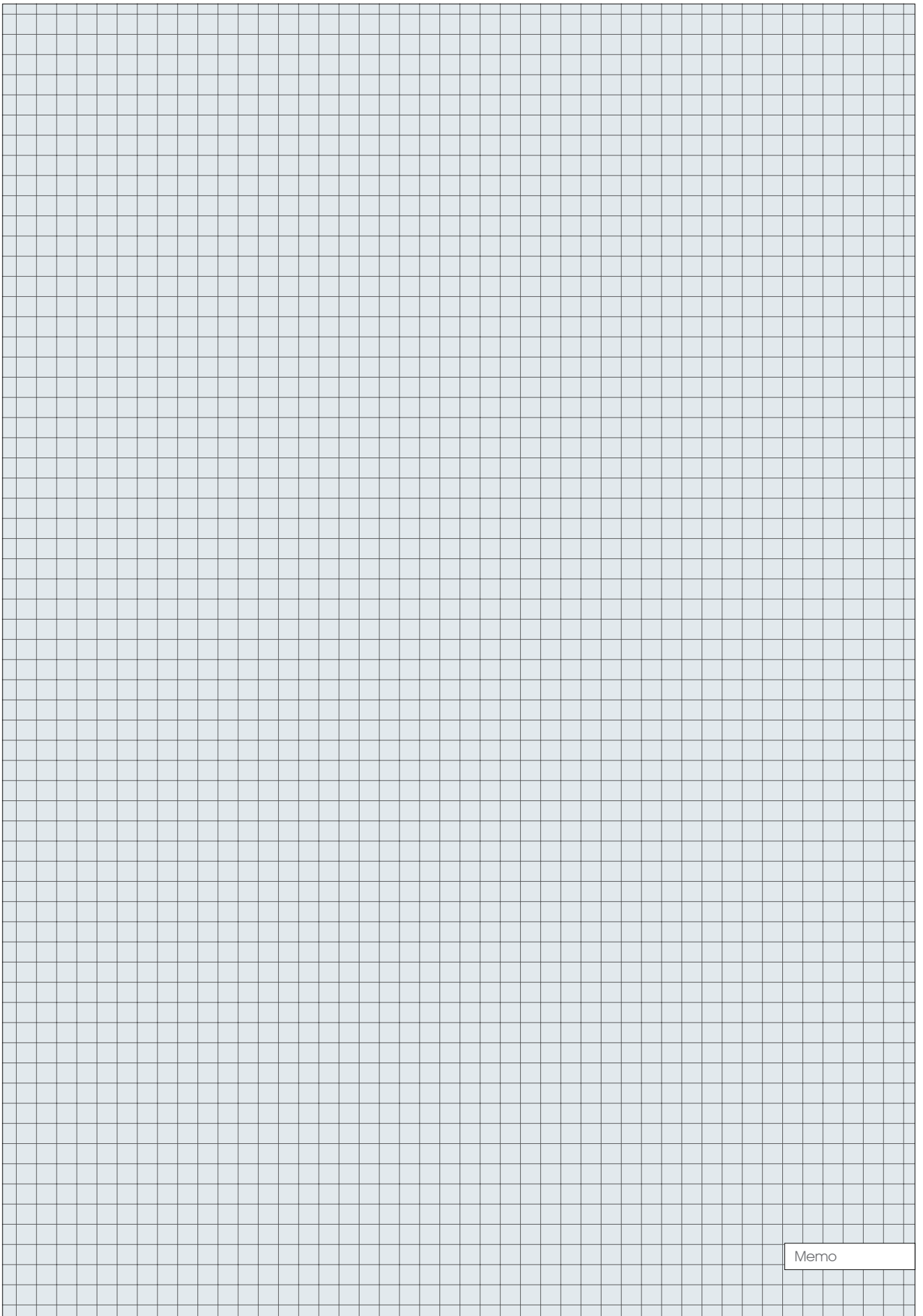

Memo

14

Special automotive tools & equipment Narzędzia i wyposażenie warsztatu samochodowego



Cabinets Szafki



222-227

Roller cabinets with tools insert

Szafki serwisowe z narzędziami..... 222

Tool cabinets

Szafki serwisowe..... 224

Workbenches & workshop desks

Stoły i biurka warsztatowe..... 225

Trolley tool boxes

Wózki narzędziowe..... 226

Lubrication tools

Narzędzia do smarowania



227-232

Grease guns & oil transfer pumps

Smarownice ręczne i pompy transferowe do oleju..... 227

Manual oil pumps

Pompy ręczne do oleju..... 228

Oil cans

Oliwiarki..... 230

Oil filter wrenches

Klucze do filtra oleju..... 230

Pullers

Ściągacze



232-233

Gear pullers

Ściągacze do łożysk..... 232

Spring pullers

Ściągacze do sprężyn..... 232

Ball joint removers

Ściągacze do sworzni kulistych..... 233

Workshop tools

Narzędzia warsztatowe



233-244

Wheel wrenches

Klucze do kół..... 233

Piston ring compressors

Zaciskacze do pierścieni..... 234

Spark plug sockets

Klucze do świec..... 234

Vacuum pumps

Pompy podciśnieniowe..... 235

Brake system tools

Narzędzia do obsługi układu hamulcowego..... 235

Paint thickness & car voltage testers

Tester grubości lakieru i samochodowe próbniki napięcia..... 236

Magnetic pick up tools

Chwytaaki magnetyczne..... 236

Workshop seats

Taborety warsztatowe..... 237

Impact wrenches

Klucze udarowe..... 237

Workshop lamps

Lampy warsztatowe..... 238

Bottle & floor jacks

Dźwigniki słupkowe i podnośniki..... 240

Scissors jacks

Podnośniki mechaniczne..... 241

Accessories for jacks

Akcesoria do podnośników..... 241

Jack stands

Podstawki pod samochód..... 241

Porta power kits

Rozpieraki hydrauliczne..... 242

Pull-back rams

Ściągacze blacharskie hydrauliczne..... 242

Battery chargers

Prostowniki..... 242

Battery testers

Testery akumulatorów..... 243

Tire pressure gauges

Mierniki ciśnienia..... 243

Chain blocks

Wciągarki łańcuchowe..... 244

Car accessories

Akcesoria samochodowe



244-255

Pumps

Pompki..... 244

Air compressors

Kompresory..... 245

Air wedges

Poduszki montażowe..... 245

Tow ropes

Linki holownicze..... 245

Battery clamp cleaners

Szczotki do czyszczenia klem..... 247

Battery hydrometers

Próbniki akumulatorowe..... 247

Booster cables

Wiązki przewodów awaryjnych..... 247

Scrapers & brushes

Skrobaczki i szczotki..... 247

Flexible funnels

Lejki..... 247

Car vacuum cleaners

Odkurzacze samochodowe..... 248

Portable shower sets

Prysznice turystyczne..... 249

First aid kits

Apteczki..... 250

Safety triangles

Trójkąty ostrzegawcze..... 250

Ratchet tie downs

Taśmy do bagażu..... 250

Tarpaulins & accessories

Plandeki i akcesoria..... 253

EN Service tool cabinet with tools
 PL Szafka serwisowa z narzędziami
 DE Werkstattwagen mit Werkzeug
 RU Сервисный шкаф с инструментами
 CZ Vozík servisní s nářadím
 RO Dulap echipat cu scule
 HU Szerszámkocsi szerszámokkal
 ES Carro taller con herramientas

177 PCS 901x770 x458 mm 6x DRAWERS LOCKING BLOKADA SZUFLAD CENTRAL LOCK BLOKADA CENTRALNA 2xT ø125mm 2X BRAKE HAMULEC BALL BEARINGS ŁOŻYSKA KULKOWE NON SLIP WORKTOP BLAT ANTY-POŚLIZGOWY UNIVERSAL PERFORATION UNIWERSALNA PERFORACJA

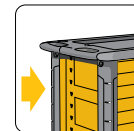

14

12 interchangeable trays with tools

12 wymiennych modułów z narzędziami



No.	Drawer quantity / Liczba szuflad	
58540	6	1

Drawer 1 / Szuflada 1

- 1/2" (12.7 mm): 10, 11, 12, 13, 14, 15, 16, 17, 18, 19, 20, 21, 22, 23, 24, 27, 30, 32 mm; CrV 50BV30;
- 1/2" (12.7 mm); (127 mm); CrV 50BV30;
- 1/2" (12.7 mm); CrV 50BV30;
- 1/2" (12.7 mm); (255 mm); 72T; CrV 6140;
- 1/2" (12.7 mm); (255 mm); CrV 50BV30;
- 1/2" (12.7 mm); 16, 21 mm; CrV 50BV30;
- 3/8" (9.5 mm): 6, 7, 8, 9, 10, 11, 12, 13, 14, 15, 16, 17, 18, 19, 20, 21, 22 mm; CrV 50BV30;
- 3/8" (9.5 mm); (76, 152.4 mm); CrV 50BV30;
- 3/8" (9.5 mm); CrV 50BV30;
- 3/8" (9.5 mm); (200 mm); 72T; CrV 6140;
- 3/8" (9.5 mm); (198 mm); CrV 50BV30;
- 1/4" (6.3 mm): 3.5, 4, 4.5, 5, 5.5, 6, 7, 8, 9, 10, 11, 12, 13, 14 mm; CrV 50BV30;
- 1/4" (6.3 mm): 8, 10, 11, 12, 13 mm; CrV 50BV30;
- 1/4" (6.3 mm); (50.8, 101.6 mm); CrV 6140;
- 1/4" (6.3 mm); CrV 50BV30;
- 1/4" (6.3 mm); (155 mm); 72T; CrV 6140;
- 1/4" (6.3 mm); (150 mm); CrV 50BV30;
- 1/4" (6.3 mm); (152.4 mm); CrV 50BV30

Drawer 2 / Szuflada 2

- 3x75 mm, 5x100 mm, 5x150 mm, 6x38 mm, 6x100 mm, 6x150 mm, 8x150 mm; CrV;
- PH0x100 mm, PH1x75 mm, PH1x100 mm, PH2x38 mm, PH2x100 mm, PH2x150 mm, PH3x150 mm; CrV;
- 180 mm;
- 160 mm;
- 160 mm;
- 160 mm; bent / wygięte

Drawer 3 / Szuflada 3

- 6x7, 8x9, 10x11, 12x13, 14x15, 16x17, 18x19 mm;
- 22, 24, 27, 28, 30, 32 mm;
- 6, 7, 8, 9, 10, 11, 12, 13, 14, 15, 16, 17, 18, 19, 20, 21 mm

Drawer 4 / Szuflada 4

- 1/2" (12.7 mm): 8, 9, 10, 11, 12, 13, 14, 15, 16, 17, 18, 19, 20, 21 mm (L=76 mm); CrV 50BV30;
- 1/2" (12.7 mm), 3/8" (9.5 mm);
- 4, 5, 6, 7, 8, 10, 12 mm (L=30 mm); 4, 5, 6, 7, 8, 10, 12 mm (L=75 mm); CrV;
- M5, M6, M7, M10, M12 (L=30 mm); M5, M6, M7, M10, M12 (L=75 mm); CrV;
- T20, T25, T30, T40, T45, T50, T55 (L=30 mm); T20, T25, T30, T40, T45, T50, T55 (L=75 mm); CrV;
- 300 g (L=300 mm);
- 40 mm (L=300 mm);
- 10x8x142 mm, 12x10x152 mm, 16x13x170 mm

EN Service tool cabinet with tools
 PL Szafka serwisowa z narzędziami
 DE Werkstattwagen mit Werkzeugzeug
 RU Сервисный шкаф с инструментами
 CZ Vozík servisní s nářadím
 RO Dulap echipat cu scule
 HU Szerszámkösi szerszámokkal
 ES Carro taller con herramientas

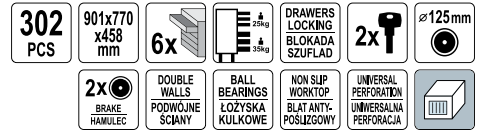

Drawer 1 / Szufłada 1

- 1/2" (12.7 mm): 10, 11, 12, 13, 14, 15, 16, 17, 18, 19, 20, 21, 22, 23, 24, 27, 30, 32 mm; CrV;
- 1/2" (12.7 mm): 45T; CrV;
- 1/2" (12.7 mm): CrV;
- 1/2" (12.7 mm): CrV;
- 1/2" (12.7 mm): 16, 21 mm; CrV;
- 3/8" (9.5 mm): 6, 7, 8, 9, 10, 11, 12, 13, 14, 15, 16, 17, 18, 19, 20, 21, 22 mm; CrV;
- 3/8" (9.5 mm): 2 PCS; CrV;
- 3/8" (9.5 mm): CrV;
- 3/8" (9.5 mm): 45T; CrV;
- 3/8" (9.5 mm): CrV;
- 1/4" (6.3 mm): 3.5, 4, 4.5, 5, 5.5, 6, 7, 8, 9, 10, 11, 12, 13, 14 mm; CrV;
- 1/4" (6.3 mm): E4, E5, E6, E7, E8; CrV;
- 1/4" (6.3 mm): CrV;
- 1/4" (6.3 mm): 2 PCS; CrV;
- 1/4" (6.3 mm): CrV;
- 1/4" (6.3 mm): CrV;
- 1/4" (6.3 mm): 45T; CrV;
- 1/4" (6.3 mm) x 1/4" (6.3 mm); CrV 50BV30;
- 1/4" (6.3 mm): 3, 4, 5.5, 6.5, 7, 8, 9 mm;
- 1/4" (6.3 mm): PH0; PH1; PH2; PH3;
- 1/4" (6.3 mm): PZ0, PZ1, PZ2, PZ3;
- 1/4" (6.3 mm): T8, T9, T10, T15, T20, T25, T27, T30;
- 1/4" (6.3 mm): T8, T9, T10, T15, T20, T25, T27, T30;
- 1/4" (6.3 mm): 3, 4, 5, 6, 7, 8 mm;
- 1/4" (6.3 mm): S0, S1, S2;
- 1/4" (6.3 mm): 4, 5.5, 6.5 mm; CrV;
- 1/4" (6.3 mm): PH1, PH2, PH3; CrV;
- 1/4" (6.3 mm): PZ1, PZ2, PZ3; CrV;
- 1/4" (6.3 mm): T8, T10, T15, T20, T25, T27, T30; CrV;
- 1/4" (6.3 mm): 5, 6, 7, 8 mm; CrV

Drawer 2 / Szufłada 2

- 3/8" (9.5 mm): 4, 5, 6, 7, 8, 10, 12 mm (L=30 mm); 4, 5, 6, 7, 8, 10, 12 mm (L=75 mm); AISI S2;
- 3/8" (9.5 mm): M5, M6, M8, M10, M12 (L=30 mm); M5, M6, M8, M10, M12 (L=75 mm); AISI S2;
- 3/8" (9.5 mm): T20, T25, T30, T40, T45, T50, T55 (L=30 mm); T20, T25, T30, T40, T45, T50, T55 (L=75 mm); AISI S2;
- 1/2" (12.7 mm) x 3/8" (9.5 mm), 3/8" (9.5 mm) x 3/8" (9.5 mm); CrV 6150;
- 1/2" (12.7 mm): 14, 15, 17, 19, 22 mm; CrV;
- 1/2" (12.7 mm): E18, E20, E24; CrV;
- 3/8" (9.5 mm): E10, E11, E12, E14, E16; CrV;
- 1/2" (12.7 mm); CrV;
- 1/2" (12.7 mm); CrV;
- 6, 7, 8, 9, 10, 11, 12, 13, 14, 15, 16, 17, 18, 19, 20, 21 mm

Drawer 3 / Szufłada 3

- 5/32" (4 mm); CrV 6150;
- 5/32" (4 mm): 1.0, 1.5, 2.0, 2.5, 3.0, 3.5 mm; CrV 6150;
- 5/32" (4 mm): PH000, PH00, PH0, PH1; CrV 6150;
- 5/32" (4 mm): PZ0, PZ1; CrV 6150;
- 5/32" (4 mm): T4, T5, T6, T7, T8, T9, T10, T15, T20; CrV 6150;
- 5/32" (4 mm): 0.7, 0.9, 1.3, 2.0, 2.5, 3.0, 4.0 mm; CrV 6150;
- 5/32" (4 mm): 2.5, 3.0, 3.5, 4.0, 4.5, 5.0, 5.5 mm;
- CrV;
- 2.0, 2.5, 3.0, 4.0, 5.0, 5.5, 6.0, 8.0, 10.0, 12 mm; CrV;
- T10, T15, T20, T25, T27, T30, T40, T45, T50; CrV;
- external straight / proste zewnętrzne;
- internal straight / proste wewnętrzne;
- external bent / wygięte zewnętrzne;
- internal bent / wygięte wewnętrzne;

Drawer 4 / Szufłada 4

- 30 Og;
- Ø28 mm;
- 12x150 mm, 16x170 mm;
- 1.5x150 mm, 3x150 mm, 5x150 mm, 8x150 mm;
- 6x100 mm, 2x140 mm;
- 3x75 mm, 5x100 mm, 6x100 mm, 8x150 mm; CrV;
- PH0x75 mm, PH1x100 mm, PH2x100 mm, PH3x150 mm; CrV;
- 300 mm;
- 300 mm;
- 300 mm;
- 300 mm;
- 300 mm

12 interchangeable trays with tools

12 wymiennych modułów z narzędziami

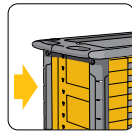

No.	Drawer quantity / Liczba szuflad	
58550	6	1

EN Roller cabinet
 PL Szafka serwisowa
 DE Werkstattrollwagen
 RU Инструментальный кабинет
 CZ Dilenská skříňka
 RO Dulap de scule
 HU Szerszámok kocsis
 ES Armario en ruedas

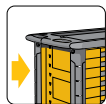
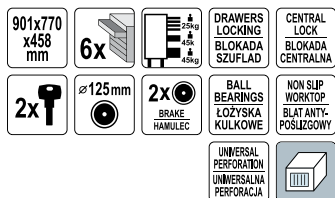

No.	Drawer quantity / Liczba szuflad	
58539	6	1

EN Shutter cabinet
 PL Szafka wisząca
 DE Hängeschrank
 RU Подвесной шкаф
 CZ Závěsná skříňka
 RO Dulap cu 2 usi
 HU Függő szekrény
 ES Armario de pared



No.	Dimensions / Wymiary [mm]	
58440	1125x265x630	1

EN Roller cabinet
 PL Szafka serwisowa
 DE Werkstattrollwagen
 RU Инструментальный кабинет
 CZ Dilenská skříňka
 RO Dulap de scule
 HU Szerszámok kocsis
 ES Armario en ruedas



No.	Drawer quantity / Liczba szuflad	
81830	6	1

EN Shutter cabinet
 PL Szafka wisząca
 DE Hängeschrank
 RU Подвесной шкаф
 CZ Závěsná skříňka
 RO Dulap cu 2 usi
 HU Függő szekrény
 ES Armario de pared

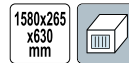

No.	Dimensions / Wymiary [mm]	
58441	1580x265x630	1

EN Magnetic tool holder
 PL Zestaw listew magnetycznych
 DE Magnet Werkzeughalter
 RU Магнитная рейка
 CZ Magnetický držák nářadí
 RO Suport magnetic
 HU Mágneses tartó
 ES Bandeja de accesorios magnética



No.	pcs / szt.	
57830	3	6/12

EN Service utility key
 PL Klucz do szafek serwisowych
 DE Schaltschrank-Schlüssel für Gängige Schränke
 RU Ключ для сервисных шкафов
 CZ Klíč na rozvodné skříně
 RO Cheie universală pt. panoul de comandă
 HU Kapsolőszekrény kulcs
 ES Llaves para armarios de control



No.		
78477		12/72

EN Workbench
 PL Stół warsztatowy
 DE Werkstattisch
 RU Бepcтaк
 CZ Pracovní stůl
 RO Banc de lucru
 HU Munkaasztal
 ES Mesa de trabajo



No.	Drawer quantity / Liczba szuflad	Dimensions / Wymiary [mm]	
58455	5	1160x600x840	1

EN Workshop desk
 PL Biurko warsztatowe
 DE Schreibtisch für Werkstatt
 RU Письменный стол для мастерской
 CZ Pracovní stůl
 RO Masa de lucru
 HU Munkaasztal
 ES Escritorio de trabajo

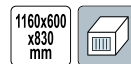

No.	Dimensions / Wymiary [mm]	
58450	1160x600x830	1

EN Workbench
 PL Stół warsztatowy
 DE Werkstattisch
 RU Бepcтaк
 CZ Pracovní stůl
 RO Banc de lucru
 HU Munkaasztal
 ES Mesa de trabajo

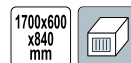

No.	Drawer quantity / Liczba szuflad	Dimensions / Wymiary [mm]	
58456	6	1700x600x840	1

EN Work bench
 PL Stolik monterski
 DE Montagetisch
 RU Монтажный столик
 CZ Montérský stolk
 RO Banc de lucru
 HU Szerelőasztal
 ES Mesa para bricolaje



No.	
29420	1

EN Trolley toolbox, 2 segments
 PL Wózek narzędziowy z wymiowanym organizerem
 DE Werkzeugtrolley mit abnehmbarem Organieraufsatz
 RU Мешок для инструментов с вынимаемым органайзером
 CZ Vozík na nářadí s odnímatelným organizérem
 RO Troler pt. scule 2 segmente
 HU Kerekes szerszámosláda kivehető szervezővel
 ES Carro de herramientas con organizador extraíble



14



No.	
78734	1

EN Trolley toolbox, 2 segments
 PL Wózek narzędziowy 2-segmentowy
 DE Werkzeugtrolley 2-Teilig
 RU Мешок для инструментов 2 секции
 CZ Vozík na nářadí 2 segmenty
 RO Troler pt. scule 2 segmente
 HU Kerekes szerszámosláda 2 részes
 ES Carro de herramientas 2 compartimentos



No.	
78731	1

EN Trolley toolbox, 3 segments
 PL Wózek narzędziowy 3-segmentowy
 DE Werkzeugtrolley 3-Teilig
 RU Мешок для инструментов 3 секции
 CZ Vozík na nářadí 3 segmenty
 RO Troler pt. scule 3 segmente
 HU Kerekes szerszámosláda 3 részes
 ES Carro de herramientas 3 compartimentos



No.	
78736	1

EN Trolley toolbox, 3 segments
 PL Wózek narzędziowy 3-segmentowy
 DE Werkzeugtrolley 3-Teilig
 RU Мешок для инструментов 3 секции
 CZ Vozík na nářadí 3 segmenty
 RO Troier pt. scule 3 segmente
 HU Kerekesszerszámosláda 3 részes
 ES Carro de herramientas 3 compartimentos



No.	Tank capacity / Pojemność zbiornika [cm ³]	Icon
78738		1

EN Lever grease gun
 PL Smarownica
 DE Handhebel-Fettpresse
 RU Шприц для масляной смазки
 CZ Páková maznice
 RO Masina de gresat cu furturn rigid
 HU Karos zsírzó
 ES Pistola de engrase

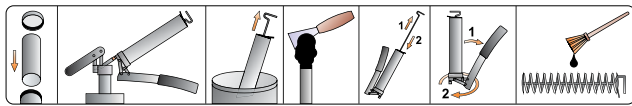
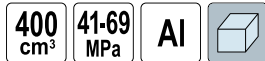

No.	Tank capacity / Pojemność zbiornika [cm ³]	Icon
78041	400	5/10

EN Lever grease gun
 PL Smarownica
 DE Handhebel-Fettpresse
 RU Шприц для масляной смазки
 CZ Páková maznice
 RO Masina de gresat cu furturn rigid
 HU Karos zsírzó
 ES Pistola de engrase



No.	Tank capacity / Pojemność zbiornika [cm ³]	Icon
78047	500	10



EN Lever grease gun
 PL Smarownica
 DE Handhebel-Fettpresse
 RU Шприц для масляной смазки
 CZ Páková maznice
 RO Masina de gresat cu furturn rigid
 HU Karos zsírzó
 ES Pistola de engrase



No.	Tank capacity / Pojemność zbiornika [cm ³]	Icon
78040	400	10

EN Lever grease gun
 PL Smarownica
 DE Handhebel-Fettpresse
 RU Шприц для масляной смазки
 CZ Páková maznice
 RO Masina de gresat cu furturn rigid
 HU Karos zsírzó
 ES Pistola de engrase



No.	Tank capacity / Pojemność zbiornika [cm ³]	Icon
78046	400	10

EN Lever grease gun
 PL Smarownica
 DE Handhebel-Fettpresse
 RU Шприц для масляной смазки
 CZ Páková maznice
 RO Masina de gresat cu furturn rigid
 HU Karos zsírzó
 ES Pistola de engrase

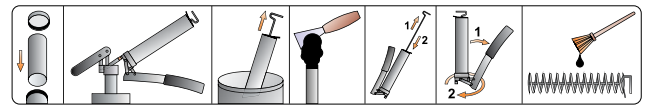
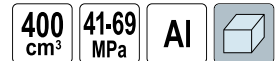

No.	Tank capacity / Pojemność zbiornika [cm ³]	Icon
78042	400	5/10



EN Lever grease gun
 PL Smarownica
 DE Handhebel-Fettresse
 RU Шприц для масляной смазки
 CZ Páková maznice
 RO Masina de gresat cu furtun rigid
 HU Karos zsírzó
 ES Pistola de engrase

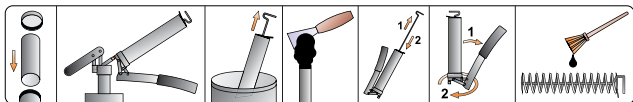
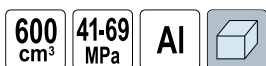

No.	Tank capacity / Pojemność zbiornika [cm³]	
78043	600	6/12

EN Grease gun
 PL Smarownica ręczna
 DE Handhebel-Fettresse
 RU Шприц для перекачки масел
 CZ Hádčka na maznice
 RO Furtun flexibil pt. pistol de gresat
 HU Tömítő a zsírzóhoz
 ES Pistola de engrase



No.	Tank capacity / Pojemność zbiornika [g]	
78039	120	30

EN Heavy duty jaw couplers
 PL Zestaw końcówek czterozczękowych do smarownic
 DE Mundstücksatz für Handhebel-Fettpressen
 RU Соединительные патроны для масляного пистолета
 CZ Sada koncovek k mazacímu lisu
 RO Doza de legatura
 HU Tömítő csatlakozó karos zsírzóhoz
 ES Juego de boquillas para engrasadores



No.	Ø [mm]	pcs / szt.	
78061	15	4	20/80

EN Manual oil pump
 PL Pompa ręczna do oleju
 DE Öl-Umfüllpumpe
 RU Ручной насос для перекачки масел

CZ Pumpa ruční na olej
 RO Pompa manuala apa ulei
 HU Kézi olajszivattyú
 ES Bomba manual para aceite

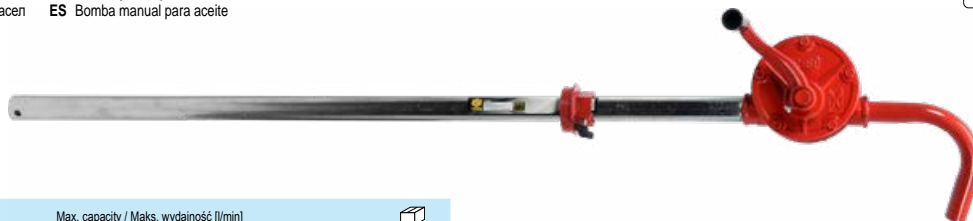
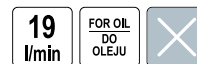

No.	Max. capacity / Maks. wydajność [l/min]	
78000	19	5

EN Push type grease gun
 PL Smarownica wyciskowa
 DE Press-Fettspritze
 RU Шприц смазочный нажимной
 CZ Vytlačovací maznice
 RO Gresor
 HU Kézi olajozó
 ES Engrasador



No.	Tank capacity / Pojemność zbiornika [g]	
78037	80	40

EN Flexible tube for grease gun
 PL Wężyk do towołnicy
 DE Schlauch für Fettresse
 RU Шприц для перекачки масел
 CZ Hádčka na maznice na šmír
 RO Furtun flexibil pt. pistol de gresat
 HU Tömítő a zsírzóhoz
 ES Manguera para engrasador



No.	L [mm]	
78045	240	50/250

EN Flexible hose for grease gun
 PL Wężyk giętki do smarownic
 DE Schlauch für Fettresse
 RU Гибкий шланг для товоłницы
 CZ Hádčka na maznice na šmír
 RO Furtun flexibil pt. pistol de gresat
 HU Tömítő a zsírzóhoz
 ES Manguera para engrasador

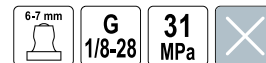

No.	L [mm]	Max. pressure / Maks. ciśnienie [MPa]	
78067	300	31	50/250
78068	500	31	50/250

EN Manual oil pump
 PL Pompa ręczna do oleju
 DE Öl-Umfüllpumpe
 RU Ручной насос для перекачки масел
 CZ Pumpa ruční na olej
 RO Pompa manuala apa ulei
 HU Kézi olajszivattyú
 ES Bomba manual para aceite

20
l/min

FOR OIL
DO
OLEJU



No.	Max. capacity / Maks. wydajność [l/min]	
78001	20	8

EN Manual oil pump
 PL Pompa ręczna do oleju
 DE Öl-Umfüllpumpe
 RU Ручной насос для перекачки масел
 CZ Pumpa ruční na olej
 RO Pompa manuala apa ulei
 HU Kézi olajszivattyú
 ES Bomba manual para aceite

20
l/min

x3
PEE
RURA

AI

FOR OIL
DO
OLEJU



No.	Max. capacity / Maks. wydajność [l/min]	
78002	20	10

EN Manual oil pump
 PL Mini pompa ręczna do oleju
 DE Öl-Umfüllpumpe
 RU Ручной насос для перекачки масел
 CZ Pumpa ruční na olej
 RO Pompa manuala apa ulei
 HU Kézi olajszivattyú
 ES Bomba manual para aceite

15
l/min

MINI

AI

FOR OIL
DO
OLEJU



No.	Max. capacity / Maks. wydajność [l/min]	
78003	15	20

EN Self-priming fuel pump
 PL Samozasysający wąż do paliwa
 DE Selbstansaugender Kraftstoffschlauch
 RU Шланг с обратным клапаном для перекачки топлива
 CZ Přeběrpávací hadice se samonasávacím ventilem
 RO Furtun pt. transfer lichide
 HU Üzemanyag légtelenítő kézi pumpa
 ES Manguera aspiración manual

13
mm

180
cm

SELF-PRIMING
SAMO-
ZASYSAJĄCY

PVC



No.	
83009	6/24

EN Oil extractor
 PL Elektryczna pompa do oleju
 DE Ölabsaugpumpe
 RU Насос перекачки масла
 CZ Čerpadlo na odsávání oleje
 RO Olajleszivó szivattyú
 HU Pompa electrica pt. extras ulei
 ES Bomba extractora de aceite eléctrica para coche

80
W

12
V

3
l/min





No.	Power / Moc [W]	
78007	80	10

EN Oil drainer
 PL Odsysarka ręczna do oleju
 DE Öl-Absaugpumpe
 RU Ручной шприц для откачки масла
 CZ Ruční odsávačka oleje
 RO Pompa de ulei
 HU Kézi olajszivattyú
 ES Bomba manual de trasvase

200
cm³





No.	Tank capacity / Pojemność zbiornika [cm ³]	
78030	200	10

EN Oil drainer
 PL Odsysarka ręczna do oleju
 DE Öl-Absaugpumpe
 RU Ручной шприц для откачки масла
 CZ Ruční odsávačka oleje
 RO Pompa de ulei
 HU Kézi olajszivattyú
 ES Bomba manual de trasvase

400
cm³



No.	Tank capacity / Pojemność zbiornika [cm ³]	
78031	400	10

- EN Oil drainer
- PL Odsysarka ręczna do oleju
- DE Öl-Absaugpumpe
- RU Ручной шприц для откачки масла
- CZ Ruční odsávačka oleje
- RO Pompa de ulei
- HU Kézi olajszivattyú
- ES Bomba manual de trasvase



No.	Tank capacity / Pojemność zbiornika [cm³]	
78044	500	10/20

- EN Manual car oil pump
- PL Odsysarka ręczna do oleju
- DE Manuelle Öl-Absaugpumpe
- RU Ручной насос для откачки масла
- CZ Ruční vakuová odsávačka oleje a kapalin
- RO Pompă de aspirație pt. aspirajta uleiului
- HU Kézi pumpás olajleszívó
- ES Bomba de vacío para aspiración de aceite



No.	Tank capacity / Pojemność zbiornika [l]	
78032	6	4

- EN Oil can with flexible hose
- PL Oliwiarka z wężykiem
- DE Ölkanne mit flexiblem Aufsatz
- RU Масленка с гибким шлангом
- CZ Olejova mазnice
- RO Cana ulei cu furtun flexibil
- HU Olajozó kanna, hajlékony tömlővel
- ES Aceitera



No.	Capacity / Pojemność [ml]	
78306	200	10/60

- EN Oil can with rigid spout
- PL Oliwiarka z końcówką sztywną
- DE Ölkanne mit starrem Aufsatz
- RU Масленка с твердым наконечником
- CZ Olejová mазnice
- RO Cana ulei cu furtun rigid
- HU Olajozó kanna, merev szárral
- ES Aceitera



No.	Capacity / Pojemność [ml]	
78303	300	10/60

- EN Manual oil pump
- PL Pompa ręczna do oleju
- DE Öl-Umfüllpumpe
- RU Ручной насос для перекачки масел

- CZ Pumpa ruční na olej
- RO Pompa manuala apa ulei
- HU Kézi olajszivattyú
- ES Bomba manual para aceite



No.	Tank capacity / Pojemność zbiornika [cm³]	
78035	500	10

- EN Oil can
- PL Oliwiarka
- DE Ölkanne
- RU Масленка
- CZ Mазnička
- RO Pompă de ulei
- HU Olajozó
- ES Aceitera



No.	Capacity / Pojemność [ml]	
78300	300	15/60

- EN Oiler
- PL Oliwiarka
- DE Ölkanne
- RU Масленка
- CZ Olejníčka
- RO Gresor
- HU Olajozó
- ES Aceitera



No.	Capacity / Pojemność [ml]	
78301	250	6/72

- EN Oil filter wrench
- PL Klucz do filtra oleju
- DE Ölfilterschlüssel
- RU Ключ к масляному фильтру
- CZ Klíč na olejový filtr
- RO Cheie pt. filtru de ulei
- HU Olajszűrő leszedő
- ES Llave para el filtro de aceite



No.	Ø	Ø [mm]	
57600	1/2" (12.7 mm), 3/8" (9.5 mm)	65-110	6/36

EN Oil filter wrench
 PL Klucz do filtra oleju zaciskowy
 DE Ölfilterschlüssel
 RU Съёмник масляных фильтров замковый

CZ Klíč na filtr oleju svěrácí
 RO Cheie cu strângere pt. filtru de ulei
 HU Olajszűrő kulcs, patintós
 ES Llave de filtro de apriete

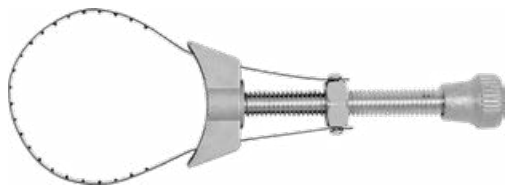

No.	Ø [mm]	
57610	55-110	10/50

EN Oil filter wrench
 PL Klucz do filtra oleju
 DE Ölfilterschlüssel
 RU Ключ к масляному фильтру

CZ Klíč na olejový filtr
 RO Cheie pt. filtru de ulei
 HU Olajszűrő leszedő
 ES Llave para el filtro de aceite



No.		
57630		10/40

EN Oil filter wrench
 PL Klucz do filtra oleju
 DE Ölfilterschlüssel
 RU Ключ к масляному фильтру
 CZ Klíč na olejový filtr
 RO Cheie pt. filtru de ulei
 HU Olajszűrő leszedő
 ES Llave para el filtro de aceite

3/8" 64-80
 9.5 mm mm



No.	Ø	Ø [mm]	
57660	3/8" (9.5 mm)	64-80	6/36

EN Oil filter wrench
 PL Klucz do filtra oleju
 DE Ölfilterschlüssel
 RU Ключ к масляному фильтру

CZ Klíč na filtr oleju
 RO Cheie pt. filtru de ulei
 HU Olajszűrő kulcs
 ES Llave para el filtro de aceite



No.	Ø [mm]	
57612	73-85	12/48
57613	83-95	12/48
57614	93-111	12/48

EN Oil filter wrench
 PL Klucz do filtra oleju
 DE Ölfilterschlüssel
 RU Ключ к масляному фильтру
 CZ Klíč na olejový filtr
 RO Cheie pt. filtru de ulei
 HU Olajszűrő leszedő
 ES Llave para el filtro de aceite



No.		
57620		10/100

EN Oil filter wrench
 PL Klucz do filtra oleju
 DE Ölfilterschlüssel
 RU Ключ к масляному фильтру

CZ Klíč na olejový filtr
 RO Cheie pt. filtru de ulei
 HU Olajszűrő leszedő
 ES Llave para el filtro de aceite



No.		
57640		25/100

EN Oil filter wrench
 PL Klucz do filtra oleju
 DE Ölfilterschlüssel
 RU Ключ к масляному фильтру

CZ Klíč na filtr oleju
 RO Cheie pt. filtru de ulei
 HU Olajszűrő kulcs
 ES Llave para el filtro de aceite



No.	Ø [mm]	
57650	75-95	10/50



- EN Strap wrench set
- PL Zestaw kluczy taśmowych do filtrów oleju
- DE Ölfilter-Bandschlüssel-Set
- RU Набор ленточных ключей для масляных фильтров
- CZ Sada řemenových klíčů na olejové filtry
- RO Set chei cu banda
- HU Olajszűrő leszedő készlet
- ES Juego de llaves de correa para filtros de aceite

2 PCS 10-110 mm 40-160 mm
TPR PP



No.	Ø [mm]	pcs / szt.	
57616	10-110, 40-160	2	6/24

- EN Gear puller
- PL Ściągacz do łożysk
- DE Dreiarmliger Abzieher
- RU Съёмник подшипников 3-х лапчатый
- CZ Stahovák na ložiska
- RO Clește cu 3 brațe pt. extras rulmenți
- HU Hidraulikus csapágyelhúzó
- ES Extractor de cojinetes



No.	Size / Rozmiar	Jaws range / Rozstaw szczęk [mm]	Wrench size / Rozmiar klucza [mm]	Arm quantity / Liczba ramion	
80470	3"	75	14	2	30
80471	4"	100	17	2	24
80472	5"	130	17	2	20
80473	6"	150	19	2	12
80474	8"	200	22	2	6

- EN Coil spring clamp
- PL Ściągacz do sprężyn
- DE Federspanner
- RU Съёмник пружин
- CZ Stahovák pružin tlumičů automobilů
- RO Presa pt. arcuiri
- HU Rugóösszehúzó
- ES Extractor de muelles

2 PCS

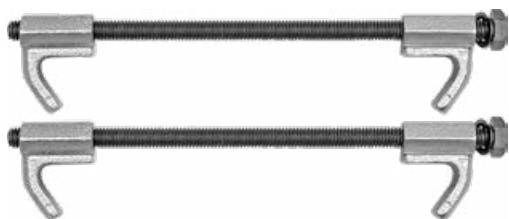

No.	pcs / szt.	
80600	2	6/12

- EN Gear puller
- PL Ściągacz do łożysk
- DE Dreiarmliger Abzieher
- RU Съёмник подшипников 3-х лапчатый
- CZ Stahovák na ložiska
- RO Clește cu 3 brațe pt. extras rulmenți
- HU Hidraulikus csapágyelhúzó
- ES Extractor de cojinetes



No.	Size / Rozmiar	Jaws range / Rozstaw szczęk [mm]	Arm quantity / Liczba ramion	
80500	3"	75	3	4/40
80510	4"	100	3	5/30
80520	6"	150	3	2/20
80530	8"	200	3	2/12

- EN Seal puller
- PL Ściągacz do uszczelek
- DE Dichtungs-Abziehwerkzeug
- RU Съёмник прокладок
- CZ Škrabka na těsnění
- RO Ancoră pt. garnituri
- HU Tömítéslehúzó
- ES Tensor para juntas

325 mm max Ø 82 mm

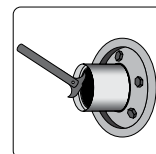

No.	L [mm]	
80701	325	6/36

- EN Coil spring clamp
- PL Ściągacz do sprężyn
- DE Federspanner
- RU Съёмник пружин
- CZ Stahovák pružin tlumičů automobilů
- RO Presa pt. arcuiri
- HU Rugóösszehúzó
- ES Extractor de muelles

2 PCS

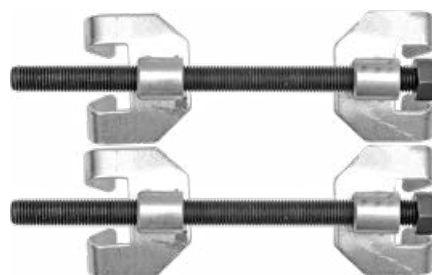

No.	pcs / szt.	
80601	2	10

EN Coil spring clamp
 PL Ściągacz do sprężyn
 DE Federspanner
 RU Съёмник пружин
 CZ Stahovák pružin tlumičů automobilů
 RO Presa pt. arcuți
 HU Rugóösszehúzó
 ES Extractor de muelles

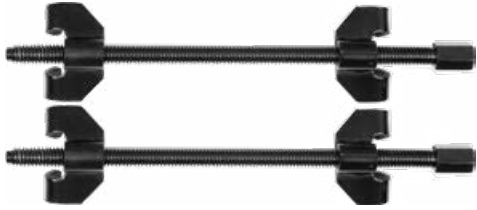
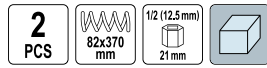

No.	Ø [mm]	L [mm]	pcs / szt.	
80602	82	370	2	12

EN Removal tool set
 PL Zestaw łomów
 DE Brechstangensatz
 RU Набор ломов
 CZ Sada páčidel
 RO Set leviere
 HU Feszítővas készlet
 ES Juego de palancas

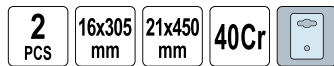

No.	Size / Rozmiar [mm]	pcs / szt.	
34182	16x305, 21x450	2	6/24

EN Tie rod end lifter
 PL Ściągacz do sworzni kulistych
 DE Universal-Kugelgelenk-Abzieher
 RU Съёмник шаровых опор
 CZ Stahovák kulových čepů řízení
 RO Extractor pt. articulatii sferice
 HU Gömbfej kinyomó
 ES Extractor de pernos esféricos



No.	
80620	25/50

EN Tire lever set
 PL Zestaw łyzek do opon
 DE Reifenlöffel-Satz
 RU Набор шинных ложек
 CZ Sada lžic na pneumatiky
 RO Set leviere
 HU Abroncs leszedő szerszámkészlet
 ES Juego de palancas para neumáticos

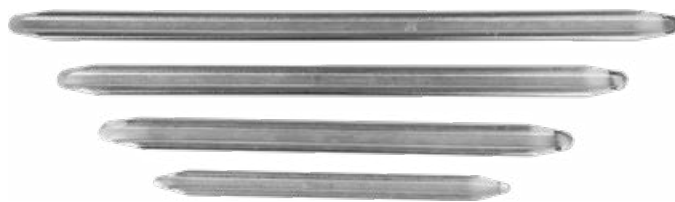

No.	pcs / szt.	
56980	4	10

EN Precision screwdriver and hook set
 PL Zestaw precyzyjnych wkręteków i haczyków
 DE Präzisions-Schraubendreher- und Haken-Satz
 RU Набор точных отверток и крючков
 CZ Sada přesných šroubováků a háčků
 RO Set surubelnite de precizie
 HU Precíziós csavarhúzó és kampó készlet
 ES Set de destornilladores precisos y ganchos



No.	pcs / szt.	
64555	12	10/40

EN Removal tool set
 PL Zestaw łomów
 DE Brechstangensatz
 RU Набор ломов
 CZ Sada páčidel
 RO Set leviere
 HU Feszítővas készlet
 ES Juego de palancas

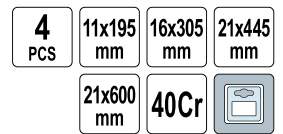

No.	Size / Rozmiar [mm]	pcs / szt.	
34184	11x195, 16x305, 21x445, 21x600	4	2/12

EN Tie rod end lifter
 PL Ściągacz do sworzni kulistych
 DE Universal-Kugelgelenk-Abzieher
 RU Съёмник шаровых опор
 CZ Stahovák kulových čepů řízení
 RO Extractor pt. articulatii sferice
 HU Gömbfej kinyomó
 ES Extractor de pernos esféricos

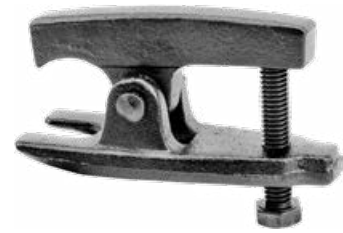

No.	
80640	25



EN Cross rim wrench
 PL Krzyżakowy klucz do kół
 DE Kreuzschlüssel
 RU Ключ-крест балонный
 CZ Klíč na kola křížový
 RO Cheie în cruce pt. roți
 HU Kereszt kerékkulcs
 ES Llave cruz para ruedas



No.	Size / Rozmiar	
57000	17x19x22x13/16" (20.6 mm)	20

EN Cross rim wrench
 PL Krzyżakowy klucz do kół
 DE Kreuzschlüssel
 RU Ключ-крест балонный
 CZ Klíč na kola křížový
 RO Cheie în cruce pt. roți
 HU Kereszt kerékkulcs
 ES Llave cruz para ruedas



No.	Size / Rozmiar	
57020	17x19x21x1/2" (12.7 mm)	10

EN Cross rim wrench
 PL Krzyżakowy klucz do kół
 DE Kreuzschlüssel
 RU Ключ-крест балонный
 CZ Klíč na kola křížový
 RO Cheie în cruce pt. roți
 HU Kereszt kerékkulcs
 ES Llave cruz para ruedas



No.	Size / Rozmiar	
57050	24x27x32x3/4" (19.0 mm)	5

EN Piston ring compressor
 PL Zaciskacz do pierścieni
 DE Kolbenring-Spannband
 RU Зажим колец
 CZ Svěrka na kroužky
 RO Cleşte pt. strâns inele
 HU Gyűrűbepattintó
 ES Pinza para anillos



AISI 304

65Mn



No.	Ø [mm]	H [mm]	
80660	50-125	75	36
80661	75-175	100	36

EN Cross rim wrench
 PL Krzyżakowy klucz do kół
 DE Kreuzschlüssel
 RU Ключ-крест балонный
 CZ Klíč na kola křížový
 RO Cheie în cruce pt. roți
 HU Kereszt kerékkulcs
 ES Llave cruz para ruedas



No.	Size / Rozmiar [mm]	
57010	17x19x21x23	20

EN Cross rim wrench
 PL Krzyżakowy klucz do kół
 DE Kreuzschlüssel
 RU Ключ-крест балонный
 CZ Klíč na kola křížový
 RO Cheie în cruce pt. roți
 HU Kereszt kerékkulcs
 ES Llave cruz para ruedas



No.	Size / Rozmiar [mm]	
57030	17x19x22x23	20

EN L-type wheel wrench
 PL Klucz do kół rozsuwany
 DE Radschlüssel
 RU Ключ баллонный телескопический L-типа
 CZ Klíč na kola rozvírány
 RO Cheie pt. roți extensibilă
 HU Kerékkulcs, kihúzható
 ES Llave para ruedas extensible

360-510 mm 17 mm 19 mm 1/2" 12.7mm



No.	Size / Rozmiar [mm]	L [mm]	Ø	
57100	17x19	360-510	1/2" (12.7 mm)	10/20

EN Spark plug wrench
 PL Klucz do świec
 DE Zündkerzenschlüssel
 RU Ключ свечной
 CZ Svíčkový klíč
 RO Cheie pt. buji
 HU Gyertyakulcs
 ES Llave para bujías



No.	Size / Rozmiar [mm]	L [mm]	
57160	16	150	25/50
57210	21	150	25/50

EN Spark plug wrench
 PL Klucz do świece
 DE Zündkerzenschlüssel
 RU Ключ свечной
 CZ Svíčkový klíč
 RO Cheie pt. buji
 HU Gyertyakulcs
 ES Llave para bujias



No.	Size / Rozmiar [mm]	L [mm]	
57260	16/21	150	25/50

EN Hand-held vacuum pump
 PL Pompka podciśnieniowa z akcesoriami
 DE Unterdruckpumpe mit Zubehör
 RU Насос вакуумметрического давления с принадлежностями
 CZ Podtlaková pumpa s příslušenstvím
 RO Pompa de vidare cu accesorii
 HU Vákuum- és ac-pumpa mérő, tartozékokkal
 ES Bomba de subpresión con accesorios



No.		
81690		10

EN Brake piston wind back
 PL Separator do zacisków hamulcowych
 DE Separator für Bremssattel
 RU Сепаратор для тормозных суппортов
 CZ Oddělovač brzdových třmenů
 RO Extractor disc de frana
 HU Féknyereg dugattyú
 ES Separador para pinzas de freno

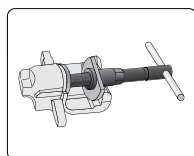

Audi, VW, Ford, Honda, Jaguar, Mazda, Mitsubishi, Nissan, Rover, Saab, Subaru, Skoda, Toyota, Volvo

No.		
57730		10/20

EN Spark plug wrench
 PL Klucz do świece
 DE Zündkerzenschlüssel
 RU Ключ свечной
 CZ Svíčkový klíč
 RO Cheie pt. buji
 HU Gyertyakulcs
 ES Llave para bujias

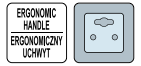

No.	Size / Rozmiar [mm]	L [mm]	
57220	16	260	20/40
57221	21	260	20/40

EN Flare nut wrenches
 PL Klucze do przewodów hamulcowych
 DE Bremsleitungschlüsselsatz
 RU Набор ключей разрезных
 CZ Klíče na vedení brzdy
 RO Cheie pt. conducte de frână
 HU Fékcsőkulcs
 ES Llaves para tubería de frenado

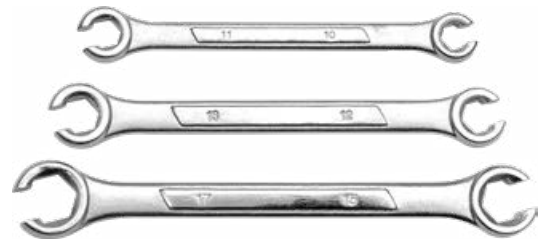

No.	pcs / szt.	
57700	3	12/60

EN Disc brake piston tool
 PL Uniwersalny klucz do wkręcania zacisków hamulcowych
 DE Bremskolbenrücksteller universal
 RU Ключ для тормозного поршня
 CZ Univerzální klíč k montáži brzdových třmenů
 RO Dispozitiv pt. impins etrier
 HU Féknyereg összenyomó
 ES Llave para comprimir pistones del freno de disco

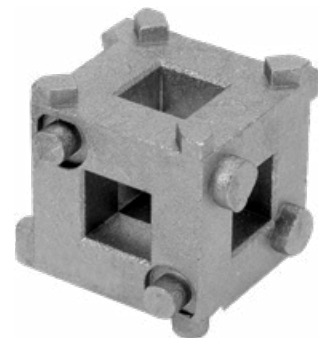
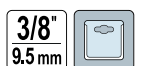

General Motors, Ford, Chrysler, VW, Fiat

No.		
57740	3/8" (9.5 mm)	6/72

- EN Paint thickness tester
- PL Tester grubości lakieru
- DE Lackdickenmessgerät
- RU Толщиномер лакокрасочного покрытия
- CZ Tester tloušťky laku
- RO Tester de buzunar grosime vopsea
- HU Rétegvastagság mérő
- ES Medidor de espesor de recubrimiento

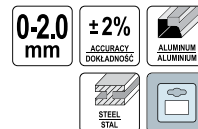

No.	Icon
81731	

- EN Car voltage tester
- PL Samochodowy próbnik napięcia
- DE Autospannungstester
- RU Пробник автомобильный
- CZ Automobilový zkoušeč napětí
- RO Creion de tensiune pt. automobile
- HU Autós fáziskereső
- ES Comprobador de corriente de coche



No.	Measuring range / Zakres pomiaru [V d.c.]	Icon
65260	6-24	

- EN Pick-up tool
- PL Łapka do podnoszenia
- DE Starer Greifer
- RU Гибкий захват „Pick-up”
- CZ Patka pro zdvínání
- RO Surubelnita flexibila
- HU Emelőlapka
- ES Grifo para recoger pick up



No.	L [mm]	Icon
78400	600	

- EN Flexible pick-up handle, magnetic
- PL Łapka magnetyczna, giętka
- DE Magnetisch flexibler Greifer
- RU Гибкий магнитный захват
- CZ Vytahováč magnetický ohebný
- RO Surubelnita flexibila magnetica
- HU Mágneses felszedő eszköz, hajlékony nyél
- ES Grifo magnético flexible



No.	L [mm]	Icon
78401	600	

- EN Car voltage tester
- PL Samochodowy próbnik napięcia
- DE Autospannungstester
- RU Пробник автомобильный
- CZ Automobilový zkoušeč napětí
- RO Creion de tensiune pt. automobile
- HU Autós fáziskereső
- ES Comprobador de corriente de coche



No.	Measuring range / Zakres pomiaru [V d.c.]	Icon
65270	6-24	

- EN Telescopic pick up and mirror set
- PL Zestaw inspekcyjny: lusterko + chwytak
- DE Inspektionssatz: Spiegel + Greifer
- RU Проверочный набор - держатель и зеркальце
- CZ Inspekční souprava: zrcadlo + držák
- RO Garnitură de control: oglindă + benă
- HU Teleszkópos ellenőrző készlet: tükör + felvevő
- ES Juego de inspección: espejo + cuchara de mordazas



No.	pcs / szt.	Icon
78410	2	

- EN Magnetic wristband
- PL Opaska magnetyczna
- DE Haftmagnet
- RU Браслет магнитный
- CZ Magnetický pás
- RO Bratară magnetica
- HU Mágneses szalag
- ES Banda magnética

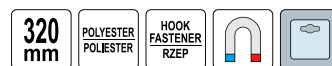

No.	L [mm]	Icon
78756	320	

EN LED magnetic pick up tool
 PL Chwytnak teleskopowy LED
 DE LED Magnet Heber
 RU Захват магнитный телескопический с подсветкой
 CZ Patka magnetická teleskopická LED
 RO Telescop magnetic cu LED
 HU LED felszedő mágnes teleszkópos nyéllel
 ES Herramienta para levantar, telescópica, con LED

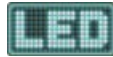
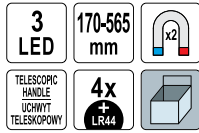

No.	Light source / Źródło światła [LED]	Battery type / Rodzaj baterii	
78405	3	4x; LR44	12/48

EN Pneumatic car seat
 PL Taboret warsztatowy teleskopowy
 DE Werkstattthocker, teleskopisch
 RU Табурет рабочий подъемный
 CZ Dílenský taburet teleskopický
 RO Taburet atelier telescopic
 HU Teleszkópos műhely zsámoly
 ES Taburete de taller telescópico

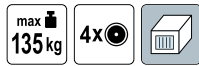

No.	Max. load capacity / Maks. obciążenie [kg]	
81825	135	4

EN Electric impact wrench
 PL Elektryczny klucz udarowy
 DE Elektro-Schlagschrauber
 RU Электрический гайковерт
 CZ Elektrický rázový uťahovák
 RO Pistol de impact electric
 HU Elektromos ütvecsavarozó
 ES llave de impacto eléctrica

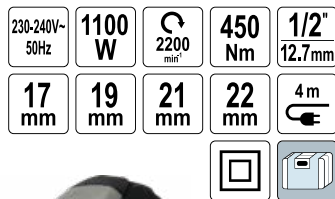

$L_{pA} = 89,0 \pm 3,0$ dB; $L_{wA} = 100,0 \pm 3,0$ dB; $a_n = 10,04 \pm 1,5$ m/s²

No.	Power / Moc [W]	ω [min ⁻¹]	
57092	1100	2200	2

EN Workshop seat with drawer
 PL Taboret warsztatowy z szufladą
 DE Werkstattthocker mit Schublade
 RU Табурет рабочий с ящиком
 CZ Dílenský taburet se zásuvkou
 RO Taburet atelier cu sertar
 HU Műhely zsámoly fiókkal
 ES Taburete de taller con cajón

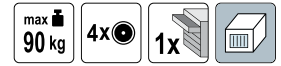

No.	Max. load capacity / Maks. obciążenie [kg]	
81824	90	4

EN Electric impact wrench
 PL Elektryczny klucz udarowy
 DE Elektro-Schlagschrauber
 RU Электрический гайковерт
 CZ Elektrický rázový uťahovák
 RO Pistol de impact electric
 HU Elektromos ütvecsavarozó
 ES llave de impacto eléctrica

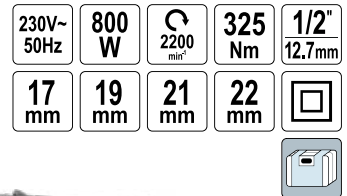

$L_{pA} = 87,5 \pm 3,0$ dB; $L_{wA} = 98,5 \pm 3,0$ dB; $a_n = 9,93 \pm 1,5$ m/s²

No.	Power / Moc [W]	ω [min ⁻¹]	
57091	800	2200	5

EN Electric impact wrench
 PL Elektryczny klucz udarowy
 DE Elektro-Schlagschrauber
 RU Электрический гайковерт
 CZ Elektrický rázový uťahovák
 RO Pistol de impact electric
 HU Elektromos ütvecsavarozó
 ES llave de impacto eléctrica

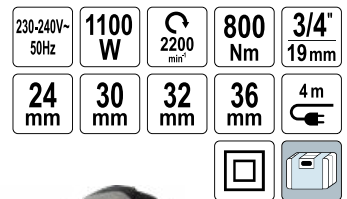

$L_{pA} = 89,0 \pm 3,0$ dB; $L_{wA} = 100,0 \pm 3,0$ dB; $a_n = 10,04 \pm 1,5$ m/s²

No.	Power / Moc [W]	ω [min ⁻¹]	
57097	1100	2200	2

- EN Workshop LED battery lamp
- PL Diodowa lampa warsztatowa akumulatorowa
- DE LED Akku-Werkstattlampe
- RU Светодиодная беспроводная лампа
- CZ Aku pracovní LED svítlna
- RO Lampa portabila cu acumulator leduri
- HU Akkumulátoros LED szerelőlámpa
- ES Lámpara de trabajo LED recargable



FRONT LIGHT
LATARKA

5+3 W

300/170 lm

3.7 V
2000mAh
Li-Ion

4h

3.5-5h

IP44

IK08

X1
HOOK
HAK

USB
CHARGING
LADÓVÁNYE

X2

X1
HOOK
HAK



No.	Power / Moc [W]	Battery capacity / Pojemność akumulatora [mAh]	
82736	5+3	2000	10

- EN LED work light
- PL Lampa robocza LED
- DE LED Handleuchte
- RU Светодиодный светильник для мастерской
- CZ Pracovní LED svítlna
- RO Lampa portabila cu LED
- HU LED szerelőlámpa
- ES Lámpara de taller LED

3W

100 lm

2
LIGHTING MODES
TÍPUS VÁZGÁLÁS

4h

3.7 V
800mAh
Li-Ion

Micro
USB

X1
HOOK
HAK

X1
HOOK
HAK



COB



No.	Power / Moc [W]	Battery capacity / Pojemność akumulatora [mAh]	
82723	3	800	12/48

- EN LED work light
- PL Lampa robocza LED
- DE LED Handleuchte
- RU Светодиодный светильник для мастерской
- CZ Pracovní LED svítlna
- RO Lampa portabila cu LED
- HU LED szerelőlámpa
- ES Lámpara de taller LED

230V~
50Hz

4.5 W

400 lm

24 LED

X1
HOOK
HAK

5m



SMD

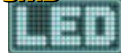

No.	Power / Moc [W]	Light source / Źródło światła [LED]	
82706	4.5	24	10/20

- EN Work light
- PL Lampa warsztatowa
- DE Werkstattlampe
- RU Лампа-переноска
- CZ Pracovní lampa
- RO Lampă pt. atelier
- HU Szerelőlámpa
- ES Lámpara de taller

230V~
50Hz

60 W

E27

5m



No.	Max. power of light source / Maks. moc źródła światła [W]	Series / Seria	
82715	60	PLASTIC	10



COB



- EN LED work light
- PL Lampa robocza LED
- DE LED Handleuchte
- RU Светодиодный светильник для мастерской
- CZ Pracovní LED svítlna
- RO Lampa portabila cu LED
- HU LED szerelőlámpa
- ES Lámpara de taller LED

230V~
50Hz

3.2 W

280 lm

16 LED

X1
HOOK
HAK

5m

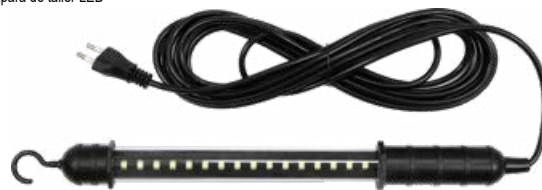

SMD



No.	Power / Moc [W]	Light source / Źródło światła [LED]	
82699	3.2	16	10/20

- EN Work light
- PL Lampa warsztatowa
- DE Werkstattlampe
- RU Лампа-переноска
- CZ Pracovní lampa
- RO Lampă pt. atelier
- HU Szerelőlámpa
- ES Lámpara de taller

230V~
50Hz

100 W

E27

5m



No.	Max. power of light source / Maks. moc źródła światła [W]	Series / Seria	
82713	100	PRACTIC	10

- EN Work light
- PL Lampa warsztatowa
- DE Werkstattlampe
- RU Лампа-переноска
- CZ Pracovní lampa
- RO Lampă pt. atelier
- HU Szerelőlámpa
- ES Lámpara de taller

230V~
50Hz

60 W

E27

5m



No.	Max. power of light source / Maks. moc źródła światła [W]	Series / Seria	
82714	60	CLASSIC	10

EN Work light
 PL Lampa warsztatowa
 DE Werkstattlampe
 RU Лампа-переноска
 CZ Pracovní lampa
 RO Lampă pt. atelier
 HU Szerelőlámpa
 ES Lámpara de taller

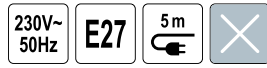

No.	Max. power of light source / Maks. moc źródła światła [W]	Series / Seria	
82717	100	GUMMI	10

EN Workshop LED battery lamp
 PL Diodowa lampa warsztatowa akumulatorowa
 DE LED Akku-Werkstattlampe
 RU Светодиодная беспроводная лампа
 CZ Aku pracovní LED svítlna
 RO Lampă portabilă cu acumulator leduri
 HU Akkumulátoros LED szerelőlámpa
 ES Lámpara de trabajo LED recargable

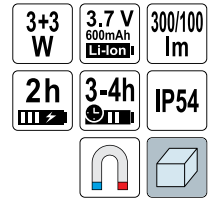

No.	Power / Moc [W]	Battery capacity / Pojemność akumulatora [mAh]	
82734	3+3	600	120

EN Workshop LED battery lamp
 PL Diodowa lampa warsztatowa akumulatorowa
 DE LED Akku-Werkstattlampe
 RU Светодиодная беспроводная лампа
 CZ Aku pracovní LED svítlna
 RO Lampă portabilă cu acumulator leduri
 HU Akkumulátoros LED szerelőlámpa
 ES Lámpara de trabajo LED recargable



No.	Power / Moc [W]	Battery capacity / Pojemność akumulatora [mAh]	
82743	8+3	2000	50



EN LED work light
 PL Lampa robocza LED
 DE LED Handleuchte
 RU Светодиодный светильник для мастерской
 CZ Pracovní LED svítlna
 RO Lampă portabilă cu LED
 HU LED szerelőlámpa
 ES Lámpara de taller LED

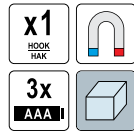

No.	Battery type / Rodzaj baterii	
82724	3x1.5V; AAA	12/48

EN LED work light
 PL Lampa robocza LED
 DE LED Handleuchte
 RU Светодиодный светильник для мастерской
 CZ Pracovní LED svítlna
 RO Lampă portabilă cu LED
 HU LED szerelőlámpa
 ES Lámpara de taller LED

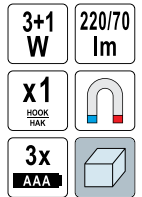

No.	Battery type / Rodzaj baterii	
82733	3x1.5V; AAA	24/48

EN LED work light
 PL Lampa robocza LED
 DE LED Handleuchte
 RU Светодиодный светильник для мастерской
 CZ Pracovní LED svítlna
 RO Lampă portabilă cu LED
 HU LED szerelőlámpa
 ES Lámpara de taller LED

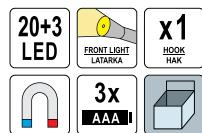

No.	Light source / Źródło światła [LED]	Battery type / Rodzaj baterii	
82730	20+3	3x1.5V; AAA	12/48

EN LED work light
 PL Lampa robocza LED
 DE LED Handleuchte
 RU Светодиодный светильник для мастерской
 CZ Pracovní LED svítlna
 RO Lampă portabilă cu LED
 HU LED szerelőlámpa
 ES Lámpara de taller LED

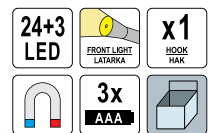

No.	Light source / Źródło światła [LED]	Battery type / Rodzaj baterii	
82731	24+3	3x1.5V; AAA	12/48

EN LED work light
 PL Lampa robocza LED
 DE LED Handleuchte
 RU Светодиодный светильник для мастерской
 CZ Pracovní LED svítidla
 RO Lampa portabilă cu LED
 HU LED szerelőlámpa
 ES Lámpara de taller LED



COB
LED



VOREL

No.	Battery type / Rodzaj baterii	
82726	3x1.5V; AA	12/48

EN UV LED flashlight and glasses set
 PL Zestaw latarka UV LED i okulary
 DE UV LED Taschenlampe mit UV Schutzbrille
 RU Комплект для проверки утечек хладагента - УФ фонарь с очками
 CZ UV LED svítilna + brýle
 RO Set lanternă UV LED și ochelari
 HU UV LED zseblámpa + szemüveg
 ES UV LED linterna con gafas para

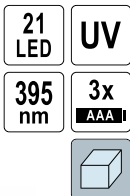

UV
LED

VOREL

No.	Light source / Źródło światła [LED]	Battery type / Rodzaj baterii	
82756	21	3x1.5V; AAA	80

EN LED flashlight
 PL Latarka LED
 DE LED Taschenlampe
 RU Светодиодный фонарь
 CZ LED svítilna
 RO Lanternă cu LED
 HU LED zseblámpa
 ES Linterna LED



POWER
LED

VOREL

No.	Power / Moc [W]	Battery type / Rodzaj baterii	
88555	5	3x1.5V; AAA	12/48

EN LED work light
 PL Lampa robocza LED
 DE LED Handleuchte
 RU Светодиодный светильник для мастерской
 CZ Pracovní LED svítidla
 RO Lampa portabilă cu LED
 HU LED szerelőlámpa
 ES Lámpara de taller LED



LED



VOREL

No.	Light source / Źródło światła [LED]	Battery type / Rodzaj baterii	
82735	36+1	4x1.5V; AAA	12/48

EN LED flashlight
 PL Latarka LED
 DE LED Taschenlampe
 RU Светодиодный фонарь
 CZ LED svítilna
 RO Lanternă cu LED
 HU LED zseblámpa
 ES Linterna LED



POWER
LED

VOREL

No.	Power / Moc [W]	Battery type / Rodzaj baterii	
88560	10	3x1.5V; AA	12/24

EN Hydraulic bottle jack
 PL Podnośnik hydrauliczny słupkowy
 DE Hydraulischer Stempelwagenheber
 RU Домкрат гидравлический

CZ Pístový zvedák hydraulický
 RO Cric hidraulic
 HU Hidraulikus emelő
 ES Gato hidráulico de botella



VOREL

No.	Max. lifting capacity / Maks. udźwig [t]	Lifting range / Zakres podnoszenia [mm]	
80012	2	140-260	6
80022	3	168-326	6
80032	5	185-355	4
80042	8	190-365	4
80052	10	195-375	4
80062	12	200-380	3
80072	15	205-390	2
80082	20	217-402	2

EN Hydraulic floor jack
 PL Podnośnik hydrauliczny
 DE Hydraulischer Rangierwagenheber
 RU Домкрат гидравлический
 CZ Pístový zvedák hydraulický
 RO Cric tip crocodil
 HU Krokodil emelő
 ES Gato hidráulico



No.	Max. lifting capacity / Maks. udźwig [t]	Lifting range / Zakres podnoszenia [mm]	
80111	2	135-340	1

EN Scissors jack
 PL Podnośnik mechaniczny trapezowy
 DE Trapezwagenheber
 RU Домкрат механический ромбовый
 CZ Lichoběžníkový zvedák
 RO Cric mecanic
 HU Trapézemelő
 ES Gato mecanico-trapezoidal

EN Scissors jack
 PL Podnośnik mechaniczny trapezowy
 DE Trapezwagenheber
 RU Домкрат механический ромбовый
 CZ Lichoběžníkový zvedák
 RO Cric mecanic
 HU Trapézemelő
 ES Gato mecanico-trapezoidal



No.	Max. lifting capacity / Maks. udźwig [t]	Lifting range / Zakres podnoszenia [mm]	
80252	1.5	95-390	5

No.	Max. lifting capacity / Maks. udźwig [t]	Lifting range / Zakres podnoszenia [mm]	
80271	1.2	100-350	4

EN Rubber pad for jacks
 PL Podkładka gumowa do podnośnika
 DE Gummianterlage für Wagenheber
 RU Резиновая шайба для домкрата
 CZ Gumová podložka zvedáku
 RO Talpa de cauciuc pentru cricuri
 HU Gumipogácsa krokodilemelőkhöz
 ES Almohadilla de caucho para gatos



No.	Ø [mm]	
80107	97	200

EN Jack stand
 PL Podstawka pod samochód
 DE Unterstellbock
 RU Подставка для автомобиля
 CZ Podstavec pod auto
 RO Chituc de metal
 HU Gépkocsi alátét
 ES Apoyos de coche



No.	Max. lifting capacity / Maks. udźwig [t]	Lifting range / Zakres podnoszenia [mm]	pcs / szt.	
80307	2	265-390	2	4
80308	3	275-415	2	4
80309	6	360-585	2	2

EN Jack stand
 PL Podstawka pod samochód
 DE Unterstellbock
 RU Подставка для автомобиля
 CZ Podstavec pod auto
 RO Chituc de metal
 HU Gépkocsi alátét
 ES Apoyos de coche



No.	Max. lifting capacity / Maks. udźwig [t]	Lifting range / Zakres podnoszenia [mm]	
80300	2	250-380	5

EN Jack stand
 PL Podstawka pod samochód
 DE Unterstellbock
 RU Подставка для автомобиля
 CZ Podstavec pod auto
 RO Chituc de metal
 HU Gépkocsi alátét
 ES Apoyos de coche



No.	Max. lifting capacity / Maks. udźwig [t]	Lifting range / Zakres podnoszenia [mm]	pcs / szt.	
80312	2	280-370	2	5

- EN Porta power repair kit
 PL Rozpieraek hydrauliczny
 DE Hydraulischer Richt und Ausbeulsatz
 RU Гидравлическая распорная стойка в наборе
- CZ Hydraulický rozpěrák
 RO Trusa pompa hidraulica + accesorii
 HU Hidraulikus bontó
 ES Gato carroceró hidráulico

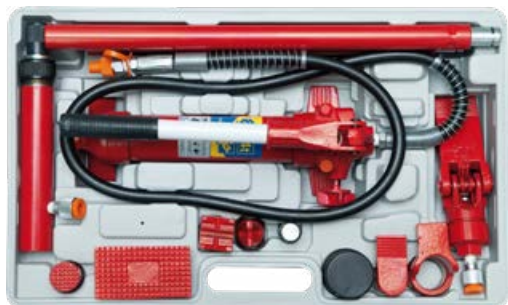

No.	Max. load capacity / Maks. obciążenie [t]	
80402	4	1

- EN Accessories for porta power
 PL Pompa do rozpiękania hydraulicznego
 DE Druckeinheit für Hydr. Spreizer
 RU Ручной насос для гидравлической распорной стойки
 CZ Pumpa na hydraulický rozpěrák
 RO Pompa hidraulica
 HU Szivattyú hidraulikus bontóhoz
 ES Bomba hidraulica para gato carroceró



No.	Max. load capacity / Maks. obciążenie [t]	
80320	4	2
80330	10	2

- EN Accessories for porta power
 PL Siłownik do rozpiękania hydraulicznego
 DE Kraftzylinder für hydraulischer Spreizer
 RU Сервомотор для гидравлической распорной стойки
 CZ Servomotor na hydraulický rozpěrák
 RO Accesorii pompa hidraulica
 HU Erőátvitel a hidraulikus bontóhoz
 ES Cilindro para gato carroceró



No.	Max. load capacity / Maks. obciążenie [t]	
80340	4	4
80350	10	4

- EN Porta power repair kit
 PL Rozpieraek hydrauliczny
 DE Hydraulischer Richt und Ausbeulsatz
 RU Гидравлическая распорная стойка в наборе
- CZ Hydraulický rozpěrák
 RO Trusa pompa hidraulica + accesorii
 HU Hidraulikus bontó
 ES Gato carroceró hidráulico



No.	Max. load capacity / Maks. obciążenie [t]	
80412	10	1

- EN Pull-back ram
 PL Ściągacz blacharski hydrauliczny
 DE Hydraulische Zugzylinderheit
 RU Гидравлическая стяжка-крюк
 CZ Klempířské stahovadlo hydraulické
 RO Carlig hidraulic tractare
 HU Hidraulikus lemezkihúzó
 ES Extractor de latonería de fontanero

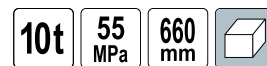

No.	Max. load capacity / Maks. obciążenie [t]	Operating pressure / Ciśnienie robocze [MPa]	
80450	10	55	4

- EN Electronic battery charger
 PL Prostownik elektroniczny
 DE Elektronisches Ladegerät
 RU Электронное зарядное устройство
 CZ Elektronická nabíječka
 RO Redresor electric
 HU Elektronikus akkumulátortöltő
 ES Cargador de batería para coche



No.	Charging voltage / Napięcie ładowania [V d.c.]	Charging current / Prąd ładowania [A]	Battery capacity / Pojemność akumulatora [Ah]	
82541	12	2.8	8-60	10

EN Electronic battery charger
 PL Prostownik elektroniczny
 DE Elektronisches Ladegerät
 RU Электронное зарядное устройство
 CZ Elektronická nabíječka
 RO Redresor electric
 HU Elektronikus akkumulátortöltő
 ES Cargador de batería para coche



max 6A CHARGING CURRENT PRĄD ŁADUNKOWY
 230V~ 50Hz
 12 V 4.2 A
 12-90 Ah WET MOKRY
 LED DISPLAY WYŚWIETLACZ

No.	Charging voltage / Napięcie ładowania [V d.c.]	Charging current / Prąd ładowania [A]	Battery capacity / Pojemność akumulatora [Ah]	
82542	12	4.2	12-90	10

EN Electronic battery charger
 PL Prostownik elektroniczny
 DE Elektronisches Ladegerät
 RU Электронное зарядное устройство
 CZ Elektronická nabíječka
 RO Redresor electric
 HU Elektronikus akkumulátortöltő
 ES Cargador de batería para coche



max 12A CHARGING CURRENT PRĄD ŁADUNKOWY
 230V~ 50Hz
 6V 12 V
 10.3 A 26-210 Ah
 WET MOKRY LED DISPLAY WYŚWIETLACZ

No.	Charging voltage / Napięcie ładowania [V d.c.]	Charging current / Prąd ładowania [A]	Battery capacity / Pojemność akumulatora [Ah]	
82544	6/12	10.3	26-210	5

EN Pressure gauge
 PL Wskaźnik ciśnienia
 DE Druckanzeige
 RU Манометр
 CZ Tlakomer
 RO Indicator de presiune
 HU Nyomásmérő
 ES Manómetro



0.05-0.75 MPa

No.	Measuring range / Zakres pomiaru [MPa/bar]	
82610	0.05-0.75 / 0.5-7.5	25/150

EN Pressure gauge
 PL Wskaźnik ciśnienia
 DE Druckanzeige
 RU Манометр
 CZ Tlakomer
 RO Indicator de presiune
 HU Nyomásmérő
 ES Manómetro



No.	Measuring range / Zakres pomiaru [MPa/bar]	
82650	0.05-0.75 / 0.5-7.5	10/100

EN Electronic battery charger
 PL Prostownik elektroniczny
 DE Elektronisches Ladegerät
 RU Электронное зарядное устройство
 CZ Elektronická nabíječka
 RO Redresor electric
 HU Elektronikus akkumulátortöltő
 ES Cargador de batería para coche



max 8A CHARGING CURRENT PRĄD ŁADUNKOWY
 230V~ 50Hz
 6V 12 V
 5.8 A 12-120 Ah
 WET MOKRY LED DISPLAY WYŚWIETLACZ

No.	Charging voltage / Napięcie ładowania [V d.c.]	Charging current / Prąd ładowania [A]	Battery capacity / Pojemność akumulatora [Ah]	
82543	6/12	5.8	12-120	5

EN Battery tester
 PL Tester akumulatorów
 DE Batterieprüfgerät
 RU Тестер аккумуляторов
 CZ Tester akumulátorů
 RO Tester acumulatori
 HU Akkuteszter
 ES Tester para acumuladores



12 V BATTERY TEST TEST AKUMULATORA ALTERNATOR TEST TEST ALTERNATORA

No.	
81741	24/48

EN Pressure gauge
 PL Wskaźnik ciśnienia
 DE Druckanzeige
 RU Манометр
 CZ Tlakomer
 RO Indicator de presiune
 HU Nyomásmérő
 ES Manómetro



0.05-0.3 MPa

No.	Measuring range / Zakres pomiaru [MPa/bar]	
82611	0.05-0.3 / 0.5-3	10

0.05-0.75 MPa

- EN Chain block
- PL Wyciągarka łańcuchowa
- DE Kettenzug Flaschenzug
- RU Таль цепная
- CZ Zvedák řetězový
- RO Scripete cu lant
- HU Láncos csigasor emelő
- ES Cabria de cadena



No.	Max. load capacity / Maks. obciążenie [kg]	Chain length / Długość łańcucha [m]	
80751	1000	3	1
80752	2000	3	1
80753	3000	3	1

- EN Foot pump with gauge
- PL Pompka nożna z manometrem
- DE Fusspumpe
- RU Насос ножный с манометром
- CZ Nožní pumpa s manometrem
- RO Pompă de picior cu manometru
- HU Lábpumpa nyomásmérővel
- ES Bomba de pierna con manometro



No.	Measuring range / Zakres pomiaru [MPa]	
82005	0-0.7	5

- EN Foot pump with gauge
- PL Pompka nożna z manometrem
- DE Fusspumpe
- RU Насос ножный с манометром
- CZ Nožní pumpa s manometrem
- RO Pompă de picior cu manometru
- HU Lábpumpa nyomásmérővel
- ES Bomba de pierna con manometro



No.	Measuring range / Zakres pomiaru [MPa]	
82015	0-0.7	6

- EN Hand pump
- PL Pompka słupkowa ręczna
- DE Hand-Luftpumpe
- RU Насос ручной
- CZ Hústlika ruční
- RO Pompa de mana
- HU Kézi pumpa
- ES Bomba de barrote de mano

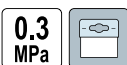

No.	Measuring range / Zakres pomiaru [MPa]	
82020	0-0.3	20

- EN Hand pump with manometer
- PL Pompka słupkowa z manometrem
- DE Hand-Luftpumpe mit Manometer
- RU Насос ручной с манометром
- CZ Pumpa s manometrem
- RO Pompa de mana cu manometru
- HU Kézi pumpa manométerrel
- ES Bomba de barrote con manometro

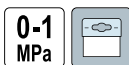

No.	Measuring range / Zakres pomiaru [MPa]	
82021	0-1	10

- EN Hand pump with manometer
- PL Pompka słupkowa z manometrem
- DE Hand-Luftpumpe mit Manometer
- RU Насос ручной с манометром
- CZ Pumpa s manometrem
- RO Pompa de mana cu manometru
- HU Kézi pumpa manométerrel
- ES Bomba de barrote con manometro



No.	Measuring range / Zakres pomiaru [MPa]	
82022	0-1.1	10

- EN Foot pump with gauge
- PL Pompka nożna z manometrem
- DE Fusspumpe
- RU Насос ножный с манометром

- CZ Nožní pumpa s manometrem
- RO Pompă de picior cu manometru
- HU Lábpumpa nyomásmérővel
- ES Bomba de pierna con manometro



No.	
82000	20

- EN Foot pump with gauge
- PL Pompka nożna z manometrem
- DE Fusspumpe
- RU Насос ножный с манометром

- CZ Nožní pumpa s manometrem
- RO Pompă de picior cu manometru
- HU Lábpumpa nyomásmérővel
- ES Bomba de pierna con manometro



No.	Measuring range / Zakres pomiaru [MPa]	
82001	0-0.7	12



EN Hand pump with manometer
 PL Pompka słupkowa z manometrem
 DE Hand-Luftpumpe mit Manometer
 RU Насос ручной с манометром
 CZ Pumpa s manometrem
 RO Pompa de mana cu manometru
 HU Kézi pumpa manométerrel
 ES Bomba de barrote con manometro



0-1.1 MPa
 100 cm
 UNIVERSAL DOUBLE HEAD
 UNIVERSALNA GŁOWICA PODWÓJNA



No.	Measuring range / Zakres pomiaru [MPa]	
82023	0-1.1	30

EN Car air compressor
 PL Kompressor samochodowy
 DE Auto-Kompressor
 RU Автомобильный компрессор
 CZ Automobilový kompresor
 RO Compresor auto
 HU Autókompresszor
 ES Compresor de coche



120 W
 12 V
 35 l/min
 1.0 MPa
 1 m
 3 m



No.	Voltage / Napięcie [V d.c.]	Power / Moc [W]	
82107	12	120	8

EN Air pump wedge set
 PL Zestaw poduszek montażowych
 DE Montagekissen-Set
 RU Набор монтажных подушек
 CZ Rozpínací polštářky
 RO Set perne de aer
 HU Szerelőpárna készlet
 ES Juego de bolsas de cuña de aer



2 PCS
 50 mm
 max 135 kg
 TPU



No.	Size / Rozmiar [mm]	pcs / szt.	
39005	190x115, 130x270	2	60

EN Tow rope
 PL Linka holownicza
 DE Abschleppseil
 RU Трос автомобильный буксировочный
 CZ Táhý provázek
 RO Șufă pt. remorcare
 HU Vonatókötél
 ES Cable de remolque



No.	Gross vehicle mass GVM / Dopuszczalna masa całkowita pojazdu DMC [kg]	
82205	2500	10

EN Car air compressor
 PL Kompressor samochodowy
 DE Auto-Kompressor
 RU Автомобильный компрессор
 CZ Automobilový kompresor
 RO Compresor auto
 HU Autókompresszor
 ES Compresor de coche



120 W
 12 V
 25 l/min
 1.0 MPa
 46 cm
 3 m



No.	Voltage / Napięcie [V d.c.]	Power / Moc [W]	
82105	12	120	36

EN Air wedge
 PL Poduszka montażowa
 DE Luft Keil
 RU Монтажная подушка для установки окон и дверей
 CZ Zvedací vzduchové měchy
 RO Perne de aer
 HU Emelőpárna
 ES Cojines elevadores



50 mm
 max 135 kg
 TPU



No.	Size / Rozmiar [mm]	
39000	160x160	120
39001	190x115	120
39002	130x270	60

EN Tow rope
 PL Linka holownicza
 DE Abschleppseil
 RU Трос автомобильный буксировочный
 CZ Táhý provázek
 RO Șufă pt. remorcare
 HU Vonatókötél
 ES Cable de remolque



No.	Gross vehicle mass GVM / Dopuszczalna masa całkowita pojazdu DMC [kg]	
82201	1500	20

EN Tow rope
 PL Linka holownicza
 DE Abschleppseil
 RU Трос автомобильный буксировочный
 CZ Táhý provázek
 RO Șufă pt. remorcare
 HU Vonatókötél
 ES Cable de remolque



No.	Gross vehicle mass GVM / Dopuszczalna masa całkowita pojazdu DMC [kg]	
82209	2500	8

EN Tow rope
 PL Linka holownicza
 DE Abschleppseil
 RU Трос автомобильный буксировочный
 CZ Tážný provázek
 RO Șufă pt. remorcare
 HU Vonatókötél
 ES Cable de remolque



No.	Gross vehicle mass GVM / Dopuszczalna masa całkowita pojazdu DMC [kg]	12
82200	3500	12

EN Tow rope
 PL Linka holownicza
 DE Abschleppseil
 RU Трос автомобильный буксировочный
 CZ Tážný provázek
 RO Șufă pt. remorcare
 HU Vonatókötél
 ES Cable de remolque



No.	Gross vehicle mass GVM / Dopuszczalna masa całkowita pojazdu DMC [kg]	20
82225	2500	20

EN Tow rope
 PL Linka holownicza z szeklą
 DE Abschleppseil
 RU Трос автомобильный буксировочный
 CZ Tážný provázek
 RO Șufă pt. remorcare
 HU Vonatókötél
 ES Cable de remolque



No.	Gross vehicle mass GVM / Dopuszczalna masa całkowita pojazdu DMC [kg]	16
82232	2500	16

EN Tow rope
 PL Linka holownicza z hakiem
 DE Abschleppseil
 RU Трос автомобильный буксировочный
 CZ Tážný provázek
 RO Șufă pt. remorcare
 HU Vonatókötél
 ES Cable de remolque



No.	Gross vehicle mass GVM / Dopuszczalna masa całkowita pojazdu DMC [kg]	20
82231	1500	20

EN Tow rope
 PL Linka holownicza
 DE Abschleppseil
 RU Трос автомобильный буксировочный
 CZ Tážný provázek
 RO Șufă pt. remorcare
 HU Vonatókötél
 ES Cable de remolque



No.	Gross vehicle mass GVM / Dopuszczalna masa całkowita pojazdu DMC [kg]	12
82206	3500	12

EN Tow rope
 PL Linka holownicza
 DE Abschleppseil
 RU Трос автомобильный буксировочный
 CZ Tážný provázek
 RO Șufă pt. remorcare
 HU Vonatókötél
 ES Cable de remolque



No.	Gross vehicle mass GVM / Dopuszczalna masa całkowita pojazdu DMC [kg]	20
82227	3500	20

EN Tow rope
 PL Linka holownicza z szeklą
 DE Abschleppseil
 RU Трос автомобильный буксировочный
 CZ Tážný provázek
 RO Șufă pt. remorcare
 HU Vonatókötél
 ES Cable de remolque



No.	Gross vehicle mass GVM / Dopuszczalna masa całkowita pojazdu DMC [kg]	12
82234	3500	12

EN Tow rope
 PL Linka holownicza z hakiem
 DE Abschleppseil
 RU Трос автомобильный буксировочный
 CZ Tážný provázek
 RO Șufă pt. remorcare
 HU Vonatókötél
 ES Cable de remolque



No.	Gross vehicle mass GVM / Dopuszczalna masa całkowita pojazdu DMC [kg]	16
82233	2500	16

EN Battery clamps cleaner
 PL Szczotka do czyszczenia klem
 DE Klemmbürste
 RU Щетка для зачистки клемм
 CZ Kartáč pro čištění svorek
 RO Perie curatat borne auto
 HU Akkumulátorsaru tisztító kefe
 ES Cepillo para limpiar bornes



No.		
82440		10/160

EN Battery clamps
 PL Komplet klem do akumulatora
 DE Aku-Polklemmen
 RU Клеммы аккумуляторные
 CZ Sada svorek na akumulátor
 RO Set de cleme pt. acumulator
 HU Akkumulátorsaru készlet
 ES Juego de bornes para acumulador



No.	pcs / szl.	
82431	2	12/120

EN Boosters cables
 PL Wiązka przewodów awaryjnych
 DE Starthilfekabel
 RU Старт-кабель
 CZ Spouštěcí kabele
 RO Cabluri de alimentare
 HU Indítókábel
 ES Pinzas de arranque



No.	Rated load / Obciążenie nominalne [A]	
82502	200	6
82504	400	6
82506	600	6

EN Flexible funnel
 PL Lejek
 DE Trichter
 RU Воронка гибкая

CZ Nálevka
 RO Pâlnie
 HU Kétrészes tölcser
 ES Embudo



No.		
83000		30

EN Battery clamps cleaner
 PL Szczotka do czyszczenia klem
 DE Klemmbürste
 RU Щетка для зачистки клемм
 CZ Kartáč pro čištění svorek
 RO Perie curatat borne auto
 HU Akkumulátorsaru tisztító kefe
 ES Cepillo para limpiar bornes



No.		
82445		10/100

EN Battery hydrometer
 PL Próbnik akumulatorowy
 DE Batteriesäureprüfer
 RU Ареометр аккумуляторный
 CZ Akumulátorový zkoušeč
 RO Instrument de verificare acumulator
 HU Akkumulátorpróbaló
 ES Probador de acumulador



No.		
82520		10/100

EN Window squeegee
 PL Guma do szyb z drewnianą rączką
 DE Scheibenreiniger-Holzstiel
 RU Стеклоочиститель с резинкой
 CZ Guma do skel z dřevěnou rukojetí
 RO Lamă-ștergător cu mâner de lemn pt. geamuri
 HU Vízlehúzó gumi fa nyéllel
 ES Goma para cristales con mango de madera



No.		
82920		50

EN Flexible funnel
 PL Lejek
 DE Trichter
 RU Воронка гибкая

CZ Nálevka
 RO Pâlnie
 HU Kétrészes tölcser
 ES Embudo



No.		
83001		30

EN Flexible funnel
 PL Lejek
 DE Trichter
 RU Воронка гибкая

CZ Nálevka
 RO Pálnie
 HU Kétrészes tölcser
 ES Embudo



VOREL

No.	Box icon
83002	30

EN Agricultural funnel
 PL Lejek rolniczy
 DE Trichter
 RU Воронка гибкая
 CZ Nálevka
 RO Pálnie
 HU Kétrészes tölcser
 ES Embudo



VOREL

No.	Ø [mm]	Box icon
83004	210	25

EN Car vacuum cleaner
 PL Odkurzacz samochodowy
 DE Handsauger
 RU Ручной пылесос для автомобиля
 CZ Vysavač do auta
 RO Aspirator de masina
 HU Autó porszívó
 ES Aspirador para coche

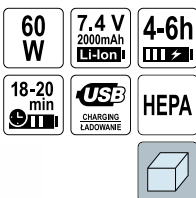

LUND

No.	Battery voltage / Napiecie akumulatora [V d.c.]	Power / Moc [W]	Box icon
82955	7.4	60	30

EN Car vacuum cleaner
 PL Odkurzacz samochodowy
 DE Handsauger
 RU Ручной пылесос для автомобиля
 CZ Vysavač do auta
 RO Aspirator de masina
 HU Autó porszívó
 ES Aspirador para coche



STHOR

No.	Voltage / Napiecie [V d.c.]	Power / Moc [W]	Box icon
82952	12	100	20

EN Funnel
 PL Lejek
 DE Trichter
 RU Воронка гибкая

CZ Nálevka
 RO Pálnie
 HU Kétrészes tölcser
 ES Embudo



VOREL

No.	Ø [mm]	H [mm]	pcs / szt.	Box icon
83005	52, 76, 100, 120	75, 110, 125, 152	4	30

EN Car vacuum cleaner
 PL Odkurzacz samochodowy
 DE Handsauger
 RU Ручной пылесос для автомобиля
 CZ Vysavač do auta
 RO Aspirator de masina
 HU Autó porszívó
 ES Aspirador para coche

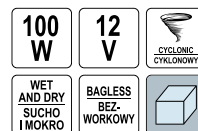

STHOR

No.	Voltage / Napiecie [V d.c.]	Power / Moc [W]	Box icon
82951	12	100	8

EN Car vacuum cleaner
 PL Odkurzacz samochodowy
 DE Handsauger
 RU Ручной пылесос для автомобиля
 CZ Vysavač do auta
 RO Aspirator de masina
 HU Autó porszívó
 ES Aspirador para coche

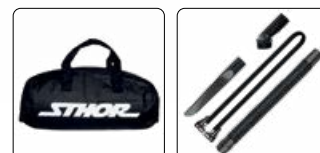
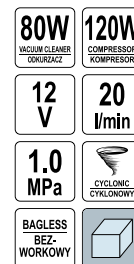

STHOR

No.	Voltage / Napiecie [V d.c.]	Vacuum cleaner power / Moc odkurzacza [W]	Compressor power / Moc kompresora [W]	Box icon
82953	12	80	120	12

EN Car vacuum cleaner
 PL Odkurzacz samochodowy
 DE Handsauger
 RU Ручной пылесос для автомобиля
 CZ Vysavač do auta
 RO Aspirator de masina
 HU Autó porszívó
 ES Aspirador para coche



STKOR

No.	Voltage / Napiecie [V d.c.]	Power / Moc [W]	Box
82967	12	100	9

EN Rechargeable car vacuum cleaner
 PL Odkurzacz samochodowy bezprzewodowy
 DE Kabelloser Auto-Staubsauger
 RU Беспроводной пылесос автомобиля
 CZ Bezdrátový automobilový vysavač
 RO Aspirator de mașină fără fir
 HU Vezeték nélküli autós porszívó
 ES Aspirador de coche inalámbrico



STKOR

No.	Voltage / Napiecie [V d.c.]	Power / Moc [W]	Box
82970	5	100	9

EN Portable car shower set
 PL Samochodowy prysznic turystyczny
 DE Campingdusche
 RU Портативный автомобиль душ
 CZ Mobilní auto sprcha
 RO Dus portabil masina
 HU Autós hordozható zuhany
 ES Portátil ducha de coche

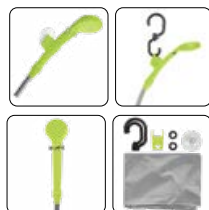

LUND

No.	Voltage / Napiecie [V d.c.]	Box
82991	12	5/10

EN Car vacuum cleaner
 PL Odkurzacz samochodowy
 DE Handsauger
 RU Ручной пылесос для автомобиля
 CZ Vysavač do auta
 RO Aspirator de masina
 HU Autó porszívó
 ES Aspirador para coche



STKOR

No.	Voltage / Napiecie [V d.c.]	Power / Moc [W]	Box
82954	7.4	80	20

EN Rechargeable car vacuum cleaner
 PL Odkurzacz samochodowy bezprzewodowy
 DE Kabelloser Auto-Staubsauger
 RU Беспроводной пылесос автомобиля
 CZ Bezdrátový automobilový vysavač
 RO Aspirator de mașină fără fir
 HU Vezeték nélküli autós porszívó
 ES Aspirador de coche inalámbrico



STKOR

No.	Voltage / Napiecie [V d.c.]	Power / Moc [W]	Box
82971	5	100	9

EN Portable car shower set
 PL Samochodowy prysznic turystyczny
 DE Campingdusche
 RU Портативный автомобиль душ
 CZ Mobilní auto sprcha
 RO Dus portabil masina
 HU Autós hordozható zuhany
 ES Portátil ducha de coche



LUND

No.	Voltage / Napiecie [V d.c.]	Box
82992	12	10

EN First aid kit
 PL Apteczka samochodowa
 DE Verbandkasten
 RU Аптечка автомобильная

CZ Příruční lékárnička první pomoci
 RO Trusă medicală de prim-ajutor
 HU Elsősegély doboz
 ES Botiquin



No.	Type / Typ	
83260	E-01	10

EN First aid kit
 PL Apteczka samochodowa
 DE Verbandkasten
 RU Аптечка автомобильная
 CZ Příruční lékárnička první pomoci
 RO Trusă medicală de prim-ajutor
 HU Elsősegély doboz
 ES Botiquin



No.	Type / Typ	
83262	E-03	5

EN Elastic tie down
 PL Spinacz bagażu
 DE Gepäckspinnensatz
 RU Стяжка для багажа
 CZ Elastické spínatka
 RO Cordelina elastica
 HU Csomagrögzítő pók
 ES Pulpo 8-ramion



No.	L [cm]	Ø [mm]	Arm quantity / Liczba ramion	
82300	80	8	8	25/50

EN Elastic straps
 PL Ściągacze elastyczne
 DE Gummispinnenset
 RU Стяжка для багажа
 CZ Elastické spínatka
 RO Cordelina elastica
 HU Rugalmas feszítő
 ES Pulpos



No.	L [cm]	Ø [mm]	pcs / szt.	
82308	80	8	2	20/80
82310	100	8	2	20/80
82315	150	8	2	25/50
82320	200	8	2	25/50

EN First aid kit
 PL Apteczka samochodowa
 DE Verbandkasten
 RU Аптечка автомобильная

CZ Příruční lékárnička první pomoci
 RO Trusă medicală de prim-ajutor
 HU Elsősegély doboz
 ES Botiquin



No.	Type / Typ	
83261	E-04	5

EN Vehicle safety triangle
 PL Trójkąt ostrzegawczy
 DE Warndreieck
 RU Предупреждающий треугольник
 CZ Výstražný trojúhelník
 RO Triunghi de avertizare
 HU Elakadásjelző háromszög
 ES Triángulo de emergencia



No.		
83280		40

EN Elastic tie down
 PL Spinacz bagażu
 DE Gepäckspinnensatz
 RU Стяжка для багажа
 CZ Elastické spínatka
 RO Cordelina elastica
 HU Csomagrögzítő pók
 ES Pulpo 8-ramion



No.	L [cm]	Ø [mm]	Arm quantity / Liczba ramion	
82301	80	8	8	25/50



EN Elastic straps
 PL Ściągacze elastyczne
 DE Gummispannseil
 RU Стяжка для багажа
 CZ Elastické spínatka
 RO Cordelina elastica
 HU Rugalmas feszítő
 ES Pulpos

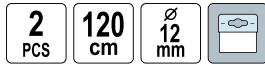

No.	L [cm]	Ø [mm]	pcs / szt.	Icon
82305	120	12	2	12/24

EN Ratchet tie down
 PL Taśma do bagażu ze sprzączką
 DE Spanngurt
 RU Ремень для крепления груза с зажимом фиксатором
 CZ Pás na zavazadla
 RO Cordelina pt. bagaje cu clichet
 HU Csomagrögzítő pánt
 ES Cintás para equipaje

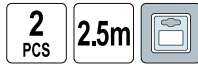

No.	L [m]	W [mm]	pcs / szt.	Icon
82331	2.5	25	2	10/80

EN Ratchet tie down
 PL Taśma do bagażu
 DE Spanngurt
 RU Ремень для крепления багажа с трещоткой
 CZ Pás na zavazadla z napínáním
 RO Cordelina pt. bagaje cu clichet
 HU Csomagrögzítő pánt feszítővel
 ES Cinta para equipaje con carraca



No.	L [m]	W [mm]	Lashing capacity / Zdolność mocowania [daN]	Icon
82377	2	35	1000	10
82378	4	35	1000	10
82379	6	35	1000	10
82380	8	35	1000	10

EN Elastic straps
 PL Płaskie ściągacze elastyczne
 DE Gummispannseil
 RU Стяжка для багажа
 CZ Elastické spínatka
 RO Cordelina elastica
 HU Rugalmas feszítő
 ES Pulpos

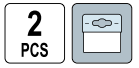

No.	L [cm]	pcs / szt.	Icon
82360	80	2	25/50
82370	100	2	20/80

EN Ratchet tie down
 PL Taśma do bagażu ze sprzączką
 DE Spanngurt
 RU Ремень для крепления груза с зажимом фиксатором
 CZ Pás na zavazadla
 RO Cordelina pt. bagaje cu clichet
 HU Csomagrögzítő pánt
 ES Cintás para equipaje



No.	L [m]	W [mm]	Icon
82341	5	25	12/48

EN Ratchet tie down
 PL Taśma do bagażu
 DE Spanngurt
 RU Ремень для крепления багажа с трещоткой

CZ Pás na zavazadla z napínáním
 RO Cordelina pt. bagaje cu clichet
 HU Csomagrögzítő pánt feszítővel
 ES Cinta para equipaje con carraca



No.	L [m]	W [mm]	Lashing capacity / Zdolność mocowania [daN]	Icon
82372	4	50	1600	8
82373	6	50	1600	7
82374	8	50	1600	6
82375	10	50	1600	5
82384	6	50	2000	6
82386	8	50	2000	6
82388	10	50	2000	5
82390	12	50	2000	5

EN Ratchet tie down
 PL Taśma do bagażu
 DE Spanngurt
 RU Ремень для крепления багажа с трещоткой
 CZ Pás na zavazadla z napínáním
 RO Cordelina pt. bagaje cu clichet
 HU Csomagrögzítő pánt feszítővel
 ES Cinta para equipaje con carraca

2
PCS





No.	L [m]	W [mm]	Lashing capacity / Zdolność mocowania [daN]	
82392	6	50	2500	6
82393	8	50	2500	6
82395	12	50	2500	5

EN Ratchet tie down
 PL Taśma do bagażu
 DE Spanngurt
 RU Ремень для крепления багажа с трещоткой
 CZ Pás na zavazadla z napínáním
 RO Cordelina pt. bagaje cu clichet
 HU Csomagrögzítő pánt feszítővel
 ES Cinta para equipaje con carraca

2
PCS



VOREL

No.	L [m]	W [mm]	Lashing capacity / Zdolność mocowania [daN]	
82401	2	38	1000	12
82402	4	38	1000	12
82403	6	38	1000	12
82404	8	38	1000	12
82405	4	50	1500	6
82406	6	50	1500	6
82407	8	50	1500	6
82408	10	50	1500	6
82409	6	50	2000	6
82410	8	50	2000	6
82411	10	50	2000	6
82412	12	50	2000	6
82413	6	50	2500	6
82414	8	50	2500	6
82415	10	50	2500	6

EN Ratchet tie down
 PL Taśma do bagażu
 DE Spanngurt
 RU Ремень для крепления багажа с трещоткой
 CZ Pás na zavazadla z napínáním
 RO Cordelina pt. bagaje cu clichet
 HU Csomagrögzítő pánt feszítővel
 ES Cinta para equipaje con carraca





No.	L [m]	W [mm]	Lashing capacity / Zdolność mocowania [daN]	
82343	4	25	1000	20

EN Ratchet tie down
 PL Taśma do bagażu
 DE Spanngurt
 RU Ремень для крепления багажа с трещоткой
 CZ Pás na zavazadla z napínáním
 RO Cordelina pt. bagaje cu clichet
 HU Csomagrögzítő pánt feszítővel
 ES Cinta para equipaje con carraca

5m





VOREL

No.	L [m]	W [mm]	
82351	5	25	12/48

EN Ratchet tie down
 PL Taśma do bagażu
 DE Spanngurt
 RU Ремень для крепления багажа с трещоткой
 CZ Pás na zavazadla z napínáním
 RO Cordelina pt. bagaje cu clichet
 HU Csomagrögzítő pánt feszítővel
 ES Cinta para equipaje con carraca

2
PCS

5m





VOREL

No.	L [m]	W [mm]	pcs / szt.	
82400	5	25	2	8/16

EN Ratchet tie down
 PL Taśma do bagażu
 DE Spanngurt
 RU Ремень для крепления багажа с трещоткой
 CZ Pás na zavazadla z napínáním
 RO Cordelina pt. bagaje cu clichet
 HU Csomagrögzítő pánt feszítővel
 ES Cinta para equipaje con carraca

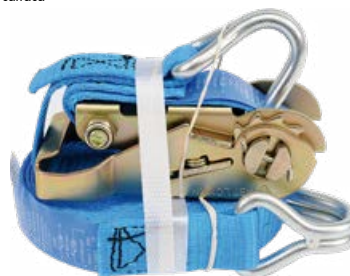
2
PCS

No.	L [m]	W [mm]	Lashing capacity / Zdolność mocowania [daN]	
82397	5	25	500	20

EN Customs securing rope RU Стальной таможенный трос HU Acél árubiztosító kótél
 PL Linka celna stalowa CZ Ocelové celní lanko ES Cable de acero de seguridad
 DE Zollschnur aus Stahl RO Cablu de ancorare



No.	Ø [mm]	L [m]	
85000	6	15	12
85001	6	16	12
85002	6	18	12
85003	6	34	12
85004	6	36	12
85005	6	42	10

EN Luggage net
 PL Siatka organizer z hakami do bagażnika
 DE Organizer Gepäcknetz mit Haken für Kofferraum
 RU Сетка-организатор с крючками для багажника
 CZ Sítka organizér zavazadlového prostoru s háčky
 RO Plasa pt. bagaje
 HU Rendszerező csomagtartó hálókampókkal
 ES Red organizador con ganchos para maletero

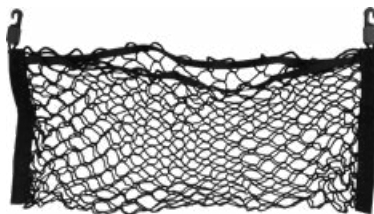

No.	Size / Rozmiar [mm]	
82260	700x300	24

EN Luggage net
 PL Siatka organizer do bagażnika z hakami
 DE Organizer Gepäcknetz mit Haken für Kofferraum
 RU Сетка-организатор для багажника с крючками
 CZ Sítka organizér zavazadlového prostoru s háčky
 RO Plasa pt. bagaje
 HU Rendszerező csomagtartó hálókampókkal
 ES Red organizador para maletero, con ganchos

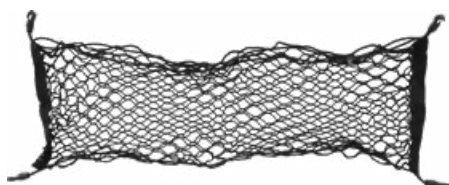

No.	Size / Rozmiar [mm]	
82262	900x300	50

EN Tarpaulin CZ Plachta
 PL Plandeka RO Husă
 DE Plane HU Ponyva
 RU Тент ES Toldo



No.	Size / Rozmiar [m]	m [g/m²]	
85122	2x3	57	30
85123	3x5	57	20
85124	4x5	57	10
85125	4x6	57	8
85126	5x8	57	5
85128	6x10	57	3
85129	8x12	57	2
85130	10x15	57	2



EN Luggage net
 PL Siatka do bagażnika z hakami
 DE Gepäcknetz mit Haken für Kofferraum
 RU Сетка с крючками для багажника
 CZ Sítka do zavazadlového prostoru s háčky
 RO Plasa pt. bagaje
 HU Csomagtartó hálókampókkal
 ES Red con ganchos para maletero



No.	Size / Rozmiar [mm]	
82261	900x900	50

EN Elastic tie down
 PL Ściągacze elastyczne z karabińczykiem
 DE Elastische Abzieher mit Karabinerhaken
 RU Эластичные шнуры для затягивания с карабином
 CZ Elastické stahovky s karabinkou
 RO Cordelina elastica pt. bagaje
 HU Rugalmas kótél karabinerekkel
 ES Elásticos con mosquetón

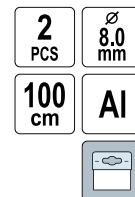

No.	Ø [mm]	L [mm]	pcs / szt.	
82322	8	1000	2	30

EN Tarpaulin
 PL Plandeka
 DE Plane
 RU Тент
 CZ Plachta
 RO Husă
 HU Ponyva
 ES Toldo



No.	Size / Rozmiar [m]	m [g/m²]	
85131	2x3	57	30
85132	3x5	57	20
85133	4x5	57	10
85134	4x6	57	8
85135	5x8	57	5

EN Tarpaulin CZ Plachta
 PL Plandeka RO Husă
 DE Plane HU Ponyva
 RU Тент ES Toldo

75
g/m²



No.	Size / Rozmiar [m]	m [g/m ²]	Icon
85112	2x3	75	30
85113	3x5	75	10
85114	4x5	75	10
85115	4x6	75	8
85116	5x8	75	5
85118	6x10	75	3
85119	8x12	75	2
85120	10x15	75	2

EN Tarpaulin clips
 PL Uchwyty zaciskowe ze śrubą do mocowania plandek
 DE Kunststoff Planenhalter
 RU Пластиковый клипс зажим для палаток и тентов
 CZ Držáky k zakrývacím plachtám
 RO Ciame pt. prelate
 HU Ponyvarögztítő klipsz
 ES Pinzas para lonas

8
PCS
NYLON
FOR
TARPAULINS
DO
PLANDEK

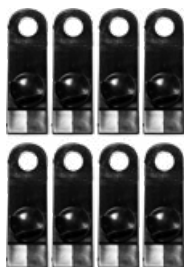

14

No.	pcs / szt.	Icon
85170	8	12/48

EN Tarpaulin clips
 PL Uchwyty zaciskowe do mocowania plandek
 DE Kunststoff Planenhalter
 RU Пластиковый клипс зажим для палаток и тентов
 CZ Držáky k zakrývacím plachtám
 RO Ciame pt. prelate
 HU Ponyvarögztítő klipsz
 ES Pinzas para lonas

8
PCS
PE
FOR
TARPAULINS
DO
PLANDEK



No.	pcs / szt.	Icon
85174	8	12/48

EN Ball bungee cords
 PL Guma mocująca z kulką
 DE Planenspanner Spanngummi mit Kunststoffkugel
 RU Резиновая петля с шариком
 CZ Upinací gumy s plastovou kuličkou
 RO Cordelina elastica cu bila fixare
 HU Ponyva rögzítő gumipók
 ES Tensor de goma con bola de plástico



EN Tarpaulin CZ Plachta
 PL Plandeka RO Husă
 DE Plane HU Ponyva
 RU Тент ES Toldo

90
g/m²



VOREL

No.	Size / Rozmiar [m]	m [g/m ²]	Icon
85020	2x3	90	30
85030	3x5	90	18
85040	4x5	90	9
85050	4x6	90	10
85060	5x8	90	5
85080	6x10	90	4
85090	8x12	90	2
85100	10x15	90	1

EN Tarpaulin clips
 PL Uchwyty zaciskowe do mocowania plandek
 DE Kunststoff Planenhalter
 RU Пластиковый клипс зажим для палаток и тентов
 CZ Držáky k zakrývacím plachtám
 RO Ciame pt. prelate
 HU Ponyvarögztítő klipsz
 ES Pinzas para lonas

8
PCS
PP
FOR
TARPAULINS
DO
PLANDEK



No.	pcs / szt.	Icon
85172	8	72

EN Elastic rope
 PL Linka pleciona, elastyczna
 DE Polypropylen-Gummileine
 RU Шнур эластичный
 CZ Lano opletené elastické
 RO Funie elastica
 HU Rugalmas kötél
 ES Cuerda trenzada

8.0
mm
PP
RUBBER
CORE
GUMOWY
ROZEN
FOR
TARPAULINS
DO
PLANDEK



VOREL

No.	Ø [mm]	L [mm]	Icon
85177	8	15	20
85178	8	30	8

8
PCS
25
mm
200
mm
FOR
TARPAULINS
DO
PLANDEK

VOREL

No.	pcs / szt.	Icon
85180	8	24/96

EN Tarpaulin repair tape
 PL Taśma klejąca do naprawy plandek
 DE Planen-Reparatur-Klebeband
 RU Самоклеющаяся лента тарпаулиновая для ремонта тентов
 CZ Páska maskovací textilní pro plachtoviny
 RO Bandă adezivă de reparații pt. prelate
 HU Szövetszalag ezüst
 ES Cinta adhesiva de reparación para lonas

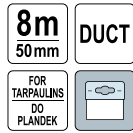

No.	W [mm]	L [m]	
85190	50	8	72

EN Tarpaulin repair tape
 PL Taśma klejąca do naprawy plandek
 DE Planen-Reparatur-Klebeband
 RU Самоклеющаяся лента тарпаулиновая для ремонта тентов
 CZ Páska maskovací textilní pro plachtoviny
 RO Bandă adezivă de reparații pt. prelate
 HU Szövetszalag ezüst
 ES Cinta adhesiva de reparación para lonas



No.	W [mm]	L [m]	
85191	50	8	72

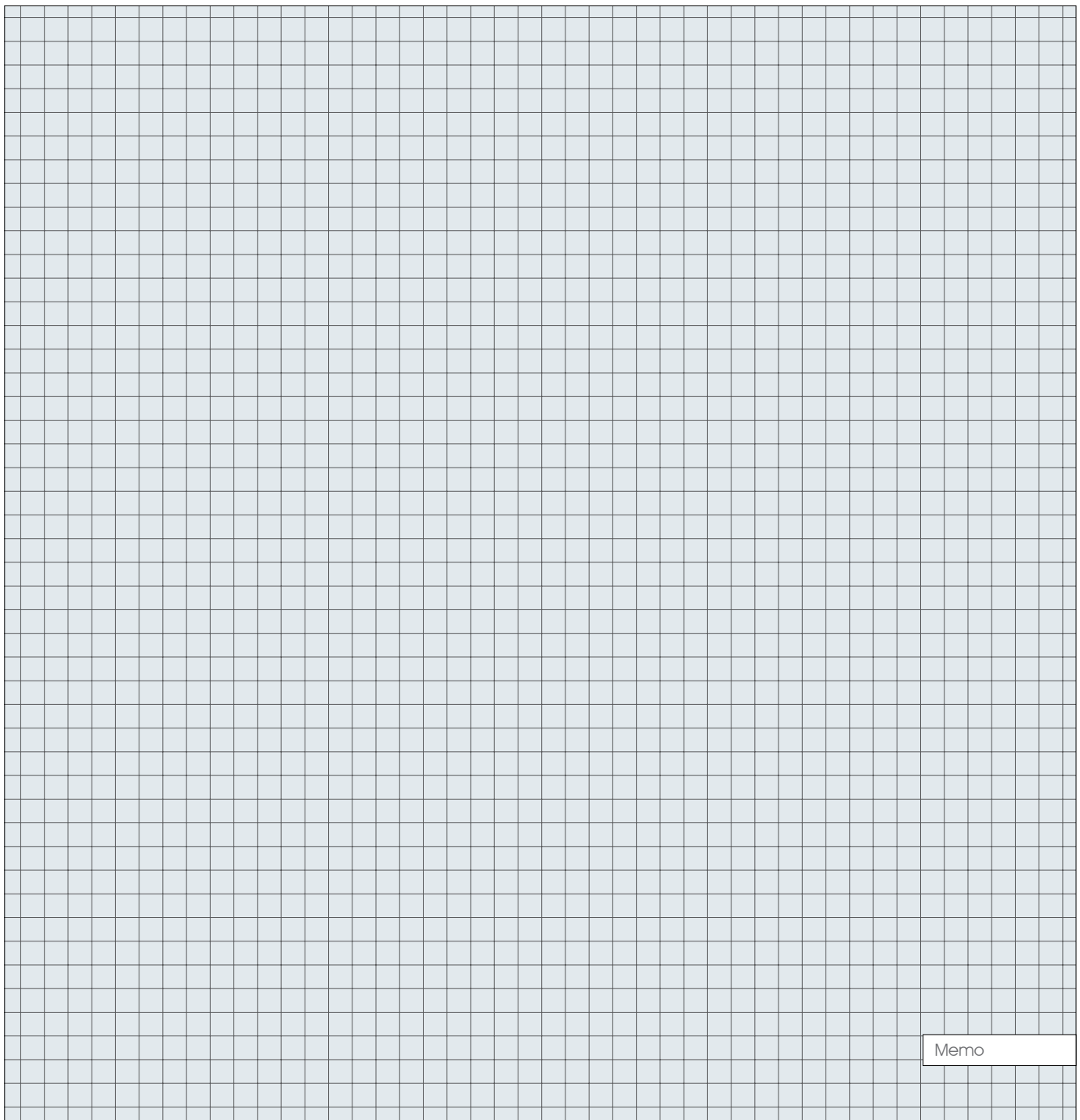

Memo

15

Power tools & accessories
Elektronarzędzia i akcesoria



Power tools STHOR
Elektronarzędzia STHOR

260-267

Impact drills	
Wiertarki udarowe.....	260
Rotary hammers	
Młoty udarowe.....	260
Cordless tools	
Urządzenia akumulatorowe.....	261
Impact wrenches	
Klucze udarowe.....	262
Angle grinders	
Szlifierki kątowe.....	262
Orbital sanders	
Szlifierki mimośrodowe.....	263
Finishing sanders	
Szlifierki oscylacyjne.....	263
Circular saws	
Pilarki tarczowe.....	263
Planers	
Strugi.....	263
Hot air guns	
Opalarki.....	263
Glue guns	
Pistolety do klejenia.....	264
Soldering guns	
Lutownice.....	264
Paint & mortar mixers	
Mieszarki do zapraw i farb.....	265
Pipe welders	
Zgrzewarki do rur.....	265
Water pumps	
Pompy wodne.....	265

Power tools LUND
Elektronarzędzia LUND

268-269

Knives for polystyrene foam	
Noże do styropianu.....	268
Car polishers	
Polerki samochodowe.....	268
Hot air guns	
Opalarki.....	268
Glue guns	
Pistolety do klejenia.....	268
Soldering guns	
Lutownice.....	269
Pipe welders	
Zgrzewarki do rur.....	269

Power tools FLO
Elektronarzędzia FLO

.....270-273



Cordless tools

Urządzenia akumulatorowe..... 270

Water pumps

Pompy wodne..... 270

Grass trimmers

Podkaszarki..... 271

Hedge shears

Nożyce do żywopłotu..... 272

Chainsaws

Piłarki łańcuchowe..... 272

Soil millers

Glebogryzarki..... 272

Scarifiers

Wertykulatory..... 272

Power tools
Elektronarzędzia

.....274



Soldering guns

Lutownice..... 274

Accessories
Akcesoria

274-282

Grass trimmer lines	
Żyłki tnące do podkaszarek.....	274
Drill chucks	
Uchwyty wiertarskie.....	277
Adapters	
Adaptory.....	277
Drill bit sharpeners	
Ostrzałki do wiertel.....	277
Stands for power tools	
Statywy do elektronarzędzi.....	278
Spare blades, brushes, etc. for power tools	
Zapassowe ostrza, szczotki, końcówki do elektronarzędzi.....	278
Soldering iron accessories	
Akcesoria do lutownic.....	279
Gasoline water pump accessories	
Akcesoria do pomp spalinowych.....	282

EN Impact drill
 PL Wiertarka udarowa
 DE Schlagbohrmaschine
 RU Ударная дрель
 CZ Nárazová vrtačka
 RO Masina de gaurit
 HU Kezelési utasítás
 ES Taladradora de percusión

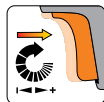
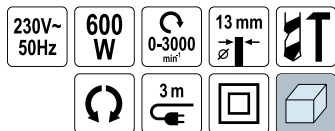

$L_{pA} = 90,0 \pm 3,0$ dB; $L_{wA} = 101,0 \pm 3,0$ dB; $a_h = 2,39 \pm 1,5 / 7,67 \pm 1,5$ m/s²

No.	Power / Moc [W]	ω [min ⁻¹]	
78992	600	0-3000	10

EN Impact drill
 PL Wiertarka udarowa
 DE Schlagbohrmaschine
 RU Ударная дрель
 CZ Nárazová vrtačka
 RO Masina de gaurit
 HU Kezelési utasítás
 ES Taladradora de percusión

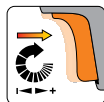

$L_{pA} = 98,06 \pm 3,0$ dB; $L_{wA} = 109,06 \pm 3,0$ dB; $a_h = 5,726 \pm 1,5 / 17,116 \pm 1,5$ m/s²

No.	Power / Moc [W]	ω [min ⁻¹]	
78997	800	0-3000	10

EN Rotary hammer
 PL Motowiertarka
 DE Bohrhammer
 RU Перфоратор
 CZ Vrtací kladivo
 RO Ciocan rotopercutor
 HU Fúrókalapács
 ES Martillo perforador

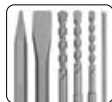

$L_{pA} = 92,0 \pm 3,0$ dB; $L_{wA} = 103,0 \pm 3,0$ dB; $a_h = 14,377 \pm 1,5 / 11,618 \pm 1,5$ m/s²

No.	Power / Moc [W]	ω [min ⁻¹]	
79054	620	0-870	5

EN Impact drill
 PL Wiertarka udarowa
 DE Schlagbohrmaschine
 RU Ударная дрель
 CZ Nárazová vrtačka
 RO Masina de gaurit
 HU Kezelési utasítás
 ES Taladradora de percusión

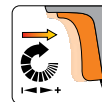

$L_{pA} = 98,06 \pm 3,0$ dB; $L_{wA} = 109,06 \pm 3,0$ dB; $a_h = 5,726 \pm 1,5 / 17,116 \pm 1,5$ m/s²

No.	Power / Moc [W]	ω [min ⁻¹]	
78995	710	0-3000	10

EN Rotary hammer
 PL Motowiertarka
 DE Bohrhammer
 RU Перфоратор
 CZ Vrtací kladivo
 RO Ciocan rotopercutor
 HU Fúrókalapács
 ES Martillo perforador

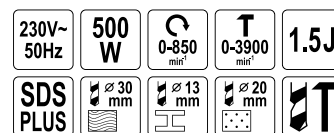

$L_{pA} = 87,0 \pm 3,0$ dB; $L_{wA} = 98,0 \pm 3,0$ dB; $a_h = 12,353 \pm 1,5 / 9,433 \pm 1,5$ m/s²

No.	Power / Moc [W]	ω [min ⁻¹]	
79049	500	0-850	5

EN Rotary hammer
 PL Motowiertarka
 DE Bohrhammer
 RU Перфоратор
 CZ Vrtací kladivo
 RO Ciocan rotopercutor
 HU Fúrókalapács
 ES Martillo perforador

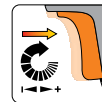
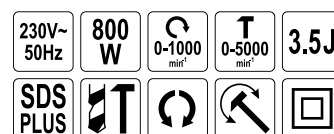

$L_{pA} = 89,4 \pm 3,0$ dB; $L_{wA} = 100,4 \pm 3,0$ dB; $a_h = 14,936 \pm 1,5 / 14,898 \pm 1,5$ m/s²

No.	Power / Moc [W]	ω [min ⁻¹]	
79053	800	0-1000	4

EN Cordless drill/driver
 PL Akumulatorowa wiertarko-wkrętarka
 DE Akku-Bohrschrauber
 RU Аккумуляторная дрель-шуруповерт
 CZ Akumulátorový vrtací šroubovák
 RO Mașină de găurit și înșurubat cu acumulator
 HU Akkus fúró-csavarozó
 ES Taladro atornillador a batería

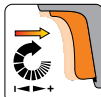
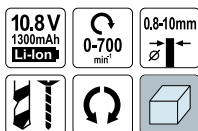

$L_{pA} = 89,0 \pm 3,0$ dB; $L_{wA} = 100,0 \pm 3,0$ dB; $a_n = 0,854 \pm 1,5 / 2,069 \pm 1,5$ m/s²

No.	Voltage / Napięcie [V d.c.]	ω [min ⁻¹]	Toolholder size / Rozmiar uchwytu narzędziowego [mm]	Box
78981	10.8	0-700	0.8-10	5

EN Cordless drill/driver
 PL Akumulatorowa wiertarko-wkrętarka
 DE Akku-Bohrschrauber
 RU Аккумуляторная дрель-шуруповерт
 CZ Akumulátorový vrtací šroubovák
 RO Mașină de găurit și înșurubat cu acumulator
 HU Akkus fúró-csavarozó
 ES Taladro atornillador a batería

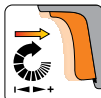
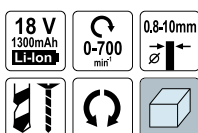

$L_{pA} = 89,0 \pm 3,0$ dB; $L_{wA} = 100,0 \pm 3,0$ dB; $a_n = 1,001 \pm 1,5 / 2,629 \pm 1,5$ m/s²

No.	Voltage / Napięcie [V d.c.]	ω [min ⁻¹]	Toolholder size / Rozmiar uchwytu narzędziowego [mm]	Box
78983	18	0-700	0.8-10	5

EN Battery charger
 PL Ładowarka
 DE Ladegerät
 RU Зарядное устройство

CZ Nabíječka
 RO Redresor
 HU Akkutöltő
 ES Rectificador



No.	Output voltage / Napięcie wyjściowe [V d.c.]	Output current / Prąd wyjściowy [mA]	For / Dla	Box
79087	15	400	79084	30
79088	18	400	79085	30
79089	24	400	79086	20

EN Cordless drill/driver
 PL Akumulatorowa wiertarko-wkrętarka
 DE Akku-Bohrschrauber
 RU Аккумуляторная дрель-шуруповерт
 CZ Akumulátorový vrtací šroubovák
 RO Mașină de găurit și înșurubat cu acumulator
 HU Akkus fúró-csavarozó
 ES Taladro atornillador a batería

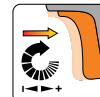
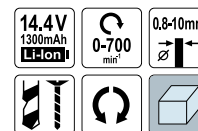

$L_{pA} = 87,0 \pm 3,0$ dB; $L_{wA} = 98,0 \pm 3,0$ dB; $a_n = 1,292 \pm 1,5 / 2,312 \pm 1,5$ m/s²

No.	Voltage / Napięcie [V d.c.]	ω [min ⁻¹]	Toolholder size / Rozmiar uchwytu narzędziowego [mm]	Box
78982	14.4	0-700	0.8-10	5

EN Battery
 PL Akumulator
 DE Akkumulator
 RU Аккумулятор
 CZ Akumulátor
 RO Acumulatorul
 HU Akkumulátor
 ES Batería



No.	Voltage / Napięcie [V d.c.]	For / Dla	Box
78985	10.8	78118, 78981	50
78986	14.4	78982	50
78987	18	78972, 78974, 78961, 78983	50

EN Cordless drill/driver
 PL Akumulatorowa wiertarko-wkrętarka
 DE Akku-Bohrschrauber
 RU Аккумуляторная дрель-шуруповерт
 CZ Akumulátorový vrtací šroubovák
 RO Mașină de găurit și înșurubat cu acumulator
 HU Akkus fúró-csavarozó
 ES Taladro atornillador a batería

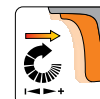
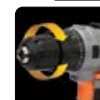

$L_{pA} = 89,0 \pm 3,0$ dB; $L_{wA} = 100,0 \pm 3,0$ dB; $a_n = 1,001 \pm 1,5 / 2,629 \pm 1,5$ m/s²

No.	Voltage / Napięcie [V d.c.]	ω [min ⁻¹]	Toolholder size / Rozmiar uchwytu narzędziowego [mm]	Box
78972	18	0-350 / 0-1300	0.8-10	5

EN Cordless impact drill/driver
 PL Akumulatorowa wiertarko-wkrętarka udarowa
 DE Akku-Schlagbohrschrauber
 RU Аккумуляторный ударный дрель-шурупверт
 CZ Akumulátorový nárazový šroubovák s příklepem
 RO Mașină de găurit și înșurubat cu percuzie cu acumulator
 HU Akkus ütvérfúró-csavarozó
 ES Taladro atornillador con percusión a batería

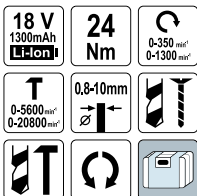

$L_{pA} = 89,0 \pm 3,0$ dB; $L_{wA} = 100,0 \pm 3,0$ dB; $a_h = 15,25 \pm 1,5$ m/s²

No.	Voltage / Napięcie [V d.c.]	ω [min ⁻¹]	Toolholder size / Rozmiar uchwyty narzędziowego [mm]	
78974	18	0-350 / 0-1300	0.8-10	5

EN Electric impact wrench
 PL Elektryczny klucz udarowy
 DE Elektro-Schlagschrauber
 RU Электрический гайковерт
 CZ Elektrický rázový uťahovák
 RO Pistol de impact electric
 HU Elektromos ütvecsavarozó
 ES llave de impacto eléctrica



$L_{pA} = 87,5 \pm 3,0$ dB; $L_{wA} = 98,5 \pm 3,0$ dB; $a_h = 9,93 \pm 1,5$ m/s²

No.	Power / Moc [W]	ω [min ⁻¹]	
57091	800	2200	5

EN Electric impact wrench
 PL Elektryczny klucz udarowy
 DE Elektro-Schlagschrauber
 RU Электрический гайковерт
 CZ Elektrický rázový uťahovák
 RO Pistol de impact electric
 HU Elektromos ütvecsavarozó
 ES llave de impacto eléctrica



$L_{pA} = 89,0 \pm 3,0$ dB; $L_{wA} = 100,0 \pm 3,0$ dB; $a_h = 10,04 \pm 1,5$ m/s²

No.	Power / Moc [W]	ω [min ⁻¹]	
57097	1100	2200	2

EN Cordless glue gun
 PL Akumulatorowy pistolet do klejenia
 DE Heissklebepistole
 RU Пистолет для клея
 CZ Pistole na lepení
 RO Pistol pt. lipit
 HU Ragasztópisztoly
 ES Pistola de cola



No.	Voltage / Napięcie [V d.c.]	
78154	7.2	10

EN Electric impact wrench
 PL Elektryczny klucz udarowy
 DE Elektro-Schlagschrauber
 RU Электрический гайковерт
 CZ Elektrický rázový uťahovák
 RO Pistol de impact electric
 HU Elektromos ütvecsavarozó
 ES llave de impacto eléctrica



$L_{pA} = 89,0 \pm 3,0$ dB; $L_{wA} = 100,0 \pm 3,0$ dB; $a_h = 10,04 \pm 1,5$ m/s²

No.	Power / Moc [W]	ω [min ⁻¹]	
57092	1100	2200	2

EN Angle grinder
 PL Szlifierka kątowa
 DE Winkelschleifmaschine
 RU Угleshлифовальная машина
 CZ Úhlová bruska
 RO Polizor unghiular
 HU Sarokcsiszoló
 ES Lijadera de angulo

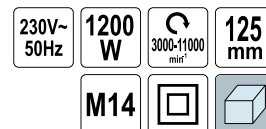

$L_{pA} = 88,0 \pm 3,0$ dB; $L_{wA} = 99,0 \pm 3,0$ dB; $a_h = 6,5 \pm 1,5$ m/s²

No.	Power / Moc [W]	ω [min ⁻¹]	
57124	1200	3000-11000	10

EN Orbital sander
 PL Szlifierka mimośrodowa
 DE Exzentrische Schleifmaschine
 RU Эксцентриковая шлифовальная машина
 CZ Excentrická bruska
 RO Polizor cu excentric
 HU Excenter csiszoló
 ES Pulidor excentrico



$L_{pA} = 81,0 \pm 3,0$ dB; $L_{wA} = 92,0 \pm 3,0$ dB; $a_h = 10,8 \pm 1,5$ m/s²

No.	Power / Moc [W]	ω [min ⁻¹]	
79309	430	6000-13000	6

EN Circular saw
 PL Pilarka ręczna
 DE Handkreissäge
 RU Дисковая пила
 CZ Pila kotoučová
 RO Fierastrau circular
 HU Kézi körfűrészgép
 ES Sierra de disco

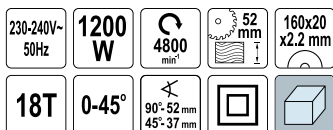

$L_{pA} = 94,0 \pm 3,0$ dB; $L_{wA} = 105,0 \pm 3,0$ dB; $a_h = 6,84 \pm 1,5$ m/s²

No.	Power / Moc [W]	ω [min ⁻¹]	
79254	1200	4800	4

EN Electric planer
 PL Strug elektryczny
 DE Elektrohobel
 RU Электрорубанок
 CZ Elektrický hoblík
 RO Rindea electrica
 HU Elektromos gyalu
 ES Garpota eléctrica

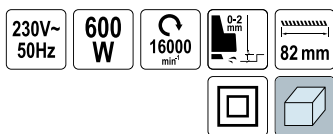

$L_{pA} = 83,0 \pm 3,0$ dB; $L_{wA} = 94,0 \pm 3,0$ dB; $a_h = 6,84 \pm 1,5$ m/s²

No.	Power / Moc [W]	ω [min ⁻¹]	
79416	600	16000	6

EN Finishing sander
 PL Szlifierka oscylacyjna
 DE Schwingschleifer
 RU Виброшлифмашина
 CZ Oscilační bruska
 RO Polizor oscilant
 HU Vibrációs csiszológép
 ES Lijadora de oscilación

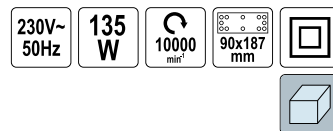

$L_{pA} = 84,0 \pm 3,0$ dB; $L_{wA} = 95,0 \pm 3,0$ dB; $a_h = 3,7 \pm 1,5$ m/s²

No.	Power / Moc [W]	ω [min ⁻¹]	
79491	135	10000	6

EN Circular saw
 PL Pilarka ręczna
 DE Handkreissäge
 RU Дисковая пила
 CZ Pila kotoučová
 RO Fierastrau circular
 HU Kézi körfűrészgép
 ES Sierra de disco



$L_{pA} = 94,0 \pm 3,0$ dB; $L_{wA} = 105,0 \pm 3,0$ dB; $a_h = 6,84 \pm 1,5$ m/s²

No.	Power / Moc [W]	ω [min ⁻¹]	
79257	1400	4800	4

EN Hot air gun
 PL Opalarka
 DE Heissluftpistole
 RU Строительный фен
 CZ Orpavací stroj
 RO Fion pt. ars vopsea
 HU Hőlégfúvó
 ES Secadora

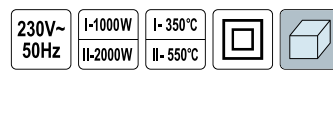

No.	Power / Moc [W]	Blast temperature / Temperatura nadmuchu [°C]	
79320	1000 (I) / 2000 (II)	350 (I) / 550 (II)	10

EN Hot air gun
 PL Opalarka
 DE Heissluftpistole
 RU Строительный фен
 CZ Opalovací stroj
 RO Fion pt. ars vopseaua
 HU Hőlégfúvó
 ES Secadora

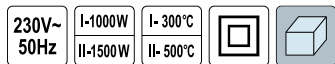

STIHL

No.	Power / Moc [W]	Blast temperature / Temperatura nadmuchu [°C]	Icon
79327	1000 (I) / 1500 (II)	300 (I) / 500 (II)	10

EN Electric glue gun
 PL Pistolet do klejenia
 DE Heissklebepistole
 RU Пистолет для клея
 CZ Pistole na lepení
 RO Pistol pt. lipit
 HU Ragasztópisztoly
 ES Pistola de cola

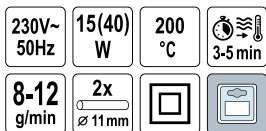

STIHL

No.	Power / Moc [W]	Glue stick diameter / Średnica wkładu klejowego [mm]	Capacity / Wydajność [g/min]	Icon
73056	15 (40)	11	8-12	6/48

EN Electric glue gun
 PL Pistolet do klejenia
 DE Heissklebepistole
 RU Пистолет для клея
 CZ Pistole na lepení
 RO Pistol pt. lipit
 HU Ragasztópisztoly
 ES Pistola de cola

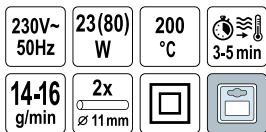

STIHL

No.	Power / Moc [W]	Glue stick diameter / Średnica wkładu klejowego [mm]	Capacity / Wydajność [g/min]	Icon
73057	23 (80)	11	14-16	6/48

EN Hot air gun with accessories
 PL Opalarka z akcesoriami
 DE Heissluftpistole
 RU Строительный фен в наборе
 CZ Opalovací stroj s příslušenstvím
 RO Fion cu accesorii pt. ars vopseaua
 HU Hőlégfúvó tartozékokkal
 ES Secadora con accesorios

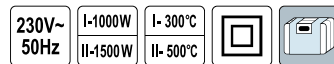

STIHL

No.	Power / Moc [W]	Blast temperature / Temperatura nadmuchu [°C]	Icon
79328	1000 (I) / 1500 (II)	300 (I) / 500 (II)	5

EN Electric glue gun
 PL Pistolet do klejenia
 DE Heissklebepistole
 RU Пистолет для клея
 CZ Pistole na lepení
 RO Pistol pt. lipit
 HU Ragasztópisztoly
 ES Pistola de cola

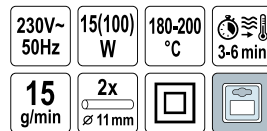

STIHL

No.	Power / Moc [W]	Glue stick diameter / Średnica wkładu klejowego [mm]	Capacity / Wydajność [g/min]	Icon
73052	15 (100)	11	15	12/48

EN Soldering iron
 PL Lutownica oporowa
 DE Lötkolben
 RU Электропаяльник
 CZ Pájka odporová
 RO Ciocan de lipit
 HU Forrasztópáka
 ES Soldador de resistencia



STIHL

No.	Power / Moc [W]	Icon
79365	30	25/50
79366	40	25/50
79367	60	25/50
79368	80	25/50

EN Transformer soldering gun
 PL Lutownica transformatorowa
 DE Lötpestole
 RU Электрический паяльник
 CZ Transformátorová páječka
 RO Pistol de lipit
 HU Forrasztópáka
 ES Soldador transformador



No.	Power / Moc [W]	Icons
79354	100	10

EN PVC plastic pipe welder
 PL Zgrzewarka do rur termoplastycznych
 DE Schweißgerät für thermoplastische Rohre
 RU Аппарат для сварки пластиковых труб
 CZ Svářečka na termoplastické trubky
 RO Masina de sudat tevi termoplastice
 HU Hegesztő berendezés termoplasztikus csövekhez
 ES Maquina de soldar las tubos termoplasticos



No.	Power / Moc [W]	Icons
78912	750, 1500	4

EN Dirty water submersible pump
 PL Pompa zatapialna do wody brudnej
 DE Tauchpumpe für Schmutzwasser
 RU Погружной насос для грязной воды
 CZ Ponorné čerpadlo pro špinavú vodu
 RO Pompă submersibilă pt. apă murdara
 HU Búvárszivattyú
 ES Bomba sumergible para agua sucia



No.	Power / Moc [W]	Max. capacity / Maks. wydajność [l/h]	Max. head / Maks. wysokość tłoczenia [m]	Icons
79909	400	6000	6	6

EN Electric paddle mixer
 PL Mieszarka do zapraw
 DE Mörtelmischgerät
 RU Электрическая мешалка для минометов
 CZ Michadlo na maltu
 RO Malaxor pt. mortar
 HU Habarcskeverő
 ES Mezcladora de mortero

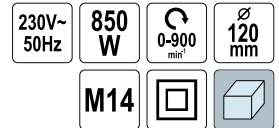

$L_{pa} = 87,0 \pm 3,0$ dB; $L_{wa} = 98,0 \pm 3,0$ dB; $a_v = 5,45 \pm 1,5$ ml/s²

No.	Power / Moc [W]	ω [min ⁻¹]	Icons
78855	850	0-900	4

EN PVC plastic pipe welder
 PL Zgrzewarka do rur termoplastycznych
 DE Schweißgerät für thermoplastische Rohre
 RU Аппарат для сварки пластиковых труб
 CZ Svářečka na termoplastické trubky
 RO Masina de sudat tevi termoplastice
 HU Hegesztő berendezés termoplasztikus csövekhez
 ES Maquina de soldar las tubos termoplasticos

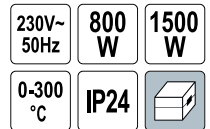

No.	Power / Moc [W]	Icons
78910	800, 1500	5

EN Dirty water submersible pump
 PL Pompa zatapialna do wody brudnej
 DE Tauchpumpe für Schmutzwasser
 RU Погружной насос для грязной воды
 CZ Ponorné čerpadlo pro špinavú vodu
 RO Pompă submersibilă pt. apă murdara
 HU Búvárszivattyú
 ES Bomba sumergible para agua sucia



No.	Power / Moc [W]	Max. capacity / Maks. wydajność [l/h]	Max. head / Maks. wysokość tłoczenia [m]	Icons
79781	400	8000	5.5	4
79782	500	10000	6.5	4
79783	600	11500	7.0	4

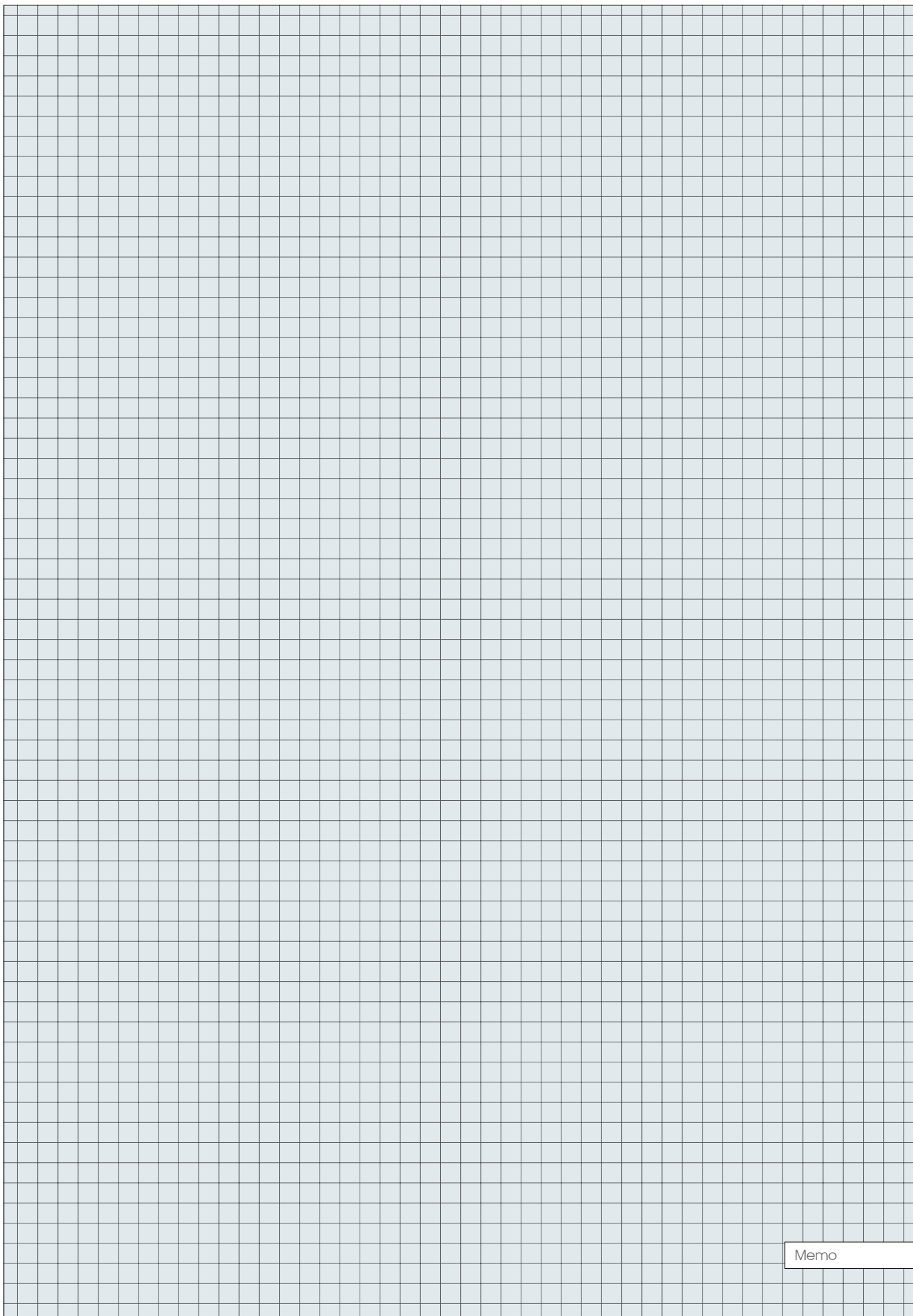

Memo

EN Thermal knife for polystyrene foam
 PL Nóż termiczny do styropianu
 DE Thermomesser für Styropor
 RU Термонож для пенопласта
 CZ Termický nůž na pěnový polystyrén
 RO Cuțit termic pt. stropian
 HU Polisztirol vágó hőkés
 ES Cuchilla térmica para poliestireno



INCLUDED:

- 3 interchangeable tips: wire 17 cm, hot knife 12 cm, engraving tool 3.5 cm
- Base
- Additional cutting wire (1 pcs)



W ZESTAWIE:

- 3 wymienne końcówki: drut 17 cm, nóż do cięcia na gorąco 12 cm, nasadka do grawerowania 3.5 cm
- Podstawka
- Zapasowy drut tnący (1 szt.)

LUND

No.	Power / Moc [W]	Box
78894	9	20

EN Car polisher
 PL Polerka samochodowa
 DE Autopoliermaschine
 RU Полировальная машинка
 CZ Leštička na automobily
 RO Masina de lustruit automobile
 HU Gépkocsi polirozógép
 ES Máquina para pulir coches



15

LUND

$L_{pa} = 55.0 \pm 3.0$ dB; $L_{wa} = 66.0 \pm 3.0$ dB; $a_s = 14.8 \pm 1.5$ m/s²

No.	Power / Moc [W]	ω [min ⁻¹]	Box
82942	120	3200	6

EN Hot air gun with accessories
 PL Opalarka z akcesoriami
 DE Heissluftpistole
 RU Строительный фен в наборе
 CZ Opalovací stroj s příslušenstvím
 RO Fion cu accesorii pt. ars vopseaua
 HU Hőlégfúvó tartozékokkal
 ES Secadora con accesorios

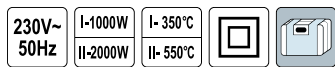

LUND

No.	Power / Moc [W]	Blast temperature / Temperatura nadmuchu [°C]	Box
79325	1000 (I) / 2000 (II)	350 (I) / 550 (II)	10

EN Mini grinder
 PL Uniwersalna szlifierka wielofunkcyjna
 DE Universal-Mehrweckschleifmaschine
 RU Универсальная шлифовальная машина
 CZ Víceúčelová univerzální bruska
 RO Mașina de șlefuit universală multifuncțională
 HU Univerzális daugjafutkés ílífuoklis
 ES Lijadora multifunción



LUND

$L_{pa} = 72.0 \pm 3.0$ dB; $L_{wa} = 83.0 \pm 3.0$ dB; $a_s = 2.6 \pm 1.5$ m/s²

No.	Power / Moc [W]	ω [min ⁻¹]	Box
79314	135	10 000 (I) / 15 000 (II) / 20 000 (III) / 25 000 (IV) / 30 000 (V) / 33 000 (VI) / 35 000 (max)	10

EN Hot air gun
 PL Opalarka
 DE Heissluftpistole
 RU Строительный фен
 CZ Opalovací stroj
 RO Fion pt. ars vopseaua
 HU Hőlégfúvó
 ES Secadora

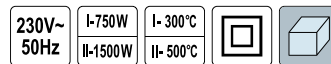

LUND

No.	Power / Moc [W]	Blast temperature / Temperatura nadmuchu [°C]	Box
79324	750 (I) / 1500 (II)	300 (I) / 500 (II)	10

EN Electric glue gun
 PL Pistolet do klejenia
 DE Heissklebepistole
 RU Пистолет для клея
 CZ Pistolet na lepení
 RO Pistol pt. lipit
 HU Ragasztópisztoly
 ES Pistola de cola

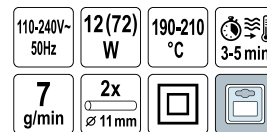

LUND

No.	Power / Moc [W]	Glue stick diameter / Średnica wkładu klejowego [mm]	Capacity / Wydajność [g/min]	Box
73051	12 (72)	11	7	12/48

EN Battery sprayer
 PL Opryskiwacz akumulatorowy
 DE Akku-Sprühgerät
 RU Аккумуляторный опрыскиватель
 CZ Bateriový postřikovač
 RO Vermorel cu acumulator
 HU Akkumulátoros permetező
 ES Pulverizador a batería



12 V 0.15-0.4 MPa
 3.1 l/min 16 L
 8.0 Ah PE
 SS STAINLESS STEEL STAL NERDZEJĄCA



No.	Voltage / Napięcie [V d.c.]	Tank capacity / Pojemność zbiornika [l]	
89610	12	16	1

EN Battery sprayer
 PL Opryskiwacz akumulatorowy
 DE Akku-Sprühgerät
 RU Аккумуляторный опрыскиватель
 CZ Bateriový postřikovač
 RO Vermorel cu acumulator
 HU Akkumulátoros permetező
 ES Pulverizador a batería



12 V 0.15-0.4 MPa
 3.1 l/min 16 L
 8.0 Ah PE
 SS STAINLESS STEEL STAL NERDZEJĄCA



No.	Voltage / Napięcie [V d.c.]	Tank capacity / Pojemność zbiornika [l]	
89611	12	16	1

EN Dirty water submersible pump
 PL Pompa zatapialna do wody brudnej
 DE Tauchpumpe für Schmutzwasser
 RU Погружной насос для грязной воды
 CZ Ponorné čerpadlo pro špinavú vodu
 RO Pompă submersibilă pt. apă murdara
 HU Búvárszivattyú
 ES Bomba sumergible para agua sucia



230V~50Hz 1" 25mm
 5/4" 1.5" 32mm 38mm



No.	Power / Moc [W]	Max. capacity / Maks. wydajność [l/h]	Max. head / Maks. wysokość tłoczenia [m]	
79771	400	10000	6.5	4
79772	550	11500	7.0	4
79773	750	14000	7.5	4
79774	900	16000	8.5	4
79775	1100	16000	8.5	4

EN Dirty water submersible pump
 PL Pompa zatapialna do wody brudnej
 DE Tauchpumpe für Schmutzwasser
 RU Погружной насос для грязной воды
 CZ Ponorné čerpadlo pro špinavú vodu
 RO Pompă submersibilă pt. apă murdara
 HU Búvárszivattyú
 ES Bomba sumergible para agua sucia



230V~50Hz 1" 25mm
 5/4" 1.5" 32mm 38mm
 INOX



No.	Power / Moc [W]	Max. capacity / Maks. wydajność [l/h]	Max. head / Maks. wysokość tłoczenia [m]	
79790	750	14000	7.5	2
79791	900	16000	8.5	2
79792	1100	20000	9.0	2

EN Membrane deep well water pump
 PL Pompa membranowa zatapialna
 DE Tauchmotorpumpe
 RU Насос погружной мембранный для чистой воды
 CZ Zátavnovací čerpadlo
 RO Pompă pt. apă cu membrană
 HU Búvárszivattyú
 ES Bomba de diafragma sumergible



220-230V~50Hz 350 W
 Q max 1200 l/h 70 m



No.	Power / Moc [W]	Max. capacity / Maks. wydajność [l/h]	Max. head / Maks. wysokość tłoczenia [m]	
79944	350	1200	70	4

EN Submersible pump for dirty water and wastewater
 PL Pompa zatapialna do wody brudnej i ścieków
 DE Tauchpumpe für Schmutzwasser
 RU Погружной насос для грязной воды
 CZ Ponorné čerpadlo pro odpadní vody
 RO Pompă submersibilă pt. apă uzată
 HU Búvárszivattyú szennyvíz
 ES Bomba sumergible para aguas residuales

230V~50Hz 450 W Q max 16000 l/h



No.	Power / Moc [W]	Max. capacity / Maks. wydajność [l/h]	Max. head / Maks. wysokość tłoczenia [m]	
79880	450	16000	9	1

EN Fountain pump
 PL Pompa fontannaowa
 DE Springbrunnenpumpe
 RU Фонтанный насос
 CZ Fontánová pumpa
 RO Pompă pt. fantana arteziana
 HU Pumpa szökőkúthoz
 ES Bomba para las fuentes



230V~50Hz 3 NOZZLES DYSE IPX8



No.	Power / Moc [W]	Max. capacity / Maks. wydajność [l/h]	Max. head / Maks. wysokość tłoczenia [m]	
79926	8	600	1.0	12
79927	16	800	1.3	12
79928	22	1000	1.6	12

EN Fountain pump
 PL Pompa fontannaowa
 DE Springbrunnenpumpe
 RU Фонтанный насос
 CZ Fontánová pumpa
 RO Pompă pt. fantana arteziana
 HU Pumpa szökőkúthoz
 ES Bomba para las fuentes



230V~50Hz 5 NOZZLES DYSE IP68 10 m



No.	Power / Moc [W]	Max. capacity / Maks. wydajność [l/h]	Max. head / Maks. wysokość tłoczenia [m]	
79931	55	2000	2.5	8
79932	85	3000	3.5	8
79933	100	4500	4.5	6

EN Jet pump
 PL Pompa ogrodowa
 DE Gartenpumpe
 RU Насос садовый

CZ Zahradní čerpadlo
 RO Pompa apa
 HU Kerti szivattyúhoz
 ES Bomba de jardín con cabeza

230V~50Hz



$L_{WA} = 95,0 \pm 3,0$ dB

No.	Power / Moc [W]	Max. capacity / Maks. wydajność [l/h]	Max. lifting height / Maks. wysokość podnoszenia [m]	Max. pumping pressure / Maks. ciśnienie tłoczenia [bar]	
79810	600	2800	35	3.5	1
79811	800	3600	40	4.0	1
79812	1000	3800	44	4.4	1

EN Fountain pump
 PL Pompa fontannaowa
 DE Springbrunnenpumpe
 RU Фонтанный насос
 CZ Fontánová pumpa
 RO Pompă pt. fantana arteziana
 HU Pumpa szökőkúthoz
 ES Bomba para las fuentes



230V~50Hz 5 NOZZLES DYSE IPX8



No.	Power / Moc [W]	Max. capacity / Maks. wydajność [l/h]	Max. head / Maks. wysokość tłoczenia [m]	
79929	28	1400	2.0	8
79930	40	1800	2.5	8

EN Electric grass trimmer
 PL Podkaszarka elektryczna
 DE Elektro-Rasentrimmer
 RU Электрический триммер
 CZ Elektrická sekačka
 RO Cositoare electrică
 HU Elektromos fűnyíró
 ES Segadora eléctrica



230V~50Hz 500 W 10500 min⁻¹ 280 mm 80-100 cm 2 POSITIONS POZICJE



$L_{pA} = 74,4 \pm 1,94$ dB; $L_{WA} = 94,1 \pm 1,94$ dB; $a_n = 0,794 \pm 1,5$ m/s²

No.	Power / Moc [W]	ω [min ⁻¹]	Cutting width / Szerokość cięcia [mm]	
79467	500	10500	280	4

EN Hedge shears
 PL Elektryczne nożyce do żywoplotu
 DE Heckenscheren
 RU Ножницы для живой изгороди
 CZ Nůžky na živý plot
 RO Foarfece pt. gard viu
 HU Sövényvágó olló
 ES Tijera para vallado



$L_{pA} = 81,6 \pm 3,0$ dB; $L_{wA} = 101,6 \pm 3,0$ dB; $a_n = 5,328 \pm 1,5 / 6,1214 \pm 1,5$ m/s²

No.	Power / Moc [W]	Cutting speed / Prędkość cięcia [min ⁻¹]	Cutting length / Długość cięcia [mm]	
79442	450	1700	410	4

EN Electric chainsaw
 PL Elektryczna piła łańcuchowa
 DE Elektrische Kettensäge
 RU Электрическая цепная пила
 CZ Elektrická řetězová pila
 RO Ferăstrau electric cu lanț
 HU Elektromos láncfűrész
 ES Sierra de cadena eléctrica

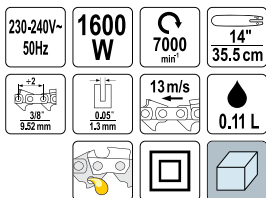

$L_{pA} = 90,2 \pm 3,0$ dB; $L_{wA} = 103,2 \pm 3,0$ dB; $a_n = 8,393 \pm 1,5 / 6,002 \pm 1,5$ m/s²

No.	Power / Moc [W]	
79675	1600	2

EN Electric scarifier
 PL Wertykulator elektryczny
 DE Elektrischer Vertikutierer
 RU Электрический скарификатор
 CZ Elektrický vertikutátor
 RO Scarificator electric
 HU Elektromos gyepszellőztető
 ES Escarificador eléctrico



$L_{pA} = 84,5 \pm 3,0$ dB; $L_{wA} = 97,3 \pm 1,05$ dB; $a_n = 4,265 \pm 1,5$ m/s²

No.	Power / Moc [W]	
79734	1500	1

EN Hedge shears
 PL Elektryczne nożyce do żywoplotu
 DE Heckenscheren
 RU Ножницы для живой изгороди
 CZ Nůžky na živý plot
 RO Foarfece pt. gard viu
 HU Sövényvágó olló
 ES Tijera para vallado



$L_{pA} = 88,0 \pm 3,0$ dB; $L_{wA} = 99,0 \pm 3,0$ dB; $a_n = 1,982 \pm 1,5 / 1,778 \pm 1,5$ m/s²

No.	Power / Moc [W]	Cutting speed / Prędkość cięcia [min ⁻¹]	Cutting length / Długość cięcia [mm]	
79448	550	1700	510	4

EN Electric soil miller
 PL Glebogryzarka elektryczna
 DE Elektro-Bodenhacke
 RU Электрический культиватор
 CZ Elektrický kultivátor
 RO Motosapa electrică
 HU Elektromos kapálógép
 ES Cultivador rotativo eléctrico



$L_{pA} = 79,0 \pm 3,0$ dB; $L_{wA} = 91,87 \pm 0,48$ dB; $a_n = 1,153 \pm 1,5 / 1,158 \pm 1,5$ m/s²

No.	Power / Moc [W]	
79725	750	1

EN Electric scarifier
 PL Wertykulator elektryczny
 DE Elektrischer Vertikutierer
 RU Электрический скарификатор
 CZ Elektrický vertikutátor
 RO Scarificator electric
 HU Elektromos gyepszellőztető
 ES Escarificador eléctrico

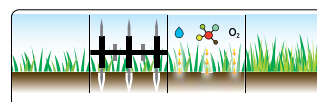
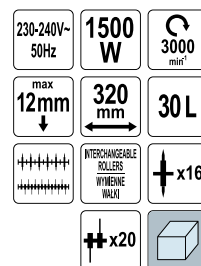



Memo

EN Soldering iron
 PL Lutownica pistoletowa
 DE Delôtkolben
 RU Электропаяльник

CZ Pájka odporová
 RO Ciocan de lipit
 HU Huforrasztópáka
 ES Soldador de resistencia



No.	Power / Moc [W]	
79358	40	25/50

EN Line head
 PL Glowica żyłkowa
 DE Trimmerkopf
 RU Головка с леской
 CZ Strunová hlava
 RO Cap cu cablu
 HU Damil fej
 ES Cabezal de hilo



No.	Ø [mm]	
79550	2.0-2.4	10/40

EN Line head
 PL Glowica żyłkowa
 DE Trimmerkopf
 RU Головка с леской
 CZ Strunová hlava
 RO Cap cu cablu
 HU Damil fej
 ES Cabezal de hilo



No.	Ø [mm]	
79552	2.4-2.7	10/40

EN 2-tooth brushcutter blade
 PL Tarcza tnąca dwuzębna
 DE 2-Zahn Dickichtmesser
 RU Нож для мотокосы двухлопастной
 CZ Žací nůž 2-zubý
 RO Lama de cosit cu 2 dinti
 HU 2-ágú bozótívágó kés
 ES Cuchilla de 2 puntas para desbrozadora



No.		
79560		25/50

EN Transformer soldering gun
 PL Lutownica transformatorowa
 DE Lötpistole
 RU Электрический паяльник

CZ Transformátorová páječka
 RO Pistol de lipit
 HU Forrasztópáka
 ES Soldador transformador

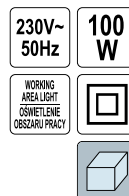

No.	Power / Moc [W]	
79350	100	24

EN Line head
 PL Glowica żyłkowa
 DE Trimmerkopf
 RU Головка с леской
 CZ Strunová hlava
 RO Cap cu cablu
 HU Damil fej
 ES Cabezal de hilo

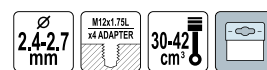

No.	Ø [mm]	
79551	2.4-2.7	10/40

EN Line head
 PL Glowica żyłkowa
 DE Trimmerkopf
 RU Головка с леской
 CZ Strunová hlava
 RO Cap cu cablu
 HU Damil fej
 ES Cabezal de hilo



No.	Ø [mm]	For / Dla	
79468	1.2	79467	20/100

EN Brushcutter chisel-tooth blade
 PL Tarcza tnąca z zębami przecinakowymi
 DE Meißelzahn-Sägeblatt für Motorsensen
 RU Нож для мотокосы
 CZ Řezací kotouč s dlatovými zuby
 RO Lama cu dinte tip dalta pt. cosit
 HU Fűrészkorong vágótárcsa
 ES Disco de corte para desbrozadora



No.		
79561		15/30

EN Grass trimmer line CZ Struna do strunové sekačky
 PL Żyłka tnąca RO Furtun gradina
 DE Mähfaden HU Damil szegélynyíró géphez
 RU Леска для триммера ES Hilo de cortar



No.	Ø [mm]	L [m]	Cutting line profile / Przekrój żyłki	☐
89401	1.3	10	○	20/240
89402	1.6	10	○	20/240
89403	2.0	10	○	20/240
89404	2.4	10	○	12/144
89405	2.6	10	○	12/144
89406	3.0	10	○	12/144



EN Grass trimmer line CZ Struna do strunové sekačky
 PL Żyłka tnąca RO Furtun gradina
 DE Mähfaden HU Damil szegélynyíró géphez
 RU Леска для триммера ES Hilo de cortar



No.	Ø [mm]	L [m]	Cutting line profile / Przekrój żyłki	☐
89441	2.0	120	○	27
89442	2.4	90	○	27
89443	2.6	70	○	27
89444	3.0	56	○	27

EN Grass trimmer line CZ Struna do strunové sekačky
 PL Żyłka tnąca RO Furtun gradina
 DE Mähfaden HU Damil szegélynyíró géphez
 RU Леска для триммера ES Hilo de cortar



No.	Ø [mm]	L [m]	Cutting line profile / Przekrój żyłki	☐
89452	2.4	90	□	16
89453	2.6	70	□	16
89454	3.0	56	□	16

EN Grass trimmer line CZ Struna do strunové sekačky
 PL Żyłka tnąca RO Furtun gradina
 DE Mähfaden HU Damil szegélynyíró géphez
 RU Леска для триммера ES Hilo de cortar



No.	Ø [mm]	L [m]	Cutting line profile / Przekrój żyłki	☐
89456	2.0	90	☆	9/27
89457	2.4	90	☆	9/27
89458	2.6	90	☆	9/27
89459	3.0	60	☆	9/27

EN Grass trimmer line CZ Struna do strunové sekačky
 PL Żyłka tnąca RO Furtun gradina
 DE Mähfaden HU Damil szegélynyíró géphez
 RU Леска для триммера ES Hilo de cortar

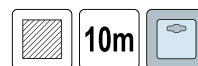

No.	Ø [mm]	L [m]	Cutting line profile / Przekrój żyłki	☐
89411	1.3	10	□	20/240
89412	1.6	10	□	20/240
89413	2.0	10	□	20/240
89414	2.4	10	□	12/144
89415	2.6	10	□	12/144
89416	3.0	10	□	12/144

EN Grass trimmer line CZ Struna do strunové sekačky
 PL Żyłka tnąca RO Furtun gradina
 DE Mähfaden HU Damil szegélynyíró géphez
 RU Леска для триммера ES Hilo de cortar



No.	Ø [mm]	L [m]	Cutting line profile / Przekrój żyłki	☐
89421	1.3	15	☆	24/288
89422	1.6	15	☆	20/240
89423	2.0	15	☆	16/192
89424	2.4	15	☆	12/144
89425	2.6	15	☆	12/144
89426	3.0	15	☆	10/120

EN Grass trimmer line CZ Struna do strunové sekačky
 PL Żyłka tnąca RO Furtun gradina
 DE Mähfaden HU Damil szegélynyíró géphez
 RU Леска для триммера ES Hilo de cortar

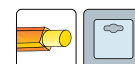

No.	Ø [mm]	L [m]	Cutting line profile / Przekrój żyłki	☐
89462	2.4	15	☐	10/120
89463	2.7	15	☐	10/120
89464	3.0	12	☐	10/120

EN Grass trimmer line
 PL Żyłka tnąca
 DE Mähfaden
 RU Леска для триммера
 CZ Struna do strunové sekačky
 RO Furtun gradina
 HU Damil szegélynyíró géphez
 ES Hilo de cortar



No.	Ø [mm]	L [m]	Cutting line profile / Przekrój żyłki	☐
89465	2.4	90	☐	10/20
89466	2.7	70	☐	10/20
89467	3.0	60	☐	10/20

EN Grass trimmer line
 PL Żyłka tnąca
 DE Mähfaden
 RU Леска для триммера
 CZ Struna do strunové sekačky
 RO Furtun gradina
 HU Damil szegélynyíró géphez
 ES Hilo de cortar

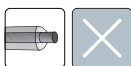

No.	Ø [mm]	L [m]	Cutting line profile / Przekrój żyłki	☐
89473	2.4	90	☐	10/20
89474	2.7	70	☐	10/20
89475	3.0	60	☐	10/20

EN Grass trimmer line
 PL Żyłka tnąca
 DE Mähfaden
 RU Леска для триммера
 CZ Struna do strunové sekačky
 RO Furtun gradina
 HU Damil szegélynyíró géphez
 ES Hilo de cortar



No.	Ø [mm]	L [m]	Cutting line profile / Przekrój żyłki	☐
89478	1.6	15	▨	20/240
89479	2.0	15	▨	12/240
89480	2.4	15	▨	10/120
89481	2.7	15	▨	10/120
89482	3.0	12	▨	10/120

EN Brass straight connection
 PL Króciec mosiężny do pomp
 DE Messingstutzen für Pumpen
 RU Латунный патрубок для насосов
 CZ Mosazná prípojka pro čerpadla
 RO Conector alama
 HU Sárgaréz csatlakozó szivattyúkhoz
 ES Conector de latón para bombas



No.	Hose diameter / Średnica węża	☐
79924	1" (25 mm)	10/80

EN Grass trimmer line
 PL Żyłka tnąca
 DE Mähfaden
 RU Леска для триммера
 CZ Struna do strunové sekačky
 RO Furtun gradina
 HU Damil szegélynyíró géphez
 ES Hilo de cortar

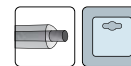

No.	Ø [mm]	L [m]	Cutting line profile / Przekrój żyłki	☐
89470	2.4	15	☐	10/120
89471	2.7	15	☐	10/120
89472	3.0	12	☐	10/120

EN Grass trimmer line
 PL Żyłka tnąca
 DE Mähfaden
 RU Леска для триммера
 CZ Struna do strunové sekačky
 RO Furtun gradina
 HU Damil szegélynyíró géphez
 ES Hilo de cortar



No.	Ø [mm]	L [m]	Cutting line profile / Przekrój żyłki	☐
89483	2.0	90	▨	10/20
89484	2.4	90	▨	10/20
89485	2.7	70	▨	10/20
89486	3.0	60	▨	10/20

EN Hose connection
 PL Przyłącze do węża do pomp zatapialnych
 DE Druckleitung-Anschlussstutze
 RU Соединитель для шланга
 CZ Koleno k hadici
 RO Ștuf de fixare furtun
 HU Tömítő csatlakozó
 ES Tubuladura para manguera para bombas de inmersiyn

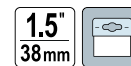

No.	☐
79919	100



EN Drill chuck
 PL Głowica do wiertarki samozaciskowej
 DE Schnellspanbohrfutter
 RU Патрон сверлильный быстрозажимной
 CZ Hlava na vrtáčku samosvorná
 RO Mandrină cu autostrângere pt. bormașină
 HU Az önbeszorulós fűrógéptokmányfej
 ES Cabeza para taladradora autoapriete



No.	Toolholder size / Rozmiar uchwyty narzędziowego [mm]	Thread size / Rozmiar gwintu	
79570	1-10	G3/8	10/40

EN Drill chuck
 PL Głowica do wiertarki samozaciskowej
 DE Schnellspanbohrfutter
 RU Патрон сверлильный быстрозажимной
 CZ Hlava na vrtáčku samosvorná
 RO Mandrină cu autostrângere pt. bormașină
 HU Az önbeszorulós fűrógéptokmányfej
 ES Cabeza para taladradora autoapriete

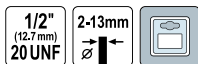

No.	Toolholder size / Rozmiar uchwyty narzędziowego [mm]	Thread size / Rozmiar gwintu	
79580	2-13	G1/2	5/40

EN Adapter SDS-plus - UNF 1/2"
 PL Adapter SDS-plus - UNF 1/2"
 DE Adapter SDS-plus - UNF 1/2"
 RU Переходник SDS-plus - UNF 1/2"
 CZ Přenoska SDS-plus - UNF 1/2"
 RO Adaptor SDS-plus - UNF 1/2"
 HU Adapter SDS-plus - UNF 1/2"
 ES Adaptor SDS-plus - UNF 1/2"



No.	Thread size / Rozmiar gwintu	
79800	G1/2	12/144

EN Multipurpose drill bit sharpener
 PL Wielofunkcyjna ostrzałka do wiertel
 DE Vielzweck Bohrererschleifgerät
 RU Машина для заточки сверл
 CZ Ostrůvka pro ostření vrtáků
 RO Mașină de ascuțit burghie
 HU Fűróélező
 ES Afiladora de brocas

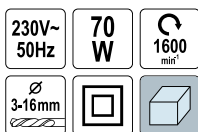

$L_{pA} = 61,0 \pm 3,0$ dB; $L_{wA} = 74,0 \pm 3,0$ dB

No.	Power / Moc [W]	
73470	70	6



EN Drill chuck
 PL Głowica do wiertarki na klucz
 DE Schnellspanbohrfutter
 RU Патрон сверлильный ключевой
 CZ Hlava na vrtáčku na klíč
 RO Mandrină cu cheie pt. bormașină
 HU Az önbeszorulós fűrógéptokmányfej
 ES Cabeza para taladradora de llave



No.	Toolholder size / Rozmiar uchwyty narzędziowego [mm]	Thread size / Rozmiar gwintu	
79630	1.5-13	G1/2	5/40

EN Rotary sharpener
 PL Ostrzałka do wiertarki
 DE Bohrercharfer-Bohrmaschinenaufsatz
 RU Точило для ножей и ножиц
 CZ Brousek na nože a nůžky
 RO Rezerva pt dispozitiv de ascuțit burghie
 HU Élezőké fűrógéphe fogható
 ES Muela afilar cuchillos y tijeras

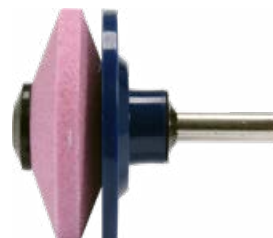

No.	
26225	80/240

EN Multi-function sharpener
 PL Ostrzałka wielofunkcyjna
 DE Multifunktionales Schärfergerät
 RU Многофункциональный заточный станок
 CZ Víceúčelová bruska
 RO Mașină de ascuțit multifuncțională
 HU Multifunkciós élezőgép
 ES Afilador multifuncional



$L_{pA} = 80,0 \pm 3,0$ dB; $L_{wA} = 93,0 \pm 3,0$ dB

No.	Power / Moc [W]	
73473	150	2

- EN Angle grinder stand
- PL Statyw do szlifierki kątowej
- DE Winkelschleif-Trennstander
- RU Стенд для угловой шлифовальной машины
- CZ Stojan pro úhlovou brusku
- RO Stativ pt. polizor unghiular
- HU Állvány sarokcsiszolóhoz
- ES Soporte para lijadora de ángulo



VOREL

No.	H [mm]	Icon
79641	4	

- EN Drill stand
- PL Statyw do wiertarki
- DE Bohrmaschinen-Ständer
- RU Штатив для дрели
- CZ Stativ do vrtačky
- RO Suport masina de gaurit
- HU Fúróállvány
- ES Soporte para taladro



VOREL

No.	H [mm]	Icon
79639	400	

- EN Rotary file set
- PL Tarniki trzpieniowe
- DE Profil-Fräser Satz
- RU Набор фрез
- CZ Hrotové rašple
- RO Răspeluri cu coadă
- HU Fareszelőkészlet, csapszárú
- ES Rotatorio archivos

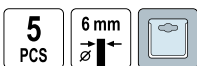

No.	Chuck diameter / Średnica trzpienia [mm]	pcs / szt.	Icon
25450	6	5	

- EN Drill stand
- PL Stojak do wiertarki
- DE Bohrmaschinenständer
- RU Сверлильная станция
- CZ Stativ do vrtačky
- RO Suport masina de gaurit
- HU Fúróállvány
- ES Soporte para taladro



VOREL

No.	H [mm]	Icon
79640	400	

- EN Spare cutting knife for electric planer
- PL Zapasowe ostrza do struga elektrycznego
- DE Hobelmesser für Elektrohobel
- RU Лезвия для электропобанка
- CZ Náhradní nůž pro elektr. hoblíku
- RO Lamă de rezervă pt. rindea electrică
- HU Tartalék gyalukés elektromos gyalugéphez
- ES Filos de repuesto para cepillo eléctrico



STHOR

No.	pcs / szt.	Icon
79346	2	

- EN Mounted stone set
- PL Kamienie szlifierskie trzpieniowe
- DE Schleifsteinaufsätze
- RU Набор абразивных наконечников
- CZ Brusné kámeny hrotové
- RO Set pietre abrazive cu tija
- HU Csiszolókó készlet, csapszárú
- ES Discos de esmeril

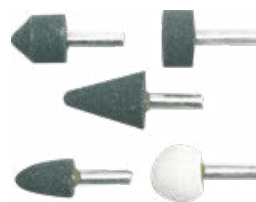
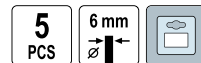

No.	Chuck diameter / Średnica trzpienia [mm]	pcs / szt.	Icon
25400	6	5	

- EN Mini grinder accessories set
- PL Zestaw końcówek do szlifierki
- DE Schleifaufsätze
- RU Набор шлифовальных и полировочных насадок
- CZ Soustava koncovek na brusku
- RO Set pietre abrazive si pasla pt. slefuit
- HU Fejkészlet csiszológéphez
- ES Juego de puntas de pulir



VOREL

No.	pcs / szt.	Icon
25410	13	

EN Mini grinder accessories set
 PL Zestaw końcówek do szlifierki
 DE Schleifaufsätze
 RU Набор шлифовальных и полировочных насадок
 CZ Soustava koncovek na brusku
 RO Set pietre abrazive si pasla pt. slefuit
 HU Fejkészlet csiszológéphez
 ES Juego de puntas de pulir



VOREL

No.	pcs / szt.	
25411	17	10/50

EN Rotary file set
 PL Tarniki trzpieniowe
 DE Profil-Fräser Satz
 RU Набор фрез
 CZ Hrotové rašple
 RO Raspeluri cu coadă
 HU Fareszelőkészlet, csapszáras
 ES Rotatorio archivos

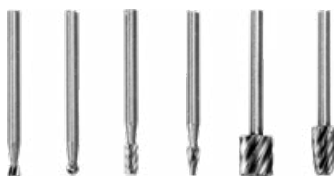

STHOR

No.	pcs / szt.	
25405	6	50/300

EN Glue sticks
 PL Wkłady klejowe
 DE Heissklebeatronen
 RU Стержин для горячей склейки
 CZ Lepicí vložky
 RO Mine cu clei
 HU Ragasztótétét
 ES Cartucho de cola



APPLICATION:

- Cardboard, wood, plastic, leather, fabrics

ZASTOSOWANIE:

- Tektura, drewno, plastik, skóra, tkaniny

VOREL

No.	Ø [mm]	L [mm]	m [kg]	
73300	11	200	1	10

EN Helping hand with magnifying glass
 PL Zestaw „trzecia ręka” z lupą
 DE Dritte Hand mit Lupe
 RU Комплект „третья ручка” с лупой
 CZ Držák třetí ruka s lupou
 RO Suport cu lupa pt. ciocan lipit
 HU Paneltartó állvány „harmadik kéz”
 ES Tercera mano con lupa



No.	Glass diameter / Średnica szkła [mm]	
73500	62	10/40

EN Mini grinder accessories set
 PL Zestaw końcówek do szlifierki
 DE Schleifaufsätze
 RU Набор шлифовальных и полировочных насадок
 CZ Soustava koncovek na brusku
 RO Set pietre abrazive si pasla pt. slefuit
 HU Fejkészlet csiszológéphez
 ES Juego de puntas de pulir



VOREL

No.	pcs / szt.	
25412	22	10/50

EN Polishing covers
 PL Nakładki polerujące
 DE Polierscheibe
 RU Полировочные накладки
 CZ Leštící kotouč
 RO Polizor captusit
 HU Polírozó korong
 ES Fundas

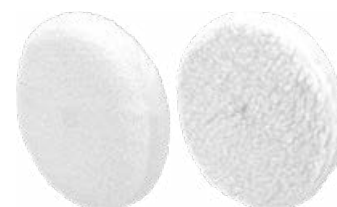
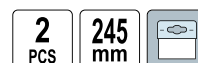

VOREL

No.	Ø [mm]	For / Dla	pcs / szt.	
82941	245	82940	2	10/100

EN Glue sticks
 PL Wkłady klejowe
 DE Heissklebeatronen
 RU Стержин для горячей склейки
 CZ Lepicí vložky
 RO Mine cu clei
 HU Ragasztótétét
 ES Cartucho de cola



APPLICATION:

- Cardboard, wood, plastic, leather, fabrics

ZASTOSOWANIE:

- Tektura, drewno, plastik, skóra, tkaniny

STHOR

No.	Ø [mm]	L [mm]	pcs / szt.	
73260	7	100	12	50/200
73270	11	100	6	20/120
73271	11	150	12	20/60

EN Soldering iron stand
 PL Stojak do lutownicy
 DE Lötkolbenständer
 RU Подставка для паяльника
 CZ Stojan na rájku
 RO Suport pt. ciocan lipit
 HU Forrasztópáka tartó
 ES Caballete de soldador



VOREL

No.		
79386		50

- EN Soldering accessories
- PL Zestaw narzędzi lutowniczych
- DE Lötzubehör
- RU Принадлежности для пайки
- CZ Pájecí příslušenství
- RO Accesorii de lipit
- HU Forrasztó tartozékok
- ES Jooteseadmed tarvikud

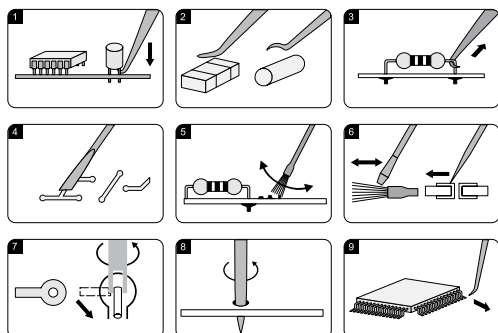

No.	pcs / szt.	Box
79398	6	25/100

- EN Solder
- PL Spoiwo lutownicze
- DE Lötzin
- RU Припой
- CZ Pájka
- RO Sarna de sudura
- HU Forrasztó ón
- ES Estaño plata



No.	Ø [mm]	m [g]	Box
76830	1	16	25/250

- EN Solder stick
- PL Cyna w lasce
- DE Stangenlötzin
- RU Припой
- CZ Pájka v tyčkách
- RO Baghete de sudura
- HU Forrasztó rúd
- ES Barra estaño plomo



No.	Dimensions / Wymiary [mm]	m [kg]	Box
76832	7x7x322	5	1

- EN Solder
- PL Spoiwo lutownicze
- DE Lötzin
- RU Припой
- CZ Pájka
- RO Sarna de sudura
- HU Forrasztó ón
- ES Estaño plata



No.	Ø [mm]	m [g]	Box
76800	0.5	100	30
76806	0.7	100	30
76807	0.7	250	20
76810	1.0	100	30
76811	1.0	250	20
76814	1.5	100	30
76815	1.5	250	20
76818	2.0	100	30
76819	2.0	250	20
76822	2.5	100	30
76823	2.5	250	20
76826	3.0	100	30

- EN Lead free solder
- PL Spoiwo lutownicze bezolowiowe
- DE Bleifreier Lötdraht
- RU Бессвинцовый припой
- CZ Bezolovnaté pájkové pojivo
- RO Rola fluor fara plumb
- HU Ólommentes forrasztó
- ES Estaño para soldar sin plomo



No.	Ø [mm]	m [g]	Box
76850	0.5	100	30
76851	0.7	100	30
76852	1.0	100	30
76853	1.0	250	20
76854	1.5	100	30
76855	1.5	250	20
76856	2.0	100	30
76857	2.0	250	20
76858	2.5	100	30
76859	3.0	100	30

EN Lead free solder in a phial
 PL Spoiwo lutownicze bezolowiowe fiołka
 DE Bleifreier Lötdraht im Spenderröhrchen
 RU Бесвинцовый припой флакон
 CZ Bezolovnaté pájkové rojivo lahvička
 RO Fludor fara plumb, in tub
 HU Ólommentes forrasztóón fiola
 ES Estaño para soldar sin plomo, en ampolla



No.	Ø [mm]	m [g]	
76870	1.0	14	250

EN Solder rods without flux
 PL Pręty lutownicze bez topnika
 DE Lötstangen ohne Flussmittel
 RU Паяльные стержни без флюса
 CZ Pájecí tyče bez tavidia
 RO Tijele de lipit fără flux
 HU Forrasztórúd gyanta nélkül
 ES Barras de soldadura sin fundente

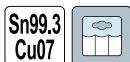

No.	Ø [mm]	m [g]	
76877	0.4	200	30

EN Solder paste
 PL Pasta lutownicza
 DE Lotpaste
 RU Паяльная паста
 CZ Pájecí pasty
 RO Pasta decapante sudura
 HU Forrasztó paszta
 ES Pasta de soldar



No.	m [g]	
76835	40	50

EN Desoldering pump
 PL Odsysacz do cyny
 DE Entlötsaugpumpe
 RU Шприц для удаления припоя
 CZ Odřájecí sací pumpra
 RO Pompa fludor
 HU Ónszippantó
 ES Bomba desoldadora



No.	
79390	100/400

EN Soft solder
 PL Spoiwo do instalacji miedzianych
 DE Lötdraht für Kupferinstallationen
 RU Припой для медных установок
 CZ Rojivo pro měděné instalace
 RO Fludor moale
 HU Forrasztóón rézhez
 ES Aglutinante para instalaciones de cobre

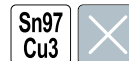

No.	Ø [mm]	m [g]	
76880	1.5	100	60
76881	2.0	100	60
76882	2.0	250	50
76883	2.5	100	60
76884	2.5	250	50

EN Rosin
 PL Kalafonia lutownicza
 DE Kolophonium
 RU Канфоль
 CZ Kalafuna
 RO Colofoniu
 HU Forrasztó gyanta
 ES Colofonia



No.	m [g]	
76836	45	50

EN Desoldering pump
 PL Odsysacz do cyny
 DE Entlötsaugpumpe
 RU Шприц для удаления припоя
 CZ Odřájecí sací pumpra
 RO Pompa fludor
 HU Ónszippantó
 ES Bomba desoldadora



No.	
79391	70/140

EN Pumping hose for motor pumps with terminals
 PL Wąż tłoczny do motopomp z końcówkami
 DE Druckschlauch für Motorpumpen mit Anschlussstücken
 RU Напорный рукав для мотопомп с наконечниками
 CZ Výtlačná hadice s koncovkami pro motorová čerpadla
 RO Furtun pt. motopompe cu capete
 HU Szivattyú nyomótömlő kapcsokkal szerelve
 ES Manguera para bombear para motobombas con terminales



No.	L [m]	Ø	Max. operating pressure / Maks. ciśnienie robocze [bar]	Bursting pressure / Ciśnienie rozrywające [bar]	
79977	20	2" (50.0 mm)	6	24	1
79978	20	3" (75.0 mm)	6	24	1
79979	20	4" (100.0 mm)	6	24	1

EN Pumping hose for motor pumps
 PL Wąż tłoczny do motopomp
 DE Druckschlauch für Motorpumpen
 RU Напорный рукав для мотопомп
 CZ Výtlačná hadice pro motorová čerpadla
 RO Furtun pt. motopompe
 HU Szivattyú nyomótömlő
 ES Manguera para bombear para motobombas



No.	L [m]	Ø	Max. operating pressure / Maks. ciśnienie robocze [bar]	Bursting pressure / Ciśnienie rozrywające [bar]	
79982	50	1" (25.0 mm)	2	6	1
79983	50	2" (50.0 mm)	2	6	1
79984	50	3" (75.0 mm)	2	6	1

EN Suction hose
 PL Wąż ssawny do pomp
 DE Saugschlauch für Pumpen
 RU Всасывающий шланг для насосов
 CZ Sací hadice do čerpadel
 RO Furtun aspiratie
 HU Szivattyútömlő
 ES Manguera de succión para bomba



15

No.	L [m]	Water outlet diameter / Średnica przyłącza wody	
79823	5	1" (25.0 mm)	6
79824	7	1" (25.0 mm)	4

Memo

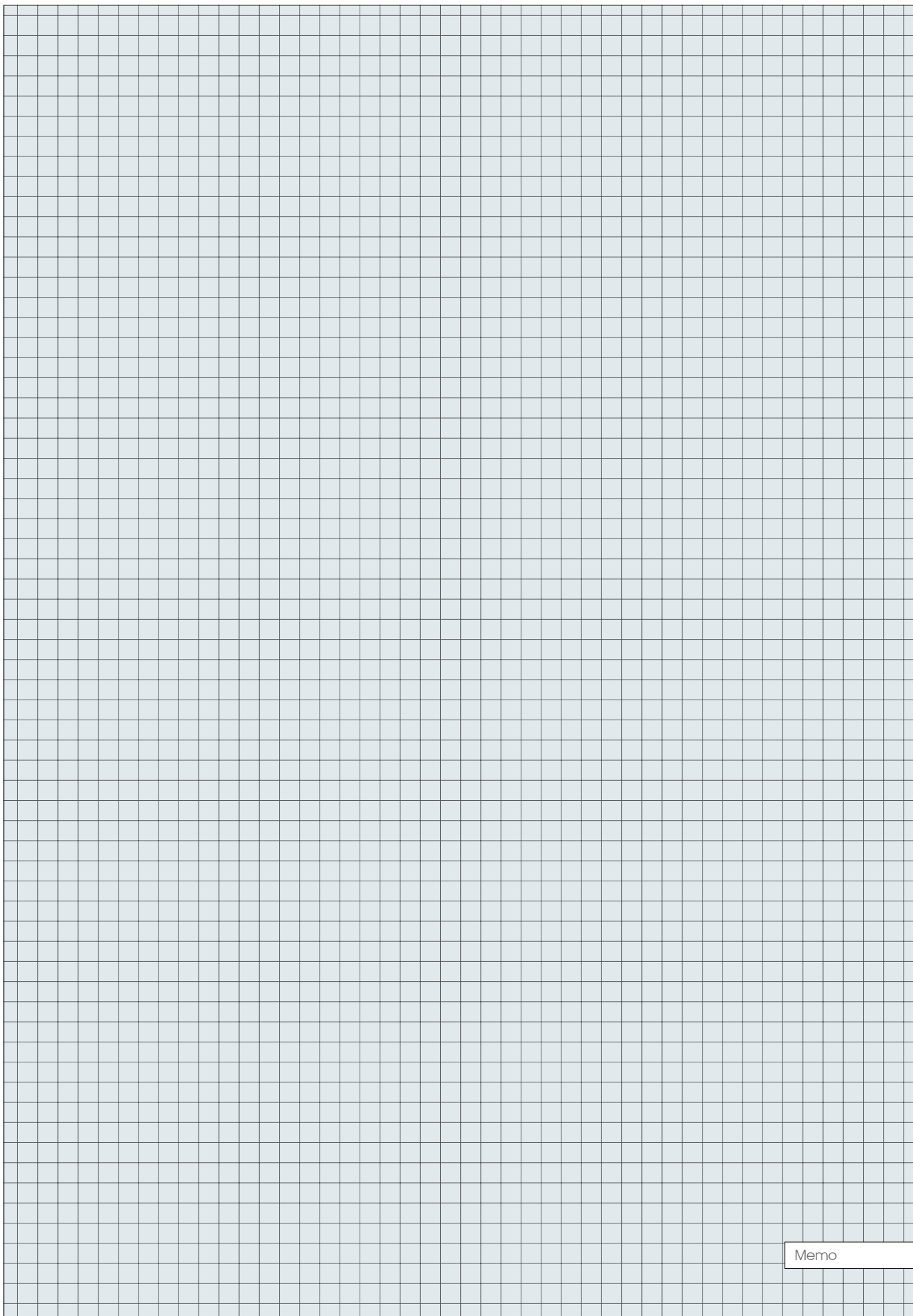

Memo

16

Welding equipment Sprzęt spawalniczy

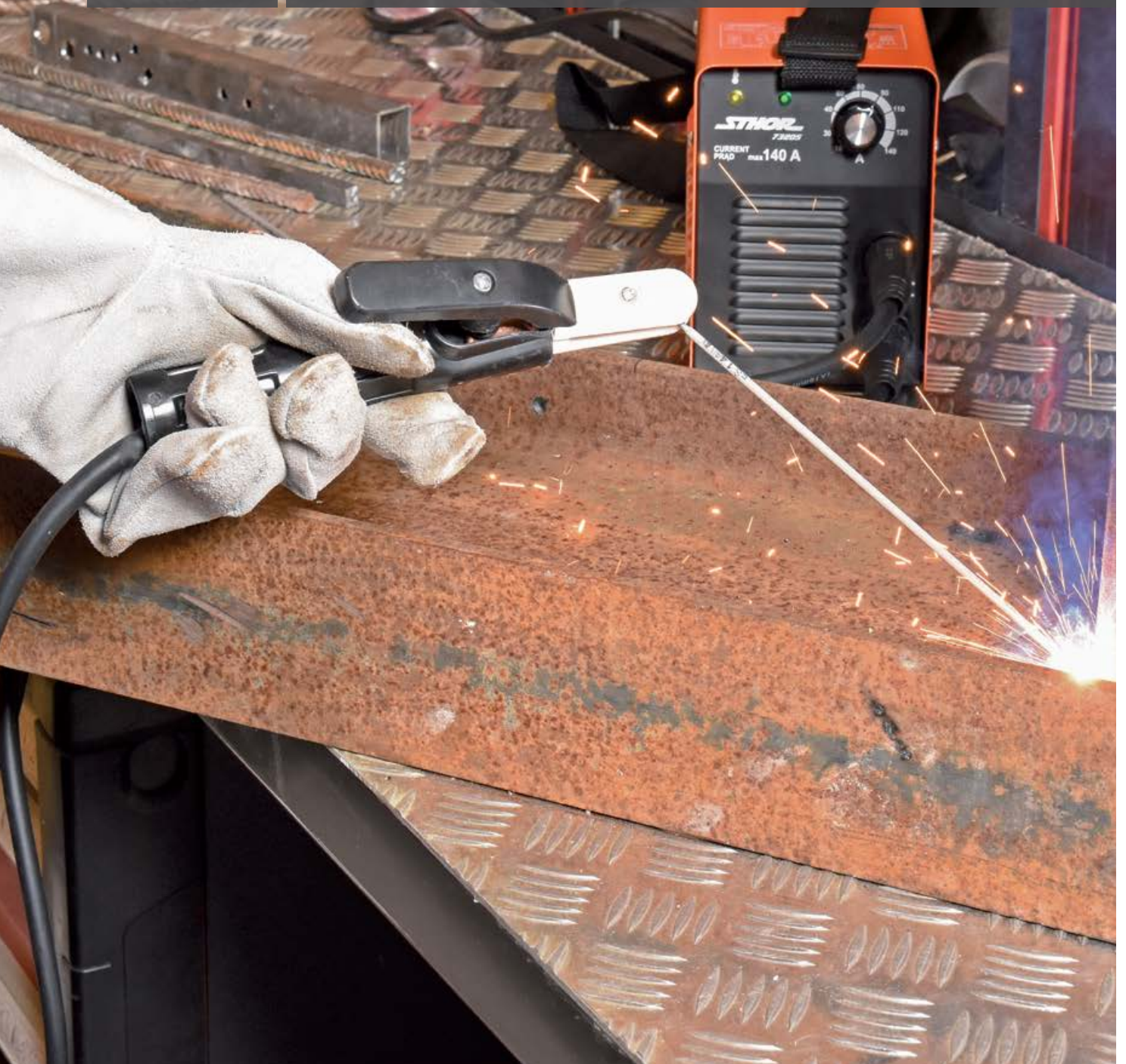

Welding accessories
Akcesoria spawalnicze

286-291

Clamps

Zaciski spawalnicze..... 286

Welding goggles & masks

Okulary i maski spawalnicze..... 286

Hammers

Młotki..... 289

Lock grip pliers & accessories

Szczypce zaciskowe i akcesoria..... 289

Tin snips

Nożyce do blachy..... 290

- EN Clamp
- PL Zacisk spawalniczy biegunowo-kleszczowy
- DE Schweisseklemme
- RU Клещи для сварки
- CZ Kleště svářečské zemníci
- RO Cleste pt. sudura
- HU Testkábel-csatlakozó
- ES Cocodrilo para soldar



No.	Max. welding current / Maks. prąd spawania [A]	Earthing cable diameter / Średnica przewodu masowego [mm ²]	Max. jaws range / Maks. rozwarcie szczęk [mm]	m [kg]	Type / Typ	
74420	160	35	50	0.21	ZBK-35	25
74421	315	70	60	0.25	ZBK-70	25
74422	520	95	70	0.29	ZBK-95	25

- EN Welding goggles
- PL Okulary spawalnicze
- DE Schweisserbrille
- RU Очки газосварщика
- CZ Brýle svářečské
- RO Ochelari pt. sudura
- HU Hegesztőszemüveg
- ES Gafas para soldar



No.	
74410	5/100

- EN Welding mask
- PL Maska spawalnicza
- DE Schweissermaske
- RU Щиток сварщика
- CZ Svářečská maska
- RO Mască de sudură
- HU Hegesztőpajzs
- ES Mascara de soldador



No.	Type / Typ	
74440	TSM-3	30

- EN Electrode holder
- PL Uchwyt spawalniczy elektrodowy
- DE Schweisselectrodengriff
- RU Клещи для сварки (электродные)
- CZ Držák elektrod
- RO Cleste pt. sudura cu electrod
- HU Elektrodafogó
- ES Abrazadera para soldar, de electrodos



No.	Max. welding current / Maks. prąd spawania [A]	Electrode diameter / Średnica elektrody [mm]	Welding cable diameter / Średnica przewodu spawalniczego [mm ²]	m [kg]	Type / Typ	
74430	200 (X=60%) / 315 (X=35%)	35-50	2-5	0.32	UE-200	25
74431	315 (X=60%) / 400 (X=35%)	50-70	2.5-6.3	0.42	UE-300	25
74432	430 (X=60%) / 530 (X=35%)	70-95	3.5-6.3	0.5	UE-400	25

- EN Welding goggles
- PL Okulary spawalnicze
- DE Schweisserbrille
- RU Очки газосварщика
- CZ Brýle svářečské
- RO Ochelari pt. sudura
- HU Hegesztőszemüveg
- ES Gafas para soldar



No.	
74411	10/100

- EN Welding mask
- PL Maska spawalnicza
- DE Schweissermaske
- RU Щиток сварщика
- CZ Svářečská maska
- RO Mască de sudură
- HU Hegesztőpajzs
- ES Mascara de soldador



No.	Type / Typ	
74442	TSM	30

EN Welding mask
 PL Przyłbica spawalnicza z podglądem
 DE Schweissermaske
 RU Щиток сварщика с подсмотром
 CZ Svářečská přilba s nakoukáním
 RO Mască de sudură cu geam
 HU Hegesztősisak kitekintővel
 ES Mascara de soldador con mirador



No.	Type / Typ	
74443	TSMP	20

EN Welding mask
 PL Maska spawalnicza
 DE Schweissermaske
 RU Щиток сварщика
 CZ Svářečská maska
 RO Mască de sudură
 HU Hegesztőpajzs
 ES Mascara de soldador



No.	Type / Typ	
74450	TSD-3	20

EN Welding mask
 PL Przyłbica spawalnicza z podglądem
 DE Schweissermaske
 RU Щиток сварщика с подсмотром
 CZ Svářečská přilba s nakoukáním
 RO Mască de sudură cu geam
 HU Hegesztősisak kitekintővel
 ES Mascara de soldador con mirador

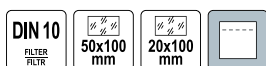

No.	Type / Typ	
74447	PSMP	20

EN Welding mask
 PL Przyłbica spawalnicza z podglądem
 DE Schweissermaske
 RU Щиток сварщика с подсмотром
 CZ Svářečská přilba s nakoukáním
 RO Mască de sudură cu geam
 HU Hegesztőpajzs
 ES Mascara de soldador con mirador



No.	Type / Typ	
74448	PS-3	10

EN Welding mask
 PL Maska spawalnicza
 DE Schweissermaske
 RU Щиток сварщика
 CZ Svářečská maska
 RO Mască de sudură
 HU Hegesztőpajzs
 ES Mascara de soldador



No.	
74441	20

EN Welding mask
 PL Przyłbica spawalnicza
 DE Schweissermaske
 RU Щиток сварщика
 CZ Svářečská přilba
 RO Mască de sudură
 HU Hegesztőpajzs
 ES Mascara de soldador



No.	
74457	20

EN Auto-darkening welding helmet
 PL Przybica spawalnicza samościemniająca
 DE Schweissmaske, selbstverdunkelnd
 RU Маска сварщика с автос затемнением
 CZ Svářečská kukla samostmívací
 RO Mască de sudură auto-intunecare
 HU Őnmagától sötétedő hegesztőpajzs
 ES Casco auto-oscurecedor para soldadura

9-13 DARK STATE STAN CIEMNY	SHADE SCIEMNIANIE	DIN 4 LIGHT STATE STAN JASNY	1 1 1 2 OPTICAL CLASS KLASA OPTYCZNA	92x42 mm
2 ARC SENSOR CZUJNIKI LUKI	1/15000s REACTION TIME CZAS REAKCJI	SENSITIVITY CZUŁOŚĆ	0.25-0.85s BRIGHTENING ROZJAŚNIANIE	DELAY OPÓZNIENIE
UV/IR	SOLAR CELL OGNIWO SŁONECZNE	3-POINT HEADGEAR WIEŻBA 3-PUNKTOWA	AUTO ON / OFF AUTO WL. WYL.	°C -5 +55
	MIG/MAG MMA/TIG	GRINDING AND WELDING SZLIFOWANIE I SPAWANIE		



STKOR

No.	
74480	6

EN Auto-darkening welding helmet
 PL Przybica spawalnicza samościemniająca
 DE Schweissmaske, selbstverdunkelnd
 RU Маска сварщика с автос затемнением
 CZ Svářečská kukla samostmívací
 RO Mască de sudură auto-intunecare
 HU Őnmagától sötétedő hegesztőpajzs
 ES Casco auto-oscurecedor para soldadura

DIN 11 DARK STATE STAN CIEMNY	DIN 3 LIGHT STATE STAN JASNY	1 1 1 2 OPTICAL CLASS KLASA OPTYCZNA	100x50 mm	4 ARC SENSOR CZUJNIKI LUKI
1/25000s REACTION TIME CZAS REAKCJI	0,1-1,0 s BRIGHTENING ROZJAŚNIANIE	DIN 16 UV/IR	SOLAR CELL OGNIWO SŁONECZNE	2x CR2032
AUTO ON / OFF AUTO WL. WYL.	AUTOMATIC SENSITIVITY ADJUSTMENT AUTOMATYCZNA REGULACJA CZUŁOŚCI	3-POINT HEADGEAR WIEŻBA 3-PUNKTOWA	°C -5 +55	MIG/MAG MMA/TIG
	GRINDING AND WELDING SZLIFOWANIE I SPAWANIE			



STKOR

No.	
74484	6

EN Welding filter
 PL Filtr spawalniczy
 DE Vorsatzglas
 RU Фильтр для сварки
 CZ Filtr svářečský
 RO Filtru pt. sudării
 HU Hegesztőszűrő
 ES Pantalla de filtro de soldador



No.	Filter size / Rozmiar filtra [mm]	Dark state / Stan ciemny [DIN]	
74452	50x100	8	100
74453	50x100	9	100
74454	50x100	10	100
74455	50x100	11	100

EN Auto-darkening welding helmet
 PL Przybica spawalnicza samościemniająca
 DE Schweissmaske, selbstverdunkelnd
 RU Маска сварщика с автос затемнением
 CZ Svářečská kukla samostmívací
 RO Mască de sudură auto-intunecare
 HU Őnmagától sötétedő hegesztőpajzs
 ES Casco auto-oscurecedor para soldadura

DIN 11 DARK STATE STAN CIEMNY	DIN 3 LIGHT STATE STAN JASNY	1 1 1 2 OPTICAL CLASS KLASA OPTYCZNA	90x35 mm	2 ARC SENSOR CZUJNIKI LUKI
1/25000s REACTION TIME CZAS REAKCJI	0,4 s BRIGHTENING ROZJAŚNIANIE	DIN 15 UV/IR	SOLAR CELL OGNIWO SŁONECZNE	1x CR1025
3-POINT HEADGEAR WIEŻBA 3-PUNKTOWA	°C -5 +55	MIG/MAG MMA/TIG	GRINDING AND WELDING SZLIFOWANIE I SPAWANIE	



STKOR

No.	
74483	6

EN Filter shield
 PL Osłona filtra
 DE Filterabdeckung
 RU Коух фильтра
 CZ Ochrana filtru
 RO Aparătoare de filtru
 HU Szűrőfedél
 ES Protección de filtro



No.	Filter size / Rozmiar filtra [mm]	Dark state / Stan ciemny [DIN]	
74451	50x100	0	100

EN Self-dimming helmet filter protection
 PL Osłona filtra przybicy samościemniającej
 DE Filtereinsatz eines selbstabdunkelnden Schutzhelmes
 RU Коух фильтра самозатемняющегося шитка
 CZ Ochranná folie filtru samostmívací kukly
 RO Carcasă filtru vizieră heliometă
 HU Hegesztőpajzs szűrő, őnsötétedő
 ES Protección del filtro de visera autooscurecedora

5 PCS	PC	
-----------------	-----------	--



No.	Filter size / Rozmiar filtra [mm]	pcs / szt.	
74439	90x110	5	20

EN Soft faced mallet
 PL Młotek blacharski, guma - plastik
 DE Ausbeulhammer
 RU Молоток рихтовочный комбинированный с деревянной ручкой

CZ Klempířské kladívko
 RO Ciocan pt. tabla
 HU Bádógos kalapács
 ES Mazo goma-plastico



No.	Head diameter / Średnica obucha [mm]	
33950	35	30/60

EN Welder's hammer
 PL Młotek spawalniczy
 DE Schweisserhammer
 RU Молоток сварщика

CZ Svářečské kladívko
 RO Ciocan de sudură
 HU Hegesztő kalapács
 ES Martillo para soldar



JUKO

No.	m [g]	
32110	350	5

EN Welding locking pliers „C” type
 PL Szczypce zaciskowe klamrowe typu „C”
 DE Klemm- und Klammerzange vom Typ „C”
 RU Клещи зажимные сварочные
 CZ Kleště samosvorné upínací typu „C”
 RO Clește autoblocant pt. sudură
 HU Hegesztő fogó
 ES Pinzas de tornillo (de apriete) de grapa tipo „C”

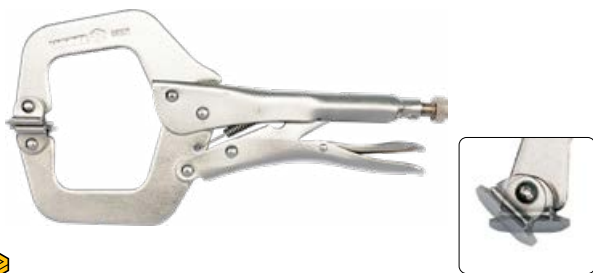

VOREL

No.	L [mm]	Type / Typ	
44301	280	C	5/30

EN Lock grip pliers
 PL Szczypce spawalnicze
 DE Schweisserzange
 RU Клещи зажимные сварочные
 CZ Svářečské kleště
 RO Clește autoblocant pt. sudură
 HU Hegesztő fogó
 ES Alicates de soldar

No.	L [mm]	Type / Typ	
44500	250	SM	6/36

EN Wooden mallet
 PL Młotek drewniany blacharski
 DE Holzhammer für Bleche
 RU Молоток жестящика, деревянный

CZ Palice dřevěná klempířská
 RO Ciocan din lemn de tinichigiu
 HU Bádógos fakalapács
 ES Martillo de madera de hojalatero



VOREL

No.	L [mm]	
33532	285	20

EN Lock grip pliers
 PL Szczypce spawalnicze
 DE Schweisserzange
 RU Клещи зажимные сварочные
 CZ Svářečské kleště
 RO Clește autoblocant pt. sudură
 HU Hegesztő fogó
 ES Alicates de soldar

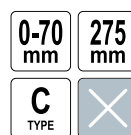

No.	L [mm]	Type / Typ	
44300	275	C	6/36

EN Lock grip pliers
 PL Szczypce spawalnicze
 DE Schweisserzange
 RU Клещи зажимные сварочные
 CZ Svářečské kleště
 RO Clește autoblocant pt. sudură
 HU Hegesztő fogó
 ES Alicates de soldar



No.	L [mm]	Type / Typ	
44400	225	U	6/36

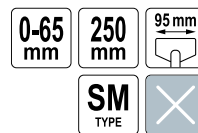

- EN Mini locking pliers set
- PL Zestaw szczypiec spawalniczych mini
- DE Mini-Schweißzangen-Satz
- RU Набор сварочных мини-клещей
- CZ Sada svařovacích kleští mini
- RO Set mini clești autoblocanti
- HU Mini testcsipesz készlet
- ES Juego de mini pinzas para soldar



- L=110 mm;
- L=125 mm;
- L=130 mm (2 PCS)



No.	L [mm]	pcs / szt.	
44330	110, 125, 130, 130	4	6/24

- EN Figure tin snips
- PL Nożyce do blachy
- DE Blechscherer
- RU Ножницы по металлу
- CZ Nůžky na plech
- RO Foarfece pt. tablă
- HU Lemezvágó olló
- ES Tijeras para hojalata



No.	L [mm]	Max. cutting capacity in cold-rolled steel / Maks. grubość cięcia w stali walcowanej na zimno [mm]	
48060	250	1.2	6/48

- EN Figure tin snips
- PL Nożyce do blachy
- DE Blechscherer
- RU Ножницы по металлу
- CZ Nůžky na plech
- RO Foarfece pt. tablă
- HU Lemezvágó olló
- ES Tijeras para hojalata



No.	L [mm]	
48100	250	6/60

- EN Figure tin snips
- PL Nożyce do blachy
- DE Blechscherer
- RU Ножницы по металлу
- CZ Nůžky na plech
- RO Foarfece pt. tablă
- HU Lemezvágó olló
- ES Tijeras para hojalata



No.	L [mm]	Max. cutting capacity in cold-rolled steel / Maks. grubość cięcia w stali walcowanej na zimno [mm]	
48000	250	1.5	6/36

- EN Figure tin snips
- PL Nożyce do blachy
- DE Blechscherer
- RU Ножницы по металлу
- CZ Nůžky na plech
- RO Foarfece pt. tablă
- HU Lemezvágó olló
- ES Tijeras para hojalata



No.	L [mm]	Max. cutting capacity in cold-rolled steel / Maks. grubość cięcia w stali walcowanej na zimno [mm]	
48080	250	1	6/36

- EN Figure tin snips
- PL Nożyce do blachy
- DE Blechscherer
- RU Ножницы по металлу
- CZ Nůžky na plech
- RO Foarfece pt. tablă
- HU Lemezvágó olló
- ES Tijeras para hojalata



No.	L [mm]	Max. cutting capacity in cold-rolled steel / Maks. grubość cięcia w stali walcowanej na zimno [mm]	
48082	250	1	6/36

EN Figure tin snips
 PL Nożyce do blachy
 DE Blechscherer
 RU Ножницы по металлу
 CZ Nůžky na plech
 RO Foarfece pt. tablă
 HU Lemezvágó olló
 ES Tijeras para hojalata



No.	L [mm]	
48200	250	6/60

EN Figure tin snips
 PL Nożyce do blachy
 DE Blechscherer
 RU Ножницы по металлу
 CZ Nůžky na plech
 RO Foarfece pt. tablă
 HU Lemezvágó olló
 ES Tijeras para hojalata



VOREL

No.	L [mm]	Max. cutting capacity in cold-rolled steel / Maks. grubość cięcia w stali walcowanej na zimno [mm]	
48070	250	1.2	6/48

EN Figure tin snips
 PL Nożyce do blachy
 DE Blechscherer
 RU Ножницы по металлу
 CZ Nůžky na plech
 RO Foarfece pt. tablă
 HU Lemezvágó olló
 ES Tijeras para hojalata



No.	L [mm]	
48150	250	6/60

EN Figure tin snips
 PL Nożyce do blachy
 DE Blechscherer
 RU Ножницы по металлу
 CZ Nůžky na plech
 RO Foarfece pt. tablă
 HU Lemezvágó olló
 ES Tijeras para hojalata



VOREL

No.	L [mm]	Max. cutting capacity in cold-rolled steel / Maks. grubość cięcia w stali walcowanej na zimno [mm]	
48050	250	1.5	6/36

EN Figure tin snips
 PL Nożyce do blachy
 DE Blechscherer
 RU Ножницы по металлу
 CZ Nůžky na plech
 RO Foarfece pt. tablă
 HU Lemezvágó olló
 ES Tijeras para hojalata



VOREL

No.	L [mm]	Max. cutting capacity in cold-rolled steel / Maks. grubość cięcia w stali walcowanej na zimno [mm]	
48081	250	1	6/36

EN Figure tin snips
 PL Nożyce do blachy
 DE Blechscherer
 RU Ножницы по металлу
 CZ Nůžky na plech
 RO Foarfece pt. tablă
 HU Lemezvágó olló
 ES Tijeras para hojalata



No.	L [mm]	pcs / szt.	
48330	250	3	5/20

17

Safes, padlocks & locks Sejfy, klódki i zamki



Safes
Sejfy

.....294

**Key boxes**
Skrzynki na klucze

.....294

**Cash boxes**
Kasetki na pieniądze

.....294-295

**Padlocks**
Kłódki

.....295-297

**Cast iron padlocks**

Kłódki żeliwne..... 295

Brass padlocks

Kłódki mosiężne..... 296

Steel padlocks

Kłódki stalowe..... 297

Lock cylinders & bodies
Wkładki do zamków i zamki

.....297-299

**Brass lock cylinders**

Wkładki mosiężne..... 297

Safety chains

Łańcuchy do drzwi..... 298

Door closers

Samozamykacze..... 298

Bicycle & motorcycle locks
Zamknięcia do rowerów i motocykli

.....299-300



EN Safe with digital lock
 PL Sejf z zamkiem cyfrowym
 DE Seif mit Digitalschloss
 RU Сейф с электронным замком

CZ Pancéřová pokladna z digitálním zámkem
 RO Seif cu broasca cu cifru
 HU Számszáras széf
 ES Caja de seguridad con cerradura digital



No.	Dimensions / Wymiary [mm]	
78641	350x250x250	1

EN Key box
 PL Skrzynka na klucze
 DE Schlüsselkasten
 RU Ящик для ключей
 CZ Skříňka na klíče
 RO Cutie pt. chei
 HU Kulcstartó doboz
 ES Caja para llaves

200x160
x78
mm

2x

x15
HOOKS
HAKI



No.	Dimensions / Wymiary [mm]	
78432	200x160x78	20

EN Key box
 PL Skrzynka na klucze
 DE Schlüsselkasten
 RU Ящик для ключей
 CZ Skříňka na klíče
 RO Cutie pt. chei
 HU Kulcstartó doboz
 ES Caja para llaves

450x380
x80
mm

2x

x80
HOOKS
HAKI



No.	Dimensions / Wymiary [mm]	
78436	450x380x80	5

EN Cash box
 PL Kasetka na pieniądze
 DE Geldkassette
 RU Ящик для денег
 CZ Kазeta na peníze
 RO Casetă (cutie) pt. bani
 HU Pénzes kassetta
 ES Caja para efectivo

200x160
x90
mm

2x



No.	Dimensions / Wymiary [mm]	Color / Kolor	
78622	200x160x90	czarny	10

EN Safe with digital lock
 PL Sejf z zamkiem cyfrowym
 DE Seif mit Digitalschloss
 RU Сейф с электронным замком

CZ Pancéřová pokladna z digitálním zámkem
 RO Seif cu broasca cu cifru
 HU Számszáras széf
 ES Caja de seguridad con cerradura digital



No.	Dimensions / Wymiary [mm]	
78642	310x200x200	1

EN Key box
 PL Skrzynka na klucze
 DE Schlüsselkasten
 RU Ящик для ключей
 CZ Skříňka na klíče
 RO Cutie pt. chei
 HU Kulcstartó doboz
 ES Caja para llaves

250x180
x80
mm

2x

x48
HOOKS
HAKI



No.	Dimensions / Wymiary [mm]	
78434	250x180x80	10

EN Cash box
 PL Kasetka na pieniądze
 DE Geldkassette
 RU Ящик для денег
 CZ Kазeta na peníze
 RO Casetă (cutie) pt. bani
 HU Pénzes kassetta
 ES Caja para efectivo

150x120
x80
mm

2x



No.	Dimensions / Wymiary [mm]	Color / Kolor	
78620	150x120x80	czarny	20

EN Cash box
 PL Kasetka na pieniądze
 DE Geldkassette
 RU Ящик для денег
 CZ Kазeta na peníze
 RO Casetă (cutie) pt. bani
 HU Pénzes kassetta
 ES Caja para efectivo

200x160
x90
mm

CODE
SZYFR



No.	Dimensions / Wymiary [mm]	Color / Kolor	
78624	200x160x90	czarny	10

EN Cash box
 PL Kasetka na pieniądze
 DE Geldkassette
 RU Ящик для денег
 CZ Kазeta na peníze
 RO Casetă (cutie) pt. bani
 HU Pénzes kasszeta
 ES Caja para efectivo

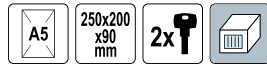

VOREL

No.	Dimensions / Wymiary [mm]	Color / Kolor	
78626	250x200x90	czarny	10

EN Cash box
 PL Kasetka na pieniądze
 DE Geldkassette
 RU Ящик для денег
 CZ Kазeta na peníze
 RO Casetă (cutie) pt. bani
 HU Pénzes kasszeta
 ES Caja para efectivo

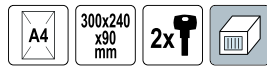

VOREL

No.	Dimensions / Wymiary [mm]	Color / Kolor	
78630	300x240x90	czarny	10

EN Iron padlock
 PL Kłódka żelazna
 DE Vorhängeschloss
 RU Замок навесной
 CZ Stavební visací zámek
 RO Lacăt pt. construcții
 HU Óriás lakat
 ES Candado de hierro fundido



VOREL

No.	Size / Rozmiar [mm]	
77061	32	12/120
77062	38	12/120
77063	50	6/60
77064	63	6/36

EN Cash box
 PL Kasetka na pieniądze
 DE Geldkassette
 RU Ящик для денег
 CZ Kазeta na peníze
 RO Casetă (cutie) pt. bani
 HU Pénzes kasszeta
 ES Caja para efectivo

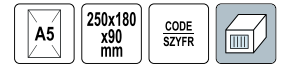

VOREL

No.	Dimensions / Wymiary [mm]	Color / Kolor	
78628	250x180x90	czarny	10

EN Cash box
 PL Kasetka na pieniądze
 DE Geldkassette
 RU Ящик для денег
 CZ Kазeta na peníze
 RO Casetă (cutie) pt. bani
 HU Pénzes kasszeta
 ES Caja para efectivo

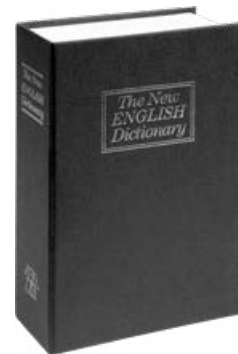

VOREL

No.	Dimensions / Wymiary [mm]	Color / Kolor	
78632	180x115x55	czarny	24
78633	240x155x55	czarny	20

EN Alloy covered iron padlock
 PL Kłódka żelazna powlekana
 DE Vorhängeschloss
 RU Замок навесной
 CZ Stavební visací zámek
 RO Lacăt pt. construcții
 HU Óriás lakat
 ES Candado de hierro fundido

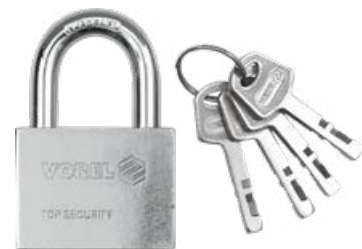

VOREL

No.	Size / Rozmiar [mm]	
77004	40	12/96
77005	50	12/72
77006	60	12/48

- EN Rectangular brass padlock
- PL Klódka trzpieniowa
- DE Messigvorhängeschloss
- RU Стержневой навесной замок латунный
- CZ Visací zámek čerový
- RO Lacăt din alamă cu belciug drept
- HU Réz hengerzáras u lakat
- ES Candado de latón de mandril



No.	Size / Rozmiar [mm]	
77210	50	6/120
77211	65	6/96
77212	75	6/60
77213	90	6/36

- EN Combination padlock
- PL Klódka szyfrowa
- DE Vorhängezahlenschloss
- RU Замок навесной кодовый
- CZ Visací zámek s číselným kódem
- RO Lacăt alama cu cifru
- HU Számszáras lakat
- ES Candado combinación

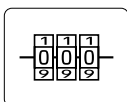

No.	Size / Rozmiar [mm]	
77606	25	12/120

17

- EN Combination padlock
- PL Klódka szyfrowa
- DE Vorhängezahlenschloss
- RU Замок навесной кодовый
- CZ Visací zámek s číselným kódem
- RO Lacăt alama cu cifru
- HU Számszáras lakat
- ES Candado combinación

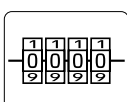

No.	Size / Rozmiar [mm]	
77608	40	12/120

- EN Plated brass padlock
- PL Klódka mosiężna
- DE Vorhängeschloss
- RU Замок навесной латунный
- CZ Zámek visací mosazný
- RO Lacăt alama
- HU Lakat sárgaréz
- ES Candado de latón



No.	Size / Rozmiar [mm]	
77250	25	12/600
77300	30	12/480
77350	35	12/300
77400	40	12/240
77500	50	12/144
77600	60	12/144

- EN Combination padlock
- PL Klódka szyfrowa
- DE Vorhängezahlenschloss
- RU Замок навесной кодовый
- CZ Visací zámek s číselným kódem
- RO Lacăt alama cu cifru
- HU Számszáras lakat
- ES Candado combinación

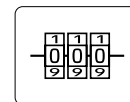

No.	
77607	12/120

- EN Combination padlock
- PL Klódka szyfrowa
- DE Vorhängezahlenschloss
- RU Замок навесной кодовый
- CZ Visací zámek s číselným kódem
- RO Lacăt alama cu cifru
- HU Számszáras lakat
- ES Candado combinación

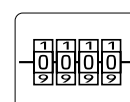

No.	Size / Rozmiar [mm]	
77609	50	6/48

EN Combination padlock
 PL Klódka szyfrowa
 DE Vorhängezschloss
 RU Замок навесной кодовый
 CZ Visací zámek s číselným kódem
 RO Lacat alama cu cifru
 HU Számszáras lakat
 ES Candado combinación

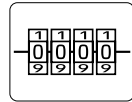
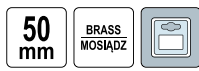

No.	Size / Rozmiar [mm]	
77612	50	6/48

EN Combination padlock
 PL Klódka szyfrowa
 DE Vorhängezschloss
 RU Замок навесной кодовый
 CZ Visací zámek s číselným kódem
 RO Lacat alama cu cifru
 HU Számszáras lakat
 ES Candado combinación

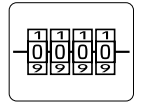

No.	Size / Rozmiar [mm]	
77618	50	6/48

EN Plated brass padlock
 PL Klódka mosiężna
 DE Vorhängeschloss
 RU Замок навесной латунный
 CZ Zámek visací mosazný
 RO Lacat alama
 HU Lakat sárgaréz
 ES Candado de latón



No.	Size / Rozmiar [mm]	
77700	40x105	12/240

EN Safety padlock with nylon isolated body
 PL Klódka specjalna z korpusem zabezpieczonym tworzywem
 DE Spezielles Vorhängeschloss, Körper mit Kunststoff gesichert
 RU Специальный навесной замок с пластиковой защитой
 CZ Speciální visací zámek, tělo zajištěno plastem
 RO Lacăt de siguranță cu corp izolat din nailon
 HU Speciális lakat műanyaggal védett ház
 ES Candado especial cuerpo, protegido con plástico



No.		
77100		10/100

EN Wire safety padlock with nylon isolation
 PL Klódka powlekana nylonem z linką
 DE Vorhängeschloss nylonbeschichtet mit Seil
 RU Навесной замок с нейлоновым покрытием и тросиком
 CZ Visací zámek potažený nylonem s lanem
 RO Lacăt de siguranță cu fir cu izolație din nailon
 HU Nylon burkolatú huzalos lakat
 ES Candado revestido con nailon y cable



No.		
77105		10/120

EN Steel safety lock out hasp
 PL Stalowa blokada klamrowa
 DE Multi-Schließklammer aus Stahl
 RU Стальной замок-скоба
 CZ Svrnková blokáda ocelová
 RO Siguranta blocare, oțel
 HU Acél lakatolható csatos zár
 ES Aldaba de seguridad de acero



No.		
77705		10/200

EN Aluminium safety lock out hasp
 PL Aluminiowa blokada klamrowa
 DE Multi-Schließklammer aus Aluminium
 RU Алюминиевый замок-скоба
 CZ Sponková blokáda hliníková
 RO Siguranta blocare, Al
 HU Alumínium lakatolható csatos zár
 ES Aldaba de seguridad de aluminio

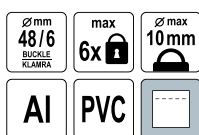

No.		
77704		10/200

EN Lock cylinder
 PL Wkładka do zamka
 DE Schliesszylinder
 RU Личинка замка латунная

CZ Vložka na zámek
 RO Yață pt. broască
 HU Zárbetét
 ES Inserción cromada



No.	L [mm]	Size / Rozmiar [mm]	Key quantity / Liczba kluczy	
77200	62	31/31	3	12/72
77203	72	31/41	3	12/72
77204	67	31/36	3	12/72
77205	87	36/51	3	12/72

EN Lock cylinder
 PL Wkładka do zamka chromowana
 DE Schliesszylinder
 RU Личинка замка
 CZ Vložka na zámeček
 RO Yală pt. broască
 HU Zárbetét
 ES Inserción cromado



No.	L [mm]	Size / Rozmiar [mm]	Key quantity / Liczba kluczy	
77170	62	31/31	3	12/72

EN Lock cylinder
 PL Wkładka do zamka chromowana
 DE Schliesszylinder
 RU Личинка замка
 CZ Vložka na zámeček
 RO Yală pt. broască
 HU Zárbetét
 ES Inserción cromado



No.	L [mm]	Size / Rozmiar [mm]	Key quantity / Liczba kluczy	
77180	62	31/31	6	12/72

EN Safety chain
 PL Łańcuch do drzwi
 DE Türsicherungskette
 RU Замок-цепь для двери

CZ Řetěz na dveře
 RO Lanț pt. ușă
 HU Ajtólánc
 ES Cadena para puerta



No.		
77910		12/120

EN Door closer
 PL Automacyjny zamykacz do drzwi
 DE Automatischer Türschließer
 RU Доводчик дверной
 CZ Automatický zavírač dveří
 RO Încuetoare automată ușă
 HU Ajtófék
 ES Muelle de puerta



No.	Door weight / Căuțar skrzydła [kg]	
78471	25-85	10

EN Lock cylinder
 PL Wkładka do zamka
 DE Schliesszylinder
 RU Личинка замка латунная
 CZ Vložka na zámeček
 RO Yală pt. broască
 HU Zárbetét
 ES Inserción cromado



No.	L [mm]	Size / Rozmiar [mm]	Key quantity / Liczba kluczy	
77190	62	31/31	6	12/72
77191	67	31/36	6	12/72
77192	72	31/41	6	12/72
77193	87	36/51	6	12/72

EN Safety chain
 PL Łańcuch do drzwi
 DE Türsicherungskette
 RU Замок-цепь для двери

CZ Řetěz na dveře
 RO Lanț pt. ușă
 HU Ajtólánc
 ES Cadena para puerta



No.	
77900	12/120

EN Door closer
 PL Automacyjny zamykacz do drzwi
 DE Automatischer Türschließer
 RU Доводчик дверной
 CZ Automatický zavírač dveří
 RO Încuetoare automată ușă
 HU Ajtófék
 ES Muelle de puerta

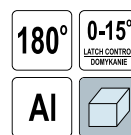

No.	Door weight / Căuțar skrzydła [kg]	
78470	20-85	10

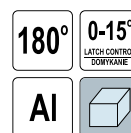

EN Door closer
 PL Automacyjny zamykacz do drzwi
 DE Automatischer Türschließer
 RU Доводчик дверной
 CZ Automaticky zavírač dveří
 RO Incuietoare automată uşă
 HU Ajtófék
 ES Muelle de puerta



No.	Door weight / Ciężar skrzydła [kg]	
78472	25-85	10

EN Bicycle lock
 PL Linka rowerowa
 DE Fahrradschloss
 RU Замок велосипедный
 CZ Zámek jízdního kola
 RO Antifurt pt. bicicleta
 HU Kerékpárzár
 ES Cable antirrobo para bicicletas



No.	L [cm]	Ø [mm]	Color / Kolor	
77830	65	8	czarny, niebieski, czerwony	12/120

EN Bicycle lock
 PL Linka rowerowa
 DE Fahrradschloss
 RU Замок велосипедный
 CZ Zámek jízdního kola
 RO Antifurt pt. bicicleta
 HU Kerékpárzár
 ES Cable antirrobo para bicicletas



No.	L [cm]	Ø [mm]	Color / Kolor	
77833	120	8	czarny, niebieski, czerwony	10/60
77834	120	10	czarny, niebieski, czerwony	10/60
77835	180	10	czarny, niebieski, czerwony	10/60

EN Bicycle lock
 PL Linka rowerowa
 DE Fahrradschloss
 RU Замок велосипедный
 CZ Zámek jízdního kola
 RO Antifurt pt. bicicleta
 HU Kerékpárzár
 ES Cable antirrobo para bicicletas



No.	L [cm]	Ø [mm]	Color / Kolor	
77845	120	10	czarny, niebieski, czerwony	20/40

EN Key holders
 PL Zawieszki plastikowe do kluczy
 DE Schlüsselanhänger
 RU Брелок для ключей
 CZ Přívěšek na klíče
 RO Breloc
 HU Kulcstartó
 ES Llaveros de plástico



No.	pcs / szt.	
77930	12	12/120

EN Bicycle lock
 PL Linka rowerowa
 DE Fahrradschloss
 RU Замок велосипедный
 CZ Zámek jízdního kola
 RO Antifurt pt. bicicleta
 HU Kerékpárzár
 ES Cable antirrobo para bicicletas



No.	L [cm]	Ø [mm]	Color / Kolor	
77831	65	8	czarny, niebieski, czerwony	12/120

EN Bicycle lock
 PL Linka rowerowa
 DE Fahrradschloss
 RU Замок велосипедный
 CZ Zámek jízdního kola
 RO Antifurt pt. bicicleta
 HU Kerékpárzár
 ES Cable antirrobo para bicicletas



No.	L [cm]	Ø [mm]	Color / Kolor	
77837	120	8	czarny, niebieski, czerwony	10/60
77838	150	10	czarny, niebieski, czerwony	10/60

EN Bicycle lock
 PL Linka rowerowa
 DE Fahrradschloss
 RU Замок велосипедный
 CZ Zámek jízdního kola
 RO Antifurt pt. bicicleta
 HU Kerékpárzár
 ES Cable antirrobo para bicicletas



EN Bicycle lock
 PL Linka rowerowa
 DE Fahrradschloss
 RU Замок велосипедный
 CZ Zámek jízdního kola
 RO Antifurt pt. bicicleta
 HU Kerékpárzár
 ES Cable antirrobo para bicicletas



No.	L [cm]	Ø [mm]	Color / Kolor	
77840	180	12	czarny, niebieski, czerwony	10/40

EN Bicycle lock
 PL Zapięcie rowerowe
 DE Fahrradschloss
 RU Замок велосипедный
 CZ Zámek jízdního kola
 RO Antifurt pt. bicicleta
 HU Kerékpárzár
 ES Cable antirrobo para bicicletas



No.	L [cm]	Ø [mm]	
77850	100	18	12/24

EN Chain lock
 PL Zapięcie łańcuchowe z zamkiem
 DE Kettenverschluss mit Schloss
 RU Цепь с замком
 CZ Bezpečnostní řetěz se zámek
 RO Încuietoare lanț cu lacăt
 HU Kerékpár lakat
 ES Candado de cadena con cerradura



No.	L [cm]	Ø [mm]	
77881	120	7	12

EN Security cable and lock
 PL Linka stalowa z kłódką
 DE Stahlseil, mit Vorhängeschloss
 RU Канат стальной с замком
 CZ Ocelové lanko s visacím zámekem
 RO Sărmă de oțel cu lacăt
 HU Drótkötél, lakattal
 ES Cuerda de acero con candado

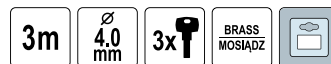

No.	L [cm]	Ø [mm]	
77815	3	4	12/48

EN Motorcycle lock
 PL Zapięcie motocyklowe
 DE Stahlgliederschloss
 RU Замок до мотоцикла
 CZ Zámek na kolo
 RO Anti-furt motocicletă
 HU Lánclakat motorbiciklihez
 ES Candado para Moto



No.	L [cm]	Ø [mm]	
77861	150	25	6/12



Memo



Memo

VOREL

VOREL

18

Accessories
Akcesoria



Tool belts Pasy na narzędzia	
.....304	
Tool bags Torby narzędziowe	
.....304	
Trolley tool boxes Wózki narzędziowe	
.....304-305	
Tool boxes Skrzynki narzędziowe	
.....305-307	

EN Tool belt with fixed bags
 PL Pas narzędziowy z naszytymi torbami
 DE Werkzeuggürtel mit Taschen
 RU Пояс для инструментов с карманами
 CZ Opasek na nářadí s taškami
 RO Centura de scule cu pungii fixe
 HU Szerszám öv táská
 ES Cinturón para herramientas con bolsas



No.	
78751	24

EN Tool belt
 PL Pas narzędziowy
 DE Werkzeuggürtel
 RU Инструмент пояса

CZ Opasek s nářadím
 RO Centura scule
 HU Szerszám öv
 ES Cinturón para herramientas



No.	
78750	50

EN Tool bag
 PL Torba narzędziowa
 DE Werkzeugtasche
 RU Сумка для инструмента
 CZ Taška montérská
 RO Geanta pt. scule
 HU Szerszámos táská
 ES Bolso de herramientas



No.	Dimensions / Wymiary [mm]	
78720	430x285x170	2

EN Trolley toolbox, 2 segments
 PL Wózek narzędziowy 2-segmentowy
 DE Werkzeuggtrolley 2-Teilig
 RU Мешок для инструментов 2 секции
 CZ Vozík na nářadí 2 segmenty
 RO Troler pt. scule 2 segmente
 HU Kerekes szerszámosláda 2 részes
 ES Carro de herramientas 2 compartimentos



No.	
78731	1

EN Tool belt with sliding bags
 PL Pas narzędziowy stolarski z przesuwanymi torbami
 DE Werkzeuggürtel mit Taschen
 RU Пояс для инструментов со сменными карманами
 CZ Opasek na nářadí s taškami
 RO Centura de scule cu pungii glisante
 HU Szerszám öv táská
 ES Cinturón para herramientas con bolsas



No.	
78752	24

EN Tool bag
 PL Torba narzędziowa
 DE Werkzeugtasche
 RU Сумка для инструмента

CZ Taška montérská
 RO Geanta pt. scule
 HU Szerszámos táská
 ES Bolso de herramientas



No.	Dimensions / Wymiary [mm]	
78700	380x250x110	4
78710	455x280x130	2

EN Tool bag
 PL Torba narzędziowa
 DE Werkzeugtasche
 RU Сумка для инструмента
 CZ Taška montérská
 RO Geanta pt. scule
 HU Szerszámos táská
 ES Bolso de herramientas



No.	Dimensions / Wymiary [mm]	
78730	400x260x140	2



EN Trolley toolbox, 2 segments
 PL Wózek narzędziowy z wyjmowanym organizerem
 DE Werkzeugtrolley mit abnehmbarem Organisaufsatz
 RU Мешок для инструментов с вынимаемым органайзером
 CZ Vozík na nářadí s odnímatelným organizérem
 RO Troler pt. scule 2 segmente
 HU Kerekesherszámoszláda kivehető szervezővel
 ES Carro de herramientas con organizador extraíble



No.	
78734	1

EN Trolley toolbox, 3 segments
 PL Wózek narzędziowy 3-segmentowy
 DE Werkzeugtrolley 3-Teilig
 RU Мешок для инструментов 3 секции
 CZ Vozík na nářadí 3 segmenty
 RO Troler pt. scule 3 segmente
 HU Kerekesherszámoszláda 3 részés
 ES Carro de herramientas 3 compartimentos



No.	
78738	1

EN Trolley toolbox, 3 segments
 PL Wózek narzędziowy 3-segmentowy
 DE Werkzeugtrolley 3-Teilig
 RU Мешок для инструментов 3 секции
 CZ Vozík na nářadí 3 segmenty
 RO Troler pt. scule 3 segmente
 HU Kerekesherszámoszláda 3 részés
 ES Carro de herramientas 3 compartimentos



No.	
78736	1

EN Toolbox
 PL Skrzynka narzędziowa
 DE Werkzeugkoffer
 RU Ящик для инструментов

CZ Skříňka na nářadí
 RO Cutie pt. scule
 HU Szerszámoszláda
 ES Caja de herramientas



No.	Size / Rozmiar	Dimensions / Wymiary [mm]	
78801	12" (30.0 cm)	312x167x130	1
78800	16" (40.0 cm)	415x226x200	1

EN Toolbox
 PL Skrzynka narzędziowa
 DE Werkzeugkoffer
 RU Ящик для инструментов
 CZ Skříňka na nářadí
 RO Cutie pt. scule
 HU Szerszámosláda
 ES Caja de herramientas



No.	Size / Rozmiar	Dimensions / Wymiary [mm]	
78802	20" (50.0 cm)	525x256x246	1

EN Toolbox
 PL Skrzynka narzędziowa
 DE Werkzeugkoffer
 RU Ящик для инструментов
 CZ Skříňka na nářadí
 RO Cutie pt. scule
 HU Szerszámosláda
 ES Caja de herramientas



No.	Size / Rozmiar	Dimensions / Wymiary [mm]	Load capacity / Noşność [kg]	
78814	20" (50.0 cm)	525x256x325	25+3	1

EN Workshop drawers
 PL Szufiadki warsztatowe
 DE Werkstattschubfächer
 RU Ящички для инструментов
 CZ Skříňka se zásobníky
 RO Sertare atelier
 HU Műhely zsámoly fiókkal
 ES Cajones para taller



No.	Dimensions / Wymiary [mm]	Compartment quantity / Liczba przegródek	
78785	225x155x100	10	20

EN Toolbox
 PL Skrzynka narzędziowa
 DE Werkzeugkoffer
 RU Ящик для инструментов
 CZ Skříňka na nářadí
 RO Cutie pt. scule
 HU Szerszámosláda
 ES Caja de herramientas



No.	Size / Rozmiar	Dimensions / Wymiary [mm]	
78811	12" (30.0 cm)	312x167x130	1
78812	16" (40.0 cm)	415x226x200	1
78813	20" (50.0 cm)	525x256x246	1
78815	26" (65.0 cm)	595x337x316	1

EN Tool organiser with storage case
 PL Tablica narzędziowa z pojemnikami
 DE Werkzeugtafel mit Behältern
 RU Таблица для инструментов с контейнерами
 CZ Organizér na nářadí s krabičkami
 RO Organizator + cutie depozitare scule
 HU Szerszámartató fal tartályokkal
 ES Tablero de herramientas con recipientes



No.	Compartment dimensions / Wymiary modulu [mm]	pcs / szt.	
78771	475x272x15	48	1

EN Organizer
 PL Organizer
 DE Werkzeugkaste
 RU Органайзер
 CZ Organizér
 RO Cutie tip organizator
 HU Csavartartó doboz
 ES Caja



No.	Dimensions / Wymiary [mm]	Compartment quantity / Liczba przegródek	
78790	200x145x35	7	10

EN Organizer
 PL Organizator
 DE Werkzeugkaste
 RU Организа́тор
 CZ Organizér
 RO Cutie tip organizator
 HU Csavartartó doboz
 ES Caja



No.	Dimensions / Wymiary [mm]	Compartment quantity / Liczba przegródek	
78791	300x220x55	10	10

EN Organizer
 PL Organizator
 DE Werkzeugkaste
 RU Организа́тор
 CZ Organizér
 RO Cutie tip organizator
 HU Csavartartó doboz
 ES Caja



No.	Dimensions / Wymiary [mm]	
78819	460x320	5

EN Storage case
 PL Pojemnik magazynowy
 DE Lagersichtbox
 RU Ящик для склада
 CZ Box skladovací
 RO Cutie scule diverse
 HU Tárolók
 ES Contenedor de almacén



No.	Dimensions / Wymiary [mm]	Type / Typ	
78830	116x112x75	XS	270
78831	116x161x75	S	190
78833	170x240x126	M	44
78834	204x340x155	L	27
78835	333x500x187	XL	7

EN Organizer
 PL Organizator
 DE Werkzeugkaste
 RU Организа́тор
 CZ Organizér
 RO Cutie tip organizator
 HU Csavartartó doboz
 ES Caja



No.	Dimensions / Wymiary [mm]	
78794	360x270	5

EN Storage case
 PL Pojemnik magazynowy
 DE Lagersichtbox
 RU Ящик для склада
 CZ Box skladovací
 RO Cutie scule diverse
 HU Tárolók
 ES Contenedor de almacén







No.	Dimensions / Wymiary [mm]	Type / Typ	
78821	108x110x75	P-1	40
78822	160x115x75	P-2	40
78824	235x173x125	P-4	20
78825	340x200x150	P-5	9
78826	440x315x180	P-6	6



19

Bicycle accessories Akcesoria rowerowe



Bicycle lamps Lampy rowerowe	
.....310	
Bicycle & motorcycle locks Zamknięcia do rowerów i motocykli	
.....310-311	
Bicycle pumps Pompki rowerowe	
.....311-313	
Bicycle tools Narzędzia rowerowe	
.....313	

- EN LED bike light set
- PL Zestaw lamp rowerowych LED
- DE Fahrrad-Beleuchtungsset LED
- RU Набор светодиодных велосипедных фонарей
- CZ Set LED osvětlení na kolo
- RO Set lanterna bicicleta LED
- HU LED kerékpár lámpa szett
- ES Juego de luces LED para bicicletas

5 LED	2x AAA	3W	150 lm
3x AAA	ZOOM		



**POWER
LED**



No.	Battery type / Rodzaj baterii	
88422	3x1.5V; AAA, 2x1.5V; AAA	12/48

- EN Bicycle lock
- PL Linka rowerowa
- DE Fahrradschloss
- RU Замок велосипедный
- CZ Zámek jízdního kola
- RO Antifurt pt. bicicleta
- HU Kerékpárzár
- ES Cable antirrobo para bicicletas

65 cm	8.0 mm	
----------	-----------	--



No.	L [cm]	Ø [mm]	Color / Kolor	
77831	65	8	czarny, niebieski, czerwony	12/120

- EN Bicycle lock
- PL Linka rowerowa
- DE Fahrradschloss
- RU Замок велосипедный
- CZ Zámek jízdního kola
- RO Antifurt pt. bicicleta
- HU Kerékpárzár
- ES Cable antirrobo para bicicletas



No.	L [cm]	Ø [mm]	Color / Kolor	
77837	120	8	czarny, niebieski, czerwony	10/60
77838	150	10	czarny, niebieski, czerwony	10/60

- EN Bicycle lock
- PL Linka rowerowa
- DE Fahrradschloss
- RU Замок велосипедный
- CZ Zámek jízdního kola
- RO Antifurt pt. bicicleta
- HU Kerékpárzár
- ES Cable antirrobo para bicicletas

65 cm	8.0 mm	
----------	-----------	--



No.	L [cm]	Ø [mm]	Color / Kolor	
77830	65	8	czarny, niebieski, czerwony	12/120

- EN Bicycle lock
- PL Linka rowerowa
- DE Fahrradschloss
- RU Замок велосипедный
- CZ Zámek jízdního kola
- RO Antifurt pt. bicicleta
- HU Kerékpárzár
- ES Cable antirrobo para bicicletas



No.	L [cm]	Ø [mm]	Color / Kolor	
77833	120	8	czarny, niebieski, czerwony	10/60
77834	120	10	czarny, niebieski, czerwony	10/60
77835	180	10	czarny, niebieski, czerwony	10/60

- EN Bicycle lock
- PL Linka rowerowa
- DE Fahrradschloss
- RU Замок велосипедный
- CZ Zámek jízdního kola
- RO Antifurt pt. bicicleta
- HU Kerékpárzár
- ES Cable antirrobo para bicicletas

120 cm	10 mm	
-----------	----------	--



No.	L [cm]	Ø [mm]	Color / Kolor	
77845	120	10	czarny, niebieski, czerwony	20/40

EN Bicycle lock
 PL Linka rowerowa
 DE Fahrradschloss
 RU Замок велосипедный
 CZ Zámek jízdního kola
 RO Antifurt pt. bicicleta
 HU Kerékpárzár
 ES Cable antirrobo para bicicletas



No.	L [cm]	Ø [mm]	Color / Kolor	Icon
77840	180	12	czarny, niebieski, czerwony	10/40

EN Bicycle lock
 PL Zapięcie rowerowe
 DE Fahrradsschloss
 RU Замок велосипедный
 CZ Zámek jízdního kola
 RO Antifurt pt. bicicleta
 HU Kerékpárzár
 ES Cable antirrobo para bicicletas



No.	L [cm]	Ø [mm]	Icon
77850	100	18	12/24

EN Chain lock
 PL Zapięcie łańcuchowe z zamkiem
 DE Kettenverschluss mit Schloss
 RU Цепь с замком
 CZ Bezpečnostní řetěz se zámkem
 RO Încuietoare lanț cu lacăt
 HU Kerékpár lakat
 ES Candado de cadena con cerradura



No.	L [cm]	Ø [mm]	Icon
77881	120	7	12

EN Bike hand pump
 PL Pompka rowerowa
 DE Fahrradpumpe
 RU Велосипед ручной насос
 CZ Pumpička na kolo
 RO Pompă de bicicletă
 HU Kerékpár pumpa
 ES Bomba de bicicleta



No.	Icon
82032	60

EN Security cable and lock
 PL Linka stalowa z kłódką
 DE Stahlseil, mit Vorhängeschloss
 RU Канат стальной с замком
 CZ Ocelové lanko s visacím zámkem
 RO Sârmă de oțel cu lacăt
 HU Drótkötél, lakattal
 ES Cuerda de acero con candado



No.	L [cm]	Ø [mm]	Icon
77815	3	4	12/48

EN Motorcycle lock
 PL Zapięcie motocyklowe
 DE Stahlgliederschloss
 RU Замок до мотоцикла
 CZ Zámek na kolo
 RO Anti-furt motocicletă
 HU Lánclakat motorbiciklihez
 ES Candado para Moto



No.	L [cm]	Ø [mm]	Icon
77861	150	25	6/12

EN Double cylinder aluminium hand pump
 PL Teleskopowa pompka aluminiowa
 DE Aluminium Handpumpe Doppelzylinder
 RU Насос телескопический алюминиевый
 CZ Pumpa ruční double-pístové hliníkové
 RO Pompa aluminiu duo telescope
 HU Pumpa alumínium dupla dugattyús
 ES Bomba de mano de doble cilindro de aluminio



No.	Icon
82031	60



EN Foot pump with gauge
 PL Pompka nożna z manometrem
 DE Fusspumpe
 RU Насос ножный с манометром

CZ Nožní pumpa s manometrem
 RO Pompă de picior cu manometru
 HU Lábpumpa nyomásmérővel
 ES Bomba de pierna con manometro



No.	Measuring range / Zakres pomiaru [MPa]	Icon
82000	20	

EN Foot pump with gauge
 PL Pompka nożna z manometrem
 DE Fusspumpe
 RU Насос ножный с манометром

CZ Nožní pumpa s manometrem
 RO Pompă de picior cu manometru
 HU Lábpumpa nyomásmérővel
 ES Bomba de pierna con manometro

0-0.7 MPa

UNIVERSAL DOUBLE HEAD
 UNIVERSALNA
 GŁOWIĆCA
 PODWÓJNA



No.	Measuring range / Zakres pomiaru [MPa]	Icon
82001	0-0.7	12

EN Hand pump
 PL Pompka słupkowa ręczna
 DE Hand-Luftpumpe
 RU Насос ручной
 CZ Hustička ruční
 RO Pompa de mana
 HU Kézi pumpa
 ES Bomba de barrote de mano

0.3 MPa



EN Hand pump with manometer
 PL Pompka słupkowa z manometrem
 DE Hand-Luftpumpe mit Manometer
 RU Насос ручной с манометром
 CZ Pumpa s manometrem
 RO Pompa de mana cu manometru
 HU Kézi pumpa manométerrel
 ES Bomba de barrote con manometro

0-1 MPa



EN Hand pump with manometer
 PL Pompka słupkowa z manometrem
 DE Hand-Luftpumpe mit Manometer
 RU Насос ручной с манометром
 CZ Pumpa s manometrem
 RO Pompa de mana cu manometru
 HU Kézi pumpa manométerrel
 ES Bomba de barrote con manometro

0-1.1 MPa

60 cm

UNIVERSAL DOUBLE HEAD
 UNIVERSALNA
 GŁOWIĆCA
 PODWÓJNA



No.	Measuring range / Zakres pomiaru [MPa]	Icon
82020	0-0.3	20



No.	Measuring range / Zakres pomiaru [MPa]	Icon
82021	0-1	10



No.	Measuring range / Zakres pomiaru [MPa]	Icon
82022	0-1.1	10

EN Hand pump with manometer
 PL Pompka słupkowa z manometrem
 DE Hand-Luftpumpe mit Manometer
 RU Насос ручной с манометром
 CZ Pumpa s manometrem
 RO Pompa de mana cu manometru
 HU Kézi pumpa manométerrel
 ES Bomba de barrote con manometro



No.	Measuring range / Zakres pomiaru [MPa]	
82023	0-1.1	30

EN Hex key set
 PL Zestaw kluczy imbusowych
 DE Sechskant-Stiftschlüsselsatz
 RU Набор шестигранников
 CZ Imbusové klíče
 RO Chei imbus
 HU Imbisz kulcs
 ES Juego de llaves Hex



No.	⌀ [mm]	pcs / szt.	
56505	1.5, 2, 2.5, 3, 4, 5, 6, 8	8	25/100

EN Hex key set
 PL Zestaw kluczy imbusowych
 DE Sechskant-Stiftschlüsselsatz
 RU Набор шестигранников
 CZ Imbusové klíče
 RO Chei imbus
 HU Imbisz kulcs
 ES Juego de llaves Hex



No.	⌀ [mm]	pcs / szt.	
56506	1.5, 2, 2.5, 3, 4, 5, 6, 8	8	25/100

EN Torx key set
 PL Zestaw kluczy Torx
 DE Torx Schlüsselsatz
 RU Набор ключи Torx
 CZ Souprava klíčů Torx
 RO Set de chei Torx
 HU Kulcskészlet Torx
 ES Juego de llaves Torx



No.	⌀	pcs / szt.	
56507	T9, T10, T15, T20, T25, T27, T30, T40	8	25/100

EN Bike hand tool set
 PL Zestaw do naprawy roweru
 DE Fahrrad-Reparatur-Satz
 RU Набор инструментов для велосипеда
 CZ Cyklistické nářadí
 RO Instrumente ciclism
 HU Kerékpár szerszámok
 ES Herramientas ciclismo



INCLUDED:

- Hex key 4, 5, 6 mm
- Ratchet screwdriver
- Adjustable wrench
- 2 crowbars
- Sockets 8, 9, 10 mm
- Wheels spokes wrench
- Bits set and adaptor
- Tire repair kit

W ZESTAWIE:

- Klucze imbusowe 4, 5, 6 mm
- Wkrętarz z grzechotką
- Klucz nastawny
- 2 łyzki do opon rowerowych
- Nasadki 8, 9, 10 mm
- Klucz do regulacji szprych
- Zestaw końcówek wkrętakowych z adapterem
- Zestaw naprawy do dętek



No.	
77795	20

EN Bike repair stand
 PL Stojak do obsługi rowerów
 DE Fahrrad Montageständer
 RU Стенд для ремонта велосипедов
 CZ Montážní stojan
 RO Stand pt. repararea bicicletei
 HU Kerékpár szerelő
 ES Soporte de reparación



No.	
77715	2

20

Kitchen & home appliance
Sprzęt AGD



Kitchen appliance
Sprzęt AGD do kuchni



.....316-337

Home appliance
Sprzęt AGD do domu



.....337-346

EN Food processor
 PL Robot kuchenny
 DE Küchenmaschine
 RU Кухонный комбайн
 CZ Kuchyňský robot
 RO Robot de bucatarie
 HU Robotgép
 ES Procesador de alimentos

FUNCTIONS:

- Chopping
- Slicing
- French-fries cutting
- Shredding
- Blending
- Grinding
- Whisking
- Kneading

FUNKCJE:

- Ścianienie
- Krojenie na plastry
- Cięcie na frytki
- Tarcie
- Blendowanie
- Mielenie
- Ubijanie
- Ugniatanie

220-240V-50/60Hz 550 W 8 in 1 8 w 1

x2 PULSE MODE TRYB PULSACYJNY ∅ 75 mm

x4 SUCTION PADS PRZYSSAWKI SS STAINLESS STEEL STAL NIERDZEWNA



LUND

No.	Power / Moc [W]	
67950	550	2

EN Stand mixer
 PL Mikser planetarny
 DE Küchenmaschine
 RU Кухонный комбайн
 CZ Kuchyňský robot
 RO Robotul multifunctional
 HU Komplex konyhai robotgép
 ES Robot de cocina

220-240V-50Hz max 1400 W 800 W

5.5 L x6 TURBO

SS STAINLESS STEEL STAL NIERDZEWNA



LUND

No.	Power / Moc [W]	
67805	800	2

EN Multifunctional kitchen robot
 PL Robot kuchenny
 DE Küchenmaschine
 RU Кухонный робот
 CZ Kuchyňský robot
 RO Roboti de bucatarie
 HU Robotgép
 ES Robot de cocina

220-240V-50/60Hz 150 W 3 in 1 3 w 1 180 min

FUNCTIONS:

- Thin slicing
- Thick slicing
- Thin shredding
- Thick shredding
- Puree blade

FUNKCJE:

- Krojenie cienkich plasterów
- Krojenie grubych plasterów
- Tarcie drobne
- Tarcie grube
- Tarcie placzków



LUND

No.	Power / Moc [W]	
67961	150	6

EN Stand mixer
 PL Mikser planetarny
 DE Küchenmaschine
 RU Кухонный комбайн
 CZ Kuchyňský robot
 RO Robotul multifunctional
 HU Komplex konyhai robotgép
 ES Robot de cocina

230V-50Hz 1000 W

1.5 L 4.5 L

x6 TURBO



LUND

No.	Power / Moc [W]	
67810	1000	2

EN Stand mixer
 PL Mikser planetarny
 DE Küchenmaschine
 RU Кухонный комбайн
 CZ Kuchyňský robot
 RO Robotul multifuncțional
 HU Komplex konyhai robotgép
 ES Robot de cocina



220-240V~50/60Hz
 max 1500 W
 1000 W
 1.5 L
 4.5 L
 x6
 TURBO



LUND

No.	Power / Moc [W]	Box
67811	1000	2

EN Hand mixer
 PL Mikser ręczny
 DE Handmixer
 RU Ручной миксер
 CZ Ruční mixér
 RO Mixer
 HU Kézi turmixgép
 ES Batidora de mano

220-240V~50-60Hz
 200 W
 x5
 TURBO
 SS
 STAINLESS STEEL
 STAL NIERDZEWNA



LUND

No.	Power / Moc [W]	Box
67781	200	8

EN Hand mixer
 PL Mikser ręczny
 DE Handmixer
 RU Ручной миксер
 CZ Ruční mixér
 RO Mixer
 HU Kézi turmixgép
 ES Batidora de mano

220-240V~50-60Hz
 150 W
 x5



LUND

No.	Power / Moc [W]	Box
67780	150	10

EN Hand mixer with bowl
 PL Mikser ręczny z misą
 DE Handmixer mit Schale
 RU Ручной миксер с чашей
 CZ Ruční mixér s mísou
 RO Mixer cu bol
 HU Kézi turmixgép tállal
 ES Batidora de mano con bol

220-240V~50-60Hz
 200 W
 3.0 L
 x3
 TURBO
 AUTOMATIC ROTATING BOWL
 AUTOMATYCZNA ROTACJA MISY
 SS
 STAINLESS STEEL
 STAL NIERDZEWNA



LUND

No.	Power / Moc [W]	Box
67790	200	6

EN Hand blender
 PL Blender ręczny
 DE Stabmixer
 RU Ручной блендер

CZ Ruční mixér
 RO Blender de mana
 HU Botmixer
 ES Batidora de mano

INCLUDED:

- Blender 700 W
- Stainless steel blade
- Cup 0.5 l
- Stainless steel whisk
- Chopper 0.5 l with stainless steel blade
- BPA free tritan bottle 0.6 l with blade and cap
- Holder for blade and whisk

W ZESTAWIE:

- Blender 700 W
- Ostrze ze stali nierdzewnej
- Pojemnik 0.5 l
- Trzepaczka ze stali nierdzewnej
- Malakser 0.5 l z ostrzem ze stali nierdzewnej
- Butelka 0.6 l wolna od BPA, wykonana z tritanu, z ostrzem i zakrętką
- Podstawa na ostrze i trzepaczkę



220-240V-50/60Hz

700 W

TURBO

SPEED REGULATOR REGULACJA PRĘDKOŚCI

SS STAINLESS STEEL STAL NIERDZEWNA



LUND

No.	Power / Moc [W]	
67700	700	6

EN Food chopper
 PL Rozdrabniacz do żywności
 DE Zerkleinerer für Lebensmittel
 RU Дробилка для сухой пищи
 CZ Drtič potravin
 RO Tocator alimente
 HU Ételtaprító
 ES Picadora de alimentos

INCLUDED:

- Glass bowl 2 l
- Steel blades
- Part for peeling garlic
- Part for whisking
- Scraper

W ZESTAWIE:

- Szklana misa 2 l
- Ostrza ze stali nierdzewnej
- Część do obierania czosnku
- Część do ubijania
- Skrobak



220-240V-50-60Hz

500 W

3in1 3w1

2L

x2

ANTI-SLIP SURFACE POWIERZCHNIA ANTYPOŚLIZGOWA

SS STAINLESS STEEL STAL NIERDZEWNA



LUND

No.	Power / Moc [W]	
67920	500	6

EN Hand blender
 PL Blender ręczny
 DE Stabmixer
 RU Ручной блендер

CZ Ruční mixér
 RO Blender de mana
 HU Botmixer
 ES Batidora de mano

INCLUDED:

- Blender 700 W
- Stainless steel blade
- Cup 0.5 l
- Stainless steel whisk
- Chopper 0.5 l with stainless steel blade
- 2 x BPA free tritan bottle 0.6 l with blade and cap
- Holder for blade and whisk
- Food processor 1.5 l with blade and 2-sided cutting plate

W ZESTAWIE:

- Blender 700 W
- Ostrze ze stali nierdzewnej
- Pojemnik 0.5 l
- Trzepaczka ze stali nierdzewnej
- Malakser 0.5 l z ostrzem ze stali nierdzewnej
- 2 x butelka 0.6 l wolna od BPA, wykonana z tritanu, z ostrzem i zakrętką
- Podstawa na ostrze i trzepaczkę
- Duży malakser 1.5 l z ostrzem i dwustronną tarką tnącą



220-240V-50/60Hz

700 W

TURBO

SPEED REGULATOR REGULACJA PRĘDKOŚCI

SS STAINLESS STEEL STAL NIERDZEWNA



LUND

No.	Power / Moc [W]	
67701	700	4

EN Smoothie blender
 PL Blender kielichowy do smoothie
 DE Standmixer
 RU Блендер

CZ Smoothie mixér
 RO Smoothie blender
 HU Smoothie turmixgép
 ES Batidora smoothie

INCLUDED:

- Blender 300 W
- Stainless steel blade
- Jar 1 l
- Bottle 0.57 l
- Bottle 0.4 l

W ZESTAWIE:

- Blender 300 W
- Ostrze ze stali nierdzewnej
- Kielich 1 l
- Butelka 0.57 l
- Butelka 0.4 l

220-240V-50/60Hz

300 W

3in1 3w1

x2 PULS

x4 SUCTION PADS PROFESJONALNI

SS STAINLESS STEEL STAL NIERDZEWNA



LUND

No.	Power / Moc [W]	
67702	300	6

EN Smoothie blender
 PL Blender kielichowy do smoothie
 DE Standmixer
 RU Блендер

CZ Smoothie mixér
 RO Smoothie blender
 HU Smoothie turmixgép
 ES Batidora smoothie

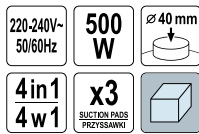

INCLUDED:

- Blender 500 W
- Stainless steel blade
- Glass jar 0.6 l
- Bottle 0.57 l
- Bottle 0.4 l
- Grinder

W ZESTAWIE:

- Blender 500 W
- Ostrze ze stali nierdzewnej
- Szklany kielich 0.6 l
- Butelka 0.57 l
- Butelka 0.4 l
- Młynek



LUND

No.	Power / Moc [W]	Box
67703	500	4

EN Stand blender
 PL Blender kielichowy
 DE Standmixer
 RU Блендер
 CZ Stolní mixér
 RO Blender
 HU Turmixgép
 ES Batidora de vaso

INCLUDED:

- Blender 600 W
- Stainless steel blade
- Jar 1.5 l

W ZESTAWIE:

- Blender 600 W
- Ostrze ze stali nierdzewnej
- Kielich 1.5 l



LUND

No.	Power / Moc [W]	Box
67705	600	4

EN Bottle
 PL Butelka
 DE Flasche
 RU Бутылка
 CZ Láhev
 RO Sticlă
 HU Üveg
 ES Botella



LUND

No.	Capacity / Pojemność [l]	For / Dla	Box
67709	0.57	67702, 67703	12

EN Stand blender
 PL Blender kielichowy
 DE Standmixer
 RU Блендер
 CZ Stolní mixér
 RO Blender
 HU Turmixgép
 ES Batidora de vaso

INCLUDED:

- Glass jar 1.5 l
- Stainless steel grinder 500 g
- Tritan bottle 0.6 l

W ZESTAWIE:

- Szklany kielich 1.5 l
- Młynek ze stali nierdzewnej 500 g
- Butelka z trytanu 0.6 l

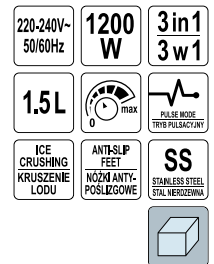

LUND

No.	Power / Moc [W]	Box
67707	1200	4

EN Portable blender USB
 PL Blender przenośny USB
 DE Mobiler USB-Stabmixer
 RU Портативный USB-блендер
 CZ Přenosný USB mixér
 RO Blender portabil USB
 HU Hordozható USB turmix
 ES Licuadora portátil USB

7.4 V
1600mAh
Li-Ion

60 W

0.35L

1.5h

USB
BATTERY CHARGER
ŁADOWNIKA

- Working time: 10-15 cycles
 - 1 cycle = 40 sec

- Czas pracy: 10-15 cykli
 - Cykl = 40 sek.



LUND

No.	Power / Moc [W]	
67710	60	10

EN Slow juicer
 PL Wyciskarka wolnoobrotowa do soków
 DE Langsam laufende Saftpresse
 RU Соковыжималка шнековая
 CZ Nízkootáčkový odšťavňovač
 RO Storcorator de fructe
 HU Gyümölcscentrifuga
 ES Saca jugo

220-240V~
50/60Hz

150 W

65 min

3 FILTERS
FILTRY

FEATURES:
 - Prepares fruit and vegetable juices, mousses, ice creams, dairy cocktails
 - Keep more nutrition and original taste than traditional juicers
 - Reverse gear
 - Dishwasher safe for a quick and easy clean up
 - Anti-drip cap
 - Anti-slip feet
 - Comfortable handle
 - Low noise <60 db

CECHY:
 - Możliwość przygotowania soków owocowych i warzywnych, przecierów, lodów i koktajli mlecznych
 - Zachowuje więcej witamin i smaku niż tradycyjna sokowirówka
 - Bieg wsteczny
 - Szybkie i łatwe czyszczenie, możliwość mycia w zmywarce
 - Korek niekapek
 - Nóżki antypoślizgowe
 - Wygodny uchwyt do przenoszenia
 - Cicha praca <60 db



LUND

No.	Power / Moc [W]	
67840	150	2

EN Juicer
 PL Sokowirówka
 DE Entsafter
 RU Соковыжималка
 CZ Odšťavňovač
 RO Storcorator
 HU Gyümölcscentrifuga
 ES Licuadora

220-240V~
50-60Hz

600 W

13000 min

65 mm

ANTI-SLIP FEET
NOŻKI ANTY-POŚLIZGOWE

SS
STAINLESS STEEL
STAL NIERDZEWNA

INCLUDED:
 - Pulp container 1.5 l
 - Juicer cup 0.45 l
 - Stainless steel grater
 - Anti-drip tap

W ZESTAWIE:
 - Pojemnik na pulpę 1.5 l
 - Pojemnik na sok 0.45 l
 - Tarcza ze stali nierdzewnej
 - Kranik zapobiegający kapaniu



LUND

No.	Power / Moc [W]	
67851	600	6

EN Slow juicer
 PL Wyciskarka wolnoobrotowa do soków
 DE Langsam laufende Saftpresse
 RU Соковыжималка шнековая
 CZ Nízkootáčkový odšťavňovač
 RO Storcorator de fructe
 HU Gyümölcscentrifuga
 ES Saca jugo

220-240V~
50/60Hz

150 W

65 min

75 mm

3 FILTERS
FILTRY

SS
STAINLESS STEEL
STAL NIERDZEWNA

FEATURES:
 - Prepares fruit and vegetable juices, mousses, ice creams, dairy cocktails
 - Keep more nutrition and original taste than traditional juicers
 - Reverse gear
 - Dishwasher safe for a quick and easy clean up
 - Anti-drip cap
 - Anti-slip feet
 - Comfortable handle
 - Low noise <60 db

CECHY:
 - Możliwość przygotowania soków owocowych i warzywnych, przecierów, lodów i koktajli mlecznych
 - Zachowuje więcej witamin i smaku niż tradycyjna sokowirówka
 - Bieg wsteczny
 - Szybkie i łatwe czyszczenie, możliwość mycia w zmywarce
 - Korek niekapek
 - Nóżki antypoślizgowe
 - Wygodny uchwyt do przenoszenia
 - Cicha praca <60 db



LUND

No.	Power / Moc [W]	
67841	150	2

EN Meat mincer
 PL Maszynka do mielenia mięsa
 DE Fleischwolf
 RU Мясорубка
 CZ Mlýnek na maso
 RO Masina de tocat
 HU Húsdaráló
 ES Picadora de carne

220-240V~50Hz
550 W
5 in 1
 1.5 kg / min
 REVERSE GEAR BIEG WSTECZNY
SS
 STAINLESS STEEL STAL NIERDZEWNA

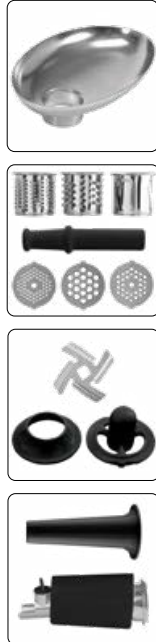

LUND

No.	Power / Moc [W]	
67900	550	4

EN Electric kettle
 PL Czajnik elektryczny
 DE Wasserkocher
 RU Электрический чайник
 CZ Rychlovarná konvice
 RO Fierbator electric
 HU Elektromos vízforraló
 ES Hervidor eléctrico

220-240V~50/60Hz
2200 W
 360°
1.8 L
SS
 STAINLESS STEEL STAL NIERDZEWNA

FEATURES:

- Automatic switch off
- Boil-dry protection
- Removable and washable filter
- Cable storage
- Cable length: 80 cm
- Stainless steel housing

CECHY:

- Automatyczne wyłączenie po zagotowaniu wody
- Ochrona przed przegrzaniem
- Filtr z możliwością wyjęcia i umycia
- Możliwość zwinięcia kabla pod podstawką
- Długość kabla: 80 cm
- Obudowa ze stali nierdzewnej



LUND

No.	Power / Moc [W]	
68172	1850-2200	8

EN Meat mincer
 PL Maszynka do mielenia mięsa
 DE Fleischwolf
 RU Мясорубка
 CZ Mlýnek na maso
 RO Masina de tocat
 HU Húsdaráló
 ES Picadora de carne

220-240V~50/60Hz
1200 W
4 in 1
 4 w 1
 2 kg / min
 x2
 REVERSE GEAR BIEG WSTECZNY
SS
 STAINLESS STEEL STAL NIERDZEWNA



LUND

No.	Power / Moc [W]	
67901	1200	1

EN Electric kettle
 PL Czajnik elektryczny
 DE Wasserkocher
 RU Электрический чайник
 CZ Rychlovarná konvice
 RO Fierbator electric
 HU Elektromos vízforraló
 ES Hervidor eléctrico

220-240V~50/60Hz
2200 W
 1.7 L
 360°
 40-100 °C
SS
 STAINLESS STEEL STAL NIERDZEWNA

FEATURES:

- Automatic switch off
- Boil-dry protection
- Cable storage
- Cable length: 80 cm
- Stainless steel housing
- Temperature control: 40-100° (40°-50°-60°-70°-80°-90°-100°)
- Keep warm

CECHY:

- Automatyczne wyłączenie po zagotowaniu wody
- Ochrona przed przegrzaniem
- Możliwość zwinięcia kabla pod podstawką
- Długość kabla: 80 cm
- Obudowa ze stali nierdzewnej
- Regulacja temperatury: 40-100° (40°-50°-60°-70°-80°-90°-100°)
- Funkcja utrzymywania temperatury



LUND

No.	Power / Moc [W]	
68173	1850-2200	8

EN Electric kettle
 PL Czajnik elektryczny
 DE Wasserkocher
 RU Электрический чайник
 CZ Rychlovarná konvice
 RO Fierbator electric
 HU Elektromos vízforraló
 ES Hervidor eléctrico

FEATURES:

- Automatic switch off
- Boil-dry protection
- Removable and washable filter
- Cable length: 75 cm
- Stainless steel housing
- Temperature control: 20-100° (20°-25°-30°...-95°-100°)
- Keep warm

CECHY:

- Automatische wyłączenie po zagotowaniu wody
- Ochrona przed przegrzaniem
- Filtr z możliwością wyjęcia i umycia
- Długość kabla: 75 cm
- Obudowa ze stali nierdzewnej
- Regulacja temperatury: 20-100° (20°-25°-30°...-95°-100°)
- Funkcja utrzymywania temperatury

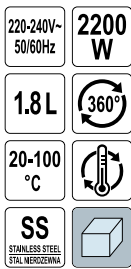

LUND

No.	Power / Moc [W]	Icon
68174	1850-2200	6

EN Electric kettle
 PL Czajnik elektryczny
 DE Wasserkocher
 RU Электрический чайник
 CZ Rychlovarná konvice
 RO Fierbator electric
 HU Elektromos vízforraló
 ES Hervidor eléctrico

FEATURES:

- Automatic switch off
- Boil-dry protection
- Removable and washable filter
- Cable storage
- Cable length: 70 cm
- Water gauge
- Stainless steel 304 heating plate and body
- Temperature control (40-45-50...-95-100)
- Keep warm

CECHY:

- Automatische wyłączenie po zagotowaniu wody
- Ochrona przed przegrzaniem
- Filtr z możliwością wyjęcia i umycia
- Możliwość zwinięcia kabla pod podstawką
- Długość kabla: 70 cm
- Wskaźnik poziomu wody
- Płyta grzewcza oraz obudowa ze stali nierdzewnej 304
- Regulacja temperatury (40-45-50...-95-100)
- Funkcja utrzymywania temperatury



LUND

No.	Power / Moc [W]	Icon
68195	1850-2200	8

EN Electric kettle
 PL Czajnik elektryczny
 DE Wasserkocher
 RU Электрический чайник
 CZ Rychlovarná konvice
 RO Fierbator electric
 HU Elektromos vízforraló
 ES Hervidor eléctrico

FEATURES:

- Automatic switch off
- Boil-dry protection
- Removable and washable filter
- Cable storage
- Cable length: 70 cm
- Water gauge
- Stainless steel 304 heating plate and body
- Temperature control (40-45-50...-95-100)
- Keep warm

CECHY:

- Automatische wyłączenie po zagotowaniu wody
- Ochrona przed przegrzaniem
- Filtr z możliwością wyjęcia i umycia
- Możliwość zwinięcia kabla pod podstawką
- Długość kabla: 70 cm
- Wskaźnik poziomu wody
- Płyta grzewcza oraz obudowa ze stali nierdzewnej 304
- Regulacja temperatury (40-45-50...-95-100)
- Funkcja utrzymywania temperatury

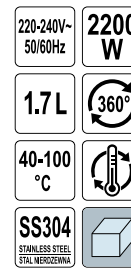

LUND

No.	Power / Moc [W]	Icon
68194	1850-2200	8

20

EN Rechargeable milk frother
 PL Bezprzewodowy sieniacz do mleka
 DE Kabelloser Milchaufschäumer
 RU Беспроводной вспениватель молока
 CZ Ruční šlehač mléka
 RO Mixer pt. spuma lapte reincarcabil
 HU Vezeték nélküli tejhabosító
 ES Espumador de leche inalámbrico

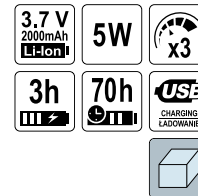

LUND

No.	Power / Moc [W]	Icon
68477	5	12

EN Milk frother
 PL Spieniacz do mleka
 DE Milchaufschäumer
 RU Вспениватель молока
 CZ Nářeňovač mléka
 RO Aparat pt. spuma de lapte
 HU Tejhabosító
 ES Espumador de leche

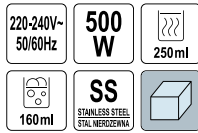

FEATURES:
 - Hot and cold froth function

CECHY:
 - Funkcja spieniania na zimno i ciepło



LUND

No.	Power / Moc [W]	Icon
68470	500	12

EN Pressure coffee maker
 PL Ekspres ciśnieniowy kolbowy
 DE Dampfdruck-Siebträger-Kaffeemaschine
 RU Кофемашина рожковая
 CZ Pákový tlakový kávovar
 RO Espresso
 HU Karos eszpresszó kávéfőző
 ES Cafetera de presión con manivela

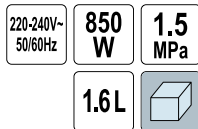

LUND

No.	Power / Moc [W]	Icon
68510	850	2

EN Drip coffee maker
 PL Ekspres przelewowy
 DE Tropfkaffeemaschine
 RU Кофемашина с переливом
 CZ Překárávací kávovar
 RO Filtru pt. cafea
 HU Átfolyós kávéfőző
 ES Cafetera de goteo

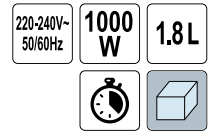

LUND

No.	Power / Moc [W]	Icon
68500	1000	4

EN Air fryer
 PL Frytkownica beztłuszczowa
 DE Heissluftfritteuse
 RU Фритюрница
 CZ Horkovzdušná fritéza
 RO Friteuză
 HU Olajsütő olaj nélkülül
 ES Freidora sin aceite



FEATURES:
 - Up to 80% less oil than in conventional fryer
 - Easy to use, timer and temperature control
 - Dishwasher safe for a quick and easy clean up
 - Faster heating up than in traditional oven
 - Preparation: fries, meat, fish, vegetables, cakes and more

CECHY:
 - Nawet 80% mniej oleju niż w standardowej frytkownicy
 - Łatwa, intuicyjna obsługa dzięki regulacji temperatury i czasu
 - Szybkie i łatwe czyszczenie, możliwość mycia w zmywarce
 - Szybsze nagrzewanie niż w tradycyjnym piekarniku
 - Przygotowanie m.in. frytek, mięsa, ryb, warzyw, ciastek

FUNCTIONS:
 - Defrost
 - Reheat
 - Bake
 - Fry
 - Grill

FUNKCJE:
 - Rozmraża
 - Podgrzewa
 - Piecze
 - Smaży
 - Grilluje



LUND

No.	Power / Moc [W]	Icon
68570	1300	1

EN Air fryer
 PL Frytkownica beztłuszczowa
 DE Heißluftfritteuse
 RU Фритюрница
 CZ Horkovzdušná fritéza
 RO Friteuză
 HU Olajsütő olaj nélkül
 ES Freidora sin aceite

220-240V~ 50-60Hz	1300 W	2.4L	80-200 °C	0-60 min
7 PROGRAMS PROGRAMY	NON-STICK COATING NEPRZYWIĘRALAJĄCA POWŁOKA		LCD	

FUNCTIONS:
 - Defrost
 - Reheat
 - Bake
 - Fry
 - Grill

FUNKCJE:
 - Rozmraża
 - Podgrzewa
 - Piecze
 - Smaży
 - Grilluje

- FEATURES:**
- Up to 80% less oil than in conventional fryer
 - Easy to use, timer and temperature control
 - Dishwasher safe for a quick and easy clean up
 - Faster heating up than in traditional oven
 - Preparation: fries, meat, fish, vegetables, cakes and more

- CECHY:**
- Nawet 80% mniej oleju niż w standardowej frytkownicy
 - Łatwa, intuicyjna obsługa dzięki regulacji temperatury i czasu
 - Szybkie i łatwe czyszczenie, możliwość mycia w zmywarce
 - Szybsze nagrzewanie niż w tradycyjnym piekarniku
 - Przygotowanie m.in. frytek, mięsa, ryb, warzyw, ciastek



80% LESS OIL (MIEJ OLEJU)

HEALTHIER CHOICE (ZDROWIEJSZY WYBÓR)

LUND

No.	Power / Moc [W]	
67571	1300	1

EN Air fryer
 PL Frytkownica beztłuszczowa
 DE Heißluftfritteuse
 RU Фритюрница
 CZ Horkovzdušná fritéza
 RO Friteuză
 HU Olajsütő olaj nélkül
 ES Freidora sin aceite

220-240V~ 50/60Hz	1800 W	5.2L	80-200 °C
0-30 min	NON-STICK COATING NEPRZYWIĘRALAJĄCA POWŁOKA		

FUNCTIONS:
 - Defrost
 - Reheat
 - Bake
 - Fry
 - Grill

FUNKCJE:
 - Rozmraża
 - Podgrzewa
 - Piecze
 - Smaży
 - Grilluje

- FEATURES:**
- Up to 80% less oil than in conventional fryer
 - Easy to use, timer and temperature control
 - Dishwasher safe for a quick and easy clean up
 - Faster heating up than in traditional oven
 - Preparation: fries, meat, fish, vegetables, cakes and more

- CECHY:**
- Nawet 80% mniej oleju niż w standardowej frytkownicy
 - Łatwa, intuicyjna obsługa dzięki regulacji temperatury i czasu
 - Szybkie i łatwe czyszczenie, możliwość mycia w zmywarce
 - Szybsze nagrzewanie niż w tradycyjnym piekarniku
 - Przygotowanie m.in. frytek, mięsa, ryb, warzyw, ciastek



80% LESS OIL (MIEJ OLEJU)

HEALTHIER CHOICE (ZDROWIEJSZY WYBÓR)

LUND

No.	Power / Moc [W]	
67573	1800	1

EN Air fryer
 PL Frytkownica beztłuszczowa
 DE Heißluftfritteuse
 RU Фритюрница
 CZ Horkovzdušná fritéza
 RO Friteuză
 HU Olajsütő olaj nélkül
 ES Freidora sin aceite

220-240V~ 50/60Hz	1400 W	3.2L	80-200 °C	0-60 min
7 PROGRAMS PROGRAMY	NON-STICK COATING NEPRZYWIĘRALAJĄCA POWŁOKA		LCD	

FUNCTIONS:
 - Defrost
 - Reheat
 - Bake
 - Fry
 - Grill

FUNKCJE:
 - Rozmraża
 - Podgrzewa
 - Piecze
 - Smaży
 - Grilluje

- FEATURES:**
- Up to 80% less oil than in conventional fryer
 - Easy to use, timer and temperature control
 - Dishwasher safe for a quick and easy clean up
 - Faster heating up than in traditional oven
 - Preparation: fries, meat, fish, vegetables, cakes and more

- CECHY:**
- Nawet 80% mniej oleju niż w standardowej frytkownicy
 - Łatwa, intuicyjna obsługa dzięki regulacji temperatury i czasu
 - Szybkie i łatwe czyszczenie, możliwość mycia w zmywarce
 - Szybsze nagrzewanie niż w tradycyjnym piekarniku
 - Przygotowanie m.in. frytek, mięsa, ryb, warzyw, ciastek



80% LESS OIL (MIEJ OLEJU)

HEALTHIER CHOICE (ZDROWIEJSZY WYBÓR)

LUND

No.	Power / Moc [W]	
67572	1400	1

EN Air fryer
 PL Frytkownica beztłuszczowa
 DE Heißluftfritteuse
 RU Фритюрница

CZ Horkovzdušná fritéza
 RO Friteuză
 HU Olajsütő olaj nélkül
 ES Freidora sin aceite

220-240V~ 50/60Hz	1800 W	5.2L	80-200 °C	0-60 min	7 PROGRAMS PROGRAMY
NON-STICK COATING NEPRZYWIĘRALAJĄCA POWŁOKA		LCD			

- FEATURES:**
- Up to 80% less oil than in conventional fryer
 - Easy to use, timer and temperature control
 - Dishwasher safe for a quick and easy clean up
 - Faster heating up than in traditional oven
 - Preparation: fries, meat, fish, vegetables, cakes and more

- CECHY:**
- Nawet 80% mniej oleju niż w standardowej frytkownicy
 - Łatwa, intuicyjna obsługa dzięki regulacji temperatury i czasu
 - Szybkie i łatwe czyszczenie, możliwość mycia w zmywarce
 - Szybsze nagrzewanie niż w tradycyjnym piekarniku
 - Przygotowanie m.in. frytek, mięsa, ryb, warzyw, ciastek



80% LESS OIL (MIEJ OLEJU)

HEALTHIER CHOICE (ZDROWIEJSZY WYBÓR)

LUND

No.	Power / Moc [W]	
67574	1800	1

EN Air fryer
 PL Frytkownica beztłuszczowa
 DE Heißluftfritteuse
 RU Фритюрница
 CZ Horkovzdušná fritéza
 RO Friteuză
 HU Olajsütő olaj nélküli
 ES Freidora sin aceite

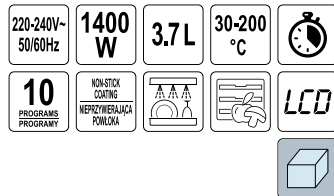

FEATURES:

- Up to 80% less oil than in conventional fryer
- Easy to use, timer and temperature control
- Dishwasher safe for a quick and easy clean up
- Faster heating up than in traditional oven
- Preparation: fries, meat, fish, vegetables, cakes and more

CECHY:

- Nawet 80% mniej oleju niż w standardowej frytkownicy
- Łatwa, intuicyjna obsługa dzięki regulacji temperatury i czasu
- Szybkie i łatwe czyszczenie, możliwość mycia w zmywarce
- Szybsze nagrzewanie niż w tradycyjnym piekarniku
- Przygotowanie m.in. frytek, mięsa, ryb, warzyw, ciastek



FUNCTIONS: FUNKCJE:

- Defrost - Rozmraża
- Reheat - Podgrzewa
- Bake - Piecze
- Fry - Smaży
- Grill - Grilluje
- Dry - Suszy
- Pickle - Kisi

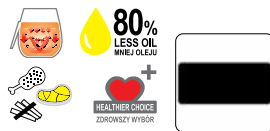

LUND

No.	Power / Moc [W]	Box
67575	1400	1

EN Air fryer
 PL Frytkownica beztłuszczowa
 DE Heißluftfritteuse
 RU Фритюрница
 CZ Horkovzdušná fritéza
 RO Friteuză
 HU Olajsütő olaj nélküli
 ES Freidora sin aceite

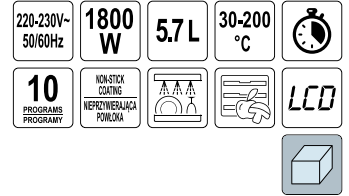

FEATURES:

- Up to 80% less oil than in conventional fryer
- Easy to use, timer and temperature control
- Dishwasher safe for a quick and easy clean up
- Faster heating up than in traditional oven
- Preparation: fries, meat, fish, vegetables, cakes and more

CECHY:

- Nawet 80% mniej oleju niż w standardowej frytkownicy
- Łatwa, intuicyjna obsługa dzięki regulacji temperatury i czasu
- Szybkie i łatwe czyszczenie, możliwość mycia w zmywarce
- Szybsze nagrzewanie niż w tradycyjnym piekarniku
- Przygotowanie m.in. frytek, mięsa, ryb, warzyw, ciastek



FUNCTIONS: FUNKCJE:

- Defrost - Rozmraża
- Reheat - Podgrzewa
- Bake - Piecze
- Fry - Smaży
- Grill - Grilluje
- Dry - Suszy
- Pickle - Kisi

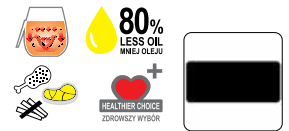

LUND

No.	Power / Moc [W]	Box
67576	1800	1

EN Air fryer
 PL Frytkownica beztłuszczowa
 DE Heißluftfritteuse
 RU Фритюрница
 CZ Horkovzdušná fritéza
 RO Friteuză
 HU Olajsütő olaj nélküli
 ES Freidora sin aceite



FEATURES:

- Up to 80% less oil than in conventional fryer
- Easy to use, timer and temperature control
- Dishwasher safe for a quick and easy clean up
- Faster heating up than in traditional oven
- Preparation: fries, meat, fish, vegetables, cakes and more

CECHY:

- Nawet 80% mniej oleju niż w standardowej frytkownicy
- Łatwa, intuicyjna obsługa dzięki regulacji temperatury i czasu
- Szybkie i łatwe czyszczenie, możliwość mycia w zmywarce
- Szybsze nagrzewanie niż w tradycyjnym piekarniku
- Przygotowanie m.in. frytek, mięsa, ryb, warzyw, ciastek

FUNCTIONS: FUNKCJE:

- Defrost - Rozmraża
- Reheat - Podgrzewa
- Bake - Piecze
- Fry - Smaży
- Grill - Grilluje
- Dry - Suszy



LUND

No.	Power / Moc [W]	Box
67590	1800	1

EN Pan for air fryers
 PL Patelnia do frytkownic beztłuszczowych
 DE Pizzapfanne für Heißluftfritteuse
 RU Скворода для аэрофритюрниц
 CZ Nizká pánev do horkovzdušné fritézy
 RO Tigăie pt. friteuza cu aer
 HU Serpenyő zsírmentes fritőzhöz
 ES Sartén para freidoras sin aceite



LUND

No.	For / Dla	Box
67585	67572, 67573, 67574, 67575, 67576	16



- EN Baking pan for air fryers
 PL Forma do pieczenia do frytkownicy beztluszczowych
 DE Backblech für Heißluftfritteuse
 RU Форма для выпекания для аэрофритюрниц
 CZ Forma na pečení do horkovzdušné fritézy
 RO Tava de copt pt. friteuza cu aer
 HU Sütőforma zsírmentes fritőzhöz
 ES Molde para freidoras sin aceite



LUND

No.	For / Dla	
67586	67572, 67573, 67574, 67575, 67576	8

- EN Tongs for air fryers
 PL Szczypce do frytkownicy beztluszczowych
 DE Zange für Heißluftfritteuse
 RU Щипцы для аэрофритюрниц
 CZ Kleště pro horkovzdušné fritézy
 RO Clește pt. friteuza cu aer
 HU Csipesz zsírmentes fritőzhöz
 ES Pinza para freidoras sin aceite



LUND

No.	For / Dla	
67588	67570, 67571, 67572, 67573, 67574, 67575, 67576, 67590	30

- EN Grate for air fryers
 PL Ruszt do frytkownicy beztluszczowych
 DE Gitterrost für Heißluftfritteuse
 RU Решетка для аэрофритюрниц
 CZ Grilovací mřížka do horkovzdušné fritézy
 RO Gratar pt. friteuza cu aer
 HU Rács zsírmentes fritőzhöz
 ES Rejilla para freidoras sin aceite

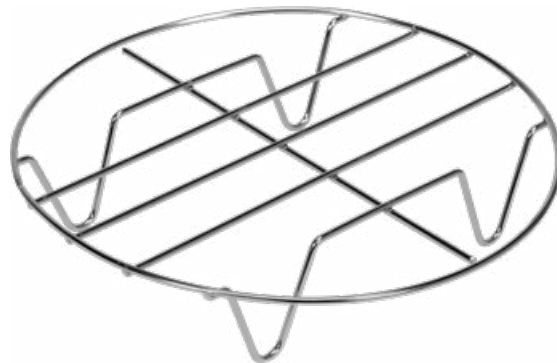

LUND

No.	For / Dla	
67587	67572, 67573, 67574, 67575, 67576	16

- EN Halogen oven
 PL Kombiwar halogenowy
 DE Halogenofen
 RU Галогеновая печь
 CZ Halogenová trouba
 RO Halogen cuptor
 HU Halogén sütő
 ES Horno halogeno



- FEATURES:**
- Cooking time is 3 to 5 times faster than in conventional ovens
 - Cooking without fats or oil
 - Safe tempered glass body
 - Low usage of electricity
 - Excellent turbo wash function for self-cleaning
 - Easy to use, timer and temperature control
 - Evenly cooked foods (convection)

- CECHY:**
- Od 3 do 5 razy szybsze gotowanie w porównaniu z tradycyjnymi piekarnikami
 - Beztłuszczowe gotowanie bez oleju
 - Bezpieczne, hartowane szkło
 - Niskie zużycie energii elektrycznej
 - Skuteczna funkcja autoczyszczenia misy
 - Łatwa, intuicyjna obsługa dzięki regulacji temperatury i czasu
 - Równomierne gotowanie potraw (termoobiegi)

- FUNCTIONS: FUNKCJE:**
- Thaw - Odmroza
 - Reheat - Podgrzewa
 - Bake - Piecze
 - Grill - Grilluje
 - Broil - Opieka
 - Cook - Gotuje
 - Steam - Gotuje na parze

- ACCESSORIES:**
- Tongs
 - Bread rack

- AKCESORIA:**
- Szczypce
 - Stojak na chleb



LUND

No.	Power / Moc [W]	
67640	1200-1400	1

EN Halogen oven
 PL Kombiwar halogenowy
 DE Halogenofen
 RU Галогеновая печь
 CZ Halogenová trouba
 RO Halogen cuptor
 HU Halogén sütő
 ES Horno halogeno

FUNCTIONS:
 - Thaw
 - Reheat
 - Bake
 - Grill
 - Broil
 - Cook
 - Steam

FUNKCJE:
 - Odmraża
 - Podgrzewa
 - Piecze
 - Grilluje
 - Opieka
 - Gotuje
 - Gotuje na parze

220-240V~
50-60Hz

1400
W

12+5L

65-250
°C

0-60 min

FEATURES:

- Cooking time is 3 to 5 times faster than in conventional ovens
- Cooking without fats or oil
- Safe tempered glass body
- Low usage of electricity
- Excellent turbo wash function for self-cleaning
- Easy to use, timer and temperature control
- Evenly cooked foods (convection)

CECHY:

- Od 3 do 5 razy szybsze gotowanie w porównaniu z tradycyjnymi piekarnikami
- Bez tłuszczowe gotowanie bez oleju
- Bezpieczne, hartowane szkło
- Niskie zużycie energii elektrycznej
- Skuteczna funkcja autoczyszczenia miski
- Łatwa, intuicyjna obsługa dzięki regulacji temperatury i czasu
- Równomierne gotowanie potraw (termoobieg)



ACCESSORIES: AKCESORIA:
 - Tongs - Szczypce
 - Bread rack - Stojak na chleb

LUND

No.	Power / Moc [W]	Icon
67641	1200-1400	1

EN Food dehydrator
 PL Suszarka spożywcza
 DE Lebensmittelrockner
 RU Сушилка для пищевых продуктов

CZ Sušička potravin
 RO Deshidrator alimente
 HU Ételszártó
 ES Secador de alimentos

220-240V~
50-60Hz

500
W

31x29.5
cm
TRAY
TACA

35-70
°C

5
TRAYS
TACE

DRIES:

- Fruit, vegetables, flowers, mushrooms, herbs, meat and much more

SUSZY:

- Owoce, warzywa, kwiaty, grzyby, zioła, mięso i wiele innych

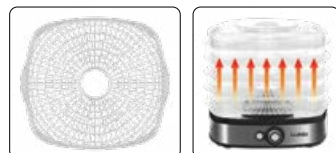

LUND

No.	Power / Moc [W]	Icon
68270	420-500	4

EN Halogen oven
 PL Kombiwar halogenowy
 DE Halogenofen
 RU Галогеновая печь
 CZ Halogenová trouba
 RO Halogen cuptor
 HU Halogén sütő
 ES Horno halogeno

FUNCTIONS:
 - Thaw
 - Reheat
 - Bake
 - Grill
 - Broil
 - Cook
 - Steam

FUNKCJE:
 - Odmraża
 - Podgrzewa
 - Piecze
 - Grilluje
 - Opieka
 - Gotuje
 - Gotuje na parze

220-240V~
50/60Hz

1400
W

12+5L

65-250
°C

0-60 min

FEATURES:

- Cooking time is 3 to 5 times faster than in conventional ovens
- Cooking without fats or oil
- Safe tempered glass body
- Low usage of electricity
- Excellent turbo wash function for self-cleaning
- Easy to use, timer and temperature control
- Evenly cooked foods (convection)

CECHY:

- Od 3 do 5 razy szybsze gotowanie w porównaniu z tradycyjnymi piekarnikami
- Bez tłuszczowe gotowanie bez oleju
- Bezpieczne, hartowane szkło
- Niskie zużycie energii elektrycznej
- Skuteczna funkcja autoczyszczenia miski
- Łatwa, intuicyjna obsługa dzięki regulacji temperatury i czasu
- Równomierne gotowanie potraw (termoobieg)



ACCESSORIES: AKCESORIA:
 - Tongs - Szczypce
 - Bread rack - Stojak na chleb

LUND

No.	Power / Moc [W]	Icon
67642	1200-1400	1

EN Food dehydrator
 PL Suszarka spożywcza
 DE Lebensmittelrockner
 RU Сушилка для пищевых продуктов

CZ Sušička potravin
 RO Deshidrator alimente
 HU Ételszártó
 ES Secador de alimentos

220-240V~
50-60Hz

500
W

31x29.5
cm
TRAY
TACA

35-70
°C

0.5-19.5 h

5
TRAYS
TACE

DRIES:

- Fruit, vegetables, flowers, mushrooms, herbs, meat and much more

SUSZY:

- Owoce, warzywa, kwiaty, grzyby, zioła, mięso i wiele innych



LUND

No.	Power / Moc [W]	Icon
68271	420-500	4

EN Food dehydrator
 PL Suszarka spożywcza
 DE Lebensmittelrockner
 RU Сушилка для пищевых продуктов

CZ Sušička potravin
 RO Deshidrator alimente
 HU Ételszáritó
 ES Secador de alimentos

DRIES:
 - Fruit, vegetables, flowers,
 mushrooms, herbs, meat
 and much more

SUSZY:
 - Owoce, warzywa, kwiaty,
 grzyby, zioła, mięso i wiele
 innych

220-240V-50-60Hz **500 W**
 32.5x30 cm TRAY TACA **35-70 °C**
 0.5-19.5 h **6 TRAYS TACE**

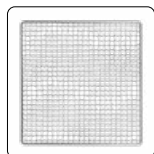



LUND

No.	Power / Moc [W]	
68272	420-500	2

EN Tray for food dehydrator
 PL Tacka do suszarki spożywczej
 DE Tablett für Dörngerät
 RU Лоток для пищевой сушилки
 CZ Táč do sušičky potravin
 RO Tava pt. deshidratarea alimentelor
 HU Tálca ételszáritóhoz
 ES Bandeja para secador de alimentos

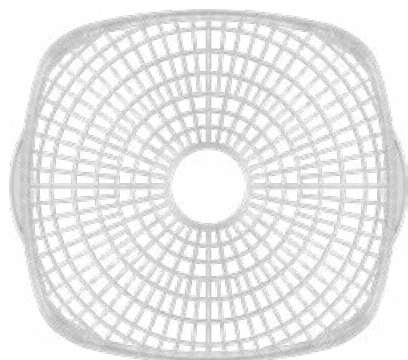
PC 



LUND

No.	Size / Rozmiar [mm]	For / Dla	
68269	310x295	68270, 68271	6

EN Food dehydrator
 PL Suszarka spożywcza
 DE Lebensmittelrockner
 RU Сушилка для пищевых продуктов

CZ Sušička potravin
 RO Deshidrator alimente
 HU Ételszáritó
 ES Secador de alimentos

DRIES:
 - Fruit, vegetables, flowers,
 mushrooms, herbs, meat
 and much more

SUSZY:
 - Owoce, warzywa, kwiaty,
 grzyby, zioła, mięso i wiele
 innych

220-240V-50-60Hz **700 W**
 32.5x30 cm TRAY TACA **35-70 °C**
 0.5-19.5 h **9 TRAYS TACE**

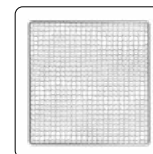
LUND

No.	Power / Moc [W]	
68273	600-700	1

EN Slow cooker
 PL Wolnowar
 DE Schongarer
 RU Медленноварка

FUNCTIONS:
 - Low temperature
 - High temperature
 - Keep warm

CZ Pomalý hrnec
 RO Oala gătit cu abur
 HU Lassúfőző edény
 ES Olla de cocción lenta

FUNKCJE:
 - Niska temperatura
 - Wysoka temperatura
 - Podtrzymywanie ciepła

220-240V-50-60Hz **280 W** **4.5 L**
 0.5-18 h **DELAY TIME OPOŹNIWY START** **3 TEMPERATURE LEVELS / POZIOMY TEMPERATURY**
SS STAINLESS STEEL / STAL NIERDZEWNA **LCD** 



LUND

No.	Power / Moc [W]	
67660	280	2

EN Slow cooker
 PL Wolnowar
 DE Schongarer
 RU Медленноварка
 CZ Pomalý hřelec
 RO Oala gătit cu abur
 HU Lassúfőző edény
 ES Olla de cocción lenta

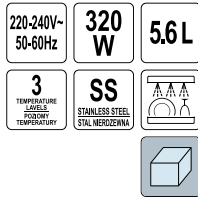

FUNCTIONS:

- Low temperature
- High temperature
- Keep warm

FUNKCJE:

- Niska temperatura
- Wysoka temperatura
- Podtrzymywanie ciepła



LUND

No.	Power / Moc [W]	Icon
67661	320	2

EN Toaster
 PL Toster
 DE Toaster
 RU Тостер

CZ Opékač topinek
 RO Aparat de prajit paine
 HU Kenyérpirító
 ES Tostadora

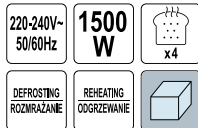

LUND

No.	Power / Moc [W]	Icon
67501	1300-1500	4

EN Toaster
 PL Toster
 DE Toaster
 RU Тостер
 CZ Opékač topinek
 RO Aparat de prajit paine
 HU Kenyérpirító
 ES Tostadora

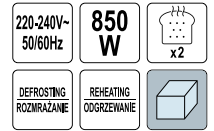

LUND

No.	Power / Moc [W]	Icon
67500	700-850	6

EN Sandwich maker
 PL Opiekacz
 DE Waffeleisen
 RU Сэндвичница

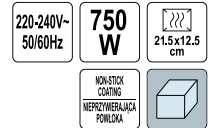

CZ Sendvičovač
 RO Aparat pt. sandwich
 HU Szendvicsütő
 ES Gratinador



LUND

No.	Power / Moc [W]	Icon
67523	750	6

- EN Sandwich maker
- PL Opiekacz
- DE Waffeleisen
- RU Сэндвичница
- CZ Sendvičovač
- RO Aparat pt. sandwich
- HU Szendvicssütő
- ES Gratinador





220-240V-50/60Hz	750 W	 x2
NON-STICK COATING / NIEPRZYWIERAJĄCA POWŁOKA		
		



LUND

No.	Power / Moc [W]	
67524	750	6

- EN Sandwich maker
- PL Opiekacz
- DE Waffeleisen
- RU Сэндвичница
- CZ Sendvičovač
- RO Aparat pt. sandwich
- HU Szendvicssütő
- ES Gratinador



220-240V-50/60Hz	760 W	 21.5x13.5 cm
 x2	 x2	3in1 3w1
NON-STICK COATING / NIEPRZYWIERAJĄCA POWŁOKA		
		



LUND

No.	Power / Moc [W]	
67525	640-760	6

- EN Sandwich maker
- PL Opiekacz
- DE Waffeleisen
- RU Сэндвичница
- CZ Sendvičovač
- RO Aparat pt. sandwich
- HU Szendvicssütő
- ES Gratinador



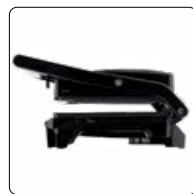

220-240V-50/60Hz	750 W	 23x14.5 cm
NON-STICK COATING / NIEPRZYWIERAJĄCA POWŁOKA		
		



LUND

No.	Power / Moc [W]	
67526	750	6

- EN Sandwich maker
- PL Opiekacz
- DE Waffeleisen
- RU Сэндвичница
- CZ Sendvičovač
- RO Aparat pt. sandwich
- HU Szendvicssütő
- ES Gratinador

220-240V-50/60Hz	900 W	 28x15 cm
 x2	 x2	3in1 3w1
NON-STICK COATING / NIEPRZYWIERAJĄCA POWŁOKA		
		



LUND

No.	Power / Moc [W]	
67530	900	3

EN Sandwich maker
 PL Opiekacz
 DE Waffeleisen
 RU Сэндвичница
 CZ Sendvičovač
 RO Aparat pt. sandwich
 HU Szendvicssütő
 ES Gratinador

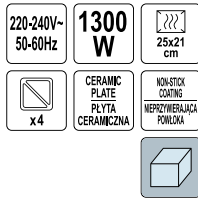

LUND

No.	Power / Moc [W]	
67521	1100-1300	5

EN Cookie maker
 PL Opiekacz do ciastek
 DE Plätzchen-Toaster
 RU Вафельница для печенья
 CZ Orpěkač na cookies
 RO Aparat pt. fursecuri
 HU Sütemény készítő gép
 ES Tostadora de galletas



LUND

No.	Power / Moc [W]	
67527	1400	6

EN Sandwich maker
 PL Opiekacz
 DE Waffeleisen
 RU Сэндвичница

CZ Sendvičovač
 RO Aparat pt. sandwich
 HU Szendvicssütő
 ES Gratinador

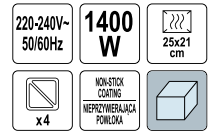

LUND

No.	Power / Moc [W]	
67520	1400	4

EN Contact grill
 PL Grill elektryczny
 DE Kontaktgrill
 RU Контактный гриль

CZ Kontaktní gril
 RO Gratar electric
 HU Elektromos grillstűtő
 ES Parrilla de contacto

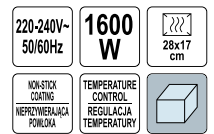

LUND

No.	Power / Moc [W]	
67458	1600	3

- EN Contact grill
- PL Grill elektryczny
- DE Kontaktgrill
- RU Контактный гриль
- CS Kontaktní gril
- RO Gratar electric
- HU Elektromos grillsütő
- ES Parrilla de contacto

220-240V~ 50/60Hz	2200 W	29x23 cm	NON-STICK COATING NEPRZYWIERAJĄCA POWŁOKA
TEMPERATURE CONTROL REGULACJA TEMPERATURY		0.8 m	



LUND

No.	Power / Moc [W]	
67451	2200	3

- EN Contact grill
- PL Grill elektryczny
- DE Kontaktgrill
- RU Контактный гриль
- CS Kontaktní gril
- RO Gratar electric
- HU Elektromos grillsütő
- ES Parrilla de contacto

220-240V~ 50-60Hz	2000 W	29.5x24 cm		30 min
NON-STICK COATING NEPRZYWIERAJĄCA POWŁOKA	TEMPERATURE CONTROL REGULACJA TEMPERATURY	0.7 m		



LUND

No.	Power / Moc [W]	
67457	2000	3

- EN Contact grill
- PL Grill elektryczny
- DE Kontaktgrill
- RU Контактный гриль
- CS Kontaktní gril
- RO Gratar electric
- HU Elektromos grillsütő
- ES Parrilla de contacto

220-240V~ 50/60Hz	2000 W	33x24 cm	NON-STICK COATING NEPRZYWIERAJĄCA POWŁOKA
TEMPERATURE CONTROL REGULACJA TEMPERATURY		0.95 m	



LUND

No.	Power / Moc [W]	
67456	2000	3

- EN Table grill
- PL Grill stołowy elektryczny
- DE Tischgrill
- RU Настольный гриль
- CS Elektrický stolní gril
- RO Gratar electric
- HU Elektromos asztali grill
- ES Plancha de asar

220-240V~ 50/60Hz	2000 W	49x27 cm	NON-STICK COATING NEPRZYWIERAJĄCA POWŁOKA
TEMPERATURE CONTROL REGULACJA TEMPERATURY		0.8 m	

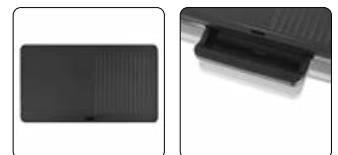

LUND

No.	Power / Moc [W]	
67453	2000	4

EN Table grill
 PL Grill stołowy elektryczny
 DE Tischgrill
 RU Настольный гриль
 CZ Elektrický stolní gril
 RO Gratar electric
 HU Elektromos asztali grill
 ES Plancha de asar

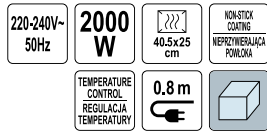

LUND

No.	Power / Moc [W]	Box
67455	2000	2

EN Waffle maker
 PL Gofrownica
 DE Waffeleisen
 RU Вафельница
 CZ Vaflovač
 RO Aparat de preparat waffle
 HU Gofrisütő
 ES Gofrera



LUND

No.	Power / Moc [W]	Box
68011	850	4

EN Electric grill
 PL Grill elektryczny
 DE Elektrogrill
 RU Электрический гриль
 CZ Elektrický gril
 RO Gratar electric
 HU Elektromos grill
 ES Barbacoa eléctrica

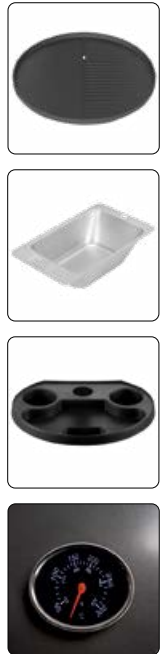

LUND

No.	Power / Moc [W]	Box
67420	2000-2200	1

EN Waffle maker
 PL Gofrownica
 DE Waffeleisen
 RU Вафельница
 CZ Vaflovač
 RO Aparat de preparat waffle
 HU Gofrisütő
 ES Gofrera



LUND

No.	Power / Moc [W]	Box
68012	1100	4

- EN Crepe maker
- PL Naleśnikarka
- DE Krepmacher
- RU Плита для блинов
- CZ Plošna na palačinky
- RO Aparat pt. clătită
- HU Palacsintasütő
- ES Crepera eléct

220-240V~50/60Hz	1000 W	$\approx 30\text{cm}$	NONSTICK COATING NEPRZYMIERALNA POWŁOKA
TEMPERATURE CONTROL REGULACJA TEMPERATURY		0.8 m	



LUND

No.	Power / Moc [W]	
67470	1000	6

- EN Pizza oven stone
- PL Kamień do pieca na pizzę
- DE Pizzaofen-Steinplatte
- RU Камень для печи для пиццы
- CZ Kámen do pece na pizzu
- RO Tava piatră pt. pizza
- HU Pizzakő kemencébe
- ES Piedra de horno para pizza

$\approx 32\text{cm}$	CORDIERITE KORDIERTY	
-----------------------	-------------------------	--



LUND

No.	Ø [mm]	For / Dla	
67481	320	67480	5

- EN Vacuum sealer
- PL Pakowarka próżniowa
- DE Vakuuierer
- RU Вакуумный упаковщик
- CZ Vakuová balíčka
- RO Aparat de ambalare in vid
- HU Vákuum csomagolóhoz
- ES Envasadora al vacío



Bags not included

Produkt nie zawiera worków w zestawie

LUND

No.	Power / Moc [W]	
67880	140	12



- EN Pizza maker
- PL Piec do pizzy
- DE Pizzaofen
- RU Печь для пиццы
- CZ Pec na pizzu
- RO Aparat preparat pizza
- HU Pizzasütő kemence
- ES Horno para pizza

220-240V~50/60Hz	1200 W	max °C 400
$\approx 32\text{cm}$	0-15 min	TEMPERATURE CONTROL REGULACJA TEMPERATURY



LUND

No.	Power / Moc [W]	
67480	1200	1

- EN Vacuum sealer
- PL Pakowarka próżniowa
- DE Vakuuierer
- RU Вакуумный упаковщик
- CZ Vakuová balíčka
- RO Aparat de ambalare in vid
- HU Vákuum csomagolóhoz
- ES Envasadora al vacío

220-240V~50-60Hz	130 W	-70 kPa	max 30cm
8-10 l/min			



LUND

No.	Power / Moc [W]	
67877	130	6

EN Vacuum sealer
 PL Pakowarka próżniowa
 DE Vakuumierer
 RU Вакуумный упаковщик
 CZ Vakuová balíčka
 RO Aparat de ambalare in vid
 HU Vákuum csomagolóhoz
 ES Envasadora al vacío



LUND

No.	Power / Moc [W]	Icon
67881	165	6

EN Vacuum bags
 PL Worki moletowane
 DE Goffrierte Vakuumbeutel
 RU Пакеты с накаткой для вакуумной упаковки
 CZ Vroubkované vakuové sáčky
 RO Pungi pt. vidat gofrate
 HU Légszatomrás vákuumtasakok
 ES Bolsas gofradas para envasar al vacío



LUND

No.	Size / Rozmiar [cm]	Thickness / Grubość [µm]	For / Dla	pcs / szt.	Icon
67887	20x30	90	67880	50	24
67888	25x35	90	67880, 67882	50	14
67889	30x40	90	67881, 67877	50	12

EN Vacuum food container
 PL Pojemnik próżniowy na żywność
 DE Vakuumbehälter
 RU Вакуумный контейнер
 CZ Vakuová dóza na potraviny
 RO Cutie alimente cu sistem vacuum
 HU Vákuumos doboz
 ES Tarros de vacío

FEATURES:

- Help to keep freshness and taste
- Possibility to set a date on the lid

CECHY:

- Pomaga zachować świeżość i smak
- Możliwość zaznaczenia daty na pokrywie



LUND

No.	Capacity / Pojemność [l]	Icon
67890	0.75, 1.5	12

EN Vacuum sealer
 PL Pakowarka próżniowa
 DE Vakuumierer
 RU Вакуумный упаковщик
 CZ Vakuová balíčka
 RO Aparat de ambalare in vid
 HU Vákuum csomagolóhoz
 ES Envasadora al vacío



Bags not included

Produkt nie zawiera worków w zestawie



LUND

No.	Power / Moc [W]	Icon
67882	175	6

EN Vacuum sealer roll
 PL Folia moletowana w rolce
 DE Goffrierte Vakuumrolle
 RU Фольга с накаткой в рулоне
 CZ Vakuovací vroubkovaná fólie na roli
 RO Rola folie gofrata pt. vidat
 HU Vákuumfólia tekercs
 ES Rollo gofrado para envasar al vacío



LUND

No.	Size / Rozmiar [cm]	Thickness / Grubość [µm]	For / Dla	Icon
67883	25x600	105	67881, 67882, 67877	42
67884	28x600	105	67881, 67877	38
67885	30x600	105	67881	34

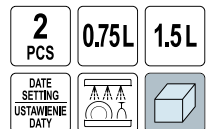

20



EN Kitchen scale
 PL Waga kuchenna
 DE Küchenwaage
 RU Кухонные весы
 CZ Kuchyňská váha
 RO Cantar bucatarie
 HU Konyhamérleg
 ES Báscula de cocina

FEATURES:
 - Weight units:
 oz, g, kg, lb

CECHY:
 - Jednostki wagi:
 oz, g, kg, lb



max 3000g	1000 ml	1g DIVISION PODZIAŁKA
TARE TAROWANIE	LCD	2x AAA
ANTI-SLIP FEET NOŻKI ANTY-POŚLIZGOWE		

LUND

No.	Max. load capacity / Maks. obciążenie [g]	
68360	3000	12

EN Kitchen scale
 PL Waga kuchenna
 DE Küchenwaage
 RU Кухонные весы
 CZ Kuchyňská váha
 RO Cantar bucatarie
 HU Konyhamérleg
 ES Báscula de cocina

FEATURES:
 - Weight units: oz, g, kg, lb
 - Scale area: 15 x 17.5 cm

CECHY:
 - Jednostki wagi: oz, g, kg, lb
 - Powierzchnia ważenia: 15 x 17.5 cm



max 5000g	1g DIVISION PODZIAŁKA	TARE TAROWANIE	LCD
SS STAINLESS STEEL STAŁ NIERDZEWNA	2x AAA	ANTI-SLIP FEET NOŻKI ANTY-POŚLIZGOWE	

LUND

No.	Max. load capacity / Maks. obciążenie [g]	
68362	5000	12

EN Kitchen scale
 PL Waga kuchenna
 DE Küchenwaage
 RU Кухонные весы
 CZ Kuchyňská váha
 RO Cantar bucatarie
 HU Konyhamérleg
 ES Báscula de cocina

FEATURES:
 - Weight units: g, oz
 - Water and milk units: ml, fl oz
 - Removeable jug

CECHY:
 - Jednostki wagi: g, oz
 - Jednostki pomiaru wody, mleka: ml, fl oz
 - Możliwość wyjęcia pojemnika



max 2000g	1200 ml	1g DIVISION PODZIAŁKA	TARE TAROWANIE
LCD	2x AAA		

LUND

No.	Max. load capacity / Maks. obciążenie [g]	
68364	2000	12

EN Kitchen scale
 PL Waga kuchenna
 DE Küchenwaage
 RU Кухонные весы
 CZ Kuchyňská váha
 RO Cantar bucatarie
 HU Konyhamérleg
 ES Báscula de cocina

FEATURES:
 - Weight units: oz, g, kg, lb
 - Removeable bowl

CECHY:
 - Jednostki wagi: oz, g, kg, lb
 - Możliwość wyjęcia miski



max 5000g	800 ml	1g DIVISION PODZIAŁKA
TARE TAROWANIE	LCD	2x AAA
ANTI-SLIP FEET NOŻKI ANTY-POŚLIZGOWE		

LUND

No.	Max. load capacity / Maks. obciążenie [g]	
68361	5000	12

EN Kitchen scale
 PL Waga kuchenna
 DE Küchenwaage
 RU Кухонные весы
 CZ Kuchyňská váha
 RO Cantar bucatarie
 HU Konyhamérleg
 ES Báscula de cocina

FEATURES:
 - Weight units: g, kg, ml
 - Scale area: 27 x 22.5 cm

CECHY:
 - Jednostki wagi: g, kg, ml
 - Powierzchnia ważenia: 27 x 22.5 cm



max 5000g	1g DIVISION PODZIAŁKA	TARE TAROWANIE	LED DISPLAY WYŚWIETLACZ
SS STAINLESS STEEL STAŁ NIERDZEWNA	2x AAA	ANTI-SLIP FEET NOŻKI ANTY-POŚLIZGOWE	

LUND

No.	Max. load capacity / Maks. obciążenie [g]	
68363	5000	12

EN Kitchen scale
 PL Waga kuchenna
 DE Küchenwaage
 RU Кухонные весы
 CZ Kuchyňská váha
 RO Cantar bucatarie
 HU Konyhamérleg
 ES Báscula de cocina

FEATURES:
 - Weight units: g, oz
 - Hold function
 - Summary function: max 3000 g

CECHY:
 - Jednostki wagi: g, oz
 - Funkcja utrzymania cyfry na wyświetlaczu
 - Funkcja sumowania: maks. 3000 g



max 300g	75 ml	0.1g DIVISION PODZIAŁKA	TARE TAROWANIE
LCD	2x AAA		

LUND

No.	Max. load capacity / Maks. obciążenie [g]	
68365	300	50

EN Cotton candy maker
 PL Urządzenie do waty cukrowej
 DE Zuckervattemaschine
 RU Сахарная вата кэнди мэйкер
 CZ Výrobník cukrové vaty
 RO Aparat de facut vata de zahar
 HU Vattacukor-készítő
 ES Máquina de algodón de azúcar

220-240V~50/60Hz 450 W 295 mm X2 SUCTION PADS PRZYSSAWKI



- INCLUDED:**
 - 10 sticks
 - Measuring spoon
- W ZESTAWIE:**
 - 10 patyczków
 - Miarka

LUND

No.	Power / Moc [W]	
68250	450	4

EN Popcorn maker
 PL Urządzenie do popcornu
 DE Popcorngerät
 RU Аппарат для попкорна
 CZ Zařízení k výrobě popcornu
 RO Aparat de facut popcorn
 HU Popcorn gép
 ES Máquina de palomitas de maíz

220-240V~50/60Hz 1200 W ANTI-SLIP FEET NÓZKI ANTY-POŚLIZGOWE



- FEATURES:**
 - Capacity: 50-60 g corn
 - Without oil
 - Ready in 3 min.
- CECHY:**
 - Pojemność: 50-60 g ziaren na cykl
 - Bez użycia oleju
 - Gotowe w 3 min

LUND

No.	Power / Moc [W]	
68260	1200	6

EN Cyclonic vacuum cleaner
 PL Odkurzacz cyklonowy
 DE Zyklonischer Staubsauger
 RU Циклонный пылесос
 CZ Cyklonový vysavač
 RO Aspirator ciclonic
 HU Cyclone porszívó
 ES Aspiradora ciclónica

220-240V~50/60Hz 700 W 1.5L AUTO-REWIND AUTOMATYCZNE ZWIĄTANIE CYCLONIC CYKLONOWY HEPA H13 BAGLESS BEZ-WORKOWY 5 m



LUND

No.	Power / Moc [W]	
67091	700	1

EN Cotton candy maker
 PL Urządzenie do waty cukrowej
 DE Zuckervattemaschine
 RU Сахарная вата кэнди мэйкер
 CZ Výrobník cukrové vaty
 RO Aparat de facut vata de zahar
 HU Vattacukor-készítő
 ES Máquina de algodón de azúcar

220-240V~50/60Hz 450 W 275 mm X3 SUCTION PADS PRZYSSAWKI



- INCLUDED:**
 - 10 sticks
 - Measuring spoon
- W ZESTAWIE:**
 - 10 patyczków
 - Miarka

LUND

No.	Power / Moc [W]	
68251	450	8

EN Cyclonic vacuum cleaner
 PL Odkurzacz cyklonowy
 DE Zyklonischer Staubsauger
 RU Циклонный пылесос
 CZ Cyklonový vysavač
 RO Aspirator ciclonic
 HU Cyclone porszívó
 ES Aspiradora ciclónica

220-240V~50/60Hz 700 W 1.5L HEPA H13 BAGLESS BEZ-WORKOWY 5 m

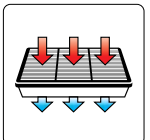

LUND

No.	Power / Moc [W]	
67090	700	1

- EN Vacuum cleaner filter
- PL Filtr do odkurzacza
- DE Staubsaugerfilter
- RU Фильтр для пылесоса
- CZ Filtr vysavače
- RO Filtru aspirator
- HU Porszívó szűrő
- ES Filtro de aspirador



LUND

No.	For / Dla	
67093	67090	250

- EN Vacuum cleaner filter
- PL Filtr do odkurzacza
- DE Staubsaugerfilter
- RU Фильтр для пылесоса
- CZ Filtr vysavače
- RO Filtru aspirator
- HU Porszívó szűrő
- ES Filtro de aspirador



LUND

No.	For / Dla	
67094	67091, 67092	250

- EN Cyclonic vacuum cleaner
- PL Odkurzacz cyklonowy
- DE Zyklonischer Staubsauger
- RU Циклонный пылесос
- CZ Cyklonový vysavač
- RO Aspirator ciclonic
- HU Cyclone porszívó
- ES Aspiradora ciclónico

220-240V-50/60Hz	800 W	1L
	BAGLESS BEZ-WORKOWY	HEPA H13
4.8 m		



LUND

No.	Power / Moc [W]	
67110	800	4

- EN Vacuum cleaner filter
- PL Filtr do odkurzacza
- DE Staubsaugerfilter
- RU Фильтр для пылесоса
- CZ Filtr vysavače
- RO Filtru aspirator
- HU Porszívó szűrő
- ES Filtro de aspirador



LUND

No.	For / Dla	
67095	67090, 67091, 67092	400

- EN Cyclonic vacuum cleaner
- PL Pionowy odkurzacz cyklonowy
- DE Zyklonischer Staubsauger
- RU Циклонный пылесос
- CZ Cyklonový vysavač
- RO Aspirator ciclonic
- HU Cyclone porszívó
- ES Aspiradora ciclónico

220-240V-50Hz	800 W	1.5L	
BAGLESS BEZ-WORKOWY	HEPA H13	4.8 m	



LUND

No.	Power / Moc [W]	
67112	800	4

EN Rechargeable vacuum cleaner
 PL Bezprzewodowy odkurzacz pionowy
 DE Akku-hand Bodenbürstsauger
 RU Перезаряжаемый пылесос
 CZ Akumulátorový vysavač
 RO Aspirator reîncărcabil
 HU Újratölthetô porszívó
 ES Aspiradora recargable



LUND

No.	Power / Moc [W]	
67120	120	4

EN Vacuum cleaner filter
 PL Filtr do odkurzacza
 DE Staubsaugerfilter
 RU Фильтр для пылесоса
 CZ Filtr vysavače
 RO Filtru aspirator
 HU Porszívó szűrô
 ES Filtro de aspirador



LUND

No.	For / Dla	
67115	67110, 67120	100
67116	67111	200

EN Roller for vacuum cleaner
 PL Walek do odkurzacza
 DE Staubsauger Bar-Rolle
 RU Валик для пылесоса
 CZ Váleček do vysavače
 RO Rolă pt. aspirator
 HU Porszívó tengely
 ES Rodillo de aspiradora



LUND

No.	For / Dla	
67123	67121	60

EN Rechargeable vacuum cleaner
 PL Bezprzewodowy odkurzacz pionowy
 DE Akku-hand Bodenbürstsauger
 RU Перезаряжаемый пылесос
 CZ Akumulátorový vysavač
 RO Aspirator reîncărcabil
 HU Újratölthetô porszívó
 ES Aspiradora recargable



LUND

No.	Power / Moc [W]	
67121	200	4

EN Vacuum cleaner filter
 PL Filtr do odkurzacza
 DE Staubsaugerfilter
 RU Фильтр для пылесоса
 CZ Filtr vysavače
 RO Filtru aspirator
 HU Porszívó szűrô
 ES Filtro de aspirador



LUND

No.	For / Dla	
67122	67121	100

EN Microfiber for vacuum cleaner
 PL Mikrofibra do odkurzacza
 DE Mikrofaser für Staubsauger
 RU Микрофибра для пылесоса
 CZ Mikrovlákno do vysavače
 RO Rezerva microfibra pt. aspirator
 HU Mikroszálás kendô porszívóhoz
 ES Microfibra de aspiradora



LUND

No.	Size / Rozmiar [cm]	For / Dla	
67124	23.5x9.5	67121	300

EN Steam cleaner
 PL Myjka parowa
 DE Dampfreiniger
 RU Паровой очиститель
 CZ Parní čistič
 RO Curator cu aburi
 HU Gőztisztító
 ES Limpiador a vapor



220-240V-50/60Hz	900-1050 W
0.3 MPa	350 ml
28 g/min	max °C 110
10 ELEMENTS ELEMENTY	2m



LUND

No.	Power / Moc [W]	
67200	900-1050	6

EN Accessories for steam cleaner
 PL Akcesoria do myjki parowej
 DE Dampfreiniger-Zubehör
 RU Аксессуары для парочистителя

CZ Příslušenství pro parní čistič
 RO Accesorii pt. curator cu aburi
 HU Tartozékok gőztisztítóhoz
 ES Accesorios para la limpiadora a vapor

4 PCS	
-------	--

- INCLUDED:**
- Brass brush
 - Bent nozzle
 - Round small nylon brush
 - Towel microfibre cloth
- W ZESTAWIE:**
- Szczotka z włosiem z mosiądzu
 - Zaokrąglona dysza
 - Mała okrągła szczotka
 - Mała nakładka z mikrofibry



LUND

No.	For / Dla	pcs / szt.	
67202	67200, 67201	4	200

20

EN Microfibre for steam cleaner
 PL Mikrofibra do myjki parowej
 DE Mikrofaser-Bezug für Dampfreiniger
 RU Микрофибра для парочистителя
 CZ Násada z mikrovlákna na parní čistič
 RO Rezerva microfibră pt. curator cu aburi
 HU Mikroszálás kendő gőztisztítóhoz
 ES Microfibra para la limpiadora a vapor



LUND

No.	Size / Rozmiar [cm]	For / Dla	pcs / szt.	
67204	35x11	67201	3	100

EN Steam cleaner
 PL Myjka parowa
 DE Dampfreiniger
 RU Паровой очиститель

CZ Parní čistič
 RO Curator cu aburi
 HU Gőztisztító
 ES Limpiador a vapor



220-240V-50/60Hz	900-1050 W
0.3 MPa	400 ml
28-40 g/min	max °C 110
17 ELEMENTS ELEMENTY	3m



LUND

No.	Power / Moc [W]	
67201	900-1050	4

EN Tube for steam cleaner
 PL Wąż do myjki parowej
 DE Schlauch für Dampfreiniger
 RU Шланг для парочистителя

CZ Hadice pro parní čistič
 RO Tub pt. curator cu aburi
 HU Tömítő gőztisztítóhoz
 ES Manguera para la limpiadora a vapor

4 PCS	
-------	--

- INCLUDED:**
- Flexible tube with nozzle
- W ZESTAWIE:**
- Elastyczny wąż z dyszą



LUND

No.	L [cm]	For / Dla	
67203	55	67200, 67201	70

3 PCS	MICROFIBER MKROFIBRA	
-------	-------------------------	--

EN Steam mop
 PL Mop parowy
 DE Dampfmop
 RU Паровая швабра
 CZ Parní mop
 RO Abur mop
 HU Gőztisztító mop
 ES Trapeador a vapor



220-240V~ 50/60Hz	1500 W
550 ml	10-26 g/min
max °C 110	14 ELEMENTS ELEMENTY
5 m	



LUND

No.	Power / Moc [W]	
67220	1500	4

EN Microfibre for steam mop
 PL Mikrofibra do mopa parowego
 DE Mikrofaser-Bezug für Dampfmopp
 RU Микрофибра для паровой швабры
 CZ Násada z mikrovlákna na parní mop
 RO Rezerva microfibră pt. mop cu abur
 HU Mikroszálas kendő gőzfelmosóhoz
 ES Microfibra para mopa a vapor

3 PCS	
-----------------	--



LUND

No.	For / Dla	pcs / szt.	
67222	67220	3	67
67223	67221	3	67

EN Tube and jet nozzle for steam mop
 PL Wąż i dysza do mopa parowego
 DE Schlauch und Düse für Dampfmopp
 RU Шланг и насадка для паровой швабры
 CZ Hadice a tryska pro parní mop
 RO Tub si duza jet pt. mop cu abur
 HU Tömlő és fúvóka gőzfelmosóhoz
 ES Manguera y boquilla para la mopa a vapor

INCLUDED:
 - Flexible tube
 - Jet nozzle

W ZESTAWIE:
 - Elastyczny wąż
 - Długa dysza

LUND

No.	L [cm]	For / Dla	pcs / szt.	
67225	80	67220, 67221	2	50

EN Steam mop
 PL Mop parowy
 DE Dampfmop
 RU Паровая швабра
 CZ Parní mop
 RO Abur mop
 HU Gőztisztító mop
 ES Trapeador a vapor



220-240V~ 50/60Hz	1500 W
450 ml	10-26 g/min
max °C 110	14 ELEMENTS ELEMENTY
UV LAMP LÁMPA	5 m



LUND

No.	Power / Moc [W]	
67221	1500	4

EN Accessories for steam mop
 PL Akcesoria do mopa parowego
 DE Dampfmopp-Zubehör
 RU Аксессуары для паровой швабры
 CZ Příslušenství pro parní mop
 RO Accesorii pt. mop cu abur
 HU Tartozékok gőzfelmosóhoz
 ES Accesorios para la mopa a vapor

INCLUDED:
 - Brass brush
 - Round small nylon brush
 - Round large nylon brush
 - Slender brush
 - Scrap shovel
 - Bent nozzle
 - Towel microfiber cloth

W ZESTAWIE:
 - Szczotka z włosiem z mosiądzu
 - Mała okrągła szczotka
 - Duża okrągła szczotka
 - Szczotka do fug
 - Skrobak
 - Zaokrąglona dysza
 - Mała nakładka z mikrofibry

7 PCS	
-----------------	--



LUND

No.	For / Dla	pcs / szt.	
67224	67220, 67221	7	150

2 PCS	80 cm	
-----------------	-----------------	--



EN Electric mop
 PL Mop elektryczny
 DE Elektrischer Wischmopp
 RU Электрическая швабра
 CZ Elektrický mop
 RO Mop electric
 HU Elektromos felmosó
 ES Mopa eléctrica



7.4 V
2000mAh
Li-Ion

125 min

3-4h

60-80 min



LUND

No.	Battery voltage / Napięcie akumulatora [V d.c.]	
67180	7.4	8

EN Microfiber pads for electric mops
 PL Mikrofibra do mopów elektrycznych
 DE Mikrofaser-Bezug für elektrische Wischmopps
 RU Микрофибра для электрических швабр
 CZ Tkanina z mikrovlákna do elektrických mopů
 RO Rezerve microfibra pt. mop electric
 HU Mikroszálas feltét elektromos felmosóhoz
 ES Microfibra para mopa eléctrica

2 PCS

MICROFIBER
MIKROFIBRA



LUND

No.	For / Dla	pcs / szt.	
67181	67180	2	168

20

EN Travel iron
 PL Żelazko turystyczne
 DE Kompakt-Bügeleisen
 RU Туристический утюг

CZ Turistická žehlička
 RO Fier de calcat pt calatorii
 HU Hordozható vasaló
 ES Plancha de viaje

FUNCTIONS:

- Dry
- Steam
- Burst of steam
- Temperature control

FUNKCJE:

- Prasowanie na sucho
- Prasowanie z parą
- Uderzenie pary
- Regulacja temperatury



220-240V~
110-120V~
50-60Hz

1100 W

80 ml

10±3 g/min

CERAMIC SOLEPLATE
CERAMICZNA STOPA

2 m

LUND

No.	Power / Moc [W]	
68100	1100	10



EN Electric mop
 PL Mop elektryczny
 DE Elektrischer Wischmopp
 RU Электрическая швабра
 CZ Elektrický mop
 RO Mop electric
 HU Elektromos felmosó
 ES Mopa eléctrica



7.4 V
2000mAh
Li-Ion

200 min

200 ml

4h

35-40 min

LED CHARGE INDICATOR
WSKAZNIK NAŁADOWANIA BATERII

TELESCOPIC HANDLE
UCHWYT TELESKOPOWY



LUND

No.	Battery voltage / Napięcie akumulatora [V d.c.]	
67182	7.4	6

EN Microfiber pads for electric mops
 PL Mikrofibra do mopów elektrycznych
 DE Mikrofaser-Bezug für elektrische Wischmopps
 RU Микрофибра для электрических швабр
 CZ Tkanina z mikrovlákna do elektrických mopů
 RO Rezerve microfibra pt. mop electric
 HU Mikroszálas feltét elektromos felmosóhoz
 ES Microfibra para mopa eléctrica

3 PCS

MICROFIBER
MIKROFIBRA



LUND

No.	For / Dla	pcs / szt.	
67183	67182	3	200

EN Steam iron
PL Żelazko parowe
DE Dampfbügeleisen
RU Паровой утюг

CZ Napařovací žehlička
RO Fier de calcat cu abur
HU Gőzölős vasaló
ES Plancha de vapor

FUNCTIONS:

- Dry
- Spray
- Steam
- Burst of steam
- Vertical steam
- Self-cleaning
- Anti-drip
- Anti-calcium
- Auto shut off
- Temperature control

FUNKCJE:

- Prasowanie na sucho
- Spryskiwacz
- Prasowanie z parą
- Uderzenie pary
- Pionowy wyrzut pary
- Funkcja samoczyszczenia
- Blokada kąpienia
- System antywapienny
- Automatyczne wyłączenie
- Regulacja temperatury

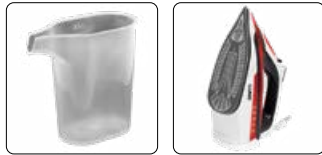

220-240V~ 50-60Hz	2800 W
320 ml	18±3 g/min
23.5x12.5 cm	CERAMIC SOLEPLATE CERAMICZNA STOPA
2m	

LUND

No.	Power / Moc [W]	
68115	2800	10

EN Aroma diffuser
PL Dyfuzor zapachu
DE Aroma-Diffusor
RU Диффузор запаха
CZ Difuzér vůně
RO Difuzer parfum
HU Illatdifúzor
ES Difusor de fragancias

5W	100 ml	15 ml/h	7 COLOURS KOLORY
15m²	3h		



LUND

No.	Power / Moc [W]	
66900	5	36

EN Aroma diffuser
PL Dyfuzor zapachu
DE Aroma-Diffusor
RU Диффузор запаха
CZ Difuzér vůně
RO Difuzer parfum
HU Illatdifúzor
ES Difusor de fragancias

12 W	500 ml	40-60 ml/h	7 COLOURS KOLORY
50m²	1h 3h 6h		



LUND

No.	Power / Moc [W]	
66902	12	12

EN Garment steamer
PL Parownica do ubrań
DE Dampfglätter
RU Отпариватель для одежды
CZ Oděv parník
RO Aparat de calcat vertical
HU Ruha gőztisztító
ES Vapor de la ropa

220-240V~ 50-60Hz	1100 W	100 ml	10 g/min
13x7.5 cm	CERAMIC SOLEPLATE CERAMICZNA STOPA	2m	



LUND

No.	Power / Moc [W]	
68090	900-1100	10

EN Aroma diffuser
PL Dyfuzor zapachu
DE Aroma-Diffusor
RU Диффузор запаха
CZ Difuzér vůně
RO Difuzer parfum
HU Illatdifúzor
ES Difusor de fragancias

12 W	120 ml	30 ml/h	7 COLOURS KOLORY
20m²	2h		



LUND

No.	Power / Moc [W]	
66901	12	24

EN Aroma diffuser
PL Dyfuzor zapachu
DE Aroma-Diffusor
RU Диффузор запаха
CZ Difuzér vůně
RO Difuzer parfum
HU Illatdifúzor
ES Difusor de fragancias

12 W	500 ml	40-60 ml/h	7 COLOURS KOLORY
50m²	1h 3h 6h		



LUND

No.	Power / Moc [W]	
66903	12	12

EN Aroma diffuser
 PL Dyfuzor zapachu
 DE Aroma-Diffusor
 RU Диффузор запаха
 CZ Difuzér vůně
 RO Difuser parfum
 HU Illatdiffúzor
 ES Difusor de fragancias

12 W 500 ml 40-60 ml/h 7 COLOURS KOLORY
 50m² 2h 4h

FEATURES:

- Work type: ultrasounds
- Mist type: low, high

CECHY:

- Rodzaj pracy: ultradźwięki
- Rodzaje mgiełki: niska, wysoka



LUND

No.	Power / Moc [W]	
66904	12	12

EN Air purifier
 PL Oczyszczacz powietrza
 DE Luftreiniger
 RU Очиститель воздуха
 CZ Čistička vzduchu
 RO Purificator aer
 HU Légtisztító
 ES Purificador de aire

220-240V-50/60Hz 40 W PM 2.5 220 m³/h CADR
 HEPA H10 8h 20-35 m³ 8min 2m

FEATURES:

- 4 stages of air purification: polypropylene pre filter, HEPA H10, carbon filter, ionizer
- 3 levels of purification speed
- Sleep mode
- Smart mode
- PM 2.5 detection
- CADR 220 m³/h (Clean Air Delivery Rate for particulate matter PM 2.5)
- Temperature detection and indicator
- Odor sensor
- Filter replace reminder

CECHY:

- 4 etapy oczyszczania: filtr polipropylenu, filtr HEPA H10, filtr węglowy, jonizator
- 3 prędkości oczyszczania
- Tryb uśpienia
- Tryb automatyczny
- Czujnik pyłu PM 2,5
- CADR 220 m³/h (szybkość dostarczania czystego powietrza dla cząstek stałych PM 2,5)
- Czujnik i wskaźnik temperatury
- Czujnik zapachu
- Funkcja przypominania o wymianie filtra

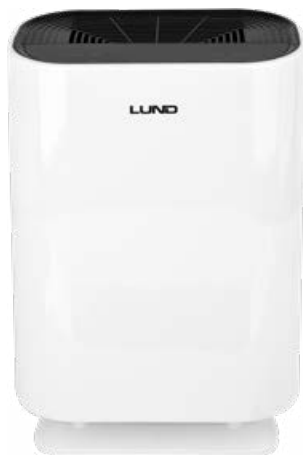

LUND

No.	Power / Moc [W]	
66930	40	1

EN Air purifier
 PL Oczyszczacz powietrza
 DE Luftreiniger
 RU Очиститель воздуха

CZ Čistička vzduchu
 RO Purificator aer
 HU Légtisztító
 ES Purificador de aire

FEATURES:

- 6 stages of air purification: aluminum mesh, UV lamp, HEPA H12, carbon filter, photocatalysis, ionizer
- Built-in air humidifier
- 4 levels of purification speed
- Sleep mode
- Smart mode
- PM 2.5 detection
- CADR 330 m³/h (Clean Air Delivery

Rate for particulate matter PM 2.5)

- CADR 68 m³/h (Clean Air Delivery Rate for formaldehyde)
- Temperature detection and indicator
- Humidity detection and indicator
- Odor sensor
- Filter replace reminder
- Safety kid lock

CECHY:

- 6 etapów oczyszczania: filtr wstępny - aluminiowa siatka, lampka UV, filtr HEPA H12, filtr węglowy, filtr fotokatalizacyjny, jonizator
- Wbudowany nawilżacz powietrza
- 4 prędkości oczyszczania
- Tryb uśpienia
- Tryb automatyczny
- Czujnik pyłu PM 2,5
- CADR 330 m³/h (szybkość dostarczania czystego

powietrza dla cząstek stałych PM 2,5)

- CADR 68 m³/h (szybkość dostarczania czystego powietrza dla formaldehydu)
- Czujnik i wskaźnik temperatury
- Czujnik i wskaźnik poziomu wilgotności
- Czujnik zapachu
- Funkcja przypominania o wymianie filtra
- Blokada rodzicielska

LUND

No.	Power / Moc [W]	
66936	55	1

EN Aroma diffuser
 PL Dyfuzor zapachu
 DE Aroma-Diffusor
 RU Диффузор запаха
 CZ Difuzér vůně
 RO Difuser parfum
 HU Illatdiffúzor
 ES Difusor de fragancias

13 W 1000 ml 50-70 ml/h 7 COLOURS KOLORY
 50m² 3h 6h 9h

FEATURES:

- Work type: ultrasounds
- Mist type: low, high

CECHY:

- Rodzaj pracy: ultradźwięki
- Rodzaje mgiełki: niska, wysoka



LUND

No.	Power / Moc [W]	
66906	13	12

EN Air purifier
 PL Oczyszczacz powietrza
 DE Luftreiniger
 RU Очиститель воздуха
 CZ Čistička vzduchu
 RO Purificator aer
 HU Légtisztító
 ES Purificador de aire

220-240V-50/60Hz 65 W PM 2.5 420 m³/h CADR HEPA H12
 8h 50-70 m³ 5min 2m

FEATURES:

- 7 stages of air purification: aluminum mesh, HEPA H12, carbon filter, photocatalysis, UV lamp, cold catalyst, ionizer
- 3 levels of purification speed
- Sleep mode
- Smart mode
- PM 2.5 detection
- CADR 420 m³/h (Clean Air Delivery Rate for particulate matter PM 2.5)
- CADR 68 m³/h (Clean Air Delivery Rate for formaldehyde)
- Temperature detection and indicator
- Humidity detection and indicator
- Odor sensor
- Filter replace reminder
- Safety kid lock

CECHY:

- 7 etapów oczyszczania: filtr wstępny - aluminiowa siatka, filtr HEPA H12, filtr węglowy, filtr fotokatalizacyjny, lampka UV, zimny filtr katalizacyjny, jonizator
- 3 prędkości oczyszczania
- Tryb uśpienia
- Tryb automatyczny
- Czujnik pyłu PM 2,5
- CADR 420 m³/h (szybkość dostarczania czystego powietrza dla cząstek stałych PM 2,5)
- CADR 68 m³/h (szybkość dostarczania czystego powietrza dla formaldehydu)
- Czujnik i wskaźnik temperatury
- Czujnik i wskaźnik poziomu wilgotności
- Czujnik zapachu
- Funkcja przypominania o wymianie filtra
- Blokada rodzicielska



LUND

No.	Power / Moc [W]	
66932	65	1

EN Air purifier filter
 PL Filtr do oczyszczacza powietrza
 DE Filter für Luftreiniger
 RU Фильтр для очистки воздуха
 CZ Filtr do čističky vzduchu
 RO Filtru pt. purificator aer
 HU Légtisztító szűrő
 ES Filtro para purificador de aire



TYPE OF FILTERS:
 - Polypropylene pre-filter
 - HEPA H10
 - Carbon filter

TYPY FILTRÓW:
 - Filtr wstępny z polipropylenu
 - HEPA H10
 - Filtr węglowy

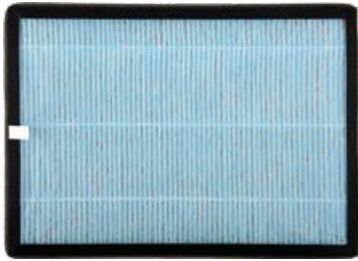

LUND

No.	For / Dla	
66931	66930	40

EN Air purifier filter
 PL Filtr do oczyszczacza powietrza
 DE Filter für Luftreiniger
 RU Фильтр для очистки воздуха
 CZ Filtr do čističky vzduchu
 RO Filtru pt. purificator aer
 HU Légtisztító szűrő
 ES Filtro para purificador de aire



TYPE OF FILTERS:
 - Aluminium mesh
 - HEPA H12
 - Carbon filter
 - Photocatalysis

TYPY FILTRÓW:
 - Aluminiowa siatka
 - HEPA H12
 - Filtr węglowy
 - Filtr fotokatalityczny

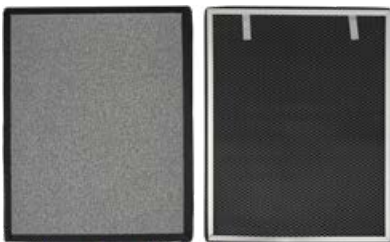

LUND

No.	For / Dla	
66937	66934, 66936	20

EN Ozone generator
 PL Generator ozonu
 DE Ozon-Generator
 RU Генератор озона
 CZ Generátor ozónu
 RO Generator ozon
 HU Ózongenerátor
 ES Generador de ozono

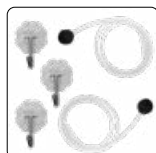
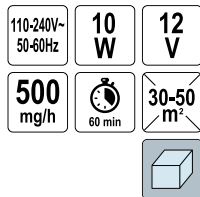

LUND

No.	Power / Moc [W]	
66950	10	10

EN Air purifier filter
 PL Filtr do oczyszczacza powietrza
 DE Filter für Luftreiniger
 RU Фильтр для очистки воздуха
 CZ Filtr do čističky vzduchu
 RO Filtru pt. purificator aer
 HU Légtisztító szűrő
 ES Filtro para purificador de aire

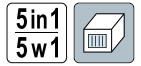

TYPE OF FILTERS:
 - Aluminium mesh
 - HEPA H12
 - Carbon filter
 - Photocatalysis
 - Cold catalyst

TYPY FILTRÓW:
 - Aluminiowa siatka
 - HEPA H12
 - Filtr węglowy
 - Filtr fotokatalityczny
 - Zimny filtr katalityczny

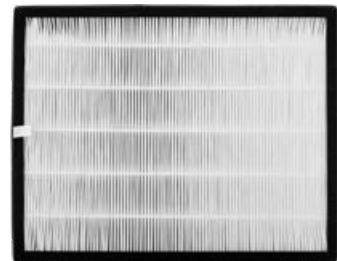

LUND

No.	For / Dla	
66933	66932	30

EN Air purifier with ozon generator
 PL Oczyszczacz powietrza z generatorem ozonu
 DE Luftreinigungsggerät mit Ozon-Generator
 RU Очиститель воздуха с генератором озона
 CZ Čistička vzduchu s generátorem ozónu
 RO Purificator aer cu generator de ozon
 HU Légtisztító ózongenerátorral
 ES Purificador de aire con generador de ozono

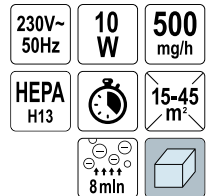

FEATURES:
 - 5 stages of air purification: HEPA H13, carbon filter, photocatalysis, UV lamp, ionizer
 - Ozone maker
 - Filter replace reminder
 - Air purifier - timer 1-12 h
 - Ozonator - timer 60 min

CECHY:
 - 5 etapów oczyszczania: filtr HEPA H13, filtr węglowy, filtr fotokatalityczny, lampa UV, jonizator
 - Generator ozonu
 - Funkcja przypominania o wymianie filtra
 - Oczyszczacz powietrza - czasomierz 1-12 h
 - Ozonator - czasomierz 60 min

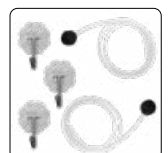

LUND

No.	Power / Moc [W]	
66940	10	6

EN Air purifier filter
 PL Filtr do oczyszczacza powietrza
 DE Filter für Luftreiniger
 RU Фильтр для очистки воздуха
 CZ Filtr do čističky vzduchu
 RO Filtru pt. purificator aer
 HU Légtisztító szűrő
 ES Filtro para purificador de aire

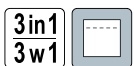

LUND

No.	For / Dla	
66955	66940	100

EN Diffuzer for ozon generator
 PL Dyfuzor do generatora ozonu
 DE Diffusur zum Ozon-Generator
 RU Диффузор для генератора озона
 CZ Difuzér do generátoru ozonu
 RO Difuzor pt. generatorul de ozon
 HU Diffúzor ózongenerátorhoz
 ES Difusor de generador de ozono



LUND

No.	For / Dla	
66956	66940, 66950	100

Memo

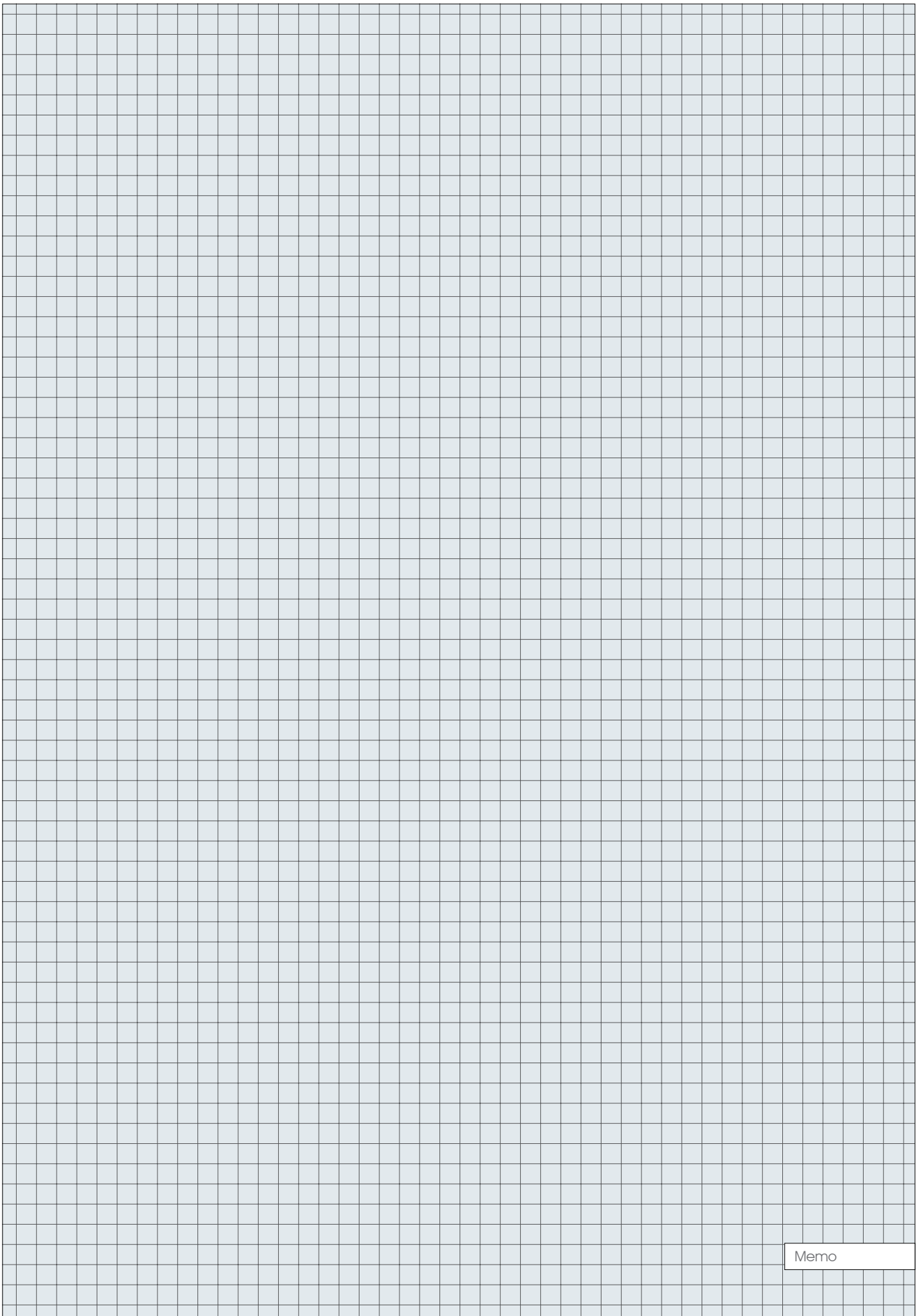







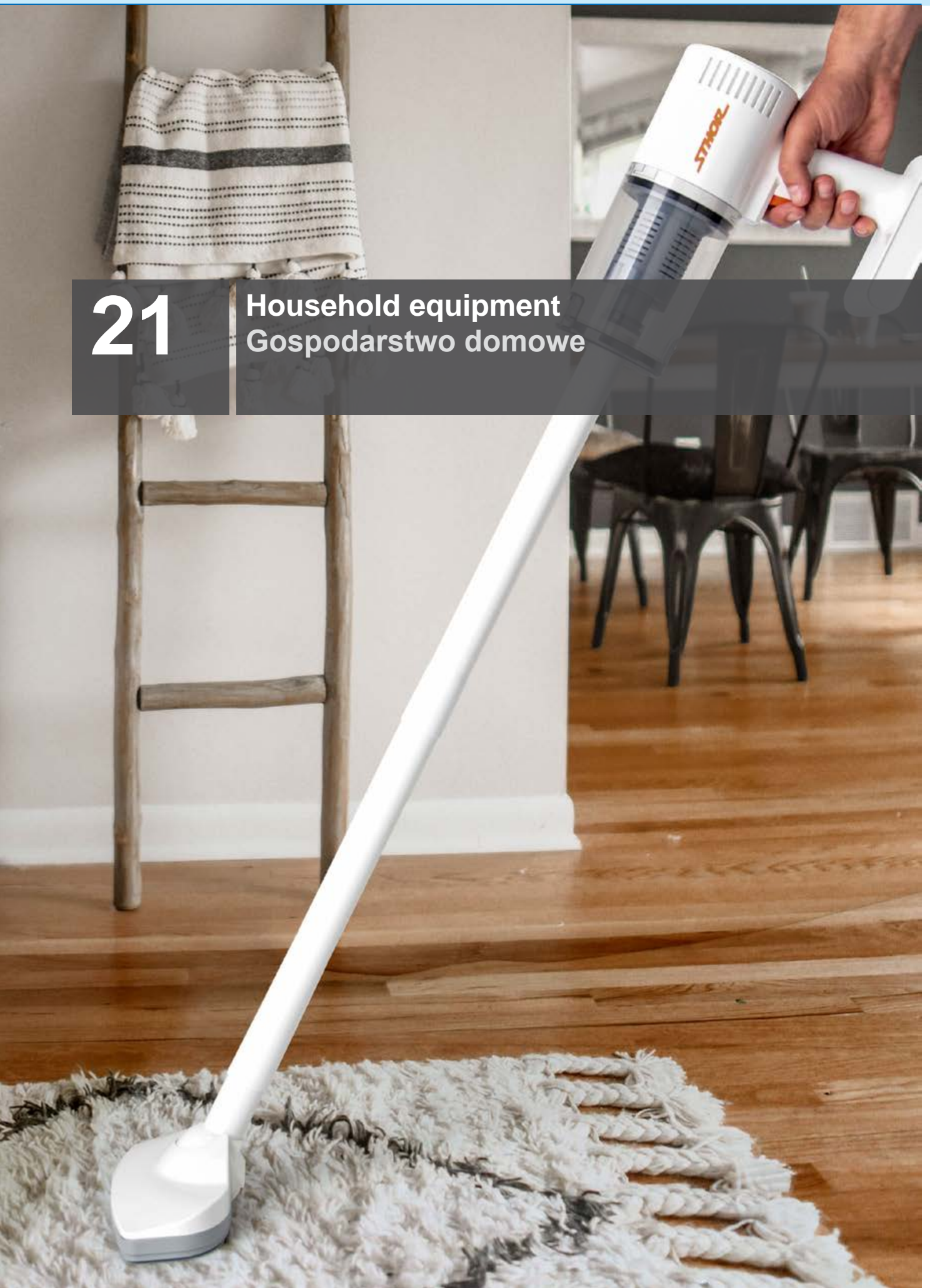



Memo

21

Household equipment
Gospodarstwo domowe



Mailboxes Skrzynki na listy	
.....350-351	
Coal stoves accessories Akcesoria do piecy węglowych	
.....351-354	
Brushes Szcotki	
.....354-359	
Mops Zgarniacze do wody	
.....359	
Multipurpose trays Podstawki gospodarcze	
.....359	
Bags Worki	
.....359-362	
Tarpaulins & accessories Plandeki i akcesoria	
.....362-363	
Vacuum cleaners, ash separators & accessories Odkurzacze, separatory popiołu i akcesoria	
.....363-366	
Syphon pumps Pompy syfonowe	
.....366	
Pumps Pompki	
.....366	

Hydraulic accessories Akcesoria hydrauliczne	
.....366	
Vaselines Wazeliny techniczne	
.....367	
Hand trucks Wózki magazynowe	
.....367	
Floor conveyors Transport poziomy	
.....368	
Casters Kółka	
.....368-370	
Seals Uszczelnienia	
.....371	
Self-adhesive furniture pads Podkładki samoprzylepne pod meble	
.....371-374	
Plastic stools Stołki plastikowe	
.....374	
Hooks & furniture protection Haczyki i zabezpieczenia	
.....374-376	

EN Mailbox
 PL Skrzynka na listy
 DE Briefkasten
 RU Почтовый ящик
 CZ Schránka na dopisy
 RO Cutie poştală
 HU Levélláda
 ES Buzón



No.	Dimensions / Wymiary [mm]	Slot width / Szerokość wrzutu [mm]	Color / Kolor	
78540	285x200x60	143	czarny	12
78541	285x200x60	143	graftowy	12
78542	285x200x60	143	brązowy	12
78543	285x200x60	143	zielony	12

EN Mailbox
 PL Skrzynka na listy
 DE Briefkasten
 RU Почтовый ящик
 CZ Schránka na dopisy
 RO Cutie poştală
 HU Levélláda
 ES Buzón



No.	Dimensions / Wymiary [mm]	Slot width / Szerokość wrzutu [mm]	Color / Kolor	
78570	400x250x100	230	czarny	6
78571	400x250x100	230	graftowy	6
78572	400x250x100	230	brązowy	6

EN Mailbox
 PL Skrzynka na listy
 DE Briefkasten
 RU Почтовый ящик
 CZ Schránka na dopisy
 RO Cutie poştală
 HU Levélláda
 ES Buzón



No.	Dimensions / Wymiary [mm]	Slot width / Szerokość wrzutu [mm]	Color / Kolor	
78580	380x320x105	220	czarny	5
78581	380x320x105	220	graftowy	5
78582	380x320x105	220	brązowy	5

EN Mailbox
 PL Skrzynka na listy
 DE Briefkasten
 RU Почтовый ящик
 CZ Schránka na dopisy
 RO Cutie poştală
 HU Levélláda
 ES Buzón

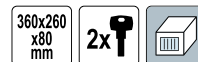

No.	Dimensions / Wymiary [mm]	Slot width / Szerokość wrzutu [mm]	Color / Kolor	
78555	360x260x80	220	czarny	6
78556	360x260x80	220	graftowy	6
78557	360x260x80	220	brązowy	6

EN Mailbox
 PL Skrzynka na listy
 DE Briefkasten
 RU Почтовый ящик
 CZ Schránka na dopisy
 RO Cutie poştală
 HU Levélláda
 ES Buzón

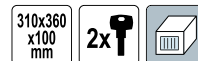

No.	Dimensions / Wymiary [mm]	Slot width / Szerokość wrzutu [mm]	Color / Kolor	
78575	310x360x100	320	czarny	6
78576	310x360x100	320	graftowy	6
78577	310x360x100	320	brązowy	6

EN Mailbox
 PL Skrzynka na listy
 DE Briefkasten
 RU Почтовый ящик
 CZ Schránka na dopisy
 RO Cutie poştală
 HU Levélláda
 ES Buzón

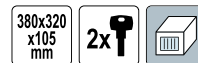

No.	Dimensions / Wymiary [mm]	Slot width / Szerokość wrzutu [mm]	Color / Kolor	
78585	380x320x105	220	czarny	5
78586	380x320x105	220	graftowy	5
78587	380x320x105	220	brązowy	5

EN Mailbox
 PL Skrzynka na listy
 DE Briefkasten
 RU Почтовый ящик
 CZ Schránka na dopisy
 RO Cutie poştală
 HU Levélláda
 ES Buzón



VOREL

No.	Dimensions / Wymiary [mm]	Slot width / Szerokość wrzutu [mm]	Color / Kolor	
78590	480x280x80	198	czarny	5
78591	480x280x80	198	grafitowy	5
78592	480x280x80	198	brązowy	5

EN Fireplace tool set
 PL Zestaw kominkowy
 DE Kaminset
 RU Каминный набор
 CZ Křbové nářadí
 RO Set unelte șemineu
 HU Kandalló tisztító készlet
 ES Herramientas de chimenea

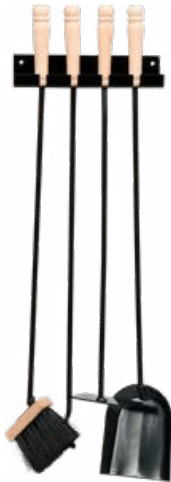

VOREL

No.	pcs / szt.	
72973	4	1

EN Stove metal plate
 PL Blacha przyściowa
 DE Ofenplatte
 RU Напольный лист для печи
 CZ Podložka pod pec z plechu
 RO Tava protecție soba
 HU Hőterelő lemez kályhához
 ES Chapa para suelo estufas



VOREL

No.	Size / Rozmiar [mm]	Thickness / Grubość [mm]	
72936	500x600	0.5	10
72937	500x800	0.5	10

EN Fireplace tool set
 PL Zestaw kominkowy
 DE Kaminset
 RU Каминный набор
 CZ Křbové nářadí
 RO Set unelte șemineu
 HU Kandalló tisztító készlet
 ES Herramientas de chimenea



VOREL

No.	pcs / szt.	
72972	4	1

EN Stove metal plate
 PL Blacha przyściowa
 DE Ofenplatte
 RU Напольный лист для печи
 CZ Podložka pod pec z plechu
 RO Tava protecție soba
 HU Hőterelő lemez kályhához
 ES Chapa para suelo estufas



VOREL

No.	Size / Rozmiar [mm]	Thickness / Grubość [mm]	
72933	300x500	0.5	10
72934	400x600	0.5	10
72935	500x650	0.5	10

EN Chimney brush
 PL Przetykacz do wycystki kominowej
 DE Kaminbürste
 RU Щетка для дымохода
 CZ Kominový kartáč
 RO Coș de perie
 HU Kéménykefe
 ES Brosse de cheminée

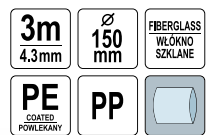

VOREL

No.	Brush diameter / Średnica wyciora [mm]	
72955	150	20

- EN Chimney cleaner
- PL Wycior kominowy
- DE Schornsteinreiniger
- RU Щетка для трубочистов
- CZ Kartáč kominový
- RO Racletă pt. coșul de fum
- HU Kéménytisztító kefe
- ES Arilla para baquetas de calefacción central



No.	Ø [mm]	
72948	120	15
72950	150	20
72951	175	18
72952	200	18

- EN Chimney cleaner
- PL Wycior kominowy
- DE Schornsteinreiniger
- RU Щетка для трубочистов
- CZ Kartáč kominový
- RO Racletă pt. coșul de fum
- HU Kéménytisztító kefe
- ES Arilla para baquetas de calefacción central



No.	Ø [mm]	
72994	120	15
72995	150	20
72996	175	18
72997	200	18
72998	250	12

- EN Chimneysweep ball
- PL Kula kominarska stalowa
- DE Zuggewicht aus Stahl
- RU Шар дымоходный для чистки дымоходов
- CZ Kominová koule
- RO Acéi öntvény kéménygolyó
- HU Bilá curatat cos de fum
- ES Bola de chimenea de acero



No.	m [kg]	
73025	1.3	5
73026	1.8	5
73027	2.5	5

- EN Chimney cleaner
- PL Wycior kominowy
- DE Schornsteinreiniger
- RU Щетка для трубочистов
- CZ Kartáč kominový
- RO Racletă pt. coșul de fum
- HU Kéménytisztító kefe
- ES Arilla para baquetas de calefacción central



No.	Ø [mm]	
72953	250	12
72954	300	8

- EN Chimney rope
- PL Lina kominarska
- DE Schornsteinfeger-Seil
- RU Трос для чистки дымоходов
- CZ Kominové lano
- RO Franghie pt. cos de fum
- HU Kémény kötél
- ES Cuerda de chimenea



No.	Ø [mm]	L [m]	
73021	6	10	15
73022	8	10	15

- EN Iron chimneysweep ball
- PL Kula kominarska żelazna
- DE Schornsteinfegerkugel
- RU Гиря для трубочистов
- CZ Kaminkrečio kamuolys
- RO Bilă pt. coșul de fum
- HU Kémény golyó
- ES Esfera del deholinador



No.	m [kg]	
72938	15	4
72939	25	4

EN Chimney brush with iron ball
 PL Zestaw kominiański
 DE Schornsteinfeger-Garnitur: Zuggewicht Russbesen Seil
 RU Набор для чистки дымохода

CZ Kominový set
 RO Perie cos cu bila + franghie
 HU Kéménytisztító szettek
 ES Redondo limpieza cepillo bola de acero



VOREL

No.	Brush diameter / Średnica wyciora [mm]	Ball weight / Masa kuli [kg]	Rope length / Długość liny [m]	
73031	125	1.3	10	1
73032	150	1.3	10	1
73033	175	1.8	10	1
73034	200	1.8	10	1
73035	250	2.5	10	1

EN Chimney wire
 PL Drut kominowy
 DE Schornsteindraht
 RU Проволока для трубочистов
 CZ Kamínkréčov trosas
 RO Sărmă pt. coșul de fum
 HU Kéménytisztító drót
 ES Alambre de chimeneas



No.	Ø [mm]	L [m]	
72942	3.5	6	25
72943	3.5	8	20
72944	3.5	10	20
72945	3.5	12	20

EN Shovel
 PL Szufelka angielska
 DE Kehrschaufel
 RU Совок
 CZ Lopatka
 RO Faras carbune
 HU Lapát
 ES Recogedor



VOREL

No.	W [mm]	L [mm]	
72974	340	200	18

EN Central heating cleaning rod
 PL Pręt do wyciorów
 DE Stab für die Reiniger der Zentralheizung
 RU Черенок для щеток – центральное отопление
 CZ Tyč k čištění
 RO Tije pt. racleți încălzire centrală
 HU CO pálcá a füstcsőtisztító keféhez
 ES Baqueta para limpiar el sistema de calefacción central



No.	Ø [mm]	L [mm]	
72956	7	600	50
72958	7	800	50
72960	7	1000	50

EN Chimney cleaner
 PL Wycior do C.O.
 DE Schornsteinreiniger
 RU Щетка для трубочистов
 CZ Kartáč kominový
 RO Racletă pt. coșul de fum
 HU Kéménytisztító kefe
 ES Arilla para baquetas de calefacción central



No.	Ø [mm]	
72963	30	50
72964	40	50
72965	50	50
72966	60	35
72967	70	35
72968	80	30
72969	90	20
72970	100	20

EN Shovel
 PL Szufelka
 DE Kehrschaufel
 RU Совок
 CZ Lopatka
 RO Lopățică
 HU Lapát
 ES Pala



VOREL

No.	W [mm]	L [mm]	
72976	220	380	20

EN Poker
 PL Pogrzebacz
 DE Schürhaken
 RU Кочерга
 CZ Pohrabáč
 RO Vătrai
 HU Piszkavas
 ES Atizador



No.	L [mm]	
72981	620	50

EN Shovel
 PL Szufelka
 DE Kehrschaufel
 RU Совок
 CZ Lopatka
 RO Lopăjică
 HU Lapát
 ES Pala



No.	W [mm]	L [mm]	
72978	145	490	40
72977	180	550	30

EN Coal hod
 PL Węglarka
 DE Kohlenkasten
 RU Ведро для угля
 CZ Uhlák
 RO Cos carbuni
 HU Szenes kosár
 ES Cubo para carbón



No.	W [mm]	H [mm]	L [mm]	
72984	210	125	385	5

EN Coal hod
 PL Węglarka
 DE Kohlenkasten
 RU Ведро для угля
 CZ Uhlák
 RO Cos carbuni
 HU Szenes kosár
 ES Cubo para carbón



No.	W [mm]	H [mm]	L [mm]	
72985	200	175	370	5

EN Shovel
 PL Szufelka
 DE Kehrschaufel
 RU Совок
 CZ Lopatka
 RO Lopăjică
 HU Lapát
 ES Pala



No.	W [mm]	L [mm]	
72975	220	460	40

EN Shovel
 PL Szufelka
 DE Kehrschaufel
 RU Совок
 CZ Lopatka
 RO Lopăjică
 HU Lapát
 ES Pala



No.	W [mm]	L [mm]	
72979	110	500	5/30

EN Microfiber spray mop and window wiper
 PL Mop ze spryskiwaczem z myjką do okien
 DE Spritz Mop
 RU Спрей швабра
 CZ Stříkací mop
 RO Mop cu pulverizare
 HU Permetező mop
 ES Rociar fregona

350 ml
 41x13 cm
 x2
 MICROFIBER
 MIKROFIBRA

FEATURES:
 - For every type of surface: wood, floor panel, tile, stone, PVC
 - Multidirectional mop head

CECHY:
 - Do każdego rodzaju powierzchni: drewna, paneli podłogowych, płytek, kamienia, PCV
 - Wielokierunkowa stopa czyszcząca

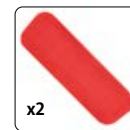

No.	
67160	12

EN Double-sided microfiber spray mop
 PL Dwustronny mop ze spryskiwaczem
 DE Spritz Mop
 RU Спрей швабра
 CZ Stříkací mop
 RO Mop cu pulverizare
 HU Permetező mop
 ES Rociar fregona

FEATURES:

- Wet & dry cleaning
- For every type of surface: wood, floor panel, tile, stone, PVC
- Multidirectional mop head

CECHY:

- Mycie na mokro i na sucho
- Do każdego rodzaju powierzchni: drewna, paneli podłogowych, płytek, kamienia, PCV
- Wielokierunkowa stopa czyszcząca



350 ml	41x13 cm
x2	DOUBLE-SIDED DWU-STRONNA
MICROFIBER MKROFIBRA	



LUND

No.		
67161		12

EN Microfiber CZ Mikrovlákno
 PL Mikrofibra RO Microfibră
 DE Mikrofaser HU Mikroszálás
 RU Микроволокно ES Microfibra



LUND

No.	Size / Rozmiar [mm]	For / Dla	
67164	410x130	67161	100

EN Microfiber
 PL Mikrofibra
 DE Mikrofaser
 RU Микроволокно
 CZ Mikrovlákno
 RO Microfibră
 HU Mikroszálás
 ES Microfibra



LUND

No.	Size / Rozmiar [mm]	For / Dla	
67166	260x70	67162	500

EN Microfiber spray mop and window wiper
 PL Mop ze spryskiwaczem z myjką do okien
 DE Spritz Mop
 RU Спрей швабра
 CZ Stříkací mop
 RO Mop cu pulverizare
 HU Permetező mop
 ES Rociar fregona

FEATURES:

- For every type of surface: wood, floor panel, tile, stone, PVC
- Multidirectional mop head

CECHY:

- Do każdego rodzaju powierzchni: drewna, paneli podłogowych, płytek, kamienia, PCV
- Wielokierunkowa stopa czyszcząca



350 ml	41x13 cm
x2	MICROFIBER MKROFIBRA



LUND

No.		
67162		12

EN Microfiber CZ Mikrovlákno
 PL Mikrofibra RO Microfibră
 DE Mikrofaser HU Mikroszálás
 RU Микроволокно ES Microfibra



LUND

No.	Size / Rozmiar [mm]	For / Dla	
67165	410x130	67160, 67162	125

EN Floor sweeper
 PL Szczotka obrotowa
 DE Boden sweeper
 RU Турбо-щётка
 CZ Mechanický zametač
 RO Podea peria
 HU Forgó keféş
 ES Barredora de escoba

FEATURES:

- Great for pet hair
- Capacious basket
- For every type of surface: wood, floor panel, tile, stone, PVC

CECHY:

- Odpowiednia do sierści zwierząt
- Pojemny kosz
- Do każdego rodzaju powierzchni: drewna, paneli podłogowych, płytek, kamienia, PCV



LUND

No.		
67163		18

EN Broom
 PL Zamiatacz
 DE Feger
 RU Подметальная машина
 CZ Smeták
 RO Matura
 HU Seprű fej
 ES Barredor



No.	Working width / Szerokość robocza [mm]	
35930	300	10

EN Broom
 PL Zamiatacz
 DE Feger
 RU Подметальная машина
 CZ Smeták
 RO Matura
 HU Seprű fej
 ES Barredor



No.	Working width / Szerokość robocza [mm]	
35932	270	18

EN Brush
 PL Zmiotka ręczna
 DE Handfeger
 RU Ручная щетка-веник
 CZ Smetáček
 RO Perie cu maner
 HU Kézi seprű
 ES Escoba manual



No.	Working width / Szerokość robocza [mm]	
35940	290	25

EN Scrubbing brush
 PL Szczotka do szorowania
 DE Scheuerbürste
 RU Щетка для чистки
 CZ Rýžový kartáč
 RO Perie pt. curatat
 HU Súrolókefe
 ES Cepillo para frotar



No.	Working width / Szerokość robocza [mm]	
35961	195	70

EN Broom with handle
 PL Zamiatacz z trzonkiem
 DE Feger mit Stiel
 RU Подметальная машина с ручкой
 CZ Smeták s násadou
 RO Matura cu coada
 HU Seprű nyéllal
 ES Barredor con mango



No.	Working width / Szerokość robocza [mm]	L [mm]	
35931	300	1180	12

EN Broom
 PL Zamiatacz z odbojnikami
 DE Feger mit Puffer
 RU Подметальная машина с бампером
 CZ Smeták s chrániči
 RO Matura cu protectie
 HU Seprű fej ütközővel
 ES Barredor con tope



No.	Working width / Szerokość robocza [mm]	
35933	290	18

EN Scrubbing brush
 PL Szczotka do szorowania
 DE Scheuerbürste
 RU Щетка для чистки
 CZ Rýžový kartáč
 RO Perie pt. curatat
 HU Súrolókefe
 ES Cepillo para frotar



No.	Working width / Szerokość robocza [mm]	
35960	195	70

EN Scrubbing brush
 PL Szczotka do szorowania
 DE Scheuerbürste
 RU Щетка для чистки
 CZ Rýžový kartáč
 RO Perie pt. curatat
 HU Súrolókefe
 ES Cepillo para frotar



No.	Working width / Szerokość robocza [mm]	
35962	230	20

EN Scrubbing brush
 PL Szczotka do szorowania
 DE Scheuerbürste
 RU Щетка для чистки
 CZ Rýžový kartáč
 RO Perie pt. curatat
 HU Súrolókefe
 ES Cepillo para frotar



VOREL

No.	Working width / Szerokość robocza [mm]	
35963	300	10

EN Scrubbing brush with a handle
 PL Szczotka z trzonkiem
 DE Bürste mit Stiel
 RU Щетка с черенком
 CZ Kartáč s násadou
 RO Perie pt. curatat cu maner
 HU Kéfe nyéllel
 ES Cepillo con mango



VOREL

No.	Working width / Szerokość robocza [mm]	L [mm]	
35968	300	1240	10

EN Hand scrub brush
 PL Szczotka ręczna
 DE Handbürste
 RU Ручная щетка
 CZ Ruční kartáč
 RO Perie de mana pt. curatat
 HU Kézi kefe
 ES Cepillo manual



VOREL

No.	Working width / Szerokość robocza [mm]	
35971	200	10

EN Broom
 PL Miotła
 DE Strassenbesen
 RU Метла

CZ Metla
 RO Matura
 HU Partvis
 ES Cepillo pelo largo



No.	
35869	10

EN Scrubbing brush
 PL Szczotka do szorowania
 DE Scheuerbürste
 RU Щетка для чистки
 CZ Rýžový kartáč
 RO Perie pt. curatat
 HU Súrolókefe
 ES Cepillo para frotar



VOREL

No.	Working width / Szerokość robocza [mm]	
35964	300	10

EN Hand scrub brush
 PL Szczotka ręczna
 DE Handbürste
 RU Ручная щетка
 CZ Ruční kartáč
 RO Perie de mana pt. curatat
 HU Kézi kefe
 ES Cepillo manual



VOREL

No.	Working width / Szerokość robocza [mm]	
35970	200	10

EN Broom
 PL Miotła
 DE Strassenbesen
 RU Метла

CZ Metla
 RO Matura
 HU Partvis
 ES Cepillo pelo largo



No.	Working width / Szerokość robocza [mm]	
35867	300	10
35868	400	10

EN Broom
 PL Miotła
 DE Strassenbesen
 RU Метла
 CZ Metla
 RO Matura
 HU Partvis
 ES Cepillo pelo largo



No.	Working width / Szerokość robocza [mm]	
35870	300	10
35872	400	10
35874	500	10
35875	600	10
35876	800	10
35877	1000	10

EN Broom
 PL Miotła
 DE Strassenbesen
 RU Метла
 CZ Metla
 RO Matura
 HU Partvis
 ES Cepillo pelo largo



No.	Working width / Szerokość robocza [mm]	
35914	400	10
35915	500	10
35916	600	10
35918	800	10

EN Wire broom for pavement
 PL Miotła druciana do bruku
 DE Stahldrahtbesen für Pflastersteine
 RU Проволочная метла для тротуара

CZ Drátěná metla do dlažby
 RO Matura pt. pavaje
 HU Drótszerű járdához
 ES Escoba de alambre para adoquines



No.	Working width / Szerokość robocza [mm]	
35923	300	6
35924	400	6

EN Wire paving brush
 PL Szczotka do bruku z radełkami
 DE Bürste mit Schaber für Reinigung von Pflastersteinen
 RU Щетка для тротуарной плитки с шипом
 CZ Kartáč do dlažby s rádylkem
 RO Perie din sarma pt. pavaj
 HU Járdakefe pengével
 ES Cepillo para adoquines, con ruedas de trazado



No.	L [mm]	
35927	1460	10

EN Broom
 PL Miotła
 DE Strassenbesen
 RU Метла
 CZ Metla
 RO Matura
 HU Partvis
 ES Cepillo pelo largo



No.	Working width / Szerokość robocza [mm]	L [mm]	
35911	250	1150	200

EN Broom
 PL Miotła
 DE Strassenbesen
 RU Метла
 CZ Metla
 RO Matura
 HU Partvis
 ES Cepillo pelo largo



No.	Working width / Szerokość robocza [mm]	
35893	300	12
35894	400	12
35895	500	12

EN Broom
 PL Miotła
 DE Strassenbesen
 RU Метла
 CZ Metla
 RO Matura
 HU Partvis
 ES Cepillo pelo largo



No.	Working width / Szerokość robocza [mm]	
35899	250	12

EN Broom
 PL Miotła
 DE Strassenbesen
 RU Метла
 CZ Metla
 RO Matura
 HU Partvis
 ES Cepillo pelo largo



No.	Bristle length / Długość włosia [mm]	
35905	275	12

EN Broom
PL Miotła
DE Strassenbesen
RU Метла
CZ Metla
RO Matura
HU Partvis
ES Cepillo pelo largo



FLO

No.	Bristle length / Długość włosia [mm]	
35906	135	12

EN Lawn mover brush
PL Szczotka do kosiarki
DE Rasenmäher Reinigungsbürste mit Schaber
RU Щетка для очистки газонокосилки
CZ Kartáč na čištění sekačky
RO Perie pt. curatat motocoase
HU Ecset a kaszák tisztításához
ES Cepillo limpieza



FLO

No.	Working width / Szerokość robocza [mm]	L [mm]	
35950	50	310	15

EN Microfiber
PL Mikrofibra
DE Mikrofaser
RU Микроволокно
CZ Mikrovlákno
RO Microfibră
HU Mikroszálás
ES Microfibra



LUND

No.	Size / Rozmiar [mm]	For / Dla	
67171	250x70	67170	500

EN All purpose boot tray
PL Wielofunkcyjna podstawka gospodarza
DE Garten- und Haushalt-Unterlage
RU Многофункциональный поднос

CZ Multifunkční podložka
RO Tava multifunctionala
HU Többfunkciós tálcá
ES Bandeja de arranque universal

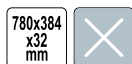

VOREL

No.	Dimensions / Wymiary [mm]	
67260	780x384x32	30

EN Broom
PL Miotła
DE Strassenbesen
RU Метла
CZ Metla
RO Matura
HU Partvis
ES Cepillo pelo largo



FLO

No.	Bristle length / Długość włosia [mm]	
35908	210	8

EN Barbecue cleaning brush
PL Szczotka do grilla
DE Grillbürste
RU Щетка для гриля
CZ Kartáč do grilu
RO Perie pt. curatat gratar
HU Grillkefe
ES Cepillo para barbacoa



VOREL

No.	L [mm]	
99528	305	16

EN Mop
PL Zgarniacz do wody
DE Wasserschieber
RU Сгон для уборки воды

CZ Stěrka s gumou
RO Mop cauciu
HU Vízlehúzó gumi
ES Recogedor de agua universal



VOREL

No.	L [mm]	
04561	330	12/120
04562	430	12/96

EN Debris bags
PL Worki na gruz, mocne
DE Müllsäcke stabil
RU Мешки для строительного мусора
CZ Pytle na sut
RO Saci pt. demolari
HU Sittes zsák
ES Bolsas para escombros

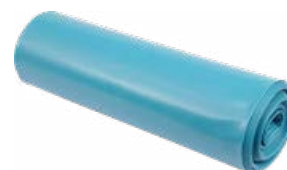

VOREL

No.	Capacity / Pojemność [l]	Thickness / Grubość [µm]	pcs / szt.	
09475	80	142	10	10
09476	80	142	3	10
09477	120	142	10	10
09478	120	142	3	10

- EN Waste bags for styrofoam
 PL Worki na styropian
 DE Styropor Entsorgungssäcke
 RU Пакеты для мусора строительные материалы
- CZ Pytle na polystyren
 RO Saci gunoi
 HU Szemeteszsák
 ES Sacos de poliestireno



LDPE



VOREL

No.	Capacity / Pojemność [l]	Thickness / Grubość [µm]	pcs / szt.	
09472	240	40	10	10

- EN Construction waste bags
 PL Worki na odpady budowlane
 DE Müllsäcke
 RU Мешки для строительного мусора
 CZ Pytle na stavební odpad
 RO Saci gunoi pt. santier
 HU Zsák építési törmelékhez
 ES Bolsas para desperdicios de construcción

LDPE



VOREL

No.	Capacity / Pojemność [l]	Thickness / Grubość [µm]	pcs / szt.	
09470	80	40	10	30
09471	120	60	15	10

- EN Garden bags with cord
 PL Worki ogrodowe z taśmą
 DE Gartensäcke mit Band
 RU Мешки для огорода с лентой
- CZ Zahradní pytle zatahovací
 RO Saci gunoi pt. gradina cu strangere
 HU Szalagos kerti szemeteszsák
 ES Bolsas de jardín con cinta

STRING TAPE TÁSMÁ SZÁGGAJÁCSA

LDPE



FLO

No.	Capacity / Pojemność [l]	Thickness / Grubość [µm]	pcs / szt.	
09480	60	60	10	12
09482	120	60	10	15

- EN Perforated waste bags for leaves
 PL Worki perforowane na liście
 DE Gartenmüllsäcke perforiert
 RU Мусорные пакеты прочные для листьев
- CZ Perforované odpadové pytle na list
 RO Szalagos kerti szemeteszsák
 HU Sac gunoi perforat pt. frunze
 ES Sacos perforadas para residuos de jardín

PERFORATED PERFOROWANY

LDPE



FLO

No.	Capacity / Pojemność [l]	Thickness / Grubość [µm]	pcs / szt.	
09484	200	40	10	12

- EN Waste bags
 PL Worki na odpady, mocne
 DE Müllbeutel
 RU Пакеты для мусора
 CZ Pytle na odpad
 RO Saci gunoi
 HU Szemeteszsák
 ES Bolsas para desperdicios

LDPE



VOREL

No.	Capacity / Pojemność [l]	Thickness / Grubość [µm]	pcs / szt.	
09465	120	30	10	25
09466	160	40	10	15
09467	240	40	10	10

- EN Garden bags
 PL Worki ogrodowe
 DE Gartensäcke
 RU Мешки для огорода
 CZ Zahradní pytle
 RO Saci gunoi pt. gradina
 HU Kerti szemeteszsák
 ES Bolsas de jardín

LDPE



FLO

No.	Capacity / Pojemność [l]	Thickness / Grubość [µm]	pcs / szt.	
09481	120	60	10	15

- EN Waste bags for grass
 PL Worki perforowane na trawę
 DE Gartenmüllsäcke perforiert
 RU Мусорные пакеты прочные для листьев
 CZ Perforované odpadové pytle na tráve
 RO Sac gunoi pt. iarba
 HU Szalagos kerti szemeteszsák
 ES Sacos perforadas para residuos de jardín

PERFORATED PERFOROWANY

LDPE



FLO

No.	Capacity / Pojemność [l]	Thickness / Grubość [µm]	pcs / szt.	
09483	120	35	10	25

- EN Waste bags
 PL Worki na odpady domowe
 DE Müllbeutel
 RU Пакеты для мусора
 CZ Pytle na odpad
 RO Saci gunoi
 HU Szemeteszsák
 ES Bolsas para desperdicios



VOREL

No.	Capacity / Pojemność [l]	Thickness / Grubość [µm]	pcs / szt.	Material / Material	
09486	35	6	50	HDPE	40
09487	35	11	30	MDPE	45
09489	60	13	20	MDPE	45

EN Waste bags super strong
 PL Worki na odpady super mocne
 DE Müllsäcke extra stark
 RU Пакеты для мусора прочные
 CZ Super- silný pytle na odpad
 RO Sac gunoi super rezistent
 HU Szemeteszsák
 ES Sacos de residuos super fuertes



VOREL

No.	Capacity / Pojemność [l]	Thickness / Grubość [µm]	pcs / szt.	
09473	35	30	50	10

EN Waste bags strong with holder
 PL Worki na odpady z uszami, mocne
 DE Müllsäcke mit Griff stark
 RU Пакеты для мусора с завязками прочные
 CZ Odpadkové pytle s rukojeťi
 RO Sac gunoi rezistent cu maner
 HU Szemeteszsák
 ES Sacos de desecho fuertes con soporte



VOREL

No.	Capacity / Pojemność [l]	Thickness / Grubość [µm]	pcs / szt.	
09474	60	20	20	25

EN Waste bags
 PL Worki na odpady z nadrukiem
 DE Müllbeutel
 RU Пакеты для мусора
 CZ Pytle na odpad
 RO Saci gunoi
 HU Szemeteszsák
 ES Bolsas para desperdicios



VOREL

No.	Capacity / Pojemność [l]	Thickness / Grubość [µm]	pcs / szt.	
10001	60	30	15	30
10011	120	40	10	25

EN Waste bags
 PL Worki na odpady z nadrukiem
 DE Müllbeutel
 RU Пакеты для мусора
 CZ Pytle na odpad
 RO Saci gunoi
 HU Szemeteszsák
 ES Bolsas para desperdicios



VOREL

No.	Capacity / Pojemność [l]	Thickness / Grubość [µm]	pcs / szt.	
10003	60	30	15	30
10013	120	40	10	25

EN Waste bags with cord
 PL Worki na odpady domowe z taśmą
 DE Müllbeutel mit Band
 RU Пакеты для мусора с лентой
 CZ Pytle na odpad
 RO Saci gunoi
 HU Szemeteszsák
 ES Bolsas para desperdicios



VOREL

No.	Capacity / Pojemność [l]	Thickness / Grubość [µm]	pcs / szt.	
09490	60	30	10	25

EN Waste bags
 PL Worki na odpady z nadrukiem
 DE Müllbeutel
 RU Пакеты для мусора
 CZ Pytle na odpad
 RO Saci gunoi
 HU Szemeteszsák
 ES Bolsas para desperdicios



VOREL

No.	Capacity / Pojemność [l]	Thickness / Grubość [µm]	pcs / szt.	
10000	60	30	15	30
10010	120	40	10	25

EN Waste bags
 PL Worki na odpady z nadrukiem
 DE Müllbeutel
 RU Пакеты для мусора
 CZ Pytle na odpad
 RO Saci gunoi
 HU Szemeteszsák
 ES Bolsas para desperdicios



VOREL

No.	Capacity / Pojemność [l]	Thickness / Grubość [µm]	pcs / szt.	
10002	60	30	15	30
10012	120	40	10	25

EN Waste bags
 PL Worki na odpady z nadrukiem
 DE Müllbeutel
 RU Пакеты для мусора
 CZ Pytle na odpad
 RO Saci gunoi
 HU Szemeteszsák
 ES Bolsas para desperdicios



VOREL

No.	Capacity / Pojemność [l]	Thickness / Grubość [µm]	pcs / szt.	
10014	120	40	10	25

EN Waste bags
 PL Worki na odpady z nadrukiem
 DE Müllbeutel
 RU Пакеты для мусора

CZ Pytle na odpad
 RO Saci gunoi
 HU Szemeteszsák
 ES Bolsas para desperdicios



No.	Capacity / Pojemność [l]	Thickness / Grubość [µm]	pcs / szt.	
10015	120	40	10	25

EN Tarpaulin
 PL Plandeka
 DE Plane
 RU Тент

CZ Plachta
 RO Husă
 HU Ponyva
 ES Toldo

57 g/m²



No.	Size / Rozmiar [m]	m [g/m ²]	
85122	2x3	57	30
85123	3x5	57	20
85124	4x5	57	10
85125	4x6	57	8
85126	5x8	57	5
85128	6x10	57	3
85129	8x12	57	2
85130	10x15	57	2

EN Tarpaulin
 PL Plandeka
 DE Plane
 RU Тент

CZ Plachta
 RO Husă
 HU Ponyva
 ES Toldo

75 g/m²



No.	Size / Rozmiar [m]	m [g/m ²]	
85112	2x3	75	30
85113	3x5	75	10
85114	4x5	75	10
85115	4x6	75	8
85116	5x8	75	5
85118	6x10	75	3
85119	8x12	75	2
85120	10x15	75	2

EN Tarpaulin
 PL Plandeka
 DE Plane
 RU Тент
 CZ Plachta
 RO Husă
 HU Ponyva
 ES Toldo

57 g/m²



No.	Size / Rozmiar [m]	m [g/m ²]	
85131	2x3	57	30
85132	3x5	57	20
85133	4x5	57	10
85134	4x6	57	8
85135	5x8	57	5

EN Tarpaulin
 PL Plandeka
 DE Plane
 RU Тент

CZ Plachta
 RO Husă
 HU Ponyva
 ES Toldo

90 g/m²



No.	Size / Rozmiar [m]	m [g/m ²]	
85020	2x3	90	30
85030	3x5	90	18
85040	4x5	90	9
85050	4x6	90	10
85060	5x8	90	5
85080	6x10	90	4
85090	8x12	90	2
85100	10x15	90	1

EN Tarpaulin clips
 PL Uchwyty zaciskowe ze śrubą do mocowania plandek
 DE Kunststoff Planenhalter
 RU Пластиковый клипс зажим для палаток и тентов
 CZ Držáky k zakrývacím plachtám
 RO Clame pt. prelate
 HU Ponyvarögzítő klipsz
 ES Pinzas para lonas



No.	pcs / szt.	
85170	8	12/48

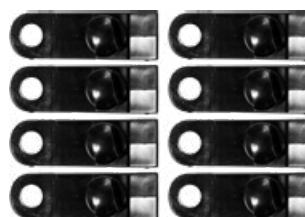
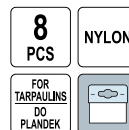

EN Tarpaulin clips
 PL Uchwyty zaciskowe do mocowania plandek
 DE Kunststoff Planenhalter
 RU Пластиковый клипс зажим для палаток и тентов
 CZ Držáky k zakrývacím plachtám
 RO Clame pt. prelate
 HU Ponyvarógzító klipsz
 ES Pinzas para lonas

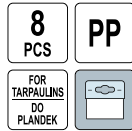

VOREL

No.	pcs / szt.	
85172	8	72

EN Elastic rope
 PL Linka pleciona, elastyczna
 DE Polypropylen-Gummileine
 RU Шнур эластичный
 CZ Lano opletené elastické
 RO Funie elastica
 HU Rugalmas kótél
 ES Cuerda trenzada

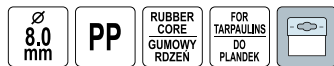

VOREL

No.	Ø [mm]	L [mm]	
85177	8	15	20
85178	8	30	8

EN Tarpaulin repair tape
 PL Taśma klejąca do naprawy plandek
 DE Planen-Reparatur-Klebeband
 RU Самоклеющаяся лента тарпаулиновая для ремонта тентов
 CZ Páska maskovací textilní pro plachtoviny
 RO Bandă adezivă de reparații pt. prelate
 HU Szóvetzalag ezüst
 ES Cinta adhesiva de reparación para lonas

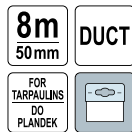

VOREL

No.	W [mm]	L [m]	
85190	50	8	72

EN Ash separator
 PL Separator do popiołu
 DE Ascheabscheider
 RU Пелла сепаратор
 CZ Odlučovač popela
 RO Filtru pt. cenușă
 HU Hamuporszívó
 ES Separador de ceniza

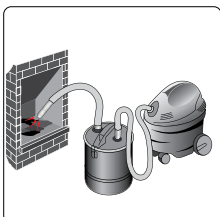

No.	
72920	1

EN Tarpaulin clips
 PL Uchwyty zaciskowe do mocowania plandek
 DE Kunststoff Planenhalter
 RU Пластиковый клипс зажим для палаток и тентов
 CZ Držáky k zakrývacím plachtám
 RO Clame pt. prelate
 HU Ponyvarógzító klipsz
 ES Pinzas para lonas



VOREL

No.	pcs / szt.	
85174	8	12/48

EN Ball bungee cords
 PL Guma mocująca z kulką
 DE Planenspanner Spanngummi mit Kunststoffkugel
 RU Резиновая петля с шариком
 CZ Upínací guma s plastovou kuličkou
 RO Cordelina elastica cu bila fixare
 HU Ponyva rögzítő gumipók
 ES Tensor de goma con bola de plástico

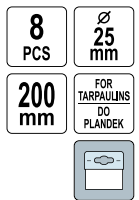

VOREL

No.	pcs / szt.	
85180	8	24/96

EN Tarpaulin repair tape
 PL Taśma klejąca do naprawy plandek
 DE Planen-Reparatur-Klebeband
 RU Самоклеющаяся лента тарпаулиновая для ремонта тентов
 CZ Páska maskovací textilní pro plachtoviny
 RO Bandă adezivă de reparații pt. prelate
 HU Szóvetzalag ezüst
 ES Cinta adhesiva de reparación para lonas



VOREL

No.	W [mm]	L [m]	
85191	50	8	72



EN Ash cleaner
 PL Odkurzacz do popiołu
 DE Aschesauger
 RU Пылесос для золы
 CZ Vysavač popela
 RO Aspirator pt. cenusa
 HU Hamuporszívó
 ES Aspirador de cenizas

220-240V~
50/60Hz

800 W

18 L

14 kPa

FOR GRILL AND FIREPLACE DO GRILLA I KOMINKA

BLOW FUNCTION FUNKCJA DMUCHAWY

FIREPROOF HOSE WAŻ ZARO-ODPORNY



No.	Power / Moc [W]	Box
72928	800	1

EN Car vacuum cleaner
 PL Odkurzacz samochodowy
 DE Handsauger
 RU Ручной пылесос для автомобиля
 CZ Vysavač do auta
 RO Aspirator de masina
 HU Autó porszívó
 ES Aspirador para coche

60 W

7.4 V
2000mAh
Li-Ion

4-6h

18-20 min

USB CHARGING ŁADOWANIE

HEPA



LUND

No.	Battery voltage / Napięcie akumulatora [V d.c.]	Power / Moc [W]	Box
82955	7.4	60	30

EN Car vacuum cleaner
 PL Odkurzacz samochodowy
 DE Handsauger
 RU Ручной пылесос для автомобиля
 CZ Vysavač do auta
 RO Aspirator de masina
 HU Autó porszívó
 ES Aspirador para coche

100 W

12 V

CYCLONIC CYKLONOWY

BAGLESS BEZ-WORKOWY



STHOR

No.	Voltage / Napięcie [V d.c.]	Power / Moc [W]	Box
82952	12	100	20

EN Ash cleaner
 PL Odkurzacz do popiołu
 DE Aschesauger
 RU Пылесос для золы
 CZ Vysavač popela
 RO Aspirator pt. cenusa
 HU Hamuporszívó
 ES Aspirador de cenizas

220-240V~
50/60Hz

800 W

20 L

16 kPa

FOR GRILL AND FIREPLACE DO GRILLA I KOMINKA

BLOW FUNCTION FUNKCJA DMUCHAWY

FIREPROOF HOSE WAŻ ZARO-ODPORNY



No.	Power / Moc [W]	Box
78870	800	1

EN Car vacuum cleaner
 PL Odkurzacz samochodowy
 DE Handsauger
 RU Ручной пылесос для автомобиля
 CZ Vysavač do auta
 RO Aspirator de masina
 HU Autó porszívó
 ES Aspirador para coche

100 W

12 V

CYCLONIC CYKLONOWY

WET AND DRY SUCHO I MOKRO

BAGLESS BEZ-WORKOWY



STHOR

No.	Voltage / Napięcie [V d.c.]	Power / Moc [W]	Box
82951	12	100	8

EN Car vacuum cleaner
 PL Odkurzacz samochodowy
 DE Handsauger
 RU Ручной пылесос для автомобиля
 CZ Vysavač do auta
 RO Aspirator de masina
 HU Autó porszívó
 ES Aspirador para coche

80W VACUUM CLEANER ODKURZACZ

120W COMPRESSOR KOMPRESOR

12 V

20 l/min

1.0 MPa

CYCLONIC CYKLONOWY

BAGLESS BEZ-WORKOWY



STHOR

No.	Voltage / Napięcie [V d.c.]	Vacuum cleaner power / Moc odkurzacza [W]	Compressor power / Moc kompresora [W]	Box
82953	12	80	120	12

EN Car vacuum cleaner
 PL Odkurzacz samochodowy
 DE Handsauger
 RU Ручной пылесос для автомобиля
 CZ Vysavač do auta
 RO Aspirator de mașină
 HU Autó porszívó
 ES Aspirador para coche



100 W 12 V
 CYCLONIC CYKLONOWY BAGLESS BEZ-WORKOWY
 3 m



No.	Voltage / Napięcie [V d.c.]	Power / Moc [W]	
82967	12	100	9

EN Rechargeable car vacuum cleaner
 PL Odkurzacz samochodowy bezprzewodowy
 DE Kabelloser Auto-Staubsauger
 RU Беспроводной пылесос автомобиля
 CZ Bezdrátový automobilový vysavač
 RO Aspirator de mașină fără fir
 HU Vezeték nélküli autós porszívó
 ES Aspirador de coche inalámbrico



100 W 2600 mAh Li-Ion
 5-6h 15-18 min
 USB BATTERY CHARGER LAZONARKA CYCLONIC CYKLONOWY
 BAGLESS BEZ-WORKOWY



No.	Voltage / Napięcie [V d.c.]	Power / Moc [W]	
82970	5	100	9

EN Filter
 PL Filtr
 DE Filter
 RU Фильтр
 CZ Filtr
 RO Filtru
 HU Szűrő
 ES Filtro



No.	For / Dla	
72931	78870	40

EN Car vacuum cleaner
 PL Odkurzacz samochodowy
 DE Handsauger
 RU Ручной пылесос для автомобиля
 CZ Vysavač do auta
 RO Aspirator de mașină
 HU Autó porszívó
 ES Aspirador para coche



80 W 7.4 V 2000mAh Li-Ion 4h
 20min CYCLONIC CYKLONOWY BAGLESS BEZ-WORKOWY



No.	Voltage / Napięcie [V d.c.]	Power / Moc [W]	
82954	7.4	80	20

EN Rechargeable car vacuum cleaner
 PL Odkurzacz samochodowy bezprzewodowy
 DE Kabelloser Auto-Staubsauger
 RU Беспроводной пылесос автомобиля
 CZ Bezdrátový automobilový vysavač
 RO Aspirator de mașină fără fir
 HU Vezeték nélküli autós porszívó
 ES Aspirador de coche inalámbrico



100 W 2600 mAh Li-Ion
 5-6h 15-18 min
 USB BATTERY CHARGER LAZONARKA CYCLONIC CYKLONOWY
 BAGLESS BEZ-WORKOWY



No.	Voltage / Napięcie [V d.c.]	Power / Moc [W]	
82971	5	100	9

EN Metal hose
 PL Wąż metalowy
 DE Metallschlauch
 RU Металлический шланг
 CZ Kovová hadice
 RO Furtun metalic
 HU Hajlékony, fém tömlő
 ES Manguera de metal

1m 38 mm GALVANIZED STEEL STAL OCYNKOWANA



No.	For / Dla	
72922	72920	20

EN Metal hose
 PL Wąż metalowy
 DE Metallschlauch
 RU Металлический шланг
 CZ Kovová hadice
 RO Furtun metalic
 HU Hajlékony, fém tömlő
 ES Manguera de metal

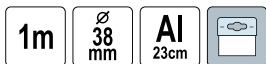

No.	For / Dla	
72932	72930	15

EN Siphon pump
 PL Pompa syfonowa
 DE Siphon-Pumpe
 RU Сифонный насос
 CZ Pumpa syfonová
 RO Pompa manuala pt. combustibil
 HU Szifon pumpa
 ES Bomba de sifón



No.	
78021	24

EN Drain cleaner
 PL Pistolet do udrażniania rur
 DE Pistole zum Reinigen von Rohren
 RU Пневматический пистолет для прочистки труб
 CZ Pistole na čištění trubek
 RO Pistol pt. curățarea țevilor
 HU Csőtisztító pisztoly
 ES Pistola desatapaños



No.	Ø [mm]	
55500	63, 135	10

EN Drain auger
 PL Spirala kanalizacyjna
 DE Hand-Rohrreinigungsspirale
 RU Трос для прочистки канализационных труб и каналов
 CZ Spirála na čištění trubek
 RO Dedeman cablu pt. desfundat canale
 HU Csőtisztító spirál
 ES Varilla para limpiar drenajes



No.	Ø [mm]	L [m]	
55541	5	1.5	20/80
55542	6	3.0	18/36

EN Syphon pump
 PL Pompa syfonowa
 DE Siphon-Pumpe
 RU Сифонный насос
 CZ Pumpa syfonová
 RO Pompa manuala pt. combustibil
 HU Szifon pumpa
 ES Bomba de sifón

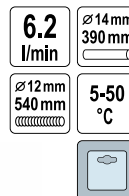

No.	
78020	30/60

EN Multi-purpose pump
 PL Pompa wielofunkcyjna
 DE Multifunktionale Pumpe
 RU Многофункциональный насос
 CZ Univerzální pumpička
 RO Pompă multifuncțională
 HU Többfunkciós szivattyú
 ES Bomba multiusos



No.	
78022	6/24

EN Drain suction pump
 PL Pompa do udrażniania kanalizacji
 DE Rohrreinigungspumpe
 RU Пневматический вантуз для прочистки труб
 CZ Čerpadlo na čištění trubek
 RO Pompă pt. curățarea țevilor
 HU Lefolyótisztító pumpa
 ES Desatascador bomba de vacío

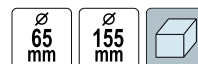

No.	Ø [mm]	
55505	65, 155	24

EN Drain auger
 PL Spirala kanalizacyjna
 DE Hand-Rohrreinigungsspirale
 RU Трос для прочистки канализационных труб и каналов

CZ Spirála na čištění trubek
 RO Dedeman cablu pt. desfundat canale
 HU Csőtisztító spirál
 ES Varilla para limpiar drenajes



No.	Ø [mm]	L [m]	
55544	9	5	5/10
55545	9	10	4/8

EN Vaseline CZ Technická vazelína
 PL Wazelina techniczna RO Vaselină tehnică
 DE Vaseline HU Műszaki vazelin
 RU Вазелин технический ES Vaselina tecnica



No.	Capacity / Pojemność [ml]	
86700	50	50
86701	100	50

EN Foldable hand truck
 PL Składany wózek magazynowy
 DE Klappbare Transportkarre
 RU Складная тележка
 CZ Skládací hliníkový rudi
 RO Carucior cu manere pliable
 HU Összecsukható kézikocsi
 ES Carretilla de mano plegable



No.	Max. load capacity / Maks. obciążenie [kg]	
78660	70	1

EN Foldable hand truck
 PL Składany wózek magazynowy
 DE Klappbare Transportkarre
 RU Складная тележка
 CZ Skládací hliníkový rudi
 RO Carucior cu manere pliable
 HU Összecsukható kézikocsi
 ES Carretilla de mano plegable

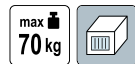

No.	Max. load capacity / Maks. obciążenie [kg]	
78662	70	5

EN Foldable hand truck
 PL Składany wózek magazynowy
 DE Klappbare Transportkarre
 RU Складная тележка
 CZ Skládací hliníkový rudi
 RO Carucior cu manere pliable
 HU Összecsukható kézikocsi
 ES Carretilla de mano plegable



No.	Max. load capacity / Maks. obciążenie [kg]	
78661	90	1

EN Foldable hand truck
 PL Składany wózek magazynowy
 DE Klappbare Transportkarre
 RU Складная тележка
 CZ Skládací hliníkový rudi
 RO Carucior cu manere pliable
 HU Összecsukható kézikocsi
 ES Carretilla de mano plegable



No.	Max. load capacity / Maks. obciążenie [kg]	
78663	130	1

EN Lifting and moving straps
 PL Pasy do przenoszenia mebli
 DE Gürtel zum Bewegen von Heben
 RU Ремни для переноски мебели
 CZ Pohyblivé pásy pro zvedání nábytku
 RO Curele pt. mutat obiecte
 HU Emelő mozgó pántok
 ES Cinturones para llevar muebles

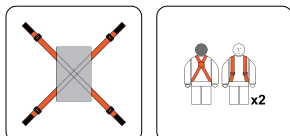
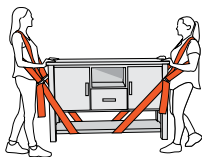
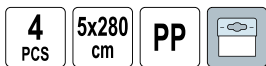

No.	pcs / szt.	Icon
74721	4	10/20

EN Lifting and moving strap
 PL Pas do przenoszenia ładunku
 DE Gürtel zum Bewegen von Heben
 RU Такелажный ремень для переноски грузов
 CZ Pás pro ruční přenášení nákladu
 RO Curea pt. mutat obiecte
 HU Emelő mozgó pánt
 ES Cinturón para llevar carga

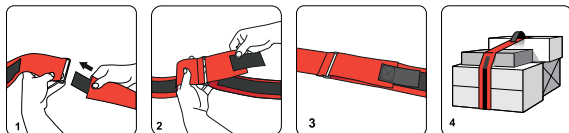

No.	pcs / szt.	Icon
74723		32/128

EN Furniture transport roller set
 PL Zestaw rolek do transportu mebli
 DE Möbel transportroller set
 RU Набор для перемещения мебели
 CZ Sada na stěhování nábytku
 RO Set transport si ridicat mobila
 HU Bútor szállító készlet
 ES Muebles transporte conjunto



No.	pcs / szt.	Icon
87245	5	12

EN Lifting and moving straps
 PL Pasy do przenoszenia mebli
 DE Gürtel zum Bewegen von Heben
 RU Ремни для переноски мебели
 CZ Pohyblivé pásy pro zvedání nábytku
 RO Curele pt. mutat obiecte
 HU Emelő mozgó pántok
 ES Cinturones para llevar muebles

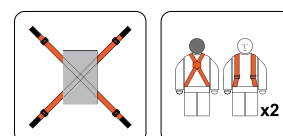
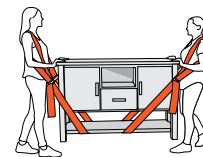

No.	pcs / szt.	Icon
74722	4	15/30

EN Lifting and moving straps
 PL Pasy do przenoszenia mebli
 DE Gürtel zum Bewegen von Heben
 RU Такелажный ремень для переноски грузов
 CZ Pohyblivé pásy pro zvedání nábytku
 RO Curele pt. mutat obiecte
 HU Emelő mozgó pántok
 ES Cinturones para llevar muebles

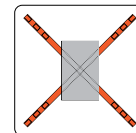

No.	pcs / szt.	Icon
74724	2	33/66

EN Fixed caster
 PL Kółko stałe
 DE Bockrolle
 RU Ролик с стационарной опорой
 CZ Pevné kolečko
 RO Roata de carucior fixa
 HU Szállítógörgők
 ES Rueda fija



No.	Ø [mm]	W [mm]	H [mm]	Max. load capacity / Maks. obciążenie [kg]	Icon
87301	75	23	97	40	60
87302	100	27	130	60	32
87303	125	34	155	100	22
87305	160	40	195	130	10
87307	200	46	235	150	8

EN Swivel caster
 PL Kółko skrętne z czarną gumą
 DE Lenkrolle mit Feststeller
 RU Ролик с вращающийся опорой
 CZ Otočné kolečko
 RO Roata de carucior mobila
 HU Szállítógörgők
 ES Rueda giratoria con freno



VOREL

No.	Ø [mm]	W [mm]	H [mm]	Max. load capacity / Maks. obciążenie [kg]	
87311	75	23	97	40	48
87312	100	27	130	60	26
87313	125	34	155	100	20
87315	160	40	195	130	10
87317	200	46	235	150	6

EN Swivel caster
 PL Kółko skrętne z szarą gumą
 DE Lenkrolle mit Feststeller
 RU Ролик с вращающийся опорой
 CZ Otočné kolečko
 RO Roata de carucior mobila
 HU Szállítógörgők
 ES Rueda giratoria con freno



VOREL

No.	Ø [mm]	W [mm]	H [mm]	Max. load capacity / Maks. obciążenie [kg]	
87331	75	22	97	40	38
87332	100	26	130	60	24
87333	125	33	153	100	18
87335	160	39	190	130	8
87337	200	44	230	150	6

EN Swivel caster
 PL Kółko skrętne z szarą gumą
 DE Lenkrolle mit Feststeller
 RU Ролик с вращающийся опорой
 CZ Otočné kolečko
 RO Roata de carucior mobila
 HU Szállítógörgők
 ES Rueda giratoria con freno



VOREL

No.	Ø [mm]	W [mm]	H [mm]	Max. load capacity / Maks. obciążenie [kg]	
87361	50	16	72	20	100
87362	75	21	104	30	52
87363	100	26	134	45	28
87364	125	27	161	50	24

EN Swivel caster
 PL Kółko skrętne z czarną gumą
 DE Lenkrolle mit Feststeller
 RU Ролик с вращающийся опорой
 CZ Otočné kolečko
 RO Roata de carucior mobila
 HU Szállítógörgők
 ES Rueda giratoria con freno



VOREL

No.	Ø [mm]	W [mm]	H [mm]	Max. load capacity / Maks. obciążenie [kg]	
87321	75	23	97	40	40
87322	100	27	130	60	20
87323	125	34	155	100	16
87325	160	40	195	130	8
87327	200	46	235	150	6

EN Fixed caster
 PL Kółko stałe
 DE Bockrolle
 RU Ролик с стационарной опорой
 CZ Pevné kolečko
 RO Roata de carucior fixa
 HU Szállítógörgők
 ES Rueda fija



VOREL

No.	Ø [mm]	W [mm]	H [mm]	Max. load capacity / Maks. obciążenie [kg]	
87351	50	16	72	20	140
87352	75	21	104	30	60
87353	100	26	134	45	38
87354	125	27	161	50	25

EN Swivel caster
 PL Kółko skrętne z szarą gumą
 DE Lenkrolle mit Feststeller
 RU Ролик с вращающийся опорой
 CZ Otočné kolečko
 RO Roata de carucior mobila
 HU Szállítógörgők
 ES Rueda giratoria con freno



VOREL

No.	Ø [mm]	W [mm]	H [mm]	Max. load capacity / Maks. obciążenie [kg]	
87371	50	16	70	20	120
87372	75	21	101	30	64
87373	100	26	132	45	34
87374	125	27	158	50	24

EN Swivel caster
 PL Kółko skrętne z szarą gumą
 DE Lenkrolle mit Feststeller
 RU Ролик с вращающейся опорой

CZ Otočné kolečko
 RO Roata de carucior mobila
 HU Szállítógörgők
 ES Rueda giratoria con freno



No.	Ø [mm]	W [mm]	H [mm]	Max. load capacity / Maks. obciążenie [kg]	
87381	50	16	72	20	96
87382	75	21	104	30	50
87383	100	26	134	45	26
87384	125	27	161	50	22

EN Swivel caster
 PL Kółko skrętne
 DE Lenkrolle mit Feststeller
 RU Ролик с вращающейся опорой

CZ Otočné kolečko
 RO Roata de carucior mobila
 HU Szállítógörgők
 ES Rueda giratoria con freno



No.	Ø [mm]	W [mm]	H [mm]	Max. load capacity / Maks. obciążenie [kg]	
87401	40	17	54	20	260
87402	50	22	65	25	120
87403	65	23	84	30	78

EN Swivel caster
 PL Kółko skrętne
 DE Lenkrolle mit Feststeller
 RU Ролик с вращающейся опорой

CZ Otočné kolečko
 RO Roata de carucior mobila
 HU Szállítógörgők
 ES Rueda giratoria con freno



No.	Ø [mm]	W [mm]	H [mm]	Max. load capacity / Maks. obciążenie [kg]	
87431	75	23	97	40	60
87432	100	31	130	60	32
87433	125	33	155	100	26
87435	160	40	195	130	12
87437	200	40	235	150	8

EN Fixed caster
 PL Kółko stałe
 DE Bockrolle
 RU Ролик с стационарной опорой

CZ Pevné kolečko
 RO Roata de carucior fixa
 HU Szállítógörgők
 ES Rueda fija



No.	Ø [mm]	W [mm]	H [mm]	Max. load capacity / Maks. obciążenie [kg]	
87391	40	17	54	20	280
87392	50	22	65	25	130
87393	65	23	84	30	90

EN Swivel caster
 PL Kółko skrętne
 DE Lenkrolle mit Feststeller
 RU Ролик с вращающейся опорой

CZ Otočné kolečko
 RO Roata de carucior mobila
 HU Szállítógörgők
 ES Rueda giratoria con freno

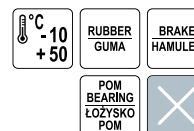

No.	Ø [mm]	W [mm]	H [mm]	Max. load capacity / Maks. obciążenie [kg]	
87411	40	17	54	20	230
87412	50	22	65	25	110
87413	65	23	84	30	72

EN Wheel
 PL Kółko, czarna guma
 DE Transportrad
 RU Ролик

CZ Kolečko
 RO Roata de carucior
 HU Önálló görgők
 ES Rueda



No.	Ø [mm]	W [mm]	Axle diameter / Średnica osi [mm]	Axle length / Długość osi [mm]	Max. load capacity / Maks. obciążenie [kg]	
87451	75	22	12	30	40	150
87452	100	26	12	40	60	66
87453	125	33	15	40	100	36
87454	150	39	20	55	110	22
87455	160	39	20	55	130	20
87456	200	44	20/25	55	150	12
87457	250	48	20/25	55	180	8

EN Seal for windows and doors
 PL Uszczelka do okien i drzwi
 DE Dichtung für Fenster und Türen
 RU Уплотнители для окон и дверей
 CZ Těsnění oken a dveří
 RO Seal pt. ferestre si usi
 HU Seal az ablakok és ajtók
 ES Sellar para ventanas y puertas



No.	Size / Rozmiar [mm]	L [m]	Type / Typ	Color / Kolor	
76752	9x7.4	6	D	biały	24
76762	9x7.4	6	D	brązowy	24

EN Seal for windows and doors
 PL Uszczelka do okien i drzwi
 DE Dichtung für Fenster und Türen
 RU Уплотнители для окон и дверей
 CZ Těsnění oken a dveří
 RO Seal pt. ferestre si usi
 HU Seal az ablakok és ajtók
 ES Sellar para ventanas y puertas



No.	Size / Rozmiar [mm]	L [m]	Type / Typ	Color / Kolor	
76750	9x4	6	E	biały	24
76760	9x4	6	E	brązowy	24

EN Seal for windows and doors
 PL Uszczelka do okien i drzwi
 DE Dichtung für Fenster und Türen
 RU Уплотнители для окон и дверей
 CZ Těsnění oken a dveří
 RO Seal pt. ferestre si usi
 HU Seal az ablakok és ajtók
 ES Sellar para ventanas y puertas



No.	Size / Rozmiar [mm]	L [m]	Type / Typ	Color / Kolor	
76751	9x5.5	6	P	biały	24
76761	9x5.5	6	P	brązowy	24

EN Self-adhesive pad for furniture
 PL Podkładka samoprzylepna, korkowa
 DE Klebegleiter für Möbel
 RU Самоклеящая подкладка под мебель

CZ Podložka samolepící pod nábytek
 RO Adeziv pad sub mobilier
 HU Öntapadó, bútórláb alátét
 ES Arandela adhesiva bajo los muebles

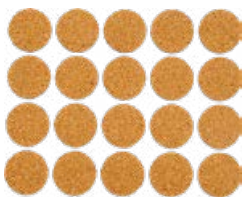

No.	Ø [mm]	pcs / szt.	
74802	20	20	60/720
74804	28	12	60/720

EN Seal for windows and doors
 PL Uszczelka do okien i drzwi
 DE Dichtung für Fenster und Türen
 RU Уплотнители для окон и дверей
 CZ Těsnění oken a dveří
 RO Seal pt. ferestre si usi
 HU Seal az ablakok és ajtók
 ES Sellar para ventanas y puertas

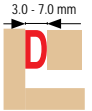

No.	Size / Rozmiar [mm]	L [m]	Type / Typ	Color / Kolor	
76757	9x7.4	100	D	biały	6
76767	9x7.4	100	D	brązowy	6

EN Seal for windows and doors
 PL Uszczelka do okien i drzwi
 DE Dichtung für Fenster und Türen
 RU Уплотнители для окон и дверей
 CZ Těsnění oken a dveří
 RO Seal pt. ferestre si usi
 HU Seal az ablakok és ajtók
 ES Sellar para ventanas y puertas



No.	Size / Rozmiar [mm]	L [m]	Type / Typ	Color / Kolor	
76755	9x4	150	E	biały	6
76765	9x4	150	E	brązowy	6

EN Seal for windows and doors
 PL Uszczelka do okien i drzwi
 DE Dichtung für Fenster und Türen
 RU Уплотнители для окон и дверей
 CZ Těsnění oken a dveří
 RO Seal pt. ferestre si usi
 HU Seal az ablakok és ajtók
 ES Sellar para ventanas y puertas



No.	Size / Rozmiar [mm]	L [m]	Type / Typ	Color / Kolor	
76756	9x5.5	100	P	biały	6
76766	9x5.5	100	P	brązowy	6

EN Self-adhesive pad for furniture
 PL Podkładka samoprzylepna, korkowa
 DE Klebegleiter für Möbel
 RU Самоклеящая подкладка под мебель

CZ Podložka samolepící pod nábytek
 RO Adeziv pad sub mobilier
 HU Öntapadó, bútórláb alátét
 ES Arandela adhesiva bajo los muebles



No.	Size / Rozmiar [mm]	pcs / szt.	
74812	100x120	1	60/720

EN Self-adhesive pad for furniture
 PL Podkładka samoprzylepna, antypoślizgowa
 DE Klebegleiter für Möbel
 RU Самоклеящая подкладка под мебель
 CZ Podložka samolepící pod nábytek
 RO Adeziv pad sub mobilier
 HU Öntapadó, bútorkláb alátét
 ES Arandela adhesiva bajo los muebles



No.	Ø [mm]	pcs / szt.	
74816	10	24	60/720
74818	20	20	60/720
74820	28	12	60/720

EN Self-adhesive pad for furniture
 PL Podkładka samoprzylepna z włókniny
 DE Klebegleiter für Möbel
 RU Самоклеящая подкладка под мебель
 CZ Podložka samolepící pod nábytek
 RO Adeziv pad sub mobilier
 HU Öntapadó, bútorkláb alátét
 ES Arandela adhesiva bajo los muebles



No.	Ø [mm]	pcs / szt.	
74831	20	20	60/720
74833	28	12	60/720
74835	40	4	60/720

EN Self-adhesive pad for furniture
 PL Podkładka samoprzylepna z włókniny
 DE Klebegleiter für Möbel
 RU Самоклеящая подкладка под мебель
 CZ Podložka samolepící pod nábytek
 RO Adeziv pad sub mobilier
 HU Öntapadó, bútorkláb alátét
 ES Arandela adhesiva bajo los muebles



No.	Size / Rozmiar [mm]	pcs / szt.	
74841	20x20	20	60/720
74843	28x28	12	60/720

EN Self-adhesive pad for furniture
 PL Podkładka samoprzylepna z włókniny
 DE Klebegleiter für Möbel
 RU Самоклеящая подкладка под мебель
 CZ Podložka samolepící pod nábytek
 RO Adeziv pad sub mobilier
 HU Öntapadó, bútorkláb alátét
 ES Arandela adhesiva bajo los muebles



No.	Size / Rozmiar [mm]	pcs / szt.	
74849	100x120	1	60/720

EN Self-adhesive pad for furniture
 PL Podkładka samoprzylepna, antypoślizgowa
 DE Klebegleiter für Möbel
 RU Самоклеящая подкладка под мебель
 CZ Podložka samolepící pod nábytek
 RO Adeziv pad sub mobilier
 HU Öntapadó, bútorkláb alátét
 ES Arandela adhesiva bajo los muebles



No.	Size / Rozmiar [mm]	pcs / szt.	
74828	100x120	1	60/720

EN Self-adhesive pad for furniture
 PL Podkładka samoprzylepna z włókniny mix
 DE Klebegleiter für Möbel
 RU Самоклеящая подкладка под мебель
 CZ Podložka samolepící pod nábytek
 RO Adeziv pad sub mobilier
 HU Öntapadó, bútorkláb alátét
 ES Arandela adhesiva bajo los muebles



No.	Ø [mm]	pcs / szt.	
74838	20, 38	12	60/720

EN Self-adhesive pad for furniture
 PL Podkładka samoprzylepna z włókniny
 DE Klebegleiter für Möbel
 RU Самоклеящая подкладка под мебель
 CZ Podložka samolepící pod nábytek
 RO Adeziv pad sub mobilier
 HU Öntapadó, bútorkláb alátét
 ES Arandela adhesiva bajo los muebles



No.	Size / Rozmiar [mm]	pcs / szt.	
74846	20x45	10	60/720

EN Self-adhesive pad for furniture
 PL Podkładka samoprzylepna z włókniny mix
 DE Klebegleiter für Möbel
 RU Самоклеящая подкладка под мебель
 CZ Podložka samolepící pod nábytek
 RO Adeziv pad sub mobilier
 HU Öntapadó, bútorkláb alátét
 ES Arandela adhesiva bajo los muebles

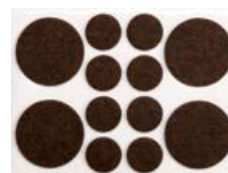

No.	Ø [mm]	pcs / szt.	
74858	20, 38	12	60/720

EN Self-adhesive pad for furniture
 PL Podkładka samoprzylepna z włókniny
 DE Klebegleiter für Möbel
 RU Самоклеящая подкладка под мебель
 CZ Podložka samolepící pod nábytek
 RO Adeziv pad sub mobilier
 HU Őntapadó, bútorláb alátét
 ES Arandela adhesiva bajo los muebles



No.	Size / Rozmiar [mm]	pcs / szt.	
74861	20x20	20	60/720
74863	28x28	20	60/720

EN Self-adhesive pad for furniture
 PL Podkładka samoprzylepna z włókniny
 DE Klebegleiter für Möbel
 RU Самоклеящая подкладка под мебель
 CZ Podložka samolepící pod nábytek
 RO Adeziv pad sub mobilier
 HU Őntapadó, bútorláb alátét
 ES Arandela adhesiva bajo los muebles



No.	Size / Rozmiar [mm]	pcs / szt.	
74866	20x45	10	60/720

EN Self-adhesive pad for furniture
 PL Podkładka samoprzylepna, antypoślizgowa
 DE Klebegleiter für Möbel
 RU Самоклеящая подкладка под мебель
 CZ Podložka samolepící pod nábytek
 RO Adeziv pad sub mobilier
 HU Őntapadó, bútorláb alátét
 ES Arandela adhesiva bajo los muebles

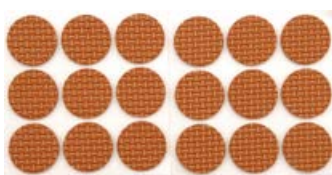

No.	Ø [mm]	pcs / szt.	
74882	25	18	24/432

EN Self-adhesive silicone pad for furniture
 PL Podkładka samoprzylepna, silikonowa
 DE Klebegleiter für Möbel
 RU Самоклеящая подкладка под мебель
 CZ Podložka samolepící pod nábytek
 RO Adeziv pad sub mobilier
 HU Őntapadó, bútorláb alátét
 ES Arandela adhesiva bajo los muebles



No.	Ø [mm]	pcs / szt.	
74910	8	25	32/576
74911	10	20	32/576
74912	13	12	32/576
74913	15	9	32/576
74914	19	6	32/576

EN Self-adhesive pad for furniture
 PL Podkładka samoprzylepna z włókniny
 DE Klebegleiter für Möbel
 RU Самоклеящая подкладка под мебель
 CZ Podložka samolepící pod nábytek
 RO Adeziv pad sub mobilier
 HU Őntapadó, bútorláb alátét
 ES Arandela adhesiva bajo los muebles



No.	Ø [mm]	pcs / szt.	
74851	20	20	60/720
74853	28	12	60/720
74855	40	4	60/720
74856	50	2	60/720

EN Self-adhesive pad for furniture
 PL Podkładka samoprzylepna z włókniny
 DE Klebegleiter für Möbel
 RU Самоклеящая подкладка под мебель
 CZ Podložka samolepící pod nábytek
 RO Adeziv pad sub mobilier
 HU Őntapadó, bútorláb alátét
 ES Arandela adhesiva bajo los muebles



No.	Size / Rozmiar [mm]	pcs / szt.	
74869	100x120	1	60/720

EN Self-adhesive pad for furniture
 PL Podkładka samoprzylepna, antypoślizgowa
 DE Klebegleiter für Möbel
 RU Самоклеящая подкладка под мебель
 CZ Podložka samolepící pod nábytek
 RO Adeziv pad sub mobilier
 HU Őntapadó, bútorláb alátét
 ES Arandela adhesiva bajo los muebles

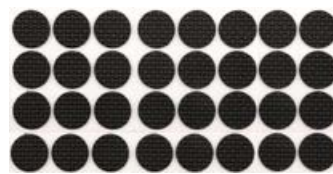

No.	Ø [mm]	pcs / szt.	
74885	18	32	24/432
74886	25	18	24/432
74887	38	8	24/432



- EN Felt & plastic furniture glides
- PL Podkładki plastikowo-filcowe na gwóźdź
- DE Kunststoff- und Filzgleiter zum Nageln
- RU Подкладки пластиковые фильцевые на гвоздь
- CZ Plastové podložky s plstí na hřebík
- RO Șaibe din plastic-pâslă pt. cuie
- HU Műanyag-filc alátét szöghöz
- ES Arandelas de plástico y fieltro con clave

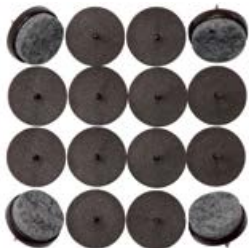

No.	Ø [mm]	pcs / szt.	
74920	17	16	16/288
74921	20	12	16/288
74922	24	12	16/288
74923	28	8	16/256
74924	30	8	16/256

- EN Plastic stool
- PL Stolek plastikowy
- DE Kunststoff Hocker
- RU Пластиковый табурет
- CZ Plastová stolička
- RO Scaun de plastic
- HU Műanyag széklét
- ES Taburete de plástico



No.	Dimensions / Wymiary [mm]	
75916	300x200x210	10/20

- EN Self-adhesive hanging hooks
- PL Haczyki naścienne samoprzylepne
- DE Selbstklebende Wandhaken
- RU Крючки настенные на липучках
- CZ Háčky nástěnné samolepící
- RO Cârlițe perete autocolante
- HU Műanyag, fali kampó, öntapadós
- ES Ganchos adhesivos para pared

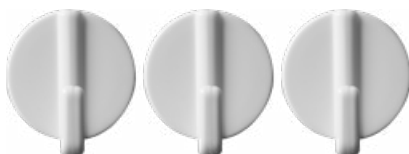

No.	Max. lifting capacity / Maks. udźwig [kg]	pcs / szt.	
74732	1	3	12/192

- EN Plastic stool
- PL Stolek plastikowy
- DE Kunststoff Hocker
- RU Пластиковый табурет
- CZ Plastová stolička
- RO Scaun de plastic
- HU Műanyag széklét
- ES Taburete de plástico



No.	Dimensions / Wymiary [mm]	
75915	300x200x210	10/20

- EN Self-adhesive hanging hooks
- PL Haczyki naścienne samoprzylepne
- DE Selbstklebende Wandhaken
- RU Крючки настенные на липучках
- CZ Háčky nástěnné samolepící
- RO Cârlițe perete autocolante
- HU Műanyag, fali kampó, öntapadós
- ES Ganchos adhesivos para pared



No.	Max. lifting capacity / Maks. udźwig [kg]	pcs / szt.	
74730	1	3	12/144

- EN Self-adhesive hanging hooks
- PL Haczyki naścienne samoprzylepne
- DE Selbstklebende Wandhaken
- RU Крючки настенные на липучках
- CZ Háčky nástěnné samolepící
- RO Cârlițe perete autocolante
- HU Műanyag, fali kampó, öntapadós
- ES Ganchos adhesivos para pared



No.	Max. lifting capacity / Maks. udźwig [kg]	pcs / szt.	
74731	0.8	3	18/216

EN Self-adhesive hanging hooks
 PL Haczyki naścienne samoprzylepne
 DE Selbstklebende Wandhaken
 RU Крючки настенные на липучках
 CZ Háčky nástěnné samolepící
 RO Cârîlige perete autocolante
 HU Műanyag, fali kampó, öntapadós
 ES Ganchos adhesivos para pared

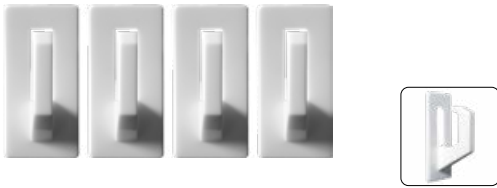

VOREL

No.	Max. lifting capacity / Maks. udźwig [kg]	pcs / szt.	
74733	0.8	4	12/192

EN Self-adhesive hanging hooks
 PL Haczyki naścienne samoprzylepne
 DE Selbstklebende Wandhaken
 RU Крючки настенные на липучках
 CZ Háčky nástěnné samolepící
 RO Cârîlige perete autocolante
 HU Műanyag, fali kampó, öntapadós
 ES Ganchos adhesivos para pared



VOREL

No.	Max. lifting capacity / Maks. udźwig [kg]	pcs / szt.	
74750	1	2	12/192

EN Self-adhesive hanging hooks
 PL Haczyki naścienne samoprzylepne
 DE Selbstklebende Wandhaken
 RU Крючки настенные на липучках
 CZ Háčky nástěnné samolepící
 RO Cârîlige perete autocolante
 HU Műanyag, fali kampó, öntapadós
 ES Ganchos adhesivos para pared



VOREL

No.	Max. lifting capacity / Maks. udźwig [kg]	pcs / szt.	
74752	1.2	3	18/216

EN Wall hooks with screws
 PL Haczyki naścienne na wkręt
 DE Wandhaken zum Anschrauben
 RU Крючки настенные на шурупах
 CZ Háčky nástěnné na šroub
 RO Cârîlige perete cu șurub
 HU Műanyag, fali kampó, csavaros
 ES Ganchos atornillados para pared



VOREL

No.	Max. lifting capacity / Maks. udźwig [kg]	pcs / szt.	
74765	5	3	18/256

EN Self-adhesive hanging hooks
 PL Haczyki naścienne samoprzylepne
 DE Selbstklebende Wandhaken
 RU Крючки настенные на липучках
 CZ Háčky nástěnné samolepící
 RO Cârîlige perete autocolante
 HU Műanyag, fali kampó, öntapadós
 ES Ganchos adhesivos para pared

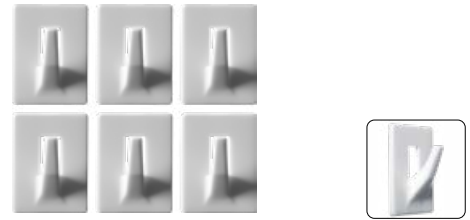

VOREL

No.	Max. lifting capacity / Maks. udźwig [kg]	pcs / szt.	
74734	0.4	6	12/192

EN Self-adhesive hanging hooks
 PL Haczyki naścienne samoprzylepne
 DE Selbstklebende Wandhaken
 RU Крючки настенные на липучках
 CZ Háčky nástěnné samolepící
 RO Cârîlige perete autocolante
 HU Műanyag, fali kampó, öntapadós
 ES Ganchos adhesivos para pared



VOREL

No.	Max. lifting capacity / Maks. udźwig [kg]	pcs / szt.	
74751	0.8	3	16/192

EN Self-adhesive hanging hooks
 PL Haczyki naścienne samoprzylepne
 DE Selbstklebende Wandhaken
 RU Крючки настенные на липучках
 CZ Háčky nástěnné samolepící
 RO Cârîlige perete autocolante
 HU Műanyag, fali kampó, öntapadós
 ES Ganchos adhesivos para pared



VOREL

No.	Max. lifting capacity / Maks. udźwig [kg]	pcs / szt.	
74753	0.4	5	16/288

EN Wall hooks with screws
 PL Haczyki naścienne na wkręt
 DE Wandhaken zum Anschrauben
 RU Крючки настенные на шурупах
 CZ Háčky nástěnné na šroub
 RO Cârîlige perete cu șurub
 HU Műanyag, fali kampó, csavaros
 ES Ganchos atornillados para pared



VOREL

No.	Max. lifting capacity / Maks. udźwig [kg]	pcs / szt.	
74766	8	3	12/192

EN Corner cushions
 PL Ochraniacze na narożniki meblowe
 DE Eckenschoner für Möbel
 RU Насадки на углы мебели
 CZ Chrániče na rohy nábytku
 RO Protecție colțuri mobilă
 HU Bútor sarokvédő
 ES Protectores esquineros para muebles

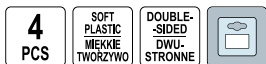

No.	pcs / szt.	
74771	4	16/288

EN Corner cushions
 PL Ochraniacze na narożniki meblowe
 DE Eckenschoner für Möbel
 RU Насадки на углы мебели
 CZ Chrániče na rohy nábytku
 RO Protecție colțuri mobilă
 HU Bútor sarokvédő
 ES Protectores esquineros para muebles



No.	pcs / szt.	
74773	4	12/144

EN Multi-purpose latches
 PL Zabezpieczenie otwarcia drzwi meblowych
 DE Schutzsicherung gegen das Öffnen der Möbeltüren
 RU Блокатор открывания дверей мебели
 CZ Pojistka proti otevření nábytkových dveří
 RO Protecție deschidere ușii mobilă
 HU Bútorajtó-útköző
 ES Protectores para las portezuelas de muebles para prevenir su apertura



No.	pcs / szt.	
74776	2	12/216

EN Corner cushions
 PL Ochraniacze na narożniki meblowe
 DE Eckenschoner für Möbel
 RU Насадки на углы мебели
 CZ Chrániče na rohy nábytku
 RO Protecție colțuri mobilă
 HU Bútor sarokvédő
 ES Protectores esquineros para muebles

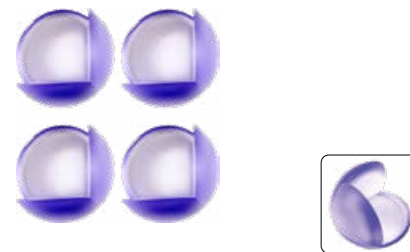

No.	pcs / szt.	
74772	4	16/288

EN Multi-purpose latches
 PL Zabezpieczenie otwarcia drzwi meblowych
 DE Schutzsicherung gegen das Öffnen der Möbeltüren
 RU Блокатор открывания дверей мебели
 CZ Pojistka proti otevření nábytkových dveří
 RO Protecție deschidere ușii mobilă
 HU Bútorajtó-útköző
 ES Protectores para las portezuelas de muebles para prevenir su apertura



No.	pcs / szt.	
74775	2	16/256

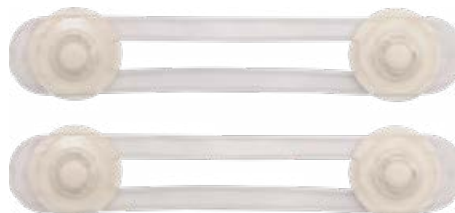

A large grid of graph paper for taking notes, consisting of approximately 30 columns and 40 rows of small squares.

Memo

22

Health & safety products
Artykuły BHP



Gloves
Rękawice

.....380-383

Goggles & shields
Okulary i osłony przeciwodpryskowe

.....383-384

Dust masks
Maski przeciwpyłowe

.....384-385

Welding goggles & masks
Okulary i maski spawalnicze

.....385-388

Knee pads
Nakolanniki

.....388-389

Hearing protectors
Nauszniki przeciwhałasowe

.....389

Safety helmets
Kaski ochronne

.....389

Rain boots
Kalosze

.....389-390

Working shoes
Buty robocze

.....391

Safety sandals

Sandaly robocze..... 391

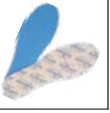
Shoes accessories
Akcesoria do obuwia

.....391

Working clothes
Odzież robocza

.....391-392

Safety vests

Kamizelki ostrzegawcze..... 391

Waterproof jackets

Kurtki przeciwdeszczowe..... 392

EN Working gloves
 PL Rękawice robocze
 DE Arbeitshandschuhe
 RU Рабочие перчатки
 CZ Pracovní rukavice
 RO Mănuși de lucru
 HU Védőkesztyű
 ES Guantes de piel

8 SIZE / ROZMIAR POLYESTER POLIESTER COTTON BAWELNA PVC



No.	Size / Rozmiar	
74094	8	240

EN Working gloves
 PL Rękawice robocze
 DE Arbeitshandschuhe
 RU Рабочие перчатки
 CZ Pracovní rukavice
 RO Mănuși de lucru
 HU Védőkesztyű
 ES Guantes de piel

8 SIZE / ROZMIAR COTTON BAWELNA PVC



No.	Size / Rozmiar	
74102	8	10/240

EN Working gloves
 PL Rękawice robocze
 DE Arbeitshandschuhe
 RU Рабочие перчатки
 CZ Pracovní rukavice
 RO Mănuși de lucru
 HU Védőkesztyű
 ES Guantes de piel

8 SIZE / ROZMIAR POLYESTER POLIESTER COTTON BAWELNA PVC



No.	Size / Rozmiar	
74106	8	10/240

EN Working gloves
 PL Rękawice robocze
 DE Arbeitshandschuhe
 RU Рабочие перчатки
 CZ Pracovní rukavice
 RO Mănuși de lucru
 HU Védőkesztyű
 ES Guantes de piel

POLYESTER POLIESTER PU



No.	Size / Rozmiar	
74125	8	12/300
74130	9	12/300
74131	10	12/300

EN Working gloves
 PL Rękawice robocze
 DE Arbeitshandschuhe
 RU Рабочие перчатки
 CZ Pracovní rukavice
 RO Mănuși
 HU Védőkesztyű
 ES Guantes de piel

10 SIZE / ROZMIAR COTTON BAWELNA PVC



No.	Size / Rozmiar	
74100	10	12/300

EN Working gloves
 PL Rękawice robocze
 DE Arbeitshandschuhe
 RU Рабочие перчатки
 CZ Pracovní rukavice
 RO Mănuși de lucru
 HU Védőkesztyű
 ES Guantes de piel

10 SIZE / ROZMIAR POLYESTER POLIESTER COTTON BAWELNA PVC



No.	Size / Rozmiar	
74104	10	10/240

EN Working gloves
 PL Rękawice robocze
 DE Arbeitshandschuhe
 RU Рабочие перчатки
 CZ Pracovní rukavice
 RO Mănuși de lucru
 HU Védőkesztyű
 ES Guantes de piel

10 SIZE / ROZMIAR POLYESTER POLIESTER COTTON BAWELNA PVC



No.	Size / Rozmiar	
74108	10	240

EN Working gloves
 PL Rękawice robocze
 DE Arbeitshandschuhe
 RU Рабочие перчатки
 CZ Pracovní rukavice
 RO Mănuși de lucru
 HU Védőkesztyű
 ES Guantes de piel



No.	Size / Rozmiar	
74126	8	12/300
74132	9	12/300

EN Working gloves
 PL Rękawice robocze
 DE Arbeitshandschuhe
 RU Рабочие перчатки
 CZ Pracovní rukavice
 RO Mănuși de lucru
 HU Védőkesztyű
 ES Guantes de piel

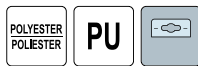

No.	Size / Rozmiar	
74128	8	12/300
74136	9	12/300
74137	10	12/300

EN Gardening gloves
 PL Rękawice ogrodnicze
 DE Arbeitshandschuh
 RU Перчатки
 CZ Pracovní rukavice
 RO Mănuși
 HU Védőkesztyű
 ES Guantes



No.	Size / Rozmiar	
74121	8	50/1000

EN Gardening gloves
 PL Rękawice ogrodnicze
 DE Arbeitshandschuh
 RU Перчатки
 CZ Pracovní rukavice
 RO Mănuși
 HU Védőkesztyű
 ES Guantes



No.	Size / Rozmiar	
74113	8	50/1000

EN Working gloves
 PL Rękawice robocze
 DE Arbeitshandschuhe
 RU Рабочие перчатки
 CZ Pracovní rukavice
 RO Mănuși de lucru
 HU Védőkesztyű
 ES Guantes de piel



No.	Size / Rozmiar	
74127	8	12/300
74134	9	12/300
74135	10	12/300

EN Gardening gloves
 PL Rękawice ogrodnicze
 DE Arbeitshandschuh
 RU Перчатки
 CZ Pracovní rukavice
 RO Mănuși
 HU Védőkesztyű
 ES Guantes



No.	Size / Rozmiar	
74117	8	50/1000

EN Gardening gloves
 PL Rękawice ogrodnicze
 DE Arbeitshandschuh
 RU Перчатки
 CZ Pracovní rukavice
 RO Mănuși
 HU Védőkesztyű
 ES Guantes



No.	Size / Rozmiar	
74123	8	50/1000

EN Gardening gloves
 PL Rękawice ogrodnicze
 DE Arbeitshandschuh
 RU Перчатки
 CZ Pracovní rukavice
 RO Mănuși
 HU Védőkesztyű
 ES Guantes



No.	Size / Rozmiar	
74115	8	50/1000

EN Working gloves
 PL Rękawice robocze
 DE Arbeitshandschuhe
 RU Рабочие перчатки
 CZ Pracovní rukavice
 RO Mănuși de lucru
 HU Védőkesztyű
 ES Guantes de piel



No.	Size / Rozmiar	
74150	10.5	12/120

EN Working gloves
 PL Rękawice robocze
 DE Arbeitshandschuhe
 RU Рабочие перчатки
 CZ Pracovní rukavice
 RO Mănuși de lucru
 HU Védőkesztyű
 ES Guantes de piel

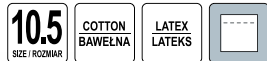

No.	Size / Rozmiar	
74160	10.5	12/120

EN Working gloves
 PL Rękawice robocze
 DE Arbeitshandschuhe
 RU Рабочие перчатки
 CZ Pracovní rukavice
 RO Mănuși de lucru
 HU Védőkesztyű
 ES Guantes de piel



No.	Size / Rozmiar	
74146	10	12/120

EN Working gloves
 PL Rękawice robocze
 DE Arbeitshandschuhe
 RU Рабочие перчатки
 CZ Pracovní rukavice
 RO Mănuși de lucru
 HU Védőkesztyű
 ES Guantes de piel



No.	Size / Rozmiar	
74079	9	12/120
74080	10	12/120

EN Working gloves
 PL Rękawice robocze
 DE Arbeitshandschuhe
 RU Рабочие перчатки
 CZ Pracovní rukavice
 RO Mănuși de lucru
 HU Védőkesztyű
 ES Guantes de piel



No.	Size / Rozmiar	
74151	10	12/120

EN Working gloves
 PL Rękawice robocze
 DE Arbeitshandschuhe
 RU Рабочие перчатки
 CZ Pracovní rukavice
 RO Mănuși de lucru
 HU Védőkesztyű
 ES Guantes de piel

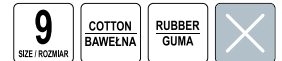

No.	Size / Rozmiar	
74162	9	600

EN Working gloves
 PL Rękawice robocze
 DE Arbeitshandschuhe
 RU Рабочие перчатки
 CZ Pracovní rukavice
 RO Mănuși de lucru
 HU Védőkesztyű
 ES Guantes de piel



No.	Size / Rozmiar	Pairs / Pary	
74145	10	12	10

EN Working gloves
 PL Rękawice robocze
 DE Arbeitshandschuhe
 RU Рабочие перчатки
 CZ Pracovní rukavice
 RO Mănuși de lucru
 HU Védőkesztyű
 ES Guantes de piel



No.	Size / Rozmiar	Pairs / Pary	
74077	9	12	10
74078	10	12	10

EN Insulated gloves
 PL Rękawice robocze ocieplane
 DE Arbeitshandschuh
 RU Перчатки
 CZ Pracovní rukavice
 RO Mănuși
 HU Védőkesztyű
 ES Guantes



No.	Size / Rozmiar	
74149	10	12/120

EN Assembly gloves
 PL Rękawice ochronne
 DE Schutzhandschuhe
 RU Защитные перчатки
 CZ Ochranné rukavice
 RO Mănuși pt. lucru
 HU Védőkesztyű
 ES Guantes de protección



No.	Size / Rozmiar	
74060	10	10/120

EN Polycarbonate protection shield
 PL Osłona twarzy przeciwdpryskowa
 DE Schutzmaske
 RU Маска защитная
 CZ Ochranná přilba
 RO Masca protectie
 HU Hegesztősisak
 ES Pantalla protectora antipedacitos



No.		
74459		25/50

EN Safety glasses
 PL Okulary ochronne
 DE Schutzbrille
 RU Очки защитные открытые
 CZ Ochranné brýle
 RO Ochelari pt. protectie
 HU Védőszemüveg
 ES Gafas protectoras



No.	Type / Typ	
74501	TVS	8/80

EN Insulated gloves
 PL Rękawice ocieplane
 DE Isolierhandschuhe
 RU Утепленные перчатки
 CZ Zimní rukavice
 RO Mănuși izolate
 HU Szigeltelt kesztyű
 ES Guantes aislados



No.	Size / Rozmiar	
74003	11	10/120

EN Working gloves
 PL Rękawice robocze
 DE Arbeitshandschuhe
 RU Рабочие перчатки
 CZ Pracovní rukavice
 RO Mănuși de lucru
 HU Védőkesztyű
 ES Guantes de piel



No.	Size / Rozmiar	
74081	9	12/120
74082	10	12/120

EN Polycarbonate protection shield
 PL Osłona twarzy przeciwdpryskowa
 DE Schutzmaske
 RU Маска защитная
 CZ Ochranná přilba
 RO Masca protectie
 HU Hegesztősisak
 ES Pantalla protectora antipedacitos



No.		
74460		20

EN Safety glasses
 PL Okulary ochronne
 DE Schutzbrille
 RU Очки защитные открытые
 CZ Ochranné brýle
 RO Ochelari pt. protectie
 HU Védőszemüveg
 ES Gafas protectoras



No.	Type / Typ	
74505	STD SG-007	12/240

EN Safety glasses
 PL Okulary ochronne
 DE Schutzbrille
 RU Очки защитные открытые
 CZ Ochranné brýle
 RO Ochelari pt. protectie
 HU Védőszemüveg
 ES Gafas protectoras



No.	Type / Typ	
74503	DY-8525	12/240

EN Safety glasses
 PL Okulary ochronne
 DE Schutzbrille
 RU Очки защитные открытые
 CZ Ochranné brýle
 RO Ochelari pt. protectie
 HU Védőszemüveg
 ES Gafas protectoras



No.	Type / Typ	
74508	HF-103	10/120

EN Disposable dust masks
 PL Półmaski filtrujące jednorazowe
 DE Atemschutzmaske
 RU Респиратор противопылевой одноразовый
 CZ Protiprašná maska
 RO Masca praf
 HU Eldobható porvédőmaszk
 ES Mascarilla desechable para protección contra polvo



No.	pcs / szt.	
74540	5	50/50

EN Disposable dust masks
 PL Półmaski filtrujące jednorazowe
 DE Atemschutzmaske
 RU Респиратор противопылевой одноразовый
 CZ Protiprašná maska
 RO Masca praf
 HU Eldobható porvédőmaszk
 ES Mascarilla desechable para protección contra polvo



No.	pcs / szt.	
74542	5	50/50

EN Safety glasses
 PL Okulary ochronne
 DE Schutzbrille
 RU Очки защитные открытые
 CZ Ochranné brýle
 RO Ochelari pt. protectie
 HU Védőszemüveg
 ES Gafas protectoras



No.	Type / Typ	
74504	DY-8526	15/150

EN Safety glasses
 PL Okulary ochronne
 DE Schutzbrille
 RU Очки защитные открытые
 CZ Ochranné brýle
 RO Ochelari pt. protectie
 HU Védőszemüveg
 ES Gafas protectoras



No.	Type / Typ	
74509	HF-105	10/100

EN Disposable dust masks
 PL Półmaski filtrujące jednorazowe
 DE Atemschutzmaske
 RU Респиратор противопылевой одноразовый
 CZ Protiprašná maska
 RO Masca praf
 HU Eldobható porvédőmaszk
 ES Mascarilla desechable para protección contra polvo



No.	pcs / szt.	
74541	5	15/50

EN Disposable dust masks
 PL Półmaski filtrujące jednorazowe
 DE Atemschutzmaske
 RU Респиратор противопылевой одноразовый
 CZ Protiprašná maska
 RO Masca praf
 HU Eldobható porvédőmaszk
 ES Mascarilla desechable para protección contra polvo



No.	pcs / szt.	
74543	5	15/50

EN Anti pollution mask
 PL Półmaska antysmogowa
 DE Atemschutzmaske-Smogmaske
 RU Антисмоговая полумаска
 CZ Ochranná maska proti znečištění ovzduší
 RO Mască antipoluare
 HU Eldobható porvédőmaszk, szelepes
 ES Mascarilla desechable para



No.	Type / Typ	Icon
74555	antysmogowa, VZ/PZ	50

EN Welding goggles
 PL Okulary spawalnicze
 DE Schweisserbrille
 RU Очки газосварщика
 CZ Brýle svářečské
 RO Ochelari pt. sudura
 HU Hegesztőszemüveg
 ES Gafas para soldar



No.	Type / Typ	Icon
74411		10/100

EN Welding mask
 PL Maska spawalnicza
 DE Schweissermaske
 RU Щиток сварщика
 CZ Svářečská maska
 RO Mască de sudură
 HU Hegesztőpajzs
 ES Mascara de soldador



No.	Type / Typ	Icon
74442	TSM	30

EN Welding mask
 PL Maska spawalnicza
 DE Schweissermaske
 RU Щиток сварщика
 CZ Svářečská maska
 RO Mască de sudură cu geam
 HU Hegesztőpajzs
 ES Mascara de soldador



No.	Type / Typ	Icon
74450	TSD-3	20

EN Welding goggles
 PL Okulary spawalnicze
 DE Schweisserbrille
 RU Очки газосварщика
 CZ Brýle svářečské
 RO Ochelari pt. sudura
 HU Hegesztőszemüveg
 ES Gafas para soldar



No.	Type / Typ	Icon
74410		5/100

EN Welding mask
 PL Maska spawalnicza
 DE Schweissermaske
 RU Щиток сварщика
 CZ Svářečská maska
 RO Mască de sudură
 HU Hegesztőpajzs
 ES Mascara de soldador



No.	Type / Typ	Icon
74440	TSM-3	30

EN Welding mask
 PL Przyłbica spawalnicza z podglądem
 DE Schweissermaske
 RU Щиток сварщика с подсмотром
 CZ Svářečská přilba s nakoukáváním
 RO Mască de sudură cu geam
 HU Hegesztősisak kitekintővel
 ES Mascara de soldador con mirador



No.	Type / Typ	Icon
74443	TSMP	20

EN Welding mask
 PL Przyłbica spawalnicza z podglądem
 DE Schweissermaske
 RU Щиток сварщика с подсмотром
 CZ Svářečská přilba s nakoukáváním
 RO Mască de sudură cu geam
 HU Hegesztősisak kitekintővel
 ES Mascara de soldador con mirador

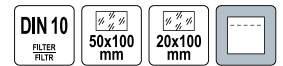

No.	Type / Typ	Icon
74447	PSMP	20

- EN Welding mask
- PL Przyłbica spawalnicza z podglądem
- DE Schweissmaske
- RU Щиток сварщика с подсмотром
- CZ Svářečská přilba s nakoukaváním
- RO Mască de sudură cu geam
- HU Hegesztősisak kitékintővel
- ES Mascara de soldador con mirador

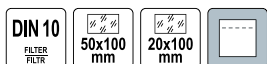

No.	Type / Typ	
74448	PS-3	10

- EN Welding mask
- PL Przyłbica spawalnicza
- DE Schweissmaske
- RU Щиток сварщика
- CZ Svářečská přilba
- RO Mască de sudură
- HU Hegesztőpajzs
- ES Mascara de soldador



No.		
74457		20

- EN Auto-darkening welding helmet
- PL Przyłbica spawalnicza samościemniająca
- DE Schweissmaske, selbstverdunkelnd
- RU Маска сварщика с автозатемнением
- CZ Svářečská kukla samostmívací
- RO Mască de sudură auto-întunecare
- HU Őnmagától sötétedő hegesztőpajzs
- ES Casco auto-oscurecedor para soldadura



No.		
74483		6

- EN Welding mask
- PL Maska spawalnicza
- DE Schweissmaske
- RU Щиток сварщика
- CZ Svářečská maska
- RO Mască de sudură
- HU Hegesztőpajzs
- ES Mascara de soldador



No.		
74441		20

- EN Auto-darkening welding helmet
- PL Przyłbica spawalnicza samościemniająca
- DE Schweissmaske, selbstverdunkelnd
- RU Маска сварщика с автозатемнением
- CZ Svářečská kukla samostmívací
- RO Mască de sudură auto-întunecare
- HU Őnmagától sötétedő hegesztőpajzs
- ES Casco auto-oscurecedor para soldadura

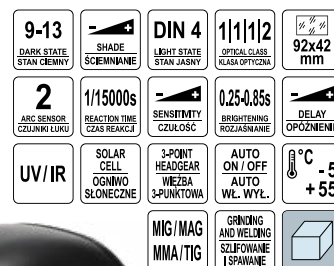

No.		
74480		6

- EN Auto-darkening welding helmet
- PL Przyłbica spawalnicza samościemniająca
- DE Schweissmaske, selbstverdunkelnd
- RU Маска сварщика с автозатемнением
- CZ Svářečská kukla samostmívací
- RO Mască de sudură auto-întunecare
- HU Őnmagától sötétedő hegesztőpajzs
- ES Casco auto-oscurecedor para soldadura

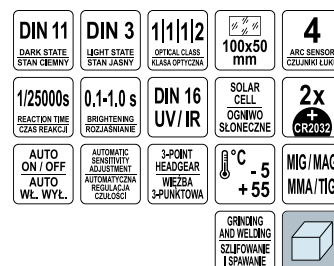

No.		
74484		6

EN Face shield with PC visor
 PL Przyłbica z osłoną wymienną
 DE Schweisserschutzhelm mit austauschbarer Abdeckung
 RU Шлем с заменяемой защитой
 CZ Štít s vyměnitelným krytem
 RO Vizieră cu protecție schimbabilă
 HU Arcvédő cserélhető pajzsral
 ES Antifaz con protección reemplazable

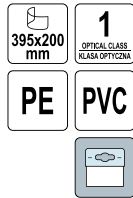

VOREL

No.	
74471	25

EN Face shield with steel mesh and ear muff
 PL Przyłbica z osłoną wymienną i nausznikami przeciwhałasowymi
 DE Schweisserschutzhelm mit austauschbarer Abdeckung und Ohrenschützer gegen Lärm
 RU Шлем с заменяемой защитой и наушниками против шума
 CZ Štít s vyměnitelným krytem a chrániči proti hluku
 RO Vizieră cu protecție schimbabilă și căști de protecție antizgomot
 HU Arcvédő cserélhető pajzsral és fülvédő kagylóval
 ES Antifaz con protección reemplazable y protectores de oídos



VOREL

No.	
74462	40

EN Welding filter
 PL Filtr spawalniczy
 DE Vorsatzglas
 RU Фильтр для сварки
 CZ Filtr svářečský
 RO Filtru pt. sudări
 HU Hegesztőszűrő
 ES Pantalla de filtro de soldador



No.	Filter size / Rozmiar filtra [mm]	Dark state / Stan ciemny [DIN]	
74452	50x100	8	100
74453	50x100	9	100
74454	50x100	10	100
74455	50x100	11	100

EN Face shield
 PL Osłona siatkowa twarzy z nagłowiem
 DE Gesichtsschutz mit Maschenvisier
 RU Сетчатая защитная маска с обвязкой для головы
 CZ Síťová ochrana tváře s postrojem
 RO Vizor protecție față
 HU Hálós arcvédő
 ES Pantalla con visor de malla metálica



FLO

No.	
74468	25

EN Filter shield
 PL Osłona filtra
 DE Filterabdeckung
 RU Кожух фильтра
 CZ Ochrana filtru
 RO Aparatoare de filtru
 HU Szűrőfedél
 ES Protección de filtro



No.	Filter size / Rozmiar filtra [mm]	Dark state / Stan ciemny [DIN]	
74451	50x100	0	100

EN Filter protection
 PL Osłona filtra
 DE Filtereinsatz
 RU Кожух фильтра
 CZ Ochranná fólie filtru
 RO Carcasă filtru
 HU Szűrő-védőburkolat
 ES Protección del filtro



No.	Size / Rozmiar [mm]	Type / Typ	For / Dia	
74466	350x200	OT 1-N	74460	10/100

- EN Self-dimming helmet filter protection
- PL Oslona filtra przyłbicy samościemniającej
- DE Filtereinsatz eines selbstabdunkelnden Schutzhelmes
- RU Кожух фильтра самозатемняющегося шлёмка
- CZ Ochranná fólie filtru samostmívající kukly
- RO Carcasă filtru vizieră heliomată
- HU Hegesztőpajzs szűrő, önsötéledő
- ES Protección del filtro de visera autooscurecedora



No.	Filter size / Rozmiar filtra [mm]	pcs / szt.	
74439	90x110	5	20

- EN Knee pads
- PL Nakolanniki
- DE Knieschützer
- RU Наколенники
- CZ Chrániče kolen
- RO Genunchiere
- HU Térdivédő
- ES Rodilleras

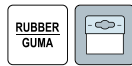

No.	
74610	20

- EN Knee pads
- PL Nakolanniki
- DE Knieschützer
- RU Наколенники
- CZ Chrániče kolen
- RO Genunchiere
- HU Térdivédő
- ES Rodilleras



No.	
74624	12/24

- EN Knee pads
- PL Nakolanniki
- DE Knieschützer
- RU Наколенники
- CZ Chrániče kolen
- RO Genunchiere
- HU Térdivédő
- ES Rodilleras



No.	
74602	6/36

- EN Knee pads
- PL Nakolanniki
- DE Knieschützer
- RU Наколенники
- CZ Chrániče kolen
- RO Genunchiere
- HU Térdivédő
- ES Rodilleras

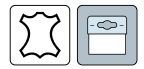

No.	
74600	50

- EN Knee pads
- PL Nakolanniki
- DE Knieschützer
- RU Наколенники
- CZ Chrániče kolen
- RO Genunchiere
- HU Térdivédő
- ES Rodilleras



No.	
74622	50

- EN Knee pads
- PL Nakolanniki
- DE Knieschützer
- RU Наколенники
- CZ Chrániče kolen
- RO Genunchiere
- HU Térdivédő
- ES Rodilleras



No.	
74601	24

- EN Knee pads
- PL Nakolanniki
- DE Knieschützer
- RU Наколенники
- CZ Chrániče kolen
- RO Genunchiere
- HU Térdivédő
- ES Rodilleras



No.	
74603	6/24

EN Knee pads
 PL Nakolanniki
 DE Knieschützer
 RU Наколенники
 CZ Chrániče kolen
 RO Genunchiere
 HU Térdvédő
 ES Rodilleras



No.		
74604		20

EN Hearing protectors
 PL Nauszniki przeciwhałasowe
 DE Gehörschutz
 RU Средства защиты слуха
 CZ Chrániče sluchu
 RO Antifoane
 HU Fültök
 ES Protectores auditivos



No.		
74580		60

EN Safety helmet
 PL Kask ochronny
 DE Schutzhelm
 RU Каска защитная
 CZ Ochranná přilba
 RO Cască de protecție
 HU Védősisak
 ES Casco de protección



No.	Color / Kolor	
74171	pomarańczowy	30
74172	żółty	30
74173	biały	30
74174	czerwony	30
74175	niebieski	30
74176	zielony	30

EN Knee pads
 PL Nakolanniki - wkładki
 DE Knieschützer
 RU Наколенники
 CZ Chrániče kolen
 RO Genunchiere
 HU Térdvédő
 ES Rodilleras

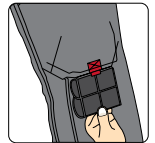

No.		
74595		60

EN Hearing protectors
 PL Nauszniki przeciwhałasowe
 DE Gehörschutz
 RU Средства защиты слуха
 CZ Chrániče sluchu
 RO Antifoane
 HU Fültök
 ES Protectores auditivos



No.		
74581		10/60

EN Women's rain boots
 PL Kalosze damskie
 DE Damen - Gummistiefel
 RU Галоши женские
 CZ Dámské galoše
 RO Cizme damă
 HU Női gumicsizma
 ES Chanclos para mujer



No.	Size / Rozmiar	
73931	36	7
73932	37	7
73933	38	7
73934	39	7
73935	40	7
73936	41	7

- EN Men's rain boots
- PL Kalosze męskie
- DE Herren - Gummistiefel
- RU Галоши мужские
- CZ Pánské galoše
- RO Cizme bărbați
- HU Férfi gumicsizma
- ES Chanclos para hombre

VOREL

No.	Size / Rozmiar	
73937	41	5
73938	42	5
73939	43	5
73940	44	5
73941	45	5
73942	46	5
73943	47	5



- EN Women's rain boots
- PL Kalosze damskie
- DE Damen - Gummistiefel
- RU Галоши женские
- CZ Dámské galoše
- RO Cizme damă
- HU Női gumicsizma
- ES Chanclos para mujer



VOREL

No.	Size / Rozmiar	
73945	37	5
73946	38	5
73947	39	5

- EN Felt PVC boots
- PL Buty gumowo-filcowe
- DE Gummistiefel mit Filtz
- RU Сапоги резиновые с войлоком
- CZ Holinky s filcem
- RO Cizme PVC
- HU Gumi - filc csizma
- ES Botas de goma fieltro



VOREL

No.	Size / Rozmiar	
73958	40	5
73959	41	5
73960	42	5
73961	43	5
73962	44	5
73963	45	5
73964	46	5

- EN Men's rain boots
- PL Kalosze męskie
- DE Herren - Gummistiefel
- RU Галоши мужские
- CZ Pánské galoše
- RO Cizme bărbați
- HU Férfi gumicsizma
- ES Chanclos para hombre



VOREL

No.	Size / Rozmiar	
73950	41	5
73951	42	5
73952	43	5
73953	44	5
73954	45	5
73955	46	5

- EN Men's rain boots
- PL Kalosze męskie
- DE Herren - Gummistiefel
- RU Галоши мужские
- CZ Pánské galoše
- RO Cizme bărbați
- HU Férfi gumicsizma
- ES Chanclos para hombre



VOREL

No.	Size / Rozmiar	
73966	40	5
73967	41	5
73968	42	5
73969	43	5
73970	44	5
73971	45	5
73972	46	5
73973	47	5

EN Safety sandals
 PL Sandały robocze
 DE Arbeitshalbschuhe
 RU Полуботинки рабочие
 CZ Pracovní polobotky
 RO Boscanci de lucru
 HU Munkavédelmi félcipő
 ES Zapato de trabajo

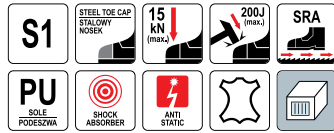

No.	Size / Rozmiar	Series / Seria	
72801	39	SALTA	10
72802	40	SALTA	10
72803	41	SALTA	10
72804	42	SALTA	10
72805	43	SALTA	10
72806	44	SALTA	10
72807	45	SALTA	10
72808	46	SALTA	10
72809	47	SALTA	10

EN Antibacterial insole
 PL Antybakteryjna wkładka do butów
 DE Antibakterielle Einlage für Schuhe
 RU Антибактериальная стелька
 CZ Antibakteriální vložka do bot
 RO Tălpici antibacterieni
 HU Antibakteriális cipőbetét
 ES Plantilla antibacterial

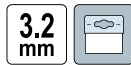

No.	Size / Rozmiar	Thickness / Grubość [mm]	
72683	39/40	3.2	50
72684	41/42	3.2	50
72685	43/44	3.2	50
72686	45/46	3.2	50

EN Reflective vest
 PL Kamizelka ostrzegawcza
 DE Warnweste
 RU Жилет безопасности
 CZ Výstražná vesta
 RO Vestă de avertizare
 HU Fényvisszaverő mellény
 ES chaleco reflectante

100% polyester



100% poliester

No.	Size / Rozmiar	Series / Seria	
74664	L	VEST-G	100
74665	XL	VEST-G	100
74666	XXL	VEST-G	100
74667	XXXL	VEST-G	100

EN Oil spray
 PL Płynny tłuszcz do obuwia
 DE Wartungs-Spray Schuhe
 RU Жидкий жир для обуви
 CZ Olejový spray na obuv
 RO Spray intretinere incaltaminte
 HU Cipőpóoló olaj
 ES Aceite para botas



No.	Capacity / Pojemność [ml]	
72890	150	20

EN Ravvivant spray
 PL Spray ożywiający kolor do nubuku i zamszu
 DE Wildleder und Nubuk Pflegespray
 RU Спрей освежающий цвет nubука и замши
 CZ Spray na semišovou obuv
 RO Spray revitalizant incaltaminte
 HU Nubukvelourápoló spray
 ES Spray para suede



No.	Capacity / Pojemność [ml]	
72891	250	20

EN Reflective vest
 PL Kamizelka ostrzegawcza
 DE Warnweste
 RU Жилет безопасности
 CZ Výstražná vesta
 RO Vestă de avertizare
 HU Fényvisszaverő mellény
 ES chaleco reflectante



100% polyester

100% poliester



No.	Size / Rozmiar	Series / Seria	
74660	L	VEST-0	100
74661	XL	VEST-0	100
74662	XXL	VEST-0	100
74663	XXXL	VEST-0	100



EN Waterproof jacket
 PL Kurtka przeciwdeszczowa
 DE Regenjacke
 RU Куртка-дождевик
 CZ Bunda do deště
 RO Giacă impermeabilă
 HU Vízhatlan dzseki
 ES Chaqueta impermeable



70% PVC, 30% polyester

70% PVC, 30% poliester



No.	Size / Rozmiar	
74626	L	20
74627	XXL	20
74628	XXXL	20

EN Raincoat
 PL Plaszcz przeciwdeszczowy
 DE Regenmantel
 RU Дождевик
 CZ Pláštěnka
 RO Pelerina ploaie
 HU Esőkabát
 ES Impermeable



70% PVC, 30% polyester

70% PVC, 30% poliester



No.	Size / Rozmiar	
74631	XL	10
74632	XXL	10
74633	XXXL	10

EN Rain suit military style
 PL Komplet przeciwdeszczowy moro
 DE Regenbekleidung militärischen Stil
 RU Дождь костюмы военный стиль
 CZ Oblek maskáčový do deště
 RO Îmbrăcămintă de ploaie camuflaj
 HU Eső ruházat
 ES Ropa de lluvia camo

70% polyester, 30% PVC

70% poliester, 30% PVC



No.	Size / Rozmiar	
74646	L	20
74647	XXL	20

EN Raincoat
 PL Plaszcz przeciwdeszczowy
 DE Regenmantel
 RU Дождевик
 CZ Pláštěnka
 RO Pelerina ploaie
 HU Esőkabát
 ES Impermeable

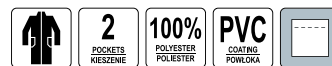

No.	Size / Rozmiar	
74653	L	20
74654	XL	20
74655	XXL	20

EN Rainsuit
 PL Komplet przeciwdeszczowy
 DE Regenschutz-Set
 RU Противодждевой набор
 CZ Protidešťová sada
 RO Costum impermeabil
 HU Esővédő szett
 ES Juego impermeable



No.	Size / Rozmiar	
74657	L	20
74658	XL	20
74659	XXL	20



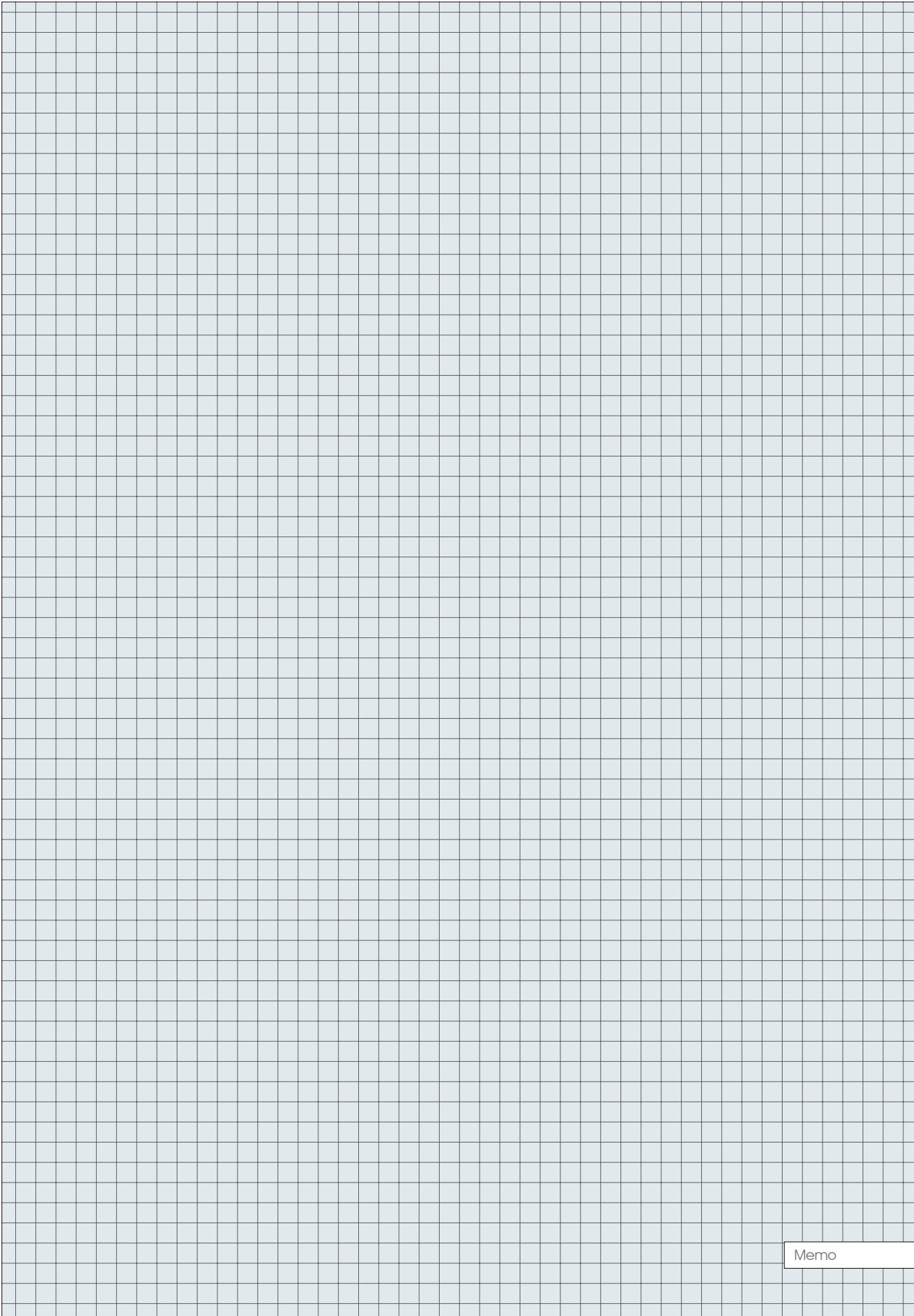

Memo

23

Electric products Artykuły elektryczne



Extension cords & cable reels Przedłużacze listwowe i bębnowe

.....396-398



Extension cords French type

Przedłużacze elektryczne z uziemieniem..... 396

Extension cords

Przedłużacze elektryczne bez uziemienia..... 397

Cable reels French type

Przedłużacze bębnowe z uziemieniem..... 398

Travel adapters Adaptory podróżne

.....398



Adaptors Rozgałęźniki

.....399



Lamps Lampy

.....399-407



Halogen bulbs

Żarniki do lamp halogenowych..... 399

Workshop lamps

Lampy warsztatowe..... 399

LED flashlights

Latarki diodowe..... 402

Hats with LED lamp

Czapki z lampką..... 403

Bicycle lamps

Lampy rowerowe..... 404

Night lamps

Lampki nocne..... 404

Insect killer lamps & accessories

Lampy owadobójcze i akcesoria..... 404

Motion detectors Czujniki ruchu

.....407



EN Surge protector power strip
 PL Listwa zasilająca przeciwprzebieciowa
 DE Überspannungsschutzleiste
 RU Колодка электрическая с защитой от перенапряжения
 CZ Prodlužovací kabel s přepětovou ochranou
 RO Prelungitor cu protecție
 HU Túlfeszültségvédő elosztó
 ES Regleta de protección contra sobretensiones

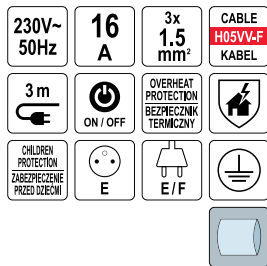

STKOR

No.	L [m]	☺	Socket type / Typ gniazda	☐
72370	3	5	E	30
72371	3	6	E	20

EN Surge protector power strip
 PL Listwa zasilająca przeciwprzebieciowa
 DE Überspannungsschutzleiste
 RU Колодка электрическая с защитой от перенапряжения
 CZ Prodlužovací kabel s přepětovou ochranou
 RO Prelungitor cu protecție
 HU Túlfeszültségvédő elosztó
 ES Regleta de protección contra sobretensiones

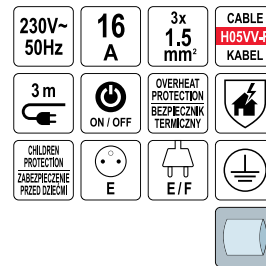

STKOR

No.	L [m]	☺	Socket type / Typ gniazda	☐
72372	3	5	E	30
72373	3	6	E	20

EN Extension cord
 PL Przedłużacz elektryczny
 DE Verlängerungsschnur
 RU Удлинитель электрический
 CZ Elektrický prodlužovač
 RO Prelungitor electric
 HU Elektromos hosszabbító
 ES Extensión eléctrica



LUND

No.	L [m]	☺	Socket type / Typ gniazda	☐
72460	2	5	E	25

EN Extension cord
 PL Przedłużacz elektryczny
 DE Verlängerungskabel
 RU Удлинитель электрический
 CZ Elektrický prodlužovač
 RO Prelungitor electric
 HU Elektromos hosszabbító
 ES Extensión eléctrica

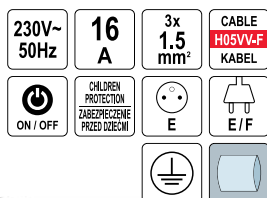

STKOR

No.	L [m]	☺	Socket type / Typ gniazda	☐
72350	1.5	3	E	40
72351	3.0	3	E	40
72352	5.0	3	E	30
72353	1.5	4	E	30
72354	3.0	4	E	30
72355	5.0	4	E	20
72356	1.5	5	E	30
72357	3.0	5	E	30
72358	5.0	5	E	20

EN Cord extension with earthing
 PL Przedłużacz elektryczny z uzziemieniem
 DE Verlängerungskabel mit Erdung
 RU Удлинитель электрический с заземлением
 CZ Elektrický prodlužovač
 RO Prelungitor electric
 HU Elektromos hosszabbító
 ES Extensión eléctrica

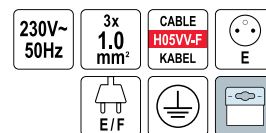

VOREL

No.	L [m]	☺	Socket type / Typ gniazda	☐
72500	1.5	3	E	12/48
72501	1.5	4	E	12/48
72504	3.0	3	E	12/48
72505	3.0	4	E	12/48
72506	3.0	5	E	12/48
72508	5.0	3	E	12/48
72509	5.0	4	E	12/48
72510	5.0	5	E	12/48

EN Cord extension with earthing
 PL Przedłużacz elektryczny z uziemieniem
 DE Verlängerungskabel mit Erdung
 RU Удлинитель электрический с заземлением
 CZ Elektrický prodloužovač
 RO Prelungitor electric
 HU Elektromos hosszabbító
 ES Extensión eléctrica

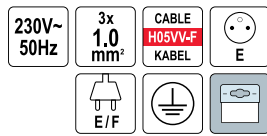

No.	L [m]	☺	Socket type / Typ gniazda	📦
72615	1.5	3	E	12/48
72616	3.0	3	E	12/48
72617	5.0	3	E	12/48
72620	1.5	4	E	12/48
72621	3.0	4	E	12/48
72622	5.0	4	E	12/48

EN Cord extension with earthing
 PL Przedłużacz elektryczny z uziemieniem
 DE Verlängerungskabel mit Erdung
 RU Удлинитель электрический с заземлением
 CZ Elektrický prodloužovač
 RO Prelungitor electric
 HU Elektromos hosszabbító
 ES Extensión eléctrica

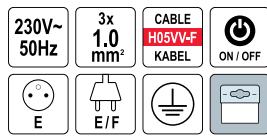

No.	L [m]	☺	Socket type / Typ gniazda	📦
72625	1.5	3	E	12/48
72626	3.0	3	E	12/48
72627	5.0	3	E	12/48
72630	1.5	4	E	12/48
72631	3.0	4	E	12/48
72632	5.0	4	E	12/48

EN Garden extension cable
 PL Przedłużacz
 DE Gartenverlängerungskabel
 RU Электроудлинитель
 CZ Prodloužovací kabel zahradní
 RO Prelungitor electric
 HU Kerti hosszabbító
 ES Cable de extensión para jardín

No.	L [m]	📦
82671	10	10
82673	20	10
82675	30	5
82677	40	5

EN Cord extension with switch
 PL Przedłużacz elektryczny z wyłącznikiem
 DE Steckdosenleiste mit Schalter
 RU Удлинитель электрический с выключателем
 CZ Elektrický prodloužovač
 RO Prelungitor electric
 HU Elektromos hosszabbító
 ES Extensión para árbol de navidad verde

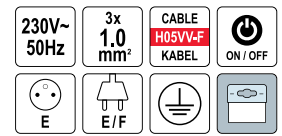

No.	L [m]	☺	Socket type / Typ gniazda	📦
72524	1.5	3	E	12/48
72525	1.5	4	E	12/48
72526	1.5	5	E	12/48
72527	1.5	6	E	12/48
72528	3.0	3	E	12/48
72529	3.0	4	E	12/48
72530	3.0	5	E	12/48
72531	3.0	6	E	12/48
72532	5.0	3	E	12/48
72533	5.0	4	E	12/48
72534	5.0	5	E	12/48
72535	5.0	6	E	12/48

EN Cord extension without earthing
 PL Przedłużacz elektryczny bez uziemienia
 DE Steckdosenleiste ohne Zuleitung
 RU Удлинитель электрический без заземления
 CZ Elektrický prodloužovač
 RO Prelungitor electric
 HU Elektromos hosszabbító
 ES Extensión eléctrica

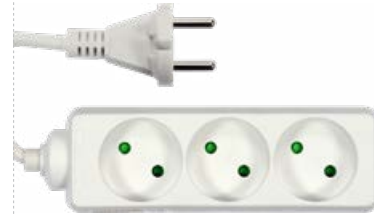
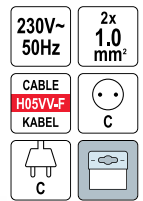

No.	L [m]	☺	Socket type / Typ gniazda	📦
72484	1.5	3	C	12/48
72486	1.5	4	C	12/48
72489	3.0	3	C	12/48
72490	3.0	4	C	12/48
72493	5.0	3	C	12/48
72494	5.0	4	C	12/48

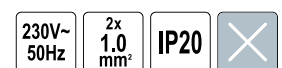

- EN Cable reel
- PL Przedłużacz bębnowy
- DE Kabeltrommel
- RU Удлинитель на катушке
- CZ Bubenový prodloužovač
- RO Prelungitor pe tambur
- HU Kábeldob
- ES Cable de prolongación de tambor



230V~50Hz

CABLE H05VV-F KABEL

OVERHEAT PROTECTION BEZPEČNÍK TERMICKÝ

CHILDREN PROTECTION ZABEZPEČENÉ PŘED DĚTMI

E

E/F



No.	L [m]	Wire section area / Pole průřezu / průřezu [mm ²]	Socket type / Typ gniazda	Box
82682	25	3Gx1.0	4 E	2
82684	40	3Gx1.0	4 E	2
82685	50	3Gx1.5	4 E	2

- EN Cable reel
- PL Przedłużacz bębnowy
- DE Kabeltrommel
- RU Удлинитель на катушке
- CZ Bubenový prodloužovač
- RO Prelungitor pe tambur
- HU Kábeldob
- ES Cable de prolongación de tambor



230V~50Hz

CABLE H05VV-F KABEL

OVERHEAT PROTECTION BEZPEČNÍK TERMICKÝ

CHILDREN PROTECTION ZABEZPEČENÉ PŘED DĚTMI

E

E/F



No.	L [m]	Wire section area / Pole průřezu / průřezu [mm ²]	Socket type / Typ gniazda	Box
82691	15	3Gx1.0	4 E	1
82692	25	3Gx1.0	4 E	1
82693	40	3Gx1.0	4 E	1
82694	50	3Gx1.5	4 E	1

- EN Travel adapter Europe to USA
- PL Adapter podróżny Europa-USA
- DE Reisestecker Europa-USA
- RU Дорожный адаптер-переходник Европа-США
- CZ Cestovní adaptér Evropa-USA
- RO Adaptor de călătorie din Europa-SUA
- HU Utazó adapter Európa-USA
- ES Adaptador de viaje Europa-EE.UU.

EURO

USA



No.	Socket type / Typ gniazda	Box
72441	F	100

- EN Cable reel
- PL Przedłużacz zwijany
- DE Einziehbares Verlängerungskabel
- RU Удлинитель электрический
- CZ Bubenový prodloužovač
- RO Prelungitor pe tambur
- HU Kábeldob
- ES Extensión eléctrica



230V~50Hz

CABLE H05VV-F KABEL

OVERHEAT PROTECTION BEZPEČNÍK TERMICKÝ

CHILDREN PROTECTION ZABEZPEČENÉ PŘED DĚTMI

E

E/F



No.	L [m]	Wire section area / Pole průřezu / průřezu [mm ²]	Socket type / Typ gniazda	Box
72570	15	3Gx1.0	4 E	4
72572	25	3Gx1.0	4 E	4
72573	30	3Gx1.5	4 E	4

- EN Travel adapter World to Europe
- PL Adapter podróżny Świat-Europa
- DE Reisestecker Welt-Europa
- RU Дорожный адаптер-переходник Мир-Европа
- CZ Cestovní adaptér Svět-Evropa
- RO Adaptor de călătorie World to Europe
- HU Utazó adapter Világ-Európa
- ES Adaptador de viaje Mundo-Europa

EURO

UK

AUS

USA

EURO



No.	Socket type / Typ gniazda	Box
72440	uniwersalne	100

- EN Travel adapter Europe to UK
- PL Adapter podróżny Europa-UK
- DE Reisestecker Europa-UK
- RU Дорожный адаптер-переходник Европа-Англия
- CZ Cestovní adaptér Evropa-UK
- RO Adaptor de călătorie din Europa-UK
- HU Utazó adapter Európa-UK
- ES Adaptador de viaje Europa-Gran Bretaña

EURO

UK



No.	Socket type / Typ gniazda	Box
72442	F	100

EN Adapter
 PL Rozgałęźnik
 DE Abzweigung
 RU Разветвитель
 CZ Rozdvojka
 RO Splitter
 HU Oszító
 ES Enchufe múltiple



No.		Socket type / Typ gniazda	
72404	2	E	100

EN Adapter
 PL Rozgałęźnik
 DE Abzweigung
 RU Разветвитель
 CZ Rozdvojka
 RO Splitter
 HU Oszító
 ES Enchufe múltiple



230V~
50Hz
16 A



No.		Socket type / Typ gniazda	
72407	3	E	100

EN Halogen projector bulbs
 PL Żarniki do lamp halogenowych
 DE Halogenstab
 RU Галогенная трубка
 CZ Žárovka do halogenové lampy
 RO Bec cu halogen pt. projector
 HU Halogén lámpaizzó
 ES Filamentos de bombillas halogenas

2 PCS
R7s



No.	Filament power / Moc żarnika halogenowego [W]	Luminous flux / Strumień świetlny [lm]	Lifetime / Żywotność [h]	
82771	120	2200	1000	50/200
82772	400	8600	1000	50/200

EN LED work light
 PL Lampka robocza LED
 DE LED Handleuchte
 RU Светодиодный светильник для мастерской
 CZ Pracovní LED svítidla
 RO Lampă portabilă cu LED
 HU LED szerelőlámpa
 ES Lámpara de taller LED

3W **100 lm** **2** LIGHTING MODES TRYBE/SWISSERA **4h** **3.7 V** 800mAh **Li-Ion**
x1 HOOK HAK



COB LED

180° **360°**



No.	Power / Moc [W]	Battery capacity / Pojemność akumulatora [mAh]	
82723	3	800	12/48



230V~
50Hz
16 A

EN Adapter
 PL Rozgałęźnik
 DE Abzweigung
 RU Разветвитель
 CZ Rozdvojka
 RO Splitter
 HU Oszító
 ES Enchufe múltiple



230V~
50Hz
2.5 A



No.		Socket type / Typ gniazda	
72400	2	C	200
72401	3	C	20/100
72402	4	C	100

EN Workshop LED battery lamp
 PL Diodowa lampa warsztatowa akumulatorowa
 DE LED Akku-Werkstattlampe
 RU Светодиодная беспроводная лампа
 CZ Aku pracovní LED svítidla
 RO Lampă portabilă cu acumulator leduri
 HU Akkumulátoros LED szerelőlámpa
 ES Lámpara de trabajo LED recargable

FRONT LIGHT LÁTARKA **5+3 W** **300/170 lm** **3.7 V** 2000mAh **Li-Ion** **4h**
3.5-5h **IP44** **IK08** **x1** HOOK HAK
CHARGING LADOPVANIE



COB LED



No.	Power / Moc [W]	Battery capacity / Pojemność akumulatora [mAh]	
82736	5+3	2000	30

EN LED work light
 PL Lampka robocza LED
 DE LED Handleuchte
 RU Светодиодный светильник для мастерской
 CZ Pracovní LED svítidla
 RO Lampă portabilă cu LED
 HU LED szerelőlámpa
 ES Lámpara de taller LED

230V~
50Hz **3.2 W** **280 lm** **16 LED**
x1 HOOK HAK **5m**

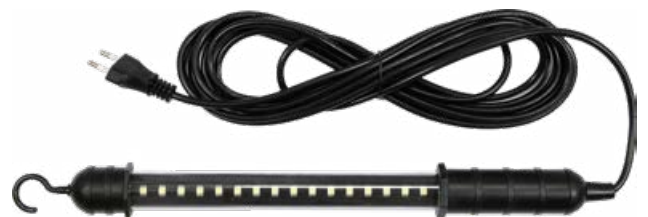

SMD LED



No.	Power / Moc [W]	Light source / Źródło światła [LED]	
82699	3.2	16	10/20

EN LED work light
 PL Lampa robocza LED
 DE LED Handleuchte
 RU Светодиодный светильник для мастерской
 CZ Pracovní LED svítidla
 RO Lampă portabilă cu LED
 HU LED szerelőlámpa
 ES Lámpara de taller LED

230V~50Hz 4.5 W 400 lm 24 LED
 X1 HOOK HAK 5m



SMD LED A A+ G



No.	Power / Moc [W]	Light source / Źródło światła [LED]	
82706	4.5	24	10/20

EN Work light
 PL Lampa warsztatowa
 DE Werkstattlampe
 RU Лампа-переноска
 CZ Pracovní lampa
 RO Lampă pt. atelier
 HU Szerelőlámpa
 ES Lámpara de taller

230V~50Hz 60 W E27 5m



No.	Max. power of light source / Maks. moc źródła światła [W]	Series / Seria	
82715	60	PLASTIC	10

EN Work light
 PL Lampa warsztatowa
 DE Werkstattlampe
 RU Лампа-переноска
 CZ Pracovní lampa
 RO Lampă pt. atelier
 HU Szerelőlámpa
 ES Lámpara de taller

230V~50Hz E27 5m



No.	Max. power of light source / Maks. moc źródła światła [W]	Series / Seria	
82717	100	GUMMI	10

EN Workshop LED battery lamp
 PL Diodowa lampa warsztatowa akumulatorowa
 DE LED Akku-Werkstattlampe
 RU Светодиодная беспроводная лампа
 CZ Aku pracovní LED svítidla
 RO Lampă portabilă cu acumulator leduri
 HU Akkumulátoros LED szerelőlámpa
 ES Lámpara de trabajo LED recargable

FRONT LIGHT LATARKA 8+3 W 50-500 /100 lm 3.7 V 2000mAh Li-Ion 3h 2-8h IP63 IK07 X1 HOOK HAK USB TYPE C



No.	Power / Moc [W]	Battery capacity / Pojemność akumulatora [mAh]	
82743	8+3	2000	50

COB SMD LED

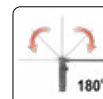

EN Work light
 PL Lampa warsztatowa
 DE Werkstattlampe
 RU Лампа-переноска
 CZ Pracovní lampa
 RO Lampă pt. atelier
 HU Szerelőlámpa
 ES Lámpara de taller

230V~50Hz 100 W E27 5m



No.	Max. power of light source / Maks. moc źródła światła [W]	Series / Seria	
82713	100	PRACTIC	10

EN Work light
 PL Lampa warsztatowa
 DE Werkstattlampe
 RU Лампа-переноска
 CZ Pracovní lampa
 RO Lampă pt. atelier
 HU Szerelőlámpa
 ES Lámpara de taller

230V~50Hz 60 W E27 5m



No.	Max. power of light source / Maks. moc źródła światła [W]	Series / Seria	
82714	60	CLASSIC	10

EN Workshop LED battery lamp
 PL Diodowa lampa warsztatowa akumulatorowa
 DE LED Akku-Werkstattlampe
 RU Светодиодная беспроводная лампа
 CZ Aku pracovní LED svítidla
 RO Lampă portabilă cu acumulator leduri
 HU Akkumulátoros LED szerelőlámpa
 ES Lámpara de trabajo LED recargable

3+3 W 3.7 V 600mAh Li-Ion 300/100 lm 2h 3-4h IP54



COB LED

No.	Power / Moc [W]	Battery capacity / Pojemność akumulatora [mAh]	
82734	3+3	600	120

EN LED work light
 PL Lampa robocza LED
 DE LED Handleuchte
 RU Светодиодный светильник для мастерской
 CZ Pracovní LED svítidla
 RO Lampa portabilă cu LED
 HU LED szerelőlámpa
 ES Lámpara de taller LED



No.	Battery type / Rodzaj baterii	
82724	3x1.5V; AAA	12/48

EN LED work light
 PL Lampa robocza LED
 DE LED Handleuchte
 RU Светодиодный светильник для мастерской
 CZ Pracovní LED svítidla
 RO Lampa portabilă cu LED
 HU LED szerelőlámpa
 ES Lámpara de taller LED

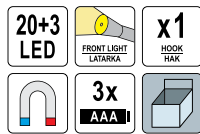

No.	Light source / Źródło światła [LED]	Battery type / Rodzaj baterii	
82730	20+3	3x1.5V; AAA	12/48

EN LED work light
 PL Lampa robocza LED
 DE LED Handleuchte
 RU Светодиодный светильник для мастерской
 CZ Pracovní LED svítidla
 RO Lampa portabilă cu LED
 HU LED szerelőlámpa
 ES Lámpara de taller LED



No.	Battery type / Rodzaj baterii	
82726	3x1.5V; AA	12/48

EN LED work light
 PL Lampa robocza LED
 DE LED Handleuchte
 RU Светодиодный светильник для мастерской
 CZ Pracovní LED svítidla
 RO Lampa portabilă cu LED
 HU LED szerelőlámpa
 ES Lámpara de taller LED

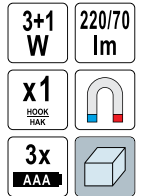

No.	Battery type / Rodzaj baterii	
82733	3x1.5V; AAA	24/48

EN LED work light
 PL Lampa robocza LED
 DE LED Handleuchte
 RU Светодиодный светильник для мастерской
 CZ Pracovní LED svítidla
 RO Lampa portabilă cu LED
 HU LED szerelőlámpa
 ES Lámpara de taller LED

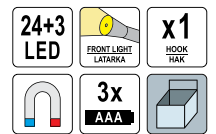

No.	Light source / Źródło światła [LED]	Battery type / Rodzaj baterii	
82731	24+3	3x1.5V; AAA	12/48

EN LED work light
 PL Lampa robocza LED
 DE LED Handleuchte
 RU Светодиодный светильник для мастерской
 CZ Pracovní LED svítidla
 RO Lampa portabilă cu LED
 HU LED szerelőlámpa
 ES Lámpara de taller LED



No.	Light source / Źródło światła [LED]	Battery type / Rodzaj baterii	
82735	36+1	4x1.5V; AAA	12/48

- EN LED magnetic pick up tool
- PL Chwytnak teleskopowy LED
- DE LED Magnet Heber
- RU Захват магнитный телескопический с подсветкой
- CZ Patka magnetická teleskopická LED
- RO Telescop magnetic cu LED
- HU LED felszedő mágnes teleszkópos nyélrel
- ES Herramienta para levantar, telescópica, con LED

3 LED 170-565 mm x2

TELESCOPIC HANDLE UCHWYT TELESKOPOWY 4x LR44



VOREL LED

No.	Light source / Źródło światła [LED]	Battery type / Rodzaj baterii	
78405	3	4x LR44	12/48

- EN LED flashlight
- PL Latarka LED
- DE LED Taschenlampe
- RU Светодиодный фонарь
- CZ LED svítilna
- RO Lanterna cu LED
- HU LED zseblámpa
- ES Linterna LED

10 W XM-L2 500 lm 3x AA



VOREL POWER LED

No.	Power / Moc [W]	Battery type / Rodzaj baterii	
88560	10	3x1.5V; AA	12/24

- EN LED headlamp
- PL Latarka czołowa LED
- DE LED Kopflampe
- RU Налобный светодиодный фонарь
- CZ Čelová lampa LED
- RO Lanterna cu LED pt. cap
- HU LED fejlámpa
- ES Lámpara LED de cabeza

5 LIGHTING MODES TRYBY ŚWIĘCENIA SOS 3x AAAA XPE

3W 130 lm 120 lm



VOREL COB POWER LED LED

No.	Battery type / Rodzaj baterii	
88678	3x1.5V; AAA	6/24

- EN UV LED flashlight and glasses set
- PL Zestaw latarka UV LED i okulary
- DE UV LED Taschenlampe mit UV Schutzbrille
- RU Комплект для проверки утечек хладагента - УФ фонарь с очками
- CZ UV LED svítilna + brýle
- RO Set lanterna UV LED si ochelari
- HU UV LED zseblámpa + szemüveg
- ES UV LED linterna con gafas para

21 LED UV 395 nm 3x AAAA



VOREL UV LED

No.	Light source / Źródło światła [LED]	Battery type / Rodzaj baterii	
82756	21	3x1.5V; AAA	80

- EN LED flashlight
- PL Latarka LED
- DE LED Taschenlampe
- RU Светодиодный фонарь
- CZ LED svítilna
- RO Lanterna cu LED
- HU LED zseblámpa
- ES Linterna LED

5W 280 lm ZOOM 3x AAA



VOREL POWER LED

No.	Power / Moc [W]	Battery type / Rodzaj baterii	
88555	5	3x1.5V; AAA	12/48

- EN LED headlamp
- PL Latarka czołowa LED
- DE LED Kopflampe
- RU Налобный светодиодный фонарь
- CZ Čelová lampa LED
- RO Lanterna cu LED pt. cap
- HU LED fejlámpa
- ES Lámpara LED de cabeza

3 LIGHTING MODES TRYBY ŚWIĘCENIA Micro USB 3.7V 850mAh Li-Ion 5h 3x AAAA XPE

3W 130 lm 4 LED 160 lm



VOREL POWER SMD LED LED

No.		
88677		12/48

EN LED headlamp
 PL Latarka czołowa LED
 DE LED Kopflampe
 RU Налобный светодиодный фонарь
 CZ Čelová lampa LED
 RO Lanterna cu LED pt. cap
 HU LED fejlámpa
 ES Lámpara LED de cabeza

8 LED 3x AAA



LED



No.	Battery type / Rodzaj baterii	
88670	3x1.5V; AAA	12/72

EN LED headlamp
 PL Latarka czołowa LED
 DE LED Kopflampe
 RU Налобный светодиодный фонарь
 CZ Čelová lampa LED
 RO Lanterna cu LED pt. cap
 HU LED fejlámpa
 ES Lámpara LED de cabeza

1 LED 1W 3 LIGHTING MODES TRYBY ŚWIĘCZENIA 3x AAA



POWER LED



No.	Battery type / Rodzaj baterii	
88673	3x1.5V; AAA	12/48

EN LED headlamp
 PL Latarka czołowa LED
 DE LED Kopflampe
 RU Налобный светодиодный фонарь
 CZ Čelová lampa LED
 RO Lanterna cu LED pt. cap
 HU LED fejlámpa
 ES Lámpara LED de cabeza

1+2 LED 100 lm 3x AAA



POWER LED



No.	Battery type / Rodzaj baterii	
88675	3x1.5V; AAA	12/48

EN Winter hat with LED lamp
 PL Czapka zimowa z lampką LED
 DE Wintermütze mit LED-Lampe
 RU Зимняя шапка со светодиодным фонариком
 CZ Zimní čepice s LED svítilnou
 RO Caciula iarna cu LED
 HU LED lámpás téli sapka
 ES Gorro de invierno con LED



No.	Color / Kolor	
74225	szary	10/80
74226	czarny	10/80
74227	granatowy	10/80

EN LED headlamp
 PL Latarka czołowa LED
 DE LED Kopflampe
 RU Налобный светодиодный фонарь
 CZ Čelová lampa LED
 RO Lanterna cu LED pt. cap
 HU LED fejlámpa
 ES Lámpara LED de cabeza

1 LED 1W 3 LIGHTING MODES TRYBY ŚWIĘCZENIA 3x AAA ELASTIC STRAP ELASTYCZNY PASEK



POWER LED



No.	Battery type / Rodzaj baterii	
88672	3x1.5V; AAA	12/60

EN LED headlamp
 PL Latarka czołowa LED
 DE LED Kopflampe
 RU Налобный светодиодный фонарь
 CZ Čelová lampa LED
 RO Lanterna cu LED pt. cap
 HU LED fejlámpa
 ES Lámpara LED de cabeza

1 LED 1W 3 LIGHTING MODES TRYBY ŚWIĘCZENIA 3x AAA



POWER LED



No.	Battery type / Rodzaj baterii	
88674	3x1.5V; AAA	12/48

EN LED headlamp
 PL Latarka czołowa LED
 DE LED Kopflampe
 RU Налобный светодиодный фонарь
 CZ Čelová lampa LED
 RO Lanterna cu LED pt. cap
 HU LED fejlámpa
 ES Lámpara LED de cabeza

3W 150 lm 3x AAA



COB LED



No.	Battery type / Rodzaj baterii	
88676	3x1.5V; AAA	12/48



UNIVERSAL SIZE ROZMIAR UNIWERSALNY 120 lm 3 LIGHTING MODES TRYBY ŚWIĘCZENIA 3.7 V 200mAh Li-Ion 1.5h 1.5-4h CHARGING ŁADOWANIE USB

- EN LED bike light set
- PL Zestaw lamp rowerowych LED
- DE Fahrrad-Beleuchtungsset LED
- RU Набор светодиодных велосипедных фонарей
- CZ Set LED osvětlení na kolo
- RO Set lanterna bicicleta LED
- HU LED kerékpár lámpa szett
- ES Juego de luces LED para bicicleta

5
LED

2x
AAA

3W

150
lm

3x
AAA

ZOOM



POWER
LED



No.	Battery type / Rodzaj baterii	
88422	3x1.5V; AAA, 2x1.5V; AAA	12/48

- EN Night lamp with body and light sensor
- PL Lampka nocna z czujnikiem ruchu i zmierzchu
- DE Nachtleuchte mit Bewegungsmelder und Helligkeitssensor
- RU Ночник с датчиком движения и сумеречного света
- CZ Noční lampka se senzorem pohybu a soumraku
- RO Lampa de veghe cu senzor lumina
- HU Mozgás- és szűrületérzékelős éjjeli lámpa
- ES Luz de noche con sensor de movimiento y crepuscular

1W

50
lm

120°

3m

3x
AAA



SMD
LED



No.	Power / Moc [W]	Luminous flux / Strumień świetlny [lm]	
82831	1	50	25/100

- EN Insect killer lamp with fan
- PL Lampa owadobójcza z wentylatorem
- DE Insektizidiampe mit Ventilator
- RU Инсектицидная лампа с вентилятором
- CZ Lampa na hubení hmyzu s ventilátorem
- RO Lampă împotriva insectelor cu ventilator
- HU Ventilátoros rovarirtó lámpa
- ES Lámpara insecticida con ventilador

- | | |
|--|---|
| FEATURES:
- Funnel prevents insects from escaping
- Storage box for insects | CECHY:
- Lejek zabezpiecza przed ucieczką owadów
- Pojemnik na owady |
|--|---|



5W

UVA
LED

365
nm

20000 h

30 m²

USB
CHARGING
LADOWANIE

ANTI-SLIP
FEET
NOŻKI ANTY-
POŚLĘGOWE



No.	Power / Moc [W]	
67011	5	12

- EN Night lamp with body and light sensor
- PL Lampka nocna z czujnikiem ruchu i zmierzchu
- DE Nachtleuchte mit Bewegungsmelder und Helligkeitssensor
- RU Ночник с датчиком движения и сумеречного света
- CZ Noční lampka se senzorem pohybu a soumraku
- RO Lampa de veghe cu senzor lumina
- HU Mozgás- és szűrületérzékelős éjjeli lámpa
- ES Luz de noche con sensor de movimiento y crepuscular

3W

120
lm

120°

3m

3x
AAA



COB
LED



No.	Power / Moc [W]	Luminous flux / Strumień świetlny [lm]	
82830	3	120	25/100

- EN Night lamp with body and light sensor
- PL Lampka nocna z czujnikiem ruchu i zmierzchu
- DE Nachtleuchte mit Bewegungsmelder und Helligkeitssensor
- RU Ночник с датчиком движения и сумеречного света
- CZ Noční lampka se senzorem pohybu a soumraku
- RO Lampa de veghe cu senzor lumina
- HU Mozgás- és szűrületérzékelős éjjeli lámpa
- ES Luz de noche con sensor de movimiento y crepuscular

1W

50
lm

120°

3m

3.7 V
600mAh
LiFePO₄

2h

3h

USB
BATTERY CHARGER
LADOWNIKA



SMD
LED



No.	Power / Moc [W]	Luminous flux / Strumień świetlny [lm]	Battery capacity / Pojemność akumulatora [mAh]	
82832	1	50	600	25/100

EN Insect killer lamp with fan
 PL Lampa owadobójcza z wentylatorem
 DE Insektizidlampe mit Ventilator
 RU Инсектицидная лампа с вентилятором
 CZ Lampa na hubení hmyzu s ventilátorem
 RO Lampă împotriva insectelor cu ventilator
 HU Ventilátoros rovarirtó lámpa
 ES Lámpara insecticida con ventilador

- FEATURES:**
- Flap prevents insects from escaping
 - Storage box for insects
 - Free standing or hanging

- CECHY:**
- Klapka zabezpieczająca przed ucieczką owadów
 - Pojemnik na owady
 - Możliwość postawienia lub zawieszenia



220-240V~50Hz **20 W**
 UVA TS 4W **365 nm**
 8000 h **25m²**
 1.1 m



LUND

No.	Power / Moc [W]	
67026	20	6

EN Insect killer lamp with fan
 PL Lampa owadobójcza z wentylatorem
 DE Insektizidlampe mit Ventilator
 RU Инсектицидная лампа с вентилятором
 CZ Lampa na hubení hmyzu s ventilátorem
 RO Lampă împotriva insectelor cu ventilator
 HU Ventilátoros rovarirtó lámpa
 ES Lámpara insecticida con ventilador

- FEATURES:**
- Funnel prevents insects from escaping
 - Storage box for insects
 - Chain 65 cm
 - Free standing or hanging
 - Inside and outside use

- CECHY:**
- Lejek zabezpiecza przed ucieczką owadów
 - Pojemnik na owady
 - Łańcuch 65 cm
 - Możliwość postawienia lub zawieszenia
 - Zastosowanie we wnętrzach i na zewnątrz



220-240V~50/60Hz **15 W**
 UVA 56V 7W **365 nm**
 3000 h **300m²**
 IPX4 **3 m**



LUND

No.	Power / Moc [W]	
67013	15	6

EN Insect killer lamp UVA
 PL Lampa owadobójcza UVA
 DE UVA-Insektenlampe
 RU Лампа от насекомых УФА
 CZ UVA lampa na hubení hmyzu
 RO Lampă UVA împotriva insectelor
 HU UVA rovarirtó lámpa
 ES Lámpara de UVA insecticida

- FEATURES:**
- Free standing or hanging
- CECHY:**
- Możliwość postawienia lub zawieszenia

220-240V~50Hz **2300V** **17 W**
 UVA TS 6W **365 nm**
 8000 h **30m²**
 1 m

EN Insect killer lamp with fan
 PL Lampa owadobójcza z wentylatorem
 DE Insektizidlampe mit Ventilator
 RU Инсектицидная лампа с вентилятором
 CZ Lampa na hubení hmyzu s ventilátorem
 RO Lampă împotriva insectelor cu ventilator
 HU Ventilátoros rovarirtó lámpa
 ES Lámpara insecticida con ventilador

- FEATURES:**
- Funnel prevents insects from escaping
 - Storage box for insects

- CECHY:**
- Lejek zabezpiecza przed ucieczką owadów
 - Pojemnik na owady

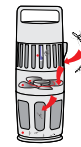

220-240V~50/60Hz **15 W**
 UVA 56V 7W **365 nm**
 3000 h **60m²**
 1.9 m



LUND

No.	Power / Moc [W]	
67012	15	6

EN Insect killer lamp with fan
 PL Lampa owadobójcza z wentylatorem
 DE Insektizidlampe mit Ventilator
 RU Инсектицидная лампа с вентилятором
 CZ Lampa na hubení hmyzu s ventilátorem
 RO Lampă împotriva insectelor cu ventilator
 HU Ventilátoros rovarirtó lámpa
 ES Lámpara insecticida con ventilador

- FEATURES:**
- Funnel prevents insects from escaping
 - Storage box for insects
 - Water tray
 - Light sensor automatically recognize the brightness of natural light to switch ON/OFF
 - Free standing or hanging
 - Inside and outside use

- CECHY:**
- Lejek zabezpiecza przed ucieczką owadów
 - Pojemnik na owady
 - Tacka na wodę
 - Czujnik światła automatycznie włącza i wyłącza urządzenie
 - Możliwość postawienia lub zawieszenia
 - Zastosowanie we wnętrzach i na zewnątrz



220-240V~50/60Hz **15 W**
 UVA 56V 7W **365 nm**
 3000 h **300m²**
 IPX4 **3 m**



LUND

No.	Power / Moc [W]	
67014	15	2

LUND

No.	Power / Moc [W]	
67032	17	6



EN Insect killer lamp UVA
 PL Lampa owadobójcza UVA
 DE UVA-Insektenlampe
 RU Лампа от насекомых УФА
 CZ UVA lampa na hubení hmyzu
 RO Lampă UVA împotriva insectelor
 HU UVA rovarirtó lámpa
 ES Lámpara de UVA insecticida

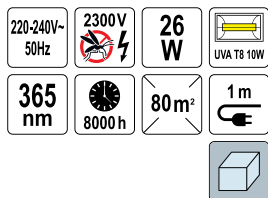

FEATURES:
 - Free standing or hanging

CECHY:
 - Możliwość postawienia lub zawieszania

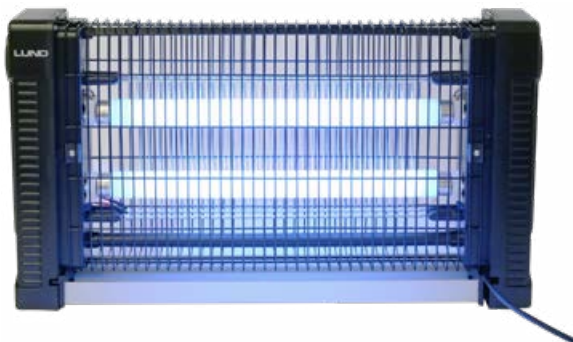

LUND

No.	Power / Moc [W]	
67033	26	6

EN UVA bulb for insect killer lamp
 PL Żarówka UVA do lamp owadobójczych
 DE UVA-Leuchte für Insektenlampen
 RU Лампочка УФА для ламп-убийц
 CZ UVA žárovka do lamp na hubení hmyzu
 RO Bec UVA pt. lampă împotriva insectelor
 HU UVA izzó rovarirtó lámpához
 ES Bombilla de UVA para lámparas insecticidas



LUND

No.	For / Dla	
67019	67012, 67013, 67014	200

EN UVA tube for insect killer lamp
 PL Światłówka UVA do lamp owadobójczych
 DE UVA-Leuchtstoffröhre für Insektenlampen
 RU Флуоресцентная лампа УФА для ламп-убийц
 CZ UVA zářivka do lamp na hubení hmyzu
 RO Tub UVA pt. lampă împotriva insectelor
 HU UVA égő rovarirtó lámpához
 ES Tubo de UVA para lámparas insecticidas



LUND

No.	For / Dla	
67054	67032	100/300

EN Insect killer lamp UVA
 PL Lampa owadobójcza UVA
 DE UVA-Insektenlampe
 RU Лампа от насекомых УФА
 CZ UVA lampa na hubení hmyzu
 RO Lampă UVA împotriva insectelor
 HU UVA rovarirtó lámpa
 ES Lámpara de UVA insecticida

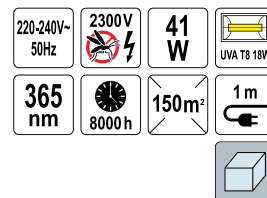

FEATURES:
 - Free standing or hanging

CECHY:
 - Możliwość postawienia lub zawieszania

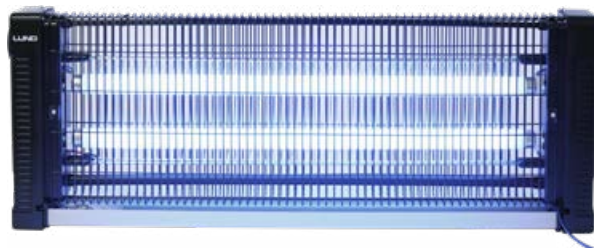

LUND

No.	Power / Moc [W]	
67034	41	4

EN UVA tube for insect killer lamp
 PL Światłówka UVA do lamp owadobójczych
 DE UVA-Leuchtstoffröhre für Insektenlampen
 RU Флуоресцентная лампа УФА для ламп-убийц
 CZ UVA zářivka do lamp na hubení hmyzu
 RO Tub UVA pt. lampă împotriva insectelor
 HU UVA égő rovarirtó lámpához
 ES Tubo de UVA para lámparas insecticidas

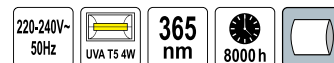

LUND

No.	For / Dla	
67053	67026	500

EN UVA tube for insect killer lamp
 PL Światłówka UVA do lamp owadobójczych
 DE UVA-Leuchtstoffröhre für Insektenlampen
 RU Флуоресцентная лампа УФА для ламп-убийц
 CZ UVA zářivka do lamp na hubení hmyzu
 RO Tub UVA pt. lampă împotriva insectelor
 HU UVA égő rovarirtó lámpához
 ES Tubo de UVA para lámparas insecticidas

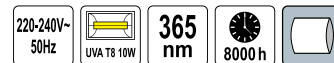

LUND

No.	For / Dla	
67055	67033	25/100

EN UVA tube for insect killer lamp
 PL Światłówka UVA do lamp owadobójczych
 DE UVA-Leuchtstoffröhre für Insektenlampen
 RU Флуоресцентная лампа УФА для ламп-убийц
 CZ UVA zářivka do lamp na hubení hmyzu
 RO Tub UVA pt. lampă împotriva insectelor
 HU UVA égó rovarirtó lámpához
 ES Tubo de UVA para lámparas insecticidas

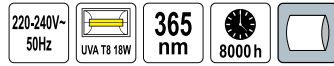

LUND

No.	For / Dia	
67056	67034	25/100

EN Motion detector
 PL Czujnik ruchu
 DE Bewegungsfühler
 RU Детектор движения
 CZ Snímač pohybu
 RO Senzor de mișcare
 HU Mozgásérzékelő
 ES Sensor del movimiento

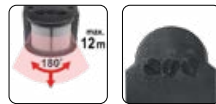
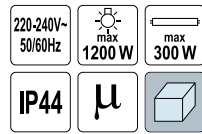

VOREL

No.		
83122		50

EN Motion detector
 PL Czujnik ruchu
 DE Bewegungsfühler
 RU Детектор движения
 CZ Snímač pohybu
 RO Senzor de mișcare
 HU Mozgásérzékelő
 ES Sensor del movimiento



VOREL

No.		
83124		50

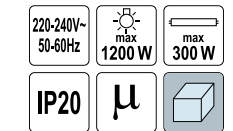

EN Motion detector
 PL Czujnik ruchu
 DE Bewegungsfühler
 RU Детектор движения
 CZ Snímač pohybu
 RO Senzor de mișcare
 HU Mozgásérzékelő
 ES Sensor del movimiento

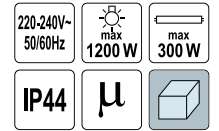

VOREL

No.		
83120		50

EN Motion detector
 PL Czujnik ruchu
 DE Bewegungsfühler
 RU Детектор движения
 CZ Snímač pohybu
 RO Senzor de mișcare
 HU Mozgásérzékelő
 ES Sensor del movimiento

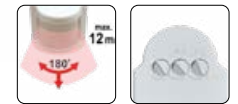
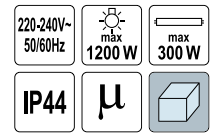

VOREL

No.		
83123		50

		Memo
--	--	------

24

Garden tools & power tools
Narzędzia i elektronarzędzia ogrodowe



Watering program
Program wodny

410-432

Hose connectors, male connectors, couplings, hose menders

Złącza, nypły, łączniki, rozgałęziacze, reparatory..... 410

Hose nozzles (sprinklers) & sets

Zraszacze i zestawy..... 414

Garden hoses

Wężę ogrodowe..... 420

Garden hose carts, holders & guides

Wózki, stojaki i prowadnice do węży..... 421

Pumps

Pompy..... 422

Irrigation valve boxes

Skrzynki zaworowe..... 424

PE pipes adapters

Złączki do rur PE..... 425

Water filters

Filtry do wody..... 431

Pruners & shears**Sekatory i nożyce ogrodowe**

432-437

Pruners

Sekatory..... 432

Lopping shears

Sekatory do gałęzi..... 434

Leverage tree pruners

Sekatory gąsienicowe..... 436

Hedge shears

Nożyce do żywopłotu..... 436

Grass shears

Nożyce do trawy..... 437

Garden saws & blades**Piły ogrodowe i brzeszczoty**

437-438

Axes & splitting wedges**Siekiery i kliny do drewna**

438-440

Hand tools**Narzędzia ręczne**

440-456

Small garden tools

Małe narzędzia ogrodowe..... 440

Big garden tools

Duże narzędzia ogrodowe..... 443

Handles

Trzonki..... 454

Sprayers & accessories**Opryskiwacze i akcesoria**

457-459

Gasoline garden tools, power tools & accessories
Ogrodowe narzędzia spalinowe, elektronarzędzia i akcesoria

459-463

Grass trimmers

Wykasarki..... 459

Hedge trimmers

Nożyce do trawy i żywopłotu..... 459

Chainsaws

Pilarki łańcuchowe..... 460

Soil millers

Gleboğrafarki..... 460

Scarifiers

Wertykulatory..... 460

Accessories

Akcesoria..... 460

Health & safety products**Artykuły BHP**

463-468

Gloves

Rękawice..... 463

Rain boots

Kalosze..... 464

Multipurpose trays

Podstawki gospodarcze..... 465

Knee pads

Nakolanniki..... 466

Head, hearing & eyesight protection

Ochrona głowy, słuchu i wzroku..... 467

Garden accessories**Akcesoria ogrodowe**

468-478

BBQ grills & accessories**Grille i akcesoria**

478-486

Gas BBQ grills

Grille gazowe..... 478

Charcoal BBQ grills

Grille węglowe..... 481

Smokers

Wędzarnie..... 483

Fire pits

Paleniska ogrodowe..... 484

Accessories

Akcesoria..... 485

EN Hose connector
 PL Złącze
 DE Universal Schnellschlauchkupplung
 RU Соединитель
 CZ Rychlospojka
 RO Mufă pt. pistol
 HU Fitting
 ES Junta estandar



1/2" 3/4"
 12.7mm 19mm
 ABS



No.	Hose diameter / Średnica węża	
89221	1/2" (12.5 mm)	150/600
89223	3/4" (19.0 mm)	60/240

EN Hose connector
 PL Złącze
 DE Universal Schnellschlauchkupplung
 RU Соединитель
 CZ Rychlospojka
 RO Mufă pt. pistol
 HU Fitting
 ES Junta estandar



1/2" 3/4"
 12.7mm 19mm
 ABS



No.	Hose diameter / Średnica węża	
89001	1/2" (12.5 mm)	30/240
89002	3/4" (19.0 mm)	30/240

EN Hose connector
 PL Złącze
 DE Universal Schnellschlauchkupplung
 RU Соединитель
 CZ Rychlospojka
 RO Mufă pt. pistol
 HU Fitting
 ES Junta estandar



1/2" 3/4"
 12.7mm 19mm
 ABS STOP



No.	Hose diameter / Średnica węża	
89226	1/2" (12.5 mm)	24/288
89228	3/4" (19.0 mm)	24/288

EN Brass hose connector
 PL Złącze mosiężne
 DE Schlauch-Schnellkupplung
 RU Быстрьюемная муфта
 CZ Rychlospojka
 RO Manșon de îmbinare
 HU Csatlakozó
 ES Conexión



1/2" 3/4"
 12.7mm 19mm
 BRASS MOSIADZ



No.	Hose diameter / Średnica węża	
89100	1/2" (12.5 mm)	48
89102	3/4" (19.0 mm)	48

EN Hose connector
 PL Złącze
 DE Universal Schnellschlauchkupplung
 RU Соединитель
 CZ Rychlospojka
 RO Mufă pt. pistol
 HU Fitting
 ES Junta estandar



1/2" 3/4"
 12.7mm 19mm
 ABS



No.	Hose diameter / Średnica węża	
89222	1/2" (12.5 mm)	24/288
89224	3/4" (19.0 mm)	24/288

EN Hose connector
 PL Złącze
 DE Universal Schnellschlauchkupplung
 RU Соединитель
 CZ Rychlospojka
 RO Mufă pt. pistol
 HU Fitting
 ES Junta estandar



1/2" 3/4"
 12.7mm 19mm
 ABS STOP



No.	Hose diameter / Średnica węża	
89225	1/2" (12.5 mm)	150/600
89227	3/4" (19.0 mm)	60/240

EN Hose connector
 PL Złącze
 DE Universal Schnellschlauchkupplung
 RU Соединитель
 CZ Rychlospojka
 RO Mufă pt. pistol
 HU Fitting
 ES Junta estandar



1/2" 3/4"
 12.7mm 19mm
 ABS STOP



No.	Hose diameter / Średnica węża	
89003	1/2" (12.5 mm)	30/240
89004	3/4" (19.0 mm)	30/240

EN Brass hose connector
 PL Złącze mosiężne
 DE Schlauch-Schnellkupplung
 RU Быстрьюемная муфта
 CZ Rychlospojka
 RO Manșon de îmbinare
 HU Csatlakozó
 ES Conexión



1/2" 3/4"
 12.7mm 19mm
 BRASS MOSIADZ STOP



No.	Hose diameter / Średnica węża	
89101	1/2" (12.5 mm)	48
89103	3/4" (19.0 mm)	48

EN Hose mender
 PL Reparatör do węża
 DE Schlauchreparator
 RU Соединитель шлангов
 CZ Opravka
 RO Mufă înădire
 HU Gyorstoldó
 ES Reparador para manguera

1/2" 3/4" ABS
 12.7mm 19mm



FLO

No.	Hose diameter / Średnica węża	
89229	1/2" (12.5 mm)	150/600
89231	3/4" (19.0 mm)	60/240

EN Hose mender
 PL Reparatör do węża
 DE Schlauchreparator
 RU Соединитель шлангов
 CZ Opravka
 RO Mufă înădire
 HU Gyorstoldó
 ES Reparador para manguera

1/2" 3/4" ABS
 12.7mm 19mm



FLO

No.	Hose diameter / Średnica węża	
89007	1/2" (12.5 mm)	30/240
89008	3/4" (19.0 mm)	30/240

EN Hose reducer
 PL Reduktor do węża
 DE Schlauch Druckminderer
 RU Редуктор
 CZ Redukce
 RO Reductor
 HU Szűkítő
 ES Reductor para manguera

1/2" 3/4" ABS
 12.7mm 19mm



FLO

No.	Hose diameter / Średnica węża	
89233	1/2" (12.5 mm), 3/4" (19.0 mm)	60/240

EN Hose reducer
 PL Reduktor do węża
 DE Schlauch Druckminderer
 RU Редуктор
 CZ Redukce
 RO Reductor
 HU Szűkítő
 ES Reductor para manguera

1/2" 3/4" ABS
 12.7mm 19mm



FLO

No.	Hose diameter / Średnica węża	
89011	1/2" (12.5 mm), 3/4" (19.0 mm)	30/240

EN Hose mender
 PL Reparatör do węża
 DE Schlauchreparator
 RU Соединитель шлангов
 CZ Opravka
 RO Mufă înădire
 HU Gyorstoldó
 ES Reparador para manguera

1/2" 3/4" ABS
 12.7mm 19mm



FLO

No.	Hose diameter / Średnica węża	
89230	1/2" (12.5 mm)	24/288
89232	3/4" (19.0 mm)	24/288

EN Hose mender
 PL Reparatör do węża
 DE Schlauchreparator
 RU Соединитель шлангов
 CZ Opravka
 RO Mufă înădire
 HU Gyorstoldó
 ES Reparador para manguera

1/2" 3/4" BRASS
 12.7mm 19mm MOSIÁZS



FLO

No.	Hose diameter / Średnica węża	
89104	1/2" (12.5 mm)	48
89105	3/4" (19.0 mm)	48

EN Hose reducer
 PL Reduktor do węża
 DE Durchflussminderer für Schläuche
 RU Редуктор для шланга
 CZ Redukce hadice
 RO Mufa inadire
 HU Tömölő reduktor
 ES Reductor para manguera

1/2" 3/4" ABS
 12.7mm 19mm



FLO

No.	Hose diameter / Średnica węża	
89234	1/2" (12.5 mm), 3/4" (19.0 mm)	24/288

EN Snap-in tap adaptor
 PL Przyłącze do kranu
 DE Wasserhahnanschluss für Gartenschlauch
 RU Адаптер внешний
 CZ Šroubení
 RO Mufă pt. robinet cu filet interior
 HU Tömölő csaphoz
 ES Tubuladura de grifo

1/2" ABS
 12.7mm



FLO

No.	Hose diameter / Średnica węża	
89253	1/2" (12.5 mm)	24/240

EN Male connector
 PL Nypel
 DE Anschlussgerätestück
 RU Адаптер внутренний
 CZ Spojka
 RO Mufă pt. robinet cu filet exterior
 HU Külső menetestölvég
 ES Nypel

3/4"
19mm ABS



No.	Connector thread size / Rozmiar gwintu przyłącza	
89239	G3/4	250/1000

EN Snap-in tap adaptor
 PL Przyłącze do kranu
 DE Wasserhahnanschluss für Gartenschlauch
 RU Адаптер внешний
 CZ Šroubení
 RO Mufă pt. robinet cu filet interior
 HU Tömölvég csaphoz
 ES Tubuladura de grifo

3/4"
19mm ABS



No.	Connector thread size / Rozmiar gwintu przyłącza	
89015	G3/4	30/240

EN Snap-in tap adaptor
 PL Przyłącze do kranu
 DE Wasserhahnanschluss für Gartenschlauch
 RU Адаптер для крана
 CZ Šroubení
 RO Mufă pt. robinet cu filet interior
 HU Tömölvég csaphoz
 ES Tubuladura de grifo

3/4"
19mm ABS



No.	Connector thread size / Rozmiar gwintu przyłącza	
89235	G3/4	250/1000

EN Snap-in tap adaptor
 PL Przyłącze do kranu
 DE Wasserhahnanschluss für Gartenschlauch
 RU Адаптер для крана
 CZ Šroubení
 RO Mufă pt. robinet cu filet interior
 HU Tömölvég csaphoz
 ES Tubuladura de grifo

3/4"
19mm ABS



No.	Connector thread size / Rozmiar gwintu przyłącza	
89013	G3/4	30/240

EN Male connector
 PL Nypel
 DE Anschlussgerätestück
 RU Адаптер внутренний
 CZ Spojka
 RO Mufă pt. robinet cu filet exterior
 HU Külső menetestölvég
 ES Nypel

3/4"
19mm ABS



No.	Connector thread size / Rozmiar gwintu przyłącza	
89240	G3/4	24/288

EN Male connector
 PL Nypel
 DE Anschlussgerätestück
 RU Адаптер внутренний
 CZ Spojka
 RO Mufă pt. robinet cu filet exterior
 HU Külső menetestölvég
 ES Nypel

3/4"
19mm BRASS MOSIADZ



No.	Connector thread size / Rozmiar gwintu przyłącza	
89110	G3/4	48

EN Snap-in tap adaptor
 PL Przyłącze do kranu
 DE Wasserhahnanschluss für Gartenschlauch
 RU Адаптер для крана
 CZ Šroubení
 RO Mufă pt. robinet cu filet interior
 HU Tömölvég csaphoz
 ES Tubuladura de grifo

3/4"
19mm ABS



No.	Connector thread size / Rozmiar gwintu przyłącza	
89236	G3/4	24/288

EN Snap-in tap adaptor
 PL Przyłącze do kranu
 DE Wasserhahnanschluss für Gartenschlauch
 RU Адаптер для крана
 CZ Šroubení
 RO Mufă pt. robinet cu filet interior
 HU Tömölvég csaphoz
 ES Tubuladura de grifo

3/4"
19mm 1" 25mm BRASS MOSIADZ



No.	Connector thread size / Rozmiar gwintu przyłącza	
89106	G3/4	48
89107	G1	48

EN Snap-in tap adaptor
 PL Przyłącze do kranu
 DE Wasserhahnanschluss für Gartenschlauch
 RU Адаптер для крана
 CZ Šroubení
 RO Mufă pt. robinet cu filet interior
 HU Tömölvég csaphoz
 ES Tubuladura de grifo

1/2" 3/4"
 12.7mm 19mm
 1" ABS
 25mm



FLO

No.	Connector thread size / Rozmiar gwintu przyłącza	
89241	G1/2, G3/4	250/1000
89251	G3/4, G1	100/1000

EN Snap-in tap adaptor
 PL Przyłącze do kranu
 DE Wasserhahnanschluss für Gartenschlauch
 RU Адаптер для крана
 CZ Šroubení
 RO Mufă pt. robinet cu filet interior
 HU Tömölvég csaphoz
 ES Tubuladura de grifo

1/2" 3/4"
 12.7mm 19mm
 1" ABS
 25mm



FLO

No.	Connector thread size / Rozmiar gwintu przyłącza	
89017	G1/2, G3/4	30/240
89018	G3/4, G1	30/240

EN 2 way coupling
 PL Złącze typu „I”
 DE Doppelkupplung
 RU Соединитель шлангов
 CZ Spojka
 RO Prelungitor furtun apă
 HU „I” típusú csötöldő idom
 ES Junta tipo „I”

1/2" ABS
 12.7mm



FLO

No.	Water outlet diameter / Średnica przyłącza wody	
89245	1/2" (12.5 mm)	125/500

EN 2 way coupling
 PL Złącze typu „I”
 DE Doppelkupplung
 RU Соединитель шлангов
 CZ Spojka
 RO Prelungitor furtun apă
 HU „I” típusú csötöldő idom
 ES Junta tipo „I”

ABS



FLO

No.	Water outlet diameter / Średnica przyłącza wody	
89020		30/240

EN Snap-in tap adaptor
 PL Przyłącze do kranu
 DE Wasserhahnanschluss für Gartenschlauch
 RU Адаптер для крана
 CZ Šroubení
 RO Mufă pt. robinet cu filet interior
 HU Tömölvég csaphoz
 ES Tubuladura de grifo

1/2" 3/4"
 12.7mm 19mm
 1" ABS
 25mm



FLO

No.	Connector thread size / Rozmiar gwintu przyłącza	
89242	G1/2, G3/4	24/288
89252	G3/4, G1	24/288

EN Snap-in tap adaptor
 PL Przyłącze do kranu
 DE Wasserhahnanschluss für Gartenschlauch
 RU Адаптер для крана
 CZ Šroubení
 RO Mufă pt. robinet cu filet interior
 HU Tömölvég csaphoz
 ES Tubuladura de grifo

1/2" 3/4"
 12.7mm 19mm
 1" BRASS
 25mm MOSIADZ



FLO

No.	Connector thread size / Rozmiar gwintu przyłącza	
89108	G1/2, G3/4	48
89109	G3/4, G1	48

EN 2 way coupling
 PL Złącze typu „I”
 DE Doppelkupplung
 RU Соединитель шлангов
 CZ Spojka
 RO Prelungitor furtun apă
 HU „I” típusú csötöldő idom
 ES Junta tipo „I”

1/2" ABS
 12.7mm



FLO

No.	Water outlet diameter / Średnica przyłącza wody	
89246	1/2" (12.5 mm)	24/288

EN 2 way coupling
 PL Złącze typu „I”
 DE Doppelkupplung
 RU Соединитель шлангов
 CZ Spojka
 RO Prelungitor furtun apă
 HU „I” típusú csötöldő idom
 ES Junta tipo „I”

1/2" BRASS
 12.7mm MOSIADZ



FLO

No.	Water outlet diameter / Średnica przyłącza wody	
89113	1/2" (12.5 mm)	48

EN 3 way coupling
 PL Rozdzielacz typu „Y”
 DE Drei Wege Kupplung
 RU Тройник для шлангов
 CZ Y-kus
 RO Distribuitor 3 căi
 HU „Y” típusú elágazás
 ES Distribuidor tipo „Y”



FLO

No.		
89243		125/250

EN 3 way coupling
 PL Rozdzielacz typu „Y”
 DE Drei Wege Kupplung
 RU Тройник для шлангов
 CZ Y-kus
 RO Distribuitor 3 căi
 HU „Y” típusú elágazás
 ES Distribuidor tipo „Y”



FLO

No.	Water outlet diameter / Średnica przyłącza wody	
89112	1/2" (12.5 mm)	48

EN Y-switch coupling with swivel
 PL Rozdzielacz z zaworami
 DE 2-Wege Ventil
 RU Распределитель внешний
 CZ Rozbočovač s uzavíracími ventily
 RO Racord iny cu robinet
 HU Y-elágazó, 2 db külső menetes elzáróval
 ES Distribuidor tipo „Y”



FLO

No.	Connector thread size / Rozmiar gwintu przyłącza	
89248	G3/4	12/96

EN Adjustable spray nozzle
 PL Zraszacz prosty regulowany
 DE Spritze
 RU Распылитель поливочный
 CZ Postřikovač
 RO Stropitor apă
 HU Szórófej
 ES Rociador



FLO

No.		
89201		25/100

EN 3 way coupling
 PL Rozdzielacz typu „Y”
 DE Drei Wege Kupplung
 RU Тройник для шлангов
 CZ Y-kus
 RO Distribuitor 3 căi
 HU „Y” típusú elágazás
 ES Distribuidor tipo „Y”



FLO

No.		
89244		24/288

EN Y-switch coupling with swivel
 PL Rozdzielacz z zaworami
 DE 2-Wege Ventil
 RU Распределитель внешний
 CZ Rozbočovač s uzavíracími ventily
 RO Racord iny cu robinet
 HU Y-elágazó, 2 db külső menetes elzáróval
 ES Distribuidor tipo „Y”



FLO

No.	Connector thread size / Rozmiar gwintu przyłącza	
89247	G3/4	24/240

EN Y-switch coupling with swivel
 PL Rozdzielacz z zaworami
 DE 2-Wege Ventil
 RU Распределитель внешний
 CZ Rozbočovač s uzavíracími ventily
 RO Racord iny cu robinet
 HU Y-elágazó, 2 db külső menetes elzáróval
 ES Distribuidor tipo „Y”

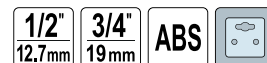

FLO

No.	Water outlet diameter / Średnica przyłącza wody	Connector thread size / Rozmiar gwintu przyłącza	
89022	1/2" (12.5 mm)	G3/4	12/120

EN Adjustable spray nozzle
 PL Zraszacz prosty regulowany
 DE Spritze
 RU Распылитель поливочный
 CZ Postřikovač
 RO Stropitor apă
 HU Szórófej
 ES Rociador



FLO

No.		
89020		12/120

EN Adjustable spray nozzle
 PL Zraszacz prosty regulowany
 DE Spritze
 RU Распылитель поливочный
 CZ Postřikovač
 RO Stropitor apă
 HU Szórófej
 ES Rociador



No.	
89200	25/200

EN Straight nozzle
 PL Pistolet zraszający regulowany
 DE Regelbare Sprühpistole
 RU Регулируемый оросительный пистолет
 CZ Kropící pistole regulovatelná
 RO Pistolet de irigare ajustabil
 HU Öntöző pisztoly állítható sugarú
 ES Pistola rociadora ajustable



No.	
89120	48

EN Adjustable spray gun
 PL Pistolet zraszający regulowany
 DE Regelbare Sprühpistole
 RU Регулируемый оросительный пистолет
 CZ Kropící pistole regulovatelná
 RO Pistolet de irigare ajustabil
 HU Öntöző pisztoly állítható sugarú
 ES Pistola rociadora ajustable

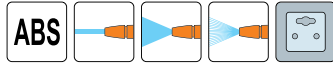

No.	
89213	12/48

EN Adjustable spray gun
 PL Pistolet zraszający regulowany
 DE Regelbare Sprühpistole
 RU Регулируемый оросительный пистолет
 CZ Kropící pistole regulovatelná
 RO Pistolet de irigare ajustabil
 HU Öntöző pisztoly állítható sugarú
 ES Pistola rociadora ajustable

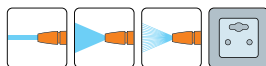

No.	
89189	12/48

EN Adjustable spray nozzle
 PL Zraszacz prosty regulowany
 DE Spritze
 RU Распылитель поливочный
 CZ Postřikovač
 RO Stropitor apă
 HU Szórófej
 ES Rociador



No.	
89187	48

EN Adjustable spray gun
 PL Pistolet zraszający regulowany
 DE Regelbare Sprühpistole
 RU Регулируемый оросительный пистолет
 CZ Kropící pistole regulovatelná
 RO Pistolet de irigare ajustabil
 HU Öntöző pisztoly állítható sugarú
 ES Pistola rociadora ajustable



No.	
89210	12/48

EN Adjustable spray gun
 PL Pistolet zraszający regulowany
 DE Regelbare Sprühpistole
 RU Регулируемый оросительный пистолет
 CZ Kropící pistole regulovatelná
 RO Pistolet de irigare ajustabil
 HU Öntöző pisztoly állítható sugarú
 ES Pistola rociadora ajustable

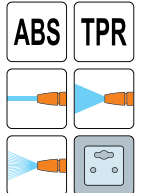

No.	
89214	12/48

EN Adjustable spray gun
 PL Pistolet zraszający regulowany
 DE Regelbare Sprühpistole
 RU Регулируемый оросительный пистолет
 CZ Kropící pistole regulovatelná
 RO Pistolet de irigare ajustabil
 HU Öntöző pisztoly állítható sugarú
 ES Pistola rociadora ajustable

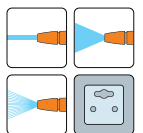

No.	
89193	12/48

- EN Adjustable spray gun
 PL Pistolet zraszający regulowany
 DE Regelbare Sprühpistole
 RU Регулируемый оросительный пистолет
 CZ Kropící pistole regulovatelná
 RO Pistolet de irigare ajustabil
 HU Öntöző pisztoly állítható sugarú
 ES Pistola rociadora ajustable

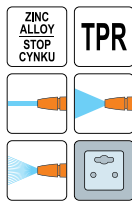

FLO

No.	
89190	12/48

- EN Sprinkling gun
 PL Pistolet zraszający
 DE Spritzpistole
 RU Оросительный пистолет
 CZ Postřikovací pistole
 RO Pistol pt. pulverizare
 HU Öntöző pisztoly
 ES Pistola para regar

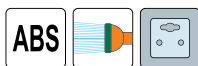

FLO

No.	
89209	12/48

- EN Multifunction sprinkling gun
 PL Wielofunkcyjny pistolet zraszający
 DE Multifunktions-Spritzpistole
 RU Многофункциональный оросительный пистолет
 CZ Multifunkční postřikovací pistole
 RO Pistol multifuncțional pt. pulverizare
 HU Többfunkciós öntöző pisztoly
 ES Pistola para regar multifuncional

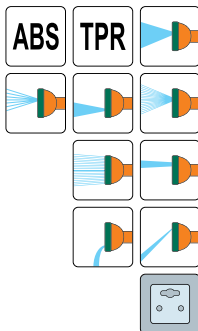

FLO

No.	
89211	12/48

- EN Multifunction sprinkling gun
 PL Wielofunkcyjny pistolet zraszający
 DE Multifunktions-Spritzpistole
 RU Многофункциональный оросительный пистолет
 CZ Multifunkční postřikovací pistole
 RO Pistol multifuncțional pt. pulverizare
 HU Többfunkciós öntöző pisztoly
 ES Pistola para regar multifuncional

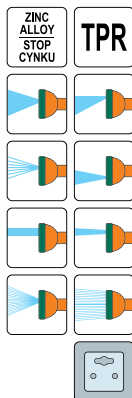

FLO

No.	
89195	6/24

- EN Adjustable spray gun
 PL Pistolet zraszający regulowany
 DE Regelbare Sprühpistole
 RU Регулируемый оросительный пистолет
 CZ Kropící pistole regulovatelná
 RO Pistolet de irigare ajustabil
 HU Öntöző pisztoly állítható sugarú
 ES Pistola rociadora ajustable

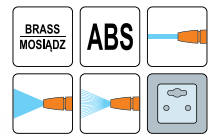

FLO

No.	
89215	12/24

- EN Multifunction sprinkling gun
 PL Wielofunkcyjny pistolet zraszający
 DE Multifunktions-Spritzpistole
 RU Многофункциональный оросительный пистолет
 CZ Multifunkční postřikovací pistole
 RO Pistol multifuncțional pt. pulverizare
 HU Többfunkciós öntöző pisztoly
 ES Pistola para regar multifuncional

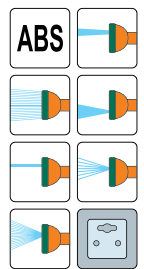

FLO

No.	
89220	12/48

- EN Multifunction sprinkling gun
 PL Wielofunkcyjny pistolet zraszający
 DE Multifunktions-Spritzpistole
 RU Многофункциональный оросительный пистолет
 CZ Multifunkční postřikovací pistole
 RO Pistol multifuncțional pt. pulverizare
 HU Többfunkciós öntöző pisztoly
 ES Pistola para regar multifuncional

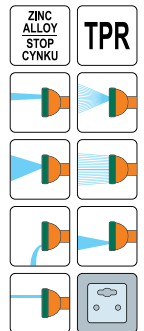

FLO

No.	
89192	12/48

- EN Multifunction sprinkling gun
 PL Wielofunkcyjny pistolet zraszający
 DE Multifunktions-Spritzpistole
 RU Многофункциональный оросительный пистолет
 CZ Multifunkční postřikovací pistole
 RO Pistol multifuncțional pt. pulverizare
 HU Többfunkciós öntöző pisztoly
 ES Pistola para regar multifuncional

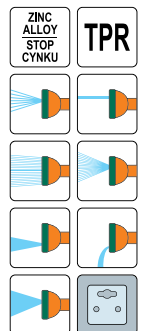

FLO

No.	
89191	12/48

EN Basic hose set with straight nozzle
 PL Zestaw złączek ze zraszaczem prostym
 DE Bewässerungs Spritz und Anschlussset
 RU Набор поливочный
 CZ Sada postřikovača a spojky
 RO Ștut furtun apă cu accesorii pt. robinet
 HU Készlet gyorskapocsal csaphoz
 ES Juego de rociar tubuladura de grifo



4 PCS 1/2" 12.7mm
 3/4" 19mm 1" 25mm
 ABS



No.	Hose diameter / Średnica węża	Connector thread size / Rozmiar gwintu przyłącza	pcs / szt.	
89203	1/2" (12.5 mm)	G3/4, G1	4	12/72
89204	1/2" (12.5 mm)	G1/2, G3/4	4	12/72

EN Basic hose set with adjustable spray gun
 PL Zestaw złączek ze zraszaczem pistoletowym
 DE Spritzbrause und Anschlussset
 RU Набор поливочный
 CZ Rozprašovací pistole na vodu + spojky
 RO Pistol reglabil cu și accesorii
 HU Részecs készlet – os tömlőhöz
 ES Juego de rociar para manguera



4 PCS ABS



No.	Hose diameter / Średnica węża	Connector thread size / Rozmiar gwintu przyłącza	pcs / szt.	
89207	3/4" (19.0 mm)	G3/4	4	12/48

EN Coil hose set with spray gun
 PL Wąż spiralny z pistoletem zraszającym
 DE Spiralschlauch mit Multifunktionsbrause
 RU Спиральный шланг в наборе с пистолетом
 CZ Pístoľ striekacia s vinutou hadicou
 RO Furtuh in spirala cu pistol pt. stropitt
 HU Locsoló pisztoly tömlővel
 ES Manguera espiral con rociador



15m EVA



No.	Hose length / Długość węża [m]	
89351	15	8

EN Sprinkling lance
 PL Lanza zraszająca wielofunkcyjna
 DE Multifunktions-Spritzstab
 RU Пика для распылителя многофункциональная
 CZ Multifunkční postřikovací nadstavec
 RO Tijă pt. irigare
 HU Többfunkciós esőztető fej
 ES Lanza para regar multifuncional

AI ABS



No.	
89218	12

EN Basic hose set with adjustable spray gun
 PL Zestaw złączek ze zraszaczem pistoletowym
 DE Spritzbrause und Anschlussset
 RU Набор поливочный
 CZ Rozprašovací pistole na vodu + spojky
 RO Pistol reglabil cu și accesorii
 HU Részecs készlet – os tömlőhöz
 ES Juego de rociar para manguera



4 PCS ABS



No.	Hose diameter / Średnica węża	Connector thread size / Rozmiar gwintu przyłącza	pcs / szt.	
89206	1/2" (12.5 mm)	G1/2	4	12/48

EN Basic hose set with adjustable spray gun
 PL Zestaw złączek ze zraszaczem pistoletowym
 DE Spritzbrause und Anschlussset
 RU Набор поливочный
 CZ Rozprašovací pistole na vodu + spojky
 RO Pistol reglabil cu și accesorii
 HU Részecs készlet – os tömlőhöz
 ES Juego de rociar para manguera



4 PCS ABS



No.	Hose diameter / Średnica węża	Connector thread size / Rozmiar gwintu przyłącza	pcs / szt.	
89208	1/2" (12.5 mm)	G1/2	4	12/48

EN Garden shower
 PL Prysznic ogrodowy
 DE Gartendusche
 RU Распылитель садовый
 CZ Zahradní sprcha
 RO Duș pt. grădină
 HU Kerti zuhany
 ES Regadera para jardín



240 165 cm



No.	
89390	6

EN 3-arms revolving sprinkler
 PL Zraszacz 3-ramienny
 DE 3-Arm Kreis-Regner
 RU Трехсторонний распылитель
 CZ Rozprašovač tříramenný
 RO Aspersol cu 3 brate
 HU Forgó locsoló leszűrhető
 ES Rociador 3-brazos



No.	
89272	12/48

EN Impulse sprinkler
 PL Zraszacz impulsowy
 DE Impulssprenger
 RU Распылитель импульсный на пике
 CZ Postřikovač
 RO Stropitor apă
 HU Impulzus szórófej
 ES Rociador

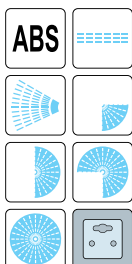

No.	
89261	12/48

EN Impulse sprinkler
 PL Zraszacz impulsowy
 DE Impulssprenger
 RU Распылитель импульсный на пике
 CZ Postřikovač
 RO Stropitor apă
 HU Impulzus szórófej
 ES Rociador

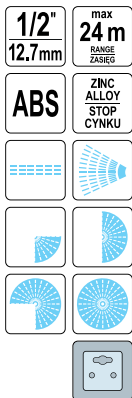

No.	
89259	48

EN Sprinkler
 PL Zraszacz szpilkowy
 DE Sprenger
 RU Дождеватель
 CZ Kolkivový zavlazovač
 RO Aspersol
 HU Esőztető
 ES Aspersor



No.	
89257	20/120

EN 3-arms revolving sprinkler
 PL Zraszacz 3-ramienny
 DE 3-Arm Kreis-Regner
 RU Трехсторонний распылитель
 CZ Rozprašovač tříramenný
 RO Aspersol cu 3 brate
 HU Forgó locsoló leszűrhető
 ES Rociador 3-brazos



No.	
89263	12/48

EN Impulse sprinkler
 PL Zraszacz impulsowy
 DE Impulssprenger
 RU Распылитель импульсный на пике
 CZ Postřikovač
 RO Stropitor apă
 HU Impulzus szórófej
 ES Rociador

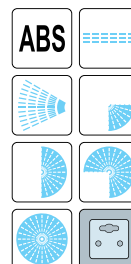

No.	
89269	12/48

EN Impulse sprinkler
 PL Zraszacz impulsowy
 DE Impulssprenger
 RU Распылитель импульсный на пике
 CZ Postřikovač
 RO Stropitor apă
 HU Impulzus szórófej
 ES Rociador

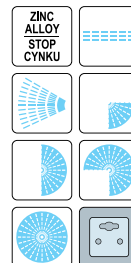

No.	
89260	12/48

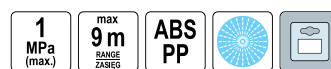

EN Impulse sprinkler
 PL Zraszacz impulsowy
 DE Impulsprenger
 RU Распылитель импульсный на пике
 CZ Postřikovač
 RO Stropitor apă
 HU Impulzus szórófej
 ES Rociador

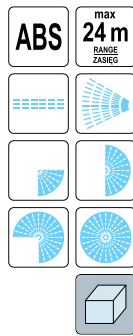

FLO

No.	48
89275	

EN Oscillating sprinkler
 PL Zraszacz oscylacyjny
 DE Rechteckregner
 RU Распылитель осциллирующий
 CZ Obdélníkový zavlažovač
 RO Aspersor oscilant
 HU Oszillációs szórófej
 ES Aspersor oscilante

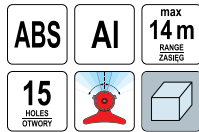

FLO

No.	12
89277	

EN Pop-up sprinkler
 PL Zraszacz wynurzalny
 DE Auftauch-Sprinkler
 RU Выдвижной спринклер
 CZ Vysuvný zavlažovač
 RO Aspersor pop-up
 HU Süllyesztett öntözőfej
 ES Aspersor emergente



FLO

No.	100
89162	

EN Pop-up sprinkler
 PL Zraszacz wynurzalny
 DE Auftauch-Sprinkler
 RU Выдвижной спринклер
 CZ Vysuvný zavlažovač
 RO Aspersor pop-up
 HU Süllyesztett öntözőfej
 ES Aspersor emergente

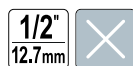

FLO

No.	50
89164	

EN Swing joint
 PL Łącznik elastyczny do zraszaczy
 DE Regneranschluss für Sprinkler
 RU Гибкий соединитель для оросителя
 CZ Elastická spojka do postřikovačů
 RO Aspersor articulat oscilant
 HU Rugalmas loscsoló összekötő
 ES Conector flexible para aspersor



FLO

No.	Connector thread size / Rozmiar gwintu przyłącza	100
88925	G1/2 (M)	

EN Impulse pop-up sprinkler
 PL Zraszacz wynurzalny
 DE Tauchimpulssprinkler
 RU Дождеватель выдвижной
 CZ Zavlažovač výsuvný
 RO Aspersor cu impuls
 HU Esőztető szórófej
 ES Rociador de emerjer



FLO

No.	12
89280	

EN Pop-up sprinkler
 PL Zraszacz wynurzalny
 DE Auftauch-Sprinkler
 RU Выдвижной спринклер
 CZ Vysuvný zavlažovač
 RO Aspersor pop-up
 HU Süllyesztett öntözőfej
 ES Aspersor emergente

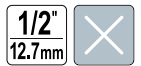

FLO

No.	100
89163	

EN Nozzle for pop-up sprinkler
 PL Głowica zraszacza
 DE Sprinklerkopf
 RU Спринклерная головка
 CZ Zavlažovací hlavice
 RO Duza pt. aspersor pop-up
 HU Öntözőfej
 ES Cabezal de aspersor



FLO

No.	30/1200
89165	

- EN Nozzle for pop-up sprinkler
- PL Głowica zraszacza
- DE Sprinklerkopf
- RU Спринклерная головка
- CZ Zavlažovací hlavice
- RO Duza pt. aspersor pop-up
- HU Öntözőfej
- ES Cabeza de aspersor



No.	30/1200
89166	

- EN Garden hose
- PL Wąż ogrodowy
- DE Gartenschlauch
- RU Садовый шланг
- CZ Zahradní hadice
- RO Furtun de gradina
- HU Kerti tömlő
- ES Manguera de jardín



No.	L [m]	Diameter / Šrednica	1
89302	20	1/2" (12.5 mm)	1
89303	30	1/2" (12.5 mm)	1
89305	50	1/2" (12.5 mm)	1
89307	20	3/4" (19.0 mm)	1
89308	30	3/4" (19.0 mm)	1
89310	50	3/4" (19.0 mm)	1
89298	20	1" (25.0 mm)	1
89299	30	1" (25.0 mm)	1
89300	50	1" (25.0 mm)	1

- EN Garden hose
- PL Wąż ogrodowy
- DE Gartenschlauch
- RU Садовый шланг
- CZ Zahradní hadice
- RO Furtun de gradina
- HU Kerti tömlő
- ES Manguera de jardín

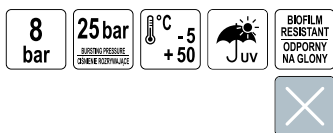

No.	L [m]	Diameter / Šrednica	1
89311	20	1/2" (12.5 mm)	1
89312	30	1/2" (12.5 mm)	1
89313	50	1/2" (12.5 mm)	1
89314	20	3/4" (19.0 mm)	1
89315	30	3/4" (19.0 mm)	1
89316	50	3/4" (19.0 mm)	1
89318	20	1" (25.0 mm)	1
89319	30	1" (25.0 mm)	1
89320	50	1" (25.0 mm)	1

- EN Nozzle for pop-up sprinkler
- PL Głowica zraszacza
- DE Sprinklerkopf
- RU Спринклерная головка
- CZ Zavlažovací hlavice
- RO Duza pt. aspersor pop-up
- HU Öntözőfej
- ES Cabeza de aspersor



No.	30/1200
89167	

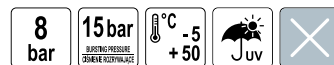

- EN Garden hose
- PL Wąż ogrodowy
- DE Gartenschlauch
- RU Садовый шланг
- CZ Zahradní hadice
- RO Furtun de gradina
- HU Kerti tömlő
- ES Manguera de jardín

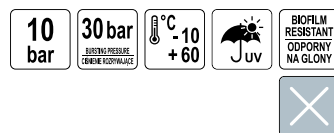

No.	L [m]	Diameter / Šrednica	1
89290	20	1/2" (12.5 mm)	1
89291	30	1/2" (12.5 mm)	1
89292	50	1/2" (12.5 mm)	1
89293	20	3/4" (19.0 mm)	1
89294	30	3/4" (19.0 mm)	1
89295	50	3/4" (19.0 mm)	1

EN Garden hose
 PL Wąż ogrodowy
 DE Gartenschlauch
 RU Садовый шланг
 CZ Zahradní hadice
 RO Furtun de gradina
 HU Kerti tömlő
 ES Manguera de jardín



No.	L [m]	Diameter / Šrednica	
89380	15	1/2" (12.5 mm)	1
89381	25	1/2" (12.5 mm)	1
89382	35	1/2" (12.5 mm)	1
89383	45	1/2" (12.5 mm)	1
89384	15	3/4" (19.0 mm)	1
89385	25	3/4" (19.0 mm)	1
89386	35	3/4" (19.0 mm)	1
89387	45	3/4" (19.0 mm)	1

EN Drip hose
 PL Wąż kroplujący
 DE Tropfschlauch
 RU Капельный шланг
 CZ Kapačí hadice
 RO Picurare furtun
 HU Locsolótömlő
 ES Manguera de goteo

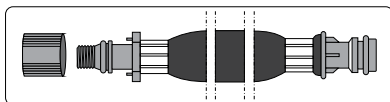
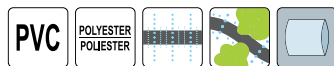

No.	L [m]	
89370	7.5	32
89371	15.0	15
89372	22.5	12
89373	30.0	8

EN Hose holder
 PL Stojak do węża ogrodowego
 DE Gartenschlauchträger
 RU Барабан для намотки поливочного шланга
 CZ Stojan navijecí na zahradní hadici
 RO Suport pt. furtun
 HU Utartódob locsolótömlőhöz
 ES Estante para manguera de jardín



No.	
89330	5

EN Soaker hose
 PL Wąż zraszający
 DE Einweichen Schlauch
 RU Спринклерный шланг
 CZ Hádiový zavlažovač
 RO Furtun de aspersoare
 HU Esőztetőtömlő
 ES Manguera de remojo

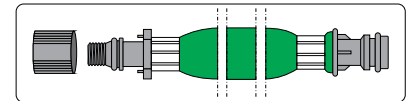
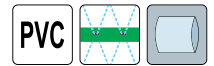

No.	L [m]	
89360	7.5	32
89361	15.0	15

EN Pump drain hose
 PL Wąż odpływowy do pomp
 DE Abflussschlauch für die Pumpen
 RU Сливной шланг для насосов
 CZ Výtlačná hadice pro čerpadla
 RO Furtun de evacuare pt. pompe
 HU Elfolyó tömlő szivattyúhoz
 ES Manguera de salida para bombas



No.	L [m]	Diameter / Šrednica	Wall thickness / Grubość ścianki [mm]	
79960	10	1" (25.0 mm)	1.2	15
79962	20	1" (25.0 mm)	1.2	8
79963	30	1" (25.0 mm)	1.2	6
79965	50	1" (25.0 mm)	1.2	3
79968	20	1-1/4" (32.0 mm)	1.4	6
79971	50	1-1/4" (32.0 mm)	1.4	3

EN Hose holder
 PL Stojak do węża ogrodowego
 DE Gartenschlauchträger
 RU Барабан для намотки поливочного шланга
 CZ Stojan navijecí na zahradní hadici
 RO Suport pt. furtun
 HU Utartódob locsolótömlőhöz
 ES Estante para manguera de jardín

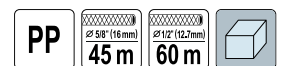

No.	
89331	5

EN Hose cart
 PL Wózek do węża ogrodowego
 DE Gartenschlauchwagen
 RU Барабан для намотки поливочного шланга
 CZ Stojan navijeci na zahradní hadici
 RO Suport pt. furtun
 HU Utartódob locsolótömlőhöz
 ES Carretilla para manguera de jardín



PP
 30 m
 45 m



No.	89335	5
-----	-------	---

EN Hose hanger
 PL Wieszak na wąż ogrodowy
 DE Gartenschlauchträger
 RU Кронштейн настенный для шланга
 CZ Věšák na hadici zahradní
 RO Suport de perete pt. furtun
 HU Kertitömlő-akasztó
 ES Colgador para manguera de jardín



ABS



No.	89345	60
-----	-------	----

EN Hand pump
 PL Pompa ręczna
 DE Schwengelpumpe
 RU Насос ручной
 CZ Pumpa ruční
 RO Pompa manuala
 HU Kézi szivattyú
 ES Bomba de mano



No.	89552	1
-----	-------	---

EN Dirty water submersible pump
 PL Pompa zatapialna do wody brudnej
 DE Tauchpumpe für Schmutzwasser
 RU Погружной насос для грязной воды
 CZ Ponorné čerpadlo pro špinavú vodu
 RO Pompă submersibilă pt. apă murdara
 HU Búvárszivattyú
 ES Bomba sumergible para agua sucia



No.	Power / Moc [W]	Max. capacity / Maks. wydajność [l/h]	Max. head / Maks. wysokość łoczenia [m]	6
79909	400	6000	6	6

EN Hose cart
 PL Wózek do węża ogrodowego
 DE Gartenschlauchwagen
 RU Барабан для намотки поливочного шланга
 CZ Stojan navijeci na zahradní hadici
 RO Suport pt. furtun
 HU Utartódob locsolótömlőhöz
 ES Carretilla para manguera de jardín



PP
 45 m
 60 m



No.	89336	5
-----	-------	---

EN Hose guide
 PL Prowadnica węża
 DE Schlauchheckführung
 RU Направляющее приспособление для шланга
 CZ Voditko s rolnami na hadici
 RO Ghidaj pt. furtun
 HU Tömlő vezető
 ES Guíddera para manguera



ABS
 19 mm
 25 mm



No.	89348	6/24
-----	-------	------

EN Pump base
 PL Podstawa pod pompę
 DE Pumpenständer
 RU Подставка для насоса
 CZ Podstavec pumpy
 RO Suport pt. pompa
 HU Szivattyútalp
 ES Soporte para bomba



No.	89553	For / Dla	89552	1
-----	-------	-----------	-------	---

230V~50Hz
 400 W
 Q max 6000 l/h
 6.0m
 1" 25mm
 5/4" 32mm
 1.5" 38mm



EN Dirty water submersible pump
 PL Pompa zatapialna do wody brudnej
 DE Tauchpumpe für Schmutzwasser
 RU Погружной насос для грязной воды
 CZ Ponorňé řepadlo pro řpinavý vodu
 RO Pompă submersibilă pt. apă murdara
 HU Búvárszivattyú
 ES Bomba sumergible para agua sucia

230V~
50Hz

1"
25mm

5/4"
32mm

1.5"
38mm



STHOR

No.	Power / Moc [W]	Max. capacity / Maks. wydajność [l/h]	Max. head / Maks. wysokość tłoczenia [m]	
79781	400	8000	5.5	4
79782	500	10000	6.5	4
79783	600	11500	7.0	4

EN Dirty water submersible pump
 PL Pompa zatapialna do wody brudnej
 DE Tauchpumpe für Schmutzwasser
 RU Погружной насос для грязной воды
 CZ Ponorňé řepadlo pro řpinavý vodu
 RO Pompă submersibilă pt. apă murdara
 HU Búvárszivattyú
 ES Bomba sumergible para agua sucia

230V~
50Hz

1"
25mm

5/4"
32mm

1.5"
38mm

INOX



FLO

No.	Power / Moc [W]	Max. capacity / Maks. wydajność [l/h]	Max. head / Maks. wysokość tłoczenia [m]	
79790	750	14000	7.5	2
79791	900	16000	8.5	2
79792	1100	20000	9.0	2

EN Membrane deep well water pump
 PL Pompa membranowa zatapialna
 DE Tauchmotorpumpe
 RU Насос погружной мембранный для чистой воды
 CZ Zátavovací řepadlo
 RO Pompă pt. apă cu membrană
 HU Búvárszivattyú
 ES Bomba de diafragma sumergible

220-230V~
50Hz

350
W

Q max
1200
l/h

70m



FLO

No.	Power / Moc [W]	Max. capacity / Maks. wydajność [l/h]	Max. head / Maks. wysokość tłoczenia [m]	
79944	350	1200	70	4

EN Dirty water submersible pump
 PL Pompa zatapialna do wody brudnej
 DE Tauchpumpe für Schmutzwasser
 RU Погружной насос для грязной воды
 CZ Ponorňé řepadlo pro řpinavý vodu
 RO Pompă submersibilă pt. apă murdara
 HU Búvárszivattyú
 ES Bomba sumergible para agua sucia

230V~
50Hz

1"
25mm

5/4"
32mm

1.5"
38mm



FLO

No.	Power / Moc [W]	Max. capacity / Maks. wydajność [l/h]	Max. head / Maks. wysokość tłoczenia [m]	
79771	400	10000	6.5	4
79772	550	11500	7.0	4
79773	750	14000	7.5	4
79774	900	16000	8.5	4
79775	1100	16000	8.5	4

EN Membrane deep well water pump
 PL Pompa membranowa zatapialna
 DE Tauchmotorpumpe
 RU Насос погружной мембранный для чистой воды
 CZ Zátavovací řepadlo
 RO Pompă pt. apă cu membrană
 HU Búvárszivattyú
 ES Bomba de diafragma sumergible

230V~
50Hz

280
W

Q max
1020
l/h

68m



STHOR

No.	Power / Moc [W]	Max. capacity / Maks. wydajność [l/h]	Max. head / Maks. wysokość tłoczenia [m]	
79943	280	1020	68	4

EN Submersible pump for dirty water and wastewater
 PL Pompa zatapialna do wody brudnej i ścieków
 DE Tauchpumpe für Schmutzwasser
 RU Погружной насос для грязной воды
 CZ Ponorňé řepadlo pro odpadní vody
 RO Pompă submersibilă pt. apă uzată
 HU Búvárszivattyú szennyvíz
 ES Bomba sumergible para aguas residuales

230V~
50Hz

450
W

Q max
16000
l/h



FLO

No.	Power / Moc [W]	Max. capacity / Maks. wydajność [l/h]	Max. head / Maks. wysokość tłoczenia [m]	
79880	450	16000	9	1

- EN Jet pump
 PL Pompa ogrodowa
 DE Gartenpumpe
 RU Насос садовый
- CZ Zahradní čerpadlo
 RO Pompa apa
 HU Kerti szivattyúhoz
 ES Bomba de jardín con cabeza

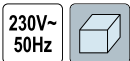

L_{max} = 95,0 ± 3,0 dB

No.	Power / Moc [W]	Max. capacity / Maks. wydajność [l/h]	Max. lifting height / Maks. wysokość podnoszenia [m]	Max. pumping pressure / Maks. ciśnienie tłoczenia [bar]	
79810	600	2800	35	3.5	1
79811	800	3600	40	4.0	1
79812	1000	3800	44	4.4	1

- EN Suction hose
 PL Wąż ssawny do pomp
 DE Saugschlauch für Pumpen
 RU Всасывающий шланг для насосов
 CZ Sací hadice do čerpadel
 RO Furtun aspiratie
 HU Szivattyútömlő
 ES Manguera de succión para bomba



No.	L [m]	Water outlet diameter / Średnica przyłącza wody	
79823	5	1" (25.0 mm)	6
79824	7	1" (25.0 mm)	4

- EN Fountain pump
 PL Pompa fontanna
 DE Springbrunnenpumpe
 RU Фонтанный насос
 CZ Fontánová pumpa
 RO Pompa pt. fantana arteziana
 HU Pumpa szökőkúthoz
 ES Bomba para las fuentes



No.	Power / Moc [W]	Max. capacity / Maks. wydajność [l/h]	Max. head / Maks. wysokość tłoczenia [m]	
79926	8	600	1.0	12
79927	16	800	1.3	12
79928	22	1000	1.6	12

- EN Fountain pump
 PL Pompa fontanna
 DE Springbrunnenpumpe
 RU Фонтанный насос
 CZ Fontánová pumpa
 RO Pompa pt. fantana arteziana
 HU Pumpa szökőkúthoz
 ES Bomba para las fuentes



No.	Power / Moc [W]	Max. capacity / Maks. wydajność [l/h]	Max. head / Maks. wysokość tłoczenia [m]	
79929	28	1400	2.0	8
79930	40	1800	2.5	8

- EN Fountain pump
 PL Pompa fontanna
 DE Springbrunnenpumpe
 RU Фонтанный насос
 CZ Fontánová pumpa
 RO Pompa pt. fantana arteziana
 HU Pumpa szökőkúthoz
 ES Bomba para las fuentes



No.	Power / Moc [W]	Max. capacity / Maks. wydajność [l/h]	Max. head / Maks. wysokość tłoczenia [m]	
79931	55	2000	2.5	8
79932	85	3000	3.5	8
79933	100	4500	4.5	6

- EN Round irrigation valve box
 PL Okrągła skrzynka zaworowa ogrodowa
 DE Rundes Gartenventilgehäuse
 RU Круглый садовый вентиляный ящик
 CZ Kulatý zahradní ventilový box
 RO Cutie rotundă de supapă de irigare
 HU Kerek kerti szelepdoboz
 ES Caja redonda para válvulas, jardín



No.	
88780	10

- EN Irrigation valve box
 PL Skrzynka zaworowa ogrodowa
 DE Gartenventilgehäuse
 RU Садовый вентиляный ящик
 CZ Zahradní ventilový box
 RO Cutie cu supapă pt. irigat
 HU Kerti szelepdoboz
 ES Caja para válvulas, jardín



No.	
88783	4

EN Irrigation valve box
 PL Skrzynka zaworowa ogrodowa
 DE Gartenventilgehäuse
 RU Садовый вентиляный ящик
 CZ Zahradní ventilový box
 RO Cutie cu supape pt. irigație
 HU Kerti szelepdoboz
 ES Caja para válvulas, jardín



No.		
88784		2

EN Quick coupler valve key
 PL Złączka do zaworu szybkozłącznego
 DE Schlüssel für Schnellkupplungsventil
 RU Ключ для клапана быстрого соединения
 CZ Klíč rychloupínacího ventilu
 RO Cheie pt. supapă cu cuplare rapidă
 HU Kulcs gyorscsatlakozó szelephez
 ES Llave para la válvula de conexión rápida



No.	Connector thread size / Rozmiar gwintu przyłącza	
88927	G3/4 (M)	40/160

EN Adapter
 PL Złączka do rur
 DE Rohrverbindung
 RU Ниппель для труб
 CZ Trubková spojka
 RO Adaptor
 HU Csatlakozó csőhöz
 ES Conector de tubos



No.	Connector thread size / Rozmiar gwintu przyłącza	Water outlet diameter / Średnica przyłącza wody [mm]	
88851	G1 (M)	25	30/240

EN Adapter
 PL Złączka do rur
 DE Rohrverbindung
 RU Ниппель для труб
 CZ Trubková spojka
 RO Adaptor
 HU Csatlakozó csőhöz
 ES Conector de tubos



No.	Connector thread size / Rozmiar gwintu przyłącza	Water outlet diameter / Średnica przyłącza wody [mm]	
88850	G3/4 (M)	25	50/200

EN Quick coupler valve
 PL Zawór szybkozłączny
 DE Schnellkupplungsventil
 RU Клапан быстрого соединения
 CZ Rychloupínací ventil
 RO Supapă cu cuplare rapidă
 HU Gyorscsatlakozó szelep
 ES Válvula de conexión rápida



No.	Connector thread size / Rozmiar gwintu przyłącza	
88926	G1 (F)	40/80

EN Adapter
 PL Złączka do rur
 DE Rohrverbindung
 RU Ниппель для труб
 CZ Trubková spojka
 RO Adaptor
 HU Csatlakozó csőhöz
 ES Conector de tubos



No.	Connector thread size / Rozmiar gwintu przyłącza	Water outlet diameter / Średnica przyłącza wody [mm]	
88897	G1-1/4 (M)	32	30/180

EN Adapter
 PL Złączka do rur
 DE Rohrverbindung
 RU Ниппель для труб
 CZ Trubková spojka
 RO Adaptor
 HU Csatlakozó csőhöz
 ES Conector de tubos



No.	Connector thread size / Rozmiar gwintu przyłącza	Water outlet diameter / Średnica przyłącza wody [mm]	
88896	G1 (M)	32	30/180

EN Adapter
 PL Złączka do rur
 DE Rohrverbindung
 RU Ниппель для труб
 CZ Trubková spojka
 RO Adaptor
 HU Csatlakozó csőhöz
 ES Conector de tubos



No.	Connector thread size / Rozmiar gwintu przyłącza	Water outlet diameter / Średnica przyłącza wody [mm]	
88895	G3/4 (M)	32	30/180

EN Adapter
 PL Złączka do rur
 DE Rohrverbindung
 RU Ниппель для труб
 CZ Trubková spojka
 RO Adaptor
 HU Csatlakozó csőhöz
 ES Conector de tubos



(M) G1/2
 Ø 25 mm
 1 MPa (max.)
 PP



No.	Connector thread size / Rozmiar gwintu przyłącza	Water outlet diameter / Średnica przyłącza wody [mm]	
88849	G1/2 (M)	25	30/240

EN Adapter
 PL Złączka do rur
 DE Rohrverbindung
 RU Ниппель для труб
 CZ Trubková spojka
 RO Adaptor
 HU Csatlakozó csőhöz
 ES Conector de tubos



(F) G1 1/4
 Ø 32 mm
 1 MPa (max.)
 PP



No.	Connector thread size / Rozmiar gwintu przyłącza	Water outlet diameter / Średnica przyłącza wody [mm]	
88893	G1-1/4 (F)	32	30/180

EN Adapter
 PL Złączka do rur
 DE Rohrverbindung
 RU Ниппель для труб
 CZ Trubková spojka
 RO Adaptor
 HU Csatlakozó csőhöz
 ES Conector de tubos



(F) G1
 Ø 32 mm
 1 MPa (max.)
 PP



No.	Connector thread size / Rozmiar gwintu przyłącza	Water outlet diameter / Średnica przyłącza wody [mm]	
88892	G1 (F)	32	30/180

EN Adapter
 PL Złączka do rur
 DE Rohrverbindung
 RU Ниппель для труб
 CZ Trubková spojka
 RO Adaptor
 HU Csatlakozó csőhöz
 ES Conector de tubos



(F) G3/4
 Ø 32 mm
 1 MPa (max.)
 PP



No.	Connector thread size / Rozmiar gwintu przyłącza	Water outlet diameter / Średnica przyłącza wody [mm]	
88891	G3/4 (F)	32	30/180

EN Adapter
 PL Złączka do rur
 DE Rohrverbindung
 RU Ниппель для труб
 CZ Trubková spojka
 RO Adaptor
 HU Csatlakozó csőhöz
 ES Conector de tubos



(M) G1/2
 Ø 32 mm
 1 MPa (max.)
 PP



No.	Connector thread size / Rozmiar gwintu przyłącza	Water outlet diameter / Średnica przyłącza wody [mm]	
88894	G1/2 (M)	32	30/180

EN Adapter
 PL Złączka do rur
 DE Rohrverbindung
 RU Ниппель для труб
 CZ Trubková spojka
 RO Adaptor
 HU Csatlakozó csőhöz
 ES Conector de tubos



(F) G1
 Ø 25 mm
 1 MPa (max.)
 PP



No.	Connector thread size / Rozmiar gwintu przyłącza	Water outlet diameter / Średnica przyłącza wody [mm]	
88842	G1 (F)	25	30/240

EN Adapter
 PL Złączka do rur
 DE Rohrverbindung
 RU Ниппель для труб
 CZ Trubková spojka
 RO Adaptor
 HU Csatlakozó csőhöz
 ES Conector de tubos



(F) G3/4
 Ø 25 mm
 1 MPa (max.)
 PP



No.	Connector thread size / Rozmiar gwintu przyłącza	Water outlet diameter / Średnica przyłącza wody [mm]	
88841	G3/4 (F)	25	30/240

EN Adapter
 PL Złączka do rur
 DE Rohrverbindung
 RU Ниппель для труб
 CZ Trubková spojka
 RO Adaptor
 HU Csatlakozó csőhöz
 ES Conector de tubos



(F) G1/2
 Ø 25 mm
 1 MPa (max.)
 PP



No.	Connector thread size / Rozmiar gwintu przyłącza	Water outlet diameter / Średnica przyłącza wody [mm]	
88840	G1/2 (F)	25	30/240

EN Adapter
 PL Złącza do rur
 DE Rohrverbindung
 RU Ниппель для труб
 CZ Trubková spojka
 RO Adaptor
 HU Csatlakozó csőhöz
 ES Conector de tubos



(F) G1/2
 ∅ 32 mm
 1 MPa (max.)
 PP



No.	Connector thread size / Rozmiar gwintu przyłącza	Water outlet diameter / Średnica przyłącza wody [mm]	
88890	G1/2 (F)	32	30/180

EN Adapter - pipe plug
 PL Ząslepka do rur
 DE Rohrstopfen
 RU Заглушка для труб
 CZ Záslepka do trubek
 RO Adaptor - conector teava
 HU Elzáró sapka csőhöz
 ES Tapa de tubos



∅ 32 mm
 1 MPa (max.)
 PP



No.	Water outlet diameter / Średnica przyłącza wody [mm]	
88920	32	30/240

EN Adapter
 PL Złącza do rur
 DE Rohrverbindung
 RU Ниппель для труб
 CZ Trubková spojka
 RO Adaptor
 HU Csatlakozó csőhöz
 ES Conector de tubos



∅ 32/25 mm
 1.0 MPa (max.)
 PP



No.	Water outlet diameter / Średnica przyłącza wody [mm]	
88859	32x25	15/90

EN Adapter 90°
 PL Kolanko do rur
 DE Rohrkümmner
 RU Колено для труб
 CZ Trubkový ohyb
 RO Adaptor 90°
 HU Derékszög csőhöz
 ES Codo para tubos



90° (M) G1-1/4 ∅ 32 mm
 1 MPa (max.) PP



No.	Connector thread size / Rozmiar gwintu przyłącza	Water outlet diameter / Średnica przyłącza wody [mm]	
88917	G1-1/4 (M)	32	15/150

EN Adapter - pipe plug
 PL Ząslepka do rur
 DE Rohrstopfen
 RU Заглушка для труб
 CZ Záslepka do trubek
 RO Adaptor - conector teava
 HU Elzáró sapka csőhöz
 ES Tapa de tubos



∅ 25 mm
 1 MPa (max.)
 PP



No.	Water outlet diameter / Średnica przyłącza wody [mm]	
88853	25	50/200

EN Adapter
 PL Złącza do rur
 DE Rohrverbindung
 RU Ниппель для труб
 CZ Trubková spojka
 RO Adaptor
 HU Csatlakozó csőhöz
 ES Conector de tubos



∅ 25 mm
 1 MPa (max.)
 PP



No.	Water outlet diameter / Średnica przyłącza wody [mm]	
88858	25x25	50/200

EN Adapter
 PL Złącza do rur
 DE Rohrverbindung
 RU Ниппель для труб
 CZ Trubková spojka
 RO Adaptor
 HU Csatlakozó csőhöz
 ES Conector de tubos



∅ 32 mm
 1 MPa (max.)
 PP



No.	Water outlet diameter / Średnica przyłącza wody [mm]	
88899	32x32	15/90

EN Adapter 90°
 PL Kolanko do rur
 DE Rohrkümmner
 RU Колено для труб
 CZ Trubkový ohyb
 RO Adaptor 90°
 HU Derékszög csőhöz
 ES Codo para tubos



90° (M) G1 ∅ 25 mm
 1 MPa (max.) PP



No.	Connector thread size / Rozmiar gwintu przyłącza	Water outlet diameter / Średnica przyłącza wody [mm]	
88870	G1 (M)	25	50/200

EN Adapter 90°
 PL Kolanko do rur
 DE Rohrkürmmer
 RU Колено для труб
 CZ Trubkový ohyb
 RO Adaptor 90°
 HU Derékszög csőhöz
 ES Codo para tubos

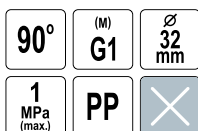

No.	Connector thread size / Rozmiar gwintu przyłącza	Water outlet diameter / Średnica przyłącza wody [mm]	
88916	G1 (M)	32	15/150

EN Adapter 90°
 PL Kolanko do rur
 DE Rohrkürmmer
 RU Колено для труб
 CZ Trubkový ohyb
 RO Adaptor 90°
 HU Derékszög csőhöz
 ES Codo para tubos



No.	Connector thread size / Rozmiar gwintu przyłącza	Water outlet diameter / Średnica przyłącza wody [mm]	
88915	G3/4 (M)	32	15/150

EN Adapter 90°
 PL Kolanko do rur
 DE Rohrkürmmer
 RU Колено для труб
 CZ Trubkový ohyb
 RO Adaptor 90°
 HU Derékszög csőhöz
 ES Codo para tubos

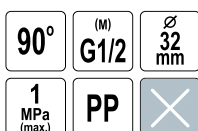

No.	Connector thread size / Rozmiar gwintu przyłącza	Water outlet diameter / Średnica przyłącza wody [mm]	
88914	G1/2 (M)	32	15/150

EN Adapter 90°
 PL Kolanko do rur
 DE Rohrkürmmer
 RU Колено для труб
 CZ Trubkový ohyb
 RO Adaptor 90°
 HU Derékszög csőhöz
 ES Codo para tubos



No.	Connector thread size / Rozmiar gwintu przyłącza	Water outlet diameter / Średnica przyłącza wody [mm]	
88913	G1 (F)	32	15/150

EN Adapter 90°
 PL Kolanko do rur
 DE Rohrkürmmer
 RU Колено для труб
 CZ Trubkový ohyb
 RO Adaptor 90°
 HU Derékszög csőhöz
 ES Codo para tubos



No.	Connector thread size / Rozmiar gwintu przyłącza	Water outlet diameter / Średnica przyłącza wody [mm]	
88869	G3/4 (M)	25	15/150

EN Adapter 90°
 PL Kolanko do rur
 DE Rohrkürmmer
 RU Колено для труб
 CZ Trubkový ohyb
 RO Adaptor 90°
 HU Derékszög csőhöz
 ES Codo para tubos

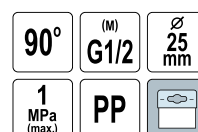

No.	Connector thread size / Rozmiar gwintu przyłącza	Water outlet diameter / Średnica przyłącza wody [mm]	
88871	G1/2 (M)	25	50/200

EN Adapter 90°
 PL Kolanko do rur
 DE Rohrkürmmer
 RU Колено для труб
 CZ Trubkový ohyb
 RO Adaptor 90°
 HU Derékszög csőhöz
 ES Codo para tubos



No.	Connector thread size / Rozmiar gwintu przyłącza	Water outlet diameter / Średnica przyłącza wody [mm]	
88874	G1 (F)	25	15/150

EN Adapter 90°
 PL Kolanko do rur
 DE Rohrkürmmer
 RU Колено для труб
 CZ Trubkový ohyb
 RO Adaptor 90°
 HU Derékszög csőhöz
 ES Codo para tubos

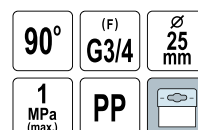

No.	Connector thread size / Rozmiar gwintu przyłącza	Water outlet diameter / Średnica przyłącza wody [mm]	
88857	G3/4 (F)	25	50/200

EN Adapter 90°
 PL Kolanko do rur
 DE Rohrkrümmmer
 RU Колено для труб
 CZ Trubkový ohyb
 RO Adaptor 90°
 HU Derékszög csőhöz
 ES Codo para tubos

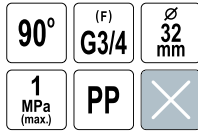

No.	Connector thread size / Rozmiar gwintu przyłącza	Water outlet diameter / Średnica przyłącza wody [mm]	Box icon
88912	G3/4 (F)	32	15/150

EN Adapter 90°
 PL Kolanko do rur
 DE Rohrkrümmmer
 RU Колено для труб
 CZ Trubkový ohyb
 RO Adaptor 90°
 HU Derékszög csőhöz
 ES Codo para tubos

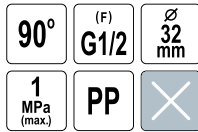

No.	Connector thread size / Rozmiar gwintu przyłącza	Water outlet diameter / Średnica przyłącza wody [mm]	Box icon
88911	G1/2 (F)	32	15/150

EN Adapter 90°
 PL Kolanko do rur
 DE Rohrkrümmmer
 RU Колено для труб
 CZ Trubkový ohyb
 RO Adaptor 90°
 HU Derékszög csőhöz
 ES Codo para tubos

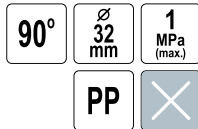

No.	Water outlet diameter / Średnica przyłącza wody [mm]	Box icon
88910	32x32	15/90

EN Adapter
 PL Trójnik
 DE T-Stück
 RU Тройник
 CZ Rozdělovač
 RO Adaptor
 HU Hármás elosztó
 ES Tubos en T



No.	Connector thread size / Rozmiar gwintu przyłącza	Water outlet diameter / Średnica przyłącza wody [mm]	Box icon
88860	G1 (M)	25x25	50/200

EN Adapter 90°
 PL Kolanko do rur
 DE Rohrkrümmmer
 RU Колено для труб
 CZ Trubkový ohyb
 RO Adaptor 90°
 HU Derékszög csőhöz
 ES Codo para tubos

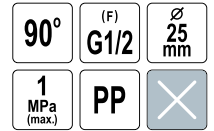

No.	Connector thread size / Rozmiar gwintu przyłącza	Water outlet diameter / Średnica przyłącza wody [mm]	Box icon
88872	G1/2 (F)	25	15/150

EN Adapter 90°
 PL Kolanko do rur
 DE Rohrkrümmmer
 RU Колено для труб
 CZ Trubkový ohyb
 RO Adaptor 90°
 HU Derékszög csőhöz
 ES Codo para tubos



No.	Water outlet diameter / Średnica przyłącza wody [mm]	Box icon
88856	25x25	50/200

EN Adapter
 PL Trójnik
 DE T-Stück
 RU Тройник
 CZ Rozdělovač
 RO Adaptor
 HU Hármás elosztó
 ES Tubos en T

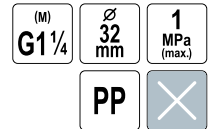

No.	Connector thread size / Rozmiar gwintu przyłącza	Water outlet diameter / Średnica przyłącza wody [mm]	Box icon
88908	G1-1/4 (M)	32x32	15/90

EN Adapter
 PL Trójnik
 DE T-Stück
 RU Тройник
 CZ Rozdělovač
 RO Adaptor
 HU Hármás elosztó
 ES Tubos en T



No.	Connector thread size / Rozmiar gwintu przyłącza	Water outlet diameter / Średnica przyłącza wody [mm]	Box icon
88907	G1 (M)	32x32	15/90

EN Adapter
 PL Trójnik
 DE T-Stück
 RU Тройник
 CZ Rozdělovač
 RO Adaptor
 HU Hármás elosztó
 ES Tubos en T



No.	Connector thread size / Rozmiar gwintu przyłącza	Water outlet diameter / Średnica przyłącza wody [mm]	
88861	G3/4 (M)	25x25	50/200

EN Adapter
 PL Trójnik
 DE T-Stück
 RU Тройник
 CZ Rozdělovač
 RO Adaptor
 HU Hármás elosztó
 ES Tubos en T



No.	Connector thread size / Rozmiar gwintu przyłącza	Water outlet diameter / Średnica przyłącza wody [mm]	
88862	G1/2 (M)	25x25	50/200

EN Adapter
 PL Trójnik
 DE T-Stück
 RU Тройник
 CZ Rozdělovač
 RO Adaptor
 HU Hármás elosztó
 ES Tubos en T



No.	Connector thread size / Rozmiar gwintu przyłącza	Water outlet diameter / Średnica przyłącza wody [mm]	
88863	G1 (F)	25x25	50/200

EN Adapter
 PL Trójnik
 DE T-Stück
 RU Тройник
 CZ Rozdělovač
 RO Adaptor
 HU Hármás elosztó
 ES Tubos en T



No.	Connector thread size / Rozmiar gwintu przyłącza	Water outlet diameter / Średnica przyłącza wody [mm]	
88855	G3/4 (F)	25x25	50/200

EN Adapter
 PL Trójnik
 DE T-Stück
 RU Тройник
 CZ Rozdělovač
 RO Adaptor
 HU Hármás elosztó
 ES Tubos en T



No.	Connector thread size / Rozmiar gwintu przyłącza	Water outlet diameter / Średnica przyłącza wody [mm]	
88906	G3/4 (M)	32x32	15/90

EN Adapter
 PL Trójnik
 DE T-Stück
 RU Тройник
 CZ Rozdělovač
 RO Adaptor
 HU Hármás elosztó
 ES Tubos en T



No.	Connector thread size / Rozmiar gwintu przyłącza	Water outlet diameter / Średnica przyłącza wody [mm]	
88905	G1/2 (M)	32x32	15/90

EN Adapter
 PL Trójnik
 DE T-Stück
 RU Тройник
 CZ Rozdělovač
 RO Adaptor
 HU Hármás elosztó
 ES Tubos en T



No.	Connector thread size / Rozmiar gwintu przyłącza	Water outlet diameter / Średnica przyłącza wody [mm]	
88904	G1 (F)	32x32	15/90

EN Adapter
 PL Trójnik
 DE T-Stück
 RU Тройник
 CZ Rozdělovač
 RO Adaptor
 HU Hármás elosztó
 ES Tubos en T



No.	Connector thread size / Rozmiar gwintu przyłącza	Water outlet diameter / Średnica przyłącza wody [mm]	
88903	G3/4 (F)	32x32	15/90

EN Adapter
 PL Trójnik
 DE T-Stück
 RU Тройник
 CZ Rozdělovač
 RO Adaptor
 HU Hármás elosztó
 ES Tubos en T



No.	Connector thread size / Rozmiar gwintu przyłącza	Water outlet diameter / Średnica przyłącza wody [mm]	Package icon
88864	G1/2 (F)	25x25	50/200

EN Adapter
 PL Trójnik
 DE T-Stück
 RU Тройник
 CZ Rozdělovač
 RO Adaptor
 HU Hármás elosztó
 ES Tubos en T

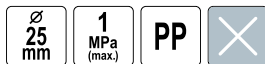

No.	Water outlet diameter / Średnica przyłącza wody [mm]	Package icon
88865	25x25x25	15/120

EN Adapter
 PL Trójnik
 DE T-Stück
 RU Тройник
 CZ Rozdělovač
 RO Adaptor
 HU Hármás elosztó
 ES Tubos en T

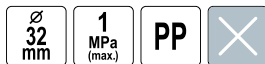

No.	Water outlet diameter / Średnica przyłącza wody [mm]	Package icon
88909	32x32x32	15/90

EN Water filter
 PL Filtr wody
 DE Wasserfilter
 RU Фильтр очистки воды
 CZ Vodní filtr
 RO Filtru apa
 HU Vízszűrő
 ES Filtro de agua



No.	Connector thread size / Rozmiar gwintu przyłącza	Package icon
88931	G1 BSP (M)	24

EN Adapter
 PL Trójnik
 DE T-Stück
 RU Тройник
 CZ Rozdělovač
 RO Adaptor
 HU Hármás elosztó
 ES Tubos en T



No.	Connector thread size / Rozmiar gwintu przyłącza	Water outlet diameter / Średnica przyłącza wody [mm]	Package icon
88900	G1/2 (F)	32x32	15/90

EN Adapter
 PL Trójnik
 DE T-Stück
 RU Тройник
 CZ Rozdělovač
 RO Adaptor
 HU Hármás elosztó
 ES Tubos en T

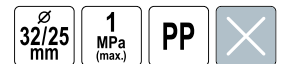

No.	Water outlet diameter / Średnica przyłącza wody [mm]	Package icon
88902	32x25x32	15/90

EN Water filter
 PL Filtr wody
 DE Wasserfilter
 RU Фильтр очистки воды
 CZ Vodní filtr
 RO Filtru apa
 HU Vízszűrő
 ES Filtro de agua



No.	Connector thread size / Rozmiar gwintu przyłącza	Package icon
88930	G3/4 BSP (M)	24

EN Water filter
 PL Filtr wody
 DE Wasserfilter
 RU Фильтр очистки воды
 CZ Vodní filtr
 RO Filtru apa
 HU Vízszűrő
 ES Filtro de agua

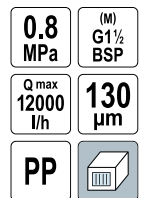

No.	Connector thread size / Rozmiar gwintu przyłącza	Package icon
88932	G1-1/2 BSP (M)	9

EN Water filter
 PL Filtr wody
 DE Wasserfilter
 RU Фильтр очистки воды
 CZ Vodní filtr
 RO Filtru apa
 HU Vízsűrű
 ES Filtro de agua



0.8 MPa (M) G2 BSP Q max 22000 l/h
 130 µm PP



No.	Connector thread size / Rozmiar gwintu przyłącza	
88933	G2 BSP (M)	9

EN Filter element of screen filter
 PL Wkład siatkowy do filtra wody
 DE Mascheneinsatz für Wasserfilter
 RU Сетчатый картридж для фильтра очистки воды
 CZ Sítovaná vložka vodního filtru
 RO Sita filtru
 HU Hálós betét vízsűrűbe
 ES Cartucho de malla para filtro de agua



(M) G1 1/2 BSP (M) G2 BSP 120 MESH SITO
 PP SS STAINLESS STEEL STAL NIERDZEWNA



No.	Connector thread size / Rozmiar gwintu przyłącza	For / Dla	
88936	G1-1/2 BSP (M), G2 BSP (M)	88932, 88933	32

EN Filter element of disc filter
 PL Wkład dyskowy do filtra wody
 DE Scheibenfiltereinsatz für Wasserfilter
 RU Дисковый картридж для фильтра очистки воды
 CZ Disková vložka do vodního filtru
 RO Disc filtru
 HU Lemezest betét vízsűrűbe
 ES Cartucho de disco para filtro de agua



(M) G1 1/2 BSP (M) G2 BSP 130 µm PP



No.	Connector thread size / Rozmiar gwintu przyłącza	For / Dla	
88939	G1-1/2 BSP (M), G2 BSP (M)	88932, 88933	32

EN Bypass pruner
 PL Sekator uniwersalny
 DE Gartenschere
 RU Секатор
 CZ Zahradní nůžky
 RO Foarfece pt. pomi
 HU Metszőolló
 ES Tijera de poda

190 mm ø 15mm



No.	L [mm]	
99194	190	12/120

EN Filter element of screen filter
 PL Wkład siatkowy do filtra wody
 DE Mascheneinsatz für Wasserfilter
 RU Сетчатый картридж для фильтра очистки воды
 CZ Sítovaná vložka vodního filtru
 RO Sita filtru
 HU Hálós betét vízsűrűbe
 ES Cartucho de malla para filtro de agua



(M) G3/4 BSP (M) G1 BSP 120 MESH SITO
 PP SS STAINLESS STEEL STAL NIERDZEWNA



No.	Connector thread size / Rozmiar gwintu przyłącza	For / Dla	
88935	G3/4 BSP (M), G1 BSP (M)	88930, 88931	144

EN Filter element of disc filter
 PL Wkład dyskowy do filtra wody
 DE Scheibenfiltereinsatz für Wasserfilter
 RU Дисковый картридж для фильтра очистки воды
 CZ Disková vložka do vodního filtru
 RO Disc filtru
 HU Lemezest betét vízsűrűbe
 ES Cartucho de disco para filtro de agua



(M) G3/4 (M) G1 130 µm PP



No.	Connector thread size / Rozmiar gwintu przyłącza	For / Dla	
88938	G3/4 BSP (M), G1 BSP (M)	88930, 88931	144

EN Bypass pruner
 PL Sekator uniwersalny
 DE Gartenschere
 RU Секатор
 CZ Zahradní nůžky
 RO Foarfece pt. pomi
 HU Metszőolló
 ES Tijera de poda

180 mm ø 10mm



No.	L [mm]	
99193	180	12/120

EN Bypass pruner
 PL Sekator uniwersalny
 DE Gartenschere
 RU Секатор
 CZ Zahradní nůžky
 RO Foarfece pt. pomi
 HU Metszőolló
 ES Tijera de poda

200 mm



No.	L [mm]	
99230	200	20/60

EN Bypass pruner
 PL Sekator uniwersalny
 DE Gartenschere
 RU Секатор
 CZ Zahradní nůžky
 RO Foarfece pt. pomi
 HU Metszőolló
 ES Tijera de poda



No.	L [mm]	
99190	200	18/72

EN Bypass pruner
 PL Sekator uniwersalny
 DE Gartenschere
 RU Секатор
 CZ Zahradní nůžky
 RO Foarfece pt. pomi
 HU Metszőolló
 ES Tijera de poda

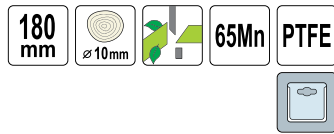

No.	L [mm]	
99202	180	18/72

EN Bypass pruner
 PL Sekator uniwersalny
 DE Gartenschere
 RU Секатор
 CZ Zahradní nůžky
 RO Foarfece pt. pomi
 HU Metszőolló
 ES Tijera de poda



No.	L [mm]	
99204	220	20/60

EN Bypass pruner
 PL Sekator uniwersalny
 DE Gartenschere
 RU Секатор
 CZ Zahradní nůžky
 RO Foarfece pt. pomi
 HU Metszőolló
 ES Tijera de poda



No.	L [mm]	
99206	210	20/60

EN Bypass pruner
 PL Sekator uniwersalny
 DE Gartenschere
 RU Секатор
 CZ Zahradní nůžky
 RO Foarfece pt. pomi
 HU Metszőolló
 ES Tijera de poda



No.	L [mm]	
99209	215	6/48

EN Bypass pruner
 PL Sekator uniwersalny
 DE Gartenschere
 RU Секатор
 CZ Zahradní nůžky
 RO Foarfece pt. pomi
 HU Metszőolló
 ES Tijera de poda

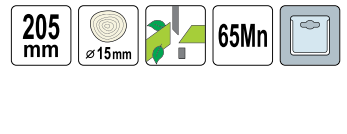

No.	L [mm]	
99203	205	20/60

EN Bypass pruner
 PL Sekator uniwersalny
 DE Gartenschere
 RU Секатор
 CZ Zahradní nůžky
 RO Foarfece pt. pomi
 HU Metszőolló
 ES Tijera de poda



No.	L [mm]	
99208	200	12/60

EN Anvil pruner
 PL Sekator kowadłkowy
 DE Amboss-Gartenschere
 RU Секатор с наковальней
 CZ Kovadlinkové zahradní nůžky
 RO Foarfecea nicovala
 HU Metszőolló
 ES Tijera de poda de yunque

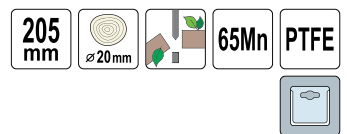

No.	L [mm]	
99207	205	20/60

EN Anvil pruner
 PL Sekator kowadełkowy
 DE Amboss-Gartenschere
 RU Секатор с наковальней
 CZ Kovadlinkové zahradní nůžky
 RO Foarfeca nicovala
 HU Metszőolló
 ES Tijera de poda de yunque



No.	L [mm]	
99191	200	18/72

EN By-pass pruners set
 PL Zestaw sekatorów
 DE Scherenset
 RU Набор ножниц
 CZ Zahradnické nůžky sada
 RO Set de foarfece pt. pomi
 HU Metszés olló készlet
 ES Juego de tijeras



No.	L [mm]	
99195	150	24

EN Flower shears
 PL Nożyce florystyczne
 DE Blumenschere
 RU Цветочные ножницы
 CZ Květinové nůžky
 RO Foarfece de grădină
 HU Virág ollók
 ES Tijeras de podar



No.	L [mm]	
99181	145	12/120

EN Flower shears
 PL Nożyce florystyczne
 DE Blumenschere
 RU Цветочные ножницы
 CZ Květinové nůžky
 RO Foarfece de grădină
 HU Virág ollók
 ES Tijeras de podar



No.	L [mm]	
99182	165	12/120

EN Grafting tool
 PL Sekator do szczepień
 DE Gartenschere zum Pfropfen
 RU Секатор для прививки
 CZ Roubovací nůžky
 RO Instrument pt. altoit
 HU Oltó olló
 ES Tijera injertadora



No.		
99250		20

EN Fruit and flower shears
 PL Sekator do obcinania zawiązków
 DE Blumen- und Rebschere
 RU Секатор
 CZ Nožnice zahradnické
 RO Foarfece pt. pomi
 HU Metszőolló
 ES Podadera para cortar germenes



No.	L [mm]	
99240	190	12/72

EN Flower shears
 PL Nożyce florystyczne
 DE Blumenschere
 RU Цветочные ножницы
 CZ Květinové nůžky
 RO Foarfece de grădină
 HU Virág ollók
 ES Tijeras de podar



No.	L [mm]	
99180	170	12/120

EN Bypass lopper
 PL Sekator do gałęzi
 DE Astschere
 RU Сучкорез
 CZ Nůžky na větve
 RO Foarfece curbata pt. taiat crengi
 HU Ágvágó olló
 ES Tijera para ramas

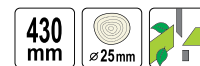

No.	L [mm]	
99101	430	12

EN Bypass lopper
 PL Sekator do gałęzi
 DE Astschere
 RU Сучкорез
 CZ Nůžky na větve
 RO Foarfeca curbata pt. taiat crengi
 HU Ágvágó olló
 ES Tijera para ramas



FLO

No.	L [mm]	
99103	535	12

EN Bypass lopper
 PL Sekator do gałęzi
 DE Astschere
 RU Сучкорез
 CZ Nůžky na větve
 RO Foarfeca curbata pt. taiat crengi
 HU Ágvágó olló
 ES Tijera para ramas

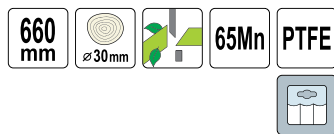

FLO

No.	L [mm]	
99109	660	12

EN Bypass lopper
 PL Sekator do gałęzi
 DE Astschere
 RU Сучкорез
 CZ Nůžky na větve
 RO Foarfeca curbata pt. taiat crengi
 HU Ágvágó olló
 ES Tijera para ramas



FLO

No.	L [mm]	
99111	700	12

EN Telescopic bypass lopper
 PL Sekator teleskopowy do gałęzi
 DE Teleskop-Astschere
 RU Сучкорез телескопический
 CZ Teleskopické nůžky na větve
 RO Foarfeca telescopica pt. crengi
 HU Ágvágó teleszkópos
 ES Tijera de poda telescópica

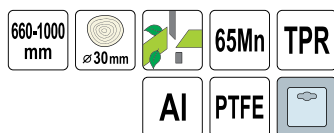

FLO

No.	L [mm]	
99114	660-1000	12

EN Bypass lopper
 PL Sekator do gałęzi
 DE Astschere
 RU Сучкорез
 CZ Nůžky na větve
 RO Foarfeca curbata pt. taiat crengi
 HU Ágvágó olló
 ES Tijera para ramas



FLO

No.	L [mm]	
99104	630	12

EN Bypass lopper
 PL Sekator do gałęzi
 DE Astschere
 RU Сучкорез
 CZ Nůžky na větve
 RO Foarfeca curbata pt. taiat crengi
 HU Ágvágó olló
 ES Tijera para ramas

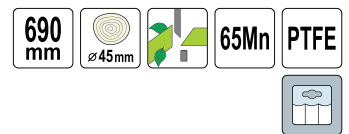

FLO

No.	L [mm]	
99116	690	12

EN Telescopic bypass lopper
 PL Sekator teleskopowy do gałęzi
 DE Teleskop-Astschere
 RU Сучкорез телескопический
 CZ Teleskopické nůžky na větve
 RO Foarfeca telescopica pt. crengi
 HU Ágvágó teleszkópos
 ES Tijera de poda telescópica

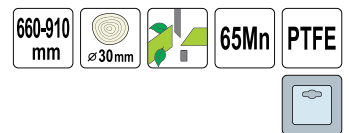

FLO

No.	L [mm]	
99119	660-910	12

EN Telescopic bypass lopper
 PL Sekator teleskopowy do gałęzi
 DE Teleskop-Astschere
 RU Сучкорез телескопический
 CZ Teleskopické nůžky na větve
 RO Foarfeca telescopica pt. crengi
 HU Ágvágó teleszkópos
 ES Tijera de poda telescópica

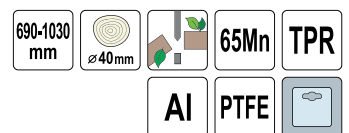

FLO

No.	L [mm]	
99113	690-1030	6

EN Bypass lopper
 PL Sekator do gałęzi
 DE Astschere
 RU Сучкорез
 CZ Nůžky na větve
 RO Foarfeca curbata pt. taiat crengi
 HU Ágvágó olló
 ES Tijera para ramas

620-940 mm   65Mn PTFE



FLO 

No.	L [mm]	
99115	620-940	12

EN Bypass lopper
 PL Sekator do gałęzi
 DE Astschere
 RU Сучкорез
 CZ Nůžky na větve
 RO Foarfeca curbata pt. taiat crengi
 HU Ágvágó olló
 ES Tijera para ramas

690 mm   65Mn PTFE

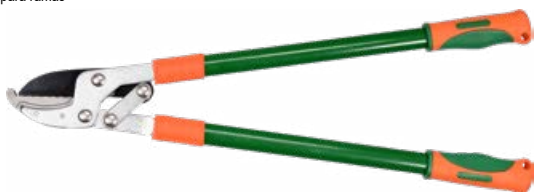

FLO 

No.	L [mm]	
99112	690	12

EN Telescopic handle
 PL Przedłużka teleskopowa
 DE Teleskopstange
 RU Рукотка телескопическая

CZ Teleskopický prodlužovač
 RO Prelungitor telescopic
 HU Teleszkópos hosszabbító
 ES Tubo de prolongación telescópico

130-237 cm 



FLO 

No.	L [mm]	
99315	1300-2370	12

EN Hedge shears
 PL Nożyce do żywoplotu
 DE Heckenschere
 RU Кусторезы
 CZ Nožnice na živý plot
 RO Foarfeca pt. gard viu
 HU Sővényvágó olló
 ES Tijeras para seto vivo

205/550 mm  65Mn 



FLO 

No.	L [mm]	
99005	550	20

EN Bypass lopper
 PL Sekator do gałęzi
 DE Astschere
 RU Сучкорез
 CZ Nůžky na větve
 RO Foarfeca curbata pt. taiat crengi
 HU Ágvágó olló
 ES Tijera para ramas

660 mm   65Mn PTFE



FLO 

No.	L [mm]	
99110	660	12

EN Leverage tree pruner
 PL Sekator gasienicowy z piłą
 DE Baumsäge mit astschere
 RU Сучкорез штанговый с пилой
 CZ Sříhač na větve s pilovým listem
 RO Fierastrau pt. pomi cu prelungitor
 HU Kőteles ágvágó
 ES Podadera de palanca con sierra

330 mm   65Mn

PTFE  



FLO 

No.	L [mm]	
99310	330	12/24

EN Hedge shears
 PL Nożyce do żywoplotu
 DE Heckenschere
 RU Кусторезы
 CZ Nožnice na živý plot
 RO Foarfeca pt. gard viu
 HU Sővényvágó olló
 ES Tijeras para seto vivo

150/415 mm  65Mn 



FLO 

No.	L [mm]	
99001	415	12

EN Hedge shears
 PL Nożyce do żywoplotu
 DE Heckenschere
 RU Кусторезы
 CZ Nožnice na živý plot
 RO Foarfeca pt. gard viu
 HU Sővényvágó olló
 ES Tijeras para seto vivo

205/630 mm  65Mn PTFE 



FLO 

No.	L [mm]	
99006	630	12

EN Hedge shears
 PL Nożyce do żywoplotu
 DE Heckenschere
 RU Кусторезы
 CZ Nožnice na živý plot
 RO Foarfeca pt. gard viu
 HU Sónyenyvágó olló
 ES Tijeras para seto vivo

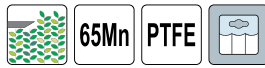

No.	L [mm]	Blade length / Długość ostrza [mm]	
99007	590	185	18
99008	620	215	18

EN Grass shears
 PL Nożyce do trawy wielopozycyjne
 DE Handgrasschere
 RU Ножницы для стрижки травы
 CZ Nožnice na trávu
 RO Foarfeca pt. gazon
 HU Forgatható fűnyíró olló
 ES Tijeras de césped



No.	L [mm]	
99300	320	12/48

EN Pruning saw
 PL Pila ogrodnicza - lisi ogon
 DE Baumsäge
 RU Пила садовая
 CZ Zahradnická pila - liščí ocas
 RO Fierăstrău de grădină - coadă de vulpe
 HU Gallyazófűrész-róka farkú
 ES Sierra de jardín - cola de zorro



No.	L [mm]	
28640	250	12/120

EN Pruning saw
 PL Pila do gałęzi z kaburą
 DE Baumsäge
 RU Пила садовая
 CZ Zahradnická pila
 RO Fierăstrău pt. perforare
 HU Gallyazófűrész
 ES Sierra de jardín

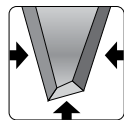

No.	L [mm]	
28642	300	12/36

EN Hedge shears
 PL Nożyce do żywoplotu
 DE Heckenschere
 RU Кусторезы
 CZ Nožnice na živý plot
 RO Foarfeca pt. gard viu
 HU Sónyenyvágó olló
 ES Tijeras para seto vivo



No.	L [mm]	
99009	650-860	12

EN Grass shears
 PL Nożyce do trawy wielopozycyjne
 DE Handgrasschere
 RU Ножницы для стрижки травы
 CZ Nožnice na trávu
 RO Foarfeca pt. gazon
 HU Forgatható fűnyíró olló
 ES Tijeras de césped



No.	L [mm]	
99301	300	12/48

EN Pruning saw
 PL Pila do gałęzi składana
 DE Baumsäge
 RU Пила садовая
 CZ Zahradnická pila
 RO Fierăstrău pt. perforare
 HU Gallyazófűrész
 ES Sierra para ramos plegable

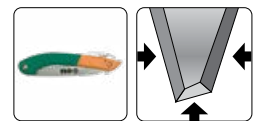

No.	L [mm]	
28641	180	20/60

EN Bow saw
 PL Pila kabłąkowa
 DE Bügelsäge
 RU Лучковая пила по дереву
 CZ Oblouková pila
 RO Ferăstrău de curbură
 HU Keretes fűrész
 ES Sierra de arco



No.	L [mm]	
28740	525	24
28750	750	24

EN Bow saw
 PL Pila kabłąkowa
 DE Bügelsäge
 RU Лучковая пила по дереву
 CZ Oblouková pila
 RO Ferăstrău de curbură
 HU Keretes fűrész
 ES Sierra de arco



FLO

No.	L [mm]	
28745	530	12/24

EN Spare blade for bow saw
 PL Brzeszczot
 DE Bügelsägeblatt
 RU Полотно для лучковой пилы по сырому дереву
 CZ Ostří na dřevo
 RO Panza fierastrau tip arc
 HU Fűrészlap fához
 ES Hoja de sierra

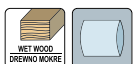

FLO

No.	L [mm]	W [mm]	
28771	530	20	60/240
28772	610	20	60/240
28773	760	20	60/240

EN Axe
 PL Siekiera
 DE Handbeil
 RU Топор

CZ Sekera
 RO Secure
 HU Szekerce
 ES Hacha

FLO

No.	m [g]	
33067	600	24
33087	800	20
33107	1000	12
33127	1250	12
33147	1400	12
33177	1600	12

EN Axe
 PL Siekiera
 DE Handbeil
 RU Топор

CZ Sekera
 RO Secure
 HU Szekerce
 ES Hacha



FLO

No.	m [g]	
32930	1000	10

EN Bow saw
 PL Pila kabłąkowa
 DE Bügelsäge
 RU Лучковая пила по дереву

CZ Oblouková pila
 RO Ferăstrău de curbură
 HU Keretes fűrész
 ES Sierra de arco



FLO

No.	L [mm]	
28746	610	12/24
28755	760	12/24

EN Drop forged hatchet
 PL Siekiera ze stali kutej
 DE Handbeil
 RU Топор кованный

CZ Sekera ocelová kovaná
 RO Toporisca lama forjată
 HU Kovácsolt acél fejű
 ES Hacha de metalo forjado



FLO

No.	m [g]	
33080	800	12/24

FLO



EN Axe with fibreglass + PVC handle
 PL Siekiera, rączka z włókna szklanego
 DE Handbeil Fiberglasstiel
 RU Топор с фиберглассовой ручкой

CZ Sekyrka
 RO Toporisca cu coada din fibra de sticla
 HU Szekerce
 ES Hacha con mango de fibra de vidrio



VOREL

No.	m [g]	
33065	600	20
33085	800	20
33105	1000	12
33125	1250	6

EN Axe
PL Siekiera
DE Handbeil
RU Топор

CZ Sekera
RO Secure
HU Szekerce
ES Hacha



JUCO

No.	m [g]	DIN	
33024	400	5131	5
33026	600	5131	5
33028	800	5131	5
33030	1000	5131	5
33032	1250	7294	5
33035	1500	7294	5
33038	1800	7294	5
33039	2000	7294	5
33040	2500	7294	5

EN Axe
PL Siekiera
DE Handbeil
RU Топор

CZ Sekera
RO Secure
HU Szekerce
ES Hacha



JUCO

No.	m [g]	DIN	
33000	400	5131	5
33001	600	5131	5
33002	800	5131	5
33003	1000	5131	5
33004	1250	7294	5
33005	1500	7294	5
33006	1800	7294	5
33007	2000	7294	5
33008	2500	7294	5

EN Axe set
PL Zestaw siekier tradycyjnych
DE Satz traditioneller Äxte
RU Набор традиционных топоров

CZ Sada klasických seker
RO Set topoare
HU Hagymányos balta készlet
ES Set de hechas tradicionales



JUCO

No.	m [kg]	
32999	0.4, 1.5	5

EN Hammer-axe for wood splitting
PL Siekiero-młot
DE Spaltaxt
RU Топор-колуш

CZ Sekera-kladívo
RO Secure-ciocan
HU Szekerce-kalapács
ES Hacha martillo para partir madera



JUCO

No.	m [g]	
32925	2500	1
32926	4000	1

EN Canadian axe
PL Siekiera kanadyjska
DE Handbeil „Kanadische Form“
RU Топор канадского типа

CZ Sekera kanadská
RO Topor canadian
HU Hosszú nyelű, hasító fejsze
ES Hacha canada

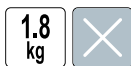

JUCO

No.	m [g]	
33022	1800	5

EN Axe
PL Siekiera z klinem
DE Handbeil
RU Топор

CZ Sekerka
RO Secure
HU Szekerce
ES Hacha



JUCO

No.	m [g]	
32924	2000	5

EN Hammer-axe for wood splitting
PL Siekiero-młot
DE Spaltaxt
RU Топор-колуш

CZ Sekera-kladívo
RO Secure-ciocan
HU Szekerce-kalapács
ES Hacha martillo para partir madera



JUCO

No.	m [g]	
32927	2100	1
32928	3200	1



- EN Hammer wedges
 PL Zestaw klinujący
 DE Keilesatz
 RU Набор клинов
- CZ Sada klínků
 RO Set cultivator
 HU Ékelő készlet
 ES Juego de sujeción

10
PCS

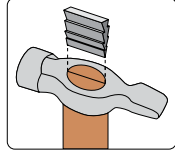
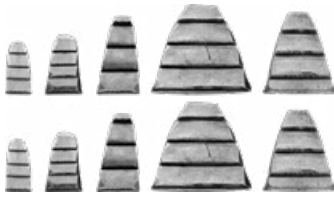

VOREL

No.	pcs / szt.	Box icon
99472	10	6/72

- EN Hammer wedges
 PL Zestaw klinujący
 DE Keilesatz
 RU Набор клинов
 CZ Sada klínků
 RO Set cultivator
 HU Ékelő készlet
 ES Juego de sujeción



JUCO

No.	For hammer / Do młotka [kg]	For axe / Do siekiery [kg]	Box icon
99463	5-6	0.6-1.0	50
99464	8-10	1.2-2.5	50

- EN Transplanter
 PL Łopatka
 DE Blumenkelle
 RU Совок посадочный
 CZ Lopatka
 RO Mini-lopata gradinarit
 HU Ásó
 ES Paleta estrecha

350
mm



FLO

No.	L [mm]	Box icon
99048	350	25/100

- EN Rake
 PL Grabki
 DE Blumenrechen
 RU Грабли
 CZ Hrabičky
 RO Mini grebla
 HU Gereblye
 ES Rastrillo

300
mm



FLO

No.	L [mm]	Box icon
99051	300	25/100

- EN Hammer wedges
 PL Zestaw klinujący
 DE Keilesatz
 RU Набор клинов
 CZ Sada klínků
 RO Set cultivator
 HU Ékelő készlet
 ES Juego de sujeción



JUCO

No.	For hammer / Do młotka [kg]	For axe / Do siekiery	Box icon
99460	0.1-0.5	-	50
99461	0.7-2.0	-	50
99462	3.0-4.0	0.4	50

- EN Wood splitter
 PL Klin do rozluźniania drewna
 DE Spaltkeil
 RU Клин для раскалывания бревен

- CZ Klín na štípání polen
 RO Pana pt. lemn
 HU Fahasító ék
 ES Cuña para partir madera



JUCO

No.	m [kg]	Box icon
32922	2	1
32923	3	1

- EN Transplanter
 PL Łopatka
 DE Blumenkelle
 RU Совок посадочный
 CZ Lopatka
 RO Mini-lopata gradinarit
 HU Ásó
 ES Paleta estrecha

350
mm



FLO

No.	L [mm]	Box icon
99047	350	25/100

- EN Hoe and cultivator
 PL Motyczka z pazurkami
 DE Kleinhacke
 RU Рыхлитель комбинированный
 CZ Motyčka s kultivátorem
 RO Cultivator cu sapaliga
 HU Kerti villás kapa
 ES Escarificador y azadilla

300
mm



FLO

No.	L [mm]	Box icon
99050	300	50

EN Hoe
 PL Motyczka
 DE Garten Handhacke
 RU Мотыжка
 CZ Motyčka
 RO Sapaliga
 HU Kerti kapa
 ES Azadilla

300 mm



FLO

No.	L [mm]	
99052	300	100

EN Transplanter
 PL Łopatka
 DE Blumenkelle
 RU Совок посадочный
 CZ Lopatka
 RO Mini-lopata gradinarit
 HU Ásó
 ES Paleta estrecha

320 mm



FLO

No.	L [mm]	
35765	320	50

EN Cultivator
 PL Pazurki
 DE Grubber
 RU Рыхлитель
 CZ Kultivátor
 RO Cultivator
 HU Kultivátor
 ES Escarifi cador

330 mm



FLO

No.	L [mm]	
35767	330	50

EN Transplanter
 PL Łopatka
 DE Blumenkelle
 RU Совок посадочный
 CZ Lopatka
 RO Mini-lopata gradinarit
 HU Ásó
 ES Paleta estrecha

330 mm



FLO

No.	L [mm]	
99035	330	24/48

EN Cultivator
 PL Pazurki
 DE Grubber
 RU Рыхлитель
 CZ Kultivátor
 RO Cultivator
 HU Kultivátor
 ES Escarifi cador

310 mm



FLO

No.	L [mm]	
99049	310	25/100

EN Hoe
 PL Motyczka
 DE Garten Handhacke
 RU Мотыжка
 CZ Motyčka
 RO Sapaliga
 HU Kerti kapa
 ES Azadilla

350 mm



FLO

No.	L [mm]	
35768	350	50

EN Transplanter
 PL Łopatka
 DE Blumenkelle
 RU Совок посадочный
 CZ Lopatka
 RO Mini-lopata gradinarit
 HU Ásó
 ES Paleta estrecha

330 mm



FLO

No.	L [mm]	
99034	330	24/48

EN Rake
 PL Grabki
 DE Blumenrechen
 RU Грабли
 CZ Hrabičky
 RO Mini grebla
 HU Gereblye
 ES Rastrillo

300 mm



FLO

No.	L [mm]	
99036	300	24/48

EN Hoe and cultivator
 PL Motyczka z pazurkami
 DE Kleinhacke
 RU Рыхлитель комбинированный
 CZ Motyčka s kultivátorem
 RO Cultivator cu sapaliga
 HU Kerti villás kapa
 ES Escarificador y azadilla

300 mm



FLO

No.	L [mm]	
99037	300	24/48

EN Garden rake
 PL Grabki wachlarzowe
 DE Landschaftsbesen
 RU Грабли веерные
 CZ Hrabičky
 RO Grebla de gradina
 HU Kerti gereblye
 ES Rastriilo de abanico de hojalata

450 mm



FLO

No.	L [mm]	
99039	450	24/48

EN Bulb planter
 PL Sadzarka do cebuli
 DE Blumenzweibelpflanzer
 RU Конус посадочный для рассады
 CZ Sázeč
 RO Plantator
 HU Palántázó
 ES Plantadora para cebollas



FLO

No.		
99033		10/60

EN Nut collector
 PL Zbieracz do orzechów
 DE Nussammler
 RU Полн для сбора ореха
 CZ Sběrač ořechů
 RO Colector nuci
 HU Diógyűjtő
 ES Recolector de nueces

127 cm 28 cm SS STAINLESS STEEL STAL NIERDZEWNA



FLO

No.	L [cm]	
89890	127	2

EN Cultivator
 PL Pazurki
 DE Grubber
 RU Рыхлитель
 CZ Kultivátor
 RO Cultivator
 HU Kultivátor
 ES Escarifi cador

395 mm



FLO

No.	L [mm]	
99038	395	24/48

EN Patio weeder
 PL Chwastownik
 DE Fugenkratzer
 RU Очиститель щелевой
 CZ Čistič mezer
 RO Cuijt pt. curăţat dale
 HU Fugakaparó
 ES Musgo cuchillo

320 mm



FLO

No.	L [mm]	
99040	320	24/48

EN Fruit pick up tool
 PL Zbierak do owoców
 DE Obstpfücker
 RU Съёмник для фруктов
 CZ Sběrač ovoce
 RO Culegator pt. fructe
 HU Karos gyümölcszedő
 ES Recojedor de frutas



FLO

No.	Ø [mm]	
89880	160	12/48

EN Nut collector
 PL Zbieracz do orzechów
 DE Nussammler
 RU Полн для сбора ореха
 CZ Sběrač ořechů
 RO Colector nuci
 HU Diógyűjtő
 ES Recolector de nueces

105-145 cm 28 cm TELESCOPIC HANDLE ÜCHWYT TELESKOPOWY SS STAINLESS STEEL STAL NIERDZEWNA AI

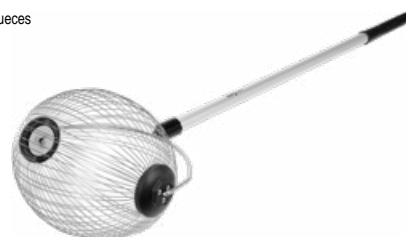

FLO

No.	L [cm]	
89891	105-145	2

EN Multifunctional shovel
 PL Saperka wielofunkcyjna
 DE Kombi-Faltschaufel
 RU Салёрная лопата многофункциональная
 CZ Lopatka víceúčelová
 RO Lopata multifunctionala
 HU Többfunkciós ásó
 ES Zapadora multifuncion

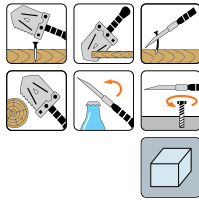

FLO

No.	36
99053	36

EN Garden tool set
 PL Komplet narzędzi ogrodowych
 DE Garten-Kleingerätesatz
 RU Набор садово-огородного инструмента
 CZ Sada zahradnického náčiní
 RO Set pt. grădinarit
 HU Kertész készlet
 ES Juego de herramientas de jardín



FLO

No.	L [mm]	50
99028	205	50

EN Garden roller
 PL Walec ogrodowy
 DE Gartenwalze
 RU Садовый каток
 CZ Zahradní váleček
 RO Tavalug gazon
 HU Kerti henger
 ES Rodillo de jardín



FLO

No.	Working part width / Szerokość części roboczej [mm]	1
88720	500	1

EN Flat spade
 PL Szpadel prosty
 DE Rodespaten
 RU Заступ
 CZ Rýč rovný
 RO Hârleţ cu coadă
 HU Egyenes ásó
 ES Pala recta



FLO

No.	Handle type / Typ trzonka	200
35809	DY	200

EN Folding shovel
 PL Saperka składana
 DE Faltschaufel
 RU Салёрная лопата складная
 CZ Lopatka skládací
 RO Lopata demontabila
 HU Összecsukható ásó
 ES Zapadora desmontable



FLO

No.	36
99054	36

EN Garden tool set
 PL Komplet narzędzi ogrodowych
 DE Garten-Kleingerätesatz
 RU Набор садово-огородного инструмента
 CZ Sada zahradnického náčiní
 RO Set pt. grădinarit
 HU Kertész készlet
 ES Juego de herramientas de jardín



FLO

No.	pcs / szt.	10/60
99056	4	10/60

EN Transplanting spade
 PL Szpadel szkólkarski
 DE Baumschulspaten
 RU Лопата для саженцев
 CZ Školkařský rýč
 RO Cazma pt. plantat
 HU Faiskolai ásó
 ES Pala de vivero



FLO

No.	Handle type / Typ trzonka	140
35811	DY	140

EN Flat spade
 PL Szpadel prosty
 DE Rodespaten
 RU Заступ
 CZ Rýč rovný
 RO Hârleţ cu coadă
 HU Egyenes ásó
 ES Pala recta



FLO

No.	Handle type / Typ trzonka	140
35720	DY	140

EN Flat spade
 PL Szpadel prosty
 DE Rodespaten
 RU Заступ
 CZ Ryč rovný
 RO Hârleț cu coadă
 HU Egyenes ásó
 ES Pala recta



120 cm
 FIBERGLASS WŁÓKNO SZKLANE
 DY



No.	Handle type / Typ trzonka	
35836	DY	6

EN Sharp spade
 PL Szpadel ostry
 DE Scharfer Spaten
 RU Штыковая лопата
 CZ Ryč špičatý
 RO Hârleț ascuțit
 HU Hegyes ásó
 ES Pala puntiaguda



DY



No.	Handle type / Typ trzonka	
35810	DY	200

EN Sharp spade
 PL Szpadel ostry
 DE Scharfer Spaten
 RU Штыковая лопата
 CZ Ryč špičatý
 RO Hârleț ascuțit
 HU Hegyes ásó
 ES Pala puntiaguda



HRC 45
 DY



No.	Handle type / Typ trzonka	
35721	DY	140

EN Sharp spade
 PL Szpadel ostry
 DE Scharfer Spaten
 RU Штыковая лопата
 CZ Ryč špičatý
 RO Hârleț ascuțit
 HU Hegyes ásó
 ES Pala puntiaguda



120 cm
 FIBERGLASS WŁÓKNO SZKLANE
 DY



No.	Handle type / Typ trzonka	
35837	DY	6

EN Mini shovel
 PL Szpaka profilowana
 DE Feldspaten
 RU Лопата саперная
 CZ Vojenská lopata
 RO Lopată mică
 HU Profilozott ásó
 ES Zapa perfilada



DY



No.	Handle type / Typ trzonka	
35833	DY	200

EN Sand shovel
 PL Łopata piaskowa
 DE Sandschaufel
 RU Лопата для песка
 CZ Lopata na písek
 RO Lopată pt. nisip
 HU Homoklapát
 ES Pala para arena



120 cm
 DY



No.	Handle type / Typ trzonka	
35843	DY	120

EN Sand shovel
 PL Łopata piaskowa
 DE Sandschaufel
 RU Лопата для песка
 CZ Lopata na písek
 RO Lopată pt. nisip
 HU Homoklapát
 ES Pala para arena



HRC 45
 DY



No.	Handle type / Typ trzonka	
35722	DY	120

EN Sand shovel
 PL Łopata piaskowa
 DE Sandschaufel
 RU Лопата для песка
 CZ Lopata na písek
 RO Lopată pt. nisip
 HU Homoklapát
 ES Pala para arena



120 cm
 FIBERGLASS WŁÓKNO SZKLANE
 DY



No.	Handle type / Typ trzonka	
35835	DY	6

EN Sand shovel
 PL Łopata piaskowa
 DE Sandschaufel
 RU Лопата для песка
 CZ Lopata na písek
 RO Lopată pt. nisip
 HU Homoklapát
 ES Pala para arena



130 cm DY



No.	Handle type / Typ trzonka	
35861	DY	120

EN Coal shovel
 PL Łopata węglowa
 DE Kohlenschaufel
 RU Лопата для угля
 CZ Lopata na uhlí
 RO Lopată pt. carbune
 HU Szénlapát
 ES Pala para carbón



No 2 DY



No.	Handle type / Typ trzonka	
35863	DY	120

EN Rake
 PL Grabie
 DE Rechen
 RU Грабли
 CZ Hrábě
 RO Greblă
 HU Gereblye
 ES Rastrillo



130 cm P



No.	Number of teeth / Liczba zębów	Handle type / Typ trzonka	
35756	10	P	250
35757	12	P	250
35758	14	P	250
35759	16	P	250

EN Hand cultivator with handle
 PL Kultywator ręczny oprawiony
 DE Handkultivator, eingefasst
 RU Культиватор ручной садовый
 CZ Ruční kultivátor s násadou
 RO Cultivator cu maner
 HU Kézi kultivátor, nyeles
 ES Cultivador manual enmarcado

P



No.	Handle type / Typ trzonka	
35701	P	250

EN Gardening shovel
 PL Łopata kanadyjska
 DE Kanadischer Spaten
 RU Канадская лопата
 CZ Kanadská lopata
 RO Hariet gradina
 HU Kanadai lapát
 ES Pala canadiense



130 cm DY



No.	Handle type / Typ trzonka	
35855	DY	140

EN Digging fork
 PL Widły
 DE Grabegabel
 RU Вилы
 CZ Zahradnické vidlice
 RO Furcă pt. grădinărit
 HU Vasvilla
 ES Horca



DY



No.	Handle type / Typ trzonka	
35817	DY	200

EN Garden hoe
 PL Motyka ogrodowa
 DE Gartenhacke
 RU Тяпка садовая
 CZ Zahradní motyka
 RO Sapaliga gradina
 HU Kerti kapa
 ES Azada de jardín



120 cm P



No.	Working width / Szerokość robocza [mm]	Handle type / Typ trzonka	
35761	120	P	500
35762	140	P	500

EN Cultivator
 PL Pazurki
 DE Grubber
 RU Рыхлитель
 CZ Kultivátor
 RO Cultivator
 HU Kultivátor
 ES Escarifi cador

P



No.	Handle type / Typ trzonka	
35705	P	500

EN Spring rake
 PL Grabie wachlarzowe
 DE Laubrechen
 RU Грабли веерные
 CZ Hrábě na listí
 RO Greblă evantai
 HU Lombseprű
 ES Rastrillo para hojas



120 cm



FLO

No.	Working width / Szerokość robocza [mm]	Number of teeth / Liczba zębów	
35799	400	21	250

EN Earth auger
 PL Świder do gleby
 DE Erdbohrer
 RU Бур шнековый
 CZ Zemní vrták
 RO Burghiu pt. pământ
 HU Talajfúró
 ES Taladro de tierra

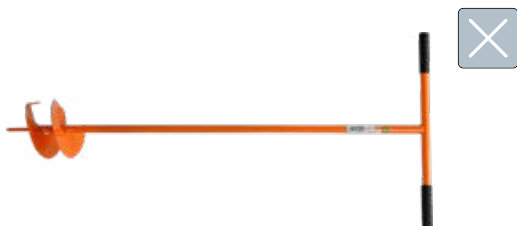

FLO

No.	Working diameter / Średnica robocza [mm]	
35667	110	50
35668	140	50
35670	170	50
35669	200	30
35672	230	25
35671	250	24

EN Long handle steel edger
 PL Nóż do darni
 DE Rasenkantenstecher
 RU Полулунный нож для обрезки краев дерна
 CZ Nůz na okraje trávníku
 RO Tăietor de borduri
 HU Gyepgondozás
 ES Cortador de bordes para césped



T



FLO

No.	Working width / Szerokość robocza [mm]	Handle type / Typ trzonka	
35680	200	T	250

EN Flat spade
 PL Szpadel prosty
 DE Rodespäten
 RU Заступ
 CZ Rýč rovný
 RO Hârleț cu coadă
 HU Egyenes ásó
 ES Pala recta



117 cm



FLO

No.	Handle type / Typ trzonka	
35800	T	140

EN Adjustable leaf rake
 PL Grabie wachlarzowe regulowane
 DE Verstellbarer Laubrechen
 RU Регулируемые веерные грабли
 CZ Hrábě na listí nastavitelné
 RO Greblă evantai reglabilă
 HU Állítható kerti lombseprű
 ES Rastrillo para hojas ajustable



P



FLO

No.	Working width / Szerokość robocza [mm]	Number of teeth / Liczba zębów	
35797	255-580	20	5

EN Manual cultivator
 PL Kultywator ręczny
 DE Handgrubber
 RU Ручной культиватор
 CZ Ruční kultivátor
 RO Cultivator manual
 HU Kézi kultivátor
 ES Cultivador manual



∅ 22 mm

95x50 cm



FLO

No.	Working width / Szerokość robocza [mm]	
35677	500	12

EN Cut lawn edger
 PL Obcinarka do krawędzi trawnika
 DE Kantenschneider
 RU Инструмент для обрезки края газона
 CZ Řezačka okrajů trávníku
 RO Tăietor marginii de gazon de grădină
 HU Gyepszegélyvágó
 ES Cortadora de bordes de césped



114 cm

150x1.5 mm

65Mn

PVC

EASY TRANSPORT
LATWY TRANSPORT

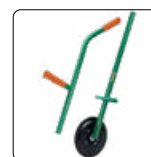

FLO

No.	Working part diameter / Średnica części roboczej [mm]	
35685	150	1

EN Flat spade
 PL Szpadel prosty
 DE Rodespäten
 RU Заступ
 CZ Rýč rovný
 RO Hârleț cu coadă
 HU Egyenes ásó
 ES Pala recta



117 cm



FLO

No.	Handle type / Typ trzonka	
35802	T	140

EN Flat spade
 PL Szpadel prosty
 DE Rodespaten
 RU Заступ
 CZ Rýč rovný
 RO Hârleț cu coadă
 HU Egyenes ásó
 ES Pala recta



No.	Handle type / Typ trzonka	
35801	T	200

EN Flat spade
 PL Szpadel prosty
 DE Rodespaten
 RU Заступ
 CZ Rýč rovný
 RO Hârleț cu coadă
 HU Egyenes ásó
 ES Pala recta

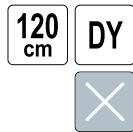

No.	Handle type / Typ trzonka	
35805	DY	140

EN Drainage spade
 PL Szpadel drenarski
 DE Drainagespaten
 RU Дренажная лопата
 CZ Drenážní rýč
 RO Cazma îngusta
 HU Drénező ásó
 ES Pala de drenaje

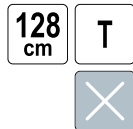

No.	Handle type / Typ trzonka	
35807	T	140

EN Sand shovel
 PL Łopata piaskowa
 DE Sandschaufel
 RU Лопата для песка
 CZ Lopata na písek
 RO Lopată pt. nisip
 HU Homoklapát
 ES Pala para arena

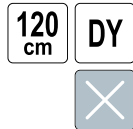

No.	Handle type / Typ trzonka	
35839	DY	120

EN Flat spade
 PL Szpadel prosty
 DE Rodespaten
 RU Заступ
 CZ Rýč rovný
 RO Hârleț cu coadă
 HU Egyenes ásó
 ES Pala recta

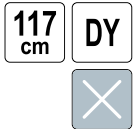

No.	Handle type / Typ trzonka	
35803	DY	140

EN Sharp spade
 PL Szpadel ostry
 DE Scharfer Spaten
 RU Штыковая лопата
 CZ Rýč špičatý
 RO Hârleț ascuțit
 HU Hegyes ásó
 ES Pala puntiaguda

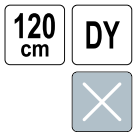

No.	Handle type / Typ trzonka	
35806	DY	140

EN Drainage spade
 PL Szpadel drenarski
 DE Drainagespaten
 RU Дренажная лопата
 CZ Drenážní rýč
 RO Cazma îngusta
 HU Drénező ásó
 ES Pala de drenaje

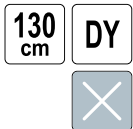

No.	Handle type / Typ trzonka	
35808	DY	140

EN Sand shovel
 PL Łopata piaskowa
 DE Sandschaufel
 RU Лопата для песка
 CZ Lopata na písek
 RO Lopată pt. nisip
 HU Homoklapát
 ES Pala para arena

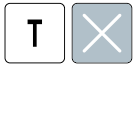

No.	Handle type / Typ trzonka	
35840	T	200

EN Shovel
 PL Łopata
 DE Schaufel
 RU Лопата
 CZ Lopata
 RO Lopată
 HU Lapát
 ES Pala



DY AI



No.	Handle type / Typ trzonka	
35846	DY	100

EN Coal shovel
 PL Łopata węgłowa
 DE Kohlschaufel
 RU Лопата для угля
 CZ Lopata na uhlí
 RO Lopata pt. carbune
 HU Szénlapát
 ES Pala para carbón



№ 3 DY



No.	Handle type / Typ trzonka	
35860	DY	90

EN Digging fork
 PL Widły
 DE Grabegabel
 RU Вилы
 CZ Zahradnické vidlice
 RO Furcă pt. grădinărit
 HU Vasvilla
 ES Horca



P



No.	Number of teeth / Liczba zębów	Handle type / Typ trzonka	
35815	3	P	100
35816	4	P	200

EN Digging fork
 PL Widły
 DE Grabegabel
 RU Вилы
 CZ Zahradnické vidlice
 RO Furcă pt. grădinărit
 HU Vasvilla
 ES Horca



x4 TEETH ZĘBY DY



No.	Number of teeth / Liczba zębów	Handle type / Typ trzonka	
35813	4	DY	140

EN Coal shovel
 PL Łopata węgłowa
 DE Kohlschaufel
 RU Лопата для угля
 CZ Lopata na uhlí
 RO Lopata pt. carbune
 HU Szénlapát
 ES Pala para carbón



№ 2 T

No.	Handle type / Typ trzonka	
35850	T	120

EN Sand shovel
 PL Łopata piaskowa
 DE Sandschaufel
 RU Лопата для песка
 CZ Lopata na písek
 RO Lopată pt. nisip
 HU Homoklapát
 ES Pala para arena



130 cm P



No.	L [cm]	Handle type / Typ trzonka	
35842	130	P	100

EN Digging fork
 PL Widły
 DE Grabegabel
 RU Вилы
 CZ Zahradnické vidlice
 RO Furcă pt. grădinărit
 HU Vasvilla
 ES Horca



x4 TEETH ZĘBY DY



No.	Number of teeth / Liczba zębów	Handle type / Typ trzonka	
35865	4	DY	140

EN Digging fork
 PL Widły
 DE Grabegabel
 RU Вилы
 CZ Zahradnické vidlice
 RO Furcă pt. grădinărit
 HU Vasvilla
 ES Horca



x4 TEETH ZĘBY DY



No.	Number of teeth / Liczba zębów	Handle type / Typ trzonka	
35864	4	DY	140

EN Digging fork
 PL Widły
 DE Grabegabel
 RU Вилы
 CZ Zahradnické vidlice
 RO Furcă pt. grădinărit
 HU Vasvilla
 ES Horca



120 cm FIBERGLASS WŁÓKNO SZKLANE DY



No.	Number of teeth / Liczba zębów	Handle type / Typ trzonka	
35890	4	DY	6

EN Digging fork
 PL Widły
 DE Grabegabel
 RU Вилы
 CZ Zahradnické vidlice
 RO Furcă pt. grădinărit
 HU Vasvilla
 ES Horca



120 cm FIBERGLASS WŁÓKNO SZKLANE DY



No.	Number of teeth / Liczba zębów	Handle type / Typ trzonka	
35892	4	DY	6

EN Cultivator CZ Kultivátor
 PL Pazurki RO Cultivator
 DE Grubber HU Kultivátor
 RU Рыхлитель ES Escarifi cador

125 cm P



No.	Handle type / Typ trzonka	
35763	P	5

EN Rake
 PL Grabie
 DE Rechen
 RU Грабли
 CZ Hrábě
 RO Greblă
 HU Gereblye
 ES Rastrillo



150 cm



No.	L [cm]	Number of teeth / Liczba zębów	
35779	150	12	150
35780	150	16	155

EN Household forks
 PL Widły gospodarcze
 DE Mistgabel
 RU Вилы хозяйственные
 CZ Hospodářské vidle
 RO Furca
 HU Szénvilla
 ES Horquilla



120 cm FIBERGLASS WŁÓKNO SZKLANE DY



No.	Number of teeth / Liczba zębów	Handle type / Typ trzonka	
35891	4	DY	6

EN Weed puller
 PL Wyrywacz chwastów
 DE Unkrautentferner
 RU Приспособление для вырывания сорняков
 CZ Vytrhávač plevelu
 RO Dispozitiv de scoas buruieni
 HU Gyomkihúzó
 ES Extractor de maleza

19 mm 98x21.5 cm ABS



No.	Working width / Szerokość robocza [mm]	
35673	215	12

EN Rake CZ Hrábě
 PL Grabie RO Greblă
 DE Rechen HU Gereblye
 RU Грабли ES Rastrillo

P



No.	Number of teeth / Liczba zębów	Handle type / Typ trzonka	
35740	6	P	10
35741	8	P	10
35781	10	P	10
35782	12	P	10
35783	16	P	10
35784	14	P	10

EN Spring rake
 PL Grabie wachlarzowe
 DE Laubrechen
 RU Грабли веерные
 CZ Hrábě na listí
 RO Greblă evantai
 HU Lombseprű
 ES Rastrillo para hojas

390 mm



FLO

No.	Working width / Szerokość robocza [mm]	Number of teeth / Liczba zębów	
35798	390	21	58

EN Spring rake
 PL Grabie wachlarzowe
 DE Laubrechen
 RU Грабли веерные
 CZ Hrábě na listí
 RO Greblă evantai
 HU Lombseprű
 ES Rastrillo para hojas

530 mm



FLO

No.	Working width / Szerokość robocza [mm]	
99400	530	24

EN Hoe and cultivator
 PL Spulchniacz z motyczką
 DE Doppelhacke mit 2 Zinken
 RU Рыхлитель с мотыгой
 CZ Kultivátor s motykou
 RO Cultivator cu sapaliga
 HU Kerti villás kapa
 ES Cultivador con azada

P



FLO

No.	Handle type / Typ trzonka	
35792	P	5

EN Garden hoe
 PL Motyka ogrodowa
 DE Gartenhacke
 RU Тряпка садовая
 CZ Zahradní motyka
 RO Sapaliga gradina
 HU Kerti kapa
 ES Azada de jardín

P



FLO

No.	Working width / Szerokość robocza [mm]	Handle type / Typ trzonka	
35773	120	P	5
35774	140	P	250
35776	160	P	5

EN Spring rake
 PL Grabie wachlarzowe
 DE Laubrechen
 RU Грабли веерные
 CZ Hrábě na listí
 RO Greblă evantai
 HU Lombseprű
 ES Rastrillo para hojas

X



FLO

No.	Working width / Szerokość robocza [mm]	L [cm]	Number of teeth / Liczba zębów	
35785	435	145	23	12

EN Hoe and cultivator
 PL Motyczka z pazurkami
 DE Kleinhacke
 RU Рыхлитель комбинированный
 CZ Motyczka s kultivátorem
 RO Cultivator cu sapaliga
 HU Kerti villás kapa
 ES Escarificador y azadilla

P



FLO

No.	Handle type / Typ trzonka	
35764	P	5

EN Garden hoe
 PL Motyka ogrodowa
 DE Gartenhacke
 RU Тряпка садовая
 CZ Zahradní motyka
 RO Sapaliga gradina
 HU Kerti kapa
 ES Azada de jardín

P



FLO

No.	Working width / Szerokość robocza [mm]	Handle type / Typ trzonka	
35770	170	P	5

EN Garden hoe
 PL Motyka ogrodowa
 DE Gartenhacke
 RU Тряпка садовая
 CZ Zahradní motyka
 RO Sapaliga gradina
 HU Kerti kapa
 ES Azada de jardín

P



FLO

No.	Working width / Szerokość robocza [mm]	Handle type / Typ trzonka	
35777	170	P	5

EN Plastic rake
 PL Grabie plastikowe
 DE Plasteharken
 RU Грабли пластиковые
 CZ Plastové hrábě
 RO Greblă de plastic
 HU Műanyag gereblye
 ES Rastrillo de plástico



No.	Working width / Szerokość robocza [mm]	Number of teeth / Liczba zębów	
35788	550	16	10
35789	590	18	10

EN Rake
 PL Grabie
 DE Rechen
 RU Грабли
 CZ Hrábě
 RO Greblă
 HU Gereblye
 ES Rastrillo

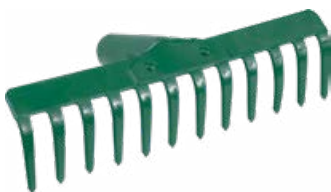

No.	Working width / Szerokość robocza [mm]	Number of teeth / Liczba zębów	
35750	270	12	48
35751	340	14	28

EN Spring rake
 PL Grabie wachlarzowe
 DE Laubrechen
 RU Грабли веерные
 CZ Hrábě na listí
 RO Greblă evantai
 HU Lombseprű
 ES Rastrillo para hojas



No.	Working width / Szerokość robocza [mm]	Number of teeth / Liczba zębów	
35786	435	23	10

EN Spring rake
 PL Grabie wachlarzowe
 DE Laubrechen
 RU Грабли веерные
 CZ Hrábě na listí
 RO Greblă evantai
 HU Lombseprű
 ES Rastrillo para hojas



No.	Working width / Szerokość robocza [mm]	Number of teeth / Liczba zębów	
35790	435	20	20
35791	580	27	20

EN Grass cultivator
 PL Wertykulator do trawy
 DE Schneidrechen
 RU Грабли азрационные
 CZ Kultivátor oboustranný
 RO Cultivator
 HU Kétoldalas talajazító, gyephez
 ES Cultivador de dos lados



No.	Working width / Szerokość robocza [mm]	
35700	380	5/10

EN Rake
 PL Grabie
 DE Rechen
 RU Грабли
 CZ Hrábě
 RO Greblă
 HU Gereblye
 ES Rastrillo



No.	Working width / Szerokość robocza [mm]	Number of teeth / Liczba zębów	
35755	360	14	20

EN Spring rake
 PL Grabie wachlarzowe
 DE Laubrechen
 RU Грабли веерные
 CZ Hrábě na listí
 RO Greblă evantai
 HU Lombseprű
 ES Rastrillo para hojas



No.	Working width / Szerokość robocza [mm]	Number of teeth / Liczba zębów	
35787	460	20	10

EN Spring rake
 PL Grabie wachlarzowe
 DE Laubrechen
 RU Грабли веерные
 CZ Hrábě na listí
 RO Greblă evantai
 HU Lombseprű
 ES Rastrillo para hojas



No.	Working width / Szerokość robocza [mm]	
99390	430	40

EN Spring rake
 PL Grabie wachlarzowe
 DE Laubrechen
 RU Грабли веерные
 CZ Hrábě na listí
 RO Greblă evantai
 HU Lombseprű
 ES Rastrillo para hojas



460 mm



No.	Working width / Szerokość robocza [mm]	
99391	460	50

EN Cultivator
 PL Pazurki
 DE Grubber
 RU Рыхлитель
 CZ Kultivátor
 RO Cultivator
 HU Kultivátor
 ES Escarifi cadór



No.	Working width / Szerokość robocza [mm]	
35793	100	60
35794	130	40

EN Hoe
 PL Motyczka
 DE Garten Handhacke
 RU Мотыжка
 CZ Motyčka
 RO Sapaliga
 HU Kerti kapá
 ES Azadilla



160 mm



No.	Working width / Szerokość robocza [mm]	
35775	160	30

EN Hoe and cultivator
 PL Motyczka z pazurkami
 DE Kleinhacke
 RU Рыхлитель комбинированный
 CZ Motyčka s kultivátorem
 RO Cultivator cu sapaliga
 HU Kerti villás kapá
 ES Escarificador y azadilla



70 mm



No.	Working width / Szerokość robocza [mm]	
35795	70	60

EN Spring rake
 PL Grabie wachlarzowe
 DE Laubrechen
 RU Грабли веерные
 CZ Hrábě na listí
 RO Greblă evantai
 HU Lombseprű
 ES Rastrillo para hojas



425 mm



No.	Working width / Szerokość robocza [mm]	
99401	425	60

EN Cultivator
 PL Obsypnik
 DE Häufel
 RU Культиватор
 CZ Zасыpávač
 RO Cultivator
 HU Kultivátor
 ES Arado



190 mm



No.	Working width / Szerokość robocza [mm]	
35710	190	5/15

EN Hoe and cultivator
 PL Motyczka z pazurkami
 DE Kleinhacke
 RU Рыхлитель комбинированный
 CZ Motyčka s kultivátorem
 RO Cultivator cu sapaliga
 HU Kerti villás kapá
 ES Escarificador y azadilla



75 mm



No.	Working width / Szerokość robocza [mm]	
35760	75	60

EN Broom
 PL Miotta
 DE Strassenbesen
 RU Метла
 CZ Metla
 RO Matura
 HU Partvis
 ES Cepillo pelo largo



SORGHUM SORGO



No.	Working width / Szerokość robocza [mm]	L [mm]	
35911	250	1150	200

EN Broom
 PL Miotła
 DE Strassenbesen
 RU Метла
 CZ Metla
 RO Matura
 HU Partvis
 ES Cepillo pelo largo



No.	Working width / Szerokość robocza [mm]	
35893	300	12
35894	400	12
35895	500	12

EN Broom
 PL Miotła
 DE Strassenbesen
 RU Метла
 CZ Metla
 RO Matura
 HU Partvis
 ES Cepillo pelo largo



No.	Working width / Szerokość robocza [mm]	
35899	250	12

EN Broom
 PL Miotła
 DE Strassenbesen
 RU Метла
 CZ Metla
 RO Matura
 HU Partvis
 ES Cepillo pelo largo



No.	Bristle length / Długość włosia [mm]	
35905	275	12

EN Broom
 PL Miotła
 DE Strassenbesen
 RU Метла
 CZ Metla
 RO Matura
 HU Partvis
 ES Cepillo pelo largo



No.	Bristle length / Długość włosia [mm]	
35906	135	12

EN Broom
 PL Miotła
 DE Strassenbesen
 RU Метла
 CZ Metla
 RO Matura
 HU Partvis
 ES Cepillo pelo largo



No.	Bristle length / Długość włosia [mm]	
35908	210	8

EN Wire paving brush
 PL Szczotka do bruku z radełkami
 DE Bürste mit Schaber für Reinigung von Pflastersteinen
 RU Щетка для тротуарной плитки с шипом
 CZ Kartáč do dlažby s rádílkem
 RO Perie din sarma pt. pavaj
 HU Járdakefe pengével
 ES Cepillo para adoquines, con ruedas de trazado



No.	L [mm]	
35927	1460	10

EN Lawn mover brush
 PL Szczotka do kosiarki
 DE Rasenmäher Reinigungsbürste mit Schaber
 RU Щетка для очистки газонокосилки
 CZ Kartáč na čištění sekačky
 RO Perie pt. curatat motocoase
 HU Ecset a kaszák tisztításához
 ES Cepillo limpieza



No.	Working width / Szerokość robocza [mm]	L [mm]	
35950	50	310	15

EN Barbecue cleaning brush
 PL Szczotka do grilla
 DE Grillbürste
 RU Щетка для гриля
 CZ Kartáč do grilu
 RO Perie pt. curatat gratar
 HU Grillkefe
 ES Cepillo para barbacoa



No.	L [mm]	
99528	305	16

EN Sickle
 PL Sierp
 DE Sichel
 RU Сепн
 CZ Srp
 RO Secera
 HU Sarló
 ES Hoz



FLO

No.	
35832	30

EN Stake for scythe
 PL Klepadło do kosy
 DE Dengelamboss für Sensen
 RU Бабка для отбивки кос (наковальня)
 CZ Naklepávací kovadlinka
 RO Inel de stângere pt. coasă
 HU Kaszaróztű gyűrű
 ES Anillo para guadanás



JUCO

No.	
35821	30

EN Wedge for scythe
 PL Klin drewniany do kosy
 DE Holzkeil für Sensen
 RU Клиn деревянный для косы
 CZ Klín dřevěný na kosu
 RO Pană de lemn pt. coasă
 HU Faék kaszához
 ES Cuna de madera para guadanás



No.	
35831	12/144

EN Wooden handle
 PL Trzonek uniwersalny
 DE Universalstiel
 RU Черенок для грабель
 CZ Násada univerzální
 RO Coada din lemn
 HU Univerzális nyél
 ES Astil universal



No.	L [cm]	Ø [mm]	Type / Typ	
99403	100	28	P	25
99404	110	28	P	25
99402	130	28	P	25
99408	150	28	P	25

EN Forged scythe
 PL Kosa kuta
 DE Sensenklänge geschmiedet
 RU Коса
 CZ Kosa kovaná
 RO Lama de coasa
 HU Kovácsolt kasza
 ES Guadana forjada



FLO

No.	Type / Typ	
35824	No 6	25
35826	No 7	25
35828	No 8	25

EN Ring for scythe
 PL Pierścień do kosy
 DE Sensenring
 RU Кольцо для косы
 CZ Kroužek na kosu
 RO Inel pt. coasa
 HU Kasza bilincs
 ES Anillo para guadaña



FLO

No.	
35823	30

EN Wooden handle for scythe
 PL Trzonek do kosy
 DE Sensenstiel
 RU Косолице деревянное
 CZ Násada na kosu
 RO Coada de coasa
 HU Kaszanyél
 ES Astil para guadanás



No.	L [cm]	
35830	174	10

EN Wooden handle for shovel
 PL Trzonek do łopaty
 DE Schaufelstiel gerade
 RU Черенок для лопаты
 CZ Násada na lopatu
 RO Coada din lemn
 HU Lapátnyél
 ES Astil para pala



No.	L [cm]	Type / Typ	
99410	130	P	10

EN Wooden handle
 PL Trzonek do grabi wachlarzowych
 DE Schaufelstiel P-Griff
 RU Черенок для лопат
 CZ Násada na lopatu
 RO Coadă de lopată cu maner
 HU Lapátnyél
 ES Astil para pala

130
cm

P



No.	L [cm]	Ø [mm]	Type / Typ	
99415	130	22	P	25

EN Wooden handle for broom
 PL Trzonek do miotły ulicznej
 DE Stiel für einen Straßenbesen
 RU Черенок для метлы
 CZ Násada na silniční metlu
 RO Coadă matură cu filet
 HU Utcaseprű nyél
 ES Palo de escoba de calle

150
cm





No.	L [cm]	
99421	150	25

EN Broom handle with thread
 PL Trzonek do miotły z gwintem
 DE Besenstiel, Holz, mit Gewinde
 RU Черенок для метлы с резьбой
 CZ Násada na metlu se závětem
 RO Coadă de mătură cu filet
 HU Menetes seprűnyél
 ES Astil para escoba con rosca

120
cm

P





No.	L [cm]	Type / Typ	
99418	120	P	25

EN Handle „T” for spade
 PL Trzonek do szpadła
 DE Spadelstiel T-griff
 RU Черенок для лопаты
 CZ Násada na rýč
 RO Coadă din lemn
 HU Ásónyél
 ES Astil para laya

90
cm

T





No.	L [cm]	Type / Typ	
99407	90	T	10

EN Wooden handle for broom
 PL Trzonek do miotły ulicznej
 DE Stiel für einen Straßenbesen
 RU Черенок для метлы
 CZ Násada na silniční metlu
 RO Coadă matură cu filet
 HU Utcaseprű nyél
 ES Palo de escoba de calle

125
cm



VOREL

No.	L [cm]	
99420	125	25

EN Broom handle with thread
 PL Trzonek do miotły z gwintem
 DE Besenstiel, Holz, mit Gewinde
 RU Черенок для метлы с резьбой
 CZ Násada na metlu se závětem
 RO Coadă de mătură cu filet
 HU Menetes seprűnyél
 ES Astil para escoba con rosca

120
cm

P



No.	L [cm]	Ø [mm]	Type / Typ	
99416	120	22	P	25

EN Steel handle with thread
 PL Trzonek metalowy z gwintem
 DE Besenstiel mit Gewinde
 RU Черенок с резьбой
 CZ Násada na metlu se závětem
 RO Coadă cu filet
 HU Menetes seprűnyél
 ES Astil para escoba con rosca

116
cm

P



FLO

No.	L [cm]	Ø [mm]	
99419	118	21	24

EN Wooden handle for shovel
 PL Trzonek do łopaty
 DE Schaufelstiel gerade
 RU Черенок для лопаты
 CZ Násada na lopatu
 RO Coadă din lemn
 HU Lapátnyél
 ES Astil para pala

115
cm

T



No.	L [cm]	Type / Typ	
99409	115	T	10

EN Wooden handle
 PL Trzonek
 DE Schaufelstiel D-Griff
 RU Черенок для лопат
 CZ Násada na lopatu
 RO Coada de lopata cu maner
 HU Lapátnyél
 ES Astil para pala



No.	L [cm]	Type / Typ	
99412	90	DY	10

EN Wooden handle for hammer-axe
 PL Trzonek do toporka
 DE Beilstiel
 RU Черенок для топора
 CZ Násada na sekeru - kalač
 RO Coada de topor
 HU Ácszekeerce nyél
 ES Astil para hacha con martillo



No.	L [cm]	For head / Do obucha [kg]	
99425	36	0.6	75
99426	40	0.8	25

EN Axe handle
 PL Trzonek do siekiery
 DE Axtstiel
 RU Рукьятка топора
 CZ Topírko do sekery
 RO Cap de topor
 HU Baltanyél
 ES Astil de hacha



No.	L [cm]	For head / Do obucha [kg]	
99427	50	1.0	25
99428	60	1.1-2.5	25
99429	70	1.25-1.8	25

EN Hammer handle
 PL Trzonek do mlotka
 DE Hammerstiel
 RU Рукьятка молотка

CZ Topírko do kladiva
 RO Cap de ciocan
 HU Kalapácsnyél
 ES Astil de martillo



No.	L [cm]	For head / Do obucha [kg]	
99435	28	0.1-0.3	65
99436	32	0.3-0.7	65
99438	36	0.7-1.5	65
99440	40	0.8-2.0	50
99442	50	2.0-3.0	50
99443	60	3.0-4.0	25
99444	70	4.0-6.0	25
99445	80	5.0-8.0	25
99446	90	8.0-10.0	10

EN Wooden handle
 PL Trzonek
 DE Schaufelstiel D-Griff
 RU Черенок для лопат
 CZ Násada na lopatu
 RO Coada de lopata cu maner
 HU Lapátnyél
 ES Astil para pala



No.	L [cm]	Type / Typ	
99413	90	DY	10

EN Handle for hammer-axe
 PL Trzonek do siekiero-młota
 DE Stiel für Hammeraxt
 RU Чернок для топора
 CZ Násada na sekeru
 RO Coada din lemn
 HU Baltanyél
 ES Astil para hachuela



No.	L [cm]	For head / Do obucha [kg]	
99405	90	2.5	10
99406	90	4.0	10

EN Axe handle
 PL Trzonek do siekiery
 DE Axtstiel
 RU Рукьятка топора
 CZ Topírko do sekery
 RO Cap de topor
 HU Baltanyél
 ES Astil de hacha



No.	L [cm]	For head / Do obucha [kg]	
99430	80	1.8-2.0	25



EN Pressure sprayer
 PL Spryskiwacz ciśnieniowy ręczny
 DE Drucksprüher
 RU Опрыскиватель ручной
 CZ Ruční tlakový postřikovač
 RO Vermorel
 HU Permetező kézi
 ES Rociador de presión, de mano



FLO

No.	Tank capacity / Pojemność zbiornika [l]	
89507	1.0	20
89508	1.5	15
89509	2.0	15

EN Pressure sprayer
 PL Opryskiwacz ciśnieniowy
 DE Drucksprüher
 RU Опрыскиватель ручной
 CZ Ruční tlakový postřikovač
 RO Pulverizator de mana
 HU Permetező kézi
 ES Rociador de presión

8 L

0.2 MPa



FLO

No.	Tank capacity / Pojemność zbiornika [l]	
89520	8	6

EN Battery sprayer
 PL Opryskiwacz akumulatorowy
 DE Akku-Sprüngerät
 RU Аккумуляторный опрыскиватель
 CZ Bateriový postřikovač
 RO Vermorel cu acumulator
 HU Akkumulátoros permetező
 ES Pulverizador a batería

FLO

No.	Voltage / Napiecie [V d.c.]	Tank capacity / Pojemność zbiornika [l]	
89610	12	16	1

EN Pressure sprayer
 PL Opryskiwacz ciśnieniowy
 DE Drucksprüher
 RU Опрыскиватель ручной
 CZ Ruční tlakový postřikovač
 RO Pulverizator de mana
 HU Permetező kézi
 ES Rociador de presión

0.2 MPa



FLO

No.	Tank capacity / Pojemność zbiornika [l]	
89515	5	6
89518	8	6

EN Pressure sprayer
 PL Opryskiwacz ciśnieniowy plecakowy
 DE Rücken-Drucksprüher
 RU Опрыскиватель ручной ранцевый
 CZ Tlakový postřikovač zádoový
 RO Pulverizator portabil
 HU Permetező hátí
 ES Rociador de presión tipo „mochila”

0.2 MPa



FLO

No.	Tank capacity / Pojemność zbiornika [l]	
89526	15	1
89528	20	1



12 V
 0.15-0.4 MPa
 3.1 l/min
 16 L
 8.0 Ah
 PE
 SS
STAINLESS STEEL
 STAL NIERDZEWNA

EN Battery sprayer
 PL Opryskiwacz akumulatorowy
 DE Akku-Sprühgerät
 RU Аккумуляторный опрыскиватель
 CZ Bateriový postřikovač
 RO Vermorel cu acumulator
 HU Akkumulátoros permetező
 ES Pulverizador a batería



12 V	0.15-0.4 MPa
3.1 l/min	16L
8.0 Ah	PE
SS STAINLESS STEEL 316L VERZICHTNA	

EN Pump for pressure sprayer
 PL Pompka do opryskiwacza
 DE Druckpumpe für Drucksprüher
 RU Насос на опрыскиватели

CZ Pumpa do postřikovače
 RO Pompa pt. vermored
 HU Szivattyú esőztetőhöz
 ES Bomba para el rociador



FLO

No.	For / Dia	
89536	89515, 89518, 89520	60

EN Straight nozzle for pressure sprayer
 PL Końcówka rozpylająca do opryskiwaczy
 DE Sprühdüse für Drucksprüher
 RU Распылитель на опрыскиватели

CZ Rozprašovací koncovka k postřikovači
 RO Doza pt. vermored
 HU Porlasztó tömlővég esőztetőhöz
 ES Puna de atomización para rociador



FLO

No.	For / Dia	
89537	89515, 89518, 89520	300

EN Shower spray gun
 PL Pistolet do opryskiwacza
 DE Spritzpistole
 RU Пистолет для опрыскивателей

CZ Rozprašovací pistole na vodu
 RO Pistol pt. stropit
 HU Locsoló pisztoly
 ES Pistola de pulverización ajustable



FLO

No.	
89539	200

EN Fibreglass spray lance
 PL Lanza z włókna szklanego
 DE Fibreglaslanze
 RU Трубка фиберглассовая
 CZ Násadec postřikovače ze skleněného vlákna
 RO Lance din fibra de sticla
 HU Üvegyapott lándzsa
 ES Lanza de fibra de vidrio

80
cm



FLO

No.	L [cm]	Ø [mm]	
89541	80	8	250

FLO

No.	Voltage / Napięcie [V d.c.]	Tank capacity / Pojemność zbiornika [l]	
89611	12	16	1

EN Spray nozzle set
 PL Zestaw końcówek rozpylających
 DE Spritzdüsenatz
 RU Форсунки сменные для опрыскивателей

CZ Sada rozprašovacích koncovok
 RO Set recorduri vermored
 HU Porlasztó tömlővég készlet
 ES Juego de boquillas rociadores



FLO

No.	
89538	100

EN Shower spray gun
 PL Pistolet do opryskiwacza
 DE Spritzpistole
 RU Пистолет для опрыскивателей

CZ Rozprašovací pistole na vodu
 RO Pistol pt. stropit
 HU Locsoló pisztoly
 ES Pistola de pulverización ajustable



FLO

No.	
89540	200

- EN Telescopic handle
- PL Lanza teleskopowa
- DE Teleskoplanze
- RU Штанга телескопическая для опрыскивателя
- CZ Násadec teleskopický
- RO Maner telescopic
- HU Teleszkópos lándzsa
- ES Lanza telescópica

70-118 cm



No.	L [cm]	
89542	70-118	100

- EN Set of gaskets for pressure sprayer
- PL Zestaw uszczelek do spryskiwaczy
- DE Dichtungssatz für Drucksprüher
- RU Набор прокладок для опрыскивателя
- CZ Sada těsnění k postřikovači
- RO Set de garnituri pt. vermoresl
- HU Tömítéskészlet esőztetőhöz
- ES Juego de juntas para rociadores



No.	For / Dia	
89545	89515, 89518, 89520	500

- EN Electric grass trimmer
- PL Podkaszarka elektryczna
- DE Elektro-Rasentrimmer
- RU Электрический триммер
- CZ Elektrická sekačka
- RO Cositoare electrică
- HU Elektromos fűnyíró
- ES Segadora eléctrica

230V~50Hz 500 W

10500 min⁻¹ 280 mm

80-100 cm 2 POSITIONS POSITIONE



$L_{pa} = 74,4 \pm 1,94$ dB; $L_{wa} = 94,1 \pm 1,94$ dB; $a_n = 0,794 \pm 1,5$ m/s²

No.	Power / Moc [W]	ω [min ⁻¹]	Cutting width / Szerokość cięcia [mm]	
79467	500	10500	280	4

- EN 4-nozzle connector
- PL Przyłącze 4-dyszowe
- DE Querlanze mit 4 Düsen
- RU Штанга с 4 форсунками для опрыскивателей (вертикальная)

- CZ Připojka 4-trysková
- RO Sistem irigații
- HU 4-fúvókás csatlakozó
- ES Conexión de cuatro surtidores

645 mm



No.	L [cm]	
89543	64.5	100

- EN Set of gaskets for pressure sprayer
- PL Zestaw uszczelek do spryskiwaczy
- DE Dichtungssatz für Drucksprüher
- RU Набор прокладок для опрыскивателя

- CZ Sada těsnění k postřikovači
- RO Set de garnituri pt. vermoresl
- HU Tömítéskészlet esőztetőhöz
- ES Juego de juntas para rociadores



No.	For / Dia	
89547	89526, 89528	500

- EN Hedge shears
- PL Elektryczne nożyce do żywopłotu
- DE Heckenscheren
- RU Ножницы для живой изгороди
- CZ Nůžky na živý plot
- RO Foarfece pt. gard viu
- HU Sövényvágó olló
- ES Tijera para vallado

230V~50Hz 450 W

1700 min⁻¹ 410 mm



$L_{pa} = 81,6 \pm 3,0$ dB; $L_{wa} = 101,6 \pm 3,0$ dB; $a_n = 5,328 \pm 1,5 / 6,1214 \pm 1,5$ m/s²

No.	Power / Moc [W]	Cutting speed / Predkość cięcia [min ⁻¹]	Cutting length / Długość cięcia [mm]	
79442	450	1700	410	4

- EN Hedge shears
- PL Elektryczne nożyce do żywopłotu
- DE Heckenscheren
- RU Ножницы для живой изгороди
- CZ Nůžky na živý plot
- RO Foarfece pt. gard viu
- HU Sövényvágó olló
- ES Tijera para vallado

230V~50Hz 550 W

1700 min⁻¹ 510 mm



$L_{pa} = 88,0 \pm 3,0$ dB; $L_{wa} = 99,0 \pm 3,0$ dB; $a_n = 1,982 \pm 1,5 / 1,778 \pm 1,5$ m/s²

No.	Power / Moc [W]	Cutting speed / Predkość cięcia [min ⁻¹]	Cutting length / Długość cięcia [mm]	
79448	550	1700	510	4

EN Electric chainsaw
 PL Elektryczna pilarka łańcuchowa
 DE Elektrische Kettensäge
 RU Электрическая цепная пила
 CZ Elektrická řetězová pila
 RO Ferăstrău electric cu lanț
 HU Elektromos láncfűrész
 ES Sierra de cadena eléctrica

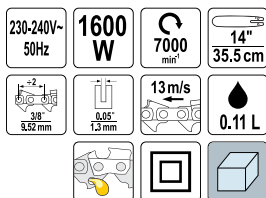

$L_{PA} = 90,2 \pm 3,0$ dB; $L_{WA} = 103,2 \pm 3,0$ dB; $a_n = 8,393 \pm 1,5 / 6,002 \pm 1,5$ m/s²

No.	Power / Moc [W]	Icon
79675	1600	2

EN Electric scarifier
 PL Wertykulator elektryczny
 DE Elektrischer Vertikutierer
 RU Электрический скарификатор
 CZ Elektrický vertikátor
 RO Scarificator electric
 HU Elektromos gepszellőztető
 ES Escarificador eléctrico

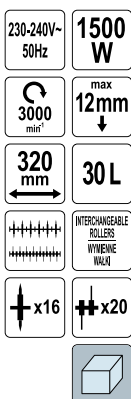

$L_{PA} = 84,5 \pm 3,0$ dB; $L_{WA} = 97,3 \pm 1,05$ dB; $a_n = 4,265 \pm 1,5$ m/s²

No.	Power / Moc [W]	Icon
79734	1500	1

EN Guide for chain saw file
 PL Przewodnik do pilnika do łańcuchów
 DE Führung für die Kettenfeile
 RU Направляющая для напильника для цепей
 CZ Vedení pro pilník na řetězy
 RO Ghidaj pt. pila pt. lanțuri
 HU Megvezető a láncfűrészhez
 ES Guía de lima para cadenas



No.	Chain pitch / Podziałka łańcucha	Ø [mm]	Icon
79865	3/8 piccolo	4.0	50/150
79866	microlite	4.5	50/150
79867	.325	4.8	50/150

EN Line head
 PL Głowica żyłkowa
 DE Trimmerkopf
 RU Головка с леской
 CZ Strunová hlava
 RO Cap cu cablu
 HU Dámlí fej
 ES Cabezal de hilo



No.	Ø [mm]	Icon
79550	2.0-2.4	10/40

EN Electric soil miller
 PL Głębogryzarka elektryczna
 DE Elektro-Bodenhacke
 RU Электрический культиватор
 CZ Elektrický kultivátor
 RO Motosapa electrică
 HU Elektromos kapálógép
 ES Cultivador rotativo eléctrico

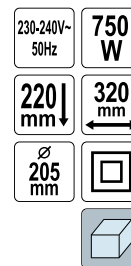

$L_{PA} = 79,0 \pm 3,0$ dB; $L_{WA} = 91,87 \pm 0,48$ dB; $a_n = 1,153 \pm 1,5 / 1,158 \pm 1,5$ m/s²

No.	Power / Moc [W]	Icon
79725	750	1

EN Chain saw file
 PL Pilnik okrągły do łańcuchów
 DE Runde Kettenfeile
 RU Цилиндрический напильник для цепей
 CZ Kulatý pilník na řetězy
 RO Pila rotundă pt. lanțuri
 HU Láncvágó körfűrész
 ES Lima redonda para cadenas



No.	L [mm]	Chain pitch / Podziałka łańcucha	Ø [mm]	pcs / szt.	Icon
79861	200	3/8 piccolo	4.0	3	4/200
79862	200	microlite	4.5	3	4/200
79863	200	.325	4.8	3	4/200

EN Universal wrench for gasoline machines
 PL Kluczyk uniwersalny do narzędzi spalinowych
 DE Universalschlüssel für Benzin Maschinen
 RU Универсальный ключ для бензинового инструмента
 CZ Univerzální klíč pro benzinové stroje
 RO Cheie universală pt. mașini pe benzină
 HU Kulccsal benzin eszköz
 ES Llave universal para máquinas de gasolina



No.	Icon
79869	10/100



No.	Ø [mm]	Icon
79550	2.0-2.4	10/40



EN Line head
 PL Glowica żyłkowa
 DE Trimmerkopf
 RU Головка с леской
 CZ Strunová hlava
 RO Cap cu cablu
 HU Damil fej
 ES Cabezal de hilo

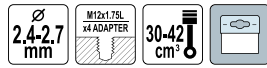

No.	Ø [mm]	
79551	2.4-2.7	10/40

EN Line head
 PL Glowica żyłkowa
 DE Trimmerkopf
 RU Головка с леской
 CZ Strunová hlava
 RO Cap cu cablu
 HU Damil fej
 ES Cabezal de hilo

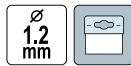

No.	Ø [mm]	For / Dia	
79468	1.2	79467	20/100

EN Brushcutter chisel-tooth blade
 PL Tarcza tnąca z zębami przecinakowymi
 DE Meißelzahn-Sägeblatt für Motorsensen
 RU Нож для мотокосы
 CZ Řezací kotouč s dřátovými zuby
 RO Lama cu dinti tip dalta pt. cosit
 HU Fűrészkorong vágótárcsa
 ES Disco de corte para desbrozadora



No.	
79561	15/30

EN Grass trimmer line
 PL Żyłka tnąca
 DE Mähfaden
 RU Леска для триммера

CZ Struna do strunové sekačky
 RO Furtun gradina
 HU Damil szegélynyíró géphez
 ES Hilo de cortar



10m



No.	Ø [mm]	L [m]	Cutting line profile / Przekrój żyłki	
89401	1.3	10	○	20/240
89402	1.6	10	○	20/240
89403	2.0	10	○	20/240
89404	2.4	10	○	12/144
89405	2.6	10	○	12/144
89406	3.0	10	○	12/144

EN Line head
 PL Glowica żyłkowa
 DE Trimmerkopf
 RU Головка с леской
 CZ Strunová hlava
 RO Cap cu cablu
 HU Damil fej
 ES Cabezal de hilo



No.	Ø [mm]	
79552	2.4-2.7	10/40

EN 2-tooth brushcutter blade
 PL Tarcza tnąca dwuzębna
 DE 2-Zahn Dickichtmesser
 RU Нож для мотокосы двулопастной
 CZ Žací nůž 2-zubý
 RO Lama de cosit cu 2 dinti
 HU 2-ágú bozótívágó kés
 ES Cuchilla de 2 puntas para desbrozadora



No.	
79560	25/50

EN 26T brushcutter blade
 PL Tarcza tnąca 26T
 DE 26-Zahn Dickichtmesser
 RU Нож для мотокосы 26-зубый
 CZ Žací nůž 26T
 RO Lama de cosit cu 26 dinti
 HU 26-ágú bozótívágó kés
 ES Cuchilla de 26 puntas para desbrozadora



EN Grass trimmer line
 PL Żyłka tnąca
 DE Mähfaden
 RU Леска для триммера

CZ Struna do strunové sekačky
 RO Furtun gradina
 HU Damil szegélynyíró géphez
 ES Hilo de cortar

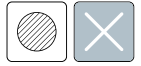

No.	Ø [mm]	L [m]	Cutting line profile / Przekrój żyłki	
89441	2.0	120	○	27
89442	2.4	90	○	27
89443	2.6	70	○	27
89444	3.0	56	○	27

EN Grass trimmer line
 PL Żyłka tnąca
 DE Mähfaden
 RU Леска для триммера
 CZ Struna do strunové sekačky
 RO Furtun gradina
 HU Damil szegélynyíró géphez
 ES Hilo de cortar



No.	Ø [mm]	L [m]	Cutting line profile / Przekrój żyłki	
89411	1.3	10		20/240
89412	1.6	10		20/240
89413	2.0	10		20/240
89414	2.4	10		12/144
89415	2.6	10		12/144
89416	3.0	10		12/144



EN Grass trimmer line
 PL Żyłka tnąca
 DE Mähfaden
 RU Леска для триммера
 CZ Struna do strunové sekačky
 RO Furtun gradina
 HU Damil szegélynyíró géphez
 ES Hilo de cortar



No.	Ø [mm]	L [m]	Cutting line profile / Przekrój żyłki	
89452	2.4	90		16
89453	2.6	70		16
89454	3.0	56		16

EN Grass trimmer line
 PL Żyłka tnąca
 DE Mähfaden
 RU Леска для триммера
 CZ Struna do strunové sekačky
 RO Furtun gradina
 HU Damil szegélynyíró géphez
 ES Hilo de cortar



No.	Ø [mm]	L [m]	Cutting line profile / Przekrój żyłki	
89456	2.0	90		9/27
89457	2.4	90		9/27
89458	2.6	90		9/27
89459	3.0	60		9/27

EN Grass trimmer line
 PL Żyłka tnąca
 DE Mähfaden
 RU Леска для триммера
 CZ Struna do strunové sekačky
 RO Furtun gradina
 HU Damil szegélynyíró géphez
 ES Hilo de cortar

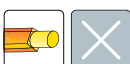

No.	Ø [mm]	L [m]	Cutting line profile / Przekrój żyłki	
89465	2.4	90		10/20
89466	2.7	70		10/20
89467	3.0	60		10/20

EN Grass trimmer line
 PL Żyłka tnąca
 DE Mähfaden
 RU Леска для триммера
 CZ Struna do strunové sekačky
 RO Furtun gradina
 HU Damil szegélynyíró géphez
 ES Hilo de cortar

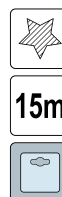

No.	Ø [mm]	L [m]	Cutting line profile / Przekrój żyłki	
89421	1.3	15		24/288
89422	1.6	15		20/240
89423	2.0	15		16/192
89424	2.4	15		12/144
89425	2.6	15		12/144
89426	3.0	15		10/120

EN Grass trimmer line
 PL Żyłka tnąca
 DE Mähfaden
 RU Леска для триммера
 CZ Struna do strunové sekačky
 RO Furtun gradina
 HU Damil szegélynyíró géphez
 ES Hilo de cortar

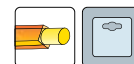

No.	Ø [mm]	L [m]	Cutting line profile / Przekrój żyłki	
89462	2.4	15		10/120
89463	2.7	15		10/120
89464	3.0	12		10/120

EN Grass trimmer line
 PL Żyłka tnąca
 DE Mähfaden
 RU Леска для триммера
 CZ Struna do strunové sekačky
 RO Furtun gradina
 HU Damil szegélynyíró géphez
 ES Hilo de cortar

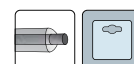

No.	Ø [mm]	L [m]	Cutting line profile / Przekrój żyłki	
89470	2.4	15		10/120
89471	2.7	15		10/120
89472	3.0	12		10/120

EN Grass trimmer line
 PL Żyłka tnąca
 DE Mähfaden
 RU Леска для триммера
 CZ Struna do strunové sekačky
 RO Furtun gradina
 HU Damil szegélynyíró géphez
 ES Hilo de cortar

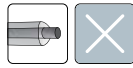

No.	Ø [mm]	L [m]	Cutting line profile / Przekrój żyłki	
89473	2.4	90		10/20
89474	2.7	70		10/20
89475	3.0	60		10/20

EN Grass trimmer line
 PL Żyłka tnąca
 DE Mähfaden
 RU Леска для триммера

CZ Struna do strunové sekačky
 RO Furtun gradina
 HU Damil szegélynyíró géphez
 ES Hilo de cortar



No.	Ø [mm]	L [m]	Cutting line profile / Przekrój żyłki	
89483	2.0	90		10/20
89484	2.4	90		10/20
89485	2.7	70		10/20
89486	3.0	60		10/20

EN Working gloves
 PL Rękawice robocze
 DE Arbeitshandschuhe
 RU Рабочие перчатки
 CZ Pracovní rukavice
 RO Mănuși
 HU Védőkesztyű
 ES Guantes de piel



No.	Size / Rozmiar	
74100	10	12/300

EN Working gloves
 PL Rękawice robocze
 DE Arbeitshandschuhe
 RU Рабочие перчатки
 CZ Pracovní rukavice
 RO Mănuși de lucru
 HU Védőkesztyű
 ES Guantes de piel



No.	Size / Rozmiar	
74126	8	12/300
74132	9	12/300

EN Grass trimmer line
 PL Żyłka tnąca
 DE Mähfaden
 RU Леска для триммера
 CZ Struna do strunové sekačky
 RO Furtun gradina
 HU Damil szegélynyíró géphez
 ES Hilo de cortar



No.	Ø [mm]	L [m]	Cutting line profile / Przekrój żyłki	
89478	1.6	15		20/240
89479	2.0	15		12/240
89480	2.4	15		10/120
89481	2.7	15		10/120
89482	3.0	12		10/120

EN Grass trimmer line
 PL Żyłka tnąca
 DE Mähfaden
 RU Леска для триммера

CZ Struna do strunové sekačky
 RO Furtun gradina
 HU Damil szegélynyíró géphez
 ES Hilo de cortar



EN Working gloves
 PL Rękawice robocze
 DE Arbeitshandschuhe
 RU Рабочие перчатки
 CZ Pracovní rukavice
 RO Mănuși de lucru
 HU Védőkesztyű
 ES Guantes de piel



No.	Size / Rozmiar	
74125	8	12/300
74130	9	12/300
74131	10	12/300

EN Working gloves
 PL Rękawice robocze
 DE Arbeitshandschuhe
 RU Рабочие перчатки
 CZ Pracovní rukavice
 RO Mănuși de lucru
 HU Védőkesztyű
 ES Guantes de piel



No.	Size / Rozmiar	
74127	8	12/300
74134	9	12/300
74135	10	12/300

EN Working gloves
 PL Rękawice robocze
 DE Arbeitshandschuhe
 RU Рабочие перчатки
 CZ Pracovní rukavice
 RO Mănuși de lucru
 HU Védőkesztyű
 ES Guantes de piel



POLYESTER
 POLYESTER

PU



No.	Size / Rozmiar	
74128	8	12/300
74136	9	12/300
74137	10	12/300

EN Gardening gloves
 PL Rękawice ogrodnicze
 DE Arbeitshandschuh
 RU Перчатки
 CZ Pracovní rukavice
 RO Mănuși
 HU Védőkesztyű
 ES Guantes



8
 SIZE / ROZMIAR

POLYESTER
 POLYESTER



No.	Size / Rozmiar	
74121	8	50/1000

EN Gardening gloves
 PL Rękawice ogrodnicze
 DE Arbeitshandschuh
 RU Перчатки
 CZ Pracovní rukavice
 RO Mănuși
 HU Védőkesztyű
 ES Guantes



8
 SIZE / ROZMIAR

POLYESTER
 POLYESTER



No.	Size / Rozmiar	
74113	8	50/1000

EN Women's rain boots
 PL Kalosze damskie
 DE Damen - Gummistiefel
 RU Галоши женские
 CZ Dámské galoše
 RO Cizme damă
 HU Női gumicsizma
 ES Chanclas para mujer



No.	Size / Rozmiar	
73931	36	7
73932	37	7
73933	38	7
73934	39	7
73935	40	7
73936	41	7

EN Gardening gloves
 PL Rękawice ogrodnicze
 DE Arbeitshandschuh
 RU Перчатки
 CZ Pracovní rukavice
 RO Mănuși
 HU Védőkesztyű
 ES Guantes



8
 SIZE / ROZMIAR

POLYESTER
 POLYESTER



No.	Size / Rozmiar	
74117	8	50/1000

EN Gardening gloves
 PL Rękawice ogrodnicze
 DE Arbeitshandschuh
 RU Перчатки
 CZ Pracovní rukavice
 RO Mănuși
 HU Védőkesztyű
 ES Guantes



8
 SIZE / ROZMIAR

POLYESTER
 POLYESTER



No.	Size / Rozmiar	
74123	8	50/1000

EN Gardening gloves
 PL Rękawice ogrodnicze
 DE Arbeitshandschuh
 RU Перчатки
 CZ Pracovní rukavice
 RO Mănuși
 HU Védőkesztyű
 ES Guantes



8
 SIZE / ROZMIAR

POLYESTER
 POLYESTER



No.	Size / Rozmiar	
74115	8	50/1000



EVA

NON-SLIP
 ANTYPISZCZEWNA

HEATING
 INSERT
 WKŁAD
 OGRZEWALNY

EN Men's rain boots
 PL Kalosze męskie
 DE Herren - Gummistiefel
 RU Галоши мужские
 CZ Pánské galoše
 RO Cizme bărbați
 HU Férfi gumicsizma
 ES Chanclos para hombre



No.	Size / Rozmiar	
73937	41	5
73938	42	5
73939	43	5
73940	44	5
73941	45	5
73942	46	5
73943	47	5

EN Men's rain boots
 PL Kalosze męskie
 DE Herren - Gummistiefel
 RU Галоши мужские
 CZ Pánské galoše
 RO Cizme bărbați
 HU Férfi gumicsizma
 ES Chanclos para hombre



No.	Size / Rozmiar	
73950	41	5
73951	42	5
73952	43	5
73953	44	5
73954	45	5
73955	46	5

EN Men's rain boots
 PL Kalosze męskie
 DE Herren - Gummistiefel
 RU Галоши мужские
 CZ Pánské galoše
 RO Cizme bărbați
 HU Férfi gumicsizma
 ES Chanclos para hombre



No.	Size / Rozmiar	
73966	40	5
73967	41	5
73968	42	5
73969	43	5
73970	44	5
73971	45	5
73972	46	5
73973	47	5

EN Women's rain boots
 PL Kalosze damskie
 DE Damen - Gummistiefel
 RU Галоши женские
 CZ Dámské galoše
 RO Cizme damă
 HU Női gumicsizma
 ES Chanclos para mujer



No.	Size / Rozmiar	
73945	37	5
73946	38	5
73947	39	5

EN Felt PVC boots
 PL Buty gumowo-filcowe
 DE Gummistiefel mit Filz
 RU Сапоги резиновые с войлоком
 CZ Holinky s filcem
 RO Cizme PVC
 HU Gumi - filc csizma
 ES Botas de goma fieltro



No.	Size / Rozmiar	
73958	40	5
73959	41	5
73960	42	5
73961	43	5
73962	44	5
73963	45	5
73964	46	5

EN All purpose boot tray
 PL Wielofunkcyjna podstawa gospodarcza
 DE Garten- und Haushalt-Unterlage
 RU Многофункциональный поднос

CZ Multifunkční podložka
 RO Tava multifunctionala
 HU Többfunkciós tálcá
 ES Bandeja de arranque universal

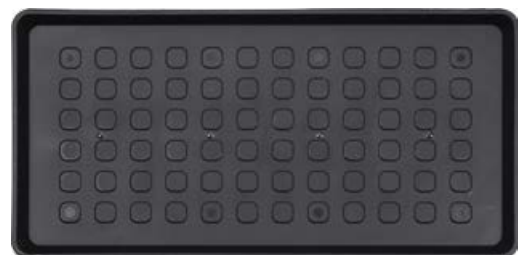
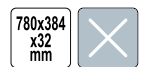

No.	Dimensions / Wymiary [mm]	
67260	780x384x32	30

EN Knee pads
 PL Nakolanniki
 DE Knieschützer
 RU Наколенники
 CZ Chrániče kolen
 RO Genunchiere
 HU Térdvédő
 ES Rodilleras



No. 74600 50

EN Knee pads
 PL Nakolanniki
 DE Knieschützer
 RU Наколенники
 CZ Chrániče kolen
 RO Genunchiere
 HU Térdvédő
 ES Rodilleras



No. 74622 50

EN Knee pads
 PL Nakolanniki
 DE Knieschützer
 RU Наколенники
 CZ Chrániče kolen
 RO Genunchiere
 HU Térdvédő
 ES Rodilleras



No. 74601 24

EN Knee pads
 PL Nakolanniki
 DE Knieschützer
 RU Наколенники
 CZ Chrániče kolen
 RO Genunchiere
 HU Térdvédő
 ES Rodilleras



No. 74603 6/24

EN Knee pads
 PL Nakolanniki
 DE Knieschützer
 RU Наколенники
 CZ Chrániče kolen
 RO Genunchiere
 HU Térdvédő
 ES Rodilleras

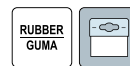

No. 74610 20

EN Knee pads
 PL Nakolanniki
 DE Knieschützer
 RU Наколенники
 CZ Chrániče kolen
 RO Genunchiere
 HU Térdvédő
 ES Rodilleras



No. 74624 12/24

EN Knee pads
 PL Nakolanniki
 DE Knieschützer
 RU Наколенники
 CZ Chrániče kolen
 RO Genunchiere
 HU Térdvédő
 ES Rodilleras



No. 74602 6/36

EN Knee pads
 PL Nakolanniki
 DE Knieschützer
 RU Наколенники
 CZ Chrániče kolen
 RO Genunchiere
 HU Térdvédő
 ES Rodilleras



No. 74604 20

EN Knee pads
 PL Nakolanniki - wkładki
 DE Knieeschützer
 RU Наколеники
 CZ Chrániče kolen
 RO Genunchiere
 HU Térdvédő
 ES Rodilleras

210x165
 x18
 mm
EVA

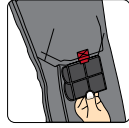

VOREL

No.	60
74595	60

EN Face shield with PC visor
 PL Przyłbica z osłoną wymienną
 DE Schweisserschutzhelm
 mit austauschbarer Abdeckung
 RU Шлем с заменяемой защитой
 CZ Štít s vyměnitelným krytem
 RO Vizieră cu protecție schimbabilă
 HU Arcvédő cserélhető pajzszal
 ES Antifaz con protección
 reemplazable

395x200
 mm
1
 OPTICAL GLASS
 KLASA OPTYCZNA

PE **PVC**



VOREL

No.	25
74471	25

EN Face shield with steel mesh and ear muff
 PL Przyłbica z osłoną wymienną i nausznikami przeciwhałasowymi
 DE Schweisserschutzhelm mit austauschbarer Abdeckung und Ohrenschilder gegen Lärm
 RU Шлем с заменяемой защитой и наушниками против шума
 CZ Štít s vyměnitelným krytem a chrániči proti hluku
 RO Vizieră cu protecție schimbabilă și căști de protecție antizgomot
 HU Arcvédő cserélhető pajzszal és fülvédő kagylóval
 ES Antifaz con protección reemplazable y protectores de oídos

395x200
 mm



VOREL

No.	40
74462	40

EN Hearing protectors
 PL Nauszniki przeciwhałasowe
 DE Gehörschutz
 RU Средства защиты слуха
 CZ Chrániče sluchu
 RO Antifoane
 HU Fültok
 ES Protectores auditivos

VOREL

No.	10/60
74581	10/60

EN Safety helmet
 PL Kask ochronny
 DE Schutzhelm
 RU Каска защитная
 CZ Ochranná přilba
 RO Cască de protecție
 HU Védősisak
 ES Casco de protección

HDPE



VOREL

No.	Color / Kolor	30
74171	pomarańczowy	30
74172	zöldy	30
74173	biály	30
74174	czerwony	30
74175	niebieski	30
74176	zöldny	30

EN Face shield
 PL Osłona siatkowa twarzy z nagłowiem
 DE Gesichtsschutz mit Maschenvisier
 RU Сетчатая защитная маска
 с обвязкой для головы
 CZ Síťová ochrana tváře s postrojem
 RO Vizor protecție față
 HU Hálós arcvédő
 ES Pantalla con visor
 de malla metálica

PE

**STEEL
 STAL**



FLO

No.	25
74468	25

EN Hearing protectors
 PL Nauszniki przeciwhałasowe
 DE Gehörschutz
 RU Средства защиты слуха
 CZ Chrániče sluchu
 RO Antifoane
 HU Fültok
 ES Protectores auditivos

**SNR
 24dB**



VOREL

No.	60
74580	60

**SNR
 20.4dB**



EN Safety glasses
 PL Okulary ochronne
 DE Schutzbrille
 RU Очки защитные открытые
 CZ Ochranné brýle
 RO Ochelari pt. protectie
 HU Védőszemüveg
 ES Gafas protectoras



No.	Type / Typ	
74501	TVS	8/80

EN Safety glasses
 PL Okulary ochronne
 DE Schutzbrille
 RU Очки защитные открытые
 CZ Ochranné brýle
 RO Ochelari pt. protectie
 HU Védőszemüveg
 ES Gafas protectoras



No.	Type / Typ	
74503	DY-8525	12/240

EN Safety glasses
 PL Okulary ochronne
 DE Schutzbrille
 RU Очки защитные открытые
 CZ Ochranné brýle
 RO Ochelari pt. protectie
 HU Védőszemüveg
 ES Gafas protectoras



No.	Type / Typ	
74508	HF-103	10/120

EN Slow release watering bag
 PL Worek nawadniający
 DE Bewässerungssack
 RU Мешок для орошения
 CZ Zavlažovací pytel
 RO Punga pt. irigat
 HU Faöntöző zsák
 ES Bolsa de riego

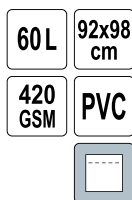

No.	Capacity / Pojemność [l]	
89715	60	24

EN Safety glasses
 PL Okulary ochronne
 DE Schutzbrille
 RU Очки защитные открытые
 CZ Ochranné brýle
 RO Ochelari pt. protectie
 HU Védőszemüveg
 ES Gafas protectoras



No.	Type / Typ	
74505	STD SG-007	12/240

EN Safety glasses
 PL Okulary ochronne
 DE Schutzbrille
 RU Очки защитные открытые
 CZ Ochranné brýle
 RO Ochelari pt. protectie
 HU Védőszemüveg
 ES Gafas protectoras



No.	Type / Typ	
74504	DY-8526	15/150

EN Safety glasses
 PL Okulary ochronne
 DE Schutzbrille
 RU Очки защитные открытые
 CZ Ochranné brýle
 RO Ochelari pt. protectie
 HU Védőszemüveg
 ES Gafas protectoras



No.	Type / Typ	
74509	HF-105	10/100

EN Slow release watering bag
 PL Worek nawadniający
 DE Bewässerungssack
 RU Мешок для орошения
 CZ Zavlažovací pytel
 RO Punga pt. irigat
 HU Faöntöző zsák
 ES Bolsa de riego

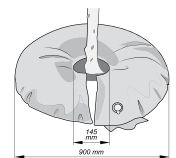
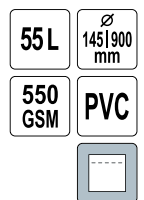

No.	Capacity / Pojemność [l]	
89720	55	20

EN Slow release watering bag
 PL Worek nawadniający
 DE Bewässerungssack
 RU Мешок для орошения
 CZ Zavlažovací pytel
 RO Punga pt. irigat
 HU Faöntöző zsák
 ES Bolsa de riego



75L 145/1000 mm
 550 GSM PVC

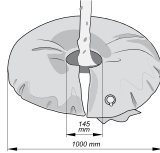

No.	Capacity / Pojemność [l]	
89722	75	20

EN Compressible rain barrel
 PL Zbiornik na wodę deszczową
 DE Regenwasserbehälter
 RU Бак для дождевой воды
 CZ Nádrž na dešťovou vodu
 RO Butoi de ploaie compresibil
 HU Esővízgyűjtő tartály
 ES Depósito de agua pluvial



250L 60x88 cm
 3/4" 19mm PVC
 PP UV



No.	Capacity / Pojemność [l]	
89702	250	6

EN Valves set
 PL Zestaw zaworów
 DE Ventil-Set
 RU Комплект клапанов

CZ Sada ventilů
 RO Set valve
 HU Szelepkészlet
 ES Juego de válvulas



No.	Hose diameter / Średnica węży	pcs / szt.	
89081	3/4" (19.0 mm)	3	50

EN Lawn edge
 PL Obrzeże trawnikowe, zielone
 DE Gartenumrandung
 RU Оградка для огорода
 CZ Plastový okraj trávníku
 RO Gărduț plastic grădină
 HU Ágyásszegély
 ES Borde para jardín



No.	H [mm]	L [m]	
88700	100	9	48
88701	150	9	36
88702	200	9	24

EN Compressible rain barrel
 PL Zbiornik na wodę deszczową
 DE Regenwasserbehälter
 RU Бак для дождевой воды
 CZ Nádrž na dešťovou vodu
 RO Butoi de ploaie compresibil
 HU Esővízgyűjtő tartály
 ES Depósito de agua pluvial



100L 40x78 cm
 3/4" 19mm PVC
 PP UV



No.	Capacity / Pojemność [l]	
89700	100	6

EN Compressible rain barrel
 PL Zbiornik na wodę deszczową
 DE Regenwasserbehälter
 RU Бак для дождевой воды
 CZ Nádrž na dešťovou vodu
 RO Butoi de ploaie compresibil
 HU Esővízgyűjtő tartály
 ES Depósito de agua pluvial



500L 80x98 cm
 3/4" 19mm PVC
 PP UV



No.	Capacity / Pojemność [l]	
89704	500	4



3 PCS 3/4" 19mm
 PVC PP

EN Lawn edge
 PL Obrzeże trawnikowe, brązowe
 DE Gartenumrandung
 RU Оградка для огорода
 CZ Plastový okraj trávníku
 RO Gărduț plastic grădină
 HU Ágyásszegély
 ES Borde para jardín



No.	H [mm]	L [m]	
88703	100	9	48
88704	150	9	36
88705	200	9	24

EN Plant protection fleece
 PL Agrowłóknina
 DE Agrotexilien
 RU Геотекстиль нетканый иглопробивной
 CZ Agrovláknina
 RO Folie láná de protecție a plantelor
 HU Geotextília
 ES Tela antiheladas



FLO

No.	Size / Rozmiar [m]	m [g/m ²]	
91000	1.6x50	19	12
91003	1.6x50	50	1

EN Ground cover staples
 PL Szpilki do agrowłókniny, agrotkaniny
 DE Erdankern für Unkrautvlies, Gartenvlies
 RU Шпильки для агроткани
 CZ Hřebíky ve tvaru U k upevnění textilií
 RO Capse pt. folie antiburieni
 HU Rögztítő tűske geotextiliához és agroszövethez
 ES Grapas para malla antihierbas, tela antiheladas



FLO

No.	pcs / szt.	
91060	100	10

EN Shade cloth
 PL Mata do cieniowania
 DE Schattenmatte
 RU Коврик для тонировки
 CZ Podložka pro stínování
 RO Panza pt. umbra
 HU Árnyékoló háló
 ES Tela de malla sombra

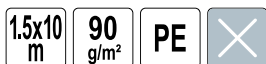

FLO

No.	Size / Rozmiar [m]	
88740	1.5x10	9

EN Twist tie with cutter
 PL Drut ogrodniczy powlekany z obcinaczem
 DE Gartendraht, beschichtet, mit Abschneider
 RU Проволока огородная с диспенсером
 CZ Drát pro zahrádkáře potažený plastem s odřezávačem
 RO Sărmă pt. grădină izolată cu tăietor
 HU Galvanizált kötöződrót, darabolóval
 ES Alambre de jardinero cubierto con tronizador

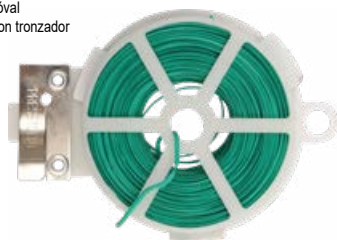

FLO

No.	L [m]	
88805	30	24/144
88806	50	24/144

EN Weed mat
 PL Agrotkanina
 DE Unkrautvlies
 RU Геотекстиль нетканый
 CZ Tkaná textilie
 RO Folie antiburieni
 HU Agroszövet
 ES Malla antihierbas



FLO

No.	Size / Rozmiar [m]	m [g/m ²]	
91050	1.6x50	70	1
91052	1.6x50	90	1

EN Ground cover pegs
 PL Kolki do agrowłókniny, agrotkaniny
 DE Bodenankern für Unkrautvlies, Gartenvlies
 RU Кольшки для крепления агроткани
 CZ Hřebíky k upevnění textilií
 RO Cuie pt. folie antiburieni
 HU Geotextília rögzítő tűske
 ES Clavos para malla antihierbas, tela antiheladas

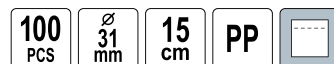

FLO

No.	pcs / szt.	
91061	100	10

EN Twist tie
 PL Drut ogrodniczy
 DE Gartendraht
 RU Проволока огородная

CZ Drát pro zahrádkáře
 RO Sărmă pt. grădină
 HU Kötöződrót
 ES Alambre de jardinero



FLO

No.	L [m]	
88801	50	12/48

EN Garden flexible tie
 PL Drut ogrodniczy w oslonie z pianki
 DE Gartendraht, in einer Abdeckung aus Schaumstoff
 RU Проволока огородная покрытая пенкой
 CZ Drát pro zahrádkáře s pěnovým pláštěm
 RO Sărmă pt. grădină cu izolație din spumă
 HU Kötöződrót, plasztik bevonattal
 ES Alambre de jardinero en cubierta de espuma

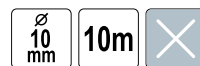

FLO

No.	L [m]	
88809	10	40

EN Plant binding set
 PL Zestaw ogrodniczy do podwiązania roślin
 DE Gartensatz zum Abbinden von Pflanzen
 RU Набор огородный для подвязки растений

CZ Souprava pro zahrádkáře k vyvazování rostlin
 RO Set pt. grădină pt. legare plante
 HU Kertészeti szett növények felkötéséhez
 ES Juego para jardín para sujetar plantas

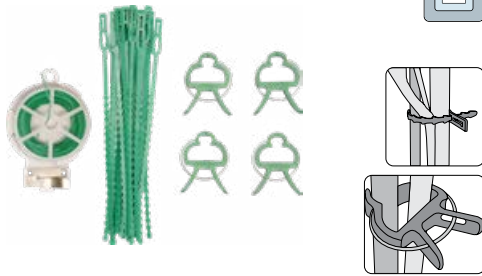

No.	pcs / szt.	Box
88811	71	24

EN String set
 PL Zestaw sznurków
 DE Schnursatz
 RU Набор шнуров
 CZ Sada provázků
 RO Set sfori
 HU Zsinórkészlet
 ES Juego de cuerdas



No.	pcs / szt.	Box
88820	6	36

EN Plant antifreeze protective cover set
 PL Pokrowce przeciw zamarzaniu roślin
 DE Winterschutzsäcke für Pflanzen
 RU Чехлы для защиты от заморозки растений
 CZ Krytí proti zamrznání rostlin
 RO Set protecții anti îngheț pt. plante
 HU Fagyvédő fólia növényekre
 ES Cubre plantas



No.	Size / Rozmiar [cm]	pcs / szt.	Box
89753	80x75	3	24

EN Vegetable growing house
 PL Miniszklarnia przydomowa
 DE Mini Garten-Gewächshaus
 RU Садовая мини-теплица
 CZ Mini skleník do zahrádky
 RO Sera pt. legume
 HU Mini kerti üvegház
 ES Mini invernadero doméstico



No.	Dimensions / Wymiary [cm]	Box
90000	100x50x150	1

EN Plant clips set
 PL Klipsy do mocowania roślin
 DE Clips
 RU Зажимы
 CZ Klipy
 RO Set clipsuri
 HU Csatok
 ES Clips



No.	pcs / szt.	Box
88812	45	24/48

EN Frost protection fleece jacket
 PL Kaptur ochronny dla roślin
 DE Pflanzenschutzhaube
 RU Укрывной колпак для растений
 CZ Ochranná kapuce na rostliny
 RO Protecție anti îngheț
 HU Védőgallér növényekre
 ES Saco protector para plantas



No.	Size / Rozmiar [cm]	Box
89750	120x180	24

EN Black net tunnel
 PL Czarny tunel ochrony roślin
 DE Pflanzenschutztunnel schwarz
 RU Черный туннель для защиты растений
 CZ Černý tunel pro ochranu rostlin
 RO Protecție plante tip tunel
 HU Fekete védőalagút növényekre
 ES Túnel de malla negra para plantas



No.	Dimensions / Wymiary [cm]	Box
89770	300x45x45	12

EN Vegetable growing house
 PL Miniszklarnia przydomowa
 DE Mini Garten-Gewächshaus
 RU Садовая мини-теплица
 CZ Mini skleník do zahrádky
 RO Sera pt. legume
 HU Mini kerti üvegház
 ES Mini invernadero doméstico



No.	Dimensions / Wymiary [cm]	Box
90001	120x60x60	1

EN 5-tier greenn house
 PL Miniszklarnia 5 poziomów
 DE Mini-Gewächshaus 5 Regale
 RU Мини-теплица 5 уровней
 CZ 5 úroňňový mini skleník
 RO Sera cu 5 rafturi
 HU Mini üvegház 5 szintes
 ES Mini invernadero 5 niveles

200x69
x49
cm

PVC



FLO

No.	Dimensions / Wymiary [cm]	
90002	200x69x49	1

EN Walk-in greenhouse
 PL Szklarnia foliowa
 DE Foliengewächshaus
 RU Пленочная теплица
 CZ Fóliový skleník
 RO Sera
 HU Fólia üvegház
 ES Invernadero de plástico

143x143
x195
cm

PE



FLO

No.	Dimensions / Wymiary [cm]	
90031	143x143x195	1

EN Garden greenhouse
 PL Miniszklarnia naskrzyniowa
 DE Mini-Gewächshaus
 RU Мини-теплица грубоук
 CZ Mini skleník podstavec
 RO Sera gradina
 HU Mini ládás üvegház
 ES Mini invernadero instalado en una base

12
mm

60x80
x120
cm

PVC



FLO

No.	Dimensions / Wymiary [cm]	
90003	60x80x120	1

EN Walk-in greenhouse
 PL Szklarnia foliowa
 DE Foliengewächshaus
 RU Пленочная теплица
 CZ Fóliový skleník
 RO Sera
 HU Fólia üvegház
 ES Invernadero de plástico

143x73
x195
cm

PVC



FLO

No.	Dimensions / Wymiary [cm]	
90030	143x73x195	1

EN Germination tray set
 PL Doniczki torfowe do rozsad
 DE Torf-Anzuchtöfpen
 RU Торфяные горшки для рассады
 CZ Rašelinové květináče pro sazenice
 RO Set tavi germinative
 HU Tőzegcserép palántázáshoz
 ES Macetas de turba para plántulas

10
PCS

30x30
mm
x100



FLO

No.	pcs / szt.	
90350	10	40

EN Germination kit
 PL Zestaw do rozsad
 DE Anzuchtset
 RU Набор для рассады
 CZ Sada pro sazenice
 RO Trusa de germinare
 HU Palántázó készlet
 ES Kit para plántulas

63
PCS

30x30
mm
x50

80mm
x38

x15

x2



FLO

No.	pcs / szt.	
90360	63	24

EN Soil survey instrument
 PL Miernik ogrodniczy
 DE Gartenmessgerät
 RU Измеритель огородный
 CZ Zahradnický měřicí přístroj
 RO Aparat de măsurat grădinăresc
 HU Négyfunkciós, kerti mérőműszer
 ES Medidor de horticultor

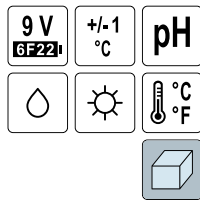

No.	Dimensions / Wymiary [cm]	Box icon
89000		10

EN Swing seat cover
 PL Pokrowiec na huśtawkę
 DE Schutzhülle für Schaukel
 RU Чехол для садовых качели
 CZ Ochranný kryt na houpačku
 RO Husa pt. balansoar terasa
 HU Kerti hintaágy takaró
 ES Funda para columpio

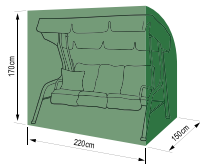

No.	Dimensions / Wymiary [cm]	Box icon
92105	220x150x170	8

EN Outdoor furniture cover
 PL Pokrowiec na meble ogrodowe
 DE Gartenmöbel-Schutzhülle
 RU Чехол для садовой мебели
 CZ Ochranný kryt na zahradní nábytek
 RO Husa mobilier de exterior
 HU Kerti butor takaró ponyva
 ES Funda para muebles de jardín

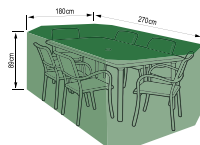
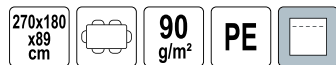

No.	Dimensions / Wymiary [cm]	Box icon
92115	270x180x89	12

EN Stackable patio chair cover
 PL Pokrowiec na krzesła ogrodowe
 DE Schutzhülle für Stapelstühle
 RU Чехол на садовые стулья
 CZ Ochranný kryt na zahradní křesla
 RO Husa pt. scaune terasa
 HU Takaró összerakott székekhez
 ES Funda para sillas de jardín

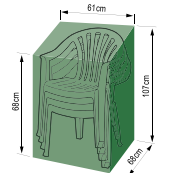
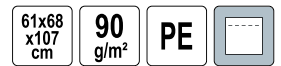

No.	Dimensions / Wymiary [cm]	Box icon
92100	61x68x107	24

EN Outdoor furniture cover
 PL Pokrowiec na meble ogrodowe
 DE Gartenmöbel-Schutzhülle
 RU Чехол для садовой мебели
 CZ Ochranný kryt na zahradní nábytek
 RO Husa mobilier de exterior
 HU Kerti butor takaró ponyva
 ES Funda para muebles de jardín

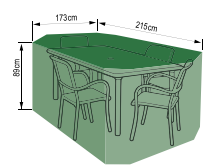

No.	Dimensions / Wymiary [cm]	Box icon
92110	215x173x89	12

EN Folding garden trash bag
 PL Kosz ogrodowy składany
 DE Klappbarer Gartenkorb
 RU Складная садовая корзина
 CZ Skládací zahradní koš
 RO Cos gunoi grădina pliant
 HU Összecsukható kerti szemetes
 ES Contenedor plegable para jardín

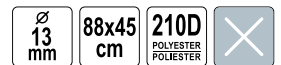

No.	Size / Rozmiar [mm]	Box icon
90150	880x450	12

- EN Garden basket
- PL Kosz ogrodniczy
- DE Gartenkorb
- RU Корзина садовая
- CZ Zahradní koš
- RO Coș de grădină
- HU Kerti kosár
- ES Cesta de jardín



No.	Capacity / Pojemność [l]	
35610	25	480
35611	35	280

- EN Garden bucket
- PL Wiadro ogrodnicze
- DE Garten Eimer
- RU Ведро огородное
- CZ Zahradní vědro
- RO Găleată de grădină
- HU Kerti vödör
- ES Cubo de jardín



No.	Capacity / Pojemność [l]	
35600	15	500

- EN Plastic bucket
- PL Wiadro budowlane
- DE Baueimer
- RU Ведро строительное
- CZ Stavební vědro
- RO Găleată pt. construcții
- HU Kőműves vödör
- ES Cubo de obra



No.	Capacity / Pojemność [l]	
06388	10	900
06390	12	680
06383	13	800
06393	16	450
06392	20	390
06384	21	400

- EN Universal grow bag
- PL Uniwersalna torba ogrodowa
- DE Mehrzweck-Gartentasche
- RU Универсальная садовая сумка
- CZ Univerzální zahradní taška
- RO Geanta univerzala pt. cultivat
- HU Univerzális kertész táská
- ES Bolsa de jardín universal



No.	Size / Rozmiar [mm]	
90240	440x370	24

- EN Galvanized bucket
- PL Wiadro ocynkowane
- DE Baueimer
- RU Ведро оцинкованное
- CZ Vědro
- RO Găleată
- HU Kőműves vödör
- ES Cubo



No.	Capacity / Pojemność [l]	
89560	5	900
89561	7	750
89562	10	600
89563	12	500
89564	15	350

- EN Garden cart
- PL Wózek ogrodowy
- DE Gartenwagen
- RU Садовая тележка
- CZ Zahradní vozík
- RO Carucior gradina
- HU Kerti kocsi
- ES Carrito de jardín

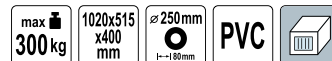

FEATURES: - Pneumatic wheels
CECHY: - Kola pompowane



No.	Max. load capacity / Maks. obciążenie [kg]	Dimensions / Wymiary [mm]	
90200	300	1020x515x400	1

EN Garden tipper trolley
 PL Wózek ogrodowy z wywrotką
 DE Gartenwagen mit Kippkarre
 RU Садовая тележка самосвал
 CZ Zahradní vozík se sklápěčem
 RO Carucior gradina
 HU Kerti kocsi billenővel
 ES Carrito de jardín basculante

FEATURES:
 - Pneumatic wheels
CECHY:
 - Kola pompowane

55 L max 150 kg 870x800 x500 mm
 ø 250mm PP



No.	Max. load capacity / Maks. obciążenie [kg]	Dimensions / Wymiary [mm]	
90204	150	870x800x500	1

EN Garden bags with cord
 PL Worki ogrodowe z taśmą
 DE Gartensäcke mit Band
 RU Мешки для огорода с лентой

CZ Zahradní pytle zalahovací
 RO Saci gunoi pt. gradina cu strangere
 HU Szalagos kerti szemeteszsák
 ES Bolsas de jardín con cinta

STRING TAPE TAŚMA ŚCIĄGAJĄCA

LDPE



No.	Capacity / Pojemność [l]	Thickness / Grubość [µm]	pcs / szt.
09480	60	60	10
09482	120	60	10

EN Perforated waste bags for leaves
 PL Worki perforowane na liście
 DE Gartenmüllsäcke perforiert

RU Мусорные пакеты прочные для листьев
 CZ Perforované odpadové pytle na list
 HU Szalagos kerti szemeteszsák

HU Sac gunoi perforat pt. frunze
 ES Sacos perforadas para residuos de jardín

PERFORATED PERFOROWANY

LDPE



No.	Capacity / Pojemność [l]	Thickness / Grubość [µm]	pcs / szt.
09484	200	40	10

EN Aluminium telescopic ladder
 PL Aluminiowa drabina teleskopowa
 DE Teleskopleiter aus Aluminium
 RU Многофункциональная стремянка
 CZ Hliníkový teleskopický žebřík
 RO Scară telescopică din aluminiu
 HU Alumínium kihúzható létra
 ES Escalera telescópica de aluminio

FEATURES:
 - Safe folding system according to newpest EN 131-6 standard
 - Safety lock

CECHY:
 - Bezpieczny system składania zgodny z normą EN 131-6
 - Blokada zabezpieczająca



No.	Max. height / Maks. wysokość [m]	Rung quantity / Liczba stopni	
17701	3.8	13	1

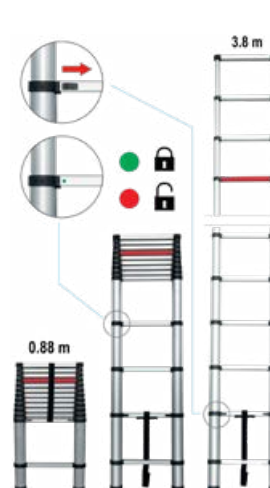

max 3.8 m 13 STEPS STOPNIE max 150 kg
 AI NYLON

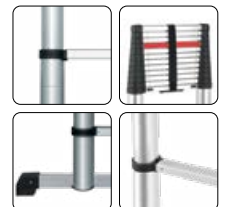

EN Trash gripper
 PL Ręczny chwytak do śmieci
 DE Manueller Abfall-Greifer
 RU Ручной захват для мусора

CZ Ruční sběrač odpadků
 RO Cleste pt. adunat gunoi
 HU Kézi szemétszedő
 ES Recogedor manual de basura

14 mm 760 mm AI
 ABS PP TPR



No.	L [mm]	
89896	760	24

EN Garden bags
 PL Worki ogrodowe
 DE Gartensäcke
 RU Мешки для огорода
 CZ Zahradní pytle
 RO Saci gunoi pt. gradina
 HU Kerti szemeteszsák
 ES Bolsas de jardín

LDPE



No.	Capacity / Pojemność [l]	Thickness / Grubość [µm]	pcs / szt.
09481	120	60	10

EN Waste bags for grass
 PL Worki perforowane na trawę
 DE Gartenmüllsäcke perforiert
 RU Мусорные пакеты прочные для листьев
 CZ Perforované odpadové pytle na trávu
 RO Sac gunoi pt. iarba
 HU Szalagos kerti szemeteszsák
 ES Sacos perforadas para residuos de jardín

PERFORATED PERFOROWANY

LDPE



No.	Capacity / Pojemność [l]	Thickness / Grubość [µm]	pcs / szt.
09483	120	35	10



PERFORATED PERFOROWANY

LDPE



EN Aluminium telescopic ladder
 PL Aluminiowa drabina teleskopowa
 DE Teleskopleiter aus Aluminium
 RU Многофункциональная стремянка
 CZ Hliníkový teleskopický žebřík
 RO Scară telescopică din aluminiu
 HU Alumínium kihúzható létra
 ES Escalera telescópica de aluminio

max 3.8 m
 13 STEPS / STÖPNE
 max 150 kg
 AI NYLON



No.	Max. height / Maks. wysokość [m]	Rung quantity / Liczba stopni	
17702	3.8	13	1

EN 2-step ladder
 PL Drabina 2-stopniowa rozkładana
 DE 2-Stufen-Leiter
 RU 2-ступенчатая лестница
 CZ Schůdky 2 stupně
 RO Scări cu 2 trepte
 HU 2 fokos lépcsők
 ES 2 pasos escaleras

90x47.5 x49 cm
 h 99 cm
 FOLDED / ZLOŽENA
 2 STEPS / STÖPNE
 max 150 kg
 SOFT GRIP / MIEKKI UCHWYT
 PROTECTION RAIL / WSPÓRNIK OCHRONNY



No.	Height / Wysokość [m]	Rung quantity / Liczba stopni	
17730	0.9	2	4

EN Multifold ladder platform
 PL Podest do drabiny wielofunkcyjnej
 DE Podest für die Multifunktionale Leiter
 RU Подставка для стремянки
 CZ Plošina pro víceúčelový žebřík
 RO Platformă pt. scară multifuncțională
 HU Páló a multifunkciós létrához
 ES Descansillos para la escala multifuncional

830x295 mm
 560x295 mm
 ZINC PLATED / OCYNKO-WANA
 max 150 kg

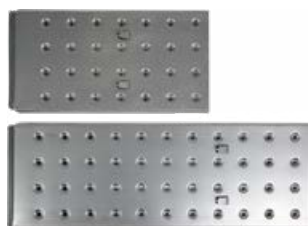

No.	For / Dla	
17705	17704	5

EN Multifold ladder
 PL Drabina wielofunkcyjna
 DE Mehrzweckleiter
 RU Лестница многофункциональная
 CZ Multifunkční žebřík
 RO Scară multifuncțională
 HU Többcéllú létra
 ES Escalera multipropósito

max 3.4 m
 4x3 STEPS / STÖPNE
 16 kg
 max 150 kg

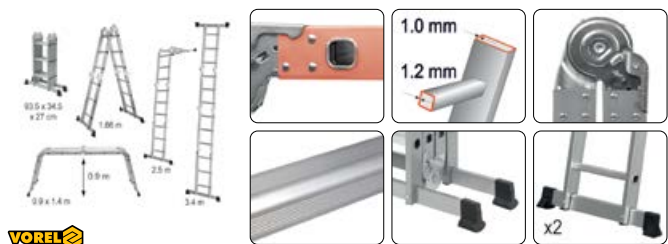

No.	Max. height / Maks. wysokość [m]	Rung quantity / Liczba stopni	
17704	3.4	4x3	1

EN 3-step ladder
 PL Drabina 3-stopniowa rozkładana
 DE 3-Stufen-Leiter
 RU 3-ступенчатая лестница
 CZ Schůdky 3 stupně
 RO Scări cu 3 trepte
 HU 3 fokos lépcsők
 ES 3 pasos escaleras

115x47.5 x65 cm
 h 125 cm
 FOLDED / ZLOŽENA
 3 STEPS / STÖPNE
 max 150 kg
 SOFT GRIP / MIEKKI UCHWYT
 PROTECTION RAIL / WSPÓRNIK OCHRONNY



No.	Height / Wysokość [m]	Rung quantity / Liczba stopni	
17733	1.15	3	2

EN Compost and gravel sieve
 PL Sito do kompostu i żwiru
 DE Sieb für Kompost und Kies
 RU Сито для компоста и гравия
 CZ Prohazovací síto na kompost a štěrky
 RO Cedazo para estiércol y guija
 HU Sítá komposztáláshoz és sóderhez
 ES Rosta komposztáláshoz és sóderhez



No.	Dimensions / Wymiary [cm]	Eyelet size / Rozmiar oczka [mm]	
34949	60x100	20x20	5/30

EN Composter
 PL Kompostownik
 DE Kompostierer
 RU Компостовник
 CZ Kompostér
 RO Compostor
 HU Komposztáló láda
 ES Compostador



No.	Capacity / Pojemność [l]	
35623	480	10

EN Composter
 PL Kompostownik
 DE Kompostierer
 RU Компостовник
 CZ Kompostér
 RO Compostor
 HU Komposztáló láda
 ES Compostador



No.	Capacity / Pojemność [l]	
35625	1000	6

EN Seeder
 PL Siewnik
 DE Streuwagen
 RU Сеялка
 CZ Sečí stroj
 RO Sernanatoare
 HU Magászóró
 ES Sembradora

12L

PP

AI



No.	Capacity / Pojemność [l]	
89870	12	1

EN Multiple holder
 PL Wieszak na narzędzia
 DE Werkzeughalter
 RU Подвеска для инструмента
 CZ Věšák na nářadí
 RO Suport multiplu
 HU Szerszámakasztó
 ES Colgador para herramientas



No.	
89950	40

EN Composter
 PL Kompostownik
 DE Kompostierer
 RU Компостовник
 CZ Kompostér
 RO Compostor
 HU Komposztáló láda
 ES Compostador



No.	Capacity / Pojemność [l]	
35624	740	7

EN Spreader
 PL Rozsiewacz
 DE Streuer
 RU Разбрасыватель-сеялка
 CZ Sečí strojek
 RO Dispozitiv de imprastiere
 HU Magászóró
 ES Esparcidor

3L

PP



No.	Capacity / Pojemność [l]	
89860	3	12

EN Garden rack
 PL Stojak ogrodowy
 DE Gartengeräteständer
 RU Садовая подставка
 CZ Zahradní stojan
 RO Raft pt. gradina
 HU Kerti állvány
 ES Soporte para herramientas de jardinería

84x74
x35
cm

max
45 kg

PP



No.	Dimensions / Wymiary [mm]	
89990	840x740x350	1

18-32
mm

x5
HOLDERS
UCHWYTY

x6
HOLDERS
HANTU

300
g

TPR
PP

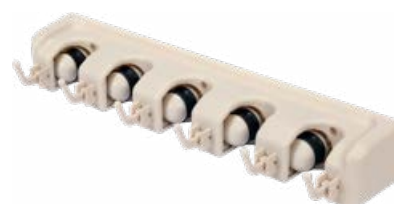

- EN Gutter mesh with hooks
 PL Siatka zabezpieczająca rynny z uchwytemi mocującymi
 DE Schutzgitter für Rinnen mit Spannvorrichtungen
 RU Защитная сетка желоба с монтажными ручками
 CZ Ochranná síť proti zanášení okapových žlabů s úchytkami
 RO Plasă de protecție burlane cu suporturi de protecție
 HU Lombofgő hálórészítő fűlékkel
 ES Malla de protección para la canaleta con mandriles de sujeción

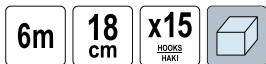

No.		
69851		30

- EN Portable car shower set
 PL Samochodowy prysznic turystyczny
 DE Campingdusche
 RU Портативный автомобиль душ
 CZ Mobilní auto sprcha
 RO Dus portabil masina
 HU Autós hordozható zuhany
 ES Portátil ducha de coche



FUNCTIONS:
 - Taking shower, washing car, washing dishes and others

FUNKCJE:
 - Prysznic, mycie samochodu, mycie naczyń i inne



No.	Voltage / Napiecie [V d.c.]	
82991	12	10

- EN Garden extension cable
 PL Przedłużacz
 DE Gartenverlängerungskabel
 RU Электродлинитель
 CZ Prodlužovací kabel zahradní
 RO Prelungitor electric
 HU Kerti hosszabbitó
 ES Cable de extensión para jardín



No.	L [m]	
82671	10	10
82673	20	10
82675	30	5

- EN Rain pipe guard
 PL Osłona rynny - sito do rury spustowej
 DE Fallrohrschutz
 RU Защитный кожух водосточного желоба
 CZ Ochrana okapového svodu
 RO Protecție pt. burlane
 HU Sító eresz burkolat leeresztő csőhöz
 ES Protector de canalón tamiza para tubo de descarga

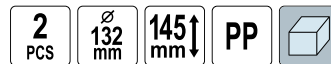

No.	Ø [mm]	pcs / szt.
69860	132	2

- EN Portable car shower set
 PL Samochodowy prysznic turystyczny
 DE Campingdusche
 RU Портативный автомобиль душ
 CZ Mobilní auto sprcha
 RO Dus portabil masina
 HU Autós hordozható zuhany
 ES Portátil ducha de coche

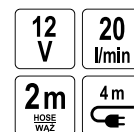

FUNCTIONS:
 - Taking shower, washing car, washing dishes, watering plants and others

FUNKCJE:
 - Prysznic, mycie samochodu, mycie naczyń, podlewanie roślin i inne

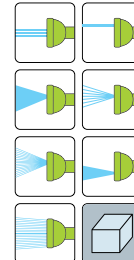

No.	Voltage / Napiecie [V d.c.]	
82992	12	10

- EN Gas BBQ grill
 PL Grill gazowy
 DE Gasgrill
 RU Газовый гриль
 CZ Plynový gril
 RO Grătarul cu gaz
 HU Gázgrill
 ES Barbacoa de gas

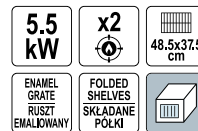

No.	
99644	1



EN Gas BBQ grill
 PL Grill gazowy
 DE Gasgrill
 RU Газовый гриль
 CZ Plynový gril
 RO Grătarul cu gaz
 HU Gázgrill
 ES Barbacoa de gas



LUND

No.

99645



1

EN Gas BBQ grill
 PL Grill gazowy
 DE Gasgrill
 RU Газовый гриль
 CZ Plynový gril
 RO Grătarul cu gaz
 HU Gázgrill
 ES Barbacoa de gas

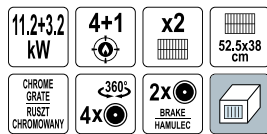

LUND

No.

99647



1

EN Gas BBQ grill
 PL Grill gazowy
 DE Gasgrill
 RU Газовый гриль
 CZ Plynový gril
 RO Grătarul cu gaz
 HU Gázgrill
 ES Barbacoa de gas

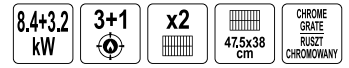

LUND

No.

99646



1

EN BBQ gas and charcoal grill
 PL Grill gazowo-węglowy
 DE Gas- und Kohlegrill
 RU Газово-угольный гриль
 CZ Gril na plyn a uhlí
 RO Gratar pe gaz si carbuni
 HU Kombinált grill, gáz, szén
 ES Barbacoa a gas y carbón

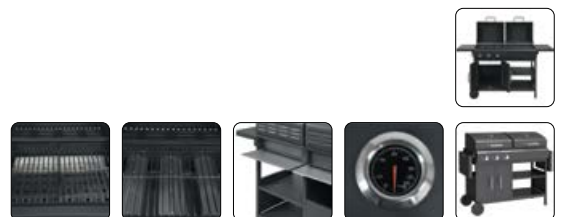
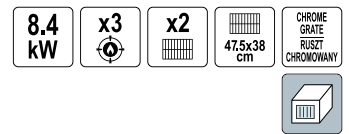

LUND

No.

99649



1

EN Gas BBQ grill
 PL Grill gazowy
 DE Gasgrill
 RU Газовый гриль
 CZ Plynový gril
 RO Grătarul cu gaz
 HU Gázgrill
 ES Barbacoa de gas

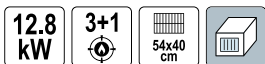

FEATURES:

- 3 main burners
- Side burner
- Ignition in the knob
- Thermo gauge
- Sliding tray for fat

CECHY:

- 3 palniki główne
- Palnik boczny
- Zapalnik w pokrętle
- Termometr
- Wysuwana taca na tłuszcz



LUND

No.	
99642	1

EN Gas BBQ grill
 PL Grill gazowy
 DE Gasgrill
 RU Газовый гриль
 CZ Plynový gril
 RO Grătarul cu gaz
 HU Gázgrill
 ES Barbacoa de gas

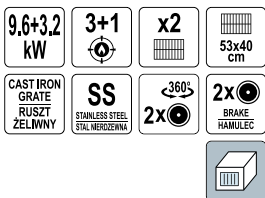

LUND

No.	
99651	1

EN Gas BBQ grill
 PL Grill gazowy
 DE Gasgrill
 RU Газовый гриль
 CZ Plynový gril
 RO Grătarul cu gaz
 HU Gázgrill
 ES Barbacoa de gas

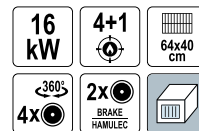

FEATURES:

- 4 main burners
- Side burner
- Ignition in the knob
- Thermo gauge
- Sliding tray for fat
- Side handles
- Wheels with a brake

CECHY:

- 4 palniki główne
- Palnik boczny
- Zapalnik w pokrętle
- Termometr
- Wysuwana taca na tłuszcz
- Uchwyty boczne
- Kola z hamulcem



LUND

No.	
99643	1

EN Gas BBQ grill
 PL Grill gazowy
 DE Gasgrill
 RU Газовый гриль
 CZ Plynový gril
 RO Grătarul cu gaz
 HU Gázgrill
 ES Barbacoa de gas

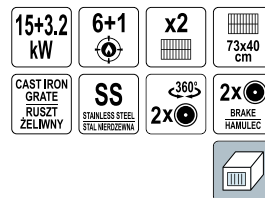

LUND

No.	
99653	1

EN Cast iron plate
 PL Płyta żeliwna
 DE Gusseisenplatte
 RU Чугунная пластина
 CZ Litinová deska
 RO Tava oțel
 HU Öntöttvas lemez
 ES Placa de acero fundido



LUND

No.	For / Dla	
99659	99642, 99643, 99651, 99652	5

EN Charcoal BBQ grill
 PL Grill węglowy z termometrem
 DE Holzkohlegrill
 RU Гриль-барбекю угольный

CZ Gril na dřevěné uhlí
 RO Gratar carbuni
 HU Faszén grill
 ES Barbacoa de carbón y lena

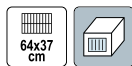

FEATURES:

- Firebowl height: 85.5 cm
- Smoker
- Thermo gauge
- Air flow
- Chimney
- Ashpan

CECHY:

- Wysokość paleniska: 85.5 cm
- Wędzarnia
- Termometr
- Obieg powietrza
- Komin
- Popielnik



LUND

No.	
99587	1

EN Charcoal BBQ grill
 PL Grill węglowy z termometrem
 DE Holzkohlegrill
 RU Гриль-барбекю угольный
 CZ Gril na dřevěné uhlí
 RO Gratar carbuni
 HU Faszén grill
 ES Barbacoa de carbón y lena

FEATURES:

- Firebowl height: 88 cm
- Grill adjustment system
- Warming rack: 65 x 20.5 cm
- Thermo gauge
- Folding shelves
- Air flow
- Bottle opener
- Ashpan
- Poker

CECHY:

- Wysokość paleniska: 88 cm
- System regulacji rusztu
- Kratka podgrzewająca: 65 x 20.5 cm
- Termometr
- Składane półki
- Obieg powietrza
- Otwieracz do butelek
- Popielnik
- Pogrzebacz



LUND

No.	
99533	1

EN Gas regulator and hose
 PL Reduktor z węzłem
 DE Schlauch und Regler
 RU Газовый шланг с редуктором
 CZ Regulátor plynu s hadicou
 RO Furtun pt. gaz cu regulator
 HU Nyomásszabályozó szett
 ES Regulador de gas con manguera



VOREL

No.	L [m]	
99670	1.0	16
99671	1.5	16

EN Big barrel BBQ with smoker
 PL Grill ogrodowy z termometrem i wędzarnią
 DE Grillwagen mit Temperaturanzeige und Räucherei
 RU Барбекю-коптильня с термометром
 CZ Zahradní udlina s grilem
 RO Grătar cu afumătoare și termometru
 HU Kultéri faszénes grill
 ES Barbacoa de carbón con soporte

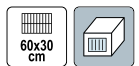

FEATURES:

- Thermo gauge
- Smoker
- Chimney



LUND

No.	
99513	1

EN Charcoal BBQ grill
 PL Grill węglowy
 DE Holzkohlegrill
 RU Гриль угольный
 CZ Gril na dřevěné uhlí
 RO Gratar carbuni
 HU Faszén grill
 ES Barbacoa de carbón y lena

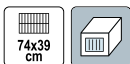

FEATURES:

- Adjustable cooking height
- Zinc plated charcoal plates
- Folding shelf

CECHY:

- Regulowana wysokość rusztów
- Ocynkowane płyty na węgiel
- Osynkowane płyty na węgiel
- Składana półka



LUND

No.

99495



1

EN Charcoal BBQ grill
 PL Grill węglowy
 DE Holzkohlegrill
 RU Гриль-барбекю угольный
 CZ Gril na dřevěné uhlí
 RO Gratar carbuni
 HU Faszén grill
 ES Barbacoa de carbón y lena

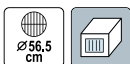

FEATURES:

- Thermo gauge
- Air flow
- Ashpan

CECHY:

- Termometr
- Obieg powietrza
- Popielnik



LUND

No.

99584



1

EN Folding charcoal grill
 PL Grill węglowy składany
 DE Holzkohle-Fallgrill
 RU Гриль угольный переносный
 CZ Přenosný gril
 RO Gratar portabil
 HU Hordozható faszenes grill
 ES Parrilla portátil

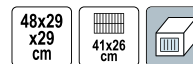

FEATURES:

- Folded size: 48 x 29 x 21 cm
- Air flow

CECHY:

- Wymiary po złożeniu: 48 x 29 x 21 cm
- Obieg powietrza



LUND

No.

99594



1

EN Charcoal BBQ grill
 PL Grill węglowy
 DE Holzkohlegrill
 RU Гриль-барбекю угольный
 CZ Gril na dřevěné uhlí
 RO Gratar carbuni
 HU Faszén grill
 ES Barbacoa de carbón y lena

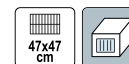

FEATURES:

- Air flow
- Metal shelf

CECHY:

- Obieg powietrza
- Metalowa półka



LUND

No.

99580



1

EN Charcoal BBQ grill
 PL Grill węglowy
 DE Holzkohleggrill
 RU Гриль-барбекю угольный
 CZ Gril na dřevěné uhlí
 RO Gratar carbuni
 HU Faszén grill
 ES Barbacoa de carbón y lena

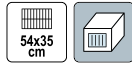

FEATURES:

- Firebowl height: 73 cm
- Warming rack: 46 x 7 cm
- 2 metal shelves

CECHY:

- Wysokość paleniska: 73 cm
- Kratka podgrzewająca: 46 x 7 cm
- 2 metalowe półki



LUND

No.

99582



1

EN Folding charcoal grill
 PL Grill węglowy składany
 DE Holzkohle-Faltgrill
 RU Гриль угольный складной
 CZ Přenosný gril
 RO Gratar portabil
 HU Hordozható faszénes grill
 ES Parrilla portátil

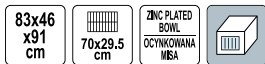

FEATURES:

- Folded size: 83 x 46 x 44 cm
- Frying plate: 31.5 x 27 cm
- Worktable
- Ashpan
- Poker

CECHY:

- Wymiary po złożeniu: 83 x 46 x 44 cm
- Płyta do smażenia: 31.5 x 27 cm
- Stolik roboczy
- Popielnik
- Pogrzebacz



LUND

No.

99595



1

EN Charcoal BBQ grill
 PL Grill węglowy z półką
 DE Holzkohleggrill
 RU Гриль-барбекю угольный
 CZ Gril na dřevěné uhlí
 RO Gratar carbuni
 HU Faszén grill
 ES Barbacoa de carbón y lena

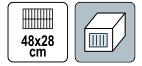

FEATURES:

- Firebowl height: 69.5 cm
- Wooden handle
- 2 wooden shelves

CECHY:

- Wysokość paleniska: 69.5 cm
- Drewniany uchwyt
- 2 drewniane półki



LUND

No.

99585



1

EN Smoker
 PL Wędzarnia
 DE Räucherer
 RU Коптильня
 CZ Udírna
 RO Afumător
 HU Füstlővel
 ES Ahumador



LUND

No.

99633



1

EN Smoker
 PL Wędzarnia
 DE Räucherei
 RU Коптильня
 CZ Udírna
 RO Afumător
 HU Füstölővel
 ES Ahumador

FEATURES:

- Thermo gauge
- 2 x cooking grill
- 2 x porcelain bowl
- 4 x vent

CECHY:

- Termometr
- 2 ruszty
- 2 porcelanowe misy
- 4 otwory wentylacyjne



54x51
x100
cm



LUND

No.

99747



1

EN Fire pit
 PL Palenisko ogrodowe
 DE Gartenfeuerstätte
 RU Садовый очаг
 CZ Zahradní ohniště
 RO Gratar tip vatra
 HU Kerti tűzrakó
 ES Fogón para jardín

INCLUDED:

- Poker

W ZESTAWIE:

- Pogrzebacz

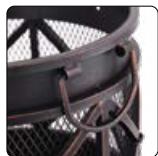

42x53
cm

x4
LEGS
NOŻKI

x2
HANDLES
UCHWYTY



LUND

No.

99702



1

EN Fire pit
 PL Palenisko ogrodowe
 DE Gartenfeuerstätte
 RU Садовый очаг
 CZ Zahradní ohniště
 RO Gratar tip vatra
 HU Kerti tűzrakó
 ES Fogón para jardín

FEATURES:

- Cooking grill
- Poker

CECHY:

- Ruszt
- Pogrzebacz



80x80
x61
cm

ø57
cm



LUND

No.

99714



1

EN Fire pit
 PL Palenisko ogrodowe
 DE Gartenfeuerstätte
 RU Садовый очаг
 CZ Zahradní ohniště
 RO Gratar tip vatra
 HU Kerti tűzrakó
 ES Fogón para jardín

FEATURES:

- Cooking grill
- Folding legs

CECHY:

- Ruszt
- Składane nożki



56x39
cm

x3
LEGS
NOŻKI



LUND

No.

99701



1

EN Fire pit
 PL Palenisko ogrodowe
 DE Gartenfeuerstätte
 RU Садовый очаг
 CZ Zahradní ohniště
 RO Gratar tip vatra
 HU Kerti tűzrakó
 ES Fogón para jardín

FEATURES:

- Log store
- Cooking grill
- Poker

CECHY:

- Drewniwnia
- Ruszt
- Pogrzebacz



58x58
x55
cm

ø50
cm



LUND

No.

99713



1

EN Fire pit
 PL Palenisko ogrodowe
 DE Gartenfeuerstätte
 RU Садовый очаг
 CZ Zahradní ohniště
 RO Gratar tip vatra
 HU Kerti tűzrakó
 ES Fogón para jardín

FEATURES:

- Cooking grill
- Poker

CECHY:

- Ruszt
- Pogrzebacz



70x60
x63
cm



LUND

No.

99703



1

EN Fire pit
 PL Palenisko ogrodowe
 DE Gartenfeuerstätte
 RU Садовый очаг
 CZ Zahradní ohniště
 RO Gratar tip vatra
 HU Kerti tűzrakó
 ES Fogón para jardín



LUND

No.		
99707		1

EN Fire pit
 PL Palenisko ogrodowe
 DE Gartenfeuerstätte
 RU Садовый очаг
 CZ Zahradní ohniště
 RO Gratar tip vatra
 HU Kerti tűzrakó
 ES Fogón para jardín



LUND

No.		
99711		1

EN BBQ cover
 PL Pokrowiec na grilla
 DE Wetterschutzhaube
 RU Обложка гриля
 CZ Obal na gril
 RO Gratar acoperă
 HU Grill takaróponyva
 ES Cubierta de barbacoa

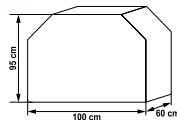
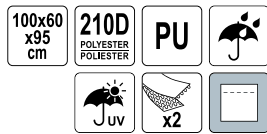

LUND

No.	Dimensions / Wymiary [cm]	For / Dla	
99760	100x60x95	99512, 99514, 99519, 99586, 99588	20

EN BBQ cover
 PL Pokrowiec na grilla
 DE Wetterschutzhaube
 RU Обложка гриля
 CZ Obal na gril
 RO Gratar acoperă
 HU Grill takaróponyva
 ES Cubierta de barbacoa

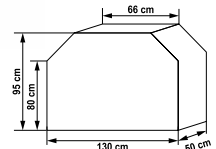
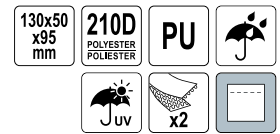

LUND

No.	Dimensions / Wymiary [cm]	For / Dla	
99761	130x50x95	99642, 99647, 99649, 99651	20

EN BBQ cover
 PL Pokrowiec na grilla
 DE Wetterschutzhaube
 RU Обложка гриля
 CZ Obal na gril
 RO Gratar acoperă
 HU Grill takaróponyva
 ES Cubierta de barbacoa

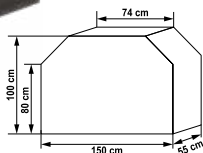
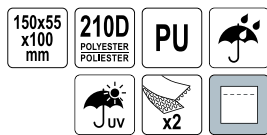

LUND

No.	Dimensions / Wymiary [cm]	For / Dla	
99762	150x55x100	99643, 99649, 99652, 99653	20

EN BBQ apron
 PL Fartuch do grillowania
 DE Grillschürze
 RU Фартук для барбекю
 CZ Grilovací zástěra
 RO Gratar șorț
 HU Grill kötény
 ES Delantal de la parrilla



No.		
99782		60

- EN BBQ apron with accessories
- PL Fartuch do grillowania z akcesoriami
- DE Grillschürze
- RU Фартук для барбекю
- CZ Grilovací zástěra
- RO Gratar șorț
- HU Grill kőtény
- ES Delantal de la parrilla



x8 ACCESSORIES AKCESORIA	WOODEN HANDLE DREWNIANA REKUCJESC	SS STAINLESS STEEL STAL NERDZIEWNA	
---------------------------------------	--	---	--

No.		
99783		8/16

- EN Rake handle
- PL Widelec ogniskowy
- DE Lagerfeuerspies
- RU Шампур-вилка для гриля
- CZ Vidlička na opékání
- RO Furculita pt. gratar
- HU Grillvilla
- ES Tenedor de fuego



No.	L [cm]	
99568	100	10/100

- EN Rake handle
- PL Widelec ogniskowy
- DE Lagerfeuerspies
- RU Шампур-вилка для гриля
- CZ Vidlička na opékání
- RO Furculita pt. gratar
- HU Grillvilla
- ES Tenedor de fuego



No.	L [cm]	
99576	120	60

- EN Barbecue cleaning brush
- PL Szczotka do grilla
- DE Grillbürste
- RU Щетка для гриля
- CZ Kartáč do grilu
- RO Perie pt. curatat gratar
- HU Grillkefe
- ES Cepillo para barbacoa



VOREL

No.	L [mm]	
99528	305	16

- EN Rake handle
- PL Widelec ogniskowy
- DE Lagerfeuerspies
- RU Шампур-вилка для гриля
- CZ Vidlička na opékání
- RO Furculita pt. gratar
- HU Grillvilla
- ES Tenedor de fuego



No.	L [cm]	
99575	120	60

24	Memo
----	------

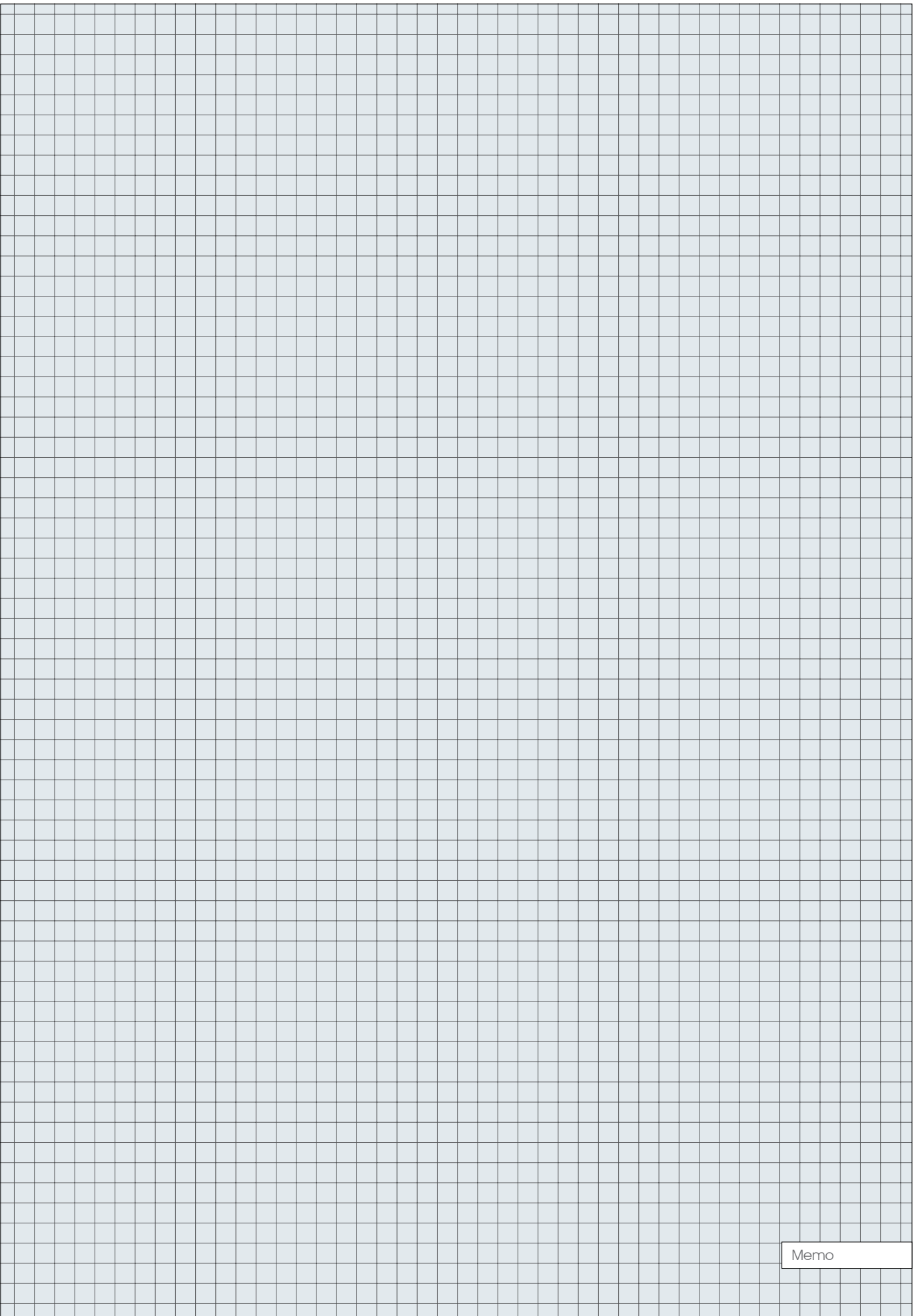

Memo

25

Sanitary ware & hydraulics
Armatura sanitarna i hydraulika

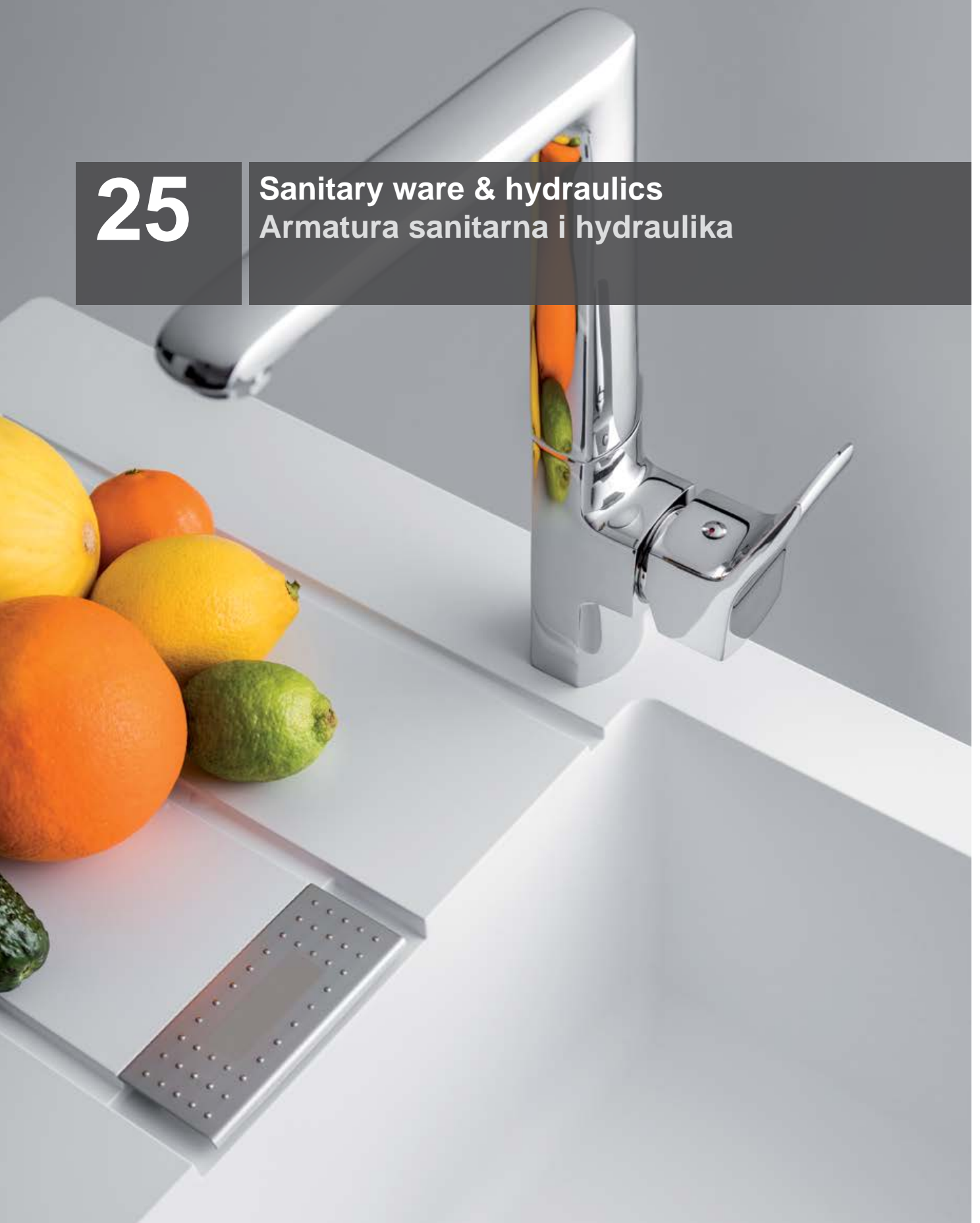

Mixers, faucets
Baterie

.....490-506

**Linear drains**
Odpływy liniowe

.....506-509

**Pop-up wastes**
Korki automatyczne

.....509-510

**Shower handles**
Słuchawki prysznicowe

.....510-513

**Shower & connecting hoses**
Wężę prysznicowe i przyłączeniowe

.....514-516

**Bathroom & shower sets**
Komplety łazienkowe i prysznicowe

.....517-520

**Bathroom accessories**
Akcesoria łazienkowe

.....520-525

**Toilet seats**
Deski toaletowe

.....525-526

**Bathroom ceramic**
Ceramika łazienkowa

.....526-527

**Bathroom scales**
Wagi łazienkowe

.....528

**Plastic stools**
Stołki plastikowe

.....528-529

**Hydraulic accessories**
Akcesoria hydrauliczne

.....529-531



The exclusive composition with sapphire hardness developed by famous spanish company.

Głowica z wkładem ceramicznym o twardości szafiru renomowanego hiszpańskiego producenta.



CORUNDOx

Mixing water flow with intake air reduces consumption by half, without splashing.

Zmieszany strumień wody z zasysanym powietrzem oszczędza zużycie o połowę i nie chlapie.



ECOflow

The most effective way to save water and energy - flowing only cold water when the lever is centered.

Najefektywniejszy sposób oszczędzania wody i energii - dla uchwytu usytuowanego na wprost popłynie tylko zimna woda.



ECOstart

Nano-size cavities on the disc surface to keep the lubrication, provides a higher durability and an improved smooth feeling.

Mikroząglębienia dzięki którym smar w głowicy nie wypłukuje się i głowica działa gładko przez wiele lat.



NANOCave

Rubbing the lime away with a finger and the stream is like in brand new faucet again.

Przetarcie palcem usuwa kamień i przywraca strumień jak w nowej baterii.



SMARTclean

Reduced noise thanks to silencer in eccentric wall connector.

Obniżony hałas dzięki użyciu tłumików w złączach.



LOWnoise

Ergonomic faucet provides more space for comfortable using.

Ergonomiczna bateria zapewniająca przestrzeń dla wygodnego użytkownika.



ERGOsize

Simple and effective installation thanks to the large nut that screw without any tools.

Łatwy i trwały montaż dzięki dużej nakrętkie, którą przykręcisz bez użycia jakiegokolwiek narzędzi.



SMARTnut

Improved lime protection: integrated honeycomb structure replaces conventional wire mesh screens prone to lime build-up.

Lepsza ochrona przeciwkwapinna: struktura plastra miodu zastępuje klasyczne wkłady siateczkowe, które mają tendencję do zarastania.

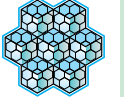

HEXAGONal

Body without holes and nooks that could accumulate dirt and microorganisms.

Korpus bez otworów i zakamarków, które gromadzą brud i mikroorganizmy.



CLEANbody

Innovative mounting system for hose nut and safe servicing aerator.

Innowacyjny system montażu wężyków i bezpiecznego serwisowania aeratora.



SMARTtool

Multi-purpose hydraulic wrench for installation of faucet and small plumbing work.

Wielofunkcyjny klucz hydrauliczny do montażu baterii i drobnych prac hydraulicznych.



SMARTtool

High quality stainless steel is characterized by increased resistance to chemicals, preserving its appearance even after many years of use.

Wysokiej jakości stal nierdzewna charakteryzuje się zwiększoną odpornością na chemikalia, zachowując swój wygląd nawet po wielu latach użytkowania.



Sus304

Stainless steel is free of zinc and lead - toxic elements, which in micro quantities get into the water in brass faucets.

Stal nierdzewna jest wolna od cynku i ołowiu - toksycznych pierwiastków, które w mikro ilościach dostają się do wody w mosiężnych kranach.



NOlead

All parts are made of stainless steel, so they are rust-resistant.

Wszystkie części wykonane są ze stali nierdzewnej i są odporne na rdzę.



FULL steel

- EN Basin mixer
- PL Bateria umywalkowa
- DE Einhand-Waschtischbatterie
- RU Смеситель для раковины
- CZ Umyvadlová baterie
- RO Bateria lavoar
- HU Mosdó csaptelep
- ES Monomando de lavabo



FALA

No.	Series / Seria	
75801	Steely 1	10

- EN Basin mixer
- PL Bateria umywalkowa
- DE Einhand-Waschtischbatterie
- RU Смеситель для раковины
- CZ Umyvadlová baterie
- RO Bateria lavoar
- HU Mosdó csaptelep
- ES Monomando de lavabo

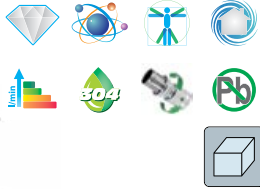

FALA

No.	Series / Seria	
75803	Steely 3	10

- EN Basin mixer
- PL Bateria umywalkowa
- DE Einhand-Waschtischbatterie
- RU Смеситель для раковины
- CZ Umyvadlová baterie
- RO Bateria lavoar
- HU Mosdó csaptelep
- ES Monomando de lavabo



FALA

No.	Series / Seria	
75802	Steely 2	12

- EN Basin mixer
- PL Bateria umywalkowa
- DE Einhand-Waschtischbatterie
- RU Смеситель для раковины
- CZ Umyvadlová baterie
- RO Bateria lavoar
- HU Mosdó csaptelep
- ES Monomando de lavabo



FALA

No.	Series / Seria	
75804	Steely 4	10

EN Shower column
 PL Kolumna prysznicowa
 DE Duschsäule
 RU Душевая штанга
 CZ Sprchový sloup
 RO Coloană de duș
 HU Zuhanyoszlop
 ES Columna de ducha



FALA

No.	Series / Seria	
75662	Steely 1	5

EN Shower column
 PL Kolumna prysznicowa
 DE Duschsäule
 RU Душевая штанга
 CZ Sprchový sloup
 RO Coloană de duș
 HU Zuhanyoszlop
 ES Columna de ducha



FALA

No.	Series / Seria	
75664	Steely 3	5

EN Single-lever sink mixer
 PL Bateria zlewozmywakowa
 DE Einhand-Spültischbatterie
 RU Смеситель для кухни
 CZ Dřezová baterie
 RO Baterie stativă bucătărie
 HU Mosogató csaptelep
 ES Monomando de fregadero

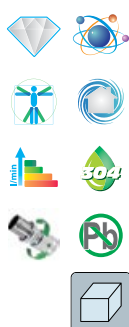

FALA

No.	Series / Seria	
75716	Steely 1	10

EN Shower column
 PL Kolumna prysznicowa
 DE Duschsäule
 RU Душевая штанга
 CZ Sprchový sloup
 RO Coloană de duș
 HU Zuhanyoszlop
 ES Columna de ducha



FALA

No.	Series / Seria	
75663	Steely 2	5

EN Shower column
 PL Kolumna prysznicowa
 DE Duschsäule
 RU Душевая штанга
 CZ Sprchový sloup
 RO Coloană de duș
 HU Zuhanyoszlop
 ES Columna de ducha



FALA

No.	Series / Seria	
75665	Steely 4	5

EN Single-lever sink mixer
 PL Bateria zlewozmywakowa
 DE Einhand-Spültischbatterie
 RU Смеситель для кухни
 CZ Dřezová baterie
 RO Baterie stativă bucătărie
 HU Mosogató csaptelep
 ES Monomando de fregadero

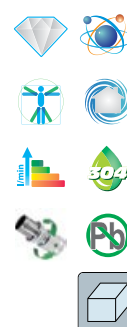

FALA

No.	Series / Seria	
75718	Steely 2	10

EN Single-lever sink mixer
 PL Bateria zlewozmywakowa
 DE Einhand-Spültischbatterie
 RU Смеситель для кухни
 CZ Dřezová baterie
 RO Baterie stativă bucatărie
 HU Mosogató csaptelep
 ES Monomando de fregadero



FALA

No.	Series / Seria	
75719	Steely 3	10

EN Single-lever sink mixer
 PL Bateria zlewozmywakowa
 DE Einhand-Spültischbatterie
 RU Смеситель для кухни
 CZ Dřezová baterie
 RO Baterie stativă bucatărie
 HU Mosogató csaptelep
 ES Monomando de fregadero



FALA

No.	Series / Seria	
75806	Steely 5	5

EN Built-in shower system
 PL Podtynkowy system prysznicowy
 DE Unterputz-duschsystem
 RU Душевой гарнитур скрытого монтажа
 CZ Sprchový podomítkový set
 RO Set de dus incastrat baterie
 HU Falsík alatti zuhanyszett
 ES Sistema dual de ducha empotrado

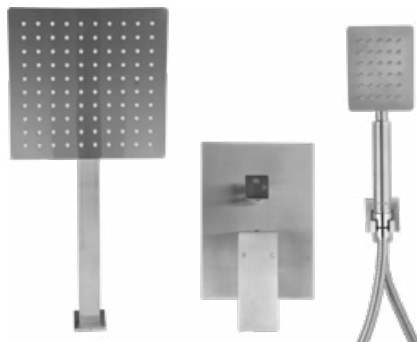

FALA

No.	Series / Seria	
75871	Steely S	4

EN Single-lever sink mixer
 PL Bateria zlewozmywakowa
 DE Einhand-Spültischbatterie
 RU Смеситель для кухни
 CZ Dřezová baterie
 RO Baterie stativă bucatărie
 HU Mosogató csaptelep
 ES Monomando de fregadero



FALA

No.	Series / Seria	
75805	Steely 4	5

EN Built-in shower system
 PL Podtynkowy system prysznicowy
 DE Unterputz-duschsystem
 RU Душевой гарнитур скрытого монтажа
 CZ Sprchový podomítkový set
 RO Set de dus incastrat baterie
 HU Falsík alatti zuhanyszett
 ES Sistema dual de ducha empotrado



FALA

No.	Series / Seria	
75870	Steely R	4

EN Basin mixer
 PL Bateria umywalkowa
 DE Einhand-Waschtischbatterie
 RU Смеситель для раковины
 CZ Umyvadlová baterie
 RO Baterie lavoar
 HU Mosdó csaptelep
 ES Monomando de lavabo



FALA

No.	Series / Seria	
75807	Retro Black 1	12

EN Bath mixer
 PL Bateria wannowa
 DE Einhand-Wannenbatterie
 RU Смеситель для ванны
 CZ Vanové baterie
 RO Baterie cada / dus
 HU Egykaros kádcsaptelep
 ES Monomando para bañoo



FALA

No.	Series / Seria	
75808	Retro Black 1	12

EN Basin mixer
 PL Bateria umywalkowa
 DE Einhand-Waschtischbatterie
 RU Смеситель для раковины
 CZ Umyvadlová baterie
 RO Baterie lavoar
 HU Mosdó csaptelep
 ES Monomando de lavabo



FALA

No.	Series / Seria	
75811	Retro Black 2	12

EN Shower column
 PL Kolumna prysznicowa
 DE Duschsäule
 RU Душевая штанга
 CZ Sprchový sloup
 RO Coloană de duș
 HU Zuhanyoszlop
 ES Columna de ducha

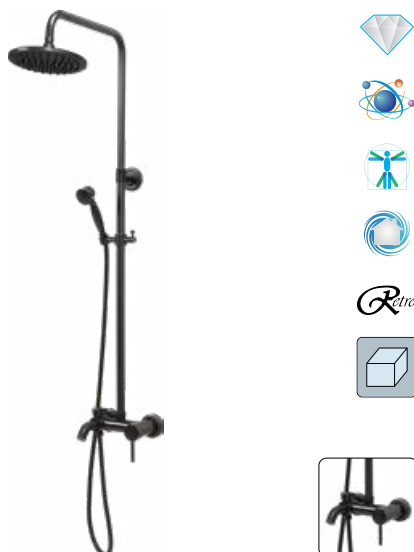

FALA

No.	Series / Seria	
75813	Retro Black 2	5

EN Shower column
 PL Kolumna prysznicowa
 DE Duschsäule
 RU Душевая штанга
 CZ Sprchový sloup
 RO Coloană de duș
 HU Zuhanyoszlop
 ES Columna de ducha



FALA

No.	Series / Seria	
75809	Retro Black 1	5

EN Basin mixer
 PL Bateria umywalkowa wysoka
 DE Einhand-Waschtischbatterie
 RU Смеситель для раковины
 CZ Umyvadlová baterie
 RO Baterie lavoar
 HU Mosdó csaptelep
 ES Monomando de lavabo



FALA

No.	Series / Seria	
75812	Retro Black 2	12

EN Basin mixer
 PL Bateria umywalkowa
 DE Einhand-Waschtischbatterie
 RU Смеситель для раковины
 CZ Umyvadlová baterie
 RO Baterie lavoar
 HU Mosdó csaptelep
 ES Monomando de lavabo



FALA

No.	Series / Seria	
75814	Retro Black 3	12

- EN Basin mixer
- PL Bateria umywalkowa wysoka
- DE Einhand-Waschtischbatterie
- RU Смеситель для раковины
- CZ Umyvadlová baterie
- RO Baterie lavabo
- HU Mosdó csaptelep
- ES Monomando de lavabo



FALA

No.	Series / Seria	Icon
75815	Retro Black 3	6

- EN Single-lever shower mixer
- PL Bateria prysznicowa
- DE Einhand-Brausebatterie
- RU Смеситель для душа
- CZ Sprchová baterie
- RO Baterie dus
- HU Egykaros zuhanycsaptelep
- ES Monomando de ducha



FALA

No.	Series / Seria	Icon
75817	Retro Black 3	12

- EN Basin mixer
- PL Bateria umywalkowa
- DE Einhand-Waschtischbatterie
- RU Смеситель для раковины
- CZ Umyvadlová baterie
- RO Baterie lavabo
- HU Mosdó csaptelep
- ES Monomando de lavabo



FALA

No.	Series / Seria	Icon
75827	Retro Bronze 1	12

- EN Bath mixer
- PL Bateria wannowa
- DE Einhand-Wannenbatterie
- RU Смеситель для ванны
- CZ Vanové baterie
- RO Baterie cada / dus
- HU Egykaros kádcsaptelep
- ES Monomando para baño



FALA

No.	Series / Seria	Icon
75816	Retro Black 3	12

- EN Shower column
- PL Kolumna prysznicowa
- DE Duschsäule
- RU Душевая штанга
- CZ Sprchový sloup
- RO Coloană de duș
- HU Zuhanyoszlop
- ES Columna de ducha



FALA

No.	Series / Seria	Icon
75818	Retro Black 3	5

- EN Bath mixer
- PL Bateria wannowa
- DE Einhand-Wannenbatterie
- RU Смеситель для ванны
- CZ Vanové baterie
- RO Baterie cada / dus
- HU Egykaros kádcsaptelep
- ES Monomando para baño



FALA

No.	Series / Seria	Icon
75828	Retro Bronze 1	12

EN Shower column
 PL Kolumna prysznicowa
 DE Duschsäule
 RU Душевая штанга
 CZ Sprchový sloup
 RO Coloană de duș
 HU Zuhanyoszlop
 ES Columna de ducha



FALA

No.	Series / Seria	
75829	Retro Bronze 1	5

EN Basin mixer
 PL Bateria umywalkowa wysoka
 DE Einhand-Waschtischbatterie
 RU Смеситель для раковины
 CZ Umyvadlová baterie
 RO Baterie lavoar
 HU Mosdó csaptelep
 ES Monomando de lavabo



FALA

No.	Series / Seria	
75837	Retro Bronze 2	12

EN Single-lever sink mixer
 PL Bateria zlewozmywakowa
 DE Einhand-Spültischbatterie
 RU Смеситель для кухни
 CZ Dřezová baterie
 RO Baterie stativă bucătărie
 HU Mosogató csaptelep
 ES Monomando de fregadero



FALA

No.	Series / Seria	
75834	Retro Black 1	12

EN Basin mixer
 PL Bateria umywalkowa
 DE Einhand-Waschtischbatterie
 RU Смеситель для раковины
 CZ Umyvadlová baterie
 RO Baterie lavoar
 HU Mosdó csaptelep
 ES Monomando de lavabo



FALA

No.	Series / Seria	
75836	Retro Bronze 2	12

EN Shower column
 PL Kolumna prysznicowa
 DE Duschsäule
 RU Душевая штанга
 CZ Sprchový sloup
 RO Coloană de duș
 HU Zuhanyoszlop
 ES Columna de ducha



FALA

No.	Series / Seria	
75838	Retro Bronze 2	5

EN Single-lever sink mixer
 PL Bateria zlewozmywakowa
 DE Einhand-Spültischbatterie
 RU Смеситель для кухни
 CZ Dřezová baterie
 RO Baterie stativă bucătărie
 HU Mosogató csaptelep
 ES Monomando de fregadero



FALA

No.	Series / Seria	
75835	Retro Black 2	12

EN Single-lever sink mixer
 PL Bateria zlewozmywakowa
 DE Einhand-Spültischbatterie
 RU Смеситель для кухни
 CZ Dřezová baterie
 RO Baterie stativă bucatărie
 HU Mosogató csaptelep
 ES Monomando de fregadero



FALA

No.	Series / Seria	Icon
75830	Retro Bronze 1	12

EN Single-lever sink mixer
 PL Bateria zlewozmywakowa
 DE Einhand-Spültischbatterie
 RU Смеситель для кухни
 CZ Dřezová baterie
 RO Baterie stativă bucatărie
 HU Mosogató csaptelep
 ES Monomando de fregadero



FALA

No.	Series / Seria	Icon
75832	Retro Bronze 3	12

EN Basin mixer
 PL Bateria umywalkowa
 DE Einhand-Waschtischbatterie
 RU Смеситель для раковины
 CZ Umyvadlová baterie
 RO Baterie lavoar
 HU Mosdó csaptelep
 ES Monomando de lavabo



FALA

No.	Series / Seria	Icon
75740	Tarragona	10

EN Single-lever sink mixer
 PL Bateria zlewozmywakowa
 DE Einhand-Spültischbatterie
 RU Смеситель для кухни
 CZ Dřezová baterie
 RO Baterie stativă bucatărie
 HU Mosogató csaptelep
 ES Monomando de fregadero



FALA

No.	Series / Seria	Icon
75831	Retro Bronze 2	12

EN Single-lever sink mixer
 PL Bateria zlewozmywakowa
 DE Einhand-Spültischbatterie
 RU Смеситель для кухни
 CZ Dřezová baterie
 RO Baterie stativă bucatărie
 HU Mosogató csaptelep
 ES Monomando de fregadero



FALA

No.	Series / Seria	Icon
75833	Retro Bronze 4	12

EN Bath mixer
 PL Bateria wannowa
 DE Einhand-Wannenbatterie
 RU Смеситель для ванны
 CZ Vanové baterie
 RO Baterie cada / dus
 HU Egykaros kádcsaptelep
 ES Monomando para baño

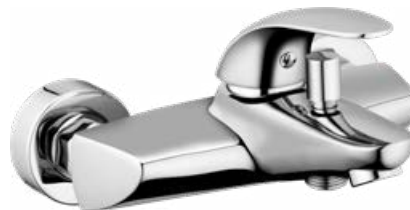
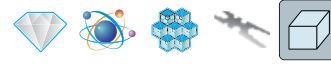

FALA

No.	Series / Seria	Icon
75742	Tarragona	8

EN Single-lever shower mixer
 PL Bateria prysznicowa
 DE Einhand-Brausebatterie
 RU Смеситель для душа
 CZ Sprchová baterie
 RO Baterie dus
 HU Egykaros zuhanycsaptelep
 ES Monomando de ducha



FALA

No.	Series / Seria	
75743	Tarragona	10

EN Bath mixer
 PL Bateria wannowa
 DE Einhand-Wannenbatterie
 RU Смеситель для ванны
 CZ Vanové baterie
 RO Baterie cada / dus
 HU Egykaros kádcsaptelep
 ES Monomando para baño

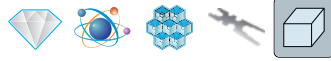

FALA

No.	Series / Seria	
75762	Soria	8

EN Single-lever sink mixer
 PL Bateria zlewozmywakowa
 DE Einhand-Spültischbatterie
 RU Смеситель для кухни
 CZ Dřezová baterie
 RO Baterie stativă bucatărie
 HU Mosogató csaptelep
 ES Monomando de fregadero

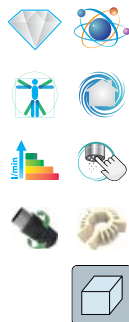

FALA

No.	Series / Seria	
75764	Soria	8

EN Basin mixer
 PL Bateria umywalkowa
 DE Einhand-Waschtischbatterie
 RU Смеситель для раковины
 CZ Umyvadlová baterie
 RO Baterie lavoar
 HU Mosdó csaptelep
 ES Monomando de lavabo



FALA

No.	Series / Seria	
75760	Soria	10

EN Single-lever shower mixer
 PL Bateria prysznicowa
 DE Einhand-Brausebatterie
 RU Смеситель для душа
 CZ Sprchová baterie
 RO Baterie dus
 HU Egykaros zuhanycsaptelep
 ES Monomando de ducha



FALA

No.	Series / Seria	
75763	Soria	10

EN Bath mixer
 PL Bateria wannowa
 DE Einhand-Wannenbatterie
 RU Смеситель для ванны
 CZ Vanové baterie
 RO Baterie cada / dus
 HU Egykaros kádcsaptelep
 ES Monomando para baño

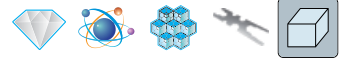

FALA

No.	Series / Seria	
75747	Burgos	8

- EN Single-lever sink mixer
- PL Bateria zlewozmywakowa
- DE Einhand-Spültischbatterie
- RU Смеситель для раковни
- CZ Dřezová baterie
- RO Baterie stativă bucătărie
- HU Mosogató csaptelep
- ES Monomando de fregadero



FALA

No.	Series / Seria	Box
75749	Burgos	8

- EN Basin mixer
- PL Bateria umywalkowa
- DE Einhand-Waschtischbatterie
- RU Смеситель для раковины
- CZ Umyvadlová baterie
- RO Baterie lavoar
- HU Mosdó csaptelep
- ES Monomando de lavabo



FALA

No.	Series / Seria	Box
75881	Noir 1	12

- EN Shower column
- PL Kolumna prysznicowa
- DE Duschsäule
- RU Душевая штанга
- CZ Sprchový sloup
- RO Coloană de duș
- HU Zuhanyoszlop
- ES Columna de ducha



FALA

No.	Series / Seria	Box
75883	Noir 1	4

- EN Basin mixer
- PL Bateria umywalkowa
- DE Einhand-Waschtischbatterie
- RU Смеситель для раковины
- CZ Umyvadlová baterie
- RO Baterie lavoar
- HU Mosdó csaptelep
- ES Monomando de lavabo



FALA

No.	Series / Seria	Box
75880	Noir 1	12

- EN Bath mixer
- PL Bateria wannowa
- DE Einhand-Wannenbatterie
- RU Смеситель для ванны
- CZ Vanové baterie
- RO Baterie cada / dus
- HU Egykaros kádcsaptelep
- ES Monomando para baño



FALA

No.	Series / Seria	Box
75882	Noir 1	8

- EN Single-lever sink mixer
- PL Bateria zlewozmywakowa
- DE Einhand-Spültischbatterie
- RU Смеситель для раковни
- CZ Dřezová baterie
- RO Baterie stativă bucătărie
- HU Mosogató csaptelep
- ES Monomando de fregadero

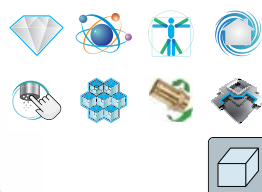

FALA

No.	Series / Seria	Box
75884	Noir 1	12

EN Basin mixer
 PL Bateria umywalkowa
 DE Einhand-Waschtischbatterie
 RU Смеситель для раковины
 CZ Umyvadlová baterie
 RO Bateria lavoar
 HU Mosdó csaptelep
 ES Monomando de lavabo



FALA

No.	Series / Seria	Box
75885	Noir 2	12

EN Basin mixer
 PL Bateria umywalkowa
 DE Einhand-Waschtischbatterie
 RU Смеситель для раковины
 CZ Umyvadlová baterie
 RO Bateria lavoar
 HU Mosdó csaptelep
 ES Monomando de lavabo



FALA

No.	Series / Seria	Box
75886	Noir 2	12

EN Single-lever shower mixer
 PL Bateria prysznicowa
 DE Einhand-Brausebatterie
 RU Смеситель для душа
 CZ Sprchová baterie
 RO Baterie dus
 HU Egykaros zuhanycsaptelep
 ES Monomando de ducha



FALA

No.	Series / Seria	Box
75887	Noir 2	8

EN Bath mixer
 PL Bateria wannowa
 DE Einhand-Wannenbatterie
 RU Смеситель для ванны
 CZ Vanové baterie
 RO Baterie cada / dus
 HU Egykaros kádcsaptelep
 ES Monomando para baño



FALA

No.	Series / Seria	Box
75888	Noir 2	8

EN Shower column
 PL Kolumna prysznicowa
 DE Duschsäule
 RU Душевая штанга
 CZ Sprchový sloup
 RO Coloană de duș
 HU Zuhanyoszlop
 ES Columna de ducha



FALA

No.	Series / Seria	Box
75889	Noir 2	4

EN Single-lever sink mixer
 PL Bateria zlewozmywakowa
 DE Einhand-Spültischbatterie
 RU Смеситель для кухни
 CZ Dřezová baterie
 RO Baterie stativă bucatărie
 HU Mosogató csaptelep
 ES Monomando de fregadero



FALA

No.	Series / Seria	Box
75705	Flexible-Black	10



EN Single-lever sink mixer
 PL Bateria zlewozmywakowa
 DE Einhand-Spültischbatterie
 RU Смеситель для кухни
 CZ Dřezová baterie
 RO Baterie stativă bucatărie
 HU Mosogató csaptelep
 ES Monomando de fregadero



FALA

No.	Series / Seria	Box
75706	Flexible-White	10

EN Single-lever sink mixer
 PL Bateria zlewozmywakowa
 DE Einhand-Spültischbatterie
 RU Смеситель для кухни
 CZ Dřezová baterie
 RO Baterie stativă bucatărie
 HU Mosogató csaptelep
 ES Monomando de fregadero



FALA

No.	Series / Seria	Box
75708	Flexible-Orange	10

EN Single-lever sink mixer
 PL Bateria zlewozmywakowa
 DE Einhand-Spültischbatterie
 RU Смеситель для кухни
 CZ Dřezová baterie
 RO Baterie stativă bucatărie
 HU Mosogató csaptelep
 ES Monomando de fregadero



FALA

No.	Series / Seria	Box
75710	Flexible-Light Grey	10

EN Single-lever sink mixer
 PL Bateria zlewozmywakowa
 DE Einhand-Spültischbatterie
 RU Смеситель для кухни
 CZ Dřezová baterie
 RO Baterie stativă bucatărie
 HU Mosogató csaptelep
 ES Monomando de fregadero



FALA

No.	Series / Seria	Box
75707	Flexible-Red	10

EN Single-lever sink mixer
 PL Bateria zlewozmywakowa
 DE Einhand-Spültischbatterie
 RU Смеситель для кухни
 CZ Dřezová baterie
 RO Baterie stativă bucatărie
 HU Mosogató csaptelep
 ES Monomando de fregadero



FALA

No.	Series / Seria	Box
75709	Flexible-Green	10

EN Single-lever sink mixer
 PL Bateria zlewozmywakowa
 DE Einhand-Spültischbatterie
 RU Смеситель для кухни
 CZ Dřezová baterie
 RO Baterie stativă bucatărie
 HU Mosogató csaptelep
 ES Monomando de fregadero



FALA

No.	Series / Seria	Box
75711	Flexible-Dark Grey	10

EN Single-lever sink mixer
 PL Bateria zlewomywakowa
 DE Einhand-Spültischbatterie
 RU Смеситель для кухни
 CZ Dřezová baterie
 RO Baterie stativă bucatărie
 HU Mosogató csaptelep
 ES Monomando de fregadero



FALA

No.	Series / Seria	Icon
75712	Flexible-Brown	10

EN Single-lever sink mixer
 PL Bateria zlewomywakowa
 DE Einhand-Spültischbatterie
 RU Смеситель для кухни
 CZ Dřezová baterie
 RO Baterie stativă bucatărie
 HU Mosogató csaptelep
 ES Monomando de fregadero



FALA

No.	Series / Seria	Icon
75775	Black Flexible-Black	10

EN Single-lever sink mixer
 PL Bateria zlewomywakowa
 DE Einhand-Spültischbatterie
 RU Смеситель для кухни
 CZ Dřezová baterie
 RO Baterie stativă bucatărie
 HU Mosogató csaptelep
 ES Monomando de fregadero



FALA

No.	Series / Seria	Icon
75777	Black Flexible-Red	10

EN Single-lever sink mixer
 PL Bateria zlewomywakowa
 DE Einhand-Spültischbatterie
 RU Смеситель для кухни
 CZ Dřezová baterie
 RO Baterie stativă bucatărie
 HU Mosogató csaptelep
 ES Monomando de fregadero



FALA

No.	Series / Seria	Icon
75729	Flexible-Steely Black	10

EN Single-lever sink mixer
 PL Bateria zlewomywakowa
 DE Einhand-Spültischbatterie
 RU Смеситель для кухни
 CZ Dřezová baterie
 RO Baterie stativă bucatărie
 HU Mosogató csaptelep
 ES Monomando de fregadero



FALA

No.	Series / Seria	Icon
75776	Black Flexible-White	10

EN Single-lever sink mixer
 PL Bateria zlewomywakowa
 DE Einhand-Spültischbatterie
 RU Смеситель для кухни
 CZ Dřezová baterie
 RO Baterie stativă bucatărie
 HU Mosogató csaptelep
 ES Monomando de fregadero



FALA

No.	Series / Seria	Icon
75778	Black Flexible-Orange	10

EN Single-lever sink mixer
 PL Bateria zlewozmywakowa
 DE Einhand-Spültischbatterie
 RU Смеситель для кухни
 CZ Dřezová baterie
 RO Baterie stativă bucatărie
 HU Mosogató csaptelep
 ES Monomando de fregadero



FALA

No.	Series / Seria	
75779	Black Flexible-Green	10

EN Single-lever sink mixer
 PL Bateria zlewozmywakowa
 DE Einhand-Spültischbatterie
 RU Смеситель для кухни
 CZ Dřezová baterie
 RO Baterie stativă bucatărie
 HU Mosogató csaptelep
 ES Monomando de fregadero



FALA

No.	Series / Seria	
75676	Flexible 2 White	10

EN Single-lever sink mixer
 PL Bateria zlewozmywakowa
 DE Einhand-Spültischbatterie
 RU Смеситель для кухни
 CZ Dřezová baterie
 RO Baterie stativă bucatărie
 HU Mosogató csaptelep
 ES Monomando de fregadero



FALA

No.	Series / Seria	
75852	Steely Black 1	10

EN Single-lever sink mixer
 PL Bateria zlewozmywakowa
 DE Einhand-Spültischbatterie
 RU Смеситель для кухни
 CZ Dřezová baterie
 RO Baterie stativă bucatărie
 HU Mosogató csaptelep
 ES Monomando de fregadero



FALA

No.	Series / Seria	
75675	Flexible 2 Black	10

EN Single-lever sink mixer
 PL Bateria zlewozmywakowa
 DE Einhand-Spültischbatterie
 RU Смеситель для кухни
 CZ Dřezová baterie
 RO Baterie stativă bucatărie
 HU Mosogató csaptelep
 ES Monomando de fregadero



FALA

No.	Series / Seria	
75677	Flexible 2 Red	10

EN Single-lever sink mixer
 PL Bateria zlewozmywakowa
 DE Einhand-Spültischbatterie
 RU Смеситель для кухни
 CZ Dřezová baterie
 RO Baterie stativă bucatărie
 HU Mosogató csaptelep
 ES Monomando de fregadero



FALA

No.	Series / Seria	
75853	Steely Black 2	10

EN Single-lever sink mixer
 PL Bateria zlewozmywakowa ścienna
 DE Einhand-Spültischbatterie
 RU Смеситель для кухни
 CZ Dřezová baterie
 RO Baterie bucătărie
 HU Mosogató csaptelep
 ES Monomando de fregadero



FALA

No.	Series / Seria	Icon
75670	Flexible-Black	10

EN Single-lever sink mixer
 PL Bateria zlewozmywakowa ścienna
 DE Einhand-Spültischbatterie
 RU Смеситель для кухни
 CZ Dřezová baterie
 RO Baterie bucătărie
 HU Mosogató csaptelep
 ES Monomando de fregadero



FALA

No.	Series / Seria	Icon
75671	Flexible-White	10

EN Single-lever sink mixer
 PL Bateria zlewozmywakowa ścienna
 DE Einhand-Spültischbatterie
 RU Смеситель для кухни
 CZ Dřezová baterie
 RO Baterie bucătărie
 HU Mosogató csaptelep
 ES Monomando de fregadero



FALA

No.	Series / Seria	Icon
75672	Flexible-Red	10

EN Single-lever sink mixer
 PL Bateria zlewozmywakowa ścienna
 DE Einhand-Spültischbatterie
 RU Смеситель для кухни
 CZ Dřezová baterie
 RO Baterie bucătărie
 HU Mosogató csaptelep
 ES Monomando de fregadero



FALA

No.	Series / Seria	Icon
75673	Flexible-Orange	10

EN Single-lever sink mixer
 PL Bateria zlewozmywakowa ścienna
 DE Einhand-Spültischbatterie
 RU Смеситель для кухни
 CZ Dřezová baterie
 RO Baterie bucătărie
 HU Mosogató csaptelep
 ES Monomando de fregadero



FALA

No.	Series / Seria	Icon
75674	Flexible-Green	10

EN Pop-up waste
 PL Korek z sitkiem
 DE Waschbecken Stöpsel
 RU Пробка
 CZ Zátka
 RO Sifon chiuveta
 HU Mosdo lefolyó elzaro
 ES Tapón

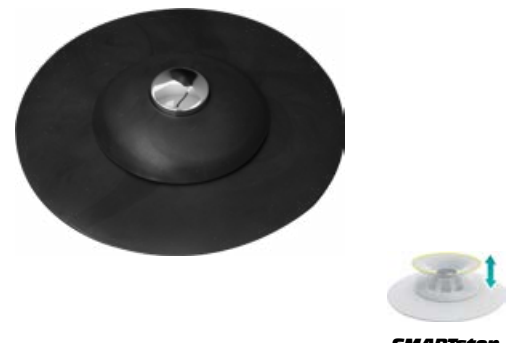

FALA

No.	Series / Seria	Icon
74780	SMARTstop	240

EN Pop-up waste
 PL Korek z sitkiem
 DE Waschbecken Stöpsel
 RU Пробка
 CZ Zátka
 RO Sifon chiuveta
 HU Mosdo lefolyo elzaro
 ES Tapón



SMARTstop

FALA

No.	
74781	240

EN Pop-up waste
 PL Korek z sitkiem
 DE Waschbecken Stöpsel
 RU Пробка
 CZ Zátka
 RO Sifon chiuveta
 HU Mosdo lefolyo elzaro
 ES Tapón



SMARTstop

FALA

No.	
74782	240

EN Pop-up waste
 PL Korek z sitkiem
 DE Waschbecken Stöpsel
 RU Пробка
 CZ Zátka
 RO Sifon chiuveta
 HU Mosdo lefolyo elzaro
 ES Tapón



SMARTstop

FALA

No.	
74783	240

EN Pop-up waste
 PL Korek z sitkiem
 DE Waschbecken Stöpsel
 RU Пробка
 CZ Zátka
 RO Sifon chiuveta
 HU Mosdo lefolyo elzaro
 ES Tapón



SMARTstop

FALA

No.	
74784	240

EN Organizer
 PL Organizer
 DE Organizer
 RU Организаер
 CZ Organizér
 RO Organizator
 HU Szervező
 ES Organizador



FALA

No.	
74785	144

EN Organizer
 PL Organizer
 DE Organizer
 RU Организаер
 CZ Organizér
 RO Organizator
 HU Szervező
 ES Organizador



FALA

No.	
74786	144

EN Organizer
 PL Organizer
 DE Organizer
 RU Опрани́зеп
 CZ Organizér
 RO Organizator
 HU Szervező
 ES Organizador



FALA

No.	
74787	144

EN Organizer
 PL Organizer
 DE Organizer
 RU Опрани́зеп
 CZ Organizér
 RO Organizator
 HU Szervező
 ES Organizador



FALA

No.	
74789	144

EN Mat
 PL Mata
 DE Matte
 RU Коврик
 CZ Podložka
 RO Mat
 HU Lábtörő
 ES Alfombra



FALA

No.	
74791	50/200

EN Mat
 PL Mata
 DE Matte
 RU Коврик
 CZ Podložka
 RO Mat
 HU Lábtörő
 ES Alfombra



FALA

No.	
74793	50/200

EN Organizer
 PL Organizer
 DE Organizer
 RU Опрани́зеп
 CZ Organizér
 RO Organizator
 HU Szervező
 ES Organizador



FALA

No.	
74788	144

EN Mat
 PL Mata
 DE Matte
 RU Коврик
 CZ Podložka
 RO Mat
 HU Lábtörő
 ES Alfombra



FALA

No.	
74790	50/200

EN Mat
 PL Mata
 DE Matte
 RU Коврик
 CZ Podložka
 RO Mat
 HU Lábtörő
 ES Alfombra



FALA

No.	
74792	50/200

EN Mat
 PL Mata
 DE Matte
 RU Коврик
 CZ Podložka
 RO Mat
 HU Lábtörő
 ES Alfombra



FALA

No.	
74794	50/200

EN Soap dispenser
 PL Dozownik mydła w płynie
 DE Seifenspender
 RU Дозатор для мыла
 CZ Dávkovač mýdla
 RO Dozator sapun lichid
 HU Folyékonyszappan adagoló
 ES Dispensador de jabón



FALA

No.	
69395	100

EN Soap dispenser
 PL Dozownik mydła w płynie
 DE Seifenspender
 RU Дозатор для мыла
 CZ Dávkovač mýdla
 RO Dozator sapun lichid
 HU Folyékonyszappan adagoló
 ES Dispensador de jabón



FALA

No.	
69397	100

EN Soap dispenser
 PL Dozownik mydła w płynie
 DE Seifenspender
 RU Дозатор для мыла
 CZ Dávkovač mýdla
 RO Dozator sapun lichid
 HU Folyékonyszappan adagoló
 ES Dispensador de jabón



FALA

No.	
69396	100

EN Soap dispenser
 PL Dozownik mydła w płynie
 DE Seifenspender
 RU Дозатор для мыла
 CZ Dávkovač mýdla
 RO Dozator sapun lichid
 HU Folyékonyszappan adagoló
 ES Dispensador de jabón



FALA

No.	
69390	60

EN Soap dispenser
 PL Dozownik mydła w płynie
 DE Seifenspender
 RU Дозатор для мыла
 CZ Dávkovač mýdla
 RO Dozator sapun lichid
 HU Folyékonyszappan adagoló
 ES Dispensador de jabón



FALA

No.	
69391	24



Special inspection window for 100% outflow control and comfortable cleaning.

Specjalne okienko rewizyjne to 100% kontroli drożności i wygodne czyszczenie.

SMARTthru

Easy to clean thanks to contained hook.

Łatwy do utrzymania w czystości dzięki dołączonemu haczykowi.

EASYclean

Stabilizing body grips, additional stiffening in the floor.

Uchwyty stabilizujące korpus. Dodatkowe usztywnienie konstrukcji w podłodze.

GRIPstrong

Waterproof cloth included – as essential part of waterproofing.

Mata uszczelniająca w zestawie – niezbędna część przy wykonywaniu hydroizolacji.

HYDRCloth

Effective and durable strainer which prevents clogging of the trap and makes cleaning easier.

Skuteczne i trwałe sito, które zapobiega zapychaniu syfonu oraz ułatwia bieżącą obsługę odpływu.

STRAINer

High quality precision welds guarantee no leaking of the drain.

Wysokiej jakości precyzyjne spawy gwarantujące szczelność odpływu.

HQwelding

Low siphon made of stainless steel AISI 304 makes installation easier.

Niski syfon wykonany ze stali nierdzewnej AISI 304 ułatwiający instalację.

52 mm

Wide range of height adjustment allows adjusting to the floor level.

Szeroki zakres regulacji wysokości, który umożliwia dopasowanie odpływu do powierzchni posadzki.

It can prevent stink and worms both in use and after dry (no water in siphon).

Zapobiega przedostawaniu się zapachów oraz robaków podczas używania jak i po wysuszeniu (brak wody w syfonie).

EN Linear drain
 PL Odpływ liniowy
 DE Duschrinne
 RU Душевой лоток
 CZ Odtokový žlab
 RO Rigola dus
 HU Zuhanyfolyóka
 ES Canal de ducha



FALA

No.	Body length / Długość rynny [mm]	Series / Seria	
75345	500	Rotary	5
75346	600	Rotary	5
75347	700	Rotary	5
75348	800	Rotary	5
75349	900	Rotary	5

EN Linear drain
 PL Odpływ liniowy
 DE Duschrinne
 RU Душевой лоток
 CZ Odtokový žlab
 RO Rigola dus
 HU Zuhanyfolyóka
 ES Canal de ducha



FALA

No.	Body length / Długość rynny [mm]	Series / Seria	
75360	300	Madeira	6
75361	400	Madeira	6
75362	500	Madeira	6

EN Linear drain
 PL Odpływ liniowy
 DE Duschrinne
 RU Душевой лоток
 CZ Odtokový žlab
 RO Rigola dus
 HU Zuhanyfolyóka
 ES Canal de ducha



FALA

No.	Body length / Długość rynny [mm]	Series / Seria	
75367	300	Tocantins	6
75368	400	Tocantins	6
75369	500	Tocantins	6

EN Linear drain
 PL Odpływ liniowy
 DE Duschrinne
 RU Душевой лоток
 CZ Odtokový žlab
 RO Rigola dus
 HU Zuhanyfolyóka
 ES Canal de ducha



FALA

No.	Body length / Długość rynny [mm]	Series / Seria	
75350	300	Brick	5
75351	400	Brick	5
75352	500	Brick	5
75353	600	Brick	5
75354	700	Brick	5
75355	800	Brick	5
75356	900	Brick	5

EN Linear drain
 PL Odpływ liniowy
 DE Duschrinne
 RU Душевой лоток
 CZ Odtokový žlab
 RO Rigola dus
 HU Zuhanyfolyóka
 ES Canal de ducha



FALA

No.	Body length / Długość rynny [mm]	Series / Seria	
75363	600	Madeira	6
75364	700	Madeira	6
75365	800	Madeira	6
75366	900	Madeira	6

EN Linear drain
 PL Odpływ liniowy
 DE Duschrinne
 RU Душевой лоток
 CZ Odtokový žlab
 RO Rigola dus
 HU Zuhanyfolyóka
 ES Canal de ducha



FALA

No.	Body length / Długość rynny [mm]	Series / Seria	
75370	600	Tocantins	6
75371	700	Tocantins	6
75372	800	Tocantins	6
75373	900	Tocantins	6

EN Linear drain
 PL Odpływ liniowy
 DE Duschrinne
 RU Душевой лоток
 CZ Odtokový žlab
 RO Rigola dus
 HU Zuhanyfolyóka
 ES Canal de ducha



FALA

No.	Body length / Długość rynny [mm]	Series / Seria	
75374	300	Napo	6
75375	400	Napo	6
75376	500	Napo	6

EN Linear drain
 PL Odpływ liniowy
 DE Duschrinne
 RU Душевой лоток

CZ Odtokový žlab
 RO Rigola dus
 HU Zuhanyfolyóka
 ES Canal de ducha



FALA

No.	Body length / Długość rynny [mm]	Series / Seria	
75381	600	White Glass	6
75382	700	White Glass	6
75383	800	White Glass	6
75384	900	White Glass	6

EN Linear drain
 PL Odpływ liniowy
 DE Duschrinne
 RU Душевой лоток

CZ Odtokový žlab
 RO Rigola dus
 HU Zuhanyfolyóka
 ES Canal de ducha



FALA

No.	Body length / Długość rynny [mm]	Series / Seria	
75386	600	Black Glass	6
75387	700	Black Glass	6
75388	800	Black Glass	6
75389	900	Black Glass	6

EN Linear drain
 PL Odpływ liniowy
 DE Duschrinne
 RU Душевой лоток
 CZ Odtokový žlab
 RO Rigola dus
 HU Zuhanyfolyóka
 ES Canal de ducha

FALA

No.	Body length / Długość rynny [mm]	Series / Seria	
75421	600	Olimp	6
75422	700	Olimp	6
75423	800	Olimp	6
75424	900	Olimp	6

EN Linear drain
 PL Odpływ liniowy
 DE Duschrinne
 RU Душевой лоток
 CZ Odtokový žlab
 RO Rigola dus
 HU Zuhanyfolyóka
 ES Canal de ducha



FALA

No.	Body length / Długość rynny [mm]	Series / Seria	
75377	600	Napo	6
75378	700	Napo	6
75379	800	Napo	6
75380	900	Napo	6

EN Linear drain
 PL Odpływ liniowy
 DE Duschrinne
 RU Душевой лоток
 CZ Odtokový žlab
 RO Rigola dus
 HU Zuhanyfolyóka
 ES Canal de ducha



FALA

No.	Body length / Długość rynny [mm]	Series / Seria	
71610	600	Wet & dry white glass	6
71611	700	Wet & dry white glass	6
71612	800	Wet & dry white glass	6

EN Linear drain
 PL Odpływ liniowy
 DE Duschrinne
 RU Душевой лоток

CZ Odtokový žlab
 RO Rigola dus
 HU Zuhanyfolyóka
 ES Canal de ducha



FALA

No.	Body length / Długość rynny [mm]	Series / Seria	
71614	600	Wet & dry black glass	6
71615	700	Wet & dry black glass	6
71616	800	Wet & dry black glass	6



EN Linear drain
PL Odpływ liniowy
DE Duschrinne
RU Душевой лоток
CZ Odtokový žlab
RO Rigola dus
HU Zuhanyfolyóka
ES Canal de ducha



FALA

No.	Body length / Długość rynny [mm]	Series / Seria	
75448	600	Line	6
75449	700	Line	6
75450	800	Line	6
75451	900	Line	6

EN Linear drain
PL Odpływ liniowy
DE Duschrinne
RU Душевой лоток

CZ Odtokový žlab
RO Rigola dus
HU Zuhanyfolyóka
ES Canal de ducha

FALA

No.	Body length / Długość rynny [mm]	Series / Seria	
71635	500	Slim black	5
71636	600	Slim black	5
71637	700	Slim black	5
71638	800	Slim black	5
71639	900	Slim black	5

EN Linear drain
PL Odpływ liniowy
DE Duschrinne
RU Душевой лоток
CZ Odtokový žlab
RO Rigola dus
HU Zuhanyfolyóka
ES Canal de ducha



FALA

No.	Body length / Długość rynny [mm]	Series / Seria	
71603	600	Wet & dry	6
71604	700	Wet & dry	6
71605	800	Wet & dry	6

EN Aerator and sealing set for sanitary mixers
PL Perfektor i zestaw uszczelek do baterii
DE Strahlregler- und Dichtungsgummisatz für Armatur
RU Аэратор с набором прокладок для смесителя
CZ Perfektor a sada těsnění do baterie
RO Sita și garnitură pt. baterii sanitare
HU Levegőztető és tömítőgumi készlet csaptelephez
ES Aireado y juego de juntas



FALA

No.	
75327	25/250

EN Linear drain
PL Odpływ liniowy
DE Duschrinne
RU Душевой лоток
CZ Odtokový žlab
RO Rigola dus
HU Zuhanyfolyóka
ES Canal de ducha



FALA

No.	Body length / Długość rynny [mm]	Series / Seria	
71630	500	Slim	5
71631	600	Slim	5
71632	700	Slim	5
71633	800	Slim	5
71634	900	Slim	5



EN Linear drain
PL Odpływ liniowy
DE Duschrinne
RU Душевой лоток
CZ Odtokový žlab
RO Rigola dus
HU Zuhanyfolyóka
ES Canal de ducha

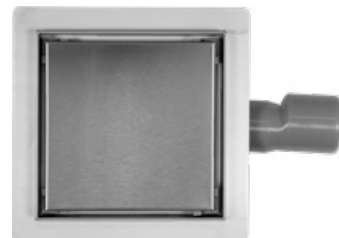

FALA

No.	Body size / Rozmiar rynny [mm]	Series / Seria	
75334	150x150	Quad	10
75335	200x200	Quad	10
75336	250x250	Quad	10

EN Pop-up waste
PL Korek do umywalki
DE Waschbecken Stöpsel
RU Автоматическая пробка
CZ Automatická zátka
RO Sifon chiuveta
HU Mosdo lefolyó elzaro
ES Tapón automat. para batería de lado



FALA

No.	
75498	12/48

- EN Pop-up waste
- PL Korek do umywalki
- DE Waschbecken Stöpsel
- RU Автоматическая пробка для умывальника
- CZ Automatická zátka
- RO Sifon chiuveta
- HU Mosdó lefolyó elzáró
- ES Tapón automat. para batería de lado



FALA

No.	
75499	12/48

- EN Pop-up waste
- PL Korek automatyczny
- DE Waschbecken Stöpsel
- RU Автоматическая пробка для умывальника
- CZ Automatická zátka
- RO Sifon chiuveta
- HU Mosdó lefolyó elzáró
- ES Tapón automat. para batería de lado



FALA

No.	
75483	48/96

- EN Pop-up waste
- PL Korek automatyczny
- DE Waschbecken Stöpsel
- RU Автоматическая пробка для умывальника
- CZ Automatická zátka
- RO Sifon chiuveta
- HU Mosdó lefolyó elzáró
- ES Tapón automat. para batería de lado



FALA

No.	
75484	20/40

- EN Pop-up waste
- PL Korek automatyczny
- DE Waschbecken Stöpsel
- RU Автоматическая пробка для умывальника
- CZ Automatická zátka
- RO Sifon chiuveta
- HU Mosdó lefolyó elzáró
- ES Tapón automat. para batería de lado

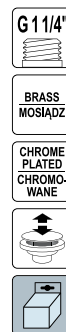

FALA

No.	
75487	20/40

- EN Shower handle
- PL Słuchawka prysznicowa
- DE Handbrause
- RU Разбрызгиватель для душа
- CZ Ruční sprcha
- RO Cap duș
- HU Kézi zuhanyfej
- ES Ducha



FALA

No.	
75544	15/60

- EN Shower handle
- PL Słuchawka prysznicowa
- DE Handbrause
- RU Разбрызгиватель для душа
- CZ Ruční sprcha
- RO Cap duș
- HU Kézi zuhanyfej
- ES Ducha



FALA

No.	
75545	15/60

- EN Shower handle
- PL Słuchawka prysznicowa
- DE Handbrause
- RU Разбрызгиватель для душа
- CZ Ruční sprcha
- RO Cap duș
- HU Kézi zuhanyfej
- ES Ducha



FALA

No.	
75551	30/60

- EN Shower handle
- PL Słuchawka prysznicowa
- DE Handbrause
- RU Разбрызгиватель для душа
- CZ Ruční sprcha
- RO Cap duș
- HU Kézi zuhanyfej
- ES Ducha



FALA

No.	
75550	30/60

EN Shower handle
 PL Słuchawka prysznicowa
 DE Handbrause
 RU Разбрызгиватель для душа
 CZ Ruční sprcha
 RO Cap duș
 HU Kézi zuhanyfej
 ES Ducha



FALA

No.	Series / Seria	
75627	Delta	24/48

EN Shower handle
 PL Słuchawka prysznicowa
 DE Handbrause
 RU Разбрызгиватель для душа
 CZ Ruční sprcha
 RO Cap duș
 HU Kézi zuhanyfej
 ES Ducha



FALA

No.	Series / Seria	
75626	Kile	25/50

EN Shower handle
 PL Słuchawka prysznicowa
 DE Handbrause
 RU Разбрызгиватель для душа
 CZ Ruční sprcha
 RO Cap duș
 HU Kézi zuhanyfej
 ES Ducha



FALA

No.	Series / Seria	
75628	Deimos	12

EN Shower handle
 PL Słuchawka prysznicowa
 DE Handbrause
 RU Разбрызгиватель для душа
 CZ Ruční sprcha
 RO Cap duș
 HU Kézi zuhanyfej
 ES Ducha



FALA

No.	Series / Seria	
75633	Japet	12



EN Shower handle
 PL Słuchawka prysznicowa
 DE Handbrause
 RU Разбрызгиватель для душа
 CZ Ruční sprcha
 RO Cap duș
 HU Kézi zuhanyfej
 ES Ducha



FALA

No.	Series / Seria	
75631	Hermana	25/50

EN Shower handle
 PL Słuchawka prysznicowa
 DE Handbrause
 RU Разбрызгиватель для душа
 CZ Ruční sprcha
 RO Cap duș
 HU Kézi zuhanyfej
 ES Ducha



FALA

No.	Series / Seria	
75625	Delfos	25/50

EN Shower handle
 PL Słuchawka prysznicowa
 DE Handbrause
 RU Разбрызгиватель для душа
 CZ Ruční sprcha
 RO Cap duș
 HU Kézi zuhanyfej
 ES Ducha



FALA

No.	Series / Seria	
75632	Fobos	12

EN Shower handle
 PL Słuchawka prysznicowa
 DE Handbrause
 RU Разбрызгиватель для душа
 CZ Ruční sprcha
 RO Cap duș
 HU Kézi zuhanyfej
 ES Ducha



FALA

No.	Series / Seria	
75634	Dione	12



EN Shower handle
 PL Słuchawka prysznicowa
 DE Handbrause
 RU Разбрызгиватель для душа
 CZ Ruční sprcha
 RO Cap duș
 HU Kézi zuhanyfej
 ES Ducha



FALA

No.	Series / Seria	Box
75635	Mimas	12

EN Shower handle
 PL Słuchawka prysznicowa
 DE Handbrause
 RU Разбрызгиватель для душа
 CZ Ruční sprcha
 RO Cap duș
 HU Kézi zuhanyfej
 ES Ducha



FALA

No.	Series / Seria	Box
75639	White Moon	12

EN Shower handle
 PL Słuchawka prysznicowa
 DE Handbrause
 RU Разбрызгиватель для душа
 CZ Ruční sprcha
 RO Cap duș
 HU Kézi zuhanyfej
 ES Ducha



FALA

No.	Series / Seria	Box
75619	Salto	25/50

EN Shower handle
 PL Słuchawka prysznicowa
 DE Handbrause
 RU Разбрызгиватель для душа
 CZ Ruční sprcha
 RO Cap duș
 HU Kézi zuhanyfej
 ES Ducha



FALA

No.	Series / Seria	Box
75621	Salto	25/50

EN Shower handle
 PL Słuchawka prysznicowa
 DE Handbrause
 RU Разбрызгиватель для душа
 CZ Ruční sprcha
 RO Cap duș
 HU Kézi zuhanyfej
 ES Ducha



FALA

No.	Series / Seria	Box
75636	Silver Moon	12

EN Shower handle
 PL Słuchawka prysznicowa
 DE Handbrause
 RU Разбрызгиватель для душа
 CZ Ruční sprcha
 RO Cap duș
 HU Kézi zuhanyfej
 ES Ducha



FALA

No.	Series / Seria	Box
75624	Salto	25/50

EN Shower handle
 PL Słuchawka prysznicowa
 DE Handbrause
 RU Разбрызгиватель для душа
 CZ Ruční sprcha
 RO Cap duș
 HU Kézi zuhanyfej
 ES Ducha



FALA

No.	Series / Seria	Box
75620	Salto	25/50

EN Shower handle
 PL Słuchawka prysznicowa
 DE Handbrause
 RU Разбрызгиватель для душа
 CZ Ruční sprcha
 RO Cap duș
 HU Kézi zuhanyfej
 ES Ducha



FALA

No.	Series / Seria	Box
75622	Salto	25/50

EN Shower handle
 PL Słuchawka prysznicowa
 DE Handbrause
 RU Разбрызгиватель для душа
 CZ Ruční sprcha
 RO Cap duș
 HU Kézi zuhanyfej
 ES Ducha



FALA

No.	Series / Seria	Icon
75623	Salto	25/50

EN Shower holder
 PL Uchwyt do słuchawki prysznicowej
 DE Brauseporter
 RU Держатель душ
 CZ Držák s kloubem na sprchu
 RO Suport pt. dus
 HU Zuhanycső tartó
 ES Grifo para ducha



FALA

No.	Icon
75535	100

EN Shower holder
 PL Uchwyt do słuchawki prysznicowej
 DE Brauseporter
 RU Держатель душ
 CZ Držák s kloubem na sprchu
 RO Suport pt. dus
 HU Zuhanycső tartó
 ES Grifo para ducha

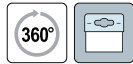

FALA

No.	Icon
75537	100

EN Shower holder
 PL Uchwyt do słuchawki prysznicowej
 DE Brauseporter
 RU Держатель душ
 CZ Držák s kloubem na sprchu
 RO Suport pt. dus
 HU Zuhanycső tartó
 ES Grifo para ducha

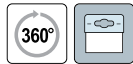

FALA

No.	Icon
75564	50/200

EN Shower holder
 PL Uchwyt do słuchawki prysznicowej
 DE Brauseporter
 RU Держатель душ
 CZ Držák s kloubem na sprchu
 RO Suport pt. dus
 HU Zuhanycső tartó
 ES Grifo para ducha



FALA

No.	Icon
75527	100

EN Shower holder
 PL Uchwyt do słuchawki prysznicowej
 DE Brauseporter
 RU Держатель душ
 CZ Držák s kloubem na sprchu
 RO Suport pt. dus
 HU Zuhanycső tartó
 ES Grifo para ducha



FALA

No.	Icon
75536	100

EN Shower holder
 PL Uchwyt do słuchawki prysznicowej
 DE Brauseporter
 RU Держатель душ
 CZ Držák s kloubem na sprchu
 RO Suport pt. dus
 HU Zuhanycső tartó
 ES Grifo para ducha

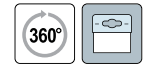

FALA

No.	Icon
75539	100

EN Shower holder
 PL Uchwyt do słuchawki prysznicowej
 DE Brauseporter
 RU Держатель душ
 CZ Držák s kloubem na sprchu
 RO Suport pt. dus
 HU Zuhanycső tartó
 ES Grifo para ducha



FALA

No.	Icon
75565	30/180

EN Shower hose
 PL Wąż prysznicowy
 DE Brausenschlauch
 RU Шланг для душа
 CS Sprchová hadice
 RO Furtun duș
 HU Zuhanycső
 ES Manguera de ducha



FALA

No.	L [m]	☐
75553	1.5	30/60
75554	1.7	30/60

EN Shower hose
 PL Wąż prysznicowy
 DE Brausenschlauch
 RU Шланг для душа
 CS Sprchová hadice
 RO Furtun duș
 HU Zuhanycső
 ES Manguera de ducha



FALA

No.	L [m]	☐
75578	1.5	30/60
75579	1.7	30/60

EN Shower hose
 PL Wąż prysznicowy
 DE Brausenschlauch
 RU Шланг для душа
 CS Sprchová hadice
 RO Furtun duș
 HU Zuhanycső
 ES Manguera de ducha

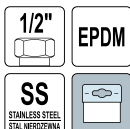

FALA

No.	L [m]	☐
75650	1.25-1.75	50

EN Shower hose
 PL Wąż prysznicowy
 DE Brausenschlauch
 RU Шланг для душа
 CS Sprchová hadice
 RO Furtun duș
 HU Zuhanycső
 ES Manguera de ducha



FALA

No.	L [m]	☐
75648	1.5	50
75649	2.0	50

EN Shower hose
 PL Wąż prysznicowy
 DE Brausenschlauch
 RU Шланг для душа
 CS Sprchová hadice
 RO Furtun duș
 HU Zuhanycső
 ES Manguera de ducha



FALA

No.	L [m]	☐
75645	1.50	50
75646	1.75	50
75647	2.00	50

EN Shower hose
 PL Wąż prysznicowy
 DE Brausenschlauch
 RU Шланг для душа
 CS Sprchová hadice
 RO Furtun duș
 HU Zuhanycső
 ES Manguera de ducha

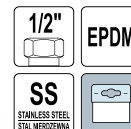

FALA

No.	L [m]	☐
75651	1.5-2.0	50

EN Shower hose
 PL Wąż prysznicowy
 DE Brausenschlauch
 RU Шланг для душа
 CS Sprchová hadice
 RO Furtun duș
 HU Zuhanycső
 ES Manguera de ducha

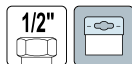

FALA

No.	L [m]	☐
75652	1.5	50
75653	2.0	50

EN Flexible connecting hose
 PL Wąż przyłączeniowy elastyczny
 DE Edelstahl Flexschlauch
 RU Гибкий шланг для смесителя
 CS Flexibilní nerezové hadice na vodu
 RO Racorduri flexibile pt. apa
 HU Rugalmas rozsdamentes acél cső a víz
 ES Manguera flexible de acero inoxidable para el agua

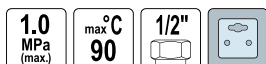

FALA

No.	L [mm]	☐
71800	300	180
71801	400	150
71802	500	120
71803	600	120
71804	800	100
71805	1000	80

EN Flexible connecting hose
 PL Wąż przyłączeniowy elastyczny
 DE Edelstahl Flexschlauch
 RU Гибкий шланг для смесителя
 CS Flexibilní nerezové hadice na vodu
 RO Racorduri flexibile pt. apa
 HU Rugalmas rozsdamentes acél cső a víz
 ES Manguera flexible de acero inoxidable para el agua

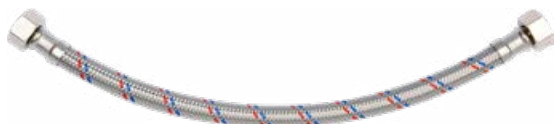
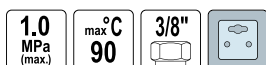

FALA

No.	L [mm]	☐
71814	300	250
71815	400	200
71816	500	150
71817	600	120
71818	800	100
71819	1000	80

EN Shower hose
 PL Wąż prysznicowy
 DE Brausenschlauch
 RU Шланг для душа
 CS Sprchová hadice
 RO Furtun duș
 HU Zuhanycső
 ES Manguera de ducha

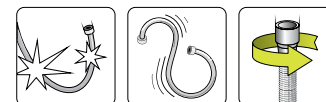
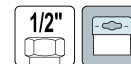

FALA

No.	L [m]	☐
75654	1.5	50
75655	2.0	50

EN Flexible connecting hose
 PL Wąż przyłączeniowy elastyczny
 DE Edelstahl Flexschlauch
 RU Гибкий шланг для смесителя
 CS Flexibilní nerezové hadice na vodu
 RO Racorduri flexibile pt. apa
 HU Rugalmas rozsdamentes acél cső a víz
 ES Manguera flexible de acero inoxidable para el agua

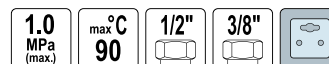

FALA

No.	L [mm]	☐
71807	300	200
71808	400	150
71809	500	120
71810	600	100
71811	800	100
71812	1000	80

EN Flexible connecting hose
 PL Wąż przyłączeniowy elastyczny
 DE Edelstahl Flexschlauch
 RU Гибкий шланг для смесителя
 CS Flexibilní nerezové hadice na vodu
 RO Racorduri flexibile pt. apa
 HU Rugalmas rozsdamentes acél cső a víz
 ES Manguera flexible de acero inoxidable para el agua

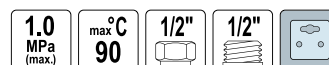

FALA

No.	L [mm]	☐
71820	300	200
71821	400	150
71822	500	120
71823	600	100
71824	800	10/100
71825	1000	80

EN Flexible connecting hose
 PL Wąż przyłączeniowy elastyczny
 DE Edelstahl Flexschlauch
 RU Гибкий шланг для смесителя
 CZ Flexibilní nerezové hadice na vodu
 RO Racorduri flexibile pt. apa
 HU Rugalmas rozsdamentes acél cső a víz
 ES Manguera flexible de acero inoxidable para el agua



FALA

No.	L [mm]	☐
71827	300	180
71828	400	150
71829	500	120
71830	600	120
71831	800	100
71832	1000	10/80

EN Flexible connecting hose
 PL Wąż przyłączeniowy elastyczny
 DE Edelstahl Flexschlauch
 RU Гибкий шланг для смесителя
 CZ Flexibilní nerezové hadice na vodu
 RO Racorduri flexibile pt. apa
 HU Rugalmas rozsdamentes acél cső a víz
 ES Manguera flexible de acero inoxidable para el agua



FALA

No.	L [mm]	☐
71840	300	200
71841	400	200
71842	500	150
71843	600	120
71844	800	100

EN Flexible connecting hose
 PL Wąż przyłączeniowy elastyczny
 DE Edelstahl Flexschlauch
 RU Гибкий шланг для смесителя
 CZ Flexibilní nerezové hadice na vodu
 RO Racorduri flexibile pt. apa
 HU Rugalmas rozsdamentes acél cső a víz
 ES Manguera flexible de acero inoxidable para el agua



FALA

No.	L [mm]	☐
71851	300	200
71852	400	180
71853	500	150
71854	600	120
71855	800	100

EN Flexible connecting hose
 PL Wąż przyłączeniowy elastyczny
 DE Edelstahl Flexschlauch
 RU Гибкий шланг для смесителя
 CZ Flexibilní nerezové hadice na vodu
 RO Racorduri flexibile pt. apa
 HU Rugalmas rozsdamentes acél cső a víz
 ES Manguera flexible de acero inoxidable para el agua



FALA

No.	L [mm]	☐
71833	300	180
71834	400	200
71835	500	120
71836	600	120
71837	800	100
71838	1000	80

EN Flexible connecting hose
 PL Wąż przyłączeniowy elastyczny
 DE Edelstahl Flexschlauch
 RU Гибкий шланг для смесителя
 CZ Flexibilní nerezové hadice na vodu
 RO Racorduri flexibile pt. apa
 HU Rugalmas rozsdamentes acél cső a víz
 ES Manguera flexible de acero inoxidable para el agua



FALA

No.	L [mm]	☐
71846	300	225
71847	400	180
71848	500	150
71849	600	120
71850	800	100

EN Flexible connecting hose
 PL Wąż przyłączeniowy elastyczny
 DE Edelstahl Flexschlauch
 RU Гибкий шланг для смесителя
 CZ Flexibilní nerezové hadice na vodu
 RO Racorduri flexibile pt. apa
 HU Rugalmas rozsdamentes acél cső a víz
 ES Manguera flexible de acero inoxidable para el agua



FALA

No.	L [mm]	☐
71856	300	200
71857	400	180
71858	500	150
71859	600	120
71860	800	10/100

EN Bathroom set
 PL Zestaw łazienkowy
 DE Brausegarnitur
 RU Набор для душевой
 CZ Sprchová souprava
 RO Set pt. dus
 HU Zuhanyzó készlet
 ES Juego de baño ducha

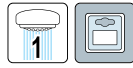

FALA

No.	
75555	12

EN Bathroom set
 PL Zestaw łazienkowy
 DE Brausegarnitur
 RU Набор для душевой
 CZ Sprchová souprava
 RO Set pt. dus
 HU Zuhanyzó készlet
 ES Juego de baño ducha



FALA

No.	
75558	12

EN Bathroom set
 PL Zestaw łazienkowy
 DE Brausegarnitur
 RU Набор для душевой
 CZ Sprchová souprava
 RO Set pt. dus
 HU Zuhanyzó készlet
 ES Juego de baño ducha



FALA

No.	
75660	5

EN Bathroom set
 PL Zestaw łazienkowy
 DE Brausegarnitur
 RU Набор для душевой
 CZ Sprchová souprava
 RO Set pt. dus
 HU Zuhanyzó készlet
 ES Juego de baño ducha



FALA

No.	
75559	16

EN Shower panel
 PL Panel prysznicowy
 DE Hydromassageduschpaneel
 RU Гидромассажная панель
 CZ Hydromasážní panel
 RO Panou de hidromasaj
 HU Hidromassázs panel
 ES Columna de hidromasaje



FALA

No.	Series / Seria	
75980	Steely 1	1

- EN Shower panel
- PL Panel prysznicowy
- DE Hydromassageduschpaneel
- RU Гидромассажная панель
- CZ Hydromasážní panel
- RO Panou de hidromasaj
- HU Hidromassázs panel
- ES Columna de hidromasaje



No.	Series / Seria	
75981	Steely 2	1

- EN Shower panel
- PL Panel prysznicowy
- DE Hydromassageduschpaneel
- RU Гидромассажная панель
- CZ Hydromasážní panel
- RO Panou de hidromasaj
- HU Hidromassázs panel
- ES Columna de hidromasaje



No.	Series / Seria	
75982	Steely 3	1

- EN Shower panel
- PL Panel prysznicowy
- DE Hydromassageduschpaneel
- RU Гидромассажная панель
- CZ Hydromasážní panel
- RO Panou de hidromasaj
- HU Hidromassázs panel
- ES Columna de hidromasaje



- EN Shower panel
- PL Panel prysznicowy
- DE Hydromassageduschpaneel
- RU Гидромассажная панель
- CZ Hydromasážní panel
- RO Panou de hidromasaj
- HU Hidromassázs panel
- ES Columna de hidromasaje



No.	Series / Seria	
75977	Steely 4	1



No.	Series / Seria	
75978	Steely 5	1

EN Shower panel
 PL Panel prysznicowy
 DE Hydromassageduschpaneel
 RU Гидромассажная панель
 CZ Hydromasážní panel
 RO Panou de hidromasaj
 HU Hidromassázs panel
 ES Columna de hidromasaje



FALA

No.	Series / Seria	1
75979	Steely 6	1

EN Shower panel
 PL Panel prysznicowy
 DE Hydromassageduschpaneel
 RU Гидромассажная панель
 CZ Hydromasážní panel
 RO Panou de hidromasaj
 HU Hidromassázs panel
 ES Columna de hidromasaje



FALA

No.	Series / Seria	1
75984	Steely 5	1

EN Shower panel
 PL Panel prysznicowy
 DE Hydromassageduschpaneel
 RU Гидромассажная панель
 CZ Hydromasážní panel
 RO Panou de hidromasaj
 HU Hidromassázs panel
 ES Columna de hidromasaje



FALA

No.	Series / Seria	1
75983	Steely 4	1

EN Bathtub screen
 PL Parawan nawanowy
 DE Badewannenabtrennung
 RU Штора для ванн
 CZ Vanová zástěna
 RO Paravan pt. duș
 HU Kádparavánok
 ES Mampara de bañera



FALA

No.	1
68621	1

EN Bathtub screen
 PL Parawan nawanowy
 DE Badewannenabtrennung
 RU Штора для ванн
 CZ Vanová zástěna
 RO Paravan pt. duș
 HU Kádparavánok
 ES Mampara de bañera



FALA

No.	Series / Seria	Icon
68623		1

EN Towel ring
 PL Uchwyt na ręcznik
 DE Handtuchring
 RU Кольцо для полотенца
 CZ Držák ručníků
 RO Portprosop
 HU Törölközőtartó
 ES Toallero anillo



FALA

No.	Series / Seria	Icon
69305	Oval Chrom	5/30

EN Toilet brush holder
 PL Szczotka WC
 DE WC-Garnitur
 RU Туалетная щетка настенная
 CZ WC štětka
 RO Suport perie WC
 HU WC kefe
 ES Escobillero mura



FALA

No.	Series / Seria	Icon
69307	Oval Chrom	4/8

EN Tumbler
 PL Kubek kosmetyczny
 DE Becher
 RU Стакан
 CZ Dóza
 RO Suport periuță
 HU Fűdőszobai pohár
 ES Vaso



FALA

No.	Series / Seria	Icon
69301	Oval Chrom	4/24

EN Soap dish
 PL Mydelniczka
 DE Seifenschale
 RU Мыльница
 CZ Mydelnička
 RO Sapuniera
 HU Szappantartó tál
 ES Jabonera



FALA

No.	Series / Seria	Icon
69302	Oval Chrom	4/24

EN Towel ring
 PL Uchwyt na ręcznik
 DE Handtuchring
 RU Кольцо для полотенца
 CZ Držák ručníků
 RO Portprosop
 HU Törölközőtartó
 ES Toallero



FALA

No.	Series / Seria	Icon
69306	Oval Chrom	4/24

EN Glass shelf
 PL Półka szklana
 DE Ablagekonsole aus Glas
 RU Этажерка настенная
 CZ Polička do koupelny
 RO Polita sticla
 HU Piperepölc - üveg
 ES Estante

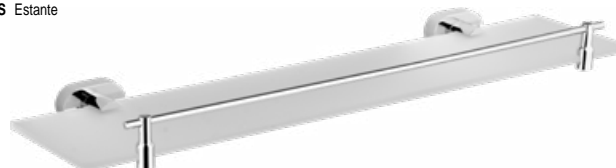

FALA

No.	Series / Seria	Icon
69308	Oval Chrom	4/8

EN Robe hook
 PL Haczyk pojedynczy
 DE Einzelhaken
 RU Крючок одинарный
 CZ Háček
 RO Agatatoare simpla
 HU Fali akasztó
 ES Perchero de pared

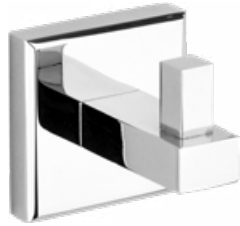

FALA

No.	Series / Seria	
69311	Quad Chrom	6/72

EN Soap dish
 PL Mydelniczka
 DE Seifenschale
 RU Мыльница
 CZ Mydelnička
 RO Sapuniera
 HU Szappantartó tál
 ES Jabonera



FALA

No.	Series / Seria	
69313	Quad Chrom	4/24

EN Toilet paper holder
 PL Uchwyt na papier toaletowy
 DE WC Papierhalter
 RU Держатель для туалетной бумаги без крышек
 CZ Držák na toaletní papír
 RO Porthartie
 HU WC papír tartó
 ES Portarrollos para papel higiénico



FALA

No.	Series / Seria	
69315	Quad Chrom	4/24

EN Towel ring
 PL Uchwyt na ręcznik
 DE Handtuchring
 RU Кольцо для полотенца
 CZ Držák ručníků
 RO Portprosop
 HU Törölközőtartó
 ES Toallero anillo



FALA

No.	Series / Seria	
69317	Quad Chrom	4/24

EN Tumbler
 PL Kubek kosmetyczny
 DE Becher
 RU Стакан
 CZ Dóza
 RO Suport periuță
 HU Fűrdőszobai pohár
 ES Vaso



FALA

No.	Series / Seria	
69312	Quad Chrom	4/24

EN Toilet paper holder
 PL Uchwyt na papier toaletowy
 DE WC Papierhalter
 RU Держатель для туалетной бумаги без крышек
 CZ Držák na toaletní papír
 RO Porthartie
 HU WC papír tartó
 ES Portarrollos para papel higiénico



FALA

No.	Series / Seria	
69314	Quad Chrom	4/24

EN Toilet paper holder
 PL Uchwyt na zapasowy papier
 DE Reserverpapierhalter
 RU Держатель для запасного рулона туалетной бумаги
 CZ Držák na toaletní papír
 RO Porthartie igienica
 HU WC papír tartó
 ES Portarrollos para papel higiénico



FALA

No.	Series / Seria	
69316	Quad Chrom	5/30

EN Towel ring
 PL Uchwyt na ręcznik
 DE Handtuchring
 RU Кольцо для полотенца
 CZ Držák ručníků
 RO Portprosop
 HU Törölközőtartó
 ES Toallero anillo



FALA

No.	Series / Seria	
69319	Quad Chrom	4/24

EN Toilet brush holder
 PL Szczotka WC
 DE WC-Garnitur
 RU Туалетная щетка настенная
 CZ WC štětka
 RO Suport perie WC
 HU WC kefe
 ES Escobillero mura



FALA

No.	Series / Seria	Icon
69320	Quad Chrom	4/8

EN Glass shelf
 PL Półka szklana
 DE Ablagekonsole aus Glas
 RU Этажерка настенная
 CZ Półička do koupelny
 RO Poarta sticla
 HU Piperepolc - üveg
 ES Estante

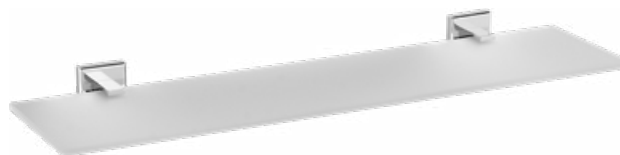

FALA

No.	Series / Seria	Icon
69321	Quad Chrom	4/8

EN Toothbrush holder
 PL Kubek na szczoteczki do zębów
 DE Zahnpfutzbecher
 RU Стакан для зубных щеток
 CZ Dóza na zubní kartáčky
 RO Suport pt. periute dinti
 HU Fogkefektartó pohár
 ES Portacepillos



FALA

No.	Series / Seria	Icon
69331	Tier	6/120

EN Soap dish
 PL Mydelniczka
 DE Seifenschale
 RU Мыльница
 CZ Mydelnička
 RO Sapuniera
 HU Szappantartó tál
 ES Jabonera



FALA

No.	Series / Seria	Icon
69332	Tier	6/144

EN Toilet brush holder
 PL Szczotka WC
 DE WC-Bürste
 RU Щетка туалетная
 CZ WC kartáč
 RO Perie WC
 HU WC kefe tartó
 ES Escobillero



FALA

No.	Series / Seria	Icon
69334	Tier	6/24

EN Tumbler
 PL Kubek kosmetyczny
 DE Becher
 RU Стакан
 CZ Dóza
 RO Suport periută
 HU Fürdőszobai pohár
 ES Vaso



FALA

No.	Series / Seria	Icon
69337	Cuboid White	6/144

EN Toothbrush holder
 PL Kubek na szczoteczki do zębów
 DE Zahnpfutzbecher
 RU Стакан для зубных щеток
 CZ Dóza na zubní kartáčky
 RO Suport pt. periute dinti
 HU Fogkefektartó pohár
 ES Portacepillos



FALA

No.	Series / Seria	Icon
69338	Cuboid White	6/72

EN Soap dish
 PL Mydelniczka
 DE Seifenschale
 RU Мыльница
 CZ Mydelnička
 RO Sapuniera
 HU Szappantartó tál
 ES Jabonera



FALA

No.	Series / Seria	Icon
69339	Cuboid White	6/144

EN Lotion dispenser
 PL Dozownik mydła w płynie
 DE Seifenspender
 RU Дозатор для жидкого мыла
 CZ Dávkovač mydla
 RO Dozator sapun
 HU Folyékony szappan adagoló
 ES Dosificador



FALA

No.	Series / Seria	
69340	Cuboid White	6/72

EN Toothbrush holder
 PL Kubek na szczoteczki do zębów
 DE Zahnrutzbecher
 RU Стакан для зубных щеток
 CZ Dóza na zubní kartáčky
 RO Suport pt. periuțe dinti
 HU Fogkefetartó pohár
 ES Portacepillos



FALA

No.	Series / Seria	
69345	Cuboid Beige	6/72

EN Toilet brush holder
 PL Szczotka WC
 DE WC-Bürste
 RU Щетка туалетная
 CZ WC kartáč
 RO Perie WC
 HU WC kefe tartó
 ES Escobillero



FALA

No.	Series / Seria	
69348	Cuboid Beige	6/48

EN Toothbrush holder
 PL Kubek na szczoteczki do zębów
 DE Zahnrutzbecher
 RU Стакан для зубных щеток
 CZ Dóza na zubní kartáčky
 RO Suport pt. periuțe dinti
 HU Fogkefetartó pohár
 ES Portacepillos



FALA

No.	Series / Seria	
69351	Nickel	6/96

EN Toilet brush holder
 PL Szczotka WC
 DE WC-Bürste
 RU Щетка туалетная
 CZ WC kartáč
 RO Perie WC
 HU WC kefe tartó
 ES Escobillero



FALA

No.	Series / Seria	
69341	Cuboid White	6/48

EN Soap dish
 PL Mydelniczka
 DE Seifenschale
 RU Мыльница
 CZ Mydelnička
 RO Sapuniera
 HU Szappantartó tál
 ES Jabonera



FALA

No.	Series / Seria	
69346	Cuboid Beige	6/144

EN Tumbler
 PL Kubek kosmetyczny
 DE Becher
 RU Стакан
 CZ Dóza
 RO Suport periuță
 HU Fürdőszobai pohár
 ES Vaso



FALA

No.	Series / Seria	
69350	Nickel	6/96

EN Soap dish
 PL Mydelniczka
 DE Seifenschale
 RU Мыльница
 CZ Mydelnička
 RO Sapuniera
 HU Szappantartó tál
 ES Jabonera



FALA

No.	Series / Seria	
69352	Nickel	6/192

EN Lotion dispenser
 PL Dozownik mydła w płynie
 DE Seifenspender
 RU Дозатор для жидкого мыла
 CZ Dávkač mydla
 RO Dozator sapun
 HU Folyékony szappan adagoló
 ES Dosificador



FALA

No.	Series / Seria	
69353	Nickel	6/72

EN Robe hook
 PL Haczyk pojedynczy
 DE Einzelhaken
 RU Крючок одинарный
 CZ Háček
 RO Agatatoare simpla
 HU Fali akasztó
 ES Perchero de pared



FALA

No.	Series / Seria	
69370	Steely	165

EN Robe hook
 PL Haczyk podwójny
 DE Einzelhaken
 RU Крючок одинарный
 CZ Háček
 RO Agatatoare simpla
 HU Fali akasztó
 ES Perchero de pared

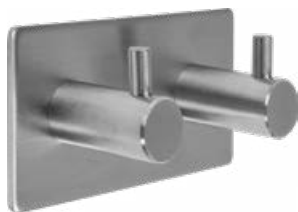

FALA

No.	Series / Seria	
69372	Steely	110

EN Towel ring
 PL Uchwyt na ręcznik
 DE Handtuchring
 RU Кольцо для полотенца
 CZ Držák ručníků
 RO Portprosop
 HU Törölközőtartó
 ES Toallero anillo



FALA

No.	Series / Seria	
69374	Steely	25

EN Toilet brush holder
 PL Szczotka WC
 DE WC-Bürste
 RU Щетка туалетная
 CZ WC kartáč
 RO Perie WC
 HU WC kefe tartó
 ES Escobillero



FALA

No.	Series / Seria	
69354	Nickel	6/24

EN Robe hook
 PL Haczyk pojedynczy
 DE Einzelhaken
 RU Крючок одинарный
 CZ Háček
 RO Agatatoare simpla
 HU Fali akasztó
 ES Perchero de pared



FALA

No.	Series / Seria	
69371	Steely	330

EN Robe hook
 PL Haczyk podwójny
 DE Einzelhaken
 RU Крючок одинарный
 CZ Háček
 RO Agatatoare simpla
 HU Fali akasztó
 ES Perchero de pared



FALA

No.	Series / Seria	
69373	Steely	220

EN Toilet paper holder
 PL Uchwyt na papier toaletowy
 DE WC Papierhalter
 RU Держатель для туалетной бумаги без крышк
 CZ Držák na toaletní papír
 RO Porthartie
 HU WC papír tartó
 ES Portarrollos para papel higiénico



FALA

No.	Series / Seria	
69375	Steely	50

EN Towel rail robe hook
 PL Uchwyt na ręcznik haczyk
 DE Badetuchstange Einzelhaken
 RU Вешалка для полотенца крючок одинарный
 CZ Držák ručníků háček
 RO Portprosop ag atatoare simpla
 HU Törkölközlartó akasztó
 ES Toallero anillo perchero de pared



FALA

No.	Series / Seria	Box
69376	Steely	20

EN Shelf
 PL Półka
 DE Ablagekonsole
 RU Этажерка настенная
 CZ Półka do koupelny
 RO Polita
 HU Piperepolc
 ES Estante



FALA

No.	Series / Seria	Box
69378	Steely	30

EN Toilet seat
 PL Deska sedesowa
 DE WC Deckel
 RU Сиденье для унитаза
 CZ WC sedátko
 RO Capac WC
 HU WC-ülöke
 ES Asiento de inodoro

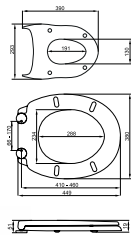

FALA

No.	Box
75467	5

EN Shelf
 PL Półka
 DE Ablagekonsole
 RU Этажерка настенная
 CZ Półka do koupelny
 RO Polita
 HU Piperepolc
 ES Estante



FALA

No.	Series / Seria	Box
69377	Steely	30

EN Toilet seat
 PL Deska sedesowa
 DE WC Deckel
 RU Сиденье для унитаза
 CZ WC sedátko
 RO Capac WC
 HU WC-ülöke
 ES Asiento de inodoro

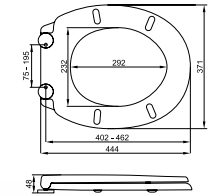

FALA

No.	Box
75465	5

EN Toilet seat
 PL Deska sedesowa
 DE WC Deckel
 RU Сиденье для унитаза
 CZ WC sedátko
 RO Capac WC
 HU WC-ülöke
 ES Asiento de inodoro

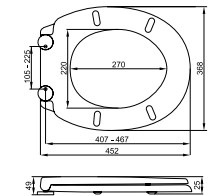

FALA

No.	Box
75469	5

- EN Toilet seat
- PL Deska sedesowa
- DE WC Deckel
- RU Сиденье для унитаза
- CZ WC sedátko
- RO Capac WC
- HU WC-ülőke
- ES Asiento de inodoro

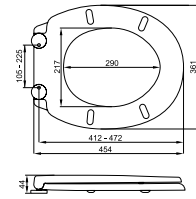

FALA

No. **75464** 5

- EN Toilet seat
- PL Deska sedesowa
- DE WC Deckel
- RU Сиденье для унитаза
- CZ WC sedátko
- RO Capac WC
- HU WC-ülőke
- ES Asiento de inodoro

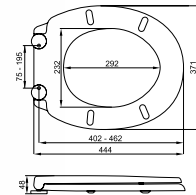

FALA

No. **75471** 5

- EN LED toilet light
- PL Lampka LED do podświetlania WC
- DE WC LED Lampe
- RU LED ночник для туалета
- CZ WC LED světlo
- RO Lumină pt. toaletă
- HU LED WC megvilágítás
- ES WC LED lámpara

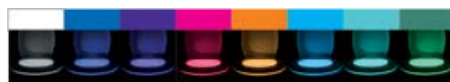

FALA

No. **75455** 100

- EN Toilet seat
- PL Deska sedesowa
- DE WC Deckel
- RU Сиденье для унитаза
- CZ WC sedátko
- RO Capac WC
- HU WC-ülőke
- ES Asiento de inodoro

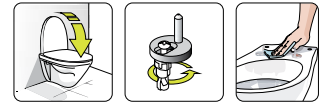

FALA

No. **75470** 6

- EN Toilet seat
- PL Deska sedesowa
- DE WC Deckel
- RU Сиденье для унитаза
- CZ WC sedátko
- RO Capac WC
- HU WC-ülőke
- ES Asiento de inodoro

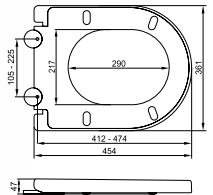

FALA

No. **75472** 5

- EN Wall hung toilet with seat
- PL Miska WC wisząca z deską
- DE Toilettenschüssel
- RU Унитаз подвесной
- CZ WC závěsný
- RO WC suspendat
- HU WC fehér
- ES Inodoro



FALA

No. **68800** 1

EN Wall hung toilet with seat
 PL Miska WC wisząca z deską
 DE Toilettenschüssel
 RU Унитаз подвесной
 CZ WC závěsný
 RO WC suspendat
 HU WC fehér
 ES Inodoro



FALA

No.	Series / Seria	1
68801		1

EN Basin
 PL Umywalka nablutowa
 DE Waschbecken
 RU Умывальник
 CZ Umyvadlo
 RO Chiuveta
 HU Mosdó
 ES Lavabo



FALA

No.	Series / Seria	1
68830	Top	1

EN Basin
 PL Umywalka nablutowa
 DE Waschbecken
 RU Умывальник
 CZ Umyvadlo
 RO Chiuveta
 HU Mosdó
 ES Lavabo



FALA

No.	Series / Seria	1
68832	Top	1

EN Basin oval
 PL Umywalka nablutowa
 DE Waschbecken
 RU Умывальник
 CZ Umyvadlo
 RO Chiuveta
 HU Mosdó
 ES Lavabo

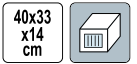

FALA

No.	Series / Seria	1
68820	Oval	1

EN Basin
 PL Umywalka nablutowa
 DE Waschbecken
 RU Умывальник
 CZ Umyvadlo
 RO Chiuveta
 HU Mosdó
 ES Lavabo

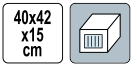

FALA

No.	Series / Seria	1
68831	Top	1

EN Basin
 PL Umywalka nablutowa
 DE Waschbecken
 RU Умывальник
 CZ Umyvadlo
 RO Chiuveta
 HU Mosdó
 ES Lavabo

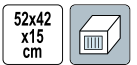

FALA

No.	Series / Seria	1
68833	Top	1

Weight/BMI – the Body Mass Index (BMI) defined as the body mass divided by the body height, is a quantification for categorizing human weight and health status.



WEIGHT

Wskaźnik masy ciała - Body Mass Index (BMI) definiuje się jako wartość masy ciała podzieloną przez kwadrat wzrostu; jest to wartość używana do klasyfikowania ludzkiej wagi i stanu zdrowia.

Weight/BMI – the Body Mass Index (BMI) defined as the body mass divided by the body height, is a quantification for categorizing human weight and health status.



BMI

Wskaźnik masy ciała - Body Mass Index (BMI) definiuje się jako wartość masy ciała podzieloną przez kwadrat wzrostu; jest to wartość używana do klasyfikowania ludzkiej wagi i stanu zdrowia.

Metabolism – Basal Metabolic Rate (BMR) is the minimal rate of energy expenditure unit time by human at rest, expressed in calories. It was measured under the circumstances when a man is awake and at complete rest.



BMR

Wskaźnik podstawowej przemiany materii - Basal Metabolic Rate (BMR) to minimalna ilość energii wyrażona w kaloriach, potrzebna do funkcjonowania organizmu w czasie odpoczynku.

Fat percentage is the total mass of fat divided by total body mass. It provides a better assessment for how fat or thin person is compared to BMI.



FAT

Procent tłuszczu ciała to całkowita masa tłuszczu podzielona przez całkowitą masę ciała; wskaźnik tłuszczu ciała odnosi się do niezbędnego tłuszczu i metabolizmu.

Body water percentage is closely related to body muscle mass, since muscle contains a large amount of water (approx. 70%).



WATER

Procent wody w organizmie jest ściśle związany z masą mięśniową, ponieważ mięśnie zawierają dużą ilość wody (ok. 70%).

Visceral Fat is fat stored within the abdominal cavity around a number of internal organs.



VISCERALfat

Tłuszcz trzewny to tłuszcz magazynowany w podbrzuszu wokół wielu narządów wewnętrznych.

Muscle mass index is calculated from muscle mass, body weight and height. It is a quantitative assessment of health status and strength.



MUSCLE

Wskaźnik masy mięśniowej jest wyliczany na podstawie masy mięśni, wagi ciała i wzrostu. To ilościowe rozumienie stanu zdrowia i siły.

Bone Mass – the human skeleton, composed of bones, supports the human body. Bone mineral density and calcium loss are the main concerns for bone health.

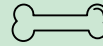

BONES

Ludzki szkielet, składający się z kości, podtrzymuje ciało. Gęstość kości i utrata wapnia to główne problemy dla zdrowia kości.

- EN Bathroom scale
- PL Waga łazienkowa
- DE Personenwaage
- RU Ванная шкала
- CZ Váha do koupelny
- RO Cantar baie
- HU Személymérleg
- ES Bascula de baño

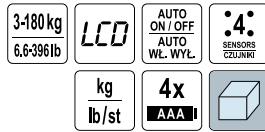

FALA

No.	
69203	8

- EN Bathroom scale
- PL Waga łazienkowa
- DE Personenwaage
- RU Ванная шкала
- CZ Váha do koupelny
- RO Cantar baie
- HU Személymérleg
- ES Bascula de baño

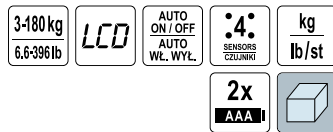

FALA

No.	
69205	8

- EN Bathroom scale
- PL Waga łazienkowa
- DE Personenwaage
- RU Ванная шкала
- CZ Váha do koupelny
- RO Cantar baie
- HU Személymérleg
- ES Bascula de baño

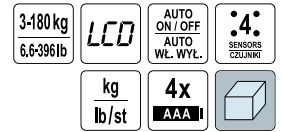

FALA

No.	
69204	8

- EN Plastic stool
- PL Stolek plastikowy
- DE Kunststoff Hocker
- RU Пластиковый табурет
- CZ Plastová stolička
- RO Scaun de plastic
- HU Műanyag székel
- ES Taburete de plástico



FALA

No.	Dimensions / Wymiary [mm]	
75915	300x200x210	10/20

EN Plastic stool
 PL Stolek plastikowy
 DE Kunststoff Hocker
 RU Пластиковый табурет
 CZ Plastová stolička
 RO Scaun de plastic
 HU Műanyag széklét
 ES Taburete de plástico



FALA

No.	Dimensions / Wymiary [mm]	
75916	300x200x210	10/20

EN Waste pump for shower and basin
 PL Pompa łazienkowa do pryszniców i umywalk
 DE Haushaltspumpe für Dusche und Waschtisch
 RU Санитарный насос
 CZ Koupelnové čerpadlo pro sprchy
 RO Pompa pt. ape uzate - dus, lovoar
 HU Szivattyú zuhanyzóhoz
 ES Bomba de evacuación



FALA

No.	Power / Moc [W]	
75945	250	1

EN Sewage lifting station with grinder
 PL Pompa sanitarna z rozdrabniaczem
 DE Kleinhebeanlage fäkalienhaltiges Abwasser
 RU Канализационная насосная установка
 CZ Sanitární kalové čerpadlo
 RO Stația pt. evacuarea apelor uzate
 HU Átemelő szivattyú
 ES Estación de levantamiento para aguas residuales



FALA

No.	Power / Moc [W]	
75953	600	1

EN Waste pump for shower and basin
 PL Pompa łazienkowa do prysznic i umywalki
 DE Haushaltspumpe für Dusche und Waschtisch
 RU Санитарный насос
 CZ Koupelnové čerpadlo pro sprchy
 RO Pompa pt. ape uzate - dus, lovoar
 HU Szivattyú zuhanyzóhoz
 ES Bomba de evacuación



FALA

No.	Power / Moc [W]	
75944	250	4

EN Sewage lifting station with grinder
 PL Pompa sanitarna z rozdrabniaczem
 DE Kleinhebeanlage fäkalienhaltiges Abwasser
 RU Канализационная насосная установка
 CZ Sanitární kalové čerpadlo
 RO Stația pt. evacuarea apelor uzate
 HU Átemelő szivattyú
 ES Estación de levantamiento para aguas residuales



FALA

No.	Power / Moc [W]	
75951	600	1



Convenient and easy to use.
Wygodna i łatwa obsługa.



Rotation 360°

Mixing water flow with intake air reduces consumption by half, without splashing.
Zmieszany strumień wody z zasysanym powietrzem oszczędza zużycie o połowę i nie chlapie.



ECOflow

Additional protection against contamination.
Dodatkowa ochrona przed zanieczyszczeniami.





built-in-filter

Simple and effective installation thanks to the nut.
Łatwy i trwały montaż dzięki nakrętce.



SMARTnut

EN Instant heating faucet
PL Przepływowy podgrzewacz wody z baterią
DE Elektrische Warmwasser-Armatur
RU Миттевий водонагрівач
CZ Ohřivač vody
RO Robinet electric
HU Átfolyós vízmelegítő csaptelep
ES Calefacción instantáneo grifo





220-240V~50-60Hz	3000 W	1/2"	0.04-0.6 MPa	200 mm
1.2 m				



FALA

No.	Series / Seria	
75930	Strokkur 1	10

EN Instant heating faucet
PL Przepływowy podgrzewacz wody z baterią
DE Elektrische Warmwasser-Armatur
RU Миттевий водонагрівач
CZ Ohřivač vody
RO Robinet electric
HU Átfolyós vízmelegítő csaptelep
ES Calefacción instantáneo grifo

220-240V~50-60Hz	3000 W	1/2"	0.04-0.6 MPa	100 mm
1.2 m				



FALA

No.	Series / Seria	
75931	Strokkur 2	10

EN Instant heating faucet
PL Przepływowy podgrzewacz wody z baterią
DE Elektrische Warmwasser-Armatur
RU Миттевий водонагрівач
CZ Ohřivač vody
RO Robinet electric
HU Átfolyós vízmelegítő csaptelep
ES Calefacción instantáneo grifo

220-240V~50-60Hz	3000 W	1/2"	0.04-0.6 MPa	200 mm	1.2 m
					



FALA

No.	Series / Seria	
75932	Strokkur 3	10

EN Instant heating faucet
PL Przepływowy podgrzewacz wody z baterią
DE Elektrische Warmwasser-Armatur
RU Миттевий водонагрівач
CZ Ohřivač vody
RO Robinet electric
HU Átfolyós vízmelegítő csaptelep
ES Calefacción instantáneo grifo





230V~50Hz	3000 W	1/2"	0.1-0.6 MPa
LCD	1.2 m		
			



FALA

No.	Series / Seria	
75921	Katla 1	10

EN Instant heating faucet
PL Przepływowy podgrzewacz wody z baterią
DE Elektrische Warmwasser-Armatur
RU Миттевий водонагрівач
CZ Ohřivač vody
RO Robinet electric
HU Átfolyós vízmelegítő csaptelep
ES Calefacción instantáneo grifo

230V~50Hz	3000 W	1/2"	0.1-0.6 MPa
LCD	1.2 m		
			



FALA

No.	Series / Seria	
75922	Katla 2	10

EN Instant heating faucet
 PL Przepływowy podgrzewacz wody z baterią
 DE Elektrische Warmwasser-Armatur
 RU Миттевий водонагревач
 CZ Ohříváč vody
 RO Robinet electric
 HU Átfolyós vízmelegítő csaptelep
 ES Calefacción instantáneo grifo

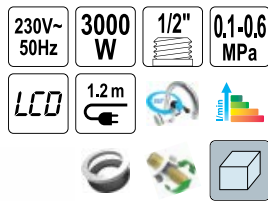

FALA

No.	Series / Seria	Icon
75923	Katla 3	10

EN Drain cleaner
 PL Pistolet do udrażniania rur
 DE Pistole zum Reinigen von Rohren
 RU Пневматический пистолет для прочистки труб
 CZ Pistole na čištění trubek
 RO Pistol pt. curățarea țevilor
 HU Csőtisztító pisztoly
 ES Pistola desatapaños

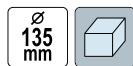

VOREL

No.	Ø [mm]	Icon
55500	63, 135	10

EN Drain auger
 PL Spirala kanalizacyjna
 DE Hand-Rohrreinigungsspirale
 RU Трос для прочистки канализационных труб и каналов
 CZ Spirála na čištění trubek
 RO Dedeman cablu pt. desfundat canale
 HU Csőtisztító spirál
 ES Varilla para limpiar drenajes



VOREL

No.	Ø [mm]	L [m]	Icon
55541	5	1.5	20/80
55542	6	3.0	18/36

EN Instant heating faucet
 PL Przepływowy podgrzewacz wody z baterią
 DE Elektrische Warmwasser-Armatur
 RU Миттевий водонагревач
 CZ Ohříváč vody
 RO Robinet electric
 HU Átfolyós vízmelegítő csaptelep
 ES Calefacción instantáneo grifo

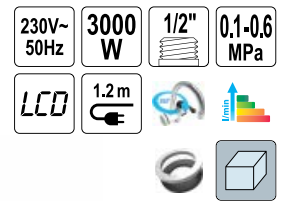

FALA

No.	Series / Seria	Icon
75924	Katla 4	10

EN Drain suction pump
 PL Pompa do udrażniania kanalizacji
 DE Rohrreinigungspumpe
 RU Пневматический вантуз для прочистки труб
 CZ Čerpadlo na čištění trubek
 RO Pompă pt. curățarea țevilor
 HU Lefolyótisztító pumpa
 ES Desatascador bomba de vacío



VOREL

No.	Ø [mm]	Icon
55505	65, 155	24

EN Drain auger
 PL Spirala kanalizacyjna
 DE Hand-Rohrreinigungsspirale
 RU Трос для прочистки канализационных труб и каналов
 CZ Spirála na čištění trubek
 RO Dedeman cablu pt. desfundat canale
 HU Csőtisztító spirál
 ES Varilla para limpiar drenajes



VOREL

No.	Ø [mm]	L [m]	Icon
55544	9	5	5/10
55545	9	10	4/8

No.	Page	No.	Page	No.	Page	No.	Page	No.	Page	No.	Page	No.	Page	No.	Page
00250	152	04610	156	05803	166	06297	169	06660	164	07580	116	08316	105	08785	91
00300	148	04620	156	05804	166	06298	169	06670	164	07610	116	08318	105	08786	91
00320	148	04630	156	05805	166	06299	169	06680	164	07620	116	08350	105	08787	91
00510	148	04640	156	05806	166	06300	169	06690	164	07630	116	08400	105	08788	91
00610	148	04650	156	05807	166	06301	169	06700	164	07664	116	08500	105	08790	91
01060	148	04660	156	05821	166	06302	169	06701	164	07665	116	08501	105	08791	91
02300	148	04668	156	05822	166	06303	169	06740	164	07666	116	08510	105	08792	91
02400	148	04670	156	05823	166	06304	169	06760	164	07667	116	08511	106	08793	91
03150	148	04677	155	05830	166	06305	169	06780	164	07668	116	08520	106	08811	92
03160	148	04680	155	05831	166	06306	169	06781	164	07879	116	08521	106	08819	92
03220	148	04681	156	05840	166	06307	169	06790	172	07880	116	08522	106	08820	92
03221	149	04682	156	05850	167	06308	169	06795	171	07881	116	08534	117	08821	92
03225	149	04683	156	05901	170	06309	169	06796	171	07882	116	08536	117	08822	92
03240	86	04684	156	05902	170	06310	170	06797	171	07883	116	08538	117	08825	92
03241	86	04690	152	05903	170	06320	170	06799	171	07884	116	08540	117	08827	92
03245	86	04691	152	05904	170	06330	170	06820	109	07885	116	08542	117	08828	92
03246	86	04692	153	05905	170	06331	170	06840	110	07886	116	08545	117	08829	92
03300	87	04693	153	05906	170	06335	172	06860	110	07910	116	08553	117	08831	92
03301	87	04699	152	05911	171	06340	165	06930	102	07911	116	08554	117	08832	92
03900	150	04700	156	05912	171	06341	165	06940	102	07912	116	08556	117	08833	92
03940	150	04710	156	05913	171	06350	165	06950	102	07913	116	08558	117	08834	92
03950	150	04714	153	05914	171	06351	165	06960	102	07914	116	08560	117	08835	92
03960	150	04715	153	05915	171	06360	165	06963	102	07915	116	08562	117	08837	92
03963	151	04716	153	05916	171	06370	165	06964	102	07916	116	08565	117	08838	92
03990	86	04717	153	05921	171	06380	165	06965	103	07930	114	08573	117	08845	92
04000	149	04718	154	05922	171	06381	183	06970	103	07950	117	08574	117	08851	92
04020	149	04720	157	05923	171	06382	183	06971	103	07955	117	08576	117	08853	92
04022	149	04721	157	05924	171	06383	183, 474	06972	103	07956	118	08578	117	08854	92
04050	151	04730	154	05925	171	06384	183, 474	06973	103	07957	118	08580	117	08855	92
04060	109, 151	04731	154	05926	171	06388	183, 474	06974	103	07960	118	08582	117	08860	94
04100	151	04732	154	05950	168	06390	183, 474	06975	103	07962	118	08585	117	08861	94
04200	149	04734	154	05960	169	06391	183	06976	103	07970	117	08630	92	08864	94
04210	149	04735	155	05971	169	06392	183, 474	06977	103	07974	93	08631	92	08865	94
04300	46, 132	04736	155	05972	170	06393	183, 474	06978	103	07975	93	08633	92	08868	94
04301	46, 132	04737	155	05973	170	06394	184	06979	103	07976	93	08635	92	08869	94
04320	134, 167	04739	155	05980	170	06395	184	06980	103	07977	93	08639	92	08873	94
04360	170	04755	167	06001	169	06396	184	06981	103	07978	93	08640	92	08875	94
04400	149	04756	167	06002	169	06397	183	06982	103	07984	93	08641	92	08876	93
04405	150	04770	167	06003	169	06398	183	06983	103	07985	93	08642	92	08900	94
04410	150	05050	109	06004	169	06399	183	06985	103	07986	93	08644	92	09005	173
04440	150	05100	109	06005	169	06400	162	06986	103	07987	93	08646	92	09006	173
04450	136	05300	184	06006	169	06401	163	06987	104	07988	93	08663	93	09010	173
04451	136	05301	184	06010	169	06410	162	06988	104	08170	92	08665	93	09015	173
04452	137	05302	184	06011	169	06420	162	06989	104	08171	92	08669	93	09017	173
04490	151	05311	184	06012	169	06430	162	06990	104	08174	92	08671	93	09025	173
04500	151	05312	185	06013	169	06440	162	06992	104	08175	92	08672	93	09028	174
04510	151	05319	185	06014	169	06450	175	06993	104	08190	93	08674	93	09031	173
04540	151	05325	185	06015	169	06452	175	06994	104	08191	93	08683	93	09032	174
04542	152	05540	87	06030	168	06453	175	06995	104	08288	116	08711	91	09036	174
04544	152	05560	87	06040	168	06457	175	07060	115	08289	116	08712	91	09038	174
04546	152	05580	87	06050	168	06460	175	07080	115	08290	116	08714	91	09040	174
04561	359	05600	87	06060	168	06470	163	07100	115	08291	116	08715	91	09044	174
04562	359	05750	172	06080	168	06472	163	07120	115	08292	116	08731	91	09046	174
04581	157	05751	172	06100	168	06500	163	07180	115	08293	116	08732	91	09048	174
04582	157	05752	172	06109	165	06510	163	07240	115	08301	116	08734	91	09049	174
04583	157	05760	172	06110	165	06512	164	07320	115	08302	116	08735	91	09050	174
04584	157	05761	172	06120	165	06520	163	07400	115	08303	116	08751	91	09051	174
04585	157	05770	172	06121	165	06530	163	07506	115	08304	116	08752	91	09052	174
04586	157	05771	172	06130	168	06532	164	07508	115	08306	116	08754	91	09054	174
04591	157	05772	172	06150	168	06537	165	07510	115	08307	116	08755	91	09056	174
04592	157	05773	172	06290	168	06538	165	07512	115	08308	116	08780	91	09060	173
04593	157	05774	172	06294	169	06540	163	07530	116	08312	104	08781	91	09062	175
04594	157	05801	166	06295	169	06640	164	07540	116	08314	104	08782	91	09063	175
04600	156	05802	166	06296	169	06650	164	07560	116	08315	105	08783	91	09065	175

No.	Page	No.	Page	No.	Page	No.	Page	No.	Page	No.	Page	No.	Page	No.	Page
09077	175	09463	180	10003	361	16300	205	18355	201	21684	81	22572	86	23594	85
09080	173	09465	360	10010	361	16301	205	18356	201	21686	81	22610	80	23601	84
09090	173	09466	360	10011	361	16340	206	18357	201	21688	81	22611	80	23602	84
09094	174	09467	360	10012	361	16360	206	18360	200	21690	81	22612	81	23603	84
09096	175	09470	181, 360	10013	361	16380	206	18361	200	21691	81	22613	81	23604	84
09097	175	09471	181, 360	10014	361	16400	206	18362	200	21692	81	22616	81	23605	85
09100	135	09472	181, 360	10015	362	16551	206	18370	201	21695	81	22617	81	23606	85
09120	136	09473	361	10061	193	16552	206	18372	201	21700	87	22640	81	23608	85
09130	136	09474	361	10062	193	16553	206	18374	201	21701	87	23311	82	23620	83
09150	136	09475	181, 359	10063	193	16554	206	18375	201	21702	87	23312	82	23640	83
09160	136	09476	181, 359	10064	193	16555	206	18377	202	21703	87	23313	82	23650	83
09163	138	09477	181, 359	10065	193	16556	206	18380	200	21704	87	23315	82	23660	83
09165	138	09478	181, 359	10101	193	16557	206	18381	200	21705	87	23316	82	23670	83
09170	137	09480	360, 475	10104	193	17300	199	18382	200	21706	87	23317	82	23680	83
09171	137	09481	360, 475	10106	193	17301	199	18390	200	21709	87	23318	82	23690	83
09172	137	09482	360, 475	10109	193	17302	199	18470	202	21900	80	23325	82	23692	83
09173	138	09483	360, 475	10111	193	17303	199	18473	201	21905	80	23326	82	23693	83
09174	137	09484	360, 475	10122	193	17304	199	18501	201	21910	80	23327	82	23694	83
09177	137	09486	360	10123	193	17310	200	18502	201	21915	80	23329	82	23710	83
09180	185	09487	360	10125	193	17430	198	18503	201	21919	80	23331	82	23720	83
09190	185	09489	360	10128	193	17435	198	18504	201	21921	80	23371	84	23722	83
09302	177	09490	361	10129	193	17470	144, 197	18530	202	21924	80	23372	84	23723	83
09303	177	09521	178	10130	193	17471	144, 197	18790	202	21927	80	23373	84	23724	83
09307	176	09522	178	10133	193	17473	144, 197	18797	201	21929	80	23374	84	23730	83
09308	176	09523	178	10135	193	17474	144, 197	18798	201	21932	80	23375	84	23740	83
09310	177	09524	178	10138	193	17480	144, 197	18799	201	21934	80	23376	84	23750	83
09311	177	09525	178	10139	193	17481	144, 197	18800	202	21936	80	23377	84	23752	83
09331	177	09531	179	12100	193	17483	144, 197	18810	202	21941	80	23379	84	23800	83
09332	177	09532	179	12200	193	17484	144, 197	19750	203	21944	80	23380	84	23820	83
09334	176	09533	179	12300	193	17488	143, 197	19755	203	21948	80	23381	84	23830	83
09336	176	09534	179	12500	193	17489	143, 197	19763	203	21950	80	23382	84	23832	83
09338	177	09535	179	13200	194	17490	143, 196	19765	203	21951	80	23390	84	23840	83
09345	176	09536	179	13300	194	17495	143, 196	19766	203	21952	80	23391	84	23850	83
09346	176	09537	179	13500	194	17497	143, 197	19767	203	21955	80	23392	84	23860	83
09359	176	09560	179	14100	194	17498	143, 197	19770	203	21956	80	23393	84	23862	83
09363	177	09561	179	14200	194	17500	196	20100	79	21958	80	23394	84	23880	83
09365	177	09562	179	14300	194	17501	196	20150	79	21961	80	23395	84	23882	83
09370	177	09581	179	14500	194	17505	196	20200	79	21963	80	23396	84	23883	83
09371	177	09583	179	15004	194	17506	196	20250	79	21966	80	23397	84	23920	83
09372	177	09585	179	15005	194	17507	196	20280	79	21998	80	23398	84	23930	83
09373	177	09587	179	15006	194	17508	196	20300	79	21999	80	23399	84	23932	83
09375	177	09589	179	15007	194	17560	206	20320	79	22130	79	23400	84	23960	83
09377	177	09590	180	15010	194	17570	202	20350	79	22180	79	23402	84	23962	83
09378	177	09636	179	15020	194	17606	206	20400	79	22190	79	23403	84	23980	83
09385	178	09638	179	15050	195	17608	206	20420	79	22250	79	23411	84	23982	83
09390	178	09640	179	15070	195	17610	206	20450	79	22300	79	23412	84	23988	84
09395	178	09642	179	15100	195	17612	206	20500	79	22310	79	23413	84	23990	83
09397	176	09647	179	15110	195	17615	206	20550	79	22330	79	23414	84	23992	83
09398	176	09648	179	15113	196	17620	206	20600	79	22340	79	23415	84	23999	83
09400	183	09649	179	15115	195	17701	160, 475	20650	79	22350	82	23416	84	24000	90
09406	178	09650	180	15120	195	17702	160, 476	20700	79	22380	82	23417	84	24060	88
09408	178	09651	179	15130	195	17704	160, 476	20800	79	22381	82	23418	84	24070	88
09413	178	09653	180	15200	195	17705	161, 476	20850	79	22430	83	23419	84	24080	88
09421	178	09655	180	15220	195	17730	161, 476	20900	79	22431	83	23420	84	24090	88
09422	178	09656	180	15240	195	17733	161, 476	21000	79	22460	82	23421	84	24091	88
09425	178	09900	165	15291	207	18002	204	21100	79	22465	83	23422	84	24095	88
09427	178	09903	165	15292	207	18020	204	21200	79	22466	83	23423	84	24100	135
09429	178	09910	166	15301	207	18021	204	21250	79	22500	83	23424	84	24112	135
09430	178	09920	180	16000	206	18180	87	21300	79	22550	90	23460	85	24122	135
09445	176	09930	180	16001	206	18200	200	21400	79	22551	90	23585	85	24130	135
09446	176	09950	180	16002	206	18201	200	21600	79	22552	90	23590	84	24140	135
09457	181	10000	361	16012	206	18250	200	21650	80	22565	86	23591	84	24295	90
09459	181	10001	361	16030	150	18300	200	21680	81	22570	86	23592	85	24300	88
09462	180	10002	361	16280	205	18350	200	21682	81	22571	86	23593	85	24310	88

No.	Page	No.	Page	No.	Page	No.	Page	No.	Page	No.	Page	No.	Page	No.	Page
24320	88	25405	90, 279	27831	102	30020	60	32705	62	34207	65	35450	64	35794	452
24330	88	25410	278	27832	102	30030	60	32715	62	34208	65	35451	64	35795	452
24340	88	25411	279	27833	102	30040	60	32720	61	34210	65	35452	64	35797	446
24350	88	25412	279	27834	102	30050	60	32900	68	34212	65	35600	184, 474	35798	450
24370	88	25420	118	27850	100	30060	60	32901	68	34220	65	35610	474	35799	446
24390	88	25450	278	28000	97, 167	30080	60	32902	68	34222	65	35611	474	35800	446
24410	88	25500	63	28010	97, 167	30100	60	32922	68, 440	34225	65	35623	477	35801	447
24430	88	25510	63	28011	97, 168	30150	60	32923	68, 440	34243	65	35624	477	35802	446
24450	88	25511	63	28012	97, 168	30200	60	32924	67, 439	34245	65	35625	477	35803	447
24470	88	25512	63	28380	96	30220	60	32925	67, 439	34247	65	35667	446	35805	447
24500	89	25513	63	28381	96	30222	60	32926	67, 439	34251	65	35668	446	35806	447
24510	89	25514	63	28382	96	30224	60	32927	67, 439	34254	65	35669	446	35807	447
24520	89	25515	63	28385	96	30310	60	32928	67, 439	34256	65	35670	446	35808	447
24530	89	25516	63	28386	96	30320	60	32930	66, 438	34300	65	35671	446	35809	443
24550	89	25517	63	28387	96	30330	60	32999	67, 439	34600	65	35672	446	35810	444
24570	89	25518	63	28394	96	30340	60	33000	66, 439	34750	65	35673	449	35811	443
24590	89	25519	63	28395	96	30350	60	33001	66, 439	34900	65	35677	446	35813	448
24610	89	25520	63	28640	437	30360	60	33002	66, 439	34944	173	35680	446	35815	448
24630	89	25521	63	28641	437	30380	60	33003	66, 439	34945	173	35685	446	35816	448
24650	89	25530	63	28642	437	30390	60	33004	66, 439	34946	173	35700	451	35817	445
24670	89	25700	64	28650	97	30395	60	33005	66, 439	34947	173	35701	445	35821	454
24700	89	25830	111	28680	86	30400	60	33006	66, 439	34949	476	35705	445	35823	454
24710	89	25881	111	28690	86	30410	60	33007	66, 439	34950	185	35710	445	35824	454
24730	89	25885	111	28710	87	30420	60	33008	66, 439	35000	186	35720	443	35826	454
24740	89	25886	111	28720	87	30430	60	33022	67, 439	35007	186	35721	444	35828	454
24750	89	25887	111	28725	87	30440	60	33024	66, 439	35010	186	35722	444	35830	454
24800	90	26130	113	28740	97, 437	30450	60	33026	66, 439	35012	186	35740	449	35831	454
24810	90	26131	113	28745	97, 438	30460	60	33028	66, 439	35013	186	35741	449	35832	454
24813	90	26132	113	28746	97, 438	30480	60	33030	66, 439	35014	187	35750	451	35833	444
24820	90	26140	113	28750	97, 437	30500	60	33032	66, 439	35015	187	35751	451	35835	444
24823	90	26150	115	28755	97, 438	30510	60	33035	66, 439	35017	187	35755	451	35836	444
24900	89	26200	115	28771	97, 438	30520	60	33038	66, 439	35018	187	35756	445	35837	444
24940	89	26210	115	28772	97, 438	30531	60	33039	66, 439	35020	187	35757	445	35839	447
24960	89	26220	115	28773	97, 438	30532	60	33040	66, 439	35021	187	35758	445	35840	447
24961	89	26225	115, 277	28790	99	30533	60	33065	66, 438	35025	187	35759	445	35842	448
24962	89	27000	97	28880	148	30534	60	33067	66, 438	35026	188	35760	452	35843	444
24963	89	27100	98	29000	99	30535	60	33080	66, 438	35030	188	35761	445	35846	448
24964	89	27200	98	29050	99	30536	60	33085	66, 438	35031	188	35762	445	35850	448
24965	89	27322	98	29090	101	31010	60	33087	66, 438	35032	188	35763	449	35855	445
24966	89	27333	98	29100	101	31030	60	33105	66, 438	35033	188	35764	450	35860	448
25160	112	27495	98	29210	99	31050	60	33107	66, 438	35060	188	35765	441	35861	445
25161	112	27500	100	29220	99	31070	60	33125	66, 438	35061	188	35767	441	35863	445
25162	112	27501	100	29311	99	31100	60	33127	66, 438	35062	188	35768	441	35864	448
25163	112	27502	100	29312	99	31150	60	33147	66, 438	35063	189	35770	450	35865	448
25164	112	27505	100	29313	99	31200	60	33177	66, 438	35064	189	35773	450	35867	357
25165	112	27506	100	29317	100	31300	61	33530	63	35210	109	35774	450	35868	357
25166	112	27510	100	29318	100	31400	61	33532	63, 289	35240	110	35775	452	35869	357
25170	113	27511	101	29319	100	31500	61	33535	63	35250	64	35776	450	35870	357
25171	114	27513	101	29323	100	31600	61	33550	62	35300	64	35777	450	35872	357
25172	114	27520	101	29400	161	31800	61	33555	63	35351	64	35779	449	35874	357
25173	114	27530	101	29401	161	32000	61	33557	62	35352	64	35780	449	35875	357
25230	114	27533	101	29404	161	32110	61, 289	33650	62	35353	64	35781	449	35876	357
25300	114	27575	92	29410	162	32201	61	33655	63	35355	64	35782	449	35877	357
25301	114	27600	98	29420	226	32202	61	33657	62	35359	64	35783	449	35890	449
25307	114	27610	98	29440	162	32203	61	33900	62	35360	64	35784	449	35891	449
25310	115	27800	101	29444	162	32204	61	33905	63	35362	64	35785	450	35892	449
25351	113	27810	102	29445	162	32205	61	33907	62	35364	64	35786	451	35893	358, 453
25352	113	27811	102	29992	61	32206	61	33925	63	35366	64	35787	451	35894	358, 453
25353	113	27812	102	29993	61	32207	61	33950	63, 289	35368	64	35788	451	35895	358, 453
25360	113	27813	102	29994	61	32208	61	34182	233	35372	64	35789	451	35899	358, 453
25370	113	27814	102	29995	61	32625	61	34184	233	35373	64	35790	451	35905	358, 453
25380	113	27815	102	29996	61	32627	62	34204	65	35374	64	35791	451	35906	359, 453
25390	113	27820	102	29997	61	32685	62	34205	65	35376	64	35792	450	35908	359, 453
25400	278	27830	102	30010	60	32687	62	34206	65	35430	64	35793	452	35911	358, 452

No.	Page	No.	Page	No.	Page	No.	Page	No.	Page	No.	Page	No.	Page	No.	Page
35914	358	38200	72	42301	46	49775	96	51630	8	53120	16	54073	13	56130	40
35915	358	38401	72	42302	47	49800	186	51640	8	53130	16	54080	13	56140	40
35916	358	38402	72	42303	46	49801	186	51645	8	53140	16	54081	13	56170	40
35918	358	38403	72	42304	47	49802	186	51650	8	53150	16	54497	51, 123	56380	40
35923	358	38404	72	42305	46, 47	49805	186	51671	9	53160	16	54498	51, 123	56390	40
35924	358	38406	72	42306	47	49806	186	51672	9	53170	16	54499	51, 123	56391	40
35927	358, 453	38407	72	42307	47	49810	185	51673	9	53180	16	54500	51, 123	56392	40
35930	356	38408	72	42308	47	49830	185	51674	9	53190	16	54510	51, 123	56393	40
35931	356	38409	72	42309	47	49840	133	51675	9	53220	16	54600	12	56400	40
35932	356	38430	74	43050	47	49841	133	51676	9	53240	16	54610	12	56470	40
35933	356	38431	74	43051	48	50070	10	51677	9	53270	16	54620	12	56473	40
35940	356	38432	74	43052	48	50090	10	51678	9	53300	16	54630	12	56475	41
35950	359, 453	38433	74	43053	48	50100	10	51679	9	53320	16	54640	12	56477	41
35960	356	38434	74	43055	47	50110	10	51680	9	53332	16	54650	12	56478	41
35961	356	38435	74	43056	48	50120	10	51681	9	53335	16	54660	12	56505	41, 313
35962	356	38436	74	43057	48	50130	10	51682	9	53336	16	54670	12	56506	41, 313
35963	357	38500	73	43058	48	50150	10	51683	9	53337	16	54680	12	56507	41, 313
35964	357	38515	73	43060	47	50170	10	51684	9	53338	16	54690	12	56600	41
35968	357	38525	73	43061	48	50190	10	51685	9	53339	16	54700	12	56620	39
35970	357	38531	73	43062	48	50220	10	51686	9	53340	16	54710	12	56621	39
35971	357	38620	73	43063	48	50270	10	51687	9	53341	16	54720	12	56622	39
36000	74	38641	73	43510	48	50330	10	51688	9	53400	16	54730	12	56623	39
36004	74	38642	73	43600	110	50560	10	51689	9	53410	16	54750	12	56624	39
36005	74	38643	73	43603	110	50580	10	51690	9	53420	16	54760	12	56625	39
36006	74	38750	73	44100	48	50590	10	51691	9	53430	16	54780	12	56626	39
36008	74	38751	73	44102	48	50610	10	51692	9	53440	16	55100	50, 123	56627	39
36014	74	38830	74	44110	48	50630	10	51693	9	53450	16	55150	50, 123	56628	39
36015	74	39000	245	44300	49, 289	50850	8	51694	9	53460	16	55200	50, 123	56629	39
36016	74	39001	245	44301	49, 289	50861	8	51695	9	53470	16	55210	50, 123	56630	39
36018	74	39002	245	44330	49, 290	50871	8	51696	9	53480	16	55211	50, 123	56631	39
36032	75	39005	245	44400	49, 289	50880	9	51705	9	53490	16	55212	50, 123	56632	39
36033	75	40010	44	44500	49, 289	51040	8	51710	9	53500	17	55215	50, 123	56633	39
36034	75	40011	44	45000	54	51042	8	51715	10	53520	17	55216	50, 123	56634	39
36037	75	40012	44	45010	55	51044	8	51720	9	53540	17	55217	50, 123	56635	39
36038	75	40013	44	45012	54	51046	8	51721	9	53560	17	55220	50, 123	56636	39
36039	75	40014	44	45020	55	51047	8	51722	9	53561	17	55221	50, 123	56637	39
36570	75, 122	40015	44	45050	54	51048	8	51740	11	53562	17	55222	50, 123	56638	39
36650	74	40016	44	45100	55	51049	8	51741	11	53563	17	55250	50, 122	56639	39
37100	72	40017	44	45151	55	51051	8	52580	11	53571	17	55300	50, 122	56640	39
37101	72	40018	44	45160	55	51060	8	52630	11	53572	17	55350	50, 122	56641	39
37102	72	40041	44	45201	55	51070	8	52652	10	53573	17	55500	127, 366, 531	56642	39
37103	72	40042	44	45500	54	51080	8	52653	10	53575	17	55505	127, 366, 531	56643	39
37104	72	40043	44	45503	54	51090	8	52654	10	53576	17	55541	127, 366, 531	56644	39
37106	72	40044	44	45504	54	51100	8	52655	10	53577	17	55542	127, 366, 531	56645	39
37107	72	40045	44	48000	94, 290	51110	8	52656	10	53580	18	55544	127, 366, 531	56646	39
37108	72	40047	44	48050	95, 291	51120	8	52657	10	53600	16	55545	127, 366, 531	56647	39
37109	72	40048	44	48060	94, 290	51130	8	52658	10	53610	16	55620	50, 122	56648	39
37110	72	40050	44	48070	95, 291	51140	8	52659	10	53630	16	55625	50, 122	56649	39
37111	72	40051	44	48080	94, 290	51150	8	52660	10	53650	16	55630	50, 122	56710	11
37112	72	40054	45	48081	95, 291	51160	8	52661	10	53670	16	55635	50, 122	56720	11
37113	72	40055	45	48082	95, 290	51170	8	52680	11	53700	17	55645	50, 122	56730	11
37114	72	40056	45	48100	94, 290	51180	8	52700	11	53710	17	55660	50, 122	56770	11
37115	72	40057	45	48150	95, 291	51190	8	52730	11	53730	17	55690	50, 122	56780	11
37150	72	40160	46	48200	95, 291	51200	8	52740	11	54000	12	55740	124	56790	11
37200	72	40180	46	48330	95, 291	51210	8	52750	11	54061	12	55792	51, 123	56980	233
37250	72	40200	46	48350	96	51220	8	52770	11	54062	12	55820	122	57000	234
37300	72	40700	46	49200	95	51240	8	52790	11	54063	12	55830	122	57010	234
37380	72	41121	45	49450	96	51270	8	52820	11	54065	12	56040	40	57020	234
37400	72	41151	45	49600	96	51300	8	52900	11	54066	12	56050	40	57030	234
37430	72	41152	45	49770	96	51320	8	52935	12	54067	12	56060	40	57050	234
37500	72	41381	45	49771	96	51560	8	52936	12	54068	12	56070	40	57091	237, 262
37800	72	41500	45	49772	96	51580	8	53002	16	54070	13	56080	40	57092	237, 262
37900	72	41510	49, 122	49773	96	51590	8	53003	16	54071	13	56100	40	57097	237, 262
38150	72	42300	46	49774	96	51620	8	53100	16	54072	13	56120	40	57100	234

No.	Page	No.	Page	No.	Page	No.	Page	No.	Page	No.	Page	No.	Page	No.	Page
57160	234	60884	26	61160	29	65150	33	67116	339	67642	327	68621	519	69508	143, 197
57210	234	60885	26	61210	29	65233	56	67120	339	67660	328	68623	520	69509	143, 197
57220	235	60886	26	61220	29	65235	56	67121	339	67661	329	68800	526	69510	143, 197
57221	235	60887	26	61230	29	65260	236	67122	339	67700	318	68801	527	69539	144, 198
57260	235	60888	26	61240	29	65270	236	67123	339	67701	318	68820	527	69540	144, 198
57300	13	60889	26	61250	29	65700	35	67124	339	67702	318	68830	527	69542	144, 198
57350	13	60890	26	61260	29	65705	35	67160	354	67703	319	68831	527	69543	144, 198
57400	13	60891	26	61270	29	65800	36	67161	355	67705	319	68832	527	69546	144, 198
57450	13	60912	26	61280	29	65840	38	67162	355	67707	319	68833	527	69550	145, 199
57451	13	60913	26	61290	29	65850	38	67163	355	67709	319	69203	528	69551	145, 199
57600	230	60914	26	61300	29	66080	38	67164	355	67710	320	69204	528	69552	145, 199
57610	231	60915	26	61320	29	66112	38	67165	355	67780	317	69205	528	69572	144, 198
57612	231	60916	26	61340	29	66113	38	67166	355	67781	317	69301	520	69608	145, 199
57613	231	60917	26	61350	29	66200	38	67171	359	67790	317	69302	520	69609	145, 199
57614	231	60918	26	61550	30	66210	38	67180	342	67805	316	69305	520	69610	145, 199
57616	232	60920	26	62160	28	66301	36	67181	342	67810	316	69306	520	69612	145, 199
57620	231	60921	26	62161	28	66302	36	67182	342	67811	317	69307	520	69613	145, 199
57630	231	60922	26	62162	28	66310	36	67183	342	67840	320	69308	520	69620	144, 198
57640	231	60923	26	62163	28	66330	36	67200	340	67841	320	69311	521	69621	144, 198
57650	231	60924	26	62164	28	66400	36	67201	340	67851	320	69312	521	69630	144, 198
57660	231	60931	26	62165	28	66410	37	67202	340	67877	334	69313	521	69631	144, 198
57700	235	60932	26	62166	28	66570	37	67203	340	67880	334	69314	521	69635	144, 198
57730	235	60933	26	62167	28	66580	37	67204	340	67881	335	69315	521	69637	144, 198
57740	235	60934	26	62170	28	66710	37	67220	341	67882	335	69316	521	69851	478
57830	225	60935	26	62171	28	66720	37	67221	341	67883	335	69317	521	69860	478
58140	19	60936	26	62172	28	66760	37	67222	341	67884	335	69319	521	70000	130
58150	19	60937	26	62173	28	66770	38	67223	341	67885	335	69320	522	70020	130
58160	18	60938	26	62174	28	66900	343	67224	341	67887	335	69321	522	70023	130
58210	18	60939	26	62175	28	66901	343	67225	341	67888	335	69322	522	70030	130
58240	18	60950	26	62176	28	66902	343	67260	180, 359, 465	67889	335	69331	522	70033	130
58260	18	60951	26	62177	28	66903	343	67420	333	67890	335	69332	522	70100	130
58440	224	60952	26	62178	28	66904	344	67451	332	67900	321	69333	522	70160	131
58441	224	60953	26	64050	33	66906	344	67453	332	67901	321	69338	522	70201	131
58450	225	60954	26	64060	33	66930	344	67455	333	67920	318	69339	522	70202	131
58455	225	60955	26	64070	33	66931	345	67456	332	67950	316	69339	522	70210	131
58456	225	60956	26	64090	33	66932	344	67457	332	67961	316	69341	523	70210	131
58539	224	60957	26	64310	34	66933	345	67458	331	68011	333	69345	523	70270	131
58540	222	60958	26	64330	34	66936	344	67470	334	68012	333	69346	523	70280	132, 218
58550	223	60959	26	64370	34	66937	345	67480	334	68090	343	69348	523	70320	131
58600	18	60961	26	64371	34	66940	345	67481	334	68100	342	69350	523	70330	131
58602	18	60962	26	64384	35	66950	345	67481	334	68115	343	69351	523	70340	131
58633	19	60963	26	64385	31	66955	346	67500	329	68172	321	69352	523	70400	131
58634	19	60964	26	64395	35	66956	346	67501	329	68173	321	69353	524	70410	131
58640	19	60965	26	64396	35	67011	404	67520	331	68174	322	69354	524	70420	131
58641	19	60966	26	64400	33	67012	405	67521	331	68194	322	69370	524	70430	131
58643	20	60967	26	64401	34	67013	405	67523	329	68195	322	69371	524	70480	131
58661	20	60968	26	64553	35	67014	405	67524	330	68250	337	69372	524	70490	131
58685	20	60969	26	64554	35	67019	406	67525	330	68251	337	69373	524	70500	131
58687	20	60970	26	64555	34, 233	67019	406	67526	330	68260	337	69374	524	70510	131
58688	21	60975	28	64650	32	67026	405	67527	331	68269	328	69375	524	71000	132
58690	21	60990	27	64654	30	67032	405	67530	330	68270	327	69376	525	71040	132
58691	22	61010	28	64655	31	67033	406	67570	323	68271	327	69377	525	71050	132
58693	23	61020	28	64658	30	67034	406	67571	324	68272	328	69378	525	71052	132
58700	22	61030	28	64660	31	67053	406	67572	324	68273	328	69378	525	71060	133
60750	28	61040	28	64952	30	67054	406	67573	324	68360	336	69390	506	71080	133
60780	27	61050	28	64960	30	67055	406	67574	324	68361	336	69391	506	71160	133
60781	27	61060	28	65025	31	67056	407	67575	325	68362	336	69395	506	71603	509
60782	27	61070	28	65041	30	67090	337	67576	325	68362	336	69396	506	71604	509
60783	27	61080	28	65045	32	67091	337	67585	325	68363	336	69397	506	71605	509
60785	27	61090	29	65100	32	67093	338	67586	326	68364	336	69502	143, 197	71610	508
60880	26	61110	29	65105	31	67094	338	67587	326	68365	336	69503	143, 197	71611	508
60881	26	61120	29	65120	32	67095	338	67588	326	68470	323	69504	143, 197	71612	508
60882	26	61140	29	65123	32	67110	338	67590	325	68477	322	69505	143, 197	71614	508
60883	26	61150	29	65124	32	67112	338	67640	326	68500	323	69506	143, 197	71615	508
						67115	339	67641	327	68510	323	69507	143, 197	71616	508

No.	Page	No.	Page	No.	Page	No.	Page	No.	Page	No.	Page	No.	Page	No.	Page
71630	509	71859	516	72505	396	72950	352	73362	160	73853	140	74081	383	74462	387, 467
71631	509	71860	516	72506	396	72951	352	73400	126, 157	73855	140	74082	383	74466	387
71632	509	71970	134	72508	396	72952	352	73403	126, 157	73875	140	74094	380	74468	387, 467
71633	509	71971	134	72509	396	72953	352	73404	126, 157	73881	139	74100	380, 463	74471	387, 467
71634	509	71972	134	72510	396	72954	352	73410	125, 158	73882	139	74102	380	74480	288, 386
71635	509	71975	134	72524	397	72955	351	73412	125, 158	73883	139	74104	380	74483	288, 386
71636	509	71976	134	72525	397	72956	353	73413	125, 158	73884	139	74106	380	74484	288, 386
71637	509	71977	134	72526	397	72958	353	73420	125, 158	73885	139	74108	380	74501	383, 468
71638	509	71978	134	72527	397	72960	353	73430	159	73886	139	74113	381, 464	74503	384, 468
71639	509	71980	134	72528	397	72963	353	73470	277	73887	139	74115	381, 464	74504	384, 468
71800	515	71981	134	72529	397	72964	353	73473	277	73888	139	74117	381, 464	74505	383, 468
71801	515	71982	134	72530	397	72965	353	73500	279	73892	139	74121	381, 464	74508	384, 468
71802	515	71983	134	72531	397	72966	353	73503	207	73893	139	74123	381, 464	74509	384, 468
71803	515	71990	134	72532	397	72967	353	73561	138	73894	139	74125	380, 463	74540	384
71804	515	71991	134	72533	397	72968	353	73562	138	73895	139	74126	381, 463	74541	384
71805	515	71992	134	72534	397	72969	353	73563	138	73896	139	74127	381, 463	74542	384
71807	515	71993	134	72535	397	72970	353	73565	138	73897	139	74128	381, 464	74543	384
71808	515	71994	134	72570	398	72972	351	73567	138	73898	139	74130	380, 463	74555	385
71809	515	71995	134	72572	398	72973	351	73568	138	73906	139	74131	380, 463	74580	389, 467
71810	515	71996	134	72573	398	72974	353	73569	138	73909	139	74132	381, 463	74581	389, 467
71811	515	71997	134	72615	397	72975	354	73570	138	73929	139	74134	381, 463	74595	389, 467
71812	515	72000	134	72616	397	72976	353	73571	138	73931	389, 464	74135	381, 463	74600	388, 466
71814	515	72001	134	72617	397	72977	354	73572	138	73932	389, 464	74136	381, 464	74601	388, 466
71815	515	72010	134	72620	397	72978	354	73573	138	73933	389, 464	74137	381, 464	74602	388, 466
71816	515	72011	134	72621	397	72979	354	73574	138	73934	389, 464	74145	382	74603	388, 466
71817	515	72012	134	72622	397	72981	354	73575	138	73935	389, 464	74146	382	74604	389, 466
71818	515	72013	134	72625	397	72984	354	73590	138	73936	389, 464	74149	383	74610	388, 466
71819	515	72040	133	72626	397	72985	354	73598	139	73937	390, 465	74150	382	74622	388, 466
71820	515	72060	133	72627	397	72994	352	73780	139	73938	390, 465	74151	382	74624	388, 466
71821	515	72080	133	72630	397	72995	352	73781	139	73939	390, 465	74160	382	74626	392
71822	515	72100	133	72631	397	72996	352	73782	139	73940	390, 465	74162	382	74627	392
71823	515	72120	133	72632	397	72997	352	73783	139	73941	390, 465	74171	389, 467	74628	392
71824	515	72140	133	72683	391	72998	352	73784	139	73942	390, 465	74172	389, 467	74631	392
71825	515	72350	396	72684	391	73021	352	73785	139	73943	390, 465	74173	389, 467	74632	392
71827	516	72351	396	72685	391	73022	352	73786	139	73945	390, 465	74174	389, 467	74633	392
71828	516	72352	396	72686	391	73025	352	73787	139	73946	390, 465	74175	389, 467	74646	392
71829	516	72353	396	72801	391	73026	352	73788	139	73947	390, 465	74176	389, 467	74647	392
71830	516	72354	396	72802	391	73027	352	73789	139	73950	390, 465	74225	403	74653	392
71831	516	72355	396	72803	391	73031	353	73790	139	73951	390, 465	74226	403	74654	392
71832	516	72356	396	72804	391	73032	353	73791	139	73952	390, 465	74227	403	74655	392
71833	516	72357	396	72805	391	73033	353	73792	139	73953	390, 465	74410	286, 385	74657	392
71834	516	72358	396	72806	391	73034	353	73793	139	73954	390, 465	74411	286, 385	74658	392
71835	516	72370	396	72807	391	73035	353	73794	139	73955	390, 465	74420	286	74659	392
71836	516	72371	396	72808	391	73051	268	73795	139	73958	390, 465	74421	286	74660	391
71837	516	72372	396	72809	391	73052	264	73796	139	73959	390, 465	74422	286	74661	391
71838	516	72373	396	72890	391	73056	264	73797	139	73960	390, 465	74430	286	74662	391
71840	516	72400	399	72891	391	73057	264	73798	139	73961	390, 465	74431	286	74663	391
71841	516	72401	399	72920	363	73060	269	73799	139	73962	390, 465	74432	286	74664	391
71842	516	72402	399	72922	365	73260	140, 279	73800	139	73963	390, 465	74439	288, 388	74665	391
71843	516	72404	399	72928	364	73270	140, 279	73801	139	73964	390, 465	74440	286, 385	74666	391
71844	516	72407	399	72931	365	73271	140, 279	73802	139	73966	390, 465	74441	287, 386	74667	391
71846	516	72440	398	72932	366	73300	140, 279	73803	139	73967	390, 465	74442	286, 385	74721	368
71847	516	72441	398	72933	351	73325	158	73804	139	73968	390, 465	74443	287, 385	74722	368
71848	516	72442	398	72934	351	73330	158	73805	139	73969	390, 465	74447	287, 385	74723	368
71849	516	72460	396	72935	351	73331	159	73806	139	73970	390, 465	74448	287, 386	74724	368
71850	516	72484	397	72936	351	73340	159	73807	139	73971	390, 465	74450	287, 385	74730	374
71851	516	72486	397	72937	351	73341	159	73808	139	73972	390, 465	74451	288, 387	74731	374
71852	516	72489	397	72938	352	73342	159	73831	138	73973	390, 465	74452	288, 387	74732	374
71853	516	72490	397	72939	352	73343	159	73833	138	74003	383	74453	288, 387	74733	375
71854	516	72493	397	72942	353	73350	160	73835	138	74060	383	74454	288, 387	74734	375
71855	516	72494	397	72943	353	73351	160	73840	140	74077	382	74455	288, 387	74750	375
71856	516	72500	396	72944	353	73352	160	73843	140	74078	382	74457	287, 386	74751	375
71857	516	72501	396	72945	353	73353	160	73845	140	74079	382	74459	383	74752	375
71858	516	72504	396	72948	352	73360	160	73850	140	74080	382	74460	383	74753	375

No.	Page	No.	Page	No.	Page	No.	Page	No.	Page	No.	Page	No.	Page	No.	Page
74765	375	75100	142, 182	75366	507	75621	512	75779	502	75984	519	76852	280	77845	299, 310
74766	375	75120	141, 181	75367	507	75622	512	75801	490	76000	107	76853	280	77850	300, 311
74771	376	75121	141, 181	75368	507	75623	513	75802	490	76010	107	76854	280	77861	300, 311
74772	376	75122	141, 181	75369	507	75624	512	75803	490	76011	107	76855	280	77881	300, 311
74773	376	75123	141, 181	75370	507	75625	511	75804	490	76015	107	76856	280	77900	298
74775	376	75124	141, 181	75371	507	75626	511	75805	492	76101	107	76857	280	77910	298
74776	376	75125	141, 181	75372	507	75627	511	75806	492	76160	107	76858	280	77930	299
74780	503	75130	141, 182	75373	507	75628	511	75807	492	76180	108	76859	280	78000	228
74781	504	75131	141, 182	75374	508	75631	511	75808	493	76181	108	76870	281	78001	229
74782	504	75132	141, 182	75375	508	75632	511	75809	493	76182	108	76877	281	78002	229
74783	504	75133	141, 182	75376	508	75633	511	75811	493	76183	108	76880	281	78003	229
74784	504	75140	142, 182	75377	508	75634	511	75812	493	76184	107	76881	281	78007	229
74785	504	75141	142, 182	75378	508	75635	512	75813	493	76185	108	76882	281	78020	366
74786	504	75201	126	75379	508	75636	512	75814	493	76186	108	76883	281	78021	366
74787	505	75202	126	75380	508	75639	512	75815	494	76190	108	76884	281	78022	366
74788	505	75230	142	75381	508	75645	514	75816	494	76210	109	77004	295	78027	140
74789	505	75231	142	75382	508	75646	514	75817	494	76214	108	77005	295	78030	229
74790	505	75233	142	75383	508	75647	514	75818	494	76220	109	77006	295	78031	229
74791	505	75238	142, 182	75384	508	75648	514	75827	494	76230	109	77061	295	78032	230
74792	505	75239	142, 182	75386	508	75649	514	75828	494	76250	109	77062	295	78035	230
74793	505	75240	142, 182	75387	508	75650	514	75829	495	76305	110	77063	295	78037	228
74794	505	75245	141, 182	75388	508	75651	514	75830	496	76311	110	77064	295	78039	228
74802	371	75246	141, 182	75389	508	75652	515	75831	496	76312	110	77100	297	78040	227
74804	371	75247	141, 182	75421	508	75653	515	75832	496	76314	110	77105	297	78041	227
74812	371	75260	141, 182	75422	508	75654	515	75833	496	76320	56	77170	298	78042	227
74816	372	75261	141, 182	75423	508	75655	515	75834	495	76526	106	77180	298	78043	228
74818	372	75262	141, 182	75424	508	75660	517	75835	495	76621	106	77190	298	78044	230
74820	372	75270	141, 181	75448	509	75662	491	75836	495	76622	106	77191	298	78045	228
74828	372	75271	141, 181	75449	509	75663	491	75837	495	76640	106	77192	298	78046	227
74831	372	75272	141, 181	75450	509	75664	491	75838	495	76650	106	77193	298	78047	227
74833	372	75273	141, 181	75451	509	75665	491	75852	502	76660	107	77200	297	78061	228
74835	372	75274	141, 181	75455	526	75670	503	75853	502	76700	111	77203	297	78067	228
74838	372	75285	141, 181	75464	526	75671	503	75870	492	76705	111	77204	297	78068	228
74841	372	75286	141, 181	75465	525	75672	503	75871	492	76710	111	77205	297	78154	262
74843	372	75287	141, 181	75467	525	75673	503	75880	498	76750	371	77210	296	78300	230
74846	372	75288	141, 181	75469	525	75674	503	75881	498	76751	371	77211	296	78301	230
74849	372	75295	140	75470	526	75675	502	75882	498	76752	371	77212	296	78303	230
74851	373	75300	141, 183	75471	526	75676	502	75883	498	76755	371	77213	296	78306	230
74853	373	75301	140, 182	75472	526	75677	502	75884	498	76756	371	77250	296	78341	124
74855	373	75302	140, 182	75483	510	75705	499	75885	499	76757	371	77300	296	78381	124
74856	373	75303	141, 183	75484	510	75706	500	75886	499	76760	371	77350	296	78385	124
74858	372	75304	141, 183	75487	510	75707	500	75887	499	76761	371	77400	296	78388	124
74861	373	75327	509	75498	509	75708	500	75888	499	76762	371	77500	296	78400	236
74863	373	75334	509	75499	510	75709	500	75889	499	76765	371	77600	296	78401	236
74866	373	75335	509	75527	513	75710	500	75915	374, 528	76766	371	77606	296	78405	237, 402
74869	373	75336	509	75535	513	75711	500	75916	374, 529	76767	371	77607	296	78410	236
74882	373	75345	507	75536	513	75712	501	75921	530	76800	280	77608	296	78432	294
74885	373	75346	507	75537	513	75716	491	75922	530	76806	280	77609	296	78434	294
74886	373	75347	507	75539	513	75718	491	75923	531	76807	280	77612	297	78436	294
74887	373	75348	507	75544	510	75719	492	75924	531	76810	280	77618	297	78470	298
74910	373	75349	507	75545	510	75729	501	75930	530	76811	280	77700	297	78471	298
74911	373	75350	507	75550	510	75740	496	75931	530	76814	280	77704	297	78472	299
74912	373	75351	507	75551	510	75742	496	75932	530	76815	280	77705	297	78477	225
74913	373	75352	507	75553	514	75743	497	75944	529	76818	280	77715	313	78540	350
74914	373	75353	507	75554	514	75747	497	75945	529	76819	280	77795	313	78541	350
74920	374	75354	507	75555	517	75749	498	75951	529	76822	280	77815	300, 311	78542	350
74921	374	75355	507	75558	517	75760	497	75953	529	76823	280	77830	299, 310	78543	350
74922	374	75356	507	75559	517	75762	497	75977	518	76826	280	77831	299, 310	78555	350
74923	374	75360	507	75564	513	75763	497	75978	518	76830	280	77833	299, 310	78556	350
74924	374	75361	507	75565	513	75764	497	75979	519	76832	280	77834	299, 310	78557	350
75000	142	75362	507	75578	514	75775	501	75980	517	76835	281	77835	299, 310	78570	350
75031	143, 183	75363	507	75579	514	75776	501	75981	518	76836	281	77837	299, 310	78571	350
75050	142	75364	507	75619	512	75777	501	75982	518	76850	280	77838	299, 310	78572	350
75060	142	75365	507	75620	512	75778	501	75983	519	76851	280	77840	300, 311	78575	350

No.	Page	No.	Page	No.	Page	No.	Page	No.	Page	No.	Page	No.	Page	No.	Page
78576	350	78894	268	79771	270, 423	80308	241	81390	217	82022	244, 312	82413	252	83001	247
78577	350	78910	125, 265	79772	270, 423	80309	241	81391	217	82023	245, 313	82414	252	83002	248
78580	350	78911	124, 269	79773	270, 423	80312	241	81399	218	82031	311	82415	252	83004	248
78581	350	78912	125, 265	79774	270, 423	80320	242	81400	218	82032	311	82431	247	83005	248
78582	350	78972	261	79775	270, 423	80330	242	81401	218	82105	245	82440	247	83009	229
78585	350	78974	262	79781	265, 423	80340	242	81490	217	82107	245	82445	247	83120	407
78586	350	78981	261	79782	265, 423	80350	242	81491	217	82200	246	82502	247	83122	407
78587	350	78982	261	79783	265, 423	80402	242	81492	217	82201	245	82504	247	83123	407
78590	351	78983	261	79790	270, 423	80412	242	81500	217	82205	245	82506	247	83124	407
78591	351	78985	261	79791	270, 423	80450	242	81501	217	82206	246	82520	247	83260	250
78592	351	78986	261	79792	270, 423	80470	232	81502	217	82209	245	82541	242	83261	250
78620	294	78987	261	79800	277	80471	232	81519	217	82225	246	82542	243	83262	250
78622	294	78992	260	79810	271, 424	80472	232	81520	217	82227	246	82543	243	83280	250
78624	294	78995	260	79811	271, 424	80473	232	81521	217	82231	246	82544	243	84400	205
78626	295	78997	260	79812	271, 424	80474	232	81522	217	82232	246	82610	243	85000	253
78628	295	79049	260	79823	282, 424	80500	232	81523	217	82233	246	82611	243	85001	253
78630	295	79053	260	79824	282, 424	80510	232	81524	217	82234	246	82650	243	85002	253
78632	295	79054	260	79861	460	80520	232	81525	217	82260	253	82671	397, 478	85003	253
78633	295	79087	261	79862	460	80530	232	81527	217	82261	253	82673	397, 478	85004	253
78641	294	79088	261	79863	460	80600	232	81553	216	82262	253	82675	397, 478	85005	253
78642	294	79089	261	79865	460	80601	232	81556	216	82300	250	82677	397	85020	254, 362
78660	367	79124	262	79866	460	80602	233	81560	216	82301	250	82682	398	85030	254, 362
78661	367	79254	263	79867	460	80620	233	81562	216	82305	251	82684	398	85040	254, 362
78662	367	79257	263	79869	460	80640	233	81570	216	82308	250	82685	398	85050	254, 362
78663	367	79309	263	79880	271, 423	80660	234	81617	214	82310	250	82691	398	85060	254, 362
78700	304	79314	268	79909	265, 422	80661	234	81618	214	82315	250	82692	398	85080	254, 362
78710	304	79320	263	79919	276	80701	232	81631	215	82320	250	82693	398	85090	254, 362
78720	304	79324	268	79924	276	80751	244	81632	215	82322	253	82694	398	85100	254, 362
78730	304	79325	268	79926	271, 424	80752	244	81633	215	82331	251	82699	238, 399	85112	254, 362
78731	226, 304	79327	264	79927	271, 424	80753	244	81634	216	82341	251	82706	238, 400	85113	254, 362
78734	226, 305	79328	264	79928	271, 424	80901	214	81638	215	82343	252	82713	238, 400	85114	254, 362
78736	226, 305	79346	278	79929	271, 424	80902	214	81640	215	82351	252	82714	238, 400	85115	254, 362
78738	227, 305	79350	274	79930	271, 424	80903	214	81643	215	82355	74	82715	238, 400	85116	254, 362
78750	304	79354	265	79931	271, 424	80970	211	81644	215	82360	251	82717	239, 400	85118	254, 362
78751	304	79355	269	79932	271, 424	81060	213	81647	216	82370	251	82723	238, 399	85119	254, 362
78752	304	79358	274	79933	271, 424	81070	212	81650	213	82372	251	82724	239, 401	85120	254, 362
78756	236	79365	264	79943	266, 423	81072	212	81651	213	82373	251	82726	240, 401	85122	253, 362
78771	306	79366	264	79944	270, 423	81073	213	81653	214	82374	251	82730	239, 401	85123	253, 362
78785	306	79367	264	79960	421	81080	212	81661	214	82375	251	82731	239, 401	85124	253, 362
78790	306	79368	264	79962	421	81100	210	81690	235	82377	251	82733	239, 401	85125	253, 362
78791	307	79386	279	79963	421	81101	210	81731	205, 236	82378	251	82734	239, 400	85126	253, 362
78794	307	79390	281	79965	421	81107	210	81741	243	82379	251	82735	240, 401	85128	253, 362
78800	305	79391	281	79968	421	81108	210	81751	205	82380	251	82736	238, 399	85129	253, 362
78801	305	79398	280	79971	421	81109	210	81773	57, 192	82384	251	82743	239, 400	85130	253, 362
78802	306	79416	263	79977	282	81110	210	81774	57, 192	82386	251	82756	240, 402	85131	253, 362
78811	306	79442	272, 459	79978	282	81114	211	81775	57, 192	82388	251	82771	399	85132	253, 362
78812	306	79448	272, 459	79979	282	81115	211	81780	56, 192	82390	251	82772	399	85133	253, 362
78813	306	79467	271, 459	79982	282	81117	211	81783	56, 192	82392	252	82830	404	85134	253, 362
78814	306	79468	274, 461	79983	282	81118	212	81784	56, 192	82393	252	82831	404	85135	253, 362
78815	306	79491	263	79984	282	81119	212	81785	204	82395	252	82832	404	85170	254, 362
78819	307	79550	274, 460	80012	240	81122	213	81786	204	82397	252	82920	247	85172	254, 363
78821	307	79551	274, 461	80022	240	81133	212	81791	203	82400	252	82941	279	85174	254, 363
78822	307	79552	274, 461	80032	240	81137	211	81794	203	82401	252	82942	268	85177	254, 363
78824	307	79560	274, 461	80042	240	81142	213	81795	204	82402	252	82951	248, 364	85178	254, 363
78825	307	79561	274, 461	80052	240	81150	211	81801	57, 193	82403	252	82952	248, 364	85180	254, 363
78826	307	79570	277	80062	240	81370	217	81824	237	82404	252	82953	248, 364	85190	255, 363
78830	307	79580	277	80072	240	81371	217	81825	237	82405	252	82954	249, 365	85191	255, 363
78831	307	79630	277	80082	240	81372	217	81830	224	82406	252	82955	248, 364	86700	367
78833	307	79639	278	80107	241	81373	217	82000	244, 312	82407	252	82967	249, 365	86701	367
78834	307	79640	278	80111	241	81374	217	82001	244, 312	82408	252	82970	249, 365	86750	126
78835	307	79641	278	80252	241	81378	217	82005	244, 312	82409	252	82971	249, 365	86751	126
78855	265	79675	272, 460	80271	241	81379	217	82015	244, 312	82410	252	82991	249, 478	86752	126
78870	364	79725	272, 460	80300	241	81380	217	82020	244, 312	82411	252	82992	249, 478	86760	126
78890	269	79734	272, 460	80307	241	81387	218	82021	244, 312	82412	252	83000	247	86761	126

86770	127	88672	403	88908	429	89200	415	89302	420	89458	275, 462	89896	475	99190	433
86771	127	88673	403	88909	431	89201	414	89303	420	89459	275, 462	89950	477	99191	434
87245	368	88674	403	88910	429	89202	414	89305	420	89462	275, 462	89990	477	99193	432
87301	368	88675	403	88911	429	89203	417	89307	420	89463	275, 462	90000	471	99194	432
87302	368	88676	403	88912	429	89204	417	89308	420	89464	275, 462	90001	471	99195	434
87303	368	88677	402	88913	428	89206	417	89310	420	89465	276, 462	90002	472	99202	433
87305	368	88678	402	88914	428	89207	417	89311	420	89466	276, 462	90003	472	99203	433
87307	368	88700	469	88915	428	89208	417	89312	420	89467	276, 462	90030	472	99204	433
87311	369	88701	469	88916	428	89209	416	89313	420	89470	276, 462	90031	472	99206	433
87312	369	88702	469	88917	427	89210	415	89314	420	89471	276, 462	90150	473	99207	433
87313	369	88703	469	88920	427	89211	416	89315	420	89472	276, 462	90200	474	99208	433
87315	369	88704	469	88925	419	89213	415	89316	420	89473	276, 463	90204	475	99209	433
87317	369	88705	469	88926	425	89214	415	89318	420	89474	276, 463	90240	474	99230	432
87321	369	88720	443	88927	425	89215	416	89319	420	89475	276, 463	90350	472	99240	434
87322	369	88740	470	88930	431	89218	417	89320	420	89478	276, 463	90360	472	99250	434
87323	369	88780	424	88931	431	89220	416	89330	421	89479	276, 463	91000	470	99300	437
87325	369	88783	424	88932	431	89221	410	89331	421	89480	276, 463	91003	470	99301	437
87327	369	88784	425	88933	432	89222	410	89335	422	89481	276, 463	91050	470	99310	436
87331	369	88801	470	88935	432	89223	410	89336	422	89482	276, 463	91052	470	99315	436
87332	369	88805	470	88936	432	89224	410	89345	422	89483	276, 463	91060	470	99390	451
87333	369	88806	470	88938	432	89225	410	89348	422	89484	276, 463	91061	470	99391	452
87335	369	88809	470	88939	432	89226	410	89351	417	89485	276, 463	92100	473	99400	450
87337	369	88811	471	89000	473	89227	410	89360	421	89486	276, 463	92105	473	99401	452
87351	369	88812	471	89001	410	89228	410	89361	421	89507	457	92110	473	99402	454
87352	369	88820	471	89002	410	89229	411	89370	421	89508	457	92115	473	99403	454
87353	369	88840	426	89003	410	89230	411	89371	421	89509	457	99001	436	99404	454
87354	369	88841	426	89004	410	89231	411	89372	421	89515	457	99005	436	99405	456
87361	369	88842	426	89007	411	89232	411	89373	421	89518	457	99006	436	99406	456
87362	369	88849	426	89008	411	89233	411	89380	421	89520	457	99007	437	99407	455
87363	369	88850	425	89011	411	89234	411	89381	421	89526	457	99008	437	99408	454
87364	369	88851	425	89013	412	89235	412	89382	421	89528	457	99009	437	99409	455
87371	369	88853	427	89015	412	89236	412	89383	421	89536	458	99028	443	99410	454
87372	369	88855	430	89017	413	89239	412	89384	421	89537	458	99033	442	99412	456
87373	369	88856	429	89018	413	89240	412	89385	421	89538	458	99034	441	99413	456
87374	369	88857	428	89020	413	89241	413	89386	421	89539	458	99035	441	99415	455
87381	370	88858	427	89022	414	89242	413	89387	421	89540	458	99036	441	99416	455
87382	370	88859	427	89081	469	89243	414	89390	417	89541	458	99037	442	99418	455
87383	370	88860	429	89100	410	89244	414	89401	275, 461	89542	459	99038	442	99419	455
87384	370	88861	430	89101	410	89245	413	89402	275, 461	89543	459	99039	442	99420	455
87391	370	88862	430	89102	410	89246	413	89403	275, 461	89545	459	99040	442	99421	455
87392	370	88863	430	89103	410	89247	414	89404	275, 461	89547	459	99047	440	99425	456
87393	370	88864	431	89104	411	89248	414	89405	275, 461	89552	422	99048	440	99426	456
87401	370	88865	431	89105	411	89251	413	89406	275, 461	89553	422	99049	441	99427	456
87402	370	88869	428	89106	412	89252	413	89411	275, 462	89560	184, 474	99050	440	99428	456
87403	370	88870	427	89107	412	89253	411	89412	275, 462	89561	184, 474	99051	440	99429	456
87411	370	88871	428	89108	413	89257	418	89413	275, 462	89562	184, 474	99052	441	99430	456
87412	370	88872	429	89109	413	89259	418	89414	275, 462	89563	184, 474	99053	443	99435	456
87413	370	88874	428	89110	412	89260	418	89415	275, 462	89564	184, 474	99054	443	99436	456
87431	370	88890	427	89112	414	89261	418	89416	275, 462	89610	270, 457	99056	443	99438	456
87432	370	88891	426	89113	413	89263	418	89421	275, 462	89611	270, 458	99101	434	99440	456
87433	370	88892	426	89120	415	89269	418	89422	275, 462	89700	469	99103	435	99442	456
87435	370	88893	426	89162	419	89272	418	89423	275, 462	89702	469	99104	435	99443	456
87437	370	88894	426	89163	419	89275	419	89424	275, 462	89704	469	99109	435	99444	456
87451	370	88895	425	89164	419	89277	419	89425	275, 462	89715	468	99110	436	99445	456
87452	370	88896	425	89165	419	89280	419	89426	275, 462	89720	468	99111	435	99446	456
87453	370	88897	425	89166	420	89290	420	89441	275, 461	89722	469	99112	436	99460	67, 440
87454	370	88899	427	89167	420	89291	420	89442	275, 461	89750	471	99113	435	99461	67, 440
87455	370	88900	431	89187	415	89292	420	89443	275, 461	89753	471	99114	435	99462	67, 440
87456	370	88902	431	89189	415	89293	420	89444	275, 461	89770	471	99115	436	99463	67, 440
87457	370	88903	430	89190	416	89294	420	89452	275, 462	89860	477	99116	435	99464	67, 440
88422	310, 404	88904	430	89191	416	89295	420	89453	275, 462	89870	477	99119	435	99472	67, 440
88555	240, 402	88905	430	89192	416	89298	420	89454	275, 462	89880	442	99180	434	99495	482
88560	240, 402	88906	430	89193	415	89299	420	89456	275, 462	89890	442	99181	434	99513	481
88670	403	88907	429	89195	416	89300	420	89457	275, 462	89891	442	99182	434	99528	359, 453, 486

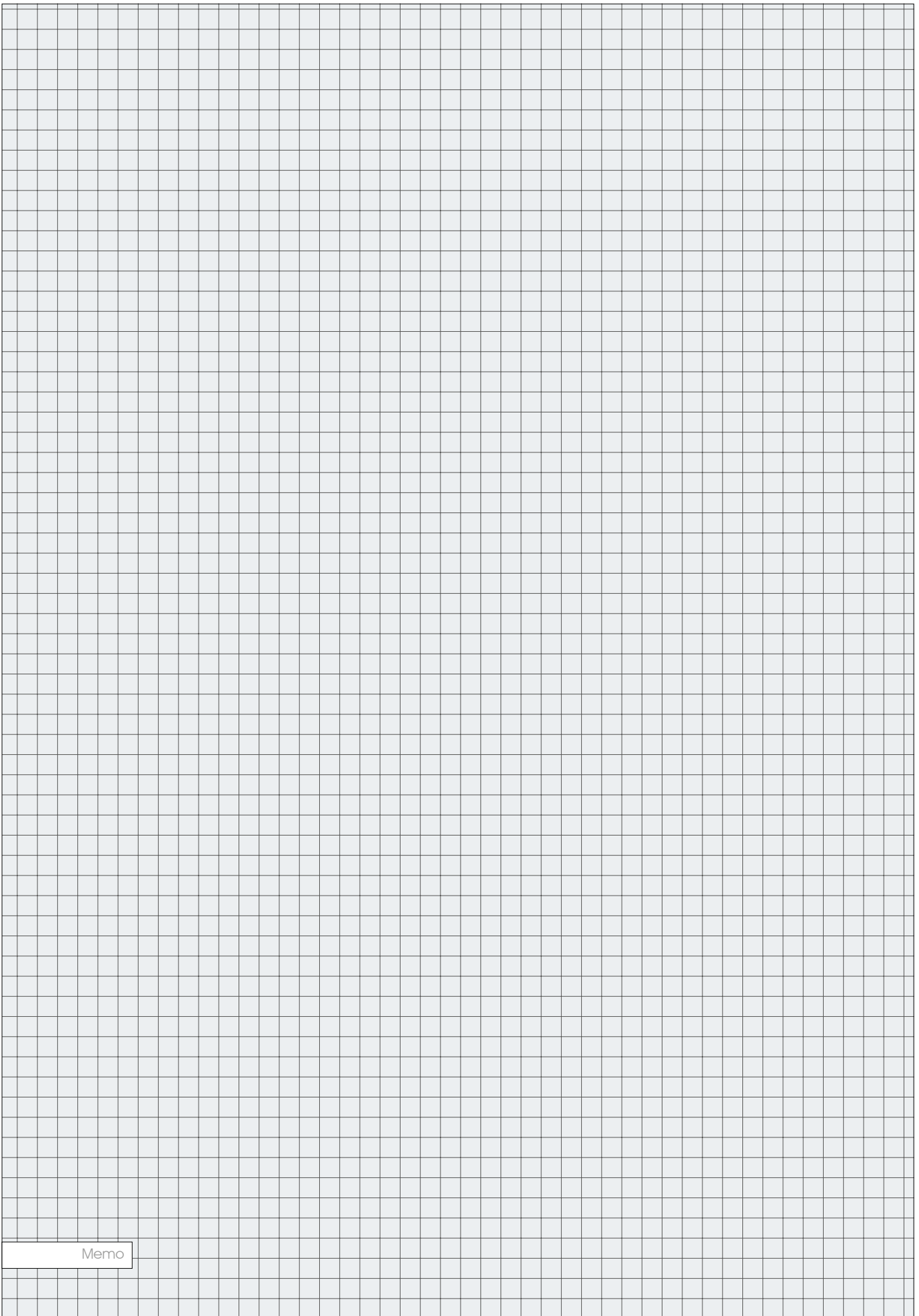

Memo

Memo

PL

I. TOYA S.A. informuje, iż:

- 1) niniejszy katalog nie stanowi oferty w rozumieniu prawa cywilnego;
 - 2) prezentowane w niniejszym katalogu artykuły mogą w rzeczywistości odbiegać od wskazanego na zdjęciach wzoru, w szczególności jeżeli chodzi o cechy zewnętrzne, tj. wielkość, kolor, sposób opakowania, ilość przedmiotów w opakowaniu;
 - 3) nie ponosi odpowiedzialności za drobne różnice w sposobie pakowania czy właściwościach artykułów pozostających bez wpływu na jego przeznaczony cel lub sposób użytkowania;
 - 4) nie ponosi odpowiedzialności wynikającej z jakichkolwiek niedokładności lub nieścisłości, co do informacji zawartych w przedmiotowym katalogu;
 - 5) nie ponosi odpowiedzialności za ewentualną szkodę powstałą w wyniku otrzymania towaru o innych właściwościach niż prezentowany na zdjęciach.
- II. Pomimo najlepszych starań poczynionych przez TOYA S.A. nie może ona zagwarantować, iż informacje zawarte w niniejszym katalogu w pełni odpowiadają rzeczywistości.
- III. Wszelkie decyzje podjęte na podstawie informacji zawartych w przedmiotowym katalogu podejmowane są na własne ryzyko osoby, która korzysta z tych informacji.

GB

I. TOYA S.A. informs that:

- 1) the present catalogue does not constitute an offer as construed in the civil law;
 - 2) the goods presented in the present catalogue may in fact differ from the models shown in the pictures, particularly as far as external properties are concerned, namely size, colour, packaging, number of items in the package;
 - 3) the company will not be held responsible for small differences in packaging or properties of the goods, which do not affect the purpose or the exploitation of the tools;
 - 4) the company will not be held responsible for any inaccuracies or imprecision regarding the information presented in the catalogue;
 - 5) the company will not be held responsible for any damage caused by goods whose properties differ from those of the tools presented in the photographs.
- II. In spite of all the efforts made by TOYA S.A., the company cannot guarantee the information contained in the present catalogue fully correspond to the reality.
- III. Any decisions made on the basis of the information contained in the present catalogue will be made at the risk of the person who makes them using the aforementioned information.

D

I. TOYA S.A. informiert, dass:

- 1) der vorliegende Katalog kein Angebot im zivilrechtlichen Sinne darstellt;
 - 2) die im vorliegenden Katalog präsentierten Artikel in der Realität von den auf den Musterfotos gezeigten abweichen können, und zwar besonders dann, wenn es um äußere Eigenschaften geht, wie z.B. Größe, Farbe, Art der Verpackung, Anzahl der Gegenstände in der Verpackung;
 - 3) sie keine Verantwortung für geringfügige Unterschiede bei der Verpackungsart oder den Eigenschaften der Artikel übernimmt, die ohne Auswirkungen auf seinen Bestimmungszweck oder die Art der Nutzung bleiben;
 - 4) sie keine Verantwortung für irgendwelche Oberflächlichkeiten und Ungenauigkeiten bzgl. der im Sachkatalog enthaltene Informationen übernimmt;
 - 5) sie keine Verantwortung für eventuelle Schäden, die im Ergebnis des Erhalts der Ware mit anderen als auf den Fotos dargestellten Eigenschaften entstanden sind, übernimmt.
- II. Trotz großer Bemühungen seitens TOYA S.A. kann die Firma nicht garantieren, dass die im vorliegenden Katalog enthaltenen Informationen voll der Realität entsprechen.
- III. Sämtliche Entscheidungen, die auf der Grundlage der im Sachkatalog enthaltenen Informationen getroffen wurden, gehen auf das Risiko der Person, die diese Informationen benutzt.

RUS

I. TOYA S.A. заявляет:

- 1) настоящий каталог не является торговым предложением с точки зрения гражданского законодательства;
 - 2) изделия, представленные в настоящем каталоге, могут отличаться от образцов на снимках, особенно внешним видом, то есть размером, цветом, способом упаковки, количеством предметов в упаковке;
 - 3) производитель не отвечает за мелкие отличия в способе упаковки или свойствах изделий, которые не влияют на предназначение или способ пользования изделиями;
 - 4) производитель не отвечает за мелкие неточности в сведениях из предметного каталога;
 - 5) производитель не отвечает за ущерб, нанесенный вследствие поставки товара, отличающегося параметрами от указанного на снимках.
- II. Несмотря на все усилия в данном направлении, компания TOYA S.A. не гарантирует, что информация, метящаяся в настоящем каталоге, полностью отвечает действительности.
- III. Риск, связанный с любыми решениями, принятыми на основании информации из предметного каталога, берут на себя лица, пользующиеся указанной информацией.

UA

I. Інформація від виробника, TOYA S.A.:

- 1) цей каталог не є комерційною пропозицією з точки зору цивільного законодавства;
 - 2) вироби, представлені в цьому каталозі, можуть відрізнятися від зображень на фотографіях, особливо зовнішнім виглядом, тобто розміром, кольором, способом упаковки, кількістю предметів в упаковці;
 - 3) виробник не несе відповідальність за дрібні відмінності у способі упаковки чи властивостях виробів, які не мають впливу на їх призначення чи спосіб користування ними;
 - 4) виробник не несе відповідальність за дрібні неточності у інформації, включеної у цей каталог;
 - 5) виробник не несе відповідальність за можливі збитки, нанесені внаслідок отримання виробів, що своїми параметрами відрізняються від зображень на фотографіях.
- II. Незважаючи на зусилля у даному напрямку, фірма TOYA S.A. не гарантує, що інформація, включена у цей каталог, повністю відповідає дійсності.

III. Приймаючи будь-які рішення на підставі інформації, включеної у цей каталог, не забувайте, що пов'язаний з ними ризик беруть на себе особи, що використовують включену у каталог інформацію.

LT

I. TOYA S.A. informuoja, kad:

- 1) šis katalogas nėra civilinės teisės supratimu pasiūlymas;
 - 2) rodomos šame kataloge prekės gali tikrumoje skirtis nuo parodyto nuotraukose pavyzdžio, ypač jų išorine išvaizda ir požymiais, t.y. dydžiu, spalva, įpakavimo būdu, elementų kiekiu pakuotėje;
 - 3) gamintojas neneša atsakomybės už nereikšmingus skirtumus įpakavime arba gaminio savybėse, kurios neturi įtakos jo paskirčiai arba jo varojimo būdui.
 - 4) neneša taip pat atsakomybės dėl bet kokių netikslumų arba nepakankamai preciziškų apibrėžimų pateiktoje kataloge informacijoje.
 - 5) neneša atsakomybės už galimai patirtus nuostolius gavus prekę su savybėmis, kurios nėra tapačios su pateiktomis nuotraukose.
- II. Nežiūrint geriausių TOYA S.A. pastangų, bendrovė negali garantuoti, kad pateikta šiame kataloge informacija pilnai atitinka tikrovę.
- III. Bet kokie sprendimai priimami šiame kataloge pateiktą informaciją pagrindu yra besinaudojančio šia informacija asmens priimami savo paties rizika.

LV

I. A/S „TOYA“ informē, ka:

- 1) šis katalogs nav piedāvājums civillikuma izpratnē;
 - 2) piedāvāti šī katalogā produkti realitātē var atšķirties no rādīta uz fotogrāfijas parauga, sevišķi ārēju īpašību sfērā, t.i. ar lielumu, krāsu, pakošanas veidu, priekšmetu skaitu iepakojumā;
 - 3) nav atbildīga par smalkām atšķirībām iepakošanas veidā vai produktu īpašībām, ja tie neietekmē ierīces paredzētu mērķu vai lietošanas veidu;
 - 4) nav atbildīga par kaut kādām neprecizitātēm informācijās, kas ir norādītas šī katalogā;
 - 5) nav atbildīga par iespējamiem zaudējumiem, savienotiem ar produkta saņemšanu ar citām īpašībām, nekā rādītas uz fotogrāfijas.
- II. Neskatoties uz visaugstāko rūpību, ar kuru A/S „TOYA“ sagatavoja savu katalogu, tā nevar garantēt, ka informācijas šī katalogā pilnīgi atbild realitātei.
- III. Visi lēmumi, pieņemti pamatojoties uz informācijās no kataloga - ir pieņemti uz personas, kura lieto šo informāciju, risku.

CZ

I. TOYA S.A. informuje že:

- 1) tento katalog nepředstavuje nabídku ve smyslu občanského práva;
 - 2) výrobky prezentované v tomto katalogu se mohou ve skutečnosti lišit od modelů uvedených na obrázcích, zejména co se týká vnějších znaků, tj. velikosti, barvy, způsobu balení, počtu předmětů v balení;
 - 3) nenese odpovědnost za drobné rozdíly ve způsobu balení nebo ve vlastnostech výrobků, které nemají zásadní vliv na jejich určený účel nebo způsob používání;
 - 4) nenese odpovědnost vyplývající z jakýchkoli nepřesností co do informací uvedených v předmětném katalogu;
 - 5) nenese odpovědnost za případné škody vzniklé v důsledku obdržení zboží s jinými vlastnostmi, než je uvedeno na obrázcích.
- II. Navzdory mimořádnému úsilí vynaloženému firmou TOYA S.A. tato nemůže garantovat, zda informace uvedené v tomto katalogu zcela odpovídají skutečnosti.
- III. Veškerá rozhodnutí přijatá na základě informací uvedených v předmětném katalogu jsou přijímána na vlastní riziko osoby, která tyto informace využívá.

SK

I. TOYA S.A. informuje že:

- 1) tento katalóg nepredstavuje ponuku v zmysle občianskeho práva;
 - 2) výrobky prezentované v tomto katalógu sa v skutočnosti môžu líšiť od modelov zobrazených na obrázkoch, najmä pokiaľ sa jedná o vonkajšie znaky, t.j. veľkosť, farbu, spôsob balenia, počet predmetov v balení;
 - 3) nenesie zodpovednosť za drobné rozdiely v spôsobe balenia či vlastnostiach výrobkov, ktoré nemajú zásadný vplyv na ich určený účel alebo spôsob používania;
 - 4) nenesie zodpovednosť vyplývajúcu z akejkoľvek nepresnosti týkajúcej sa informácií uvedených v predmetnom katalógu;
 - 5) nenesie zodpovednosť za prípadné škody vzniknuté v dôsledku obdržania tovaru s inými vlastnosťami, než je uvedené na obrázkoch.
- II. Aj napriek mimoriadnemu úsilíu zo strany firmy TOYA S.A. táto nemôže garantovať, či informácie uvedené v tomto katalógu plne zodpovedajú skutočnosti.
- III. Všetky rozhodnutia prijaté na základe informácií uvedených v predmetnom katalógu sú prijímané na vlastné riziko osoby, ktorá tieto informácie využíva.

H

I. A TOYA S.A. tájékoztatja, hogy:

- 1) a jelen katalógus a polgári jog szerinti nem kereskedelmi ajánlat;
 - 2) a jelen katalógusban bemutatott árucikkek a valóságban eltérhetnek a képeken látható mintától, különösen a külső tulajdonságok, mint a méret, szín, csomagolási mód, a csomagban lévő tárgyak száma tekintetében;
 - 3) nem vállal felelősséget a csomagolás módjában vagy az árucikkek olyan tulajdonságaiban történt változtatásokért, amelyek nem befolyásolják lényeges módon annak rendeltetését vagy a felhasználás módját;
 - 4) nem vállal felelősséget a jelen katalógusban lévő információk pontatlanságáért;
 - 5) nem vállal felelősséget azokért az esetleges károkért, amik az árucikkek a fényképeken látható tulajdonságoktól eltérő tulajdonságokkal történő leszállításból erednek.
- II. A TOYA S.A. minden igyekezete ellenére nem tudja garantálni, hogy a jelen katalógusban

található információk teljes egészében megfelelnek a valóságnak.

III. A tárgyi katalógusban található információk alapján meghozott bármilyen döntés annak a személynek a rizikója, aki ezeket az információkat felhasználja.

RO

I. TOYA S.A. informează că:

- 1) prezentul catalog nu constituie ofertă în înțelesul dreptului civil;
- 2) articolele prezentate în prezentul catalog se pot diferi față de mostrele din fotografiile, în special aspectul exterior, adică mărimea, culoarea, modul de ambalare, cantitatea obiectelor în ambalaj;
- 3) nu-și asumă răspunderea referitor la mici diferențe la modul de ambalare sau la articolele al căror proprietăți nu au influență referitor la destinația sau modul lor de utilizare;
- 4) nu-și asumă răspunderea referitor la orice inexactitate sau imprecizie, datorită informațiilor cuprinse în catalogul respectiv;
- 5) nu-și asumă răspunderea referitor la o eventuală pagubă ca urmare a primirii marfei cu alte proprietăți decât cele prezentate pe fotografii;

II. Cu toate strădanile TOYA S.A., firma nu poate garanta că, informațiile din prezentul catalog corespund realității;

III. Orice decizie preluată în baza informațiilor cuprinse în catalogul respectiv, sunt preluate pe riscul și răspunderea persoanei care a făcut folos de aceste informații.

E

I. TOYA S.A. comunica lo siguiente:

- 1) el presente catálogo no constituye una oferta, en el sentido que la noción adquiere en la ley civil;
 - 2) los artículos presentados en el presente catálogo pueden en realidad diferir de los modelos indicados en las fotografías, especialmente en cuanto a sus propiedades externas, es decir el tamaño, el color, el empaque o la cantidad de los objetos en el empaque;
 - 3) la empresa no se hace responsable por pequeñas diferencias en cuanto al empaque o las propiedades de los artículos, siempre y cuando estas diferencias no afectan el propósito o el modo de operación de las herramientas;
 - 4) la empresa no se hace responsable por ninguna imprecisión en cuanto a la información presentada en el presente catálogo;
 - 5) la empresa no se hace responsable por ningún daño que surja del hecho de que los artículos recibidos difieran de los artículos presentados en las fotografías en cuanto a sus propiedades.
- II. A pesar de los mejores intentos de parte TOYA S.A. la empresa no puede garantizar que la información presentada en el presente catálogo corresponda completamente a la realidad.
- III. Todas las decisiones tomadas en base a la información presentada en el presente son responsabilidad de la persona que recurra a la dicha información.

Memo



REG-707
Branded rack YATO 100 cm /
Regał firmowy YATO 100 cm



REG-777
Hangers set for power tools YATO /
Zestaw zawieszni na elektronarzędzia YATO

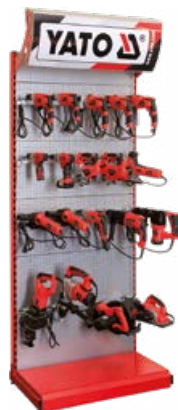

REG-779
Hangers set for power tools YATO 18 V /
Zestaw zawieszni na elektronarzędzia YATO 18 V



REG-918
Display for sanding paper YATO in rolls /
Ekspozytor na papier ścierny YATO w rolkach



REG-919
Display for sanding paper YATO in sheets /
Ekspozytor na papier ścierny YATO w arkuszach



REG-908
Standing display for YATO rectifiers /
Ekspozytor stojący na prostownik YATO



REG-925
Display for YATO work clothes /
Ekspozytor na ubrania robocze YATO



REG-603
Rotary display rack YATO /
Ekspozytor obrotowy YATO



REG-776
Standing triangular display for YATO sets /
Trójstronny ekspozytor stojący na zestawy YATO



REG-763
Standing display for YATO shoes /
Ekspozytor stojący na buty YATO



REG-977
Chrome tube mannequin /
Manekin z rury chromowej



REG-764
Standing display for YATO levels /
Ekspozytor stojący na poziomie YATO



REG-708
Branded rack VOREL 100 cm /
Regał firmowy VOREL 100 cm



REG-999
Standing display for window seals VOREL /
Ekspozytor stojący na uszczelki na okien VOREL



REG-954
Display for ropes / Ekspozytor na liny



REG-706
Branded rack STHOR 100 cm /
Regał firmowy STHOR 100 cm



REG-709
Branded rack FLO 100 cm /
Regał firmowy FLO 100 cm



REG-715
Mesh display rack FLO 230 cm /
Regał siatkowy FLO 230 cm



REG-147
Kitchen faucet display rack FALA /
Ekspozytor na baterie kuchenne FALA



REG-146
Bath faucet display rack FALA /
Ekspozytor na baterie łazienkowe FALA



REG-149
Stand for linear drains FALA /
Ekspozytor na odpływy liniowe FALA



REG-808
Display for wave toilet seats FALA /
Ekspozytor na deski toaletowe FALA



REG-992
Display rack for REG-707 for pipe wrenches YATO /
Ekspozytor do REG-707 na klucze do rur YATO



REG-994
Display rack for REG-707 for YATO bits /
Ekspozytor do REG-707 na nasadki YATO

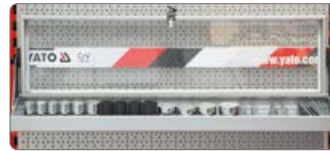

REG-994P
Display rack with the lid for REG-707 for YATO bits /
Ekspozytor z pokrywą do REG-707 na nasadki YATO



REG-998
Display rack for REG-707 for YATO hammers /
Ekspozytor do REG-707 na młotki YATO



REG-993
Display rack for REG-707 for YATO pneumatic tools /
Ekspozytor do REG-707 na narzędzia pneumatyczne YATO



REG-951
Display for carpentry clamps /
Ekspozytor na ściiski stolarskie



REG-804
Tag for YATO shoes / Zawieszka na buty YATO



REG-991
Display rack for REG-707 for YATO disc saws /
Ekspozytor do REG-707 na piły tarczowe YATO



REG-952
Display for the disc for disc cutters /
Ekspozytor na tarcze do szlifierek kątowych



REG-761
Hook for axes / Wieszak na siekiery



REG-930
Display for YATO buck saws /
Ekspozytor na piły kabłąkowe YATO



REG-868
Hook 30 cm for trowels / Hak 30 cm na kielnie



REG-144
Pendant for wall mounted faucet FALA /
Zawieszka na baterię ścienną FALA



REG-145
Pendant for deck mounted faucet FALA /
Zawieszka na baterię stojącą FALA



REG-909
Display stand for FLO garden tools /
Ekspozytor na narzędzia ogrodowe FLO



REG-911
Pallet display for garden tools /
Ekspozytor paletowy na narzędzia ogrodnicze



REG-799
Display stand VOREL /
Display ekspozycyjny VOREL



REG-902
Standing display for YATO sockets /
Ekspozytor stojący na nasadki YATO



REG-807
Display box for STHOR drill bits /
Ekspozytor skrzynka na wiertła STHOR



REG-604
Wall-stand display rack YATO /
Ekspozytor stojąco-wiszący YATO



REG-605
Waterfall display rack YATO /
Ekspozytor kaskadowy YATO





























REG-705
Advertising wobler YATO /
Wobler reklamowy YATO



REG-803
YATO wrench tester /
Tester kluczy YATO



REG-711
Rack shelf for REG-707 YATO /
Półka do REG-707 YATO

	Colour box		Sleeve
	Box with colour label		White sleeve with label
	PVC colour box		Carton envelope
	Box		Bulk
	Display colour box		Plastic holder
	Hanging colour box		Flag tied on card
	Blister card		Metal box
	Double blister card		Metal box with colour label
	Double blister transparent		Metal box with sleeve
	Half double blister card		Plastic box
	Sliding card		Plastic box with colour sleeve
	Plastic hanger		Plastic case with colour label
	Hanging card		Plastic case with label
	Header card		Plastic case with colour sleeve
	Tied on card		Plastic tube with colour label
	Skin card		Metal clip
	Polybag with header card		Wooden box with sleeve
	Polybag		Pouch
	Printed polybag		Shrink card / Plastic tray
	Polybag with hanger		Nylon case

FALA linear drains create unlimited possibilities for arranging your bathroom!
 Odpływy liniowe FALA stwarzają nieograniczone możliwości w aranżacji Twojej łazienki!



INOX
 STAINLESS
 STEEL

White Glass
75381 – 60 cm
75382 – 70 cm
75383 – 80 cm
75384 – 90 cm

Black Glass
75386 – 60 cm
75387 – 70 cm
75388 – 80 cm
75389 – 90 cm

Olimp
75421 – 60 cm
75422 – 70 cm
75423 – 80 cm
75424 – 90 cm

Line
75448 – 60 cm
75449 – 70 cm
75450 – 80 cm
75451 – 90 cm

It can prevent stink and worms both in use and after dry.

Zapobiega przedostawaniu się zapachów oraz robaków podczas używania, jak i po wysuszeniu.



WET&DRY

Efficient and durable screen prevents siphon trap from clogging up.

Skuteczne i trwałe sito zapobiega zapychaniu syfonu.



STRAINER

Easy cleaning due to a hook included in the delivery.

Łatwe do utrzymania w czystości dzięki dołączonemu haczykowi.



EASYclean

Top-quality precise welded joints warrant drain tightness.

Wysokiej jakości precyzyjne spawy gwarantują szczelność odpływu.



HQwelding

Holders stabilising the body. Additional rigidity through structure supports.

Uchwyty stabilizujące korpus. Dodatkowe usztywnienie konstrukcji w podłodze.



GRIPstrong

Low siphon trap, made of AISI 304 stainless steel, easy to install.

Niski syfon wykonany ze stali nierdzewnej AISI 304 ułatwia instalację.



EXTRAslim

52 mm

Sealing mat included in delivery – necessary in case hydroisolation is to be applied.

Mata uszczelniająca w zestawie – niezbędna część przy wykonywaniu hydroizolacji.



HYDRocloth

Extensive height regulation which enables the drain to be adjusted against the floor level.

Szeroki zakres regulacji wysokości umożliwia dopasowanie odpływu do powierzchni posadzki.



EASYfix





MANUFACTURER / PRODUCENT

TOYA S.A.
ul. Softysowicka 13-15
51-168 Wrocław
☎ (+48 71) 32 46 200
fax: (+48 71) 32 46 370

sales@yato.pl (sale)
export@yato.pl (export)
import@yato.pl (import)

ODDZIAŁ WARSZAWSKI
Teren ProLogis Park Nadarzyn
al. Kaszlanowa 160
05-831 Młochów k. Warszawy

☎ (+48 22) 73 82 800
☎ (+48 22) 73 82 828
sales@yato.pl (sale)
export@yato.pl (export)

TOYA ROMANIA S.A.
Șos. Stefănești, 8-8A,
Stefănești De Jos, Ilfov
☎ (+40 031) 710 8692
office@yato.ro

YATO TOOLS (SHANGHAI) CO., LTD.
No. 1, Lane 1300, East Kangqiao Road
Shanghai, China 201315
☎ (+86 21) 681 829 50
fax: (+86 21) 681 829 51
yato@yato-sh.com

YATO TOOLS (JIAXING) CO., LTD.
No.1033 Yan Hu Road, Baibu Town,
Haiyan County, Jiaxing City, Zhejiang Province, China
☎ (+86 21) 681 829 50
yato@yato-sh.com

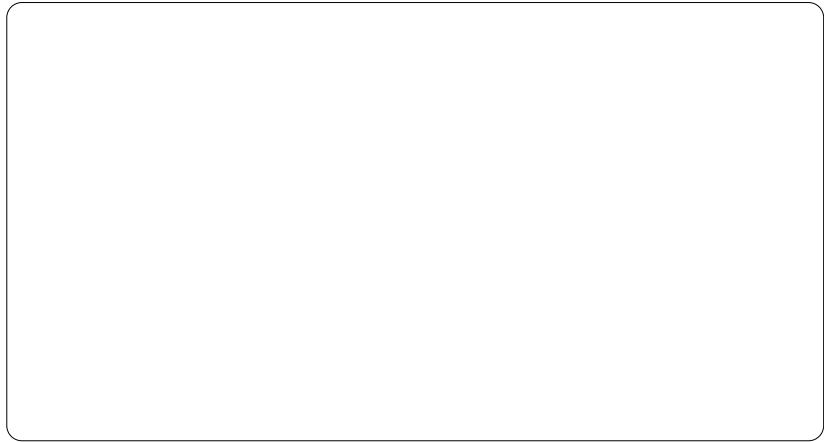

YOUR TRUSTED SUPPLIER / TWÓJ ZAUFANY DOSTAWCA



GET ACQUAINTED WITH OUR WIDE OFFER /
ZOBACZ NASZĄ BOGATĄ OFERTĘ

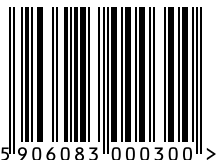
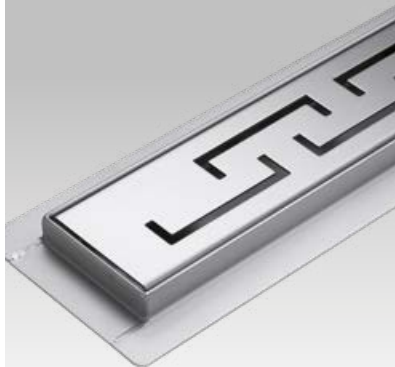

5 906083 000300 >

Copyright © TOYA S.A.