



BIG APPLE

A pleasant disconnection

A pleasant disconnection



The "Big Apple" can be placed in any environment. Placed in an outdoor space, placed in an ambience with bookshelves, or with sound elements, or it can stand alone where an extraordinary ambience begins.



You will find safety and shelter. Without noise and in constant connection with the environment itself.

**BIG
APPLE**

A pleasant disconnection



Wherever you place it, the Big Apple will bring a special atmosphere.



**BIG
APPLE**

Configurator

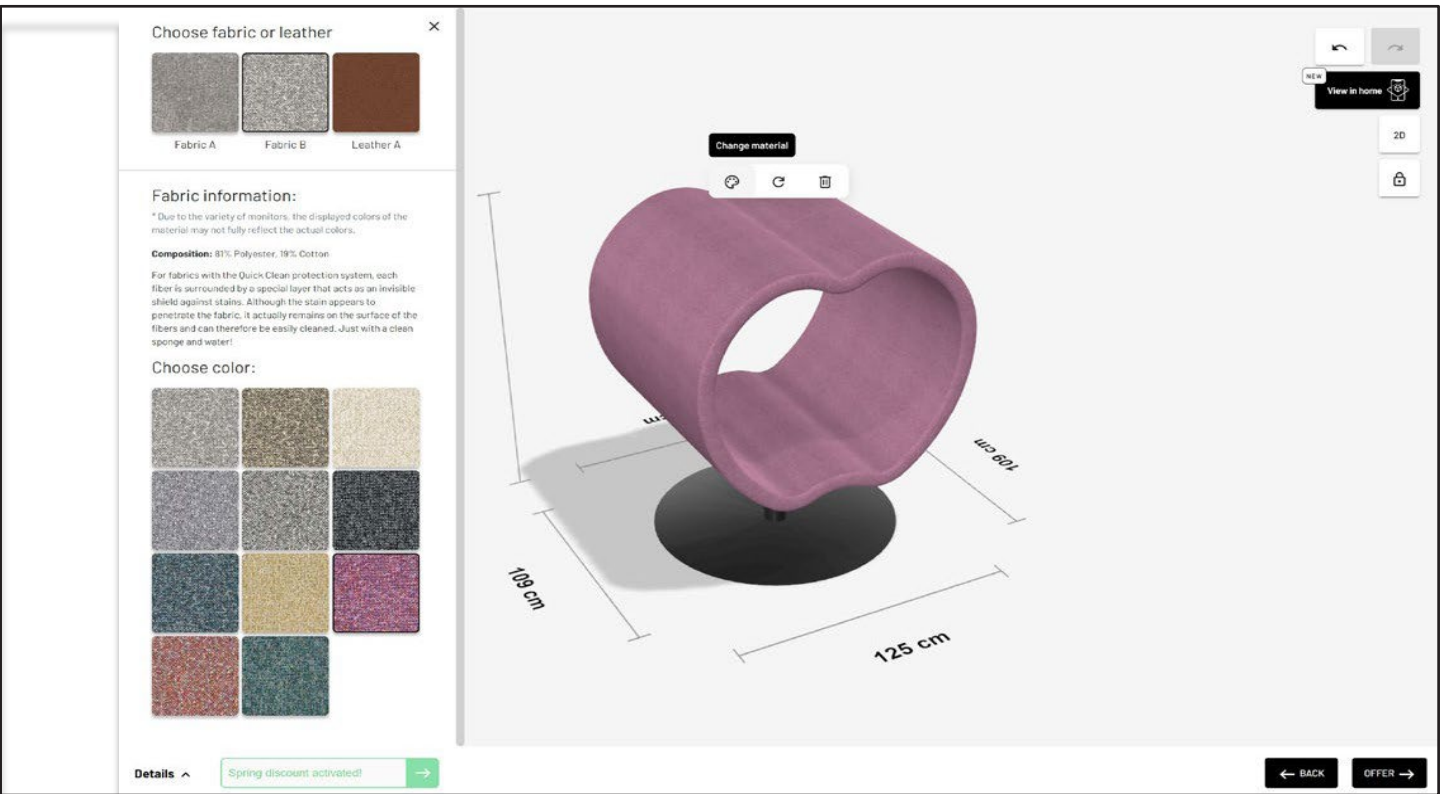

Available in a wide variety of materials that will conjure up comfort according to your taste.

BIG
APPLE

Technical information

Self standing element

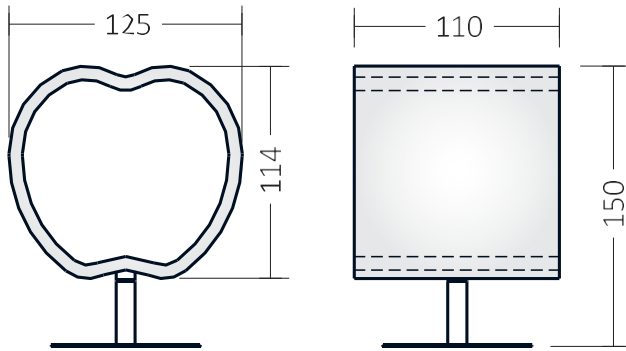

Wall mounted element

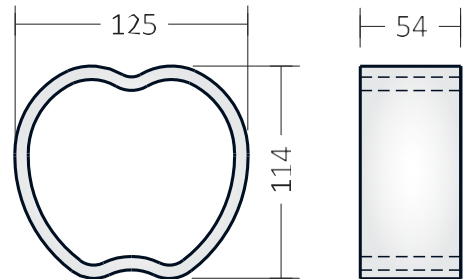

Ergonomics and materials:

Construction:

Hand made element with metal construction and high quality foam.

Upholstery:

Fabrics, artificial or natural leather in many colours.

Optional:

Big apple can be equipped with speakers and bluetooth, holder with charger for smartohone, remote controlled from all devices.

Design:

Klun ambienti / Robert Klun architect

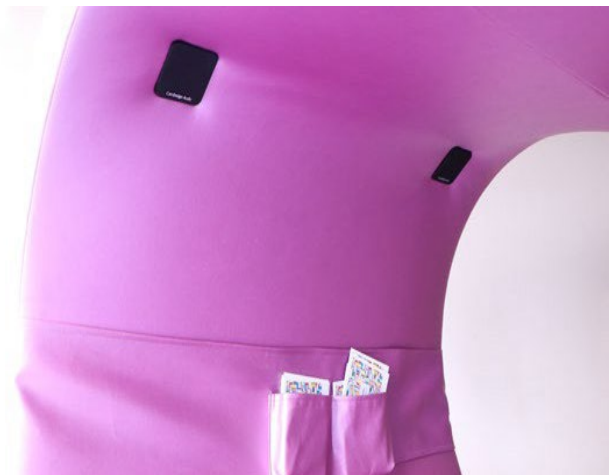

Many additional equipment options are available.

BIG
APPLE

Upholstery materials

Fabrics

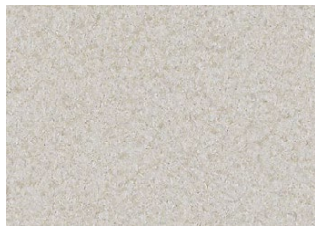
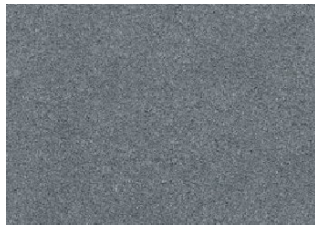
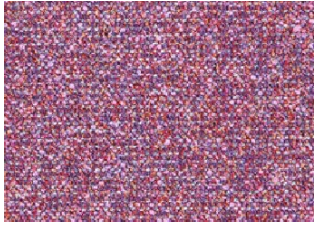

Leather

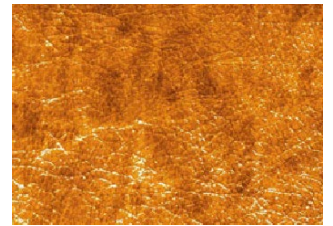
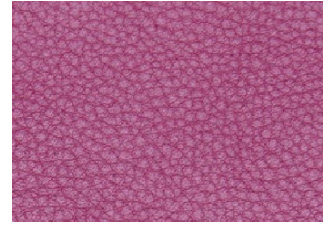
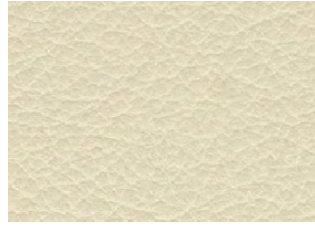

and many other

TOUCH THE HEAVEN

BIG
APPLE

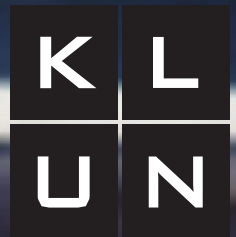

TW CONSULTING
& TRADE LTD.

Wolfgang Tweraser
CEO/President

Tel EU: +356 2701 9052 (office)
Tel EU: +356 9942 9829 (mobile)
Tel UAE: +971 50 209 3055

wolfgang@TWCTMT.com
www.TWCTMT.com