



# structural design portfolio

## Contact us:

☎ VIBER +639686568190

✉ info.znbc@gmail.com

**CLICK HERE TO**  
REQUEST FOR A FREE QUOTE

**ZENO BUILD & CO.**  
DESIGN+CONSTRUCT



STRUCTURAL DESIGN AND ANALYSIS CALCULATIONS START AT  
P35.00/SQM

## RESIDENTIAL STRUCTURE



STRUCTURAL DESIGN AND ANALYSIS CALCULATIONS START AT  
P45.00/SQM

## APARTMENT STRUCTURE



STRUCTURAL DESIGN AND ANALYSIS CALCULATIONS START AT  
P45.00/SQM

## COMMERCIAL STRUCTURE



STRUCTURAL DESIGN AND ANALYSIS CALCULATIONS START AT  
P50.00/SQM

## INDUSTRIAL STRUCTURE

CLICK ON THE CATEGORIES TO VIEW THE PROJECTS

CLICK **HERE** TO  
REQUEST FOR A FREE QUOTE

**ZENOBUILD&CO.**  
DESIGN+CONSTRUCT

**structural  
design  
projects**

**(residential)**

DESIGNERS.BUILDERS.CONSULTANTS  
ZENOBUILD&CO. DESIGN+CONSTRUCT

**ZENOBUILD&CO.**  
DESIGN+CONSTRUCT



PROJECT: DUNGLAO RESIDENCE  
LOCATION: VILLA VICTORIA SUBD. CSFP  
CLIENT: INNOVARC DESIGN & CONSTRUCTION

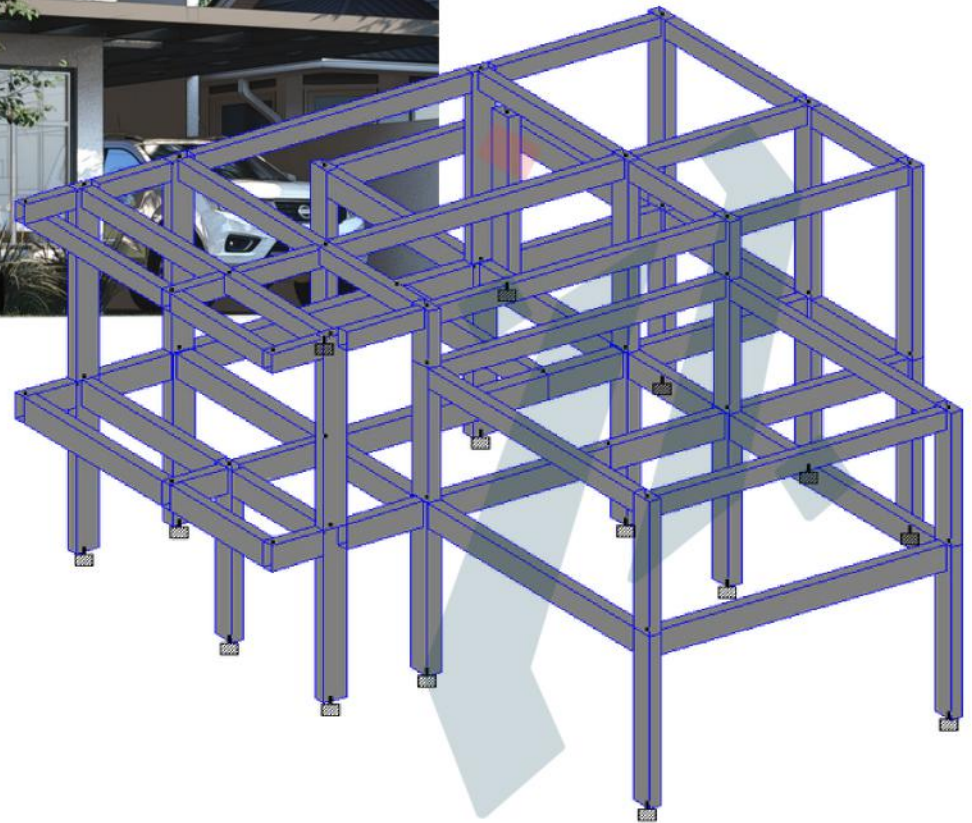

# structural design services

DESIGNERS.BUILDERS.CONSULTANTS  
ZENOBUILD&CO. DESIGN+CONSTRUCT

**ZENOBUILD&CO.**  
DESIGN+CONSTRUCT



PROJECT: PROPOSED 4 BEDROOM 2 STOREY RESIDENCE  
LOCATION: BUENAVISTA SUBD. MABALACAT CITY, PAMPANGA  
CLIENT: INNOVARC DESIGN & CONSTRUCTION

# structural design services

DESIGNERS.BUILDERS.CONSULTANTS  
ZENOBUILD&CO. DESIGN+CONSTRUCT

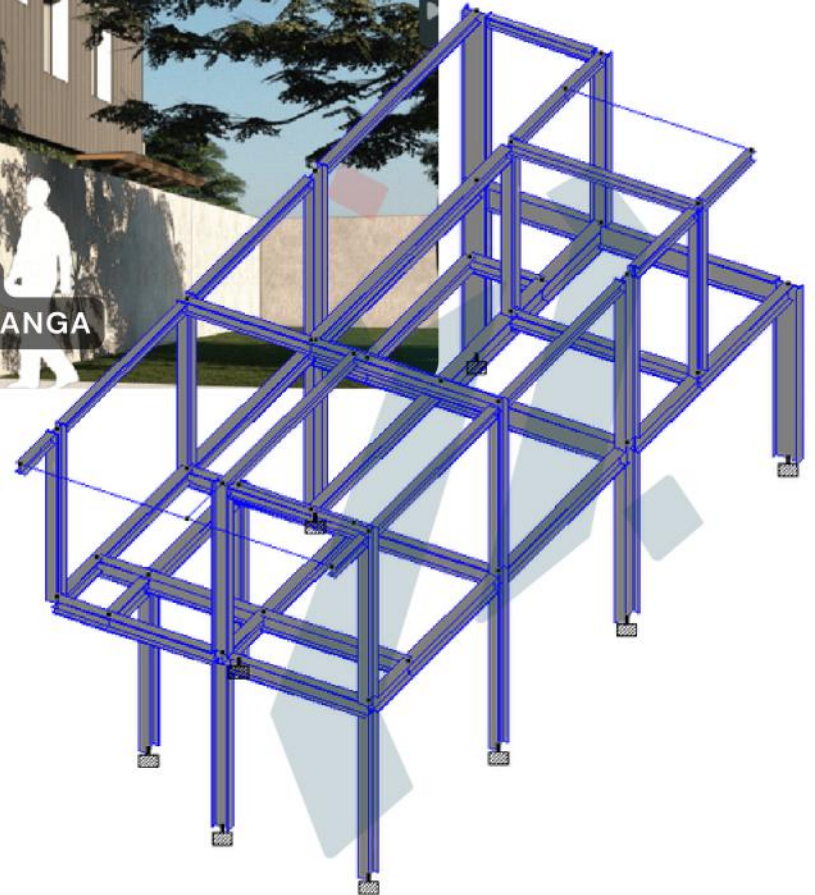

**ZENOBUILD&CO.**  
DESIGN+CONSTRUCT



PROJECT: PROPOSED 3 STOREY RESIDENTIAL BUILDING  
LOCATION: WOODLAND HILLS, SAN MATEO, RIZAL  
CLIENT: INNOVARC DESIGN & CONSTRUCTION

# structural design services

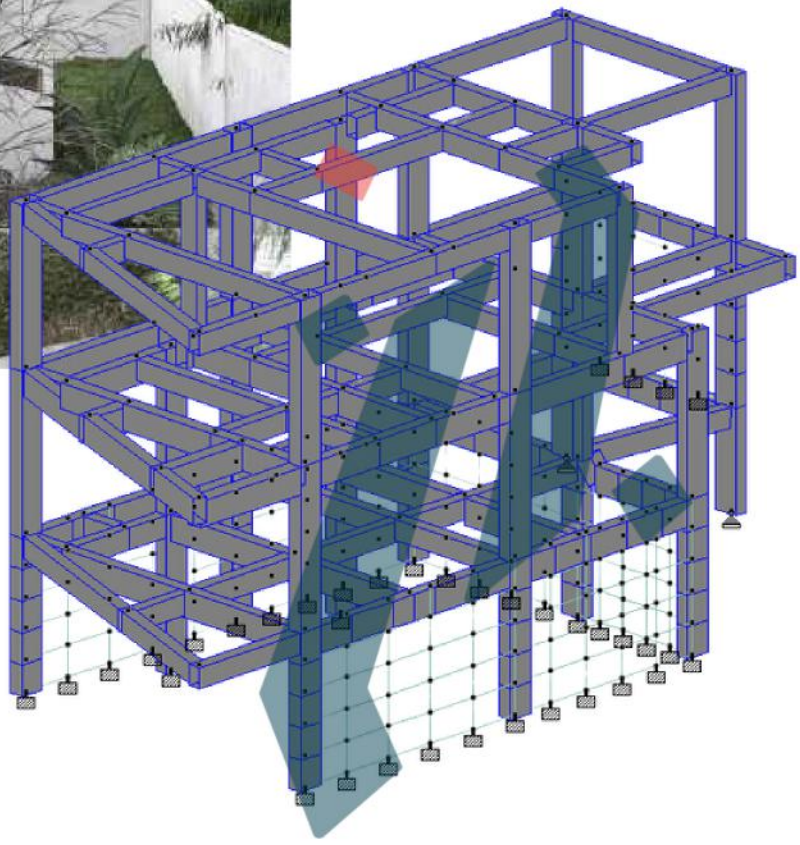

DESIGNERS.BUILDERS.CONSULTANTS  
ZENOBUILD&CO. DESIGN+CONSTRUCT

**ZENOBUILD&CO.**  
DESIGN+CONSTRUCT



PROJECT: PROPOSED 2 STOREY RESIDENTIAL  
LOCATION: BEVERLY PLACE MEXICO, PAMPANGA  
CLIENT: INNOVARC DESIGN & CONSTRUCTION

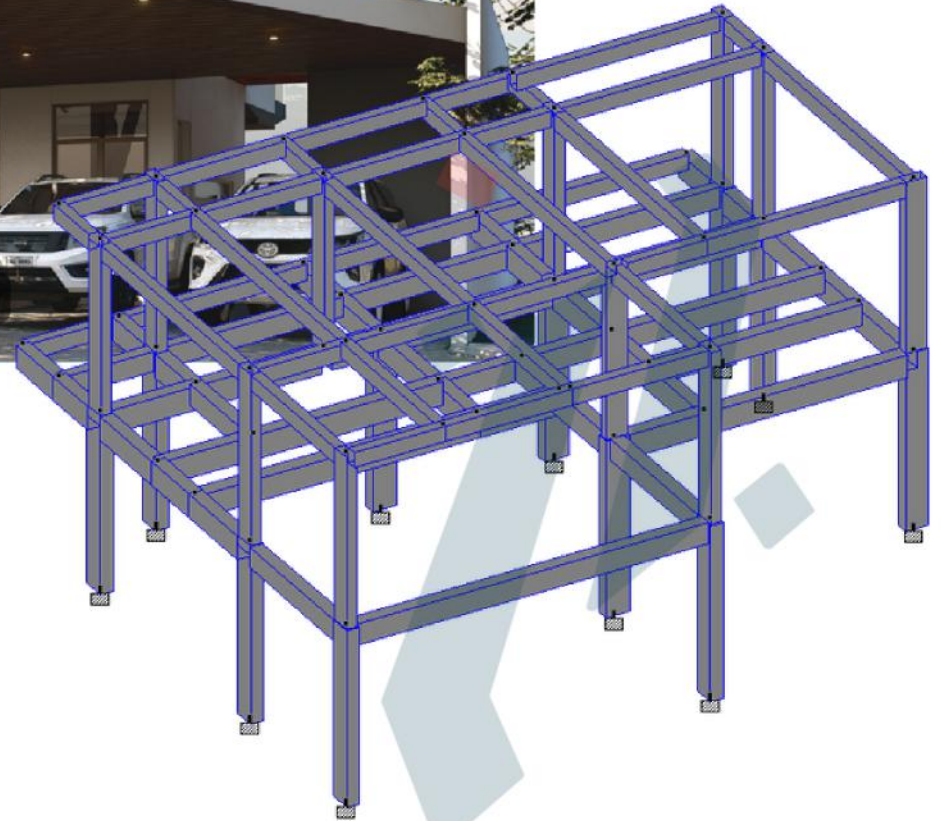

# structural design services

DESIGNERS.BUILDERS.CONSULTANTS  
ZENOBUILD&CO. DESIGN+CONSTRUCT

**ZENOBUILD&CO.**  
DESIGN+CONSTRUCT



PROJECT: PROPOSED TWO STOREY RESIDENCE  
LOCATION: NORTHFIELDS, BULACAN  
CLIENT: INNOVARC DESIGN & CONSTRUCTION

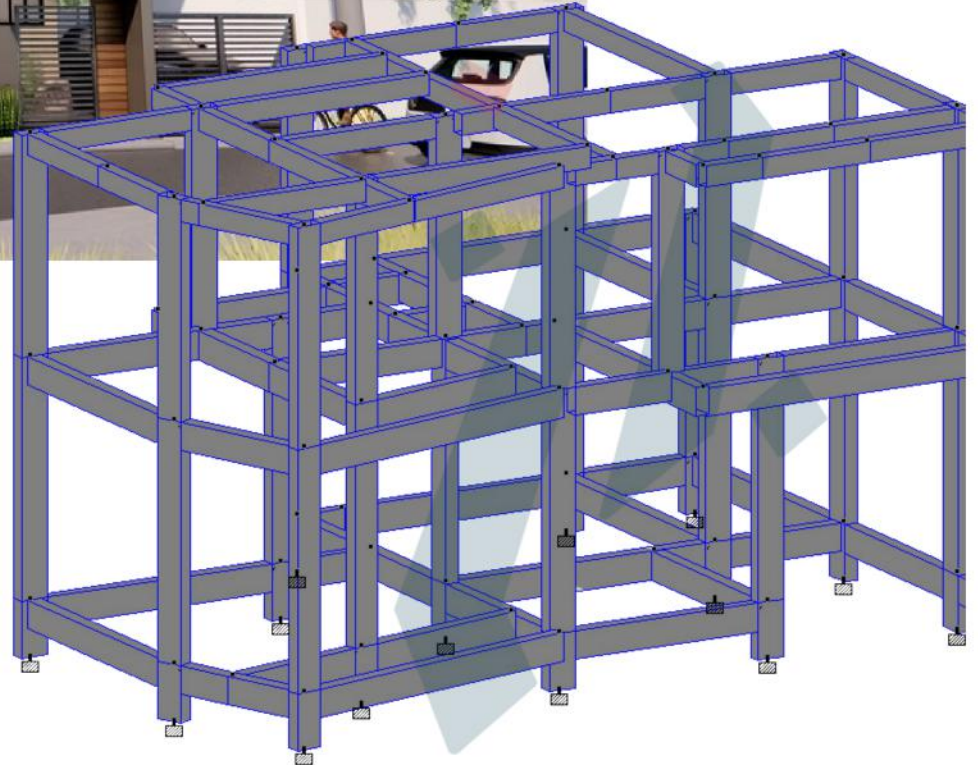

# structural design services

DESIGNERS.BUILDERS.CONSULTANTS  
ZENOBUILD&CO. DESIGN+CONSTRUCT

**ZENOBUILD&CO.**  
DESIGN+CONSTRUCT





PROJECT: A 2 UNIT RESIDENTIAL  
LOCATION: E. SANTOS ST., CONCEPCION  
UNO, MARIKINA CITY  
CLIENT: INNOVARC DESIGN & CONSTRUCTION

# structural design services

DESIGNERS.BUILDERS.CONSULTANTS  
ZENOBUILD&CO. DESIGN+CONSTRUCT

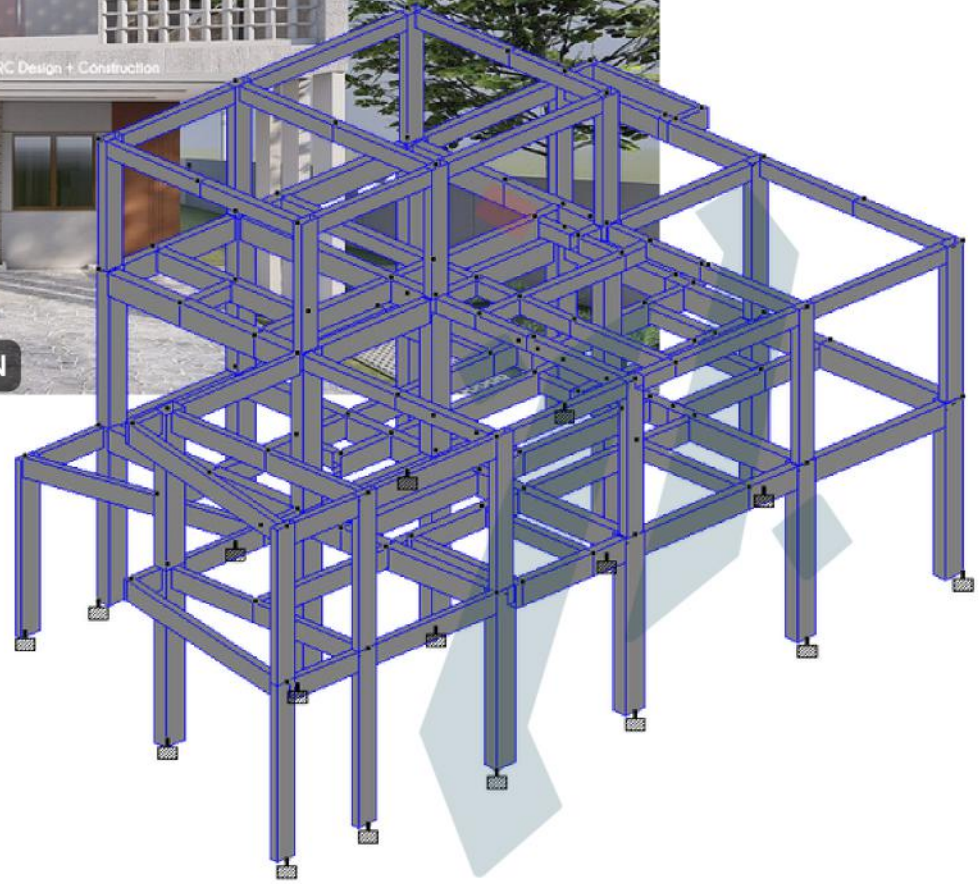

**ZENOBUILD&CO.**  
DESIGN+CONSTRUCT



**PROJECT: PROPOSED TWO STOREY 4 BEDROOM RESIDENCE**  
**LOCATION: PANDI BUSTOS PROVINCIAL RD. BULACAN**  
**CLIENT: INNOVARC DESIGN & CONSTRUCTION**

# structural design services

DESIGNERS.BUILDERS.CONSULTANTS  
ZENOBUILD&CO. DESIGN+CONSTRUCT

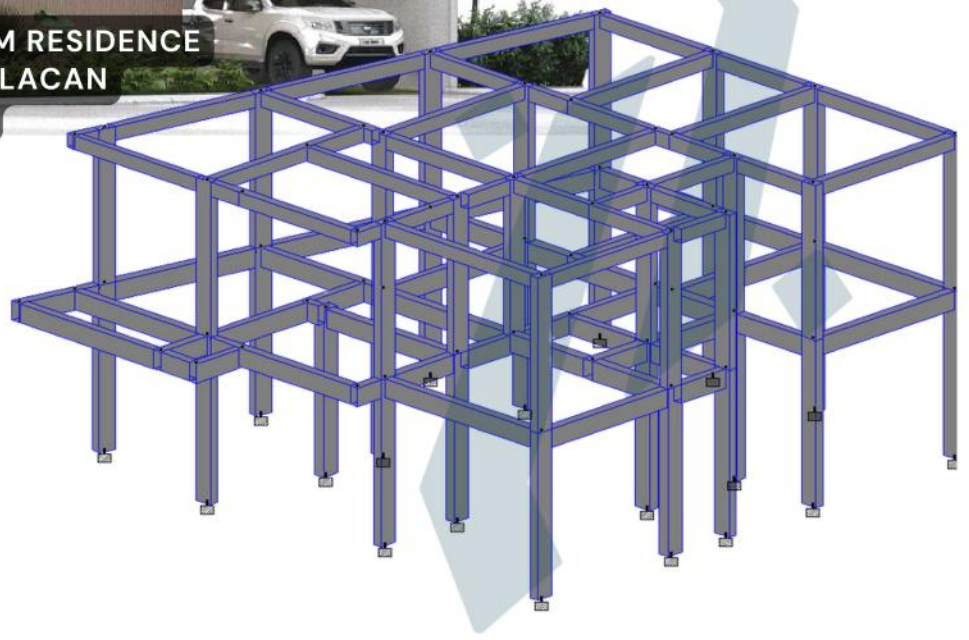



PROJECT: PROPOSED 4-BEDROOM 2-STOREY RESIDENCE  
LOCATION: QUEENSBOROUGH SUBD. SAN JOSE, CITY OF SAN  
FERNANDO, PAMPANGA  
CLIENT: INNOVARC DESIGN & CONSTRUCTION

# structural design services

DESIGNERS.BUILDERS.CONSULTANTS  
ZENOBUILD&CO. DESIGN+CONSTRUCT



**ZENOBUILD&CO.**  
DESIGN+CONSTRUCT



PROJECT: PROPOSED 4-BEDROOM 2-STOREY RESIDENCE  
LOCATION: GREENFIELDS COUNTRY CLUB HOMES  
SINDALANM CITY OF SAN FERNANDO PAMPANGA  
CLIENT: INNOVARC DESIGN & CONSTRUCTION

# structural design services

DESIGNERS.BUILDERS.CONSULTANTS  
ZENOBUILD&CO. DESIGN+CONSTRUCT



**ZENOBUILD&CO.**  
DESIGN+CONSTRUCT



**PROJECT: PROPOSED 2 STOREY 4 BEDROOM RESIDENCE**  
**LOCATION: FOREST PARK HOMES NORTH,**  
**ANGELES CITY, PAMPANGA**  
**CLIENT: JUNIOR BUILDS**

# structural design services

DESIGNERS.BUILDERS.CONSULTANTS  
ZENOBUILD&CO. DESIGN+CONSTRUCT

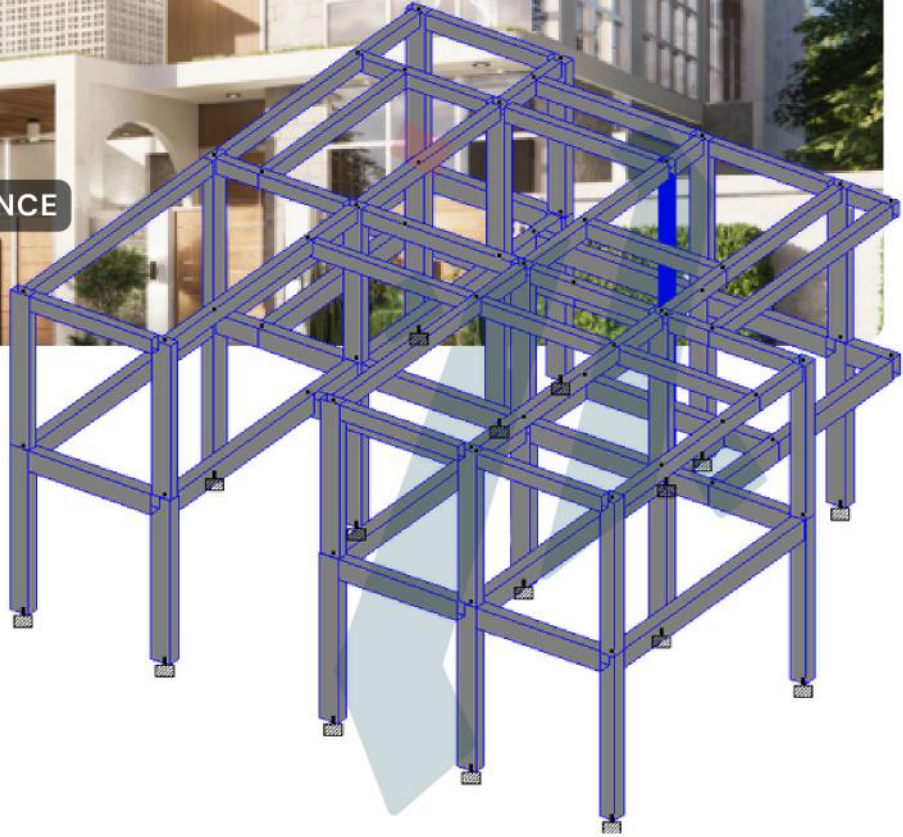

**ZENOBUILD&CO.**  
**DESIGN+CONSTRUCT**



PROJECT: TWO STOREY SHOWROOM RESIDENCE  
LOCATION: ST. FRIENDSHIP PLAZA, ANGELES CITY  
CLIENT: JUNIOR BUILDS

# structural design services

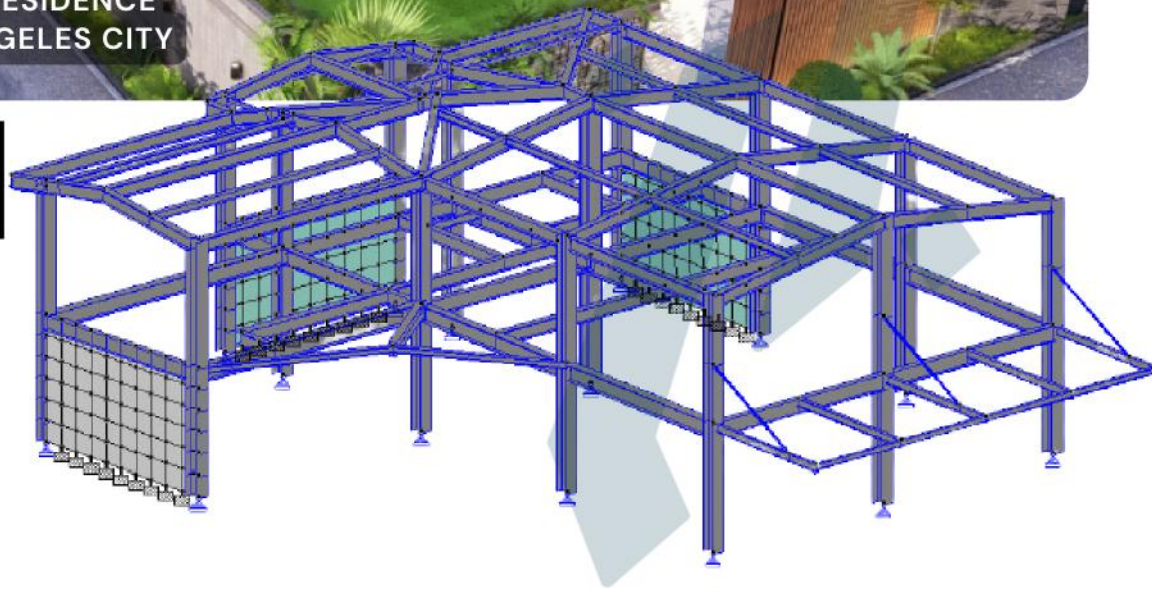

DESIGNERS.BUILDERS.CONSULTANTS  
ZENOBUILD&CO. DESIGN+CONSTRUCT

**ZENOBUILD&CO.**  
DESIGN+CONSTRUCT



PROJECT: TWO STOREY RESIDENTIAL  
LOCATION: NORTHVIEW 2, FILINVEST, QUEZON CITY

# structural design services

DESIGNERS.BUILDERS.CONSULTANTS  
ZENOBUILD&CO. DESIGN+CONSTRUCT

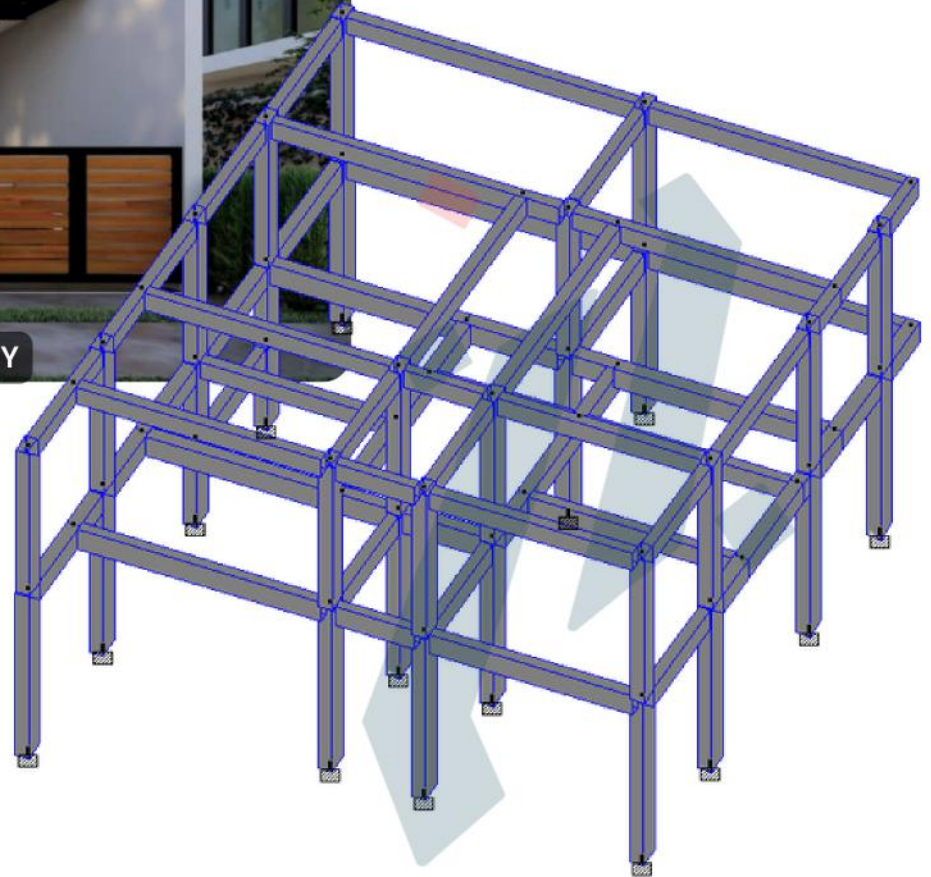

**ZENOBUILD&CO.**  
DESIGN+CONSTRUCT



PROJECT: PROPOSED TWO STOREY RESIDENCE  
LOCATION: BUENAVISTA RESIDENTIAL VILLAGE SUBD.,  
MABALACAT, PAMPANGA

# structural design services

DESIGNERS.BUILDERS.CONSULTANTS  
ZENOBUILD&CO. DESIGN+CONSTRUCT

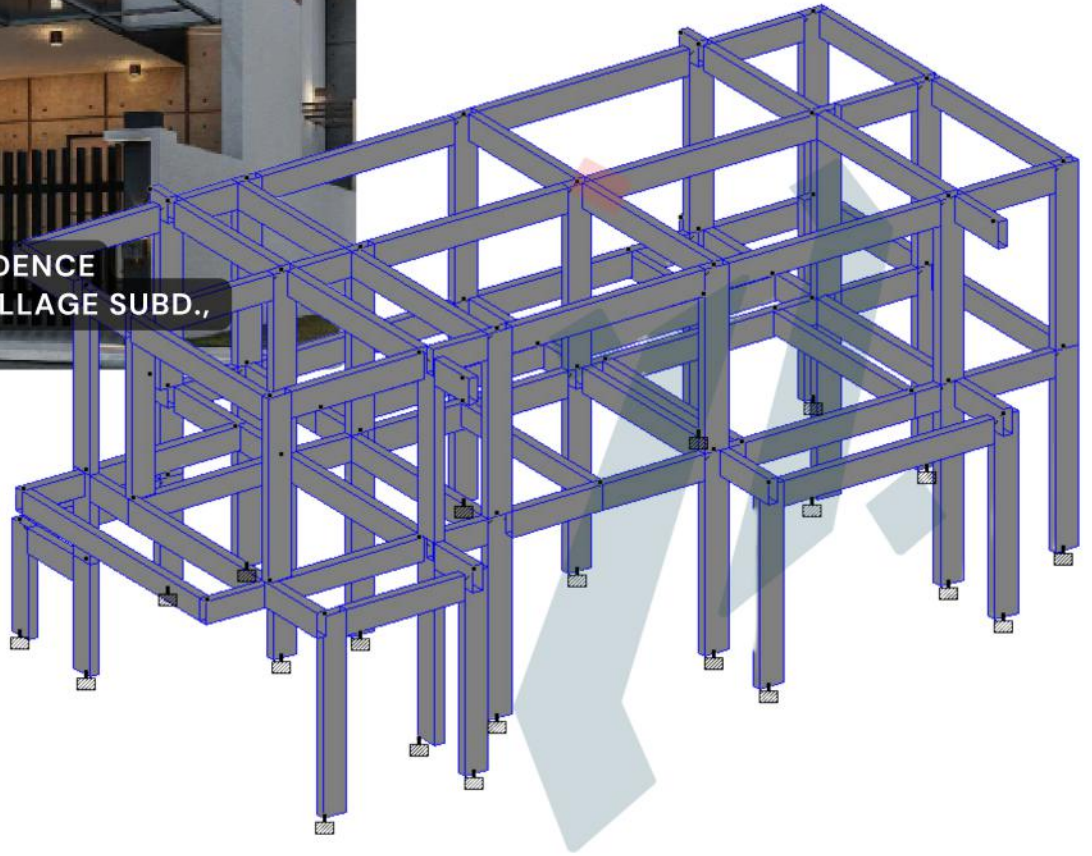

**ZENOBUILD&CO.**  
DESIGN+CONSTRUCT





PROJECT: PROPOSED BUNGALOW W/ MEZZANINE  
LOCATION: BRGY. LAPAZ, SAN NARCISO, ZAMBALES

# structural design services

DESIGNERS.BUILDERS.CONSULTANTS  
ZENOBUILD&CO. DESIGN+CONSTRUCT

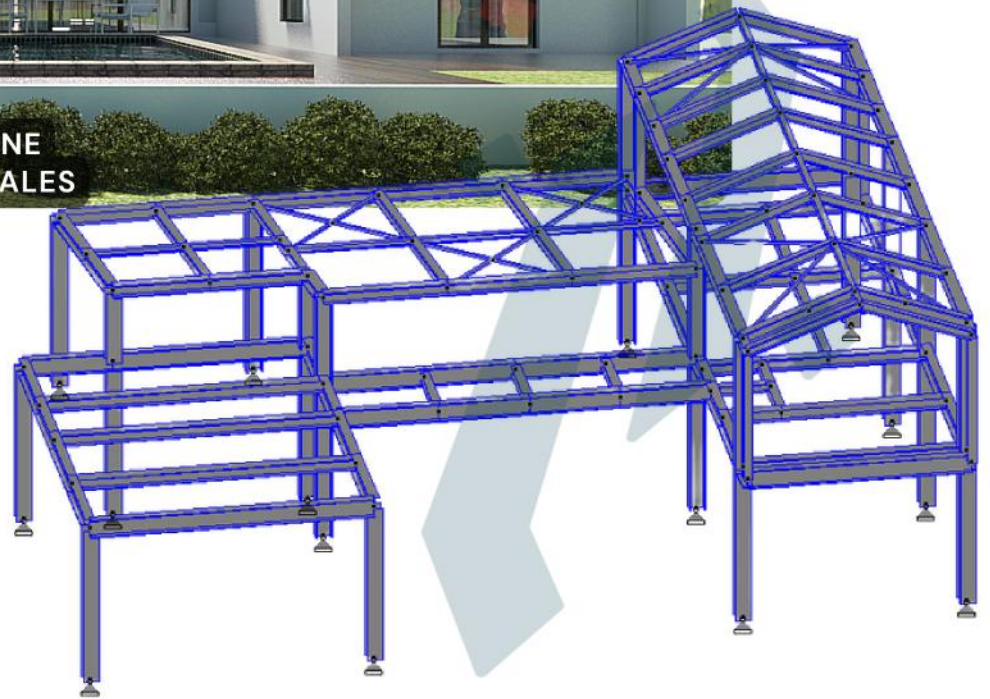

**ZENOBUILD&CO.**  
DESIGN+CONSTRUCT



PROJECT: PROPOSED TWO STOREY RESIDENTIAL BUILDING  
LOCATION: AMAIA SCAPES

# structural design services

DESIGNERS.BUILDERS.CONSULTANTS  
ZENOBUILD&CO. DESIGN+CONSTRUCT

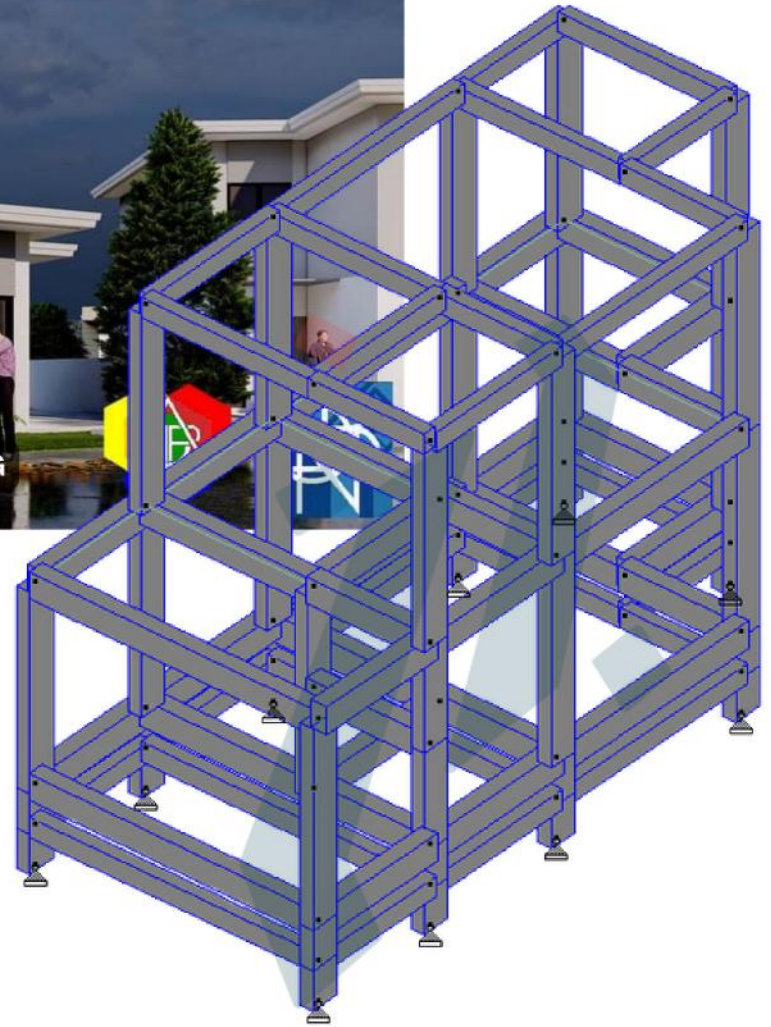

**ZENOBUILD&CO.**  
DESIGN+CONSTRUCT



PROJECT: PROPOSED 2 STOREY RESIDENCE  
LOCATION: BRGY. MINING, ANGELES CITY, PAMPANGA

# structural design services

DESIGNERS.BUILDERS.CONSULTANTS  
ZENOBUILD&CO. DESIGN+CONSTRUCT

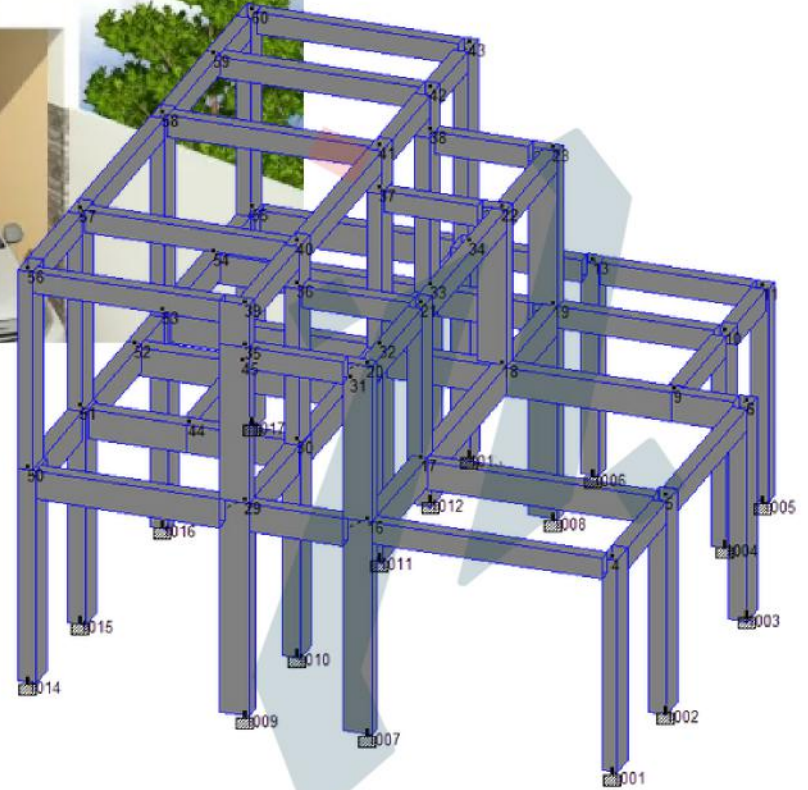

**ZENOBUILD&CO.**  
DESIGN+CONSTRUCT



PROJECT: PROPOSED RESIDENTIAL BUILDING  
LOCATION: METROGATE DASMARINAS, CAVITE  
CLIENT: AR. FRANCIS ACOSTA

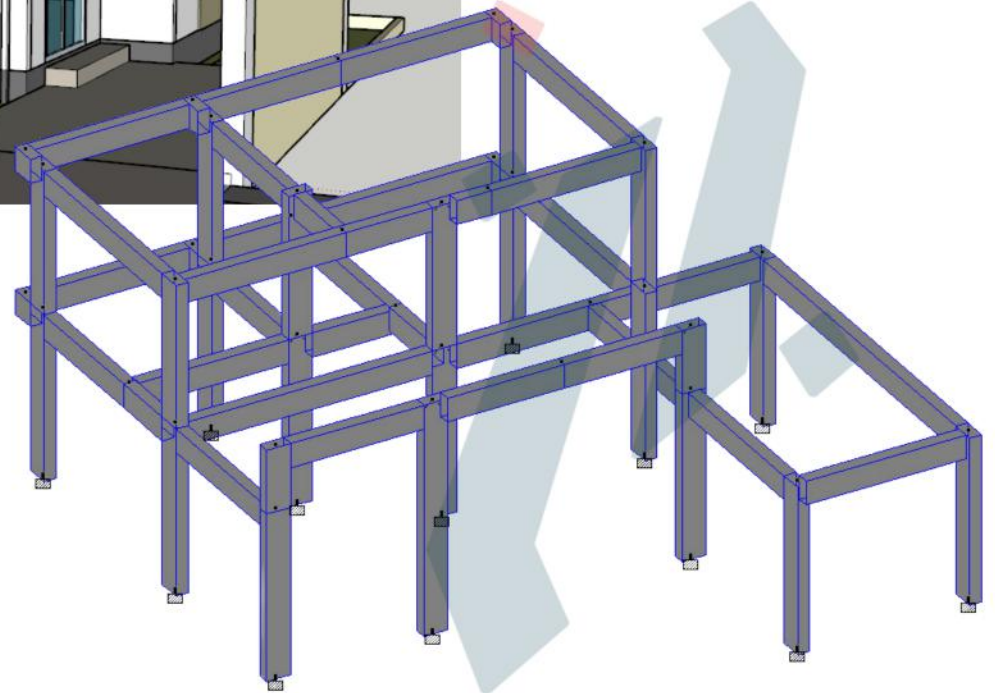

# structural design services

DESIGNERS.BUILDERS.CONSULTANTS  
ZENOBUILD&CO. DESIGN+CONSTRUCT

**ZENOBUILD&CO.**  
DESIGN+CONSTRUCT



PROJECT: PROPOSED 2 STOREY RESIDENCE  
LOCATION: CITY OF MALOLOS, BULACAN

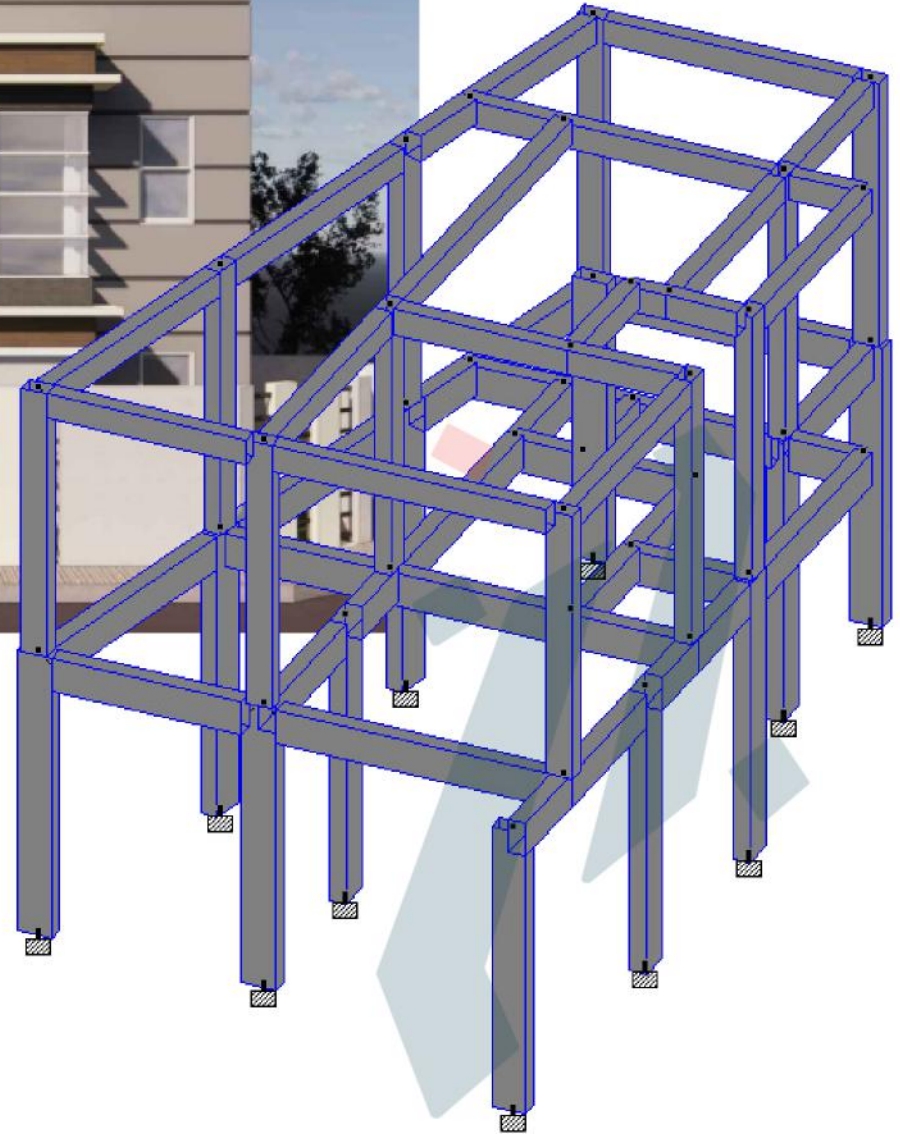

# structural design services

DESIGNERS.BUILDERS.CONSULTANTS  
ZENOBUILD&CO. DESIGN+CONSTRUCT

**ZENOBUILD&CO.**  
DESIGN+CONSTRUCT



PROJECT: PROPOSED 2 STOREY RESIDENCE  
LOCATION: CITY OF MABALACAT, PAMPANGA

# structural design services

DESIGNERS.BUILDERS.CONSULTANTS  
ZENOBUILD&CO. DESIGN+CONSTRUCT

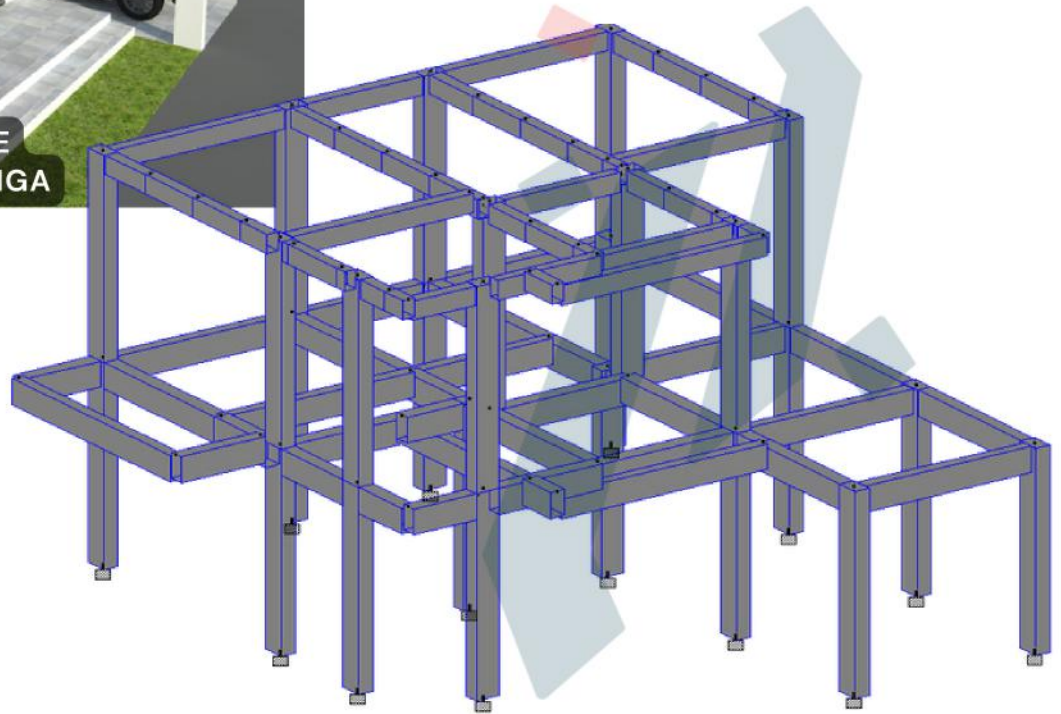

**ZENOBUILD&CO.**  
DESIGN+CONSTRUCT



PROJECT: PROPOSED TWO STOREY RESIDENCE  
LOCATION: CITY OF MABALACAT, PAMPANGA

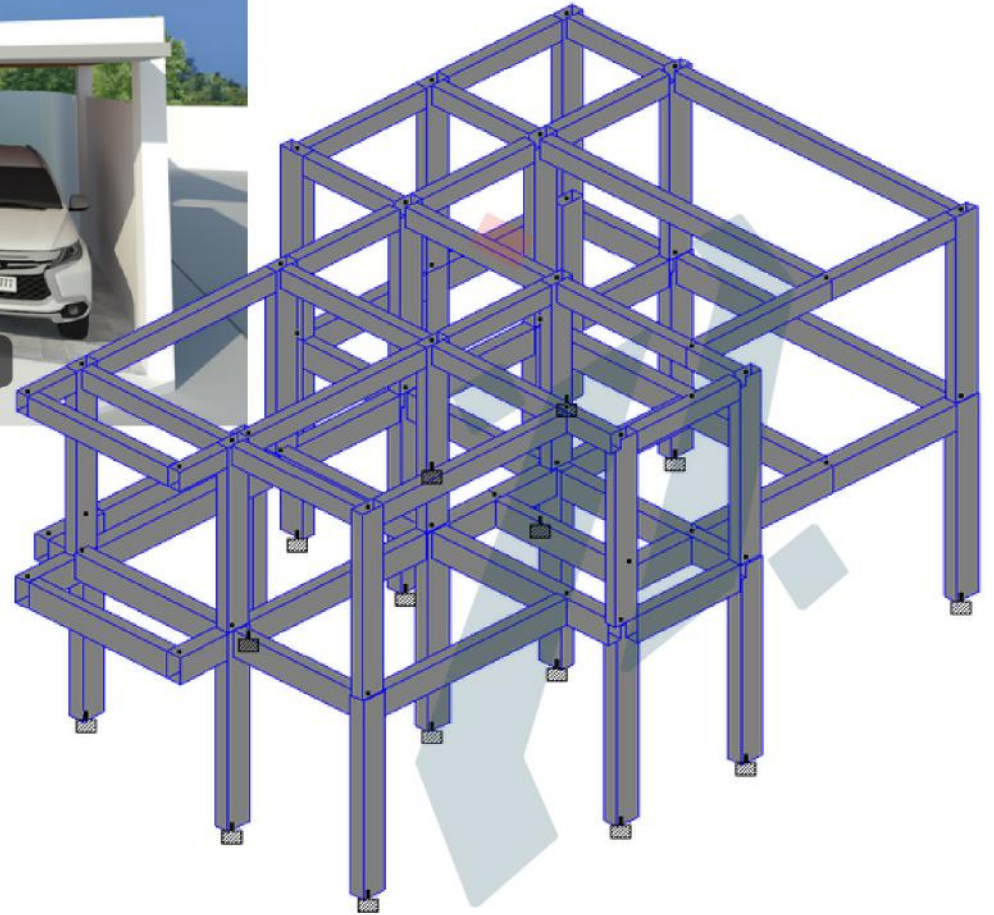

# structural design services

DESIGNERS.BUILDERS.CONSULTANTS  
ZENOBUILD&CO. DESIGN+CONSTRUCT

**ZENOBUILD&CO.**  
DESIGN+CONSTRUCT



PROJECT: PROPOSED TWO STOREY RESIDENCE  
LOCATION: TOWN AND COUNTRY HOMES ANGELES CITY

# structural design services

DESIGNERS.BUILDERS.CONULTANTS  
ZENOBUILD&CO. DESIGN+CONSTRUCT

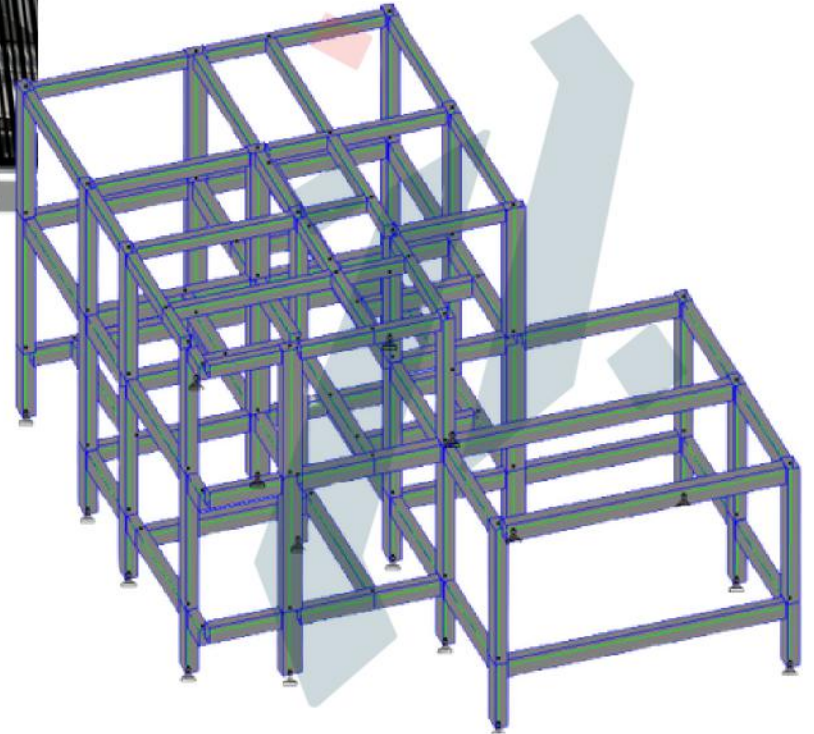

**ZENOBUILD&CO.**  
DESIGN+CONSTRUCT





PROJECT: PROPOSED 2 STOREY RESIDENCE  
LOCATION: VILLA FRANDA SUBD.  
CITY OF SAN FERNANDO, PAMPANGA

# structural design services

DESIGNERS.BUILDERS.CONSULTANTS  
ZENOBUILD&CO. DESIGN+CONSTRUCT

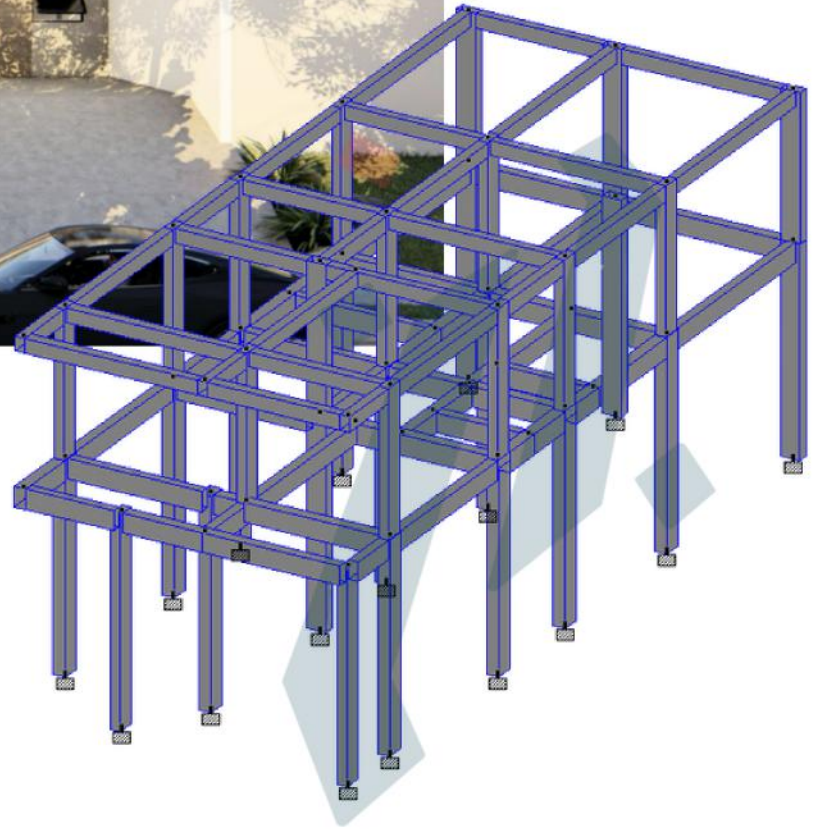

**ZENOBUILD&CO.**  
DESIGN+CONSTRUCT



PROJECT: PROPOSED 2 STOREY RESIDENTIAL BUILDING  
LOCATION: BRGY. POBLACION PORAC, PAMPANGA  
CLIENT: 30 DRAGON DEVELOPMENT CORPORATION

# structural design services

DESIGNERS.BUILDERS.CONSULTANTS  
ZENOBUILD&CO. DESIGN+CONSTRUCT

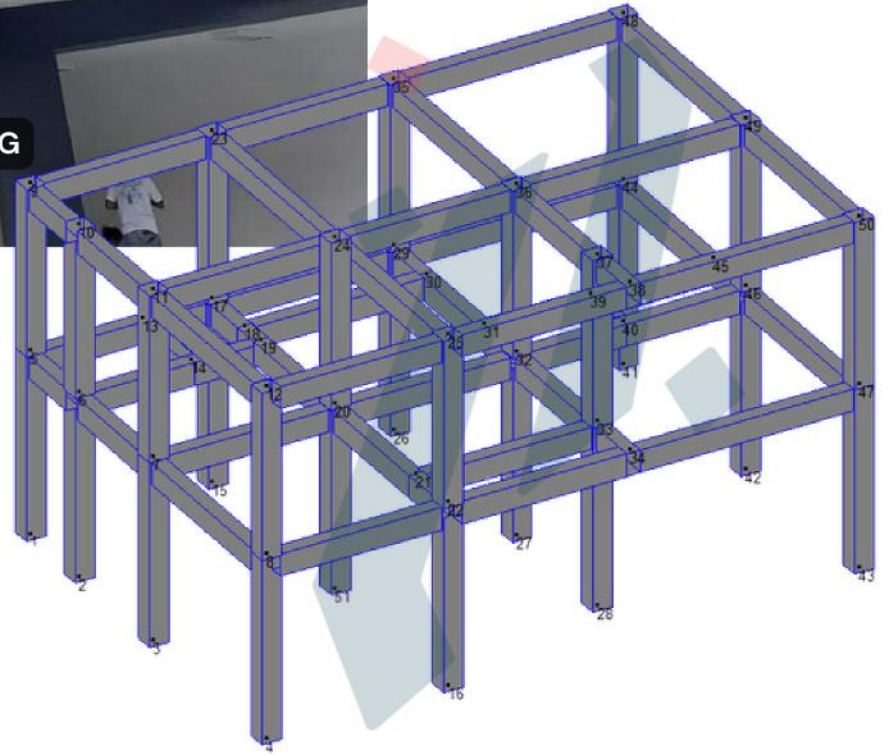

**ZENOBUILD&CO.**  
DESIGN+CONSTRUCT



PROJECT: PROPOSED SPLIT LEVEL  
RESIDENTIAL BUILDING  
LOCATION: CLARK MANOR, MABALACAT, PAMPANGA

# structural design services

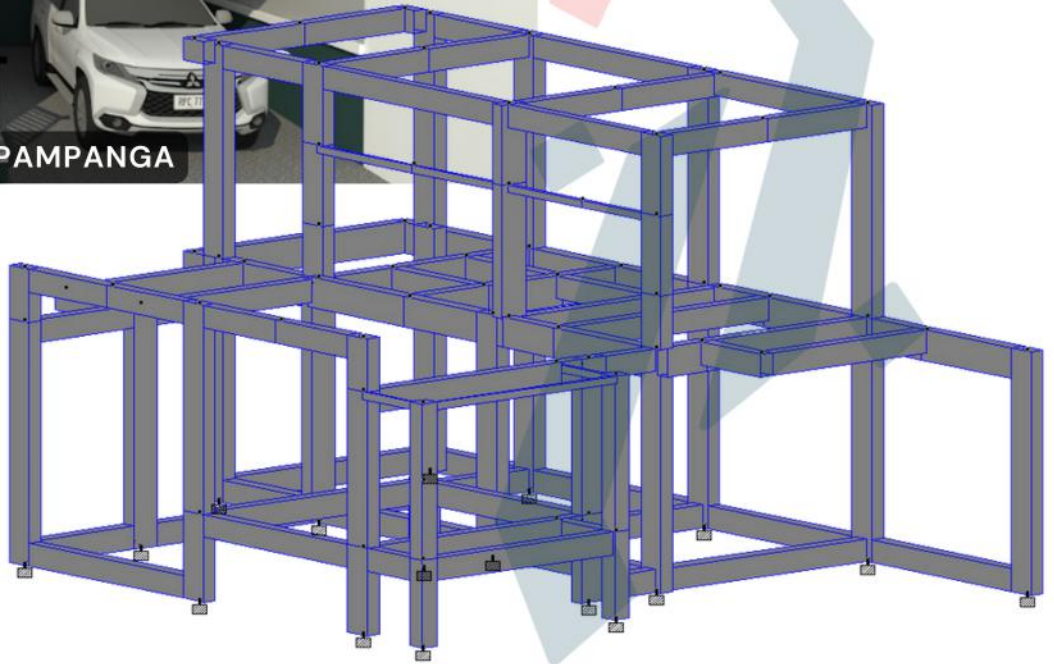

DESIGNERS.BUILDERS.CONULTANTS  
ZENOBUILD&CO. DESIGN+CONSTRUCT

**ZENOBUILD&CO.**  
DESIGN+CONSTRUCT



PROJECT: PROPOSED 2 STOREY 3 BEDROOM RESIDENCE  
LOCATION: CITY OF SAN FERNANDO, PAMPANGA

# structural design services

DESIGNERS.BUILDERS.CONSULTANTS  
ZENOBUILD&CO. DESIGN+CONSTRUCT

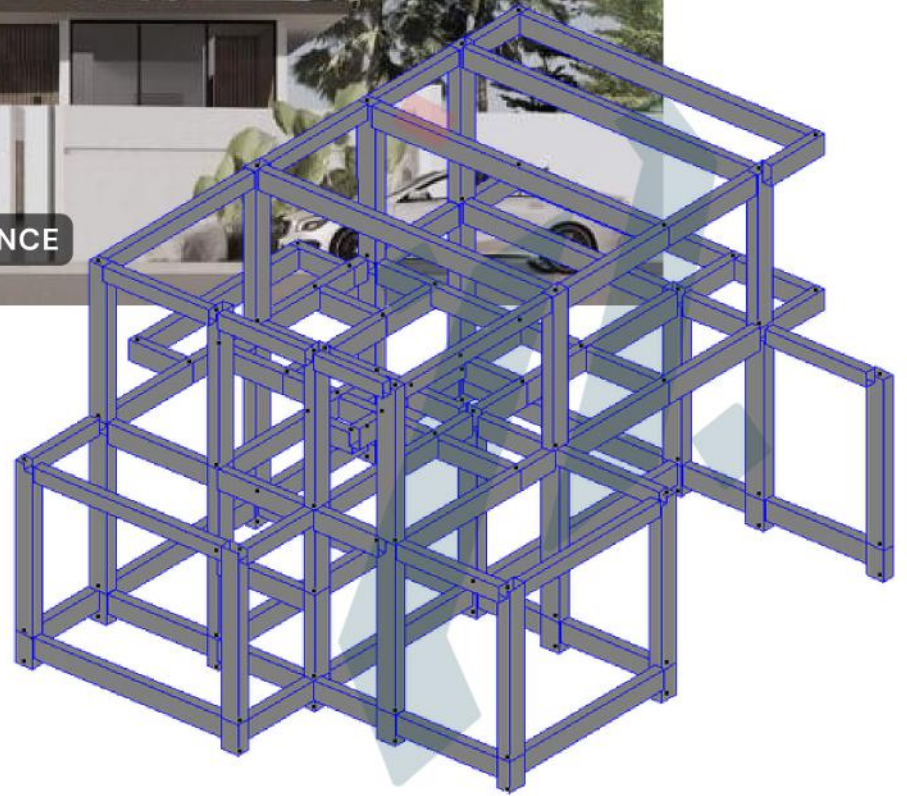

**ZENOBUILD&CO.**  
DESIGN+CONSTRUCT



PROJECT: PROPOSED FIVE BEDROOM,  
THREE STOREY RESIDENTIAL  
LOCATION: SAN SIMON, PAMPANGA

# structural design services

DESIGNERS.BUILDERS.CONSULTANTS  
ZENOBUILD&CO. DESIGN+CONSTRUCT

**ZENOBUILD&CO.**  
DESIGN+CONSTRUCT



PROJECT: PROPOSED 6 BEDROOM 3 STOREY RESIDENTIAL  
LOCATION: KINGSVILLE, BRGY. MAYAMOT, ANTIPOLO, RIZAL  
CLIENT: CONFABRICOR MODERN ARCHITECTURE

1:1

# structural design services

DESIGNERS.BUILDERS.CONSULTANTS  
ZENOBUILD&CO. DESIGN+CONSTRUCT

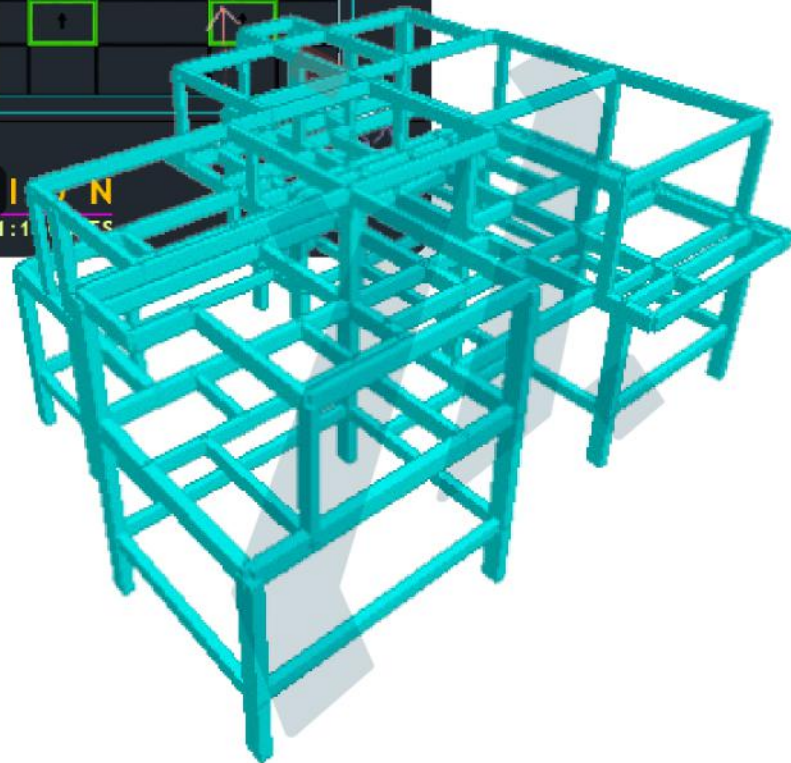

**ZENOBUILD&CO.**  
DESIGN+CONSTRUCT



PROJECT: PROPOSED 2 STOREY RESIDENTIAL BUILDING  
LOCATION: BRGY. STA. INES, MABALACAT CITY, PAMPANGA

# structural design services

DESIGNERS.BUILDERS.CONSULTANTS  
ZENOBUILD&CO. DESIGN+CONSTRUCT

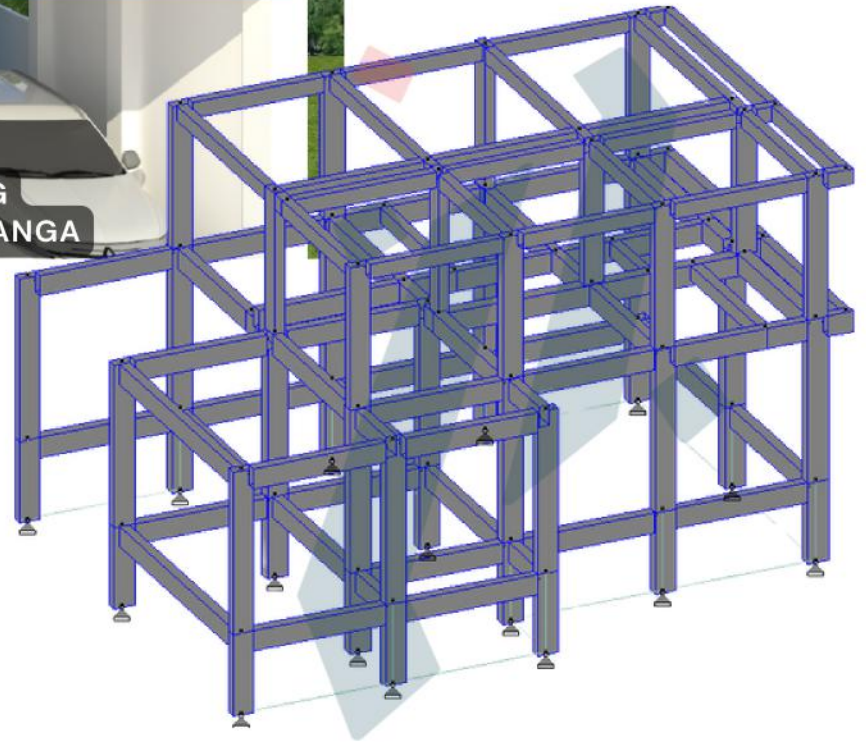

**ZENOBUILD&CO.**  
DESIGN+CONSTRUCT



PROJECT: PROPOSED 2 STOREY RESIDENTIAL BUILDING  
LOCATION: BRGY. STA. CATALINA, ANGELES CITY, PAMPANGA

# structural design services

DESIGNERS.BUILDERS.CONSULTANTS  
ZENOBUILD&CO. DESIGN+CONSTRUCT

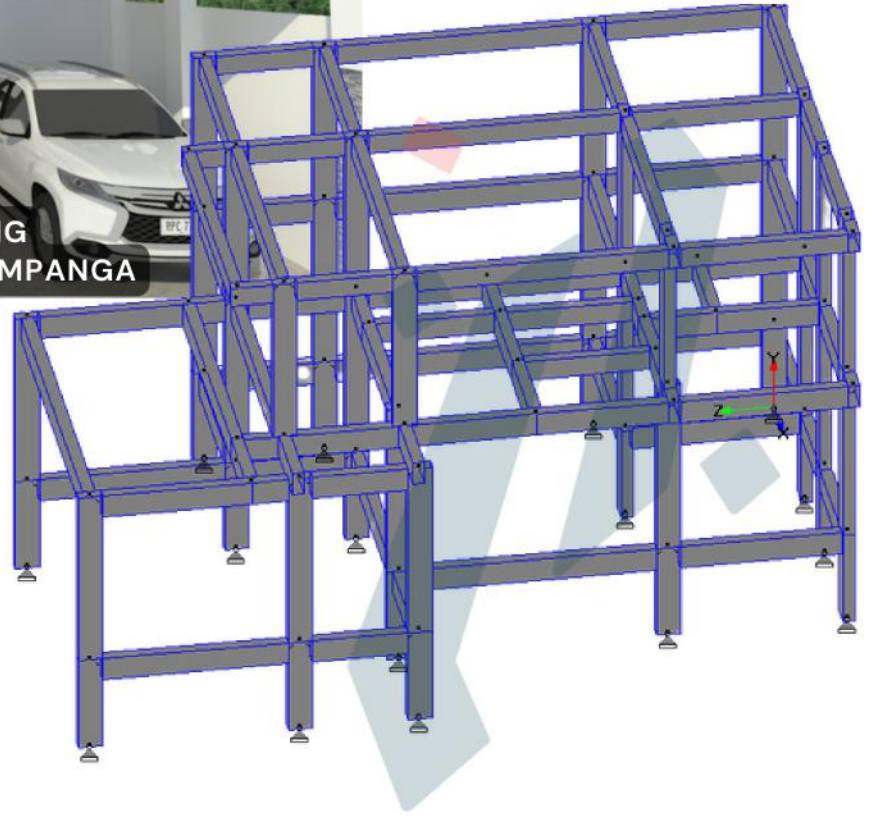

**ZENOBUILD&CO.**  
DESIGN+CONSTRUCT



# structural design projects (apartments)

DESIGNERS.BUILDERS.CONSULTANTS  
ZENOBUILD&CO. DESIGN+CONSTRUCT

**ZENOBUILD&CO.**  
DESIGN+CONSTRUCT



PROJECT: PROPOSED THREE STOREY APARTMENT  
LOCATION: BRGY. TABUN ANGELES CITY, PAMPANGA

# structural design services

DESIGNERS.BUILDERS.CONSULTANTS  
ZENOBUILD&CO. DESIGN+CONSTRUCT

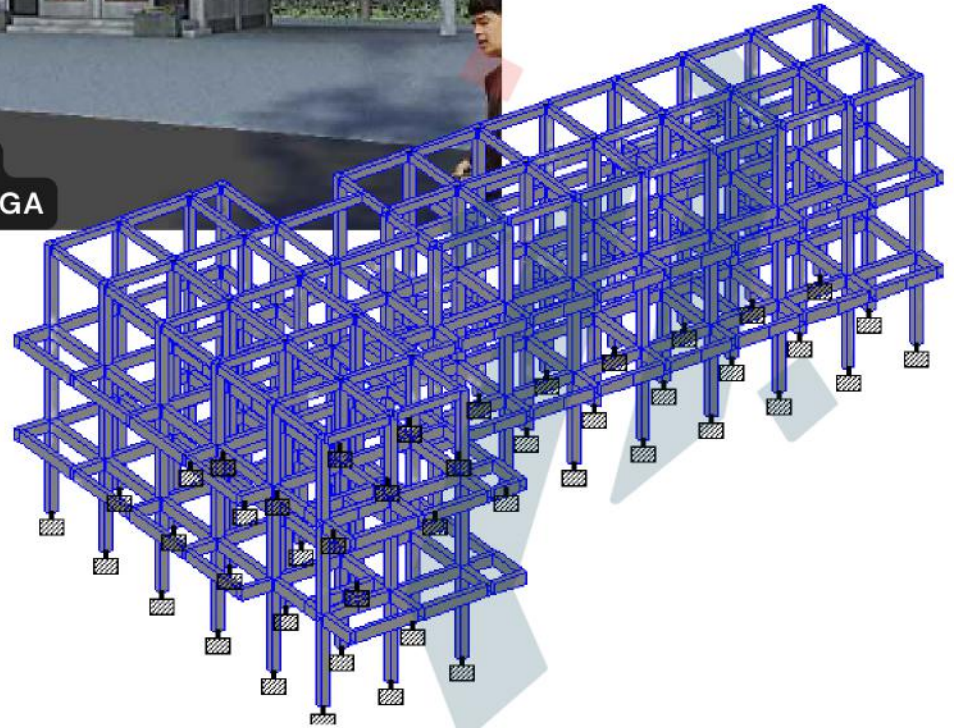

**ZENOBUILD&CO.**  
DESIGN+CONSTRUCT



PROJECT: PROPOSED TWO STOREY DORMITORY  
LOCATION: BRGY. CUTCUT ANGELES CITY  
CLIENT: 30DRAGON DEVELOPMENT CORPORATION

# structural design services

DESIGNERS.BUILDERS.CONSULTANTS  
ZENOBUILD&CO. DESIGN+CONSTRUCT

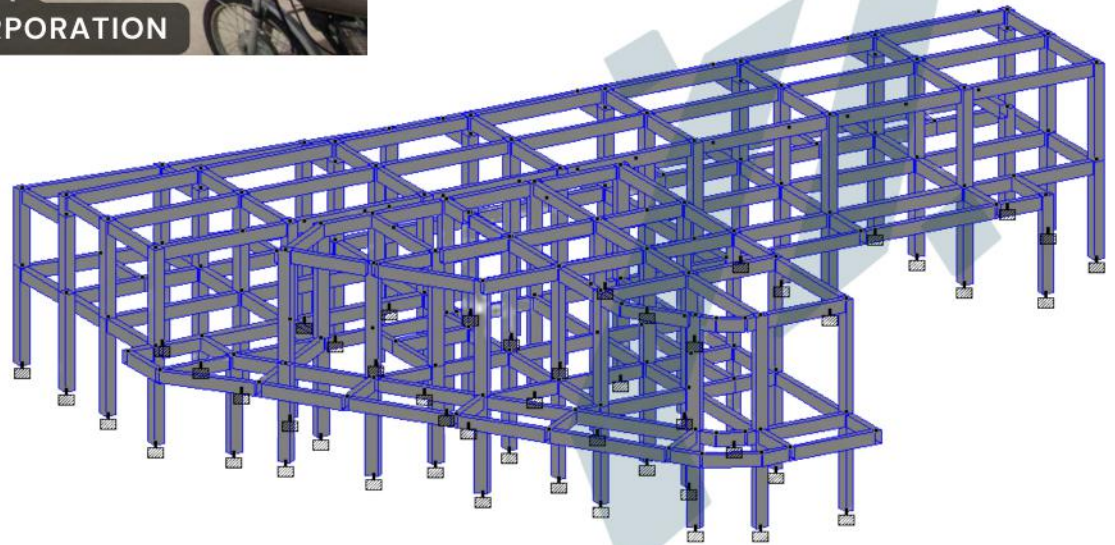

**ZENOBUILD&CO.**  
DESIGN+CONSTRUCT



PROJECT: PROPOSED TWO STOREY 6-UNITS APARTMENT  
LOCATION: BRGY. DAU, MABALACAT, PAMPANGA

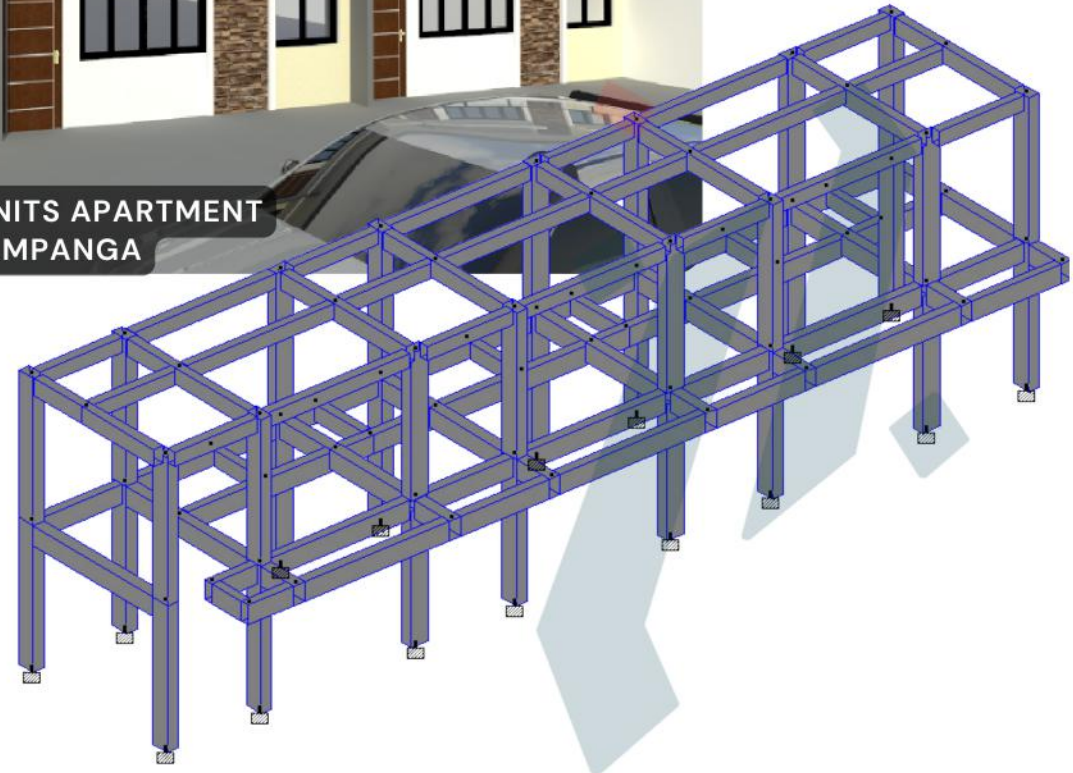

# structural design services

DESIGNERS.BUILDERS.CONSULTANTS  
ZENOBUILD&CO. DESIGN+CONSTRUCT

**ZENOBUILD&CO.**  
DESIGN+CONSTRUCT



PROJECT: PROPOSED 2 STOREY 7 UNIT APARTMENT  
LOCATION: M.L. QUEZON CITY ST., IBA MABALACAT, PAMPANGA

# structural design services

DESIGNERS.BUILDERS.CONSULTANTS  
ZENOBUILD&CO. DESIGN+CONSTRUCT

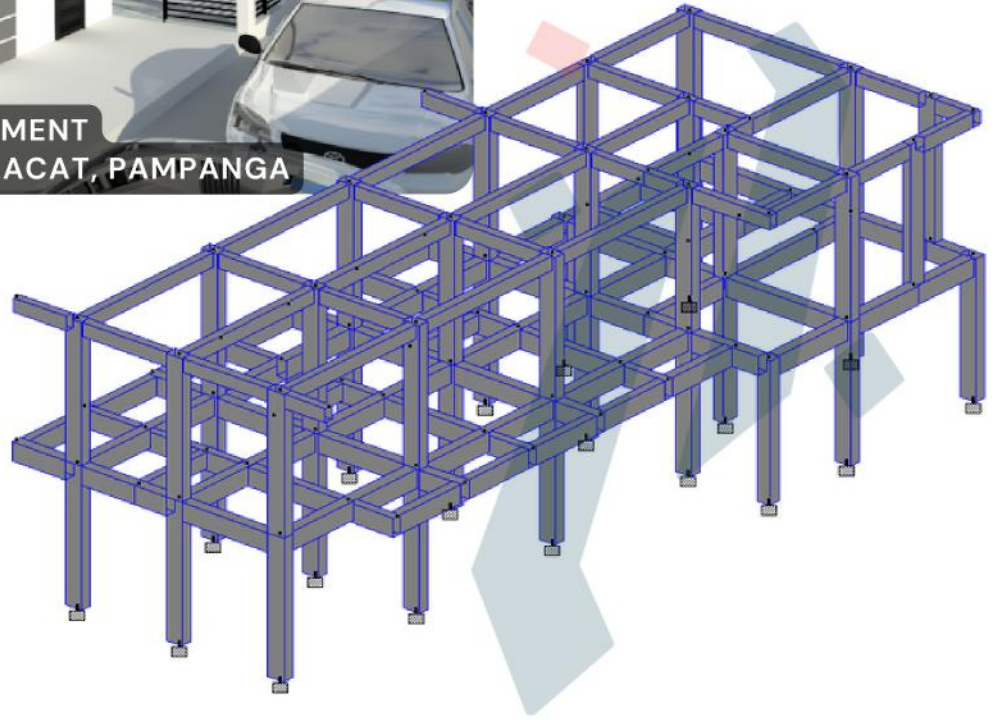

**ZENOBUILD&CO.**  
DESIGN+CONSTRUCT



PROJECT: PROPOSED TWO STOREY 9 UNITS APARTMENT  
LOCATION: BRGY. PANDAN, ANGELES CITY, PAMPANGA

# structural design services

DESIGNERS.BUILDERS.CONSULTANTS  
ZENOBUILD&CO. DESIGN+CONSTRUCT



**ZENOBUILD&CO.**  
DESIGN+CONSTRUCT



PROJECT: PROPOSED TWO STOREY 7-UNITS APARTMENT  
LOCATION: BRGY. SAN FRANCISCO, MABALACAT, PAMPANGA

# structural design services

DESIGNERS.BUILDERS.CONSULTANTS  
ZENOBUILD&CO. DESIGN+CONSTRUCT

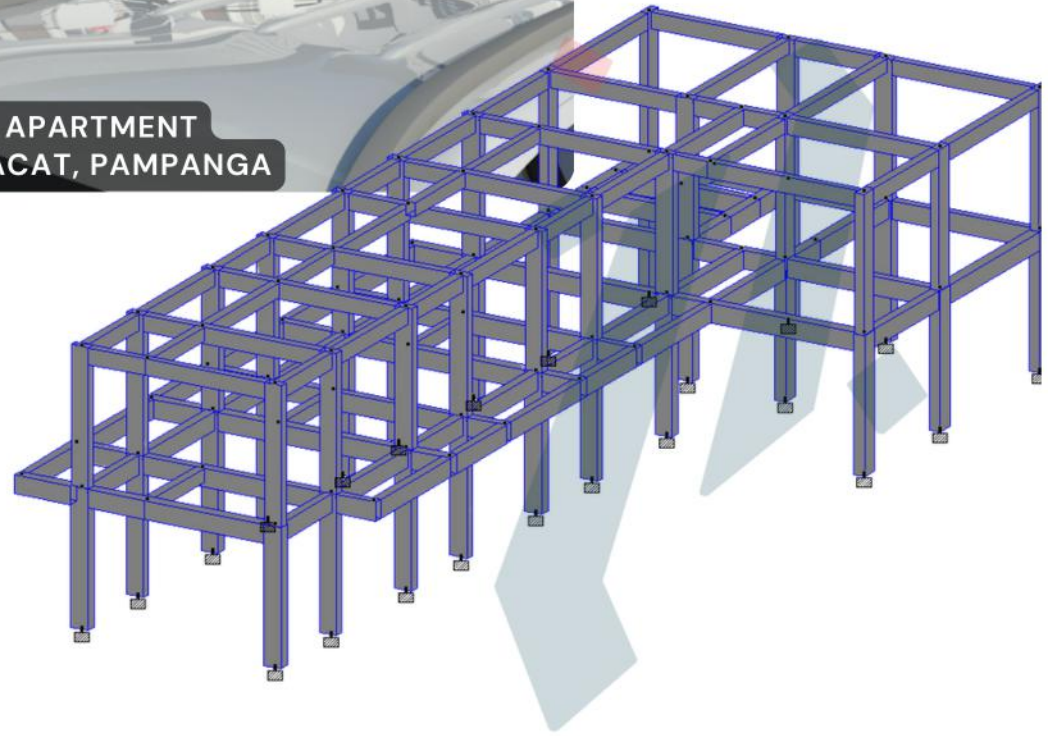

**ZENOBUILD&CO.**  
DESIGN+CONSTRUCT



PROJECT: PROPOSED 7 UNIT 2 STOREY RESIDENTIAL  
& 2 UNIT RESIDENTIAL BUILDINGS  
LOCATION: BRGY. HOLY SPIRIT, QUEZON CITY

# structural design services

DESIGNERS.BUILDERS.CONSULTANTS  
ZENOBUILD&CO. DESIGN+CONSTRUCT

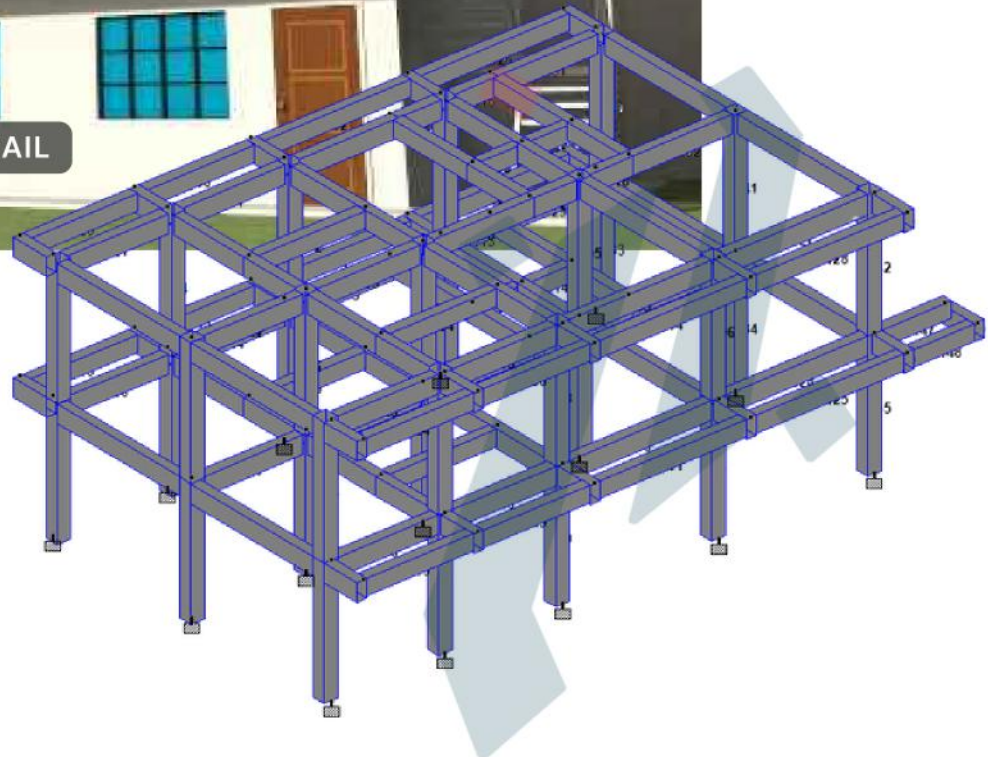



**structural  
design  
projects  
(commercial)**

DESIGNERS.BUILDERS.CONSULTANTS  
ZENOBUILD&CO. DESIGN+CONSTRUCT

**ZENOBUILD&CO.**  
DESIGN+CONSTRUCT



**PROJECT: RMM BUILDING**  
**LOCATION: FIL-AM FRIENDSHIP HIGHWAY**  
**ANGELES CITY, PAMPANGA**  
**CLIENT: 30DRAGON DEVELOPMENT CORPORATION**

# structural design services

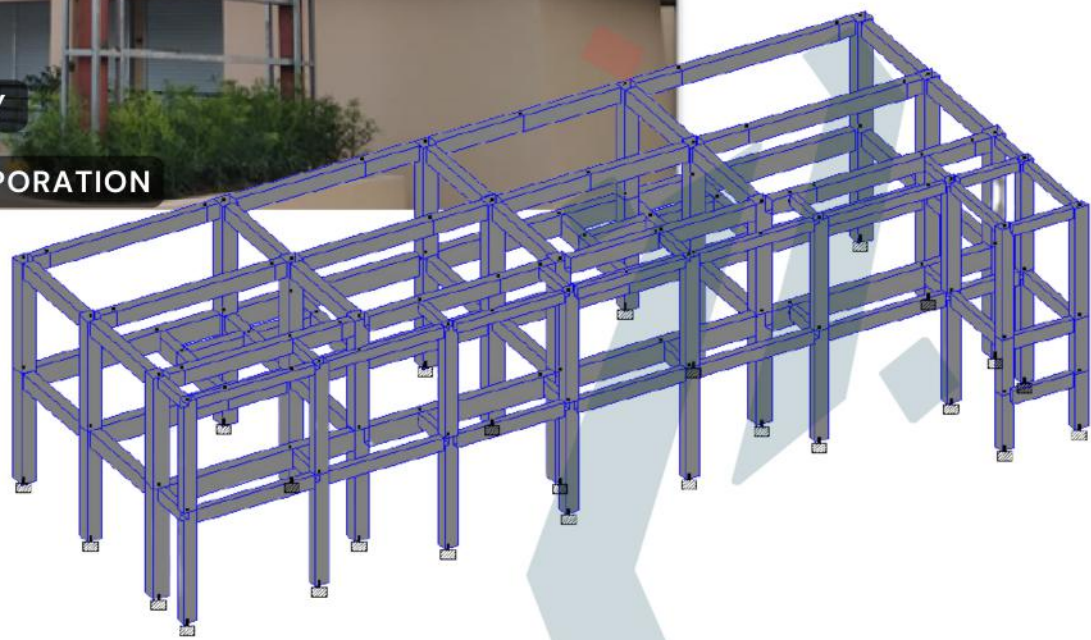

DESIGNERS.BUILDERS.CONSULTANTS  
ZENOBUILD&CO. DESIGN+CONSTRUCT

**ZENOBUILD&CO.**  
DESIGN+CONSTRUCT



PROJECT: 10 UNIT COMMERCIAL AND RESIDENTIAL BUILDING  
LOCATION: POBLACION, PORAC, PAMPANGA  
CLIENT: 3ODRAGON DEVELOPMENT CORPORATION

# structural design services

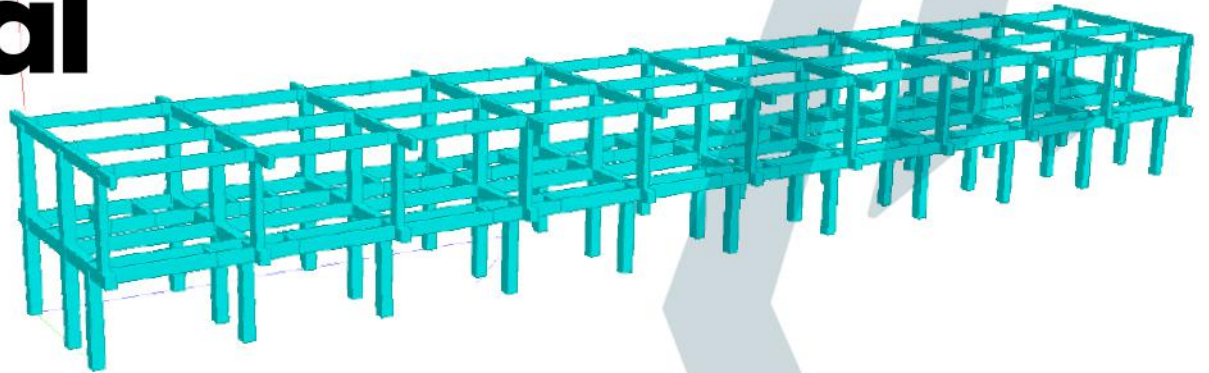

DESIGNERS.BUILDERS.CONSULTANTS  
ZENOBUILD&CO. DESIGN+CONSTRUCT

**ZENOBUILD&CO.**  
DESIGN+CONSTRUCT



PROJECT: PROPOSED EXTENSION OF TWO-STOREY COMMERCIAL BUILDING  
LOCATION: BRGY. POBLACION, PORAC, PAMPANGA  
CLIENT: 3ODRAGON DEVELOPMENT CORPORATION

# structural design services

DESIGNERS.BUILDERS.CONSULTANTS  
ZENOBUILD&CO. DESIGN+CONSTRUCT

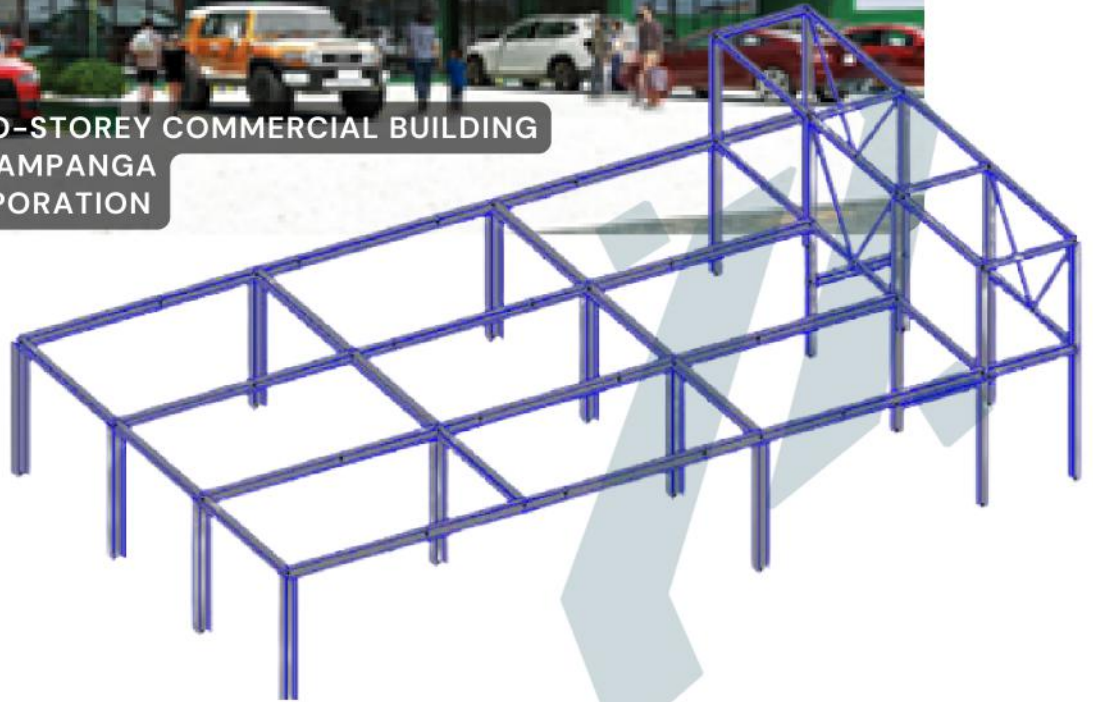

**ZENOBUILD&CO.**  
DESIGN+CONSTRUCT



PROJECT: PROPOSED 4 STOREY MIXED USE BUILDING  
LOCATION: SAN PABLO ST. CM RECTO ANGELES CITY  
CLIENT: JUNIOR BUILDS

# structural design services

DESIGNERS.BUILDERS.CONSULTANTS  
ZENOBUILD&CO. DESIGN+CONSTRUCT

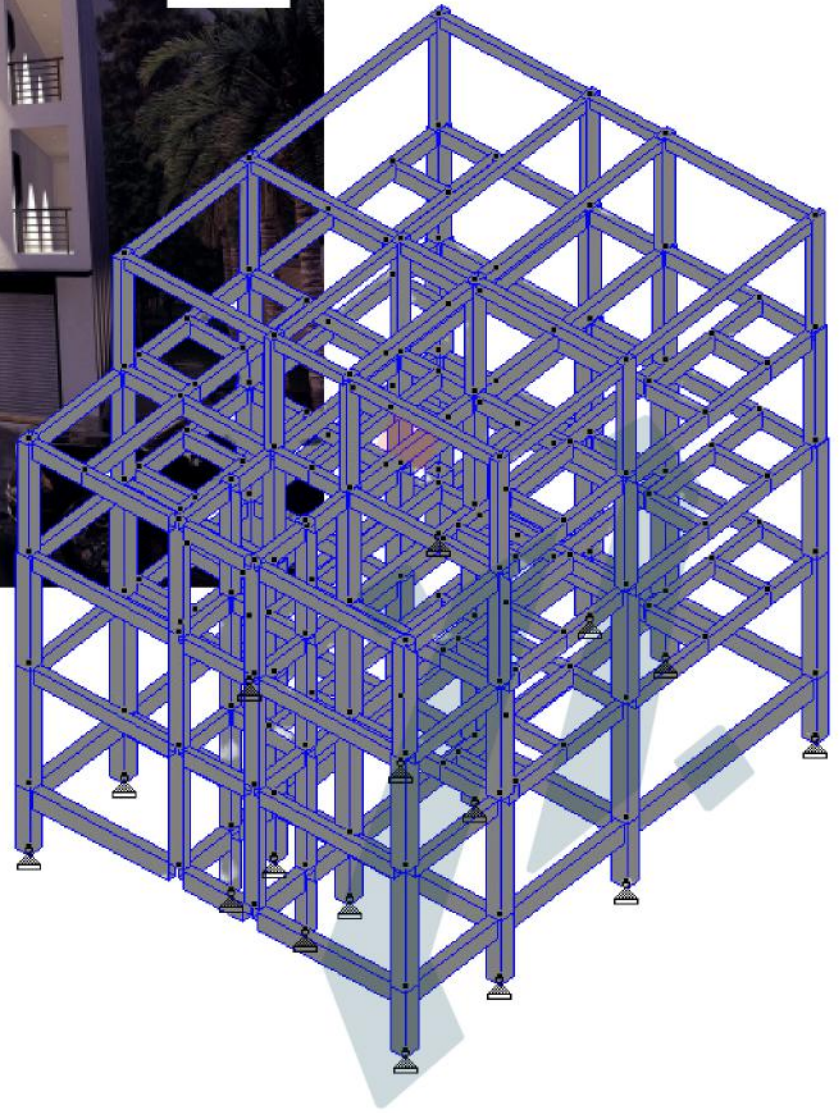

**ZENOBUILD&CO.**  
DESIGN+CONSTRUCT



PROJECT: PRIVATE EVENTS PLACE  
LOCATION: BICAL, MABALACAT, PAMPANGA

# structural design services

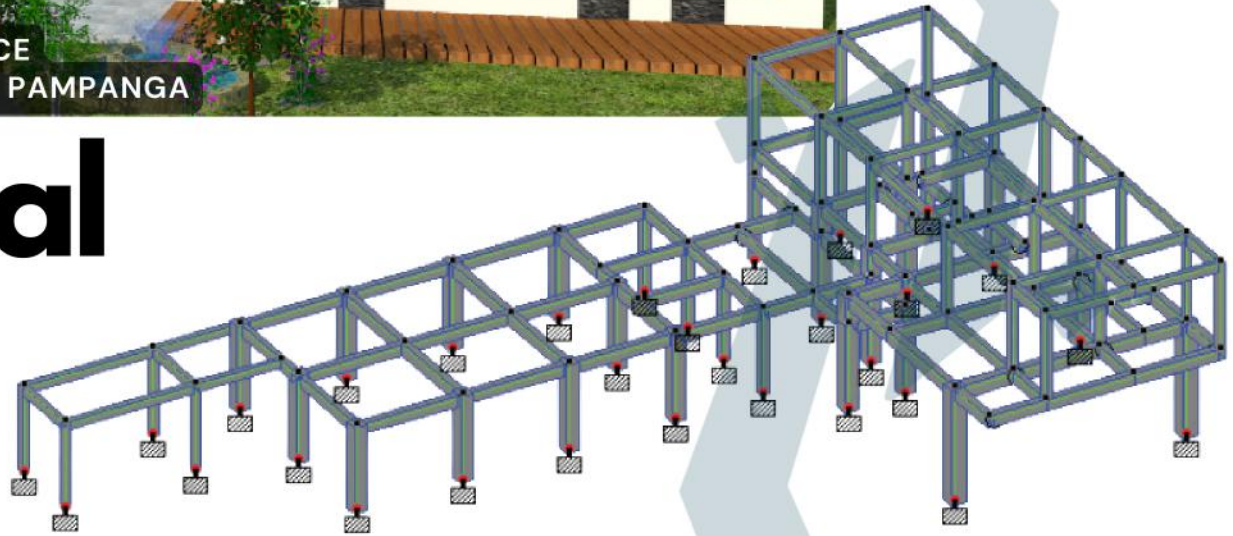

DESIGNERS.BUILDERS.CONSULTANTS  
ZENOBUILD&CO. DESIGN+CONSTRUCT

**ZENOBUILD&CO.**  
DESIGN+CONSTRUCT



PROJECT: PRIVATE RESORT  
LOCATION: BRGY. CAMACHILES, MABALACAT, PAMPANGA

# structural design services

DESIGNERS.BUILDERS.CONSULTANTS  
ZENOBUILD&CO. DESIGN+CONSTRUCT

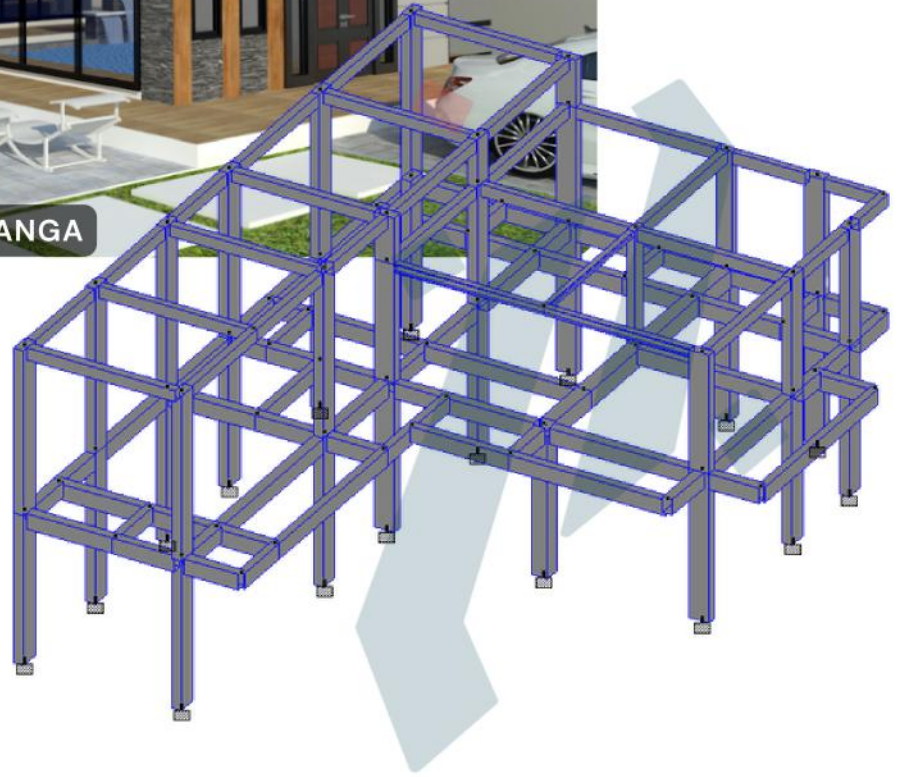

**ZENOBUILD&CO.**  
DESIGN+CONSTRUCT



PROJECT: PROPOSED MULTIFUNCTION BUILDING  
LOCATION: QUEZON CITY, PHILIPPINES

# structural design services

DESIGNERS.BUILDERS.CONSULTANTS  
ZENOBUILD&CO. DESIGN+CONSTRUCT

**ZENOBUILD&CO.**  
DESIGN+CONSTRUCT





PROJECT: PROPOSED THREE STOREY MIXED-USE BUILDING  
LOCATION: BRGY. STO DOMINGO, ANGELES CITY, PAMPANGA

# structural design services

DESIGNERS.BUILDERS.CONSULTANTS  
ZENOBUILD&CO. DESIGN+CONSTRUCT

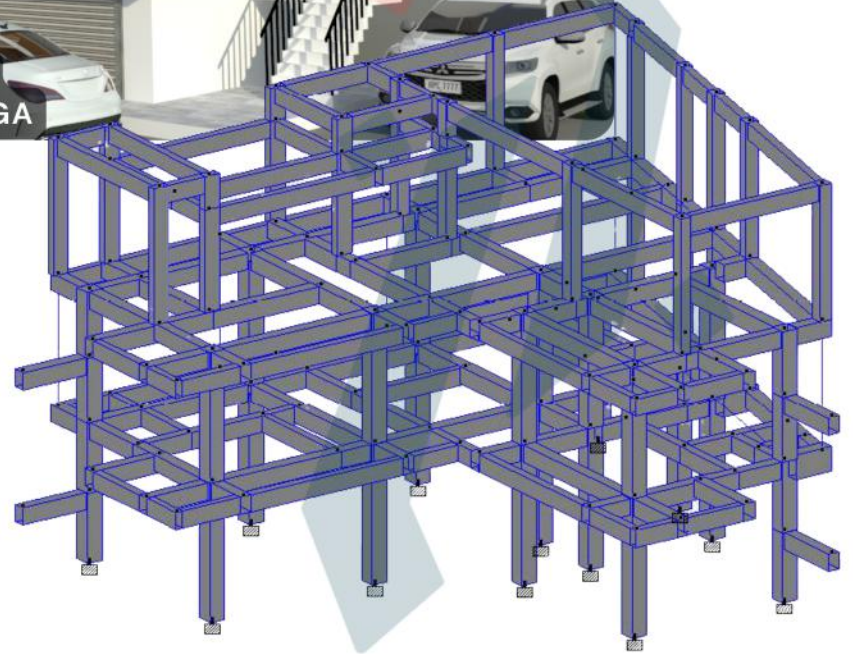

**ZENOBUILD&CO.**  
DESIGN+CONSTRUCT



PROJECT: A&F VENUE FUNCTION HALL  
LOCATION: SIEMPO ST., SAN JOSE, SAN MIGUEL BULACAN  
CLIENT: INNOVARC DESIGN & CONSTRUCTION

# structural design services

DESIGNERS.BUILDERS.CONSULTANTS  
ZENOBUILD&CO. DESIGN+CONSTRUCT

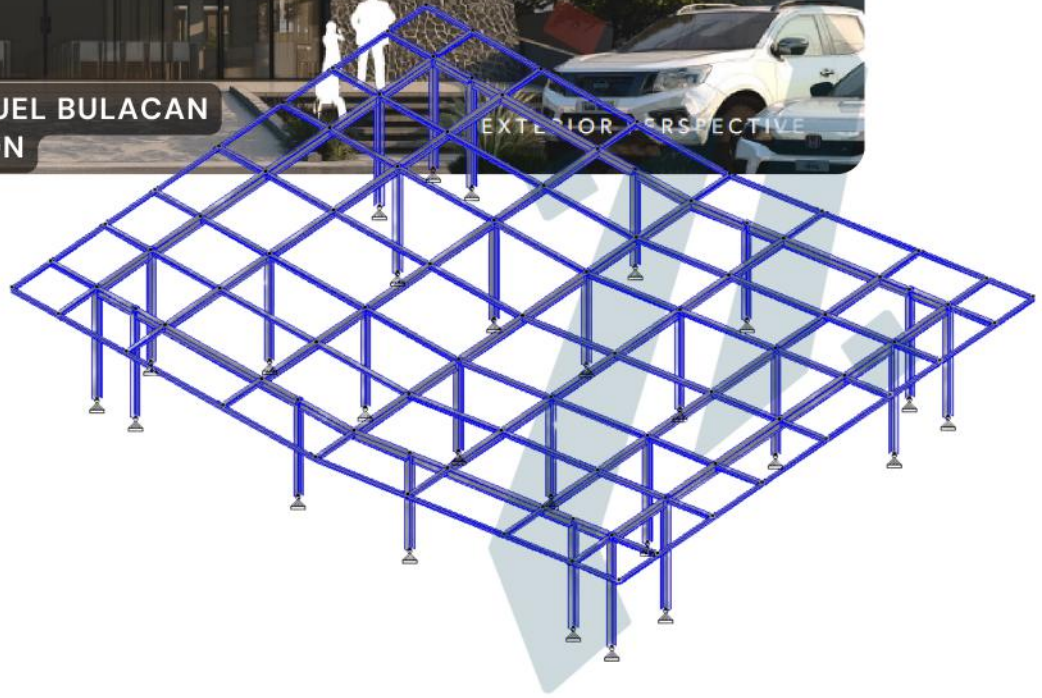

**ZENOBUILD&CO.**  
DESIGN+CONSTRUCT

# **structural design projects (industrial)**

DESIGNERS.BUILDERS.CONSULTANTS  
ZENOBUILD&CO. DESIGN+CONSTRUCT

**ZENOBUILD&CO.**  
DESIGN+CONSTRUCT



PROJECT: PROPOSED COLD STORAGE  
LOCATION: BONUAN BINLOC, DAGUPAN, PANGASINAN  
CLIENT: 3ODRAGON DEVELOPMENT CORPORATION

# structural design services

DESIGNERS.BUILDERS.CONSULTANTS  
ZENOBUILD&CO. DESIGN+CONSTRUCT

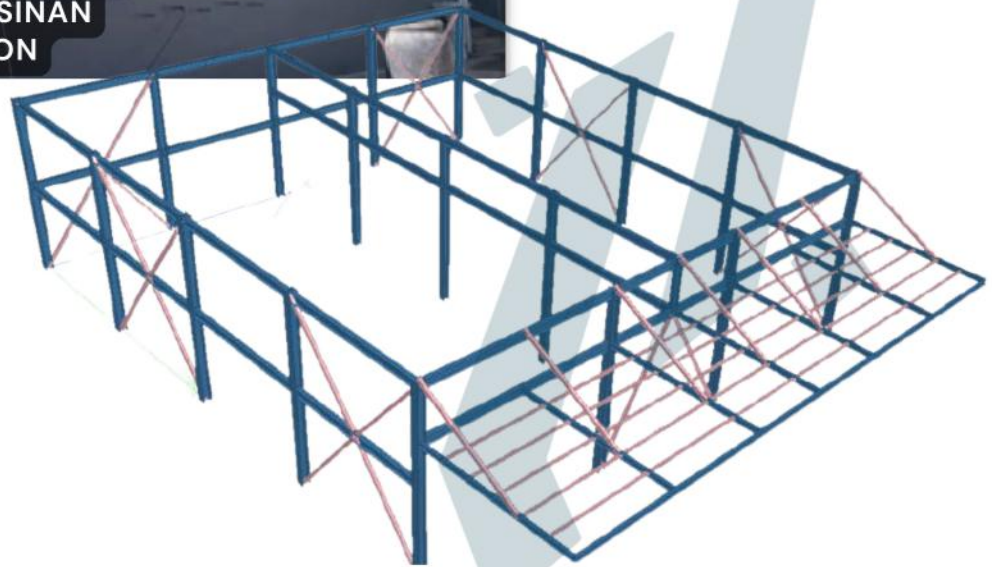

**ZENOBUILD&CO.**  
DESIGN+CONSTRUCT



PROJECT: RMM COLD STORAGE MAIN BUILDING  
LOCATION: DAU MABALACAT, PAMPANGA  
CLIENT: RMM COLD STORAGES

# structural design services

DESIGNERS.BUILDERS.CONSULTANTS  
ZENOBUILD&CO. DESIGN+CONSTRUCT

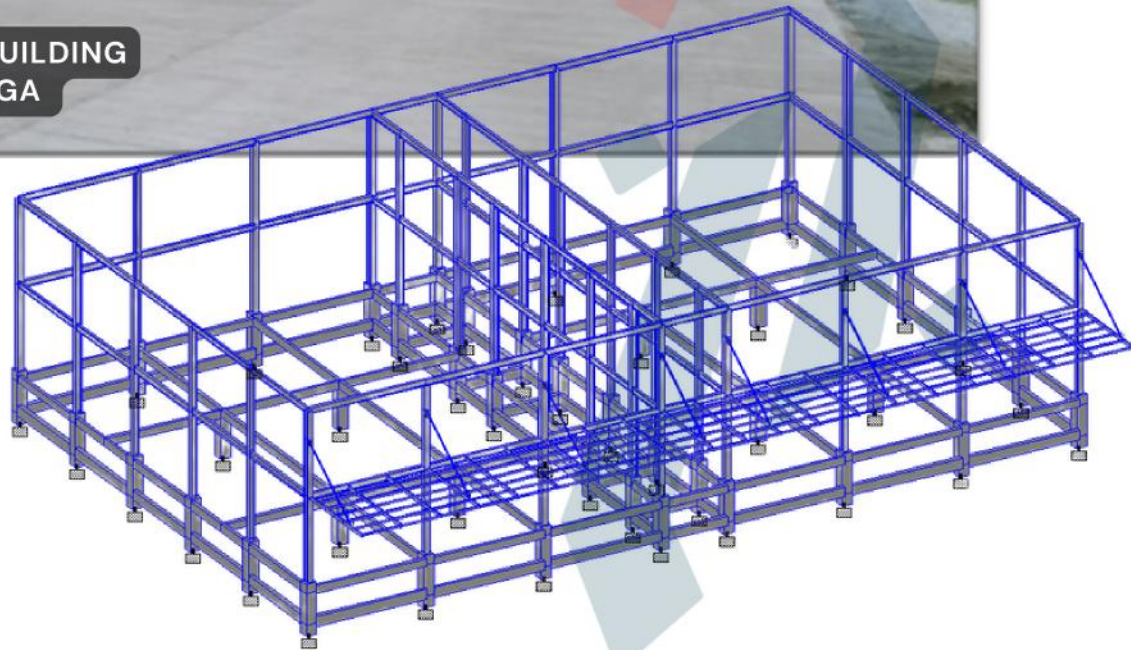

**ZENOBUILD&CO.**  
DESIGN+CONSTRUCT



PROJECT: RMM COLD STORAGE EXTENSION  
LOCATION: DAU MABALACAT, PAMPANGA  
CLIENT: RMM COLD STORAGES

05/12/2022 13:53

# structural design services

DESIGNERS.BUILDERS.CONSULTANTS  
ZENOBUILD&CO. DESIGN+CONSTRUCT

**ZENOBUILD&CO.**  
DESIGN+CONSTRUCT

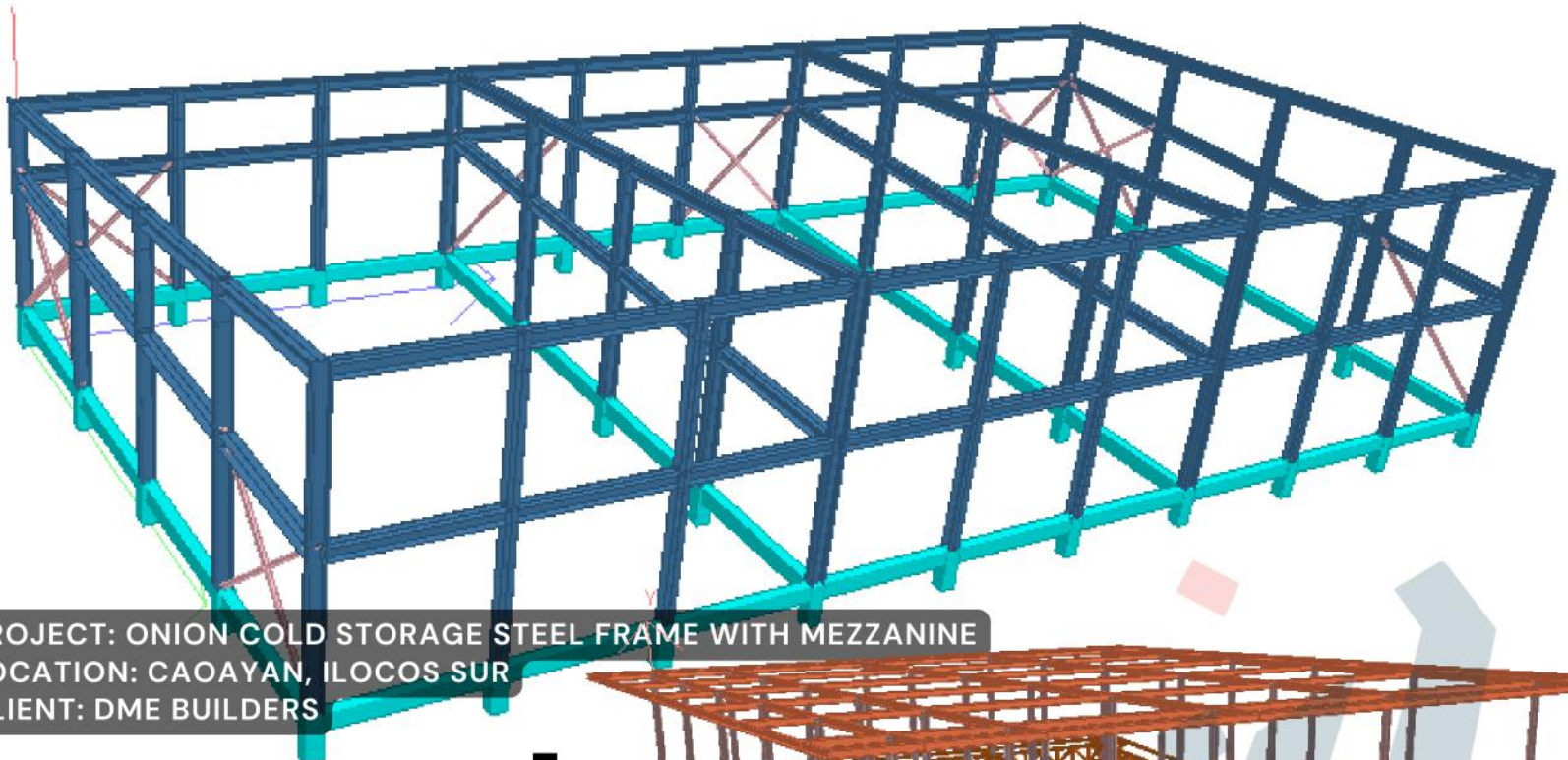

PROJECT: ONION COLD STORAGE STEEL FRAME WITH MEZZANINE  
LOCATION: CAOAYAN, ILOCOS SUR  
CLIENT: DME BUILDERS

# structural design services

DESIGNERS.BUILDERS.CONSULTANTS  
ZENOBUILD&CO. DESIGN+CONSTRUCT

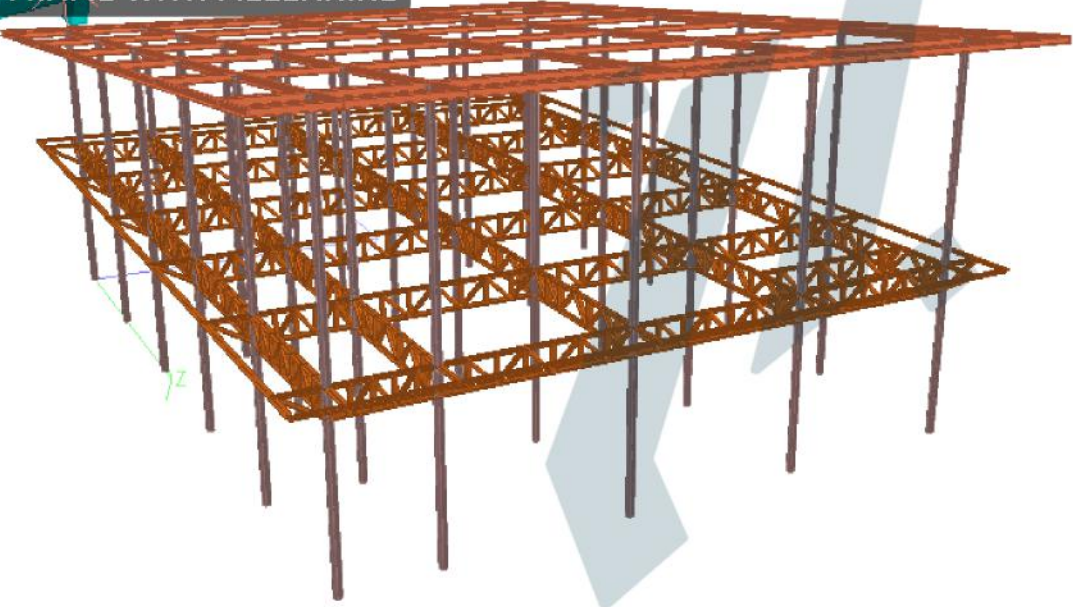

**ZENOBUILD&CO.**  
DESIGN+CONSTRUCT

# structural design projects (special)

DESIGNERS.BUILDERS.CONSULTANTS  
ZENOBUILD&CO. DESIGN+CONSTRUCT

**ZENOBUILD&CO.**  
DESIGN+CONSTRUCT





PROJECT: TIGER GASOLINE STATION  
LOCATION: BRGY. SAPANG BIABAS,  
MABALACAT CITY, PAMPANGA  
CLIENT: 30 DRAGON DEVELOPMENT CORPORATION

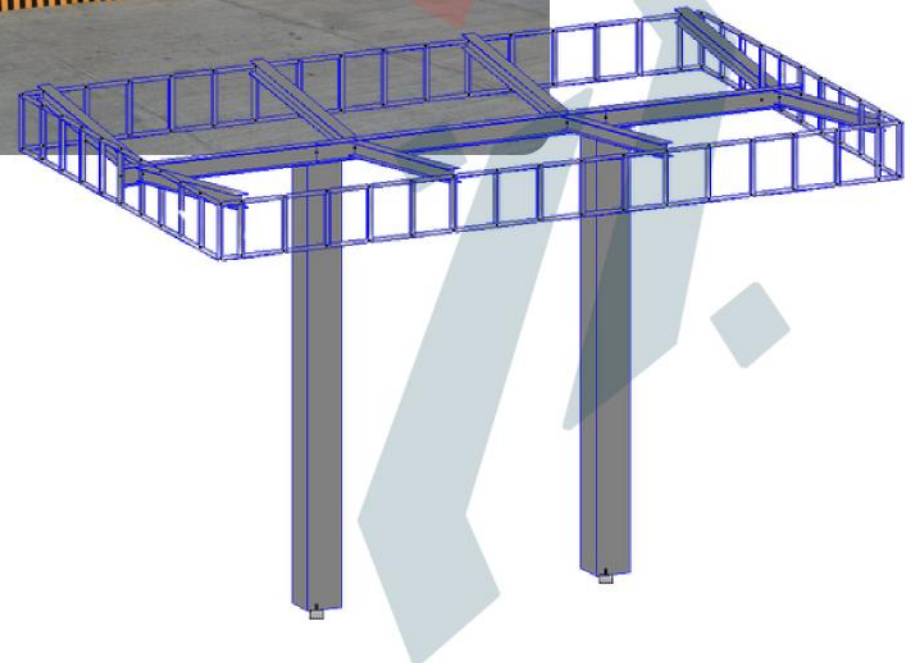

# structural design services

DESIGNERS.BUILDERS.CONSULTANTS  
ZENOBUILD&CO. DESIGN+CONSTRUCT

**ZENOBUILD&CO.**  
DESIGN+CONSTRUCT

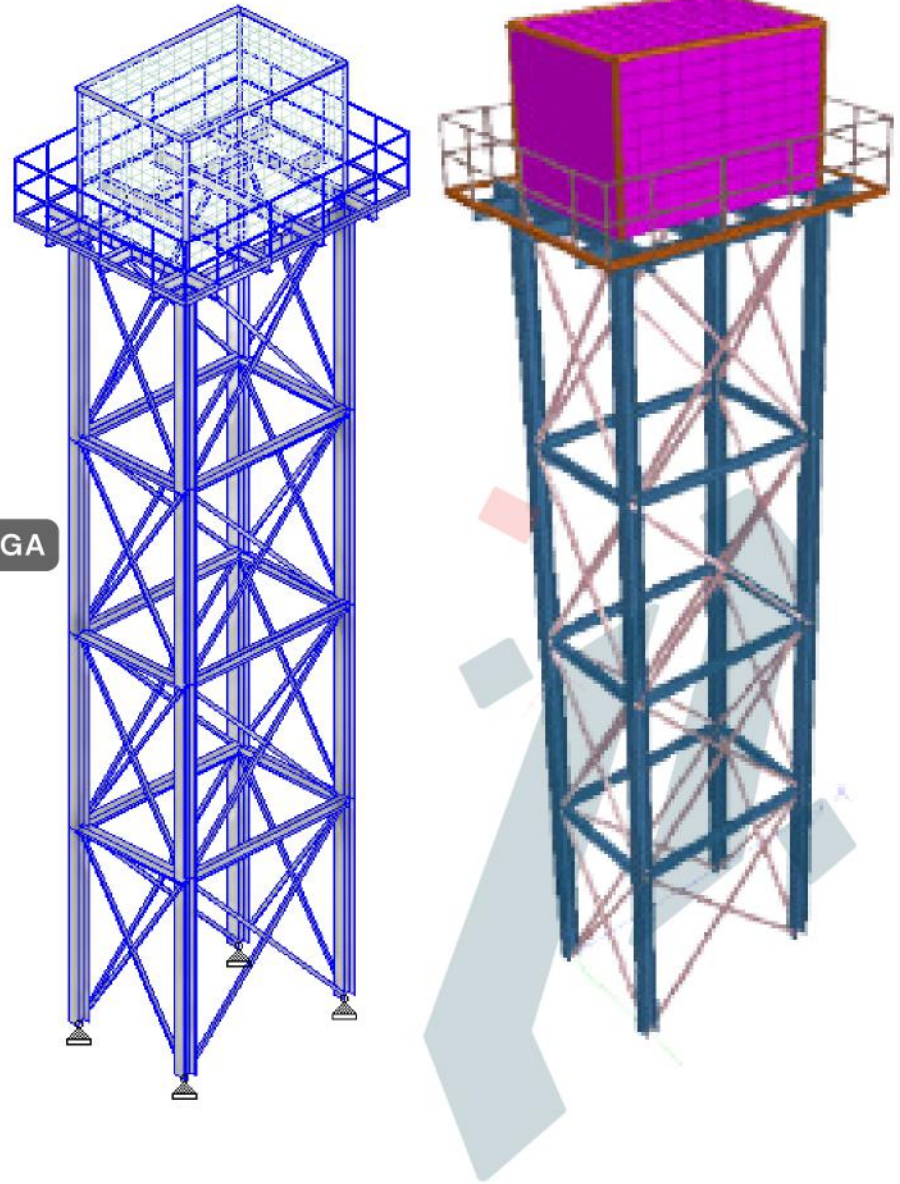
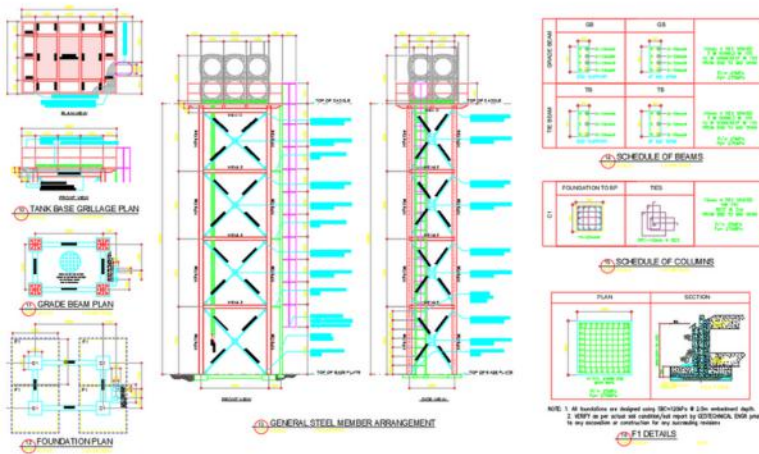

PROJECT: PROPOSED OVERHEAD WATER TANK  
 LOCATION: MANIBAUG LIBUTAD PORAC, PAMPANGA

# structural design services

DESIGNERS.BUILDERS.CONSULTANTS  
 ZENOBUILD&CO. DESIGN+CONSTRUCT

**ZENOBUILD&CO.**  
 DESIGN+CONSTRUCT

# contact us at ZENOBUILD&CO.

AND BE PART OF THE GROWING  
LIST OF HAPPY CLIENTS AT THE  
#ZENOBILLIONAIRESCLUB

☎ viber: +639686568190

✉ info.znbc@gmail.com

📍 UNIT 9 RMM BLDG. FRIENDSHIP HIWAY  
ANGELES CITY



**ZENOBUILD&CO.**  
DESIGN+CONSTRUCT

**ZENOBUILD&CO.**  
DESIGN+CONSTRUCT