

HDCVI PRODUCT SELECTION | 2022 Ver.1

HDCVI Cameras / PTZ / Recorders / Display & Control / Accessories /
Video Management Software / DORI Distance



CONTENTS



17

HDCVI CAMERAS

Pro Series / Lite Series / Cooper Series / Active Deterrence Series /
Panorama Series / PoC Series / Micro-size Series

68

HDCVI PTZ CAMERAS

Pro Series / Lite Series



73

HDCVI RECORDERS

WizSense 4K-N & 5MP Series /
WizSense 5M-N & 1080P Series / WizSense 1080N
& 720P Series / Cooper-I Series

84

DISPLAY & CONTROL

90

ACCESSORIES /
VIDEO MANAGEMENT SOFTWARE /
DORI DISTANCE (D/O/R/I)



HDCVI TEN

2022 marks the 10th anniversary of Dahua's independently developed HDCVI technology! Since the first release of HDCVI technology in 2012, Dahua has insisted on innovation and continuously invested in HDCVI technology in the past ten years, leading the coaxial industry to achieve many key technological breakthroughs, such as industry-leading Audio-over Coax, AI function, AI Coding, 4K Real-time, Super Adapt and other technologies. This year, Dahua launches the new HDCVI TEN equipped with AI-for-all, Scheduled AI, Smart Dual Illuminators and Real 5MP 16:9 technologies, blazing a trail to the over-coax AI era.

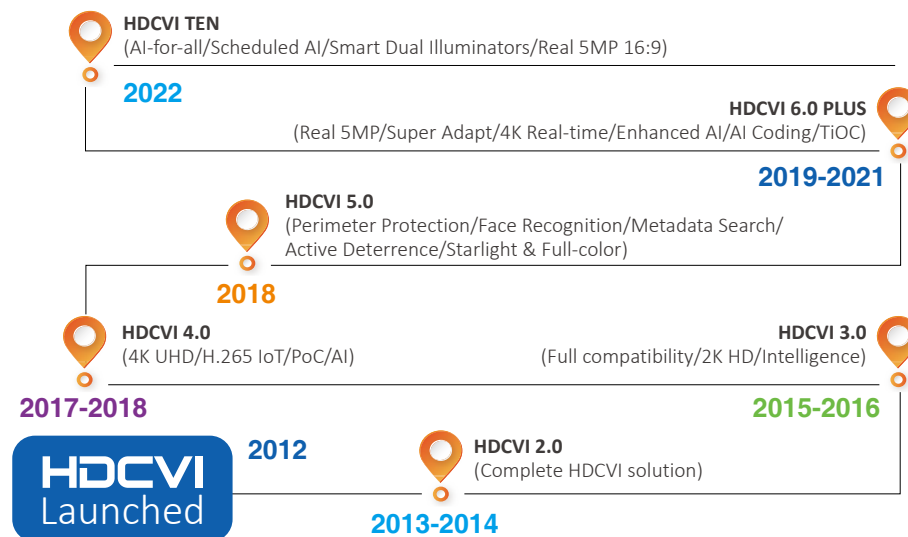

HDCVI TEN

Blazing A Trail To The Over-coax AI Era



AI-for-all



Scheduled AI



Smart Dual Illuminators



Real 5MP 16:9

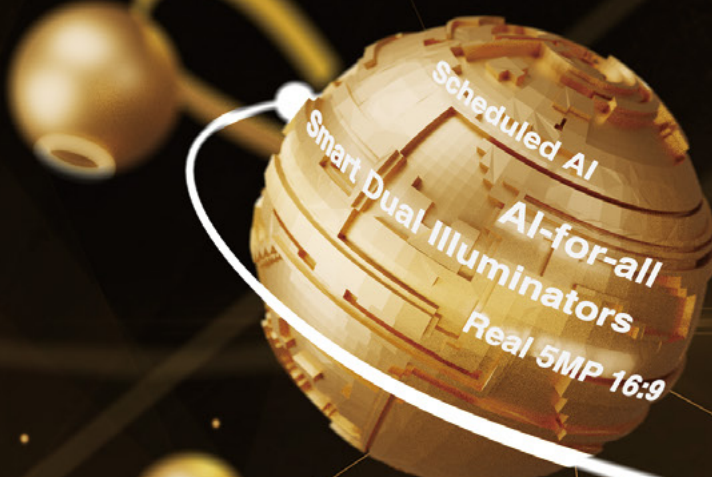

Wiz Sense

Focus on Human and Vehicle



WizSense

Launched by Dahua Technology, WizSense is a series of wide range AI products and solutions that adopt independent AI chip and deep learning algorithm. It can recognize human and vehicle in an image with high accuracy, enabling users to focus on real targets. Based on Dahua's advanced technology, WizSense makes your video intelligent, simple and inclusive.



Intelligent refers to WizSense powered by AI chip and deep learning algorithm. It provides various features that realize accurate alarms for human and vehicle, as well as quick target search, maximizing resources to increase overall efficiency.



Simple means WizSense offers simple configuration, especially for SMD Plus and AI Coding enabled by default. It eases your customer's daily job and also empowers them to make better business decisions.



Inclusivity of WizSense is the idea that everyone gets the opportunities and benefits from AI. With affordable prices and easy configuration of Dahua WizSense, AI is no longer confined to the ivory tower, but applied to real scenarios instead.

Full-color 2.0

The Full-color camera provides 24/7 color images with vivid color details that can accurately identify people or objects in low light conditions. Its latest upgrade, Full-color 2.0, has adopted a new packaging design with lively and eye-catching color palette. This new series offers enhanced image performance powered by WDR, 3DNR and Super Adapt technologies, providing users with a better visual experience.



High Performance Chipset

Provides high color reproduction and excellent low light performance for a more vivid and brighter image.



Smart White Light

Serves as supplementary light to guarantee image usability even in total darkness.



24/7 Color Monitoring

Increases probability of collecting valid human, vehicle, and event evidence.



Wide Application

Suitable for low-light environment, such as parking lots, streets, cinemas, shops, schools, etc.

Full-color Camera



Colorful View Ever, Dark World Never



SMD Plus

One major problem with traditional motion detection is the false alarm triggered by non-target objects, such as pets, insects, leaves, branches, raindrops, lights, etc. Dealing with messages reporting false alarms is not only annoying but also a huge waste of time and money. In addition, due to lengthy surveillance videos, it usually takes a significant amount of time and effort to find relevant clips that contain crucial information. As an improved version of a typical Smart Motion Detection, SMD Plus is equipped with built-in independent AI intelligent chip that reduces false alarms and surveillance costs. At the same time, it also features practical functions empowered by deep learning AI algorithms.

SMD Plus Work Process



Perimeter Protection

Perimeter Protection system refers to the fortifications built to either keep intruders out or to keep captives contained within the area the boundary surrounds. The Dahua Perimeter Protection is an intelligent analysis based on tripwire and area intrusion. It is powered by AI focuses on human and vehicle, sending alarms only when unwanted movements by human or vehicle have been detected, saving users from unnecessary actions caused by false alarms.



Difference between SMD Plus and Perimeter Protection		
	Perimeter Protection	SMD Plus
Supported Channels	Up to 8 channels	Up to full channels
Configuration	Draw tripwire or intrusion rules	Enabled by default
Application Scenario	Applicable to specific areas, especially places that need direction	Whole scene by default

Perimeter Protection has been improved from 1 channel to max. 8 channels. The IVS mode can be configured to Advanced Model or General Model.

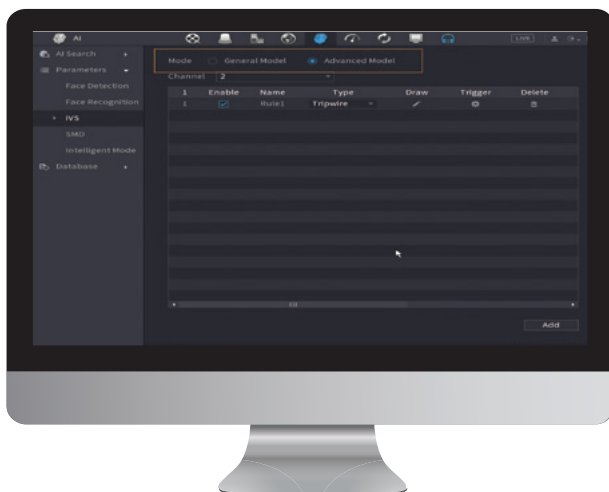

IVS Channels	Advanced Model	General Model
XVR5x04/08-I3	1-channel	2-channels
XVR5x16-I3	2-channels	4-channels
XVR5x32-I3	2-channels	4-channels
XVR5x04-4KL-I3	1-channel	4-channels
XVR5x08/16-4KL-I3	2-channels	8-channels

AI Coding

As video moves toward high definition, how to save storage costs while maintaining image quality has become one of the users' concerns. Dahua AI Coding puts emphasis on human and vehicle while encoding, ensuring the target image quality while saving 50% bandwidth and storage costs compared with standard H.265. Through its CBR (Constant Bit Rate) algorithm framework, AI Coding does not lose its decoding compatibility when integrated with 3rd party players or platforms. Furthermore, AI Coding requires fixed bandwidth construction, making it easy to deploy bandwidth and improve bandwidth utilization.

AI Coding function is enabled by default in the newest firmware version.

Saves 50% of bandwidth and storage space!

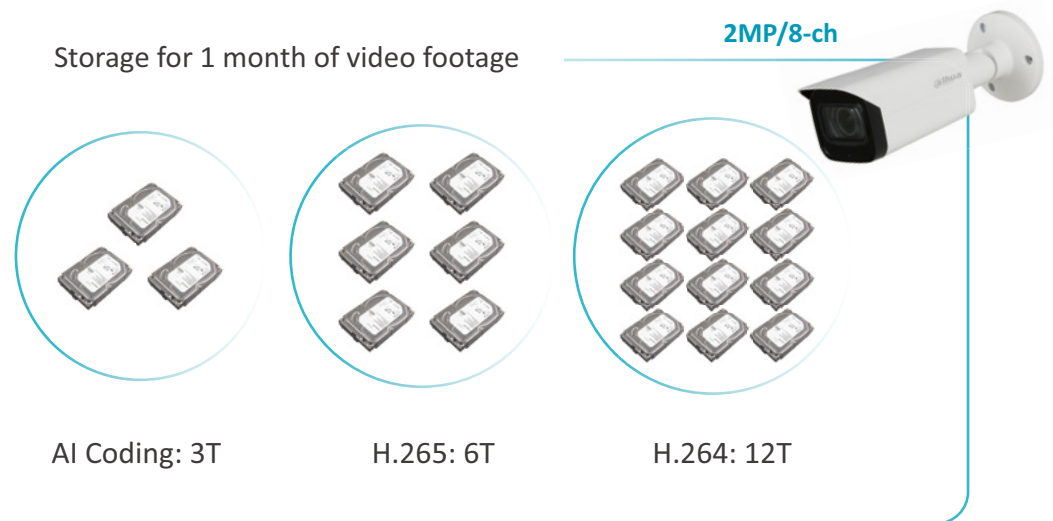
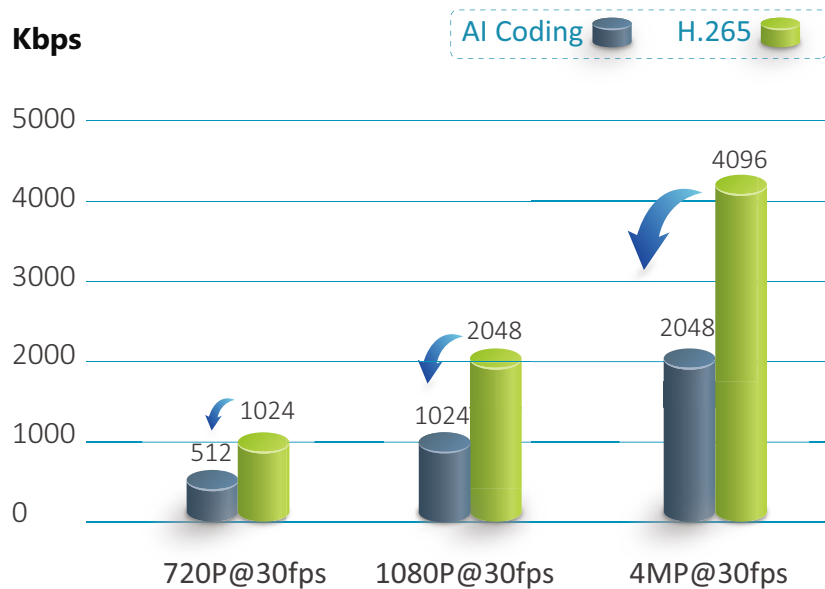

Face Recognition

By comparing detected face image with a customized face image database, users can gain more business value through VIP recognition, blacklist alarm, stranger alarm, etc.

AI Search enables target searching using attributes or face images, helping users to efficiently and quickly find out when and where a person of interest has appeared in monitored scenes.

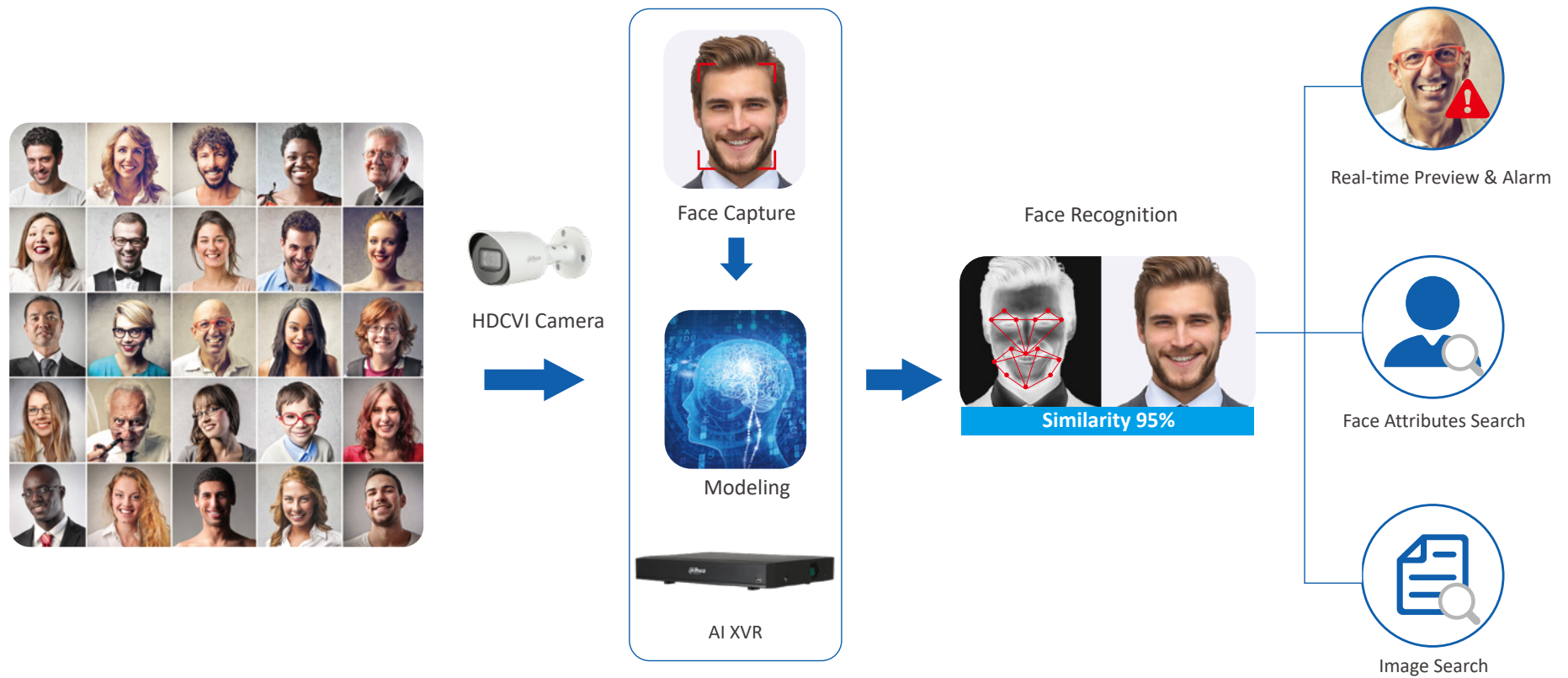

Smart Dual Illuminators

- Industry-leading smart dual illuminators technology expands the range of Full-color product's application scenarios.
- Switches between white light mode and IR mode based on target detection status, which helps reduce light pollution.
- Links with Perimeter Protection and SMD Plus of AI XVR, accurately detecting real targets and filtering out false alarms.
- Full-color monitoring in white light mode effectively captures vivid color information and clear details of human/vehicles targets.
- One-tap switching of various illumination modes through the DMSS app provides users with flexible configuration.

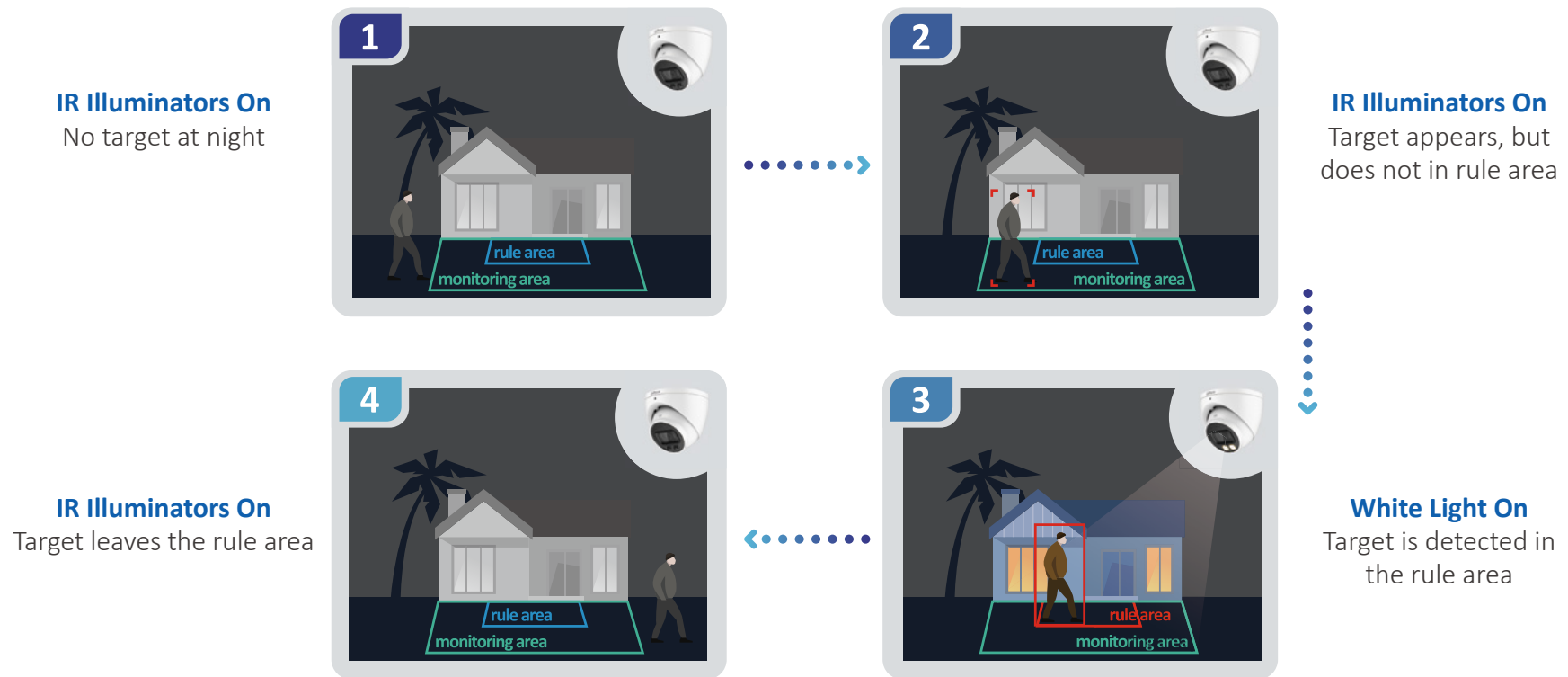

TiOC 2.0

- TiOC (Three-in-One Camera) 2.0 integrates smart dual illuminators, active deterrence and AI into one solution.
- Accurately detects intrusion by Perimeter Protection/SMD Plus and filters out false alarms.
- Actively warns off intruders with red blue light and siren even before users become aware of the incident.
- Colorful and HD monitoring in white light mode provides efficient verification with more useful evidence.
- Industry-leading smart dual illuminators technology expands the application scenarios of TiOC 2.0 product.
- Protection Against Red Blue Light Interference captures more clear image details and provide better image effects.

1 Perimeter Protection/SMD Plus identifies intrusion



2 Actively warns off intruders



3 Alarm over coax



XVR

3 Users can verify alarm with video

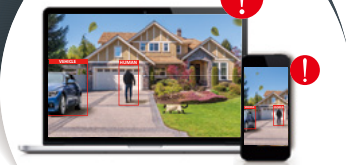

Scheduled AI

- AI functions can be set according to different time periods, max. six time segments per day.
- Users can set Scheduled AI by week according to actual needs. Reoccurring daily schedules are supported.
- Simplifies the operation and provides more flexible choices for multiple application scenarios.

* Note: The Scheduled AI function is only supported by XVR5000-4KL-I3 series, and all models support 1 channel.

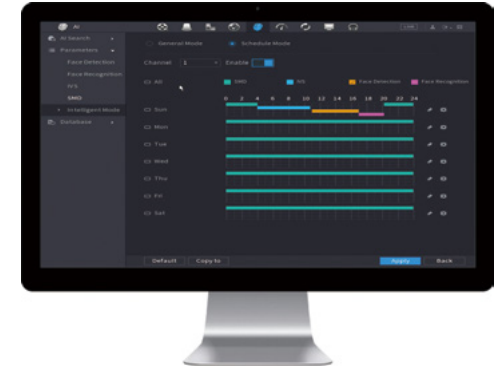

8:00 am – 9:00 pm



SMD Plus

In the daytime, the XVR is automatically configured with the SMD Plus function and links the TiOC 2.0 HDCVI camera, which can be used to welcome customers.



9:00 pm – 8:00 am



Perimeter Protection

In the nighttime, the XVR is automatically configured with the Perimeter Protection function and links the TiOC 2.0 HDCVI camera, which can be used for active deterrence.

* Note: The voice-setting function by time can only be used with the TiOC 2.0 camera.

Customized Alarm Ringtone

The TiOC alarm sound can be customized, bringing more convenience and flexibility for end-users.

Two ways to upload customized ringtones:



By DMSS

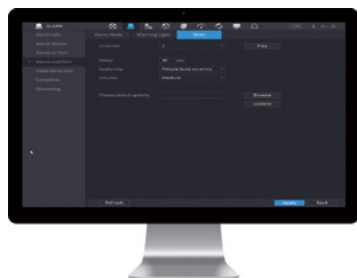

By Local/Web

Support WAV/BIN format file, max. 78KB

*Note: 1B-I does not support this function.



Store: "Welcome"



Dangerous Place: "No Entry"



Fire Exits: "No Parking"



Construction Sites: "Keep Out"

One-tap Arming and Disarming

Users can conveniently switch the arming/disarming function for the siren and warning light via the DMSS app. Notifications to app or platform can also be disabled to avoid disturbance.



Arming / Disarming Controlled by Local Alarm

Aside from controlling via the XVR user interface or DMSS app, the disarming/arming function can also be controlled by the local alarm of the device, bringing great convenience for end users.

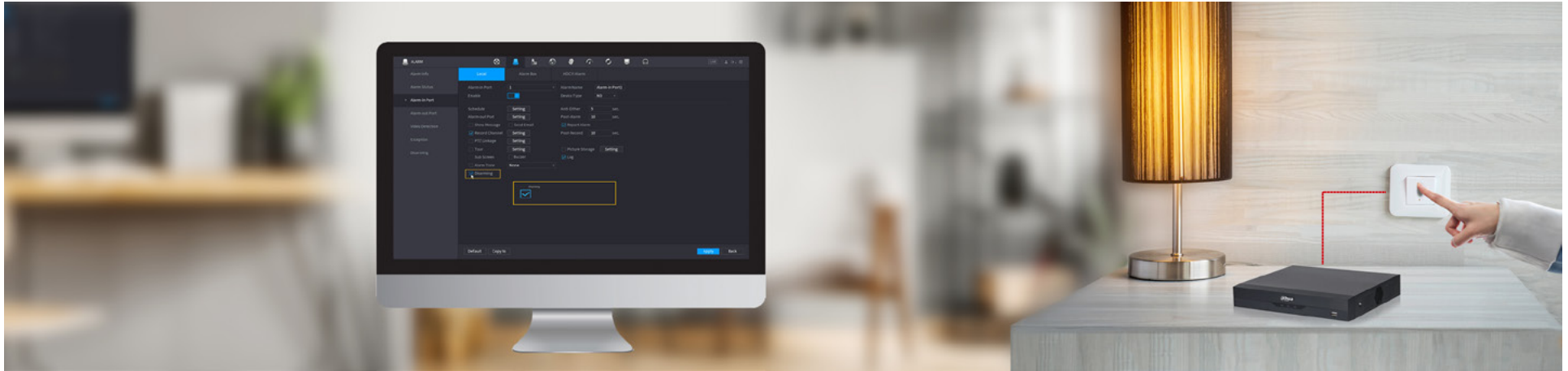

DAC Technology

Audio information can bring supplementary evidence in video surveillance. HDCVI DAC (Digital Audio-over-Coax) technology can provide users with a lossless and real-time auditory experience and a high-quality video & audio surveillance solution.

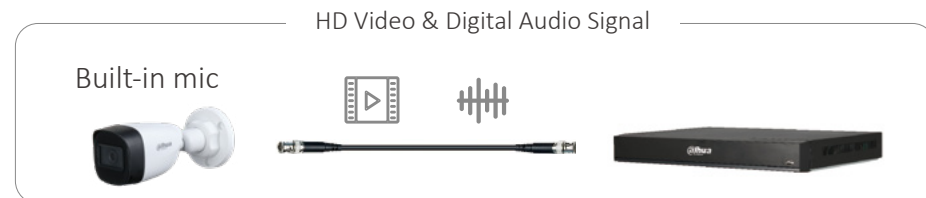

- One coaxial cable transmission of audio and video simplifies installation and saves labor costs.
- Lossless and real-time digital audio signal transmission achieves broadcast-level audio quality.
- All XVR models support audio-over-coax, protecting users' investment.

4K Real-time

4K Real-time, one of the core features of the brand-new HDCVI 6.0, is a unique and leading technology in HD-over-Coax market. It restores the monitoring scene with 25/30fps for a better visual experience, and offers superior clarity by capturing even tiny details of the scene.

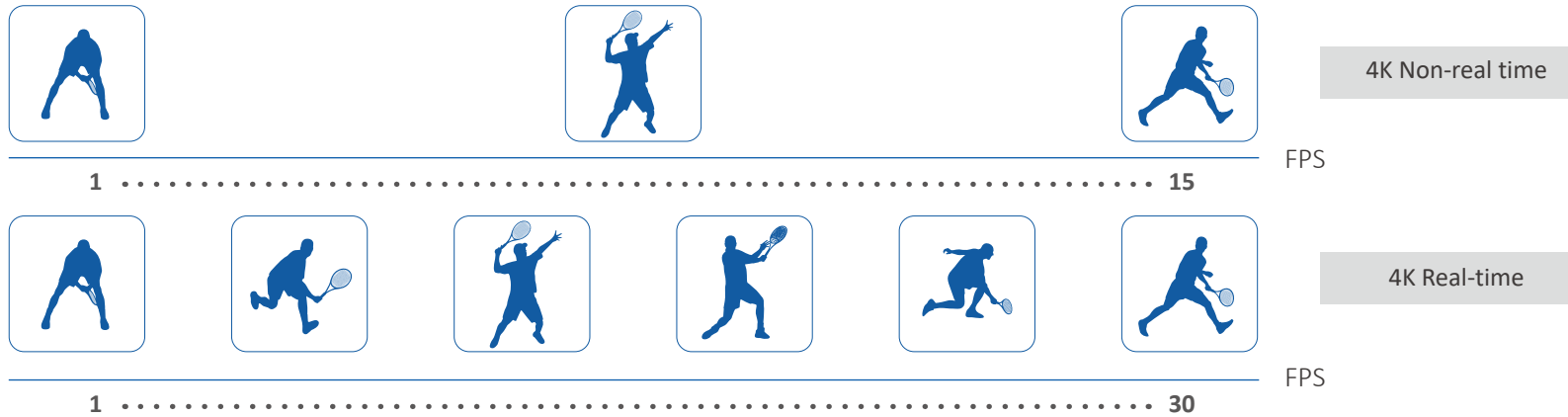

Real 5MP 16:9

- 5MP 16:9 original image output, achieving undistorted 5MP image performance and super clear details.
- Starlight feature presents clean and bright images even in the low light environment.
- 5MP@25fps feature provides more fluent visual experience and abundant details.



Super Adapt

HDCVI Super Adapt camera can recognize various monitoring environment such as indoor, outdoor or intense lighting, and automatically adjust the parameters to present the optimal image. No more manual camera debugging work is required, greatly saving the cost for installers.



Without Super Adapt



With Super Adapt

Quick-to-Install

The HDCVI quick-to-install camera adopts aesthetic design with universal joints and quick-to-install pedestal structure, enabling an easy and convenient installation to save labor costs. In addition, all quick-to-install cameras are equipped with built-in mic to collect more useful audio evidence.



HDCVI CAMERAS





Pro Series

Pro Series is a perfect choice for SMB solutions and projects where both high reliability and flexibility are required. All cameras are equipped with Starlight feature, true WDR and 3DNR, and are able to provide clear images and rich details even under tough lighting conditions. Full-color cameras can provide 24/7 vivid color images.



High Definition

Pro Series supports ultra high definition up to 4K, which equals to 4 times 1080P resolution, creating images with impressive clarity and details.



Starlight

Starlight camera can provide bright and clear image even under extreme lowlight environment, allowing more details and longer color image periods to be captured.



WDR (Wide Dynamic Range)

WDR technology optimizes both the bright and dark areas of a scene at the same time to provide usable video in intense contrast lighting conditions.









DAC (Digital Audio-over-Coax)

Audio information is used as supplementary evidence for video surveillance. The DAC technology supports high quality overcoax audio transmission with low noise.

HDCVI CAMERAS

Pro Series

	Box Camera		Vari-focal Bullet				
Model	HAC-HF3805G	HAC-HF3231E (-T)	HAC-HFW2802T-Z-A(-DP)	HAC-HFW2501TU-Z-A(-DP)	HAC-HFW2402T-Z-A(-DP)	HAC-HFW2241TU-Z-A(-DP)	HAC-HFW3231E-Z12
Appearance	 Full Color	 Starlight	 Starlight	 Starlight	 Starlight	 Starlight	 Starlight
Image Sensor	4K CMOS	2MP CMOS	4K CMOS	5MP (16:9) CMOS	4MP CMOS	2MP CMOS	2MP CMOS
Min. Illumination	0.001Lux/F1.2 (Color)	0.005Lux/F1.2 (Color) 0.0005Lux/F1.2 (B/W)	0.005Lux/F1.5 (Color) 0Lux/F1.5 (IR on)	0.001Lux/F1.6 (Color) 0Lux/F1.6 (IR On)	0.002Lux/F1.9 (Color) 0Lux/F1.9 (IR on)	0.001Lux/F1.5 (Color) 0Lux/F1.5 (IR on)	0.005Lux/F1.6 (Color) 0Lux/F1.6 (IR on)
Lens	M43, Auto Iris	C/CS, Auto Iris	3.7-11mm, Motorized	2.7~13.5mm, Motorized	3.7-11mm, Motorized	2.7~13.5mm, Motorized	5.3~64mm, Motorized, Auto Iris
FOV-H	--	--	112°~46°	113°~31.4°	114.3°~47.2°	108°~30°	58°~5°
Day/Night	Color	ICR	ICR	ICR	ICR	ICR	ICR
Max. IR Distance	--	--	80m (262ft), Smart IR	80m (262ft), Smart IR	80m (262ft), Smart IR	80m (262ft), Smart IR	100m (328ft), Smart IR
OSD Menu	Multi-language	Multi-language	Multi-language	Multi-language	Multi-language	Multi-language	Multi-language
WDR	140dB	120dB	120dB	120dB	120dB	130dB	120dB
Noise Reduction	2D/3D	2D/3D	2D/3D	2D/3D	2D/3D	2D/3D	2D/3D
Frame Rate	HDMI: 30fps@4K 30fps@4MP BNC: 15fps@4K 30fps@4MP	30fps@1080P 30fps@720P	15fps@4K 20fps@6MP 30fps@4MP	25fps@5MP (16:9) 30fps@4MP 30fps@1080P	30fps@4MP 30fps@1080P	30fps@1080P 30fps@720P	30fps@1080P 30fps@720P
Video Output	HD (HDMI & BNC Output)	HD/SD Dual-output SDI Output (-T)	HD/SD Switchable	HD/SD Switchable	HD/SD Switchable	HD/SD Switchable	HD/SD Dual-output SD Tester-out
Audio In	1ch in & Built-in Mic	1ch in & Built-in Mic	1ch in & Built-in Mic	Built-in Mic	1ch in & Built-in Mic	1ch in & Built-in Mic	1
Alarm In/Out	2/1	2/1	--	--	--	--	2/1
Pan/Tilt/Rotation	--	--	Pan: 0°~360°; Tilt: 0°~90° Rotation: 0°~360°	Pan: 0°~360°; Tilt: 0°~90° Rotation: 0°~360°	Pan: 0°~360°; Tilt: 0°~90° Rotation: 0°~360°	Pan: 0°~360°; Tilt: 0°~90° Rotation: 0°~360°	Pan: 0°~360°; Tilt: 0°~90° Rotation: 0°~360°
Ingress Protection	--	--	IP67	IP67	IP67	IP67	IP67, IK10
Working Temperature	-30°C~+60°C (-22°F~+140°F)	-30°C~+60°C (-22°F~+140°F)	-30°C~+60°C (-22°F~+140°F)	-30°C~+60°C (-22°F~+140°F)	-30°C~+60°C (-22°F~+140°F)	-30°C~+60°C (-22°F~+140°F)	-30°C~+60°C (-22°F~+140°F)
Power	AC24V±25%/DC12V±25% Max. 6.4W	AC24V±25%/DC12V±25% Max. 4.7W	DC12V±30%, Max. 12.5W DC 12V±30%/AC 24V±30% Max. 15W (-DP) Output: DC12V, Max. 2W (-DP)	DC12V±30%, Max. 10.7W DC12V±10%/AC24V±25% Max. 12.5W (-DP)	DC12V±30%, Max. 10.8W DC12V±30%/AC24V±30% Max. 13.5W (-DP) Output: DC12V, Max. 2W (-DP)	DC12V±30%, Max. 9.4W AC24V±25%/DC12V±10% Max. 12.5W (-DP) Output: DC12V, Max. 2W (-DP)	AC24V±25%/DC12V±25% Max. 15.6W

HDCVI CAMERAS







Pro Series

Vari-focal Dome

Vari-focal Eyeball

Model	HAC-HDBW2802R-Z (-DP)	HAC-HDBW2501R-Z (-DP)	HAC-HDBW2402R-Z (-DP)	HAC-HDBW2241RA-Z (-DP)	HAC-HDBW3231E-Z (-DP)	HAC-HDW2501TMQ-Z-A(-DP)
Appearance	 Starlight	 Starlight	 Starlight	 Starlight	 Starlight	 Starlight
Image Sensor	4K CMOS	5MP (16:9) CMOS	4MP CMOS	2MP CMOS	2MP CMOS	5MP (16:9) CMOS
Min. Illumination	0.005Lux/F1.5 (Color) 0Lux/F1.5 (IR on)	0.001Lux/F1.6 (Color) 0Lux/F1.6 (IR On)	0.002Lux/F1.9 (Color) 0Lux/F1.9 (IR on)	0.001Lux/F1.5 (Color) 0Lux/F1.5 (IR on)	0.001Lux/F1.6 (Color) 0Lux/F1.6 (IR on)	0.001Lux/F1.6 (Color) 0Lux/F1.6 (IR On)
Lens	3.7-11mm, Motorized	2.7~13.5mm, Motorized	3.7-11mm, Motorized	2.7~13.5mm, Motorized	2.7~13.5mm, Motorized	2.7~13.5mm, Motorized
FOV-H	112°~46°	113°~31.4°	114.3°~47.2°	108°~30°	109°~30°	113°~31.4°
Day/Night	ICR	ICR	ICR	ICR	ICR	ICR
Max. IR Distance	30m (98ft), Smart IR	30m (98ft), Smart IR	30m (98ft), Smart IR	60m (197ft), Smart IR	60m (197ft), Smart IR	60m (197ft), Smart IR
OSD Menu	Multi-language	Multi-language	Multi-language	Multi-language	Multi-language	Multi-language
WDR	120dB	120dB	120dB	130dB	120dB	120dB
Noise Reduction	2D/3D	2D/3D	2D/3D	2D/3D	2D/3D	2D/3D
Frame Rate	15fps@4K 20fps@6MP 30fps@4MP	25fps@5MP (16:9) 30fps@4MP 30fps@1080P	30fps@4MP 30fps@1080P	30fps@1080P 30fps@720P	30fps@1080P 30fps@720P	25fps@5MP (16:9) 30fps@4MP 30fps@1080P
Video Output	HD/SD Switchable	HD/SD Switchable	HD/SD Switchable	HD/SD Switchable	HD/SD Switchable	HD/SD Switchable
Audio In	1	--	1	1ch in & Built-in Mic	1	Built-in Mic
Alarm In/Out	--	--	--	--	--	--
Pan/Tilt/Rotation	Pan: 0°~355°; Tilt: 0°~75° Rotation: 0°~355°	Pan: 0°~355°; Tilt: 0°~75° Rotation: 0°~355°	Pan: 0° ~ 355°; Tilt: 0° ~ 75° Rotation: 0° ~ 355°	Pan: 0°~355°; Tilt: 0°~80° Rotation: 0°~355°	Pan: 0°~355°; Tilt: 0°~70° Rotation: 0°~355°	Pan: 0°~360°; Tilt: 0°~78° Rotation: 0°~360°
Ingress Protection	IP67, IK10	IP67, IK10	IP67, IK10	IP67, IK10	IP67, IK10	IP67
Working Temperature	-30°C~+60°C (-22°F~+140°F)	-30°C~+60°C (-22°F~+140°F)	-30°C~+60°C (-22°F~+140°F)	-30°C~+60°C (-22°F~+140°F)	-30°C~+60°C (-22°F~+140°F)	-30°C~+60°C (-22°F~+140°F)
Power	DC12V±30%, Max. 7W DC 12V±30%/AC 24V±30% Max. 8.4W (-DP) Output: DC12V, Max. 2W (-DP)	DC12V±30%, Max. 6.6W DC12V±10%/AC24V±25% Max. 8.7W (-DP)	DC12V±30%, Max. 8.8W DC12V±30%/AC24V±30% Max. 11.8W (-DP) Output: DC12V, Max. 2W (-DP)	DC12V±30%, Max. 6.9W AC24V±25%/DC12V±10% Max. 9.9W (-DP) Output: DC12V, Max. 2W (-DP)	DC12V±10%/AC24V±25% Max. 13W	DC12V±30%, Max. 7.9W DC12V±10%/AC24V±25% Max. 9.5W (-DP)







HDCVI CAMERAS

Pro Series						
Vari-focal Eyeball						Fixed-focal Bullet
Model	HAC-HDW2241TMQ-Z-A (-DP)	HAC-HDW2802T-Z-A (-DP)	HAC-HDW2501T-Z-A (-DP)	HAC-HDW2402T-Z-A (-DP)	HAC-HDW2241T-Z-A (-DP)	HAC-HFW2802T-I8-A
Appearance	 Starlight	 Starlight	 Starlight	 Starlight	 Starlight	 Starlight
Image Sensor	2MP CMOS	4K CMOS	5MP (16:9) CMOS	4MP CMOS	2MP CMOS	4K CMOS
Min. Illumination	0.001Lux/F1.5 (Color) 0Lux/F1.5 (IR on)	0.005Lux/F1.5 (Color) 0Lux/F1.5 (IR on)	0.001Lux/F1.6 (Color) 0Lux/F1.6 (IR On)	0.002Lux/F1.9 (Color) 0Lux/F1.9 (IR on)	0.001Lux/F1.5 (Color) 0Lux/F1.5 (IR on)	0.005Lux/F1.6 (Color) 0Lux/F1.6 (IR on)
Lens	2.7~13.5mm, Motorized	3.7-11mm, Motorized	2.7~13.5mm, Motorized	3.7-11mm, Motorized	2.7~13.5mm, Motorized	3.6mm (6mm Optional)
FOV-H	108°~30°	112°~46°	113°~31.4°	114.3°~47.2°	108°~30°	87° (55°)
Day/Night	ICR	ICR	ICR	ICR	ICR	ICR
Max. IR Distance	60m (197ft), Smart IR	60m (197ft), Smart IR	60m (197ft), Smart IR	60m (197ft), Smart IR	60m (197ft), Smart IR	80m (262ft), Smart IR
OSD Menu	Multi-language	Multi-language	Multi-language	Multi-language	Multi-language	Multi-language
WDR	130dB	120dB	120dB	120dB	130dB	120dB
Noise Reduction	2D/3D	2D/3D	2D/3D	2D/3D	2D/3D	2D/3D
Frame Rate	30fps@1080P 30fps@720P	15fps@4K 20fps@6MP 30fps@4MP	25fps@5MP (16:9) 30fps@4MP 30fps@1080P	30fps@4MP 30fps@1080P	30fps@1080P 30fps@720P	15fps@4K 20fps@6MP 30fps@4MP
Video Output	HD/SD Switchable	HD/SD Switchable	HD/SD Switchable	HD/SD Switchable	HD/SD Switchable	HD/SD Switchable
Audio In	1ch in & Built-in Mic	1ch in & Built-in Mic	Built-in Mic	1ch in & Built-in Mic	1ch in & Built-in Mic	1ch in & Built-in Mic
Alarm In/Out	--	--	--	--	--	--
Pan/Tilt/Rotation	Pan: 0°~360°; Tilt: 0°~78° Rotation: 0°~360°	Pan: 0°~360°; Tilt: 0°~78° Rotation: 0°~360°	Pan: 0°~360°; Tilt: 0°~78° Rotation: 0°~360°	Pan: 0° ~ 360°; Tilt: 0° ~ 78° Rotation: 0° ~ 360°	Pan: 0°~360°; Tilt: 0°~78° Rotation: 0°~360°	Pan: 0°~360°; Tilt: 0°~90° Rotation: 0°~360°
Ingress Protection	IP67	IP67	IP67	IP67	IP67	IP67
Working Temperature	-30°C~+60°C (-22°F~+140°F)	-30°C~+60°C (-22°F~+140°F)	-30°C~+60°C (-22°F~+140°F)	-30°C~+60°C (-22°F~+140°F)	-30°C~+60°C (-22°F~+140°F)	-30°C~+60°C (-22°F~+140°F)
Power	DC12V±30%, Max. 6.4W AC24V±25%/DC12V±10% Max. 8.1W (-DP) Output: DC12V, Max. 2W (-DP)	DC12V±30%, Max. 9.5W DC 12V±30%/AC 24V±30% Max. 12W (-DP) Output: DC12V, Max. 2W (-DP)	DC12V±30%, Max. 7.9W DC12V±10%/AC24V±25% Max. 9.5W (-DP)	DC12V±30%, Max. 7.9W DC12V±30%/AC24V±30% Max. 10.3W (-DP) Output: DC12V, Max. 2W (-DP)	DC12V±30%, Max. 6.4W AC24V±25%/DC12V±10% Max. 8.1W (-DP) Output: DC12V, Max. 2W (-DP)	DC12V±30% Max. 11.3W

HDCVI CAMERAS

Pro Series

Fixed-focal Bullet







Model	HAC-HFW2501TU-A	HAC-HFW2402T-I8-A	HAC-HFW2241TU-A	HAC-HFW2509TU-A-LED	HAC-HFW2249TU-A-LED	HAC-HFW2802E-A
Appearance			 Starlight	 Full-Color	 Full-Color	 Starlight
Image Sensor	5MP (16:9) CMOS	4MP CMOS	2MP CMOS	5MP (16:9) CMOS	2MP CMOS	4K CMOS
Min. Illumination	0.001Lux/F1.6 (Color) 0Lux/F1.6 (IR On)	0.002Lux/F1.6 (Color) 0Lux/F1.6 (IR on)	0.001Lux/F1.6 (Color) 0Lux/F1.6 (IR on)	0.0002Lux/F1.0 (Color) 0Lux/F1.0 (IR On)	0.0002Lux/F1.0 (Color) 0.0002Lux/F1.0 (IR on)	0.005Lux/F1.6 (Color) 0Lux/F1.6 (IR on)
Lens	3.6mm (6mm, 8mm Optional)	3.6mm (2.8mm, 6mm Optional)	3.6mm (6mm, 8mm Optional)	3.6mm (2.8mm, 6mm Optional)	3.6mm (2.8mm, 6mm Optional)	3.6mm (2.8mm, 6mm Optional)
FOV-H	92° (57°/43°)	88.5° (112.7°/55.8°)	86° (54°/41°)	88° (111°/59°)	84° (106°/57°)	87° (110.8°/55°)
Day/Night	ICR	ICR	ICR	ICR	ICR	ICR
Max. IR Distance	80m (262ft), Smart IR	80m (262ft), Smart IR	80m (262ft), Smart IR	60m (197ft), Smart IR	60m (197ft), Smart IR	40m (131ft), Smart IR
OSD Menu	Multi-language	Multi-language	Multi-language	Multi-language	Multi-language	Multi-language
WDR	120dB	120dB	130dB	120dB	120dB	120dB
Noise Reduction	2D/3D	2D/3D	2D/3D	2D/3D	2D/3D	2D/3D
Frame Rate	25fps@5MP (16:9) 30fps@4MP 30fps@1080P	30fps@4MP 30fps@1080P	30fps@1080P 30fps@720P	25fps@5MP (16:9) 30fps@4MP 30fps@1080P	30fps@1080P 30fps@720P	15fps@4K 20fps@6MP 30fps@4MP
Video Output	HD/SD Switchable	HD/SD Switchable	HD/SD Switchable	HD/SD Switchable	HD/SD Switchable	HD/SD Switchable
Audio In	Built-in Mic	1ch in & Built-in Mic	1ch in & Built-in Mic	Built-in Mic	1ch in & Built-in Mic	1ch in & Built-in Mic
Alarm In/Out	--	--	--	--	--	--
Pan/Tilt/Rotation	Pan: 0°~360°; Tilt: 0°~90° Rotation: 0°~360°	Pan: 0°~360°; Tilt: 0°~90° Rotation: 0°~360°	Pan: 0°~360°; Tilt: 0°~90° Rotation: 0°~360°	Pan: 0°~360°; Tilt: 0°~90° Rotation: 0°~360°	Pan: 0°~360°; Tilt: 0°~90° Rotation: 0°~360°	Pan: 0°~360°; Tilt: 0°~90° Rotation: 0°~360°
Ingress Protection	IP67	IP67	IP67	IP67	IP67	IP67
Working Temperature	-40°C~+60°C (-40°F~+140°F)	-40°C~+60°C (-40°F~+140°F)	-40°C~+60°C (-40°F~+140°F)	-40°C~+60°C (-40°F~+140°F)	-40°C~+60°C (-40°F~+140°F)	-30°C~+60°C (-22°F~+140°F)
Power	DC12V±30% Max. 9.6W	DC12V±30% Max. 11.5W	DC12V±30% Max. 7.7W	DC12V±30% Max. 10.7W	DC12V±30% Max. 10.2W	DC12V±30% Max. 6.8W

HDCVI CAMERAS

Pro Series







Fixed-focal Bullet

Fixed-focal Dome

Model	HAC-HFW2501E-A	HAC-HFW2509T-A-LED	HAC-HFW2249T-A-LED	HAC-HFW2501CM-A	HAC-HFW2241CM-A	HAC-HDBW2802R
Appearance	 Starlight	 Full-color	 Full-color	 Starlight	 Starlight	 Starlight
Image Sensor	5MP (16:9) CMOS	5MP (16:9) CMOS	2MP CMOS	5MP (16:9) CMOS	2MP CMOS	4K CMOS
Min. Illumination	0.001Lux/F1.6 (Color) 0Lux/F1.6 (IR On)	0.0002Lux/F1.0 (Color) 0.0002Lux/F1.0 (IR on)	0.0002Lux/F1.0 (Color) 0.0002Lux/F1.0 (IR on)	0.001Lux/F1.6 (Color) 0Lux/F1.6 (IR On)	0.001Lux/F1.6 (Color) 0Lux/F1.6 (IR on)	0.005Lux/F1.6 (Color) 0Lux/F1.6 (IR on)
Lens	3.6mm (2.8mm, 6mm Optional)	3.6mm (2.8mm Optional)	3.6mm (2.8mm Optional)	3.6mm (2.8mm Optional)	3.6mm (2.8mm Optional)	3.6mm (2.8mm Optional)
FOV-H	92° (111°/57°)	88° (111°)	84° (106°)	92° (111°)	86° (109°)	87° (110.8°)
Day/Night	ICR	ICR	ICR	ICR	ICR	ICR
Max. IR Distance	40m (131ft), Smart IR	20m (65ft), Smart IR	20m (65ft), Smart IR	30m (98ft), Smart IR	30m (98ft), Smart IR	30m (98ft), Smart IR
OSD Menu	Multi-language	Multi-language	Multi-language	Multi-language	Multi-language	Multi-language
WDR	120dB	120dB	120dB	120dB	130dB	120dB
Noise Reduction	2D/3D	2D/3D	2D/3D	2D/3D	2D/3D	2D/3D
Frame Rate	25fps@5MP (16:9) 30fps@4MP 30fps@1080P	25fps@5MP (16:9) 30fps@4MP 30fps@1080P	30fps@1080P 30fps@720P	25fps@5MP (16:9) 30fps@4MP 30fps@1080P	30fps@1080P 30fps@720P	15fps@4K 20fps@6MP 30fps@4MP
Video Output	HD/SD Switchable	HD/SD Switchable	HD/SD Switchable	HD/SD Switchable	HD/SD Switchable	HD/SD Switchable
Audio In	Built-in Mic	1ch in & Built-in Mic	1ch in & Built-in Mic	Built-in Mic	1ch in & Built-in Mic	1
Alarm In/Out	--	--	--	--	--	--
Pan/Tilt/Rotation	Pan: 0°~360°; Tilt: 0°~90° Rotation: 0°~360°	Pan: 0°~360°; Tilt: 0°~90° Rotation: 0°~360°	Pan: 0°~360°; Tilt: 0°~90° Rotation: 0°~360°	Pan: 0°~360°; Tilt: 0°~90° Rotation: 0°~360°	Pan: 0°~360°; Tilt: 0°~90° Rotation: 0°~360°	Pan: 0°~355°; Tilt: 0°~75° Rotation: 0°~355°
Ingress Protection	IP67	IP67	IP67	IP67	IP67	IP67, IK10
Working Temperature	-40°C~+60°C (-40°F~+140°F)	-40°C~+60°C (-40°F~+140°F)	-40°C~+60°C (-40°F~+140°F)	-40°C~+60°C (-40°F~+140°F)	-40°C~+60°C (-40°F~+140°F)	-30°C~+60°C (-22°F~+140°F)
Power	DC12V±30% Max. 5.9W	DC12V±30% Max. 4.4W	DC12V±30% Max. 4.2W	DC12V±30% Max. 4.7W	DC12V±30% Max. 3W	DC12V±30% Max. 7W







HDCVI CAMERAS

Pro Series

	Vari-focal Dome			Fixed-focal Eyeball		
Model	HAC-HDBW2402R	HAC-HDBW2501E	HAC-HDBW2241EA-A	HAC-HDW2501TMQ-A	HAC-HDW2241TMQ-A	HAC-HDW2501TQ-A
Appearance	 Starlight	 Starlight	 Starlight	 Starlight	 Starlight	 Starlight
Image Sensor	4MP CMOS	5MP (16:9) CMOS	2MP CMOS	5MP (16:9) CMOS	2MP CMOS	5MP (16:9) CMOS
Min. Illumination	0.002Lux/F1.6 (Color) 0Lux/F1.6 (IR on)	0.001Lux/F1.6 (Color) 0Lux/F1.6 (IR On)	0.001Lux/F1.6 (Color) 0Lux/F1.6 (IR on)	0.001Lux/F1.6 (Color) 0Lux/F1.6 (IR On)	0.001Lux/F1.6 (Color) 0Lux/F1.6 (IR on)	0.001Lux/F1.6 (Color) 0Lux/F1.6 (IR On)
Lens	3.6mm (2.8mm Optional)	3.6mm (2.8mm Optional)	3.6mm (2.8mm Optional)	3.6mm (2.8mm, 6mm Optional)	3.6mm (2.8mm, 6mm Optional)	3.6mm (2.8mm, 6mm Optional)
FOV-H	88.5° (112.7°)	92° (111°)	86° (109°)	92° (111°/57°)	86° (109°/54°)	92° (111°/57°)
Day/Night	ICR	ICR	ICR	ICR	ICR	ICR
Max. IR Distance	30m (98ft), Smart IR	30m (98ft), Smart IR	40m (132ft), Smart IR	60m (197ft), Smart IR	60m (197ft), Smart IR	40m (131ft), Smart IR
OSD Menu	Multi-language	Multi-language	Multi-language	Multi-language	Multi-language	Multi-language
WDR	120dB	120dB	130dB	120dB	130dB	120dB
Noise Reduction	2D/3D	2D/3D	2D/3D	2D/3D	2D/3D	2D/3D
Frame Rate	30fps@4MP 30fps@1080P	25fps@5MP (16:9) 30fps@4MP 30fps@1080P	30fps@1080P 30fps@720P	25fps@5MP (16:9) 30fps@4MP 30fps@1080P	30fps@1080P 30fps@720P	25fps@5MP (16:9) 30fps@4MP 30fps@1080P
Video Output	HD/SD Switchable	HD/SD Switchable	HD/SD Switchable	HD/SD Switchable	HD/SD Switchable	HD/SD Switchable
Audio In	1	Built-in Mic	1ch in & Built-in Mic	Built-in Mic	1ch in & Built-in Mic	Built-in Mic
Alarm In/Out	--	--	--	--	--	--
Pan/Tilt/Rotation	Pan: 0° ~ 355°; Tilt: 0° ~ 75° Rotation: 0° ~ 355°	Pan: 0°~355°; Tilt: 0°~65° Rotation: 0°~355°	Pan: 0°~355°; Tilt: 0°~75° Rotation: 0°~355°	Pan: 0°~360°; Tilt: 0°~78° Rotation: 0°~360°	Pan: 0° ~ 360°; Tilt: 0° ~ 78° Rotation: 0° ~ 360°	Pan: 0°~360°; Tilt: 0°~78° Rotation: 0°~360°
Ingress Protection	IP67, IK10	IP67, IK10	IP67	IP67	IP67	IP67
Working Temperature	-40°C~+60°C (-40°F~+140°F)	-40°C~+60°C (-40°F~+140°F)	-40°C~+60°C (-40°F~+140°F)	-40°C~+60°C (-40°F~+140°F)	-40°C~+60°C (-40°F~+140°F)	-40°C~+60°C (-40°F~+140°F)
Power	DC12V±30% Max. 5.8W	DC12V±30% Max. 4.5W	DC12V±30% Max. 3.1W	DC12V±30% Max. 5.9W	DC12V±30% Max. 5.1W	DC12V±30% Max. 4.3W







Pro Series

Fixed-focal Eyeball

Model	HAC-HDW2802T-A	HAC-HDW2402T-A	HAC-HDW2509T-A-LED	HAC-HDW2249T-A-LED	HAC-HDW2501TLMQ-A	HAC-HDW2241TLMQ-A
Appearance	 Starlight	 Starlight	 Full-color	 Full-color	 Starlight	 Starlight
Image Sensor	4K CMOS	4MP CMOS	5MP (16:9) CMOS	2MP CMOS	5MP (16:9) CMOS	2MP CMOS
Min. Illumination	0.005Lux/F1.6 (Color) 0Lux/F1.6 (IR on)	0.002Lux/F1.6 (Color) 0Lux/F1.6 (IR on)	0.0002Lux/F1.0 (Color) 0.0002Lux/F1.0 (IR on)	0.0002Lux/F1.0 (Color) 0.0002Lux/F1.0 (IR on)	0.001Lux/F1.6 (Color) 0Lux/F1.6 (IR On)	0.001Lux/F1.6 (Color) 0Lux/F1.6 (IR on)
Lens	3.6mm (2.8mm, 6mm Optional)	3.6mm (2.8mm, 6mm Optional)	3.6mm (2.8mm Optional)	3.6mm (2.8mm Optional)	3.6mm (2.8mm Optional)	3.6mm (2.8mm Optional)
FOV-H	87° (110.8°/55°)	88.5° (112.7°/55.8°)	88° (111°)	84° (106°)	92° (111°)	86° (109°)
Day/Night	ICR	ICR	ICR	ICR	ICR	ICR
Max. IR Distance	50m (164ft), Smart IR	50m (164ft), Smart IR	40m (131ft), Smart IR	40m (131ft), Smart IR	30m (197ft), Smart IR	30m (98ft), Smart IR
OSD Menu	Multi-language	Multi-language	Multi-language	Multi-language	Multi-language	Multi-language
WDR	120dB	120dB	120dB	120dB	120dB	130dB
Noise Reduction	2D/3D	2D/3D	2D/3D	2D/3D	2D/3D	2D/3D
Frame Rate	15fps@4K 20fps@6MP 30fps@4MP	30fps@4MP 30fps@1080P	25fps@5MP (16:9) 30fps@4MP 30fps@1080P	30fps@1080P 30fps@720P	25fps@5MP (16:9) 30fps@4MP 30fps@1080P	30fps@1080P 30fps@720P
Video Output	HD/SD Switchable	HD/SD Switchable	HD/SD Switchable	HD/SD Switchable	HD/SD Switchable	HD/SD Switchable
Audio In	1ch in & Built-in Mic	1ch in & Built-in Mic	Built-in Mic	1ch in & Built-in Mic	Built-in Mic	1ch in & Built-in Mic
Alarm In/Out	--	--	--	--	--	--
Pan/Tilt/Rotation	Pan: 0°~360°; Tilt: 0°~78° Rotation: 0°~360°	Pan: 0° ~ 360°; Tilt: 0° ~ 78° Rotation: 0° ~ 360°	Pan: 0°~360°; Tilt: 0°~78° Rotation: 0°~360°	Pan: 0° ~ 360°; Tilt: 0° ~ 78° Rotation: 0° ~ 360°	Pan: 0°~360°; Tilt: 0°~78° Rotation: 0°~360°	Pan: 0° ~ 360°; Tilt: 0° ~ 78° Rotation: 0° ~ 360°
Ingress Protection	IP67	IP67	IP67	IP67	IP67	IP67
Working Temperature	-30°C~+60°C (-22°F~+140°F)	-40°C~+60°C (-40°F~+140°F)	-40°C~+60°C (-40°F~+140°F)	-40°C~+60°C (-40°F~+140°F)	-40°C~+60°C (-40°F~+140°F)	-40°C~+60°C (-40°F~+140°F)
Power	DC12V±30% Max. 8W	DC12V±30% Max. 7.1W	DC12V±30% Max. 6.4W	DC12V±30% Max. 5.8W	DC12V±30% Max. 4.3W	DC12V±30% Max. 3.1W

HDCVI CAMERAS

Pro Series

	Fixed-focal Eyeball				Wedge Dome	
Model	HAC-HDW2501TLM-A	HAC-HDW2241TLM-A	HAC-HDW2509TLM-A-LED	HAC-HDW2249TLM-A-LED	HAC-HDBW2501F-A	HAC-HDBW2241F-A
Appearance	 Starlight	 Starlight	 Full-color	 Full-color	 Starlight	 Starlight
Image Sensor	5MP (16:9) CMOS	2MP CMOS	5MP (16:9) CMOS	2MP CMOS	5MP (16:9) CMOS	2MP CMOS
Min. Illumination	0.001Lux/F1.6 (Color) 0Lux/F1.6 (IR On)	0.001Lux/F1.6 (Color) 0Lux/F1.6 (IR On)	0.0002Lux/F1.0 (Color) 0.0002Lux/F1.0 (IR on)	0.0002Lux/F1.0 (Color) 0.0002Lux/F1.0 (IR on)	0.001Lux/F1.6 (Color) 0Lux/F1.6 (IR On)	0.001Lux/F1.6 (Color) 0Lux/F1.6 (IR on)
Lens	3.6mm (2.8mm Optional)	3.6mm (2.8mm Optional)	3.6mm (2.8mm Optional)	3.6mm (2.8mm Optional)	3.6mm (2.8mm Optional)	3.6mm (2.8mm Optional)
FOV-H	92° (111°)	86° (109°)	88° (111°)	84° (106°)	92° (111°)	86° (109°)
Day/Night	ICR	ICR	ICR	ICR	ICR	ICR
Max. IR Distance	30m (98ft), Smart IR	30m (98ft), Smart IR	20m (65ft), Smart IR	20m (65ft), Smart IR	30m (197ft), Smart IR	30m (98ft), Smart IR
OSD Menu	Multi-language	Multi-language	Multi-language	Multi-language	Multi-language	Multi-language
WDR	120dB	130dB	120dB	120dB	120dB	130dB
Noise Reduction	2D/3D	2D/3D	2D/3D	2D/3D	2D/3D	2D/3D
Frame Rate	25fps@5MP (16:9) 30fps@4MP 30fps@1080P	30fps@1080P 30fps@720P	25fps@5MP (16:9) 30fps@4MP 30fps@1080P	30fps@1080P 30fps@720P	25fps@5MP (16:9) 30fps@4MP 30fps@1080P	30fps@1080P 30fps@720P
Video Output	HD/SD Switchable	HD/SD Switchable	HD/SD Switchable	HD/SD Switchable	HD/SD Switchable	HD/SD Switchable
Audio In	1ch in & Built-in Mic	1ch in & Built-in Mic	Built-in Mic	1ch in & Built-in Mic	Built-in Mic	1ch in & Built-in Mic
Alarm In/Out	--	--	--	--	--	--
Pan/Tilt/Rotation	Pan: 0° ~ 360°; Tilt: 0° ~ 78° Rotation: 0° ~ 360°	Pan: 0° ~ 360°; Tilt: 0° ~ 78° Rotation: 0° ~ 360°	Pan: 0°~360°; Tilt: 0°~78° Rotation: 0°~360°	Pan: 0° ~ 360°; Tilt: 0° ~ 78° Rotation: 0° ~ 360°	Pan: 0°~60°; Tilt: 0°~80° Rotation: 0°~360°	Pan: 0° ~ 360°; Tilt: 0° ~ 78° Rotation: 0° ~ 360°
Ingress Protection	IP67	IP67	IP67	IP67	IP67, IK10	IP67
Working Temperature	-40°C~+60°C (-40°F~+140°F)	-40°C~+60°C (-40°F~+140°F)	-40°C~+60°C (-40°F~+140°F)	-40°C~+60°C (-40°F~+140°F)	-40°C~+60°C (-40°F~+140°F)	-40°C~+60°C (-40°F~+140°F)
Power	DC12V±30% Max. 4.3W	DC12V±30% Max. 3.1W	DC12V±30% Max. 4.4W	DC12V±30% Max. 4.2W	DC12V±30% Max. 4.0W	DC12V±30% Max. 3.1W

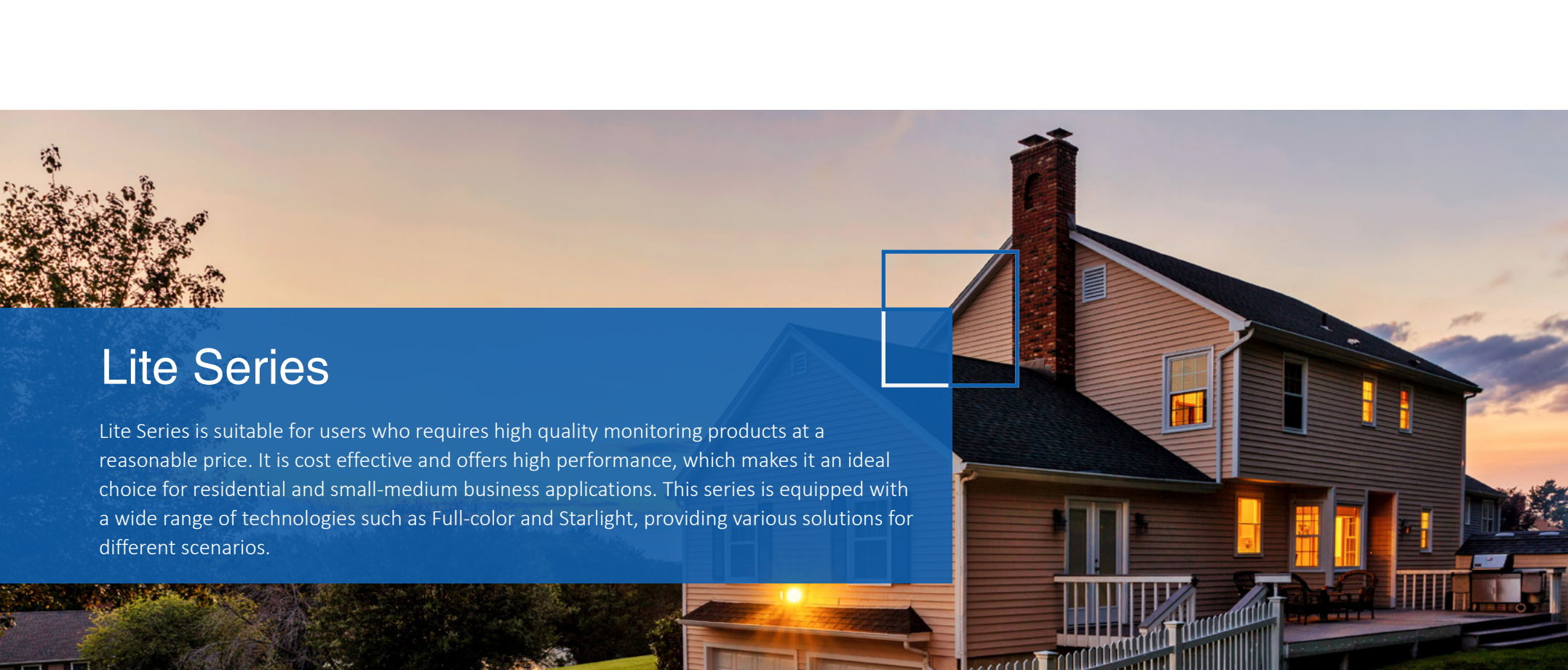

Lite Series

Lite Series is suitable for users who requires high quality monitoring products at a reasonable price. It is cost effective and offers high performance, which makes it an ideal choice for residential and small-medium business applications. This series is equipped with a wide range of technologies such as Full-color and Starlight, providing various solutions for different scenarios.

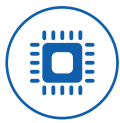

High Performance

Lite Series adopts advanced in-house ISP and high performance sensor to deliver high quality image with high resolution ranging from 1080P to 4K.



Quick-to-Install

Quick-to-Install structure design allows quick and convenient installation and adjustment, saving time and labor costs.



Full-color

Full-color cameras present 24/7 colored images with clear details to accurately identify people or objects even under low light conditions.









Built-in Mic

Lite Series offers optional models with built-in mic, which can collect high quality audio information as supplementary evidence for video surveillance.

HDCVI CAMERAS









Lite Series

Vari-focal Bullet

Model	HAC-HFW1509TU-Z-A-LED (-DP)	HAC-HFW1239TU-Z-A-LED (-DP)	HAC-HFW1801R-Z-IRE6 (-A)	HAC-HFW1500R-Z-IRE6 (-A/DP)	HAC-HFW1231R-Z-A (-DP)	HAC-HFW1200R-Z-IRE6 (-A)
Appearance						
Image Sensor	5MP (16:9) CMOS	2MP CMOS	4K CMOS	5MP (16:9) CMOS	2MP CMOS	2MP CMOS
Min. Illumination	0.001Lux/F1.0 (Color) 0Lux/F1.0 (LED On)	0.001Lux/F1.2 (Color) 0Lux/F1.2 (LED On)	0.03Lux/F1.7 (Color) 0Lux/F1.7 (IR On)	0.005Lux/F1.6 (Color) 0Lux/F1.6 (IR On)	0.002Lux/F1.5 (Color) 0Lux/F1.5 (IR On)	0.02Lux/F1.7 (Color) 0Lux/F1.7 (IR On)
Lens	2.7-13.5mm, Motorized	2.7-13.5mm, Motorized	2.7-13.5mm, Motorized	2.7-12mm, Motorized	2.7-12mm, Motorized	2.7-12mm, Motorized
FOV-H	112°~35°	107°~34°	105°~33°	106°~35°	102°~33°	102°~33°
Day/Night	ICR	ICR	ICR	ICR	ICR	ICR
Max. IR Distance	LED: 60m (197ft), Smart Light	LED: 60m (197ft), Smart Light	60m (197ft), Smart IR	60m (197ft), Smart IR	80m (262.5ft), Smart IR	60m (197ft), Smart IR
OSD Menu	Multi-language	Multi-language	Multi-language	Multi-language	Multi-language	Multi-language
WDR	120dB	130dB	120dB	DWDR	130dB	DWDR
Noise Reduction	2D/3D	2D/3D	2D/3D	2D	2D/3D	2D
Frame Rate	25fps@5MP (16:9) 25fps@4MP 25fps@1080P	30fps@1080P	15fps@4K 20fps@5MP 30fps@4MP	25fps@5MP (16:9) 30fps@4MP 30fps@1080P	30fps@1080P	30fps@1080P 30fps@720P
Video Output	HD/SD Switchable	HD/SD Switchable	HD/SD Switchable	HD/SD Switchable	HD/SD Switchable	HD/SD Switchable
Audio In	Built-in Mic(-A)	Built-in Mic	Built-in Mic (-A)	Built-in Mic (-A)	Built-in Mic	Built-in Mic (-A)
Alarm In/Out	--	--	--	--	--	--
Pan/Tilt/Rotation	Pan: 0°~360°; Tilt: 0°~90° Rotation: 0°~360°	Pan: 0°~360°; Tilt: 0°~90° Rotation: 0°~360°	Pan: 0°~360°; Tilt: 0°~90° Rotation: 0°~360°	Pan: 0°~360°; Tilt: 0°~90° Rotation: 0°~360°	Pan: 0°~360°; Tilt: 0°~90° Rotation: 0°~360°	Pan: 0°~360°; Tilt: 0°~90° Rotation: 0°~360°
Ingress Protection	IP67	IP67	IP67	IP67	IP67	IP67
Working Temperature	-30°C~+60°C (-22°F~+140°F)	-30°C~+60°C (-22°F~+140°F)	-30°C~+60°C (-22°F~+140°F)	-30°C~+60°C (-22°F~+140°F)	-30°C~+60°C (-22°F~+140°F)	-30°C~+60°C (-22°F~+140°F)
Power	DC12V±30%, Max. 11.88W DC12V±10%/AC24V±25% Max. 14.92W (-DP)	DC12V±30%, Max. 10.2W DC12V±10%/AC24V±25% Max. 13.2W (-DP)	DC12V±30% Max. 11W	DC12V±30%, Max. 11W DC12V±10%/AC24V±25% Max. 11.5W (-DP)	DC12V±30%, Max. 12.1W DC12V±10%/AC24V±25% Max. 9.5W (-DP)	DC12V±30% Max. 12.1W

HDCVI CAMERAS







Lite Series

	Vari-focal Dome				Vari-focal Eyeball	
Model	HAC-HDBW1231RA-Z-A (-DP)	HAC-HDBW1801R-Z	HAC-HDBW1500R-Z (-DP)	HAC-HDBW1200R-Z	HAC-HDW1801T-Z (-A)	HAC-HDW1509T-Z-A-LED (-DP)
Appearance	 		 			 
Image Sensor	2MP CMOS	4K CMOS	5MP (16:9) CMOS	2MP CMOS	4K CMOS	5MP (16:9) CMOS
Min. Illumination	0.002Lux/F1.5 (Color) 0Lux/F1.5 (IR On)	0.03Lux/F1.7 (Color) 0Lux/F1.7 (IR On)	0.005Lux/F1.6 (Color) 0Lux/F1.6 (IR On)	0.02Lux/F1.7 (Color) 0Lux/F1.7 (IR On)	0.03Lux/F1.7 (Color) 0Lux/F1.7 (IR On)	0.001Lux/F1.0 (Color) 0Lux/F1.0 (LED On)
Lens	2.7-12mm, Motorized	2.7-13.5mm, Motorized	2.7-12mm, Motorized	2.7-12mm, Motorized	2.7-13.5mm, Motorized	2.7-13.5mm, Motorized
FOV-H	102°~33°	105°~33°	106°~35°	102°~33°	105°~33°	112°~35°
Day/Night	ICR	ICR	ICR	ICR	ICR	ICR
Max. IR Distance	60m (197ft), Smart IR	30m (98ft), Smart IR	30m (98ft), Smart IR	30m (98ft), Smart IR	60m (197ft), Smart IR	LED: 40m (131ft), Smart IR
OSD Menu	Multi-language	Multi-language	Multi-language	Multi-language	Multi-language	Multi-language
WDR	130dB	120dB	DWDR	DWDR	120dB	120dB
Noise Reduction	2D/3D	2D/3D	2D	2D	2D/3D	2D/3D
Frame Rate	30fps@1080P	15fps@4K 20fps@5MP 30fps@4MP	25fps@5MP (16:9) 30fps@4MP 30fps@1080P	30fps@1080P 30fps@720P	15fps@4K 20fps@5MP 30fps@4MP	25fps@5MP (16:9) 25fps@4MP 25fps@1080P
Video Output	HD/SD Switchable	HD/SD Switchable	HD/SD Switchable	HD/SD Switchable	HD/SD Switchable	HD/SD Switchable
Audio In	Built-in Mic	--	--	--	Built-in Mic(-A)	Built-in Mic
Alarm In/Out	--	--	--	--	--	--
Pan/Tilt/Rotation	Pan: 0°~355°; Tilt: 0°~80° Rotation: 0°~355°	Pan: 0°~355°; Tilt: 0°~75° Rotation: 0°~355°	Pan: 0°~355°; Tilt: 0°~75° Rotation: 0°~355°	Pan: 0°~360°; Tilt: 0°~75° Rotation: 0°~360°	Pan: 0°~360°; Tilt: 0°~78° Rotation: 0°~360°	Pan: 0°~360°; Tilt: 0°~78° Rotation: 0°~360°
Ingress Protection	IP67, IK10	IP67, IK10	IP67, IK10	IP67, IK10	IP67	IP67
Working Temperature	-30°C~+60°C (-22°F~+140°F)	-30°C~+60°C (-22°F~+140°F)	-30°C~+60°C (-22°F~+140°F)	-30°C~+60°C (-22°F~+140°F)	-30°C~+60°C (-22°F~+140°F)	-30°C~+60°C (-22°F~+140°F)
Power	DC12V±30%, Max. 6.9W DC12V±10%/AC24V±25% Max. 9.5W (-DP)	DC12V±30% Max. 6.9W	DC12V±30%, Max. 5.5W DC12V±10%/AC24V±25% Max. 6.9W (-DP)	DC12V±30% Max. 6.3W	DC12V±30% Max. 7.8W	DC12V±30%, Max. 7.92W DC12V±10%/AC24V±25% Max. 9.9W (-DP)



HDCVI CAMERAS

Lite Series

Vari-focal Eyeball

Model	HAC-HDW1500T-Z (-A/DP)	HAC-HDW1239T-Z-A-LED(-DP)	HAC-HDW1231T-Z-A (-DP)	HAC-HDW1200T-Z (-A)	HAC-HDW1500TMQ-Z (-A/DP)	HAC-HDW1231TMQ-Z-A (-DP)
Appearance	 Starlight	 Full-Color	 Starlight	 Starlight	 Starlight	 Starlight
Image Sensor	5MP (16:9) CMOS	2MP CMOS	2MP CMOS	2MP CMOS	5MP (16:9) CMOS	2MP CMOS
Min. Illumination	0.005Lux/F1.6 (Color) 0Lux/F1.6 (IR On)	0.001Lux/F1.2 (Color) 0Lux/F1.2 (LED On)	0.002Lux/F1.5 (Color) 0Lux/F1.5 (IR On)	0.02Lux/F1.7 (Color) 0Lux/F1.7 (IR On)	0.005Lux/F1.6 (Color) 0Lux/F1.6 (IR On)	0.002Lux/F1.5 (Color) 0Lux/F1.5 (IR On)
Lens	2.7-12mm, Motorized	2.7-13.5mm, Motorized	2.7-12mm, Motorized	2.7-12mm, Motorized	2.7-12mm, Motorized	2.7-12mm, Motorized
FOV-H	106°~35°	107°~34°	102°~33°	102°~33°	106°~35°	102°~33°
Day/Night	ICR	ICR	ICR	ICR	ICR	ICR
Max. IR Distance	60m (197ft), Smart IR	LED: 40m (131ft), Smart Light	60m (197ft), Smart IR	60m (197ft), Smart IR	60m (197ft), Smart IR	60m (197ft), Smart IR
OSD Menu	Multi-language	Multi-language	Multi-language	Multi-language	Multi-language	Multi-language
WDR	DWDR	130dB	130dB	DWDR	DWDR	130dB
Noise Reduction	2D	2D/3D	2D/3D	2D	2D	2D/3D
Frame Rate	25fps@5MP (16:9) 30fps@4MP 30fps@1080P	30fps@1080P	30fps@1080P	30fps@1080P 30fps@720P	25fps@5MP (16:9) 30fps@4MP 30fps@1080P	30fps@1080P
Video Output	HD/SD Switchable	HD/SD Switchable	HD/SD Switchable	HD/SD Switchable	HD/SD Switchable	HD/SD Switchable
Audio In	Built-in Mic(-A)	Built-in Mic	Built-in Mic	Built-in Mic(-A)	Built-in Mic(-A)	Built-in Mic
Alarm In/Out	--	--	--	--	--	--
Pan/Tilt/Rotation	Pan: 0°~360°; Tilt: 0°~78° Rotation: 0°~360°	Pan: 0°~360°; Tilt: 0°~78° Rotation: 0°~360°	Pan: 0°~360°; Tilt: 0°~78° Rotation: 0°~360°	Pan: 0°~360°; Tilt: 0°~78° Rotation: 0°~360°	Pan: 0°~360°; Tilt: 0°~78° Rotation: 0°~360°	Pan: 0°~360°; Tilt: 0°~78° Rotation: 0°~360°
Ingress Protection	IP67	IP67	IP67	IP67	IP67	IP67
Working Temperature	-30°C~+60°C (-22°F~+140°F)	-30°C~+60°C (-22°F~+140°F)	-30°C~+60°C (-22°F~+140°F)	-30°C~+60°C (-22°F~+140°F)	-30°C~+60°C (-22°F~+140°F)	-30°C~+60°C (-22°F~+140°F)
Power	DC12V±30%, Max. 6.6W DC12V±10%/AC24V±25% Max. 8.2W (-DP)	DC12V±30%, Max. 6.7W DC12V±10%/AC24V±25% Max. 8.2W (-DP)	DC12V±30%, Max. 8.2W DC12V±10%/AC24V±25% Max. 8.2W (-DP)	DC12V±30% Max. 8.2W	DC12V±30%, Max. 6.6W DC12V±10%/AC24V±25% Max. 8.2W (-DP)	DC12V±30%, Max. 6.1W DC12V±10%/AC24V±25% Max. 8.2W (-DP)







Lite Series

	Vari-focal Eyeball	Fixed-focal Bullet				
Model	HAC-HDW1200TMQ-Z (-A)	HAC-HFW1801D	HAC-HFW1500D	HAC-HFW1200D	HAC-HFW1801TH-I8	HAC-HFW1800TH-I8
Appearance			 Starlight			 4K Real-time
Image Sensor	2MP CMOS	4K CMOS	5MP (16:9) CMOS	2MP CMOS	4K CMOS	4K CMOS
Min. Illumination	0.02Lux/F1.7 (Color) 0Lux/F1.7 (IR On)	0.03Lux/F2.0 (Color) 0Lux/F2.0 (IR On)	0.005Lux/F1.6 (Color) 0Lux/F1.6 (IR On)	0.02Lux/F1.9 (Color) 0Lux/F1.9 (IR On)	0.03Lux/F2.0 (Color) 0Lux/F2.0 (IR On)	0.03Lux/F2.0 (Color) 0Lux/F2.0 (IR On)
Lens	2.7-12mm, Motorized	3.6mm (6mm Optional)	3.6mm (6mm, 8mm Optional)	3.6mm (6mm, 8mm Optional)	3.6mm (6mm Optional)	3.6mm (6mm Optional)
FOV-H	102°~33°	87° (54.7°)	92° (57°/43°)	84° (56°/40°)	87° (54.7°)	87° (54.7°)
Day/Night	ICR	ICR	ICR	ICR	ICR	ICR
Max. IR Distance	60m (197ft), Smart IR	80m (262ft), Smart IR	80m (262ft), Smart IR	80m (262ft), Smart IR	80m (262ft), Smart IR	80m (262ft), Smart IR
OSD Menu	Multi-language	Multi-language	Multi-language	Multi-language	Multi-language	Multi-language
WDR	DWDR	120dB	DWDR	DWDR	120dB	DWDR
Noise Reduction	2D	2D/3D	2D	2D	2D/3D	2D
Frame Rate	30fps@1080P 30fps@720P	15fps@4K 20fps@5MP 30fps@4MP	25fps@5MP (16:9) 30fps@4MP 30fps@1080P	30fps@1080P 30fps@720P	15fps@4K 20fps@5MP 30fps@4MP	30fps@4K 20fps@5MP 30fps@4MP
Video Output	HD/SD Switchable	HD/SD Switchable	HD/SD Switchable	HD/SD Switchable	HD/SD Switchable	HD/SD Switchable
Audio In	Built-in Mic(-A)	--	--	--	--	--
Alarm In/Out	--	--	--	--	--	--
Pan/Tilt/Rotation	Pan: 0°~360°; Tilt: 0°~78° Rotation: 0°~360°	Pan: 0°~360°; Tilt: 0°~87° Rotation: 0°~360°	Pan: 0°~360°; Tilt: 0°~87° Rotation: 0°~360°	Pan: 0°~360°; Tilt: 0°~87° Rotation: 0°~360°	Pan: 0°~360°; Tilt: 0°~90° Rotation: 0°~360°	Pan: 0°~360°; Tilt: 0°~90° Rotation: 0°~360°
Ingress Protection	IP67	IP67	IP67	IP67	IP67	IP67
Working Temperature	-30°C~+60°C (-22°F~+140°F)	-40°C~+60°C (-40°F~+140°F)	-40°C~+60°C (-40°F~+140°F)	-40°C~+60°C (-40°F~+140°F)	-40°C~+60°C (-40°F~+140°F)	-40°C~+60°C (-40°F~+140°F)
Power	DC12V±30% Max. 6.1W	DC12V±30% Max. 6.5W	DC12V±30% Max. 4.9W	DC12V±30% Max. 4.9W	DC12V±30% Max. 5.9W	DC12V±30% Max. 6W

HDCVI CAMERAS

Lite Series

Fixed-focal Bullet

Model	HAC-HFW1500TH-I8	HAC-HFW1200TH-I8	HAC-HFW1801TH-I4	HAC-HFW1800TH-I4	HAC-HFW1500TH-I4	HAC-HFW1200TH-I4
Appearance	 Starlight			 4K Real-time	 Starlight	 Starlight
Image Sensor	5MP (16:9) CMOS	2MP CMOS	4K CMOS	4K CMOS	5MP (16:9) CMOS	2MP CMOS
Min. Illumination	0.005Lux/F1.6 (Color) 0Lux/F1.6 (IR On)	0.02Lux/F1.9 (Color) 0Lux/F1.9 (IR On)	0.03Lux/F2.0 (Color) 0Lux/F2.0 (IR On)	0.03Lux/F2.0 (Color) 0Lux/F2.0 (IR On)	0.005Lux/F1.6 (Color) 0Lux/F1.6 (IR On)	0.02Lux/F1.9 (Color) 0Lux/F1.9 (IR On)
Lens	3.6mm (6mm, 8mm Optional)	3.6mm (6mm, 8mm Optional)	3.6mm (2.8mm, 6mm Optional)	3.6mm (2.8mm, 6mm Optional)	3.6mm (6mm Optional)	3.6mm (2.8mm, 6mm Optional)
FOV-H	92° (57°/43°)	84° (56°/40°)	87° (105°/54.7°)	87° (105°/54.7°)	92° (57°)	84° (101°/56°)
Day/Night	ICR	ICR	ICR	ICR	ICR	ICR
Max. IR Distance	80m (262ft), Smart IR	80m (262ft), Smart IR	40m (131ft), Smart IR	40m (131ft), Smart IR	40m (131ft), Smart IR	40m (131ft), Smart IR
OSD Menu	Multi-language	Multi-language	Multi-language	Multi-language	Multi-language	Multi-language
WDR	DWDR	DWDR	120dB	DWDR	DWDR	DWDR
Noise Reduction	2D	2D	2D/3D	2D	2D	2D
Frame Rate	25fps@5MP (16:9) 30fps@4MP 30fps@1080P	30fps@1080P 30fps@720P	15fps@4K 20fps@5MP 30fps@4MP	30fps@4K 20fps@5MP 30fps@4MP	25fps@5MP (16:9) 30fps@4MP 30fps@1080P	30fps@1080P 30fps@720P
Video Output	HD/SD Switchable	HD/SD Switchable	HD/SD Switchable	HD/SD Switchable	HD/SD Switchable	HD/SD Switchable
Audio In	--	--	--	--	--	--
Alarm In/Out	--	--	--	--	--	--
Pan/Tilt/Rotation	Pan: 0°~360°; Tilt: 0°~90° Rotation: 0°~360°	Pan: 0°~360°; Tilt: 0°~90° Rotation: 0°~360°	Pan: 0°~360°; Tilt: 0°~90° Rotation: 0°~360°	Pan: 0°~360°; Tilt: 0°~90° Rotation: 0°~360°	Pan: 0°~360°; Tilt: 0°~90° Rotation: 0°~360°	Pan: 0°~360°; Tilt: 0°~90° Rotation: 0°~360°
Ingress Protection	IP67	IP67	IP67	IP67	IP67	IP67
Working Temperature	-40°C~+60°C (-40°F~+140°F)	-40°C~+60°C (-40°F~+140°F)	-40°C~+60°C (-40°F~+140°F)	-40°C~+60°C (-40°F~+140°F)	-40°C~+60°C (-40°F~+140°F)	-40°C~+60°C (-40°F~+140°F)
Power	DC12V±30% Max. 5.2W	DC12V±30% Max. 4.9W	DC12V±30% Max. 4.4W	DC12V±30% Max. 4.3W	DC12V±30% Max. 3.2W	DC12V±30% Max. 2.8W

Lite Series





Fixed-focal Bullet

Model	HAC-HFW1509TM-IL-A	HAC-HFW1239TM-IL-A	HAC-HFW1231TM-18-A	HAC-HFW1801TL-A	HAC-HFW1800TL-A
Appearance	 Smart Dual Illuminators	 Smart Dual Illuminators			 4K Real-time
Image Sensor	5MP (16:9) CMOS	2MP CMOS	2MP CMOS	4K CMOS	4K CMOS
Min. Illumination	0.001 lux@F1.0 (Color, 30 IRE) 0.0001 lux@F1.0 (B/W, 30 IRE) 0 lux (Illuminator on)	0.001 Lux@F1.6 (Color, 30IRE) 0.0001 Lux@F1.6 (B/W, 30 IRE) 0 lux (Illuminator on)	0.002Lux/F1.6 (Color) 0Lux/F1.6 (IR On)	0.03Lux/F2.0 (Color) 0Lux/F2.0 (IR On)	0.03Lux/F2.0 (Color) 0Lux/F2.0 (IR On)
Lens	3.6mm (2.8mm Optional)	3.6mm (2.8mm Optional)	3.6mm (2.8mm, 6mm, 8mm Optional)	3.6mm (2.8mm, 6mm Optional)	3.6mm (2.8mm,6mm Optional)
FOV-H	89° (111°)	89° (111°)	86° (107°/54°/41°)	87° (105°/54.7°)	87° (105°/54.7°)
Day/Night	Auto(ICR)/Color/B/W	Auto(ICR)/Color/B/W	ICR	ICR	ICR
Max. IR Distance	IR: 40m (131.23 ft) Warm Light: 40m (131.23 ft)	IR: 40m (131.23 ft) Warm Light: 40m (131.23 ft)	80m (262ft), Smart IR	80m (262ft), Smart IR	80m (262ft), Smart IR
OSD Menu	Multi-language	Multi-language	Multi-language	Multi-language	Multi-language
WDR	120dB	120dB	130dB	120dB	DWDR
Noise Reduction	2D/3D	2D/3D	2D/3D	2D/3D	2D
Frame Rate	25fps@5MP (16:9) 30fps@4MP 30fps@1080P	30fps@1080P	30fps@1080P	15fps@4K 20fps@5MP 30fps@4MP	30fps@4K 20fps@5MP 30fps@4MP
Video Output	HD/SD Switchable	HD/SD Switchable	HD/SD Switchable	HD/SD Switchable	HD/SD Switchable
Audio In	Built-in Mic	Built-in Mic	Built-in Mic	Built-in Mic	Built-in Mic
Alarm In/Out	--	--	--	--	--
Pan/Tilt/Rotation	Pan: 0°~360°; Tilt: 0°~90° Rotation: 0°~360°	Pan: 0°~360°; Tilt: 0°~78° Rotation: 0°~360°	Pan: 0°~360°; Tilt: 0°~90° Rotation: 0°~360°	Pan: 0°~360°; Tilt: 0°~90° Rotation: 0°~360°	Pan: 0°~360°; Tilt: 0°~90° Rotation: 0°~360°
Ingress Protection	IP67	IP67	IP67	IP67	IP67
Working Temperature	-40°C~+60°C (-40°F~+140°F)	-40°C~+60°C (-40°F~+140°F)	-40°C~+60°C (-40°F~+140°F)	-40°C~+60°C (-40°F~+140°F)	-40°C~+60°C (-40°F~+140°F)
Power	DC12V±30% Max. 6.4W	DC12V±30% Max. 4.0W	DC12V±30% Max. 5.1W	DC12V±30% Max. 6.6W	DC12V±30% Max. 6W

HDCVI CAMERAS







Lite Series

Fixed-focal Bullet

Model	HAC-HFW1500TL-A	HAC-HFW1200TL-A	HAC-HFW1801TL	HAC-HFW1800TL	HAC-HFW1500TL
Appearance	 Starlight		 4K Real-time	 Starlight	
Image Sensor	5MP (16:9) CMOS	2MP CMOS	4K CMOS	4K CMOS	5MP (16:9) CMOS
Min. Illumination	0.005Lux/F1.6 (Color) 0Lux/F1.6 (IR On)	0.02Lux/F1.9 (Color) 0Lux/F1.9 (IR On)	0.03Lux/F2.0 (Color) 0Lux/F2.0 (IR On)	0.03Lux/F2.0 (Color) 0Lux/F2.0 (IR On)	0.005Lux/F1.6 (Color) 0Lux/F1.6 (IR On)
Lens	3.6mm (2.8mm, 6mm, 8mm Optional)	3.6mm (2.8mm, 6mm Optional)	3.6mm (2.8mm, 6mm Optional)	3.6mm (2.8mm, 6mm Optional)	3.6mm (2.8mm, 6mm Optional)
FOV-H	92° (111°/57°/43°)	84° (101°/56°)	87° (105°/54.7°)	87° (105°/54.7°)	92° (111°/57°)
Day/Night	ICR	ICR	ICR	ICR	ICR
Max. IR Distance	80m (262ft), Smart IR	80m (262ft), Smart IR	80m (262ft), Smart IR	80m (262ft), Smart IR	40m (131ft), Smart IR
OSD Menu	Multi-language	Multi-language	Multi-language	Multi-language	Multi-language
WDR	DWDR	DWDR	120dB	DWDR	DWDR
Noise Reduction	2D	2D	2D/3D	2D	2D
Frame Rate	25fps@5MP (16:9) 30fps@4MP 30fps@1080P	30fps@1080P 30fps@720P	15fps@4K 20fps@5MP 30fps@4MP	30fps@4K 20fps@5MP 30fps@4MP	25fps@5MP (16:9) 30fps@4MP 30fps@1080P
Video Output	HD/SD Switchable	HD/SD Switchable	HD/SD Switchable	HD/SD Switchable	HD/SD Switchable
Audio In	Built-in Mic	Built-in Mic	--	--	--
Alarm In/Out	--	--	--	--	--
Pan/Tilt/Rotation	Pan: 0°~360°; Tilt: 0°~90° Rotation: 0°~360°	Pan: 0°~360°; Tilt: 0°~90° Rotation: 0°~360°	Pan: 0°~360°; Tilt: 0°~90° Rotation: 0°~360°	Pan: 0°~360°; Tilt: 0°~90° Rotation: 0°~360°	Pan: 0°~360°; Tilt: 0°~90° Rotation: 0°~360°
Ingress Protection	IP67	IP67	IP67	IP67	IP67
Working Temperature	-40°C~+60°C (-40°F~+140°F)	-40°C~+60°C (-40°F~+140°F)	-40°C~+60°C (-40°F~+140°F)	-40°C~+60°C (-40°F~+140°F)	-40°C~+60°C (-40°F~+140°F)
Power	DC12V±30% Max. 5.2W	DC12V±30% Max. 4.9W	DC12V±30% Max. 6.6W	DC12V±30% Max. 6W	DC12V±30% Max. 3.1W

Lite Series







Fixed-focal Bullet

Model	HAC-HFW1200TL	HAC-HFW1509TLM (-A)-LED	HAC-HFW1509TLM-IL-A	HAC-HFW1239TLM (-A)-LED	HAC-HFW1239TLM-IL-A	HAC-HFW1231TLM-I6 (-A)
Appearance						
Image Sensor	2MP CMOS	5MP (16:9) CMOS	5MP (16:9) CMOS	2MP CMOS	2MP CMOS	2MP CMOS
Min. Illumination	0.02Lux/F1.9 (Color) 0Lux/F1.9 (IR On)	0.001Lux/F1.0 (Color) 0Lux/F1.0 (LED On)	0.001 lux@F1.0 (Color, 30 IRE) 0.0001 lux@F1.0 (B/W, 30 IRE) 0 lux (Illuminator on)	0.001Lux/F1.6 (Color) 0Lux/F1.6 (LED On)	0.001 Lux@F1.6 (Color, 30IRE) 0.0001 Lux@F1.6 (B/W, 30 IRE) 0 lux (Illuminator on)	0.002Lux/F1.6 (Color) 0Lux/F1.6 (IR On)
Lens	3.6mm (2.8mm, 6mm Optional)	3.6mm (2.8mm Optional)	3.6mm (2.8mm Optional)	3.6mm (2.8mm Optional)	3.6mm (2.8mm Optional)	3.6mm (2.8mm, 6mm Optional)
FOV-H	84° (101°/56°)	88° (112°)	89° (111°)	86° (107°)	86° (107°)	86° (107°/54°)
Day/Night	ICR	Color	Auto(ICR)/Color/B/W	ICR	Auto(ICR)/Color/B/W	ICR
Max. IR Distance	40m (131ft), Smart IR	LED: 40m (131ft), Smart Light	IR: 40m (131.23 ft) Warm Light: 40 m (131.23 ft)	LED: 40m (131ft), Smart Light	IR: 40m (131.23 ft) Warm Light: 40m (131.23 ft)	60m (197ft), Smart IR
OSD Menu	Multi-language	Multi-language	Multi-language	Multi-language	Multi-language	Multi-language
WDR	DWDR	120dB	120dB	130dB	120dB	130dB
Noise Reduction	2D	2D/3D	2D/3D	2D/3D	2D/3D	2D/3D
Frame Rate	30fps@1080P 30fps@720P	25fps@5MP (16:9) 30fps@4MP 30fps@1080P	25fps@5MP (16:9) 30fps@4MP 30fps@1080P	30fps@1080P	30fps@1080P	30fps@1080P
Video Output	HD/SD Switchable	HD/SD Switchable	HD/SD Switchable	HD/SD Switchable	HD/SD Switchable	HD/SD Switchable
Audio In	--	Built-in Mic (-A)	Built-in Mic	Built-in Mic (-A)	Built-in Mic	Built-in Mic (-A)
Alarm In/Out	--	--	--	--	--	--
Pan/Tilt/Rotation	Pan: 0°~360°; Tilt: 0°~90° Rotation: 0°~360°	Pan: 0°~360°; Tilt: 0°~90° Rotation: 0°~360°	Pan: 0°~360°; Tilt: 0°~90° Rotation: 0°~360°	Pan: 0°~360°; Tilt: 0°~90° Rotation: 0°~360°	Pan: 0°~360°; Tilt: 0°~78° Rotation: 0°~360°	Pan: 0°~360°; Tilt: 0°~90° Rotation: 0°~360°
Ingress Protection	IP67	IP67	IP67	IP67	IP67	IP67
Working Temperature	-40°C~+60°C (-40°F~+140°F)	-40°C~+60°C (-40°F~+140°F)	-40°C~+60°C (-40°F~+140°F)	-40°C~+60°C (-40°F~+140°F)	-40°C~+60°C (-40°F~+140°F)	-40°C~+60°C (-40°F~+140°F)
Power	DC12V±30% Max. 2.8W	DC12V±30% Max. 6.4W	DC12V±30% Max. 6.4W	DC12V±30% Max. 5.1W	DC12V±30% Max. 4.0W	DC12V±30% Max. 5.1W

HDCVI CAMERAS







Lite Series

Fixed-focal Bullet

Model	HAC-HFW1509MH-A-LED	HAC-HFW1239MH-A-LED	HAC-HFW1801T (-A)	HAC-HFW1800T (-A)	HAC-HFW1500T (-A)	HAC-HFW1200T (-A)
Appearance	 Full-color	 Full-color		 4K Real-time	 Starlight	
Image Sensor	5MP (16:9) CMOS	2MP CMOS	4K CMOS	4K CMOS	5MP (16:9) CMOS	2MP CMOS
Min. Illumination	0.001Lux/F1.0 (Color) 0Lux/F1.0 (LED On)	0.001Lux/F1.6 (Color) 0Lux/F1.6 (LED On)	0.03Lux/F2.0 (Color) 0Lux/F2.0 (IR On)	0.03Lux/F2.0 (Color) 0Lux/F2.0 (IR On)	0.005Lux/F1.6 (Color) 0Lux/F1.6 (IR On)	0.02Lux/F1.9 (Color) 0Lux/F1.9 (IR On)
Lens	3.6mm (6mm Optional)	3.6mm (6mm Optional)	3.6mm (2.8mm, 6mm Optional)	3.6mm (2.8mm, 6mm Optional)	3.6mm (2.8mm Optional)	3.6mm (2.8mm, 6mm Optional)
FOV-H	88° (59°)	86° (54°)	87° (105°/54.7°)	87° (105°/54.7°)	92° (111°)	84° (101°/56°)
Day/Night	ICR	ICR	ICR	ICR	ICR	ICR
Max. IR Distance	LED: 50m (1641ft), Smart Light	LED: 50m (1641ft), Smart Light	30m (98ft), Smart IR	30m (98ft), Smart IR	30m (98ft), Smart IR	30m (98ft), Smart IR
OSD Menu	Multi-language	Multi-language	Multi-language	Multi-language	Multi-language	Multi-language
WDR	120dB	130dB	120dB	DWDR	DWDR	DWDR
Noise Reduction	2D/3D	2D/3D	2D/3D	2D	2D	2D
Frame Rate	25fps@5MP (16:9) 25fps@4MP 25fps@1080P	30fps@1080P	15fps@4K 20fps@5MP 30fps@4MP	30fps@4K 20fps@5MP 30fps@4MP	25fps@5MP (16:9) 30fps@4MP 30fps@1080P	30fps@1080P 30fps@720P
Video Output	HD/SD Switchable	HD/SD Switchable	HD/SD Switchable	HD/SD Switchable	HD/SD Switchable	HD/SD Switchable
Audio In	Built-in Mic	Built-in Mic	Built-in Mic (-A)	Built-in Mic (-A)	Built-in Mic (-A)	Built-in Mic (-A)
Alarm In/Out	--	--	--	--	--	--
Pan/Tilt/Rotation	Pan: 0°~360°; Tilt: 0°~90° Rotation: 0°~360°	Pan: 0°~360°; Tilt: 0°~90° Rotation: 0°~360°	Pan: 0°~360°; Tilt: 0°~90° Rotation: 0°~360°	Pan: 0°~360°; Tilt: 0°~90° Rotation: 0°~360°	Pan: 0°~360°; Tilt: 0°~90° Rotation: 0°~360°	Pan: 0°~360°; Tilt: 0°~90° Rotation: 0°~360°
Ingress Protection	IP67	IP67	IP67	IP67	IP67	IP67
Working Temperature	-40°C~+60°C (-40°F~+140°F)	-40°C~+60°C (-40°F~+140°F)	-40°C~+60°C (-40°F~+140°F)	-40°C~+60°C (-40°F~+140°F)	-40°C~+60°C (-40°F~+140°F)	-40°C~+60°C (-40°F~+140°F)
Power	DC12V±30% Max. 6.4W	DC12V±30% Max. 5.1W	DC12V±30% Max. 5.2W	DC12V±30% Max. 4.3W	DC12V±30% Max. 3.2W	DC12V±30% Max. 3.3W

Lite Series







Fixed-focal Bullet

Model	HAC-HFW1509T (-A)-LED	HAC-HFW1239T (-A)-LED	HAC-HFW1801S	HAC-HFW1200S	HAC-HFW1500CM (-A)	HAC-HFW1231CM (-A)
Appearance	 Full-color	 Full-color			 Starlight	 Starlight
Image Sensor	5MP (16:9) CMOS	2MP CMOS	4K CMOS	2MP CMOS	5MP (16:9) CMOS	2MP CMOS
Min. Illumination	0.001Lux/F1.0 (Color) 0Lux/F1.0 (LED On)	0.001Lux/F1.6 (Color) 0Lux/F1.6 (LED On)	0.03Lux/F2.0 (Color) 0Lux/F2.0 (IR On)	0.02Lux/F1.9 (Color) 0Lux/F1.9 (IR On)	0.005Lux/F1.6 (Color) 0Lux/F1.6 (IR On)	0.002Lux/F1.6 (Color) 0Lux/F1.6 (IR On)
Lens	3.6mm (2.8mm Optional)	3.6mm (2.8mm Optional)	3.6mm (2.8mm, 6mm Optional)	3.6mm (2.8mm Optional)	3.6mm (2.8mm Optional)	3.6mm (2.8mm Optional)
FOV-H	88° (112°)	86° (107°)	87° (105°/54.7°)	84° (101°)	92° (111°)	86° (107°)
Day/Night	Color	Color	ICR	ICR	ICR	ICR
Max. IR Distance	LED: 20m (66ft), Smart Light	LED: 20m (66ft), Smart Light	30m (98ft), Smart IR	30m (98ft), Smart IR	30m (98ft), Smart IR	30m (98ft), Smart IR
OSD Menu	Multi-language	Multi-language	Multi-language	Multi-language	Multi-language	Multi-language
WDR	120dB	130dB	120dB	DWDR	DWDR	130dB
Noise Reduction	2D/3D	2D/3D	2D/3D	2D	2D	2D/3D
Frame Rate	25fps@5MP (16:9) 30fps@4MP 30fps@1080P	30fps@1080P	15fps@4K 20fps@5MP 30fps@4MP	30fps@1080P 30fps@720P	25fps@5MP (16:9) 30fps@4MP 30fps@1080P	30fps@1080P
Video Output	HD/SD Switchable	HD/SD Switchable	HD/SD Switchable	HD/SD Switchable	HD/SD Switchable	HD/SD Switchable
Audio In	Built-in Mic (-A)	Built-in Mic (-A)	--	--	Built-in Mic (-A)	Built-in Mic (-A)
Alarm In/Out	--	--	--	--	--	--
Pan/Tilt/Rotation	Pan: 0°~360°; Tilt: 0°~90° Rotation: 0°~360°	Pan: 0°~360°; Tilt: 0°~90° Rotation: 0°~360°	Pan: 0°~360°; Tilt: 0°~90° Rotation: 0°~360°	Pan: 0°~360°; Tilt: 0°~90° Rotation: 0°~360°	Pan: 0°~360°; Tilt: 0°~90° Rotation: 0°~360°	Pan: 0°~360°; Tilt: 0°~90° Rotation: 0°~360°
Ingress Protection	IP67	IP67	IP67	IP67	IP67	IP67
Working Temperature	-40°C~+60°C (-40°F~+140°F)	-40°C~+60°C (-40°F~+140°F)	-40°C~+60°C (-40°F~+140°F)	-40°C~+60°C (-40°F~+140°F)	-40°C~+60°C (-40°F~+140°F)	-40°C~+60°C (-40°F~+140°F)
Power	DC12V±30% Max. 4.4W	DC12V±30% Max. 3W	DC12V±30% Max. 6W	DC12V±30% Max. 4.1W	DC12V±30% Max. 3.7W	DC12V±30% Max. 3W

HDCVI CAMERAS







Lite Series

Fixed-focal Bullet

Model	HAC-HFW1200CM (-A)	HAC-HFW1509C (-A)-LED	HAC-HFW1500C (-A)	HAC-HFW1239C (-A)-LED	HAC-HFW1231C-A	HAC-HFW1200C (-A)
Appearance						
Image Sensor	2MP CMOS	5MP (16:9) CMOS	5MP (16:9) CMOS	2MP CMOS	2MP CMOS	2MP CMOS
Min. Illumination	0.02Lux/F1.9 (Color) 0Lux/F1.9 (IR On)	0.001Lux/F1.0 (Color) 0Lux/F1.0 (IR On)	0.005Lux/F1.6 (Color) 0Lux/F1.6 (IR On)	0.001Lux/F1.6 (Color) 0Lux/F1.6 (LED On)	0.002Lux/F1.6 (Color) 0Lux/F1.6 (IR On)	0.02Lux/F1.9 (Color) 0Lux/F1.9 (IR On)
Lens	3.6mm (2.8mm Optional)	3.6mm (2.8mm Optional)	3.6mm (2.8mm Optional)	3.6mm (2.8mm Optional)	3.6mm (2.8mm Optional)	3.6mm (2.8mm Optional)
FOV-H	84° (101°)	88° (112°)	92° (111°)	86° (107°)	86° (107°)	84° (101°)
Day/Night	ICR	ICR	ICR	ICR	ICR	ICR
Max. IR Distance	30m (98ft), Smart IR	20m (66ft), Smart IR	30m (98ft), Smart IR	LED: 20m (66ft), Smart Light	30m (98ft), Smart IR	30m (98ft), Smart IR
OSD Menu	Multi-language	Multi-language	Multi-language	Multi-language	Multi-language	Multi-language
WDR	DWDR	120dB	DWDR	130dB	130dB	DWDR
Noise Reduction	2D	2D/3D	2D	2D/3D	2D/3D	2D
Frame Rate	30fps@1080P 30fps@720P	25fps@5MP (16:9) 25fps@4MP 25fps@1080P	25fps@5MP (16:9) 30fps@4MP 30fps@1080P	30fps@1080P	30fps@1080P	30fps@1080P 30fps@720P
Video Output	HD/SD Switchable	HD/SD Switchable	HD/SD Switchable	HD/SD Switchable	HD/SD Switchable	HD/SD Switchable
Audio In	Built-in Mic (-A)	Built-in Mic (-A)	Built-in Mic (-A)	Built-in Mic (-A)	Built-in Mic	Built-in Mic (-A)
Alarm In/Out	--	--	--	--	--	--
Pan/Tilt/Rotation	Pan: 0°~360°; Tilt: 0°~90° Rotation: 0°~360°	Pan: 0°~360°; Tilt: 0°~90° Rotation: 0°~360°	Pan: 0°~360°; Tilt: 0°~90° Rotation: 0°~360°	Pan: 0°~360°; Tilt: 0°~90° Rotation: 0°~360°	Pan: 0°~360°; Tilt: 0°~90° Rotation: 0°~360°	Pan: 0°~360°; Tilt: 0°~90° Rotation: 0°~360°
Ingress Protection	IP67	IP67	IP67	IP67	IP67	IP67
Working Temperature	-40°C~+60°C (-40°F~+140°F)	-40°C~+60°C (-40°F~+140°F)	-40°C~+60°C (-40°F~+140°F)	-40°C~+60°C (-40°F~+140°F)	-40°C~+60°C (-40°F~+140°F)	-40°C~+60°C (-40°F~+140°F)
Power	DC12V±30% Max. 2.7W	DC12V±30% Max. 4.4W	DC12V±30% Max. 3.7W	DC12V±30% Max. 3.3W	DC12V±30% Max. 3W	DC12V±30% Max. 2.7W

HDCVI CAMERAS







Lite Series

	Fixed-focal Bullet	Fixed-focal Dome					
Model	HAC-HFW1200R	HAC-HDBW1509RA-IL-A	HAC-HDBW1239RA-IL-A	HAC-HDBW1231EA-A	HAC-HDBW1801E	HAC-HDBW1500E	HAC-HDBW1200E
Appearance		 Smart Dual Illuminators	 Smart Dual Illuminators	 Starlight	 Starlight	 Starlight	 Starlight
Image Sensor	2MP CMOS	5MP (16:9) CMOS	2MP CMOS	2MP CMOS	4K CMOS	5MP(16:9) CMOS	2MP CMOS
Min. Illumination	0.02Lux/F1.9 (Color) 0Lux/F1.9 (IR On)	0.001 lux@F1.0 (Color, 30 IRE) 0.0001 lux@F1.0 (B/W, 30 IRE) 0 lux (Illuminator on)	0.001 Lux@F1.6 (Color, 30 IRE) 0.0001 Lux@F1.6 (B/W, 30 IRE) 0 lux (Illuminator on)	0.002Lux/F1.6 (Color) 0Lux/F1.6 (IR On)	0.03Lux/F2.0 (Color) 0Lux/F2.0 (IR On)	0.005Lux/F1.6 (Color) 0Lux/F1.6 (IR On)	0.02Lux/F1.9 (Color) 0Lux/F1.9 (IR On)
Lens	3.6mm (2.8mm, 6mm Optional)	3.6mm (2.8mm Optional)	3.6mm (2.8mm Optional)	3.6mm (2.8mm Optional)	3.6mm (2.8mm Optional)	3.6mm (2.8mm Optional)	3.6mm (2.8mm Optional)
FOV-H	84° (101°/56°)	89° (111°)	86° (107°)	86° (107°)	87° (105°)	92° (111°)	84° (101°)
Day/Night	ICR	Auto(ICR)/Color/B/W	Auto(ICR)/Color/B/W	ICR	ICR	ICR	ICR
Max. IR Distance	20m (66ft), Smart IR	IR: 40m (131.23 ft) Warm Light: 40m (131.23 ft)	IR: 40m (131.23 ft) Warm Light: 40m (131.23 ft)	40m (131.2ft), Smart IR	30m (98ft), Smart IR	30m (98ft), Smart IR	30m (98ft), Smart IR
OSD Menu	Multi-language	Multi-language	Multi-language	Multi-language	Multi-language	Multi-language	Multi-language
WDR	DWDR	120dB	120dB	130dB	120dB	DWDR	DWDR
Noise Reduction	2D	2D/3D	2D/3D	2D/3D	2D/3D	2D	2D
Frame Rate	30fps@1080P 30fps@720P	25fps@5MP (16:9) 30fps@4MP 30fps@1080P	30fps@1080P	30fps@1080P	15fps@4K 20fps@5MP 30fps@4MP	25fps@5MP (16:9) 30fps@4MP 30fps@1080P	30fps@1080P 30fps@720P
Video Output	HD/SD Switchable	HD/SD Switchable	HD/SD Switchable	HD/SD Switchable	HD/SD Switchable	HD/SD Switchable	HD/SD Switchable
Audio In	--	Built-in Mic	Built-in Mic	Built-in Mic	--	--	--
Alarm In/Out	--	--	--	--	--	--	--
Pan/Tilt/Rotation	Pan: 0°~360°; Tilt: 0°~90° Rotation: 0°~360°	Pan: 0°~355°; Tilt: 0°~80° Rotation: 0°~355°	Pan: 0°~360°; Tilt: 0°~78° Rotation: 0°~360°	Pan: 0°~355°; Tilt: 0°~80° Rotation: 0°~355°	Pan: 0°~355°; Tilt: 0°~65° Rotation: 0°~355°	Pan: 0°~355°; Tilt: 0°~65° Rotation: 0°~355°	Pan: 0°~355°; Tilt: 0°~65° Rotation: 0°~355°
Ingress Protection	IP67	IP67, IK10	IP67, IK10	IP67, IK10	IP67, IK10	IP67, IK10	IP67, IK10
Working Temperature	-40°C~+60°C (-40°F~+140°F)	-40°C~+60°C (-40°F~+140°F)	-40°C~+60°C (-40°F~+140°F)	-40°C~+60°C (-40°F~+140°F)	-40°C~+60°C (-40°F~+140°F)	-40°C~+60°C (-40°F~+140°F)	-40°C~+60°C (-40°F~+140°F)
Power	DC12V±30% Max. 3.1W	DC12V±30% Max. 5.1W	DC12V±30% Max. 5.3W	DC12V±30% Max. 3W	DC12V±30% Max. 4.8W	DC12V±30% Max. 3.5W	DC12V±25% Max. 3.4W

HDCVI CAMERAS







Lite Series

Fixed-focal Eyeball

Model	HAC-HDW1801EM (-A)	HAC-HDW1200EM (-A)	HAC-HDW1500TMQ (-A)	HAC-HDW1231TMQ-A	HAC-HDW1200TMQ (-A)	HAC-HDW1500TQ (-A)
Appearance			 Starlight	 Starlight		 Starlight
Image Sensor	4K CMOS	2MP CMOS	5MP (16:9) CMOS	2MP CMOS	2MP CMOS	5MP (16:9) CMOS
Min. Illumination	0.03Lux/F2.0 (Color) 0Lux/F2.0 (IR On)	0.02Lux/F1.9 (Color) 0Lux/F1.9 (IR On)	0.005Lux/F1.6 (Color) 0Lux/F1.6 (IR On)	0.002Lux/F1.6 (Color) 0Lux/F1.6 (IR On)	0.02Lux/F1.9 (Color) 0Lux/F1.9 (IR On)	0.005Lux/F1.6 (Color) 0Lux/F1.6 (IR On)
Lens	3.6mm (6mm Optional)	3.6mm (2.8mm, 6mm Optional)	3.6mm (2.8mm, 6mm Optional)	3.6mm (2.8mm, 6mm Optional)	3.6mm (2.8mm, 6mm Optional)	3.6mm (2.8mm, 6mm Optional)
FOV-H	87° (54.7°)	84° (101°/56°)	92° (111°/57°)	86° (107°/54°)	84° (101°/56°)	92° (111°/57°)
Day/Night	ICR	ICR	ICR	ICR	ICR	ICR
Max. IR Distance	50m (164ft), Smart IR	50m (164ft), Smart IR	60m (197ft), Smart IR	60m (197ft), Smart IR	60m (197ft), Smart IR	40m (131ft), Smart IR
OSD Menu	Multi-language	Multi-language	Multi-language	Multi-language	Multi-language	Multi-language
WDR	120dB	DWDR	DWDR	130dB	DWDR	DWDR
Noise Reduction	2D/3D	2D	2D	2D/3D	2D	2D
Frame Rate	15fps@4K 20fps@5MP 30fps@4MP	30fps@1080P 30fps@720P	25fps@5MP (16:9) 30fps@4MP 30fps@1080P	30fps@1080P	30fps@1080P 30fps@720P	25fps@5MP (16:9) 30fps@4MP 30fps@1080P
Video Output	HD/SD Switchable	HD/SD Switchable	HD/SD Switchable	HD/SD Switchable	HD/SD Switchable	HD/SD Switchable
Audio In	Built-in Mic (-A)	Built-in Mic (-A)	Built-in Mic (-A)	Built-in Mic	Built-in Mic (-A)	Built-in Mic (-A)
Alarm In/Out	--	--	--	--	--	--
Pan/Tilt/Rotation	Pan: 0°~360°; Tilt: 0°~78° Rotation: 0°~360°	Pan: 0°~360°; Tilt: 0°~78° Rotation: 0°~360°	Pan: 0°~360°; Tilt: 0°~78° Rotation: 0°~360°	Pan: 0°~360°; Tilt: 0°~78° Rotation: 0°~360°	Pan: 0°~360°; Tilt: 0°~78° Rotation: 0°~360°	Pan: 0°~360°; Tilt: 0°~78° Rotation: 0°~360°
Ingress Protection	IP67	IP67	IP67	IP67	IP67	IP67
Working Temperature	-40°C~+60°C (-40°F~+140°F)	-40°C~+60°C (-40°F~+140°F)	-40°C~+60°C (-40°F~+140°F)	-40°C~+60°C (-40°F~+140°F)	-40°C~+60°C (-40°F~+140°F)	-40°C~+60°C (-40°F~+140°F)
Power	DC12V±30% Max. 4.5W	DC12V±30% Max. 3.2W	DC12V±30% Max. 5.2W	DC12V±30% Max. 5.1W	DC12V±30% Max. 4.9W	DC12V±30% Max. 3.2W

Lite Series







Fixed-focal Eyeball

Model	HAC-HDW1231TQ-A	HAC-HDW1200TQ (-A)	HAC-HDW1509T (-A)-LED	HAC-HDW1509T-IL-A	HAC-HDW1239T (-A)-LED	HAC-HDW1239T-IL-A
Appearance	 Starlight		 Full-color	 Smart Dual Illuminators	 Full-color	 Smart Dual Illuminators
Image Sensor	2MP CMOS	2MP CMOS	5MP (16:9) CMOS	5MP (16:9) CMOS	2MP CMOS	2MP CMOS
Min. Illumination	0.002Lux/F1.6 (Color) 0Lux/F1.6 (IR On)	0.02Lux/F1.9 (Color) 0Lux/F1.9 (IR On)	0.001Lux/F1.0 (Color) 0Lux/F1.0 (LED On)	0.001 lux@F1.0 (Color, 30 IRE) 0.0001 lux@F1.0 (B/W, 30 IRE) 0 lux (Illuminator on)	0.001Lux/F1.6 (Color) 0Lux/F1.6 (LED On)	0.001 Lux@F1.6 (Color, 30 IRE) 0.0001 Lux@F1.6 (B/W, 30 IRE) 0 lux (Illuminator on)
Lens	3.6mm (2.8mm, 6mm Optional)	3.6mm (2.8mm, 6mm Optional)	3.6mm (2.8mm Optional)	3.6mm (2.8mm Optional)	3.6mm (2.8mm Optional)	3.6mm (2.8mm Optional)
FOV-H	86° (107°/54°)	84° (101°/56°)	88° (112°)	89° (111°)	86° (107°)	86° (107°)
Day/Night	ICR	ICR	Color	Auto(ICR)/Color/B/W	Color	Auto(ICR)/Color/B/W
Max. IR Distance	40m (131ft), Smart IR	40m (131ft), Smart IR	LED: 40m (131ft), Smart Light	IR: 40 m (131.23 ft) Warm Light: 40 m (131.23 ft)	LED: 40m (131ft), Smart Light	IR: 40m (131.2 ft) Warm light: 40m (131.2 ft)
OSD Menu	Multi-language	Multi-language	Multi-language	Multi-language	Multi-language	Multi-language
WDR	130dB	DWDR	120dB	120dB	130dB	120dB
Noise Reduction	2D/3D	2D	2D/3D	2D/3D	2D/3D	2D/3D
Frame Rate	30fps@1080P	30fps@1080P 30fps@720P	25fps@5MP (16:9) 30fps@4MP 30fps@1080P	25fps@5MP (16:9) 30fps@4MP 30fps@1080P	30fps@1080P	30fps@1080P
Video Output	HD/SD Switchable	HD/SD Switchable	HD/SD Switchable	HD/SD Switchable	HD/SD Switchable	HD/SD Switchable
Audio In	Built-in Mic	Built-in Mic (-A)	Built-in Mic (-A)	Built-in Mic	Built-in Mic (-A)	Built-in Mic
Alarm In/Out	--	--	--	--	--	--
Pan/Tilt/Rotation	Pan: 0°~360°; Tilt: 0°~78° Rotation: 0°~360°	Pan: 0°~360°; Tilt: 0°~78° Rotation: 0°~360°	Pan: 0°~360°; Tilt: 0°~78° Rotation: 0°~360°	Pan: 0°~360°; Tilt: 0°~78° Rotation: 0°~360°	Pan: 0°~360°; Tilt: 0°~78° Rotation: 0°~360°	Pan: 0°~360°; Tilt: 0°~78° Rotation: 0°~360°
Ingress Protection	IP67	IP67	IP67	IP67	IP67	IP67
Working Temperature	-40°C~+60°C (-40°F~+140°F)	-40°C~+60°C (-40°F~+140°F)	-40°C~+60°C (-40°F~+140°F)	-40°C~+60°C (-40°F~+140°F)	-40°C~+60°C (-40°F~+140°F)	-40°C~+60°C (-40°F~+140°F)
Power	DC12V±30% Max. 3.1W	DC12V±30% Max. 2.9W	DC12V±30% Max. 6.4W	DC12V±30% Max. 6.4W	DC12V±30% Max.5.1W	DC12V±30% Max. 4.0W

HDCVI CAMERAS





Lite Series

Fixed-focal Eyeball

Model	HAC-HDW1801TL (-A)	HAC-HDW1800TL (-A)	HAC-HDW1200TL-A	HAC-HDW1500TLMQ (-A)	HAC-HDW1231TLMQ (-A)	HAC-HDW1200TLMQ (-A)
Appearance		 4K Real-time		 Starlight	 Starlight	
Image Sensor	4K CMOS	4K CMOS	2MP CMOS	5MP(16:9) CMOS	2MP CMOS	2MP CMOS
Min. Illumination	0.03Lux/F2.0 (Color) 0Lux/F2.0 (IR On)	0.03Lux/F2.0 (Color) 0Lux/F2.0 (IR On)	0.02Lux/F1.9 (Color) 0Lux/F1.9 (IR On)	0.005Lux/F1.6 (Color) 0Lux/F1.6 (IR On)	0.002Lux/F1.6 (Color) 0Lux/F1.6 (IR On)	0.02Lux/F1.9 (Color) 0Lux/F1.9 (IR On)
Lens	3.6mm (2.8mm Optional)	3.6mm (2.8mm Optional)	3.6mm (2.8mm Optional)	3.6mm (2.8mm Optional)	3.6mm (2.8mm Optional)	3.6mm (2.8mm Optional)
FOV-H	87° (105°)	87° (105°)	84° (101°)	92° (111°)	86° (107°)	84° (101°)
Day/Night	ICR	ICR	ICR	ICR	ICR	ICR
Max. IR Distance	30m (98ft), Smart IR	30m (98ft), Smart IR	30m (98ft), Smart IR	30m (98ft), Smart IR	30m (98ft), Smart IR	30m (98ft), Smart IR
OSD Menu	Multi-language	Multi-language	Multi-language	Multi-language	Multi-language	Multi-language
WDR	120dB	DWDR	DWDR	DWDR	130dB	DWDR
Noise Reduction	2D/3D	2D	2D	2D	2D/3D	2D
Frame Rate	15fps@4K 20fps@5MP 30fps@4MP	30fps@4K 20fps@5MP 30fps@4MP	30fps@1080P 30fps@720P	25fps@5MP (16:9) 30fps@4MP 30fps@1080P	30fps@1080P	30fps@1080P 30fps@720P
Video Output	HD/SD Switchable	HD/SD Switchable	HD/SD Switchable	HD/SD Switchable	HD/SD Switchable	HD/SD Switchable
Audio In	Built-in Mic(-A)	Built-in Mic(-A)	Built-in Mic	Built-in Mic(-A)	Built-in Mic	Built-in Mic(-A)
Alarm In/Out	--	--	--	--	--	--
Pan/Tilt/Rotation	Pan: 0°~360°; Tilt: 0°~78° Rotation: 0°~360°	Pan: 0°~360°; Tilt: 0°~78° Rotation: 0°~360°	Pan: 0°~360°; Tilt: 0°~78° Rotation: 0°~360°	Pan: 0°~360°; Tilt: 0°~78° Rotation: 0°~360°	Pan: 0°~360°; Tilt: 0°~78° Rotation: 0°~360°	Pan: 0°~360°; Tilt: 0°~78° Rotation: 0°~360°
Ingress Protection	IP67	IP67	IP67	IP67	IP67	IP67
Working Temperature	-40°C~+60°C (-40°F~+140°F)	-40°C~+60°C (-40°F~+140°F)	-40°C~+60°C (-40°F~+140°F)	-40°C~+60°C (-40°F~+140°F)	-40°C~+60°C (-40°F~+140°F)	-40°C~+60°C (-40°F~+140°F)
Power	DC12V±30% Max. 5.2W	DC12V±30% Max. 4.3W	DC12V±30% Max. 3.3W	DC12V±30% Max. 3.2W	DC12V±30% Max. 3.1W	DC12V±30% Max. 2.9W

Lite Series







Fixed-focal Eyeball

Model	HAC-HDW1801TLM (-A)	HAC-HDW1800TLM (-A)	HAC-HDW1500TLM (-A)	HAC-HDW1231TLM (-A)	HAC-HDW1200TLM (-A)
Appearance		 4K Real-time	 Starlight	 Starlight	
Image Sensor	4K CMOS	4K CMOS	5MP (16:9) CMOS	2MP CMOS	2MP CMOS
Min. Illumination	0.03Lux/F2.0 (Color) 0Lux/F2.0 (IR On)	0.03Lux/F2.0 (Color) 0Lux/F2.0 (IR On)	0.005Lux/F1.6 (Color) 0Lux/F1.6 (IR On)	0.002Lux/F1.6 (Color) 0Lux/F1.6 (IR On)	0.02Lux/F2.0 (Color) 0Lux/F2.0 (IR On)
Lens	3.6mm (2.8mm Optional)	3.6mm (2.8mm Optional)	3.6mm (2.8mm Optional)	3.6mm (2.8mm Optional)	3.6mm (2.8mm Optional)
FOV-H	87° (105°)	87° (105°)	92° (111°)	86° (107°)	85° (102°)
Day/Night	ICR	ICR	ICR	ICR	ICR
Max. IR Distance	30m (98ft), Smart IR	30m (98ft), Smart IR	30m (98ft), Smart IR	30m (98ft), Smart IR	30m (98ft), Smart IR
OSD Menu	Multi-language	Multi-language	Multi-language	Multi-language	Multi-language
WDR	120dB	DWDR	DWDR	130dB	DWDR
Noise Reduction	2D/3D	2D	2D	2D/3D	2D
Frame Rate	15fps@4K 20fps@5MP 30fps@4MP	30fps@4K 20fps@5MP 30fps@4MP	25fps@5MP (16:9) 30fps@4MP 30fps@1080P	30fps@1080P	30fps@1080P 30fps@720P
Video Output	HD/SD Switchable	HD/SD Switchable	HD/SD Switchable	HD/SD Switchable	HD/SD Switchable
Audio In	Built-in Mic (-A)	Built-in Mic (-A)	Built-in Mic (-A)	Built-in Mic (-A)	Built-in Mic (-A)
Alarm In/Outi	--	--	--	--	--
Pan/Tilt/Rotation	Pan: 0°~360°; Tilt: 0°~78° Rotation: 0°~360°	Pan: 0°~360°; Tilt: 0°~78° Rotation: 0°~360°	Pan: 0°~360°; Tilt: 0°~78° Rotation: 0°~360°	Pan: 0°~360°; Tilt: 0°~78° Rotation: 0°~360°	Pan: 0°~360°; Tilt: 0°~78° Rotation: 0°~360°
Ingress Protection	IP67	IP67	IP67	IP67	IP67
Working Temperature	-40°C~+60°C (-40°F~+140°F)	-40°C~+60°C (-40°F~+140°F)	-40°C~+60°C (-40°F~+140°F)	-40°C~+60°C (-40°F~+140°F)	-40°C~+60°C (-40°F~+140°F)
Power	DC12V±30% Max. 5.2W	DC12V±30% Max. 4.3W	DC12V±30% Max. 3.2W	DC12V±30% Max. 3.1W	DC12V±30% Max. 2.9W

HDCVI CAMERAS





Lite Series

Fixed-focal Eyeball

Model	HAC-HDW1801M	HAC-HDW1800M	HAC-HDW1200M	HAC-HDW1509TLQ (-A)-LED	HAC-HDW1500TLQ-A	HAC-HDW1239TLQ (-A)-LED
Appearance		 4K Real-time		 Full-color	 Starlight	 Full-color
Image Sensor	4K CMOS	4K CMOS	2MP CMOS	5MP (16:9) CMOS	5MP (16:9) CMOS	2MP CMOS
Min. Illumination	0.03Lux/F2.0 (Color) 0Lux/F2.0 (IR On)	0.03Lux/F2.0 (Color) 0Lux/F2.0 (IR On)	0.02Lux/F1.9 (Color) 0Lux/F1.9 (IR On)	0.001Lux/F1.0 (Color) 0Lux/F1.0 (LED On)	0.005Lux/F1.6 (Color) 0Lux/F1.6 (IR On)	0.001Lux/F1.6 (Color) 0Lux/F1.6 (LED On)
Lens	3.6mm (2.8mm Optional)	3.6mm (2.8mm,6mm Optional)	3.6mm (2.8mm Optional)	3.6mm (2.8mm Optional)	3.6mm (2.8mm Optional)	3.6mm (2.8mm Optional)
FOV-H	87° (105°)	87° (105°/54.7°)	84° (101°)	88° (112°)	92° (111°)	86° (107°)
Day/Night	ICR	ICR	ICR	Color	ICR	ICR
Max. IR Distance	30m (98ft), Smart IR	30m (98ft), Smart IR	30m (98ft), Smart IR	LED: 20m (66ft), Smart Light	30m (98ft), Smart IR	LED: 20m (66ft), Smart Light
OSD Menu	Multi-language	Multi-language	Multi-language	Multi-language	Multi-language	Multi-language
WDR	120dB	DWDR	DWDR	120dB	DWDR	130dB
Noise Reduction	2D/3D	2D	2D	2D/3D	2D	2D/3D
Frame Rate	15fps@4K 20fps@5MP 30fps@4MP	30fps@4K 20fps@5MP 30fps@4MP	30fps@1080P 30fps@720P	25fps@5MP(16:9) 30fps@4MP 30fps@1080P	25fps@5MP(16:9) 30fps@4MP 30fps@1080P	30fps@1080P
Video Output	HD/SD Switchable	HD/SD Switchable	HD/SD Switchable	HD/SD Switchable	HD/SD Switchable	HD/SD Switchable
Audio In	--	--	--	Built-in Mic (-A)	Built-in Mic	Built-in Mic (-A)
Alarm In/Out	--	--	--	--	--	--
Pan/Tilt/Rotation	Pan: 0°~360°; Tilt: 0°~78° Rotation: 0°~360°	Pan: 0°~360°; Tilt: 0°~78° Rotation: 0°~360°	Pan: 0°~360°; Tilt: 0°~78° Rotation: 0°~360°	Pan: 0°~360°; Tilt: 0°~78° Rotation: 0°~360°	Pan: 0°~360°; Tilt: 0°~90° Rotation: 0°~360°	Pan: 0°~360°; Tilt: 0°~90° Rotation: 0°~360°
Ingress Protection	IP67	IP67	IP67	IP67	IP67	IP67
Working Temperature	-40°C~+60°C (-40°F~+140°F)	-40°C~+60°C (-40°F~+140°F)	-40°C~+60°C (-40°F~+140°F)	-40°C~+60°C (-40°F~+140°F)	-40°C~+60°C (-40°F~+140°F)	-40°C~+60°C (-40°F~+140°F)
Power	DC12V±30% Max. 4.9W	DC12V±30% Max. 4.3W	DC12V±30% Max. 3.1W	DC12V±30% Max. 4.4W	DC12V±30% Max. 3.2W	DC12V±30% Max. 3.3W

Lite Series

Fixed-focal Eyeball

Model	HAC-HDW1500TRQ (-A)	HAC-HDW1231TRQ-A	HAC-HDW1200TRQ (-A)	HAC-HDW1200R	HAC-HDW1231G-A
Appearance	 Starlight	 Starlight			 Starlight
Image Sensor	5MP (16:9) CMOS	2MP CMOS	2MP CMOS	2MP CMOS	2MP CMOS
Min. Illumination	0.005Lux/F1.6 (Color) 0Lux/F1.6 (IR On)	0.002Lux/F1.6 (Color) 0Lux/F1.6 (IR On)	0.02Lux/F1.9 (Color) 0Lux/F1.9 (IR On)	0.02Lux/F1.9 (Color) 0Lux/F1.9 (IR On)	0.002Lux/F1.6 (Color) 0Lux/F1.6 (IR On)
Lens	3.6mm (2.8mm Optional)	3.6mm (2.8mm Optional)	3.6mm (2.8mm Optional)	3.6mm (2.8mm Optional)	3.6mm (2.8mm Optional)
FOV-H	92° (111°)	86° (107°)	84° (101°)	84° (101°)	86° (107°)
Day/Night	ICR	ICR	ICR	ICR	ICR
Max. IR Distance	25m (82ft), Smart IR	30m (98ft), Smart IR	25m (82ft), Smart IR	20m (66ft), Smart IR	30m (98ft), Smart IR
OSD Menu	Multi-language	Multi-language	Multi-language	Multi-language	Multi-language
WDR	DWDR	130dB	DWDR	DWDR	130dB
Noise Reduction	2D	2D/3D	2D	2D	2D/3D
Frame Rate	25fps@5MP (16:9) 30fps@4MP 30fps@1080P	30fps@1080P	30fps@1080P 30fps@720P	30fps@1080P 30fps@720P	30fps@1080P
Video Output	HD/SD Switchable	HD/SD Switchable	HD/SD Switchable	HD/SD Switchable	HD/SD Switchable
Audio In	Built-in Mic (-A)	Built-in Mic	Built-in Mic (-A)	--	Built-in Mic
Alarm In/Out	--	--	--	--	--
Pan/Tilt/Rotation	Pan: 0°~360°; Tilt: 0°~90° Rotation: 0°~360°	Pan: 0°~360°; Tilt: 0°~78° Rotation: 0°~360°	Pan: 0°~360°; Tilt: 0°~78° Rotation: 0°~360°	Pan: 0°~360°; Tilt: 0°~78° Rotation: 0°~360°	Pan: 0°~360°; Tilt: 0°~78° Rotation: 0°~360°
Ingress Protection	--	--	--	--	IP67
Working Temperature	-40°C~+60°C (-40°F~+140°F)	-40°C~+50°C (-40°F~+122°F)	-40°C~+50°C (-40°F~+122°F)	-40°C~+60°C (-40°F~+140°F)	-40°C~+60°C (-40°F~+140°F)
Power	DC12V±30% Max. 3.0W	DC12V±30% Max. 2.8W	DC12V±30% Max. 2.6W	DC12V±30% Max. 3.1W	DC12V±30% Max. 2.4W



Cooper Series

Cooper Series offers simple and highly cost-effective HDCVI solutions. It offers 24/7 reliable monitoring with high-quality image performance, saving both product and labor costs. It is also highly guaranteed by Dahua quality standard.



Reliable Monitoring

Cooper Series provides bright and clear image with rich details day and night. It offers up to 5MP resolution and vari-focal/ fixed lens options to fit various scenarios.



Dahua Quality

Cooper Series is designed with complete structure and hardware protection and is fully in line with Dahua's quality assurance standard.









Cost Saving

With real plug & play and compact housing, this series allows easy installation that saves time and labor costs. Its competitive price also saves system deployment for customers.







HDCVI CAMERAS

Cooper Series

	Vari-focal Bullet			Vari-focal Dome		
Model	HAC-B4A21-VF	HAC-B3A51-Z	HAC-B3A21-Z	HAC-D3A21-VF	HAC-D3A51-Z	HAC-D3A21-Z
Appearance						
Image Sensor	2MP CMOS	5MP (16:9) CMOS	2MP CMOS	2MP CMOS	5MP (16:9) CMOS	2MP CMOS
Min. Illumination	0.04Lux/F1.8 (Color) 0Lux/F1.8 (IR On)	0.01Lux/F1.6 (Color) 0Lux/F1.6 (IR On)	0.04Lux/F1.7 (Color) 0Lux/F1.7 (IR On)	0.04Lux/F1.8 (Color) 0Lux/F1.8 (IR On)	0.01Lux/F1.6 (Color) 0Lux/F1.6 (IR On)	0.04Lux/F1.7 (Color) 0Lux/F1.7 (IR On)
Lens	2.7~12mm, Manual	2.7~12mm, Motorized	2.7~12mm, Motorized	2.7~12mm, Manual	2.7~12mm, Motorized	2.7~12mm, Motorized
FOV-H	106°~33°	106°~35°	102°~33°	106°~33°	106°~35°	102°~33°
Day/Night	ICR	ICR	ICR	ICR	ICR	ICR
Max. IR Distance	40m (131ft), Smart IR	40m (131ft), Smart IR	40m (131ft), Smart IR	30m (98ft), Smart IR	30m (98ft), Smart IR	30m (98ft), Smart IR
OSD Menu	Multi-language	Multi-language	Multi-language	Multi-language	Multi-language	Multi-language
WDR	DWDR	DWDR	DWDR	DWDR	DWDR	DWDR
Noise Reduction	2D	2D	2D	2D	2D	2D
Frame Rate	30fps@1080P 30fps@720P	25fps@5MP (16:9) 30fps@4MP 30fps@1080P	30fps@1080P 30fps@720P	30fps@1080P 30fps@720P	25fps@5MP (16:9) 30fps@4MP 30fps@1080P	30fps@1080P 30fps@720P
Video Output	HD/SD Switchable	HD/SD Switchable	HD/SD Switchable	HD/SD Switchable	HD/SD Switchable	HD/SD Switchable
Audio In	--	--	--	--	--	--
Alarm In/Out	--	--	--	--	--	--
Pan/Tilt/Rotation	Pan: 0°~360°; Tilt: 0°~87° Rotation: 0°~360°	Pan: 0°~360°; Tilt: 0°~90° Rotation: 0°~360°	Pan: 0°~360°; Tilt: 0°~90° Rotation: 0°~360°	Pan: 0°~355°; Tilt: 0°~75° Rotation: 0°~355°	Pan: 0°~355°; Tilt: 0°~75° Rotation: 0°~355°	Pan: 0°~355°; Tilt: 0°~75° Rotation: 0°~355°
Ingress Protection	IP67	IP67	IP67	IP67	IP67	IP67
Working Temperature	-30°C~+60°C (-22°F~+140°F)	-30°C~+60°C (-22°F~+140°F)	-30°C~+60°C (-22°F~+140°F)	-30°C~+60°C (-22°F~+140°F)	-30°C~+60°C (-22°F~+140°F)	-30°C~+60°C (-22°F~+140°F)
Power	DC12V±30% Max. 4.4W	DC12V±30% Max. 6.6W	DC12V±30% Max. 6.6W	DC12V±30% Max. 3.5W	DC12V±30% Max. 5.3W	DC12V±30% Max. 5.3W



HDCVI CAMERAS

Cooper Series

	Vari-focal Eyeball			Fixed-focal Bullet			
Model	HAC-T3A21-VF	HAC-T3A51-Z	HAC-T3A21-Z	HAC-B2A51	HAC-B2A21	HAC-B1A51	HAC-B1A21
Appearance							
Image Sensor	2MP CMOS	5MP (16:9) CMOS	2MP CMOS	5MP (16:9) CMOS	2MP CMOS	5MP (16:9) CMOS	2MP CMOS
Min. Illumination	0.04Lux/F1.8 (Color) 0Lux/F1.8 (IR On)	0.01Lux/F1.6 (Color) 0Lux/F1.6 (IR On)	0.04Lux/F1.7 (Color) 0Lux/F1.7 (IR On)	0.02Lux/F2.0 (Color) 0Lux/F2.0 (IR On)	0.04Lux/F1.85 (Color) 0Lux/F1.85 (IR On)	0.02Lux/F2.0 (Color) 0Lux/F2.0 (IR On)	0.04Lux/F1.85 (Color) 0Lux/F1.85 (IR On)
Lens	2.7~12mm, Manual	2.7~12mm, Motorized	2.7~12mm, Motorized	3.6mm (2.8mm Optional)	3.6mm (2.8mm,6mm Optional)	3.6mm (2.8mm Optional)	3.6mm (2.8mm,6mm Optional)
FOV-H	106°~33°	106°~35°	102°~33°	88°(106°)	93°(103°/54.7°)	88°(106°)	93°(103°/54.7°)
Day/Night	ICR	ICR	ICR	ICR	ICR	ICR	ICR
Max. IR Distance	40m (131ft), Smart IR	40m (131ft), Smart IR	40m (131ft), Smart IR	20m (66ft), Smart IR	20m (66ft), Smart IR	20m (66ft), Smart IR	20m (66ft), Smart IR
OSD Menu	Multi-language	Multi-language	Multi-language	Multi-language	Multi-language	Multi-language	Multi-language
WDR	DWDR	DWDR	DWDR	DWDR	DWDR	DWDR	DWDR
Noise Reduction	2D	2D	2D	2D	2D	2D	2D
Frame Rate	30fps@1080P 30fps@720P	25fps@5MP (16:9) 30fps@4MP 30fps@1080P	30fps@1080P 30fps@720P	25fps@5MP (16:9) 30fps@4MP 30fps@1080P	30fps@1080P 30fps@720P	25fps@5MP (16:9) 30fps@4MP 30fps@1080P	30fps@1080P 30fps@720P
Video Output	HD/SD Switchable	HD/SD Switchable	HD/SD Switchable	HD/SD Switchable	HD/SD Switchable	HD/SD Switchable	HD/SD Switchable
Audio In	--	--	--	--	--	--	--
Alarm In/Out	--	--	--	--	--	--	--
Pan/Tilt/Rotation	Pan: 0°~355°; Tilt: 0°~75° Rotation: 0°~355°	Pan: 0°~355°; Tilt: 0°~75° Rotation: 0°~355°	Pan: 0°~360°; Tilt: 0°~78° Rotation: 0°~360°	Pan: 0°~360°; Tilt: 0°~90° Rotation: 0°~360°	Pan: 0°~360°; Tilt: 0°~90° Rotation: 0°~360°	Pan: 0°~360°; Tilt: 0°~90° Rotation: 0°~360°	Pan: 0°~360°; Tilt: 0°~90° Rotation: 0°~360°
Ingress Protection	IP67	IP67	IP67	IP67	IP67	IP67	IP67
Working Temperature	-30°C~+60°C (-22°F~+140°F)	-30°C~+60°C (-22°F~+140°F)	-30°C~+60°C (-22°F~+140°F)	-40°C~+60°C (-40°F~+140°F)	-40°C~+60°C (-40°F~+140°F)	-40°C~+60°C (-40°F~+140°F)	-40°C~+60°C (-40°F~+140°F)
Power	DC12V±30% Max. 4.6W	DC12V±30% Max. 6.6W	DC12V±30% Max. 6.6W	DC12V±30% Max. 3.7W	DC12V±30% Max. 2.7W	DC12V±30% Max. 3.7W	DC12V±30% Max. 2.7W

Cooper Series

Fixed-focal Eyeball

Model	HAC-D1A51	HAC-D1A21	HAC-T2A51	HAC-T2A21	HAC-T1A51	HAC-T1A21
Appearance						
Image Sensor	5MP (16:9) CMOS	2MP CMOS	5MP (16:9) CMOS	2MP CMOS	5MP (16:9) CMOS	2MP CMOS
Min. Illumination	0.02Lux/F2.0 (Color) 0Lux/F2.0 (IR On)	0.04Lux/F1.85 (Color) 0Lux/F1.85 (IR On)	0.02Lux/F2.0 (Color) 0Lux/F2.0 (IR On)	0.04Lux/F1.85 (Color) 0Lux/F1.85 (IR On)	0.02Lux/F2.0 (Color) 0Lux/F2.0 (IR On)	0.04Lux/F1.85 (Color) 0Lux/F1.85 (IR On)
Lens	3.6mm (2.8mm Optional)	3.6mm (2.8mm Optional)	3.6mm (2.8mm Optional)	3.6mm (2.8mm, 6mm Optional)	3.6mm (2.8mm Optional)	3.6mm (2.8mm, 6mm Optional)
FOV-H	88° (106°)	93° (103°)	88° (106°)	93° (103°/54.7°)	88° (106°)	93° (103°/54.7°)
Day/Night	ICR	ICR	ICR	ICR	ICR	ICR
Max. IR Distance	20m (66ft), Smart IR	20m (66ft), Smart IR	20m (66ft), Smart IR	20m (66ft), Smart IR	20m (66ft), Smart IR	20m (66ft), Smart IR
OSD Menu	Multi-language	Multi-language	Multi-language	Multi-language	Multi-language	Multi-language
WDR	DWDR	DWDR	DWDR	DWDR	DWDR	DWDR
Noise Reduction	2D	2D	2D	2D	2D	2D
Frame Rate	25fps@5MP (16:9) 30fps@4MP 30fps@1080P	30fps@1080P 30fps@720P	25fps@5MP (16:9) 30fps@4MP 30fps@1080P	30fps@1080P 30fps@720P	25fps@5MP (16:9) 30fps@4MP 30fps@1080P	30fps@1080P 30fps@720P
Video Output	HD/SD Switchable	HD/SD Switchable	HD/SD Switchable	HD/SD Switchable	HD/SD Switchable	HD/SD Switchable
Audio In	--	--	--	--	--	--
Alarm In/Out	--	--	--	--	--	--
Pan/Tilt/Rotation	Pan: 0°~355°; Tilt: 0°~70° Rotation: 0°~355°	Pan: 0°~355°; Tilt: 0°~70° Rotation: 0°~355°	Pan: 0°~360°; Tilt: 0°~78° Rotation: 0°~360°	Pan: 0°~360°; Tilt: 0°~78° Rotation: 0°~360°	Pan: 0°~360°; Tilt: 0°~78° Rotation: 0°~360°	Pan: 0°~360°; Tilt: 0°~78° Rotation: 0°~360°
Ingress Protection	--	--	IP67	IP67	--	--
Working Temperature	-40°C~+45°C (-40°F~+113°F)	-40°C~+45°C (-40°F~+113°F)	-40°C~+60°C (-40°F~+140°F)	-40°C~+60°C (-40°F~+140°F)	-40°C~+55°C (-40°F~+131°F)	-40°C~+55°C (-40°F~+131°F)
Power	DC12V±30% Max. 3.2W	DC12V±30% Max. 3.0W	DC12V±30% Max. 3.7W	DC12V±30% Max. 2.7W	DC12V±30% Max. 2.7W	DC12V±30% Max. 2.3W



Active Deterrence Series

Active Deterrence Series provides multi-dimensional system that links video with audio, information and alarm to verify potential risks. Active deterrence camera can actively warn off intruders with light and siren, alert users in real-time with alarm-over-coax, and provide visual verification with HDCVI video.



Active Deterrence

Instead of checking recordings and taking action after an incident, active deterrence camera with embedded light and siren warns off intruders on time, which can help prevent incident from happening and protect lives and properties.



Accurate Alarm

With PIR and motion dual detection, the PIR camera can accurately alarm when human intrusion has been detected, avoiding false alarms and saving storage space for motion-triggered recordings.









Multiple Info Over Coax

In addition to video and audio, multiple data types including alarm, temperature, humidity, etc., can be transmitted over a single coaxial cable.







Active Deterrence Series

TIOC

Model	HAC-ME1809TH-A-PV	HAC-ME1809TH-A-PV-POC	HAC-ME1509TH-PV	HAC-ME1509TH-A-PV	HAC-ME1509TH-A-PV-POC	HAC-ME1809H-A-PV
Appearance						
Image Sensor	4K CMOS	4K CMOS	5MP CMOS	5MP CMOS	5MP CMOS	4K CMOS
Min. Illumination	0.005 Lux/F1.6 (Color) 0Lux/F1.6 (LED On)	0.005 Lux/F1.6 (Color) 0Lux/F1.6 (LED On)	0.005Lux/F1.2 (Color) 0Lux/F1.2 (LED On)	0.005 Lux/F1.2 (Color) 0Lux/F1.2 (LED On)	0.005 Lux/F1.2 (Color) 0Lux/F1.2 (LED On)	0.005Lux/F1.6 (Color) 0Lux/F1.6 (LED On)
Lens	3.6 mm	3.6 mm	3.6mm (6mm Optional)	3.6 mm	3.6 mm	3.6mm (2.8mm Optional)
FOV-H	89°	89°	83°(53°)	83°	83°	89°(107°)
Day/Night	Color	Color	Color	Color	Color	Color
Max. IR Distance	LED: 40m (131ft), Smart Light	LED: 40m (131ft), Smart Light	LED: 40m (131ft), Smart Light	LED: 40m (131ft), Smart Light	LED: 40m (131ft), Smart Light	LED: 40m (131ft), Smart Light
OSD Menu	Multi-language	Multi-language	Multi-language	Multi-language	Multi-language	Multi-language
WDR	DWDR	DWDR	DWDR	DWDR	DWDR	DWDR
Noise Reduction	2D	2D	2D	2D	2D	2D
Frame Rate	15/25/30fps@4K 25/30fps@4MP	15/25/30fps@4K 25/30fps@4MP	20fps@5MP 30fps@4MP 30fps@1080P	20fps@5MP 25/30fps@4MP 25/30fps@1080P	20fps@5MP 25/30fps@4MP 25/30fps@1080P	15/25/30fps@4K 25/30fps@4MP
Video Output	HD/SD Switchable	HD/SD Switchable	HD/SD Switchable	HD/SD Switchable	HD/SD Switchable	HD/SD Switchable
Audio In	Built-in mic	Built-in mic	--	Built-in mic	Built-in mic	Built-in mic
IoT Features	Active Deterrence with Red Blue Light & Siren & Alarm out Interface	Active Deterrence with Red Blue Light & Siren & Alarm out Interface	Active Deterrence with Red Blue Light & Siren & Alarm out Interface	Active Deterrence with Red Blue Light & Siren & Alarm out Interface	Active Deterrence with Red Blue Light & Siren & Alarm out Interface	Active Deterrence with Red Blue Light & Siren & Alarm out Interface
Pan/Tilt/Rotation	Pan:0°~360°; Tilt: 0°~90° Rotation: 0°~360°	Pan:0°~360°; Tilt: 0°~90° Rotation: 0°~360°	Pan:0°~360°; Tilt: 0°~180° Rotation: 0°~360°	Pan:0°~360°; Tilt: 0°~90° Rotation: 0°~360°	Pan:0°~360°; Tilt: 0°~90° Rotation: 0°~360°	Pan:0°~360°; Tilt: 0°~78° Rotation: 0°~360°
Ingress Protection	IP67	IP67	IP67	IP67	IP67	IP67
Working Temperature	-40°C~+60°C (-40°F~+140°F)	-40°C~+60°C (-40°F~+140°F)	-40°C~+60°C (-40°F~+140°F)	-40°C~+60°C (-40°F~+140°F)	-40°C~+60°C (-40°F~+140°F)	-40°C~+60°C (-40°F~+140°F)
Power	DC12V±30% Max. 7.7W	POC/DC12V±30% Max. 7.7W	DC12V±30% Max. 7.7W	DC12V±30% Max. 7.7W	POC/DC12V±30% Max. 7.7W	DC12V±30% Max. 7.7W







HDCVI CAMERAS

Active Deterrence Series

	TiOC				Active Deterrence 2.0	
Model	HAC-ME1809H-A-PV-POC	HAC-ME1509H-A-PV	HAC-ME1509H-A-PV-POC	HAC-ME1509TQ-PV	HAC-ME1800TH-PV	HAC-ME1800TQ-PV
Appearance						
Image Sensor	4K CMOS	5MP CMOS	5MP CMOS	5MP CMOS	4K CMOS	4K CMOS
Min. Illumination	0.005Lux/F1.6 (Color) 0Lux/F1.6 (LED On)	0.005 Lux/F1.2 (Color) 0Lux/F1.2 (LED On)	0.005 Lux/F1.2 (Color) 0Lux/F1.2 (LED On)	0.005Lux/F1.2 (Color) 0Lux/F1.2 (LED On)	0.02Lux/F2.0 (Color) 0Lux/F2.0 (IR On)	0.02Lux/F2.0 (Color) 0Lux/F2.0 (IR On)
Lens	3.6mm (2.8mm Optional)	3.6mm (2.8mm Optional)	3.6mm (2.8mm Optional)	3.6mm (2.8mm Optional)	3.6mm (6mm Optional)	3.6mm (2.8mm Optional)
FOV-H	89° (107°)	83° (98°)	83° (98°)	83° (98°)	87° (55°)	87° (105°)
Day/Night	Color	Color	Color	Color	Color	Color
Max. IR Distance	LED: 40m (131ft), Smart Light	LED: 40m (131ft), Smart Light	LED: 40m (131ft), Smart Light	LED: 40m (131ft), Smart Light	80m (266ft), Smart IR	60m (197ft), Smart IR
OSD Menu	Multi-language	Multi-language	Multi-language	Multi-language	Multi-language	Multi-language
WDR	DWDR	DWDR	DWDR	DWDR	DWDR	DWDR
Noise Reduction	2D	2D	2D	2D	2D	2D
Frame Rate	15/25/30fps@4K 25/30fps@4MP	20fps@5MP 25/30fps@4MP 25/30fps@1080P	20fps@5MP 25/30fps@4MP 25/30fps@1080P	20fps@5MP 30fps@4MP 30fps@1080P	30fps@4K 20fps@5MP 30fps@4MP	30fps@4K 20fps@5MP 30fps@4MP
Video Output	HD/SD Switchable	HD/SD Switchable	HD/SD Switchable	HD/SD Switchable	HD/SD Switchable	HD/SD Switchable
Audio In	Built-in mic	Built-in mic	Built-in mic	--	--	--
IoT Features	Active Deterrence with Red Blue Light & Siren & Alarm out Interface	Active Deterrence with Red Blue Light & Siren & Alarm out Interface	Active Deterrence with Red Blue Light & Siren & Alarm out Interface	Active Deterrence with Red Blue Light & Siren & Alarm out Interface	Active Deterrence with Red Blue Light & Siren & Alarm out Interface	Active Deterrence with Red Blue Light & Siren & Alarm out Interface
Pan/Tilt/Rotation	Pan:0°~360°; Tilt: 0°~78° Rotation: 0°~360°	Pan:0°~360°; Tilt: 0°~78° Rotation: 0°~360°	Pan:0°~360°; Tilt: 0°~78° Rotation: 0°~360°	Pan:0°~360°; Tilt: 0°~78° Rotation: 0°~360°	Pan:0°~360°; Tilt: 0°~90° Rotation: 0°~360°	Pan:0°~360°; Tilt: 0°~78° Rotation: 0°~360°
Ingress Protection	IP67	IP67	IP67	IP67	IP67	IP67
Working Temperature	-40°C~+60°C (-40°F~+140°F)	-40°C~+60°C (-40°F~+140°F)	-40°C~+60°C (-40°F~+140°F)	-40°C~+60°C (-40°F~+140°F)	-40°C~+60°C (-40°F~+140°F)	-40°C~+60°C (-40°F~+140°F)
Power	POC/DC12V±30% Max. 7.7W	DC12V±30% Max. 7.7W	POC/DC12V±30% Max. 7.7W	DC12V±30% Max. 7.7W	DC12V±30% Max. 8.5W	DC12V±30% Max. 8.5W

Active Deterrence Series







Active Deterrence 2.0

Model	HAC-ME1800B-LS	HAC-ME1509B-LS	HAC-ME1800EQ-LS	HAC-ME1509EQ-LS	HAC-ME1800B-L	HAC-ME1800EQ-L
Appearance						
Image Sensor	4K CMOS	5MP CMOS	4K CMOS	5MP CMOS	4K CMOS	4K CMOS
Min. Illumination	0.02Lux/F2.0 (Color) 0Lux/F2.0 (IR On)	0.005Lux/F1.2 (Color) 0Lux/F1.2 (LED On)	0.02Lux/F2.0 (Color) 0Lux/F2.0 (IR On)	0.005Lux/F1.2 (Color) 0Lux/F1.2 (LED On)	0.02Lux/F2.0 (Color) 0Lux/F2.0 (IR On)	0.02Lux/F2.0 (Color) 0Lux/F2.0 (IR On)
Lens	2.8mm	3.6mm (2.8mm Optional)	2.8mm	3.6mm (2.8mm Optional)	2.8mm	2.8mm
FOV-H	105°	83° (98°)	105°	83° (98°)	105°	105°
Day/Night	ICR	Color	ICR	Color	ICR	ICR
Max. IR Distance	20m (66ft), Smart IR	LED: 40m (131ft), Smart Light	20m (66ft), Smart IR	LED: 40m (131ft), Smart Light	20m (66ft), Smart IR	20m (66ft), Smart IR
OSD Menu	Multi-language	Multi-language	Multi-language	Multi-language	Multi-language	Multi-language
WDR	DWDR	DWDR	DWDR	DWDR	DWDR	DWDR
Noise Reduction	2D	2D	2D	2D	2D	2D
Frame Rate	30fps@4K 20fps@5MP 30fps@4MP	20fps@5MP 30fps@4MP 30fps@1080P	30fps@4K 20fps@5MP 30fps@4MP	20fps@5MP 30fps@4MP 30fps@1080P	30fps@4K 20fps@5MP 30fps@4MP	30fps@4K 20fps@5MP 30fps@4MP
Video Output	HD/SD Switchable	HD/SD Switchable	HD/SD Switchable	HD/SD Switchable	HD/SD Switchable	HD/SD Switchable
Audio In	--	--	--	--	--	--
IoT Features	Active Deterrence with White Light & Siren; Accurate Alarm Based on PIR & Motion Dual-detection; Coax Alarm Out	Active Deterrence with White Light & Siren; Accurate Alarm Based on PIR & Motion Dual-detection; Coax Alarm Out	Active Deterrence with White Light & Siren; Accurate Alarm Based on PIR & Motion Dual-detection; Coax Alarm Out	Active Deterrence with White Light & Siren; Accurate Alarm Based on PIR & Motion Dual-detection; Coax Alarm Out	Active Deterrence with White Light ; Accurate Alarm Based on PIR & Motion Dual-detection; Coax Alarm Out	Active Deterrence with White Light ; Accurate Alarm Based on PIR & Motion Dual-detection; Coax Alarm Out
Pan/Tilt/Rotation	Pan:0°~360°; Tilt: 0°~90° Rotation: 0°~360°	Pan:0°~360°; Tilt: 0°~90° Rotation: 0°~360°	Pan:0°~360°; Tilt: 0°~78° Rotation: 0°~360°	Pan:0°~360°; Tilt: 0°~78° Rotation: 0°~360°	Pan:0°~360°; Tilt: 0°~90° Rotation: 0°~360°	Pan:0°~360°; Tilt: 0°~78° Rotation: 0°~360°
Ingress Protection	IP67	IP67	IP67	IP67	IP67	IP67
Working Temperature	-40°C~+60°C (-40°F~+140°F)	-40°C~+60°C (-40°F~+140°F)	-40°C~+60°C (-40°F~+140°F)	-40°C~+60°C (-40°F~+140°F)	-40°C~+60°C (-40°F~+140°F)	-40°C~+60°C (-40°F~+140°F)
Power	DC12V±30% Max. 8.5W	DC12V±30% Max. 7.0W	DC12V±30% Max. 8.5W	DC12V±30% Max. 7.0W	DC12V±30% Max. 7.2W	DC12V±30% Max. 7.2W

HDCVI CAMERAS

Active Deterrence Series

Active Deterrence 2.0

Model	HAC-ME1500D-LS	HAC-ME1200D-LS	HAC-ME1500B-LS	HAC-ME1500B-L	HAC-ME1200B-LS	HAC-ME1200B-L
Appearance						
Image Sensor	5MP CMOS	2MP CMOS	5MP CMOS	5MP CMOS	2MP CMOS	2MP CMOS
Min. Illumination	0.005Lux/F1.6 (Color) 0Lux/F1.6 (IR On)	0.02Lux/F2.0 (Color) 0Lux/F2.0 (IR On)	0.005Lux/F1.6 (Color) 0Lux/F1.6 (IR On)	0.005Lux/F1.6 (Color) 0Lux/F1.6 (IR On)	0.02Lux/F2.0 (Color) 0Lux/F2.0 (IR On)	0.02Lux/F2.0 (Color) 0Lux/F2.0 (IR On)
Lens	3.6mm (2.8mm Optional)	3.6mm (2.8mm Optional)	3.6mm (2.8mm Optional)	3.6mm (2.8mm Optional)	3.6mm (2.8mm Optional)	3.6mm (2.8mm Optional)
FOV-H	90° (113°)	83° (100°)	90° (113°)	90° (113°)	83° (100°)	83° (100°)
Day/Night	ICR	ICR	ICR	ICR	ICR	ICR
Max. IR Distance	30m (98ft), Smart IR	30m (98ft), Smart IR	30m (98ft), Smart IR	30m (98ft), Smart IR	30m (98ft), Smart IR	30m (98ft), Smart IR
OSD Menu	Multi-language	Multi-language	Multi-language	Multi-language	Multi-language	Multi-language
WDR	DWDR	DWDR	DWDR	DWDR	DWDR	DWDR
Noise Reduction	2D	2D	2D	2D	2D	2D
Frame Rate	25fps@5MP 30fps@4MP 30fps@1080P	30fps@1080P	25fps@5MP 30fps@4MP 30fps@1080P	25fps@5MP 30fps@4MP 30fps@1080P	30fps@1080P	30fps@1080P
Video Output	HD/SD Switchable	HD/SD Switchable	HD/SD Switchable	HD/SD Switchable	HD/SD Switchable	HD/SD Switchable
Audio In	--	--	--	--	--	--
IoT Features	Active Deterrence with Warm Light & siren; Accurate Alarm Based on PIR & Motion Dual-detection; Coax Alarm Out	Active Deterrence with Warm Light and speaker; Accurate Alarm Based on PIR & Motion Dual-detection; Coax Alarm Out	Active Deterrence with Warm Light & siren; Accurate Alarm Based on PIR & Motion Dual-detection; Coax Alarm Out	Active Deterrence with Warm Light; Accurate Alarm Based on PIR & Motion Dual-detection; Coax Alarm Out	Active Deterrence with Warm Light and speaker; Accurate Alarm Based on PIR & Motion Dual-detection; Coax Alarm Out	Active Deterrence with Warm Light; Accurate Alarm Based on PIR & Motion Dual-detection; Coax Alarm Out
Pan/Tilt/Rotation	Pan:0°~360°; Tilt: 0°~90° Rotation: 0°~360°	Pan:0°~360°; Tilt: 0°~90° Rotation: 0°~360°	Pan:0°~360°; Tilt: 0°~90° Rotation: 0°~360°	Pan:0°~360°; Tilt: 0°~90° Rotation: 0°~360°	Pan:0°~360°; Tilt: 0°~90° Rotation: 0°~360°	Pan:0°~360°; Tilt: 0°~90° Rotation: 0°~360°
Ingress Protection	IP67	IP67	IP67	IP67	IP67	IP67
Working Temperature	-40°C~+60°C (-40°F~+140°F)	-40°C~+60°C (-40°F~+140°F)	-40°C~+60°C (-40°F~+140°F)	-40°C~+60°C (-40°F~+140°F)	-40°C~+60°C (-40°F~+140°F)	-40°C~+60°C (-40°F~+140°F)
Power	DC12V±30% Max. 4.9W	DC12V±30% Max. 4.9W	DC12V±30% Max. 4.9W	DC12V±30% Max. 4.5W	DC12V±30% Max. 4.9W	DC12V±30% Max. 4.5W

HDCVI CAMERAS

Active Deterrence Series

Active Deterrence 2.0

PIR

Model	HAC-ME1500EQ-LS	HAC-ME1500EQ-L	HAC-ME1200EQ-LS	HAC-ME1200EQ-L	HAC-ME2802B
Appearance					
Image Sensor	5MP CMOS	5MP CMOS	2MP CMOS	2MP CMOS	4K CMOS
Min. Illumination	0.005Lux/F1.6 (Color) 0Lux/F1.6 (IR On)	0.005Lux/F1.6 (Color) 0Lux/F1.6 (IR On)	0.02Lux/F2.0 (Color) 0Lux/F2.0 (IR On)	0.02Lux/F2.0 (Color) 0Lux/F2.0 (IR On)	0.005Lux/F1.6 (Color) 0Lux/F1.6 (IR On)
Lens	3.6mm (2.8mm Optional)	3.6mm (2.8mm Optional)	3.6mm (2.8mm Optional)	3.6mm (2.8mm Optional)	2.8mm
FOV-H	90° (113°)	90° (113°)	83° (100°)	83° (100°)	110.8°
Day/Night	ICR	ICR	ICR	ICR	ICR
Max. IR Distance	30m (98ft), Smart IR	30m (98ft), Smart IR	30m (98ft), Smart IR	30m (98ft), Smart IR	20m (66ft), Smart IR
OSD Menu	Multi-language	Multi-language	Multi-language	Multi-language	Multi-language
WDR	DWDR	DWDR	DWDR	DWDR	DWDR
Noise Reduction	2D	2D	2D	2D	2D
Frame Rate	25fps@5MP 30fps@4MP 30fps@1080P	25fps@5MP 30fps@4MP 30fps@1080P	30fps@1080P	30fps@1080P	15fps@4K 20fps@5MP 30fps@4MP
Video Output	HD/SD Switchable	HD/SD Switchable	HD/SD Switchable	HD/SD Switchable	HD/SD Switchable (Video only)
Audio In	--	--	--	--	--
IoT Features	Active Deterrence with Warm Light & siren; Accurate Alarm Based on PIR & Motion Dual-detection; Coax Alarm Out	Active Deterrence with Warm Light; Accurate Alarm Based on PIR & Motion Dual-detection; Coax Alarm Out	Active Deterrence with Warm Light and speaker; Accurate Alarm Based on PIR & Motion Dual-detection; Coax Alarm Out	Active Deterrence with Warm Light; Accurate Alarm Based on PIR & Motion Dual-detection; Coax Alarm Out	Accurate Alarm Based on PIR & Motion Dual-detection; Coax Alarm Out
Pan/Tilt/Rotation	Pan:0°~360°; Tilt: 0°~78° Rotation: 0°~360°	Pan:0°~360°; Tilt: 0°~78° Rotation: 0°~360°	Pan:0°~360°; Tilt: 0°~78° Rotation: 0°~360°	Pan:0°~360°; Tilt: 0°~78° Rotation: 0°~360°	Pan:0°~360°; Tilt: 0°~90° Rotation: 0°~360°
Ingress Protection	IP67	IP67	IP67	IP67	IP67
Working Temperature	-40°C~+60°C (-40°F~+140°F)	-40°C~+60°C (-40°F~+140°F)	-40°C~+60°C (-40°F~+140°F)	-40°C~+60°C (-40°F~+140°F)	-10°C~+50°C (14°F~+122°F)
Power	DC12V±30% Max. 4.9W	DC12V±30% Max. 4.5W	DC12V±30% Max. 4.9W	DC12V±30% Max. 4.5W	DC12V±30% Max. 5.3W

Panorama Series

Panorama Series offers a wide range of intelligent cameras including fisheye, multi-sensor and dual-lens that cater different scenarios. A single panoramic camera can cover an extremely wide field of view, which makes it suitable for large-scale monitoring applications and greatly simplifies system installation and maintenance.



Multi-sensor Camera

Provides a 180 degree panoramic view which consists of three 1080P single views. The camera has 4 BNCs and outputs one panoramic view and three individual images.



Fisheye Camera

Adopts fisheye lens to provide a 360 degree round view, covering a whole large area. It also offers options for models with 4K/5MP high resolution.







Dual-lens Camera

Monitors two directions with separate cameras, saving installation work. This camera is suitable for monitoring scenes such as corridors, corners and stairs.



Simplicity

Panoramic camera can replace multiple cameras, making installation, adjustment and maintenance easier, and saving product and labor costs for customers.

Panorama Series				
	Multi-sensor	Fisheye		Dual-lens
Model	HAC-PFW3601-A180 (-AC24)	HAC-EBW3802	HAC-EW2501	HAC-HDW2241M-E2
Appearance	 Starlight	 Starlight	 Starlight	 Starlight
Image Sensor	2MP CMOS	4K CMOS	5MP CMOS	2MP CMOS
Min. Illumination	0.005Lux/F1.8 (Color) 0Lux/F1.8 (IR On)	0.005Lux/F2.0 (Color) 0Lux/F2.0 (IR On)	0.005Lux/F2.0 (Color) 0Lux/F2.0 (IR On)	0.004Lux/F1.6 (Color) 0Lux/F1.6 (IR On)
Lens	3x3.6mm	2.5mm	1.4mm	2x3.6mm (2.8mm, 6mm Optional)
FOV-H	Panoramic View: 180° Single View: 3x87°	180°	180°	Single View: 2x86.9°(110°/52.8°)
Day/Night	ICR	ICR	ICR	ICR
Max. IR Distance	20m (66ft), Smart IR	15m (49ft), Smart IR	10m (33ft), Smart IR	30m (98ft), Smart IR
OSD Menu	Multi-language	Multi-language	Multi-language	Multi-language
WDR	120dB	120dB	120dB	120dB
Noise Reduction	2D/3D	2D/3D	2D/3D	2D/3D
Frame Rate	Panoramic View: 15fps@4K, 25fps@4MP Single View: 25fps@1080P	15fps@4K 30fps@4MP	20fps@5MP 30fps@4MP 30fps@1080P	Single View: 30fps@1080P 30/60fps@720P
Video Output	HD (1xPanoramic View & 3xSingle View Output) SD Tester-out (Panoramic View)	HD/SD Dual-output	HD/SD Switchable	HD/SD Switchable
Audio In	1	1ch in & Built-in Mic	Built-in Mic	1
Alarm In/Out	2/1	2/1	--	--
Pan/Tilt/Rotation	Pan: 0°~360°; Tilt: 0°~90° Rotation: 0°~360°	--	--	Pan: 0°~360°; Tilt: 0°~78° Rotation: 0°~360°
Ingress Protection	IP67, IK10	IP67, IK10	--	IP67
Working Temperature	-30°C~+60°C (-22°F~+140°F)	-30°C~+60°C (-22°F~+140°F)	-30°C~+60°C (-22°F~+140°F)	-40°C~+60°C (-40°F~+140°F)
Power	DC12V±25%, Max. 22W (AC24V±25% Optional, Max. 22W)	DC12V±25% Max. 7.4W	DC12V±25% Max. 7.3W	1xDC12V±30% Max. 9.2W

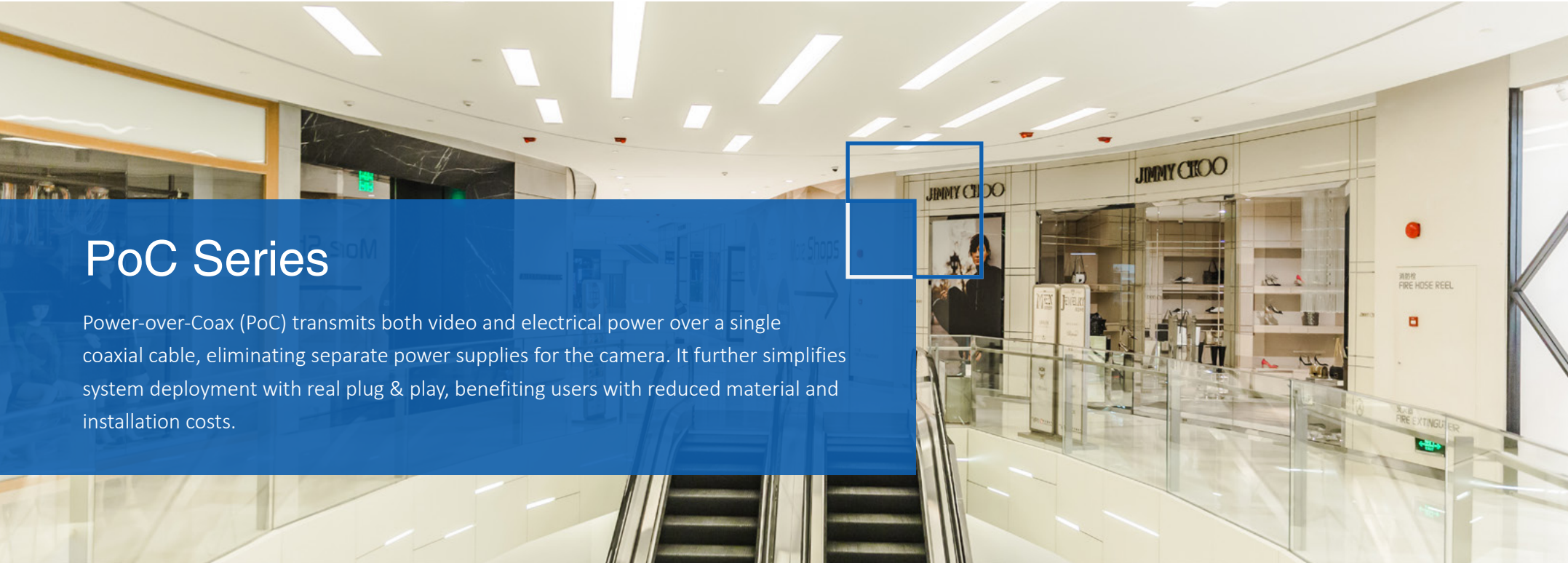

PoC Series

Power-over-Coax (PoC) transmits both video and electrical power over a single coaxial cable, eliminating separate power supplies for the camera. It further simplifies system deployment with real plug & play, benefiting users with reduced material and installation costs.



Power-over-coax

PoC technology transmits power over the same coaxial cable with video, audio and data.



Long Distance

Dahua PoC transmission distance can reach up to 200 meters for AF cameras and 100 meters for AT cameras.



Cost Saving

HDCVI PoC technology simplifies HDCVI system deployment and enhances power system stability, reducing installation and maintenance costs.



Safe Operation

In case of connection with non-PoC devices or short-circuits in the cable, the PoC system automatically identifies the risk and cuts off power at once, avoiding damage and injuries.

HDCVI CAMERAS

PoC Series





Vari-focal Bullet

Vari-focal Dome

Model	HAC-HFW2501TU-Z-A-POC	HAC-HFW2241TU-Z-A-POC	HAC-HFW1500R-Z-IRE6-A-POC	HAC-HFW1200R-Z-IRE6-A-POC	HAC-HDBW2501R-Z-POC
Appearance	 Starlight	 Starlight	 Starlight	 Starlight	 Starlight
Image Sensor	5MP (16:9) CMOS	2MP CMOS	5MP (16:9) CMOS	2MP CMOS	5MP (16:9) CMOS
Min. Illumination	0.001Lux/F1.6 (Color) 0Lux/F1.6 (IR On)	0.001Lux/F1.6 (Color) 0Lux/F1.6 (IR On)	0.005Lux/F1.6 (Color) 0Lux/F1.6 (IR On)	0.02Lux/F1.7 (Color) 0Lux/F1.7 (IR On)	0.001Lux/F1.6 (Color) 0Lux/F1.6 (IR On)
Lens	2.7~13.5mm, Motorized	2.7~13.5mm, Motorized	2.7-12mm, Motorized	2.7-12mm, Motorized	2.7~13.5mm, Motorized
FOV-H	113°~31.4°	108°~30°	107°~34°	102°~33°	113°~31.4°
Day/Night	ICR	ICR	ICR	ICR	ICR
Max. IR Distance	80m (262ft), Smart IR	80m (262ft), Smart IR	60m (197ft), Smart IR	60m (197ft), Smart IR	30m (98ft), Smart IR
OSD Menu	Multi-language	Multi-language	Multi-language	Multi-language	Multi-language
WDR	120dB	130dB	DWDR	DWDR	120dB
Noise Reduction	2D/3D	2D/3D	2D	2D	2D/3D
Frame Rate	25fps@5MP (16:9) 30fps@4MP	30fps@1080P 30fps@720P	25fps@5MP (16:9) 30fps@4MP 30fps@1080P	30fps@1080P 30fps@720P	25fps@5MP (16:9) 30fps@4MP
Video Output	HD/SD Switchable	HD/SD Switchable	HD/SD Switchable	HD/SD Switchable	HD/SD Switchable
Audio In	Built-in Mic	1ch in & Built-in Mic	Built-in Mic	Built-in Mic	--
Alarm In/Out	--	--	--	--	--
Pan/Tilt/Rotation	Pan: 0°~360°; Tilt: 0°~90° Rotation: 0°~360°	Pan: 0°~360°; Tilt: 0°~90° Rotation: 0°~360°	Pan: 0°~360°; Tilt: 0°~90° Rotation: 0°~360°	Pan: 0°~360°; Tilt: 0°~90° Rotation: 0°~360°	Pan: 0°~355°; Tilt: 0°~75° Rotation: 0°~355°
Ingress Protection	IP67	IP67	IP67	IP67	IP67, IK10
Working Temperature	-30°C~+60°C (-22°F~+140°F)	-30°C~+60°C (-22°F~+140°F)	-30°C~+60°C (-22°F~+140°F)	-30°C~+60°C (-22°F~+140°F)	-30°C~+60°C (-22°F~+140°F)
Power	POC/DC12V±30% Max. 8.2W	POC/DC12V±30% Max. 6.7W	POC/DC12V±30% Max. 9.8W	POC/DC12V±30% Max. 7.2W	POC/DC12V±30% Max. 6.6W







HDCVI CAMERAS

PoC Series

	Vari-focal Dome			Vari-focal Eyeball	
Model	HAC-HDBW1500R-Z-POC	HAC-HDBW2241RA-Z-A-POC	HAC-HDBW1200R-Z-POC	HAC-HDW2501TMQ-Z-A-POC	HAC-HDW1500TMQ-Z-A-POC
Appearance	 Starlight	 Starlight		 Starlight	 Starlight
Image Sensor	5MP (16:9) CMOS	2MP CMOS	2MP CMOS	5MP (16:9) CMOS	5MP (16:9) CMOS
Min. Illumination	0.005Lux/F1.6 (Color) 0Lux/F1.6 (IR On)	0.001Lux/F1.6 (Color) 0Lux/F1.6 (IR On)	0.02Lux/F1.7 (Color) 0Lux/F1.7 (IR On)	0.001Lux/F1.6 (Color) 0Lux/F1.6 (IR On)	0.005Lux/F1.6 (Color) 0Lux/F1.6 (IR On)
Lens	2.7-12mm, Motorized	2.7~13.5mm, Motorized	2.7-12mm, Motorized	2.7~13.5mm, Motorized	2.7-12mm, Motorized
FOV-H	107°~34°	108°~30°	102°~33°	113°~31.4°	107°~34°
Day/Night	ICR	ICR	ICR	ICR	ICR
Max. IR Distance	30m (98ft), Smart IR	60m (197ft), Smart IR	30m (98ft), Smart IR	60m (197ft), Smart IR	60m (197ft), Smart IR
OSD Menu	Multi-language	Multi-language	Multi-language	Multi-language	Multi-language
WDR	DWDR	130dB	DWDR	120dB	DWDR
Noise Reduction	2D	2D/3D	2D	2D/3D	2D
Frame Rate	25fps@5MP (16:9) 30fps@4MP 30fps@1080P	30fps@1080P 30fps@720P	30fps@1080P 30fps@720P	25fps@5MP (16:9) 30fps@4MP	25fps@5MP (16:9) 30fps@4MP 30fps@1080P
Video Output	HD/SD Switchable	HD/SD Switchable	HD/SD Switchable	HD/SD Switchable	HD/SD Switchable
Audio In	--	1ch in & Built-in Mic	--	Built-in Mic	Built-in Mic
Alarm In/Out	--	--	--	--	--
Pan/Tilt/Rotation	Pan: 0°~355°; Tilt: 0°~75° Rotation: 0°~355°	Pan: 0°~355°; Tilt: 0°~80° Rotation: 0°~355°	Pan: 0°~355°; Tilt: 0°~75° Rotation: 0°~355°	Pan: 0°~360°; Tilt: 0°~78° Rotation: 0°~360°	Pan: 0°~360°; Tilt: 0°~78° Rotation: 0°~360°
Ingress Protection	IP67, IK10	IP67, IK10	IP67, IK10	IP67	IP67
Working Temperature	-30°C~+60°C (-22°F~+140°F)	-30°C~+60°C (-22°F~+140°F)	-30°C~+60°C (-22°F~+140°F)	-30°C~+60°C (-22°F~+140°F)	-30°C~+60°C (-22°F~+140°F)
Power	POC/DC12V±30% Max. 5.5W	POC/DC12V±30% Max. 6.9W	POC/DC12V±30% Max. 5.2W	POC/DC12V±30% Max. 8W	POC/DC12V±30% Max. 6.6W

PoC Series







Vari-focal Eyeball

Model	HAC-HDW2241TMQ-Z-A-POC	HAC-HDW1200TMQ-Z-A-POC	HAC-HDW2501T-Z-A-POC	HAC-HDW1500T-Z-A-POC	HAC-HDW2241T-Z-A-POC	HAC-HDW1200T-Z-A-POC
Appearance	 Starlight		 Starlight	 Starlight	 Starlight	
Image Sensor	2MP CMOS	2MP CMOS	5MP (16:9) CMOS	5MP (16:9) CMOS	2MP CMOS	2MP CMOS
Min. Illumination	0.001Lux/F1.6 (Color) 0Lux/F1.6 (IR on)	0.02Lux/F1.7 (Color) 0Lux/F1.7 (IR On)	0.001Lux/F1.6 (Color) 0Lux/F1.6 (IR On)	0.005Lux/F1.6 (Color) 0Lux/F1.6 (IR On)	0.001Lux/F1.6 (Color) 0Lux/F1.6 (IR On)	0.02Lux/F1.7 (Color) 0Lux/F1.7 (IR On)
Lens	2.7~13.5mm, Motorized	2.7-12mm, Motorized	2.7~13.5mm, Motorized	2.7-12mm, Motorized	2.7~13.5mm, Motorized	2.7-12mm, Motorized
FOV-H	113°~31.4°	102°~33°	113°~31.4°	107°~34°	108°~30°	102°~33°
Day/Night	ICR	ICR	ICR	ICR	ICR	ICR
Max. IR Distance	60m (197ft), Smart IR	60m (197ft), Smart IR	60m (197ft), Smart IR	60m (197ft), Smart IR	60m (197ft), Smart IR	60m (197ft), Smart IR
OSD Menu	Multi-language	Multi-language	Multi-language	Multi-language	Multi-language	Multi-language
WDR	130dB	DWDR	120dB	DWDR	130dB	DWDR
Noise Reduction	2D/3D	2D	2D/3D	2D	2D/3D	2D
Frame Rate	30fps@1080P 30fps@720P	30fps@1080P 30fps@720P	25fps@5MP (16:9) 30fps@4MP	25fps@5MP (16:9) 30fps@4MP 30fps@1080P	30fps@1080P 30fps@720P	30fps@1080P 30fps@720P
Video Output	HD/SD Switchable	HD/SD Switchable	HD/SD Switchable	HD/SD Switchable	HD/SD Switchable	HD/SD Switchable
Audio In	1ch in & Built-in Mic	1ch in & Built-in Mic	Built-in Mic	Built-in Mic	1ch in & Built-in Mic	1ch in & Built-in Mic
Alarm In/Out	--	--	--	--	--	--
Pan/Tilt/Rotation	Pan: 0°~360°; Tilt: 0°~78° Rotation: 0°~360°	Pan: 0°~360°; Tilt: 0°~78° Rotation: 0°~360°	Pan: 0°~360°; Tilt: 0°~78° Rotation: 0°~360°	Pan: 0°~360°; Tilt: 0°~78° Rotation: 0°~360°	Pan: 0°~360°; Tilt: 0°~78° Rotation: 0°~360°	Pan: 0°~360°; Tilt: 0°~78° Rotation: 0°~360°
Ingress Protection	IP67	IP67	IP67	IP67	IP67	IP67
Working Temperature	-30°C~+60°C (-22°F~+140°F)	-30°C~+60°C (-22°F~+140°F)	-30°C~+60°C (-22°F~+140°F)	-30°C~+60°C (-22°F~+140°F)	-30°C~+60°C (-22°F~+140°F)	-30°C~+60°C (-22°F~+140°F)
Power	POC/DC12V±30% Max. 8.0W	POC/DC12V±30% Max. 6.4W	POC/DC12V±30% Max. 8W	POC/DC12V±30% Max. 6.6W	POC/DC12V±30% Max. 6.4W	POC/DC12V±30% Max. 6.4W

HDCVI CAMERAS







PoC Series

Fixed-focal Bullet

Model	HAC-HFW2501TU-A-POC	HAC-HFW2241TU-A-POC	HAC-HFW1500TH-I8-A-POC	HAC-HFW1200TH-I8-A-POC	HAC-HFW1509T-A-LED-POC	HAC-HFW2501CM-A-POC
Appearance	 Starlight	 Starlight	 Starlight	 Starlight	 Full-color	 Starlight
Image Sensor	5MP (16:9) CMOS	2MP CMOS	5MP (16:9) CMOS	2MP CMOS	5MP (16:9) CMOS	5MP (16:9) CMOS
Min. Illumination	0.001Lux/F1.6 (Color) 0Lux/F1.6 (IR On)	0.001Lux/F1.6 (Color) 0Lux/F1.6 (IR On)	0.005Lux/F1.6 (Color) 0Lux/F1.6 (IR On)	0.02Lux/F1.9 (Color) 0Lux/F1.9 (IR On)	0.001Lux/F1.0 (Color) 0Lux/F1.0 (IR On)	0.001Lux/F1.6 (Color) 0Lux/F1.6 (IR On)
Lens	3.6mm (6mm, 8mm Optional)	3.6mm (6mm Optional)	3.6mm (6mm, 8mm Optional)	3.6mm (6mm, 8mm Optional)	3.6mm (2.8mm Optional)	3.6mm (2.8mm Optional)
FOV-H	92°(57°/43°)	86°(54°)	92°(57°/43°)	84°(56°/40°)	88°(112°)	92°(111°)
Day/Night	ICR	ICR	ICR	ICR	ICR	ICR
Max. IR Distance	80m (262ft), Smart IR	80m (262ft), Smart IR	80m (262ft), Smart IR	80m (262ft), Smart IR	20 m (65.61 ft), Smart IR	30m (98ft), Smart IR
OSD Menu	Multi-language	Multi-language	Multi-language	Multi-language	Multi-language	Multi-language
WDR	120dB	130dB	DWDR	DWDR	120dB	120dB
Noise Reduction	2D/3D	2D/3D	2D	2D	3D	2D/3D
Frame Rate	25fps@5MP (16:9) 30fps@4MP	30fps@1080P 30fps@720P	25fps@5MP (16:9) 30fps@4MP 30fps@1080P	30fps@1080P 30fps@720P	25fps@5MP (16:9) 25fps@4MP 25fps@1080P	25fps@5MP (16:9) 30fps@4MP
Video Output	HD/SD Switchable	HD/SD Switchable	HD/SD Switchable	HD/SD Switchable	HD/SD Switchable	HD/SD Switchable
Audio In	Built-in Mic	1ch in & Built-in Mic	Built-in Mic	1ch in & Built-in Mic	Built-in Mic	Built-in Mic
Alarm In/Out	--	--	--	--	--	--
Pan/Tilt/Rotation	Pan: 0°~360°; Tilt: 0°~90° Rotation: 0°~360°	Pan: 0°~360°; Tilt: 0°~90° Rotation: 0°~360°	Pan: 0°~360°; Tilt: 0°~180° Rotation: 0°~360°	Pan: 0°~360°; Tilt: 0°~90° Rotation: 0°~360°	Pan: 0°~360°; Tilt: 0°~90° Rotation: 0°~360°	Pan: 0°~360°; Tilt: 0°~90° Rotation: 0°~360°
Ingress Protection	IP67	IP67	IP67	IP67	IP67	IP67
Working Temperature	-40°C~+60°C (-40°F~+140°F)	-40°C~+60°C (-40°F~+140°F)	-40°C~+60°C (-40°F~+140°F)	-40°C~+60°C (-40°F~+140°F)	-40°C~+60°C (-40°F~+140°F)	-40°C~+60°C (-40°F~+140°F)
Power	POC/DC12V±30% Max. 6.8W	POC/DC12V±30% Max. 5.3W	POC/DC12V±30% Max. 5.2W	POC/DC12V±30% Max. 4.9W	POC/DC12V±30% Max. 4.4W	POC/DC12V±30% Max. 4.7W

HDCVI CAMERAS







PoC Series

	Fixed-focal Bullet			Fixed-focal Eyeball		
Model	HAC-HFW1500CM-A-POC	HAC-HFW2241CM-A-POC	HAC-HFW1200CM-A-POC	HAC-HDW2501TMQ-A-POC	HAC-HDW1500TMQ-A-POC	HAC-HDW2241TMQ-A-POC
Appearance	 Starlight	 Starlight	 Starlight	 Starlight	 Starlight	 Starlight
Image Sensor	5MP (16:9) CMOS	2MP CMOS	2MP CMOS	5MP (16:9) CMOS	5MP (16:9) CMOS	2MP CMOS
Min. Illumination	0.005Lux/F1.6 (Color) 0Lux/F1.6 (IR On)	0.001Lux/F1.6 (Color) 0Lux/F1.6 (IR On)	0.02Lux/F1.9 (Color) 0Lux/F1.9 (IR On)	0.001Lux/F1.6 (Color) 0Lux/F1.6 (IR On)	0.005Lux/F1.6 (Color) 0Lux/F1.6 (IR On)	0.001Lux/F1.6 (Color) 0Lux/F1.6 (IR On)
Lens	3.6mm (2.8mm Optional)	3.6mm (2.8mm Optional)	3.6mm (2.8mm Optional)	3.6mm (2.8mm, 6mm Optional)	3.6mm (2.8mm, 6mm Optional)	3.6mm (2.8mm, 6mm Optional)
FOV-H	92° (111°)	86° (109°)	84° (101°)	92° (111°/57°)	92° (111°/57°)	86° (109°/54°)
Day/Night	ICR	ICR	ICR	ICR	ICR	ICR
Max. IR Distance	30m (98ft), Smart IR	30m (98ft), Smart IR	30m (98ft), Smart IR	60m (197ft), Smart IR	60m (197ft), Smart IR	60m (197ft), Smart IR
OSD Menu	Multi-language	Multi-language	Multi-language	Multi-language	Multi-language	Multi-language
WDR	DWDR	130dB	DWDR	120dB	DWDR	130dB
Noise Reduction	2D	2D/3D	2D	2D/3D	2D	2D/3D
Frame Rate	25fps@5MP (16:9) 30fps@4MP 30fps@1080P	30fps@1080P 30fps@720P	30fps@1080P 30fps@720P	25fps@5MP(16:9) 30fps@4MP	25fps@5MP (16:9) 30fps@4MP 30fps@1080P	30fps@1080P 30fps@720P
Video Output	HD/SD Switchable	HD/SD Switchable	HD/SD Switchable	HD/SD Switchable	HD/SD Switchable	HD/SD Switchable
Audio In	Built-in Mic	1ch in & Built-in Mic	1ch in & Built-in Mic	Built-in Mic	Built-in Mic	1ch in & Built-in Mic
Alarm In/Out	--	--	--	--	--	--
Pan/Tilt/Rotation	Pan: 0°~360°; Tilt: 0°~90° Rotation: 0°~360°	Pan: 0°~360°; Tilt: 0°~90° Rotation: 0°~360°	Pan: 0°~360°; Tilt: 0°~90° Rotation: 0°~360°	Pan: 0°~360°; Tilt: 0°~78° Rotation: 0°~360°	Pan: 0°~360°; Tilt: 0°~78° Rotation: 0°~360°	Pan: 0°~360°; Tilt: 0°~78° Rotation: 0°~360°
Ingress Protection	IP67	IP67	IP67	IP67	IP67	IP67
Working Temperature	-40°C~+60°C (-40°F~+140°F)	-40°C~+60°C (-40°F~+140°F)	-40°C~+60°C (-40°F~+140°F)	-40°C~+60°C (-40°F~+140°F)	-40°C~+60°C (-40°F~+140°F)	-40°C~+60°C (-40°F~+140°F)
Power	POC/DC12V±30% Max. 3.7W	POC/DC12V±30% Max. 3W	POC/DC12V±30% Max. 2.8W	POC/DC12V±30% Max. 5.9W	POC/DC12V±30% Max. 5.2W	POC/DC12V±30% Max. 5.1W

HDCVI CAMERAS

PoC Series







Fixed-focal Eyeball

Model	HAC-HDW1200TMQ-A-POC	HAC-HDW2501TQ-A-POC	HAC-HDW1500TQ-A-POC	HAC-HDW1200TQ-A-POC	HAC-HDW1509T-A-LED-POC	HAC-HDW2501TLM-A-POC
Appearance	 Starlight	 Starlight	 Starlight		 Full-Color	 Starlight
Image Sensor	2MP CMOS	5MP (16:9) CMOS	5MP (16:9) CMOS	2MP CMOS	5MP (16:9) CMOS	5MP (16:9) CMOS
Min. Illumination	0.02Lux/F1.9 (Color) 0Lux/F1.9 (IR On)	0.001Lux/F1.6 (Color) 0Lux/F1.6 (IR On)	0.005Lux/F1.6 (Color) 0Lux/F1.6 (IR On)	0.02Lux/F1.9 (Color) 0Lux/F1.9 (IR On)	0.001Lux/F1.0 (Color) 0Lux/F1.0 (IR On)	0.001Lux/F1.6 (Color) 0Lux/F1.6 (IR On)
Lens	3.6mm (2.8mm, 6mm Optional)	3.6mm (2.8mm, 6mm Optional)	3.6mm (2.8mm, 6mm Optional)	3.6mm (2.8mm, 6mm Optional)	3.6mm (2.8mm Optional)	3.6mm (2.8mm Optional)
FOV-H	84° (101°/56°)	92° (111°/57°)	92° (111°/57°)	84° (101°/56°)	88° (112°)	92° (111°)
Day/Night	ICR	ICR	ICR	ICR	ICR	ICR
Max. IR Distance	60m (197ft), Smart IR	40m (131ft), Smart IR	40m (131ft), Smart IR	40m (131ft), Smart IR	40m (131.23 ft), Smart IR	30m (98ft), Smart IR
OSD Menu	Multi-language	Multi-language	Multi-language	Multi-language	Multi-language	Multi-language
WDR	DWDR	120dB	DWDR	DWDR	120dB	120dB
Noise Reduction	2D	2D/3D	2D	2D	2D/3D	2D/3D
Frame Rate	30fps@1080P 30fps@720P	25fps@5MP (16:9) 30fps@4MP	25fps@5MP (16:9) 30fps@4MP 30fps@1080P	30fps@1080P 30fps@720P	25fps@5MP (16:9) 25fps@4MP 25fps@1080P	25fps@5MP (16:9) 30fps@4MP 30fps@1080P
Video Output	HD/SD Switchable	HD/SD Switchable	HD/SD Switchable	HD/SD Switchable	HD/SD Switchable	HD/SD Switchable
Audio In	1ch in & Built-in Mic	Built-in Mic	Built-in Mic	1ch in & Built-in Mic	Built-in Mic	1ch in & Built-in Mic
Alarm In/Out	--	--	--	--	--	--
Pan/Tilt/Rotation	Pan: 0°~360°; Tilt: 0°~78° Rotation: 0°~360°	Pan: 0°~360°; Tilt: 0°~78° Rotation: 0°~360°	Pan: 0°~360°; Tilt: 0°~78° Rotation: 0°~360°	Pan: 0°~360°; Tilt: 0°~78° Rotation: 0°~360°	Pan: 0°~360°; Tilt: 0°~78° Rotation: 0°~360°	Pan: 0°~360°; Tilt: 0°~78° Rotation: 0°~360°
Ingress Protection	IP67	IP67	IP67	IP67	IP67	IP67
Working Temperature	-40°C~+60°C (-40°F~+140°F)	-40°C~+60°C (-40°F~+140°F)	-40°C~+60°C (-40°F~+140°F)	-40°C~+60°C (-40°F~+140°F)	-40°C~+60°C (-40°F~+140°F)	-40°C~+60°C (-40°F~+140°F)
Power	POC/DC12V±30% Max. 4.9W	POC/DC12V±30% Max. 4.3W	POC/DC12V±30% Max. 3.5W	POC/DC12V±30% Max. 2.9W	POC/DC12V±30% Max. 6.4W	POC/DC12V±30% Max. 4.3W

HDCVI CAMERAS

PoC Series

Fixed-focal Eyeball

Model	HAC-HDW1500TLM-A-POC	HAC-HDW2241TLM-A-POC	HAC-HDW1200TLM-A-POC	HAC-HDW2501TLMQ-A-POC	HAC-HDW1500TLMQ-A-POC	HAC-HDW1200TLMQ-A-POC
Appearance	 Starlight	 Starlight		 Starlight	 Starlight	
Image Sensor	5MP (16:9) CMOS	2MP CMOS	2MP CMOS	5MP (16:9) CMOS	5MP (16:9) CMOS	2MP CMOS
Min. Illumination	0.005Lux/F1.6 (Color) 0Lux/F1.6 (IR On)	0.001Lux/F1.6 (Color) 0Lux/F1.6 (IR On)	0.02Lux/F2.0 (Color) 0Lux/F2.0 (IR On)	0.001Lux/F1.6 (Color) 0Lux/F1.6 (IR On)	0.005Lux/F1.6 (Color) 0Lux/F1.6 (IR On)	0.02Lux/F1.9 (Color) 0Lux/F1.9 (IR On)
Lens	3.6mm (2.8mm Optional)	3.6mm (2.8mm Optional)	3.6mm (2.8mm Optional)	3.6mm (2.8mm Optional)	3.6mm (2.8mm Optional)	3.6mm (2.8mm Optional)
FOV-H	92° (111°)	86° (109°)	85° (102°)	92° (111°)	92° (111°)	84° (101°)
Day/Night	ICR	ICR	ICR	ICR	ICR	ICR
Max. IR Distance	30m (98ft), Smart IR	30m (98ft), Smart IR	30m (98ft), Smart IR	60m (197ft), Smart IR	30m (98ft), Smart IR	30m (98ft), Smart IR
OSD Menu	Multi-language	Multi-language	Multi-language	Multi-language	Multi-language	Multi-language
WDR	DWDR	130dB	DWDR	120dB	DWDR	DWDR
Noise Reduction	2D	2D/3D	2D	2D/3D	2D	2D
Frame Rate	25fps@5MP (16:9) 30fps@4MP 30fps@1080P	30fps@1080P 30fps@720P	30fps@1080P 30fps@720P	25fps@5MP (16:9) 30fps@4MP	25fps@5MP (16:9) 30fps@4MP 30fps@1080P	30fps@1080P 30fps@720P
Video Output	HD/SD Switchable	HD/SD Switchable	HD/SD Switchable	HD/SD Switchable	HD/SD Switchable	HD/SD Switchable
Audio In	1ch in & Built-in Mic	1ch in & Built-in Mic	1ch in & Built-in Mic	Built-in Mic	Built-in Mic	1ch in & Built-in Mic
Alarm In/Out	--	--	--	--	--	--
Pan/Tilt/Rotation	Pan: 0°~360°; Tilt: 0°~78° Rotation: 0°~360°	Pan: 0°~360°; Tilt: 0°~78° Rotation: 0°~360°	Pan: 0°~360°; Tilt: 0°~78° Rotation: 0°~360°	Pan: 0°~360°; Tilt: 0°~78° Rotation: 0°~360°	Pan: 0°~360°; Tilt: 0°~78° Rotation: 0°~360°	Pan: 0°~360°; Tilt: 0°~78° Rotation: 0°~360°
Ingress Protection	IP67	IP67	IP67	IP67	IP67	IP67
Working Temperature	-40°C~+60°C (-40°F~+140°F)	-40°C~+60°C (-40°F~+140°F)	-40°C~+60°C (-40°F~+140°F)	-40°C~+60°C (-40°F~+140°F)	-40°C~+60°C (-40°F~+140°F)	-40°C~+60°C (-40°F~+140°F)
Power	POC/DC12V±30% Max. 3.2W	POC/DC12V±30% Max. 3.1W	POC/DC12V±30% Max. 2.9W	POC/DC12V±30% Max. 4.3W	POC/DC12V±30% Max. 3.2W	POC/DC12V±30% Max. 2.9W

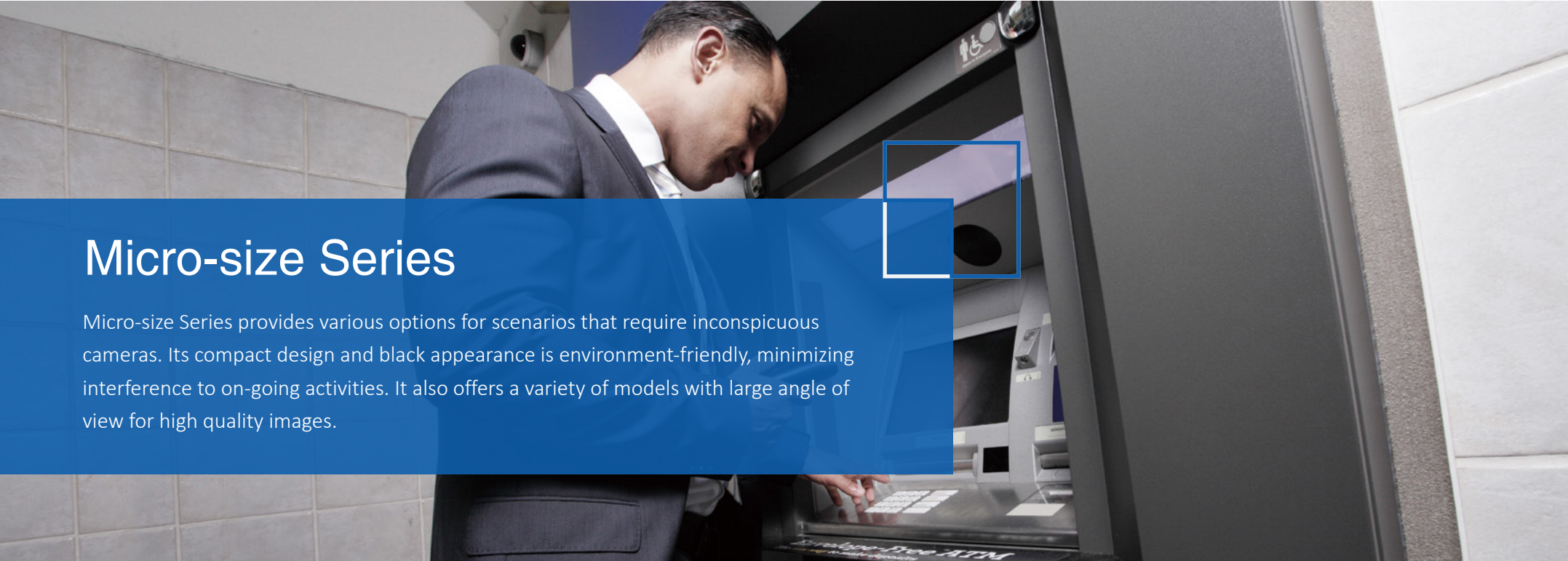

Micro-size Series

Micro-size Series provides various options for scenarios that require inconspicuous cameras. Its compact design and black appearance is environment-friendly, minimizing interference to on-going activities. It also offers a variety of models with large angle of view for high quality images.



Micro Size Design



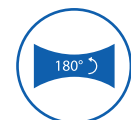

Its impressive micro-sized housing has minimum impact to the environment, offering effective concealment to avoid discomfort to people.



Large Angle of View

It adopts lens with larger field of view to monitor wider range and collect more information and details with one camera.

Micro-size Series

	Pinhole		Micro-size		
Model	HAC-HUM3201B-P	HAC-HUM3201B-B	HAC-HDW3200G	HAC-HDW3200L	HAC-HDBW3200F
Appearance	 Starlight	 Starlight			
Image Sensor	2MP CMOS	2MP CMOS	2MP CMOS	2MP CMOS	2MP CMOS
Min. Illumination	0.004Lux/F2.4 (Color) 0.0004Lux/F2.4 (B/W)	0.004Lux/F2.4 (Color) 0.0004Lux/F2.4 (B/W)	0.02Lux/F2.0 (Color) 0Lux/F2.0 (IR On)	0.02Lux/F2.0 (Color) 0Lux/F2.0 (IR On)	0.02Lux/F2.0 (Color) 0Lux/F2.0 (IR On)
Lens	2.8mm	2.8mm	3.6mm (2.8mm Optional)	2.1mm	2.8mm
FOV-H	103°	110°	84° (101°)	132°	106°
Day/Night	ICR	ICR	ICR	ICR	ICR
Max. IR Distance	--	--	20m (66ft), Smart IR	3m (10ft), Smart IR	20m (66ft), Smart IR
OSD Menu	Multi-language	Multi-language	Multi-language	Multi-language	Multi-language
WDR	120dB	120dB	DWDR	DWDR	DWDR
Noise Reduction	2D/3D	2D/3D	2D	2D	2D
Frame Rate	30fps@1080P 30fps@720P	30fps@1080P 30fps@720P	30fps@1080P 30/60fps@720P	30fps@1080P 30/60fps@720P	30fps@1080P 30/60fps@720P
Video Output	HD/SD Switchable	HD/SD Switchable	HD/SD Switchable	HD/SD Switchable	HD/SD Switchable
Audio In	--	--	Built-in Mic	Built-in Mic	Built-in Mic
Alarm In/Out	--	--	--	--	--
Pan/Tilt/Rotation	Pan: 0°~360°; Tilt: 0°~180° Rotation: NA	Pan: 0°~360°; Tilt: 0°~180° Rotation: NA	Pan: 0°~360°; Tilt: 0°~78° Rotation: 0°~360°	Pan: 0°~40°; Tilt: 0°~55° Rotation: 0°~360°	Pan: -30°~30°; Tilt: 0°~80° Rotation: 0°~360°
Ingress Protection	--	--	IP67	--	IP67;IK10
Working Temperature	-30°C~+60°C (-22°F~+140°F)	-30°C~+60°C (-22°F~+140°F)	-40°C~+60°C (-40°F~+140°F)	-40°C~+60°C (-40°F~+140°F)	-40°C~+60°C (-40°F~+140°F)
Power	DC12V±25% Max. 2.2W	DC12V±25% Max. 2.2W	DC12V±30% Max. 2.3W	DC12V±30% Max. 1.9W	DC12V±30% Max. 2.6W

HDCVI PTZ CAMERAS





Pro Series

The Pro Series PTZ is designed to meet high image quality and low-light surveillance requirements with the help of Starlight technology. Various housings and model selections are available to meet the diverse application needs of customers.



Powerful Zoom

It can cover large areas with up to 32x optical zoom capability.



Long IR Range

It offers up to 150m IR range that is suitable for low light environments.



Optimized Image

High quality images with Starlight technology.



Multi-scene Monitoring

Multiple settings that can be preset to expand the camera's coverage.

HDCVI PTZ CAMERAS

Pro Series

	32x optical zoom			25x optical zoom		
Model	SD59232-HC-LA	SD50232-HC-LA	SD52C232-HC-LA	SD59225-HC-LA	SD50225-HC-LA	SD52C225-HC-LA
Appearance						
Image Sensor	1/2.8" 2MP STARVIS™ CMOS	1/2.8" 2MP STARVIS™ CMOS	1/2.8" 2MP STARVIS™ CMOS	1/2.8" 2MP STARVIS™ CMOS	1/2.8" 2MP STARVIS™ CMOS	1/2.8" 2MP STARVIS™ CMOS
Min. Illumination	0.005Lux/F1.6 (Color) 0Lux/F1.6 (IR on)	0.005Lux/F1.6 (Color) 0.0005Lux/F1.6 (B/W)	0.005Lux/F1.6 (Color) 0.0005Lux/F1.6 (B/W)	0.005Lux/F1.6 (Color) 0Lux/F1.6 (IR on)	0.005Lux/F1.6 (Color) 0.0005Lux/F1.6 (B/W)	0.005Lux/F1.6 (Color) 0.0005Lux/F1.6 (B/W)
Lens	4.5~144mm (32x Optical zoom)	4.5~144mm (32x Optical zoom)	4.5~144mm (32x Optical zoom)	4.8~120mm (25x Optical zoom)	4.8~120mm (25x Optical zoom)	4.8~120mm (25x Optical zoom)
FOV-H	60.14°~2.75°	60.14°~2.75°	60.14°~2.75°	58.5°~2.8°	58.5°~2.8°	58.5°~2.8°
Day/Night	ICR	ICR	ICR	ICR	ICR	ICR
Max. IR Distance	150m(492ft)	--	--	150m(492ft)	--	--
OSD Menu	Supported	Supported	Supported	Supported	Supported	Supported
WDR	120dB True WDR	120dB True WDR	120dB True WDR	120dB True WDR	120dB True WDR	120dB True WDR
Noise Reduction	2D/3D	2D/3D	2D/3D	2D/3D	2D/3D	2D/3D
Frame Rate	30fps@1080P 30/60fps@720P	30fps@1080P 30/60fps@720P	30fps@1080P 30/60fps@720P	30fps@1080P 30/60fps@720P	30fps@1080P 30/60fps@720P	30fps@1080P 30/60fps@720P
Video Output	HD/SD Switchable	HD/SD Switchable	HD/SD Switchable	HD/SD Switchable	HD/SD Switchable	HD/SD Switchable
Pan/Tilt	Pan: 0° ~ 360° endless Tilt: -15° ~ 90°	Pan: 0° ~ 360° endless Tilt: 0° ~ 90°	Pan: 0° ~ 360° endless Tilt: 0° ~ 90°	Pan: 0° ~ 360° endless Tilt: -15° ~ 90°	Pan: 0° ~ 360° endless Tilt: 0° ~ 90°	Pan: 0° ~ 360° endless Tilt: 0° ~ 90°
Preset Speed	Pan: 400°/s Tilt: 300°/s	Pan: 500°/s Tilt: 500°/s	Pan: 500°/s Tilt: 500°/s	Pan: 400°/s Tilt: 300°/s	Pan: 500°/s Tilt: 500°/s	Pan: 500°/s Tilt: 500°/s
Audio In	1	1	1	1	1	1
Alarm In/Out	2/1	2/1	2/1	2/1	2/1	2/1
Ingress Protection	IP66	IP67, IK10	IK10	IP66	IP67, IK10	IK10
Working Temperature	-40°C~+70°C (-40°F~+158°F)	-40°C~+60°C (-40°F~+140°F)	-30°C ~ +60°C (-22°F~+140°F)	-40°C~+70°C (-40°F~+158°F)	-40°C~+60°C (-40°F~+140°F)	-30°C ~ +60°C (-22°F~+140°F)
Power	DC24V Max. 22W	DC24V Max. 18.5W	DC24V Max. 12.5W	DC24V Max. 22W	DC24V Max. 18.5W	DC24V Max. 12.5W



Lite Series

The Lite Series PTZ offers a cost-effective and high-performance solution that is suitable for a wide range of applications. Its compact design based on Dahua quality standards and assurance enables the products in the entire series to meet customer's requirements.



Mini IR PTZ

Pan, tilt, zoom and IR functions in one compact housing.



Compact Design

Its small compact design can fit in a number of places.



Multi-scene Monitoring

Offers multiple settings that can be preset to expand the camera's coverage.





Powerful Zoom

It can cover large areas with up to 25x optical zoom capability.

HDCVI PTZ CAMERAS

Lite Series

	25x optical zoom		15x optical zoom		4x optical zoom
Model	SD49225-HC-LA	SD40215-HC-LA	SD42215-HC-LA	SD42C215-HC-LA	SD22204-GC-LB
Appearance					
Image Sensor	1/2.8" 2MP STARVIS™ CMOS	1/2.8" 2MP STARVIS™ CMOS	1/2.8" 2MP STARVIS™ CMOS	1/2.8" 2MP STARVIS™ CMOS	1/2.8" STARVIS™ CMOS
Min. Illumination	0.005Lux/F1.6 (Color) 0Lux/F1.6 (IR on)	0.005Lux/F1.6 (Color) 0.0005Lux/F1.6 (B/W)	0.005Lux/F1.6 (Color) 0.0005Lux/F1.6 (B/W)	0.005Lux/F1.6 (Color) 0.0005Lux/F1.6 (B/W)	0.05Lux/F1.6 (Color) 0.005Lux/F1.6 (B/W)
Lens	4.8~120mm (25x Optical zoom)	5~75mm (15x Optical zoom)	5~75mm (15x Optical zoom)	5~75mm (15x Optical zoom)	2.7~11mm (4x Optical zoom)
FOV-H	58.5°~2.8°	58.9°~5.1°	58.9°~5.1°	58.9°~5.1°	112.5° ~ 30°
Day/Night	ICR	ICR	ICR	ICR	ICR
Max. IR Distance	100m(328ft)	--	--	--	--
OSD Menu	Supported	Supported	Supported	Supported	Supported
WDR	120dB True WDR	120dB True WDR	120dB True WDR	120dB True WDR	120dB True WDR
Noise Reduction	2D/3D	2D/3D	2D/3D	2D/3D	2D/3D
Frame Rate	30fps@1080P 30/60fps@720P	30fps@1080P 30/60fps@720P	30fps@1080P 30/60fps@720P	30fps@1080P 30/60fps@720P	30fps@1080P 30/60fps@720P
Video Output	HD/SD Switchable	HD/SD Switchable	HD/SD Switchable	HD/SD Switchable	HD/SD Switchable
Pan/Tilt	Pan: 0° ~ 360° endless Tilt: -15° ~ 90°	Pan: 0° ~ 360° endless Tilt: 0° ~ 90°	Pan: 0° ~ 360° endless Tilt: 0° ~ 90°	Pan: 0° ~ 360° endless Tilt: 0° ~ 90°	Pan: 0° ~ 355° Tilt: 0° ~ 90°
Preset Speed	Pan: 240°/s Tilt: 200°/s	Pan: 300°/s Tilt: 200°/s	Pan: 300°/s Tilt: 200°/s	Pan: 300°/s Tilt: 200°/s	Pan: 100°/s Tilt: 60°/s
Audio In	1	1	1	1	--
Alarm In/Out	2/1	2/1	2/1	2/1	--
Ingress Protection	IP66	IP66, IK10	IP66, IK10	IK10	IP66, IK10
Working Temperature	-40°C~+70°C (-40°F~+158°F)	-40°C~+60°C (-40°F~+140°F)	-30°C ~ +60°C (-22°F~+140°F)	-30°C ~ +60°C (-22°F~+140°F)	-30°C ~ +60°C (-22°F~+140°F)
Power	DC12V Max. 23.2W	DC12V Max. 12W	DC12V Max. 12W	DC12V Max. 12W	DC12V Max. 6W

HDCVI RECORDERS



WizSense 4K-N/5MP Series

HDCVI is not only the first technology to release a 4K version, but also the first one to release 16:9 5MP. It leads the industry again with a new and complete high resolution product series that better fits the needs of various applications and projects with different scales and budgets. Also, its adoption of AI significantly saves end-users' time and labor costs and greatly reduces the Total Cost of Ownership (TCO).



SMD Plus

Categorizes the targets detected by motion detection and filters false alarms triggered by non-target objects, realizing accurate alarm for humans and vehicles.



Face Recognition

Supports real-time face comparison, recording of face image metadata, as well as quick location of targets using image and face attribute search.



Perimeter Protection

Offers tripwire and area intrusion detection with people and vehicle classification, achieving highly accurate alarms and reducing unnecessary alarm notifications.



AI Coding

Automatically encodes target's details through recognition of moving human or vehicle, significantly decreasing bandwidth and reducing HDD storage costs.

HDCVI RECORDERS

WizSense 4K-N/5MP Series

2 HDD







1 HDD

Model	XVR5216A-4KL-I3	XVR5208A-4KL-I3	XVR5216AN-4KL-I3	XVR5208AN-4KL-I3	XVR5116HE-4KL-I3	XVR5108HE-4KL-I3
Appearance						
Video Compression	AI Coding/H.265+/H.265/ H.264+/H.264	AI Coding/H.265+/H.265/ H.264+/H.264	AI Coding/H.265+/H.265/ H.264+/H.264	AI Coding/H.265+/H.265/ H.264+/H.264	AI Coding/H.265+/H.265/ H.264+/H.264	AI Coding/H.265+/H.265/ H.264+/H.264
Audio Compression	G.711/PCM	G.711/PCM	G.711/PCM	G.711/PCM	G.711/PCM	G.711/PCM
Video Standard	HDCVI/AHD/CVBS/TVI (Auto-detect)	HDCVI/AHD/CVBS/TVI (Auto-detect)	HDCVI/AHD/CVBS/TVI (Auto-detect)	HDCVI/AHD/CVBS/TVI (Auto-detect)	HDCVI/AHD/CVBS/TVI (Auto-detect)	HDCVI/AHD/CVBS/TVI (Auto-detect)
Max. Recording Resolution	CH01-16: 4K	CH01-08: 4K	CH01-16: 4K	CH01-08: 4K	CH01-16: 4K	CH01-08: 4K
Max. HDCVI Recording Rate	7fps@4K 10fps@6MP 12fps@5MP 15fps@4MP 15fps@3MP 30fps@4M-N 30fps@1080P	7fps@4K 10fps@6MP 12fps@5MP 15fps@4MP 15fps@3MP 30fps@4M-N 30fps@1080P	7fps@4K 10fps@6MP 12fps@5MP 15fps@4MP 15fps@3MP 30fps@4M-N 30fps@1080P	7fps@4K 10fps@6MP 12fps@5MP 15fps@4MP 15fps@3MP 30fps@4M-N 30fps@1080P	7fps@4K 10fps@6MP 12fps@5MP 15fps@4MP 15fps@3MP 30fps@4M-N 30fps@1080P	7fps@4K 10fps@6MP 12fps@5MP 15fps@4MP 15fps@3MP 30fps@4M-N 30fps@1080P
CVBS Input	16CH,1.0Vp-p,75Ω	8CH,1.0Vp-p,75Ω	16CH,1.0Vp-p,75Ω	8CH,1.0Vp-p,75Ω	16CH,1.0Vp-p,75Ω	8CH,1.0Vp-p,75Ω
IP Camera Input	16+16 Up to 8MP	8+8 Up to 8MP	16+16 Up to 8MP	8+8 Up to 8MP	16+16 Up to 8MP	8+8 Up to 8MP
Max IP Input/Record	128Mbps/128Mbps	128Mbps/128Mbps	128Mbps/128Mbps	128Mbps/128Mbps	128Mbps/128Mbps	128Mbps/128Mbps
Audio In/out	4/1, 2-way	4/1, 2-way	1/1, 2-way	1/1, 2-way	16/1, 2-way	8/1, 2-way
Max HDD	2x16TB	2x16TB	2x16TB	2x16TB	1x16TB	1x16TB
Display	HDMI (3840x2160) VGA (1920x1080) *Simultaneous/heterogeneous video sources output for VGA and HDMI is configurable.	HDMI (3840x2160) VGA (1920x1080) *Simultaneous/heterogeneous video sources output for VGA and HDMI is configurable.	HDMI (3840x2160) VGA (1920x1080) *Simultaneous/heterogeneous video sources output for VGA and HDMI is configurable.	HDMI (3840x2160) VGA (1920x1080) *Simultaneous/heterogeneous video sources output for VGA and HDMI is configurable.	HDMI (3840x2160) VGA (1920x1080) *Simultaneous/heterogeneous video sources output for VGA and HDMI is configurable.	HDMI (3840x2160) VGA (1920x1080) *Simultaneous/heterogeneous video sources output for VGA and HDMI is configurable.
eSATA	--	--	--	--	--	--
USB	1 USB 2.0, 1 USB 3.0	1 USB 2.0, 1 USB 3.0	1 USB 2.0, 1 USB 3.0	1 USB 2.0, 1 USB 3.0	1 USB 2.0, 1 USB 3.0	1 USB 2.0, 1 USB 3.0
DVD Burner	USB	USB	USB	USB	USB	USB
Alarm In/Out	16/3	8/3	--	--	16/3	8/3
Ethernet	1 Gigabit port	1 Gigabit port	1 Gigabit port	1 Gigabit port	1 Gigabit port	1 Gigabit port
Remote User Login	128	128	128	128	128	128
Dimensions	375.0mmx289.0mmx53.0mm (14.76"x11.38"x2.09")	375.0mmx289.0mmx53.0mm (14.76"x11.38"x2.09")	375.0mmx289.0mmx53.0mm (14.76"x11.38"x2.09")	375.0mmx289.0mmx53.0mm (14.76"x11.38"x2.09")	325.0mmx256.6mmx55.0mm (12.80"x10.10"x2.17")	325.0mmx256.6mmx55.0mm (12.80"x10.10"x2.17")
Power	DC12V/5A, ≤15W (Without HDD)	DC12V/4A, ≤10W (Without HDD)	DC12V/5A, ≤15W (Without HDD)	DC12V/4A, ≤10W (Without HDD)	DC12V/3A, ≤15W (Without HDD)	DC12V/2A, ≤10W (Without HDD)
Perimeter Protection	Up to 8 channels	Up to 8 channels	Up to 8 channels	Up to 8 channels	Up to 8 channels	Up to 8 channels
Face Recognition	Up to 12 face pic/s face recognition 2 channel video stream 10 face database with up to 20,000 face images in total	Up to 12 face pic/s face recognition 2 channel video stream 10 face database with up to 20,000 face images in total	Up to 12 face pic/s face recognition 2 channel video stream 10 face database with up to 20,000 face images in total	Up to 12 face pic/s face recognition 2 channel video stream 10 face database with up to 20,000 face images in total	Up to 12 face pic/s face recognition 2 channel video stream 10 face database with up to 20,000 face images in total	Up to 12 face pic/s face recognition 2 channel video stream 10 face database with up to 20,000 face images in total
SMD Plus	Up to 16 channels	Up to 8 channels	Up to 16 channels	Up to 8 channels	Up to 16 channels	Up to 8 channels

HDCVI RECORDERS

WizSense 4K-N/5MP Series

1 HDD

Model	XVR5104HE-4KL-I3	XVR5116H-4KL-I3	XVR5108H-4KL-I3	XVR5104H-4KL-I3	XVR5108HS-4KL-I3	XVR5104HS-4KL-I3	XVR5104C-4KL-I3
Appearance							
Video Compression	AI Coding/H.265+/H.265/H.264+/H.264	AI Coding/H.265+/H.265/H.264+/H.264	AI Coding/H.265+/H.265/H.264+/H.264	AI Coding/H.265+/H.265/H.264+/H.264	AI Coding/H.265+/H.265/H.264+/H.264	AI Coding/H.265+/H.265/H.264+/H.264	AI Coding/H.265+/H.265/H.264+/H.264
Audio Compression	G.711/PCM	G.711/PCM	G.711/PCM	G.711/PCM	G.711/PCM	G.711/PCM	G.711/PCM
Video Standard	HDCVI/AHD/CVBS/TVI (Auto-detect)	HDCVI/AHD/CVBS/TVI (Auto-detect)	HDCVI/AHD/CVBS/TVI (Auto-detect)	HDCVI/AHD/CVBS/TVI (Auto-detect)	HDCVI/AHD/CVBS/TVI (Auto-detect)	HDCVI/AHD/CVBS/TVI (Auto-detect)	HDCVI/AHD/CVBS/TVI (Auto-detect)
Max. Recording Resolution	CH01-04: 4K	CH01-16: 4K	CH01-08: 4K	CH01-04: 4K	CH01-08: 4K	CH01-04: 4K	CH01-04: 4K
Max. HDCVI Recording Rate	7fps@4K 10fps@6MP 12fps@5MP 15fps@4MP 15fps@3MP 30fps@4M-N 30fps@1080P	7fps@4K 10fps@6MP 12fps@5MP 15fps@4MP 15fps@3MP 30fps@4M-N 30fps@1080P	7fps@4K 10fps@6MP 12fps@5MP 15fps@4MP 15fps@3MP 30fps@4M-N 30fps@1080P	7fps@4K 10fps@6MP 12fps@5MP 15fps@4MP 15fps@3MP 30fps@4M-N 30fps@1080P	7fps@4K 10fps@6MP 12fps@5MP 15fps@4MP 15fps@3MP 30fps@4M-N 30fps@1080P	7fps@4K 10fps@6MP 12fps@5MP 15fps@4MP 15fps@3MP 30fps@4M-N 30fps@1080P	7fps@4K 10fps@6MP 12fps@5MP 15fps@4MP 15fps@3MP 30fps@4M-N 30fps@1080P
CVBS Input	4CH,1.0Vp-p,75Ω	16CH,1.0Vp-p,75Ω	8CH,1.0Vp-p,75Ω	4CH,1.0Vp-p,75Ω	8CH,1.0Vp-p,75Ω	4CH,1.0Vp-p,75Ω	4CH,1.0Vp-p,75Ω
IP Camera Input	4+4 Up to 8MP	16+16 Up to 8MP	8+8 Up to 8MP	4+4 Up to 8MP	8+8 Up to 8MP	4+4 Up to 8MP	4+4 Up to 8MP
Max IP Input/Record	64Mbps/64Mbps	128Mbps/128Mbps	128Mbps/128Mbps	64Mbps/64Mbps	128Mbps/128Mbps	64Mbps/64Mbps	64Mbps/64Mbps
Audio In/out	4/1, 2-way	1/1, 2-way	1/1, 2-way	1/1, 2-way	1/1, 2-way	1/1, 2-way	1/1, 2-way
Max HDD	1x10TB	1x16TB	1x16TB	1x10TB	1x16TB	1x10TB	1x10TB
Display	HDMI (3840x2160) VGA (1920x1080)	HDMI (3840x2160) VGA (1920x1080) *Simultaneous/heterogeneous video sources output for VGA and HDMI is configurable.	HDMI (3840x2160) VGA (1920x1080) *Simultaneous/heterogeneous video sources output for VGA and HDMI is configurable.	HDMI (3840x2160) VGA (1920x1080)	HDMI (3840x2160) VGA (1920x1080) *Simultaneous/heterogeneous video sources output for VGA and HDMI is configurable.	HDMI (3840x2160) VGA (1920x1080)	HDMI (3840x2160) VGA (1920x1080)
eSATA	--	--	--	--	--	--	--
USB	2 USB 2.0	1 USB 2.0, 1 USB 3.0	1 USB 2.0, 1 USB 3.0	2 USB 2.0	1 USB 2.0, 1 USB 3.0	2 USB 2.0	2 USB 2.0
DVD Burner	USB	USB	USB	USB	USB	USB	USB
Alarm In/Out	8/3	--	--	--	--	--	--
Ethernet	1x100M port	1 Gigabit port	1 Gigabit port	1x100M port	1 Gigabit port	1x100M port	1x100M port
Remote User Login	128	128	128	128	128	128	128
Dimensions	325.0mmx256.6mmx55.0mm (12.80"x10.10"x2.17")	325.0mmx256.6mmx55.0mm (12.80"x10.10"x2.17")	325.0mmx256.6mmx55.0mm (12.80"x10.10"x2.17")	325.0mmx256.6mmx55.0mm (12.80"x10.10"x2.17")	260.0mmx237.4mmx47.6mm (10.24"x9.35"x1.87")	260.0x237.9x47.6mm (10.24"x9.37"x1.87")	204.6mmx210.9mmx45.6mm (8.06"x8.30"x1.80")
Power	DC12V/2A, ≤7W (Without HDD)	DC12V/3A, ≤15W (Without HDD)	DC12V/2A, ≤10W (Without HDD)	DC12V/2A, ≤7W (Without HDD)	DC12V/2A, ≤10W (Without HDD)	DC12V/2A, ≤7W (Without HDD)	DC12V/2A, ≤7W (Without HDD)
Perimeter Protection	Up to 4 channels	Up to 8 channels	Up to 8 channels	Up to 4 channels	Up to 8 channels	Up to 4 channels	Up to 4 channels
Face Recognition	Up to 8 face pic/s face recognition 1 channel video stream 10 face database with up to 20,000 face images in total	Up to 12 face pic/s face recognition 2 channel video stream 10 face database with up to 20,000 face images in total	Up to 12 face pic/s face recognition 2 channel video stream 10 face database with up to 20,000 face images in total	Up to 8 face pic/s face recognition 1 channel video stream 10 face database with up to 20,000 face images in total	Up to 12 face pic/s face recognition 2 channel video stream 10 face database with up to 20,000 face images in total	Up to 8 face pic/s face recognition 1 channel video stream 10 face database with up to 20,000 face images in total	Up to 8 face pic/s face recognition 1 channel video stream 10 face database with up to 20,000 face images in total
SMD Plus	Up to 4 channels	Up to 16 channels	Up to 8 channels	Up to 4 channels	Up to 8 channels	Up to 4 channels	Up to 4 channels

HDCVI RECORDERS

WizSense 5M-N/1080P Series

The WizSense 5M-N/1080P Series provides an excellent cost/performance solution suitable for various applications. This series offers 5MP HDCVI camera, providing users with the most cost-effective 5MP solution. In addition, it is also equipped with AI features that bring more value to customers.



SMD Plus

Categorizes the targets detected by motion detection and filters false alarms triggered by non-target objects, realizing accurate alarm for humans and vehicles.



Face Recognition

Supports real-time face comparison, recording of face image metadata, as well as quick location of targets using image and face attribute search.



Perimeter Protection

Offers tripwire and area intrusion detection with people and vehicle classification, achieving highly accurate alarms and reducing unnecessary alarm notifications.









AI Coding

Automatically encodes target's details through recognition of moving human or vehicle, significantly decreasing bandwidth and reducing HDD storage costs.

HDCVI RECORDERS

WizSense 5M-N/1080P Series

	2 HDD			1 HDD			
Model	XVR5216A-I3	XVR5232AN-I3	XVR5216AN-I3	XVR5116HE-I3	XVR5108HE-I3	XVR5104HE-I3	XVR5116H-I3
Appearance							
Video Compression	AI Coding/H.265+/H.265/H.264+/H.264	AI Coding/H.265+/H.265/H.264+/H.264	AI Coding/H.265+/H.265/H.264+/H.264	AI Coding/H.265+/H.265/H.264+/H.264	AI Coding/H.265+/H.265/H.264+/H.264	AI Coding/H.265+/H.265/H.264+/H.264	AI Coding/H.265+/H.265/H.264+/H.264
Audio Compression	G.711/PCM	G.711/PCM	G.711/PCM	G.711/PCM	G.711/PCM	G.711/PCM	G.711/PCM
Video Standard	HDCVI/AHD/CVBS/TVI (Auto-detect)	HDCVI/AHD/CVBS/TVI (Auto-detect)	HDCVI/AHD/CVBS/TVI (Auto-detect)	HDCVI/AHD/CVBS/TVI (Auto-detect)	HDCVI/AHD/CVBS/TVI (Auto-detect)	HDCVI/AHD/CVBS/TVI (Auto-detect)	HDCVI/AHD/CVBS/TVI (Auto-detect)
Max. Recording Resolution	CH01-16: 5M-N/4M-N/1080P	CH01-32: 5M-N/4M-N/1080P	CH01-16: 5M-N/4M-N/1080P	CH01-16: 5M-N/4M-N/1080P	CH01-08: 5M-N/4M-N/1080P	CH01-04: 5M-N/4M-N/1080P	CH01-16: 5M-N/4M-N/1080P
Max. HDCVI Recording Rate	10fps@5M-N 15fps@4M-N 15fps@1080P 30fps@720P	10fps@5M-N 15fps@4M-N 15fps@1080P 30fps@720P	10fps@5M-N 15fps@4M-N 15fps@1080P 30fps@720P	10fps@5M-N 15fps@4M-N 15fps@1080P 30fps@720P	10fps@5M-N 15fps@4M-N 15fps@1080P 30fps@720P	10fps@5M-N 15fps@4M-N 15fps@1080P 30fps@720P	10fps@5M-N 15fps@4M-N 15fps@1080P 30fps@720P
CVBS Input	16CH,1.0Vp-p,75Ω	32CH,1.0Vp-p,75Ω	16CH,1.0Vp-p,75Ω	16CH,1.0Vp-p,75Ω	8CH,1.0Vp-p,75Ω	4CH,1.0Vp-p,75Ω	16CH,1.0Vp-p,75Ω
IP Camera Input	16+8 Up to 6MP	32 Up to 6MP	16+8 Up to 6MP	16+8 Up to 6MP	8+4 Up to 6MP	4+2 Up to 6MP	16+8 Up to 6MP
Max IP Input/Record	128Mbps/128Mbps	128Mbps/128Mbps	128Mbps/128Mbps	128Mbps/128Mbps	64Mbps/64Mbps	32Mbps/32Mbps	128Mbps/128Mbps
Audio In/out	4/1, 2-way	1/1, 2-way	1/1, 2-way	16/1, 2-way	8/1, 2-way	4/1, 2-way	1/1, 2-way
Max HDD	2x16TB	2x16TB	2x16TB	1x16TB	1x10TB	1x6TB	1x16TB
Display	HDMI (3840x2160) VGA (1920x1080)	HDMI (3840x2160) VGA (1920x1080), TV *Simultaneous/heterogeneous video sources output for VGA and HDMI is configurable.	HDMI (3840x2160) VGA (1920x1080)	HDMI (3840x2160) VGA (1920x1080)	HDMI/VGA (1920x1080)	HDMI/VGA (1920x1080)	HDMI (3840x2160) VGA (1920x1080)
eSATA	--	--	--	--	--	--	--
USB	1 USB 2.0, 1 USB 3.0	1 USB 2.0, 1 USB 3.0	1 USB 2.0, 1 USB 3.0	1 USB 2.0, 1 USB 3.0	2 USB 2.0	2 USB 2.0	1 USB 2.0, 1 USB 3.0
DVD Burner	USB	USB	USB	USB	USB	USB	USB
Alarm In/Out	16/3	--	--	16/3	8/3	8/3	--
Ethernet	1 Gigabit port	1 Gigabit port	1 Gigabit port	1 Gigabit port	1x100M port	1x100M port	1 Gigabit port
Remote User Login	128	128	128	128	128	128	128
Dimensions	375.0mmx289.0mmx53.0mm (14.76"x11.38"x2.09")	375.0mmx289.0mmx53.0mm (14.76"x11.38"x2.09")	375.0mmx289.0mmx53.0mm (14.76"x11.38"x2.09")	325.0mmx256.6mmx55.0mm (12.80"x10.10"x2.17")	325.0mmx256.6mmx55.0mm (12.80"x10.10"x2.17")	325.0mmx256.6mmx55.0mm (12.80"x10.10"x2.17")	325.0mmx256.6mmx55.0mm (12.80"x10.10"x2.17")
Power	DC12V/4A, ≤12W (Without HDD)	DC12V/5A, ≤17W (Without HDD)	DC12V/4A, ≤12W (Without HDD)	DC12V/2A, ≤12W (Without HDD)	DC12V/2A, ≤7W (Without HDD)	DC12V/1.5A, ≤4W (Without HDD)	DC12V/2A, ≤12W (Without HDD)
Perimeter Protection	Up to 4 channels	Up to 4 channels	Up to 4 channels	Up to 4 channels	Up to 2 channels	Up to 2 channels	Up to 4 channels
Face Recognition	Up to 12 face pic/s face recognition 2 channel video stream 10 face database with up to 10,000 face images in total	Up to 12 face pic/s face recognition 2 channel video stream 10 face database with up to 10,000 face images in total	Up to 12 face pic/s face recognition 2 channel video stream 10 face database with up to 10,000 face images in total	Up to 12 face pic/s face recognition 2 channel video stream 10 face database with up to 10,000 face images in total	Up to 8 face pic/s face recognition 1 channel video stream 10 face database with up to 10,000 face images in total	Up to 8 face pic/s face recognition 1 channel video stream 10 face database with up to 10,000 face images in total	Up to 12 face pic/s face recognition 2 channel video stream 10 face database with up to 10,000 face images in total
SMD Plus	Up to 16 channels	Up to 16 channels	Up to 16 channels	Up to 16 channels	Up to 8 channels	Up to 4 channels	Up to 16 channels

HDCVI RECORDERS

WizSense 5M-N/1080P Series

1 HDD

Model	XVR5108H-I3	XVR5104H-I3	XVR5116HS-I3	XVR5108HS-I3	XVR5104HS-I3	XVR5108C-I3	XVR5104C-I3
Appearance							
Video Compression	AI Coding/H.265+/H.265/H.264+/H.264	AI Coding/H.265+/H.265/H.264+/H.264	AI Coding/H.265+/H.265/H.264+/H.264	AI Coding/H.265+/H.265/H.264+/H.264	AI Coding/H.265+/H.265/H.264+/H.264	AI Coding/H.265+/H.265/H.264+/H.264	AI Coding/H.265+/H.265/H.264+/H.264
Audio Compression	G.711/PCM	G.711/PCM	G.711/PCM	G.711/PCM	G.711/PCM	G.711/PCM	G.711/PCM
Video Standard	HDCVI/AHD/CVBS/TVI (Auto-detect)	HDCVI/AHD/CVBS/TVI (Auto-detect)	HDCVI/AHD/CVBS/TVI (Auto-detect)	HDCVI/AHD/CVBS/TVI (Auto-detect)	HDCVI/AHD/CVBS/TVI (Auto-detect)	HDCVI/AHD/CVBS/TVI (Auto-detect)	HDCVI/AHD/CVBS/TVI (Auto-detect)
Max. Recording Resolution	CH01-08: 5M-N/4M-N/1080P	CH01-04: 5M-N/4M-N/1080P	CH01-16: 5M-N/4M-N/1080P	CH01-08: 5M-N/4M-N/1080P	CH01-04: 5M-N/4M-N/1080P	CH01-08: 5M-N/4M-N/1080P	CH01-04: 5M-N/4M-N/1080P
Max. HDCVI Recording Rate	10fps@5M-N 15fps@4M-N 15fps@1080P 30fps@720P	10fps@5M-N 15fps@4M-N 15fps@1080P 30fps@720P	10fps@5M-N 15fps@4M-N 15fps@1080P 30fps@720P	10fps@5M-N 15fps@4M-N 15fps@1080P 30fps@720P	10fps@5M-N 15fps@4M-N 15fps@1080P 30fps@720P	10fps@5M-N 15fps@4M-N 15fps@1080P 30fps@720P	10fps@5M-N 15fps@4M-N 15fps@1080P 30fps@720P
CVBS Input	8CH,1.0Vp-p,75Ω	4CH,1.0Vp-p,75Ω	16CH,1.0Vp-p,75Ω	8CH,1.0Vp-p,75Ω	4CH,1.0Vp-p,75Ω	8CH,1.0Vp-p,75Ω	4CH,1.0Vp-p,75Ω
IP Camera Input	8+4 Up to 6MP	4+2 Up to 6MP	16+8 Up to 6MP	8+4 Up to 6MP	4+2 Up to 6MP	8+4 Up to 6MP	4+2 Up to 6MP
Max IP Input/Record	64Mbps/64Mbps	32Mbps/32Mbps	128Mbps/128Mbps	64Mbps/64Mbps	32Mbps/32Mbps	64Mbps/64Mbps	32Mbps/32Mbps
Audio In/out	1/1, 2-way	1/1, 2-way	1/1, 2-way	1/1, 2-way	1/1, 2-way	1/1, 2-way	1/1, 2-way
Max HDD	1x10TB	1x6TB	1x16TB	1x10TB	1x6TB	1x10TB	1x6TB
Display	HDMI/VGA (1920x1080)	HDMI/VGA (1920x1080)	HDMI (3840x2160) VGA (1920x1080)	HDMI/VGA (1920x1080)	HDMI/VGA (1920x1080)	HDMI/VGA (1920x1080)	HDMI/VGA (1920x1080)
eSATA	--	--	--	--	--	--	--
USB	2 USB 2.0	2 USB 2.0	1 USB 2.0, 1 USB 3.0	2 USB 2.0	2 USB 2.0	2 USB 2.0	2 USB 2.0
DVD Burner	USB	USB	USB	USB	USB	USB	USB
Alarm In/Out	--	--	--	--	--	--	--
Ethernet	1x100M port	1x100M port	1 Gigabit port	1x100M port	1x100M port	1x100M port	1x100M port
Remote User Login	128	128	128	128	128	128	128
Dimensions	325.0mmx256.6mmx55.0mm (12.80"x10.10"x2.17")	325.0mmx256.6mmx55.0mm (12.80"x10.10"x2.17")	260.0mmx237.4mmx47.6mm (10.24"x9.35"x1.87")	260.0mmx237.9mmx47.6mm (10.24"x9.37"x1.87")	260.0mmx237.9mmx47.6mm (10.24"x9.37"x1.87")	204.6mmx210.9mmx45.6mm (8.06"x8.30"x1.80")	204.6mmx210.9mmx45.6mm (8.06"x8.30"x1.80")
Power	DC12V/2A, ≤7W (Without HDD)	DC12V/1.5A, ≤4W (Without HDD)	DC12V/2A, ≤12W (Without HDD)	DC12V/2A, ≤7W (Without HDD)	DC12V/1.5A, ≤4W (Without HDD)	DC12V/2A, ≤7W (Without HDD)	DC12V/1.5A, ≤4W (Without HDD)
Perimeter Protection	Up to 2 channels	Up to 2 channels	Up to 4 channels	Up to 2 channels	Up to 2 channels	Up to 2 channels	Up to 2 channels
Face Recognition	Up to 8 face pic/s face recognition 1 channel video stream 10 face database with up to 10,000 face images in total	Up to 8 face pic/s face recognition 1 channel video stream 10 face database with up to 10,000 face images in total	Up to 12 face pic/s face recognition 2 channel video stream 10 face database with up to 10,000 face images in total	Up to 8 face pic/s face recognition 1 channel video stream 10 face database with up to 10,000 face images in total	Up to 8 face pic/s face recognition 1 channel video stream 10 face database with up to 10,000 face images in total	Up to 8 face pic/s face recognition 1 channel video stream 10 face database with up to 10,000 face images in total	Up to 8 face pic/s face recognition 1 channel video stream 10 face database with up to 10,000 face images in total
SMD Plus	Up to 8 channels	Up to 4 channels	Up to 16 channels	Up to 8 channels	Up to 4 channels	Up to 8 channels	Up to 4 channels



WizSense 1080N/720P Series

This series is designed for cost-effective and high performance applications. It offers great solutions for users facing budget constraints and requiring both quality and performance. With its AI functions, the XVR is able to provide end users the simplicity of analog system, lower system cost and more application value.



SMD Plus
Categorizes the targets detected by motion detection and filters false alarms triggered by non-target objects, realizing accurate alarm for humans and vehicles.



AI Coding
Automatically encodes target's details through recognition of moving human or vehicle, significantly decreasing bandwidth and reducing HDD storage costs.



DAC (Digital Audio-over-Coax)
Audio information is used as supplementary evidence for video surveillance. The DAC technology supports high quality over-coax audio transmission with low noise.

HDCVI RECORDERS

WizSense 1080N/720P Series

	2 HDD		1 HDD				
Model	XVR4232AN-I	XVR4216AN-I	XVR4116HS-I	XVR4108HS-I	XVR4104HS-I	XVR4108C-I	XVR4104C-I
Appearance							
Video Compression	AI Coding/H.265+/H.265/ H.264+/H.264	AI Coding/H.265+/H.265/ H.264+/H.264	AI Coding/H.265+/H.265/ H.264+/H.264	AI Coding/H.265+/H.265/ H.264+/H.264	AI Coding/H.265+/H.265/ H.264+/H.264	AI Coding/H.265+/H.265/ H.264+/H.264	AI Coding/H.265+/H.265/ H.264+/H.264
Audio Compression	G.711/PCM	G.711/PCM	G.711/PCM	G.711/PCM	G.711/PCM	G.711/PCM	G.711/PCM
Video Standard	HDCVI/AHD/CVBS/TVI (Auto-detect)	HDCVI/AHD/CVBS/TVI (Auto-detect)	HDCVI/AHD/CVBS/TVI (Auto-detect)	HDCVI/AHD/CVBS/TVI (Auto-detect)	HDCVI/AHD/CVBS/TVI (Auto-detect)	HDCVI/AHD/CVBS/TVI (Auto-detect)	HDCVI/AHD/CVBS/TVI (Auto-detect)
Max. Recording Resolution	CH01-32: 1080N/720P	CH01-16: 1080N/720P	CH01-16: 1080N/720P	CH01-08: 1080N/720P	CH01-04: 1080N/720P	CH01-08: 1080N/720P	CH01-04: 1080N/720P
Max. HDCVI Recording Rate	15fps@1080N 15fps@720P	15fps@1080N 15fps@720P	15fps@1080N 15fps@720P	15fps@1080N 15fps@720P	30fps@1080N 30fps@720P	15fps@1080N 15fps@720P	30fps@1080N 30fps@720P
CVBS Input	32CH,1.0Vp-p,75Ω	16CH,1.0Vp-p,75Ω	16CH,1.0Vp-p,75Ω	8CH,1.0Vp-p,75Ω	4CH,1.0Vp-p,75Ω	8CH,1.0Vp-p,75Ω	4CH,1.0Vp-p,75Ω
IP Camera Input	32 Up to 6MP	16+2 Up to 6MP	16+2 Up to 6MP	8+2 Up to 6MP	4+1 Up to 2MP	8+2 Up to 6MP	4+1 Up to 2MP
Max IP Input/Record	128Mbps/128Mbps	64Mbps/64Mbps	64Mbps/64Mbps	32Mbps/32Mbps	32Mbps/32Mbps	32Mbps/32Mbps	32Mbps/32Mbps
Audio In/out	1/1, 2-way	1/1, 2-way	1/1, 2-way	1/1, 2-way	1/1, 2-way	1/1, 2-way	1/1, 2-way
Max HDD	2×16TB	2×10TB	1×10TB	1×6TB	1×6TB	1×6TB	1×6TB
Display	HDMI/VGA (1920×1080) TV	HDMI/VGA (1920×1080)	HDMI/VGA (1920×1080)	HDMI/VGA (1920×1080)	HDMI/VGA (1920×1080)	HDMI/VGA (1920×1080)	HDMI/VGA (1920×1080)
eSATA	--	--	--	--	--	--	--
USB	1 USB 2.0, 1 USB 3.0	2 USB 2.0	2 USB 2.0	2 USB 2.0	2 USB 2.0	2 USB 2.0	2 USB 2.0
DVD Burner	USB	USB	USB	USB	USB	USB	USB
Alarm In/Out	--	--	--	--	--	--	--
Ethernet	1 Gigabit port	1x100M port	1x100M port	1x100M port	1x100M port	1x100M port	1x100M port
Remote User Login	128	128	128	128	128	128	128
Dimensions	375.0mm×289.0mm×53.0mm (14.76"×11.38"×2.09")	375.0mm×289.4mm×53.0mm (14.76"×11.39"×2.09")	260.0mm×237.9mm×47.6mm (10.24"×9.37"×1.87")	260.0mm×237.9mm×47.6mm (10.24"×9.37"×1.87")	260.0mm×237.9mm×47.6mm (10.24"×9.37"×1.87")	204.6mm×210.9mm×45.6mm (8.06"×8.30"×1.80")	204.6mm×210.9mm×45.6mm (8.06"×8.30"×1.80")
Power	DC12V/4A, ≤12W (Without HDD)	DC12V/4A, ≤10W (Without HDD)	DC12V/2A, ≤10W (Without HDD)	DC12V/1.5A, ≤7W (Without HDD)	DC12V/1.5A, ≤4W (Without HDD)	DC12V/1.5A, ≤7W (Without HDD)	DC12V/1.5A, ≤4W (Without HDD)
Perimeter Protection	--	--	--	--	--	--	--
Face Recognition	--	--	--	--	--	--	--
SMD Plus	Up to 16 channels	Up to 8 channels	Up to 8 channels	Up to 8 channels	Up to 4 channels	Up to 8 channels	Up to 4 channels



WizSense Cooper-I Series

The Cooper-I Series offers simple and highly cost-effective HDCVI solutions. It meets the requirements for 24/7 reliable monitoring with high-quality image performance, and saves customers' product and labor costs. It is also guaranteed by Dahua quality standards.



SMD Plus

Categorizes the targets detected by motion detection and filters false alarms triggered by non-target objects, realizing accurate alarm for humans and vehicles.



AI Coding

Automatically encodes target's details through recognition of moving human or vehicle, significantly decreasing bandwidth and reducing HDD storage costs.



Cost Saving

With real plug & play, compact housing designs, and competitive prices, this series allows easy installation and simple system deployment, saving time and labor costs for customers.

HDCVI RECORDERS

WizSense Cooper-I Series

1HDD

Model	XVR1B16H-I	XVR1B08H-I	XVR1B04H-I	XVR1B16-I	XVR1B08-I	XVR1B04-I
Appearance						
Video Compression	AI Coding/H.265+/H.265/ H.264+/H.264	AI Coding/H.265+/H.265/ H.264+/H.264	AI Coding/H.265+/H.265/ H.264+/H.264	AI Coding/H.265+/H.265/ H.264+/H.264	AI Coding/H.265+/H.265/ H.264+/H.264	AI Coding/H.265+/H.265/ H.264+/H.264
Audio Compression	G.711/PCM	G.711/PCM	G.711/PCM	G.711/PCM	G.711/PCM	G.711/PCM
Video Standard	HDCVI/AHD/CVBS/TVI (Auto-detect)	HDCVI/AHD/CVBS/TVI (Auto-detect)	HDCVI/AHD/CVBS/TVI (Auto-detect)	HDCVI/AHD/CVBS/TVI (Auto-detect)	HDCVI/AHD/CVBS/TVI (Auto-detect)	HDCVI/AHD/CVBS/TVI (Auto-detect)
Max. Recording Resolution	CH01-16: 5M-N/4M-N/1080P	CH01-08: 5M-N/4M-N/1080P	CH01-04: 5M-N/4M-N/1080P	CH01-16: 1080N/720P	CH01-08: 1080N/720P	CH01-04: 1080N/720P
Max. HDCVI Recording Rate	10fps@5M-N 15fps@4M-N 15fps@1080P 30fps@720P	10fps@5M-N 15fps@4M-N 15fps@1080P 30fps@720P	10fps@5M-N 15fps@4M-N 15fps@1080P 30fps@720P	15fps@1080N 15fps@720P	15fps@1080N 15fps@720P	30fps@1080N 30fps@720P
CVBS Input	16CH,1.0Vp-p,75Ω	8CH,1.0Vp-p,75Ω	4CH,1.0Vp-p,75Ω	16CH,1.0Vp-p,75Ω	8CH,1.0Vp-p,75Ω	4CH,1.0Vp-p,75Ω
IP Camera Input	16+8 Up to 6MP	8+4 Up to 6MP	4+2 Up to 6MP	16+2 Up to 6MP	8+2 Up to 6MP	4+1 Up to 2MP
Max IP Input/Record	128Mbps/128Mbps	64Mbps/64Mbps	32Mbps/32Mbps	64Mbps/64Mbps	40Mbps/40Mbps	20Mbps/20Mbps
Audio In/out	1/1, 2-way	1/1, 2-way	1/1, 2-way	1/1, 2-way	1/1, 2-way	1/1, 2-way
Max HDD	1×6TB	1×6TB	1×6TB	1×6TB	1×6TB	1×6TB
Display	HDMI/VGA (1920×1080)	HDMI/VGA (1920×1080)	HDMI/VGA (1920×1080)	HDMI/VGA (1920×1080)	HDMI/VGA (1920×1080)	HDMI/VGA (1920×1080)
eSATA	--	--	--	--	--	--
USB	2 USB 2.0	2 USB 2.0	2 USB 2.0	2 USB 2.0	2 USB 2.0	2 USB 2.0
DVD Burner	USB	USB	USB	USB	USB	USB
Alarm In/Out	--	--	--	--	--	--
Ethernet	1 Gigabit port	1x100M port	1x100M port	1x100M port	1x100M port	1x100M port
Remote User Login	128	128	128	128	128	128
Dimensions	260.0mm×231.4mm×47.6mm (10.24"×9.11"×1.87")	198.3mm×203.4mm×41.5mm (7.81"×8.01"×1.63")	198.3mm×203.4mm×41.5mm (7.81"×8.01"×1.63")	260.0mm×231.4mm×47.6mm (10.24"×9.11"×1.87")	198mm×202.9mm×41.5mm (7.81"×7.99"×1.63")	198mm×202.9mm×41.5mm (7.81"×7.99"×1.63")
Power	DC12V/2A, ≤12W (Without HDD)	DC12V/2A, ≤7W (Without HDD)	DC12V/1.5A, ≤4W (Without HDD)	DC12V/2A, ≤10W (Without HDD)	DC12V/1.5A, ≤7W (Without HDD)	DC12V/1.5A, ≤7W (Without HDD)
Perimeter Protection	--	--	--	--	--	--
Face Recognition	--	--	--	--	--	--
SMD Plus	Up to 16 channels	Up to 8 channels	Up to 4 channels	Up to 8 channels	Up to 4 channels	Up to 4 channels

DISPLAY & CONTROL



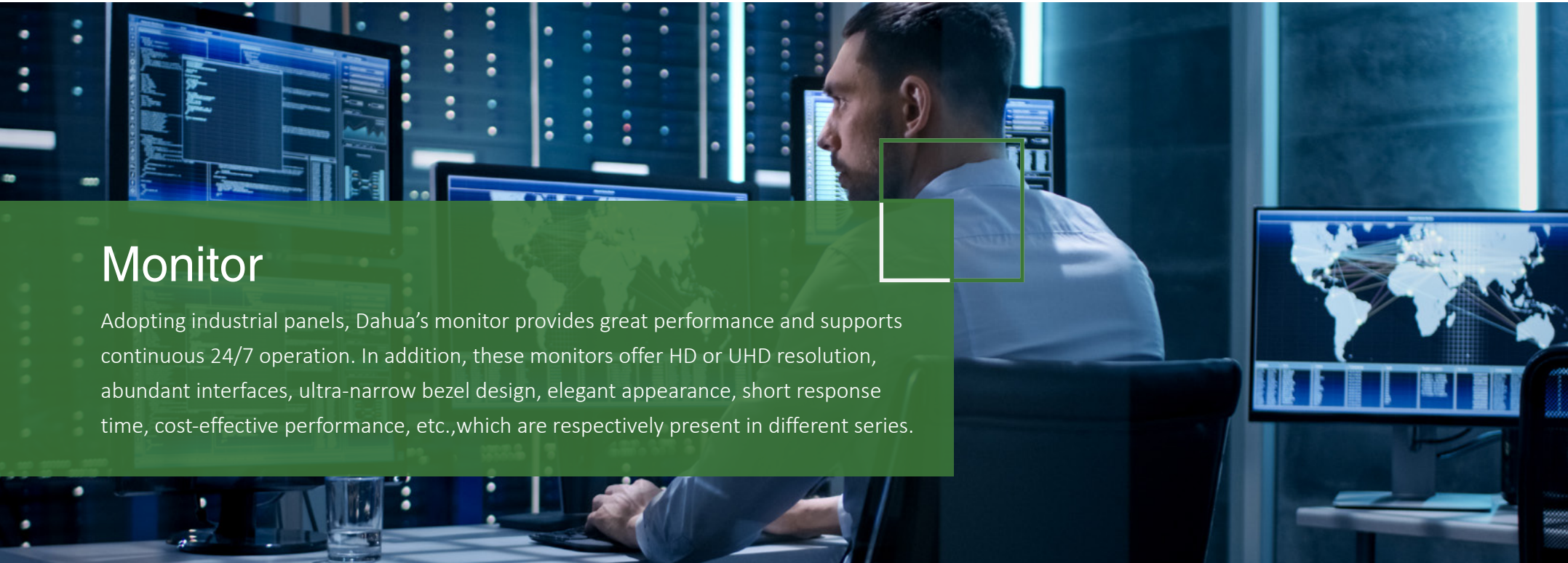

Monitor

Adopting industrial panels, Dahua's monitor provides great performance and supports continuous 24/7 operation. In addition, these monitors offer HD or UHD resolution, abundant interfaces, ultra-narrow bezel design, elegant appearance, short response time, cost-effective performance, etc., which are respectively present in different series.



4K UHD Display

Support 3840x2160 UHD display and 1.07G display color, to present a realistic and vivid image.



Economical Display

The Light series models adopts light and plastic housing, which makes it lightweight and cost-effective.

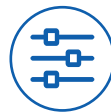

Multiple Interfaces

4K metal monitor supports multiple signals input, such as HDMI, DP, VGA, USB multimedia, Audio, RS232. Thereby adapting to more scenarios.







Industrial Design

The monitor adopts industrial panel which supports 7*24 continuous operation, making it more suitable for security applications.

DISPLAY & CONTROL

Monitors

Model	LM22-H200	LM32-F200	LM43-F200	LM43-S400	LM55-S400
Appearance					
Screen Size	21.45"(16:9)	31.5"(16:9)	43"(16:9)	43"(16:9)	55"(16:9)
Resolution	1920×1080	1920×1080	1920×1080	3840×2160	3840×2160
Brightness	250cd/m ²	240 cd/m ²	330 cd/m ²	450cd/m ²	450cd/m ²
Contrast Ratio	3000:1	1400:1	1200:1	1000:1	1000:1
Viewing Angle	H 178°, V 178°	H 178°, V 178°	H 178°, V 178°	H 178°, V 178°	H 178°, V 178°
Response Time	6.5ms	8ms	8ms	8ms	6ms
Display Color	8bit	8bit	8bit	10bit	10bit
Input	1 VGA, 1 HDMI, Audio In	VGA×1, HDMI×1, USB×1	VGA×1, HDMI×1, USB×1	1 DP, 2 HDMI, 1 VGA, 1 USB, 1 Audio, 1 RJ45(RS232)	1 DP, 2 HDMI, 1 VGA, 1 USB, 1 Audio, 1 RJ45(RS232)
Output	2 Speakers	2 Speakers	2 Speakers	1 RJ45 (RS232), 2 Speakers	1 RJ45 (RS232), 2 Speakers
Control	Physical Button	Physical Button, Infrared Remote	Physical Button, Infrared Remote	RS232, Infrared Remote	RS232, Infrared Remote
Working Temperature	0°C~+40°C (+32°F~+104°F)	0°C~+40°C (+32°F~+104°F)	0°C~+40°C (+32°F~+104°F)	0°C~+40°C (+32°F~+104°F)	0°C~+40°C (+32°F~+104°F)
Working Humidity	10~85%	20~85%	20~85%	10~85%	10~85%
Power & Consumption	DC 12V, 2A	AC100~240V(+/-10%), 55W	AC100~240V(+/-10%), 75W	AC110~240V, 70W	AC110~240V, 120W
Bezel Width	2.6mm (U/R/L), 16.7mm (B)"	13.9mm (U/R/L), 20.5mm (B)	12.8mm (U/R/L), 22mm (B)	8mm (U/L/R/B)	8mm (U/L/R/B)
VESA	75×75mm	75×75mm	400×200mm	400×400mm	400×400mm
Dimensions	491.7×38×285.1mm (19.4"×1.5"×11.2")	731.4×432.6×67.5mm (28.8"×17"×2.7")	969.1×566.8×82.4mm (38.2"×22.3"×3.2")	960.7×550.7×65.0mm (37.8"×21.7"×2.6")	1227.2×699.6×65.0mm (48.3"×27.5"×2.6")
Weight	2.1kg (4.63lb)	3.9kg (8.6lb)	7.4kg (16.3lb)	16.6kg (36.6lb)	25.2kg (55.6lb)



LCD Video Wall

Provides excellent visual experience with a variety of options for panel size, bezel width, resolution and brightness.

- Continuous 24h/7 operation
- 3.5mm narrow bezel
- Anti-glare panel, vivid image quality
- Abundant interfaces with daisy chain function
- Fast response time and no image ghosting
- Fast stacking installation



LCD Video Wall

Model	LS550UCM-EF	LS490UCM-EF	LS460UCM-EF
Appearance			
Screen Size	55"(16:9)	49"(16:9)	46"(16:9)
LCD Technology	ADS	ADS	ADS
Resolution	1920x1080	1920x1080	1920x1080
Backlight	Direct LED	Direct LED	Direct LED
Bezel Width	2.3mm (U/L), 1.2mm (R/B)	2.3mm (U/L), 1.2mm (R/B)	2.3mm (U/L), 1.2mm (R/B)
Pixel Density	40dpi	46dpi	48dpi
Brightness	500cd/m ²	500cd/m ²	500cd/m ²
Contrast Ratio	1200:1	1200:1	1200:1
Viewing Angle	H 178°, V 178°	H 178°, V 178°	H 178°, V 178°
Response Time	8ms	8ms	8ms
Display Color	8bit	8bit	8bit
Color Temperature	10,000K	10,000K	10,000K
MTBF	50,000h	50,000h	50,000h
Input	1 CVBS, 1 VGA, 1 DVI-D, 1 HDMI, 1 RS232, 2 USB, 1 Audio in, 1 IR	1 CVBS, 1 VGA, 1 DVI-D, 1 HDMI, 1 RS232, 2 USB, 1 Audio in, 1 IR	1 CVBS, 1 VGA, 1 DVI-D, 1 HDMI, 1 RS232, 2 USB, 1 Audio in, 1 IR
Output	1 CVBS, 1 RS232, 2 HDMI, 1 VGA, 1 Audio out	1 CVBS, 1 RS232, 2 HDMI, 1 VGA, 1 Audio out	1 CVBS, 1 RS232, 2 HDMI, 1 VGA, 1 Audio out
Control	RS232, Infrared Remote	RS232, Infrared Remote	RS232, Infrared Remote
Working Temperature	0°C~+50°C (+32°F~+122°F)	0°C~+50°C (+32°F~+122°F)	0°C~+50°C (+32°F~+122°F)
Working Humidity	10%~80%	10%~80%	10%~80%
Power & Consumption	AC100~240V, 164W	AC100~240V, 115W	AC100~240V, 95W
Dimensions	1213.7×684.5×121.8mm (47.8"×26.9"×4.8")	1078.4×608.4×120.8mm (42.5"×24"×4.8")	1022×576.6×121.8mm (40.2"×22.7"×4.8")
Installation	Floor-standing, Wall-mounted (Optional)	Floor-standing, Wall-mounted (Optional)	Floor-standing, Wall-mounted (Optional)

DISPLAY & CONTROL





Decoder

Supports 4K/8K signal decoding and 4K output to ensure an ultra-high definition viewing experience using monitors or video walls.

- Local signal collection
- Flexible image display
- Powerful collection and decoding capability
- Excellent compatibility with devices from top brands



Decoder

Model	NVD0905DH-4I-4K	NVD0605DH-4I-4K	NVD0405UH-2I-8K	NVD0105DH-4K
Appearance				
Screen Quantity	9 Screens	6 Screens	4 Screens	1 Screen
Splicing Control Modes	Zoom/Merge/Roam/Overlay	Zoom/Merge/Roam/Overlay	Zoom/Merge/Roam/Overlay	Zoom/Roam/Overlay
Split Mode	1/4/6/8/9/16/25/36	1/4/6/8/9/16/25/36	1/4/6/8/9/16/25/36	1/4/9/16/25/36/64
Max Decoding	3CH@32MP(25fps)/ 9CH@12MP (15fps)/ 12CH@8MP/48CH@1080P/ 108CH@720P/192CH@D1	2CH@32MP(25fps)/ 6CH@12MP(15fps)/ 8CH@8MP/32CH@1080P/ 72CH@720P/128CH@D1	2CH@32MP(25fps)/ 7CH@12MP(25fps)/ 10CH@8MP/36CH@1080P/ 72CH@720P/144CH@D1	1ch@32MP(25fps)/ 3ch@12Mp(15fps)/ 4ch@8MP/16ch@1080P/ 36ch@720P/64ch@D1
Local Video Input	2CH HDMI, 2CH DVI-I	2CH HDMI, 2CH DVI-I	2CH HDMI	—
Network Video Input	IPC/DVR/NVR, etc.	IPC/DVR/NVR, etc.	IPC/DVR/NVR, etc.	IPC/DVR/NVR, etc.
Video Output	HDMI (DVI with convertor)	HDMI (DVI with convertor)	HDMI (DVI with convertor)	HDMI/VGA
Audio Out	HDMI (embedded)	HDMI (embedded)	1 Pair 3.5mm Jack	HDMI (embedded)
Alarm In/Out	4/4 (30VDC 1A, 125VAC 0.5A, Relay output)	4/4 (30VDC 1A, 125VAC 0.5A, Relay output)	4/4 (30VDC 1A, 125VAC 0.5A, Relay output)	4/4 (30VDC 1A, 125VAC 0.5A, Relay output)
Intercom	1 Pair 3.5mm Jack (reserved)	1 Pair 3.5mm Jack (reserved)	1 Pair 3.5mm Jack	1 Pair RCA (reserved)
Processor	Embedded processor	Embedded processor	Embedded processor	Embedded processor
Case	1.5U 19"	1.5U 19"	1U 19"	1U 19"
Ethernet	2 RJ-45 port (10/100/1000M)	2 RJ-45 port (10/100/1000M)	2 RJ-45 port (10/100/1000M)	1 RJ-45 port (10/100/1000M)
USB	1 USB2.0, 1 USB3.0	1 USB2.0, 1 USB3.0	2 USB3.0	2 USB2.0
Power	AC100~240V, 50 Hz~60Hz	AC100~240V, 50 Hz~60Hz	AC100~240V, 50 Hz~60Hz	DC12V/3.3A
Control Modes	WEB/Video Platform/ Network keyboard/Pad	WEB/Video Platform/ Network keyboard/Pad	WEB/Video Platform/ Network keyboard/Pad	WEB/Local GUI/Video Platform/ Network keyboard/Pad
Highlights	8K & H.265 & H.265+ decoding, Fisheye dewarp, PC signal collection	8K & H.265 & H.265+ decoding, Fisheye dewarp, PC signal collection	8K & H.265 & H.265+ decoding, Fisheye dewarp, PC signal collection	8K & H.265 & H.265+ decoding, Fisheye dewarp, Supports the display of intelligent regular line

Keyboard

A network keyboard is a control device with joystick that can realize convenient PTZ operation, video wall control, etc.

- Powerful control capability
- Easy connection
- Flexible joystick
- Multiple combination key



Keyboard

Model	NKB1000-E	NKB5200
Appearance		
Control Mode(s)	Direct mode, Network mode, USB mode	Direct mode, Network mode
Control Interface	1 RJ-45 port (100/1000M), RS232, RS485, RS422(reserved), USB	1 RJ-45 port (100/1000M), Wi-Fi, RS485
DVR/NVR Protocol	DH2	DH2
Dome Protocol	DH-SD1/PELCO-D/PELCO-P	DH-SD1/PELCO-D/PELCO-P
Max. Users	64 (All can manage up to 2048 unit devices via network)	32 (All can manage up to 5000 channels via network)
Screen	Monochrome LCD screen (128*64)	10.1" TFT LCD touch screen (1280*800)
Local Split Display Mode	--	1/4/9/16
Video Output	--	1CH HDMI/VGA
Local Decoding	--	1CH@4K/4CH@1080P
Intercom	--	1 Pair (reserved)
Joystick	3-axis (zoom, focus, iris)	4-axis (zoom, focus, iris)
Main Processor	Industrial embedded microprocessor	Six-core processor
Operating System	Embedded LINUX	Android
USB	1 USB2.0	1 USB3.0, 2 USB2.0
Power	DC12V, 1A	DC12V, 4A;POE
Highlights	Multi-user access control; Control DVR, NVR, EVS, Decoder, Matrix; Work with SmartPSS or DSSClient via USB port	All touch screen, 4K&H.265 decoding, Video roaming@Video local display@Scheme preset@Control NVR, DVR, EVS, Decoder, Matrix, Platform, Local visible control

ACCESSORIES



Accessories

Accessory products offer a series of supporting equipment for CCTV monitoring devices promoted by Dahua, which enhance product integrity and user experience, and supplement the insufficiencies of traditional products and solutions.



Camera Mount

Provides a series of solutions for the installation of cameras.



Power Supply

Provides different power supply type for devices with different specifications.



Audio

Collects live sound signals for the camera.



Cabling

Provides different cable products to meet the transmission requirements of different equipment.

ACCESSORIES

HFxxE, HFxxG Series		
		
Model	PFB110W	PFB121W
Mount	Wall/ceiling/plane mount	Wall mount

HFWxxR-Z, HFWxxT, HFWxxD, HFWxxTH, B4Axx-VF, B3Axx-Z, HFWxxTM, HFWxxTU-A(-LED), MExxTH Series		
		
Model	PFA130-E	PFA130-E+PFA152-E
Mount	Junction box	Pole mount







HFWxxE, HFWxxE-Z Series		
		
Model	PFA121	PFA121+PFA156
Mount	Junction box	Pole mount

HFWxxS/SL, HFWxxR, HFWxxT, HFWxxTL, B1Axx, B2Axx, MExxB, HFWxxC, HFWxxTLM, HFWxxCM Series		
		
Model	PFA134	PFA134+PFA152-E
Mount	Junction box	Pole mount

PFW3601-A180		
		
Model	PFA124-B	PFA124-B+PFA150
Mount	Junction box	Pole mount

HDBWxxE (A) Series				
				
Model	PFA136	PFB203W	PFB203W+PFA152-E	PFA136+PFA200W
Mount	Junction box	Wall mount	Pole mount	Rain shade

ACCESSORIES

HDBWxxE-Z(-DP) Series					
					
Model	PFA138	PFB210W	PFB210W+PFA152-E	PFA101+PFB300C	PFB201C
Mount	Junction box	Wall mount	Pole mount	Ceiling mount	In-ceiling mount

HDBWxxR(-Z), D3Axx-VF/E Series					
					
Model	PFA137	PFB203W	PFB203W+PFA152-E	PFA106+PFB220C	PFA137+PFA200W
Mount	Junction box	Wall mount	Pole mount	Ceiling mount (extensible)	Rain shade



HDBWxxRA Series		
		
Model	PFA197R	PFB206W
Mount	Junction box	Wall mount

EW Series			
			
Model	PFB203W	PFB110W	PFB203W+PFA152-E
Mount	Wall mount	Ceiling mount	Pole mount

HDWxxT-Z Series			
			
Model	PFA130-E	PFB203W	PFB203W+PFB152-E
Mount	Junction box	Wall mount	Pole mount

ACCESSORIES

HDWxxR, T1Axx Series				
				
Model	PFA12A(plastic)	PFA135	PFB205W-E	PFB205W-E+PFA152-E
Mount	Junction box		Wall mount	Pole mount

HDWxxSL, HDWxxTL, D1Axx, HDWxxTQ, HDWxxTLMQ, HDWxxxxTRQ, MExxE/EQ/H/TQ Series				
				
Model	PFA13G	PFB205W-E	PFB205W-E+PFA152-E	
Mount	Junction box	Wall mount	Pole mount	

EBW3802		
		
Model	PFA132-E	PFA132-E+PFA152-E
Mount	Junction box	Pole mount

HDWxxM, HDWxxTLM, T2Axx Series				
				
Model	PFA13A-E	PFB205W-E	PFB205W-E+PFA152-E	
Mount	Junction box	Wall mount	Pole mount	





HDBWxxF Series				
				
Model	PFA139	PFB204W	PFB204W+PFA152-E	
Mount	Junction box	Wall mount	Pole mount	

HDWxxEM, HDWxxT Series				
				
Model	PFA130-E	PFB204W	PFB204W+PFA152-E	
Mount	Junction box	Wall mount	Pole mount	

T3Axx Series				
				
Model	PFA137	PFB205W-E	PFB205W-E+PFA152-E	
Mount	Junction box	Wall mount	Pole mount	

ACCESSORIES

SD22 Series				
				
Model	PFA137	PFB203W	PFB203W+PFA152-E	PFB200C
Mount	Junction box	Wall mount	Pole mount	In-ceiling mount

HDWxxTMQ Series			
			
Model	PFA13F	PFB211W	PFB211W+PFA152-E
Mount	Junction box	Wall mount	Pole mount

SD42 Series				
				
Model	PFA102+PFB302S		PFA102+PFB302S+PFA150	
Mount	Wall mount		Pole mount	

SD42 Series			
			
Model		PFA102+PFB302S+PFA151	
Mount		Corner mount	

SD59/50/40 Series							
							
Model	PFA110+PFB300S	PFA110+PFB300S+PFA120	PFA110+PFB300C	PFA150	PFA151	PFA140	PFA110+PFB303S
Mount	Wall mount	Junction box	Ceiling mount	Pole mount	Corner mount	Power box	Parapet mount

SD49 Series								
								
Model	PFB305W	PFB310W	PFB305W+PFA120	PFA111+PFB300C	PFA150	PFA151	PFA140	PFA111+PFB303S
Mount	Wall mount		Junction box	Ceiling mount	Pole mount	Corner Mount	Power box	Parapet mount

ACCESSORIES

Housings

Provide a multi-functional shield for the box camera.

- Aesthetic design
- All weather protection, suitable for different scenes
- IP66/67, IK10 ingress protection
- Supports remote RS485 control of IR lights and wiper function



Housings

Model	PFH610N-IR-W	PFH610V
Appearance		
Inside Dimension	255mm×90mm×70.5mm (10.04"×3.54"×2.78") 215mm×90mm×83mm (8.46"×3.54"×3.27")	255×90×83mm (10.04"×3.54"×3.27")
Window Dimension	φ60mm (φ2.36")	φ60mm (φ2.36")
Wiper	Supported	--
Vandal-proof	--	Supported
Anti-corrosion	--	--
Compatibility	HFxxE, HFxxF	HFxxE, HFxxF
IR Distance	0~100m (0~328.08ft)	--
RS485 Control	Use RS485 to control IR light & wiper	--
Power Supply	AC24V/5A	DC12V, AC24V
Power Consumption	Max. 70W	--
Operating Temperature	Set: -40°C~+60°C (-40°F~+140°F) Heater: ON: 5±5 °C/OFF: 15±5 °C Cooler: ON: 37±5°C/OFF: 20±5°C ON: 5±5 °C/OFF: 15±5°C	Set: -30°C~+60°C (-22°F~+140°F) Heater: N/A Cooler: N/A
Ingress Protection	IP66	IP67
Vandal Resistance	--	IK10
Material	Aluminum (case) & PC (others)	Aluminum (case) & PC (others)
Dimension (LxWxH)	404mm×164mm×175mm (15.91"×6.46"×6.89")	404mm×164mm×132mm (15.91"×6.46"×5.2")
Certification	CE, FCC, ICES	CE, FCC, ICES

Housings

Model	PFH610V-H	PFH610V-IR	PFH610A	PFH610A-H	PFH610A-IR	PFH610A-IR-W
Appearance						
Inside Dimension	255×90×70.5mm (10.04"×3.54"×2.78") 215×90×83mm (8.46"×3.54"×3.27")	255×90×70.5mm (10.04"×3.54"×2.78") 215×90×83mm (8.46"×3.54"×3.27")	255×90×83mm (10.04"×3.54"×3.27")	255×90×70.5mm (10.04"×3.54"×2.78") 215×90×83mm (8.46"×3.54"×3.27")	255×90×70.5mm (10.04"×3.54"×2.78") 215×90×83mm (8.46"×3.54"×3.27")	255mm×90mm×70.5mm (10.04"×3.54"×2.78") 215mm×90mm×83mm (8.46"×3.54"×3.27")
Window Dimension	φ60mm (φ2.36")	φ60mm (φ2.36")	φ60mm (φ2.36")	φ60mm (φ2.36")	φ60mm (φ2.36")	φ60mm (φ2.36")
Wiper	--	--	--	--	--	Supported
Vandal-proof	Supported	Supported	--	--	--	--
Anti-corrosion	--	--	Supported	Supported	Supported	Supported
Compatibility	HFxxE, HFxxF	HFxxE, HFxxF	HFxxE, HFxxF	HFxxE, HFxxF	HFxxE, HFxxF	HFxxE, HFxxF
IR Distance	--	0~100m (0~328.08ft)	--	--	0~100m(0~328.08ft)	0~100m (0~328.08ft)
RS485 Control	--	Use RS484 to control IR light	--	--	--	Use RS485 to control IR light & wiper
Power Supply	AC24V/3A	AC24V/5A	DC12V, AC24V	AC24V/3A	AC24V/5A,	AC24V/5A
Power Consumption	30W	55W	N/A	30W	55W	Max. 70W
Operating Temperature	Set: -40°C ~+60°C (-40°F~+140°F) Heater: ON: 5±5 °C/OFF: 15±5 °C Cooler: ON: 37±5 °C/OFF: 20±5 °C ON: 5±5 °C/OFF: 15±5 °C	Set: -40°C ~+60°C (-40°F~+140°F) Heater: ON: 5±5°C/OFF: 15±5°C Cooler: ON: 37±5°C/OFF: 20±5°C ON: 5±5°C/OFF: 15±5°C	Set: -30°C ~+60°C (-22°F~+140°F) Heater: ON: N/A Cooler: ON: N/A	Set: -40°C ~+60°C (-40°F~+140°F) Heater: ON: ON: 5±5°C/OFF: 15±5°C Cooler: ON: 37±5°C/OFF: 20±5°C ON: 5±5°C/OFF: 15±5°C	Set: -40°C ~+60°C (-40°F~+140°F) Heater: ON: 5±5°C/OFF: 15±5°C Cooler: ON: 37±5°C/OFF: 20±5°C ON: 5±5°C/OFF: 15±5°C	Set: -40°C ~+60°C (-40°F~+140°F) Heater: ON: 5±5 °C/OFF: 15±5 °C Cooler: ON: 37±5°C/OFF: 20±5°C ON: 5±5 °C/OFF: 15±5°C
Ingress Protection	IP67	IP67	IP67	IP67	IP67	IP66
Vandal Resistance	IK10	IK10	IK10	IK10	IK10	--
Material	Aluminum (case) & PC (others)	Aluminum (case) & PC (others)	Aluminum (case) & PC (others)	Aluminum (case) & PC (others)	Aluminum (case) & PC (others)	Aluminum (case) &PC (others)
Dimension (LxWxH)	404mm×164mm×132mm (15.91"×6.46"×5.2")	404mm×164mm×132mm (15.91"×6.46"×5.2")	404mm×164mm×132mm (15.91"×6.46"×5.2")	404mm×164mm×132mm (15.91"×6.46"×5.2")	404mm×164mm×132mm (15.91"×6.46"×5.2")	404mm×164mm×175mm (15.91"×6.46"×6.89")
Certification	CE, FCC, UL, EAC, ICES	CE, FCC, UL, EAC, ICES	CE, FCC, ICES	CE, FCC, UL, EAC, ICES	CE, FCC, UL, EAC, ICEzS	CE, FCC, ICES

ACCESSORIES

Lenses

A wide range of multi-functional lenses for box cameras.

- Super edge resolution
- Great highlight performance
- Outstanding starlight technology
- Better temperature performance



Lens					
Model	PFL2712-E6D	PFL0550-E6D	PLZ20C0-D	PLZ21C0-D	PFL1575-A12D
Appearance					
Image Format	1/2.7"	1/2.7"	1/1.7"	1/1.7"	1/1.7"
Focal Length	2.7-12mm	5-50mm	3.7-16mm	10.5-42mm	15-75mm
Lens Pixel	6MP	6MP	12MP	12MP	12MP
Aperture	F1.6	F1.6	F1.5	F1.5	F1.5
Mount	CS	CS	CS	CS	C
Focus Control	Manual	Manual	Manual	Manual	Manual
Zoom Control	Manual	Manual	Manual	Manual	Manual
Iris Control	DC-iris	DC-iris	DC-iris	DC-iris	DC-iris
IR Correction	Supported (420~850nm)	Supported	Supported	Supported	Supported
M.O.D.	0.3m (0.98ft)	0.5m (1.64ft)	0.5m (1.64ft)	0.3m (0.98ft)	1.5m (4.92ft)
Operating Temperature	-30°C~+70°C (-22°F~+158°F)	-30°C~+70°C (-22°F~+158°F)	-30°C~+70°C (-22°F~+158°F)	-30°C~+70°C (-22°F~+158°F)	-30°C~+70°C (-22°F~+158°F)

Lens					
Model	PLZ20C0-P	PLZ21C0-P	PFL010542-A12PE	PFL1040-K9PE	PFL1640-L12PE
Appearance					
Image Format	1/1.7"	1/1.7"	1/1.7"	1"	1.1"
Focal Length	3.7-16mm	10.5-42mm	10.5-42mm	10-40mm	16-40mm
Lens Pixel	12MP	12MP	12MP	9MP	12MP
Aperture	F1.5	F1.5	F1.5	F1.5	F1.4
Mount	CS	CS	CS	C	C
Focus Control	Manual	Manual	Motorized	Motorized	Motorized
Zoom Control	Manual	Manual	Motorized	Motorized	Motorized
Iris Control	P-iris	P-iris	P-Iris	P-Iris	P-Iris
IR Correction	Supported	Supported	Supported	--	Supported
M.O.D.	0.5m (1.64ft)	0.3m (0.98ft)	1 m (3.28 ft)	2.5m (8.2ft)	1.5 m (4.92 ft) (W)-2.5 m (8.20 ft) (T)
Operating Temperature	-30°C~+70°C (-22°F~+158°F)	-30°C~+70°C (-22°F~+158°F)	-30°C~+70°C (-22°F~+158°F)	-30°C~+70°C (-22°F~+158°F)	-30°C~+70°C (-22°F~+158°F)

Camera Testers

It allows easier testing of cameras that only requires a single person to operate, saving significant amount of time and labor costs.

- Camera video tester
- Small tools: DMM/Wifi test/OPM/Data monitor
- Cable tester: TDR/ Analog video generator
- Power supply: PoE+/ DC12V2A/ USB5V2A output



Camera Testers







Model	PFM900-E	PFM904	PFM907-E
Appearance			
Operation System	Linux	Linux	Linux
Language	Multi-language interface	Multi-language interface	Multi-language interface
Operation Mode	Keyboard	Keyboard	Touch screen and keyboard
Screen	4.0" TFT screen, 800×480 resolution	4.3" TFT screen, 480×272 resolution	7 inch capacitive touch screen display, 1920×1200 resolution
Update	Online and local update	Local update	Online and local update
Analog Video Test	HDCV: 1/2/4/5/6/8MP HDTV: 1/2/4/5MP AHD: 1/2/4MP CVBS: PAL/NTSC	HDCV: 1/2/4/5/6/8MP HDTV: 1/2/4/5MP AHD: 1/2/4/5MP CVBS: PAL/NTSC	HDCV: 1/2/4/5/6/8MP HDTV: 1/2/4/5/8MP AHD: 1/2/4/8MP CVBS: PAL/NTSC
IPC Test	Discovering the device, real-time video, camera configuration, PTZ test, discovering ONVIF device	--	Discovering the device, real-time video, camera configuration, PTZ test, discovering ONVIF device
Camera Power Supply	DC12V/2A output	DC12V/1A output	DC12V/2A output
RS485	Receive and display protocol data with a RS485 cable	Receive and display protocol data with a RS485 cable	Captures and analyzes the command data from controlling device via RS485
PTZ Control Test	OSD menu display and PTZ control	OSD menu display and PTZ control	OSD menu display and PTZ control
Accessibility	Audio Test, TDR Test, Digital Multimeter, OE Test, UTC (SD to HD)	UTC (SD to HD)	Audio Test, TDR Test, Digital Multimeter, Optical Power Meter, HDMI Output, PoE Test, HDMI- IN/OUTPUT, WiFi Test, UTC (SD to HD)
Charger	PoE 48V/0.32A	Micro USB 5V/1A	DC 12V/1.5A
Working Temperature	-10°C~+55°C (+14°F~+131°F)	-10°C to +55°C (+14°F ~+131°F)	-10°C~+55°C (+14°F~+131°F)

HDCVI Accessories

Balun can transmit analog signals through the network cable, which greatly reduces transmission costs. Balun can also realize power supply transmission.

- Real-time transmission over UTP CAT5E/6 cable.
- With female BNC connector, and pluggable screw terminal connections
- Excellent anti-thunder, anti-static and anti-interference capabilities
- Compatible format: HDCVI/TVI/AHD/CVBS

Baluns

Model	PFM800-E	PFM800-4K	PFM800B-4K	PFM802	PFM801-4MP	PFM809-4MP
Appearance						
Power Supply	--	--	--	DC12-15V	DC24V/DC36V	--
Transmission Signal	1-CH	1-CH	1-CH	1-CH	1-CH	16-CH
Network cable Type	UTP CAT 5E/6	UTP CAT5E/6	UTP CAT5E/6	UTP CAT5E/6	UTP CAT5E/6	UTP CAT5E/6
Compatible Format	HDCVI/TVI/AHD/CVBS	HDCVI/TVI/AHD/CVBS	HDCVI/TVI/AHD/CVBS	HDCVI/TVI/AHD/CVBS	HDCVI/TVI/AHD/CVBS	HDCVI/TVI/AHD/CVBS
Resolution	720P/1080P	720P/1080P/4MP/5MP/4K	720P/1080P/4MP/5MP/4K	720P/1080P/4MP/4K	720P/1080P/4MP/4K	720P/1080P/4MP/4K
Coaxial Video Connector	BNC-M	BNC-M	BNC-M	BNC-M	BNC-M	BNC-M
Connection Way	RJ45	RJ45	RJ45	RJ45	RJ45	RJ45
ESD Protection	1a contact discharge electricity level 3 1b air discharge electricity level 3 Per: IEC61000-4-2	1a contact discharge electricity level 3 1b air discharge electricity level 3 Per: IEC61000-4-2	1a contact discharge electricity level 3 1b air discharge electricity level 3 Per: IEC61000-4-2	1a contact discharge electricity level 3 1b air discharge electricity level 3 Per: IEC61000-4-2	1a contact discharge electricity level 3 1b air discharge electricity level 3 Per: IEC61000-4-2	1a contact discharge electricity level 3 1b air discharge electricity level 3 Per: IEC61000-4-2
Coaxial Cable Connector Protection	2KV (common-mode) Per: IEC61000-4-5	2KV (common-mode) Per: IEC61000-4-5	2KV (common-mode) Per: IEC61000-4-5	1KV (different-mode), 2KV (common-mode) Per: IEC61000-4-5	2KV (common-mode) Per: IEC61000-4-5	2KV (common-mode) Per: IEC61000-4-5
UTP Cable Connector Protection	2KV (different-mode), 4KV (common-mode) Per: IEC61000-4-5	2KV (different-mode), 4KV (common-mode) Per: IEC61000-4-5	2KV (different-mode), 4KV (common-mode) Per: IEC61000-4-5	1KV (different-mode), 2KV (common-mode) Per: IEC61000-4-5	2KV (different-mode), 4KV (common-mode) Per: IEC61000-4-5	2KV (different-mode), 4KV (common-mode)
Power Connector Protection	--	--	--	18.1kg (39.9lb)	13kg (28.66lb)	Per: IEC61000-4-5
BNC Male Impedance	75 ohms	75 ohms	75 ohms	75 ohms	75 ohms	75 ohms
UTP Cable Impedance	100 ohms	100 ohms	100 ohms	100 ohms	100 ohms	100 ohms
Operating Temperature	-10°C~+55°C (+14°F~+131°F)	-10°C~+55°C (+14°F~+131°F)	-10°C~+55°C (+14°F~+131°F)	-10°C~+55°C (+14°F~+131°F)	-10°C~+55°C (+14°F~+131°F)	-10°C~+55°C (+14°F~+131°F)

ACCESSORIES



Video Extension

Allows video signal extension and branching.

- Real-time transmission of HDMI signals
- Real-time transmission of VGA signal
- No need to install drivers
- Excellent anti-thunder, anti-static and anti-interference capabilities



Video Extension



Model	PFM700-E	PFM710
Appearance		
Transmission Signal	1channel HDMI	1channel VGA
Transmission Distance	50m	35m
Video Signal Input Interface	HDMI interface	Female 15, VGA port
Video Input Port	HDMI interface	Female 15, VGA port
Transmission Port	RJ45 port	RJ45 port
Resolution	1080P/1080i/720P/576P/ 576i/480P/480i	640*480/800*600/1600*1050/ 1600*1200/1920*1200/1920*1080
Working Temperature	-10°C~55°C (14°F~131°F)	0°C~+55°C (+32°F~+131°F)

Power Supply





Safe and reliable power supply accessories for our products.

- DC power adapter: Wide temperature operation from -30°C~+70°C and lightning protection up to 4KV
- Distributed power: Offers wall mount installation, providing convenient power supply to different devices
- Switch power: High quality, reliable, widely used, and flexible
- UPS: Temporary power discharge equipment between utility and equipment

DC Power Adapter

Model	PFM321D-EN/BS/US	PFM320D-EN/BS/US	PFM321-EN/BS/US	PFM320D-015	PFM300
Appearance					
Input	100~240V, 50/60Hz, 0.5A	100~240V, 50/60Hz, 0.6A	90~264V	AC100~240V, 50/60Hz, 0.6A	AC180~264V, 50/60Hz, 0.6A
Output	12V(+7%, -3%), 1A	12V(+7%, -3%), 2A	12V(+7%, -3%), 1A	DC12V (+7%, -3%), 1.5A	DC12V (±5%), 2A
Working Temperature	-30°C~+70°C (-22°F~+158°F)	-30°C~+70°C (-22°F~+158°F)	-10°C~+55°C (+14°F~+131°F)	-30°C~+70°C (-22°F~+158°F)	-30°C~+70°C (-22°F~+158°F)
Surge Protection	Common Mode ±4KV (12 ohms) Differential Mode ±2kV (2 ohms)	Common Mode ±4KV (12 ohms) Differential Mode ±2kV (2 ohms)	Common Mode ±4KV (12 ohms) Differential Mode ±2kV (2 ohms)	Common Mode ±4KV (12 ohms) Differential Mode ±2kV (2 ohms)	Common Mode ±4KV (12 ohms) Differential Mode ±2kV (2 ohms)

Distributed Power Box

Model	PFM340-5CH	PFM341-9CH	PFM342-9CH	PFM343-19CH
Appearance				
Input	AC90~264V	AC90~264V	AC90~264V	AC90~264V
Output	5 x 12VDC (-3%~+7%), 4A	9 x 12VDC (-3%~+7%), 5A	9 x 12VDC (-3%~+7%), 10A	19 x 12VDC (-3%~+7%), 20A
Working Temperature	-20°C~+45°C (-4°F~+113°F)	-20°C~+45°C (-4°F~+113°F)	-20°C~+45°C (-4°F~+113°F)	-20°C~+45°C (-4°F~+113°F)
Surge Protection	Line to ground: 4000V Line to line: 2000V	Line to ground: 4000V Line to line: 2000V	Line to ground: 4000V Line to line: 2000V	Line to ground: 4000V Line to line: 2000V



Switching Power&UPS

Model	PFM320S-150	PFM320S-50
Appearance		
Input	88~132Vac/176~264Vac	90~264Vac
Output	12Vdc, 12.5A	12Vdc, 4.2A
Working Temperature	20°C~+50°C (60% output at +70°C)	-20°C~+50°C (60% output at +70°C)
Surge Protection	Line to ground: ±2000V Line to line: ±1000V	Line to ground: ±2000V Line to line: ±1000V
Output Rated Frequency	--	--
Operating Temperature	--	--



ACCESSORIES

Switching Power&UPS

Model	PFM350-360	PFM350-900
Appearance		
Capacity	600VA/360W	1500VA/900W
Input Voltage	220Vac~240Vac 110Vac~120Vac (US)	220Vac~240Vac 110Vac~120Vac (US)
Power factor	0.6	0.6
Output Voltage	220/230/240 Vac 110/120 Vac (US)	220/230/240 Vac 110/120 Vac (US)
Transfer Time	2-6ms	2-6ms
Battery type & number	12 V/7 Ah × 1	12 V/9 Ah × 2
Protection	Overload, discharge and overcharge protection	Overload, discharge and overcharge protection
Operating Temperature	0°C~+40°C (32°F~+104°F)	0°C~+40°C (32°F~+104°F)
Dimensions	279mm×101mm×142mm (10.98"×3.98"×5.59")	320mm×130mm×182mm (15.6"×5.12"×7.17")
Weight	4.25kg (9.37lb)	10.4kg (22.93lb)

Cables

Network/Coaxial cables with higher quality and higher cost-performance ratio.

- 305m CAT5e/CAT6 network cables and RG59 coaxial cables meet all user requirements
- High-purity and oxygen-free copper conductor material
- Customized PVC sheath, CE CPR Eca or ANSI UL CM flame retardant class certified

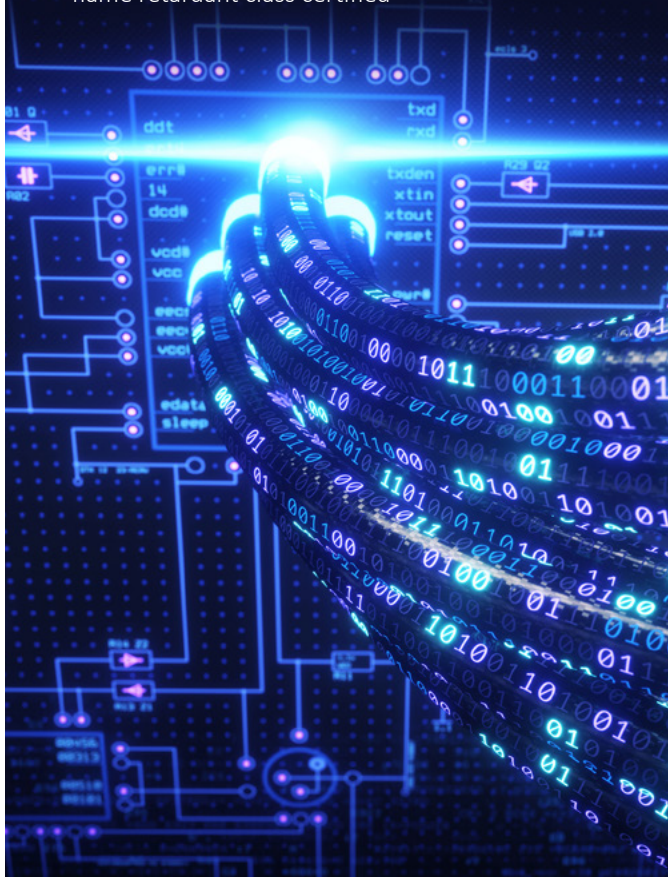

Network Cables







Model	PFM920I-5EUN	PFM920I-6UN-C	PFM922I-6UN-C	PFM923I-6UN-C
Appearance				
Category	CAT5e	CAT6	CAT6	CAT6
Conductor Material	Oxygen free copper (99.97% purity)	Oxygen free copper (99.97% purity)	CCA (Copper content 8%~12%)	Oxygen free copper (99.97% purity)
Conductor Diameter	0.45 mm ± 0.01 mm	0.53 mm ± 0.005 mm	0.57 mm ± 0.01 mm, 23AWG	0.53 mm ± 0.005 mm
Sheath	PVC	PVC	PVC	LSZH
Certification	CPR Eca	CPR Eca	CPR Eca	CPR Eca
Length	305m (1000ft)	305m (1000ft)	305m (1000ft)	305m (1000ft)
Color	White	White, Orange, Blue	Orange	White

Coaxial Cables

Model	PFM930-59N-100	PFM930-59N-200	PFM940I-59N/2
Appearance			
Category	RG59	RG59	RG59+2C
Conductor Material	OFC	OFC	OFC/OFC(2C)
Conductor Diameter	0.81 mm±0.1 mm (0.03"±0.004")	0.81 mm±0.1 mm (0.03"±0.004")	20AWG (0.8mm)/0.32mm*7 (2C)
Sheath	PVC	PVC	PVC/PVC(2C)
Certification	CPR Eca	CPR Eca	CPR Eca
Length	100m (328 ft)	200m (656.17ft)	200m (656.17ft)
Color	Black	Black	Black

ACCESSORIES

CCTV Video and Power Cable

Model	PFM942I-20-3	PFM942I-30-3	PFM942I-10-5	PFM942I-20-5	PFM942I-30-5	PFM942I-50-5	PFM942I-20-9
Appearance							
Length	20 m ± 0.3 m (65.62 ft ± 7.87 ft)	30 m ± 0.4 m (98.43 ft ± 1.31 ft)	10 m ± 0.2 m (32.81 ft ± 0.66 ft)	20 m ± 0.3 m (65.62 ft ± 7.87 ft)	30 m ± 0.4 m (98.43 ft ± 1.31 ft)	50 m ± 0.6 m (164.04 ft ± 1.97 ft)	20 m ± 0.3 m (65.62 ft ± 7.87 ft)
Max. Supporting Power	3.3W	3.3W	5.6W	5.6W	5.6W	5.6W	9.0W
Conductor Material	Coaxial cable/Power wire: oxygen-free copper	Coaxial cable/Power wire: oxygen-free copper	Coaxial cable/Power wire: oxygen-free copper	Coaxial cable/Power wire: oxygen-free copper	Coaxial cable/Power wire: oxygen-free copper	Coaxial cable/Power wire: oxygen-free copper	Coaxial cable/Power wire: oxygen-free copper
Conductor Diameter	Coaxial cable/Power wire: 7/0.127 mm ± 0.01 mm (7/0.005" ± 0.0004")	Coaxial cable: 7/0.127 mm ± 0.01 mm (7/0.005" ± 0.0004"); Power wire: 7/0.160 mm ± 0.01 mm (7/0.006" ± 0.0004")	Coaxial cable/Power wire: 7/0.127 mm ± 0.01 mm (7/0.005" ± 0.0004")	Coaxial cable: 7/0.127 mm ± 0.01 mm (7/0.005" ± 0.0004"); Power wire: 7/0.160 mm ± 0.01 mm (7/0.006" ± 0.0004")	Coaxial cable: 7/0.127 mm ± 0.01 mm (7/0.005" ± 0.0004"); Power wire: 7/0.203 mm ± 0.01 mm (7/0.008" ± 0.0004")	Coaxial cable: 7/0.127 mm ± 0.01 mm (7/0.005" ± 0.0004"); Power wire: 7/0.203 mm ± 0.01 mm (7/0.008" ± 0.0004")	Coaxial cable: 7/0.127 mm ± 0.01 mm (7/0.005" ± 0.0004"); Power wire: 7/0.203 mm ± 0.01 mm (7/0.008" ± 0.0004")
Conductor Wire Gauge	Coaxial cable/Power wire: 28AWG	Coaxial cable: 28AWG; Power wire: 26AWG	Coaxial cable/Power wire: 28AWG	Coaxial cable: 28AWG; Power wire: 26AWG	Coaxial cable: 28AWG; Power wire: 24AWG	Coaxial cable: 28AWG; Power wire: 24AWG	Coaxial cable: 28AWG; Power wire: 24AWG
Sheath Material	Coaxial cable/Power wire: PVC	Coaxial cable/Power wire: PVC	Coaxial cable/Power wire: PVC	Coaxial cable/Power wire: PVC	Coaxial cable/Power wire: PVC	Coaxial cable/Power wire: PVC	Coaxial cable/Power wire: PVC
Sheath Diameter	Coaxial cable/Power wire: 2.8 mm ± 0.2 mm (0.11" ± 0.008")	Coaxial cable/Power wire: 2.8 mm ± 0.2 mm (0.11" ± 0.008")	Coaxial cable/Power wire: 2.8 mm ± 0.2 mm (0.11" ± 0.008")	Coaxial cable/Power wire: 2.8 mm ± 0.2 mm (0.11" ± 0.008")	Coaxial cable/Power wire: 2.8 mm ± 0.2 mm (0.11" ± 0.008")	Coaxial cable/Power wire: 2.8 mm ± 0.2 mm (0.11" ± 0.008")	Coaxial cable/Power wire: 2.8 mm ± 0.2 mm (0.11" ± 0.008")
Certification	CPR (Eca)	CPR (Eca)	CPR (Eca)	CPR (Eca)	CPR (Eca)	CPR (Eca)	CPR (Eca)

Cabinets

Cabinets provide protection and stable working environment for storage devices. It also serves as shield against electromagnetic interference.

- Aesthetic design
- Standard 19" rack
- Supports wall mount and plane mount
- Cable entry on the top cover and bottom panel
- The four sides of the cabinet can be opened



Cabinets

Model	PFC200D-6U4D	PFC200D-9U4D	PFC200D-12U4D	PFC200D-18U6D
Appearance				
Material	SPCC	SPCC	SPCC	SPCC
Dimension (WxDxH)	600mm×450mm×372mm (23.62"×17.72"×14.57")	600mm×450mm×505mm (23.62"×17.72"×19.88")	600mm×450mm×638mm (23.62"×17.72"×25.12")	600mm×600mm×990mm (23.62"×23.62"×38.98")
Weight	13kg (28.66lb)	15.6kg (34.39lb)	18.1kg (39.9lb)	39.5kg (87.08lb)
Load Bearing	40kg (88.18lb)	40kg (88.18lb)	40kg (88.18lb)	300kg (661.39lb)
Color	Black	Black	Black	Black

Cabinets

Model	PFC200D-42U8D	PFC610-4D	PFC610-6D	PFC610-8D
Appearance				
Material	SPCC	SPCC	SPCC	SPCC
Dimension (WxDxH)	600mm×800mm×2055mm (23.62"×31.5"×80.91")	489mm×275mm×47.6mm (19.25"×10.83"×1.87")	472mm×350mm×48mm (18.56"×13.78"×1.87")	472mm×550mm×48mm (18.56"×21.65"×1.87")
Weight	89kg (196.21lb)	1.6kg (3.53lb)	1.9kg (4.19lb)	2.8kg (6.17lb)
Load Bearing	300kg (661.39lb)	40kg (88.18lb)	40kg (88.18lb)	40kg (88.18lb)
Color	Black	Black	Black	Black

ACCESSORIES

Cabinets			
Model	PFC200D-6U4D	PFC200D-9U4D	PFC200D-18U6D
Appearance			
Voltage	220 V	220 V	220 V
Rotational Speed	2,200±10% RPM	2,200±10% RPM	2,200±10% RPM
Noise	45 dB (A)	45 dB (A)	45 dB (A)
Power	30 W	30 W	30 W
Lifespan	30,000 hours at +25 °C (+77 °F)	30,000 hours at +25 °C (+77 °F)	30,000 hours at +25 °C (+77 °F)
Casing	Cold rolled sheet [width: 0.8 mm (0.03")]	Cold rolled sheet [width: 0.8 mm (0.03")]	Cold rolled sheet [width: 0.8 mm (0.03")]
Color	Black	Black	Black
Operating Temperature	-10 °C to +60 °C (+14 °F to +140 °F)	-10 °C to +60 °C (+14 °F to +140 °F)	-10 °C to +60 °C (+14 °F to +140 °F)
Dimensions	346 mm×155 mm×76 mm (13.62"×6.10"×2.99")	450 mm×365 mm×46 mm (17.72"×14.37"×1.81")	564 mm×450 mm×46 mm (22.20"×17.72"×1.18")
Weight	1.1 kg (2.43 lb)	2.2 kg (4.85 lb)	3.6 kg (7.94 lb)

Cabinets			
Model	ZZM10/PDU (8 European 250)	ZZM10/PDU (8 British 250)	ZZM10/PDU (8 USA 250)
Appearance			
Input rated voltage	Max. 250Vac	Max. 250Vac	Max. 250Vac
Load current	16A	13A	10A
Max. load power	4000W	3250W	2500W
Input plug/cable	European/1.5mm2, 2m	British/1.5mm2, 2m	North American/1.3mm2, 3m
Output plug	8 outlet 3-pin European	8 outlet 3-pin British	8 outlet 3-pin, Universal (North American)
Protection	Overload protection module and switch	N/A (no extra space)	Overload protection module and switch
Installation	Horizontal, rackmount in the 19" cabinet	Horizontal, rackmount in the 19" cabinet	Horizontal, rackmount in the 19" cabinet
Operating conditions	-40°C~+70°C (-40°F~+158°F), 95% RH	-40°C~+70°C (-40°F~+158°F), 95% RH	-40°C~+70°C (-40°F~+158°F), 95% RH
Dimensions	482.6mm×45mm×45mm (19"×1.77"×1.77")	482.6mm×45mm×45mm (19"×1.77"×1.77")	482.6mm×45mm×45mm (19"×1.77"×1.77")
Net Weight	0.8kg (1.76lb)	0.8kg (1.76lb)	1.0kg (2.2lb)





ACCESSORIES

Pickups

Choose from a variety of pickup products to effectively capture live sounds.

- High sensitivity microphone
- Intelligent noise reduction
- Smart audio crack protection
- Wide dynamic range processing technology
- Automatic supplement function







Pickups				
Model	HAP100	HAP201	HAP301	HAP120
Appearance				
Scope	5-40m ²	1-150m ²	1-150m ²	10-70m ²
Sensitivity	-40dB	-38 dB	-38 dB	-34dB
Frequency Response	20Hz~20kHz	20 Hz~20 kHz	20 Hz~20 kHz	80Hz~16kHz
Directional Characteristic	Omni-directional	Omni-directional	Omni-directional	Omni-directional
SNR	70dB	85 dB	85 dB	58dB
Dynamic Range	104dB	106 dB	106 dB	74dB
Max.Sustainable Sound Pressure	120dB SPL(1kHz, THD 1%)	120 dB SPL (1 kHz,THD 1%)	120 dB SPL (1 kHz,THD 1%)	110dB SPL (1kHz, THD 1%)
Output Impedance	600Ω (non-equilibrium)	25 Ω non-balanced	25 Ω non-balanced	600Ω (non-equilibrium)
Output Signal Amplitude	2.5Vpp/-25dB	2.5 VPP/-25 dB	2.5 VPP/-25 Db	2.5Vpp/88dB SPL
M.O.D.	0.3m (0.98ft)	0.5m (1.64ft)	0.5m (1.64ft)	0.3m (0.98ft)
Working Temperature	-30°C ~ +70°C (-22°F ~ +158°F)	-20 °C ~ +60 °C (-4 °F ~ +140 °F)	-20°C ~ +60°C (-4 °F ~ +140 °F)	-30°C ~ +70°C (-22°F ~ +158°F)

Pickups			
Model	HAP320	HAP120-V	HAP320-V
Appearance			
Scope	10-150m ²	5m	5-100m ²
Sensitivity	-35dB	-43dB	-24dB
Frequency Response	20Hz~20kHz	20Hz~20kHz	20Hz~20kHz
Directional Characteristic	Omni-directional	Omni-directional	Omni-directional
SNR	65dB	58dB	68dB
Dynamic Range	86dB	74dB	84dB
Max.Sustainable Sound Pressure	115dB SPL (1kHz, THD 1%)	110dB SPL (1kHz, THD 1%)	110dB SPL (1kHz, THD 1%)
Output Impedance	100Ω (non-equilibrium)	100Ω (non-equilibrium)	100Ω (non-equilibrium)
Output Signal Amplitude	2.5Vpp/92dB SPL	2.5Vpp/101dB SPL	2.5Vpp/90dB SPL
M.O.D.	0.3m (0.98ft)	0.5m (1.64ft)	0.5m (1.64ft)
Working Temperature	0°C ~ +50°C (32°F ~ +122°F)	-30°C ~ +70°C (-22°F ~ +158°F)	-30°C ~ +70°C (-22°F ~ +158°F)

VIDEO MANAGEMENT SOFTWARE

DSS Products

	Model	DSS Express (Free Version)	DSS Express (License Version)	DSS Professional	DSS4004-S2	DSS7016D (R)-S2
Appearance						
Deployment	OS	Windows	Windows	Windows	Linux	Linux
	Form	Software	Software	Software	All-in-One	All-in-One
	Type of Deployment	Single-server	Single-server	Distribute and Cascade	Single-server	Distribute
	Hot Standby	--	--	Supported	--	Supported
	N+M	--	--	Supported	--	Supported
Performance	Number of Camera Per Server	64 devices; 64 channels	256 devices; 256 channels	1,000 devices; 2,000 channels	256 devices; 256 channels	500 devices; 1,000 channels
	Number of FR Per Server	8 devices; 8 channels	8 devices; 8 channels	100 devices; 500 channels	8 devices; 32 channels	20 devices; 100 channels
	Number of ANPR Per Server	8 (4 channels for entrance)	8 (4 channels for entrance)	500 (60 channels for entrance)	32 (6 channels for entrance)	100 (16 channels for entrance)
	Number of Video Metadata Per Server	8 channels	8 channels	500 channels	32 channels	100 channels
	Users	10 online users and 50 total users	10 online users and 50 total users	200 online users and 2,500 total users	10 online users and 50 total users	50 online users and 200 total users
	Microsoft Active Directory	--	--	Supported	--	Supported
	Video Input or Output Per Server	200Mbps	200Mbps	600Mbps	350Mbps	600Mbps
	Video Storage Bandwidth Per Server	100Mbps	100Mbps	600Mbps	150Mbps	600Mbps
	Maximum Capacity Per Storage Server (Local)	7Days	2TB	200TB	100TB	200TB
Maximum Capacity Per Storage Server (IPSAN)	--	--	400TB	100TB	200TB	
Features	Live View	Supported	Supported	Supported	Supported	Supported
	Record Playback	Supported	Supported	Supported	Supported	Supported
	Video Wall		Supported (Only NVD)	Supported	Supported	Supported
	Google Map	--	--	Supported	--	Supported
	Event Center	Supported	Supported	Supported	Supported	Supported
	DeepXplore	Supported	Supported	Supported	Supported	Supported
	Track Generation	--	--	Supported	--	Supported
	Case Bank	--	--	Supported	--	--
	Maintenance Center	--	--	Supported	--	Supported

* For more detailed parameters, please refer to DSS products datasheet.

VIDEO MANAGEMENT SOFTWARE

DMSS

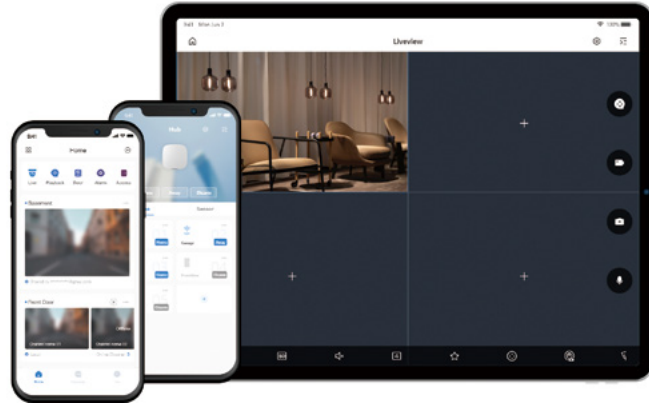

Digital Mobile Surveillance System

Monitor anything using your smartphone or tablet anytime, anywhere.



DMSS	Digital Mobile Surveillance System	Security at Fingertips
Devices	Supported Devices	XVR, NVR, IPC, PTZ, VTO, DoorBell, Access Controller, Alarm Hub, Accessory (PIR, siren, door detector, etc.)
	Max. Devices Recommended to Add	1024
	Add Device Method	IP/Domain, SN/Scan, LAN Search, Wired, Wireless (smartconfig, soft AP)
	Features	Live and Playback, Alarm push, Device Sharing, Export Device, Time Zone, Cloud Update, Remote Configuration
Video	Compression Format	H.265 / H.264 / MPEG-4 / JPEG
	Display Resolution	up to 1920-1080
Live	Split Live View	Display in 1, 4, 9, 16 views
	Features	Snapshot, Video Recording, Playback, Play/Pause, Mute/Unmute, Orientation/Landscape, Video Stream, Two-way Audio, Favorite, PTZ Control, White Light/Buzzer, Fisheye, Wiper, Alarm Message, Unlock the Door, etc.
Playback	Video Playback Duration	24h
	Features	Snapshot, Video Recording, Play/Pause, Mute/Unmute, Orientation/Landscape, Clip, Play slowly/Play fast, Timebar, Frame-in-frame
Alarm Push	Alarm Type	Motion Detection, SMD, Intrusion Alarm, Tripwire Alarm, Scene Changing, Video Mask, Disk Alarm(no disk, low space, disk error), Object Detection, Face Alarm, IPC Offline, License Plate Recognition, Missing Object, Temperature Alarm, Fast Moving, Defocus, Local Alarm, Crowd Alarm, Network Alarm, Fire Alarm, Smoking Alarm, Phone Call, etc.
	Push Type	Alarm Video, Preview, Message, Video Call

DORI Distance (D/O/R/I)

Find the Optimal Camera for Your Individual Surveillance Needs

The DORI distance is a “general proximity” of distance that can easily pinpoint the right camera based on your needs and requirements. The DORI distance is calculated based on sensor specification and lab test result according to EN 62676-4 which defines the criteria for Detect, Observe, Recognize and Identify respectively.

- Detect: 25ppm
- Observe: 63ppm
- Recognize: 125ppm
- Identify: 250ppm

HDCVI CAMERA

Pro Series

2802 Series

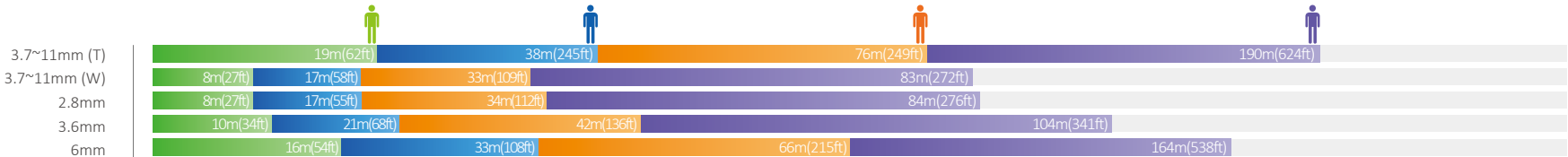

2509 Series

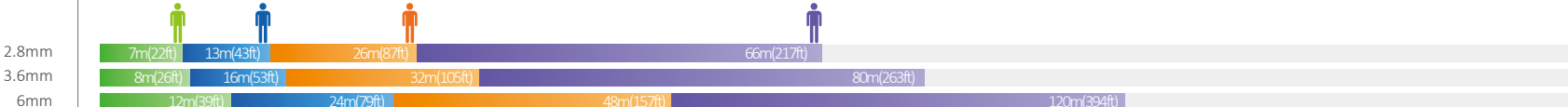

2501 Series

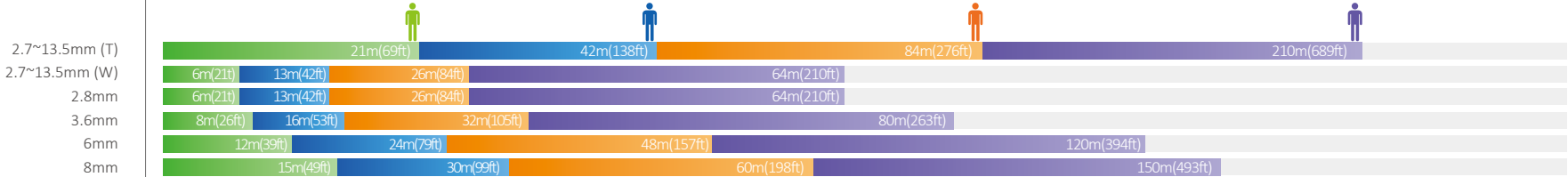

2402 Series

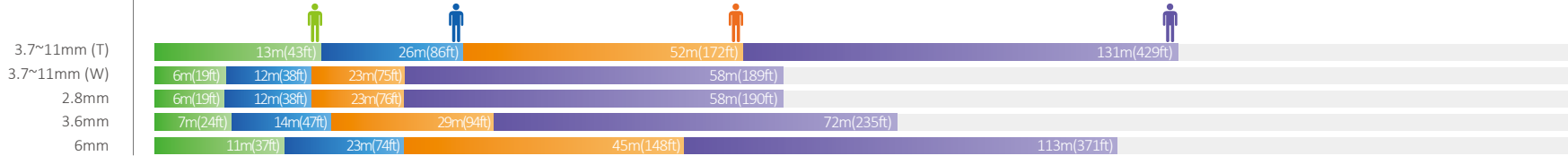

DORI Distance (D/O/R/I)

Pro Series

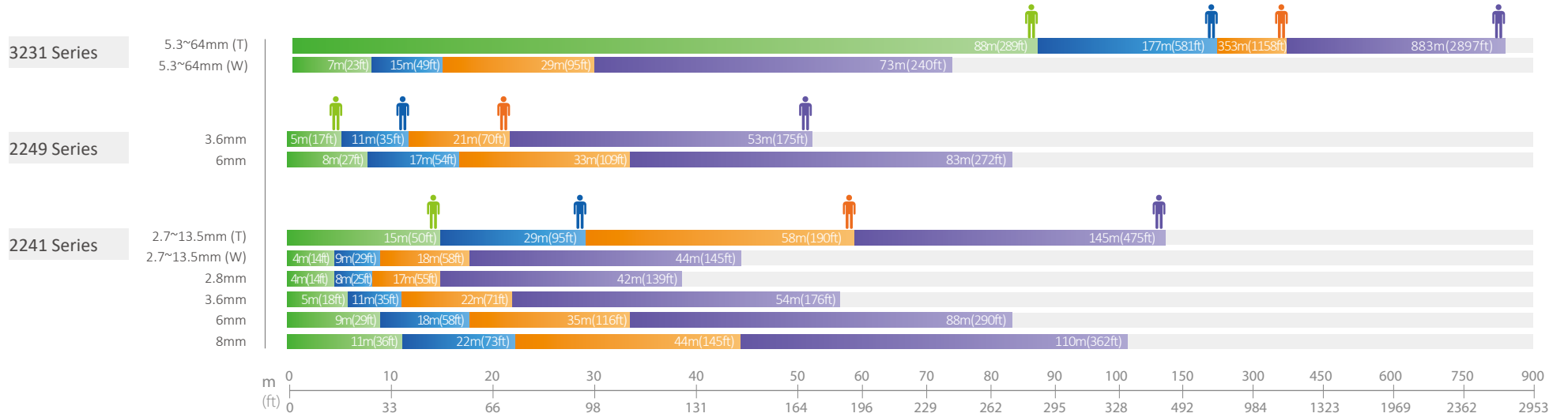

Lite Series

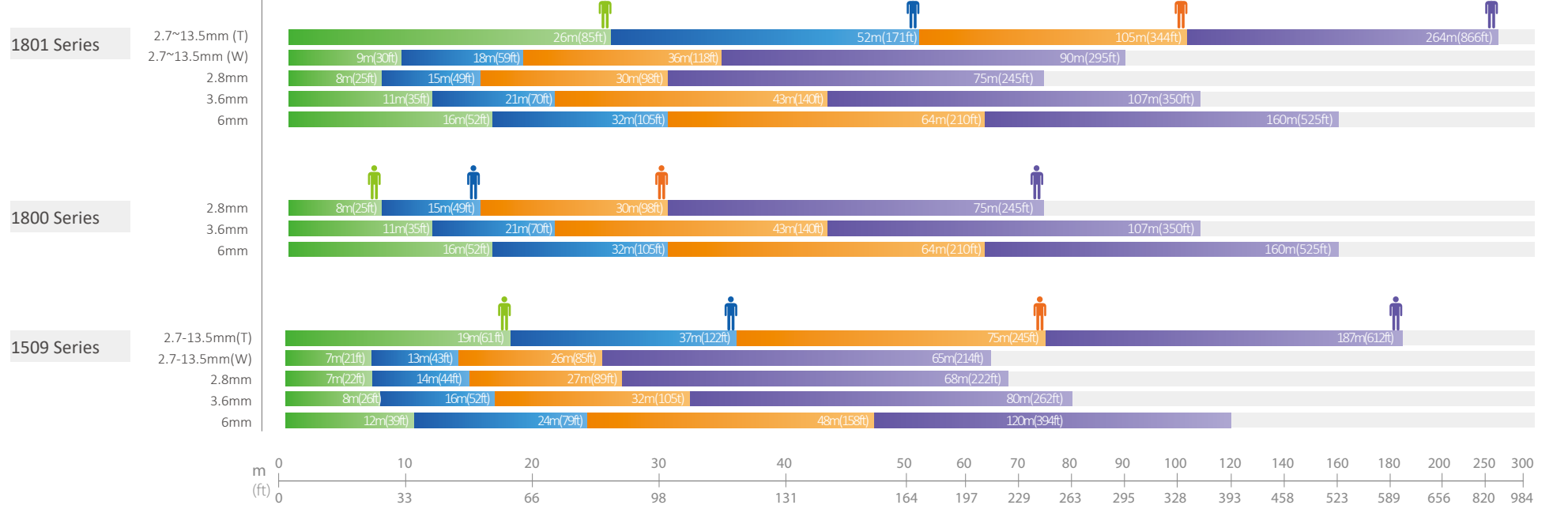

DORI Distance (D/O/R/I)

Lite Series

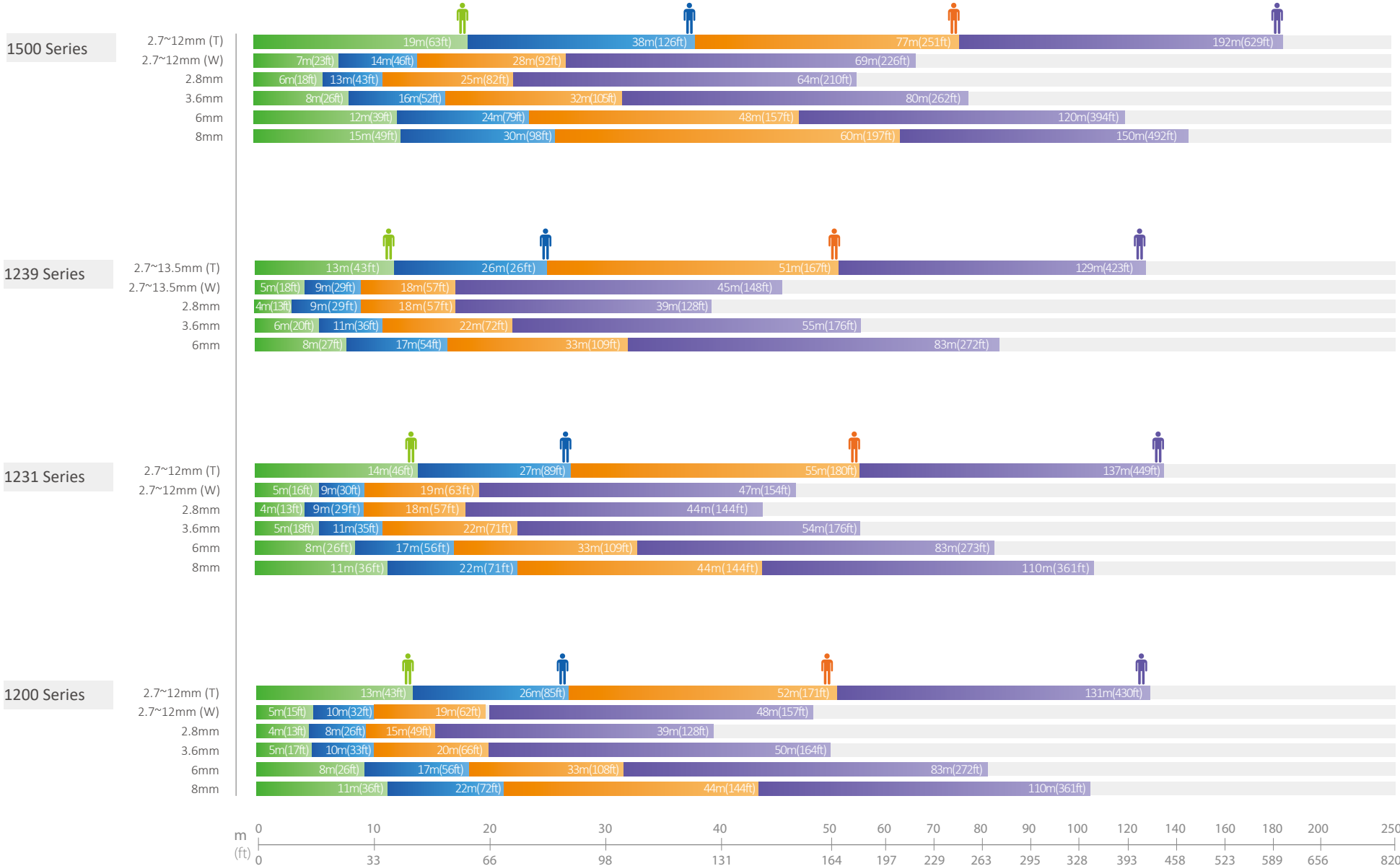

DORI Distance (D/O/R/I)

Cooper Series

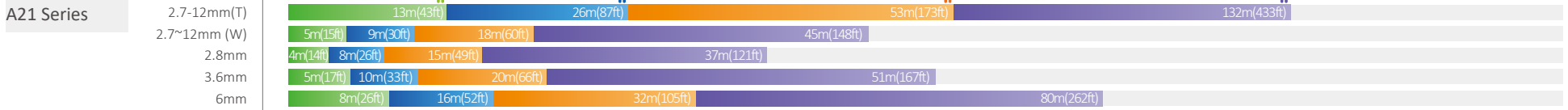
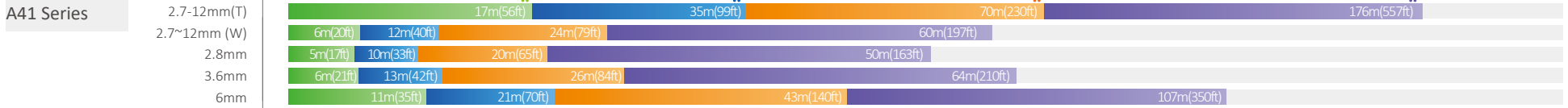

Panorama Series

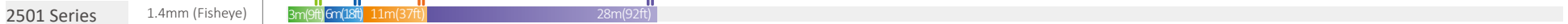

DORI Distance (D/O/R/I)

HDCVI PTZ CAMERA

Pro Series

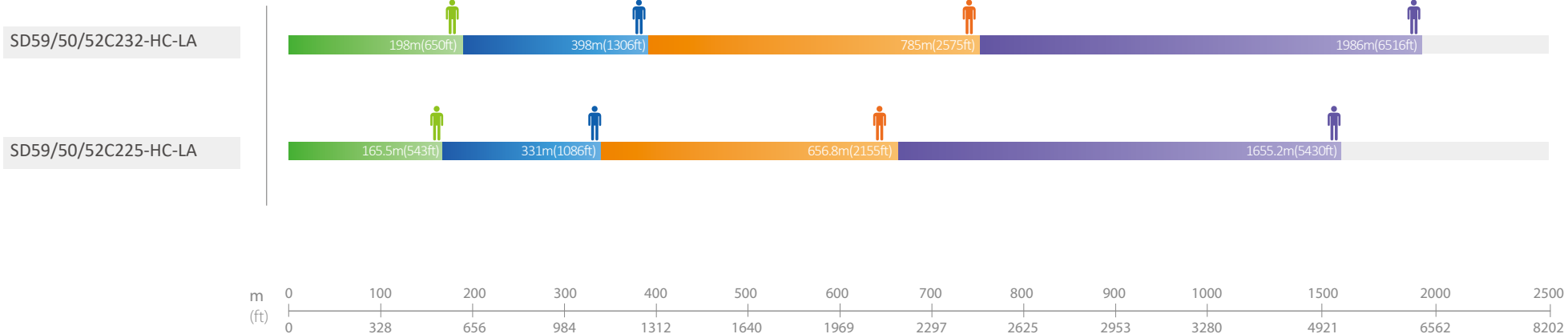

Lite Series

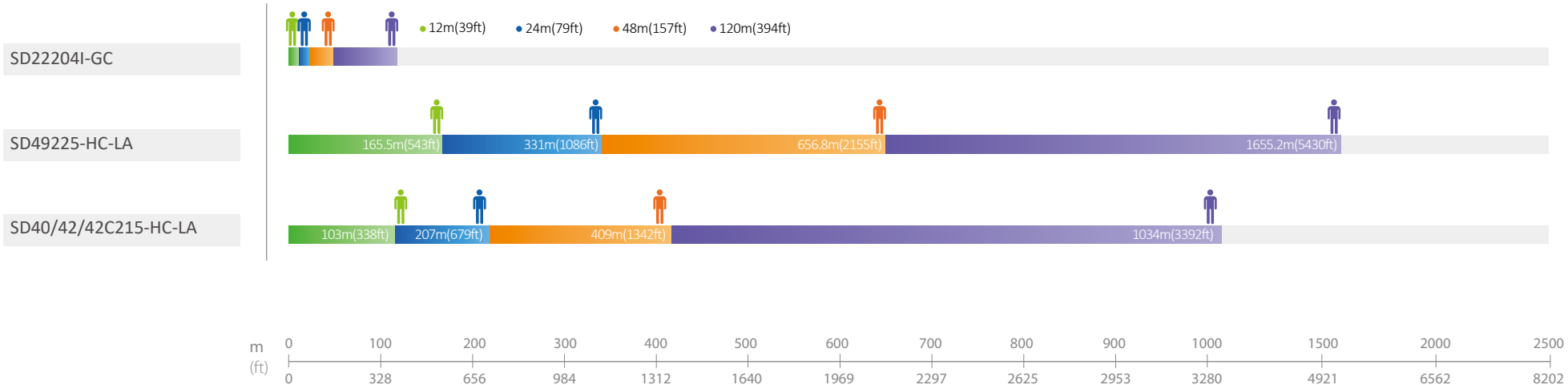

ENABLING A SAFER SOCIETY AND SMARTER LIVING

Dahua CEE & Nordic
Tel: +48 223957400
Email: dh.cen@dahuatech.com

Dahua Technology Poland SP.ZO.O
Tel: +48 223957400
Email: biuro.pl@dahuatech.com

Dahua Technology SRB D.O.O
Tel: +38 1 (11) 4429999
Email: dh.srb@dahuatech.com

Dahua Technology Denmark Aps
Email: Nordic.ne@dahuatech.com

Dahua Technology Hungary LTD
Tel: +36 17899852
Email: sales.hu@dahuatech.com

Dahua Technology Bulgaria EOOD
Tel: +35929950013
Support: support.bg@dahuatech.com

Dahua Technology SRL
Email: marketing.ro@dahuatech.com

Dahua Technology Czech.s.r.o.
Tel: +420 225 986 001
Email: admin.cz@dahuatech.com

Dahua Guvenlik Teknolojileri Sanayi ve Ticaret A.S.
Email: sales.tr@dahuatech.com

Dahua Technology Middle East FZE
Email: info.me@dahuatech.com

Dahua Technology Mexico S.A. DE C.V.
Tel: +52 55 67231936
Email: sales.mx@dahuatech.com
Support: support.mx@dahuatech.com

Dahua Technology Colombia S.A.S.
Tel: +57 6013106176
Email: marketing.co@dahuatech.com
Support: support.co@dahuatech.com

Dahua Technology Perú S.A.C
Tel: +511 500-8555
Email: sales.pe@dahuatech.com
Support: support.pe@dahuatech.com

Dahua Technology Chile SpA
Tel: +56 232705421
Email: sales.cl@dahuatech.com
Support: support.chile@dahuatech.com

Dahua Technology Argentina S.A.
Email: project.ar@dahuatech.com

Dahua Technology Panama S.A.
Email: sales.pa@dahuatech.com
Support: support.pa@dahuatech.com

Dahua Brazil
Tel: +55 11 32511871
Suporte Técnico: suporte.br@dahuatech.com
Vendas: comercial.br@dahuatech.com

Dahua Technology USA Inc.
Tel: +1 (949) 679-7777
Email: sales.usa@dahuatech.com
Support: support.usa@dahuatech.com

Dahua Technology Canada
Tel: +1 877-606-1590
Email: sales.usa@dahuatech.com
Support: support.usa@dahuatech.com

Dahua Europe BV
Tel: +31 (0) 85-0715700
Email: sales.benelux@dahuatech.com
Support: support.benelux@dahuatech.com

Dahua Iberia, S.L.
Tel: +34 917649862
Email: sales.iberia@dahuatech.com
Support: support.iberia@dahuatech.com

Dahua Technology Italy s.r.l.
Tel: +39 02 99912900
Email: info.italy@dahuatech.com
Support: support.italy@dahuatech.com

Dahua Technology GmbH
Tel: +49 211 2054 4120
Email: sales.de@dahuatech.com
Support: support.de@dahuatech.com

Dahua Technology France
Tel: +33 (0) 1 48 53 70 53
Email: sales.france@dahuatech.com
Support: support.france@dahuatech.com

Dahua Singapore
Tel: +65 65380952
Email: sales.sg@dahuatech.com

Dahua Malaysia
Tel: +60376620732
Email: sales.my@dahuatech.com

Dahua Indonesia
Tel: +6227893330
Email: sales.id@dahuatech.com
Support: support.id@dahuatech.com

Dahua Australia
Tel: +61 290306000
Email: sales.oc@dahuatech.com

Dahua New Zealand
Tel: +64 09 2823467
Technical Hotline: 0800 854 857
Email: Dahua_NZ@dahuatech.com

Dahua Philippines
Email: Dahua_Philippines@dahuatech.com

Dahua Russia (Dahua Technology Rus LLC.)
Tel: 8 (800) 707-67-66
Email: info.ru@dahuatech.com

Dahua Kazakhstan (Dahua Technology Kazakhstan LLP)
Tel: +7 727 3110838
Email: sales.kz@dahuatech.com

Dahua Uzbekistan (OOO "Dahua Vision")
Tel: +998 781488666

Dahua Technology Ukraine Office
Tel: +380674011526
Email: dahua.ukraine@dahuatech.com

Dahua Technology UK Limited
Tel: +44 (0) 1628 613 500
Email: sales.uk@dahuatech.com
Support: support.uk@dahuatech.com

Dahua Technology South Africa (Pty) Ltd | Head Office
Office Line: +27 10 593 3242
WhatsApp Business Help-Line: +27 84 072 9260
Toll-Free Help-Line: 080 099 0064
Email: sales.za@dahuatech.com
Support: support.za@dahuatech.com

Dahua Technology Nigeria Representative Ltd.
Email: Westafrica@dahuatech.com

Dahua Thailand
Tel: +66 2541 5188
Email: info.th@dahuatech.com

Dahua Republic of Korea
Tel: +82-2-6486-8889
Email: sales.kr@dahuatech.com

Dahua Vietnam
Tel: +84 24 3202 6616
Email: DH_VIET@dahuatech.com

Dahua Technology Japan
Tel: +81-3-6661-6818
Fax: +81-3-6661-6857
Email: Dahua_Japan@dahuatech.com

Dahua Technology India Private Limited
Tel: +91 124 4569100
Email: sales.india@dahuatech.com

*Design and specifications are subject to change without notice.

Ver. 1, Jun. 2022

DAHUA TECHNOLOGY

Add: No.1199 Bin'an Road, Binjiang District, Hangzhou, China. 310053
Email: overseas@dahuatech.com
Website: www.dahuasecurity.com



YouTube



LinkedIn



Partner App



Website