



SURGICAL

instruments



PANTHER
S U R G I C A L

MANUFACTURERS
EXPORTERS

panthersurgical@gmail.com

www.panthersurgical.com



Company Profile :

Company Name : **Panther Surgical**

Establishment : **2009**

Business : **Manufacturers-Exporters of Surgical, Dental, Beauty Instruments & all Sort of Scissors**

Persons To Be Contacted: **Susan Phillips**
Director

Kashif Bajwa
Exports Director

Contact:

Manufacturing Office:

P.O Box Kammanwala
Sialkot-51310 Pakistan
E-Mail:info@panthersurgical.com
Web:www.panthersurgical.com

London Office:

27 Lea View House Springfield
London E5 9Dx United Kingdom
Tel:+44 20 33047497
Mob:+44 7473336953
E-mail:panthersurgical@gmail.com
Web:www.panthersurgical.com

CONTENTS:

01 Diagnostics
11 to 16

05 General Instruments
Dressing Forceps
84 to 96

02 General Instruments
Scalpels
17 to 28

06 General Instruments
Retractors
97 to 151

03 General Instruments
Scissors
29 to 50

07 General Instruments
Probes
152 to 156

04 General Instruments
Artery Forceps
51 to 83

08 Vaccination And Puncture
157 to 163

09

Anaesthesia

164 to 169

18

Urology

306 to 315

10

Suture

170 to 184

19

Gynecology

316 to 339

11

Dressing

185 to 190

20

Obstetrics

340 to 343

12

Bone Surgery

191 to 201

21

Otology

344 to 357

13

Bone Surgery

202 to 243

22

Rhinology

358 to 375

14

Cardiovascular Surgery

244 to 266

23

Oral, Maxillo Palate, Tonsils

376 to 390

15

Neurosurgery & Laminectomy

267 to 287

24

Ophthalmology

391 to 409

16

Tracheotomy

288 to 292

25

TC Instruments

410 to 418

17

Intestine

293 to 305

26

Sterilization

419 to 424



Welcome to Panther surgical

About us we have been trading and manufacturing surgical, dental & beauty instruments since 2009 internationally. The manufacturing is based in Sialkot Pakistan we also have an office based in London United Kingdom. We are dedicated to produce high quality surgical stainless steel to all our customers.

The Material we use

Surgical, dental & beauty instruments are specifically manufactured tools to carry out particular procedures. The instruments are made from high quality surgical stainless which is non erosive material and hygienic easy for sterilising. The instruments are strong reliable for the task needed they can withstand corrosion, we also produce non stainable material.

Quality control

Panther Surgical continually monitors quality of all stages manufacturing to ensure highest standard of all our instruments. Our goal is to produce superior product that is reliable and meet our customer specifications. We have a number of strict checks after each manufacturing process, once passed only then it will proceed to the next stage of manufacturing. By having this system of strict quality checks in place ensures that the highest standard is always met.

Warranty/ Returns

At Panther Surgical we have a 60 day return policy dated on invoice, the returns including catalogue number must be unused and in original packaging. After 60 days customers will have to cover 50% of the invoice value including shipping costs. All returns have to returned within 120days stated on invoice including catalogue number all must be unused and in original packaging.

DIAGNOSTICS

INSTRUMENTS



Percussion Hammers

Sensibility Instruments, Stethoscopes

Diagnostic Sets

Blood Pressure Manometers, Head Mirrors

Diagnostics - Diagnostik
 Perkussionshämmer
 Percussion Hammers



Buck Telescopic
 01-101-18
 18cm/ 7"



Buck
 01-102-18
 18cm/ 7"



Taylor
 Mod. USA
 01-103-20
 20cm/ 8"



Dejerine
 01-104-20
 20cm/ 8"



Dejerine
 01-105-21
 21cm/ 8 1/4"

Diagnostics - Diagnostik
Perkussionshämmer
Percussion Hammers



Babinsky
Metal Handle
01-106-24
24cm/ 9½"



Babinsky
Plastic Handle
01-107-22
22cm/ 8¾"



Vernon
01-108-28
28cm/ 11"



National Hospital Patt
Plastic Handle
01-109-33
33cm/ 13"



Queen Telescopic
01-110-25



Diagnostics - Diagnostik
Sensibilitäts-Instrumente, Stethoskope
Sensitivity Instruments, Stethoscopes



Pinard Aluminium
01-111-15
15cm/ 6"



Pinard Plastic
In Different Colours
01-112-14
14cm/ 5½"



Wartenberg
01-113-19
19cm/ 7½"



Aluminium anodized
extra lightweight

Duplex
01-114-00

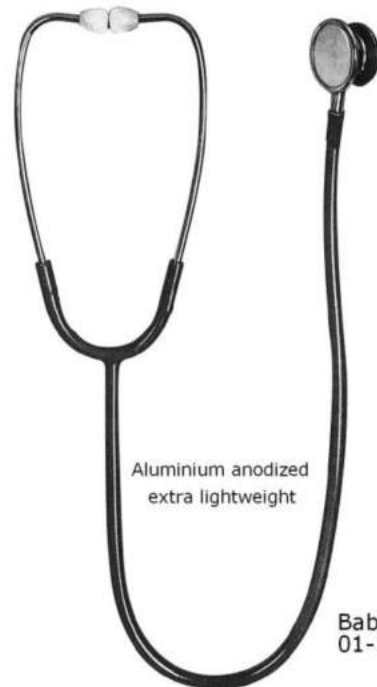

Aluminium anodized
extra lightweight

Baby-Duplex
01-115-00



Diagnostics - Diagnostik
Diagnostik-Bestecke
Diagnostic Sets

Otoscope
01-116-01



01-116-01

Otoscope Set, Consisting of battery handle
(without batteries), 3 ear specula, 1 bulb, in velvet lined case.

Diagnostic Set
01-117-01



01-117-01

Diagnostic-Set in case,
including:
Otoscope with three specula, nasal speculum,
lamp holder, two laryngeal mirrors, tongue
blade holder, One ophthalmoscope, Pin-con-
tract- battery handle, one spare bulb for
otoscope and lamp holder.

Diagnostics - Diagnostik
Blutdruckmeßapparate, Stirnspiegel
Blood Pressure Manometers, Head Mirrors



01-118-00

Mercury Blood Pressure Manometer
in case with mercury tube 300 mm,
with velcro cuff



01-119-00

Blood Pressure Manometer, in pouch,
calibrated with velcro cuff



01-120-09

Ziegler Head Mirror, complete with coloured
head band, socket-joint, 90 mmØ,
without protecting cover

GENERAL INSTRUMENTS

SCALPELS



Dissecting Knives

Autopsy Knives, Cartilage Knives

Razor Blade Holder & Breakers

Scalpels Handles

Operating Knives, Amputating Knives

Scalpel Blades

Razors, Dermatomens

Allgemeines Instrumentarium
Anatomische Skalpelle
Dissecting Knives

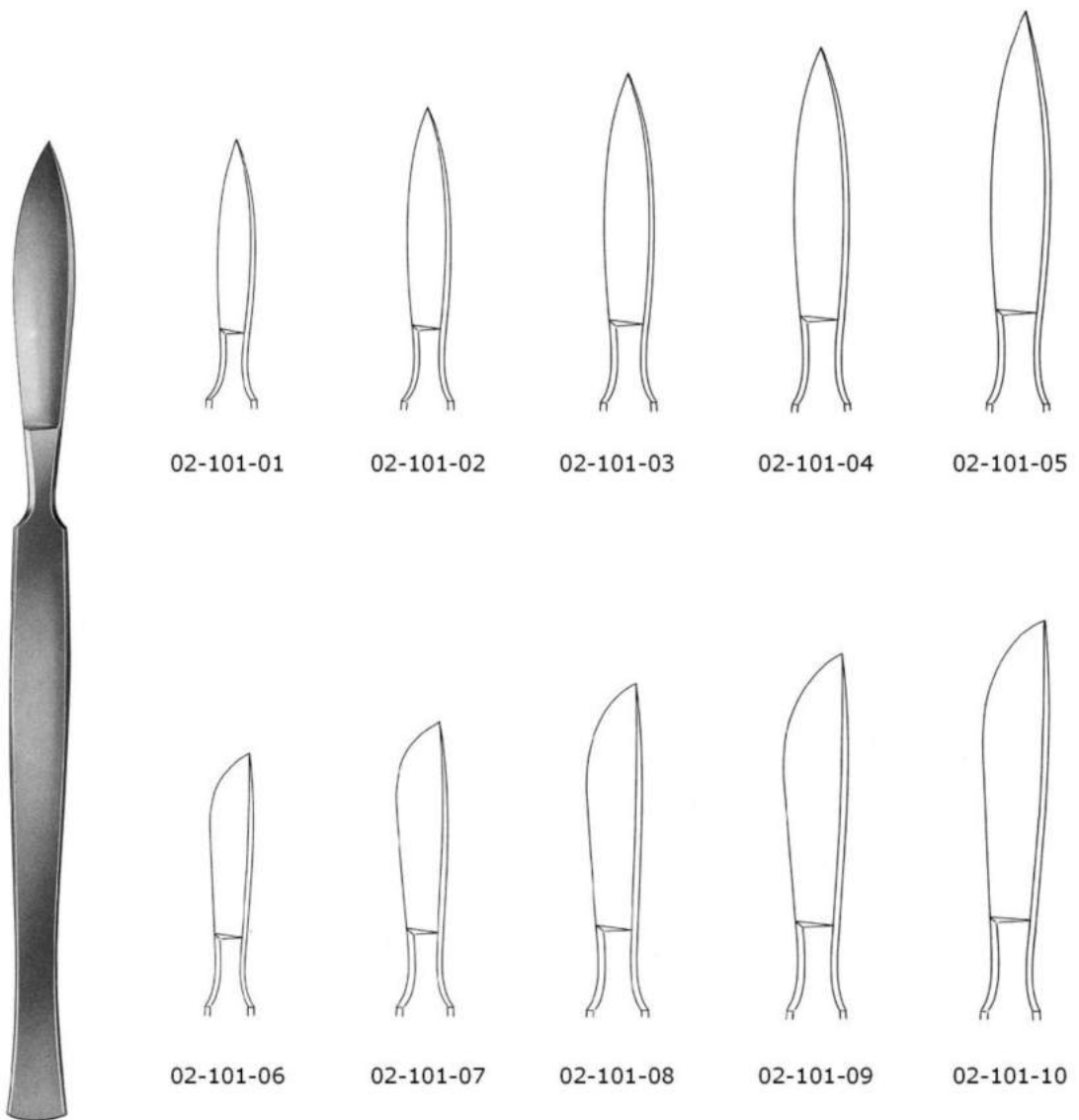

Dissecting Knives
02-101-01 - 02-101-10
Stainless Steel

General Instruments
Seziermesser, Knorpelmesser
Autopsy Knives, Cartilage Knives



Virchow	Blade Size
02-102-16	16cm/ 6 1/4"
02-102-20	20cm/ 8"
02-102-24	24cm/ 9 1/2"

Brain Knives,
with metal handles



Walb	Blade Size
02-103-11	11cm/ 4 1/2"
02-103-14	14cm/ 5 1/2"
02-103-17	17cm/ 6 3/4"

Postmortem Knives
with wooden handles



Virchow
02-104-20
20cm/ 8"



02-105-25
25.5cm/ 10"

Allgemeines Instrumentarium
Rasierklingenhalter und-brecher
Razor Blade Holders and Breakers



Troutman-Chris
02-106-10
Ø5.5mm
10cm/ 4"



Troutman-Chris
02-107-10
Ø5.5mm
10cm/ 4"



02-108-11
11cm/ 4 1/4"



Castroviejo
02-109-13
Ø8mm
13cm/ 5 1/4"

General Instruments
Skalpelli-Griffe
Scalpel Handles



02-110-04
No. 4
solid



02-111-34
No. 3 & 4
solid



02-112-04
No. 4L
solid angled



02-113-04
No. 4L
solid straight

Allgemeines Instrumentarium
Skalpell-Griffe
Scalpel Handles



02-114-04
plastic



Collin
02-115-08
No. 8
hollow



Collin
02-116-09
No. 9
hollow

General Instruments
Skalpell-Griffe
Scalpel Handles



02-117-03
No. 3
solid



02-118-03
No. 3
solid



02-119-03
No. 3L
solid angled



02-120-03
No. 3L
solid straight

Allgemeines Instrumentarium
Skalpell-Griffe
Scalpel Handles



02-121-03
No. 3
solid angled



02-122-03
No. 3
solid straight



02-123-71
No. 7K
solid



02-124-07
No. 7
solid



02-125-03
No. 3
hollow

General Instruments - Allgemeines Instrun
 Operations-Skalpelle, Amputationsmesser
 Operating Knives, Amputating Knives



02-130-01
solid



Collin
02-131-13
02-131-28



Catlin
02-132-16
02-132-22



Liston
02-133-17



Langenbeck
02-134-12

Lengths of Blades		Collin	Catlin	Liston	Langenbeck
cm	in.				
9.5	3 $\frac{3}{4}$				
11.0	4 $\frac{1}{2}$				
12.0	4 $\frac{3}{4}$				02-134-12
13.0	5	02-131-13			
16.0	6 $\frac{1}{4}$	02-131-16	02-132-16		
17.0	6 $\frac{3}{4}$			02-133-17	
19.0	7 $\frac{1}{2}$	02-131-19	02-132-19		
22.0	8 $\frac{3}{4}$	02-131-22	02-132-22		
28.0	11 $\frac{1}{4}$	02-131-28			

Allgemeines Instrumentarium
Skalpell-Klingen
Scalpel Blades

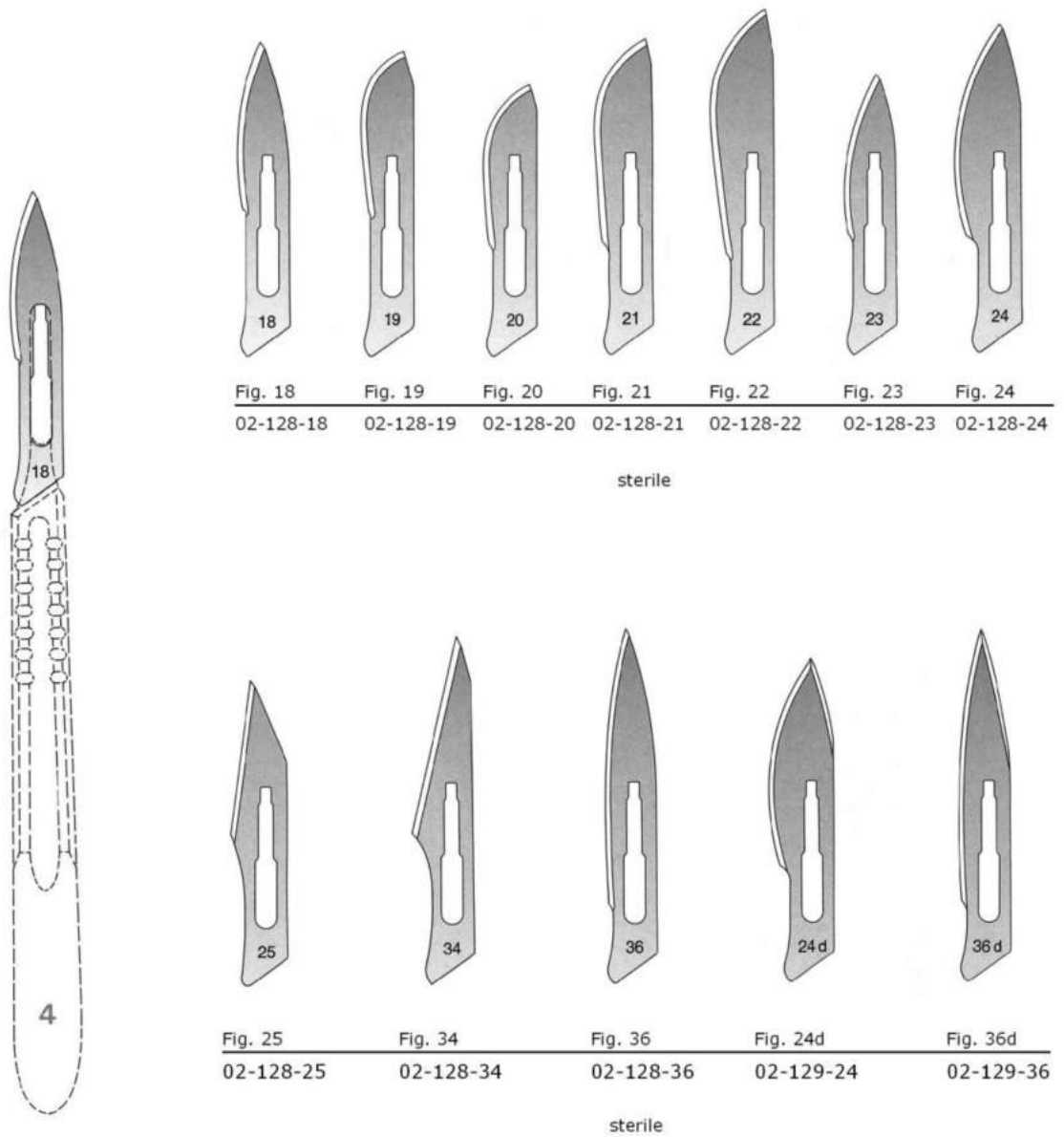

General Instruments - Allgemeines Instrun
Operations-Skalpelle, Amputationsmesser
Operating Knives, Amputating Knives



02-130-01
solid



Collin
02-131-13
02-131-28



Catlin
02-132-16
02-132-22



Liston
02-133-17



Langenbeck
02-134-12

Lengths of Blades		Collin	Catlin	Liston	Langenbeck
cm	in.				
9.5	3 $\frac{3}{4}$				
11.0	4 $\frac{1}{2}$				
12.0	4 $\frac{3}{4}$				02-134-12
13.0	5	02-131-13			
16.0	6 $\frac{1}{4}$	02-131-16	02-132-16		
17.0	6 $\frac{3}{4}$			02-133-17	
19.0	7 $\frac{1}{2}$	02-131-19	02-132-19		
22.0	8 $\frac{1}{2}$	02-131-22	02-132-22		
28.0	11 $\frac{1}{4}$	02-131-28			

Allgemeines Instrumentarium
Rasiermesser, Dermatome
Razors, Dermatomes



Langenbeck
02-135-05
18cm/ 7"
5.5cm/ 2 1/4" Blade

Langenbeck
02-136-05
18cm/ 7"
5.5cm/ 2 1/4" Blade

02-137-00
Handle Metal/Plastic
Both sides Hollow

02-138-00
Handle Metal/Plastic
One side Hollow



Schink
02-139-30
30cm/ 12"



02-140-01

02-139-30



02-141-02

02-140-01
02-141-02

Dermatome, adjustable from 0,1 to 2,0 mm, compl. with 1 interchangeable blade
Spare blade only
Skin straightening plate only



Silver
02-142-19
19cm/ 7 1/2"

GENERAL INSTRUMENTS

SCISSORS



Operating Scissors

Dissecting Scissors

Gynaecological Scissors

Fine Operating Scissors

Vascular Scissors

Neurosurgical Scissors

Tonsil & Nasal Scissors

Episiotomy Scissors

Umbilical Scissors

Enterotomy & Ligature Scissors

Allgemeines Instrumentarium
 Chirurgische Scheren
 Operating Scissors



03-101-14
14cm/ 5½"



03-102-14
14cm/ 5½"

- Standard
- 03-101-11 11cm/ 4½"
 - 03-101-13 13cm/ 5"
 - 03-101-14 14cm/ 5½"
 - 03-101-15 15cm/ 6"
 - 03-101-18 18cm/ 7"
 - 03-101-20 20cm/ 8"

- Standard
- 03-102-11 11cm/ 4½"
 - 03-102-13 13cm/ 5"
 - 03-102-14 14cm/ 5½"
 - 03-102-15 15cm/ 6"
 - 03-102-18 18cm/ 7"
 - 03-102-20 20cm/ 8"

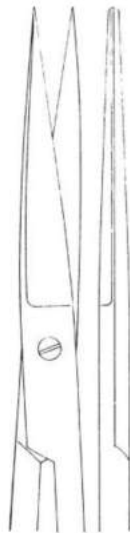

03-103-14
14cm/ 5½"

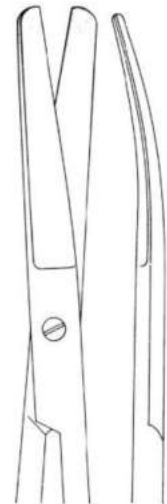

03-104-14
14cm/ 5½"

- Standard
- 03-103-11 11cm/ 4½"
 - 03-103-13 13cm/ 5"
 - 03-103-14 14cm/ 5½"
 - 03-103-15 15cm/ 6"
 - 03-103-18 18cm/ 7"
 - 03-103-20 20cm/ 8"

- Standard
- 03-104-11 11cm/ 4½"
 - 03-104-13 13cm/ 5"
 - 03-104-14 14cm/ 5½"
 - 03-104-15 15cm/ 6"
 - 03-104-18 18cm/ 7"
 - 03-104-20 20cm/ 8"

General Instruments
Chirurgische Scheren
Operating Scissors

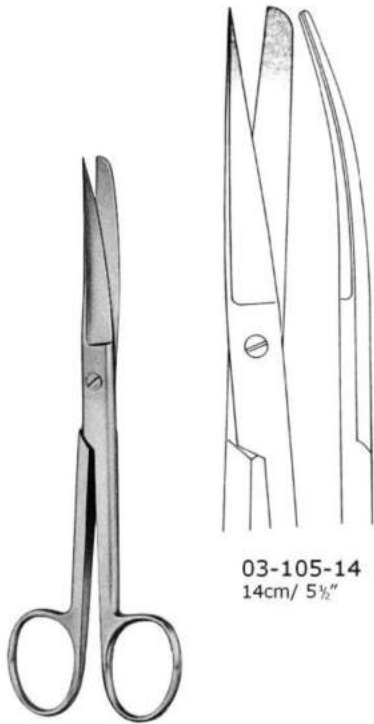

03-105-14
14cm/ 5½"

Standard

- 03-105-11 11cm/ 4½"
- 03-105-13 13cm/ 5"
- 03-105-14 14cm/ 5½"
- 03-105-15 15cm/ 6"
- 03-105-18 18cm/ 7"
- 03-105-20 20cm/ 8"

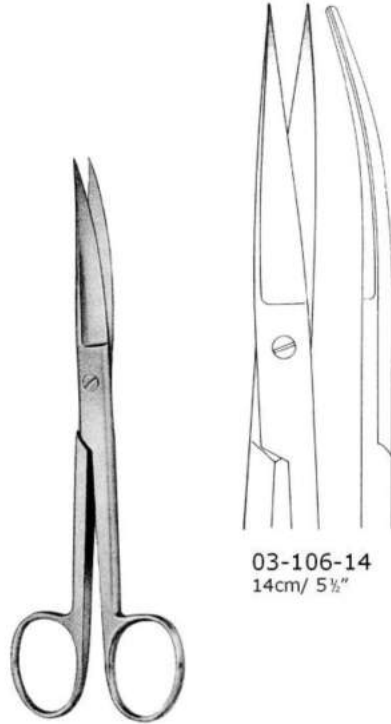

03-106-14
14cm/ 5½"

Standard

- 03-106-11 11cm/ 4½"
- 03-106-13 13cm/ 5"
- 03-106-14 14cm/ 5½"
- 03-106-15 15cm/ 6"
- 03-106-18 18cm/ 7"
- 03-106-20 20cm/ 8"

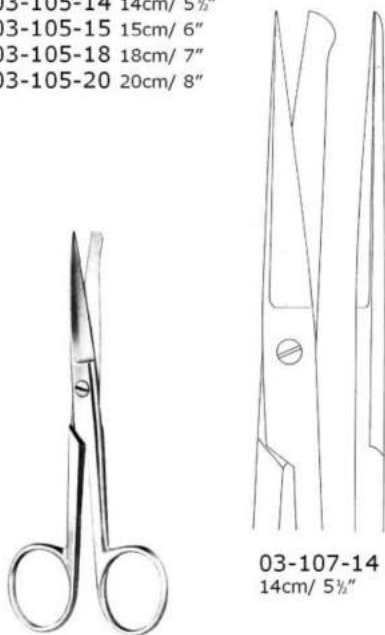

03-107-14
14cm/ 5½"

03-107-14
14cm/ 5½"

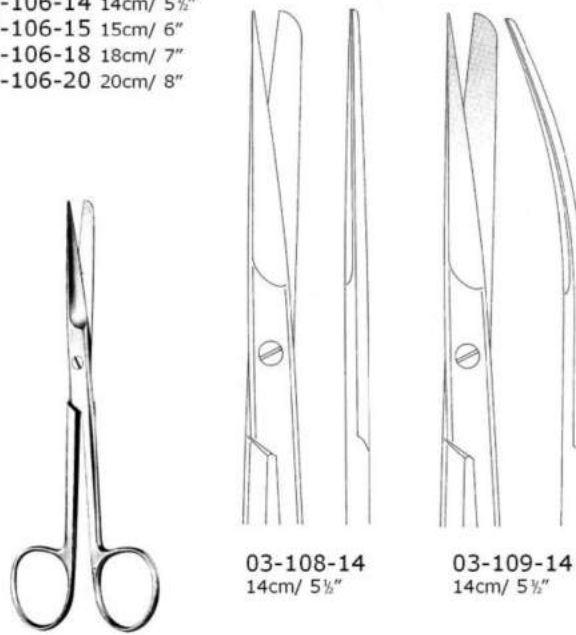

03-108-14
14cm/ 5½"

03-109-14
14cm/ 5½"

Deaver
03-108-14 - 03-109-14

Allgemeines Instrumentarium
Präparierscheren
Dissecting Scissors

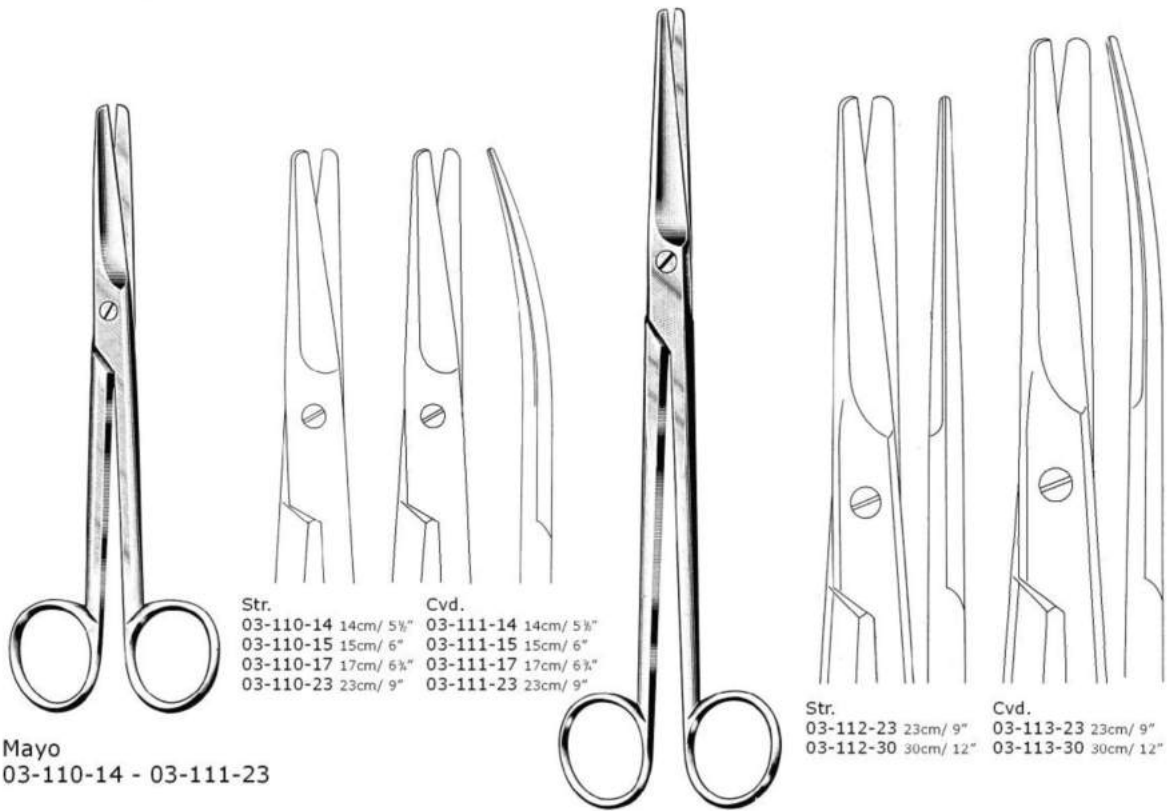

Mayo
03-110-14 - 03-111-23

Str.	03-110-14 14cm/ 5½"	Cvd.	03-111-14 14cm/ 5½"
	03-110-15 15cm/ 6"		03-111-15 15cm/ 6"
	03-110-17 17cm/ 6½"		03-111-17 17cm/ 6½"
	03-110-23 23cm/ 9"		03-111-23 23cm/ 9"

Mayo-Harrington
03-112-23 - 03-113-30

Str.	03-112-23 23cm/ 9"	Cvd.	03-113-23 23cm/ 9"
	03-112-30 30cm/ 12"		03-113-30 30cm/ 12"

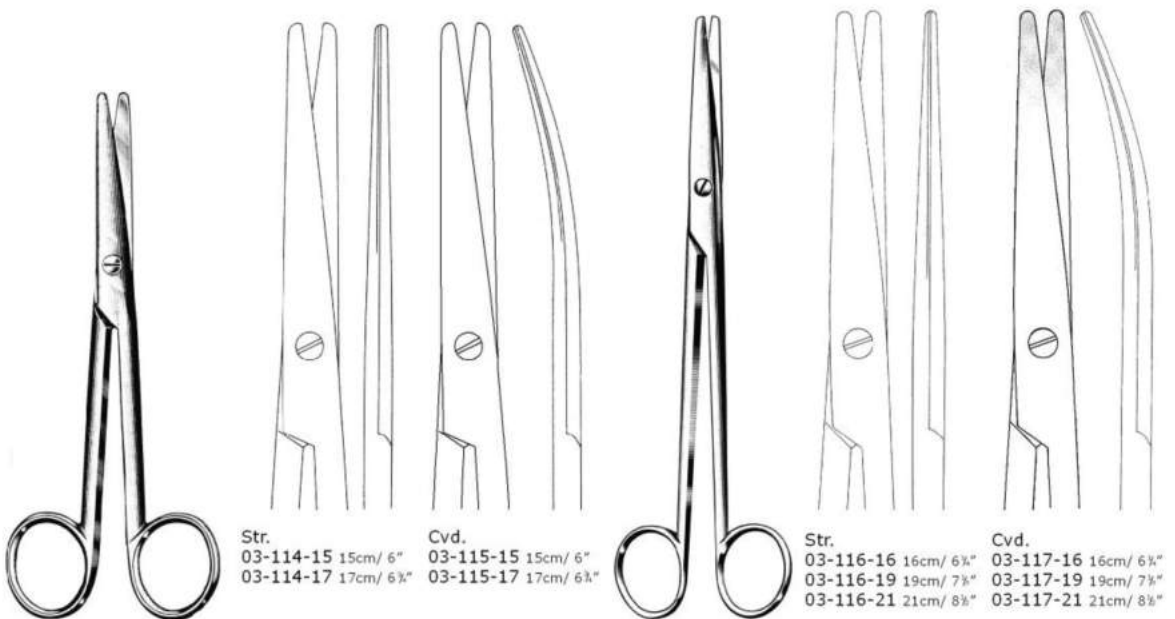

32 Mayo-Stille
03-114-15 - 03-115-17

Str.	03-114-15 15cm/ 6"	Cvd.	03-115-15 15cm/ 6"
	03-114-17 17cm/ 6½"		03-115-17 17cm/ 6½"

Mayo-Stille
03-116-16 - 03-117-21

Str.	03-116-16 16cm/ 6½"	Cvd.	03-117-16 16cm/ 6½"
	03-116-19 19cm/ 7½"		03-117-19 19cm/ 7½"
	03-116-21 21cm/ 8½"		03-117-21 21cm/ 8½"

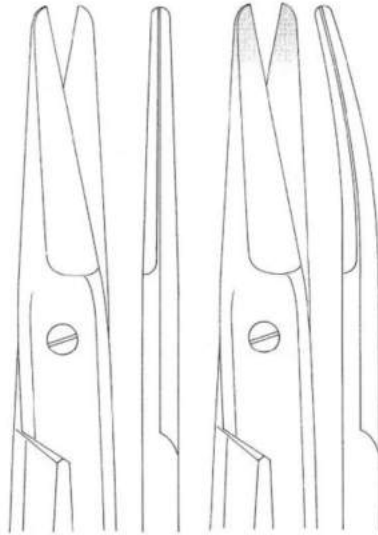

03-118-17

03-119-17

Mayo-Noble
03-118-17 - 03-119-17
17cm/ 6 3/4"

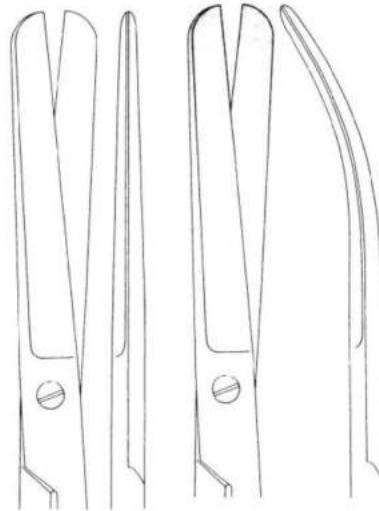
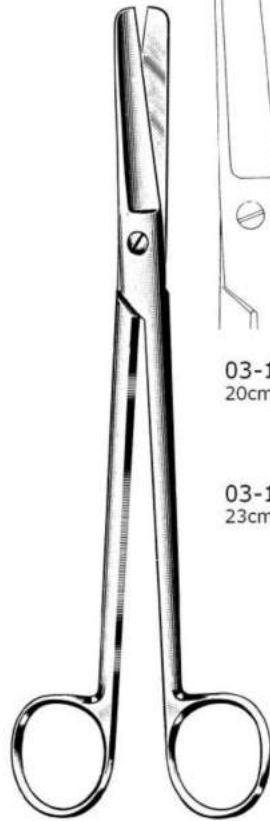

03-120-20
20cm/ 8"

03-121-20
20cm/ 8"

03-120-23
23cm/ 9"

03-121-23
23cm/ 9"

Sims
03-120-20 - 03-121-23

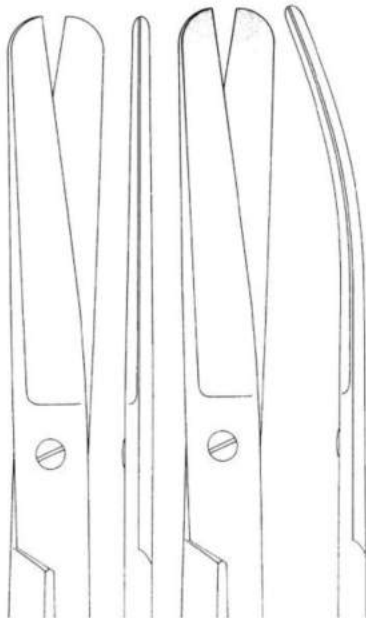
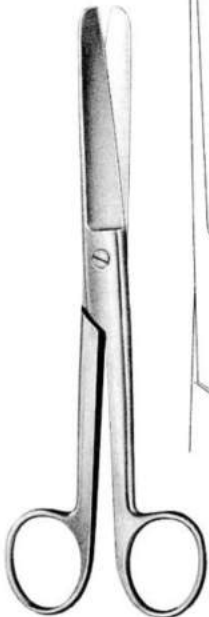

03-122-17
17.5cm/ 7"

03-123-17
17.5cm/ 7"

Doyen
03-122-17 - 03-123-17



Allgemeines Instrumentarium
 Chirurgische Scheren, Präparierscheren
 Operating Scissors, Dissecting Scissors

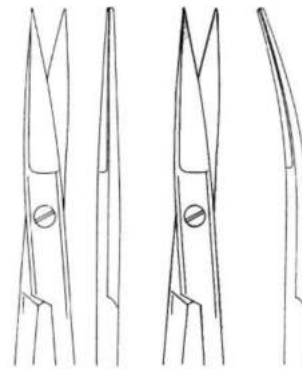

03-124-16 03-125-16

Kelly
 03-124-16 - 03-125-16
 16cm/ 6 1/2"

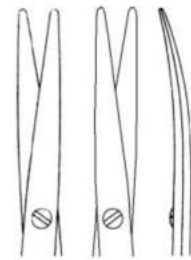
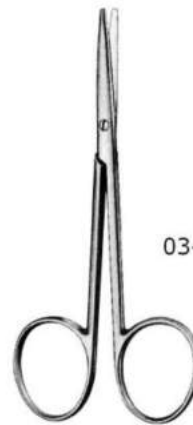

03-126-11 03-127-11

Metzenbaum
 03-126-11 - 03-127-11
 11.5cm/ 4 1/2"

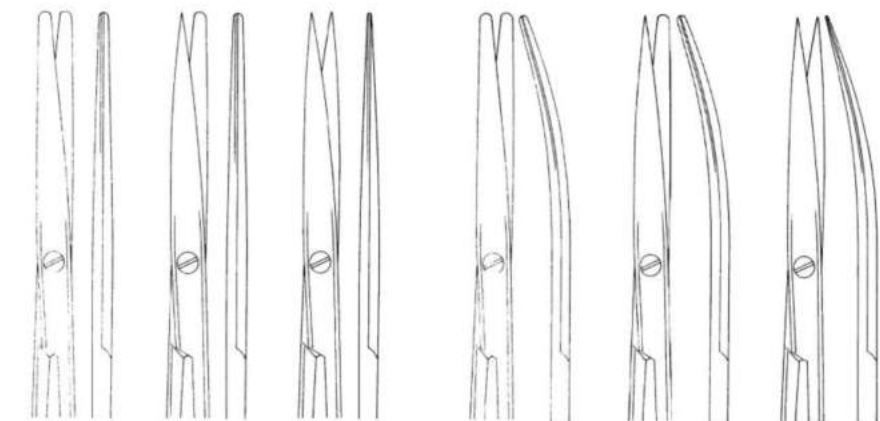
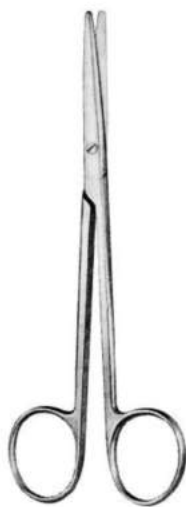

03-128-14 03-129-14 03-130-14 03-131-14 03-132-14 03-133-14

Metzenbaum
 03-128-14 - 03-133-14
 14cm/ 5 1/2"



General Instruments
Präparierscheren
Dissecting Scissors

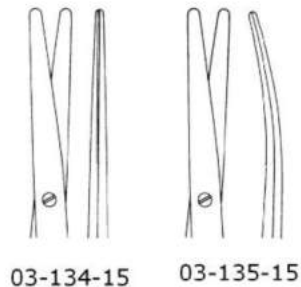

03-134-15

03-135-15

Metzenbaum
03-134-15 - 03-135-15
15cm/ 6"



- 03-136-18 18cm/ 7"
- 03-136-20 20cm/ 8"
- 03-136-23 23cm/ 9"
- 03-136-25 25cm/ 10"
- 03-136-30 30cm/ 12"

Metzenbaum-Nelson
03-136-18 - 03-136-30



- 03-137-18 18cm/ 7"
- 03-137-20 20cm/ 8"
- 03-137-23 23cm/ 9"
- 03-137-25 25cm/ 10"
- 03-137-30 30cm/ 12"

Metzenbaum-Nelson
03-137-18 - 03-137-30

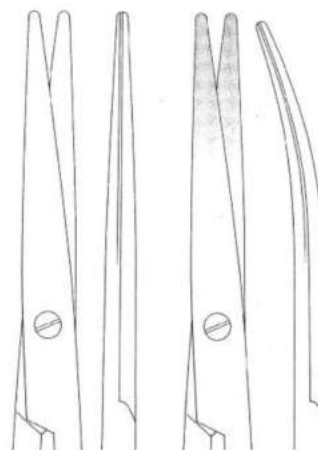

03-138-16

03-139-16

Lexer
03-138-16 - 03-139-16
16cm/ 6 1/2"

Allgemeines Instrumentarium
 Präparierscheren
 Dissecting Scissors



Fomon
 03-140-13
 13.5cm/ 5 1/4"

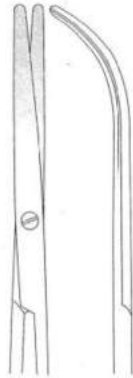

Thorek
 03-141-19
 19cm/ 7 1/2"

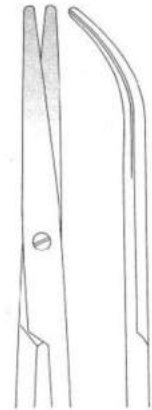

Lexer-Baby
 03-142-10 - 03-143-10
 10cm/ 4"

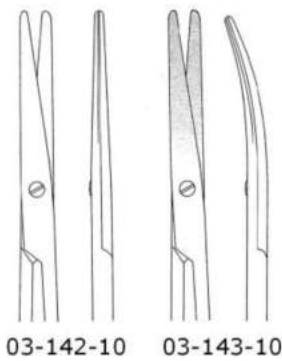

Lexer-Fino
 03-143-16
 16cm/ 6 1/4"

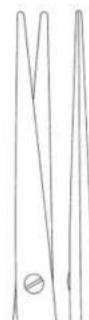



General Instruments
Präparierscheren, Fino-Linie
Dissecting Scissors, Fino Line

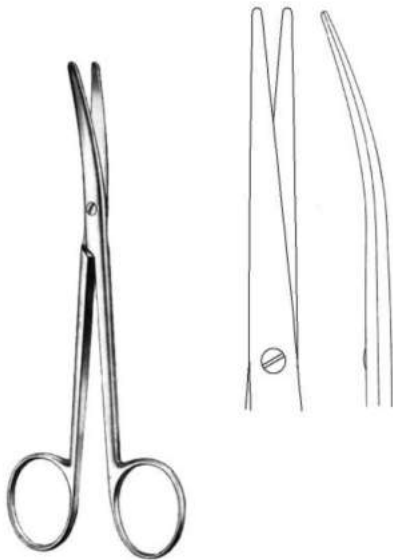

Lexer-Fino
03-144-16
16cm/ 6 1/2"

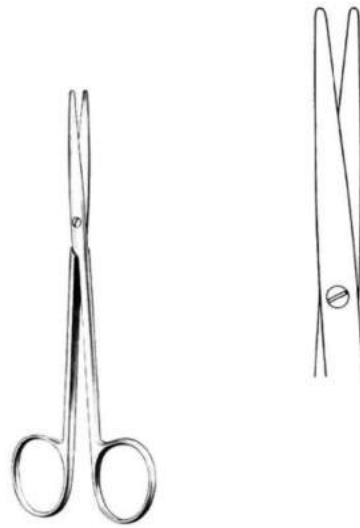

Metzenbaum-Fino
03-145-14
14cm/ 5 1/2"

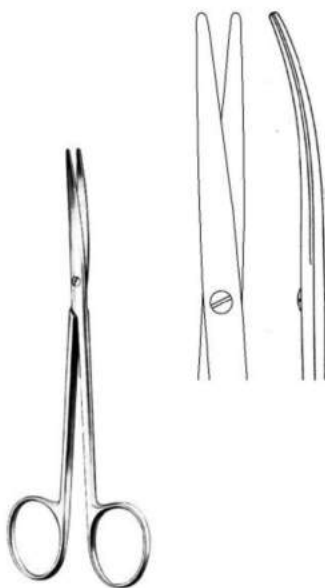

Metzenbaum-Fino
03-146-14
14cm/ 5 1/2"

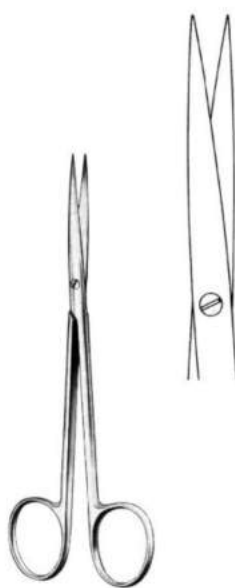

Metzenbaum-Fino
03-147-14
14cm/ 5 1/2"

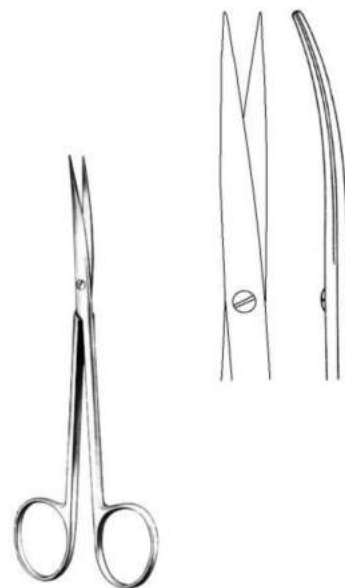

Metzenbaum-Fino
03-148-14
14cm/ 5 1/2"



Allgemeines Instrumentarium
 Präparierscheren, Fino-Linie
 Dissecting Scissors, Fino Line



Metzenbaum-Fino
 03-149-18 18cm/ 7"
 03-149-20 20cm/ 8"
 03-149-23 23cm/ 9"



Metzenbaum-Fino
 03-150-18 18cm/ 7"
 03-150-20 20cm/ 8"
 03-150-23 23cm/ 9"

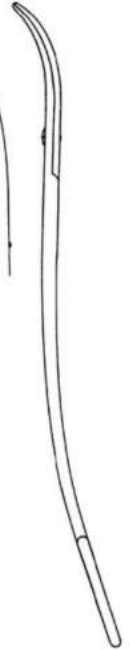

Metzenbaum-Fino
 03-151-18 18cm/ 7"
 03-151-20 20cm/ 8"
 03-151-23 23cm/ 9"



Sanvenero
 03-152-14 - 03-153-14
 14cm/ 5½"

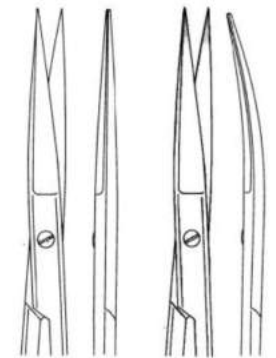

03-152-14 03-153-14



Fine Operating
 03-154-11 - 03-155-11
 11cm/ 4½"

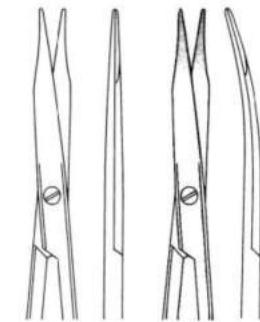

03-154-11 03-155-11

General Instruments
 Feine chirurgische Scheren
 Fine Operating Scissors

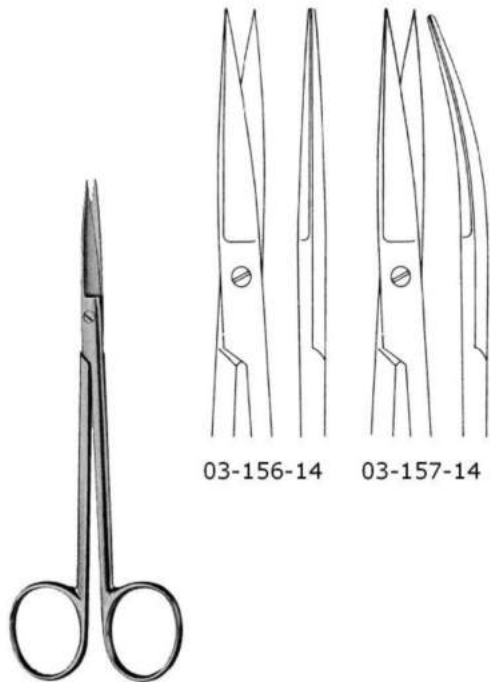

03-156-14 03-157-14

Joseph
 03-156-14 - 03-157-14
 14cm/ 5½"

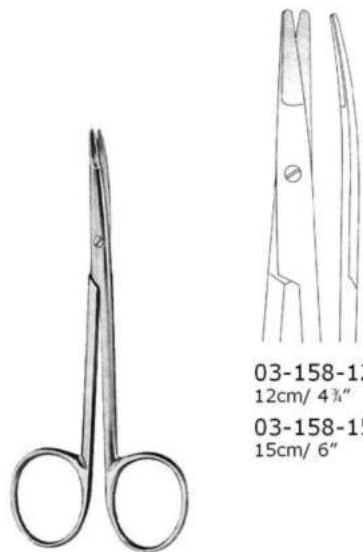

03-158-12
 12cm/ 4¾"
 03-158-15
 15cm/ 6"

Kilner
 03-158-12 - 03-158-15

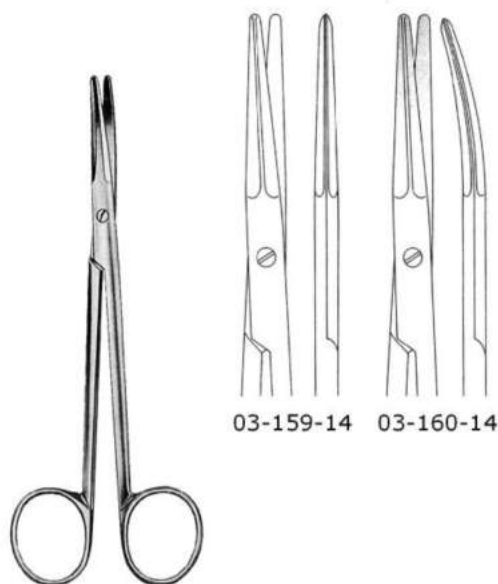

03-159-14 03-160-14

Dissecting
 03-159-14 - 03-160-14
 14cm/ 5½"
 Outside Cutting Edge

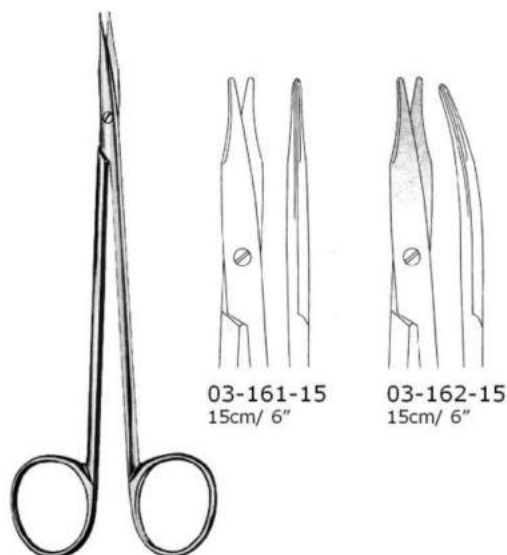

03-161-15 03-162-15
 15cm/ 6" 15cm/ 6"

Reynolds
 03-161-15 - 03-162-15
 15cm/ 6"

Allgemeines Instrumentarium
Gefäßscheren
Vascular Scissors

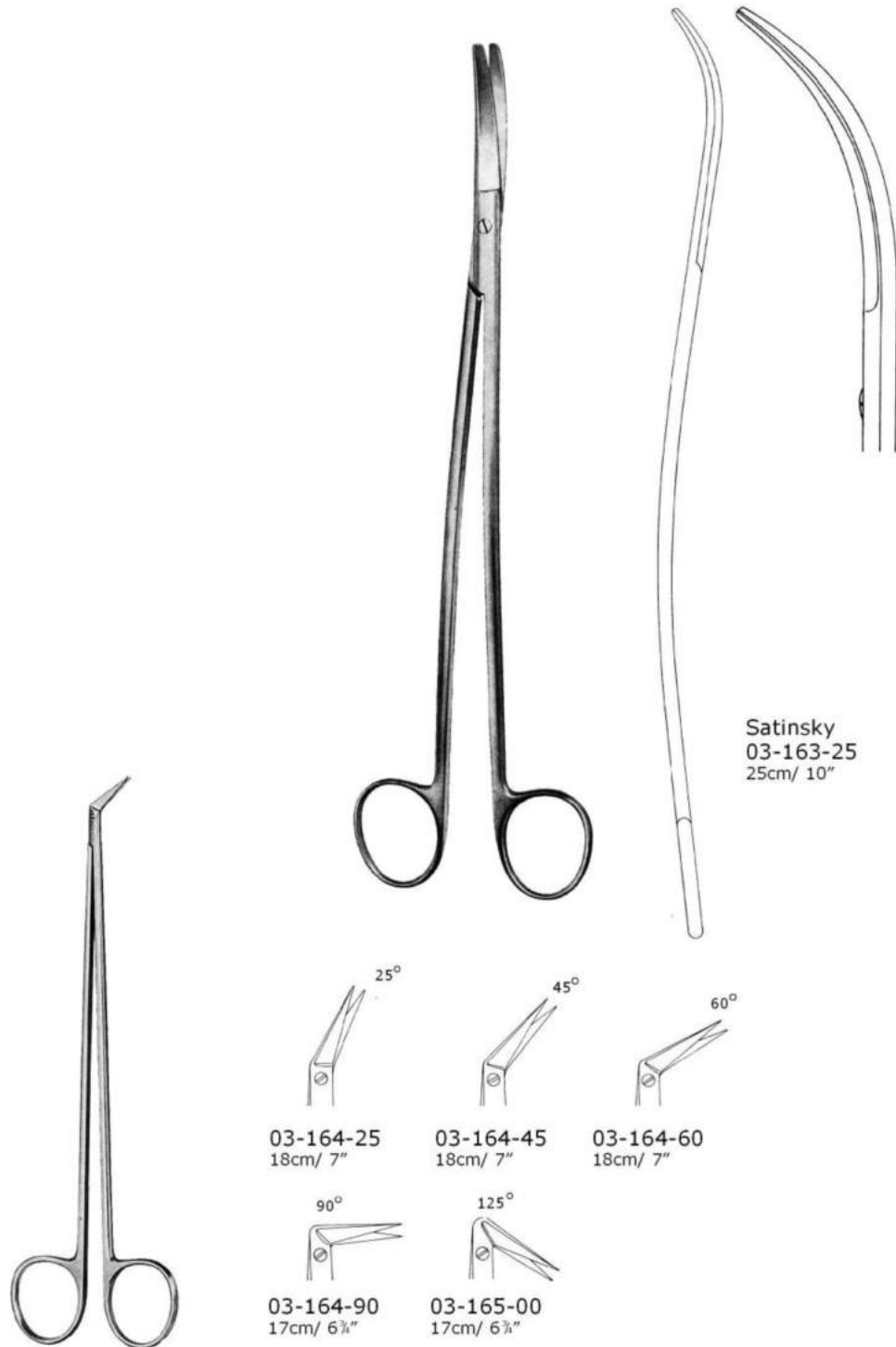

Satinsky
03-163-25
25cm/ 10"

Dietrich
03-164-25 - 03-165-00

03-164-25
18cm/ 7"

03-164-45
18cm/ 7"

03-164-60
18cm/ 7"

03-164-90
17cm/ 6 3/4"

03-165-00
17cm/ 6 3/4"



General Instruments
Gefäßscheren
Vascular Scissors

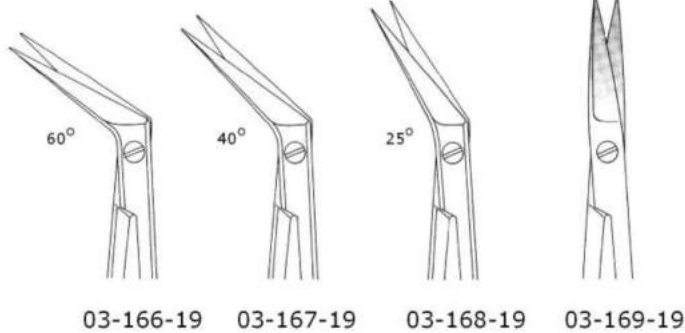

03-166-19 03-167-19 03-168-19 03-169-19

Potts-Smith
03-166-19 - 03-169-19
19cm/ 7½"



Allgemeines Instrumentarium
Scheren für Neurochirurgie
Neurosurgical Scissors



Toennis-Adson
03-170-18
18cm/ 7"

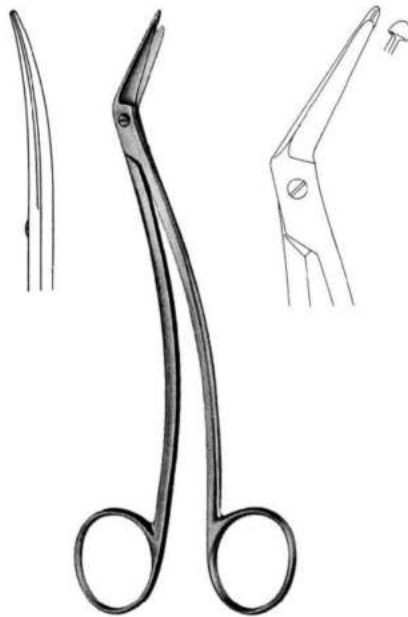

Schmieden-Taylor
03-171-17
17cm/ 6½"

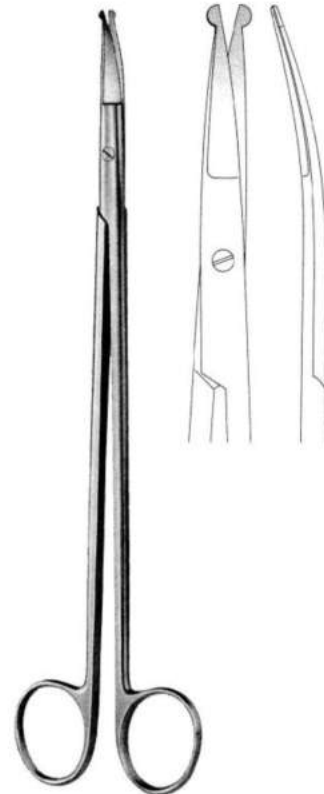

Strully
03-172-22
22cm/ 8½"



Olivecrona
03-173-23
23cm/ 9"

General Instruments
Tonsillen- und Nasenschere
Tonsil and Nasal Scissors



Fomon
03-174-15
15cm/ 6"

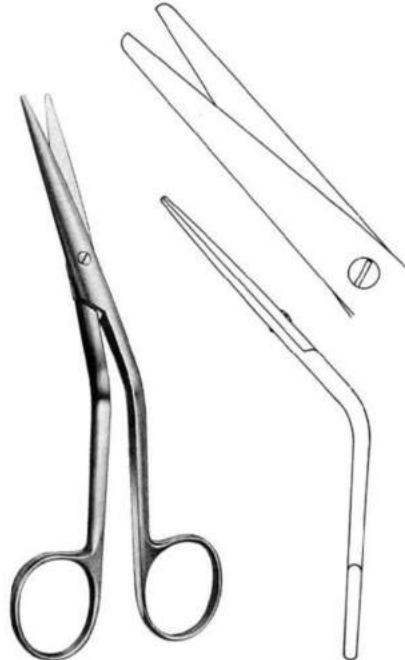

Cottle
03-175-16
16cm/ 6 1/4"

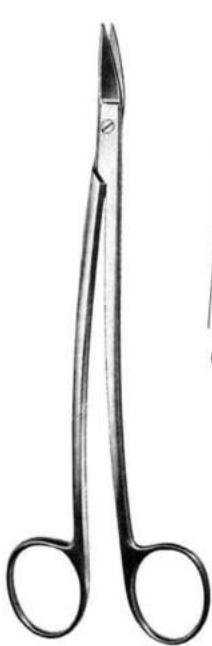

Dean
03-176-17 - 03-177-17
17cm/ 6 3/4"

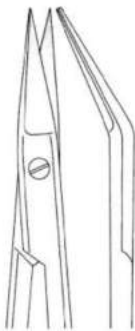

03-176-17

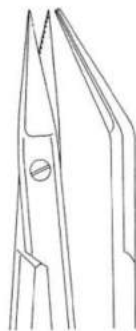

03-177-17
serrated

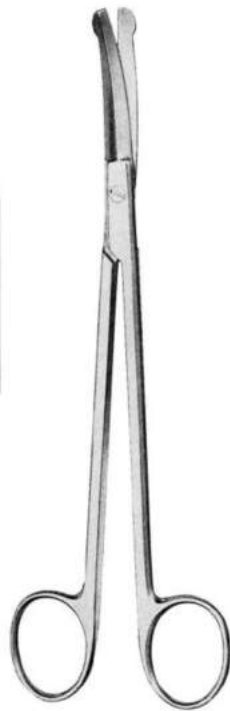

Good
03-178-19
19cm/ 7 1/2"

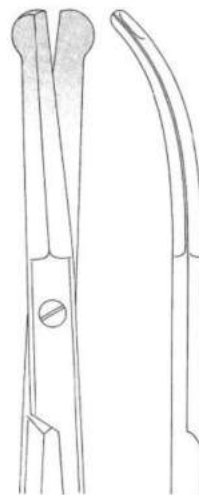



Allgemeines Instrumentarium
Episiotomie-Scheren
Episiotomy Scissors

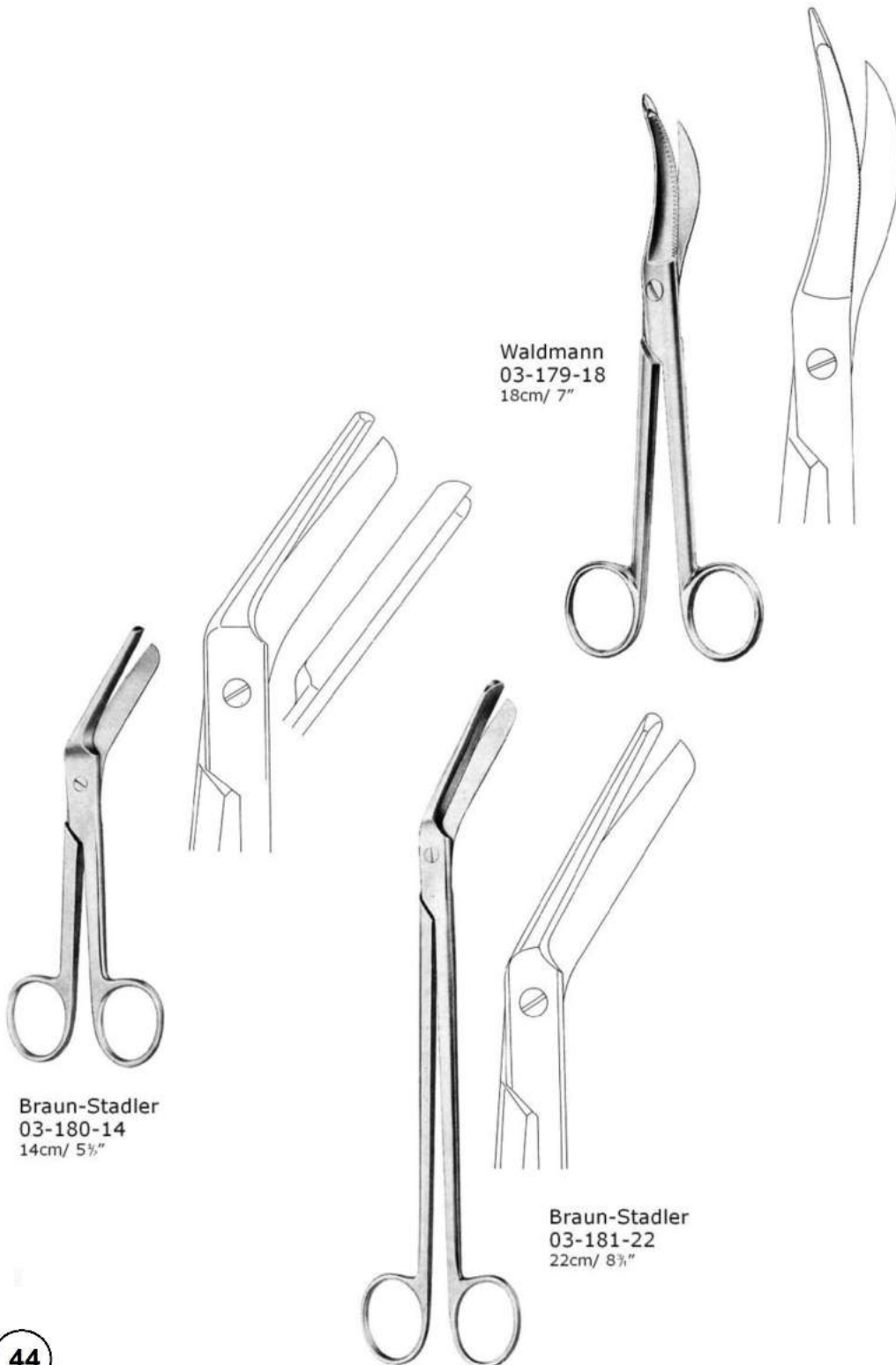

Waldmann
03-179-18
18cm/ 7"

Braun-Stadler
03-180-14
14cm/ 5½"

Braun-Stadler
03-181-22
22cm/ 8¾"



General Instruments ·
Nabelschnur-Scheren
Umbilical Scissors

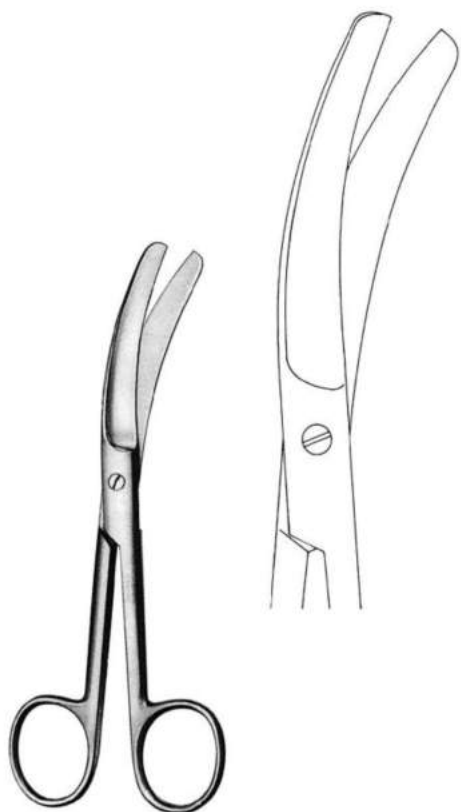

Busch
03-182-16
16cm/ 6 1/4"



Mod. USA
03-184-10
10.5cm/ 4 1/4"

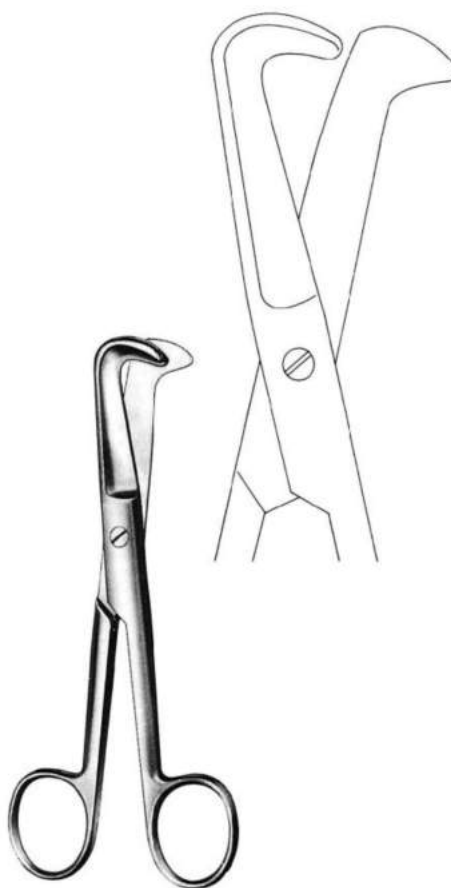

Schuhmacher
03-183-15
15cm/ 6"

Allgemeines Instrumentarium
 Feine chirurgische Scheren
 Fine Operating Scissors

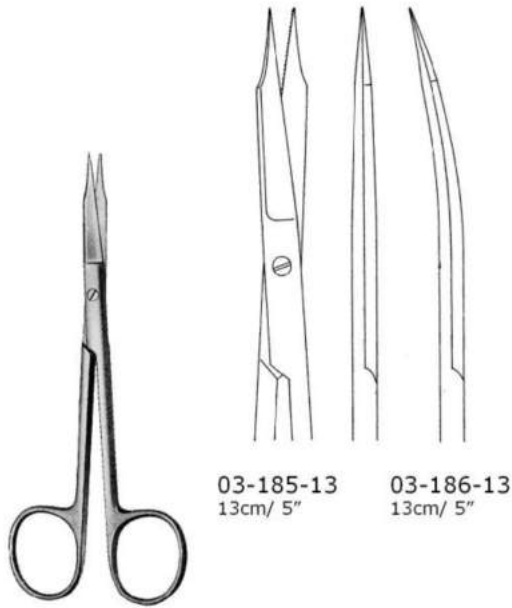

03-185-13
 13cm/ 5"

03-186-13
 13cm/ 5"

03-187-12
 12cm/ 4 1/2"

03-188-12
 12cm/ 4 1/2"

Goldmann-Fox
 03-185-13 - 03-186-13

Wagner
 03-187-12 - 03-188-12

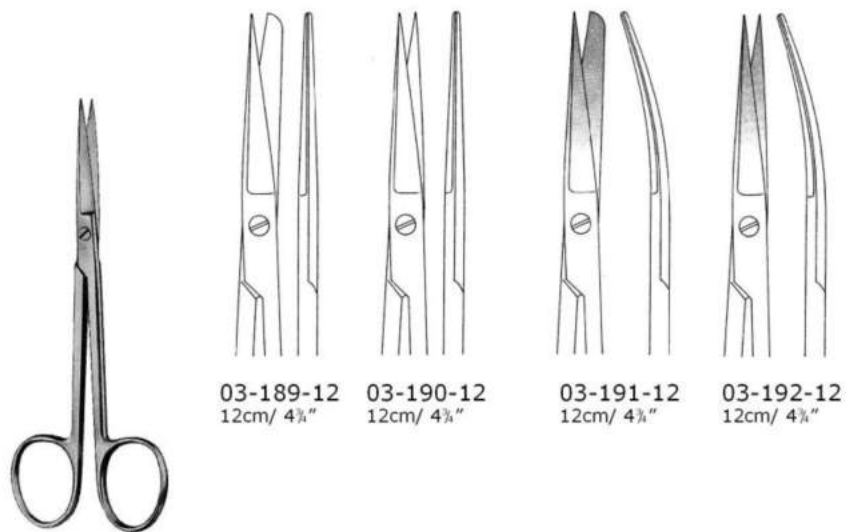

03-189-12
 12cm/ 4 1/2"

03-190-12
 12cm/ 4 1/2"

03-191-12
 12cm/ 4 1/2"

03-192-12
 12cm/ 4 1/2"

Operating
 03-189-12 - 03-192-12

General Instruments - Allge
 Feine chirurgische Scheren
 Fine Operating Scissors

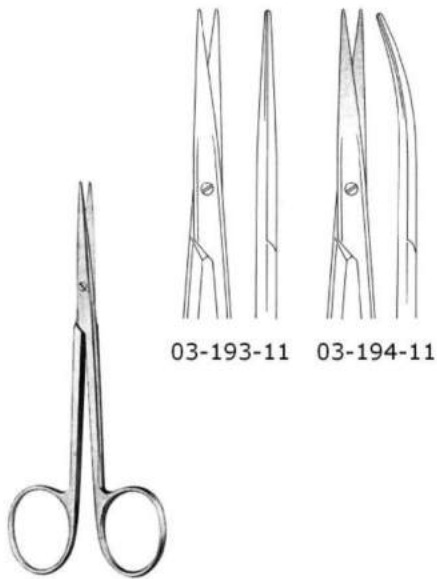

03-193-11 03-194-11

Operating
 03-193-11 - 03-194-11
 11.5cm/ 4½"

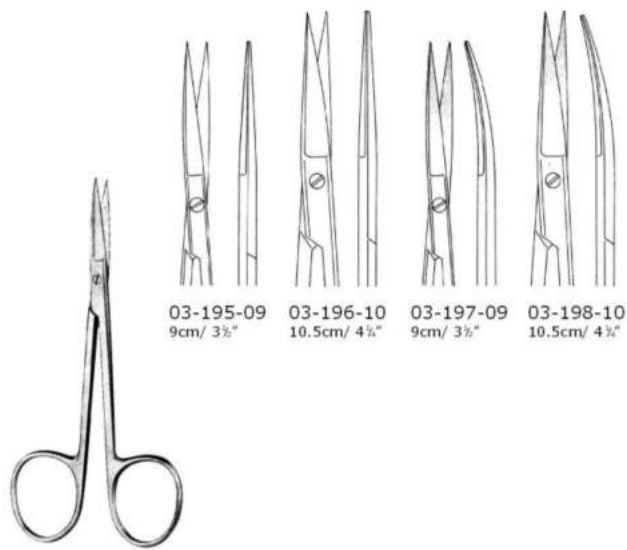

03-195-09 03-196-10 03-197-09 03-198-10
 9cm/ 3½" 10.5cm/ 4¼" 9cm/ 3½" 10.5cm/ 4¼"

Iris
 03-195-09 - 03-198-10

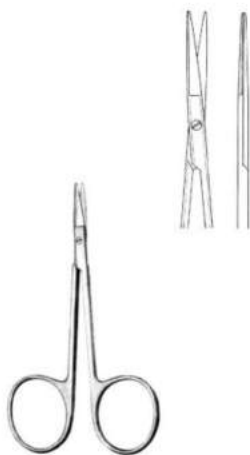

Bonn
 03-199-09
 9cm/ 3½"

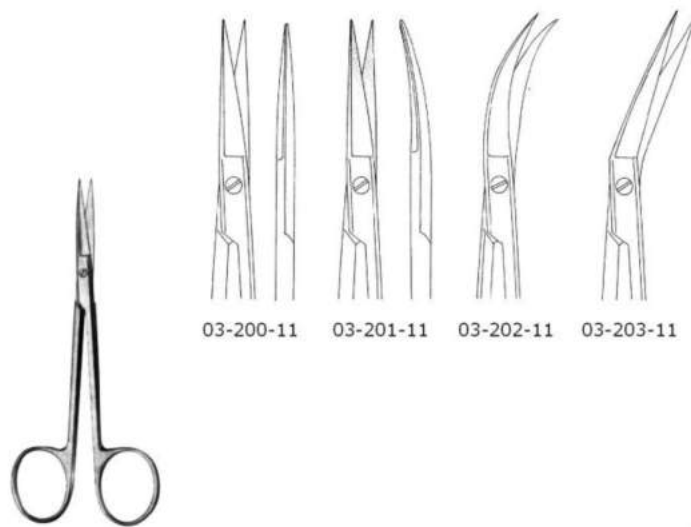

03-200-11 03-201-11 03-202-11 03-203-11

Iris
 03-200-11 - 03-203-11
 11.5cm/ 4½"



Allgemeines Instrumentarium
 Feine chirurgische Scheren
 Fine Operating Scissors

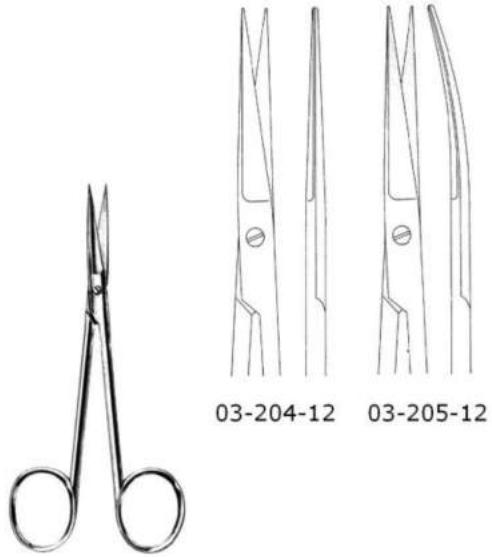

03-204-12 03-205-12

Iris
 03-204-12 - 03-205-12
 12cm/ 4 1/4"



03-206-11 03-207-11

Strabismus
 03-206-11 - 03-207-11
 11.5cm/ 4 1/2"

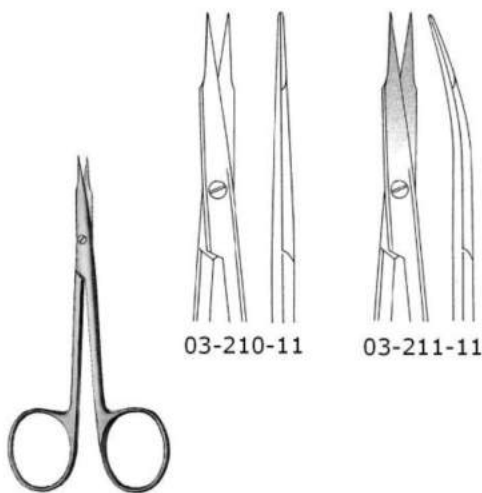

03-210-11 03-211-11

Tenotomy
 03-210-11 - 03-211-11
 11.5 cm/ 4 1/2"
 Sharp

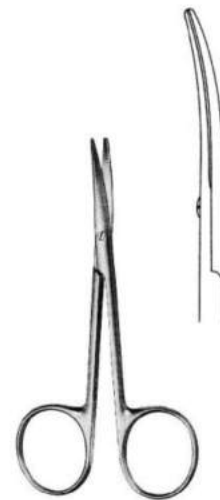

Enucleation Scissor
 03-212-11
 11.5 cm/ 4 1/2"



General Instruments - Allgemeines Instru
 Darmscheren, Ligaturscheren
 Enterotomy and Ligature Scissors

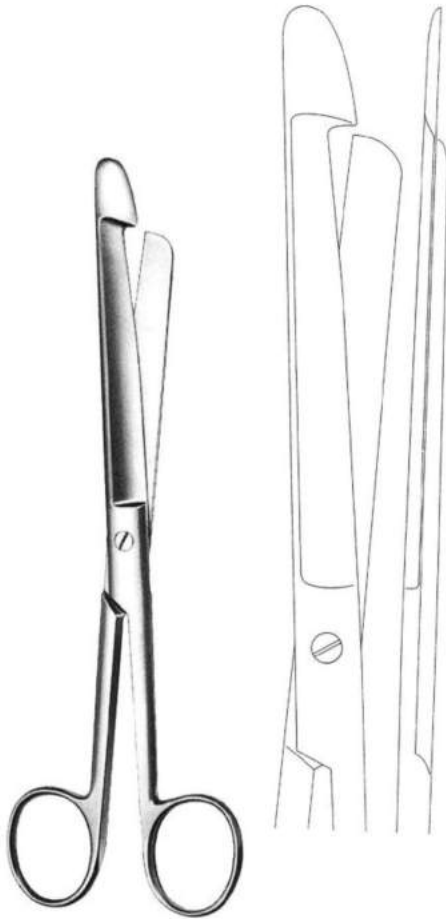

Autopsy
 03-213-21
 21cm/ 8½"

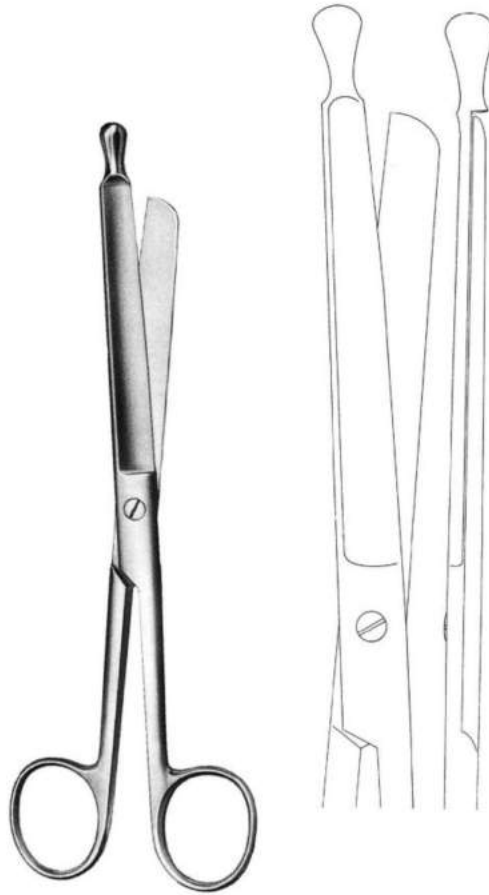

Autopsy
 03-214-21
 21cm/ 8½"

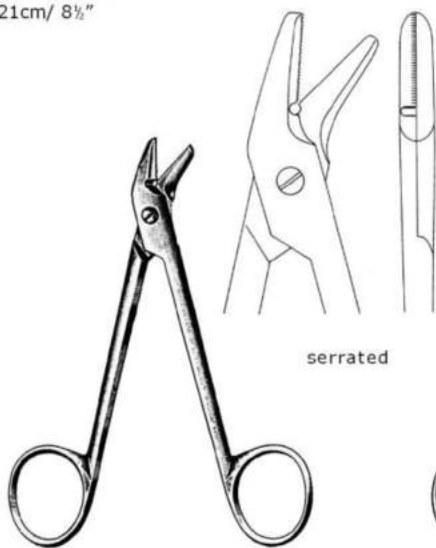

Universal
 03-215-12
 12cm/4 ½"

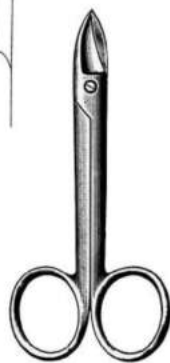

Wire Scissors
 03-216-10 - 03-218-12
 Beebe sharp point

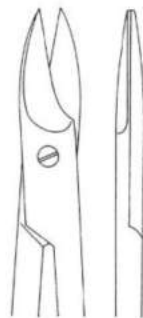

03-216-10
 10cm/4"

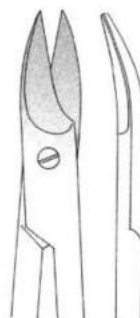

03-217-10
 10cm/4"

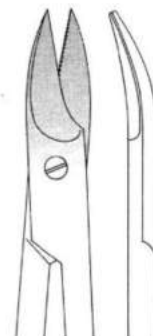

03-218-12
 12cm/4 ½"
 1blade saw edge



Allgemeines Instrumentarium
 Ligaturscheren, Fadenscheren
 Ligature Scissors, Stitch Scissors

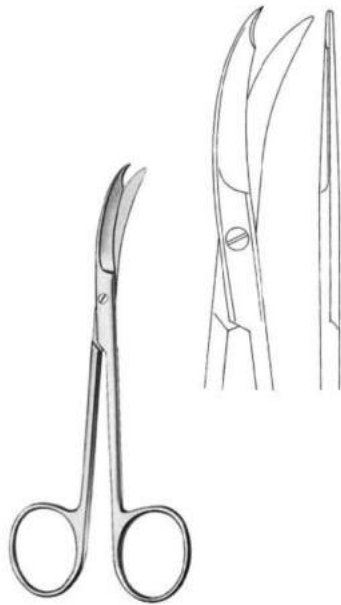

Northbent
 03-219-13
 13cm/5"

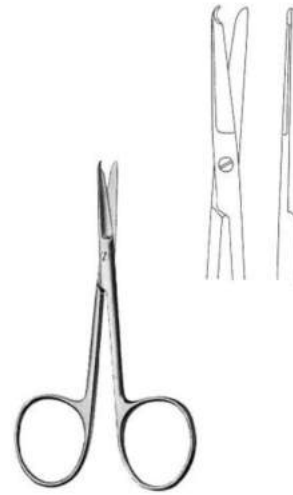

Spencer
 03-220-09 9cm/ 3 1/2"
 03-220-11 11cm/ 4 1/4"
 03-221-13 13cm/ 5"

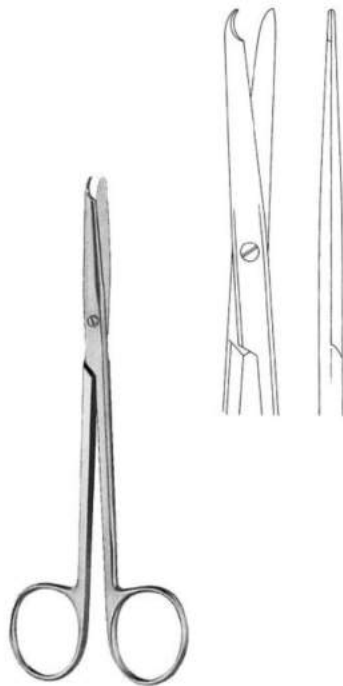

Buck
 03-222-14
 14cm/5 1/2"

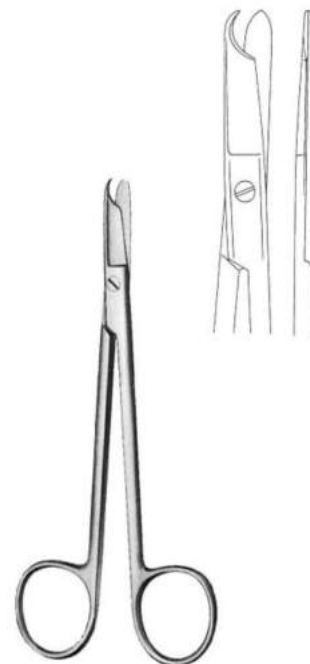

Littauer
 03-223-14
 14cm/ 5 1/2"



GENERAL INSTRUMENTS

ARTERY FORCEPS



Bulldog Clamps

Tissue & Organ Holding Forceps

Artery Forceps

Dissecting Forces & Ligature Forceps

Forceps, Bronchus & Gall Ducts Clamps

Tangential Forceps, Kidney Clamps

Forceps, Hysterectomy & Vaginal Forceps

Towel Forceps

Tubing Clamps

Dressing Forceps

Polypus, Tumor, Swab Forceps



Allgemeines Instrumentarium
Bulldogklemmen
Bulldog Clamps

	04-101-06 6cm/ 2½"	04-102-06 6cm/ 2½"		
	04-103-05 5cm/ 2"	04-104-05 5cm/ 2"		
Dieffenbach 04-101-06 - 04-106-06	04-105-06 6cm/ 2½"	04-106-06 6cm/ 2½"	Johns Hopkins 04-107-05 - 04-107-07	04-107-05 5cm/ 2" 04-107-06 6.5cm/ 2½" 04-107-07 7.5cm/ 3"

ATRAUMA

	04-108-05 5cm/ 2"	04-108-06 6cm/ 2½"		
Diethrich 04-108-05 - 04-109-06	04-109-05 5cm/ 2"	04-109-06 6cm/ 2½"	DeBakey-Diethrich 04-110-05 - 04-111-06	04-110-05 5cm/ 2" 04-110-06 6cm/ 2½"
				04-111-05 5cm/ 2" 04-111-06 6cm/ 2½"



General Instruments - Allgemeines I
Gewebe- und Organ-Faßzangen
Tissue and Organ Holding Forceps



04-112-24 - 04-112-26



04-112-24
24cm/9½"



04-112-26
26cm/10½"

ATRAUMA



Chaput
04-113-13
13cm/5"



Tuffier
04-114-13
13cm/5"

Allgemeines Instrumentarium
 Gewebe- und Organ-Faßzangen
 Tissue and Organ Holding Forceps



04-115-15
15cm/6"

Pennington
04-115-15 - 04-115-20



04-115-20
20cm/8"



Pratt
04-116-15
15cm/6"



Martel
04-117-14
14cm/5½"



Duval
04-118-14
14cm/5½"



Collin
04-119-16
16cm/ 6¼"
04-119-20
20cm/8"

General Instruments
Arterienklemmen
Artery Forceps



04-120-14 14cm/5½"
04-120-16 16cm/6¼"

Pean
04-120-14 - 04-120-16



04-121-13 13cm/5"
04-121-14 14cm/5½"
04-121-15 15cm/6"
04-121-18 18cm/7"
04-121-20 20cm/8"

04-122-13 13cm/5"
04-122-14 14cm/5½"
04-122-15 15cm/6"
04-122-18 18cm/7"
04-122-20 20cm/8"

Spencer-Wells
04-121-13 - 04-122-20



04-123-01 04-123-02

Baby-Mixer
04-123-01 - 04-123-02
14cm/5½"

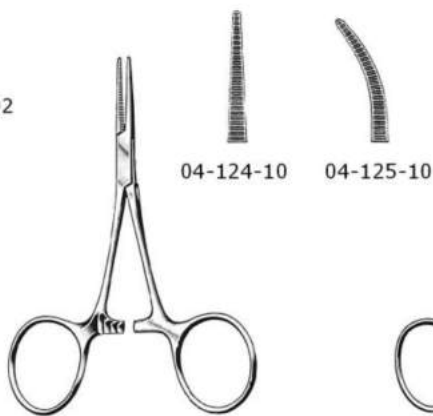

04-124-10 04-125-10

Hartmann
04-124-10 - 04-125-10
10cm/4"

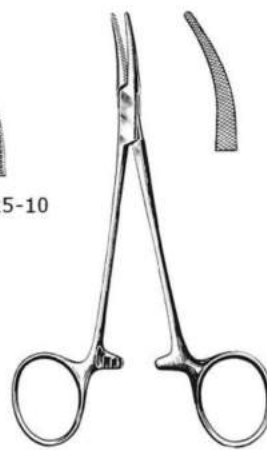

Artery Forcep
04-126-12
12cm/4¾"

Allgemeines Instrumentarium
Arterienklemmen
Artery Forceps



Halstead-Mosquito
04-127-12 - 04-130-14

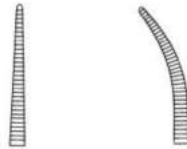

04-127-12 12.5cm/5"
04-127-14 14cm/5½"
04-128-12 12.5cm/5" cvd
04-128-14 14cm/5½" cvd

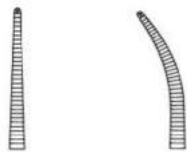

04-129-12 12.5cm/5"
04-129-14 14cm/5½"
04-130-12 12.5cm/5" cvd
04-130-14 14cm/5½" cvd
1:2 teeth



Halstead-Mosquito
04-131-12 - 04-134-12
12cm/4½"

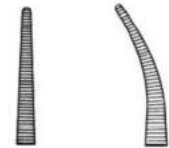

04-131-12 04-132-12



04-133-12 04-134-12
1:2 teeth

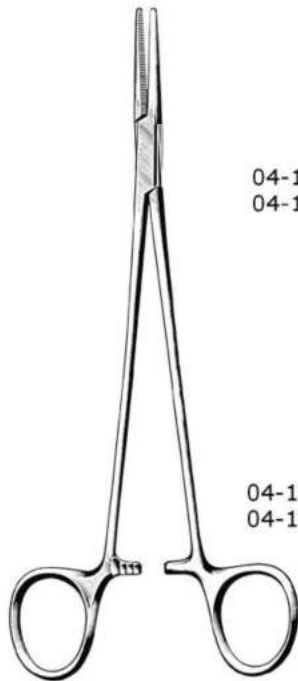

Halstead-Mosquito
04-135-18 - 04-138-21

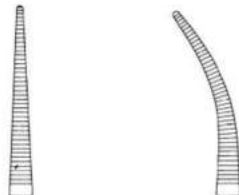

04-135-18 18cm/7"
04-135-21 21cm/8¼"
04-136-18 18cm/7"
04-136-21 21cm/8¼"

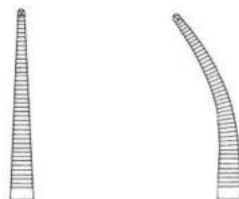

04-137-18 18cm/7"
04-137-21 21cm/8¼"
04-138-18 18cm/7"
04-138-21 21cm/8¼"
1:2 teeth

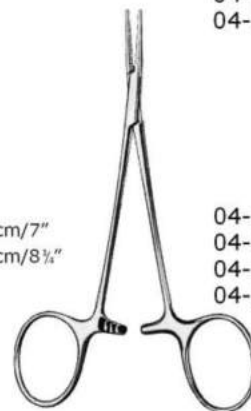

Micro-Mosquito
04-139-10 - 04-142-12



04-139-10 10cm/4"
04-139-12 12cm/4¾"
04-140-10 10cm/4" cvd
04-140-12 12cm/4¾"cvd



04-141-10 10cm/4"
04-141-12 12cm/4¾"
04-142-10 10cm/4"cvd
04-142-12 12cm/4¾"cvd
1:2 teeth

General Instruments
Arterienklemmen
Artery Forceps

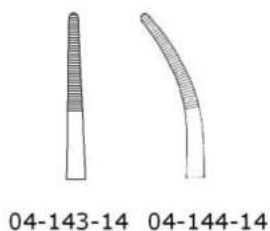

Providence-Hospital
04-143-14 - 04-144-14
14cm/5½"

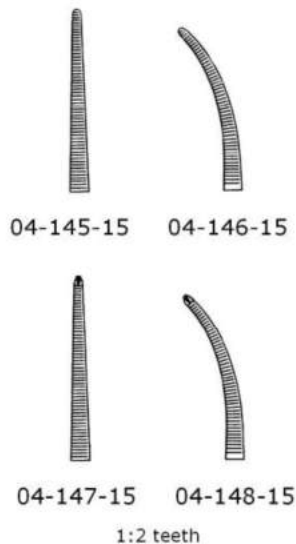

Leriche
04-145-15 - 04-148-15
15cm/6"

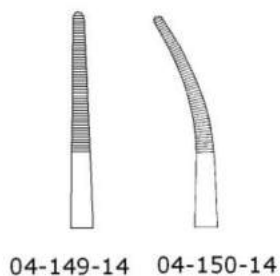

Kelly Fine
04-149-14 - 04-150-14
14cm/5½"

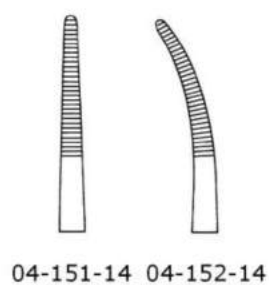

Kelly
04-151-14 - 04-152-14
14cm/5½"



Allgemeines Instrumentarium
Arterienklemmen
Artery Forceps

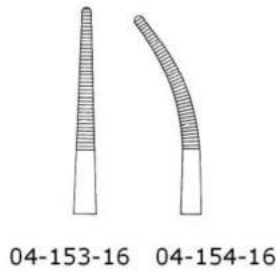

Kelly-Rankin
04-153-16 - 04-154-16
16cm/6 1/2"



Baby-Overholt
04-155-14
14cm/5 1/2"

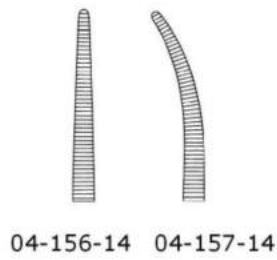

Crile
04-156-14 - 04-159-14
14cm/5 1/2"

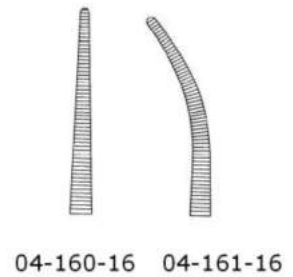

Crile-Rankin
04-160-16 - 04-161-16
16cm/6 1/2"

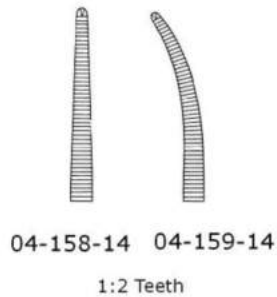

General Instruments
Arterienklemmen
Artery Forceps

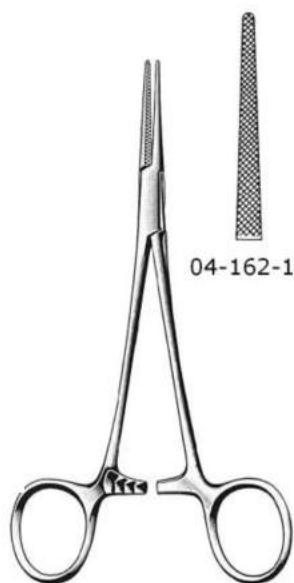

04-162-15



Lovelace
04-162-15 - 04-163-15
15cm/6"



04-163-15
1:2 Teeth

Mosquito-Dandy
04-164-12
12cm/4 1/2"



Dandy
04-165-14 - 04-166-14
14cm/5 1/2"

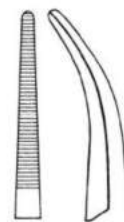

04-165-14

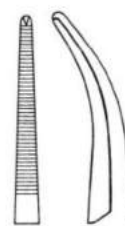

04-166-14
1:2 Teeth



04-167-18
18cm/7"



Schidt
04-167-18 - 04-167-19

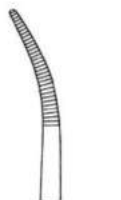

04-167-19
19cm/7 1/2"



04-168-18 04-169-18



Adson
04-168-18 - 04-169-18
18.5cm/7 1/4"

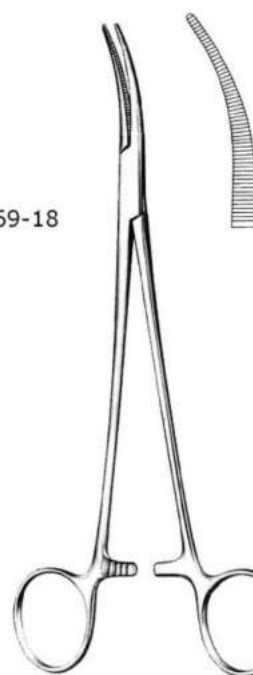

Fuchsig
04-170-20
20cm/8"



Allgemeines Instrumentarium
Arterienklemmen
Artery Forceps



Rochester-Carmalt
04-171-16 - 04-172-20

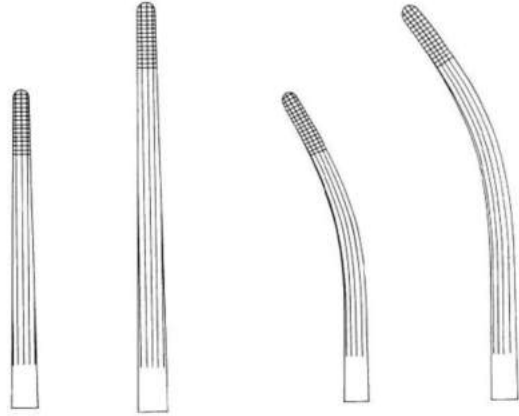

04-171-16 16cm/6¼"
04-171-20 20cm/8"

04-172-16 16cm/6¼"
04-172-20 20cm/8"



Bengolea
04-173-20 - 04-180-26

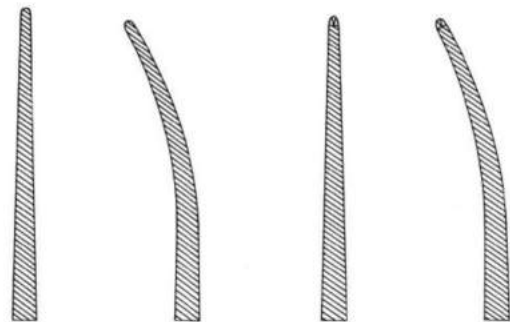

04-173-20
20cm/8"

04-174-20
20cm/8"

04-175-20
20cm/8"

04-176-20
20cm/8"

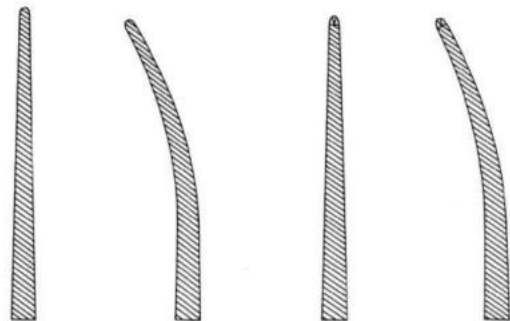

1:2 Teeth

04-177-26
26cm/10¼"

04-178-26
26cm/10¼"

04-179-26
26cm/10¼"

04-180-26
26cm/10¼"

1:2 Teeth



General Instruments
Arterienklemmen
Artery Forceps



Pean
04-181-13 - 04-182-16
Delicate Pattern



04-181-13
13cm/5"



04-181-14
14cm/5½"

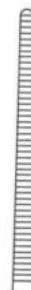

04-181-16
16cm/6½"



04-182-13
13cm/5"



04-182-14
14cm/5½"



04-182-16
16cm/6½"



Kocher
04-183-13 - 04-184-16
Delicate Pattern
1:2 Teeth



04-183-13
13cm/5"



04-183-14
14cm/5½"



04-183-16
16cm/6½"



04-184-13
13cm/5"



04-184-14
14cm/5½"



04-184-16
16cm/6½"



Allgemeines Instrumentarium
Arterienklemmen
Artery Forceps

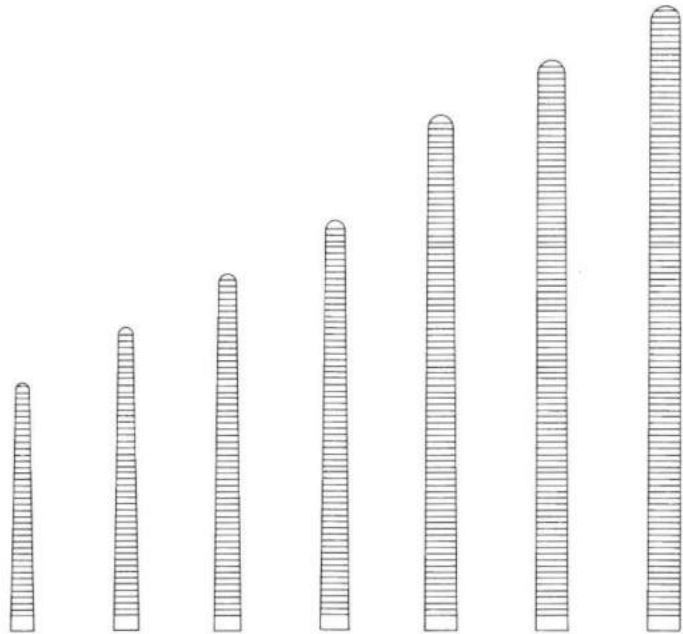

04-185-14	04-185-16	04-185-18	04-185-20	04-185-24	04-185-26	04-185-30
14cm/5½"	16cm/6¼"	18cm/7"	20cm/8"	24cm/9½"	26cm/10¼"	30cm/12"



Pean (Rochester)
04-185-14 - 04-186-30

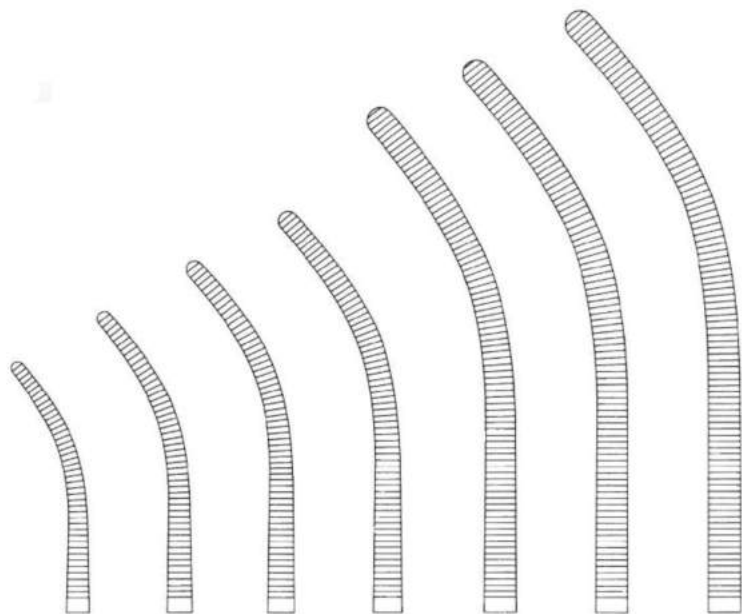

04-186-14	04-186-16	04-186-18	04-186-20	04-186-24	04-186-26	04-186-30
14cm/5½"	16cm/6¼"	18cm/7"	20cm/8"	24cm/9½"	26cm/10¼"	30cm/12"



General Instruments
Arterienklemmen
Artery Forceps

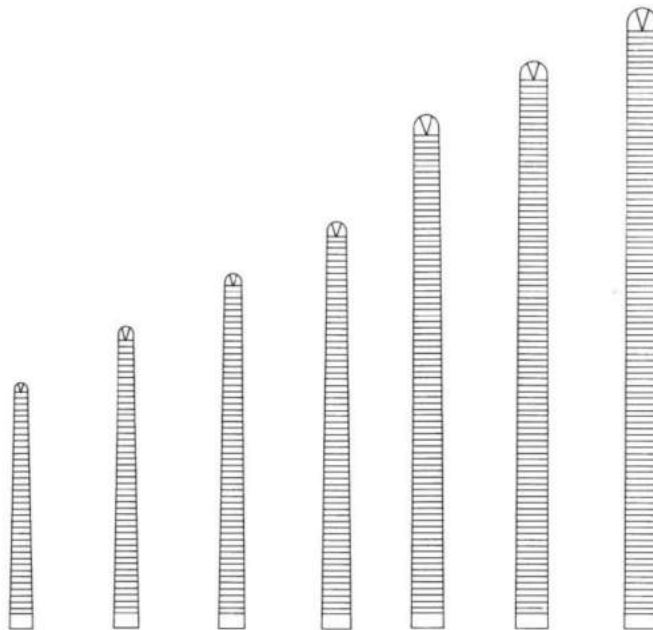

04-187-14	04-187-16	04-187-18	04-187-20	04-187-24	04-187-26	04-187-30
14cm/5 1/2"	16cm/6 1/2"	18cm/7"	20cm/8"	24cm/9 1/2"	26cm/10 1/2"	30cm/12"



Kocher (Ochsner)
04-187-14 - 04-188-30
1:2 Teeth

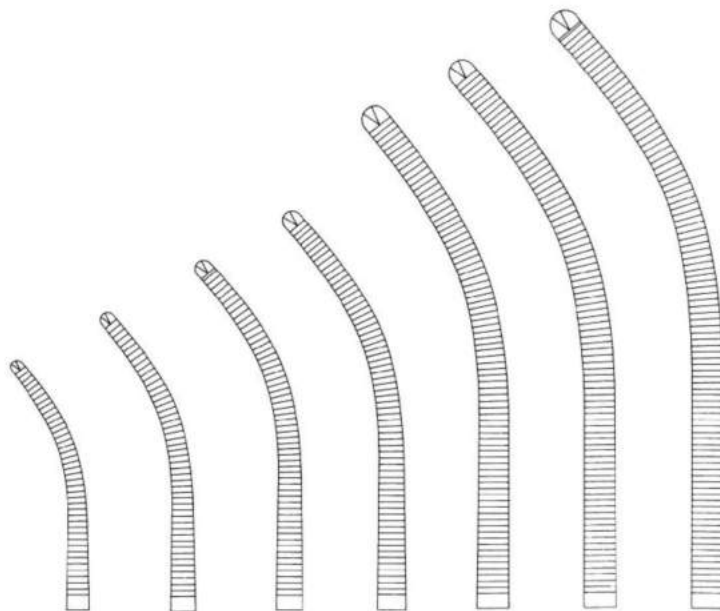

04-188-14	04-188-16	04-188-18	04-188-20	04-188-24	04-188-26	04-188-30
14cm/5 1/2"	16cm/6 1/2"	18cm/7"	20cm/8"	24cm/9 1/2"	26cm/10 1/2"	30cm/12"



Allgemeines Instrumentarium
 Präparier- und Ligaturklemmen
 Dissecting and Ligature Forceps

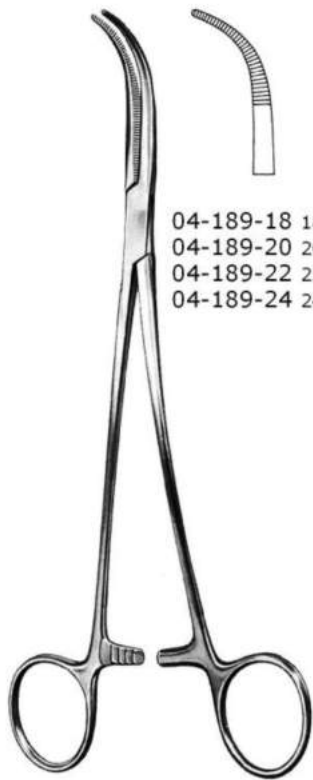

04-189-18 18.5cm/7½"
 04-189-20 20cm/8"
 04-189-22 22cm/8½"
 04-189-24 24cm/9½"

Overholt
 04-189-18 - 04-189-24



Baby-Mixer
 04-190-18
 18cm/7"



Baby-Adson
 04-191-14 - 04-191-18

04-191-14 14cm/5½"
 04-191-18 18cm/7"



Heiss
 04-192-20 - 04-194-20
 20cm/8"



04-192-20 04-193-20 04-194-20

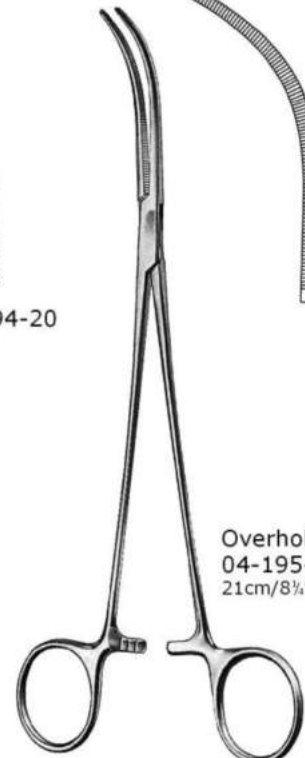

Overholt-Mixer
 04-195-21
 21cm/8½"



General Instruments
Arterienklemmen, Präparier- und Ligaturklemm
Artery Forceps, Dissecting and Ligature Forceps

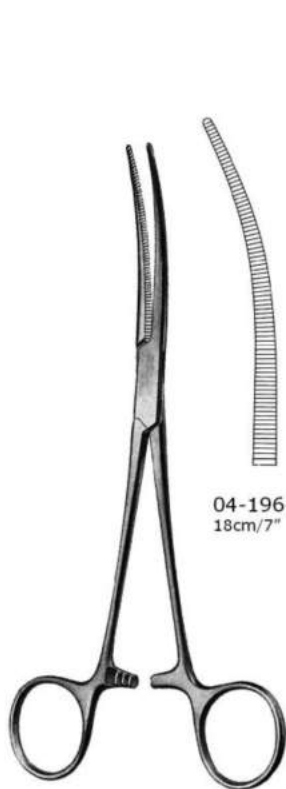

Crafoord
04-196-18 - 04-197-24

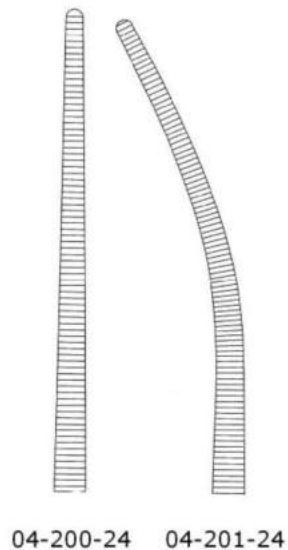
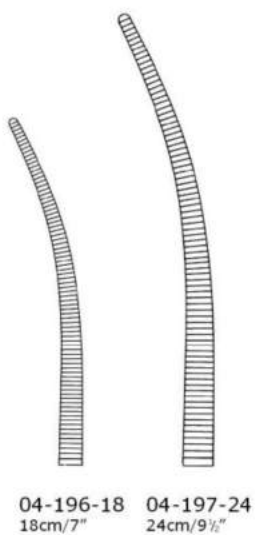

Sarot
04-200-24 - 04-201-24
24cm/9½"

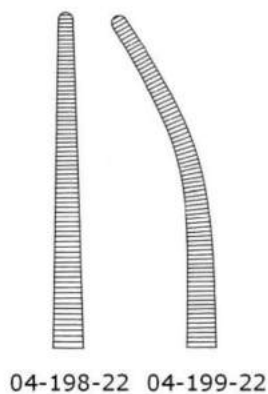

Roberts
04-198-22 - 04-199-22
22cm/8½"





Allgemeines Instrumentarium
 Präparier- und Ligaturklemmen
 Dissecting and Ligature Forceps

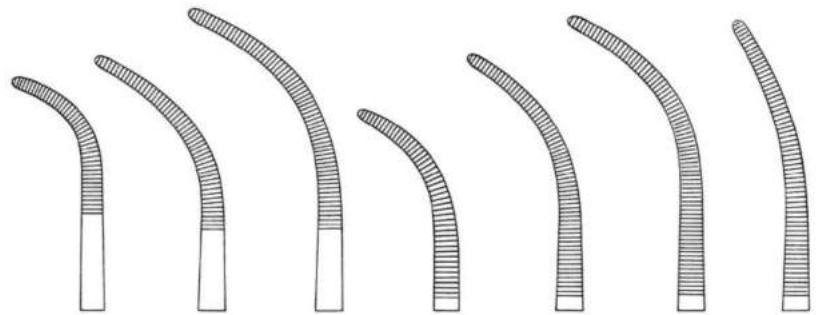

04-202-01 21cm/8 1/2" 04-202-02 21cm/8 1/2" 04-202-03 21cm/8 1/2" 04-202-04 21cm/8 1/2" 04-202-05 21cm/8 1/2" 04-202-06 21cm/8 1/2" 04-202-07 21cm/8 1/2"

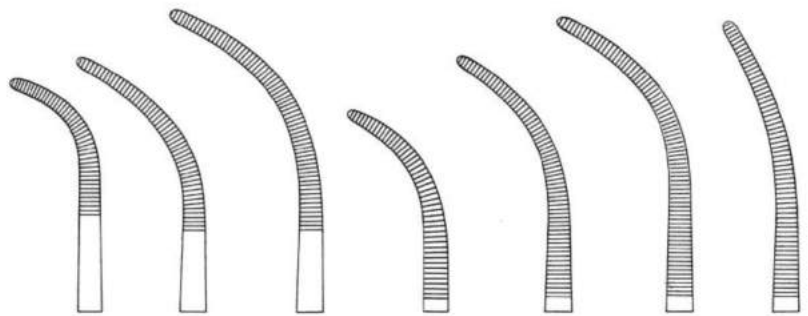

04-203-01 27cm/10 1/2" 04-203-02 27cm/10 1/2" 04-203-03 27cm/10 1/2" 04-203-04 27cm/10 1/2" 04-203-05 27cm/10 1/2" 04-203-06 27cm/10 1/2" 04-203-07 27cm/10 1/2"

Overholt-Geissendoerfer
 04-202-01 - 04-203-07



General Instruments
Präparier- und Ligaturklemmen
Dissecting and Ligature Forceps

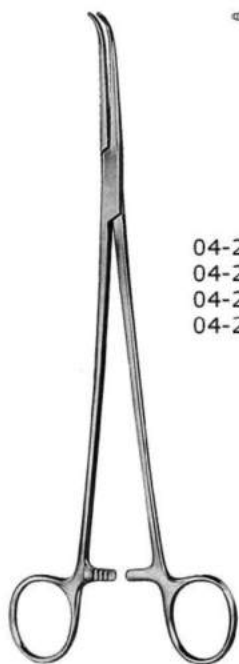

04-204-18 18cm/7"
04-204-22 22cm/8½"
04-204-25 25cm/10"
04-204-28 28cm/11"



04-205-13 13cm/5"
04-205-16 16cm/6½"
04-205-18 18cm/7"
04-205-20 20cm/8"
04-205-23 23cm/9"
04-205-25 25cm/10"
04-205-28 28cm/11"

Mini-Gemini
04-204-18 - 04-204-28

Gemini
04-205-13 - 04-205-28



Rumel
04-206-01 - 04-206-05
23cm/9"



04-206-01



04-206-02

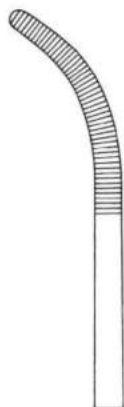

04-206-03



04-206-04

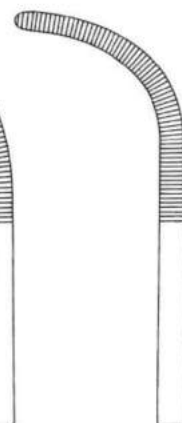

04-206-05



Allgemeines Instrumentarium
 Bronchusklemmen, Gallenkanalklemmen
 Forceps, Bronchus and Gall Duct Clamps



Mixer Baby
 04-207-14
 14cm/5½"



Mixer
 04-208-15 - 04-208-18

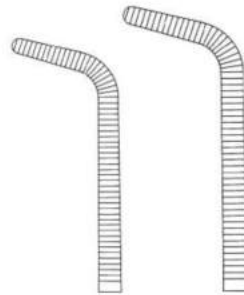

04-208-15 04-208-18
 15cm/6" 18cm/7"



Mixer-O'Shaugnessy
 04-209-18
 18cm/7"

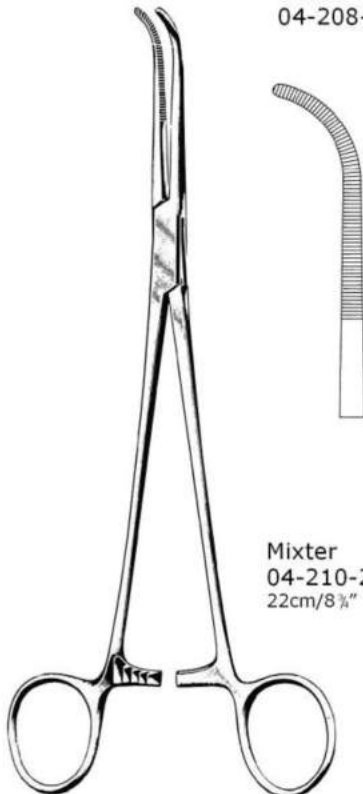

Mixer
 04-210-22
 22cm/8½"

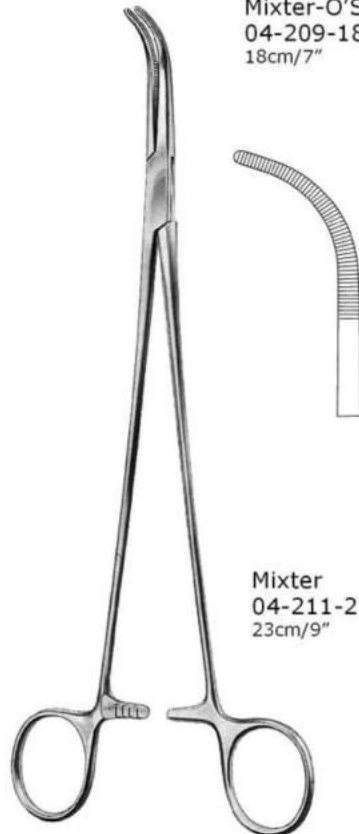

Mixer
 04-211-23
 23cm/9"



General Instruments
 Arterien- und Bronchusklemmen,
 Artery Forceps, Bronchus and Gall Duct Clamps



04-212-20 20cm/8"
 04-212-24 24cm/9½"

Wickström
 04-212-20 - 04-212-24



04-213-22 22cm/8¾"
 04-214-25 25cm/10"
 04-215-28 28cm/11"

Mixer
 04-213-22 - 04-215-28



Lower
 04-216-18
 18cm/7"



04-217-19 19cm/7½"
 04-218-23 23cm/9"

Lahey
 04-217-19 - 04-218-23

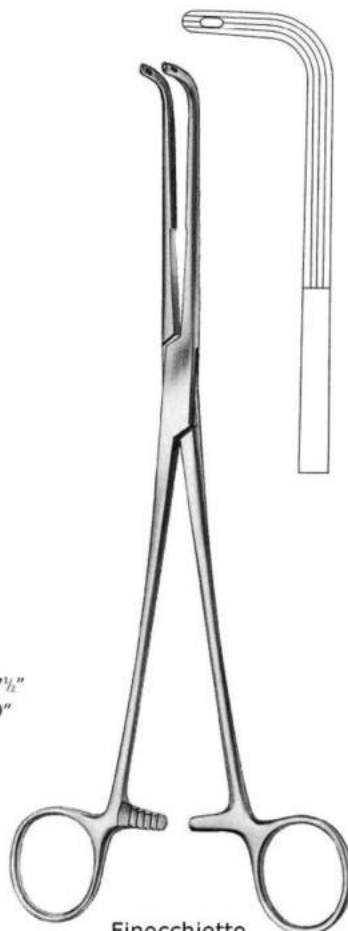

Finocchietto
 04-219-24
 24cm/9½"

Allgemeines Instrumentarium
Tangential- und Nierenstielklemmen
Tangential Forceps, Kidney Clamps

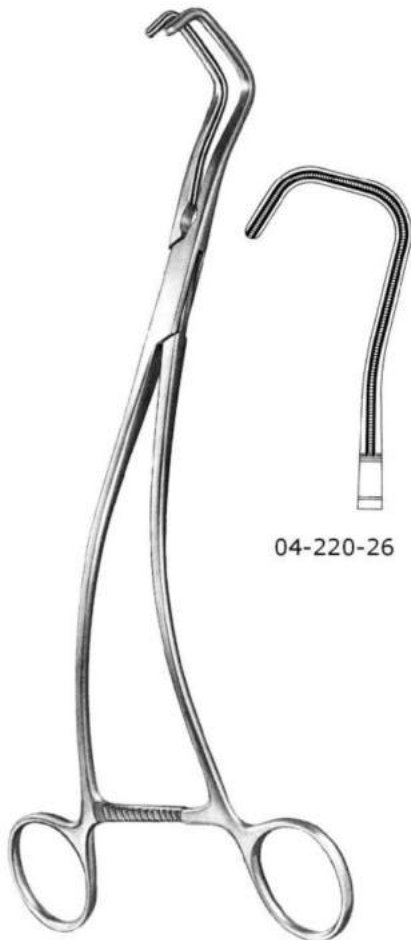

04-220-26

Uro-Tangential
04-220-26
26cm/10 $\frac{1}{4}$ "



Guyon
04-222-23 - 04-222-24

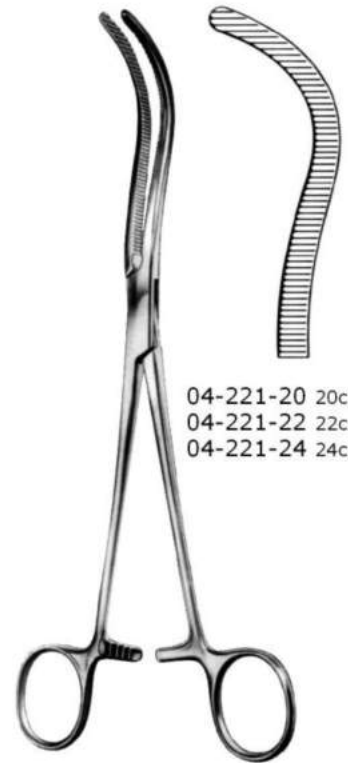

04-221-20 20cm/8"
04-221-22 22cm/8 $\frac{3}{4}$ "
04-221-24 24cm/9 $\frac{1}{2}$ "

Guyon
04-221-20 - 04-221-24



Atrauma

04-222-23 23cm/9"
04-222-24 24cm/9 $\frac{1}{2}$ "

General Instruments
 Arterienklemmen, Präparier
 Artery Forceps, Dissecting and Ligature Forceps

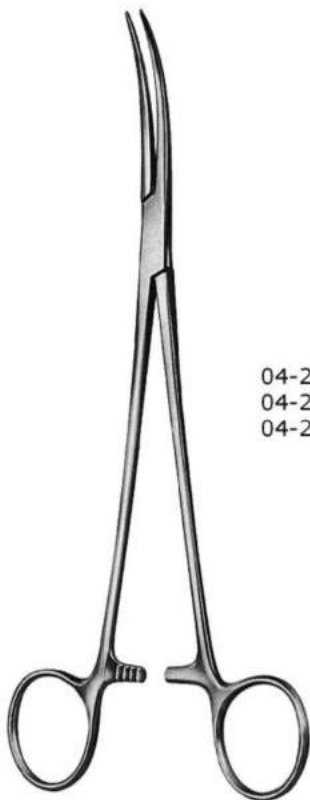

Kelly
 04-223-19 - 04-225-24



04-223-19 19cm/7½"
 04-223-22 22cm/8¾"
 04-223-24 24cm/9½"



04-224-19 19cm/7½"
 04-224-22 22cm/8¾"
 04-224-24 24cm/9½"



04-225-19 19cm/7½"
 04-225-22 22cm/8¾"
 04-225-24 24cm/9½"

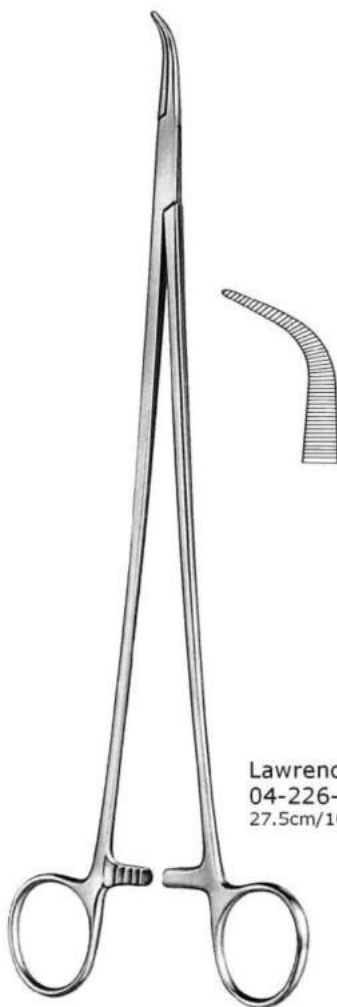

Lawrence
 04-226-28
 27.5cm/10¾"



Meeker
 04-227-28
 27.5cm/10¾"

Allgemeines Instrumentarium
 Hysterektomieklemmen, Vaginalklemmen
 Forceps, Hysterectomy and Vaginal Forceps



04-228-21

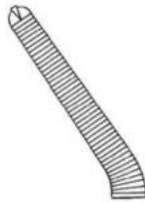

04-229-21

Phaneuf
 04-228-21 - 04-229-21
 21.5cm/8½"
 1:2 Teeth



Wertheim-Cullen
 04-230-21
 21.5cm/8½"



04-231-19 19cm/7½"
 04-231-21 21cm/8¼"
 04-231-23 23cm/9"



04-232-19 19cm/7½"
 04-232-21 21cm/8¼"
 04-232-23 23cm/9"

Heaney
 04-231-19 - 04-232-23

ATRAUMA



Rogers
 04-233-01 - 04-234-04

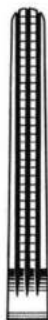

04-233-01
 22cm/8 $\frac{1}{4}$ "



04-233-02
 21.5cm/8 $\frac{1}{2}$ "



04-233-03
 21cm/8 $\frac{1}{4}$ "

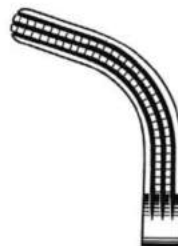

04-233-04
 20cm/8"

04-234-01
 25cm/10"

04-234-02
 25cm/10"

04-234-03
 24.5cm/9 $\frac{1}{4}$ "

04-234-04
 23cm/9"

Instruments - Allgemeines Instrumentarium
 Hysterektomieklemmen, Vaginalklemmen
 Forceps, Hysterectomy and Vaginal Forceps

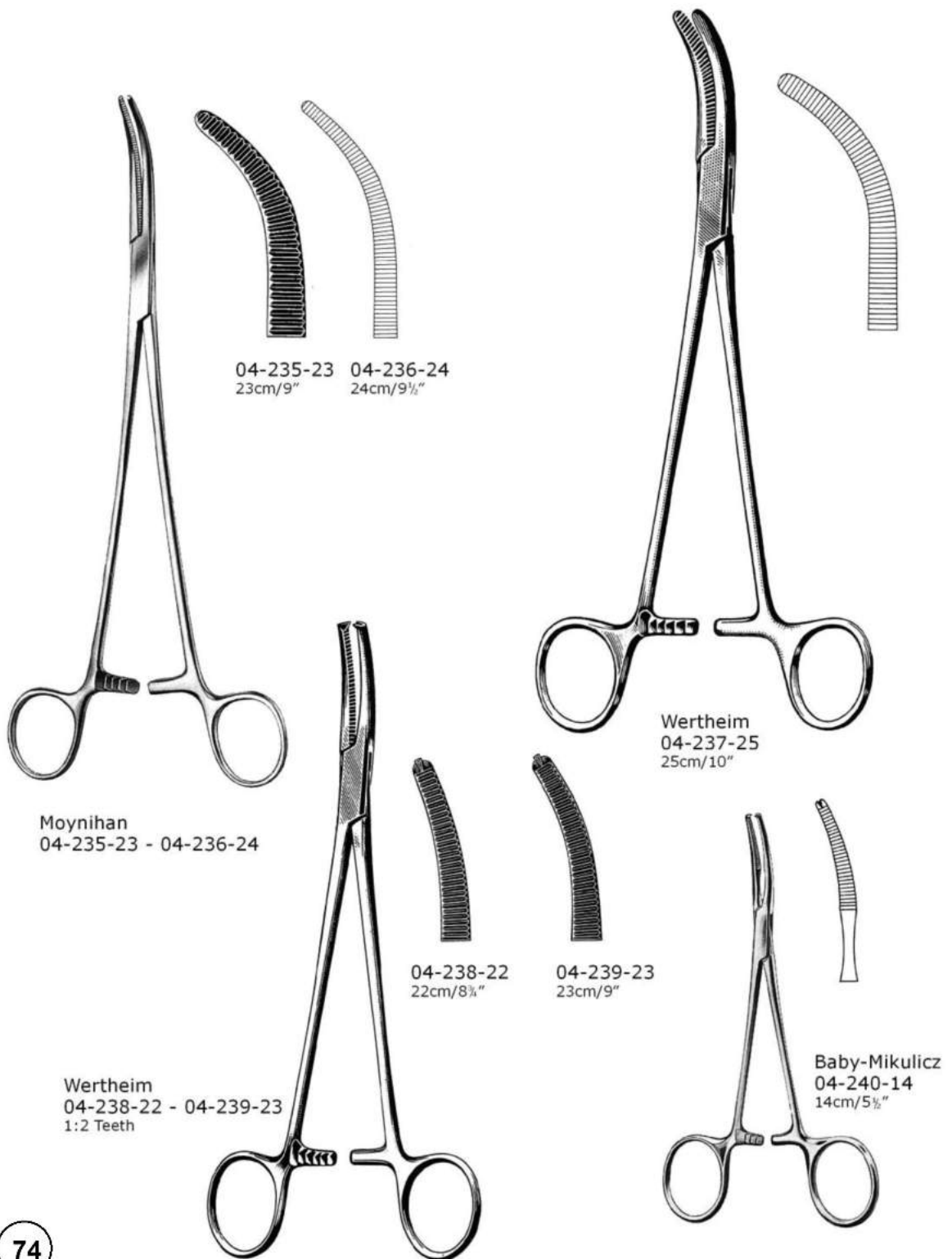

General Instruments
 Arterien- und Peritoneumklemmen
 Artery Forceps, Peritoneal Clamp Forceps

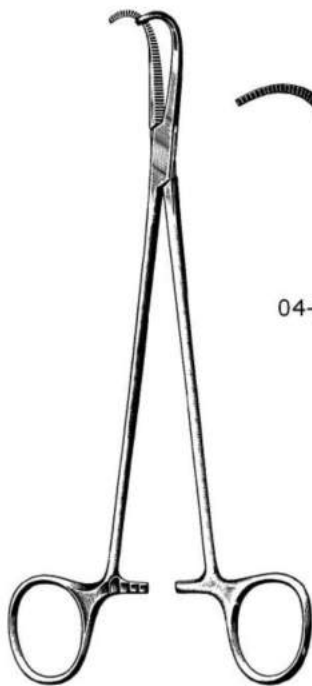

Negus
 04-241-19 - 04-242-19
 19cm/7½"



04-241-19



04-242-19

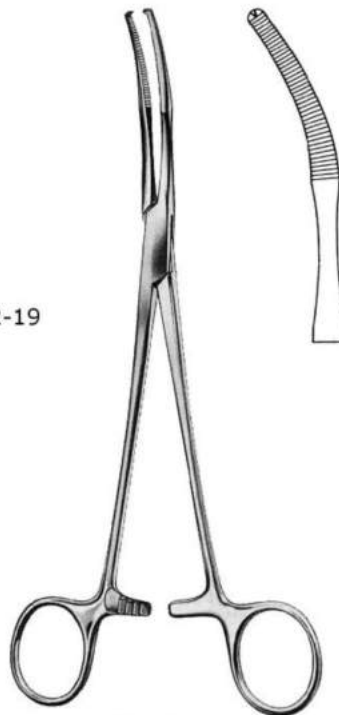

Mikulicz
 04-243-20
 20cm/8"

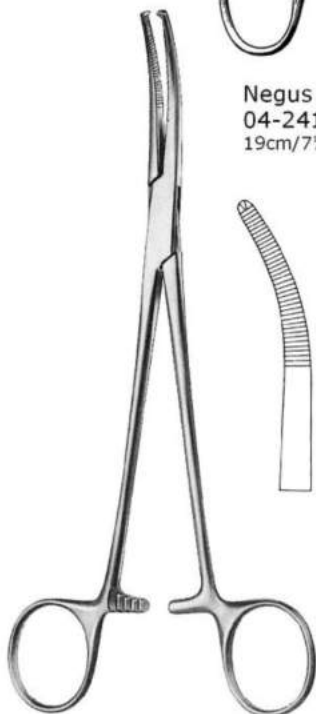

Mikulicz
 04-244-20
 20cm/8"



Faure
 04-245-20 - 04-246-20
 20cm/8"



04-245-20



04-246-20



Allgemeines Instrumentarium
Tuchklemmen
Towel Forceps



Schaedel
04-247-09
9cm/3½"



Jones
04-248-05 5cm/2"
04-248-09 9cm/3½"



Jones
04-249-09
9cm/3½"
With Clip for Tubing or Cable



Towel Forcep
04-250-11 11.5cm/4½"
04-250-13 13cm/5"
delicate pattern

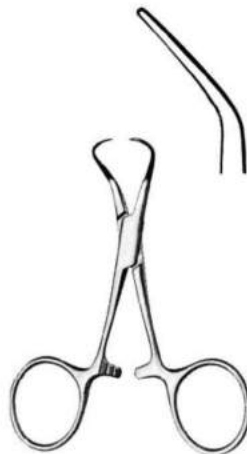

Backhaus
04-251-08 8cm/3½"
04-251-11 11.5cm/4½"
04-251-13 13cm/5½"
04-251-15 15cm/6"



Roeder
04-252-13 13cm/5"
04-252-15 15cm/6"



General Instruments
Tuchklemmen
Towel Forceps



Tohoku
04-253-10 10cm/4"
04-253-13 13cm/5"

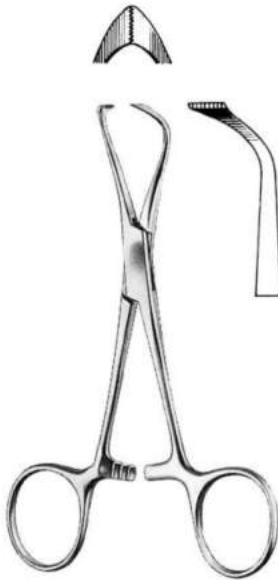

Lorna
04-254-10 10cm/4"
04-254-13 13cm/5"

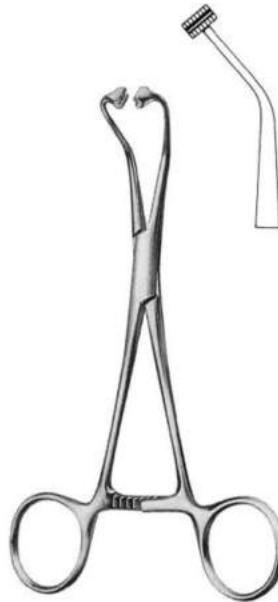

Peers-Bertram
04-255-14
14.5cm/5½"



Lane
04-256-20
20cm/8"



Bernhard
04-257-16
16.5cm/6½"

Allgemeines Instrumentarium
Schlauchklemmen
Tubing Clamps



Tubing Clamp
04-258-14
14.5cm/5 7/8"



Tubing Clamp
04-259-16
16.5cm/6 1/2"



Standard
04-260-15 - 04-260-20



04-260-15 15cm/6"
04-260-18 18cm/7"
04-260-20 20cm/8"

General Instruments
Tupferzangen, Korn-(Polypen-)
Cotton Swab Forceps, Polypus

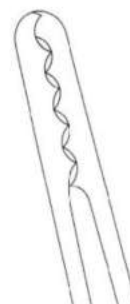
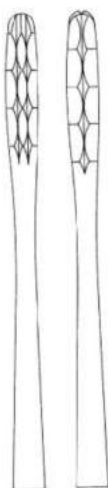

04-261-22 22cm/8 1/4"
04-261-25 25cm/10"
04-261-27 27cm/10 3/4"

04-262-22 22cm/8 1/4"
04-262-25 25cm/10"
04-262-27 27cm/10 3/4"

Ulrich
04-261-22 - 04-262-27



04-263-13 13cm/5"
04-263-16 16cm/6 1/4"
04-263-18 18cm/7"



04-264-17 04-265-17

04-264-17 - 04-265-17
17cm/6 3/4"

Lister
04-263-13 - 04-263-18



Allgemeines Instrumentarium
Korn- und Tupferzangen
Dressing and Cotton Swab Forceps



General Instruments
 Korn-(Polypen-)Zangen, Tupferzangen
 Polypus and Dressing Forceps, Cotton Swab Forceps

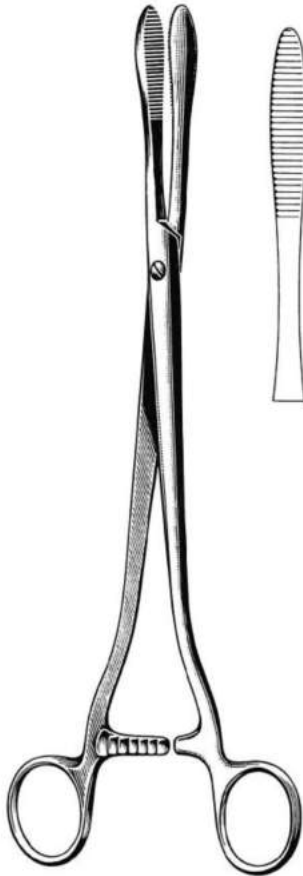

Collin
 04-269-25
 25cm/10"



Cheron
 04-270-25
 25cm/10"

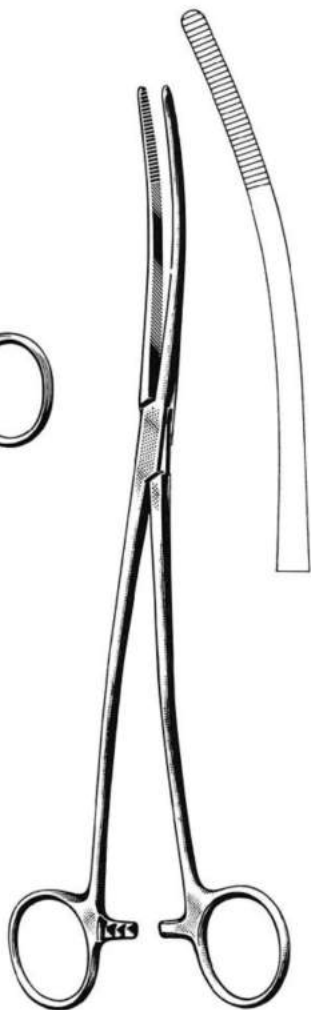

Bozemann
 04-271-26
 26cm/10 1/2"



Bozemann-Douglas
 04-272-26
 26cm/10 1/2"

Allgemeines Instrumentarium
 Polypen-, Tumor-, Schwammzangen
 Polypus, Tumor, Swab Forceps



Foerster
 04-273-18 - 04-276-25

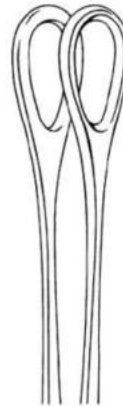

04-273-18=18cm/ 7"
 04-273-20=20cm/ 8"
 04-273-25=25cm/ 10"

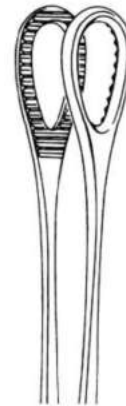

04-274-18=18cm/ 7"
 04-274-20=20cm/ 8"
 04-274-25=25cm/ 10"

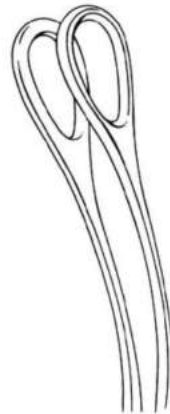

04-275-18=18cm/ 7"
 04-275-20=20cm/ 8"
 04-275-25=25cm/ 10"

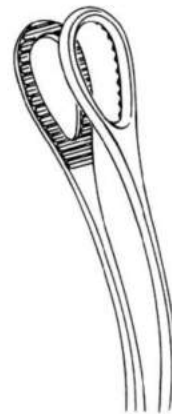

04-276-18=18cm/ 7"
 04-276-20=20cm/ 8"
 04-276-25=25cm/ 10"

General Instruments
Polypen-, Tumor-, Schwammzangen
Polypus, Tumor, Swab Forceps



Foerster
04-277-25 - 04-278-25
25cm/10"

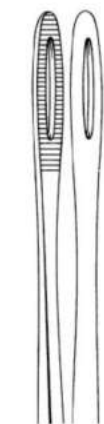

04-277-25

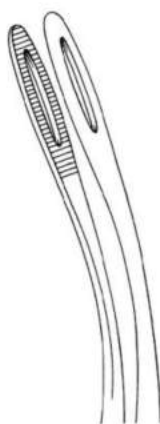

04-278-25

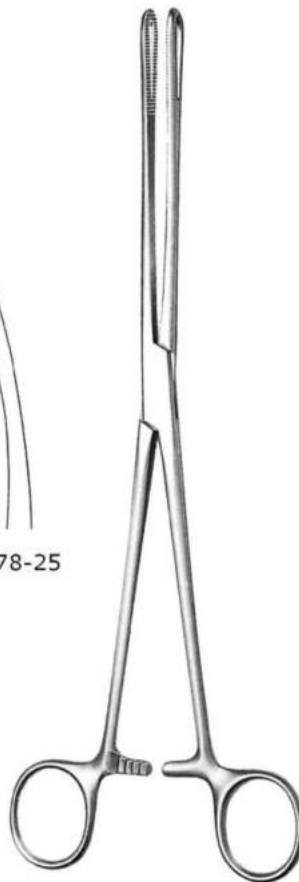

Rampley
04-279-18 - 04-279-25



04-279-18
18cm/7"

04-279-25
25cm/10"

GENERAL INSTRUMENTS

DRESSING FORCEPS



Dressing forceps

Atrauma tissue Forceps

Tissue Forceps

Micro Forceps

Cilial Forceps

Splinter Forceps



General Instruments
Anatomische Pinzetten
Dressing Forceps

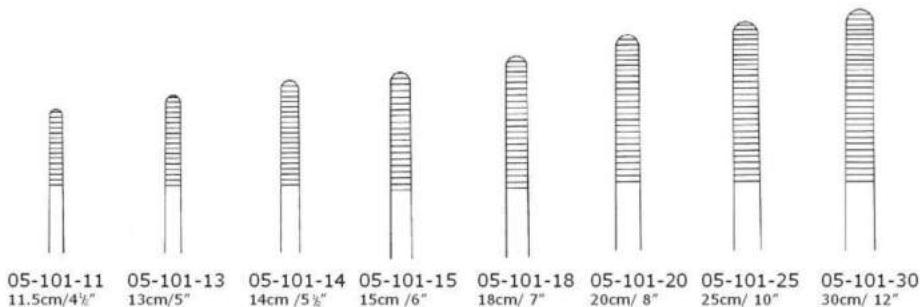

Standard
05-101-11 - 05-101-30

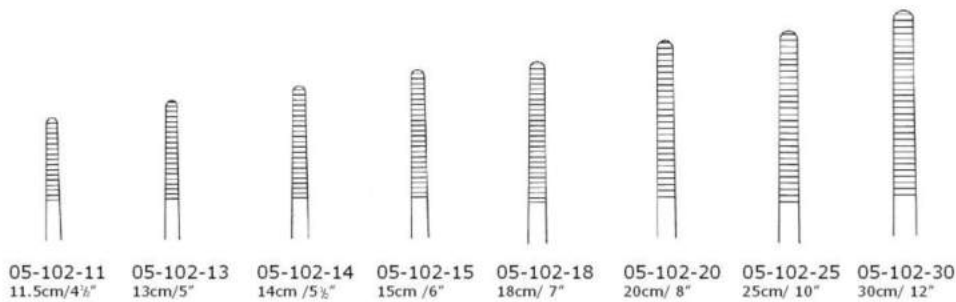

Standard
05-102-11 - 05-102-30
Delicate



Allgemeines Instrumentarium
Anatomische Pinzetten
Dressing Forceps



05-103-13 05-103-14
13cm/5" 14cm /5½"

Standard Fine
05-103-13 - 05-103-14



Stille
05-104-15
15cm/6"



Mini-Adson
05-105-12
12cm/4¾"



05-106-12 05-106-15
12cm/4¾" 15cm/6"

Adson
05-106-12 - 05-106-15



McIndoe
05-107-15
15cm/6"



05-108-17 05-109-17

Gerald
05-108-17 - 05-109-17
17cm/6¾"



General Instruments
Anatomische Pinzetten
Dressing Forceps



05-110-13
13cm/5"



05-110-15
15cm/6"

Semken
05-110-13 - 05-110-15



Taylor
05-111-18
18cm/7"



Taylor
05-112-18
18cm/7"



Taylor
05-113-18
18cm/7"



Cushing
05-114-18
18cm/7"



05-114-18



Potts-Smith
05-115-18 - 05-115-25



05-115-18
18cm/7"



05-115-21
21cm/8 1/4"



05-115-25
25cm/10"

Allgemeines Instrumentarium
Atrauma-Pinzetten
Atrauma Tissue Forceps



05-116-16	05-116-20	05-116-24
16cm/6 $\frac{1}{4}$ "	20cm/8"	24cm/9 $\frac{1}{2}$ "
1.6 mm	1.6 mm	1.6 mm



05-117-16	05-117-20	05-117-24
16cm/6 $\frac{1}{4}$ "	20cm/8"	24cm/9 $\frac{1}{2}$ "
1.8 mm	1.8 mm	1.8 mm

De Bakey
05-116-16 - 05-117-24

88

General Instruments
Chirurgische Pinzetten
Tissue Forceps



05-118-11 11.5cm/4½"
05-118-13 13cm/5"
05-118-14 14cm/5½"
05-118-15 15cm/6"
05-118-18 18cm/7"
05-118-20 20cm/8"
05-118-25 25cm/10"
05-118-30 30cm/12"

Tissue Forceps
05-118-11 - 05-118-30
1:2 Teeth



05-119-11 11.5cm/4½"
05-119-13 13cm/5"
05-119-14 14cm/5½"
05-119-15 15cm/6"
05-119-18 18cm/7"
05-119-20 20cm/8"
05-119-25 25cm/10"
05-119-30 30cm/12"

Tissue Forceps
05-119-11 - 05-119-30
2:3 Teeth



05-120-14 14cm/5½"
05-120-15 15cm/6"
05-120-18 18cm/7"

Tissue Forceps
05-120-14 - 05-120-18
3:4 Teeth



05-121-14 14cm/5½"
05-121-15 15cm/6"

Tissue Forceps
05-121-14 - 05-121-15
4:5 Teeth



05-122-13 13cm/5"
05-122-14 14cm/5½"
05-122-15 15cm/6"
05-122-20 20cm/8"

Tissue Forceps
Delicate
05-122-13 - 05-122-20
1:2 Teeth



05-123-13 13 cm/5"
05-123-14 14cm/5½"

Tissue Forceps Fine
05-123-13 - 05-123-14
1:2 Teeth

Allgemeines Instrumentarium
Chirurgische Pinzetten
Tissue Forceps



Stille
05-124-15
15 cm/6"
1:2 Teeth



Stille
05-125-15
15 cm/6"
2:3 Teeth



Stone
05-126-15
15 cm/6"
4:5 Teeth



Lerche
05-127-15
15 cm/6"
5:6 Teeth



Adson Tissue
05-128-12 - 05-129-15
1:2 Teeth



05-128-12
12 cm /4 3/4"



05-129-15
15 cm /6"



Gillies
05-130-15
15 cm/6"
1:2 Teeth

General Instruments
Chirurgische Pinzetten
Tissue Forceps

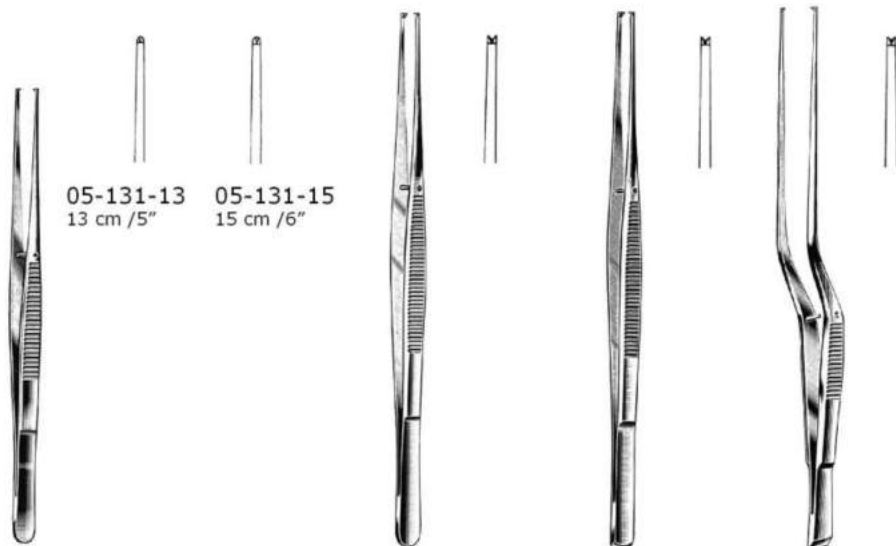

05-131-13
13 cm / 5"

05-131-15
15 cm / 6"

Semken
05-131-13 - 05-131-15

Taylor
05-132-18
18cm/ 7"
1:2 Teeth

Taylor
05-133-18
18cm/ 7"
1:2 Teeth

Taylor
05-134-18
18cm/ 7"
1:2 Teeth

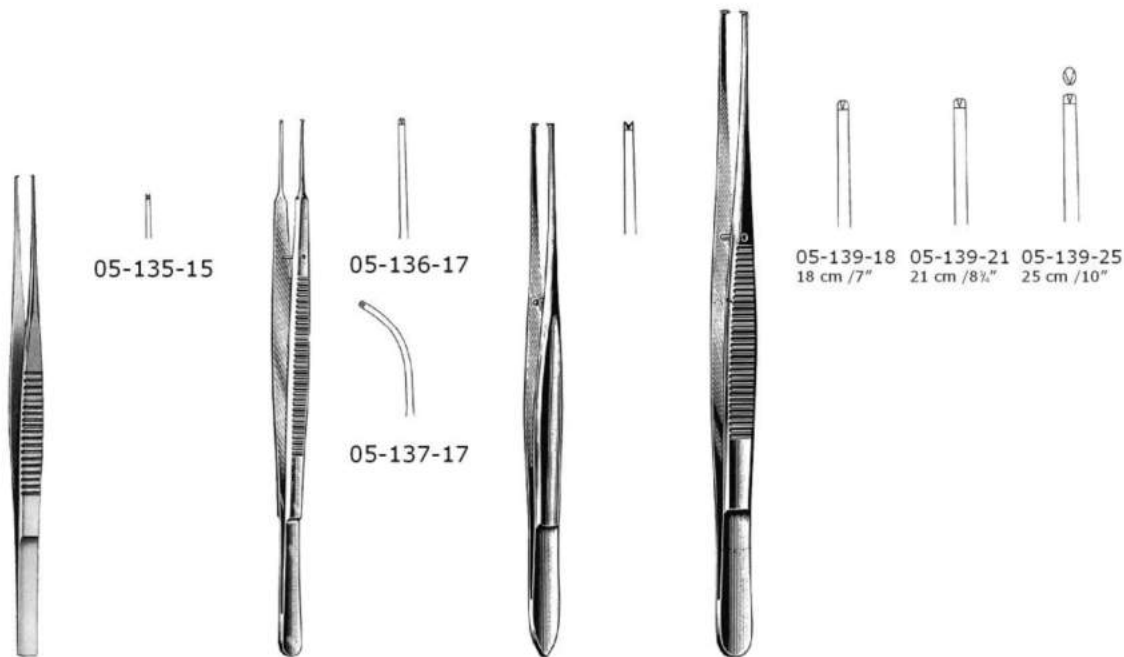

05-135-15

05-136-17

05-137-17

05-139-18
18 cm / 7"

05-139-21
21 cm / 8 1/2"

05-139-25
25 cm / 10"

Tissue Forcep
05-135-15
15 cm / 6"

Gerald
05-136-17 - 05-137-17
17 cm/6 1/4"

Cushing
05-138-17
17 cm/6 1/4"

Potts-Smith
05-139-18 - 05-139-25

Allgemeines Instrumentarium
 Micro-Pinzetten, Chirurgische Pinzetten
 Micro Forceps, Tissue Forceps



Adson-Brown
 05-140-12
 12 cm/4 3/4"



Mini-Adson
 05-141-12
 12 cm/4 3/4"
 1:2 Teeth



Micro-Adson
 05-142-12
 12 cm/4 3/4"



Micro-Adson
 05-143-12
 12 cm/4 3/4"
 1:2 Teeth



Tissue Forcep
 05-144-11
 11.5 cm/4 1/2"

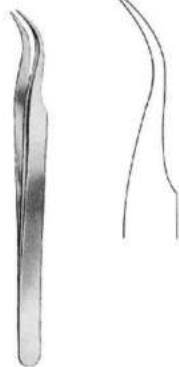

Watch Maker No:7
 05-145-12
 11cm/ 4 1/4"



Watch Maker No:3
 05-146-12
 11cm/ 4 1/4"



Duval
 05-147-14
 14 cm/ 5 1/2 "



General Instruments
 Chirurgische Pinzetten, Faßpinzetten
 Tissue Forceps, Grasping Forceps



05-148-15 15 cm /6"
 05-148-20 20 cm /8"
 05-148-25 25 cm /10"

Russ. Model
 05-148-15 - 05-148-25



Durante
 05-149-14 - 05-149-20

05-149-14 14 cm /5½"
 05-149-15 15 cm /6"
 05-149-20 20 cm /8"



Bonney
 05-150-18
 18 cm /7"



Mayo-Russ
 05-151-23
 23 cm /9"



Singley-Tuttle
 05-152-23
 23 cm /9"



Nelson
 05-153-23
 23 cm /9"



Allgemeines Instrumentarium
 Feine Modelle Pinzetten
 Fine pattern Forceps



Splinter
 05-154-11
 11.5 cm/4½"
 without pin-plain



Splinter
 05-155-11
 11.5 cm/4½"
 without pin-plain



Splinter
 05-156-11
 11.5 cm/4½"
 without pin-serr

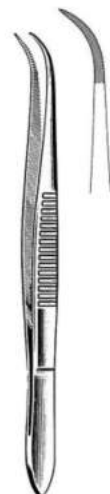

Splinter
 05-157-11
 11.5 cm/4½"
 without pin-serr



05-158-13
 13 cm/5"



Feilchenfeld
 05-159-09 - 05-159-11



05-159-09 05-159-11
 9 cm/3½" 11.5 cm/4½"

General Instruments
Cilienpinzetten
Cilia Forceps



Littauer
05-160-09
9 cm/3½"



Douglas
05-161-09
9 cm/3½"



Douglas
05-162-09
9 cm/3½"



Douglas
05-163-09
9 cm/3½"



Beer
05-164-09
9 cm/3½"



Barraquer
05-165-11
11 cm/4¼"



Shaaf
05-166-09
9 cm/3½"



Allgemeines Instrumentarium
 Splitterzangen
 Splinter Forceps



Hunter
 05-167-10 - 05-168-10
 10.5 cm/4 1/4"



Stieglitz
 05-169-14 - 05-170-14
 14 cm/5 1/2"



Peet
 05-171-11
 11.5 cm/4 1/2"

Ralk
 05-172-15 - 05-173-15
 15 cm/6"



GENERAL INSTRUMENTS

RETRACTORS



Retractors

Abdominal Retractors

Abdominal Spatulas



Allgemeines Instrumentarium
Wundhaken
Retractors



Skin hook

Vickers
06-101-18
18cm/7"



Bone hook

Vickers
06-102-17
17cm/6 3/4"

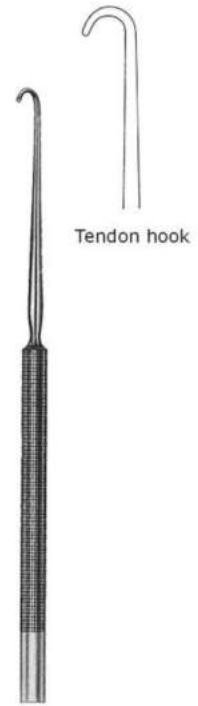

Tendon hook

Vickers
06-103-17
17cm/6 3/4"



Vickers
06-104-16
16cm/6 1/4"



Vickers
06-105-16
16cm/6 1/4"

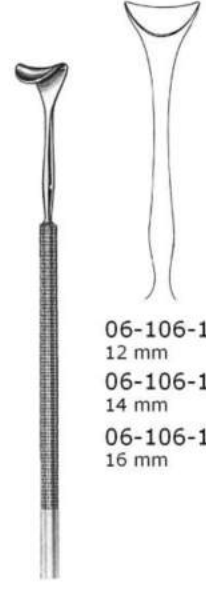

Vickers
06-106-12 - 06-106-16
14 cm/5 1/2"

06-106-12
12 mm
06-106-14
14 mm
06-106-16
16 mm



General Instruments
Wundhaken
Retractors



06-107-01
Sharp

06-107-02
blunt

Graefe
06-107-01 - 06-107-02
16 cm/6 1/4"



Retractor
06-108-01
16 cm/6 1/4"



O'Connor
06-109-16
16cm/6 1/4"



06-110-01 06-110-02

Guthrie
06-110-01 - 06-110-02
16 cm/6 1/4"



Allgemeines Instrumentarium
Wundhaken
Retractors

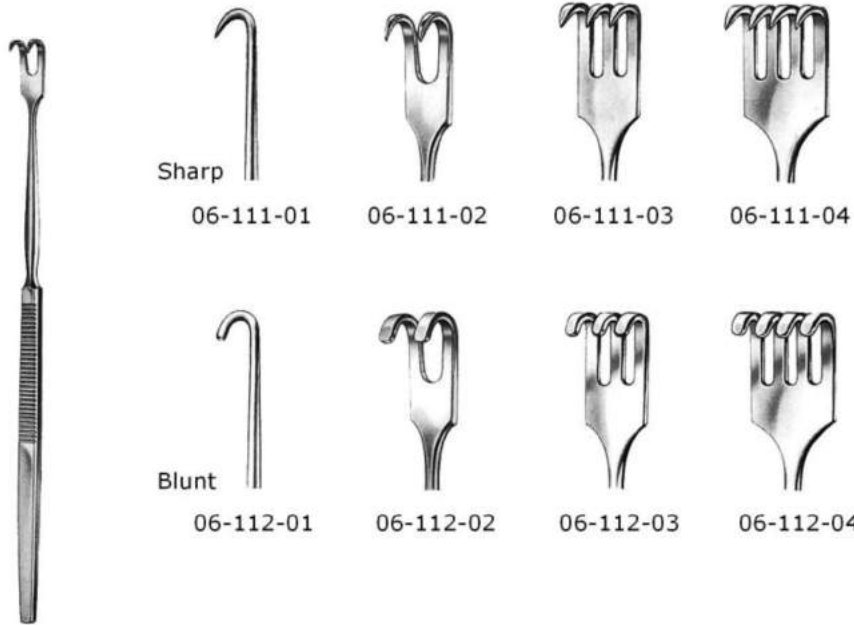

06-111-01 - 06-112-04
16.5 cm/6 1/2"

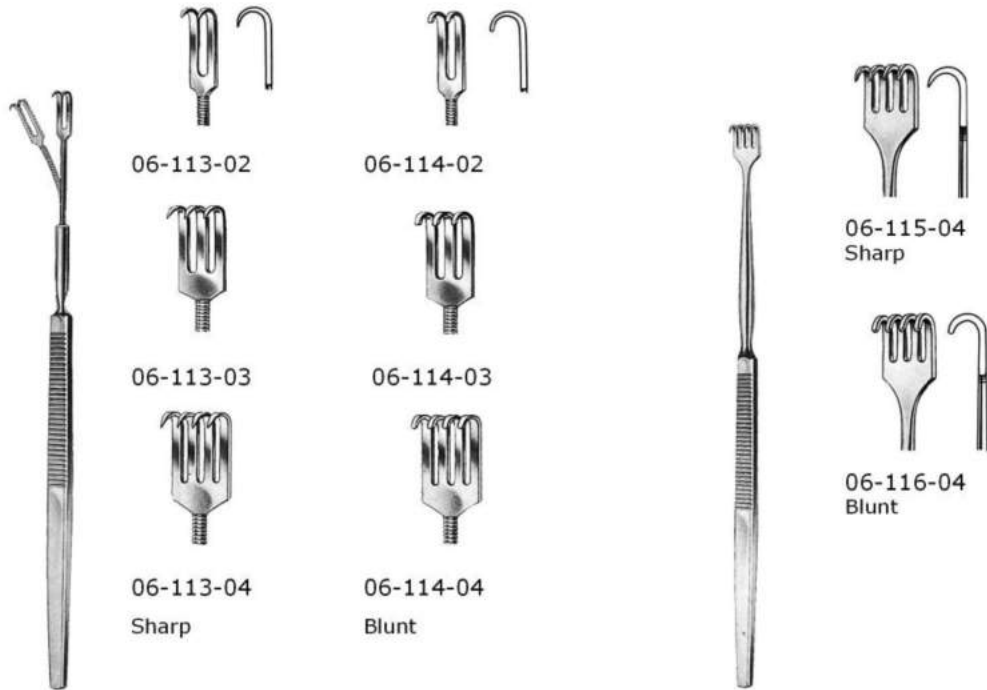

06-113-02 - 06-114-04
16 cm/6 1/4"

flexible

06-115-04 - 06-116-04
16.5 cm/6 1/2"





General Instruments
Wundhaken
Retractors

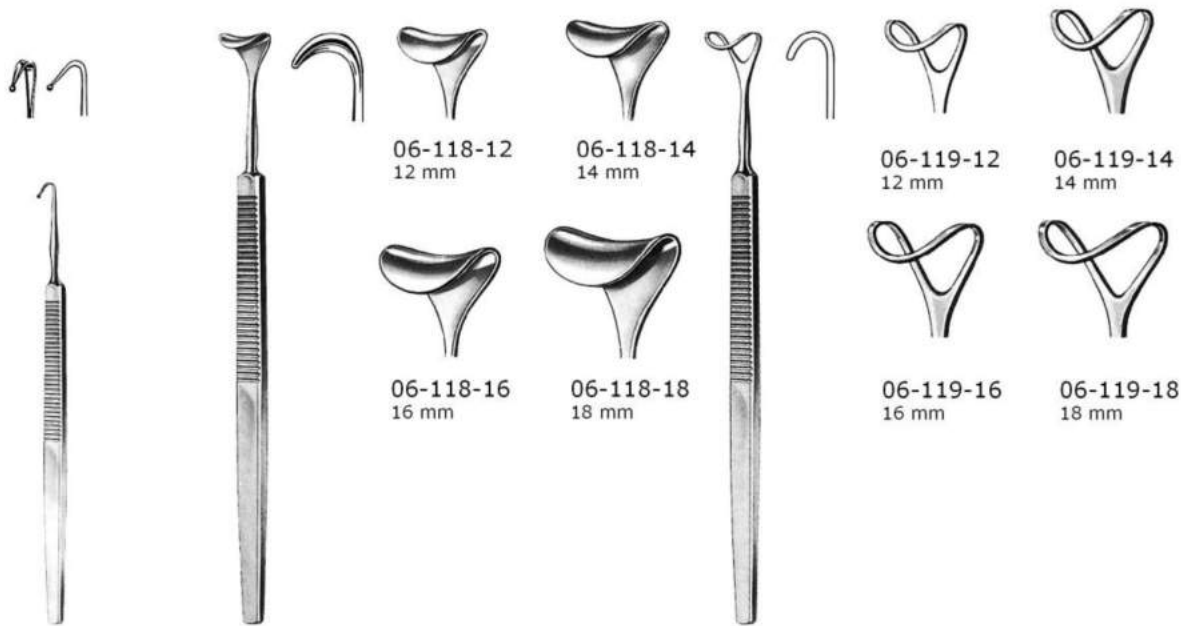

06-117-12
12 cm/4 3/4"

Desmarres
06-118-12 - 06-118-18
16 cm/6 1/4"

06-119-12 - 06-119-18
16 cm/6 1/4"

06-118-12
12 mm

06-118-14
14 mm

06-119-12
12 mm

06-119-14
14 mm

06-118-16
16 mm

06-118-18
18 mm

06-119-16
16 mm

06-119-18
18 mm



06-120-10
10x6 mm

06-120-17
17x5 mm

14x8 mm

06-120-22
22x8 mm

Mini-Langenbeck
06-120-10 - 06-120-22
16 cm/6 1/4"

06-121-16
16 cm/6 1/4"

Allgemeines Instrumentarium
Wundhaken
Retractors



06-122-01

06-122-02

06-122-03

06-122-04



06-123-01

06-123-02

06-123-03

06-123-04

06-122-01 - 06-123-04
16.5 cm/6 1/2"



06-124-01
18x7 mm



06-124-02
16x5 mm



06-124-03
10x4 mm



06-124-04
10x4 mm

Meyerding
06-124-01 - 06-124-04
18 cm/7"

General Instruments
Wundhaken
Retractors



06-125-01
20x6 mm

06-125-02
10x6 mm

Senn-Green
06-125-01 - 06-125-02
15 cm/6"



8x4 mm

15x5.5 mm

Ragnell-Davis
06-126-14
14 cm/5½"

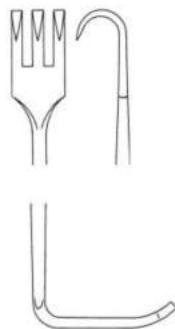

Sharp
06-127-16
7x8.5 mm

Blunt
06-128-16
7x8.5 mm

Senn-Mueller
06-127-16 - 06-128-16
16 cm/6¼"

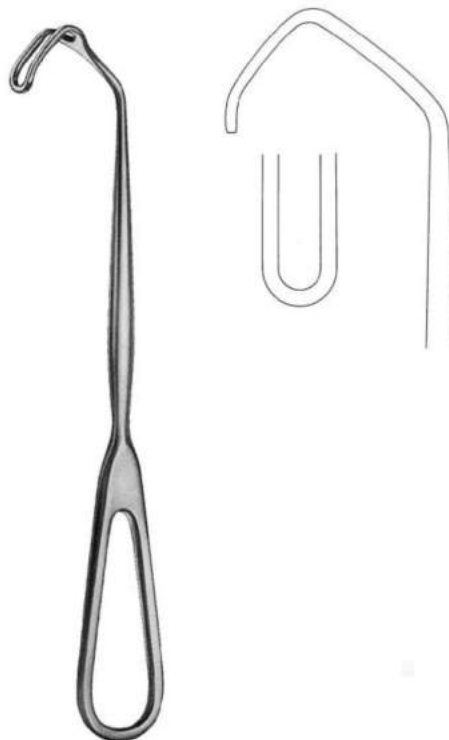

Cushing
06-129-20
20 cm/8"

Allgemeines Instrumentarium
Wundhaken
Retractors

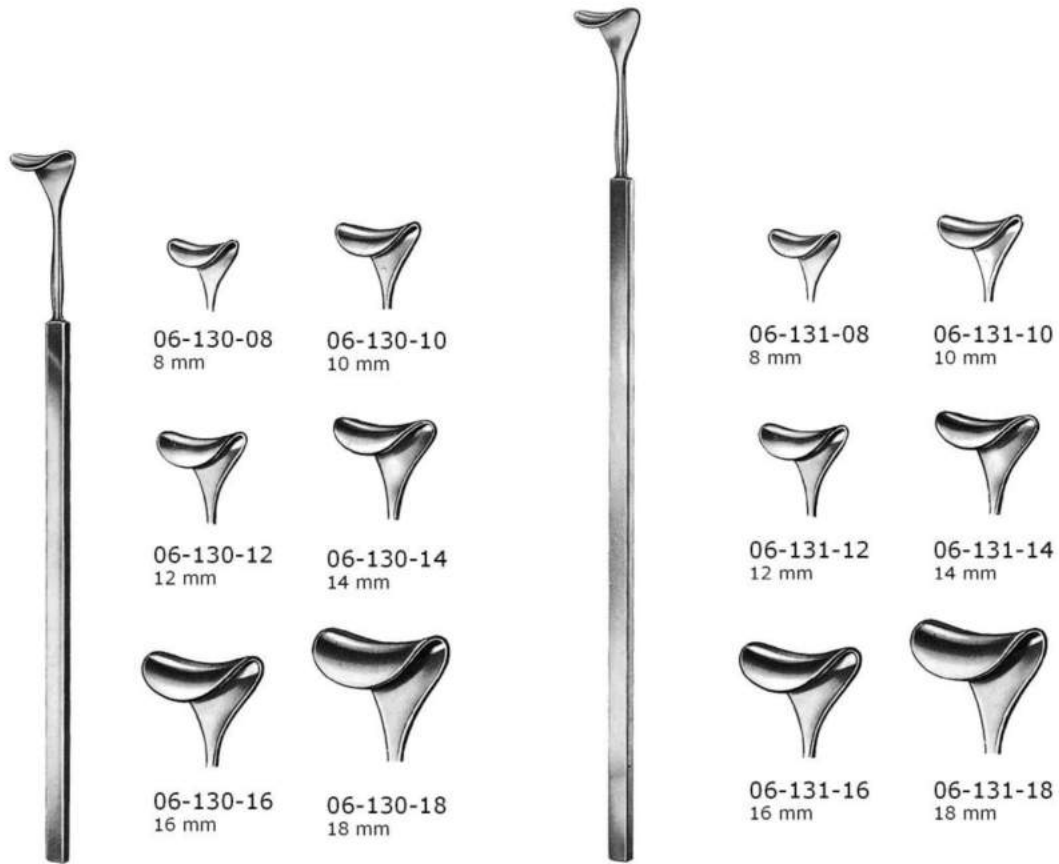

Cushing
06-130-08 - 06-130-18
20 cm/8"

Cushing
06-131-08 - 06-131-18
24 cm/9½"

06-132-01

06-132-02

06-133-01

06-133-02
toothed

Venenhaken Brom
06-132-01 - 06-132-02
19 cm/7½"

Strandell-Stille
06-133-01 - 06-133-02
19 cm/7½"



General Instruments
Wundhaken
Retractors

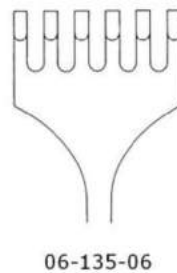
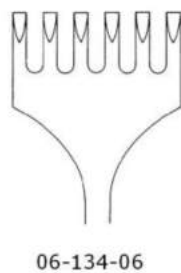
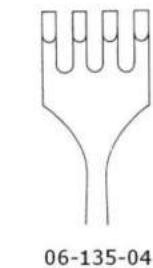
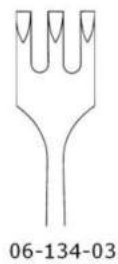
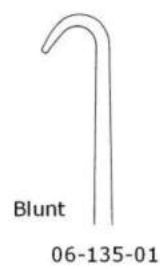
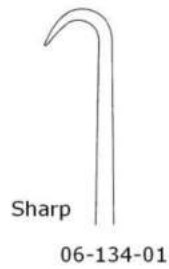

Volkman
06-134-01 - 06-135-06
21.5 cm/8 1/2"





Allgemeines Instrumentarium
Wundhaken
Retractors

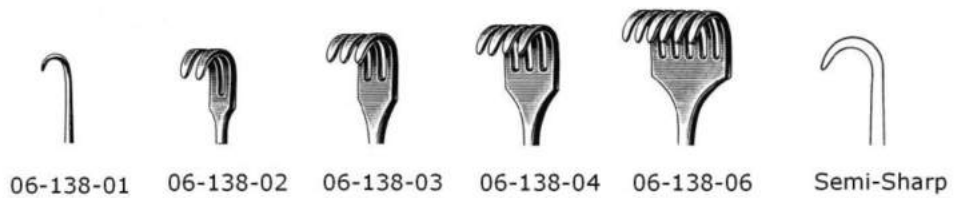
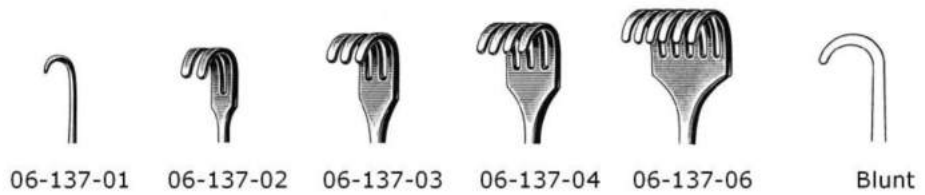
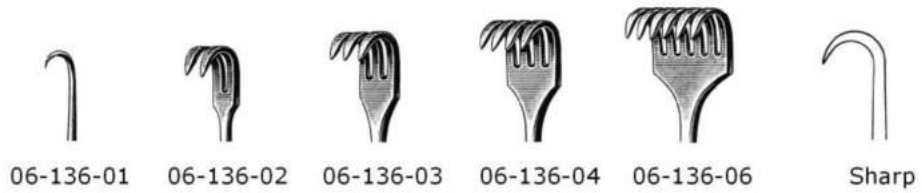

Volkman
06-136-01 - 06-138-06
22 cm/8 1/2"



General Instruments
Wundhaken
Retractors

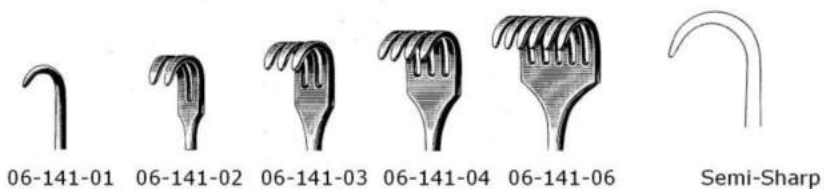
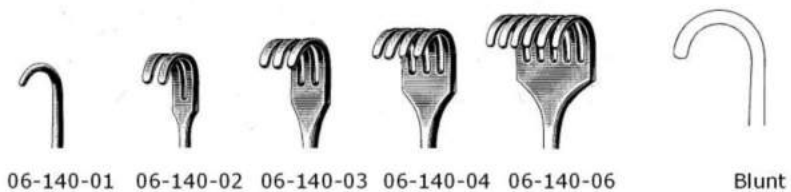
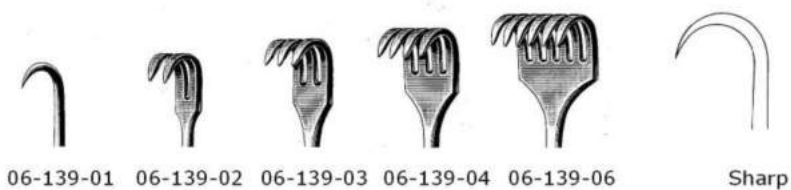

Kocher
06-139-01 - 06-141-06
22 cm/8 1/2"



Allgemeines Instrumentarium
Wundhaken
Retractors



Sharp

06-142-02



Blunt

06-143-02



06-142-03



06-143-03



06-142-04



06-143-04



06-142-06



06-143-06

06-142-02 - 06-143-06
22 cm/8 7/8"



General Instruments
Wundhaken
Retractors

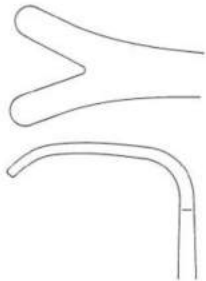

33x20 mm

Wassmund
06-144-02
20.5 cm/8¹/₄"



06-146-04
36x60 mm

06-145-03
36x30 mm

Ollier
06-145-03 - 06-146-04
24 cm/9¹/₂"



06-147-08
46x30 mm
Sharp

06-148-08
46x30 mm
Blunt

Koerte
06-147-08 - 06-148-08
23.5 cm/9¹/₄"



Allgemeines Instrumentarium
Wundhaken
Retractors



06-149-04 - 06-152-07
23.5 cm/9 1/4"



06-149-04 40x40 mm
06-150-05 45x50 mm
06-151-06 50x60 mm
06-152-07 70x70 mm



06-153-01 30x11 mm
06-153-02 30x14 mm
06-153-03 30x16 mm
06-153-04 40x11 mm
06-153-05 50x11 mm

Langenbeck
06-153-01 - 06-153-05
22 cm/8 1/2"



06-154-01 30x11 mm
06-154-02 30x14 mm
06-154-03 30x16 mm
06-154-04 40x11 mm
06-154-05 50x11 mm

Langenbeck
06-154-01 - 06-154-05
22 cm/8 1/2"



General Instruments
Wundhaken
Retractors

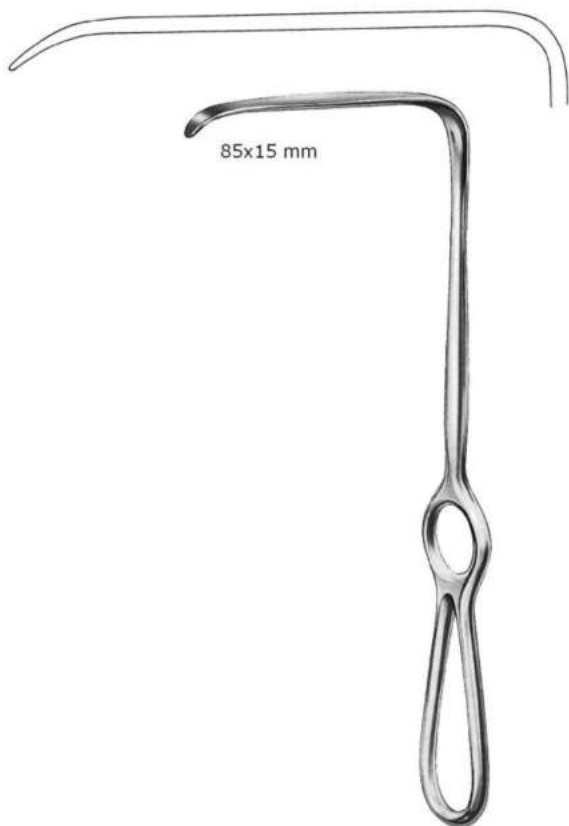

Langenbeck
06-155-22
22 cm/8 7/8"



Langenbeck
06-156-22
22 cm/8 7/8"



Allgemeines Instrumentarium
Wundhaken
Retractors

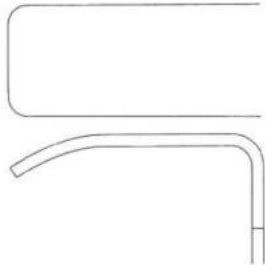

- 06-157-18 40x18 mm
- 06-157-20 60x20 mm
- 06-157-25 60x25 mm
- 06-157-30 75x30 mm
- 06-157-40 75x40 mm



Kocher
06-157-18 - 06-157-40
23 cm/9"



- 06-158-01 25x6 mm
- 06-158-02 35x8 mm
- 06-158-03 35x11mm
- 06-158-04 35x15mm
- 06-158-05 40x11mm
- 06-158-06 55x11 mm
- 06-158-07 70x14 mm
- 06-158-08 80x16 mm

Kocher-Langenbeck
06-158-01 - 06-158-08
22 cm/8½"



- 06-159-01 35x8 mm
23.5 cm/9¼"
- 06-159-02 60x12 mm
26 cm/10¼"
- 06-159-03 75x12 mm
27.5 cm/10¾"
- 06-159-04 85x20 mm
29 cm/11¼"
- 06-159-05 100x25 mm
30 cm/12"



Zenker
06-159-01 - 06-159-05



General Instruments
Wundhaken
Retractors

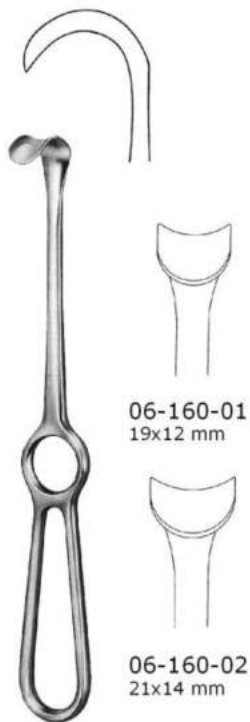

06-160-01
19x12 mm

06-160-02
21x14 mm

Kocher
06-160-01 - 06-160-02
20 cm/8"

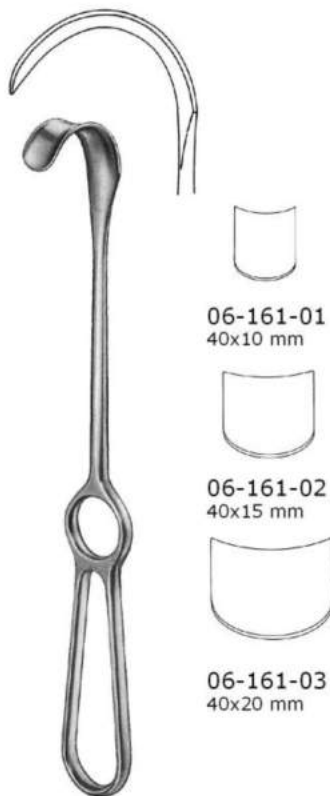

06-161-01
40x10 mm

06-161-02
40x15 mm

06-161-03
40x20 mm

Kocher
06-161-01 - 06-161-03
22 cm/8 7/8"

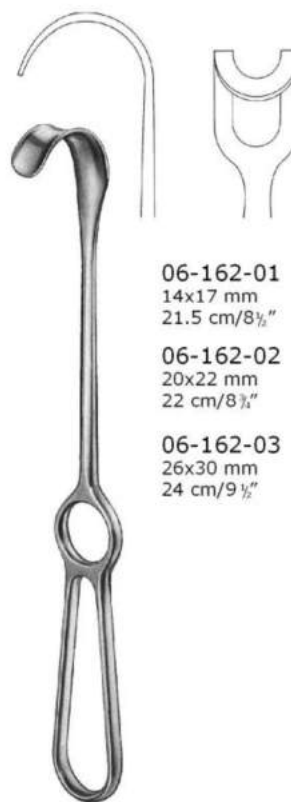

06-162-01
14x17 mm
21.5 cm/8 1/2"

06-162-02
20x22 mm
22 cm/8 3/4"

06-162-03
26x30 mm
24 cm/9 1/2"

Middeldorpf
06-162-01 - 06-162-03



Allgemeines Instrumentarium
Wundhaken
Retractors

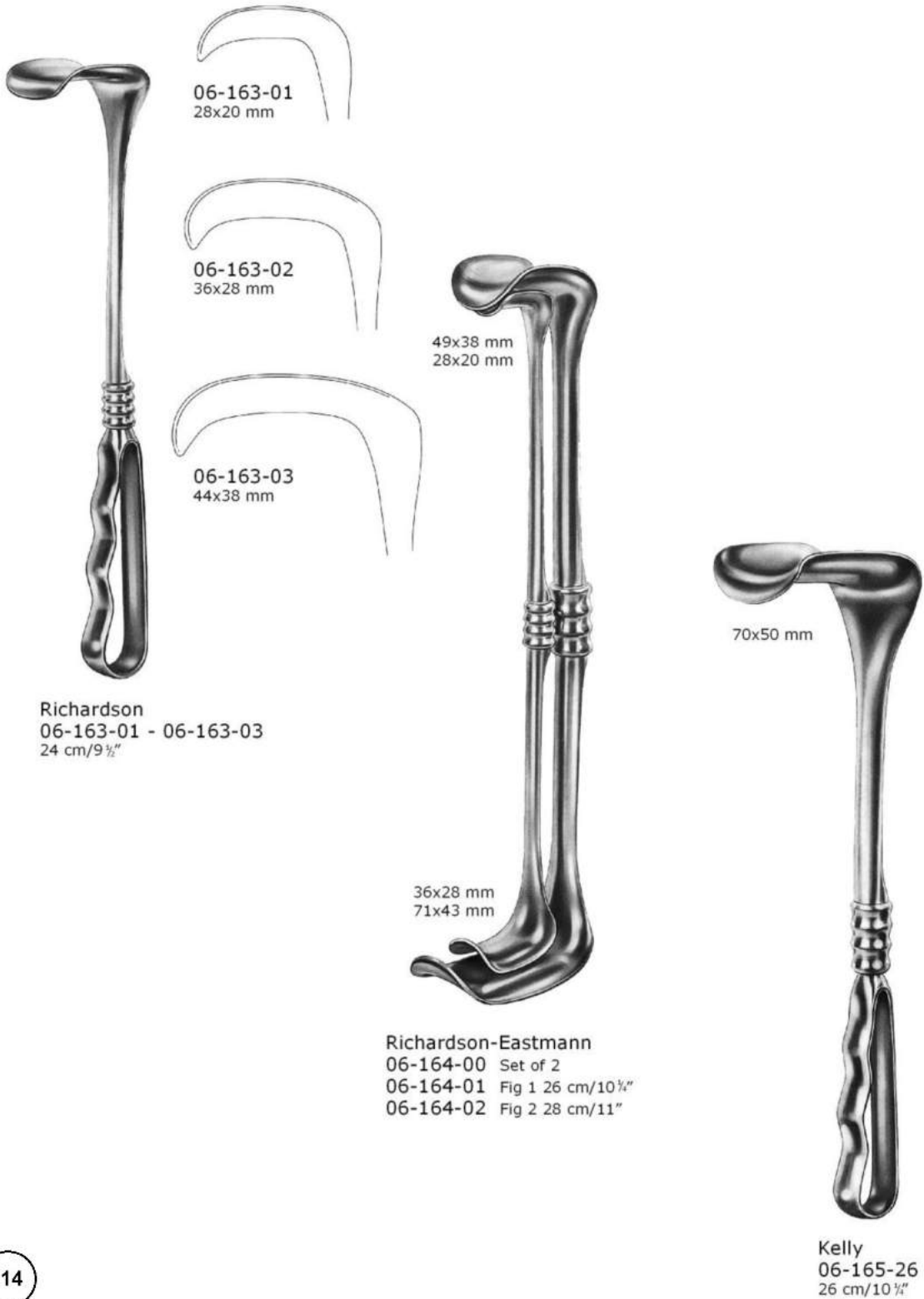

General Instruments
Wundhaken
Retractors

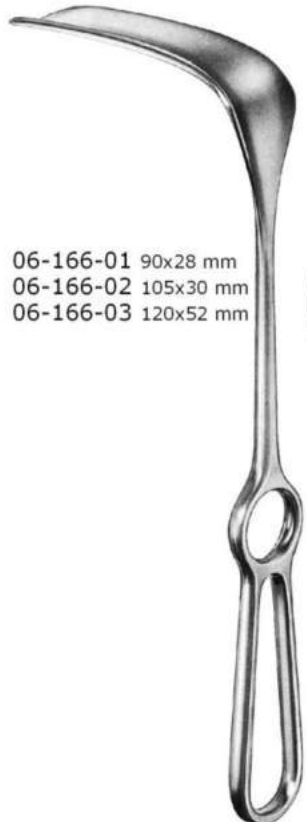

06-166-01 90x28 mm
06-166-02 105x30 mm
06-166-03 120x52 mm

06-166-01 - 06-166-03
25 cm/10"



06-167-01 60x20 mm
06-167-02 50x30 mm
06-167-03 100x30 mm
06-167-04 120x30 mm
06-167-05 140x30 mm
06-167-06 140x40 mm

Hosel
06-167-01 - 06-167-06
26 cm/10 1/4"

Allgemeines Instrumentarium
Wundhaken
Retractors



Middeldorpf
06-168-01 - 06-168-03
27.5 cm/10 7/8"



06-168-01 45x45 mm
06-168-02 45x50 mm
06-168-03 55x70 mm



06-169-01 32x40 mm
06-169-02 40x50 mm
06-169-03 40x60 mm
06-169-04 45x75 mm
06-169-05 65x85 mm

Fritsch
06-169-01 - 06-169-05
23 cm/9"

General Instruments
Wundhaken
Retractors



70x25 mm

Kocher
06-170-24
24 cm/9½"



06-171-01 80x45 mm
06-171-02 80x55 mm
06-171-03 80x65 mm

Kocher
06-171-01 - 06-171-03
25 cm/10"



45x85 mm

Doyen
06-172-25
25 cm/10"

Allgemeines Instrumentarium
Wundhaken
Retractors





General Instruments
Wundhaken
Retractors



06-176-03
115x65 mm



06-176-01
82x22 mm



06-176-02
108x43 mm

Coryllos
06-176-01 - 06-176-03
24 cm/9½"

Allgemeines Instrumentarium
Wundhaken
Retractors



Davidson
06-177-01
16 cm/6 1/4"
75 x 50mm



Davidson
06-177-02
16 cm/6 1/4"
75 x 90mm

General Instruments
Wundhaken
Retractors

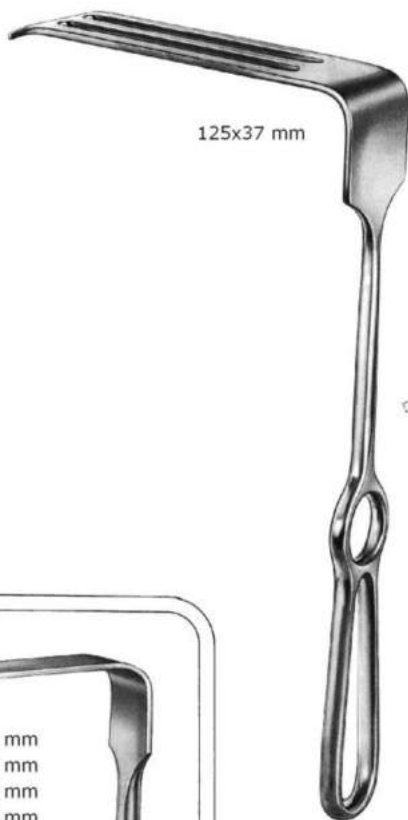

125x37 mm

Sauerbruch
06-179-25
25 cm/10"

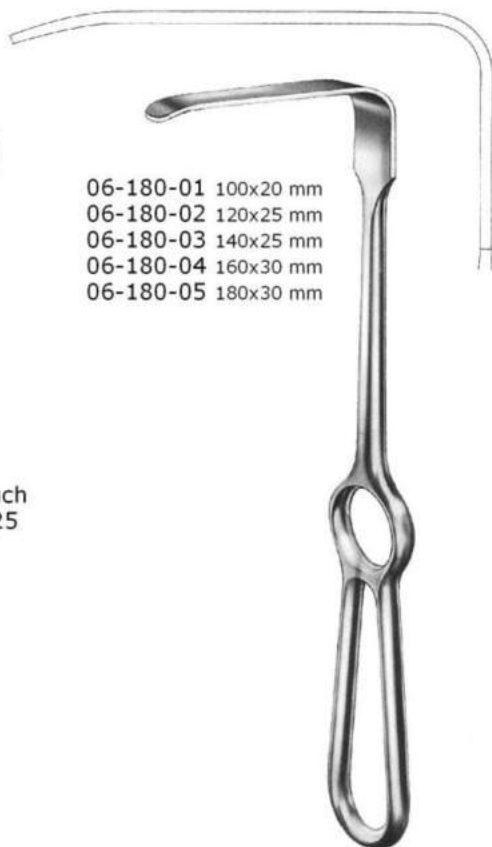

- 06-180-01 100x20 mm
- 06-180-02 120x25 mm
- 06-180-03 140x25 mm
- 06-180-04 160x30 mm
- 06-180-05 180x30 mm

Brunner
06-180-01 - 06-180-05
25 cm/10"

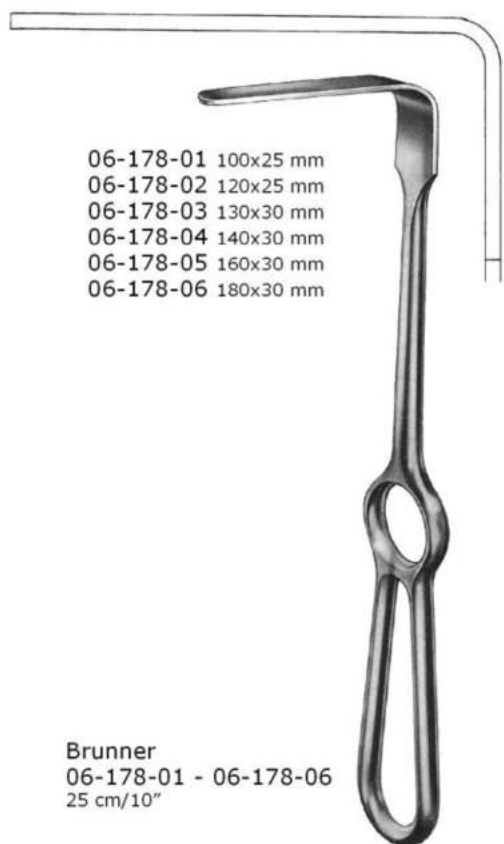

- 06-178-01 100x25 mm
- 06-178-02 120x25 mm
- 06-178-03 130x30 mm
- 06-178-04 140x30 mm
- 06-178-05 160x30 mm
- 06-178-06 180x30 mm

Brunner
06-178-01 - 06-178-06
25 cm/10"



Allgemeines Instrumentarium
Wundhaken
Retractors



Ross
06-182-01 - 06-182-06
25 cm/10"



Crawford
06-181-01 - 06-181-02
19 cm/7 1/2"

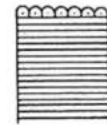

06-181-01
15x15 mm

06-181-02
15x25 mm



06-182-01
Fig. 1



06-182-02
Fig. 2



06-182-03
Fig. 3



06-182-04
Fig. 4



06-182-05
Fig. 5



06-182-06
Fig. 6



General Instruments
Wundhaken
Retractors



Polloson
06-183-27
27 cm/10 7/8"



Allgemeines Instrumentarium
Wundhaken
Retractors





General Instruments
Wundhaken
Retractors



Deaver
06-186-01
18 cm/ 7"

Deaver
06-186-02
21.5 cm/8½"

Deaver
06-186-03
23 cm/ 9"

Deaver
06-186-30 30 cm/ 12"
06-186-33 33 cm/ 13"
06-186-36 36 cm/ 14"

Deaver
06-187-07
30 cm/ 12"



Allgemeines Instrumentarium
Wundhaken
Retractors



06-188-04 25 mm
06-188-07 38 mm
06-188-08 50 mm
06-188-10 100 mm

Deaver
06-188-04 - 06-188-10
30 cm/12"

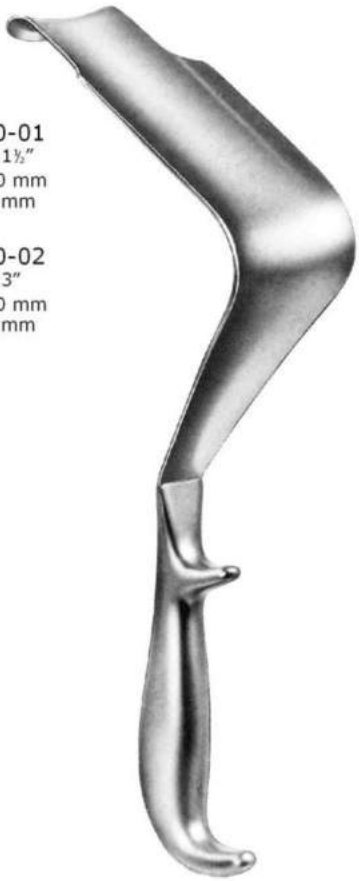

06-190-01
29 cm/11½"
130 x 60 mm
35 x 45 mm

06-190-02
33 cm/13"
180 x 60 mm
60 x 45 mm

St. Marks
06-190-01 - 06-190-02



Mikulicz
06-189-01 - 06-189-03
25 cm/10"

06-189-01 95 x 35 mm
06-189-02 120 x 50 mm
06-189-03 150 x 50 mm

General Instruments
Wundhaken
Retractors



Mikulicz
06-191-26
26 cm/10 1/2"

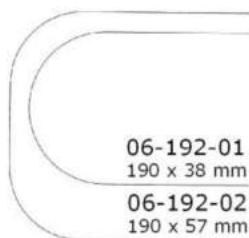

Kelly
06-192-01 - 06-192-02
27 cm/10 1/2"



Farabeuf
06-193-12
12 cm/4 3/4"
Set of 2

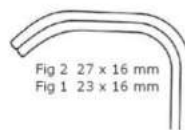
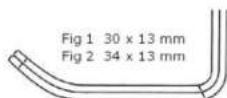
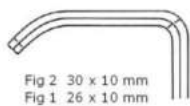

Farabeuf
06-194-15
15 cm/6"
Set of 2

Allgemeines Instrumentarium
Wundhaken
Retractors



Fig.1 24 x 20 mm
Fig.2 29 x 26 mm
Fig.3 33 x 29 mm

Fig.1 30 x 28 mm
Fig.2 36 x 36 mm
Fig.3 38 x 43 mm

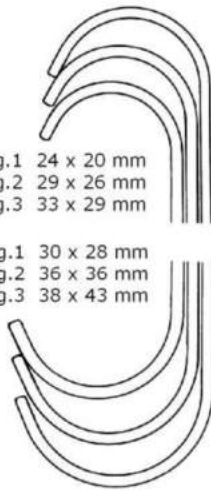

Roux
06-195-00 Set of 3
06-195-01 Fig.1= 14 cm/ 5½"
06-195-02 Fig.2= 15 cm/ 6"
06-195-03 Fig.3= 17 cm/ 6½"

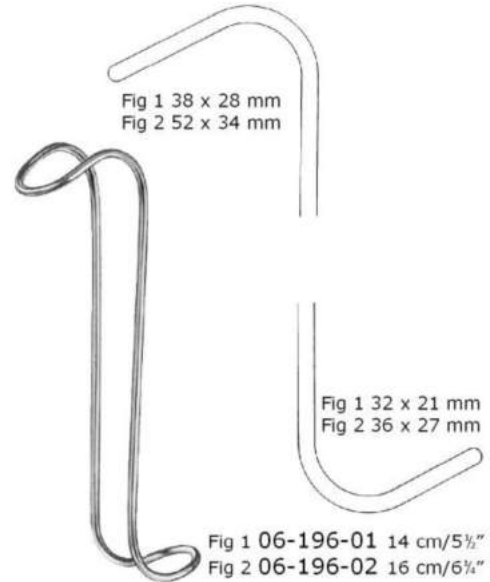

Fig 1 38 x 28 mm
Fig 2 52 x 34 mm

Fig 1 32 x 21 mm
Fig 2 36 x 27 mm

Fig 1 06-196-01 14 cm/5½"
Fig 2 06-196-02 16 cm/6½"

Collin-Hartmann
06-196-00 Set of 2
06-196-01 Fig 1
06-196-02 Fig 2



Fig.1 26 x 25 mm
Fig.2 29 x 25 mm

Fig.2 27 x 25 mm
Fig.1 24 x 25 mm



Parker
06-197-02 Set of 2
18 cm/ 7"



Parker-Mott
06-197-00 Set of 2
16 cm/ 6½"



Fig.2 25 x 24 mm
Fig.1 21 x 24 mm

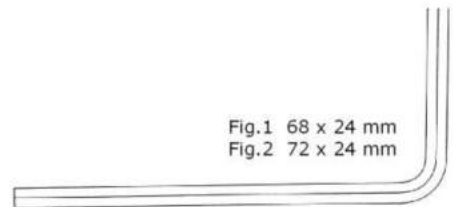
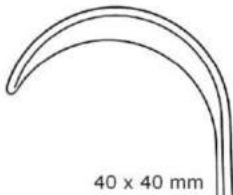
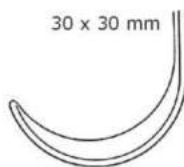

Fig.1 68 x 24 mm
Fig.2 72 x 24 mm

General Instruments
Wundhaken
Retractors



40 x 40 mm



30 x 30 mm

Goelet
06-198-00
19 cm / 7½"

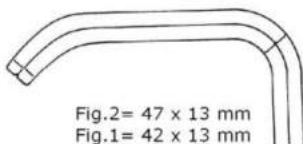

Fig.2= 47 x 13 mm
Fig.1= 42 x 13 mm

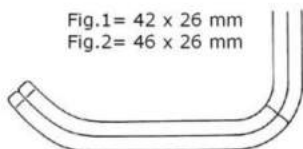

Fig.1= 42 x 26 mm
Fig.2= 46 x 26 mm

Mathieu
06-199-00 Set of 2
20 cm / 8"

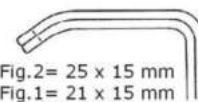

Fig.2= 25 x 15 mm
Fig.1= 21 x 15 mm

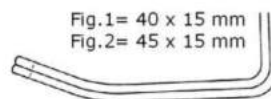
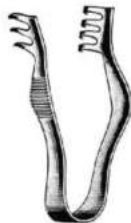

Fig.1= 40 x 15 mm
Fig.2= 45 x 15 mm

US Army
06-200-00 Set of 2
21 cm / 8½"

Allgemeines Instrumentarium
Wundsperrer
Retractors



06-201-05
Sharp



06-202-05
Blunt

Finsen
06-201-05 - 06-202-05
5 cm/ 2"
3x4 teeth



06-203-07
Sharp

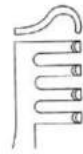

06-204-07
Blunt

Finsen
06-203-07 - 06-204-07
7 cm/ 2 3/4"
3x4 teeth

General Instruments
Wundsperrer
Retractors



Cross action
06-205-10
10 cm/ 4"
4x4 teeth
Blunt



Jansen
06-206-10
10 cm/ 4"
3x3 teeth
Blunt



Alm
06-207-07 - 06-208-10



06-207-07
7 cm/ 2 3/4"
3x3 Teeth
Sharp



06-207-10
10 cm/ 4"
4x4 Teeth
Sharp

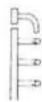

06-208-07
7 cm/ 2 3/4"
3x3 Teeth
Blunt

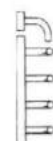

06-208-10
10 cm/ 4"
4x4 Teeth
Blunt



Allgemeines Instrumentarium
Wundsperrer
Retractors



Weitlaner
06-209-20 - 06-210-20
20 cm/ 8"
3x4 teeth

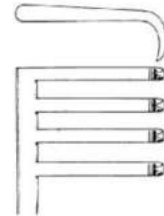

06-209-20
Sharp

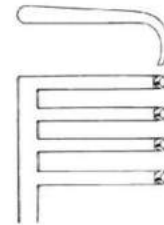

06-210-20
Blunt



Anderson-Adson
06-211-20
20 cm/ 8"
4x4 teeth

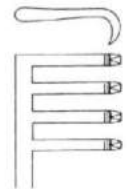
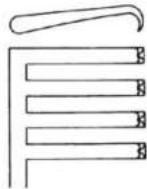

06-212-14
Sharp

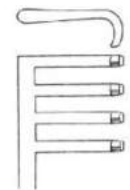

06-213-14
Blunt



Scalp Contour
06-212-14 - 06-213-14
14 cm/ 5 1/2"
3x4 teeth

General Instruments
Wundsperrer
Retractors



Adson
06-217-26 - 06-220-26
26.5 cm/ 10 1/2"

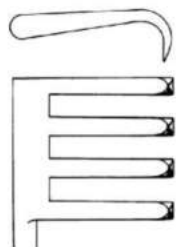

06-217-26 Sharp
3x4 Teeth

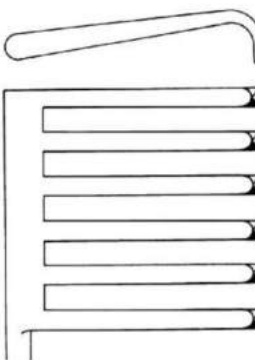

06-219-26 Sharp
5x6 Teeth

06-220-26 Blunt



Central Blades
06-214-19
16mm x 19mm
06-214-25
16mm x 25mm
06-214-32
16mm x 32mm



Henley
06-215-00 - 06-216-00
16.5 cm/ 6 1/2"
3:4 teeth



06-215-00
Sharp



06-216-00
Blunt

Allgemeines Instrumentarium
Wundsperrer
Retractors

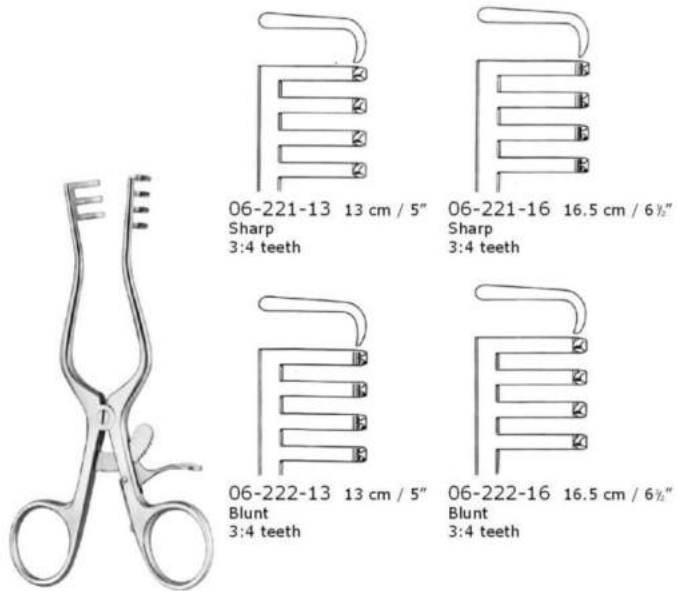

Weitlaner
06-221-13 - 06-222-16

06-221-13 13 cm / 5"
Sharp
3:4 teeth

06-221-16 16.5 cm / 6½"
Sharp
3:4 teeth

06-222-13 13 cm / 5"
Blunt
3:4 teeth

06-222-16 16.5 cm / 6½"
Blunt
3:4 teeth



Mollison
06-223-15
15 cm / 6"

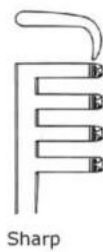

Weitlaner-Wullstein
06-224-13 - 06-225-13
13 cm / 5"

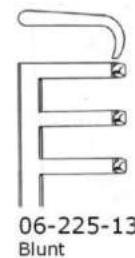
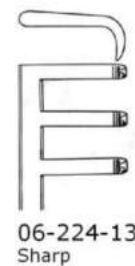

General Instruments
Wundsperrer
Retractors

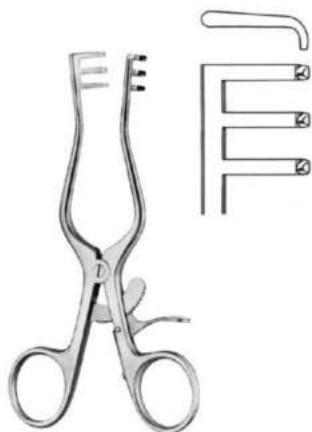

Milligan
06-226-13
13 cm/ 5"
3:3 Teeth

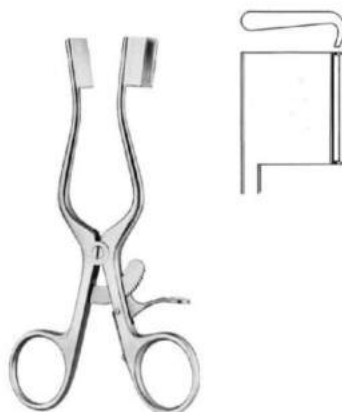

Weitlaner-Baby
06-227-13
13 cm/ 5"

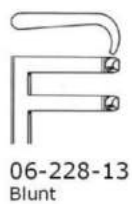

06-228-13
Blunt

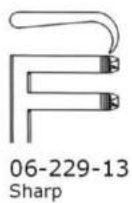

06-229-13
Sharp

Plester
06-228-13 - 06-229-13
13 cm/ 5"
2:2 Teeth



Plester
06-230-12
12 cm/ 4 1/2"
Blunt

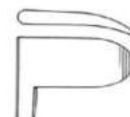

Plester
06-231-12
12 cm/ 4 1/2"
Blunt



Allgemeines Instrumentarium
Wundsperrer
Retractors

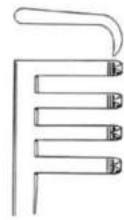

06-232-16
16 cm/ 6 1/4"

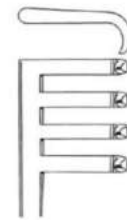

06-233-16
16 cm/ 6 1/4"

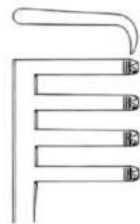

06-232-20
20 cm/ 8"



06-233-20
20 cm/ 8"

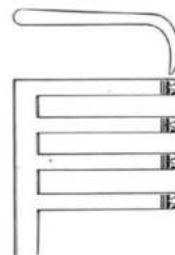

06-232-26
26 cm/ 10 1/4"
Sharp

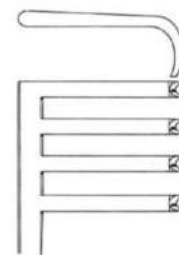

06-233-26
26 cm/ 10 1/4"
Blunt

136

Adson
06-232-16 - 06-233-26
3:4 Teeth



General Instruments
Wundsperrer
Retractors



Cloward
06-234-40 - 06-234-60
25 cm/ 10"



- 06-234-40 40 mm
- 06-234-45 45 mm
- 06-234-50 50 mm
- 06-234-55 55 mm
- 06-234-60 60 mm



- 06-235-40 40 mm
- 06-235-45 45 mm
- 06-235-50 50 mm
- 06-235-55 55 mm
- 06-235-60 60 mm



Cloward
06-235-40 - 06-235-60
16 cm/ 6 1/2"

Allgemeines Instrumentarium
Wundsperrer
Retractors



Adson
06-236-32
32 cm/ 12½"
4:5 Teeth



Beckmann
06-237-31
31 cm/ 12¼"
4:4 Teeth

General Instruments
Wundsperrer
Retractors



06-238-00
Blunt



06-238-02
Sharp

Beckmann-Adson
06-238-00 - 06-238-02
31 cm/ 12 1/2"
4:4 Teeth

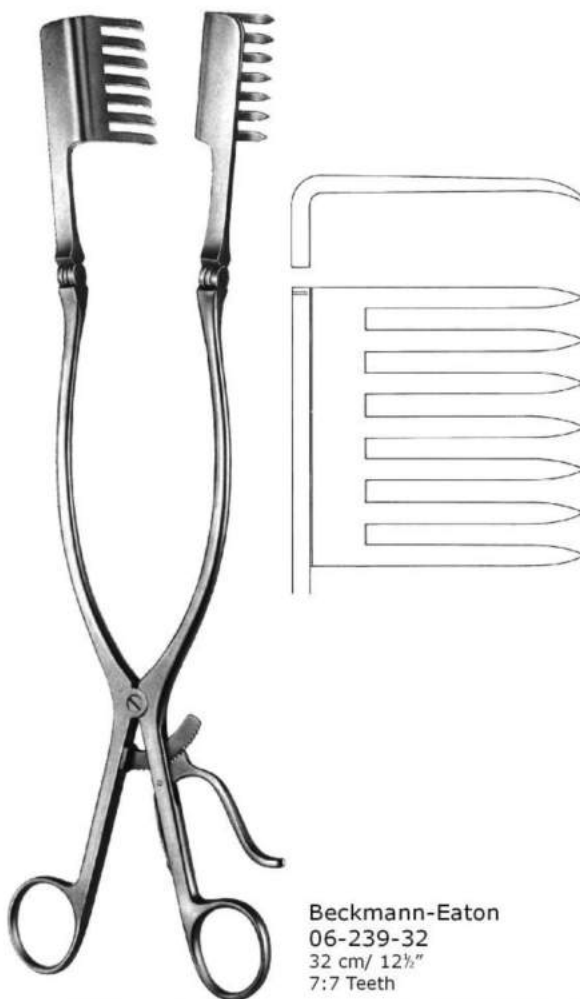

Beckmann-Eaton
06-239-32
32 cm/ 12 1/2"
7:7 Teeth

Allgemeines Instrumentarium
Wundsperrer
Retractors

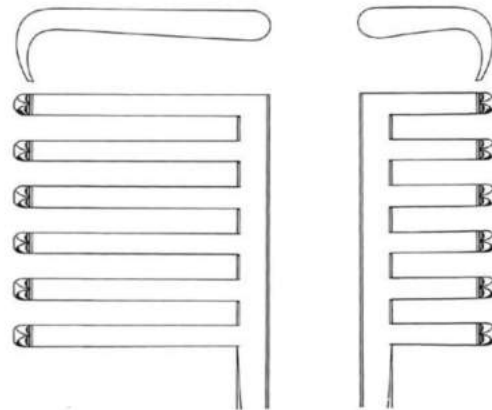

06-240-01 Right
06-240-02 Left

Retractor
06-240-01 - 06-240-02
27 cm/ 10 $\frac{3}{4}$ "
6:6 Teeth

General Instruments
Wundsperrer
Retractors



Gelpi-Loktite
06-241-14
14 cm/5½"



Gelpi-Loktite
06-242-18
18 cm/7"



Gelpi-Loktite
06-243-18
18 cm/7"

Allgemeines Instrumentarium
Bauchdeckenhalter
Abdominal Retractors

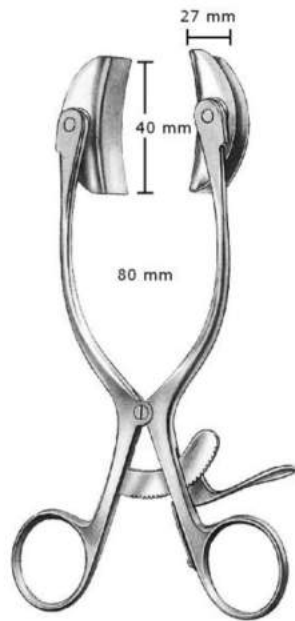

Baby-Collin
06-244-00
Complete with 1 Pair of blades
27 x 40 mm

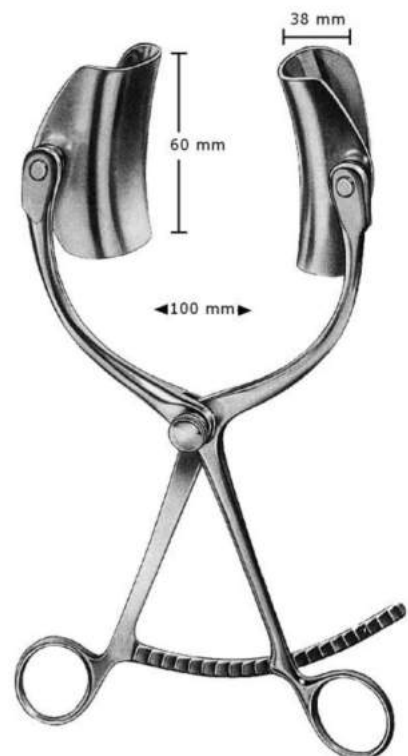

Collin
06-245-22
Complete with 1 Pair of blades
38 x 60 mm

General Instruments
Bauchdeckenhalter
Abdominal Retractors



Collin	Lateral Blades	Central Blades
06-246-00	38 x 60 mm	38 x 55 mm
06-247-00	38 x 80 mm	50 x 75 mm



Collin-Loktite
06-248-00
26 cm / 10 1/2"
Central blade 75x60 mm

Allgemeines Instrumentarium
Bauchdeckenhalter
Abdominal Retractors



Ricard
06-249-00 28 cm/ 11"
06-250-00 30 cm/ 12"
Complete

Lateral Blades	Center Blades
50 x 58 mm	55 x 70 mm
60 x 80 mm	80 x 90 mm

General Instruments
Bauchdeckenhalter
Abdominal Retractors

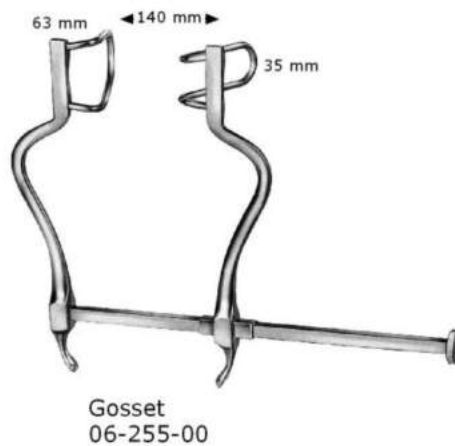



Allgemeines Instrumentarium
Bauchdeckenhalter
Abdominal Retractors



Balfour-Baby
06-257-00

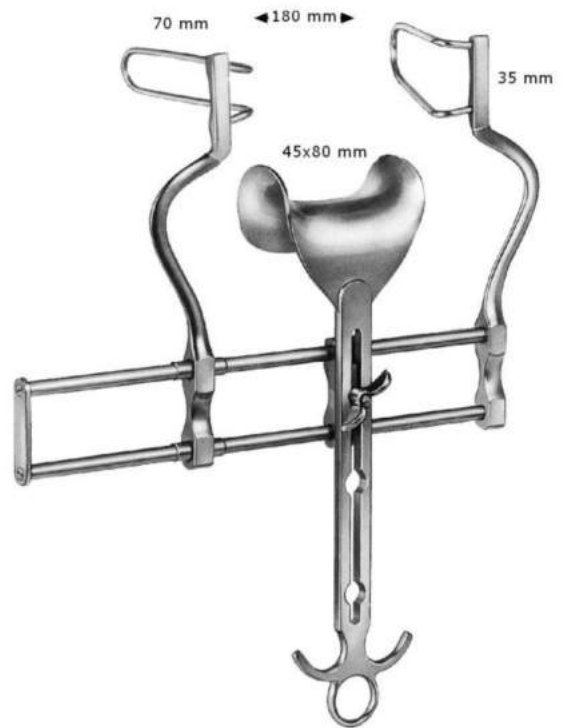

Balfour
06-258-00



Balfour
06-259-00



General Instruments
Bauchdeckenhalter
Abdominal Retractors

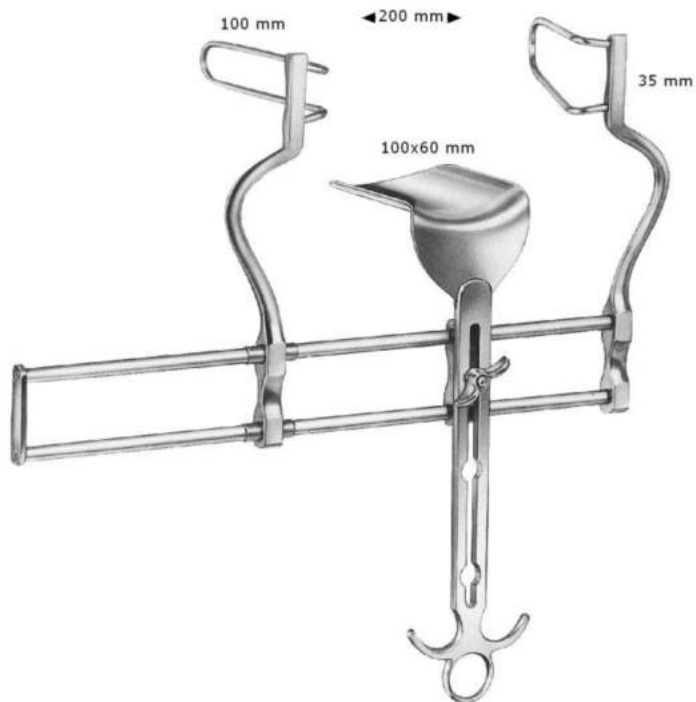

Balfour
06-260-00

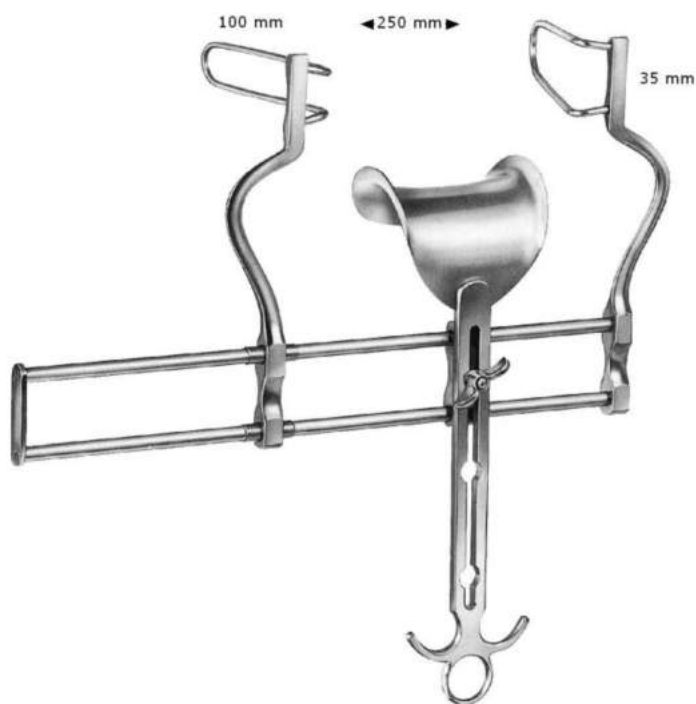

Balfour Center Blades
06-261-00 45 x 80 mm
06-261-01 70 x 85 mm
Complete

Allgemeines Instrumentarium
Bauchdeckenhalter
Abdominal Retractors



Balfour
06-262-06
06-262-08
Complete

Lateral Blades	Center Blades
6 cm deep	40 x 68 mm
8 cm deep	68 x 85 mm

General Instruments
Bauchdeckenhalter
Abdominal Retractors



Scoville
06-263-00
Frame only



Scoville
06-263-01
50mm/ 2"



Scoville
06-263-02
50mm/ 2"



Scoville
06-263-03
70mm/ 2 1/2"



Scoville
06-263-04 64x25 mm
06-263-05 64x50 mm
06-263-06 88x25 mm



Taylor
06-263-07 48x50 mm
06-263-08 64x50 mm
06-263-09 64x64 mm
06-263-10 80x57 mm



O'Sullivan-O'Connor
06-264-00
Complete

110 x 70 mm



2 Blades
80x45mm

Allgemeines Instrumentarium
Bauchdeckenhalter
Abdominal Retractors

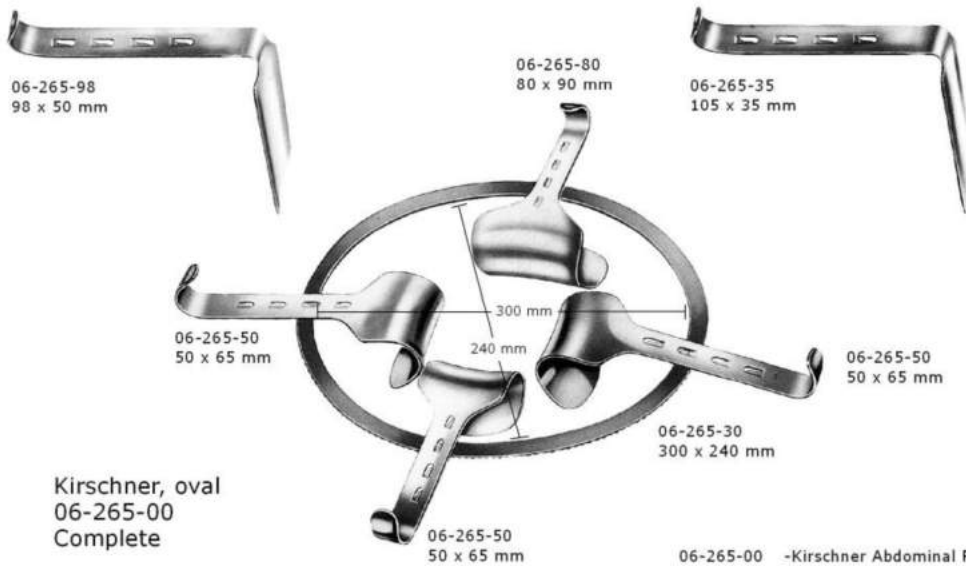

Kirschner, oval
06-265-00
Complete

- 06-265-00 -Kirschner Abdominal Retractor, oval,
-complete, consisting of:
06-265-30 -1 Frame, 300 x 240 mm
06-265-50 -3 Hook-on retractors, 50 x 65 mm
06-265-80 -1 ditto, 80 x 90 mm
06-265-98 -1 ditto, 98 x 50 mm
06-265-35 -1 ditto, 105 x 35 mm

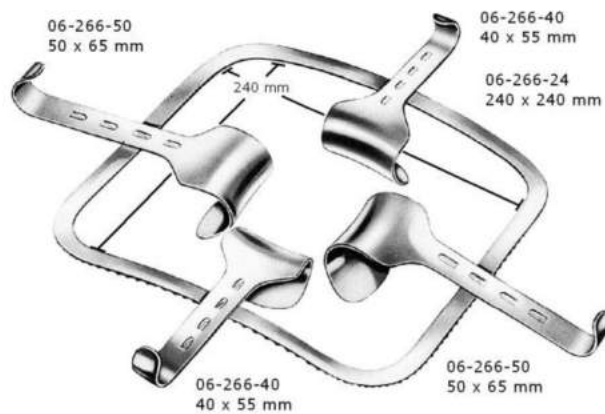

Kirschner
06-266-00
Complete

- 06-266-00 -Abdominal Retractor,
-complete, consisting of:
06-266-24 -1 Frame, rigid, 240 x 240 mm
06-266-40 -2 Hook-on Retractors, 40 x 55 mm
06-266-50 -2 ditto, 50 x 65 mm

General Instruments
Bauchspatel
Abdominal Spatulas

malleable and very soft



Spatula
06-267-06 20 cm x 6.5 mm
06-267-09 20 cm x 9.5 mm
06-267-13 20 cm x 13 mm
06-267-16 20 cm x 16 mm
06-267-19 20 cm x 19 mm

Flexible



Haberer
06-268-00 20 cm/ 8", 17/25 mm
06-268-01 28 cm/ 11", 25/30 mm
06-268-02 30 cm/ 12", 37/45 mm



Reverdin
06-269-28
28 cm/ 11"

Flexible



Spatula
06-270-01 33 cm/ 13", 30 mm
06-270-02 33 cm/ 13", 40 mm
06-270-03 33 cm/ 13", 50 mm

GENERAL INSTRUMENTS

PROBES



Probes

Varicose Probes

Ring Strippers, Cotton Applicator

General Instruments
Sonden
Probes



Probe D/End

07-101-13 13 cm/ 5"
07-101-14 14 cm/ 5½"
07-101-16 16 cm/6¼"
07-101-18 18 cm/ 7"
07-101-20 20 cm/ 8"
2 mm ϕ



Probe D/End

07-102-13 13 cm/ 5"
07-102-14 14 cm/ 5½"
07-102-16 16 cm/6¼"
07-102-18 18 cm/ 7"
07-102-20 20 cm/ 8"
1 mm ϕ



Probe with Eye

07-103-13 13 cm/ 5"
07-103-14 14 cm/ 5½"
07-103-16 16 cm/ 6¼"
07-103-18 18 cm/ 7"
2 mm ϕ



Bowman
13 cm/ 5"

07-104-00 Fig 00/0
07-104-01 Fig 1/2
07-104-03 Fig 3/4
07-104-05 Fig 5/6
07-104-07 Fig 7/8



Stacke

07-104-10
10.5 cm/ 4¼"
1 mm ϕ



Probe

07-105-14 14 cm/ 5½"
07-105-16 16 cm/ 6¼"



Allgemeines Instrumentarium
Sonden
Probes



Butterfly
07-106-13 13 cm/ 5"
07-106-14 14 cm/ 5½"
07-106-16 16 cm/ 6¼"



Butterfly with Probe
07-107-13 13 cm/ 5"
07-107-14 14 cm/ 5½"
07-107-16 16 cm/ 6¼"



Doyen
06-108-14
14 cm/ 5½"



Lockhart-Mummery
07-109-16
16.5 cm/6½"

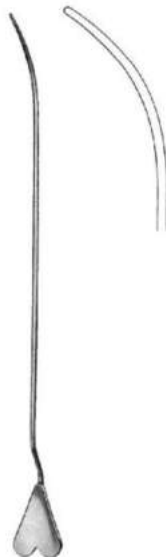

07-110-16
16.5 cm/6½"

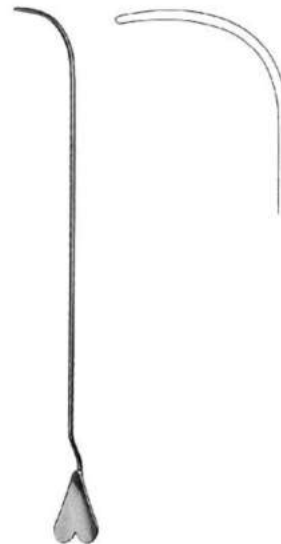

07-111-16
16.5 cm/6½"



07-112-16
16.5 cm/6½"



General Instruments
Krampfader-Besteck
Varicose Vein Probe Set

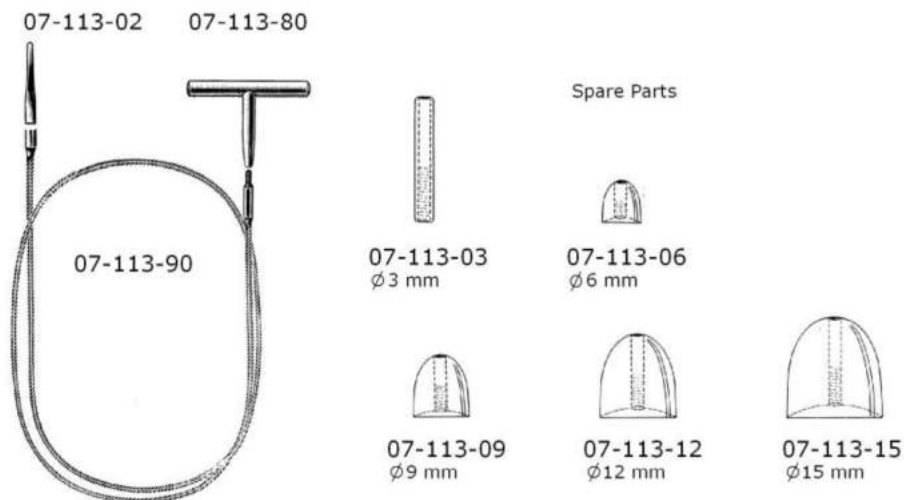

07-113-00 -Varicose Vein Probe Set, in metal case, sterilizable, consisting of:
07-113-02 Probe Tip, plastic material

07-113-03 Olive, 3 mm ϕ
07-113-06 ditto, 6 mm ϕ
07-113-09 ditto, 9 mm ϕ
07-113-12 ditto, 12 mm ϕ
07-113-15 ditto, 15 mm ϕ
07-113-80 Handle only
07-113-90 Cable, flexible
07-113-95 Metal case

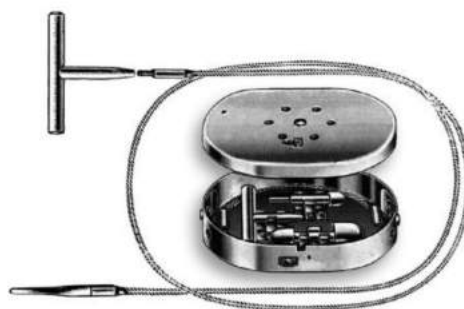

Nabatoff
07-113-00
135 x 100 x 25 mm
Complete Set in Metal Case

Allgemeines Instrumentarium
Ringstripper, Watteträger
Ring Strippers, Cotton Applicators



Round Model

- 07-114-03 3 mm \varnothing
- 07-114-04 4 mm \varnothing
- 07-114-06 6 mm \varnothing
- 07-114-07 7 mm \varnothing
- 07-114-08 8.5 mm \varnothing
- 07-114-10 10 mm \varnothing
- 07-114-12 12 mm \varnothing
- 07-114-14 14 mm \varnothing
- 50 cm/20"



Handle
07-114-30
12 cm/ 4 3/4"

Vollmar
07-114-03 - 07-114-14
50 cm/ 20"



Oval Model

- 07-115-04 5.2 x 4 mm
- 07-115-05 6.5 x 5 mm
- 07-115-06 7.8 x 6 mm
- 07-115-07 9 x 7 mm
- 07-115-08 10.5 x 8 mm
- 07-115-09 11.5 x 9 mm

Vollmar
07-115-04 - 07-115-09
50 cm/ 20"



- 07-116-12 12 cm/ 4 3/4"
- 07-116-14 14 cm/ 5 1/2"
- 07-116-16 16 cm/ 6 1/4"
- 1.2 mm \varnothing

Cotton Applicator
07-116-12 - 07-116-16



- 07-117-12 12 cm/ 4 3/4", 0.9 mm \varnothing
- 07-117-14 14 cm/ 5 1/2", 0.9 mm \varnothing
- 07-117-16 16.5 cm/ 6 1/2", 1.1 mm \varnothing

Farrel
07-117-12 - 07-117-16

VACCINATION & PUNCTURE



Trocars

Suction Tubes

Guide Needles

Hypodermic & Special Needles

Puncture - Impfen und Punktion
Trokare
Trocars



Universal
08-101-03 set of 3 pieces
08-102-04 set of 4 pieces



Standard
08-103-12 3 mm ϕ
08-104-12 4 mm ϕ
08-105-12 5 mm ϕ
08-106-12 6 mm ϕ



Krause
08-107-15
5.5 mm ϕ



08-108-14 4 mm ϕ
08-109-14 5.5 mm ϕ
08-110-14 6.5 mm ϕ

Ochsner
08-108-14 - 08-110-14
14 cm/ 5½"



Lichtwitz
08-111-19
1.8 mm ϕ



Nelson
08-112-07 - 08-114-11
21 cm/ 8½"



08-112-07 08-113-09 08-114-11

Vaccination and Puncture
Saugrohre
Suction Tubes

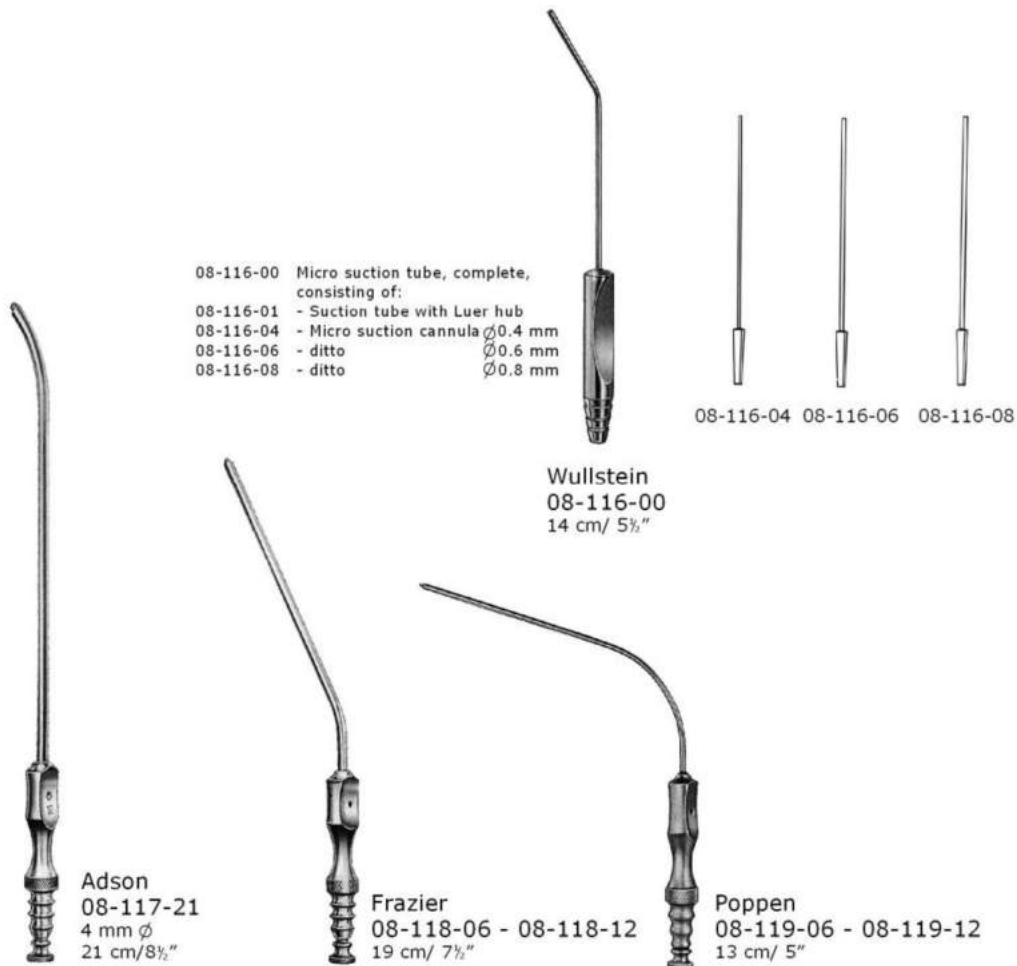
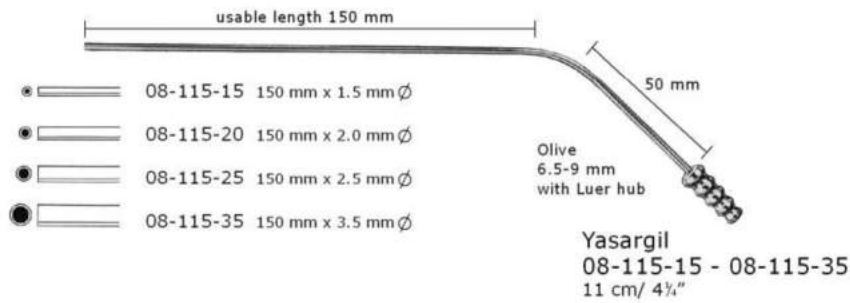

Charr./Fr.	
6	08-118-06
8	08-118-08
10	08-118-10
12	08-118-12

Charr./Fr.	
6	08-119-06
8	08-119-08
10	08-119-10
12	08-119-12

Vaccination and Puncture - Impfen und Punktion
Saugrohre
Suction Tubes

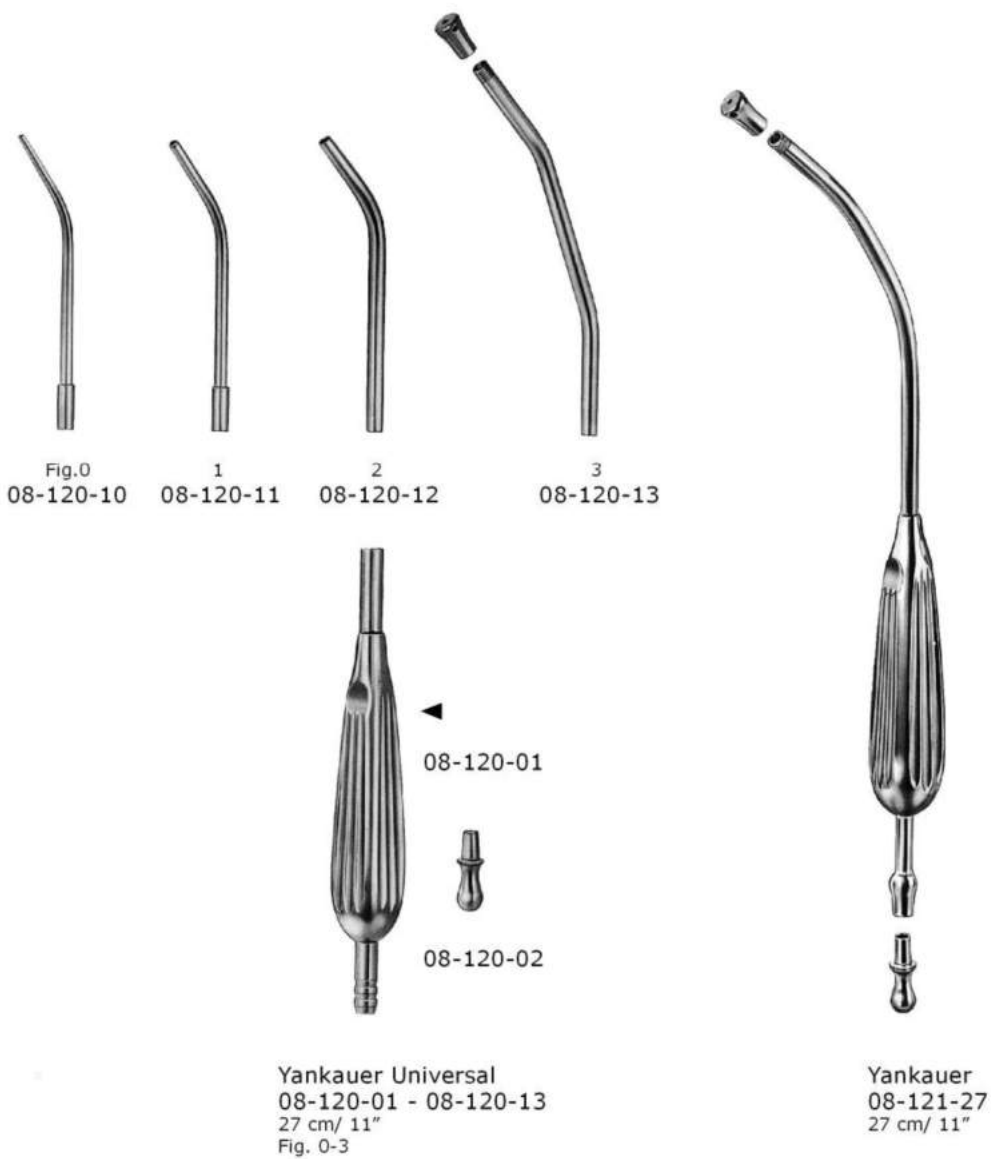

Vaccination and Puncture
Saugrohre
Suction Tubes



Poole
08-122-22
22 cm/8 7/8"
10 mm ϕ
(Charr./Fr 30)



Poole
08-123-22
22 cm/8 7/8"
8 mm ϕ
(Charr./Fr 23)



Cooley
08-124-30
30 cm/12"
10 mm ϕ



Cooley
08-125-30
30 cm/12"
7 mm ϕ



Cooley
08-126-33
33 cm/13 1/4"
8 mm ϕ



Cooley
08-127-35
35 cm/14"
8 mm ϕ

Puncture - Impfen und Punktion
 Führungsnadeln
 Guide Needles



Guide Needles
 08-128-08 - 08-128-18
 with lancet tip

Charr./Fr.	
8	08-128-08
10	08-128-10
12	08-128-12
14	08-128-14
16	08-128-16
18	08-128-18



Guide Needles
 08-129-08 - 08-129-18

Charr./Fr.	
8	08-129-08
10	08-129-10
12	08-129-12
14	08-129-14
16	08-129-16
18	08-129-18



Guide Needles
 08-130-08 - 08-130-18
 Curved

Charr./Fr.	
8	08-130-08
10	08-130-10
12	08-130-12
14	08-130-14
16	08-130-16
18	08-130-18

Vaccination and Puncture
Injektions- und Spezialkanülen
Hypodermic and Special Needles

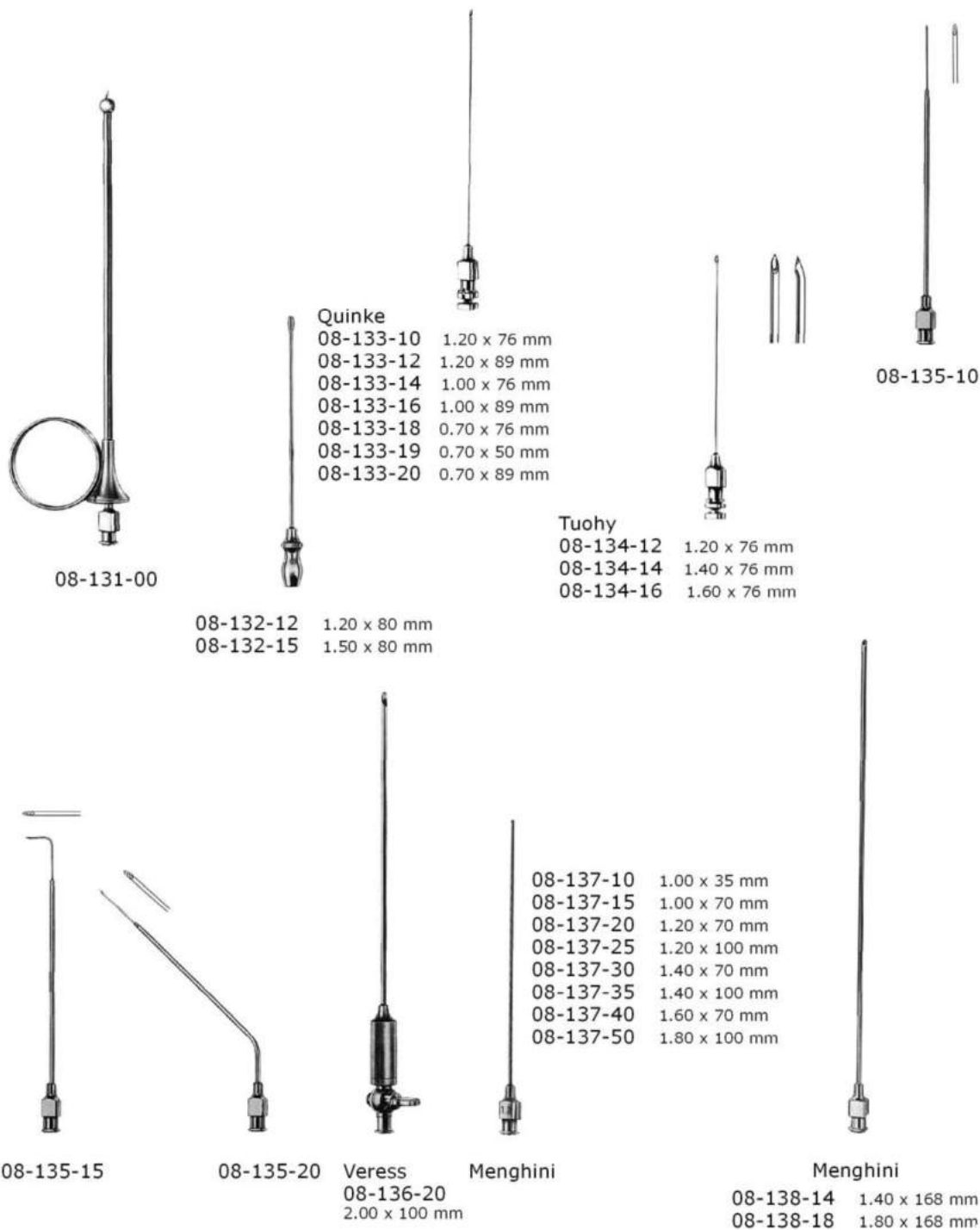

ANAESTHESIA



Cartheter Forceps

Laryngoscopes

Anaesthesia - Narkose
Katheterzangen
Catheter Forceps



Magill
09-101-15 - 09-101-25



09-101-15
15 cm/ 6"
Infants



09-101-20
20 cm/ 8"
Children



09-101-25
25 cm/ 10"
Adults

Anaesthesia - Narkose
Laryngoskope
Laryngoscopes

Fig.1



09-102-80
Working length 80mm

Fig.0



09-102-55
Working length 55mm

Miller-Baby
09-102-00

Laryngoscope Set, Baby and Infant,
consisting of:
09-102-01 Battery Handle (Without Batteries)
09-102-55 Miller Baby Blade, Fig. 0
(Working length 55mm)
09-102-80 Miller Infant Blade, Fig. 1
(Working length 80mm)

Anaesthesia - Narkose
Laryngoskope
Laryngoscopes



Fig. 4



Fig. 3



Fig. 2



Fig. 1



Fig. 0



Miller
09-103-00

09-103-00

Laryngoscope Set

Cosisting of:

- 09-103-01 Battery Handle (without batteries)
- 09-104-00 Miller blade Fig. 0
- 09-104-01 ditto Fig. 1
- 09-104-02 ditto Fig. 2
- 09-104-03 ditto Fig. 3
- 09-104-04 ditto Fig. 4
- 09-104-05 Case

Miller Laryngoscope Blades

- 09-104-00 Fig. 0, working length 55mm, baby's
- 09-104-01 Fig. 1, working length 80mm, children's
- 09-104-02 Fig. 2, working length 130mm, adult's
- 09-104-03 Fig. 3, working length 170mm, women's
- 09-104-04 Fig. 4, working length 180mm, men's



Anaesthesia - Narkose
Laryngoskope
Laryngoscopes



McIntosh
09-105-00



09-106-00



09-106-01



09-106-02



09-106-03



09-106-04

09-105-00
Laryngoscope Set,
consisting of:
09-105-01 Battery Handle (Without batteries)
09-106-01 McIntosh Blade, Fig. 1
09-106-02 ditto, Fig. 2
09-106-03 ditto, Fig. 3
09-105-02 Case for 3 curved blades

McIntosh Laryngoscope Blades
09-106-00 Fig. 0
09-106-01 Fig. 1
09-106-02 Fig. 2
09-106-03 Fig. 3
09-106-04 Fig. 4



Anaesthesia - Narkose
Laryngoskope
Laryngoscopes



Foregger
09-107-00

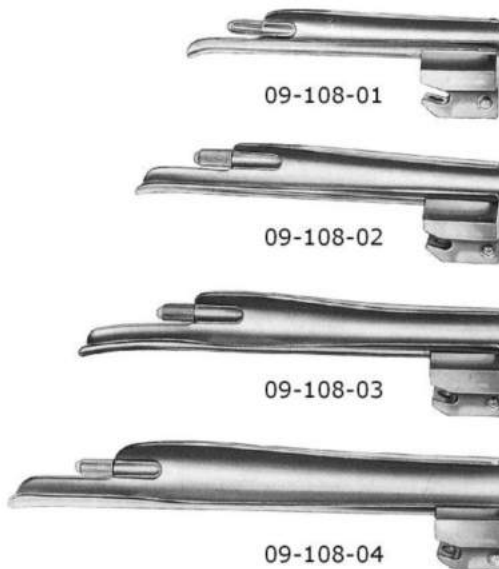

09-107-00
Laryngoscope Set,
consisting of:
09-107-01 Battery Handle (Without batteries)
09-108-02 Foregger Blade, Fig. 2
09-108-03 ditto, Fig. 3
09-108-04 ditto, Fig. 4
09-107-02 Case for 3 straight blades

Foregger Laryngoscope Blades
09-108-01 Fig. 1, working length 70 mm, children's
09-108-02 Fig. 2, working length 90 mm, adult's
09-108-03 Fig. 3, working length 110 mm, women's
09-108-04 Fig. 4, working length 135 mm, men's

SUTURE



Needle Holders

Reverdin Needles

Suture Instruments, Ligature Needles

Ligature Conductors

Suture Clips, Suture Set

Suture - Naht
Nadelhalter
Needle Holders

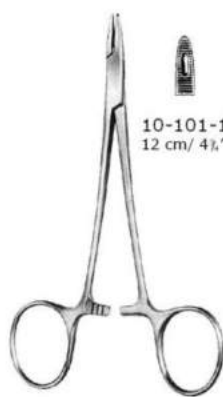

10-101-12 10-102-13
12 cm/ 4½" 13 cm/ 5"

Derf
10-101-12 - 10-102-13



Collier
10-103-13
13 cm/ 5"

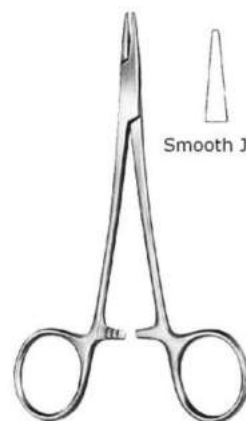

Webster
10-104-13
13 cm/ 5"

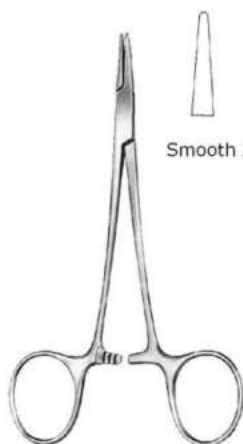

Halsey
10-105-13
13 cm/ 5"



Hegar-Baumgartner
10-106-14
14 cm/ 5½"



Brown
10-107-13 13 cm/ 5"
10-107-18 18 cm/ 7"



Suture - Naht
Nadelhalter
Needle Holders



Crile-Murray
10-108-15
15 cm/ 6"



Crile-Wood
10-109-15
15 cm/ 6"



Adson
10-110-18
18 cm/ 7"

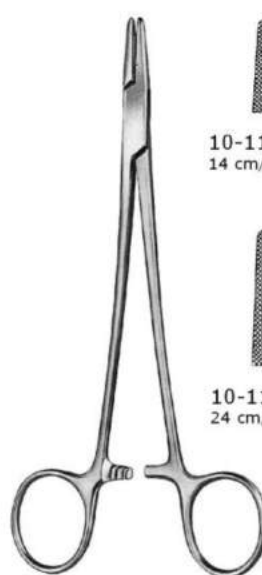

Mayo-Hegar
10-111-14 - 10-111-30

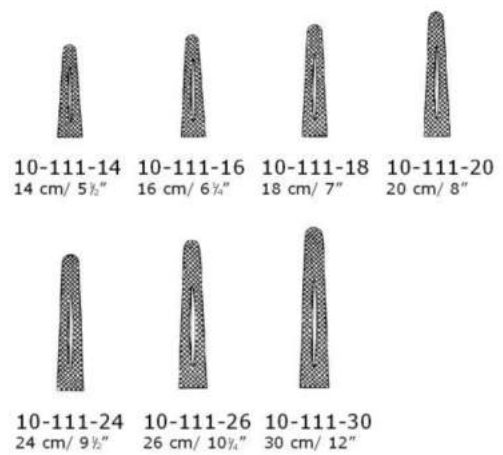

Suture - Naht
Nadelhalter
Needle Holders



Heaney
10-112-21
21 cm / 8 1/4"

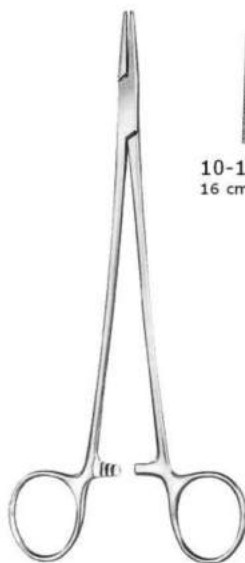

Mayo-Hegar
10-113-16 - 10-113-20

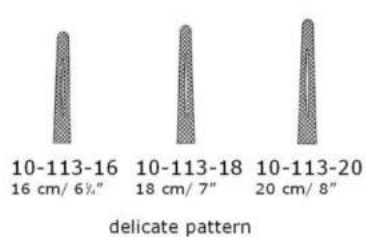

Jamison
10-114-23
23.5 cm / 9 1/4"

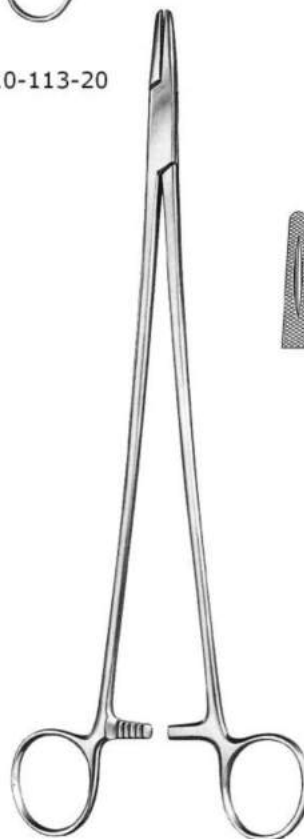

Masson
10-115-27
27 cm / 10 1/2"



Suture - Naht
Nadelhalter
Needle Holders



Wangenstein
10-116-27
27 cm/ 10½"



Finocchietto
10-117-27
27 cm/ 10½"



Johnson
10-118-27
27 cm/ 10½"



Suture - Naht
Nadelhalter
Needle Holders

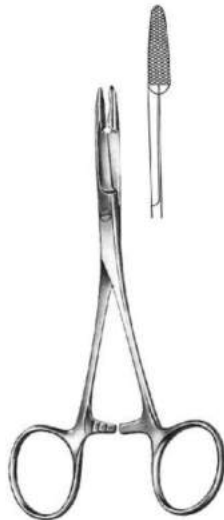

Olsen-Hegar
10-119-14
14 cm/ 5½"

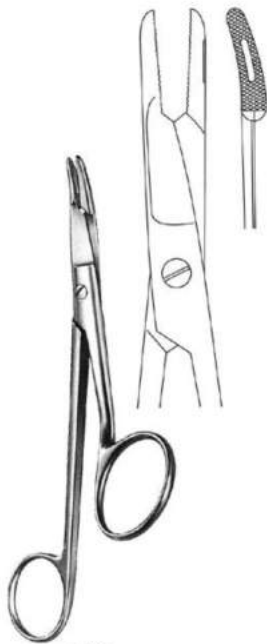

Gillies
10-120-16
16 cm/ 6¼"



Stratte
10-121-23
23 cm/ 9"



Suture - Naht
Nadelhalter
Needle Holders



Crile
10-122-15
15 cm / 6"



Toennis
10-123-18
18 cm / 7"

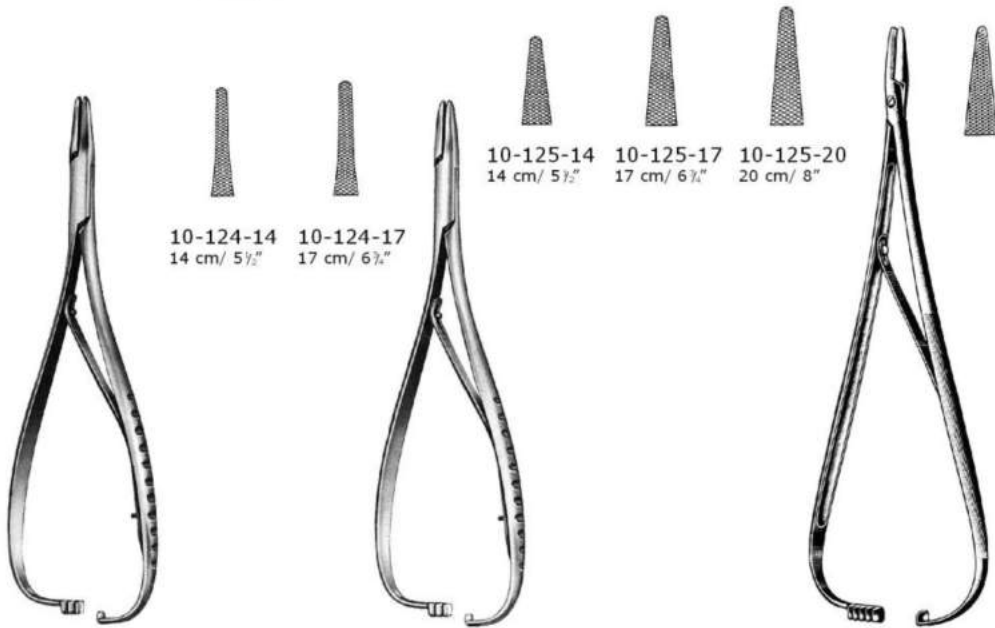

10-124-14 10-124-17
14 cm / 5½" 17 cm / 6½"

10-125-14 10-125-17 10-125-20
14 cm / 5½" 17 cm / 6½" 20 cm / 8"

Mathieu
10-124-14 - 10-124-17

Mathieu
10-125-14 - 10-125-20

Lichtenberg
10-126-20
20 cm / 8"



Suture - Naht
Reverdin-Nadeln
Reverdin Needles



10-127-14
Fig-1



10-128-14
2



10-129-14
3



10-130-14
4



Reverdin
10-127-14 - 10-130-14
14 cm/5 1/2"



10-131-19
10-135-23



10-132-19
10-136-23



10-133-19
10-137-23



10-134-19
10-138-23

Reverdin
10-131-19 - 10-134-19
19.5 cm/ 7 1/4"
10-135-23 - 10-138-23
23 cm/ 9"

Suture - Naht
 Naht-Instrumente, Unterbindungsnadeln
 Suture Instruments, Ligature Needles

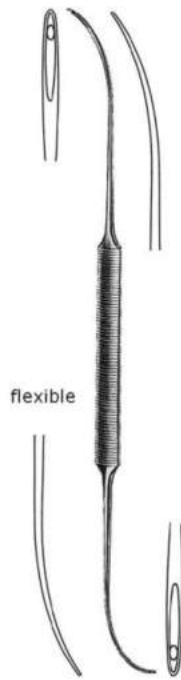

Schmieden-Dick
 10-139-30
 30 cm/ 12"

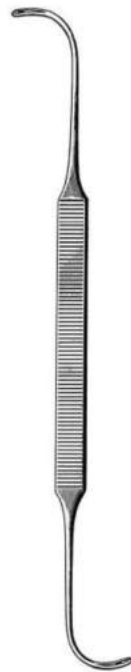

Schmieden
 10-140-24
 24 cm/ 9½"

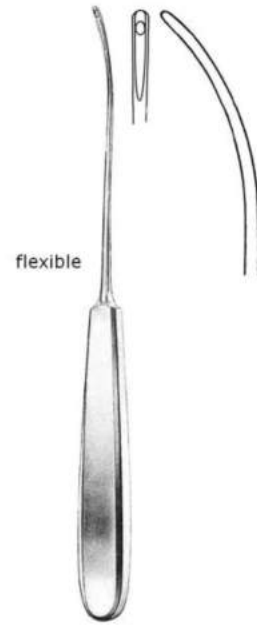

flexible
 10-141-20
 20 cm/ 8"

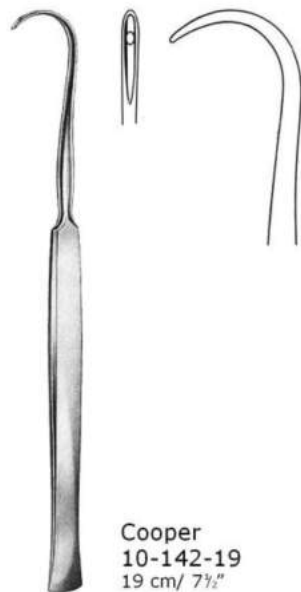

Cooper
 10-142-19
 19 cm/ 7½"



Kronecker
 10-143-13
 13 cm/ 5"

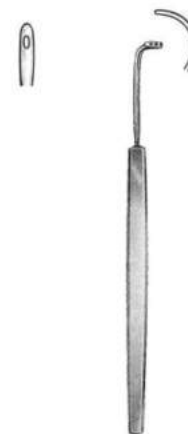

Kronecker
 10-144-13
 13 cm/ 5"

Suture - Naht
 Unterbindungsnadeln
 Ligature Needles

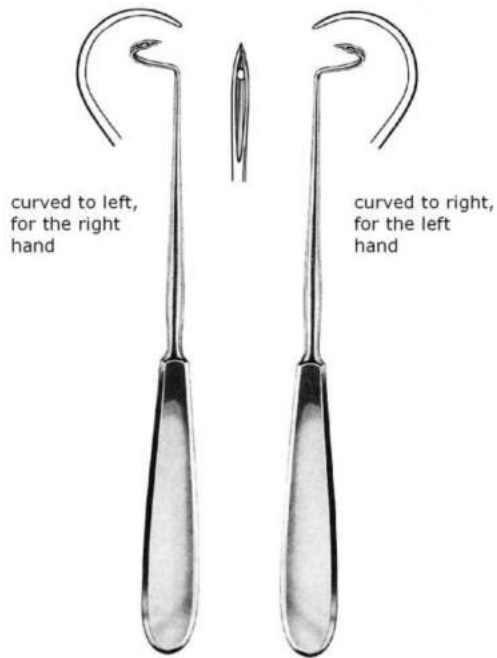

Deschamps
 10-145-20 - 10-146-20
 20 cm/ 8"
 Sharp

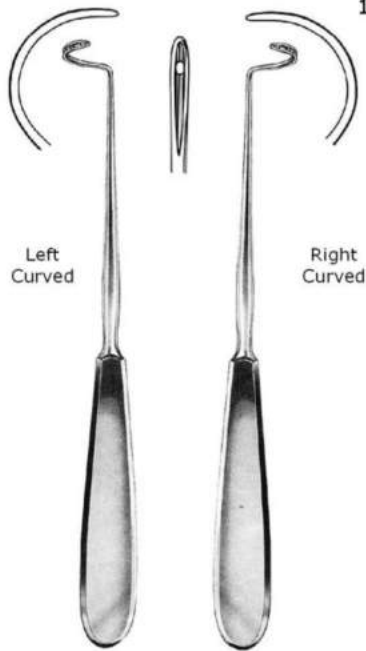

Deschamps
 10-147-20 - 10-148-20
 20 cm/ 8"
 Blunt

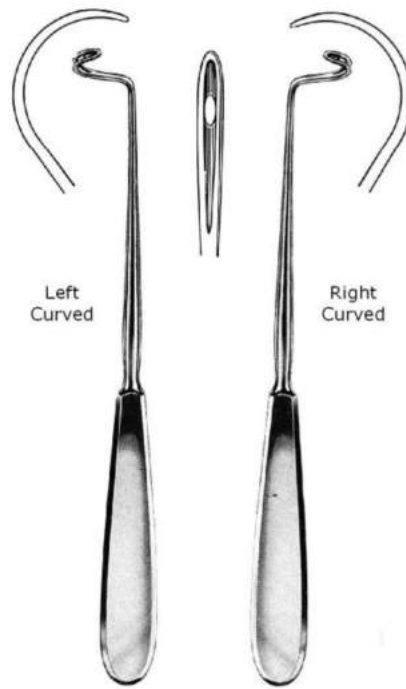

Deschamps
 10-149-21 - 10-150-21
 21 cm/ 8 1/2"
 Blunt

Suture - Naht
Unterbindungsnadeln
Ligature Needles

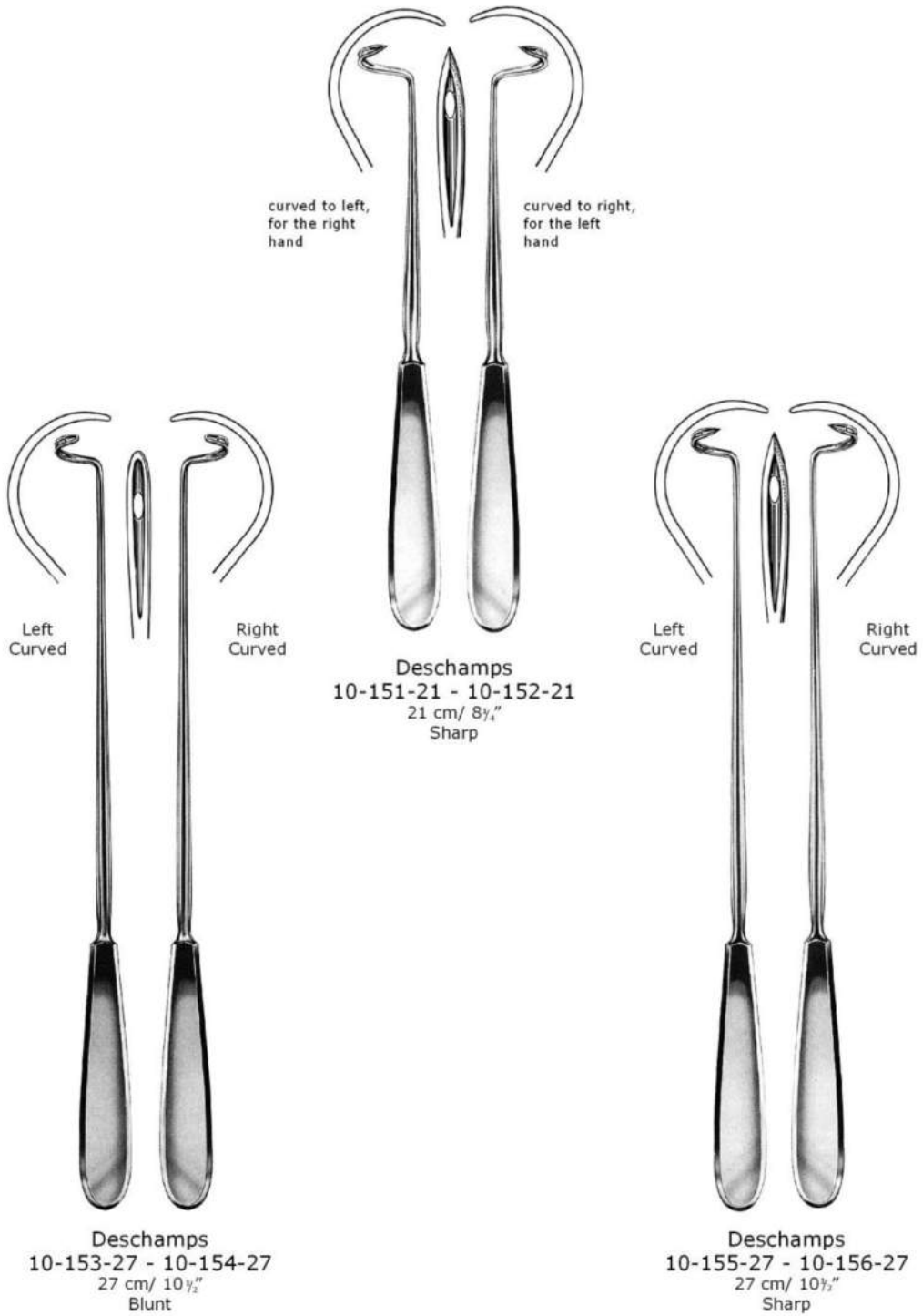

Suture - Naht
Führungshohlsonden
Ligature Conductors

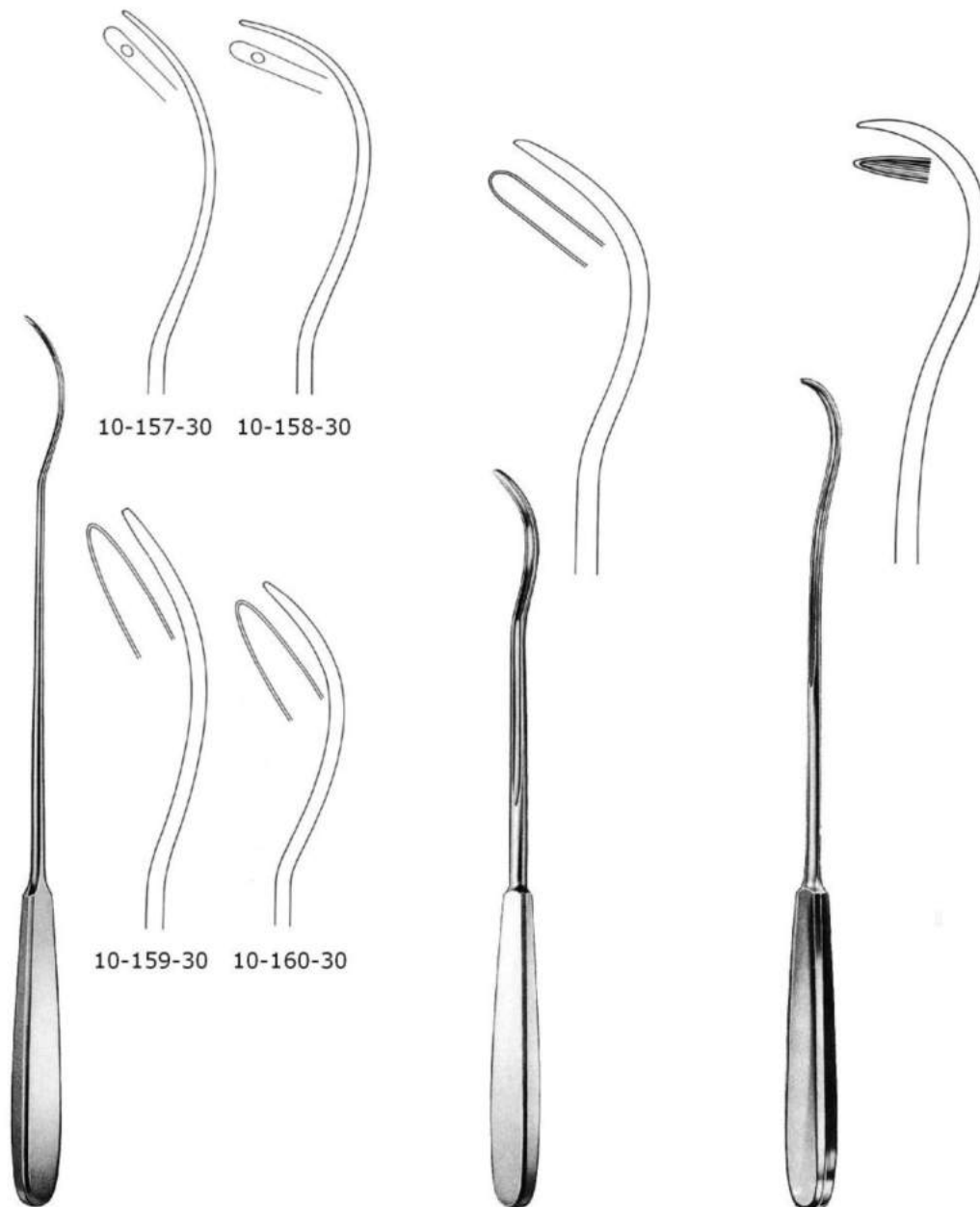

Brunner
10-157-30 - 10-160-30
30 cm/ 12"

Kirschner
10-161-25
25 cm/ 10"

10-162-28
28 cm/ 11"

Suture - Naht
 Führungshohlsonden, Fadenknoter, Fänger
 Conductors, Knot Tiers, Ligature Catcher

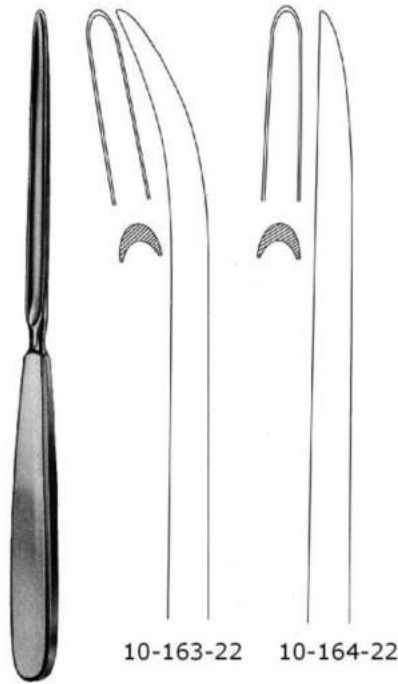

Payr
 10-163-22 - 10-164-22
 22 cm/ 8 7/8"



Lucae
 10-165-23
 23 cm/ 9"



10-166-23
 23 cm/ 9"



König
 10-167-03 - 10-169-07



10-167-03
 19.5 cm/ 7 7/8"
 3mm



10-168-05
 19.5 cm/ 7 7/8"
 5mm



10-169-07
 20 cm/ 8"
 7mm

Suture - Naht
Nahtinstrumente
Suture Instruments



Ochsner
10-170-14
14 cm/ 5½"



Lange
10-171-10
10 cm/ 4"



Michel
10-173-12
12 cm/ 4½"



Wachenfeldt
10-174-13
13 cm/ 5"



Hegenbarth
10-175-13
13 cm/ 5"



Wachenfeldt
10-176-13
13 cm/ 5"



Michel
10-177-12
12 cm/ 4½"



Michel
10-178-12
12 cm/ 4½"











Collin
10-179-13
13 cm/ 5"



Richter-Heath
10-180-14
14 cm/ 5½"

Suture - Naht
Wundklammern, Wundnahtbesteck
Suture Clips, Suture Set

	Sizes mm	
	10-181-01 7.5 x 1.75	
	10-181-02 11 x 2	
	10-181-03 12 x 3	
	10-181-04 14 x 3	
	10-181-05 16 x 3	
	10-181-06 18 x 3	
	10-181-07 20 x 3	
	10-181-08 22 x 3	

Michel Clips
10-181-01 - 10-181-08

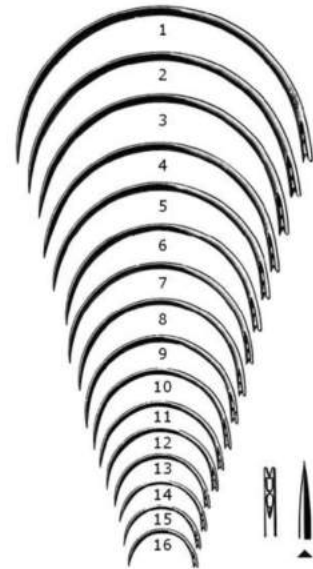

G
10-182-01
Curved 1/2 circle
Fig.1 - Fig.16

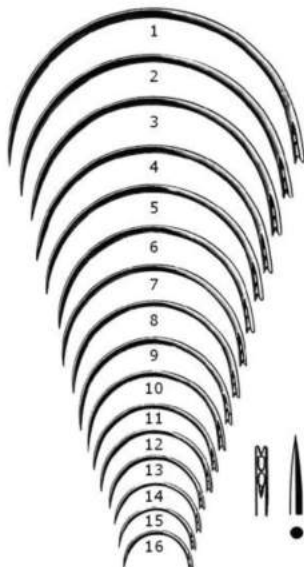

Gr
10-183-01
Curved 1/2 circle
Fig.1 - Fig.16

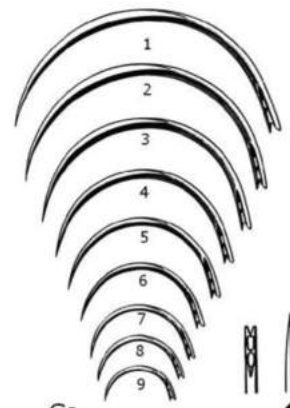

Ga
10-184-01
Curved 1/2 circle
Fig.1 - Fig.9

DRESSING



Bandage Scissors

Plaster of Paris Shears, Bandage Scissors

Plaster of Paris Knives, Saws

Plaster Cast Instruments

Dressing - Verband und Gips
 Verbandscheren
 Bandage Scissors

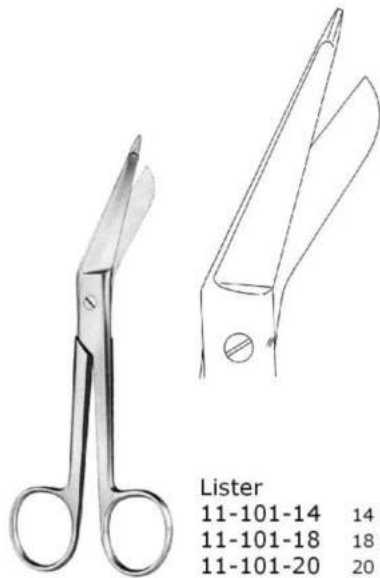

Lister
 11-101-14 14 cm/ 5½"
 11-101-18 18 cm/ 7¼"
 11-101-20 20 cm/ 8"



Lister
 11-102-15 15 cm/ 6"
 11-102-18 18 cm/ 7¼"
 Different Colours



Bergmann
 11-103-23
 23 cm/ 9"

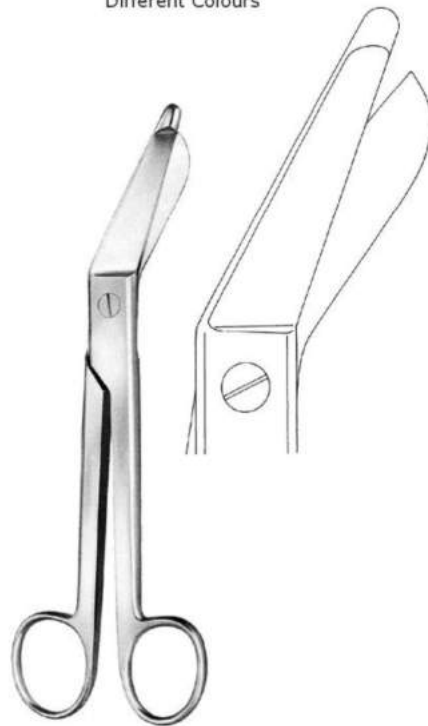

Esmarch
 11-104-20
 20 cm/ 8"

Dressing - Verband und Gips
Gipsscheren, Verbandscheren
Plaster of Paris Shears, Bandage Scissors

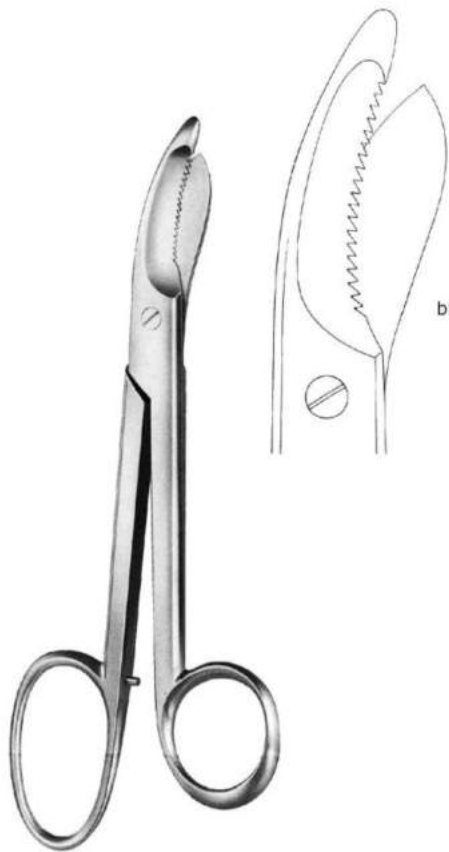

blade with saw edge

Brun's
11-105-24
24 cm/ 9½"



Stille
11-106-26 - 11-106-37
11-106-26 26 cm/ 10¼"
11-106-37 37 cm/ 14½"

Dressing - Verband und Gips
Gipsmesser, Gipssäge
Plaster of Paris Knives, Saws



Engel
11-107-14



Hopkins
11-108-20
20 cm/ 8"



Esmarch
11-109-18
18 cm/ 7"



Reiner
11-110-18
18.5 cm/ 7 1/4"



11-111-21
21 cm/ 8 1/4"

Dressing - Verband und Gips
Gipsspreizer
Plaster Cast Instruments



Hermann
11-112-48
48 cm/ 19"



Hennig
11-113-28
28 cm/ 11"

Dressing - Verband und Gips
Gipsspreizer
Plaster Cast Instruments



Quatro
11-114-23
23 cm/ 9"

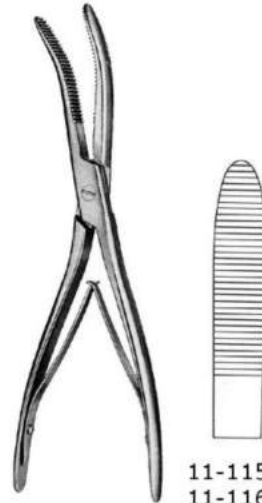

Wolff
11-115-18 - 11-116-24

11-115-18 18 cm/ 7"
11-116-24 24 cm/ 9½"

BONE SURGERY



Amputating & Resection Saws

Bone Drills, & Reamers

Hand Drills

Bone Holding Clamps

Flat Nose Pliers, Wire Cutting Pliers, Seizing Forceps

Extension Bows

Bone Surgery - Knochenchirurgie
Amputations- und Resektionssägen
Amputating and Resection Saws



Charriere
12-101-35
35 cm/ 14"



Langenbeck
12-102-23
23 cm/ 9"

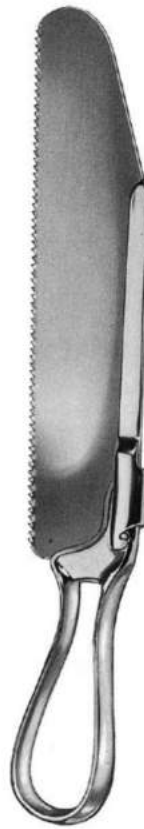

Charriere
12-103-27
27 cm/ 10½"



Satterlee
12-104-29
29 cm /11½"
Length of blade
20 cm/ 8"
Spare saw blade
12-104-20

Bone Surgery - Knochenchirurgie
Bohrinstrumente, Pfrieme
Bone Drills, Reamers



Perthes
12-105-18
18 cm / 7"



Perthes
12-106-21
21 cm / 8 1/4"



Bone Drill
12-107-14
14 cm / 5 1/2"



Reamer
12-108-14
14 cm / 5 1/2"

Bone Surgery - Knochenchirurgie
Handbohrapparate
Hand Drills



Stille
12-109-00
20 cm / 8"

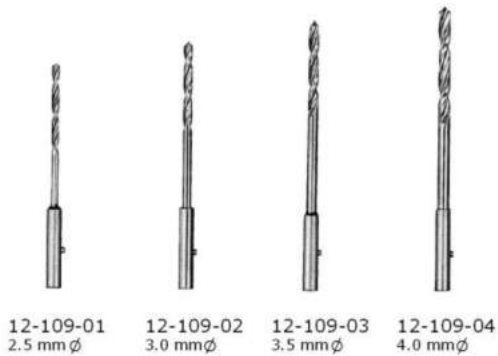

12-109-01 2.5 mm ϕ 12-109-02 3.0 mm ϕ 12-109-03 3.5 mm ϕ 12-109-04 4.0 mm ϕ



12-109-05 8.0 mm ϕ 12-109-06 12.0 mm ϕ 12-109-07 16.0 mm ϕ 12-109-08 1.0 mm ϕ 12-109-09 1.5 mm ϕ 12-109-10 2.0 mm ϕ

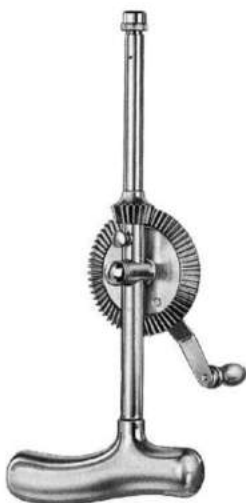

Stille-Sherman
12-110-00
24 cm / 9½"

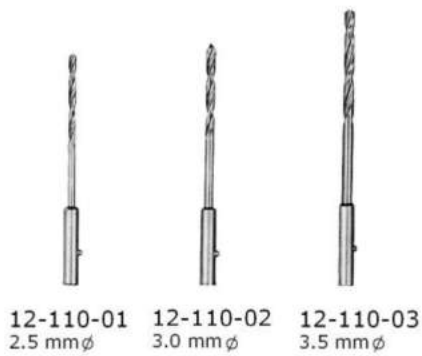

12-110-01 2.5 mm ϕ 12-110-02 3.0 mm ϕ 12-110-03 3.5 mm ϕ

Bone Surgery - Knochenchirurgie
Handbohrapparate
Hand Drills



12-111-08



12-111-01
9 mmØ



12-111-02
14 mmØ



12-111-03
16 mmØ



12-111-04
22 mmØ



Hudson
12-111-00
27 cm/ 10½"



Cushing
12-111-05
14 mmØ



McKenzie
12-111-06
13 mmØ



Errico
12-111-07
16 mmØ

Bone Surgery - Knochenchirurgie
Handbohrapparate
Hand Drills



Moore
12-112-00



12-112-02
Set
-Hand Drill, with 2 twist drills



mmø			
1.0		12-114-10	
1.2		12-114-12	
1.5		12-114-15	
1.8		12-114-18	12-115-18
2.0	12-113-20	12-114-20	12-115-20
2.2		12-114-22	12-115-22
2.5	12-113-25	12-114-25	12-115-25
2.8		12-114-28	
3.0	12-113-30	12-114-30	12-115-30
3.2	12-113-32	12-114-32	
3.5	12-113-35	12-114-35	12-115-35
4.0	12-113-40	12-114-40	12-115-40
5.0	12-113-50	12-114-50	12-115-50
6.0	12-113-60		
7.0	12-113-70		



mmø	Doyen	Doyen	Doyen	Doyen	Albee	Borchardt
4.0	12-116-04	12-117-04				
6.0	12-116-06	12-117-06				
7.0						
8.0	12-116-08	12-117-08		12-119-08		12-121-08
10.0	12-116-10	12-117-10		12-119-10		12-121-10
12.0	12-116-12	12-117-12	12-118-12		12-120-12	12-121-12
13.0						
14.0	12-116-14	12-117-14				12-122-13
15.0					12-120-15	
16.0	12-116-16	12-117-16				
25.0						



Bone Surgery - Knochenchirurgie
Knochenhalteklammern
Bone Holding Clamps

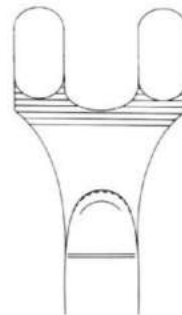
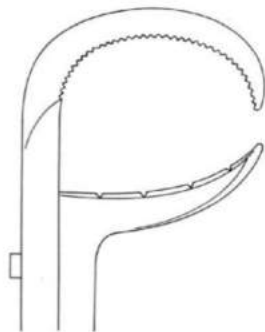

12-123-18 18 cm/ 7"
12-123-20 20 cm/ 8"
12-123-22 22 cm/ 8 7/8"



Gerster-Lowmann
12-123-18 - 12-123-22



Bone Surgery - Knochenchirurgie
 Flachzangen, Draht-Kneifzangen, Faßzangen
 Flat Nose Pliers, Wire Cutting Pliers, Seizing Forceps



12-124-15
 15 cm/ 6"



12-125-17
 17 cm/ 6 3/4"



12-126-18
 18 cm/ 7"



12-127-25
 25 cm/ 10"

12-127-23
 23 cm/ 9"

Bone Surgery - Knochenchirurgie
Flachzangen
Flat Nose Pliers



12-128-16
16 cm/ 6¼"



12-129-01 12-129-02

12-129-01 - 12-129-02
17 cm/ 6¾"



12-130-19
19 cm/ 7½"

Wire Cutting Pliers



12-131-16
16 cm/ 6¼"



12-132-16
16 cm/ 6¼"



12-133-15
15 cm/ 6"

Bone Surgery - Knochenchirurgie
 Draht-Kneifzangen
 Wire Cutting Pliers

TC (Tungsten Carbide Tip)

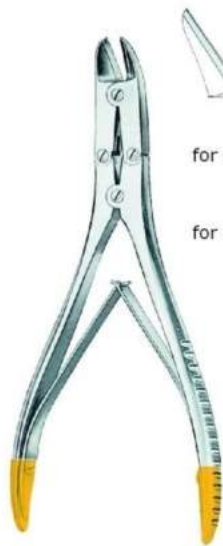

for hard wires up to 1.6 mm ϕ
 for soft wires up to 2.0 mm ϕ

12-134-16
 16 cm/ 6 1/4"

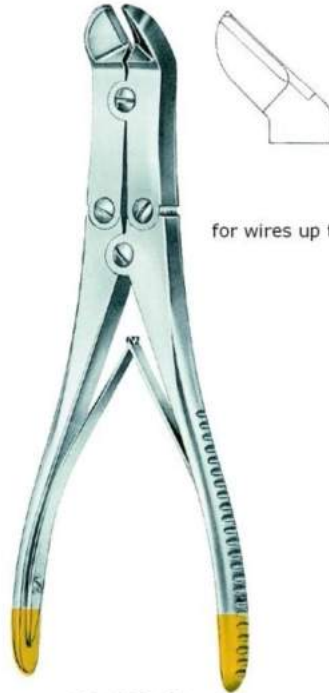

for wires up to 2.5 mm ϕ

12-135-22
 22 cm/ 8 1/4"

Flat Nose Pliers



for soft wires
 up to 2 mm ϕ

for soft wires
 up to 1.5 mm ϕ

12-136-18
 18 cm/ 7"



12-137-01 12-137-02 12-137-03

12-137-01 - 12-137-03
 18 cm/ 7"

Bone Surgery - Knochenchirurgie
 Extensionsbügel
 Extension Bows

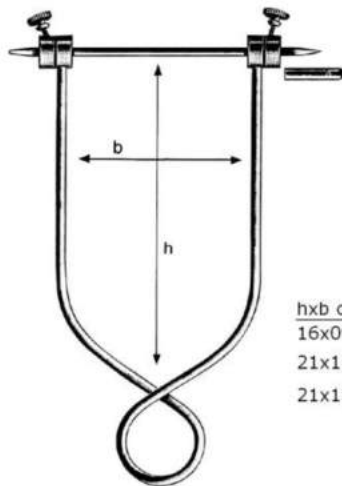

hxb cm
 16x09 12-138-09 for arm
 21x11 12-138-11 for thigh and knee
 21x15 12-138-15 for femur and knee

Bohler
 12-138-09 - 12-138-15



12-139-01
 18.5 cm/ 7 1/2"
 0-40 mm

12-139-02
 27 cm/ 10 1/2"
 35-200 mm

Kirschner
 12-139-01 - 12-139-02



Clear width
 cm
 12-140-18 18 x 10
 12-140-27 27 x 16

12-140-18 - 12-140-27