



I P D INTELLIGENT PROSTHETIC DENTISTRY

ENGLISH



CATALOGUE IPD
2024



I N T E L L I G E N T
P R O S T H E T I C
D E N T I S T R Y

Index

Compatibilities

●	AB Serie	MULTI-UNIT [ø4.8]	7
●	NOBEL BIOCARE®		
	AA Serie	BRANEMARK SYSTEM® [ø3.5 / ø4.1 / ø5.1]	9
	AC Serie	NOBEL REPLACE® SELECT [ø3.5 / ø4.3 / ø5]	13
	AD Serie	NOBEL ACTIVE® [ø3.0 / ø3.5 / ø4.3]	17
●	BIOMET® 3i®		
	BA Serie	OSSEOTITE® [ø3.4 / ø4.1 / ø5]	21
	BB Serie	CERTAIN® [ø3.4 / ø4.1 / ø5]	25
●	KLOCKNER®		
	CA Serie	SK2-NK2 [ø4.2]	29
	CB Serie	ESSENTIAL CONE® [ø4.5]	31
	CC Serie	KL™ [ø3.5 / ø4.1 / ø5.1]	33
	CD Serie	VEGA® [ø3.5 / ø4.0 / ø4.5]	37
●	STRAUMANN®		
	DA Serie	TISSUE LEVEL [ø4.8 RN / ø6.5 WN]	39
	DB Serie	BONE LEVEL [ø3.3 NC / ø4.1 RC]	41
	DC Serie	BLX® [RB/WB]	45
	DD Serie	SRA® [ø3.5/ø4.6]	47
●	ASTRA®		
	EA Serie	OSSEOSPEED™ [ø3 / ø3.5-4 / ø4.5-5]	49
	EB Serie	EVOLUTION® [ø3.6 / ø4.2]	53
●	ZIMMER®		
	FA Serie	SCREW VENT® [ø3.5 / ø4.5 / ø5.7]	55
	FB Serie	SWISSPLUS® [ø4.8]	59
	FC Serie	EZTETIC® [ø3.1]	61
●	BTI®		
	GA Serie	EXTERNAL [ø3.5 / ø4.1 / ø5.5]	63
	GB Serie	INTERNAL UNIVERSAL® [Universal® ø4.1 / Wide ø5.5]	67
	GC Serie	MULTI-IM® [ø4.1]	69
●	MICRODENT®		
	HA Serie	SYSTEM [ø3.5 / ø4.2 / ø5.1]	71
	HB Serie	UNIVERSAL™ [ø3.5 / ø4.1 / ø5.1]	73
●	DENTSPLY®		
	IA Serie	XIVE® FRIADENT® [ø3.4 / ø3.8 / ø4.5]	77
	IB Serie	ANKYLOS® [C/X]	79
●	CAMLOG®		
	JA Serie	CAMLOG® [ø3.3 / ø3.8 / ø4.3 / ø5.0]	81
	JB Serie	CONOLOG® [ø3.3 / ø3.8 / ø4.3]	83
●	BIOHORIZONS®		
	LB Serie	TAPERED INTERNAL [ø3 / ø3.5 / ø4.5 / ø5.7]	85
●	SWEDEN & MARTINA®		
	MA Serie	OUTLINK® [ø3.3 / ø4.1 / ø5]	89
	MB Serie	PREMIUM™ KOHNO® [ø3.3 / ø3.8 / ø4.25 / ø5]	93
●	PHIBO®		
	NA Serie	TSH® [S2 / S3-S4 / S5]	95



●	OSSTEM IMPLANT®		
	OB Serie	TSIII [ø3.5 / ø4.0]	99
●	BIOTECH® DENTAL		
	QB Serie	KONTACT® [RP]	103
●	NEODENT®		
	RA Serie	HELIX® HE [ø3.3 / ø4.1 / ø5.0]	105
	RB Serie	GRAND MORSE™ GM [GM]	109
	RC Serie	GM ABUTMENT [RP]	111
	RD Serie	GM MICRO ABUTMENT [ø3.5]	113
●	BEGO® SEMADOS®		
	SB Serie	SC/RS [ø3.25 / ø3.75 / ø4.1 / ø4.5]	115
●	MIS®		
	TA Serie	SEVEN® [Narrow 3.3 / Standard / Wide]	119
	TB Serie	C1 / V3® [Standard]	123
●	DIO®		
	UB Serie	UFII [NP / RP]	125
●	MEGAGEN®		
	WA Serie	ANYONE® [RP]	127
	WB Serie	ANYRIDGE® [ø4.0]	129
●	DENTIUM®		
	XA Serie	IMPLANTIUM® / SUPERLINE™ [RP]	131
●	MEDENTIS®		
	YB Serie	ICX [RP]	133
●	GLOBAL D®		
	1A Serie	IN-KONE® [RP]	135
●	ANTHOGYR®		
	2A Serie	AXIOM® BL [RP]	137
●	GALIMPLANT®		
	3A Serie	MULTI-POSITION AESTHETIC® [ø3.8]	139

Working Systems

●	STUMP DIE 3D	143
●	CEREC Ti-BASE	144
●	CUSTOM Ti-BASE SYSTEM	146
●	MULTI-UNIT SYSTEM	156
●	PSD SYSTEM	168
●	HOLLOW SCREW SYSTEM	176
●	ACCESSORIES	184
●	TECHNICAL SPECIFICATIONS	188



Download the catalog in other languages.



Download the English version of the catalog.

Some products may not be available in your country. Please contact your official distributor for more details.





Compatibility

AB Serie MULTI-UNIT [ø4.8]



INTRA-ORAL / DESKTOP / CONTACT PROBE SCAN BODY

Platform	Height (mm)		
ø4.8	10.0	IPD/AB-SR-00	IPD/AB-SR-01

Captive screw included. 1.20 Hex Screwdriver.





SCAN TRANSFER

Platform	Height (mm)		Screw
ø4.8	1.5	IPD/AB-SR-11	IPD/AB-TR-11/C

IPD/AB-SR-11 includes screw and a protective cap



Ti-BASE

Platform	Post height (mm)	Gingival height		
ø4.8	3.5	0.5	IPD/AB-IR-00/3D	-
		0.2	-	IPD/AB-IR-01/3D
	6.5	0.5	-	IPD/AB-IR-01
		0.2	IPD/AB-IR-02/3D	-
	-	-	-	IPD/AB-IR-03/3D

Please see [page 147](#) for the **IPD Custom Ti-Base System**® accessories.
IPD/AB-IR-01 is a **IPD Hollow Screw System**® Ti-Base.



SCREW / TPA SCREW FOR ANGLED PROSTHESIS

Platform	Screwdriver	Height	Reference	TiN Reference
ø4.8	Unigrip	-	IPD/AB-TR-00	IPD/AB-TR-00/TiN
	TPA	For 3.5 mm high Ti-Base	-	IPD/AB-TR-50
	TPA	For 6.5 mm high Ti-Base	-	IPD/AB-TR-51



ANALOG / DIGITAL ANALOG

Platform	Reference	Digital reference
ø4.8	IPD/AB-AR-00	IPD/AB-AR-00/3D
Bottom Screw	-	IPD/KA-TA-00
Side Screw	-	IPD/KA-TA-01



TEMPORARY ABUTMENT / OPEN TRAY COPING

Platform			Coping screw
ø4.8	IPD/AB-PR-01	IPD/AB-PR-00	IPD/AB-TR-00/C
	-	IPD/AB-PR-06	-

The same abutment can be used as a temporary abutment with the occlusal screw or as an impression coping using the coping screw.

IPD/AB-PR-06 corresponds to the Classic design and cannot be used as a coping.



OPEN AND CLOSED TRAY COPING

Platform		Reference
ø4.8	Open tray coping	IPD/AB-CR-00
	Closed tray coping	IPD/AB-CR-01

Classic design.

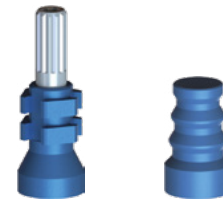

HEALING ABUTMENT Titanium / Plastic POM

Platform	Material	Reference
ø4.8	Plastic POM	IPD/AB-DR-00
	Titanium	IPD/AB-DR-01

IPD/AB-TR-00 screw not includes.



CASTABLE

Platform		Reference
ø4.8		IPD/AB-RR-00



PSD FOR MULTI-UNIT

Platform	Units	Height	Reference
ø4.8	2	3.35 mm	IPD/AB-LR-02

Please see [page 169](#) for the PSD system accessories.



STRAIGHT AND ANGLED CASTABLE ABUTMENT WITH A Co-Cr BASE Straight, 15° & 25°

Platform	Angulation		
ø4.8	Straight	IPD/AB-BR-00	IPD/AB-BR-01
	15°	IPD/AB-BR-10	IPD/AB-BR-11
	25°	IPD/AB-BR-20	IPD/AB-BR-21

Co-Cr Base for digital workflow		Scan Body
ø4.8	Straight / Angled	IPD/SC-AN-B2

All angled castable abutments include a TPA screw.



ANGLED MULTI-UNIT CARRIER

Platform	Reference
ø4.8	IPD/LL-TM-00



SCREWDRIVER

Lengths (mm)	Screwdriver	Reference
18	Unigrip	IPD/PU-00-18
25	Unigrip	IPD/PU-00-25
32	Unigrip	IPD/PU-00-32
20	2.0 Hex	IPD/LL-AB-00





Compatibility

NOBEL BIO CARE®



AA Serie BRANEMARK SYSTEM®

[ϕ 3.5 / ϕ 4.1 / ϕ 5.1]



Nobel Biocare®



INTRA-ORAL / DESKTOP / CONTACT PROBE SCAN BODY

Platform	Height (mm)		
ϕ 3.5	10	IPD/AA-SN-00	IPD/AA-SN-01
	15	IPD/AA-SN-02	-
ϕ 4.1	10	IPD/AA-SR-00	IPD/AA-SR-01
	15	IPD/AA-SR-02	-
ϕ 5.1	10	IPD/AA-SW-00	IPD/AA-SW-01

Captive screw included. 1.20 Hex Screwdriver.



Ti-BASE  Custom Ti-Base System®

Platform	Height (mm)		
ϕ 3.5	1.5	IPD/AA-IN-02/3D	IPD/AA-IN-03/3D
	0.5	IPD/AA-IR-00/3D	IPD/AA-IR-01/3D
ϕ 4.1	1.5	IPD/AA-IR-02/3D	IPD/AA-IR-03/3D
	2.5	IPD/AA-IR-04/3D	IPD/AA-IR-05/3D
ϕ 5.1	1.3	IPD/AA-IW-02/3D	IPD/AA-IW-03/3D



Please see [page 147](#) for the  Custom Ti-Base System® accessories.



SCREW / TPA SCREW FOR ANGLED PROSTHESIS

Platform	Screwdriver	Seat	Reference	TiN Reference
ϕ 3.5	Unigrip	Conical	IPD/AA-TN-00	IPD/AA-TN-00/TIN
	Unigrip	Conical	IPD/AA-TR-00	IPD/AA-TR-00/TIN
ϕ 4.1	Unigrip	Flat	IPD/AA-TR-02	IPD/AA-TR-02/TIN
	1.20 Hex	Low profile conical	IPD/AA-TR-01	IPD/AA-TR-01/TIN
ϕ 5.1	Unigrip	Conical	IPD/AA-TW-00	IPD/AA-TW-00/TIN
			IPD/AA-TW-01	IPD/AA-TW-01/TIN
ϕ 3.5	TPA	Conical	-	IPD/AA-TN-50
ϕ 4.1	TPA	Conical	-	IPD/AA-TR-50
ϕ 4.1	TPA	Flat	-	IPD/AA-TR-52
			-	IPD/AA-TW-50

The IPD/AA-TW-01 screw is compatible with the Ti-Bases IPD/AA-IW-02/3D and IPD/AA-IW-03/3D

-  Lengths 18/25/32 mm. Please see [page 185](#) for more information.
-  Lengths 18/25/32 mm. Please see [page 184](#) for more information.
-  Lengths 18/25/32 mm. Please see [page 186](#) for more information.

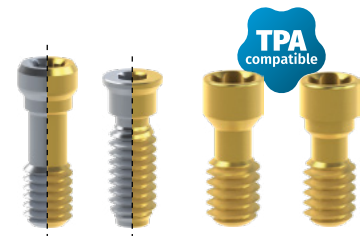

ANALOG / DIGITAL ANALOG

Platform	Reference	Digital Reference
ø3.5	IPD/AA-AN-00	IPD/AA-AN-00/3D
ø4.1	IPD/AA-AR-00	IPD/AA-AR-00/3D
ø5.1	IPD/AA-AW-00	IPD/AA-AW-00/3D
Bottom Screw	-	IPD/KA-TA-00
Side screw	-	IPD/KA-TA-01



STRAIGHT AND ANGLED MULTI-UNIT ABUTMENT



Straight, 17° & 30°

Platform	Height (mm)	Straight	17°	30°
ø4.1	1.0	IPD/AB-MR-01	-	-
	2.0	IPD/AB-MR-02	IPD/AB-MR-12	-
	3.0	IPD/AB-MR-03	IPD/AB-MR-13	IPD/AB-MR-33
	4.0	IPD/AB-MR-04	IPD/AB-MR-14	IPD/AB-MR-34
	5.0	IPD/AB-MR-05	-	IPD/AB-MR-35



Our straight Multi-units can be used for single and multiple restorations. Please see [page 157](#) for the Multi-unit system accessories.

TEMPORARY ABUTMENT / OPEN TRAY COPING

Platform			Coping screw
ø3.5	IPD/AA-PN-06	IPD/AA-PN-07	IPD/AA-TN-00/C
ø4.1	IPD/AA-PR-06	IPD/AA-PR-07	IPD/AA-TR-00/C
ø5.1	IPD/AA-PW-06	IPD/AA-PW-07	IPD/AA-TW-00/C

The same abutment can be used as a temporary abutment with the occlusal screw or as an impression coping using the coping screw.

For references IPD/AA-PW-06 and IPD/AA-PW-07 use the screw IPD/AA-TW-01 if it is used as a temporary.



OPEN AND CLOSED TRAY COPING



Platform	Reference	
ø4.1	Open tray coping	IPD/AA-CR-00
	Closed tray coping	IPD/AA-CR-01
ø5.1	Open tray coping	IPD/AA-CW-00

Classic design.



STRAIGHT AND ANGLED CASTABLE ABUTMENT WITH A Co-Cr BASE

Straight, 15° & 25°

Platform	Angulation		
ø3.5	Straight	IPD/AA-BN-00	IPD/AA-BN-01
	15°	IPD/AA-BN-10	IPD/AA-BN-11
	25°	IPD/AA-BN-20	IPD/AA-BN-21
ø4.1	Straight	IPD/AA-BR-00	IPD/AA-BR-01
	15°	IPD/AA-BR-10	IPD/AA-BR-11
	25°	IPD/AA-BR-20	IPD/AA-BR-21



Co-Cr Base for digital workflow	Scan Body
ø3.5 Straight / Angled	IPD/AA-BN-00/3D IPD/AA-BN-01/3D IPD/SC-AN-B1
ø4.1 Straight / Angled	IPD/AA-BR-00/3D IPD/AA-BR-01/3D IPD/SC-AN-B1

All angled castable abutments include a TPA screw.

PSD OVERDENTURE ABUTMENT

Platform	Height (mm)	Digital Reference
ø3.5	1.0	IPD/AA-LN-01
	3.0	IPD/AA-LN-03
	5.0	IPD/AA-LN-05
ø4.1	1.0	IPD/AA-LR-01
	2.0	IPD/AA-LR-02
	3.0	IPD/AA-LR-03
	4.0	IPD/AA-LR-04
	5.0	IPD/AA-LR-05
ø5.1	2.0	IPD/RA-LW-02
	3.0	IPD/RA-LW-03
	4.0	IPD/RA-LW-04



Please see [page 169](#) for the PSD system accessories.



HEALING ABUTMENT

Platform	Height (mm)	Reference
ø3.5	2.0	IPD/AA-DN-02
	3.0	IPD/AA-DN-03
	4.0	IPD/AA-DN-04
ø4.1	2.0	IPD/AA-DR-02
	3.0	IPD/AA-DR-03
	4.0	IPD/AA-DR-04
	5.0	IPD/AA-DR-05
	2.0	IPD/AA-DW-02
ø5.1	3.0	IPD/AA-DW-03
	4.0	IPD/AA-DW-04



STRAIGHT AND ANGLED ABUTMENT

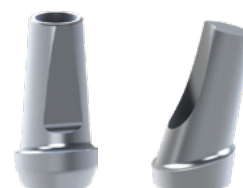

Straight, 15° & 25°

Platform	Height (mm)	Angulation	Reference	
				
ø4.1	1.0	Straight	IPD/AA-PR-00	IPD/AA-PR-01
		15°	IPD/AA-PR-02	-
	25°	IPD/AA-PR-03	-	
	2.0	15°	IPD/AA-PR-04	-
		25°	IPD/AA-PR-05	-



Using the low profile IPD/AA-TR-01 screw for IPD/AA-PR-03 is recommended.

CASTABLE

Platform	Reference	
		
ø4.1	IPD/AA-HR-00	IPD/AA-RR-00
ø5.1	IPD/AA-HW-00	IPD/AA-RW-00



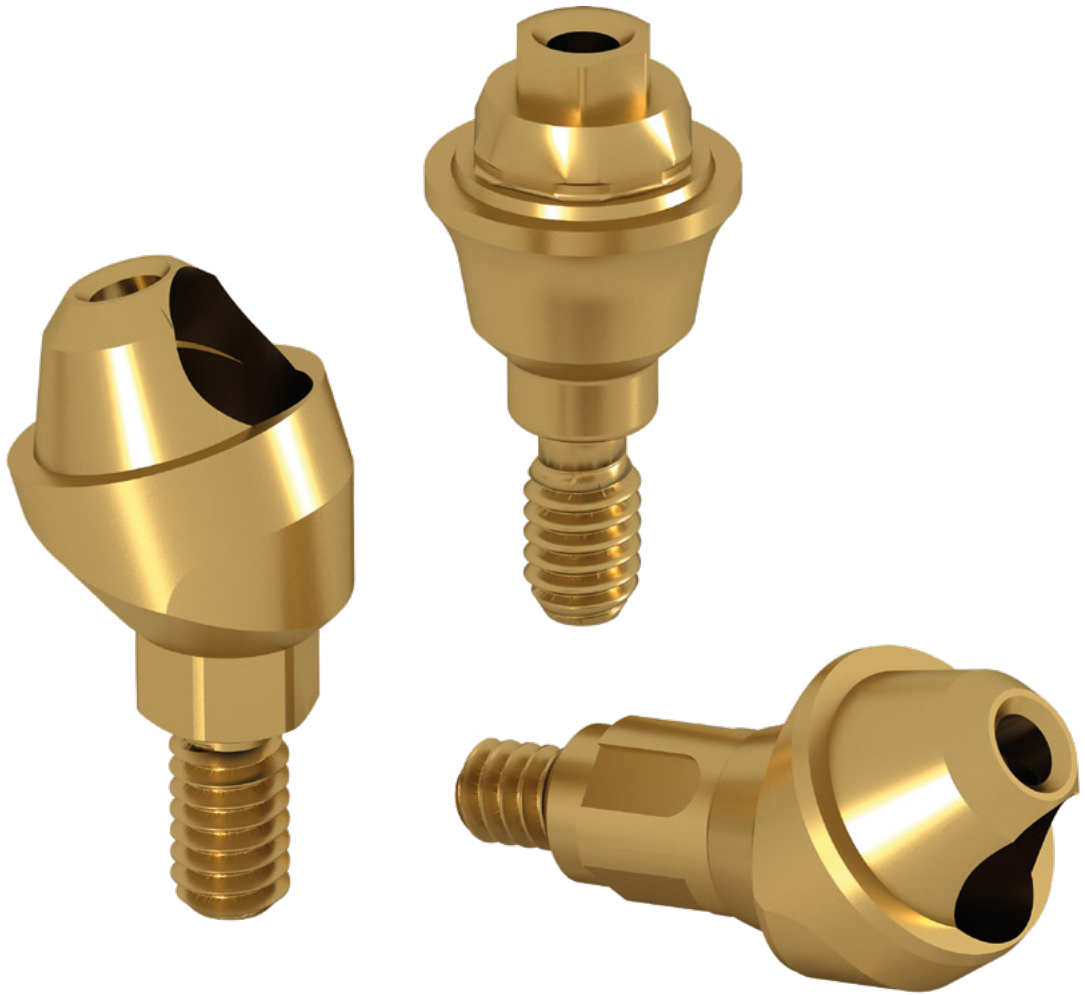



Compatibility

NOBEL BIO CARE®

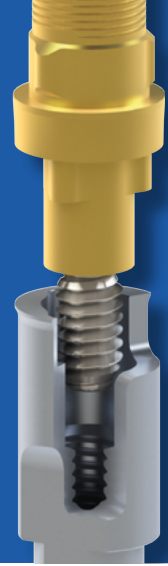

AC Serie NOBEL REPLACE® SELECT

[ϕ 3.5 / ϕ 4.3 / ϕ 5.0]



Nobel Biocare®



INTRA-ORAL / DESKTOP / CONTACT PROBE SCAN BODY

Platform	Height (mm)		
ϕ 3.5	10	IPD/AC-SN-00	IPD/AC-SN-01
	15	IPD/AC-SN-02	-
ϕ 4.3	10	IPD/AC-SR-00	IPD/AC-SR-01
	15	IPD/AC-SR-02	-
ϕ 5.0	10	IPD/AC-SW-00	IPD/AC-SW-01
	15	IPD/AC-SW-02	-

Captive screw included. 1.20 Hex Screwdriver.



Ti-BASE  Custom Ti-Base System®

Platform	Height (mm)		
ϕ 3.5	0.5	IPD/AC-IN-00/3D	IPD/AC-IN-01/3D
	1.5	IPD/AC-IN-02/3D	IPD/AC-IN-03/3D
ϕ 4.3	0.5	IPD/AC-IR-00/3D	IPD/AC-IR-01/3D
	1.5	IPD/AC-IR-02/3D	IPD/AC-IR-03/3D
ϕ 5.0	0.5	IPD/AC-IW-00/3D	IPD/AC-IW-01/3D
	1.5	IPD/AC-IW-02/3D	IPD/AC-IW-03/3D

High version of the non-engaging Custom Ti-Base subject to availability. Please see [page 147](#) for the  Custom Ti-Base System® accessories.



SCREW / TPA SCREW FOR ANGLED PROSTHESIS

Platform	Screwdriver	Seat	Reference	TiN Reference
ϕ 3.5	Unigrip	Flat	IPD/AC-TN-00	IPD/AC-TN-00/TiN
ϕ 4.3 ϕ 5.0	Unigrip	Flat	IPD/AC-TR-00	IPD/AC-TR-00/TiN
ϕ 3.5	TPA	Flat	-	IPD/AC-TN-50
	TPA	Flat	-	IPD/AC-TN-51
ϕ 4.3 ϕ 5.0	TPA	Flat	-	IPD/AC-TR-50
	TPA	Flat	-	IPD/AC-TR-51

IPD/AC-TN-51 is a specific screw for angled Ti-Bases  Hollow Screw System®, IPD/AC-BN-20, and IPD/AC-BN-21. IPD/AC-TR-51 is a specific screw for angled Ti-Bases  Hollow Screw System® and Co-Cr from IPD 2004.

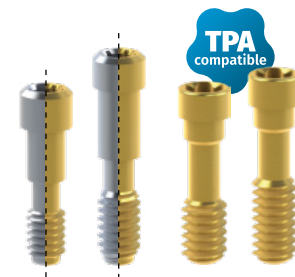
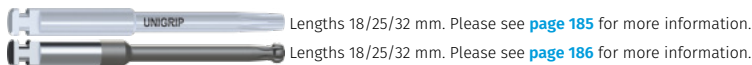

ANALOG / DIGITAL ANALOG

Platform	Reference	Digital reference
ø3.5	IPD/AC-AN-00	IPD/AC-AN-00/3D
ø4.3	IPD/AC-AR-00	IPD/AC-AR-00/3D
ø5.0	IPD/AC-AW-00	IPD/AC-AW-00/3D
Bottom Screw	-	IPD/KA-TA-00
Side Screw	-	IPD/KA-TA-01





STRAIGHT AND ANGLED MULTI-UNIT ABUTMENT

Platform	Height (mm)	Straight	17°	30°
ø3.5	1.0	IPD/AC-MN-01	-	-
	2.0	IPD/AC-MN-02	-	-
	1.0	IPD/AC-MR-01	-	-
ø4.3	2.0	IPD/AC-MR-02	IPD/AC-MR-12	-
	3.0	IPD/AC-MR-03	IPD/AC-MR-13	-
	4.0	IPD/AC-MR-04	-	IPD/AC-MR-34
	5.0	IPD/AC-MR-05	-	-



Our straight Multi-units can be used for single and multiple restorations. Please see [page 157](#) for the Multi-unit system accessories.

TEMPORARY ABUTMENT / OPEN TRAY COPING

Platform			Coping screw
ø3.5	IPD/AC-PN-06	IPD/AC-PN-07	IPD/AC-TN-00/C
ø4.3	IPD/AC-PR-06	IPD/AC-PR-07	IPD/AC-TR-00/C

The same abutment can be used as a temporary abutment with the occlusal screw or as an impression coping using the coping screw.

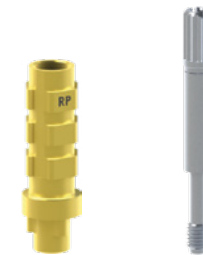

OPEN AND CLOSED TRAY COPING



Platform	Reference
ø3.5	Closed tray coping IPD/AC-CN-01
ø4.3	Closed tray coping IPD/AC-CR-01
ø5.0	Open tray coping IPD/AC-CW-00

Classic design.



STRAIGHT AND ANGLED CASTABLE ABUTMENT WITH A Co-Cr BASE

Straight, 15° & 25°

Platform	Angulation		
ø3.5	Straight	IPD/AC-BN-00	PD/AC-BN-01
	15°	IPD/AC-BN-10	IPD/AC-BN-11
	25°	IPD/AC-BN-20	IPD/AC-BN-21
ø4.3	Straight	IPD/AC-BR-00	IPD/AC-BR-01
	15°	IPD/AC-BR-10	IPD/AC-BR-11

Co-Cr Base for digital workflow

Platform	Scan Body
ø3.5	Straight IPD/AC-BN-00/3D IPD/AC-BN-01/3D IPD/SC-AN-B1
	Angled IPD/AC-BN-A0/3D IPD/AC-BN-A1/3D IPD/SC-AN-B1
ø4.3	Straight IPD/AC-BR-00/3D IPD/AC-BR-01/3D IPD/SC-AN-B1
	Angled IPD/AC-BR-A0/3D IPD/AC-BR-A1/3D IPD/SC-AN-B1

All angled castable abutments include a TPA screw.



PSD OVERDENTURE ABUTMENT

Platform	Height (mm)	Reference
ø3.5	3.0	IPD/AC-LN-03
	5.0	IPD/AC-LN-05
ø4.3	1.0	IPD/AC-LR-01
	3.0	IPD/AC-LR-03
	5.0	IPD/AC-LR-05

Please see [page 169](#) for the PSD system accessories.



HEALING ABUTMENT

Platform	Height (mm)	Reference
ø3.5	3.0	IPD/AC-DN-03
	5.0	IPD/AC-DN-05
	7.0	IPD/AC-DN-07
ø4.3	3.0	IPD/AC-DR-03
	5.0	IPD/AC-DR-05
ø5.0	3.0	IPD/AC-DW-03
	5.0	IPD/AC-DW-05



STRAIGHT ABUTMENT

Platform	Reference
ø3.5	IPD/AC-PN-00
ø4.3	IPD/AC-PR-00
ø5.0	IPD/AC-PW-00



CASTABLE

Platform		
ø4.3	IPD/AC-HR-00	IPD/AC-RR-00
ø5.0	IPD/AC-HW-00	IPD/AC-RW-00







Compatibility

NOBEL BIO CARE®



AD Serie NOBEL ACTIVE®

[ϕ 3.0 / ϕ 3.5 / ϕ 4.3]



Nobel Biocare®



INTRA-ORAL / DESKTOP / CONTACT PROBE SCAN BODY

Platform	Height (mm)		
ϕ 3.0	10	IPD/AD-ST-00	IPD/AD-ST-01
	15	IPD/AD-ST-02	-
ϕ 3.5	10	IPD/AD-SN-00	IPD/AD-SN-01
	15	IPD/AD-SN-02	-
ϕ 4.3	10	IPD/AD-SR-00	IPD/AD-SR-01
	15	IPD/AD-SR-02	-

Captive screw included. 1.20 Hex Screwdriver.



Ti-BASE  Custom Ti-Base System®

Platform	Height (mm)		
ϕ 3.0	0.8	IPD/AD-IT-00/3D	IPD/AD-IT-01/3D
	1.5	IPD/AD-IT-02/3D	IPD/AD-IT-03/3D
	2.5	IPD/AD-IT-04/3D	IPD/AD-IT-05/3D
ϕ 3.5	0.5	IPD/AD-IN-00/3D	IPD/AD-IN-01/3D
	1.5	IPD/AD-IN-02/3D	IPD/AD-IN-03/3D
	2.5	IPD/AD-IN-04/3D	IPD/AD-IN-05/3D
ϕ 4.3	0.5	IPD/AD-IN-06/3D	IPD/AD-IN-07/3D
	0.5	IPD/AD-IR-00/3D	IPD/AD-IR-01/3D
	1.5	IPD/AD-IR-02/3D	IPD/AD-IR-03/3D
	2.5	IPD/AD-IR-04/3D	IPD/AD-IR-05/3D



High version of the non-engaging Custom Ti-Base subject to availability. Please see [page 147](#) for the  Custom Ti-Base System® accessories.

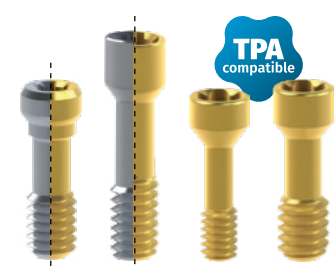

SCREW / TPA SCREW FOR ANGLED PROSTHESIS

Platform	Screwdriver	Seat	Reference	TiN Reference
ϕ 3.0	Unigrip	Conical	IPD/AD-TT-00	IPD/AD-TT-00/TIN
ϕ 3.5	Unigrip	Conical	IPD/AA-TN-00	IPD/AA-TN-00/TIN
ϕ 4.3	Unigrip	Conical	IPD/AA-TR-00	IPD/AA-TR-00/TIN
ϕ 3.0	TPA	Conical	-	IPD/AD-TT-50
ϕ 3.5	TPA	Conical	-	IPD/AA-TN-50
ϕ 4.3	TPA	Conical	-	IPD/AD-TR-50



 Lengths 18/25/32 mm. Please see [page 185](#) for more information.
 Lengths 18/25/32 mm. Please see [page 186](#) for more information.

ANALOG / DIGITAL ANALOG

Platform	Reference	Digital reference
ø3.0	IPD/AD-AT-00	IPD/AD-AT-00/3D
ø3.5	IPD/AD-AN-00	IPD/AD-AN-00/3D
ø4.3	IPD/AD-AR-00	IPD/AD-AR-00/3D
Bottom Screw	-	IPD/KA-TA-00
Side Screw	-	IPD/KA-TA-01





STRAIGHT AND ANGLED MULTI-UNIT ABUTMENT

Platform	Height (mm)	Straight	17°	30°
ø3.5	1.5	IPD/AD-MN-01	-	-
	2.5	IPD/AD-MN-02	IPD/AD-MN-12	-
	3.5	IPD/AD-MN-03	IPD/AD-MN-13	IPD/AD-MN-33
	4.5	IPD/AD-MN-04	-	IPD/AD-MN-34
ø4.3	1.5	IPD/AD-MR-01	-	-
	2.5	IPD/AD-MR-02	IPD/AD-MR-12	-
	3.5	IPD/AD-MR-03	IPD/AD-MR-13	IPD/AD-MR-33
	4.5	IPD/AD-MR-04	-	IPD/AD-MR-34



Our straight Multi-units can be used for single and multiple restorations. Please see [page 157](#) for the Multi-unit system accessories.

TEMPORARY ABUTMENT / OPEN TRAY COPING

Platform			Coping screw
ø3.0	IPD/AD-PT-06	IPD/AD-PT-07	IPD/AD-TT-00/C
ø3.5	IPD/AD-PN-06	IPD/AD-PN-07	IPD/AD-TN-00/C
ø4.3	IPD/AD-PR-06	IPD/AD-PR-07	IPD/AD-TR-00/C

The same abutment can be used as a temporary abutment with the occlusal screw or as an impression coping using the coping screw.



OPEN TRAY COPING

Platform	Reference
ø3.0	IPD/AD-CT-00

Classic design.





CASTABLE

Platform		
ø4.3	IPD/AD-HR-00	IPD/AD-RR-00



STRAIGHT AND ANGLED CASTABLE ABUTMENT WITH A Co-Cr BASE
 Straight, 15° & 25°

Platform	Angulation		
ø3.0	Straight	IPD/AD-BT-00	IPD/AD-BT-01
	15°	IPD/AD-BT-10	IPD/AD-BT-11
	25°	IPD/AD-BT-20	IPD/AD-BT-21
ø3.5	Straight	IPD/AD-BN-00	IPD/AD-BN-01
	15°	IPD/AD-BN-10	IPD/AD-BN-11
	25°	IPD/AD-BN-20	IPD/AD-BN-21
ø4.3	Straight	IPD/AD-BR-00	IPD/AD-BR-01
	15°	IPD/AD-BR-10	IPD/AD-BR-11
	25°	IPD/AD-BR-20	IPD/AD-BR-21



Co-Cr Base for digital workflow			Scan Body		
ø3.0	Straight	IPD/AD-BT-00/3D	IPD/AD-BT-01/3D	IPD/SC-AN-B1	
	Angled	IPD/AD-BT-A0/3D	IPD/AD-BT-A1/3D	IPD/SC-AN-B1	
ø3.5	Straight / Angled		IPD/AD-BN-00/3D	IPD/AD-BN-01/3D	IPD/SC-AN-B1
	Straight		IPD/AD-BR-00/3D	IPD/AD-BR-01/3D	IPD/SC-AN-B1
ø4.3	Straight		IPD/AD-BR-00/3D	IPD/AD-BR-01/3D	IPD/SC-AN-B1
	Angled		IPD/AD-BR-A0/3D	IPD/AD-BR-A1/3D	IPD/SC-AN-B1

All angled castable abutments include a TPA screw.

PSD OVERDENTURE ABUTMENT

Platform	Height (mm)	Reference
ø3.5	1.0	IPD/AD-LN-01
	2.0	IPD/AD-LN-02
	3.0	IPD/AD-LN-03
	4.0	IPD/AD-LN-04
	5.0	IPD/AD-LN-05
ø4.3	1.0	IPD/AD-LR-01
	2.0	IPD/AD-LR-02
	3.0	IPD/AD-LR-03
	4.0	IPD/AD-LR-04
	5.0	IPD/AD-LR-05



Please see [page 169](#) for the PSD system accessories.

HEALING ABUTMENT

Platform	Height (mm)	Reference
ø3.0	3.0	IPD/AD-DT-03
	5.0	IPD/AD-DT-05
	7.0	IPD/AD-DT-07
ø3.5	Sealing cap	IPD/AD-DN-00
	1.5	IPD/AD-DN-01
	3.0	IPD/AD-DN-03
	5.0	IPD/AD-DN-05
	3.0 wide	IPD/AD-DN-13
	5.0 wide	IPD/AD-DN-15
	Sealing cap	IPD/AD-DR-00
ø4.3	1.5	IPD/AD-DR-01
	3.0	IPD/AD-DR-03
	5.0	IPD/AD-DR-05



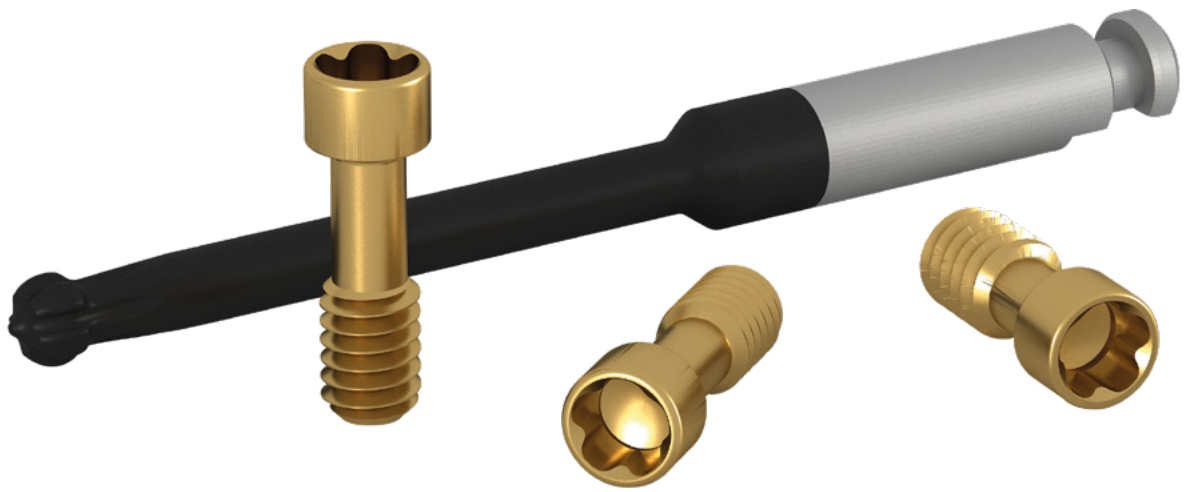



Compatibility

BIOMET® 3i®



BA Serie OSSEOTITE®

[ϕ 3.4 / ϕ 4.1 / ϕ 5.0]



Biomet 3i



INTRA-ORAL / DESKTOP / CONTACT PROBE SCAN BODY

Platform	Height (mm)		
ϕ 3.4	10	IPD/BA-SN-00	IPD/BA-SN-01
	15	IPD/BA-SN-02	-
ϕ 4.1	10	IPD/AA-SR-00	IPD/AA-SR-01
	15	IPD/AA-SR-02	-
ϕ 5.0	10	IPD/BA-SW-00	IPD/BA-SW-01
	15	IPD/BA-SW-02	-

Captive screw included. 1.20 Hex Screwdriver.



Ti-BASE  Custom Ti-Base System®

Platform	Height (mm)		
ϕ 3.4	1.5	IPD/BA-IN-02/3D	IPD/BA-IN-03/3D
	0.5	IPD/AA-IR-00/3D	IPD/AA-IR-01/3D
ϕ 4.1	1.5	IPD/AA-IR-02/3D	IPD/AA-IR-03/3D
	2.5	IPD/AA-IR-04/3D	IPD/AA-IR-05/3D
ϕ 5.0	0.5	IPD/BA-IW-00/3D	IPD/BA-IW-01/3D
	1.5	IPD/BA-IW-02/3D	IPD/BA-IW-03/3D





High version of the non-engaging Custom Ti-Base subject to availability. Please see [page 147](#) for the  Custom Ti-Base System® accessories.

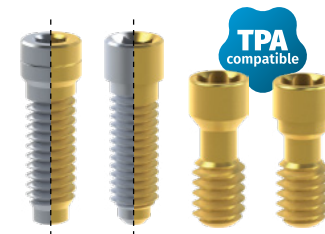

SCREW / TPA SCREW FOR ANGLED PROSTHESIS

Platform	Screwdriver	Seat	Reference	TiN Reference
ϕ 3.4 ϕ 4.1 ϕ 5.0	1.20 Hex	Conical	IPD/BA-TR-00	IPD/BA-TR-00/TIN
	1.25 Hex	Conical	IPD/BA-TR-01	IPD/BA-TR-01/TIN
	Square	Flat	IPD/BA-TR-02	IPD/BA-TR-02/TIN
	1.20 Hex	Low profile conical	IPD/AA-TR-01	IPD/AA-TR-01/TIN
ϕ 3.4 ϕ 4.1 ϕ 5.0	TPA	Conical	-	IPD/AA-TR-50
		Flat	-	IPD/AA-TR-52



-  Lengths 18/25/32 mm. Please see [page 182](#) for more information.
-  Lengths 18/25/32 mm. Please see [page 182](#) for more information.
-  Lengths 18/25/32 mm. Please see [page 183](#) for more information.
-  Lengths 18/25/32 mm. Please see [page 184](#) for more information.

ANALOG / DIGITAL ANALOG

Platform	Reference	Digital reference
ø3.4	IPD/BA-AN-00	IPD/BA-AN-00/3D
ø4.1	IPD/AA-AR-00	IPD/AA-AR-00/3D
ø5.0	IPD/BA-AW-00	IPD/BA-AW-00/3D
Bottom Screw	-	IPD/KA-TA-00
Side Screw	-	IPD/KA-TA-01





STRAIGHT AND ANGLED MULTI-UNIT ABUTMENT

Platform	Height (mm)	Straight	17°	30°
ø4.1	1.0	IPD/AB-MR-01	-	-
	2.0	IPD/AB-MR-02	IPD/AB-MR-12	-
	3.0	IPD/AB-MR-03	IPD/AB-MR-13	IPD/AB-MR-33
	4.0	IPD/AB-MR-04	IPD/AB-MR-14	IPD/AB-MR-34
	5.0	IPD/AB-MR-05	-	IPD/AB-MR-35



Our straight Multi-units can be used for single and multiple restorations. Please see [page 157](#) for the Multi-unit system accessories.

TEMPORARY ABUTMENT / OPEN TRAY COPING

Platform			Coping screw
ø3.4	IPD/BA-PN-06	IPD/BA-PN-07	IPD/AA-TR-00/C
ø4.1	IPD/AA-PR-06	IPD/AA-PR-07	IPD/AA-TR-00/C

The same abutment can be used as a temporary abutment with the occlusal screw or as an impression coping using the coping screw.



OPEN AND CLOSED TRAY COPING



Platform	Reference	
ø4.1	Open tray coping	IPD/AA-CR-00
	Closed tray coping	IPD/AA-CR-01
ø5.0	Open tray coping	IPD/BA-CW-00

Classic design.



STRAIGHT AND ANGLED ABUTMENT

Straight, 15° & 25°



Platform	Height (mm)	Angulation		
ø4.1	1.0	Straight	IPD/AA-PR-00	IPD/AA-PR-01
		15°	IPD/AA-PR-02	-
		25°	IPD/AA-PR-03	-
	2.0	15°	IPD/AA-PR-04	-
		25°	IPD/AA-PR-05	-



Using the low profile IPD/AA-TR-01 screw for IPD/AA-PR-03 is recommended.

STRAIGHT AND ANGLED CASTABLE ABUTMENT WITH A Co-Cr BASE

Straight, 15° & 25°

Platform	Angulation		
ø3.4	Straight	IPD/BA-BN-00	IPD/BA-BN-01
	15°	IPD/BA-BN-10	IPD/BA-BN-11
	25°	IPD/BA-BN-20	IPD/BA-BN-21
ø4.1	Straight	IPD/AA-BR-00	IPD/AA-BR-01
	15°	IPD/AA-BR-10	IPD/AA-BR-11
	25°	IPD/AA-BR-20	IPD/AA-BR-21
ø5.0	Straight	IPD/BA-BW-00	IPD/BA-BW-01
	15°	IPD/BA-BW-10	IPD/BA-BW-11
	25°	IPD/BA-BW-20	IPD/BA-BW-21



Co-Cr Base for digital workflow			Scan Body	
ø3.4	Straight / Angled	IPD/BA-BN-00/3D	IPD/BA-BN-01/3D	IPD/SC-AN-B1
ø4.1	Straight / Angled	IPD/AA-BR-00/3D	IPD/AA-BR-01/3D	IPD/SC-AN-B1
ø5.0	Straight / Angled	IPD/BA-BW-00/3D	IPD/BA-BW-01/3D	IPD/SC-AN-B1

All angled castable abutments include a TPA screw.

PSD OVERDENTURE ABUTMENT

Platform	Height (mm)	Reference
ø3.4	1.0	IPD/BA-LN-01
	3.0	IPD/BA-LN-03
	1.0	IPD/AA-LR-01
ø4.1	2.0	IPD/AA-LR-02
	3.0	IPD/AA-LR-03
	4.0	IPD/AA-LR-04
	5.0	IPD/AA-LR-05





Please see [page 169](#) for the PSD system accessories.

HEALING ABUTMENT

Platform	Height (mm)	Reference
ø3.4	2.0	IPD/BA-DN-02
	3.0	IPD/BA-DN-03
	4.0	IPD/BA-DN-04
ø4.1	2.0	IPD/AA-DR-02
	3.0	IPD/AA-DR-03
	4.0	IPD/AA-DR-04
	5.0	IPD/AA-DR-05
ø5.0	2.0	IPD/BA-DW-02
	3.0	IPD/BA-DW-03
	4.0	IPD/BA-DW-04



CASTABLE

Platform		
ø4.1	IPD/AA-HR-00	IPD/AA-RR-00
ø5.0	IPD/BA-HW-00	IPD/BA-RW-00



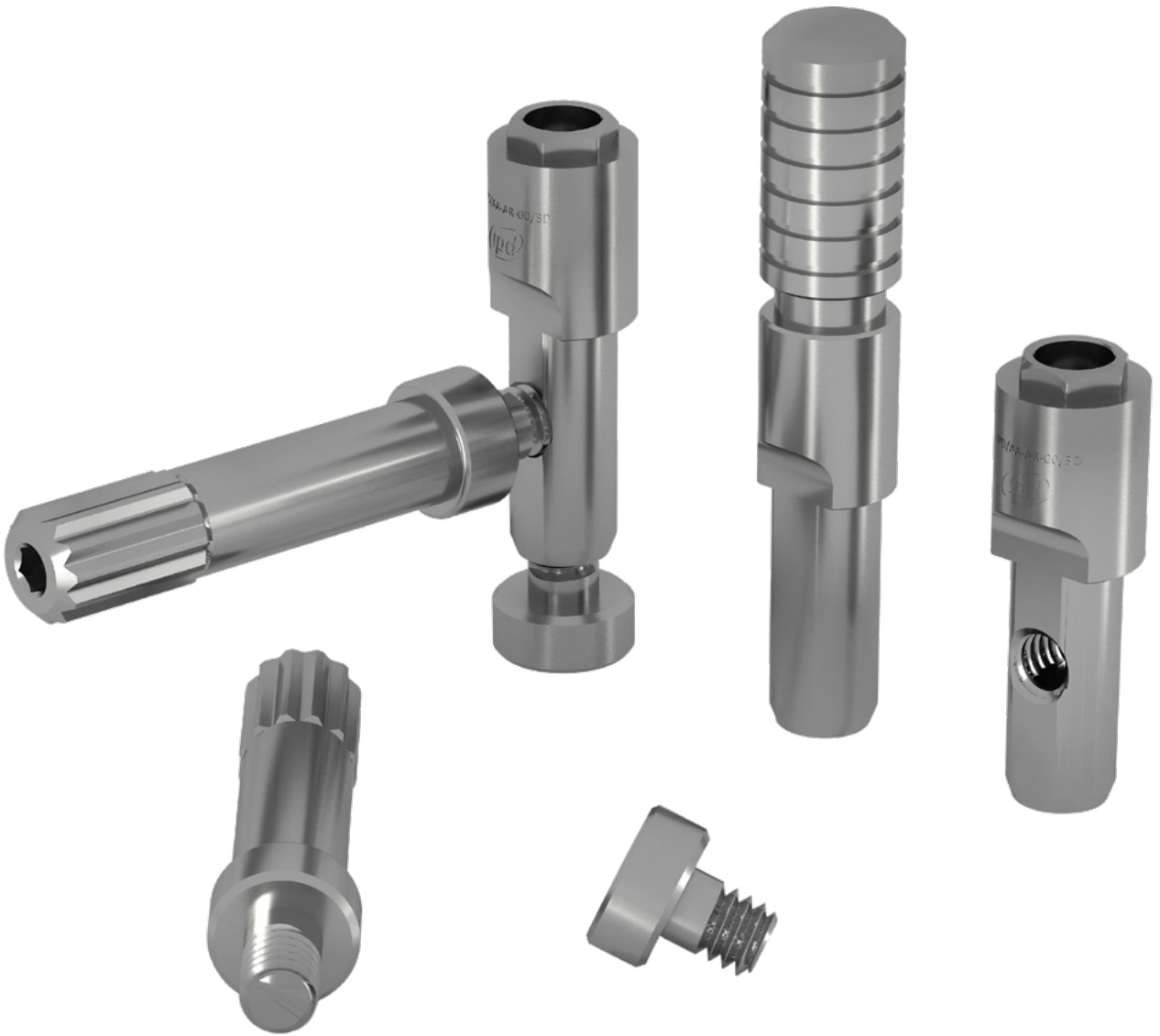



Compatibility

BIOMET® 3i®

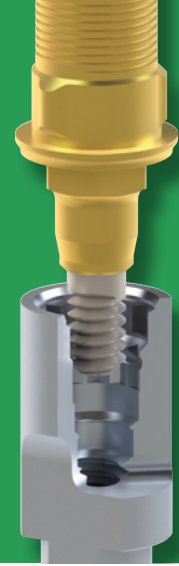

BB Serie Certain®

[ø3.4 / ø4.1 / ø5.0]



Biomet® 3i®



INTRA-ORAL / DESKTOP / CONTACT PROBE SCAN BODY

Platform	Height (mm)		
ø3.4	10	IPD/BB-SN-00	IPD/BB-SN-01
	15	IPD/BB-SN-02	-
ø4.1	10	IPD/BB-SR-00	IPD/BB-SR-01
	15	IPD/BB-SR-02	-
ø5.0	10	IPD/BB-SW-00	IPD/BB-SW-01
	15	IPD/BB-SW-02	-

Captive screw included. 1.20 Hex Screwdriver.



Ti-BASE Custom Ti-Base System®

Platform	Height (mm)		
ø3.4	0.5	IPD/BB-IN-00/3D	IPD/BB-IN-01/3D
	1.5	IPD/BB-IN-02/3D	IPD/BB-IN-03/3D
	2.5	IPD/BB-IN-04/3D	IPD/BB-IN-05/3D
ø4.1	0.5	IPD/BB-IR-00/3D	IPD/BB-IR-01/3D
	1.5	IPD/BB-IR-02/3D	IPD/BB-IR-03/3D
	2.5	IPD/BB-IR-04/3D	IPD/BB-IR-05/3D
ø5.0	0.5	IPD/BB-IW-00/3D	IPD/BB-IW-01/3D
	1.5	IPD/BB-IW-02/3D	IPD/BB-IW-03/3D

High version of the non-engaging Custom Ti-Base subject to availability.
Please see [page 147](#) for the  Custom Ti-Base System® accessories.



SCREW / TPA SCREW FOR ANGLED PROSTHESIS

Platform	Screwdriver	Seat	Reference	TiN Reference
ø3.4 ø4.1 ø5.0	1.20 Hex	Flat	IPD/BB-TR-01	IPD/BB-TR-01/TiN
ø4.1 ø5.0	1.20 Hex	Conical	IPD/BB-TR-02	-
ø3.4 ø4.1 ø5.0	TPA	Flat	-	IPD/BB-TR-51

IPD/BB-TR-02 is a specific screw for models IPD/BB-RR-00 and IPD/BB-RW-00

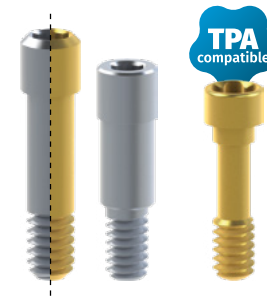
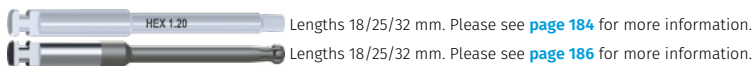

ANALOG / DIGITAL ANALOG

Platform	Reference	Digital reference
ø3.4	IPD/BB-AN-00	IPD/BB-AN-00/3D
ø4.1	IPD/BB-AR-00	IPD/BB-AR-00/3D
ø5.0	IPD/BB-AW-00	IPD/BB-AW-00/3D
Bottom Screw	-	IPD/KA-TA-00
Side Screw	-	IPD/KA-TA-01





STRAIGHT AND ANGLED MULTI-UNIT ABUTMENT

Platform	Height (mm)	Straight	17°	30°
ø3.4	1.0	IPD/BB-MN-01	-	-
	2.0	IPD/BB-MN-02	-	-
	3.0	IPD/BB-MN-03	-	-
	4.0	IPD/BB-MN-04	-	-
ø4.1	1.0	IPD/BB-MR-01	-	-
	2.0	IPD/BB-MR-02	IPD/BB-MR-12	-
	3.0	IPD/BB-MR-03	IPD/BB-MR-13	-
	4.0	IPD/BB-MR-04	-	IPD/BB-MR-34
	5.0	IPD/BB-MR-05	-	-



Our straight Multi-units can be used for single and multiple restorations. Please see [page 157](#) for the Multi-unit system accessories.

TEMPORARY ABUTMENT / OPEN TRAY COPING

Platform			Coping screw
ø3.4	IPD/BB-PN-06	IPD/BB-PN-07	IPD/BB-TR-01/C
ø4.1	IPD/BB-PR-06	IPD/BB-PR-07	IPD/BB-TR-01/C

The same abutment can be used as a temporary abutment with the occlusal screw or as an impression coping using the coping screw.

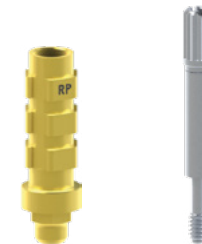



OPEN TRAY COPING

Platform	Reference
ø5.0	Open tray coping IPD/BB-CW-00

Classic design.



STRAIGHT AND ANGLED CASTABLE ABUTMENT WITH A Co-Cr BASE

Platform	Angulation		
ø3.4	Straight	IPD/BB-BN-00	IPD/BB-BN-01
	15°	IPD/BB-BN-10	IPD/BB-BN-11
	25°	IPD/BB-BN-20	IPD/BB-BN-21
ø4.1	Straight	IPD/BB-BR-00	IPD/BB-BR-01
	15°	IPD/BB-BR-10	IPD/BB-BR-11
	25°	IPD/BB-BR-20	IPD/BB-BR-21

Co-Cr Base for digital workflow	Scan Body
ø3.4	Straight IPD/BB-BN-00/3D IPD/BB-BN-01/3D IPD/SC-AN-B1
	Angled IPD/BB-BN-A0/3D IPD/BB-BN-A1/3D IPD/SC-AN-B1
ø4.1	Straight / Angled IPD/BB-BR-00/3D IPD/BB-BR-01/3D IPD/SC-AN-B1

All angled castable abutments include a TPA screw.



PSD OVERDENTURE ABUTMENT

Platform	Height (mm)	Reference
ø3.4	1.0	IPD/BB-LN-01
	3.0	IPD/BB-LN-03
	5.0	IPD/BB-LN-05
ø4.1	1.0	IPD/BB-LR-01
	3.0	IPD/BB-LR-03
	5.0	IPD/BB-LR-05

Please see [page 169](#) for the PSD system accessories.



HEALING ABUTMENT

Platform	Height (mm)	Reference
ø3.4	2.0	IPD/BB-DN-02
	3.0	IPD/BB-DN-03
	4.0	IPD/BB-DN-04
ø4.1	2.0	IPD/BB-DR-02
	3.0	IPD/BB-DR-03
	4.0	IPD/BB-DR-04
ø5.0	2.0	IPD/BB-DW-02
	3.0	IPD/BB-DW-03
	4.0	IPD/BB-DW-04



STRAIGHT ABUTMENT

Platform	Reference
ø3.4	IPD/BB-PN-00
ø4.1	IPD/BB-PR-00
ø5.0	IPD/BB-PW-00



CASTABLE

Platform		
ø4.1	IPD/BB-HR-00	IPD/BB-RR-00
ø5.0	IPD/BB-HW-00	IPD/BB-RW-00

Non-Engaging castables should be used with the IPD/BB-TR-02 screw.







Compatibility

KLOCKNER®

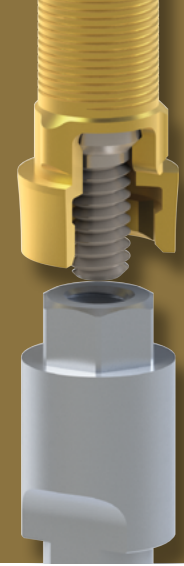

CA Serie SK2-NK2

[ø4.2]



Klockner®



INTRA-ORAL / DESKTOP / CONTACT PROBE SCAN BODY

Platform	Height (mm)		
ø4.2	10	IPD/CA-SR-00	IPD/CA-SR-01

Captive screw included. 1.20 Hex Screwdriver.



Ti-BASE Custom Ti-Base System®

Platform	Height (mm)		
ø4.2	0.5	IPD/CA-IR-00/3D	IPD/CA-IR-01/3D
	2.25	IPD/CA-IR-04/3D	IPD/CA-IR-05/3D

References IPD/CA-IR-00/3D and IPD/CA-IR-01/3D must be used with the wide platform cutting guides and milling of the angulation window is not allowed.

Please see [page 147](#) for the  Custom Ti-Base System® accessories.



SCREW / TPA SCREW FOR ANGLED PROSTHESIS

Platform	Screwdriver	Seat	Reference	TiN Reference
ø4.2	1.70 Hex	Conical	IPD/CA-TR-00	IPD/CA-TR-00/TiN
	Cruciform	Conical	IPD/CA-TR-01	IPD/CA-TR-01/TiN
	TPA	Conical	-	IPD/CA-TR-50

 Lengths 18/25/32 mm. Please see [page 184](#) for more information.

 Lengths 18/25/32 mm. Please see [page 186](#) for more information.

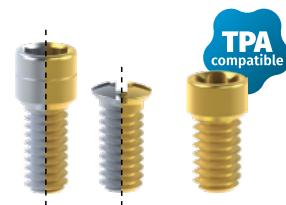

ANALOG / DIGITAL ANALOG

Platform	Reference	Digital reference
ø4.2	IPD/CA-AR-00	IPD/CA-AR-00/3D
Bottom Screw	-	IPD/KA-TA-00
Side Screw	-	IPD/KA-TA-01



TEMPORARY ABUTMENT / OPEN TRAY COPING

Platform			Screw coping
ø4.2	IPD/CA-PR-06	IPD/CA-PR-07	IPD/CA-TR-00/C

The same abutment can be used as a temporary abutment with the occlusal screw or as an impression coping using the coping screw.



HEALING ABUTMENT

Platform	Height (mm)	Reference
ø4.2	5.0	IPD/CA-DR-00

Screw IPD/CA-TR-00 not included.



STRAIGHT ABUTMENT

Platform	Reference
ø4.2	IPD/CA-PR-00





CASTABLE

Platform		
ø4.2	IPD/CA-HR-00	IPD/CA-RR-00



STRAIGHT AND ANGLED CASTABLE ABUTMENT WITH A Co-Cr BASE Straight, 15° & 25°

Platform	Angulation		
		IPD/CA-BR-00	IPD/CA-BR-01
ø4.2	15°	IPD/CA-BR-10	IPD/CA-BR-11
	25°	IPD/CA-BR-20	IPD/CA-BR-21

Co-Cr Base for digital workflow		Scan Body	
ø4.2	Straight / Angled	IPD/CA-BR-00/3D	IPD/CA-BR-01/3D

All angled castable abutments include a TPA screw.





Compatibility

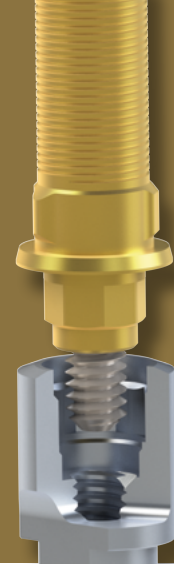

KLOCKNER®

CB Serie ESSENTIAL CONE®
[ø4.5]



Klockner®



INTRA-ORAL / DESKTOP / CONTACT PROBE SCAN BODY

Platform	Height (mm)		
ø4.5	10	IPD/CB-SR-00	IPD/CB-SR-01
	15	IPD/CB-SR-02	-

Captive screw included. 1.20 Hex Screwdriver.



Ti-BASE  Custom Ti-Base System®

Platform	Height (mm)		
ø4.5	0.5	IPD/CB-IR-00/3D	IPD/CB-IR-01/3D

Please see [page 147](#) for the  Custom Ti-Base System® accessories.



SCREW / TPA SCREW FOR ANGLED PROSTHESIS

Platform	Screwdriver	Seat	Reference	TiN Reference
ø4.5	Star	Conical	IPD/CB-TR-00	IPD/CB-TR-00/TiN
	TPA	Conical	-	IPD/CB-TR-50

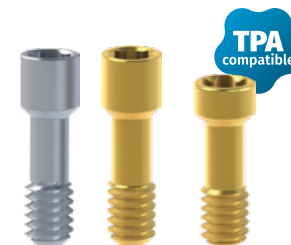
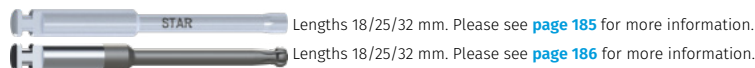

ANALOG / DIGITAL ANALOG

Platform	Reference	Digital reference
ø4.5	IPD/CB-AR-00	IPD/CB-AR-00/3D
Bottom Screw	-	IPD/KA-TA-00
Side Screw	-	IPD/KA-TA-01



TEMPORARY ABUTMENT / OPEN TRAY COPING

Platform			Coping screw
ø4.5	IPD/CB-PR-06	IPD/CB-PR-07	IPD/CB-TR-00/C

The same abutment can be used as a temporary abutment with the occlusal screw or as an impression coping using the coping screw.



PSD OVERDENTURE ABUTMENT

Platform	Height (mm)	Reference
ø4.5	1.0	IPD/CB-LR-01
	3.0	IPD/CB-LR-03

Please see [page 169](#) for the PSD system accessories.





HEALING ABUTMENT

Platform	Height (mm)	Reference
ø4.5	1.5	IPD/CB-DR-01
	3.0	IPD/CB-DR-03
	4.5	IPD/CB-DR-04



STRAIGHT AND ANGLED CASTABLE ABUTMENT WITH A CO-CR BASE Straight, 15° & 25°

Platform	Angulation			
ø4.5	Straight	IPD/CB-BR-00	IPD/CB-BR-01	
	15°	IPD/CB-BR-10	IPD/CB-BR-11	
	25°	IPD/CB-BR-20	IPD/CB-BR-21	
Co-Cr Base for digital workflow			Scan Body	
ø4.5	Straight / Angled	IPD/CB-BR-00/3D	IPD/CB-BR-01/3D	IPD/SC-AN-B2

All angled castable abutments include a TPA screw.





Compatibility

KLOCKNER®



CC Serie KL™

[ø3.5 / ø4.1 / ø5.1]



Klockner®



INTRA-ORAL / DESKTOP / CONTACT PROBE SCAN BODY

Platform	Height (mm)		
ø3.5	10	IPD/AA-SN-00	IPD/AA-SN-01
	15	IPD/AA-SN-02	-
ø4.1	10	IPD/AA-SR-00	IPD/AA-SR-01
	15	IPD/AA-SR-02	-
ø5.1	10	IPD/AA-SW-00	IPD/AA-SW-01

Captive screw included. 1.20 Hex Screwdriver.



Ti-BASE Custom Ti-Base System®

Platform	Height (mm)		
ø3.5	1.5	IPD/AA-IN-02/3D	IPD/AA-IN-03/3D
	0.5	IPD/AA-IR-00/3D	IPD/AA-IR-01/3D
ø4.1	1.5	IPD/AA-IR-02/3D	IPD/AA-IR-03/3D
	2.5	IPD/AA-IR-04/3D	IPD/AA-IR-05/3D
ø5.1	1.3	IPD/AA-IW-02/3D	IPD/AA-IW-03/3D

The IPD/AA-TW-01 screw is compatible with the Ti-Bases IPD/AA-IW-02/3D and IPD/AA-IW-03/3D
Please see [page 147](#) for the  Custom T-Base System® accessories.



SCREW / TPA SCREW FOR ANGLED PROSTHESIS

Platform	Screwdriver	Seat	Reference	TiN Reference
ø3.5	Unigrip	Conical	IPD/AA-TN-00	IPD/AA-TN-00/TiN
	Unigrip	Conical	IPD/AA-TR-00	IPD/AA-TR-00/TiN
ø4.1	1.20 Hex	Conical	IPD/BA-TR-00	IPD/BA-TR-00/TiN
	1.20 Hex	Low profile conical	IPD/AA-TR-01	IPD/AA-TR-01/TiN
ø5.1	Unigrip	Conical	IPD/AA-TW-00	IPD/AA-TW-00/TiN
			IPD/AA-TW-01	IPD/AA-TW-01/TiN
ø3.5	TPA	Conical	-	IPD/AA-TN-50
ø4.1		Conical	-	IPD/AA-TR-50
ø4.1	TPA	Flat	-	IPD/AA-TR-52
ø5.1		Conical	-	IPD/AA-TW-50

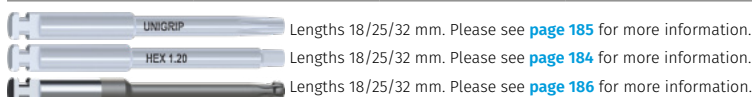
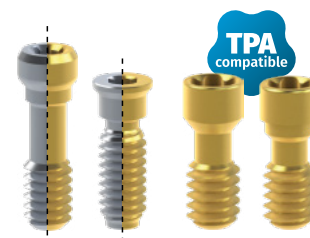

ANALOG / DIGITAL ANALOG

Platform	Reference	Digital reference
ø3.5	IPD/AA-AN-00	IPD/AA-AN-00/3D
ø4.1	IPD/AA-AR-00	IPD/AA-AR-00/3D
ø5.1	IPD/AA-AW-00	IPD/AA-AW-00/3D
Bottom Screw	-	IPD/KA-TA-00
Side Screw	-	IPD/KA-TA-01





STRAIGHT AND ANGLED MULTI-UNIT ABUTMENT

Platform	Height (mm)	Straight	17°	30°
ø4.1	1.0	IPD/AB-MR-01	-	-
	2.0	IPD/AB-MR-02	IPD/AB-MR-12	-
	3.0	IPD/AB-MR-03	IPD/AB-MR-13	IPD/AB-MR-33
	4.0	IPD/AB-MR-04	IPD/AB-MR-14	IPD/AB-MR-34
	5.0	IPD/AB-MR-05	-	IPD/AB-MR-35



Our straight Multi-units can be used for single and multiple restorations. Please see [page 157](#) for the Multi-unit system accessories.

TEMPORARY ABUTMENT / OPEN TRAY COPING

Platform			Coping screw
ø3.5	IPD/AA-PN-06	IPD/AA-PN-07	IPD/AA-TN-00/C
ø4.1	IPD/AA-PR-06	IPD/AA-PR-07	IPD/AA-TR-00/C
ø5.1	IPD/AA-PW-06	IPD/AA-PW-07	IPD/AA-TW-00/C

The same abutment can be used as a temporary abutment with the occlusal screw or as an impression coping using the coping screw.

For references IPD/AA-PW-06 and IPD/AA-PW-07 use the screw IPD/AA-TW-01 if it is used as a temporary.



OPEN AND CLOSED TRAY COPING



Platform	Reference
ø4.1	Open tray coping
	Closed tray coping
ø5.1	Open tray coping

Classic design.



STRAIGHT AND ANGLED CASTABLE ABUTMENT WITH A Co-Cr BASE

Straight, 15° & 25°

Platform	Angulation		
ø3.5	Straight	IPD/AA-BN-00	IPD/AA-BN-01
	15°	IPD/AA-BN-10	IPD/AA-BN-11
	25°	IPD/AA-BN-20	IPD/AA-BN-21
ø4.1	Straight	IPD/AA-BR-00	IPD/AA-BR-01
	15°	IPD/AA-BR-10	IPD/AA-BR-11
	25°	IPD/AA-BR-20	IPD/AA-BR-21

Co-Cr Base for digital workflow			Scan Body	
ø3.5	Straight / Angled	IPD/AA-BN-00/3D	IPD/AA-BN-01/3D	IPD/SC-AN-B1
ø4.1	Straight / Angled	IPD/AA-BR-00/3D	IPD/AA-BR-01/3D	IPD/SC-AN-B1

All angled castable abutments include a TPA screw.



PSD OVERDENTURE ABUTMENT

Platform	Height (mm)	Reference
ø3.5	1.0	IPD/AA-LN-01
	3.0	IPD/AA-LN-03
	5.0	IPD/AA-LN-05
ø4.1	1.0	IPD/AA-LR-01
	2.0	IPD/AA-LR-02
	3.0	IPD/AA-LR-03
	4.0	IPD/AA-LR-04
	5.0	IPD/AA-LR-05

Please see [page 169](#) for the PSD system accessories.





HEALING ABUTMENT

Platform	Height (mm)	Reference
ø3.5	2.0	IPD/AA-DN-02
	3.0	IPD/AA-DN-03
	4.0	IPD/AA-DN-04
ø4.1	2.0	IPD/AA-DR-02
	3.0	IPD/AA-DR-03
	4.0	IPD/AA-DR-04
	5.0	IPD/AA-DR-05
	ø5.1	2.0
3.0		IPD/AA-DW-03
4.0		IPD/AA-DW-04



STRAIGHT AND ANGLED ABUTMENT



Straight, 15° & 25°

Platform	Height (mm)	Angulation		
ø4.1	1.0	Straight	IPD/AA-PR-00	IPD/AA-PR-01
		15°	IPD/AA-PR-02	-
		25°	IPD/AA-PR-03	-
	2.0	15°	IPD/AA-PR-04	-
		25°	IPD/AA-PR-05	-

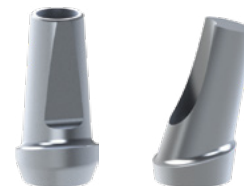
Using the low profile IPD/AA-TR-01 screw for IPD/AA-PR-03 is recommended.



CASTABLE

Platform		
ø4.1	IPD/AA-HR-00	IPD/AA-RR-00
ø5.1	IPD/AA-HW-00	IPD/AA-RW-00







Compatibility

KLOCKNER®

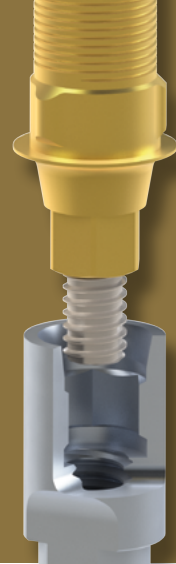

CD Serie Vega®

[ϕ 3.5 / ϕ 4.0 / ϕ 4.5]



Klockner®



INTRA-ORAL / DESKTOP / CONTACT PROBE SCAN BODY

Platform	Height (mm)		
ϕ 3.5	10	IPD/CD-SN-00	IPD/CD-SN-01
	15	IPD/CD-SN-02	-
ϕ 4.0 ϕ 4.5	10	IPD/CD-SR-00	IPD/CD-SR-01
	15	IPD/CD-SR-02	-

Captive screw included. 1.20 Hex Screwdriver.



Ti-BASE Custom Ti-Base System®

Platform	Height (mm)		
ϕ 3.5	0.7	IPD/CD-IN-00/3D	IPD/CD-IN-01/3D
	1.5	IPD/CD-IN-02/3D	IPD/CD-IN-03/3D
	2.5	IPD/CD-IN-04/3D	IPD/CD-IN-05/3D
	0.7	IPD/CD-IR-00/3D	IPD/CD-IR-01/3D
ϕ 4.0 ϕ 4.5	1.5	IPD/CD-IR-02/3D	IPD/CD-IR-03/3D
	2.5	IPD/CD-IR-04/3D	IPD/CD-IR-05/3D

Please see [page 147](#) for the  Custom Ti-Base System® accessories.



SCREW / TPA SCREW FOR ANGLED PROSTHESIS

Platform	Screwdriver	Seat	Reference	TiN Reference
ϕ 3.5	Star	Conical	IPD/CD-TN-00	IPD/CD-TN-00/TiN
ϕ 4.0 ϕ 4.5	Star	Conical	IPD/CD-TR-00	IPD/CD-TR-00/TiN
ϕ 3.5	TPA	Conical	-	IPD/CD-TN-50
ϕ 4.0 ϕ 4.5	TPA	Conical	-	IPD/CD-TR-50

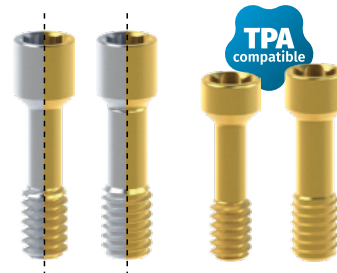
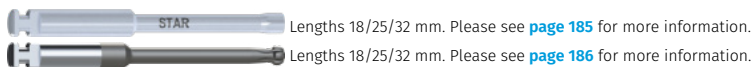

ANALOG / DIGITAL ANALOG

Platform	Reference	Digital reference
ϕ 3.5	IPD/CD-AN-00	IPD/CD-AN-00/3D
ϕ 4.0 ϕ 4.5	IPD/CD-AR-00	IPD/CD-AR-00/3D
Bottom Screw	-	IPD/KA-TA-00
Side Screw	-	IPD/KA-TA-01





STRAIGHT AND ANGLED MULTI-UNIT ABUTMENT

Platform	Height (mm)	Straight	17°	30°
ø3.5	1.5	IPD/CD-MN-01	-	-
	2.5	IPD/CD-MN-02	IPD/CD-MN-12	-
	3.5	IPD/CD-MN-03	-	IPD/CD-MN-33
	4.5	IPD/CD-MN-04	-	-
	5.5	IPD/CD-MN-05	-	-
ø4.0 ø4.5	1.5	IPD/CD-MR-01	-	-
	2.5	IPD/CD-MR-02	IPD/CD-MR-12	-
	3.5	IPD/CD-MR-03	-	IPD/CD-MR-33
	4.5	IPD/CD-MR-04	-	-
	5.5	IPD/CD-MR-05	-	-



Our straight Multi-units can be used for single and multiple restorations. Please see page 157 for the Multi-unit system accessories.

TEMPORARY ABUTMENT / OPEN TRAY COPING

Platform			Tornillo Coping
ø3.5	IPD/CD-PN-06	IPD/CD-PN-07	IPD/CD-TN-00/C
ø4.0 ø4.5	IPD/CD-PR-06	IPD/CD-PR-07	IPD/CD-TR-00/C



The same abutment can be used as a temporary abutment with the occlusal screw or as an impression coping using the coping screw.

PSD OVERDENTURE ABUTMENT

Platform	Height (mm)	Reference
ø3.5	1.0	IPD/CD-LN-01
	2.0	IPD/CD-LN-02
	3.0	IPD/CD-LN-03
	4.0	IPD/CD-LN-04
	5.0	IPD/CD-LN-05
ø4.0 ø4.5	1.0	IPD/CD-LR-01
	2.0	IPD/CD-LR-02
	3.0	IPD/CD-LR-03
	4.0	IPD/CD-LR-04
	5.0	IPD/CD-LR-05



Please see page 169 for the PSD system accessories.



HEALING ABUTMENT

Platform	Height (mm)	Reference
ø3.5	1.5	IPD/CD-DN-01
	3.0	IPD/CD-DN-03
	5.0	IPD/CD-DN-05
ø4.0 ø4.5	1.5	IPD/CD-DR-01
	3.0	IPD/CD-DR-03
	5.0	IPD/CD-DR-05



STRAIGHT AND ANGLED CASTABLE ABUTMENT WITH A Co-Cr BASE

Straight, 15° & 25°

Platform	Angulation		
ø3.5	Straight	IPD/CD-BN-00	IPD/CD-BN-01
	15°	IPD/CD-BN-10	IPD/CD-BN-11
	25°	IPD/CD-BN-20	IPD/CD-BN-21
ø4.0 ø4.5	Straight	IPD/CD-BR-00	IPD/CD-BR-01
	15°	IPD/CD-BR-10	IPD/CD-BR-11



Co-Cr Base for digital workflow			Scan Body	
ø3.5	Straight / Angled	IPD/CD-BN-00/3D	IPD/CD-BN-01/3D	IPD/SC-AN-B1
ø4.0 ø4.5	Straight / Angled	IPD/CD-BR-00/3D	IPD/CD-BR-01/3D	IPD/SC-AN-B1

All angled castable abutments include a TPA screw.



Compatibility

STRAUMANN®

DA Serie TISSUE LEVEL

[ϕ 4.8 RN / ϕ 6.5 WN]



INTRA-ORAL / DESKTOP / CONTACT PROBE SCAN BODY

Platform	Height (mm)		
ϕ 4.8 RN	10	IPD/DA-SR-00	IPD/DA-SR-01
	15	IPD/DA-SR-02	-
ϕ 6.5 WN	10	IPD/DA-SW-00	IPD/DA-SW-01

Captive screw included. 1.20 Hex Screwdriver.



Ti-BASE Custom Ti-Base System®

Platform	Height (mm)		
ϕ 4.8 RN	0.4	IPD/DA-IR-00/3D	IPD/DA-IR-01/3D
ϕ 6.5 WN	0.4	IPD/DA-IW-02/3D	IPD/DA-IW-03/3D

Please see [page 147](#) for the Custom Ti-Base System® accessories.



SCREW / TPA SCREW FOR ANGLED PROSTHESIS

Platform	Screwdriver	Seat	Reference	TiN Reference
ϕ 4.8 RN ϕ 6.5 WN Implant level	Torx	Conical	IPD/DA-TR-01	IPD/DA-TR-01/TiN
	Torx	Flat	IPD/DA-TR-02	-
	Torx	Conical	IPD/DA-TR-03	IPD/DA-TR-03/TiN
ϕ 4.8 RN synOcta®	Torx	Conical	IPD/DA-TR-00	IPD/DA-TR-00/TiN
ϕ 4.8 RN ϕ 6.5 WN	TPA	Conical synOcta®	-	IPD/DA-TR-50
		Implant level conical	-	IPD/DA-TR-51

The IPD/DA-TR-03 screw has the same measurements as the original direct implant screw.
IPD/DA-TR-01 screw is a narrower headed screw to be used on Custom Ti-Base System®

Lengths 18/25/32 mm. Please see [page 185](#) for more information.

Lengths 18/25/32 mm. Please see [page 186](#) for more information.

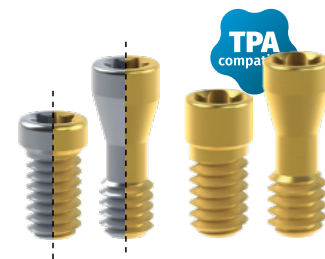

ANALOG / DIGITAL ANALOG

Platform	Reference	Digital reference
ϕ 4.8 RN	IPD/DA-AR-00	IPD/DA-AR-00/3D
	synOcta®	-
ϕ 6.5 WN	IPD/DA-AW-00	IPD/DA-AW-00/3D
Bottom Screw	-	IPD/KA-TA-00
Side Screw	-	IPD/KA-TA-01





MULTI-UNIT STRAIGHT ABUTMENT

Platform	Height (mm)	Straight
ϕ 4.8 RN	0.9	IPD/DA-MR-01

Our straight Multi-units can be used for single and multiple restorations. Please see [page 157](#) for the Multi-unit system accessories.



TEMPORARY ABUTMENT / OPEN TRAY COPING

Platform			Coping screw
ø4.8 RN	IPD/DA-PR-06	IPD/DA-PR-07	IPD/DA-TR-01/C
synOcta®	IPD/DA-PR-09	IPD/DA-PR-08	IPD/DA-TR-00/C
ø6.5 WN	IPD/DA-PW-06	IPD/DA-PW-07	IPD/DA-TR-01/C

The same abutment can be used as a temporary abutment with the occlusal screw or as an impression coping using the coping screw.

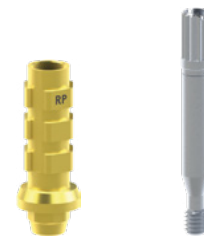

PSD OVERDENTURE ABUTMENT

Platform	Height (mm)	Reference
	1.0	IPD/DA-LR-01
ø4.8 RN	2.0	IPD/DA-LR-02
	3.0	IPD/DA-LR-03

Please see [page 169](#) for the PSD system accessories.



HEALING ABUTMENT

Platform	Height (mm)	Reference
	0.0 Sealing cap	IPD/DA-DR-00
	1.5	IPD/DA-DR-01
ø4.8 RN	3.0	IPD/DA-DR-03
	4.5	IPD/DA-DR-04





STRAIGHT ABUTMENT
SynOcta® and Straight

Platform	Reference
ø4.8 RN	IPD/DA-PR-00
synOcta®	IPD/DA-PR-01
ø6.5 WN	IPD/DA-PW-00





CASTABLE

Platform		
ø4.8 RN	IPD/DA-HR-01	IPD/DA-RR-01
synOcta®	IPD/DA-HR-00	IPD/DA-RR-00



STRAIGHT AND ANGLED CASTABLE ABUTMENT WITH A Co-Cr BASE
Straight, 15° & 25°

Platform	Angulation		
	Straight	IPD/DA-BR-00	IPD/DA-BR-01
ø4.8 RN	15°	IPD/DA-BR-10	IPD/DA-BR-11
	25°	IPD/DA-BR-20	IPD/DA-BR-21
ø4.8 RN synOcta®	Straight	IPD/DA-BR-03	IPD/DA-BR-02
	15°	IPD/DA-BR-13	IPD/DA-BR-12
	Straight	IPD/DA-BW-00	IPD/DA-BW-01
ø6.5 WN	15°	IPD/DA-BW-10	IPD/DA-BW-11
	25°	IPD/DA-BW-20	IPD/DA-BW-21



Co-Cr Base for digital workflow	Scan Body			
ø4.8 RN	Straight / Angled	IPD/DA-BR-00/3D	IPD/DA-BR-01/3D	IPD/SC-AN-B2
ø4.8 RN synOcta®	Straight / Angled	IPD/DA-BR-03/3D	IPD/DA-BR-02/3D	IPD/SC-AN-B2
ø6.5 WN	Straight / Angled	IPD/DA-BW-00/3D	IPD/DA-BW-01/3D	IPD/SC-AN-B2

All angled castable abutments include a TPA screw.



Compatibility



STRAUMANN®

DB Serie BONE LEVEL

[ϕ 3.3 NC / ϕ 4.1 RC]





INTRA-ORAL / DESKTOP / CONTACT PROBE SCAN BODY

Platform	Height (mm)		
ϕ 3.3 NC	10	IPD/DB-SN-00	IPD/DB-SN-01
	15	IPD/DB-SN-02	-
ϕ 4.1 RC	10	IPD/DB-SR-00	IPD/DB-SR-01
	15	IPD/DB-SR-02	-

Captive screw included. 1.20 Hex Screwdriver.



Ti-BASE  Custom Ti-Base System®

Platform	Height (mm)			
ϕ 3.3 NC	0.5	IPD/DB-IN-00/3D	IPD/DB-IN-01/3D	
	1.5	IPD/DB-IN-02/3D	IPD/DB-IN-03/3D	
	2.5	IPD/DB-IN-04/3D	IPD/DB-IN-05/3D	
	3.5	IPD/DB-IN-06/3D	IPD/DB-IN-07/3D	
	ϕ 4.1 RC	0.5	IPD/DB-IR-00/3D	IPD/DB-IR-01/3D
		1.5	IPD/DB-IR-02/3D	IPD/DB-IR-03/3D
2.5		IPD/DB-IR-04/3D	IPD/DB-IR-05/3D	
	3.5	IPD/DB-IR-06/3D	IPD/DB-IR-07/3D	

Please see [page 147](#) for the  Custom Ti-Base System® accessories.



SCREW / TPA SCREW FOR ANGLED PROSTHESIS

Platform	Screwdriver	Seat	Reference	TiN Reference
ϕ 3.3 NC ϕ 4.1 RC	Torx	Conical	IPD/DB-TR-00	IPD/DB-TR-00/TiN
	TPA	Conical	-	IPD/DB-TR-50



Straumann®

ANALOG / DIGITAL ANALOG

Platform	Reference	Digital reference
ø3.3 NC	IPD/DB-AN-00	IPD/DB-AN-00/3D
ø4.1 RC	IPD/DB-AR-00	IPD/DB-AR-00/3D
Bottom Screw	-	IPD/KA-TA-00
Side Screw	-	IPD/KA-TA-01





STRAIGHT AND ANGLED MULTI-UNIT ABUTMENT

Platform	Height (mm)	Straight	17°	30°
ø3.3 NC	1.5	IPD/DB-MN-01	-	-
	2.5	IPD/DB-MN-02	IPD/DB-MN-12	-
	3.5	IPD/DB-MN-03	IPD/DB-MN-13	IPD/DB-MN-33
	4.5	IPD/DB-MN-04	-	IPD/DB-MN-34
ø4.1 RC	1.5	IPD/DB-MR-01	-	-
	2.5	IPD/DB-MR-02	IPD/DB-MR-12	-
	3.5	IPD/DB-MR-03	IPD/DB-MR-13	IPD/DB-MR-33
	4.5	IPD/DB-MR-04	-	IPD/DB-MR-34



Our straight Multi-units can be used for single and multiple restorations. Please see [page 157](#) for the Multi-unit system accessories.

TEMPORARY ABUTMENT / OPEN TRAY COPING

Platform			Coping screw
ø3.3 NC	IPD/DB-PN-06	IPD/DB-PN-07	IPD/DB-TR-00/C
ø4.1 RC	IPD/DB-PR-06	IPD/DB-PR-07	IPD/DB-TR-00/C

The same abutment can be used as a temporary abutment with the occlusal screw or as an impression coping using the coping screw.

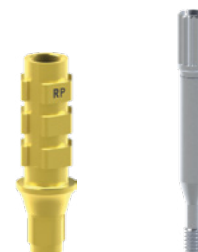



PSD OVERDENTURE ABUTMENT

Platform	Height (mm)	Reference
ø3.3 NC	1.0	IPD/DB-LN-01
	2.0	IPD/DB-LN-02
	3.0	IPD/DB-LN-03
	4.0	IPD/DB-LN-04
	5.0	IPD/DB-LN-05
ø4.1 RC	1.0	IPD/DB-LR-01
	2.0	IPD/DB-LR-02
	3.0	IPD/DB-LR-03
	4.0	IPD/DB-LR-04
	5.0	IPD/DB-LR-05



Please see [page 169](#) for the PSD system accessories.

STRAIGHT AND ANGLED CASTABLE ABUTMENT WITH A Co-Cr BASE Straight & 15°

Platform	Angulation			
ø3.3 NC	Straight	IPD/DB-BN-00	IPD/DB-BN-01	
	15°	IPD/DB-BN-10	IPD/DB-BN-11	
ø4.1 RC	Straight	IPD/DB-BR-00	IPD/DB-BR-01	
	15°	IPD/DB-BR-10	IPD/DB-BR-11	
Co-Cr Base for digital workflow			Scan Body	
ø3.3 NC	Straight / Angled	IPD/DB-BN-00/3D	IPD/DB-BN-01/3D	IPD/SC-AN-B1
ø4.1 RC	Straight / Angled	IPD/DB-BR-00/3D	IPD/DB-BR-01/3D	IPD/SC-AN-B1

All angled castable abutments include a TPA screw.



HEALING ABUTMENT

Platform	Height (mm)	Reference
ø3.3 NC	2.0	IPD/DB-DN-02
	3.5	IPD/DB-DN-03
	5.0	IPD/DB-DN-05
ø4.1 RC	2.0	IPD/DB-DR-02
	4.0	IPD/DB-DR-04
	6.0	IPD/DB-DR-06



STRAIGHT ABUTMENT

Platform	Reference
ø4.1 RC	IPD/DB-PR-00



CASTABLE

Platform		
ø4.1 RC	IPD/DB-HR-00	IPD/DB-RR-00



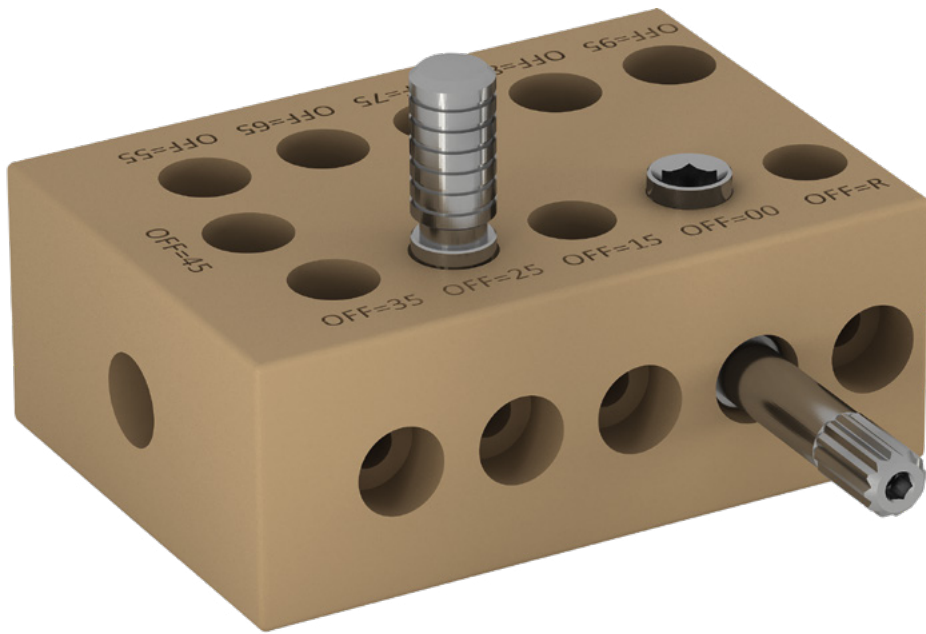



Compatibility



STRAUMANN®

DC Serie BLX®

[RB / WB]





INTRA-ORAL / DESKTOP / CONTACT PROBE SCAN BODY

Platform	Height (mm)		
RB/WB	10	IPD/DC-SR-00	IPD/DC-SR-01
	15	IPD/DC-SR-02	-

Captive screw included. 1.20 Hex Screwdriver.



Ti-BASE Custom Ti-Base System®

Platform	Height (mm)		
	1.0	IPD/DC-IR-00/3D	IPD/DC-IR-01/3D
RB/WB	2.0	IPD/DC-IR-02/3D	IPD/DC-IR-03/3D
	3.0	IPD/DC-IR-04/3D	IPD/DC-IR-05/3D

Please see [page 147](#) for the  Custom Ti-Base System® accessories.



SCREW

Platform	Screwdriver	Seat	Reference	TiN Reference
RB/WB	Torx	Conical	IPD/DC-TR-00	IPD/DC-TR-00/TiN
			IPD/DC-TR-01	-

The IPD/DC-TR-01 model is an abutment extractor screw.

 Lengths 18/25/32 mm. Please see [page 185](#) for more information.

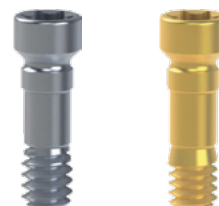

ANALOG / DIGITAL ANALOG

Platform	Reference	Digital reference
RB	IPD/DC-AR-00	IPD/DC-AR-00/3D
Bottom Screw	-	IPD/KA-TA-00
Side Screw	-	IPD/KA-TA-01



STRAIGHT AND ANGLED MULTI-UNIT ABUTMENT

Straight, 17° & 30°

Platform	Height (mm)	Straight	17°	30°
RB/WB	1.5	IPD/DC-MR-01	-	-
	2.5	IPD/DC-MR-02	-	-
	3.5	IPD/DC-MR-03	IPD/DC-MR-13	-
	4.5	-	-	IPD/DC-MR-34

Our straight Multi-units can be used for single and multiple restorations. Please see [page 157](#) for the Multi-unit system accessories.



TEMPORARY ABUTMENT / OPEN TRAY COPING

Platform			Coping screw
RB/WB	IPD/DC-PR-06	IPD/DC-PR-07	IPD/DC-TR-00/C

The same abutment can be used as a temporary abutment with the occlusal screw or as an impression coping using the coping screw.



PSD OVERDENTURE ABUTMENT

Platform	Height (mm)	Reference
RB/WB	2.0	IPD/DC-LR-02
	3.0	IPD/DC-LR-03
	4.0	IPD/DC-LR-04
	5.0	IPD/DC-LR-05

Please see [page 169](#) for the PSD system accessories.





HEALING ABUTMENT

Platform	Height (mm)	Reference
RB/WB	1.5	IPD/DC-DR-01
	3.0	IPD/DC-DR-03
	5.0	IPD/DC-DR-05



STRAIGHT AND ANGLED CASTABLE ABUTMENT WITH A Co-Cr BASE

Straight & 15°

Platform	Angulation			
RB/WB	Straight	IPD/DC-BR-00	IPD/DC-BR-01	
Co-Cr Base for digital workflow				Scan Body
RB/WB	Straight	IPD/DC-BR-00/3D	IPD/DC-BR-01/3D	IPD/DC-AN-B1

All angled castable abutments include a TPA screw.





Compatibility



STRAUMANN®

DD Serie SRA®

[ø3.5 / ø4.6]





INTRA-ORAL / DESKTOP / CONTACT PROBE SCAN BODY

Platform	Height (mm)		
ø3.5	8.0	-	IPD/DD-SN-01
ø4.6	8.0	-	IPD/DD-SR-01

Captive screw included. 1.20 Hex Screwdriver.



Ti-BASE Custom Ti-Base System®

Platform	Height (mm)		
ø3.5	0.2	-	IPD/DD-IN-01/3D
ø4.6	0.2	-	IPD/DD-IR-01/3D



SCREW

Platform	Screwdriver	Seat	Reference	TiN Reference
ø3.5 / ø4.6	Torx	Cónico	IPD/DD-TR-00	IPD/DD-TR-00/TIN
			-	IPD/DD-TR-50

 Lengths 18/25/32 mm. Please see [page 185](#) for more information.

 Lengths 18/25/32 mm. Please see [page 186](#) for more information.

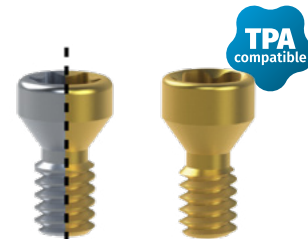



ANALOG / DIGITAL ANALOG

Platform	Reference	Digital Reference
ø3.5	IPD/DD-AN-00	IPD/DD-AN-00/3D
ø4.6	IPD/DD-AR-00	IPD/DD-AR-00/3D
Bottom screw	-	IPD/KA-TA-00
Side screw	-	IPD/KA-TA-01



TEMPORARY ABUTMENT

Platform			Copying screw
ø3.5	IPD/DD-PN-06	IPD/DD-PN-07	IPD/DD-TR-00/C
ø4.6	IPD/DD-PR-06	IPD/DD-PR-07	

The same abutment can be used as a temporary abutment with the occlusal screw or as an impression coping using the coping screw.



HEALING ABUTMENT

Platform	Height (mm)	Reference
ø3.5	4.5	IPD/DD-DN-04
ø4.6	4.5	IPD/DD-DR-04

IPD/DD-TR-00 screw not includes.





Compatibility



ASTRA[®]

EA Serie OSSEOSPEED[™]

[ϕ 3.0 / ϕ 3.5-4.0 / ϕ 4.5-5.0]



INTRA-ORAL / DESKTOP / CONTACT PROBE SCAN BODY

Platform	Height (mm)		
ϕ 3.0	10	IPD/EA-SN-00	IPD/EA-SN-01
	15	IPD/EA-SN-02	-
ϕ 3.5-4.0	10	IPD/EA-SR-00	IPD/EA-SR-01
	15	IPD/EA-SR-02	-
ϕ 4.5-5.0	10	IPD/EA-SW-00	IPD/EA-SW-01
	15	IPD/EA-SW-02	-

Captive screw included. 1.20 Hex Screwdriver.



Ti-BASE  Custom Ti-Base System[®]

Platform	Height (mm)		
ϕ 3.0	0.8	IPD/EA-IN-00/3D	IPD/EA-IN-01/3D
	1.5	IPD/EA-IN-02/3D	IPD/EA-IN-03/3D
	2.5	IPD/EA-IN-04/3D	IPD/EA-IN-05/3D
ϕ 3.5-4.0	0.5	IPD/EA-IR-00/3D	IPD/EA-IR-01/3D
	1.5	IPD/EA-IR-02/3D	IPD/EA-IR-03/3D
	2.5	IPD/EA-IR-04/3D	IPD/EA-IR-05/3D
ϕ 4.5-5.0	3.5	IPD/EA-IR-06/3D	IPD/EA-IR-07/3D
	0.5	IPD/EA-IW-00/3D	IPD/EA-IW-01/3D
	1.5	IPD/EA-IW-02/3D	IPD/EA-IW-03/3D
	2.5	IPD/EA-IW-04/3D	IPD/EA-IW-05/3D



High version of the non-engaging Custom Ti-Base subject to availability. Please see [page 147](#) for the  Custom Ti-Base System[®] accessories.

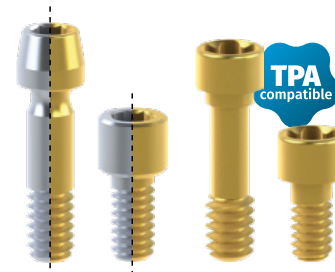

SCREW / TPA SCREW FOR ANGLED PROSTHESIS

Platform	Screwdriver	Seat	Reference	TiN Reference
ϕ 3.0	1.27 Hex	Conical	IPD/EA-TN-00	IPD/EA-TN-00/TiN
ϕ 3.5-4.0	1.27 Hex	Flat	IPD/EA-TR-00	IPD/EA-TR-00/TiN
ϕ 4.5-5.0	1.27 Hex	Flat	IPD/EA-TW-00	IPD/EA-TW-00/TiN
ϕ 3.5-4.0 / ϕ 4.5-5.0	1.27 Hex	Flat	IPD/EA-TR-01	IPD/EA-TR-01/TiN
ϕ 3.0	TPA	Conical		IPD/EA-TN-50
ϕ 3.5-4.0	TPA	Flat		IPD/EA-TR-50
ϕ 4.5-5.0	TPA	Flat		IPD/AC-TR-50
				IPD/AC-TR-51
ϕ 3.5-4.0 / ϕ 4.5-5.0	TPA	Flat		IPD/EA-TR-51



IPD/EA-TR-01 is a screw for the 20° and 45° UniAbutment.
 IPD/AC-TR-50 is a specific screw for  Custom Interface System[®] Ti-Bases.
 IPD/AC-TR-51 is a specific screw for angled  Hollow Screw System[®] Ti-Bases and IPD 2004 Co-Cr Bases.
 IPD/EA-TR-51 is a screw for the 20° and 45° UniAbutment.

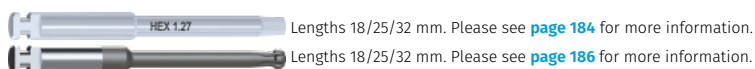

Lengths 18/25/32 mm. Please see [page 184](#) for more information.

Lengths 18/25/32 mm. Please see [page 186](#) for more information.

ANALOG / DIGITAL ANALOG

Platform	Reference	Digital reference
ø3.0	IPD/EA-AN-00	IPD/EA-AN-00/3D
ø3.5-4.0	IPD/EA-AR-00	IPD/EA-AR-00/3D
ø4.5-5.0	IPD/EA-AW-00	IPD/EA-AW-00/3D
ø3.5-4.0 / ø4.5-5.0	IPD/EA-AR-01	-
RP - Compatible Galimplant® & etk Naturactis®	IPD/EA-AR-02	IPD/EA-AR-02/3D
Bottom Screw	-	IPD/KA-TA-00
Side Screw	-	IPD/KA-TA-01

IPD/EA-AR-01 is an analog for 20° UniAbutment.



STRAIGHT AND ANGLED MULTI-UNIT ABUTMENT



Straight, 17° & 30°

Platform	Height (mm)	Straight	17°	30°
ø3.5-4.0	1.5	IPD/EA-MR-01	-	-
	2.5	IPD/EA-MR-02	IPD/EA-MR-12	-
	3.5	IPD/EA-MR-03	IPD/EA-MR-13	IPD/EA-MR-33
	4.5	IPD/EA-MR-04	-	IPD/EA-MR-34
ø4.5-5.0	1.5	IPD/EA-MW-01	-	-
	2.5	IPD/EA-MW-02	IPD/EA-MW-12	-
	3.5	IPD/EA-MW-03	-	IPD/EA-MW-33
	4.5	IPD/EA-MW-04	-	-

Our straight Multi-units can be used for single and multiple restorations. Please see [page 157](#) for the Multi-unit system accessories.



TEMPORARY ABUTMENT / OPEN TRAY COPING

Platform			Coping screw
ø3.0	IPD/EA-PN-06	IPD/EA-PN-07	IPD/EA-TN-00/C
ø3.5-4.0	IPD/EA-PR-06	IPD/EA-PR-07	IPD/EA-TR-00/C
ø4.5-5.0	IPD/EA-PW-06	IPD/EA-PW-07	IPD/EA-TW-00/C

The same abutment can be used as a temporary abutment with the occlusal screw or as an impression coping using the coping screw.





OPEN TRAY COPING

Platform	Reference
ø3.0	Open tray coping IPD/EA-CN-00

Classic design.



STRAIGHT AND ANGLED CASTABLE ABUTMENT WITH A Co-Cr BASE

Platform	Angulation		
ø3.0	Straight	IPD/EA-BN-00	IPD/EA-BN-01
	15°	IPD/EA-BN-10	IPD/EA-BN-11
	25°	IPD/EA-BN-20	IPD/EA-BN-21
ø3.5-4.0	Straight	IPD/EA-BR-00	IPD/EA-BR-01
	15°	IPD/EA-BR-10	IPD/EA-BR-11
	25°	IPD/EA-BR-20	IPD/EA-BR-21
ø4.5-5.0	Straight	IPD/EA-BW-00	IPD/EA-BW-01
	15°	IPD/EA-BW-10	IPD/EA-BW-11

Co-Cr Base for digital workflow	Scan Body
ø3.0 Straight / Angled	IPD/EA-BN-00/3D IPD/EA-BN-01/3D IPD/SC-AN-B1
ø3.5-4.0 Straight / Angled	IPD/EA-BR-00/3D IPD/EA-BR-01/3D IPD/SC-AN-B1
ø4.5-5.0 Straight / Angled	IPD/EA-BW-00/3D IPD/EA-BW-01/3D IPD/SC-AN-B1

All angled castable abutments include a TPA screw.



PSD OVERDENTURE ABUTMENT

Platform	Height (mm)	Reference
ø3.5-4.0	1.0	IPD/EA-LR-01
	2.0	IPD/EA-LR-02
	3.0	IPD/EA-LR-03
	4.0	IPD/EA-LR-04
	5.0	IPD/EA-LR-05
ø4.5-5.0	1.0	IPD/EA-LW-01
	2.0	IPD/EA-LW-02
	3.0	IPD/EA-LW-03
	4.0	IPD/EA-LW-04
	5.0	IPD/EA-LW-05



Please see [page 169](#) for the PSD system accessories.

HEALING ABUTMENT

Platform	Height (mm)	Reference
ø3.5-4.0	2.0	IPD/EA-DR-02
	4.0	IPD/EA-DR-04
	6.0	IPD/EA-DR-06
	8.0	IPD/EA-DR-08
	10.0	IPD/EA-DR-10
ø4.5-5.0	2.0	IPD/EA-DW-02
	4.0	IPD/EA-DW-04
	8.0	IPD/EA-DW-08





STRAIGHT ABUTMENT

Platform	Reference
ø3.5-4.0	IPD/EA-PR-00
ø4.5-5.0	IPD/EA-PW-00



CASTABLE

Platform		
ø3.5-4.0	IPD/EA-HR-00	IPD/EA-RR-00
ø4.5-5.0	IPD/EA-HW-00	IPD/EA-RW-00
ø3.5-4.0 / ø4.5-5.0	-	IPD/EA-RR-01

IPD/EA-RR-01 is a castable for 20° UniAbutment.



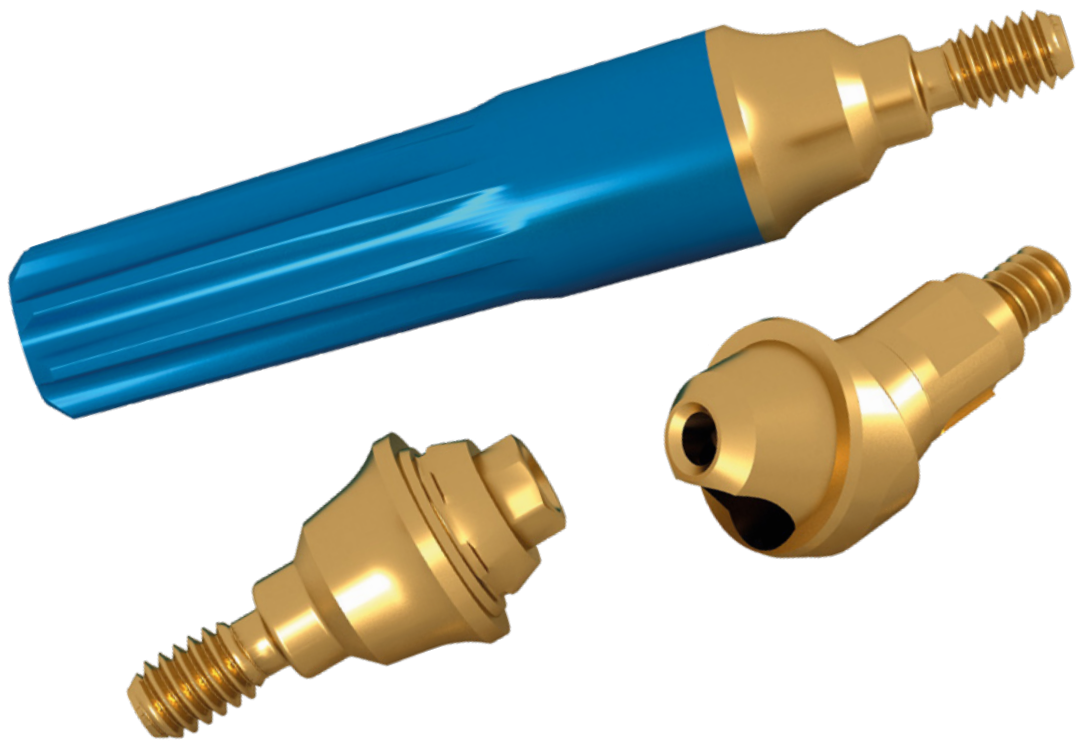



Compatibility



ASTRA®

EB Serie EVOLUTION®

[ϕ 3.6 / ϕ 4.2]





INTRA-ORAL / DESKTOP / CONTACT PROBE SCAN BODY

Platform	Height (mm)		
ϕ 3.6	10	IPD/EB-SN-00	IPD/EB-SN-01
	15	IPD/EB-SN-02	-
ϕ 4.2	10	IPD/EB-SR-00	IPD/EB-SR-01
	15	IPD/EB-SR-02	-

Captive screw included. 1.20 Hex Screwdriver.



Ti-BASE Custom Ti-Base System®

Platform	Height (mm)		
ϕ 3.6	0.5	IPD/EB-IN-00/3D	IPD/EB-IN-01/3D
	1.5	IPD/EB-IN-02/3D	IPD/EB-IN-03/3D
	2.5	IPD/EB-IN-04/3D	IPD/EB-IN-05/3D
ϕ 4.2	0.5	IPD/EB-IR-00/3D	IPD/EB-IR-01/3D
	1.5	IPD/EB-IR-02/3D	IPD/EB-IR-03/3D
	2.5	IPD/EB-IR-04/3D	IPD/EB-IR-05/3D

High version of the non-engaging Custom Ti-Base subject to availability. Please see [page 147](#) for the  Custom Ti-Base System® accessories.



SCREW / TPA SCREW FOR ANGLED PROSTHESIS

Platform	Screwdriver	Seat	Reference	TiN Reference
ϕ 3.6	1.27 Hex	Conical	IPD/EB-TN-00	IPD/EB-TN-00/TIN
ϕ 4.2	1.27 Hex	Conical	IPD/EB-TR-00	IPD/EB-TR-00/TIN
ϕ 3.6	TPA	Conical	-	IPD/EB-TN-50
ϕ 4.2	TPA	Conical	-	IPD/EB-TR-50

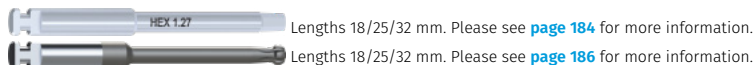

ANALOG / DIGITAL ANALOG

Platform	Reference	Digital reference
ϕ 3.6	IPD/EB-AN-00	IPD/EB-AN-00/3D
ϕ 4.2	IPD/EB-AR-00	IPD/EB-AR-00/3D
Bottom Screw	-	IPD/KA-TA-00
Side Screw	-	IPD/KA-TA-01





STRAIGHT AND ANGLED MULTI-UNIT ABUTMENT Straight, 17° & 30°

Platform	Height (mm)	Straight	17°	30°
ø3.6	1.5	IPD/EB-MN-01	-	-
	2.5	IPD/EB-MN-02	IPD/EB-MN-12	-
	3.5	IPD/EB-MN-03	-	IPD/EB-MN-33
ø4.2	1.5	IPD/EB-MR-01	-	-
	2.5	IPD/EB-MR-02	IPD/EB-MR-12	-
	3.5	IPD/EB-MR-03	IPD/EB-MR-13	IPD/EB-MR-33

Our straight Multi-units can be used for single and multiple restorations. Please see [page 155](#) for the Multi-unit system accessories.



TEMPORARY ABUTMENT / OPEN TRAY COPING

Platform			Coping screw
ø3.6	IPD/EB-PN-06	IPD/EB-PN-07	IPD/EB-TN-00/C
ø4.2	IPD/EB-PR-06	IPD/EB-PR-07	IPD/EB-TR-00/C

The same abutment can be used as a temporary abutment with the occlusal screw or as an impression coping using the coping screw.

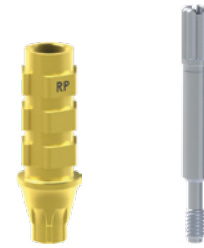

PSD OVERDENTURE ABUTMENT

Platform	Height (mm)	Reference
ø4.2	1.0	IPD/EB-LR-01
	3.0	IPD/EB-LR-03
	5.0	IPD/EB-LR-05

Please see [page 169](#) for the PSD system accessories.





HEALING ABUTMENT

Platform	Height (mm)	Reference
ø3.6	3.5	IPD/EB-DN-03
	4.5	IPD/EB-DN-04
	5.5	IPD/EB-DN-05
ø4.2	3.5	IPD/EB-DR-03
	4.5	IPD/EB-DR-04
	5.5	IPD/EB-DR-05



STRAIGHT AND ANGLED CASTABLE ABUTMENT WITH A Co-Cr BASE Straight, 15° & 25°

Platform	Angulation		
ø3.6	Straight	IPD/EB-BN-00	IPD/EB-BN-01
	15°	IPD/EB-BN-10	IPD/EB-BN-11
	25°	IPD/EB-BN-20	IPD/EB-BN-21
ø4.2	Straight	IPD/EB-BR-00	IPD/EB-BR-01
	15°	IPD/EB-BR-10	IPD/EB-BR-11

Co-Cr Base for digital workflow	Scan Body
ø3.6 Straight / Angled	IPD/EB-BN-00/3D IPD/EB-BN-01/3D IPD/SC-AN-B1
ø4.2 Straight / Angled	IPD/EB-BR-00/3D IPD/EB-BR-01/3D IPD/SC-AN-B1

All angled castable abutments include a TPA screw.





Compatibility



ZIMMER®

FA Serie SCREW VENT®

[ϕ 3.5 / ϕ 4.5 / ϕ 5.7]





INTRA-ORAL / DESKTOP / CONTACT PROBE SCAN BODY

Platform	Height (mm)		
ϕ 3.5	10	IPD/FA-SN-00	IPD/FA-SN-01
	15	IPD/FA-SN-02	-
ϕ 4.5	10	IPD/FA-SR-00	IPD/FA-SR-01
	15	IPD/FA-SR-02	-
ϕ 5.7	10	IPD/FA-SW-00	IPD/FA-SW-01
	15	IPD/FA-SW-02	-

Captive screw included. 1.20 Hex Screwdriver.



Ti-BASE Custom Ti-Base System®

Platform	Height (mm)		
ϕ 3.5	0.5	IPD/FA-IN-00/3D	IPD/FA-IN-01/3D
	1.5	IPD/FA-IN-02/3D	IPD/FA-IN-03/3D
	2.5	IPD/FA-IN-04/3D	IPD/FA-IN-05/3D
ϕ 4.5	0.5	IPD/FA-IR-00/3D	IPD/FA-IR-01/3D
	1.5	IPD/FA-IR-02/3D	IPD/FA-IR-03/3D
	2.5	IPD/FA-IR-04/3D	IPD/FA-IR-05/3D
ϕ 5.7	0.5	IPD/FA-IW-00/3D	IPD/FA-IW-01/3D

Please see [page 147](#) for the  Custom Ti-Base System® accessories.



SCREW / TPA SCREW FOR ANGLED PROSTHESIS

Platform	Screwdriver	Seat	Reference	TiN Reference
ϕ 3.5 ϕ 4.5 ϕ 5.7	1.25 Hex	Conical	IPD/FA-TR-00	IPD/FA-TR-00/TIN
ϕ 3.5 ϕ 4.5 ϕ 5.7	TPA	Conical	-	IPD/FA-TR-50

 Lengths 18/25/32 mm. Please see [page 184](#) for more information.

 Lengths 18/25/32 mm. Please see [page 186](#) for more information.



ANALOG / DIGITAL ANALOG

Platform	Reference	Digital reference
ϕ 3.5	IPD/FA-AN-00	IPD/FA-AN-00/3D
ϕ 4.5	IPD/FA-AR-00	IPD/FA-AR-00/3D
ϕ 5.7	IPD/FA-AW-00	IPD/FA-AW-00/3D
Bottom Screw	-	IPD/KA-TA-00
Side Screw	-	IPD/KA-TA-01



STRAIGHT AND ANGLED MULTI-UNIT ABUTMENT



Straight, 17° & 30°

Platform	Height (mm)	Straight	17°	30°
ø3.5	0.9	IPD/FA-MN-00	-	-
	1.5	IPD/FA-MN-01	-	-
	2.5	IPD/FA-MN-02	IPD/FA-MN-12	-
	3.5	IPD/FA-MN-03	IPD/FA-MN-13	IPD/FA-MN-33
	4.5	IPD/FA-MN-04	-	IPD/FA-MN-34
ø4.5	1.5	IPD/FA-MR-01	-	-
	2.5	IPD/FA-MR-02	-	-
	3.0	-	IPD/FA-MR-13	-
	3.5	IPD/FA-MR-03	-	IPD/FA-MR-33
	4.0	-	IPD/FA-MR-14	-
	4.5	IPD/FA-MR-04	-	IPD/FA-MR-34

Our straight Multi-units can be used for single and multiple restorations. Please see [page 157](#) for the Multi-unit system accessories.



TEMPORARY ABUTMENT / OPEN TRAY COPING

Platform			Coping screw
ø3.5	IPD/FA-PN-06	IPD/FA-PN-07	IPD/FA-TR-00/C
ø4.5	IPD/FA-PR-06	IPD/FA-PR-07	
ø5.7	IPD/FA-PW-06	IPD/FA-PW-07	

The same abutment can be used as a temporary abutment with the occlusal screw or as an impression coping using the coping screw.



OPEN TRAY COPING

Platform		Reference
ø3.5	Open tray coping	IPD/FA-CN-00
ø5.7	Open tray coping	IPD/FA-CW-00

Classic design.



PSD OVERDENTURE ABUTMENT

Platform	Height (mm)	Reference
ø3.5	1.0	IPD/FA-LN-01
	2.0	IPD/FA-LN-02
	3.0	IPD/FA-LN-03
	4.0	IPD/FA-LN-04
	5.0	IPD/FA-LN-05
ø4.5	1.0	IPD/FA-LR-01
	2.0	IPD/FA-LR-02
	3.0	IPD/FA-LR-03
	4.0	IPD/FA-LR-04
	5.0	IPD/FA-LR-05

Please see [page 169](#) for the PSD system accessories.



HEALING ABUTMENT

Platform	Height (mm)	Reference
ø3.5	1.5	IPD/FA-DN-01
	3.0	IPD/FA-DN-03
	5.0	IPD/FA-DN-05
ø4.5	1.5	IPD/FA-DR-01
	3.0	IPD/FA-DR-03
	5.0	IPD/FA-DR-05
ø5.7	3.0	IPD/FA-DW-03
	5.0	IPD/FA-DW-05





STRAIGHT AND ANGLED ABUTMENT

Straight, 15° & 25°

Platform	Height (mm)	Angulation	Reference
ø3.5	1.0	Straight	IPD/FA-PN-00
		15°	IPD/FA-PN-02
		25°	IPD/FA-PN-04
	2.0	Straight	IPD/FA-PN-01
		15°	IPD/FA-PN-03
		25°	IPD/FA-PN-05





CASTABLE

Platform		
ø3.5	IPD/FA-HN-00	IPD/FA-RN-00
ø4.5	IPD/FA-HR-00	IPD/FA-RR-00
ø5.7	IPD/FA-HW-00	IPD/FA-RW-00



STRAIGHT AND ANGLED CASTABLE ABUTMENT WITH A Co-Cr BASE

Straight, 15° & 25°

Platform	Angulation		
ø3.5	Straight	IPD/FA-BN-00	IPD/FA-BN-01
	15°	IPD/FA-BN-10	IPD/FA-BN-11
	25°	IPD/FA-BN-20	IPD/FA-BN-21
ø4.5	Straight	IPD/FA-BR-00	IPD/FA-BR-01
	15°	IPD/FA-BR-10	IPD/FA-BR-11
	25°	IPD/FA-BR-20	IPD/FA-BR-21



Co-Cr Base for digital workflow			Scan Body	
ø3.5	Straight / Angled	IPD/FA-BN-00/3D	IPD/FA-BN-01/3D	IPD/SC-AN-B1
		IPD/FA-BR-00/3D	IPD/FA-BR-01/3D	IPD/SC-AN-B1
ø4.5	Angled	IPD/FA-BR-A0/3D	IPD/FA-BR-A1/3D	IPD/SC-AN-B1

All angled castable abutments include a TPA screw.





Compatibility



ZIMMER®

FB Serie SWISSPLUS®

[ø4.8]





INTRA-ORAL / DESKTOP / CONTACT PROBE SCAN BODY

Platform	Height (mm)		
ø4.8	10	IPD/DA-SR-00	IPD/DA-SR-01
	15	IPD/DA-SR-02	-

Captive screw included. 1.20 Hex Screwdriver.



Ti-BASE Custom Ti-Base System®

Platform	Height (mm)		
ø4.8	0.4	IPD/DA-IR-00/3D	IPD/DA-IR-01/3D

Please see [page 147](#) for the  Custom Ti-Base System® accessories.



SCREW / TPA SCREW FOR ANGLED PROSTHESIS

Platform	Screwdriver	Seat	Reference	TiN Reference
ø4.8	Torx	Conical synOcta®	IPD/DA-TR-00	IPD/DA-TR-00/TiN
		Conical	IPD/FB-TR-00	IPD/FB-TR-00/TiN
	1.25 Hex	Conical	IPD/FB-TR-01	IPD/FB-TR-01/TiN
		Conical synOcta®	-	IPD/DA-TR-50
	TPA	Conical Implant level	-	IPD/DA-TR-51

IPD/FB-TR-00 and /TiN are exclusive implant level screws for original SWISSPLUS® abutments.
IPD/FB-TR-01 and /TiN are implant level screws compatible for use with IPD abutments.

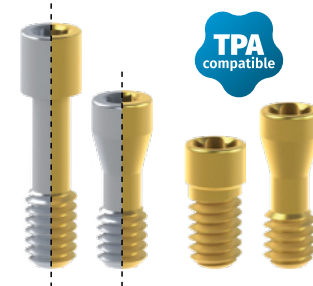
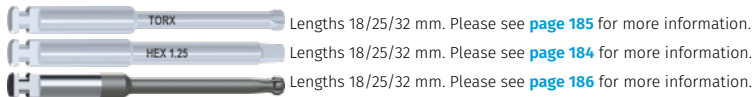

ANALOG / DIGITAL ANALOG

Platform	Reference	Digital reference
ø4.8	IPD/DA-AR-00	IPD/DA-AR-00/3D
Bottom Screw	-	IPD/KA-TA-00
Side Screw	-	IPD/KA-TA-01





MULTI-UNIT STRAIGHT ABUTMENT

Platform	Height (mm)	Straight
ø4.8	0.9	IPD/DA-MR-01

Our straight Multi-units can be used for single and multiple restorations.
Please see [page 157](#) for the Multi-unit system accessories.



TEMPORARY ABUTMENT / OPEN TRAY COPING

Platform				Coping screw
ø4.8		IPD/DA-PR-06	IPD/DA-PR-07	IPD/DA-TR-01/C
	synOcta®	IPD/DA-PR-09	IPD/DA-PR-08	IPD/DA-TR-00/C

The same abutment can be used as a temporary abutment with the occlusal screw or as an impression coping using the coping screw.



PSD OVERDENTURE ABUTMENT

Platform	Height (mm)	Reference
ø4.8	1.0	IPD/DA-LR-01
	2.0	IPD/DA-LR-02
	3.0	IPD/DA-LR-03

Please see [page 169](#) for the PSD system accessories.



HEALING ABUTMENT

Platform	Height (mm)	Reference
ø4.8	0.0 Sealing cap	IPD/DA-DR-00
	1.5	IPD/DA-DR-01
	3.0	IPD/DA-DR-03
	4.5	IPD/DA-DR-04





STRAIGHT ABUTMENT

Platform	Reference
ø4.8	IPD/DA-PR-01
	IPD/DA-PR-00





CASTABLE

Platform			
ø4.8		IPD/DA-HR-01	IPD/DA-RR-01
	synOcta®	IPD/DA-HR-00	IPD/DA-RR-00



STRAIGHT AND ANGLED CASTABLE ABUTMENT WITH A Co-Cr BASE Straight, 15° & 25°

Platform	Angulation		
ø4.8	Straight	IPD/DA-BR-00	IPD/DA-BR-01
		synOcta® IPD/DA-BR-03	IPD/DA-BR-02
	15°	IPD/DA-BR-10	IPD/DA-BR-11
		synOcta® IPD/DA-BR-13	IPD/DA-BR-12
	25°	IPD/DA-BR-20	IPD/DA-BR-21

CoCr for digital workflow	Scan Body
ø4.8 Straight / Angled	IPD/DA-BR-00/3D IPD/DA-BR-01/3D IPD/SC-AN-B2
ø4.8 synOcta® Straight / Angled	IPD/DA-BR-03/3D IPD/DA-BR-02/3D IPD/SC-AN-B2

All angled castable abutments include a TPA screw.





Compatibility



ZIMMER®

FC Serie EZTETIC®

[ø3.1]





INTRA-ORAL / DESKTOP / CONTACT PROBE SCAN BODY

Platform	Height (mm)		
ø3.1	10	IPD/FC-ST-00	IPD/FC-ST-01
	15	IPD/FC-ST-02	-

Captive screw included. 1.20 Hex Screwdriver.



Ti-BASE Custom Ti-Base System®

Platform	Height (mm)		
ø3.1	1.0	IPD/FC-IT-00/3D	IPD/FC-IT-01/3D
	2.0	IPD/FC-IT-02/3D	IPD/FC-IT-03/3D
	3.0	IPD/FC-IT-04/3D	IPD/FC-IT-05/3D

Please see [page 147](#) for the  Custom Ti-Base System® accessories.



SCREW / TPA SCREW FOR ANGLED PROSTHESIS

Platform	Screwdriver	Seat	Reference	TiN Reference
ø3.1	1.25 Hex	Conical	IPD/FC-TT-00	IPD/FC-TT-00/TiN
	TPA	Conical	-	IPD/FC-TT-50

 Lengths 18/25/32 mm. Please see [page 184](#) for more information.

 Lengths 18/25/32 mm. Please see [page 186](#) for more information.



ANALOG / DIGITAL ANALOG

Platform	Reference	Digital reference
ø3.1	IPD/FC-AT-00	IPD/FC-AT-00/3D
Bottom Screw	-	IPD/KA-TA-00
Side Screw	-	IPD/KA-TA-01



STRAIGHT AND ANGLED MULTI-UNIT ABUTMENT

Straight, 17° & 30°

Platform	Height (mm)	Straight	17°	30°
ø3.1	1.5	IPD/FC-MT-01	-	-
	2.5	IPD/FC-MT-02	IPD/FC-MT-12	-
	3.5	IPD/FC-MT-03	-	IPD/FC-MT-33

Our straight Multi-units can be used for single and multiple restorations. Please see [page 157](#) for the Multi-unit system accessories.



TEMPORARY ABUTMENT / OPEN TRAY COPING

Platform			Coping screw
ø3.1	IPD/FC-PT-06	IPD/FC-PT-07	IPD/FC-TT-00/C

The same abutment can be used as a temporary abutment with the occlusal screw or as an impression coping using the coping screw.



PSD OVERDENTURE ABUTMENT

Platform	Height (mm)	Reference
ø3.1	2.0	IPD/FC-LT-02
	3.0	IPD/FC-LT-03
	4.0	IPD/FC-LT-04
	5.0	IPD/FC-LT-05

Please see [page 169](#) for the PSD system accessories.





HEALING ABUTMENT

Platform	Height (mm)	Reference
ø3.1	1.0	IPD/FC-DT-01
	2.5	IPD/FC-DT-02
	4.0	IPD/FC-DT-04



STRAIGHT AND ANGLED CASTABLE ABUTMENT WITH A Co-Cr BASE

Straight, 15° & 25°

Platform	Angulation		
ø3.1	Straight	IPD/FC-BT-00	IPD/FC-BT-01
	15°	IPD/FC-BT-10	IPD/FC-BT-11

Co-Cr Base for digital workflow	Scan Body
ø3.1 Straight / Angled	IPD/FC-BT-00/3D IPD/FC-BT-01/3D IPD/SC-AN-B1

All angled castable abutments include a TPA screw.





Compatibility



BTI[®]

GA Serie EXTERNAL

[ϕ 3.5 / ϕ 4.1 / ϕ 5.5]





INTRA-ORAL / DESKTOP / CONTACT PROBE SCAN BODY

Platform	Height (mm)		
ϕ 3.5 Tiny [®]	10	IPD/GA-SN-00	IPD/GA-SN-01
	15	IPD/GA-SN-02	-
ϕ 4.1	10	IPD/AA-SR-00	IPD/AA-SR-01
	15	IPD/AA-SR-02	-

Captive screw included. 1.20 Hex Screwdriver.



Ti-BASE Custom Ti-Base System[®]

Platform	Height (mm)		
ϕ 3.5 Tiny [®]	1.5	IPD/GA-IN-02/3D	IPD/GA-IN-03/3D
	0.5	IPD/AA-IR-00/3D	IPD/AA-IR-01/3D
ϕ 4.1	1.5	IPD/AA-IR-02/3D	IPD/AA-IR-03/3D
	2.5	IPD/AA-IR-04/3D	IPD/AA-IR-05/3D

High version of the non-engaging Custom Ti-Base subject to availability. Please see [page 147](#) for the  Custom Interface System[®] accessories.



SCREW / TPA SCREW FOR ANGLED PROSTHESIS

Platform	Screwdriver	Seat	Reference	TiN Reference
ϕ 3.5 Tiny [®]	1.20 Hex	Flat	IPD/GA-TN-00	IPD/GA-TN-00/TiN
ϕ 4.1	1.20 Hex	Conical	IPD/BA-TR-00	IPD/BA-TR-00/TiN
ϕ 5.5	1.20 Hex	Flat	IPD/GA-TW-00	IPD/GA-TW-00/TiN
ϕ 3.5 Tiny [®]	TPA	Flat	-	IPD/GA-TN-50
ϕ 4.1 ϕ 5.5	TPA	Conical	-	IPD/AA-TR-50
	TPA	Flat	-	IPD/AA-TR-52

 Lengths 18/25/32 mm. Please see [page 184](#) for more information.

 Lengths 18/25/32 mm. Please see [page 186](#) for more information.

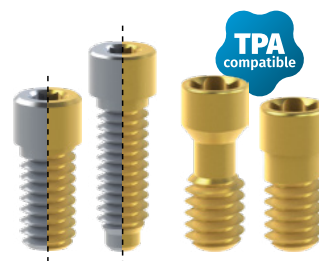

ANALOG / DIGITAL ANALOG

Platform	Reference	Digital reference
ϕ 3.5 Tiny [®]	IPD/GA-AN-00	IPD/GA-AN-00/3D
ϕ 4.1	IPD/AA-AR-00	IPD/AA-AR-00/3D
ϕ 5.5	IPD/GA-AW-00	-
Bottom Screw	-	IPD/KA-TA-00
Side Screw	-	IPD/KA-TA-01

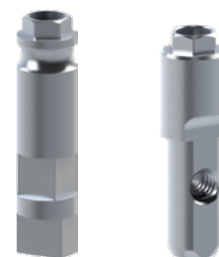

STRAIGHT AND ANGLED MULTI-UNIT ABUTMENT

Platform	Height (mm)	Straight	17°	30°
ø4.1	1.0	IPD/AB-MR-01	-	-
	2.0	IPD/AB-MR-02	IPD/AB-MR-12	-
	3.0	IPD/AB-MR-03	IPD/AB-MR-13	IPD/AB-MR-33
	4.0	IPD/AB-MR-04	IPD/AB-MR-14	IPD/AB-MR-34
	5.0	IPD/AB-MR-05	-	IPD/AB-MR-35

Our straight Multi-units can be used for single and multiple restorations. Please see [page 157](#) for the Multi-unit system accessories.



TEMPORARY ABUTMENT / OPEN TRAY COPING

Platform			Coping screw
ø4.1	IPD/AA-PR-06	IPD/AA-PR-07	IPD/AA-TR-00/C

The same abutment can be used as a temporary abutment with the occlusal screw or as an impression coping using the coping screw.



OPEN AND CLOSED TRAY COPING

Platform		Reference
ø3.5 Tiny®	Open tray coping	IPD/GA-CN-00
ø4.1	Open tray coping	IPD/AA-CR-00
	Closed tray coping	IPD/AA-CR-01

Classic design.



PSD OVERDENTURE ABUTMENT

Platform	Height (mm)	Reference
ø4.1	1.0	IPD/AA-LR-01
	2.0	IPD/AA-LR-02
	3.0	IPD/AA-LR-03
	4.0	IPD/AA-LR-04
	5.0	IPD/AA-LR-05

Please see page 169 for the PSD system accessories.





HEALING ABUTMENT

Platform	Height (mm)	Reference
ø3.5 Tiny®	4.0	IPD/GA-DN-04
ø4.1	2.0	IPD/AA-DR-02
	3.0	IPD/AA-DR-03
	4.0	IPD/AA-DR-04
	5.0	IPD/AA-DR-05



STRAIGHT AND ANGLED CASTABLE ABUTMENT WITH A Co-Cr BASE

Straight, 15° & 25°



Platform	Angulation			
ø3.5 Tiny®	Straight	IPD/GA-BN-00	IPD/GA-BN-01	
	15°	IPD/GA-BN-10	IPD/GA-BN-11	
	25°	IPD/GA-BN-20	IPD/GA-BN-21	
ø4.1	Straight	IPD/AA-BR-00	IPD/AA-BR-01	
	15°	IPD/AA-BR-10	IPD/AA-BR-11	
	25°	IPD/AA-BR-20	IPD/AA-BR-21	
Co-Cr Base for digital workflow				
ø3.5 Tiny®	Straight / Angled	IPD/GA-BN-00/3D	IPD/GA-BN-01/3D	IPD/SC-AN-B1
ø4.1	Straight / Angled	IPD/AA-BR-00/3D	IPD/AA-BR-01/3D	IPD/SC-AN-B1

All angled castable abutments include a TPA screw.



STRAIGHT AND ANGLED ABUTMENT



Straight, 15° & 25°

Platform	Height (mm)	Angulation		
ø3.5 Tiny®		Straight	IPD/GA-PN-00	-
		Straight	IPD/AA-PR-00	IPD/AA-PR-01
ø4.1	1.0	15°	IPD/AA-PR-02	-
		25°	IPD/AA-PR-03	-
	2.0	15°	IPD/AA-PR-04	-
		25°	IPD/AA-PR-05	-
ø5.5		Straight	IPD/GA-PW-00	-
		Straight	IPD/GA-PW-01	-

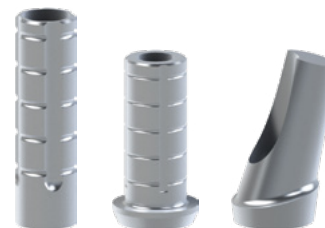
Using the low profile IPD/AA-TR-01 screw for IPD/AA-PR-03 is recommended. The IPD/GA-PW-01 model has a broader shoulder than the IPD/GA-PW-00.



CASTABLE

Platform		
ø4.1	IPD/AA-HR-00	IPD/AA-RR-00
ø5.5	IPD/GA-HW-00	IPD/GA-RW-00





Compatibility



BTI®

GB Serie INTERNAL UNIVERSAL®

[Universal® ø4.1 / Wide ø5.5]





INTRA-ORAL / DESKTOP / CONTACT PROBE SCAN BODY

Platform	Height (mm)		
ø4.1	10	IPD/GB-SR-00	IPD/GB-SR-01
	15	IPD/GB-SR-02	-

Captive screw included. 1.20 Hex Screwdriver.



Ti-BASE Custom Ti-Base System®

Platform	Height (mm)		
ø4.1	0.5	IPD/GB-IR-00/3D	IPD/GB-IR-01/3D
	1.5	IPD/GB-IR-02/3D	IPD/GB-IR-03/3D
	2.5	IPD/GB-IR-04/3D	IPD/GB-IR-05/3D

High version of the non-engaging Custom Ti-Base subject to availability. Please see [page 147](#) for the  Custom Ti-Base System® accessories.



SCREW / TPA SCREW FOR ANGLED PROSTHESIS

Platform	Screwdriver	Seat	Reference	TiN Reference
ø4.1 ø5.5	1.20 Hex	Flat	IPD/GB-TR-00	IPD/GB-TR-00/TiN
ø4.1 ø5.5	TPA	Flat	-	IPD/GB-TR-50

 Lengths 18/25/32 mm. Please see [page 184](#) for more information.

 Lengths 18/25/32 mm. Please see [page 186](#) for more information.



ANALOG / DIGITAL ANALOG

Platform	Reference	Digital reference
ø4.1	IPD/GB-AR-00	IPD/GB-AR-00/3D
ø5.5	IPD/GB-AW-00	-
Bottom Screw	-	IPD/KA-TA-00
Side Screw	-	IPD/KA-TA-01



STRAIGHT AND ANGLED MULTI-UNIT ABUTMENT

Platform	Height (mm)	Straight	17°	30°
ø4.1	1.0	IPD/GB-MR-01	-	-
	2.0	IPD/GB-MR-02	-	-
	3.0	IPD/GB-MR-03	IPD/GB-MR-13	-
	4.0	IPD/GB-MR-04	IPD/GB-MR-14	IPD/GB-MR-34
	5.0	IPD/GB-MR-05	-	IPD/GB-MR-35

Our straight Multi-units can be used for single and multiple restorations. Please see [page 157](#) for the Multi-unit system accessories.

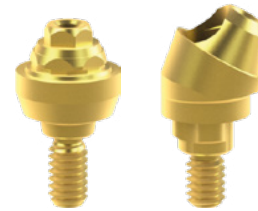

TEMPORARY ABUTMENT / OPEN TRAY COPING

Platform			Coping screw
ø4.1	IPD/GB-PR-06	IPD/GB-PR-07	IPD/GB-TR-00/C

The same abutment can be used as a temporary abutment with the occlusal screw or as an impression coping using the coping screw.



PSD OVERDENTURE ABUTMENT

Platform	Height (mm)	Reference
ø4.1	1.0	IPD/GB-LR-01
	3.0	IPD/GB-LR-03
	5.0	IPD/GB-LR-05

Please see [page 169](#) for the PSD system accessories.





HEALING ABUTMENT

Platform	Height (mm)	Reference
ø4.1	1.0	IPD/GB-DR-01
	3.0	IPD/GB-DR-03
	5.0	IPD/GB-DR-05



STRAIGHT AND ANGLED CASTABLE ABUTMENT WITH A Co-Cr BASE

Straight, 15° & 25°

Platform	Angulation		
ø4.1	Straight	IPD/GB-BR-00	IPD/GB-BR-01
	15°	IPD/GB-BR-10	IPD/GB-BR-11
	25°	IPD/GB-BR-20	IPD/GB-BR-21

Co-Cr Base for digital workflow	Scan Body
ø4.1 Straight / Angled	IPD/GB-BR-00/3D IPD/GB-BR-01/3D IPD/SC-AN-B1

All angled castable abutments include a TPA screw.



CASTABLE

Platform		
ø4.1	IPD/GB-HR-00	IPD/GB-RR-00
ø5.5	-	IPD/GB-RW-00





Compatibility

BTI[®]

GC Serie MULTI-IM[®]

[ø4.1]



INTRA-ORAL / DESKTOP / CONTACT PROBE SCAN BODY

Platform	Height (mm)	
ø4.1	10	IPD/GC-SR-01

Captive screw included. 1.20 Hex Screwdriver.



Ti-BASE Custom Ti-Base System[®]

Platform	Height (mm)	
ø4.1	0.3	IPD/GC-IR-01/3D

Please see [page 147](#) for the  Custom Ti-Base System[®] accessories.



SCREW / TPA SCREW FOR ANGLED PROSTHESIS

Platform	Screwdriver	Seat	Reference	TiN Reference
ø4.1	1.20 Hex	Flat	IPD/GC-TR-01	IPD/GC-TR-01/TIN
	TPA	Flat	-	IPD/AB-TR-50

 Lengths 18/25/32 mm. Please see [page 184](#) for more information.
 Lengths 18/25/32 mm. Please see [page 186](#) for more information.

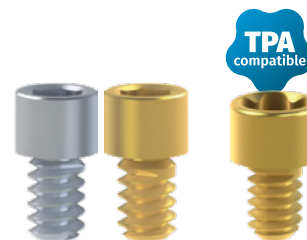

ANALOG / DIGITAL ANALOG

Platform	Reference	Digital reference
ø4.1	IPD/GC-AR-00	IPD/GC-AR-00/3D
Bottom Screw	-	IPD/KA-TA-00
Side Screw	-	IPD/KA-TA-01



TEMPORARY ABUTMENT / OPEN TRAY COPING

Platform		Coping screw
ø4.1	IPD/GC-PR-07	IPD/GC-TR-01/C

The same abutment can be used as a temporary abutment with the occlusal screw or as an impression coping using the coping screw.



HEALING ABUTMENT

Platform	Height (mm)	Reference
ø4.1	4.0	IPD/GC-DN-00



STRAIGHT AND ANGLED CASTABLE ABUTMENT WITH A Co-Cr BASE

Straight, 15° & 25°

Platform	Angulation	
ø4.1	Straight	IPD/GC-BR-01
	15°	IPD/GC-BR-11
	25°	IPD/GC-BR-21

Co-Cr Base for digital workflow	Scan Body
ø4.1 Straight / Angled	IPD/GC-BR-01/3D IPD/SC-AN-B2

All angled castable abutments include a TPA screw.





Compatibility

MICRODENT[®]

HA Serie MICRODENT[®] SYSTEM

[ϕ 3.5 / ϕ 4.2 / ϕ 5.1]

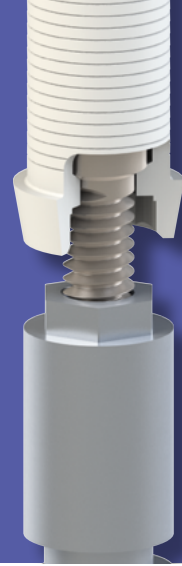

INTRA-ORAL / DESKTOP / CONTACT PROBE SCAN BODY

Platform

ϕ 5.1



IPD/NA-SW-00



IPD/NA-SW-01



Captive screw included. 1.20 Hex screwdriver.

Ti-BASE Custom Ti-Base System[®]

Platform

ϕ 5.1

Height (mm)

1.3



IPD/NA-IW-02/3D



IPD/NA-IW-03/3D







Please see [page 147](#) for the  Custom Ti-Base System[®] accessories.

For the Ti-Base it is recommended to use the screw IPD/NA-TW-00 or the IPD/MB-TR-50 for angled solutions.

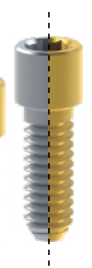
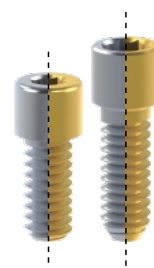
SCREW / TPA SCREW FOR ANGLED PROSTHESIS

Platform	Screwdriver	Seat	Reference	TiN Reference
ϕ 3.5	1.20 Hex	Conical	IPD/HA-TN-00	IPD/HA-TN-00/TIN
ϕ 4.2 ϕ 5.1	1.75 Hex	Conical	IPD/HA-TR-00	IPD/HA-TR-00/TIN
ϕ 5.1	1.25 Hex	Conical	IPD/NA-TW-00	-
ϕ 3.5	TPA	Conical	-	IPD/HA-TN-50
ϕ 4.2 ϕ 5.1	TPA	Conical	-	IPD/HA-TR-50
ϕ 5.1	TPA	Conical	-	IPD/MB-TR-50





-  HEX 1.20 Lengths 18/25/32 mm. Please see [page 184](#) for more information.
-  HEX 1.25 Lengths 18/25/32 mm. Please see [page 184](#) for more information.
-  Lengths 18/25/32 mm. Please see [page 186](#) for more information.

ANALOG

Platform	Reference	Digital Reference
ϕ 3.5	IPD/HA-AN-00	-
ϕ 4.2	IPD/HA-AR-00	-
ϕ 5.1	IPD/HA-AW-00	IPD/NA-AW-00/3D



TEMPORARY ABUTMENT / OPEN TRAY COPING

Platform			Coping screw
ø5.1	IPD/NA-PW-06	IPD/NA-PW-07	IPD/NA-TW-00/C

The same abutment can be used as a temporary abutment with the occlusal screw or as an impression coping using the coping screw.



HEALING ABUTMENT

Platform	Height (mm)	Reference
ø5.1	3.0	IPD/NA-DW-03
	5.0	IPD/NA-DW-05



CASTABLE

Platform		
ø3.5	IPD/HA-HN-00	IPD/HA-RN-00
ø4.2	IPD/HA-HR-00	IPD/HA-RR-00
ø5.1	IPD/HA-HW-00	IPD/HA-RW-00





Compatibility



MICRODENT®

HB Serie MICRODENT® UNIVERSAL™

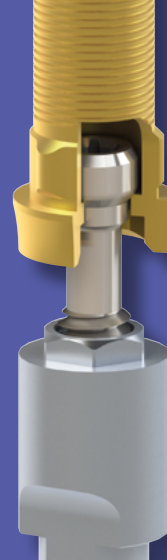
[ø3.5 / ø4.1 / ø5.1]





INTRA-ORAL / DESKTOP / CONTACT PROBE SCAN BODY

Platform	Height (mm)		
ø4.1	10	IPD/AA-SR-00	IPD/AA-SR-01
	15	IPD/AA-SR-02	-
ø5.1	10	IPD/BA-SW-00	IPD/BA-SW-01
	15	IPD/BA-SW-02	-

Captive screw included. 1.20 Hex Screwdriver.



Ti-BASE Custom Ti-Base System®

Platform	Height (mm)		
ø4.1	0.5	IPD/AA-IR-00/3D	IPD/AA-IR-01/3D
	1.5	IPD/AA-IR-02/3D	IPD/AA-IR-03/3D
	2.5	IPD/AA-IR-04/3D	IPD/AA-IR-05/3D
ø5.1	0.5	IPD/BA-IW-00/3D	IPD/BA-IW-01/3D
	1.5	IPD/BA-IW-02/3D	IPD/BA-IW-03/3D

Please see [page 147](#) for the  Custom Ti-Base System® accessories.



SCREW / TPA SCREW FOR ANGLED PROSTHESIS

Platform	Screwdriver	Seat	Reference	TiN Reference
ø3.5	1.20 Hex	Conical	IPD/HA-TN-00	IPD/HA-TN-00/TIN
ø4.1 ø5.1	1.20 Hex	Conical	IPD/BA-TR-00	IPD/BA-TR-00/TIN
	1.20 Hex	Low profile conical	IPD/AA-TR-01	IPD/AA-TR-01/TIN
ø3.5	TPA	Conical	-	IPD/HA-TN-50
ø4.1 ø5.1	TPA	Conical	-	IPD/AA-TR-50
	TPA	Flat	-	IPD/AA-TR-52

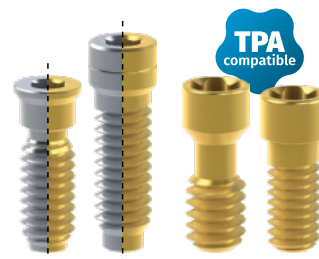

 Lengths 18/25/32 mm. Please see [page 184](#) for more information.

 Lengths 18/25/32 mm. Please see [page 186](#) for more information.

ANALOG / DIGITAL ANALOG

Platform	Reference	Digital reference
ø3.5	IPD/HA-AN-00	-
ø4.1	IPD/AA-AR-00	IPD/AA-AR-00/3D
ø5.1	IPD/BA-AW-00	IPD/BA-AW-00/3D
Bottom Screw	-	IPD/KA-TA-00
Side Screw	-	IPD/KA-TA-01



STRAIGHT AND ANGLED MULTI-UNIT ABUTMENT

Platform	Height (mm)	Straight	17°	30°
ø4.1	1.0	IPD/AB-MR-01	-	-
	2.0	IPD/AB-MR-02	IPD/AB-MR-12	-
	3.0	IPD/AB-MR-03	IPD/AB-MR-13	IPD/AB-MR-33
	4.0	IPD/AB-MR-04	IPD/AB-MR-14	IPD/AB-MR-34
	5.0	IPD/AB-MR-05	-	IPD/AB-MR-35

Our straight Multi-units can be used for single and multiple restorations. Please see [page 157](#) for the Multi-unit system accessories.



TEMPORARY ABUTMENT / OPEN TRAY COPING

Platform			Coping screw
ø4.1	IPD/AA-PR-06	IPD/AA-PR-07	IPD/AA-TR-00/C

The same abutment can be used as a temporary abutment with the occlusal screw or as an impression coping using the coping screw.



OPEN AND CLOSED TRAY COPING

Platform		Reference
ø4.1	Open tray coping	IPD/AA-CR-00
	Closed tray coping	IPD/AA-CR-01
ø5.1	Open tray coping	IPD/BA-CW-00

Classic design.



PSD OVERDENTURE ABUTMENT

Platform	Height (mm)	Reference
ø4.1	1.0	IPD/AA-LR-01
	2.0	IPD/AA-LR-02
	3.0	IPD/AA-LR-03
	4.0	IPD/AA-LR-04
	5.0	IPD/AA-LR-05

Please see [page 170](#) for the PSD system accessories.





HEALING ABUTMENT

Platform	Height (mm)	Reference
ø4.1	2.0	IPD/AA-DR-02
	3.0	IPD/AA-DR-03
	4.0	IPD/AA-DR-04
	5.0	IPD/AA-DR-05
	ø5.1	2.0
3.0		IPD/BA-DW-03
4.0		IPD/BA-DW-04





STRAIGHT AND ANGLED CASTABLE ABUTMENT WITH A Co-Cr BASE Straight, 15° & 25°

Platform	Angulation			
ø4.1	Straight	IPD/AA-BR-00	IPD/AA-BR-01	
	15°	IPD/AA-BR-10	IPD/AA-BR-11	
	25°	IPD/AA-BR-20	IPD/AA-BR-21	
ø5.1	Straight	IPD/BA-BW-00	IPD/BA-BW-01	
	15°	IPD/BA-BW-10	IPD/BA-BW-11	
	25°	IPD/BA-BW-20	IPD/BA-BW-21	
Co-Cr Base for digital workflow				
		Scan Body		
ø4.1	Straight / Angled	IPD/AA-BR-00/3D	IPD/AA-BR-01/3D	IPD/SC-AN-B1
ø5.1	Straight / Angled	IPD/BA-BW-00/3D	IPD/BA-BW-01/3D	IPD/SC-AN-B1



All angled castable abutments include a TPA screw.

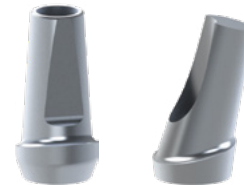

STRAIGHT AND ANGLED ABUTMENT Straight, 15° & 25°

Platform	Height (mm)	Angulation		
ø4.1	1.0	Straight	IPD/AA-PR-00	IPD/AA-PR-01
		15°	IPD/AA-PR-02	-
		25°	IPD/AA-PR-03	-
	2.0	15°	IPD/AA-PR-04	-
		25°	IPD/AA-PR-05	-



Using the low profile IPD/AA-TR-01 screw for IPD/AA-PR-03 is recommended.

CASTABLE

Platform		
ø3.5	IPD/HA-HN-00	IPD/HA-RN-00
ø4.1	IPD/AA-HR-00	IPD/AA-RR-00
ø5.1	IPD/BA-HW-00	IPD/BA-RW-00







Compatibility



DENTSPLY®

IA Serie XIVE® FRIADENT®

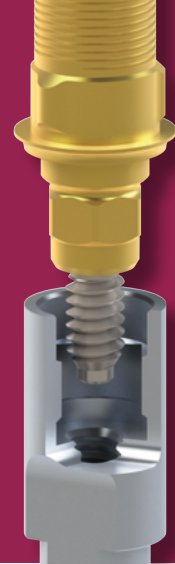
[ϕ 3.4 / ϕ 3.8 / ϕ 4.5]





INTRA-ORAL / DESKTOP / CONTACT PROBE SCAN BODY

Platform	Height (mm)		
ϕ 3.4	10	IPD/IA-SN-00	IPD/IA-SN-01
	15	IPD/IA-SN-02	-
ϕ 3.8	10	IPD/IA-SR-00	IPD/IA-SR-01
	15	IPD/IA-SR-02	-

Captive screw included. 1.20 Hex Screwdriver.



Ti-BASE  Custom Ti-Base System®

Platform	Height (mm)		
ϕ 3.4	1.5	IPD/IA-IN-02/3D	IPD/IA-IN-03/3D
	0.5	IPD/IA-IR-00/3D	IPD/IA-IR-01/3D
ϕ 3.8	1.5	IPD/IA-IR-02/3D	IPD/IA-IR-03/3D

High version of the non-engaging Custom Ti-Base subject to availability. Please see [page 147](#) for the  Custom Ti-Base System® accessories.



SCREW / TPA SCREW FOR ANGLED PROSTHESIS

Platform	Screwdriver	Seat	Reference	TiN Reference
ϕ 3.4 / ϕ 3.8 / ϕ 4.5	1.20 Hex	Conical	IPD/IA-TR-00	IPD/IA-TR-00/TiN
ϕ 3.4 / ϕ 3.8 / ϕ 4.5	TPA	Conical	-	IPD/IA-TR-50

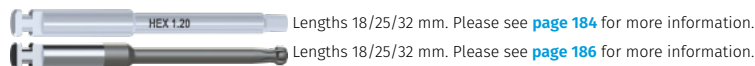

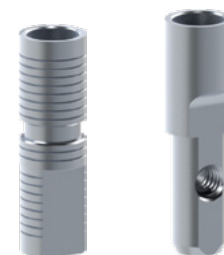

ANALOG / DIGITAL ANALOG

Platform	Reference	Digital reference
ϕ 3.4	IPD/IA-AN-00	IPD/IA-AN-00/3D
ϕ 3.8	IPD/IA-AR-00	IPD/IA-AR-00/3D
ϕ 4.5	IPD/IA-AW-00	-
Bottom Screw	-	IPD/KA-TA-00
Side Screw	-	IPD/KA-TA-01



TEMPORARY ABUTMENT / OPEN TRAY COPING

Platform			Coping screw
ø3.4	IPD/IA-PN-06	IPD/IA-PN-07	IPD/IA-TR-00/C
ø3.8	IPD/IA-PR-06	IPD/IA-PR-07	IPD/IA-TR-00/C
ø4.5	IPD/IA-PW-06	IPD/IA-PW-07	IPD/IA-TR-00/C

The same abutment can be used as a temporary abutment with the occlusal screw or as an impression coping using the coping screw.





HEALING ABUTMENT

Platform	Height (mm)	Reference
ø3.4	2.0	IPD/IA-DN-02
	3.5	IPD/IA-DN-03
	5.0	IPD/IA-DN-05
ø3.8	2.0	IPD/IA-DR-02
	3.5	IPD/IA-DR-03
	5.0	IPD/IA-DR-05
ø4.5	2.0	IPD/IA-DW-02
	3.5	IPD/IA-DW-03
	5.0	IPD/IA-DW-05





CASTABLE

Platform		
ø3.8	IPD/IA-HR-00	IPD/IA-RR-00
ø4.5	IPD/IA-HW-00	IPD/IA-RW-00



STRAIGHT AND ANGLED CASTABLE ABUTMENT WITH A Co-Cr BASE Straight, 15° & 25°

Platform	Angulation		
ø3.4	Straight	IPD/IA-BN-00	IPD/IA-BN-01
	Straight	IPD/IA-BR-00	IPD/IA-BR-01
ø3.8	15°	IPD/IA-BR-10	IPD/IA-BR-11
	25°	IPD/IA-BR-20	IPD/IA-BR-21

Co-Cr Base for digital workflow		Scan Body		
ø3.4	Straight / Angled	IPD/IA-BN-00/3D	IPD/IA-BN-01/3D	IPD/SC-AN-B1
ø3.8	Straight / Angled	IPD/IA-BR-00/3D	IPD/IA-BR-01/3D	IPD/SC-AN-B1

All angled castable abutments include a TPA screw.





Compatibility



DENTSPLY®

IB Serie ANKYLOS®

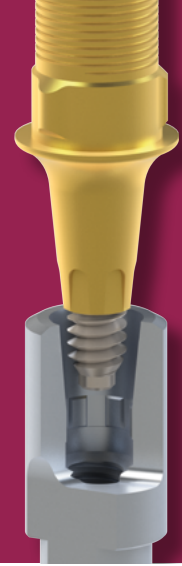
[c/x]





INTRA-ORAL / DESKTOP / CONTACT PROBE SCAN BODY

Platform	Height (mm)		
C/X	10	IPD/IB-SR-00	IPD/IB-SR-01
	15	IPD/IB-SR-02	-

Captive screw included. 1.20 Hex Screwdriver.



Ti-BASE Custom Ti-Base System®

Platform	Height (mm)		
C/X	1.5	IPD/IB-IR-02/3D	IPD/IB-IR-03/3D
	2.5	IPD/IB-IR-04/3D	IPD/IB-IR-05/3D

High version of the non-engaging Custom Ti-Base subject to availability. Please see [page 147](#) for the  Custom Ti-Base System® accessories.

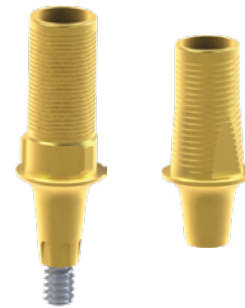

SCREW / TPA SCREW FOR ANGLED PROSTHESIS

Platform	Screwdriver	Seat	Reference
C/X	1.00 Hex	Conical for Balance base Narrow	IPD/IB-TR-00
		Conical for Non-Engaging Ti-Base	IPD/IB-TR-01
	TPA	Conical	IPD/IB-TR-51

IPD/IB-TR-51 is a specific screw for Hollow Ti-Base IPD/IB-IR-31.

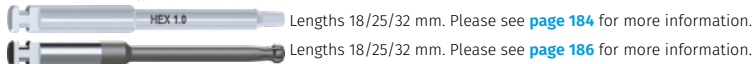

ANALOG / DIGITAL ANALOG

Platform	Reference	Digital reference
C/X	IPD/IB-AR-00	IPD/IB-AR-00/3D
Bottom Screw	-	IPD/KA-TA-00
Side Screw	-	IPD/KA-TA-01



OPEN TRAY COPING

Platform		Reference
C/X	Open tray coping	IPD/IB-CR-00



HEALING ABUTMENT

Platform	Height (mm)	Reference
C/X	3.0	IPD/IB-DR-03





Compatibility



CAMLOG[®]

JA Serie CAMLOG[®]

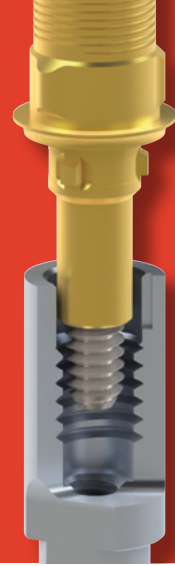
[ϕ 3.3 / ϕ 3.8 / ϕ 4.3 / ϕ 5.0]





INTRA-ORAL / DESKTOP / CONTACT PROBE SCAN BODY

Platform	Height (mm)		
ϕ 3.3	10	IPD/JA-SN-00	IPD/JA-SN-01
	15	IPD/JA-SN-02	-
ϕ 3.8	10	IPD/JA-SR-00	IPD/JA-SR-01
	15	IPD/JA-SR-02	-
ϕ 4.3	10	IPD/JA-SW-00	IPD/JA-SW-01
	15	IPD/JA-SW-02	-
ϕ 5.0	10	IPD/JA-SX-00	IPD/JA-SX-01
	15	IPD/JA-SX-02	-



Captive screw included. 1.20 Hex Screwdriver.

Ti-BASE  Custom Ti-Base System[®]

Platform	Height (mm)		
ϕ 3.3	1.5	IPD/JA-IN-02/3D	IPD/JA-IN-03/3D
	0.5	IPD/JA-IR-00/3D	IPD/JA-IR-01/3D
ϕ 3.8	1.5	IPD/JA-IR-02/3D	IPD/JA-IR-03/3D
	0.5	IPD/JA-IW-00/3D	IPD/JA-IW-01/3D
ϕ 4.3	1.5	IPD/JA-IW-02/3D	IPD/JA-IW-03/3D
	0.5	IPD/JA-IX-00/3D	IPD/JA-IX-01/3D
ϕ 5.0	1.5	IPD/JA-IX-02/3D	IPD/JA-IX-03/3D

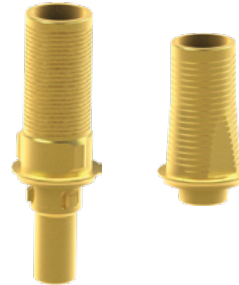

High version of the non-engaging Custom Ti-Base subject to availability. Please see [page 147](#) for the  Custom Ti-Base System[®] accessories.

SCREW

Platform	Screwdriver	Seat	Reference	TiN Reference
ϕ 3.3 ϕ 3.8 ϕ 4.3	Hex 1.25	Cónico	IPD/JA-TR-00	IPD/JA-TR-00/TiN
ϕ 5.0			IPD/JA-TX-00	IPD/JA-TX-00/TiN

 Lengths 18/25/32 mm. Please see [page 184](#) for more information.



ANALOG / DIGITAL ANALOG

Platform	Reference	Digital reference
ϕ 3.3	IPD/JA-AN-00	IPD/JA-AN-00/3D
ϕ 3.8	IPD/JA-AR-00	IPD/JA-AR-00/3D
ϕ 4.3	IPD/JA-AW-00	IPD/JA-AW-00/3D
ϕ 5.0	IPD/JA-AX-00	IPD/JA-AX-00/3D
Bottom Screw	-	IPD/KA-TA-00
Side Screw	-	IPD/KA-TA-01





STRAIGHT AND ANGLED MULTI-UNIT ABUTMENT
Straight, 17° & 30°

Platform	Height (mm)	Straight	17°	30°
ø3.8	1.0	IPD/JA-MR-01	-	-
	2.0	IPD/JA-MR-02	-	-
	2.5	-	IPD/JA-MR-12	-
	3.5	-	-	IPD/JA-MR-33
ø4.3	1.0	IPD/JA-MW-01	-	-
	2.0	IPD/JA-MW-02	-	-
	2.5	-	IPD/JA-MW-12	-
	3.5	-	-	IPD/JA-MW-33
ø5.0	1.0	IPD/JA-MX-01	-	-
	2.0	IPD/JA-MX-02	-	-
	2.5	-	IPD/JA-MX-12	-
	3.5	-	-	IPD/JA-MX-33



Our straight Multi-units can be used for single and multiple restorations. Please see [page 157](#) for the Multi-unit system accessories.

TEMPORARY ABUTMENT / OPEN TRAY COPING

Platform			Coping screw
ø3.3	IPD/JA-PN-06	IPD/JA-PN-07	
ø3.8	IPD/JA-PR-06	IPD/JA-PR-07	IPD/JA-TR-00/C
ø4.3	IPD/JA-PW-06	IPD/JA-PW-07	
ø5.0	IPD/JA-PX-06	IPD/JA-PX-07	IPD/JA-TX-00/C



The same abutment can be used as a temporary abutment with the occlusal screw or as an impression coping using the coping screw.

PSD OVERDENTURE ABUTMENT

Platform	Height (mm)	Reference
ø3.8	1.0	IPD/JA-LR-01
	3.0	IPD/JA-LR-03
	5.0	IPD/JA-LR-05
ø4.3	1.0	IPD/JA-LW-01
	3.0	IPD/JA-LW-03
	5.0	IPD/JA-LW-05
ø5.0	1.0	IPD/JA-LX-01
	2.0	IPD/JA-LX-02
	3.0	IPD/JA-LX-03
	4.0	IPD/JA-LX-04



Please see [page 169](#) for the PSD system accessories.

HEALING ABUTMENT

Platform	Height (mm)	Reference
ø3.3	2.0	IPD/JA-DN-02
	4.0	IPD/JA-DN-04
	6.0	IPD/JA-DN-06
ø3.8	2.0	IPD/JA-DR-02
	4.0	IPD/JA-DR-04
	6.0	IPD/JA-DR-06
ø4.3	2.0	IPD/JA-DW-02
	4.0	IPD/JA-DW-04
	6.0	IPD/JA-DW-06
ø5.0	2.0	IPD/JA-DX-02
	4.0	IPD/JA-DX-04
	6.0	IPD/JA-DX-06





Compatibility



CAMLOG[®]

JB Serie CONELOG[®]

[ϕ 3.3 / ϕ 3.8 / ϕ 4.3]





INTRA-ORAL / DESKTOP / CONTACT PROBE SCAN BODY

Platform	Height (mm)		
ϕ 3.3	10	IPD/JB-ST-00	IPD/JB-ST-01
	15	IPD/JB-ST-02	-
ϕ 3.8	10	IPD/JB-SN-00	IPD/JB-SN-01
	15	IPD/JB-SN-02	-
ϕ 4.3	10	IPD/JB-SR-00	IPD/JB-SR-01
	15	IPD/JB-SR-02	-



Captive screw included. 1.20 Hex Screwdriver.

Ti-BASE  Custom Ti-Base System[®]

Platform	Height (mm)		
ϕ 3.3	0.5	IPD/JB-IT-00/3D	IPD/JB-IT-01/3D
	1.5	IPD/JB-IT-02/3D	IPD/JB-IT-03/3D
ϕ 3.8	0.5	IPD/JB-IN-00/3D	IPD/JB-IN-01/3D
	1.5	IPD/JB-IN-02/3D	IPD/JB-IN-03/3D
ϕ 4.3	0.5	IPD/JB-IR-00/3D	IPD/JB-IR-01/3D
	1.5	IPD/JB-IR-02/3D	IPD/JB-IR-03/3D



Please see [page 147](#) for the  Custom Ti-Base System[®] accessories.

SCREW

Platform	Screwdriver	Seat	Reference	TiN Reference
ϕ 3.3 ϕ 3.8 ϕ 4.3	Hex 1.25	Cónico	IPD/JB-TR-00 IPD/JB-TR-01	IPD/JB-TR-00/TiN

The reference IPD/JB-TR-01 is an abutment extractor screw.
The IPD/JB-TR-01 Abutment Extractor Screw cannot be used if angled systems are used with the ConeLog[®] System.

 HEX 1.25 Lengths 18/25/32 mm. Please see [page 184](#) for more information.



ANALOG / DIGITAL ANALOG

Platform	Reference	Digital reference
ϕ 3.3	IPD/JB-AT-00	IPD/JB-AT-00/3D
ϕ 3.8	IPD/JB-AN-00	IPD/JB-AN-00/3D
ϕ 4.3	IPD/JB-AR-00	IPD/JB-AR-00/3D
Bottom Screw	-	IPD/KA-TA-00
Side Screw	-	IPD/KA-TA-01



STRAIGHT AND ANGLED MULTI-UNIT ABUTMENT



Straight, 17° & 30°

Platform	Height (mm)	Straight	17°	30°
ø3.8	1.5	IPD/JB-MN-01	-	-
	2.5	IPD/JB-MN-02	IPD/JB-MN-12	-
	3.5	-	-	IPD/JB-MN-33
ø4.3	1.5	IPD/JB-MR-01	-	-
	2.5	IPD/JB-MR-02	IPD/JB-MR-12	-
	3.5	-	-	IPD/JB-MR-33

Our straight Multi-units can be used for single and multiple restorations. Please see [page 157](#) for the Multi-unit system accessories.



TEMPORARY ABUTMENT / OPEN TRAY COPING

Platform			Coping screw
ø3.3	IPD/JB-PT-06	IPD/JB-PT-07	IPD/JB-TR-00/C
ø3.8	IPD/JB-PN-06	IPD/JB-PN-07	
ø4.3	IPD/JB-PR-06	IPD/JB-PR-07	

The same abutment can be used as a temporary abutment with the occlusal screw or as an impression coping using the coping screw.



PSD OVERDENTURE ABUTMENT

Platform	Height (mm)	Reference
ø3.8	2.0	IPD/JB-LN-02
	3.0	IPD/JB-LN-03
	4.0	IPD/JB-LN-04
ø4.3	2.0	IPD/JB-LR-02
	3.0	IPD/JB-LR-03
	4.0	IPD/JB-LR-04

Please see [page 169](#) for the PSD system accessories.



HEALING ABUTMENT

Platform	Height (mm)	Reference
ø3.3	2.0	IPD/JB-DT-02
	4.0	IPD/JB-DT-04
	6.0	IPD/JB-DT-06
ø3.8	2.0	IPD/JB-DN-02
	4.0	IPD/JB-DN-04
	6.0	IPD/JB-DN-06
ø4.3	2.0	IPD/JB-DR-02
	4.0	IPD/JB-DR-04
	6.0	IPD/JB-DR-06





Compatibility



BIOHORIZONS®

LB Serie TAPERED INTERNAL

[$\phi 3.0$ / $\phi 3.5$ / $\phi 4.5$ / $\phi 5.7$]





INTRA-ORAL / DESKTOP / CONTACT PROBE SCAN BODY

Platform	Height (mm)		
$\phi 3.0$	10	IPD/LB-ST-00	IPD/LB-ST-01
	15	IPD/LB-ST-02	-
$\phi 3.5$	10	IPD/LB-SN-00	IPD/LB-SN-01
	15	IPD/LB-SN-02	-
$\phi 4.5$	10	IPD/LB-SR-00	IPD/LB-SR-01
	15	IPD/LB-SR-02	-
$\phi 5.7$	10	IPD/LB-SW-00	IPD/LB-SW-01
	15	IPD/LB-SW-02	-



Captive screw included. 1.20 Hex Screwdriver.

Ti-BASE  Custom Ti-Base System®

Platform	Height (mm)		
$\phi 3.0$	0.5	IPD/LB-IT-00/3D	IPD/LB-IT-01/3D
	1.5	IPD/LB-IT-02/3D	IPD/LB-IT-03/3D
	2.5	IPD/LB-IT-04/3D	IPD/LB-IT-05/3D
$\phi 3.5$	0.5	IPD/LB-IN-00/3D	IPD/LB-IN-01/3D
	1.5	IPD/LB-IN-02/3D	IPD/LB-IN-03/3D
	2.5	IPD/LB-IN-04/3D	IPD/LB-IN-05/3D
$\phi 4.5$	0.5	IPD/LB-IR-00/3D	IPD/LB-IR-01/3D
	1.5	IPD/LB-IR-02/3D	IPD/LB-IR-03/3D
	2.5	IPD/LB-IR-04/3D	IPD/LB-IR-05/3D
$\phi 5.7$	0.5	IPD/LB-IW-00/3D	IPD/LB-IW-01/3D



Please see [page 147](#) for the  Custom Ti-Base System® accessories.

SCREW / TPA SCREW FOR ANGLED PROSTHESIS

Platform	Screwdriver	Seat	Reference	TiN Reference
$\phi 3.0$ $\phi 3.5$ $\phi 4.5$ $\phi 5.7$	1.27 Hex	Conical	IPD/LB-TR-00	IPD/LB-TR-00/TiN
$\phi 3.0$ $\phi 3.5$ $\phi 4.5$ $\phi 5.7$	TPA	Conical	-	IPD/LB-TR-50

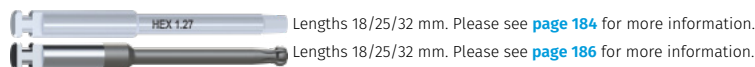

ANALOG / DIGITAL ANALOG

Platform	Reference	Digital reference
ø3.0	IPD/LB-AT-00	IPD/LB-AT-00/3D
ø3.5	IPD/LB-AN-00	IPD/LB-AN-00/3D
ø4.5	IPD/LB-AR-00	IPD/LB-AR-00/3D
ø5.7	IPD/LB-AW-00	IPD/LB-AW-00/3D
Bottom Screw	-	IPD/KA-TA-00
Side Screw	-	IPD/KA-TA-01



STRAIGHT AND ANGLED MULTI-UNIT ABUTMENT

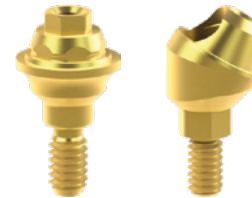

Straight, 17° & 30°

Platform	Height (mm)	Straight	17°	30°
ø3.5	1.5	IPD/FA-MN-01	-	-
	2.5	IPD/FA-MN-02	IPD/LB-MN-12	-
	3.5	IPD/FA-MN-03	IPD/LB-MN-13	IPD/LB-MN-33
	4.5	IPD/FA-MN-04	-	IPD/LB-MN-34
ø4.5	1.5	IPD/FA-MR-01	-	-
	2.5	IPD/FA-MR-02	-	-
	3.5	IPD/FA-MR-03	-	-
	4.5	IPD/FA-MR-04	-	-



Our straight Multi-units can be used for single and multiple restorations. Please see [page 157](#) for the Multi-unit system accessories.

TEMPORARY ABUTMENT / OPEN TRAY COPING

Platform			Coping screw
ø3.0	IPD/LB-PT-06	IPD/LB-PT-07	IPD/LB-TR-00/C
ø3.5	IPD/LB-PN-06	IPD/LB-PN-07	
ø4.5	IPD/LB-PR-06	IPD/LB-PR-07	
ø5.7	IPD/LB-PW-06	IPD/LB-PW-07	

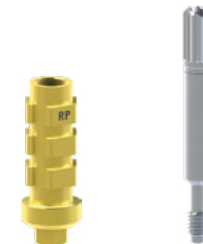

The same abutment can be used as a temporary abutment with the occlusal screw or as an impression coping using the coping screw.

OPEN TRAY COPING

Platform	Reference
ø5.7	Open tray coping IPD/LB-CW-00

Classic design.





PSD OVERDENTURE ABUTMENT

Platform	Height (mm)	Reference
ø3.0	2.0	IPD/LB-LT-02
	3.0	IPD/LB-LT-03
	4.0	IPD/LB-LT-04
	5.0	IPD/LB-LT-05
	1.0	IPD/FA-LN-01
ø3.5	2.0	IPD/FA-LN-02
	3.0	IPD/FA-LN-03
	4.0	IPD/FA-LN-04
	5.0	IPD/FA-LN-05
	1.0	IPD/FA-LR-01
ø4.5	2.0	IPD/FA-LR-02
	3.0	IPD/FA-LR-03
	4.0	IPD/FA-LR-04
	5.0	IPD/FA-LR-05



Please see [page 169](#) for the PSD system accessories.

STRAIGHT AND ANGLED CASTABLE ABUTMENT WITH A Co-Cr BASE
 Straight, 15° & 25°

Platform	Angulation		
ø3.0	Straight	IPD/LB-BT-00	IPD/LB-BT-01
	15°	IPD/LB-BT-10	IPD/LB-BT-11
	25°	IPD/LB-BT-20	IPD/LB-BT-21
ø3.5	Straight	IPD/LB-BN-00	IPD/LB-BN-01
	15°	IPD/LB-BN-10	IPD/LB-BN-11
	25°	IPD/LB-BN-20	IPD/LB-BN-21
ø4.5	Straight	IPD/LB-BR-00	IPD/LB-BR-01
	15°	IPD/LB-BR-10	IPD/LB-BR-11
	25°	IPD/LB-BR-20	IPD/LB-BR-21



Co-Cr Base for digital workflow			Scan Body	
ø3.0	Straight / Angled	IPD/LB-BT-00/3D	IPD/LB-BT-01/3D	IPD/SC-AN-B1
ø3.5	Straight / Angled	IPD/LB-BN-00/3D	IPD/LB-BN-01/3D	IPD/SC-AN-B1
ø4.5	Straight / Angled	IPD/LB-BR-00/3D	IPD/LB-BR-01/3D	IPD/SC-AN-B1



All angled castable abutments include a TPA screw.

HEALING ABUTMENT

Platform	Height (mm)	Reference
ø3.0	2.0	IPD/LB-DT-02
	3.0	IPD/LB-DT-03
	5.0	IPD/LB-DT-05
ø3.5	1.5	IPD/FA-DN-01
	3.0	IPD/FA-DN-03
	5.0	IPD/FA-DN-05
ø4.5	1.5	IPD/FA-DR-01
	3.0	IPD/FA-DR-03
	5.0	IPD/FA-DR-05
ø5.7	3.0	IPD/FA-DW-03
	5.0	IPD/FA-DW-05



CASTABLE

Platform		
ø3.5	IPD/LB-HN-00	IPD/LB-RN-00
ø4.5	IPD/LB-HR-00	IPD/LB-RR-00
ø5.7	IPD/LB-HW-00	IPD/LB-RW-00







Compatibility



SWEDEN & MARTINA®

MA Serie OUTLINK®

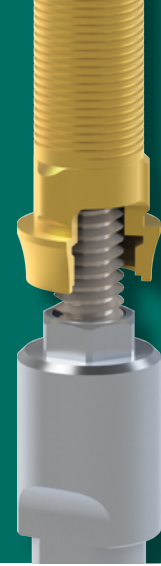
[ø3.3 / ø4.1 / ø5.0]





INTRA-ORAL / DESKTOP / CONTACT PROBE SCAN BODY

Platform	Height (mm)		
ø3.3	10	IPD/MA-SN-00	IPD/MA-SN-01
	15	IPD/MA-SN-02	-
ø4.1	10	IPD/AA-SR-00	IPD/AA-SR-01
	15	IPD/AA-SR-02	-
ø5.0	10	IPD/BA-SW-00	IPD/BA-SW-01
	15	IPD/BA-SW-02	-



Captive screw included. 1.20 Hex Screwdriver.

Ti-BASE Custom Ti-Base System®

Platform	Height (mm)		
ø3.3	1.5	IPD/MA-IN-02/3D	IPD/MA-IN-03/3D
	2.5	IPD/MA-IN-04/3D	IPD/MA-IN-05/3D
ø4.1	0.5	IPD/AA-IR-00/3D	IPD/AA-IR-01/3D
	1.5	IPD/AA-IR-02/3D	IPD/AA-IR-03/3D
ø5.0	0.5	IPD/AA-IR-04/3D	IPD/AA-IR-05/3D
	1.5	IPD/BA-IW-00/3D	IPD/BA-IW-01/3D
		IPD/BA-IW-02/3D	IPD/BA-IW-03/3D



High version of the non-engaging Custom Ti-Base subject to availability. Please see [page 147](#) for the  Custom Ti-Base System® accessories.

SCREW / TPA SCREW FOR ANGLED PROSTHESIS

Platform	Screwdriver	Seat	Reference	TiN Reference
ø3.3	1.25 Hex	Conical	IPD/MA-TN-00	IPD/MA-TN-00/TiN
ø4.1 ø5.0	1.25 Hex	Conical	IPD/BA-TR-01	IPD/BA-TR-01/TiN
	1.20 Hex	Low profile conical	IPD/AA-TR-01	IPD/AA-TR-01/TiN
ø3.3	TPA	Conical		IPD/MA-TN-50
ø4.1 ø5.0	TPA	Conical		IPD/AA-TR-50
	TPA	Flat		IPD/AA-TR-52

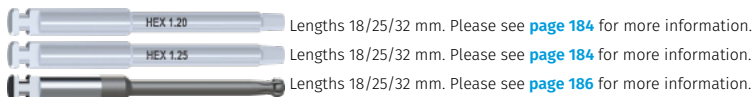
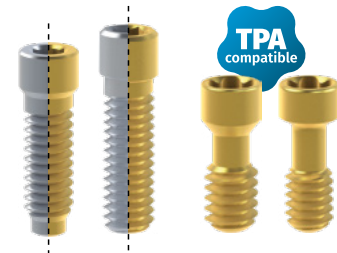

ANALOG / DIGITAL ANALOG

Platform	Reference	Digital reference
ø3.3	IPD/MA-AN-00	IPD/MA-AN-00/3D
ø4.1	IPD/AA-AR-00	IPD/AA-AR-00/3D
ø5.0	IPD/BA-AW-00	IPD/BA-AW-00/3D
Bottom Screw	-	IPD/KA-TA-00
Side Screw	-	IPD/KA-TA-01



STRAIGHT AND ANGLED MULTI-UNIT ABUTMENT



Straight, 17° & 30°

Platform	Height (mm)	Straight	17°	30°
ø4.1	1.0	IPD/AB-MR-01	-	-
	2.0	IPD/AB-MR-02	IPD/AB-MR-12	-
	3.0	IPD/AB-MR-03	IPD/AB-MR-13	IPD/AB-MR-33
	4.0	IPD/AB-MR-04	IPD/AB-MR-14	IPD/AB-MR-34
	5.0	IPD/AB-MR-05	-	IPD/AB-MR-35



Our straight Multi-units can be used for single and multiple restorations. Please see [page 157](#) for the Multi-unit system accessories.

TEMPORARY ABUTMENT / OPEN TRAY COPING

Platform			Coping screw
ø3.3	IPD/MA-PN-06	IPD/MA-PN-07	IPD/MA-TN-00/C
ø4.1	IPD/AA-PR-06	IPD/AA-PR-07	IPD/AA-TR-00/C

The same abutment can be used as a temporary abutment with the occlusal screw or as an impression coping using the coping screw.



OPEN AND CLOSED TRAY COPING

Platform	Reference	
ø4.1	Open tray coping	IPD/AA-CR-00
	Closed tray coping	IPD/AA-CR-01
ø5.0	Open tray coping	IPD/BA-CW-00

Classic design.





PSD OVERDENTURE ABUTMENT

Platform	Height (mm)	Reference
ø3.3	2.0	IPD/MA-LN-02
	3.0	IPD/MA-LN-03
	4.0	IPD/MA-LN-04
	5.0	IPD/MA-LN-05
	1.0	IPD/AA-LR-01
ø4.1	2.0	IPD/AA-LR-02
	3.0	IPD/AA-LR-03
	4.0	IPD/AA-LR-04
	5.0	IPD/AA-LR-05



Please see [page 169](#) for the PSD system accessories.

STRAIGHT AND ANGLED CASTABLE ABUTMENT WITH A Co-Cr BASE Straight, 15° & 25°

Platform	Angulation		
ø3.3	Straight	IPD/MA-BN-00	IPD/MA-BN-01
	15°	IPD/MA-BN-10	IPD/MA-BN-11
ø4.1	Straight	IPD/AA-BR-00	IPD/AA-BR-01
	15°	IPD/AA-BR-10	IPD/AA-BR-11
	25°	IPD/AA-BR-20	IPD/AA-BR-21
ø5.0	Straight	IPD/BA-BW-00	IPD/BA-BW-01
	15°	IPD/BA-BW-10	IPD/BA-BW-11
	25°	IPD/BA-BW-20	IPD/BA-BW-21



Co-Cr Base for digital workflow			Scan Body	
ø3.3	Straight / Angled	IPD/MA-BN-00/3D	IPD/MA-BN-01/3D	IPD/SC-AN-B1
ø4.1	Straight / Angled	IPD/AA-BR-00/3D	IPD/AA-BR-01/3D	IPD/SC-AN-B1
ø5.0	Straight / Angled	IPD/BA-BW-00/3D	IPD/BA-BW-01/3D	IPD/SC-AN-B1



All angled castable abutments include a TPA screw.

HEALING ABUTMENT

Platform	Height (mm)	Reference
ø3.3	3.0	IPD/MA-DN-03
	4.0	IPD/MA-DN-04
	5.0	IPD/MA-DN-05
ø4.1	2.0	IPD/AA-DR-02
	3.0	IPD/AA-DR-03
	4.0	IPD/AA-DR-04
ø5.0	5.0	IPD/AA-DR-05
	2.0	IPD/BA-DW-02
	3.0	IPD/BA-DW-03
	4.0	IPD/BA-DW-04



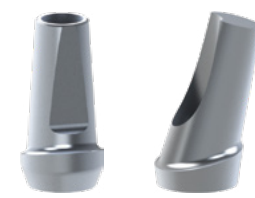

STRAIGHT AND ANGLED ABUTMENT Straight, 15° & 25°

Platform	Height (mm)	Angulation		
ø4.1	1.0	Straight	IPD/AA-PR-00	IPD/AA-PR-01
		15°	IPD/AA-PR-02	-
	25°	IPD/AA-PR-03	-	
	2.0	15°	IPD/AA-PR-04	-
		25°	IPD/AA-PR-05	-



Using the low profile IPD/AA-TR-01 screw for IPD/AA-PR-03 is recommended.

CASTABLE

Platform		
ø4.1	IPD/AA-HR-00	IPD/AA-RR-00
ø5.0	IPD/BA-HW-00	IPD/BA-RW-00



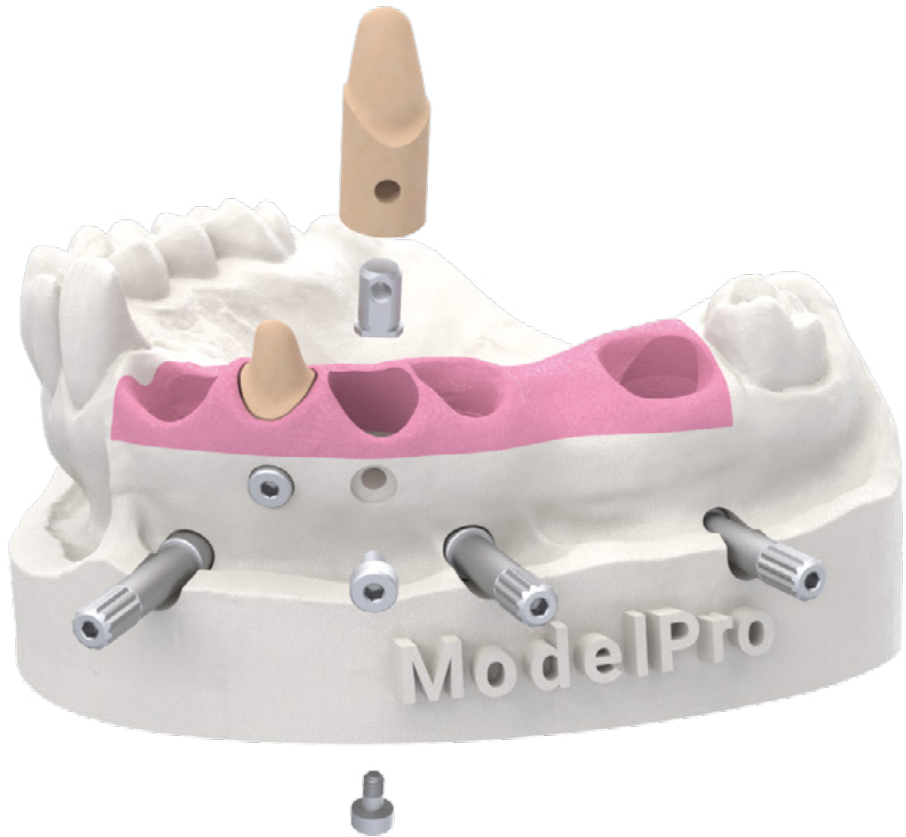



Compatibility



SWEDEN & MARTINA®

MB Serie PREMIUM™ KOHNO®

[ϕ 3.3 / ϕ 3.8 / ϕ 4.25 / ϕ 5.0]





INTRA-ORAL / DESKTOP / CONTACT PROBE SCAN BODY

Platform	Height (mm)		
ϕ 3.3	10	IPD/MB-ST-00	IPD/MB-ST-01
	15	IPD/MB-ST-02	-
ϕ 3.8	10	IPD/MB-SN-00	IPD/MB-SN-01
	15	IPD/MB-SN-02	-
ϕ 4.25	10	IPD/MB-SR-00	IPD/MB-SR-01
	15	IPD/MB-SR-02	-



Captive screw included. 1.20 Hex Screwdriver.

Ti-BASE Custom Ti-Base System®

Platform	Height (mm)		
ϕ 3.3	0.5	IPD/MB-IT-00/3D	IPD/MB-IT-01/3D
	1.5	IPD/MB-IT-02/3D	IPD/MB-IT-03/3D
ϕ 3.8	0.7	IPD/MB-IN-00/3D	IPD/MB-IN-01/3D
	1.5	IPD/MB-IN-02/3D	IPD/MB-IN-03/3D
ϕ 4.25	0.7	IPD/MB-IR-00/3D	IPD/MB-IR-01/3D
	1.5	IPD/MB-IR-02/3D	IPD/MB-IR-03/3D



High version of the non-engaging Custom Ti-Base subject to availability. Please see [page 147](#) for the  Custom Ti-Base System® accessories.

SCREW / TPA SCREW FOR ANGLED PROSTHESIS

Platform	Screwdriver	Seat	Reference	TiN Reference
ϕ 3.3 ϕ 3.8	1.25 Hex	Conical	IPD/MB-TN-00	IPD/MB-TN-00/TiN
ϕ 4.25 ϕ 5.0	1.25 Hex	Conical	IPD/MB-TR-00	IPD/MB-TR-00/TiN
ϕ 3.3 ϕ 3.8	TPA	Conical	-	IPD/MB-TN-50
ϕ 4.25 ϕ 5.0	TPA	Conical	-	IPD/MB-TR-50

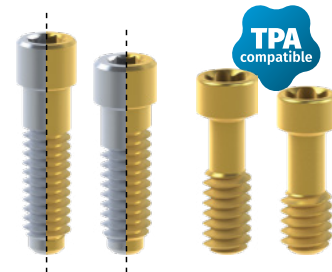
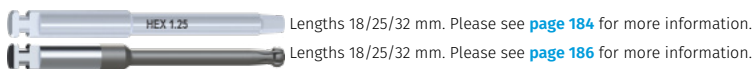

ANALOG / DIGITAL ANALOG

Platform	Reference	Digital reference
ϕ 3.3	IPD/MB-AT-00	IPD/MB-AT-00/3D
ϕ 3.8	IPD/MB-AN-00	IPD/MB-AN-00/3D
ϕ 4.25	IPD/MB-AR-00	IPD/MB-AR-00/3D
ϕ 5.0	IPD/MB-AW-00	-
Bottom Screw	-	IPD/KA-TA-00
Side Screw	-	IPD/KA-TA-01





STRAIGHT MULTI-UNIT ABUTMENT

Platform	Height (mm)	Reference
ø3.8	1.5	IPD/MB-MN-01
	3.0	IPD/MB-MN-03
	4.0	IPD/MB-MN-04

Our straight Multi-units can be used for single and multiple restorations. Please see [page 157](#) for the Multi-unit system accessories.





TEMPORARY ABUTMENT / OPEN TRAY COPING

Platform			Coping screw
ø3.3	IPD/MB-PT-06	IPD/MB-PT-07	IPD/MB-TN-00/C
ø3.8	IPD/MB-PN-06	IPD/MB-PN-07	IPD/MB-TN-00/C
ø4.25	IPD/MB-PR-06	IPD/MB-PR-07	IPD/MB-TR-00/C

The same abutment can be used as a temporary abutment with the occlusal screw or as an impression coping using the coping screw.



CASTABLE

Platform		
ø3.8	IPD/MB-HN-00	IPD/MB-RN-00
ø4.25	IPD/MB-HR-00	IPD/MB-RR-00
ø5.0	IPD/MB-HW-00	IPD/MB-RW-00



PSD OVERDENTURE ABUTMENT

Platform	Height (mm)	Reference
ø3.3	1.0	IPD/MB-LT-01
	3.0	IPD/MB-LT-03
ø3.8	1.0	IPD/MB-LN-01
	3.0	IPD/MB-LN-03
	5.0	IPD/MB-LN-05
ø4.25	1.0	IPD/MB-LR-01
	3.0	IPD/MB-LR-03
	5.0	IPD/MB-LR-05



Please see [page 169](#) for the PSD system accessories.



HEALING ABUTMENT

Platform	Height (mm)	Reference
ø3.8	2.0	IPD/MB-DN-02
	3.0	IPD/MB-DN-03
	4.0	IPD/MB-DN-04
	6.0	IPD/MB-DN-06
ø4.25	2.0	IPD/MB-DR-02
	3.0	IPD/MB-DR-03
	4.0	IPD/MB-DR-04
	6.0	IPD/MB-DR-06



STRAIGHT AND ANGLED CASTABLE ABUTMENT WITH A Co-Cr BASE

Straight, 15° & 25°

Platform	Angulation		
ø3.3	Straight	IPD/MB-BT-00	IPD/MB-BT-01
	15°	IPD/MB-BT-10	IPD/MB-BT-11
	Straight	IPD/MB-BN-00	IPD/MB-BN-01
ø3.8	15°	IPD/MB-BN-10	IPD/MB-BN-11
	25°	IPD/MB-BN-20	IPD/MB-BN-21
	Straight	IPD/MB-BR-00	IPD/MB-BR-01
ø4.25	15°	IPD/MB-BR-10	IPD/MB-BR-11
	25°	IPD/MB-BR-20	IPD/MB-BR-21



Co-Cr Base for digital workflow			Scan Body	
ø3.3	Straight / Angled	IPD/MB-BT-00/3D	IPD/MB-BT-01/3D	IPD/SC-AN-B1
ø3.8	Straight / Angled	IPD/MB-BN-00/3D	IPD/MB-BN-01/3D	IPD/SC-AN-B1
ø4.25	Straight / Angled	IPD/MB-BR-00/3D	IPD/MB-BR-01/3D	IPD/SC-AN-B1

All angled castable abutments include a TPA screw.

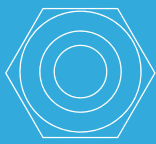

Compatibility



PHIBO[®]

NA Serie TSH[®]

[S2 / S3-S4 / S5]





INTRA-ORAL / DESKTOP / CONTACT PROBE SCAN BODY

Platform	Height (mm)		
S2	10	IPD/NA-SN-00	IPD/NA-SN-01
	15	IPD/NA-SN-02	-
S3-S4	10	IPD/AA-SR-00	IPD/AA-SR-01
	15	IPD/AA-SR-02	-
S5	10	IPD/NA-SW-00	IPD/NA-SW-01

Captive screw included. 1.20 Hex Screwdriver.



Ti-BASE  Custom Ti-Base System[®]

Platform	Height (mm)		
S2	1.5	IPD/NA-IN-02/3D	IPD/NA-IN-03/3D
	0.5	IPD/AA-IR-00/3D	IPD/AA-IR-01/3D
S3-S4	1.5	IPD/AA-IR-02/3D	IPD/AA-IR-03/3D
	2.5	IPD/AA-IR-04/3D	IPD/AA-IR-05/3D
S5	1.3	IPD/NA-IW-02/3D	IPD/NA-IW-03/3D



High version of the non-engaging Custom Ti-Base subject to availability. Please see [page 147](#) for the  Custom Ti-Base System[®] accessories.

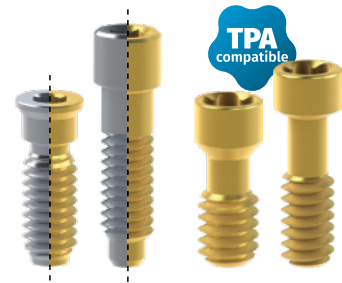

SCREW / TPA SCREW FOR ANGLED PROSTHESIS

Platform	Screwdriver	Seat	Reference	TiN Reference
S2	1.25 Hex	Conical	IPD/NA-TN-00	IPD/NA-TN-00/TIN
S3-S4	1.25 Hex	Conical	IPD/BA-TR-01	IPD/BA-TR-01/TIN
	1.20 Hex	Low profile conical	IPD/AA-TR-01	IPD/AA-TR-01/TIN
S5	1.25 Hex	Conical	IPD/NA-TW-00	-
S2	TPA	Conical	-	IPD/MB-TN-50
	TPA	Conical	-	IPD/AA-TR-50
S3-S4	TPA	Flat	-	IPD/AA-TR-52
	TPA	Conical	-	IPD/MB-TR-50



-  HEX 1.20 Lengths 18/25/32 mm. Please see [page 184](#) for more information.
-  HEX 1.25 Lengths 18/25/32 mm. Please see [page 184](#) for more information.
-  Lengths 18/25/32 mm. Please see [page 186](#) for more information.

ANALOG / DIGITAL ANALOG

Platform	Reference	Digital reference
S2	IPD/NA-AN-00	IPD/NA-AN-00/3D
S3-S4	IPD/AA-AR-00	IPD/AA-AR-00/3D
S5	IPD/HA-AW-00	IPD/NA-AW-00/3D
Bottom Screw	-	IPD/KA-TA-00
Side Screw	-	IPD/KA-TA-01



STRAIGHT AND ANGLED MULTI-UNIT ABUTMENT



Straight, 17° & 30°

Platform	Height (mm)	Straight	17°	30°
S3-S4	1.0	IPD/AB-MR-01	-	-
	2.0	IPD/AB-MR-02	IPD/AB-MR-12	-
	3.0	IPD/AB-MR-03	IPD/AB-MR-13	IPD/AB-MR-33
	4.0	IPD/AB-MR-04	IPD/AB-MR-14	IPD/AB-MR-34
	5.0	IPD/AB-MR-05	-	IPD/AB-MR-35



Our straight Multi-units can be used for single and multiple restorations. Please see [page 157](#) for the Multi-unit system accessories.

TEMPORARY ABUTMENT / OPEN TRAY COPING

Platform			Coping screw
S2	IPD/NA-PN-06	IPD/NA-PN-07	IPD/NA-TN-00/C
S3-S4	IPD/AA-PR-06	IPD/AA-PR-07	IPD/AA-TR-00/C
S5	IPD/NA-PW-06	IPD/NA-PW-07	IPD/NA-TW-00/C

The same abutment can be used as a temporary abutment with the occlusal screw or as an impression coping using the coping screw.



OPEN AND CLOSED TRAY COPING

Platform	Reference
S3-S4	Open tray coping
	Closed tray coping

Classic design.



PSD OVERDENTURE ABUTMENT



Platform	Height (mm)	Reference
S2	1.0	IPD/NA-LN-01
	3.0	IPD/NA-LN-03
	5.0	IPD/NA-LN-05
S3-S4	1.0	IPD/AA-LR-01
	2.0	IPD/AA-LR-02
	3.0	IPD/AA-LR-03
	4.0	IPD/AA-LR-04
	5.0	IPD/AA-LR-05



Please see [page 169](#) for the PSD system accessories.

STRAIGHT AND ANGLED CASTABLE ABUTMENT WITH A Co-Cr BASE

Straight, 15° & 25°

Platform	Angulation			
S3-S4	Straight	IPD/AA-BR-00	IPD/AA-BR-01	
	15°	IPD/AA-BR-10	IPD/AA-BR-11	
	25°	IPD/AA-BR-20	IPD/AA-BR-21	
Co-Cr Base for digital workflow			Scan Body	
S3-S4		IPD/AA-BR-00/3D	IPD/AA-BR-01/3D	IPD/SC-AN-B1

All angled castable abutments include a TPA screw.





HEALING ABUTMENT

Platform	Height (mm)	Reference
S2	3.0	IPD/NA-DN-03
	4.0	IPD/NA-DN-04
	5.0	IPD/NA-DN-05
S3-S4	2.0	IPD/AA-DR-02
	3.0	IPD/AA-DR-03
	4.0	IPD/AA-DR-04
S5	5.0	IPD/AA-DR-05
	3.0	IPD/NA-DW-03
	5.0	IPD/NA-DW-05



STRAIGHT AND ANGLED ABUTMENT



Straight, 15° & 25°

Platform	Height (mm)	Angulation		
S3-S4	1.0	Straight	IPD/AA-PR-00	IPD/AA-PR-01
		15°	IPD/AA-PR-02	-
		25°	IPD/AA-PR-03	-
	2.0	15°	IPD/AA-PR-04	-
		25°	IPD/AA-PR-05	-

Using the low profile IPD/AA-TR-01 screw for IPD/AA-PR-03 is recommended.



CASTABLE

Platform		
S2	IPD/NA-HN-00	IPD/NA-RN-00
S3-S4	IPD/AA-HR-00	IPD/AA-RR-00
S5	IPD/HA-HW-00	IPD/HA-RW-00



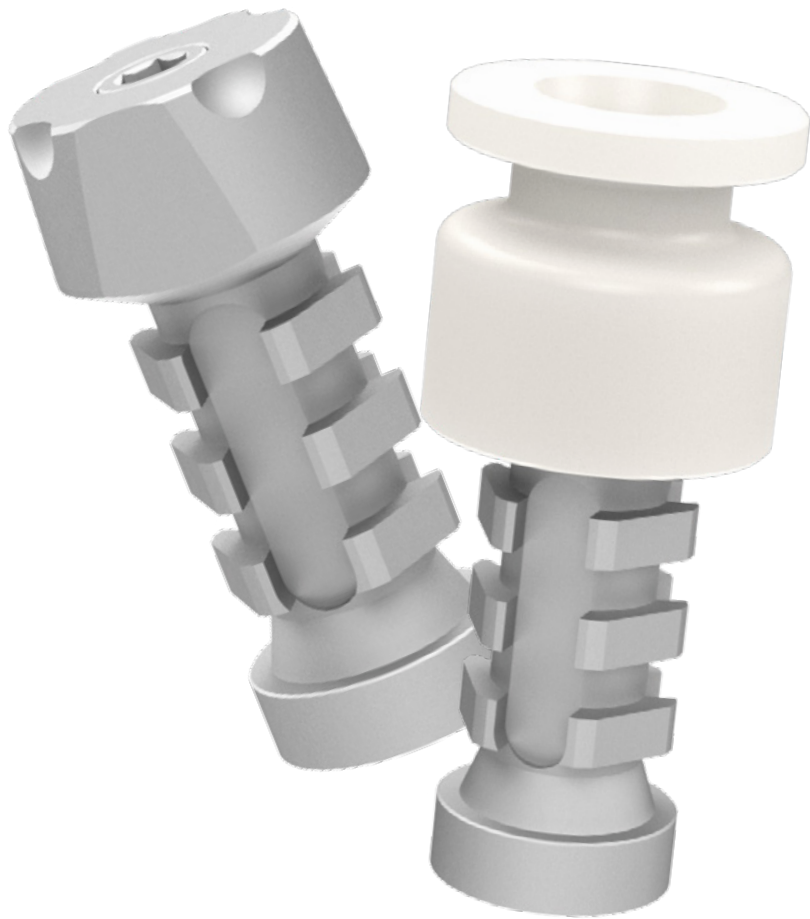



Compatibility



OSSTEM IMPLANT®

OB Serie TSIII

[ϕ 3.5 / ϕ 4.0]





INTRA-ORAL / DESKTOP / CONTACT PROBE SCAN BODY

Platform	Height (mm)		
ϕ 3.5	10	IPD/OB-SN-00	IPD/OB-SN-01
	15	IPD/OB-SN-02	-
ϕ 4.0	10	IPD/OB-SR-00	IPD/OB-SR-01
	15	IPD/OB-SR-02	-

Captive screw included. 1.20 Hex Screwdriver.



Ti-BASE Custom Ti-Base System®

Platform	Height (mm)		
ϕ 3.5	1.0	IPD/OB-IN-00/3D	IPD/OB-IN-01/3D
	2.0	IPD/OB-IN-02/3D	IPD/OB-IN-03/3D
	3.0	IPD/OB-IN-04/3D	IPD/OB-IN-05/3D
ϕ 4.0	1.0	IPD/OB-IR-00/3D	IPD/OB-IR-01/3D
	2.0	IPD/OB-IR-02/3D	IPD/OB-IR-03/3D
	3.0	IPD/OB-IR-04/3D	IPD/OB-IR-05/3D

Please see [page 147](#) for the  Custom Ti-Base System® accessories.



SCREW / TPA SCREW FOR ANGLED PROSTHESIS

Platform	Screwdriver	Seat	Reference	TiN Reference
ϕ 3.5	1.20 Hex	Conical	IPD/OB-TN-00	IPD/OB-TN-00/TIN
ϕ 4.0	1.20 Hex	Conical	IPD/OB-TR-00	IPD/OB-TR-00/TIN
ϕ 3.5	TPA	Conical		IPD/OB-TN-50
ϕ 4.0	TPA	Conical		IPD/OB-TR-50

 Lengths 18/25/32 mm. Please see [page 184](#) for more information.

 Lengths 18/25/32 mm. Please see [page 186](#) for more information.

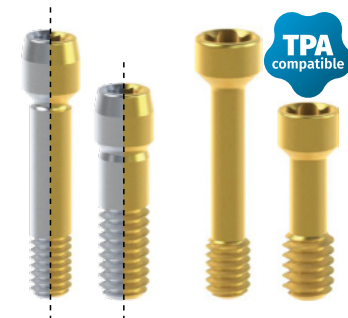

ANALOG / DIGITAL ANALOG

Platform	Reference	Digital reference
ø3.5	IPD/OB-AN-00	IPD/OB-AN-00/3D
ø4.0	IPD/OB-AR-00	IPD/OB-AR-00/3D
Bottom Screw	-	IPD/KA-TA-00
Side Screw	-	IPD/KA-TA-01



STRAIGHT AND ANGLED MULTI-UNIT ABUTMENT



Straight, 17° & 30°

Platform	Height (mm)	Straight	17°	30°
ø3.5	1.5	IPD/OB-MN-01	-	-
	2.5	IPD/OB-MN-02	IPD/OB-MN-12	-
	3.5	IPD/OB-MN-03	IPD/OB-MN-13	IPD/OB-MN-33
	4.5	IPD/OB-MN-04	-	IPD/OB-MN-34
	5.5	IPD/OB-MN-05	-	-
ø4.0	1.5	IPD/OB-MR-01	-	-
	2.5	IPD/OB-MR-02	IPD/OB-MR-12	-
	3.5	IPD/OB-MR-03	IPD/OB-MR-13	IPD/OB-MR-33
	4.5	IPD/OB-MR-04	-	IPD/OB-MR-34
	5.5	IPD/OB-MR-05	-	-



Our straight Multi-units can be used for single and multiple restorations. Please see [page 157](#) for the Multi-unit system accessories.

TEMPORARY ABUTMENT / OPEN TRAY COPING

Platform			Coping screw
ø3.5	IPD/OB-PN-06	IPD/OB-PN-07	IPD/OB-TN-00/C
ø4.0	IPD/OB-PR-06	IPD/OB-PR-07	IPD/OB-TR-00/C

The same abutment can be used as a temporary abutment with the occlusal screw or as an impression coping using the coping screw.



PSD OVERDENTURE ABUTMENT



Platform	Height (mm)	Reference
ø3.5	1.0	IPD/OB-LN-01
	2.0	IPD/OB-LN-02
	3.0	IPD/OB-LN-03
	4.0	IPD/OB-LN-04
	5.0	IPD/OB-LN-05
ø4.0	1.0	IPD/OB-LR-01
	2.0	IPD/OB-LR-02
	3.0	IPD/OB-LR-03
	4.0	IPD/OB-LR-04
	5.0	IPD/OB-LR-05



Please see [page 169](#) for the PSD system accessories.

STRAIGHT AND ANGLED CASTABLE ABUTMENT WITH A Co-Cr BASE

Straight, 15° & 25°

Platform	Angulation			
ø3.5	Straight	IPD/OB-BN-00	IPD/OB-BN-01	
	15°	IPD/OB-BN-10	IPD/OB-BN-11	
ø4.0	Straight	IPD/OB-BR-00	IPD/OB-BR-01	
	15°	IPD/OB-BR-10	IPD/OB-BR-11	
Co-Cr Base for digital workflow			Scan Body	
ø3.5	Straight / Angled	IPD/OB-BN-00/3D	IPD/OB-BN-01/3D	IPD/SC-AN-B1
ø4.0	Straight / Angled	IPD/OB-BR-00/3D	IPD/OB-BR-01/3D	IPD/SC-AN-B1



All angled castable abutments include a TPA screw.

HEALING ABUTMENT

Platform	Height (mm)	Reference
ø3.5	3.0	IPD/OB-DN-03
	5.0	IPD/OB-DN-05
	7.0	IPD/OB-DN-07
ø4.0	3.0	IPD/OB-DR-03
	5.0	IPD/OB-DR-05
	7.0	IPD/OB-DR-07



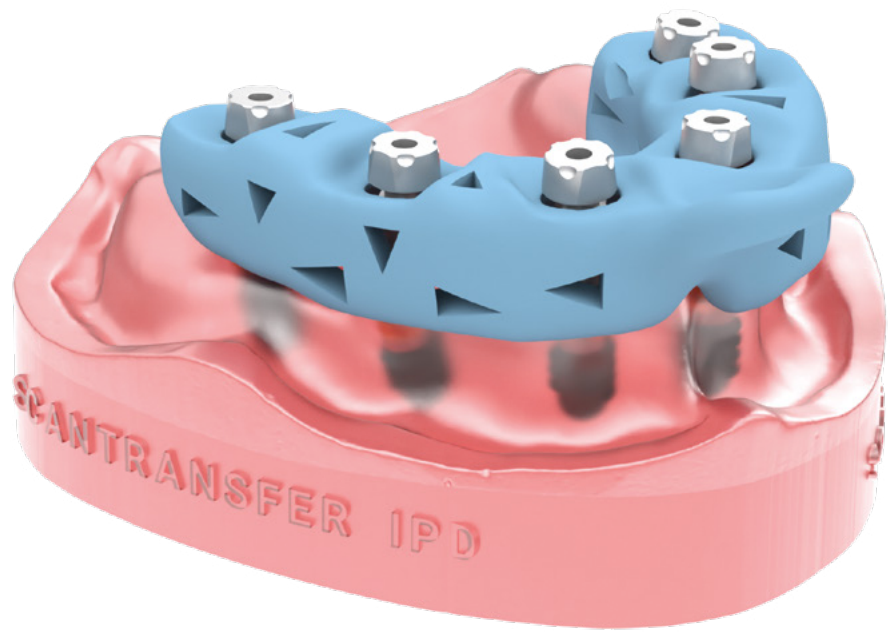



Compatibility



BIOTECH® DENTAL

QB Serie KONTACT®

[RP]





INTRA-ORAL / DESKTOP / CONTACT PROBE SCAN BODY

Platform	Height (mm)		
RP	10	IPD/QB-SR-00	IPD/QB-SR-01
	15	IPD/QB-SR-02	-

Captive screw included. 1.20 Hex Screwdriver.



Ti-BASE

Platform	Height (mm)		
RP	1.0	IPD/QB-IR-00/3D	IPD/QB-IR-01/3D
	2.0	IPD/QB-IR-02/3D	IPD/QB-IR-03/3D
	3.0	IPD/QB-IR-04/3D	IPD/QB-IR-05/3D

Please see [page 147](#) for the  accessories.



SCREW / TPA SCREW FOR ANGLED PROSTHESIS

Platform	Screwdriver	Seat	Reference	TiN Reference
RP	1.20 Hex	Conical	IPD/QB-TR-00	IPD/QB-TR-00/TiN
			IPD/QB-TR-01	-
	TPA	Conical	-	IPD/QB-TR-50

The IPD/QB-TR-01 model is an abutment extractor screw.

The IPD/QB-TR-01 abutment extractor screw cannot be used if angled systems are used with the Contact® system.

 Lengths 18/25/32 mm. Please see [page 184](#) for more information.

 Lengths 18/25/32 mm. Please see [page 186](#) for more information.



ANALOG / DIGITAL ANALOG

Platform	Reference	Digital reference
RP	IPD/QB-AR-00	IPD/QB-AR-00/3D
Bottom Screw	-	IPD/KA-TA-00
Side Screw	-	IPD/KA-TA-01



STRAIGHT AND ANGLED MULTI-UNIT ABUTMENT

Straight, 17° & 30°

Platform	Height (mm)	Straight	17°	30°
RP	1.5	IPD/QB-MR-01	-	-
	2.5	IPD/QB-MR-02	-	-
	3.5	IPD/QB-MR-03	IPD/QB-MR-13	-
	4.5	-	-	IPD/QB-MR-34

Our straight Multi-units can be used for single and multiple restorations. Please see [page 157](#) for the Multi-unit system accessories.



TEMPORARY ABUTMENT / OPEN TRAY COPING

Platform			Coping screw
RP	IPD/QB-PR-06	IPD/QB-PR-07	IPD/QB-TR-00/C

The same abutment can be used as a temporary abutment with the occlusal screw or as an impression coping using the coping screw.



PSD OVERDENTURE ABUTMENT

Platform	Height (mm)	Reference
RP	2.0	IPD/QB-LR-02
	3.0	IPD/QB-LR-03
	4.0	IPD/QB-LR-04

Please see [page 169](#) for the PSD system accessories.





HEALING ABUTMENT

Platform	Height (mm)	Reference
RP	1.5	IPD/QB-DR-01
	3.0	IPD/QB-DR-03
	5.0	IPD/QB-DR-05



STRAIGHT AND ANGLED CASTABLE ABUTMENT WITH A Co-Cr BASE

Straight, 15° & 25°

Platform	Angulation		
RP	Straight	IPD/QB-BR-00	IPD/QB-BR-01
	15°	IPD/QB-BR-10	IPD/QB-BR-11

Co-Cr Base for digital workflow	Scan Body			
RP	Straight	IPD/QB-BR-00/3D	IPD/QB-BR-01/3D	IPD/SC-AN-B1

All angled castable abutments include a TPA screw.





Compatibility

NEODENT®

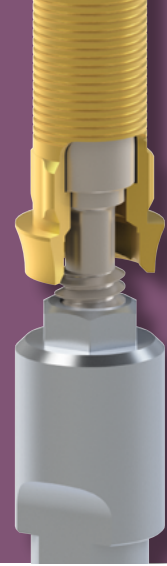

RA Serie HELIX® HE

[ϕ 3.3 / ϕ 4.1 / ϕ 5.0]



Neodent®



INTRA-ORAL / DESKTOP / CONTACT PROBE SCAN BODY

Platform	Height (mm)		
ϕ 3.3	10	IPD/RA-SN-00	IPD/RA-SN-01
	15	IPD/RA-SN-02	-
ϕ 4.1	10	IPD/AA-SR-00	IPD/AA-SR-01
	15	IPD/AA-SR-02	-
ϕ 5.0	10	IPD/RA-SW-00	IPD/RA-SW-01
	15	IPD/RA-SW-02	-



Captive screw included. 1.20 Hex Screwdriver.

Ti-BASE  Custom Ti-Base System®

Platform	Height (mm)		
ϕ 3.3	1.3	IPD/RA-IN-02/3D	IPD/RA-IN-03/3D
	2.5	IPD/RA-IN-04/3D	IPD/RA-IN-05/3D
	0.5	IPD/AA-IR-00/3D	IPD/AA-IR-01/3D
ϕ 4.1	1.5	IPD/AA-IR-02/3D	IPD/AA-IR-03/3D
	2.5	IPD/AA-IR-04/3D	IPD/AA-IR-05/3D
	1.3	IPD/RA-IW-02/3D	IPD/RA-IW-03/3D





Please see [page 147](#) for the  Custom Ti-Base System® accessories.

SCREW / TPA SCREW FOR ANGLED PROSTHESIS

Platform	Screwdriver	Seat	Reference	TiN Reference
ϕ 3.3	1.20 Hex	Flat	IPD/RA-TN-00	IPD/RA-TN-00/TiN
	Unigrip	Conical	IPD/AA-TR-00	IPD/AA-TR-00/TiN
ϕ 4.1	1.20 Hex	Conical	IPD/BA-TR-00	IPD/BA-TR-00/TiN
	Unigrip	Flat	IPD/AA-TR-02	IPD/AA-TR-02/TiN
	1.20 Hex	Low profile conical	IPD/AA-TR-01	IPD/AA-TR-01/TiN
ϕ 5.0	1.20 Hex	Flat	IPD/RA-TW-00	IPD/RA-TW-00/TiN
ϕ 3.3	TPA	Flat		IPD/RA-TN-50
ϕ 4.1	TPA	Conical		IPD/AA-TR-50
	TPA	Flat		IPD/AA-TR-52
ϕ 5.0	TPA	Flat		IPD/RA-TW-50



-  UNIGRIP Lengths 18/25/32 mm. Please see [page 185](#) for more information.
-  HEX 1.20 Lengths 18/25/32 mm. Please see [page 184](#) for more information.
-  Lengths 18/25/32 mm. Please see [page 186](#) for more information.

ANALOG / DIGITAL ANALOG

Platform	Reference	Reference
ø3.3	IPD/RA-AN-00	IPD/RA-AN-00/3D
ø4.1	IPD/AA-AR-00	IPD/AA-AR-00/3D
ø5.0	IPD/RA-AW-00	IPD/RA-AW-00/3D
Bottom Screw	-	IPD/KA-TA-00
Side screw	-	IPD/KA-TA-01



STRAIGHT AND ANGLED MULTI-UNIT ABUTMENT



Straight, 17° & 30°

Platform	Height (mm)	Straight	17°	30°
ø3.3	1.5	IPD/RA-MN-01	-	-
	2.5	IPD/RA-MN-02	IPD/RA-MN-12	-
	3.5	IPD/RA-MN-03	-	IPD/RA-MN-33
ø4.1	1.0	IPD/AB-MR-01	-	-
	2.0	IPD/AB-MR-02	IPD/AB-MR-12	-
	3.0	IPD/AB-MR-03	IPD/AB-MR-13	IPD/AB-MR-33
ø5.0	4.0	IPD/AB-MR-04	IPD/AB-MR-14	IPD/AB-MR-34
	5.0	IPD/AB-MR-05	-	IPD/AB-MR-35
	1.5	IPD/RA-MW-01	-	-
ø5.0	2.5	IPD/RA-MW-02	IPD/RA-MW-12	-
	3.5	IPD/RA-MW-03	-	IPD/RA-MW-33



Our straight Multi-units can be used for single and multiple restorations. Please see [page 157](#) for the Multi-unit system accessories.

TEMPORARY ABUTMENT / OPEN TRAY COPING

Platform			Coping screw
ø3.3	IPD/RA-PN-06	IPD/RA-PN-07	IPD/RA-TN-00/C
ø4.1	IPD/AA-PR-06	IPD/AA-PR-07	IPD/AA-TR-00/C
ø5.0	IPD/RA-PW-06	IPD/RA-PW-07	IPD/RA-TW-00/C

The same abutment can be used as a temporary abutment with the occlusal screw or as an impression coping using the coping screw.



OPEN AND CLOSED TRAY COPING



Platform	Reference	
ø4.1	Open tray coping	IPD/AA-CR-00
	Closed tray coping	IPD/AA-CR-01

Classic design.



STRAIGHT AND ANGLED CASTABLE ABUTMENT WITH A Co-Cr BASE

Straight, 15° & 25°

Platform	Angulation		
ø3.3	Straight	IPD/RA-BN-00	IPD/RA-BN-01
	15°	IPD/RA-BN-10	IPD/RA-BN-11
	Straight	IPD/AA-BR-00	IPD/AA-BR-01
ø4.1	15°	IPD/AA-BR-10	IPD/AA-BR-11
	25°	IPD/AA-BR-20	IPD/AA-BR-21
ø5.0	Straight	IPD/RA-BW-00	IPD/RA-BW-01

Co-Cr Base for digital workflow	Scan Body			
ø3.3	Straight / Angled	IPD/RA-BN-00/3D	IPD/RA-BN-01/3D	IPD/SC-AN-B1
ø4.1	Straight / Angled	IPD/AA-BR-00/3D	IPD/AA-BR-01/3D	IPD/SC-AN-B1
ø5.0	Straight / Angled	IPD/RA-BW-00/3D	IPD/RA-BW-01/3D	IPD/SC-AN-B1



All angled castable abutments include a TPA screw.

PSD OVERDENTURE ABUTMENT

Platform	Height (mm)	Reference
ø3.3	2.0	IPD/RA-LN-02
	3.0	IPD/RA-LN-03
	4.0	IPD/RA-LN-04
ø4.1	1.0	IPD/AA-LR-01
	2.0	IPD/AA-LR-02
	3.0	IPD/AA-LR-03
	4.0	IPD/AA-LR-04
	5.0	IPD/AA-LR-05
ø5.0	2.0	IPD/RA-LW-02
	3.0	IPD/RA-LW-03
	4.0	IPD/RA-LW-04

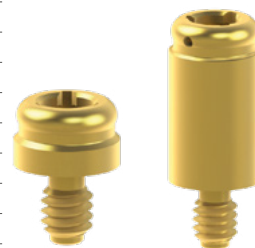

Please see [page 169](#) for the PSD system accessories.



HEALING ABUTMENT

Platform	Height (mm)	Reference
ø3.3	2.0	IPD/RA-DN-02
	3.0	IPD/RA-DN-03
	4.0	IPD/RA-DN-04
ø4.1	2.0	IPD/AA-DR-02
	3.0	IPD/AA-DR-03
	4.0	IPD/AA-DR-04
	5.0	IPD/AA-DR-05
	2.0	IPD/RA-DW-02
ø5.0	3.0	IPD/RA-DW-03
	4.0	IPD/RA-DW-04



STRAIGHT AND ANGLED ABUTMENT

Straight, 15° & 25°

Platform	Height (mm)	Angulation		
			IPD/AA-PR-00	IPD/AA-PR-01
ø4.1	1.0	Straight	IPD/AA-PR-00	IPD/AA-PR-01
		15°	IPD/AA-PR-02	-
	25°	IPD/AA-PR-03	-	
	2.0	15°	IPD/AA-PR-04	-
		25°	IPD/AA-PR-05	-

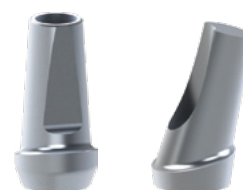

Using the low profile IPD/AA-TR-01 screw for IPD/AA-PR-03 is recommended.

CASTABLE

Platform		
ø4.1	IPD/AA-HR-00	IPD/AA-RR-00







Compatibility



NEODENT®

RB Serie GRAND MORSE™ GM
[GM]



Neodent®



INTRA-ORAL / DESKTOP / CONTACT PROBE SCAN BODY

Platform	Height (mm)		
GM	10	IPD/RB-SR-00	IPD/RB-SR-01
	15	IPD/RB-SR-02	-

Captive screw included. 1.20 Hex Screwdriver.



Ti-BASE  Custom Ti-Base System®

Platform	Height (mm)		
GM	1.0	IPD/RB-IR-00/3D	IPD/RB-IR-01/3D
	2.0	IPD/RB-IR-02/3D	IPD/RB-IR-03/3D
	3.0	IPD/RB-IR-04/3D	IPD/RB-IR-05/3D
	4.0	IPD/RB-IR-06/3D	IPD/RB-IR-07/3D

Please see [page 147](#) for the  Custom Ti-Base System® accessories.



SCREW / TPA SCREW FOR ANGLED PROSTHESIS

Platform	Screwdriver	Seat	Reference	TiN Reference
GM	Neo GM	Conical	IPD/RB-TR-00	IPD/RB-TR-00/TiN
	TPA	Conical	-	IPD/RB-TR-50

 Lengths 18/25/32 mm. Please see [page 185](#) for more information.

 Lengths 18/25/32 mm. Please see [page 186](#) for more information.



ANALOG / DIGITAL ANALOG

Platform	Reference	Digital reference
GM	IPD/RB-AR-00	IPD/RB-AR-00/3D
Bottom Screw	-	IPD/KA-TA-00
Side Screw	-	IPD/KA-TA-01



STRAIGHT AND ANGLED MULTI-UNIT ABUTMENT

Straight, 17° & 30°

Platform	Height (mm)	Straight	17°	30°
GM	1.5	IPD/RB-MR-01	-	-
	2.5	IPD/RB-MR-02	IPD/RB-MR-12	-
	3.5	IPD/RB-MR-03	-	IPD/RB-MR-33
	4.5	IPD/RB-MR-04	-	-

Our straight Multi-units can be used for single and multiple restorations. Please see [page 157](#) for the Multi-unit system accessories.



TEMPORARY ABUTMENT / OPEN TRAY COPING

Platform			Coping screw
GM	IPD/RB-PR-06	IPD/RB-PR-07	IPD/RB-TR-00/C

The same abutment can be used as a temporary abutment with the occlusal screw or as an impression coping using the coping screw.



PSD OVERDENTURE ABUTMENT

Platform	Height (mm)	Reference
GM	2.0	IPD/RB-LR-02
	3.0	IPD/RB-LR-03
	4.0	IPD/RB-LR-04
	5.0	IPD/RB-LR-05

Please see [page 169](#) for the PSD system accessories.





HEALING ABUTMENT

Platform	Height (mm)	Reference
GM	1.5	IPD/RB-DR-01
	3.0	IPD/RB-DR-03
	5.0	IPD/RB-DR-05
	7.0	IPD/RB-DR-07



STRAIGHT CASTABLE ABUTMENT WITH A Co-Cr BASE

Platform	Angulation			
GM		IPD/RB-BR-00	IPD/RB-BR-01	
Co-Cr Base for digital workflow				
Platform	Angulation	Reference	Scan Body	
GM	Straight / Angled	IPD/RB-BR-00/3D	IPD/RB-BR-01/3D	IPD/SC-AN-B1





Compatibility

NEODENT®

RC Serie GM ABUTMENT

[RP]

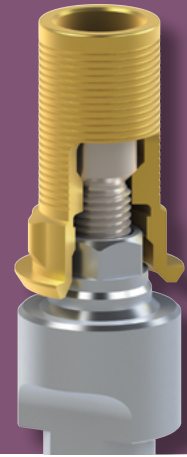

Neodent®

INTRA-ORAL / DESKTOP / CONTACT PROBE SCAN BODY

Platform	Height (mm)	
RP	10	IPD/RC-SR-00

Captive screw included. 1.20 Hex Screwdriver.



Ti-BASE Custom Ti-Base System®

Platform	Height (mm)	
RP	0.5	IPD/RC-IR-00/3D

Please see [page 147](#) for the  Custom Interface System® accessories. Use wide platform cutting guides.



SCREW / TPA SCREW FOR ANGLED PROSTHESIS

Platform	Screwdriver	Seat	Reference	TiN Reference
RP	Neo GM	Conical	IPD/RC-TR-00	IPD/RC-TR-00/TIN
	TPA	Conical	-	IPD/RC-TR-50

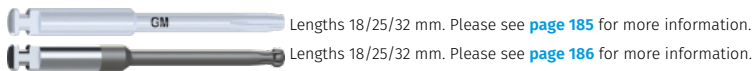

ANALOG / DIGITAL ANALOG

Platform	Reference	Digital reference
RP	IPD/RC-AR-00	IPD/RC-AR-00/3D
Bottom Screw	-	IPD/KA-TA-00
Side Screw	-	IPD/KA-TA-01



TEMPORARY ABUTMENT / OPEN TRAY COPING

Platform		Coping screw
RP	IPD/RC-PR-06	IPD/RC-TR-00/C

The same abutment can be used as a temporary abutment with the occlusal screw or as an impression coping using the coping screw.



HEALING ABUTMENT

Platform	Height (mm)	Reference
RP	4.75	IPD/RC-DR-03

IPD/RC-TR-00 screw not includes.



STRAIGHT AND ANGLED CASTABLE ABUTMENT WITH A Co-Cr BASE

Straight, 15° & 25°

Platform	Angulation	
	Straight	IPD/RC-BR-00
RP	15°	IPD/RC-BR-10
	25°	IPD/RC-BR-20
Co-Cr Base for digital workflow		Scan Body
RP	Straight / Angled	IPD/RC-BR-00/3D IPD/SC-AN-B1

All angled castable abutments include a TPA screw.





Compatibility

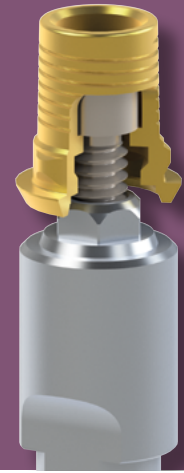

NEODENT®

RD Serie GM MICRO ABUTMENT
[ø3.5]



Neodent®



INTRA-ORAL / DESKTOP / CONTACT PROBE SCAN BODY

Platform	Height (mm)		
ø3.5	10	IPD/RD-SN-00	IPD/RD-SN-01

Captive screw included. 1.20 Hex Screwdriver.



Ti-BASE  Custom Ti-Base System®

Platform	Height (mm)		
ø3.5	0.3	-	IPD/RD-IN-01/3D
	0.5	IPD/RD-IN-00/3D	-

Please see [page 147](#) for the  Custom Ti-Base System® accessories.



SCREW / TPA SCREW FOR ANGLED PROSTHESIS

Platform	Screwdriver	Seat	Reference	TiN Reference
ø3.5	Neo GM	Flat	IPD/RD-TN-00	IPD/RD-TN-00/TIN
	TPA	Flat	-	IPD/RD-TN-50

 Lengths 18/25/32 mm. Please see [page 185](#) for more information.

 Lengths 18/25/32 mm. Please see [page 186](#) for more information.



ANALOG / DIGITAL ANALOG

Platform	Reference	Digital reference
ø3.5	IPD/RD-AN-00	IPD/RD-AN-00/3D
Bottom Screw	-	IPD/KA-TA-00
Side Screw	-	IPD/KA-TA-01



TEMPORARY ABUTMENT / OPEN TRAY COPING

Platform			Coping screw
ø3.5	IPD/RD-PN-06	IPD/RD-PN-07	IPD/RD-TN-00/C

The same abutment can be used as a temporary abutment with the occlusal screw or as an impression coping using the coping screw.





HEALING ABUTMENT

Platform	Height (mm)	Reference
ø3.5	3.25	IPD/RD-DN-03

IPD/RD-TN-00 screw not includes.



STRAIGHT CASTABLE ABUTMENT WITH A Co-Cr BASE

Platform	Angulation		
		IPD/RD-BN-00	IPD/RD-BN-01
ø3.5	15°	IPD/RD-BN-10	IPD/RD-BN-11
	25°	IPD/RD-BN-20	IPD/RD-BN-21

Co-Cr Base for digital workflow			Scan Body
ø3.5	Straight / Angled	IPD/RD-BN-00/3D	IPD/RD-BN-01/3D
			IPD/SC-AN-B1

All angled castable abutments include a TPA screw.





Compatibility

BEGO® SEMADOS®



SB Serie SC/RS

[ϕ 3.25 / ϕ 3.75 / ϕ 4.1 / ϕ 4.5]



Bego® Semados®

INTRA-ORAL / DESKTOP / CONTACT PROBE SCAN BODY

Platform	Height (mm)		
ϕ 3.25 ϕ 3.75	10	IPD/SB-SN-00	IPD/SB-SN-01
	15	IPD/SB-SN-02	-
ϕ 4.1	10	IPD/SB-SR-00	IPD/SB-SR-01
	15	IPD/SB-SR-02	-
ϕ 4.5	10	IPD/SB-SW-00	IPD/SB-SW-01
	15	IPD/SB-SW-02	-

Captive screw included. 1.20 Hex Screwdriver.



Ti-BASE Custom Ti-Base System®

Platform	Height (mm)		
ϕ 3.25 ϕ 3.75	0.5	IPD/SB-IN-00/3D	IPD/SB-IN-01/3D
	1.5	IPD/SB-IN-02/3D	IPD/SB-IN-03/3D
	2.5	IPD/SB-IN-04/3D	IPD/SB-IN-05/3D
ϕ 4.1	0.5	IPD/SB-IR-00/3D	IPD/SB-IR-01/3D
	1.5	IPD/SB-IR-02/3D	IPD/SB-IR-03/3D
	2.5	IPD/SB-IR-04/3D	IPD/SB-IR-05/3D
ϕ 4.5	0.5	IPD/SB-IW-00/3D	IPD/SB-IW-01/3D
	1.5	IPD/SB-IW-02/3D	IPD/SB-IW-03/3D
	2.5	IPD/SB-IW-04/3D	IPD/SB-IW-05/3D

Please see [page 147](#) for the  Custom Ti-Base System® accessories.



SCREW / TPA SCREW FOR ANGLED PROSTHESIS

Platform	Screwdriver	Seat	Reference	TiN Reference
ϕ 3.25 ϕ 3.75 ϕ 4.1 ϕ 4.5	1.25 Hex	Conical	IPD/SB-TR-00	IPD/SB-TR-00/TiN
ϕ 3.25 ϕ 3.75 ϕ 4.1 ϕ 4.5	TPA	Conical	-	IPD/SB-TR-50

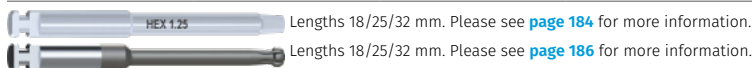

ANALOG / DIGITAL ANALOG

Platform	Reference	Digital reference
ϕ 3.25 ϕ 3.75	IPD/SB-AN-00	IPD/SB-AN-00/3D
ϕ 4.1	IPD/SB-AR-00	IPD/SB-AR-00/3D
ϕ 4.5	IPD/SB-AW-00	IPD/SB-AW-00/3D
Bottom Screw	-	IPD/KA-TA-00
Side Screw	-	IPD/KA-TA-01



STRAIGHT AND ANGLED MULTI-UNIT ABUTMENT



Straight, 17° & 30°

Platform	Height (mm)	Straight	17°	30°
ø3.25 ø3.75	1.5	IPD/SB-MN-01	-	-
	2.5	IPD/SB-MN-02	IPD/SB-MN-12	-
	3.5	IPD/SB-MN-03	IPD/SB-MN-13	IPD/SB-MN-33
	4.5	IPD/SB-MN-04	-	IPD/SB-MN-34
	5.5	IPD/SB-MN-05	-	-
ø4.1	1.5	IPD/SB-MR-01	-	-
	2.5	IPD/SB-MR-02	IPD/SB-MR-12	-
	3.5	IPD/SB-MR-03	-	IPD/SB-MR-33
	4.5	IPD/SB-MR-04	-	-
ø4.5	1.5	IPD/SB-MW-01	-	-
	2.5	IPD/SB-MW-02	IPD/SB-MW-12	-
	3.5	-	-	IPD/SB-MW-33



Our straight Multi-units can be used for single and multiple restorations. Please see [page 157](#) for the Multi-unit system accessories.

TEMPORARY ABUTMENT / OPEN TRAY COPING

Platform			Coping screw
ø3.25 ø3.75	IPD/SB-PN-06	IPD/SB-PN-07	IPD/SB-TR-00/C
ø4.1	IPD/SB-PR-06	IPD/SB-PR-07	
ø4.5	IPD/SB-PW-06	IPD/SB-PW-07	



The same abutment can be used as a temporary abutment with the occlusal screw or as an impression coping using the coping screw.

PSD OVERDENTURE ABUTMENT



Platform	Height (mm)	Reference
ø3.25 ø3.75	1.0	IPD/SB-LN-01
	2.0	IPD/SB-LN-02
	3.0	IPD/SB-LN-03
	4.0	IPD/SB-LN-04
	5.0	IPD/SB-LN-05
ø4.1	1.0	IPD/SB-LR-01
	2.0	IPD/SB-LR-02
	3.0	IPD/SB-LR-03
	4.0	IPD/SB-LR-04
	5.0	IPD/SB-LR-05
ø4.5	1.0	IPD/SB-LW-01
	2.0	IPD/SB-LW-02
	3.0	IPD/SB-LW-03
	4.0	IPD/SB-LW-04
	5.0	IPD/SB-LW-05



Please see page 169 for the PSD system accessories.

STRAIGHT AND ANGLED CASTABLE ABUTMENT WITH A Co-Cr BASE

Straight, 15° & 25°

Platform	Angulation		
ø3.25 ø3.75	Straight	IPD/SB-BN-00	IPD/SB-BN-01
	15°	IPD/SB-BN-10	IPD/SB-BN-11
	25°	IPD/SB-BN-20	IPD/SB-BN-21
ø4.1	Straight	IPD/SB-BR-00	IPD/SB-BR-01
	15°	IPD/SB-BR-10	IPD/SB-BR-11
	25°	IPD/SB-BR-20	IPD/SB-BR-21
ø4.5	Straight	IPD/SB-BW-00	IPD/SB-BW-01
	15°	IPD/SB-BW-10	IPD/SB-BW-11
	25°	IPD/SB-BW-20	IPD/SB-BW-21



Co-Cr Base for digital workflow			Scan Body	
ø3.25 ø3.75	Straight / Angled	IPD/SB-BN-00/3D	IPD/SB-BN-01/3D	IPD/SC-AN-B1
ø4.1	Straight / Angled	IPD/SB-BR-00/3D	IPD/SB-BR-01/3D	IPD/SC-AN-B1
ø4.5	Straight / Angled	IPD/SB-BW-00/3D	IPD/SB-BW-01/3D	IPD/SC-AN-B1

All angled castable abutments include a TPA screw.

HEALING ABUTMENT

Platform	Height (mm)	Reference
ø3.25 ø3.75	3.0	IPD/SB-DN-03
	5.0	IPD/SB-DN-05
	7.0	IPD/SB-DN-07
ø4.1	3.0	IPD/SB-DR-03
	5.0	IPD/SB-DR-05
	7.0	IPD/SB-DR-07
ø4.5	3.0	IPD/SB-DW-03
	5.0	IPD/SB-DW-05
	7.0	IPD/SB-DW-07







Compatibility



MIS[®]

TA Serie SEVEN[®]

[Narrow 3.3 / Standard / Wide]





INTRA-ORAL / DESKTOP / CONTACT PROBE SCAN BODY

Platform	Height (mm)		
Narrow 3.3	10	IPD/TA-ST-00	IPD/TA-ST-01
	15	IPD/TA-ST-02	-
Standard	10	IPD/FA-SN-00	IPD/FA-SN-01
	15	IPD/FA-SN-02	-
Wide	10	IPD/FA-SR-00	IPD/FA-SR-01
	15	IPD/FA-SR-02	-

Captive screw included. 1.20 Hex Screwdriver.



Ti-BASE Custom Ti-Base System[®]

Platform	Height (mm)		
Narrow 3.3	0.5	IPD/TA-IT-00/3D	IPD/TA-IT-01/3D
	1.5	IPD/TA-IT-02/3D	IPD/TA-IT-03/3D
	2.5	IPD/TA-IT-04/3D	IPD/TA-IT-05/3D
Standard	0.5	IPD/FA-IN-00/3D	IPD/FA-IN-01/3D
	1.5	IPD/FA-IN-02/3D	IPD/FA-IN-03/3D
	2.5	IPD/FA-IN-04/3D	IPD/FA-IN-05/3D
Wide	0.5	IPD/FA-IR-00/3D	IPD/FA-IR-01/3D
	1.5	IPD/FA-IR-02/3D	IPD/FA-IR-03/3D
	2.5	IPD/FA-IR-04/3D	IPD/FA-IR-05/3D

Please see [page 147](#) for the  Custom Ti-Base System[®] accessories.



SCREW / TPA SCREW FOR ANGLED PROSTHESIS

Platform	Screwdriver	Seat	Reference	TiN Reference
Narrow 3.3	1.25 Hex	Conical	IPD/TA-TT-00	IPD/TA-TT-00/TiN
Standard / Wide	1.25 Hex	Conical	IPD/FA-TR-00	IPD/FA-TR-00/TiN
Narrow 3.3	TPA	Conical	-	IPD/TA-TT-50
Standard / Wide	TPA	Conical	-	IPD/FA-TR-50

 Lengths 18/25/32 mm. Please see [page 184](#) for more information.

 Lengths 18/25/32 mm. Please see [page 186](#) for more information.

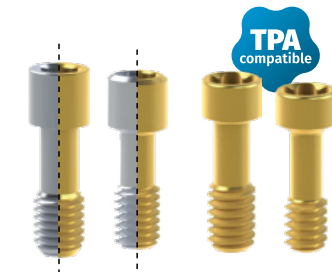

ANALOG / DIGITAL ANALOG

Platform	Reference	Digital reference
Narrow 3.3	IPD/TA-AT-00	IPD/TA-AT-00/3D
Standard	IPD/FA-AN-00	IPD/FA-AN-00/3D
Wide	IPD/FA-AR-00	IPD/FA-AR-00/3D
Bottom Screw	-	IPD/KA-TA-00
Side Screw	-	IPD/KA-TA-01



STRAIGHT AND ANGLED MULTI-UNIT ABUTMENT



Straight, 17° & 30°

Platform	Height (mm)	Straight	17°	30°
Standard	0.9	IPD/FA-MN-00	-	-
	1.5	IPD/FA-MN-01	-	-
	2.5	IPD/FA-MN-02	IPD/FA-MN-12	-
	3.5	IPD/FA-MN-03	IPD/FA-MN-13	IPD/FA-MN-33
	4.5	IPD/FA-MN-04	-	IPD/FA-MN-34
Wide	1.5	IPD/FA-MR-01	-	-
	2.5	IPD/FA-MR-02	-	-
	3.0	-	IPD/FA-MR-13	-
	3.5	IPD/FA-MR-03	-	IPD/FA-MR-33
	4.0	-	IPD/FA-MR-14	-
	4.5	IPD/FA-MR-04	-	IPD/FA-MR-34

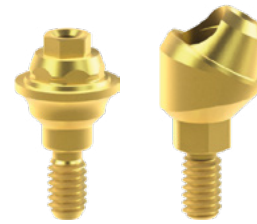
Our straight Multi-units can be used for single and multiple restorations. Please see [page 157](#) for the Multi-unit system accessories.



TEMPORARY ABUTMENT / OPEN TRAY COPING

Platform			Coping screw
Narrow 3.3	IPD/TA-PT-06	IPD/TA-PT-07	IPD/TA-TT-00/C
Standard	IPD/FA-PN-06	IPD/FA-PN-07	IPD/FA-TR-00/C
Wide	IPD/FA-PR-06	IPD/FA-PR-07	IPD/FA-TR-00/C

The same abutment can be used as a temporary abutment with the occlusal screw or as an impression coping using the coping screw.



OPEN TRAY COPING

Platform	Reference
Standard	Open tray coping IPD/FA-CN-00

Classic design.



PSD OVERDENTURE ABUTMENT



Platform	Height (mm)	Reference
Narrow 3.3	1.0	IPD/TA-LT-01
	2.0	IPD/TA-LT-02
	3.0	IPD/TA-LT-03
	4.0	IPD/TA-LT-04
	5.0	IPD/TA-LT-05
Standard	1.0	IPD/FA-LN-01
	2.0	IPD/FA-LN-02
	3.0	IPD/FA-LN-03
	4.0	IPD/FA-LN-04
	5.0	IPD/FA-LN-05
Wide	1.0	IPD/FA-LR-01
	2.0	IPD/FA-LR-02
	3.0	IPD/FA-LR-03
	4.0	IPD/FA-LR-04
	5.0	IPD/FA-LR-05



Please see [page 169](#) for the PSD system accessories.

STRAIGHT AND ANGLED CASTABLE ABUTMENT WITH A Co-Cr BASE

Straight, 15° & 25°

Platform	Angulation		
Narrow 3.3	Straight	IPD/TA-BT-00	IPD/TA-BT-01
	15°	IPD/TA-BT-10	IPD/TA-BT-11
	25°	IPD/TA-BT-20	IPD/TA-BT-21
Standard	Straight	IPD/FA-BN-00	IPD/FA-BN-01
	15°	IPD/FA-BN-10	IPD/FA-BN-11
	25°	IPD/FA-BN-20	IPD/FA-BN-21
Wide	Straight	IPD/FA-BR-00	IPD/FA-BR-01
	15°	IPD/FA-BR-10	IPD/FA-BR-11
	25°	IPD/FA-BR-20	IPD/FA-BR-21



Co-Cr Base for digital workflow			Scan Body	
Narrow 3.3	Straight / Angled	IPD/TA-BT-00/3D	IPD/TA-BT-01/3D	IPD/SC-AN-B1
Standard	Straight / Angled	IPD/FA-BN-00/3D	IPD/FA-BN-01/3D	IPD/SC-AN-B1
Wide	Straight	IPD/FA-BR-00/3D	IPD/FA-BR-01/3D	IPD/SC-AN-B1
	Angled	IPD/FA-BR-A0/3D	IPD/FA-BR-A1/3D	IPD/SC-AN-B1

All angled castable abutments include a TPA screw.

HEALING ABUTMENT

Platform	Height (mm)	Reference
Narrow 3.3	2.0	IPD/TA-DT-02
	3.0	IPD/TA-DT-03
	4.0	IPD/TA-DT-04
	5.0	IPD/TA-DT-05
	Standard	1.5
Standard	3.0	IPD/FA-DN-03
	5.0	IPD/FA-DN-05
Wide	1.5	IPD/FA-DR-01
	3.0	IPD/FA-DR-03
	5.0	IPD/FA-DR-05





STRAIGHT AND ANGLED ABUTMENT

Straight, 15° & 25°

Platform	Height (mm)	Angulation	
Standard	1.0	Straight	IPD/FA-PN-00
		15°	IPD/FA-PN-02
		25°	IPD/FA-PN-04
Standard	2.0	Straight	IPD/FA-PN-01
		15°	IPD/FA-PN-03
		25°	IPD/FA-PN-05



CASTABLE

Platform		
Standard	IPD/FA-HN-00	IPD/FA-RN-00
Wide	IPD/FA-HR-00	IPD/FA-RR-00



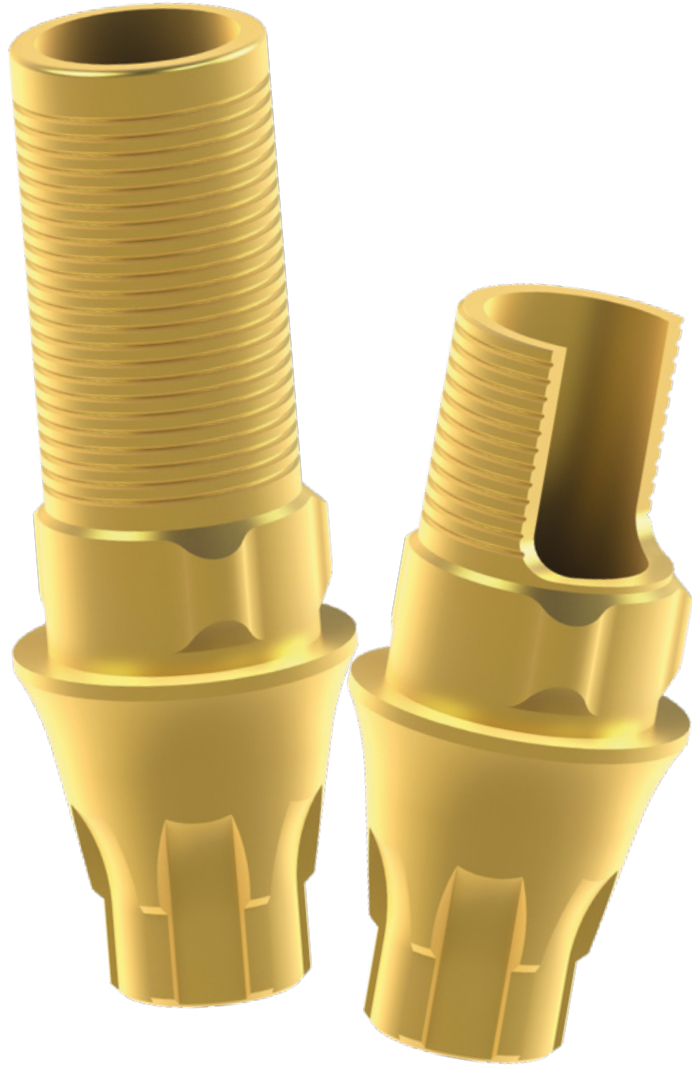



Compatibility

MIS[®]

TB Serie C1/V3[®]

[Standard]



INTRA-ORAL / DESKTOP / CONTACT PROBE SCAN BODY

Platform	Height (mm)		
Standard	10	IPD/TB-SR-00	IPD/TB-SR-01
	15	IPD/TB-SR-02	-

Captive screw included. 1.20 Hex Screwdriver.



Ti-BASE Custom Ti-Base System[®]

Platform	Height (mm)		
Standard	0.7	IPD/TB-IR-00/3D	IPD/TB-IR-01/3D
	1.5	IPD/TB-IR-02/3D	IPD/TB-IR-03/3D
	2.5	IPD/TB-IR-04/3D	IPD/TB-IR-05/3D
	3.5	IPD/TB-IR-06/3D	IPD/TB-IR-07/3D

High version of the non-engaging Custom Ti-Base subject to availability. Please see [page 147](#) for the Custom Ti-Base System[®] accessories.



SCREW / TPA SCREW FOR ANGLED PROSTHESIS

Platform	Screwdriver	Seat	Reference	TiN Reference
Standard	1.25 Hex	Conical	IPD/TB-TR-00	IPD/TB-TR-00/TiN
	TPA	Conical	-	IPD/TB-TR-50

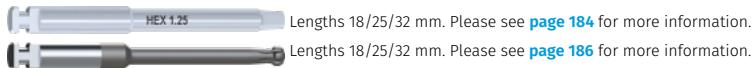

ANALOG / DIGITAL ANALOG

Platform	Reference	Digital reference
Standard	IPD/TB-AR-00	IPD/TB-AR-00/3D
Bottom Screw	-	IPD/KA-TA-00
Side Screw	-	IPD/KA-TA-01



STRAIGHT AND ANGLED MULTI-UNIT ABUTMENT

Straight, 17° & 30°

Platform	Height (mm)	Straight	17°	30°
Standard	1.0	IPD/TB-MR-01	-	-
	2.0	IPD/TB-MR-02	-	-
	2.5	-	IPD/TB-MR-12	-
	3.0	IPD/TB-MR-03	-	-
	3.5	-	-	IPD/TB-MR-33
	4.0	IPD/TB-MR-04	-	-

Our straight Multi-units can be used for single and multiple restorations. Please see [page 157](#) for the Multi-unit system accessories.



TEMPORARY ABUTMENT / OPEN TRAY COPING

Platform			Coping screw
Standard	IPD/TB-PR-06	IPD/TB-PR-07	IPD/TB-TR-00/C

The same abutment can be used as a temporary abutment with the occlusal screw or as an impression coping using the coping screw.



PSD OVERDENTURE ABUTMENT

Platform	Height (mm)	Reference
Standard	1.0	IPD/TB-LR-01
	2.0	IPD/TB-LR-02
	3.0	IPD/TB-LR-03
	4.0	IPD/TB-LR-04
	5.0	IPD/TB-LR-05

Please see [page 169](#) for the PSD system accessories.





HEALING ABUTMENT

Platform	Height (mm)	Reference
Standard	2.0	IPD/TB-DR-02
	3.0	IPD/TB-DR-03
	4.0	IPD/TB-DR-04
	5.0	IPD/TB-DR-05



STRAIGHT AND ANGLED CASTABLE ABUTMENT WITH A Co-Cr BASE

Straight, 15° & 25°

Platform	Angulation		
Standard	Straight	IPD/TB-BR-00	IPD/TB-BR-01
	15°	IPD/TB-BR-10	IPD/TB-BR-11
	25°	IPD/TB-BR-20	IPD/TB-BR-21

Co-Cr Base for digital workflow			Scan Body	
Standard	Straight / Angled	IPD/TB-BR-00/3D	IPD/TB-BR-01/3D	IPD/SC-AN-B1

All angled castable abutments include a TPA screw.





Compatibility



DIO®

UB Serie UFII

[NP/RP]





INTRA-ORAL / DESKTOP / CONTACT PROBE SCAN BODY

Platform	Height (mm)		
NP	10	IPD/UB-SN-00	IPD/UB-SN-01
	15	IPD/UB-SN-02	-
RP	10	IPD/UB-SR-00	IPD/UB-SR-01
	15	IPD/UB-SR-02	-

Captive screw included. 1.20 Hex Screwdriver.



Ti-BASE Custom Ti-Base System®

Platform	Height (mm)		
NP	1.0	IPD/UB-IN-00/3D	IPD/UB-IN-01/3D
	2.0	IPD/UB-IN-02/3D	IPD/UB-IN-03/3D
	3.0	IPD/UB-IN-04/3D	IPD/UB-IN-05/3D
RP	1.0	IPD/UB-IR-00/3D	IPD/UB-IR-01/3D
	2.0	IPD/UB-IR-02/3D	IPD/UB-IR-03/3D
	3.0	IPD/UB-IR-04/3D	IPD/UB-IR-05/3D

Please see [page 147](#) for the  Custom Ti-Base System® accessories.



SCREW / TPA SCREW FOR ANGLED PROSTHESIS

Platform	Screwdriver	Seat	Reference	TiN Reference
NP	1.20 Hex	Conical	IPD/UB-TN-00	IPD/UB-TN-00/TiN
RP	1.20 Hex	Conical	IPD/UB-TR-00	IPD/UB-TR-00/TiN
NP	TPA	Conical	-	IPD/UB-TN-50
RP	TPA	Conical	-	IPD/UB-TR-50



ANALOG / DIGITAL ANALOG

Platform	Reference	Digital reference
NP	IPD/UB-AN-00	IPD/UB-AN-00/3D
RP	IPD/UB-AR-00	IPD/UB-AR-00/3D
Bottom Screw	-	IPD/KA-TA-00
Side Screw	-	IPD/KA-TA-01



STRAIGHT AND ANGLED MULTI-UNIT ABUTMENT



Straight, 17° & 30°

Platform	Height (mm)	Straight	17°	30°
NP	1.5	IPD/UB-MN-01	-	-
	2.5	IPD/UB-MN-02	IPD/UB-MN-12	-
	3.5	IPD/UB-MN-03	-	IPD/UB-MN-33
RP	1.5	IPD/UB-MR-01	-	-
	2.5	IPD/UB-MR-02	IPD/UB-MR-12	-
	3.5	IPD/UB-MR-03	-	IPD/UB-MR-33

Our straight Multi-units can be used for single and multiple restorations. Please see [page 157](#) for the Multi-unit system accessories.



TEMPORARY ABUTMENT / OPEN TRAY COPING

Platform			Coping screw
NP	IPD/UB-PN-06	IPD/UB-PN-07	IPD/UB-TN-00/C
RP	IPD/UB-PR-06	IPD/UB-PR-07	IPD/UB-TR-00/C

The same abutment can be used as a temporary abutment with the occlusal screw or as an impression coping using the coping screw.



PSD OVERDENTURE ABUTMENT

Platform	Height (mm)	Reference
NP	2.0	IPD/UB-LN-02
	3.0	IPD/UB-LN-03
	4.0	IPD/UB-LN-04
RP	2.0	IPD/UB-LR-02
	3.0	IPD/UB-LR-03
	4.0	IPD/UB-LR-04

Please see [page 169](#) for the PSD system accessories.





HEALING ABUTMENT

Platform	Height (mm)	Reference
NP	2.0	IPD/UB-DN-02
	3.5	IPD/UB-DN-03
	5.0	IPD/UB-DN-05
RP	2.0	IPD/UB-DR-02
	3.5	IPD/UB-DR-03
	5.0	IPD/UB-DR-05



STRAIGHT AND ANGLED CASTABLE ABUTMENT WITH A Co-Cr BASE

Straight, 15° & 25°

Platform	Angulation		
NP	Straight	IPD/UB-BN-00	IPD/UB-BN-01
	15°	IPD/UB-BN-10	IPD/UB-BN-11
RP	Straight	IPD/UB-BR-00	IPD/UB-BR-01

Co-Cr Base for digital workflow			Scan Body	
NP	Straight / Angled	IPD/UB-BN-00/3D	IPD/UB-BN-01/3D	IPD/SC-AN-B1
RP	Straight / Angled	IPD/UB-BR-00/3D	IPD/UB-BR-01/3D	IPD/SC-AN-B1

All angled castable abutments include a TPA screw.





Compatibility



MEGAGEN[®]

WA Serie ANYONE[®]

[RP]





INTRA-ORAL / DESKTOP / CONTACT PROBE SCAN BODY

Platform	Height (mm)		
RP	10	IPD/WA-SR-00	IPD/WA-SR-01
	15	IPD/WA-SR-02	-

Captive screw included. 1.20 Hex Screwdriver.



Ti-BASE Custom Ti-Base System[®]

Platform	Height (mm)		
RP	1.0	IPD/WA-IR-00/3D	IPD/WA-IR-01/3D
	2.0	IPD/WA-IR-02/3D	IPD/WA-IR-03/3D
	3.0	IPD/WA-IR-04/3D	IPD/WA-IR-05/3D

Please see [page 147](#) for the  Custom Ti-Base System[®] accessories.



SCREW / TPA SCREW FOR ANGLED PROSTHESIS

Platform	Screwdriver	Seat	Reference	TiN Reference
RP	1.20 Hex	Conical	IPD/WA-TR-00	IPD/WA-TR-00/TIN
	TPA	Conical	-	IPD/WA-TR-50



ANALOG / DIGITAL ANALOG

Platform	Reference	Reference
RP	IPD/WA-AR-00	IPD/WA-AR-00/3D
Bottom Screw	-	IPD/KA-TA-00
Side Screw	-	IPD/KA-TA-01



STRAIGHT AND ANGLED MULTI-UNIT ABUTMENT

Straight, 17° & 30°

Platform	Height (mm)	Straight	17°	30°
RP	1.5	IPD/WA-MR-01	-	-
	2.5	IPD/WA-MR-02	IPD/WA-MR-12	-
	3.5	IPD/WA-MR-03	-	IPD/WA-MR-33

Our straight Multi-units can be used for single and multiple restorations. Please see [page 157](#) for the Multi-unit system accessories.



TEMPORARY ABUTMENT / OPEN TRAY COPING

Platform			Coping screw
RP	IPD/WA-PR-06	IPD/WA-PR-07	IPD/WA-TR-00/C

The same abutment can be used as a temporary abutment with the occlusal screw or as an impression coping using the coping screw.



PSD OVERDENTURE ABUTMENT

Platform	Height (mm)	Reference
RP	2.0	IPD/WA-LR-02
	3.0	IPD/WA-LR-03
	4.0	IPD/WA-LR-04
	5.0	IPD/WA-LR-05

Please see [page 169](#) for the PSD system accessories.





HEALING ABUTMENT

Platform	Height (mm)	Reference
RP	3.0	IPD/WA-DR-03
	5.0	IPD/WA-DR-05
	7.0	IPD/WA-DR-07



STRAIGHT CASTABLE ABUTMENT WITH A CO-CR BASE

Platform	Angulation			
RP	Straight	IPD/WA-BR-00	IPD/WA-BR-01	
Co-Cr Base for digital workflow				Scan Body
RP	Straight / Angled	IPD/WB-BR-00/3D	IPD/WB-BR-01/3D	IPD/SC-AN-B1





Compatibility



MEGAGEN[®]

WB Serie ANYRIDGE[®]

[ϕ 4.0]





INTRA-ORAL / DESKTOP / CONTACT PROBE SCAN BODY

Platform	Height (mm)		
ϕ 4.0	10	IPD/WB-SR-00	IPD/WB-SR-01
	15	IPD/WB-SR-02	-

Captive screw included. 1.20 Hex Screwdriver.



Ti-BASE Custom Ti-Base System[®]

Platform	Height (mm)		
ϕ 4.0	1.0	IPD/WB-IR-00/3D	IPD/WB-IR-01/3D
	2.0	IPD/WB-IR-02/3D	IPD/WB-IR-03/3D
	3.0	IPD/WB-IR-04/3D	IPD/WB-IR-05/3D

Please see [page 147](#) for the  Custom Ti-Base System[®] accessories.

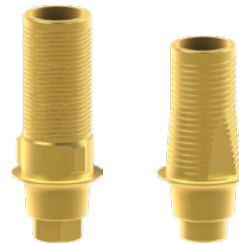

SCREW

Platform	Screwdriver	Seat	Reference	TiN Reference
ϕ 4.0	1.20 Hex	Flat	IPD/WB-TR-00	IPD/WB-TR-00/TiN
			-	IPD/WB-TR-01

The IPD/WB-TR-01 model is an abutment extractor screw.

 Lengths 18/25/32 mm. Please see [page 184](#) for more information.

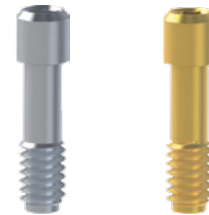

ANALOG / DIGITAL ANALOG

Platform	Reference	Digital reference
ϕ 4.0	IPD/WB-AR-00	IPD/WB-AR-00/3D
Bottom Screw	-	IPD/KA-TA-00
Side Screw	-	IPD/KA-TA-01



STRAIGHT AND ANGLED MULTI-UNIT ABUTMENT

Straight, 17° & 30°

Platform	Height (mm)	Straight	17°	30°
ø4.0	1.5	IPD/WB-MR-01	-	-
	2.5	IPD/WB-MR-02	IPD/WB-MR-12	-
	3.5	IPD/WB-MR-03	-	IPD/WB-MR-33

Our straight Multi-units can be used for single and multiple restorations. Please see [page 157](#) for the Multi-unit system accessories.



TEMPORARY ABUTMENT / OPEN TRAY COPING

Platform			Coping screw
ø4.0	IPD/WB-PR-06	IPD/WB-PR-07	IPD/WB-TR-00/C

The same abutment can be used as a temporary abutment with the occlusal screw or as an impression coping using the coping screw.



PSD OVERDENTURE ABUTMENT

Platform	Height (mm)	Reference
ø4.0	2.0	IPD/WB-LR-02
	3.0	IPD/WB-LR-03
	4.0	IPD/WB-LR-04
	5.0	IPD/WB-LR-05

Please see [page 169](#) for the PSD system accessories.





HEALING ABUTMENT

Platform	Height (mm)	Reference
ø4.0	1.5	IPD/WB-DR-01
	3.0	IPD/WB-DR-03
	5.0	IPD/WB-DR-05



STRAIGHT CASTABLE ABUTMENT WITH A Co-Cr BASE

Platform	Angulation		
ø4.0	Straight	IPD/WB-BR-00	IPD/WB-BR-01

Co-Cr Base for digital workflow	Scan Body			
ø4.0	Straight	IPD/WB-BR-00/3D	IPD/WB-BR-01/3D	IPD/SC-AN-B1

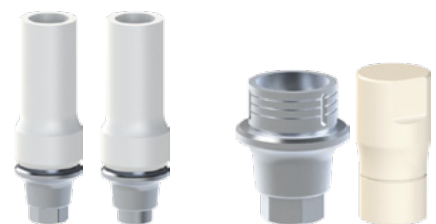





Compatibility

DENTIUM[®]

XA Serie IMPLANTIUM[®]/SUPERLINE[™]
[RP]





INTRA-ORAL / DESKTOP / CONTACT PROBE SCAN BODY

Platform	Height (mm)		
RP	10	IPD/XA-SR-00	IPD/XA-SR-01
	15	IPD/XA-SR-02	-

Captive screw included. 1.20 Hex Screwdriver.



Ti-BASE  Custom Ti-Base System[®]

Platform	Height (mm)		
	1.0	IPD/XA-IR-00/3D	IPD/XA-IR-01/3D
RP	2.0	IPD/XA-IR-02/3D	IPD/XA-IR-03/3D
	3.0	IPD/XA-IR-04/3D	IPD/XA-IR-05/3D

High version of the non-engaging Custom Ti-Base subject to availability.
Please see [page 147](#) for the  Custom Ti-Base System[®] accessories.



SCREW / TPA SCREW FOR ANGLED PROSTHESIS

Platform	Screwdriver	Seat	Reference	TiN Reference
RP	1.27 Hex	Conical	IPD/XA-TR-00	IPD/XA-TR-00/TIN
	TPA	Conical	-	IPD/XA-TR-50



ANALOG / DIGITAL ANALOG

Platform	Reference	Digital reference
RP	IPD/XA-AR-00	IPD/XA-AR-00/3D
Bottom Screw	-	IPD/KA-TA-00
Side Screw	-	IPD/KA-TA-01



STRAIGHT AND ANGLED MULTI-UNIT ABUTMENT



Straight, 17° & 30°

Platform	Height (mm)	Straight	17°	30°
RP	1.5	IPD/XA-MR-01	-	-
	2.5	IPD/XA-MR-02	IPD/XA-MR-12	-
	3.5	IPD/XA-MR-03	-	IPD/XA-MR-33

Our straight Multi-units can be used for single and multiple restorations. Please see [page 157](#) for the Multi-unit system accessories.



TEMPORARY ABUTMENT / OPEN TRAY COPING

Platform			Coping screw
RP	IPD/XA-PR-06	IPD/XA-PR-07	IPD/XA-TR-00/C

The same abutment can be used as a temporary abutment with the occlusal screw or as an impression coping using the coping screw.



PSD OVERDENTURE ABUTMENT

Platform	Height (mm)	Reference
RP	2.0	IPD/XA-LR-02
	3.0	IPD/XA-LR-03
	4.0	IPD/XA-LR-04
	5.0	IPD/XA-LR-05

Please see [page 169](#) for the PSD system accessories.





HEALING ABUTMENT

Platform	Height (mm)	Reference
RP	2.0	IPD/XA-DR-02
	3.5	IPD/XA-DR-03
	5.0	IPD/XA-DR-05



STRAIGHT CASTABLE ABUTMENT WITH A Co-Cr BASE

Platform	Angulation		
RP	Straight	IPD/XA-BR-00	IPD/XA-BR-01

Co-Cr Base for digital workflow			Scan Body
RP	Straight / Angled	IPD/XA-BR-00/3D	IPD/SC-AN-B1





Compatibility



MEDENTIS®

YB Serie ICX

[RP]





INTRA-ORAL / DESKTOP / CONTACT PROBE SCAN BODY

Platform	Height (mm)		
RP	10	IPD/YB-SR-00	IPD/YB-SR-01
	15	IPD/YB-SR-02	-

Captive screw included. 1.20 Hex Screwdriver.



Ti-BASE Custom Ti-Base System®

Platform	Height (mm)		
RP	1.0	IPD/YB-IR-00/3D	IPD/YB-IR-01/3D
	2.0	IPD/YB-IR-02/3D	IPD/YB-IR-03/3D
	3.0	IPD/YB-IR-04/3D	IPD/YB-IR-05/3D

Please see [page 147](#) for the  Custom Ti-Base System® accessories.



SCREW / TPA SCREW FOR ANGLED PROSTHESIS

Platform	Screwdriver	Seat	Reference	TiN Reference
RP	1.40 Hex	Conical	IPD/YB-TR-00	IPD/YB-TR-00/TiN
	TPA	Conical	-	IPD/YB-TR-50

 Lengths 18/25/32 mm. Please see [page 184](#) for more information.

 Lengths 18/25/32 mm. Please see [page 186](#) for more information.



ANALOG / DIGITAL ANALOG

Platform	Reference	Digital reference
RP	IPD/YB-AR-00	IPD/YB-AR-00/3D
Bottom Screw	-	IPD/KA-TA-00
Side Screw	-	IPD/KA-TA-01



STRAIGHT AND ANGLED MULTI-UNIT ABUTMENT



Straight, 17° & 30°

Platform	Height (mm)	Straight	17°	30°
RP	1.5	IPD/YB-MR-01	-	-
	2.5	IPD/YB-MR-02	IPD/YB-MR-12	-
	3.5	IPD/YB-MR-03	-	IPD/YB-MR-33

Our straight Multi-units can be used for single and multiple restorations. Please see [page 157](#) for the Multi-unit system accessories.



TEMPORARY ABUTMENT / OPEN TRAY COPING

Platform			Coping screw
RP	IPD/YB-PR-06	IPD/YB-PR-07	IPD/YB-TR-00/C

The same abutment can be used as a temporary abutment with the occlusal screw or as an impression coping using the coping screw.



PSD OVERDENTURE ABUTMENT

Platform	Height (mm)	Reference
RP	2.0	IPD/YB-LR-02
	3.0	IPD/YB-LR-03
	4.0	IPD/YB-LR-04
	5.0	IPD/YB-LR-05

Please see [page 169](#) for the PSD system accessories.





HEALING ABUTMENT

Platform	Height (mm)	Reference
RP	1.0	IPD/YB-DR-01
	2.5	IPD/YB-DR-02
	4.0	IPD/YB-DR-04



STRAIGHT CASTABLE ABUTMENT WITH A Co-Cr BASE

Platform	Angulation		
RP	Straight	IPD/YB-BR-00	IPD/YB-BR-01
	15°	IPD/YB-BR-10	IPD/YB-BR-11
	25°	IPD/YB-BR-20	IPD/YB-BR-21

Co-Cr Base for digital workflow			Scan Body	
RP	Straight / Angled	IPD/YB-BR-00/3D	IPD/YB-BR-01/3D	IPD/SC-AN-B1

All angled castable abutments include a TPA screw.





Compatibility



GLOBAL D[®]

1A Serie IN-KONE[®]

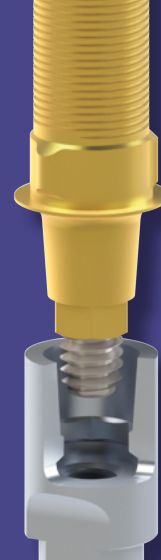
[RP]





INTRA-ORAL / DESKTOP / CONTACT PROBE SCAN BODY

Platform	Height (mm)		
RP	10	IPD/1A-SR-00	IPD/1A-SR-01
	15	IPD/1A-SR-02	-

Captive screw included. 1.20 Hex Screwdriver.



Ti-BASE Custom Ti-Base System[®]

Platform	Height (mm)		
RP	1.0	IPD/1A-IR-00/3D	IPD/1A-IR-01/3D
	2.0	IPD/1A-IR-02/3D	IPD/1A-IR-03/3D
	3.0	IPD/1A-IR-04/3D	IPD/1A-IR-05/3D

Please see [page 147](#) for the  Custom Ti-Base System[®] accessories.



SCREW

Platform	Screwdriver	Seat	Reference	TiN Reference
RP	1.20 Hex	Conical	IPD/1A-TR-00	IPD/1A-TR-00/TiN
			IPD/1A-TR-01	-

The IPD/1A-TR-01 model is an abutment extractor screw.

 Lengths 18/25/32 mm. Please see [page 184](#) for more information.



ANALOG / DIGITAL ANALOG

Platform	Reference	Digital reference
RP	IPD/1A-AR-00	IPD/1A-AR-00/3D
Bottom Screw	-	IPD/KA-TA-00
Side Screw	-	IPD/KA-TA-01



STRAIGHT AND ANGLED MULTI-UNIT ABUTMENT



Straight, 17° & 30°

Platform	Height (mm)	Straight	17°	30°
RP	1.5	IPD/1A-MR-01	-	-
	2.5	IPD/1A-MR-02	IPD/1A-MR-12	-
	3.5	IPD/1A-MR-03	-	IPD/1A-MR-33

Our straight Multi-units can be used for single and multiple restorations. Please see [page 157](#) for the Multi-unit system accessories.



TEMPORARY ABUTMENT / OPEN TRAY COPING

Platform			Coping screw
RP	IPD/1A-PR-06	IPD/1A-PR-07	IPD/1A-TR-00/C

The same abutment can be used as a temporary abutment with the occlusal screw or as an impression coping using the coping screw.

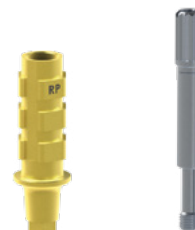

PSD OVERDENTURE ABUTMENT

Platform	Height (mm)	Reference
RP	2.0	IPD/1A-LR-02
	3.0	IPD/1A-LR-03
	4.0	IPD/1A-LR-04
	5.0	IPD/1A-LR-05

Please see [page 169](#) for the PSD system accessories.





HEALING ABUTMENT

Platform	Height (mm)	Reference
RP	1.5	IPD/1A-DR-01
	3.0	IPD/1A-DR-03
	4.5	IPD/1A-DR-04



STRAIGHT CASTABLE ABUTMENT WITH A Co-Cr BASE

Platform	Angulation		
RP	Straight	IPD/1A-BR-00	IPD/1A-BR-01

Co-Cr Base for digital workflow	Scan Body
RP	Straight

IPD/1A-BR-00/3D IPD/1A-BR-01/3D IPD/SC-AN-B1





Compatibility



ANTHOGYR®

2A Serie AXIOM® BL

[RP]





INTRA-ORAL / DESKTOP / CONTACT PROBE SCAN BODY

Platform	Height (mm)		
RP	10	IPD/2A-SR-00	IPD/2A-SR-01
	15	IPD/2A-SR-02	-

Captive screw included. 1.20 Hex Screwdriver.



Ti-BASE  Custom Ti-Base System®

Platform	Height (mm)		
RP	1.5	IPD/2A-IR-02/3D	IPD/2A-IR-03/3D
	2.5	IPD/2A-IR-04/3D	IPD/2A-IR-05/3D
	3.5	IPD/2A-IR-06/3D	IPD/2A-IR-07/3D

Please see [page 147](#) for the  Custom Ti-Base System® accessories.

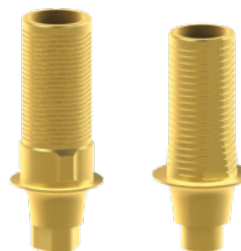

SCREW / TPA SCREW FOR ANGLED PROSTHESIS

Platform	Screwdriver	Seat	Reference	TiN Reference
RP	1.18 Hex	Conical	IPD/2A-TR-00 IPD/2A-TR-01	IPD/2A-TR-00/TiN -

The IPD/2A-TR-01 model is an abutment extractor screw.

 Lengths 18/25/32 mm. Please see [page 184](#) for more information.



ANALOG / DIGITAL ANALOG

Platform	Reference	Digital reference
RP	IPD/2A-AR-00	IPD/2A-AR-00/3D
Bottom Screw	-	IPD/KA-TA-00
Side Screw	-	IPD/KA-TA-01



STRAIGHT AND ANGLED MULTI-UNIT ABUTMENT



Straight, 17° & 30°

Platform	Height (mm)	Straight	17°	30°
RP	1.5	IPD/2A-MR-01	-	-
	2.5	IPD/2A-MR-02	IPD/2A-MR-12	-
	3.5	IPD/2A-MR-03	-	IPD/2A-MR-33

Our straight Multi-units can be used for single and multiple restorations. Please see [page 157](#) for the Multi-unit system accessories.



TEMPORARY ABUTMENT / OPEN TRAY COPING

Platform			Coping screw
RP	IPD/2A-PR-06	IPD/2A-PR-07	IPD/2A-TR-00/C

The same abutment can be used as a temporary abutment with the occlusal screw or as an impression coping using the coping screw.



PSD OVERDENTURE ABUTMENT

Platform	Height (mm)	Reference
RP	2.0	IPD/2A-LR-02
	3.0	IPD/2A-LR-03
	4.0	IPD/2A-LR-04
	5.0	IPD/2A-LR-05

Please see [page 169](#) for the PSD system accessories.





HEALING ABUTMENT

Platform	Height (mm)	Digital reference
RP	1.5	IPD/2A-DR-01
	3.0	IPD/2A-DR-03
	4.5	IPD/2A-DR-04



STRAIGHT CASTABLE ABUTMENT WITH A Co-Cr BASE

Platform	Angulation		
RP	Straight	IPD/2A-BR-00	IPD/2A-BR-01

Co-Cr Base for digital workflow	Scan Body			
RP	Straight	IPD/2A-BR-00/3D	IPD/2A-BR-01/3D	IPD/SC-AN-B1







Compatibility

GALIMPLANT®

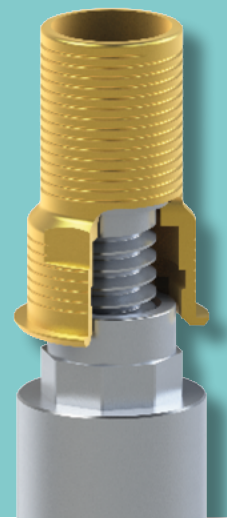
3A Serie MULTI-POSITION AESTHETIC® [ø3.8]





INTRA-ORAL / DESKTOP / CONTACT PROBE SCAN BODY

Platform	Height (mm)		
ø3.8	10	IPD/3A-SR-00	IPD/3A-SR-01

Captive screw included. 1.20 Hex Screwdriver.



Ti-BASE

Platform	Post height (mm)	Gingival height		
ø3.8	4.15	0.2	IPD/3A-IR-00/3D	IPD/3A-IR-01/3D
	6.5		IPD/3A-IR-02/3D	IPD/3A-IR-03/3D

Please see [page 147](#) for the  accessories.



SCREW / TPA SCREW FOR ANGLED PROSTHESIS

Platform	Screwdriver	Seat	Reference	TiN Reference
ø3.8	Hex 1.30	Conical	IPD/3A-TR-00	IPD/3A-TR-00/TIN
			IPD/3A-TR-50	-
	TPA		IPD/3A-TR-51	-

 Lengths 18/25/32 mm. Please see [page 184](#) for more information

 Lengths 18/25/32 mm. Please see [page 186](#) for more information

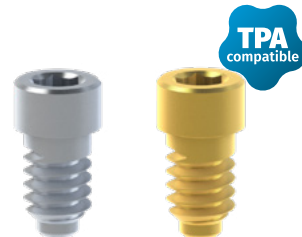

ANALOG / DIGITAL ANALOG

Platform	Reference	Digital reference
ø3.8	IPD/3A-AR-00	IPD/3A-AR-00/3D
Bottom Screw	-	IPD/KA-TA-00
Side Screw	-	IPD/KA-TA-01



TEMPORARY ABUTMENT / OPEN TRAY COPING

Platform			Coping screw
ø3.8	IPD/3A-PR-06	IPD/3A-PR-07	IPD/3A-TR-00/C

The same abutment can be used as a temporary abutment with the occlusal screw or as an impression coping using the coping screw.



HEALING ABUTMENT



Platform	Height (mm)	Digital reference
ø3.8	4.5	IPD/3A-DR-04

IPD/3A-TR-00 screw not includes.





Working Systems

- STUMP DIE 3D
- CEREC® Ti-BASE
-  Custom Ti-Base System®
- MULTI-UNIT SYSTEM
- PSD SYSTEM
-  Hollow Screw System®
- ACCESORIES
- TECHNICAL SPECIFICATIONS



We understand that producing accurate, detachable dies in 3D printed models can be a challenge. We have developed a system which prevents any mobility and rotation of the detachable die. This solution ensures accurate positioning of the die in relation to the contact points of the adjacent teeth.

IPD's unique **ModelPro** solution gives you the tools to ensure predictability and consistency with the removable dies in your 3D printed models.

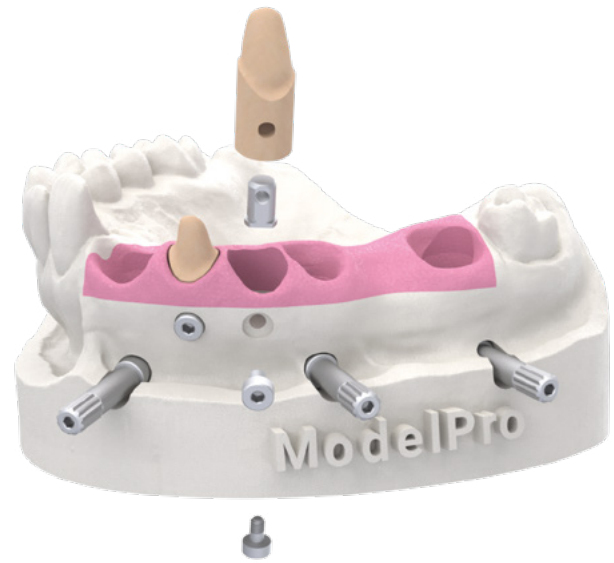

Technical Specifications

- Double fixation at 90° which ensures the correct position of the die in the model.
- Screws with **quick thread** for easy handling.
- Unidirectional plane for **positioning** according to the model design.
- Extended width at the base of the insert to check for **proper seating**.
- **Reduced size** to enable its use in all types of dies.

Printer calibration



Screw attachment to the insert for easy manipulation of the test fixture



The Stump Die 3D master file will allow to check printer resolution enabling to choose the relevant OFF value into ModelPro aiding to achieve a proper fitting.

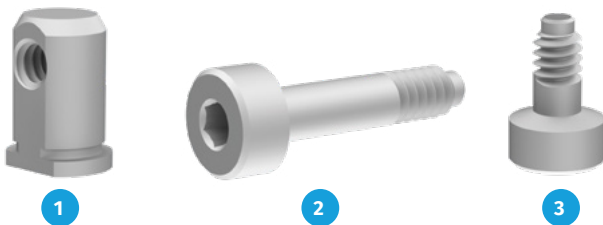

*ModelPro and Stump 3D subject to territorial availability. Consult us for disponibility.

Config.	Product	Units	Reference
1	Body	1	IPD/KA-ST-01
2	Side Screw (long)	1	IPD/KA-ST-02
3	Low Screw (short)	1	IPD/KA-ST-03
1 + 2 + 3	Kit body + 2 screws	1	IPD/KT-ST-00
1 + 2 + 3	Kit body + 2 screws	10	IPD/KT-ST-10

WORKING SYSTEMS Cerec® Ti-Base

Compatibility	Platform	Gingival height (mm)	Reference	Interfaz integrada
Nobel Biocare® Branemark System®	Ø3.5	0.5	IPD/AA-IN-00/SI	L
		1.5	IPD/AA-IN-02/SI	L
		2.5	IPD/AA-IN-04/SI	L
	Ø4.1	0.5	IPD/AA-IR-00/SI	L
		1.5	IPD/AA-IR-02/SI	L
		2.5	IPD/AA-IR-04/SI	L
Nobel Biocare® Nobel Active®	Ø3.5	0.5	IPD/AD-IN-00/SI	S
		1.5	IPD/AD-IN-02/SI	S
		2.5	IPD/AD-IN-04/SI	S
	Ø4.3	0.5	IPD/AD-IR-00/SI	L
		1.5	IPD/AD-IR-02/SI	L
		2.5	IPD/AD-IR-04/SI	L
Biomet® 3i® Certain®	Ø3.4	0.5	IPD/BB-IN-00/SI	S
		1.5	IPD/BB-IN-02/SI	S
	Ø4.1	0.5	IPD/BB-IR-00/SI	L
		1.5	IPD/BB-IR-02/SI	L
Straumann® Tissue Level	Ø4.8	0.8	IPD/DA-IR-00/SI	L
Straumann® Bone Level	Ø3.3	1.0	IPD/DB-IN-00/SI	L
		2.0	IPD/DB-IN-02/SI	L
		3.0	IPD/DB-IN-04/SI	L
	Ø4.1	1.0	IPD/DB-IR-00/SI	L
		2.0	IPD/DB-IR-02/SI	L
		3.0	IPD/DB-IR-04/SI	L



Compatibility	Platform	Gingival height (mm)	Reference	Interfaz integrada
Astra® Osseospeed® TX™	Ø3.5-4.0	1.0	IPD/EA-IR-00/SI	S
		2.0	IPD/EA-IR-02/SI	S
		3.0	IPD/EA-IR-04/SI	S
Astra® Evolution®	Ø3.6	0.5	IPD/EB-IN-00/SI	S
		1.5	IPD/EB-IN-02/SI	S
		2.5	IPD/EB-IN-04/SI	S
	Ø4.2	0.5	IPD/EB-IR-00/SI	L
		1.5	IPD/EB-IR-02/SI	L
		2.5	IPD/EB-IR-04/SI	L
Zimmer® Screw Vent®	Ø3.5	0.5	IPD/FA-IN-00/SI	S
		1.5	IPD/FA-IN-02/SI	S
		2.5	IPD/FA-IN-04/SI	S
	Ø4.5	0.5	IPD/FA-IR-00/SI	L
		1.5	IPD/FA-IR-02/SI	L
		2.5	IPD/FA-IR-04/SI	L
BioHorizons® Tapered Internal	Ø3.0	0.5	IPD/LB-IT-00/SI	S
		1.5	IPD/LB-IT-02/SI	S
		2.5	IPD/LB-IT-04/SI	S
	Ø3.5	0.5	IPD/LB-IN-00/SI	S
		1.5	IPD/LB-IN-02/SI	S
		2.5	IPD/LB-IN-04/SI	S
	Ø4.5	0.5	IPD/LB-IR-00/SI	L
		1.5	IPD/LB-IR-02/SI	L
		2.5	IPD/LB-IR-04/SI	L



Gingival heights available

WORKFLOW DIAGRAM

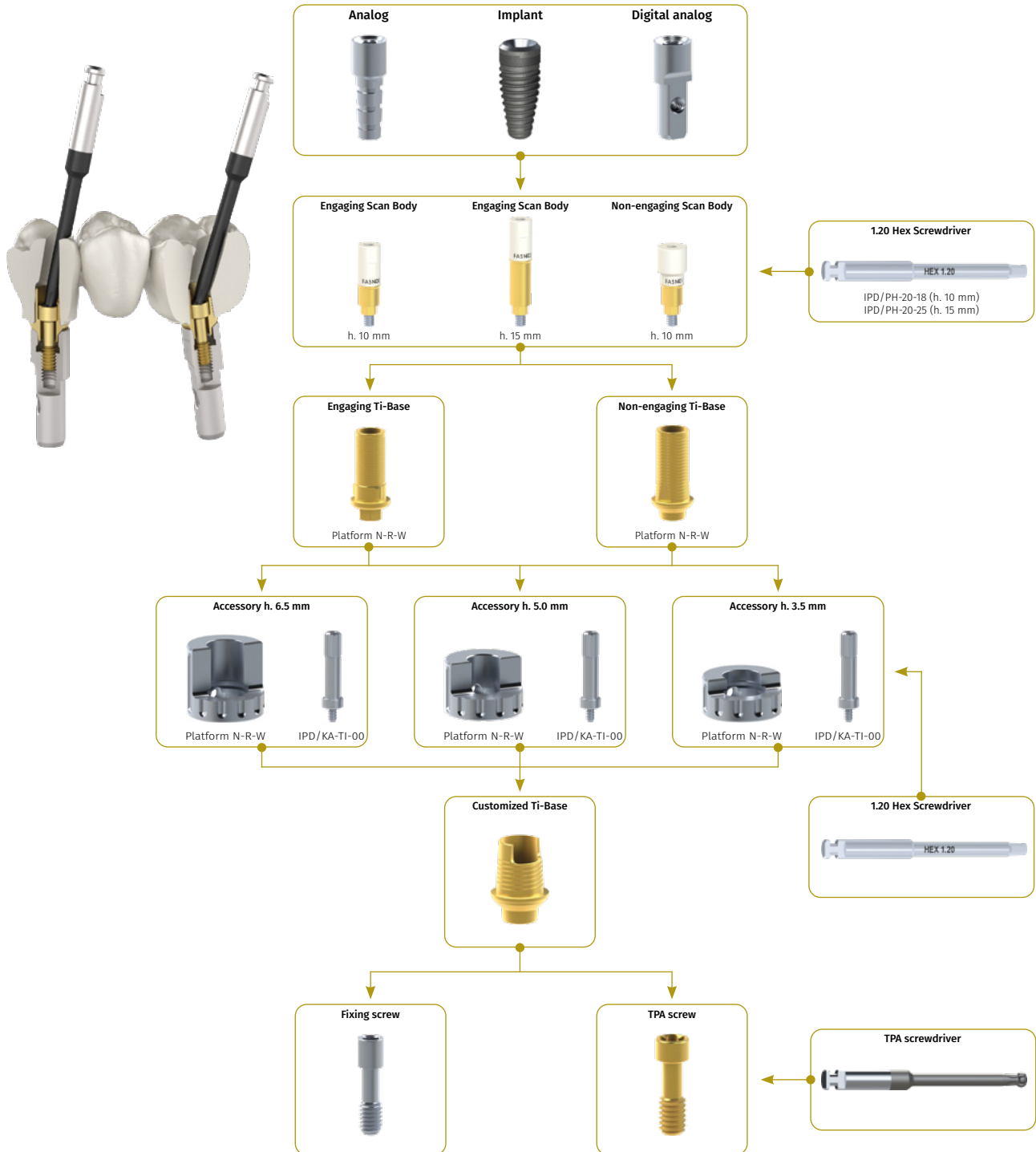

CUTTING GUIDE

Engaging

Platform	Height (mm)	Reference
Narrow	3.5	IPD/KA-IN-35
	5.0	IPD/KA-IN-50
	6.5	IPD/KA-IN-65
Standard	3.5	IPD/KA-IR-35
	5.0	IPD/KA-IR-50
	6.5	IPD/KA-IR-65
Wide	3.5	IPD/KA-IW-35
	5.0	IPD/KA-IW-50
	6.5	IPD/KA-IW-65

Version with agulation window subject to availability.



NON-ENGAGING

Platform	Height (mm)	Reference
Narrow	3.5	IPD/KR-IN-35
	5.0	IPD/KR-IN-50
	6.5	IPD/KR-IN-65
Standard	3.5	IPD/KR-IR-35
	5.0	IPD/KR-IR-50
	6.5	IPD/KR-IR-65
Wide	3.5	IPD/KR-IW-35
	5.0	IPD/KR-IW-50
	6.5	IPD/KR-IW-65

Version with agulation window subject to availability.



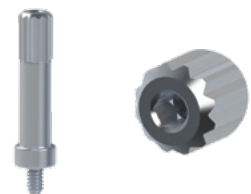

FIXING SCREW

	Screwdriver	Reference
Every cutting guide	1.20 Hex	IPD/KA-TI-00



CUTTING GUIDE KITS

Platform	Heights (mm)		
Narrow	3.5 / 5.0 / 6.5	IPD/KT-IN-00	IPD/KT-IN-01
Standard	3.5 / 5.0 / 6.5	IPD/KT-IR-00	IPD/KT-IR-01
Wide	3.5 / 5.0 / 6.5	IPD/KT-IW-00	IPD/KT-IW-01

All kits include the locking screw IPD/KA-TI-00



SCAN BODY SCREWDRIVER

Scan Body height (mm)	Reference
10	IPD/PH-20-18
15	IPD/PH-20-25



WORKING SYSTEMS



Compatibility	Platform	Connection	GH (mm)	Reference	Cutting guides	
Nobel Biocare® Branemark System® Klockner® KL™	Ø3.5	Engaging	1.5	IPD/AA-IN-02/3D	IPD/KT-IN-00	
		Non-engaging		IPD/AA-IN-03/3D	IPD/KT-IN-01	
Nobel Biocare® Branemark System® Biomet® 3i® Osseotite® BTI® External Hex Sweden & Martina® Outlink® Microdent® Microdent® Universal™ Klockner® KL™ Neodent® Helix® HE	Ø4.1	Engaging	0.5	IPD/AA-IR-00/3D	IPD/KT-IR-00	
			1.5	IPD/AA-IR-02/3D		
			2.5	IPD/AA-IR-04/3D		
		Non-engaging	0.5	IPD/AA-IR-01/3D	IPD/KT-IR-01	
			1.5	IPD/AA-IR-03/3D		
			2.5	IPD/AA-IR-05/3D		
Nobel Biocare® Branemark System®	Ø5.1	Engaging	1.3	IPD/AA-IW-02/3D	IPD/KT-IW-00	
		Non-engaging		IPD/AA-IW-03/3D	-	
Nobel Biocare® Multi-unit System	Ø4.8	Engaging	0.5	IPD/AB-IR-00/3D	-	
			0.5	IPD/AB-IR-02/3D		
			0.2	IPD/AB-IR-01/3D		
		Non-engaging	0.2	IPD/AB-IR-03/3D	-	
			0.5	IPD/AC-IN-00/3D		
			1.5	IPD/AC-IN-02/3D		
Nobel Biocare® Replace® Select	Ø3.5	Engaging	0.5	IPD/AC-IN-01/3D	IPD/KT-IN-00	
			1.5	IPD/AC-IN-03/3D		
		Non-engaging	0.5	IPD/AC-IN-01/3D		IPD/KT-IN-01
	Ø4.3	Engaging	0.5	IPD/AC-IR-00/3D	IPD/KT-IR-00	
			1.5	IPD/AC-IR-02/3D		
		Non-engaging	0.5	IPD/AC-IR-01/3D		IPD/KT-IR-01
Ø5.0	Engaging	0.5	IPD/AC-IW-00/3D	IPD/KT-IW-00		
		1.5	IPD/AC-IW-02/3D			
	Non-engaging	0.5	IPD/AC-IW-01/3D		IPD/KT-IW-01	
Nobel Biocare® Nobel Active®	Ø3.0	Engaging	0.8	IPD/AD-IT-00/3D		IPD/KT-IN-00
			1.5	IPD/AD-IT-02/3D		
			2.5	IPD/AD-IT-04/3D		
		Non-engaging	0.8	IPD/AD-IT-01/3D	IPD/KT-IN-01	
			1.5	IPD/AD-IT-03/3D		
			2.5	IPD/AD-IT-05/3D		
Nobel Biocare® Nobel Active®	Ø3.5	Engaging	0.5	IPD/AD-IN-00/3D	IPD/KT-IN-00	
			1.5	IPD/AD-IN-02/3D		
			2.5	IPD/AD-IN-04/3D		
		Non-engaging	3.5	IPD/AD-IN-06/3D	IPD/KT-IN-01	
			0.5	IPD/AD-IN-01/3D		
			1.5	IPD/AD-IN-03/3D		
Nobel Biocare® Nobel Active®	Ø4.3	Engaging	2.5	IPD/AD-IN-05/3D	IPD/KT-IR-00	
			3.5	IPD/AD-IN-07/3D		
			0.5	IPD/AD-IR-00/3D		
		Non-engaging	1.5	IPD/AD-IR-02/3D	IPD/KT-IR-00	
			2.5	IPD/AD-IR-04/3D		
			0.5	IPD/AD-IR-01/3D		
Nobel Biocare® Nobel Active®	Ø4.3	Non-engaging	1.5	IPD/AD-IR-03/3D	IPD/KT-IR-01	
			2.5	IPD/AD-IR-05/3D		
			0.5	IPD/AD-IR-01/3D		
Biomet® 3i® External™ 3i®	Ø3.4	Engaging	1.5	IPD/BA-IN-02/3D	IPD/KT-IN-00	
		Non-engaging		IPD/BA-IN-03/3D	IPD/KT-IN-01	
	Ø5.0	Engaging	0.5	IPD/BA-IW-00/3D	IPD/KT-IW-00	
			1.5	IPD/BA-IW-02/3D		
Microdent® Microdent® Universal™	Ø5.1	Non-engaging	0.5	IPD/BA-IW-01/3D	IPD/KT-IW-01	
			1.5	IPD/BA-IW-03/3D		

Compatibility	Platform	Connection	GH (mm)	Reference	Cutting guides
Biomet® 3i® Certain®	Ø3.4	Engaging	0.5	IPD/BB-IN-00/3D	IPD/KT-IN-00
			1.5	IPD/BB-IN-02/3D	
			2.5	IPD/BB-IN-04/3D	
		Non-engaging	0.5	IPD/BB-IN-01/3D	
			1.5	IPD/BB-IN-03/3D	
			2.5	IPD/BB-IN-05/3D	
	Ø4.1	Engaging	0.5	IPD/BB-IR-00/3D	IPD/KT-IR-00
			1.5	IPD/BB-IR-02/3D	
		Non-engaging	0.5	IPD/BB-IR-01/3D	
	1.5		IPD/BB-IR-03/3D		
	Ø5.0	Engaging	0.5	IPD/BB-IW-00/3D	IPD/KT-IW-00
			1.5	IPD/BB-IW-02/3D	
0.5			IPD/BB-IW-01/3D		
Non-engaging		1.5	IPD/BB-IW-03/3D		
		0.5	IPD/CA-IR-00/3D	IPD/KT-IW-00	
		2.25	IPD/CA-IR-04/3D		
Ø4.2	Engaging	0.5	IPD/CA-IR-01/3D		IPD/KT-IW-01
		2.25	IPD/CA-IR-05/3D		
	Non-engaging	0.5	IPD/CA-IR-01/3D	IPD/KT-IR-01	
2.25		IPD/CA-IR-05/3D			
Klockner® Essential Cone®	Ø4.5	Engaging	0.5		IPD/CB-IR-00/3D
		Non-engaging	0.5	IPD/CB-IR-01/3D	IPD/KT-IR-01
Klockner® Vega®	Ø3.5	Engaging	0.7	IPD/CD-IN-00/3D	IPD/KT-IN-00
			1.5	IPD/CD-IN-02/3D	
			2.5	IPD/CD-IN-04/3D	
		Non-engaging	0.7	IPD/CD-IN-01/3D	
			1.5	IPD/CD-IN-03/3D	
			2.5	IPD/CD-IN-05/3D	
	Ø4.1/Ø4.5	Engaging	0.7	IPD/CD-IR-00/3D	IPD/KT-IR-00
			1.5	IPD/CD-IR-02/3D	
			2.5	IPD/CD-IR-04/3D	
		Non-engaging	0.7	IPD/CD-IR-01/3D	
			1.5	IPD/CD-IR-03/3D	
			2.5	IPD/CD-IR-05/3D	
Straumann® Tissue Level	Ø4.8	Engaging		IPD/DA-IR-00/3D	IPD/KT-IR-00
		Non-engaging		IPD/DA-IR-01/3D	IPD/KT-IR-01
	Ø6.5	Engaging	0.4	IPD/DA-IW-02/3D	IPD/KT-IW-00
		Non-engaging	0.4	IPD/DA-IW-03/3D	IPD/KT-IW-01
Straumann® Bone Level	Ø3.3 NC	Engaging	0.5	IPD/DB-IN-00/3D	IPD/KT-IN-00
			1.5	IPD/DB-IN-02/3D	
			2.5	IPD/DB-IN-04/3D	
		Non-engaging	3.5	IPD/DB-IN-06/3D	
			0.5	IPD/DB-IN-01/3D	
			1.5	IPD/DB-IN-03/3D	
	Ø4.1 RC	Engaging	2.5	IPD/DB-IN-05/3D	IPD/KT-IN-01
			3.5	IPD/DB-IN-07/3D	
			0.5	IPD/DB-IR-00/3D	
		Non-engaging	1.5	IPD/DB-IR-02/3D	
			2.5	IPD/DB-IR-04/3D	
			3.5	IPD/DB-IR-06/3D	
Ø4.1 RC	Engaging	0.5	IPD/DB-IR-01/3D	IPD/KT-IR-01	
		1.5	IPD/DB-IR-03/3D		
	Non-engaging	2.5	IPD/DB-IR-05/3D		
		3.5	IPD/DB-IR-07/3D		
		3.5	IPD/DB-IR-07/3D		

Compatibility	Platform	Connection	GH (mm)	Reference	Cutting guides
Straumann® BLX®	RB/WB	Engaging	1.0	IPD/DC-IR-00/3D	IPD/KT-IR-00
			2.0	IPD/DC-IR-02/3D	
			3.0	IPD/DC-IR-04/3D	
		Non-engaging	1.0	IPD/DC-IR-01/3D	
			2.0	IPD/DC-IR-03/3D	
			3.0	IPD/DC-IR-05/3D	
Straumann® SRA®	Ø3.5	Engaging	0.2	IPD/DD-IN-01/3D	-
	Ø4.6		IPD/DD-IR-01/3D		
Astra® Osseospeed®	Ø3.0	Engaging	0.8	IPD/EA-IN-00/3D	IPD/KT-IN-00
			1.5	IPD/EA-IN-02/3D	
			2.5	IPD/EA-IN-04/3D	
		Non-engaging	0.8	IPD/EA-IN-01/3D	
			1.5	IPD/EA-IN-03/3D	
			2.5	IPD/EA-IN-05/3D	
	Ø3.5-4.0	Engaging	0.5	IPD/EA-IR-00/3D	IPD/KT-IN-00
			1.5	IPD/EA-IR-02/3D	
			2.5	IPD/EA-IR-04/3D	
		Non-engaging	0.5	IPD/EA-IR-01/3D	
			1.5	IPD/EA-IR-03/3D	
			2.5	IPD/EA-IR-05/3D	
	Ø4.5-5.0	Engaging	0.5	IPD/EA-IW-00/3D	IPD/KT-IR-00
			1.5	IPD/EA-IW-02/3D	
			1.5	IPD/EA-IW-03/3D	
Non-engaging		0.5	IPD/EA-IW-01/3D		
		1.5	IPD/EA-IW-03/3D		
		1.5	IPD/EA-IW-03/3D		
Astra® Evolution®	Ø3.6	Engaging	0.5	IPD/EB-IN-00/3D	IPD/KT-IN-00
			1.5	IPD/EB-IN-02/3D	
			2.5	IPD/EB-IN-04/3D	
		Non-engaging	0.5	IPD/EB-IN-01/3D	
			1.5	IPD/EB-IN-03/3D	
			2.5	IPD/EB-IN-05/3D	
Astra® Evolution®	Ø4.2	Engaging	0.5	IPD/EB-IR-00/3D	IPD/KT-IR-00
			1.5	IPD/EB-IR-02/3D	
			2.5	IPD/EB-IR-04/3D	
		Non-engaging	0.5	IPD/EB-IR-01/3D	
			1.5	IPD/EB-IR-03/3D	
			2.5	IPD/EB-IR-05/3D	
Zimmer® Screw Vent®	Ø3.5	Engaging	0.5	IPD/FA-IN-00/3D	IPD/KT-IN-00
			1.5	IPD/FA-IN-02/3D	
			2.5	IPD/FA-IN-04/3D	
		Non-engaging	0.5	IPD/FA-IN-01/3D	
			1.5	IPD/FA-IN-03/3D	
			2.5	IPD/FA-IN-05/3D	
	Ø4.5	Engaging	0.5	IPD/FA-IR-00/3D	IPD/KT-IR-00
			1.5	IPD/FA-IR-02/3D	
			2.5	IPD/FA-IR-04/3D	
		Non-engaging	0.5	IPD/FA-IR-01/3D	
			1.5	IPD/FA-IR-03/3D	
			2.5	IPD/FA-IR-05/3D	
Ø5.7	Engaging	0.5	IPD/FA-IW-00/3D	IPD/KT-IW-00	
	Non-engaging	0.5	IPD/FA-IW-01/3D	IPD/KT-IW-01	

Compatibility	Platform	Connection	GH (mm)	Reference	Cutting guides
Zimmer® Eztetic®	Ø3.1	Engaging	1.0	IPD/FC-IT-00/3D	IPD/KT-IN-00
			2.0	IPD/FC-IT-02/3D	
			3.0	IPD/FC-IT-04/3D	
		Non-engaging	1.0	IPD/FC-IT-01/3D	
			2.0	IPD/FC-IT-03/3D	
			3.0	IPD/FC-IT-05/3D	
BTI® Tiny BTI®	Ø3.5	Engaging	1.5	IPD/GA-IN-02/3D	IPD/KT-IN-00
		Non-engaging		IPD/GA-IN-03/3D	IPD/KT-IN-01
BTI® Interna Universal®	Ø4.1	Engaging	0.5	IPD/GB-IR-00/3D	IPD/KT-IR-00
			1.5	IPD/GB-IR-02/3D	
			2.5	IPD/GB-IR-04/3D	
		Non-engaging	0.5	IPD/GB-IR-01/3D	
			1.5	IPD/GB-IR-03/3D	
			2.5	IPD/GB-IR-05/3D	
BTI® Multi-im®	Ø4.1	Non-engaging	0.3	IPD/GC-IR-01/3D	-
		Ø3.4	Engaging	1.5	IPD/IA-IN-02/3D
	Non-engaging		1.5	IPD/IA-IN-03/3D	IPD/KT-IN-01
Dentsply® Xive® Friadent®	Ø3.8	Engaging	0.5	IPD/IA-IR-00/3D	IPD/KT-IR-00
			1.5	IPD/IA-IR-02/3D	
		Non-engaging	0.5	IPD/IA-IR-01/3D	
			1.5	IPD/IA-IR-03/3D	
			1.5	IPD/IB-IR-02/3D	
			2.5	IPD/IB-IR-04/3D	
Dentsply® Ankylos®	C/X	Engaging	1.5	IPD/IB-IR-02/3D	IPD/KT-IR-00
			2.5	IPD/IB-IR-04/3D	
		Non-engaging	1.5	IPD/IB-IR-03/3D	
			2.5	IPD/IB-IR-05/3D	
Camlog® Camlog®	Ø3.3	Engaging	1.5	IPD/JA-IN-02/3D	IPD/KT-IN-00
		Non-engaging	1.5	IPD/JA-IN-03/3D	IPD/KT-IN-01
	Ø3.8	Engaging	0.5	IPD/JA-IR-00/3D	IPD/KT-IR-00
		1.5	IPD/JA-IR-02/3D		
	Ø4.3	Non-engaging	0.5	IPD/JA-IR-01/3D	IPD/KT-IR-01
			1.5	IPD/JA-IR-03/3D	
		Engaging	0.5	IPD/JA-IW-00/3D	
			1.5	IPD/JA-IW-02/3D	
	Ø5.0	Non-engaging	0.5	IPD/JA-IW-01/3D	IPD/KT-IR-01
			1.5	IPD/JA-IW-03/3D	
		Engaging	0.5	IPD/JA-IX-00/3D	
			1.5	IPD/JA-IX-02/3D	
0.5			IPD/JA-IX-01/3D		
1.5			IPD/JA-IX-03/3D		

Compatibility	Platform	Connection	GH (mm)	Reference	Cutting guides
Camlog® Conelog®	Ø3.3	Engaging	0.5	IPD/JB-IT-00/3D	IPD/KT-IN-00
			1.5	IPD/JB-IT-02/3D	
		Non-engaging	0.5	IPD/JB-IT-01/3D	IPD/KT-IN-01
			1.5	IPD/JB-IT-03/3D	
	Ø3.8	Engaging	0.5	IPD/JB-IN-00/3D	IPD/KT-IR-00
			1.5	IPD/JB-IN-02/3D	
		Non-engaging	0.5	IPD/JB-IN-01/3D	IPD/KT-IR-01
			1.5	IPD/JB-IN-03/3D	
	Ø4.3	Engaging	0.5	IPD/JB-IR-00/3D	IPD/KT-IR-00
			1.5	IPD/JB-IR-02/3D	
		Non-engaging	0.5	IPD/JB-IR-01/3D	IPD/KT-IR-01
			1.5	IPD/JB-IR-03/3D	
BioHorizons® Tapered Internal	Ø3.0	Engaging	0.5	IPD/LB-IT-00/3D	IPD/KT-IN-00
			1.5	IPD/LB-IT-02/3D	
			2.5	IPD/LB-IT-04/3D	
		Non-engaging	0.5	IPD/LB-IT-01/3D	IPD/KT-IN-01
			1.5	IPD/LB-IT-03/3D	
			2.5	IPD/LB-IT-05/3D	
	Ø3.5	Engaging	0.5	IPD/LB-IN-00/3D	IPD/KT-IN-00
			1.5	IPD/LB-IN-02/3D	
			2.5	IPD/LB-IN-04/3D	
		Non-engaging	0.5	IPD/LB-IN-01/3D	IPD/KT-IN-01
			1.5	IPD/LB-IN-03/3D	
			2.5	IPD/LB-IN-05/3D	
	Ø4.5	Engaging	0.5	IPD/LB-IR-00/3D	IPD/KT-IR-00
			1.5	IPD/LB-IR-02/3D	
			2.5	IPD/LB-IR-04/3D	
		Non-engaging	0.5	IPD/LB-IR-01/3D	IPD/KT-IR-01
			1.5	IPD/LB-IR-03/3D	
			2.5	IPD/LB-IR-05/3D	
Ø5.7	Engaging	0.5	IPD/LB-IW-00/3D	IPD/KT-IW-00	
	Non-engaging	0.5	IPD/LB-IW-01/3D	IPD/KT-IW-01	
Sweden & Martina® Outlink®	Ø3.5	Engaging	1.5	IPD/MA-IN-02/3D	IPD/KT-IN-00
			2.5	IPD/MA-IN-04/3D	
		Non-engaging	1.5	IPD/MA-IN-03/3D	IPD/KT-IN-01
			2.5	IPD/MA-IN-05/3D	
	Ø5.0	Engaging	0.5	IPD/BA-IW-00/3D	IPD/KT-IW-00
			1.5	IPD/BA-IW-02/3D	
		Non-engaging	0.5	IPD/BA-IW-01/3D	IPD/KT-IW-01
			1.5	IPD/BA-IW-03/3D	
Sweden & Martina® Premium™ Kohnno®	Ø3.3	Engaging	0.5	IPD/MB-IT-00/3D	IPD/KT-IN-00
			1.5	IPD/MB-IT-02/3D	
		Non-engaging	0.5	IPD/MB-IT-01/3D	IPD/KT-IN-01
			1.5	IPD/MB-IT-03/3D	
	Ø3.8	Engaging	0.7	IPD/MB-IN-00/3D	IPD/KT-IN-00
			1.5	IPD/MB-IN-02/3D	
		Non-engaging	0.7	IPD/MB-IN-01/3D	IPD/KT-IN-01
			1.5	IPD/MB-IN-03/3D	

Compatibility	Platform	Connection	GH (mm)	Reference	Cutting guides
Sweden & Martina® Premium™ Kohno®	Ø4.25	Engaging	0.7	IPD/MB-IR-00/3D	IPD/KT-IR-00
			1.5	IPD/MB-IR-02/3D	
		Non-engaging	0.7	IPD/MB-IR-01/3D	IPD/KT-IR-01
			1.5	IPD/MB-IR-03/3D	
Phibo® TSH®	S2	Engaging	1.5	IPD/NA-IN-02/3D	IPD/KT-IN-00
			1.5	IPD/NA-IN-03/3D	
	S5	Engaging	1.3	IPD/NA-IW-02/3D	IPD/KT-IW-00
			1.3	IPD/NA-IW-03/3D	
Osstem® TSIII®	Ø3.5 Mini	Engaging	1.0	IPD/OB-IN-00/3D	IPD/KT-IN-00
			2.0	IPD/OB-IN-02/3D	
			3.0	IPD/OB-IN-04/3D	
		Non-engaging	1.0	IPD/OB-IN-01/3D	
			2.0	IPD/OB-IN-03/3D	
	Ø4.0 Regular	Engaging	3.0	IPD/OB-IN-05/3D	IPD/KT-IR-01
			1.0	IPD/OB-IR-00/3D	
			2.0	IPD/OB-IR-02/3D	
			3.0	IPD/OB-IR-04/3D	
			1.0	IPD/OB-IR-01/3D	
Biotech® Dental Kontakt®	RP	Engaging	2.0	IPD/OB-IR-03/3D	IPD/KT-IR-01
			3.0	IPD/OB-IR-05/3D	
			3.0	IPD/OB-IR-05/3D	
		Non-engaging	1.0	IPD/QB-IR-00/3D	
			2.0	IPD/QB-IR-03/3D	
Neodent® Helix® HE	Ø3.3	Engaging	3.0	IPD/QB-IR-04/3D	-
			1.0	IPD/QB-IR-01/3D	
			2.0	IPD/QB-IR-03/3D	
	Ø5.0	Non-engaging	3.0	IPD/QB-IR-05/3D	-
			1.3	IPD/RA-IN-02/3D	
			2.5	IPD/RA-IN-04/3D	
Neodent® Grand Morse™ GM	GM	Engaging	1.3	IPD/RA-IN-03/3D	-
			2.5	IPD/RA-IN-05/3D	
			2.5	IPD/RA-IN-05/3D	
		Non-engaging	1.3	IPD/RA-IW-02/3D	
			1.3	IPD/RA-IW-03/3D	
			1.0	IPD/RB-IR-00/3D	
			2.0	IPD/RB-IR-02/3D	
Neodent® GM Abutment	RP	Engaging	3.0	IPD/RB-IR-04/3D	IPD/KT-IR-00
			4.0	IPD/RB-IR-06/3D	
			1.0	IPD/RB-IR-01/3D	
			2.0	IPD/RB-IR-03/3D	
			3.0	IPD/RB-IR-05/3D	
Neodent® GM Micro Abutment	NP	Non-engaging	4.0	IPD/RB-IR-07/3D	IPD/KT-IR-01
			0.5	IPD/RC-IR-00/3D	
Bego® Semados®	Ø3.25/3.75	Engaging	0.5	IPD/RD-IN-00/3D	-
			1.5	IPD/RD-IN-01/3D	
			2.5	IPD/RD-IN-01/3D	
		Non-engaging	0.5	IPD/SB-IN-00/3D	IPD/KT-IN-00
			1.5	IPD/SB-IN-02/3D	
			2.5	IPD/SB-IN-04/3D	
Bego® Semados®	Ø3.25/3.75	Non-engaging	0.5	IPD/SB-IN-01/3D	IPD/KT-IN-01
			1.5	IPD/SB-IN-03/3D	
			2.5	IPD/SB-IN-05/3D	

Compatibility	Platform	Connection	GH (mm)	Reference	Cutting guides	
Bego® Semados®	Ø4.1	Engaging	0.5	IPD/SB-IR-00/3D	IPD/KT-IR-00	
			1.5	IPD/SB-IR-02/3D		
			2.5	IPD/SB-IR-04/3D		
		Non-engaging	0.5	IPD/SB-IR-01/3D		IPD/KT-IR-01
			1.5	IPD/SB-IR-03/3D		
			2.5	IPD/SB-IR-05/3D		
	Ø4.5	Engaging	0.5	IPD/SB-IW-00/3D	IPD/KT-IR-00	
			1.5	IPD/SB-IW-02/3D		
			2.5	IPD/SB-IW-04/3D		
		Non-engaging	0.5	IPD/SB-IW-01/3D		IPD/KT-IR-01
			1.5	IPD/SB-IW-03/3D		
			2.5	IPD/SB-IW-05/3D		
MIS® Seven®	Narrow Ø3.3	Engaging	0.5	IPD/TA-IT-00/3D	IPD/KT-IN-00	
			1.5	IPD/TA-IT-02/3D		
			2.5	IPD/TA-IT-04/3D		
		Non-engaging	0.5	IPD/TA-IT-01/3D		IPD/KT-IN-01
			1.5	IPD/TA-IT-03/3D		
			2.5	IPD/TA-IT-05/3D		
	Standard Ø3.75/4.2	Engaging	0.5	IPD/FA-IN-00/3D	IPD/KT-IN-00	
			1.5	IPD/FA-IN-02/3D		
			2.5	IPD/FA-IN-04/3D		
		Non-engaging	0.5	IPD/FA-IN-01/3D		IPD/KT-IN-01
			1.5	IPD/FA-IN-03/3D		
			2.5	IPD/FA-IN-05/3D		
Wide Ø5.0/6.0	Engaging	0.5	IPD/FA-IR-00/3D	IPD/KT-IR-00		
		1.5	IPD/FA-IR-02/3D			
		2.5	IPD/FA-IR-04/3D			
	Non-engaging	0.5	IPD/FA-IR-01/3D		IPD/KT-IR-01	
		1.5	IPD/FA-IR-03/3D			
		2.5	IPD/FA-IR-05/3D			
MIS® C1/V3®	Standard	Engaging	0.7	IPD/TB-IR-00/3D		IPD/KT-IR-00
			1.5	IPD/TB-IR-02/3D		
			2.5	IPD/TB-IR-04/3D		
		Non-engaging	3.5	IPD/TB-IR-06/3D	IPD/KT-IR-01	
			0.7	IPD/TB-IR-01/3D		
			1.5	IPD/TB-IR-03/3D		
			2.5	IPD/TB-IR-05/3D		
DIO® UFII	NP	Engaging	3.5	IPD/TB-IR-07/3D		IPD/KT-IN-00
			1.0	IPD/UB-IN-00/3D		
			2.0	IPD/UB-IN-02/3D		
		Non-engaging	3.0	IPD/UB-IN-04/3D	IPD/KT-IN-01	
			1.0	IPD/UB-IN-01/3D		
			2.0	IPD/UB-IN-03/3D		
			3.0	IPD/UB-IN-05/3D		
DIO® UFII	RP	Engaging	1.0	IPD/UB-IR-00/3D		IPD/KT-IR-00
			2.0	IPD/UB-IR-02/3D		
			3.0	IPD/UB-IR-04/3D		
		Non-engaging	1.0	IPD/UB-IR-01/3D	IPD/KT-IR-01	
			2.0	IPD/UB-IR-03/3D		
			3.0	IPD/UB-IR-05/3D		



Compatibility	Platform	Connection	GH (mm)	Reference	Cutting guides	
Megagen® AnyOne®	RP	Engaging	1.0	IPD/WA-IR-00/3D	IPD/KT-IR-00	
			2.0	IPD/WA-IR-02/3D		
			3.0	IPD/WA-IR-04/3D		
		Non-engaging	1.0	IPD/WA-IR-01/3D		IPD/KT-IR-01
			2.0	IPD/WA-IR-03/3D		
			3.0	IPD/WA-IR-05/3D		
Megagen® AnyRidge®	RP	Engaging	1.0	IPD/WB-IR-00/3D	IPD/KT-IR-00	
			2.0	IPD/WB-IR-02/3D		
			3.0	IPD/WB-IR-04/3D		
		Non-engaging	1.0	IPD/WB-IR-01/3D		IPD/KT-IR-01
			2.0	IPD/WB-IR-03/3D		
			3.0	IPD/WB-IR-05/3D		
Dentium® Implantium® / Superline™	RP	Engaging	1.0	IPD/XA-IR-00/3D	IPD/KT-IR-00	
			2.0	IPD/XA-IR-02/3D		
			3.0	IPD/XA-IR-04/3D		
		Non-engaging	1.0	IPD/XA-IR-01/3D		IPD/KT-IR-01
			2.0	IPD/XA-IR-03/3D		
			3.0	IPD/XA-IR-05/3D		
Medentis® ICX	RP	Engaging	1.0	IPD/YB-IR-00/3D	IPD/KT-IR-00	
			2.0	IPD/YB-IR-02/3D		
			3.0	IPD/YB-IR-04/3D		
		Non-engaging	1.0	IPD/YB-IR-01/3D		IPD/KT-IR-01
			2.0	IPD/YB-IR-03/3D		
			3.0	IPD/YB-IR-05/3D		
Global D® In-Kone®	RP	Engaging	1.0	IPD/1A-IR-00/3D	IPD/KT-IR-00	
			2.0	IPD/1A-IR-02/3D		
			3.0	IPD/1A-IR-04/3D		
		Non-engaging	1.0	IPD/1A-IR-01/3D		IPD/KT-IR-01
			2.0	IPD/1A-IR-03/3D		
			3.0	IPD/1A-IR-05/3D		
Anthogyr® Axiom® BL	RP	Engaging	1.5	IPD/2A-IR-00/3D	IPD/KT-IR-00	
			2.5	IPD/2A-IR-02/3D		
			3.5	IPD/2A-IR-04/3D		
		Non-engaging	1.5	IPD/2A-IR-01/3D		IPD/KT-IR-01
			2.5	IPD/2A-IR-03/3D		
			3.5	IPD/2A-IR-05/3D		
Galimplant® Multi-Position Aesthetic®	Ø3.8	Antirrotativa	0.2	IPD/3A-IR-00/3D	-	
				IPD/3A-IR-02/3D		
		Rotativa		IPD/3A-IR-01/3D		
				IPD/3A-IR-03/3D		

WORKING SYSTEMS Multi-unit System

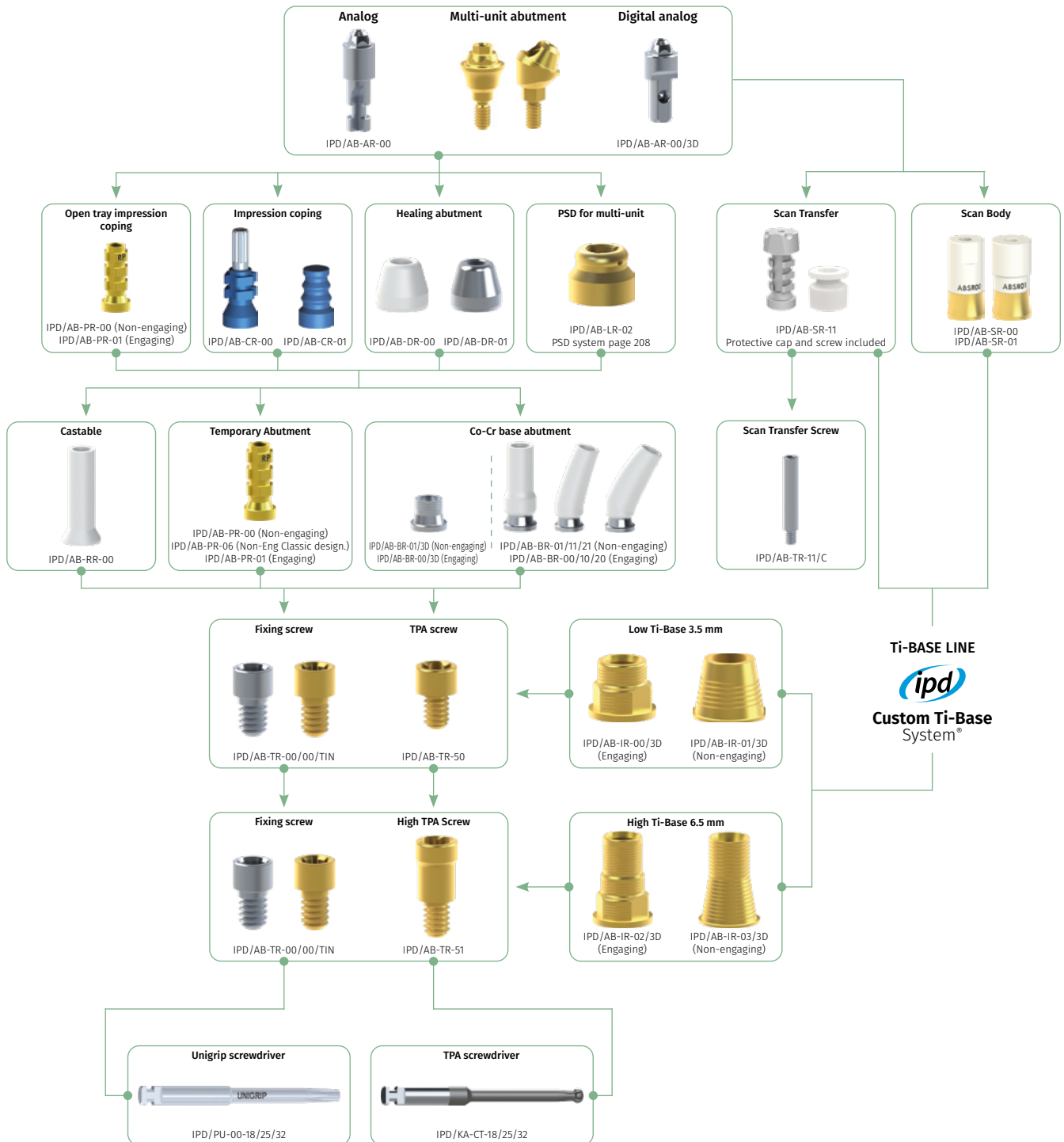
WORKFLOW DIAGRAM



INTRA-ORAL / DESKTOP / CONTACT PROBE SCAN BODY

Platform	Height (mm)		
ø4.8	10.0	IPD/AB-SR-00	IPD/AB-SR-01

Captive screw included. 1.20 Hex Screwdriver.





SCAN TRANSFER

Platform	Height (mm)		Screw
ø4.8	12.5	IPD/AB-SR-11	IPD/AB-TR-11/C

IPD/AB-SR-11 includes screw and a protective cap.



Ti-BASE

Platform	Post height (mm)	Gingival height		
ø4.8	3.5	0.5	IPD/AB-IR-00/3D	-
		0.2	-	IPD/AB-IR-01/3D
	6.5	0.5	IPD/AB-IR-02/3D	-
		0.2	-	IPD/AB-IR-03/3D

Please see [page 145](#) for the  Custom Ti-Base System® accessories.
IPD/AB-IR-01 is a  Hollow Screw System® Ti-Base



SCREW / TPA SCREW FOR ANGLED PROSTHESIS

Platform	Screwdriver	Height	Reference	TiN Reference
ø4.8	Unigrip		IPD/AB-TR-00	IPD/AB-TR-00/TiN
	TPA	For 3.5 mm high Ti-Base	-	IPD/AB-TR-50
	TPA	For 6.5 mm high Ti-Base	-	IPD/AB-TR-51



ANALOG / DIGITAL ANALOG

Platform	Reference	Digital reference
ø4.8	IPD/AB-AR-00	IPD/AB-AR-00/3D
Bottom Screw	-	IPD/KA-TA-00
Side Screw	-	IPD/KA-TA-01



TEMPORARY ABUTMENT / OPEN TRAY COPING

Platform			Coping screw
ø4.8	IPD/AB-PR-01	IPD/AB-PR-00	IPD/AB-TR-00/C
	-	IPD/AB-PR-06	-

The same abutment can be used as a temporary abutment with the occlusal screw or as an impression coping using the coping screw.

IPD/AB-PR-06 corresponds to the Classic design, and cannot be used as a coping.

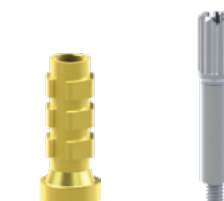

WORKING SYSTEMS Multi-unit System

OPEN AND CLOSED TRAY COPING

Platform		Reference
ø4.8	Open tray coping	IPD/AB-CR-00
	Closed tray coping	IPD/AB-CR-01

Classic design.



HEALING ABUTMENT

Titanium / Plastic POM

Platform	Material	Reference
ø4.8	Plastic POM	IPD/AB-DR-00
	Titanium	IPD/AB-DR-01

IPD/AB-TR-00 screw not included.



CASTABLE

Platform		Reference
ø4.8		IPD/AB-RR-00



PSD FOR MULTI-UNIT



Platform	Units	Height	Reference
ø4.8	2	3.35 mm	IPD/AB-LR-02

Please see [page 169](#) for the PSD system accessories.



STRAIGHT AND ANGLED CASTABLE ABUTMENT WITH A Co-Cr BASE

Straight, 15° & 25°

Platform	Angulation		
ø4.8	Straight	IPD/AB-BR-00	IPD/AB-BR-01
	15°	IPD/AB-BR-10	IPD/AB-BR-11
	25°	IPD/AB-BR-20	IPD/AB-BR-21

Co-Cr Base for digital workflow			Scan Body	
ø4.8	Straight / Angled	IPD/AB-BR-00/3D	IPD/AB-BR-01/3D	IPD/SC-AN-B2

All angled castable abutments include a TPA screw.



ANGLED MULTI-UNIT CARRIER

Platform

ø4.8

Reference

IPD/LL-TM-00



UNGRIP SCREWDRIVER

Lengths (mm)

18

25

32

Reference

IPD/PU-00-18

IPD/PU-00-25

IPD/PU-00-32



STRAIGHT MULTI-UNIT SCREWDRIVER

Longitud (mm)

20

Reference

IPD/LL-AB-00



WORKING SYSTEMS

Multi-unit System

Compatibility	Platform	Angulation	Height (mm)	Reference	
Nobel Biocare® Branemark System® Biomet® 3i® Osseotite® BTI® External Hex Sweden & Martina® Outlink® Microdent® Microdent® Universal™ Klockner® KL™ Neodent® Helix® HE	ø4.1	Straight	1.0	IPD/AB-MR-01	
			2.0	IPD/AB-MR-02	
			3.0	IPD/AB-MR-03	
			4.0	IPD/AB-MR-04	
			5.0	IPD/AB-MR-05	
		17°	2.0	IPD/AB-MR-12	
			3.0	IPD/AB-MR-13	
			4.0	IPD/AB-MR-14	
			3.0	IPD/AB-MR-33	
			3.0	IPD/AB-MR-34	
Phibo® TSH®	S3-S4	30°	4.0	IPD/AB-MR-34	
			5.0	IPD/AB-MR-35	
Nobel Biocare® Nobel Replace® Select	ø3.5	Straight	1.0	IPD/AC-MN-01	
			2.0	IPD/AC-MN-02	
			1.0	IPD/AC-MR-01	
			2.0	IPD/AC-MR-02	
			3.0	IPD/AC-MR-03	
		17°	4.0	IPD/AC-MR-04	
			5.0	IPD/AC-MR-05	
			2.0	IPD/AC-MR-12	
			3.0	IPD/AC-MR-13	
			4.0	IPD/AC-MR-34	
Nobel Biocare® Nobel Active®	ø3.5	Straight	1.5	IPD/AD-MN-01	
			2.5	IPD/AD-MN-02	
			3.5	IPD/AD-MN-03	
			4.5	IPD/AD-MN-04	
			2.5	IPD/AD-MN-12	
		17°	3.5	IPD/AD-MN-13	
			3.5	IPD/AD-MN-33	
			4.5	IPD/AD-MN-34	
			30°	1.5	IPD/AD-MR-01
				2.5	IPD/AD-MR-02
3.5	IPD/AD-MR-03				
4.5	IPD/AD-MR-04				
2.5	IPD/AD-MR-12				
17°	3.5	IPD/AD-MR-13			
	3.5	IPD/AD-MR-33			
	4.5	IPD/AD-MR-34			
	30°	1.0	IPD/BB-MN-01		
		2.0	IPD/BB-MN-02		
3.0		IPD/BB-MN-03			
4.0		IPD/BB-MN-04			
Biomet® 3i® Certain®		ø3.4	Straight	1.0	IPD/BB-MN-01
	2.0			IPD/BB-MN-02	
	3.0			IPD/BB-MN-03	
	4.0			IPD/BB-MN-04	

WORKING SYSTEMS

Multi-unit System

Compatibility	Platform	Angulation	Height (mm)	Reference		
Biomet® 3i® Certain®	Ø4.1	Straight	2.0	IPD/BB-MR-02		
			3.0	IPD/BB-MR-03		
			4.0	IPD/BB-MR-04		
			5.0	IPD/BB-MR-05		
		17°	2.0	IPD/BB-MR-12		
			3.0	IPD/BB-MR-13		
			4.0	IPD/BB-MR-34		
Klockner® Vega®	Ø3.5	Straight	1.5	IPD/CD-MN-01		
			2.5	IPD/CD-MN-02		
			3.5	IPD/CD-MN-03		
			4.5	IPD/CD-MN-04		
			5.5	IPD/CD-MN-05		
		17°	2.5	IPD/CD-MN-12		
			3.5	IPD/CD-MN-33		
		Ø4.0 / Ø4.5	Straight	1.5	IPD/CD-MR-01	
				2.5	IPD/CD-MR-02	
				3.5	IPD/CD-MR-03	
4.5	IPD/CD-MR-04					
5.5	IPD/CD-MR-05					
17°	2.5			IPD/CD-MR-12		
30°	3.5			IPD/CD-MR-33		
Straumann® Tissue Level	Ø4.8	Straight	0.9	IPD/DA-MR-01		
Straumann® Bone Level	Ø3.3 NC	Straight	1.5	IPD/DB-MN-01		
			2.5	IPD/DB-MN-02		
			3.5	IPD/DB-MN-03		
			4.5	IPD/DB-MN-04		
		17°	2.5	IPD/DB-MN-12		
			3.5	IPD/DB-MN-13		
		30°	3.5	IPD/DB-MN-33		
			4.5	IPD/DB-MN-34		
			Ø4.1 RC	Straight	1.5	IPD/DB-MR-01
					2.5	IPD/DB-MR-02
3.5	IPD/DB-MR-03					
4.5	IPD/DB-MR-04					
17°	2.5	IPD/DB-MR-12				
	3.5	IPD/DB-MR-13				
30°	3.5	IPD/DB-MR-33				
	4.5	IPD/DB-MR-34				
Straumann® BLX®	RB/WB	Straight	1.5	IPD/DC-MR-01		
			2.5	IPD/DC-MR-02		
			3.5	IPD/DC-MR-03		
		17°	3.5	IPD/DC-MR-13		
			30°	4.5	IPD/DC-MR-34	

WORKING SYSTEMS

Multi-unit System

Compatibility	Platform	Angulation	Height (mm)	Reference	
Astra® Osseospeed™	ø3.5 / ø4.0	Straight	1.5	IPD/EA-MR-01	
			2.5	IPD/EA-MR-02	
			3.5	IPD/EA-MR-03	
			4.5	IPD/EA-MR-04	
		17°	2.5	IPD/EA-MR-12	
			3.5	IPD/EA-MR-13	
	30°	3.5	IPD/EA-MR-33		
		4.5	IPD/EA-MR-34		
	ø4.5 / ø5.0	Straight	1.5	IPD/EA-MW-01	
			2.5	IPD/EA-MW-02	
			3.5	IPD/EA-MW-03	
			4.5	IPD/EA-MW-04	
17°		2.5	IPD/EA-MW-12		
		3.5	IPD/EA-MW-33		
Astra® Evolution®	ø3.6	Straight	1.5	IPD/EB-MN-01	
			2.5	IPD/EB-MN-02	
		17°	2.5	IPD/EB-MN-12	
			3.5	IPD/EB-MN-33	
	ø4.2	Straight	1.5	IPD/EB-MR-01	
			2.5	IPD/EB-MR-02	
		17°	2.5	IPD/EB-MR-12	
			3.5	IPD/EB-MR-33	
	Zimmer® Screw Vent®	ø3.5	Straight	0.9	IPD/FA-MN-00
				1.5	IPD/FA-MN-01
				2.5	IPD/FA-MN-02
				3.5	IPD/FA-MN-03
17°			2.5	IPD/FA-MN-12	
			3.5	IPD/FA-MN-13	
30°		3.5	IPD/FA-MN-33		
		4.5	IPD/FA-MN-34		
ø4.5		Straight	1.5	IPD/FA-MR-01	
			2.5	IPD/FA-MR-02	
			3.5	IPD/FA-MR-03	
			4.5	IPD/FA-MR-04	
	17°	3.0	IPD/FA-MR-13		
		4.0	IPD/FA-MR-14		
30°	3.5	IPD/FA-MR-33			
	4.5	IPD/FA-MR-34			
Zimmer® Eztetic®	ø3.1	Straight	1.5	IPD/FC-MT-01	
			2.5	IPD/FC-MT-02	
			3.5	IPD/FC-MT-03	
		17°	2.5	IPD/FC-MT-12	
			3.5	IPD/FC-MT-33	

WORKING SYSTEMS Multi-unit System

Compatibility	Platform	Angulation	Height (mm)	Reference	
BTI® Interna Universal®	Ø4.1	Straight	1.0	IPD/GB-MR-01	
			2.0	IPD/GB-MR-02	
			3.0	IPD/GB-MR-03	
			4.0	IPD/GB-MR-04	
			5.0	IPD/GB-MR-05	
		17°	3.0	IPD/GB-MR-13	
			4.0	IPD/GB-MR-14	
			4.0	IPD/GB-MR-34	
		30°	5.0	IPD/GB-MR-35	
			Straight	1.5	IPD/MB-MN-01
3.0	IPD/MB-MN-03				
4.0	IPD/MB-MN-04				
Sweden & Martina® Premium™ Khono®	Ø3.8	Straight	0.9	IPD/FA-MN-00	
			1.5	IPD/FA-MN-01	
			2.5	IPD/FA-MN-02	
			3.5	IPD/FA-MN-03	
			4.5	IPD/FA-MN-04	
			17°	2.5	IPD/LB-MN-12
				3.5	IPD/LB-MN-13
		3.5		IPD/LB-MN-33	
		30°	4.5	IPD/LB-MN-34	
			Straight	1.5	IPD/FA-MR-01
				2.5	IPD/FA-MR-02
				3.5	IPD/FA-MR-03
		4.5		IPD/FA-MR-04	
		BioHorizons® Tapered Internal	Ø3.5	Straight	1.0
2.0	IPD/JA-MR-02				
2.5	IPD/JA-MR-12				
3.5	IPD/JA-MR-33				
3.5	IPD/JA-MR-33				
17°	1.0			IPD/JA-MW-01	
	2.0			IPD/JA-MW-02	
	2.5			IPD/JA-MW-12	
30°	3.5			IPD/JA-MW-33	
	Straight			1.0	IPD/JA-MX-01
		2.0	IPD/JA-MX-02		
2.5		IPD/JA-MX-12			
Camlog® Camlog®	Ø4.3	Straight	3.5	IPD/JA-MX-33	
			1.0	IPD/JB-MN-01	
			2.0	IPD/JB-MN-02	
		17°	2.5	IPD/JB-MN-12	
			3.5	IPD/JB-MN-33	
			3.5	IPD/JB-MN-33	
Camlog® Conelog®	Ø4.3	Straight	1.5	IPD/JB-MR-01	
			2.5	IPD/JB-MR-02	
			2.5	IPD/JB-MR-12	
		17°	2.5	IPD/JB-MR-12	
			3.5	IPD/JB-MR-33	
			3.5	IPD/JB-MR-33	

WORKING SYSTEMS

Multi-unit System

Compatibility	Platform	Angulation	Height (mm)	Reference
Osstem Implant® TSIII	Ø3.5	Straight	1.5	IPD/OB-MN-01
			2.5	IPD/OB-MN-02
			3.5	IPD/OB-MN-03
		4.5	IPD/OB-MN-04	
		5.5	IPD/OB-MN-05	
		17°	2.5	IPD/OB-MN-12
	3.5		IPD/OB-MN-13	
	3.5		IPD/OB-MN-33	
	Ø4.0	Straight	4.5	IPD/OB-MN-34
			1.5	IPD/OB-MR-01
			2.5	IPD/OB-MR-02
		3.5	IPD/OB-MR-03	
4.5		IPD/OB-MR-04		
5.5		IPD/OB-MR-05		
Biotech® Dental Kontakt®	RP	Straight	2.5	IPD/OB-MR-12
			3.5	IPD/OB-MR-13
			3.5	IPD/OB-MR-33
	17°	4.5	IPD/OB-MR-34	
		1.5	IPD/QB-MR-01	
		2.5	IPD/QB-MR-02	
Neodent® Helix® HE	NP	Straight	3.5	IPD/QB-MR-03
			1.5	IPD/RA-MN-01
			2.5	IPD/RA-MN-02
	17°	3.5	IPD/RA-MN-03	
		2.5	IPD/RA-MN-12	
		3.5	IPD/RA-MN-33	
Neodent® Grand Morse™ GM	WP	Straight	1.5	IPD/RA-MW-01
			2.5	IPD/RA-MW-02
			3.5	IPD/RA-MW-03
	17°	2.5	IPD/RA-MW-12	
		3.5	IPD/RA-MW-33	
		1.5	IPD/RB-MR-01	
GM	Straight	2.5	IPD/RB-MR-02	
		3.5	IPD/RB-MR-03	
		1.5	IPD/RB-MR-01	
17°	Straight	2.5	IPD/RB-MR-02	
		3.5	IPD/RB-MR-03	
		2.5	IPD/RB-MR-12	
30°	Straight	3.5	IPD/RB-MR-33	
		1.5	IPD/RB-MR-01	
		2.5	IPD/RB-MR-02	

WORKING SYSTEMS Multi-unit System

Compatibility	Platform	Angulation	Height (mm)	Reference	
Bego® Semados®	Ø3.25 / Ø3.75	Straight	1.5	IPD/SB-MN-01	
			2.5	IPD/SB-MN-02	
			3.5	IPD/SB-MN-03	
			4.5	IPD/SB-MN-04	
			5.5	IPD/SB-MN-05	
		17°	2.5	IPD/SB-MN-12	
			3.5	IPD/SB-MN-13	
			30°	3.5	IPD/SB-MN-33
				4.5	IPD/SB-MN-34
				1.5	IPD/SB-MR-01
	Ø4.1	Straight	2.5	IPD/SB-MR-02	
			3.5	IPD/SB-MR-03	
			4.5	IPD/SB-MR-04	
		17°	2.5	IPD/SB-MR-12	
			30°	3.5	IPD/SB-MR-33
				1.5	IPD/SB-MW-01
	Ø4.5	Straight		2.5	IPD/SB-MW-02
			2.5	IPD/SB-MW-12	
		17°	2.5	IPD/SB-MW-12	
			3.5	IPD/SB-MW-33	
MIS® Seven®	Standard Ø3.75 / Ø4.2	Straight	0.9	IPD/FA-MN-00	
			1.5	IPD/FA-MN-01	
			2.5	IPD/FA-MN-02	
			3.5	IPD/FA-MN-03	
			4.5	IPD/FA-MN-04	
		17°	2.5	IPD/FA-MN-12	
			3.5	IPD/FA-MN-13	
			30°	3.5	IPD/FA-MN-33
				4.5	IPD/FA-MN-34
				1.5	IPD/FA-MR-01
	Wide Ø5.0 / Ø6.0	Straight	2.5	IPD/FA-MR-02	
			3.5	IPD/FA-MR-03	
			4.5	IPD/FA-MR-04	
		17°	3.0	IPD/FA-MR-13	
			4.0	IPD/FA-MR-14	
			30°	3.5	IPD/FA-MR-33
4.5	IPD/FA-MR-34				
MIS® C1/V3®	Standard Ø3.75 / Ø4.20	Straight		1.0	IPD/TB-MR-01
			2.0	IPD/TB-MR-02	
			3.0	IPD/TB-MR-03	
			4.0	IPD/TB-MR-04	
		17°	2.5	IPD/TB-MR-12	
			30°	3.5	IPD/TB-MR-33

WORKING SYSTEMS

Multi-unit System

Compatibility	Platform	Angulation	Height (mm)	Reference
DIO® UFII	NP	Straight	1.5	IPD/UB-MN-01
			2.5	IPD/UB-MN-02
			3.5	IPD/UB-MN-03
		17°	2.5	IPD/UB-MN-12
		30°	3.5	IPD/UB-MN-33
	RP	Straight	1.5	IPD/UB-MR-01
			2.5	IPD/UB-MR-02
			3.5	IPD/UB-MR-03
		17°	2.5	IPD/UB-MR-12
		30°	3.5	IPD/UB-MR-33
Megagen® AnyOne®	RP	Straight	1.5	IPD/WA-MR-01
			2.5	IPD/WA-MR-02
			3.5	IPD/WA-MR-03
		17°	2.5	IPD/WA-MR-12
		30°	3.5	IPD/WA-MR-33
Megagen® AnyRidge®	RP	Straight	1.5	IPD/WB-MR-01
			2.5	IPD/WB-MR-02
			3.5	IPD/WB-MR-03
		17°	2.5	IPD/WB-MR-12
		30°	3.5	IPD/WB-MR-33
Dentium® Implantium® /Superline®	RP	Straight	1.5	IPD/XA-MR-01
			2.5	IPD/XA-MR-02
			3.5	IPD/XA-MR-03
		17°	2.5	IPD/XA-MR-12
		30°	3.5	IPD/XA-MR-33
Medentis® ICX	RP	Straight	1.5	IPD/YB-MR-01
			2.5	IPD/YB-MR-02
			3.5	IPD/YB-MR-03
		17°	2.5	IPD/YB-MR-12
Global D® In-Kone®	RP	Straight	1.5	IPD/1A-MR-01
			2.5	IPD/1A-MR-02
			3.5	IPD/1A-MR-03
		17°	2.5	IPD/1A-MR-12
		30°	3.5	IPD/1A-MR-33
Anthogyr® Axiom® BL	RP	Straight	1.5	IPD/2A-MR-01
			2.5	IPD/2A-MR-02
			3.5	IPD/2A-MR-03
		17°	3.5	IPD/2A-MR-13
		30°	4.5	IPD/2A-MR-34

WORKING SYSTEMS PSD System

WORKFLOW DIAGRAM

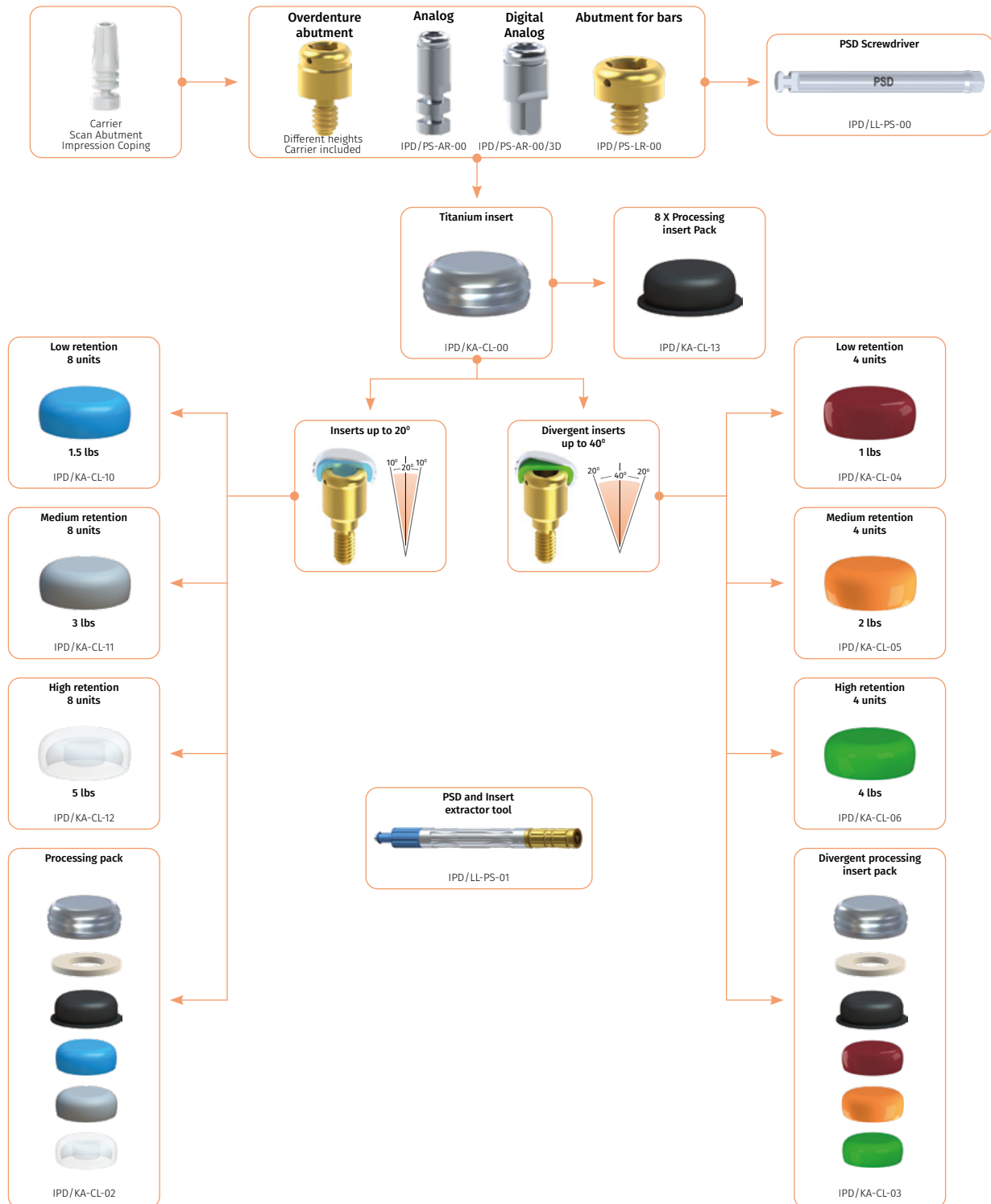

ANALOG

Description	Reference	Digital Reference
PSD analog	IPD/PS-AR-00	IPD/PS-AR-00/3D



TITANIUM INSERT

Description	Reference
Titanium insert	IPD/KA-CL-00
Titanium insert + 4 Retention inserts	IPD/KA-CL-02
Titanium insert + 4 Divergent Retention inserts	IPD/KA-CL-03



INSERTS

Description	Retention	Units	Reference
Combined inserts up to 20°	-	Pack 4	IPD/KA-CL-01
Red divergent inserts	1 lbs	Pack 4	IPD/KA-CL-04
Orange divergent inserts	2 lbs	Pack 4	IPD/KA-CL-05
Green divergent inserts	4 lbs	Pack 4	IPD/KA-CL-06
Inserts up to 20° in blue	1.5 lbs	Pack 8	IPD/KA-CL-10
Inserts up to 20° in grey	3 lbs	Pack 8	IPD/KA-CL-11
Inserts up to 20° colourless	5 lbs	Pack 8	IPD/KA-CL-12
Black processing inserts	-	Pack 8	IPD/KA-CL-13



ABUTMENT FOR BARS

Platform	Height (mm)	Metric	Units	Reference
PSD para barras	1	2 mm	2	IPD/PS-LR-00



PSD SCREWDRIVER

Description	Reference
	IPD/LL-PS-00

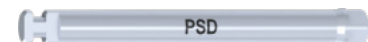

PSD TOOL

Description	Reference
PSD Screwdriver + insert extractor tool	IPD/LL-PS-01



WORKING SYSTEMS PSD System

Compatibility	Platform	Height (mm)	Reference
Nobel Biocare® Branemark System® Klockner® KL™	Ø3.5	1.0	IPD/AA-LN-01
		3.0	IPD/AA-LN-03
		5.0	IPD/AA-LN-05
Nobel Biocare® Branemark System® Biomet® 3i® Osseotite® BTI® External Hex Sweden & Martina® Outlink® Microdent® Microdent® Universal™	Ø4.1	1.0	IPD/AA-LR-01
		2.0	IPD/AA-LR-02
		3.0	IPD/AA-LR-03
		4.0	IPD/AA-LR-04
		5.0	IPD/AA-LR-05
Phibo® TSH®	S3-S4		
Multi-unit	Ø4.8	3.35	IPD/AB-LR-02
		3.0	IPD/AC-LN-03
		5.0	IPD/AC-LN-05
Nobel Biocare® Nobel Replace® Select	Ø4.3	1.0	IPD/AC-LR-01
		3.0	IPD/AC-LR-03
		5.0	IPD/AC-LR-05
		1.0	IPD/AD-LN-01
		2.0	IPD/AD-LN-02
Nobel Biocare® Nobel Active®	Ø3.5	3.0	IPD/AD-LN-03
		4.0	IPD/AD-LN-04
		5.0	IPD/AD-LN-05
	Ø4.3	1.0	IPD/AD-LR-01
		2.0	IPD/AD-LR-02
		3.0	IPD/AD-LR-03
		4.0	IPD/AD-LR-04
Biomet® 3i® Osseotite®	Ø3.4	5.0	IPD/AD-LR-05
		1.0	IPD/BA-LN-01
		3.0	IPD/BA-LN-03
Biomet® 3i® Certain®	Ø3.4	1.0	IPD/BB-LN-01
		3.0	IPD/BB-LN-03
		5.0	IPD/BB-LN-05
	Ø4.1	1.0	IPD/BB-LR-01
		3.0	IPD/BB-LR-03
Klockner® Essential Cone®	Ø4.5	5.0	IPD/BB-LR-05
		1.0	IPD/CB-LR-01
		3.0	IPD/CB-LR-03
	Ø3.5	1.0	IPD/CD-LN-01
		2.0	IPD/CD-LN-02
Klockner® Vega®	Ø4.0 / Ø4.5	3.0	IPD/CD-LN-03
		4.0	IPD/CD-LN-04
		5.0	IPD/CD-LN-05
		1.0	IPD/CD-LR-01
		2.0	IPD/CD-LR-02
		3.0	IPD/CD-LR-03
		4.0	IPD/CD-LR-04
		5.0	IPD/CD-LR-05

Compatibility	Platform	Height (mm)	Reference
Straumann® Tissue Level	ø4.8	1.0	IPD/DA-LR-01
		2.0	IPD/DA-LR-02
		3.0	IPD/DA-LR-03
Straumann® Bone Level	ø3.5	1.0	IPD/DB-LN-01
		2.0	IPD/DB-LN-02
		3.0	IPD/DB-LN-03
		4.0	IPD/DB-LN-04
		5.0	IPD/DB-LN-05
	ø4.1	1.0	IPD/DB-LR-01
		2.0	IPD/DB-LR-02
		4.0	IPD/DB-LR-04
		5.0	IPD/DB-LR-05
Straumann® BLX®	RB/WB	2.0	IPD/DC-LR-02
		3.0	IPD/DC-LR-03
		4.0	IPD/DC-LR-04
		1.0	IPD/EA-LR-01
		2.0	IPD/EA-LR-02
Astra® Osseospeed™	ø3.5 / ø4.0	3.0	IPD/EA-LR-03
		4.0	IPD/EA-LR-04
		5.0	IPD/EA-LR-05
		1.0	IPD/EA-LW-01
		2.0	IPD/EA-LW-02
	ø4.5 / ø5.0	3.0	IPD/EA-LW-03
		4.0	IPD/EA-LW-04
		5.0	IPD/EA-LW-05
		1.0	IPD/EA-LW-01
Astra® Evolution®	ø4.2	3.0	IPD/EB-LR-03
		5.0	IPD/EB-LR-05
		1.0	IPD/EB-LR-01
Zimmer® Screw Vent® BioHorizons® Tapered Internal MIS® Seven®	ø3.5	2.0	IPD/FA-LN-02
		3.0	IPD/FA-LN-03
		4.0	IPD/FA-LN-04
		5.0	IPD/FA-LN-05
		1.0	IPD/FA-LR-01
	ø4.5	2.0	IPD/FA-LR-02
		3.0	IPD/FA-LR-03
		4.0	IPD/FA-LR-04
		5.0	IPD/FA-LR-05
Zimmer® Eztetic®	ø3.1	2.0	IPD/FC-LT-02
		3.0	IPD/FC-LT-03
		4.0	IPD/FC-LT-04
		5.0	IPD/FC-LT-05
		3.0	IPD/FC-LT-03

WORKING SYSTEMS PSD System

Compatibility	Platform	Height (mm)	Reference
BTI® Interna Universal®	ø4.1	1.0	IPD/GB-LR-01
		3.0	IPD/GB-LR-03
		5.0	IPD/GB-LR-05
	ø3.8	1.0	IPD/JA-LR-01
		3.0	IPD/JA-LR-03
		5.0	IPD/JA-LR-05
Camlog® Camlog®	ø4.3	1.0	IPD/JA-LW-01
		3.0	IPD/JA-LW-03
		5.0	IPD/JA-LW-05
	ø5.0	1.0	IPD/JA-LX-01
		2.0	IPD/JA-LX-02
		3.0	IPD/JA-LX-03
Camlog® Conelog®	ø3.8	4.0	IPD/JA-LX-04
		2.0	IPD/JB-LN-02
		3.0	IPD/JB-LN-03
	ø4.3	4.0	IPD/JB-LN-04
		2.0	IPD/JB-LR-02
		3.0	IPD/JB-LR-03
BioHorizons® Tapered Internal	ø3.0	4.0	IPD/JB-LR-04
		2.0	IPD/LB-LT-02
		3.0	IPD/LB-LT-03
	ø3.3	4.0	IPD/LB-LT-04
		5.0	IPD/LB-LT-05
		2.0	IPD/MA-LN-02
Sweden & Martina® Outlink®	ø3.3	3.0	IPD/MA-LN-03
		4.0	IPD/MA-LN-04
		5.0	IPD/MA-LN-05
	ø3.8	1.0	IPD/MB-LN-01
		3.0	IPD/MB-LN-03
		5.0	IPD/MB-LN-05
Sweden & Martina® Premium™ Kohno®	ø4.25	1.0	IPD/MB-LR-01
		3.0	IPD/MB-LR-03
		5.0	IPD/MB-LR-05
	S2	1.0	IPD/NA-LN-01
		3.0	IPD/NA-LN-03
		5.0	IPD/NA-LN-05
Phibo® TSH®	S2	1.0	IPD/NA-LN-01
		3.0	IPD/NA-LN-03
		5.0	IPD/NA-LN-05

Compatibility	Platform	Height (mm)	Reference
Osstem Implant® TSIII	Ø3.5	1.0	IPD/OB-LN-01
		2.0	IPD/OB-LN-02
		3.0	IPD/OB-LN-03
		4.0	IPD/OB-LN-04
		5.0	IPD/OB-LN-05
	Ø4.0	1.0	IPD/OB-LR-01
		2.0	IPD/OB-LR-02
		3.0	IPD/OB-LR-03
		4.0	IPD/OB-LR-04
		5.0	IPD/OB-LR-05
Biotech® Dental Kontakt®	RP	2.0	IPD/QB-LR-02
		3.0	IPD/QB-LR-03
		4.0	IPD/QB-LR-04
		2.0	IPD/RA-LN-02
Neodent® Helix® HE	Ø3.3	3.0	IPD/RA-LN-03
		4.0	IPD/RA-LN-04
	Ø5.0	2.0	IPD/RA-LW-02
		3.0	IPD/RA-LW-03
Neodent® Grand Morse™ GM	GM	4.0	IPD/RA-LW-04
		2.0	IPD/RB-LR-02
		3.0	IPD/RB-LR-03
		4.0	IPD/RB-LR-04
Bego® Semados®	Ø3.25 / Ø3.75	1.0	IPD/SB-LN-01
		2.0	IPD/SB-LN-02
		3.0	IPD/SB-LN-03
		4.0	IPD/SB-LN-04
		5.0	IPD/SB-LN-05
	Ø4.1	1.0	IPD/SB-LR-01
		2.0	IPD/SB-LR-02
		3.0	IPD/SB-LR-03
		4.0	IPD/SB-LR-04
		5.0	IPD/SB-LR-05
Ø4.5	1.0	IPD/SB-LW-01	
	2.0	IPD/SB-LW-02	
	3.0	IPD/SB-LW-03	
	4.0	IPD/SB-LW-04	
	5.0	IPD/SB-LW-05	

WORKING SYSTEMS PSD System

Compatibility	Platform	Height (mm)	Reference
MIS® Seven®	ø3.3	1.0	IPD/TA-LT-01
		2.0	IPD/TA-LT-02
		3.0	IPD/TA-LT-03
		4.0	IPD/TA-LT-04
		5.0	IPD/TA-LT-05
MIS® C1/V3®	Standard	1.0	IPD/TB-LR-01
		2.0	IPD/TB-LR-02
		3.0	IPD/TB-LR-03
		4.0	IPD/TB-LR-04
		5.0	IPD/TB-LR-05
DIO® UFII	NP	2.0	IPD/UB-LN-02
		3.0	IPD/UB-LN-03
	RP	4.0	IPD/UB-LN-04
		2.0	IPD/UB-LR-02
		3.0	IPD/UB-LR-03
Megagen® AnyOne®	RP	4.0	IPD/UB-LR-04
		2.0	IPD/WA-LR-02
		3.0	IPD/WA-LR-03
Megagen® AnyRidge®	RP	4.0	IPD/WA-LR-04
		2.0	IPD/WB-LR-02
		3.0	IPD/WB-LR-03
Dentium® Implantium® / Superline™	RP	4.0	IPD/WB-LR-04
		2.0	IPD/XA-LR-02
		3.0	IPD/XA-LR-03
Medentis® ICX	RP	4.0	IPD/XA-LR-04
		2.0	IPD/YB-LR-02
		3.0	IPD/YB-LR-03
Global D® In-Kone®	RP	4.0	IPD/YB-LR-04
		2.0	IPD/1A-LR-02
		3.0	IPD/1A-LR-03
Anthogyr® Axiom® BL	RP	4.0	IPD/1A-LR-04
		2.0	IPD/2A-LR-02
		3.0	IPD/2A-LR-03
		4.0	IPD/2A-LR-04

WORKING SYSTEMS

Hollow Screw System

WORKFLOW DIAGRAM

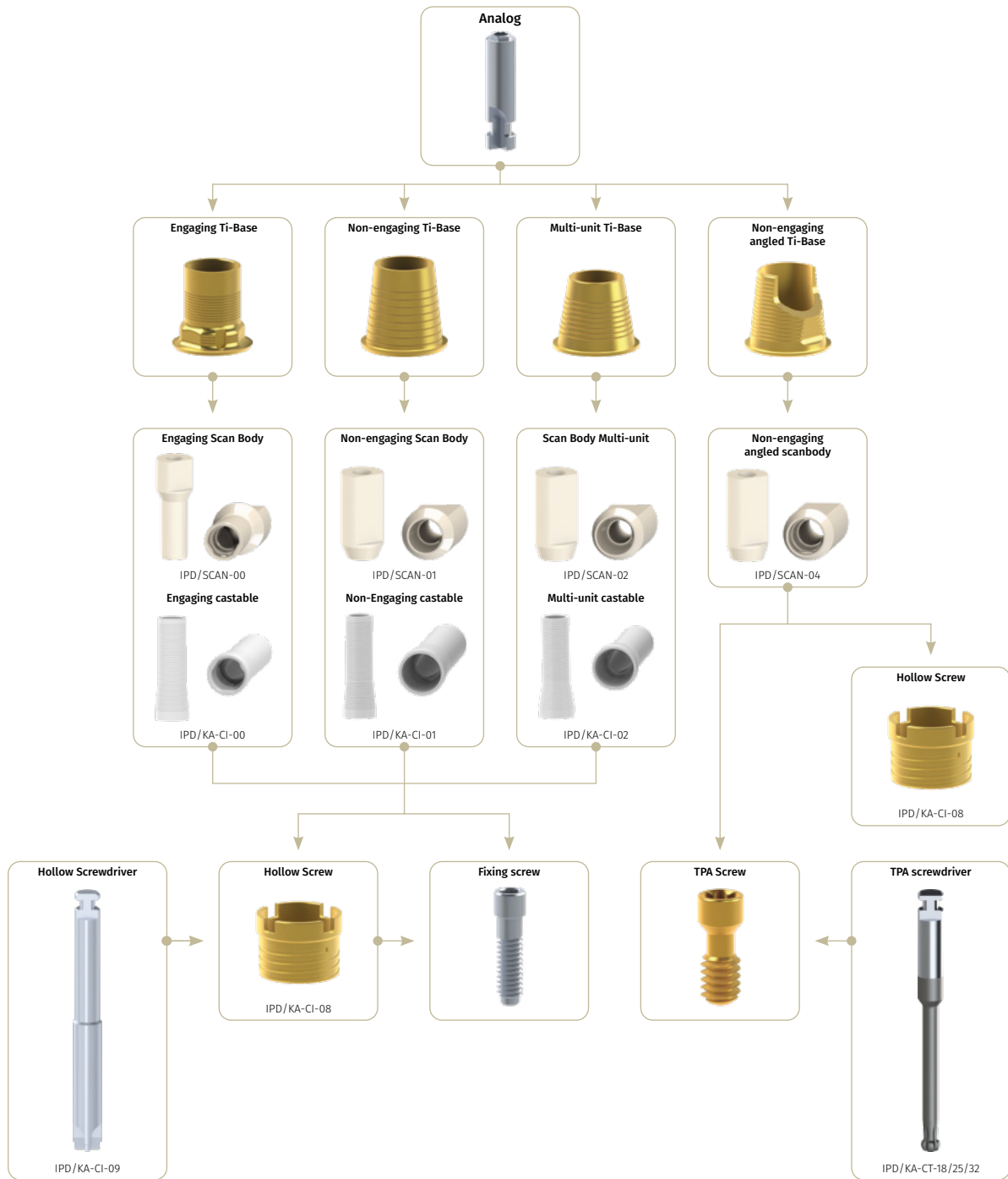

Hollow Screw System

SCAN BODY

Engaging and Non-engaging



IPD/SCAN-00



IPD/SCAN-01



Multi-unit

Reference

IPD/SCAN-02



Non-engaging angled

Reference

IPD/SCAN-04



CASTABLE

Engaging and Non-engaging



IPD/KA-CI-00



IPD/KA-CI-01



Multi-unit

Reference

IPD/KA-CI-02



HOLLOW SCREW

Engaging and Non-engaging

Reference

IPD/KA-CI-08



HOLLOW SCREWDRIVER

Reference

IPD/KA-CI-09



WORKING SYSTEMS

Hollow Screw System

Compatibility	Platform	Connection	Model	Height (mm)	Reference
Nobel Biocare® Branemark System® Biomet® Osseotite® BTI® External Hex Sweden & Martina® Outlink® Microdent® Microdent® Universal™ Klockner® KL™	ø4.1	Engaging	Straight	0.2	IPD/AA-IR-00
				1.5	IPD/AA-IR-02
		Non-engaging		2.5	IPD/AA-IR-04
				0.2	IPD/AA-IR-01
				1.5	IPD/AA-IR-03
Phibo® TSH®	S3-S4		For angulations	2.5	IPD/AA-IR-05
				0.2	IPD/AA-IR-31
Nobel Biocare® Branemark System® Klockner® KL™	ø3.5	Engaging	Straight	1.0	IPD/AA-IN-00
				2.5	IPD/AA-IN-02
		Non-engaging		1.0	IPD/AA-IN-01
				2.5	IPD/AA-IN-03
				1.0	IPD/AA-IN-31
Multi-unit	Non-engaging	Straight	0.2	IPD/AB-IR-01	
	ø3.5	Engaging	Straight	1.0	IPD/AC-IN-00
				2.5	IPD/AC-IN-02
		Non-engaging		1.0	IPD/AC-IN-01
				2.5	IPD/AC-IN-03
				3.5	IPD/AC-IN-31
Nobel Biocare® Nobel Replace® Select	ø4.3	Engaging	Straight	0.2	IPD/AC-IR-00
				1.5	IPD/AC-IR-02
		Non-engaging		2.5	IPD/AC-IR-04
				0.2	IPD/AC-IR-01
				1.5	IPD/AC-IR-03
	ø5.0	Engaging	Straight	2.5	IPD/AC-IR-05
				0.2	IPD/AC-IW-00
		Non-engaging		1.5	IPD/AC-IW-02
				2.5	IPD/AC-IW-04
				0.2	IPD/AC-IW-01
Nobel Biocare® Nobel Active®	ø3.5	Engaging	Straight	1.5	IPD/AC-IW-03
				2.5	IPD/AC-IW-05
		Non-engaging		0.2	IPD/AC-IW-31
				0.9	IPD/AD-IN-00
				2.5	IPD/AD-IN-02
				0.9	IPD/AD-IN-01
				2.5	IPD/AD-IN-03
			For angulations	0.9	IPD/AD-IN-31

WORKING SYSTEMS

Hollow Screw System

Compatibility	Platform	Connection	Model	Height (mm)	Reference
Nobel Biocare® Nobel Active®	ø4.3	Engaging	Straight	0.9	IPD/AD-IR-00
				2.5	IPD/AD-IR-02
		Non-engaging		0.9	IPD/AD-IR-01
				2.5	IPD/AD-IR-03
				For angulations	1.0
Biomet® 3i® Osseotite®	ø3.4	Engaging	Straight	1.0	IPD/BA-IN-00
		Non-engaging		2.5	IPD/BA-IN-02
				1.0	IPD/BA-IN-01
	ø5.0	Engaging	Straight	2.5	IPD/BA-IN-03
				0.2	IPD/BA-IW-00
		Non-engaging		1.5	IPD/BA-IW-02
				2.5	IPD/BA-IW-04
Biomet® 3i® Certain®	ø3.4	Engaging	Straight	0.2	IPD/BA-IW-01
		Non-engaging		1.5	IPD/BA-IW-03
				2.5	IPD/BA-IW-05
	ø4.1	Engaging	Straight	0.9	IPD/BB-IN-00
				2.5	IPD/BB-IN-02
		Non-engaging		0.9	IPD/BB-IN-01
				For angulations	2.5
Biomet® 3i® Certain®	ø5.0	Engaging	Straight	0.9	IPD/BB-IN-31
				1.5	IPD/BB-IR-02
		Non-engaging		2.5	IPD/BB-IR-04
				0.3	IPD/BB-IR-01
				1.5	IPD/BB-IR-03
Klockner® Essential Cone®	ø4.5	Engaging	Straight	2.5	IPD/BB-IR-05
				0.3	IPD/BB-IR-31
		Non-engaging		0.3	IPD/BB-IW-00
				1.5	IPD/BB-IW-02
				2.5	IPD/BB-IW-04
Straumann® Tissue Level	ø4.8	Engaging	Straight	0.3	IPD/BB-IW-01
				1.5	IPD/BB-IW-03
		Non-engaging		2.5	IPD/BB-IW-05
				0.3	IPD/CB-IR-00
				0.3	IPD/CB-IR-01
Klockner® Essential Cone®	ø4.5	Engaging	Straight	0.35	IPD/CB-IR-31
				Non-engaging	IPD/DA-IR-00
		IPD/DA-IR-01			
Straumann® Tissue Level	ø4.8	Engaging	Straight	0.85	IPD/DA-IR-11
				Non-engaging	IPD/DA-IR-31
		IPD/DA-IR-31			

WORKING SYSTEMS

Hollow Screw System

Compatibility	Platform	Connection	Model	Height (mm)	Reference	
Straumann® Bone Level	ø3.3 NC	Engaging	Straight	1.0	IPD/DB-IN-00	
				2.5	IPD/DB-IN-02	
		Non-engaging		1.0	IPD/DB-IN-01	
		2.5	IPD/DB-IN-03			
		For angulations	1.0	IPD/DB-IN-31		
Straumann® Bone Level	ø4.1 RC	Engaging	Straight	1.0	IPD/DB-IR-00	
				2.5	IPD/DB-IR-02	
		Non-engaging		1.0	IPD/DB-IR-01	
		2.5	IPD/DB-IR-03			
		For angulations	1.0	IPD/DB-IR-31		
Astra® Osseospeed™	ø3.0	Engaging	Straight	1.5	IPD/EA-IN-00	
				2.5	IPD/EA-IN-02	
		Non-engaging		1.5	IPD/EA-IN-01	
				2.5	IPD/EA-IN-03	
	For angulations	1.5	IPD/EA-IN-31			
Astra® Osseospeed™	ø3.5/4.0	Engaging	Straight	1.1	IPD/EA-IR-00	
				2.5	IPD/EA-IR-02	
		Non-engaging		1.1	IPD/EA-IR-01	
		2.5	IPD/EA-IR-03			
		For angulations	1.1	IPD/EA-IR-31		
Astra® Osseospeed™	ø4.5/5.0	Non-engaging	Straight	0.9	IPD/EA-IW-01	
				2.5	IPD/EA-IW-03	
				For angulations	0.9	IPD/EA-IW-31
Astra® Evolution®	ø3.6	Engaging	Straight		IPD/EB-IN-00	
					IPD/EB-IN-01	
		Non-engaging		For angulations		IPD/EB-IN-31
	ø4.2	Engaging	Straight	1.0	IPD/EB-IR-00	
					IPD/EB-IR-01	
		Non-engaging		For angulations		IPD/EB-IR-31

WORKING SYSTEMS

Hollow Screw System

Compatibility	Platform	Connection	Model	Height (mm)	Reference	
Zimmer® Screw Vent®	ø3.5	Engaging	Straight	0.9	IPD/FA-IN-00	
				2.5	IPD/FA-IN-02	
		Non-engaging		0.9	IPD/FA-IN-01	
				2.5	IPD/FA-IN-03	
				For angulations	0.9	IPD/FA-IN-31
	ø4.5	Engaging	Straight	0.1	IPD/FA-IR-00	
				1.5	IPD/FA-IR-02	
		Non-engaging		2.5	IPD/FA-IR-04	
				0.1	IPD/FA-IR-01	
				1.5	IPD/FA-IR-03	
2.5	IPD/FA-IR-05					
For angulations	0.1	IPD/FA-IR-31				
BTI® Tiny BTI®	ø3.5	Engaging	Straight	1.0	IPD/GA-IN-00	
				2.5	IPD/GA-IN-02	
		Non-engaging		1.0	IPD/GA-IN-01	
				2.5	IPD/GA-IN-03	
				For angulations	1.0	IPD/GA-IN-31
					1.0	IPD/GA-IN-01
BTI® Wide	ø5.5	Engaging	Straight	1.6	IPD/GA-IW-00	
		Non-engaging		1.6	IPD/GA-IW-01	
BTI® Interna Universal®	ø5.5	Engaging	Straight	0.3	IPD/GB-IR-00	
				1.5	IPD/GB-IR-02	
		Non-engaging		2.5	IPD/GB-IR-04	
				0.3	IPD/GB-IR-01	
				1.5	IPD/GB-IR-03	
		For angulations		2.5	IPD/GB-IR-05	
				0.3	IPD/GB-IR-31	
Dentsply® Xive® Friadent®	ø3.4	Engaging	Straight	1.0	IPD/IA-IN-00	
		Non-engaging		1.0	IPD/IA-IN-01	
	ø3.8	Engaging	Straight	1.0	IPD/IA-IR-00	
		Non-engaging		0.5	IPD/IA-IR-01	
	ø4.5	Engaging	Straight	0.5	IPD/IA-IR-31	
				0.5	IPD/IA-IR-01	
ø4.5	Engaging	Straight	0.3	IPD/IA-IW-00		
	Non-engaging		0.3	IPD/IA-IW-01		
Dentsply® Ankylos®	C/X	Engaging	Straight	1.0	IPD/IB-IR-00	
				2.0	IPD/IB-IR-02	
		Non-engaging		1.0	IPD/IB-IR-01	
				2.0	IPD/IB-IR-03	
				For angulations	1.0	IPD/IB-IR-31

WORKING SYSTEMS

Hollow Screw System

Compatibility	Platform	Connection	Model	Height (mm)	Reference
Camlog® Camlog®	ø3.3	Engaging	Straight	1.0	IPD/JA-IN-00
		Non-engaging			IPD/JA-IN-01
	ø3.8	Non-engaging		0.7	IPD/JA-IR-01
		ø4.3		Engaging	0.3
Non-engaging	IPD/JA-IW-01				
BioHorizons® Tapered Internal	ø3.5	Engaging	Straight For angulations	0.9	IPD/LB-IN-00
		Non-engaging			IPD/LB-IN-01
					IPD/LB-IN-31
	ø4.5	Engaging	Straight For angulations	0.1	IPD/LB-IR-00
		Non-engaging			IPD/LB-IR-01
					IPD/LB-IR-31
Sweden & Martina® Premium™ Kohno®	ø3.8	Engaging	Straight For angulations	0.7	IPD/MB-IN-00
		Non-engaging			IPD/MB-IN-01
					IPD/MB-IN-31
	ø4.25	Engaging	Straight For angulations	0.7	IPD/MB-IR-00
		Non-engaging			IPD/MB-IR-01
					IPD/MB-IR-31
Phibo® TSH®	S2	Engaging	Straight For angulations	1.0	IPD/NA-IN-00
		Non-engaging			IPD/NA-IN-01
Megagen® AnyRidge®	4.2	Engaging	Straight	1.0	IPD/WB-IR-00

Consultar disponibilidad.

Accessories

1.00 HEX SCREWDRIVER

Lengths (mm)	Reference
18	IPD/PH-00-18
25	IPD/PH-00-25
32	IPD/PH-00-32



1.18 HEX SCREWDRIVER

Lengths (mm)	Reference
18	IPD/PH-18-18
25	IPD/PH-18-25
32	IPD/PH-18-32



1.20 HEX SCREWDRIVER

Lengths (mm)	Reference
18	IPD/PH-20-18
25	IPD/PH-20-25
32	IPD/PH-20-32



1.25 HEX SCREWDRIVER

Lengths (mm)	Reference
18	IPD/PH-25-18
25	IPD/PH-25-25
32	IPD/PH-25-32



1.27 HEX SCREWDRIVER

Lengths (mm)	Reference
18	IPD/PH-27-18
25	IPD/PH-27-25
32	IPD/PH-27-32



1.30 HEX SCREWDRIVER

Lengths (mm)	Reference
18	IPD/PH-30-18
25	IPD/PH-30-25
32	IPD/PH-30-32



1.40 HEX SCREWDRIVER

Lengths (mm)	Reference
18	IPD/PH-40-18
25	IPD/PH-40-25
32	IPD/PH-40-32



1.70 HEX SCREWDRIVER

Lengths (mm)	Reference
18	IPD/PH-70-18
25	IPD/PH-70-25
32	IPD/PH-70-32



1.25 SQUARE SCREWDRIVER

Lengths (mm)	Reference
18	IPD/PC-25-18
25	IPD/PC-25-25
32	IPD/PC-25-32



STAR SCREWDRIVER (Klockner Essential® / Vega®)

Lengths (mm)	Reference
18	IPD/PS-00-18
25	IPD/PS-00-25
32	IPD/PS-00-32



UNIGRIP SCREWDRIVER

Lengths (mm)	Reference
18	IPD/PU-00-18
25	IPD/PU-00-25
32	IPD/PU-00-32



NEO GM SCREWDRIVER

Lengths (mm)	Reference
18	IPD/PU-01-18
25	IPD/PU-01-25
32	IPD/PU-01-32



FLAT SCREWDRIVER

Lengths (mm)	Reference
18	IPD/PP-00-18
25	IPD/PP-00-25
32	IPD/PP-00-32



TORX SCREWDRIVER

Lengths (mm)	Reference
18	IPD/PT-00-18
25	IPD/PT-00-25
32	IPD/PT-00-32



MULTI-UNIT SCREWDRIVER

Lengths (mm)	Reference
20	IPD/LL-AB-00



PSD SCREWDRIVER

Lengths (mm)	Reference
25	IPD/LL-PS-00

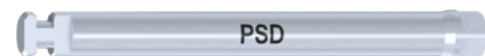

Accessories

PSD AND INSERT EXTRACTOR TOOL

Reference

IPD/LL-PS-01



HOLLOW SCREWDRIVER

Lengths (mm)

26

Reference

IPD/KA-CI-09



TPA SCREWDRIVER

Lengths (mm)

18

25

32

Reference

IPD/KA-CT-18

IPD/KA-CT-25

IPD/KA-CT-32



CLINICAL RA SHANK HANDLE

Lengths (mm)

16

Reference

IPD/MC-00-16



LABORATORY RA SHANK HANDLE

Lengths (mm)

70

Reference

IPD/ML-00-70



RA SHANK RATCHET

Lengths (mm)

90

Reference

IPD/DI-00-90

Ratchet adapter included.

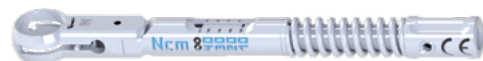

RATCHET ADAPTER

Lengths (mm)

Ratchet adapter

Reference

IPD/DI-KA-90

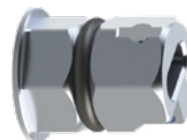

Accessories kits

Reference

Description	Reference	
	IPD/KT-DI-18	IPD/KT-DI-25
	Lengths	
1.20 Hex Screwdriver	18 mm	25 mm
1.25 Hex Screwdriver	18 mm	25 mm
1.27 Hex Screwdriver	18 mm	25 mm
1.70 Hex Screwdriver	18 mm	25 mm
1.25 Square screwdriver	18 mm	25 mm
Unigrip screwdriver	18 mm	25 mm
Flat screwdriver	18 mm	25 mm
TPA screwdriver	18 mm	25 mm
Torx screwdriver	18 mm	25 mm
Multi-unit screwdriver	20 mm	20 mm
RA Shank Ratchet	90 mm	90 mm



Reference

Description	Reference	
	IPD/KT-MC-18	IPD/KT-MC-25
	Lengths	
1.20 Hex Screwdriver	18 mm	25 mm
1.25 Hex Screwdriver	18 mm	25 mm
1.27 Hex Screwdriver	18 mm	25 mm
1.70 Hex Screwdriver	18 mm	25 mm
1.25 Square screwdriver	18 mm	25 mm
Unigrip screwdriver	18 mm	25 mm
Flat screwdriver	18 mm	25 mm
TPA screwdriver	18 mm	25 mm
Torx screwdriver	18 mm	25 mm
Multi-unit screwdriver	20 mm	20 mm
Clinical RA Shank Handle	16 mm	16 mm



Reference

Description	Reference
	IPD/KT-ML-32
	Lengths
1.20 Hex Screwdriver	32 mm
1.25 Hex Screwdriver	32 mm
1.27 Hex Screwdriver	32 mm
1.70 Hex Screwdriver	32 mm
1.25 Square screwdriver	32 mm
Unigrip screwdriver	32 mm
Flat screwdriver	32 mm
TPA screwdriver	32 mm
Torx screwdriver	32 mm
Laboratory RA Shank Handle	70 mm



Screws technical specifications

DESCRIPTION				CHARACTERISTIC							
REFERENCE	TiN Reference	COMPATIBILITY	PLATFORM	SEAT	HEAD DIAMETER	METRIC	HEAD (L1)	BODY (L2)	TOTAL (LT)	SCREW-DRIVER	TORQUE (NCM)
IPD/AA-TN-00	IPD/AA-TN-00/TIN	Nobel Biocare® Branemark System®	Ø3.5	70°	2.25	M1.6x0.35	2.15	5.15	7.30	Unigrip	35
		Nobel Biocare® Nobel Active®	Ø3.5								
IPD/AA-TR-00	IPD/AA-TR-00/TIN	Nobel Biocare® Branemark System®	Ø4.1	75°	2.4	M2x0.4	1.5	5.85	7.35	Unigrip	35
		Nobel Biocare® Nobel Active®	Ø4.3								
IPD/AA-TR-01	IPD/AA-TR-01/TIN	External Hex (Plat. Regular)	Ø4.1	75°	2.5	M2x0.4	1.67	4.6	6.27	1.20 Hex	20
IPD/AA-TR-02	IPD/AA-TR-02/TIN	Nobel Biocare® Branemark System®	Ø4.1	Flat	2.40	M2x0.4	1.45	5.9	7.35	Unigrip	35
		Nobel Biocare® Nobel Active®	Ø4.3								
IPD/AA-TW-00	IPD/AA-TW-00/TIN	Nobel Biocare® Branemark System®	Ø5.1	72°	3.40	M2.5x0.45	1.37	5.33	6.7	Unigrip	35
IPD/AB-TR-00	IPD/AB-TR-00/TIN	Multi-unit	Ø4.8	Flat	2.00	M1.4x0.3	1.35	2.1	3.45	Unigrip	15
IPD/AC-TN-00	IPD/AC-TN-00/TIN	Nobel Biocare® Nobel Replace® Select	Ø3.5	Flat	2.35	M1.8x0.35	1.8	6.5	8.3	Unigrip	35
IPD/AC-TR-00	IPD/AC-TR-00/TIN	Nobel Biocare® Nobel Replace® Select	Ø4.3 / Ø5.0	Flat	2.4	M2x0.4	1.55	8.35	9.9	Unigrip	35
IPD/AD-TT-00	IPD/AD-TT-00/TIN	Nobel Biocare® Nobel Active®	Ø3.0	70°	1.82	M1.4x0.3	1.86	4.84	6.7	Unigrip	15
IPD/BA-TR-00	IPD/BA-TR-00/TIN	Biomet® 3i® Osseotite® (Plat. R)	Ø4.1	75°	2.35	M2x0.4	1.79	5.81	7.6	1.20 Hex	20
IPD/BA-TR-01	IPD/BA-TR-01/TIN	Biomet® 3i® Osseotite® (Plat. R)	Ø4.1	75°	2.35	M2x0.4	1.79	5.81	7.6	1.25 Hex	25
IPD/BA-TR-02	IPD/BA-TR-02/TIN	Biomet® 3i® Osseotite®	Ø3.4 / Ø4.1 / Ø5.0	Flat	2.4	M2x0.4	1.65	6.15	7.8	1.25 Square	35
IPD/BB-TR-01	IPD/BB-TR-01/TIN	Biomet® 3i® Certain®	Ø3.4 / Ø4.1 / Ø5.0	Flat	2.0	M1.6x0.35	1.9	6.5	8.4	1.20 Hex	20
IPD/BB-TR-02	-	Biomet® 3i® Certain®	Ø4.1 / Ø5.0	140°	2.30	M1.6x0.35	2.05	6.35	8.4	1.20 Hex	20
IPD/CA-TR-00	IPD/CA-TR-00/TIN	Klockner® SK2-NK2	Ø4.2	90°	2.45	M1.8x0.35	2.39	3.56	5.95	1.70 Hex	30
IPD/CA-TR-01	IPD/CA-TR-01/TIN	Klockner® SK2-NK2	Ø4.2	90°	2.45	M1.8x0.35	0.72	3.58	4.3	Cross	30
IPD/CB-TR-00	IPD/CB-TR-00/TIN	Klockner® Essential Cone®	Ø4.5	90°	2.18	M1.8x0.35	2.3	4.9	7.2	Star	30
IPD/CD-TN-00	IPD/CD-TN-00/TIN	Klockner® Vega®	Ø3.5	90°	2.15	M1.6x0.35	2.43	5.57	8	Star	25
IPD/CD-TR-00	IPD/CD-TR-00/TIN	Klockner® Vega®	Ø4.0-4.5	90°	2.15	Special	2.32	5.68	8	Star	25
IPD/DA-TR-00	IPD/DA-TR-00/TIN	Straumann® Tissue Level (synOcta® level)	Ø4.8	90°	2.4	M2x0.4	1.2	3.3	4.5	Torx	35
IPD/DA-TR-01	IPD/DA-TR-01/TIN	Straumann® Tissue Level (Implant level)	Ø4.8 / Ø6.5	30°	2.4	M2x0.4	3.03	3.67	6.7	Torx	35
IPD/DA-TR-02	-	Straumann® Tissue Level	Ø4.8	Flat	2.52	M2x0.4	1.45	5.9	7.35	Torx	35
IPD/DA-TR-03	IPD/DA-TR-03/TIN	Straumann® Tissue Level	Ø4.8	30°	2.57	M2x0.4	3.05	3.65	6.7	Torx	35
IPD/DB-TR-00	IPD/DB-TR-00/TIN	Straumann® Bone Level	Ø3.3 / Ø4.1	30°	2.1	M1.6x0.35	2.31	5.54	7.85	Torx	35
IPD/DC-TR-00	IPD/DC-TR-00/TIN	Straumann® BLX®	RB/WB	90°	2.1	M1.6x0.35	1.5	4.6	6.1	Torx	30
IPD/DD-TR-00	IPD/DD-TR-00/TIN	Straumann® SRA®	Ø3.5 / Ø4.6	70°	2.20	M1.4x0.3	1.65	2.0	3.65	Torx	15
IPD/EA-TN-00	IPD/EA-TN-00/TIN	Astra® Osseospeed™	Ø3.0	120°	2.1	M1.4x0.3	2	5.5	7.5	1.27 Hex	15
IPD/EA-TR-00	IPD/EA-TR-00/TIN	Astra® Osseospeed™	Ø3.5 - Ø4.0	Flat	2.35	M1.6x0.35	1.95	6.3	8.25	1.27 Hex	20
IPD/EA-TR-01	IPD/EA-TR-01/TIN	Astra® Cono 20°	Ø3.5-Ø4.0 / Ø4.5-Ø5.0	Flat	2.25	M1.4x0.3	1.85	2.95	4.8	1.27 Hex	15
IPD/EA-TW-00	IPD/EA-TW-00/TIN	Astra® Osseospeed™	Ø4.5 - Ø5.0	Flat	2.35	M2x0.4	1.9	8.4	10.3	1.27 Hex	25
IPD/EB-TN-00	IPD/EB-TN-00/TIN	Astra® Evolution®	Ø3.6	60°	2.15	M1.6x0.35	2.12	5.33	7.45	1.27 Hex	20
IPD/EB-TR-00	IPD/EB-TR-00/TIN	Astra® Evolution®	Ø4.2	100°	2.35	M1.8x0.35	1.92	5.70	7.62	1.27 Hex	20
IPD/FA-TR-00	IPD/FA-TR-00/TIN	Zimmer® Screw Vent®	Ø3.5 / Ø4.5 / Ø5.7	140°	2.1	M1.8x0.35	2.54	5.66	8.2	1.25 Hex	30
IPD/FB-TR-00	IPD/FB-TR-00/TIN	Zimmer® SwissPlus®	Ø4.8	140°	2.3	M2x0.4	2.55	6.75	9.3	1.25 Hex	30
IPD/FB-TR-01	IPD/FB-TR-01/TIN	Zimmer® SwissPlus®	Ø4.8	30°	2.4	M2x0.4	3.03	3.87	6.9	1.25 Hex	30
IPD/FC-TT-00	IPD/FC-TT-00/TIN	Zimmer® Eztec®	Ø3.1	140°	1.95	M1.6x0.35	2.81	5.94	8.75	1.25 Hex	30
IPD/GA-TN-00	IPD/GA-TN-00/TIN	BTI® External Hex	Ø3.5	Flat	2.35	M2x0.4	1.7	3.85	5.55	1.20 Hex	20
IPD/GA-TW-00	IPD/GA-TW-00/TIN	BTI® External Hex	Ø5.5	Flat	2.25	M2x0.4	1.7	6.15	7.85	1.20 Hex	20
IPD/GB-TR-00	IPD/GB-TR-00/TIN	BTI® Internal Universal®	Universal® Ø4.1 / Wide Ø5.5	Flat	2.4	M1.8x0.35	1.85	5.2	7.05	1.20 Hex	20

Screws technical specifications

DESCRIPTION				CHARACTERISTIC							
REFERENCE	TiN Reference	COMPATIBILITY	PLATFORM	SEAT	HEAD DIAMETER	METRIC	HEAD (L1)	BODY (L2)	TOTAL (LT)	SCREW-DRIVER	TORQUE (NCM)
IPD/GC-TR-01	IPD/GC-TR-01/TIN	BTI® Multi-im®	RP	Flat	2.0	M1.4x0.3	1.5	2.1	3.6	120 Hex	20
IPD/HA-TN-00	IPD/HA-TN-00/TIN	Microdent® Microdent® System	Ø3.5	140°	2.5	M1.8x0.35	2.13	3.87	6	120 Hex	20
IPD/HA-TR-00	IPD/HA-TR-00/TIN	Microdent® Microdent® System	Ø4.2 / Ø5.1	120°	2.7	M2x0.4	2.5	5.5	8	1.75 Hex	30
IPD/IA-TR-00	IPD/IA-TR-00/TIN	Dentsply® Xive® Friadent®	Ø3.4 / Ø3.8 / Ø4.5	90°	2.05	M1.6x0.35	2.1	6.75	8.85	120 Hex	24
IPD/IB-TR-00	-	Dentsply® Ankylos® Balance Base Narrow	C/X	60°	2.4	M1.6x0.35	1.66	3.04	4.7	1.0 Hex	15
IPD/IB-TR-01	-	Dentsply® Ankylos®	C/X	60°	2.05	M1.8x0.35	2	6.15	8.15	1.0 Hex	25
IPD/ID-TT-00	-	OsteoPlus® Iridium™ Argentum®	Ø3.3 / Ø3.8 / Ø4.2 / Ø4.8	120°	2.40	M1.8x0.35	1.69	5.83	7.52	1.25 Hex	25
IPD/JA-TR-00	IPD/JA-TR-00/TIN	Camlog® Camlog® Implant System	Ø3.3 / Ø3.8 / Ø4.3	90°	2.1	M1.6x0.35	2.35	8.1	10.45	1.25 Hex	20
IPD/JA-TX-00	IPD/JA-TX-00/TIN	Camlog® Camlog® Implant System	Ø5.0	90°	2.5	M2x0.4	2.34	8.12	10.45	1.27 Hex	20
IPD/JB-TR-00	IPD/JB-TN-00/TIN	Camlog® Conelog® System	Ø3.3 / Ø3.8 / Ø4.3	120°	2.15	M1.6x0.35	2.01	6.86	8.87	Hex 1.25	20
IPD/KA-CI-08	-	Hollow Screw	-	Flat	2.8	M2.65x0.3	0.7	1.4	2.1	IPD cross	10
IPD/LB-TR-00	IPD/LB-TR-00/TIN	BioHorizons® Tapered Internal	Ø3 / Ø3.5 / Ø4.5 / Ø5.7	90°	2.35	M1.8x0.35	2.42	4.83	7.25	1.27 Hex	35
IPD/MA-TN-00	IPD/MA-TN-00/TIN	Sweden & Martina® Outlink®	Ø3.3	120°	2.18	M1.8x0.35	1.75	5.75	7.5	1.27 Hex	25
IPD/MB-TN-00	IPD/MB-TN-00/TIN	Sweden & Martina® Premium™ Kohno®	Ø3.3 / Ø3.8	120°	2.2	M1.8x0.35	1.78	6.32	8.1	1.27 Hex	25
IPD/MB-TR-00	IPD/MB-TR-00/TIN	Sweden & Martina® Premium™ Kohno®	Ø4.25 / Ø5.0	120°	2.4	M2x0.4	1.78	6	7.78	1.27 Hex	25
IPD/NA-TN-00	IPD/NA-TN-00/TIN	Phibo® TSH®	S2	120°	2.23	M1.8x0.35	1.92	6.08	8	1.25 Hex	35
IPD/NA-TW-00	-	Phibo® TSH®	S5	120°	2.5	M2x0.4	2.5	5.5	8	1.25 Hex	35
IPD/OB-TN-00	IPD/OB-TN-00/TIN	Osstem Implant® TSIII	Ø3.5	90°	2.20	M1.6x0.35	2.41	7.79	10.2	120 Hex	20
IPD/OB-TR-00	IPD/OB-TR-00/TIN	Osstem Implant® TSIII	Ø4.0	90°	2.30	M2x0.4	2.23	6.12	8.35	120 Hex	30
IPD/QB-TR-00	IPD/QB-TR-00/TIN	Biotech® Dental Kontakt®	RP	90°	1.95	M1.4x0.3	1.8	6.02	7.82	120 Hex	20
IPD/RA-TN-00	IPD/RA-TN-00/TIN	Neodent® Helix® HE	Ø3.3	Flat	2.30	M1.8x0.35	1.9	5.8	7.7	Hex 1.20	32
IPD/RA-TW-00	IPD/RA-TW-00/TIN	Neodent® Helix® HE	Ø5.0	Flat	3.00	M2.5x0.45	2.1	5.5	7.6	Hex 1.20	32
IPD/RB-TR-00	IPD/RB-TR-00/TIN	Neodent® Grand Morse™ GM	RP	60°	1.86	M1.6x0.35	1.84	7.93	9.77	Neo GM	20
IPD/RC-TR-00	IPD/RC-TR-00/TIN	Neodent® GM abutment	Ø4.8	90°	2.35	M2x0.25	1.53	2.25	3.78	Neo GM	10
IPD/RD-TN-00	IPD/RD-TN-00/TIN	Neodent® GM micro abutment	Ø3.5	Flat	1.90	M1.4x0.3	1.72	1.99	3.71	Neo GM	10
IPD/SB-TR-00	IPD/SB-TR-00/TIN	Bego® Semados®	Ø3.25-3.75 / Ø4.1 / Ø4.5	70°	2.35	M1.8x0.35	2.35	5.25	7.6	1.25 Hex	30
IPD/TA-TT-00	IPD/TA-TT-00/TIN	MIS® Seven®	Narrow 3.3	120°	2.1	M1.6x0.35	2.58	5.1	7.68	1.25 Hex	30
IPD/TB-TR-00	IPD/TB-TR-00/TIN	MIS® C1/V3®	Standard	120°	2.2	UNF 1-72	2.44	5.18	7.62	1.25 Hex	30
IPD/UB-TN-00	IPD/UB-TN-00/TIN	DIO® UFII	NP	90°	1.85	M1.4x0.3	2.05	5.45	7.5	120 Hex	20
IPD/UB-TR-00	IPD/UB-TR-00/TIN	DIO® UFII	RP	120°	2.45	M2x0.4	1.95	6.55	8.5	120 Hex	30
IPD/WA-TR-00	IPD/WA-TR-00/TIN	Megagen® AnyOne®	RP	120°	2.3	M2x0.4	1.9	8.0	9.9	120 Hex	35
IPD/WB-TR-00	IPD/WB-TR-00/TIN	Megagen® AnyRidge®	RP	Flat	2.1	M1.8x0.35	2	6	8	120 Hex	25
IPD/VA-TR-00	-			Flat	2.4	M2x0.4	2.2	5.8	8	120 Hex	25
IPD/XA-TR-00	IPD/XA-TR-00/TIN	Dentium® Implantium® / Superline™	Ø4.0 / Ø4.5 / Ø5.0	120°	2.3	M2x0.4	2.18	8.01	10.2	1.27 Hex	25
IPD/XA-TR-02	-	Nobel Biocare® Branemark System®	Ø4.1	Flat	2.52	M2x0.4	1.45	5.9	7.35	120 Hex	30
		Nobel Biocare® Nobel Active®	Ø4.3								
IPD/YB-TR-00	IPD/YB-TR-00/TIN	Medentis® ICX	RP	30°	2.5	M1.6x0.35	2.92	6.6	9.52	140 Hex	30
IPD/ZA-TR-00	-	Bredent® Blue Sky™	Ø3.5/Ø4.5/Ø5.5	120°	2.17	M1.8x0.35	1.75	7.45	9.2	Unigrip Bredent®	25
IPD/1A-TR-00	IPD/1A-TR-00/TIN	Global D® In-kone®	RP	120°	2.15	M1.8x0.35	2.24	6.24	8.48	Hex 1.20	15
IPD/2A-TR-00	IPD/2A-TR-00/TIN	Anthogyr® Axiom® BL	RP	40°	2.20	M1.6x0.35	2.38	5.54	7.92	Hex 1.18	25
IPD/3A-TR-00	IPD/3A-TR-00/TIN	Galimplant® Multi-Position Aesthetic®	Ø3.8	140°	2.5	M2x0.4	1.5	3.1	4.6	Hex 1.30	25

TPA screw technical specifications

DESCRIPTION		CHARCATERISTIC								
REFERENCE	COMPATIBILITY	PLATFORM	SEAT	HEAD DIAMETER	METRIC	HEAD (L1)	BODY (L2)	TOTAL (LT)	SCREW-DRIVER	TORQUE (NCM)
IPD/AA-TN-50	Nobel Biocare® Branemark System®	Ø3.5	70°	2.3	M1.6x0.35	2.08	4.72	6.8	TPA	20
	Nobel Biocare® Nobel Active®	Ø3.5								
IPD/AA-TR-50	Nobel Biocare® Branemark System®	Ø4.1	75°	2.3	M2x0.4	1.93	3.87	5.8	TPA	25
	Sweden & Martina® Outlink®									
	Phibo® TSH®	S3-S4								
IPD/AA-TR-52	Nobel Biocare® Branemark System®	Ø4.1	Flat	2.3	M2x0.4	1.4	4.4	5.8	TPA	25
	Biomet® 3i® Externa™ 3i®	Ø3.25 / Ø4.1 / Ø5.1								
	BTI® Hexágono externo	Ø4.1 / Ø5.5								
IPD/AA-TW-50	Nobel Biocare® Branemark System®	Ø5.1	72°	2.85	M2.5x0.45	1.61	4.8	6.41	TPA	25
IPD/AB-TR-50	Multi-unit / Multi-im®	Ø4.8	Flat	2.3	M1.4x0.3	1.5	2.1	3.6	TPA	15
IPD/AB-TR-51	Multi-unit	Ø4.8	Flat	2.25	M1.4x0.3	3.25	2.10	5.35	TPA	15
IPD/AC-TN-50	Nobel Biocare® Nobel Replace® Select	Ø3.5	Flat	2.25	M1.8x0.35	1.4	6.1	7.5	TPA	25
IPD/AC-TN-51	Nobel Biocare® Nobel Replace® Select	Ø3.5	Flat	2.25	M1.8x0.35	1.4	5.4	6.8	TPA	25
IPD/AC-TR-50	Nobel Biocare® Nobel Replace® Select	Ø4.3 / Ø5.0	Flat	2.3	M2x0.4	1.4	7.4	8.8	TPA	25
	Astra® OsseoSpeed®	Ø4.5-Ø5.0								
IPD/AC-TR-51	Nobel Biocare® Nobel Replace® Select	Ø4.3 / Ø5.0	Flat	2.3	M2x0.4	1.3	6.8	8.1	TPA	25
IPD/AD-TR-50	Nobel Biocare® Nobel Active®	Ø4.3	75°	2.3	M2x0.4	2.0	5.0	7	TPA	25
IPD/AD-TT-50	Nobel Biocare® Nobel Active®	Ø3.0	70°	2.3	M1.4x0.3	2.0	4.65	6.65	TPA	15
IPD/BB-TR-51	Biomet® 3i® Certain®	Ø3.4 / Ø4.1 / Ø5.0	Flat	2.25	M1.6x0.35	1.35	6.25	7.6	TPA	20
IPD/CA-TR-50	Klockner® SK2-NK2	Ø4.2	90°	2.3	M1.8x0.35	1.50	3.00	4.5	TPA	25
IPD/CB-TR-50	Klockner® Essential Cone®	Ø4.5	90°	2.3	M1.8x0.35	1.65	4.85	6.5	TPA	25
IPD/CD-TN-50	Klockner® Vega®	Ø3.5	90°	2.3	M1.6x0.35	1.65	5.7	7.35	TPA	25
IPD/CD-TR-50	Klockner® Vega®	Ø4.0 / Ø4.5	90°	2.25	Especial	1.8	5.65	7.45	TPA	25
IPD/DA-TR-50	Straumann® Tissue Level (Sobre synOcta®)	Ø4.8 / Ø6.0	90°	2.3	M2x0.4	1.65	3.32	4.97	TPA	25
IPD/DA-TR-51	Straumann® Tissue Level (Implant level)	Ø4.8 / Ø6.0	30°	2.3	M2x0.4	2.65	3.65	6.3	TPA	25
IPD/DB-TR-50	Straumann® Bone Level	Ø3.3 / Ø4.1	30°	2.3	M1.6x0.35	2.15	5.55	7.7	TPA	20
IPD/DD-TR-50	Straumann® SRA®	Ø3.5 / Ø4.6	70°	2.25	M1.4x0.3	1.82	5.55	3.91	TPA	20
IPD/EA-TN-50	Astra® OsseoSpeed®	Ø3.0	120°	2.25	M1.4x0.35	1.65	5.45	7.1	TPA	15
IPD/EA-TR-50	Astra® OsseoSpeed®	Ø3.5-Ø4.0	Flat	2.25	M1.6x0.35	1.35	6.05	7.4	TPA	20
IPD/EA-TR-51	Astra Uni 20° / 45°	All	Flat	2.3	M1.4x0.3	1.50	2.90	4.4	TPA	15
IPD/EB-TN-50	Astra® Evolution®	Ø3.6	60°	2.3	M1.6x0.35	1.99	5.11	7.1	TPA	20
IPD/EB-TR-50	Astra® Evolution®	Ø4.2	100°	2.3	M1.8x0.35	2.22	5.38	7.6	TPA	25
IPD/FA-TR-50	Zimmer® Screw Vent®	Ø3.5 / Ø4.5 / Ø5.7	140°	2.25	M1.8x0.35	1.73	4.97	6.7	TPA	25
IPD/FC-TT-50	Zimmer® Eztetic®	Ø3.1	140°	2.3	M1.6x0.35	1.56	5.72	7.28	TPA	20
IPD/GA-TN-50	BTI® Externa Universal	Ø3.5	Flat	2.3	M2x0.4	1.5	3.6	5.1	TPA	25
IPD/GB-TR-50	BTI® Interna	Universal® Ø4.1 / Ancha Ø5.5	Flat	2.3	M1.8x0.35	1.5	5.0	6.5	TPA	25
IPD/HA-TN-50	Microdent® Microdent® System	Ø3.5	140°	2.3	M1.8x0.35	1.6	4.0	5.6	TPA	25
IPD/HA-TR-50	Microdent® Microdent® System	Ø4.2 / Ø5.1	120°	2.3	M2x0.4	1.85	4.15	6	TPA	25

TPA screw technical specifications

DESCRIPTION		CHARCATERISTIC								
REFERENCE	COMPATIBILITY	PLATFORM	SEAT	HEAD DIAMETER	METRIC	HEAD (L1)	BODY (L2)	TOTAL (LT)	SCREW-DRIVER	TORQUE (NCM)
IPD/IA-TR-50	Dentsply® Xive® Friadent®	Ø3.8	90°	2.3	M1.6x0.35	1.66	5.44	7.1	TPA	20
IPD/IB-TR-51	Dentsply® Ankylos®	C/X	60°	2.3	M1.8x0.35	1.89	5.41	7.3	TPA	25
IPD/LB-TR-50	BioHorizons® Tapered Internal	Ø3.0 / Ø3.5 / Ø4.5 / Ø5.7	90°	2.3	M1.8x0.35	1.89	4.61	6.5	TPA	25
IPD/MA-TN-50	Sweden & Martina® Outlink®	Ø3.3	120°	2.3	M1.8x0.35	1.55	4.25	5.80	TPA	25
IPD/MB-TN-50	Sweden & Martina® Premium™ Kohno®	Ø3.3 / Ø3.8	120°	2.3	M1.8x0.35	1.52	4.88	6.4	TPA	25
	Phibo® TSH®	S2								
IPD/MB-TR-50	Sweden & Martina® Premium™ Kohno®	Ø4.25 / Ø5.0	120°	2.3	M2x0.4	1.55	4.85	6.4	TPA	25
IPD/OB-TN-50	Osstem Implant® TSIII	Ø3.5	60°	2.3	M1.55x0.35	1.98	7.52	9.50	TPA	20
IPD/OB-TR-50	Osstem Implant® TSIII	Ø4.0	90°	2.3	M2x0.4	1.36	6.14	7.50	TPA	25
IPD/QB-TR-50	Biotech® Dental Kontakt®	RP	90°	2.3	M1.4x0.3	1.75	6.0	7.75	TPA	15
IPD/RA-TN-50	Neodent® Helix® HE	Ø3.3	Flat	2.25	M1.8x0.35	1.25	4.85	6.10	TPA	25
IPD/RA-TW-50	Neodent® Helix® HE	Ø5.0	Flat	2.85	M2.5x0.45	0.50	5.40	5.90	TPA	25
IPD/RB-TR-50	Neodent® Grand Morse™ GM	GM	60°	2.3	M1.6x0.35	1.98	7.52	9.50	TPA	20
IPD/RC-TR-50	Neodent® GM abutment	Ø4.8	90°	2.35	M2x0.25	1.60	2.23	3.83	TPA	10
IPD/RD-TN-50	Neodent® GM micro abutment	Ø3.5	Flat	2.25	M1.4x0.3	1.40	1.99	3.99	TPA	10
IPD/SB-TR-50	Bego® Semados®	Ø3.25-Ø3.75 / Ø4.1 / Ø4.5	70°	2.3	M1.80x0.35	1.95	4.95	6.90	TPA	25
IPD/TA-TT-50	MIS® Seven®	Narrow 3.3	120°	2.3	M1.6x0.35	1.72	4.88	6.6	TPA	25
IPD/TB-TR-50	MIS® C1/V3®	Standard	120°	2.3	UNF 1-72	2.35	4.85	7.2	TPA	25
IPD/UB-TN-50	DIO® UFII	NP	90°	2.3	M1.40x0.3	1.6	5.35	6.95	TPA	20
IPD/UB-TR-50	DIO® UFII	RP	120°	2.3	M2x0.4	1.95	6.55	8.5	TPA	25
IPD/WA-TR-50	Megagen® AnyOne®	RP	120°	2.3	M2x0.4	1.8	7.95	9.75	TPA	25
IPD/XA-TR-50	Dentium® Implantium® /Superline™	RP	120°	2.3	M2x0.4	1.8	7.95	9.75	TPA	25
IPD/YB-TR-50	Medentis® ICX	RP	30°	2.3	M1.6x0.35	3.2	5.25	8.45	TPA	20
IPD/3A-TR-50	Galimplant® Multi-Position Aesthetic®	Ø3.8	140°	2.5	M2x0.4	1.5	2.65	4.15	TPA	25
IPD/3A-TR-51	Galimplant® Multi-Position Aesthetic®	Ø3.8	140°	2.5	M2x0.4	3.85	2.65	6.50	TPA	25



Now you have seen our complete range of products, be part of *ipd*.

www.ipd2004.com







C/ Rosa dels Vents, 9-15
08338 Premià de Dalt (Barcelona)

Phone: (+34) 93 278 84 91
info@ipd2004.com
www.ipd2004.com

