

 **puertascarrasco**
puertas e interiorismo

SERIE I

Puertas Rústicas

Características Puertas Rústicas SERIE I · Features of SERIES I doors · Caractéristiques des portes SÉRIE I

- Fabricadas con madera de pino silvestre de Suecia de primera calidad.
- Marco directo 95 x 95 mm moldurado y tallado.
- Cerradura de seguridad de tres puntos.
- Tratamiento especial a poro abierto para exterior y acabado nogal a la cera.
- Burlete de goma embutida en el perfil del marco.
- Herrajes de forja artesanales según modelo.
- Cortavientos automático marca HSS.

- Premium wood doors made from Swedish Wild Pine.
- Moulded and carved frame 95 x 95 mm.
- Three point security lock.
- Open pore treatment for exterior and waxed walnut finish.
- Weatherstrip (Seals drafts from around the top and sides of the door).
- Handmade ironworks.
- Automatic door bottom seal (HSS brand).

- Portes en bois de grande qualité fabriquées en pin sauvage de Suède.
- Cadre moulé et sculpté de 95 x 95 mm.
- Serrure de sécurité trois points.
- Traitement spécial à pores ouvertes pour extérieur, finition noyer ciré.
- Cadre de porte avec joint d'isolation en caoutchouc.
- Éléments métalliques forgés à la main.
- Coupe-vent automatique de la marque HSS.

PUERTAS RÚSTICAS



Cristal laminado

Ventana abatible

Burlete de goma

Cerradura de seguridad

Cortavientos

SECCIÓN PUERTAS SERIE I DOORS SECTION SERIES I · SECTION PORTES SÉRIE I

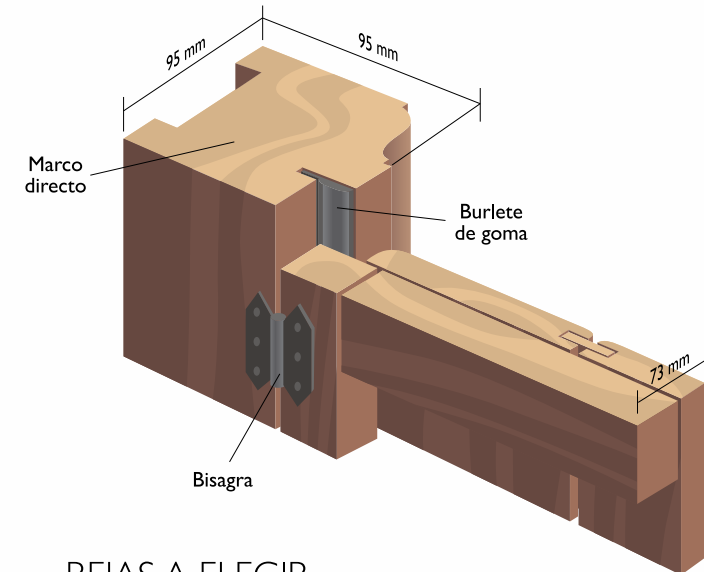

Marco directo

Burlete de goma

Bisagra

REJAS A ELEGIR

WROUGHT IRON GRILLS OPTIONS

GRILLES EN FER FORGÉ À CHOISIR (compris dans le tarif)



Ref. 1

Ref. 2

Ref. 3

Ref. 4

Ref. 5

Ref. 6

· Todas las puertas se fabrican con marcado CE

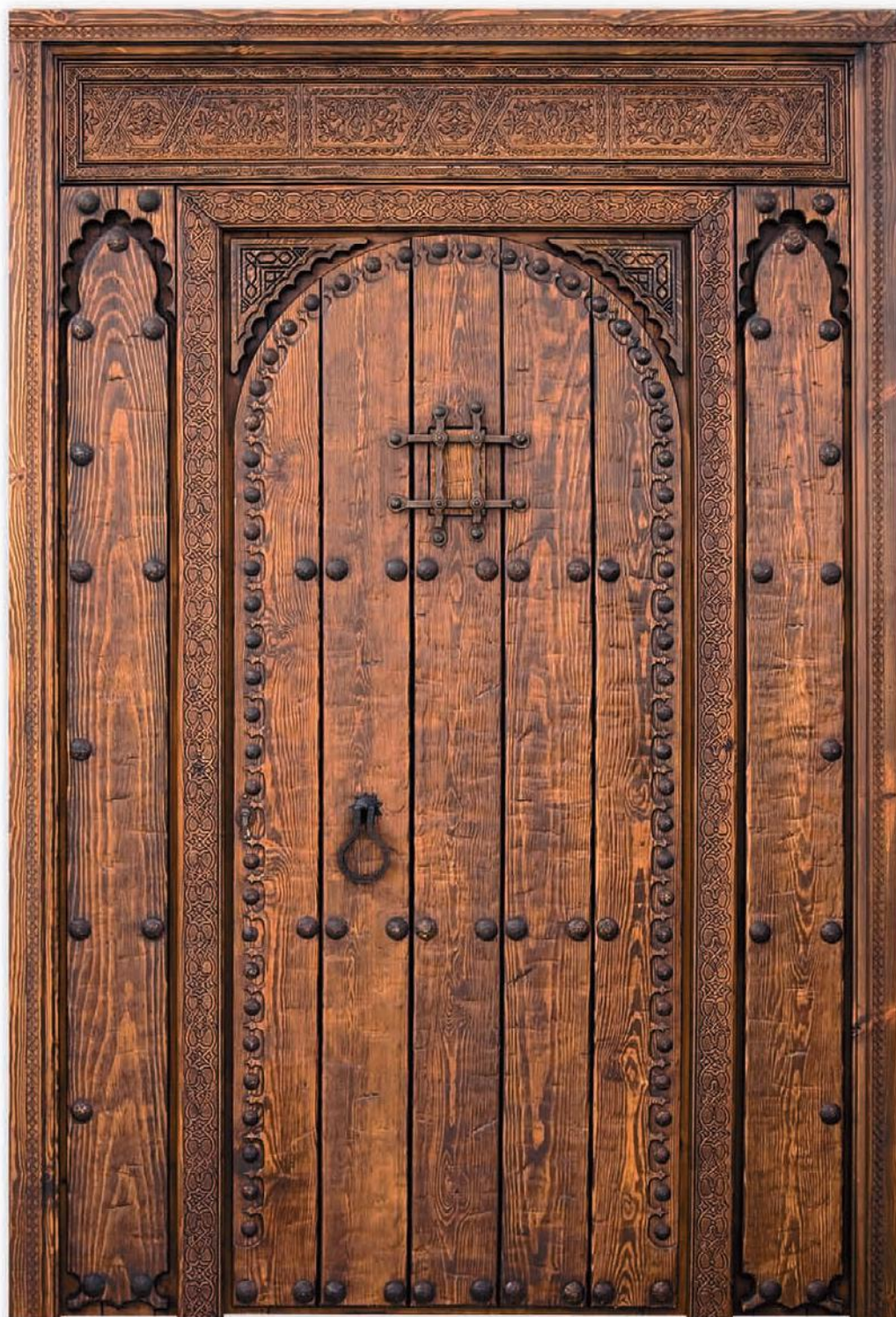

Hoja: 92,5 x 210 cm

Mod.A11 (170 x 250)



Vista frontal Mod. A11 (170 x 250)

Model A11 front view (170 x 250)

Vue face du modèle A11 (170 x 250)

SERIE I Exterior

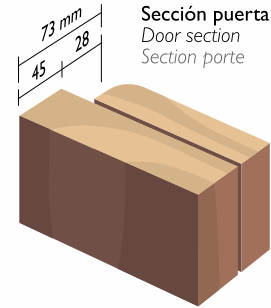

Sección puerta
Door section
Section porte

Tabla de 28 mm. Grueso total de la hoja: 73 mm
Panel thickness: 28 mm. Total door thickness: 73 mm
Épaisseur du panneau: 28 mm. Épaisseur totale de la porte: 73 mm



Mod.A12 con 2 Fijos (162 x 211)
Mod.A13 con 2 Fijos (172 x 218)



Mod.A12 con 1 Fijo (131 x 211)



Mod.A13 con 1 Fijo (141 x 218)



Hoja: 82 x 203 cm Mod. A12 (99 x 211)
Hoja: 92 x 210 cm Mod. A13 (109 x 218)



2 Hojas: 64 x 215 cm Mod.A14 (144 x 224)

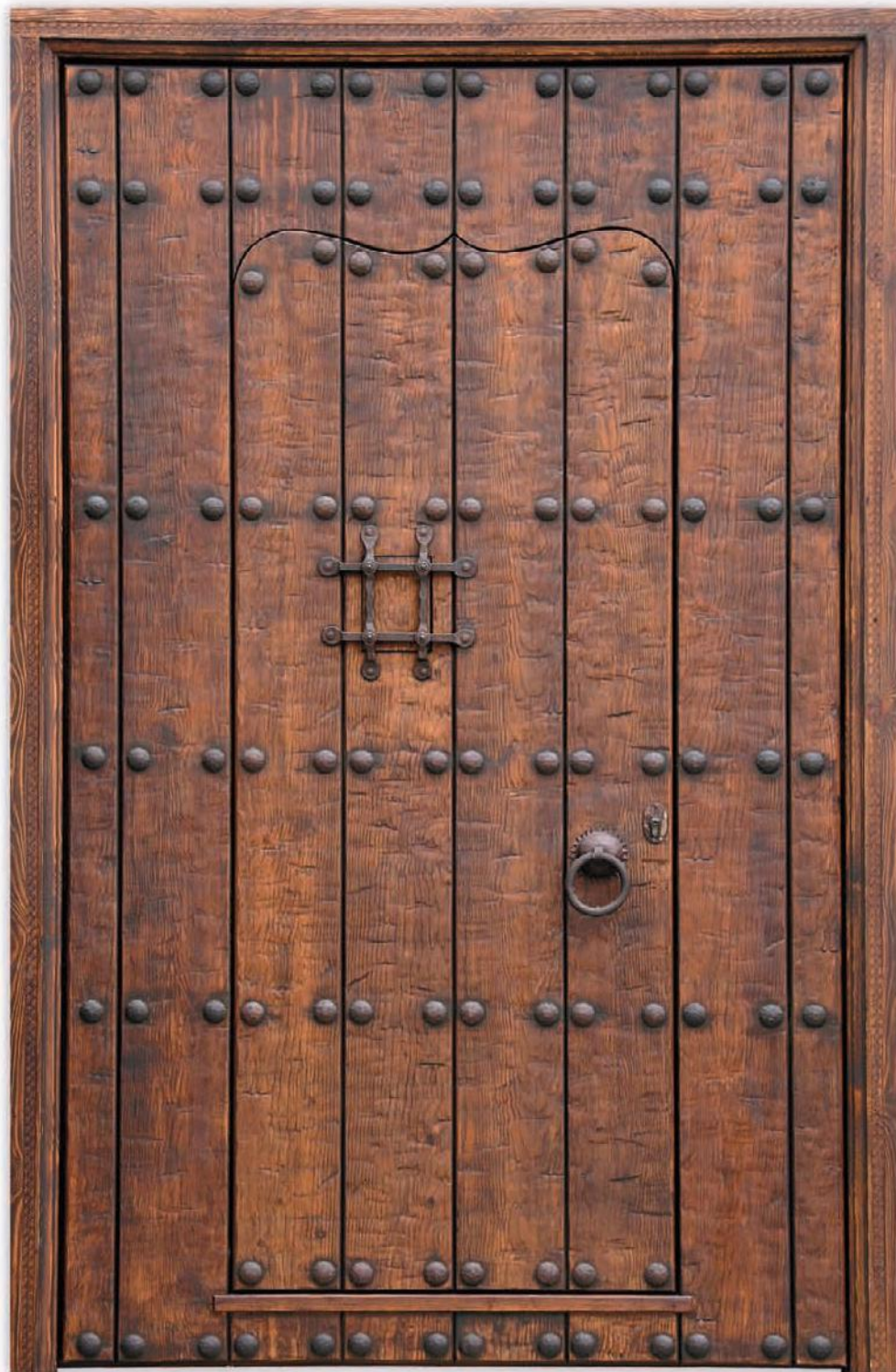

Hoja ext: 139 x 232 / Hoja int: 82,5 x 192

Mod. B1 (155 x 240)



Vista frontal Mod. B1 (155 x 240)
 Model B1 front view (155 x 240)
 Vue face du modèle B1 (155 x 240)

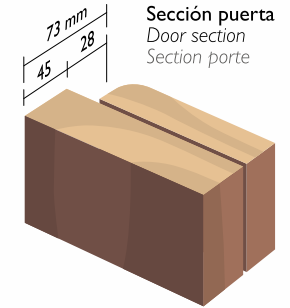

Sección puerta
 Door section
 Section porte

Tabla de 28 mm. Grueso total de la hoja: 73 mm
 Panel thickness: 28 mm. Total door thickness: 73 mm
 Épaisseur du panneau: 28 mm. Épaisseur totale de la porte: 73 mm



Vista trasera Mod. B3 (99 x 211)
 Model B3 back view (99 x 211)
 Vue arrière du modèle B3 (99 x 211)



Hoja: 82,5 x 203

Mod. B3 (99 x 211)

SERIE I Exterior



Hoja: 82,5 x 203
Hoja: 92,5 x 210

Mod. B2 (99 x 211)
Mod. B4 (109 x 218)

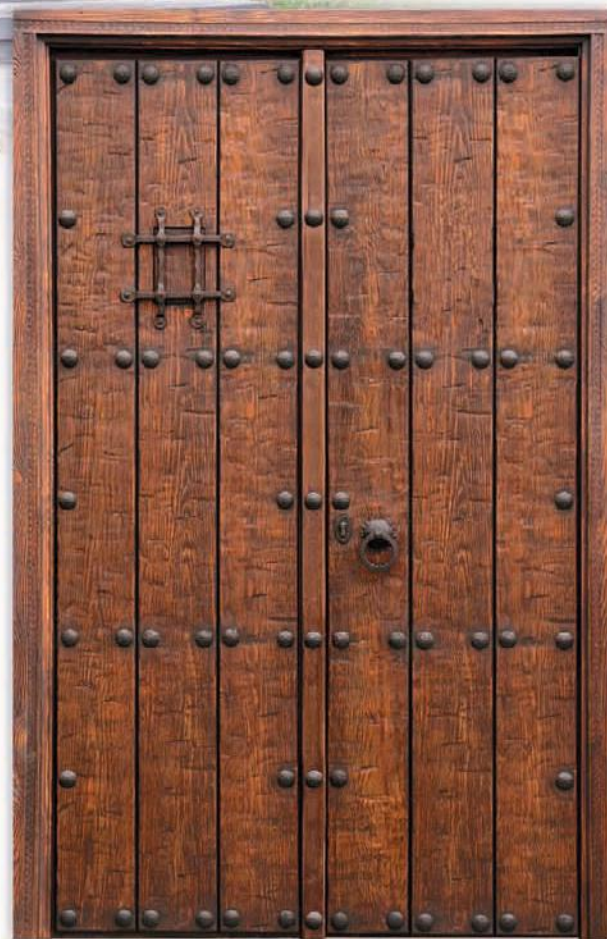

2 Hojas de 64 x 215

Mod. B5 (144 x 224)



Mod. B2 con 2 Fijos (162 x 211)
Mod. B4 con 2 Fijos (172 x 218)



Mod. B2 con 1 Fijo (131 x 211)



Mod. B4 con 1 Fijo (141 x 218)

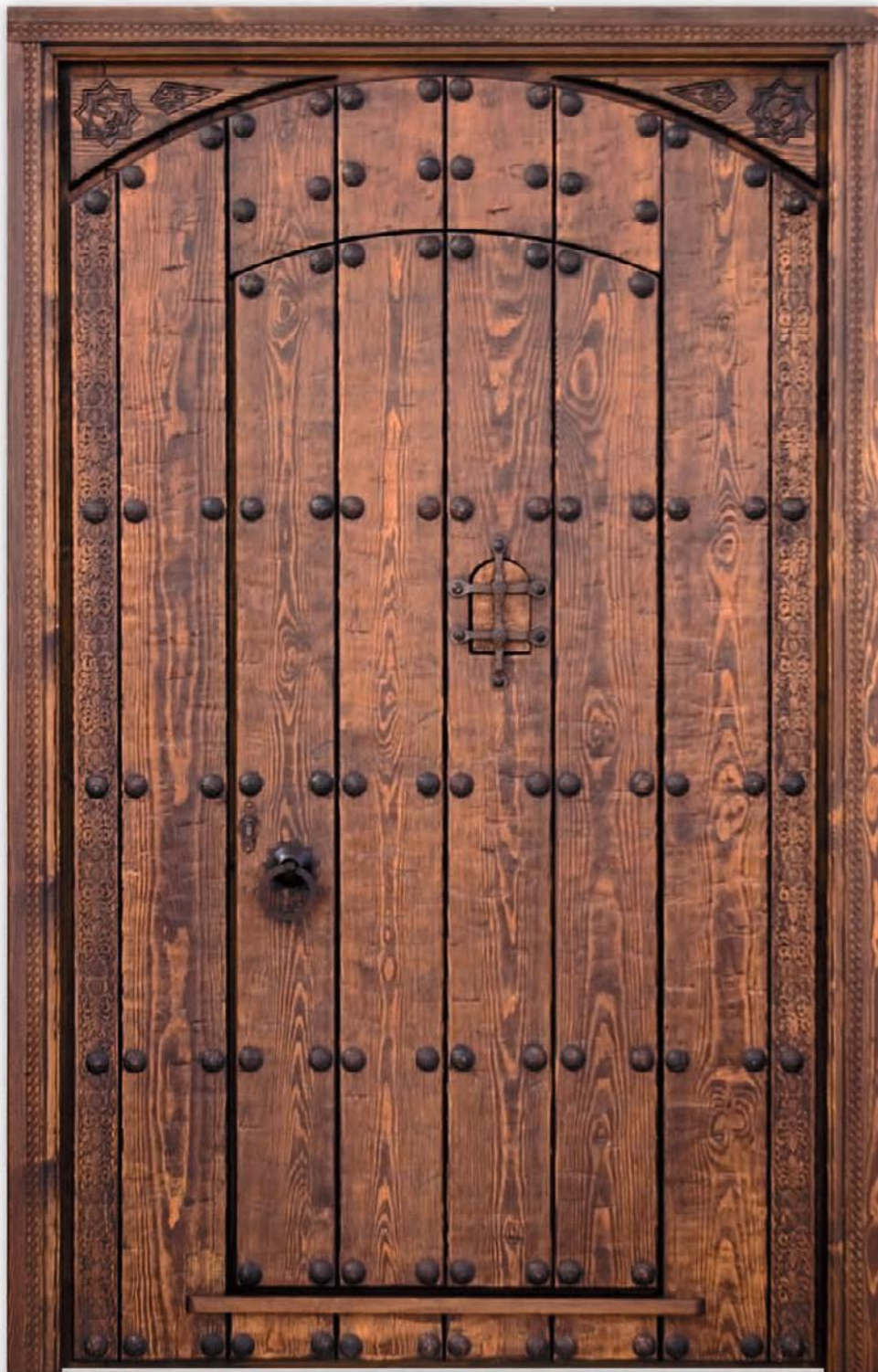

Hoja ext: 139 x 232 / Hoja int: 82,5 x 192

Mod. C11 (155 x 240)



Vista frontal C11 (155 x 240)
Model C11 front view (155 x 240)
Vue face du modèle C11 (155 x 240)



Vista trasera Mod. C11 (155 x 240)
Model C11 back view (155 x 240)
Vue arrière du modèle C11 (155 x 240)

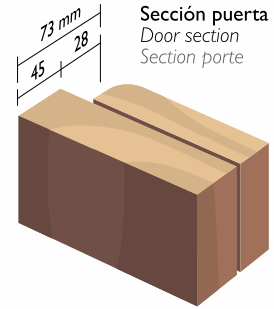

Sección puerta
Door section
Section porte

Tabla de 28 mm. Grueso total de la hoja: 73 mm
Panel thickness: 28 mm. Total door thickness: 73 mm
Épaisseur du panneau: 28 mm. Épaisseur totale de la porte: 73 mm

SERIE I Exterior



Mod. C12 con 2 Fijos (162 x 211)
Mod. C13 con 2 Fijos (172 x 218)



Hoja: 82,5 x 203
Hoja: 92,5 x 210
Mod. C12 (99 x 211)
Mod. C13 (109 x 218)



2 Hojas de 64 x 215
Mod. C14 (144 x 224)



Mod. C12 con 1 Fijo (131 x 211)



Mod. C13 con 1 Fijo (141 x 218)

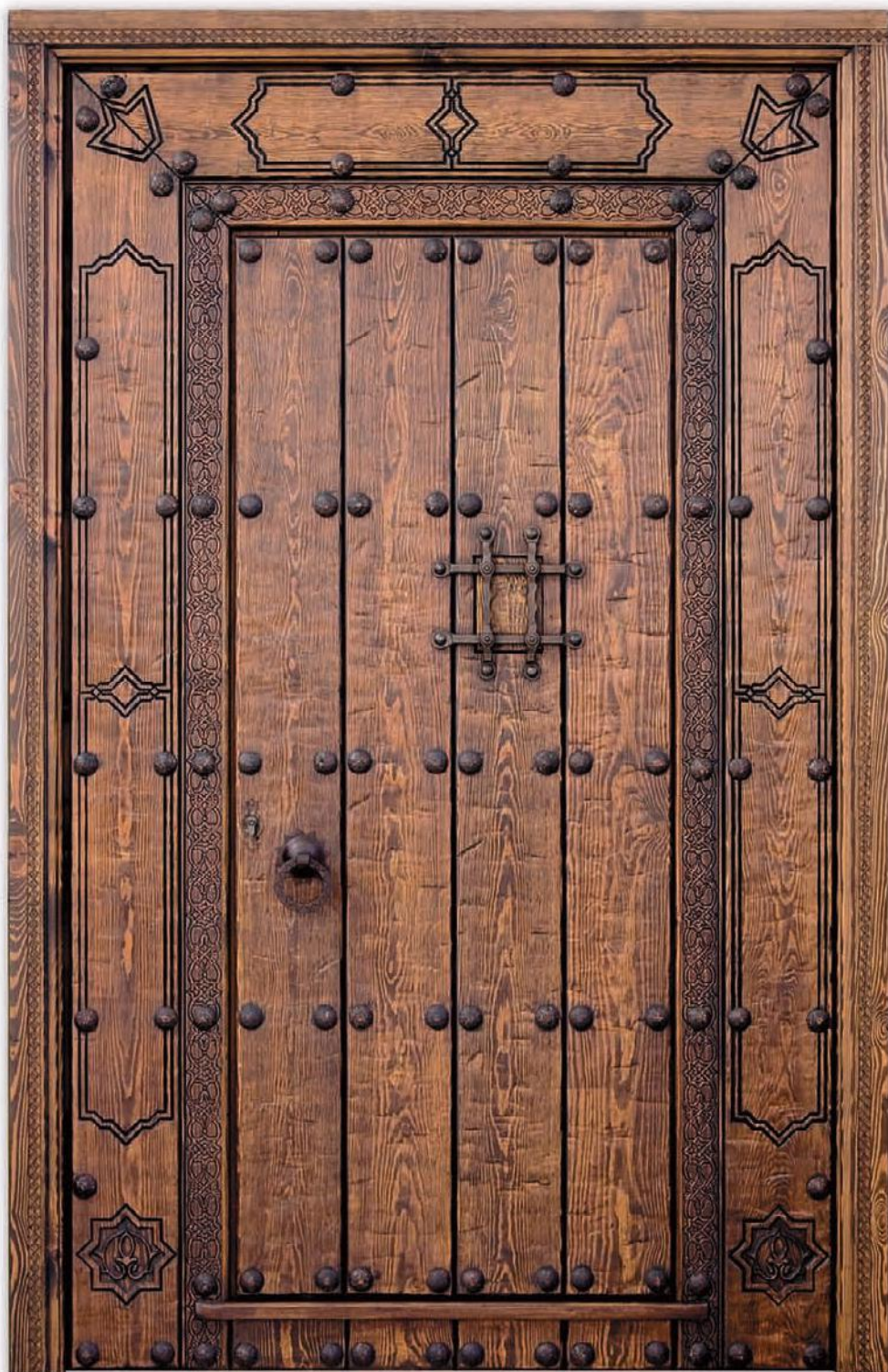

Hoja ext: 139 x 232 / Hoja int: 82,5 x 192

Mod. D11 (155 x 240)



Vista frontal D11 (155 x 240)
Model D11 front view (155 x 240)
Vue face du modèle D11 (155 x 240)



Vista trasera Mod. D11 (155 x 240)
View of back Mod. D11 (155 x 240)
Vista trasera Mod. D11 (155 x 240)



Tabla de 28 mm. Grueso total de la hoja: 73 mm
 Panel thickness: 28 mm. Total door thickness: 73 mm
 Épaisseur du panneau: 28 mm. Épaisseur totale de la porte: 73 mm

SERIE I Exterior



Mod. D12 con 2 Fijos (162 x 211)
 Mod. D13 con 2 Fijos (172 x 218)

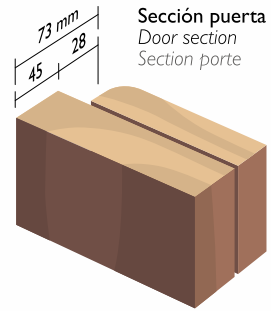

Hoja: 82,5 x 203
 Hoja: 92,5 x 210
 Mod. D12 (99 x 211)
 Mod. D13 (109 x 218)



2 Hojas de 64 x 215
 Mod. D14 (144 x 223)



Mod. D12 con 1 Fijo (131 x 211)



Mod. D13 con 1 Fijo (141 x 218)



2 Hojas de 64 x 215



Mod. EI (144 x 224)



Tabla de 28 mm. Grueso total de la hoja: 73 mm
Panel thickness: 28 mm. Total door thickness: 73 mm
Épaisseur du panneau: 28 mm. Épaisseur totale de la porte: 73 mm

SERIE I Exterior

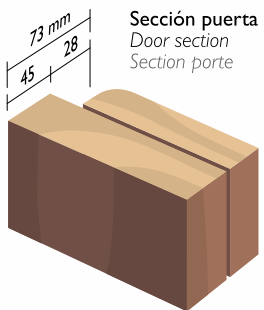

Hoja: 82,5 x 203

Mod. E2 (99 x 211)



Hoja: 92,5 x 210

Mod. E3 (109 x 218)



Mod. E2 con 2 Fijos (162 x 211)
Mod. E3 con 2 Fijos (172 x 218)



Mod. E2 con 1 Fijo (131 x 211)



Mod. E3 con 1 Fijo (141 x 218)

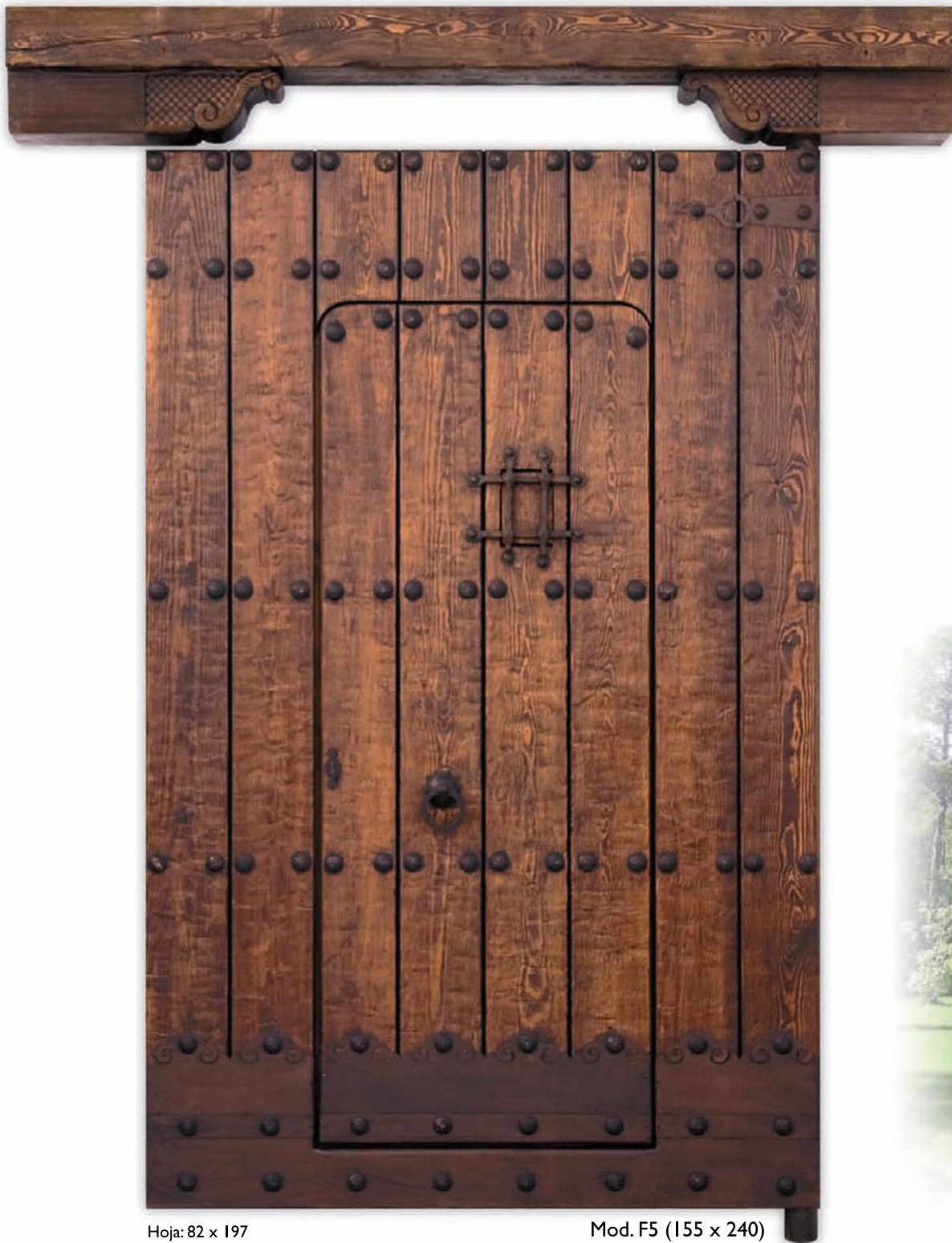

Hoja: 82 x 197

Mod. F5 (155 x 240)



Vista puertas F5 (155 x 240)

View of door Mod. F5 (155 x 240)

Vista puertas Mod. F5 (155 x 240)



Tabla de 28 mm. Grueso total de la hoja: 73 mm
 Panel thickness: 28 mm. Total door thickness: 73 mm
 Épaisseur du panneau: 28 mm. Épaisseur totale de la porte: 73 mm

SERIE I Exterior



Mod. F2 con 2 Fijos (162 x 211)
 Mod. F3 con 2 Fijos (172 x 218)

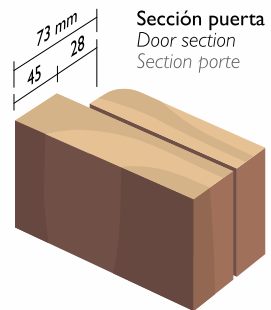

Hoja: 82,5 x 203
 Hoja: 92,5 x 210
 Mod. F2 (99 x 211)
 Mod. F3 (109 x 218)



2 Hojas de 64 x 215
 Mod. F1 (144 x 223)



Mod. F3 con 1 Fijo (141 x 218)



Mod. F2 con 1 Fijo (131 x 211)



Hoja: 92,5 x 210

Mod. G1 (109 x 218)



Hoja: 82,5 x 203
Hoja: 92,5 x 210

Mod. G30 (99 x 211)
Mod. G31 (109 x 218)



Hoja: 82,5 x 203
Hoja: 92,5 x 210

Mod. G20 (99 x 211)
Mod. G21 (109 x 218)



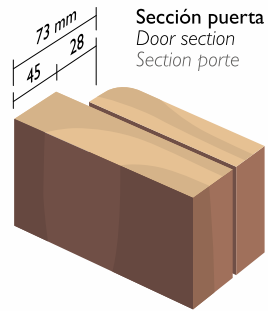

Sección puerta
Door section
Section porte

SERIE I Exterior

Tabla de 28 mm. Grueso total de la hoja: 73 mm
Panel thickness: 28 mm. Total door thickness: 73 mm
Épaisseur du panneau: 28 mm. Épaisseur totale de la porte: 73 mm



Mod. G1 con 2 Fijos (172 x 218)



Mod. G20 con 2 Fijos (162 x 211)
Mod. G21 con 2 Fijos (172 x 218)



Mod. G30 con 2 Fijos (162 x 211)
Mod. G31 con 2 Fijos (172 x 218)



Mod. G1 con 1 Fijo (141 x 218)



Mod. G20 con 1 Fijo (131 x 211)
Mod. G21 con 1 Fijo (141 x 218)



Mod. G30 con 1 Fijo (131 x 211)
Mod. G31 con 1 Fijo (141 x 218)

SERIE I Exterior



Hoja: 82,5 x 203
Hoja: 92,5 x 210

Mod. III (99 x 211)
Mod. II2 (109 x 218)



Vista trasera Mod. II2 (109 x 218)
View of back Mod. I12 (109 x 218)
Vista trasera Mod. I12 (109 x 218)



Mod. III con 2 Fijos (162 x 211)
Mod. II2 con 2 Fijos (172 x 218)



Mod. III con 1 Fijo (131 x 211)



Mod. II2 con 1 Fijo (141 x 218)

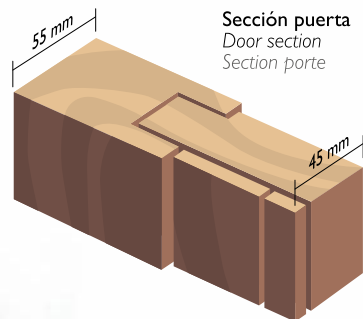
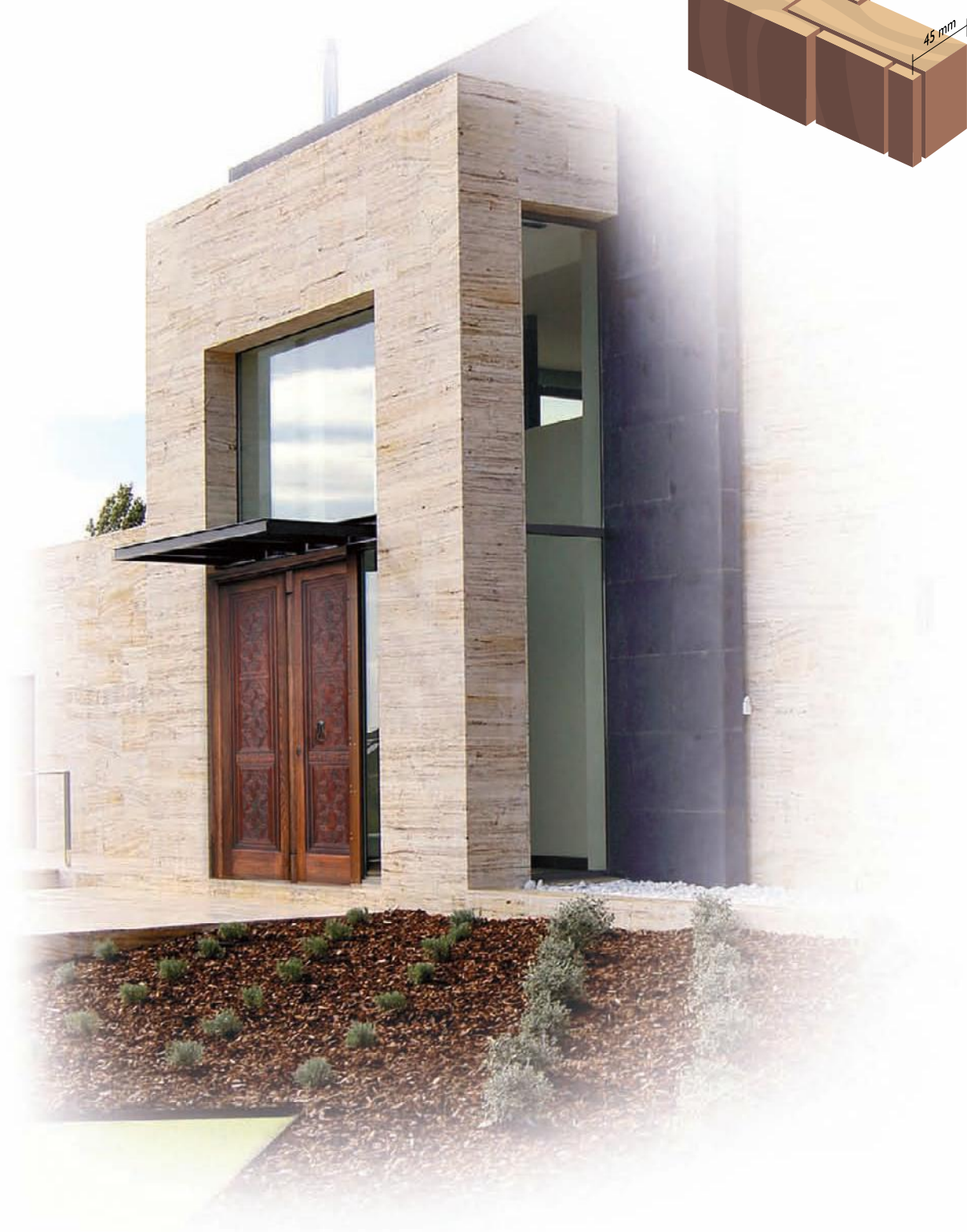

Sección puerta
Door section
Section porte

Tabla de 45 mm. Grueso total de la hoja: 55 mm
Panel thickness: 45 mm. Total door thickness: 55 mm
Épaisseur du panneau: 45 mm. Épaisseur totale de la porte: 55 mm

SERIE I Exterior



2 Hojas de 59 x 228

Mod. H3 (134 x 236)

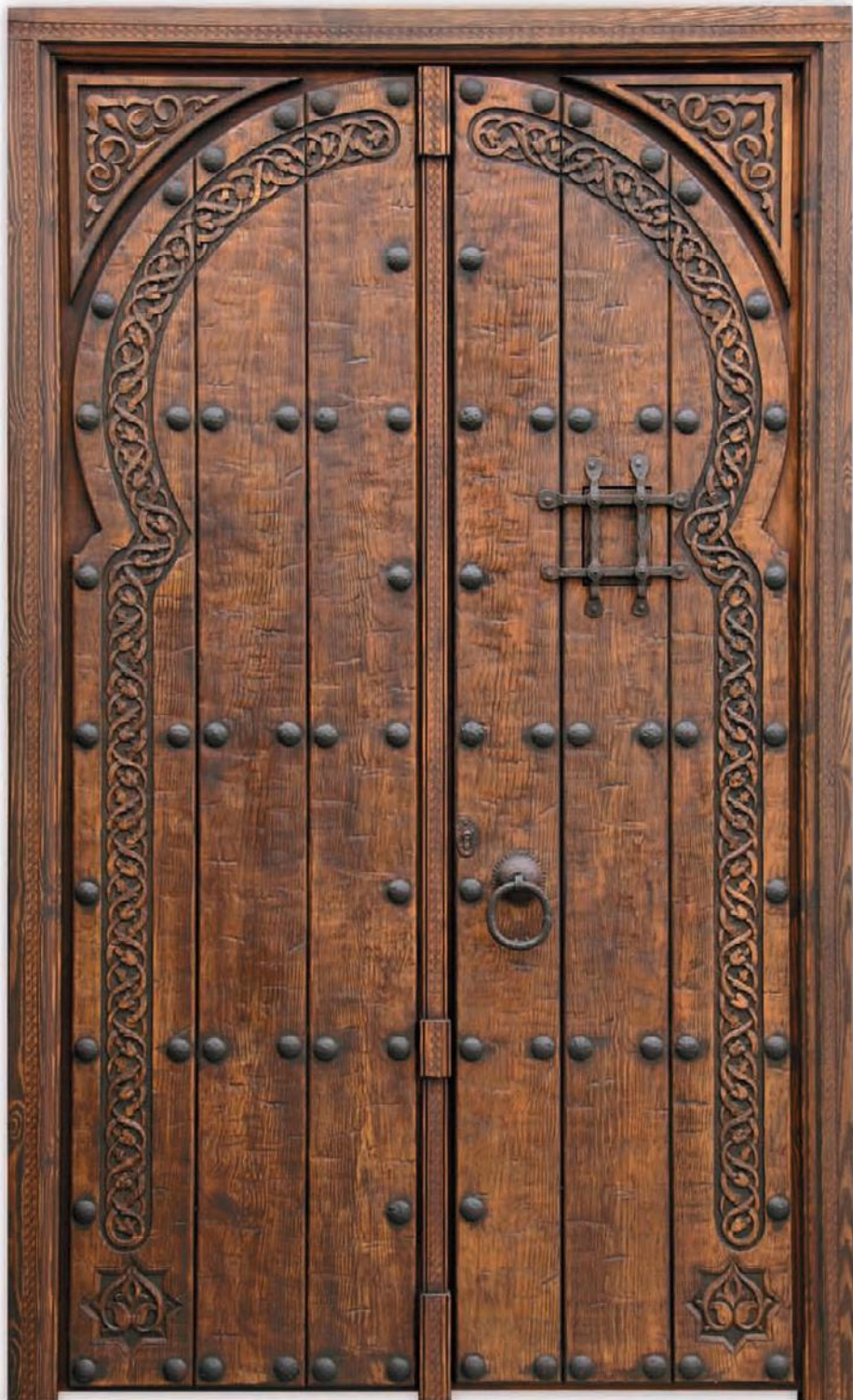

2 Hojas de 66,5 x 232



Mod. JI (149 x 240)



Tabla de 28 mm. Grueso total de la hoja: 73 mm
Panel thickness: 28 mm. Total door thickness: 73 mm
Épaisseur du panneau: 28 mm. Épaisseur totale de la porte: 73 mm

SERIE I Exterior

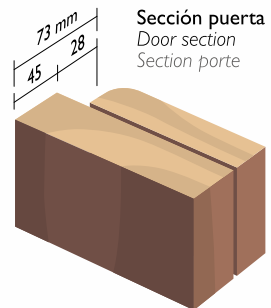

Hoja: 82,5 x 215

Mod. J2 (99 x 223)



Hoja: 92,5 x 215

Mod. J3 (109 x 223)



Mod. J2 con 2 Fijos (162 x 223)
Mod. J3 con 2 Fijos (172 x 223)



Mod. J2 con 1 Fijo (131 x 223)



Mod. J3 con 1 Fijo (141 x 223)

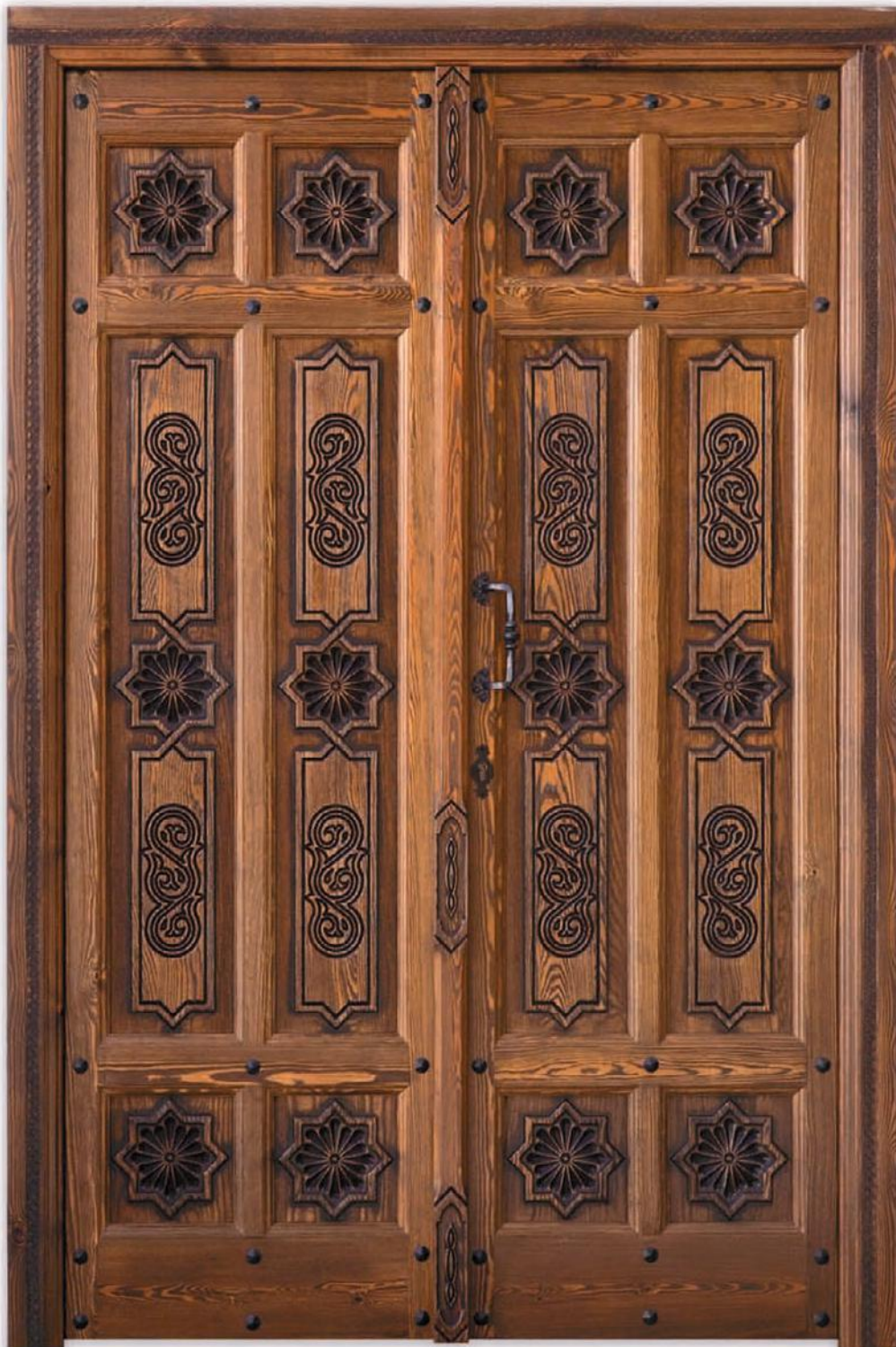

2 Hojas: de 68 x 215

Mod. HA-1 (152 x 224)



Hoja: 82 x 203
Hoja: 92 x 210

Mod. HA-2 (99 x 211)
Mod. HA-3 (109 x 218)



Vista trasera Mod. HA-2 (99 x 211)
 Model HA-2 back view (99 x 211)
 Vue arrière du modèle HA-2 (99 x 211)

SERIE I Exterior



Tabla de 28 mm. Grueso total de la hoja: 55 mm
 Panel thickness: 28 mm. Total door thickness: 55 mm
 Épaisseur du panneau: 28 mm. Épaisseur totale de la porte: 55 mm



Mod. HA-2 + 1 Fijo (131 x 211)

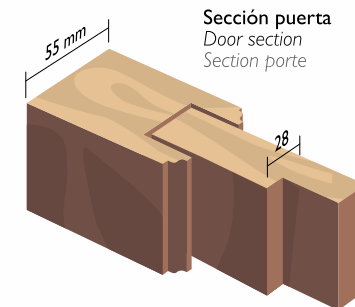

Mod. HA-3 + 1 Fijo (141 x 218)



Mod. HA-2 + 2 Fijos (162 x 211)
 Mod. HA-3 + 2 Fijos (172 x 218)

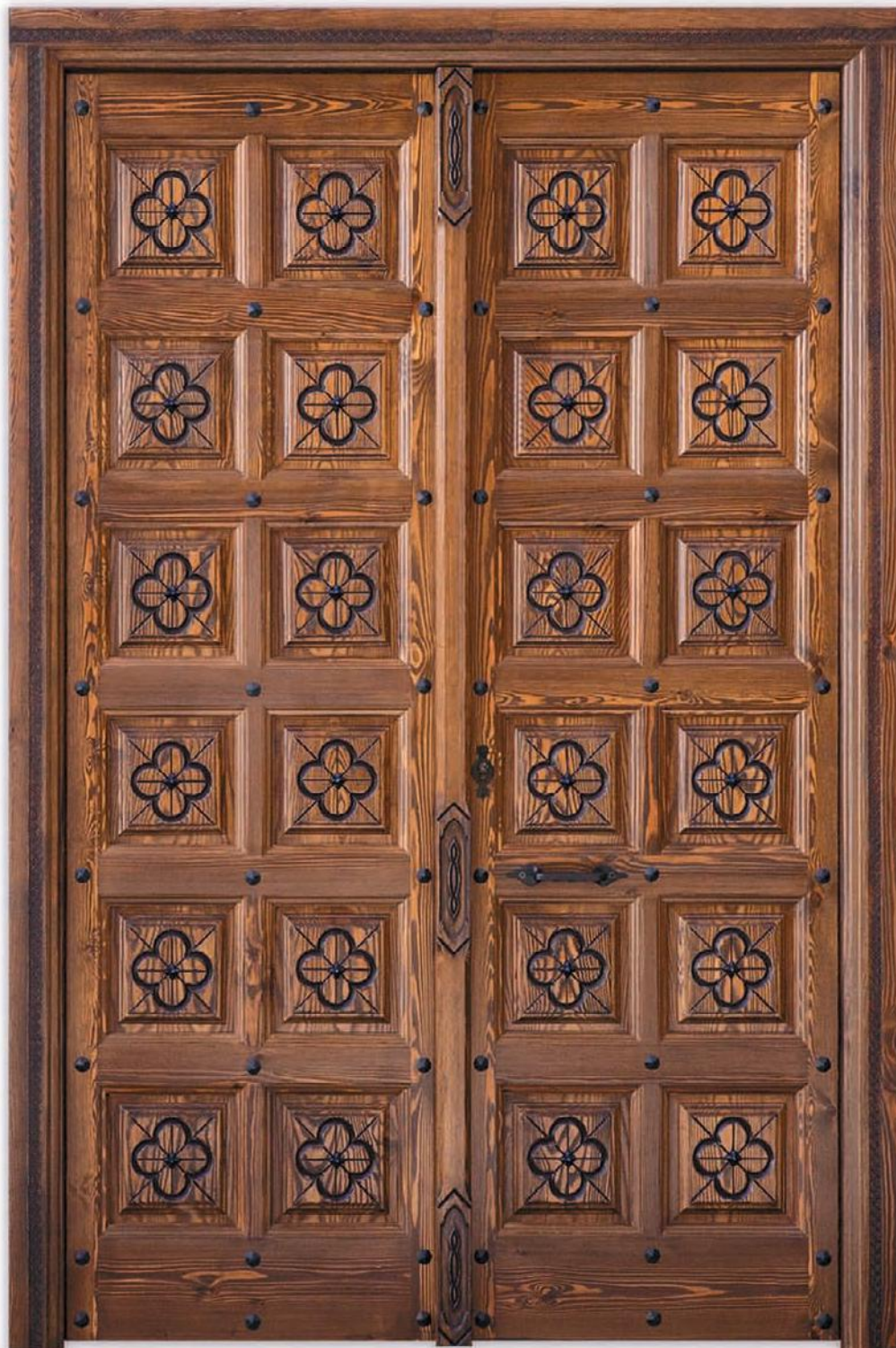

2 Hojas de 68 x 215

Mod. XA-1 (152 x 224)



Hoja: 82 x 203
Hoja: 92 x 210

Mod. XA-2 (99 x 211)
Mod. XA-3 (109 x 218)



SERIE I Exterior



Tabla de 28 mm. Grueso total de la hoja: 55 mm
 Panel thickness: 28 mm. Total door thickness: 55 mm
 Épaisseur du panneau: 28 mm. Épaisseur totale de la porte: 55 mm



Mod. XA-2 + 1 Fijo (131 x 211)

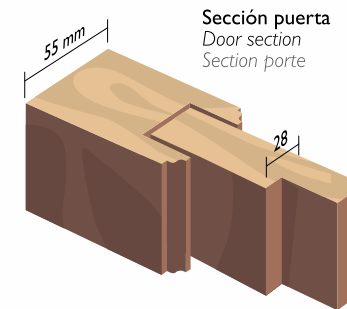

Mod. XA-3 + 1 Fijo (141 x 218)



Mod. XA-2 + 2 Fijos (162 x 211)
 Mod. XA-3 + 2 Fijos (172 x 218)



2 Hojas: 68 x 215

Mod.VA-1 (144 x 224)



Hoja: 82 x 203
Hoja: 92 x 210

Mod.VA-2 (99 x 211)
Mod.VA-3 (109 x 218)

SERIE I Exterior



Vista trasera Mod.VA-I (144 x 224)
 Model VA-I back view (144 x 224)
 Vue arrière du modèle VA-I (144 x 224)



Tabla de 25 mm. Grueso total de la hoja: 78 mm
 Panel thickness: 28 mm. Total door thickness: 78 mm
 Épaisseur du panneau: 28 mm. Épaisseur totale de la porte: 78 mm



Mod.VA-2 + 1 Fijo (131 x 211)

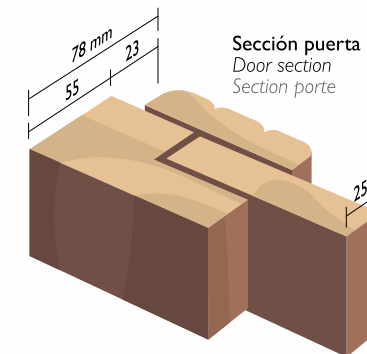

Mod.VA-3 + 1 Fijo (141 x 218)



Mod.VA-2 + 2 Fijos (162 x 211)
 Mod.VA-3 + 2 Fijos (172 x 218)



Hoja grande: 113 x 220
Hoja paso: 92 x 200

Mod. ZA-1 (141 x 258)



Hoja: 92 x 210

Mod. ZA-2 (120 x 225)



Detalle Mod. ZA-2



Detalle Mod. ZA-2



Detalle Mod. ZA-3



Hoja: 82,5 x 203

Mod. ZA-3 (99 x 211)

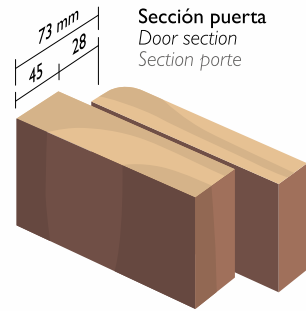

Sección puerta
Door section
Section porte

Tabla de 28 mm. Grueso total de la hoja: 73 mm
Panel thickness: 28 mm. Total door thickness: 73 mm
Épaisseur du panneau: 28 mm. Épaisseur totale de la porte: 73 mm

SERIE I Exterior



Vista trasera Mod. ZA-3 (99 x 211)

Model ZA-3 back view (99 x 211)

Vue arrière du modèle ZA-3 (99 x 211)

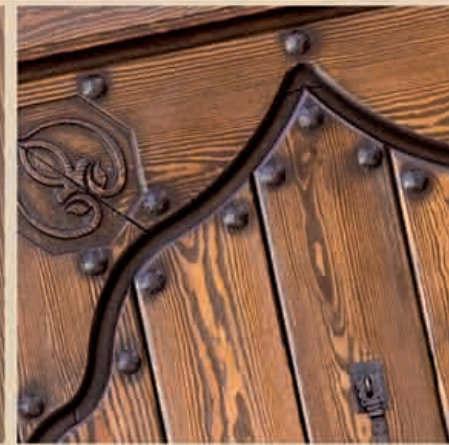

puertascarrasco
puertas e interiorismo

SERIE II

Puertas Rústicas

Características Puertas Rústicas SERIE II · Features of SERIES II doors · Caractéristiques des portes SÉRIE II

- Puertas exteriores fabricadas con madera de pino rojo.
- Marco directo moldurado 70 x 95 mm (grueso por ancho).
- Grosor de hoja (armazón + tablas) de 68 mm.
- Herrajes y pernios entrelazados.
- Cerradura de seguridad de tres puntos.
- Llamador y tiradores rústicos envejecidos.
- Tratamiento especial a poro abierto para exterior y acabado nogal a la cera.

- Exterior doors made from red pine wood.
- Moulded frame 70 x 95 mm (thick x width).
- Total door thickness: 68mm (frame + panel).
- High quality hinges.
- Three point security lock.
- Aged rustic doorknob and knocker.
- Open pore treatment for exterior and waxed walnut finish.

- Portes en bois pour extérieur fabriquées en pin rouge.
- Cadre moulé de 70 x 95 mm (épaisseur X largeur).
- Épaisseur de porte totale: 68mm (cadre + panneaux).
- Charnières de grande qualité.
- Serrure de sécurité trois points.
- Pommeau et heurtoirs rustiques vieillis.
- Traitement spécial à pores ouvertes pour extérieur, finition noyer ciré.

PUERTAS RÚSTICAS



Cerradura de seguridad

SECCIÓN PUERTAS SERIE II DOORS SECTION SERIES II · SECTION PORTES SÉRIE II

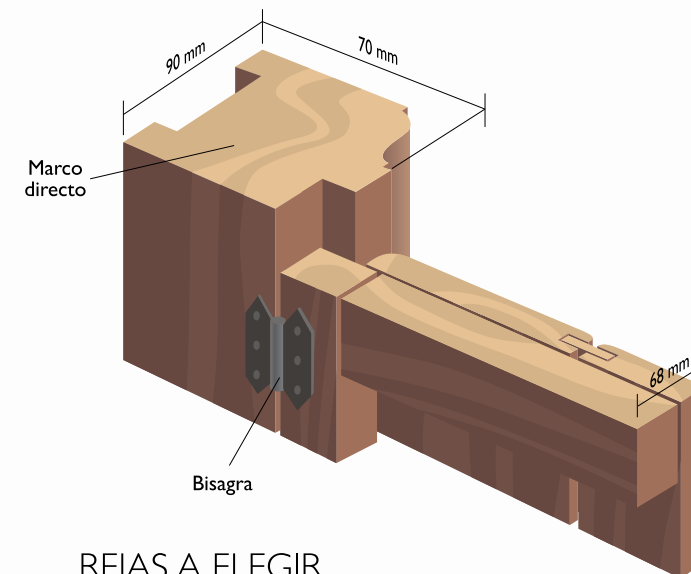

REJAS A ELEGIR WROUGHT IRON GRILLS OPTIONS GRILLES EN FER FORGÉ À CHOISIR

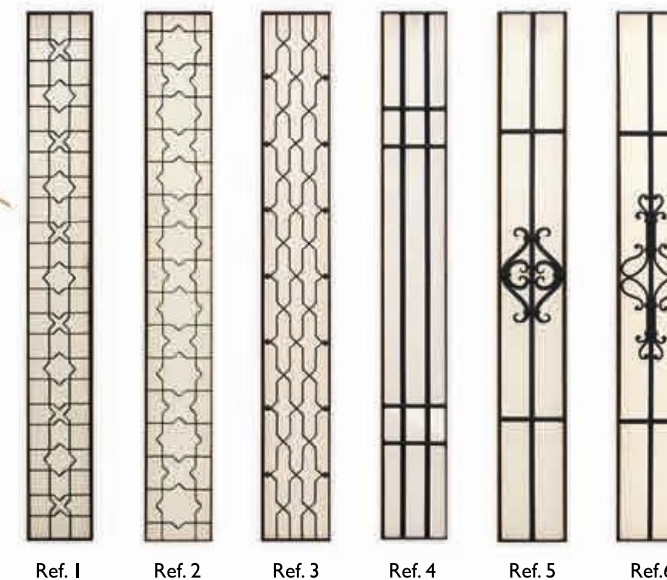

· Todas las puertas se fabrican con marcado 

Sección puerta
Door section
Section porte



Tabla de 23 mm. Grueso total de la hoja: 68 mm
Panel thickness: 23 mm. Total door thickness: 68 mm
Épaisseur du panneau: 23 mm. Épaisseur totale de la porte: 68 mm

SERIE II Exterior

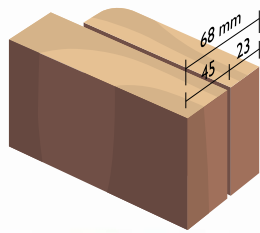

2 Hojas de 64 x 215

Mod. U1 (139 x 221)



Hoja: 82,5 x 203
Hoja: 92,5 x 210

Mod. U2 (94 x 209)
Mod. U3 (104 x 216)



Mod. U2 con 2 Fijos (152 x 209)
Mod. U3 con 2 Fijos (162 x 216)



Mod. U2 con 1 Fijo (123 x 209)



Mod. U3 con 1 Fijo (133 x 216)

Sección puerta
Door section
Section porte



Tabla de 23 mm. Grueso total de la hoja: 68 mm
Panel thickness: 23 mm. Total door thickness: 68 mm
Épaisseur du panneau: 23 mm. Épaisseur totale de la porte: 68 mm

SERIE II Exterior

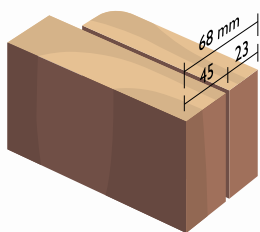

2 Hojas de 64 x 215

Mod. P1 (139 x 221)



Hoja: 82,5 x 203
Hoja: 92,5 x 210

Mod. P2 (94 x 209)
Mod. P3 (104 x 216)



Mod. P2 con 2 Fijos (152 x 209)
Mod. P3 con 2 Fijos (162 x 216)



Mod. P2 con 1 Fijo (123 x 209)



Mod. P2 con 1 Fijo (133 x 216)

Sección puerta
Door section
Section porte



Tabla de 28 mm. Grueso total de la hoja: 73 mm
Panel thickness: 28 mm. Total door thickness: 73 mm
Épaisseur du panneau: 28 mm. Épaisseur totale de la porte: 73 mm

SERIE II Exterior

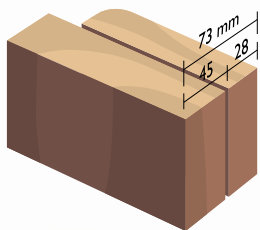

2 Hojas de 64 x 215

Mod. Q1 (139 x 221)



Hoja: 82,5 x 203
Hoja: 92,5 x 210

Mod. Q2 (94 x 209)
Mod. Q3 (104 x 216)



Mod. Q2 con 2 Fijos (152 x 209)
Mod. Q3 con 2 Fijos (162 x 216)



Mod. Q2 con 1 Fijo (123 x 209)



Mod. Q3 con 1 Fijo (133 x 216)

Sección puerta
Door section
Section porte



Tabla de 23 mm. Grueso total de la hoja: 68 mm
Panel thickness: 23 mm. Total door thickness: 68 mm
Épaisseur du panneau: 23 mm. Épaisseur totale de la porte: 68 mm

SERIE II Exterior

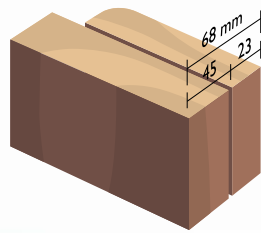

2 Hojas de 64 x 215

Mod. R1 (139 x 221)



Hoja: 82,5 x 203
Hoja: 92,5 x 210

Mod. R2 (94 x 209)
Mod. R3 (104 x 216)



Mod. R2 con 2 Fijos (152 x 209)
Mod. R3 con 2 Fijos (162 x 216)



Mod. R2 con 1 Fijo (123 x 209)



Mod. R3 con 1 Fijo (133 x 216)

Sección puerta
Door section
Section porte



Tabla de 23 mm. Grueso total de la hoja: 68 mm
Panel thickness: 23 mm. Total door thickness: 68 mm
Épaisseur du panneau: 23 mm. Épaisseur totale de la porte: 68 mm

SERIE II Exterior

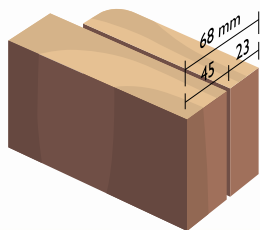

2 Hojas de 64 x 215

Mod. S1 (139 x 221)



Hoja: 82,5 x 203
Hoja: 92,5 x 210

Mod. S2 (94 x 209)
Mod. S3 (104 x 216)



Mod. S2 con 2 Fijos (152 x 209)
Mod. S3 con 2 Fijos (162 x 216)



Mod. S2 con 1 Fijo (123 x 209)



Mod. S3 con 1 Fijo (133 x 216)

Sección puerta
Door section
Section porte



Tabla de 23 mm. Grueso total de la hoja: 68 mm
Panel thickness: 23 mm. Total door thickness: 68 mm
Épaisseur du panneau: 23 mm. Épaisseur totale de la porte: 68 mm

SERIE II Exterior

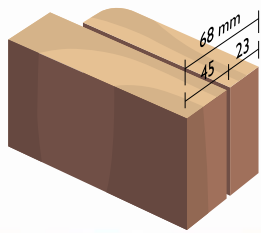

2 Hojas de 64 x 215

Mod. N1 (139 x 221)



Hoja: 82,5 x 203
Hoja: 92,5 x 210

Mod. N2 (94 x 209)
Mod. N3 (104 x 216)



Mod. N2 con 2 Fijos (152 x 209)
Mod. N3 con 2 Fijos (162 x 216)



Mod. N2 con 1 Fijo (123 x 209)



Mod. N3 con 1 Fijo (133 x 216)

Sección puerta
Door section
Section porte



Tabla de 23 mm. Grueso total de la hoja: 68 mm
Panel thickness: 23 mm. Total door thickness: 68 mm
Épaisseur du panneau: 23 mm. Épaisseur totale de la porte: 68 mm

SERIE II Exterior

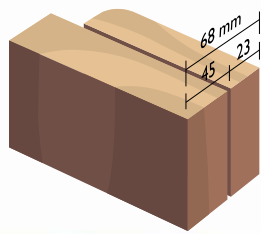
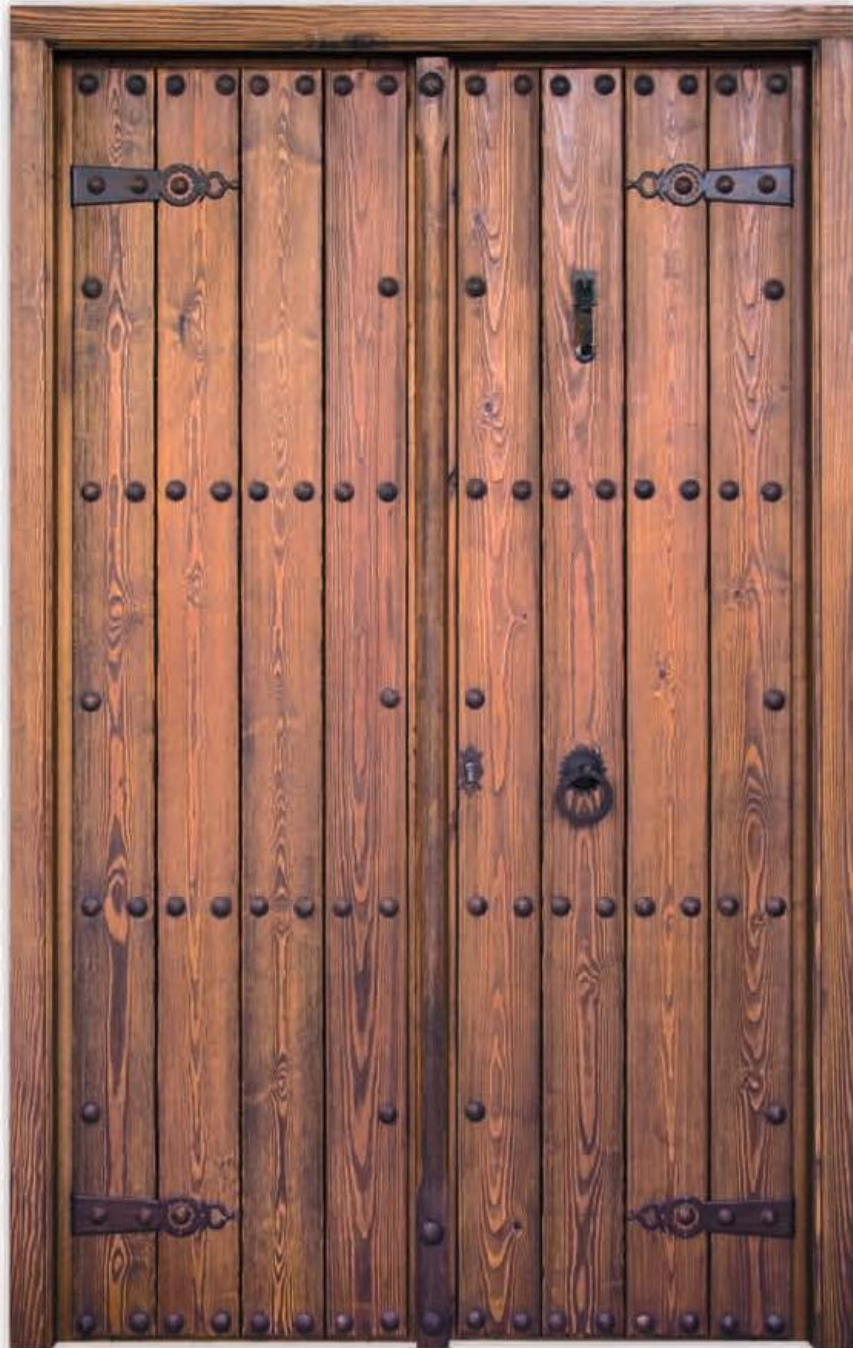

2 Hojas de 64 x 215

Mod.T1 (139 x 221)



Hoja: 82,5 x 203
Hoja: 92,5 x 210

Mod. T2 (94 x 209)
Mod. T3 (104 x 216)



Mod.T2 con 2 Fijos (152 x 209)
Mod.T3 con 2 Fijos (162 x 216)



Mod.T2 con 1 Fijo (123 x 209I)



Mod.T3 con 1 Fijo (133 x 216)

Sección puerta
Door section
Section porte



Tabla de 23 mm. Grueso total de la hoja: 68 mm
Panel thickness: 23 mm. Total door thickness: 68 mm
Épaisseur du panneau: 23 mm. Épaisseur totale de la porte: 68 mm

SERIE II Exterior

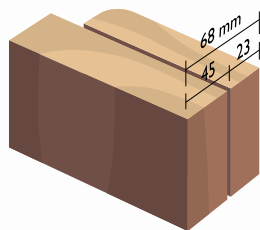

Hoja: 82,5 x 203
Hoja: 92,5 x 210

Mod. ANI (94 x 209)
Mod. AN2 (104 x 216)



Mod. ANI con 2 Fijos (152 x 209)
Mod. AN2 con 2 Fijos (162 x 216)



Mod. ANI con 1 Fijo (123 x 209)



Mod. AN2 con 1 Fijo (133 x 216)



SERIE INTERIOR
Puertas Rústicas

Características Puertas Rústicas SERIE INTERIOR

Features of *SERIES INTERIOR* doors

Caractéristiques des portes *SÉRIE INTÉRIEUR*

- Puertas elaboradas en madera de pino rojo montadas en block.
- Incluyen bisagras, mecanizado del block más pernios y picaporte de petaca.
- Galce de 30 mm fabricado a medida del cliente.
- Tapajuntas tallados de 90 mm a dos caras.
- Barniz para interiores con acabado nogal a la cera.
- No incluyen cristales ni manivelas.

- Pre-hung door made from red pine wood.
- Hinges and drilling the door for a handle are included.
- Frame thickness: 30mm. It's made to client measurement.
- Carved door casing 90 mm (external and internal side).
- Varnish for interior and waxed walnut finish.
- Handle and glass not included.

- Bloc-porte en pin rouge.
- Charnières et réservation de poignée incluses.
- Épaisseur de cadre: 30mm, fabriqué sur mesure.
- Chambranle sculpté en 90 mm (des deux côtés).
- Vernis pour intérieur finition noyer ciré.
- Poignées et verre en option.

SECCIÓN PUERTAS DE INTERIOR INTERIOR DOORS SECTION · SECTION PORTES INTÉRIEURES

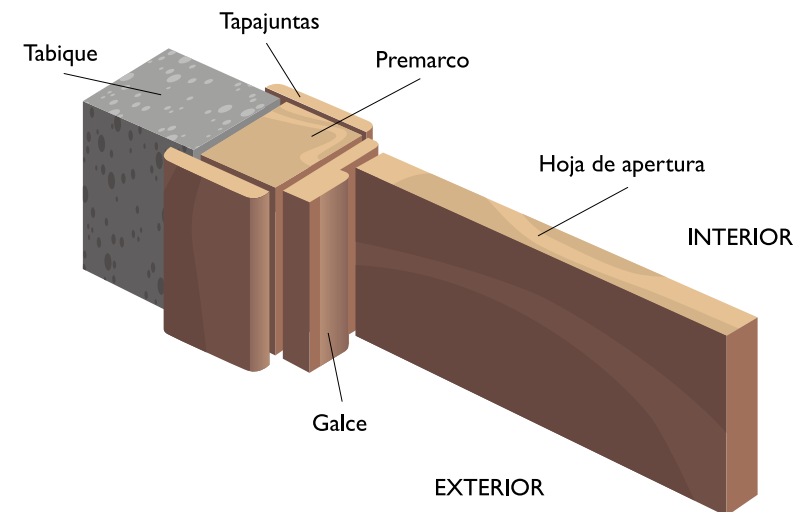

ELEMENTOS OPCIONALES

OPTIONAL ACCESSORIES · ACCESSOIRES EN OPTION

Manivelas · Handles · Poignée



Manivela negra
Black handle
Poignée noire



Manivela bronce
envejecido satinado
Aged bronze handle
Poignée en bronze satiné et vieilli

APERTURA DE PUERTA HANDING · OUVERTURE

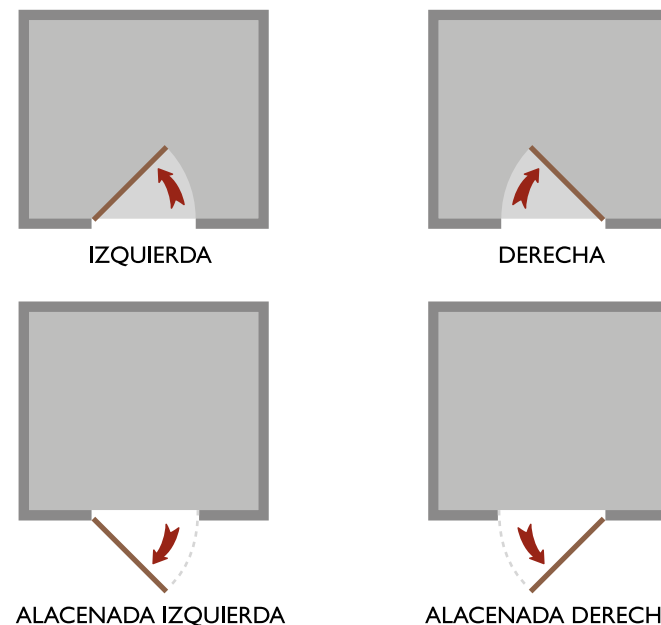

Sección puerta
Door section
Section porte



Tabla de 22 mm. Grueso total de la hoja: 45 mm
Panel thickness: 22 mm. Total door thickness: 45 mm
Épaisseur du panneau: 22 mm. Épaisseur totale de la porte: 45 mm

SERIE Interior

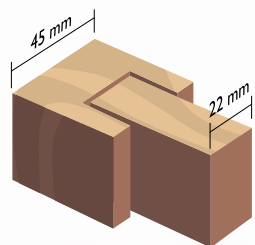

Hoja: 62,5 x 203
Hoja: 72,5 x 203
Hoja: 82,5 x 203

Mod.Ab1 (66 x 205)
Mod.Ab2 (76 x 205)
Mod.Ab3 (86 x 205)



Hoja: 62,5 x 203
Hoja: 72,5 x 203
Hoja: 82,5 x 203

Mod.Ab4 (66 x 205)
Mod.Ab5 (76 x 205)
Mod.Ab6 (86 x 205)



Sección puerta
Door section
Section porte



Tabla de 22 mm. Grueso total de la hoja: 45 mm
Panel thickness: 22 mm. Total door thickness: 45 mm
Épaisseur du panneau: 22 mm. Épaisseur totale de la porte: 45 mm

SERIE Interior

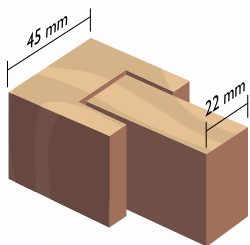

Hoja: 62,5 x 203
Hoja: 72,5 x 203
Hoja: 82,5 x 203

Mod. X1 (66 x 205)
Mod. X2 (76 x 205)
Mod. X3 (86 x 205)



Hoja: 62,5 x 203
Hoja: 72,5 x 203
Hoja: 82,5 x 203

Mod. X4 (66 x 205)
Mod. X5 (76 x 205)
Mod. X6 (86 x 205)



Sección puerta
Door section
Section porte



Tabla de 22 mm. Grueso total de la hoja: 35 mm
Panel thickness: 22 mm. Total door thickness: 35 mm
Épaisseur du panneau: 22 mm. Épaisseur totale de la porte: 35 mm



Sección puerta ambas caras talladas. OPCIONAL
Section of both carved sides. OPTIONAL.
Section de porte sculptée des deux côtés en OPTION.

SERIE Interior

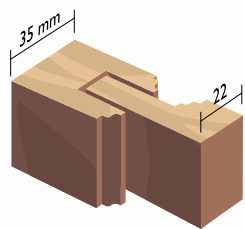
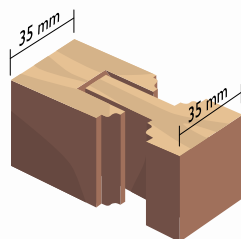

Hoja: 62,5 x 203
Hoja: 72,5 x 203
Hoja: 82,5 x 203

Mod.V1 (66 x 205)
Mod.V2 (76 x 205)
Mod.V3 (86 x 205)



Hoja: 62,5 x 203
Hoja: 72,5 x 203
Hoja: 82,5 x 203

Mod.V4 (66 x 205)
Mod.V5 (76 x 205)
Mod.V6 (86 x 205)





Tabla de 28 mm. Grueso total de la hoja: 45 mm
Panel thickness: 28 mm. Total door thickness: 45 mm
Épaisseur du panneau: 28 mm. Épaisseur totale de la porte: 45 mm



Hoja: 62,5 x 203
Hoja: 72,5 x 203
Hoja: 82,5 x 203

Mod. K11 (66 x 205)
Mod. K12 (76 x 205)
Mod. K13 (86 x 205)

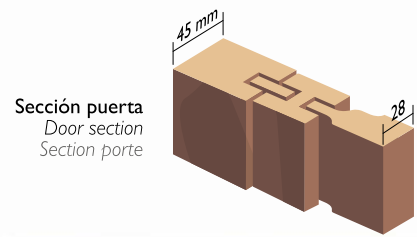

Hoja: 62,5 x 203
Hoja: 72,5 x 203
Hoja: 82,5 x 203

Mod. K14 (66 x 205)
Mod. K15 (76 x 205)
Mod. K16 (86 x 205)



Sección puerta
Door section
Section porte



Tabla de 28 mm. Grueso total de la hoja: 45 mm
Panel thickness: 28 mm. Total door thickness: 45 mm
Épaisseur du panneau: 28 mm. Épaisseur totale de la porte: 45 mm



Sección puerta ambas caras talladas. OPCIONAL
Section of both carved sides. OPTIONAL.
OPTIONAL.
Section de porte sculptée des deux côtés en OPTION.

SERIE Interior

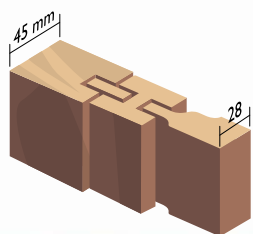
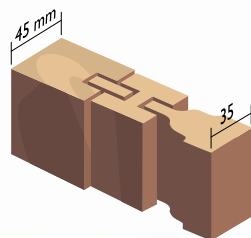

Hoja: 62,5 x 203
Hoja: 72,5 x 203
Hoja: 82,5 x 203

Mod. L11 (66 x 205)
Mod. L12 (76 x 205)
Mod. L13 (86 x 205)



Hoja: 62,5 x 203
Hoja: 72,5 x 203
Hoja: 82,5 x 203

Mod. L14 (66 x 205)
Mod. L15 (76 x 205)
Mod. L16 (86 x 205)





Tabla de 28 mm. Grueso total de la hoja: 45 mm
Panel thickness: 28 mm. Total door thickness: 45 mm
Épaisseur du panneau: 28 mm. Épaisseur totale de la porte: 45 mm



Hoja: 62,5 x 203
Hoja: 72,5 x 203
Hoja: 82,5 x 203

Mod. M11 (66 x 205)
Mod. M12 (76 x 205)
Mod. M13 (86 x 205)

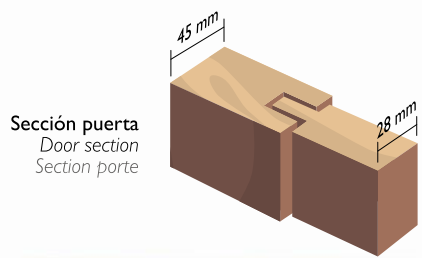

Hoja: 62,5 x 203
Hoja: 72,5 x 203
Hoja: 82,5 x 203

Mod. M14 (66 x 205)
Mod. M15 (76 x 205)
Mod. M16 (86 x 205)



Sección puerta
Door section
Section porte



Tabla de 23 mm. Grueso total de la hoja: 35 mm
Panel thickness: 23 mm. Total door thickness: 35 mm
Épaisseur du panneau: 23 mm. Épaisseur totale de la porte: 35 mm



Sección puerta ambas caras talladas. OPCIONAL
Section of both carved sides. OPTIONAL.
Section de porte sculptée des deux côtés en OPTION.

SERIE Interior

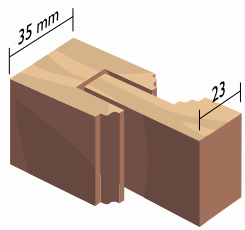
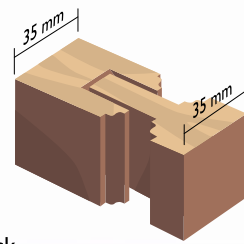
Con arco en block



Hoja: 62,5 x 203
Hoja: 72,5 x 203
Hoja: 82,5 x 203

Mod. YA-1 (66 x 205)
Mod. YA-2 (76 x 205)
Mod. YA-3 (86 x 205)

Con arco en block



Hoja: 62,5 x 203
Hoja: 72,5 x 203
Hoja: 82,5 x 203

Mod. YA-4 (66 x 205)
Mod. YA-5 (76 x 205)
Mod. YA-6 (86 x 205)



Sección puerta
Door section
Section porte



Tabla de 23 mm. Grueso total de la hoja: 35 mm
Panel thickness: 23 mm. Total door thickness: 35 mm
Épaisseur du panneau: 23 mm. Épaisseur totale de la porte: 35 mm



Sección puerta ambas caras talladas. OPCIONAL
Section of both carved sides. OPTIONAL.
Section de porte sculptée des deux côtés en OPTION.

SERIE Interior

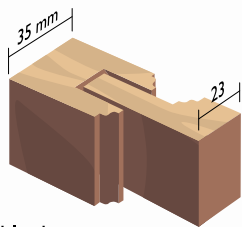
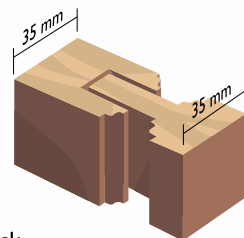
Sin arco en block



Hoja: 62,5 x 203
Hoja: 72,5 x 203
Hoja: 82,5 x 203

Mod.YA-7 (66 x 205)
Mod.YA-8 (76 x 205)
Mod.YA-9 (86 x 205)

Sin arco en block



Hoja: 62,5 x 203
Hoja: 72,5 x 203
Hoja: 82,5 x 203

Mod.YA-10 (66 x 205)
Mod.YA-11 (76 x 205)
Mod.YA-12 (86 x 205)



Puertas por encargo

Customized door · Portes fabriquées sur mesure



Hoja: 64 x 215

Mod. G60 (144 x 223)



Mod. G50 (145 x 280)



Detalle Mod. G50



Detalle Mod. G60

Frentes de armario a medida

Customized closet door · Portes de placard sur mesure



EMBOCADURAS

ARCHITRAVES · CHAMBRANLE AVEC BAGUETTE DÉCORATIVE

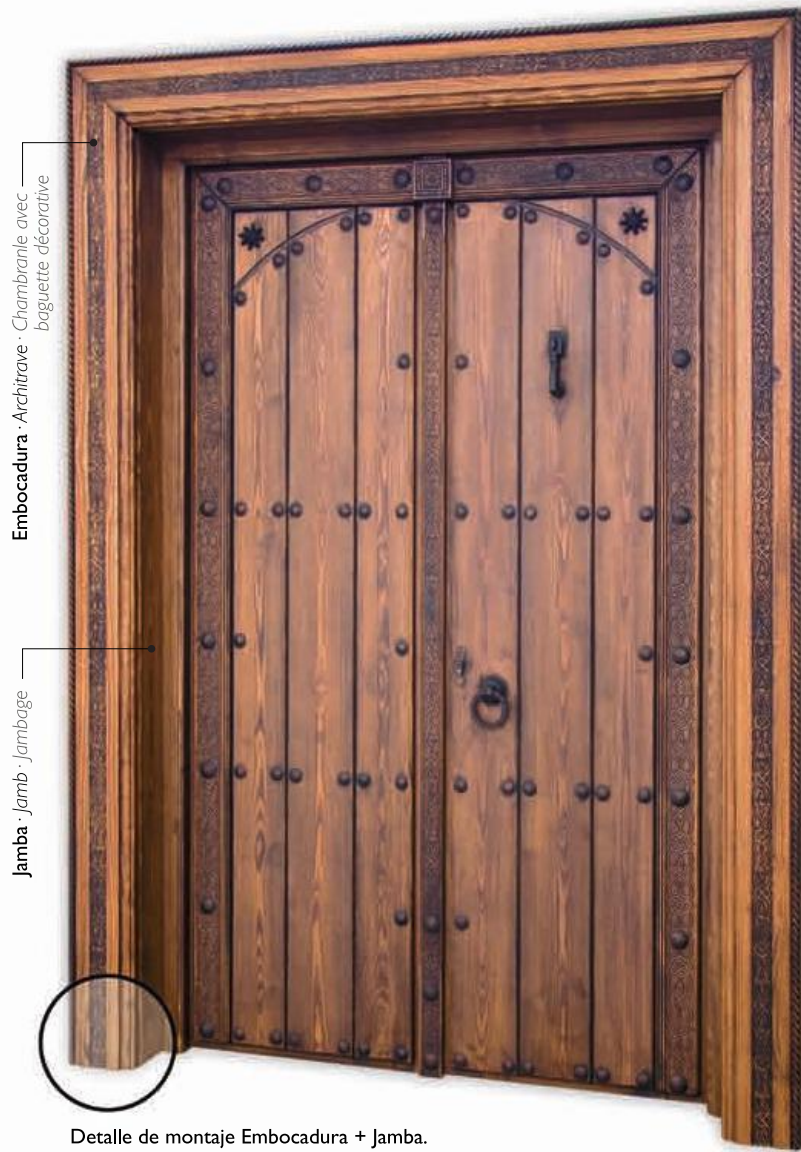

Embocadura · Architrave · Chambranle avec baguette décorative

Jamba · Jamb · Jambage

Detalle de montaje Embocadura + Jamba.
Detail of assembly (Architrave + Jamb).
Détail d'assemblage du chambranle avec baguette décorative + jambage.

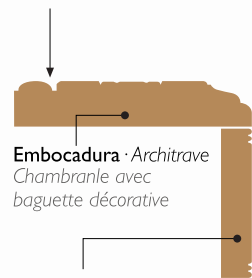

Embocadura · Architrave
Chambranle avec baguette décorative

Jamba (X mm) según obra
Jamb made to the wall measure
Jambage (X mm) fournis selon les mesures de la paroi

Características Jambas

· Se fabrican a medida de la obra.

Características Embocaduras

· Se sirven en tiras para todos los modelos de puertas y marcos con fijos.
· La medida se hace proporcional a la puerta (según indicaciones del cliente).

Jamb's features

· Made to the wall measure.

Architraves features

· Provided in pieces. Available for all door models.
· Made to the door measure (According to clients specifications).

Caractéristiques Jambage

· Fournis selon les mesures de la paroi.

Caractéristiques chambranle avec baguette décorative

· Fournis en sections pour tous les modèles de portes et d'encadrements.
· A la mesure de la porte (selon les indications du client).



Detalle de montaje a inglete.
Detail of miter joint.
Détail de montage sur l'onglet.

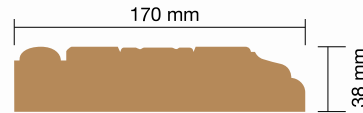

Embocadura EBI - 170 mm
Architrave EBI - 170 mm
Chambranle avec baguette décorative EBI - 170 mm

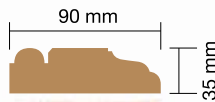

Embocadura EB2 - 90 mm
Architrave EB2 - 90 mm
Chambranle avec baguette décorative EB2 - 90 mm

Accesorios opcionales para puertas de exterior

Optional accessories for exterior doors

Accessoires en option pour les portes extérieures

TAPAJUNTAS · CASING · CHAMBRANLE

Se sirven por caras según la medida de la puerta.

It provides two sides and one top with the door specifications.

Fournis selon les mesures de la porte.



RTT taco tallado 95 mm.
RTT Carved corner block 95 mm.
RTT bloc d'angle sculpté 95 mm.



Detalle montaje taco.
Detail of assembled corner block.
Détail d'assemblage du bloc d'angle.



RT1 - 90mm



RT2 - 70mm



RT3 - 90mm



RT4 - 90mm

CORTAVIENTOS AUTOMATIC DOOR BOTTOM SEAL COUPE-VENT AUTOMATIQUE



Opción cortavientos sólo para SERIE II
Option: automatic door bottom seal (SERIES II)
Option: Coupe-vent automatique (SÉRIE II)

KIT DE MANTENIMIENTO MAINTENANCE KIT KIT D'ENTRETIEN



Compuesto por:
· Taco lija de espuma
· Guantes de látex
· Brocha
· Cinta
· Gamuza de algodón
· Impregnante
· Jabón neutro

Composed of:
· Foam sanding block
· Latex gloves
· Paint brush
· Masking tape
· Chamois cloth
· Impregnant
· Mild soap

Composition:
· Cale-éponge à poncer en mousse
· Gants en latex
· Brosse
· Ruban de masquage
· Peau de chamois
· Lasure d'imprégnation
· Savon doux



Artesonados y Zócalos

Coffered Ceilings and Baseboards · Lambris plafonds et murs en bois massif



Para más información consulte nuestro catálogo.
For more information, see our catalogue.
Pour plus d'informations, n'hésitez pas à consulter notre catalogue.

