





Maître Horloger - Les Genevez
depuis 1884

EDOXIONARY
FOR WATCH PROFESSIONALS
2023 - 2024

EDOXIONARY
FOR WATCH PROFESSIONALS
2023 - 2024

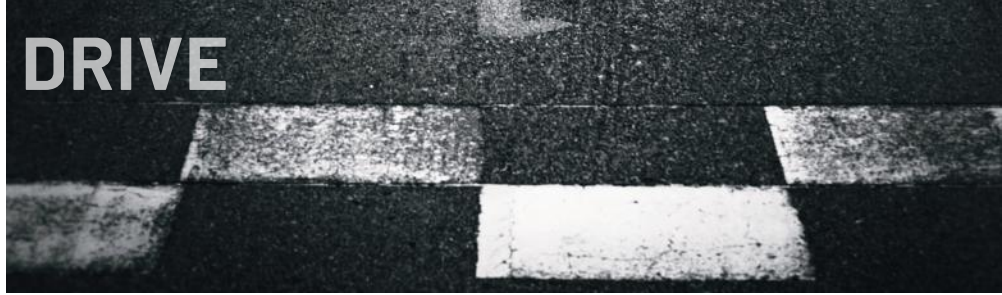

Maître Horloger - Les Genevez
depuis 1884

	<p>THE EDOX HISTORY 4</p>
	<p>CO-1 8 NEPTUNIAN 18 DELFIN THE ORIGINAL 28 NORTH SEA 44 HYDRO-SUB 48</p>
	<p>SKYDIVER 52</p>
	<p>CHRONORALLY 62</p>
	<p>MARKETING & MORE 72 POS MATERIAL 76 TECHNICAL INFORMATION 83</p>

THE EDOX HISTORY

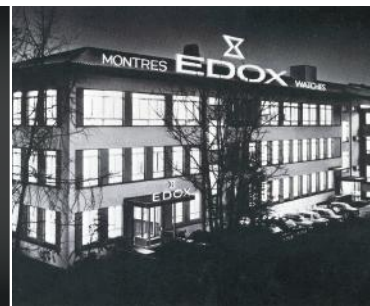

1860

CHRISTIAN RUEFLI-FLURY

In 1860, Christian Ruefli-Flury was born in Courrendlin (Switzerland). In 1870, he commenced his horology apprenticeship with Urs Schild before joining the Eterna watch company. In 1883, he married Pauline Flury and worked for Jean Aegler. He then made several contributions to the city of Biel.

1884

**IT ALL BEGAN WITH
A TRUE LOVE STORY**

Christian Ruefli-Flury, produced a pocket watch for the 25th birthday of his beloved wife Pauline. Impressed by this exquisite gift, she convinced her husband to set up his own watch making company in Biel, a city famous for its well-educated watch engineers. Christian Ruefli-Flury called his company "Edox" which means "measuring of time" in ancient Greek.

1900

THE BIRTH OF A LOGO

The hourglass was officially used as a timeless symbol of Edox and since then, it has been a proud part of the official Edox company logo.

1955

A GROWING COMPANY

At that time, Edox employed up to 500 watchmakers and the company moved into new, modern and larger production facilities. Edox was amongst Switzerland's leading watch companies.

THE WATER CHAMPION



1961

DELFIN THE ORIGINAL

The famous "Delfin" timepiece was launched, featuring a double caseback, special protective gaskets and a specially invented double O'ring system, setting new standards of shock protection and water resistance. Edox became known as "The Water Champion" of Swiss watchmaking.



1965
HYDRO-SUB

The revolutionary Hydro-Sub collection was launched, featuring the famous double O'crown patented Edox gasket for increased water resistance.



1970
THE FIRST GENUINE
WORLD TIME WATCH

This year saw the introduction of the world's first truly global timepiece, the "Geoscope" watch. Covering all time zones, the watch provided timekeeping for almost 50 different cities around the world, as well as local time.



1998
WORLD RECORD STILL
UNBROKEN

Edox engineers and watchmakers developed the world's slimmest calendar watch, the "Les Bémonts Ultra Slim" collection. The movement had a thickness of only 1.4 mm, which is a technical record still held by Edox to this day.



2010-2023
THE TIMEKEEPER
BMW M MOTORSPORT

After being associated to many prestigious racing competition such as WRC, Rally Dakar, and to the Sauber F1 Team, Edox is now the **Official Timing Partner of BMW M Motorsport**.

This partnership is a strong testimony of Edox's presence amongst the most renowned and active Swiss watch brands.



THE NEPTUNIAN COMPLETES ITS EVOLUTION

Nearly 50 years ago, Edox launched the legendary SkyDiver, a durable sports timepiece created especially for a military elite group. Now, with the release of the Neptunian, Edox completes its 1973 model's transformation into an extremely rugged dive watch and a new collection in its own right.





COOL
COOL
COOL

DIVE



10242 TIN NIN

DIVE

OFFSHORE INSTRUMENTS

By becoming the Official Timekeeper of the Class-1 World Powerboat Championship in 2007 and creating the CO-1 collection, Edox raised the resistance to water and shocks of its watches to an even higher level.

COLLECTION'S EVOLUTION



2007

Official Timing partner of Class 1 World Powerboat Championship
Designed with a scratch-resistant ceramic bezel.



2007

Edox presented the second generation of the Class 1 collection in Dubai. For the first time, a punched propeller of a racing boat adorned the 4mm thick case back of the collection. Since that date, the propeller has been an actual symbol of this high-grade sports watch.



2008

CO-1 Chronometer Automatic
With materials as in the construction of racing boats: ceramic, titanium, steel.



2010

The automatic helium valve replaced the manual version and was installed in every CO-1 watch.



2013

CO-1 Automatic Chronograph Skeleton - the Ghost Ship.



2019

CO-1 Carbon Chronograph Automatic
New case design: carbon cover. Extremely water-resistant.



01125 CLNGN BUNN



- 1** Strong steel and carbon case construction
 Boîtier solide en acier et carbone
 Stabile Karbon- und Edelstahlkonstruktion
 Caja sólida fabricada en acero y carbono.
 カーボンとセラミックを重ね合わせたハイブリッド
 ケース
 錶殼採用不銹鋼和碳纖維物料，結構材質堅固
 Прочная конструкция корпуса из стали и
 карбона

صلب قوي و عليه من الكربون

- 2** 3 mm thickness of sapphire crystal
 Épaisseur du verre saphir de 3 mm
 3 mm dickes Saphirglas
 Cristal de zafiro de 3 mm
 3mm厚のサファイアクリスタル
 3毫米厚的藍寶石水晶鏡面
 Сапфировое стекло толщиной 3 мм

زجاجة كريستال بلوري بسك ٣ م

- 3** Automatic Helium valve for specific deep sea diving
 Valve à hélium automatique spécifiquement conçue
 pour la plongée en eau profonde
 Automatisches Heliumventil für Tieftauchgänge
 Válvula automática de helio para inmersión profunda
 本格的な深海ダイビングのためのオートヘリウム
 バルブ
 特別為深海潛水設計的自動排氦
 Автоматический гелиевый клапан для
 глубоководного погружения

صام هيليوم أوتوماتيكي خاص بالغوص في أعماق البحار

- WATER RESISTANT
- SWISS MADE
- DAY DATE
- ST STEEL
- CARBON
- 50 ATM
- 25mm
- 16.5mm
- 148g

CARBON CHRONOGRAPH AUTOMATIC
01125 CLNGN BUNN Ø 45 MM

- WATER RESISTANT
- SWISS MADE
- DAY DATE
- ST STEEL
- CARBON
- 50 ATM
- 25mm
- 16.5mm
- 148g

CARBON CHRONOGRAPH AUTOMATIC
01125 CLNGN NING Ø 45 MM



- WATER RESISTANT
- SWISS MADE
- DAY DATE
- ST STEEL
- CARBON
- 50 ATM
- 25mm
- 16.5mm
- 148g

CARBON CHRONOGRAPH AUTOMATIC **NEW**
01125 CCN GNO Ø 45 MM

- WATER RESISTANT
- SWISS MADE
- DAY DATE
- ST STEEL
- CARBON
- 50 ATM
- 25mm
- 16.5mm
- 148g

CARBON CHRONOGRAPH AUTOMATIC **NEW**
01125 CCN NR Ø 45 MM





CHRONOGRAPH **NEW**
10242 TINM BUIDN Ø 45 MM



CHRONOGRAPH **NEW**
10242 TINM GIDNO Ø 45 MM



CHRONOGRAPH **NEW**
10242 TIN BUIDN Ø 45 MM



CHRONOGRAPH **NEW**
10242 TINRCA BRDR Ø 45 MM



CHRONOGRAPH **NEW**
10242 TINB BBUINR Ø 45 MM



CHRONOGRAPH **NEW**
10242 TINB BUICDNO Ø 45 MM



CHRONOGRAPH **NEW**
10242 TINBN VIDNO Ø 45 MM

- QUARTZ
- ANTI-MAGNETIC
- WATER RESISTANT
- SWISS MADE
- DATE
- CHRONOGRAPH
- HEAVY METAL
- TITANIUM
- PVD
- 100 ATM
- 25mm
- 15.5mm
- 130g



CHRONOGRAPH
10242 TINNO BUIJN Ø 45 MM

- QUARTZ
- ANTI-MAGNETIC
- WATER RESISTANT
- SWISS MADE
- DATE
- CHRONOGRAPH
- HEAVY METAL
- TITANIUM
- PVD
- 100 ATM
- 25mm
- 15.5mm
- 130g



CHRONOGRAPH
10242 TINR BUIRN Ø 45 MM

- QUARTZ
- ANTI-MAGNETIC
- WATER RESISTANT
- SWISS MADE
- DATE
- CHRONOGRAPH
- HEAVY METAL
- TITANIUM
- PVD
- 100 ATM
- 25mm
- 15.5mm
- 130g



CHRONOGRAPH
10242 TIN VIN Ø 45 MM

- QUARTZ
- ANTI-MAGNETIC
- WATER RESISTANT
- SWISS MADE
- DATE
- CHRONOGRAPH
- HEAVY METAL
- TITANIUM
- PVD
- 100 ATM
- 25mm
- 15.5mm
- 130g



CHRONOGRAPH
10242 TIN BUIJN Ø 45 MM

- QUARTZ
- ANTI-MAGNETIC
- WATER RESISTANT
- SWISS MADE
- DATE
- CHRONOGRAPH
- HEAVY METAL
- TITANIUM
- PVD
- 100 ATM
- 25mm
- 15.5mm
- 130g



CHRONOGRAPH
10242 TIN NIN Ø 45 MM

- QUARTZ
- ANTI-MAGNETIC
- WATER RESISTANT
- SWISS MADE
- DATE
- CHRONOGRAPH
- HEAVY METAL
- PVD
- ST STEEL
- 100 ATM
- 25mm
- 15.5mm
- 165g



CHRONOGRAPH
10250 37R NIR Ø 45 MM



An underwater scene featuring a dense forest of green seaweed on the left side. In the background, a school of small, silvery fish is visible, swimming in the clear, blue-green water.

NEPTUNIAN

DIVE



80120 3BUM BUF

DIVE

HIGH PRESSURE RESISTANT

Water-resistant to an incredible 1'000m, the Edox Neptunian is built ultra-tough to handle not only the pressures of the deep but, thanks to its strong and durable stainless-steel case, anything on the surface as well. A 3mm-thick sapphire crystal protects the classic, clean dial encircled by a ceramic bezel. The case back features a striking engraving of Neptune, the Roman God of the Sea.

COLLECTION'S EVOLUTION



1969

SkyDiver Automatic
Original Produced for Swiss
paratroopers.



1973

SkyDiver Automatic
Second generation with
greater water-resistance.



2019

SkyDiver Military Automatic
Reedition of the SkyDiver
from 1973



2020

SkyDiver Neptunian Automatic
Evolution of a Legend, first
SkyDiver Neptunian.



2022

First Edox Neptunian
The Neptunian completes its
evolution and becomes an
independent collection



80120 3NM BUIDN



- 1** Highly water-resistant up to 1'000 meters / 100 ATM
 Excellente résistance à l'eau jusqu'à 1'000 mètres / 100 ATM
 Extrem wasserdicht bis zu 1'000 Meter / 100 ATM
 1'000 Meter / 100 ATM
 Alta resistencia al agua hasta 1'000 metros / 100 ATM
 1.000m/100ATM高防水
 深潛1000米防水
 Высокая степень водозащиты до 1000 метров/100 ATM

مقاومة عالية للماء حتى 1,000 متر / 100 ضغط



- 2** Rotating ceramic bezel
 Lunette tournante en céramique
 Drehbarer Tauchring aus Keramik
 Bisel de cerámica giratorio
 回転式セラミックベゼル
 可旋轉的陶瓷錶圈
 Вращающийся керамический безель

إطار دوار من السيراميك



- 3** 3 mm thickness of sapphire crystal
 Épaisseur du verre saphir de 3 mm
 3 mm dickes Saphirglas
 Cristal de zafiro de 3 mm
 3mm厚 of サファイアクリスタル
 3毫米厚的藍寶石水晶鏡面
 Сапфировое стекло толщиной 3 мм

زجاجة كريستال بلوري بسمك 3 م



- 4** Superluminova applied on the hands and indices for reinforced luminescence (60% better than standard quality)
 Superluminova appliqué sur les aiguilles et index pour une luminescence renforcée (60% meilleure que la qualité habituelle)
 Indizes sowie Zeiger mit Leuchtmasse (Superluminova GL X1) beschichtet. Dies führt zu einer ca. 60% besseren Leuchtkraft gegenüber einer Standardqualität.
 Superluminova en agujas e índices para reforzar la luminiscencia (60% mejor que la calidad standard)
 アップライドインデックスと針にスーパールミノヴァを採用。(通常のルミノヴァよりも60%以上の発光)
 加強夜光效果的指針與刻度。(比標準亮度高出60%)
 Суперлюминова нанесена на стрелки и индексы для обеспечения более яркого свечения (на 60% лучше стандартного качества)

طلاء سوبرلومينوفا الفسفوري على عقارب الساعة وعلى الأرقام لإنتاج (أقوى بـ 60% من النوعية العادية)



- 5** Automatic Helium valve for specific deep sea diving
 Valve à hélium automatique spécifiquement conçue pour la plongée en eau profonde
 Automatisches Heliumventil für Tieftauchgänge
 Válvula automática de helio para inmersión profunda
 本格的な深海ダイビングのためのオートヘリウムバルブ
 特別為深海潛水設計的自動排氦
 Автоматический гелиевый клапан для глубоководного погружения

صمام هيليوم أوتوماتيكي خاص بالغوص في أعماق البحار



NEPTUNIAN AUTOMATIC
80120 3NM BUIDN Ø 44 MM



NEPTUNIAN AUTOMATIC
80120 3NM NIN Ø 44 MM



NEPTUNIAN AUTOMATIC
80120 3NCA BUIDN Ø 44 MM



NEPTUNIAN AUTOMATIC
80120 3NCA NIN Ø 44 MM



NEPTUNIAN AUTOMATIC
80120 37RNNCA NIR Ø 44 MM





21mm

15.6mm

155g

NEPTUNIAN AUTOMATIC
80120 3NM ODN Ø 44 MM



21mm

15.6mm

155g

NEPTUNIAN AUTOMATIC
80120 3NM VDN Ø 44 MM



21mm

15.6mm

155g

NEPTUNIAN AUTOMATIC
80120 3VM VDN1 Ø 44 MM



21mm

15.6mm

105g

NEPTUNIAN AUTOMATIC
80120 3NCA ODN Ø 44 MM



21mm

15.6mm

105g

NEPTUNIAN AUTOMATIC
80120 3NCA VDN Ø 44 MM





21mm

15.6mm

155g

NEPTUNIAN AUTOMATIC **NEW**
80120 3NM BRD Ø 44 MM



21mm

15.6mm

155g

NEPTUNIAN AUTOMATIC **NEW**
80120 3BUM BUF Ø 44 MM



21mm

15.6mm

155g

NEPTUNIAN AUTOMATIC **NEW**
80120 3VM NIN Ø 44 MM

MARIANNA GILLESPIE
WATER CHAMPION AMBASSADOR

World Record holder and
six-times World Champion.



DEL FIN

DELFIN

DIVE



85303 357RN NRN

DIVE

THE WATER CHAMPION WATCH

The Delfin collection was first launched in 1961 and used revolutionary watch parts such as double O'ring gaskets for crowns and pushers and a special shock absorbing caseback in order to withstand an impressive water resistance of 200 meters.

Nowadays, this special equipment is still featured in Edox Delfin timepieces.

COLLECTION'S EVOLUTION



1961

Delfin The Original
First Edox watch equipped with a double O'ring and a double caseback.



1969

Delfin day & date
Equipped with an in-house mechanical movement.



1973

Delfin with its iconic dodecagonal bezel.



2020

Delfin Mecano
Skeletonised dial and movement bring 21st Century twist to the legendary design.



10113 3CAB BUIN



1

Superluminova applied on the hands and indices for reinforced luminescence (60% better than standard quality)

Superluminova appliqué sur les aiguilles et index pour une luminescence renforcée (60% meilleure que la qualité habituelle)

Indizes sowie Zeiger mit Leuchtmasse (Superluminova GL X1) beschichtet. Dies führt zu einer ca. 60% besseren Leuchtkraft gegenüber einer Standardqualität.

Superluminova en agujas e índices para reforzar la luminiscencia (60% mejor que la calidad standard)

アップライドインデックスと針にスーパールミノヴァを採用。(通常のルミノヴァよりも60%以上の発光)

加強夜光效果的指針與刻度。(比標準亮度高出60%)
Суперлюминова нанесена на стрелки и индексы для обеспечения более яркого свечения (на 60% лучше стандартного качества)

طلاء سوبرلومینوفا الفسفوري على عقارب الساعة وعلى الأرقام لإضاءة قوية (أقوى بـ 60% من النوعية العادية)

2

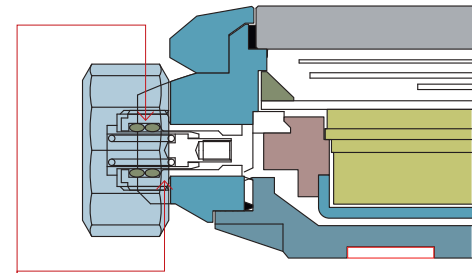

2

Double O-rings for crowns and pushers, special shock absorbing caseback

Joints doubles pour la couronne et les poussoirs, fond spécial pour absorber les chocs

Krone und Drücker mit Doppel-O-Ring-Dichtung; verstärkter Gehäuseboden für besondere Stossicherheit

Juntas dobles en coronas y pushers, tapa especial con mayor protección antigolpes

ダブルOリングを備えたリューズとプッシュボタン、耐衝撃性能のケースバック

雙防水圈的錶冠及按把，特殊防震後蓋，
Двойные O-прокладки заводных головок и кнопок хронографа, специальный амортизирующий корпус

حلقتان للتيجان والمكبس، وغطاء خلفي مصمم لامتصاص الصدمات



MECANO AUTOMATIC
85303 3NM NBG Ø 43 MM



MECANO AUTOMATIC
85303 3M BUIGB Ø 43 MM



MECANO AUTOMATIC
85303 3NN VB Ø 43 MM



MECANO AUTOMATIC
85303 357RN NRN Ø 43 MM



MECANO AUTOMATIC
85303 357GN NGN Ø 43 MM



MECANO AUTOMATIC
85303 357GR NRN Ø 43 MM







24mm

12.5mm

120g

EDOX DELFIN MECANO 60TH ANNIVERSARY
85304 357GN NRN1 Ø 43 MM
LIMITED EDITION OF 600 PIECES



DELIVERED WITH A SPECIAL
WATER-RESISTANT BAG





DAY DATE AUTOMATIC
88005 3M BUIN Ø 43 MM



DAY DATE AUTOMATIC
88005 3M NIN Ø 43 MM



DAY DATE AUTOMATIC
88005 3CA BUIR Ø 43 MM



DAY DATE AUTOMATIC
88005 3CA NIN Ø 43 MM



DAY DATE AUTOMATIC
88005 357RNCA NIR Ø 43 MM



24mm

12.9mm

186g

CHRONOGRAPH **NEW**
10113 3M BUIN Ø 43 MM



24mm

12.9mm

186g

CHRONOGRAPH **NEW**
10113 3M NIN Ø 43 MM



24mm

12.9mm

117g

CHRONOGRAPH **NEW**
10113 3CAB BUIN Ø 43 MM



24mm

12.9mm

117g

CHRONOGRAPH **NEW**
10113 3CA NIN Ø 43 MM



24mm

12.9mm

117g

CHRONOGRAPH **NEW**
10113 376NCA NGIN Ø 43 MM



24mm

12.9mm

117g

CHRONOGRAPH **NEW**
10113 376NCA GNO Ø 43 MM



24mm

12.9mm

117g

CHRONOGRAPH **NEW**
10113 376NCA NIR Ø 43 MM



CHRONOGRAPH **NEW**
10112 3BUM BUIN Ø 43 MM



CHRONOGRAPH **NEW**
10112 3NM NIN Ø 43 MM



CHRONOGRAPH **NEW**
10112 3NCA NIN Ø 43 MM



CHRONOGRAPH **NEW**
10112 357GRNCA BRNR Ø 43 MM



CHRONOGRAPH **NEW**
10112 37GNOCA ANO Ø 43 MM



CHRONOGRAPH **NEW**
10112 37GNVCA ANV Ø 43 MM



DIVER DATE LADY **NEW**
SPECIAL EDITION
53020 3M BUDDR Ø 38 MM



MARIANNA GILLESPIE
WATER CHAMPION AMBASSADOR



 QUARTZ
 WATERPROOF
 DATE WINDOW
 SWIM
 DIVER
 CROWN
 CLEAR GLASS
 ST STEEL
 20 ATM
 20mm
 11.3mm
 137g













DIVER DATE LADY NEW
 53020 3M NADN Ø 38 MM
 DIAMOND CERTIFICATE



 QUARTZ
 WATERPROOF
 DATE WINDOW
 SWIM
 DIVER
 CROWN
 CLEAR GLASS
 ST STEEL
 20 ATM
 20mm
 11.3mm
 137g

DIVER DATE LADY
 53020 3M BUN Ø 38 MM



 QUARTZ
 WATERPROOF
 DATE WINDOW
 SWIM
 DIVER
 CROWN
 CLEAR GLASS
 ST STEEL
 20 ATM
 20mm
 11.3mm
 137g

DIVER DATE LADY
 53020 3M NANND Ø 38 MM
 DIAMOND CERTIFICATE



 QUARTZ
 WATERPROOF
 DATE WINDOW
 SWIM
 DIVER
 CROWN
 CLEAR GLASS
 ST STEEL
 PVD
 20 ATM
 20mm
 11.3mm
 137g

DIVER DATE LADY
 53020 357RM ROR Ø 38 MM



 QUARTZ
 WATERPROOF
 DATE WINDOW
 SWIM
 DIVER
 CROWN
 CLEAR GLASS
 ST STEEL
 20 ATM
 20mm
 11.3mm
 137g

DIVER DATE LADY NEW
 53020 3D120M BUCND Ø 38 MM
 DIAMOND CERTIFICATE



-  QUARTZ
- 
- 
- 
- 
- 
-  ST STEEL
-  20 ATM
-  20mm
-  11.3mm
-  79g

DIVER DATE LADY
53020 3C NARN Ø 38 MM



-  QUARTZ
- 
- 
- 
- 
- 
-  ST STEEL
-  PVD
-  20 ATM
-  20mm
-  11.3mm
-  79g

DIVER DATE LADY
53020 37RC NANR Ø 38 MM



-  QUARTZ
- 
- 
- 
- 
- 
-  ST STEEL
-  PVD
-  20 ATM
-  20mm
-  11.3mm
-  79g

DIVER DATE LADY
53020 37RC VR Ø 38 MM



-  QUARTZ
- 
- 
- 
- 
- 
-  ST STEEL
-  PVD
-  20 ATM
-  20mm
-  11.3mm
-  79g

DIVER DATE LADY **NEW**
53020 37JC NADD Ø 38 MM



-  QUARTZ
- 
- 
- 
- 
- 
-  ST STEEL
-  PVD
-  20 ATM
-  20mm
-  11.3mm
-  79g

DIVER DATE LADY **NEW**
53020 37JC NANRUD Ø 38 MM

THE NORTH SEA'S FRIGID WATERS ARE UNFORGIVING.

Working more than 300m deep, in pitch black and under crushing pressure more than 30 times greater than that on the surface, requires courage and skill. The North Sea Divers, who in 1967 first helped unlock the riches off the coast of Norway, had those qualities in droves.

NORTH SEA

THE INVERSE MOON LANDING.

The Moon landings captured the imagination of all mankind. But an equally audacious adventure unfolded on Earth in 1978 when divers made their own 'giant leap' 320m under the icy waters off Norway. Dubbed 'The Inverse Moon Landing', it was the deepest ever dive in the North Sea.





HYDRO- SUB DIVE



80128 3BUM BUJO

THE SUBMARINE WATCH

The Hydro-Sub Special Edition is new, improved and with 21st century smarts – but still infused with the timelessly cool DNA of the original 1960s Hydro-Sub, the timepiece that helped make Edox the ‘water champion’ of the watch industry.

COLLECTION'S EVOLUTION



1965

Original Hydro-Sub
Water-resistant down to 500m,
an incredible achievement in
the 1960s.



2014

Edox Hydro-Sub North Pole
Limited Edition
A certified chronometer
featuring an inhouse
developed crown protection
system named “Master-Lock”.



2021

Hydro-Sub Automatic
Chronometer
Improved but still infused
with the timelessly cool DNA
of the original 1960s.







SKY DIVER ER

FLY



80126 3N NINB

ON LAND, AIR OR SEA

Rumoured to be launched following a Swiss colonel secret request in 1973, the SkyDiver collection pays tribute to paratroopers and the extreme conditions they might face - on land, air or sea.

COLLECTION'S EVOLUTION



1969

SkyDiver Automatic
Original Produced for Swiss
paratroopers.



1973

SkyDiver Automatic
Second generation with
greater water-resistance.



2019

SkyDiver Military Automatic
Reedition of the SkyDiver
from 1973



2021

Reedition of the SkyDiver
Original



80126 3N NINB

- 1** Screw-down crown
Couronne vissée
Sicherheitsschraubkrone
Corona de seguridad enroscable
ネジ込み式リュウズ
旋緊式安全表冠
Закручивающаяся
защитная коронка

زر تاج مسندود

- 2** Superluminova X1 on hands and indices
Superluminova X1 sur les aiguilles et indexes
Superluminova X1 auf den Zeigern sowie Indizes
Superluminova X1 en manecillas e índices.
スーパールミノバを施した針とインデックス
指針和時標採用 Superluminova X1 超越夜光物料
Покрытие Superluminova X1 на стрелках и
индексах

سوبرلومینوفا X1 على العقارب والمؤشرات

- 3** Rotating ceramic bezel
Lunette tournante en céramique
Drehbarer Tauchring aus Keramik
Bisel de cerámica giratorio
回転式セラミックベゼル
可旋轉的陶瓷錶圈
Вращающийся керамический безель
إطار دوار من السيراميك

Paratroopers emblem on the caseback
Insigne des parachutistes de l'armée gravé sur le fond
Geprägtes Fallschirmjäger Emblem auf der
Gehäuserückseite

Emblema de los paracaidistas en la tapa del reloj
パラシュート部隊のエンブレムをあしらったケース
バック

底蓋刻有傘兵圖案

Эмблема парашютиста на задней крышке

شعار المظليين على العلبه الخلفية

Design inspired by the original SkyDiver model from 1973.

Design inspiré par le modèle original SkyDiver de 1973.

Das Design stammt von der originalen SkyDiver Uhr aus dem Jahre 1973.

Diseño inspirado en el modelo original SkyDiver de 1973.

1973年にリリースした軍用時計「スカイダイバー」の復刻デザイン

設計靈感來自1973年的 SkyDiver 原型

Дизайн вдохновлен оригинальной моделью SkyDiver 1973 года.

التصميم مستوحى من الموديل الاصلى للاسكاي ديفر منذ عام 1973



22mm

13.9mm

99g

SKYDIVER DATE AUTOMATIC
80126 3N N1NB Ø 42 MM
LIMITED EDITION OF 600 PIECES

EXTRA LEATHER STRAP







22mm

13.9mm

162g

SKYDIVER DATE AUTOMATIC **NEW**
80126 357RNM NIRB Ø 42 MM
LIMITED EDITION OF 600 PIECES



EXTRA LEATHEAR STRAP



22mm

13.9mm

162g

SKYDIVER DATE AUTOMATIC **NEW**
80126 3BUM BUIN Ø 42 MM
LIMITED EDITION OF 600 PIECES



EXTRA LEATHEAR STRAP



22mm

13.9mm

99g

SKYDIVER DATE AUTOMATIC **NEW**
80126 3VIN GDN Ø 42 MM
AGED STEEL
LIMITED EDITION OF 600 PIECES



EXTRA LEATHEAR STRAP



22mm

13.9mm

99g

SKYDIVER DATE AUTOMATIC **NEW**
80126 BRN BUIDR Ø 42 MM
LIMITED EDITION OF 600 PIECES



EXTRA LEATHEAR STRAP



-
-
-
-
-
-
-
-
-
-
-
-

SKYDIVER 38 DATE AUTOMATIC **NEW**
80131 3BUM BUIN Ø 38 MM



-
-
-
-
-
-
-
-
-
-
-
-

SKYDIVER 38 DATE AUTOMATIC **NEW**
80131 3NM NIB Ø 38 MM



-
-
-
-
-
-
-
-
-
-
-
-

SKYDIVER 38 DATE AUTOMATIC **NEW**
80131 3BUC BUICO Ø 38 MM
SPECIAL EDITION



-
-
-
-
-
-
-
-
-
-
-
-

SKYDIVER 38 DATE AUTOMATIC **NEW**
80131 3NC VI Ø 38 MM
SPECIAL EDITION



-
-
-
-
-
-
-
-
-
-
-
-
-

SKYDIVER 38 DATE AUTOMATIC **NEW**
80131 37RNC VD BEI Ø 38 MM
SPECIAL EDITION



-
-
-
-
-
-

SKYDIVER 38 DATE AUTOMATIC **NEW**
80131 3NC NDR0 Ø 38 MM
SPECIAL EDITION



-
-
-
-
-
-

SKYDIVER 38 DATE AUTOMATIC **NEW**
80131 37RNC NI Ø 38 MM
SPECIAL EDITION



-
-
-
-
-
-

SKYDIVER 38 DATE AUTOMATIC **NEW**
80131 357RNC VIO Ø 38 MM
SPECIAL EDITION



-
-
-
-
-
-

SKYDIVER 38 DATE AUTOMATIC **NEW**
80131 357JNC BI Ø 38 MM
SPECIAL EDITION

EDOX

Maitre Horloger - Les Genevez
depuis 1884

Official Timing
Partner



Motorsport





CHR

DRIVE

ONO

RALLY



38001 TINNO3 NO3

RALLY INSTRUMENTS

The Chronorally is a revolutionary chronograph with new, sophisticated technical functions originally developed for rally drivers. It has been the official collection of FIA World Rally Championship (WRC), the Dakar Rally, the FIA World Rallycross championship and for the former Formula 1 team Sauber. It will now be worn by BMW drivers.

COLLECTION'S EVOLUTION



1970

Sportsman Chronograph



2010

Official Timing Partner of the
WRC World Rally Championship



2017

Chronorally Sauber F1 Team
Limited Edition



2019

Chronorally FIA World Rallycross
Limited Edition



2022

Chronorally Limited Edition
inspired by the sponsorship with
BMW M Motorsport.



38001 TINNO3 N03



- 1** Over-sized pusher for perfect grip on the watch commands
 Poussoir de grande taille pour une maîtrise parfaite des fonctions de la montre
 Besonders grosser Drücker für sicheren Zugriff auf die Uhrenfunktionen
 Pusher de gran tamaño para una sujeción perfecta de los mandos
 時計の操作がしやすい大型プッシュボタン
 超大尺寸計時按把為手錶贏得十足的吸引力
 Увеличенная кнопка хронографа для удобного использования часов

مكبس كبير لتحكم مثالي في ضبط الساعة

- 2** Rubber strap with tyre imprints
 Bracelet en caoutchouc avec design empreintes de pneu
 Kautschukarmband mit Reifenprofil
 Correa de caucho con motivos de neumáticos
 タイヤ模様のラバーストラップ
 車胎紋矽橡膠帶
 Каучуковый ремешок с рисунком протектора шин

سوار مطاطي مزين برسوم العجلات

- 3** Robust titanium construction for extreme use conditions
 Construction en titane pour des conditions d'utilisation extrêmes
 Robuste Titanausführung für Widerstandsfähigkeit unter Extrembedingungen
 Construido en titanio macizo para condiciones extremas de uso
 過酷な環境下にも耐え得る堅牢なスチール構造
 堅硬鈦金屬結構適合用於激烈的情況下使用
 Прочный титановый корпус для использования в экстремальных условиях

بنية من الفولاذ الصلب لتحمل ظروف الاستعمال القاسية

EDOX
Maitre Horloger - Les Genevez
depuis 1884

Official Timing
Partner



Motorsport

CHRONORALLY

- Q QUARTZ
- SWISS MADE
- 2 | 8 REG. DATE
- 10 ATM
- 25mm
- 15mm
- 130g



CHRONORALLY
LIMITED EDITION OF 2'000 PIECES **NEW**
38001 TINNBU BN Ø 48 MM ADDITIONAL STRAP

- Q QUARTZ
- SWISS MADE
- 2 | 8 REG. DATE
- 10 ATM
- 25mm
- 15mm
- 130g



CHRONORALLY
LIMITED EDITION OF 2'000 PIECES **NEW**
38001 TINR BUDN Ø 48 MM ADDITIONAL STRAP

CHRONORALLY







DOMINIQUE AEGERTER
 2022 FIM MOTOE(TM) WORLD CUP WINNER
 2021 AND 2022 FIM SUPERSPORT WORLD CHAMPION

-
-
-
-
-
-
-
-
-



CHRONORALLY AUTOMATIC **NEW**
 01129 TNCA BENO Ø 48 MM



CHRONORALLY



MARKETING
& MORE

EDOX
Maître Horloger - Les Genes
depuis 1884



mares

EDOX

Maitre Horloger - Les Genevez
depuis 1884

Mares, world leader in the diving equipment industry since 1949, and Edox agreed on a long term partnership that will reinforce the Swiss premium brand's position as The Water Champion of the watchmaking industry.

SPONSORING

OFFICIAL TIMING PARTNER OF BMW M MOTORSPORT

Edox will be the exclusive “Official Timing Partner” of BMW M Motorsport. The partnership includes engagements in the BMW Junior Team, the BMW M2 Cup, as well as the GT3 highlight, the 24h race at the Nürburgring.

This partnership is a strong testimony of Edox's presence amongst the most reknown and active Swiss watch brands.



MARIANNA GILLESPIE WATER CHAMPION AMBASSADOR

The Russian-born Frenchwoman, is the current French national and world record holder in multiple disciplines. Marianna has been world champion six times, ranked No. 1 in the world multiple times and she is also the youngest winner of the prestigious Vertical Blue competition.

She is an ambassador for the iconic Edox Delfin diver's watch collection and offered product-specific guidance to further refine the new Delfin lady collection.



DOMINIQUE AEGERTER INTERNATIONAL EDOX AMBASSADOR PROFESSIONAL MOTORBIKE DRIVER

Swiss motorcycle ace Dominique Aegerter has joined Edox Swiss Watches as an international brand ambassador.

Aegerter started in Moto 2 at only 20 years old. He is the current MotoE and Supersport World Champion.



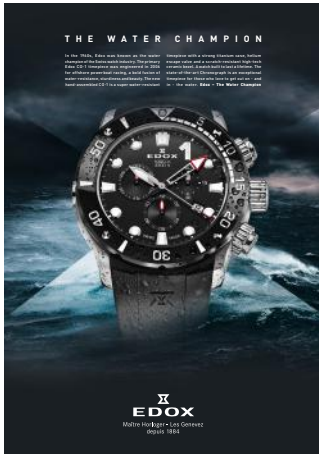

CO-1
10242 TIN NIN



NEPTUNIAN AUTOMATIC
80120 3NM BUIDN



NEPTUNIAN AUTOMATIC
80120 3BUM BUF



NEPTUNIAN AUTOMATIC
80120 3VM NIN



DELFIN
85303 357RN NRN



DELFIN
85303 357GN NGN

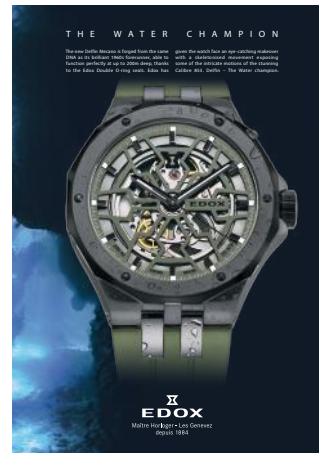

DELFIN
85303 357GNCAV VONB



DELFIN
85303 37NCA BEIO



CHRONORALLY AUTOMATIC
01129 TRCA NCAR



CHRONORALLY AUTOMATIC
38001 TINBU BN



SKYDIVER VINTAGE LIMITED EDITION
80126 3N NINB



SKYDIVER DATE AUTOMATIC
80126 BRN BUIDR

DISPLAYS

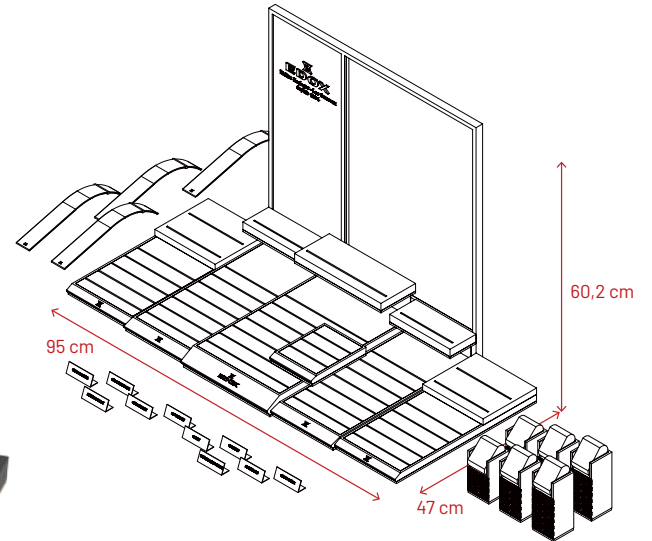

- 1111 Edox Big Display
- 44 C-rings
 - 1 Base
 - 2 Sides
 - 4 Tobogans
 - 6 Watch Stands
 - 10 Product Plates

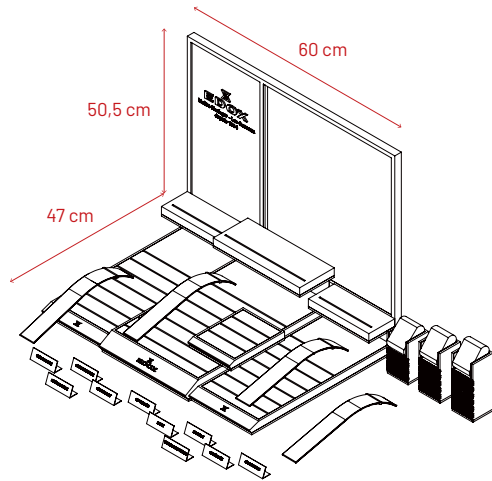

- 1112 Edox Medium Display
- 30 C-rings
 - 1 Base
 - 4 Tobogans
 - 3 Watch Stands
 - 10 Product Plates



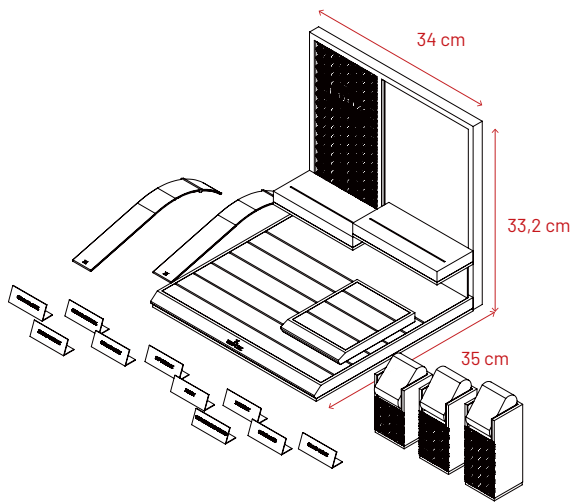

1114 Edox Small Display

- 9 C-rings
- 1 Base
- 2 Tobogans
- 3 Watch Stands
- 10 Product Plates

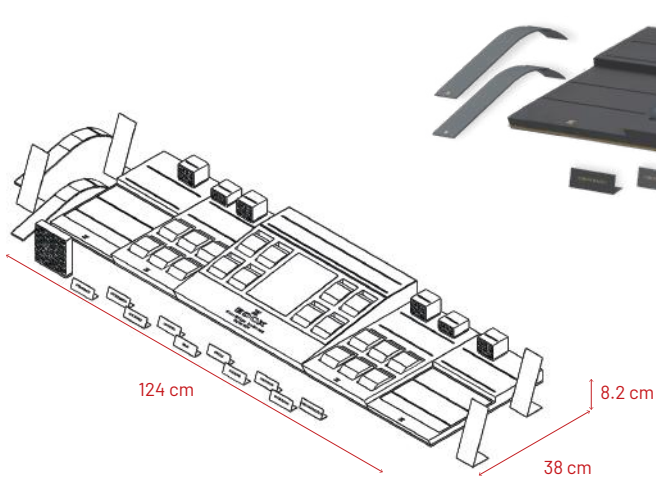

1113 EDox Incase Display Large

- 36 C-rings
- 1 Base
- 2 Tobogans
- 3 Watch Stands 3cm
- 3 Watch Stands 4.5cm
- 10 Product Plates

SHOP IN SHOP

All item finishes may be finalized,
please contact us accordingly.



1124 EDOX Counter, including display material
(W 141 x D 50 x H 120 cm)



1123 EDOX Free Standing Show Cabinet, including
display material
(W 50 x D 50 x H 160 cm)



1125 EDOX Wall
(W 180 x D 50 x H 240 cm)
Dimensions can be adapted



DISPLAY ACCESSORIES



1115 EDOX Watch Stand
Set of 3 pieces
4, 6 and 8 cm height



1118 Edox Retailer Plate
W 10 x D 2.2 x H 10 cm



1159 EDOX Chronorally wall clock
Ø 40cm - 3.5kg



1119 Edox Product Plate
(set of 6 plates, available in Chinese, English, French,
German, Japanese, Polish, Russian and Spanish)



1116 Edox Presentation Tray
35 x 32 cm

PACKAGING – CATALOGUES – CERTIFICATES



1143 New Packaging for all collections with warranty card



1088 After Sale Service and Duty Free Programme Watch Box



1110 Edox Selvyt



4059 Edox Black Gloves



1138 Edox shopping bag

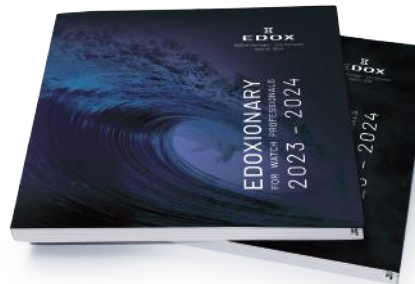

0040 Edoxionary for watch professionals

GIVE-AWAYS



1140 Edox Watch winder
W 11.5 x D 15 x H 11.5cm



1137 Edox Umbrella



1162 Edox Outdoor Duffle Bag
50 liters



1153 Edox Water-resistant Cap



1133 Edox Lanyard



1146 Edox Key Holder



1144 Edox Notebook

TECHNICAL INFORMATION



MOVEMENTS







CLASP & BUCKLE



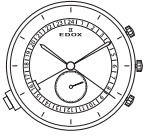

EDOX QUALITY

REFERENCE NUMBER SYSTEM

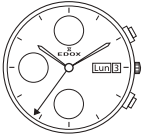
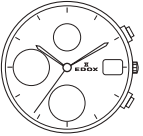



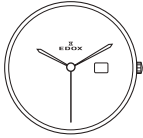
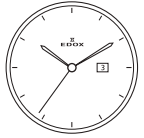
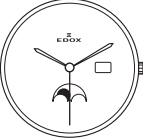

PICTOGRAMS



MECHANICAL MOVEMENTS

CALIBER / MANUFACTURER	07	SW 300 DUBOIS-DÉPRAZ 312	08	DUBOIS-DÉPRAZ 2040	011	VALJOUX 7750 / SW500	30	ETA 2892-2 DUBOIS-DÉPRAZ 285
MOVEMENT								
								
FUNCTIONS	Display of hours, minutes, seconds and date. 24 time zone display		Display of hours, minutes, seconds, date and chronograph		Display of hours, minutes, seconds and date, chronograph, day and date		Display of hours, minutes, seconds, chronograph and date	
Frequency	28'800 A/h		28'800 A/h		28'800 A/h		28'800 A/h	
Power reserve	40-44 h		38h		46 h / 48 h		42 h	
Diameter	25.60 mm (1 1/2''')		25.60 mm (1 1/2''')		30.00 mm (1 3/4''')		30.00 mm (1 3/4''')	
Movement height	4.85 mm		7.50 mm		7.90 mm		6.50 mm	
Number of jewels	25 jewels		50 jewels		25 jewels		41 jewels	
Shock resistance	Incabloc		Novodiac or Etachocs		Incabloc		Incabloc	
Max. variation all positions	22 s/d		30s/ds		20 s/d		22 s/d	



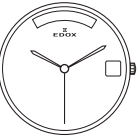

CALIBER / MANUFACTURER	77	ETA 2892-A2 DUBOIS-DÉPRAZ 14070	80	ETA 2824 / SW 200	802	SW 200	805	SW 280-1
MOVEMENT								
								
FUNCTIONS	Display of hours, minutes, seconds and date, regulator		Display of hours, minutes, seconds and date		Display of hours, minutes, seconds and date		Display of hours, minutes, seconds, date and moon phase	
Frequency	28'800 A/h		28'800 A/h		28'800 A/h		28'800 A/h	
Power reserve	42 h		38 h		38 h		38 h	
Diameter	30.00 mm (1 3/4''')		25.60 mm (1 1/2''')		25.60 mm (1 1/2''')		25.60 mm (1 1/2''')	
Movement height	5.20 mm		4.60 mm		3.60 mm		5.40 mm	
Number of jewels	25 jewels		25 jewels / 26 jewels		26 jewels		26 jewels	
Shock resistance	Incabloc		Novodiac or Etachocs		Incabloc		Novodiac	
Max. variation all positions	22 s/d		30 s/d		30 s/d		30 s/d	

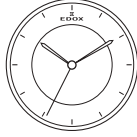



MECHANICAL MOVEMENTS

CALIBER / MANUFACTURER	806	SW 200 COSC CERTIFIED	82	ETA 2004-1	83	ETA 2834 / SW 240	85	ETA 2824 / SW 200
MOVEMENT								
								
FUNCTIONS	Display of hours, minutes, seconds and date		Display of hours, minutes, seconds and date		Display of hours, minutes, seconds, day and date		Display of hours, minutes and seconds	
Frequency	28'800 A/h		28'800 A/h		28'800 A/h		28'800 A/h	
Power reserve	38 h		40 h		42 h		38 h	
Diameter	25.60 mm (1 1/2'')		23.30 mm (10 1/2'')		29.00 mm (13'')		25.60 mm (1 1/2'')	
Movement height	3.60 mm		3.60 mm		5.05 mm		4.60 mm	
Number of jewels	26 jewels		20 jewels		26 jewels		25 jewels	
Shock resistance	Incabloc		Incabloc		Incabloc or Etachocs		Novodiac	
Max. variation all positions	-4/+6 s/d		30 s/d		30 s/d		30 s/d	





CALIBER / MANUFACTURER	853	SW200(SEMI- SKELETONISED)	87	ETA 2892-A2 DUBOIS DÉPRAZ DK 87
MOVEMENT				
				
FUNCTIONS	Display of hours, minutes and seconds		5 minute repeater Indication of time by the tone of 2 striking hammers	
Frequency	28'800 A/h		28'800 A/h	
Power reserve	42 h		42 h	
Diameter	25.60 mm (1 1/2'')		36.00 mm (16'')	
Movement height	4.60 mm		7.35 mm	
Number of jewels	26 jewels		21 jewels	
Shock resistance	Novodiac		Incabloc	
Max. variation all positions	30 s/d		22 s/d	



MECHANICAL MOVEMENTS



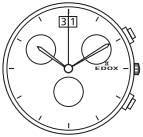

CALIBER / MANUFACTURER	88	SW 220-1	91	ETA 2824-2 / SW200 DUBOIS DÉPRAZ 291
MOVEMENT				
				
FUNCTIONS	Display of hours, minutes, seconds, day and date		Display of hours, minutes, seconds, date and chronograph	
Frequency	28'800 A/h		28'800 A/h	
Power reserve	38 h		38 h	
Diameter	25.8mm (1 1/2''')		30.00 mm (1 3/4''')	
Movement height	5.05 mm		7.50 mm	
Number of jewels	26 jewels		46 jewels	
Shock resistance	Incabloc		Incabloc	
Max. variation all positions	30 s/d		30 s/d	

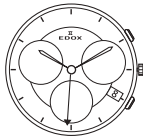
CALIBER / MANUFACTURER	94	ETA 2892-A2 SOPROD 9090	95	ETA 2894 S2L
MOVEMENT				
				
FUNCTIONS	Display of hours, minutes, seconds, power reserve and big date		Display of hours, minutes, seconds and chronograph	
Frequency	28'800 A/h		28'800 A/h	
Power reserve	42 h		42 h	
Diameter	25.80 mm (1 1/2''')		28.00 mm (1 1/2''')	
Movement height	5.10 mm		6.10 mm	
Number of jewels	28 jewels		37 jewels	
Shock resistance	Incabloc		Incabloc	
Max. variation all positions	20 s/d		30 s/d	

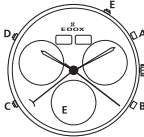
QUARTZ MOVEMENTS

CALIBER / MANUFACTURER	0165	ETA G10.962	095	ISA 8371.B	10	RONDA 5040.B	101	RONDA 5021.D
MOVEMENT								
FUNCTIONS	Display of hours, minutes, seconds, chronograph, moon phase		Display of hours, minutes, seconds, date, chronograph		Display of hours, minutes, seconds and big date, chronograph, split time		Display of hours, minutes, seconds, date and chronograph	
Diameter	31.75 mm (13 1/4"')		30.60 mm (13 1/4"')		28.00 mm (12 1/2"')		28.00 mm (12 1/2"')	
Movement height	5.12 mm		5.50 mm		4.40 mm		4.40 mm	
Battery	N° 394		N° 394		N° 395		N° 395	

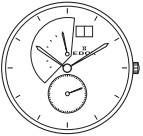
CALIBER / MANUFACTURER	102	RONDA 5030.D	103	RONDA 5021.D	104	RONDA 5040.D	105	RONDA 5040.F
MOVEMENT								
FUNCTIONS	Display of hours, minutes, seconds, date and chronograph		Display of hours, minutes, seconds, date and chronograph		Display of hours, minutes, seconds, date, chronograph		Display of hours, minutes, seconds, day, date, month, chronograph	
Diameter	28.00 mm (12 1/2"')		28.00 mm (12 1/2"')		28.00 mm (12 1/2"')		28.00 mm (12 1/2"')	
Movement height	4.40 mm		4.40 mm		4.40 mm		5.40 mm	
Battery	N° 395		N° 395		N° 395		N° 395	

CALIBER / MANUFACTURER	13N	ETA 251.272	34	RONDA 7004	345	RONDA 7004P	38	RONDA 8040.N
MOVEMENT								
FUNCTIONS	Display of hours, minutes, seconds, date and chronograph		Display of hours, minutes, small second, date retrograde		Display of hours, minutes, small second, big date, day retrograde		Display of hours, minutes, small seconds, day date, chronograph	
Diameter	30.00 mm (13 1/2"')		33.80 mm (15"')		33.80 mm (15"')		33.80 mm (15"')	
Movement height	5.00 mm		5.60 mm		5.60 mm		5.60 mm	
Battery	N° 394		N° 381		N° 381		N° 395	

QUARTZ MOVEMENTS

CALIBER / MANUFACTURER	38s	RONDA 8020.N
MOVEMENT		
FUNCTIONS	Display of hours, minutes, day date, chronograph	
Diameter	33.80 mm (1 3/8")	
Movement height	5.60 mm	
Battery	N° 395	

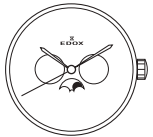
CALIBER / MANUFACTURER	40	RONDA 706.1
MOVEMENT		
FUNCTIONS	Display of hours, minutes, seconds, date and moon phase	
Diameter	23.30 mm (10 1/2")	
Movement height	3.00 mm	
Battery	N° 371	

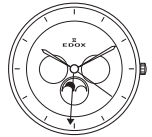
CALIBER / MANUFACTURER	401	RONDA 706.B
MOVEMENT		
FUNCTIONS	Display of hours, minutes, seconds, day date and moon phase	
Diameter	23.30 mm (10 1/2")	
Movement height	3.70 mm	
Battery	N° 371	

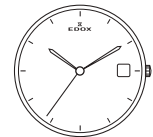
CALIBER / MANUFACTURER	53	RONDA 515
MOVEMENT		
FUNCTIONS	Display of hours, minutes, seconds and date	
Diameter	25.60 mm (1 1/2")	
Movement height	3.00 mm	
Battery	N° 371	

CALIBER / MANUFACTURER	54	RONDA 585
MOVEMENT		
FUNCTIONS	Display of hours, minutes, seconds and date	
Diameter	19.40 mm (8 3/4")	
Movement height	3.00 mm	
Battery	N° 362	

CALIBER / MANUFACTURER	56	RONDA 714
MOVEMENT		
FUNCTIONS	Display of hours, minutes and date	
Diameter	25.60 mm (1 1/2")	
Movement height	2.50 mm	
Battery	N° 371	

CALIBER / MANUFACTURER	57	RONDA 784
MOVEMENT		
FUNCTIONS	Display of hours, minutes and date	
Diameter	19.40 mm (8 3/4")	
Movement height	2.50 mm	
Battery	N° 362	

CALIBER / MANUFACTURER	64	RONDA 6004B
MOVEMENT		
FUNCTIONS	Display of hours, minutes, small seconds and big date	
Diameter	25.60 mm (1 1/2")	
Movement height	3.30 mm	
Battery	N° 373	

CALIBER / MANUFACTURER	84	RONDA 517
MOVEMENT		
FUNCTIONS	Display of hours, minutes, seconds, day and date	
Diameter	25.60 mm (1 1/2")	
Movement height	3.00 mm	
Battery	N° 371	



CO-1



01125 CLNGN	CARBON CHRONOGRAPH AUTOMATIC	page 13
10242 TINNO	CHRONOGRAPH	page 17
10242 TINR	CHRONOGRAPH	page 17
10242 TINRCA	CHRONOGRAPH	page 15
10250 37R	CHRONOGRAPH	page 17

NEPTUNIAN



80120 3NM	NEPTUNIAN AUTOMATIC	page 23
80120 3VM	NEPTUNIAN AUTOMATIC	page 27
80120 3BUM	NEPTUNIAN AUTOMATIC	page 27

DELFIN THE ORIGINAL



85303 3M	MECANO AUTOMATIC	page 33
85303 3NM	MECANO AUTOMATIC	page 33
88005 3M	DAY DATE AUTOMATIC	page 38



10242 TIN	CHRONOGRAPH	page 17
10242 TINM	CHRONOGRAPH	page 15



80120 3NCA	NEPTUNIAN AUTOMATIC	page 25
-------------------	---------------------	---------

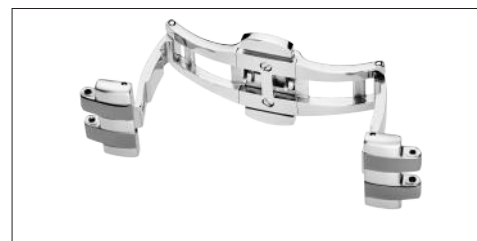

85303 357GM	MECANO AUTOMATIC	page 34
--------------------	------------------	---------



80120 37RNCA	NEPTUNIAN AUTOMATIC	page 23
---------------------	---------------------	---------



53020 3M	DELFIN DIVER DATE LADY	page 42
53020 357RM	DELFIN DIVER DATE LADY	page 42

DELFIN THE ORIGINAL



10112 37GNOCA	CHRONOGRAPH	page 40
10112 37GNVCA	CHRONOGRAPH	page 40
10112 357GRNCA	CHRONOGRAPH	page 40
10113 37GNCA	DELFIN CHRONOGRAPH	page 39
80118 357NG	NORTH SEA 1978	page 45
80118 BRN	NORTH SEA 1967	page 45
85303 357RN	MECANO AUTOMATIC	page 33
85303 357GN	MECANO AUTOMATIC	page 31
85303 357GR	DAY DATE AUTOMATIC	page 31
85303 3NN	MECANO AUTOMATIC	page 31
85303 357GNCAV	MECANO AUTOMATIC	page 34
85303 37NCA	MECANO AUTOMATIC	page 34



10112 3NCA	CHRONOGRAPH	page 40
10113 3CAB	CHRONOGRAPH	page 38
10113 3CA	CHRONOGRAPH	page 38
85303 357BUCAB	MECANO AUTOMATIC	page 34
88005 3CA	DAY DATE AUTOMATIC	page 34
88005 357RCA	DAY DATE AUTOMATIC	page 34



10113 37RNCA	DELFIN CHRONOGRAPH	page 39
88005 357RNCA	DAY DATE AUTOMATIC	page 37

DELFIN THE ORIGINAL



53020 3C	DIVER DATE LADY	page 43
-----------------	-----------------	---------



53020 37RC	DIVER DATE LADY	page 43
53020 37JC	DIVER DATE LADY	page 43



10112 3BUM	CHRONOGRAPH	page 40
10112 3NM	CHRONOGRAPH	page 40
10113 3M	CHRONOGRAPH	page 38

HYDRO-SUB



80128 3BUM	DATE AUTOMATIC CHRONOMETER	page 51
80128 3NBM	DATE AUTOMATIC CHRONOMETER	page 51



80128 37NJM	DATE AUTOMATIC CHRONOMETER	page 51
--------------------	----------------------------	---------

SKYDIVER



80126 357RNM	DATE AUTOMATIC LIMITED EDITION	page 59
80126 3BUN	DATE AUTOMATIC LIMITED EDITION	page 59



80131 3NM	SKYDIVER DATE AUTOMATIC	page 60
80131 3BUM	SKYDIVER DATE AUTOMATIC	page 60

SKYDIVER



80126 3N	DATE AUTOMATIC LIMITED EDITION	page 57
-----------------	--------------------------------	---------



80126 BRN	DATE AUTOMATIC LIMITED EDITION	page 59
80126 3VIN	DATE AUTOMATIC LIMITED EDITION	page 59



80131 3BUC	SKYDIVER DATE AUTOMATIC	page 60
80131 3NC	SKYDIVER DATE AUTOMATIC	page 60
80131 357JNC	SKYDIVER DATE AUTOMATIC	page 61
80131 357RNRC	SKYDIVER DATE AUTOMATIC	page 61



80131 37RNC	SKYDIVER DATE AUTOMATIC	page 61
--------------------	-------------------------	---------

CHRONORALLY



38001 TIN	CHRONORALLY	page 68
38001 TINNO3	CHRONORALLY	page 68
38001 TINNBU3	CHRONORALLY	page 68
38001 TINV	CHRONORALLY	page 68
38001 TINGNAEG	CHRONORALLY AEGERTER	page 71



01129 TBUCBR	CHRONORALLY AUTOMATIC	page 70
01129 TGNOCO	CHRONORALLY AUTOMATIC	page 70
01129 TRCA	CHRONORALLY AUTOMATIC	page 70
01129 TTNJCN	CHRONORALLY AUTOMATIC	page 70
01129 TNCA	CHRONORALLY AUTOMATIC	page 71
38001 TINNBU	CHRONORALLY LIMITED EDITION	page 68
38001 TINOCAO	CHRONORALLY	page 68
38001 TINOCA	CHRONORALLY	page 68



EDOX QUALITY

Batteries

In compliance with global regulations and standards, Edox equips its quartz timepieces with mercury-free batteries. This is a positive step towards environmental sustainability with no effect on the watch precision and efficiency.



Edox double O'ring Crown or Pusher

Since the 70's, Edox has set specific quality and technical standards for ensuring the water resistance of diving timepieces. The double O'ring crown or pusher has been engineered by Edox to allow to increase the resistance to water pressure. Timepieces equipped with crowns or pushers featuring a double O'ring are featuring the special pictogram for easy understanding.



Helium Escape Valve

Some of our CO-1 and Neptunian timepieces are equipped with a decompression system which allows helium to escape from inside the watch when worn for professional use in pressure chambers (long-term underwater work, crude oil exploration, etc).

The Edox helium valve opens and closes automatically. It is imperative that the models equipped with a non-automatic helium escape valve (such as older Edox timepieces) have the helium valve screwed back in order to guarantee their water resistance.



Ceramic

Up to four times harder than stainless steel, ceramic is scratch-resistant and thus extremely durable. Mainly used to build the bezels of Edox watches, this material will also prevent the colours from fading.



Carbon

Carbon first became widespread in industries like aerospace and Formula 1. Exceptionally strong yet surprisingly light, Edox uses this material to build solid case constructions while giving them a very unique and distinctive look.



Chronometer

When Edox creates a chronometer watch, it means that the movement hosted has successfully undergone the precision test of the Official Swiss Chronometer Testing Institute (COSC), based in Switzerland.

These movements have a certified precision of $-4/+6$ seconds per day, about three times better than a standard Swiss mechanical movement.



Bronze

Bronze has natural properties that set it apart from other materials. Bronze does not rust and is therefore widely used in nautical applications and for some Edox diving watch cases, bronze will react with other elements producing a layer of oxidization on its surface. This patina then acts as a protective coating and makes every Edox bronze watch unique.



DLC

Diamond-Like Carbon (DLC) is a coating in a layer of extremely durable and scratch-resistant carbon particles. It possesses the most desirable physical characteristics of diamond – hardness and durability – and with a sleek beauty. This treatment will improve the durability and the aesthetics of the Edox watch cases.

Hand-assembled

Every single Edox watch is carefully hand-assembled by qualified Swiss watchmakers in our ateliers in Les Genevez. Each one of them is checked and controlled over a long period of time – by both human beings as well as special equipment to ensure optimal quality.

Leather

All Edox leather straps are specially cut, stitched and padded by expert craftspeople. Various ways of tanning provide different touch and feel for the straps made of cow or calf leather. It is always important to remember that colors and suppleness of leather are subject to change with time and exposure to external factors. Daily showers or swims are not recommended. If your consumers live a very active lifestyle, especially one involving frequent exposure to salt water and heavy perspiration, we recommend a steel bracelet or rubber strap.



Luminescence

This technology, branded under the name Super-Luminova, offers brightness in low-light conditions, thanks to a non-radioactive and non-toxic material like the tritium previously employed in the industry. Edox uses Super-Luminova X1 for its highly functional attributes. It is applied on watch parts such as hands, numerals, bezel indices, etc.

Mother-of-pearl

Resilient, and iridescent, mother-of-pearl is integrated in many Edox dial designs. It is produced inside the shells of certain mollusk shells. This is why each dial made of mother-of-pearl is unique.

Movements

Mechanical movement:

A mechanical movement undergoes several stresses in its life. To ensure it will remain functional and precise as long as possible, Edox simulates watch wearing in its own quality office for every single manual and self-winding mechanism.



PVD, PVD

Edox uses PVD coatings which is a high-performance pollution-free and non-allergenic technology also used in the aeronautic industry, is widely used in watchmaking. The process involves putting a fine titanium coating on stainless steel by condensing a metal vapor in a partial vacuum.

Rubber

Edox uses genuine high-grade rubber for its straps (a natural material and extremely comfortable). The rubber is silky finished and easy to maintain with the proper cleaning.



Sapphire crystals

100% of Edox timepieces are fitted with a scratch-resistant crystal that has been cut from a polished slice of solid sapphire. Each has a triple-coated anti-reflective treatment on the internal side for better legibility.



Stainless Steel

The 316L stainless steel alloy used in Edox cases and bracelets has strong anti-magnetic properties and is optimized for toughness and corrosion resistance. It is also a good choice for consumers allergic to nickels.







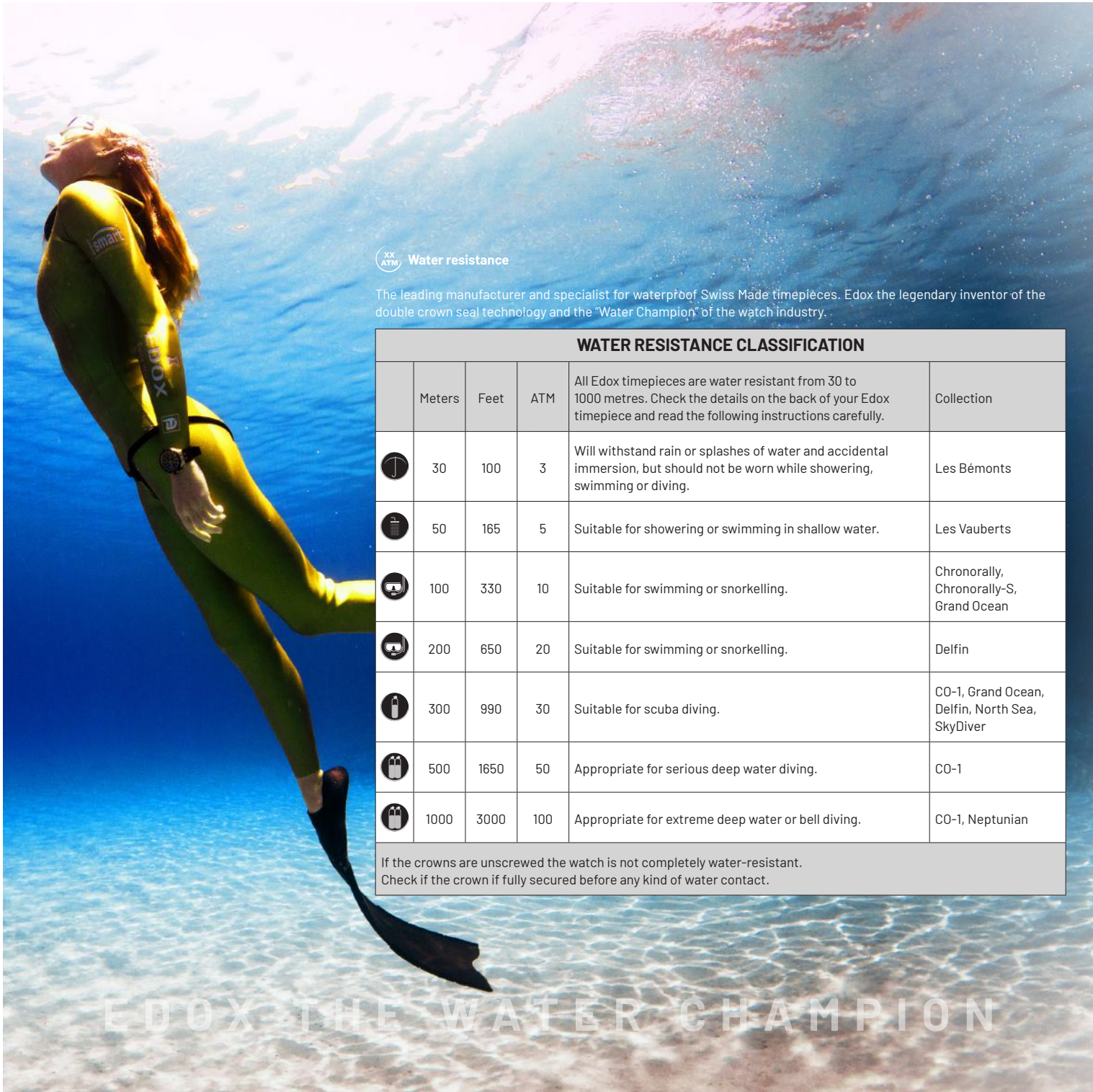

Titanium

Edox integrates this metal to some of its sports timepieces, as it is as strong as steel but 45% lighter and highly resistant to corrosion. The high tensile strength to density ratio makes it the ideal material for active lifestyles.



XX ATM Water resistance

The leading manufacturer and specialist for waterproof Swiss Made timepieces. Edox the legendary inventor of the double crown seal technology and the "Water Champion" of the watch industry.

WATER RESISTANCE CLASSIFICATION					
	Meters	Feet	ATM	All Edox timepieces are water resistant from 30 to 1000 metres. Check the details on the back of your Edox timepiece and read the following instructions carefully.	Collection
	30	100	3	Will withstand rain or splashes of water and accidental immersion, but should not be worn while showering, swimming or diving.	Les Bémonts
	50	165	5	Suitable for showering or swimming in shallow water.	Les Vauberts
	100	330	10	Suitable for swimming or snorkelling.	Chronorally, Chronorally-S, Grand Ocean
	200	650	20	Suitable for swimming or snorkelling.	Delfin
	300	990	30	Suitable for scuba diving.	CO-1, Grand Ocean, Delfin, North Sea, SkyDiver
	500	1650	50	Appropriate for serious deep water diving.	CO-1
	1000	3000	100	Appropriate for extreme deep water or bell diving.	CO-1, Neptunian

If the crowns are unscrewed the watch is not completely water-resistant. Check if the crown is fully secured before any kind of water contact.

EDOX THE WATER CHAMPION

REFERENCE NUMBER SYSTEM

The following information will help you on how to handle the Edox reference number, which will give you helpful product information regarding movements, dials and cases.

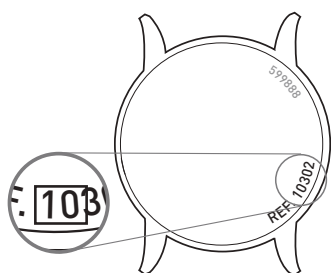

CO-1
01125 | CLNGN | BUNN | Ø 45 MM

01125 CLNGN BUNN

MOVEMENT

The first 2 or 3 digits of these five figures represent the Edox movement code. Please refer to the page 112-116 of this catalogue.

01125 **CLNGN** BUNN

CASE MATERIAL

The digits and/or letters represent the material and surface treatment (colour) of the case. (See the table)

01125 CLNGN **BUNN**

DIAL VARIATIONS

The digits and letters represent the colour and design of the dial.

MOVEMENT	
011	please refer to the page 84

CASE MATERIAL	
3 / 3A / 3B / 3N	Stainless steel 316
3BNM	Stainless steel 316 / White bezel / Steel bracelet
3BN	Stainless steel 316 / White bezel
3BU	Stainless steel 316L / Blue bezel
3BUCA	Stainless steel 316L / Blue bezel Rubber strap
3BUCBU	Stainless steel 316L / Blue details / Blue leather strap
3BUM	Stainless steel 316L / Blue bezel / Steel bracelet
3BUO	Stainless steel 316L / Blue and orange bezel
3BU7	Stainless steel 316L / Dark blue bezel
3C	Stainless steel 316L / Leather strap
3CA	Stainless steel 316L / Rubber strap
CLN5N	Black Carbon / Pink bezel
CLNBUN	Black Carbon / Blue bezel
CLNGN	Black and Grey Carbon
CLNRN	Black and red Carbon
3M	Stainless steel 316L / Steel bracelet
3MV	Stainless steel 316L / Green pusher / Steel bracelet
3N	Stainless steel 316L / Black bezel
3NBU	Stainless steel 316L / Black and blue bezel
3NCA	Stainless steel 316L / Black bezel / Rubber strap
3NGCA	Stainless steel 316L / Black and grey bezel / Rubber strap
3NGM	Stainless steel 316L / Black and grey bezel / Steel bracelet
3NM	Stainless steel 316L / Black bezel / Steel bracelet
3NOCA	Stainless steel 316L / Black and orange bezel / Rubber strap
3NOM	Stainless steel 316L / Black and orange bezel / Steel bracelet
3O	Stainless steel 316L / Black and orange bezel
3OCA	Stainless steel 316L / Orange bezel / Rubber strap
3OM	Stainless steel 316L / Orange bezel / Steel bracelet
3OR	Stainless steel 316L / Orange bezel
3ORC	Stainless steel 316L / Leather strap
3ORCA	Stainless steel 316L / Orange bezel / Rubber strap
3NP18	Stainless steel 316L / Northpole 2018 Edition
3NRCA	Stainless steel 316L / Black and red bezel / Rubber strap
3NRM	Stainless steel 316L / Black and red bezel / Steel bracelet
3NVCA	Stainless steel 316L / Black and green bezel / Rubber strap
3NVM	Stainless steel 316L / Black and green bezel / Steel bracelet
3PBU	Stainless steel 316L / Blue pusher
3PR	Stainless steel 316L / Red pusher
3R	Stainless steel 316L / Black and red bezel or red pusher
3V / 3V2	Stainless steel 316L / Green pusher
37GR	Stainless steel 316L / Grey and pink bezel
37GRM	Stainless steel 316L / Grey and pink bezel / Steel bracelet
37J	Yellow PVD coating
37JC	Yellow PVD coating / Leather strap
37JA	Yellow PVD coating, silver ring
37JG	Yellow PVD coating, golden ring

CASE MATERIAL	
37N	Black PVD coating
37NJ	Black PVD coating, golden pusher
37NNONANN	Black PVD coating, black details / Black NATO Strap
37NNVCV	Black PVD coating, black details / Green leather strap
37NNNAG	Black PVD coating, black details / Black NATO Strap
37NPN	Black PVD coating, black pusher
37NRCN	Black PVD coating, pink details / Black leather strap
37R	Pink PVD coating
37RBU	Yellow PVD coating / Blue bezel
37RC	Yellow PVD coating / Leather strap
37RM	Yellow PVD coating / Steel bracelet
357A / 357J	Stainless steel 316L / Yellow PVD coating
357BR	Stainless steel 316L / Brown PVD coating
357B	Stainless steel 316L / Blue PVD coating
357BU	Stainless steel 316L / Blue PVD coating
357BUNCA	Stainless steel 316L / Black PVD coating, blue bezel
357BRR	Stainless steel 316L / Brown and pink PVD coating
357GC / 357GNCA	Stainless steel 316 / Black and Grey PVD coating
357JBUCA	Stainless steel 316L / Pink PVD coating / Blue bezel / Rubber strap
357JCA	Stainless steel 316L / Yellow PVD coating / Rubber strap
357JVM	Stainless steel 316L / Green and yellow PVD coating / Steel bracelet
357RBUM	Stainless steel 316L / Pink PVD coating / Blue PVD bezel / Steel bracelet
357RC	Pink PVD coating / Leather strap
357RCA	Stainless steel 316L / Pink PVD coating / Rubber strap
357RM	Pink PVD coating / Steel bracelet
357N	Stainless steel 316L / Black PVD coating
357NCA	Stainless steel 316L / Pink PVD coating / Black bezel / Rubber strap
357R	Stainless steel 316L / Pink PVD coating
357RCA	Stainless steel 316L / Pink PVD coating / Rubber strap
357RD	Stainless steel 316L / Pink PVD coating, diamonds
357RN	Pink and black PVD coating
357RNCA	Stainless steel 316L / Pink PVD coating / Black PVD bezel / Rubber strap
TINBU1	Titanium / Blue PVD coating
TIN / TINR	Titanium

DIAL VARIATION	
AIBU	Silver / Blue indices
AID / AID2	Silver / Golden indices
AIN / AIN2	Silver / Silver indices
AINO	Silver / Black indices
AIR	Silver / Pink indices
ABUN	Silver / Blue and silver indices
AR	Silver / Roman numberings
BEBN	Beige / Silver Breguet numberings
BEBR	Beige / Pink Breguet numberings
BEIR	Beige / Pink indices
BER	Beige / Roman numberings
BIBU	White / blue indices
BINN	White / Silver and black indices
BINR	White / Black and pink indices

DIAL VARIATION	
BIR	White / Pink indices
BRID	Brown / Yellow indices
BRIN	Brown / Silver indices
BRIR	Brown / Pink indices
BU	Blue
BUBEB	Blue / Nickel Breguet numberings
BUBG	Blue / White and grey indices
BUBN	Blue / Silver Breguet numberings
BUNN	Blue / Black and silver indices
BUIB1	Blue / Black details
BUID	Blue / Golden indices
BUIN / BUIN7	Blue / Silver indices
BUINO	Blue / Silver and orange indices
BUIR	Blue / Pink indices
BUV3	Blue / Green indices
DI	Golden
GID	Grey / Golden indices
GIN	Grey / Silver indices
GIR	Grey / Pink indices
GR3	Grey / Red details
NADN	Mother-of-pearl / Diamonds and silver indices
NADR	Mother-of-pearl / Diamonds and pink indices
NAIN	Mother-of-pearl / Silver indices
NANN	Mother-of-pearl / Black indices
NAIR	Mother-of-pearl / Pink indices
NBN	Black / Silver Breguet numberings
NBUJ	Black / Blue and yellow indices
NBUN	Black / Silver and blue indices
NBUR	Black / Blue and pink indices
NBU	Black / Blue indices
NIBU	Black / Blue indices
NID	Black / Golden indices
NIN / NIN2	Black / Silver indices
NINB	Black / Black and beige indices
NINBU	Black / Silver and blue indices
NING	Black / Black and grey indices
NINJ	Black / Black and yellow indices
NINO	Black / Silver and orange indices
NINRO	Black / Silver and red indices
NIR / NIR7	Black / Pink indices
NBUR	Black / Blue and red indices
NOBU	Black / Orange and blue indices
NOJ / NOJ3	Black / Orange and yellow indices
NOO	Black / Orange indices
NOR	Black / Orange indices
NNO	Black / Black and orange details
NNP18	Black / Northpole 2018 Edition
NNV	Black / Green details
NNR	Black / Pink details
NRO	Black / Red indices
NV	Black / Green indices
VID	Green / Golden indices

Visit Edox at www.edox.ch



EDOX SWISS WATCHES

LA SAGNE AU DROZ 18
CH-2714 LES GENEVEZ
SWITZERLAND

TEL. +41 32 484 70 10 FAX. +41 32 484 70 19
INFO@EDOX.CH WWW.EDOX.CH

The models and product lines in this 2021-2022 catalogue are subject to change without notice. All models are subject to availability. The information provided refers to the model named, or is of a general nature. Not all watches and movements in this catalogue are shown in their actual size. The colours of the watches and movements illustrated may vary due to the printing process. No part of this brochure may be reproduced, scanned or transmitted either online or in any form without prior written permission from Edox.

Edox is a registered trademark.

Printed in Switzerland

