

E-MAGAZINE

December 2023



A Message From Guidely To All Serious Bank Aspirants

Hai all,

Our Guidely platform has been doing a great job for the past eight years in supporting the banking aspirants. In this beautiful journey, we have been providing quality mock test packages, bundle PDF courses, and various other study materials at affordable prices. This journey will continue for the upcoming years to uplift all the banking aspirants.

Lakhs of students come into this competition with a passion to become bankers. In this battle, a majority of people have been starving for success for a long period of time. They have been facing failures for many years. Due to continuous failures, many are thinking of quitting this competition.

In reality, success will not come to you overnight. You must handle your failures in a calm and composed manner. More importantly, you have to learn more from your failures. Only after a fine-tuned practice and a perfect preparation for the long term can you attain success. In this period, you have to be motivated, work hard, and use smart strategies to find progress in your success journey.

For that, Guidely will provide you with an enormous amount of quality study materials. You can rely on Guidely for standard mock test packages, bundle PDFs, and other materials at affordable price ranges. The only thing you have to do is follow us and work hard with a hundred percent hope. Guidely will end your journey with fruitful success. So, don't feel bad for your failures. Guidely will show you the best ways to crack the upcoming bank exams.

-Team Guidely

Index

Success Story	3
Booster Dose	4
Important News Topic wise - December 2023	14
Article Related to Most Important News of the Month	92
RRB PO Prelims Practice Set	95
RRB PO Prelims Memory Based Paper	126
Hindu Editorial Vocabulary	149





SUCCESS STORY

Name : Ashu Soni

Email ID : coolashusoni@gmail.com

Date of Birth : 18/09/1994

State : Haryana

Edu Qualification : B.Sc. (NON MEDICAL) ,
B.Ed. , M.Sc. (PHYSICS).

Final Selection: ESIC UDC , IBPS CLERK , SBI CLERK ,
RRB PO (2023).

1 What is your special strategy that you followed to crack the bank exam?

I used to attempt mains mock tests on alternate days, whether I had my mains exam or not. I prepared my own current affairs notes and that made easier for me to remember CA.

2 What would you advise the banking aspirant to prepare seriously for bank exams?

1. Just focus on the accuracy not the attempts.
2. Attempt mains mock test regularly.
3. Last but not the least , you must have ur own daily target and stick to your plan.
4. Be consistent and be patient.

3 What is the contribution of Guidely to your success?

Guidely has the full contribution. I have attempted mock tests from almost every platform , but I personally recommend that the quality of guidely mock test is the best. The interface and the way to present a question is exceptional. Guidely will make you to be ready for the worst. This quality makes it different from others.

4 What is your real feeling after achieving your dream bank job?

This is something unexplainable. The feeling of Jan 1 2024 can't be describe in words. Those tears will make every second of your hardwork and passion count. It feels out of world when you set a goal and achieve it.

5 To whom will you dedicate your success?

To my family (without their support it wouldn't been possible) , friends , teachers and guidely.



BOOSTER DOSE

DECEMBER 2023



1 World Soil Day 2023 is observed on the 5th of December 2023.



6 India has been unanimously elected as a member representing Asian region in the Executive Committee of Codex Alimentarius Commission (CAC) during its 46th meeting being held at FAO Headquarters at Rome.



2 Union Minister for Mines Pralhad Joshi has launched the first-ever tranche auction of critical mineral blocks at a function in New Delhi.



7 18 countries endorsed new global guidelines, developed by the United States (US) and the United Kingdom (UK), to make artificial intelligence (AI) "secure by design" and "raise the AI cybersecurity bar."



3 According to the Periodic Labour Force Survey (PLFS), the unemployment rate in urban areas has decreased from 7.2% in July–September, 2022 to 6.6% in July–September 2023.



8 The Ministry of Tourism, Government of India is organising the 11th edition of International Tourism Mart at Shillong, Meghalaya.



4 The World's first portable hospital, 'Aarogya Maitri Aid Cube' was unveiled in Gurugram.



9 The 24th edition of the Hornbill Festival has commenced at Naga Heritage Village Kisama.



5 In elections held at its assembly for the 2024–25 biennium, India was re-elected to the International Maritime Organisation (IMO) Council with the highest tally.



10 Chennai Metro Rail Limited (CMRL) has partnered with PhonePe to introduce digital QR-based ticketing for metro travellers.



15 India's banking system liquidity deficit has widened to the highest in nearly 5 years on monthly goods and services tax payments.

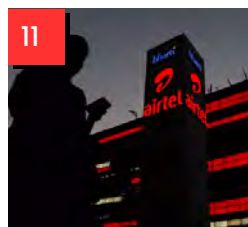

11 The full market capitalisation of Bharti Airtel (partly plus fully paid-up) hit ₹6 lakh crore for the first time on Mcap.



16 Suganthy Sundararaj received the PRSI National Award for Outstanding Contributions to Healthcare Communications services tax payments.



12 The Asian Development Bank (ADB) has approved a significant loan of USD 170 million for the modernization of water supply services in Kochi, Kerala.

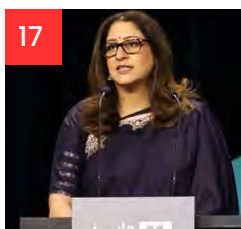

17 The prestigious WISE Award was honoured to Safina Hussain at the WISE 11 Summit (World Innovation Summit for Education).



13 TATA AIG General Insurance Company Limited introduced "Health Supercharge" with the aim of offering a fivefold enhancement in health insurance coverage, addressing the dynamic nature of health-related uncertainties.



18 Sheetal Devi win best young athlete award in APC conference

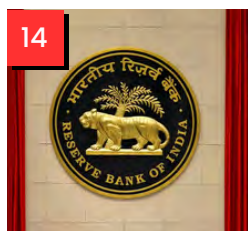

14 The Reserve Bank of India (RBI) permitted banks to open additional current accounts for export proceeds in addition to special rupee vostro accounts with a view to providing greater operational flexibility to exporters.

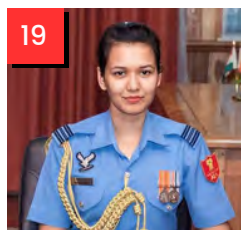

19 Mizoram Governor Dr Hari Babu Kambhampati has appointed a woman Indian Air Force officer from Odisha, squadron leader Manisha Padhi, as India's first Woman Aide-De-Camp (ADC) from the Indian Armed Forces at a brief ceremony held at the Raj Bhawan in Aizawl.



20 An MoU has been signed between Nasscom and NRW Global to establish a launchpad in Germany

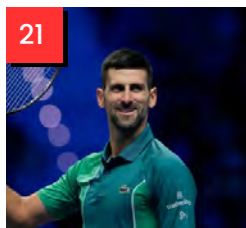

21

Novak Djokovic earned the year-end No. 1 spot in the ATP rankings for the eighth time, adding to a record he already held.



26

Mahe, Malvan and Mangrol, the first three ships of 08 x ASW Shallow Water Craft (CSL) project being built by CSL, Kochi for the Indian Navy, were launched CSL, Kochi.



22

The Bloomberg Billionaires Index is a daily ranking of the world's richest people. South African-born Elon Musk is the new richest person in the world, having recently surpassed United States Jeff Bezos



27

The Ministry of Textiles will organize the country's largest ever 'One Bharat Sari Walkathon' in India's financial capital, Mumbai.



23

The Bloomberg Billionaires Index is a daily ranking of the world's richest people. South African-born Elon Musk is the new richest person in the world, having recently surpassed United States Jeff Bezos



28

India will host a four-day 27th WAIPA World Investment Conference in New Delhi.

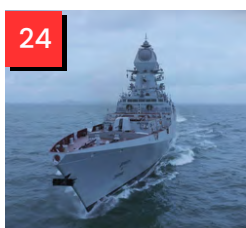

24

The crest of Yard 12706 (Imphal), the third amongst the four Project 15B stealth guided missile destroyers, was unveiled by Raksha Mantri Shri Rajnath Singh, in the presence of Manipur Chief Minister Shri N Biren Singh, in New Delhi.



29

PM Formalisation of Micro food processing Enterprises (PMFME) Scheme is a centrally sponsored scheme launched in 2020

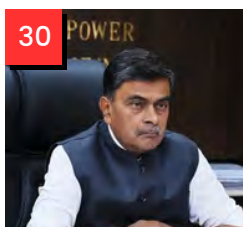

30

4E Wave has been launched by Union Minister for Power and New & Renewable Energy Shri R. K. Singh.



25

In 2025, Saturn's rings will seemingly disappear from Earth's view due to the phenomenon known as the "Saturnian equinox."



31

Sri Lanka has achieved an "agreement in principle" with India and the Paris Club group of creditors on a debt treatment plan.

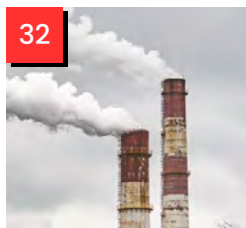

32

According to a government report India reduced its GDP emission intensity by 33 per cent between 2005 and 2019, achieving the target 11 years in advance, India's GDP grew at a cumulative annual growth rate of 7 per cent but its emissions rose by only 4 per cent per year.



36

generation.

New Zealand's newly elected government has repealed the decision to implement a smoking ban for the new



33

Raksha Mantri Shri Rajnath Singh inaugurated a 10-foot tall statue of Mahatma Gandhi at Gandhi Darshan near Rajghat, Delhi. Raksha Mantri described the statue as a befitting tribute to the Father of the Nation



37

Sweden signed a defence cooperation agreement with the United States in Washington.

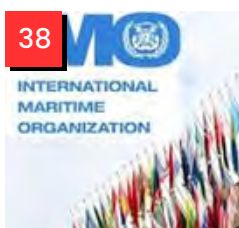

38

Voyage2050 Project.

India has been selected as the pioneer lead country for the International Maritime Organization (IMO) Green



34

The Ministry of Tourism (MoT) in collaboration with Ministry of Environment, Forest & Climate Change (MoEFCC) launched an Alternative Livelihood Programme under the Amrit Dharohar Capacity Building Scheme in Sultanpur National Park, a Ramsar Site in Haryana.

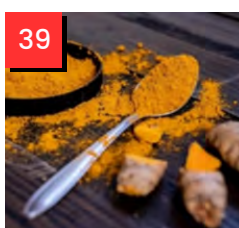

39

Meghalaya's Lakadong turmeric has been awarded the Geographical Indication (GI) tag.



40

Arunachal Pradesh Chief Minister (CM) Pema Khandu and US Ambassador to India Eric Garcetti inaugurated 'The Hump WWII Museum', the 2nd museum in Asia dedicated to the fallen airmen of the Allied Forces during the WWII at Pasighat in Arunachal Pradesh.



35

The Asian Development Bank (ADB) has approved a \$98 million loan to improve horticulture crop farmers' access to certified disease-free planting materials, which will boost their crops' yield, quality, and resilience to climate impacts.



41

ICICI Lombard has introduced MaxProtect, the latest addition to its range of customer-focused products.



42

Gujarat, the State government has signed a memorandum of understanding (MoU) with the Airports

Authority of India (AAI) to develop 11 new greenfield airports and expand 9 existing ones.

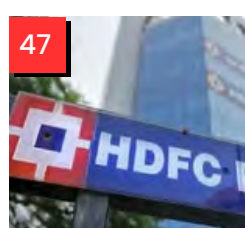

47

The Reserve Bank of India (RBI) has approved an 'Offline Retail Payments' product developed by HDFC Bank, in partnership with Crunchfish AB, for adoption by banks and other financial institutions.



43

Bharatiya Janata Party leader Vishnu Deo Sai will take oath as the new Chhattisgarh chief minister on December 13,

2023 in Raipur.

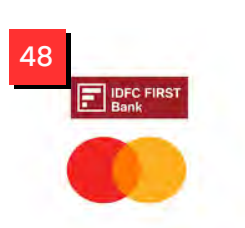

48

IDFC FIRST Bank has introduced a youth-centric "FIRST SWYP" credit card in partnership with Mastercard.



44

The Securities and Exchange Board of India (SEBI) has extended the timeline for implementation of linking SEBI

Complaint Redressal (SCORES) with the online dispute resolution platform to April 1, 2024.

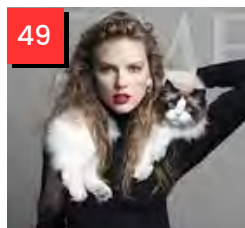

49

Taylor Swift is ending her year with another accolade: The pop superstar was named Time magazine's 2023

"Person of the Year," beating out Barbie and King Charles III.

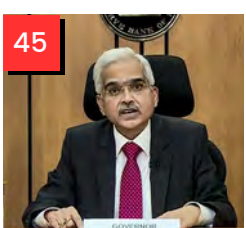

45

The Reserve Bank of India's Monetary Policy Committee (MPC) kept the repo rate unchanged for the fifth time in a row

at 6.5%.



50

Telangana Congress President, Anumula Revanth Reddy, appointed as the new Chief Minister of

Telangana.



46

The Reserve Bank of India (RBI) is actively working on establishing a dedicated cloud facility for the financial sector in

India



51

Kanchan Devi has become the first woman Director General of the Indian Council of Forestry Research Education

(ICFRE).

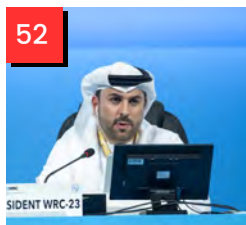

52 The United Arab Emirates's (UAE) Mohammed Al Ramsi appointed as the Chairman of the World

Radio communication Conference (WRC) 2023.



57 Captain Geetika Koul from the Snow Leopard Brigade has become the first woman medical officer in the Indian Army

to be deployed at Siachen, the world's highest battlefield, the Fire and Fury Corps.

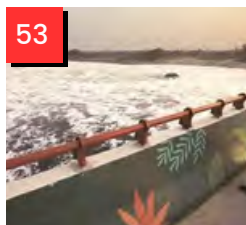

53 The National Mission for Clean Ganga (NMCG) recently signed a Memorandum of Common Purpose

(MoCP) with the Mississippi River Cities and Towns Initiative (MRCTI), which represents 124 cities/towns situated along the banks of the Mississippi River, the United States



58 The Reserve Bank of India (RBI) increased the limit for automatic payments through Unified Payments Interface (UPI)

to Rs 1 lakh per transaction from the existing Rs 15,000 for certain categories, including subscription to mutual funds.

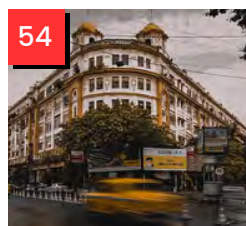

54 The most recent report from the National Crime Records Bureau (NCRB) shows that Kolkata has remained India's safest

city for the third consecutive year, with an incidence of recognized crime (IPC) of 86.5 in 2023.



59 Reliance Industries Limited (RIL) and DBS Bank India have collaborated to establish a financing programme

customised to the requirements of the compressed biogas project initiated by RIL.



55 The measles and rubella vaccine "Mabella" launched by Vaccine maker Indian Immunologicals (IIL) for

children.



60 iVIS, a subsidiary of Magellanic Cloud, has announced its empanelment with ICICI Bank for the delivery of e-surveillance services across branches.



56 Youth for Unnati and Vikas with AI' (YUVAI) is set to be prominently featured at the upcoming Global Partnership on

Artificial Intelligence (GPAI) Summit.



61 Bandhan Bank has been authorised by RBI to disburse pensions on behalf of Indian Railways.



62 India's first six-lane steel slag-based Road Connecting NH-6 to Hazira Port has been constructed.

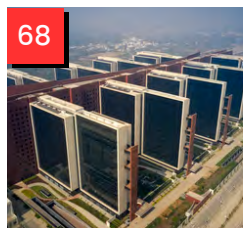

68 In Gujarat, Prime Minister Narendra Modi has dedicated the newly Built Diamond Bourse, the World's largest corporate office hub in Surat.



63 PNB Housing Finance, the third largest housing finance company in India, announced that it has achieved a loan book size of Rs 1,000 crore in the affordable housing segment.



69 IIT Madras developed 'AMRIT' (Arsenic and Metal Removal by Indian Technology) for removing Arsenic and Metal ions from water.

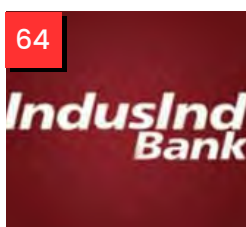

64 IndusInd Bank has introduced the 'Indus Solitaire Program,' a specialized community banking initiative tailored for the diamond industry.



70 India, South Korea and the United States (US) will start an informal trilateral technology dialogue in the first quarter of 2024 in response to China's rapid progress in critical technologies within the Indo-Pacific region.



65 The Ministry of Environment, Forests and Climate Change has launched the Indian Forest & Wood Certification Scheme.



71 The first-of-its-kind, Nature Interpretation Centre at the Eastern Ghats Biodiversity Centre along the periphery of the Kambalakonda Wildlife Sanctuary in Visakhapatnam was inaugurated.



66 The 29th Kolkata International Film Festival ended & Israeli film 'Children of Nobody' won the Best Film Award under International Competition in Innovation Moving Images



72 The Ministry of Finance, that the Gross Direct Tax collections for the Financial Year 2023-24 have registered a growth of over 17 per cent.



67 Union Minister Kiren Rijiju flagged off India's first-ever winter science expedition to the Arctic region.



73

Mohan Yadav, the BJP legislature party leader and MLA from Ujjain South, was sworn in as the 19th Chief Minister of Madhya Pradesh (MP) replacing Shivraj Singh Chouhan.

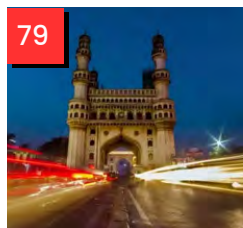

79

According to the Quality of Living Index 2023 released by Mercer, Hyderabad is in the top spot in terms of 'quality of living' in India & Hyderabad attained the 153rd spot in the Quality of Living Index 2023.



74

Guinea-Bissau's President Umaro Sissoco Embalo has reappointed Geraldo Martins as prime minister (PM) after dissolving his government.



80

The first-ever Khelo India Para Games (KIPG) concluded in New Delhi with Haryana winning the inaugural title by securing 105 medals including 40 gold, 39 silver, and 26 bronze.



75

Kabir Bedi has been honoured with the highest civilian honour of Italy



81

Bangladesh won the Under-19 Asia Cup by defeating UAE in the finals



76

Indian Armed Forces officers have been awarded the 'Golden Owl' for their outstanding performance.

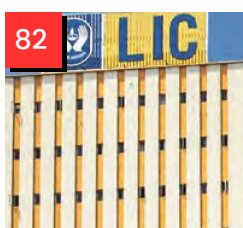

82

Life Insurance Corp (LIC), the country's biggest institutional holder of marketable securities, is officially an anchor investor for an upcoming bond sale by the National Bank for Agricultural and Rural Development (NABARD), marking the first such occurrence in India's corporate debt market.



77

Indian Air Force (IAF) successfully conducted the test of the 'SAMAR' standing for Surface to Air Missile for Assured Retaliation, air defence missile system during 'Exercise Astrashakti-2023.'

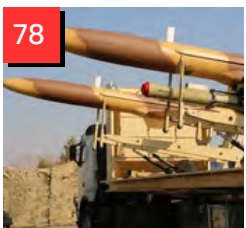

78

Iran unveiled advanced Karrar combat drones armed with air-to-air missiles, enhancing its air defence capabilities.



83

CASHe, a leading credit-led Artificial Intelligence (AI)-driven financial wellness platform, has unveiled its super app with the tagline - 'Bharat Ka Money App.'



84 Kotak Mahindra Life Insurance Company has introduced a new insurance product known as T.U.L.I.P – Term with Unit Linked Insurance Plan.

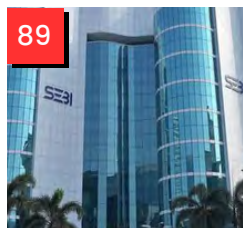

89 The Securities and Exchange Board of India (SEBI) has proposed the introduction of a facility for clearing and settlement of funds and securities on T+0 (same day) and instant settlement cycle on an optional basis.



85 Unclaimed deposits with banks have seen a notable 28% year-on-year increase, soaring to Rs 42,270 crore by March 2023, up from Rs 32,934 crore in the fiscal year 2022.



90 President of France Emmanuel Macron will be the Chief Guest for the 75th Republic Day celebrations.

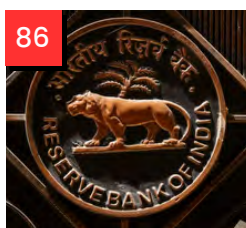

86 The Reserve Bank of India's (RBI's) Dynamic Stochastic General Equilibrium (DSGE) model forecasts retail inflation to be 4.8% in the fiscal year 2024-25.



91 Vice-President of India, Jagdeep Dhankhar launched this new logo of the Institute of Chartered Accountants of India (ICAI).



87 IndusInd Bank has launched 'eSvarna', the country's first corporate credit card on the RuPay network, enabling the private sector lender to become the first to integrate UPI functionality with a corporate credit card.



92 The Central Board of Direct Taxes (CBDT) has notified two new return forms, ITR-1 (SAHAJ) and ITR-4 (SUGAM), for the Assessment Year 2024-25. These forms will come into effect from April 1, 2024.



88 The Reserve Bank of India (RBI) has imposed monetary penalties on 4 co-operative banks, ranging from Rs 50,000 to Rs 7 lakh, for some non-compliances.



93 The Union Cabinet chaired by the Prime Minister, Shri Narendra Modi has approved the proposal to open of a Consulate General of India in Auckland, New Zealand.



94 Mitchell Starc became the most expensive player in IPL history, bought by KKR for Rs 24.75 crore.



98 The Ministry of Defence (MoD) has given the green light for the acquisition of 6,400 new rockets for the Pinaka weapon system.



95 Prime Minister Narendra Modi becomes first world leader to reach 2 crore subscribers on YouTube channel.



99 Tesla has unveiled "Optimus Gen 2", a new generation of its humanoid robot that should be able to take over repetitive tasks from humans.



96 UNESCO has awarded Rambagh Gate and Ramparts in Amritsar, Punjab.

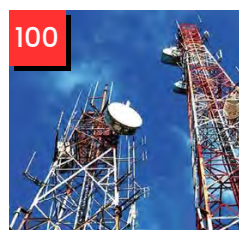

100 At present, the Indian Telecommunications sector is governed by three separate Acts of Parliament – Indian Telegraph Act 1885, Indian Wireless Telegraphy Act 1933, Telegraph Wires, (Unlawful Protection) Act 1950



97 India and Russia signed the agreement on the construction of future power units of the Kudankulam nuclear plant

guidely

ONE GOAL, ONE DREAM - MISSION SELECTION 2024

PREMIUM BUNDLE PDF COURSE 2024

UIIC Assistant PDF Course Included

STARTS FROM

₹599

EXTRA 10% Off

USE CODE: **GUIDELY10**

*Special Offer For PRIME Users

Highlighting Segments

- Beginners Bundle Quiz Course
- Topic-Wise Bundle Course
- Exam-Wise Bundle PDF Course
- Section-Wise Bundle PDF Course
- Memory Based Questions Bundle Course
- Prelims Scoring Part Bundle Course
- Mains Booster Bundle Course
- Critical Reasoning Bundle Course
- Mains Two Mark Questions Bundle Course
- Daily Editorial Based English Questions PDF
- Special Quants Arithmetic Bundle Course
- Special DI & Caselet Bundle Course
- Special Puzzles & Seating Bundle Course
- 101 Version 2.0 New Pattern Puzzles & DI Questions
- Current Affairs Bundle PDF Course
- Static Banking & Static GK Bundle Course
- Computer Awareness Bundle Course

One Time Offer Ends Soon - Hurry!!!

GRAB IT NOW

E-MAGAZINE

December 2023



IMPORTANT DAYS

International Day of Persons with Disabilities 2023: 3rd December



International Day of Persons with Disabilities 2023 is observed on

the 3rd of December 2023. The theme for 2023 is **'United in action to rescue and achieve the sustainable development goals for, with and by persons with disabilities'**. In 1976, the UN General Assembly decided that from 1981 International Day of Persons with Disabilities will be celebrated globally. The UN announced 3rd December as the official date for celebrating the International Day of Persons with Disabilities. The first **Paralympic games were hosted in 1960**.

International Volunteer Day: 5th December



International Volunteer Day 2023 is observed on the 5th of December 2023.

This year's theme is **"If everyone did..."** Volunteerism started in Europe to support elderly people within the community by carrying out Church-related work and helping the poor. Organized Volunteering was started in the 18th Century and mainly to carry out military services rather than give back to society.

World AIDS Day: 1st December

World AIDS Day 2023 is observed on the 1st of December 2023. On 1st December, WHO, together with communities and partners will commemorate World AIDS Day 2023, **under the theme "Let communities lead"**.



World AIDS Day was first initiated in 1998 and observed on December 1. World AIDS Day was the first day celebrated for health awareness.

National Pollution Control Day: 2nd December

National Pollution Control Day 2023 is observed on the 2nd of December 2023. National Pollution Control Day is observed to create awareness about pollution which is causing harm to our environment and living beings. It is nationally observed for the **remembrance of an industrial accident that took place in Bhopal which took thousands of lives in 1984**. The



Bhopal gas tragedy happened on the night of 2nd and 3rd December in the year 1984 because of the unintentional discharge of the poisonous chemical known as Methyl Isocyanate (also called MIC) as well as some other chemicals released from the Union Carbide Chemical Plant positioned in the city.

International Day for the Abolition of Slavery: 2nd December

International Day for the Abolition of Slavery 2023 is observed on the 2nd of December 2023. The International Day for the Abolition of Slavery focuses on eradicating modern forms of slavery like trafficking, sexual exploitation, child labour, forced marriage, and forced recruitment of children into armed conflict.



The International Labor Organization puts the number of victims of modern slavery at 40 million worldwide. U.N. Working Group on Slavery submitted a report that tendered the date for consideration as the **World Day for the Abolition of Slavery in 1985**.

World Computer Literacy Day: 2nd December

World Computer Literacy Day 2023 is observed on the 2nd of December 2023. World Computer Literacy Day was launched in 2001 by an Indian company called N.I.I.T. to celebrate its 20th anniversary. The Company was founded in



1981 by Rajendra Singh Pawar and Vijay K. Thadani. **N.I.I.T stands for National Institute of Information Technology**, is a skills and talent development company.

Nobel Prize Day: 10th December

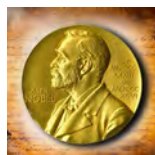

Nobel Prize Day 2023 is observed on the 10th of December

2023. Alfred Nobel's father was an engineer himself and Alfred Nobel expressed early interest in engineering, and explosives in particular. Nobel became interested in stabilizing the unpredictable explosive nitroglycerin. While conducting the experiments an unexpected accident took place which cost the life of his brother. Alfred Nobel died on 10 December 1896, in Sanremo, Italy, at his very last residence, Villa Nobel, overlooking the Mediterranean Sea.

International Mountain Day: 11th December

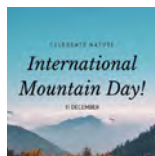

International Mountain Day 2023 is observed on the 11th of December

2023. The United Nations General Assembly declared the International Year of Mountains in 2002. The U.N. establishes December 11 as International Mountain Day each year for the protection and sustainability of mountains. Mountain Day is established and celebrated in Japan as a national holiday for people.

UNICEF Foundation: 11th December



UNICEF Foundation Day 2023 is observed on the 11th of December

2023. UNICEF was created by the **U.N. Relief Rehabilitation Administration in 1946 to provide relief funds for children and mothers affected by World War II** with immediate aid. In that same year, the U.N. General

Indian Navy Day: 4th December

Indian Navy Day 2023 is observed on the 4th of December 2023. The Indian Navy was **established by the East India Company in 1612. Indo-Pakistan took place**



Indian air bases.

in 1971. During the war, Pakistan launched an attack on December 3 on

World Soil Day: 5th December

World Soil Day 2023 is observed on the 5th of December 2023. Life begins and ends from the soil. It's the source of food, medicine, and naturally filters water through its layers and makes it pure water to drink. Most of us take soil for granted and assume it will always be around. But that's not the truth. It takes



200 to 400 years to form a 1cm layer of soil. Making fertile soil takes nearly 3000 years. In **2014, the U.N. General Assembly designated December 5 as the first official World Soil Day at the 68th UN General Assembly.**

International Anti-Corruption Day: 9th December

International Anti-Corruption Day 2023 is observed on the 9th of December 2023. Corruption has existed from time immemorial. Some of the earliest records of anti-corruption texts can be **found in the Code of Hammurabi of Babylonia, the Great Edict of**



Horemheb in Egypt, and Arthashastra in India. These texts spoke about bribery practices among officers of the state and law. The Concept of Public Interest and welfare started to begin in the 19th Century.

Human Rights Day: 10th December

Human Rights Day 2023 is observed on the 10th of December 2023. Human Rights Day's **first observation was started in 1948 when the United Nations General Assembly** adopted the Universal Declaration



of Human Rights. The day was popular to all when the UN issued a Human Rights Stamp which covered and understood the concept by millions of people.

Minorities Rights Day in India: 18th December

Minorities Rights Day 2023 is observed on the 18th of December 2023. Minorities Rights Day was first observed on December 18th, 1992 by the United Nations. The UN adopted the statement on the individual Rights belonging to religious or Linguistic National or Ethnic



Minorities. In India, it is the responsibility of the National Commission for Minorities (NCM) to carry out the events on this day. The NCM was established by the Union Government under the National Commission for Minorities Act, in 1992.

Assembly founded the United Nations International Children's Emergency Fund (UNICEF) to further institutionalize post-war relief work. In 2019, UNICEF's 137

government partners, along with intergovernmental organizations and inter-organizational arrangements, contributed \$4.7 billion.

Goa's Liberation Day: 19th December



Goa's Liberation Day 2023 is observed on the 19th of December 2023.

Goa was still in disrepair after 450 years of Portuguese rule on August 15, 1947, when India attained freedom. One of the first nations to colonize sections of India was Portugal, which continued to cling onto Goa and other Indian regions even after India gained her freedom. Action Vijay, which translates to **"Operation Victory,"** was a 36-hour military operation that began on December 18, 1961, and by the combined forces of the Indian Navy, Air Force, and Army. 451 years of Portuguese rule in the region officially came to an end and the territory was taken back by India on December 19, 1961.

International Human Solidarity Day: 20th December



International Human Solidarity Day 2023 is observed on the 20th of December

2023. **On December 22, 2005, the UN General Assembly** recognized solidarity as one of the fundamental and enduring values of the **twenty-first century by passing Revolution 60/209.** Through the creation of the World Solidarity Fund to end poverty and the declaration of International Human Solidarity Day, the idea of solidarity was propagated.

Universal Health Coverage Day: 12th December

Universal Health Coverage Day 2023 is observed on the 12th of December 2023. The first healthcare system was established by a German named Chancellor Otto von Bismarck in 1883. The insurance model called the **'Bismarckian system'**, required everyone to have insurance for their



medical expenses, which was similar to the current-day non-profit health insurance companies. The World Health Organization is part of the United Nations and is responsible for international public health.

National Energy Conservation Day: 14th December

National Energy Conservation Day 2023 is observed on the 14th of December 2023. National Energy Conservation Day 2023 was **first observed on December 14th, 1991 by the Bureau of Energy Efficiency BEE,** under the Union Ministry of Power which falls under the government of India. The Bureau of Energy Efficiency assists in developing



and implementing strategies and policies to reduce excessive energy consumption. The committee also executed **'The Energy Conservation Act'** in 2001. The main objective of the day is to reduce energy use and encourage people to use it efficiently.

Vijay Diwas: 16th December

Vijay Diwas 2023 is observed on the 16th of December 2023. Vijay Diwas is celebrated for the remembrance of the victory of the Indian Armed Forces in **'Operation: Vijay' against the infiltrating Pakistani troops.** Rich tributes are given to the Armed Soldiers who lost their lives



in the war. Pakistani troops attacked 11 Indian airfields that proved the war on December 3, 1971. At that time Indira Gandhi was the Prime Minister of India. The war ended in just 13 days which is considered one of the shortest wars in history.

International Migrants Day: 18th December

International Migrants Day 2023 is observed on the 18th of December 2023. Although the day was established in 2000, it has been observed **since 1997 that several Asian migrant organizations** designated December 18 as the day to advocate for the respect, rights,



and protection of migrants. On account of the ever-increasing number of migrants around the world, on December 4, 2000, the United Nations General Assembly declared December 18 as the day for International Migrants

Christmas Day: 25th December

Christmas Day 2023 is observed on the 25th of December 2023. The truth is that nobody is certain of the date and location of Jesus' birth. **Sextus Julius Africanus, the earliest Christian historian**, is largely responsible for the creation of December 25. The birth of Jesus would take place exactly nine months later, on December 25.



Good Governance Day: 25th December

Good Governance Day 2023 is observed on the 25th of December 2023. Good Governance Day 2023 is observed for the **birth anniversary of Former prime minister Atal Bihari Vajpayee. Atal Bihari Vajpayee, a former prime minister, and Pandit Madan Mohan Malaviya** were both named as recipients



National Mathematics Day: 22nd December

National Mathematics Day 2023 is observed on the 22nd of December 2023. The renowned mathematician **Srinivasa Ramanujan**, whose works had a widespread impact both in India and around the world, is the driving force behind the establishment of Mathematics Day in that country. Ramanujan was born in 1887 to an Iyengar Brahmin family in

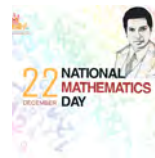

Erode, Tamil Nadu. Despite having little formal schooling, he mastered

trigonometry at the age of 12 and created a number of his own theorems. In 1918, he also became a Fellow of the Royal Society, one of the youngest individuals to hold this prestigious status.

National Consumer Rights Day: 24th December

National Consumer Rights Day 2023 is observed on the 24th of December 2023. When India's Consumer Protection Act of 1986 was passed, consumer rights were given serious consideration. **On August 6, 2019, India's parliament passed the amended Consumer Protection Bill**, taking into account this dynamic and



modern economy. The Right to Information Act, which made India's

governance procedures open to the public and had significant ramifications for consumer rights, is a **supplement to the Consumer Protection Acts of 1986 and 2019.**

of the Bharat Ratna, the country's highest civilian honor, on December 23, 2014.

ONE GOAL, ONE DREAM - MISSION SELECTION 2024

PREMIUM BUNDLE PDF COURSE 2024

UIIC Assistant PDF Course Included

STARTS FROM

₹599

EXTRA 10% Off

USE CODE: GUIDELY10

*Special Offer For PRIME Users

Highlighting Segments

- Beginners Bundle Quiz Course
- Topic-Wise Bundle Course
- Exam-Wise Bundle PDF Course
- Section-Wise Bundle PDF Course
- Memory Based Questions Bundle Course
- Prelims Scoring Part Bundle Course
- Mains Booster Bundle Course
- Critical Reasoning Bundle Course
- Mains Two Mark Questions Bundle Course
- Daily Editorial Based English Questions PDF
- Special Quants Arithmetic Bundle Course
- Special DI & Caselet Bundle Course
- Special Puzzles & Seating Bundle Course
- 101 Version 2.0 New Pattern Puzzles & DI Questions
- Current Affairs Bundle PDF Course
- Static Banking & Static GK Bundle Course
- Computer Awareness Bundle Course

One Time Offer Ends Soon - Hurry!!!

GRAB IT NOW

NATIONAL

Mines Ministry Launches First-Ever Auction of Critical and Strategic Minerals



Union Coal and Mines Minister Pralhad Joshi launched the first-ever critical minerals auction process. The first tranche **e-auction of Critical & Strategic Minerals was launched by Union Minister of Parliamentary Affairs, Coal and Mines, Shri Pralhad Joshi** here on 29th November, 2023. A total of 20 critical mineral blocks will be auctioned in the first tranche, out of which 16 mineral blocks are put up for a grant of Composite Licence and **four mineral blocks for a grant of Mining Lease. SBI Capital Markets Limited and MECL are assisting the Ministry of Mines in conducting the auction process as a Transaction Advisor and Technical Advisor, respectively.**

India joins Executive Committee of Codex Alimentarius Commission



India has been unanimously elected as a member representing the Asian region in the Executive Committee of Codex Alimentarius Commission (CAC) during its **46th meeting being held at FAO Headquarters in Rome. Codex Alimentarius Commission** (CAC), is the food safety and quality standard-setting body created by the UN executive Committee is an important arm of the CAC and the member

Defence Minister Rajnath Singh approves capital acquisition proposals worth Rs 2.23 lakh crore to boost Indian Defence Industry

Defence Acquisition Council headed by Raksha Mantri Rajnath Singh approved capital acquisition proposals worth 2 lakh 23 thousand crore rupees to enhance the operational capabilities of the Armed Forces. Defence Ministry, **98 per cent of the total amount will be sourced from domestic industries.** This will give a substantial boost to the Indian Defence Industry



with the aim of achieving the goal of Aatmanirbharta. The Council has approved the procurement of two types of Anti-tank Munitions namely, **Area Denial Munition (ADM) Type-2 and Type-3**, which are capable of neutralising Tanks and Armoured personnel carriers and enemy personnel.

World's first portable hospital 'Aarogya Maitri Aid Cube' unveiled in Gurugram

The World's first portable hospital, 'Aarogya Maitri Aid Cube' was unveiled in Gurugram. Designed indigenously under the Project 'BHISHM', the modular trauma management and aid system is made up of 72 detachable mini-cubes, each being a specialized station



for emergency response and humanitarian efforts. It can handle bullet injuries, burns, head, spinal and chest injuries, minor surgeries, fractures and major bleeding.

PM launches Green Credit Initiative at COP28 climate conference aimed at reshaping global environmental policies

Prime Minister Narendra Modi launched the 'Green Credit Initiative,' a pathbreaking program aimed at reshaping global environmental policies. He also launched the official portal of the Green Credit Initiative at COP28. The Prime Minister highlighted the limitations of the current carbon credit system, influenced by commercial interests and lacking a sense of countries have a considerable interest in getting its membership.



social responsibility, paving the way for a new philosophy embodied in the **'Green Credit'** concept. Ulf Kristersson, Prime Minister of Sweden, praised the initiative, citing Sweden's success with the Climate Leap, reducing climate emissions by 3.3 million tonnes per year through collective action.

India re-elected to International Maritime Organisation with the highest vote tally



In elections held at its assembly for the 2024-25 biennium, India was re-elected to the International Maritime Organisation (IMO) Council with the highest tally. India's re-election falls under the Category of 10 states with "the largest interest in international seaborne trade", alongside Australia, Brazil, Canada, France, Germany, the Netherlands, Spain, Sweden, and the United Arab Emirates (UAE). India has been elected in the category of ten countries with the largest interest in international seaborne trade. **The term of the Council will be for the biennium 2024-25.**

India will be the largest cotton producer



According to the Union Minister for Textiles, Commerce and Industry, **India will strive to become the largest cotton producer globally.** He was inaugurating an annual global meeting - the 81st plenary session of the **International Cotton Advisory Committee (ICAC)** - a UN recognised body of cotton producing and consuming nations. Cotton is one of the most important commercial crops cultivated in India and accounts for around 25% of the total global cotton production. India has the largest area under cotton cultivation and is the second largest producer (after China).

Indian Railways allows MNCs to deploy indigenous Kavach anti-train collision system on the network

India's ability to deploy automatic train collision avoidance systems - Kavach - is expected to get a fillip with global companies getting approvals to install it on the national transporter. Germany's Siemens and Japan's Kyosan are the two newly approved Kavach deployment companies. Railways Minister **Ashwini Vaishnaw Kavach deployment will increase to 5000 kilometers (kms) per annum in the financial**



year 2025-26, up from 1500 kms annually.

About KAVACH

The KAVACH is an indigenously developed ATP system by the Research Design and Standards Organisation (RDSO) in collaboration with Indian industry.

KAVACH is meant to provide protection by preventing trains to pass the signal at Danger (Red) and avoid collision.

Cabinet approves Terms of Reference for the Sixteenth Finance Commission

The Union Cabinet chaired by the Prime Minister, **Shri Narendra Modi has approved the Terms of Reference for the Sixteenth Finance Commission.** The Terms of Reference for the Sixteenth Finance Commission will be notified in due course of time. The 16th Finance Commission's recommendations, upon acceptance by the government, **would cover a period of five (5) years commencing April 1, 2026.** Article 280(1) of the Constitution lays down that the modalities for setting up of a Finance



Commission to make recommendation on the distribution of net proceeds of taxes between the Union and the States, allocation between the States of respective shares of such proceeds; grants-in-aid and the revenues of the States and measures needed to supplement the resources of the Panchayats during the award period. The Fifteenth Finance Commission was constituted on November 27, 2017.

Centre approves reconstruction plan worth over 1658 crore rupees for Joshimath in Uttarakhand

Centre has approved the recovery and reconstruction plan of over 1658 crore rupees for Joshimath which was affected by landslide and ground subsidence early this year. A High-Level Committee under the **chairmanship of Union Home Minister Amit Shah approved the plan.** Under it, around 1080



crore rupees of Central assistance will be provided from the recovery and reconstruction window of the National Disaster Response Fund. The Uttarakhand government will provide over 126 crore rupees from its State Disaster Response Fund towards relief assistance.

Ministry of railways launched Amrit Bharat Station scheme for the development of stations



The Ministry of Railways has launched the Amrit Bharat Station

Scheme for the development of stations on Indian Railways. So far, **1309 Stations** as appended have been identified for development under this scheme. Modernisation/upgradation of railway stations is a continuous and ongoing process. The Ministry of Railways also envisages exploration of various models for the development and/or maintenance of railway stations including **Engineering, Procurement and Construction (EPC), non-EPC modes etc. and a minuscule number of stations under Public Private Partnership (PPP) mode.**

India to host four-day 27th WAIPA World Investment Conference in New Delhi



India will host four-day 27th WAIPA World Investment Conference in

New Delhi. National Investment Promotion and Facilitation Agency of the Government of India, and World Association of Investment Promotion Agencies are organizing the conference at the India International Convention & Expo Centre - Yashobhoomi, New Delhi. Under the aegis of the Department for Promotion of Industry and Internal Trade, it will be the **largest World Investment Conference ever.** Union Minister of Commerce & Industry, Consumer Affairs, Food & Public Distribution, and Textiles, Piyush Goyal will

'India Internet Governance Forum 2023' to discuss public policy issues related to Internet in New Delhi

India Internet Governance Forum 2023' will be held in New Delhi. The forum is a multi-stakeholder platform bringing together representatives from various groups to discuss public policy issues related to the Internet. The theme of the event is **Moving Forward - Calibrating Bharat's Digital Agenda.** Electronic and IT Ministry stated, the event is an effort to discuss issues



such as building a secure, trusted and resilient cyberspace for Bharat,

Enabling Innovation for India's Developmental Goals, Bridging Divides and Calibrating Bharat's Digital Agenda. The India Internet Governance Forum is an initiative associated with the UN Internet Governance Forum.

South Central Railway commissions electrification of 64 Km line between Devarkadra-Krishna in ongoing Munirabad-Mahabubnagar new railway line project

South Central Railway has completed electrification of the existing rail network in Telangana region except for the newly laid rail lines. In the next step, as part of electrification of newly constructed lines, 64 route Kms between **Devarkadra - Krishna** has been electrified on mission mode. The New Broad Gauge line between **Krishna -**



Devarkadra has been completed and recently commissioned

as part of Mahabubnagar - Munirabad new line project. The DEMU passenger train services were also commissioned in this new section recently in October, 2023.

India emerges as major contributor to organic and natural products market globally

India has emerged as a major contributor to the organic and natural products market globally and its share in the market was **17 thousand 8 hundred 53 crore** Rupees in the last three years. In a written reply in Lok Sabha, Union Minister for Agriculture and Farmer Welfare Narendra Singh Tomar stated that as per the report of the World of Organic Agriculture Statistics and Emerging Trends 2023, the



demand for organic products has increased throughout the world

from 21 Billion US Dollars in 2001 to 135.50 Billion US Dollars in 2021. The major organic products exported from the country during the last three years include **Cereals, millet, Processed Food, Tea, Spices, Condiments, Dry Fruits, Sugar, Medicinal plant products, Pulses, Coffee, Oil seeds.**

deliver the keynote address on the Role of Trade and Investment in the Decade of Action.

India Joins Consortium to Advance Deployment Of Battery Energy Storage Systems



India became a member of the Battery Energy Storage Systems (BESS) Consortium, an initiative led by The Global Leadership Council (GLC) of the Global Energy Alliance for People and Planet (GEAPP). As a part of this collaborative effort, India stands among the pioneering nations committed to securing 5 Gw of BESS commitments by the conclusion of 2024. In September, the government endorsed viability gap funding for BESS development. The scheme aims to facilitate establishing 4,000 Mwh of BESS projects by 2030-31, providing financial assistance of up to 40 per cent of the capital cost through budgetary support in the form of VGF.

IRCON International shares tank over 8% as govt launches OFS to sell up to 8% stake



The Union government has proposed to sell an 8% stake in IRCON International through an offer for sale (OFS). The government will offload about 3.76 crore shares, which represents a 4% stake through the OFS, and in the case of oversubscription, an additional 4% stake will be under sale. The offer for sale will take place on December 8 through a separate window on the stock exchanges. As of September-end, the government holds a 73.18% stake in the company.

India to spend 57 lakh crore rupees on adaptation to climate change over next 7 years

India spent about Rs 13.35 lakh crore in 2021-22, just over 5.5% of its GDP, on climate adaptation and expects to incur another about **Rs 57 lakh crore over the next seven years for this purpose**. But this is only in the business-as-usual scenario, that is only if climate vulnerability does not deteriorate during this period. Climate-induced damage could escalate this amount by another



Rs 15.5 lakh crore. The Central government informed the UN Framework for Climate Change Convention (UNFCCC), recently. The UNFCCC secretariat (UN Climate Change) is the United Nations entity tasked with supporting the global response to the threat of climate change.

PM Formalization of Micro Food Processing Enterprises Scheme

PM Formalisation of Micro food processing Enterprises (PMFME) Scheme is a centrally sponsored scheme launched in 2020. The scheme is operational for a period of five years from 2020-21 to 2024-25 with an outlay of Rs. 10,000 Crore for supporting 2 lakh micro food processing

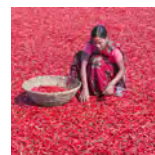

enterprises. Funding: 90:10 ratios with North Eastern and Himalayan States. 60:40 ratios with UTs with legislature, and 100% by Centre for other UTs. 60:40 ratios between Central and State Governments for other states.

NMCG Launches Global River Cities Alliance at the United Nations Climate Change Conference in Dubai

The Global River Cities Alliance (GRCA) was launched at COP28, the United Nations Climate Change Conference in Dubai, UAE. The National Mission for Clean Ganga (NMCG) led the alliance under the Ministry of Jal Shakti, Government of India. The alliance includes countries such as **Egypt, Netherlands, Denmark, Ghana, Australia, Bhutan, Cambodia, Japan, and river-cities of The Hague (Den Haag) from the Netherlands, Adelaide from Australia, and**



Szolnok of Hungary. International funding agencies like the World Bank, Asian Development Bank (ADB), Asian Infrastructure Investment Bank (AIIB), and knowledge management institutions like KPMG have entered into a partnership to expand the reach of the existing River Cities Alliance (RCA), which was formed by NMCG in association with the National Institute of Urban Affairs (NIUA) in 2021.

Union Minister for Power RK Singh inaugurates National Conference on “Energy Transition in India in Gandhinagar



Union Minister for Power and New and Renewable Energy Shri R.K.

Singh inaugurated a two-day National Conference on “**Energy Transition in India - Road Travelled and Opportunities Ahead**” in Gandhinagar. Shri Kanubhai Desai, Minister of Energy Petrochemicals and Finance, Government of Gujarat was also present along with other dignitaries on the occasion. Organized as a part of the upcoming Vibrant Gujarat Global Summit 2024, the event is being attended by more than 250 Indian and foreign representatives of power and renewable energy sector.

Union Minister for Power RK Singh inaugurates National Conference on “Energy Transition in India in Gandhinagar



Union Minister for Power and New and Renewable Energy Shri R.K.

Singh inaugurated a two-day National Conference on “**Energy Transition in India - Road Travelled and Opportunities Ahead**” in Gandhinagar. Shri Kanubhai Desai, Minister of Energy Petrochemicals and Finance, Government of Gujarat was also present along with other dignitaries on the occasion. Organized as a part of the upcoming Vibrant Gujarat Global Summit 2024, the event is being attended by more than 250 Indian and foreign representatives of power and renewable energy sector.

DARPG launches Scheme and Web-portal for National Awards for e-Governance 2024

The Web portal (<http://www.nceg.gov.in>) for the National Awards for e-Governance (NAeG) 2024 was launched. The formal launching was organised by the Department of Administrative Reforms & Public Grievances (DARPG). The Central Ministries / Departments as well as the Principal Secretaries (AR) and (IT) and the DCs/DMs of all **the 28 States and 8 UTs of India as well as Award Winners of NAeG 2023 were invited for the launch ceremony in hybrid mode.** The web portal for National Awards for



e-Governance 2024 has been made live on 8th December, 2023. The

advertisement in this regard has also appeared in newspapers on 2nd December, 2023 and the last date for submission of nominations is 29th December, 2023. The portal, namely, www.nceg.gov.in for due registration and the submission of applications for the NAeG, 2024 will also be operational from 8th December 2023 to 29th December, 2023.

517 UDAN Routes Operate Across 76 Airports; INR 1000 Cr Allocated for Further Development

Under the government's flagship regional connectivity scheme UDAN (Ude Desh Ka Aam Nagrik), **517 RCS routes have so far commenced operations connecting 76 airports, including nine Heliports & two water aerodromes.** The UDAN scheme aims at fostering regional air connectivity at affordable rates and has been designed to facilitate air operations on



underserved and unserved routes. Airlines participating in the UDAN scheme

are required to allocate a specified number of seats as RCS seats, varying based on the type and size of the aircraft deployed for RCS flights. Selected Airline Operators also receive financial support in the form of Viability Gap Funding (VGF).

Ministry of Textiles to host ‘One Bharat Sari Walkathon’ in Mumbai

The Ministry of Textiles will organize the country's largest ever ‘OneBharatSariWalkathon’ in India's financial capital, Mumbai. The event aims to promote the handloom sari culture in India by inviting participation of women across the country to showcase their ways of wearing saris and thus present India as a country of “**Unity in Diversity**”. It will



also promote the spirit of traditional textile & support the idea of “**Vocal for**

Local” and will raise awareness about fitness among women and to encourage them lead healthier lives. Previously, the Sari Walkathon was organized in Surat.

Raksha Mantri Shri Rajnath Singh inaugurates 10-foot tall statue of Mahatma Gandhi, Delhi



Raksha Mantri Shri Rajnath Singh inaugurated a 10-foot tall statue of Mahatma Gandhi at Gandhi Darshan near Rajghat, Delhi. Raksha Mantri described the statue as a befitting tribute to the Father of the Nation, who played a central role in freeing India from foreign rule and worked for the upliftment of the weaker sections of society to lead a dignified life. Shri Rajnath Singh emphasised that the Government's focus has always been on planned progress, which has resulted in India becoming the **5th largest economy in the world.**

PM inaugurates 'Uttarakhand Global Investors Summit 2023'



The Prime Minister, Shri Narendra Modi inaugurated 'Uttarakhand Global Investors Summit 2023' being held at Forest Research Institute, Dehradun, Uttarakhand. Shri Modi also took a walkthrough of the exhibition and unveiled the Ground Breaking Wall. Prime Minister Modi also launched a book Sashakt Uttarakhand and the brand House of Himalayas. The theme of the Summit is '**Peace to Prosperity**'. Industry leaders also expressed their views on the occasion.

Ministry of Tourism launches National Best Tourism Village and National Best Rural Homestays Competition 2024

Ministry of Tourism has launched National Best Tourism Village Competition 2024 and the National Best Rural Homestay Competition 2024 to strengthen the promotion and development of Rural Tourism in the country. The earlier version of the National Best Tourism Village Competition 2023 recognized 35 villages all over India in the Gold, Silver, and Bronze categories. For



the enhancement of Rural Tourism in India the Ministry of Tourism, Government of India launched the comprehensive National Strategy and Roadmap for the Development of Rural Tourism in India, along with the National Strategy for the Promotion of Rural Homestays.

"HaritSagar" Green Port Guidelines to reduce carbon intensity and to develop an environment-friendly ecosystem at all Major Ports

The Ministry of Ports, Shipping and Waterways, Shri Sarbananda Sonowal has launched "HaritSagar" Green Port Guidelines to reduce carbon intensity and to develop an environment-friendly ecosystem at all Major Ports. Under these guidelines, various green interventions such as ship-to-shore power supply, electrification of Port equipment, usage of alternate fuels such as green Hydrogen/Green Ammonia/Methanol in port crafts, creation of infrastructure at select Ports for



storage, bunkering, and refuelling of Green hydrogen/Green Ammonia, increase share of Renewable Energy etc. have been provided. **Deendayal Port, Visakhapatnam Port and New Mangalore Port** are generating surplus renewable energy. The management and notification of berth/jetty in Major Ports for chemicals and dangerous materials are being carried out as per the **Port Regulation framed in the ambit of the Explosive Act, 1884.**

Youth for Unnati and Vikas with AI (YUVAi) to feature in GPAI Summit 2023

Youth for Unnati and Vikas with AI' (YUVAi) is set to be prominently featured at the upcoming Global Partnership on Artificial Intelligence (GPAI) Summit. '**Youth for Growth and Vikas with AI**' is a collaboration-based initiative of the National e-Governance Division (NeGD), Ministry of Electronics and Information Technology, Government of India, and Intel India. The GPAI summit is



beginning on 12 December in New Delhi. This program is designed to equip youth with essential AI skills. The program is drawing attention to its innovative approach and commitment aimed at enabling a future-ready workforce. Youth for Unnati and Vikas with AI aims to promote a deeper understanding of AI.

Union Health Minister Dr Mansukh Mandaviya inaugurates new State-of-the-Art facilities at ICMR-NIMR



Dr. Mansukh Mandaviya, Union Minister of

Health and Family Welfare while inaugurating five new facilities at the **Indian Council of Medical Research - National Institute of Malaria Research (ICMR-NIMR)**. The facilities included a Test Research Laboratory, an Innovation Complex, a Conference Hall Complex and a 300-seat Auditorium. He was joined by Prof. S.P. Singh Baghel and Dr. Bharati Pravin Pawar, Union Ministers of State for Health and Family Welfare. The Union Health Minister highlighted the century-long journey of ICMR and its role in shaping India's medical research landscape. Strengthening the institute's infrastructure is a step towards moving to malaria elimination in the country by 2030.

India's first Six Lane Steel Slag based Road Connecting NH-6 to Hazira Port has been constructed



India's first Six six-lane steel slag-based Road

Connecting NH-6 to Hazira Port has been constructed. Steel Slag is produced as a solid waste during steel production. Around 180 - 200 kg of steel slag is generated per tonne of steel production. The Ministry of Steel has funded a R&D project on **"Development of Design Guidelines and Specifications for utilization of Steel Slag in road construction"**.

Youth for Unnati and Via Ministry of Tourism kicks off Amrit Dharohar Capacity Building Scheme 2023 in collaboration with Ministry of Environment, Forest & Climate Change kas with AI (YUVAi) to feature in GPAI Summit 2023

The Ministry of Tourism (MoT) in collaboration with Ministry of Environment, Forest & Climate Change (MoEFCC) launched an Alternative Livelihood Programme under the Amrit Dharohar Capacity Building Scheme in Sultanpur National Park, a Ramsar Site in Haryana. Under this initiative, **IITM, an autonomous body under MoT, in collaboration with MoEFCC will build the capacity of local community members** around different Ramsar sites in order to



strengthen nature tourism at these sites and provide alternative livelihood

to the local community. Sultanpur is one of the five priority Ramsar Sites besides Bhitarkanika and Chilika in Odisha and Yashwant Sagar and Sirpur in Madhya Pradesh identified in first phase by MoT and MoEFCC for taking up training programmes for local communities under the Alternative Livelihood Programme (ALP).

Union Minister Shri Arjun Munda inaugurates ASEAN-India Millet Festival at New Delhi

Union Minister of Agriculture and Farmers' Welfare and Tribal Affairs Shri Arjun Munda inaugurated ASEAN-India Millet Festival today at New Delhi. Ministers of States for Agriculture and Farmers' Welfare Shri Kailash Choudhary and Sushri Shobha Karandlaje and Secretary, Department of Agriculture and Farmers' Welfare, Shri Manoj Ahuja were also present on the occasion. In line with the International Year of Millets, the festival aims to increase awareness and establish a larger market for millet and millet-



based products. The festival will conclude on 15th December 2023. The event

followed a preceding festival held in Jakarta, Indonesia from 22-26 November 2023. On day two of the festival, a Business-to-Business (B2B) meeting is organized by APEDA. Under the visionary leadership of Prime Minister **Shri Narendra Modi, the Government of India has played an important role in organizing the mega event of International Millets Year 2023.**

The 29th Kolkata International Film Festival: Israeli film 'Children of Nobody' won the Best film award

The 29th Kolkata International Film Festival ended. Israeli film 'Children of Nobody' won the Best Film Award under International Competition in Innovation Moving Images. It is directed by Erez Tadmor. Director duo Sharmistha Maity and Rajdeep Paul's 'Mon Potongo' won the award for the best film under the Bengali Panorama category. In addition



to these, Hiralal Memorial Trophy, and Netpack Award were also given 29th

Kolkata International Film Festival was organized by the Information and Cultural Affairs Department, Government of West Bengal. It was held from 5 - 12 December 2023 in Kolkata.

Prime Minister Shri Narendra Modi to inaugurate Kashi Tamil Sangamam 2023



The second phase of Kashi Tamil Sangamam will be inaugurated by Prime Minister Shri Narendra Modi at the Namohat, Varanasi. The first batch of Tamil delegation comprising a group of students from various parts of Tamil Nadu named after the sacred river '**Ganga**' reached the holy city of Kashi (Varanasi) to attend the 15-day-long second phase of Kashi Tamil Sangamam. They were received with a grand welcome upon arrival at the Varanasi Cantt. Railway Station. During their stay, they will also visit Prayagraj and Ayodhya. Six more groups comprising Teachers (Yamuna), Professionals (Godavari), Spiritual (Sarawati), Farmers and Artisans (Narmada), Writers (Sindhu) and Traders and Businessmen (Kaveri) will be reaching Kashi to participate in the Sangamam during the event.

CCI approves scheme of arrangement involving Dhani Services Limited, Indiabulls Enterprises Limited, Savren Medicare Limited



The Competition Commission of India (CCI) has approved the scheme of arrangement involving Dhani Services Limited, Indiabulls Enterprises Limited, Savren Medicare Limited, Auxesia Soft Solutions Limited, Gyansagar Buildtech Limited, Pushpanjali Finsolutions Limited, Devata Tradelink Limited, Evinos Developers Limited, Milky Way Buildcon Limited, Indiabulls

Indian Forest & Wood Certification Scheme launched to promote Sustainable Management of forests and agroforestry

The Ministry of Environment, Forests and Climate Change has launched the Indian Forest & Wood Certification Scheme. This national forest certification scheme offers voluntary **third-party certification designed to promote sustainable forest management and agroforestry in the country.** The scheme includes forest management certification, tree outside forest management certification, and chain of custody certification. The Forest Management certification

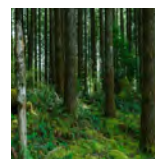

is based on the Indian Forest Management Standard, consisting of 8 criteria, 69 indicators and 254 verifiers, which is an integral part of the National Working Plan Code 2023, launched earlier this year. Indian Institute of Forest Management, Bhopal will act as the scheme operating agency and will be responsible for overall management of the scheme.

Rajya Sabha Passes Bill On Appointment Of Chief Election Commissioner and Election Commissioners

The Rajya Sabha has passed a Bill to regulate the appointment of the Election Commission of India. The bill retained the status of the CEC and two ECs on par with judges of the Supreme Court. The earlier Bill sought to downgrade their service conditions, aligning them with those of a Cabinet Secretary. The Election Commission is a permanent and independent body by Article 324 of the Constitution of India. The Chief Election Commissioner and other Election Commissioners (Appointment, Conditions of Service and Term of Office) Bill, 2023, was passed in the Upper House of Parliament with a voice vote. The bill seeks to replace



the Chief Justice of India with a Cabinet Minister nominated by the Prime Minister in the committee for selection of the CECs and ECs. First, a Search Committee, **headed by the Law Minister, would propose a panel of names to the selection committee.** The Selection committee will be chaired by the PM and will include the Leader of the Opposition or leader of the single largest Opposition party in Lok Sabha and a Cabinet Minister nominated by the Prime Minister. The terms of the CEC and ECs remain unchanged, at six years or until they reach the age of 65 years, whichever is earlier.

Consumer Products Limited, Indiabulls Infra Resources Limited, Jwala Technology Systems Private Limited, Mabon Properties Limited, YDI Consumer India Limited, Indiabulls General Insurance Limited, Indiabulls Life Insurance Company Limited, Juventus Estate Limited, India Land Hotels Mumbai Private

Limited, Indiabulls Pharmcare Limited, and Yaari Digital Integrated Services Limited.

NTPC Group achieves its fastest-ever 300 Billion Units Electricity Generation



NTPC Group has achieved the fastest-ever

300 Billion Units (BU) electricity generation. This milestone was achieved in just 262 days in FY 2023-24, which is 18 days early compared to the last financial year. In FY 2022-23, the **company had crossed 300 BU generation on 5th January 2023.** On a standalone basis, 256 BU generation has been recorded from NTPC stations in FY 2023-24. This accomplishment reinforces NTPC's commitment to delivering reliable and affordable power to the Nation. While **NTPC has an installed capacity of approximately 74 GW, over 18 GW capacity including 5 GW Renewables is under construction.** The company is committed to achieve 60 GW of Renewable Energy capacity by the year 2032.

Amrit Technology For Removal Of Arsenic And Metal Ions From Water

IT Madras developed 'AMRIT' for removing Arsenic and Metal ions from water. 'AMRIT' (Arsenic and Metal Removal by Indian Technology) uses nano-scale iron oxy-hydroxide. It removes arsenic when water is passed through it. This water purifier technology has been developed for both domestic as well as community levels. This technology has been recommended by the 'Standing Committee' of the Department of Drinking Water and Sanitation for the examination of the best technologies related to water and sanitation. Government launched the Jal Jeevan Mission (JJM) for the planning, approval, implementation, operation, and maintenance of drinking water supply schemes.

Pradhan Mantri Bhartiya Janaushadhi Pariyojana achieved their target of Rs. 1000 Crore in sales in FY 2023-24

Pradhan Mantri Bhartiya Janaushadhi Pariyojana (PMBJP) has created another landmark in the history of generic medicines in the country by selling medicines worth Rs. 1000 Crore this year. This achievement was made possible only by the people of the country, who have saved approximately 5000 crores by purchasing medicines from Jan Aushadhi Kendras which is present in more than 785 districts of the country. Hon'ble Prime Minister in his Independence Day speech, 2023 has announced the opening of 25,000 Pradhan Mantri Bhartiya Janaushadhi Kendras (PMBJKs) across the country. The Prime Minister virtually launched the **10,000th Janaushadhi Kendra at AIIMS, Deoghar,**



Jharkhand on 30th November, 2023 and further paved the way for

expanding the number of Kendras to 25,000 for wider outreach and easy accessibility of medicines to the people of the country. Accordingly, the Government has set a target to open 25,000 Janaushadhi Kendras across the country by March, 2026. Online applications have been called for opening of new Janaushadhi Kendras across all districts of the nation through the official website of PMBI, i.e.; - www.janaushadhi.gov.in and for any further communication, anyone may contact through the national toll-free number i.e.; 1800 180 8080.

CCI approves certain business undertakings of Ind Swift Laboratories Limited and Essix Biosciences Limited by Synthimed Labs Private Limited

The Competition Commission of India (CCI) has approved the proposed acquisition of certain business undertakings of Ind Swift Laboratories Limited and Essix Biosciences Limited by Synthimed Labs Private Limited. The Proposed Combination involves slump sale of certain business undertakings (on a going concern basis) of Ind



Swift Laboratories Limited (ISLL) and Essix Biosciences Limited (Essix)

(collectively, "**Target Business**") to Synthimed Labs Private Limited (Synthimed). Subsequently, ISLL will acquire a minority shareholding in the Acquirer.

Unnati Foundation : First Entity To List On The Social Stock Exchanges

Unnati Foundation became the first entity to list on the social stock exchanges (SSE). SUF is a not-for-profit organisation (NPO) incorporated in 2011 that has trained over 45,000 youth. The entity had raised **₹1.8 crore from Zerodha, Nabard, Govind Iyer, and Ashish Kacholia during its fundraising period between October 30 and November 22.** On listing, the Zero Coupon Zero Principal (ZCZP) instruments



with a face value of ₹1 each will get credited into the demat accounts of

the respective donors. The SEBI board recently approved halving the minimum size of ZCZPs by NPOs on SSEs to Rs 50 lakh from Rs 1 crore. The minimum application size will be reduced to ₹10,000 from ₹2 lakh to enable wider participation.

Govt gives Rs 5,228 crore subsidy to incentivize 11.53 lakh EVs in 2023



The government has given 5,228 crore rupees subsidy to incentivize 11.53 lakh Electric Vehicles in the country in 2023. The government has also sanctioned 800 crore rupees to PSU Oil marketing companies for setting up seven thousand 432 public fast-charging stations across the country. Ministry of Heavy Industries said that a total of 148 Electronic Vehicles Public Charging Stations are currently working in the country. The Ministry said that it is implementing Phase II of the Faster Adoption and Manufacturing Electric Vehicles (FAME-II) scheme to reduce dependence on fossil fuels and address the issue of vehicular emissions.

Home Minister Amit Shah inaugurates and lays foundation stone of several projects worth over Rs 3500 crore in Chandigarh



Union Home Minister Amit Shah inaugurated 9 projects worth 368 crore rupees and laid the foundation stone of three projects worth 3200 crore rupees in Chandigarh. He also flagged off the fleet of Chandigarh Police cars worth 3.75 crore rupees and a state-of-the-art police control vehicle 'Eagle'. The Home Minister also handed over appointment letters to newly recruited 700 constables and 44 ASI in Chandigarh police today and congratulated them. Cyber Operation and Security Centre (CENCOPS) has also been inaugurated.

India's coal demand to grow at 3.5% annually till 2026: IEA

India's coal demand is expected to increase by 3.5% annually till 2026, according to the International Energy Agency (IEA) In its latest coal report, IEA estimates India's coal demand to rise to 1,397 million tonnes (mt). Coal demand in India accounted for 14% of the global demand. It is expected that the demand have increased by 8% or 98 mt in 2023. IEA forecasts 2.4% annual growth in coal consumption for power generation for the next



three years. IEA said renewable energy generation is forecast to grow by 12% annually. IEA estimates a moderate increase in coal for power generation of 69 mt to 2026. IEA estimates non-power thermal coal and lignite consumption to have increased by 12 mt in 2023, to 243 mt. India is the world's second largest consumer of the coal.

Union Home Minister Amit Shah introduces re-drafted criminal Bills in Lok Sabha

Union Home Minister Amit Shah introduced re-drafted criminal Bills. Union Home Minister Amit Shah presented three re-drafted Bills in the Lok Sabha to replace the existing British-era criminal laws. The new bills incorporate the changes recommended by a parliamentary committee. The Bharatiya Nyaya (Second) Sanhita Bill (BNSS), 2023 will take the place of the Indian Penal Code of 1860. The "economic security" and "damage or destruction



of any property in India or in a foreign country used or intended to be used for the defense of India" have been included in the definition of terrorist. The Bharatiya Sakshya (Second) Bill, 2023 and the Bharatiya Nagarik Suraksha (Second) Sanhita Bill, 2023 will also replace the Indian Evidence Act, 1872 and the Code of Criminal Procedure, 1898, respectively

Govt allows extra borrowing ceiling of over Rs 60,000 crore to states for NPS

Government allowed additional borrowing of Rs 60,000 crore to 22 states for the National Pension Scheme. The Department of Expenditure approved an extra borrowing of Rs 60,876.8 crore to 22 States in 2023-24 for the National Pension Scheme. 3 per cent of the Gross State Domestic Product (GSDP) or Rs 8,59,988 crore in absolute terms was fixed as the normal net

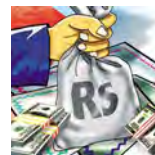

borrowing ceiling for states in FY24. The central government has earlier approved additional financial incentives worth Rs 66,413 crore to 12 states for reforms in the power sector. Additional borrowing of Rs 39,175 crore was allowed to 12 states in 2021-22 and Rs 27,238 crore to 6 States in 2022-23.

ICAI unveils new CA India logo

Vice-President of India, Jagdeep Dhankhar launched this new logo of the Institute of Chartered Accountants of India (ICAI). The new logo has been unveiled at a recently held Global Professional Accountants Convention (GloPAC), in Gandhinagar. It is made up of the letters 'CA' in blue with a tricolour tick mark (upside down) on a white background. The blue colour denotes innovativeness, creativity, knowledge, trust, integrity, stability, truth, and depth. The upside-down tick mark in tricolor has been included to symbolise the wisdom and value of the professionals.

CBDT notifies ITR Forms ITR-1 and ITR-4 for AY 2024-25

The Central Board of Direct Taxes (CBDT) has notified two new return forms, ITR-1 (SAHAJ) and ITR-4 (SUGAM), for the Assessment Year 2024-25. These forms will come into effect from April 1, 2024. ITR-1 (SAHAJ) is to be used by individuals with total income up to Rs 50 lakh, having income from salaries, one house property, other sources (like interest) and agricultural income up to Rs 5,000. On the other hand, ITR-4 (SUGAM) is applicable to individuals, HUFs and firms (other than LLPs) with total income up to Rs 50 lakh and income from business and profession computed under Sections 44AD, 44ADA or 44AE. July 31, 2024 is the last date to file ITR for FY 2023-24 (AY 2024-25), unless it gets extended.

France President Emmanuel Macron to be Chief Guest for 75th Republic Day celebrations

President of France Emmanuel Macron will be the Chief Guest for the 75th Republic Day celebrations. External Affairs Ministry, at the invitation of Prime Minister Narendra Modi, the President of France will visit India for the Republic Day celebrations. India and France share a high degree of convergence on a



range of regional and global issues. This year, both countries are celebrating the 25th anniversary of the India-France Strategic Partnership. Prime Minister Modi was the Guest of Honour at the Bastille Day Parade held on 14 July 2023 in Paris.

Union Minister Smriti Irani inaugurates National Programme on Anganwadi-cum-Crèches in New Delhi

Union Minister Smriti Irani inaugurated the National Programme on Anganwadi-cum-Crèches in New Delhi. The government is planning to open 17 thousand creches all around the country. The objective of Anganwadi-cum-Crèches is to provide quality Creche facilities in a safe and secure environment for children aged between 6 months



to 6 years. These crèches will provide nutritional support, health and cognitive development of children. It will also ensure immunization, education etc. of children's. Palna, a sub-scheme under Mission Shakti, was launched in April 2022 to provide daycare facilities and protection to children.

Union Minister Bhupender Yadav launches a NITI Aayog report, 'A Green and Sustainable Growth Agenda for the Global Economy'

Union Minister Bhupender Yadav launched a NITI Aayog report, 'A Green and Sustainable Growth Agenda for the Global Economy'. A report titled 'A Green and Sustainable Growth Agenda for the Global Economy' has been released in the presence of Amitabh Kant, Sherpa, G20 India, and Suman Bery, Vice Chairman, NITI Aayog. NITI Aayog



published this report in partnership with the International Development Research Centre (IDRC) and the Global Development Network (GDN). This report has been released to enable the transfer of knowledge that came out of the G20 international conferences.

Centre releases ₹72,961 crore as tax devolution to States

The Centre has released ₹72,961 crore in the form of tax devolution to States. Out of the ₹72,961.21 crores installment disbursed, the largest share has gone to Uttar Pradesh. Uttar Pradesh is followed by Bihar at



₹7,338.44 crore, Madhya Pradesh at ₹5,727.44 crore and West Bengal ₹5,488.88 crore. It would submit its report to the President by October 31, 2025.

1467 projects of National Highways Authority of India (NHAI) have been brought under the Bhoomi Rashi Portal



The Union Minister of Road Transport and Highways, 1467 projects of the National Highways Authority of India (NHAI) have been brought under the Bhoomi Rashi Portal. It is an e-governance initiative of the Ministry of Road Transport and Highways. The portal intends to expedite the process of land acquisition for National Highways. It acts as a single-point platform for the online processing of land acquisition notifications to accelerate highway infrastructure development projects in India. This portal would enhance the efficiency of the land acquisition process, ensure transparency and accountability, and result in the e-transfer of benefits directly to the accounts of the beneficiaries.

Cabinet approves opening of Consulate General of India in Auckland, New Zealand



The Union Cabinet chaired by the Prime Minister, Shri Narendra Modi has approved the proposal to open of a Consulate General of India in Auckland, New Zealand. Opening of Consulate General of India in Auckland would help in increasing India's diplomatic footprint and strengthen India's diplomatic representation in view of India's increasing global engagement. This will also help promote India's strategic and commercial interests and better serve the welfare of Indian community in Auckland. The Consulate is likely to be opened and fully operationalized within a time frame of 12 months.

Govt app to allow live tracking of cargo across land, rail, sea & air

India will launch an app that will enable companies to track their live cargo across land, rail, sea, and air. The app has garnered interest from over 700 companies across courier, logistics, shipping, and manufacturing. The National Industrial Corridor Development Corporation (NICDC) is reportedly developing this app, NICDC will use specific tracking codes to track and trace the consignment. The initiative is part of India's



plan to streamline logistics and reduce costs. India's logistics cost was 7.8-8.9% of the country's gross domestic product (GDP) in fiscal year 2022. India wants to reduce it to 5-6%. The app also aligns with India's broader plan to improve its ranking in the World Bank's Logistics Performance Index, from 38 currently down to 25.

Dr. Mansukh Mandaviya virtually launches 'MedTech Mitra': A Strategic Initiative to Empower MedTech Innovators and Advance Healthcare Solutions

India will launch an app that will enable companies to track their live cargo across land, rail, sea, and air. The app has garnered interest from over 700 companies across courier, logistics, shipping, and manufacturing. The National Industrial Corridor Development Corporation (NICDC) is reportedly developing this app, NICDC will use specific tracking codes to track and trace the consignment. The initiative is part of India's



plan to streamline logistics and reduce costs. India's logistics cost was 7.8-8.9% of the country's gross domestic product (GDP) in fiscal year 2022. India wants to reduce it to 5-6%. The app also aligns with India's broader plan to improve its ranking in the World Bank's Logistics Performance Index, from 38 currently down to 25.

Centre launches 3 sub-schemes under RAMP including Online Dispute Resolution for Delayed Payments for MSMEs

Union Minister for Micro, Small & Medium Enterprises (MSME) launched three sub-schemes under the aegis of the RAMP programme. These are MSME Green Investment and Financing for Transformation Scheme (MSE GIFT Scheme), MSE Scheme for Promotion and Investment in Circular Economy (MSE SPICE Scheme) MSE Scheme on Online Dispute Resolution for Delayed Payments. The first scheme - The MSME Green Investment and Financing for Transformation Scheme (MSME GIFT Scheme) intends to help MSMEs adopt green technology with interest subvention and credit guarantee support. The MSE Scheme for



Promotion and Investment in Circular Economy (MSE SPICE Scheme) is the first-ever scheme in the Government to support circular economy projects which will be done through credit subsidy and will lead to realising the dream of MSME sector towards zero emissions by 2070. The Support for Commercialisation of IP Programme (MSME - SCIP Programme) will enable the innovators in the MSME sector to commercialize their IPR. In addition, the ZED Scheme of the Ministry has now been made completely free for women led MSMEs.

Cabinet approves improvement and widening of 135 km stretch of Khowai-Harina road in Tripura



The Cabinet Committee on Economic Affairs, chaired by Prime Minister Shri Narendra Modi, has given its approval for Improvement & Widening to two lanes with a paved shoulder of road from km 101.300 (Khowai) to km 236.213 (Harina) of NH-208, covering a total length of 134.913 kms in the State of Tripura. The project involves an investment of Rs.2,486.78 crore which includes a loan component of Rs.1,511.70 crore (JPY 23,129 Million). The loan assistant will be from the Japan International Cooperation Agency (JICA) under Official Development Assistance (ODA) scheme. The project is envisaged to facilitate better road connectivity between various parts of Tripura and to provide alternative access to Assam and Meghalaya from Tripura apart from existing NH-8.

Shri Nitin Gadkari sanctions 29 road projects in Ladakh worth Rs 1170.16 crore



Union Minister for Road Transport and Highways Shri Nitin Gadkari has sanctioned in the Union territory of Ladakh an allocation of 1170.16 crore for 29 roads projects, encompassing state Highway, major and other District roads. Shri Gadkari, additionally, 181.71 crore has been allocated for 8 bridges under the CRIF Scheme for the fiscal year 2023-24. The Union Minister, Ladakh, the largest Union Territory in terms of area and the second least populous in India, will witness improved connectivity to its remote villages through the approved initiatives.

Cabinet approves the Migration and Mobility Agreement between India and Italy

The Union Cabinet chaired by the Prime Minister, Shri Narendra Modi has given its ex-post facto approval to the proposal of Ministry of External Affairs to sign and ratify the Migration and Mobility Agreement between the Government of the Republic of India and the Government of the Italian Republic. The Agreement would enhance people-to-people contacts, foster mobility of students, skilled workers, business people and young professionals and strengthen cooperation on issues related to irregular migration between the two sides. Additionally, the Agreement also



formalises joint working on furthering mobility pathways between India and Italy through agreements on Youth Mobility and Facilitation of Recruitment of Indian qualified professionals in the healthcare and medical services sectors which will be discussed under the Joint Working Group (JWG). Cooperation between the two parties in fight against irregular migration has also been formalised through the Agreement.

Cabinet approves India and Malaysia sign an MoU for Cooperation in Broadcasting between Prasar Bharati and Radio Televisyen Malaysia

The Union Cabinet chaired by the Prime Minister, Shri Narendra Modi was apprised of the MoU/Agreement signed which has an immense potential to strengthen the cooperation in the field of broadcasting, exchange of news, and audio-visual programmes as well as significantly augment India's friendly relations with the country. With this, the total number of MoUs signed by Prasar Bharati with different countries has increased to 46. These MoUs are going to be



crucial in distribution of content in other countries, in developing partnerships with international broadcasters and exploring new strategies to address the demands of new technologies. The major benefit arising out of signing of MoUs are exchange of programmes in the areas of Culture, Education, Science, Technology, Sports, News and other fields on gratis/non-gratis basis.

Major impact, including employment generation potential:

This project is aimed at providing faster commute and to provide better connectivity between North and South Parts of the Bihar. Thus, promoting the socio-economic growth of the entire region. The Bridge will connect two Districts namely Patna at Digha on South side and Saran on North Side across River Ganga, Bihar. Government



has declared the stretch "the Highway starting from its junction with NH-139 near Patna (AIIMS) connecting Bakarpur, Manikpur, Sahebganj, Areraj and terminating at its junction with NH- 727 near Bettiah in the State of Bihar" as NH-139(W) vide Gazette Notification dated 8th July 2021.

Cabinet approves construction of New 4.56 km long, 6-Lane Bridge across River Ganga connecting Digha and Sonepur in Bihar



The Cabinet Committee on Economic Affairs chaired by the Prime Minister, Shri Narendra Modi, gave its approval for the Construction of New 4556 m long, 6-Lane High Level/ Extra Dosed Cable stayed Bridge across River Ganga (Parallel to Western Side of Existing Digha-Sonepur Rail-Cum Road Bridge) and its approaches on both sides in the Districts of Patna and Saran (NH-139W) in the State of Bihar on EPC mode. The Total cost for the project is Rs.3,064.45 crore which includes civil construction cost of Rs.2,233.81 crore. The work is to be implemented on EPC Mode with the use latest technology like 5D-Building Information Modelling (BIM), Bridge Health Monitoring System (BHMS), monthly drone mapping to ensure quality of construction and operations.

Environment Minister Launches National Transit Pass System for Forest Produce Movement



Union Environment Minister Bhupendra Yadav launched the National Transit Pass System (NTPS) pan-India to facilitate the seamless transit of timber, bamboo, and other forest produce across the country. Mr Yadav said that NTPS is envisioned as a 'One Nation-One Pass' regime that will contribute to the ease of doing business. The system will also serve as a bridge between the rural and urban economy. Minister of State for Environment Ashwini Kumar Choubey emphasized that the NTPS is a game-changer for agroforestry and trees outside the forest. NTPS is designed for user convenience, featuring desktop and mobile applications for easy registration and permit applications.

Parliament passes 'Telecommunications Bill, 2023'

The Telecommunications Bill, 2023, was passed in the Parliament. At present, the Indian Telecommunications sector is governed by three separate Acts of Parliament – Indian Telegraph Act 1885, Indian Wireless Telegraphy Act 1933, Telegraph Wires, (Unlawful Protection) Act 1950. The Telecommunications Bill, of 2023 aims to consolidate these three separate Acts. Specified purposes include: (i) national security and defence, (ii) disaster management, (iii) weather forecasting, (iv) transport, (v) satellite services such as DTH and satellite telephony, and (vi) BSNL, MTNL, and public broadcasting



services. The Bill amends the TRAI Act to also allow individuals with: (i) at least 30 years of professional experience to serve as the Chairperson, (ii) at least 25 years of professional experience to serve as members.

The Universal Service Obligation Fund has been established under the Indian Telegraph Act, 1885 to provide for telecom services in underserved areas. The Bill retains this provision, renames the fund as Digital Bharat Nidhi, and also allows its use for research and development in telecom.

World Bank and Department of Economic Affairs launch PPP Beginner's e-course to foster collaboration between public and private sectors in infrastructure capacity-building

In a step towards fostering collaboration between the public and private sectors in infrastructure capacity-building, the Department of Economic Affairs (DEA), Ministry of Finance, Government of India, and World Bank Group have launched an e-course. The e-course was launched by Ajay Banga, President, World Bank Group, and the Public-Private Partnership (PPP) Beginner's e-Course. The course on PPPs comprises 5 modules



which covers the major elements associated with the lifecycle of PPP projects, including introduction to PPPs, identification of PPP projects, structuring of projects, tendering and implementation and monitoring aspects of PPP projects. The duration of the course is 7 hours and 15 mins but is designed to be self-paced.

Prime Minister Narendra Modi becomes first world leader to reach 2 crore subscribers on YouTube channel

Prime Minister Narendra Modi becomes first world leader to reach 2 crore subscribers on YouTube channel. Prime Minister Narendra Modi has become the world's first leader to have 20 million subscribers on the YouTube channel. He has surpassed global leaders in terms of both subscribers and video views. Former Brazilian president Jair Bolsonaro is



second on the list of subscriber numbers with around 64 lakh. In terms of views, Ukrainian President Volodymyr Zelenskyy is in second spot with 22.4 crore views. Among the Indian leaders, Rahul Gandhi's channel has more than 35 lakh subscribers. Prime Minister Narendra Modi set up his YouTube channel in 2007.

INTERNATIONAL

India-Sweden Industry Transition Partnership, LeadIT 2.0 Launched at COP28 Dubai



India and Sweden launched Leadership Group for Industry Transition (LeadIT) 2.0 during the COP28 World Climate Action Summit, hosted in Dubai for the period 2024-26, at COP-28 in Dubai. LeadIT was initially co-launched by India and Sweden at the UN Climate Action Summit in New York in 2019. LeadIT has grown into a collaborative effort involving 18 countries and 20 industry-leading companies. The LeadIT initiative, initially centred around pivotal sectors such as iron, steel, cement, and aluminium, focused on industry transition and knowledge sharing.

The UAE announced a US\$30 billion commitment to the newly launched catalytic climate vehicle, ALTERRA.

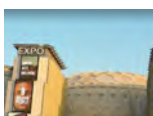

With this US\$30 billion commitment, ALTERRA becomes the world's largest private investment vehicle for climate change action and will aim to mobilize US\$250 billion globally by 2030. It aims to steer private markets towards climate investments and focus on transforming emerging markets and developing economies, where traditional investment has been lacking due to the higher perceived risks across those geographies. ALTERRA has been established by Lunate, an independent global investment manager, and is domiciled in the Abu Dhabi Global Market.

Ministry of Tourism Hosts International Tourism Mart in Shillong, Meghalaya to Showcase Northeast Region's Tourism Potential

The Ministry of Tourism, Government of India is organising the 11th edition of the International Tourism Mart at Shillong, Meghalaya. The International Tourism Mart is an annual event held by the Ministry in one of the Northeastern States on a rotation basis. The International Mart is also going to be a unique event, as it has been planned as a Green Event by



adopting low carbon options on the lines of the action points formulated by Ministry of Environment, Forest and Climate Change, GOI for implementation of Mission LIFE and sensitising the tourism stakeholders and generating greater awareness about its objectives.

18 Countries Back New Global Guidelines, Crafted by the US and UK, to Enhance Cybersecurity in Artificial Intelligence (AI)

18 countries endorsed new global guidelines, developed by the United States (US) and the United Kingdom (UK), to make artificial intelligence (AI) "secure by design" and "raise the AI cybersecurity bar. The Guidelines for Secure AI System Development deal with secure design, development, deployment and operation and maintenance of AI systems. The guidelines were



formulated by the UK's National Cyber Security Centre (NCSC) and the US's Cybersecurity and Infrastructure Security Agency (CISA). They aim to "raise the cybersecurity levels of artificial intelligence and help ensure that it is designed, developed, and deployed securely.

Prime Minister Shri Narendra Modi Advocates India as Host for 2028 Climate Conference, Urges Nations to Prioritise Global Interests

Prime Minister (PM) Shri Narendra Modi calls on countries to prioritise global interests over self-interest and fulfil all climate obligations. Emphasizes the need for developing countries to have appropriate access to the remaining global carbon budget. Speaking at the high-level segment of the COP28



meeting in Dubai (UAE), he also proposed to host the 2028 climate change conference, COP33, in India. India has hosted the annual climate change conference called the conference of parties (COP) of the UNFCCC once earlier - COP8 in 2002.

Pakistan Submits BRICS Membership Application in 2024



Pakistan has filed an application to join the BRICS group of nations in 2024 and is counting on Russia's assistance during the membership process. Pakistan's application came as the grouping of emerging economies was set for its biggest expansion with 6 new members under Russia's rotating Presidency in 2024. New Members: Argentina, Egypt, Ethiopia, Iran, Saudi Arabia, and the United Arab Emirates (UAE) as new members formally admitted to the BRICS summit-2023 held in South Africa. However, they will formally join during the 2024 summit in Kazan, Russia.

India Pledges \$1 Million in Immediate Relief Aid to Papua New Guinea Following Mount Ulawun Volcanic Eruption



India announces a \$1 million relief assistance package for Papua New Guinea in the aftermath of the Mount Ulawun volcanic eruption. The financial aid is designated for immediate relief and will support rehabilitation and reconstruction efforts in Papua New Guinea. Ulawun is the highest mountain in New Britain and the second in the Bismarck Archipelago at 2,334 metres, and is one of the most active volcanoes in Papua New Guinea. India, as a close friend and in solidarity with the people of Papua New Guinea, will provide immediate relief assistance to aid rehabilitation and reconstruction efforts.

UNICEF and India Jointly Launch "Green Rising" Initiative at COP28 to Mobilize Youth for Climate Action

The United Nations Children's Fund (UNICEF), originally known as the United Nations International Children's Emergency Fund, and India will launch the "Green Rising" initiative at the COP28 Summit in Dubai. UNICEF's Generation Unlimited, in collaboration with India's Ministry of Environment, Forest, and Climate Change will launch this initiative. This initiative will be



launched to mobilize youth to drive climate action. The "Green Rising India

Alliance" and the global "Green Rising" programme are the result of a partnership between UNICEF, Generation Unlimited, and a wide range of youth, public, and business partners.

Sweden and United States Ink Defence Cooperation Agreement in Washington

Sweden signed a defence cooperation agreement with the United States in Washington. It will allow the US to access all of the military bases in the Scandinavian country which is about to join the trans-Atlantic security alliance, North Atlantic Treaty Organization (NATO). The US struck a similar deal with Sweden's neighbour, Norway, in 2021 and is currently negotiating



such an agreement with two other Nordic countries, Finland and Denmark.

Sweden and Finland decided to drop their long-standing policy of non-alignment and apply for NATO membership following Russia's full-scale invasion of Ukraine last year. Finland joined NATO in April, 2023.

Argentina's Entry into BRICS Postponed; Not Joining Developing Economies Bloc Next Year as Planned

Argentina's entry into the BRICS bloc of developing economies, originally scheduled for January 1, 2024, has been postponed. The decision is seen as a precursor to a significant foreign policy shift in Argentina under the leadership of right-wing populist Mr. Milei, indicating



potential changes in diplomatic priorities. Argentina was one of six countries

invited in August to join BRICS, comprising Brazil, Russia, India, China, and South Africa. The move aimed to expand the bloc to an 11-nation alliance.

Italy withdraws from China's Belt and Road project

Italy has officially pulled out of China's Belt and Road infrastructure initiative, making this move more than four years after initially joining as the sole G7 nation to do so. Italy had initially signed an agreement to join the BRI in 2019. However, after 4 years, the expected benefits did not materialize for Italy. The



agreement with China was supposed to be automatically renewed after

expiring in March 2024, unless Rome gave at least three months' written warning of pulling out. Chinese FDI in Italy dropped from \$650 million in 2019 to just \$33 million in 2021.

India and the United States Collaborate on a \$390 Million Funding Initiative to Implement 50,000 Electric Buses by 2027



India is aiming to get 50,000 electric buses on its streets by 2027 with help from a joint finance mechanism with the United States (US). The \$390 million fund will act as a guarantee for manufacturers seeking loans to expand production, Indian and US officials said at a side event at COP28. India currently only has 12,000 e-buses in operation. The payment security mechanism, established with \$150 million from the US government and philanthropic groups, and \$240 million from the Indian government.

India and the United States Collaborate on a \$390 Million Funding Initiative to Implement 50,000 Electric Buses by 2027



India is aiming to get 50,000 electric buses on its streets by 2027 with help from a joint finance mechanism with the United States (US). The \$390 million fund will act as a guarantee for manufacturers seeking loans to expand production, Indian and US officials said at a side event at COP28. India currently only has 12,000 e-buses in operation. The payment security mechanism, established with \$150 million from the US government and philanthropic groups, and \$240 million from the Indian government.

Nepal Achieves Milestone as the First South Asian Nation to Legally Recognize Same-Sex Marriage



Nepal has become the first South Asian country to officially register same-sex marriage. The marriage between 36-year-old Ram Bahadur (Maya) Gurun

Dubai Unveils World's Largest Concentrated Solar Power Project during COP28

The fourth phase of the Mohammed bin Rashid Al Maktoum Solar Park has been inaugurated by Sheikh Mohammed bin Rashid Al Maktoum, Vice President and Prime Minister of the UAE and Ruler of Dubai. This marks the launch of the world's largest Concentrated Solar Power (CSP) project. Built at an investment of AED15.78 billion, the 950 MW project utilises three hybrid technologies. The three



hybrid technologies used are 600 MW from a parabolic basin complex, 100 MW from a CSP tower, and 250 MW from photovoltaic solar panels. According to Guinness World Records, the project includes the world's tallest solar tower at 263.126 metres and the largest thermal energy storage capacity with a capacity of 5,907 megawatt hours.

Sri Lanka Secures Debt Treatment Agreement with India and Paris Club

Sri Lanka has achieved an "agreement in principle" with India and the Paris Club group of creditors on a debt treatment plan. Objective of the Agreement : The agreement facilitates Sri Lanka's access to the next installment of the International Monetary Fund's (IMF) nearly \$3 billion recovery package. Terms of Debt Treatment Agreement : Sri Lanka and the Official Creditor Committee (OCC) reached an



agreement on the main parameters of debt treatment. These parameters are consistent with those of the Extended Fund Facility (EFF) arrangement between Sri Lanka and the IMF. Default on Foreign Debt by Sri Lanka : Sri Lanka decided to default on its almost \$51 billion foreign debt.

India and UAE Jointly Host Global Green Credit Initiative at COP-28

Prime Minister Narendra Modi together with President Sheikh Mohammed bin Zayed Al Nahyan of the United Arab Emirates (UAE), co-hosted the High-level event on 'Green Credits Programme' at COP-28, in Dubai. The Green Credit Initiative has been conceptualised as a mechanism to incentivize voluntary pro-planet actions, as an effective response to the challenge of climate change. It



envisions the issue of Green Credits for plantations on waste/degraded lands and river catchment areas, to rejuvenate and revive natural eco-systems. In a landmark announcement at COP28 (1st December 2023), the Indian PM launched the 'Green Credit Initiative,' a pathbreaking program aimed at reshaping global environmental policies.

and Surendra Pandey has been registered in Nepal. The registration of same-sex marriage in Nepal is facilitated by an interim order from the Supreme Court, which supports

the legal recognition of marriages between same-sex couples.

Pakistan Secures Vice Chair Post at UNESCO with a 10-Vote Lead Over India



Pakistan secured a significant victory over India in the UNESCO executive board election for the post of vice-chair. The Pakistani candidate received 38 votes, while the Indian candidate received only 18. Pakistan's victory of being elected as vice chair of the UNESCO Executive Board for 2023–2025 from the Asia Pacific Group, is being seen as a major setback for Indian diplomats in the UN.

Australia Hit by Tropical Cyclone Jasper, Coastal Communities Brace for Life-Threatening Floods



Thousands of people were affected when Tropical Cyclone Jasper hit northeastern Australia. People in coastal areas are living without electricity and facing the crisis of floods. The Australian Meteorological Department stated that the cyclone has slowly reached some areas. Wind speeds of up to 113 kilometres (70 miles) per hour were recorded as Tropical Cyclone Jasper made landfall on the coast. A tropical cyclone is described as a low-pressure system with very high winds circulating around it. These cyclones typically occur in the region between 5–35° latitude north or south of the equator. In Australia, tropical cyclones are colloquially referred to as "willy-willy."

India, South Korea, and the United States to Establish Technology Triologue

India, South Korea and the United States (US) will start an informal trilateral technology dialogue in the first quarter of 2024 in response to China's rapid progress in critical technologies within the Indo-Pacific region. The decision was made during the inaugural US-South Korea Next Generation Critical & Emerging Technologies Dialogue held in Seoul. The two sides agreed to hold "National Security Council and National Security Office-led consultations with like-minded partners on critical and emerging technologies including through launching an informal trilateral technology dialogue with India in the first quarter of 2024". An Initiative on Critical and Emerging Technology (iCET), announced by India and the US in 2022, has been



one high-profile example. Similar to the Quad group, the India-US-South Korea trilateral dialogue aims to address critical technologies. This collaboration could complement the Quad initiative. The Quad countries (Australia, India, Japan, and the US) launched the Quad Principles on Technology Design, Development, Governance, and Use at the Quad Leaders' Summit on September 24, 2021. The Seoul meeting, chaired by US National Security Advisor Jake Sullivan and Republic of Korea (ROK) National Security Advisor Cho Tae-yong, outlined six main strategic technology areas for cooperation.

Prime Minister Shri Narendra Modi inaugurates annual Global Partnership on Artificial Intelligence (GPAI) Summit in New Delhi

The Global Partnership on Artificial Intelligence (GPAI) Summit was inaugurated at Bharat Mandapam in New Delhi. Prime Minister Modi emphasized that Artificial Intelligence is for social development and inclusive growth and the government has drafted its policies and programs with the spirit of AI for All. GPAI is a multi-stakeholder initiative with 29 member countries. Its goal is to bridge the gap between theory



and practice on AI by supporting cutting-edge research and practical activities on AI-related priorities. GPAI Formation : Canada and France first proposed the GPAI at the 2018 44th G7 summit. GPAI was officially launched in June 2020 with fifteen founding members. The Organization for Economic Co-operation and Development (OECD) hosts GPAI.

New Zealand's Newly Elected Government Reverses Decision on Smoking Ban

New Zealand's newly elected government has repealed the decision to implement a smoking ban for the new generation. The decision to ban smoking for the new generation has been reversed by the newly-elected



government. The smoking ban in New Zealand was initially implemented to save lives and prevent youths from taking up smoking.

Australia Hit by Tropical Cyclone Jasper, Coastal Communities Brace for Life-Threatening Floods



Thousands of people were affected when Tropical Cyclone Jasper hit northeastern Australia. People in coastal areas are living without electricity and facing the crisis of floods. The Australian Meteorological Department stated that the cyclone has slowly reached some areas. Wind speeds of up to 113 kilometres (70 miles) per hour were recorded as Tropical Cyclone Jasper made landfall on the coast. A tropical cyclone is described as a low-pressure system with very high winds circulating around it. These cyclones typically occur in the region between 5–35° latitude north or south of the equator. In Australia, tropical cyclones are colloquially referred to as “willy-willy.”

GCC-South Korea sign free trade deal in boost to Gulf-Asia economic ties



The GCC has signed a free trade agreement with South Korea to boost trade and economic ties between the six-member bloc and Seoul. This is the second such trade deal signed by the GCC in recent months following an agreement with Pakistan in September, the GCC Secretary General Jassem Al Budaiwi stated. The region is forecast to grow by 1 per cent in 2023 before rebounding to 3.6 per cent and 3.7 per cent in 2024 and 2025, respectively, the World Bank said last month. The UAE, the Arab world’s second-largest economy, is pursuing a target of Dh4 trillion (\$1.09 trillion) in foreign trade by 2031 as part of its diversification plans. It also aims to double the size of its economy by 2030. The UAE’s non-oil foreign trade hit a record Dh1.24 trillion in the first half of the year, up 14.4 per cent year-on-year. It has

United Kingdom to Implement Climate Levy on Imported Steel from 2027

The United Kingdom government follows the European Union in deciding to enforce a carbon border tax on specific commodities such as iron, steel, aluminium, ceramics, and cement, starting in 2027. Objective of the Tax Levy : The introduction of this tax aims to ensure that carbon-intensive products like steel and ceramics from other nations face a carbon price comparable to those produced within the UK. Confidence for UK Industry: The carbon border tax is expected to instill confidence in the UK industry to invest in decarbonization efforts, aligning with the country’s commitment



to environmental sustainability. India’s Opposition to EU’s CBAM: India has expressed opposition to the European Union’s carbon border adjustment mechanism (CBAM) and has formally protested at the World Trade Organization (WTO). WTO Rules and UN Framework Argument: India contends that the EU’s CBAM goes against the differentiated approach for developing countries and is inconsistent with the rules of the WTO and the United Nations framework.

Colorado Supreme Court Rules to Exclude Donald Trump from State’s 2024 Presidential Election Ballot

The top court in the United States (US) state of Colorado ordered former US President Donald Trump to be taken off the ballot in the state for the Presidential elections next year. Basis of Disqualification: The Colorado Supreme Court cited Section Three of the Fourteenth Amendment to the United States Constitution as the grounds for disqualifying Trump from holding the office of President. Section Three of the Fourteenth Amendment: The court’s ruling is based on Section Three of the Fourteenth Amendment, which states that individuals who participated in an insurrection or rebellion are ineligible to hold public office. January 6,

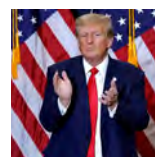

2021 Attacks: The court’s judgement is connected to Trump’s alleged involvement in the January 6, 2021, attacks on the US Capitol by his supporters during the certification of the Electoral College results. Unprecedented Application of Section Three: This marks the first instance where Section Three of the Fourteenth Amendment has been invoked concerning a former President. Historical Context: The application of Section Three of the Fourteenth Amendment in this case is described as a rare occurrence, highlighting the unique circumstances surrounding the events of January 6, 2021.

signed deals with India, Israel, Turkey, Indonesia, Cambodia and Georgia, each of which are designed to boost economic activity and secure supply chains. The first four agreements are already in effect. The UAE is South Korea’s second-largest Arab trade partner, with bilateral non-oil trade in

the first half of the year reaching \$3 billion, similar to the first half of 2022, state news agency Wam reported.



CURRENT AFFAIRS



Nagaland Gears Up for the Commencement of the 24th Hornbill Festival 2023 at Naga Heritage Village, Kisama

The 24th edition of the Hornbill Festival has commenced at Naga Heritage Village Kisama. The United States of America (USA), Germany, and Colombia are the Country Partners, and Assam is the Partner State for the 24th Hornbill Festival. Governor of Nagaland, La Ganesan, and Chief Minister Neiphiu Rio were the Chief Guests at the festival. The main hornbill stage will showcase 40 bands and acts, featuring a total of 800 artists. Bands from Germany, the United States of America (USA), Colombia, and South Korea are participating in the festival. For the first time, there will be an exhibition featuring Mithun and Tenyi Vo.

Bihar Government Initiates Program for 25 Lakh Academically Challenged School Children

The Bihar government will launch a programme in December 01, 2023 for nearly 2.5 million children lagging woefully behind their peers in schools with some of them incapable of reading simple Hindi words despite having reached upper primary classes. As part of the programme, 'Mission Daksh', the state Education Department has directed teachers to intensively mentor such students, in batches of not more than five, with the "warning" that any laxity will cause



them to face action. The effective implementation of 'Mission Daksh' will be monitored by District-wise monitoring committees led by district magistrates (DMs). All 25 lakh (approximately) such (academically weak) students will appear in their final examinations in April, 2024.

Delhi Government Set to Notify Motor Vehicle Aggregator Scheme

Delhi Government has introduced the Delhi Motor Vehicle Aggregator and Delivery Service Provider Scheme. The scheme mandates a complete transition to electric vehicles (EVs) for all cab aggregators and delivery service providers by 2030. Coverage : The policy applies to all aggregators offering passenger transport services in Delhi. It also includes those engaged in delivery services, including e-commerce vehicles. Registration and



Licensing : Interested parties must register with the government within 90 days from the date of notification. The licence will be valid for 5 years. Electric Bike Taxis : Even though the scheme made provisions to allow bike taxis again, only electric two-wheelers will be considered valid with immediate effect..

Meta & Karnataka government collaborate for on-line safety training

Meta, the parent company of Instagram and Facebook, has entered into a two-year partnership with the Karnataka government with an aim to focus on digital education and online user safety for students in Karnataka. The Karnataka government is working on



launching a comprehensive blueprint to equip students with digital skills, enhancing their employability.



India's 1st Telecom Centre of Excellence to come up in Uttar Pradesh's Saharanpur

The Uttar Pradesh (UP) government has announced plans to build India's first Telecom Centre of Excellence in Indian Institute of Technology (IIT) Roorkee. According to the state government, the new centre will not just widen UP's participation in technology and innovation but will also propel the telecommunications sector. The state government has announced to shell out as much as Rs 30 crore in establishing a research centre at IIT Roorkee in Saharanpur. The centre will focus on the intersection of 5G technology and artificial intelligence (AI) and will lay the groundwork for the launch of 6G technology.



Lakadong Turmeric from Meghalaya Receives Geographical Indication Status

Meghalaya's Lakadong turmeric has been awarded the Geographical Indication (GI) tag. It is considered to be one of the world's best varieties of turmeric, with a curcumin content of around 6.8 to 7.5%. It is darker in colour and is grown organically without the use of fertilisers. It is found in the Lakadong area of Jaintia Hills, and has high curcumin content.

Delhi Government School Pioneers First-of-its-Kind Biodiversity Park to Foster Ecosystem Education and Green Practices

A Delhi government school has established the first-of-its-kind biodiversity park to promote the ecosystem and provide students with hands-on learning experiences in agriculture, farming, nature, and greenery. The biodiversity park is located at Sarvodaya Kanya Vidyalaya in Defence Colony, Delhi. Open to the public, people can visit the park during the winter season. The park features a diverse range of



plant life, including native Indian flowers, various rose varieties, an Amrapali mango tree, different types of curry leaves, lemon trees, and plants imported from Telangana and South Africa.

Governor of Maharashtra Introduces Five School Initiatives Aimed at Holistic Student Development

Maharashtra Governor Ramesh Bais launches 5 school initiatives for holistic student development. These five futuristic initiatives include

- Chief Minister Majhi Shala Sundar Shala
- Maha Vachan Utsav
- Adopt a School Campaign
- Majhi Shala Majhi Parasbag,



- Swachata Monitor.

These initiatives aim to develop the holistic personality of the students to ensure that future generations are sensitive and responsible towards their environment.

Assam's Royal Burial Grounds Submitted As Nomination For UNESCO Tag

Assam's Charaideo Moidams, the royal burial mounds of the Ahom dynasty, is India's official nomination for inclusion in the UNESCO World Heritage List for 2023-24. The burial mounds, characterized by pyramid-like structures called 'moidams,' were utilized by the Tai-Ahom dynasty. This dynasty ruled Assam for approximately 600 years, spanning from the 13th century to the 19th century. The government has confirmed India's nomination



for consideration as a World Heritage site for the 2023-24 cycle. Hindu cremation rituals. Selection of sites or properties for World Heritage nomination depends upon its Outstanding Universal Value (OUV), Authenticity and Integrity.



Gujarat Government Enters into Memorandum of Understanding with Airports Authority of India for the Development of 11 Airports

Gujarat, the State government has signed a memorandum of understanding (MoU) with the Airports Authority of India (AAI) to develop 11 new greenfield airports and expand 9 existing ones. Though an estimate for these projects have not been drawn, each airport is likely to cost ₹1,500-3,000 crore. Ankleshwar, Morbi, Rajpipla, Botad, Dwarka, Dhordo, Rajula, Dahod, Ambaji, Dholavira and Palitana have been identified for the development of greenfield airports.



Government Approves Cheetah Breeding Center in Gujarat's Banni Grasslands

The Central Government has granted approval for the establishment of a cheetah breeding and conservation centre in Gujarat's Banni Grassland. The Gujarat government submitted a proposal for the cheetah breeding center to the National Compensatory Afforestation Fund Management Authority under National CAMPA. Banni Grassland is situated along the northern border of Kachchh district in the State of Gujarat. Banni Grassland is recognized as one of the largest grasslands in the Indian subcontinent, covering an extensive area of over 2500 square kilometres.

Telangana Chief Minister launches free bus rides for women and enhanced Aarogyasri Scheme

Chief Minister of Telangana, A. Revanth Reddy launched Maha Lakshmi Scheme and Rajiv Aarogyasri Scheme enhanced to ₹10 lakh in Hyderabad. These two are among the six guarantees of Congress. The scheme allows girls, women, and transgender persons of all ages, domiciled in Telangana, to travel free of cost in TSRTC buses. The Rajiv Arogyasri Scheme provides financial protection to families living below the poverty line. It offers up to ₹10



lakh in a year for the treatment of serious ailments requiring hospitalisation and surgery and also financial coverage up to ₹10 lakh for high end procedures, according to the Rajiv Aarogyasri Health Care Trust.

Prime Minister Shri Narendra Modi Gives Green Signal to Chennai's First Urban Flood Mitigation Project Worth ₹561.29 Crore

Prime Minister Shri Narendra Modi sanctioned a ₹561.29 crore urban flood mitigation project for Chennai after the impact of Cyclone Michuung in Tamil Nadu. The project is funded under the National Disaster Mitigation Fund (NDMF) The approved project is titled 'Integrated Urban Flood Management activities for Chennai Basin Project.' Defence Minister Rajnath Singh with Tamil



Nadu Minister for Finance & Human Resources Management Thangam Thenarasu and Chief Secretary Shiv Das Meena also carried out an aerial survey of areas ravaged by cyclone Michuung in-and-around Chennai.

Arunachal Pradesh Chief Minister Pema Khandu and US Ambassador Jointly Inaugurate 'The Hump WWII Museum

Arunachal Pradesh Chief Minister (CM) Pema Khandu and US Ambassador to India Eric Garcetti inaugurated 'The Hump WWII Museum', the 2nd museum in Asia dedicated to the fallen airmen of the Allied Forces during the WWII at Pasighat in Arunachal Pradesh. The Hump, Garcetti claimed, isn't just a museum in some remote part of India, half the world round from the US but already a world class



museum. The pilots of the Allied Forces nicknamed the air-route from airfields in Assam to those in Yunnan in China 'The Hump' because their aircraft had to navigate deep gorges and then quickly fly over mountains rising beyond 10,000 feet.



Odisha Chief Minister Naveen Patnaik Unveils Ama Bank for Banking Services via Customer Service Points (CSP)

Odisha Chief Minister (CM) Shri Naveen Patnaik has inaugurated Ama Bank, a banking initiative aimed at providing services through Customer Service Points (CSP). Ama Bank is part of the financial inclusion program and aims to cover 4,373 unbanked gram panchayats in Odisha.



PM to launch several development projects worth over 15 thousand crore rupees at Ayodhya, UP

Prime Minister Narendra Modi will visit Ayodhya in Uttar Pradesh and launch multiple development projects worth over 15,000 crore rupees in the state. Mr Modi will inaugurate the redeveloped Ayodhya Railway Station named as Ayodhya Dham Junction Railway Station and flag off new Amrit Bharat trains and Vande Bharat trains. He will also dedicate several other railway projects to the nation. The Prime Minister will inaugurate the newly built Ayodhya Airport. Mr Modi will also participate in a public programme where he will inaugurate, dedicate to the nation and lay the foundation stone of multiple development projects worth more than 15,700 crore rupees in the state. These include

Apple supplier Corning to build a Rs 1000 crore facility in Tamil Nadu

Key Apple supplier and American Gorilla glass maker, Corning Inc., is investing Rs 1,000 crore to set up a manufacturing facility in Tamil Nadu (TN). The facility will be set up at Pillaipakkam, near Sriperumbudur, on a 25-acre plot, which can be expanded if the need arises and will employ around 300 people. Corning Inc. is a Fortune 500 materials science



company headquartered in New York. They are known as the inventors of gorilla glass, a strengthened glass widely used in portable devices such as mobile phones, tablets, and laptops.

A first-of-its-kind Eastern Ghats Nature Interpretation Centre in Visakhapatnam

The first-of-its-kind, Nature Interpretation Centre at the Eastern Ghats Biodiversity Centre along the periphery of the Kambalakonda Wildlife Sanctuary in Visakhapatnam was inaugurated. It is located in the state of Andhra Pradesh. It is named after the local



hillock "Kambalakonda" acting as a green lung for citizens of Vizianagaram, is this large and sprawling sanctuary.

Uttarakhand Government Introduces India's First Himalayan AirSafari with Gyrocopters to Revolutionize Tourism

The Uttarakhand government is set to transform tourism by launching India's first-ever Himalayan AirSafari using gyrocopters, compact and agile aircraft. The first trial flight of gyrocopters was successfully conducted at Bairagi Camp, Haridwar, marking a significant milestone in the initiative. The Uttarakhand Tourism Development Board is collaborating with Rajas Aerosports and Adventures Pvt Ltd to introduce gyrocopters as an innovative way for tourists to

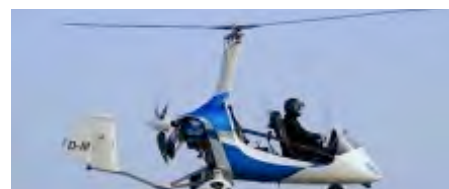

explore the state's picturesque landscapes. Germany-supplied state-of-the-art gyrocopters have been procured for the Himalayan Air Safari initiative. The gyrocopters will be part of the innovative Himalayan Air Safari scheme, which is aligned with the Breakfast Tourism initiative introduced by the department.

projects worth about 11,100 crore rupees for development of Ayodhya and its surrounding areas and projects worth about 4600 crore rupees related to other projects across Uttar Pradesh.



J&K Panchayati Raj Act amended to incorporate OBC reservation

The Jammu and Kashmir administration has amended the Union Territory's Panchayati Raj Act to incorporate reservation for Other Backward Classes (OBC), an official spokesperson stated. Earlier, the draft Jammu and Kashmir Panchayati Raj (Amendment) Bill, 2023 was submitted to the Union Ministry of Home Affairs (MHA). The amendment bill proposes the incorporation of the definition of the OBC for providing reservation to them, explaining the method of disqualification from the membership of a Halqa Panchayat and suspension and removal of a sarpanch, naib-sarpanch and panch by the government, the spokesperson stated. He added that the bill also defines the process for removal and conditions of service of the state election commissioner (SEC) here.

Madhya Pradesh Government to Establish Prime Minister College of Excellence in Every District across the State

Madhya Pradesh (MP) government will set up PM College of Excellence in all districts of the state. One college in every district out of a total of 570 government colleges will be upgraded by the MP government as "PM College of Excellence". Financial Allocation : The government will spend more than Rs 460 crore on the development of these colleges. Digital Documentation in Education : In addition to this, the degree and mark sheets of students in all government and private universities will be uploaded in DigiLocker. Tendu Leaf Collection Rate Increase :



The tendu leaf collection rate has been increased by the government from Rs 3,000 per bag to Rs 4,000 per bag. Cyber-Tehsil System Implementation : In MP, the Council of Ministers has also decided to implement a cyber-tehsil system in all the districts. Ban on Illegal Use of Loudspeakers : It has also decided to implement a ban on the illegal use of loudspeakers at religious and other places.

12th DIVYA KALA MELA-2023 to be inaugurated in Surat, Gujarat

Department of Empowerment of Persons with Disabilities (Divyangjan) {DEPWD), MoS&E, GoI through National Divyangjan Finance and Development Corporation (NDFDC, an apex corporation under (DEPWD) is organizing a unique event showcasing the products and craftsmanship of Divyang entrepreneurs/artisans from across the country, 'Divya Kala Mela' from 29th December 2023 - 7th January 2024 in Surat, Gujarat. The event would present an enthralling experience to the visitors as vibrant products from various parts of the country including Jammu and Kashmir, North Eastern states, handicrafts, handlooms, embroidery works and packaged food etc. will be seen together. This is a unique



initiative towards the economic empowerment of PwD/Divyangjan. The Divya Kala Mela presents a bigger platform for marketing and showcasing the products and skills of Divyangjan (PwD). The Divya Kala Mela, Surat is the 12th one in series starting from 2022. Around 100 Divyang artisans/artists and entrepreneurs from about 20 states/UTs will be displaying their products and skills. It will be an opportunity for all to go 'vocal for local' and products made by Divyang craftsmen with their extra determination can be seen/purchased.

BANKING & ECONOMY



RBI and Bank of England Ink MoU for Collaboration and Information Sharing on CCIL



The Reserve Bank of India (RBI) and the Bank of England (BoE) signed a Memorandum of Understanding (MoU) for cooperation and information exchange regarding the Clearing Corporation of India Ltd. (CCIL). Objective of the MoU : To encourage the European Securities and Markets Authority (ESMA) to reconsider recognizing at least one of the Indian central counterparties (CCPs).

RBI Allows Banks to Open Current Accounts for Export Proceeds Alongside Special Rupee Vostro Accounts



The Reserve Bank of India (RBI) permitted banks to open additional

current accounts for export proceeds in addition to special rupee vostro accounts with a view to provide greater operational flexibility to exporters. To provide greater operational flexibility to exporters, banks maintaining a special rupee vostro account as per the provisions of the RBI circular dated July 11, 2022 are permitted to open an additional special current account for its exporter constituent exclusively for settlement of their export transactions. In July 2022, the RBI had asked banks to put in place additional arrangements for

India Records Near 5-Year High Banking Liquidity Deficit

India's banking system liquidity deficit has widened to the highest in nearly 5 years on monthly goods and services tax payments. The liquidity deficit is the amount of funds banks need to borrow from the interbank market or from the central bank. Liquidity in the banking system refers to readily available cash



that banks need to meet short-term business and financial needs. According to the Reserve Bank of India (RBI), the liquidity deficit stood at Rs 1.74 lakh crore (\$20.90 billion).

Amazon Pay Introduces Video KYC Service in Sign Language for Customers with Hearing and Speech Impairments

Amazon Pay has launched a video sign language Know Your Customer (KYC) service for hearing and speech impaired customers, which involves communication through sign languages, a pioneering initiative in the digital payments sector in India. The company has rolled out the initiative that enables two-way video communication in sign-language between



Amazon Pay employees and customers. The goal is to make the KYC process effortless for those who rely on sign language, and making digital payments more inclusive.

SEBI Grants Approval to Jana Small Finance Bank for IPO

Jana Small Finance Bank, backed by TPG Capital, has received approval from the Securities & Exchange Board of India (SEBI) for its initial public offering (IPO). The IPO comprises a fresh issue of equity shares worth Rs 575 crore with a face value of Rs 10 each. Additionally, there is an offer for sale of up to



4.05 million shares by existing shareholders and promoters. Jana Small Finance Bank, upon successful listing, will become the 7th small finance bank (SFB) to be listed on the stock exchange.

export and import transactions in Indian rupees in view of increasing interest of the global trading community in the

domestic currency.



Mutual Funds Allocate ₹3,000 Crore for Debt Fund Backstop Facility

Mutual funds have set aside ₹3,100 crore as part of the Corporate Debt Market Development Fund (CDMDF) created by the capital market regulator Securities and Exchange Board of India (SEBI) as a backstop arrangement to bailout specified debt schemes in times of crisis in the market. SBI Mutual Fund will manage the funds deposited by mutual funds for the CDMDF. Contributions by Asset Management Companies : Asset management companies will make a one-time contribution equivalent to 2 basis points (bps) of the Assets Under Management (AUM) of specified debt-oriented schemes. Basis for Initial Contribution : The initial contribution will be based on the AUM of specified mutual fund schemes as of December 31, 2022. Background and Rationale : The decision to establish a backstop facility was prompted by market crises, including the defaults by IL&FS and DHFL, as well as the abrupt closure of six debt mutual fund schemes by Franklin Templeton during the Covid pandemic.

Mutual Funds Allocate ₹3,000 Crore for Debt Fund Backstop Facility

Mutual funds have set aside ₹3,100 crore as part of the Corporate Debt Market Development Fund (CDMDF) created by the capital market regulator Securities and Exchange Board of India (SEBI) as a backstop arrangement to bailout specified debt schemes in times of crisis in the market. SBI Mutual Fund will manage the funds deposited by mutual funds for the CDMDF. Contributions by Asset Management Companies : Asset management companies will make a one-time contribution equivalent to 2 basis points (bps) of the Assets Under Management



(AUM) of specified debt-oriented schemes. Basis for Initial Contribution : The initial contribution will be based on the AUM of specified mutual fund schemes as of December 31, 2022. Background and Rationale : The decision to establish a backstop facility was prompted by market crises, including the defaults by IL&FS and DHFL, as well as the abrupt closure of six debt mutual fund schemes by Franklin Templeton during the Covid pandemic.

RBI Grants Approval to SBI Mutual Fund for Acquisition of 9.99% Paid-Up Share Capital in IndusInd Bank

SBI Mutual Fund has received approval from the Reserve Bank of India (RBI) to acquire a stake of up to **9.99% in IndusInd Bank**, a private sector lender. The approval is conditional on compliance with RBI regulations, as well as foreign exchange and capital market regulations. As per RBI guidance, SBI MF will acquire the shareholding in IndusInd Bank

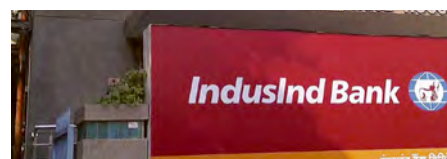

within a period of one year, i.e., by **Oct. 10, 2024**. SBI MF must ensure that the aggregate holding in the bank does not exceed 9.99% of the paid-up share capital or voting rights of the bank at all times.

India's Pioneering Bad Bank, the Stressed Asset Stabilization Fund (SASF), Nears Conclusion of its Two-Decade Journey

India's first bad bank, the **Stressed asset stabilisation fund (SASF)**, a special purpose vehicle for housing bad loans that was created two decades ago is being wound down as it approaches the end of its life cycle. The Stressed Asset Stabilization Fund (SASF) was established as a trust by the Government of India in **September 2004** Its **primary purpose** was to isolate bad loans of IDBI Bank and create a separate entity to help the bank



achieve a cleaner balance sheet. SASF was set up with a defined life cycle of **20 years**. A process has been initiated to evaluate about **400 non-performing loans** that were transferred to the trust, and these loans have continued to remain non-performing. NARCL's purpose is to segregate and manage bad loans from multiple banks.



LIC Launches New Whole Life Insurance Policy 'Jeevan Utsav'

Life Insurance Corporation of India (LIC), has launched a new individual, savings, and Whole Life Insurance plan called Jeevan Utsav. The Plan is a Non-Linked, Non-Participating Plan. Consider the following points before opting for the policy. Policy Eligibility : This plan is available for age starting from 90 days to 65 years. It gives guaranteed lifelong income and lifelong risk cover. Premium Payment Terms : The minimum premium paying term is 5 years and the maximum premium paying term is 16 years

ADB Approves \$500 Million Loan for Healthcare and Medical Education in Maharashtra



The Asian Development Bank (ADB) has approved a loan

package worth USD 500 million to improve access to quality and affordable tertiary health care and medical education in Maharashtra, India. ADB has been working with the state government of Maharashtra to achieve its vision of providing affordable and accessible tertiary health care to all by 2030 and strengthening quality and professional medical practitioners.

Global bank ranking removes Unicredit and moves up UBS, China banks

The Financial Stability Board removed Italy's UniCredit from its list of Global Systemically Important Banks (G-SIBs) and moved 3 banks up a category. The identification process for G-SIBs involves collaboration between the Financial Stability Board (FSB), the Basel Committee on Banking Supervision (BCBS), and national authorities. The Financial Stability Board (FSB) is an international body that monitors and makes recommendations about the global financial system.



To promote international financial stability by coordinating with national financial authorities and international standard-setting bodies. Its decisions are not legally binding on its members, as it operates by moral suasion and peer pressure, in order to set internationally agreed policies and minimum standards.

BharatPe Achieves Ebitda Positivity for the First Time in October, Achieves Annual Recurring Revenue (ARR) of Rs 1,500 Crore

Fintech major BharatPe turned Ebitda-positive in October and clocked an annualised revenue of Rs 1,500 crore, up 31% from the year-ago period, on the back of a significant growth in lending and payments business. The company also reduced its cash burn, which was averaging Rs 60 crore a month in FY23, to

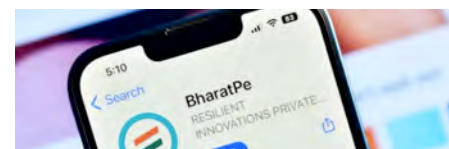

attain a positive Ebitda. EBITDA, or earnings before interest, taxes, depreciation, and amortization, is an alternative measure of a company's overall financial performance.

Tata AIG General Insurance Company Launches 'Health Supercharge' for Comprehensive Well-being Coverage

TATA AIG General Insurance Company Limited introduced "Health Supercharge" with the aim of offering a fivefold enhancement in health insurance coverage, addressing the dynamic nature of health-related uncertainties. The new plan caters to the healthcare needs of families residing in Tier I to Tier IV locations, ensuring inclusivity across various geographical segments. Tata AIG Health Supercharge offers a sum



insured ranging from ₹5 lakhs to ₹20 lakhs. Tata AIG General Insurance

Company Limited is an Indian general insurance company and a joint venture between the Tata Group and American International Group (AIG). Tata Group holds a 74% stake in the insurance venture with AIG holding the balance of 26%.



RBI Announces Plans to Set Up Cloud Facility for the Financial Sector to Strengthen Data Security

The Reserve Bank of India (RBI) is actively working on establishing a dedicated cloud facility for the financial sector in India. The primary objective of the proposed cloud facility is to significantly enhance the security, integrity, and privacy of data within the financial sector. The cloud facility will be set up and initially operated by Indian Financial Technology & Allied Services (IFTAS), a wholly-owned subsidiary of RBI. Over time, the cloud facility will be transitioned to a separate entity, with ownership vested in financial sector participants.



SBI Card joins Bharat BillPay in the credit card category

NPCI Bharat BillPay Ltd. (NBBL), the wholly-owned subsidiary of the National Payments Corporation of India (NPCI), announced that it has on-boarded SBI Card, under the credit card category of Bharat BillPay. Aim : To simplify the way customers manage their credit card bill payments by providing them better convenience and accessibility. The other major credit card issuers under this category are Kotak Mahindra Bank, BoB Financial, Federal Bank, AU Small Finance Bank, IndusInd Bank, and Canara Bank.

Asian Development Bank Commits USD 170 Million to Transform Kochi's Water Landscape

The Asian Development Bank (ADB) has approved a significant loan of USD 170 million for the modernization of water supply services in Kochi, Kerala. Objective of the Loan : To modernize water supply services, elevate urban living standards, ensure access to clean water, and enhance climate resilience in Kochi. ADB's intervention is particularly crucial due to Kerala experiencing severe dry spells and droughts, notably in 2016, which significantly impacted

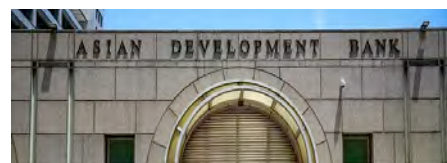

water availability in the region. The ambitious project involves the rehabilitation and upgrade of 5 existing water treatment plants. The project will rehabilitate and upgrade five existing water treatment plants that have a cumulative production capacity of 325 million litres per day (MLD), as well as build a new plant with 190 MLD capacity.

S&P Global Study: LIC Ranks as the Fourth-Largest Insurer Globally by Reserves

Insurance behemoth Life Insurance Corporation of India (LIC) is the fourth largest insurer in the world, according to a ranking based on life and accident & health reserves of companies in 2022 by S&P Global Market Intelligence. LIC follows Allianz SE, China Life Insurance Company, and Nippon Life Insurance Company in global rankings. According to the report, LIC's



reserves stood at \$503.7 billion. Germany's Allianz SE (\$750.20 billion), China Life Insurance Company (\$616.90 billion) and Nippon Life Insurance Company (\$536.80 billion) are the top three insurance companies in the world.

RBI to Develop Regulatory Framework for Oversight of Loan Aggregators

The Reserve Bank of India (RBI) announced that it will soon release a regulatory framework aimed at overseeing web-based loan comparison platforms known as web-aggregators of loan products (WALP). WALP offers the service of aggregating loan offers from multiple lenders on an electronic platform which allows borrowers to easily compare different offers and choose the most suitable loan option available from the participating lenders. Objective



of the Framework : The RBI aims to create a structured system for loan aggregation services provided by lending service providers (LSPs). The framework aims to enhance transparency in the operations of WALPs or digital lending. It focuses on increasing customer centricity and enabling borrowers to make informed choices.



DICGC report: Banks witness drop in insured deposits

The ratio of insured deposits to assessable deposits in the banking system declined to 46.31% in FY2023 from 49% in FY2022 as customers, lured by attractive deposit rates, placed larger deposits (over and above the Rs 5 lakh deposit insurance cover) with banks, going by latest Deposit Insurance and Credit Guarantee Corporation (DICGC) data. This means that bank customers preferred to place larger quantum (Rs 5 lakh and above) of deposits (accounting for 53.69% of the deposits by value), which remained uninsured. In the preceding year, 51% of the deposits were uninsured. Deposit insurance cover is available on deposits up to Rs 5 lakh.

Ministry of Finance Reports Banks Writing Off ₹10.6 Lakh Crore in the Last 5 Years



The government informed the Lok Sabha that in the last five years, Scheduled Commercial Banks (SCBs) wrote off nearly Rs 10.6 lakh crore, with almost half of this amount belonging to large industrial houses. Half of the written-off amount, approximately 50%, is attributed to large industrial houses. Defaulted Borrowers and Outstanding Amount: Nearly 2300 borrowers, categorised as wilful defaulters, defaulted on around Rs 2 lakh crore. These borrowers are having a loan amount of Rs 5 crore or more.

Aditya Birla Health Launches 'Activ One' Product Offering 100% Returns

Aditya Birla Health Insurance Company Limited (ABHICL), the health insurance division of Aditya Birla Capital, a prominent and diversified financial services provider in India, has introduced 'Activ One.' This streamlined and all-encompassing health insurance plan is designed to offer policyholders personalised solutions, addressing not only their health insurance requirements but also fostering their journey towards optimal well-being. Packed with cutting-



edge features like complete health returns, claim protection, no sub-limits, super reload, and super credit, Activ One stands as ABHICL's most extensive offering to date. This all-inclusive product provides customers with a singular solution for both their health assurance and health insurance requirements.

Asian Infrastructure Investment Bank and United Nations Development Programme Ink Memorandum of Understanding to Advance Sustainable Infrastructure Development

The Asian Infrastructure Investment Bank (AIIB) and the United Nations Development Programme (UNDP) have signed a Memorandum of Understanding (MoU) to strengthen collaboration in promoting sustainable infrastructure development and address development challenges in Asia and beyond. AIIB is a multilateral development bank whose mission is financing the "Infrastructure for Tomorrow," infrastructure that

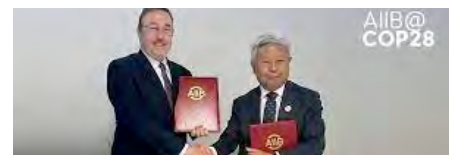

is inclusive and sustainable socially, environmentally and economically. UNDP partners with people at all levels of society to help build nations that can withstand crises, and drive and sustain the kind of growth that improves the quality of life for everyone.

RBI Permits Reversal of Liquidity Facilities under Standing Deposit Facility and Marginal Standing Facility on Weekends and Holidays

The Reserve Bank of India (RBI) has decided to allow the reversal of liquidity facilities under both SDF (standing deposit facility) and MSF (marginal standing facility) even during weekends and holidays with effect from December 30, 2023, to address the situation arising out of simultaneous high utilisation of both these facilities by banks. This move is expected to facilitate better fund management



by the banks. At present, the standing facilities of the Reserve Bank under the LAF (liquidity adjustment facility) – the SDF and the MSF – can be availed from 17:30 hours to 23:59 hours on all days including weekends and holidays.



UPI Transaction Value Hits Record ₹17.4 Lakh Crore in November 2023

Unified Payments Interface (UPI) transaction value reached a new high level at ₹17.4 lakh crore in November 2023. UPI transaction volume declined slightly to 1,124 crore from 1,141 crore in October. UPI transaction value was ₹17.16 lakh crore in October. UPI transactions fell slightly by 1.5% to 1,124 crore from 1,141 crore in October.



ADB Grants \$98 Million Loan to Enhance Access to Disease-Free Planting Materials for Horticulture Crop Farmers in India

The Asian Development Bank (ADB) has approved a \$98 million loan to improve horticulture crop farmers' access to certified disease-free planting materials, which will boost their crops' yield, quality, and resilience to climate impacts. This project supports India's agricultural transformation. ADB's financing will support the Government of India's Atmanirbhar Clean Plant Program (CPP), which was announced in February 2023 to establish clean plant centers and a certification scheme that will ensure farmers can purchase disease-free planting materials from private nurseries.

SEBI Extends Deadline for Integration of SCORES with Online Dispute Resolution Platform to April 1, 2024

The Securities and Exchange Board of India (SEBI) has extended the timeline for implementation of linking SEBI Complaint Redressal (SCORES) with the online dispute resolution platform to April 1, 2024. Earlier, the deadline for linking both the platforms was December 4, 2023. The market entities need to keep submitting the Action Taken Report (ATR) SCORES



within 21 calendar days from the date of receipt of the complaint.

In September, 2023 the capital market regulator had issued a circular saying that market entities will need to apply for SCORES authentication and for Application Programming Interface (API) integration.

Government of India and Asian Development Bank sign \$175 million loan to improve connectivity in Madhya Pradesh

The Government of India and the Asian Development Bank (ADB) signed a \$175 million loan to improve connectivity and resilience of roads in the state of Madhya Pradesh. The signatories to the loan agreement for the Enhancing Connectivity and Resilience of the Madhya Pradesh Road Network Project were Ms. Juhi Mukherjee, Joint Secretary, Department of Economic Affairs, in the Ministry of Finance,



for the Government of India, and Takeo Konishi, Country Director of ADB's India Resident Mission, for ADB. This project will enhance connectivity in the state road network in 14 districts to enable balanced economic development in Madhya Pradesh.

ICICI Lombard Unveils MaxProtect, the Newest Addition to its Customer-Centric Product Portfolio

ICICI Lombard has introduced MaxProtect, the latest addition to its range of customer-focused products. Tailored to align with the dynamic lifestyles of customers, MaxProtect aims to deliver comprehensive coverage at a competitive price. This product is designed to provide a cost-effective, inflation-adjusted



solution to address the healthcare requirements of both individuals and families. MaxProtect offers a choice between two customer-centric insurance plans.



28 Virtual Digital Asset Platforms Successfully Register with FIU-India to Ensure Compliance with PMLA Norms

As many as 28 Virtual Digital Assets (VDA) service providers, including WazirX, Coin DCX and Coin Switch, have registered themselves with the Financial Intelligence Unit-India (FIU-IND). The Finance Ministry in March, 2023 had stated that entities dealing in VDAs, crypto exchanges and intermediaries would be considered "reporting entities" under the Prevention of money laundering Act (PMLA). Accordingly, crypto exchanges and intermediaries dealing with VDAs were required to perform KYC of their clients and users of the platform. 28 entities have registered themselves for providing services related to VDAs.



RBI Grants Approval for CSB Bank Promoter to Maintain 26% Stake in the Lender

The promoter of CSB Bank Terstwhile Catholic Syrian Bank Limited in India has obtained approval from the Reserve Bank of India (RBI) to maintain a 26% stake in the bank. Initially advised by the RBI to reduce their stake to 15%, the promoter has now been allowed to retain a higher stake of 26%.

JICA Commits Up to \$1.5 Billion for ADB-Administered LEAP 2 Fund to Bolster Infrastructure in Asia and the Pacific

The Asian Development Bank (ADB) and Japan International Cooperation Agency (JICA) have agreed to launch a new fund aimed at boosting private infrastructure in the Asia-Pacific, where China is making inroads with its investments. The organisations stated that the new fund, named Leading Asia's Private Infrastructure Fund 2 (LEAP 2), would have capital of up to \$1.5 billion provided by JICA, serving



as the successor fund to LEAP. The launch, a symbol of ties between Japan and developing Asia, comes a week ahead of summit meetings between Japanese Prime Minister Fumio Kishida and the leaders of the Association of Southeast Asian Nations (ASEAN).

SEBI's Proposal to Reduce NCD Face Value from ₹1 Lakh to ₹10,000

The Securities and Exchange Board of India (SEBI) proposed to permit companies to issue non-convertible debentures (NCDs) and non-convertible redeemable preference shares (NCRPS) with the face value of Rs. 10,000 as against the current system of Rs one lakh face value. According to a SEBI consultation paper, the measure aims to enhance the participation of non-institutional investors in the corporate bond market coupled with mitigation and management of risk to safeguard and protect the interest of such non-institutional investors. SEBI, in the agenda 'Introduction of



Regulatory Framework for Online Bond Platforms' placed before the Board in the meeting held on September 30, 2023 approved the proposal to reduce the face value from Rs 10 lakh to Rs 1 lakh. The SEBI has also proposed a framework for the issuance of subordinate units in Real Estate Investment Trusts (Reits) and Infrastructure Investment Trusts (InvITs) to sponsors, sponsor groups, and associates.

Bank of India Introduces Nari Shakti Savings Account

Bank of India (BoI) has launched an exclusive savings bank product for women (Nari Shakti Savings Account) with an independent source of income. To provide them with enhanced privileges and features to support their financial empowerment Personal accident insurance cover: This account comes with a comprehensive personal accident insurance cover of up to Rs.



100 lakhs, ensuring the safety and security of women account holders. Discounted health insurance and wellness products: Women holding the Nari Shakti Savings Account can avail attractive discounts on health insurance and wellness products, promoting their overall well-being.



Reliance Industries Collaborates with DBS Bank for Financing Program for Compressed Biogas (CBG) Plants

Reliance Industries Limited (RIL) and DBS Bank India have collaborated to establish a financing programme customised to the requirements of the compressed biogas project initiated by RIL. The financing initiative aims to support the ecosystem development for vendor partners involved in aggregating agri-residue as inputs for Reliance's CBG production plants across India. At Reliance's 46th annual general meeting (AGM), Chairman Mukesh Ambani had informed that the company targets to establish 100 compressed biogas (CBG) plants in the next 5 years, consuming 5.5 million tonnes of agro-residue and organic waste. The CBG plants are expected to mitigate nearly 2 million tonnes of carbon emissions annually and produce 2.5 million tonnes of organic manure.



IDFC FIRST Bank and Mastercard Unveil the FIRST SWYP Credit Card

IDFC FIRST Bank has introduced a youth-centric "FIRST SWYP" credit card in partnership with Mastercard. The card will address demands of new-age customers, blending benefits across their favourite categories of spends and lifestyle-related offers and innovative propositions. The new card is the Bank's second youth-focused credit card. It had earlier launched "FIRST Millennia Credit Cards".

Universal Sampo General Insurance Unveils "Muskaan" - a Socially Impactful Health Insurance Policy for Domestic Workers and Staff

Universal Sampo General Insurance introduced "Muskaan", an innovative health insurance policy carefully designed to create a positive social impact and uplift domestic workers and staff. Muskaan stands as a specialised health insurance offering dedicated support to domestic workers, providing them with effortless access to comprehensive coverage for medical needs and assistance in the event of an accident. It provides extensive



coverage under Section 1 (Health), encompassing in-patient treatment, pre-hospitalisation, post-hospitalisation, domiciliary treatment, and AYUSH treatment. Additionally, Section 2 (Personal Accident) offers comprehensive coverage for accidental death and permanent total disability.

HDFC Bank, Axis Bank, and AU Small Finance Bank Embrace FICO Platform as Early Adopters

Globally renowned data analytics company FICO has commenced operations in India, establishing collaborations with leading financial institutions, including HDFC Bank, Axis Bank, and AU Small Finance Bank. HDFC Bank, Axis Bank, and AU Small Finance Bank are utilizing the FICO platform to undergo digital transformations in various financial processes, such as those related to home loans, credit cards, and auto loans. FICO emphasizes the efficiency of its



cloud-based platform, enabling swift loan approvals within seconds, reflecting the integration of advanced technology to streamline lending operations. Vishal Goyal, the Country Director for India at FICO, underscores that the FICO analytics platform has the potential to enhance approval rates for lenders.

ACKO Partners with PhonePe to Facilitate Insurance Accessibility for Millions

ACKO General Insurance and PhonePe have collaborated to provide a range of inclusive car and bike insurance products directly to users through the PhonePe platform. This strategic partnership combines ACKO's customer-centric approach with PhonePe's extensive distribution network, ensuring convenient access to insurance as a readily



available financial option for PhonePe users. In addition, this partnership will witness ACKO expanding its product range to encompass health insurance and various other lines in the coming years.



YOUR PERFECT BANKING PARTNER

Federal Bank Named “Bank of the Year India” by The Banker Financial Times

Federal Bank, a leading financial institution, has been recognised as “Bank of the Year (India)” by Financial Times owned The Banker, one of the only three global awards that considers the work of banks spanning 120 countries. This prestigious recognition is a testament to the Bank’s unwavering commitment to innovation, customer-centric services, and its outstanding contributions to the banking industry over the past year. One of the standout initiatives that garnered attention was the introduction of the Digital Personal Loan by Federal Bank. Recognizing the challenges faced by customers in rural areas in accessing banking services, Federal Bank launched the ‘Bank on the Go’ initiative. Federal Bank has also embraced cutting-edge technology to enhance customer support, introducing “Feddy”, an artificial intelligence-powered chatbot.

iVIS Collaborates with ICICI Bank to Enhance Security through Advanced E-Surveillance Services



iVIS, a subsidiary of Magellanic Cloud, has announced its empanelment with ICICI Bank for the delivery of e-surveillance services across branches. This strategic collaboration enables iVIS to offer AI/ML and IoT technology-enabled e-surveillance services, which will include real-time video monitoring and recording, facial recognition, incident detection, reporting, and data analytics.

Poonawalla Housing Finance undergoes rebranding, emerges as Grihum Housing Finance

Following a change in ownership, Poonawalla Housing Finance has been rebranded as Grihum Housing Finance with global private equity firm TPG now holding 99.02 per cent stake in the housing finance company. Before being promoted by Poonawalla Fincorp, the housing financier was a part of the Magma Group. The new name, Grihum, is a fusion of ‘Grih’ (home) and ‘Hum’ (togetherness), reflecting the company’s commitment to fostering collaboration and unity. The company, which has seen a compound annual growth rate (CAGR) of 28% in its Assets Under Management (AUM) during the



last six years, expects to continue that trend and touch an AUM of Rs 11,000 crore by March 2025. Currently, the AUM of the firm stands at approximately Rs 7,500 crore. Speaking on fund-raising plans, the company plans to raise around Rs 2,500 crore in order to boost the growth of AUM through banks, Non-Convertible Debentures (NCDs), and other multilateral agencies. MD and CEO of Grihum Housing Finance : Manish Jaiswal

Finance Ministry Allocates Rs 10,000 Crore as Urgent Aid for National Rural Employment Guarantee Scheme (NREGS)

The finance ministry has released ₹10,000 crore in urgent assistance to meet unexpected enhanced expenditure under the rural job guarantee scheme until the first batch of supplementary demands for grants is approved by parliament at its next session. The unusual move came after 95% of the FY24 budgetary outlay of ₹60,000 crore for the Mahatma Gandhi National Rural Employment Guarantee Scheme (MGNREGS) was exhausted well



before the commencement of the winter session of parliament. The urgent funds, released last week to the rural development ministry, will form a part of the additional ₹28,000 crore that could be allocated for the scheme in the first batch of supplementary demands for grants for FY24.

CoinSwitch introduces the overarching brand PeepalCo, targeting expansion in wealth technology

Cryptocurrency platform CoinSwitch has unveiled PeepalCo, a new umbrella brand to house all its business segments, as it plans to expand into a wealth-tech platform. PeepalCo will house CoinSwitch, the crypto retail app, and CoinSwitch PRO, the advanced trading platform, soon-to-be-launched platform with newer investment classes



and wealth-management division catering to high net worth Individuals (HNIs). The unicorn is backed by multiple investors including Andreessen Horowitz (a16z), Tiger Global, Peak XV Partners (was Sequoia Capital India), Ribbit Capital, Paradigm and Coinbase Ventures.

SBI to sign 70 million euro LoC with KfW for solar projects



SBI signed a 70 million euro (approximately Rs 630 crore) Line of Credit (LoC) with KfW. The LoC with German Development Bank KfW is for promoting solar projects in the country. The agreement was signed on 14 December at the bank's IFSC Gift City Branch in Ahmedabad. LoC aims to support Solar Photovoltaics (PV) projects in India. SBI has shown a 9.13% growth in consolidated net profit for the September quarter. It reported a total income of more than Rs 1.12 lakh crore for September quarter.

IndusInd Bank Unveils Innovative 'Indus Solitaire Program' Community Banking Initiative for Diamond Cohorts



IndusInd Bank has introduced the 'Indus Solitaire Program,' a specialized community banking initiative tailored for the diamond industry. This curated banking program will be offered through Bank's flagship branches in prime locations across various cities with concentration in Mumbai and Surat and will provide a range of exclusive benefits along with distinct features and enriched offerings to customers in the diamond industry. The program offers exclusive benefits such as 24*7 locker access, add-on family accounts, and membership benefits at top-tier hotels. Debit and credit cards under this program provide concierge services, complimentary golf lessons and movie tickets, zero cross-currency mark-up fee on foreign exchange, and complimentary lounge access.

Intellect Secures ₹80-Crore Agreement with Indian Bank for Implementation of Cash Management System

Intellect Design Arena Limited, the Chennai-based FinTech company for financial and insurance clients, has signed a ₹80 crore, 5-year deal with Indian Bank to deploy Intellect's eMACH.ai powered Cash Management System. The partnership is a pivotal moment - adding another feather to Intellect's growing footprint in the Indian BFSI industry, rendering the capabilities of a cognitive enterprise for revolutionising



transaction banking. As part of the project 'INDLEAP', the Indian Bank has taken on the objective of digital transformation by leveraging technology wherever possible with transaction banking and supply chain management being the key growth engines.

India, ADB sign \$200 million loan agreement for Uttarakhand power system project

India and ADB have signed a \$200 million loan agreement with Uttarakhand for the Power System Project. This loan agreement is to improve the quality, efficiency, and reliability of power supply in Uttarakhand. This loan agreement is for the Uttarakhand Climate Resilient Power System Development Project. The Asian Development Bank (ADB) will fund the project. This will strengthen the power system infrastructure in Uttarakhand. The project involves



enhancing the power system network's capabilities. The project will modernise Dehradun city's power network infrastructure. The Japan Fund for Prosperous and Resilient Asia and the Pacific will provide a \$2 million grant to support livelihood enhancement, and training activities of the project.

Weighted average cut-off yield of State Govt Security issuances rose 73 bps during FY23: RBI report

The weighted average cut-off yield of State Government Security issuances increased to 7.71% as per RBI report. The RBI report is titled "State Finances: A Study of Budgets of 2023-24". As per the report, the weighted average cut-off yield of State Government Security issuances increased 73 basis points (bps) during 2022-23 from 6.98% in the previous year. The weighted average spread (WAS) between SGS issuances and comparable-maturity Central government



securities, however, decreased from 41 basis points to 31 basis points in 2022-2023. The next ten years will see the maturation of almost 79% of SGS. According to the report, this increase was concentrated in states like Andhra Pradesh, Gujarat, Himachal Pradesh, Madhya Pradesh, Haryana and Assam.



Bain Capital sells a 1.1% stake in Axis Bank for over Rs 3,700 cr

Private equity firm Bain Capital has offloaded a 1.1% stake in Axis Bank through the open market raking in a profit of more than Rs 3,700 crore. This is the second time in 2023 that Bain Capital has sold a stake in the private sector lender. In June, it sold a 0.7% stake in Axis Bank at an average price of Rs 968 apiece, aggregating Rs 2,178 crore. Prior to this, the private equity firm had sold a 1.2% stake in October 2022. Meanwhile, several foreign portfolio investors (FPIs) picked up stakes in Axis Bank through separate block deals.



RBI authorised Bandhan Bank to disburse pensions on behalf of Indian Railways

Bandhan Bank has been authorised by RBI to disburse pensions on behalf of Indian Railways. With this authorisation, Bandhan Bank will be allowed to give pensions to all former employees of the Ministry of Railways. It will have access to nearly 50,000 Indian Railways retirees every year on average across all offices of Indian Railways. The net profit of Bandhan Bank more than tripled for the quarter ended September 2023 to Rs 721 crore. The net profit increased by a huge 245%.

'10 PSBs transferred NPAs of over `11,617 cr to NAR-CL from Jan-Nov 2023'



A total of 10 Public Sector Banks (PSBs) have transferred Non-Performing Assets (NPAs) of over Rs 11,617 crore to NARCL between January and November this year. In a written reply to a question in the Rajya Sabha, Minister of State for Finance Bhagwat Karad said the National Asset Reconstruction Company Ltd (NARCL) has recovered Rs 16.64 crore as of November 30, 2023. As per details of the debt assigned to the NARCL by these 10 PSBs, as on November 30, SBI has transferred the largest

amount of Rs 4,508 crore, followed by PNB, and Canara Bank at Rs 2,138 crore and Rs 1,858 crore, respectively. Union Bank of India has transferred Rs 1,831 crore to NARCL between January and November. The other PSBs include the Bank of Baroda, Bank of India, Bank of Maharashtra, Central Bank, Indian Bank, and Indian Overseas Bank. These 10 PSBs had aggregate gross NPAs of over Rs 3.65 lakh crore as of September 30, 2023, as per the data shared by the Finance Ministry to the Rajya Sabha.

IRDAI Relaxes Claim Settlement Rules for Cyclone Michaung Victims

The Insurance Regulatory and Development Authority of India (IRDAI) has raised the limits on losses for the appointment of Surveyors and Loss Assessors. The limits have been increased for Motor Insurance to Rs 1 lakh from the existing Rs 50,000. For other than motor insurance, it has been increased from the current Rs 1 lakh to Rs 5 lakh. A surveyor and loss assessor is an insurance intermediary licensed by IRDAI to investigate, manage, quantify, validate and deal with losses (whether insured or not) arising from any contingency,



on behalf of the company or the policyholder. The special dispensation is effective for a period of 2 months from the date of the circular's issuance. Cyclone Michuung (pronounced as 'Migjaum') intensified into a severe cyclone after forming in the Bay of Bengal during the 2023 North Indian Ocean cyclone season.

LIC Announces Increase in Gratuity Limit for Agents from Rs 3 Lakh to Rs 5 Lakh

Life Insurance Corporation (LIC) has notified an increase in gratuity limit to Rs 5 lakh from Rs 3 lakh for LIC agents with an aim to bring substantial improvements to the working conditions and benefits for them. The increase was affected by amending the Life Insurance Corporation of India (Agents) Regulations, 2017. These regulations may be called



the Life Insurance Corporation of India (Agents) Amendment Regulations, 2023. Currently, LIC agents are not eligible for renewal commission on any business completed under the old agency.

Insurance Ombudsman Resolves 92% of Complaints in FY23



The insurance ombudsman disposed of 92% of the complaints it received from the insured during 2022-23. It received 55,946 complaints during the year across its offices in the country, of which 51,625 were disposed of. The Delhi centre disposed of all the 5,257 complaints it got during the year, according to a press statement issued by the Delhi office of the Insurance Ombudsman. The offices of the Insurance Ombudsman are under the administrative control of the Council for Insurance Ombudsman (CIO).

SBI Mutual Fund Acquires 1.5% Stake in Karur Vysya Bank for Rs 190 Crore



SBI Mutual Fund acquired shares of scheduled commercial bank Karur Vysya Bank (KVB) for Rs 190 crore through open market transactions. According to the bulk deal data available with the BSE and NSE, SBI Mutual Fund (MF) purchased a total of 1,20,00,000 shares, amounting to a 1.5% stake in Karur Vysya Bank. The shares were picked at an average price of Rs 162 apiece on both bourses, taking the combined aggregate deal size to Rs 194.40 crore. Shares of Karur Vysya Bank rose 1.32 per cent to close at Rs 164.90 apiece on the BSE and gained 0.52 per cent to settle at Rs 164.70 per piece on the NSE.

Foreign Direct Investment (FDI) Inflows into Gujarat Experience 30% Decline in the First Half of FY24, Marking a 2-Year Slowing Trend

Since the last two years, foreign direct investment (FDI) inflows into Gujarat have remained subdued, despite the state topping the FDI charts in 2020-21. In the first six months of the current financial year 2023-24, FDI flows into Gujarat experienced a nearly 30% decline, marking the third consecutive year of subdued performance. Gujarat's FDI decline is the second-highest among Indian states during this period, with Karnataka experiencing a larger decline of



almost 44%. Gujarat attracted ₹18,884 crore between April and September, which is lower than the ₹26,866 crore FDI for the same period in 2022-23, according to state figures published by the Department for Promotion of Industry and Internal Trade (DPIIT).

Cashfree Payments Introduces 'FlowWise,' India's Pioneering Self-Hosted Payments Orchestration Platform

Cashfree Payments, India's leading payments and API banking company, announced its foray into payment orchestration with the launch of 'FlowWise' that helps Indian businesses manage payments more efficiently. The newly introduced platform will allow businesses to easily use multiple payment services with just one setup and direct payments to different partners based on specific needs in real-time. With FlowWise, Cashfree Payments has introduced an innovative and industry-first concept of 'self-hosted payments



orchestration', allowing payment management to take place directly on the merchant's infrastructure. It is India's first cloud-native orchestration platform and aims to improve success rate by up to 10% and cut the processing costs up to 40%. FlowWise's self hosting feature eliminates safety concerns, making it one of the most secure, scalable and cost effective solutions for merchants. CEO and Co-founder, Cashfree Payments : Akash Sinha

PNB Housing Finance completes Rs 1,000 cr loan bookmark under its affordable housing scheme

PNB Housing Finance, the third largest housing finance company in India, announced that it has achieved a loan book size of Rs 1,000 crore in the affordable housing segment. It said that under its Roshni scheme for affordable housing, it aims to double the loan book by March 2025. The scheme was launched



in December last year. Girish Kousgi, managing director and chief executive officer at PNB Housing Finance. Under the Roshni scheme, the company provides loans for ticket sizes in the range of Rs 5 lakh to Rs 35 lakh.

HDFC Life and Karur Vysya Bank (KVB) Join Forces in Corporate Agency Partnership for Life Insurance Solutions



Private sector Karur Vysya Bank Limited (KVB) and HDFC Life Insurance

Company Limited (HDFC Life) have entered into a corporate agency (CA) agreement to offer life insurance products to their respective customers. This corporate agency arrangement would enable customers of Karur Vysya Bank to avail HDFC Life's wide range of life insurance products which include solutions for protection, savings and investment, retirement and critical illness. The collaboration is aligned with the goal of Insurance for all by 2047 set by the Insurance Regulatory and Development Authority (IRDAI). Since HDFC Life offers claim intimation process online, our customers can avail the services without stepping out of their homes.

CASHe Unveils its Super App & Repositions itself as 'Bharat Ka Money App'

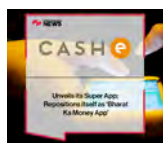

CASHe, a leading credit-led Artificial Intelligence (AI)-driven financial

wellness platform, has unveiled its super app with the tagline - 'Bharat Ka Money App.' CASHe represents commitment to delivering accessible, innovative, and empowering financial solutions to all. "Simultaneously, CASHe has launched a revamped website (www.cashe.co.in) along with the launch of its mobile application, designed to expand its financial offerings to a broader audience and reinforce its national presence.

State Bank of India (SBI) Set to Ink \$165 Million Line of Credit (LoC) Agreement with World Bank for Rooftop Solar Projects

State Bank of India (SBI) has signed a \$165 million (over Rs 1,300 crore) Line of Credit (LoC) with the World Bank for promoting rooftop solar projects in India. The LoC is specifically aimed at supporting grid-connected rooftop solar photovoltaic (PV) projects in both residential and institutional sectors. The SBI has outstanding forex loans of \$2.3 billion from various multilateral agencies, including the World Bank, the Asian Development Bank, and Germany's KfW. SBI is



planning to make it mandatory for builders to make rooftop solar installations if the project is funded from the bank's green funds. SBI registered a 9.13% growth in consolidated net profit in the September quarter to Rs 16,099.58 crore as against Rs 14,752 crore in the year-ago period.

Bandhan Bank Receives Mandate to Collect Revenue on Assam Government's e-GRAS Portal

Bandhan Bank has obtained a mandate to oversee revenue collection on the Assam government's e-GRAS portal. This will enable people of Assam to make their tax payments as well as non-tax payments through the Government Receipt Accounting System Portal (GRAS). This initiative aims to streamline transactions, making them more accessible and paperless for the people of Assam. Through Assam e-GRAS portal, a citizen can pay to 70 various departments for a



range of services offered by them. In the fiscal year 2022-23, the total collection through the Assam e-GRAS portal reached nearly Rs 16,000 crore. Assam eGRAS provides 24 X 7 facility and the citizens of Assam can generate e-challan for required services and make online payments anytime from anywhere.

Kotak Mahindra Life Insurance Unveils T.U.L.I.P, a New Term with Unit-Linked Insurance Plan (ULIP)

Kotak Mahindra Life Insurance Company has introduced a new insurance product known as T.U.L.I.P - Term with Unit Linked Insurance Plan. This is a unit-linked term insurance plan designed to provide life coverage up to 100 times the annual premium, allowing customers to potentially earn returns similar to a unit-linked insurance plan (ULIP). Loyalty additions of up to 30% of the fund value, incorporated by the company as part of maturity



benefits. Refund of two times the premium allocation charges in the 10th, 11th, 12th, and 13th year. Flexibility to withdraw funds in case of a financial emergency.. T.U.L.I.P offers policyholders the flexibility of selecting from eight fund options that encompass equity, including mid-cap, debt, and hybrid categories.

HDFC Life and NKGSB Co-Operative Bank Form Strategic Corporate Partnership



HDFC Life, one of India's leading insurers, and NKGSB Co-operative Bank Limited, having a legacy of 106 years, have entered into a Corporate Agency tie-up enabling NKGSB Co-operative Bank customers to avail life insurance products of HDFC Life. NKGSB Co-operative Bank with a Banking legacy of 106 years is delighted to enter into a strategic and momentous alliance with HDFC Life Insurance Company to provide life insurance solutions that cater to various needs of individuals – protection, pension, savings, investment and annuity. This alliance reflects our Bank's commitment in ensuring the well-being and financial security of its valued customers."

LIC Granted Extension Until May 2032 to Attain 25% Minimum Public Shareholding



Life Insurance Corporation of India (LIC) will get time till May 2032 to comply with Minimum Public Shareholding (MPS) norms prescribed by the Securities and Exchange Board of India (SEBI) under Rule 19A (6) of the Securities Contract (Regulations) Rules (SCRR) 1957. As of September 30, 2023, the government owns 96.5% in LIC. Rule 19A of the Securities Contract Regulation Rules says every listed company, other than a public sector company, shall maintain a public shareholding of at least 25%. Such a provision aims to bring more public shareholding. The public can be an individual or an institution.

IDFC FIRST Bank, LIC Cards and Mastercard Collaborate to Launch a Co-branded Credit Card to Meet the Financial Needs of India

IDFC First Bank, LIC Cards, and Mastercard announced their collaboration to launch an exclusive co-branded credit card to meet the dynamic financial needs of the country. The credit card is available in two variants – LIC Classic and LIC Select. Financial Benefits : No joining and annual fees for the credit card. Low interest rates starting from 9% p.a. Insurance Benefits : Cardholders enjoy a personal accident insurance cover of up to Rs. 5 lakh. Up to Rs. 50,000 cover for lost card liability. Roadside



Vehicle Assistance : Additional perk includes roadside vehicle assistance worth Rs. 1,399. Fee Structure : Zero joining fee and zero annual fee. No minimum spend conditions Dynamic APR (Annual Percentage Rate). Low revolving credit for better credit customers.

PFRDA Releases Preliminary Risk Management Framework for Credit Rating Agencies (CRAs)

Pension regulator Pension Fund Regulatory and Development Authority (PFRDA) has issued a Draft Risk Management Framework for the Central Record Keeping Agencies (CRAs) under National Pension System (NPS) architecture. The stakeholders including CRAs have been given time till January 1 to provide their feedback/suggestions/inputs on the draft proposals. Currently, there are 3 CRAs registered with the Pension Fund Regulatory and Development Authority. They are Computer Age Management Services Ltd (CAMS), Protean eGov Technologies Ltd. (Formerly NSDL



e-Governance Infrastructure Limited), and KFin Technologies Limited. The objective of the Risk Management Framework includes managing risk in a consistent manner across the organisational set up of the CRA; have a strong risk culture wherein managing risk would be part of regular work of the CRA; and deliver fair outcomes for subscribers, maintain an orderly and transparent operation of services of the CRAs to subscribers and all other stakeholders.

ICICI Prudential Mutual Fund revises symbols for 28 ETF schemes

ICICI Prudential Mutual Fund has announced changes in its 28 exchange-traded fund (ETF) product symbols on the Bombay Stock Exchange (BSE) and National Stock Exchange (NSE). The codes will now be a combination of the name of the fund and the suffix 'IETF' (stands for ICICI Prudential ETF). The move to standardise the naming



convention of schemes comes in line with the Securities Exchange Board of India's (SEBI's) master circular, which outlines the categorisation of schemes.



IndusInd Bank introduces 'eSvarna', India's first Corporate Credit Card on RuPay network

IndusInd Bank has launched 'eSvarna', the country's first corporate credit card on the RuPay network, enabling the private sector lender to become the first to integrate UPI functionality with a corporate credit card. The card facilitates smooth transactions at merchant outlets and allows users the flexibility to make UPI payments by linking the card with UPI-enabled apps. The IndusInd Bank eSvarna credit card on the RuPay network comes with an array of exclusive perks and rewards. IndusInd Bank eSvarna credit cardholders can look forward to a luxurious travel experience, including complimentary lounge access and fuel surcharge waiver. Corporate travellers can receive the added benefit of comprehensive travel insurance coverage and an exclusive rewards program meticulously crafted for corporate entities, which makes this credit card a valuable financial solution for various business transactions

NABARD's Initiative to Access Global Climate Capital for the Indian Agricultural Sector

The National Bank for Agriculture and Rural Development (NABARD) has teamed up with the Asian Development Bank (ADB) to help the farming sector tackle the adverse impact of climate change. The two organisations, in association with the Bill and Melinda Gates Foundation, will tap climate capital to fund agricultural, natural resources and rural development (ANR) initiatives. The collaboration is aimed at enhancing food security and climate financing



in India's ANR sector. Intellectap Advisory Services Private Limited will manage the TCU set up under the agreement. The projects eligible for support include climate-resilient agriculture and agroforestry projects, irrigation modernisation projects and JIVA (agro-ecology programme for revitalising natural resources management).

IndusInd Bank Divests from Nippon Life India Asset, Sells Shares Valued at Rs 795 Crore

Hinduja-promoted IndusInd Bank sold its entire 2.86% stake in Nippon Life India Asset Management for Rs 795 crore through open market transactions. SBI Mutual Fund (MF), ICICI Prudential MF, Bajaj Allianz Life Insurance, ICICI Prudential Asset Management Company, Societe Generale and Morgan Stanley Asia Singapore, were among the buyers. Through 13 tranches, IndusInd Bank offloaded 1,78,57,355 shares, amounting



to a 2.86% stake in Nippon Life India Asset Management (NAM-INDIA), as per the block deal data available with the BSE. According to the block deal data available with the National Stock Exchange (NSE), K S Kolbenschmidt GMBH sold 39 lakh shares, amounting to a 8.85 per cent stake in Shriram Pistons & Rings Ltd.

ETO Motors gets Rs 12.45 crore grant from SIDBI to deploy 300 electric three-wheelers in Delhi and Hyderabad

The Small Industries Development Bank of India (SIDBI) has granted Rs 12.45 crore to ETO Motors to deploy 300 electric three-wheelers in Hyderabad, Telangana and New Delhi, Delhi for first- and last-mile passenger connectivity. The EV maker will also build an EV charging infrastructure to support the deployment of the electric three-wheelers. The objective of this scheme is to provide access to affordable financing for electric vehicles and to develop



charging infrastructure, including battery swapping. As part of the funding, ETO Motors is expected to set up 180 charging points in the two cities. The electric three-wheelers will be manufactured at ETO Motors' capacity in Jadcherla, Telangana which also includes a modern research and development lab.

MSME lender U Gro Capital raises ₹250 crore from Dutch development bank



Micro, Small and Medium Enterprises (MSME) lender U Gro Capital has raised ₹250 crore from a Dutch development bank through rupee-denominated non-convertible debentures (NCDs). The association will help strengthen the fund's commitment towards greater financial inclusion in India. The MSME-lending-focused NBFC has provided credit to more than 80,000 small businesses. Prior to this, it had raised ₹240 crore from Denmark's Investment Fund for Developing Countries (IFU) in May 2023. Out of U Gro Capital's total borrowings, about 20% are from development financial institutions and impact funds like Responsibility, Calvert Impact Capital, Enabling Capital, SIDBI, and others

LIC Becomes First Anchor Investor in NABARD's Corporate Debt Market Bond Sale



Life Insurance Corp (LIC), the country's biggest institutional holder of marketable securities, is officially an anchor investor for an upcoming bond sale by the National Bank for Agricultural and Rural Development (NABARD), marking the first such occurrence in India's corporate debt market. LIC is the anchor investor for the ₹5,000-crore infrastructure bond sale by Nabard on December 20, 2023. The issuer, Nabard, has a green shoe option of ₹5,000 crore in addition to the base amount. As the anchor investor, LIC will take up 30% of the bond sale, amounting to ₹1,500 crore. Currently, LIC holds approximately 22% share in the overall bond market and 4% of the total market capitalization

IMF Reclassified India's Exchange Rate Regime from Floating to Stabilized Arrangement

India's de facto exchange rate regime has been reclassified by the International Monetary Fund (IMF) from "floating" to "stabilised arrangement" for the period December 2022 to October 2023. IMF Article IV Review Process: A team from the IMF staff visits the nation as part of the Article IV review process. Rupee-Dollar Fluctuations : The staff saw that the rupee-dollar had fluctuated dramatically during the previous two years, losing almost 15% of its value between December 2019 and November 2022. Reform



Efforts and Potential Growth : India has a far higher potential growth rate, according to the IMF, if reform efforts are advanced. Economic Projections : The IMF stated that real GDP is projected to grow at 6.3% in FY 2023/24 and FY2024/25. Inflation Outlook : Headline inflation is expected to gradually decline to the target. Current Account Deficit Improvement : The current account deficit is expected to improve to 1.8% of GDP in FY 2023/24.

RBI's Model Anticipates Retail Inflation to Reach 4.8% in FY25

The Reserve Bank of India's (RBI's) Dynamic Stochastic General Equilibrium (DSGE) model forecasts retail inflation to be 4.8% in the fiscal year 2024-25. The projected inflation rate surpasses the Monetary Policy Committee's (MPC) target of 4%. CPI Inflation Trends: The Consumer Price Index (CPI) inflation is anticipated to ease post Q3 FY24, averaging at 5.3% for the entire FY24 and further moderating to 4.8% in FY25. Repo Rate Implications: The DSGE model suggests that, based on the retail inflation forecast, the repo rate is likely to remain at 6.5% for the majority of FY25. MPC Focus on Accommodation Withdrawal: The Monetary Policy Committee plans to maintain the repo rate at 6.5% as part of its strategy to withdraw accommodation and align with the 4% inflation target. Real GDP Growth Projection (2023-24): The DSGE model projects a real GDP growth rate



of 7.1% for the financial year 2023-24. DSGE Model Overview : The Dynamic Stochastic General Equilibrium (DSGE) model for the Indian economy captures the dynamic interactions between various agents in the economy as well as their response to shocks. For arriving at FY24 and FY25 real GDP growth projections, the DSGE model has made following assumptions:

- Global GDP growth of 2.6% and 2.1% for 2023-24 and 2024- 25, respectively
- Global CPI inflation of 5.5% and 4.0% for FY24 and FY25 respectively
- Unchanged policy reparate and US Fed funds rate at 6.5% and 5.5% for the current and next financial year, respectively.

in Indian equities. Nabard's bonds are rated AAA by rating agencies ICRA and India Ratings and will mature on April 28, 2034. In Nov

2023, LIC had invested a little more than ₹13,000 crore out of a ₹20,000-crore bond sale by Reliance Industries in November.

SEBI proposes same-day trade settlement on optional basis



The Securities and Exchange Board of India (SEBI) has proposed the introduction of a facility for clearing and settlement of funds and securities on T+0 (same day) and instant settlement cycle on an optional basis. The facility will be in addition to the existing T+1 (trade plus one day) settlement cycle in the secondary markets for the equity cash segment. Settlement is a two-way process which involves the transfer of funds and securities on the settlement date. SEBI has shortened the settlement cycle to T+3 from T+5 in 2002 and subsequently to T+2 in 2003. Currently, the Indian stock market follows the cycle of T+1. The migration to the T+1 cycle came into effect in January 2023. India became the second country in the world to start the T+1 settlement cycle in top-listed securities after China. In addition to the existing T+1 settlement cycle, a shorter settlement cycle may be introduced as an option. The proposed changes are planned to be implemented in two phases.

-Phase 1 - T+0 Settlement Cycle
: An optional T+0 settlement cycle (for trades till 1:30 PM) is envisaged, with settlement of funds and securities to be completed on the same day by 4:30 PM.

-Phase 2: Instant Settlement Cycle: An optional immediate trade-by-trade settlement (funds and securities) may be carried out. In the second phase, trading will be carried out till 3.30 pm. **Benefits of Instant Settlement :** An instant settlement mechanism would enable instant receipt of funds and securities, vis-a-vis existing pay-out on T+1 day.

RBI permits lending and borrowing of G-Secs

The Reserve Bank of India (RBI) announced new guidelines focused on lending and borrowing practices of government securities. **Aim :** To deepen the market for securities lending and borrowing and enhance the depth and liquidity of the Government Securities (G-Sec) market. Under newly issued guidelines, Government Securities (excluding Treasury Bills) issued by the central government are eligible for lending or borrowing through a Government Security Lending (GSL) transaction. Further, G-Secs, including Treasury Bills and state government bonds, can also be used as collateral in GSL transactions. **Tenure and Flexibility :** The minimum tenure for a GSL transaction is 1 day, while the maximum period would be the maximum period prescribed



to cover short sales. **Settlement Process :** On the settlement front, the RBI stated that all GSL transactions shall settle on a Delivery versus Delivery basis. This move comes even as India is set to be included in the globally tracked JP Morgan's Government Bond Index-Emerging Markets (GBI-EM) index, starting June 28, 2024. **Use of Borrowed Securities :** Further, entities engaging in GSL transactions may use borrowed securities for various purposes like sales, meeting delivery obligations, and availing the RBI's Liquidity Adjustment Facility. **Market Participation and Returns :** This move aims to broaden participation in the securities lending market by providing investors an option to utilise idle securities, potentially boosting portfolio returns.

Reserve Bank of India approves IDFC-IDFC First Bank merger

The Reserve Bank of India (RBI) has given its approval for the reverse merger of IDFC Limited and IDFC Financial Holding Company (IDFC FHCL) with its banking subsidiary IDFC First Bank. "This is in connection with our letter dated July 03, 2023 informing about the decision taken by the Board of Directors of IDFC FHCL, IDFC and IDFC FIRST Bank approving the proposed Scheme under Sections 230 to 232 of the Companies Act, 2013, the Companies (Compromises, Arrangements and Amalgamations) Rules, 2016 and other rules and regulations



framed thereunder, subject to receipt of various statutory and regulatory approvals. Under the planned reverse merger method, an IDFC shareholder will receive 155 shares for every 100 shares held in the bank. Each share is worth Rs 10 in face value. IDFC originated as an infra lender in 1997. The RBI granted it in-principle approval to establish a bank in April 2014, and in October 2015, it established IDFC Bank when on-tap licensing began, following which IDFC's debts and liabilities were transferred to the bank.

BUSINESS

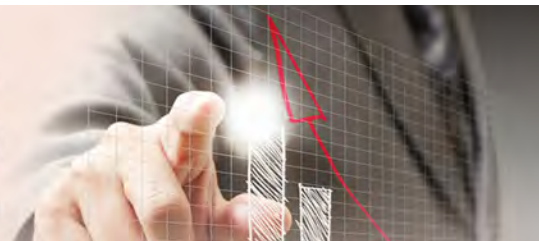

LIC stock crosses ₹700 mark after 11 months

Following a subdued performance post listing, LIC shares experienced a notable upswing in November, concluding with a substantial gain of 12.83%, marking the most significant monthly increase for the stock since its debut in May 2022. In the previous trading session, the stock crossed the ₹700 mark after 11 months, finishing the trade at ₹719. At current levels, the stock is just 4.9% away from its 52-week high of ₹754.20 apiece. The surge in momentum is attributed to the anticipation surrounding its new non-par product, 'Jeevan Utsav,' translating to the "celebration of life." LIC has introduced a new non-par product, LIC Jeevan Utsav, featuring a combination of limited pay (5–16 years) with lifelong income.

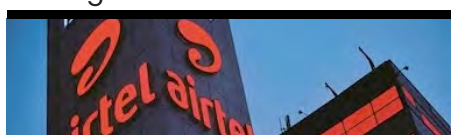

Bharti Airtel becomes the 8th company to surpass ₹6 lakh crore Mcap

The full market capitalisation of Bharti Airtel (partly plus fully paid-up) hit ₹6 lakh crore for the first time on Mcap. Share of Bharti Airtel added another 2%, taking their year-to-date gain to 28%. In contrast, the benchmark Nifty has gained 14.3% during the same period. The stock has been generating positive returns for the last five years, with 2019 being the highest. After a close to 60% surge in 2019, the stock of

Historic sale of Khadi and village industry products worth Rs 15.03 crore in India International Trade Fair-2023

Khadi and Village Industries Commission (KVIC), Ministry of Micro, Small and Medium Enterprises, participated in the 42nd India International Trade Fair (IITF) – 2023 held at Pragati Maidan, New Delhi from 14 to 27 November, 2023. In this international trade fair that lasted for 14 days, Khadi lovers made huge purchases in the



'Khadi Pavilion' set up in Hall No. 3. For the first time in the history of the KVIC,

the sales figure of Khadi and village industry products at IITF cross Historic sale of Khadi and village industry products worth Rs 15.03 crore in India International Trade Fair-2023.

Coal production from commercial coal mines remain around 12 million tonnes in November 2023

The Coal production from commercial coal mines remained around 12 million tonnes in November this year, with a growth of 37 per cent compared to last year. Union Coal Ministry, the average daily coal dispatch from such mines is also the highest ever with 4.3 lakh tonnes per day. Coal production and dispatch from captive and commercial coal blocks has



shown a remarkable growth during April to November this year. The total coal production from these commercial coal mines during the same period was around 83 million tonnes, while the total coal dispatch was over 89 million tonnes.

India's foreign exchange reserves increase by 2.538 billion US dollar to 597.935 billion US dollar

The Reserve Bank of India (RBI), India's foreign exchange reserves increased by 2.538 billion US dollar to 597.935 billion US dollar for the week ended 24th November. In the previous reporting week, the overall reserves had jumped 5.077 billion US dollar to 595.397 billion US dollar. reserves, increased by



2.14 billion US dollar to 528.531 billion US dollar. The apex bank Gold reserves were up 296 million US dollar to 46.338 billion US dollar during the week. The Special Drawing Rights (SDRs) were up 87 million US dollars to 18.218 billion US dollars.

Bharti Airtel gained 12% and 37%, respectively in 2020 and 2021.



India's overall exports in November 2023 is estimated at USD 62.58 Billion; an increase of 1.23 percent over USD 61.82 Billion in November 2022

India's overall exports (Merchandise and Services combined) in November 2023* are estimated to be USD 62.58 Billion, exhibiting a positive growth of 1.23 per cent over November 2022. Overall imports in November 2023* is estimated to be USD 67.88 Billion, exhibiting a negative growth of (-) 6.16 per cent over November 2022. India's overall exports (Merchandise and Services combined) in April–November 2023* are estimated to be USD 499.46 Billion, exhibiting a negative growth of (-) 1.39 per cent over April–November 2022.



FY 2023-24 Sees 17% Surge in Gross Direct Tax Collections

The Ministry of Finance, that the Gross Direct Tax collections for the Financial Year 2023-24 have registered a growth of over 17 per cent. The Gross Collection of Direct Taxes for the Financial year 2023-24 before adjusting refunds, stands at over 15 lakh 95 thousand crore rupees as compared to 13 lakh 63 thousand crore in the corresponding period of 2022-23. Direct Tax collections for the year 2023-24 up to the 17th of this month, show that net collections are at 13 lakh 70 thousand crore rupees as compared to 11 lakh 35 thousand crore rupees in the corresponding period of last Fiscal. It represents an increase of 20.66 percent.

India's foreign exchange reserves increase by 2.538 billion US dollar to 597.935 billion US dollar

The Reserve Bank of India (RBI), India's foreign exchange reserves increased by 2.538 billion US dollar to 597.935 billion US dollar for the week ended 24th November. In the previous reporting week, the overall reserves had jumped 5.077 billion US dollar to 595.397 billion US dollar. reserves, increased by



2.14 billion US dollar to 528.531 billion US dollar. The apex bank Gold reserves were up 296 million US dollar to 46.338 billion US dollar during the week. The Special Drawing Rights (SDRs) were up 87 million US dollars to 18.218 billion US dollars.

Bulls take BSE market cap to new high of \$4.03 trillion

The market capitalisation of all BSE-listed companies hitting a new high of \$4.03 trillion, aided by positive signals from the global markets and a fall in crude oil prices. This makes India one of the few countries with a market cap in excess of its gross domestic product. The journey from \$3 trillion to \$4 trillion took



two-and-a-half years. The bellwether Sensex gained 728 points to 66,902 points, with foreign portfolio investors pumping in ₹1,786 crore. The Nifty was up 207 points to 20,096 points as the buying spree by both domestic and foreign investors continued.

India's Retail Inflation 5.55 per cent in November 2023

The National Statistical Office (NSO), Ministry of Statistics and Programme Implementation (MoSPI) is releasing the All India Consumer Price Index (CPI) on Base 2012=100 and the corresponding Consumer Food Price Index (CFPI) for Rural (R), Urban (U) and Combined (C). CPIs for Subgroups and Groups for both All India and all States/UTs are also being released. The price data are collected from selected



1114 urban Markets and 1181 villages covering all States/UTs through personal visits by field staff of the Field Operations Division of NSO, MoSPI on a weekly roster. During November 2023, NSO collected prices from 99.9% villages and 98.6% urban markets while the market-wise prices reported therein were 90.0% for rural and 92.2% for urban.

India's imports of thermal coal from the US reached a two-year high.

Inbound shipments of thermal coal from the US increased to 1.40 million tonnes (MT), highest in over a year. According to Kpler (an energy intelligence firm), India imported a total of 17.51 MT of thermal coal in November 2023. This was lower than 15-month high of 18.66 MT recorded in October 2023. India



imported 23.27 MT of seaborne coal in November 2023. As of October 2023, US is India's second biggest supplier of coking coal after Australia. Russia is the third biggest supplier. During April–October 2023, Australia remained the largest supplier of coking coal with 20.17 MT.



India's e-retail market estimated to cross USD 160 billion by 2028

E-retail in India is expected to surge past USD 160 billion (over Rs 13 lakh crore) mark by 2028, a report released by Bain & Company in collaboration with Flipkart. The E-retail market is expected to be around USD 57-USD 60 billion (Rs 4.75 lakh crore to 5 lakh crore) in 2023, with an annual shopper base of around 240 million representing an annual addition of USD 8-12 billion in 2020. According to the report, the majority of India's retail spend (94-95 per cent) continues to be offline, with general trade accounting for 87 per cent of the overall retail spend. More than half of the total seller base hails from 7 cities, namely Delhi NCR, Surat, Jaipur, Mumbai, Bengaluru, Hyderabad, and Kolkata

India's trade deficit shrinks to \$20.58 billion in November, imports fall by 4.3%

Trade deficit for November 2023 declined to \$20.58 billion from the all-time high level of \$31.5 billion in October 2023. India's goods exports declined by 2.83% in November to \$33.9 billion. Imports declined by 4.33% to \$54.48 billion. The trade deficit for the period April-November 2023 was \$166.35 billion compared with \$189.21 billion during April-November 2022. India's top merchandise export destinations

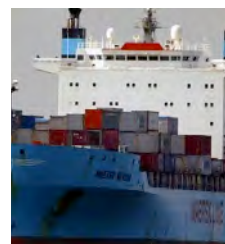

during April-November 2023 were the US, the UAE, the Netherlands, China, the UK,

Singapore, Saudi Arabia, and Bangladesh. Top import sources were China, Russia, the US, the UAE, Saudi Arabia and Iraq, according to official data.

India's logistics cost declined to 7.8-8.9% of GDP in FY22: NCAER

The National Council of Applied Economic Research (NCAER) has made a secondary data-based estimate of logistics cost in India. As per the estimate, logistics cost in India was 7.8% to 8.9% of GDP in 2021-22. The estimate was part of a report on the assessment of logistics costs in India by the Department for Promotion of Industry and Internal Trade (DPIIT). The government had released a National Logistics



Policy. It aimed at reducing logistics cost to below 10% (of GDP). It also aimed to improve India's ranking in the World Bank's Logistics Performance Index (LPI) from 38th at present to below 25. ADB, partnered the DPIIT in the workshop on logistics costs.

Coal Production Touches 664.37 Million Tonne during FY 2023-24 up to 25th December

As per the latest statistics of the Ministry of Coal, the cumulative achievement in coal production during FY' 2023-24 from April 2023 to 25th December 2023, has touched 664.37 million tonne (MT), indicating a substantial 12.29% growth compared to the corresponding period last year at 591.64 MT. In terms of coal dispatch, the Cumulative achievement in FY' 2023-24 from April 2023 to 25th December 2023 amounted to 692.84 MT, indicating a noteworthy 11.32% growth compared to the corresponding period of the previous year at 622.40 MT. This increase ensures a consistent and robust coal



supply to meet the energy needs of the power sector. Overall coal stock position, including mines, thermal power plants (DCB), transit, etc., reached 91.05 MT, showing a commendable 21.57% growth from 74.90 MT on 25.12.22. Additionally, Pithead Coal Stock at Coal India Limited (CIL) on 25.12.23 stands at 47.29 MT, demonstrating a notable growth of 53.02% compared to the coal stock of 30.88 MT on 25.12.22.

**निश्चित तयारी, Selection की सिर्फ
Platinum Mock Test के साथ**

3000+Mock Tests | Includes All Bank Pre+ Mains
Exams 2023 | All Other Major Bank &
Insurance Exams 2023

**9 years of Paving the students
Towards Their Success & Still counting**

Best Quality & Affordability

VALIDITY: **5+5 MONTHS**

Extra 10% Off

USE CODE:
GUIDELY 10

Buy Now

APPOINTMENTS & RESIGNATIONS

Air Force officer Manisha Padhi appointed as India's first woman Aide de Camp



Mizoram Governor Dr Hari Babu Kambhampati has appointed a woman Indian Air Force

officer from Odisha, squadron leader Manisha Padhi, as India's first Woman Aide-De-Camp (ADC) from the Indian Armed Forces at a brief ceremony held at the Raj Bhawan in Aizawl.

Veera Rana Creates History as Second Female Bureaucrat Appointed Chief Secretary of Madhya Pradesh



Senior Indian Administrative Service (IAS) officer Veera Rana, from the 1988 batch,

has been appointed the Chief Secretary of Madhya Pradesh (MP) as an additional charge. Veera Rana's appointment marks the 2nd time a woman officer has taken on the role of Chief Secretary in Madhya Pradesh. The first woman to hold this position was Nirmala Buch, a 1960 batch officer, during the BJP government in 1991.

Madagascar Court Upholds Andry Rajoelina's Presidential Election Victory

Madagascar's Constitutional Court has confirmed President Andry Rajoelina re-election following a controversial election a fortnight ago. The court said Mr Rajoelina secured 59% of the votes cast, declaring him elected for a third term. It dismissed complaints by the opposition over the credibility of the vote, which recorded a low turnout of 46%. 10 out of 13 presidential contenders had



withdrawn their candidacies but their names remained on the ballot. Mr Rajoelina defeated his two closest rivals, Siteny Randrianasoloniaiko and ex-President Marc Ravalomanana, who got 14% and 12% of the vote respectively.

Pradeep Kumar Pal (IRSSE) Assumes Director Role at UPSC

Pradeep Kumar Pal, an officer from the Indian Railway Service of Signal Engineers (IRSSE) of the 2009 batch, has been selected for the position of Director in the Union Public Service Commission (UPSC). According to an order issued from the Department of Personnel & Training (DoPT), Pal has been selected for the appointment under the Central



Staffing Scheme for a period of 5 years from the date of taking over charge of the post or until further orders, whichever event takes place earlier.

Microsoft hires ex-OpenAI leaders Altman and Brockman to lead new AI group

Microsoft's Chief Executive Officer (CEO) Satya Nadella, stated that the company has hired OpenAI co-founders Sam Altman and Greg Brockman to lead a new advanced AI research team. The announcement followed closely after OpenAI's board of directors stated that Sam Altman would not be returning to his position at OpenAI. The sudden



removal of Sam Altman surprised not only OpenAI's employees but also major investors, including Microsoft.



India-born media veteran Dr. Samir Shah appointed as the new chairman of the BBC

Dr Samir Shah, an India-born media executive with over 40 years of experience in TV production and journalism, has been named as the United Kingdom (UK) government's preferred candidate to take over as the new BBC chairman. Dr Shah will replace Richard Sharp, who was forced to resign after his communication with former prime minister Boris Johnson came under scrutiny. Shah will now be quizzed by cross-party MPs of the House of Commons Media Culture, Media and Sport Select Committee for pre-appointment scrutiny before formally taking charge of the public service broadcaster.



Hindustan Unilever Limited Appoints Former Revenue Secretary Tarun Bajaj as Independent Director for a 5-Year Term

Hindustan Unilever Limited (HUL) has appointed Tarun Bajaj (61) as an independent director on its board, effective 1st December 2023, for a period of 5 years. Bajaj belongs to the Indian Administrative Service, 1988 batch, Haryana Cadre. He was the Revenue Secretary, Govt of India before superannuating in November 2022. He also contributed towards a significant increase in revenue collections under GST and Income Tax.

Rajat Kumar Jain was appointed as the Chairman of Fino Payments Bank

Mumbai-based Fino Payments Bank has received approval from the Reserve Bank of India (RBI) for the appointment of former managing director of Xerox India and Walt Disney India,



Rajat Kumar Jain, as its part-time chairman. The RBI has approved the appointment with effect from November 24, 2023 till November 1, 2025.

Narayan Sheshadri appointed as IDRCL chair & incumbent Diwakar Gupta to head NARCL

Former KPMG managing partner Narayan Sheshadri will take over as chairman of the India Debt Resolution Co Ltd (IDRCL), the agent to the government-backed bad bank. The IDRCL chairman position became vacant after Diwakar Gupta resigned earlier this week to take up a post at parent National Asset Reconstruction Co Ltd

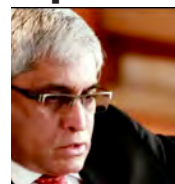

(NARCL). Sheshadri, a chartered accountant, is a financial sector veteran with experience in buying and turning around distressed companies. He is currently an independent director in the company and will take over immediately.

World Radiocommunication Conference 2023 appoints UAE's Mohammed Al Ramsi as Chairman

The United Arab Emirates's (UAE) Mohammed Al Ramsi appointed as the Chairman of the World Radiocommunication Conference (WRC) 2023. This appointment marks the fulfilment of the decision taken by the WRC during its last session in Sharm El Sheikh, Egypt in 2019. This conference started from



20th November and will continue till 15th December in Dubai, UAE. This year, more than 4,000 government officials and 900 international organisations from 193 countries are attending the conference.

ZPM Chief Lalduhoma Set to Take Oath as New Chief Minister of Mizoram

Lalduhoma will take oath as the 6th Chief Minister (CM) of Mizoram. His swearing-in ceremony will be held at Raj Bhawan in Aizawl. Governor Hari Babu Kambhampati will administer the oath to Mr Lalduhoma. During the ceremony, several other ZPM leaders also took oath as ministers. Lalrinpuii is the lone woman minister in the 12-member council of ministry. 7 of the 12 ministers are first time



winners. The other ministers who took oath include, K. Sapdanga, Vanlalhlana, C. Lalsawivunga, Lalthansanga, Dr. Vanlalhlana, P.C. Vanlalruata, Lalrinpuii, all cabinet ministers rank F. Rodingliana, B. Lalchhanzova, Prof. Lalnilawma and Lalnghinglova Hmar, all ministers of state rank.

Israeli Ministry of Foreign Affairs Designates Reuven Azar as New Ambassador to India



Heeralal Samariya, an Information Commissioner, was sworn in as the **Chief Information Commissioner (CIC)** by President Droupadi Murmu. Heeralal Samariya became **India's 1st Dalit Chief Information Commissioner.**

The top position of the Central Information Commission (CIC) had been vacant after the completion of **Y.K. Sinha's** tenure on October 3, 2023. The oath of office was administered to Heeralal Samariya at a ceremony held at the Rashtrapati Bhavan, with President Droupadi Murmu officiating the event.

India's Uma Sekhar gets elected to the Governing Council of UNIDROIT



In a historic moment for India, India's first woman candidate, Ms. Uma Sekhar secured a remarkable victory by garnering 45 out of 59 votes in the initial round of elections for the Governing Council of the International Institute for the Unification of Private Law (UNIDROIT) held in Rome, Italy. With this, India will be a member of the Governing Council for the period from 1 January 2024- 31 December 2028. Notably, the Governing Council consists of 25 positions, all of which are held by distinguished legal experts. The candidates from Russia, the United States of America (USA) and China failed to win positions on the governing council. In the election, there were 32 contestants in the fray including those from the USA, China, Saudi

Mohan Yadav Takes Oath as the 19th Chief Minister of Madhya Pradesh

Mohan Yadav, the BJP legislature party leader and MLA from Ujjain South, was sworn in as the 19th Chief Minister of Madhya Pradesh (MP) replacing Shivraj Singh Chouhan. The 58-year-old leader was administered the oath of office by Governor Mangubhai Patel at the Lal Parade Ground in State



capital Bhopal, MP. BJP legislators Jagdish Devda and Rajendra Shukla were sworn in as the Deputy Chief Ministers by the Governor. Mr. Tomar will be the next Assembly Speaker.

Indian social activist Nikhil Dey was named as International Anti-Corruption Champion by US State Department

Nikhil Dey, an Indian social activist, has been named as the International Anti-Corruption Champion by the US State Department. The US Bureau of International Narcotics and Law Enforcement Affairs stated that it recognises Dey as an Anti-Corruption Champion for his important role in social movements aimed at transparency and accountability, public audits, and participatory

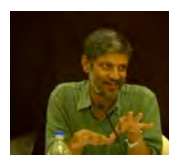

democracy to counter corruption in government welfare programmes in India. Dey's efforts as a co-founder of Mazdoor Kisan Shakti Sangathan (MKSS) contributed to anti-corruption and transparency reforms in India, assisting the state of Rajasthan in establishing public policies that promote accountability and transparency.

Parama Sen appointed as a part-time member of the Pension Fund Regulatory and Development Authority board

The Centre has appointed Parama Sen, Additional Secretary, Department of Expenditure in the Finance Ministry, as a part-time member of the Pension Fund Regulatory and Development Authority (PFRDA). All three part-time member positions on the PFRDA



board have been filled. Sen, a 1994 batch Indian Audit and Accounts Services (IAAS) officer, replaces Anne George Mathew, Additional Secretary in the Finance Ministry, who demitted office this year.

Guinea-Bissau president reappoints Geraldo Martins as Prime Minister

Guinea-Bissau's President Umaro Sissoco Embaló has reappointed Geraldo Martins as prime minister (PM) after dissolving his government.



Geraldo Martins was first appointed prime minister in August, 2023.

Arabia, Turkey, France, and others.

Sanjay Singh elected as new president of Wrestling Federation of India



Sanjay Kumar Singh has won the election for the new president of the Wrestling Federation of India (WFI). He got 40 votes in the election. The other applicant, Commonwealth Games gold medal-winning wrestler Anita Sheoran got 7 votes. Mr Singh is also the vice president of the Uttar Pradesh (UP) Wrestling Association. He previously served on the WFI's executive council. He has also been its joint secretary since 2019. He will succeed controversial Brij Bhushan Sharan Singh as WFI chief. Brij Bhushan Sharan Singh was forced to resign from his position after some wrestlers made accusations against him.

Quaker ropes in celebrity couple Kiara Advani and Sidharth Malhotra as brand ambassadors



PepsiCo India has roped in celebrity couple Kiara Advani and Sidharth Malhotra brand ambassador for brand Quaker. The new brand ambassadors will play a pivotal role in forthcoming campaigns and launches deepening engagement with the audiences. Quaker Oats was launched in India in 2006. The range includes Quaker Plain Oats, Quaker Oats Multigrain, Quaker Oats with Flavour Mix and Quaker Oats Muesli.

AS-IT-IS Nutrition Appoints Ravindra Jadeja, Indian Cricket Sensation, as Brand Ambassador

AS-IT-IS Nutrition, a trusted leader in the fitness and sports nutrition sector, has signed Ravindra Jadeja, the celebrated Indian cricketer, to their distinguished brand ambassador lineup. AS-IT-IS



Nutrition stands out for its commitment to delivering nutritional products in their most natural form, without any added fillers or additives.

Vishnu Deo Sai to be sworn in as Chief Minister of Chhattisgarh

Bharatiya Janata Party leader Vishnu Deo Sai will take oath as the new Chhattisgarh chief minister on December 13, 2023 in Raipur. He will be the 4th Chief Minister of the state and the 1st tribal Chief Minister. Sai hails from the influential Sahu (Teli) community which has a sizable presence in Durg, Raipur



and Bilaspur divisions. The BJP won 54 seats in the 90-member Assembly in the recently held polls, unseating the Bhupesh Baghel-led Congress government. The Congress ended with 35 seats, down from 68 it won in 2018.

Kanchan Devi Makes History as First Female Officer Appointed as Director General of ICFRE

Kanchan Devi has become the first woman Director General of the Indian Council of Forestry Research Education (ICFRE). Kanchan Devi is an Indian Forest Service officer from the 1991 batch of the Madhya Pradesh cadre. She brings to her new role an impressive track record of over 30 years in the realm of forestry.



Her extensive expertise spans a myriad of aspects, including forest management, administration, education, human resource development, research, and extension. She played an important role in setting up the Centre of Excellence on Sustainable Land Management.

RBI Grants Approval for 2-Year Extension of Sandeep Batra as Executive Director at ICICI Bank

The Reserve Bank of India (RBI) has approved the reappointment of Sandeep Batra as Executive Director of ICICI Bank, effective from December 23, 2023, to December 22, 2025. This renewed term of two years is within the five-year term previously approved by the shareholders. Batra is an ED on



the Board of ICICI Bank and has been responsible for the Corporate Centre since July 2018. He also serves on the board of ICICI Prudential Life Insurance, ICICI Lombard General Insurance, ICICI Prudential Asset Management and ICICI Venture.

IPS Nina Singh is CISF's first woman chief; Anish Dayal Singh appointed CRPF head



The Central Industrial Security Force (CISF) was assigned its first woman chief in Nina Singh, who has been appointed as the Director-General (DG). Nina Singh, a 1989-batch IPS officer of Rajasthan cadre, is currently working as Special DG, CISF. She has been appointed to the post till her superannuation on July 31, 2024, the order stated. Nina Singh has been with the CISF since 2021 and will remain at the helm till her retirement on July 31 next year.

Satish Kumar Kalra Appointed as Interim Managing Director & Chief Executive Officer of North East Small Finance Bank

Bengaluru-based fintech Slice-backed North East Small Finance Bank (NESFB) has appointed Satish Kumar Kalra as its interim Managing Director (MD) and Chief Executive Officer (CEO). The appointment has been approved by the Reserve Bank



of India (RBI). The ownership of the merged entity primarily rests with Slice shareholders, holding a 95-97% stake, while the remainder belongs to North East SFB shareholders.

SEBI approves appointment of ex-IAS Pramod Agrawal as BSE Chairman

The Securities and Exchange Board of India (SEBI) has given its nod to the appointment of Pramod Agrawal, the former Chief of Coal India, as the Chairman of the Bombay Stock Exchange (BSE). His appointment will become effective from January 17, 2024. He will take the place of SS Mundra, who was appointed as BSE chairman in May 2022.



Pramod Agrawal, a distinguished former Indian Administrative Service (IAS) officer of the Madhya Pradesh cadre, brings a diverse professional background to his new role. He served as Coal India Chairman from February 2020 to June 2023.

Sony Sports Network ropes in Bollywood actor Kartik Aaryan as brand ambassador for football

Sony Sports Network, the destination for football in India, has joined hands with Bollywood's Gen Z actor and youth icon - Kartik Aaryan to become their brand ambassador for football. Sony Sports Network



has launched the first film from the 'Your Home of Football' campaign which will be followed by four additional films in the coming weeks.

English Mastery Course 2023

Learn Grammar with Real Exam Point of View

- For the first time, here you will learn grammar with real exam usage.
- Consists of Grammar Explanatory Videos + PDFs, Real Exam Examples (Video+PDF), Practice Quizzes on each topic.
- 100+ Recorded Videos, 500+ Practice Questions
- After this with proper practice you can easily score with 90 - 100% Accuracy in English Section
- Created by the faculty with 10 years of experience

EXTRA
10% OFF

USE CODE
GUIDELY10

GRAB IT NOW



AWARDS & HONORS

NTPC Wins Two Silver Awards in Brandon Hall Group's Excellence in Technology Awards



NTPC, India's largest integrated power company, has been declared as the winner at the Brandon Hall Group's Excellence in Technology Awards 2023 in an online broadcast held. NTPC stands out as the only PSU in India to secure dual accolades in the Technology Awards category. The company received the coveted silver awards in two distinct categories: "Best Advance in Corporate Wellbeing Technology" and "Best Advance in Augmented and Virtual Reality." This recognition underscores NTPC's commitment to innovation and technological excellence, placing it at the forefront of advancements in corporate wellbeing and immersive technologies.

Safeena Husain, Founder of Educate Girls, honoured with the WISE Prize for Education



The prestigious WISE Award was honoured to Safina Hussain at the WISE II Summit (World Innovation Summit for Education). The WISE Prize for Education is the first global award of its kind that honours an individual for outstanding contributions to education.

NATIONAL METALLURGIST AWARDS

The National Metallurgist Award was announced. This award was announced by the Union Steel Ministry. Union Minister of State for Steel, congratulated the five distinguished metallurgists on being conferred with coveted NMA 2022 in four categories. The awardees and categories:-

- Dr Kamachi Mudali Uthandi - Lifetime Achievement Award
- Dr Debashish Bhattacharjee - National Metallurgist Award
- Dr Rameshwar Sah - R&D in Iron & Steel Sector



- Dr Niloy Kundu - Young Metallurgist (Environment) Award
- Agilan Muthumanickam - Award Young Metallurgist (Metal Science) Award
- India's production and consumption of steel during April-October 2023 YoY has grown by 15% to about 82 million tonnes and 75.8 million tonnes respectively.
- India has achieved the status of 2nd largest steel producer globally.

Rizz crowned Oxford Word of the Year 2023

After over 30,000 language lovers around the world got involved to help refine our shortlist of eight words, we are pleased to announce that the Oxford Word of the Year 2023 is rizz. This year, we created a shortlist of eight words, all chosen to reflect the mood, ethos, or preoccupations of the past year, and put them to the public to vote for their favourites. Through head-to-head competitions over

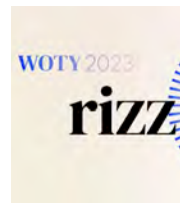

a four-day voting period, the public narrowed down our shortlist of worthy contenders to four

finalists: rizz, Swiftie, prompt, and situationship. These words were then put to our language experts, who considered our corpus data, the vote counts, and the public commentary around the words to choose the definitive word of the year for 2023.

PR Icon Suganthy Sundararaj Receives PRSI National Award for Outstanding Contributions to Healthcare Communications

Suganthy Sundararaj received the PRSI National Award for Outstanding Contributions to Healthcare Communications. She received the honour for Outstanding Contributions to the Public Relations Society of India and the public relations industry. Suganthy Sundararaj received the Award at the International Public Relations



Festival in New Delhi. This event has brought together professionals and young minds from the PR space to facilitate knowledge exchange. The Festival this year is being organized around the theme 'G20: Showcasing Indian Values and The Emerging India to the World: Opportunities for Public Relations'.

Activist Ali Abu Awwad and pianist Daniel Barenboim win the Indira Gandhi Peace Prize



2023 Indira Gandhi Prize for Peace, Disarmament, and Development awarded to Ali Abu Awwad and Daniel Barenboim. The award has been given for their efforts in bringing together the youth and peoples of Israel and the Arab World for a non-violent resolution of the Israel-Palestine conflict. Former Chief Justice of India T.S. Thakur chaired the International Jury of the Indira Gandhi Prize for Peace, Disarmament and Development. Maestro Barenboim is an Argentine-born, distinguished classical pianist and conductor, renowned for performing with and directing some of the world's leading orchestras. Mr. Awwad is a distinguished Palestinian peace activist who has been working tirelessly with the people of Palestine and Israel for a peaceful resolution to the ongoing conflict in the Middle East. This award is given to doctors, nurses, paramedics, and karamchari for their selfless service, unwavering dedication, and perseverance in the face of adversity. The award is given annually by the Indira Gandhi Memorial Trust to individuals or organizations. The award carries a cash award of 2.5 million Indian rupees and a citation.

Javed Akhtar to be felicitated with Padmapani Lifetime Achievement Award at the Ajanta-Ellora Film Festival



Veteran lyricist-screenwriter Javed Akhtar will be honoured with the Padmapani Lifetime Achievement Award at the Ajanta-Ellora Film

2022 FIFA World Cup winner Lionel Messi named Time Magazine's Athlete of the Year for 2023

Football superstar Lionel Messi has been named as Time Magazine's 2023 Athlete Of The Year. The 36-year-old won his record-extending eighth Ballon d'Or Award in October, and scored 11 goals in 14 games across competitions for Inter Miami - after joining them in July - to help the Major League



Soccer (MLS) club lift the Leagues Cup trophy for the first time. Argentina defeated the reigning champions France in the World Cup final in December of last year, Messi was a major factor in leading his country to its first victory in 36 years.

Sheetal Devi win best young athlete award in APC conference

Riyadh, (IANS) Hangzhou 2022 Asian Para Games gold medallist Asila Mirzayorova from Uzbekistan and the winner of China's historic first cross-country skiing gold medal, Peng Zheng were announced as best female and best male athlete at the fourth edition of Asian Awards at an awards ceremony during the Asian Paralympic Committee's Conference and General Assembly. India's Sheetal Devi, the 'armless archer' who went viral after her performances in Hangzhou picked up the best



youth athlete. Award winners were announced in six categories - Best Male Athlete, Best Female Athlete, Best Youth Athlete, Best Team Performance, Best Photography and Exemplary Asian Official. The best photography award went to Masamine Kawaguchi from Japan for his images from Beijing 2022 Winter Paralympic Games which captured the dynamism, skill, and speed of the downhill skiers.

NCRTC bags award for "Environmental Initiatives of Tunnelling" at TAI Tunnelling Awards 2023

National Capital Region Transport Corporation (NCRTC) bagged the award in "Environmental Initiatives of Tunnelling" category at the 4th edition of the prestigious TAI Tunnelling Awards 2023, organised by the Tunnelling Association of India. National Capital Region Transport Corporation (NCRTC) won the 4th edition of the prestigious TAI



Tunnelling Awards 2023, organised by the Tunnelling Association of India. The NCRTC team was awarded under the "Environmental Initiatives of Tunnelling" category. These awards celebrate the most ambitious underground projects in India as well as the latest innovations, techniques, and methods in tunnelling.

Festival. The award ceremony will take place at Rukmini Auditorium in the MGM University campus. The Padmapani Award selection committee comprises Girish Kasarvall, Ashok Vajpeyi, Latika Padgaonkar, Ashok Rane and Chandrakant Kulkarni. Ajanta-

Ellora International Film Festival is to showcase the best of film produced recently and in the past. It is organized by Marathwada Art Culture and Film Foundation. It will be organized by 3rd-7th January, 2024.

Writer Pushpa Bharati's memoir selected for Vyas Samman award



Pushpa Bharati's from Moradabad of Uttar Pradesh 2016 memoir 'Yaadein, Yaadein aur Yaadein' has been selected for the 33rd Vyas Samman. The award is presented to an outstanding Hindi literary work by an Indian citizen published during the last 10 years. A selection committee headed by eminent litterateur Prof Ramji Tiwari picked Bharati's Yaadein, Yaadein aur Yaadein for the Vyas Samman award. The award carries a cash prize of ₹4 lakh, a citation and a plaque. The Vyas Samman Award was instituted in 1991. It is given by the KK Birla Foundation.

Kabir Bedi feted with Italy's highest civilian honour



Kabir Bedi has been honoured with the highest civilian honour of Italy. He was awarded the Order of Merit of the Italian Republic (Merito della Repubblica Italiana). Niccolo Fabi gave a unique live musical performance following the occasion in Mumbai. The Order of Merit is Italy's highest honour. It's even higher than Cavaliere (Knight).

Former Somali Refugee Wins Prestigious UN Award



Abdullahi Mire of somalia has been named the winner of the UNHRC's prestigious Nansen Award. Abdullahi Mire has received the award for giving 1,00,000 books to the hands of children in Kenya's crowded Dadaab refugee camps. Abdullahi Mire has spent 23 years in Dadaab, where 90,000 refugees reside.

Indian Armed Forces officers awarded 'Golden Owl' for outstanding performance at DSCSC Sri Lanka

Indian Armed Forces officers have been awarded the 'Golden Owl' for their outstanding performance. The officers were undergoing the Command and Staff Course at the Defence Services Command and Staff College (DSCSC) in Sri Lanka. The DSCSC course is designed to prepare senior officers for leadership roles in joint operations and higher command. The award was given to Wing



Commander Sumeet Mahajan, Major Rohit and Lieutenant Commander Sunny Sharma by Sri Lankan President Ranil Wickremesinghe. The "Golden Owl" award admires strategic thinking, analytical skills and potential for future leadership. Recently, the joint military exercise between India and Sri Lanka concluded at the Southern Command Foreign Training Node, Aundh in Pune.

ET Awards for Corporate Excellence: Levers of growth meet shades of talent at Chanel

Leena Nair, the global CEO of luxury brand Chanel, has several significant firsts to her credit. At Unilever, Nair, 54, was the first woman to lead global human resources. And then, Chanel appointed her as its first global CEO of Indian origin. She was a fashion industry outsider when picked by the French fashion house to lead it in 2022. She has been chosen for the Global Indian Award. The State Bank of India, the country's largest lender, bagged the coveted Company of the Year award in a unanimous vote for its spectacular turnaround from heavy losses a few years ago. The power-packed jury headed by Tata Sons chairman



N Chandrasekaran picked external affairs minister S Jaishankar as Reformer of the Year for his stellar efforts in defending and furthering India's economic and trade interests amid a geopolitical minefield. The Lifetime Achievement Award went to AM Naik, chairman emeritus, Larsen & Toubro, for building the company into an economic bellwether of the country with a presence across defence, manufacturing, technology and construction. HDFC Bank was selected as the Conscious Corporate of the Year for using its Rs 800 crore corporate social responsibility (CSR) corpus for community development.

Former bureaucrat Poonam Khetrpal Singh honoured by Bhutanese King

Dr Poonam Khetrpal Singh has been awarded Bhutan's National Order of Merit Gold Medal. Dr Poonam Khetrpal Singh is the WHO Regional Director (South-East Asia). The King of Bhutan Jigme Khesar Namgyel Wangchuk honoured



her at Bhutan's 116th National Day celebration. She is the first woman regional director of the WHO South-East Asia region. During her tenure, Bhutan became one of the first countries to eliminate measles and rubella ahead of schedule.

Mumbai professor wins prestigious award for contribution to chemistry



Professor Savita Ladage from Mumbai's Homi Bhabha Centre for Science Education (HBCSE), Tata Institute of Fundamental Research (TIFR) has been named winner of the Royal Society of Chemistry's (RSC) Nyholm Prize for Education in recognition of her contribution to chemistry education. It is awarded to inspirational, innovative and dedicated individuals or teams making a substantial and sustained impact within education. This prize was established to commemorate the life and work of Sir Ronald Nyholm, president of the Royal Society of Chemistry from 1968 to 1970. For 2023, the prize was open to nominees based anywhere in the world.

-The winner(s) receives £5000, a medal and a certificate.

-The winner(s) will complete a series of lectures or workshops in the UK.

-The winner(s) will be chosen by the Education Prize Committee.

UNESCO award for Amritsar's Rambagh Gate & Ramparts, Gurdaspur's Peepal Haveli

UNESCO has awarded Rambagh Gate and Ramparts in Amritsar, Punjab. It has also awarded heritage conservation projects related to Haryana's Church of Epiphany and Delhi's Bikaner House. The Rambagh Gate and Ramparts project received the highest honor, the 'Award of Excellence'. It received the award for its inclusivity and access to the broader community. Three projects, namely the Fanling Golf



Course in Hong Kong SAR, China; Dongguan Garden Residences in Yangzhou, China; and Karnikara Mandapam at Kunnamangalam Bhagawati Temple, Kerala, India, garnered an Award of Distinction. This year, the awards panel recognised twelve projects from China, India, and Nepal. Five projects are from China, six are from India, and one is from Nepal.

Poet Sukrita Paul Kumar bags Tagore Literary Prize

Sukrita Paul Kumar has won the sixth edition of the Rabindranath Tagore Literary Prize for her book, 'Salt & Pepper: Selected Poems'. She received USD 5,000, a Tagore statue and a certificate for contribution to literature at the award ceremony. The award was started in 2018 by US-based publisher Peter



Bundalo. The award is a platform for world peace, literature, art, education and human rights. It also recognises works towards human rights and world peace with the Social Achievement Prize. Journalist-author Raj Kamal Jha won the prize last year for his novel 'The City and The Sea'.

ISRO bags Leif Erikson Lunar Prize for Chandrayaan-3

ISRO has been awarded the Leif Erikson Lunar Prize by the Husavik Museum for its achievements in advancing lunar exploration and contributing to understanding celestial mysteries through the successful Chandrayaan-3 mission. The Leif Erikson Lunar Prize is an annual award presented by the Exploration

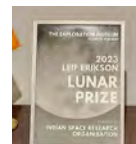

Museum in Husavik, Iceland. It is dedicated to the history of human exploration, from the early explorers to the exploration of space. It is named after the Icelandic explorer Leif Erikson who is considered the first European to land in North America.



BEGINNER'S GUIDE

Special Beginners' Bundle Quiz

- ✔ Specially for Beginners (Basic Level)
- ✔ 5000+ Questions
- ✔ Covered All Topics
- ✔ Best Source to Practice Basic Questions

Guidely's Special Beginners' Kit (Printed Edition)



Extra
10% Off

USE CODE
GUIDELY10

Grab It Now

RANKING & REPORTS

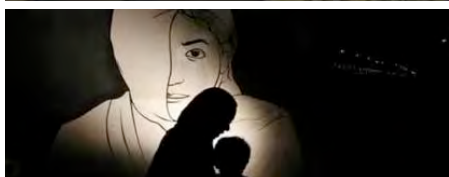

Delhi Remains Unsafe for Women: Alarming Rise In Crimes Revealed By NCRB Data

With an average three rapes a day, Delhi is still among the most unsafe metropolitan city for women in the country, according to data shared by the National Crime Records Bureau (NCRB), with 14,158 crimes against women reported in 2022. This figure was a slight increase from the 13,982 crimes against women reported in 2021. Delhi's figures translated to 186.9 crimes against women per 100,000 people. The city accounted for 29.04% of the 48,755 crimes against women reported in 19 major cities across the country, suggesting that law and order authorities were not working properly to create a safe environment for women.

The Richest Person In The World by Bloomberg Billionaires Index



The Bloomberg Billionaires Index is a daily ranking of the world's richest people. South African-born Elon Musk is the new richest person in the world, having recently surpassed United States Jeff Bezos. They are followed by Frances Bernard Arnault, who rounds out the Top 3. The rest of the Top 10, in order, are: Bill Gates, Larry Ellison, Steve Ballmer, Warren Buffet, Larry Page, Mark Zuckerberg, and Sergey Brin. Gautam Adani becomes 16th richest globally as Adani Group and his wealth tops \$70 billion.

WHO published a report titled 'World Malaria Report 2023'

The World Health Organisation (WHO) published a report titled 'World Malaria Report 2023'. Malaria is a disease caused by the Plasmodium parasite. Each year, WHO's World malaria report provides a comprehensive and up-to-date assessment of trends in malaria control and elimination across the globe. According to the World Malaria Report, India accounted for 66% of malaria



cases in the World Health Organization's South-East Asia region in 2022. The WHO South-East Asia Region accounted for about 2% of malaria cases globally while malaria cases declined by 76%, from 23 million in 2000 to about five million in 2022.

Murali Sreeshankar wins three medals in 2023; ranked 4th in the world:

India's long jumper Murali Sreeshankar had a splendid outing this year, winning three medals. The World no.4 athlete in the long jump, won a couple of silver medals and a bronze medal this year. Sreeshankar won silver medals at the Asian Games 2023 in Hangzhou and Asian Championships in Thailand. He secured a bronze medal at the Paris Diamond League held in June. Moreover, the 24-year-old also won a silver medal at



the Commonwealth Games last year and had the opportunity to represent his nation at the Tokyo Olympics. He is a frontrunner to win a medal for India at the upcoming Paris Olympics. The player will look for a podium finish at the quadrennial event in Paris next year.

Novak Djokovic finishes No. 1 in ATP rankings for record 8th time

Novak Djokovic earned the year-end No. 1 spot in the ATP rankings for the eighth time, adding to a record he already held. Djokovic won three of the four Grand Slam tournaments -- the Australian Open in January, French Open in June and US Open in September -- to raise his career total to a men's-record 24 and was the runner-up at the other, Wimbledon. He went 56-7 this season while leading the tour with seven titles, including at the ATP Finals last month. The 36-year-old from



Serbia regained the top ranking from Carlos Alcaraz, who edged him in a five-set final at the All England Club in July. Alcaraz finished 2023 at No. 2 after the two men swapped No. 1 back-and-forth repeatedly this year. Iga Swiatek claimed the WTA's year-end No. 1 ranking for the second consecutive year by winning the WTA Finals last month.

Hyderabad ranked 1st in food adulteration cases: NCRB



According to the data released by the National Crime Records Bureau (NCRB), Hyderabad is in first position in India regarding food adulteration cases. In cases of food adulteration, Andhra Pradesh stood next to Telangana. The seized items include adulterated finger garlic paste, ice creams, and tea powder. A total of 291 cases of food adulteration were reported across 19 major cities in India in 2021. Food adulteration is a critical concern for the health of the Public.

India tops remittance flows at USD 125 bn in 2023: World Bank



According to the World Bank's latest Migration and Development Report, India with 125 billion dollars remittance remains the largest recipient of remittances in the world in 2023. Mexico (67 billion dollars), China (50 billion dollars), the Philippines (40 billion dollars), and Egypt (24 billion dollars) are among the top five remittance recipient countries in the world. In the South Asia region, remittance flows to India registered a growth. This region witnessed a 7.2 per cent increase in remittances in 2023. Remittance flows to Europe and Central Asia decreased by 1.4 per cent. The report shows continuous growth in remittance flows to low- and middle-income countries (LMICs) in 2023. The United States continued to be the largest source of remittances. World Bank Migration and Development Brief is prepared by the Migration and Remittances Unit, Development Economics (DEC), the premier research and data arm of the World Bank. The brief is produced twice a year.

Climate Change Performance Index (CCPI) 2024:

The Climate Change Performance Index (CCPI) 2024 was released on the sidelines of the ongoing COP28 in Dubai. India ranked 7th in this year's Climate Change Performance Index, up one spot from the previous one. CCPI is a scoring system that measures the climate protection performance of countries. It was first published in 2005. It is designed to improve transparency in international climate politics. The CCPI uses



a standardized framework to compare the climate performance of 63 countries and the EU, which together account for over 90% of global greenhouse gas emissions. The CCPI assesses each country's performance in four categories: Greenhouse Gas (GHG) Emissions (40%), Renewable Energy(20%), Energy Use(20%), Climate Policy (20%).

Number of women voters projected to outstrip men voters in 2029: SBI report

The number of women voters is projected to be greater than men voters in 2029, according to SBI's economic research department (ERD). SBI's ERD has projected women voter turnout might increase to 55% and men voter turnout might decline to 45% in 2047 (probable election year 2049). As per ERD's analysis, the voter turnout increased by 13.7 crore to 55 crore. Out of this, 26 crore were women. In a special report, the ERD said total voter turnout could touch 73 crore in 2029. Based on NSS data, ERD's analysis shows that the



total contribution of unpaid women to the economy is around 22.7 lakh crore. This is almost 7.5% of GDP of India. One of the best examples of women's empowerment given in the report was the "MP (Madhya Pradesh) MukhyaMantri Ladli Behna scheme." This scheme provides financial endowment for women in the 21-60 age group to improve the health and nutritional status of women and children dependent on them.

For the 6th time, Hyderabad emerges as the best city to live in India

As per Mercer's survey, Hyderabad has the best 'quality of living' in India. According to the Quality of Living Index 2023 released by Mercer, Hyderabad is in the top spot in terms of 'quality of living' in India. Hyderabad attained the 153rd spot in the Quality of Living Index 2023. Pune has the second-best 'quality of living' in India. It has secured the 154th position in Mercer's Quality of Living City Index. Bengaluru (156th) Chennai is the fourth Indian city in the list at 161 spot followed by Mumbai at 164. Kolkata (170) and New Delhi (172). Vienna (Austria), Zurich



(Switzerland) and Auckland (New Zealand) Copenhagen (Denmark) Geneva (Switzerland) are the top five cities in the Quality of Living Index 2023. Seven European countries were in the top 10. This index evaluates the quality of life for employees working abroad. It has taken data from more than 500 cities all over the world Quality of Living Index is based on different factors like Water Potability, Waste Removal, Sewage, Air Pollution, Water availability, Traffic Congestion.

SCIENCE & TECHNOLOGY



China Establishes World's First 'Near-Space Command'

China has established the world's first near-space command, which is the fifth branch of the People's Liberation Army (PLA), focusing on the development of hypersonic weapons. The near-space command operates in the near-space area, ranging from an altitude of 20 km to the lower boundary of space at 100km. Equipped with hypersonic missiles, the near-space command is designed to target critical military assets and conduct high-altitude surveillance globally using automated drones and spy balloons. Hypersonic weapons possess speeds of at least Mach 5, making them highly maneuverable and capable of changing course during flight. The term "Mach" is a unit of measurement representing the speed of a moving object relative to the speed of sound.

NASA Unveils Initiative to Send ISRO-Selected Indian Astronaut to International Space Station by 2024



US space agency National Aeronautics and Space

Administration (NASA) plans to train an Indian astronaut for a mission to the International Space Station (ISS) by the end of 2024.

IndiGo Introduces AI Chatbot 6Eskai for Assistance in Flight Booking, Web Check-in, and Discount Information

In a significant leap forward in the realm of Indian aviation, IndiGo, the country's largest airline, has unveiled a cutting-edge AI chat assistant, 6Eskai, powered by GPT-4 technology. This innovative chatbot, developed in collaboration with Microsoft, is poised to reshape the passenger



experience by efficiently handling customer queries in 10 different languages. To begin with, it will address customer queries in 10 different languages. Early results show a 75% reduction in customer service agent workload.

Google Delays Launch of Next-Gen AI Model Gemini to 2024

Google has quietly pushed back the launch of next-gen AI model Gemini until 2024. Gemini is touted as Google's most sophisticated artificial intelligence model. Gemini has been stated to strongly outperform OpenAI's GPT-4 as it harnesses vastly more computing



power than its competitor. Gemini is reported to strongly outperform OpenAI's GPT-4, emphasizing its superior computing capabilities. CEO of Google and Alphabet : Sundar Pichai

India set to launch its first X-Ray Polarimeter Satellite - ISRO



Polarimeter Satellite (XPoSats)

India is preparing to launch its inaugural X-Ray

using the Polar Satellite Launch Vehicle (PSLV) from the Satish Dhawan Space Center in Sriharikota, Andhra Pradesh.

Saturn's Rings Will Temporarily Disappear From View in 2025



Google, Inc. set a 2024 target to assemble its Pixel line of smartphones in India. The flagship device will feature the latest iteration of the Tensor chip, which was designed in India for global use. The Tensor chips were

first introduced in 2021, coinciding with the launch of the Google Pixel 6. While these 'system-on-chip' processors were conceptualised by the company in 2016, they took five years to develop for use. The latest is the 3rd generation of the Tensor chip.

Bill Nelson, the administrator of NASA, made this announcement during his visit to Delhi, India. A major collaboration between

India and the United States is the NISAR satellite, set to be launched in the first quarter of 2024.



Indian Immunologicals Launches Measles and Rubella Vaccine Catering to Children

The measles and rubella vaccine “Mabella” was launched by Vaccine maker Indian Immunologicals (IIL) for children. The live-attenuated MR vaccine, Mabella, was developed through an exclusive partnership with the Polyvac Institute of Vietnam. Mabella was launched as part of the 25th celebrations of the IIL division Human Biologicals Institute (HBI) in Udthagamandalam (Ooty), Tamil Nadu (TN) The vaccine has been proven to be safe and effective through extensive human clinical trials.



Google Introduces Gemini: An AI Model Engineered to Mimic Human Behavior

Google has embarked on its latest venture in artificial intelligence with the introduction of Project Gemini, an AI model designed to emulate human-like behaviour, sparking discussions about the technology’s potential and challenges. Gemini is a new

Iran Sends Animals into Space in Resumption of Human Mission Pursuit

Iran has sent a capsule carrying animals into space as it boosts its Western-contested space programme in preparation for human missions. Capsule was launched 130 kilometres (80 miles) into orbit. The Salman rocket carried an “all indigenous” capsule weighing 500 kg (1,100 pounds), which is reportedly the heaviest biological capsule ever successfully carried in the history



of the Iranian space programme. The capsule was ordered by the Iranian Space Agency and developed by the aerospace division of the Ministry of Science, Research and Technology.

Voice Over 5G Or Vo5G Is Gradually Replacing VoLTE Across The Globe

Vo5G/VoNR is the future standard for voice calling that operates over 5G networks, providing improved speed, capacity, and responsiveness compared to 4G networks. It leverages the capabilities of 5G networks, aiming to enhance voice calling experiences through higher quality, reduced latency, and better reliability. VoNR aims to provide superior voice quality, clearer audio, and reduced latency compared to previous voice technologies like VoLTE.



VoNR operates using the 5G Core (5GC) network architecture, which provides a more flexible and scalable framework for delivering voice services. It supports modern codecs like EVS (Enhanced Voice Service) and AMR-WB (Adaptive Multi-Rate Wideband), enabling high-definition voice calling.

artificial intelligence model that outperforms other models in tasks like understanding, summarising, reasoning, coding, and planning. It comes in 3 versions: Pro, Ultra, and Nano. The Pro version is already available, and the Ultra version will be released early 2024. These versions will be

immediately integrated into Google’s AI-driven chatbot Bard and the Pixel 8 Pro smartphone.



Nasa PACE mission is set to unravel how smoke, dust shape Earth's climate

NASA is gearing up to enhance our understanding of Earth's atmosphere with the upcoming Plankton, Aerosol, Cloud, ocean Ecosystem (PACE) mission, scheduled for launch in early 2024. The mission will employ advanced polarimeters to study the interplay of light, aerosols, and clouds, contributing to a deeper comprehension of their impact on air quality and climate. Aerosols, which include tiny particles like smoke, dust, and pollutants, may seem inconspicuous, but they play a crucial role in influencing our climate. The PACE mission will not only analyze aerosols but also delve into studying the color of the ocean. The primary science instrument for PACE is the Ocean Color Instrument (OCI), designed to measure the ocean's color across a spectrum from ultraviolet to shortwave infrared. Additionally, PACE will feature two polarimeters – the Spectro-polarimeter for Planetary Exploration (SPEXone) and the Hyper Angular Research Polarimeter (HARP2).

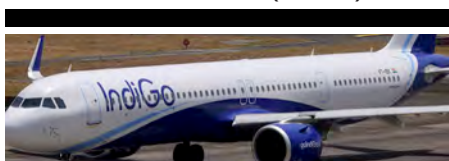

IndiGo Achieves Milestone as First Indian Airline to Transport 100 Million Passengers in a Year

IndiGo has achieved the distinction of becoming the first Indian airline to transport 100 million passengers in a single year. IndiGo has further made history by being the 1st Indian airline to operate more than 2,000 flights per day in the year 2023. IndiGo holds the position of India's largest airline, operating in both the domestic and international aviation sectors. In the international segment (July-

China begins commercial operations at world's first fourth-generation nuclear reactor

China has started commercial operations at a new generation nuclear reactor that is the first of its kind in the world. Compared with previous reactors, the fourth-generation Shidaowan plant in China's northern Shandong province is designed to use fuel more efficiently and improve its economics, safety and environmental footprint as China turns to nuclear power to try to meet carbon emissions goals. The 200 megawatt (MW) high-



temperature, gas-cooled reactor (HTGCR) plant developed jointly by state-run utility Huaneng, Tsinghua University and China National Nuclear Corporation, uses a modular design. NuScale Power, previously expected to be the first U.S. company licensed to build a small modular reactor.

Geojit to set up Centre of Excellence in Sustainability at Cochin University of Science and Technology

Geojit Financial Services Limited is establishing a Centre of Excellence in Sustainability at the Cochin University of Science and Technology. The proposal to set up the centre named Geojit Cusat Centre of Sustainability Studies (GCCOSS) has been approved by the University Syndicate. Geojit stands committed to providing an endowment of ₹5 crore over a period of four years. It will strive to be an autonomous hub for creating high-quality scientists and entrepreneurs



while engaging in global collaborations to create the best research output, academic rigour, and technical innovations. Environmental, Social, and Governance (ESG) goals have emerged as an important agenda for governments as well as corporations.

Iran Reveals Upgraded Karrar Drones Equipped with Air-to-Air Missiles

Iran unveiled advanced Karrar combat drones armed with air-to-air missiles, enhancing its air defence capabilities. It is an Unmanned Combat Air Vehicle (UCAV) developed by Iran. It is the first long-endurance, combat-capable Iranian drone. The Karrar drone, which was first introduced in



2010, has an operational range of up to 1,000 kilometres (620 miles). It has a maximum speed granted by its turbojet installation of 560 miles per hour. It reportedly boasts a service ceiling altitude of 47,000 feet.

September), IndiGo maintained a substantial market share of 18.5% among airlines operating flights to and from India. Earlier in the year, IndiGo created history by placing

an order for 500 Airbus A320 family planes. This order stands as the largest-ever aircraft order in the aviation industry.

Ola CEO Bhavish Agarwal's AI startup is building a multilingual Large Language Model



Krutrim Si Designs, the new artificial intelligence (AI)

venture of Ola co-founder Bhavish Aggarwal, has unveiled a family of multilingual artificial intelligence (AI) models to cater to the unique requirements of the Indian ecosystem. Krutrim, 'artificial' in Sanskrit, will come in two sizes: a base model named Krutrim trained on 2 trillion tokens and unique datasets, and a larger, more complex model called Krutrim Pro, launching next quarter for advanced problem-solving and task execution capabilities. Krutrim can understand 22 Indian languages and generate content in about 10, including Marathi, Hindi, Bengali, Tamil, Kannada, Telugu, Odia, Gujarati, and Malayalam. The full open release of Krutrim is scheduled for January 2024, and Krutrim APIs will be accessible to developers from February 2024. Krutrim Si Designs was launched in April 2023.

India to launch 50 satellites in next five years to shore up geo-intelligence gathering, says ISRO Chief S Somanath



Indian Space Research Organisation (ISRO) is planning to launch 50 satellites in the next five years for geo-intelligence gathering.

Speaking at Techfest', an annual science and technology event organised by the Indian Institute of Technology Bombay, ISRO Chairman S Somanath stated, this will include the creation of a layer of satellites in different orbits with a capacity to track the movement of troops and image thousands of kilometers of area. Somanath stated, for realising India's aspiration to become a strong nation, the current size of its satellite fleet is not enough and it should be ten times what we have today. He also stated that it was important to improve the ability of satellites to

ISRO to launch Chandrayaan-4 to bring back samples from Moon in 4 yrs: - Chairman Somanath

The Indian Space Research Organisation (ISRO) has planned to launch Chandrayaan-4 to bring back samples from the Moon in 4 years stated its chairperson S Somanath while elaborating on the space agency's Vision 2047. The first module of the Bharatiya Antariksh Station - India's planned space station, that will be capable of conducting experiments with the help of robots will be launched by 2028. Prime Minister Narendra Modi had previously called on the space agency to set up a space station by 2035 and send a man



to the Moon by 2040. Bharatiya Antariksh Station is India's planned space station. The SPADEX experiment will demonstrate autonomous docking capability. In the process known as docking, two spacecraft are aligned in a precise orbit and joined together. ISRO has shown how to use leftover fuel from the propulsion module to return a spacecraft from the Moon to Earth orbit. The Next Generation Launch Vehicle (NGVL), being designed by ISRO, will be able to transport 16 to 25 T into low Earth orbit.

President Putin Leads Flag-Raising Ceremony for Strategic Nuclear Submarines, Highlighting Russia's Naval Power Projection

Russian President Vladimir Putin participated in a televised flag-raising ceremony for two significant Russian nuclear submarines. Submarine Identities: Emperor Alexander III: A notable submarine belonging to Russia's new Borei class, representing a technological advancement since the Cold War. Krasnoyarsk: A submarine of the Yasen class, designed for multipurpose use and equipped with long-range, high-precision missiles. Borei Class Significance: Emperor Alexander III is part of the Borei class, denoted as the "Arctic



Wind," highlighting Russia's strategic focus on advanced naval capabilities in the Arctic region. Missile Capabilities: The Krasnoyarsk, belonging to the Yasen class, is equipped with long-range, high-precision missiles capable of striking both sea and land targets. Expansion Plans: President Putin mentioned the ongoing construction of five more Yasen-class submarines, indicating a commitment to expanding Russia's naval capabilities.

Tesla Introduces 'Optimus Gen 2,' an Advanced Humanoid Robot Designed to Automate Repetitive Tasks

Tesla has unveiled "Optimus Gen 2", a new generation of its humanoid robot that should be able to take over repetitive tasks from humans. Optimus, also known as Tesla Bot, has not been taken seriously by many outside of the more hardcore Tesla fans,



and for good reason. With this new version, Tesla says that the robot is now able to walk 30% faster. The company also claims a 10 kg weight reduction while improving balance.

detect changes, to bring in a more AI-related and data-driven approach to analyse data, reduce data

downloads and get only the necessary information.

NASA's OSIRIS-REx Spacecraft, Renamed OSIRIS-APEX



In an unprecedented extension of its celestial duties, the spacecraft that delivered asteroid samples from Bennu, OSIRIS-REx, has embarked on a new mission, and NASA has renamed it as OSIRIS-APEX. It is a mission to study the physical changes to asteroid Apophis that will result from its rare close encounter with Earth in April 2029. In April 2029, Apophis' orbit will bring it within 20,000 miles (32,000 kilometres) of Earth's surface closer to Earth than our highest-altitude satellites. Mission Objectives : OSIRIS-APEX aims to observe and analyze the physical changes induced by Earth's gravitational pull during Apophis' close flyby. Spacecraft Maneuvers : The OSIRIS-APEX spacecraft will execute maneuvers to dip toward the surface of asteroid Apophis. Asteroid Apophis Characteristics : Apophis is an "S-type" asteroid composed of silicate (rocky) material, with a mixture of metallic nickel and iron. It was discovered on June 19, 2004. It originated in the main asteroid belt between Mars and Jupiter.

ISRO to welcome 2024 with India's first X-Ray Polarimeter Satellite

Building on the momentum of 2023, Indian Space Research Organisation or ISRO is set to start 2024 with a bang. India is set to launch its first X-Ray Polarimeter Satellite on January 1. The XPoSat mission will lift off at 9:10 am using a Polar Satellite Launch Vehicle (PSLV), the space agency announced. ISRO's XPoSat mission will help understand emission mechanisms of various astronomical sources like black



holes, neutron stars. India's XPoSat mission in its 5 years of

life will measure orientation of vibration in the light wave which will help understand radiation mechanism and geometry of celestial sources. The mission "capturing the degree and angle of polarization, would add two crucial dimensions to our comprehension".

NASA's OSIRIS-REx Spacecraft, Renamed OSIRIS-APEX

Euclid is a crucial component of the European Space Agency's (ESA) Cosmic Vision programme, designed to explore the universe's origin, components, and fundamental laws. The primary objective of the Euclid



mission is to delve into the "dark side" of the universe, with a specific emphasis on investigating dark matter and dark energy.

China launched 2 MEO satellites to mega BeiDou constellation

The BeiDou Satellite Navigation System, also known as the BDS - China's largest space-borne infrastructure to date that provides quality services to worldwide users - added two more satellites to its mega constellation. Carrying the 57th and the 58th satellites of the BDS system, a Long March-3B carrier rocket and the Yuanzheng-1 upper stage attached to the carrier rocket thundered into the sky from the Xichang Satellite Launch Center in Southwest China's Sichuan Province. The launch marked the first mission



of sending two MEO satellites in one go to the BDS-3 since the system

was completed and officially commissioned in 2020, and also the finale of the Xichang Satellite Launch Center for the year 2023. As of 2022, the core industrial scale of China's BDS has topped 140 billion yuan (\$19.62 billion). With the successful launch of the two new MEO satellites, the BDS now has 15 BeiDou-2 satellites and 33 BDS-3 satellites.

NASA and IBM Unveil watsonx.ai AI Tool on Open-Source Platform Hugging Space at COP28

At the COP28, National Aeronautics and Space Administration (NASA) and International Business Machines Corporation (IBM) announced that an Artificial Intelligence (AI) tool called watsonx.ai would be available on the open-source AI platform Hugging Space. It is an Artificial Intelligence tool jointly built by IBM and NASA. It will help users monitor the Earth from space, measuring environmental changes that have

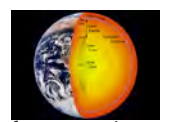

already happened while also making predictions about the future. The model is also designed to be extremely simple to use. In the case of watsonx.ai, NASA provides the datasets (in terms of satellite images instead of words,) and IBM created the foundation model to interpret them. It is a fit-for-purpose data store optimised for governed data and AI workloads.

China launched 3 satellites into orbit from south china sea



China successfully launched a Long March-11 carrier rocket into space, sending 3 satellites into planned orbit. The Taiyuan Satellite Launch Center launched the rocket from waters off the coast of Yangjiang, south China's Guangdong province. The satellites, Shiyang-24C, will be mainly used for space science and technology experiments. It was the 503rd mission of the Long March carrier rocket series. The Shiyang-24C satellites were developed by the Shanghai Academy of Spaceflight Technology (SAST) and have the capability to carry out extensive space technology tests. The Long March 11 rocket model, with a length of 20.8 metres, a diameter of 2 metres, and a liftoff weight of 58 metric tons, is capable of sending satellites to low-Earth orbit or sun-synchronous orbit. The China Aerospace Science and Technology Corporation (CASC), the primary contractor for the Chinese space program, has been instrumental in these developments.

IIT Guwahati Researchers Introduce BRAHMA-2D Model for Comprehensive Understanding of Large Braided River Flow



Researchers at the Indian Institute of Technology Guwahati (IIT Guwahati) developed an indigenous river model, BRAHMA-2D. BRAHMA-2D (Braided River Aid: Hydro-Morphological Analyzer) is a mathematical model to gauge the flow of large braided rivers like the Brahmaputra. It is a quasi-3D river flow model which helps to understand how fast the water moves at different depths inside a river and its circulation around a structure like a

Google Maps, ONDC, and Namma Yatri Collaborate to Offer a Seamless Mobility Experience

Google Maps, Namma Yatri, and the government-backed Open Network for Digital Commerce (ONDC) have joined forces in a three-way collaboration to enhance the open mobility experience for users. ONDC, as a government-backed open network for online commerce, is actively engaged in partnerships with Namma Yatri and Google Maps to facilitate the integration of various mobility options such as local trains, autorickshaws, cabs, and metro. End-to-End Seamless Experience: The primary goal of



the partnership is to provide users with an end-to-end seamless experience in open mobility, ensuring convenience and efficiency in navigating through various transportation options. Namma Yatri's Contribution: Namma Yatri, an open network mobility app, is working in conjunction with ONDC to integrate the scheduling, booking, and related services of Kochi Metro into the Google Maps platform for the benefit of users.

Meta Collaborates with ONDC to Bolster Small Businesses in India

Meta, a prominent technology company, has entered into a collaboration with the government-backed ecommerce network Open Network for Digital Commerce (ONDC). To provide support and upskilling opportunities for small businesses in India, leveraging Meta's business and technical solution providers. Enhanced Buyer-Seller Experiences: Meta's involvement includes the deployment of its business and technical solution providers to enhance conversational experiences between buyers and sellers on WhatsApp, a Meta-owned platform. ONDC's Role in Business Transformation: ONDC will play a crucial role in assisting businesses to become seller apps and facilitating their onboarding onto the network, contributing to



the digitization and transformation of these enterprises. Meta Small Business Academy: The Meta Small Business Academy is introduced as part of the initiative, offering certification programs for entrepreneurs and marketers. These programs focus on imparting digital marketing skills essential for growth on Meta's platforms, including WhatsApp, Facebook, and Instagram. Integration with ONDC's Seller Support Chatbot Sahayak: As a component of the collaboration, Meta plans to enhance the services provided on ONDC's seller support WhatsApp chatbot, Sahayak. This is aimed at improving the efficiency and effectiveness of seller support services.

spur installed to prevent river bank erosion. It was developed by the researchers at IIT Guwahati in collaboration with the Brahmaputra Board under the Union Ministry of Jal Shakti. It was successfully validated on the Brahmaputra River near Majuli Island, the second largest freshwater River

Island in the world, in Assam, which is prone to river bank erosion. It integrates a two-dimensional model of water movement with a theory about entropy, a measure of disorder or randomness.

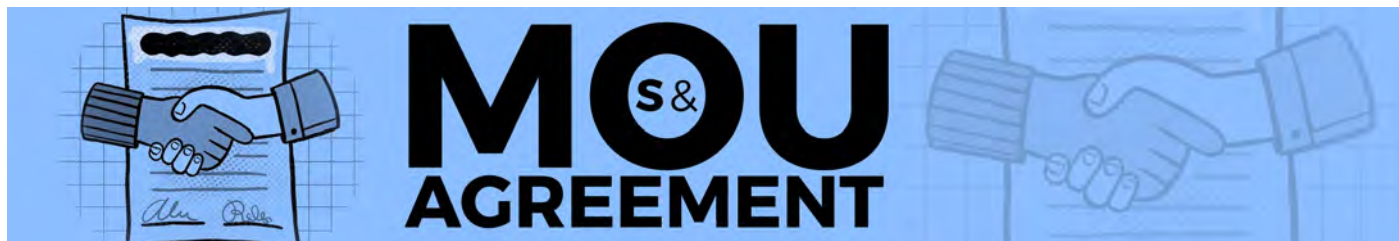

Indian Oil and EKI Energy ink deal to promote 'Surya Nutan'



Global carbon credit developer and supplier EKI Energy Services and state-owned refiner Indian Oil Corporation have collaborated to promote sustainable indoor solar cooking system. According to the statement, this strategic collaboration aims to promote 'Surya Nutan', IndianOil's innovative indoor solar cooking system. IndianOil, the country's largest fuel refiner and retailer, has a prominent presence across the entire hydrocarbon value chain. Under the MOU, IndianOil will share the technology of Surya Nutan with EKI Energy to enhance its production and distribution, supported by carbon finance while contributing towards the betterment of society and the environment.

REC signs 200 million euro loan with German Bank KfW to propel distribution sector reforms



REC Limited, a Maharatna CPSE under the Ministry of Power, has signed a 200 million Euro loan agreement with the German bank KfW. This marks REC's sixth line of credit under the Indo-German Development Cooperation and demonstrates the corporation's commitment to enhancing the distribution infrastructure of DISCOMs in line with the Revamped Distribution Sector Scheme (RDSS) of the Government of India. This occasion marks a significant step in REC's ongoing commitment to reform the distribution sector in the country. REC is the nodal agency to implement the RDSS scheme.

NLCIL Signs MoU with TNSDC & NTTF for Skill Development Training Programme for Unemployed Youth

NLC India Limited, a Navratna PSU under the Ministry of Coal, entered into a tripartite Memorandum of Understanding (MoU) in Chennai with Tamil Nadu Skill Development Corporation (TNSDC), the Nodal Agency of Government of Tamil Nadu for skill development and M/s Nettur Technical Training Foundation (NTTF), Bengaluru, a



pioneer institution on providing skill training to unemployed youth, to meet the present industry demands. NLCIL has committed to spend Rs.12 lakh per candidate for this free residential programme under its budget for Rehabilitation and Resettlement (R&R).

UNICEF in collaboration with India to launch the "Green Rising" initiative at the COP28 Summit in Dubai

UNICEF's Generation Unlimited, in collaboration with India's Ministry of Environment, Forest, and Climate Change will unveil the "Green Rising" initiative at COP28 in Dubai. The global "Green Rising" initiative and the "Green Rising India Alliance" marks a collaborative effort involving UNICEF, Generation Unlimited, and a diverse network of public,



private, and youth partners. The main goal is to mobilize millions of young people worldwide, encouraging their active participation in green initiatives addressing and adapting to the severe impacts of climate change on their communities.

Gujarat govt, AAI signs MoU to develop 11 greenfield airports

Gujarat, the State government has signed a memorandum of understanding with the Airports Authority of India (AAI) to develop 11 new greenfield airports and expand nine existing ones. Though an estimate for these projects have not been drawn, each airport is likely to cost ₹1,500-3,000 crore. Ankleshwar, Morbi, Rajpipla, Botad, Dwarka, Dhordo, Rajula, Dahod, Ambaji, Dholavira and Palitana have been identified for the development of greenfield airports. As per the agreement with the AAI, Gujarat government



will provide the necessary land and other utility services like electricity and water needed for the airports. The government stated that it will also explore possibilities of three additional greenfield airports at Vadnagar, Siddhpur and Kevadia. Apart from the greenfield airport development, the state government is also looking at brownfield development of nine airports.

MoD inks contract worth over Rs 588 cr with TCIL for Digital Coast Guard project



In alignment with the Government of India's strategic vision for Digital Armed Forces, the Ministry of Defence has signed a contract with Telecommunications Consultants India Limited (TCIL), at a total cost of Rs 588.68 crore, for the acquisition of Digital Coast Guard (DCG) project, under the Buy (Indian) category. A pivotal Initiative for the Indian Coast Guard (ICG), the DCG Project will unfold a comprehensive narrative of technological progression, encompassing the construction of an advanced Data Centre, and the establishment of a robust Disaster Recovery Data Centre. At its core, the DCG project marks the establishment of a Tier-III standard Data Centre, armed with the latest technological capabilities.

UNLF signs peace agreement with Centre & Manipur government



Government of India and Government of Manipur signed a Peace Agreement with United National Liberation Front (UNLF), the oldest valley-based armed group of Manipur in New Delhi. The UNLF was formed in 1964 and has been operating both within and outside Indian Territory. A Peace Monitoring Committee (PMC) will be constituted to oversee enforcement of the agreed ground rules. The development is likely to be a significant step in restoring peace and normalcy in the State.

Nasscom signs MoU with NRW Global to establish launchpad in Germany

An MoU has been signed between Nasscom and NRW Global to establish a launchpad in Germany. The MoU has been signed to promote innovation, investment, and tech-

Clean Ganga Mission signs pact with Mississippi River Initiative

The National Mission for Clean Ganga (NMCG) recently signed a Memorandum of Common Purpose (MoCP) with the Mississippi River Cities and Towns Initiative (MRCTI), which represents 124 cities/towns situated along the banks of the Mississippi River, the United States. This significant agreement



positions NMCG a step closer to the imminent launch of the Global River Cities Alliance (GRCA), as the current River Cities Alliance (RCA) has now expanded its strength to the membership of 267 global river-cities including India, USA and Denmark.

NHAI Inks Agreement to Develop Multi Modal Logistics Park at Nagpur at a cost of Rs. 673 crores

NHAI has signed an agreement with M/s. DC Multi-Modal Park (Nagpur) Limited, a SPV of M/S. DeltaBulk Shipping India Pvt. Ltd., for the development of Multi Modal Logistics Park (MMLP) at Nagpur. The MMLP will be developed in an area of 150 acres under the Public Private Partnership model at an estimated cost of Rs.673 crore. This project is poised to be the first MMLP in Maharashtra



under the PM Gati Shakti National Master Plan, making it a significant milestone in the country's development. The MMLP will be developed in three phases. Phase I with an investment of Rs. 137 crore is expected to be completed in two years.

National Mission for Clean Ganga Inks Pact for Sewage Treatment Plant Development at Gokul Barrage in Mathura

National Mission for Clean Ganga (NMCG) has entered into a tripartite Concession Agreement with the Uttar Pradesh Jal Nigam and M/s. EIEL Mathura Infra Engineers Pvt. Ltd. This Special Purpose Vehicle (SPV), formed through a joint venture between M/s. Enviro Infra Engineers Limited and M/s. Micro Transmission Systems, will spearhead the development of a Sewage Treatment Plant (STP) for



the Gokul Barrage in Mathura. The Concession Agreement, executed under the Hybrid Annuity PPP mode, involves a contract valued at Rs. 240.01 Crores, marking a transformative moment in river conservation and urban sewage management.

nological exchange between North Rhine-Westfalia (NRW) in Germany and India. The state-owned foreign trade promotion agency NRW Global Business is the partner for all companies to investment projects and settling in North Rhine-Westphalia.



India-Oman FTA may be signed in January 2024:



India and Oman will likely sign a free trade agreement in early 2024. This free trade agreement will benefit export sectors such as motor gasoline, iron and steel products, electronics, machinery, etc. Currently, these goods face a 5% import duty in Oman. Oman's import duty ranges from 0 to 100%. A duty of 100% is on specific items such as meats, wines, and tobacco products. Both sides have concluded the negotiations on most of the issues. Oman is India's third-largest export destination among the Gulf Cooperation Council (GCC) countries. India has already signed similar agreements between India and other GCC countries like UAE. India's merchandise imports from Oman are around USD 250 million.

India, Russia ink pacts on construction of future power units of Kudankulam nuclear plant



India and Russia signed the agreement on the construction of future power units of the Kudankulam nuclear plant. Agreements have also been signed in the areas of medicines, pharmaceutical substances and medical devices. The Kudankulam nuclear power plant is being constructed in Tamil Nadu with the technical assistance of Russia. The construction started in March 2002. In 2027, the plant is anticipated to begin running at full capacity. External Affairs Minister S. Jaishankar is on a five-day visit to Russia. India and Russia agreed that their negotiating teams would hold a meeting by the end of January to start in-person negotiations on the free trade agreement (FTA) between India and the Eurasian Economic Zone.

The government of India and ADB sign a \$100 million loan agreement to improve urban services and tourism facilities in Tripura

The Government of India today signed an agreement with Asian Development Bank (ADB) to avail a USD 100 million loan to improve urban services and tourism facilities in the northeastern state of Tripura. After signing the loan agreement, Ms. Mukherjee stated that the project will improve the municipal infrastructure and public services in urban local bodies (ULBs) along the main national highways in Tripura besides upgrading key tourism sites. The project will upgrade

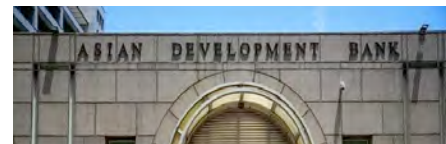

urban water supply systems by installing 42 kilometres (km) of new transmission and distribution pipes, establishing 4 new water treatment plants, and improving 55 km of stormwater drains. It will improve 21 km of urban roads that will incorporate features that respond to the needs of the elderly, women, children, and differently-abled.

Ministry of Rural Development signs MoU with Reliance Retail's JioMart, to onboard DAY-NRLM's SHGs

The Ministry of Rural Development (MoRD) has signed a memorandum of understanding (MoU) with Reliance Retail's JioMart as part of its efforts to enhance the outreach of the products of self-help groups (SHGs) of Deendayal Antyodaya Yojana-National Rural Livelihoods Mission (DAY-NRLM). This initiative will further boost MoRD's provision under the SARAS collection to be available to a larger consumer



base. JioMart will also help set-up and support them to navigate and operate their account on the marketplace. Additionally, JioMart will jointly participate in trainings and workshops facilitated by MoRD to enable sellers to familiarise selling experience on the portal.

Tripartite Peace Accord Signed in Delhi

A historic tripartite peace accord was signed between the Centre, the Assam Government and the United Liberation Front of Assam (ULFA) in New Delhi. The deal is intended to bring lasting peace in the North East region. The Memorandum of Settlement was signed in the presence of Union Home Minister Amit Shah. Union Home Minister Amit Shah, Assam Chief Minister Himanta Biswa Sarma, and more than a dozen top leaders of the pro-talks faction of the ULFA, headed by Arabinda Rajkhowa, will be present during the signing of the peace agreement. Two top leaders of the



Rajkhowa group -- Anup Chetia and Sashdhar Choudhary -- have been in the national capital since last week and gave the final touches to the peace agreement along with government interlocutors. The Rajkhowa faction joined peace talks with the government on September 3, 2011 after an agreement for Suspension of Operations (SoO) was signed between the ULFA, central and state governments.

ACQUISITIONS & MERGERS



Infibeam Avenues acquires 49% stake in Pirimid Fintech

Infibeam Avenues Limited (IAL), a Gandhinagar, Gujarat based fintech company, announces its strategic foray into the capital markets and digital lending software market by acquiring a significant 49% equity stake in Pirimid Fintech, a Ahmedabad, Gujarat based Financial Services Company investing Rs 25 crore to solidify this strategic partnership. This move is in direct response to the surging demand in the thriving global capital markets for cutting-edge secured and zero latency Artificial Intelligence (AI) backed software to streamline trading, research and investment processes.



UltraTech to Purchase Kesoram's Cement Business in Acquisition Deal

UltraTech, part of the Aditya Birla Group, is set to acquire the cement business of Kesoram Industries in an all-stock deal. The estimated enterprise value of the deal is approximately ₹7,600 crore, including the assumption of debt. Demerger of Cement Business : Kesoram Industries, a flagship company of the BK Birla Group, has decided to demerge its cement business. The cement business includes two integrated cement units located in Karnataka and Telangana, boasting a combined installed capacity of 10.75 million tonnes per annum. Integration into

SBI Mutual Fund Receives RBI Approval for Acquisition of 9.99% Stake in Karur Vysya Bank

The Reserve Bank of India (RBI) has given its approval to SBI Mutual Fund (SBI MF) for acquiring an aggregate holding of up to 9.99% of the paid-up share capital or voting rights of private sector lender Karur Vysya Bank Limited. The approval comes with stringent conditions to ensure regulatory compliance and



adherence to relevant laws and

guidelines.

Time-bound

Shareholding Acquisition : The approval is contingent on SBI MF acquiring a major shareholding within one year from the date of RBI's letter.

SBI to acquire 20% stake in SBI Pension Funds

The State Bank of India (SBI) announced that it is planning to acquire a 20% stake in SBI Pension Funds, which is held by SBI Capital Markets. SBI currently holds a 60% stake in SBI Pension Funds. Through this latest transaction, the company is set



to increase its stake to 80%, acquiring the

additional shares for a sum of ₹229.52 crore. The remaining 20% stake in SBI Pension Funds is held by SBI Funds Management.

Government Plans to Generate ₹1,200 Crore through Sale of 8% Stake in IRCON via Offer for Sale (OFS) with Floor Price Fixed at ₹154 per Share

The Union government has proposed to sell 8% stake in IRCON International through an offer for sale (OFS). The government will offload about 3.76 crore shares, which represents 4% stake through the OFS, and in the case of oversubscription,



an additional 4% stake will be under sale.

The offer for sale will take place on December 8, 2023 through a separate window on the stock exchanges.

LIC Reduces Shareholding In Dixon Technologies From 5.012% To 3%

Life Insurance Corporation of India (LIC) announced that Corporation's shareholding in "Dixon Technologies India Limited" has decreased from 29,97,913 to 17,94,395 Equity Shares, decreasing its shareholding from 5.012% to 3.000% of the paid-up capital of the Company. There



was a decrease of 2% in holding during the period from April

20, 2022 to December 15, 2023. The shareholding reduction was executed at an average cost of Rs 5,877.65 per share.

UltraTech Cement : As per the deal, the demerged cement business from

Kesoram Industries will be integrated into UltraTech Cement.



Defence Minister Shri Rajnath Singh Reveals Crest of Project 15B Stealth Guided Missile Destroyer Yard 12706 (Imphal)

The crest of Yard 12706 (Imphal), the third amongst the four Project 15B stealth guided missile destroyers, was unveiled by Raksha Mantri Shri Rajnath Singh, in the presence of Manipur Chief Minister Shri N Biren Singh, in New Delhi. The unveiling of Imphal's crest, adorned with the Kangla Palace and 'Kangla-Sa' is a befitting tribute to the sacrifice made by the people of Manipur towards India's independence, sovereignty and security. The crest design depicts the Kangla Palace on the left and 'Kangla-Sa' on the right. The Kangla Palace is an important historical and archaeological site of Manipur, and was the traditional seat of the past kingdom.

Indian Coast Guard Conducts 9th National Level Pollution Response Exercise (NATPOLREX-IX) off Vadinar, Gujarat



Indian Coast Guard conducted the 9th National Level Pollution Response Exercise (NATPOLREX-IX) near Vadinar, Gujarat. DG Rakesh Pal, Director General Indian Coast Guard, and the Chairman NOSDCP reviewed the preparedness of all agencies during the exercise. Various

Ministry of Defence inks deal with Agnit Semiconductors

The Ministry of Defence (MoD) has signed a contract with Agnit Semiconductors Private Limited for design and development of advanced Gallium Nitride (GaN) semiconductors essential for the next generation of wireless transmitters in defence applications ranging from radars to electronics warfare jammers. This contract marks the 300th agreement under the Innovations for Defence Excellence (iDEX)



initiative of the Defence Innovation Organisation (DIO). The iDEX-DIO aims to eliminate imports in Gallium Nitride (GaN) components, classified as sensitive and cutting-edge technology with controlled and restricted exports by many countries.

Simultaneous Launch of First Three Ships (MAHE, MALVAN, and MANGROL) under ASW SWC (CSL) Project at CSL, Kochi

Mahe, Malvan and Mangrol, the first three ships of 08 x ASW Shallow Water Craft (CSL) project being built by CSL, Kochi for the Indian Navy, were launched at CSL, Kochi. Mahe was launched by Mrs Anjali Bahl in the presence of VAdm Puneet Bahl, Commandant INA, Malvan was launched by Mrs Kangana Berry in the presence of VAdm Suraj Berry, C-in-C, and Mangrol was launched by Mrs Zarine Lord Singh. The ships were launched to the invocation from Atharva Veda. The Mahe class ASW Shallow Water Crafts



have been named after ports of strategic importance along the coast of India, and will look to carry forward the glorious legacy of the erstwhile minesweepers which were their namesake. The contract for building 8 ASW SWC ships was signed between the Ministry of Defence and Cochin Shipyard Limited on 30 Apr 19.

ministries and departments of central and coastal state governments, ports, oil handling agencies, and other stakeholders participated in the exercise. More than 31 foreign observers and 80 delegates participated in the exercise. The NATPOLREX-IX accomplished its objective of testing the level of preparedness and coordination between

various resource agencies to respond to a marine oil spill invoking provisions of the National Oil Spill Disaster Contingency Plan or NOSDCP. Pollution Response Vessels (PRVs), Offshore Patrol Vessels (OPVs), Advanced Light Helicopter Mk-III, and Dornier Aircraft participated in the exercise.

Ministry of Defence Signs Rs 588.68 Crore Contract with Telecommunications Consultants India Limited for Digital Coast Guard Project



In alignment with the Government of India's strategic vision for Digital Armed Forces, the Ministry of Defence has signed a contract with Telecommunications Consultants India Limited (TCIL), at a total cost of Rs 588.68 crore, for the acquisition of Digital Coast Guard (DCG) project, under the Buy (Indian) category.



Defense Ministry Greenlights Acquisition of 6,400 Rockets for Pinaka Weapon System

The Ministry of Defence (MoD) has given the green light for the acquisition of 6,400 new rockets for the Pinaka weapon system. The Defence Ministry has given approval to Rs 2,800 crore proposal for buying around 6,400 rockets for Pinaka multi-barrel rocket launcher systems. At its recent meeting, the Defence Acquisition Council approved the proposal for the acquisition of two types of these rockets, called Area Denial Munition Type 2 and Type-3. Two main contenders include the Economic Explosives Limited of Solar Industries and the Munitions India Limited. Pinaka weapon system is named after the bow of Hindu god Shiva. It can fire 12 rockets in 44 seconds, with a maximum range of 40 km for the Mark-I and 120 km for the Mark-I enhanced version. It has been developed by the Defence Research and Development

Indian Navy to induct Fast Attack Craft, 'INS Tarmugli'

The Indian Navy will be re-inducting a refurbished 22-year-old fast attack craft, INS Tarmugli, in a ceremonial commissioning ceremony at the naval dockyard, Visakhapatnam, more than 17 years after she was gifted to Maldives which used it for years and returned to India in May, 2023. The ship has a unique distinction of having served under the flag of two nations with three names during her distinguished service till date. Commissioned in the Indian Navy as INS Tillanchang, a Trinkat Class ship, she was in active service till 2006, and thereafter gifted



to the Maldives National Defence Force (MNDF) by the Govt of India, as part of diplomatic outreach in the Indian Ocean Region (IOR). The ship, according to the Indian Navy, was commissioned into MNDF as MCGS Huravee on 16 April 2006, and served there till its decommissioning in May 2023. The vessel was originally designed and constructed by Kolkata-based Garden Reach Shipbuilders & Engineers and was commissioned into the Indian Navy on March 17, 2001.

Ministry of Defence Signs Contract with Bharat Heavy Electricals Limited for ₹2956.89 Cr to Acquire 16 Upgraded Super Rapid Gun Mounts and Accessories for Indian Navy

The Ministry of Defence has signed a contract with M/s Bharat Heavy Electricals Limited (BHEL), Haridwar for procurement of 16 Upgraded Super Rapid Gun Mount (SRGM) along with associated equipment/accessories for Indian Navy under Buy (Indian) category at a total cost of ₹2956.89 Cr. The



upgraded SRGM will be manufactured by BHEL at its Haridwar Plant. The upgraded SRGM is described as a medium-caliber anti-missile/anti-aircraft point defense weapon system.

14th edition of India-United States of America Joint Military Exercise 'Vajra Prahar'

The 14th Edition of the Indo-US Joint Special Forces exercise, "VAJRA PRAHAR 2023," has commenced at the Joint Training Node in Umroi, Meghalaya spanning from 21st November to 11th December 2023. The US contingent comprises personnel



from the 1st Special Forces Group (SFG) of the US Special Forces, while the Indian Army contingent is led by Special Forces personnel fr

Organisation (DRDO). Private sector companies like Larsen & Toubro, Tata Defence, and Economic Explosives Limited are actively involved in the Pinaka weapon system project, indicating collaboration between

the government and the private sector in defense initiatives.

INS Imphal – Indian Navy’s indigenous destroyer to be commissioned



Indian Naval Ship (INS) Imphal, the third warship of Project 15B forming the Visakhapatnam class stealth-guided missile destroyers, is set to be commissioned into the Indian Navy. Project 15B - Under this initiative, Visakhapatnam Class 4 warships (Visakhapatnam, Mormugao, Imphal, Surat) were planned. The Visakhapatnam and Mormugao are already commissioned in the Indian Navy. INS Imphal is the first warship to have been named after a city from the Northeastern region, the approval for which was accorded by the President in April 2019. The naming of the ship after the capital city of Manipur underlines the importance of the Northeastern region for national security and prosperity. Built by Mazagon Dock Limited, the ship boasts a high indigenous content of approximately 75% that includes BrahMos surface-to-surface missiles, medium-range surface-to-air missiles, anti-submarine indigenous rocket launchers, and 76mm super rapid gun mount. The ship is a part of Project 15B (Visakhapatnam class) and follows the lineage of indigenous destroyers like Project 15A (Kolkata class) and Project 15 (Delhi class). With a length of 163 metres and 7,400 tons displacement, Imphal is a formidable naval presence. The ship is a potent and versatile platform equipped with state-of-the-art weapons and sensors, including surface-to-air missiles, anti-ship missiles, and torpedoes. Powered by Combined Gas and Gas (COGAG) propulsion, the ship is capable of achieving speeds above 30 knots (56 km/hour).

Indian Air Force Conducts Successful Test of ‘SAMAR’ Air Defense Missile System in Andhra Pradesh

Indian Air Force (IAF) successfully conducted the test of the ‘SAMAR’ standing for Surface to Air Missile for Assured Retaliation, air defence missile system during ‘Exercise Astrashakti-2023.’ Exercise Astrashakti-2023 took place at Suryalanka Air Force Station in Andhra Pradesh. SAMAR is an indigenous air defence missile system developed by the Indian Air Force. SAMAR participated for the first time in Exercise Astrashakti-2023 to undergo operational field trials and test its surface-to-air weapon systems. SAMAR is capable of destroying aerial threats, operating at a speed range of 2 to 2.5 Mach. It features a twin-turret launch platform. SAMAR air defence system has been developed by the 7 Base Repair Depot (BRD), showcasing indigenous technological advancements. SAMAR can launch two missiles in both single and salvo mode,



demonstrating its flexibility and versatility in different combat

situations. SAMAR is a quick reaction surface-to-air missile system, ingeniously crafted by the IAF’s 7 Base Repair Depot (BRD) and 11 BRD, in collaboration with Simran Flowtech Industries and Yamazuki Denki. Notably, the system repurposes old Russian-origin Vympel R-73 and R-27 air-to-air missiles, demonstrating an innovative approach to maximize existing resources. India also showcased the firepower of its indigenous Akash surface-to-air (SAM) weapon system during Exercise Astrashakti 2023. The Akash Weapon System is designed and developed by the Defence Research and Development Organisation (DRDO), emphasizing India’s self-reliance in defense technology.

8th edition of Indian Ocean Naval Symposium Conclave of Chiefs concludes in Bangkok, Thailand

The 8th edition of Indian Ocean Naval Symposium (IONS) Conclave of Chiefs (CoC) was conducted by the Royal Thai Navy at Bangkok, Thailand. Naval chiefs and senior representatives of 27 member countries and observer countries participated in this conference. Admiral R Hari Kumar, Chief of the Naval Staff, represented three members of the Indian delegation. The Republic of Korea Navy was welcomed by the Conclave as the latest ‘Observer’, raising the collective strength of IONS to 34 (25 Members &



09 Observers). During the Conclave, CNS, IN held fruitful

interaction with the host, Adm Adoong Pan-lam, Commander-in-Chief, Royal Thai Navy and complimented him for taking over Chairmanship of IONS. On the side-lines of Conclave, the CNS also visited Indian Naval Ship Kadmatt, at Bangkok, and interacted with the ship’s crew, commending them for successful long range deployment.

After being commissioned, the ship will join the Western Naval Command.

SPORTS

Chennai Grand Masters 2023; Dommaraju Gukesh clinches title

In Chennai Grand Masters 2023 tournament, Indian chess prodigy, Dommaraju Gukesh clinched the title by holding compatriot Pentala Harikrishna for a draw. Meanwhile, Arjun Erigaisi secured the second spot. Both Arjun and Gukesh finished the event at 4.5 points out of 7. Pentala Harikrishna finished third with 4 points, as all three Indians in the tournament ended the campaign with a podium finish. With this win, Gukesh takes the lead in the FIDE Circuit.



If he keeps the lead till 1st January 2024, he will qualify for the highly coveted Candidates Tournament 2024. The 2024 Candidates Tournament is an eight-player chess tournament, held to determine the challenger for the 2024 World Chess Championship. It is scheduled to be held from 2 to 25 April 2024 in Toronto, Canada.

Union Minister Anurag Singh Thakur to launch Official logo and mascot for Khelo India Youth Games in Chennai

Union Minister of Information and Broadcasting Anurag Singh Thakur will launch the Official logo and mascot for Khelo India Youth Games in Chennai. He will attend the ceremony as the chief guest for the launch of official logo, jersey, mascot, and torch. The Khelo India Youth Games will be held from January 19th to 31st next year. The upcoming edition will



take place in Chennai, Trichy, Madurai and Coimbatore. The previous editions of the Youth Games have been held in Delhi, Pune, Guwahati, Panchkula, and Bhopal.

Anmol Kharb wins women's singles title at National Badminton Championships in Guwahati

In Badminton, Anmol Kharb has won the women's singles title at the National Badminton Championships 2023 in Guwahati. The teenager lost the first game of the final to Tanvi Sharma but fought back to level the score. The men's singles title clash saw an upset as the unseeded Chirag Sen secured the national title after defeating fourth-seed Tharun M. In the mixed doubles summit clash, Dhruv Kapila and Tanisha Crasto defeated the sixth-seeded duo of Nitin Kumar-Navdha M anglam 21-13, 21-8 to claim their maiden national



title. Priya Devi Konjengbam and Shruti Mishra lifted the women's doubles title with a win over Ritika Thaker-Simran Singh. The men's doubles final was an edge-of-the-seat thriller where K Pruthvi Roy-Suraj Goala caused an upset by defeating Krishna Prasad Garaga-Vishnuvardhan Goud Panjala.

Raftaar Reasoning Batch 1.0

- ✓ 40+ Class of Live Session
- ✓ Topic PDF By Faculty
- ✓ 5 Days Class (Mon - Fri)
- ✓ Class Time 5 Pm
- ✓ Content English & Hindi
- ✓ Exam Covered SBI, IBPS PO / Clerk, RRB PO Clerk
- ✓ Zoom 1 - 1 Interaction

1 Year Validity

Mr. Rohit Sir

Reasoning Expert
5+ Years

Extra **10% Off**

USE CODE **GUIDELY10**

Grab It Now →



Sakshi Malik: India's Olympic medal winner quits wrestling

Olympic bronze medalist Sakshi Malik announced her retirement from wrestling in New Delhi. Sakshi Malik last participated in the Commonwealth Games in 2022 in Birmingham. The Indian wrestler won the gold medal in the women's 62 kg category but has not participated in international events since then. Sakshi was born on 3 September 1992 in the Rohtak district of Haryana.



Vaishali Rameshbabu makes history by becoming India's third Female Grandmaster

In a historic achievement for Indian chess, Vaishali Rameshbabu secured her grandmaster title by crossing 2,500 International Chess Federation (FIDE) ranking points during the IV El Llobregat Open in Spain. Vaishali has defeated Turkish Tamer Tarik Selbes (2238) in the second round to surpass rating and has started the tournament with two consecutive wins. She has now become the third Indian female player to achieve this prestigious title, joining the elite company of Koneru Humpy and Harika Dronavalli.

India's Hardik Singh named FIH player of the year, Savita Punia bags third women's goal-keeper of the year award

Indian hockey players Hardik Singh and Savita Punia have won major awards at the FIH Hockey Star Awards for the 2023 season. Singh was named the men's player of the year while Punia won the best women's goalkeeper of the year award. Hardik became the third male player from India to win the coveted award, joining Manpreet Singh (2019) and Harmanpreet Singh (2020-21 and 2021-22). Besides Hardik, India women's team skipper Savita Punia won the FIH Goalkeeper



of the Year award for the third consecutive time. Notably, this is Hardik's second significant accolade this year as he had won the esteemed Hockey India Balbir Singh Sr Award for Player of the Year 2022 earlier this year.

Coca-Cola extends global partnership with ICC

Beverage major Coca-Cola has renewed its partnership with the International Cricket Council (ICC), securing an eight-year commitment that stretches through 2031, encompassing all major ICC world events in various cricket formats. This move solidifies one of ICC's longest-ever associations with a single brand, continuing a partnership that began in 2019. Coca-



Cola's association with major sports events is a long-standing tradition, highlighted by its eight-decade-long relationship with the Olympics and over forty years with FIFA and the T20 World Cup.

IOA constitutes Ad Hoc committee to supervise operations of Wrestling Federation of India

The Indian Olympic Association (IOA) constituted an Ad Hoc committee comprising Bhupinder Singh Bajwa as Chairman, MM Somaya and Manjusha Kanwar as Members. The committee is given the responsibility to observe and supervise the operations of the Wrestling Federation of India (WFI). The Indian Olympic Association stated that in its order, that it has found that the recently appointed President and officials of WFI have made



arbitrary decisions in violation of constitutional provisions. The officials overturned the rulings of the IOA-appointed ad hoc committee without following due process. This not only highlights a governance gap within the Federation but also signifies a noticeable departure from established norms.



India's Ashwini Ponnappa and Tanisha Crasto win women's doubles title at Guwahati Masters badminton tournament

India's Ashwini Ponnappa and Tanisha Crasto won the women's doubles title at the Guwahati Masters 2023 badminton tournament. Ashwini Ponnappa and Tanisha Crasto, the second seeds at the BWF Super 100 tournament, beat Taipei's Sung Shuo Yun and Yu Chien Hui 21-13, 21-19 to win what was their second title as a pair. Results at the Guwahati Masters 2023 badminton tournament will count towards players' qualifying rankings for the Paris 2024 Olympics.



Khelo India Games to be held in Tamil Nadu in January 2024

Khelo India Games will be held in Tamil Nadu in January 2024. The State Government said that the games will be held in Chennai, Coimbatore, Madurai and Trichy from 19th to 31st January, 2024. More than 5,500 sports persons and over 1,600 coaches are expected to participate in the event. More than 1000 referees and 1200 volunteers will be part of the sporting event in which 27 types of sport will be played. For the first time, squash will be included in Khelo India games.

India to take on hosts South Africa in their first T20 International in Durban

India will take on hosts South Africa in their first T20 International in Durban. Suryakumar Yadav-led young squad has many new names as the senior brass of the team comes in during the Test format of the tour. Aiden Markram is leading the South African squad and they have also



included many emerging players who will show their potential in the great team.

Indian Army's Captain Geetika Koul becomes first woman medical officer to be deployed at Siachen

Captain Geetika Koul from the Snow Leopard Brigade has become the first woman medical officer in the Indian Army to be deployed at Siachen, the world's highest battlefield, the Fire and Fury Corps. This achievement follows her successful completion of rigorous induction training at the esteemed Siachen Battle School, which includes high-altitude acclimatisation, survival techniques, and specialised medical procedures. The Fire and



Fury Corps of the Indian Army announced this milestone on social media, highlighting the significance of Captain Koul's deployment in promoting gender inclusion within the military.

Union Minister Anurag Singh Thakur formally inaugurates first-ever Khelo India Para Games in New Delhi

Union Minister of Youth Affairs and Sports Anurag Singh Thakur formally inaugurated the first-ever Khelo India Para Games (KIPGs) in New Delhi. Mr Thakur said that the event is not just the celebration of our spirit of sportsmanship but it is a light that will bring inclusivity and empowerment in India. He further pointed out that KIPGs will further reiterate the PM's vision of "Kheloge to Khiloge". More than 1,400 participants from across 32 states and Union Territories



including Services Sports Control Board are participating in the 8-day event. The Para athletes will compete for honours in 7 disciplines including para athletics, para shooting, para archery, para football, para badminton, para table tennis and para weight lifting.



National Sports Awards 2023 Announced; Chirag C Shetty and Satwik Sai Raj Rankireddy to Receive Major Dhyan Chand Khel Ratna Award

The Government announced the National Sports Awards 2023. Badminton players Chirag C Shetty and Satwik Sai Raj Rankireddy will be honoured with the Major Dhyan Chand Khel Ratna Award. Twenty-six sportspersons will receive the Arjuna Awards. Wrestling coach Lalit Kumar, Chess coach R. B. Ramesh, Para Athletics coach Mahaveer Prasad Saini, Hockey coach Shivendra Singh and Mallakhamb coach Ganesh Prabhakar Devrukhkar will be honoured with the Dronacharya Award in the regular category. Golf coach Jaskirat Singh Grewal, Kabaddi coach Bhaskaran E and Table Tennis player Jayanta Kumar Pushilal will be honoured with the Dronacharya Award in the lifetime category. Dhyan Chand Award for Lifetime Achievement in Sports and Games, will be given to Manjusha Kanwar for Badminton, Vineet Kumar Sharma for Hockey and Kavitha Selvaraj for Kabaddi. Maulana Abul Kalam Azad (MAKA) Trophy 2023 will be presented to Guru Nanak Dev University, Amritsar as the overall winning university, Lovely Professional University, Punjab is the 1st runner up University and Kurukshetra University, Haryana is the 2nd runner up University. The awardees will receive their awards from President Droupadi Murmu in a function at Rashtrapati Bhavan on the 9th of next month.

Khelo India and Svayam collaborated to improve support for Para Athletes at Khelo India Para Games 2023

Khelo India, the flagship program of the Ministry of Youth Affairs and Sports, and Svayam, India's pioneering accessibility organisation, joined hands to ensure transportation and infrastructure are accessible in New Delhi during the Khelo India Para Games. Accessible transportation services were



provided for more than 1400 para-athletes. At the Khelo India Para Games 2023, more than 500 wheelchair-using players participated.

First-ever Khelo India Para Games conclude in New Delhi

The first-ever Khelo India Para Games (KIPG) concluded in New Delhi with Haryana winning the inaugural title by securing 105 medals including 40 gold, 39 silver, and 26 bronze. KIPG 2023, which began on December 10, witnessed the participation of around 1,450 para-athletes from across the country. Uttar Pradesh came second with 62 medals including 25 gold, 23 silver, and 14 bronze, while Tamil Nadu finished third with 20 gold, eight silver, and 14 bronze medals. Athletes from 32 states and Union Territories participated in the Games. 75th Inter State-Inter Zonal Badminton Championship 2023: Maharashtra bags women's and AAI wins men's title events in Guwahati In team events of the 75th Inter State-Inter Zonal Badminton Championship 2023,



Maharashtra bagged women's and Airport Authority of India (AAI) won the men's title events in Guwahati. The prestigious national championship organized by Badminton Association of India is being held in Assam after four years. The dominant AAI team appeared in both the men's and women's team finals and managed to win the title in the men's category as they outclassed Karnataka 3-0. In the women's team event final, Maharashtra dominated AAI 3-0 with impressive displays from Shruti Mundada, Alisha Naik and the doubles pair of Simran Singhi and Ritika Thaker.

Under-19 Asia Cup: Bangladesh crushes UAE to lift trophy

Bangladesh won the Under-19 Asia Cup by defeating UAE in the finals. Bangladesh clinched the Under-19 Asia Cup title by defeating UAE by 195 runs. UAE gets all out at 87 runs in 24.5 overs. Bangladesh scored 282/8 after UAE opted to field. Ashiqur is declared as both player of the match and series. Ashiqur scored 378 runs in five innings The 2023



ACC Under-19 Asia Cup was played between 8 to 17 December 2023 Afghanistan, Bangladesh, India, Nepal, United Arab Emirates Japan, Pakistan and Sri Lanka took part in the tournament It was held in the United Arab Emirates.

OBITUARY

Vijayakanth death: Tributes pour in for DKDM founder



Chennai: Desiya Murpokku Dravida Kazhagam (DMDK) founder

and popular yesteryear Tamil actor Narayanan Vijayaraj Alagarwami, popularly known as Vijayakanth, who raised his voice against corruption on the big screen before taking the political plunge, passed away after a prolonged illness on December 28. He was 71. Popularly known as 'Captain' after he performed the role of an IFS officer in the 1991 blockbuster Tamil movie 'Captain Prabhakaran', Vijayakanth was not in good health since 2016, leading him to stay away from party affairs. He was last spotted at the DMDK's general council meeting on December 14, when his wife V Premalatha, was elected as party chief.

Father of European integration, Jacques Delors dies at 98



Jacques Delors, a passionate advocate of post-war European integration

and a founding father of the European Union's single currency project, has died. The French socialist served as president of the European Commission, the EU executive, for three terms - longer than any other holder of the office - from January 1985 until the end of 1994, a time of rapid change for Europe's emerging union. The era was marked by forthright clashes of vision between federalists such as Delors, who believed passionately in an "ever closer union", and Britain's then prime minister Margaret Thatcher, who firmly resisted any shift of power to Brussels. So antagonistic

American diplomat and Nobel winner Henry Kissinger Passed away

American diplomat and Nobel winner Henry Kissinger passed away at the age of 100 years. Heinz Alfred Kissinger was born in Furth, Germany, on May 27, 1923, and moved to the United States with his family in 1938 before the Nazi campaign to exterminate European Jews. He was a German-born American diplomat, political scientist, geopolitical consultant, and politician. Awards & Honors :



• The 1973 Peace Prize was awarded jointly to Henry Kissinger and Le Duc Tho of North Vietnam.

- Le Duc Tho had declined the award, making it one of the most controversial prizes ever awarded.
- On January 13, 1977, Kissinger received the Presidential Medal of Freedom from President Gerald Ford.

Veteran Communist and CPI Kerala secretary Kanam Rajendran passed away

The state secretary of the ruling Communist Party of India (Marxist) Kanam Rajendran passed away at the age of 73 in Kochi, Kerala. Kanam Rajendran was born on 10 November 1950 in Koottikkal village of Kerala's



Kottayam district. He entered politics at a tender age and became the state secretary of the Communist Party of India's (CPI's) youth wing All India Youth Front (AIYF) at 23.

Kuwait's ruling emir, Sheikh Nawaf Al Ahmad Al Sabah Passed away

Kuwait's ruling emir, Sheikh Nawaf Al Ahmad Al Sabah passed away at the age of 86. Kuwait's deputy ruler and his half-brother, Sheikh Meshal Al Ahmad Al Jaber, now 83, had been the world's oldest crown prince. Meshal, a longtime leader in the country's security services, had been named new emir and now is one of the Gulf Arab countries' last octogenarian leaders. Nawaf Al-Ahmed Al-Jaber Al-Sabah



was born on 25 June 1937 in Kuwait City, Kuwait. Nawaf was nominated as crown prince on 7 February 2006, during the reign of his half-brother Sabah Al-Ahmad Al-Jaber Al-Sabah. During his three-year rule as emir, he grappled with internal political disputes. He was Emir of Kuwait from 29 September 2020 until his death in 2023.

did relations between London and Brussels become towards the end of Thatcher's time in office, especially over the plans for monetary union, that The Sun tabloid famously ran a front page headline reading: "Up Yours Delors". Delors' death came three years after Britain fully exited

the EU on Dec. 31, 2020, following tortuous negotiations and 47 years of membership.

Article Related To Most Important News of The Month



RBI Monetary Policy : Repo rate kept unchanged at 6.5%, FY24 GDP estimate hiked to 7%



The Reserve Bank of India's Monetary Policy Committee (MPC) kept the repo rate unchanged for the fifth time in a row at 6.5%. The real GDP growth projection for the fiscal year 2023-24 has been revised upward to 7% from the previous estimate of 6.5%. The inflation forecast for the fiscal year 2023-24 remains unchanged at 5.4%. The policy repo rate under the liquidity adjustment facility (LAF) has been kept steady at 6.50%. The standing deposit facility (SDF) rate is maintained at 6.25%, and the marginal standing facility (MSF) rate, along with the Bank Rate, remains at 6.75%.

Central Government Raises Interest Rates on Select Small Savings Schemes



The Central government has increased the rate of interest on two small savings schemes for January-March 2024 quarter by up to 20 basis points. As per a notification by the Finance Ministry, the rate of interest on the Sukanya Samriddhi Account Scheme has been raised by 20 basis points to 8.2 percent from 8 percent. Further, interest on the three-year time deposit has been increased by 10 basis points to 7.1 percent from 7.0 percent. All other small savings schemes will continue to offer the same rate of interest as they did in October-December quarter.

India to Extend \$250 Million Line of Credit to Kenya for the Modernization of its Agricultural Sector

India has committed a \$250 million Line of Credit to Kenya for the modernization of its agricultural sector. The announcement came following talks between Indian Prime Minister Narendra Modi and Kenyan President William Samoei



Ruto. Modi and Ruto discussed and agreed to strengthen bilateral ties in various sectors, including defence, trade, energy, digital public infrastructure, and healthcare.

India Chosen as the Flagship Nation for the International Maritime Organization (IMO) Green Voyage 2050 Project

India has been selected as the pioneer lead country for the International Maritime Organization (IMO) Green Voyage 2050 Project. The overall goal of the Project is to support effective implementation of the Initial IMO GHG Strategy. The



Initial IMO Strategy sets out a clear vision and levels of ambition, one of which is to reduce the total annual GHG emissions by at least 50% by 2050 compared to 2008.

Garba Dance from Gujarat Recognized as UNESCO's 'Intangible Cultural Heritage'

The United Nations Educational, Scientific and Cultural Organization (UNESCO) approved the inclusion of garba, Gujarat's most popular folk dance form, in its Representative List of Intangible Cultural Heritage (ICH) of Humanity. A decision to "inscribe" the dance form as "intangible heritage" was taken at the 18th session of UNESCO's



Intergovernmental Committee for Safeguarding of Intangible Cultural Heritage held in the Republic of Botswana. With this, 15 elements from various parts of India have been inscribed to UNESCO's representative list of ICH.

GST revenue collection for November stands at around Rs 1.68 lakh crore

The gross Goods and Services Tax, GST revenue collection in the month of November this year stood at around one lakh 68 thousand crore rupees. The revenue for the month of



November is 15 per cent higher than the GST revenue in the same month of last year and the highest for any month year-on-year during this financial year.

RBI Increases UPI Payment Limits for Hospitals and Educational Institutions to Rs 5 Lakhs per Transaction, Up from Rs 1 Lakh



The Reserve Bank of India (RBI) has increased the transaction limits for Unified Payments Interface (UPI) payments for hospitals and educational institutions from Rs 1 lakh to Rs 5 lakhs per transaction. The decision was announced by RBI Governor Shaktikanta Das during the bi-monthly Monetary Policy Committee (MPC) meeting. The higher UPI payment limits aim to assist consumers in making transactions of larger amounts for educational and healthcare purposes. The RBI has also proposed to enhance the limits of e-mandates for recurring online transactions to Rs 1 lakh per transaction from Rs 15,000 per transaction for mutual fund subscriptions, insurance premium subscriptions, and credit card repayments. The transaction limit for UPI payments for capital markets (AMC, broking, mutual funds, etc.), collections (credit card payments, loan repayments, EMI), insurance, etc. was limited to Rs 2 lakh.

SEBI Extends Nomination Filing Deadline for Mutual Funds and Demat Accounts Until June 2024

Capital markets regulator Securities and Exchange Board of India (SEBI) has once again extended the deadline for mutual fund and demat account holders to add the name of the beneficiary/beneficiaries or opt out of it till June 30, 2024. Earlier, the deadline for the same was December 31, 2023. The move is aimed at helping investors to secure their assets and pass them on to their legal heirs.

Nomination Filing Requirement : Investors are required to either select nominee(s) or explicitly opt out of nomination by submitting a declaration before the extended deadline.

Consequences of Missing Deadline : If investors fail to meet the nomination deadline, SEBI may freeze debits from their holdings.

Eligibility for Nomination : Only individuals holding demat



accounts singly or jointly can nominate beneficiaries. Nomination by Joint Holders : Joint holders are allowed to nominate, and in the event of one holder's demise, the securities will be transferred to the surviving holders unless there is a nominee. Nomination by NRIs : NRIs can directly nominate, but power of attorney holders cannot nominate on their behalf. Exclusion of Minors : Minors are not eligible to nominate either directly or through a guardian. SEBI's Communication Directive : SEBI has instructed asset management companies (AMCs), depository participants, and Registrar and Transfer Agents (RTAs) to regularly communicate with demat account holders and mutual fund unit holders.

Taylor Swift named Time's 'Person of the Year'

Taylor Swift is ending her year with another accolade: The pop superstar was named Time magazine's 2023 "Person of the Year," beating out Barbie and King Charles III. Time said Swift was selected because she found a way to give people around the world hope in some seriously dark times. Swift broke her own Spotify record by becoming the most-streamed artist in a single day in the streamer's history,



while "1989 (Taylor's Version)" became Spotify's most-streamed album in a single day this year. Ukrainian President Volodymyr Zelensky was Time's 2022 person of the year. Taylor Swift was named TIME's 2023 Person of the Year—making her the first woman to appear twice on a Person of the Year cover since the franchise began in 1927.

RBI Increases Unified Payments Interface Automatic Payment Limit to Rs 1 Lakh

The Reserve Bank of India (RBI) increased the limit for automatic payments through Unified Payments Interface (UPI) to Rs 1 lakh per transaction from the existing Rs 15,000 for certain categories, including subscription to mutual funds. As of now, relaxation in Additional Factor of Authentication (AFA) is permitted while processing e-mandates/standing instructions



on cards, prepaid payment instruments and UPI (Unified Payments Interface), for subsequent recurring transactions with values up to Rs 15,000. UPI has emerged as a preferred mode of payment for a large section of the population with over 11.23 billion transactions recorded in November, 2023.

Cabinet Approvals

Cabinet approves Memorandum of Cooperation signed between India and Kingdom of Saudi Arabia on cooperation in the field of Digitization and Electronic Manufacturing



The Cabinet chaired by Hon'ble Prime Minister Shri Narendra Modi was apprised of a Memorandum of Cooperation (MoC) signed between the Ministry of Electronics and Information Technology of the Republic of India and the Ministry of Communications and Information Technology of the Kingdom of Saudi Arabia on cooperation in the field of Digitization and Electronic Manufacturing. The Memorandum of Cooperation intends to strengthen collaboration in the field of Digitization, Electronic Manufacturing, e-Governance, smart infrastructure, e-Health and e-Education, promote partnership in research in digital innovation and the use of emerging technologies such as Artificial Intelligence (AI), Internet of Things (IoT), Robots, Cloud Computing and Blockchain, etc. The MoC aims to promote ways of innovative training and development through e-teaching, e-learning and exchange programs in digitization and electronics manufacturing.



Cabinet approves declaration of Surat Airport as an International Airport

The Union Cabinet chaired by the Prime Minister, Shri Narendra Modi has approved the proposal

Cabinet approves Memorandum of Understanding (MoU) signed between India and Tanzania on Cooperation in the field of sharing successful Digital Solutions implemented at Population Scale for Digital Transformations:

The Union Cabinet chaired by Hon'ble Prime Minister Shri Narendra Modi was apprised of a MoU signed between the Ministry of Electronics and Information Technology of the Republic of India and the Ministry of Information, Communication and Information Technology of the United Republic of Tanzania on cooperation in the field of sharing successful Digital Solutions implemented at Population Scale for Digital Transformation. The MoU intends to promote



closer cooperation and exchange of experiences, digital technologies-based solutions in the implementation of digital transformational initiatives of both the countries. Both G2G and B2B bilateral Cooperation in the field of Digital Public Infrastructure (DPI) will be enhanced. The activities contemplated in this MoU would be financed through their administration's regular operating allocations.

Union Cabinet approves the memorandum of understanding between the United States of America and the Republic of India

The Union Cabinet chaired by Hon'ble Prime Minister, Shri Narendra Modi, approved the draft Memorandum of Understanding (MoU) between the United States of America and the Republic of India to enhance innovation ecosystems through an innovation handshake. The 5th India-U.S. Commercial Dialogue was held on 10th March 2023 during the visit of U.S. Secretary of Commerce Gina Raimondo between 8-10 March. At the meeting the Commercial Dialogue was re-launched with strategic focus on supply chain resiliency, climate and clean technology cooperation, advancing inclusive digital economy, and facilitating post-pandemic economic recovery



especially for SMEs and start-ups. The Joint Statement released by President Biden and Prime Minister Modi in June 2023 welcomed focused efforts to establish an "Innovation Handshake" that shall connect the two sides' dynamic startup ecosystems, address specific regulatory hurdles to cooperation, and promote innovation and job growth, particularly in critical and emerging technologies (CET). The scope of cooperation would include a series of India-U.S. Innovation Handshake events, round tables with private sector, including hackathon and "Open Innovation" programs, information sharing and other activities.

to declare Surat Airport as an International Airport. Surat Airport will not only become a gateway for international travellers but also facilitate seamless export-import operations for the thriving

diamond and textile - industries. Elevating Surat Airport to international status is paramount for enhancing economic growth, attracting foreign investment, and bolstering diplomatic ties.

RRB PO Prelims 2023 Practice Set

Quantitative Aptitude

Directions (1-5): Find out the wrong number in the following number series.

1. 15, 22, 41, 72, 118, 170

- A.170
- B.22
- C.118
- D.72
- E.41

2. 4, 10, 24, 69, 204, 609

- A.10
- B.69
- C.609
- D.204
- E.24

3. 60, 90, 101, 93, 66, 30

- A.90
- B.101
- C.60
- D.30
- E.66

4. 364, 348, 316, 268, 204, 120

- A.348
- B.120
- C.316
- D.204
- E.268

5. 100, 101, 109, 136, 204, 325

- A.325
- B.100
- C.101
- D.109
- E.204

Directions (6-10): Study the following data carefully and answer the questions given below:

There is a certain number of students in three different schools i.e. M, N and O. The number of boys in school M is 75% more than the number of girls in the same school. The ratio between the number of girls in schools N to M is 1:4. Number of boys in school O is 100 less than the number of girls in school O. The ratio of the total number of students in schools M, N and O is 11:8:6 respectively and the difference between the number of boys and girls in school M is 150

6. Find the difference between the average number of boys in school M and N together and the average number of girls in all schools together.

- A.90
- B.200
- C.85
- D.65
- E.110

[Get our Premium Bundle PDF Course](#)

[Get our Mock Test Series](#) e-Magazine Dec 2023

7. If the number of boys in school P is X more than that in school N and the number of girls in school P is $(X/20)$ times that in school O. Find the total number of students in school P, if the ratio of the number of boys to girls school P is 4:5.

- A.420
- B.240
- C.900
- D.180
- E.120

8. In school M, 40% of the students who are going to school by bicycle and rest are going to school by bus. The bus fee of each student is Rs. 500. Find the total revenue generated from the students who are going to school by bus in school M.

- A.Rs. 114500
- B.Rs. 132000
- C.Rs. 165000
- D.Rs. 176000
- E.Rs. 148000

9. In school N, 20% of students passed the exam in grade A. Among the remaining students, 70% passed the exam in grade B while the rest are failed. Find the number of boys who passed the exam in school N, if the ratio of the number of boys to girls who failed the exam is 3:1.

- A.96
- B.102

- C.116
- D.132
- E.278

10. The total number of students in school M is how much percent more/less than the number of boys in school O?

- A.27.27% less
- B.150% more
- C.36.36% less
- D.90% more
- E.450% more

Directions (11-15): What value should come in the place of (?) in the following questions?

11. $\{(1/6) + (5/18) + (7/24)\} * (? / 53) = 5$

- A.220
- B.500
- C.420
- D.360
- E.280

12. $(23 - 9) * ? - 150 \div 6 + 48 = 8 * 18 + 19$

- A.5
- B.14
- C.30
- D.10
- E.8

13. $(6 (1/3) + 5 (1/4)) * 24 - 53 = ?^2$

- A.18
- B.12
- C.15

D.9
E.20

E.2620

14. $(23)^2 - \sqrt{961} + 41^2 = ? - (21)^2$

- A.2887
- B.2640
- C.2765
- D.2730

15. $15 \text{ of } 28 \div 21 + 80 \div 8 - 21 = ?$

- A.19
- B.11
- C.9
- D.21
- E.7

Directions (16–20): Study the following data carefully and answer the questions given below:

The given bar graph shows the total number of earbuds (white + black + red) sold by four different companies i.e. A, B, C and D in the month of January.

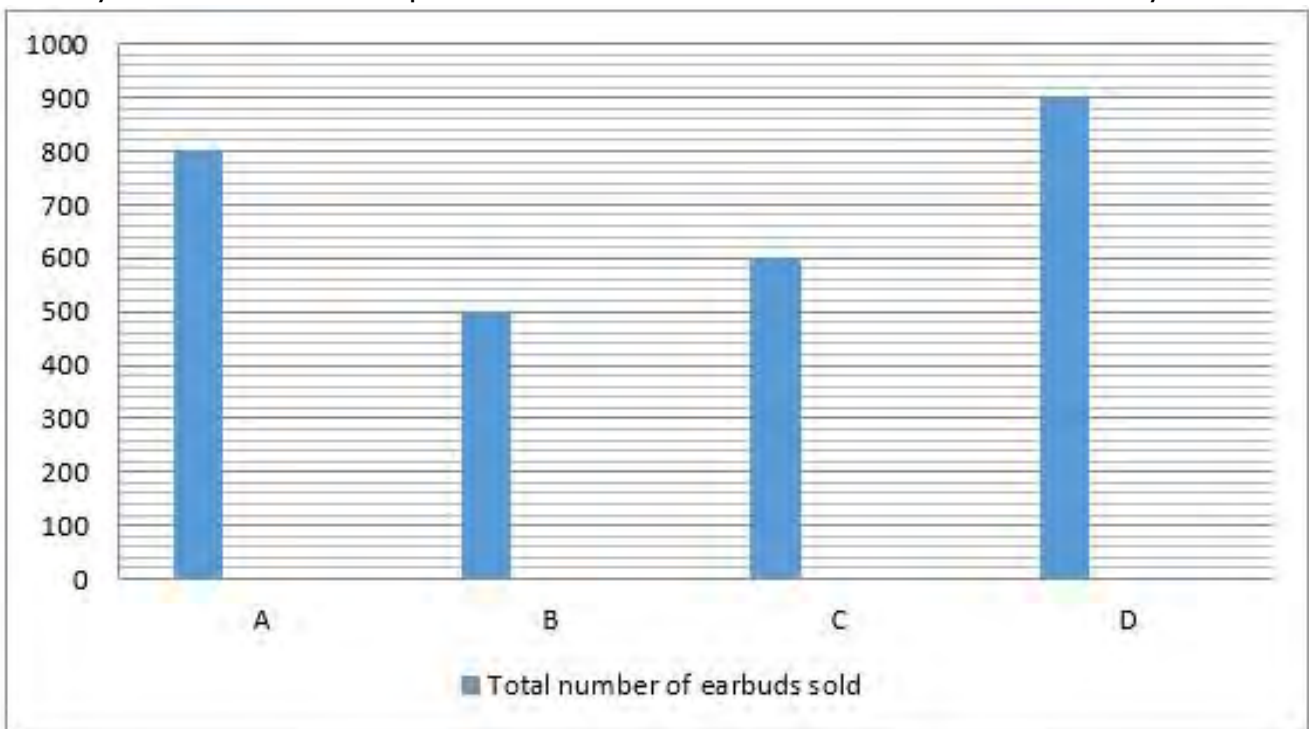

The given table chart shows the percentage of the number of red colour ear buds sold out of the total number of ear buds sold by the respective companies and also given the percentage of the number of black ear buds sold is more than that of white ear buds sold by these four companies in the month of January.

Companies	Percentage of the number of red color ear buds sold out of total number of ear buds sold by the respective companies	Percentage of the number of black color ear buds sold is more than that of white color ear buds sold
A	25%	40%
B	35%	60%
C	40%	25%
D	30%	25%

16. Find the ratio of the total number of red-colored earbuds sold in companies A and C together to the total number of black-colored earbuds sold in companies A and B together and to the total number of white-colored earbuds sold in companies C and D together.

- A.4:4:5
- B.5:4:4
- C.5:5:3
- D.5:5:4
- E.4:5:4

17. The total revenue generated by black color and white color earbuds sold in company C is Rs. 11400. The ratio of the price of each white, black and red color earbuds sold by company C is 8:5:6. Find the revenue generated by all red color earbuds sold in company C.

- A.Rs. 5400
- B.Rs. 6400
- C.Rs. 7200
- D.Rs. 8400
- E.Rs. 8000

18. In company E, the total number of earbuds sold is the average number of earbuds sold in A and D. The ratio of the number of red, white and black color earbuds sold in E is 4:5:8, then find the average number of black color earbuds sold in all five companies.

- A.240
- B.300
- C.360
- D.270
- E.330

19. In company D, 25% of total number of earbuds manufactured are defective and rest of earbuds are sold. Find the total number of earbuds manufactured in company D.

- A.1200
- B.1350
- C.1450
- D.1500
- E.1100

20. If the total number of red and black color earbuds sold in

company C in February is 20% less than and 20% more than the previous month respectively, then find the total number of red and black color ear buds sold in C in February?

- A.430
- B.432
- C.436
- D.438
- E.440

Directions (21-25): Following question contains two equations as I and II. You have to solve both equations and determine the relationship between them

21.

I. $x^2 - 8x + 15 = 0$

II. $y^3 = 36.45\%$ of 2000

- A. $x > y$
- B. $x \geq y$
- C. $x \leq y$
- D. $x < y$

E. $x = y$ or the relation cannot be established.

22.

I. $2x^2 - 15x + 28 = 0$

II. $y = \sqrt{12.25}$

- A. $x > y$
- B. $x \geq y$
- C. $x \leq y$
- D. $x < y$

E. $x = y$ or the relation cannot be established.

23.

I. $x^2 - 12x + 35 = 0$

II. $2y^2 - 15y + 18 = 0$

- A. $x > y$
- B. $x \geq y$
- C. $x \leq y$
- D. $x < y$

E. $x = y$ or the relation cannot be established.

24.

I. $x^2 + 10x + 25 = 0$

II. $2y^2 + 11y + 12 = 0$

- A. $x > y$
- B. $x \geq y$
- C. $x \leq y$
- D. $x < y$

E. $x = y$ or the relation cannot be established.

25.

I. $x^2 - 25x + 156 = 0$

II. $y^2 = 290 - 13^2$

- A. $x > y$
- B. $x \geq y$
- C. $x \leq y$
- D. $x < y$

E. $x = y$ or the relation cannot be established

Directions (26–30): Study the following data carefully and answer the questions given below:

The given line graph shows the average number of employees in two departments i.e. System Analyst (SA) & Data Scientist (DS) in five different companies i.e. TCS, CTS, HCL, WIPRO and ZOHO respectively and also given the difference between the number of employees in these two departments of these five companies.

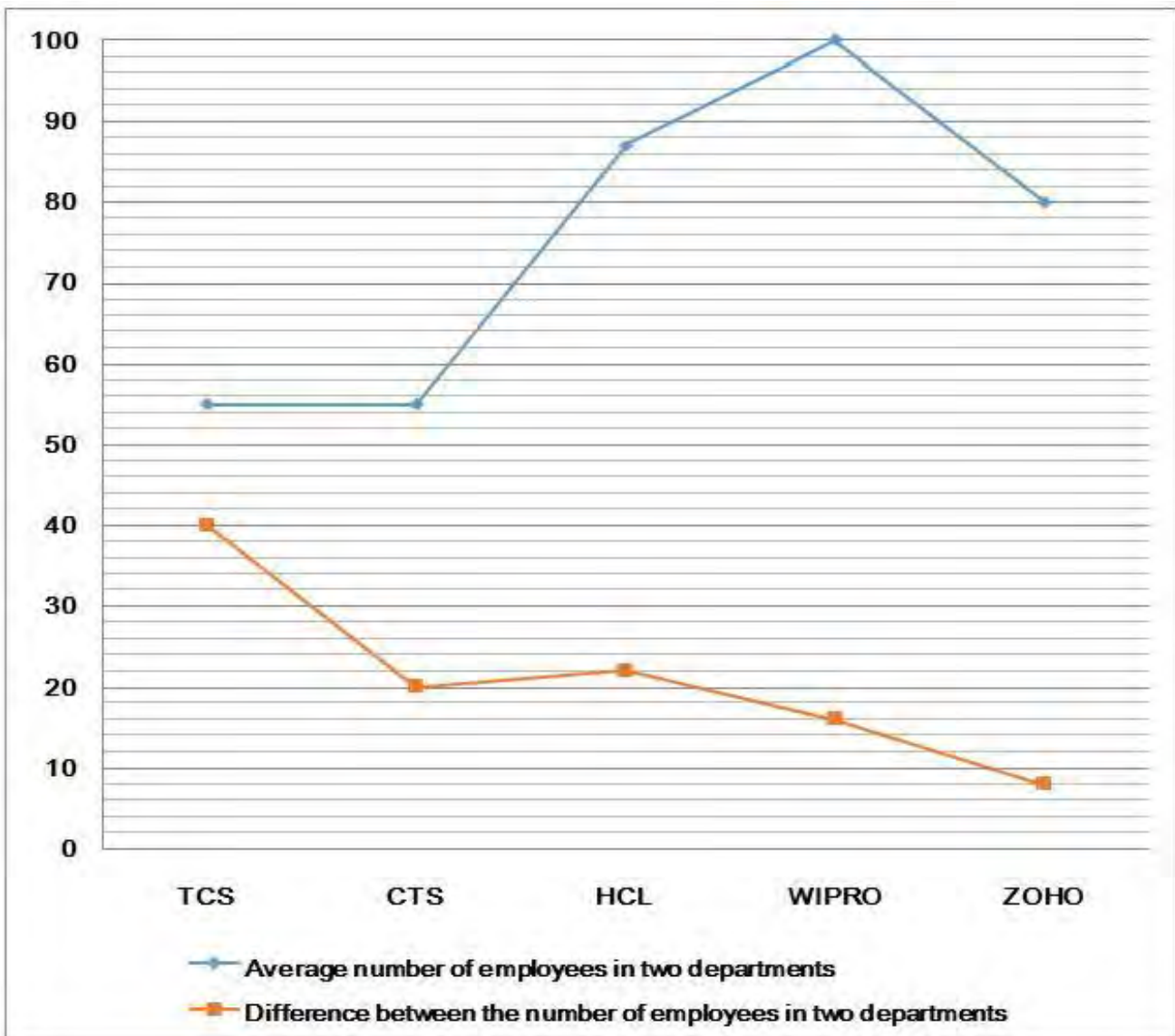

Note:

- I. The numbers of employees in Data Scientist is more than that of System Analyst in companies TCS, CTS & HCL and otherwise vice – versa.
- II. Total number of employees in each company = sum of the number of employees in data scientist department and the number of employees in system analyst department.

[Get our Premium Bundle PDF Course](#) [Get our Mock Test Series](#) e-Magazine Dec 2023

26. The average number of employees in SA department in companies TCS, CTS and HCL together is how much percent of the total number of employees in ZOHO Company?

- A.22.5%
- B.27.5%
- C.33.33%
- D.32.5%
- E.None of these.

27. In M, the number of employees in DS dept is 7 less than the average number of employees in DS and SA dept in HCL. If the average number of employees in DS and SA dept in M is 120, then find the number of employees in SA dept in M

- A.120
- B.135
- C.145
- D.154
- E.160

28. In CTS, 'X' employees in DS dept are resigned them work. At the time in CTS, 2X employees in SA dept are promoted as DS and the resultant ratio of the number of employees in DS to SA dept is 2:1. Find the number of employees in DS dept in CTS now.

- A.45
- B.64
- C.70
- D.84

E.88

29. If every 2 out of 5 employees are working in work from home and rest of the employees are working in office in TCS. $\frac{1}{4}$ th of work from home employees are SA in TCS. Find difference between the number of DS employees working in office and the number of DS employees in WIPRO

- A.45
- B.50
- C.54
- D.63
- E.72

30. Ratio of the number of female to male employees in companies TCS, CTS, HCL and WIPRO together is 4:7. The number of male employees in companies TCS, CTS, HCL and WIPRO together is how many times of the number of SA employees in WIPRO.

- A.2.5
- B.1.25
- C.1.9
- D.3.15
- E.3.5

31. Mixture A contains chocolate syrup and milk in the ratio of 3:2, respectively. Mixture A is mixed with 80 litres of mixture B (chocolate syrup + milk) in which the quantity of chocolate syrup is 62.5% less than the total mixture of B. Find the initial

quantity of mixture A, if the ratio of the quantities of chocolate syrup and milk in the final mixture becomes 12:11 respectively.

- A.75 litres
- B.90 litres
- C.120 litres
- D.150 litres
- E.115 litres

32. A work can be completed by Ajay and Sujay in $(x + 4)$ days and $(x - 4)$ days respectively. They both started doing the work together and completed it in $(48/5)$ days. Find the number of days taken by Ajay to complete the work.

- A.16 days
- B.20 days
- C.24 days
- D.32 days
- E.36 days

33. Anil and Akhil started a business by investing Rs. x and Rs. $(x + 650)$ respectively. Four months later, Anil doubled his investment. If at the end of a year, the total profit share is Rs. 74000 and Profit share of Akhil is Rs. 14000 more than that of Anil. Find the amount invested by Akhil?

- A.Rs. 750
- B.Rs. 960
- C.Rs. 1050
- D.Rs. 1100
- E.Rs. 1240

34. Boat A takes 2 hours 30 minutes to cover 70 km in still water and the upstream speed of Boat A is 75% of its downstream speed. If the ratio of the downstream speed of boat A to upstream speed of boat B is 16:15, then find the speed of boat B in still water, if the speed of stream for both boats are same.

- A.28 km/hr
- B.34 km/hr
- C.32 km/hr
- D.30 km/hr
- E.24 km/hr

35. The total surface area of a cylinder is 266π cm². If the curved surface area of the same cylinder is 168π cm², then find the volume of the cylinder?

- A.1764 cm³
- B.1331 cm³
- C.1848 cm³
- D.1681 cm³
- E.1448 cm³

36. When Rs. P is invested at compound interest of $R\%$ p.a. for 2 years and the compound interest becomes 0.21 times itself. If Rs. $(P - 300)$ is invested at compound interest of $2R\%$ p.a. compounded half yearly and it gives an interest of Rs. 827.5 at the end of 18 months, then find the value of P .

- A.2400
- B.2800

- C.2680
- D.2500
- E.2430

37. A shopkeeper marked the price of an article at 36% above its cost price and the shopkeeper gave a discount of 25% and sold the article at a profit of Rs. 300. If the article was marked at 20% above its cost price and sold after giving a discount of Rs. 1400, then now find the selling price of the article.

- A.Rs. 15000
- B.Rs. 16000
- C.Rs. 15400
- D.Rs. 17600
- E.Rs. 16600

38. Out of total monthly income of Thara, she spent 25% on paying rent and 20% of the remaining on buying groceries. Out of the amount left after paying rent and buying groceries, she spent 30% on paying network charges and then distributed the remaining amount to her medical expenses and savings is in the ratio of 9:5 respectively. If the annual medical expenses received by Thara is Rs. 97200, then find the monthly income of Thara.

- A.Rs. 30000
- B.Rs. 24000
- C.Rs. 32000
- D.Rs. 45000
- E.Rs. 39000

39. Present age of the mother is 5 times more the present age of her son. The present age of the father is 7 years more than 5 times the present age of son. If the average present age of the mother and father is 31 years, then find the ratio of the age of son 40 years hence from now to the age of mother 12 years ago from now.

- A.2:5
- B.2:7
- C.7:2
- D.5:7
- E.5:2

40. The ratio of number of males and females in the office was 5:3. Some new males and females were joining the office in the ratio 5:7. As a result, the total number of workers (males + females) in the office became 1500 and the ratio of males to females changed to 7:5. Find the difference between number of new joining males and females.

- A.45
- B.36
- C.72
- D.50
- E.58

Reasoning Ability

Directions (41-45): Study the following information carefully and answer the given questions.

Eight houses viz., A, B, C, D, E, F, G and H were sold in two different months viz. March and September of four different years – 2019, 2020, 2021 and 2022. Only one house was sold in the same month of the same year.

B was sold in the month having 31 days of an odd numbered year. Only one house was sold between B and G. As many houses sold before G as after D. A was sold immediately after D. H was sold in the same month as A, but not in 2021. As many houses sold between H and B as before F. C was sold after F. E was not sold in an odd numbered year.

41. Which of the following house was sold in September 2022?

- A. House C
- B. House A
- C. House D
- D. House E
- E. House F

42. ___ and ___ house were sold in the same year.

- A. E and H
- B. A and F
- C. C and D
- D. B and G
- E. H and C

43. How many months are there between the months in which houses E and C were sold?

- A. 5 months
- B. 14 months
- C. 12 months
- D. 13 months
- E. 11 months

44. Which of the following statement(s) is/are false with respect to the final arrangement?

I. House C was sold in September 2022

II. Only two houses were sold between C and A

III. Houses H and B were sold in the same month

- A. Only II
- B. Only I and III
- C. Only I
- D. Only II and III
- E. All given statements are False

45. If H is related to A and F is related to C in a certain way, then which of the following house is related to G?

- A. House B
- B. House E
- C. House D
- D. House F
- E. House C

Directions (46-50): Study the following information carefully and answer the given questions.

JMA EQC YDK XAT IWL

46. If all the letters are reversed within the word, then all the consonants in each word are changed to the immediate previous letter and all the vowels are changed to the immediate next letter as per the English alphabetical series, then which of the following word thus formed will end with a vowel?

- A.EQC
- B.IWL
- C.JMA
- D.YDK
- E.XAT

47. If the position of the second and the third letters from the left end of each word will be interchanged, then how many meaningful words thus formed?

- A.One
- B.Two
- C.Three
- D.Four
- E.None

48. If all the letters are arranged in alphabetical order within the word, then how many words thus formed will remain unchanged?

- A.One
- B.Two
- C.Three
- D.Four
- E.None

49. If all the words are arranged in the dictionary order from left to right, then which of the following word is second from the right end?

- A.IWL
- B.XAT
- C.JMA
- D.EQC
- E.YDK

50. If all the letters in the word "SOMETHING" are arranged in reverse alphabetical order, then what is the difference between the place values(as per the alphabetical series) of the letters which are second from both the ends?

- A.5
- B.13
- C.8
- D.12
- E.7

Directions (51-55): Study the following information carefully and answer the given questions.

Eight persons viz. P, Q, R, S, T, U, V and W are sitting around a square table in such a way that four of them are sitting at the corners and facing away from the centre while four of them are sitting in the middle of the sides and facing the centre.

Only one person sits between P and W (either from left or right). W doesn't sit at the corner of the table. V sits immediate right of the one who faces

P. T sits second to the right of V. Three persons sit between T and Q. As many persons sit between Q and W as between T and R. Two persons sit between R and S, who doesn't sit adjacent to U.

51. Who among the following person sits exactly between P and U when counted from the right of U?

- A.S
- B.V
- C.R
- D.Q
- E.T

52. Who among the following person does not sit in the middle of the table?

- A.U
- B.The one who sits immediate right of R
- C.P
- D.The one who sits second to the right of P
- E.R

53. Who among the following person sits opposite to R?

- A.U
- B.T
- C.P
- D.W
- E.Q

54. What is the position of Q with respect to the one who is facing U?

- A.Third to the right

- B.Second to the left
- C.Fourth to the right
- D.Second to the right
- E.Immediate left

55. What will come in the place of ___?

QR, VU, TW, __

- A.SP
- B.QV
- C.WU
- D.SW
- E.TR

Directions (56–59): Study the following statements and then decide which of the given conclusions logically follows from the given statements disregarding the commonly known facts.

56. Statements:

Only a few buds are sprout

Only a few sprouts are seed

No seed is flower

All flowers are leaf

Conclusions:

A.All sprouts can be flower

B.All buds being seed is not a possibility

C.Some buds being seed is a possibility

D.No leaf is sprout

E.None of these

57. Statements:

Only a few brides are groom

At least some groom is company

No company is agency
Only a few agencies are club

Conclusions:

- A. Some groom being not agency is a possibility
- B. No agency is bride
- C. Some club is not groom
- D. All brides can be groom
- E. Some club is definitely not company

58. Statements:

Few puzzles are answer
Only a few answers are question
No question is paper
Only paper is rubber

Conclusions:

- A. All questions are puzzle
- B. Some answers are not paper
- C. All questions can be rubber
- D. Some puzzles are not paper
- E. All paper can be answer

59. Statements:

Only a few furniture is table
All rooms are table
No bench is table
All benches are pen

Conclusions:

- A. All furniture may be room
- B. No pen is table
- C. All furniture can be bench
- D. Some benches are definitely not room
- E. Some rooms are definitely not pen

Directions (60-64): Study the following information carefully and answer the given questions.

Eight persons are sitting in two parallel rows in such a way that there is an equal distance between the adjacent persons. In row 1 L, M, N and O are seated and all of them are facing south. In row 2 P, Q, R and S are seated and all of them are facing north. Each person in row 1 faces exactly one person in row 2. Each of them likes different food order apps viz. Swiggy, Zomato, Dunzo, Pizza, Eatsure, Box8, Eat.fit and Caviar.

N sits second to the right of the one who likes Eat.fit app. The one who faces N sits immediate left of Q. Only one person sits between Q and the one who likes Pizza. As many persons sit to the right of the one who likes pizza as to the left of L. The one who likes Box8 faces the one who sits adjacent to L. Only one person sits between S and the one who likes Box8. O sits second to the left of the one who likes Dunzo. M didn't like Eat.fit. The one who faces M likes Caviar. R sits immediate left of the one who likes Caviar. P faces the one who likes Swiggy. S didn't like Eatsure.

60. Four of the following five are alike in a certain way based on the given arrangement and thus form a group. Which one of the following does not belong to the group?

- A. QS

- B.LM
- C.PR
- D.MO
- E.RQ

61. What is the position of L with respect to the one who likes Eatsure app?

- A.Immediate right
- B.Second to the left
- C.Immediate left
- D.Third to the left
- E.Second to the right

62. Who among the following person sits diagonally opposite to S?

- A.The one who likes Dunzo app
- B.M
- C.The one who likes Swiggy app
- D.O
- E.None of these

63. Who among the following person likes Pizza app?

- A.P
- B.O
- C.Q
- D.M
- E.S

64. Which of the following combination is true?

- A.O-Caviar
- B.S-Dunzo
- C.M-Box8
- D.L-Swiggy
- E.P-Zomato

65. If all the digits of the number "3276589436" are arranged in descending order from the left end, then what is the sum of the digits which are fourth from the left end and second from the right end?

- A.10
- B.11
- C.12
- D.9
- E.13

Directions (66–69): Study the following information carefully and answer the given questions.

Nine boxes viz., P, Q, R, S, T, U, V, W and X are kept one above another in a single stack, but not necessarily in the same order.

Only three boxes are kept between boxes R and X. Only one box is kept between boxes R and U, which is kept above box R. Box Q is kept immediately below box U. Box T is kept three boxes below box Q. As many boxes kept between boxes T and X as between boxes U and S. Box V is kept below box P but above box W. Box P is not kept adjacent to box S.

66. How many boxes are kept between box W and box R?

- A.One
- B.Three
- C.Two
- D.Five
- E.None

67. The number of boxes kept below box P is one more than the number of boxes kept above ____.

- A.Box X
- B.Box U
- C.Box S
- D.Box T
- E.Box Q

68. If box X is related to box U and box Q is related to box V in a certain way, then which of the following box is related to box R?

- A.Box P
- B.Box U
- C.Box S
- D.Box W
- E.Box T

69. Which of the following box is kept immediately below box P?

- A.Box W
- B.The box which is kept at the bottommost position
- C.Box R
- D.Box T
- E.The box which is kept immediately above box Q

Directions (70-72): Study the following information carefully and answer the given questions.

V is the son-in-law of R, who is the grandmother of G. G is the only son of A, who is the only sibling of M. H is the husband of A and does not have any

siblings. L is the niece of A. Y is the daughter-in-law of H. E is the grandmother of L.

70. If I is the spouse of E, then how is I related to M?

- A.Father-in-law
- B.Nephew
- C.Father
- D.Brother
- E.Grandfather

71. Four of the following five are alike in a certain way based on the given relation and thus form a group. Which one of the following does not belong to the group?

- A.A
- B.H
- C.L
- D.Y
- E.G

72. How is H related to R?

- A.Father
- B.Grandson
- C.Uncle
- D.Son-in-law
- E.Cannot be determined

Directions (73-77): Study the following information carefully and answer the given questions.

Eight persons viz., E, F, G, H, I, J, K and L are living on different floors of the four storey building, where the lowermost floor is numbered as one

and the floor immediately above it is numbered as two and so on.

Note-I: Each floor has two types of flats viz., Flat-P and Flat-Q, where Flat P is to the west of flat Q.

Note-II: Flat Q of floor 2 is immediately above Flat Q of floor 1 and immediately below Flat Q of floor 3 and so on. Similarly, Flat P of floor 2 is immediately above Flat P of floor 1 and immediately below Flat P of floor 3 and so on.

Note-III: The area of each flat is same.

Note-IV: Only two persons live on each floor and only one person lives in each flat.

G lives in flat Q of an even numbered floor. Only one floor is between G and L, both live in the different type of flats. As many floors above L as below H. K lives immediately above H' flat. Only one floor is between K and I, who lives on the adjacent floor of J. F lives two floors below J, both live in the same type of flats. E doesn't live on the bottom most floor.

73. In which direction F lives with respect to K?

- A.North
- B.South west
- C.West
- D.North east
- E.South east

74. Four of the following five are alike in a certain way based on the given

arrangement and thus form a group. Which one of the following does not belong to the group?

- A.L
- B.F
- C.I
- D.K
- E.G

75. Who among the following person lives to the east of E?

- A.The one who lives immediately below H
- B.F
- C.L
- D.The one who lives immediately above G's flat
- E.None of these

76. H lives on which of the following floor and flat?

- A.Floor 2, Flat Q
- B.Floor 3, Flat P
- C.Floor 1, Flat P
- D.Floor 1, Flat Q
- E.Floor 3, Flat Q

77. Which of the following statement(s) is/are true with respect to the final arrangement?

- A.Both E and J are living on the same floor
- B.H lives north-west of K
- C.F lives three floors below E
- D.Both a and b
- E.Both b and c

Directions (78-80): Study the following information carefully and answer the given questions

Six persons viz., S, T, U, V, W and X sent different number of documents to the uploading team. T sent more documents than S but less than X. W sent more documents than V but less than U. X sent less documents than W. As many persons sent more documents than W as less than V. The persons who sent third highest and third lowest number of documents sent 50 and 48 documents.

78. If U sent twice the documents sent by X and V sent half of the document sent by T, then what is the average of the number of documents sent by U and V?

- A.22
- B.32
- C.88

- D.62
- E.70

79. How many persons sent more documents than V?

- A.One
- B.Two
- C.Four
- D.Three
- E.Cannot be determined

80. If the sum of the number of documents sent by X and W is 105 and the difference between the number of documents sent by T and V is 13, then what is the sum of the number of documents sent by W and V?

- A.100
- B.34
- C.23
- D.78
- E.90

ANSWER WITH EXPLANATION

1. Answer: C

	+12	+12	+12	+12	
+7	+19	+31	+43	+55	
15	22	41	72	115	170

Therefore, 115 will come in place of 118.
Hence, option C.

2. Answer: A
 $(4 * 3) - 3 = 9$

$$(9 * 3) - 3 = 24$$

$$(24 * 3) - 3 = 69$$

$$(69 * 3) - 3 = 204$$

$$(204 * 3) - 3 = 609$$

Therefore, 9 will come in place of 10.
Hence, option A.

3. Answer: D

$$\begin{array}{cccccc}
 & -19 & -19 & -19 & -19 & \\
 +30 & +11 & -8 & -27 & -46 & \\
 60 & 90 & 101 & 93 & 66 & 20
 \end{array}$$

Therefore, 20 will come in place of 30.

Hence, option D.

4. Answer: B

$$364 - (16 * 1) = 348$$

$$348 - (16 * 2) = 316$$

$$316 - (16 * 3) = 268$$

$$268 - (16 * 4) = 204$$

$$204 - (16 * 5) = \mathbf{124}$$

Therefore, 124 will come in place of 120.

Hence, option B.

5. Answer: E

$$100 + 1^3 = 101$$

$$101 + 2^3 = 109$$

$$109 + 3^3 = 136$$

$$136 + 4^3 = \mathbf{200}$$

$$200 + 5^3 = 325$$

Therefore, 200 will come in place of 204.

Hence, option E.

Directions (6-10):

Let the number of girls in school M be $4x$

So, number of boys in school M = $4x * 175\% = 7x$

$$175\% = 7x$$

According to the question,

$$7x - 4x = 150$$

$$3x = 150$$

$$x = 50$$

$$\begin{aligned}
 \text{Number of boys in school M} &= 7 * 50 \\
 &= 350
 \end{aligned}$$

$$\begin{aligned}
 \text{Number of girls in school M} &= 4 * 50 \\
 &= 200
 \end{aligned}$$

$$\begin{aligned}
 \text{Number of students in school M} &= 350 + 200 = 550
 \end{aligned}$$

$$\begin{aligned}
 \text{Number of students in school N} &= 550 * (8/11) = 400
 \end{aligned}$$

$$\begin{aligned}
 \text{Number of students in school O} &= 550 * (6/11) = 300
 \end{aligned}$$

$$\begin{aligned}
 \text{Number of girls in school N} &= 200 * (1/4) = 50
 \end{aligned}$$

$$\begin{aligned}
 \text{Number of boys in school N} &= 400 - 50 = 350
 \end{aligned}$$

In school O,

$$B + G = 300 \text{ ----> (1)}$$

$$G - B = 100 \text{ ----> (2)}$$

By solving equation (1) and equation (2), we get

$$\text{Number of girls in school O} = 200$$

$$\text{Number of boys in school O} = 100$$

Schools	Number of boys	Number of girls	Total number of students
M	350	200	550
N	350	50	400
O	100	200	300

6. Answer: B

$$\begin{aligned}
 \text{Average number of boys in school M and N together} &= (350 + 350)/2 = 700/2 = 350
 \end{aligned}$$

$$\begin{aligned}
 \text{Average number of girls in all schools together} &= (200 + 50 + 200)/3 = 150
 \end{aligned}$$

$$\begin{aligned}
 \text{Required difference} &= 350 - 150 = 200
 \end{aligned}$$

7. Answer: C

According to the question,

$$(350 + x) / (200 * (x/20)) = 4/5$$

$$350 + x = 160 * (x/20)$$

$$350 + x = 8x$$

$$350 = 7x$$

$$x = 50$$

$$\text{Number of boys in school P} = 350 + 50 = 400$$

$$\text{Number of girls in school P} = 200 * (50/20) = 500$$

$$\text{Total number of students in school P} = 400 + 500 = 900$$

8. Answer: C

Number of students going to school by bus in school M = $550 * (100\% - 40\%)$

$$= 550 * 60\% = 330$$

$$\text{Required answer} = 330 * 500 = \text{Rs.165000}$$

9. Answer: E

Number of boys who are failed in the examination in school N = $400 * (100\% - 20\%) * (100\% - 70%) * (3/4) = 400 * 80\% * 30\% * (3/4) = 72$

Number of boys who are passed in the examination in school N = $350 - 72 = 278$

10. Answer: E

$$\begin{aligned} \text{Required percentage} &= ((550 - 100)/100) * 100 \\ &= (450/100) * 100 \\ &= 450\% \text{ more} \end{aligned}$$

11. Answer: D

$$\{(1/6) + (5/18) + (7/24)\} * (? / 53) = 5$$

$$\{(1*12 + 5*4 + 7*3) \div 72\} * (? / 53) = 5$$

$$\{(12 + 20 + 21) \div 72\} * (? / 53) = 5$$

$$(53/72) * (? / 53) = 5$$

$$(53/53) * (? / 72) = 5$$

$$? = 72 * 5$$

$$? = 360$$

12. Answer: D

$$(23 - 9) * ? - 150 \div 6 + 48 = 8 * 18 + 19$$

$$14 * ? - 25 + 48 = 144 + 19$$

$$14 * ? + 23 = 163$$

$$14 * ? = 163 - 23$$

$$? = 140 \div 14$$

$$? = 10$$

13. Answer: C

$$(6(1/3) + 5(1/4)) * 24 - 53 = ?^2$$

$$?^2 = \{(19 * 4 + 21 * 3) \div (3 * 4)\} * 24 - 53$$

$$?^2 = \{(76 + 63) \div 12\} * 24 - 53$$

$$?^2 = 139 * 2 - 53$$

$$?^2 = 278 - 53$$

$$?^2 = 225$$

$$? = 15$$

14. Answer: E

$$(23)^2 - \sqrt{961 + 41^2} = ? - (21)^2$$

$$529 - 31 + 1681 = ? - 441$$

$$? = 2620$$

15. Answer: C

$$15 \text{ of } 28 \div 21 + 80 \div 8 - 21 = ?$$

$$15 * 28 \div 21 + 10 - 21 = ?$$

$$20 + 10 - 21 = ?$$

$$? = 9$$

Directions (16-20):

In company A,

Total number of earbuds sold = 800

Number of red color earbuds sold = $800 * 25\% = 200$

Number of black color earbuds sold = $140\% * \text{number of white color earbuds sold}$

Ratio of number of black to white color earbuds sold = 7:5

Number of black color earbuds sold = $(800 - 200) * (7/12)$
 $= 600 * (7/12) = 350$

Number of white color earbuds sold = $800 - 200 - 350 = 250$

Similarly, we can calculate others value.

Companies	Total number of earbuds sold	Number of red color earbuds sold	Number of black color earbuds sold	Number of white color earbuds sold
A	800	200	350	250
B	500	175	200	125
C	600	240	200	160
D	900	270	350	280

16. Answer: E

Required ratio = $(200 + 240) : (350 + 200) : (160 + 280)$
 $= 440:550:440$
 $= 4:5:4$

17. Answer: C

Let the price of each white, black and red color earbuds sold in company C is $8x$, $5x$ and $6x$ respectively.

According to the question,
 $(160 * 8x) + (200 * 5x) = 11400$
 $1280x + 1000x = 11400$
 $2280x = 11400$
 $x = 5$

Each price of red color earbuds = $6 * 5 = \text{Rs. } 30$

Revenue generated by all red color earbuds = $240 * 30 = \text{Rs. } 7200$

18. Answer: B

Total number of earbuds sold in company E = $(800 + 900)/2 = 850$
 Number of black color earbuds sold in company E = $850 * (8/17) = 400$
 Required average = $(350 + 200 + 200 + 350 + 400)/5 = 1500/5 = 300$

19. Answer: A

Number of earbuds manufactured in company D = $900 * (100/75) = 1200$

20. Answer: B

In February number of red color earbuds sold in company C = $240 * 80\% = 192$
 In February number of black color earbuds sold in company C = $200 * 120\% = 240$
 Required total = $192 + 240 = 432$

21. Answer: D

From I,
 $x^2 - 8x + 15 = 0$
 $x^2 - 5x - 3x + 15 = 0$
 $x(x - 5) - 3(x - 5) = 0$
 $(x - 3)(x - 5) = 0$
 $x = 3, 5$
 From II,
 $y^3 = 36.45\% \text{ of } 2000$
 $y^3 = 729$

$$y = 9$$

So, $x < y$

Hence, option D.

22. Answer: B

From I,

$$2x^2 - 15x + 28 = 0$$

$$2x^2 - 8x - 7x + 28 = 0$$

$$2x(x - 4) - 7(x - 4) = 0$$

$$(2x - 7)(x - 4) = 0$$

$$x = 3.5, 4$$

From II,

$$y = \sqrt{12.25}$$

$$y = 3.5$$

So, $x \geq y$

Hence, option B.

23. Answer: E

From I,

$$x^2 - 12x + 35 = 0$$

$$x^2 - 7x - 5x + 35 = 0$$

$$x(x - 7) - 5(x - 7) = 0$$

$$(x - 5)(x - 7) = 0$$

$$x = 5, 7$$

From II,

$$2y^2 - 15y + 18 = 0$$

$$2y^2 - 12y - 3y + 18 = 0$$

$$2y(y - 6) - 3(y - 6) = 0$$

$$(2y - 3)(y - 6) = 0$$

$$y = (3/2), 6$$

So, no relation can be established between 'x' and 'y'.

Hence, option E.

24. Answer: D

From I,

$$x^2 + 10x + 25 = 0$$

$$x^2 + 5x + 5x + 25 = 0$$

$$x(x + 5) + 5(x + 5) = 0$$

$$(x + 5)(x + 5) = 0$$

$$x = -5, -5$$

From II,

$$2y^2 + 11y + 12 = 0$$

$$2y^2 + 8y + 3y + 12 = 0$$

$$2y(y + 4) + 3(y + 4) = 0$$

$$(2y + 3)(y + 4) = 0$$

$$y = (-3/2), -4$$

So, $x < y$

Hence, option D.

25. Answer: A

From I,

$$x^2 - 25x + 156 = 0$$

$$x^2 - 12x - 13x + 156 = 0$$

$$x(x - 12) - 13(x - 12) = 0$$

$$(x - 13)(x - 12) = 0$$

$$x = 13, 12$$

From II,

$$y^2 = 290 - 13^2$$

$$y^2 = 290 - 169 = 121$$

$$y = \pm 11$$

So, $x > y$

Hence, option A.

Directions (26-30):

In company TCS,

Sum of the number of employees in two departments = $55 * 2 = 110$

$$SA + DS = 110 \text{ ----} \rightarrow (1)$$

$$DS - SA = 40 \text{ -----} \rightarrow (2)$$

By solving equation (1) and (2), we get

Number of employees in Data Scientist department = 75

Number of employees in System Analyst department = 35

Similarly, we can calculate other values.

Companies	Number of employees in Data Scientist department	Number of employees in System Analyst department	Total number of employees
TCS	75	35	110
CTS	65	45	110
HCL	98	76	174
WIPRO	92	108	200
ZOHO	76	84	160

26. Answer: D

Average number of system analyst employees in TCS, CTS and HCL = $(35 + 45 + 76)/3 = 156/3 = 52$

Required % = $(52/160) * 100 = 32.5\%$

27. Answer: E

Number of employees in data scientist department (DS dept) from M = $174/2 - 7 = 87 - 7 = 80$

Average number of employees in M = 120

Total number of employees in M = $120 * 2 = 240$

Number of employees in system analyst department in M = $240 - 80 = 160$

28. Answer: C

According to the question,
 $(65 - x + 2x) / (45 - 2x) = 2/1$
 $2 * (45 - 2x) = (65 + x)$
 $90 - 4x = 65 + x$
 $5x = 25$
 $x = 5$

Number of data scientist in CTS = 65 + 5 = 70

29. Answer: B

Number of employees working in Work from home = $110 * (2/5) = 44$

Number of data scientist employees working in Work from home = $44 * (1 - (1/4)) = 44 * (3/4) = 33$

Number of data scientist employees working in office = $75 - 33 = 42$

Required difference = $92 - 42 = 50$

30. Answer: E

Total number of employees in companies TCS, CTS, HCL and WIPRO together = $110 + 110 + 174 + 200 = 594$

Number of male employees in companies TCS, CTS, HCL and WIPRO together = $594 * (7/11) = 54 * 7 = 378$

Required answer = $378/108 = 3.5$ times

31. Answer: D

Let the quantity of Chocolate syrup in mixture A and quantity of milk in mixture A be $3x$ and $2x$ respectively.

Quantity of Chocolate syrup in mixture B = $(1 - 62.5\%) * \text{total quantity of mixture B}$

= $37.5\% * 80 = (3/8) * 80 = 30$ litres

Quantity of Chocolate syrup in mixture B = 30 litres

Quantity of milk in mixture B = $80 - 30 = 50$ litres

According to the question,

$(3x + 30) / (2x + 50) = 12/11$

$$33x + 330 = 24x + 600$$

$$33x - 24x = 600 - 330$$

$$9x = 270$$

$$x = 30$$

Quantity of mixture A = $5x = 5 * 30 = 150$ litres

32. Answer: C

$$\left(\frac{1}{x+4}\right) + \left(\frac{1}{x-4}\right) = \frac{5}{48}$$

$$\frac{(x-4+x+4)}{(x^2-16)} = \frac{5}{48}$$

$$2x * 48 = 5(x^2 - 16)$$

$$96x = 5x^2 - 80$$

$$5x^2 - 96x - 80 = 0$$

$$5x^2 - 100x + 4x - 80 = 0$$

$$5x(x-20) + 4(x-20) = 0$$

$$(5x+4)(x-20) = 0$$

$x = -4/5, 20$ (negative value can be ignored)

$$x = 20$$

Required answer = $20 + 4 = 24$ days

33. Answer: D

Let the profit share of Anil be Rs. Z

So, the profit share of Akhil = Rs. (Z + 14000)

$$Z + Z + 14000 = 74000$$

$$2Z = 74000 - 14000$$

$$Z = 60000/2$$

$$Z = 30000$$

Profit share of Anil = Rs. 30000

Profit share of Akhil = $30000 + 14000 = \text{Rs. } 44000$

According to the question,

$$\frac{[(x * 4) + (2x * 8)]}{((x + 650) * 12)} = \frac{30000}{44000}$$

$$\frac{(x + 4x)}{((x + 650) * 3)} = \frac{15}{22}$$

$$22 * 5x = 45 * (x + 650)$$

$$22x = 9x + 5850$$

$$13x = 5850$$

$$x = 450$$

Akhil's investment amount = $650 + 450 = \text{Rs. } 1100$

34. Answer: B

Speed of boat A in still water = $70 / 2 (1/2)$

$$= (70 * 2) / 5 = 28 \text{ km/hr}$$

Let the speed of stream be x km/hr

Upstream and downstream speed of boat A is $(28 - x)$ km/hr and $(28 + x)$ km/hr respectively.

According to the question,

$$(28 - x) = 75\% * (28 + x)$$

$$4(28 - x) = 3 * (28 + x)$$

$$112 - 4x = 84 + 3x$$

$$7x = 28$$

$$x = 4$$

Downstream speed of boat A = $28 + 4 = 32$ km/hr

So, upstream speed of boat B = $32 * (15/16) = 30$ km/hr

The speed of boat B in still water = $30 + 4 = 34$ km/hr

35. Answer: C

Let 'r' and 'h' be the radius and height of cylinder respectively.

TSA of cylinder = CSA of cylinder + (2 * area of base)

$$266\pi = 168\pi + 2 * (\text{area of base})$$

$$98\pi = 2\pi r^2$$

$$r^2 = 49$$

$$r = 7 \text{ cm}$$

$$\text{CSA of cylinder} = 2\pi rh$$

$$2\pi * 7 * h = 168\pi$$

$$h = 84/7 = 12 \text{ cm}$$

$$\text{Height of the cylinder} = 12 \text{ cm}$$

$$\text{Volume of cylinder} = \pi r^2 h = (22/7) * 7$$

$$* 7 * 12$$

$$= 22 * 84 = 1848 \text{ cm}^3$$

36. Answer: B

According to the question,

$$P * (1 + R/100)^2 = 0.21P + P$$

$$P * (1 + R/100)^2 = 1.21P$$

$$(1 + R/100) = 1.1$$

$$R/100 = 1/10$$

$$R = 10$$

$$\text{Rate of interest} = 10\%$$

$$\text{Rate of interest at compounded half yearly} = 2R\%/2 = R\% = 10\%$$

$$\text{Effective terms} = (18/12) * 2 = 3 \text{ terms}$$

$$(P - 300) * [(110/100)^3 - 1] = 827.5$$

$$(P - 300) * [1.331 - 1] = 827.5$$

$$P - 300 = 827.5/0.331$$

$$P - 300 = 827500/331$$

$$P - 300 = 2500$$

$$P = 2800$$

37. Answer: E

Let the cost price of the article be Rs. 100x

According to the question,

$$100x * 136\% * 75\% = 100x + 300$$

$$102x - 100x = 300$$

$$2x = 300$$

$$x = 150$$

$$\text{Cost price of the article} = 100 * 150 = \text{Rs. } 15000$$

$$\text{Selling price of the article} = (15000 * 120\%) - 1400$$

$$= 18000 - 1400 = \text{Rs. } 16600$$

38. Answer: A

$$\text{Monthly medical expenses} = 97200/12 = \text{Rs. } 8100$$

Let the monthly salary of Thara be Rs. 100x

$$\text{Amount spent on paying rent} = 100x * 25\% = \text{Rs. } 25x$$

$$\text{Amount spent on buying groceries} = (100x - 25x) * 20\% = 75x * 20\% = \text{Rs. } 15x$$

$$\text{Amount spent on network charges} = (100x - 25x - 15x) * 30\% = 60x * 30\% = \text{Rs. } 18x$$

$$\text{Remaining amount} = 100x - 25x - 15x - 18x = \text{Rs. } 42x$$

$$\text{Amount spend on medical expenses} = 42x * (9/14) = \text{Rs. } 27x$$

$$27x = 8100$$

$$x = 300$$

$$\text{Monthly income by Thara} = 100 * 300 = \text{Rs. } 30000$$

39. Answer: E

Let the present age of the son be 'x' years

Therefore, present age of the mother = 6 * x = 6x years

Present age of father = (5x + 7) years

According to the question,

$$5x + 7 + 6x = 31 * 2$$

$$11x + 7 = 62$$

$$11x = 55$$

$$x = 5$$

Present age of son = 5 years

Present age of mother = $6 * 5 = 30$ years

$$\begin{aligned} \text{Required ratio} &= (5 + 40) : (30 - 12) \\ &= 45 : 18 = 5 : 2 \end{aligned}$$

40. Answer: D

Let the initial number of males and number of females $5x$ and $3x$ respectively.

Let the number of new joining males and females $5y$ and $7y$ respectively.

$$\text{Number of males after joining} = 1500 * (7/12) = 7 * 125 = 875$$

$$\text{Number of females after joining} = 1500 * (5/12) = 5 * 125 = 625$$

According to the question,

$$5x + 5y = 875$$

$$x + y = 175 \text{ ----} \rightarrow (1)$$

$$3x + 7y = 625 \text{ ----} \rightarrow (2)$$

Equation (1) multiply by 3, we get

$$3x + 3y = 525 \text{ ----} \rightarrow (3)$$

By solving equation (2) & (3), we get

$$4y = 100$$

$$y = 25$$

$$\begin{aligned} \text{Required difference} &= 7y - 5y = 2y = \\ &= 2 * 25 = 50 \end{aligned}$$

Directions (41-45):

Final arrangement

Month	Year	Persons
March	2019	H
September	2019	D
March	2020	A
September	2020	F
March	2021	B
September	2021	C
March	2022	G
September	2022	E

We have

- B was sold in the month having 31 days of an odd numbered year.
- Only one house was sold between B and G.

From the above conditions, there are two possibilities

		Case-1	Case-2	Case-3
Month	Year	Persons	Persons	Persons
March	2019	B		
September	2019			
March	2020	G	G	
September	2020			
March	2021		B	B
September	2021			
March	2022			G
September	2022			

Again, we have

- As many houses sold before G as after D.
- A was sold immediately after D.
- H was sold in the same month as A, but not in 2021.

After applying the above conditions case-1 gets eliminated because house H was not sold in the year 2021.

		Case-1	Case-2	Case-3
Month	Year	Persons	Persons	Persons
March	2019	B	H	H
September	2019			D
March	2020	G	G	A
September	2020			
March	2021		B	B
September	2021	D	D	
March	2022	A	A	G
September	2022			

Again, we have

- As many houses sold between H and B as before F.
- C was sold after F.
- E was not sold in an odd numbered year.

After applying the above conditions case-2 gets eliminated because house E was sold in an odd numbered year, hence case-3 shows the final arrangement.

		Case-2	Case-3
Month	Year	Persons	Persons
March	2019	H	H
September	2019	E	D
March	2020	G	A
September	2020	F	F
March	2021	B	B
September	2021	D	C
March	2022	A	G
September	2022	C	E

41. Answer: D

42. Answer: B

43. Answer: E

44. Answer: C

45. Answer: A

46. Answer: C

Given series

JMA EQC YDK XAT IWL

AMJ CQE KDY TAX LWI

BLI BPF JCX SBW KVJ

47. Answer: A

Given series

JMA EQC YDK XAT IWL

JAM ECQ YKD XTA ILW

48. Answer: E

Given series

JMA EQC YDK XAT IWL

AJM CEQ DKY ATX ILW

49. Answer: B

Given series

JMA EQC YDK XAT IWL

EQC IWL JMA **XAT** YDK

50. Answer: D

SOMETHING

T S O N M I H G E

S-19; G-7

19-7=12

Directions (51-55):

Final arrangement

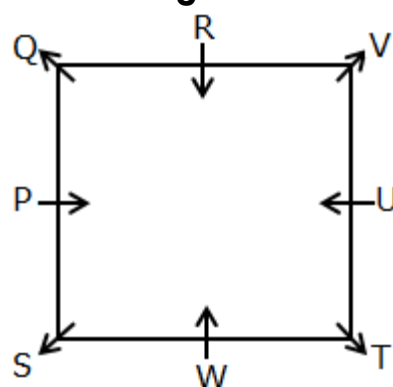

We have

- Only one person sits between P and W (either from left or right).

- W doesn't sit at the corner of the table.
- V sits immediate right of the one who faces P.

From the above conditions, there are two possibilities

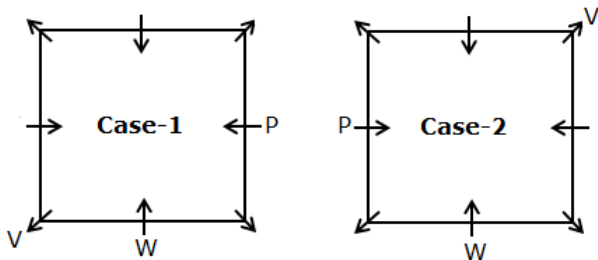

Again, we have

- T sits second to the right of V.
- Three persons sit between T and Q.

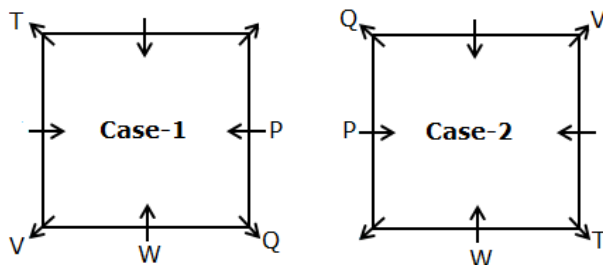

Again, we have

- As many persons sit between Q and W as between T and R.
- Two persons sit between R and S, who doesn't sit adjacent to U.

After applying the above conditions case-1 gets eliminated because U sits adjacent to S, hence case-2 shows the final arrangement.

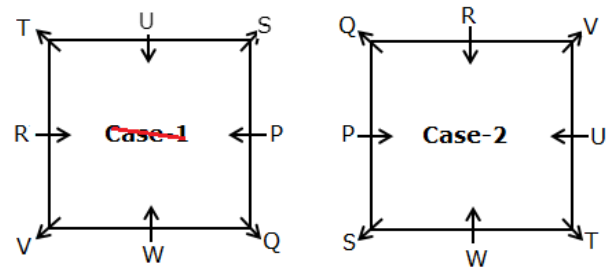

51. Answer: C

52. Answer: B

53. Answer: D

54. Answer: E

55. Answer: A (First person sits in the corner and the second person is immediate right of the first person)

56. Answer: C

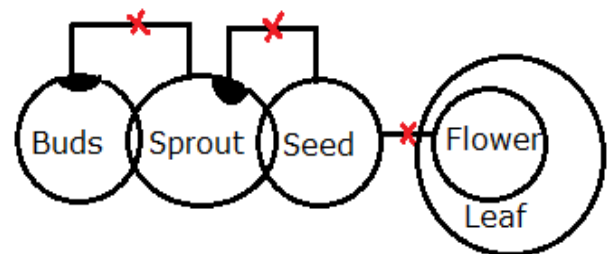

57. Answer: E

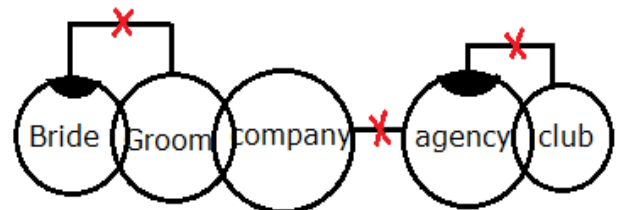

58. Answer: B

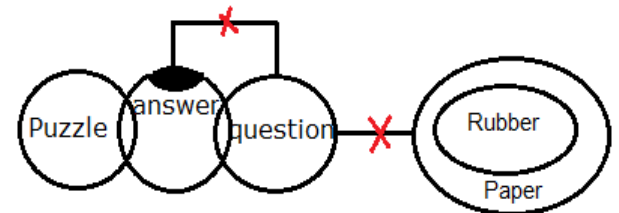

59. Answer: D

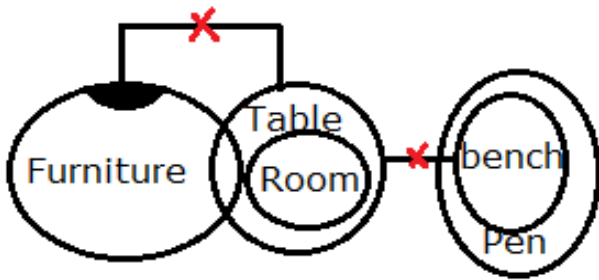

Directions (60-64):

Final arrangement

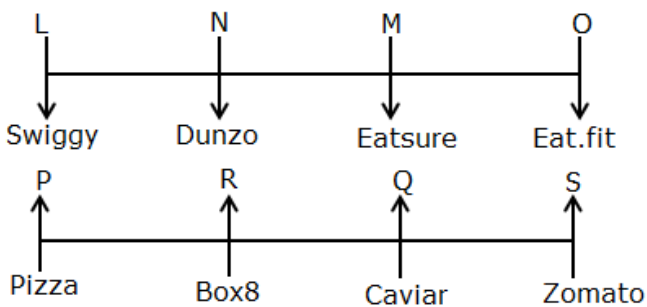

We have,

- N sits second to the right of the one who likes Eat.fit app.
- The one who faces N sits immediate left of Q.
- Only one person sits between Q and the one who likes Pizza.

From the above conditions, there are two possibilities.

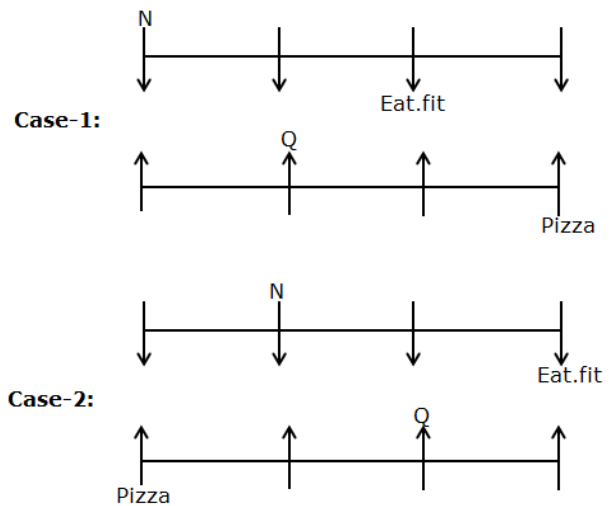

Again, we have

- As many persons sit to the right of the one who likes pizza as to the left of L.
- The one who faces N sits adjacent to L.
- Only one person sits between S and the one who likes Box8.

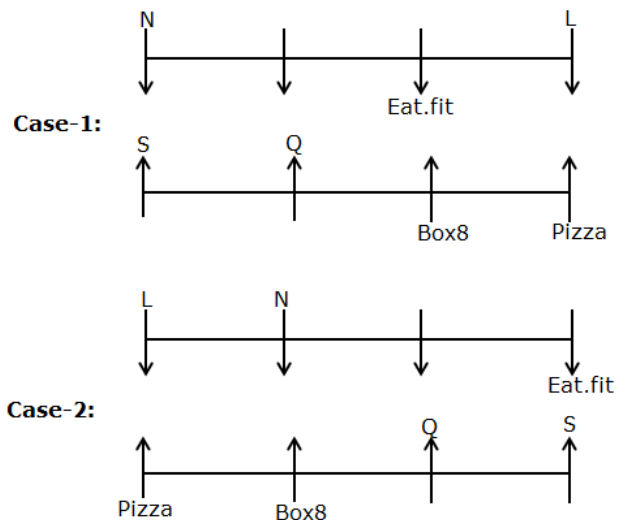

Again, we have

- O sits second to the left of the one who likes Dunzo.
- M didn't like Eat.fit.
- The one who faces M likes Caviar.

- R sits immediate left of the one who likes Caviar.
- P faces the one who likes Swiggy.
- S didn't like Eatsure.

After applying the above conditions case-1 gets eliminated because there is no possibility to place R, hence case-2 shows the final arrangement.

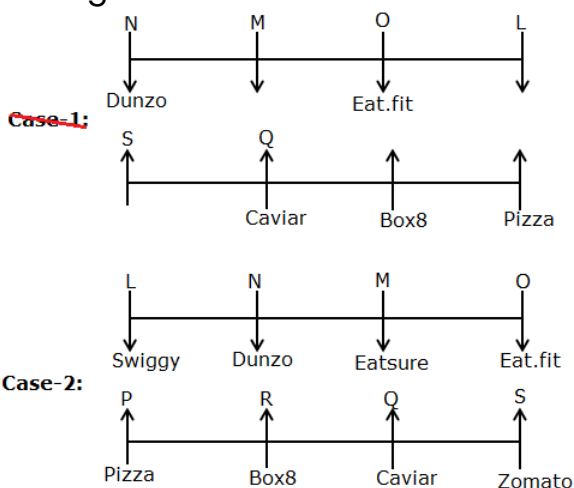

60. Answer: B (No person sits between both the person except option b)

61. Answer: E

62. Answer: C

63. Answer: A

64. Answer: D

65. Answer: D

3276589436

9 8 7 **6** 6 5 4 3 **3** 2

6+3=9

Directions (66-69):

Final arrangement

Boxes
X
P
U
Q
R
V
T
W
S

We have

- Only three boxes are kept between boxes R and X.
- Only one box is kept between boxes R and U, which is kept above box R.

From the above conditions, there are two possibilities.

Case-1	Case-2
Boxes	Boxes
U	X
R	U
	R
X	

Again, we have

- Box Q is kept immediately below box U.
- Box T is kept three boxes below box Q.
- As many boxes kept between boxes T and X as between boxes U and S.

Case-1 Boxes	Case-2 Boxes
S	X
U	U
Q	Q
R	R
T	T
X	S

Again, we have

- Box V is kept below box P but above box W.
- Box P is not kept adjacent to box S.

After applying the above conditions case-1 gets eliminated because box P is kept adjacent to box S, hence case-2 shows the final arrangement.

Case-1 Boxes	Case-2 Boxes
S	X
P	P
U	U
Q	Q
R	R
V	V
T	T
W	W
X	S

66. Answer: C

67. Answer: D

68. Answer: B

69. Answer: E

Directions (70-72):

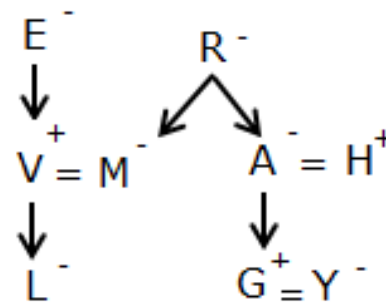

70. Answer: A

71. Answer: C (Except option c, all the persons are married)

72. Answer: D

Directions (73-77):

Final arrangement

Floor	Flat P	Flat Q
4	L	I
3	E	J
2	K	G
1	H	F

We have

- G lives in flat Q of an even numbered floor.
- Only one floor is between G and L, both live in different type of flats.

From the above conditions, there are two possibilities

	Case-1		Case-2	
Floor	Flat P	Flat Q	Flat P	Flat Q
4		G	L	
3				
2	L			G
1				

Again, we have

- As many floors above L as below H.
- K lives immediately above H' flat.

	Case-1		Case-2	
Floor	Flat P	Flat Q	Flat P	Flat Q
4	K	G	L	
3	H			
2	L		K	G
1			H	

Again, we have

- Only one floor is between K and I, who lives on the adjacent floor of J.
- F lives two floors below J, both live in the same type of flats.
- E doesn't live on the bottom most floor.

After applying the above conditions case-1 gets eliminated because E lives on bottom most floor. Hence Case 2 shows the final arrangement.

	Case-1		Case-2	
Floor	Flat P	Flat Q	Flat P	Flat Q
4	K	G	L	I
3	H	J	E	J
2	L	I	K	G
1	E	F	H	F

73. Answer: E

74. Answer: B (All person live on an even numbered floor except option b)

75. Answer: D

76. Answer: C

77. Answer: A

Directions (78-80):

78. Answer: D

$U > W > X (50) > T (48) > V > S$

$X=50; U=100$

$T=48; V=24$

Average of U & V $\rightarrow 124/2=62$

79. Answer: C

80. Answer: E

$U > W > X (50) > T (48) > V > S$

The sum of the number of documents sent by X and W is 105 -
 $\rightarrow 50+W=105 \rightarrow W=55$

The difference between the number of documents sent by T and V is 13 -
 $\rightarrow 48-V=13 \rightarrow V=35$

Sum of T and V $\rightarrow 55+35=90$

- T sent more documents than S but less than X.

$X > T > S$

- W sent more documents than V but less than U.

$U > W > V$

- X sent less documents than W.
- As many persons sent more documents than W as less than V.
- The persons who sent the third highest and third lowest number of documents sent 50 and 48 documents.

$U > W > X (50) > T (48) > V > S$

IBPS RRB PO Prelims Memory Based Paper

(Memory Based Paper held on 06th August 2023)

Reasoning Ability

Directions (1-5): Study the following information carefully and answer the given questions.

Nine persons - A, B, C, D, E, F, G, H and J live on nine different floors of a nine storey building where the lowermost floor is numbered one and the floor immediately above it is numbered two and so on. No two persons live on the same floor.

Not more than one person lives above D. Only four persons live between D and C. J lives immediately below C. Only two persons live between J and A. Only two persons live between F and E. F lives on an even numbered floor and lives above E. B lives immediately below H. B lives in an odd numbered floor.

1. How many person lives between H and G?

- A.**Three
- B.**As many persons live between D and A
- C.**One
- D.**As many persons live between J and F
- E.**Five

2. Which of the following statement(s) is/are true as per the final arrangement?

- I.** A lives above F
 - II.** C lives on an odd numbered floor
 - III.** More than two persons live between G and J
- A.**Only II
 - B.**Both I and III
 - C.**Only III
 - D.**Both I and II
 - E.**Both II and III

3. In which of the following option the first person lives two floors below the second person?

- A.**GE
- B.**CH
- C.**FA
- D.**CA
- E.**JD

4. Who among the following person lives on the lowermost floor?

- A.**J
- B.**B
- C.**A
- D.**C
- E.**F

5. Four of the following five are alike in a certain way based on the given

[Get our Premium Bundle PDF Course](#)

[Get our Mock Test Series](#) e-Magazine Dec 2023

arrangement and thus forms a group. Which one of the following does not belong to the group?

- A.C and H
- B.A and C
- C.J and Fifth floor
- D.G and Eighth floor
- E.F and A

Directions (6-10): Study the following information carefully and answer the given questions.

Eight persons – L, M, N, O, P, Q, R and S are sitting around a circular table with equal distance between adjacent persons. Some of them are facing the centre while some of them are facing away from the centre.

O sits facing towards the centre. Only one person sits between O and L (either from the left or right). N sits second to the left of L and both are facing opposite direction. Q sits immediate left of N. R sits second to the right of Q and sits adjacent to L. Three persons sit between R and S. P sits immediate left of S. Immediate neighbours of P face opposite direction of P. M faces away from the center. The one who sits immediate right of O faces towards the center.

6. Who among the following person sits opposite to the one who sits third to the right of M?

- A.L

B.The one who sits immediate left of R

C.P

D.The one who sits immediate right of S

E.Q

7. Which of the following statement is not false as per the final arrangement?

A.L sits immediate left of Q

B.S sits third to the right of O

C.N sits opposite to M

D.P sits third to the left of Q

E.M sits second right of S

8. If one of the neighbors of R is L, then who among the following person is the second neighbor?

A.Q

B.The one who sits immediate right of N

C.P

D.The one who sits immediate left of M

E.S

9. Four of the following five are alike in a certain way based on the given arrangement and thus forms a group. Which one of the following does not belong to the group?

A.S

B.Q

C.R

D.M

[Get our Premium Bundle PDF Course](#) [Get our Mock Test Series](#) e-Magazine Dec 2023

E.L

10. Who among the following person sits exactly in the middle of P and L, when counted from the left of L?

- A.S
- B.Q
- C.R
- D.N
- E.M

Directions (11-13): Study the following information carefully and answer the given questions.

Point A is 17m west of point B. Point C is 7m north of point B. Point D is 5m west of point C. Point E is 9m south of point D. Point F is 5m west of point E. Point G is 4m north of point F. Point H is 7m west of point G.

11. What is the distance and direction of point A with respect to point H?

- A.3m, North
- B.2m, North
- C.2m, South
- D.3m, South
- E.4m, South

12. Four of the following five pair of points are alike in a certain way based on the directions in the given arrangement and thus form a group. Which one of the following does not belong to the group?

A.GA

B.DH

C.CE

D.EG

E.BF

13. If point Z is exactly in the middle of points G and F, then what is the distance between points Z and B?

- A.9m
- B.10m
- C.11m
- D.13m
- E.12m

Directions (14-16): Study the following information carefully and answer the given questions.

A certain number of persons are sitting in a linear row and facing the north with equal distance between adjacent persons.

R sits eighth from the left end of the row. Only five persons sit between R and T. B sits eighth to the right of T. Z sits seventh to the left of B. P sits second to the left of Z. Only four persons sit between P and Q. L sits exactly between Q and B. S sits sixth to the right of L. C sits third to the left of S and sits sixth from the right end of the row.

14. How many persons are sitting in the linear row as per the final arrangement?

A.20

[Get our Premium Bundle PDF Course](#) [Get our Mock Test Series](#) e-Magazine Dec 2023

- B.23
- C.28
- D.25
- E.32

15. As many persons sit between Q and C as between __ and __.

- A.P and Z
- B.R and P
- C.B and S
- D.Z and L
- E.Both b and d

16. What is the position of S with respect to Z?

- A.Eighth to the right
- B.Ninth to the left
- C.Seventh to the right
- D.Eleventh to the right
- E.Tenth to the left

Directions (17-21): Study the following information carefully and answer the given questions.

Eight persons - A, B, C, D, E, F, G and H were born in eight different years viz. 1961, 1969, 1971, 1973, 1981, 1985, 1991 and 1997.

Note I: The age of each person is calculated with respect to the year 2021.

Note II: All the persons were born on the same date and same month.

Note III: The age of the person is only in years.

The difference between the present ages of H and C is 6 years. H is elder than C. The present age of B is twice the present age of C. Only two persons were born between B and F. The sum of the present ages of F and G is 100 years. The present age of F is 8 years more than the present age of A. E is 16 years younger than A. The sum of the present ages of E and D is 74 years.

17. What is the sum of the ages of D and G?

- A.100 years
- B.97 years
- C.102 years
- D.87 years
- E.115 years

18. Four of the following five are alike in a certain way based on the given arrangement and thus form a group. Which one of the following does not belong to the group?

- A.BD
- B.GF
- C.HE
- D.FA
- E.DA

19. If C's father is 27 years elder than C, then the father of C was born in which of the following year?

- A.1964
- B.1954
- C.1948

[Get our Premium Bundle PDF Course](#) [Get our Mock Test Series](#) e-Magazine Dec 2023

D.1943

E.1956

20. Who among the following person was born in 1973?

A.The one who was born immediately after B

B.B

C.A

D.C

E.The one who was born two persons after G

21. Which of the following statement is/are true as per the given arrangement?

A.G was born 7 years after B

B.Only three persons were born after A

C.The age of H is twice the age of G

D.The sum of the ages of E and B is 102 years

E.All the given statements are true

22. If in the given number "34578921", one is subtracted from the odd digits and two is subtracted from the even digits, then how many digits are repeated more than once?

A.One

B.Two

C.Three

D.Four

E.None

23. Find the odd one out __.

A.QROM

B.WXVT

C.JKHF

D.RSPN

E.EFCA

24. If "all is well" is coded as "fb jd xw", "well done" is coded as "sa jd", "all good" is coded as "ns xw", then what is the code for the phrase "good is done"?

A.ns sa fb

B.jd xw sa

C.fb xw sa

D.xw ns jd

E.Cannot be determined

Directions (25-29): Study the following information carefully and answer the given questions

Seven boxes – P, Q, R, S, T, U and W are kept one above another in a single stack. Each box is from different country– Argentina, Bermuda, Canada, Denmark, Ethiopia, Finland and Germany.

Only three boxes are kept between T and the box from Bermuda. Only one box is kept between W and the box from Bermuda, which is kept above W. Only two boxes are kept between W and the box from Canada, which is not kept immediately below T. Only one box is kept between the box from Ethiopia and the box from

[Get our Premium Bundle PDF Course](#) [Get our Mock Test Series](#) e-Magazine Dec 2023

Canada. Only one box is kept between the box from Ethiopia and the box from Germany. Only one box is kept between the box from Germany and R, which is not from Ethiopia.. Only two boxes are kept between the box from Denmark and R. Only three boxes are kept between the box from Finland and U. Box S is kept above the box from Germany. Only one box is kept between U and Q. Only three boxes are kept between the box from Argentina and P.

25. Which of the following box is from Argentina?

- A.Box R
- B.The box which is kept immediately above Q
- C.Box U
- D.The box which is kept two boxes below W
- E.Box S

26. Which of the following combination is true?

- A.U-Denmark
- B.Q-Finland
- C.P-Germany
- D.T-Ethiopia
- E.S-Canada

27. As many boxes kept above the box from Ethiopia as below __.

- A.Box P
- B.The box from Germany
- C.Box T

- D.Box R
- E.The box from Canada

28. Box R is from which of the following country?

- A.Argentina
- B.Bermuda
- C.Finland
- D.Denmark
- E.Canada

29. How many boxes are kept between box P and the box from Denmark?

- A.One
- B.Two
- C.Three
- D.None
- E.More than three

Directions (30–33): Study the following information carefully and answer the given questions

In a certain code language, "Red suits take colour" is coded as "cb ag lo nk"

"The red is ball" is coded as "ag pj ut qs"

"is you take time" is coded as "ih ut nk yx"

"One ball there time" is coded as "qs tm ih ks"

(Note: All the given codes are two letter codes only)

30. What is the word for the code "yx" in the given code language?

[Get our Premium Bundle PDF Course](#) [Get our Mock Test Series](#) e-Magazine Dec 2023

- A.is
- B.Suits
- C.There
- D.You
- E.Can't be determined

31. What is the code for the word "One" in the given code language?

- A.cb
- B.pj
- C.qs
- D.ih
- E.Either tm or ks

32. If "Purple colour love" is coded as "cb qm wn" and "Love happy time" is coded as "wn ty ih", then what is the code for the phrase "Suits purple happy" in the given coded language?

- A.ih lo qm
- B.ty lo cb
- C.wn ty qm
- D.lo qm ty
- E.cb wn ty

33. Which of the following combination is true as per the given code language?

- A.Ball-tm
- B.Red-nk
- C.Time-ks
- D.The-pj
- E.Take-ut

Directions (34-36): Study the following statements and then decide which of the given conclusions logically follows from the given statements disregarding the commonly known facts.

- a) If only conclusion I follows
- b) If only conclusion II follows
- c) If either conclusion I or II follows
- d) If neither conclusion I nor II follows
- e) If both conclusions I and II follow

34. Statements:

Only a few Lakes are pond

No pond is stream

All Lakes are river

Conclusions:

- I. All streams are river is a possibility
- II. Some lake is definitely not stream

- A.a
- B.b
- C.c
- D.d
- E.e

35. Statements:

All boxes are container

Only a few containers are package

Only a few boxes are shipment

Conclusions:

- I. Some boxes are package
- II. No shipment is package is a possibility.

- A.a
- B.b

- C.c
D.d
E.e

36. Statements:

Only a few missiles are torpedoes

Only a few torpedoes are rocket

No torpedo is Projectile

Conclusions:

I. All rockets can never be Projectile

II. Some Missiles can be Rocket

- A.a
B.b
C.c
D.d
E.e

Directions (37-40): In the given questions, the relationship between different elements is shown in the statements followed by some conclusions. Find the conclusion which is definitely true.

37. Statements:

$A \geq C = F < J \leq L; T > M \geq C > B$

Conclusions:

I) $J \geq B$

II) $T > F$

- A.Only conclusion I is true
B.Only conclusion II is true
C.Either conclusion I or II is true
D.Neither conclusion I nor II is true
E.Both conclusions I and II are true

38. Statements:

$Z = K \leq L < P \leq Q; F > U \geq L < J$

Conclusions:

I) $Z \leq U$

II) $Q > J$

- A.Only conclusion I is true
B.Only conclusion II is true
C.Either conclusion I or II is true
D.Neither conclusion I nor II is true
E.Both conclusions I and II are true

39. Statements:

$B > D \geq E < X = S; A \leq Y < T = E$

Conclusions:

I) $S > A$

II) $B > Y$

- A.Only conclusion I is true
B.Only conclusion II is true
C.Either conclusion I or II is true
D.Neither conclusion I nor II is true
E.Both conclusions I and II are true

40. Statement:

$A < H = T \geq O = R = Q \geq F \geq D = L$

Conclusions:

I) $D < T$

II) $T = D$

- A.Only conclusion I is true
B.Only conclusion II is true
C.Either conclusion I or II is true
D.Neither conclusion I nor II is true
E.Both conclusions I and II are true

Quantitative Aptitude

Directions (41-45): What approximate value should come in

[Get our Premium Bundle PDF Course](#) [Get our Mock Test Series](#) e-Magazine Dec 2023

the place of (?) in the following questions?

41. $89.98 - 32.02 * ? + 109.79 = 99.89$

- A.9
- B.1
- C.7
- D.3
- E.8

42. $131.85 - 90.99 - 4.02^2 = \sqrt{?}$

- A.625
- B.400
- C.576
- D.729
- E.841

43. $128.30 - 100.05 \div ? + 17.07 = 139.59$

- A.18
- B.33
- C.12
- D.55
- E.20

44. $?^2 + 225.05 * 9.9 \div 8.78 = 370.73$

- A.20
- B.15
- C.11
- D.9
- E.17

45. $25\% \text{ of } 119.78 + ? = 24.68 * \sqrt{37}$

- A.104
- B.84
- C.75
- D.120
- E.90

Directions (46–50): Find out the wrong number in the following number series.

46. 3, 7, 27, 112, 565, 3396, 23779

- A.7
- B.27
- C.112
- D.3396
- E.23779

47. 4, 6, 12, 30, 90, 317, 1260

- A.4
- B.6
- C.12
- D.90
- E.317

48. 19, 23, 32, 48, 72, 109, 158

- A.19
- B.23
- C.72
- D.109
- E.158

49. 14, 16, 12, 18, 10, 22, 8

- A.14
- B.16
- C.18
- D.22
- E.8

50. 6400, 400, 50, 12.5, 6.25, 3, 12.5

- A.50
- B.3
- C.12.5
- D.400

[Get our Premium Bundle PDF Course](#) [Get our Mock Test Series](#) e-Magazine Dec 2023

E.6.25

Directions (51-55): The following question contains two equations as I and II. You have to solve both equations and determine the relationship between them and give the answer as,

51.

I) $4x^2 - 27x + 35 = 0$

II) $y^2 - 5y + 6 = 0$

A. $x > y$

B. $x \geq y$

C. $x = y$ or relationship can't be determined.

D. $x < y$

E. $x \leq y$

52.

I) $x^2 - 5x - 104 = 0$

II) $y^2 + 23y + 120 = 0$

A. $x > y$

B. $x \geq y$

C. $x = y$ or relationship can't be determined.

D. $x < y$

E. $x \leq y$

53.

I) $3x^2 + x - 24 = 0$

II) $2y^2 - 25y + 78 = 0$

A. $x > y$

B. $x \geq y$

C. $x = y$ or relationship can't be determined.

D. $x < y$

E. $x \leq y$

54.

I) $5x^2 + 17x + 14 = 0$

II) $y^2 + 11y + 24 = 0$

A. $x > y$

B. $x \geq y$

C. $x = y$ or relationship can't be determined.

D. $x < y$

E. $x \leq y$

55.

I) $x^2 - 8x + 15 = 0$

II) $y^2 - 22y + 85 = 0$

A. $x > y$

B. $x \geq y$

C. $x = y$ or relationship can't be determined.

D. $x < y$

E. $x \leq y$

Directions (56-60): Study the following information carefully and answer the questions.

The given table chart shows the total number of rooms and the number of vacant rooms in five different hotels i.e. A, B, C, D and E.

Note: Total number of rooms = Number of occupied rooms + Number of vacant rooms

Hotels	Total number of rooms	Number of vacant rooms (Out of the total number of rooms)
A	220	105
B	140	103
C	160	27
D	180	95
E	210	109

[Get our Premium Bundle PDF Course](#) [Get our Mock Test Series](#) e-Magazine Dec 2023

56. Find the difference between the total number of rooms in hotels A and C together and the total number of vacant rooms in hotels B and D together.

- A.300
- B.182
- C.400
- D.230
- E.None of these

57. The total number of rooms in hotel E is what percentage of the total number of occupied rooms in hotels A and D together?

- A.120%
- B.100%
- C.190%
- D.105%
- E.170%

58. Find the ratio of the total number of occupied rooms in hotels A and E together to the number of vacant rooms in hotel C.

- A.3:2
- B.5:4

- C.8:1
- D.9:4
- E.2:1

59. Find the average number of occupied rooms in hotels A, B and C?

- A.95
- B.49
- C.63
- D.77
- E.None of these

60. In hotel B, 50 rooms are owned by company X and the remaining rooms are owned by company Y. If the number of vacant rooms owned by company Y in hotel B is 25, then find the number of occupied rooms occupied by company X in hotel B.

- A.38
- B.45
- C.70
- D.25
- E.None of these

Directions (61-65): Study the following information carefully and answer the questions.

The given bar graph shows the number of vegetarian hotels and non-vegetarian hotels in five different cities i.e. A, B, C, D, and E.

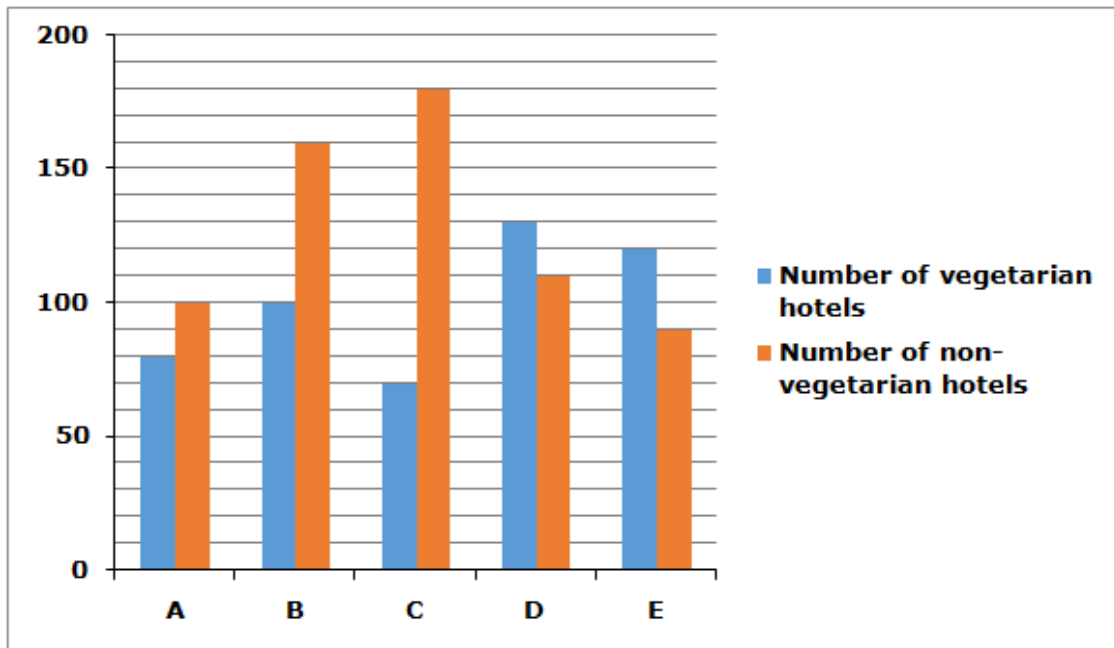

61. In city C, 20% of vegetarian hotels are owned by females and 40% of non-vegetarian hotels are owned by females, then find the average number of vegetarian and non-vegetarian hotels owned by males.

- A.80
- B.82
- C.90
- D.99
- E.None of these

62. In city A, the opening time of vegetarian and non-vegetarian hotels are 8 a.m. to 8 p.m. and 1 p.m. to 7 p.m. respectively, then find the total opening hours of vegetarian and non-vegetarian hotels in a day?

- A.1200 hours
- B.3200 hours

- C.1560 hours
- D.1000 hours
- E.None of these

63. Find the ratio of the total number of non-vegetarian hotels in cities A and E together to the number of vegetarian hotels in cities B and D together.

- A.19:23
- B.23:25
- C.12:13
- D.11:19
- E.None of these

64. The total number of (veg + non-veg) hotels in city E is how much less or more than the total number of non-vegetarian hotels in cities B and D together?

- A.90
- B.60

- C.50
- D.70
- E.None of these

65. The number of (veg + non-veg) hotels in city D is what percentage of the total number of non-vegetarian hotels in cities B and E together?

- A.55%
- B.96%
- C.74%
- D.50%
- E.None of these

66. Five years hence, the average age of A, B and C is 20 years. Three years ago, the average age of B, C and D is 33 years. If the sum of the present age of A and D is 83 years, then find the age of D five years ago.

- A.45 years
- B.70 years
- C.68 years
- D.53 years
- E.None of these

67. A right-angle triangle has a height $8\sqrt{10}$ cm and its base is 50% of its height. If the height and radius of the cylinder are the same as the height and base of the right angle triangle respectively, then find the curved surface area of the cylinder using $\pi = 3$.

- A.1920

- B.1440
- C.3680
- D.1840
- E.None of these

68. Boat A covers 105 km upstream in 7 hours and the speed of boat A in still water is six times the speed of the stream and the speed of boat B in still water is the same as the downstream speed of boat A, then find the time taken by boat B to cover 140 km downstream in minutes.

- A.350
- B.560
- C.420
- D.490
- E.None of these

69. In an examination P secured 40% marks and he failed by 40 marks, while in the same exam, Q secured 70% marks and his marks are 20 marks more than the passing marks. Find the maximum marks for the examination.

- A.300
- B.240
- C.200
- D.100
- E.None of these

70. A mixture of milk and water contains 8 liters of water. On adding 6 liters of water and 5 liters of milk,

[Get our Premium Bundle PDF Course](#) [Get our Mock Test Series](#) e-Magazine Dec 2023

the amount of milk becomes 75% of the new mixture. Now 10 liters of mixture is removed, then find the quantity of milk in the final mixture.

- A.32.5 liters
- B.34.5 liters
- C.37.5 liters
- D.32 liters
- E.None of these

71. A person invested Rs.X in scheme P for two years at 10% compound interest and also he invested Rs.(X + 500) for two years at 12% simple interest. If the interest received from scheme Q is Rs.150 more than that of scheme P, then find the total amount invested by the person in both schemes.

- A.Rs.2500
- B.Rs.3000
- C.Rs.2000
- D.Rs.4500
- E.None of these

72. A and B started a business with an investment of Rs.1300 and Rs.1800. After six months, C joined the business with an investment of Rs.1400. If at the end of the year profit share of C is Rs.1400, then find the difference between the profit share of A and B.

- A.Rs.1350
- B.Rs.2100
- C.Rs.1050

- D.Rs.1800
- E.Rs.1000

73. Pipes P and Q together can fill $\frac{1}{4}$ th of the tank in $1\frac{1}{2}$ hours and pipes P and R together can fill $\frac{2}{5}$ th of the tank in 3.6 hours. If pipes P, Q and R together can fill the tank in $4\frac{1}{2}$ hours, then how many hours pipe P fill half of the tank?

- A.12 hours
- B.18 hours
- C.10 hours
- D.9 hours
- E.None of these

74. A 150 m long train crosses a standing man in 22.5 seconds and also crosses a man walking at x km/hr in opposite directions in 20 seconds. Find the value of x.

- A.3
- B.4
- C.7
- D.5
- E.None of these

75. The ratio of the cost price of the shirt to the jean is 4:3 and the selling price of the shirt is Rs.400 more than that of the jean. If the shirt sold at 10% profit and the jean sold at 20% profit, then find the cost price of the jean.

- A.Rs.1800
- B.Rs.1500

[Get our Premium Bundle PDF Course](#) [Get our Mock Test Series](#) e-Magazine Dec 2023

- C.Rs.1200
- D.Rs.1000
- E.None of these

76. The ratio of the number of sweets in box A to B is 3:4 and the ratio of the number of sweets in box B to C is 2:1. If 10 sweets are added to each sweet box A and C, then the ratio of the number of sweets in box A to C is 10:7. Find the number of sweets in box B.

- A.120
- B.100
- C.180
- D.160
- E.None of these

77. Ratio of the number of male and female employees in company A is 6:5 and the number of male employees in B is 25% more than that of A and the number of female employees in B is 20% more than that of A. If the total number of employees in B is 1377, then find the total number of employees in company A.

- A.1748
- B.1506
- C.1060
- D.1122
- E.1425

Directions (78–80): Following questions have two quantities as

[Get our Premium Bundle PDF Course](#) [Get our Mock Test Series](#) e-Magazine Dec 2023

Quantity I and Quantity II. You have to determine the relationship between them and give answer as,
78. Quantity I: The average weight of x students in a class is 36 kg and the average weight of $(x - 16)$ boys is 40 kg. If the average weight of girls is 30 kg, then find the total weight of the class.

Quantity II: 1080 kg

- A.Quantity I > Quantity II
- B.Quantity I \geq Quantity II
- C.Quantity II > Quantity I
- D.Quantity II \geq Quantity I
- E.Quantity I = Quantity II or Relation cannot be established

79. Quantity I: The boat covers 160 km downstream in 8 hours. If the speed of the boat in still water is 17 km/hr, then find the distance covered by the boat upstream in 5 hours.

Quantity II: The speed of the train is 25 m/sec. Find the distance covered by the train in 1.5 hours.

- A.Quantity I > Quantity II
- B.Quantity I \geq Quantity II
- C.Quantity II > Quantity I
- D.Quantity II \geq Quantity I
- E.Quantity I = Quantity II or Relation cannot be established

80. Quantity I: The perimeter of the rectangle is 154 cm^2 . If the area of the square is 625 cm^2 and the length

of the rectangle is 80% more than the side of the square, then find the area of the rectangle.

Quantity II: 1440 cm²

- A.Quantity I > Quantity II
- B.Quantity I ≥ Quantity II

C.Quantity II > Quantity I

D.Quantity II ≥ Quantity I

E.Quantity I = Quantity II or Relation cannot be established

ANSWER WITH EXPLANATION

Directions (1-5):

- 1. Answer: D
- 2. Answer: C
- 3. Answer: D
- 4. Answer: B
- 5. Answer: D (Only one floor is between the given pair of persons, except in option d)

Final arrangement:

Floors	Persons
9	D
8	F
7	G
6	A
5	E
4	C
3	J
2	H
1	B

Directions (6-10):

- 6. Answer: B
- 7. Answer: D
- 8. Answer: D
- 9. Answer: C
- 10. Answer: D

Final arrangement:

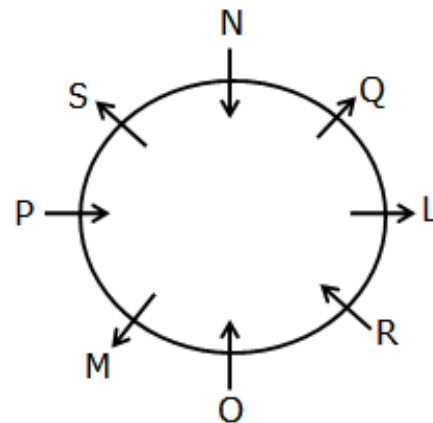

Directions (11-13):

Final arrangement:

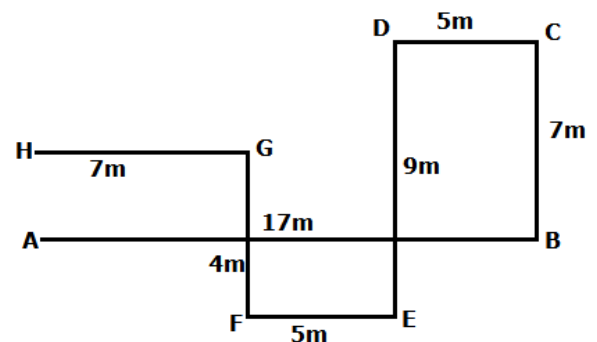

11. Answer: C

12. Answer: D (The first point is north-east of the second point, except in option d)

13. Answer: B

Directions (14-16):

Final arrangement

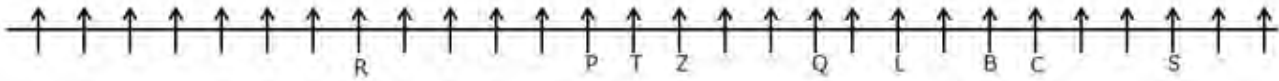

- 14. Answer: C
- 15. Answer: E
- 16. Answer: D

Directions (17-21):

- 17. Answer: C
- 18. Answer: D (Only one person was born between the given pair of persons, except option d)
- 19. Answer: A
- 20. Answer: E
- 21. Answer: B

Final arrangement:

Years	Ages	Persons
1961	60	B
1969	52	G
1971	50	D
1973	48	F
1981	40	A
1985	36	H
1991	30	C
1997	24	E

- 22. Answer: C
34578921
22466800
- 23. Answer: B
- 24. Answer: A

Directions (25-29):

Final arrangement:

Boxes	Country
S	Canada
P	Bermuda
U	Ethiopia
W	Denmark
Q	Germany
T	Argentina
R	Finland

- 25. Answer: D
- 26. Answer: E
- 27. Answer: B
- 28. Answer: C
- 29. Answer: A

Directions (30-33):

- 30. Answer: D
- 31. Answer: E
- 32. Answer: D
- 33. Answer: D

Phrase	Code
Red	ag
Suits/Colour	cb/lo
Take	Nk
The	Pj
Ball	Qs
Is	Ut
You	Yx
Time	Ih
One/There	tm/ks

34. Answer: E

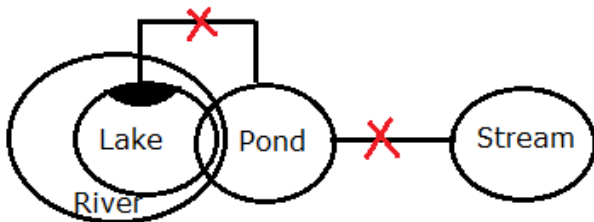

35. Answer: B

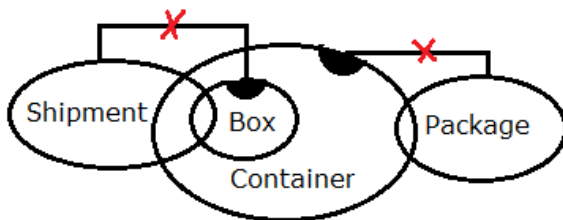

36. Answer: E

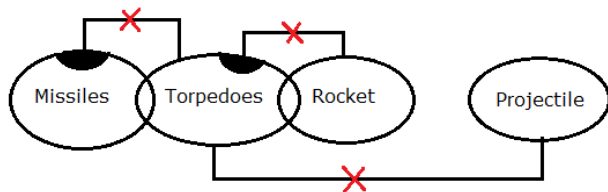

37. Answer: B

- I) $J \geq B$ ($J > F = C > B$) False
- II) $T > F$ ($T > M \geq C = F$) True

38. Answer: A

- I) $Z \leq U$ ($Z = K \leq L \leq U$) True
- II) $Q > J$ ($Q \geq P > L < J$) False

39. Answer: E

- I) $S > A$ ($S = X > E = T > Y \geq A$) True
- II) $B > Y$ ($B > D \geq E = T > Y$) True

40. Answer: C

41. Answer: D

$$90 - 32 * ? + 110 = 100$$

$$? * 32 = 200 - 100$$

$$? = 100/32 = 3.125 = 3$$

42. Answer: A

$$132 - 91 - 16 = \sqrt{?}$$

$$\sqrt{?} = 25$$

$$? = 625$$

43. Answer: E

$$128 - 100/? + 17 = 140$$

$$100/? = 145 - 140$$

$$? = 100/5 = 20$$

44. Answer: C

$$?^2 + 225 * 10/9 = 371$$

$$?^2 = 371 - 250 = 121 = 11^2$$

$$? = 11$$

45. Answer: D

$$25 * 120/100 + ? = 25 * 6$$

$$? = 150 - 30 = 120$$

46. Answer: A

$$3 * 2 + 2 = 8$$

$$8 * 3 + 3 = 27$$

$$27 * 4 + 4 = 112$$

$$112 * 5 + 5 = 565$$

$$565 * 6 + 6 = 3396$$

$$3396 * 7 + 7 = 23779$$

47. Answer: E

$$4 * 1.5 = 6$$

$$6 * 2 = 12$$

$$12 * 2.5 = 30$$

$$30 * 3 = 90$$

$$90 * 3.5 = \mathbf{315}$$

$$315 * 4 = 1260$$

48. Answer: C

$$19 + 2^2 = 23$$

$$23 + 3^2 = 32$$

$$32 + 4^2 = 48$$

$$48 + 5^2 = \mathbf{73}$$

$$73 + 6^2 = 109$$

$$109 + 7^2 = 158$$

49. Answer: D

$$14 + 2 = 16$$

$$16 - 4 = 12$$

$$12 + 6 = 18$$

$$18 - 8 = 10$$

$$10 + 10 = \mathbf{20}$$

$$20 - 12 = 8$$

50. Answer: B

$$6400 \div 16 = 400$$

$$400 \div 8 = 50$$

$$50 \div 4 = 12.5$$

$$12.5 \div 2 = 6.25$$

$$6.25 \div 1 = \mathbf{6.25}$$

$$6.25 \div 0.5 = 12.5$$

51. Answer: C

$$4x^2 - 27x + 35 = 0$$

$$4x^2 - 20x - 7x + 35 = 0$$

$$4x(x - 5) - 7(x - 5) = 0$$

$$x = + 5, + 7/4$$

$$y^2 - 5y + 6 = 0$$

$$y^2 - 3y - 2y + 6 = 0$$

$$y(y - 3) - 2(y - 3) = 0$$

$$y = + 3, + 2$$

The relationship can't be determined

52. Answer: B

$$x^2 - 5x - 104 = 0$$

$$x^2 - 13x + 8x - 104 = 0$$

$$x(x - 13) + 8(x - 13) = 0$$

$$x = + 13, - 8$$

$$y^2 + 23y + 120 = 0$$

$$y^2 + 15y + 8y + 120 = 0$$

$$y(y + 15) + 8(y + 15) = 0$$

$$y = - 15, - 8$$

Hence, $x \geq y$

53. Answer: D

$$3x^2 + x - 24 = 0$$

$$3x^2 + 9x - 8x - 24 = 0$$

$$3x(x + 3) - 8(x + 3) = 0$$

$$x = - 3, + 8/3$$

$$2y^2 - 25y + 78 = 0$$

$$2y^2 - 12y - 13y + 78 = 0$$

$$2y(y - 6) - 13(y - 6) = 0$$

$$y = + 6, + 13/2$$

Hence, $x < y$

54. Answer: A

$$5x^2 + 17x + 14 = 0$$

$$5x^2 + 10x + 7x + 14 = 0$$

$$5x(x + 2) + 7(x + 2) = 0$$

$$x = - 2, - 7/5$$

$$y^2 + 11y + 24 = 0$$

$$y^2 + 3y + 8y + 24 = 0$$

$$y(y + 3) + 8(y + 3) = 0$$

$$y = - 3, - 9$$

[Get our Premium Bundle PDF Course](#) [Get our Mock Test Series](#) e-Magazine Dec 2023

Hence, $x > y$

55. Answer: E

$$x^2 - 8x + 15 = 0$$

$$x^2 - 5x - 3x + 15 = 0$$

$$x(x - 5) - 3(x - 5) = 0$$

$$x = + 5, + 3$$

$$y^2 - 22y + 85 = 0$$

$$y^2 - 17y - 5y + 85 = 0$$

$$y(y - 17) - 5(y - 17) = 0$$

$$y = + 17, + 5$$

Hence, $x \leq y$

Directions (56-60):

In Hotel A,

Total number of rooms = 220

The number of vacant rooms = 105

And the number of occupied rooms = $220 - 105 = 115$

Similarly, we can find all other given hotels

Hotels	Total number of rooms	Number of vacant rooms	Number of occupied rooms
A	220	105	$220 - 105 = 115$
B	140	103	$140 - 103 = 37$
C	160	27	$160 - 27 = 133$
D	180	95	$180 - 95 = 85$
E	210	109	$210 - 109 = 101$

56. Answer: B

The total number of rooms in hotels A and C together = $(220 + 160) = 380$

And the total number of vacant rooms in hotels B and D together = $(103 + 95) = 198$

Required difference = $(220 + 160) - (103 + 95) = 380 - 198 = 182$

57. Answer: D

The total number of occupied rooms in hotels A and D together = $(115 + 85) = 200$

Required percentage = $210/200 * 100 = 105\%$

58. Answer: C

The total number of occupied rooms in hotels A and E together = $(115 + 101) = 216$

Required ratio = $216:27 = 8:1$

59. Answer: A

Required average = $(115 + 37 + 133)/3 = 285/3 = 95$

60. Answer: A

The number of vacant rooms owned by company X in hotel B = $37 - 25 = 12$

The number of occupied rooms owned by company X in hotel B = $50 - 12 = 38$

Directions (61-65):

Cities	Number of vegetarian hotels	Number of non-vegetarian hotels
A	80	100
B	100	160
C	70	180
D	130	110
E	120	90

61. Answer: B

In city C,

Number of vegetarian hotels owned by females = $20/100 * 70 = 14$

Number of vegetarian hotels owned by males = $70 - 14 = 56$

Number of non-vegetarian hotels owned by females = $40/100 * 180 = 72$

Number of non-vegetarian hotels owned by males = $180 - 72 = 108$

Required average = $(56 + 108)/2 = 82$

62. Answer: C

In city A,

Opening hours of one vegetarian hotel = (8 p.m. – 8 a.m.) = 12 hours

Opening hours of one non-vegetarian hotel = (7 p.m. – 1 p.m.) = 6 hours

The total opening hours of vegetarian hotels = $12 * 80 = 960$ hours

The total opening hours of non-vegetarian hotels = $6 * 100 = 600$ hours

The total opening hours of vegetarian and non-vegetarian hotels = $960 + 600 = 1560$ hours

63. Answer: A

Required ratio = $(100 + 90):(100 + 130) = 190:230 = 19:23$

64. Answer: B

Required difference = $(120 + 90) - (160 + 110) = 210 - 270 = 60$

65. Answer: B

Required percentage = $(130 + 110)/(160 + 90) = 240/250 * 100 = 96\%$

66. Answer: C

The sum of the present age of A, B and C = $20 * 3 - 3 * 5 = 60 - 15 = 45$ years

The sum of the present age of B, C and D = $33 * 3 + 3 * 3 = 99 + 9 = 108$ years

$B + C + D - (A + B + C) = 108 - 45$

$D - A = 63$ years

$A + D = 83$ years

$D = 146/2 = 73$

The age of D five years ago = $73 - 5 = 68$ years

67. Answer: A

The base of the right angle triangle = $8\sqrt{10} * 50/100 = 4\sqrt{10}$ cm

The curved surface area of the cylinder = $2 * 3 * 8\sqrt{10} * 4\sqrt{10} = 1920$ cm²

68. Answer: A

The upstream speed of boat A = $105/7 = 15$ km/hr

Ratio of the speed of boat A in still water to the speed of the stream = 6:1

$6x - x = 15$

$x = 15/5 = 3$

The downstream speed of boat A = $(6 + 1) * 3 = 21$ km/hr

The speed of boat B in still water = 21 km/hr

The downstream speed of boat B = $21 + 3 = 24$ km/hr

[Get our Premium Bundle PDF Course](#) [Get our Mock Test Series](#) e-Magazine Dec 2023

Required time = $140/24 * 60 = 350$ minutes

69. Answer: C

Let the maximum mark for the examination be x.

$$x * 40/100 + 40 = x * 70/100 - 20$$

$$70x - 40x = 6000$$

$$x = 6000/30 = 200$$

70. Answer: B

Let the initial quantity of milk in the mixture be a liters.

$$(a + 5)/(8 + 6) = 75/(100 - 75)$$

$$a + 5 = 14 * 3$$

$$a = 37$$

Ratio of the quantity of milk to water in the mixture = $(37 + 5) : (8 + 6) = 42:14 = 3:1$

The quantity of milk left in the final mixture = $42 - 10 * 3/(3 + 1) = 42 - 10 * 3/4 = 34.5$ liters

71. Answer: A

$$(X + 500) * 12 * 2/100 - [X * (1 + 10/100)^2 - x] = 150$$

$$(X + 500) * 24/100 - [X * 121/100 - X] = 150$$

$$24X + 12000 - 121x + 100X = 15000$$

$$X = 3000/3 = 1000$$

$$\text{Required total} = 1000 + (1000 + 500) = \text{Rs.}2500$$

72. Answer: E

Ratio of the profit share of A, B and C = $(1300 * 12) : (1800 * 12) : (1400 * 6)$

$$= 26:36:14 = 13:18:7$$

The difference between the profit share of A and B = $1400 * (18 - 13)/7 = 1400 * 5/7 = \text{Rs.}1000$

73. Answer: D

Pipes P and Q together fill the whole tank = $1.5 * 4/1 = 6$ hours

Pipe R fill the tank = $1/4.5 - 1/6 = (4 - 3)/18 = 1/18 = 18$ hours

Pipes P and R together fill the tank = $3.6 * 5/2 = 9$ hours

Pipe P fill the tank = $1/9 - 1/18 = (2 - 1)/18 = 1/18 = 18$ hours

Required time = $18/2 = 9$ hours

74. Answer: A

Let the speed of the train be a km/hr.

$$150 = a * 5/18 * 22.5$$

$$a = 24$$

$$20 * (24 + x) * 5/18 = 150$$

$$24 + x = 150/20 * 18/5$$

$$x = 27 - 24 = 3$$

75. Answer: B

Let the selling price of the jean be Rs.x.

And the selling price of the shirt = x + 400

$$((x + 400) * 100/110)/(x * 100/120) = 4/3$$

$$3x + 1200 = 4x * 110/120$$

$$11x/3 - 3x = 1200$$

$$2x = 1200 * 3$$

$$x = 1800$$

[Get our Premium Bundle PDF Course](#) [Get our Mock Test Series](#) e-Magazine Dec 2023

The cost price of the jean = $1800 * 100/120 = \text{Rs.}1500$

76. Answer: A

Let the number of sweets in box B = $4x$

The number of sweets in box A = $3x$

The number of sweets in box C = $4x * 1/2 = 2x$

$$(3x + 10)/(2x + 10) = 10/7$$

$$21x + 70 = 20x + 100$$

$$x = 30$$

The number of sweets in box B = $4 * 30 = 120$

77. Answer: D

ACQ,

$$6x * 125/100 + 5x * 120/100 = 1377$$

$$x = 102$$

The total number of employees in company A = $11 * 102 = 1122$

78. Answer: A

Quantity I,

The number of girls in the class = $x - (x - 16) = 16$

$$x * 36 = (x - 16) * 40 + 16 * 30$$

$$36x = 40x - 640 + 480$$

$$4x = 160$$

$$x = 40$$

The total weight of the class = $40 * 36 = 1440 \text{ kg}$

Quantity I > Quantity II

79. Answer: C

Quantity I,

The downstream speed of the boat = $160/8 = 20 \text{ km/hr}$

The speed of the boat in still water = $20 - 3 = 17 \text{ km/hr}$

Required distance = $5 * (17 - 3) = 5 * 14 = 70 \text{ km}$

Quantity II,

The speed of the train = $25 * 18/5 = 90 \text{ km/hr}$

Required distance = $90 * 1.5 = 135 \text{ km}$

Quantity II > Quantity I

80. Answer: E

Quantity I,

Side of the square = $(625)^{(1/2)} = 25 \text{ cm}$

Length of the rectangle = $25 * 180/100 = 45 \text{ cm}$

Breath of the rectangle = $154/2 - 45 = 32 \text{ cm}$

Area of the rectangle = $45 * 32 = 1440 \text{ cm}^2$

Quantity I = Quantity II

1. Doctrine(noun)

a set of beliefs that is taught by a church, political party, etc

Synonyms- dogma, belief, credo

Antonyms- multiculturalism, formalism, nationalism

Example- the doctrine of predestination



2.Strike Down(phrasal verb)

abolish a law or regulation

Synonyms- repealed, set aside

Antonyms- enact, establish, and lay down

Example- the law was struck down by the Supreme Court



3. Scrapped(verb)

to get rid of something that you do not want any more; abolish or cancel (a plan, policy, or law)

Synonyms- throw away, throw out, discard,

Antonyms- keep, preserve, restore

Example- he supports the idea that road tax should be scrapped



4. Precarious(adjecive)

in a dangerous state because of not being safe or not being held in place firmly

Synonyms- dangerous, uncertain, insecure, unpredictable

Antonyms- safe, secure

Example- he made a precarious living as a painter



5. Abstaining(verb)

decline or refuse to work; restrain oneself from doing or enjoying something

Synonyms- quit, cease, renounce

Antonyms- accept, continue, encourage

Example- he abstained from taking part in the discussion



6. Implications(noun)

a likely consequence of something

Synonyms- suggestion, inference,

Antonyms- proof, reality, truth

Example- the implication is that no one person at the bank is responsible



7. Culpable(adjecive)

responsible for something bad that has happened; deserving blame

Synonyms- guilty, at fault, blamable

Antonyms- blameless, innocent

Example- They held her culpable for the accident



8. Lament(verb)

express regret or disappointment about something

Synonyms- bemoan, bewail, and mourn

Antonyms- celebrate, rejoice

Example- she lamented the lack of shops in the town

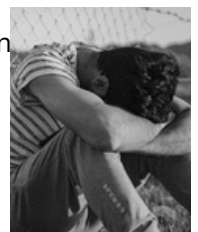

9. Taper off (phrasal verb)

to become gradually less in number, amount, degree, etc.

Synonyms- decrease, diminish

Antonyms- increase, build

Example- Her voice tapered off as she realized everyone was listening

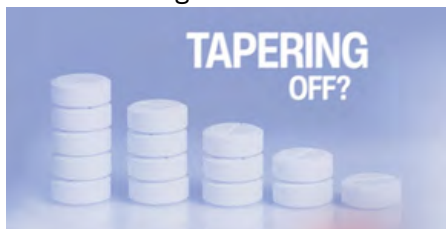

10. Fervor(noun)

very strong feelings about something; enthusiasm

Synonyms- passion, ardour, intensity

Antonyms- apathy

Example- he talked with all the fervor of a new convert



11. Corroborated(verb)

to support a statement, idea, etc, by providing new evidence

Synonyms- Buttress, confirm, endorse

Antonyms- contradict

Example- Alice corroborated what Blair had said



12. Steered(verb)

to take control of a situation and try to influence the way it develops

Synonyms- guide, direct, manoeuvre

Antonyms- undock, refrain,

Example- He steered his car carefully into the parking space



13. Devoid(adjective)

without something; entirely lacking or free from

Synonyms- void, destitute, barren

Antonyms- filled, full of

Example- Lisa kept her voice devoid of emotion

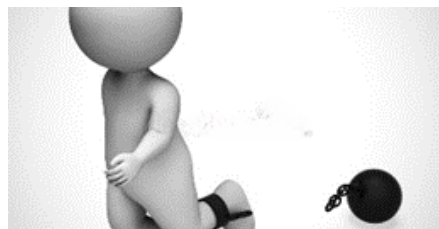

14. Discrepancies(noun)

a difference between two things that should be the same

Synonyms- inconsistency, difference, disparity

Antonyms- similarity, correspondence

Example- there is a discrepancy between your account and his



15. Borne Out(phrasal verb)

support or confirm something

Synonyms- validated, proven, certified

Antonyms- refuted, rebutted, denied

Example- several of these early assumptions were not borne out in the final program



16. Pander(verb)

to provide gratification for other's desires

Synonyms- satisfy, indulge

Antonyms- frustrate, upset

Example- Films that pander to the basest emotions



17. Solidarity(noun)

the support of one group of people for another, because they agree their aims

Synonyms- unanimity, accord

Antonyms- discord, conflict

Example- factory workers voiced solidarity with the striking students



18. Shed light on(phrase)

to make it easier to understand, because more information is known about it

Synonyms- explain, elucidate, and clarify

Antonyms- obscure, complicate

Example- A new approach offers an answer, and may shed light on a bigger question

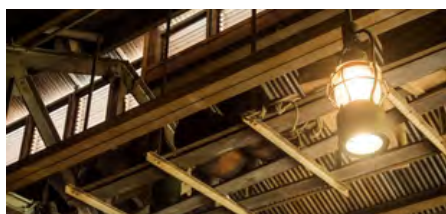

19. Rudimentary(adjecive)

very basic or simple

Synonyms- elementary, introductory

Antonyms- advanced, sophisticated

Example- he received a rudimentary education



20. Tableau(noun)

A graphic description or representation

Synonyms- picture, portrayal,

Antonyms- exclude, Theory

Example- they admired the tableau of the nativity



21. Imperialism (noun)

a system in which a country rules other countries, sometimes having used force to get power over them.

Synonyms- hostility, jingoism, militarism

Antonyms- pacifism, antimilitarism

Example- the struggle against imperialism



22. Faction (noun)

a small group of people within a larger one whose members have some different aims and beliefs to those of the larger group.

Synonyms- infighting, dissent, wrangling

Antonyms- peace, unity, harmony

Example- a council increasingly split by faction



23. Embattled (adjective)

involved in or prepared for war, especially because surrounded by enemy forces.

Synonyms- beset, fortified, strengthen

Antonyms- weaken, hurt, dissuade

Example- the embattled northern province



24. Emphatic(adjective)

said or expressed in a strong way

Synonyms- vehement, firm

Antonyms- hesitant, tentative

Example- his response was immediate and emphatic



25. Capricious(adjective)

changing behavior suddenly in a way that is difficult to predict, unstable

Synonyms- fickle, changeable, vacillating

Antonyms- stable, consistent

Example- a capricious climate



26. Expeditiously(adjective)

with speed and efficiency

Synonyms- hasty, swift, rapid

Antonyms- slowly, leisurely

Example- the directors will move expeditiously to reach a conclusion



27. Abstinence(noun)

the practice of not doing or having something that is wanted or enjoyable

Synonyms- desisting, self-resistant, shunning

Antonyms- promiscuity

Example- I started drinking again after six years of abstinence



28. Buoyed(verb)

to keep somebody happy and confident; keep (someone or something) afloat

Synonyms- cheer, bolster, boost

Antonyms- depress, despondent

Example- she was buoyed up by the warm reception her audience gave her



29. Embarking upon(phrasal verb)

to start something new or important; to begin (a journey)

Synonyms- commencing, starting, opening

Antonyms- finish, end

Example- they embarked on their trip to America with high hopes



30. Spat (noun)

an argument about something not important.

Synonyms- altercation, bickering, feud

Antonyms- concurrence, concord

Example- once she spat on the floor as she walked into the classroom



31. Rift (noun)

a serious disagreement between friends, groups, etc.; a crack, split, or break in something

Synonyms- breach, division, fault, flaw

Antonyms- unification, reconciliation

Example- the rift between the two branches of the legal profession



32. Tryst(noun, verb)

a meeting between two people

Synonyms- appointment, interview,

Antonyms- nonparticipation, separation

Example- the day of the purge itself found her enjoying a tryst at a beach



33. Exhilarating(adjective)

make one feeling very happy or thrilling

Synonyms- excite, rousing, inspiring,

Antonyms- boring, depressing

Example- an exhilarating two-hour rafting experience



34. Glitzy(adjective)

having a fashionable appearance intended to attract attention

Synonyms- flaring, flagrant, overt

Antonyms- secret, moral, concealed

Example- glitzy hotel restaurants



35. Adjudicating(verb)

to make an official decision about who is right in (a dispute): to settle judicially

Synonyms- judge, hear, arbitrate

Antonyms- hesitate, dodge

Example- he was adjudicated bankrupt



36. Imprimatur(noun)

a person's authoritative approval

Synonyms- endorsement, sanction

Antonyms- refusal, criticism

Example- a distinguished scholar from elsewhere gave an imprimatur regarding standards



37. Obstinacy(noun)

the quality or state of being obstinate: stubbornness

Synonyms- intransigence, rigidity, firmness

Antonyms- submissive

Example- his reputation for obstinacy



38. Luminary(noun)

a person of prominence or brilliant achievement

Synonyms- master, expert, leader

Antonyms- nobody, pleb

Example- various leading luminaries of the arts were invited



39. Linger(verb)

stay in a place longer than necessary because of a reluctance to leave

Synonyms- remain, loiter, and dawdle

Antonyms- leave, vanish

Example- the tourists didn't linger very long



40. Asserted(verb)

to say something clearly and firmly

Synonyms- declare, state, pronounce

Antonyms- deny, disclaim

Example- the company asserts that the cuts will not affect development



declare [diklɛər]

41. Reckon(verb)

to think; to have an opinion about something; establish by calculation

Synonyms- compute, evaluate, and estimate

Antonyms- discredit, renounce

Example- the event was reckoned a failure



42. In tatters(idiom)

badly damaged or completely spoiled

Synonyms- impaired, ruin

Antonyms- fair, well-kept

Example- after the newspaper story appeared his reputation was in tatters



43. Dovetailed(verb)

fit or cause to fit together easily and conveniently

Synonyms- join, correlate, and concur

Antonyms- clash, fight, and differ

Example- plan to enable parents to dovetail their career and family commitments



44. Deleterious(adjective)

causing harm or damage

Synonyms- detrimental, injurious, pernicious

Antonyms- beneficial, advantageous

Example- divorce is assumed to have deleterious effects on children



45. Conundrum(noun)

a confusing and difficult problem or question

Synonyms- riddle, quandary, enigma

Antonyms- solution, boon, breakthrough

Example- one of the most difficult conundrums for the experts



46. Hurtling(verb)

to move with great speed, perhaps causing danger

Synonyms- rush, chase, and dash

Antonyms- go slowly

Example- a runaway car hurtled towards them



47. Stint(noun)

a fixed period of time that you spend doing something

Synonyms- stretch, session, shift

Antonyms- entertainment, pastime

Example- his varied career included a stint as a magician



48. Salutory(adjective)

producing a beneficial effect

Synonyms- productive, profitable

Antonyms- unwelcome, irrelevant

Example- the accident was a salutary reminder of the dangers of climbing



49. Refrain(verb)

to stop yourself doing something; to not do something

Synonyms- abstain, desist, and hold back

Antonyms- consume, ingest

Example- she refrained from comment



50. Conspicuous(adjecive)

easily seen or noticed

Synonyms- visible, observable, evident

Antonyms- subtle, unobtrusive

Example- she showed conspicuous bravery



51. Vexatious(adjecive)

difficult to deal with and causing a lot of anger, worry, or argument

Synonyms- Annoying, vexing, irksome

Antonyms- pleasant, agreeable

Example- His home, however vexatious, was the source of his greatest art

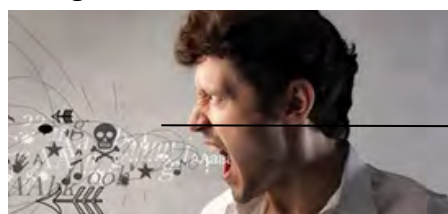

52. Unfettered(adjecive)

not controlled or limited by anyone or anything

Synonyms- unrestrained, unrestricted

Antonyms- restricted, fettered

Example- unfettered artistic genius



53. Preempt(verb)

to prevent something from happening by taking action to stop it

Synonyms- prevent, forestall, and anticipate

Antonyms- aid, assist, allow

Example- the second session will focus on policies to pre-empt problems



54. Reprieve(verb)

to delay or cancel the punishment of (someone, such as a condemned prisoner)

Synonyms- spare, acquit, pardon

Antonyms- charge, punish

Example- he was sentenced to death but then reprieved



55. Abrupt(adjecive)

sudden and unexpected

Synonyms- immediate, startling, precipitate

Antonyms- gradual, unhurried

Example- I was surprised by the abrupt change of subject



56. Relinquish(verb)

to stop having or doing something

Synonyms- give up, renounce

Antonyms- keep, retain

Example- he relinquished his managerial role to become chief executive



57. Stalking(verb)

to follow a person over a period of time in a frightening or annoying way

Synonyms- trail, creep up on

Antonyms- ignore, flee, let go

Example- a cat stalking a bird



58. Clout(noun)

influence or power, especially in politics or business

Synonyms- leverage, dominance

Antonyms- impotence, lethargy

Example- I knew she carried a lot of clout



59. Usher in(phrasal verb)

to welcome someone, or signal the beginning of something

Synonyms- initiate, inaugurate, commence

Antonyms- dodge, disregard

Example- the party was an elegant way to usher in the New Year



60.Vagaries(noun)

an unexpected and inexplicable change in a situation or in someone's behavior

Synonyms- fluctuation, quirk, caprice

Antonyms- stable, fixed

Example- the vagaries of the weather



61. Reinforce(verb)

to make something stronger

Synonyms- underpin, assist, enrich

Antonyms- fade, rebut, and wane

Example- the captain sent out another squad to reinforce the troops



62. Abysmal(adjecitive)

extremely bad; of very poor quality

Synonyms- dreadful, appalling, deplorable

Antonyms- superb

Example- the quality of her work is abysmal



63. Setback(noun)

a difficulty or problem that stops you progressing as fast as you would like

Synonyms- issue, hitch, impediment

Antonyms- breakthrough, step forward

Example- a serious setback for the peace process



64.Supine(adjecitive)

done or acting with insufficient attention

Synonyms- sluggish, indifferent

Antonyms- proactive, tenacious

Example- the supine attitude of some of our politicians



65. Envisage(verb)

to think of something as being possible in the future; to imagine

Synonyms- foresee, forecast

Antonyms- neglect, disbelieve

Example- I can't envisage her coping with this job



66. Seditious(noun)

Language or behavior that is intended to persuade other people to oppose their government

Synonyms- agitation, incitement

Antonyms- peaceful, togetherness

Example- the leaders of the group have been arrested and charged with seditious



67. Toppled(verb)

to become less steady and fall down

Synonyms- tumble, overturn, and plummet

Antonyms- rise, uprising, and ascend

Example- she toppled over when I touched her



68. Touting(verb)

to advertise, talk about, or praise something or someone repeatedly

Synonyms- talked up, reviewed

Antonyms- abnormal, unusual

Example- Sanjay was touting his wares



69. Insurrection(noun)

violent action against the rulers of a country or the government

Synonyms- rebellion, revolt

Antonyms- relinquishment, surrender, succumbing

Example- the insurrection was savagely put down



70. Egging on(phrasal verb)

to urge or encourage(someone) to do something that is usually foolish or dangerous

Synonyms- exhort, stimulate, spur

Antonyms- hold back, discourage

Example- he continued to take off his clothes while the crowd egged him on



71. Demit(verb)

resign from (an office or position)

Synonyms- abandon, abdicate, and step down

Antonyms- takes over, claims

Example- arguments within his congregation led to his demitting his post



72. Demagoguery(noun)

a leader who makes use of popular prejudices and false claims and promises in order to gain power

Synonyms- troublemaker, incendiary

Antonyms- conciliator, placate

Example- a gifted demagogue with particular skill in manipulating the press



73. Subordinate(adjective/noun)

having less power or authority than somebody else

Synonyms- inferior, minor, lower

Antonyms- superior, senior

Example- Nearly all her subordinates adored her



74. Scrupulously(adverb)

in a very careful and thorough way

Synonyms- conscientious, upright

Antonyms- inaccurate, negligent

Example- the policies must be scrupulously observed



75. Battered (adjective)

having suffered repeated violence from a spouse, partner, or parent; (of a thing) damaged by age and repeated use.

Synonyms- assaulted, thrashed

Antonyms- unbroken, uninjured

Example- a pair of battered black boots



76. Enormity(noun)

the very great size, effect, etc. of something; the fact that something is very serious

Synonyms-wickedness, depravity

Antonyms- goodness

Example- the enormities of war



77. Intriguingly(adverb)

in a way that is very interesting because it is unusual or does not have an obvious answer

Synonyms- fascinate, alluring

Antonyms- bore

Example- an intriguing story



78. Cohesive(adjective)

something that sticks together literally or figuratively

Synonyms- coherent, compatible

Antonyms-incoherence, detached

Example- their tribe is a small but cohesive group



79.Acrimony(noun)

angry and bitter feelings or words

Synonyms- bitterness, rancour, resentment

Antonyms- goodwill

Example-the AGM dissolved into acrimony



80. Stymie(verb)

to prevent somebody from doing something/ to prevent something from happening

Synonyms- impede, hamper

Antonyms- assist, help

Example- the changes must not be allowed to stymie new medical treatments



81. Arbitrary(adjective)

not seeming to be based on any reason or plan and sometimes seeming unfair

Synonyms- whimsical, erratic, random

Antonyms- rational, reasoned

Example- an arbitrary decision



82. Delve into(phrasal verb)

to search in order to find a thing or information

Synonyms- explore, investigate, audit

Antonyms- approve, overlook, neglect

Example- Now is not the time to delve into the past



83. Browbeating(verb)

to frighten or threaten somebody in order to make him/ her do something

Synonyms- bully, hector, intimidate

Antonyms- praise, compliment

Example- a witness is being browbeaten under cross-examination



84.Indiscriminately(adverb)

in a way that does not show careful choice or planning, usually with harmful results

Synonyms- haphazard, unsystematic

Antonyms- selective, discriminating

Example- this indiscriminate use of antibiotics can cause problems



85. Dunce(noun)

a person who is slow at learning; a stupid person

Synonyms- moron, imbecile, cretin

Antonyms- intellectual, genius

Example- he was baffled by arithmetic and they called him a dunce at school



86.Exacerbated(verb)

to make something worse, especially a disease or problem

Synonyms- aggravate, inflame

Antonyms- calm, reduce

Example- the exorbitant cost of land in urban areas only exacerbated the problem



87. Discretionary(adjective)

available for use at the discretion of the user

Synonyms- unrestricted, optional, voluntary

Antonyms- mandatory, compulsory

Example- the company used to give discretionary bonus payments



88. Hails from(phrasal verb)

to come from or have been born in a particular place

Synonyms- come from, originate in

Antonyms- disparage, slam, blame

Example- his father hailed from Italy



89. Grapples with(phrasal verb)

to try to deal with or understand a difficult problem or subject

Synonyms- struggle, contend, and tussle

Antonyms- avoid, free, idle

Example- the grappled desperately for control of the weapon



90. Pegged(verb)

to fix or keep something at a certain level; to understand what kind of person someone is

Synonyms- secure, ranked, limit

Antonyms- confused, scrambled

Example-the salesman had me pegged in a matter of minutes



91. Entrants (noun)

a person who enters a profession, competition, exam, university, etc.

Synonyms- newcomer, beginner, recruit

Antonyms- veteran

Example- the prize will be awarded to the entrant who wins the tiebreak

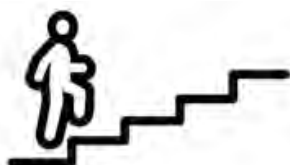

92. Resurgence(noun)

the return and growth of an activity that had stopped

Synonyms- renewal, revival, recovery

Antonyms- downturn, abasement

Example- the small town restaurant noticed resurgence in business after the shopping mall closed



93. Heralded(verb)

to be a sign that something is going to happen soon

Synonyms- signal, indicate, announce

Antonyms- retracted

Example- the speech heralded a change in policy



94. Overtures(noun)

an approach made to someone in order to discuss or establish some something

Synonyms- prelude, introduction, preliminary

Antonyms- rebuff, denial

Example- the talks were no more than an overture to a long debate



95. Burgeoning(adjective)

beginning to grow or increase rapidly

Synonyms- flourishing, shoot up, prospering

Antonyms- shrink

Example- the result has been a burgeoning budget surplus



96. Relegated(verb)

to put somebody/something into a lower level or position

Synonyms- downgrade, demote

Antonyms- upgrade, promote

Example- They aim to prevent women from being relegated to a secondary role



97. Parvenus (noun)

a person of humble origin who has gained wealth, influence, or celebrity

Synonyms- upstart, arriviste

Antonyms- stale, nonmodern

Example- the political inexperience of a parvenu



98. Vociferous (adjective)

expressing your opinions or feelings in a loud and confident way.

Synonyms- vehement, outspoken

Antonyms- silent, quiet

Example- he was a vociferous opponent of the takeover



99. Succor (noun)

help or sympathy given to somebody who is suffering or has problems

Synonyms- assistance, support, aid

Antonyms- unkindness, disservice

Example- he wounded had little chance of succor



100. Stalemate (noun)

a situation in an argument in which neither side can win or make any progress

Synonyms- deadlock, impasse

Antonyms- advance, acceptance, equilibrium

Example- the war had again reached stalemate



ONE GOAL, ONE DREAM - MISSION SELECTION 2024

PREMIUM BUNDLE PDF COURSE 2024

UIIC Assistant PDF Course Included

STARTS FROM

₹599

EXTRA 10% Off

USE CODE: GUIDELY10

*Special Offer For PRIME Users

Highlighting Segments

- Beginners Bundle Quiz Course
- Topic-Wise Bundle Course
- Exam-Wise Bundle PDF Course
- Section-Wise Bundle PDF Course
- Memory Based Questions Bundle Course
- Prelims Scoring Part Bundle Course
- Mains Booster Bundle Course
- Critical Reasoning Bundle Course
- Mains Two Mark Questions Bundle Course
- Daily Editorial Based English Questions PDF
- Special Quants Arithmetic Bundle Course
- Special DI & Caselet Bundle Course
- Special Puzzles & Seating Bundle Course
- 101 Version 2.0 New Pattern Puzzles & DI Questions
- Current Affairs Bundle PDF Course
- Static Banking & Static GK Bundle Course
- Computer Awareness Bundle Course

One Time Offer Ends Soon - Hurry!!!

GRAB IT NOW