

GET SMART

# THE CONNECTED SHOP



**SMART DOOR LOCK**  
USER MANUAL

Your step-by-step guide for installing, configuring, and connecting your Smart Door Lock Slim.

This device is engineered for ease of use and is compatible with various modern door types, including main entry doors, bedroom doors, sliding doors, and traditional swing doors.

This lock is designed to seamlessly replace existing door handles, ensuring both convenience and security.



# SUMMARY

---

## I. Before Installation



a) Packaging List.....	Page 4
b) Device Details.....	Page 6
c) Handle Direction.....	Page 7
d) Clutch Direction.....	Page 8

## II. Device Installation



a) Remove Existing Lock.....	Page 9
b) Insert New Mortise.....	Page 9
c) Install Cylinder Lock.....	Page 9
d) Adjust Keyhole.....	Page 9
e) Install Lock Handles.....	Page 10
f) Insert Cable Cord.....	Page 10
g) Install New Batteries.....	Page 10

## III. Device Programming



a) Reset & Keypad Legend.....	Page 11
b) Access Door Lock Settings.....	Page 12
c) Add Administrator.....	Page 13
d) Delete Administrator.....	Page 14
e) Add User.....	Page 15
f) Delete User.....	Page 17
g) Date and Time Settings.....	Page 18
h) Volume Adjustment.....	Page 19
i) Language Setting.....	Page 20
j) Passage Mode.....	Page 21

# SUMMARY

---

## IV. Mobile App Connection



- a) Download the Mobile App.....Page 22
- b) Log In & Register.....Page 22
- c) Reset Password.....Page 23
- d) Add Locations.....Page 24
- e) Connect To Network.....Page 26
- f) Add Devices.....Page 27
- g) Add Members.....Page 32

## V. Mobile App Features



- a) Access Log Records.....Page 33
- b) Alert Notifications.....Page 33
- c) Dynamic Password.....Page 34
- d) Temporary Password.....Page 34
- e) Remote Unlock.....Page 35

## VI. Additional Information







- a) Auto Lock.....Page 36
- b) Wrong Password Lockout.....Page 36
- c) Low Battery Notifications.....Page 36

## I. BEFORE INSTALLATION





## a) Packaging List

<p>1. Handles</p> 	<p>The smart door handles that will replace your current door handles on your door.</p>
<p>2. Mortise</p> 	<p>The lock mechanism to fit in the pocket cutout into your door's edge. This is paired with the smart door lock handles</p>
<p>3. Strike Plate</p> 	<p>The metal plate on the doorjamb for the lock bolt to engage in. This comes with the mortise.</p>
<p>4. Cylinder Lock</p> 	<p>The lock cylinder for the physical backup key to unlock the smart door lock.</p>
<p>5. Metal Rod/Spindle</p> 	<p>The metal rod connecting the door handles to the lock mechanism inside the door.</p>

## I. BEFORE INSTALLATION



## a) Packaging List

6. Screws		The screws hold the lock handles firm on the door and the mortise in position inside the door.
7. Mechanical Keys		Physical backup keys to open the lock in case of low battery.
8. Key Cards		The plastic cards with magnetic data used as a door key.

## I. BEFORE INSTALLATION



### b) Device Details

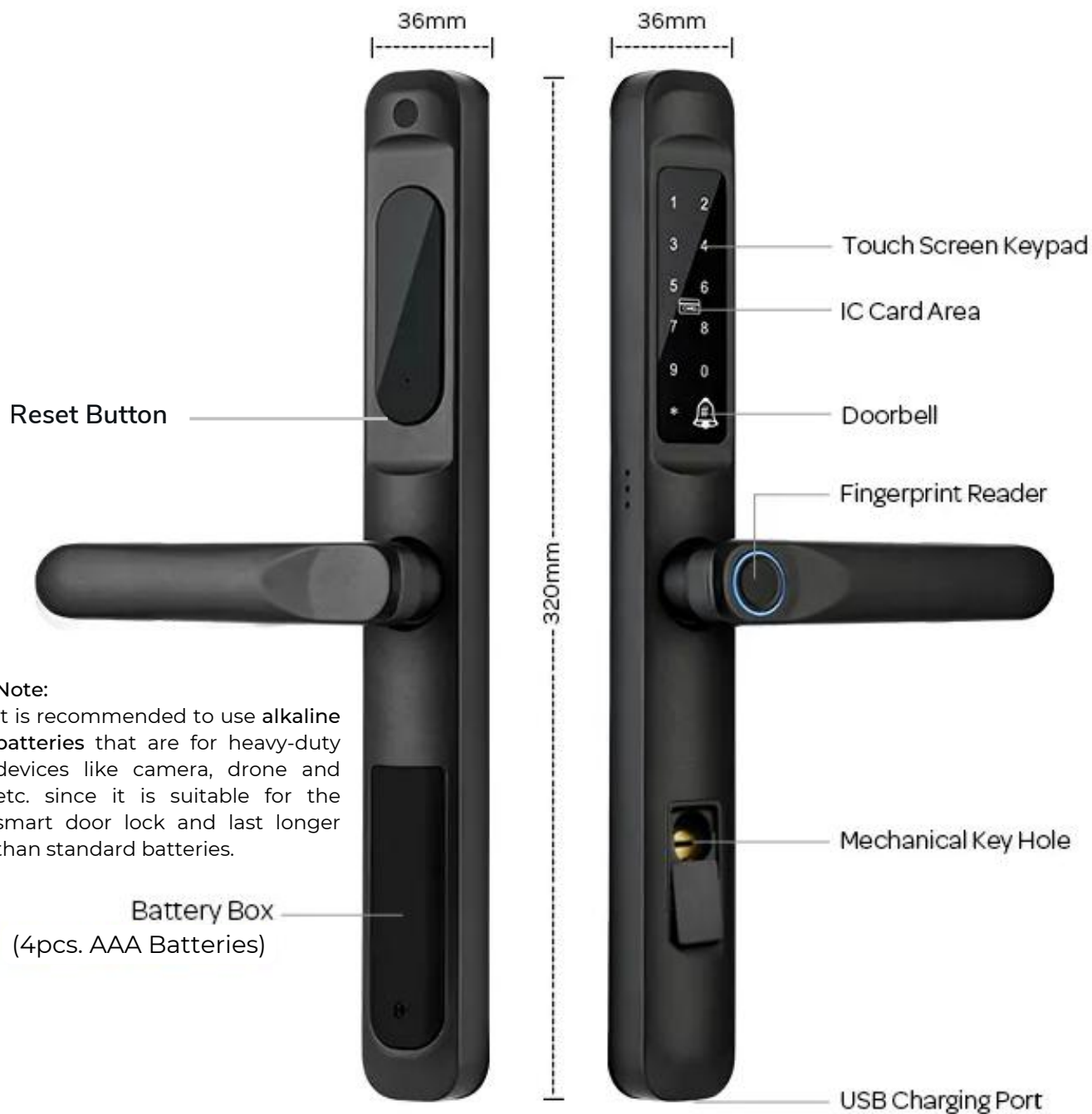

**Note:**

It is recommended to use **alkaline batteries** that are for heavy-duty devices like camera, drone and etc. since it is suitable for the smart door lock and last longer than standard batteries.

## I. BEFORE INSTALLATION



### c) Handle Direction (Optional)

To adjust the handle direction on the Smart Lock based on your door's opening or orientation, ensure the handle is properly aligned before securing the screws.

Please refer to the video below:



#### **Important Note:**

Verify that the handle returns to its correct position after adjustment; otherwise, it may become misaligned or too loose.

## I. BEFORE INSTALLATION



### d) Clutch Direction (Required)

Before installing the lock, it's crucial to correctly set the clutch to ensure proper functionality of the locking mechanism.

If your door handle faces left, align the letter "L" with the arrow. If the door handle faces right, align the letter "R" with the arrow. This alignment is essential for the lock to operate smoothly.

The clutch is located behind the center of the door handle. Refer to the diagram below:

Right door clutch direction adjustment:

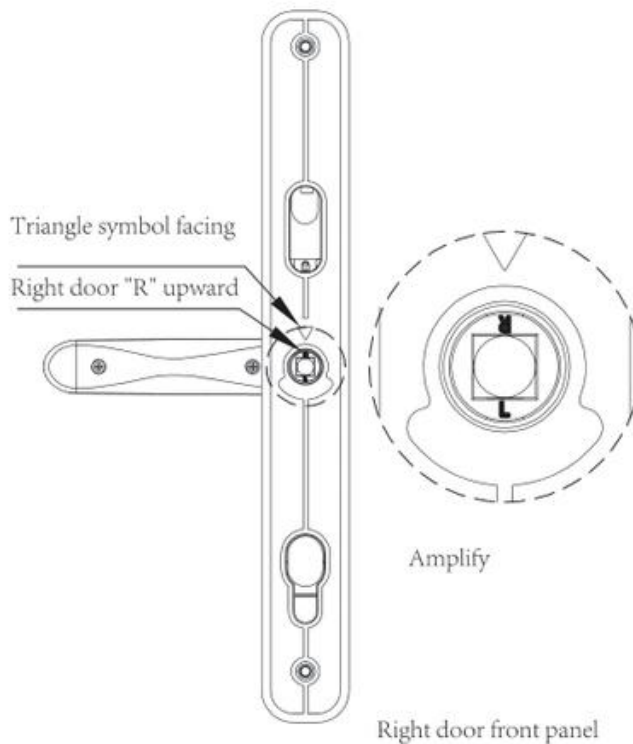

Left door clutch direction adjustment:

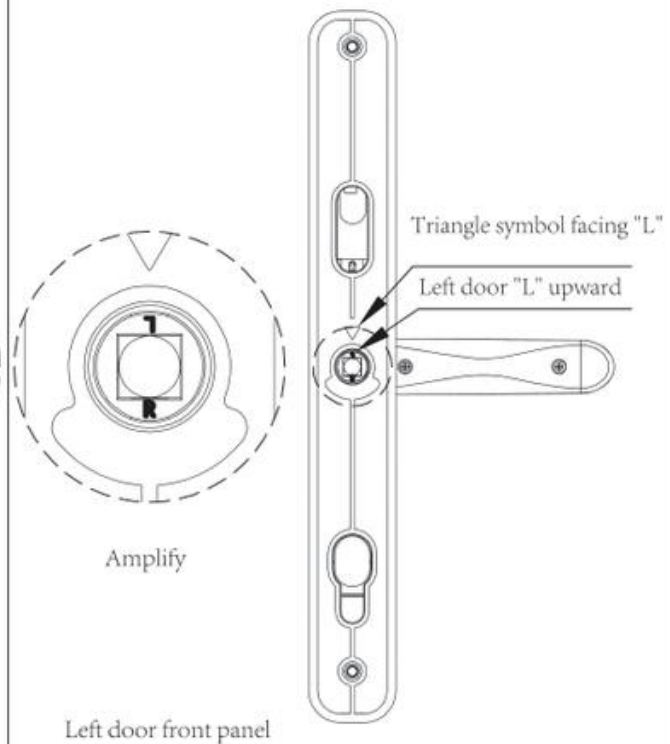

Once the clutch is adjusted correctly, the smart door lock will be secure, and entry will only be possible using a fingerprint, passcode, or keycard.

#### Important Note:

If the clutch direction is not set correctly, the smart lock will not function properly, even though the system may indicate it is "locked."

## II. DEVICE INSTALLATION



### a) Remove Existing Lock

Begin by unscrewing the bolts that secure your current door knob. Carefully pull out the existing lock.

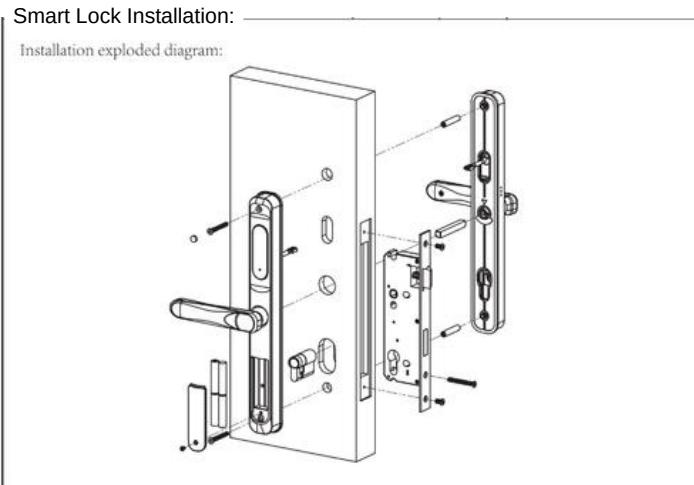

### b) Insert New Mortise

- Insert the new Mortise and Strike Plate into the door frame.
- Secure them by tightening the screws on the top and bottom sides.
- Ensure that the latch bolt is positioned at the top side of the lock.

### c) Install Cylinder Lock

Position the Cylinder Lock using the Cylinder Fixing Screws as indicated in the diagram below.

### d) Adjust Keyhole

- Make sure the keyhole is facing the exterior of the door.
- Insert the key and rotate it to ensure the bolt retracts smoothly.
- Once confirmed, securely fasten the screw.

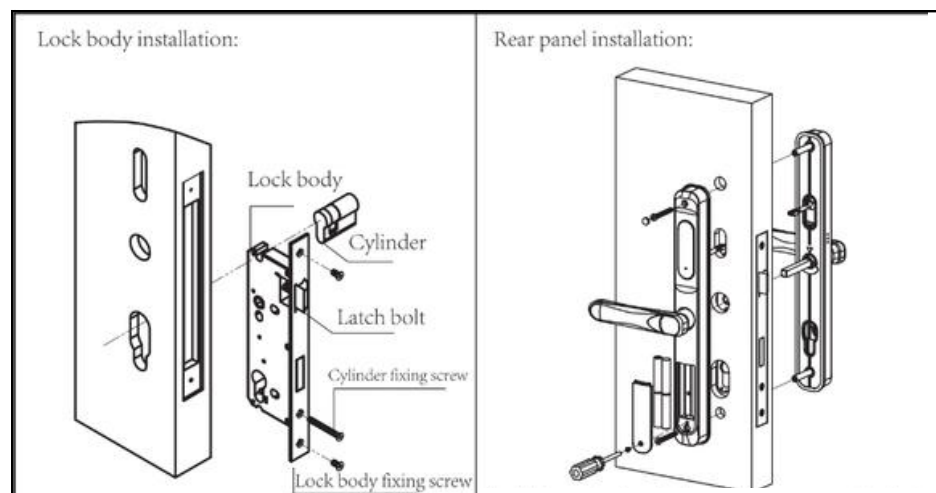

## II. DEVICE INSTALLATION



### e) Install Lock Handles

Secure the Front Handle to the door by inserting the Metal Rod into the middle hole behind the handle. Ensure the positioning pin pops out and holds the handle in place. Use the Lock Body Screws to pass the Metal Rod through the door, securing the handle firmly.

### f) Insert Cable Cord

Insert the power cord from the Front Handle through the door to connect it to the Back Door Handle.



### g) Install New Batteries

After fixing both handles with screws, insert the batteries into the designated compartment. Close the compartment by placing the cover on top and securing it with screws.

### III. DEVICE PROGRAMMING



#### a) Reset & Keypad Legend

To ensure that your smart lock is in its initial state before programming, perform a reset.

Locate the small hole on the battery compartment cover of the inside lock panel, which serves as the reset button. Using a pin or similar object, press and hold this button for 5 seconds until you hear the voice prompt, "Initialization Successful."

Alternatively, you can reset the lock by pressing "4" followed by "#" on the keypad after entering your user information.



\* = to go back or return.

# = to enter or confirm everytime you input a code

 = to request remote unlock and send a notification to the app

123456 = the default administrator information.

#### Note:

Under the initial state, any fingerprint, keycard, and password can unlock or open the smart lock.

### III. DEVICE PROGRAMMING



#### b) Access Door Lock Settings

- To begin programming the lock, touch the keypad, and you'll hear a "Hello" prompt.
- Then, press \* followed by #, and the voice prompt will say, "Please enter Administrator Authorization." If no code, fingerprint, or card has been added yet, the default administrator code is 123456.
- Press # to confirm.
- Once successfully entered, you'll hear a voice command confirming the operation.
  - "Press 1 - Create New User"
  - "Press 2 - Delete User"
  - "Press 3 - System Settings"
  - "Press 4 - Factory Reset"

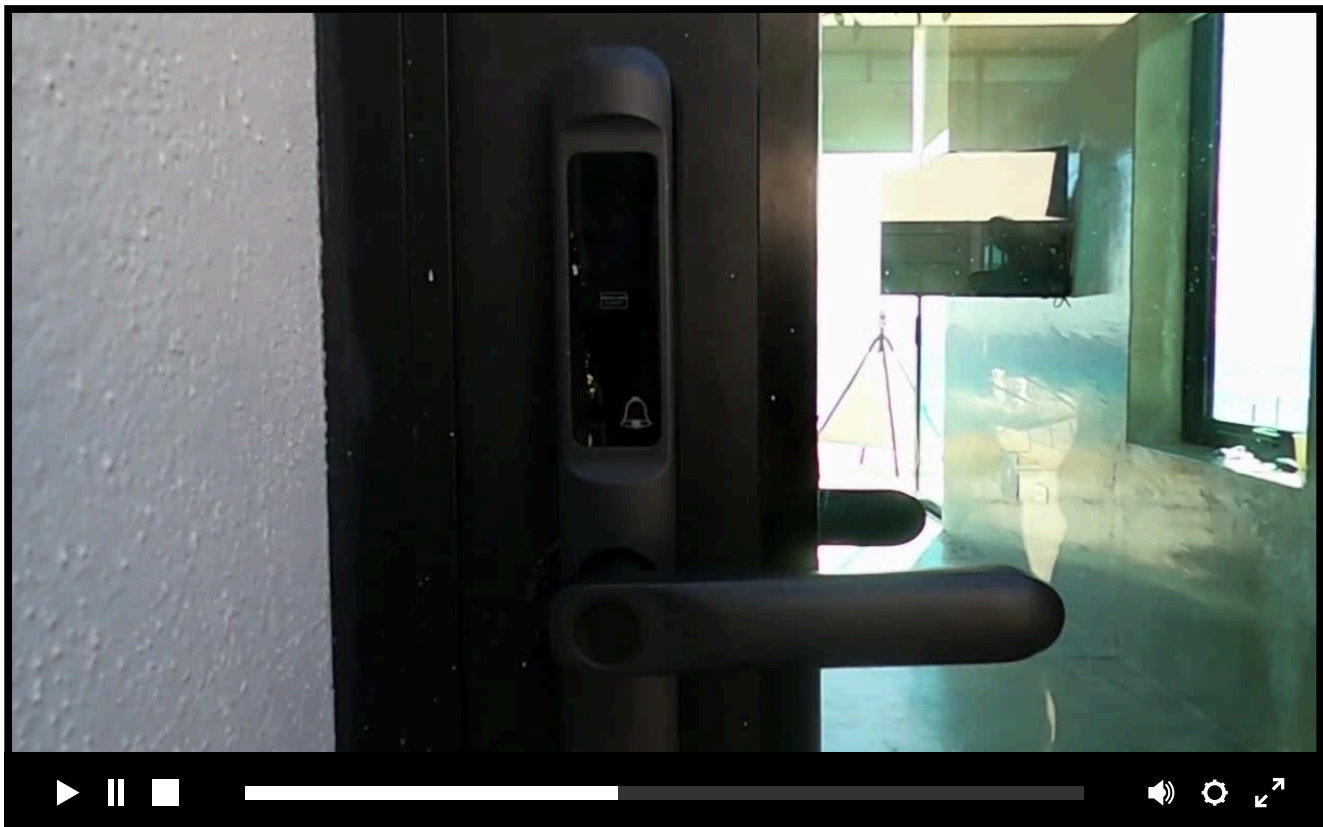

### III. DEVICE PROGRAMMING



#### c) Add Administrator

Make sure to reset the lock before adding an administrator for the first time. The Administrator will be User 00 and can be set up using a passcode, fingerprint, or card.

To add an Administrator for the first time:

- Access settings by pressing \* and #, then enter 123456 followed by #.
- Press 1 to "Add User."
- A voice prompt will say, "User 00, please enter the secret key." This is your cue to add a 6-8 digit passcode, your fingerprint, or a key fob/card as the administrator.

Instructions for Input:

- Fingerprint: Place your finger on the sensor 4 times.
- Passcode: Enter a 6-8 digit passcode twice.
- Keycard: Swipe the card once.

You'll be prompted to "please enter again" after each input. Follow the instructions until you hear "Operation Succeed," which confirms successful registration.

- If you don't want to add more users, either press the \* key to return to the main menu or let the lock time out on its own.



### III. DEVICE PROGRAMMING



#### d) Delete Administrator

To delete an administrator, you must reset the lock entirely.

- To reset the lock, please refer to page 11 of this user manual.



### III. DEVICE PROGRAMMING



#### e) Add User

To add a user, follow these steps:

- Activate your Smart Lock by pressing the \* and # keys and then enter your Administrator Password.
- Select option 1 to "Add User."
- A voice prompt will instruct, "Please enter the User ID."

User IDs for standard users begin with "01" onwards, while "User 00" is reserved for the administrator. Enter a two-digit User ID on the keypad (e.g., "01"). The system will then prompt, "User 01, please enter the secret key."

Instructions for Input:

- Fingerprint: Place your finger on the sensor 4 times.
- Passcode: Enter a 6-8 digit passcode twice.
- Keycard: Swipe the card once.

Refer to the video on the next page.

### III. DEVICE PROGRAMMING



The system may prompt, "Please enter again." Follow the instructions until you receive a confirmation stating "Operation Succeed."

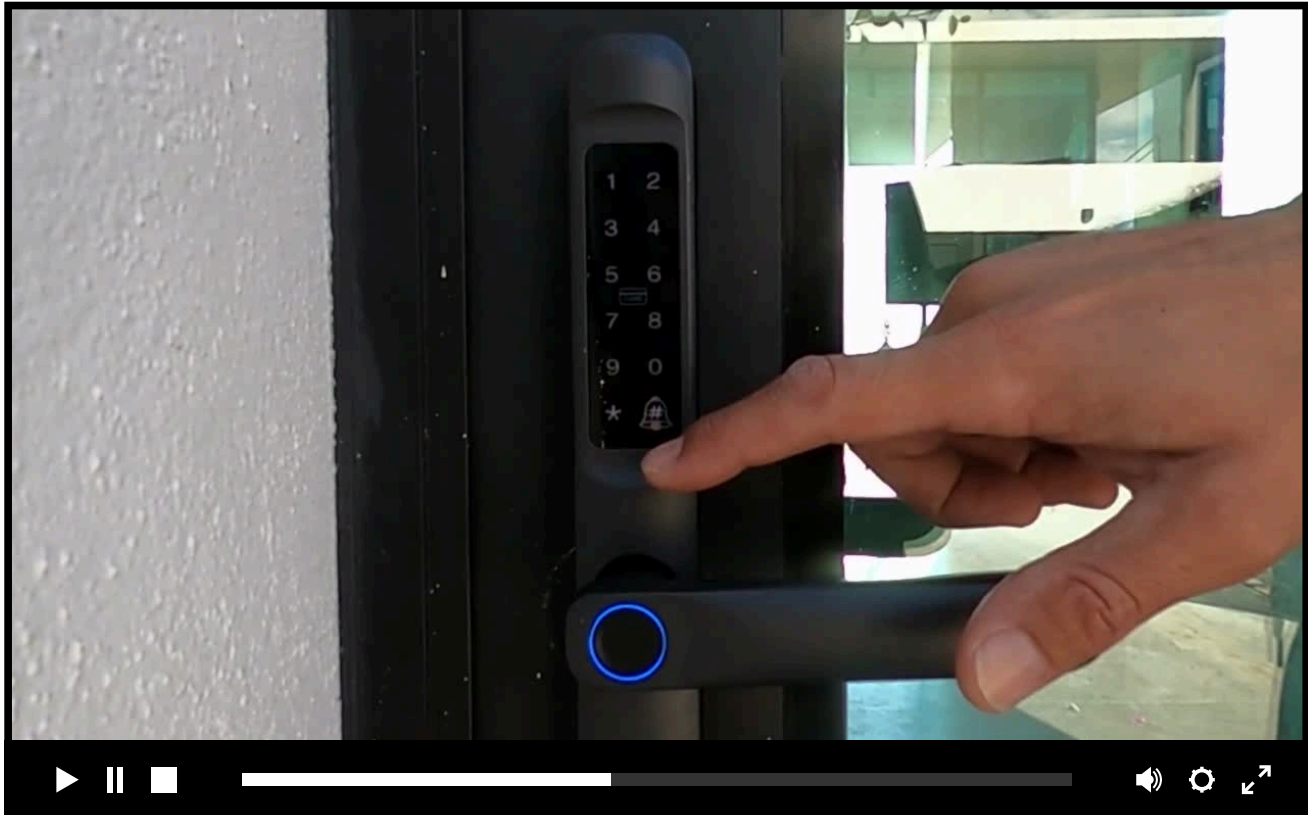

Note: Once the system confirms "Operation Succeed," the user information has been successfully registered. If the lock continues to prompt "Please enter the secret key," it allows you to add additional user details (such as another code, fingerprint, or keycard). If you do not wish to add more information, either press the \* key to return to the main menu or wait for the session to time out.

### III. DEVICE PROGRAMMING



#### f) Delete User

To delete a user from your Smart Lock, follow these steps:

- Activate your Smart Lock by pressing the \* and # keys and then enter your Administrator Password.
- Select option 2 for "Delete User."
- A voice prompt will request, "Please enter the User ID."

User IDs for regular users start from "01" onwards, while "User 00" is designated for the administrator. Identify the User ID you wish to delete, enter it, and press # to confirm (e.g., "03 #").

After the operation is completed, press the \* key to either add another user, delete another user, or exit the settings menu.

### III. DEVICE PROGRAMMING



#### g) Date and Time Settings

To set the time and date on your Smart Lock, follow these steps:

- Activate your Smart Lock by pressing the \* and # keys and then enter your Administrator Password.
- Follow the voice command and press 3.
- Continue following the voice command and press 1.
- When prompted, enter the desired date and time in the specified format:
  - *Year/Month/Day (e.g., 22/11/06 for November 6, 2022)*
  - *Hour/Minute (e.g., 11/01 for 11:01 AM)*

Complete the process by following the remaining voice commands to save the new settings.

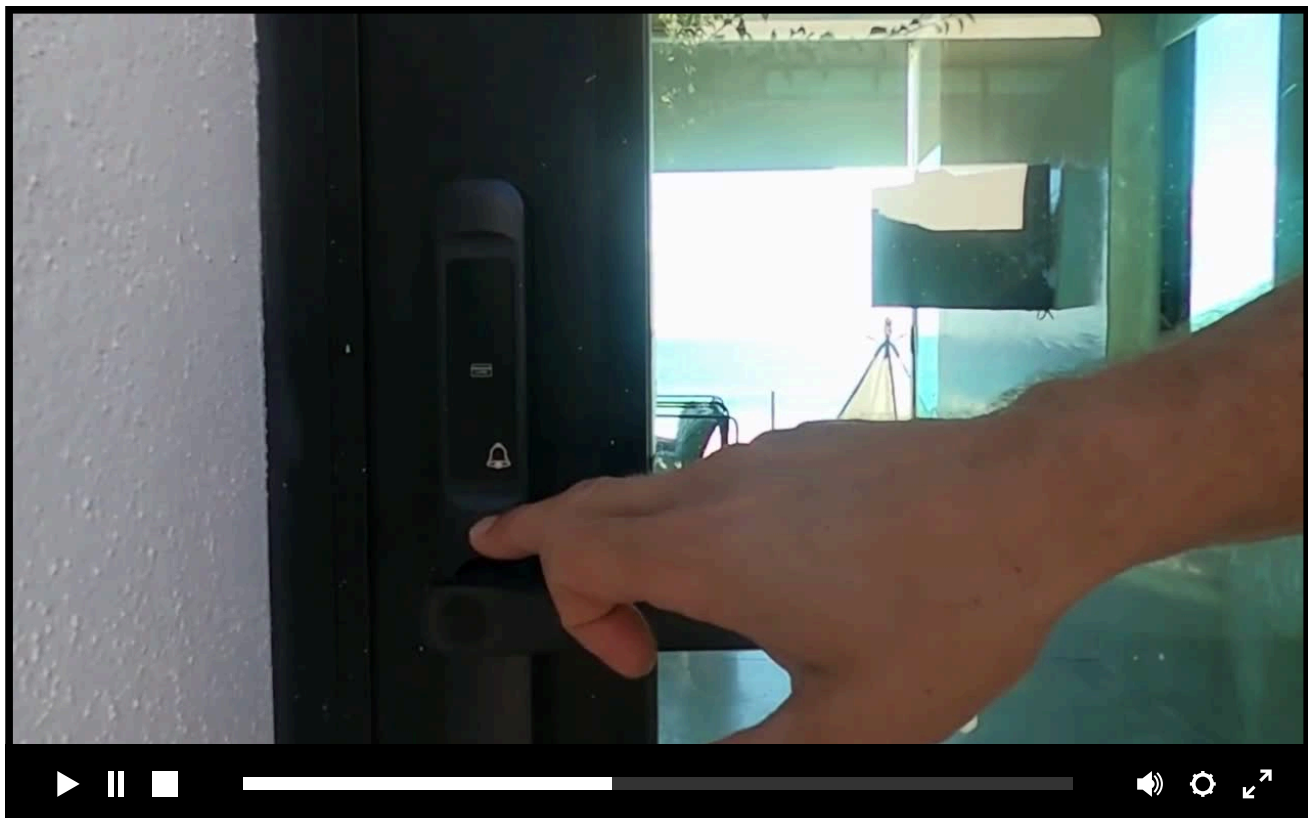

### III. DEVICE PROGRAMMING



#### h) Volume Adjustment

To adjust the volume on your Smart Lock, follow these steps:

- Activate your Smart Lock by pressing the \* and # keys and entering your Administrator Password.
- Follow the voice command and press 3.
- When prompted, press 2 to access the volume settings.
- To adjust the volume:
  - Press 1 to increase the volume.
  - Press 2 to decrease the volume.

Repeat as needed to achieve the desired volume level.

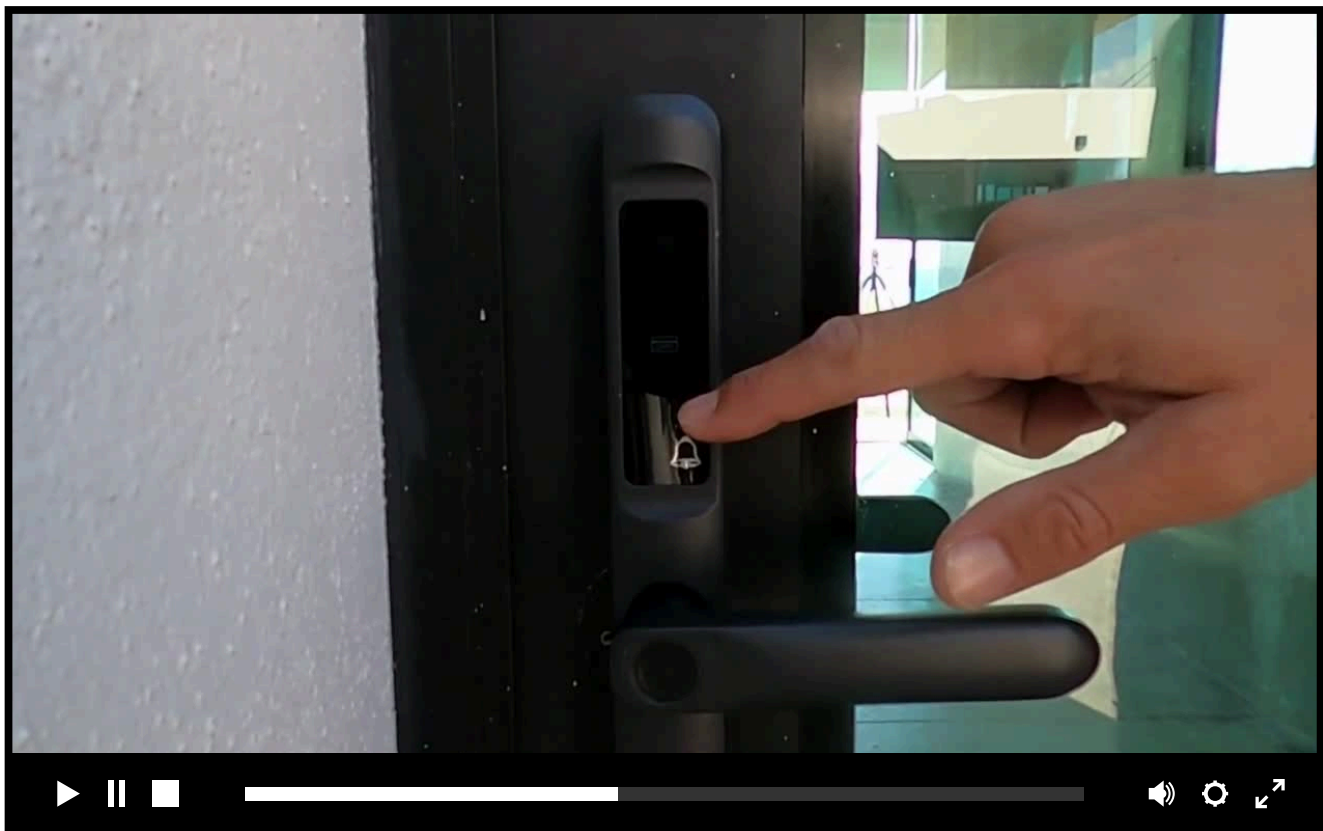

### III. DEVICE PROGRAMMING



#### i) Language Setting

To set the language of your Smart Lock to English, follow these steps:

- Activate your Smart Lock by pressing the \* and # keys, then enter your Administrator Password.
- Follow the voice command and press 3.
- Continue following the voice command and press 4 to access the language settings.
- Follow the voice prompts and press 2 to select English as the language.

Complete the process by confirming the selection as instructed.



### III. DEVICE PROGRAMMING



#### j) Passage Mode

To enable Passage Mode on your Smart Lock, allowing it to remain unlocked for a certain period, follow these steps:

- Activate your Smart Lock by pressing the \* and # keys, then enter your Administrator Password.
- Follow the voice command and press 3 to access the System Settings.
- Continue following the voice command and press 5 for Passage Mode.
- Follow the voice prompts:
  - Press 1 to disable Passage Mode.
  - Press 2 to enable Passage Mode.

Complete the process by confirming your selection as instructed.



## IV. MOBILE APP CONNECTION



### a) Download The Mobile App

Download the app from the Google Play Store or Apple App Store by searching for “Tuya Smart” or by scanning the provided QR code.



Look for the Tuya Smart Logo



### b) Log In and Register

- After downloading, select your country.
- You will be redirected to register via email.
  - For existing users, log in using your registered email and password on the login page.
- A verification code will be sent to your email; enter it in the app within the specified time limit.
- Once the verification code is entered, you will be prompted to set your password.
- After completing these steps, you will have full access to the Tuya Smart app on your mobile phone to start adding your device.

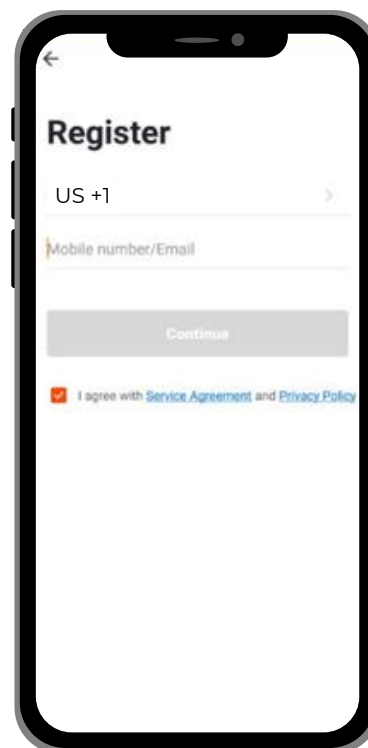

## IV. MOBILE APP CONNECTION



### c) Reset Password

- On the login page, click the “Forgot Password” button located below the “Login” button.
- Select your country, which the app will usually detect automatically, and proceed with the password reset process.
- Enter your email address to receive a verification code.
- Once you receive the code, enter it into the app within the allotted time.
- You will then be prompted to set a new password, giving you full access to the Tuya Smart Platform.

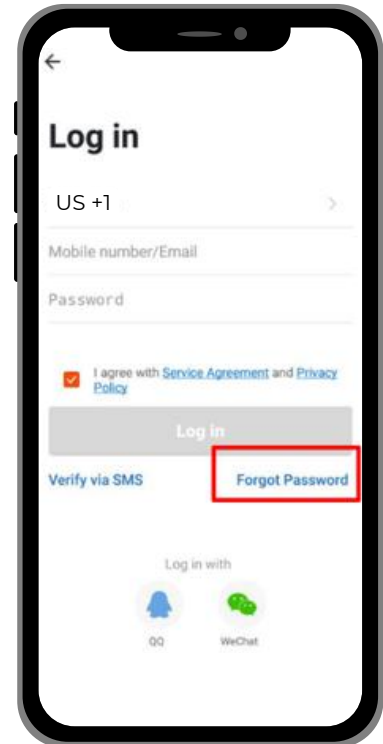

## IV. MOBILE APP CONNECTION



### d) Add Locations

- Tap the button in the top-left corner of the screen and select 'Home Management' from the dropdown list.
- A single account can manage multiple locations simultaneously, allowing the user to operate multiple devices within a selected location.

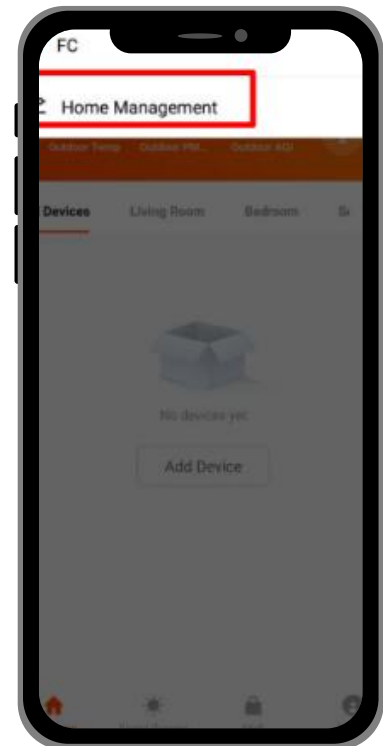

## IV. MOBILE APP CONNECTION

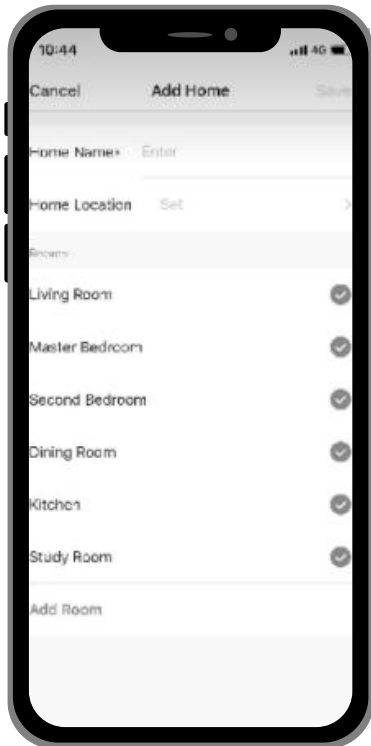

- If you already have a Home set up, click 'Join a Home.' If not, click 'Create a Home.'
- Enter the required details on the screen and click 'Confirm.'

Note: Other household members will have the ability to control the smart devices registered to this household, but they will not have the authority to modify, add, or delete devices.

## IV. MOBILE APP CONNECTION



### e) Connect To Network

To pair your Smart Lock with the mobile app:

- Press "1" followed by "#" on the keypad, then enter your Administrator Passcode.
- The device will automatically begin searching for the network.
- Keep the mobile app open and close to the device to ensure successful pairing.
- Wait for the loading screen on your phone to complete before exiting the app.

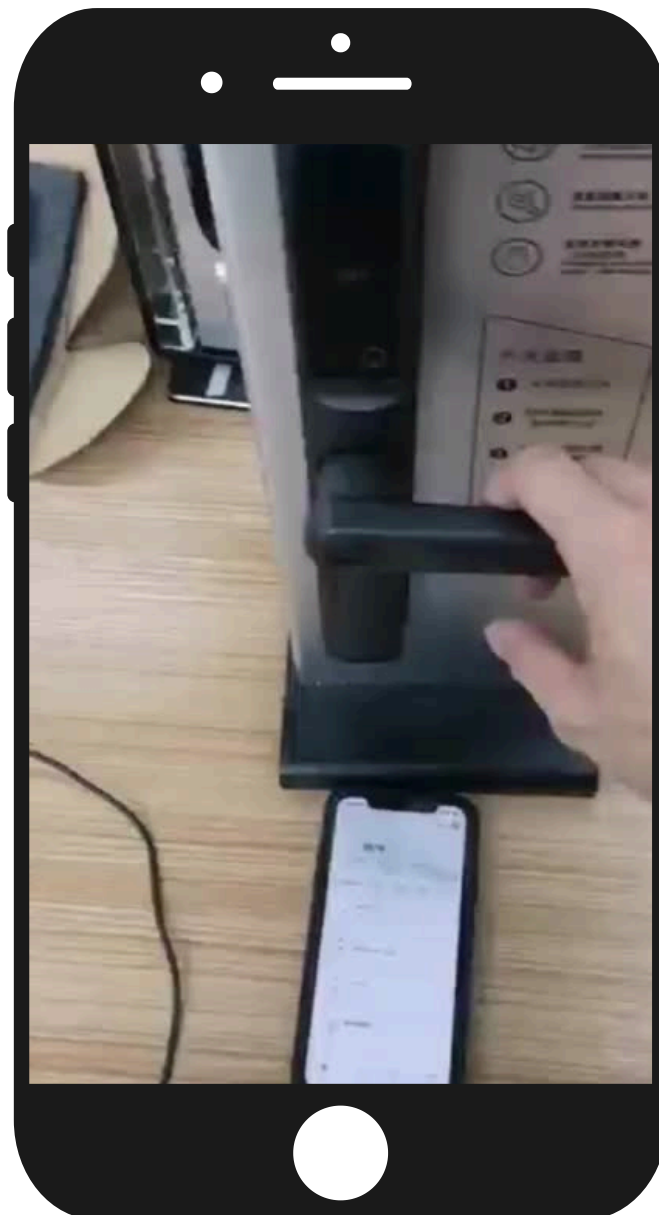

## IV. MOBILE APP CONNECTION



### f) Add Devices

- Ensure that both your devices and phone are connected to the same 2.4GHz Wi-Fi network.
- To connect the lock to the app, touch any button on the keypad to light it up.
- Press "1" followed by "#". The lock will then prompt you for administrator information. If no administrator is set, enter the default code "123456" and press "#" to confirm.
- The lock's hotspot will now be activated. Make sure you have the Tuya Smart app downloaded on your phone.

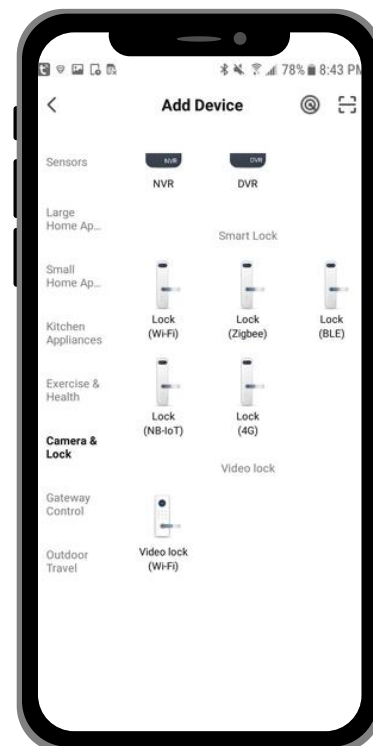

## IV. MOBILE APP CONNECTION

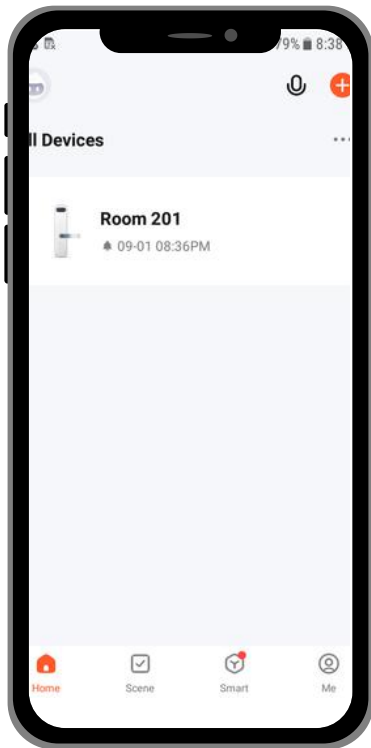

- To add a device, tap 'Add Device' or the "Plus" button at the top-right corner of the app screen, and select 'Add Device.'
- From the list of devices, choose 'Camera & Lock' on the left side, then click 'Lock (Wi-Fi)' to select your Smart Lock device.

Follow the remaining prompts to complete the setup process.

## IV. MOBILE APP CONNECTION

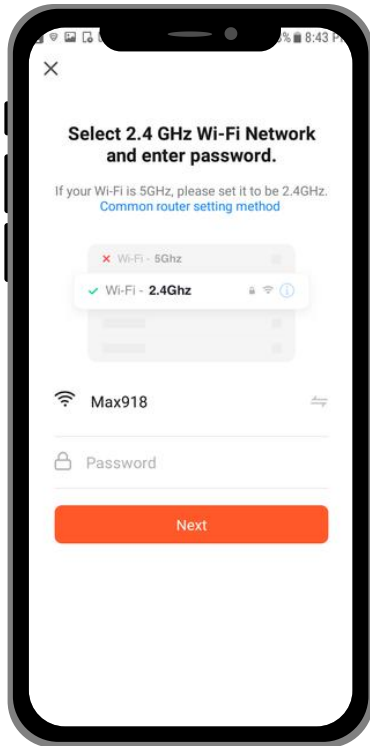

- You will be prompted to connect the Smart Lock to your 2.4 GHz home WiFi network. Ensure that you input the WiFi password correctly. Next, select AP mode and confirm that the indicator light is blinking. At the same time, make sure that the "0" is blinking on the keypad.
- Then, go to your phone's Settings > WiFi, refresh the page, and find the "Smart Life xxx" connection. Connect to this network.
- Do not worry if the connection shows "no internet," as this is the lock's hotspot that will connect to your home WiFi network.

Note: Ensure that both your phone and the Smart Lock are connected to the 2.4 GHz WiFi network, not a 5 GHz or other network, as the lock will not be added to the app on other connections.

Note: Ensure that both your phone and the Smart Lock are connected to the 2.4 GHz WiFi network, not a 5 GHz or other network, as the lock will not be added to the app on other connections.

## IV. MOBILE APP CONNECTION



- Check if the light indicator is blinking.
- After tapping the 'Confirmation' button, you will be prompted to select the current status of the light indicator. You will have two options:
  - AP Mode ("Access Point mode"): This uses access points like a Wi-Fi Hotspot. If you choose AP Mode, you must connect your phone to the lock or device's hotspot before proceeding to the next step.
  - EZ Mode ("Easy-connect mode"): This mode is generally most compatible if you are directly connecting your phone to the Wi-Fi router.

Select the appropriate mode based on your current setup to continue.

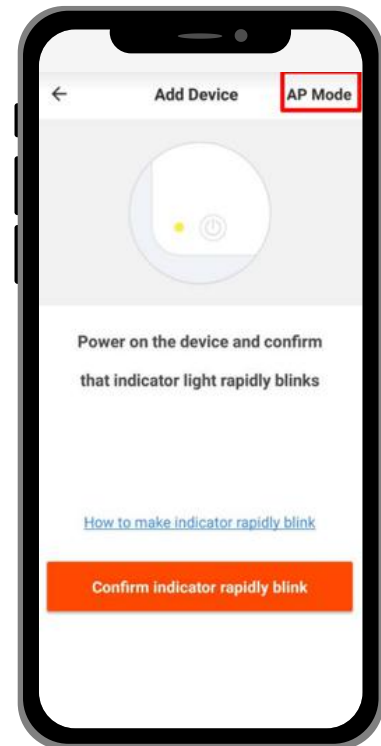

## IV. MOBILE APP CONNECTION



- After completing these steps, ensure that your phone and the device are close. You will receive a prompt on both the lock and your screen confirming that the pairing was successful.

- Once pairing is completed, you can proceed to finish adding your device. Afterward, you have the option to change the device's name and manage its functions as needed.

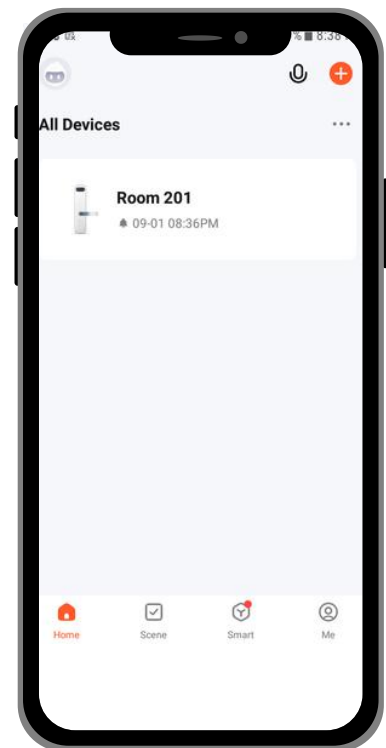

## IV. MOBILE APP CONNECTION



### g) Add Members

To grant others access to a device by adding them as members of a specific location or room, follow these steps:

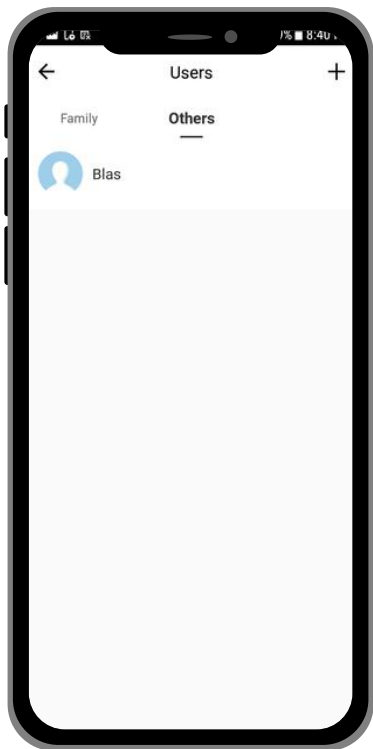

- Tap the 'Me' tab at the bottom-right corner of your screen.
- Click on 'Home Management.'
- Select the location where you want to add the new member.
- Tap 'Add Member' and choose the method to share the invitation with the new member.

## V. MOBILE APP FEATURES



### a) Access Log Records

- From the Home Page, select the Smart Lock you want to review.
- Click on 'Records' to access the unlock history.

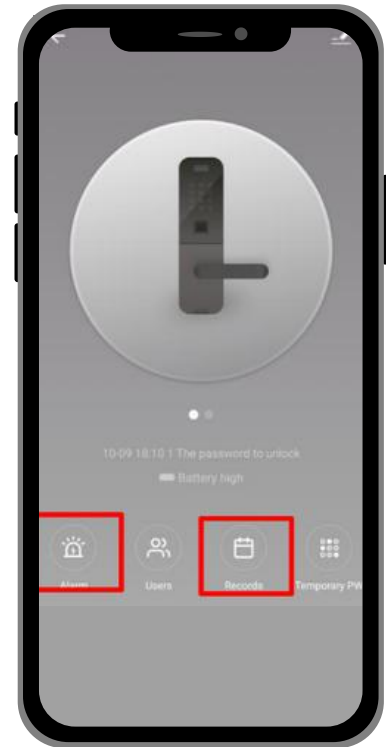

### b) Alert Notifications

- From the Home Page, select the Smart Lock you wish to use.
- Choose the 'Alarm' option to view the history of the lock, including any instances where it may have been compromised or when an incorrect password was entered.

## V. MOBILE APP FEATURES



### c) Dynamic Password (optional)

- Tap the 'Key' button on your phone screen to generate a Dynamic Password (a short-term password valid for only a few minutes).
- Enter the Dynamic Password on the lock pad to unlock the device.

### d) Temporary Password (optional)

- On the Lock Screen, tap the 'Temporary PW' button located at the bottom right.
- Click 'Add' and set the temporary password, the name of the user, and the start and end date/time. Ensure that the time on your mobile app and the lock are synchronized.
- Click 'Done' in the top-right corner to complete the setup.
- Activate the lock pad, enter the temporary code you created, and press '#' to confirm and enable the temporary lock function.

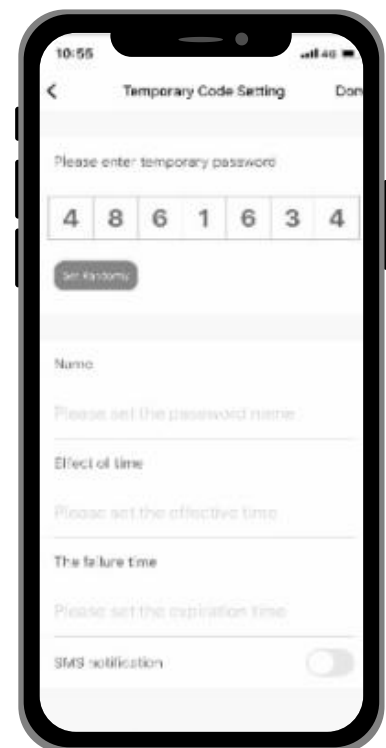

## V. MOBILE APP FEATURES



### e) Remote Unlock

To grant access to someone when you are away, instruct them to either press '9' and '#' on the Lock Pad or press the Doorbell button. This action will send a notification or request to your mobile app, allowing you to confirm and remotely unlock the door.

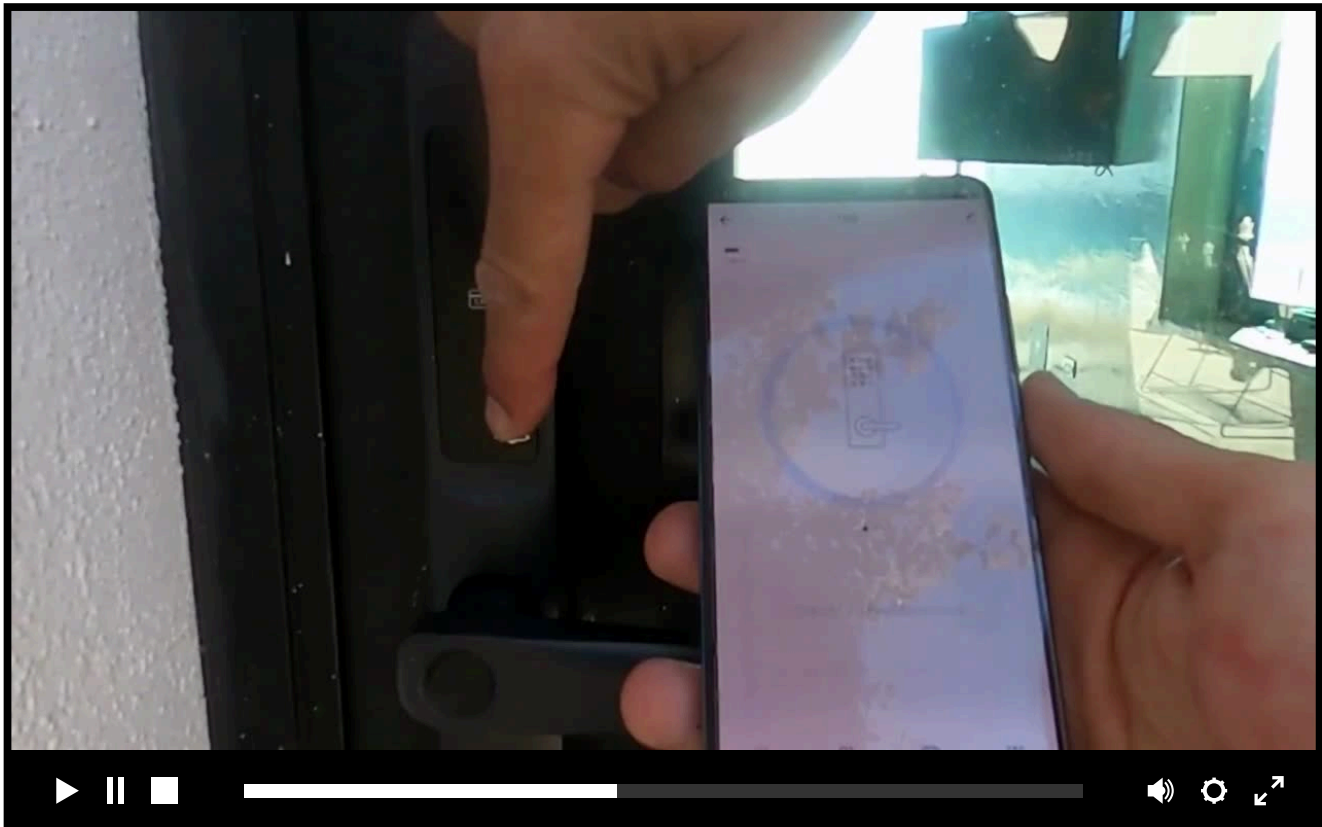

## VI. ADDITIONAL INFORMATION



### a) Auto Lock

The system will automatically exit if there is no operation for over 10 seconds.

### b) Wrong Password Lockout

If an incorrect password is entered more than five times consecutively, the keypad will lock for 30 seconds and will not respond to any input during this time.

### c) Low Battery Notifications

When the battery is low, the lock will emit a sound each time it is opened. After the alarm sounds, the lock can only be opened 200 more times. Once this limit is reached, each unlocking attempt will be delayed by 5 seconds. It is essential to replace the batteries before reaching the 200 unlock limit.

Congratulations!

You have successfully installed your very own Smart Door Lock Slim.  
Thank you for being a valued customer of The Connected Shop.

[THECONNECTEDSHOP.COM](http://THECONNECTEDSHOP.COM)

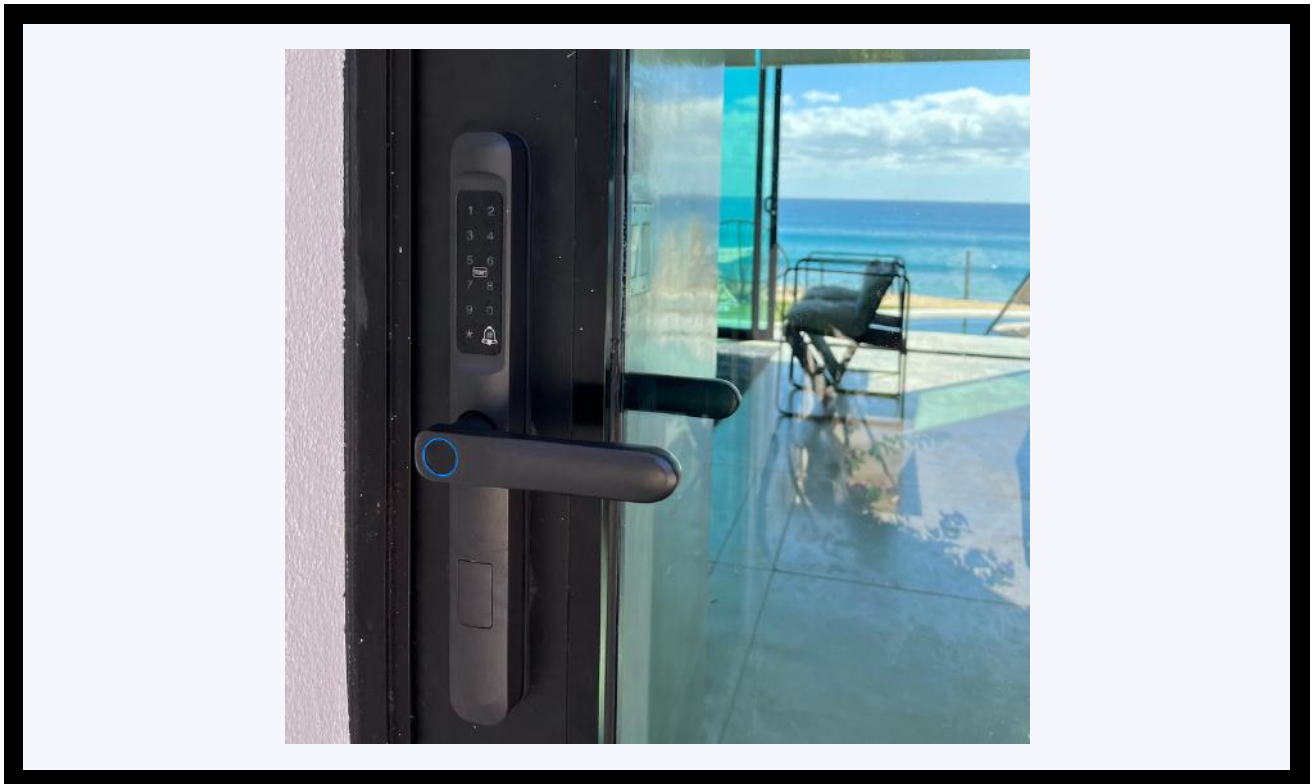



GET SMART

THE  CONNECTED SHOP