

GET SMART

THE CONNECTED SHOP



SMART DOOR LOCK
USER MANUAL

Welcome to the Smart Door Lock XL User Manual. Your easy, step-by-step guide to install, set up, and connect your Smart Door Lock XL. The device is designed to be easy-to-use and to replace all modern door knobs—be it on the main door, bedroom door knobs, and so on—for the new, modern geek smart fingerprint door lock. The locks can also be utilized as a smart lock for a sliding door and traditional swing doors.



SUMMARY

I. Device Installation



1. Installation Guide
 - a) Installation Video

II. Initialization



2. Initial State of your Smart Lock
 - a) Access door lock settings
 - b) Add Administrator
 - c) Delete Administrator
 - d) Add User
 - e) Delete User
 - f) Verification Mode
 - g) Language Setting
 - h) Time and Date Settings
 - i) Volume Adjustment
 - j) Factory Reset
 - k) Anti-prying Setting

III. Mobile App Connection



3. Registering on the Mobile App
 - a) Downloading the Mobile App
 - b) Logging In & Registering
 - c) Resetting your Password
 - d) Adding Locations
 - e) Adding Devices
 - f) Adding Members

IV. Device Functions



4. Functions

- a) Remote Functions over Mobile App
- b) Dynamic Password
- c) Remote Unlock

V. Additional Information



5. Other Notes

PACKAGING DETAILS



1	Front Smart Lock Handle	6	Lock Body Screws
2	Mortise and Mortise Screws	7	M5 Countersunk Head Screws
3	Strike Plate	8	Mechanical Key
4	Metal Rod	9	Key Fobs/Cards
5	Back Smart Lock Handle	10	Wristband Key

STEP BY STEP SMART LOCK INSTALLATION GUIDE



1. INSTALLATION



Smart Lock Installation:

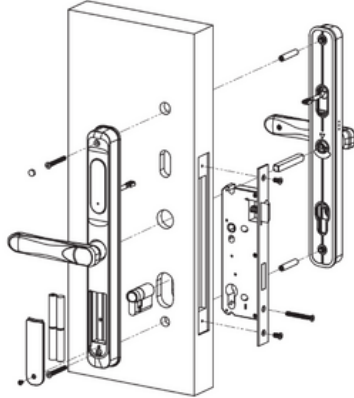

- a. Start by removing your current lock. This is generally done by unscrewing the bolts and pulling out your current door knob.
- b. Insert your new (2) Mortise and (3) Strike Plate into the door frame. Tighten the (2) Mortise Screws on the top and bottom sides. Making sure the latch bolt is on the top side of the lock.

c. Affix the (1) Front Door Handle unto the door. Insert the (4) Metal Rod into the middle hole behind the handle. Install the handle by passing the Metal Rod through the door with the use of the (6) Lock Body Screws.

Rear panel installation:

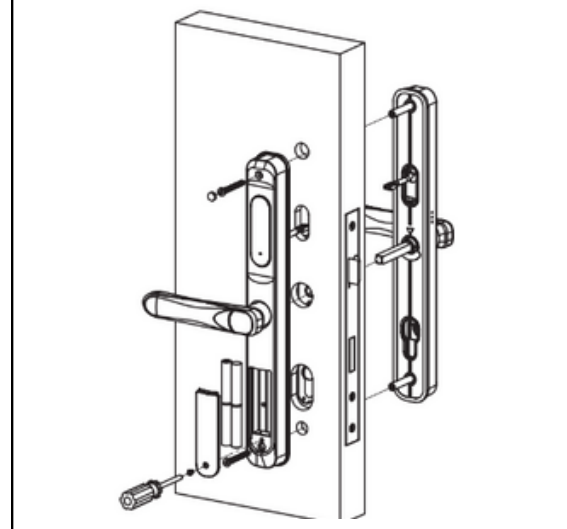

1. INSTALLATION



- f. Insert the power cord of the Front Handle through the door to connect it to the (5) Back Door Handle.
- g. After both handles are fixed with the (7) M5 Countersunk Head Screws, install the batteries in its compartment. Place the cover on top and close it with the screws.



2. INITIAL STATE OF YOUR SMART LOCK



- The factory administrator initial password is 123456#
- Under the initial state, any fingerprint, keycard, and password can open the lock.

a) Access Door Lock Settings (Step 1)

- To activate your Smart Lock, quickly press '*' and then press '#'
- You will hear the voice prompt to enter the Administrator Information (For first time users, try to enter 123456#)
- After the successful operation, you will hear the following voice command:
 - "Press 1 - Administrator Setting"
 - "Press 2 - User Setting"
 - "Press 3 - System Settings"
 - "Press 4 - Restore Factory Reset"



2. INITIAL STATE OF YOUR SMART LOCK



b) Add Administrator

- Activate your Smart Lock (Press '*' and '#') and enter the initial Administrator Password (123456#)
- Follow the voice command. Press 1 for Administrator Settings and then press 1 again to add an administrator
 - Input the intended fingerprint 4 times
 - Input a 6-8 digit password 2 times
 - Input an Keycard 1 time
- After the successful operation, press '*' to continue to add another administrator or delete an administrator

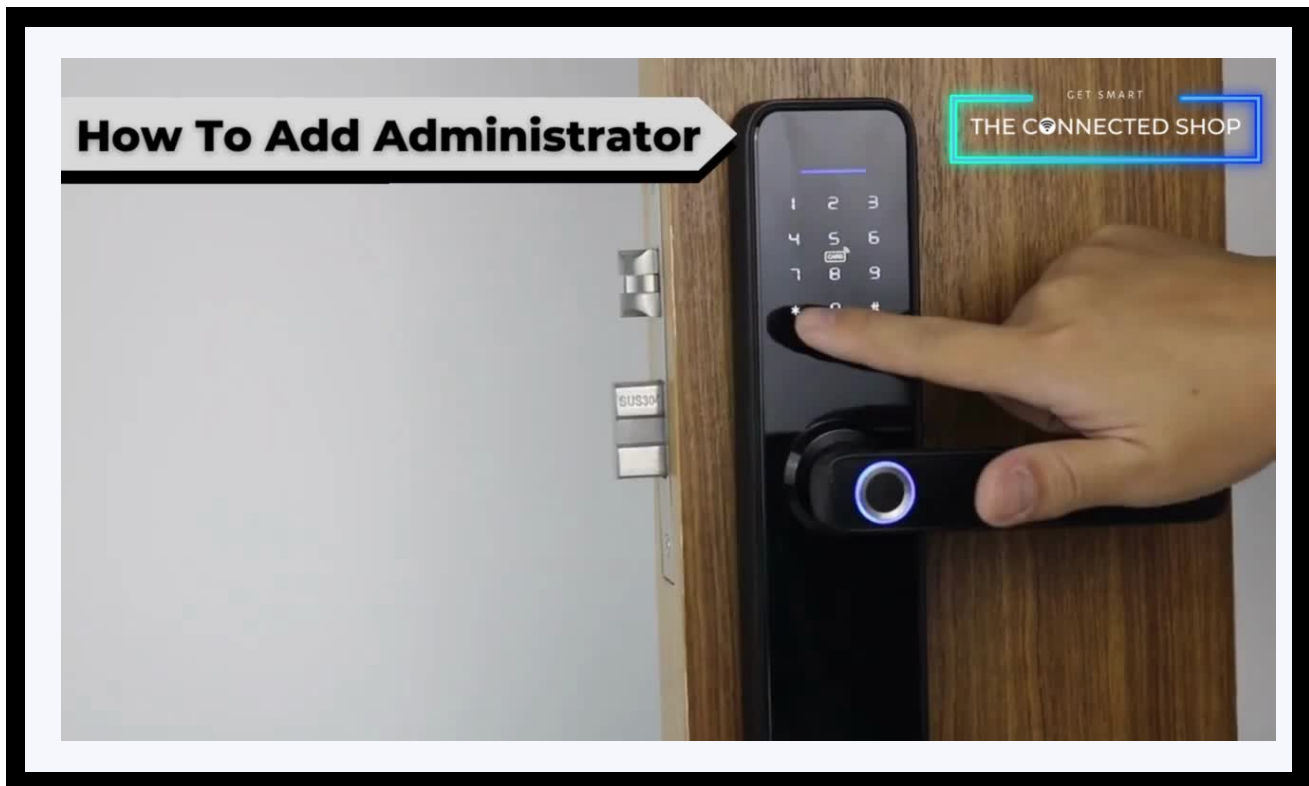

2. INITIAL STATE OF YOUR SMART LOCK



c) Delete Administrator

- Activate your Smart Lock (Press '*' and '#') and enter your Administrator Password
- Follow the voice command. Press 1 for Administrator Settings and then press 2 to delete an administrator
- Enter the number of the Administrator you intend to delete
- Press '#' to confirm (e.g., 003 #)
- After the successful operation, press '*' to continue to add an administrator or delete another administrator



2. INITIAL STATE OF YOUR SMART LOCK



d) Add User

- Activate your Smart Lock (Press '*' and '#') and enter your Administrator Password
- Follow the voice command and press 2 for User Settings. Press 1 to add a user
 - Input the intended fingerprint 4 times
 - Input a 6-8 digit password 2 times
 - Input an Keycard 1 time
- After the successful operation, press '*' to continue to add another user or delete a user

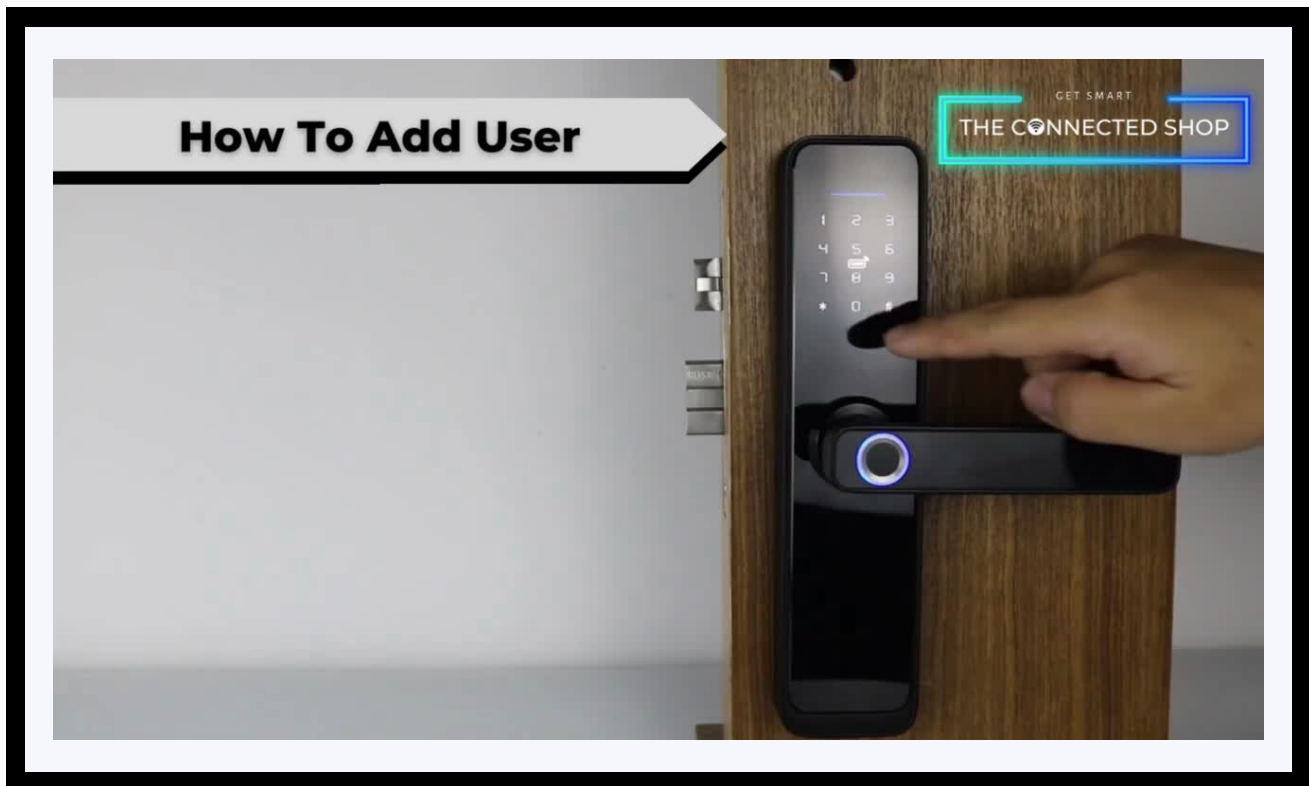

2. INITIAL STATE OF YOUR SMART LOCK



e) Delete User

- Activate your Smart Lock (Press '*' and '#') and enter your Administrator Password
- Follow the voice command and press 2 for User Settings. Press 2 again to delete a user
- Enter the number of the User you intend to delete by pressing 1
- Press '#' to confirm (e.g., 011 #)
- After the successful operation, press '*' to continue to add a user or delete another user



2. INITIAL STATE OF YOUR SMART LOCK



f) Verification Mode

- To add extra security for your lock with this mode, activate your Smart Lock (Press '*' and '#') and enter your Administrator Password
- Follow the voice command and press 3
- Follow the voice command and press 2
- Follow the voice command to either press 1 to select single verification mode or press 2 to select the double (combination) verification mode for added security (verification) when unlocking your Smart Lock

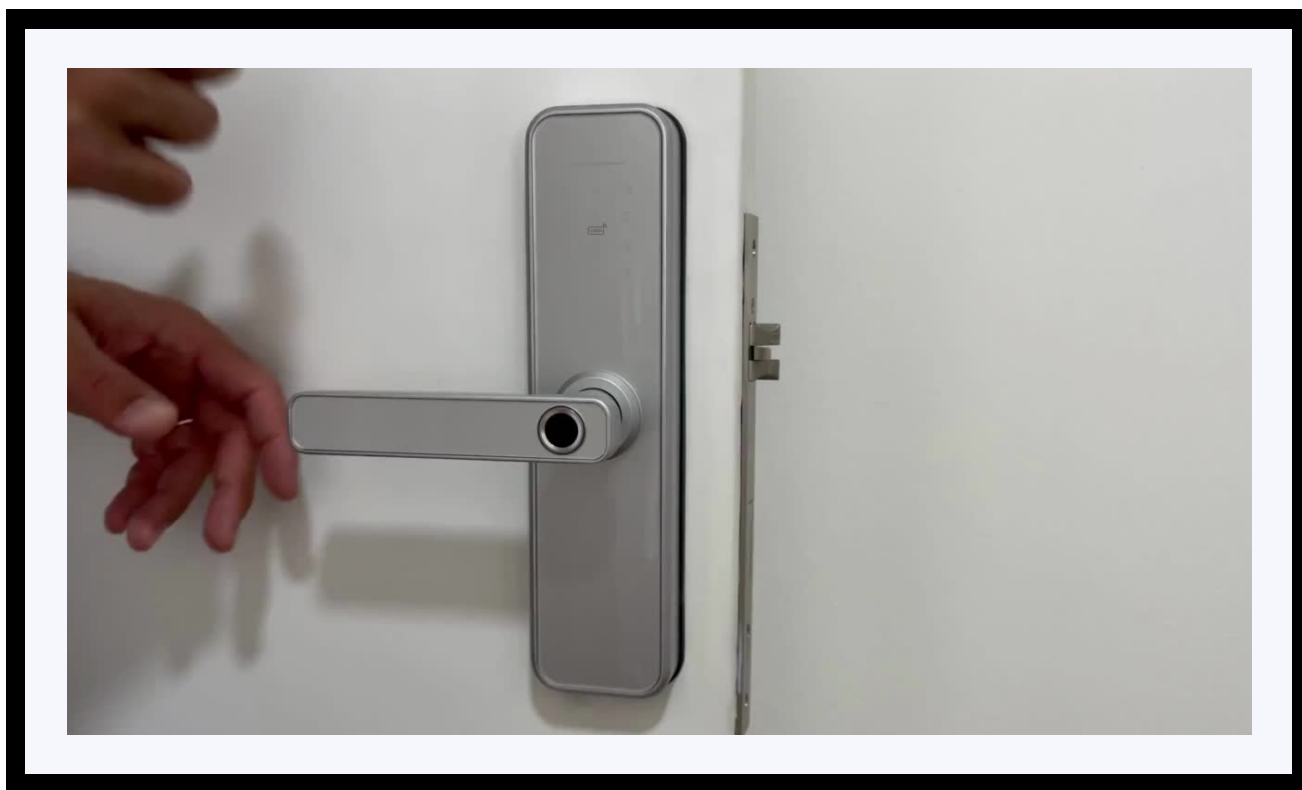

2. INITIAL STATE OF YOUR SMART LOCK



g) Language Setting

- Activate your Smart Lock (Press '*' and '#') and enter your Administrator Password
- Follow the voice command and Press 3 for System Settings
- Follow the voice command and Press 3 for Language Settings
- Follow the voice prompts and Press 2 for English



2. INITIAL STATE OF YOUR SMART LOCK



h) Time and Date Settings

- Activate your Smart Lock (Press '*' and '#') and enter your Administrator Password
- Follow the voice command and Press 3 for System Settings
- Follow the voice command and Press 4 for Time Settings
- Follow the voice command to enter the Time and Date of the Smart Lock
- Modify based on the following format:
 - year / month / day / time (for example, today is December 04, 2022 11:03 so it should be: 2212041103)
- Press '#' to confirm

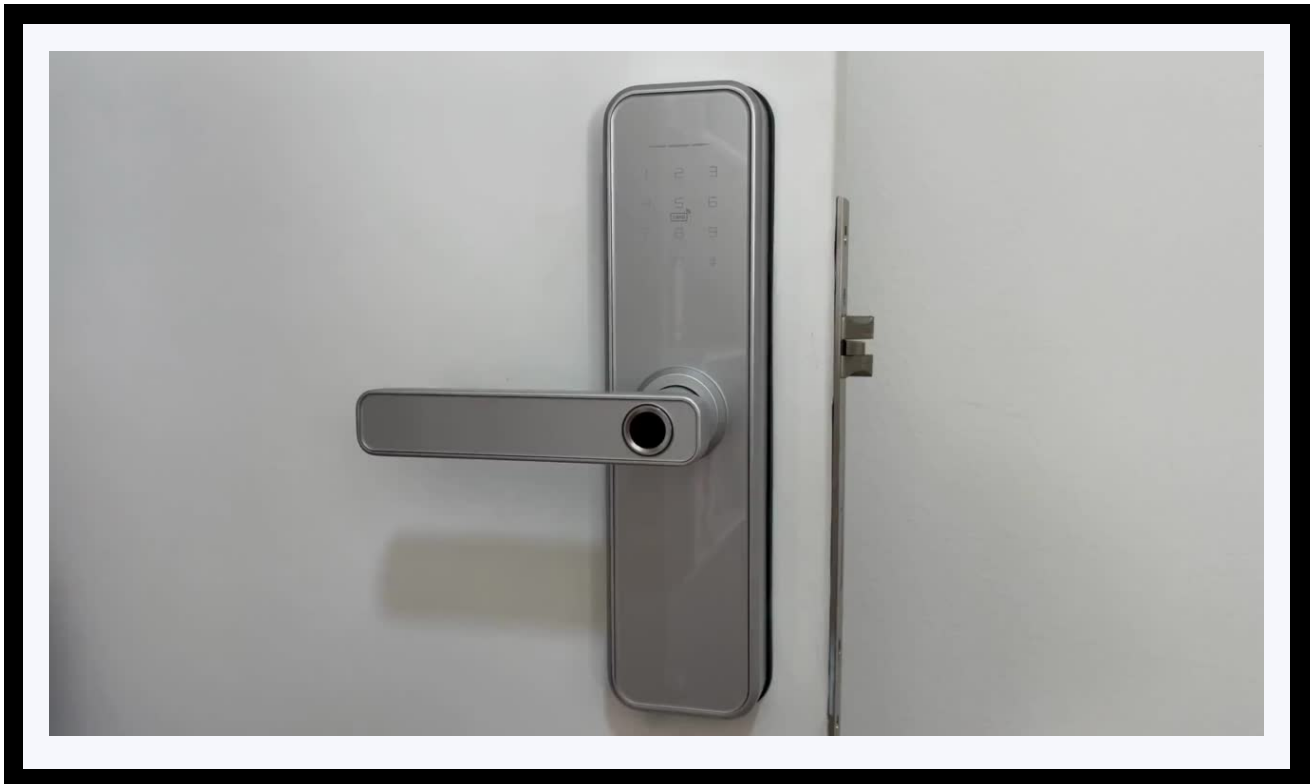

2. INITIAL STATE OF YOUR SMART LOCK



i) Volume Adjustment

- Activate your Smart Lock (Press '*' and '#') and enter your Administrator Password
- Follow the voice command and press 3 for System Settings
- Follow the voice command and press 1 for Voice Settings
- Follow the voice command and continuously press 1 or 2 in order to enable or disable speaker, respectively



2. INITIAL STATE OF YOUR SMART LOCK



j) Factory Reset

- On your Smart Lock, open the battery compartment by unscrewing the cover
- Underneath where the batteries are located, there should be a small button that can only be pressed by a pin or any thin rod
- Long press the button until you hear beeping sounds or a voice command initiating the reset
- Alternatively, you may activate your Smart Lock and enter your Administrator Password
- Follow the voice command and press 4 to restore factory reset
- Input your Administrator Password again and press # to confirm



2. INITIAL STATE OF YOUR SMART LOCK



k) Anti-prying Setting

- Activate your Smart Lock (Press '*' and '#') and enter your Administrator Password
- Follow the voice commands and Press 4
- Press either 1 or 2 to enable or disable anti-prying mode, respectively

3. MOBILE APP CONNECTION



a) Downloading the App

Download the application on the Google Play Store or Apple AppStore by searching “Tuya Smart” or by scanning the QR code below



b) Logging in and Registering

After Downloading the App

- Select the country from which you will be using the device, usually the app will prompt it automatically
- You will be redirected to register via email where a verification code will be sent and proceed to enter it on the app in the allotted time limit
- Once the verification code has been entered into the app, you will be asked to set your password
- You will then have full access to the Tuya Smart Platform

3. MOBILE APP CONNECTION

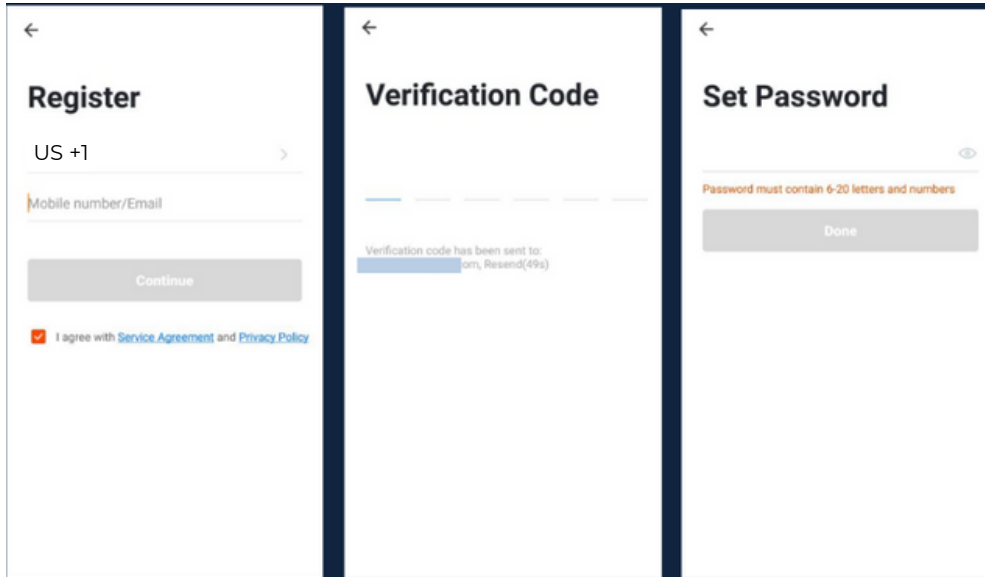

Should you be an existing user to the Tuya Smart Platform, log in using your email and password from the login page.

c) Resetting your Password

In case you have forgotten your password and need to reset it, please follow the steps below:

- On the Login Page, when prompted for your email & password, click “Forgot Password” button located below the “Login” button
- Select the country from which you will be using the device, usually the app will prompt it automatically

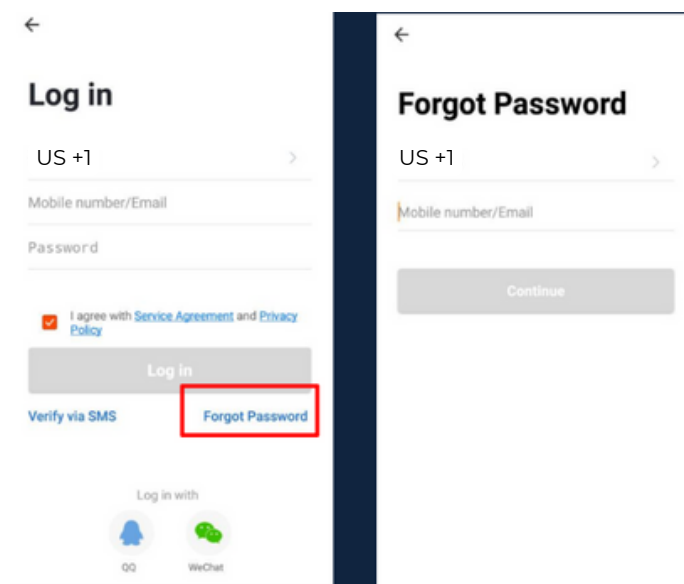

3. MOBILE APP CONNECTION

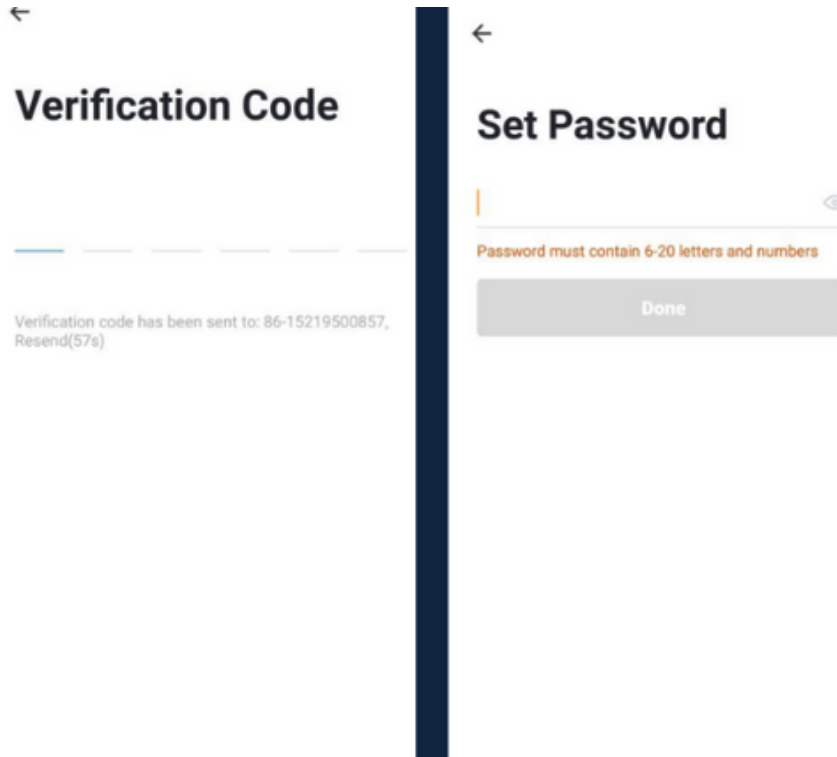

- You will be prompted to enter the email where a verification code will be sent and proceed to enter it on the app in the allotted time limit
- Once the verification code has been entered into the app, you will be asked to set your new password
- You will then have full access to the Tuya Smart Platform

In the case that you would like to change your password from the app, please follow the steps below:

- Tap the 'Me' tab on the bottom right hand corner of your screen
- Click 'Change Login Password'
- You will be taken to the 'Account Verification' page and then tap 'Get Verification Code' button
- This will send a verification to your registered email
- Enter the code in the app
- Proceed to enter the new password

3. MOBILE APP CONNECTION

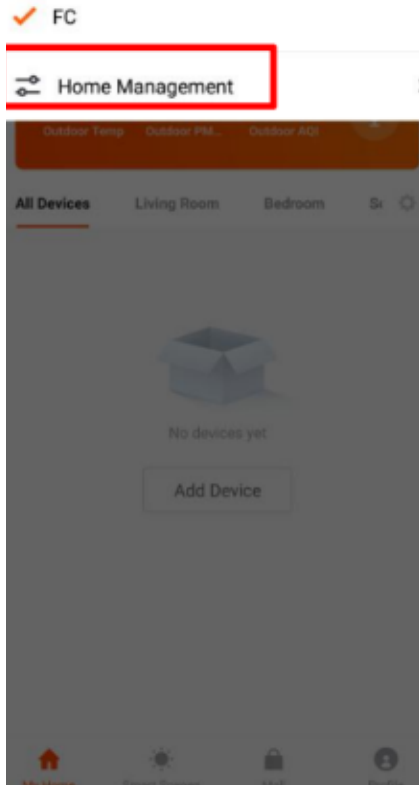

d) Adding Locations

- Tap the button on the top-left corner of the screen & select 'Home Management' from the dropdown list
 - One account can manage multiple locations at the same time. The user can operate multiple devices in a single location by selecting it from the drop-down menu

- If you already have a Home setup, simply click 'Join a Home'. Otherwise, click 'Create a home'
- Enter the details on the screen
- Click Confirm
 - Other Household members can also control the smart devices that are registered in this household, but will not be able to modify, add, or delete devices

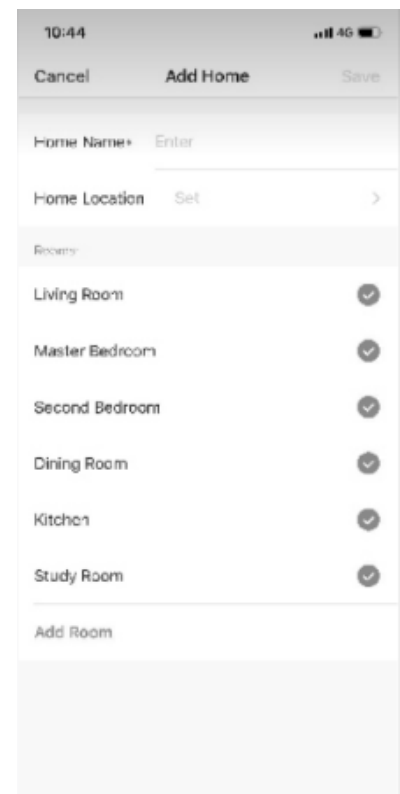

3. MOBILE APP CONNECTION



e) Adding Devices

To add devices on the app, please follow the instructions below. Your devices and phone must be connected to the same 2.4GHz Wi-Fi network in order for this to work.

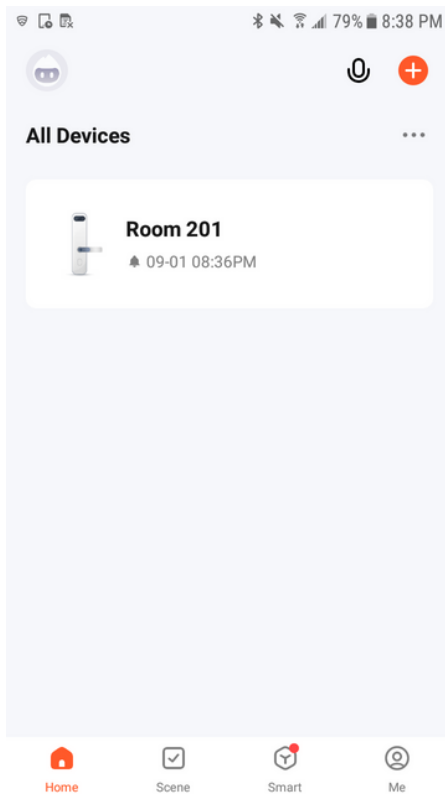

- To add a device, click the 'Add Device' or tap the 'Plus' button on the top-right corner of your screen and select 'Add Device'

- This will bring up a list of devices. Go to 'Camera & Lock' from the left side and then click 'Lock (Wi-Fi)' to select your Smart Lock device



3. MOBILE APP CONNECTION



📶 🔋 78% 8:43 PM

✕

Select 2.4 GHz Wi-Fi Network and enter password.

If your Wi-Fi is 5GHz, please set it to be 2.4GHz.
[Common router setting method](#)

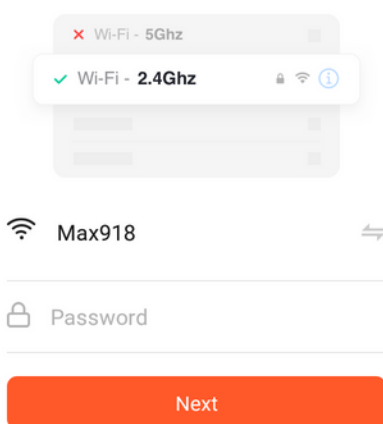

- Activate your smart lock by pressing the '*' & '#' on your smart lock keypad to authenticate administrator identity and then press '1' to access administrator settings
- There will be a voice prompt to press '4' for network configuration
- Connect your phone to the 2.4 GHz Wi-Fi network and follow the onscreen instructions
- Shortcut: press '1' and '#', and then enter administrator information to enter into network-configuration state

- Check if the light indicator is blinking.
- Once you've tapped the 'Confirmation' button, you will be asked to select the current status of the light indicator. Options are AP Mode ("Access Point mode" or by default, uses access points like a Wi-Fi Hotspot) or EZ Mode ("Easy-connect mode" which is most compatible if you will directly connect your phone to the Wi-Fi router)
 - Should you select the AP mode, you will have to connect your phone to the device's hotspot before moving onto the next step
- Afterwards, the light should flash rapidly

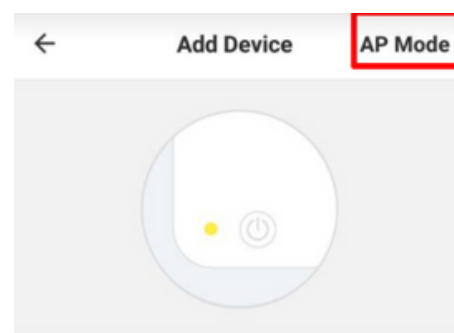

Power on the device and confirm that indicator light rapidly blinks

[How to make indicator rapidly blink](#)

Confirm indicator rapidly blink

3. MOBILE APP CONNECTION



- Once you've completed these steps, make sure your phone and device are as close as possible. There will be a prompt from the lock and on the screen that pairing was a success

- Finish adding your device. Once this has been done successfully, you can go on to change the name of your device and control its functions

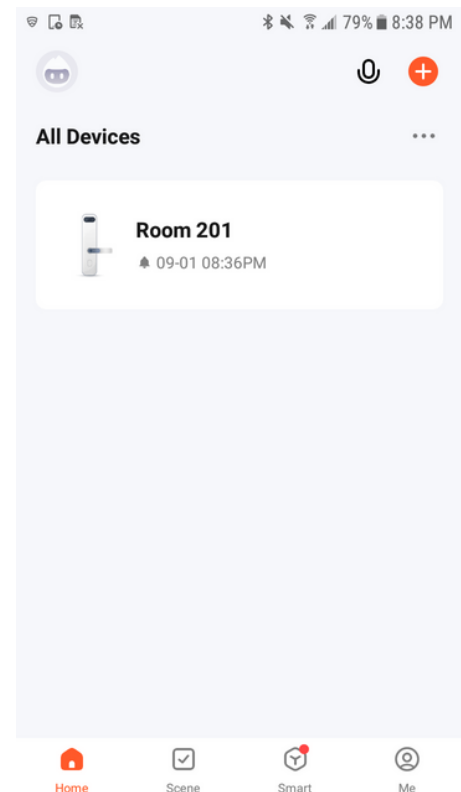

3. MOBILE APP CONNECTION



f) Adding Members

In order for others to gain access to a device, they will have to be added as members to the location/room.

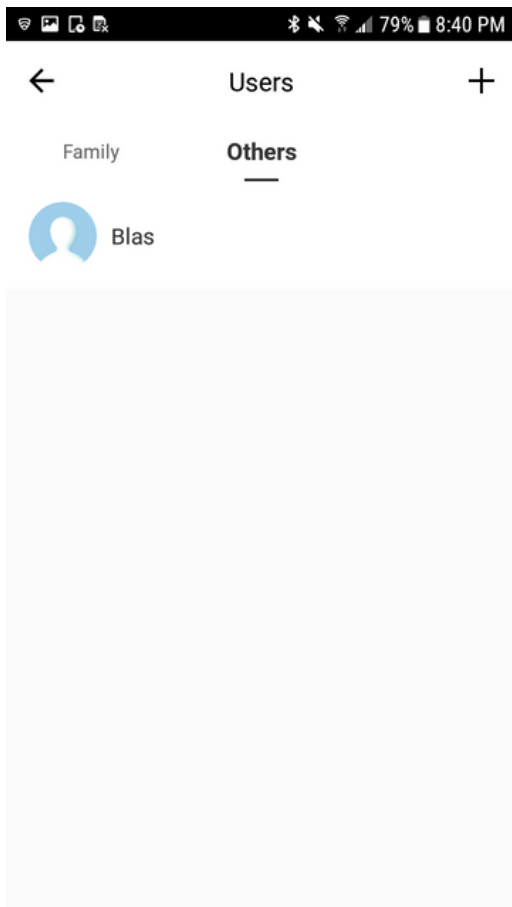

To add a member to the location, please follow the following steps:

- Tap the 'Me' tab at the bottom-right corner of your screen
- Click on 'Home Management'
- Select the location you would like to add the new member to
- Tap 'Add Member' and select how you would like to share the invitation to the new member

4. DEVICE FUNCTIONS



a) Remote Functions via The Mobile App

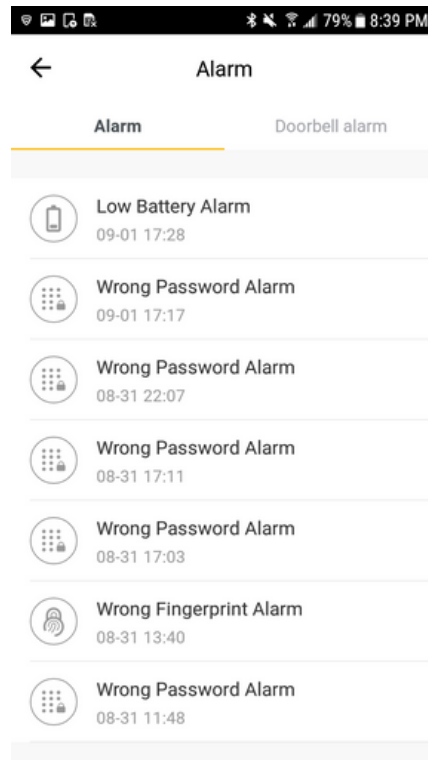
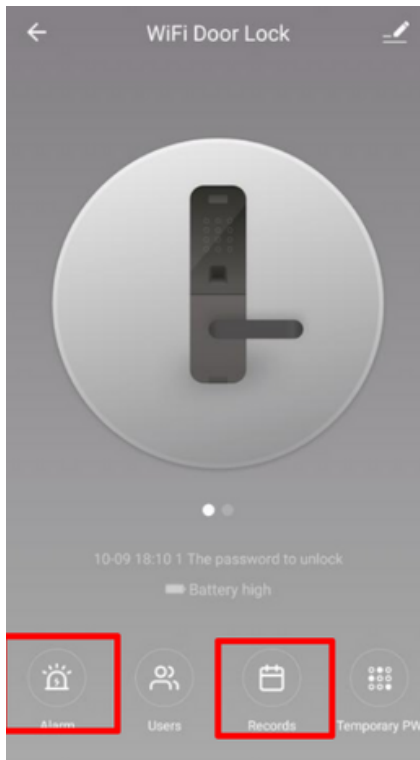

- Select the Smart Lock you would like to use from the Home Page
- Click 'Alarm' to check the battery state
- Click 'Records' to check the unlock records

4. DEVICE FUNCTIONS

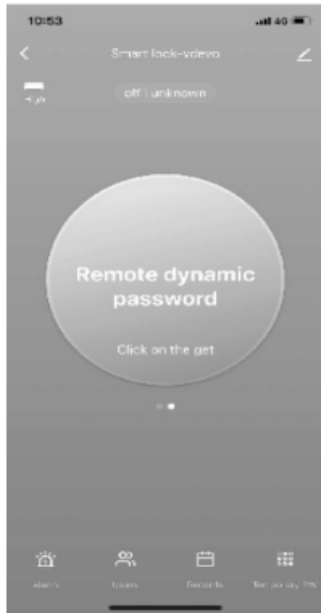

b) Dynamic Password (optional)

- Click the 'Key' button on the phone screen to get your Dynamic Password (this is a short-term password that will last only for a few minutes)

- Enter the Dynamic Password to unlock the device

c) Temporary Password (optional)

- On the Lock Screen tap the bottom-right 'Temporary PW' button

- Click 'Add'. Set your own Temporary Password, name of user, and the start and end date time. Make sure that the time on your mobile app and lock are synchronized

- Click 'Done' on the top-right corner to complete the operation

- Activate the lock pad and enter the code you've put in to activate the temporary-lock function and press '#' to confirm

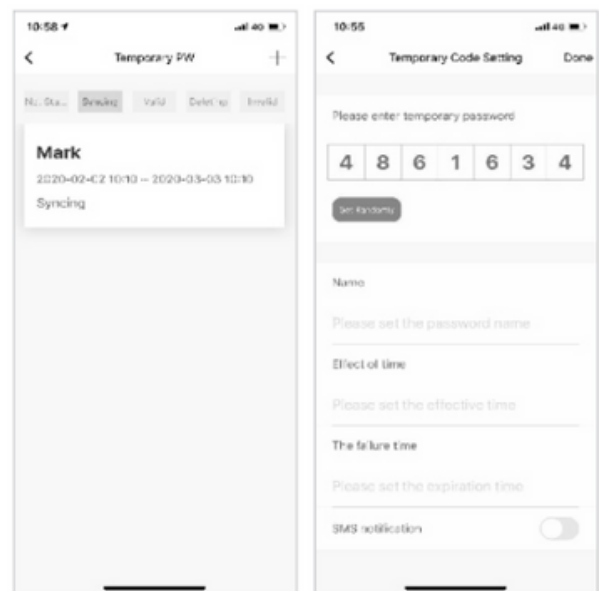

4. DEVICE FUNCTIONS



d) Remote Unlock

- To grant access to someone when you are away, instruct them to press '9' and '#' on the Lock Pad. This will prompt a message or request on your mobile app to confirm remote unlocking.

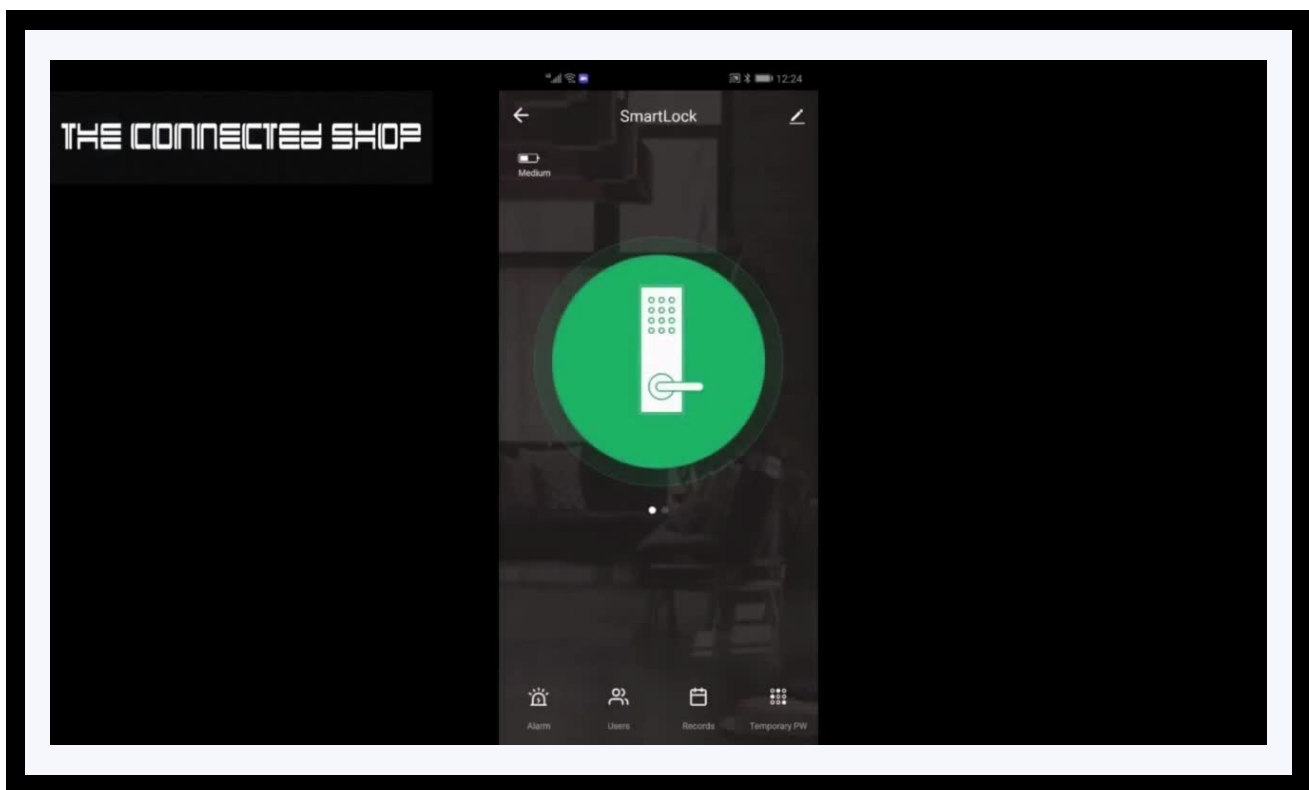

5. OTHER NOTES



Created by Design Circle

- If you Input the wrong password more than 5 times in a row, the keypad locks for 30 seconds. It does not respond to any operating system within the said time frame.
- **Password peeping prevention function:** Input passcode as follows when opening the door: **XXX password XXX**. Simply add some extraneous numbers (XXX) before and after the right passcode, and then press # to confirm.

5. OTHER NOTES



Created by Design Circle

- If there is no operation for more than **10 seconds** , the system will automatically exit.
- **Once the battery is low**, the lock will automatically notify you every time it is opened. After the alarm goes off, the lock can only be opened 200 times more. Afterwards, each attempt to unlock it, it will be delayed for 5 seconds. New batteries must be placed before the number of 200 unlocks is reached.



5. OTHER NOTES



- To enable and/or disable passage mode, activate your Smart Lock and enter your Administrator Passcode. Follow the voice command and press 3, and then press 2. Follow the voice command to either press 3 or 4 in order to enable or disable passage mode, respectively. When enabled, you will be able to keep the lock unlocked even when the door is closed.



5. OTHER NOTES



Created By Design Circle

- **To set up network:** Activate your Smart Lock & enter your Administrator Passcode. Follow the voice command and press 1 for administrator setting and then, press 3 to go to Networking Setting. Press 1 to connect to a network. The device will then automatically search for a network connection. Keep the mobile app open and near the lock to ensure successful pairing. Wait for the loading screen on your phone to finish before closing the app.

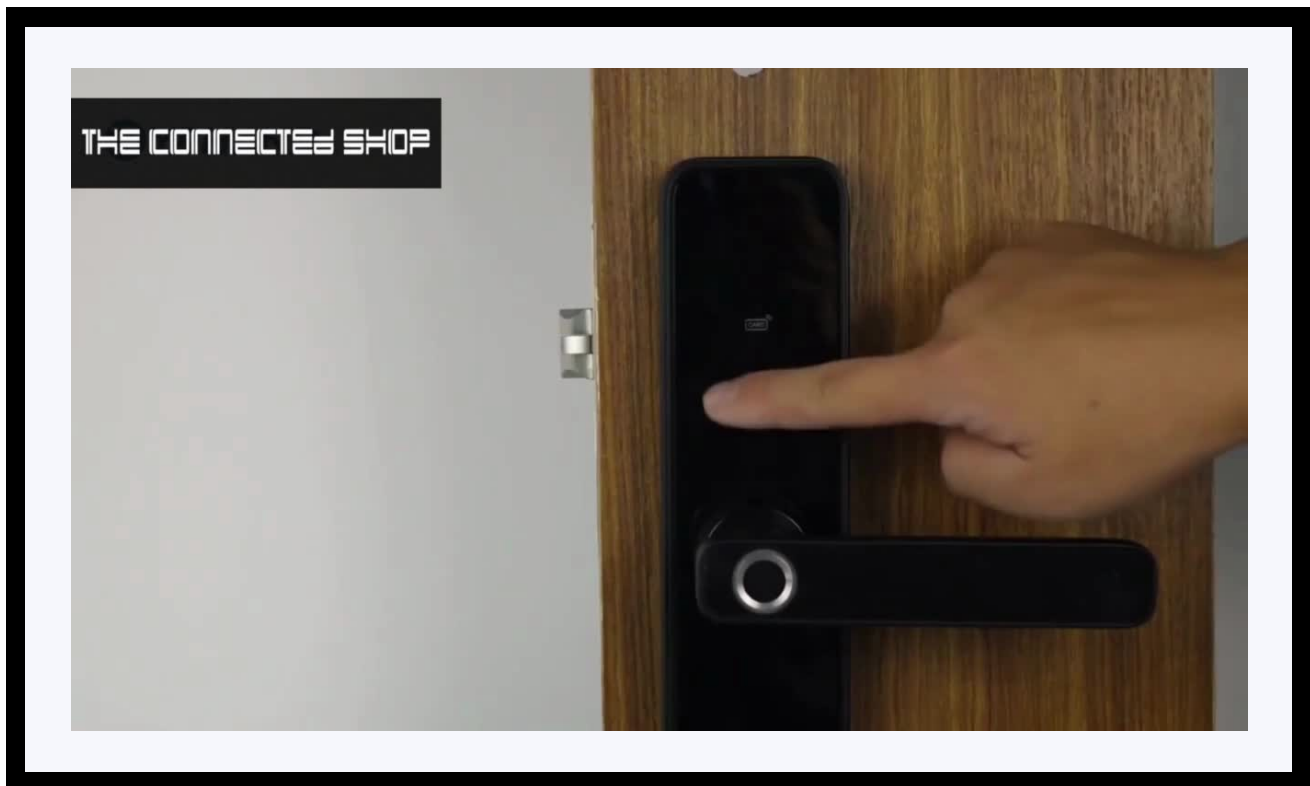

5. OTHER NOTES



Created by Design Circle

- **To change the direction of the handle:** First, loosen the screw of the handle found at the back by using a screwdriver. Rotate the handle according to the preferred orientation. Once done, continue by tightening the screw to lock the final direction of the handle. Lastly, ensure that the installation is done properly by checking the alignment of the 'Reversing Screw' or the clutch at the back of the lock. Usually, the red mark should be facing down.



Congratulations!

You have successfully installed your very own Smart Door Lock X.
Thank you for being a valued customer of The Connected Shop.

www.theconnectedshop.com





THE CONNECTED SHOP