

PROFESIONAL 2026
UTILLAJE
Catálogo



Duproflex

ÍNDICE

| | |
|-----|---------------------|
| 03 | Utillaje |
| 93 | Moldes de silicona |
| 111 | Moldes de chocolate |
| 128 | Maquinaria |
| 157 | Expositores |
| 167 | Envases |
| 179 | Almacenaje |
| 184 | Útiles de tienda |

UTILLAJE

Pastry tools



Mango de plástico reforzado con fibra de vidrio, con **16 varillas** finas de acero inoxidable. Resistente a altas temperaturas. Especial para masas densas.

Fiberglass reinforced plastic handle, with 16 thin stainless steel rods. High temperature resistant./ Special for soft doughs.

| Cod. | mm | Material | Pack | Filo |
|--------|-----|--------------|------|-------|
| AO1529 | 250 | Inox. - Sst. | 1 | 1,5mm |
| AO1530 | 300 | Inox. - Sst. | 1 | 1,8mm |
| AO1531 | 350 | Inox. - Sst. | 1 | 1,8mm |
| AO0932 | 400 | Inox. - Sst. | 1 | 1,8mm |
| AO0933 | 450 | Inox. - Sst. | 1 | 2 mm |
| AO0959 | 500 | Inox - Sst | 1 | 2 mm |

Mango de plástico reforzado con fibra de vidrio, con **16 varillas** finas de acero inoxidable. Resistente a altas temperaturas. Con asa para colgar de forma higiénica.

Fiberglass reinforced plastic handle, with 16 thin stainless steel rods. High temperature resistant./ Special for soft doughs. With a handle for hygienic hanging.

| Cod. | mm | Material | Pack | Filo |
|--------|-----|--------------|------|-------|
| AO0586 | 250 | Inox. - Sst. | 1 | 1,5mm |
| AO0587 | 300 | Inox. - Sst. | 1 | 1,8mm |
| AO0584 | 350 | Inox. - Sst. | 1 | 1,8mm |
| AO0578 | 400 | Inox. - Sst. | 1 | 1,8mm |
| AO0585 | 450 | Inox. - Sst. | 1 | 2 mm |
| AO0588 | 500 | Inox - Sst | 1 | 2 mm |

Mango inoxidable, con varillas de **2,3 mm.** de acero inoxidable. Resistente a altas temperaturas. Especial para masas densas.

Stainless handle, with 2.3 mm rods. Stainless steel. High temperature resistant. Special for dense masses.

| Cod. | mm | Material | Pack | Filo |
|------|-----|--------------|------|--------|
| WW30 | 300 | Inox. - Sst. | 1 | 2,3 mm |
| WW35 | 350 | Inox. - Sst. | 1 | 2,3 mm |
| WW40 | 400 | Inox. - Sst. | 1 | 2,3 mm |
| WW45 | 450 | Inox. - Sst. | 1 | 2,3 mm |
| WW50 | 500 | Inox. - Sst. | 1 | 2,3 mm |

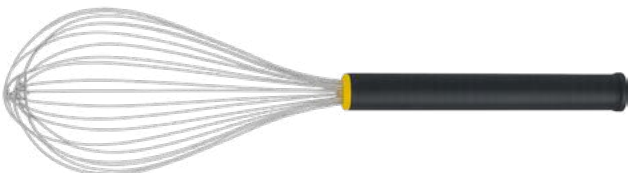
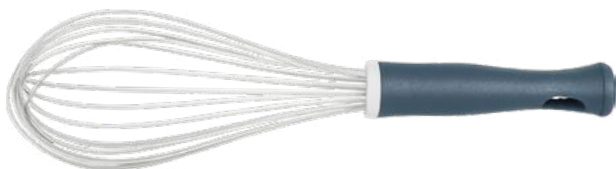

Mango de plástico con **6 varillas** finas de acero inoxidable. Resistente a altas temperaturas. Especial para masas densas.

Plastic handle with 6 thin stainless steel rods. High temperature resistant. Special for dense masses.

| Cod. | mm | Material | Pack | Filo |
|---------|-----|--------------|------|---------|
| AO1529N | 250 | Inox. - Sst. | 1 | 1,4 mm. |
| AO1530N | 300 | Inox. - Sst. | 1 | 1,4mm |
| AO1531N | 350 | Inox. - Sst. | 1 | 1,4mm |
| AO0932N | 400 | Inox. - Sst. | 1 | 1,4mm |
| AO0933N | 450 | Inox. - Sst. | 1 | 1,4mm |

Mango de plástico reforzado con fibra de vidrio, con varillas finas de acero inoxidable de **2 mm.** Resistente a altas temperaturas. Especial para masas suaves.

Fiberglass reinforced plastic handle, with thin 2 mm stainless steel rods. High temperature resistant. Special for soft doughs.

| Cod. | mm | Material | Pack | Filo |
|--------|-----|--------------|------|------|
| AO0555 | 450 | Inox. - Sst. | 1 | 2 mm |



Medidas: Ancho de la brocha. - Measures: Brush width.
Medidas cerdas: 60 mm. - Sows measures: 60 mm.

Cerdas 100% naturales, para una mejor absorción.
100% natural bristles, for better absorption.

| Cod. | mm | Material | Pack |
|---------|----|----------|------|
| AO0590N | 40 | P.V.C. | 12 |
| AO0579N | 60 | P.V.C. | 12 |
| AO0589N | 70 | P.V.C. | 12 |
| AO0591N | 80 | P.V.C. | 12 |



Medidas: Ancho de la brocha. - Measures: Brush width.
Grosor de 15 mm. - Thick 15 mm.

Cerdas 100% Sintética con diseño anti-caída
100% Synthetic bristles, designed to not lose bristles.
Ideal para chocolate. - Ideal for chocolate.

| Cod. | mm | Material | Pack |
|--------|----|----------|------|
| AO0367 | 30 | P.V.C. | 12 |
| AO0579 | 60 | P.V.C. | 12 |
| AO0529 | 50 | P.V.C. | 12 |



Cepillo multiuso con cerdas de alta calidad y mango de plástico combinado con goma para mayor comodidad. Resistente hasta 120°C y apto para el lavavajillas.

Multi-purpose brush with high-quality bristles and a plastic handle combined with rubber for greater comfort. Heat resistant up to 120 °C and dishwasher safe.

| Cod. | mm | Material | Pack |
|--------|-----------|----------|------|
| AO1077 | 168x53x30 | P.V.C. | 1 |
| AO1078 | 170x53x40 | P.V.C. | 1 |
| AO1079 | 173x60x50 | P.V.C. | 1 |
| AO1080 | 175x65x60 | P.V.C. | 1 |
| AO1081 | 178x65x70 | P.V.C. | 1 |



Ideal para restauración. - Ideal for catering.

| Cod. | mm | Material | Pack |
|--------|----------|-------------------|------|
| AO0764 | 210 x 33 | Silicona-Silicone | 6 |
| AO0765 | 280 x 45 | Silicona-Silicone | 6 |
| AO1605 | 90 x 210 | Silicona-Silicone | 6 |

NUESTRA MARCA PROPIA

Duproflex[®] 
Equipamiento profesional



Estándares de calidad y durabilidad.



Cerdas de nylon. Apto hasta 130°C.
Nylon bristles. Up to 120°C.

| Cod. | mm | Material | Pack |
|--------|----------|----------|------|
| AO0755 | 24 x 7,5 | P.V.C. | 1 |



Cerdas naturales. Apto hasta 90°C.
Natural bristles. Up to 90°C.

| Cod. | mm | Material | Pack |
|--------|----------|---------------|------|
| AO0753 | 40 x 400 | Madera - Wood | 1 |



Cerdas de nylon. Apto hasta 120°C.
Nylon bristles. Up to 120°C.

| Cod. | mm | Material | Pack |
|--------|----------|----------|------|
| AO0754 | 40 x 400 | P.V.C. | 1 |

Recogedor de migas.
Remainder of leftovers.

| Cod. | mm | Material | Pack |
|--------|-----------|------------|------|
| AO0760 | 160 x 170 | Inox./Sst. | 1 |



FABRICACIÓN DE MANGAS

SLEEVE MANUFACTURING PROCESS

Fabricación de nuestras mangas desechables **DUPROFLEX**. Diseñadas en diferentes modelos para adaptarse al profesional más exigente, facilitando el laborioso trabajo del pastelero.

Manufacture of our disposable sleeves **DUPROFLEX**. Designed in different models to adapt to the most demanding professional. Facilitating the careful daily work of the baker.

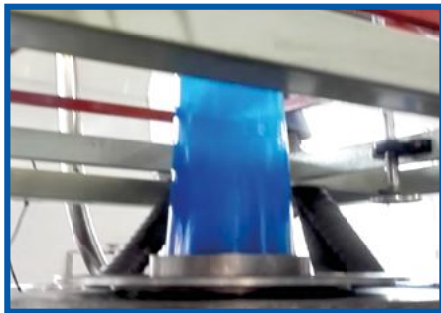

Soplado tubular
Tubular blowing

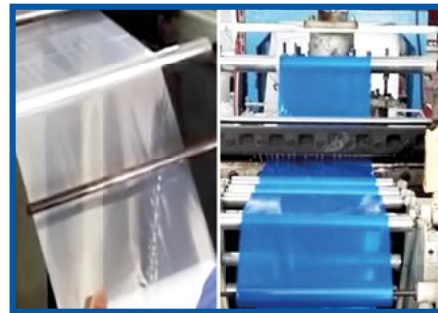

Bobinado
Winding



Corte individual
Individual cut

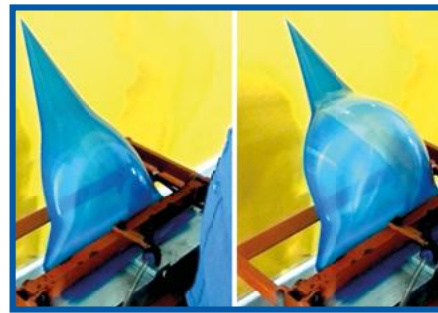

Test de resistencia
Resistance test



Empaquetado
Packaging



Envíos
Order preparation

Mangas fabricadas como material principal el nylon.
 Termosellada de alta resistencia.
 Transpirable e impermeable,
 con doble costura reforzada.
 Gancho para fácil almacenaje.

Sleeves made of nylon as the main material.
 Great heat-sealing resistance.
 Breathable and waterproof, with double reinforced seam.
 Easy storage hook.

| Cod. | mm | Material | Pack |
|--------|-----|----------|------|
| AO0531 | 300 | Nylon | 10 |
| AO0532 | 350 | Nylon | 10 |
| AO0533 | 400 | Nylon | 10 |
| AO0534 | 450 | Nylon | 10 |
| AO0535 | 500 | Nylon | 10 |
| AO0536 | 550 | Nylon | 10 |
| AO0537 | 600 | Nylon | 10 |
| AO0538 | 650 | Nylon | 10 |
| AO0539 | 700 | Nylon | 10 |
| AO0777 | 760 | Nylon | 10 |

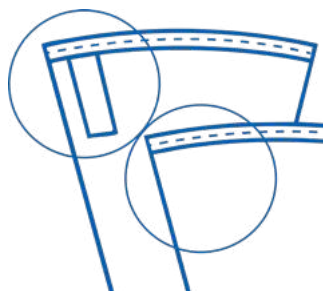

Borde Rim



Gancho Hook

Mangas fabricadas como material principal el poliéster y algodón.
 Termosellada de alta resistencia.
 Transpirable e impermeable, con costura invisible reforzada.
 Gancho para fácil almacenaje.

Sleeves made of polyester and cotton as the main material.
 Great heat-sealing resistance.
 Breathable and waterproof, with reinforced invisible seam.
 Easy storage hook.

| Cod. | mm | Material | Pack |
|---------|-----|---|------|
| AO0533S | 400 | Poliéster y algodón Polyester and cotton | 10 |
| AO0535S | 500 | Poliéster y algodón Polyester and cotton | 10 |
| AO0537S | 600 | Poliéster y algodón Polyester and cotton | 10 |
| AO0539S | 700 | Poliéster y algodón Polyester and cotton | 10 |





Manga pastelera- pastry bag.
Fácil adaptación al uso- Easily adaptable for the use.
Gancho de fácil almacenaje- Easy storage hook.

| Cod. | mm | Material | Pack |
|--------|-----|-------------------|------|
| AO7065 | 340 | Silicona-Silicone | 6 |
| AO7066 | 450 | Silicona-Silicone | 6 |
| AO7067 | 500 | Silicona-Silicone | 6 |



Manga pastelera doble. Double pastry bag.
Fácil adaptación al uso- Easily adaptable for the use.
Gancho de fácil almacenaje- Easy storage hook.

| Cod. | mm | Material | Pack |
|--------|-----|-------------------|------|
| AO7063 | 500 | Silicona-Silicone | 6 |



Manga pastelera triple. Triple pastry bag.
Fácil adaptación al uso- Easily adaptable for the use.
Gancho de fácil almacenaje- Easy storage hook.

| Cod. | mm | Material | Pack |
|--------|-----|-------------------|------|
| AO7064 | 500 | Silicona-Silicone | 6 |



50 Mangas pastelera doble. 50 Double pastry bags.
Fácil adaptación al uso. - Easily adaptable for the use.

| Cod. | mm | Material | Pack |
|--------|-----|----------------|------|
| AO7062 | 550 | P.V.C. - 60 µm | 1 |



Set adaptador manga doble con 6 boquillas.
 Double sleeve adapter set with 6 nozzles.

| Cod. | mm | Material | Pack |
|--------|----|----------|------|
| TC4303 | - | P.V.C. | 6 |



Duproflex
Crystal

Cada detalle cuenta, cada manga
Duproflex responde.

Duproflex®

Model Clear

100 Mangas opacas de forma triángular con tapa interna deslizante para una mejor expulsión del producto. Ideal para la decoración y todo tipo de cremas y masas.

100 Opaque triangular pastry bags with inner sliding layer for a better ejection of product. //Ideal for decoration and every kinds of creams and doughes.

| Cod. | mm | Material | Pack |
|--------|-----------|----------------|------|
| AO7050 | 400 x 250 | P.V.C. - 75 µm | 10 |
| AO7051 | 550 x 290 | P.V.C. - 75 µm | 10 |
| AO7052 | 650 x 340 | P.V.C. - 75 µm | 10 |

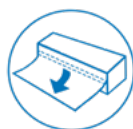

Caja dispensadora
Dispenser box



Model Crystal

100 Mangas transparentes económicas en forma triángular, fabricada en plástico con una flexibilidad óptima para obtener un rendimiento excelente.

Ideal para todo tipos de cremas, masas, merengues y chocolates.

100 Economical transparent pastry bags in triangular shape, made of plastic.

with optimal flexibility for excellent performance. Ideal for all types of creams, doughs, meringues and chocolates.

| Cod. | mm | Material | Pack |
|--------|-----------|----------------|------|
| AO7059 | 400 x 250 | P.V.C. - 60 µm | 10 |
| AO7060 | 550 x 290 | P.V.C. - 65 µm | 10 |
| AO7061 | 650 x 340 | P.V.C. - 65 µm | 10 |
| AO7068 | 300 x 210 | P.V.C. - 60 µm | 10 |



Caja dispensadora
Dispenser box



Model Blue

100 Mangas azules de diseño más alargado, facilitando la manipulación en grandes cargas de producto, posee una capa interna deslizante para una mejor expulsión del producto. Ideal para todo tipo de cremas, masas y merengues.

100 Blue pastry bags with extended design that makes the manipulation easier for big amounts of product. Ideal for every creams, doughes and meringues.

| Cod. | mm | Material | Pack |
|--------|-----------------|----------------|------|
| AO7057 | 550 x 290 + 50 | P.V.C. - 75 µm | 10 |
| AO7058 | 650 x 340 + 180 | P.V.C. - 75 µm | 10 |

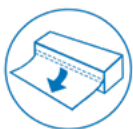

Caja dispensadora
Dispenser box

Modelo con corte en ángulo: diseño optimizado que proporciona mayor capacidad de carga y mejor aprovechamiento del volumen interno



Model Green

100 Modernas mangas envolventes en color verde, creando un ambiente más relajante. Forma triangular con una capa interna deslizante para una mejor expulsión del producto. Ideal para todo tipo de cremas y masas.

100 Modern wraparound green pastry bags, creating a relaxing atmosphere. Triangular shape with inner sliding layer for a better ejection of product. Ideal for every creams and doughes.

| Cod. | mm | Material | Pack |
|--------|-----------|----------------|------|
| AO7054 | 550 x 290 | P.V.C. - 75 µm | 10 |
| AO7055 | 650 x 340 | P.V.C. - 75 µm | 10 |



Caja dispensadora
Dispenser box



Thermo

model

NUEVO



100 Modernas mangas envolventes en color rojo, capa externa antideslizante, capa interna deslizante para una mejor expulsión del producto.

Especial para productos calientes (85 micras) 🔥

100 modern red shrink sleeves, with a non-slip outer layer and a sliding inner layer for better product release. Specially designed for hot products (+ microns).

| Cod. | mm | Material | Pack |
|--------|-----------|----------------|------|
| AO7070 | 600 x 290 | P.V.C. - 85 µm | 10 |

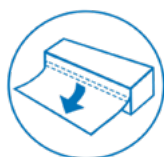

Caja dispensadora
Dispenser box

Boquillas para el uso de decoración en pastelería

Nozzles for use in pastry decoration, made of **stainless steel**.

Fabricadas en acero inoxidable



| Cod. | mm | Pack |
|-----------|----|------|
| AO0001.02 | 2 | 6 |
| AO0001.03 | 3 | 6 |
| AO0001.04 | 4 | 6 |
| AO0001.05 | 5 | 6 |
| AO0001.06 | 6 | 6 |
| AO0001.07 | 7 | 6 |
| AO0001.08 | 8 | 6 |
| AO0001.09 | 9 | 6 |

| | | |
|-----------|----|---|
| AO0001.10 | 10 | 6 |
| AO0001.11 | 11 | 6 |
| AO0001.12 | 12 | 6 |
| AO0001.13 | 13 | 6 |
| AO0001.15 | 15 | 6 |
| AO0001.20 | 20 | 6 |
| AO0001.25 | 25 | 6 |

| Cod. | mm | Pack |
|-----------|----|------|
| AO0002.02 | 2 | 6 |
| AO0002.03 | 3 | 6 |
| AO0002.04 | 4 | 6 |
| AO0002.05 | 5 | 6 |
| AO0002.06 | 6 | 6 |
| AO0002.07 | 7 | 6 |
| AO0002.08 | 8 | 6 |

| | | |
|-----------|----|---|
| AO0002.09 | 9 | 6 |
| AO0002.10 | 10 | 6 |
| AO0002.11 | 11 | 6 |
| AO0002.12 | 12 | 6 |
| AO0002.13 | 13 | 6 |
| AO0002.15 | 15 | 6 |

| Cod. | mm | Pack |
|------|-----|------|
| BP0 | 0.5 | 6 |
| BP1 | 1 | 6 |
| BP2 | 2 | 6 |
| BP4 | 4 | 6 |
| BP6 | 6 | 6 |
| BP8 | 8 | 6 |
| BP10 | 10 | 6 |
| BP12 | 12 | 6 |
| BP14 | 14 | 6 |
| BP16 | 16 | 6 |
| BP18 | 18 | 6 |

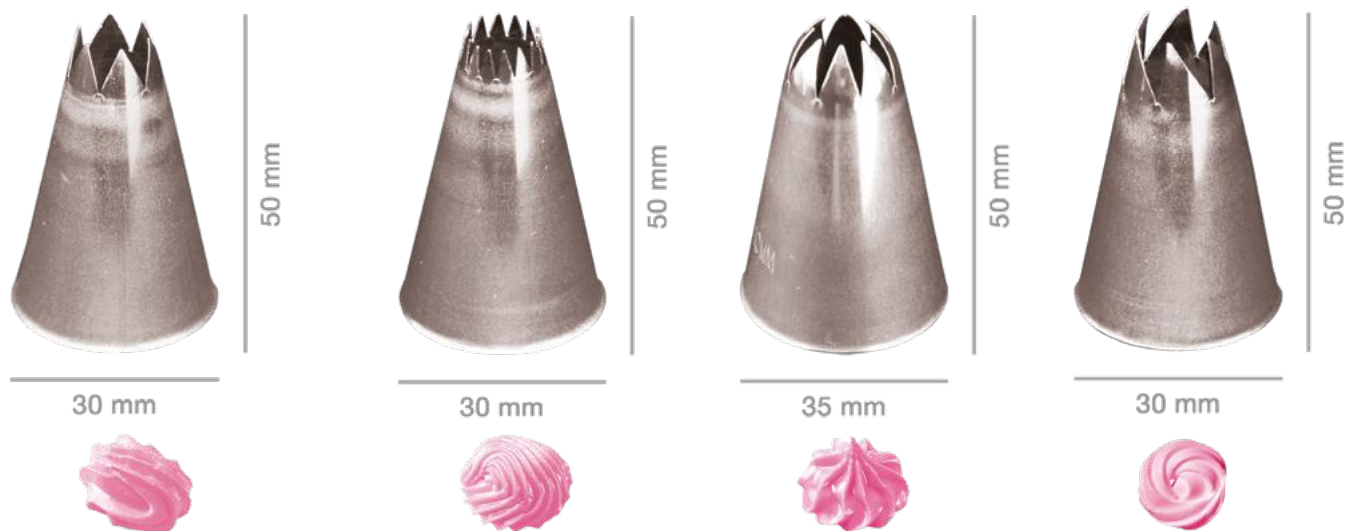

| Cod. | mm | Pack |
|------|----|------|
| BS2 | 2 | 6 |
| BS4 | 4 | 6 |
| BS6 | 6 | 6 |
| BS8 | 8 | 6 |
| BS10 | 10 | 6 |
| BS12 | 12 | 6 |
| BS14 | 14 | 6 |
| BS16 | 16 | 6 |
| BS18 | 18 | 6 |

| Cod. | mm | Pack |
|------|----|------|
| BF2 | 2 | 6 |
| BF4 | 4 | 6 |
| BF6 | 6 | 6 |
| BF8 | 8 | 6 |
| BF10 | 10 | 6 |
| BF12 | 12 | 6 |
| BF14 | 14 | 6 |
| BF16 | 16 | 6 |
| BF18 | 18 | 6 |

| Cod. | mm | Pack |
|------|----|------|
| BC2 | 2 | 6 |
| BC4 | 4 | 6 |
| BC6 | 6 | 6 |
| BC8 | 8 | 6 |
| BC10 | 10 | 6 |
| BC12 | 12 | 6 |

| Cod. | mm | Pack |
|-------|----|------|
| BXT11 | 11 | 6 |
| BXT13 | 13 | 6 |
| BXT15 | 15 | 6 |



Ideal para forrar tartas
Ideal for linings cakes

| Cod. | mm | Pack |
|--------------|--------|------|
| BX789 | 50 x 8 | 6 |

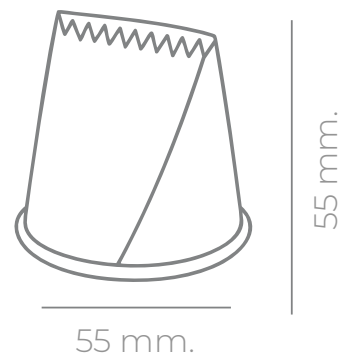

Ideal para sultanas
Ideal for sultanas

| Cod. | mm | Pack |
|--------------|-----------|------|
| BX796 | 25 x 30,4 | 6 |

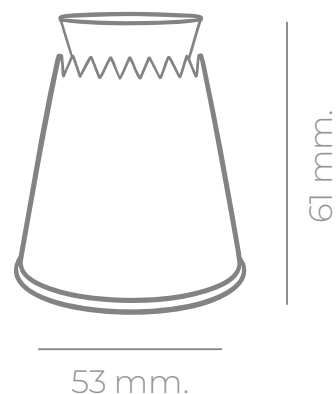

Ideal para rellenar / inyectar
Ideal for filling / inject

| Cod. | mm | Pack |
|---------------|----|------|
| AO0519 | 4 | 6 |
| AO0530 | 8 | 6 |

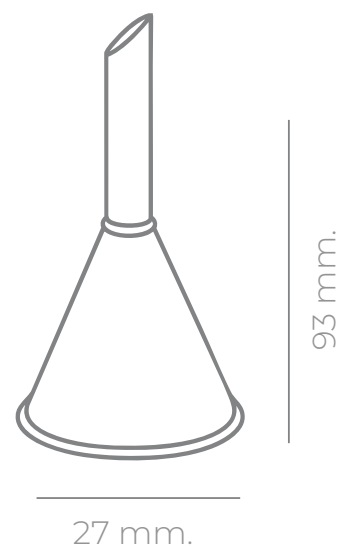

Envasadas en paquetes de 6 unidades.

Las boquillas están clasificadas según su forma y tamaño (Pequeña, mediana y grande).

Packaged in 6 units.

The nozzles are classified according to their side and shape (Small, Medium and Large). Pack. 6 uds.

Pack. 6 uds.

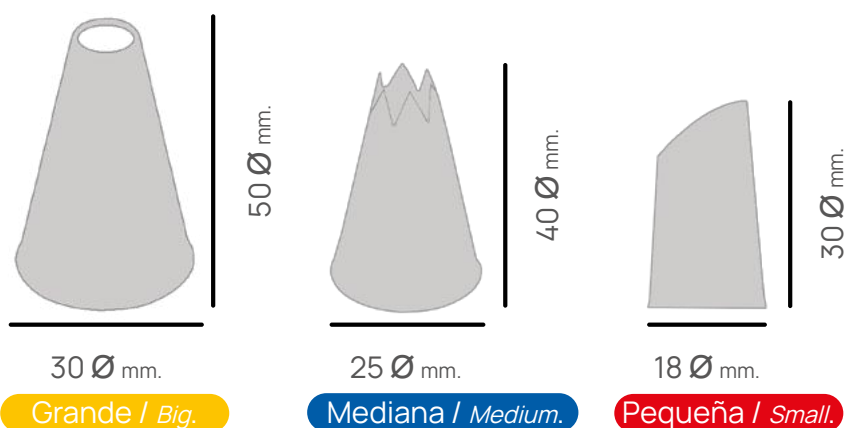

Boquillas para pétalos / Petals nozzles

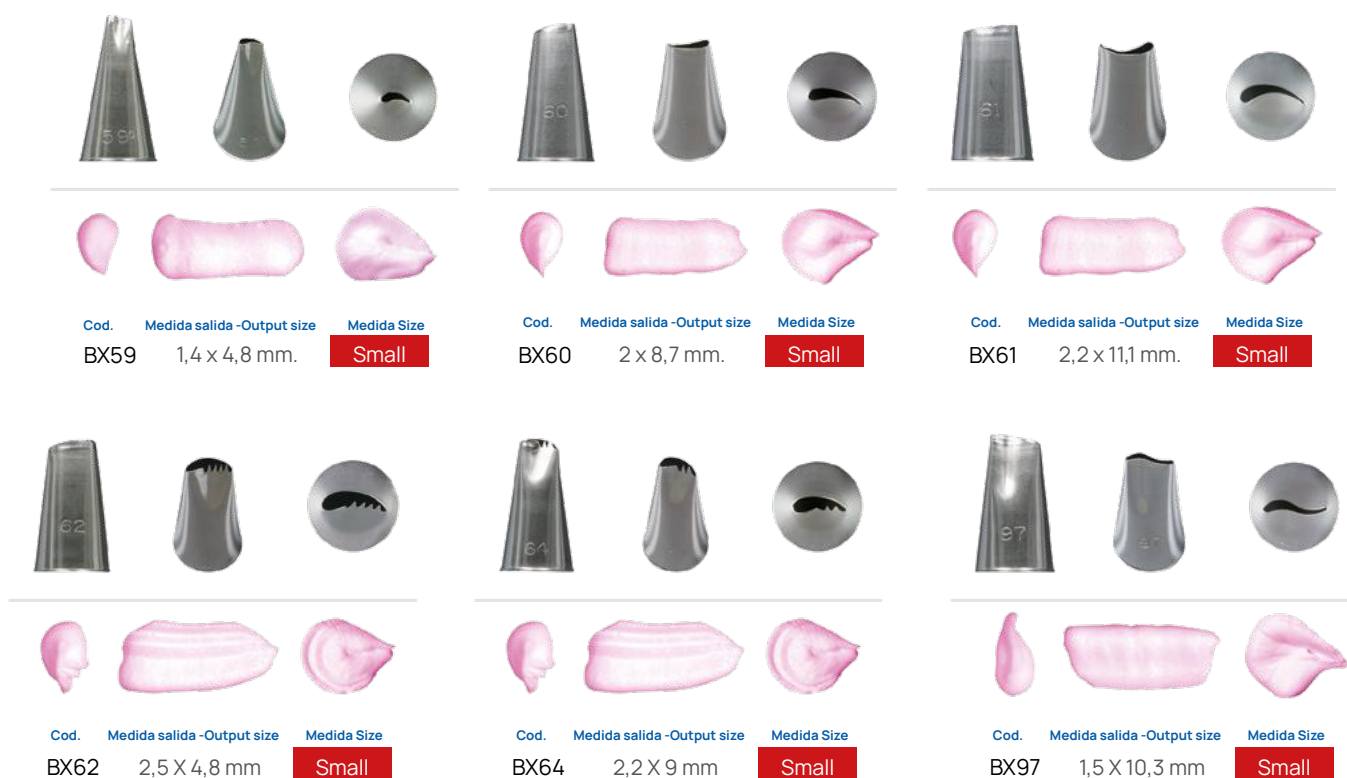

Cod. Medida salida -Output size Medida Size
 BX101 1,5 X 7,4 mm **Small**

Cod. Medida salida -Output size Medida Size
 BX102 2 X 9,1 mm **Small**

Cod. Medida salida -Output size Medida Size
 BX103 2,5 X 10,3 mm **Small**

Cod. Medida salida -Output size Medida Size
 BX104 3 X 12,5 mm **Small**

Cod. Medida salida -Output size Medida Size
 BX150 1,5 X 11,8 mm **Small**

Cod. Medida salida -Output size Medida Size
 BX7520 1,5 X 11,8 mm **Big**

Cod. Medida salida -Output size Medida Size
 BX121 3 x 14 mm **Medium**

Cod. Medida salida -Output size Medida Size
 BX117 3,5 x 16 mm **Medium**

Cod. Medida salida -Output size Medida Size
 BX119 4,5 x 19 mm **Medium**

Cod. Medida salida -Output size Medida Size
 BX124 3 x 14,5 mm **Medium**

Cod. Medida salida -Output size Medida Size
 BX122 3,5 x 15,5 mm **Medium**

Cod. Medida salida -Output size Medida Size
 BX123 4 x 17 mm **Medium**



Cod. Medida salida -Output size Medida Size
 BX127 4,5 x 19 mm Medium



Cod. Medida salida -Output size Medida Size
 BX125 3,5 x 16 mm Medium



Cod. Medida salida -Output size Medida Size
 BX126 4 x 17,5 mm Medium



Cod. Medida salida -Output size Medida Size
 BX1217 4,5 x 19 mm Medium



Cod. Medida salida -Output size Medida Size
 BX1405 6,5 x 20,5 mm Medium



Cod. Medida salida -Output size Medida Size
 BX128 5 x 23 mm Big



Boquillas para hoja / Leaves nozzle



Cod. Medida salida -Output size Medida Size
 BX65 0,6 x 5,3 mm Small



Cod. Medida salida -Output size Medida Size
 BX67 1 x 7,3 mm Small



Cod. Medida salida -Output size Medida Size
 BX68 1,3 x 9,3 mm Small



Cod. Medida salida -Output size Medida Size
 BX69 1,6 x 10,5 mm Small



Cod. Medida salida -Output size Medida Size
 BX70 1,9 x 12,1 mm Small



Cod. Medida salida -Output size Medida Size
 BX73 5,7 mm Small





Boquillas corte en "V" / Cut "V" nozzles

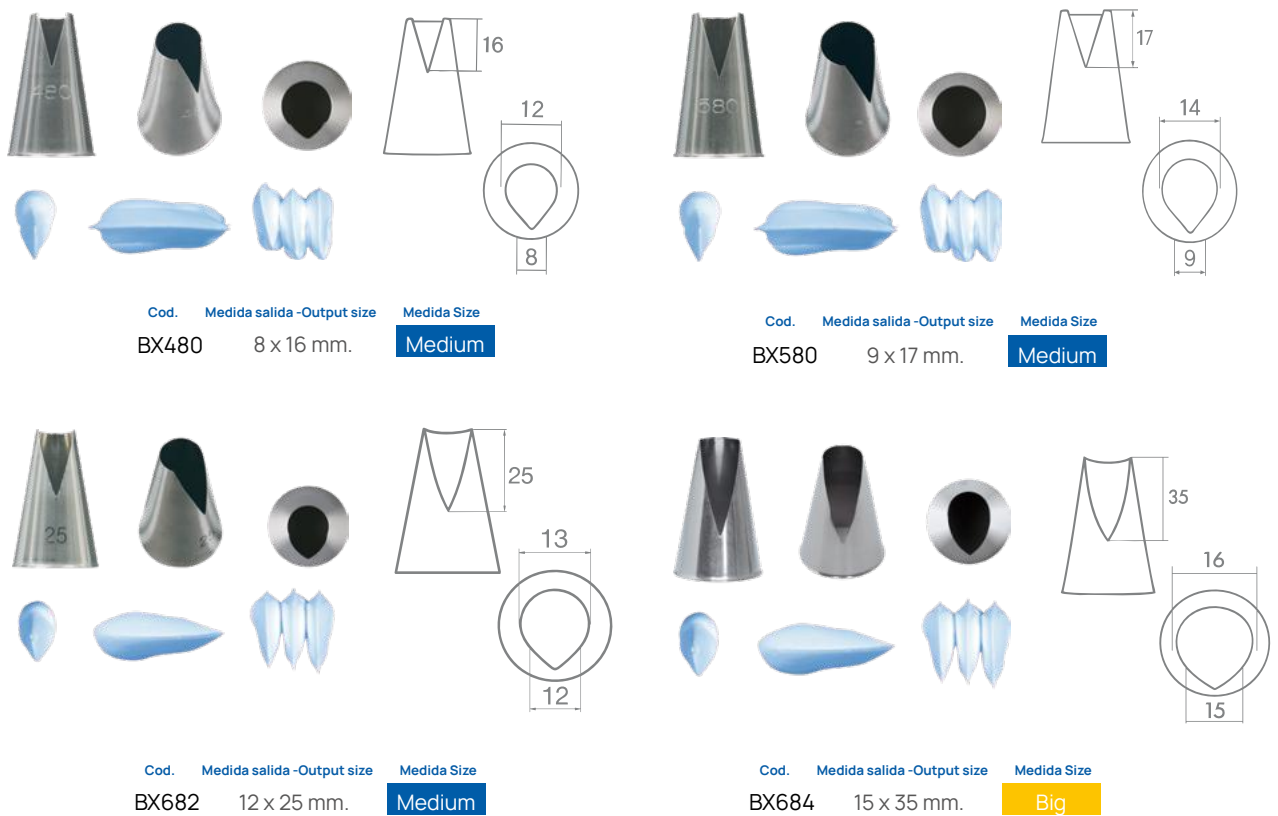

Boquillas multiapertura / Multi opening nozzles



Cod. Medida salida -Output size Medida Size
 BX42 7 mm. **Small**



Cod. Medida salida -Output size Medida Size
 BX89 7,6 mm. **Small**



Cod. Medida salida -Output size Medida Size
 BX134 7,6 mm. **Small**



Cod. Medida salida -Output size Medida Size
 BX234 2,5 mm. **Medium**



Cod. Medida salida -Output size Medida Size
 BX2010 4 mm. **Medium**

Boquillas "Volante" / Ruffle nozzles



Cod. Medida salida -Output size Medida Size
 BX40 1,8 mm. **Small**



Cod. Medida salida -Output size Medida Size
 BX86 1,7 x 10,1 mm. **Small**



Cod. Medida salida -Output size Medida Size
 BX87 1,7 x 10,1 mm. **Small**



Cod. Medida salida -Output size Medida Size
 BX88 2,6 x 10,1 mm. **Small**



Cod. Medida salida -Output size Medida Size
 BX90 18 mm. **Small**



Cod. Medida salida -Output size Medida Size
 BX100 18 mm. **Small**



Cod. Medida salida -Output size Medida Size
 BX401 1,2 x 10,6 mm. **Small**



Cod. Medida salida -Output size Medida Size
 BX402 2 x 15,8 mm. **Medium**



Boquillas especiales / Special nozzles

| | | | | | | | | |
|---|---|---|---|---|---|---|---|---|
|  |  |  |  |  |  |  |  |  |
|  |  |  |  |  |  |  |  |  |
| Cod. BX77 | Medida salida -Output size 0,9 mm. | Medida Size Small | Cod. BX78 | Medida salida -Output size 2,4 mm. | Medida Size Small | Cod. BX79 | Medida salida -Output size 1,2 x 8 mm. | Medida Size Small |

| | | | | | | | | |
|---|---|---|---|---|--|---|---|---|
|  |  |  |  |  |  |  |  |  |
|  |  |  |  |  |  |  |  |  |
| Cod. BX80 | Medida salida -Output size 1,2 x 7 mm. | Medida Size Small | Cod. BX81 | Medida salida -Output size 0,8 x 5,8 mm. | Medida Size Small | Cod. BX83 | Medida salida -Output size 5 mm. | Medida Size Small |

| | | | | | | | | |
|---|---|---|---|---|---|---|---|---|
|  |  |  |  |  |  |  |  |  |
|  |  |  |  |  |  |  |  |  |
| Cod. BX96 | Medida salida -Output size 5 mm. | Medida Size Small | Cod. BX105 | Medida salida -Output size 7,8 mm. | Medida Size Small | Cod. BX106 | Medida salida -Output size 8,3 mm. | Medida Size Small |

| | | | | | | | | |
|---|---|---|---|---|---|---|---|---|
|  |  |  |  |  |  |  |  |  |
|  |  |  |  |  |  |  |  |  |
| Cod. BX107 | Medida salida -Output size 8,4 mm. | Medida Size Small | Cod. BX129 | Medida salida -Output size 8,2 mm. | Medida Size Small | Cod. BX225 | Medida salida -Output size 6,2 mm. | Medida Size Small |

| | | | | | | | | |
|---|---|---|---|---|---|---|---|---|
|  |  |  |  |  |  |  |  |  |
|  |  |  |  |  |  |  |  |  |
| Cod. BX109 | Medida salida -Output size 12,2 mm. | Medida Size Medium | Cod. BX190 | Medida salida -Output size 12,4 mm. | Medida Size Medium | Cod. BX509 | Medida salida -Output size 5 x 19 mm. | Medida Size Big |

Boquillas para bordes / Nozzles for edges



Cod. Medida salida -Output size Medida Size
 BX44 1 x 7,2 mm. **Small**



Cod. Medida salida -Output size Medida Size
 BX45 1,4 x 10,7 mm. **Small**



Cod. Medida salida -Output size Medida Size
 BX46 1 x 7,8 mm. **Small**



Cod. Medida salida -Output size Medida Size
 BX47 1,2 x 9,3 mm. **Small**



Cod. Medida salida -Output size Medida Size
 BX48 1,4 x 11,5 mm. **Small**



Cod. Medida salida -Output size Medida Size
 BX892 1 x 20,5 mm. **Small**



Cod. Medida salida -Output size Medida Size
 BX897 3 x 21,5 mm. **Medium**



Cod. Medida salida -Output size Medida Size
 BX898 3,5 x 26,5 mm. **Big**

Boquillas Rusas / Russian nozzles



Cod. mm Material Pack
 AO1351 35 x 42 Inox. - Sst. Kit 6 uds.



Kit boquillas de 26 piezas.
 Nozzles kit of 26 pzs.

Cod. mm Material
 AO1380 15 x 35 Inox. - Sst.



Cod. mm Material Pack
 52 30 x 60 Inox. - Sst. Kit 7 uds.

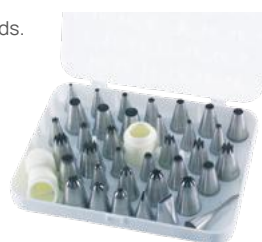

Kit boquillas de 36 piezas.
 Nozzles kit of 36 pzs.

Cod. mm Material
 AO1381 30 x 50 Inox. - Sst.



Kit boquillas de 52 piezas.
 Nozzles kit of 52 pzs.

Cod. mm Material
 AO1382 15 x 35 Inox. - Sst.

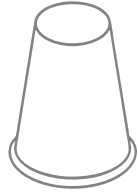

35 mm.

60 mm.

| Cod. | mm | Pack |
|-----------|----|------|
| AO0005.5 | 5 | 6 |
| AO0005.7 | 7 | 6 |
| AO0005.9 | 9 | 6 |
| AO0005.11 | 11 | 6 |
| AO0005.13 | 13 | 6 |
| AO0005.15 | 15 | 6 |
| AO0005.17 | 17 | 6 |
| AO0005.19 | 19 | 6 |
| AO0005.23 | 23 | 6 |



35 mm.

60 mm.

| Cod. | mm | Pack |
|-----------|----|------|
| AO0006.3 | 3 | 6 |
| AO0006.5 | 5 | 6 |
| AO0006.7 | 7 | 6 |
| AO0006.9 | 9 | 6 |
| AO0006.11 | 11 | 6 |
| AO0006.13 | 13 | 6 |
| AO0006.15 | 15 | 6 |
| AO0006.17 | 17 | 6 |



Tapón silicona para todo tipo de boquillas.
Silicone lid for every kinds of nozzles.

| Cod. | mm | Material | Pack |
|--------|---------|----------|------|
| AO1300 | 34 x 39 | Silicona | 6 |



Set limpia boquillas 6 piezas.
Cleaning kit for nozzles 6 pieces.

| Cod. | mm | Material | Pack |
|---------|----------|----------|------|
| AO64410 | 24 x 130 | Silicona | 6 |



Adaptador de boquillas pequeñas.
Adapter for small nozzles.

| Cod. | Material | Pack |
|--------|----------|------|
| TC4301 | PVC | 6 |



Adaptador de boquillas medianas y grandes.
Adapter for medium and big nozzles.

| Cod. | Material | Pack |
|--------|----------|------|
| TC4302 | PVC | 6 |



Soporte para mangas pasteleras.
Pastry bag holder.

| Cod. | Material | Pack |
|--------|----------|------|
| TC9085 | P.V.C | 2 |



| Cod. | Material | Pack |
|--------|----------|------|
| AO0542 | P.V.C | 1 |

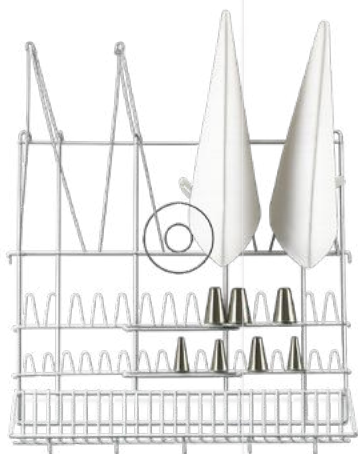

| Cod. | Material | Pack |
|--------|------------|------|
| AO0543 | P.V.C | 1 |
| AO0544 | Inox - Sst | 1 |



| Cod. | Material | Pack |
|--------|----------|------|
| AO0541 | P.V.C | 2 |





Termómetro digital con batería recargable por USB.
Posibilidad de guardar un registro de temperaturas.
Digital thermometer with USB rechargeable battery.
Possibility of keeping a temperature log.

| Cod. | Sonda - Lead | Med. - Measur. | Pack |
|---------------|--------------|----------------|------|
| AO1481 | 100 mm. | -50°C / +300°C | 1 |



Termómetro digital con batería recargable.
Cable 1 metro
Digital thermometer with rechargeable battery.
1 Meter wire

| Cod. | Sonda - Lead | Med. - Measur. | Pack |
|---------------|--------------|----------------|------|
| AO0524 | 150 mm. | -50°C / +300°C | 1 |



| Cod. | Sonda - Lead | Med. - Measur. | Pack |
|---------------|--------------|----------------|------|
| AO1480 | 150 mm. | -50°C / +330°C | 1 |



Cable 1,2 metro - 1,2 Meter wire.

| Cod. | Sonda - Lead | Med. - Measur. | Pack |
|---------------|--------------|----------------|------|
| AO1482 | 180 mm. | -0°C / +250°C | 1 |



| Cod. | Sonda - Lead | Med. - Measur. | Pack |
|---------------|--------------|----------------|------|
| AO0525 | 210 mm. | -50°C / +300°C | 1 |



Termómetro caramelo inoxidable.
Stainless caramel thermometer.

| Cod. | Sonda - Lead | Med. - Measur. | Pack |
|---------------|--------------|----------------|------|
| AO0523 | 300 mm. | +80°C / +200°C | 1 |

Para el control del contenido de azúcar: 2 escalas graduadas de 0 a 50 % para sorbetes, helados y jugos de fruta concentrados al 50 %, así como para caramelos de fruta, mermeladas y jarabes concentrados. Se entrega en un estuche rígido.

For the control of sugar content: 2 graduations of 0th 50% for sorbet, ice cream, 50 % concentrated fruit juice for fruit drops, jams, concentrated syrups. Comes in a hard case.



Sorbetómetro.
Sorbetometer.

| Cod. | Medida-Size | Bolsa-Bag | Pack |
|----------------|-------------|-----------|--------|
| AO69002 | 130 mm. | 1Kg. | 14 Kg. |

NUEVO



Termómetro caramelo con soporte.
Candy thermometer with support.

| Cod. | Sonda - Lead | Med. - Measur. | Pack |
|---------------|---------------|----------------|------|
| AO1486 | 310 x 5,1 mm. | 40°C / +200°C | 1 |



Soporte para termómetro caramelo.
Candy thermometer holder.

| Cod. | Med. Measur. | Material | Pack |
|---------------|--------------|-------------|------|
| AO0468 | 137 mm. | Inox - Sst. | 1 |



Soporte para termómetro caramelo.
Candy thermometer holder.

| Cod. | Med. Measur. | Material | Pack |
|---------------|--------------|-------------|------|
| AO3580 | 450 mm. | Inox - Sst. | 1 |



Probeta para densímetro
Test tube for densimeter

| Cod. | Med. Measur. | Medición | Material |
|---------------|--------------|----------|----------|
| AO0520 | 30 x 250 mm. | 100 ml. | P.V.C |



Densímetro pesa jarabes. Grados Baumé.
Densimeter weighs syrups. Baumé degrees.

| Cod. | Med. Measur. | Medición |
|---------------|----------------|----------|
| AO0488 | 1100/1400 g/l. | 100 ml. |



Termómetro digital cámaras frigoríficas.
Digital thermometer for cold stores.

| Cod. | Medida - Size | Med. - Measur. | Pack |
|---------------|---------------|----------------|------|
| AO1484 | 67x25x43m mm. | -20°C / +60°C | 1 |

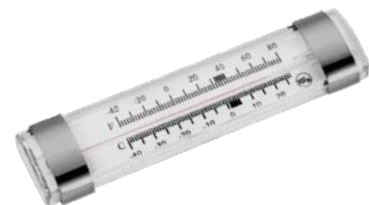

Termómetro analógico cámaras frigoríficas.
Analogic thermometer for cold stores.

| Cod. | Med. Measur. | Material |
|---------------|---------------|----------|
| AO0577 | -40°C / +80°C | P.V.C |



Termómetro láser - 1 punto.
Laser thermometer - 1 point.

| Cod. | Med. Measurem. | Pack |
|---------------|------------------|------|
| AO1487 | - 50°C / + 380°C | 1 |



Termómetro analógico cámaras frigoríficas.
Analogic thermometer for cold stores.

| Cod. | Med. Measurem. | Pack |
|----------------|-----------------|------|
| AO62450 | - 20°C / + 80°C | 1 |



Termómetro para cámara congelación, sonda 1m.
Thermometer for freezing chamber, probe 1 m.

| Cod. | mm. | Med - Measurem. |
|---------------|------------------|------------------|
| AO1483 | 47 x 29 x 15 mm. | - 50°C / + 110°C |



Termómetro para horno.
Oven thermometer.

| Cod. | Med - Measurem. | Material |
|---------------|------------------|--------------|
| AO0489 | - 50°C / + 300°C | Inox. - Sst. |



Avisador Acústico.
Acoustic Warning

| Cod. | mm. | Pack |
|----------------|----------|------|
| AO60805 | 150 x 70 | 1 |

- Características:
- Función hora
 - Alarma sonora programable
 - Dispone de memoria
- Characteristics:
- Time function
 - Programmable audible alarm
 - It has memory



Termómetro para aceite.
Oil thermometer.

| Cod. | Medida - Size | Med. Measurem. |
|---------------|---------------|----------------|
| AO1485 | 300 mm. | 0°C / + 300°C |



Termómetro de leche para cafeterías.
Milk thermometer for coffee shop.

| Cod. | Med. Measurem. |
|---------------|----------------|
| AO0950 | -10°C / + 0°C |



Termómetro de aceite para freidoras.
Oil thermometer for fryers.

| Cod. | Med. Measurem. |
|---------------|----------------|
| AO0985 | 0°C / + 300°C |



Balanza profesional división 1 gr.

Professional scale division 1 gr.

| Cod. | Material | Capac. |
|---------------|-------------|--------|
| AO0938 | Inox. . Sst | 30 Kg |

CARACTERÍSTICAS / FEATURES

- Plato en acero inoxidable. / Stainless steel plate
- Dimensiones del plato: 290 x 230 mm.
Plate dimensions: 290 x 230 mm.
- Protección IP44. / IP44 protection.
- Protección contra sobrecargas. / Overload protection.
- Nivel burbuja. / Spirit level.
- Unidades: gr. / Kg. / lb. / oz. / Units: g / Kg / lb / oz.
- 4 pies de altura regulable. / 4 height-adjustable feet.
- Batería interna recargable. / Internal rechargeable battery.
- Alimentación de 230 Vac. / 230 Vac poer supply.

FUNCIONES / FUNCTIONS

- Acumulación. / Accumulation.
- Cero / Tara. / Zero / Tare.
- Bruto / Neto. / Gross / Net.
- Cuenta piezas. / Piece counting.



Balanza profesional división 1 gr.

Professional scale division 1 gr.

| Cod. | Material | Capac. |
|---------------|-------------|--------|
| AO0944 | Inox. . Sst | 5 Kg |

CARACTERÍSTICAS / FEATURES

- Plato en acero inoxidable. / Stainless steel plate
- Unidades: Kg. / lb. / Units: Kg / lb
- Alimentación con 4 pilas AA (No incluida) / Powered by 4 AA batteries (not included)

FUNCIONES / FUNCTIONS

- Tara. / Tare.
- Autoapagado / Auto power off



Balanza profesional analógica.

Analog scale division.

| Cod. | Material | Capac. |
|----------------|-------------|------------|
| AO61714 | Inox. . Sst | 20 gr-5 Kg |



Medidor con graduación en relieve.
Measure with raised graduation.

| Cod. | Med-Measur. | Material |
|---------------|-------------|----------|
| AO0084 | 500 ml. | P.V.C. |
| AO0080 | 1000 ml. | P.V.C. |
| AO0081 | 2000 ml. | P.V.C. |
| AO0083 | 3000 ml. | P.V.C. |
| AO0085 | 5000 ml. | P.V.C. |



Medidor con graduación en relieve.
Measure with raised graduation.

| Cod. | Med-Mesur. | Material |
|---------------|------------|----------|
| AO0687 | 1000 ml. | P.V.C. |
| AO0688 | 2000 ml. | P.V.C. |
| AO0689 | 3000 ml. | P.V.C. |
| AO0690 | 5000 ml. | P.V.C. |



Medidor con graduación serigrafiada.
Graded screen measure.

| Cod. | Med-Measur. | Material |
|---------------|-------------|----------|
| AO1389 | 500 ml. | P.V.C. |
| AO1390 | 1000 ml. | P.V.C. |
| AO1391 | 2000 ml. | P.V.C. |
| AO1392 | 3000 ml. | P.V.C. |

| Cod. | Med. Measur. | Material |
|--------|--------------|----------|
| AO0780 | 200 ml. | P.V.C. |
| AO0781 | 300 ml. | P.V.C. |
| AO0782 | 600 ml. | P.V.C. |
| AO0783 | 900 ml. | P.V.C. |



| Cod. | Cantidad-Quantity | Material |
|--------|-------------------|----------|
| AO0903 | 3 uds. | P.V.C. |



| Cod. | Med. Measur. | Material |
|--------|--------------|--------------|
| AO1151 | 350 ml. | Inox. - Sst. |
| AO1152 | 700 ml. | Inox. - Sst. |
| AO1153 | 1100 ml. | Inox. - Sst. |
| AO1154 | 1700 ml. | Inox. - Sst. |



Medidor con graduación serigrafiada.
Graded screen measure.

| Cod. | Medición - Measurement | Material |
|--------|------------------------|----------|
| AO1425 | 100 cc. | P.V.C. |
| AO1426 | 250 cc. | P.V.C. |
| AO1427 | 500 cc. | P.V.C. |
| AO1428 | 1000 cc. | P.V.C. |



Botella para calado graduada.
Graduated draught bottle.

| Cod. | Medición - Measurement | Material |
|--------|------------------------|----------|
| AO1429 | 1000 ml. | P.V.C. |



Recipiente con fondo oval.
Container with oval bottom.

| Cod. | Capacidad - Capacity | Medida - Size | Material |
|---------------|----------------------|---------------|----------|
| AO0676 | 2,5 l. | Ø 23 cm. | P.V.C. |
| AO0677 | 4 l. | Ø 28 cm. | P.V.C. |
| AO0678 | 8 l. | Ø 32 cm. | P.V.C. |
| AO0679 | 10 l. | Ø 38 cm. | P.V.C. |



Medidor con graduación en relieve.
Gauge with raised gradation.

| Cod. | Capacidad - Capacity | Material |
|---------------|----------------------|--------------|
| AO0455 | 250 cc. | Inox. - Sst. |
| AO0456 | 500 cc. | Inox. - Sst. |
| AO0457 | 1000 cc. | Inox. - Sst. |

Juego de medidores.
Set of measures.

| Cod. | Medidas | Material. |
|---------------|------------------|--------------|
| AO0213 | 60-80-125-250ml. | Inox. - Sst. |



Contenedor alimentario para harina, azúcar, etc.
Food container for flour, sugar, etc.

| Cod. | Medidas | Material. |
|---------------|---------|-----------|
| AO1100 | 100l. | P.V.C. |



Contenedores alimentarios para harina, azúcar, etc.
Food containers for flour, sugar, etc.

| Cod. | Medidas | Material. |
|---------------|---------|-----------|
| AO1144 | 30l. x3 | P.V.C. |



Cedazo para azúcar y harina.
Strainer for sugar and flour.

| Cod. | Medida - Size | Filtro - Filter | Material. |
|---------------|---------------|-----------------|--------------|
| AO0070 | Ø 160 mm. | Azúcar - Sugar | Inox. - Sst. |
| AO0071 | Ø 200 mm. | Azúcar - Sugar | Inox. - Sst. |
| AO0072 | Ø 260 mm. | Azúcar - Sugar | Inox. - Sst. |
| AO0652 | Ø 300 mm. | Azúcar - Sugar | Inox. - Sst. |
| AO1317 | Ø 220 mm. | Harina - Flour | Inox. - Sst. |
| AO0074 | Ø 300 mm. | Harina - Flour | Inox. - Sst. |
| AO0075 | Ø 400 mm. | Harina - Flour | Inox. - Sst. |



Colador reforzado con gancho.
Reinforced hook sieve.

| Cod. | Medición - Measurement | Material |
|----------------|------------------------|--------------|
| AO0396 | Ø 160 mm. | Inox. - Sst. |
| AO24019 | Ø 190 mm. | Inox. - Sst. |
| AO24022 | Ø 220 mm. | Inox. - Sst. |
| AO24025 | Ø 250 mm. | Inox. - Sst. |



Colador con gancho.
Strainer with hook.

| Cod. | Medida - Size | Material. |
|---------------|---------------|--------------|
| AO0078 | Ø 160 mm. | Inox. - Sst. |
| AO0747 | Ø 180 mm. | Inox. - Sst. |
| AO0079 | Ø 200 mm. | Inox. - Sst. |
| AO0068 | Ø 240 mm. | Inox. - Sst. |



Lustrero con gatillo.
Sugar sprinkling with trigger.

| Cod. | Medida - Size | Material |
|--------------|---------------|--------------|
| ACC01 | 110 mm. | Inox. - Sst. |



Lustrero.
Sugar sprinkling.

| | Cod. | Medida - Size | Material. |
|---|----------------|---------------|--------------|
| A | AT0134 | 70 x 95 mm. | Inox. - Sst. |
| B | AO62903 | 70 x 95 mm. | Inox. - Sst. |



Dosificador con soporte.
Boquilla de salida 6 Ø mm.
Dispenser with stand.
Outlet nozzles 6 Ø mm.

| Cod. | Capacidad - Capacity | Material |
|---------------|----------------------|--------------|
| TC8020 | 1000 ml. | Inox. - Sst. |



Dosificador con soporte.
Contiene dos boquillas (4 y 6 Ø mm.)
Dispenser with stand.
Cotains two nozzles (4 y 6 Ø mm.)

| Cod. | Capacidad - Capacity | Material |
|---------------|----------------------|--------------|
| AO1273 | 1000 ml. | Inox. - Sst. |



Hilahuevo 5 boquillas.
5 nozzles dispenser.

| Cod. | Capacidad - Capacity | Material |
|---------------|----------------------|--------------|
| AO0597 | 500 ml. | Inox. - Sst. |



Hilahuevo 8 boquillas.
8 nozzles dispenser.

| Cod. | Capacidad - Capacity | Material |
|---------------|----------------------|--------------|
| AO0313 | 500 ml. | Inox. - Sst. |



Hilahuevo 5 boquillas.
5 nozzles dispenser.

| Cod. | Capacidad - Capacity | Material. |
|---------------|----------------------|--------------|
| AO0311 | 1L. | Inox. - Sst. |





Cacillo Inox. 18/10.
Ladle Stainless 18/10.

| Cod. | Medida - Size | Material |
|---------------|---------------|--------------|
| AO1274 | Ø 100 mm. | Inox. - Sst. |
| AO1275 | Ø 120 mm. | Inox. - Sst. |
| AO1276 | Ø 140 mm. | Inox. - Sst. |



Cacillo Inox. 18/10. Modelo ECO
Ladle Stainless 18/10. ECO model

| Cod. | Medida - Size | Material |
|----------------|---------------|--------------|
| AO0217 | Ø 100 mm. | Inox. - Sst. |
| AO60312 | Ø 120 mm. | Inox. - Sst. |
| AO0218 | Ø 140 mm. | Inox. - Sst. |



Espumadera con refuerzo. Inox. 18/10.
Slotted spoon reinforced. Stainless 18/10.

| Cod. | Medida - Size | Material |
|----------------|---------------|--------------|
| AO0460 | Ø 100 mm. | Inox. - Sst. |
| AO60412 | Ø 120 mm. | Inox. - Sst. |
| AO0461 | Ø 150 mm. | Inox. - Sst. |
| AO0967 | Ø 180 mm. | Inox. - Sst. |
| AO0462 | Ø 200 mm. | Inox. - Sst. |



Espumadera. Inox. 18/10.
Slotted spoon. Stainless 18/10.

| Cod. | Medida - Size | Material |
|----------------|---------------|--------------|
| AO60409 | Ø 100 mm. | Inox. - Sst. |
| AO60411 | Ø 120 mm. | Inox. - Sst. |
| AO60413 | Ø 140 mm. | Inox. - Sst. |
| AO60417 | Ø 180 mm. | Inox. - Sst. |
| AO60419 | Ø 200 mm. | Inox. - Sst. |



Espumadera Inox. 18/10.
Slotted spoon. Stainless 18/10.

| Cod. | Medida - Size | Material |
|---------------|---------------|--------------|
| AO0102 | Ø 120 mm. | Inox. - Sst. |
| AO0114 | Ø 140 mm. | Inox. - Sst. |
| AO0115 | Ø 180 mm. | Inox. - Sst. |



Espumadera araña con refuerzo. Inox. 18/10.
Spider slotted spoon with reinforced. Stainless 18/10.

| Cod. | Medida - Size | Material |
|---------------|---------------|--------------|
| AO1236 | Ø 130 mm. | Inox. - Sst. |
| AO1237 | Ø 180 mm. | Inox. - Sst. |
| AO1238 | Ø 220 mm. | Inox. - Sst. |

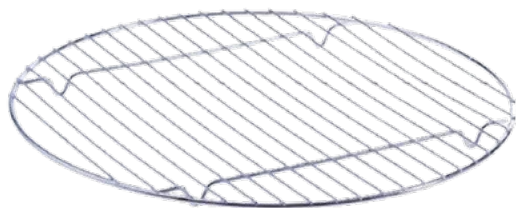

| Cod. | Medida - Size | Material |
|---------------|---------------|--------------|
| AO0820 | Ø 300 mm. | Inox. - Sst. |
| AO0821 | Ø 400 mm. | Inox. - Sst. |

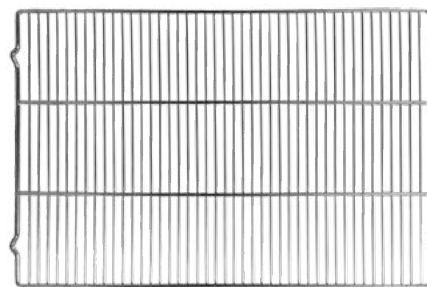

| Cod. | Medida - Size | Material. |
|---------------|---------------|--------------|
| AO0822 | 400 x 600mm. | Inox. - Sst. |

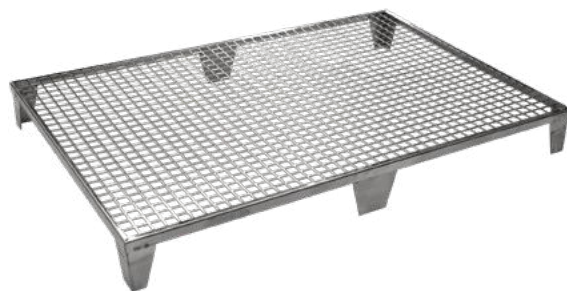

Rejilla candilera - Grid mold.

| Cod. | Medida - Size | Material. |
|---------------|-------------------|--------------|
| AO0319 | 300 x 400 x 60mm. | Inox. - Sst. |
| AO0320 | 400 x 600 x 60mm. | Inox. - Sst. |



Candidera con asas.
Mold with handles

| Cod. | Medida - Size | Material |
|---------------|-------------------|--------------|
| AO0317 | 300 x 400 x 60mm. | Inox. - Sst. |
| AO0318 | 400 x 600 x 60mm. | Inox. - Sst. |



Kit candidera + rejilla.
Mold + grid kit.

| Cod. | Medida - Size | Material. |
|---------------|-------------------|--------------|
| AO1277 | 300 x 400 x 60mm. | Inox. - Sst. |
| AO1279 | 400 x 600 x 60mm. | Inox. - Sst. |

Bandeja embutidas / Rounded tra

Las bandejas pueden fabricarse también con una capa de silicona o una capa de teflón, generando así una alta durabilidad. Servicio mínimo para siliconar o teflonar las bandejas son de 10 unidades por modelo.

The trays can also be manufactured with a silicone layer or a teflon layer, generating high durability. Minimum service for silicone or teflon trays ara 10 units per model.

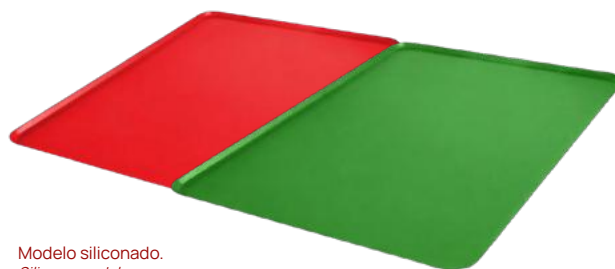

Modelo siliconado.
Silicone model.
Modelo teflonado.
Teflon model.

| Cod. | Medida - Size | Material. |
|---------------|----------------------|------------|
| AO0628 | 400 x 600 x 10 h mm. | Siliconado |
| AO0400 | 400 x 600 x 10 h mm. | Teflonado |

Bandeja de cantos embutidos con grosor de 0,12 mm.
Rounded boulders tray. Thickness: 0,12 mm.

| Cod. | Medida - Size | Material. | Pack. |
|---------------|-----------------------|---------------------|-------|
| AO0627 | 400 x 600 x 10 h mm. | Aluminio - Aluminum | 10 |
| AO0660 | 600 x 800 x 10 h mm. | Aluminio - Aluminum | 5 |
| AO0661 | 800 x 1000 x 10 h mm. | Aluminio - Aluminum | 5 |

Bandeja de cantos embutidos con grosor de 0,12 mm.
Rounded boulders tray. Thickness: 0,12 mm.

| Cod. | Medida - Size | Material. | Pack. |
|---------------|----------------------|--------------------------|-------|
| AO0623 | 400 x 600 x 10 h mm. | Hierro Pavonado - B.Iron | 5 |

Bandeja 2 bordes rectos con grosor de 0,12 mm.
Straight 2 edges tray. Thickness: 0,12 mm.

| Cod. | Medida - Size | Material. | Pack |
|---------------|----------------------|--------------------------|------|
| AO1374 | 400 x 600 x 10 h mm. | Hierro Pavonado - B.Iron | 5 |



NUEVO

Bolsa estándar cubre bandejas, 50 bolsas.
Standard bag covers trays, 50 bags.

| Cod. | Medida - Size | Material. |
|---------------|-----------------------|---------------|
| AO1543 | 460 x 720 + 100 h mm. | P.V.C. 20 µm. |



Microperforaciones para una salida óptima de las bolsas.
Microperforations for optimal bag dispensing.

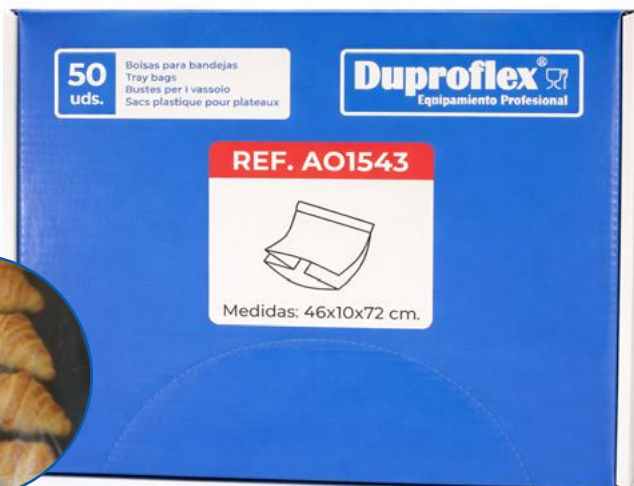

BANDEJA DE CANTOS RECTOS / Straight edges tray



Bandeja de cantos rectos con grosor de 0,12 mm.
Straight edges tray. Thickness: 0,12 mm.

| Cod. | Medida - Size | Material | Pack. |
|---------------|----------------------|------------------------------|-------|
| AO0312 | 400 x 600 x 10 h mm. | Hierro Pavonado - Blued iron | 5 |
| AO0407 | 300 x 400 x 10 h mm. | Aluminio - Aluminum | 5 |
| AO0490 | 400 x 600 x 10 h mm. | Aluminio - Aluminum | 5 |
| AO0304 | 300 x 400 x 10 h mm. | Inoxidable - Stainless | 5 |
| AO0805 | 400 x 600 x 10 h mm. | Inoxidable - Stainless | 5 |

BANDEJA PERFORADA / Perforated tray



Bandeja perforada de cantos embutidos con grosor de 0,12 mm.
Perforated rounded boulders tray. Thickness: 0,12 mm.

| Cod. | Medida - Size | Material. |
|---------------|-----------------------|---------------------|
| AO0629 | 400 x 600 x 10 h mm. | Aluminio - Aluminum |
| AO0662 | 600 x 800 x 10 h mm. | Aluminio - Aluminum |
| AO0674 | 800 x 1000 x 10 h mm. | Aluminio - Aluminum |

Bandeja perforada para pan con grosor de 0,12 mm.
Perforated tray for bread. Thickness: 0,12 mm.

| Cod. | Medida - Size | Material. | Pack. |
|------------------|----------------|---------------------|-------|
| A AO0493 | 400 x 600 mm. | Aluminio - Aluminum | 5 |
| A AO0680 | 600 x 800 mm. | Aluminio - Aluminum | 5 |
| A AO0681 | 800 x 1000 mm. | Aluminio - Aluminum | 5 |
| B AO0493B | 400 x 600 mm. | Aluminio - Aluminum | 5 |
| B AO0680B | 600 x 800 mm. | Aluminio - Aluminum | 5 |
| B AO0681B | 800 x 1000 mm. | Aluminio - Aluminum | 5 |

BANDEJA ESPECIAL / Special tray



Bandeja electrolítica siliconada.
Electrolytic silicone tray.

| Cod. | Medida - Size | Material. | Pack. |
|---------------|---------------------|--------------------|-------|
| AO0915 | 400 x 600 x 5 h mm. | Chapa - Sheet iron | 10 |



Bandeja rejada para pizza.
Tray for pizza.

| Cod. | Medida - Size | Material. | Pack. |
|----------------|---------------|---------------------|-------|
| AO63030 | 300 Ø mm. | Aluminio - Aluminum | 5 |
| AO63035 | 350 Ø mm. | Aluminio - Aluminum | 5 |
| AO63040 | 400 Ø mm. | Aluminio - Aluminum | 5 |

LÁMINAS PARA HORNO / Baking sheets



ESPECIAL PASTELERÍA

Lámina teflonada con fibra de vidrio.
 Temperatura máxima 250 °C.
*Tefloned sheet with fiberglass.
 Maximum temperature 250 °C.*

| Cod. | Medida - Size | Material. | Pack |
|---------------------|------------------------|------------|------|
| TEFLONPAT | 400 x 600 x 0,12 h mm. | Fiberglass | 11 |
| TEFLONPATSUP | 400 x 600 x 0,20 h mm. | Fiberglass | 11 |



ESPECIAL PANADERÍA

Lámina teflonada con fibra de vidrio.
 Temperatura máxima 250 °C.
*Tefloned sheet with fiberglass.
 Maximum temperature 250 °C.*

| Cod. | Medida - Size | Material. | Pack |
|--------------------|------------------------|------------|------|
| TEFLONPATSP | 490 x 740 x 0,12 h mm. | Fiberglass | 6 |



Lámina teflonada con fibra de vidrio. Borde redondo.
 Temperatura máxima 250 °C.
*Tefloned sheet with fiberglass. Round edge.
 Maximum temperature 250 °C.*

| Cod. | Medida - Size | Material | Pack |
|--------------------|------------------------|------------|------|
| TEFLONPATBR | 400 x 600 x 0,12 h mm. | Fiberglass | 11 |



Lámina teflonada con fibra de vidrio. Borde redondo.
 Temperatura máxima 250 °C.
*Tefloned sheet with fiberglass. Round edge.
 Maximum temperature 250 °C.*

| Cod. | Medida - Size | Material. | Pack. |
|--------------------|------------------------|------------|-------|
| TEFLONPATPQ | 300 x 400 x 0,12 h mm. | Fiberglass | 3 |

APTO PARA PASTELERÍA O PANADERÍA
 SUITABLE FOR PASTRY OR BAKERY

Uniformidad, textura y
facilidad de trabajo.



Duproflex®



Lámina siliconada perforada.
Perforated silicone sheet.

| Cod. | Medida - Size | Material. | Pack. |
|---------------|---------------|---------------------|-------|
| TC3079 | 395 x 595 mm. | Silicona - Silicone | 1 |

Duproflex®

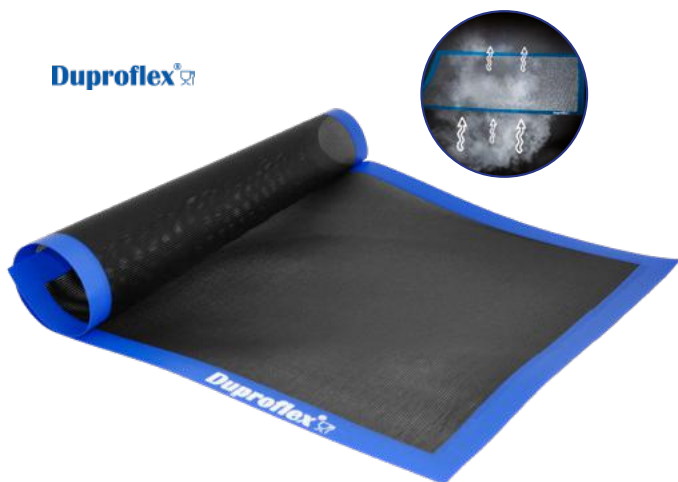

Lámina siliconada perforada eclair.
Eclair perforated silicone sheet.

| Cod. | Medida - Size | Material. | Pack. |
|----------------|---------------|---------------------|-------|
| TC3079C | 395 x 595 mm. | Silicona - Silicone | 1 |

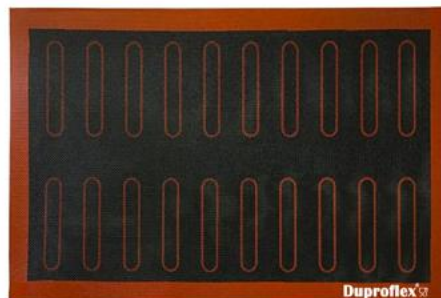

Lámina siliconada con borde alto.
Silicone sheet with high edge.

| Cod. | Medida - Size | Material. | Pack |
|--------------------|----------------------|---------------------|------|
| TAPISROUL02 | 350 x 540 x 80 h mm. | Silicona - Silicone | 1 |



Lámina siliconada lisa.
Smooth silicone sheet.

| Cod. | Medida - Size | Material. | Pack. |
|---------------------|---------------|---------------------|-------|
| SILICOPAT1/R | 395 x 595 mm. | Silicona - Silicone | 1 |

Duproflex®



Lámina siliconada con fibra en su interior para una mayor duración.
Silicone sheet with fiber inside for a longer duration.

| Cod. | Medida - Size | Material. | Pack |
|---------------|---------------|---------------------|------|
| TC3078 | 395 x 595 mm. | Silicona - Silicone | 1 |

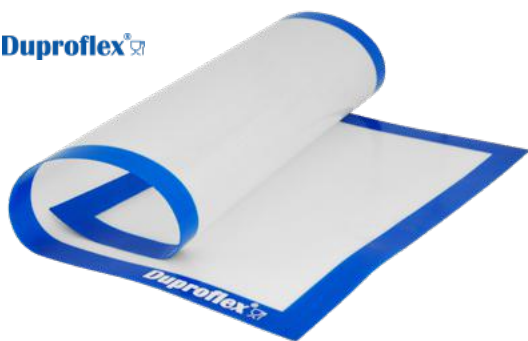

Lámina siliconada de medición.
Silicone measuring sheet.

| Cod. | Medida - Size | Material. | Pack |
|---------------|---------------|---------------------|------|
| TC3080 | 400 x 600 mm. | Silicona - Silicone | 1 |

Duproflex®

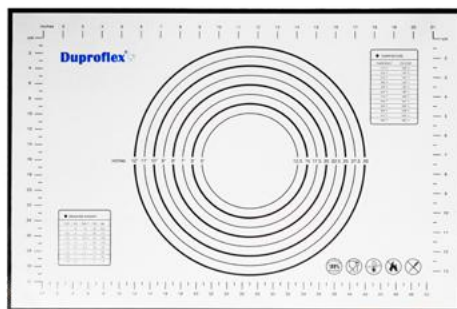

Papel siliconado blanco, especial horno.
Con gramaje de 40 gramos.
*White silicone paper, special oven.
With grammage of 40grams.*

| Cod. | Medida - Size | Cantidad - Quantity | Pack. |
|---------------|---------------|---------------------|-------|
| CA0799 | 400m x 6 cm. | 400 | 1 |

Duproflex®



Papel siliconado redondo para horno. 40 grs.
Round silicone paper for oven. 40 grs.

| Cod | Medida - Size | Material. | Pack. |
|---------------|---------------|---------------|-------|
| CA0805 | Ø 180 mm. | Papel - Paper | 500 |
| CA0806 | Ø 200 mm. | Papel - Paper | 500 |
| CA0807 | Ø 220 mm. | Papel - Paper | 500 |
| CA0808 | Ø 240 mm. | Papel - Paper | 500 |
| CA0809 | Ø 260 mm. | Papel - Paper | 500 |

Papel siliconado blanco, especial horno.
Con gramaje de 41 gramos y siliconado ambas caras.
*White silicone paper, special oven.
With grammage of 41 grams and silicone both sides.*

| Cod. | Medida - Size | Resmas - Reams. | Pack |
|---------------|---------------|-----------------|------|
| CA0261 | 400 x 600 mm. | 500 | 1 |







Estantería para bandejas.
Ruedas de alto rendimiento.
Capacidad: 21 Bandejas.
Medidas de bandejas: 40 x 60cm.
*Shelving for trays.
High performance wheels
Capacity: 21 Trays.
Tray measures: 40 x 60 cm.*

| Cod. | Medida - Size | Material. |
|--------|---------------------|---------------------------|
| AO1593 | 47 x 62 x 185 h cm. | 18/10 Inox. 18/10 Sst. |



Estantería para bandejas.
Ruedas de alto rendimiento.
Capacidad: 22 Bandejas.
Medidas de bandejas: 40 x 60cm.
Opción apertura 60 cm.

Opción a fabricar medidas especiales.

*Shelving for trays.
High performance wheels
Capacity: 22 or 25 Trays.
Tray measures: 40 x 60 cm.
60 cm opening option.*

Option to manufacture special measures.

| Cod. | Medida - Size | Material. |
|--------|---------------------|---------------------------|
| AO0275 | 45 x 65 x 185 h cm. | 18/10 Inox. 18/10 Sst. |

OPCIÓN DE APERTURA
A 60 CM



Ventajas de la opción de apertura 60 cm
-Permite introducir bandejas de 40x60 cm, por el lado de 60 cm.
-Facilita escoger la orientación de colocación (longitudinal o transversal) en su fabricación.

*Advantages of the 60 cm opening option
-Allows inserting 40x60 cm trays by supporting their long side (60 cm).
-Makes it easy to choose the tray orientation (longitudinal or transverse).*



Varillero para bandejas.
Ruedas de alto rendimiento.
Capacidad: 32 Bandejas.
Medidas de bandejas: 40 x 60 cm.
*Rack for trays.
High performance wheels
Capacity: 32 Trays
Tray measures: 40 x 60 cm.*

| Cod. | Medida - Size | Material. |
|--------|---------------------|---------------------------------------|
| AO0298 | 65 x 90 x 175 h cm. | Hierro Galvanizado Galvanized iron |

Mesa con bandejero.
Ruedas de alto rendimiento.
Capacidad: 20 Bandejas.
Medidas de bandejas: 400 x 600 mm.
Altura entre bandejas de 7 h cm.
Opción fabricar medidas especiales.

*Table with bandejero.
High performance wheels
Capacity: 20 Trays.
Tray measures: 400 x 600 mm.
Height between trays of 7 h cm.
Option to manufacture special measures.*



| Cod. | Medida - Size | Capacidad - Capacity | Material |
|---------------|--------------------|-------------------------|---------------------------|
| AO1423 | 60 x 90 x 90 h cm. | 20 Bandejas 20 Trays | 18/10 Inox. 18/10 Sst. |

Funda para estantería de 22 bandejas.
Apertura de 40 cm.
Opción medidas especiales.
Medidas: 46 x 67 x 185 h cm.
*Shelf for 22 shelves.
40 cm opening.
Special measures option.
Measures: 46 x 67 x 185 h cm.*

| Cod. | Apertura - Opening | Cierre - Lock | Material. |
|----------------|--------------------|---------------------|-----------|
| AO0596 | 40 cm. | Cremallera - Zipper | P.V.C. |
| AO0596B | 60 cm. | Cremallera - Zipper | P.V.C. |
| AO0647 | 40 cm. | Velcro | P.V.C. |
| AO0647B | 60 cm. | Velcro | P.V.C. |



Microperforaciones para una salida óptima de las bolsas.
Microperforations for optimal bag dispensing.

50 Fundas desechables para estanterías.
Bolsas individuales.
*50 disposable shelving covers.
Individual bags.*

| Cod. | Medida - Size | Material |
|---------------|----------------------|---------------|
| AO1544 | 680 x 520 x 2100 mm. | P.V.C. 20 µm. |

MANOPLAS DE PIEL IGNÍFUGAS

Ref: **AO0616**

Ideales para hornos profesionales, panaderías, pastelerías, pizzerías, cocinas, para manipulación de bandejas, carros, rejillas y accesorios calientes.

Protección térmica elevada: soporta temperaturas aproximadamente de hasta 350°C durante al menos 15 segundos (EN 407:2020) - Calor por contacto.

Permiten trabajar con mayor destreza y agilidad.

Especialmente diseñados para la extracción de bandejas de hornos.

Buena resistencia para el desgaste perforación y desgarró (EN 388:2006+A1:2018).



**MANOPLAS
DE PIEL
REFORZADAS**
Reinforced leather mittens



| | | |
|--|--|--|
| CE 0075 | EN388  | EN407  |
|  | 4244X | 4334XX |
| EPI Categoría III | | |
| Manopla piel ignífuga con refuerzo. Medida: 39 cm. | Cod. AO0616 | |
|  | 02/2026 02/2031 | |
| 8 434252 023616 Pol. Ind. Río San Pedro, C/ Colombia, 8 C.P. 11519 Puerto Real - Cádiz - España Fabricado en P.R.C. | | |

Duproflex 

NUEVO

Manopla reforzada. Especial horno.
Reinforced pastry mitten. Special oven.

| Cod. | Medida - Size | Material | Pack. |
|--------|---------------|----------------|-------|
| A00616 | 360 mm. | Piel - Leather | 1 |



Manopla reforzada con anillas inoxidable. Especial horno.
Reinforced pastry mitten with steel pins. Special oven.

| Cod. | Medida - Size | Material | Pack. |
|--------|---------------|----------------|-------|
| A00615 | 360 mm. | Piel - Leather | 1 |



Manopla modelo ECO. Especial horno.
ECO model mitten. Special oven.

| Cod. | Medida - Size | Material | Pack. |
|------|---------------|----------------|-------|
| GL2 | 390 mm. | Piel - Leather | 1 |





Paño anti-calórico. Especial horno.
Anti-caloric cloth. Special oven.

| Cod. | Medida - Size | Pack. |
|---------------|---------------|--------|
| AO0619 | 250 x 300 mm. | P.V.C. |



Guantes para hornos.
Oven gloves.

| Cod. | Medida - Size | Material. | Pack. |
|---------------|--------------------|-----------------|-------|
| AO0613 | Estándar - Standar | Cuero - Leather | 1 |



Guantes para cámaras frigoríficas.
Gloves for cold stores.

| Cod. | Medida - Size | Material. | Pack. |
|---------------|--------------------|-----------------|-------|
| AO0617 | Estándar - Standar | Cuero - Leather | 1 |



Gancho para extraer latas del horno.
Hook for removing the cans from the oven.

| Cod. | Medida - Size | Material. |
|---------------|---------------|--------------|
| AO0478 | 300 mm. | Inox. - Sst. |
| AO0480 | 600 mm. | Inox. - Sst. |

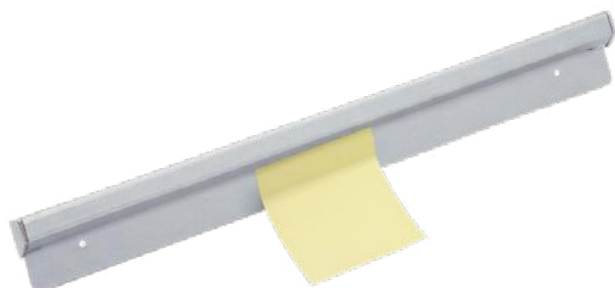

NUEVO

Comandero de aluminio sujeta notas.
Aluminum note holder

| Cod. | Medida - Size | Material. | Pack |
|---------------|---------------|--------------------|------|
| AO0484 | 615x50x20 mm. | Aluminio-Aluminium | 1 |



Caldero fondo bombeado. Apto para el fuego.
Pumped bottom cauldron. Suitable for fire.

| Cod. | Medida - Size | Litros - Liters. | Material |
|---------------|-------------------|------------------|--------------------|
| AO1318 | Ø 250 x 130 h mm. | 3,8 | 18/10 Inox. - Sst. |
| AO0974 | Ø 300 x 160 h mm. | 6,5 | 18/10 Inox. - Sst. |
| AO0996 | Ø 400 x 190 h mm. | 13 | 18/10 Inox. - Sst. |
| AO0997 | Ø 500 x 235 h mm. | 25 | 18/10 Inox. - Sst. |



Caldero cónico de fondo plano. Modelo ECO. Apto para el fuego.
Flat bottom conical cauldron. ECO model. Suitable for fire.

| Cod. | Medida - Size | Litros - Liters. | Material. |
|----------------|-------------------|------------------|--------------------|
| AO50828 | Ø 280 x 132 h mm. | 5 | 18/10 Inox. - Sst. |
| AO50832 | Ø 320 x 145 h mm. | 7 | 18/10 Inox. - Sst. |
| AO50836 | Ø 360 x 160 h mm. | 11 | 18/10 Inox. - Sst. |
| AO50840 | Ø 400 x 180 h mm. | 15 | 18/10 Inox. - Sst. |
| AO50845 | Ø 450 x 200 h mm. | 22 | 18/10 Inox. - Sst. |



Caldero de fondo bombeado "Timbal". Apto para el fuego.
Pumped bottom cauldron "Kettledrum". Suitable for fire.

| Cod. | Medida - Size | Litros - Liters. | Material |
|----------------|-------------------|------------------|--------------------|
| AO50323 | Ø 220 x 110 h mm. | 2,7 | 18/10 Inox. - Sst. |
| AO50327 | Ø 260 x 130 h mm. | 4 | 18/10 Inox. - Sst. |
| AO50333 | Ø 320 x 170 h mm. | 9,5 | 18/10 Inox. - Sst. |
| AO50337 | Ø 360 x 180 h mm. | 12 | 18/10 Inox. - Sst. |
| AO50341 | Ø 400 x 210 h mm. | 14,5 | 18/10 Inox. - Sst. |



Caldero de fondo plano. Apto para el fuego.
Flat bottom cauldron. Suitable for fire.

| Cod. | Medida - Size | Litros - Liters. | Material |
|---------------|---------------|------------------|--------------------|
| AO0199 | Ø 200 mm. | 2,2 | 18/10 Inox. - Sst. |
| AO0200 | Ø 250 mm. | 3,5 | 18/10 Inox. - Sst. |
| AO0201 | Ø 300 mm. | 6 | 18/10 Inox. - Sst. |
| AO0202 | Ø 350 mm. | 8,5 | 18/10 Inox. - Sst. |
| AO0203 | Ø 400 mm. | 13 | 18/10 Inox. - Sst. |
| AO0204 | Ø 450 mm. | 20 | 18/10 Inox. - Sst. |
| AO0205 | Ø 500 mm. | 25 | 18/10 Inox. - Sst. |
| AO0206 | Ø 550 mm. | 35 | 18/10 Inox. - Sst. |
| AO0207 | Ø 600 mm. | 45 | 18/10 Inox. - Sst. |
| AO0208 | Ø 650 mm. | 55 | 18/10 Inox. - Sst. |
| AO0209 | Ø 700 mm. | 65 | 18/10 Inox. - Sst. |



Caldero de fondo plano. Apto para el fuego.
Flat bottom cauldron. Suitable for fire.

| Cod. | Medida - Size | Litros - Liters. | Material |
|----------------|-------------------|------------------|--------------------|
| AO14016 | Ø 160 x 65 h mm. | 0,9 | 18/10 Inox. - Sst. |
| AO14019 | Ø 200 x 75 h mm. | 1,4 | 18/10 Inox. - Sst. |
| AO14025 | Ø 240 x 90 h mm. | 2,5 | 18/10 Inox. - Sst. |
| AO14029 | Ø 300 x 110 h mm. | 4,3 | 18/10 Inox. - Sst. |
| AO14033 | Ø 340 x 135 h mm. | 7,5 | 18/10 Inox. - Sst. |



Soporte sobremesa para calderos.
Table support for cauldrons.

| Cod. | Medida - Size | Material |
|-----------------|---------------|---------------------|
| AO50300 | - | Inox. - Sst. |
| AO751100 | - | Silicona - Silicone |





Cazo con doble pico de Inducción
Cauldron with double peak. for induction

| Cod. | Litros - Liters. | Material. |
|--------|------------------|--------------|
| AO0731 | 1,5 | Inox. - Sst. |
| AO0826 | 3,1 | Inox. - Sst. |



Cazo con pico. Apto para el fuego.
Cauldron with peak. Suitable for fire.

| Cod. | Medida - Size | Litros - Liters. | Material |
|--------|-------------------|------------------|--------------------|
| AO0195 | 160 Ø x 75 h mm. | 1 | 18/10 Inox. - Sst. |
| AO0196 | 180 Ø x 80 h mm. | 1,5 | 18/10 Inox. - Sst. |
| AO0197 | 200 Ø x 100 h mm. | 2,5 | 18/10 Inox. - Sst. |
| AO0198 | 220 Ø x 115 h mm. | 3,5 | 18/10 Inox. - Sst. |
| AO0500 | 240 Ø x 120 h mm. | 4,5 | 18/10 Inox. - Sst. |



Soporte estándar para todas las medidas de calderos.
Standard holder for every pots measures.

| Cod. | Medida - Size | Material |
|--------|---------------|--------------|
| AO0401 | - | Inox. - Sst. |



Cubo con asa.
Bucket with handle.

| Cod. | Medida - Size | Litros - Liters. | Material |
|--------|-------------------|------------------|--------------|
| AO0485 | 240 Ø x 200 h mm. | 6 | Inox. - Sst. |
| AO0486 | 280 Ø x 260 h mm. | 12 | Inox. - Sst. |



Cubo con pico y asa.
Bucket with pick and handle.

| Cod. | Litros - Liters. | Material |
|--------|------------------|----------|
| AO0691 | 12 | P.V.C. |
| AO0692 | 15 | P.V.C. |
| AO0693 | 18 | P.V.C. |



Las medidas del rodillo son sin mangos.
Rolling pins measures are without handles.

| Cod. | Medida - Size | Material |
|---------------|----------------|---------------|
| AO1431 | 80 Ø x 500 mm. | Madera - Wood |
| AO1432 | 70 Ø x 600 mm. | Madera - Wood |
| AO1433 | 80 Ø x 600 mm. | Madera - Wood |



Rodillo mangos giratorios.
Las medidas del rodillo son sin mangos.
Rotary handles rolling pin.
Rolling pins measures are without handles.

| Cod. | Medida - Size | Material |
|---------------|----------------|---------------|
| AO1640 | 80 Ø x 400 mm. | Madera - Wood |
| AO1641 | 80 Ø x 500 mm. | Madera - Wood |
| AO1642 | 80 Ø x 500 mm. | Madera - Wood |



Rodillo mangos giratorios.
Las medidas del rodillo son sin mangos.
Rotary handles rolling pin.
Rolling pins measures are without handles.

| Cod. | Medida - Size | Material |
|---------------|----------------|----------|
| AO1434 | 70 Ø x 300 mm. | Nylon |
| AO1435 | 70 Ø x 400 mm. | Nylon |
| AO1436 | 70 Ø x 500 mm. | Nylon |





| Cod. | Medida - Size | Material |
|--------|---------------|----------|
| AO1439 | 195mm. | Nylon |



| Cod. | Medida - Size | Material. |
|--------|----------------|-----------|
| AO1140 | 30 Ø x 400 mm. | Nylon |
| AO1141 | 40 Ø x 350 mm. | Nylon |
| AO1142 | 30 Ø x 190 mm. | Nylon |



| Cod. | Medida - Size | Material |
|---------|----------------|---------------|
| AO68142 | 45 Ø x 430 mm. | Madera - Wood |



| Cod. | Medida - Size | Material |
|--------|---------------|--------------|
| AO1444 | 120 mm. | Inox. - Sst. |

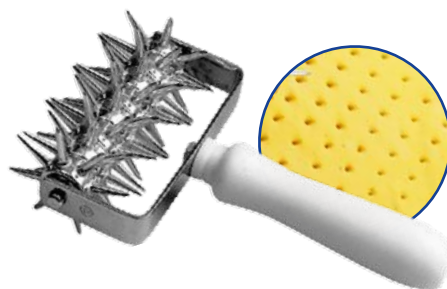

| Cod. | Medida - Size | Material |
|--------|---------------|--------------|
| AO1443 | 120 mm. | Inox. - Sst. |



| Cod. | Medida - Size | Material. |
|-------|---------------|-----------|
| RFP12 | 120 mm. | P.V.C. |



| Cod. | Medida - Size | Material. |
|--------|---------------|-----------|
| AO1441 | 120 mm. | P.V.C. |



| Cod. | Medida - Size | Material. |
|--------|---------------|-----------|
| AO1442 | 60 mm. | P.V.C. |



| Cod. | Medida - Size | Porciones - Portions | Material |
|--------|---------------|----------------------|--------------|
| AO1445 | 320 Ø mm. | 8 | Inox. - Sst. |
| AO1446 | 320 Ø mm. | 10 | Inox. - Sst. |
| AO1447 | 320 Ø mm. | 12 | Inox. - Sst. |
| AO1448 | 320 Ø mm. | 14 | Inox. - Sst. |
| AO1449 | 320 Ø mm. | 16 | Inox. - Sst. |
| AO1450 | 320 Ø mm. | 18 | Inox. - Sst. |

| Cod. | Medida - Size | Porciones - Portions | Material |
|--------|---------------|----------------------|----------|
| AO1532 | 265 Ø mm. | 10 - 12 | P.V.C. |



Marcador de porciones para tartas.
Portion marker for cakes.

| Cod. | Medida - Size | Porciones - Portions | Material |
|--------|---------------|----------------------|---------------------|
| AO1049 | 230 Ø mm. | 6 | Aluminio - Aluminum |
| AO0125 | 230 Ø mm. | 8 | Aluminio - Aluminum |
| AO0126 | 230 Ø mm. | 10 | Aluminio - Aluminum |
| AO0127 | 230 Ø mm. | 12 | Aluminio - Aluminum |



| Cod. | Medida - Size | Material |
|--------|---------------|----------|
| AO1457 | 300 Ø mm. | P.V.C. |

Medidas de corte para croissant.
Cutting measures for croissant.



Cod. Medida - Size Corte - Cut Material
AO1462 410 mm. 110 x h 150 mm. Inox. - Sst.

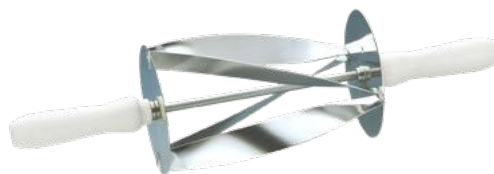

Cod. Medida - Size Corte - Cut Material
AO1464 450 mm. 180 x h 200 mm. Inox. - Sst.



Cod. Medida - Size Corte - Cut Material
AO1465 460 mm. 97 x h 210 mm. Inox. - Sst.



Cod. Medida - Size Corte - Cut Material
AO1461 660 mm. 180 x h 200 mm. Inox. - Sst.



| | | |
|---------------|--------------------------------|--------------|
| Cod. | Rueda de corte - Cutting wheel | Material |
| AO1458 | 5 ruedas lisas - 5 Flat wheels | Inox. - Sst. |
| AO0833 | 7 ruedas lisas - 7 Flat wheels | Inox. - Sst. |

| | | |
|---------------|--|--------------|
| | Doble - Double | |
| AO0836 | 5 ruedas lisas - 5 Flat wheels ruedas onduladas - 5 Wavy wheels | Inox. - Sst. |

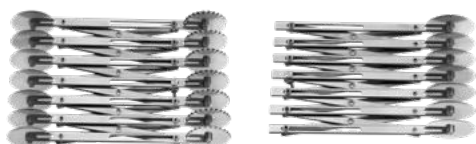

| | | |
|---------------|--|--------------|
| | Doble - Double | |
| AO0835 | 7 ruedas lisas - 7 Flat wheels ruedas onduladas - 7 Wavy wheels | Inox. - Sst. |



Cod. Medida - Size Material.
AO1474 60 Ø mm. P.V.C.



Cod. Medida - Size Material.
AO1470 55 Ø mm. P.V.C.



Cod. Medida - Size Material.
AO1473 120 Ø mm. P.V.C.

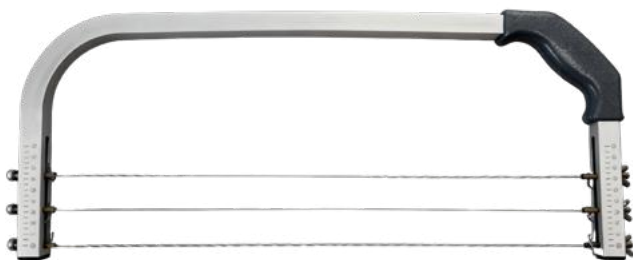

Segueta triple cuchilla, ideal para bizcochos.
Triple blade hacksaw, ideal for sponge cake.

| Cod. | Medida - Size | Material |
|--------|---------------|--------------|
| AO1490 | 460 mm. | Inox. - Sst. |



| Cod. | Material. | Pack. |
|--------|--------------|-------|
| AO0035 | Inox. - Sst. | 5 |



| Cod. | Material. | Pack. |
|--------|--------------|-------|
| AO1494 | Inox. - Sst. | 5 |



Pack con 10 unidades.
Pack with 10 units.

| Cod. | Material. | Pack. |
|--------|--------------|-------|
| AO0037 | Inox. - Sst. | 1 |

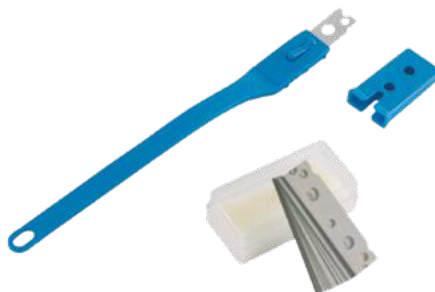

Cutter con 25 repuestos.
Cutter with 25 replacements

| Cod. | Material. | Pack. |
|--------|--------------|-------|
| AO1491 | Inox. - Sst. | 1 |



| Cod. | Material. | Pack. |
|--------|--------------|-------|
| TC1700 | Inox. - Sst. | 5 |



| Cod. | Material | Pack |
|--------|--------------|------|
| AO1497 | Inox. - Sst. | 5 |



| Cod | Material | Pack |
|--------|--------------|------|
| AO1495 | Inox. - Sst. | 5 |



| Cod. | Material. | Pack |
|--------|--------------|------|
| AO1496 | Inox. - Sst. | 5 |

Cestas de ratán para la fermentación de masas.

Rattan baskets for dough proofing.



NUEVO

Cesta de fermentación de ratán
Rattan proofing basket

| Cod. | Medida - Size | Material |
|---------|----------------------|----------|
| AO01003 | 85 h 220 Ø | Ratán |
| AO01004 | 85 h 250 Ø | Ratán |
| AO01005 | 80 h 280 Ø | Ratán |
| AO01006 | 440 x 100 x 55 h cm. | Ratán |
| AO01007 | 290 x 150 x 80 h cm. | Ratán |
| AO01008 | 270 x 130 x 65 h cm. | Ratán |



Útiles de tienda / Storage useful

Todas las medidas son de la hoja.
All measurements are from the sheet.



Sierra con terminación en punta, para una mejor terminación en el corte de bizcochos.
Saw with tip termination, for better termination in biscuit cutting.

Cuchillos inoxidable con mango de fhenolkraft.
Stainless knives with phenolcraft handles.

| Cod. | Medida - Size | Material |
|--------|---------------|--------------|
| AO0091 | 38 x 280 mm. | Inox. - Sst. |
| AO0497 | 40 x 330 mm. | Inox. - Sst. |



| Cod. | Medida - Size | Material |
|--------|---------------|--------------|
| AO0801 | 32 x 250 mm. | Inox. - Sst. |
| AO0092 | 32 x 330 mm. | Inox. - Sst. |
| AO0093 | 32 x 460 mm. | Inox. - Sst. |



| Cod. | Medida - Size | Material |
|--------|---------------|--------------|
| AO1309 | 35 x 250 mm. | Inox. - Sst. |
| AO1310 | 35 x 300 mm. | Inox. - Sst. |



| Cod. | Medida - Size | Material. |
|--------|---------------|--------------|
| AO0095 | 26 x 200 mm. | Inox. - Sst. |



| Cod. | Medida - Size | Material |
|--------|---------------|--------------|
| AO0094 | 45 x 200 mm. | Inox. - Sst. |
| AO0565 | 50 x 250 mm. | Inox. - Sst. |
| AO0817 | 60 x 300 mm. | Inox. - Sst. |
| AO1327 | 85 x 350 mm. | Inox. - Sst. |



| Cod. | Medida - Size | Material |
|--------|---------------|--------------|
| AO1312 | 45 x 250 mm. | Inox. - Sst. |
| AO1313 | 50 x 300 mm. | Inox. - Sst. |
| AO0412 | 55 x 350 mm. | Inox. - Sst. |



| Cod. | Medida - Size | Material |
|--------|---------------|--------------|
| AO0299 | 60 x 410 mm. | Inox. - Sst. |



NUEVO

| Cod. | Medida - Size | Material |
|--------|---------------|--------------|
| AO1006 | 600mm | Inox. - Sst. |



Colgador magnético para pared.
Magnetic hook for walls.

| Cod. | Medida - Size | Material |
|----------|---------------|----------|
| AO39009A | 410 mm. | P.V.C. |





| Cod. | Medida - Size | Material |
|---------------|---------------|--------------|
| AO0182 | 180 mm. | Inox. - Sst. |
| AO0470 | 200 mm. | Inox. - Sst. |



| Cod. | Medida - Size | Material |
|---------------|---------------|--------------|
| AO0482 | 180 mm. | Inox. - Sst. |



Mango de P.V.C.
P.V.C. Handle.

| Cod. | Medida - Size | Material |
|---------------|---------------|--------------|
| AO0041 | 210 mm. | Inox. - Sst. |



Mango de P.V.C.
P.V.C. Handle.

| Cod. | Medida - Size | Material |
|---------------|---------------|--------------|
| AT0272 | 210 mm. | Inox. - Sst. |



Cota de malla para corte estándar.
Chain mail glove for standard cut.

| Cod. | Medida - Size | Material |
|----------------|---------------|--------------|
| AO69001 | - | Inox. - Sst. |



Cota de malla para corte estándar.
Chain mail glove for standard cut.

| Cod. | Medida - Size | Material |
|---------------|---------------|--------------|
| AO1643 | - | Inox. - Sst. |



Abrelatas de mesa.
Table opener.

| Cod. | Medida - Size | Material |
|----------------|---------------|--------------|
| AO63005 | - | Inox. - Sst. |

Fabricado en España.
Made in Spain.



Abrelatas.
Opener.

| Cod. | Medida - Size | Material |
|---------------|---------------|--------------|
| AO0193 | 7,5 cm. | Inox. - Sst. |



Abrelatas.
Opener.

| Cod. | Medida - Size | Material |
|----------------|---------------|--------------|
| AO62689 | 200 mm. | Inox. - Sst. |

- Pela, quita el corazón y corta en un sólo paso.
- Eficiencia: 5 manzanas en un minuto.
- Sin pérdidas: Peladuras finas.
- La cuchilla "Cortador" quita el corazón y corta en espiral mientras que la cuchilla "pelador" pela.
- Para obtener rebanadas: Cortar verticalmente un lado de la espiral.
- Para obtener medio rebanadas (Tarta de manzana): Cortar verticalmente un lado y el lado opuesto, de la espiral.
- Función zest cuando se quita la "Cuchilla cortadora".

- To peel, core and slice in one operation.
- Efficiency: 5 apples in a minute.
- No loss: Thin peelings.
- The "Cutting" blade cores and cuts in spiral while the "Peeling" blade peels.
- To get slices: Cut vertically one side of the spiral.
- To get half-slices (apple pie): Cut vertically one side and the opposite side, of the spiral.
- Zest function when taking off the "Cutting blade".

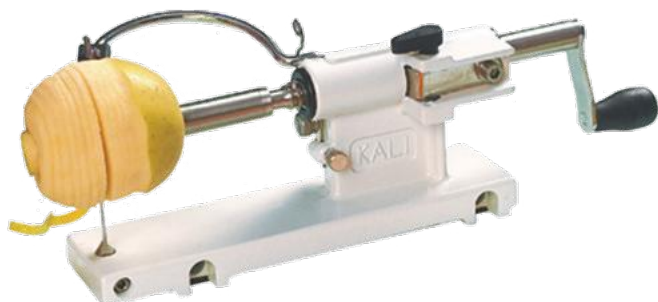

Pela manzanas profesional "Mod. KALI".
Peel apples professional "Mod. KALI".

| Cod. | Medida - Size | Material |
|---------------|---------------------|--------------|
| AO1373 | Estándar / Standard | Inox. - Sst. |

Recambio Cuchilla "Mod. KALI".
Consultar otras piezas disponibles
Spare Blade "Mod. KALI". Consult other available pieces

| Cod. | Medida - Size | Material |
|----------------|---------------|--------------|
| AO1373R | 200 mm. | Inox. - Sst. |



Pela manzanas sobremesa con ventosa.
Peel apples desktop with suction cup.

| Cod. | Medida - Size |
|---------------|---------------------|
| AO0302 | Estándar / Standard |



Pela manzanas con tornillo para mesa.
Peel apples with table screw.

| Cod. | Medida - Size |
|---------------|---------------------|
| AO0614 | Estándar / Standard |



Mandolina con 5 cuchillas diferentes.
Mandolin with 5 different blades.

| Cod. | Medida - Size | Material |
|----------------|---------------|--------------|
| AO60356 | 140 x 420 mm. | Inox. - Sst. |



Rallador de 4 caras diferentes.
Multi slides grater.

| Cod. | Medida - Size | Material |
|---------------|---------------|--------------|
| AO0459 | 230 h mm. | Inox. - Sst. |



Rallador corte grueso.
Grater cut thick.

| Cod. | Medida - Size | Material |
|----------------|---------------|--------------|
| AO60302 | 110 x 260 mm. | Inox. - Sst. |



Rallador corte fino.
Grater cut fine.

| Cod. | Medida - Size | Material |
|----------------|---------------|--------------|
| AO60303 | 110 x 260 mm. | Inox. - Sst. |

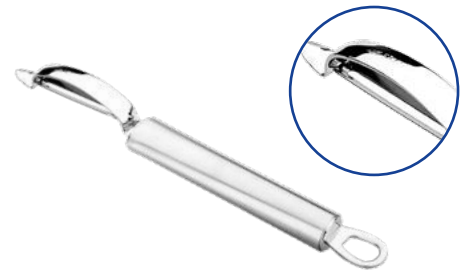

Pelador.
Peeler.

| Cod. | Medida - Size | Material |
|----------------|---------------|--------------|
| AO62688 | 200 mm. | Inox. - Sst. |



Pelador doble.
Double peeler.

| Cod. | Medida - Size | Material |
|----------------|---------------|--------------|
| AO60347 | 100 x 120 mm. | Inox. - Sst. |



Cortador doble para huevos.
Double cutter for eggs.

| Cod. | Medida - Size | Material |
|----------------|---------------|--------------|
| AO68307 | 100 x 150 mm. | Inox. - Sst. |



Cortador para Melón.
Cutter for Melon.

| Cod. | Medida - Size | Material |
|---------------|---------------|--------------|
| AO0761 | 200 Ø mm. | Inox. - Sst. |

12 Cortadores
12 Cutters



29-36-43-50-57-64-71-77-84-91-98-104 Ø mm.

Cod. **Medida - Size** **Material**
AO68069 52 h mm. Inox. - Sst.

12 Cortadores
12 Cutters



29-36-43-50-57-64-71-77-84-91-98-104 Ø mm.

Cod. **Medida - Size** **Material**
AO68070 52 h mm. Inox. - Sst.

9 Cortadores
9 Cutters



37-51-66-82-96-110-125-137-150 Ø mm.

Cod **Material**
AO0701 Inox. - Sst.

7 Cortadores
7 Cutters



30-42-53-55-65-80-90 Ø mm.

Cod. **Material**
AO0702 Inox. - Sst.

9 Cortadores
9 Cutters



Cod. **Medida - Size** **Material**
AO0712 46 x 20 h mm. Inox. - Sst.

26 Cortadores
26 Cutters



Cod. **Medida - Size** **Material**
AO0713 30 x 20 h mm. Inox. - Sst.

12 Cortadores
12 Cutters

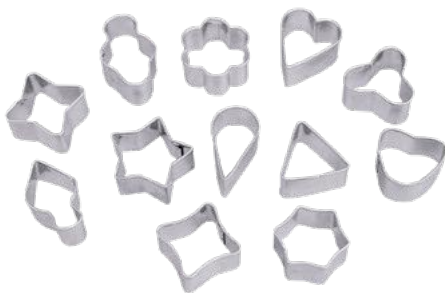

Cod. **Medida - Size** **Material**
AO0854 18 h mm. Inox. - Sst.

Mazapán
Marzipan



Cod **Medida - Size** **Material**
AO1541 50 h mm. Inox. - Sst.



| Cod. | Medida - Size | Material |
|--------|---------------|--------------|
| AO0014 | 75 Ø mm. | Inox. - Sst. |



Cortador expulsión con muelle.
Ejection cutter with spring.

| Cod. | Medida - Size | Material |
|---------|---------------|--------------|
| AO0767A | 50 Ø mm. | Inox. - Sst. |
| AO0767 | 73 Ø mm. | Inox. - Sst. |
| AO0766 | 100 Ø mm. | Inox. - Sst. |



Kit 3 cortadores rizados con asa.
Kit 3 curly cutters with handle.

| Cod. | Medida - Size | Material |
|--------|-----------------|--------------|
| AO0720 | 60 Ø x 35 h mm. | Inox. - Sst. |
| | 70 Ø x 35 h mm. | |
| | 80 Ø x 35 h mm. | |



Kit 3 cortadores lisos con asa.
Kit 3 smooth cutters with handle.

| Cod. | Medida - Size | Material |
|--------|-----------------|--------------|
| AO0721 | 60 Ø x 35 h mm. | Inox. - Sst. |
| | 70 Ø x 35 h mm. | |
| | 80 Ø x 35 h mm. | |





Kit 9 cortadores lisos. *Kit 9 smooth cutters.*

| Cod. | Medida - Size | Material |
|---------------|---|--------------|
| AO0723 | 36-43-52-60-70-80-90-100-110 Ø mm. x 35 h mm. | Inox. - Sst. |

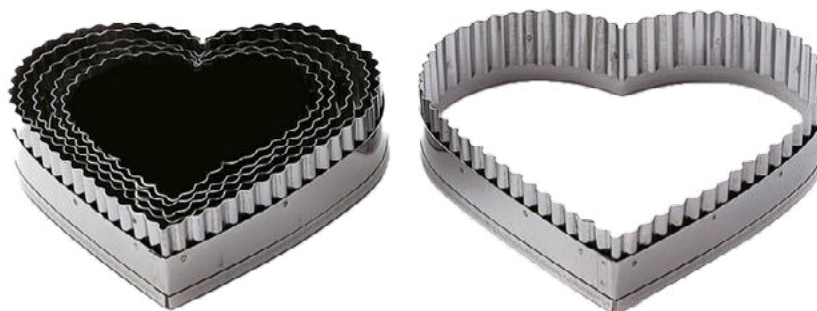

Kit 9 cortadores rizados. *Kit 9 curly cutters.*

| Cod. | Medida - Size | Material |
|---------------|--|--------------|
| AO0730 | 60-70-80-90-100-110-120-130-140 Ø x 35 h mm. | Inox. - Sst. |



| Cod. | Medida - Size | Material |
|---------------|-----------------|--------------|
| AO0741 | 89 Ø x 20 h mm. | Inox. - Sst. |



| Cod. | Medida - Size | Material |
|---------------|---------------------|---------------------|
| AO0416 | 150 x 55 x 45 h mm. | Inox. - Sst. |
| TC1023 | 28 x 67 h mm. | Aluminio - Aluminum |



20-30-40-50-60-70-80-90-100 Ø mm.

9 Cortadores
9 Cutters

| | |
|---------------|------------------|
| Cod. | Material. |
| AO1130 | P.V.C. |



20-30-40-50-60-70-80-90-100 Ø mm.

9 Cortadores
9 Cutters

| | |
|---------------|------------------|
| Cod. | Material. |
| AO1129 | P.V.C. |



20-35-50-65-80-95-110 Ø mm.

7 Cortadores
7 Cutters

| | |
|---------------|-----------------|
| Cod. | Material |
| AO1131 | P.V.C. |



45-55-65-75-85-95 Ø mm.

6 Cortadores Liso - Rizado
6 Straight - Curly Cutters

| | |
|---------------|-----------------|
| Cod. | Material |
| TC2066 | P.V.C. |

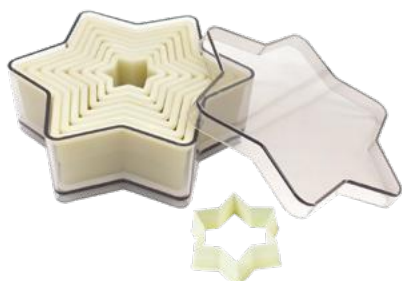

30-40-60-70-85-100-120 Ø mm.

7 Cortadores
7 Cutters

| | |
|---------------|-----------------|
| Cod. | Material |
| AO1143 | P.V.C. |



10 Cortadores
10 Cutters

| | | |
|---------------|---------------------------|-----------------|
| Cod. | Medida - Size | Material |
| AO1127 | 52 x 40 x 15 h mm. | P.V.C. |



26 Cortadores
26 Cutters

| | | |
|---------------|---------------------------|-----------------|
| Cod. | Medida - Size | Material |
| AO1128 | 25 x 25 x 30 h mm. | P.V.C. |



Sirve tus tartas como
un profesional.

Duproflex[®] 
Equipamiento profesional



| Cod. | Medida - Size | Material |
|------------|---------------|--------------|
| TS1 | 280 Ø mm. | Inox. - Sst. |

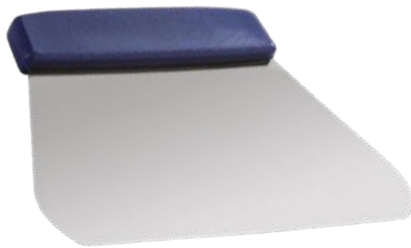

| Cod. | Medida - Size | Material |
|---------------|---------------|--------------|
| AO0778 | 145 x 195 mm. | Inox. - Sst. |



| Cod. | Medida - Size | Material |
|---------------|---------------|--------------|
| AO0787 | 100 x 130 mm. | Inox. - Sst. |
| AO0795 | 100 x 175 mm. | Inox. - Sst. |



| Cod. | Medida - Size | Material |
|---------------|---------------|--------------|
| AO0796 | 150 x 170 mm. | Inox. - Sst. |



| Cod. | Medida - Size | Material |
|---------------|---------------|--------------|
| AO0798 | 145 x 210 mm. | Inox. - Sst. |
| AO0802 | 200 x 225 mm. | Inox. - Sst. |



| Cod. | Medida - Size | Material |
|---------------|---------------|--------------|
| AO0857 | 110 x 120 mm. | Inox. - Sst. |
| AO0866 | 115 x 120 mm. | Inox. - Sst. |



| Cod | Medida - Size | Material |
|---------------|---------------|--------------|
| AO0838 | 245 mm. | Inox. - Sst. |
| AO0954 | 300 mm. | Inox. - Sst. |

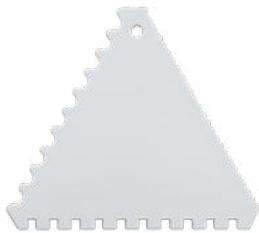

| Cod. | Medida - Size | Material |
|----------------|---------------|----------|
| AO68136 | 110 mm. | P.V.C |



*Choco
Style*

Duproflex[®] 

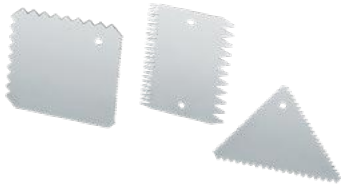

Ideal para chocolate.
Ideal for chocolate.

| Cod. | Medida - Size | Material |
|---------------|---------------|--------------|
| AO0867 | 100 x 100 mm. | Inox. - Sst. |



P.V.C. Pack 10 pzs.

| Cod. | Medida - Size | Material |
|---------------|---------------|----------|
| AO0874 | 90 x 125 mm. | Rígido. |
| AO0891 | 90 x 125 mm. | Flexible |



P.V.C. Pack 10 pzs.

| Cod. | Medida - Size | Material |
|---------------|---------------|----------|
| AO0904 | 110 x 150 mm. | Rígido |
| AO0963 | 110 x 150 mm. | Flexible |



P.V.C. Pack 10 pzs.

| Cod. | Medida - Size | Material |
|---------------|---------------|----------|
| AO0964 | 90 x 120 mm. | Rígido. |
| AO0983 | 90 x 120 mm. | Flexible |



P.V.C. Pack 10 pzs.

| Cod. | Medida - Size | Material |
|---------------|---------------|----------|
| AO0934 | 95 x 145 mm. | Rígido |
| AO0935 | 95 x 145 mm. | Flexible |



P.V.C. Pack 10 pzs.

| Cod. | Medida - Size | Material |
|---------------|---------------|----------|
| AO0936 | 90 x 140 mm. | Rígido |
| AO0937 | 90 x 140 mm. | Flexible |



P.V.C. Pack 10 pzs.

| Cod | Medida - Size | Material |
|---------------|---------------|----------|
| AO0945 | 95 x 145 mm. | Rígido. |



P.V.C. Pack 5 pzs.

| Cod. | Medida - Size | Material. |
|---------------|---------------|-----------|
| AO0946 | 130 x 215 mm. | Rígido |



P.V.C. Pack 5 pzs.

| Cod. | Medida - Size | Material |
|---------------|---------------|----------|
| AO0947 | 150 x 200 mm. | Rígido |



Rasquetas personalizables bajo pedido.
Personalizables en color dorado o hendido.
Mínimo 500 pzs.
Customizable pastry scrapers on order.
Customizable in gold color or debossed
Minimum 500 pzs.



P.V.C. Pack 5 pzs.

| Cod. | Medida - Size | Material |
|---------------|---------------|----------|
| AO0951 | 150 x 195 mm. | Rígido |

Todas las medidas son de la hoja.
All measurements are from the sheet.



Espátula con mango de Fenolkraft.
Spatula with Fenolkraft handle.

| Cod. | Medida - Size | Material |
|--------|---------------|--------------|
| AO0314 | 70 mm. | Inox. - Sst. |



Espátula con mango de Fenolkraft.
Spatula with Fenolkraft handle.

| Cod. | Medida - Size | Material |
|--------|---------------|--------------|
| AO0067 | 110 mm. | Inox. - Sst. |
| AO0105 | 150 mm. | Inox. - Sst. |
| AO0106 | 200 mm. | Inox. - Sst. |
| AO0107 | 260 mm. | Inox. - Sst. |
| AO0108 | 310 mm. | Inox. - Sst. |
| AO0109 | 360 mm. | Inox. - Sst. |



Espátula triangular con mango de Fenolkraft.
Triangular spatula with Fenolkraft handle.

| Cod. | Medida - Size | Material |
|--------|---------------|--------------|
| AO0110 | 100 x 130 mm. | Inox. - Sst. |



Espátula ángulo con mango de Fenolkraft.
Angular spatula with Fenolkraft handle.

| Cod. | Medida - Size | Material |
|--------|---------------|--------------|
| AO0122 | 200 mm. | Inox. - Sst. |
| AO0104 | 260 mm. | Inox. - Sst. |
| AO1269 | 300 mm. | Inox. - Sst. |



Espátula ángulo con mango de Fenolkraft.
Angular spatula with Fenolkraft handle.

| Cod. | Medida - Size | Material |
|---------|---------------|--------------|
| AO60420 | 75 x 215 mm. | Inox. - Sst. |



Espátula recta con mango de P.V.C.
Straight spatula with P.V.C.

| Cod. | Medida - Size | Material |
|---------|---------------|--------------|
| AO1358B | 120 mm. | Inox. - Sst. |

Espátula ángulo con mango de P.V.C.
Angular spatula with P.V.C.

| Cod. | Medida - Size | Material |
|---------|---------------|--------------|
| AO1358A | 120 mm. | Inox. - Sst. |

Espátula ángulo de pico con mango de P.V.C.
Tip angle spatula with P.V.C.

| Cod. | Medida - Size | Material |
|---------|---------------|--------------|
| AO1358C | 120 mm. | Inox. - Sst. |





Espátula silicona. Resistente hasta 110°C.
Silicone spatula. Heat resistant up to 110°C.

| Cod. | Medida - Size | Material |
|---------------|---------------|----------------------|
| AO0929 | 280 mm. | Silicona - Silicone. |
| AO0930 | 350 mm. | Silicona - Silicone. |
| AO0931 | 400 mm. | Silicona - Silicone. |



Espátula de goma. Resistente hasta 110°C.
Rubber spatula. Heat resistant up to 110°C.

| Cod. | Medida - Size | Material. |
|--------------|---------------|----------------|
| PVS25 | 250 mm. | Goma - Rubber. |
| PVS35 | 350 mm. | Goma - Rubber. |
| PVS40 | 400 mm. | Goma - Rubber. |

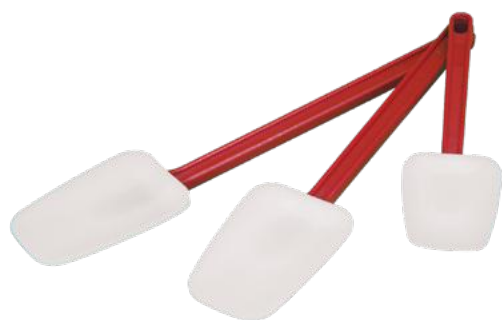

Espátula silicona. Modelo cuchara. Resistente hasta 180°C.
Silicone spatula. Spoon model. Heat resistant up to 180°C.

| Cod. | Medida - Size | Material |
|--------------|---------------|----------------------|
| BSS25 | 250 mm. | Silicona - Silicone. |
| BSS35 | 350 mm. | Silicona - Silicone. |
| BSS40 | 400 mm. | Silicona - Silicone. |

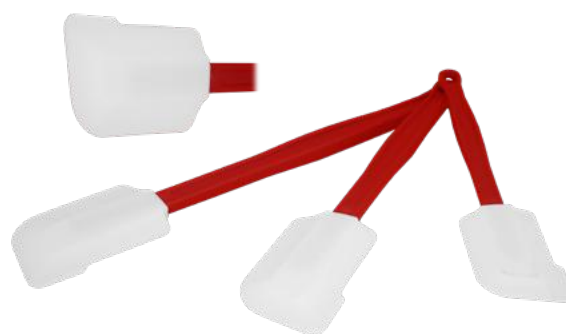

Espátula silicona. Resistente hasta 180°C.
Silicone spatula. Heat resistant up to 180°C.

| Cod. | Medida - Size | Material. |
|---------------|---------------|----------------------|
| SIS25 | 250 mm. | Silicona - Silicone. |
| AO0906 | 280 mm. | Silicona - Silicone. |
| AO0907 | 350 mm. | Silicona - Silicone. |
| AO0908 | 420 mm. | Silicona - Silicone. |



Espátula de silicona. Resistente hasta 250°C.
Silicone spatula. Heat resistant up to 250°C.

| Cod. | Medida - Size | Material. |
|---------------|---------------|----------------------|
| AO1603 | 280 mm. | Silicona - Silicone. |
| AO1604 | 350 mm. | Silicona - Silicone. |



Espátula de goma. Resistente hasta 110°C.
Rubber spatula. Heat resistant up to 110°C.

| Cod. | Medida - Size | Material |
|---------------|---------------|----------------|
| AO1478 | 250 mm. | Goma - Rubber. |
| AO1479 | 350 mm. | Goma - Rubber. |



Espátula rígida de polyglass. Resistente hasta 220°C.
Polyglass rigid spatula. Heat resistant up to 220°C.

| Cod. | Medida - Size | Material |
|---------------|---------------|----------|
| AO0632 | 250 mm. | P.V.C. |
| AO0633 | 300 mm. | P.V.C. |
| AO0634 | 350 mm. | P.V.C. |
| AO0635 | 400 mm. | P.V.C. |
| AO0636 | 450 mm. | P.V.C. |
| AO0637 | 500 mm. | P.V.C. |



Espátula rígida de ABS. Resistente hasta 140°C.
ABS rigid spatula. Heat resistant up to 140°C.

| Cod. | Medida - Size | Material |
|---------------|---------------|----------|
| AO1475 | 300 mm. | P.V.C. |
| AO1476 | 350 mm. | P.V.C. |
| AO1477 | 400 mm. | P.V.C. |



Remos para mover grandes cantidades.
Rewing to mix big amounts.

| Cod. | Medida - Size | Material |
|---------------|---------------|--------------|
| AO1239 | 700 mm. | Inox. - Sst. |
| AO1240 | 1000 mm. | Inox. - Sst. |

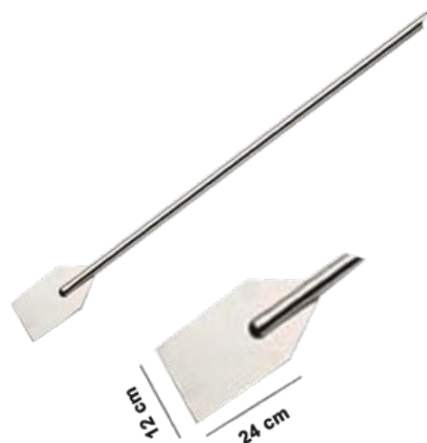

Remos para mover grandes cantidades.
Rewing to mix big amounts.

| Cod. | Medida - Size | Material |
|----------------|---------------|--------------|
| AO61481 | 800 mm. | Inox. - Sst. |
| AO61421 | 1200 mm. | Inox. - Sst. |



Molde nido. Nest mold

| Cod. | Medida - Size | Material |
|---------------|---------------|--------------|
| AO0279 | 85 mm. | Inox. - Sst. |



Molde buñuelos. Mold fritters.

| Cod. | Medida - Size | Material |
|---------------|---------------|--------------|
| AO0740 | 75 mm. | Inox. - Sst. |



Molde florón. Flower mold.

| Cod. | Medida - Size | Material |
|---------------|---------------|--------------|
| AO0746 | 93 mm. | Inox. - Sst. |

Molde recto Hojalata.
Tin straight mould.

| Cod. | Medida - Size |
|---------------|----------------|
| AO0406 | 120 x 40 h mm. |
| AO0140 | 140 x 45 h mm. |
| AO1202 | 160 x 45 h mm. |
| AO1200 | 180 x 45 h mm. |
| AO1201 | 200 x 45 h mm. |
| AO1306 | 220 x 50 h mm. |
| AO0145 | 240 x 50 h mm. |
| AO1186 | 260 x 55 h mm. |
| AO1224 | 300 x 55 h mm. |

Molde recto Aluminio.
Aluminum straight mould.

| Cod. | Medida - Size |
|---------------|----------------|
| AO0141 | 160 x 60 h mm. |
| AO0142 | 180 x 70 h mm. |
| AO0143 | 200 x 70 h mm. |
| AO1241 | 220 x 70 h mm. |
| AO1242 | 240 x 70 h mm. |
| AO0146 | 260 x 70 h mm. |
| AO0148 | 300 x 70 h mm. |



Molde recto Aluminio.
Aluminum straight mould.

| Cod. | Medida - Size |
|---------------|-----------------|
| AO1360 | 140 x 100 h mm. |
| AO1361 | 160 x 100 h mm. |
| AO1362 | 180 x 100 h mm. |
| AO1363 | 200 x 100 h mm. |
| AO1364 | 220 x 100 h mm. |
| AO1365 | 240 x 100 h mm. |
| AO1366 | 260 x 100 h mm. |
| AO1367 | 280 x 100 h mm. |
| AO1368 | 300 x 100 h mm. |



Molde aluminio cónico.
Aluminum conical mould.

| Cod. | Medida - Size |
|---------------|----------------|
| AO1243 | 120 x 35 h mm. |
| AO1244 | 140 x 35 h mm. |
| AO0499 | 160 x 35 h mm. |
| AO0429 | 180 x 40 h mm. |
| AO0428 | 200 x 50 h mm. |
| AO0430 | 220 x 50 h mm. |
| AO0426 | 240 x 50 h mm. |
| AO0437 | 260 x 55 h mm. |
| AO0438 | 280 x 55 h mm. |
| AO0436 | 300 x 60 h mm. |



Molde aluminio Savarin tradicional.
Aluminum Savarin traditional mould.

| Cod. | Medida - Size |
|--------|----------------|
| AO1250 | 120 x 40 h mm. |
| AO1251 | 140 x 40 h mm. |
| AO1252 | 160 x 40 h mm. |
| AO0445 | 180 x 45 h mm. |
| AO0446 | 200 x 55 h mm. |
| AO0447 | 220 x 60 h mm. |
| AO0448 | 240 x 65 h mm. |
| AO0449 | 260 x 65 h mm. |
| AO0726 | 280 x 65 h mm. |



Molde de Hojalata.
Tin mould.

| Cod. | Medida - Size |
|--------|----------------|
| AO0373 | 180 x 25 h mm. |
| AO0374 | 200 x 25 h mm. |
| AO0375 | 220 x 25 h mm. |
| AO0376 | 240 x 25 h mm. |
| AO0377 | 260 x 25 h mm. |
| AO0378 | 280 x 25 h mm. |
| AO0379 | 300 x 25 h mm. |
| AO0380 | 320 x 25 h mm. |

Molde de Aluminio.
Aluminum mould.

| Cod. | Medida - Size |
|--------|----------------|
| AO1253 | 180 x 25 h mm. |
| AO1254 | 200 x 25 h mm. |
| AO1255 | 220 x 25 h mm. |
| AO1256 | 240 x 25 h mm. |
| AO1257 | 260 x 25 h mm. |
| AO1258 | 280 x 25 h mm. |
| AO1259 | 300 x 25 h mm. |
| AO1260 | 320 x 25 h mm. |



Molde bajo de hojalata.
Small baking tin mould.

| Cod. | Medida - Size |
|--------|----------------|
| AO0483 | 230 x 20 h mm. |
| AO0597 | 400 x 20 h mm. |



Molde cónico desmontable aluminio.
Removable conical aluminum mould.

| Cod. | Medida - Size |
|--------|----------------|
| AO1245 | 220 x 50 h mm. |
| AO1246 | 240 x 50 h mm. |
| AO1247 | 260 x 55 h mm. |
| AO1248 | 280 x 55 h mm. |
| AO1249 | 300 x 60 h mm. |





Molde rizado de Acero Inox.
Stainless curly mould.

| Cod. | Medida - Size |
|---------------|------------------|
| AO0474 | 200 Ø x 30 h mm. |
| AO0475 | 220 Ø x 30 h mm. |
| AO0476 | 240 Ø x 30 h mm. |

Molde rizado antihaderente Aluminio.
Aluminum non-stick curly mold.

| Cod. | Medida - Size |
|----------------|------------------|
| AO0474A | 200 Ø x 30 h mm. |
| AO0475A | 220 Ø x 30 h mm. |



Molde de Hojalata.
Tin mould.

| Cod. | Medida - Size |
|---------------|----------------|
| AO0387 | 220 x 25 h mm. |
| AO0388 | 240 x 25 h mm. |
| AO0389 | 260 x 25 h mm. |
| AO0390 | 280 x 25 h mm. |
| AO0391 | 300 x 25 h mm. |
| AO0392 | 320 x 25 h mm. |

Molde de Aluminio.
Aluminum mould.

| Cod. | Medida - Size |
|---------------|----------------|
| AO1261 | 220 x 25 h mm. |
| AO1262 | 240 x 25 h mm. |
| AO1263 | 260 x 25 h mm. |
| AO1264 | 280 x 25 h mm. |
| AO1265 | 300 x 25 h mm. |
| AO1266 | 320 x 25 h mm. |



Molde de Hojalata.
Tin mould.

| Cod. | Medida - Size |
|---------------|----------------|
| AO0465 | 220 x 70 h mm. |
| AO0467 | 240 x 70 h mm. |
| AO1150 | 260 x 70 h mm. |

Molde inoxidable.
Stainless mould.

| Cod. | Medida - Size |
|---------------|----------------|
| AO0506 | 220 x 70 h mm. |
| AO0466 | 240 x 70 h mm. |
| AO0192 | 260 x 70 h mm. |



Molde inoxidable, ideal para Plum Cake.
Stainless mould, ideal for Plum Cake.

Cod. **Medida - Size**

AO0157 140 x 250 x 80 h mm.

AO0158 140 x 300 x 80 h mm.

AO0159 140 x 350 x 80 h mm.

AO1321 140 x 400 x 80 h mm.



Molde inoxidable, ideal para pan de molde.
Stainless mould, ideal for sliced bread.

Cod. **Medida - Size**

AO0659 100 x 250 x 100 h mm.

AO0610 100 x 300 x 100 h mm.

AO0620 110 x 350 x 110 h mm.

AO0612 120 x 400 x 120 h mm.



Molde antihaderente, ideal para pan de molde.
Non-stick mould, ideal for sliced bread.

Cod. **Medida - Size**

AO0659A 100 x 250 x 100 h mm.

AO0610A 100 x 300 x 100 h mm.

AO0620A 110 x 350 x 110 h mm.

AO0612A 120 x 400 x 120 h mm.



Molde antihaderente, forma de cubo.
Non-stick mould, cube shape.

Cod. **Medida - Size**

AO0613A 103 x 83 x 86 h mm.



Molde con asas y tapadera de chapa anodizada, ideal para pan Inglés. Con tratamiento siliconado para una larga duración.

Mould with handles and aluminum plate cover, ideal for English bread. With siliconized treatment for a long duration.

Cod. **Medida - Size**

AO2001 100 x 300 x 100 h mm.

AO2002 100 x 350 x 100 h mm.

AO2003 100 x 400 x 100 h mm.

Molde inoxidable flan Chino.
Chinese flan stainless mould.

| Cod. | Medida - Size | Cod. | Medida - Size |
|--------|----------------------|--------|----------------------|
| AO0325 | 180 x 240 x 40 h mm. | AO0161 | 250 x 250 x 40 h mm. |
| AO0160 | 200 x 200 x 40 h mm. | AO0329 | 280 x 350 x 40 h mm. |
| AO0326 | 200 x 260 x 40 h mm. | AO0162 | 300 x 300 x 40 h mm. |
| AO0808 | 200 x 280 x 40 h mm. | AO0306 | 300 x 400 x 40 h mm. |
| AO0328 | 200 x 350 x 40 h mm. | AO0163 | 350 x 350 x 40 h mm. |
| AO0210 | 220 x 280 x 40 h mm. | AO0164 | 400 x 400 x 40 h mm. |
| AO0327 | 240 x 300 x 40 h mm. | AO0165 | 450 x 450 x 40 h mm. |
| AO0276 | 240 x 360 x 40 h mm. | AO0170 | 500 x 500 x 40 h mm. |



Posibilidad de realizar medidas especiales.

Molde cuadrado inoxidable.
Stainless square mould.

| Cod. | Medida - Size |
|--------|----------------------|
| AO0913 | 100 x 100 x 45 h mm. |
| AO0792 | 120 x 120 x 45 h mm. |
| AO0819 | 180 x 180 x 45 h mm. |
| AO0791 | 200 x 200 x 45 h mm. |
| AO0790 | 240 x 240 x 45 h mm. |

Molde corazón inoxidable.
Stainless heart mould.

| Cod. | Medida - Size |
|--------|----------------------|
| AO0957 | 100 x 100 x 45 h mm. |
| AO0832 | 120 x 120 x 45 h mm. |
| AO0271 | 140 x 140 x 45 h mm. |
| AO0806 | 160 x 160 x 45 h mm. |
| AO0419 | 180 x 180 x 45 h mm. |
| AO0962 | 200 x 200 x 45 h mm. |
| AO0496 | 220 x 220 x 45 h mm. |
| AO0273 | 240 x 240 x 45 h mm. |
| AO0592 | 260 x 260 x 45 h mm. |
| AO0274 | 280 x 280 x 45 h mm. |
| AO0807 | 300 x 300 x 45 h mm. |

Molde aro inoxidable.
Stainless ring mould.

| Cod. | Medida - Size |
|---------|----------------|
| AO68506 | 60 x 45 h mm. |
| AO0123 | 80 x 45 h mm. |
| AO0129 | 100 x 45 h mm. |
| AO0130 | 120 x 45 h mm. |
| AO0131 | 140 x 45 h mm. |
| AO0132 | 160 x 45 h mm. |
| AO0133 | 180 x 45 h mm. |
| AO0134 | 200 x 45 h mm. |
| AO0135 | 220 x 45 h mm. |
| AO0136 | 240 x 45 h mm. |
| AO0137 | 260 x 45 h mm. |
| AO0138 | 280 x 45 h mm. |
| AO0139 | 300 x 45 h mm. |





Molde aro perforado inoxidable.
Stainless perforated ring mould.

| Cod. | Medida - Size |
|---------|----------------|
| AO68536 | 160 x 20 h mm. |
| AO68538 | 180 x 20 h mm. |
| AO68540 | 200 x 20 h mm. |
| AO68544 | 240 x 20 h mm. |
| AO68546 | 160 x 35 h mm. |
| AO68548 | 180 x 35 h mm. |
| AO68550 | 200 x 35 h mm. |
| AO68554 | 240 x 35 h mm. |



Aro acanalado perforado de acero inoxidable
Stainless steel perforated fluted circle

| Cod. | Medida - Size |
|--------|----------------|
| AO1204 | 80 x 30 h mm. |
| AO1209 | 80 x 20 h mm. |
| AO1210 | 90 x 20 h mm. |
| AO1211 | 120 x 25 h mm. |
| AO1213 | 140 x 25 h mm. |

AO1188

AO1180

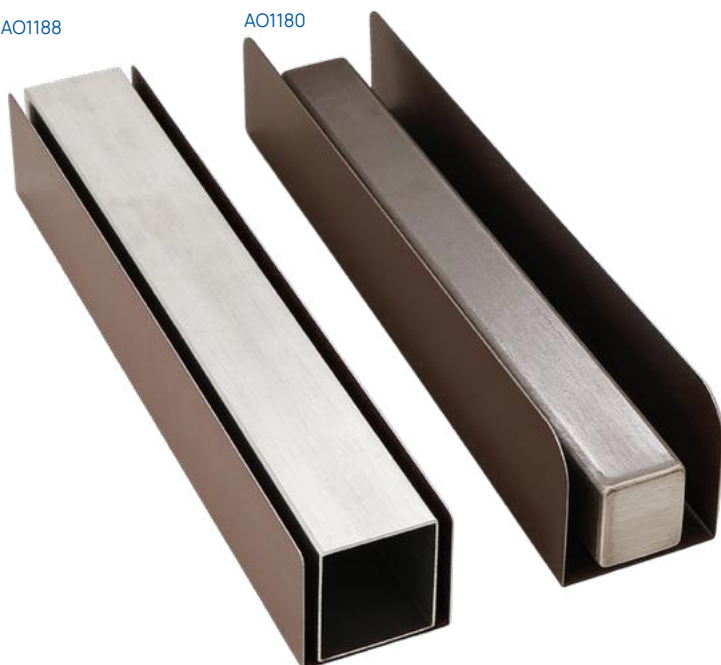

KITS Moldes antiadhesivo viennoiserie
KITS Viennoiserie bar mold KIT

| Cod. | Medida - Size |
|--------|---------------------|
| AO1188 | 250 x 76 x 60 h mm. |
| AO1180 | 250 x 42 x 40 h mm. |



Posibilidad de realizar medidas especiales.



Molde rectangular "Sin bandeja".
Rectangular mould "without tray".

Molde rectangular "Con bandeja".
Rectangular mould "with tray".

| Cod. | Medida - Size |
|--------|-----------------------------------|
| AO0069 | 300 x 400 x 30 h mm. Inox. - Sst. |
| AO0899 | 300 x 400 x 40 h mm. Inox. - Sst. |
| AO0984 | 300 x 400 x 45 h mm. Inox. - Sst. |
| AO0813 | 300 x 400 x 50 h mm. Inox. - Sst. |
| AO0919 | 300 x 400 x 70 h mm. Inox. - Sst. |
| AO1332 | 400 x 600 x 30 h mm. Inox. - Sst. |
| AO1003 | 400 x 600 x 40 h mm. Inox. - Sst. |
| AO0887 | 400 x 600 x 45 h mm. Inox. - Sst. |
| AO0812 | 400 x 600 x 50 h mm. Inox. - Sst. |
| AO1045 | 400 x 600 x 55 h mm. Inox. - Sst. |
| AO1322 | 400 x 600 x 60 h mm. Inox. - Sst. |
| AO0814 | 400 x 600 x 70 h mm. Inox. - Sst. |

| Cod. | Medida - Size |
|--------|-----------------------------------|
| AO0675 | 300 x 400 x 30 h mm. Inox. - Sst. |
| AO0724 | 300 x 400 x 40 h mm. Inox. - Sst. |
| AO0889 | 300 x 400 x 45 h mm. Inox. - Sst. |
| AO0420 | 300 x 400 x 50 h mm. Inox. - Sst. |
| AO0421 | 300 x 400 x 70 h mm. Inox. - Sst. |
| AO0888 | 400 x 600 x 30 h mm. Inox. - Sst. |
| AO1014 | 400 x 600 x 40 h mm. Inox. - Sst. |
| AO0948 | 400 x 600 x 45 h mm. Inox. - Sst. |
| AO0422 | 400 x 600 x 50 h mm. Inox. - Sst. |
| AO0940 | 400 x 600 x 55 h mm. Inox. - Sst. |
| AO0725 | 400 x 600 x 60 h mm. Inox. - Sst. |



Bandeja de bordes rectos con grosor de 1,2 mm.
Straight edges tray. Thickness: 1,2 mm.

| Cod. | Medida - Size |
|--------|-----------------------------------|
| AO0304 | 300 x 400 x 10 h mm. Inox. - Sst. |
| AO0805 | 400 x 600 x 10 h mm. Inox. - Sst. |

Molde número gigante inoxidable.
Giant stainless number mold.

| Cod. | Medida - Size | Nº | Capac. |
|--------|----------------------|-----|----------|
| AO1503 | 160 x 300 x 40 h mm. | Nº0 | 1937 ml. |
| AO1504 | 93 x 300 x 40 h mm. | Nº1 | 1171 ml. |
| AO1505 | 160 x 300 x 40 h mm. | Nº2 | 1823 ml. |
| AO1506 | 160 x 300 x 40 h mm. | Nº3 | 1663 ml. |
| AO1507 | 170 x 300 x 40 h mm. | Nº4 | 1757 ml. |
| AO1508 | 160 x 300 x 40 h mm. | Nº5 | 1809 ml. |
| AO1509 | 160 x 300 x 40 h mm. | Nº6 | 1968 ml. |
| AO1510 | 160 x 300 x 40 h mm. | Nº7 | 1356 ml. |
| AO1511 | 160 x 300 x 40 h mm. | Nº8 | 2017 ml. |
| AO1512 | 160 x 300 x 40 h mm. | Nº9 | 1968 ml. |



Molde rectangular extensible.
Extensible rectangular mould.

| Cod. | Medida - Size | Material |
|--------------------|----------------------|--------------|
| RETSPECIAL1 | 305 x 305 x 40 h mm. | Inox. - Sst. |
| | 570 x 570 x 40 h mm. | |
| RETSPECIAL2 | 305 x 305 x 50 h mm. | Inox. - Sst. |
| | 570 x 570 x 50 h mm. | |

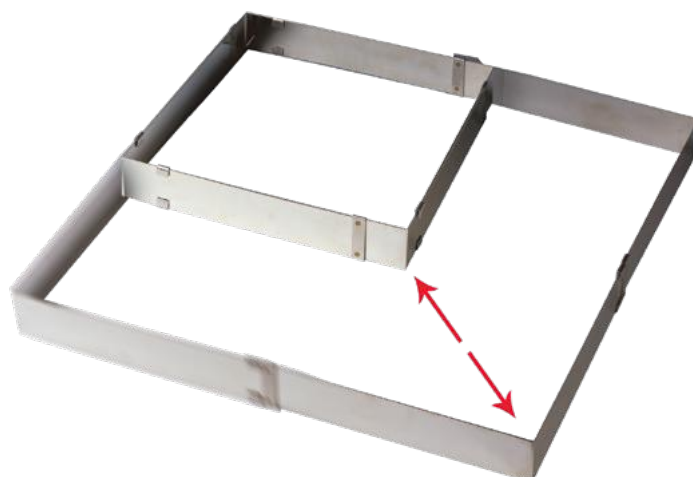

Molde rectangular extensible.
Extensible rectangular mould.

| Cod. | Medida - Size | Material |
|---------------|----------------------|--------------|
| TC4073 | 340 x 275 x 50 h mm. | Inox. - Sst. |
| | 340 x 525 x 50 h mm. | |

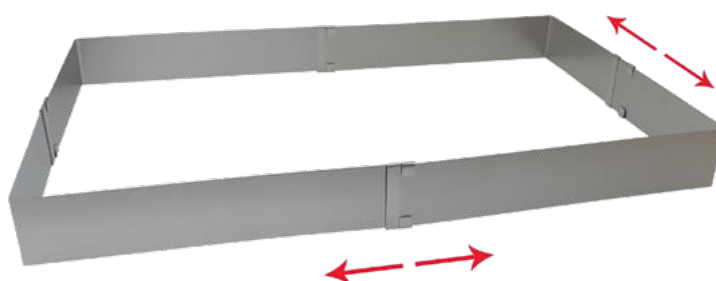

Molde redondo extensible con graduación.
Extensible round mould with graduation.

| Cod. | Medida - Size | Material |
|---------------|------------------|--------------|
| TC4074 | 160 Ø x 95 h mm. | Inox. - Sst. |
| | 300 Ø x 95 h mm. | |

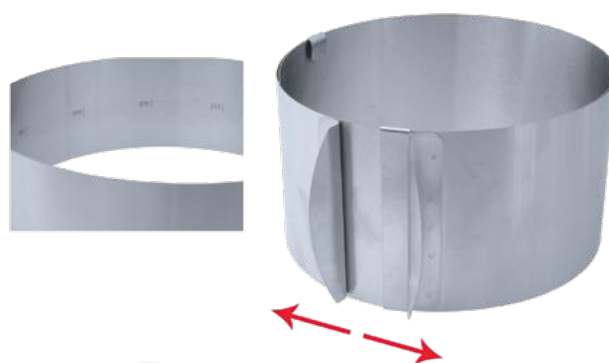

Molde corazón extensible con graduación.
Extensible heart mould with graduation.

| Cod. | Medida - Size | Material |
|---------------|----------------|--------------|
| TC4077 | 120 x 50 h mm. | Inox. - Sst. |
| | 260 x 50 h mm. | |

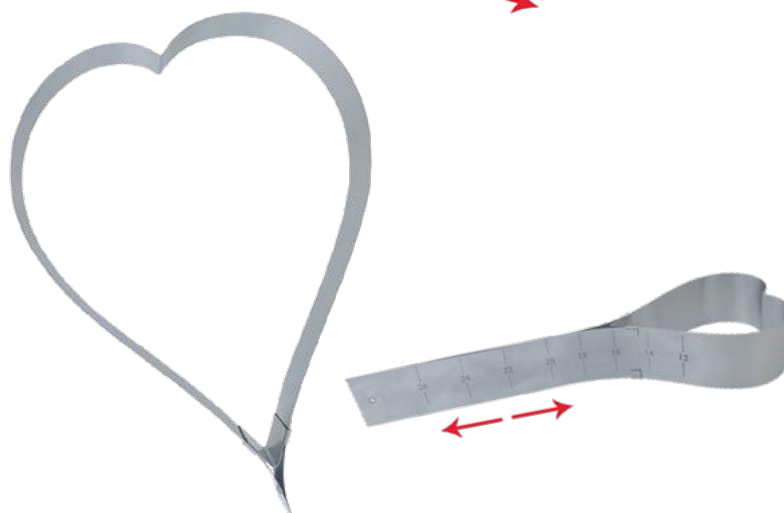



Molde canastilla "Onda normal".
Individual pie mould. Model: Normal waves.

| Cod. | Medida - Size | Material | Pack |
|--------|------------------|-----------------|------|
| AO0303 | 40 Ø x 18 h mm. | Hojalata - Tin. | 12 |
| AO0368 | 50 Ø x 22 h mm. | Hojalata - Tin. | 12 |
| AO0340 | 60 Ø x 22 h mm. | Hojalata - Tin. | 12 |
| AO0176 | 70 Ø x 28 h mm. | Hojalata - Tin. | 12 |
| AO0178 | 80 Ø x 28 h mm. | Hojalata - Tin. | 12 |
| AO0341 | 100 Ø x 30 h mm. | Hojalata - Tin. | 12 |



Molde tartaleta con "Bordón".
Individual pie mould with "Edge".

| Cod. | Medida - Size | Material. |
|--------|------------------|------------------------|
| AO0330 | 50 Ø x 20 h mm. | Aluminio - Aluminum 12 |
| AO0076 | 65 Ø x 25 h mm. | Aluminio - Aluminum 12 |
| AO0332 | 85 Ø x 30 h mm. | Aluminio - Aluminum 12 |
| AO0333 | 100 Ø x 35 h mm. | Aluminio - Aluminum 12 |
| AO0316 | 110 Ø x 35 h mm. | Aluminio - Aluminum 12 |



Molde canastilla rectangular.
Individual pie mould. Model: Rectangular.

| Cod. | Medida - Size | Material |
|--------|---------------------|--------------------|
| AO0345 | 45 x 95 x 20 h mm. | Hojalata - Tin. 12 |
| AO0346 | 50 x 125 x 20 h mm. | Hojalata - Tin. 12 |
| AO0347 | 55 x 145 x 20 h mm. | Hojalata - Tin. 12 |



Molde canastilla "Onda estrecha".
Individual pie mould. Model: Narrow waves.

| Cod. | Medida - Size | Material |
|--------|-----------------|--------------------|
| AO0342 | 55 Ø x 22 h mm. | Hojalata - Tin. 12 |
| AO0343 | 65 Ø x 24 h mm. | Hojalata - Tin. 12 |
| AO0344 | 75 Ø x 25 h mm. | Hojalata - Tin. 12 |



Molde tartaleta baja lisa.
Small individual pie mould. Model: Flat.

| Cod. | Medida - Size | Material. | Pack |
|--------|------------------|-----------------|------|
| AO0336 | 50 Ø x 15 h mm. | Hojalata - Tin. | 12 |
| AO0337 | 60 Ø x 15 h mm. | Hojalata - Tin. | 12 |
| AO0338 | 70 Ø x 15 h mm. | Hojalata - Tin. | 12 |
| AO0631 | 90 Ø x 15 h mm. | Hojalata - Tin. | 12 |
| AO0339 | 100 Ø x 15 h mm. | Hojalata - Tin. | 12 |



Molde ideal para flanes individuales.
Ideal mould for individual creme caramel.

| Cod. | Medida - Size | Material. |
|--------|---------------|-------------------------|
| AO0603 | 25 x 25 h mm. | Aluminio - Aluminum. 12 |
| AO0604 | 30 x 30 h mm. | Aluminio - Aluminum. 12 |
| AO0605 | 40 x 40 h mm. | Aluminio - Aluminum. 12 |
| AO0601 | 50 x 50 h mm. | Aluminio - Aluminum. 12 |
| AO0433 | 60 x 60 h mm. | Aluminio - Aluminum. 12 |
| AO0602 | 70 x 70 h mm. | Aluminio - Aluminum. 12 |



Molde tartaleta alta lisa.
High individual pie mould. Model: Flat.

| Cod. | Medida - Size | Material. |
|--------|------------------|--------------------|
| AO0334 | 40 Ø x 20 h mm. | Hojalata - Tin. 12 |
| AO0308 | 50 Ø x 20 h mm. | Hojalata - Tin. 12 |
| AO0335 | 60 Ø x 20 h mm. | Hojalata - Tin. 12 |
| AO0349 | 70 Ø x 20 h mm. | Hojalata - Tin. 12 |
| AO0305 | 100 Ø x 25 h mm. | Hojalata - Tin. 12 |



Molde canastilla forma de barco.
Boat shaped basket mould.

| Cod. | Medida - Size | Material. |
|--------|---------------------|--------------------|
| AO0362 | 27 x 75 x 10 h mm. | Hojalata - Tin. 12 |
| AO0363 | 40 x 95 x 12 h mm. | Hojalata - Tin. 12 |
| AO0364 | 50 x 110 x 15 h mm. | Hojalata - Tin. 12 |
| AO0365 | 60 x 130 x 20 h mm. | Hojalata - Tin. 12 |



Molde para "Caracola".
Apto para congelación y para hornear.
Pack 10 pzs.
Snail mould.
Suitable for freezing and oven. Pack 10 pcs.

| Cod. | Medida - Size | Material. |
|---------------|----------------|-----------|
| AO1513 | 145 x 30 Ø mm. | P.V.C. |



Molde cilíndrico para "Cañas". *Cylindrical cane mould.*

| Cod. | Medida - Size | Material |
|---------------|----------------|--------------------|
| AO0166 | 80 x 20 Ø mm. | Hojalata - Tin. 12 |
| AO0167 | 100 x 20 Ø mm. | Hojalata - Tin. 12 |
| AO0168 | 120 x 20 Ø mm. | Hojalata - Tin. 12 |
| AO0169 | 140 x 20 Ø mm. | Hojalata - Tin. 12 |



Molde para "Caracola".
Corte recto, con posibilidad de corte en ángulo.
Snail mould. Straight cut. Angled cutting (Optional).

| Cod. | Medida - Size | Material. | Pack |
|---------------|----------------|--------------|------|
| AO0172 | 90 x 30 Ø mm. | Inox. - Sst. | 12 |
| AO0173 | 120 x 40 Ø mm. | Inox. - Sst. | 12 |
| AO0174 | 150 x 40 Ø mm. | Inox. - Sst. | 12 |



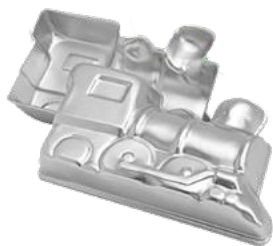

Molde ideal para cumpleaños.
Ideal mould for birthdays cakes.

Cod. **Medida - Size** **Material**
TC8046 280 x 160 x 80 h mm. Aluminio - Aluminum.



Molde ideal para cumpleaños.
Ideal mould for birthdays cakes.

Cod. **Medida - Size** **Material**
TC1070 270 x 140 x 75 h mm. Aluminio - Aluminum.



Molde libro. Ideal para tartas de Comunión.
Book shaped mould, ideal for communion cakes.

Cod. **Medida - Size** **Material**
TC1156 220 x 250 x 60 h mm. Aluminio - Aluminum.



Molde ideal para bautizos.
Ideal mould for baptism cakes.

Cod. **Medida - Size** **Material**
TC1157 245 x 245 x 50 h mm. Aluminio - Aluminum.



Molde ideal para cumpleaños.
Mould ideal for birthdays cakes.

Cod. **Medida - Size** **Material**
TC1155 190 x 240 x 50 h mm. Aluminio - Aluminum.



Molde ideal para cumpleaños.
Mould ideal for birthdays cakes.

Cod. **Medida - Size** **Material**
TC1069 230 x 228 x 70 h mm. Aluminio - Aluminum.

SEMIFRÍO SEMICOLD

Molde ideal para pastelería fría.
El molde se compone de:
* 1 Bandeja de 400x600x20h mm.
* 7 Moldes del mismo modelo.
Medida del pastel Ø 65 mm.
35 piezas por molde.

*Ideal mould for cold bakery.
The mould consist of:
* 1 Tray 400x600x20h mm.
* 7 Identical models.
Cake's size Ø 65 mm.
35 Pieces per mould.*

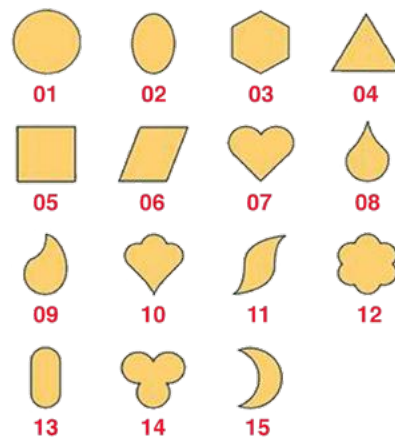
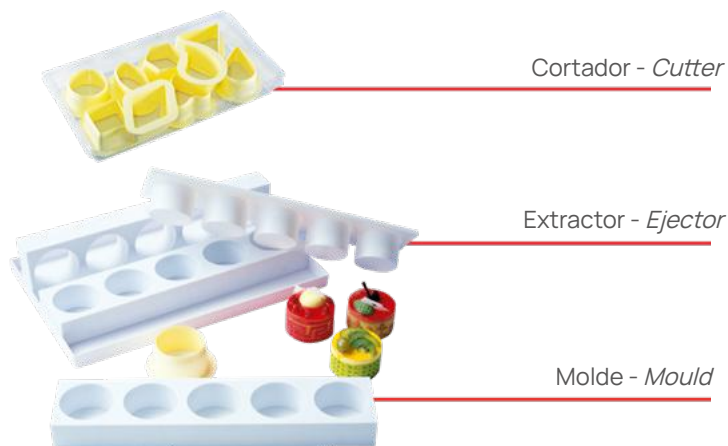
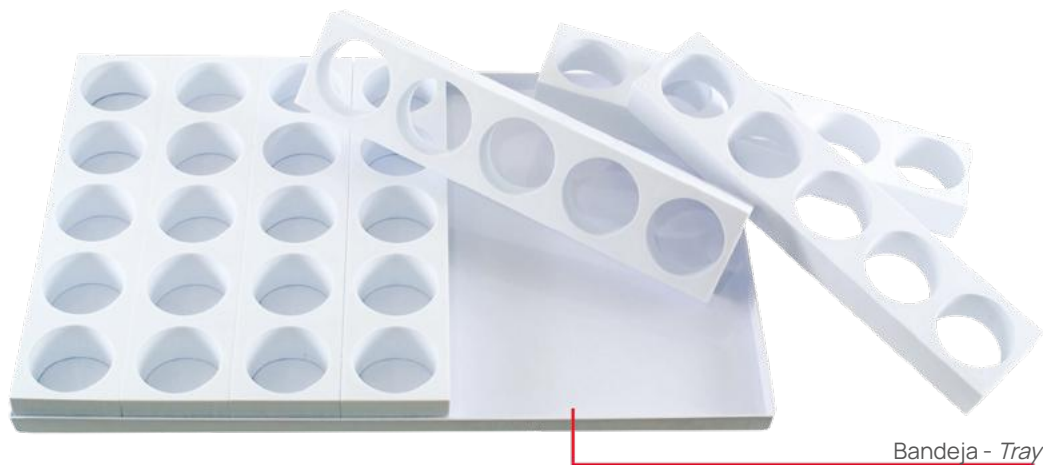

| Forma Shape | Código molde Mould code | Medida molde Mould measure | Medida pieza Measure piece | Piezas Pieces | Volumen Volumen | Extractor Extractor | Cortador Cutter |
|-----------------|----------------------------|-------------------------------|-------------------------------|------------------|--------------------|------------------------|--------------------|
| 01 | MONOPC001 | 400 x 600 x 40 h mm. | 60 Ø x 45 mm. | 35 | 75 gr. | EM1 | TPG1 |
| 02 | MONOPC002 | 400 x 600 x 40 h mm. | 60 Ø x 45 mm. | 35 | 75 gr. | EM2 | TPG2 |
| 03 | MONOPC003 | 400 x 600 x 40 h mm. | 60 Ø x 45 mm. | 35 | 75 gr. | EM3 | TPG3 |
| 04 | MONOPC004 | 400 x 600 x 40 h mm. | 60 Ø x 45 mm. | 35 | 75 gr. | EM4 | TPG4 |
| 05 | MONOPC005 | 400 x 600 x 40 h mm. | 60 Ø x 45 mm. | 35 | 75 gr. | EM5 | TPG5 |
| 06 | MONOPC006 | 400 x 600 x 40 h mm. | 60 Ø x 45 mm. | 35 | 75 gr. | EM6 | TPG6 |
| 07 | MONOPC007 | 400 x 600 x 40 h mm. | 60 Ø x 45 mm. | 35 | 75 gr. | EM7 | TPG7 |
| 08 | MONOPC008 | 400 x 600 x 40 h mm. | 60 Ø x 45 mm. | 35 | 75 gr. | EM8 | TPG8 |
| 09 | MONOPC009 | 400 x 600 x 40 h mm. | 60 Ø x 45 mm. | 35 | 75 gr. | EM9 | TPG9 |
| 10 | MONOPC010 | 400 x 600 x 40 h mm. | 60 Ø x 45 mm. | 35 | 75 gr. | EM10 | TPG10 |
| 11 | MONOPC011 | 400 x 600 x 40 h mm. | 60 Ø x 45 mm. | 35 | 75 gr. | EM11 | TPG11 |
| 12 | MONOPC012 | 400 x 600 x 40 h mm. | 60 Ø x 45 mm. | 35 | 75 gr. | EM12 | TPG12 |
| 13 | MONOPC013 | 400 x 600 x 40 h mm. | 60 Ø x 45 mm. | 35 | 75 gr. | EM13 | TPG13 |
| 14 | MONOPC014 | 400 x 600 x 40 h mm. | 60 Ø x 45 mm. | 35 | 75 gr. | EM14 | TPG14 |
| 15 | MONOPC015 | 400 x 600 x 40 h mm. | 60 Ø x 45 mm. | 35 | 75 gr. | EM15 | TPG15 |
| Bandeja Tray | VASSOIOCMO | 400 x 600 x 20 h mm. | | | | | |

P.V.C. ALIMENTARIO *FOODGRADE P.V.C.*

Acetato en bobinas de 100 metros (200 micras).
Acetate roll 100 meters (200 microns).

| Cod. | Medida - Size | Material. |
|---------------|---------------|-------------------|
| AO0705 | 30 h mm. | Acetato - Acetate |
| AO0710 | 35 h mm. | Acetato - Acetate |
| AO0706 | 40 h mm. | Acetato - Acetate |
| AO0707 | 45 h mm. | Acetato - Acetate |
| AO0708 | 50 h mm. | Acetato - Acetate |
| AO0709 | 60 h mm. | Acetato - Acetate |
| AO0454 | - | Acetato - Acetate |

* **AO0454** - Acetato personalizado para personalizar sus tartas y postres de semifrío.
 * **AO0454** - *Personalized acetate to customize your semi-cold cakes and desserts.*



Opción para la personalización de micras.



Pack de 1000 láminas cortadas para postres (90 micras).
 Otras medidas consultar
*Pack 1000 sheets for desserts (90 microns).
 Consult other measures*

| Cod. | Medida - Size | Material |
|---------------|----------------|-------------------|
| AO1514 | 240 x 40 h mm. | Acetato - Acetate |



Acetato en bobinas de 50 metros (150 micras).
Acetate roll 50 meters (150 microns).

| Cod. | Medida - Size | Material |
|----------------|-----------------|-------------------|
| AO1566 | 100 mm x 50 m. | Acetato - Acetate |
| AO1567 | 120 mm x 50 m. | Acetato - Acetate |
| AO1566B | 100 mm x 100 m. | Acetato - Acetate |
| AO1567B | 120 mm x 100 m. | Acetato - Acetate |



Pack de 50 láminas cortadas (90 micras).
Pack 50 sheets (90 microns).

| Cod. | Medida - Size | Material |
|---------------|---------------|-------------------|
| AO1515 | 400 x 600 mm. | Acetato - Acetate |



Pack de 100 láminas cortadas (55 micras).
Pack 100 sheets (55 microns).

| Cod. | Medida - Size | Material |
|---------------|---------------|----------|
| AO0013 | 400 x 600 mm. | PP |



Base giratoria. - *Rotatory base.*

| Cod. | Medida - Size | Material |
|-----------------|-------------------|--------------|
| ● AO1516 | 300 Ø x 135 h mm. | Inox. - Sst. |
| ● AO1517 | 300 Ø x 135 h mm. | Inox. - Sst. |
| ● AO1518 | 300 Ø x 135 h mm. | Inox. - Sst. |



Base giratoria profesional.
Professional rotatory base.

| Cod. | Medida - Size | Material. |
|---------------|-------------------|--------------|
| AO1501 | 320 Ø x 110 h mm. | Inox. - Sst. |

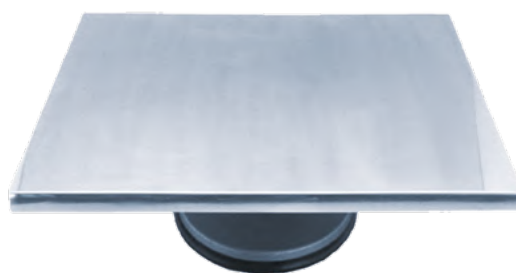

Base giratoria profesional.
Professional rotatory base.

| Cod. | Medida - Size | Material |
|---------------|-----------------------|--------------|
| AO1502 | 410 x 310 x 110 h mm. | Inox. - Sst. |



Base giratoria. - *Rotatory base.*

| Cod. | Medida - Size | Material. |
|---------------|-------------------|-----------|
| AO1519 | 310 Ø x 125 h mm. | P.V.C. |



Base giratoria. - *Rotatory base.*

| Cod. | Medida - Size | Material. |
|---------------|------------------|-----------|
| AO0277 | 280 Ø x 80 h mm. | P.V.C. |



Base giratoria. - *Rotatory base.*

| Cod. | Medida - Size | Material |
|---------------|-------------------|----------|
| TC8053 | 290 Ø x 136 h mm. | P.V.C. |



Base giratoria inclinable y antideslizante.
Tilt and non-slip swivel base.

| Cod. | Medida - Size | Material |
|---------------|-------------------|----------|
| TC9072 | 290 Ø x 136 h mm. | P.V.C. |

MOLDES DE SILICONA

Silicone molds



FABRICACIÓN DE MOLDES

MOLDS MANUFACTURING PROCESS

Fabricación de nuestros moldes de silicona DUPROFLEX, diseñados en varios modelos para adaptarse a los profesionales más exigentes. Elaborados con materiales de alta calidad y rigurosos controles para ofrecer a nuestros clientes los mejores productos del mercado.

Manufacturing of our DUPROFLEX silicone molds, designed in various models to meet the needs of demanding professionals. Made with top-quality materials and strict quality controls to offer our customers the best products on the market.



Diseño previo
Previous design

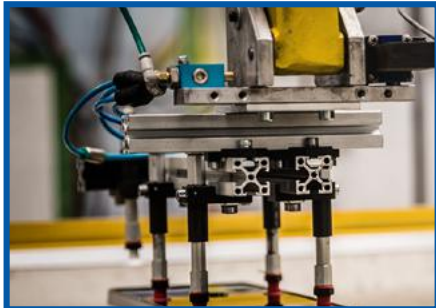

Creación de troquel
Die creation



Inspección e inyectado
Inspection and injected



| Cod. | Medida - Size | Volumen - Volume |
|------------------|------------------|------------------|
| PRIMAVERA | 220 Ø x 50 h mm. | 1500 ml. |



| Cod. | Medida - Size | Volumen - Volume |
|----------------|------------------|------------------|
| MOMENTS | 160 Ø x 60 h mm. | 1000 ml. |



| Cod. | Medida - Size | Vol. |
|------------------|------------------------------|----------|
| ABBRACCIO | 263 x 299 x 65 h - 220 Ø mm. | 1690 ml. |



| Cod. | Medida - Size | Volumen - Volume |
|------------|------------------|------------------|
| DOT | 200 Ø x 60 h mm. | 1500ml. |



| Cod. | Medida - Size | Vol. |
|------------------|----------------------|----------|
| MATELASSE | 160 x 160 x 53 h mm. | 1000 ml. |



| Cod. | Medida - Size | Vol. |
|----------------|----------------------|----------|
| GEM1000 | 160 x 160 x 50 h mm. | 1000 ml. |
| GEM600 | 132 x 132 x 40 h mm. | 600 ml. |





Set molde numeros del 0 al 9 (10 uds).
Set mould numbers from 0 to 9 (10 units).

Cod. Medida - Size
AO1520 250 x 215 x 57 h mm.

MOLDES SILICONA PARA PIEZAS INDIVIDUALES GRAN TAMAÑO
SILICONE MOLDS FOR LARGE INDIVIDUAL PIECES.



DESMONTABLE
REMOVABLE

Cod. Medida - Size Pcs.
K025 75 x 40 x 15 h mm. 40

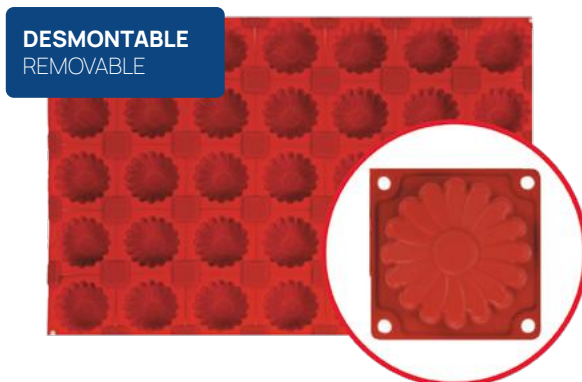

DESMONTABLE
REMOVABLE

Cod. Medida - Size Pcs.
K007 65 Ø x 25 h mm. 35

TARTAS CAKES



| Cod | Medida - Size |
|---------------|------------------|
| SFT424 | 240 Ø x 30 h mm. |
| SFT426 | 260 Ø x 30 h mm. |
| SFT428 | 280 Ø x 30 h mm. |



| Cod. | Medida - Size |
|---------------|------------------|
| SFT118 | 180 Ø x 40 h mm. |
| SFT120 | 200 Ø x 40 h mm. |
| SFT122 | 220 Ø x 42 h mm. |
| SFT124 | 240 Ø x 42 h mm. |
| SFT126 | 260 Ø x 45 h mm. |
| SFT128 | 280 Ø x 47 h mm. |



| Cod. | Medida - Size |
|---------------|-------------------|
| SFT249 | 200 Ø x 90 h mm. |
| SFT250 | 220 Ø x 110 h mm. |
| SFT224 | 240 Ø x 60 h mm. |



| Cod. | Medida - Size |
|---------------|------------------|
| SFT205 | 240 Ø x 55 h mm. |



| Cod. | Medida - Size |
|---------------|----------------------|
| SFT326 | 240 x 105 x 65 h mm. |
| SFT330 | 260 x 100 x 70 h mm. |
| SFT331 | 300 x 100 x 70 h mm. |



| Cod. | Medida - Size |
|---------------|------------------|
| SFT313 | 180 Ø x 95 h mm. |

MONOPORCIONES SINGLE PORTIONS



| Cod. | Medida - Size | Volumen - Volume | Pcs |
|-------------------|---------------------|------------------|-----|
| CYLINDRE75 | 126 x 27 x 27 h mm. | 76 ml. | 10 |



| Cod. | Medida - Size | Volumen - Volume | Pcs |
|-----------------|--------------------|------------------|-----|
| PILLOW80 | 82 x 43 x 32 h mm. | 80 ml. | 8 |
| PILLOW30 | 58 x 30 x 23 h mm. | 30 ml. | 12 |



| Cod. | Medida - Size | Volumen - Volume | Pcs |
|------------------|---------------------|------------------|-----|
| FINGERS75 | 130 x 27 x 27 h mm. | 75 ml. | 8 |



| Cod. | Medida - Size | Volumen - Volume | Pcs |
|-----------------|--------------------|------------------|-----|
| BUCHETTE | 75 x 50 x 46 h mm. | 140 ml. | 8 |



Cod. **AO4407** Medida - Size 45 Ø x 60 h mm. Volumen - Volume 100 ml. Pcs 8



Cod. **AO4411** Medida - Size 75 Ø x 48 h mm. Volumen - Volume 90 ml. Pcs 6



Cod. **GEM100** Medida - Size 61 x 61 x 30 h mm. Volumen - Volume 100 ml. Pcs 8



Cod. **UNIVERSO90** Medida - Size 67 Ø x 27 h mm. Volumen - Volume 90 ml. Pcs 6



| Cod. | Medida - Size | Volumen - Volume | Pcs |
|--------------------|-------------------|------------------|-----|
| TRUFFLES5 | 22 Ø x 19,5 h mm. | 5 ml. | 35 |
| TRUFFLES20 | 32 Ø x 28 h mm. | 20 ml. | 15 |
| TRUFFLES40 | 42 Ø x 36 h mm. | 40 ml. | 15 |
| TRUFFLES70 | 52 Ø x 45 h mm. | 70 ml. | 8 |
| TRUFFLES120 | 62 Ø x 52 h mm. | 120 ml. | 8 |



| Cod. | Medida - Size | Volumen - Volume | Pcs |
|---------------|---------------|------------------|-----|
| AO4406 | 60Øx76 h mm. | 115 ml. | 8 |



| Cod. | Medida - Size | Volumen - Volume | Pcs |
|----------------|---------------|------------------|-----|
| FRAGOLE | 59Øx61 h mm. | 95 ml. | 6 |



| Cod. | Medida - Size | Volumen - Volume | Pcs |
|---------------|--------------------|------------------|-----|
| LIMONE | 85 x 59 x 42 h mm. | 106 ml. | 6 |



Medidas exteriores 30 x 17,5 cm.
External size 30 x 17,5 cm.

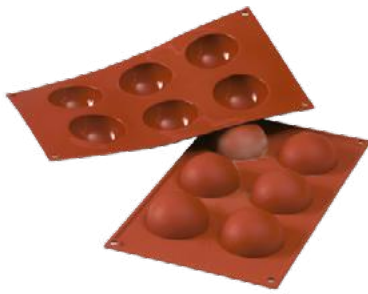

| Cod. | Medida - Size | Vol. | Pcs |
|--------------|-----------------|---------|-----|
| SF001 | 80 Ø x 40 h mm. | 120 ml. | 5 |
| SF002 | 70 Ø x 35 h mm. | 80 ml. | 6 |
| SF003 | 60 Ø x 30 h mm. | 60 ml. | 6 |
| SF004 | 50 Ø x 25 h mm. | 30 ml. | 8 |
| SF005 | 40 Ø x 20 h mm. | 20 ml. | 15 |

| Cod. | Medida - Size | Vol. | Pcs |
|--------------|-----------------|--------|-----|
| SF010 | 41 Ø x 12 h mm. | 18 ml. | 18 |
| SF011 | 65 Ø x 21 h mm. | 50 ml. | 8 |
| SF012 | 72 Ø x 23 h mm. | 62 ml. | 6 |



| Cod. | Medida - Size | Vol. | Pcs. |
|--------------|-----------------|---------|------|
| SF022 | 51 Ø x 28 h mm. | 50 ml. | 11 |
| SF023 | 69 Ø x 35 h mm. | 100 ml. | 6 |
| SF024 | 81 Ø x 32 h mm. | 135 ml. | 5 |

| Cod. | Medida - Size | Vol. | Pcs |
|--------------|-----------------|--------|-----|
| SF013 | 45 Ø x 10 h mm. | 20 ml. | 15 |
| SF014 | 50 Ø x 15 h mm. | 25 ml. | 15 |
| SF015 | 60 Ø x 17 h mm. | 40 ml. | 8 |
| SF016 | 70 Ø x 20 h mm. | 70 ml. | 6 |



| Cod. | Medida - Size | Vol. | Pcs. |
|--------------|-----------------|---------|------|
| SF027 | 40 Ø x 20 h mm. | 30 ml. | 15 |
| SF028 | 60 Ø x 35 h mm. | 90 ml. | 8 |
| SF098 | 48 Ø x 50 h mm. | 83 ml. | 12 |
| SF119 | 63 Ø x 40 h mm. | 123 ml. | 8 |
| SF127 | 70 Ø x 35 h mm. | 133 ml. | 6 |

| Cod. | Medida - Size | Vol. | Pcs |
|--------------|-----------------|--------|-----|
| SF029 | 60 Ø x 12 h mm. | 35 ml. | 8 |
| SF030 | 35 Ø x 5 h mm. | 5 ml. | 24 |



| Cod. | Medida - Size | Vol. | Pcs. |
|--------------|-----------------|--------|------|
| SF093 | 60 Ø x 51 h mm. | 72 ml. | 8 |
| SF094 | 49 Ø x 43 h mm. | 41 ml. | 15 |
| SF095 | 36 Ø x 31 h mm. | 16 ml. | 24 |



| Cod. | Medida - Size | Pcs |
|---------------|------------------|-----|
| TC2005 | 280 Ø x 60 h mm. | 10 |



| Cod. | Medida - Size | Vol. | Pcs. |
|--------------|--------------------|---------|------|
| SF017 | 55 x 33 x 20 h mm. | 30 ml. | 16 |
| SF018 | 70 x 50 x 20 h mm. | 50 ml. | 9 |
| SF055 | 75 x 55 x 35 h mm. | 110 ml. | 8 |
| SF111 | 88 x 53 x 24 h mm. | 85 ml. | 6 |



| Cod. | Medida - Size | Vol. | Pcs. |
|--------------|---------------|---------|------|
| SF036 | 65 x 40 h mm. | 130 ml. | 6 |
| SF040 | 60 x 35 h mm. | 90 ml. | 8 |



| Cod. | Medida - Size | Vol. | Pcs. |
|--------------|---------------------|--------|------|
| SF038 | 72 x 30 x 12 h mm. | 20 ml. | 12 |
| SF039 | 100 x 44 x 15 h mm. | 40 ml. | 9 |



| Cod. | Medida - Size | Vol. | Pcs. |
|--------------|--------------------|--------|------|
| SF083 | 41 x 29 x 20 h mm. | 16 ml. | 24 |
| SF084 | 67 x 49 x 23 h mm. | 48 ml. | 10 |
| SF085 | 74 x 57 x 27 h mm. | 72 ml. | 8 |



| Cod. | Medida - Size | Vol. | Pcs. |
|--------------|--------------------|---------|------|
| SF087 | 59 x 62 x 32 h mm. | 72 ml. | 8 |
| SF088 | 49 x 54 x 28 h mm. | 45 ml. | 10 |
| SF089 | 33 x 35 x 22 h mm. | 16 ml. | 24 |
| SF124 | 69 x 72 x 39 h mm. | 125 ml. | 6 |



| Cod. | Medida - Size | Vol. | Pcs. |
|--------------|--------------------|--------|------|
| SF031 | 44 x 34 x 10 h mm. | 10 ml. | 15 |
| SF032 | 68 x 45 x 17 h mm. | 30 ml. | 9 |



| Cod. | Medida - Size | Vol. |
|--------------|-----------------|-----------|
| SF034 | 79 Ø x 37 h mm. | 110 ml. 6 |
| SF035 | 79 Ø x 30 h mm. | 110 ml. 6 |
| SF109 | 58 Ø x 22 h mm. | 33 ml. 12 |





| Cod. | Medida - Size | Vol. | Pcs. |
|--------------|--------------------|--------|------|
| SF007 | 71 x 71 x 40 h mm. | 90 ml. | 6 |
| SF008 | 36 x 36 x 22 h mm. | 20 ml. | 15 |



| Cod. | Medida - Size | Vol. | Pcs. |
|--------------|------------------------|--------|------|
| SF080 | 32,5 x 32,5 x 20 h mm. | 16 ml. | 24 |
| SF081 | 42,5 x 42,5 x 28 h mm. | 45 ml. | 15 |
| SF082 | 62,5 x 62,5 x 25 h mm. | 73 ml. | 8 |



| Cod. | Medida - Size | Vol. | Pcs. |
|--------------|--------------------|--------|------|
| SF025 | 49 x 26 x 11 h mm. | 20 ml. | 20 |
| SF054 | 95 x 45 x 12 h mm. | 50 ml. | 7 |



| Cod. | Medida - Size | Vol. | Pcs. |
|--------------|--------------------|--------|------|
| SF090 | 72 x 45 x 26 h mm. | 72 ml. | 8 |
| SF091 | 58 x 37 x 25 h mm. | 45 ml. | 10 |
| SF092 | 41 x 23 x 21 h mm. | 16 ml. | 25 |

| Cod. | Medida - Size | Vol. | Pcs. |
|----------------|----------------------|----------|------|
| SQ014 | 495 x 80 x 63 h mm. | 2137 ml. | 4 |
| KITWOOD | 250 x 185 x 70 h mm. | 250 ml. | 1 |

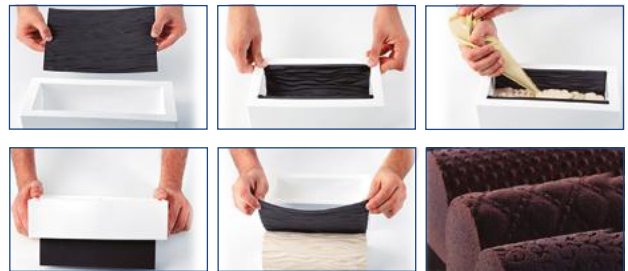
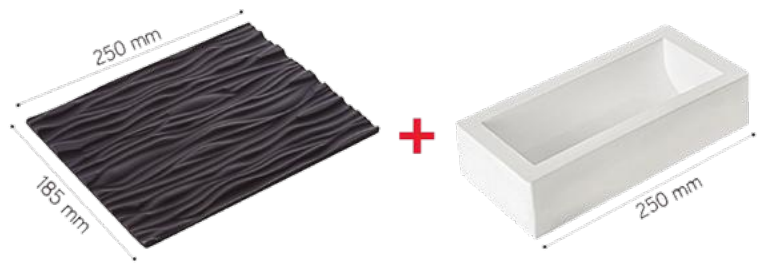
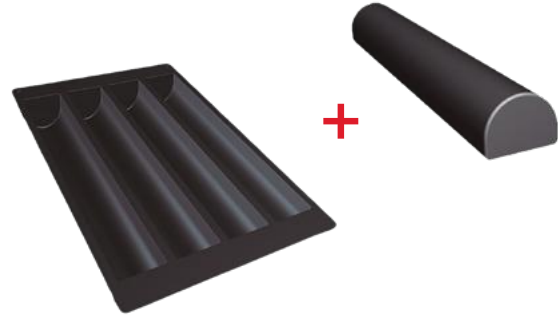
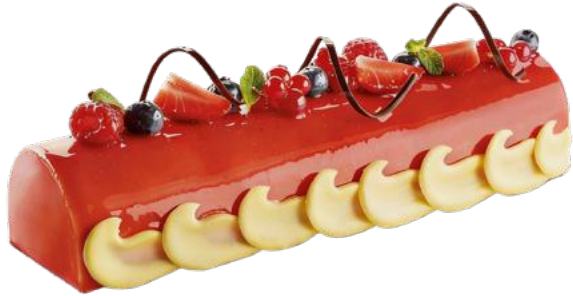

MOLDES SILICONA PARA PIEZAS INDIVIDUALES GRAN TAMAÑO
SILICONE MOLDS FOR LARGE INDIVIDUAL PIECES.



Medidas externas 40 x 60 cm.
 External size 40 x 60 cm.



Cod. Medida - Size Pcs.
SQ001 75 x 40 h mm. 35



Cod. Medida - Size Pcs.
K002 80 Ø x 40 h mm. 20



Cod. Medida - Size Pcs.
K003 70 Ø x 35 h mm. 24



Cod. Medida - Size Pcs.
SQ009 69 Ø x 39 h mm. 24



Cod. Medida - Size Pcs.
K036 80 x 53 x 40 h mm. 25



Cod. Medida - Size Pcs.
SQ005 77 x 44 x 18 h mm. 44



Cod. Medida - Size Pcs.
K035 52 x 52 x 36 h mm. 35

MOLDES SILICONA PARA PIEZAS INDIVIDUALES GRAN TAMAÑO
SILICONE MOLDS FOR LARGE INDIVIDUAL PIECES.



Cod. Medida - Size Pcs.
K041 65 Ø x 50 h mm. 24



Cod. Medida - Size Pcs.
K043 57 x 51 x 50 h mm. 35



Cod. Medida - Size Pcs.
K038 60 Ø x 70 h mm. 28



Cod. Medida - Size Pcs.
K039 124 x 31 x 36 h mm. 28



Cod. Medida - Size Pcs.
K045 60 Ø x 45 h mm. 28



Cod. Medida - Size Pcs.
K037 120 x 33 x 32 h mm. 24



MOLDES SILICONA PARA PIEZAS INDIVIDUALES GRAN TAMAÑO
 SILICONE MOLDS FOR LARGE INDIVIDUAL PIECES.



medidas externas 40 x 60 cm.
 external size 40 x 60 cm.



Cod. **K049** Medida - Size 157 x 41 h mm. Pcs. 35



Cod. **K050** Medida - Size 95 x 53 x 35 h mm. Pcs. 25



Cod. **K052** Medida - Size 70 x 70 x 36 h mm. Pcs. 24



Cod. **K059** Medida - Size 65 x 65 x 35 h mm. Pcs. 28



Cod. **K054** Medida - Size 120 x 39 x 31 h mm. Pcs. 24



Cod. **K061** Medida - Size 120 x 60 x 35 h mm. Pcs. 20



Cod. **K063** Medida - Size 70 x 45 x 35 h mm. Pcs. 36



Cod. **K071** Medida - Size 75 x 67 x 35 h mm. Pcs. 36

MOLDES 100% RECICLABLES 100% RECYCLABLE MOLDS



Prácticos, económicos y rápidos, los moldes desechables para semifríos, monodosis y tartas individuales permiten agilizar la producción, ahorrar tiempo y reducir costes.

Practical, economical and fast, the disposable molds for semifreddos, single doses and individual cakes allow you to speed up production, save time and reduce costs.

| Cod. | Medida - Size | Pack |
|--------------|------------------|---------|
| ONE16 | 160 Ø x 40 h mm. | 100uds. |
| ONE18 | 180 Ø x 40 h mm. | 100uds. |
| ONE20 | 200 Ø x 40 h mm. | 100uds. |
| ONE22 | 220 Ø x 40 h mm. | 100uds. |

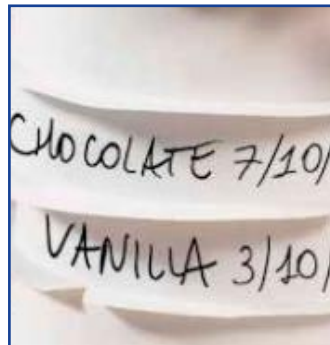

MOLDES
DE CHOCOLATE

Chocolate molds



Medidas externas molde 13,50 x 17,5 cm.
External size mold 13,50 x 17,5 cm.

Moldes de policarbonato para chocolate.
Polycarbonate moulds for chocolate.



MA1001

19x30x15h mm.
7 gr. / 21 pz.



MA1002

Ø24x16h mm.
7 gr. / 21 pz.



MA1003

25x35x19h mm.
5 gr. / 24 pz.



MA1019

20x20x19h mm.
7 gr. / 36 pz.



MA1024

25x25x16h mm.
8 gr. / 21 pz.



MA1025

18x29x16h mm.
8 gr. / 24 pz.



MA1028

22x27x15h mm.
7 gr. / 24 pz.



MA1032

18x30x11h mm.
5 gr. / 25 pz.



MA1036

26x26x19h mm.
13 gr. / 24 pz.



MA1045

28x25x18h mm.
12 gr. / 24 pz.



MA1047

Ø27x34h mm.
12 gr. / 21 pz.



MA1064

21x32x14h mm.
8 gr. / 24 pz.



MA1065

Ø28x20h mm.
12 gr. / 24 pz.



MA1080

28x14x11h mm.
5 gr. / 24 pz.



MA1082

28x33x17h mm.
11 gr. / 30 pz.



MA1088

28x32x23h mm.
15 gr. / 28 pz.



MA1093

29x37x14h mm.
8 gr. / 24 pz.



MA1113

30x28x15h mm.
10 gr. / 24 pz.



MA1134

21x27x17h mm.
8 gr. / 24 pz.

medidas externas molde 13,50 x 17,5 cm.
external size mold 13,50 x 17,5 cm.



MA1218

28x24x16h mm.
6 gr. / 21 pz.



MA1219

21x18x13h mm.
5 gr. / 24 pz.



MA1327

19x29x13h mm.
6 gr. / 24 pz.



MA1334

27x16x13h mm.
6 gr. / 24 pz.



MA1555

Ø30x21h mm.
12 gr. / 21 pz.



MA1557

26x26x19h mm.
12 gr. / 24 pz.



MA1564

Ø32x16h mm.
13 gr. / 21 pz.



MA1637

29x25x20h mm.
12 gr. / 28 pz.



MA1701

26x26x16h mm.
11 gr. / 24 pz.



MA1708

30x21x15h mm.
10 gr. / 27 pz.



MA1709

25x25x12h mm.
10 gr. / 27 pz.



MA1710

28x28x17h mm.
11 gr. / 21 pz.



MA1717

Ø29x18h mm.
9 gr. / 21 pz.



MA1719

26x26x19h mm.
13 gr. / 21 pz.



MA1722

27x27x18h mm.
11 gr. / 21 pz.



MA1729

30x15x25h mm.
9 gr. / 24 pz.



MA1738

34x34x9h mm.
7 gr. / 21 pz.



MA1760

37x17x17h mm.
10 gr. / 30 pz.



MA1761

15x37x15h mm.
10 gr. / 30 pz.



MA1762

37x17x17h mm.
10 gr. / 30 pz.



MA1763

16x37x16h mm.
10 gr. / 30 pz.



MA1764

Ø26x17h mm.
10 gr. / 21 pz.



MA1765

23x26x21h mm.
10 gr. / 24 pz.



MA1766

22x16x28h mm.
10 gr. / 32 pz.



MA1768

18x18x28h mm.
10 gr. / 36 pz.

Especial relleno / Special filling

Medidas externas molde 13,50 x 17,5 cm.
External size mold 13,50 x 17,5 cm.



MA1770

30x30x11h mm.
11 gr. / 18 pz.



MA1771

50x25x13 mm.
9 gr. / 16 pz.



MA1772

33x33x17 h mm.
21 pz.



MA1773

48x25x17 h mm.
15 gr. / 21 pz.



MA1774

31x24x15h mm.
8 gr. / 21 pz.



MA1775

30Øx19h mm.
12 gr. / 21 pz.



MA1776

Ø35x19h mm.
15 gr. / 15 pz.



MA1777

55x25x17h mm.
11 gr. / 18 pz.



MA1780

48x25x17 h mm.
15 gr. / 21 pz.



MA1215

46x23x13h mm.
10 gr. / 22 pz.



MA1778

35x39x6h mm.
5 gr. / 26 pz.



MA1779

35x40x8h mm.
5 gr. / 30 pz.



MA1644

55x27x21h mm.
9 gr. / 2x8 pz.



MA1656

38x28x15h mm.
15 gr. / 18 pz.



MA1680

50x38x15h mm.
19 gr. / 10 pz.



MA3061

40x50x8h mm.
8 gr. / 12 pz.

Moldea la perfección
en cada *bombón.*



Duproflex[®] 

Moldes de policarbonato para chocolate “Magnéticos”.

Magnetics polycarbonate moulds for chocolate.

Medidas externas 175 x 275 x 2,5 h mm.
External size 175 x 275 x 2,5 h mm.



| Cod. | Medida - Size | Vol. | Pcs |
|---------------|---------------|--------|-----|
| MA8004 | 30x30x10h mm. | 11 gr. | 20 |

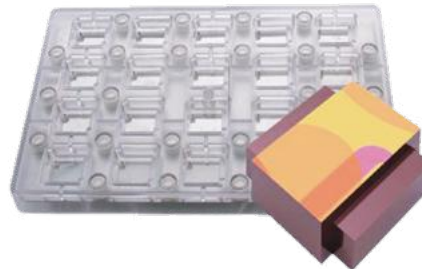

| Cod. | Medida - Size | Vol. | Pcs |
|---------------|---------------|--------|-----|
| MA8002 | 30x30x10h mm. | 11 gr. | 20 |

Moldes rígido piruleta - Rigid lollipop moulds



| Cod. | Medida - Size | Vol. | Pcs |
|---------------|---------------|--------|-----|
| MA2463 | 32x50x24h mm. | 8 gr. | 9 |
| MA2464 | 36x50x13h mm. | 12 gr. | 9 |
| MA2465 | 35x50x15h mm. | 20 gr. | 7 |

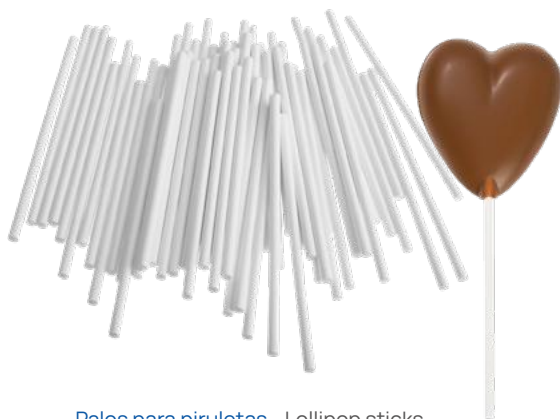

Palos para piruletas - Lollipop sticks

| Cod. | Medida - Size | Mat. | Pcs |
|--------------|---------------|---------------|-----|
| A0666 | Ø4 x 150 mm. | Papel - Paper | 100 |



| Cod. | Medida - Size | Vol. | Pcs |
|---------------|---------------|-------|-----|
| MA1781 | 115x25x8h mm. | 9 gr. | 10 |



2 pz

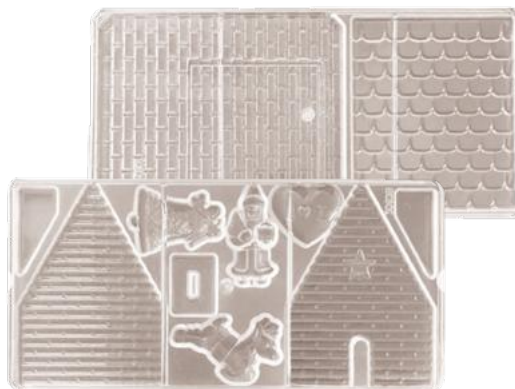

MA1782

88x150x125h mm.



2 pz
1 pz

MAC800S

160h mm.

MAC801S

205h mm.



1 pz

MAC823S

160h mm.



2 pz



MA0020

75x12,7x35h mm.

36x63x17,5h mm.



1 pz



MA0004

120x115x53h mm.



3 pz



MA0005

88x58x60h mm.

65x58x46h mm.



1 pz

MA0030

150x130x70h mm. 1pz.



1 pz

MA0326

95x105x40h mm. 1pz.



1 pz

MA0031

150x135x65h mm. 1pz.



1 pz

MA0033

150x130x70h mm. .



1 pz

MA0001

218x93x75h mm. .



1 pz

MA0032

170x55x55h mm.



1 pz

MA0021

160x120x30h mm.



3 pz

MA0034

125x120x60h mm.
91x87x45h mm.
63x60x32h mm.



2 pz

MA0022

134x120x60h mm.
70x72x30h mm.

Medidas externas 13,50 x 17,5 cm.
External size 13,50 x 17,5 cm.



Cod. **MA0050** Medida - Size 90x67x74h mm.



| Cod. | Medida - Size | Vol. |
|---------------|----------------|-----------------|
| MA1661 | 96x64x32h mm. | 126 gr. / 4 pz. |
| MA2442 | 110x74x37h mm. | 190 gr. / 3 pz. |
| MA1665 | 140x94x47h mm. | 405 gr. / 2 pz. |



| Cod. | Medida - Size | Vol. |
|---------------|-----------------|-----------------|
| MA2462 | 75x50x25h mm. | 66 gr. / 8 pz. |
| MA1663 | 96x63x32h mm. | 132 gr. / 4 pz. |
| MA2460 | 110x75x35h mm. | 198 gr. / 3 pz. |
| MA1669 | 140x94x47h mm. | 405 gr. / 2 pz. |
| MA1670 | 180x120x60h mm. | 865 gr. / 1 pz. |



| Cod. | Medida - Size | Vol. |
|---------------|-----------------|-----------------|
| MA2451 | 70x47x24h mm. | 50 gr. / 8 pz. |
| MA1651 | 81x54x27h mm. | 80 gr. / 6 pz. |
| MA1652 | 100x67x33h mm. | 137 gr. / 4 pz. |
| MA1667 | 140x94x47h mm. | 405 gr. / 2 pz. |
| MA1668 | 180x120x60h mm. | 865 gr. / 1 pz. |



Moldes rígidos grandes - Large rigid mould

| Cod. | Medida - Size | Vol. |
|-----------------|---------------|-----------------------|
| SUT25X17 | 250x170 mm. | 0,5 - 1 kg. / 1 pz. |
| SUT28X18 | 280x185 mm. | 0,8 - 1,2 kg. / 1 pz. |
| SUT34X25 | 325x240 mm. | 1,5 - 2 kg. / 1 pz. |
| SUT40X27 | 390x265 mm. | 2 - 2,5 kg. / 1 pz. |
| SUT45X32 | 435x310 mm. | 2,5 - 3,5 kg. / 1 pz. |
| SUT54X36 | 520x350 mm. | 4 - 6 kg. / 1 pz. |



Moldes flexibles forma huevo liso.
Flexible moulds form plain egg.

| Cod. | Medida - Size | Cant. |
|------|---------------|--------|
| 422 | 25x40h mm. | 5 pzs. |
| 415 | 40x60h mm. | 3 pzs. |
| 410 | 60x85h mm. | 1 pz. |
| 412 | 85x120h mm. | 1 pz. |
| 404 | 105x165h mm. | 1 pz. |
| 402 | 130x190h mm. | 1 pz. |
| 437 | 170x245h mm. | 1 pz. |
| 401 | 205x275h mm. | 1 pz. |
| 423 | 220x360h mm. | 1 pz. |
| 424 | 300x425h mm. | 1 pz. |



Moldes flexibles forma huevo decorado.
Flexible moulds form decorate egg.

| Cod. | Medida - Size | Cant. |
|------|---------------|--------|
| 416 | 35x50h mm. | 3 pzs. |
| 430 | 70x95h mm. | 1 pz. |
| 428 | 95x140h mm. | 1 pz. |
| 435 | 120x170h mm. | 1 pz. |
| 433 | 150x210h mm. | 1 pz. |



| Cod. | Medida - Size |
|----------|---------------|
| 90-13453 | 55x35x18h mm. |



Kit 10 pcs

| Cod. | Medida - Size |
|--------|---------------|
| AO1206 | 100x80x7h mm. |

Medidas externas molde 13,50 x 17,5 cm.
External mold size 13,50 x 17,5 cm.

Moldes de policarbonato para tabletas de chocolate
Polycarbonate moulds for chocolate tablets.



MA2020 130x65x9h mm.
40 gr. / 4 pz.



MA1431 100x62x9h mm.
62 gr. / 3 pz.



MA2110 150x74x8h mm.
86 gr. / 3 pz.

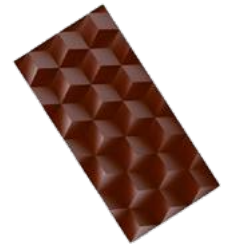

MA2381 148x74x9h mm.
96 gr. / 3 pz.



MA2016 120x60x9h mm.
54 gr. / 3 pz.



MA2010 102x22x10h mm.
22 gr. / 7 pz.



MA2902 150x75x15h mm.
175 gr. / 3 pz.

Moldes flexibles para tabletas de chocolate y turrón. Posibilidad de personalización.
Flexible moulds for chocolate and nougat tablets. Possibility of customization.



Cod. Medida - Size
80-1301 196x83x20h mm.



Cod. Medida - Size
80-1316 195x83x20h mm.



Cod. Medida - Size
80-1328 195x82x20h mm.



Cod. Medida - Size
80-1081 243x102x16h mm.

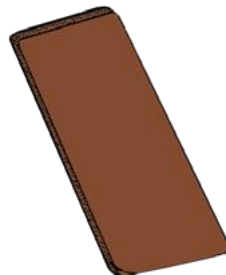

Cod. Medida - Size
80-1335 195x82x20h mm.



Cod. Medida - Size
80-1056 164x84x12h mm.



Cod. Medida - Size
80-1307 196x83x17h mm.



Cod. Medida - Size
80-1615 193x81x18h mm.



Cod. Medida - Size
80-1344 196x82x19h mm.



Cod. Medida - Size
80-1621 193x80x19h mm.



Tu evento, tu
chocolate, tu

estilo.





Moldes de silicona para
caramelo y chocolate.
258x135x3,3h mm.

*Silicone moulds for
caramel and chocolate.
258x135x3,3h mm.*



QM001 55x57x1,8h mm. 8 pz.



QM007 55x105x1,8h mm. 8 pz.

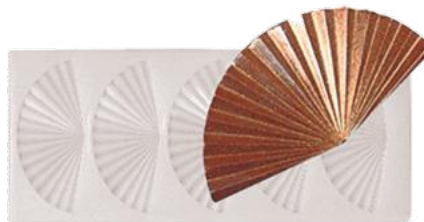

QM011 40x85x1,8h mm. 5 pz.



QM012 44x95x1,8h mm. 7 pz.



QM013 45x110x1,8h mm. 8 pz.



QM016 48x75x1,8h mm. 8 pz.



QM017 Ø57x2,5h mm. 8 pz.

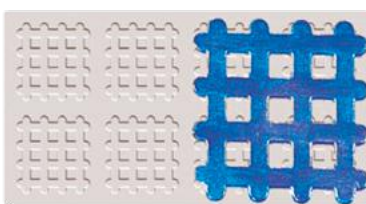

QM025 45x45x2,5h mm. 8 pz.



QM031 40x40x1,8h mm. 15 pz.

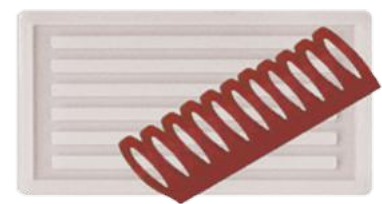

QM033 65x125x1,8h mm. 1 pz.



QM038 55x55x1,8h mm. 8 pz.



QM039 40x50x2,5h mm. 12 pz.



QM040 50x50x2,5h mm. 8 pz.

Moldes de Acrílicos de relieve para Chocolate. 258x135x6h mm.

Acrylic embossed moulds for chocolate. 258x135x6h mm.

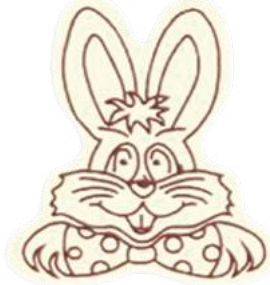
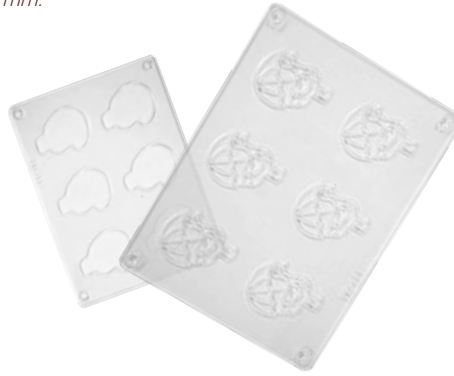
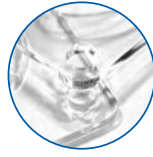

YY0029 37x43x5h mm. 6 pz.



YY0033 34x39x5h mm. 6 pz.



YY0048 38x39x5h mm. 6 pz.



YY0140 82x112x5h mm. 2 pz.



YY0173 41x55x5h mm. 6 pz.



YY0176 46x51x5h mm. 6 pz.



YY0177 42x51x5h mm. 6 pz.



YY0180 42x52x5h mm. 6 pz.



YY0183 38x55x5h mm. 6 pz.



YY0184 43x45x5h mm. 6 pz.



YY0261 40x55x5h mm. 8 pz.



YY0271 35x65x5h mm. 7 pz.



YY0277 35x55x5h mm. 8 pz.

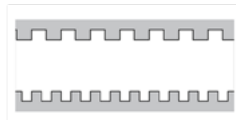

Peines para el chocolate.
Chocolate combs

| Cod. | Medida - Size | Material. |
|---------------|---------------|---------------|
| PDM1/2 | 340 mm. | Goma - Rubber |
| PD1/2 | 700 mm. | Goma - Rubber |

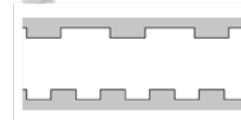
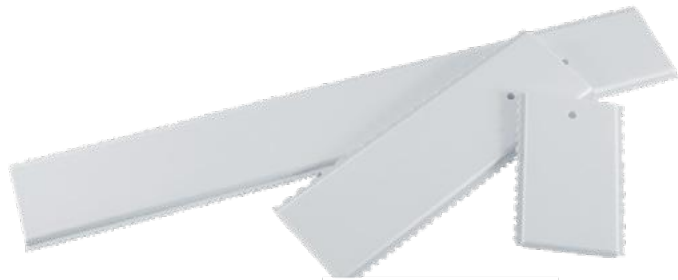

Peines para el chocolate.
Chocolate combs

| Cod. | Medida - Size | Material. |
|---------------|---------------|---------------|
| PDM3/4 | 340 mm. | Goma - Rubber |
| PD3/4 | 700 mm. | Goma - Rubber |



Ideal para chocolate.
Ideal for chocolate.

| Cod. | Medida - Size | Material. |
|---------------|---------------|--------------|
| AO0867 | 100 x 100 mm. | Inox. - Sst. |



Tenedores para bañar en chocolate.
Forks to bathe in chocolate.

| Cod. | Medida - Size | Material. |
|---------------|---------------|--------------|
| AO1024 | - | Inox. - Sst. |

P.V.C. ALIMENTARIO *FOODGRADE P.V.C.*



Pack de 50 láminas cortadas (90 micras).
Pack 50 sheets (90 microns).

| Cod. | Medida - Size | Material. |
|---------------|---------------|--------------------|
| AO1515 | 400 x 600 mm. | Acetato - Acetate. |



Pack de 100 láminas cortadas (55 micras).
Pack 100 sheets (55 microns).

| Cod. | Medida - Size | Material. |
|---------------|---------------|--------------------------------|
| AO0013 | 400 x 600 mm. | Polipropileno - Polypropylene. |

DECORACIÓN EN GELATINA JELLY DECORATION



Juego completo de agujas con formas y jeringuilla.
Complete set of needles with shapes and syringe.

| Cod. | Medida - Size | Material |
|--------|---------------|--------------|
| AO1607 | - | Inox. - Sst. |

Gelatina neutra en láminas Gold. Gold neutral sheet gelatin.

Presentada en hojas rectangulares con apariencia plástica y rígidas.
Una vez hidratadas en agua fría se vuelven maleables y están listas para ser usadas. Se puede utilizar para gelificar un producto completamente o solo para darle espesor y densidad.

*Presented in rectangular sheets with a plastic and rigid appearance.
Once hydrated in cold water, they become malleable and ready to be used.
It can be used to gel a product completely or just to give it thickness and density.*



| Cod. | Capacidad - Capacity |
|--------|----------------------|
| MA-063 | 1kg. |

3D



MAQUINARIA

Machinery





25 l.



7,5 l.



4 l.

Cazos eléctricos. Electric coppers.

- Cazos eléctricos de cobre con baño de acero inoxidable.
- Resistencia exterior soldada en la parte inferior de los cazos, para una perfecta difusión del calor gracias al material de cobre proporcionando el mismo calor en la parte inferior que en la superior.
- Cable de conexión eléctrico desmontable de silicona.
- Asa plastificada y mango para uso directo al fuego.

- Electric copper saucepans with stainless steel bath.
- External resistance welded in the bottom of the buckets, for a perfect heat diffusion thanks to the copper material providing the same heat at the bottom as at the top.
- Detachable silicone electrical connection cable.
- Plasticized handle and handle for direct use on fire.

| Cod. | Medida Size | Litros Liters | Material | Conexión desmontable Removable connection | Voltaje Voltage | Potencia Max. Max. Power | Peso Weight |
|--------|-------------------|------------------|----------------|--|---|-----------------------------|----------------|
| AO0694 | 395 Ø x 290 h mm. | 25 l. | Cobre - Cooper | Monofásico (Opción trifásico) Monophase (Three-phase) | 220 V (Opción 380 V) (Option 380 V) | Min. 3000 W Max. 6000 W | 9,6 Kg. |
| AO0292 | 265 Ø x 205 h mm. | 7,5 l. | Cobre - Cooper | Monofásico Monophase | 220 V | 2000 W | 4 Kg. |
| AO0646 | 210 Ø x 170 h mm. | 4 l. | Cobre - Cooper | Monofásico Monophase | 220 V | 1500 W | 3 Kg. |

En nuestro taller disponemos de servicio de reparación.

- Baños de acero inoxidable.
- Reparación conexión del mango.
- Recambio de resistencias.

In our workshop we have repair service.

- Stainless steel bathrooms.
- Repair handle connection.
- Resistance replacement.



Quemadores eléctricos.

Electric burners.

- Quemadores eléctricos en forma redonda y rectangular.
- Resistencia blindada en tubos de acero soldada en la parte superior de la plancha de acero inoxidable.
- Cable de conexión eléctrico desmontable de silicona.

- Electric burners in round and rectangular shape.
- Shielded resistance in steel tubes welded on the part top of the stainless steel plate.
- Detachable silicone electrical connection cable.

| Cod. | Medida plancha Size griddle | Material | Resistencia Resistance | Conexión desmontable Removable connection | Voltaje Voltage | Potencia Max. Max. Power | Peso Weight |
|---------|--------------------------------|--------------|---------------------------|--|--------------------|-----------------------------|----------------|
| AO0288D | 105 Ø mm. | Inox. - Sst. | Doble - Double. | Monofásico Monophase | 220 V | 900 W | 1,2 Kg. |
| AO0366 | 75 x 235 x 5 h mm. | Inox. - Sst. | Triple - Triple. | Monofásico Monophase | 230 V | 2000 W | 1,7 Kg. |
| AO0289 | 70 x 230 x 3 h mm. | Inox. - Sst. | Doble - Double. | Monofásico Monophase | 230 V | 1500 W | 1,2 Kg. |



Cuadro eléctrico regulador de temperatura con temporizador.
Electric panel temperature regulator with timer.

| Cod. | Material | Uso - Use |
|---------|----------|-------------------------------|
| AO0717 | P.V.C | Quemadores - Electric burners |
| AO0717C | P.V.C | Cazos - Electric Copper |



Soporte de sobremesa para quemadores.
Desktop support for electric burners.



Cable para quemadores y cazos - Cable for burners and cooper.

| Cod. | Características - Characteristic |
|--------|--|
| AO0600 | 2 Bornas - 2 Terminals |
| AO0599 | 3 Bornas - 3 Terminals |
| AO0639 | 3 Bornas "Rosca" - 3 Terminals "Threads" |

| Cod. | Medida - Size | Material |
|--------|---------------------|--------------|
| AO0008 | Estándar - Standard | Inox. - Sst. |

Freidora industrial.

Industrial fryer.

Fabricada en acero inoxidable. Con una cuba amplia embutida. Sus resistencias especiales de acero inoxidable de alta duración, alcanzan la temperatura de trabajo en un tiempo muy corto. Sus resistencias extra-grandes permiten un calentamiento más homogéneo del aceite, optimizando el rendimiento a una potencia determinada. Además hace posible trabajar sin quemar el aceite, obteniendo un ahorro de aceite de hasta el 60%.

Made of stainless steel. With a large embedded tank. Its special long-lasting stainless steel resistors reach working temperature in a very short time. Its extra-large resistances allow a more homogeneous heating of the oil, optimizing performance at a given power. It also makes it possible to work without burning the oil, obtaining an oil saving of up to 60%.

Freidora industrial para uso diario.

- Control de temperatura regulable.
- Resistencia blindada en tubos de acero.
- Grifo para vaciado.
- Tapa inoxidable.
- Cesta inoxidable con asas.
- Reja inoxidable para sumergir el producto.

Industrial fryer for daily use.

- Adjustable temperature control.
- Armored resistance in steel tubes.
- Drain tap.
- Stainless lid
- Stainless basket with handles.
- Stainless grill to submerge the product.



AO0786



AO1350



AO1326



AO1324 - AO1324B



AO1356



AO1325 - AO1325B

| Cod. | Descripción Description | Medida Size | Material | Conexión Connection | Voltaje Voltage | Potencia Max. Max. Power | Capacidad aceite Oil capacity |
|---------|---------------------------------|--|---------------|--|---|-----------------------------|--------------------------------------|
| AO0786 | Freidora completa Full fryer | Cesta - Basket 420 x 420 x 170 h mm. Freidora - Fryer 530 x 480 x 230 h mm. | Inox. Sst. | Monofásico (Opción trifásico) Monophase (Three-phase) | 220 V (Opción 380 V) (Option 380 V) | 5500 W | Max.: 20 l. Trabajo - Work: 12 l. |
| AO1350 | Freidora completa Full fryer | Cesta - Basket 1000 x 520 x 170 h mm. Freidora - Fryer 1110 x 580 x 230 h mm. | Inox. Sst. | Monofásico (Opción trifásico) Monophase (Three-phase) | 220 V (Opción 380 V) (Option 380 V) | 11000 W | Max.: 60 l. Trabajo - Work: 32 l. |
| AO1325 | Tapadera - Cover | 500 x 500 mm. | Inox- Sst. | | | | |
| AO1325B | Tapadera - Cover | 500 x 1000 mm. | Inox- Sst. | | | | |
| AO1326 | Grifo - Tap | - | Inox- Sst. | | | | |
| AO1324 | Cesta - Basket | 420 x 420 x 170 h mm. | Inox- Sst. | | | | |
| AO1324B | Cesta - Basket | 1000 x 520 x 170 h mm. | Inox- Sst. | | | | |

* Las referencias AO0786 y AO1350 son freidoras completas que contienen tapadera, grifo y cesta.
* The references AO0786 and AO1350 are deep fryers complete with cover, tap and basket.

Freidora profesional.

Professional fryer.

Fabricada en acero inoxidable. Con una cuba amplia embudida. Sus resistencias especiales de acero inoxidable de alta duración, alcanzan la temperatura de trabajo en un tiempo muy corto. Sus resistencias extra-grandes permiten un calentamiento más homogéneo del aceite, optimizando el rendimiento a una potencia determinada. Además hace posible trabajar sin quemar el aceite, obteniendo un ahorro de aceite de hasta el 60%.

Made of stainless steel. With a large embedded tank. Its special long-lasting stainless steel resistors reach working temperature in a very short time. Its extra-large resistances allow a more homogeneous heating of the oil, optimizing performance at a given power. It also makes it possible to work without burning the oil, obtaining an oil saving of up to 60%.



Freidora completa profesional para uso diario.

- Control de temperatura regulable.
- Resistencia blindada en tubos de acero.
- Grifo para vaciado.
- Tapa inoxidable.
- Cesta inoxidable con asas.

Industrial fryer for daily use.

- Adjustable temperature control.
- Armored resistance in steel tubes.
- Drain tap.
- Stainless lid
- Stainless basket with handles.



| Cod. | Medida Size | Material | Conexión Connection | Voltaje Voltage | Potencia Max. Max. Power | Peso Weight | Capacidad aceite Oil capacity |
|--------|-----------------------|---------------|-------------------------|--------------------|-----------------------------|----------------|----------------------------------|
| AO1589 | 590 x 540 x 360 h mm. | Inox. Sst. | Monofásico Monophase | 220 V/240V | 3KW | 18Kg. | 20 l. |
| AO1597 | 600 x 580 x 430 h mm. | Inox. Sst. | Monofásico Monophase | 220 V/240V | 6KW | 22Kg. | 30 l. |
| AO1612 | 425 x 285 x 350 h mm. | Inox. Sst. | Monofásico Monophase | 220 V/240V | 2KW | 10Kg. | 4 l. |



Accesorios para batidora 5l./10l.
5 l. / 10l. Mixer accessories.



Bol de acero inoxidable.
Stainless steel bowl.



Batidor inoxidable "Varilla"
Stainless "Rod" Beater.



Batidor "Gancho"
"Hook" Beater.



Batidor "Mariposa"
"Butterfly" Beater.

DUPROFLEX 5 l.
AO1587

DUPROFLEX 10 l.
AO1588

Contiene - Contains:

- Bol de acero inoxidable - Stainless steel bowl.
- Batidor inoxidable "Varilla" - Stainless "Rod" Beater.
- Batidor "Gancho" - "Hook" Beater.
- Batidor "Mariposa" - "Butterfly" Beater.
- Tapadera protección - Protection cover.

| Cod. | Descripción Description | Medida Size | Voltaje V Voltage V | Potencia Power | Capacidad Capacity | Peso Weight |
|---------|---|-----------------------|------------------------|-------------------|-----------------------|----------------|
| AO1587 | Batidora 5 l. completa - Mixer 5 l. complete | 380 x 240 x 375 h mm. | 220-240 | 0,5 KW | 5 l. | 13 Kg. |
| AO1588 | Batidora 10 l. completa - Mixer 10 l. complete | 390 x 260 x 445 h mm. | 220-240 | 0,5 KW | 10 l. | 15 Kg. |
| AO1587B | Bol de acero inoxidable - Stainless steel bowl | - | - | - | 5 l. | - |
| AO1588B | Bol de acero inoxidable - Stainless steel bowl | - | - | - | 10 l. | - |
| AO1587V | Batidor inoxidable "Varilla" - Stainless "Rod" Beater | - | - | - | 5 l. | - |
| AO1588V | Batidor inoxidable "Varilla" - Stainless "Rod" Beater | - | - | - | 10 l. | - |
| AO1587G | Batidor "Gancho" - "Hook" Beater | - | - | - | 5 l. | - |
| AO1588G | Batidor "Gancho" - "Hook" Beater | - | - | - | 10 l. | - |
| AO1587M | Batidor "Mariposa" - "Butterfly" Beater | - | - | - | 5 l. | - |
| AO1588M | Batidor "Mariposa" - "Butterfly" Beater | - | - | - | 10 l. | - |
| AO1587E | Recambio de escobillas | - | - | - | - | - |



OPCIÓN DE REPUESTOS

Montadora de natas. *Whipped cream machine.*

Monta la nata entre 3 y 6 minutos, aumentando el volumen de la nata.

La nata debe de estar fría al incorporarla a la máquina.

Se aconseja que la máquina se utilice en el lugar más fresco del lugar de trabajo.

Pour the cream between 3 and 6 minutes, increasing the volume of the cream.

The cream must be cold when incorporated into the machine.

It is advisable to use the machine in the coolest place in the workplace.

| Cod. | Material | Conexión Connection | Voltaje Voltage | Capacidad Capacity |
|--------|---------------|--|---|-----------------------|
| AO0258 | Inox. Sst. | Monofásico (Opción trifásico) Monophase (Three-phase) | 220 V (Opción 380 V) (Option 380 V) | 5 l. |



AO1323
Bandeja - Tray



Cocedor de tocinillos. *Electric cooker.*

Cocedor eléctrico con las resistencias en seco. Tiene una capacidad para 3 bandejas. Regulador de temperatura.

Electric cooker with dry resistors. It has a capacity for 3 trays. With thermostat.

| Cod. | Descripción Description | Medida Size | Material | Conexión Connection | Voltaje Voltage | Capacidad Capacity |
|--------|--------------------------------------|-----------------------|---------------|-------------------------|--------------------|-----------------------|
| AO0598 | Cocedor eléctrico Electric cooker | 300 x 500 x 260 h mm. | Inox. Sst. | Monofásico Monophase | 230 V | 3 Bandejas 3 Trays |
| AO1323 | Bandeja Tray | 270 x 400 x 40 h mm. | Inox. Sst. | - | - | - |

Niveladoras de bizcochos.
Cake leveling machine.



| Cod. | Descripción Description | Medida Size | Material | Pack. |
|---------|--------------------------------------|----------------|--------------|-------|
| AO0649C | Nivelador 480 mm. - 480 mm. Leveling | 480 mm. | Inox. - Sst. | 1 |



| Cod. | Descripción Description | Medida Size | Material | Pack. |
|---------|--|----------------|----------------------------------|-------|
| AO0649 | Nivelador 370 mm. - 370 mm. Leveling | 370 mm. | Inox. - Sst. | 1 |
| AO0649B | Nivelador 400 mm. - 400 mm. Leveling | 400 mm. | Inox. - Sst. | 1 |
| AO0649P | Peine recambio 370 mm. - <i>Spare comb 370 mm.</i> | 370 mm. | Inox. - Sst. | 1 |
| AO0649G | Peine recambio 400 mm. - <i>Spare comb 400 mm.</i> | 400 mm. | Inox. - Sst. | 1 |
| AO0287 | Bobina papel 370 mm. - <i>Paper roll 370 mm.</i> | 1 (4,16 kg.) | Papel kraft - <i>Kraft paper</i> | 1 |
| AO0290 | Bobina papel 380 mm. - <i>Paper roll 380 mm.</i> | 1 (4,16 kg.) | Papel kraft - <i>Kraft paper</i> | 1 |
| AO0828 | Bobina papel 400 mm. - <i>Paper roll 400 mm.</i> | 1 (4,16 kg.) | Papel kraft - <i>Kraft paper</i> | 1 |
| AO0828B | Bobina papel 400 mm. - <i>Paper roll 400 mm.</i> | 1 (15 kg.) | Papel kraft - <i>Kraft paper</i> | 1 |
| AO1328 | Resma papel 400 x 600 mm. - <i>Sheet paper 400 x 600 mm.</i> | 10 kg. | Papel kraft - <i>Kraft paper</i> | 1 |

Inyectora manual.
Manual desktop.

Inyectora manual de sobremesa.
Fácil desmontable para su limpieza.
Contiene 3 boquillas diferentes.
Tornillos adaptables a la mesa.

Manual desktop injector.
Easy removable for cleaning.
It contains 3 different nozzles.
Screws adaptable to the table.



AO0775



AO0775B

| Cod. | Descrip. | Capac. | Material |
|---------|--|--------|--------------|
| AO0775 | Inyectora manual <i>Manual injector</i> | 9L | Inox. - Sst. |
| AO07751 | Recambio muelle <i>Spring replacement</i> | - | Inox. - Sst. |
| AO0775B | Inyectora manual <i>Manual injector</i> | 3L | Inox. - Sst. |

| Cod. | Descrip. | Kw | Material |
|--------|--|-------------------------------|--------------|
| AO1598 | Molinillo picador almendras, 3Kg. <i>Almond chopper, 3 Kg.</i> | 220V / 3.75KW 25000 r.p.m. | Inox. - Sst. |





Inyectora automática. *Automatic injector.*

Inyectora automática inoxidable de sobremesa.
Regulador electrónico de cantidad.
Fácil desmontable para su limpieza.
Contiene boquillas de diferentes tamaños.

*Automatic stainless tabletop injector.
Electronic quantity regulator.
Easy removable for cleaning.
It contains nozzles of different sizes.*

| Cod. | Medida - Size | V | W | Capac. | Kg |
|---------|-----------------------|-------|-------|--------|--------|
| AO0775A | 450 x 300 x 630 h mm. | 240 V | 180 W | 8,5l. | 27 Kg. |



Alisadora profesional.
Professional straightener.

Posee una estética moderna y atractiva con recubrimiento en polvo. Su espátula está hecha de acero inoxidable 304 y la plataforma es de alta calidad realizada en aleación de aluminio. Fácil de utilizar gracias a sus controles digitales, regulable en altura mediante control analógico, con un rendimiento extraordinario sin apenas ruido y de bajo consumo. El sentido de rotación puede ser cambiado de las agujas del reloj al sentido contrario. Ideal para alisar todo tipo de pasteles con diferentes coberturas suaves (merengues, glazas, natas, etc...).

It has a modern and attractive powder-coated aesthetic. Its spatula is made of 304 stainless steel and the platform is of high quality made of aluminum alloy. Easy to use thanks to its digital controls, adjustable in height by analog control, with extraordinary performance with little noise and low consumption. The direction of rotation can be changed from clockwise to counterclockwise. Ideal for smoothing all kinds of cakes with different soft toppings (meringues, glazes, creams, etc...).

Regulador Manual Perfiles



| Cod. | Medida - Size | V | Kw | Capac. | Kg |
|--------|-----------------|---------|-------|-----------|--------|
| AO1586 | 360X500X570 mm. | 220-240 | 0,2KW | 100/300mm | 28 Kg. |

Rociadora de gelatina.
Jelly sprinkler.



Apta para congelación.
Suitable for freezing.

Máquina de sobremesa ideal para rociar gelatina a gran velocidad reduciendo el tiempo del trabajo.
Con regulador de presión de 0,5 a 3,5 bar.
También se puede regular la temperatura digitalmente hasta los 90°C.
La rociadora aspira el producto de una caldera que calienta la gelatina ubicada en el interior de la máquina.
La rociadora emplea tubos calentados eléctricamente que, combinados con el control digital, mantienen constantemente la temperatura configurada.

*Ideal desktop machine for spraying gelatine at high speed reducing the time of work.
With pressure regulator from 0.5 to 3.5 bar.
The temperature can also be regulated digitally up to 90 °C.
The sprayer sucks the product from a boiler that heats the gelatine inside the machine.
The sprayer uses electrically heated tubes which, combined with the digital control, constantly maintain the set temperature.*

| Cod. | Descrip. | Medida - Size | Mod. | V | Kw | Capac. | Kg |
|---------|---|-----------------------|-------------------------|-----------|--------|--------|--------|
| AO1417 | Rociadora gelatina - Jelly sprinkler | 340 x 450 x 430 h mm. | Monofásico Monophase | 220 - 240 | 1,1 Kw | 2,5 l. | 29 Kg. |
| AO1417P | Pistola de recambio - Replacement gun | - | - | - | - | - | - |
| AO1417M | Manguera de recambio - Replacement hose | - | - | - | - | - | - |
| A0602 | Spraygel - Gelatina especial rociadora | - | - | - | - | - | 12 Kg. |

Lámpara para caramelo.
Candy lamp.



| Cod. | Descrip. | Medida - Size | Mod. | W |
|--------|--|-------------------------------|-------------------------|-----------|
| AO1521 | Lámpara para caramelo - Candy lamp | 450 x 625 mm. | Monofásico Monophase | 2 x 600 W |
| AO1522 | Protector - Protector | - | - | - |
| AO1523 | Perilla de aire en cobre - Air pump made of cooper | - | - | - |
| AO1524 | Soporte perilla de aire - Air pump support | - | - | - |
| AO1525 | Tijera para azúcar - Sugar scissors | - | - | - |
| AO1526 | Guantes - Gloves | Talla 7 - Size 7 | - | - |
| AO1527 | Guantes - Gloves | Talla 9 - Size 9 | - | - |
| AO0468 | Soporte termómetro - Candy thermometer holder | 137 h mm. 310 h mm. | - | - |
| AO1486 | Termómetro para caramelo - Candy thermometer | + 40°C / + 200°C | - | - |
| AO0523 | Termómetro para caramelo - Candy thermometer | 300 h mm. + 80°C / + 200°C | - | - |



Mechero recargable de gas semiprofesional.
Gas rechargeable lighter semiprofesional use.

Cod. Medida - Size
AO1600 69 x 103 x 142 h mm.



Mechero recargable de gas profesional.
Gas rechargeable lighter profesional use.

Cod. Medida - Size
AO1601 74 x 154 x 198 h mm.



Mechero de gas uso industrial.
Bombona no incluida.
Gas lighter industrial use.
Gas cylinder not included.

Cod. Kw
AO1602 1,9 Kw

Atemperadores Digitales para chocolate con calor en seco. Digital chocolate melters with dry heat.

Realizado en material plástico termoresistente, así como una bandeja y una tapa extraíbles en acero inoxidable y un sensor térmico para la adecuada regulación de la temperatura del chocolate. La placa electrónica controla la temperatura interna asegurándose de conseguir los mejores resultados, además detecta la temperatura externa del chocolate mediante un sensor de temperatura dedicado a ayudarlo a templar el chocolate rápidamente y de un modo mucho más preciso. Posee un panel frontal para controlar de temperatura, el cual puede ser regulado manualmente mediante 3 programas diferentes dependiendo del tipo de chocolate que vaya a utilizar: blanco, con leche u oscuro. Las indicaciones en la pantalla le ayudará a controlar la temperatura y templar el chocolate.

Made of heat-resistant plastic material, as well as a removable tray, a stainless steel cover and a thermal sensor for the proper regulation of the chocolate's temperature. The electronic board controls the internal temperature ensuring the best results. It also detects the external temperature of the chocolate thanks to a thermal sensor dedicated to make quickly the chocolate milder and in a much more precise way. It has a front panel to control the temperature, which can be regulated manually by 3 different programs depending on the type of chocolate you are going to use: white, milk or dark. The indications on the screen will help you to control the temperature and temper the chocolate.



Cubetas y tapas de repuesto disponibles

Código:AO1591R

| Cod. | Medida1 - Size1 | Medida2-Size2 | Capac. | Cod. | Medida1 - Size1 | Medida2 - Size2 | Capac. |
|--------|-----------------------|-----------------------|--------|--------|-----------------------|-----------------------|--------|
| AO1550 | 240 x 400 x 135 h mm. | 180 x 325 x 100 h mm. | 3,6 l. | AO1551 | 330 x 400 x 135 h mm. | 265 x 320 x 100 h mm. | 6 l. |



| Cod. | Medida - Size | Mode | Capac. | Cod. | Medida - Size | Mode | Capac. |
|--------|-----------------------|-----------------------|--------|--------|-----------------------|-----------------------|---------|
| AO1552 | 395 x 450 x 135 h mm. | 320 x 353 x 100 h mm. | 9 l. | AO1553 | 395 x 620 x 135 h mm. | 325 x 530 x 100 h mm. | 13,7 l. |

Atemperadores Analógicos para chocolate con calor en seco.
Analogic chocolate melters with dry heat.



| Cod. | Medida1 - Size1 | Medida2 - Size2 | Capac. |
|---------------|-----------------------|-----------------------|--------|
| AO1554 | 240 x 260 x 135 h mm. | 140 x 155 x 100 h mm. | 1,5 l. |
| AO1555 | 240 x 400 x 135 h mm. | 180 x 325 x 100 h mm. | 3,6 l. |
| AO1556 | 330 x 400 x 135 h mm. | 265 x 320 x 100 h mm. | 6 l. |
| AO1557 | 395 x 450 x 135 h mm. | 320 x 353 x 100 h mm. | 9 l. |



| Cod. | Medida1 - Size1 | Medida2 - Size2 | Capac. | Cod. | Medida1 - Size1 | Medida2 - Size2 | Capac. |
|---------------|-----------------------|-----------------------|------------|---------------|-----------------------|-----------------------|------------|
| AO1559 | 420 x 260 x 135 h mm. | 140 x 155 x 100 h mm. | 2 x 1,5 l. | AO1560 | 610 x 260 x 135 h mm. | 140 x 155 x 100 h mm. | 3 x 1,5 l. |

Atemperador digital para chocolate

Digital chocolate melters.

Cuerpo realizado en acero inoxidable de primera calidad, así como la tapa extraíble. Con un sensor térmico y controlador digital para la adecuada regulación de la temperatura del chocolate. La placa electrónica controla la temperatura interna asegurándose de conseguir los mejores resultados, además detecta la temperatura externa del chocolate mediante un sensor dedicado a ayudarle a templarlo rápidamente (entre 0° y 90°) y de un modo mucho más estable.

Las indicaciones en la pantalla le ayudará a controlar la temperatura y templar el chocolate.

Ponemos a su disposición dos modelos independientes, con una sola cubeta de 12 l. o como segunda opción con doble cubetala de 6 l. + 6 l.

Body made of top quality stainless steel, as well as the removable lid. With a thermal sensor and digital controller for the proper regulation of the temperature of the chocolate. The electronic board controls the internal temperature making sure to achieve the best results, it also detects the external temperature of the chocolate through a dedicated sensor to help it temper it quickly (between 0° and 90°) and in a much more stable way.

The indications on the screen will help you control the temperature and temper the chocolate.

We put at your disposal two independent models, with a single 12 l tank. or as a second option with a double bucket of 6 l. + 6 l.

Cubetas y tapas de repuesto disponibles

Código:AO1591R



AO1591



AO1592



AO1606

| Cod. | Medida1 - Size1 | Medida2 - Size2 | Capac. | V | Kw | Temp. | Kg |
|---------------|-----------------------|-----------------------|--------------|------|-------|--------|-------|
| AO1591 | 465 x 355 x 260 h mm. | 353 x 325 x 150 h mm. | 12 l. | 220V | 1 KW. | 0°-95° | 10Kg. |
| AO1592 | 465 x 355 x 260 h mm. | 325 x 176 x 150 h mm. | 6 + 6 l. | 220V | 1 KW. | 0°-95° | 10Kg |
| AO1606 | 465 x 355 x 260 h mm. | 325 x 176 x 150 h mm. | 4 + 4 + 4 l. | 220V | 1 KW. | 0°-95° | 10Kg |

Atemperadora profesional de sobremesa para chocolate. Professional melter table top for chocolate.

Templadoras de mostrador, con capacidad de 5,5 y 11 Kg, que permiten templar el chocolate de modo profesional al igual que las máquinas más grandes, pero con inversiones y estorbos reducidos. Sólida estructura de acero inoxidable.

Dos motores independientes, uno para la còclea y uno para el agitador, para una mayor duración por largo tiempo.

Còclea removible de serie de acero inoxidable para facilitar la limpieza y para cambiar rápidamente el chocolate.

Posibilidad de controlar el flujo de chocolate mediante el pedal.

Pantalla táctil con diversas opciones:

- Dosificaciones automáticas para erogar la correcta cantidad de chocolate.

- Modalidad nocturna para mantener el chocolate fundido, limitando el consumo durante la noche.

- Rotación contraria de la còclea, útil durante la limpieza y para vaciar la boquilla.

Table top melters machines with a capacity of 5.5 and 11 Kg, that make it easy to temper chocolate in a professional manner as if using larger machines, but with a space efficient equipment and at lower costs. Robust stainless steel structure.

Two motors, one for the auger screw and the other for the stirrer, for enhanced motor life over the long-term.

Removable stainless steel auger screw as standard to facilitate cleaning the equipment and for a quick chocolate change.

Pedal to control the chocolate flow.

Touch-screen panel with different options:

- Automatic dosing to dispense the right amount of chocolate.

- Night-mode to keep chocolate melted and to keep consumption under control when the equipment is not used.

- Auger screw can rotate in the opposite direction, a highly useful function to clean and to empty the nozzle.



| Cod. | Medida - Size | Mod. | V | Kw | Capac. | Kg |
|-----------|-----------------------|-------------------------|-----------|---------|--------|--------|
| AO1418 | 460 x 480 x 620 h mm. | Monofásico Monophase | 110 - 240 | 1,1 Kw | 5,5 l. | 52 Kg. |
| AO141811L | 550 x 500 x 720 h mm. | Monofásico Monophase | 110 - 240 | 1,75 Kw | 11 l. | 63 Kg. |

Olla eléctrica para coberturas / gelatinas. Electric pot for toppings / jellies.

Olla eléctrica profesional para la realización de todo tipo de coberturas y/o gelatinas. Con una capacidad de 5l., un termostato regulable y un volumen reducido se convierte en la herramienta perfecta para dar ese toque profesional a todas sus coberturas.

Professional electric pot for making all kinds of toppings and/or jellies. With a 5l capacity, an adjustable thermostat and a reduced volume, it becomes the perfect tool to give that professional touch to all your toppings.



| Cod. | Medida - Size | Mod. | V | Kw | Capac. |
|--------|---------------|-------------------------|-----|--------|--------|
| AO0116 | Ø24x14 cms | Monofásico Monophase | 230 | 0,6 Kw | 5 l. |

Atemperadora profesional con pedal para chocolate. Professional melter with chocolate pedal.

Sólida estructura de acero inoxidable.
 Dos motores independientes, uno para la cóclea y uno para el agitador, para una mayor duración por largo tiempo.
 Cóclea removible de serie de acero inoxidable para facilitar la limpieza y para cambiar rápidamente el chocolate.
 Posibilidad de controlar el flujo de chocolate mediante el pedal.
 Pantalla táctil con diversas opciones:
 - Dosificaciones automáticas para erogar la correcta cantidad de chocolate.
 - Modalidad nocturna para mantener el chocolate fundido, limitando el consumo durante la noche.
 - Rotación contraria de la cóclea, útil durante la limpieza y para vaciar la boquilla.

*Robust stainless steel structure.
 Two motors, one for the auger screw and the other for the stirrer, for enhanced motor life over the long-term.
 Removable stainless steel auger screw as standard to facilitate cleaning the equipment and for a quick chocolate change.
 Pedal to control the chocolate flow.
 Touch-screen panel with different options:
 - Automatic dosing to dispense the right amount of chocolate.
 - Night-mode to keep chocolate melted and to keep consumption under control when the equipment is not used.
 - Auger screw can rotate in the opposite direction, a highly useful function to clean and to empty the nozzle.*



| Cod. | Medida - Size | V | Kw | Capac. | Kg |
|------------|------------------------|-----------|--------|--------|---------|
| AO1418P12L | 520 x 800 x 1540 h mm. | 380 - 400 | 2,6 Kw | 12 l. | 159 Kg. |
| AO1418P24L | 620 x 900 x 1540 h mm. | 380 - 400 | 3 Kw | 24 l. | 185 Kg. |

Dispensadora de chocolate profesional. Professional Chocolate Dispenser.

Dispensadora de chocolate de banco, creada para integrarse en los mostradores de pastelerías, heladerías, chocolaterías.
 Se puede utilizar para llenar conos y copas, realizar decoraciones, etc...
 Cóclea removible de acero inoxidable para facilitar la limpieza y para cambiar rápidamente el chocolate utilizado.
 Dos motores independientes, uno para la cóclea y uno para el agitador, para una mayor duración por largo tiempo.
 Posibilidad de encajar la máquina en el mostrador gracias al kit de encaje.
 Dosificaciones automáticas y posibilidad de controlar el flujo de chocolate mediante el pedal o el botón pertinente.
 Modalidad nocturna para mantener el chocolate fundido, limitando el consumo durante los lapsos de no empleo.
 Rotación contraria de la cóclea, útil durante la limpieza y para vaciar la boquilla.
 A disposición cinco boquillas especiales y aparadores portátiles.

*Dispenser invented specifically for ice cream parlours and chocolate shops and can be used to top ice cream cones and tubs, to make pretty decorations, etc...
 Removable stainless steel auger screw to facilitate cleaning the equipment and for a quick chocolate change.
 Two motors, one for the auger screw and the other for the stirrer, for enhanced motor life over the long-term.
 Thanks to a practical kit the machine can be built in the counter.
 Automatic dosing, button and pedal to control the chocolate flow.
 Night-mode to keep chocolate melted and to keep consumption under control when the equipment is not used.
 Auger screw can rotate in the opposite direction, a highly useful function to clean and empty the nozzle.
 Five special nozzles and mobile counters available.*



| Cod. | Medida - Size | V | Kw | Cap. | Kg |
|---------|-----------------------|-----------|---------|--------|--------|
| AO1418D | 390 x 460 x 830 h mm. | 110 - 240 | 0,95 Kw | 5,5 l. | 37 Kg. |

Rociadora profesional para chocolate. Professional chocolate sprayer.

Máquina para rociar chocolate, sucedáneo y manteca de cacao. Es la solución ideal para rociar chocolate en tartas, moldes, praliné, y para obtener en pocos minutos productos decorados perfectamente y con un aspecto atractivo.

Mediante la regulación de la presión, de la cantidad de chocolate y del ángulo del inyector es posible obtener diferentes efectos decorativos: terciopelo, nieve, piel de naranja, líneas, puntos, etc...
Cabineta porta pistola calentada a temperatura regulable para mantener el chocolate fundido en los lapsos de no empleo y evitar obstrucciones del inyector.

El compresor no está incluido, se suministra bajo pedido.

Machine for spraying chocolate, substitute and cocoa butter. It is the ideal solution to sprinkle chocolate on cakes, molds, praline, and to obtain in a few minutes perfectly decorated products with an attractive appearance.

By regulating the pressure, the amount of chocolate and the angle of the injector it is possible to obtain different decorative effects: velvet, snow, orange peel, lines, points, etc...

Gun carrier booth heated to adjustable temperature to keep molten chocolate in periods of non-use and avoid clogging of the injector.

The compressor is not included, it is supplied upon request.



| Cod. | Pres. | Mod. | V | W | Capac. | Kg |
|--------|----------------|-------------------------|-----------|---------|--------|--------|
| AO1416 | 0,5 - 3,5 bar. | Monofásico Monophase | 110 - 240 | 0,55 Kw | 1l. | 12 Kg. |

Mesa vibradora para moldes de chocolate. Vibrating table for chocolate moulds.

Máquina vibradora ideas para creaciones con moldes de policarbonato para chocolate.
Rápida y fácil de utilizar.

*Vibrating machine ideas for creations with polycarbonate molds for chocolate.
Quick and easy to use.*



| Cod. | Medida - Size | Mod. | V |
|--------|-----------------------|-------------------------|-----------|
| AO1419 | 540 x 320 x 125 h mm. | Monofásico Monophase | 110 - 240 |

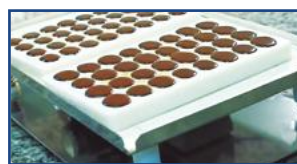

Fuentes para chocolate. Chocolate fountains.



AO69319



AO69321



AO69320

| Cod. | Descrip. | Medida - Size | Mod. | V | W | Capac. | Temp. |
|---------|----------------|-------------------|------------------------|-----------|-------|------------|-------------|
| AO69320 | Fuente - Fount | 380 Ø x 800 h mm. | Monofásico - Monophase | 230 | 370 W | 6,5 - 7 l. | 36°C - 39°C |
| AO69321 | Fuente - Fount | 280 Ø x 630 h mm. | Monofásico - Monophase | 220 - 240 | - | 4,5 - 5 l. | 36°C - 39°C |
| AO69319 | Fuente - Fount | 230 Ø x 380 h mm. | Monofásico - Monophase | 220 - 240 | 80 W | 1,8 l. | 40°C - 50°C |

Máquina de algodón de azúcar Cotton candy floss machine.



Equipada con una potencia de calentamiento de 900 W y un robusto motor de 35 W, nuestra máquina comercial de algodón de azúcar puede trabajar de forma continua y sólo le cuesta 30 segundos producir un algodón de azúcar. Funcionamiento sencillo con control de temperatura. Estructura fiable y fácil de limpiar.

Equipped with 900W heating power and 35W strong motor, our commercial cotton candy machine can work continuously and it only takes 30 seconds to produce one cotton candy. Simple operation with temperature control. Reliable structure and easy to clean.

| Cod. | Material | Mod. | W | Capac. |
|--------|------------|---|------|--------|
| AO1590 | Inox. Sst. | Monofásico (Opción trifásico) Monophase (Three-phase) | 900W | 4 oz. |



Armario conservador de coberturas.
Conservative coverings cabinet.

| Cod. | Medida - Size | Capac. |
|---------------|---|--|
| AO1375 | 2 Pisos - 2 Floors 420 x 855 x 617 h mm. | 4 Bools 350 Ø mm. 4 Bowls 350 Ø mm. |



Placa calentamiento para chocolate.
Heating plate for chocolate.

| Cod. | Medida - Size | W | Temp. |
|---------------|-----------------------|------|-----------|
| AO1272 | 320 x 400 x 115 h mm. | 80 W | 0 - 90 °C |

Kit bombón almadrado.
Almond chocolate kit.

Composición:
1 Base de polietileno sin fondo.
2 Bandejas de 60 orificios.
1 Espátula P.V.C. rectangular.

Elements:
1 Polyethylene base.
2 Trays of 60 holes.
1 Rectangular P.V.C. spatula.

| Cod. | Medida - Size |
|---------------|----------------------|
| AO1549 | 400 x 600 x 50 h mm. |



Kit bombón cortado.
Cut chocolate kit

Composición:
1 Base de polietileno 480x600mm.
1 Regla de P.V.C.
2 Marcos en P.V.C. de 365x365x3h mm.
2 Marcos en P.V.C. de 365x365x5h mm.

Elements:
1 Polyethylene base 480x600mm.
1 Rule P.V.C.
2 Frames in P.V.C. of 365x365x3h mm.
2 Frames in P.V.C. of 365x365x5h mm.

| Cod. | Medida - Size |
|------------------|---------------|
| TLSPECIAL | 480 x 600 mm. |



Máquina para hacer bolas de mazapán. Machine for making marzipan balls.

Ideal para elaborar bolas de mazapán de manera rápida y efectiva.
Ideal for making marzipan balls quickly and effectively.

Modo de uso / How to use :

1. Preparar la masa con un grosor de 24h mm.
2. Posicionar la masa en la base de la máquina de bolas y presionar con la cobertura para obtener tiras de masa.
3. Posicionar las tiras de masa horizontalmente.
4. Presionar nuevamente la cobertura contra la base y deslizar para obtener las bolas.

1. Prepare the dough with thickness of 24h mm.
2. Set the dough on the base of your ball machine and press with the cover to obtain strips.
3. Lay the strips of dough horizontally.
4. Press the cover up and down in order to obtain balls.



Cod. PALL3
Dimens. 24 Ø mm.

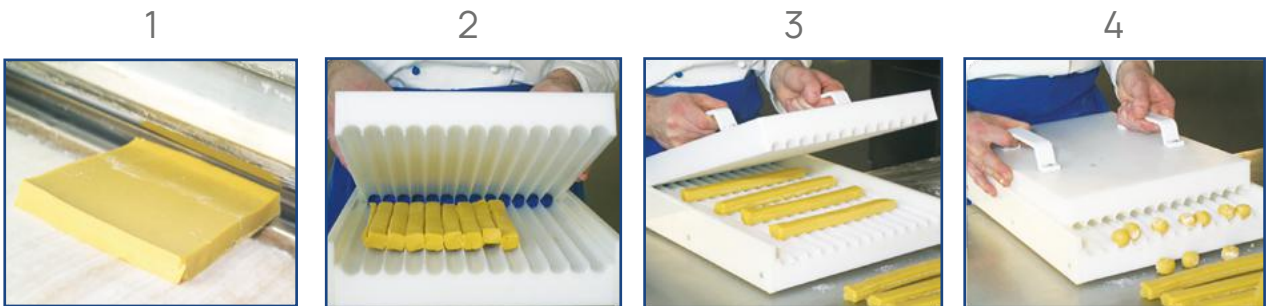

Cod. AO1541
Medida - Size -
Pcs. 9



Cod. MARSET12
Medida - Size -
Pcs. 15



Cod. AO1125
Medida - Size 140 mm.
Pcs. 12

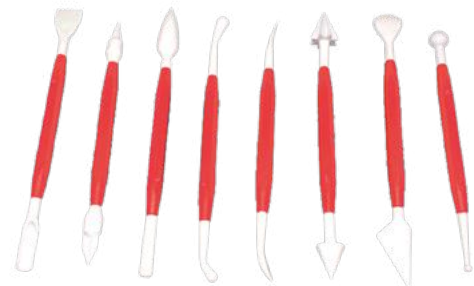

Cod. AO1126
Medida - Size 160 mm.
Pcs. 8

Máquina de sellado Sealing machine.

Fabricada en Acero inoxidable y ABS de gran duración, asegurándonos un correcto funcionamiento y un sellado rápido y eficaz. Es una selladora térmica ideal para cualquier utilidad, compatible con diferentes materiales, como plástico, papel o aluminio. Dependiendo del material ajustaremos la intensidad de la selladora térmica.

Made of long-lasting stainless steel and ABS, ensuring correct operation and a fast and effective seal. It is an ideal heat sealer for any utility, compatible with different materials, such as plastic, paper or aluminum. Depending on the material we will adjust the intensity of the heat sealer.

| Cod. | Material | Mod. | V | Capac. |
|--------|------------|---|-------------------------------------|--------|
| AO1594 | Inox. Sst. | Monofásico (Opción trifásico) Monophase (Three-phase) | 220 V (Opción 380 V) (Option 380 V) | 5 l. |



Kit aerógrafo con pistola inoxidable. Airbrush kit with stainless mechanism.

Kit ideal para la iniciación en el mundo de la aereografía pastelera. Tiene una alta precisión gracias a su regulador de potencia.

Ideal kit for initiation in the world of pastry aereography. It has high precision thanks to its power regulator.

| Cod. | Precis. | V |
|--------|---------|-------|
| AO1400 | 0,3 mm. | 220 V |



Compresor aerógrafo estándar. Standard airbrush compressor.

Compresor profesional con presión Medio - Alta. Tiene una alta precisión gracias a su regulador de potencia. Facil de manejar gracias a su peso de 2,4 kg. y al cable de 1,5 m.

Professional compressor with medium - high pressure. It has high precision thanks to its power regulator. Easy to handle thanks to its weight of 2.4 kg. and to the wire 1.5 m.

| Cod. | Medida- Size | BAR | V |
|--------|-----------------------|--------------------|--------------------|
| AO1401 | 190 x 130 x 170 h mm. | Start 2,4 Stop 3,1 | 220 - 240 V 50 Hz. |

Pistolas de aerografía para pastelería. Airbrush guns for pastry.

Medida - Size: 155 mm.
Cable conexión al compresor no incluido.
Compressor wire connection not included.



| Cod. | Precis. | Capac. | Material | Cod. | Precis. | Capac. | Material | Cod. | Precis. | Capac. | Material |
|--------|---------|--------|--------------|--------|---------|--------|--------------|--------|---------|-----------------|--------------|
| AO1403 | 0,3 mm. | 7 c.c. | Inox. - Sst. | AO1404 | 0,3 mm. | 9 c.c. | Inox. - Sst. | AO1405 | 0,3 mm. | 9 c.c. + 20c.c. | Inox. - Sst. |

Accesorios para pistolas de aerógrafo. Accessories for airbrush guns.



| Cod. | Descrip. | Medida - Size |
|---------|--|-----------------------|
| AO1406 | Recipiente limpiador - Cleaner container | 7 |
| AO1408 | Set 5 limpiadores - Set 5 cleaners | 100 mm. |
| AO1407 | Cable conexión - Wire connection | 1,8 m. |
| AOREPAG | Aguja repuesto pistola - Spare needle gun | - |
| AO1424 | Soporte para 2 pistolas - Support for 2 guns | 450 x 395 x 315 h mm. |



Colorante en pasta. Coloring in paste form.



(SIN E171)

Colorantes en pastas ideal para la decoración de pastelería en general. Los colorantes en pastas son fundamentales en el mundo pastelero ya que nos permiten colorear cualquier tipo de masas, cremas, mazapanes, galletas, caramelos etc...

Dyes in pastes ideal for decorating pastry in general. Dyes in pastes are essential in the pastry world since they allow us to color any type of dough, cream, marzipan, cookie, candy etc ...

| Cod. | Color | Capac. |
|---------|-------------------------------|---------|
| OF33100 | Rojo fresa - Strawberry red | 200 gr. |
| OF33108 | Rojo vivo - Deep red | 200 gr. |
| OF33101 | Amarillo limón - Lemon yellow | 200 gr. |
| OF33102 | Verde menta - Mint green | 200 gr. |
| OF33103 | Azul - Blue | 200 gr. |
| OF33105 | Violeta - Violet | 200 gr. |
| OF33106 | Marrón - Brown | 200 gr. |
| OF33104 | Naranja - Orange | 200 gr. |

Colorante en spray mate. Coloring in matte spray form.



(SIN E171)

Colorante en spray opaco con base de alcohol para superficies de producto alimenticios. Ideal para colorear superficies de: Chocolate, pasta de azúcar, pastillaje, pasta de almendras, repostería, natas y cremas. Listo para usar. Agite bien antes de usar. Pulverizar desde una distancia de 25/30 cm manteniendo la botella lo más vertical posible.

Matt colouring spray alcohol based for the surface of foodstuff. Ideal for colouring the surface of chocolate, sugarpaste, gumpaste, almond paste, bakery products and cream. Ready to use. Shake well before use. Spray from a distance of 25/30 cm maintaining the can as vertical as possible.

| Cod. | Color | Capac. |
|-------|-------------------|---------|
| A0975 | Rosa - Pink | 150 ml. |
| A0976 | Azul - Blue | 150 ml. |
| A0977 | Rojo - Red | 150 ml. |
| A0978 | Verde - Green | 150 ml. |
| A0979 | Amarillo - Yellow | 150 ml. |
| A0980 | Marrón - Brown | 150 ml. |
| A0983 | Oro - Gold | 150 ml. |
| A0982 | Plata - Silver | 150 ml. |

Colorante en polvo liposoluble. Fat-soluble powder coloring.



Colorante concentrado liposoluble en polvo. Ideal para la coloración de masas y superficies de: chocolate, crema de mantequilla, merengues, Fondant, masas grasas en general. Listo para usar. Vierta el tinte en la mezcla y mezcle bien. Para superficies, aplicar el polvo seco con brocha o diluido en alcohol alimentario o aceite.

Liposoluble concentrated colouring powder. Ideal for colouring the surface of chocolate, buttercream, swiss meringue, sugarpaste, fat masses in general. Ready to use. Pour the colouring into the dough and mix well. For surfaces apply the dry colouring powder with a brush or diluted in alcohol or oil.

| Cod. | Color | Capac. |
|-------|--------------------------|--------|
| A0986 | Rojo - Red | 50 gr. |
| A0987 | Gris - Grey | 50 gr. |
| A0988 | Verde - Green | 50 gr. |
| A0989 | Naranja - Orange | 50 gr. |
| A0990 | Amarillo - Yellow | 50 gr. |
| A0991 | Azul - Blue | 50 gr. |
| A0936 | Blanco - White | 50 gr. |
| A0937 | Choc. Leche - Milk Choc. | 50 gr. |
| A0994 | Oro - Gold | 40 gr. |
| A0993 | Plata - Silver | 40 gr. |
| A0961 | Bronce - Bronze | 40 gr. |
| A0994 | Oro Real - Royal Gold | 40 gr. |
| A0962 | Cobre - Copper | 40 gr. |

(SIN E171)



COLORANTE ALIMENTARIO EN POLVO
Cada Sachet 10g

Contiene: azúcar, Noi simple, 3D glic, Lact, Van, etc.

Colorante Alimentario en Polvo

Gelatina Neutra en frío.
Liposoluble liquid (Airbrush).

Gelatina concentrada de textura cremosa que permite ser aplicada directamente. Insípida e incolora. Ideal para fijar láminas de oblea y de azúcar al instante creando así una protección e intensificando los colores impresos.

Creamy texture concentrated gelatin that can be applied directly. Tasteless and colorless. Ideal for fixing wafer and sugar sheets instantly creating protection and intensifying printed colors.

Cod. **Capac.**
MA-234 1Kg.
MA-235 6Kg.
MA-063 Láminas (1Kg.)



Spray desmoldeante.
Release spray.



Desmoldeante alimentario en spray fabricado con aceites vegetales de alta calidad.

Food release spray made with high quality vegetable oils.

Cod. **Capac.**
A0780 600ml.

Spray brillo.
Shine spray.



Spray alimentario ideal para dar brillo a decoraciones artísticas en chocolate, azúcar, mazapán etc.

Food spray ideal for giving shine to artistic decorations in chocolate, sugar, marzipan etc.

Cod. **Capac.**
A0985 400 ml.

Spray secado.
Dry spray.



Spray alimentario ideal para refrigerar rápidamente decoraciones artísticas en chocolate y azúcar.

Food spray ideal for quickly refrigerating artistic decorations in chocolate and sugar.

(SIN E171)

Cod. **Capac.**
A0984 400 ml.



Cartuchos tinta alimentaria. Food ink cartridges.



Consumibles compatibles para impresoras de la marca Canon.

Compatible consumables for Canon brand printers.



Modelo Cartucho 580 / 581
Modelo Cartucho 570 / 571

| Cod. | Color | Cod. | Color |
|----------|----------------------------|----------|----------------------------|
| OG000581 | Negro fino Thin black | OG000571 | Negro fino Thin black |
| OG001581 | Negro ancho Width black | OG001571 | Negro ancho Width black |
| OG002581 | Magenta Magenta | OG002571 | Magenta Magenta |
| OG003581 | Amarillo Yellow | OG003571 | Amarillo Yellow |
| OG004581 | Cian Cyan | OG004571 | Cian Cyan |

Hoja comestible con alta resolución de impresión.
Edible sheet with high print resolution.

| Cod. | Medida - Size | Pack | Box |
|-------|---------------------|---------|---------|
| A0890 | 210 x 297 mm. A4 | 25 uds. | 25 pack |

Hoja flexible, ligera, sin azúcar, y perfecta para cortar. Se puede utilizar sobre cualquier soporte para la decoración de productos alimentarios, mediante tecnología ink-jet. Soporta diferentes

Flexible, light, sugar-free blade, and perfect for cutting. It can be used on any support to decorate food products, using ink-jet technology. Withstands different temperatures.



Láminas Impresión

Printing sheets.



Lámina de oblea para impresora.
Absorbe muy bien la gelatina neutra.
Wafer sheet for printer.
Absorbs neutral gelatin very well.

| Cod. | Medida - Size | Material | Pcs. |
|--------------|---------------------|----------------|------|
| O0009 | 210 x 297 mm. A4 | Oblea Wafer | 50 |
| O0019 | 297 x 420 mm. A3 | Oblea Wafer | 50 |



Lámina plástica con manteca de cacao para impresora. "Chocotransfer".
Absorbe muy bien la gelatina neutra.
Chocotransfer sheet for printer.
Absorbs neutral gelatin very well.

| Cod. | Medida - Size | Material | Pcs. |
|---------------|---------------------|----------|------|
| AO0890 | 210 x 297 mm. A4 | Transfer | 25 |



Lámina de azúcar para impresora.
Absorbe muy bien la gelatina neutra.
Sugar sheet for printer.
Absorbs neutral gelatin very well.

| Cod. | Descrip. | Medida - Size | Material | Pcs. |
|--------------|----------------------|---------------------|-----------------|------|
| A0132 | Estándar Standard | 210 x 297 mm. A4 | Azúcar Sugar | 20 |
| A0138 | Gruesa Gross | 210 x 297 mm. A4 | Azúcar Sugar | 25 |



EXPOSITORES

Stands





Cod. Medida - Size Material
AO1376 590 x 220 X 270 mm. Inox. - Sst.



LED incluido.
LED included.

Cod. Medida - Size Material
AO1216 3 x 250 Ø mm.
1 x 300 Ø mm. Inox. - Sst.

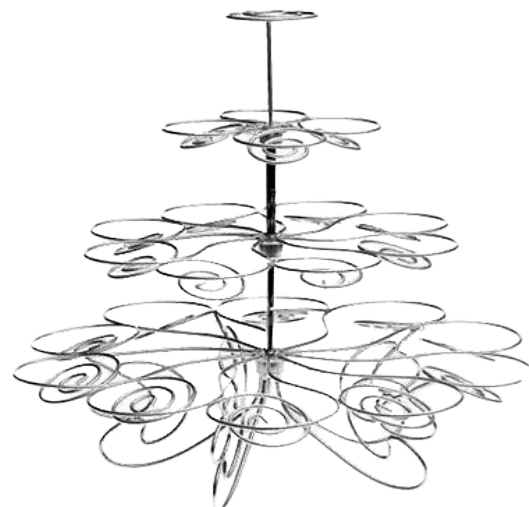

Cod. Medida - Size Material
TC8009 450 Ø x 360 h mm. Metal



Cod. AO1215 **Medida - Size** 310 Ø x 90 h mm. **Material** Inox. - Sst.



Cod. AO1220 **Medida - Size** 310 Ø x 140 h mm. **Material** Inox. - Sst.



LED incluido.
LED included.

Cod. AO1218 **Medida - Size** 400 Ø x 200 h mm. **Material** Inox. - Sst.





Cod. **Medida - Size** **Material**
AO0872 145 x 910 h mm. Metal
 1 pz 300 Ø mm.
 2 pzs 300 x 400 mm.
 1 pz 400 x 600 mm.

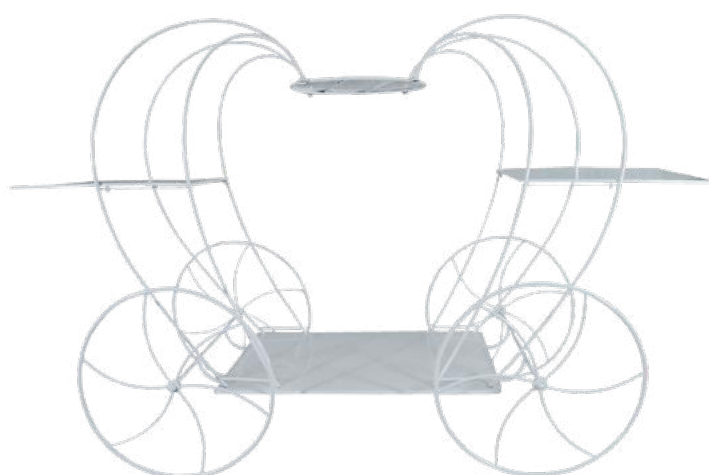

Cod. **Medida - Size** **Material**
AO0880 145 x 910 h mm. Metal
 1 pz 300 Ø mm.
 2 pzs 300 x 400 mm.
 1 pz 400 x 600 mm.



Platos de cristal.
 Glass dishes.

Cod. **Medida - Size** **Material**
AO0892 340 x 990 x 620 h mm. Metal
 1 pz 295 x 370 mm.



Platos de cristal.
 Glass dishes.

Cod. **Medida - Size** **Material**
AO0879 1200 x 660 h mm. Metal
 2 pzs x 260 Ø mm.
 3 pzs x 300 Ø mm.

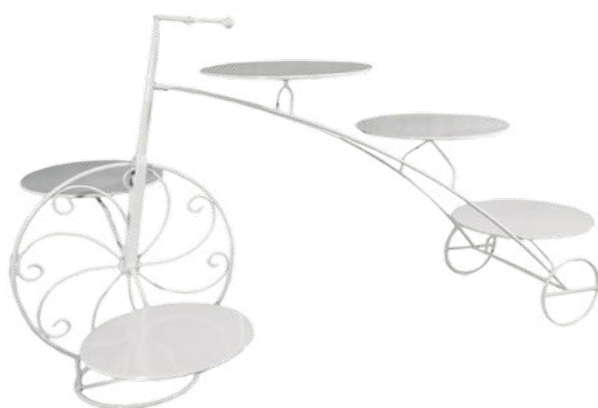

Cod. **Medida - Size** **Material**
AO0870 1200 x 660 h mm. Metal
 2 pzs x 260 Ø mm.
 3 pzs x 300 Ø mm.

*El camino más dulce,
empieza aquí.*





| Cod. | Medida - Size | Material |
|---------------|-----------------|----------|
| AO0873 | 620 x 680 h mm. | Metal |
| | 1 pz 200 Ø mm. | |
| | 2 pzs 300 Ø mm. | |
| | 1 pz 350 Ø mm. | |



| Cod. | Medida - Size | Material |
|---------------|-----------------|----------|
| AO0895 | 300 x 110 h mm. | Metal |



Platos de cristal.
Glass dishes.

| Cod. | Medida - Size | Material |
|---------------|-----------------------|----------|
| AO0875 | 840 x 840 x 740 h mm. | Metal |

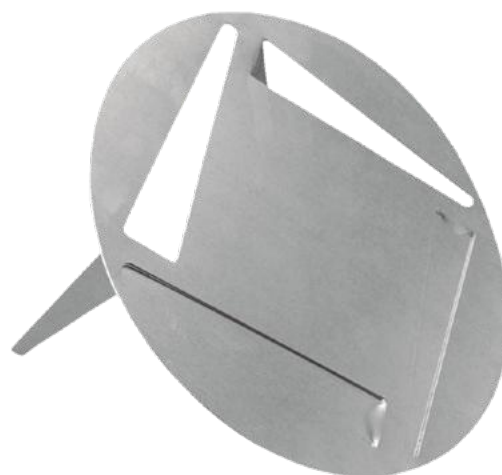

Soporte con patas plegables.
Support with folding legs.

| Cod. | Medida - Size | Material | Pack |
|---------------|---------------|----------------------|------|
| AO0255 | 160 Ø mm. | Aluminio - Aluminium | 25 |
| AO0256 | 200 Ø mm. | Aluminio - Aluminium | 25 |
| AO0257 | 240 Ø mm. | Aluminio - Aluminium | 25 |

Soporte "Genuino Inglés", varios pisos con base de 30 Ø cm.

"English Genuine" Cake stand, several floors with base of Ø30 cm.

| Cod. | Medida - Size | Descrip. | Material |
|---------------|---------------------------|------------------|-------------|
| AO0222 | Base 30 Ø cm. | 3 Pisos - floors | Inox.- Sst. |
| | Plato - Plate 20Ø 25Ø cm. | | |

| Cod. | Medida - Size | Descrip. | Material |
|---------------|---------------------------------------|------------------|-------------|
| AO0223 | Base 30 Ø cm. | 5 Pisos - floors | Inox.- Sst. |
| | Plato - Plate 15Ø 20Ø 25Ø 30Ø 35Ø cm. | | |

| Cod. | Medida - Size | Descrip. | Material |
|---------------|---|------------------|-------------|
| AO0224 | Base 30 Ø cm. | 6 Pisos - floors | Inox.- Sst. |
| | Plato - Plate 15Ø 20Ø 25Ø 30Ø 35Ø 40Ø cm. | | |

| Cod. | Medida - Size | Descrip. | Material |
|---------------|---|------------------|-------------|
| AO0225 | Base 30 Ø cm. | 7 Pisos - floors | Inox.- Sst. |
| | Plato - Plate 15Ø 20Ø 25Ø 30Ø 35Ø 40Ø 45Ø cm. | | |

| Cod. | Medida - Size | Descrip. | Material |
|---------------|---|------------------|-------------|
| AO0226 | Base 30 Ø cm. | 8 Pisos - floors | Inox.- Sst. |
| | Plato - Plate 15Ø 20Ø 25Ø 30Ø 35Ø 40Ø 45Ø 50Ø cm. | | |

| Cod. | Medida - Size | Descrip. | Material |
|---------------|---|-------------------|-------------|
| AO0227 | Base 30 Ø cm. | 10 Pisos - floors | Inox.- Sst. |
| | Plato - Plate 15Ø 20Ø 25Ø 30Ø 35Ø 40Ø 45Ø 50Ø 55Ø 60Ø cm. | | |



Base soporte.
Base for the cake stand.

| Cod. | Medida - Size | Material |
|---------------|---------------|--------------|
| AO0230 | 30 Ø cm. | Inox. - Sst. |



Base soporte.
Base for the cake stand.

| Cod. | Medida - Size | Material |
|---------------|---------------|--------------|
| AO2015 | 30 Ø cm. | Inox. - Sst. |



Discos redondos para soporte "Genuino Inglés".
Round disc for "English Genuine" Cake stand.

| Cod. | Medida - Size | Material |
|--------|---------------|----------------------|
| AO0232 | 15 Ø cm. | Aluminio - Aluminum. |
| AO0233 | 20 Ø cm. | Aluminio - Aluminum. |
| AO0234 | 25 Ø cm. | Aluminio - Aluminum. |
| AO0235 | 30 Ø cm. | Aluminio - Aluminum. |
| AO0236 | 35 Ø cm. | Aluminio - Aluminum. |
| AO0237 | 40 Ø cm. | Aluminio - Aluminum. |
| AO0238 | 45 Ø cm. | Aluminio - Aluminum. |
| AO0239 | 50 Ø cm. | Aluminio - Aluminum. |
| AO0240 | 55 Ø cm. | Aluminio - Aluminum. |
| AO0241 | 60 Ø cm. | Aluminio - Aluminum. |
| AO0284 | 65 Ø cm. | Aluminio - Aluminum. |

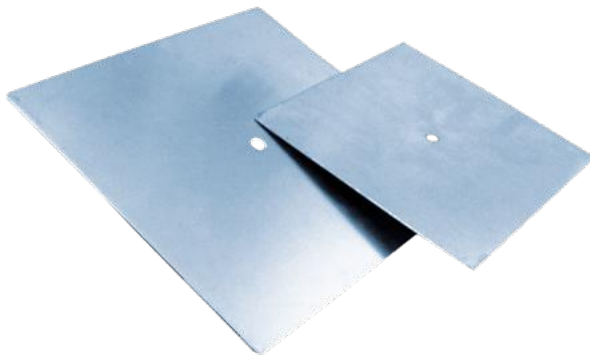

Discos cuadrados para soporte "Genuino Inglés".
Squared disc for "English Genuine" Cake stand.

| Cod. | Medida - Size | Material |
|--------|---------------|----------------------|
| AO0354 | 15 x 15 cm. | Aluminio - Aluminum. |
| AO0355 | 20 x 20 cm. | Aluminio - Aluminum. |
| AO0356 | 25 x 25 cm. | Aluminio - Aluminum. |
| AO0357 | 30 x 30 cm. | Aluminio - Aluminum. |
| AO0358 | 35 x 35 cm. | Aluminio - Aluminum. |
| AO0359 | 40 x 40 cm. | Aluminio - Aluminum. |
| AO0360 | 45 x 45 cm. | Aluminio - Aluminum. |
| AO0361 | 50 x 50 cm. | Aluminio - Aluminum. |



Tija para soportes.
Shank for cake stands.

| Cod. | Medida - Size | Descripción - Description | Material |
|--------|---------------|---------------------------------|--------------|
| AO0248 | 11h cm. | Tija terminal - Final shank | Inox. - Sst. |
| AO0910 | 18h cm. | Tija terminal - Final shank | Inox. - Sst. |
| AO0249 | - | Tornillo terminal - Final screw | Inox. - Sst. |
| AO0281 | - | "Florón" | Inox. - Sst. |



Tija con arandela.
Shank with washer.

| Cod. | Medida - Size | Material |
|--------|---------------|--------------|
| AO0242 | 12 h cm. | Inox. - Sst. |
| AO0243 | 14 h cm. | Inox. - Sst. |
| AO0244 | 16 h cm. | Inox. - Sst. |
| AO0245 | 18 h cm. | Inox. - Sst. |
| AO0246 | 20 h cm. | Inox. - Sst. |
| AO0247 | 22 h cm. | Inox. - Sst. |



Soporte curvo "3 Pisos".
Curved cake stand "3 Floors".

| Cod. | Medida - Size | Material |
|--------------|---------------|----------|
| P6816 | 3 x 28 Ø cm. | P.V.C. |



Soporte cuna.
Curved cake stand "3 Floors".

| Cod. | Medida - Size | Material |
|---------------|--------------------|----------|
| AO2008 | 35 x 47 x 50 h cm. | Plástico |

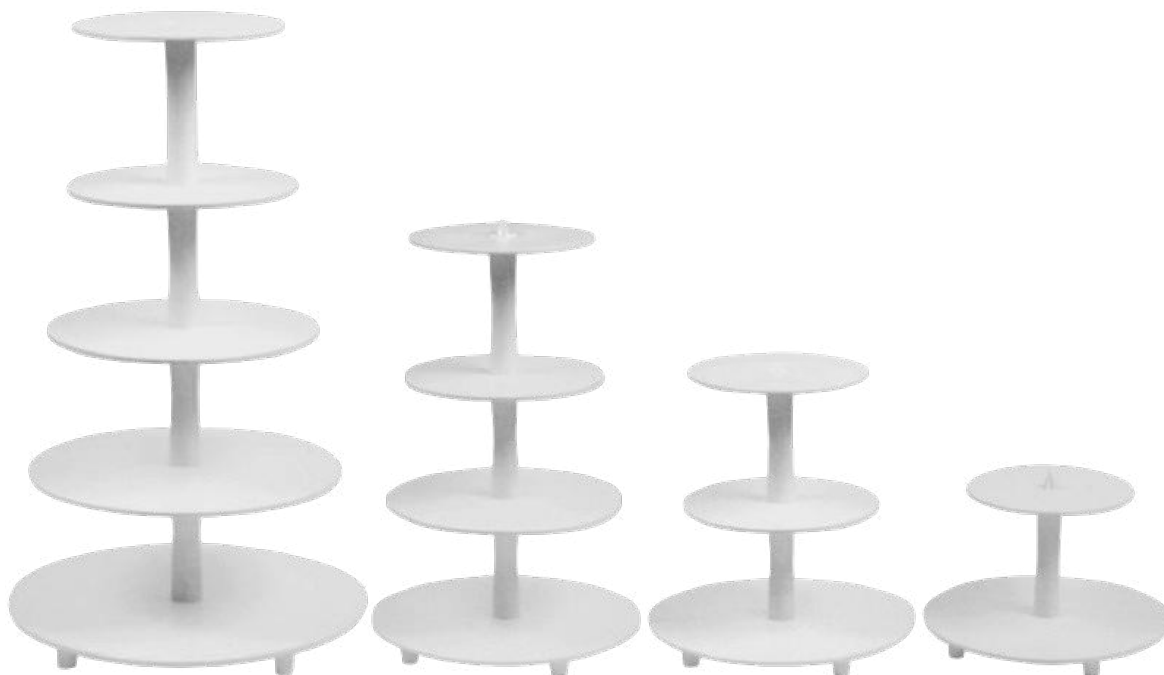

| Cod. | Medida - Size | Descrip. | Material | Platos - Plates |
|---------------|-----------------|------------------|----------|--------------------------------------|
| P06812 | 34 Ø x 20 h cm. | 2 Pisos - Floors | P.V.C. | 20 Ø - 34 Ø cm. |
| P06813 | 34 Ø x 34 h cm. | 3 Pisos - Floors | P.V.C. | 20 Ø - 30 Ø - 34 Ø cm. |
| P06814 | 34 Ø x 51 h cm. | 4 Pisos - Floors | P.V.C. | 20 Ø - 25 Ø - 30 Ø - 34 Ø cm. |
| P06815 | 34 Ø x 66 h cm. | 5 Pisos - Floors | P.V.C. | 20 Ø - 23 Ø - 25 Ø - 30 Ø - 34 Ø cm. |

Convierte cualquier mesa
dulce en un rincón lleno de

emoción y dulzura.



Duproflex[®] 

ENVASES

Packaging



Cápsula papel "Standar" 50gr.
Thick paper capsule "Standar" 50 gr.

| Cod. | Nº | ☐ | ☐ | Pcs. |
|--------|----|--------|--------|------|
| AO0058 | 3 | 28 mm. | 21 mm. | 1000 |
| AO0059 | 4 | 32 mm. | 24 mm. | 1000 |
| AO0060 | 5 | 38 mm. | 24 mm. | 1000 |
| AO0061 | 6 | 40 mm. | 25 mm. | 1000 |
| AO0062 | 7 | 45 mm. | 27 mm. | 1000 |
| AO0063 | 8 | 53 mm. | 28 mm. | 1000 |

Cápsula papel "Super Extra" 70gr.
Thick paper capsule "Super"Extra 70 gr.

| Cod. | Nº | ☐ | ☐ | Pcs. |
|--------|----|--------|--------|------|
| AO0031 | 5 | 38 mm. | 24 mm. | 1000 |
| AO0023 | 6 | 40 mm. | 25 mm. | 1000 |
| AO0503 | 7 | 45 mm. | 27 mm. | 1000 |
| AO0215 | 8 | 53 mm. | 28 mm. | 1000 |
| AO0057 | 9 | 55 mm. | 32 mm. | 1000 |
| AO0098 | 10 | 60 mm. | 35 mm. | 1000 |
| AO0772 | 12 | 68 mm. | 31 mm. | 1000 |



Cápsula papel "Barba Extra" 85gr.
Thick paper capsule "Barba Extra" 85 gr.

| Cod. | Nº | ☐ | ☐ | Pcs. |
|--------|----|--------|--------|------|
| AO1184 | 5 | 38 mm. | 24 mm. | 1000 |
| AO1291 | 6 | 40 mm. | 25 mm. | 1000 |
| AO1334 | 7 | 45 mm. | 27 mm. | 1000 |
| AO0504 | 8 | 53 mm. | 28 mm. | 1000 |
| AO1302 | 9 | 55 mm. | 32 mm. | 1000 |
| AO1539 | 10 | 60 mm. | 35 mm. | 1000 |

Cápsula papel pastelería pergamino 35gr.
Capsule paper pastry 35gr.

| Cod. | Nº | ☐ | ☐ | Pcs. |
|--------|----|--------|--------|------|
| AO0082 | 3 | 30 mm. | 21 mm. | 1000 |
| AO0560 | 4 | 32 mm. | 24 mm. | 1000 |
| AO1305 | 5 | 38 mm. | 24 mm. | 1000 |
| AO0064 | 6 | 40 mm. | 24 mm. | 1000 |
| AO0027 | 7 | 45 mm. | 27 mm. | 1000 |
| AO0824 | 8 | 50 mm. | 30 mm. | 1000 |



Cápsula papel pastelería pergamino 35gr.
Capsule paper pastry 35gr.

| Cod. | Nº | ☐ | ☐ | Pcs. |
|--------|----|--------|--------|------|
| AO0054 | 2 | 26 mm. | 17 mm. | 1000 |
| AO0055 | 3 | 30 mm. | 21 mm. | 1000 |
| AO0056 | 7 | 45 mm. | 27 mm. | 1000 |
| AO0033 | 8 | 50 mm. | 30 mm. | 1000 |



Cápsula papel "Muffin".
"Muffin" paper capsule.

| Cod. | ☐ | ☐ | Pcs. | Color |
|--------|--------|--------|------|----------------|
| AO1093 | 50 mm. | 90 mm. | 1000 | Marrón - Brown |
| AO1092 | 50 mm. | 90 mm. | 1000 | Blanco - White |
| AO1067 | 50 mm. | 80 mm. | 1000 | Marrón - Brown |
| AO1095 | 50 mm. | 80 mm. | 1000 | Blanco - White |



Cápsula alargada papel "Barba Extra" pastelería 85 gr.
Elongated pastry paper "Barba Extra" capsule 85 gr.

| Cod. | Nº | ☐ | ☐ | Pcs. |
|--------|----|--------------|--------|------|
| AO1357 | 8 | 82 x 26 mm. | 23 mm. | 1000 |
| AO0066 | 12 | 106 x 37 mm. | 28 mm. | 1000 |



Cápsula colores 50 grs.
Capsule colors 50 grs.

| Cod. | Nº | ☰ | ☲ | Pcs. |
|--------|----|--------|--------|------|
| CA0482 | 2 | 26 mm. | 17 mm. | 1000 |
| CA0481 | 3 | 30 mm. | 21 mm. | 1000 |
| CA0474 | 7 | 45 mm. | 27 mm. | 1000 |



Cápsula papel kraft 130 grs.
Capsule kraft paper 130 gr.

| Cod. | Nº | ☰ | ☲ | Pcs. |
|--------|----|--------|--------|------|
| CA0483 | 10 | 60 mm. | 35 mm. | 1000 |
| CA0480 | 14 | 89 mm. | 27 mm. | 1000 |



Platito cartulina dorada 200 gr.
Gold cardboard plate 200 gr.

| Cod. | Nº | ☰ | ☲ | Pcs. |
|--------|----|--------|--------|------|
| AO1060 | 4 | 52 mm. | 14 mm. | 1000 |
| AO1061 | 6 | 68 mm. | 11 mm. | 1000 |



Bandejita cartulina dorada 200 gr.
Gold cardboard plate 200 gr.

| Cod. | Nº | ☰ | ☲ | Pcs. |
|--------|----|-----------|--------|------|
| AO1055 | 2 | 40x40 mm. | 10 mm. | 1000 |
| AO1059 | 4 | 60x60 mm. | 10 mm. | 1000 |



Personalización de Cápsulas de papel

Personalized paper capsule.

Paso 1. Cliché.

Step 1. Cliche

Imagen o texto proporcionado por el cliente para personalización.
Image or text provided by the client for personalization.

Paso 2. Color.

Step 2. Colour

Colores disponibles sobre fondo claro:
Colors available on light background:



Colores disponibles sobre fondo oscuro:
Colors available on dark background:



Paso 3. Decoración.

Step 3. Decoration.



BORDE TRIPLE



BORDE ONDULADO

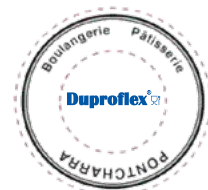

BORDE DOBLE

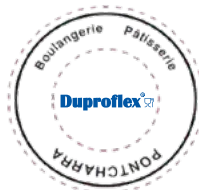

BORDE SIMPLE

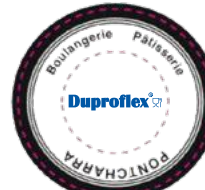

BORDE CORTE TRIPLE

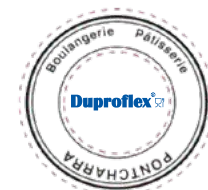

BORDE TRIPLE DIVIDIDO

Paso 4. Tipografía de impresión.

Step 4. Print typography.



Paso 5. Texto a imprimir.

Step 5. Print text.

Alrededor o Fondo
Around or Bottom

| Cod. | Nº | Ø | ☐ | ☒ | Pcs. |
|--------|----|--------|--------|--------|-------|
| AO1528 | 2 | 53mm. | 20 mm. | 16 mm. | 10000 |
| AO1563 | 3 | 57mm. | 23 mm. | 17 mm. | 10000 |
| AO1576 | 4 | 61mm. | 25 mm. | 18 mm. | 10000 |
| AO1359 | 5 | 68mm. | 28 mm. | 20 mm. | 10000 |
| AO1577 | 6 | 73mm. | 33 mm. | 20 mm. | 10000 |
| AO1341 | 7 | 81mm. | 35 mm. | 23 mm. | 10000 |
| AO0774 | 8 | 90mm. | 40 mm. | 25 mm. | 10000 |
| AO1585 | 9 | 97mm. | 43 mm. | 27 mm. | 10000 |
| AO1608 | 10 | 108mm. | 48 mm. | 30 mm. | 10000 |

| Cod. | Nº | Ø | ☐ | ☒ | Pcs. |
|--------|-------|--------|--------|--------|-------|
| AO0575 | 10b | 117mm. | 53 mm. | 32 mm. | 10000 |
| AO0576 | 1201 | 110mm. | 60 mm. | 25 mm. | 10000 |
| AO1578 | 1201f | 110mm. | 70 mm. | 20 mm. | 10000 |
| AO1579 | 1202 | 61mm. | 35 mm. | 13 mm. | 10000 |
| AO1580 | 1203 | 70mm. | 40 mm. | 15 mm. | 10000 |
| AO1581 | 1204 | 81mm. | 45 mm. | 18 mm. | 10000 |
| AO1582 | 1205 | 90mm. | 70 mm. | 30 mm. | 10000 |
| AO1583 | 1207 | 130mm. | 80 mm. | 30 mm. | 10000 |
| AO1584 | 1208 | 140mm. | 90 mm. | 25 mm. | 10000 |

Molde redondo papel para horno.
Round baking paper mold.



| Cod. | ☐ | ☐ | Color | Pcs. |
|---------|---------|--------|---------|------|
| CA0433 | 175 mm. | 25 mm. | Natural | 250 |
| CA0434 | 214 mm. | 20 mm. | Natural | 300 |
| CA0435 | 250 mm. | 24 mm. | Natural | 250 |
| CA0436 | 300 mm. | 15 mm. | Natural | 125 |
| CA0433M | 175 mm. | 25 mm. | Marrón | 250 |
| CA0434M | 214 mm. | 20 mm. | Marrón | 300 |
| CA0435M | 250 mm. | 24 mm. | Marrón | 250 |



| Cod. | ☐ | ☐ | Pcs. |
|--------|--------------|--------|------|
| CA0211 | 79 x 40 mm. | 40 mm. | 2040 |
| CA0199 | 175 x 85 mm. | 40 mm. | 600 |
| CA0198 | 197 x 65 mm. | 48 mm. | 300 |
| CA0212 | 240 x 80 mm. | 70 mm. | 300 |



Molde PANETTONE de papel para horno.
PANETTONE baking paper mold, directly.

| Cod. | ☐ | ☐ | Cap. | Pcs. | Pack |
|--------|---------|---------|---------|------|------|
| CA1007 | 70 mm. | 50 mm. | 90 gr. | 100 | 2000 |
| CA1024 | 100 mm. | 80 mm. | 300 gr. | 100 | 2000 |
| CA1005 | 135 mm. | 95 mm. | 500 gr. | 100 | 1200 |
| CA1023 | 160 mm. | 130 mm. | 900 gr. | 100 | 1200 |



Bolsa para PANETTONE. PANETTONE bag.

| Cod. | ☐ | ☐ | Cap. | Pcs. | Pack |
|---------|---------|---------|---------|------|------|
| CA1001 | 270 mm. | 330 mm. | 300-500 | 200 | 1000 |
| CA1001B | 270 mm. | 330 mm. | 900 | 200 | 2000 |

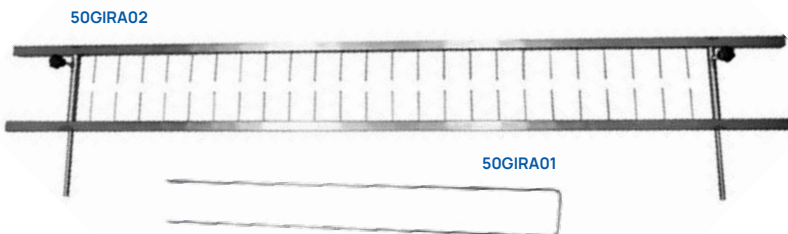

Pincho gira PANETTONE.
Skewer rotates PANETTONE.

Soporte gira PANETTONE.
PANETTONE tour support.

| Cod. | Medida - Size | Material |
|----------|---------------|--------------|
| 50GIRA02 | 200 cm. | Inox. - Sst. |
| 50GIRA01 | 60 cm. | Inox. - Sst. |



Molde aluminio PANDORO.
PANDORO aluminum mould.

| Cod. | Medida - Size |
|--------|---------------|
| AO1396 | 500 grs. |
| AO1397 | 1000 grs. |

Molde cocer madera ideal para presentación de bizcochos artesanales.
Cada molde contiene un papel siliconado.
*Wooden baking mould ideal for presenting artisanal cakes.
Each mould contains a silicone paper.*

| Cod. | Medida - Size | Pack |
|--------|---------------------|------|
| CA0411 | 140 x 90 x 45h mm. | 200 |
| CA0412 | 185 x 115 x 55h mm. | 100 |
| CA0413 | 250 x 120 x 70h mm. | 100 |



Molde cocer madera ideal para presentación de tartas en horno.
Soporta cocción hasta 220°C y congelación de -40°C
Cada molde contiene un papel siliconado por ambas caras.
*Wooden baking pan ideal for presentation of cakes in the oven.
Withstands baking up to 220°C and freezing up to -40°C.
Each mold contains a silicone paper on both sides.*

| Cod. | Medida - Size | Pack |
|--------|-----------------|------|
| CA0765 | 60 Ø x 30h mm. | 50 |
| CA0766 | 80 Ø x 30h mm. | 40 |
| CA0767 | 100 Ø x 30h mm. | 40 |
| CA0768 | 110 Ø x 40h mm. | 30 |
| CA0769 | 120 Ø x 30h mm. | 30 |
| CA0770 | 140 Ø x 40h mm. | 25 |
| CA0771 | 160 Ø x 35h mm. | 25 |



Molde cocer madera ideal para presentación de tartas en horno.
Cada molde contiene una cápsula de papel/PET.
*Wooden baking pan ideal for presentation of cakes in the oven.
Each mold contains paper capsule/PET.*

| Cod. | Medida - Size | Pack |
|--------|-----------------|------|
| CA0772 | 53 Ø x 32h mm. | 100 |
| CA0773 | 82 Ø x 40h mm. | 100 |
| CA0774 | 120 Ø x 50h mm. | 50 |
| CA0775 | 135 Ø x 50h mm. | 50 |
| CA0776 | 163 Ø x 60h mm. | 25 |



Cápsula papel color kraft.
Kraft paper capsule.

Cápsula papel blanco con borde
White paper capsule with border



| Cod. | Medida - Size | Pack | Bordes - Edges |
|----------|-----------------|------|----------------|
| ● CA0777 | 90 Ø x 25h mm. | 1200 | Si |
| ● CA0778 | 130 Ø x 40h mm. | 2500 | Si |
| ● CA0779 | 160 Ø x 40h mm. | 1600 | No |
| ● CA0782 | 230 Ø x 30h mm. | 900 | No |
| ○ CA0344 | 125 Ø x 40h mm. | 800 | Si |





Ø30 Ø24 19

Cod. Pcs.
AO0415 1000



Ø31 Ø26 16

Cod. Pcs.
AO0052 4000
AO1301 1000



Ø38 Ø28 17

Cod. Pcs.
AO0065 2000
AO1304 1000



Ø46 Ø33 17

Cod. Pcs.
AO0053 1000
AO1377 1000



Ø47 Ø40 12

Cod. Pcs.
AO0994 4000



Ø80 Ø70 20

Cod. Pcs.
AO0648 5000



Ø90 Ø70 20

Cod. Pcs.
AO0043 3000



Ø68 Ø60 30

Cod. Pcs.
AO1181 2200



36x36 28x28 17

Cod. Pcs.
AO0045 1000



30x50 25x45 16

Cod. Pcs.
AO0980 2600



35x45 42x52 15

Cod. Pcs.
AO0981 3000



55x100 45x90 20

Cod. **Pcs.**
AO0650 1200



40x40 35x35 16

Cod. **Pcs.**
AO1414 2000



Ø85 Ø60 36

Cod. **Pcs.**
AO0044 1000





Cod.    **Pcs.**
AO0050 82 mm. 38 mm. 23 mm. 3000



Cod.    **Pcs.**
AO0047 112 mm. 86 mm. 15 mm. 5500



Cod.    **Pcs.**
AO0049 93 mm. 72 mm. 15 mm. 2000



Cod.    **Pcs.**
AO01240 200 mm. 190 mm. 15 mm. 1500



Cod.    **Pcs.**
AO0089 74x74mm. 52x52mm. 10 mm. 6000



Cod.    **Pcs.**
AO05510 72 mm. 48 mm. 47 mm. 1000





Cod.    **Pcs.**
AO01110 295 mm. 270 mm. 17 mm. 800





Cod.    **Pcs.**
AO01113 330 mm. 307 mm. 15 mm. 400



Cod.    **Pcs.**
A001790 250 mm. 220 mm. 15 mm. 600





Cod.    **Pcs.**
A004220 315x212 mm. 280x175 mm. 44 mm. 500





Cod.    **Pcs.**
A001115 278 mm. 248 mm. 24 mm. 1000



Cod.    **Pcs.**
A004650 221 mm. 203 mm. 14 mm. 1000





Cod.    **Pcs.**
A005100 230x175 mm. 194x138 mm. 34 mm. 1000





Cod.    **Pcs.**
A005077 210x140 mm. 175x105 mm. 38 mm. 1000



Cod.    **Pcs.**
A000640 203x94 mm. 168x58 mm. 53 mm. 1000



Cod.    **Pcs.**
A004590 187x137 mm. 158x109 mm. 33 mm. 1500



Vasito postre P.V.C. - P.V.C. Cup dessert.

| Cod. | Medida - Size | Cap. |
|----------|----------------|---------|
| PMOCO001 | 65 Ø x 55h mm. | 90 ml. |
| PMOCO002 | 70 Ø x 67h mm. | 135 ml. |
| PMOCO003 | 75 Ø x 73h mm. | 150 ml. |



Vasito postre P.V.C. - P.V.C. Cup dessert.

| Cod. | Medida - Size | Cap. |
|----------|-------------------|---------|
| PMOCU001 | 40 x 40 x 55h mm. | 60 ml. |
| PMOCU002 | 50 x 50 x 70h mm. | 120 ml. |
| PMOCU003 | 55 x 55 x 80h mm. | 175 ml. |



Tapadera P.V.C. - P.V.C. Lid.

| Cod. |
|------------|
| PMOCU002/C |
| PMOCU003/C |



Vasito postre P.V.C. - P.V.C. Cup dessert.

| Cod. | Medida - Size | Cap. |
|----------|----------------|---------|
| PMOTO001 | 42 Ø x 65h mm. | 65 ml. |
| PMOTO002 | 50 Ø x 65h mm. | 90 ml. |
| PMOTO003 | 55 Ø x 70h mm. | 120 ml. |
| PMOTO004 | 60 Ø x 90h mm. | 170 ml. |



Vasito postre P.V.C. - P.V.C. Cup dessert.

| Cod. | Medida - Size | Cap. |
|----------|----------------|---------|
| PMO07.00 | 85 Ø x 65h mm. | 175 ml. |



Tapadera P.V.C. - P.V.C.

| Cod. |
|---------|
| PMO07/C |



Vasito postre P.V.C. - P.V.C. Cup

| Cod. | Medida - Size | Cap. |
|----------|---------------|---------|
| PMOPE001 | 68x65x56h mm. | 120 ml. |



Vasito postre P.V.C. - P.V.C. Cup

| Cod. | Medida - Size | Cap. |
|----------|----------------|---------|
| PMOCL001 | 137x37x41h mm. | 120 ml. |



Tapadera P.V.C. - P.V.C. Lid.

| Cod. |
|------------|
| PMOCL001/C |



Vasito postre P.V.C. - P.V.C. Cup

| Cod. | Medida - Size | Cap. |
|----------|----------------|---------|
| PMOCO004 | 90 Ø x 75h mm. | 215 ml. |



Vasito postre P.V.C. - P.V.C. Cup

| Cod. | Medida - Size | Cap. |
|----------|----------------|---------|
| PMOCO005 | 90 Ø x 75h mm. | 165 ml. |



Vasito postre P.V.C. - P.V.C. Cup dessert.

| Cod. | Medida - Size | Cap. |
|----------|----------------|---------|
| PMOCO006 | 75 Ø x 85h mm. | 150 ml. |



Vasito postre P.V.C. - P.V.C. Cup dessert.

| Cod. | Medida - Size | Cap. |
|-----------------|----------------|---------|
| PMOCO007 | 75 Ø x 85h mm. | 190 ml. |



Vasito postre P.V.C. - P.V.C. Cup dessert.

| Cod. | Medida - Size | Cap. |
|-----------------|----------------|---------|
| PMOCO008 | 50 Ø x 57h mm. | 50 ml. |
| PMOCO009 | 73 Ø x 61h mm. | 120 ml. |
| PMOCO010 | 92 Ø x 75h mm. | 190 ml. |



Vasito postre P.V.C. - P.V.C. Cup dessert.

| Cod. | Medida - Size | Cap. |
|-----------------|-------------------|---------|
| PMOCE001 | 64 x 46 x 53h mm. | 50 ml. |
| PMOCE002 | 85 x 60 x 70h mm. | 120 ml. |
| PMOCE003 | 90 x 83 x 74h mm. | 200 ml. |



Vasito postre P.V.C. - P.V.C. Cup dessert.

| Cod. | Medida - Size | Cap. |
|-----------------|-------------------|---------|
| PMOCO011 | 63 x 69 x 57h mm. | 85 ml. |
| PMOCO012 | 73 x 81 x 67h mm. | 140 ml. |
| PMOCO013 | 64 x 62 x 59h mm. | 70 ml. |



Vasito postre P.V.C. - P.V.C. Cup dessert.

| Cod. | Medida - Size | Cap. |
|-------------------|----------------|---------|
| PMOTO005 | 78 Ø x 57h mm. | 210 ml. |
| PMOTO005/C | Tapadera. | |



Vasito redondo postre "ECO" P.V.C.
P.V.C. Cup dessert round "ECO".

| Cod. | Medida - Size | Cap. |
|---------------|----------------|---------|
| P04603 | 42 Ø x 56h mm. | 50 cc. |
| P04606 | 55 Ø x 65h mm. | 120 cc. |



Vasito cuadrado postre "ECO" P.V.C.
P.V.C. Cup dessert square "ECO".

| Cod. | Medida - Size | Cap. |
|---------------|-------------------|---------|
| P04600 | 50 x 50 x 42h mm. | 60 cc. |
| P04601 | 60 x 60 x 55h mm. | 120 cc. |
| P04602 | 72 x 72 x 72h mm. | 200 cc. |



Vasito hexagonal postre "ECO" P.V.C.
P.V.C. Cup dessert hexagonal "ECO".

| Cod. | Medida - Size | Cap. |
|---------------|-------------------|--------|
| P04609 | 55 x 55 x 42h mm. | 60 cc. |



Vasito hexagonal postre "ECO" P.V.C.
P.V.C. Cup dessert hexagonal "ECO".

| Cod. | Medida - Size | Cap. |
|---------------|-------------------|---------|
| P04610 | 66 x 66 x 72h mm. | 130 cc. |



Platos individuales P.V.C.
P.V.C. Individual dishes.

| Cod. | Medida - Size | Material |
|-------------|--------------------|----------|
| PM05 | 110 x 105 x 6h mm. | P.V.C. |



Platos individuales P.V.C.
P.V.C. Individual dishes.

| Cod. | Medida - Size | Material |
|-------------|--------------------|----------|
| PM06 | 120 x 100 x 6h mm. | P.V.C. |



Platos individuales P.V.C.
P.V.C. Individual dishes.

| Cod. | Medida - Size | Material |
|-------------|-------------------|----------|
| PM04 | 110 x 75 x 6h mm. | P.V.C. |

ALMACENAJE Y

TRANSPORTE

Storage & transport



Cesta apilable isotérmica de polypropileno para uso alimentario.
Fácil acceso en el interior de la cesta.
Densidad del material: 45 gr./l.

*Isothermal polypropylene basket for food use
stackable.
Easy acces inside the basket.*

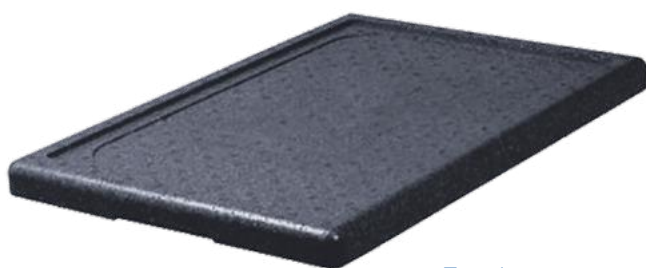

Tapaderas.
Lids.



Cestas.
Baskets.

Cestas con hueco especial para acceder a las bandejas con facilidad.
Baskets with special hole to access the trays with easy.

| Cod. | Medida - Size | Pcs. | Descrip. |
|---------|------------------------|------|----------------|
| AO05529 | 44,5 x 62,5 x 12 h cm. | 1 | Cesta - Basket |
| AO05528 | - | 1 | Tapadera - Lid |

Apilable y con opción a base con ruedas para su fácil desplazamiento.
Stockable and option based on wheels for easy movement.



Asas inoxidable incorporadas para su fácil colocación.
Built-in stainless handles for easy placement.



Contenedor isotérmico profesional apilable.
 Idóneo para el contacto alimentario.
 Fácilmente lavable.
 No deja olores y no altera los sabores de los alimentos.
 Higiénico y reciclable al 100%.
 Ideal para el transporte de pasteles y tartas.

*Isothermal professional stackable container.
 It doesn't leave smellings and doesn't alter the taste of the food.
 Suitable for food containers without any smelling or taste.
 Hygienic and 100% recyclable.*



| Cod. | Medida-Size | Capac. | Descrip. |
|--------|--------------------|------------------------|--------------------------------|
| AO0719 | 40 x 60 x 5 h cm. | 6 Bandejas - 6 Trays | Contenedor - Container |
| AO0716 | 40 x 60 x 12 h cm. | 10 Bandejas - 10 Trays | Contenedor - Container |
| AO1000 | - | - | Base con ruedas - Wheeled base |



Contenedor apilable de aluminio con asas para el transporte.
Stockable aluminum container with handles for transport.

| Cod. | Medida - Size | Capac. | Descrip. |
|--------|--------------------|----------------------|--------------------------------|
| AO0017 | 40 x 60 x 6 h cm. | 8 Bandejas - 8 Trays | Contenedor - Container |
| AO0018 | 40 x 60 x 12 h cm. | - | Base con ruedas - Wheeled base |

Cesta apilables fondo liso P.V.C.
Flat bottom stackable basket P.V.C.

| Cod. | Medida-Measure | Descrip. | Pcs. |
|--------|--------------------------|----------------|------|
| AO0696 | 36,5 x 56,5 x 9,5 h cm. | Bandeja - Tray | 1 |
| AO0697 | 36,5 x 56,5 x 12,7 h cm. | Bandeja - Tray | 1 |
| AO0684 | 40 x 60 x 11 h cm. | Bandeja - Tray | 1 |
| AO0698 | 36,5 x 56,5 cm. | Tapa - Lid | 1 |
| AO0700 | 42 x 62 x 14 h cm. | Base | 1 |

* La base con ruedas y la tapa no son adaptables a las cestas de 40 x 60 x 11 h cm de interior.

* The base with wheels and the lid are not adaptable to baskets 40 x 60 x 11 h cm inside.



Cesta apilable con asas de cartón.
Stackable basket with cardboard handles.

| Cod. | Medida-Size | Pcs. |
|--------|-----------------------|------|
| CA0490 | 58 x 33,5 x 8,5 h cm. | 50 |



Tapadera con bandejas apilables. Fabricadas en P.V.C. duro y resistente.
Lid with stackable trays. Manufactured in P.V.C. hard and resistant.

| Cod. | Bandeja | Descrip. | Pcs. |
|-------------|---------------------|------------------------------|------|
| TOTALIGLO05 | 40 x 60 x 5,5 h cm. | Tapa + Bandeja Lid + Tray | 1 |
| TOTALIGLO08 | 40 x 60 x 8,5 h cm. | Tapa + Bandeja Lid + Tray | 1 |
| IGLO05 | 40 x 60 x 5,5 h cm. | Tapa - Lid | 1 |
| IGLO08 | 40 x 60 x 8,5 h cm. | Tapa - Lid | 1 |
| VGEL02 | 40 x 60 x 2,2 h cm. | Bandeja - Tray | 1 |



Bobina film manual de 23 micras.
23 micron manual film reel.

| Cod. | Medidas - Size | Pack | Caja |
|----------|----------------|------|------|
| AO3001 | 115 m. | 1 | 8 |
| ● AO3002 | 115 m. | 1 | 8 |



Apto para rollos de 50 mm. x 66 m.
Suitable for 50 mm. x 60 m. rolls.

| Cod. | Material. | Pack |
|--------|--------------|------|
| AT0107 | Inox. - Sst. | 1 |



Apto para rollos de 75 mm. x 172 m.
Suitable for 75 mm. x 172 m. rolls.

| Cod. | Material. | Pack |
|--------|--------------|------|
| AT0114 | Inox. - Sst. | 1 |

Blanco
White
AT0110

Transparente
Transparent
AT0110T

Blanco
White
AT0273



Apto para soportes de 50 mm. x 66 m.
Suitable for supports of 50 mm. x 66 m.

| Cod. | Medidas - Size | Pack | Caja - Box |
|---------|-----------------|------|------------|
| AT0110 | 50 mm. x 66 m. | 6 | 36 |
| AT0110T | 50 mm. x 66 m. | 6 | 36 |
| AT0273 | 75 mm. x 132 m. | 6 | 32 |

ÚTILES
DE TIENDA
Storage useful





Bandeja "Alta resistencia" para tartas.
Exhibition tray "High resistance" for cakes.

| Cod. | Medida - Size | Color | Pack |
|---------------|------------------|--------|------|
| P5727A | 30 x 40 x 1h cm. | P.V.C. | 32 |
| P05728 | 37 x 48 x 1h cm. | P.V.C. | 25 |
| P05729 | 43 x 53 x 1h cm. | P.V.C. | 22 |

*Opción personalización en Stamping.
*Stamping customization option.



Formatos de cartón para pasteles individuales.
Cardboard formats for individual cakes.

| Cod. | Medida - Size | Descrip. | Pcs. |
|---------------|---------------|-------------------|------|
| CA0064 | 80 Ø mm. | Redondo - Round | 100 |
| CA0065 | 60 x 105 mm. | Rectangular | 100 |
| CA0414 | 95 mm. | Triángular | 100 |
| CA0427 | 90 x 100 mm. | Corazón - Heart | 100 |
| CA0610 | 75 x 75 mm. | Cuadrado - Square | 100 |



Bandeja cartón grueso "Alta resistencia" para tartas.
Gold tray strong cardboard "High resistance" for cakes.

| Cod. | Medida - Size | Color | Pack |
|---------------|--------------------|---------------|------|
| CA0517 | 25 x 35 x 0,4h cm. | Dorada - Gold | 54 |
| CA0599 | 30 x 40 x 0,4h cm. | Dorada - Gold | 39 |
| CA0598 | 34 x 44 x 0,4h cm. | Dorada - Gold | 32 |
| CA0607 | 35 x 50 x 0,4h cm. | Dorada - Gold | 27 |
| CA0732 | 40 x 50 x 0,4h cm. | Dorada - Gold | 24 |
| CA0518 | 40 x 60 x 0,4h cm. | Dorada - Gold | 20 |
| CA0608 | 45 x 55 x 0,4h cm. | Dorada - Gold | 19 |
| CA0609 | 45 x 65 x 0,4h cm. | Dorada - Gold | 16 |



Discos de cartón ligeros para tartas.
Light cardboard discs for cakes.

| Cod. | Medida - Size | Pcs. |
|---------------|---------------|------|
| CA0578 | 10 Ø cm. | 100 |
| CA0579 | 16 Ø cm. | 100 |
| CA0452 | 18 Ø cm. | 100 |
| CA0061 | 20 Ø cm. | 100 |
| CA0226 | 22 Ø cm. | 100 |
| CA0153 | 24 Ø cm. | 100 |
| CA0154 | 26 Ø cm. | 100 |
| CA0169 | 28 Ø cm. | 100 |
| CA0180 | 30 Ø cm. | 100 |
| CA0372 | 32 Ø cm. | 100 |

Blonda de cartón grueso "Alta resistencia" para tartas.
Tray with thick cardboard "High resistance" for cakes.

| Cod. | Medida - Size | Color | Pack |
|---------------|---------------|---------------|------|
| CA0467 | 15 x 31 cm. | Dorada - Gold | 100 |
| CA0465 | 15 x 38 cm. | Dorada - Gold | 100 |
| CA0466 | 17 x 42 cm. | Dorada - Gold | 100 |
| CA0464 | 18 x 25 cm. | Dorada - Gold | 100 |
| CA0496 | 22 x 27 cm. | Dorada - Gold | 100 |
| CA0497 | 27 x 32 cm. | Dorada - Gold | 100 |
| CA0498 | 31 x 39 cm. | Dorada - Gold | 100 |
| CA0489 | 35 x 41 cm. | Dorada - Gold | 100 |

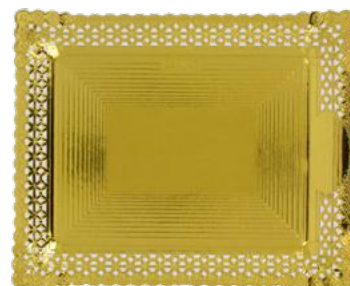



Platos de cartón para tartas.
Cardboard plates for cakes.

| Blanco - White | Dorado - Gold | Plata - Silver | Medida - Size | Pcs. |
|----------------|---------------|----------------|---------------|------|
| CA0000 | CA0457 | - | 10 Ø cm. | 100 |
| CA0001 | CA0367 | - | 12 Ø cm. | 100 |
| CA0002 | - | - | 14 Ø cm. | 100 |
| CA0003 | - | - | 16 Ø cm. | 100 |
| CA0004 | CA0442 | - | 18 Ø cm. | 100 |
| CA0005 | CA0033 | CA0251 | 21 Ø cm. | 100 |
| CA0006 | CA0015 | CA0260 | 23 Ø cm. | 100 |
| CA0007 | CA0034 | CA0258 | 25 Ø cm. | 100 |
| CA0008 | CA0123 | CA0017 | 27 Ø cm. | 100 |
| CA0009 | CA0355 | CA0018 | 30 Ø cm. | 100 |
| CA0010 | CA0108 | CA0325 | 32 Ø cm. | 50 |
| CA0011 | CA0334 | CA0371 | 34 Ø cm. | 50 |
| CA0237 | CA0334S | - | 35 Ø cm. | 50 |
| CA0012 | CA0263 | CA0382 | 38 Ø cm. | 50 |
| CA0013 | CA0392 | CA0390 | 40 Ø cm. | 25 |
| - | CA0392S | - | 41 Ø cm. | 50 |
| CA0014 | CA0393 | CA0391 | 44 Ø cm. | 25 |



Plato exposición cartón grueso
"Alta resistencia" para tartas.
Gold exhibition plate strong cardboard
"High resistance" for cakes.

*Opción personalización en Stamping.
*Stamping customization option.

| Cod. | Medida - Size | Pcs. |
|--------|---------------|------|
| CA0631 | 24 Ø cm. | 104 |
| CA0632 | 26 Ø cm. | 89 |
| CA0633 | 28 Ø cm. | 76 |
| CA0634 | 30 Ø cm. | 65 |
| CA0635 | 32 Ø cm. | 58 |
| CA0636 | 34 Ø cm. | 51 |
| CA0637 | 36 Ø cm. | 45 |
| CA0638 | 38 Ø cm. | 41 |
| CA0639 | 40 Ø cm. | 38 |
| CA0640 | 42 Ø cm. | 35 |
| CA0641 | 45 Ø cm. | 29 |



Plato cartón grueso con blonda para tartas.
Thick cardboard plate with lace for cakes.

| Cod. | Medida - Size | Pcs |
|--------|---------------|-----|
| CA0342 | 20 Ø cm. | 100 |
| CA0557 | 23 Ø cm. | 100 |
| CA0558 | 25 Ø cm. | 100 |
| CA0559 | 28 Ø cm. | 100 |
| CA0560 | 31 Ø cm. | 100 |
| CA0561 | 33 Ø cm. | 100 |
| CA0380 | 35 Ø cm. | 100 |
| CA0236 | 38 Ø cm. | 100 |



Disco cartón grueso cuadrado para tartas.
Square thick cardboard disc for cakes.

*Opción personalización en Stamping.
*Stamping customization option.

| Cod. | Medida - Size | Pcs. |
|--------|---------------|------|
| CA0643 | 23 x 23 cm. | 91 |
| CA0644 | 25 x 25 cm. | 75 |
| CA0645 | 28 x 28 cm. | 60 |
| CA0646 | 32 x 32 cm. | 46 |
| CA0647 | 35 x 35 cm. | 39 |
| CA0648 | 39 x 39 cm. | 31 |



Plato exposición P.V.C. para tartas.
Exhibition plate P.V.C. for cakes.

| Cod. | Medida - Size | Pcs |
|--------|---------------|-----|
| CA0626 | 20 Ø cm. | 120 |
| CA0023 | 24 Ø cm. | 100 |
| CA0024 | 27 Ø cm. | 100 |
| CA0026 | 30 Ø cm. | 100 |
| CA0027 | 32 Ø cm. | 100 |
| CA0028 | 35 Ø cm. | 100 |
| CA0029 | 37 Ø cm. | 100 |



Plato exposición en cartón para tartas.
Exhibition plate paperboard for cakes.

| Cod. | Medida - Size | Pcs. |
|--------|---------------|------|
| CA0683 | 25 Ø cm. | 1 |
| CA0727 | 30 Ø cm. | 1 |
| CA0728 | 35 Ø cm. | 1 |
| CA0729 | 40 Ø cm. | 1 |





Bandeja aluminio negra de exposición para vitrinas.
Fácil limpieza.

Black aluminum display tray for display cases. Easy cleaning.

| Cod. | Medida - Size | Material |
|---------------|-----------------------|---------------------|
| AT0361 | 15 x 40 x 1 h cm. | Aluminio - Aluminum |
| AT0360 | 20 x 60 x 1 h cm. | Aluminio - Aluminum |
| AT0354 | 17,5 x 25,5 x 1 h cm. | Aluminio - Aluminum |
| AT0355 | 21 x 27,5 x 1 h cm. | Aluminio - Aluminum |
| AT0356 | 24 x 32 x 1 h cm. | Aluminio - Aluminum |
| AT0357 | 25,5 x 30 x 1 h cm. | Aluminio - Aluminum |
| AT0358 | 26 x 35 x 1 h cm. | Aluminio - Aluminum |
| AT0359 | 30 x 40 x 1 h cm. | Aluminio - Aluminum |
| AT0364 | 34 x 48 x 1 h cm. | Aluminio - Aluminum |



Bandeja aluminio oro de exposición para vitrinas. Fácil limpieza.

Gold aluminum display tray for display cases. Easy cleaning.

| Cod. | Medida - Size | Material |
|---------------|-----------------|---------------------|
| AT0346 | 21 x 27,5 cm. | Aluminio - Aluminum |
| AT0345 | 17,5 x 25,5 cm. | Aluminio - Aluminum |
| AT0351 | 30 x 40 cm. | Aluminio - Aluminum |
| AT0349 | 26 x 35 cm. | Aluminio - Aluminum |
| AT0348 | 25,5 x 30 cm. | Aluminio - Aluminum |
| AT0347 | 24 x 32 cm. | Aluminio - Aluminum |
| AT0352 | 20 x 60 cm. | Aluminio - Aluminum |
| AT0353 | 15 x 40 cm. | Aluminio - Aluminum |
| AT0368 | 19 x 29 cm. | Aluminio - Aluminum |
| AT0363 | 10,5 x 31,2 cm. | Aluminio - Aluminum |



Bandeja aluminio plata de exposición para vitrinas.
Fácil limpieza.

Anodized aluminum tray for display cases. Easy cleaning.

| Cod. | Medida - Size | Material |
|---------------|-----------------|---------------------|
| AT0327 | 21 x 27,5 cm. | Aluminio - Aluminum |
| AT0326 | 17,5 x 25,5 cm. | Aluminio - Aluminum |
| AT0337 | 30 x 40 cm. | Aluminio - Aluminum |
| AT0002 | 26 x 35 cm. | Aluminio - Aluminum |
| AT0329 | 25,5 x 30 cm. | Aluminio - Aluminum |
| AT0328 | 24 x 32 cm. | Aluminio - Aluminum |
| AT0343 | 20 x 60 cm. | Aluminio - Aluminum |
| AT0344 | 15 x 40 cm. | Aluminio - Aluminum |



Bandeja P.V.C. de exposición para vitrinas.
P.V.C. Exhibition tray for showcases.

| Cod. | Medida - Size | Material |
|--------|---------------|----------|
| CA0303 | 20 x 25 cm. | P.V.C. |
| CA0304 | 25 x 32 cm. | P.V.C. |
| CA0305 | 28 x 35 cm. | P.V.C. |
| CA0306 | 33 x 40 cm. | P.V.C. |
| CA0020 | 12 x 37 cm. | P.V.C. |
| CA0021 | 15 x 44 cm. | P.V.C. |



Bandeja acero de exposición para vitrinas.
Steel exhibition tray for showcases.

| Cod. | Medida - Size | Material |
|--------|-----------------------|--------------|
| AT0317 | 15 x 40 x 1 h cm. | Inox. - Sst. |
| AT0224 | 20 x 60 x 1 h cm. | Inox. - Sst. |
| AT0221 | 17,5 x 25,5 x 1 h cm. | Inox. - Sst. |
| AT0225 | 21 x 27,5 x 1 h cm. | Inox. - Sst. |
| AT0220 | 24 x 32 x 1 h cm. | Inox. - Sst. |
| AT0222 | 25,5 x 30 x 1 h cm. | Inox. - Sst. |
| AT0226 | 26 x 35 x 1 h cm. | Inox. - Sst. |



Bandeja P.V.C. de exposición para vitrinas.
P.V.C. Exhibition tray for showcases.

| Cod. | Medida - Size | Material |
|----------|-------------------|----------|
| AT0710 | 19 x 28 x 1,2 cm. | P.V.C. |
| AT0711 | 24 x 35 x 1,2 cm. | P.V.C. |
| AT0712 | 30 x 42 x 1,2 cm. | P.V.C. |
| ● AT0713 | 19 x 28 x 1,2 cm. | P.V.C. |
| ● AT0714 | 24 x 35 x 1,2 cm. | P.V.C. |
| ● AT0715 | 30 x 42 x 1,2 cm. | P.V.C. |



Alza platos para vitrina.
Raise dishes for showcase.

| Cod. | Medida - Size | Material |
|--------|---------------|--------------|
| AT0028 | 10 x 10 h cm. | Inox. - Sst. |
| AT0049 | 10 x 15 h cm. | Inox. - Sst. |



Expovitrina.
Expovitrina.

| Cod. | Medida - Size | Material |
|--------|--------------------------|-------------------------------|
| AT9289 | 26,5 x 32,5 x 11,8 h cm. | Policarbonato - Polycarbonate |
| AT9288 | 32,5 x 53,5 x 8,2 h cm. | Policarbonato - Polycarbonate |





Bandeja de cartón para pasteles "Blanca".
Cardboard tray for cakes "White".

| Cod. | Medida - Size | Nº Ref. | Pack |
|--------|---------------|---------|------|
| CA0040 | 10 x 17 cm. | Nº 2 | 100 |
| CA0041 | 12 x 19 cm. | Nº 3 | 100 |
| CA0042 | 14 x 21 cm. | Nº 4 | 100 |
| CA0043 | 16 x 23 cm. | Nº 5 | 100 |
| CA0044 | 18 x 25 cm. | Nº 6 | 100 |
| CA0045 | 20 x 27 cm. | Nº 7 | 100 |
| CA0046 | 22 x 28 cm. | Nº 8 | 100 |
| CA0047 | 24 x 30 cm. | Nº 9 | 100 |
| CA0048 | 25 x 33 cm. | Nº 10 | 100 |
| CA0049 | 28 x 36 cm. | Nº 11 | 50 |
| CA0050 | 31 x 38 cm. | Nº 12 | 50 |
| CA0051 | 34 x 42 cm. | Nº 13 | 50 |
| CA0052 | 37 x 47 cm. | Nº 13B | 50 |
| CA0053 | 40 x 50 cm. | Nº 14 | 25 |
| CA0054 | 45 x 55 cm. | Nº 15 | 25 |



Bandeja de cartón para pasteles "Dorada".
Cardboard tray for cakes "Golden".

| Cod. | Medida - Size | Nº Ref. | Pack |
|--------|---------------|---------|------|
| CA0104 | 10 x 16 cm. | Nº 2 | 100 |
| CA0062 | 12 x 19 cm. | Nº 3 | 100 |
| CA0063 | 14 x 21 cm. | Nº 4 | 100 |
| CA0066 | 16 x 22 cm. | Nº 5 | 100 |
| CA0103 | 18 x 24 cm. | Nº 6 | 100 |
| CA0068 | 20 x 27 cm. | Nº 7 | 100 |
| CA0069 | 22 x 28 cm. | Nº 8 | 100 |
| CA0067 | 24 x 30 cm. | Nº 9 | 100 |
| CA0105 | 25 x 34 cm. | Nº 10 | 100 |
| CA0107 | 28 x 36 cm. | Nº 11 | 100 |
| CA0106 | 31 x 38 cm. | Nº 12 | 100 |
| CA0122 | 34 x 42 cm. | Nº 13 | 100 |
| CA0387 | 40 x 50 cm. | Nº 14 | 100 |
| CA0386 | 45 x 55 cm. | Nº 15 | 25 |



Bandeja de cartón para pasteles "Plateada".
Cardboard tray for cakes "Silver".

| Cod. | Medida - Size | Nº Ref. | Pack |
|--------|---------------|---------|------|
| CA0070 | 10 x 16 cm. | Nº 2 | 100 |
| CA0071 | 12 x 19 cm. | Nº 3 | 100 |
| CA0072 | 14 x 21 cm. | Nº 4 | 100 |
| CA0073 | 16 x 22 cm. | Nº 5 | 100 |
| CA0074 | 18 x 24 cm. | Nº 6 | 100 |
| CA0075 | 20 x 27 cm. | Nº 7 | 100 |
| CA0076 | 22 x 28 cm. | Nº 8 | 100 |
| CA0077 | 24 x 30 cm. | Nº 9 | 100 |
| CA0078 | 25 x 34 cm. | Nº 10 | 100 |
| CA0079 | 28 x 36 cm. | Nº 11 | 100 |
| CA0182 | 31 x 38 cm. | Nº 12 | 100 |
| CA0181 | 34 x 42 cm. | Nº 13 | 100 |
| CA0400 | 40 x 50 cm. | Nº 14 | 100 |



Bandeja de cartón kraft para pasteles.
Kraft cardboard tray for cakes

| Cod. | Medida - Size | Nº Ref. | Pack |
|--------|---------------|---------|------|
| CA0461 | 10 x 17 cm. | Nº 2 | 100 |
| CA0462 | 14 x 21 cm. | Nº 4 | 100 |
| CA0463 | 18 x 25 cm. | Nº 6 | 100 |
| CA0447 | 22 x 28 cm. | Nº 8 | 100 |



Batea cartón con asas "Negra".
Tray cardboard with handles "Black".

| Cod. | Medida - Size | Pack |
|--------|---------------------|------|
| CA0750 | 16 x 23 x 2,5 h cm. | 100 |
| CA0751 | 18 x 25 x 2,5 h cm. | 100 |
| CA0752 | 22 x 28 x 2,5 h cm. | 100 |
| CA0753 | 25 x 34 x 2,5 h cm. | 100 |
| CA0754 | 12 x 30 x 2,5 h cm. | 100 |
| CA0755 | 12 x 35 x 2,5 h cm. | 100 |



Batea cartón con asas "Dorada".
Tray cardboard with handles "Golden".

| Cod. | Medida - Size | Pack |
|--------|---------------------|------|
| CA0680 | 16 x 23 x 2,5 h cm. | 100 |
| CA0417 | 18 x 25 x 2,5 h cm. | 100 |
| CA0681 | 22 x 28 x 2,5 h cm. | 100 |
| CA0758 | 25 x 34 x 2,5 h cm. | 100 |
| CA0759 | 12 x 30 x 2,5 h cm. | 100 |
| CA0682 | 12 x 35 x 2,5 h cm. | 100 |



Rodal parafinado blanco.
White paraffined stand.

| Cod. | Medida - Size | Pack |
|--------|---------------|------|
| CA0110 | 18 Ø cm. | 100 |
| CA0111 | 21 Ø cm. | 100 |
| CA0224 | 23 Ø cm. | 100 |
| CA0112 | 25 Ø cm. | 100 |
| CA0113 | 27 Ø cm. | 100 |
| CA0114 | 30 Ø cm. | 100 |
| CA0115 | 32 Ø cm. | 100 |
| CA0116 | 35 Ø cm. | 100 |
| CA0117 | 38 Ø cm. | 100 |
| CA0225 | 40 Ø cm. | 100 |
| CA0118 | 42 Ø cm. | 100 |
| CA0119 | 45 Ø cm. | 100 |
| CA0120 | 50 Ø cm. | 100 |



Blonda parafinada blanca.
White paraffined lace.

| Cod. | Medida - Size | Pack |
|--------|---------------|------|
| CA0184 | 13 x 18 cm. | 100 |
| CA0185 | 16 x 22 cm. | 100 |
| CA0189 | 21 x 27 cm. | 100 |
| CA0190 | 26 x 32 cm. | 100 |
| CA0191 | 28 x 36 cm. | 100 |
| CA0192 | 31 x 38 cm. | 100 |
| CA0193 | 34 x 43 cm. | 100 |
| CA0196 | 36 x 41 cm. | 100 |
| CA0368 | 40 x 47 cm. | 100 |
| CA0195 | 45 x 55 cm. | 100 |
| CA0456 | 50 x 60 cm. | 100 |
| CA0194 | 41 x 48 cm. | 100 |
| CA0214 | 17 x 24 cm. | 100 |





Caja cartón pasteles **con ventana.**
Cakes cardboard box with window.

| Cod. | Medida - Size | Capac. | Pack |
|---------------|-------------------------|-----------|------|
| CA0687 | 18,2 x 13,5 x 5,4 h cm. | 1/2 Kg. | 100 |
| CA0688 | 20,2 x 15,7 x 6 h cm. | 1 Kg. | 100 |
| CA0689 | 22 x 16,3 x 6,3 h cm. | 1 1/2 Kg. | 100 |
| CA0690 | 26 x 19 x 8 h cm. | 2 Kg. | 100 |
| CA0691 | 30 x 20 x 9 h cm. | 3 Kg. | 100 |

Caja cartón pasteles **sin ventana.**
Cakes cardboard box without window.

| Cod. | Medida - Size | Capac. | Pack |
|---------------|-------------------------|-----------|------|
| CA0277 | 17,5 x 11,5 x 4,7 h cm. | 1/4 Kg. | 100 |
| CA0280 | 18,2 x 13,5 x 5,4 h cm. | 1/2 Kg. | 100 |
| CA0519 | 19 x 15,6 x 6 h cm. | 3/4 Kg. | 100 |
| CA0281 | 20,2 x 15,7 x 6 h cm. | 1 Kg. | 100 |
| CA0684 | 22 x 16,3 x 6,3 h cm. | 1 1/2 Kg. | 100 |
| CA0290 | 26 x 19 x 8 h cm. | 2 Kg. | 100 |
| CA0685 | 30 x 20 x 9 h cm. | 3 Kg. | 100 |
| CA0686 | 30,5 x 24,2 x 9,5 h cm. | 4 Kg. | 100 |



Caja cartón pasteles sin ventana "Kraft".
Cakes cardboard box without window "Kraft".

| Cod. | Medida - Size | Capac. | Pack |
|---------------|-------------------------|---------|------|
| CA0523 | 18,2 x 13,5 x 5,4 h cm. | 500 g. | 100 |
| CA0524 | 20,2 x 15,7 x 6 h cm. | 1 Kg. | 100 |
| CA0515 | 22 x 16,3 x 6,3 h cm. | 1,5 Kg. | 100 |
| CA0525 | 26 x 19 x 8 h cm. | 2 Kg. | 100 |



Caja cartón pasteles sin ventana cuadrada.
Cakes cardboard box without square window.

| Cod. | Medida - Size | Pack |
|--------|--------------------|------|
| CA0581 | 18 x 18 x 8 h cm. | 50 |
| CA0520 | 20 x 20 x 8 h cm. | 50 |
| CA0522 | 22 x 22 x 8 h cm. | 50 |
| CA0521 | 25 x 25 x 8 h cm. | 50 |
| CA0623 | 28 x 28 x 8 h cm. | 50 |
| CA0708 | 32 x 32 x 8 h cm. | 50 |
| CA0709 | 18 x 18 x 13 h cm. | 50 |
| CA0710 | 20 x 20 x 13 h cm. | 50 |
| CA0711 | 23 x 23 x 13 h cm. | 50 |
| CA0712 | 26 x 26 x 13 h cm. | 50 |
| CA0713 | 29 x 29 x 13 h cm. | 50 |
| CA0714 | 32 x 32 x 13 h cm. | 25 |

Personalización de cajas de cartón
Personalized cardboard box.



Caja cartón pasteles sin ventana rectangular
"Blanca" o "Personalizada".
Cardboard cake box without rectangular window
"White" or "Customized".

| Cod. | Medida - Size | Pack |
|--------|-------------------|------|
| CA0741 | 17 x 14 x 6 h cm. | 50 |
| CA0743 | 20 x 15 x 7 h cm. | 50 |
| CA0744 | 23 x 16 x 7 h cm. | 50 |
| CA0745 | 26 x 18 x 8 h cm. | 50 |

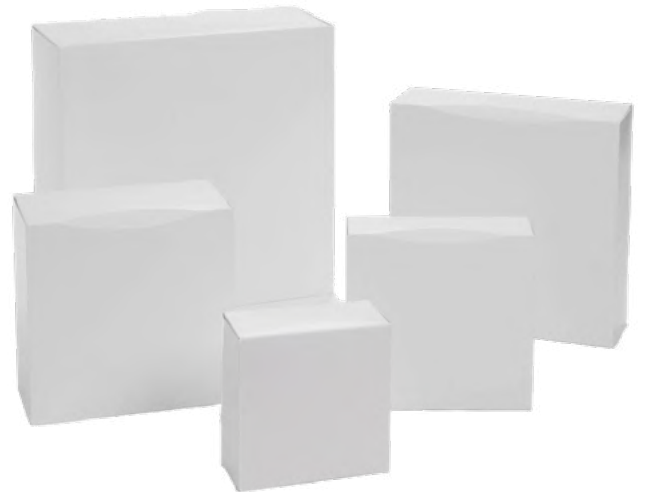

Caja cartón pasteles sin ventana cuadrada "Blanca".
Cakes cardboard box without square window "White".

| Cod. | Medida - Size | Pack |
|--------|--------------------|------|
| CA0692 | 18 x 18 x 8 h cm. | 50 |
| CA0693 | 20 x 20 x 8 h cm. | 50 |
| CA0694 | 22 x 22 x 8 h cm. | 50 |
| CA0730 | 25 x 25 x 8 h cm. | 50 |
| CA0695 | 28 x 28 x 8 h cm. | 50 |
| CA0696 | 32 x 32 x 8 h cm. | 50 |
| CA0699 | 23 x 23 x 13 h cm. | 50 |
| CA0700 | 26 x 26 x 13 h cm. | 50 |
| CA0702 | 32 x 32 x 13 h cm. | 50 |

Caja cartón anónima blanca.
Posibilidad de Personalización en
Digital o Stamping.
Anonymous white cardboard box.
Possibility of Customization in Digital or Stamping.





Caja cartón cuadrada, Modelo París.
Square cardboard box.

*Opción personalización en Stamping / Serigrafía.
*Stamping / Serigraphy customization option.

| Cod. | Medida - Size | Pcs. |
|----------|--------------------|------|
| CA0613 | 22 x 22 x 10 h cm. | 100 |
| CA0614 | 24 x 24 x 10 h cm. | 100 |
| CA0615 | 28 x 28 x 10 h cm. | 100 |
| CA0624 | 30 x 30 x 10 h cm. | 100 |
| CA0616 | 32 x 32 x 10 h cm. | 100 |
| CA0629 | 36 x 36 x 10 h cm. | 100 |
| CA0630 | 38 x 38 x 10 h cm. | 100 |
| ● CA0675 | 24 x 24 x 14 h cm. | 100 |
| ● CA0738 | 28 x 28 x 15 h cm. | 100 |



Caja cartón rectangular con ventana.
Rectangular cardboard box with window.

| Cod. | Medida - Size | Pcs. |
|--------|--------------------|------|
| CA0539 | 44 x 30 x 8 h cm. | 25 |
| CA0538 | 44 x 30 x 12 h cm. | 25 |
| CA0537 | 62 x 42 x 8 h cm. | 25 |
| CA0553 | 62 x 42 x 13 h cm. | 25 |



Caja cartón cuadrada / rectangular dorada.
Golden square / rectangular cardboard box.

| Cod. | Medida - Size | Pcs. |
|--------|--------------------------|------|
| CA0326 | 25 x 19 x 8 h cm. | 100 |
| CA0327 | 30 x 23,5 x 8 h cm. | 100 |
| CA0328 | 35,5 x 26,5 x 8 h cm. | 100 |
| CA0329 | 39,5 x 32,5 x 8 h cm. | 100 |
| CA0330 | 38,5 x 12 x 10,5 h cm. | 100 |
| CA0331 | 45,5 x 12,5 x 10,5 h cm. | 100 |
| CA0332 | 44 x 16 x 10,5 h cm. | 100 |
| CA0320 | 24 x 24 cm. | 50 |
| CA0321 | 27 x 27 cm. | 50 |
| CA0322 | 30 x 30 cm. | 50 |
| CA0323 | 32 x 32 cm. | 50 |
| CA0324 | 34 x 34 cm. | 50 |



Tiras de cartón protectoras de pasteles.
Protective cardboard strips of cakes.

| Cod. | Medida - Size | Kgs. |
|--------|---------------|------|
| CA0035 | 75 x 3,5 cm. | 10 |
| CA0453 | 62 x 3,5 cm. | 10 |
| CA0036 | 52 x 3,5 cm. | 10 |
| CA0441 | 42 x 3,5 cm. | 10 |





Blonda parafinada brazo "Tronco".
Blond paraffin arm "Trunk".

| Cod. | Medida - Size | Pack |
|--------|---------------|------|
| CA0717 | 13 x 31 cm. | 100 |
| CA0718 | 14 x 39 cm. | 100 |
| CA0186 | 16 x 42 cm. | 100 |
| CA0187 | 18 x 50 cm. | 100 |



Bandeja cartón dorada brazo "Tronco".
Golden cardboard tray arm "Trunk".

| Cod. | Medida - Size | Pack |
|--------|---------------|------|
| CA0349 | 12 x 34 cm. | 100 |
| CA0374 | 12,5 x 38 cm. | 100 |
| CA0348 | 13 x 45 cm. | 100 |



Caja cartón con alveolo para bombones.
Cardboard box with socket for chocolates.

| Cod. | Medida - Size | Pack |
|--------|---------------|------|
| CA0532 | 11,5 x 20 cm. | 25 |
| CA0527 | 22,5 x 20 cm. | 25 |
| CA0540 | 33,5 x 20 cm. | 25 |



Batea dorada con tapa.
Golden bowl with lid.

| Cod. | Medida - Size | Pack |
|--------|-----------------|------|
| CA0502 | 21 x 14 x 5 cm. | 100 |
| CA0504 | 23 x 16 x 5 cm. | 100 |
| CA0503 | 25 x 18 x 5 cm. | 100 |
| CA0505 | 26 x 20 x 5 cm. | 100 |
| CA0516 | 28 x 22 x 5 cm. | 100 |
| CA0506 | 34 x 25 x 5 cm. | 100 |

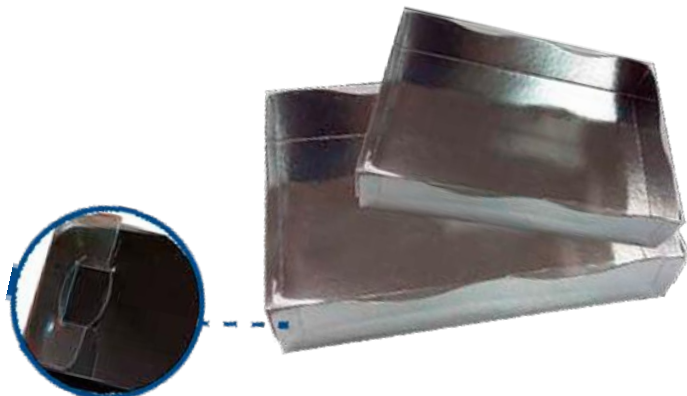

Caja con tapa automontable.
Posibilidad de personalización.
Box with self-assembling lid.
Possibility of customization.

| Cod. | Medida - Size | Pack |
|--------|-----------------|------|
| CA0620 | 19 x 13 x 6 cm. | 100 |
| CA0621 | 23 x 17 x 6 cm. | 100 |
| CA0622 | 27 x 21 x 6 cm. | 100 |



Caja cartón brazo "Tronco".
Cardboard box "Trunk" arm.

| Cod. | Medida - Size | Pack |
|--------|----------------------|------|
| CA0468 | 29 x 11 x 10 h cm. | 100 |
| CA0469 | 35,5 x 13 x 10 h cm. | 100 |
| CA0470 | 38,5 x 13 x 10 h cm. | 100 |
| CA0491 | 45,5 x 14 x 10 h cm. | 100 |



Caja cartón rectangular.
Rectangular cardboard box.

| Cod. | Medida - Size | Pack |
|--------|--------------------|------|
| CA0656 | 35 x 27 x 10 h cm. | 50 |
| CA0657 | 38 x 30 x 10 h cm. | 50 |
| CA0658 | 40 x 33 x 10 h cm. | 50 |
| CA0659 | 45 x 36 x 11 h cm. | 50 |



Caja cartón cuadrada.
Square cardboard box.

| Cod. | Medida - Size | Pack |
|--------|--------------------|------|
| CA0650 | 24 x 24 x 10 h cm. | 50 |
| CA0651 | 26 x 26 x 10 h cm. | 50 |
| CA0652 | 28 x 28 x 10 h cm. | 50 |
| CA0653 | 31 x 31 x 10 h cm. | 50 |
| CA0654 | 33 x 33 x 10 h cm. | 50 |
| CA0655 | 37 x 37 x 10 h cm. | 50 |



Caja cartón hexagonal.
Hexagonal cardboard box.

| Cod. | Medida - Size | Pcs |
|--------|-----------------|-----|
| CA0282 | 24 Ø x 12 h cm. | 50 |
| CA0283 | 27 Ø x 14 h cm. | 50 |
| CA0289 | 28 Ø x 14 h cm. | 50 |
| CA0284 | 31 Ø x 15 h cm. | 50 |
| CA0288 | 33 Ø x 16 h cm. | 50 |
| CA0285 | 35 Ø x 16 h cm. | 50 |
| CA0286 | 37 Ø x 17 h cm. | 50 |
| CA0287 | 41 Ø x 17 h cm. | 50 |



Caja cartón "Mona".
Rectangular cardboard box.

| Cod. | Medida - Size | Pcs. |
|--------|-----------------|------|
| CA0760 | 24 Ø x 19 h cm. | 50 |
| CA0444 | 28 Ø x 19 h cm. | 50 |
| CA0443 | 31 Ø x 19 h cm. | 50 |
| CA0762 | 35 Ø x 19 h cm. | 50 |



Bolsas de papel variadas personalizables

Assorted customizable paper bags.



Bolsa papel blanca o Kraft para panes y bollería.
White or Kraft paper bag for breads and pastries.

| Cod. | Cod. | Medida - Size | Pack |
|--------|---------|-------------------|------|
| CA0509 | CA0510 | 12 + 6 x 20 h cm. | 1000 |
| CA0275 | CA0510B | 14 + 6 x 26 h cm. | 1000 |
| CA0353 | CA0535 | 18 + 5 x 32 h cm. | 1000 |



Bolsa papel blanca para bocadillos.
White paper bag for sandwiches.

| Cod. | Medida - Size | Pack |
|--------|------------------|------|
| CA0541 | 9 + 5 x 24 h cm. | 1000 |
| CA0542 | 9 + 5 x 32 h cm. | 1000 |

Bolsa papel Kraft para panes y bollería.
Kraft paper bag for breads and pastries.

| Cod. | Medida - Size | Descrip. | Pack |
|--------|--------------------|--------------------|------|
| CA0500 | 10 + 3 x 50 h cm. | 1 Barra - Bread | 1000 |
| CA0508 | 12 + 9 x 50 h cm. | 2 Barras - Breads | 1000 |
| CA0228 | 17 + 7 x 50 h cm. | 3 Barras - Breads | 1000 |
| CA0352 | 30 + 11 x 60 h cm. | +3 Barras - Breads | 500 |



*Opción personalización en Serigrafía.
*Serigraphy customization option.

Bolsas de papel con fondo ancho. Posibilidad de Personalización.
Wide bottom paper bags. Possibility of Personalization.

| Cod. | Medida - Size | Color | Material |
|--------|--------------------|------------------|-----------------------------|
| CA0801 | 26 x 17 x 26 h cm. | Kraft - Kraft | Papel 80 gr. - Paper 80 gr. |
| CA0429 | 26 x 17 x 26 h cm. | Granate - Maroon | Papel 80 gr. - Paper 80 gr. |
| CA0416 | 26 x 17 x 26 h cm. | Blanco - White | Papel 80 gr. - Paper 80 gr. |
| CA0445 | 32 x 22 x 26 h cm. | Kraft - Kraft | Papel 80 gr. - Paper 80 gr. |
| CA0409 | 32 x 22 x 26 h cm. | Granate - Maroon | Papel 80 gr. - Paper 80 gr. |
| CA0602 | 32 x 22 x 26 h cm. | Blanco - White | Papel 80 gr. - Paper 80 gr. |



Bolsa formato especial para cajas de tartas y pasteles.

Bolsa transparente de polietileno.
Transparent polyethylene bag.

| Cod. | Medida - Size | Pack | Pack |
|--------|---------------|------|------|
| AT0565 | 450x150x600 | 5 | 100 |





Papel antigrasa 50grs.
Greaseproof paper

| Cod. | Medidas - Size | Material | Pack |
|--------|----------------|---------------|----------|
| AO2410 | 290 x 300 mm. | Papel - paper | 500 uds. |



Papel polvorón.
Polvoron paper.

| Cod. | Medidas - Size | Material | Pack |
|--------|----------------|---------------|-----------|
| AO2411 | 290 x 300 mm. | Papel - paper | 1000 uds. |



Papel aluminio dorado, ideal para conservar pasteles cortados.
Gold aluminium paper, ideal to keep the cut cakes.

| Cod. | Medidas - Size | Material | Pack |
|--------|----------------|----------------------------------|-------|
| AO0425 | 100 x 120 mm. | Papel aluminio - Aluminium paper | 1 Kg. |
| AO1046 | 100 x 120 mm. | Papel aluminio - Aluminum paper | 1 Kg. |

Papel parafinado cristal, ideal para conservar pasteles cortados.
Waxed paper, ideal to keep the cut cakes.

| Cod. | Medidas - Size | Material | Pack |
|--------|----------------|--------------------------------|-------|
| AO0410 | 100 x 120 mm. | Papel parafinado - Waxed paper | 2 Kg. |



Papel celofán incoloro, ideal para conservar pasteles cortados.
Colorless cellophane paper, ideal to keep the cut cakes.

| Cod. | Medidas - Size | Material | Pack |
|--------|----------------|----------------------------------|----------|
| AO0574 | 100 x 120 mm. | Papel celofán - Cellophane paper | 1000uds. |



Las bolsas son aptas para estar en contacto con los alimentos, disponen de la declaración de conformidad MOCA, como productos adecuados para el contacto directo con alimentos.

The bags are suitable for contact with food, they have the MOCA declaration of conformity, as suitable products for direct contact with food.

* Las medidas son ancho x altura (h) + fondo.

* Measurements are width x height (h) + depth.



| Cod. | Medidas - Size | Material | Box | Pack |
|--------|----------------------|-----------------------------|------|------|
| AT0502 | 60 x 200 h + 50 mm. | Polipropileno-Polypropylene | 1500 | 100 |
| AT0506 | 80 x 240 h + 40 mm. | Polipropileno-Polypropylene | 1500 | 100 |
| AT0507 | 100 x 300 h + 60 mm. | Polipropileno-Polypropylene | 1500 | 100 |
| AT0511 | 120 x 370 h + 70 mm. | Polipropileno-Polypropylene | 1500 | 100 |
| AT0008 | 45 x 210 h + 30 mm. | Celofán - Cellophane | 1000 | 100 |
| AT0058 | 75 x 170 h + 30 mm. | Celofán - Cellophane | 1000 | 100 |
| AT0012 | 85 x 190 h + 30 mm. | Celofán - Cellophane | 1000 | 100 |
| AT0127 | 95 x 210 h + 35 mm. | Celofán - Cellophane | 1000 | 100 |
| AT0059 | 100 x 230 h + 40 mm. | Celofán - Cellophane | 1000 | 100 |
| AT0568 | 145 x 270 h + 55 mm. | Celofán - Cellophane | 1000 | 100 |

| Cod. | Medidas - Size | Material |
|--------|----------------|----------------------|
| AT0095 | 60 x 1000 cm. | Celofán - Cellophane |
| AT0099 | 60 x 5000 cm. | Celofán - Cellophane |
| AT0097 | 90 x 1000 cm. | Celofán - Cellophane |



* Posibilidad de personalizar.
* Ability to customize.

| Cod. | Medidas - Size | Material | Pack |
|--------|----------------|----------|----------|
| AO1336 | 9x13 cm | Polip. | 1000 uds |



Soporte para 2 bobinas de papel para envolver.
Support for 2 rolls of paper to wrap.

Papel blanco alimentario para envolver 30 grs.
White food wrapping paper 30grs.

Papel alimentario con estampado 40grs.
Food paper to wrap with print 40grs.

| Cod. | Medidas - Size | Material |
|--------|----------------|--------------|
| AT0140 | 31 - 62 cm. | Inox. - Sst. |

| Cod. | Medidas - Size | Pcs. |
|---------|----------------|------|
| CA03018 | 62 x 86 cm. | 500 |

| Cod. | Medidas - Size |
|---------|----------------|
| CA03015 | 31 cm. |
| CA0302 | 62 cm. |



Papel fantasía para regalos. "Modelos variados".
Fantasy paper for gifts. "Varied models".

| Cod. | Medidas - Size | Pcs. | Pack |
|--------|----------------|------|------|
| AT0350 | 70 x 99 cm. | 100 | 1 |



* Con adhesivo.
* With adhesive.

Lazos metalizados para regalos. "Colores variados".
Metallic gift bows. "Assorted colors".

| Cod. | Medidas - Size | Pcs. | Pack |
|-------|----------------|------|------|
| L0042 | 6,5 Ø cm. | 100 | 1 |



Pegatina plateada "Felicidades".
Silver sticker "Felicidades".

| Cod. | Medidas - Size | Pack |
|--------|----------------|------|
| AT0900 | 40 x 15 h mm. | 500 |



Pegatina dorada "Felicidades".
Golden sticker "Felicidades".

| Cod. | Medidas - Size | Pack |
|--------|----------------|------|
| AT0901 | 40 x 15 h mm. | 500 |

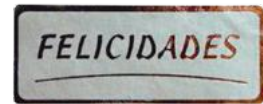

Pegatina plateada "Felicidades".
Silver sticker "Felicidades".

| Cod. | Medidas - Siz | Pack |
|--------|---------------|------|
| AT0904 | 40 x 15 h mm. | 500 |



Pegatina plateada "Deseo que...".
Silver sticker "Deseo que...".

| Cod. | Medidas - Size | Pack |
|--------|----------------|------|
| AT0902 | 40 x 15 h mm. | 500 |



Pegatina dorada "Deseo que...".
Golden sticker "Deseo que...".

| Cod. | Medidas - Size | Pack |
|--------|----------------|------|
| AT0903 | 40 x 15 h mm. | 500 |

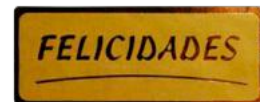

Pegatina dorada "Felicidades".
Golden sticker "Felicidades".

| Cod. | Medidas - Size | Pack |
|--------|----------------|------|
| AT0905 | 40 x 15 h mm. | 500 |



Pegatina silueta "Felicidades".
Silhouette sticker "Felicidades".

| Cod. | Medidas - Size | Pack |
|--------|----------------|------|
| AT0906 | 30 x 50 mm. | 250 |



Pegatina cuadrada "Deseo que...".
Square sticker "Deseo que...".

| Cod. | Medidas - Size | Pack |
|--------|----------------|------|
| AT0907 | 40 x 40 h mm. | 500 |

Etiquetas adhesivas personalizadas. Custom adhesive labels.

REFERENCIAS PARA
IMPRESIONES A 1 TINTA

Le ofrecemos la posibilidad de personalizar con su logo o marca los diferentes modelos de etiquetas adhesivas en varias técnicas de estampación como "hot stamping" o "impresión digital".
We offer you the possibility of customizing the different models of adhesive labels with your logo or brand in various printing techniques such as "hot stamping" or "digital printing".



DE REF. N°9 A REF. N°25. + 30% adicional
2 TINTAS. + 30% adicional
3 TINTAS. + 50% adicional

REF. N°9 TO REF. N°25. + 30% additional
2 INKS. + 30% additional
3 INKS. + 50% additional
Printing More than 50% of the mass +30%

Paso 1: Elegir la forma de tu etiqueta



Paso 2: Elegir el color tanto de fondo como de tu marca.

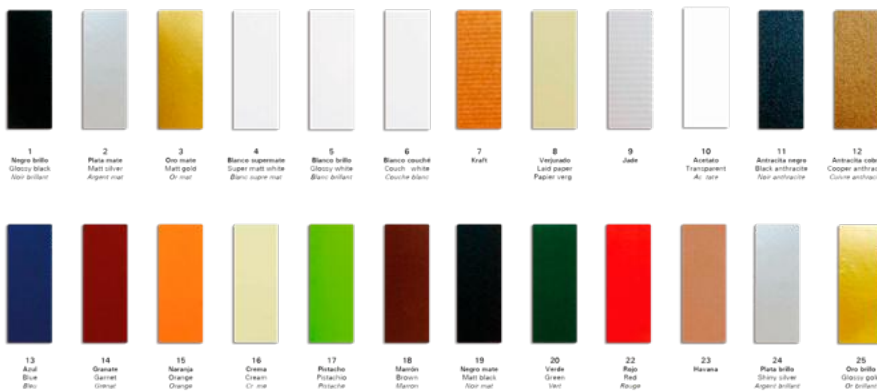

*Consultar para más colores.



Paso 4: Elegir el tamaño de tus pegatinas

Digital Stamping

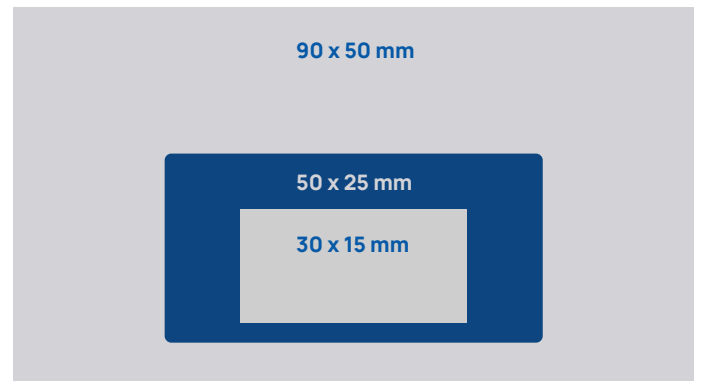
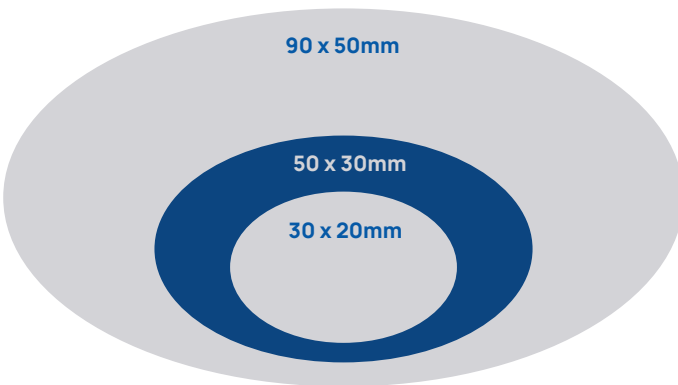
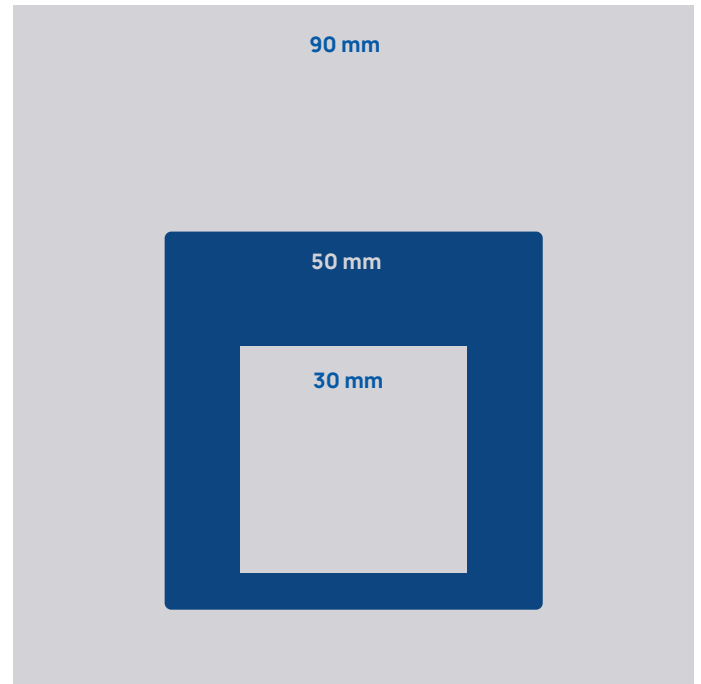
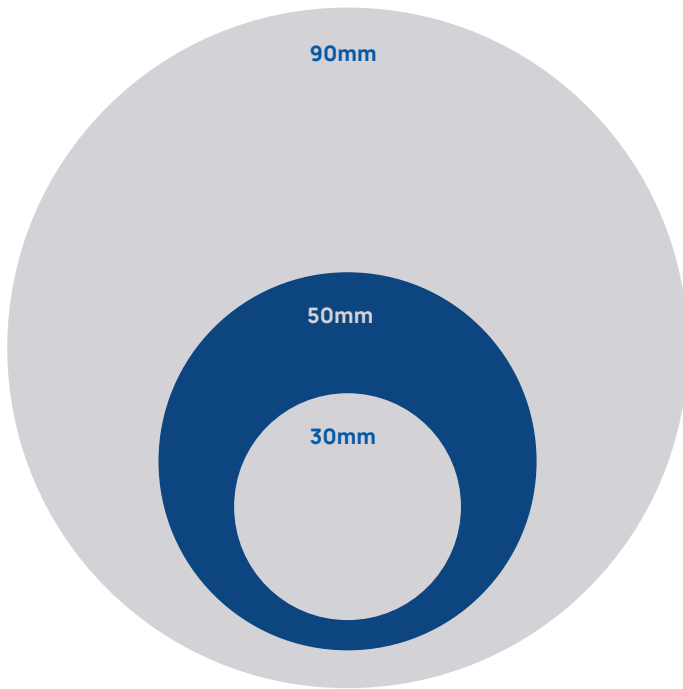

| Cod. | Medidas - Size | Pack |
|----------|----------------|----------|
| AT0905D3 | 30 Ø mm. | 3000uds. |
| AT0905D5 | 50 Ø mm. | 3000uds. |
| AT0905D9 | 90 Ø mm. | 3000uds. |
| AT0905S3 | 30 Ø mm. | 3000uds. |
| AT0905S5 | 50 Ø mm. | 3000uds. |
| AT0905S9 | 90 Ø mm. | 3000uds. |



| Cod. | Medidas - Size | Pack |
|----------|----------------|----------|
| AT0907D3 | 30 x 30 mm. | 3000uds. |
| AT0907D5 | 50 x 50 mm. | 3000uds. |
| AT0907D9 | 90 x 90 mm. | 3000uds. |
| AT0907S3 | 30 x 30 mm. | 3000uds. |
| AT0907S5 | 50 x 50 mm. | 3000uds. |
| AT0907S9 | 90 x 90 mm. | 3000uds. |



| Cod. | Medidas-Size | Pack |
|----------|--------------|----------|
| AT0906D3 | 30 x 20 mm. | 3000uds. |
| AT0906D5 | 50 x 30 mm. | 3000uds. |
| AT0906D9 | 90 x 50 mm. | 3000uds. |
| AT0906S3 | 30 x 20 mm. | 3000uds. |
| AT0906S5 | 50 x 30 mm. | 3000uds. |
| AT0906S9 | 90 x 50 mm. | 3000uds. |



| Cod. | Medidas - Size | Pack |
|----------|----------------|----------|
| AT0908D3 | 30 x 15 mm. | 3000uds. |
| AT0908D5 | 50 x 25 mm. | 3000uds. |
| AT0908D9 | 90 x 50 mm. | 3000uds. |
| AT0908S3 | 30 x 15 mm. | 3000uds. |
| AT0908S5 | 50 x 25 mm. | 3000uds. |
| AT0908S9 | 90 x 50 mm. | 3000uds. |



Cod. SEG002 **Medidas - Size** 6 x 8 cm. **Material** P.V.C. **Pack** 25



Cod. SEG006 **Medidas - Size** 6 x 5 cm. **Material** P.V.C. **Pack** 50



Cod. AT0271 **Medidas - Size** 2,5x2,5x11h cm. **Material** P.V.C. **Pack** 25



Cod. J0148 **Medidas - Size** 8 h cm. **Material** Inox. - Sst **Pack** 12



Cod. SEG027 **Medidas - Size** 6,5x6,2 cm. **Material** P.V.C. **Pack** 15

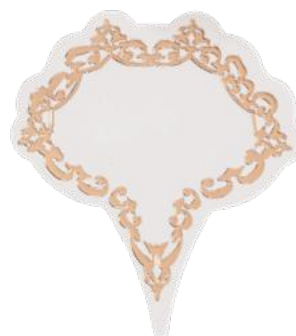

Cod. SEG004 **Medidas - Size** 3,5 x 4 cm. **Material** P.V.C. **Pack** 30



Cod. AT0119 **Medidas - Size** 3,4 x 5,3 cm. **Material** P.V.C. **Pack** 100

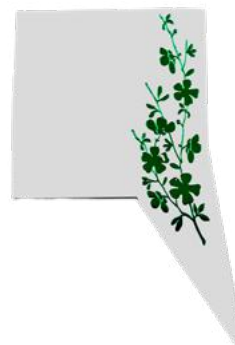

Cod. SEG028 **Medidas - Size** 9 h cm. **Material** Inox. - Sst **Pack** 100

Duproflex®





* Posibilidad de elegir el pack de un sólo color.
 * Possibility of choosing the single color pack.

Cinta P.V.C. para envolver.
 P.V.C. Strip for wrapping.

| Cod. | Medidas - Size | Material | Pack |
|-------|----------------|----------|------|
| L0008 | 5mm x 500 m. | P.V.C. | 5 |



* Posibilidad de elegir el pack de un sólo color.
 * Possibility of choosing the single color pack.

Cinta vegetal para envolver.
 Vegetable strip for wrapping.

Pack con 12 ovillos.
 Pack with 12 rolls.

| Cod. | Medidas - Size | Material | Pack |
|--------|----------------|---------------------|------|
| AT0022 | 800 m. | Vegetal / Vegetable | 1 |



Alambre cierrabolsas de P.V.C.
 P.V.C. Wire bag closers

| Cod. | Medidas - Size | Material | Pack |
|--------|----------------|----------|------|
| A00563 | 9,5 h cm. | P.V.C. | 1000 |



Hilo de algodón para envolver.
 Cotton thread for wrapping.

Pack con 12 ovillos.
 Pack with 12 rolls.

| Cod. | Medidas - Size | Material | Pack |
|--------|----------------|------------------|------|
| AT0274 | 1 kg. | Algodón / Cotton | 1 |



Lazo elástico dorado.
Golden elastic bow.

| Cod. | Medidas - Size | Pack |
|-------|----------------|------|
| L0045 | 50 cm. | 100 |



Cordón elástico dorado.
Golden elastic cord.

| Cod. | Medidas - Size |
|-------|----------------|
| L0032 | 1 mm. x 100 m. |
| L0043 | 2 mm. x 50 m. |



Cinta. - Ribbon.

Color metalizado dorado.
Gold metallic color.

| Cod. | Medidas - Size |
|-------|------------------|
| L0007 | 30 mm. x 100 m. |
| L0051 | 30 mm. x 30 uds. |



Color metalizado rojo.
Red metallic color.

| Cod. | Medidas - Size |
|-------|------------------|
| L0006 | 30 mm. x 100 m. |
| L0052 | 30 mm. x 30 uds. |



Color metalizado azul.
Blue metallic color.

| Cod. | Medidas - Size |
|-------|------------------|
| L0050 | 30 mm. x 100 m. |
| L0054 | 30 mm. x 30 uds. |



Color metalizado verde.
Green metallic color.

| Cod. | Medidas - Size |
|-------|------------------|
| L0048 | 30 mm. x 100 m. |
| L0053 | 30 mm. x 30 uds. |



Color metalizado marrón.
Brown metallic color.

| Cod. | Medidas - Size |
|-------|------------------|
| L0047 | 30 mm. x 100 m. |
| L0056 | 30 mm. x 30 uds. |



Lazo automático. - Automatic loop.



Apto para soportes de 66 m.
Suitable for supports of 66 m.

| Cod. | Medidas - Size | Pack | Caja - Box |
|--------|----------------|------|------------|
| AT0109 | 12 mm. x 66 m. | 9 | 108 |
| AT0020 | 19 mm. x 66 m. | 8 | 96 |



Apto para soportes de 33 m.
Suitable for supports of 33 m.

| Cod. | Medidas - Size | Pack | Caja - Box |
|--------|----------------|------|------------|
| AT0138 | 19 mm. x 33 m. | 16 | 192 |



Apto para soportes de 12 mm x 66 m.
Suitable for supports of 12 mm. x 66 m.

| Cod. | Medidas - Size | Pack | Caja - Box |
|-----------|----------------|------|------------|
| ● AT0021R | 12 mm. x 66 m. | 24 | 144 |
| ● AT0021Y | 12 mm. x 66 m. | 24 | 144 |
| ● AT0021B | 12 mm. x 66 m. | 24 | 144 |
| ● AT0021G | 12 mm. x 66 m. | 24 | 144 |

Blanco
White

Transparente
Transparent



Apto para soportes de 50 mm. x 66 m.
Suitable for supports of 50 mm. x 66 m.

| Cod. | Medidas - Size | Pack | Caja - Box |
|-----------|----------------|------|------------|
| ○ AT0110 | 50 mm. x 66 m. | 6 | 36 |
| ○ AT0110T | 50 mm. x 66 m. | 6 | 36 |

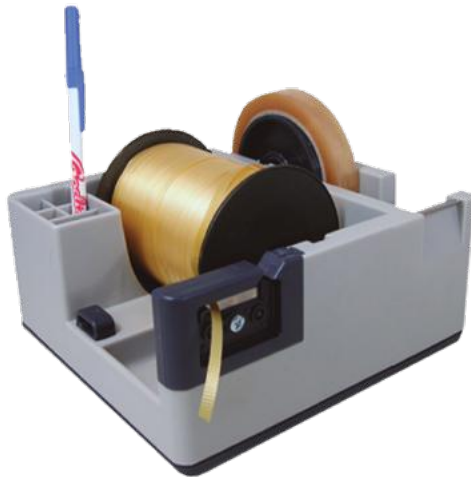

Apto para rollos de 33 m. y 66 m.
Suitable for 33 m. and 66 m rolls.

Cod.
AT0113



Apto para cintas de 500 m. y 800 m.
Suitable for tapes of 500 m. and 800 m.

Cod.
AT0011

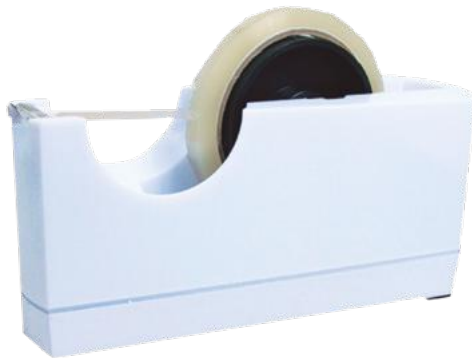

Apto para rollos de 33 m. y 66 m.
Suitable for 33 m. and 66 m rolls.

Cod.
AT0112



Apto para rollos de 33 m.
Suitable for 33 m. rolls.

Cod.
AT0111



Apto para rollos de 12 mm. x 66 m.
Suitable for 12 mm. x 66 m rolls.

Cod. Material
AT0137 Metal
AT0106 P.V.C.



Apto para rollos de 50 mm. x 66 m.
Suitable for 50 mm. x 60 m. rolls.

Cod.
AT0107



Guante especial para panadería con imán.
Special bakery glove with magnet.

| Cod. | Descripción - Description | Material |
|---------------|---|----------|
| AT0108 | Kit con 3 recambios Kit with 3 replacement | P.V.C. |
| AT0205 | 100 recambios 100 Replacement gloves | P.V.C. |



Pinza pastelera especial para pasteles delicados.
Special pastry clamp for delicate cakes.

| Cod. | Medidas - Size | Material |
|---------------|----------------|--------------|
| AT0047 | 200 mm. | Inox. - Sst. |



Pinza pastelera especial para pasteles resistentes.
Special pastry clamp for solid cakes.

| Cod. | Medidas - Size | Material |
|---------------|----------------|--------------|
| AT0031 | 160 mm. | Inox. - Sst. |



Pinza pastelera rejada.
Grilled pastry clamp.

| Cod. | Medidas - Size | Material |
|---------------|----------------|--------------|
| AT0034 | 190 mm. | Inox. - Sst. |



Pala serrada para tartas.
Blade for cakes.

| Cod. | Medidas - Size | Material |
|---------------|----------------|--------------|
| AT0025 | 100 x 290 mm. | Inox. - Sst. |



Pinza especial para tartas.
Special pastry clamp cakes.

| Cod. | Medidas - Size | Material |
|---------------|----------------|--------------|
| AT0026 | 50 x 240 mm. | Inox. - Sst. |



Lustrero con palanca.
Sieve with lever.

Cod. Medidas Size Material
ACC01 11 h cm. Inox. - Sst.

Lustrero malla fina.
Sieve of fine mesh.

Cod. Medidas - Size Material
A062903 7 Ø x 9,5 h cm. Inox. - Sst.

Lustrero malla gruesa.
Sieve of coarse mesh.

Cod. Medidas - Size Material
AT0134 7 Ø x 9,5 h cm. Inox. - Sst.



Lechera con asa.
Milkmaid with handle.

Cod. Medidas - Size Material
AT0700 600 ml. Inox. - Sst.
AT0701 1000 ml. Inox. - Sst.
AT0702 1500 ml. Inox. - Sst.



Tetera con asa.
Teapot with handle.

Cod. Medidas - Size Material
AT0703 150 ml. Inox. - Sst.
AT62023 250 ml. Inox. - Sst.
AT62035 350 ml. Inox. - Sst.

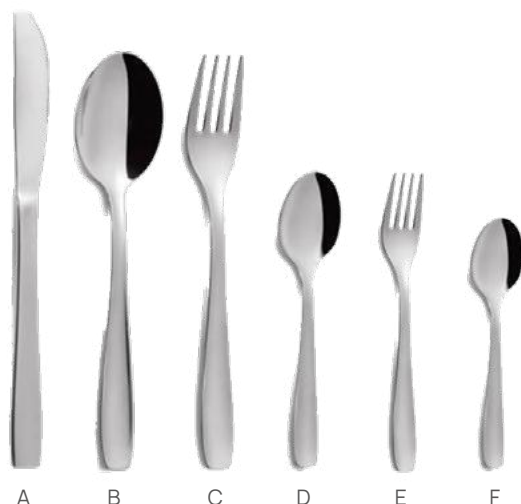

Cubertería 12 uds.
Cutlery 12 units.

| | Cod. | Descripción - Description | Material |
|---|----------------|----------------------------------|-----------------|
| A | A033403 | Cuchillo postre - Dessert knife | Inox. - Sst. |
| B | A034107 | Cuchara mesa - Table spoon | Inox. - Sst. |
| C | A034102 | Tenedor mesa - Table fork | Inox. - Sst. |
| D | A033404 | Cuchara postre - Dessert spoon | Inox. - Sst. |
| E | A034104 | Tenedor postre - Dessert fork | Inox. - Sst. |
| F | A033107 | Cuchara moka - Moka spoon | Inox. - Sst. |

HELADERÍAS ICE CREAM SHOP

El arte del helado enrollado.
The art of rolled ice cream.



Espátula triangular con mango de Fenolkraft.
Triangle spatula with Fenolkraft handle.

Cod. Medidas -Size Material
AO0110 100 x 130 mm. Inox. - Sst.



Racionador bola de helado.
Ice cream scooper.

| Cod. | Medidas Size | Volumen Volume | Material |
|---------------|-----------------|-------------------|--------------|
| AT0065 | 4 Ø cm. | 15 cc. | Inox. - Sst. |
| AT0085 | 5 Ø cm. | 32 cc. | Inox. - Sst. |
| AT0086 | 6 Ø cm. | 54 cc. | Inox. - Sst. |
| AT0087 | 7 Ø cm. | 90 cc. | Inox. - Sst. |



Paleta para servir helado.
Palette to serve ice cream.

Cod. Medidas - Size Material
AT0082 27 h cm. Inox. - Sst.



Cacillo para granizada
Ladle for iced drinks

Cod. Medidas - Size Material
AT0079 11,5 x 6 x 50 h cm. Inox. - Sst.



Cacillo para horchata
Ladle for tiger nut milk drink

Cod. Medidas - Size Material
AT0078 9 x 7,5 x 50 h cm. Inox. - Sst.

Versión ecológica que respeta el medio ambiente, de productos dedicados a la heladería. Hechas en PLA.

An eco-friendly version of disposable items dedicated to catering. Suitable either for pastry shops and events, they are made of PLA.

CALIDAD Y RESPETO POR EL PLANETA

Gracias al uso de este material ecológico de alta calidad y versatilidad, las características que hacen que los productos de la línea sean únicos permanecen inalterados y cumplen con los estándares europeos de idoneidad para el contacto con alimentos.

QUALITY AND RESPECT FOR THE PLANET

By using this high quality and versatility eco-friendly material, the features that make these products range unique remain unchanged and respectful of European laws of suitability for food contact.



Paleta reutilizable heladería.
Reusable ice cream palette.

| Cod. | Medida - Size | Bolsa - Bag | Caja - Box |
|--------|---------------|-------------|------------|
| P04030 | 95 mm. | 1 kg. | 10 kg. |



Cuchara reutilizable.
Reusable spoon.

| Cod. | Medida - Size | Bolsa - Bag | Caja - Box |
|---------|---------------|-------------|------------|
| P04634C | 130 mm. | 1 kg. | 14 kg. |



Duproflex[®]
Equipamiento profesional

CRÊPES y BATIDOS

SABORES QUE ENAMORAN



INGREDIENTES
DE CALIDAD
PARA MOMENTOS
INOLVIDABLES



CRÊPES
DULCES E
IRRRESISTIBLES



BATIDOS
FRESCOS,
CREMOSOS Y
DELICIOSOS



NATA
MONTADA
EL TOQUE FINAL
PERFECTO



DISFRUTA. COMPARTE. REPITE.





Batidora para helados.
Blender for Ice Cream.

| Cod. | Medida Size | Capacidad Capacity | Voltaje Voltage |
|---------|----------------|-----------------------|--------------------|
| AO69111 | 21x15x51cm. | 600 ml. | 400W. |



AO68402
Pack 10 uds.

Sifón para nata.
Cream siphon.

| Cod. | Capacidad-Capacity |
|---------|--------------------|
| AO68605 | 1000 ml. |
| AO68402 | 8 grs. |

La línea de crepes eléctricos. Ideal para preparaciones dulces y saladas, nuestras creperas están equipadas con una placa de cocción antiadherente de hierro fundido de 30 / 40 cm. de diámetro (según modelo).

The line of electric crepes. Ideal for sweet and savory preparations, our crepes are equipped with a 30 / 40 cm cast iron non-stick cooking plate. in diameter (depending on the model).



| Cod. | Descripción. Description. | Medidas Size | Conexión Connection | Voltaje Voltage | Potencia Power | Peso Weight |
|---------|------------------------------|--|-------------------------|--------------------|-------------------|----------------|
| AO69122 | Simple | 40 x 36 x 11 cm Útil - Useful 30 Ø cm. | Monofásico Monophase | 220/240 | 1 Kw | 2,12 Kg. |
| AO69196 | Simple | 45 x 49 x 22,5 cm Útil - Useful 40 Ø cm. | Monofásico Monophase | 220/240 | 3 Kw | 23 Kg. |



Medidor con graduación en relieve en P.V.C.
Measure with raised graduation P.V.C.

| Cod. | Medición - Measure. |
|--------|---------------------|
| AO0084 | 500 ml. |
| AO0080 | 1000 ml. |
| AO0081 | 2000 ml. |
| AO0083 | 3000 ml. |
| AO0085 | 5000 ml. |



Medidor con graduación en relieve en P.V.C.
Measure with raised graduation P.V.C.

| Cod. | Medición - Measure. |
|--------|---------------------|
| AO0687 | 1000 ml. |
| AO0688 | 2000 ml. |
| AO0689 | 3000 ml. |
| AO0690 | 5000 ml. |



Soporte para 3 cucuruchos inox.
Support for 3 cones inox.

| Cod. | Medidas - Size |
|--------|--------------------|
| AT0704 | 21 x 7 x 8,5 h cm. |



Cubo con graduación en relieve en P.V.C.
Cube with relief graduation P.V.C.

| Cod. | Medición - Measure. |
|--------|---------------------|
| AO0691 | 12 l. |
| AO0692 | 15 l. |
| AO0693 | 18 l. |



Cubeta para helados inox.
Ice cream bucket inox.

| Cod. | Medidas Size | Volumen Volume |
|--------|-------------------|----------------|
| AO2007 | 36 x 25 x 8 h cm. | 5,4 l. |



Cubeta para helados inox.
Ice cream bucket inox.

| Cod. | Medidas Size | Volumen Volume |
|--------|----------------------|----------------|
| AO2006 | 36 x 16,5 x 8 h cm. | 3,4 l. |
| AO2004 | 36 x 16,5 x 12 h cm. | 5 l. |
| AO2005 | 36 x 16,5 x 15 h cm. | 7 l. |

Duproflex®



Donde empieza
la experiencia del

helado.

NUEVO



Cocotera.
Coconut.

| Cod. | Medidas - Size | Material | Pack | Box |
|--------|----------------|---------------|------|-----|
| A0260B | 11 h cm. | Papel - Paper | 144 | 12 |

NUEVO



Dinos.
Dinos.

| Cod. | Medidas - Size | Material | Pack | Box |
|--------|----------------|---------------|------|-----|
| A02104 | 11 h cm. | Papel - Paper | 100 | 12 |

Pequeños detalles, grandes sonrisas.





Pavo real.
Peacock.

| Cod. | Medidas - Size | Material | Pack | Box |
|-------|----------------|---------------|------|-----|
| A0212 | 11 h cm. | Papel - Paper | 144 | 12 |



Isla con palmera.
Island with palm tree.

| Cod. | Medidas - Size | Material | Pack | Box |
|-------|----------------|---------------|------|-----|
| A0229 | 12 h cm. | Papel - Paper | 144 | 12 |



Sombrilla.
Umbrella.

| Cod. | Medidas - Size | Material | Pack | Box |
|-------|----------------|---------------|------|-----|
| A0219 | 10 h cm. | Papel - Paper | 144 | 12 |



Mariposas.
Butterflies.

| Cod. | Medidas - Size | Material | Pack | Box |
|-------|----------------|---------------|------|-----|
| A0223 | 12 h cm. | Papel - Paper | 144 | 12 |



Sombrillas.
Umbrellas.

| Cod. | Medidas - Size | Material | Pack | Box |
|-------|----------------|----------|------|-----|
| A0240 | 12 h cm. | P.V.C. | 144 | 12 |



Molinos.
Mills.

| Cod. | Medidas - Size | Material | Pack | Box |
|-------|----------------|----------|------|-----|
| A0211 | 12 h cm. | P.V.C. | 50 | 12 |

HIGIENE
HYGIENE



Cubre zapatos ajustables desechables.
Covers disposable adjustable shoes.

| Cod. | Material | Pcs. |
|-------|----------------------------|------|
| VZ016 | Polietileno - Polyethylene | 100 |



Guantes de nitrilo, idela para el trabajo.
Nitrile gloves, ideal for work.

| Cod. | Espesor - Thickness | Pcs. |
|-------|---------------------|------|
| VZ021 | 3.5 grs. | 100 |
| VZ022 | 4,5 grs. | 100 |



Batas desechables.
Disposable Coats.

| Cod. | Material | Pcs. |
|-------|--------------------------------|------|
| VZ017 | Polipropileno Polypropilene | 10 |



Delantal pastelero desechable.
Disposable pastry apron.

| Cod. | Medida - Size | Material | Pack. | Box |
|--------|----------------|----------|-------|-----|
| AO1207 | 70 x 107 h cm. | P.V.C. | 100 | 10 |



Delantal pastelero.
Pastry apron.

| Cod. | Material | Pcs |
|--------|--------------|-----|
| AO0100 | P.V.C. | 1 |
| AO0101 | Tela - Cloth | 1 |



Mascarillas desechables.
Disposable mask.

| Cod. | Material | Pcs. |
|-------|--------------------------------|------|
| VZ019 | Polipropileno Polypropilene | 50 |



Gorros desechables.
Disposable hats.

| Cod. | Material | Pcs. |
|-------|--------------------------------|------|
| VZ020 | Polipropileno Polypropilene | 100 |



Producción del día

- Biscocho genovés
- Crema pastelera
- Mousse de chocolate
- Merengue italiano
- Glaseado espejo

CALIDAD
PASIÓN
PRECISIÓN

HIGIENE

HYGIENE

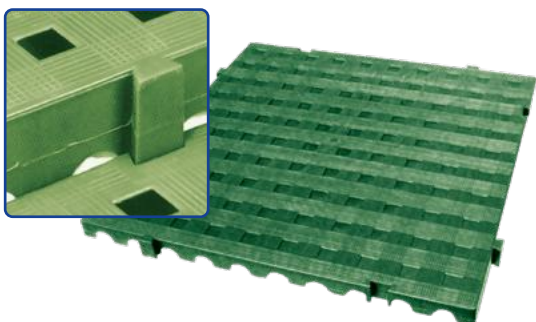

Suelo encajable.
Fitted floor.

| Cod. | Medida - Size | Material | Max. | Pcs. |
|---------------|---------------------|----------|----------|------|
| AO0417 | 50 x 50 x 2,5 h cm. | P.V.C. | 1250 Kg. | 1 |



Palet almacenaje.
Storage pallet.

| Cod. | Medida - Size | Material | Max. | Pcs. |
|---------------|--------------------|----------|---------|------|
| AO0403 | 40 x 60 x 13 h cm. | P.V.C. | 250 Kg. | 1 |



Palet almacenaje.
Storage pallet.

| Cod. | Medida - Size | Material | Max. | Pcs. |
|---------------|----------------------|----------|---------|------|
| AO0402 | 80 x 1200 x 13 h cm. | P.V.C. | 500 Kg. | 1 |



Palet almacenaje.
Storage pallet.

| Cod. | Medida - Size | Material | Max. | Pcs. |
|---------------|----------------------|----------|----------|------|
| AO0404 | 80 x 1200 x 16 h cm. | P.V.C. | 4000 Kg. | 1 |



| | |
|---------------|---------|
| 240 l. | |
| A | 1070 |
| B | 995 |
| C | 655 |
| D | 730 |
| E | 580 |
| F | 420 |
| PESO / WEIGHT | 13,5 Kg |

240 L.

Cubo residuos con ruedas y pedal inoxidable.
Waste bin with wheels and stainless pedal.

Cod. Material Pack
A00672 P.V.C. y Inox. 1

Aro y pedal inoxidable.
Stainless rim and pedal.

Medidas - Sizes
460x560x940 h

120 L.

Cubo residuos con ruedas y pedal inoxidable.
Waste bin with wheels and stainless pedal.

Cod. Material Pack
A00672B P.V.C. y Inox. 1

Medidas - Sizes
450x500x780 h mm.

80 L.

Cubo residuos con ruedas y pedal inoxidable.
Waste bin with wheels and stainless pedal.

Cod. Material Pack
A00672C P.V.C. y Inox. 1



Aro y pedal inoxidable.
Stainless rim and pedal.

UTILLAJE

2026

Duproflex www.fantasiagodie.com
(+34) 956 805 280