



Attributes

Product Code
 Net weight
 Max. weight load
 Dimensions (w x l x h)
 Color options

2-1-028

2 kg

-

40x121x280 mm



For more color options, discuss with your sales representative.

Warranty

Structure
 Steel
 Paint
 Plastic
 Rubber
 Moving parts

Detailed information in the warranty document

25-15 years

5-10 years

2 years

5-10 years

1-3 years

2 years

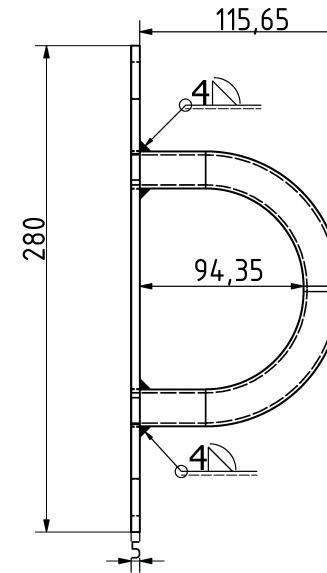
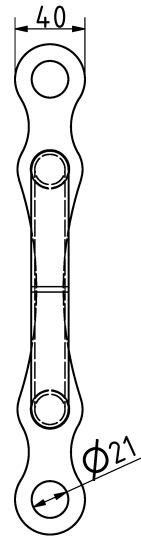

BESTRONG

 [bestrongworld](#)  [bestrongworld](#)  [global.bestrong.com](#)  info@bestrong.com

