

Your Brand
Ambassador



Think BIC

2023

Think about a pen or a lighter.
Think efficient, reliable service.
Think sustainability and social initiatives.
Think about working together to find
the best solutions.

And now think of all the things we can
do for a brand, for your own brand.

Think big.

Think BIC

Contents

BIC GRAPHIC

8

Being an icon	8	Sustainability	18
Creativity	10	Innovation	24
BIC® Timeline	12	Printing techniques	26
Trust	14	Full colour britePix™ Digital range	28
Social Responsibility	16	Sustainable Ecolutions® range	30

BIC® WRITING INSTRUMENTS

36

BALLPENS

BIC® Style	38	BIC® 4 Colours® Shine	126
BIC® Round Stic®	42	BIC® 4 Colours® Glacé	128
BIC® Round Stic® BGuard™ antibacterial	48	BIC® 4 Colours® Fine	130
BIC® M10® Clic	50	BIC® 4 Colours® Fluo	131
BIC® Media Clic	52	BIC® 4 Colours® 3+1 ^{HB}	132
BIC® Media Clic Grip	58	METALLIC PENS	
BIC® Media Clic BGuard™ antibacterial	63	BIC® Metal Pro	134
BIC® Media Clic BGuard™ antimicrobial Ecolutions®	66	BIC® Cristal® Re'New™	138
BIC® Media Clic Bio-Based Ecolutions®	68	ROLLERS AND GELS	
BIC® Media Clic Bio-Based BGuard™ antibacterial	71	BIC® Grip Roller	142
BIC® Media Clic Shine	73	BIC® XS Finestyle	146
BIC® Media Clic Glacé	74	BIC® Intensity® Gel Clic	148
BIC® Clic Stic	76	HIGHLIGHTERS AND MARKERS	
BIC® Clic Stic BGuard™ antibacterial	84	BIC® Brite Liner® Grip	152
BIC® Clic Stic Stylus BGuard™ antibacterial	86	BIC® Velleda® White Board Marker Fine	154
BIC® Super Clip	88	BIC® Velleda® White Board Marker Grip	155
BIC® Super Clip BGuard™ antibacterial	94	BIC® Mark-It Permanent Marker	156
BIC® Super Clip Advance	96	BIC® Permanent Marker Ecolutions®	157
BIC® Super Clip Glacé	100	MECHANICAL PENCILS	
BIC® Super Clip Glacé Advance	100	BIC® Matic®	160
BIC® Super Clip Soft	102	BIC® Media Clic Mechanical pencil	52
BIC® Super Clip Soft Advance	102	BIC® Media Clic Grip Mechanical pencil	58
BIC® Super Clip Origin	104	PENCILS	
BIC® Wide Body™	106	BIC® Evolution® Ecolutions®	164
BIC® Wide Body™ BGuard™ antibacterial	112	Sprout™ Graphite pencil	168
BIC® 4 Colours®	114		
BIC® 4 Colours® Soft	118		
BIC® 4 Colours® Wood Style	120		
BIC® 4 Colours® Sun	122		
BIC® 4 Colours® Fashion	124		

OTHER WRITING INSTRUMENTS 170

PLASTIC PENS

Basic Pen	172
Click Pen	174
Striped Grip Pen	176

STYLUS PENS

Sleek Stylus Pen	178
------------------	-----

NOTEBOOKS 180

ROCKETBOOK®

Rocketbook® Core Executive A5	184
Rocketbook® Fusion Executive A5	186
Rocketbook® Core Mini A6	188

BIC® LIGHTERS AND CASES 190

LIGHTERS

BIC® J25 Lighter	196
BIC® J23 Lighter	200
BIC® J26 Lighter	204
BIC® J38 Lighter	208

LIGHTER CASES

BIC® Styl'it Luxury Case	212
BIC® Aluminium Flat Case	214
BIC® Clip Case	215
BIC® 3D Case	216

OTHER PRODUCTS

BIC® Pocket Ashtray	218
---------------------	-----

BIC® PACKAGING 220

BIC® Packaging Ecolutions	222
BIC® Packaging	224

GENERAL INFORMATION 228

Make it simple!	230	General information	234
48-hour printing service	231	Product index	235
Symbols and abbreviations	232	Colour table	236

**Hello
again!**

Introductions usually come first and then we get to know each other. But there are always exceptions and this is one of them. You may not realise it, but you've known us for a long time.

Because that's exactly what we do. We make it look like nothing is happening and everything is flowing smoothly. We're talking about essential products in consumers' daily lives.

To be more precise, we could say that we create safe, high-quality, affordable and reliable products. For example, right now you might have one of our pens in your hand or one of our lighters in your pocket.

But that's not all. Let's take it to the next level: the pen you're holding is a personalised pen. It bears a customised logo, phrase or design. And you like it. You connect with it.

You see, that's exactly what we do at BIC Graphic: we offer a fast, sustainable, personalised service and a wide range of products and printing techniques so that you can add value to your brand and communicate its values. And make the most of a powerful communication tool. To connect.

And connecting is not just about what is done, but how it's done. In our case, it's based on the values of integrity, responsibility, sustainability, simplicity, ingenuity and teamwork. The what and how come together.

So, we say hello again. You knew us, but just didn't know it. In fact, you've known us for some time because there's no denying that we've been around for a long time and we're probably the first name that comes to mind for "a brand that sells pens and lighters". We've been in your life for a long time and our designs have always been with you. That's a fact.

So now you know us a little better. Just turn the page and it will be our pleasure to share with you a world of values, people and life that we're passionate about.

Hello again.

Think BIC

The icon, in icons.

When a brand becomes an icon, the scenario suddenly changes. The bar is raised. There comes a time when words are superfluous and only facts matter. This objective approach is not subject to anyone's interpretation.

That's what makes an icon.

Certifications



ISO CERTIFIED
ISO 9001 - ISO 14001



GOLD
RATING



CO2 NEUTRAL
WEBSITE



AUDITED BY
COCA-COLA



IMPRIM'VERT
LABEL



MEMBERS OF THE
UN GLOBAL
COMPACT



AUDITED BY WCA



AMFORI MEMBERS AND
AUDITED BY BSCI



SEDEX MEMBERS AND
AUDITED BY SMETA

Iconic and innovative

This constant vocation for innovation is manifested in the implementation of new product personalisation techniques, the launch of more sustainable and better quality products, and new special and trend-setting finishes for the most iconic products. A globally recognisable brand and an icon on the cutting edge for its innovative spirit.

Trusted

The brand is also a benchmark in terms of its compliance with the highest quality and safety standards, not to mention its social, environmental and ethical commitment.

Close to you

Local production, closer to you, to reduce the carbon footprint. We're close by and anticipate your needs by offering the maximum level of product personalisation, along with digital tools to make personalisation configuration as convenient as possible.

How does a brand become an icon?

In our case, BIC began simply. It's what we call pure, joyful simplicity: offering simple, straightforward solutions that make life easier.

It all starts with a quick movement: someone reaches, retrieves a pen from the bottom of a pocket and draws a sketch on a piece of paper or writes something down. A small, universal movement. Something we've all done at one time or another. And that's how that pen became something different: it turned into the symbol of that moment of inspiration. It became an icon.

MoMA

2001 - BIC® CRISTAL® IS INCLUDED IN THE MUSEUM OF MODERN ART (MOMA), NEW YORK.

The BIC® Cristal® ballpoint pen is considered the handwriting instrument with the best design in the world, which is why it has been in the MoMA permanent collection since 2001.

Centre Pompidou

2006 - BIC IS INCLUDED IN THE COLLECTION OF THE MUSÉE NATIONAL D'ART MODERNE, PARIS.

The BIC® Cristal® ballpoint pen, the large BIC® pocket lighter and the BIC® Classic Original and Classic Sensitive razors were included in the permanent collection of the Musée National d'Art Moderne - Centre de Création Industrielle - Centre Georges Pompidou, Paris.



1973



1950



1975

A house, a tree, a poem.

Think of everything that can be
imagined with a pen in your hand.

The tip of the pen you're holding comes into contact with the sheet of paper. You imagine something and your hand draws it. A panther? A stadium? A tooth? Anything you can imagine. This drawing is the perfect representation of how the brand became an icon.

The same is true of the collection of 250 pieces by internationally renowned artists that were created or inspired by BIC® products. Just like the BIC® products that have inspired prestigious brands around the world:

Just imagine.

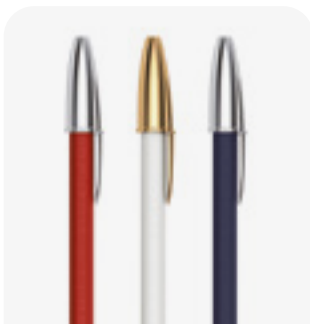

BIC BALLPEN AND PINEL & PINEL

BIC® Cristal covered in leather
by Maison Pinel & Pinel.



BIC & TOURNAIRE BALLPEN

A limited series (500 pcs) of
numbered BIC® 4 Colours®
ballpens. Each pen is handmade
like a piece of jewellery by Maison
Tournaire.

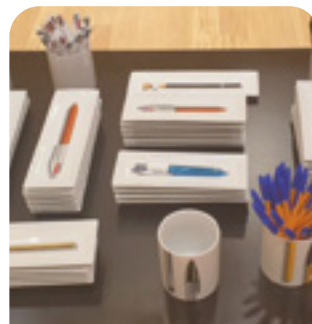

CERAMIC PEN TRAYS

Since 2016, the French artist
Catherine Courty-Truelle has
been creating ceramic pen trays,
each featuring a BIC® writing
product.

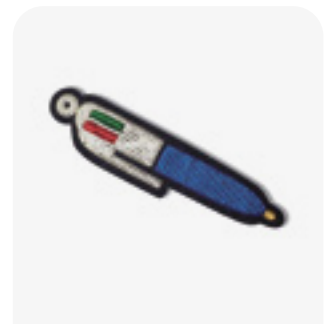

A HAND-EMBROIDERED BROOCH BY MACON & LESQUOY

French designers Macon &
Lesquoy expanded their range
with two hand-embroidered
brooches in the shape of a BIC®
Cristal® and a BIC® 4 Colours® pen.



01. Ubuntu - Astral Msekeli 02. CICLOTRAMA 115 - Janaina Mello Landini 03. Timmy - The Kid 04. La Collection BIC au 104 : sublimation du basique 05. THE BIC CONTEMPORARY ART COLLECTION.

Times change, but the spirit remains.

Think about it: the world was very different almost a century ago. What could lead a couple of young people to create a project to provide simple solutions for people's everyday lives? Probably a good number of ideas and meetings, a handful of decisions and plenty of analysis. But, more than anything, a great spirit of innovation.

A lot was happening at that time. Some say that everything has really changed, yet one thing has remained the same.

1944

Marcel Bich founds the PPA Company (Porte-plume, Porte-mines et Accessoires, or Penholder, Mechanical Pencils and Accessories) in Clichy-la-Garenne (France), thus laying the foundations of the BIC® Group.

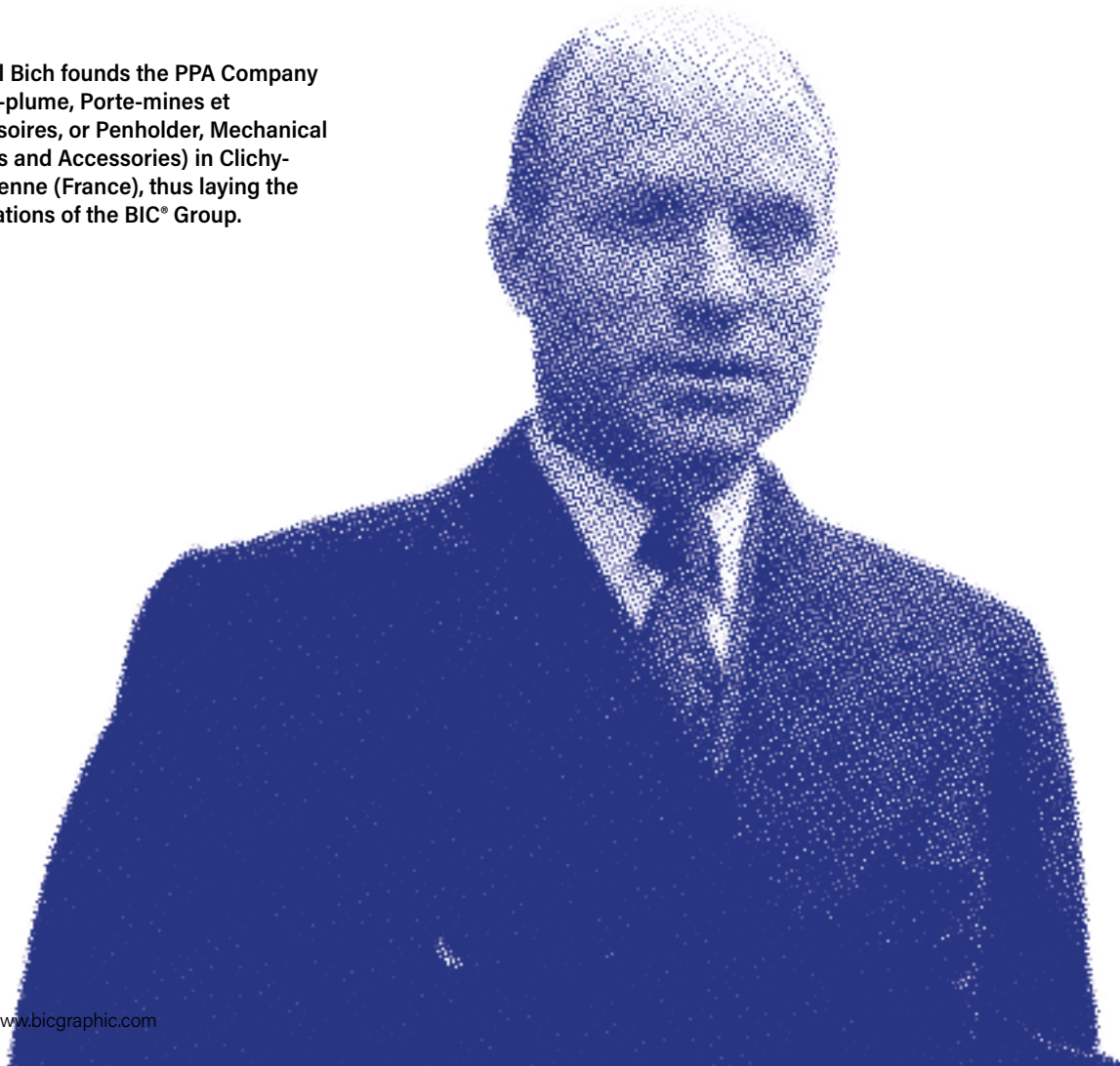

1950
The BIC® brand is born.

Launch of the BIC® Cristal® in France.



1951
First exports (to Belgium).



1954
BIC enters Italy.

A licensed manufacturing unit is opened in Spain to serve the Iberian Peninsula.

1956
First steps in Brazil.



1957
Acquisition of the English group Biro Swan, which opens up BIC® to sterling area markets.

1958
Establishment in the United States and consolidation in North Africa and the Middle East.

1961
Launch of a new tip made of tungsten carbide.

Raymond Savignac designs the "BIC boy", which is placed next to the BIC name to create the brand logo.



1969
Launch of BIC Graphic, the promotional product division.

1970
Launch of the BIC® 4 Colours.



1972
Société BIC is listed on the Paris Stock Exchange.

1973
Launch of the first BIC® Maxi lighter.



1975
Launch of the first BIC single-blade one-piece razor.



1995
Consolidation of the Eastern and Central European market.

Expansion of BIC Graphic's advertising printing business in Europe.

2001
The BIC® Cristal® ballpen is on display at the MoMA in New York.

MoMA



2003
Launch of the BIC sustainable development programme.

2016
Creation of the BIC Corporate Foundation for Education.



2017
In collaboration with Plas Eco, launch of the Plas Eco range of furniture made from recycled pens.



2018
Exhibition of the BIC Contemporary Art Collection.

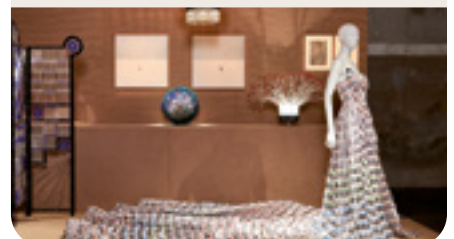

2020
Acquisition of Rocketbook, a brand of smart reusable notebooks.



2022
Acquisition of INKBOX, a leading manufacturer of high quality semi-permanent tattoos, and Tattly, a manufacturer of high-quality, cleverly designed temporary tattoo stickers.



2022
BIC® acquires AMI (Advanced Magnetic Interaction), a small French company specialising in augmented interaction technology and the creator of the ISKN Repaper drawing tablet, which allows users to display writings and drawings on paper in electronic format.



Why do we trust the people we trust?

Many things make you trust those you trust. It's never just one thing, but many.

Some are tangible and easy to see. They come in the form of sales figures that reflect leadership and demonstrate that we are consumers' brand of choice and have been for more than 50 years. They are the result of local production, products of proven quality, and of always being there, providing sustainable, competitive solutions.

But there are other things that cannot be touched because they come from pure emotion.

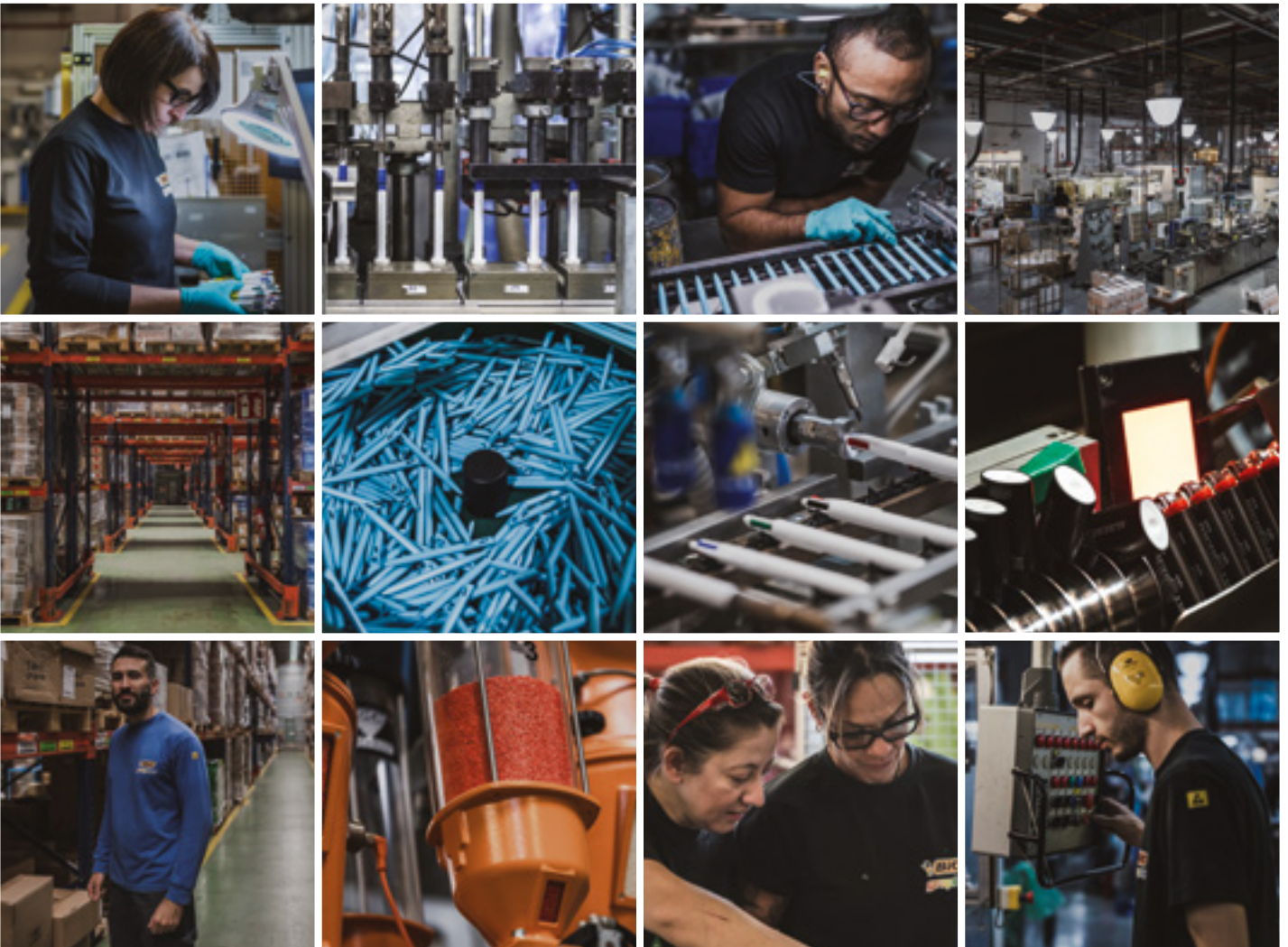

91 %

Of products are produced by the BIC® Group.

24

Factories on four continents.

15,898

Worldwide employees.

100 %

Of writing instruments are printed at BIC® Graphic Europe.

26 M.

BIC® products are chosen every day all over the world.

CSR before all the talk about CSR.

First, the facts.

For more than 75 years, we've been working on actions to support education because we believe it's an essential and fundamental human right. In this context, the BIC Corporate Foundation was created in 2016 to support educational initiatives around the world, primarily through three types of actions: providing grants and product donations, volunteering in our communities and forming global partnerships.

One of the most relevant initiatives in recent years has been the annual BIC Global Education Week, in which team members actively work for one week to improve learning conditions around the world through specific volunteer activities. Those are the facts.

And now, the words.

Three specific words make up the concept that everyone's talking about: Corporate Social Responsibility. But let's make one thing clear: while there's currently plenty of talk about CSR, we've actually been taking action in the true spirit of corporate social responsibility for many years.

Facts first and then words.





Being truly sustainable involves thinking beyond the obvious.

Let's do it. Let's think beyond the obvious by starting with something easy: let's travel back in time. Specifically, to 20 years ago. At that time, very few people were talking about sustainability, yet our approach as a brand was already based on sustainable development.

That was just the beginning. Actions to foster product innovation, such as the Origin line made from 100% Bio-Based materials, taking action against climate change and saving the environment. All this has been achieved by proactively involving supplier companies.

Today, sustainability is a fundamental part of our business, another demonstration of our commitment to thinking beyond the obvious and acting as a responsible company.



B GUARD

BIO BASED
ANTIBACTERIAL*

From words to actions.

If we say "Writing the future together", some might think it's just a pretty phrase. That is certainly not the case. It is an ambitious sustainable development programme with clearly measurable targets for 2025.

Let's go through them one by one



Fostering sustainable innovation in BIC® products.



Acting against climate change.



Committing to a safe work environment.



Proactively involving suppliers.



Improving lives through education.

Our commitment goes beyond trends and specific contexts. We are committed to facts.



Our most recent industry awards:



1st PLACE IN
Economic Excellence
Social Initiative
Sustainable Products

2nd PLACE IN
Social Initiative

3rd PLACE IN
Environmental Initiative



***Writing
the future
together***



Imagine what you can do with just a handful of used pens.

Imagine. Imagine harder;
let your imagination run wild.



Because a handful of used pens is much more than that. It makes sense, since 100% of BIC® writing instruments are recyclable thanks to Ubicuity™.

Welcome to the future!

This means travelling in time. To the needs that consumers don't know they'll have yet. Because that's innovation: anticipating dreams and desires. And doing it with a "consumer-centred" approach, which involves thinking about the consumer or, better yet, thinking like a consumer.

This translates into the development of technologies that enable sustainable production processes and help reduce the carbon footprint; the latest printing technologies; solutions to make more long-lasting products; and functional features that contribute to design excellence.

The future is not here yet. But we've already settled in and there's plenty of room for you.

Welcome.

NEW!

THE FUTURE IS ORIGIN

If there's one thing we know about the future, it's that it will have to be green. That's why eco-design plays such an important role when it comes to innovation, and that's why we've been working in this direction for more than 20 years.

ORIGIN 



Organic castor oil



Wood sawdust

From sustainably managed European forests



Talc

Mined in Europe



To be or not to be

In the context of our product innovation and commitment to ecodesign, we're beginning a new stage with **Origin** products made from bio-based materials composed of natural polymers not based on petroleum or other fossil fuels.

To be or not to be. It also applies to us, who have been pioneers in sustainability since before everyone was talking about how important it was to be sustainable. To be or not to be, that is the question.

We made the decision to be sustainable a very long time ago.

Printing techniques

QUALITY CONTROL TESTS

Our product customization process is regulated by strict quality controls, is in accordance with all EU regulations and passes 5 different quality tests:

- Adhesion Test
- Scratch test (ISO 12137:11)
- Abrasion Test
- Tumble Test
- Exposure to artificial perspiration test

Every imprinted order passes 4 different quality controls:

- Cosmetic appearance control
- Imprint colour control
- Imprint adherence control
- Resistance to scratching





With more than 50 years of experience as a guarantee!

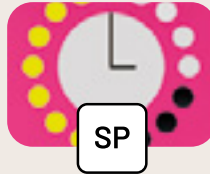

SP

Screen printing

Perfect technique for creating high-quality prints and exact colour matches.



BP

BritePix™ Personalisation

BritePix™ personalisation. Personalise each unit within the same britePix™ order.



BP

BritePix™ Texture

BritePix™ Texture is a fresh addition to our britePix™ concept: now you don't just see the full colour – you can feel it!

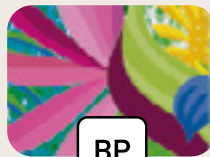

BP

BritePix™

Full-colour with photographic excellence, producing a durable imprint that ensures lasting impressions of your logo.



BP

BritePix™ Digital

The solution for full-colour communication. Now on coloured barrels!



PG

Puffy Glitter

Embellish your designs with the shimmering effect of glitter. See and feel its coloured glitter texture.



P

Puffy

Highlighted personalisation that gives a relief effect to your logo.



BR

Brilliant

Choose the brilliant finish for a dazzling final effect.



M

Metallic

Create great effects! Metallic effects in texts, images and backgrounds.

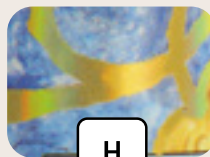

H

Holographic

Stand out from the crowd! Play with gold or silver reflections in your design.



MT

Matt

Use the matt finish to add a touch of elegance to your design.



UV

UV

Highlight your brand with a high-gloss finish! Combine a matt and gloss finish to highlight contrasts.

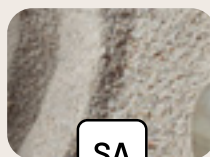

SA

Sandy

Create a sand effect with a grainy texture.



LE

Laser

Laser engraving brings elegance to your communication. Use it to make a lasting impression.

The solution for full colour communication

britePix™

**BIC GRAPHIC EUROPE THE
PIONEER IN DIGITAL PRINTING**



BritePix™ Texture

BritePix™ Texture is a fresh addition to our britePix™ concept: now you don't just see the full colour - you can feel it!



BritePix™

Full-colour with photographic excellence, producing a durable imprint that ensures lasting impressions of your logo.



BritePix™ Digital

The solution for full colour communication. Now on coloured barrels!



BritePix™ Personalisation

Personalise each unit within the same britePix™ order.



BIC® Evolution® Evolutions®



BIC® Media Clic



BIC® Round Stic®



BIC® Clic Stic



BIC® Wide Body™



BIC® 4 Colours®



BIC® Super Clip Advance



360°
printing area



Colourful



Photo quality



High Definition



Unlimited and
enhanced colours

BIC Graphic: our commitment to the environment

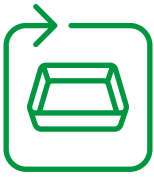

Made from the scrap of fruit and vegetables trays.



BIC® WIDE BODY™
ECOLUTIONS®

BIC® CLIC STIC
ECOLUTIONS®

BIC® ROUND STIC®
ECOLUTIONS®



Made from pharmaceutical waste.



BIC® PERMANENT
MARKER
ECOLUTIONS®

BIC® MATIC®
ECOLUTIONS®



Made from the scraps of plastic car parts.



BIC® MEDIA CLIC
GRIP ECOLUTIONS®

BIC® MEDIA CLIC
ECOLUTIONS®

BIC® SUPER CLIP
ECOLUTIONS®

**OUR ECOLUTIONS®
RANGE, MADE
FROM SUSTAINABLE
MATERIALS**

- Recycled and recyclable materials
- Bio-Based materials
- Paper from sustainable forests (FSC)
- Recycled paper



**BIC® MEDIA CLIC
BIO-BASED
ECOLUTIONS®**



Made from
sugar cane.



**SPROUT™
GRAPHITE PENCIL**



FSC and recyclable
cardboard.



**BIC® EVOLUTION®
ECOLUTIONS®**



Made from
recycled fridges
and yogurt pots.

BIC® Packaging Ecolutions®, sustainable packaging

The days of good intentions are long gone. We have entered the age of getting things done. In 2004, BIC® launched its first sustainable development plan. It established a set of principles that are now more relevant than ever. And that led to other things, such as more sustainable solutions for our packaging, made from 100% recycled material and designed to be reused to reduce the ecological footprint.

ECOLOGICAL VALUE

- Reduced and optimized recycled and recyclable materials.
- Reduced carbon footprint.
- Designed to have multiple uses.

SUSTAINABLE MATERIALS

- 100% Recycled cardboard.
- Plastics such as PET, PP or PS that are 100% recyclable.
- Raw materials from sustainable forests (FSC).

To find out more, see page 222.

SOCIAL VALUE

- Supporting agro-local projects in Kenya thanks to the BIC Graphic forest and Tredom.



The packaging with the Tredom® logo is contributing to the creation of the BIC Graphic Forest in Kenya. Thanks to your support, with this campaign, we can improve the environment (reducing the carbon footprint) and support agro-forestry projects that implement sustainable ecosystems.

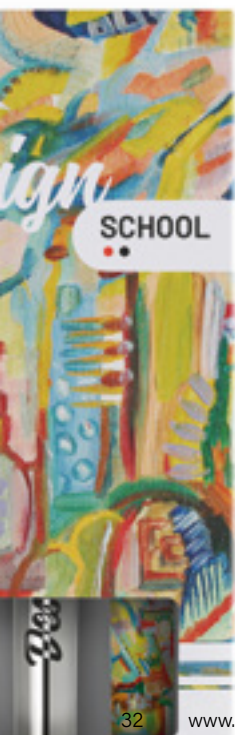

Recycled/recyclable cardboard
Recyclable plastics



FSC Raw materials



-90,100 KG CO₂
The trees we have chosen to plant can absorb enough CO₂ from the atmosphere to fill up 469 trucks!



Made in Europe

New special boxes for BIC® products

FSC cardboard box, customizable on each side and offering large communication surfaces. Ideal for combining our iconic BIC® products as a collection. More than a pen, a great way to optimize your sales.

BIC® COLLECTION BOX

Special packaging for:

- BIC® 4 COLOURS®**
- BIC® WIDE BODY™**
- BIC® SUPER CLIP**
- BIC® BRITE LINER® GRIP**
- BIC® GRIP ROLLER**



**BIC® COLLECTION
BOX 1 UNIT**
991212

**BIC® COLLECTION
BOX 2 UNITS**
991213

**BIC® COLLECTION
BOX 3 UNITS**
991214

Introducing a new refill service for your pen.

Think of the pleasant feeling of holding the pen that's just right for you. You use it so much that it eventually runs out of ink. Now you can extend the life of your BIC® 4 Colours® or even your BIC® Super Clip Advance with our new refill service. If you think about it, it's a sustainable solution that's consistent with our way of thinking. It should come as no surprise. And yet it does...



BIC® SUPER CLIP ADVANCE

BIC® 4 COLOURS®

Refill service on request.
Ask your sales representative about this new service.

NEW!

Recycle



Contents

01

BIC®

WRITING

INSTRUMENTS

BALLPENS

BIC® Style	38
BIC® Round Stic®	42
BIC® Round Stic® BGuard™ antibacterial	48
BIC® M10® Clic	50
BIC® Media Clic	52
BIC® Media Clic Grip	58
BIC® Media Clic BGuard™ antibacterial	63
BIC® Media Clic BGuard™ antimicrobial Ecolutions®	66
BIC® Media Clic Bio-Based Ecolutions®	68
BIC® Media Clic Bio-Based BGuard™ antibacterial	71
BIC® Media Clic Shine	73
BIC® Media Clic Glacé	74
BIC® Clic Stic	76
BIC® Clic Stic BGuard™ antibacterial	84
BIC® Clic Stic Stylus BGuard™ antibacterial	86
BIC® Super Clip	88
BIC® Super Clip BGuard™ antibacterial	94
BIC® Super Clip Advance	96
BIC® Super Clip Glacé	100
BIC® Super Clip Glacé Advance	100
BIC® Super Clip Soft	102
BIC® Super Clip Soft Advance	102
BIC® Super Clip Origin	104
BIC® Wide Body™	106
BIC® Wide Body™ BGuard™ antibacterial	112
BIC® 4 Colours®	114
BIC® 4 Colours® Soft	118
BIC® 4 Colours® Wood Style	120
BIC® 4 Colours® Sun	122
BIC® 4 Colours® Fashion	124
BIC® 4 Colours® Shine	126
BIC® 4 Colours® Glacé	128
BIC® 4 Colours® Fine	130
BIC® 4 Colours® Fluo	131
BIC® 4 Colours® 3+1 ^{HB}	132

METALLIC PENS

BIC® Metal Pro	134
BIC® Cristal® Re'New™	138

ROLLERS AND GELS

BIC® Grip Roller	142
BIC® XS Finestyle	146
BIC® Intensity® Gel Clic	148

HIGHLIGHTERS AND MARKERS

BIC® Brite Liner® Grip	152
BIC® Velleda® White Board Marker Fine	154
BIC® Velleda® White Board Marker Grip	155
BIC® Mark-It Permanent Marker	156
BIC® Permanent Marker Ecolutions®	157

MECHANICAL PENCILS

BIC® Matic®	160
BIC® Media Clic Mechanical pencil	52
BIC® Media Clic Grip Mechanical pencil	58

PENCILS

BIC® Evolution® Ecolutions®	164
Sprout™ Graphite pencil	168

BIC® STYLE

**Worldwide recognised
BIC® cap shape.**

**The BIC® Style
offers excellent
value for money.**



BIC® STYLE

1610 Opaque

Colour ink



01/01

01/03

01/04

01/02

02/02

04

10

100%

●
Only available
in black ink

●
Only available
in blue ink

●
Only available
in black ink

SPECIFICATIONS



MANUFACTURED
AND PRINTED IN
BIC FACTORIES



REGULATORY
COMPLIANCE



IMPRIM'VERT®



100%
RECYCLABLE



100% RENEWABLE
ELECTRICITY

WRITING MODES



BALLPEN M

**PRINTING
TECHNIQUES**



SCREEN PRINTING

See page 233 for a detailed explanation of the icons

BIC® STYLE

1610 Clear

Colour ink



Decoration

BIC® STYLE

1610 Opaque
A SP: max. 2 col.

BIC® STYLE

1610 Clear
B SP: max. 1 col.

MOQ 500 units

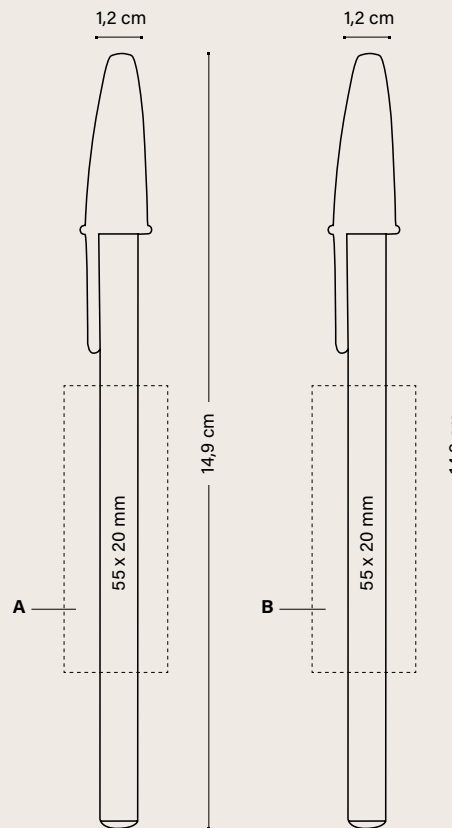

	Price (€)			
BIC® STYLE	500-999	1000-2499	2500-4999	5000
1610				
SP	0,48	0,43	0,41	0,39

Additional imprint charge per colour & position				
SP	0,14	0,14	0,14	0,13

Prices include one colour in screen printing in one position.

OPTIONAL SPECIAL PACKAGING



PLASTIC POUCH

+ INFO PAGES 222 TO 227

EXTERNAL PACKAGING



SPECIFICATIONS



MANUFACTURED AND PRINTED IN BIC FACTORIES



REGULATORY COMPLIANCE



ISO certified



100% RECYCLABLE

WRITING MODES



BALLPEN M

PRINTING TECHNIQUES



SCREEN PRINTING

BIC® ROUND STIC®

**The iconic BIC® Round Stic®
offers a timeless style and
high quality.**

**Its classic design
is easy to identify
and symbolises
long-term reliability.**



BIC® ROUND STIC®



*Embossed
iconic BIC® brand!*

BIC® ROUND STIC®

1010 Opaque

Colour ink



Red Ink available under request



12



05



07



18



02



03



100%

*360°
Printing*

*Only available
on white barrel*



SPECIFICATIONS



**MIX &
MATCH**



PERSONALIZED
COLOURS



MANUFACTURED
AND PRINTED IN
BIC FACTORIES



MADE
IN SPAIN



REGULATORY
COMPLIANCE



**ISO
certified**



100%
RECYCLABLE



100% RENEWABLE
ELECTRICITY



LOW ENVIRONMENTAL
IMPACT

WRITING MODES



BALLPEN M

PRINTING TECHNIQUES



SCREEN PRINTING



DIGITAL

See page 233 for a detailed explanation of the icons

BIC® ROUND STIC®

1010 Frosted

Colour ink

● ● ●

Red Ink available under request



ECO version and standard at the same price!

ecolutions®
 MADE FROM 94% RECYCLED MATERIAL**

FRUIT AND VEGETABLE TRAYS



BIC® ROUND STIC®
 1E10 Opaque
 Colour ink
 ● ● ●
 Red Ink available under request



BIC® ROUND STIC®
 1E10 Frosted
 Colour ink
 ● ● ●
 Red Ink available under request



Only available on white barrel



SPECIFICATIONS



PERSONALIZED COLOURS



MANUFACTURED AND PRINTED IN BIC FACTORIES



MADE IN SPAIN



REGULATORY COMPLIANCE



ISO certified

IMPRIM'VERT®

ecolutions®



FRUIT AND VEGETABLE TRAYS



100% RECYCLABLE



100% RENEWABLE ELECTRICITY



LOW ENVIRONMENTAL IMPACT

WRITING MODES



BALLPEN M

PRINTING TECHNIQUES



SCREEN PRINTING



DIGITAL

See page 233 for a detailed explanation of the icons

*48h not available in Digital finishes.

**The percentage is calculated based on total weight of the barrel. Due to the recycled content of the raw materials used to make the product, we cannot guarantee that the colours shown in the catalogue or colours customised to order will always have the same colour and appearance.

No extra charge

BIC® ROUND STIC®

1010 / **ecolutions®** 1E10 Opaque
 1010 / **ecolutions®** 1E10 Frosted

MOQ 500 units.
 Standard colours combination

ecolutions®



FRUIT AND
 VEGETABLE
 TRAYS

Standard colours
 combination***

Plug

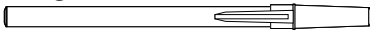

Clip

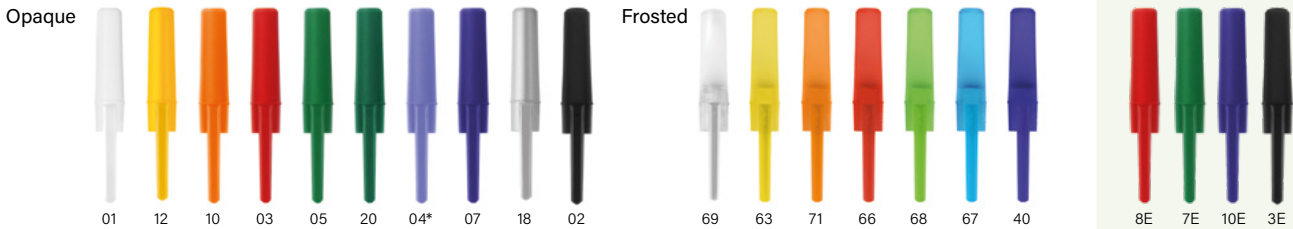
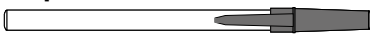

Section

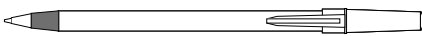

Barrel



Exact colour match: ≥ 10.000 units



Add the Möbius loop to your artwork at no additional charge. Please specify it on your order. (Möbius loop imprint defaults to left-hand corner.)

**While stocks last. **48h not available in Digital finishes.
 ***Due to the recycled content of the raw materials used to make the product, we cannot guarantee that the colours shown in the catalogue or colours customised to order will always have the same colour and appearance.*

Decoration

BIC® ROUND STIC®

1010

ecolutions® 1E10

A SP: max. 3 col.

B SP: max. 1 col.

C DG: full-colour

(Only available on white barrel)

MOQ 500 units.

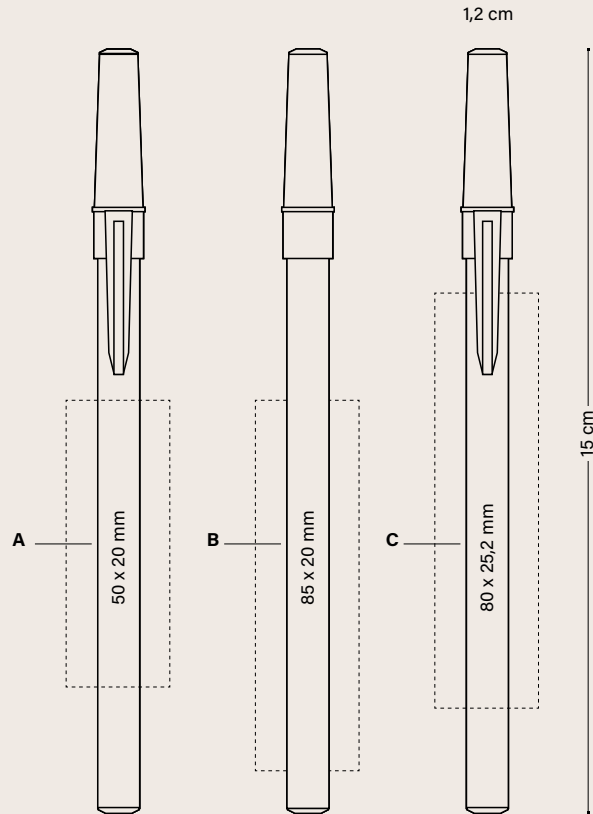

BIC® ROUND STIC®	500-999	1000-2499	2500-4999	Price (€)
1010 / ecolutions® 1E10				5000
SP	0,53	0,51	0,47	0,44
DG	0,77	0,73	0,67	0,63

Additional imprint charge per colour & position

SP	0,14	0,14	0,14	0,13
----	------	------	------	------

Prices include one imprint in one position according to specified technique.

OPTIONAL SPECIAL PACKAGING



PLASTIC
POUCH

+ INFO PAGES 222 TO 227

EXTERNAL PACKAGING



500 ± 2,5 KG

SPECIFICATIONS



PERSONALIZED
COLOURS



MANUFACTURED
AND PRINTED IN
BIC FACTORIES



MADE
IN SPAIN



REGULATORY
COMPLIANCE



ISO
certified



IMPRIM'VERT®



ecolutions®



FRUIT AND
VEGETABLE TRAYS



100%
RECYCLABLE



100% RENEWABLE
ELECTRICITY



LOW ENVIRONMENTAL
IMPACT

**WRITING
MODES**



BALLPEN M

**PRINTING
TECHNIQUES**



SCREEN PRINTING



DIGITAL

See page 233 for a detailed explanation of the icons

BIC® ROUND STIC® BGUARD™ ANTIBACTERIAL



Bacterial elimination



Entire pen protection



Timeless protection



Antibacterial Test protocol



Embossed iconic BIC® brand!

ANTIBACTERIAL™

BIC® ROUND STIC® BGUARD™ ANTIBACTERIAL

1011 Opaque

Colour ink



Red Ink available under request



07BG

02BG

03BG

01BG

360° Printing

100%

Only available on white barrel



MIX & MATCH

No extra charge

MOQ 500 units
Standard colours combination

Plug

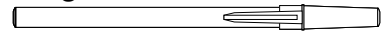

Opaque 1BG 3BG 2BG 7BG

Clip

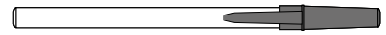

Opaque 1BG 3BG 2BG 7BG

Section

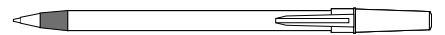

Opaque 1BG 3BG 2BG 7BG

Barrel



Opaque 1BG 3BG 2BG 7BG

Exact colour match: ≥ 10.000 units



*48h not available in Digital finishes.

Available in selected countries, please ask your customer service representative.

Decoration

**BIC® ROUND STIC®
BGUARD™ ANTIBACTERIAL**
1011

A SP: max. 2 col.
B DG: full-colour

MOQ 500 units.

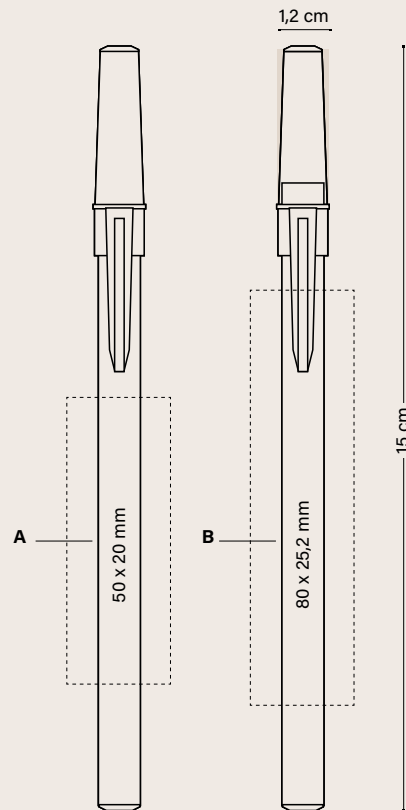

	Price (€)			
BIC® ROUND STIC® BGUARD™ ANTIBACTERIAL	500-999	1000-2499	2500-4999	5000
1011				
SP	0,61	0,58	0,53	0,50
DG	0,83	0,79	0,73	0,69

Additional imprint charge per colour & position

SP	0,14	0,14	0,14	0,13
-----------	------	------	------	------

Prices include one imprint in one position according to specified technique.

OPTIONAL SPECIAL PACKAGING



PLASTIC
POUCH

+ INFO PAGES 222 TO 227

EXTERNAL PACKAGING



500 ± 2,5 KG

SPECIFICATIONS



PERSONALIZED
COLOURS



MANUFACTURED
AND PRINTED IN
BIC FACTORIES



MADE
IN SPAIN



REGULATORY
COMPLIANCE



ISO
certified



100%
RECYCLABLE



100% RENEWABLE
ELECTRICITY



LOW ENVIRONMENTAL
IMPACT

**WRITING
MODES**



BALLPEN M

**PRINTING
TECHNIQUES**



SCREEN PRINTING



DIGITAL

See page 233 for a detailed explanation of the icons



*Embossed
iconic BIC® brand!*

BIC® M10® CLIC

1590

Colour ink



01

8G

10

14

59

04

02

3D

100%

●
Only available
in black ink

Decoration

BIC® M10® CLIC
1590

A SP: max. 2 col.

MOQ 500 units

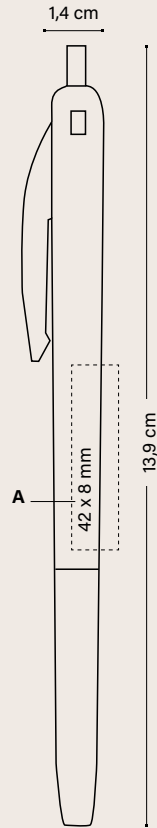

	Price (€)			
BIC® M10® CLIC	500-999	1000-2499	2500-4999	5000
1590				
SP	0,58	0,56	0,52	0,49
Additional imprint charge per colour & position				
SP	0,14	0,14	0,14	0,13

Prices include one colour in screen printing in one position.

OPTIONAL SPECIAL PACKAGING



+ INFO PAGES 222 TO 227

EXTERNAL PACKAGING



SPECIFICATIONS



MADE IN FRANCE



WRITING MODES



PRINTING TECHNIQUES



CHECK OUT THE VIDEO

See page 233 for a detailed explanation of the icons





BIC[®] MEDIA CLIC

One of the best sellers in the industry, a functional and widely recognized design, our BIC[®] Media Clic is a lasting product available in different materials. Choose between the Standard, Recycled, Bio-Based, Antibacterial and Antimicrobial. Be inspired with the wide range of finishes and colours, and match them to enhance your brand.

Ecolutions[®]

Grip

Grip Ecolutions[®]

BGuard[™] Antibacterial

BGuard[™] Antimicrobial

Bio-Based

Bio-Based BGuard[™] Antibacterial

Shine

Glacé

Mechanical pencil

britePix
DIGITAL THE SOLUTION FOR
FULL COLOUR COMMUNICATION

Now on
coloured barrels



Also in
Mechanical pencil

BIC® MEDIA CLIC

1025 Ballpen

1028 Mechanical pencil

Polished

Colour ink



Red Ink available under request



←
More than
10000 clicks!
- Increased
visibility for
your brand

360°
Printing

100%



Embossed
iconic BIC® brand!



Also in
Mechanical pencil

BIC® MEDIA CLIC
1025 Ballpen / 1028 Mechanical pencil

Frosted
Colour ink
● ● ●

Red Ink available under request



SPECIFICATIONS



PERSONALIZED
COLOURS



MANUFACTURED
AND PRINTED IN
BIC FACTORIES



MADE
IN SPAIN



REGULATORY
COMPLIANCE



ISO
certified



IMPRIM'VERT*



100%
RECYCLABLE



100% RENEWABLE
ELECTRICITY



LOW ENVIRONMENTAL
IMPACT

WRITING
MODES



BALLPEN M

PRINTING
TECHNIQUES



SP
SCREEN PRINTING



DG
DIGITAL

* 48h not available in Digital finishes.
Mechanical pencil 1028 available in: 3B, 63, 71, 39, 67.



*Embossed
iconic BIC® brand!*



*Also in
Mechanical pencil*

BIC® MEDIA CLIC

1025 Ballpen / 1028 Mechanical pencil

Opaque

Colour ink



Red Ink available under request



SPECIFICATIONS



PERSONALIZED COLOURS



MANUFACTURED AND PRINTED IN BIC FACTORIES



MADE IN SPAIN



REGULATORY COMPLIANCE



IMPRIM'VERT®

ecolutions®



PLASTIC CAR PARTS



RECYCLABLE



100% RENEWABLE ELECTRICITY



LOW ENVIRONMENTAL IMPACT

WRITING MODES



BALLPEN M

PRINTING TECHNIQUES



SCREEN PRINTING



DIGITAL

ECO version and standard at the same price!

ecolutions®



MADE FROM 92% RECYCLED MATERIAL***



PLASTIC CAR PARTS

BIC® MEDIA CLIC

1E25 Ballpen

Opaque

Colour ink



360° Printing

100%

3E

1E

Only available on white barrel



*While stocks last**48h not available in Digital finishes.

***The percentage is calculated based on total weight of the barrel. Due to the recycled content of the raw materials used to make the product, we cannot guarantee that the colours shown in the catalogue or colours customised to order will always have the same colour and appearance.

See page 233 for a detailed explanation of the icons

BIC® MEDIA CLIC / BIC® MEDIA CLIC GRIP

BIC® MEDIA CLIC

1025 Ballpen

Clear

Colour ink



1R*



4D



92



93



72*

100%



*Also in
Mechanical pencil*

BIC® MEDIA CLIC GRIP

1020 Ballpen / 1021 Mechanical pencil

Opaque

Colour ink



*360°
Printing*

01/12

100%

*Only available
on white barrel*



BIC® MEDIA CLIC GRIP



Also in
Mechanical pencil

BIC® MEDIA CLIC GRIP

1020 Ballpen / 1021 Mechanical pencil

Frosted

Colour ink



01/69

69/69

71/69

82/69

40/69

100%



Also in
Mechanical pencil

ECO version and
standard at the
same price!

ecolutions®

MADE FROM 92%
RECYCLED MATERIAL***



PLASTIC
CAR PARTS

BIC® MEDIA CLIC GRIP

1E20 Ballpen / 1E21 Mechanical pencil

Opaque

Colour ink



01/12

01/03

01/05

01/02



01/07

100%

SPECIFICATIONS



MIX &
MATCH



PERSONALIZED
COLOURS



MANUFACTURED
AND PRINTED IN
BIC FACTORIES



MADE
IN SPAIN



REGULATORY
COMPLIANCE



ISO
certified

IMPRIM'VERT®

ecolutions®



PLASTIC
CAR PARTS



100%
RECYCLABLE



100% RENEWABLE
ELECTRICITY



LOW ENVIRONMENTAL
IMPACT

WRITING MODES



BALLPEN M

PRINTING TECHNIQUES



SCREEN PRINTING



DIGITAL

**48h not available in Digital finishes.

***The percentage is calculated based on total weight of the barrel. Due to the recycled content of the raw materials used to make the product, we cannot guarantee that the colours shown in the catalogue or colours customised to order will always have the same colour and appearance.

BIC® MEDIA CLIC BALLPEN

BIC® MEDIA CLIC

1025 Ballpen / **ecolutions®** 1E25 Ballpen

BIC® MEDIA CLIC GRIP

1020 Ballpen / **ecolutions®** 1E20 Ballpen



No extra charge

MOQ 500 units

ecolutions® Standard colours combination

Plug



Opaque



Frosted



Clip

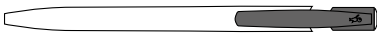

Opaque

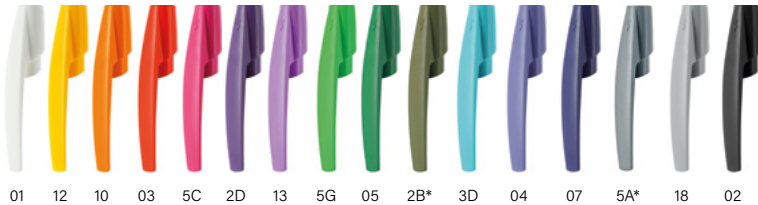

Frosted



Barrel



Opaque

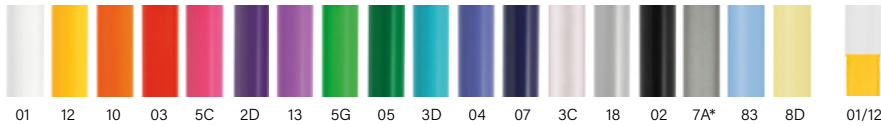

Frosted

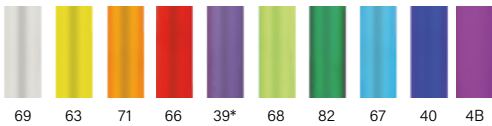

Polished

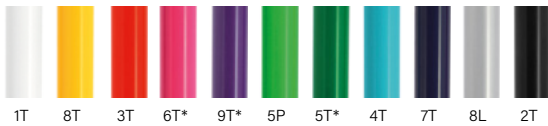

Clear

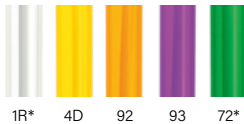

Barrel & Grip

Barrel & Grip

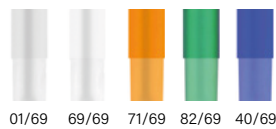

Standard colours combination***

Opaque



Barrel & Grip Opaque

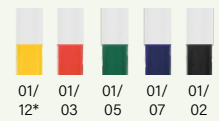

Add the Möbius loop to your artwork at no additional charge. Please specify "Print the Möbius loop" on your order. (Möbius loop imprint defaults to left-hand corner.)

Exact colour match: ≥ 10.000 units 1025/1E25

Exact colour match: ≥ 20.000 units 1020/1E20



britePix DIGITAL THE SOLUTION FOR FULL COLOUR COMMUNICATION!

SPECIFICATIONS



PERSONALIZED COLOURS



MANUFACTURED AND PRINTED IN BIC FACTORIES



PLASTIC CAR PARTS



100% RECYCLABLE

WRITING MODES



BALLPEN M

PRINTING TECHNIQUES



SCREEN PRINTING



DIGITAL

BIC® MEDIA CLIC MECHANICAL PENCIL

BIC® MEDIA CLIC
1028 Mechanical pencil

BIC® MEDIA CLIC GRIP
1021 Mechanical pencil / **ecolutions®** 1E21 Mechanical pencil



No extra charge

MOQ 500 units
Standard colours combination

Clip

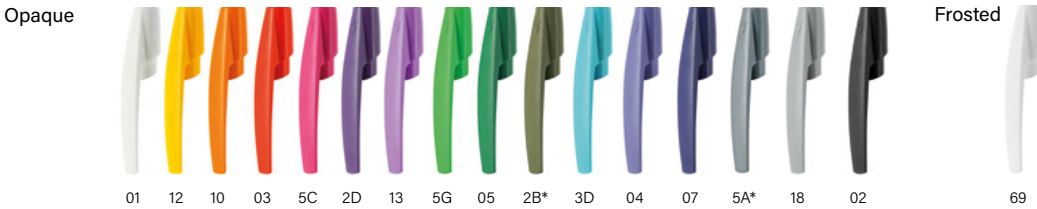
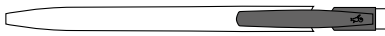

Barrel

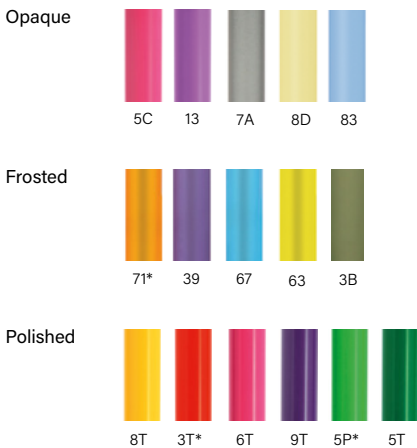

All colour range available in Digital britePix™

Exact colour match: ≥ 10.000 units 1028
Exact colour match: ≥ 20.000 units 1021 / 1E21



Barrel & Grip

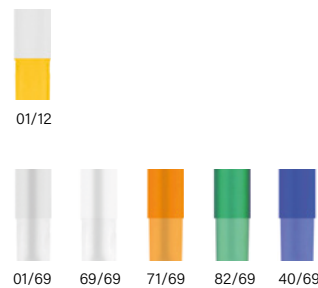

THE SOLUTION FOR
**FULL COLOUR
COMMUNICATION!**

ecolutions®



Standard colours combination***

Barrel & Grip

Opaque



Add the Möbius loop to your artwork at no additional charge. Please specify "Print the Möbius loop" on your order. (Möbius loop imprint defaults to left-hand corner.)

SPECIFICATIONS



WRITING MODES



PRINTING TECHNIQUES



See page 233 for a detailed explanation of the icons. *While stocks last **48h not available in Digital finishes.
***Due to the recycled content of the raw materials used to make the product, we cannot guarantee that the colours shown in the catalogue or colours customised to order will always have the same colour and appearance.

Decoration

BIC® MEDIA CLIC

1025 Ballpen
1028 Mechanical pencil
eColutions® 1E25 Ballpen

A SP: max. 4 col.
B SP: max. 2 col.
C DG: full-colour

MOQ 500 units.

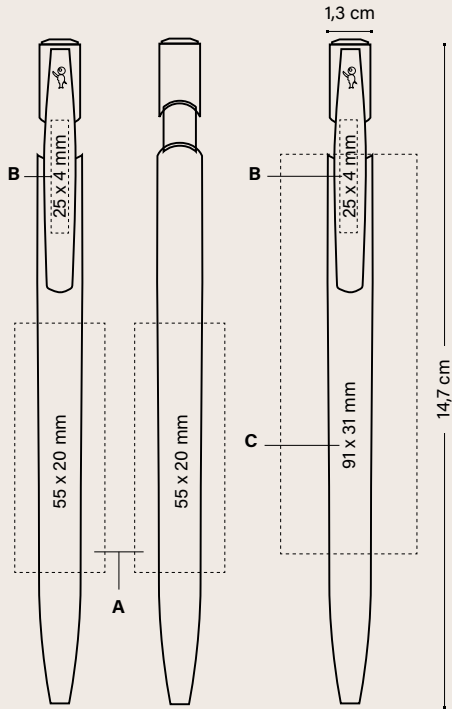

Price (€)

BIC® MEDIA CLIC	500-999	1000-2499	2500-4999	5000
1025 / eColutions® 1E25 (Ballpen)				
SP	0,65	0,58	0,54	0,50
DG	0,89	0,82	0,76	0,72
1028 (Mechanical pencil)				
SP	0,87	0,78	0,73	0,69
DG	1,03	0,94	0,87	0,83

Additional imprint charge per colour & position

SP	0,14	0,14	0,14	0,13
----	------	------	------	------

Prices include one imprint in one position according to specified technique.

OPTIONAL SPECIAL PACKAGING



ECO SLEEVE

PLASTIC POUCH

WINDOW BOX

+ INFO PAGES 222 TO 227

EXTERNAL PACKAGING



500 ± 4,1 KG

Decoration

BIC® MEDIA CLIC GRIP

1020 Ballpen eColutions® 1E20 Ballpen
1021 Mechanical pencil eColutions® 1E21 Mechanical pencil

D SP: max. 4 col.
E SP: max. 2 col.
F DG: full-colour

MOQ 500 units.

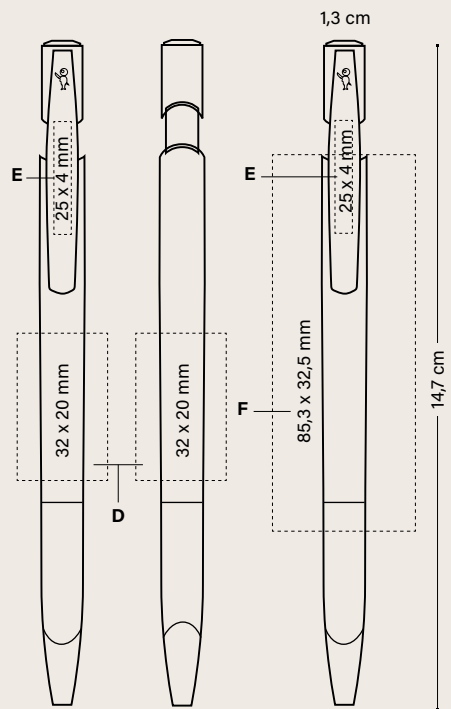

Price (€)

BIC® MEDIA CLIC GRIP	500-999	1000-2499	2500-4999	5000
1020 / eColutions® 1E20 (Ballpen)				
SP	0,90	0,84	0,79	0,73
DG	1,12	1,05	0,98	0,92

1021 / eColutions® 1E21 (Mechanical pencil)

SP	1,03	0,96	0,90	0,84
DG	1,26	1,17	1,09	1,04

Additional imprint charge per colour & position

SP	0,14	0,14	0,14	0,13
----	------	------	------	------

Prices include one imprint in one position according to specified technique.

OPTIONAL SPECIAL PACKAGING



ECO SLEEVE

PLASTIC POUCH

WINDOW BOX

+ INFO PAGES 222 TO 227

EXTERNAL PACKAGING



500 ± 4,3 KG

SPECIFICATIONS



MANUFACTURED AND PRINTED IN BIC FACTORIES



MADE IN SPAIN



PLASTIC CAR PARTS



100% RECYCLABLE

WRITING MODES



BALLPEN M

PRINTING TECHNIQUES



SCREEN PRINTING



DIGITAL

BIC® MEDIA CLIC

Antibacterial



Bacteria
elimination



Entire pen
protection



Timeless
protection



Antibacterial
Test protocol



1E27

1026

BIC® MEDIA CLIC BGUARD™ ANTIBACTERIAL

BGUARD™



Bacteria elimination



Entire pen protection



Timeless protection



Antibacterial Test protocol

britePix DIGITAL THE SOLUTION FOR FULL COLOUR COMMUNICATION!

BIC® MEDIA CLIC BGUARD™ ANTIBACTERIAL

1026: antibacterial logo

1027: SARS-CoV-2 logo

Opaque

Colour ink



Red Ink available under request



MIX & MATCH

No extra charge

BIC® MEDIA CLIC BGUARD™ ANTIBACTERIAL

1026: antibacterial logo

1027: SARS-CoV-2 logo

Opaque

MOQ 500 units

Standard colours combination

Plug

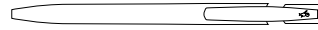

Opaque

1BG 3BG* 7BG 2BG

Clip

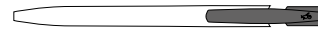

Opaque



Barrel



Opaque

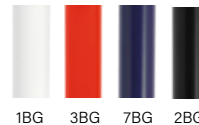

Exact colour match: ≥ 10.000 units



Iconic BIC® Boy and Antibacterial logo always visible!

ANTIBACTERIAL™

*While stocks last

Decoration:

**BIC® MEDIA CLIC BGUARD™
ANTIBACTERIAL**

1026: antibacterial logo
1027: SARS-CoV-2 logo

A **SP**: max. 2 col.
B **SP**: max. 1 col.
C **DG**: full-colour

MOQ 500 units.

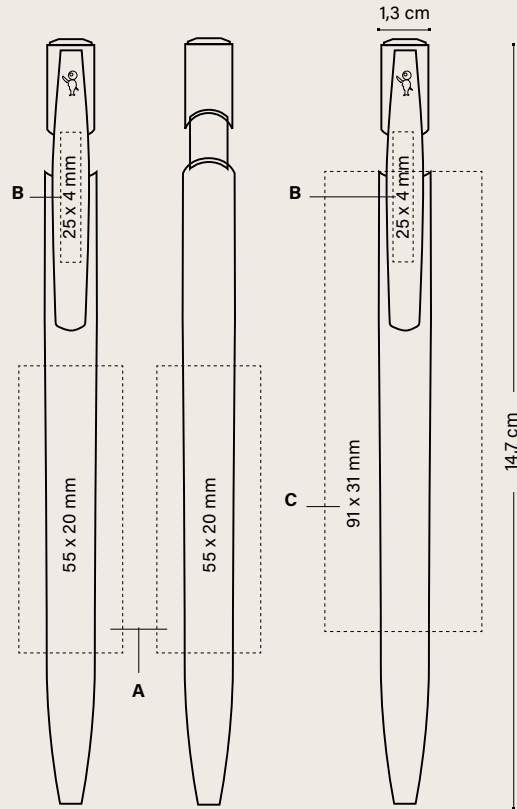

	Price (€)			
BIC® MEDIA CLIC BGUARD™ ANTIBACTERIAL	500-999	1000-2499	2500-4999	5000
1026/1027				
SP	0,72	0,64	0,60	0,55
DG	0,95	0,88	0,82	0,77

Additional imprint charge per colour & position

SP	0,14	0,14	0,14	0,13
-----------	------	------	------	------

Prices include one imprint in one position according to specified technique.

OPTIONAL SPECIAL PACKAGING



+ INFO PAGES 222 TO 227

EXTERNAL PACKAGING



SPECIFICATIONS



PERSONALIZED
COLOURS



MANUFACTURED
AND PRINTED IN
BIC FACTORIES



MADE
IN SPAIN



REGULATORY
COMPLIANCE



ISO
certified



IMPRIM'VERT®



100%
RECYCLABLE



100% RENEWABLE
ELECTRICITY



LOW ENVIRONMENTAL
IMPACT



WRITING
MODES



BALLPEN M



PRINTING
TECHNIQUES



SP
SCREEN PRINTING



DG
DIGITAL

See page 233 for a detailed explanation of the icons

BIC® MEDIA CLIC BGUARD™ ANTIMICROBIAL ECOLUTIONS®



ANTIMICROBIAL™* =



Bacteria elimination
99% en 24h

+



Viral reduction
93% in 24 h

+



Fungal inhibition
for 24 h

BGUARD™ **ecolutions®**

**MIX &
MATCH**

No extra charge

ecolutions®



MADE FROM 86%
RECYCLED MATERIAL***

PLASTIC
CAR PARTS



BIC® MEDIA CLIC BGUARD™ ANTIMICROBIAL ECOLUTIONS®

ecolutions® 1E26: antimicrobial logo

ecolutions® 1E27: SARS-CoV-2 logo

Opaque

Colour ink



Red Ink available under request



ecolutions®

PLASTIC
CAR PARTS



BIC® MEDIA CLIC BGUARD™ ANTIMICROBIAL ECOLUTIONS®

ecolutions® 1E26 / ecolutions® 1E27



Add the Möbius loop to your artwork at no additional charge. Please specify it on your order. (Möbius loop imprint defaults to left-hand corner.)

MOQ 500 units
Standard colours combination

Plug



Opaque 1BG 3BG* 7BG 2BG

Clip

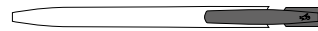

Opaque 1BG 3BG* 7BG* 2BG

Barrel



Opaque 1E 3E

Exact colour match: ≥ 10.000 units



You can also choose to print the SARS-CoV-2 reduction logo.
Ask your Customer Service representative for more information.

*99.9% of bacteria is eliminated from the surface in 24 hours (and more than 30% in 2 hours).
Tested under ISO 22196 protocol adapted to real usage of the pen.
93% of viruses, Sars-Cov-2 Coronavirus causing Covid-19 disease, are eliminated from the surface in 24 hours, (and around 50% in 2 hours).
Tested under ISO 22196 protocol adapted to real usage of the pen.
Fungi present on the surface is inhibited within 24 hours.
Tested under ISO 22196 protocol adapted to fungi and to real usage of the pen.



Entire pen protection



Timeless protection



Antibacterial Test protocol



Adapted to fungus test protocol



Antiviral test protocol

Decoration

BIC® MEDIA CLIC Bguard™ ANTIMICROBIAL ECOLUTIONS®

ecolutions® 1E26: antimicrobial logo
ecolutions® 1E27: SARS-CoV-2 logo

A SP: max. 2 col.
B SP: max. 2 col.

MOQ 500 units.

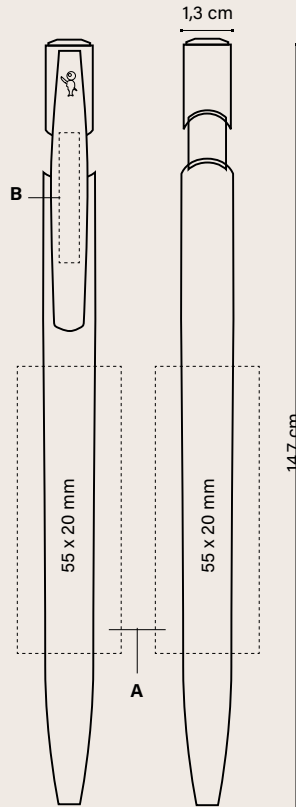

	Price (€)			
BIC® MEDIA CLIC Bguard™ ANTIMICROBIAL	500-999	1000-2499	2500-4999	5000
ecolutions® 1E26 / ecolutions® 1E27				
SP	0,78	0,71	0,67	0,59

Additional imprint charge per colour & position

SP	0,14	0,14	0,14	0,13
----	------	------	------	------

Prices include one colour in screen printing in one position.

OPTIONAL SPECIAL PACKAGING



ECO SLEEVE



PLASTIC POUCH



WINDOW BOX

+ INFO PAGES 222 TO 227

EXTERNAL PACKAGING



500 ± 4,1 KG

SPECIFICATIONS



MADE IN SPAIN



REGULATORY COMPLIANCE



ISO certified



IMPRIM'VERT®



ecolutions®



PLASTIC CAR PARTS



100% RECYCLABLE



100% RENEWABLE ELECTRICITY



LOW ENVIRONMENTAL IMPACT

WRITING MODES



BALLPEN M

PRINTING TECHNIQUES



SCREEN PRINTING

See page 233 for a detailed explanation of the icons

Available in selected countries, please ask your customer service representative.

**The percentage is calculated based on total weight of the barrel. Due to the recycled content of the raw materials used to make the product, we cannot guarantee that the colours shown in the catalogue or colours customised to order will always have the same colour and appearance.

BIC® MEDIA CLIC
BIO-BASED ECOLUTIONS®

The top priority of the ballpen life cycle is sustainability.

Made to last:

- More than 10,000 clicks
- Increased visibility for your brand
- Break resistant clip



BIO-BASED PEN

There's no more ink in the pen?
No problem, now you can compost it*.

The barrel is **100% Bio-Based**.



100% renewable electricity

Produced in our factory and printing facilities which are both powered by electricity **100% produced using renewable sources**.



LOW TRANSPORT IMPACT:

Production, printing and even raw material.



100% Recyclable
Ubicuity™

70% Bio-Based MATERIAL**

100% Bio-Based COLORANTS

BIC® MEDIA CLIC BIO-BASED ECOLUTIONS®



BIO BASED *MADE FROM 70% BIO-SOURCED** & 100% INDUSTRIALLY COMPOSTABLE MATERIAL*

ecolutions®

SUGAR CANE

BIC® MEDIA CLIC BIO-BASED ECOLUTIONS®

1972 Ballpen
 Opaque
 Colour ink
 ● ● ●
 Red Ink available under request



Available on white barrel



SPECIFICATIONS



PERSONALIZED COLOURS



MANUFACTURED AND PRINTED IN BIC FACTORIES



MADE IN SPAIN



REGULATORY COMPLIANCE



ISO certified



SUGAR CANE



100% RECYCLABLE



100% RENEWABLE ELECTRICITY



LOW ENVIRONMENTAL IMPACT

WRITING MODES



BALLPEN M

PRINTING TECHNIQUES



SCREEN PRINTING



DIGITAL

See page 233 for a detailed explanation of the icons

**The percentage is calculated based on total weight of the barrel. Due to the natural content of the raw materials used to make the product, we cannot guarantee that the colours shown in the catalogue or colours customised to order will always have the same colour and appearance.
 ***48h not available in Digital finishes.

BIC® MEDIA CLIC BIO-BASED ECOLUTIONS®



BIC® MEDIA CLIC BIO-BASED ECOLUTIONS® 1972 Ballpen Opaque

MOQ 500 units
Standard colours combination

Plug



Clip

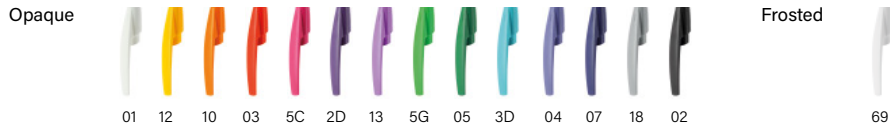

Barrel

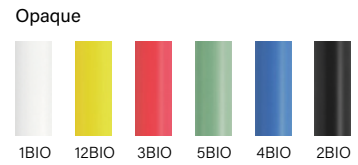

Exact colour match:
≥ 10.000 units

SPECIFICATIONS



MANUFACTURED AND PRINTED IN BIC FACTORIES



MADE IN SPAIN



SUGAR CANE



RECYCLABLE

WRITING MODES



BALLPEN M

PRINTING TECHNIQUES



SCREEN PRINTING



DIGITAL

Decoration

BIC® MEDIA CLIC BIO-BASED ECOLUTIONS®

1972

A SP: max. 2 col.

B SP: max. 2 col.

C DG: full-colour

MOQ 500 units.

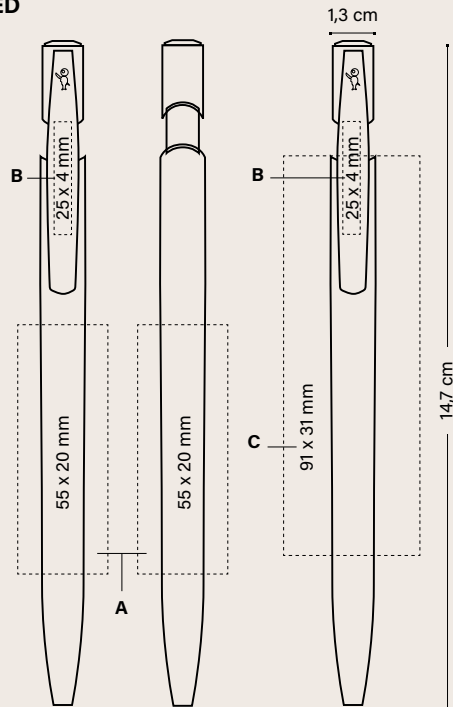

Price (€)

BIC® MEDIA CLIC BIO-BASED	500-999	1000-2499	2500-4999	5000
ecolutions® 1972				
SP	0,78	0,72	0,67	0,62
DG	1,05	0,97	0,90	0,84

Additional imprint charge per colour & position

SP	0,14	0,14	0,14	0,13
-----------	------	------	------	------

Prices include one imprint in one position according to specified technique.

OPTIONAL SPECIAL PACKAGING



+ INFO PAGES 222 TO 227

EXTERNAL PACKAGING



See page 233 for a detailed explanation of the icons

**Due to the natural content of the raw materials used to make the product, we cannot guarantee that the colours shown in the catalogue or colours customised to order will always have the same colour and appearance.

BIC® MEDIA CLIC BIO-BASED BGuARD™ ANTIBACTERIAL

BGuARD™



Bacteria elimination



Entire pen protection



Timeless protection



Antibacterial Test protocol

BIO BASED



SUGAR CANE

MADE FROM 70% BIO-SOURCED**
& 100% INDUSTRIALLY
COMPOSTABLE MATERIAL

BIC® MEDIA CLIC BIO-BASED BGuARD™ ANTIBACTERIAL

1973 Ballpen

Opaque ink

Colour ink



Red Ink available under request



04



02



05



100%

Available on
white barrel



SPECIFICATIONS



MIX & MATCH



PERSONALIZED COLOURS



MANUFACTURED AND PRINTED IN BIC FACTORIES



MADE IN SPAIN



REGULATORY COMPLIANCE



IMPRIM'VERT*



SUGAR CANE



100% RECYCLABLE



100% RENEWABLE ELECTRICITY



LOW ENVIRONMENTAL IMPACT

WRITING MODES



BALLPEN M

PRINTING TECHNIQUES



SCREEN PRINTING



DIGITAL

See page 233 for a detailed explanation of the icons

*48h not available in Digital finishes.

**The percentage is calculated based on total weight of the barrel.

Due to the natural content of the raw materials used to make the product, we cannot guarantee that the colours shown in the catalogue or colours customised to order will always have the same colour and appearance.

BIC® MEDIA CLIC BIO-BASED BGUARD™ ANTIBACTERIAL



BIC® MEDIA CLIC BIO-BASED BGUARD™ ANTIBACTERIAL
1973 Ballpen Opaque
MOQ 500 units. Standard colours combination.

Plug

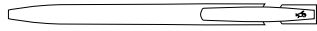

Opaque
01BG 03BG 07BG 02BG

Clip



Opaque
01BG 03BG 07BG 02BG

Barrel



Opaque
01 05 04 02

Exact colour match: ≥ 10.000 units



SPECIFICATIONS



PERSONALIZED COLOURS



MANUFACTURED AND PRINTED IN BIC FACTORIES



MADE IN SPAIN



SUGAR CANE



RECYCLABLE



BALLPEN M



SCREEN PRINTING



DIGITAL

Decoration

BIC® MEDIA CLIC BIO-BASED BGUARD™ ANTIBACTERIAL

1973

A SP: max. 2 col.
B SP: max. 2 col.
C DG: full-colour

MOQ 500 units.

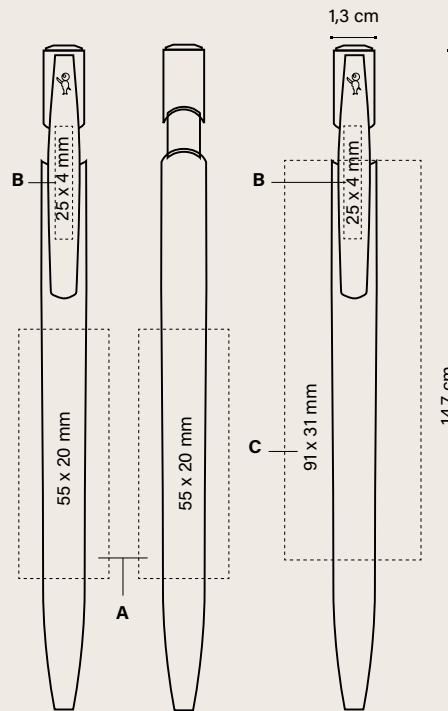

Price (€)

BIC® MEDIA CLIC BIO-BASED BGUARD™ ANTIBACTERIAL	500-999	1000-2499	2500-4999	5000
eColutions® 1973				
SP	0,86	0,81	0,73	0,68
DG	1,24	1,13	1,05	0,99

Additional imprint charge per colour & position

SP	0,14	0,14	0,14	0,13
----	------	------	------	------

Prices include one imprint in one position according to specified technique.

OPTIONAL SPECIAL PACKAGING



+ INFO PAGES 222 TO 227

EXTERNAL PACKAGING



250 ± 4,3 KG

BIC® MEDIA CLIC SHINE



BIC® MEDIA CLIC SHINE 1975 Ballpen Opaque

MOQ 500 units. Standard colours combination.

Plug

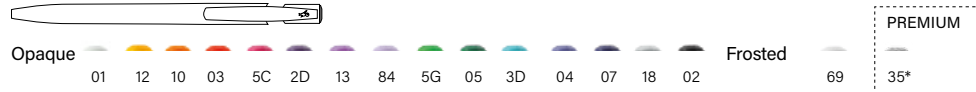

Clip

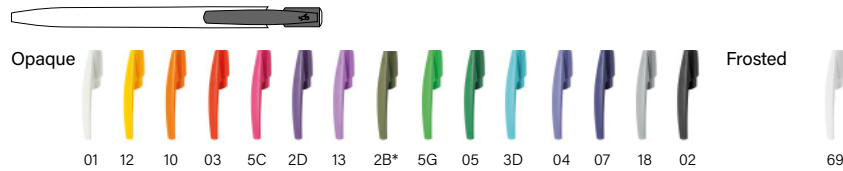

Barrel

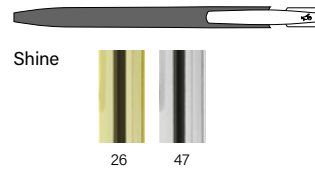

BIC® MEDIA CLIC SHINE

1975 Ballpen
Opaque

Colour ink
● ● ●

Red Ink available under request



47



26

100%

BIC® MEDIA CLIC SHINE

1975

A SP: max. 2 col.

B SP: max. 2 col.

MOQ 500 units.

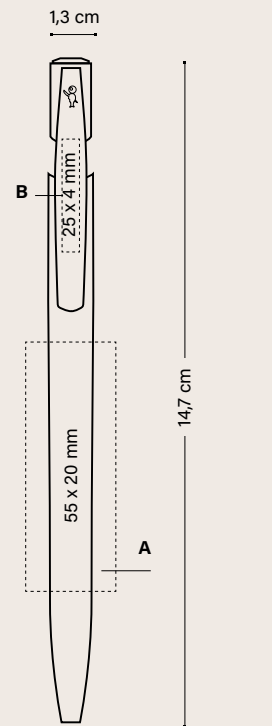

Price (€)

BIC® MEDIA CLIC SHINE	500-999	1000-2499	2500-4999	5000
1975				
SP	1,65	1,43	1,33	1,23
SP (Premium)	1,80	1,57	1,46	1,35

Additional imprint charge per colour & position

SP	0,14	0,14	0,14	0,13
----	------	------	------	------

Prices include one colour in screen printing in one position.

OPTIONAL SPECIAL PACKAGING



+ INFO PAGES 222 TO 227

EXTERNAL PACKAGING



SPECIFICATIONS



PERSONALIZED COLOURS



MANUFACTURED AND PRINTED IN BIC FACTORIES



MADE IN SPAIN



REGULATORY COMPLIANCE



ISO certified



IMPRIM'VERT®



100% RECYCLABLE



100% RENEWABLE ELECTRICITY



LOW ENVIRONMENTAL IMPACT

WRITING MODES



BALLPEN M

PRINTING TECHNIQUES



SCREEN PRINTING

See page 233 for a detailed explanation of the icons

BIC® MEDIA CLIC GLACÉ

Our best seller
in elegant colours.

BIC® MEDIA CLIC GLACÉ

1030 Opaque

Colour ink



Red Ink available under request



47G



76



03G



05G



04G



14G

BIC® MEDIA CLIC GLACÉ



BIC® MEDIA CLIC GLACÉ 1030 Ballpen Opaque

MOQ 500 units
Standard colours combination

Plug



Clip

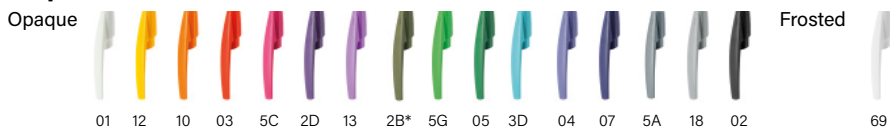

Barrel

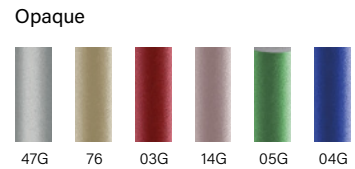

Decoration

BIC® MEDIA CLIC GLACÉ

1030

A SP: max. 2 col.

B SP: max. 2 col.

MOQ 500 units.

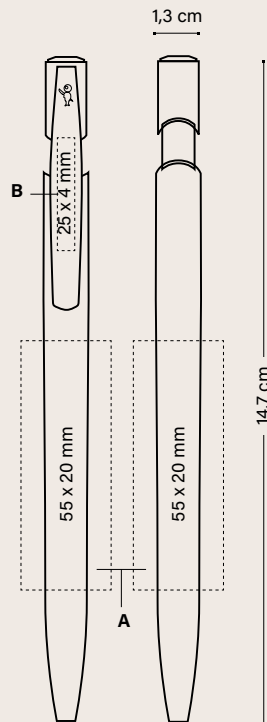

	Price (€)			
BIC® MEDIA CLIC GLACÉ	500-999	1000-2499	2500-4999	5000
1030				
SP	1,19	1,02	0,97	0,88

Additional imprint charge per colour & position

SP	0,14	0,14	0,14	0,13
-----------	------	------	------	------

Prices include one colour in screen printing in one position.

OPTIONAL SPECIAL PACKAGING



+ INFO PAGES 222 TO 227

EXTERNAL PACKAGING



SPECIFICATIONS



MANUFACTURED AND PRINTED IN BIC FACTORIES



MADE IN SPAIN



REGULATORY COMPLIANCE



IMPRIM'VERT®



RECYCLABLE



100% RENEWABLE ELECTRICITY



LOW ENVIRONMENTAL IMPACT

WRITING MODES



BALLPEN M

PRINTING TECHNIQUES



SCREEN PRINTING

BIC® CLIC STIC

**Modern, flexible,
reliable. That's how
BIC® Clic Stic is!**

A large variety of
finishes such as Digital,
Stylus, Softfeel®,
Mini or Antibacterial.

*Thousands
of colour
combinations!*





BIC® CLIC STIC
1000 Opaque
Colour ink
● ● ●



Available on
white barrel
britePix
DIGITAL

ECO version and standard at the same price!

ecolutions® FRUIT AND VEGETABLE TRAYS

MADE FROM 78% RECYCLED MATERIAL***

BIC® CLIC STIC
1E00 Opaque
Colour ink
● ● ●



Available on
white barrel
britePix
DIGITAL

SPECIFICATIONS



PERSONALIZED COLOURS



MANUFACTURED AND PRINTED IN BIC FACTORIES



MADE IN SPAIN



REGULATORY COMPLIANCE



ISO certified



IMPRIM'VERT®



FRUIT AND VEGETABLE TRAYS



100% RECYCLABLE



100% RENEWABLE ELECTRICITY



LOW ENVIRONMENTAL IMPACT



WRITING MODES



BALLPEN M



SCREEN PRINTING



DIGITAL

SP
DG

*While stocks last
**48h not available in Digital finishes.
***The percentage is calculated based on total weight of the barrel.
Due to the recycled content of the raw materials used to make the product, we cannot guarantee that the colours shown in the catalogue or colours customised to order will always have the same colour and appearance.

ECO version and standard at the same price!

ecolutions®
 MADE FROM
78% RECYCLED MATERIAL**



 FRUIT AND VEGETABLE TRAYS

BIC® CLIC STIC

1000 Frosted

Colour ink



Red Ink available under request



Break resistant clip!



BIC® CLIC STIC

1E00 Frosted

Colour ink



Red Ink available under request



BIC® CLIC STIC

SOFTFEEL®

1005 Opaque

Colour ink



Red Ink available under request



BIC® CLIC STIC SOFTFEEL®
 1005 Frosted
 Colour ink
 ● ● ●
 Red Ink available under request



40

BIC® CLIC STIC STYLUS
 1847 Opaque
 Colour ink
 ● ● ●
 Red Ink available under request

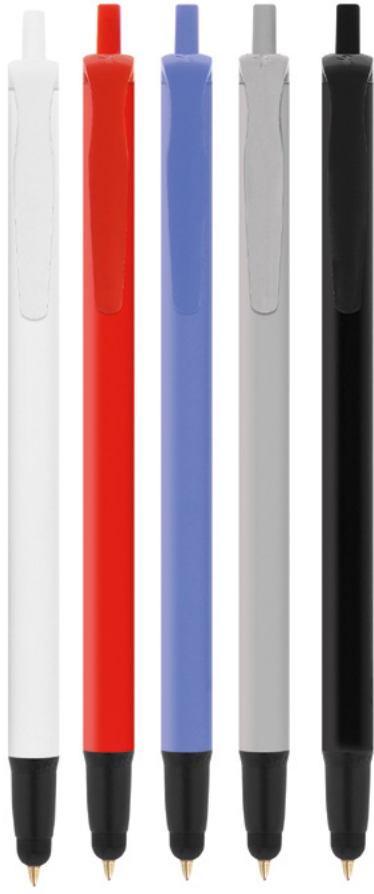

01

03

04

18

02

07

ECO version and standard at the same price!

ecolutions®
 MADE FROM
78% RECYCLED MATERIAL**



BIC® CLIC STIC STYLUS
 1846 Opaque
 Colour ink
 ● ● ●
 Red Ink available under request



1E

3E
 100%

SPECIFICATIONS



MIX & MATCH



PERSONALIZED COLOURS



MANUFACTURED AND PRINTED IN BIC FACTORIES



MADE IN SPAIN



REGULATORY COMPLIANCE



IMPRIM'VERT®

ecolutions®



FRUIT AND VEGETABLE TRAYS



100% RECYCLABLE



100% RENEWABLE ELECTRICITY



LOW ENVIRONMENTAL IMPACT

WRITING MODES



BALLPEN M

PRINTING TECHNIQUES



SCREEN PRINTING



DIGITAL

*48h not available in Digital finishes.

**The percentage is calculated based on total weight of the barrel. Due to the recycled content of the raw materials used to make the product, we cannot guarantee that the colours shown in the catalogue or colours customised to order will always have the same colour and appearance.

See page 233 for a detailed explanation of the icons

SPECIFICATIONS



MIX & MATCH



PERSONALIZED COLOURS



MANUFACTURED AND PRINTED IN BIC FACTORIES



MADE IN SPAIN



REGULATORY COMPLIANCE



IMPRIM'VERT®



FRUIT AND VEGETABLE TRAYS



RECYCLABLE



100% RENEWABLE ELECTRICITY



LOW ENVIRONMENTAL IMPACT

WRITING MODES



BALLPEN M

PRINTING TECHNIQUES



SCREEN PRINTING



DIGITAL

BIC® CLIC STIC MINI

1892 Opaque

Colour ink



Red Ink available under request

BIC® CLIC STIC MINI

1892 Frosted

Colour ink



Red Ink available under request



Available on white barrel



BIC® CLIC STIC

1000 Opaque / **ecolutions®** 1E00 Opaque
 1000 Frosted / **ecolutions®** 1E00 Frosted
 1005 Opaque / Frosted
 MOQ 500 units. Standard colours combination

BIC® CLIC STIC STYLUS

1846 / 1847 Opaque

BIC® CLIC STIC MINI

1892 Opaque / Frosted



Plug

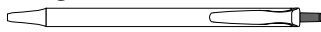

Opaque



Frosted

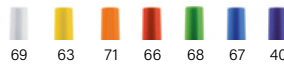

Clip

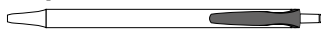

Opaque

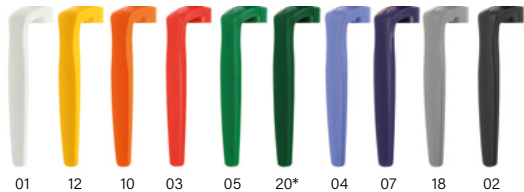

Frosted

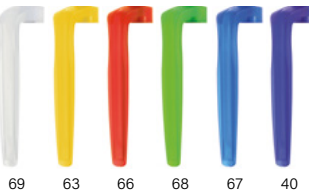

Section

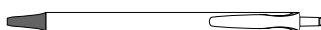

Opaque

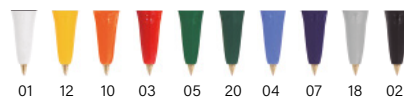

Frosted

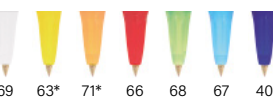

Stylus

Opaque



Barrel



Opaque

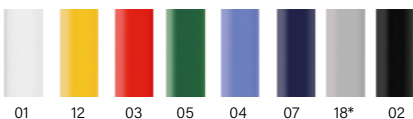

Stylus

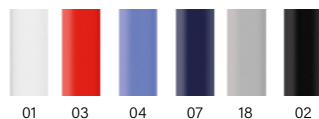

Softfeel®

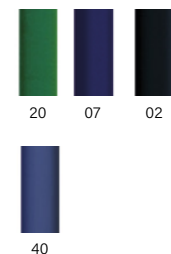

Mini



Frosted

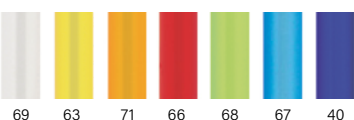

Exact colour match: ≥ 10.000 units



MOQ 500 units
ecolutions® Standard colours combination**



Add the Möbius loop to your artwork at no additional charge. Please specify it on your order. (Möbius loop imprint defaults to left-hand corner.)

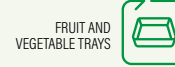

Plug



Opaque



Section



Opaque

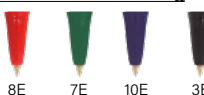

Stylus

Opaque



Clip



Opaque



Barrel



Opaque



Stylus

Opaque



Exact colour match: ≥ 10.000 units

*While stocks last

**Due to the recycled content of the raw materials used to make the product, we cannot guarantee that the colours shown in the catalogue or colours customised to order will always have the same colour and appearance.

ESPECIFICACIONES



PERSONALIZED COLOURS



MANUFACTURED AND PRINTED IN BIC FACTORIES



MADE IN SPAIN



REGULATORY COMPLIANCE



FRUIT AND VEGETABLE TRAYS



100% RECYCLABLE



100% RENEWABLE ELECTRICITY



LOW ENVIRONMENTAL IMPACT

WRITING MODES



BALLPEN M

PRINTING TECHNIQUES



SCREEN PRINTING



DIGITAL

Decoration

BIC® CLIC STIC

1000 / **ecolutions**® 1E00

BIC® CLIC STIC STYLUS

1847 / **ecolutions**® 1846

A SP: max. 3 col.

B SP: max. 1 col.

C SP: max. 2 col.

D DG: full-colour (area for text)
(Only available on white barrel)

MOQ 500 units.

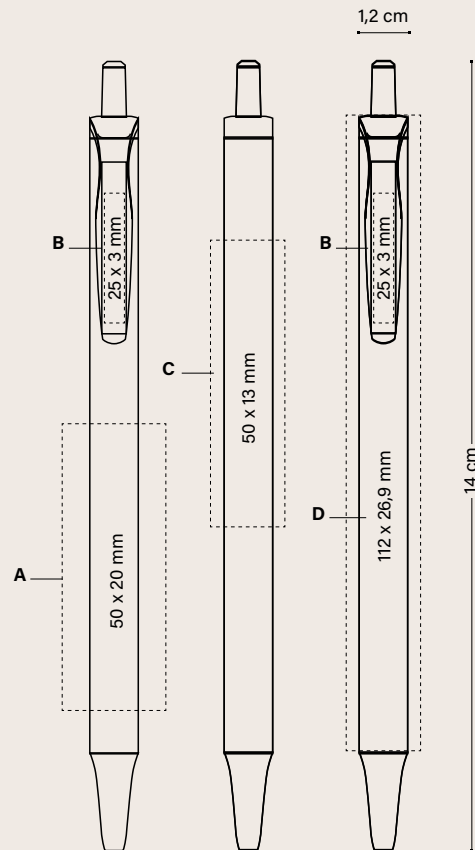

	500-999	1000-2499	2500-4999	Price (€)
BIC® CLIC STIC				5000
1000 / ecolutions ® 1E00				
SP	0,85	0,74	0,70	0,66
DG	1,14	1,02	0,96	0,90
1847 / ecolutions ® 1846				
SP	1,02	0,91	0,85	0,77
DG	1,31	1,15	1,08	1,02

Additional imprint charge per colour & position

SP	0,14	0,14	0,14	0,13
-----------	------	------	------	------

Prices include one imprint in one position according to specified technique.

OPTIONAL SPECIAL PACKAGING



ECO SLEEVE



PLASTIC POUCH

+ INFO PAGES 222 TO 227

EXTERNAL PACKAGING



500 ± 2,9 KG

Decoration

BIC® CLIC STIC SOFTFEEL®
1005

A/B SP: max. 1 col.

MOQ 500 units.

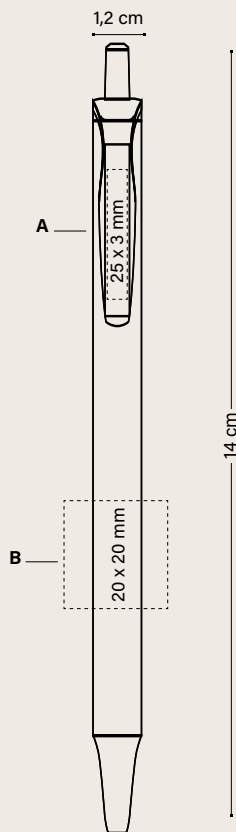

Price (€)

BIC® CLIC STIC SOFTFEEL®	500-999	1000-2499	2500-4999	5000
1005				
SP	1,05	0,94	0,88	0,80

Additional imprint charge per colour & position

SP	0,14	0,14	0,14	0,13
----	------	------	------	------

Prices include one colour in screen printing in one position.

OPTIONAL SPECIAL PACKAGING



+ INFO PAGES 222 TO 227

EXTERNAL PACKAGING



Decoration

BIC® CLIC STIC MINI
1892

A SP: max. 1 col.

B SP: max. 1 col.

C DG: full-colour (area for text)
(Only available on white barrel)

MOQ 500 units.

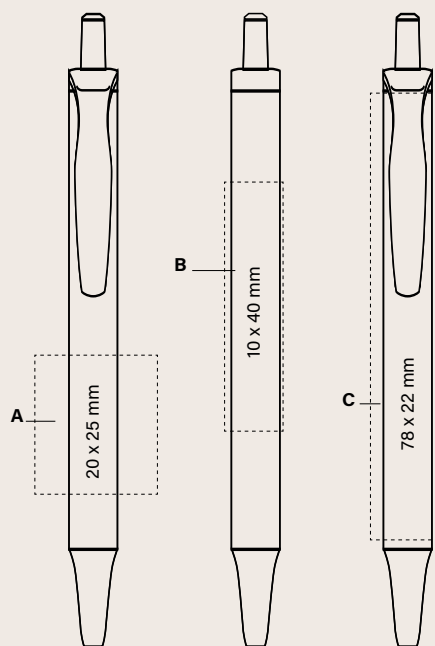

Price (€)

BIC® CLIC STIC MINI	500-999	1000-2499	2500-4999	5000
1892				
SP	0,71	0,64	0,60	0,57
DG	1,06	0,95	0,88	0,82

Prices include one imprint in one position according to specified technique.

OPTIONAL SPECIAL PACKAGING



+ INFO PAGES 222 TO 227

EXTERNAL PACKAGING



SPECIFICATIONS



PERSONALIZED COLOURS



MANUFACTURED AND PRINTED IN BIC FACTORIES



MADE IN SPAIN



REGULATORY COMPLIANCE



ISO certified



IMPRIM'VERT®



100% RECYCLABLE



100% RENEWABLE ELECTRICITY



LOW ENVIRONMENTAL IMPACT

WRITING MODES



BALLPEN M

PRINTING TECHNIQUES



SCREEN PRINTING



DIGITAL

BIC® CLIC STIC BGUARD™ ANTIBACTERIAL

BGUARD™



Bacteria elimination



Entire pen protection



Timeless protection



Antibacterial Test protocol



Iconic BIC® Boy and Antibacterial logo always visible!

ANTIBACTERIAL™

BIC® CLIC STIC BGUARD™ ANTIBACTERIAL

1001 Opaque

Colour ink



Red Ink available under request



7BG



2BG



3BG



100%

Available on white barrel



MIX & MATCH

No extra charge

BIC® CLIC STIC BGUARD™ ANTIBACTERIAL

1001 Opaque

MOQ 500 units.

Standard colours combination

Plug

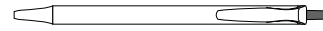

Opaque



Clip

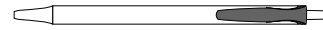

Opaque



Section

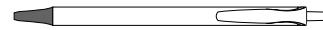

Opaque



Barrel



Opaque

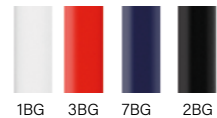

Exact colour match: > 10.000 units



Decoration

**BIC® CLIC STIC BGUARD™
ANTIBACTERIAL**

1001

A SP: max. 2 col.

B SP: max. 1 col.

C DG: full-colour

MOQ 500 units.

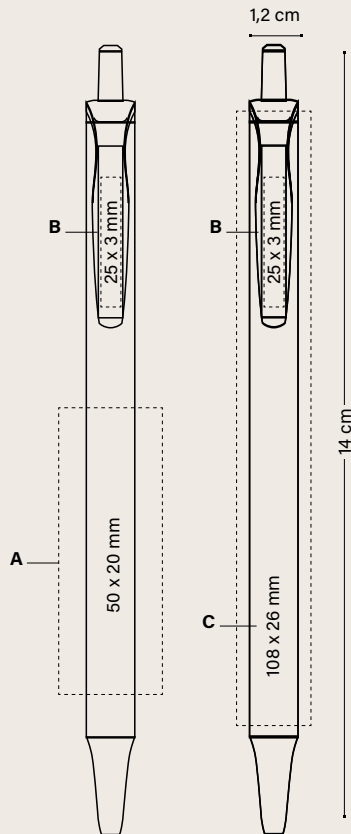

	Price (€)			
BIC® CLIC STIC BGUARD™ ANTIBACTERIAL	500-999	1000-2499	2500-4999	5000
1001				
SP	0,87	0,77	0,72	0,68
DG	1,16	1,03	0,96	0,91

Additional imprint charge per colour & position

SP	0,14	0,14	0,14	0,13
-----------	------	------	------	------

Prices include one imprint in one position according to specified technique.

OPTIONAL SPECIAL PACKAGING



+ INFO PAGES 222 TO 227



EXTERNAL PACKAGING



SPECIFICATIONS



PERSONALIZED
COLOURS



MANUFACTURED
AND PRINTED IN
BIC FACTORIES



MADE IN SPAIN



REGULATORY
COMPLIANCE



ISO
certified



100%
RECYCLABLE



100% RENEWABLE
ELECTRICITY



LOW ENVIRONMENTAL
IMPACT

**WRITING
MODES**



BALLPEN M

**PRINTING
TECHNIQUES**



SCREEN PRINTING



DIGITAL

See page 233 for a detailed explanation of the icons

BIC® CLIC STIC STYLUS BGUARD™ ANTIBACTERIAL

BGUARD™



Bacteria elimination



Entire pen protection



Timeless protection



Antibacterial Test protocol



Iconic BIC® Boy and Antibacterial logo always visible!

ANTIBACTERIAL™

BIC® CLIC STIC STYLUS BGUARD™ ANTIBACTERIAL

1848 Opaque

Colour ink



Red Ink available under request



First antibacterial stylus pen!

MIX & MATCH
No extra charge

BIC® CLIC STIC STYLUS BGUARD™ ANTIBACTERIAL

1848 Opaque

MOQ 500 units

Standard colours combination

Plug



Opaque



Clip



Opaque



Section



Stylus

Opaque



02

Barrel



Opaque

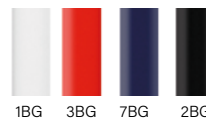

Exact colour match: ≥ 10.000 units



Available on white barrel



Decoration

**BIC® CLIC STIC STYLUS
BGUARD™ ANTIBACTERIAL**

1848

A SP: max. 2 col.

B SP: max. 1 col.

C DG: full-colour

(Only available on white barrel)

MOQ 500 units.

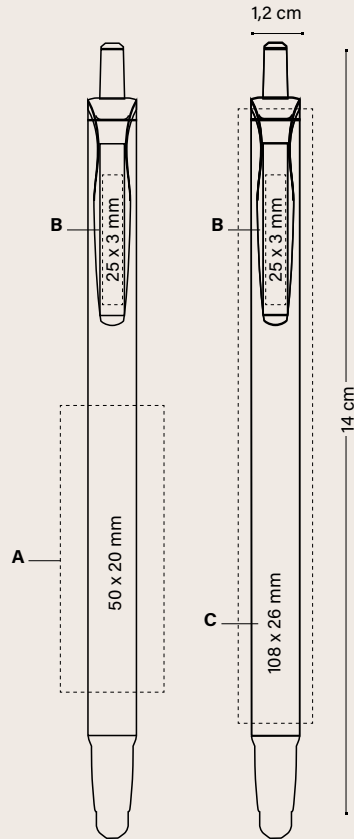

BIC® CLIC STIC STYLUS BGUARD™ ANTIBACTERIAL 1848	Price (€)			
	500-999	1000-2499	2500-4999	5000
SP	1,13	1,00	0,95	0,88
DG	1,44	1,27	1,19	1,12

Additional imprint charge per colour & position

SP	0,14	0,14	0,14	0,13
-----------	------	------	------	------

Prices include one imprint in one position according to specified technique.

OPTIONAL SPECIAL PACKAGING



+ INFO PAGES 222 TO 227



EXTERNAL PACKAGING



SPECIFICATIONS



PERSONALIZED COLOURS



MANUFACTURED AND PRINTED IN BIC FACTORIES



MADE IN SPAIN



REGULATORY COMPLIANCE



ISO certified
IMPRIM'VERT®



100% RECYCLABLE



100% RENEWABLE ELECTRICITY



LOW ENVIRONMENTAL IMPACT

WRITING MODES



BALLPEN M

PRINTING TECHNIQUES



SCREEN PRINTING



DIGITAL





BIC[®] SUPER CLIP

Discover the eye-catching clip and its gentle twist mechanism. Large printing areas offer a wide range of personalisation possibilities in the standard, advance and antibacterial versions. Now also available in soft and glacé versions.

In addition, the Super Clip Origin is the first pen in a more innovative and sustainable new phase.

Welcome to the future!

Evolutions[®]

BGuard[™] Antibacterial

Advance

Glacé

Glacé Advance

Soft

Soft Advance

Origin

BIC® SUPER CLIP

BIC® SUPER CLIP

1039 Opaque

Colour ink



Available on
white barrel



ECO version and standard at the same price!

ecolutions®
 MADE FROM 78% RECYCLED MATERIAL***
 PLASTIC CAR PARTS

BIC® SUPER CLIP
 1E50 Opaque
 Colour ink
 ● ●



BIC® SUPER CLIP
 1039 Clear
 Colour ink
 ● ●



SPECIFICATIONS



PERSONALIZED COLOURS



MANUFACTURED AND PRINTED IN BIC FACTORIES



MADE IN SPAIN



REGULATORY COMPLIANCE



ISO certified



PLASTIC CAR PARTS



100% RECYCLABLE



100% RENEWABLE ELECTRICITY



LOW ENVIRONMENTAL IMPACT

WRITING MODES



BALLPEN M

PRINTING TECHNIQUES



SCREEN PRINTING



DIGITAL



BRITEPIX™
 BRITEPIX™ TEXTURE
 BRITEPIX™ PERSONALISATION

**48h not available in Digital finishes.

***The percentage is calculated based on total weight of the barrel. Due to the recycled content of the raw materials used to make the product, we cannot guarantee that the colours shown in the catalogue or colours customised to order will always have the same colour and appearance.

See page 233 for a detailed explanation of the icons

BIC® SUPER CLIP

BIC® SUPER CLIP

1039 Opaque

ecolutions® 1E50 Opaque

1039 Clear

MOQ 250 units

Standard colours combination



No extra charge

Clip



Opaque

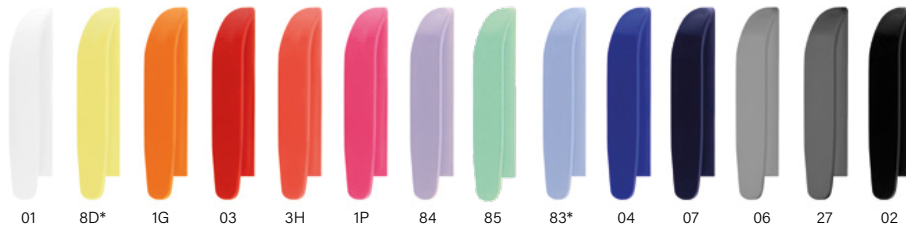

Clear

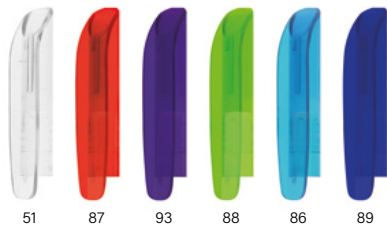

ecolutions®



PLASTIC CAR PARTS

Standard colours combination**



1E 1E



Add the Möbius loop to your artwork at no additional charge. Please specify it on your order. (Möbius loop imprint defaults to left-hand hand corner.)

Barrel



Opaque

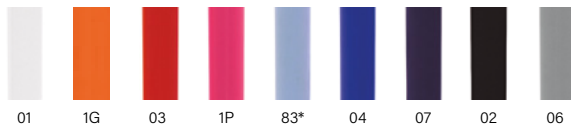

Clear

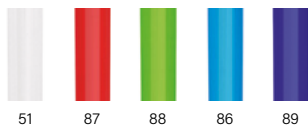

Exact colour match: ≥ 10.000 units



*While stocks last

**Due to the recycled content of the raw materials used to make the product, we cannot guarantee that the colours shown in the catalogue or colours customised to order will always have the same colour and appearance.

Decoration

BIC® SUPER CLIP

1039

ecolutions® 1E50

A SP: max. 2 col.

B SP: max. 1 col.

C DG: full-colour

MOQ 250 units.

1039

D BP: full-colour

BP Texture: full-colour

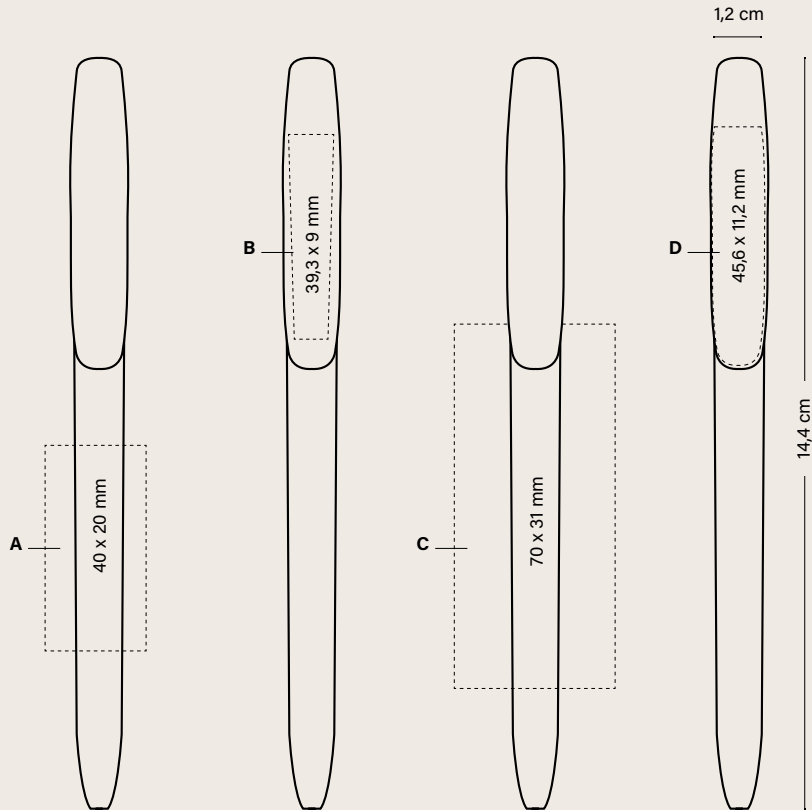

BIC® SUPER CLIP	250-499	500-999	1000-2499	2500-4999	Price (€)
1039 / ecolutions® 1E50					5000
SP	1,08	0,97	0,92	0,88	0,86
DG	1,40	1,26	1,20	1,16	1,14
BP	1,34	1,22	1,16	1,12	1,09

Additional imprint charge per colour & position

SP	0,17	0,14	0,14	0,14	0,13
BP	0,24	0,22	0,21	0,20	0,19
BP Texture	0,18	0,16	0,15	0,15	0,14

Prices include one imprint in one position according to specified technique.

OPTIONAL SPECIAL PACKAGING



+ INFO PAGES 222 TO 227

EXTERNAL PACKAGING



New!
Collection Box
(1, 2 & 3 units)

250 ± 2,6 KG

SPECIFICATIONS



PERSONALIZED COLOURS



MANUFACTURED AND PRINTED IN BIC FACTORIES



MADE IN SPAIN



REGULATORY COMPLIANCE



ISO certified



IMPRIM'VERT®



ecolutions®



PLASTIC CAR PARTS



100% RECYCLABLE



100% RENEWABLE ELECTRICITY



LOW ENVIRONMENTAL IMPACT



WRITING MODES



BALLPEN M



PRINTING TECHNIQUES



SCREEN PRINTING



DIGITAL



BRITEPIX™

BRITEPIX™ TEXTURE

BRITEPIX™ PERSONALISATION

See page 233 for a detailed explanation of the icons

BIC® SUPER CLIP BGUARD™ ANTIBACTERIAL

BGUARD™



Bacteria elimination



Entire pen protection



Timeless protection



Antibacterial Test protocol

MIX & MATCH

No extra charge

BIC® SUPER CLIP BGUARD™ ANTIBACTERIAL

1040 Opaque

Colour ink



1BG

3BG

7BG

2BG

100%

BIC® SUPER CLIP BGUARD™ ANTIBACTERIAL

1040 Opaque

MOQ 250 units

Standard colours combination

Clip

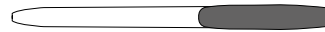

Opaque



1BG

3BG

7BG

2BG

Barrel



Opaque



1BG

3BG

7BG

2BG

Exact colour match: ≥ 10.000 units



ANTIBACTERIAL™

Antibacterial logo always visible!

Decoration

**BIC® SUPER CLIP
BGUARD™ ANTIBACTERIAL**

1040

A/B SP: max. 1 col.

MOQ 250 units.

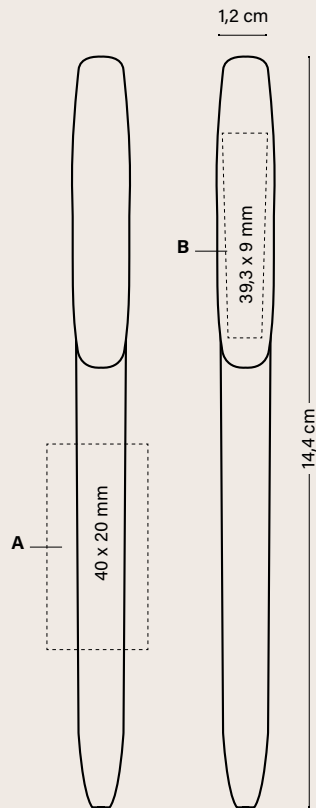

	Price (€)				
BIC® SUPER CLIP BGUARD™ ANTIBACTERIAL	250-499	500-999	1000-2499	2500-4999	5000
1040					
SP	1,23	1,10	1,06	1,03	1,00

Additional imprint charge per colour & position

SP	0,17	0,14	0,14	0,14	0,13
-----------	------	------	------	------	------

Prices include one colour in screen printing in one position.

OPTIONAL SPECIAL PACKAGING



+ INFO PAGES 222 TO 227

EXTERNAL PACKAGING



250 ± 2,6 KG

*New!
Collection Box
(1, 2 & 3 units)*

SPECIFICATIONS



PERSONALIZED
COLOURS



MANUFACTURED
AND PRINTED IN
BIC FACTORIES



MADE IN SPAIN



REGULATORY
COMPLIANCE



ISO
certified



100%
RECYCLABLE



100% RENEWABLE
ELECTRICITY



LOW ENVIRONMENTAL
IMPACT

**WRITING
MODES**



BALLPEN M

**PRINTING
TECHNIQUES**



SCREEN PRINTING

BIC® SUPER CLIP ADVANCE

1073 Opaque

Colour ink



*Choose from three
metal section finishes!*

Metal section!

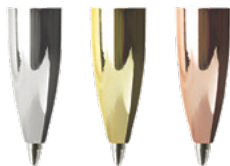

35

26

97

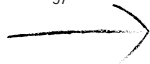

03/26



04/35



*Refill
service on
request*

07/35



Available on white barrel



SPECIFICATIONS



PERSONALIZED COLOURS



MANUFACTURED AND PRINTED IN BIC FACTORIES



MADE IN SPAIN



REGULATORY COMPLIANCE



ISO certified



IMPRIM'VERT®



100% RECYCLABLE



100% RENEWABLE ELECTRICITY



LOW ENVIRONMENTAL IMPACT

WRITING MODES



BALLPEN M

PRINTING TECHNIQUES



SCREEN PRINTING



DIGITAL



BRITEPIX™
BRITEPIX™ TEXTURE
BRITEPIX™ PERSONALISATION

See page 233 for a detailed explanation of the icons

*48h not available in Digital finishes.

BIC® SUPER CLIP ADVANCE

BIC® SUPER CLIP ADVANCE
1073 Opaque

MOQ 250 units
Standard colours combination

**MIX &
MATCH**

No extra charge

Clip



Opaque



01 1G 03 1P 04 07 06 02

Clear



51 87 93 88 86 89

Barrel



Opaque



01 03 1P 04 07 06 02

Section

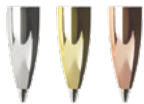
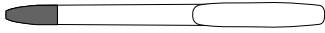

35 26 97

Exact colour match: ≥ 10.000 units



Decoration

BIC® SUPER CLIP ADVANCE

1073

A SP: max. 2 col.

B SP: max. 1 col.

C DG: full-colour

D BP: full-colour

BP Texture: full-colour

MOQ 250 units.

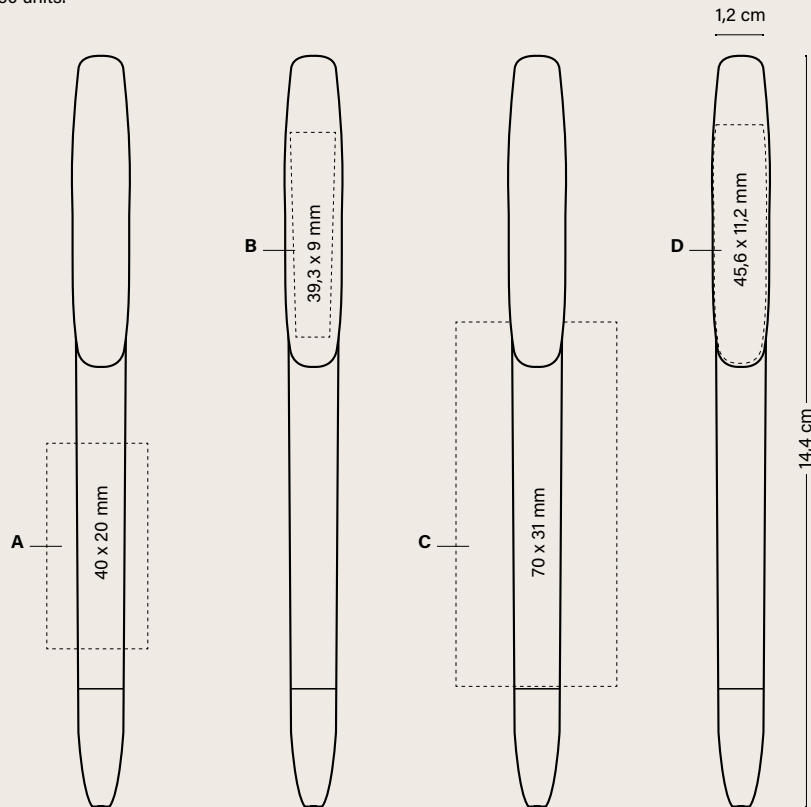

Price (€)

BIC® SUPER CLIP ADVANCE	250-499	500-999	1000-2499	2500-4999	5000
1073					
SP	1,55	1,35	1,29	1,26	1,21
DG	1,90	1,63	1,56	1,51	1,47
BP	1,78	1,54	1,48	1,43	1,39

Additional imprint charge per colour & position

SP	0,17	0,14	0,14	0,14	0,13
BP	0,24	0,22	0,21	0,20	0,19
BP Texture	0,18	0,16	0,15	0,15	0,14
Gold / Pink Section	0,15	0,15	0,15	0,15	0,15

Prices include one imprint in one position according to specified technique.

OPTIONAL SPECIAL PACKAGING



ECO SLEEVE

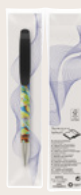

PLASTIC POUCH



WINDOW BOX



COLLECTION BOX

New! Collection Box (1, 2 & 3 units)



250 ± 2,6 KG

+ INFO PAGES 222 TO 227

EXTERNAL PACKAGING

SPECIFICATIONS



PERSONALIZED COLOURS



MANUFACTURED AND PRINTED IN BIC FACTORIES



MADE IN SPAIN



REGULATORY COMPLIANCE



ISO certified



IMPRIM'VERT®



100% RECYCLABLE



100% RENEWABLE ELECTRICITY



LOW ENVIRONMENTAL IMPACT

WRITING MODES



BALLPEN M

PRINTING TECHNIQUES



SCREEN PRINTING



DIGITAL



BRITEPIX™
BRITEPIX™ TEXTURE
BRITEPIX™ PERSONALISATION

See page 233 for a detailed explanation of the icons

NEW!

BIC® SUPER CLIP GLACÉ & ADVANCE

Discover the BIC® Super Clip in a new glamorous version.

BIC® SUPER CLIP GLACÉ

1082

Colour ink



47G 76 014G 03G 04G 05G

BIC® SUPER CLIP GLACÉ ADVANCE

1084

Colour ink



47G/97 05G/26 014G/35 03G/97 04G/35 76/35

*Refill
service on
request*

*Available in
three finishes:
silver, gold and pink*



35 26 97

BIC® SUPER CLIP GLACÉ & ADVANCE

Section

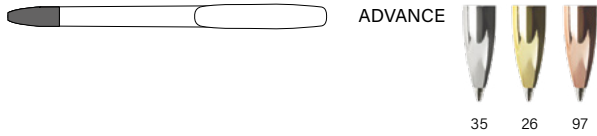

Decoration

BIC® SUPER CLIP GLACÉ
1082

**BIC® SUPER CLIP GLACÉ
ADVANCE**
1084

A SP: max. 1 col.
B SP: max. 1 col.

MOQ 250 units
Standard colours combination

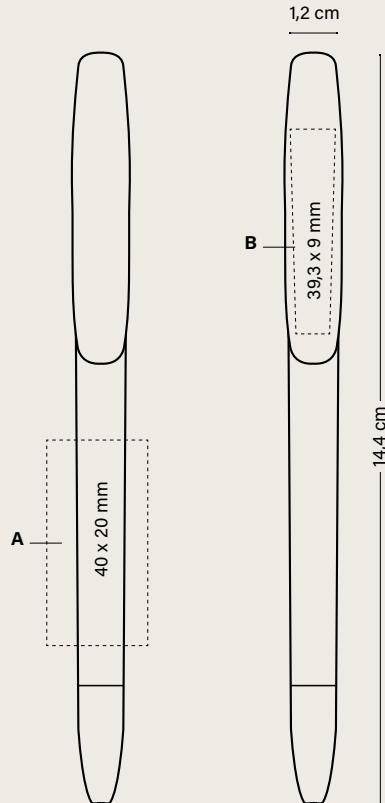

	Price (€)				
BIC® SUPER CLIP GLACÉ	250-499	500-999	1000-2499	2500-4999	5000
1082					
SP	1,80	1,58	1,47	1,42	1,37
1084					
SP	2,10	1,81	1,70	1,65	1,60

Additional imprint charge per colour & position

SP	0,17	0,14	0,14	0,14	0,13
Gold / Pink Section	0,15	0,15	0,15	0,15	0,15

Prices include one imprint in one position according to specified technique.

OPTIONAL SPECIAL PACKAGING



+ INFO PAGES 222 TO 227

EXTERNAL PACKAGING



250 ± 2,6 KG

New!
Collection Box
(1, 2 & 3 units)

SPECIFICATIONS

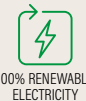

WRITING MODES



PRINTING TECHNIQUES



SCREEN PRINTING



CHECK OUT THE VIDEO

See page 233 for a detailed explanation of the icons

NEW!

BIC® SUPER CLIP SOFT & ADVANCE

Feel the incredible softness of our new BIC® Super Clip version with twist mechanism.



BIC® SUPER CLIP SOFT

1083

Colour ink



02F

03F

07F

BIC® SUPER CLIP SOFT

ADVANCE

1085

Colour ink



02F/97

03F/26

07F/35

Refill service on request

Available in three finishes: silver, gold and pink

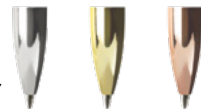

35

26

97

BIC® SUPER CLIP SOFT & ADVANCE

Section

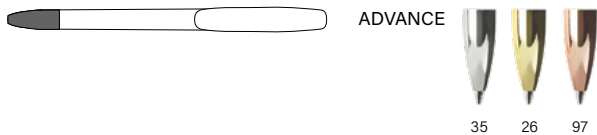

Decoration

BIC® SUPER CLIP SOFT
1083

**BIC® SUPER CLIP SOFT
ADVANCE**
1085

A SP: max. 1 col.

MOQ 250 units
Standard colours combination

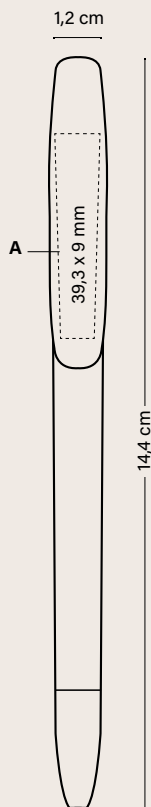

					Price (€)
BIC® SUPER CLIP SOFT	250-499	500-999	1000-2499	2500-4999	5000
1083					
SP	2,22	1,94	1,83	1,75	1,71
1085					
SP	2,51	2,19	2,06	1,98	1,94

Additional imprint charge per colour & position

SP	0,17	0,14	0,14	0,14	0,13
Gold / Pink Section	0,15	0,15	0,15	0,15	0,15

Prices include one imprint in one position according to specified technique.

OPTIONAL SPECIAL PACKAGING



ECO SLEEVE



PLASTIC POUCH



WINDOW BOX



COLLECTION BOX

New!
Collection Box
(1, 2 & 3 units)



250 ± 2,6 KG

+ INFO PAGES 222 TO 227

SPECIFICATIONS



MANUFACTURED AND PRINTED IN BIC FACTORIES



MADE IN EUROPE



REGULATORY COMPLIANCE



IMPRIM'VERT®



100% RECYCLABLE



100% RENEWABLE ELECTRICITY



LOW ENVIRONMENTAL IMPACT

WRITING MODES



BALLPEN M

PRINTING TECHNIQUES



SCREEN PRINTING



CHECK OUT THE VIDEO

See page 233 for a detailed explanation of the icons

NEW!

BIC® SUPER CLIP ORIGIN

Our new BIC® Super Clip is made from natural materials.

ecolutions® MADE WITH A BIO-BASED** MATERIAL

BIC® SUPER CLIP ORIGIN

1038

Colour ink



ORIGIN
BIOBASED

BIC® Super Clip Origin is made from a bio-based material composed of natural polymers without petroleum, oil or fossil energy*.



Organic castor oil



Wood sawdust
From sustainably managed European forests



Talc
Mined in Europe



Manufactured and printed in factories 100% powered by electricity produced using renewable sources.



Barrel and clip are 100% Bio-Based.



100% of BIC® writing instruments are recyclable thanks to the UBICUITY™ programme.



Made in Europe; low transport impact.



Gentle twist mechanism!

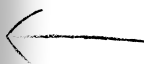

60

BIC® SUPER CLIP ORIGIN

Decoration

BIC® SUPER CLIP ORIGIN

1038

A SP: max. 1 col.

MOQ 250 units
Standard colours combination

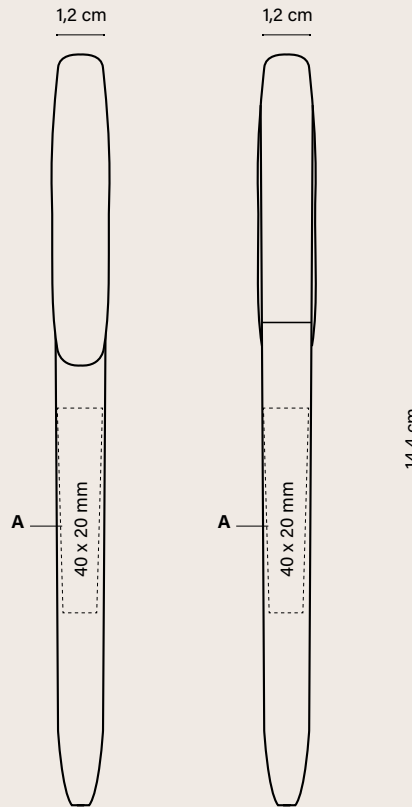

Price (€)

BIC® SUPER CLIP ORIGIN	250-499	500-999	1000-2499	2500-4999	5000
1038					
SP	1,93	1,84	1,76	1,68	1,64

Prices include one colour in screen printing in one position.

OPTIONAL SPECIAL PACKAGING



+ INFO PAGES 222 TO 227

EXTERNAL PACKAGING



250 ± 2,6 KG

New!
Collection Box
(1, 2 & 3 units)

SPECIFICATIONS



PERSONALIZED COLOURS



MANUFACTURED AND PRINTED IN BIC FACTORIES



MADE IN EUROPE



REGULATORY COMPLIANCE



ISO certified



IMPRIM'VERT®

ORIGIN

BIO BASED



ORGANIC CASTOR OIL



WOOD SAWDUST



TALC



100% RECYCLABLE



100% RENEWABLE ELECTRICITY



LOW ENVIRONMENTAL IMPACT

PRINTING TECHNIQUES



SCREEN PRINTING

See page 233 for a detailed explanation of the icons

BIC® WIDE BODY™

**The right size for
showing the true
value of your brand!**

**Wide profile and wide
variety of possibilities to
maximise your message.**



BIC® WIDE BODY™



BIC® WIDE BODY™

1079 Opaque Chrome

1080 Opaque

Colour ink



Red Ink available under request



07

01

07

02

18



100%

03

1E

03

Available on white barrel



Available on white barrel



ECO version and standard at the same price!

ecolutions®

MADE FROM 94% RECYCLED MATERIAL**



FRUIT AND VEGETABLE TRAYS

SPECIFICATIONS



MIX & MATCH



PERSONALIZED COLOURS



MANUFACTURED AND PRINTED IN BIC FACTORIES



MADE IN SPAIN



REGULATORY COMPLIANCE



ISO certified



IMPRIM'VERT®

ecolutions®



FRUIT AND VEGETABLE TRAYS



100% RECYCLABLE



100% RENEWABLE ELECTRICITY



LOW ENVIRONMENTAL IMPACT

WRITING MODES



BALLPEN M

PRINTING TECHNIQUES



SCREEN PRINTING



DIGITAL

*48h not available in Digital finishes.

**The percentage is calculated based on total weight of the barrel. Due to the recycled content of the raw materials used to make the product, we cannot guarantee that the colours shown in the catalogue or colours customised to order will always have the same colour and appearance.

BIC® WIDE BODY™

1080 Frosted

Colour ink



40

63

67

68

69

66

71

100%

Large printing areas!

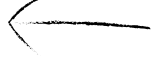

BIC® WIDE BODY™

MINI DIGITAL

1893 Opaque

1896 Chrome Opaque

Colour ink



01

01

100%

360° Printing

Available on white barrel



BIC® WIDE BODY™

1080 Opaque
 eColutions® 1E80 Opaque
 1080 Frosted

BIC® WIDE BODY™ MINI DIGITAL

1893 Opaque
 1896 Chrome Opaque

MOQ 250 units
 Standard colours combination



No extra charge

Plug



Opaque



Frosted

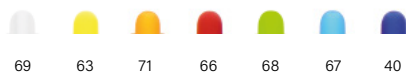

Chrome



Clip



Opaque

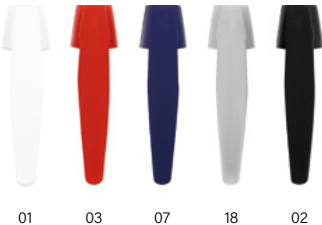

Frosted

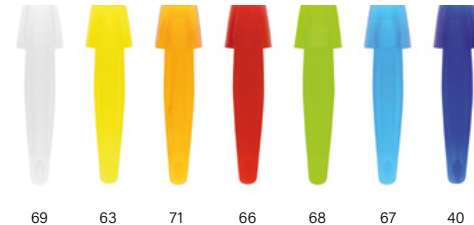

Barrel



Opaque



Frosted

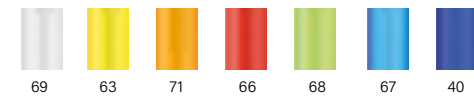

Opaque



eColutions® ***



Add the Möbius loop to your artwork at no additional charge. Please specify "Print the Möbius loop" on your order. (Möbius loop imprint defaults to left-hand corner.)



FRUIT AND VEGETABLE TRAYS

Section



Opaque

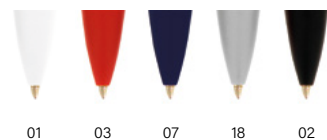

Frosted

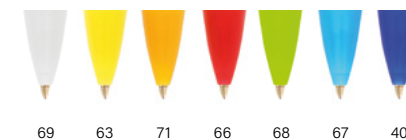

Chrome



Exact colour match: ≥ 10.000 units



SPECIFICATIONS



MIX & MATCH



PERSONALIZED COLOURS



MANUFACTURED AND PRINTED IN BIC FACTORIES



MADE IN SPAIN



REGULATORY COMPLIANCE



ISO certified



IMPRIM'VERT®

eColutions®



FRUIT AND VEGETABLE TRAYS



100% RECYCLABLE



100% RENEWABLE ELECTRICITY



LOW ENVIRONMENTAL IMPACT

WRITING MODES



BALLPEN M

PRINTING TECHNIQUES



SCREEN PRINTING



DIGITAL

*While stocks last.

**48h not available in Digital finishes.

***Due to the recycled content of the raw materials used to make the product, we cannot guarantee that the colours shown in the catalogue or colours customised to order will always have the same colour and appearance.

BIC® WIDE BODY™

BIC® WIDE BODY™

1080 Opaque
1079 Opaque Chrome
eColutions® 1E80

A/C SP: max. 2 col.
B/F SP: max. 1 col.
D DG: full-colour (area for images)
E DG: full-colour (area for text)

MOQ 250 units (SP)
MOQ 500 units (DG)

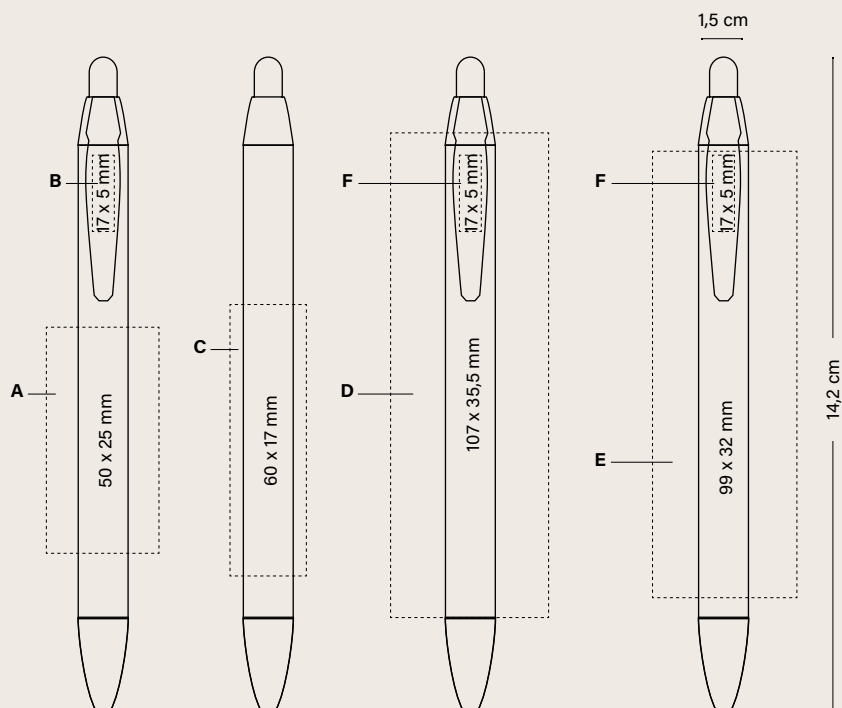

					Price (€)
BIC® WIDE BODY™	250-499	500-999	1000-2499	2500-4999	5000
1080 / eColutions® 1E80					
SP	1,25	1,02	0,96	0,90	0,82
DG	-	1,42	1,32	1,23	1,15
1079					
SP	2,39	1,94	1,79	1,70	1,56
DG	-	2,32	2,16	2,05	1,91

Additional imprint charge per colour & position

SP	0,17	0,14	0,14	0,14	0,13
----	------	------	------	------	------

Prices include one imprint in one position according to specified technique.

OPTIONAL SPECIAL PACKAGING



+ INFO PAGES 222 TO 227

EXTERNAL PACKAGING

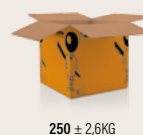

*New!
Collection Box
(1, 2 & 3 units)*

250 ± 2,6KG

**BIC® WIDE BODY™
MINI DIGITAL**

1893

**BIC® WIDE BODY™
MINI CHROME DIGITAL**

1896

A DG: full-colour (area for images)

B DG: full-colour (area for text)

MOQ 500 units (DG)

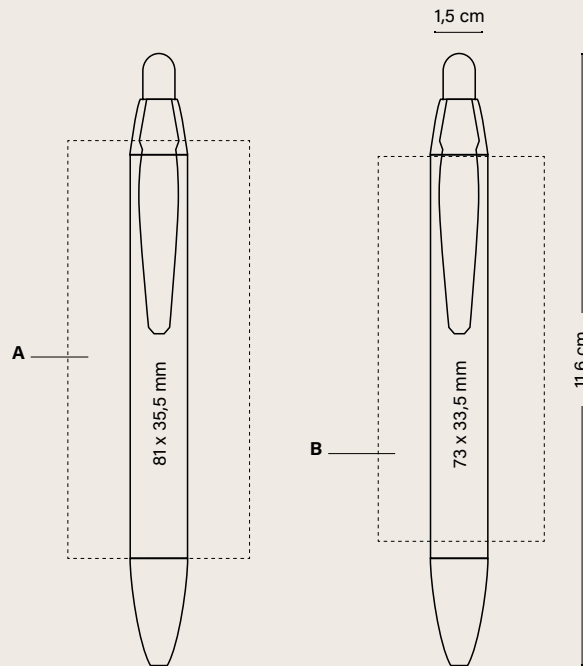

	Price (€)			
BIC® WIDE BODY™ MINI DIGITAL	500-999	1000-2499	2500-4999	5000
1893				
DG	1,25	1,16	1,09	1,03
1896				
DG	2,16	2,02	1,92	1,76

Prices include the digital imprint on the body.

OPTIONAL SPECIAL PACKAGING



+ INFO PAGES 222 TO 227



*New!
Collection Box
(1, 2 & 3 units)*

EXTERNAL PACKAGING



250 ± 2,6KG

SPECIFICATIONS



PERSONALIZED COLOURS



MANUFACTURED AND PRINTED IN BIC FACTORIES



MADE IN SPAIN



REGULATORY COMPLIANCE



ISO certified



IMPRIM'VERT®



ECOlutions®



FRUIT AND VEGETABLE TRAYS



100% RECYCLABLE



100% RENEWABLE ELECTRICITY



LOW ENVIRONMENTAL IMPACT

WRITING MODES



BALLPEN M

PRINTING TECHNIQUES



SCREEN PRINTING



DIGITAL

See page 233 for a detailed explanation of the icons

BIC® WIDE BODY™ BGUARD™ ANTIBACTERIAL



Bacteria elimination



Entire pen protection



Timeless protection



Antibacterial Test protocol

ANTIBACTERIAL™

Antibacterial logo always visible!

WIDE BODY™ BGUARD™ ANTIBACTERIAL

1081 Opaque

Colour ink



Red Ink available under request



360° Printing

Available on white barrel



MOQ 250 units

Plug



Opaque

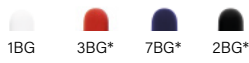

Barrel



Opaque

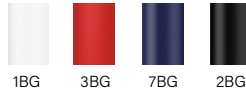

Clip



Opaque

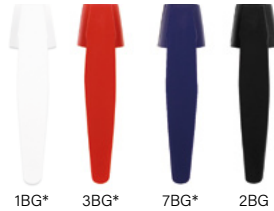

Section



Opaque

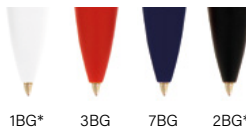

Exact colour match: > 10.000 units

**BIC® WIDE BODY™
BGUARD™
ANTIBACTERIAL**
1081

A/C SP: max. 1 col.
B/F SP: max. 1 col.
D DG: full-colour
(area for images)
E DG: full-colour
(area for text)

MOQ 250 units (SP)
MOQ 500 units (DG)

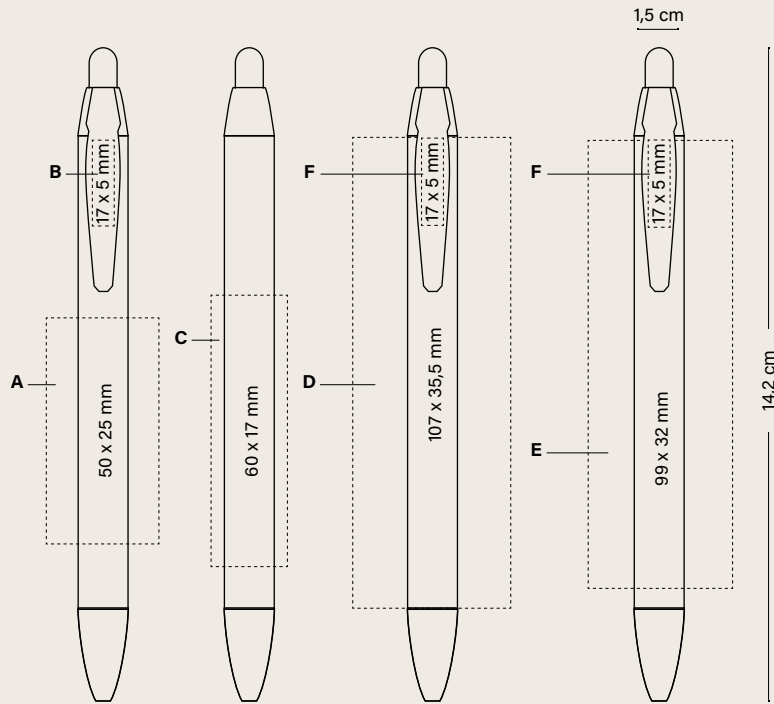

**BIC® WIDE BODY™
BGUARD™
ANTIBACTERIAL**
1081

	250-499	500-999	1000-2499	2500-4999	5000
SP	1,31	1,07	1,01	0,94	0,87
DG	-	1,49	1,38	1,29	1,22

Additional imprint charge per colour & position

	0,17	0,14	0,14	0,14	0,13
SP					

Prices include one imprint in one position according to specified technique.

OPTIONAL SPECIAL PACKAGING



*New!
Collection Box
(1, 2 & 3 units)*



250 ± 2,6KG

+ INFO PAGES 222 TO 227

SPECIFICATIONS



WRITING MODES



PRINTING TECHNIQUES







BIC[®] 4 COLOURS[®]

The world-renowned BIC[®] 4 Colours[®] ballpen gives you the convenience of four different ink colours in one ballpoint pen, making it a great choice to organise notes and record data in different colours. This versatile pen has a 1.0 mm medium point and is filled with long-lasting ink. For added convenience, it has a lanyard hole, so you can take it with you anywhere. Discover all the versions: Classic, Fashion, Sun, Fine, Shine, Fluo, 3+1^{HB} (with mechanical pencil), Glacé and the latest versions Soft and Wood Style. Don't wait...start your collection today!

Soft

Wood Style

Sun

Fashion

Shine

Glacé

Fine

Fluo

3+1^{HB}



THE SOLUTION
FOR FULL COLOUR
COMMUNICATION!

*Now in
coloured barrels*

BIC® 4 COLOURS®

1100 Opaque

1101 With lanyard

Colour ink



01/01

02/02

01/03

01/05

01/02

01/07

100%

*360°
Printing*

*Refill
service on
request*

Decoration

BIC® 4 COLOURS®

1100/1101

- A SP:** max. 4 col.
- B DG:** Digital print (area for images)
- C BP:** full-colour

MOQ 250 units (SP, DG)
MOQ 100 units (BP)

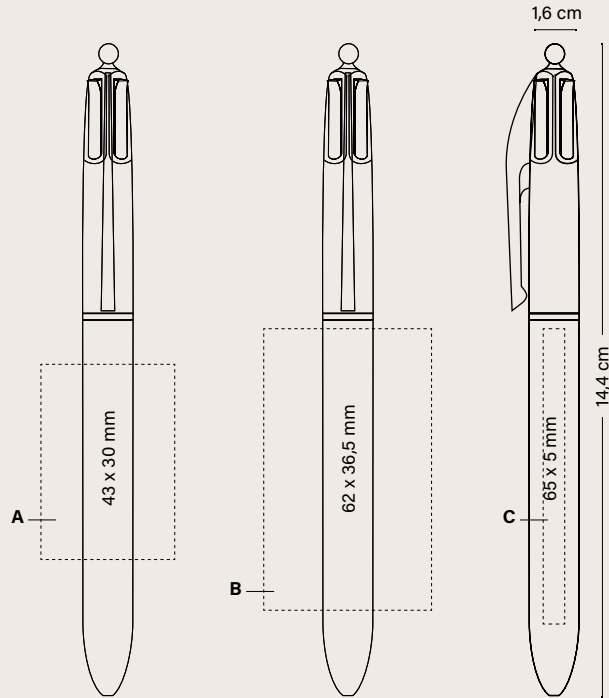

BIC® 4 COLOURS®	100-249	250-499	500-999	1000-2499	2500-4999	5000	Price (€)
1100							
SP	-	3,41	3,09	2,85	2,67		2,51
DG	-	4,66	4,22	3,92	3,64		3,44
BP	4,51	3,68	3,33	3,10	2,90		2,73
1101 (lanyard)							
SP	-	3,68	3,50	3,24	3,05		2,85
DG	-	5,11	4,64	4,29	4,00		3,79
BP	5,06	4,14	3,75	3,48	3,27		3,08

Additional imprint charge per colour & position

SP	-	0,17	0,14	0,14	0,14	0,13
BP	0,26	0,24	0,22	0,21	0,20	0,19
BP Texture	0,20	0,18	0,16	0,15	0,15	0,14

Prices include one imprint in one position according to specified technique.

OPTIONAL SPECIAL PACKAGING



+ INFO PAGES 222 TO 227

EXTERNAL PACKAGING



New!
Collection Box
(1, 2 & 3 units)

SPECIFICATIONS



PERSONALIZED COLOURS



MANUFACTURED AND PRINTED IN BIC FACTORIES



MADE IN FRANCE



REGULATORY COMPLIANCE



ISO certified



IMPRIM'VERT®



100% RECYCLABLE



100% RENEWABLE ELECTRICITY



LOW ENVIRONMENTAL IMPACT

WRITING SMODES



BALLPEN M

PRINTING TECHNIQUES



SCREEN PRINTING



DIGITAL



BRITEPIX™

See page 233 for a detailed explanation of the icons

BIC® 4 COLOURS® SOFT

A soft touch you won't want to put down!



BIC® 4 COLOURS® SOFT

- 1060 Opaque
- 1063 With Lanyard
- Colour ink



01/03F

01/02F

01/07F

collection



Feel the softness in your hands

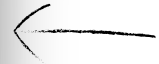

Refill service on request



BIC® 4 COLOURS® SOFT

Decoration

BIC® 4 COLOURS® SOFT

1060/1063

A SP: max. 1 col.

MOQ 250 units

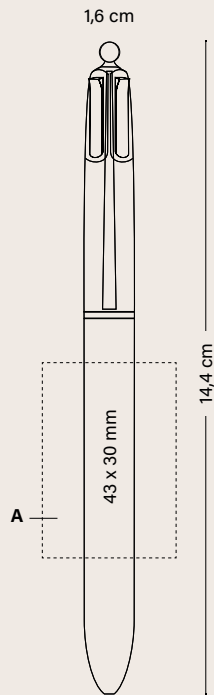

Price (€)

BIC® 4 COLOURS® SOFT	250-499	500-999	1000-2499	2500-4999	5000
1060					
SP	4,06	3,67	3,40	3,18	3,00
1063 (lanyard)					
SP	4,52	4,08	3,78	3,55	3,35

Additional imprint charge per colour & position

SP	0,17	0,14	0,14	0,14	0,13
----	------	------	------	------	------

Prices include one colour in screen printing in one position.

OPTIONAL SPECIAL PACKAGING



+ INFO PAGES 222 TO 227

EXTERNAL PACKAGING



SPECIFICATIONS



PERSONALIZED COLOURS



MANUFACTURED AND PRINTED IN BIC FACTORIES



MADE IN FRANCE



REGULATORY COMPLIANCE



IMPRIM'VERT®



100% RECYCLABLE



100% RENEWABLE ELECTRICITY



LOW ENVIRONMENTAL IMPACT

WRITING MODES



BALLPEN M

PRINTING TECHNIQUES



SCREEN PRINTING

See page 233 for a detailed explanation of the icons

BIC® 4 COLOURS® WOOD STYLE

Be impressed
with the spectacular
wood finish!



BIC® 4 COLOURS® WOOD STYLE

1061 Opaque
1064 With Lanyard

Colour ink
● ● ● ●



01/6AW

01/05W

01/02W

01/12W

collection
● ● ● ●

*Bring warmth
to your brand*

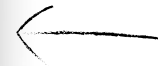

*Refill
service on
request*



Decoration

BIC® 4 COLOURS® WOOD STYLE

1061/1064

A SP: max. 1 col.

MOQ 250 units

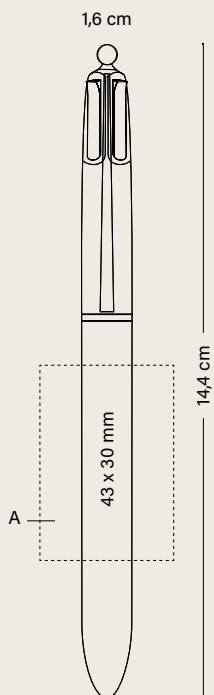

	Price (€)				
BIC® 4 COLOURS® WOOD STYLE	250-499	500-999	1000-2499	2500-4999	5000
1061					
SP	4,06	3,67	3,40	3,18	3,00
1064 (lanyard)					
SP	4,52	4,08	3,78	3,55	3,35
Additional imprint charge per colour & position					
SP	0,17	0,14	0,14	0,14	0,13

Prices include one colour in screen printing in one position.

OPTIONAL SPECIAL PACKAGING

EXTERNAL PACKAGING



+ INFO PAGES 222 TO 227

SPECIFICATIONS



MADE IN FRANCE



WRITING MODES



PRINTING TECHNIQUES



SCREEN PRINTING



THE SOLUTION
FOR FULL COLOUR
COMMUNICATION!

BIC® 4 COLOURS® SUN

- 1097 Opaque
- 1098 With Lanyard
- Colour ink



01/12

01/12

Decoration

BIC® 4 COLOURS® SUN

1097/1098

A SP: max. 4 col.

B DG: Digital print (area for images)

C BP: full-colour

MOQ 250 units (SP, DG)

MOQ 100 units (BP)

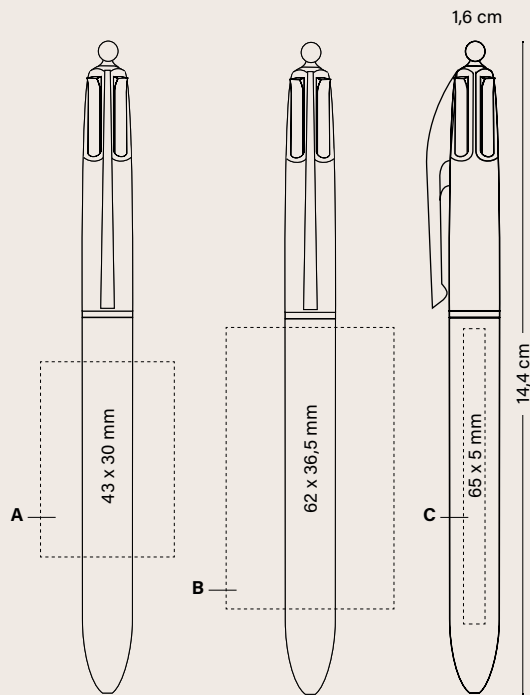

						Price (€)
BIC® 4 COLOURS® SUN	100-249	250-499	500-999	1000-2499	2500-4999	5000
1097						
SP	-	3,41	3,09	2,85	2,67	2,51
DG	-	4,66	4,22	3,92	3,64	3,44
BP	4,51	3,68	3,33	3,10	2,90	2,73
1098 (lanyard)						
SP	-	3,86	3,50	3,24	3,05	2,85
DG	-	5,11	4,64	4,29	4,00	3,79
BP	5,06	4,14	3,75	3,48	3,27	3,08
Additional imprint charge per colour & position						
SP	-	0,17	0,14	0,14	0,14	0,13
BP	0,26	0,24	0,22	0,21	0,20	0,19
BP Texture	0,20	0,18	0,16	0,15	0,15	0,14

Prices include one imprint in one position according to specified technique.

OPTIONAL SPECIAL PACKAGING



+ INFO PAGES 222 TO 227

EXTERNAL PACKAGING



250 ± 3,2KG

New!
Collection Box
(1, 2 & 3 units)

SPECIFICATIONS



WRITING MODES



PRINTING TECHNIQUES



SCREEN PRINTING



DIGITAL



BRITEPIX™
BRITEPIX™ TEXTURE
BRITEPIX™ PERSONALISATION

See page 233 for a detailed explanation of the icons



THE SOLUTION
FOR FULL COLOUR
COMMUNICATION!

*Now on
coloured barrels*

4 COLOURS® FASHION

1102 Opaque
1108 With Lanyard

Colour ink
●●●●



Decoration

BIC® 4 COLOURS® FASHION
1102/1108

A SP: max. 4 col.
B DG: Digital print (area for images)
C BP: full-colour

MOQ 250 units (SP, DG)
MOQ 100 units (BP)

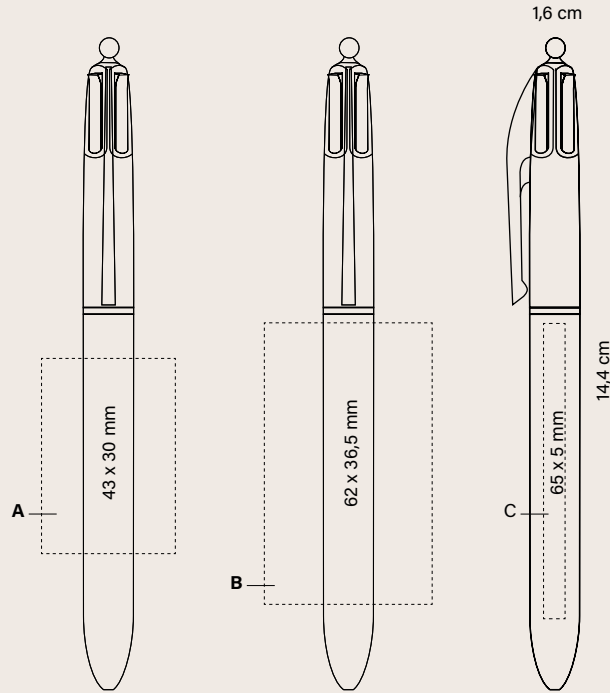

Price (€)

BIC® 4 COLOURS® FASHION	100-249	250-499	500-999	1000-2499	2500-4999	5000
1102						
SP	-	3,41	3,09	2,85	2,67	2,51
DG	-	4,66	4,22	3,92	3,64	3,44
BP	4,51	3,68	3,33	3,10	2,90	2,73
1108 (lanyard)						
SP	-	3,86	3,50	3,24	3,05	2,85
DG	-	5,11	4,64	4,29	4,00	3,79
BP	5,06	4,14	3,75	3,48	3,27	3,08

Additional imprint charge per colour & position

SP	-	0,17	0,14	0,14	0,14	0,13
BP	0,26	0,24	0,22	0,21	0,20	0,19
BP Texture	0,20	0,18	0,16	0,15	0,15	0,14

Prices include one imprint in one position according to specified technique.

OPTIONAL SPECIAL PACKAGING



+ INFO PAGES 222 TO 227

EXTERNAL PACKAGING



SPECIFICATIONS



WRITING MODES



PRINTING TECHNIQUES



See page 233 for a detailed explanation of the icons

BIC® 4 COLOURS® SHINE

Brighten up your brand.

BIC® 4 COLOURS® SHINE

1106 Opaque
1107 With Lanyard

Colour ink



01/75



01/26



01/7G



01/34



01/97

collection
● ● ● ●

*Super Shiny
barrels!*



*Refill
service on
request*



BIC® 4 COLOURS® SHINE

Decoration

BIC® 4 COLOURS® SHINE
1106/1107

A SP: max. 2 col.

B LE

C LE

D LE: 360°

MOQ 250 units

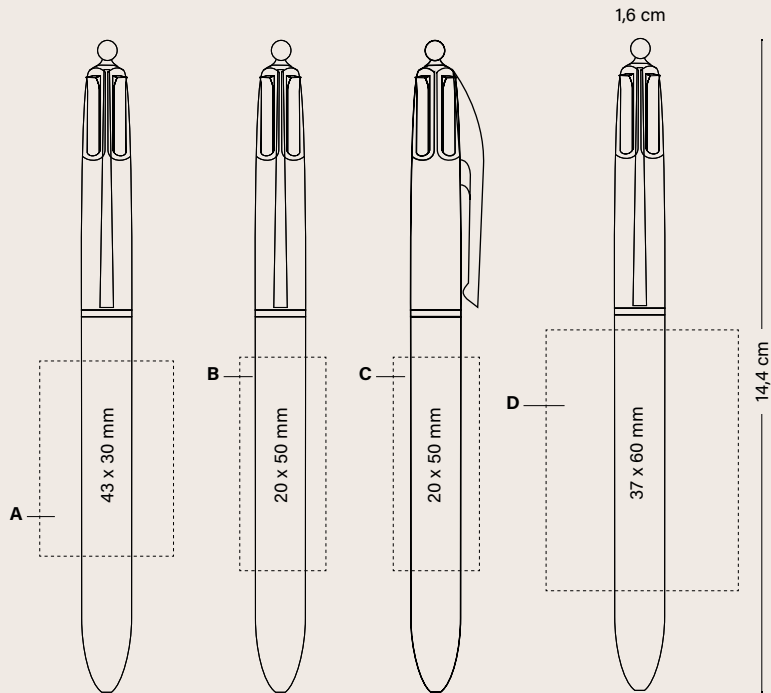

Price (€)

BIC® 4 COLOURS® SHINE	250-499	500-999	1000-2499	2500-4999	5000
1106					
SP	3,90	3,51	3,27	3,06	2,85
LE	4,80	4,31	4,00	3,73	3,52
LE 360°	5,43	4,89	4,55	4,24	3,99
1107 (lanyard)					
SP	4,38	3,95	3,66	3,44	3,21
LE	5,27	4,74	4,41	4,13	3,88
LE 360°	5,92	5,34	4,95	4,64	4,36

Additional imprint charge per colour & position

SP	0,17	0,14	0,14	0,14	0,13
----	------	------	------	------	------

Prices include one imprint in one position according to specified technique.

OPTIONAL SPECIAL PACKAGING

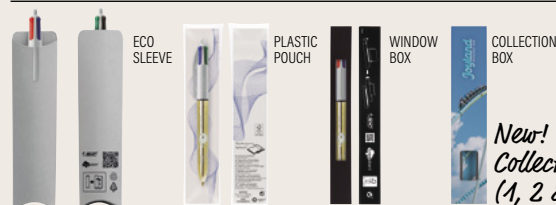

+ INFO PAGES 222 TO 227

EXTERNAL PACKAGING



250 ± 3,2KG

SPECIFICATIONS



MADE IN FRANCE



WRITING MODES



PRINTING TECHNIQUES



See page 233 for a detailed explanation of the icons

BIC® 4 COLOURS® GLACÉ

Our classic pen dressed up.

BIC® 4 COLOURS® GLACÉ
1057 Opaque
1058 With Lanyard
Colour ink
● ● ● ●

collection
● ● ● ●



76

47G

03G

05G

04G

14G

*Refill
service on
request*

BIC® 4 COLOURS® GLACÉ

Decoration

BIC® 4 COLOURS® GLACÉ

1057/1058

A SP: max. 2 col.

MOQ 250 units

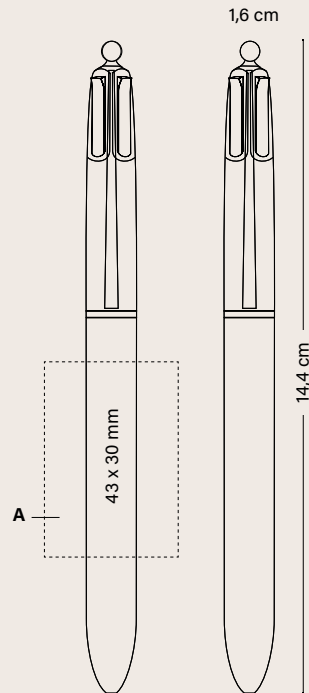

	Price (€)				
BIC® 4 COLOURS® GLACÉ	250-499	500-999	1000-2499	2500-4999	5000
1057					
SP	3,90	3,51	3,27	3,06	2,85
1058 (lanyard)					
SP	4,36	3,93	3,64	3,42	3,19
Additional imprint charge per colour & position					
SP	0,17	0,14	0,14	0,14	0,13

Prices include one colour in screen printing in one position.

OPTIONAL SPECIAL PACKAGING



+ INFO PAGES 222 TO 227



New!
Collection Box
(1, 2 & 3 units)

EXTERNAL PACKAGING



250 ± 3,2KG

SPECIFICATIONS



PERSONALIZED COLOURS



MANUFACTURED AND PRINTED IN BIC FACTORIES



MADE IN FRANCE



REGULATORY COMPLIANCE



IMPRIM'VERT®



100% RECYCLABLE



100% RENEWABLE ELECTRICITY



LOW ENVIRONMENTAL IMPACT

WRITING MODES



BALLPEN M

PRINTING TECHNIQUES



SCREEN PRINTING



THE SOLUTION FOR FULL COLOUR COMMUNICATION!

BIC® 4 COLOURS® FINE

1109 Opaque
1111 With Lanyard
Colour ink





Decoration

BIC® 4 COLOURS® FINE

1109/1111

A SP: max. 4 col.
B DG: Digital print
C BP: full-colour

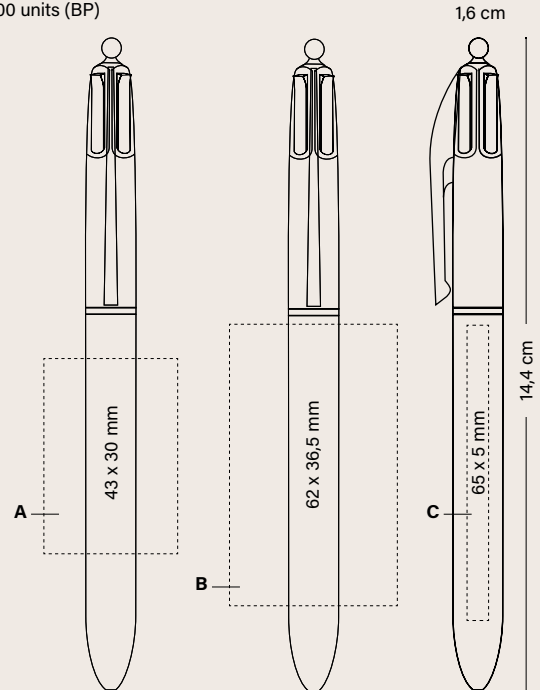
MOQ 250 units (SP, DG)
MOQ 100 units (BP)



Price (€)

BIC® 4 COLOURS® FINE

	100-249	250-499	500-999	1000-2499	2500-4999	5000
--	---------	---------	---------	-----------	-----------	------

1109						
SP	-	3,41	3,09	2,85	2,67	2,51
DG	-	4,66	4,22	3,92	3,64	3,44
BP	4,51	3,68	3,33	3,10	2,90	2,73
1111 (lanyard)						
SP	-	3,86	3,50	3,24	3,05	2,85
DG	-	5,11	4,64	4,29	4,00	3,79
BP	5,06	4,14	3,75	3,48	3,27	3,08

Additional imprint charge per colour & position

SP	-	0,17	0,14	0,14	0,14	0,13
BP	0,26	0,24	0,22	0,21	0,20	0,19
BP Texture	0,20	0,18	0,16	0,15	0,15	0,14

Prices include one imprint in one position according to specified technique.

OPTIONAL SPECIAL PACKAGING



EXTERNAL PACKAGING



SPECIFICATIONS

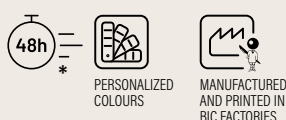

WRITING MODES



PRINTING TECHNIQUES



*48h not available in Digital finishes
Available without lanyard. See page 233 for a detailed explanation of the icons



Decoration

BIC® 4 COLOURS® FLUO

1114/1116

A SP: max. 4 col.
B BP: full-colour

MOQ 250 units (SP, DG)
MOQ 100 units (BP)

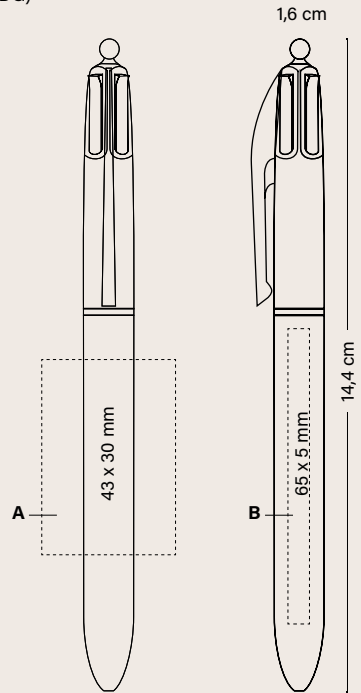

Price (€)

BIC® 4 COLOURS® FLUO 100-249 250-499 500-999 1000-2499 2500-4999 5000

1114						
SP	-	3,69	3,33	3,09	2,89	2,73
BP	4,51	3,96	3,58	3,32	3,11	2,94

1116 (lanyard)						
SP	-	4,18	3,78	3,49	3,28	3,10
BP	5,40	4,45	4,02	3,72	3,50	3,31

Additional imprint charge per colour & position

SP	-	0,17	0,14	0,14	0,14	0,13
BP	0,26	0,24	0,22	0,21	0,20	0,19
BP Texture	0,20	0,18	0,16	0,15	0,15	0,14

Prices include one imprint in one position according to specified technique.

OPTIONAL SPECIAL PACKAGING



EXTERNAL PACKAGING



SPECIFICATIONS

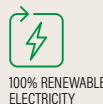
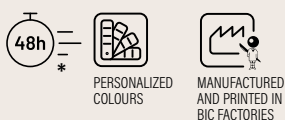

WRITING MODES



PRINTING TECHNIQUES



*48h not available in Digital finishes
Available without lanyard. See page 233 for a detailed explanation of the icons

BIC® 4 COLOURS® 3+1^{HB}
1099 Opaque
Colour ink
●●●●

*3 ballpens +
1 mechanical pencil.*



Decoration

BIC® 4 COLOURS® 3+1^{HB}

1099 Opaque

A/B LE

MOQ 250 units

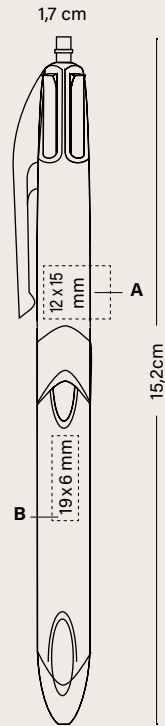

Price (€)

BIC® 4 COLOURS® 3+1^{HB} 250-499 500-999 1000-2499 2500-4999 5000

1099

LE	5,12	4,63	4,30	4,00	3,79
-----------	------	------	------	------	------

Additional imprint charge per colour & position

LE	1,27	1,14	1,01	1,01	1,01
-----------	------	------	------	------	------

Prices include one laser engraving in one position.

OPTIONAL SPECIAL PACKAGING



PLASTIC POUCH



COLLECTION BOX

*New!
Collection Box
(1, 2 & 3 units)*

+ INFO PAGES 222 TO 227

EXTERNAL PACKAGING



250 ± 3,5 KG

SPECIFICATIONS



PERSONALIZED COLOURS



MANUFACTURED AND PRINTED IN BIC FACTORIES



REGULATORY COMPLIANCE



ISO certified



IMPRIM'VERT®



100% RECYCLABLE



100% RENEWABLE ELECTRICITY



LOW ENVIRONMENTAL IMPACT

WRITING MODES



BALLPEN M



MECHANICAL PENCIL MP Ø 0,7MM

PRINTING TECHNIQUES



LASER



CHECK OUT THE VIDEO

See page 233 for a detailed explanation of the icons

BIC® METAL PRO

Metal accents, modern design
with a large selection of
colours and finishes.

BIC® METAL PRO
1290 Soft
Colour ink
● ●



01F



10F*



03F*



02F



04F

*Maximum
writing comfort*

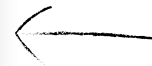

*Generous ink for
writing up to 8 km.*

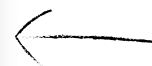

BIC® METAL PRO

1290 Polished

Colour ink



01E



02E



03E*



05E*



04E



06P*

SPECIFICATIONS



ASSEMBLED
AND PRINTED IN
BIC FACTORIES



MADE IN GERMANY



REGULATORY
COMPLIANCE



ISO
certified



IMPRIM'VERT®



100%
RECYCLABLE

WRITING MODES



BALLPEN M

PRINTING TECHNIQUES



SP
SCREEN PRINTING



LE
LASER

See page 233 for a detailed explanation of the icons.

BIC® METAL PRO

1290 Matt

Colour ink



01D

10D*

03D*

02D

04D

100%

Decoration

BIC® METAL PRO

1290

A SP: max. 2 col.
(Not available in soft finish)

B LE/SP: max. 1 col.

C LE 360°

MOQ 50 units

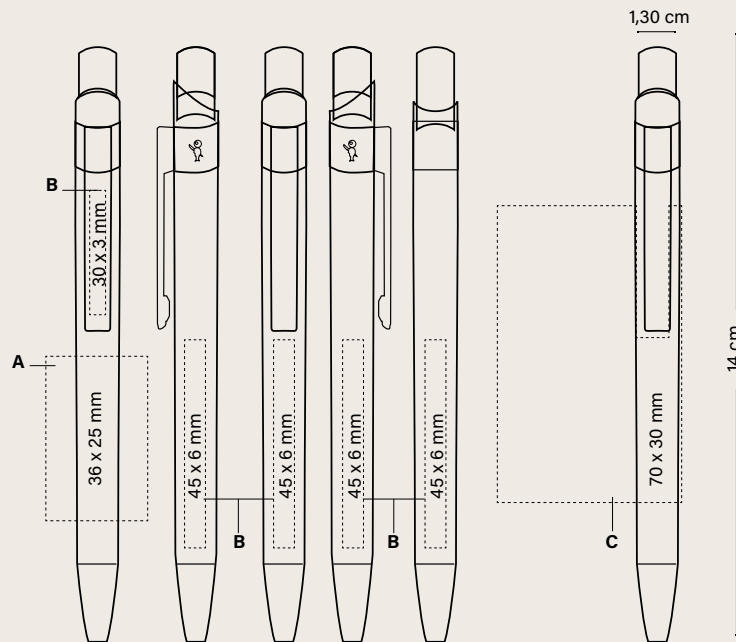

	Price (€)			
BIC® METAL PRO	50-99	100-249	250-499	500-1000
1290				
SP	4,88	4,58	4,37	4,16
LE	6,73	5,62	5,32	5,02
LE 360° (minimum quantity 100 units)	-	7,94	6,38	5,96

Additional imprint charge per colour & position

SP	0,45	0,42	0,37	0,32
LE	1,66	1,42	1,29	1,17

Prices include one imprint in one position according to specified technique.

OPTIONAL SPECIAL PACKAGING



+ INFO PAGES 222 TO 227

EXTERNAL PACKAGING



SPECIFICATIONS



ASSEMBLED
AND PRINTED IN
BIC FACTORIES



MADE IN GERMANY



REGULATORY
COMPLIANCE



ISO
certified



IMPRIM'VERT®



100%
RECYCLABLE

**WRITING
MODES**



BALLPEN M

**PRINTING
TECHNIQUES**



SP
SCREEN PRINTING



LE
LASER

See page 233 for a detailed explanation of the icons.



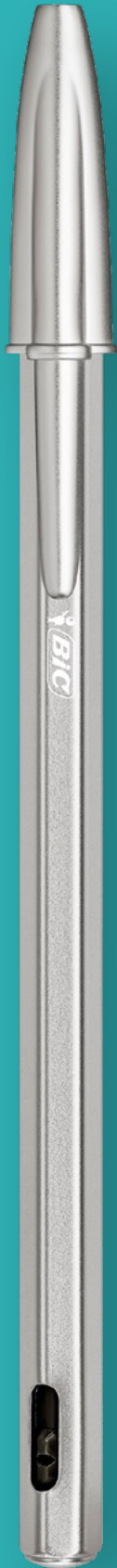

BIC[®] CRISTAL[®]

RE'NEW[™]

The iconic BIC[®] Cristal[®] in a metal version. The BIC[®] Cristal[®] Re'New[™] adds to the iconic BIC[®] Cristal[®] original, attaching a sense of modernity to its aluminum matt barrel and the laser engraved BIC[®] logo. The cap has been also redesigned; it's matt gray and manufactured from 96% recycled plastic. Refillable with blue or black inks. Includes 2 cartridges. The same ingenious hexagonal shape as the original BIC[®] Cristal[®] for controlled grip and comfort. Sustainable design, trusted quality, and timeless value. The product comes with BIC[®] Window Box packaging.

BIC® CRISTAL®
RE'NEW™

1090

Colour ink



1 pen + 2 refills

BIC® WINDOW BOX

*Your Cristal® Re'New™
comes with this packaging!*

(Included in the price)

Decoration

BIC® CRISTAL® RE'NEW™
1090

A LE: max. 1 col.

MOQ 25 units

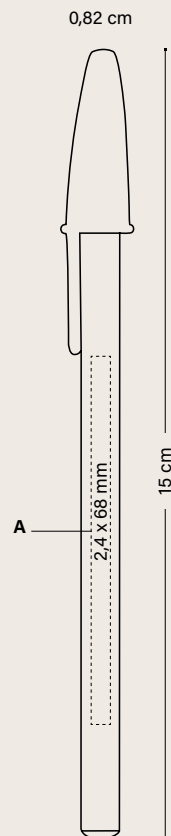

SPECIFICATIONS



MANUFACTURED AND PRINTED IN BIC FACTORIES



REGULATORY COMPLIANCE



ISO certified



IMPRIM'VERT®



100% RECYCLABLE

WRITING MODES



BALLPEN M

PRINTING TECHNIQUES



LASER

Price (€)

BIC® CRISTAL® RE'NEW™	25-49	50-99	100-249	250-499	500-1000
1090					
LE	7,47	6,95	6,44	6,18	5,92

Additional imprint charge per colour & position

LE	1,98	1,66	1,42	1,29	1,17
----	------	------	------	------	------

Prices include one laser engraving in one position.

EXTERNAL PACKAGING



44 ± 1KG

See page 233 for a detailed explanation of the icons.





BIC[®] GRIP ROLLER

Enjoy a smooth writing experience. Glide across the paper easily without smudging thanks to the quick-drying ink, ideal for both left and right-handed people.

BIC® GRIP ROLLER



MEDIUM WRITING
Ø 0,7 MM

*High quality medium point liquid ink roller
pen for smooth and fluid writing*

BIC® GRIP ROLLER

1187

Colour ink



01/35

12/35

10/35

03/35

59/35

24/35

07/35

06/35

27/35

02/35

14/35

Also available
in blue ink

Also available
in blue ink

Also available
in blue ink

100%

Decoration

BIC® GRIP ROLLER

1187

A/B SP: max. 3 col.

MOQ 250 units

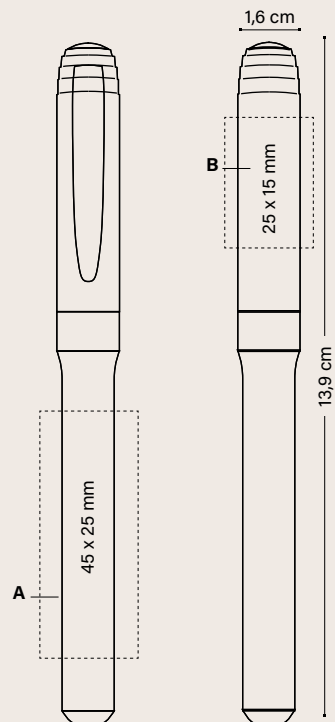

					Price (€)
BIC® GRIP ROLLER	250-499	500-999	1000-2499	2500-4999	5000
1187					
SP	1,86	1,68	1,56	1,46	1,37

Additional imprint charge per colour & position

SP	0,17	0,14	0,14	0,14	0,13
-----------	------	------	------	------	------

Prices include one colour in screen printing in one position.

OPTIONAL SPECIAL PACKAGING



ECO SLEEVE



PLASTIC POUCH



WINDOW BOX



MARKING SET

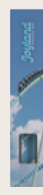

COLLECTION BOX

+ INFO PAGES 222 TO 227

EXTERNAL PACKAGING



250 ± 3 KG

*New! Collection Box
(1, 2 & 3 units)*

SPECIFICATIONS



MANUFACTURED AND PRINTED IN BIC FACTORIES



REGULATORY COMPLIANCE



ISO certified



IMPRIM'VERT®



100% RECYCLABLE

WRITING MODES



ROLLER R
Ø 0,7 MM

PRINTING TECHNIQUES



SCREEN PRINTING

See page 233 for a detailed explanation of the icons.

BIC® XS FINESTYLE
1851 Opaque
Colour ink



01/03



01/25



01/06

●
Also available
in black ink

BIC® XS FINESTYLE
1851 Clear
Colour ink



89/01

100%

Decoration

BIC® XS FINESTYLE

1851

A PD: max. 2 col.

B SP: max. 2 col.

C BP: full-colour

MOQ 250 units

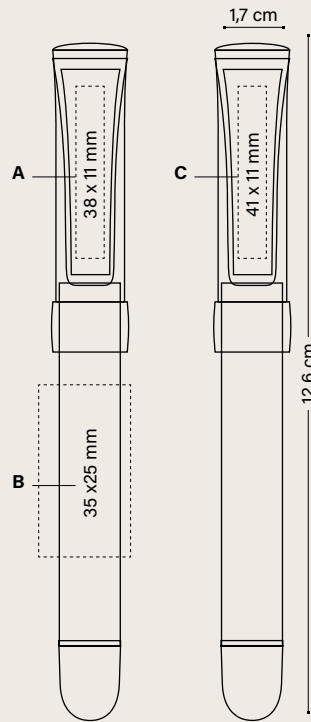

	Price (€)				
BIC® XS FINESTYLE	250-499	500-999	1000-2499	2500-4999	5000
1851					
SP/PD	1,97	1,72	1,61	1,50	1,40
BP	2,24	1,95	1,83	1,71	1,59

Additional imprint charge per colour & position

SP/PD	0,17	0,14	0,14	0,14	0,13
BP Texture	0,18	0,16	0,15	0,15	0,14

Prices include one imprint in one position according to specified technique.

OPTIONAL SPECIAL PACKAGING



ECO SLEEVE



PLASTIC POUCH

+ INFO PAGES 222 TO 227

EXTERNAL PACKAGING



250 ± 2,8KG

SPECIFICATIONS



MANUFACTURED AND PRINTED IN BIC FACTORIES



MADE IN SPAIN



REGULATORY COMPLIANCE



ISO certified



IMPRIM'VERT®



100% RECYCLABLE



100% RENEWABLE ELECTRICITY



LOW ENVIRONMENTAL IMPACT

WRITING MODES



FINESTYLE
Ø 0,7 MM

PRINTING TECHNIQUES



SCREEN PRINTING



PAD PRINTING



BRITEPIX™
BRITEPIX™
TEXTURE
BRITEPIX™
PERSONALISATION

See page 233 for a detailed explanation of the icons.



BIC® INTENSITY® GEL CLIC

1196 Opaque
Colour ink



01



02

100%

BIC® INTENSITY® GEL CLIC

1196 Clear
Colour ink



92



88



86

100%

Decoration

BIC® INTENSITY® GEL CLIC

1196

A SP: max. 2 col.

B SP: max. 4 col.

MOQ 250 units

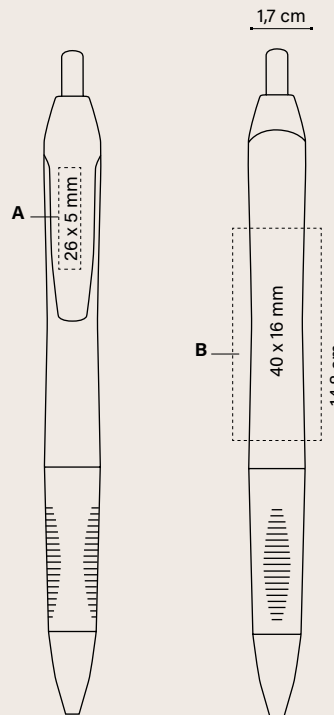

	Price (€)				
BIC® INTENSITY® GEL CLIC	250-499	500-999	1000-2499	2500-4999	5000
1196					
SP	2,91	2,63	2,44	2,27	2,15
Additional imprint charge per colour & position					
SP	0,17	0,14	0,14	0,14	0,13

Prices include one colour in screen printing in one position.

OPTIONAL SPECIAL PACKAGING



+ INFO PAGES 222 TO 227

EXTERNAL PACKAGING



SPECIFICATIONS



MANUFACTURED AND PRINTED IN BIC FACTORIES



REGULATORY COMPLIANCE



ISO certified



100% RECYCLABLE

WRITING MODES



GEL G
Ø 0,7 MM

PRINTING TECHNIQUES



SCREEN PRINTING

See page 233 for a detailed explanation of the icons.



Plan B

Audit

→ Sol
Oibvo

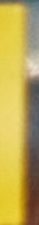



BIC[®] HIGHLIGHTERS AND MARKERS

BIC[®] Markers offer you products specifically designed to write in a highly visible way and mark on surfaces or material that other writing instruments cannot mark on. Make your ideas visible and express yourself whatever the surface with BIC[®] Markers.

BIC[®] Brite Liner[®] Grip

BIC[®] Velleda[®] White Board Marker Fine

BIC[®] Velleda[®] White Board Marker Grip

BIC[®] Mark-It Permanent Marker

BIC[®] Permanent Marker Ecolutions[®]

BIC® BRITE LINER® GRIP

BIC® BRITE LINER® GRIP
1192



*Textured rubberised
grip for more
precision and
control*

12 10 24 59 14
● ● ● ● ●
Colour ink Colour ink Colour ink Colour ink Colour ink

100%

Decoration

BIC® BRITE LINER® GRIP

1192

A/B SP: max. 3 col.

MOQ 250 units

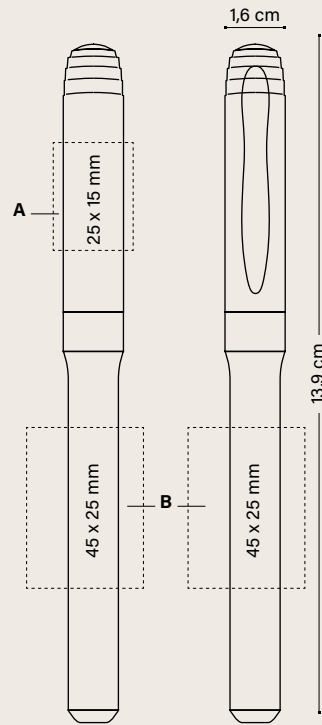

						Price (€)
BIC® BRITE LINER® GRIP	250-499	500-999	1000-2499	2500-4999	5000	
1192						
SP	1,67	1,54	1,42	1,31	1,23	

Additional imprint charge per colour & position

SP	0,17	0,14	0,14	0,14	0,13
-----------	------	------	------	------	------

Prices include one colour in screen printing in one position.

OPTIONAL SPECIAL PACKAGING



MARKING SET

+ INFO PAGES 222 TO 227



COLLECTION BOX

New! Collection Box (1, 2 & 3 units)

EXTERNAL PACKAGING



250 ± 2,8KG

SPECIFICATIONS



MANUFACTURED AND PRINTED IN BIC FACTORIES



REGULATORY COMPLIANCE



ISO certified
IMPRIM'VERT®



100% RECYCLABLE



WILL NOT DRY OUT IN 24H

WRITING MODES



HIGHLIGHTER HL

PRINTING TECHNIQUES



SCREEN PRINTING

SUITABLE FOR



FAXES



PHOTOCOPIES



PRINTERS



PAPER

See page 233 for a detailed explanation of the icons

BIC® VELLEDA® WHITE BOARD MARKER FINE

Velleda®

BIC® VELLEDA® WHITE BOARD MARKER FINE
1651



01/04

Colour ink



01/02

Colour ink

100%

Decoration

BIC® VELLEDA® WHITE BOARD MARKER FINE
1651

A SP: max. 1 col.

MOQ 500 units

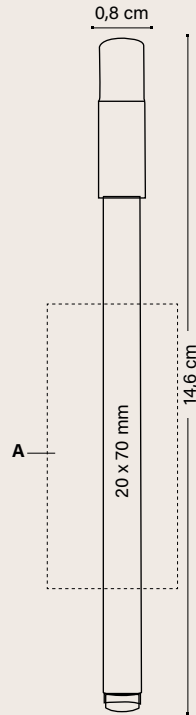

BIC® VELLEDA® WHITE BOARD MARKER FINE

1651

SP	500-999	1000-2499	2500-4999	5000
	0,60	0,54	0,51	0,48

Price (€)

Prices include one colour in screen printing in one position.

OPTIONAL SPECIAL PACKAGING



MARKING SET

Now you can have it as a set!

+ INFO PAGES 222 TO 227

EXTERNAL PACKAGING



500 ± 3,2KG

SPECIFICATIONS



MANUFACTURED AND PRINTED IN BIC FACTORIES

FABRIQUÉ EN FRANCE

MADE IN FRANCE



REGULATORY COMPLIANCE



ISO certified



IMPRIM'VERT®



RECYCLABLE



LOW ENVIRONMENTAL IMPACT



RESISTANT TIP

WRITING MODES



MARKER MK

PRINTING TECHNIQUES



SCREEN PRINTING

BIC® VELLEDA® WHITE BOARD MARKER GRIP



BIC® VELLEDA® WHITE BOARD MARKER GRIP 1213



01/02
●
Colour ink

→
Textured rubberised grip for more precision and control

Decoration

BIC® VELLEDA® WHITE BOARD MARKER GRIP 1213

A/B SP: max. 3 col.

MOQ 250 units

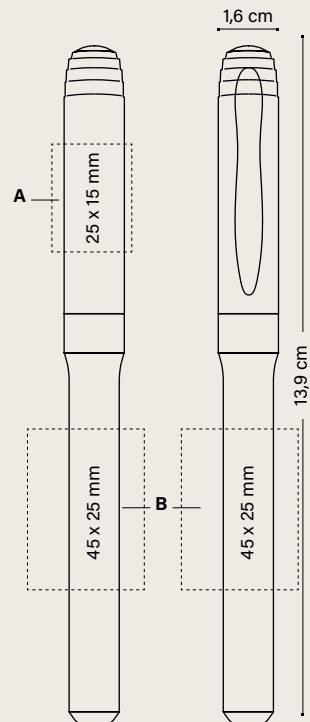

BIC® VELLEDA® WHITE BOARD MARKER GRIP

1213

SP	250-499	500-999	1000-2499	2500-4999	5000
	1,64	1,48	1,37	1,27	1,19

Additional imprint charge per colour & position

SP	0,17	0,14	0,14	0,14	0,13

Prices include one colour in screen printing in one position.

Price (€)

OPTIONAL SPECIAL PACKAGING



MARKING SET

Now you can have it as a set!

EXTERNAL PACKAGING



250 ± 2,7KG

+ INFO PAGES 222 TO 227

SPECIFICATIONS



MANUFACTURED AND PRINTED IN BIC FACTORIES



REGULATORY COMPLIANCE



ISO certified



IMPRIM'VERT®



100% RECYCLABLE



RESISTANT TIP

WRITING MODES



WHITE BOARD MARKER FINE MK

PRINTING TECHNIQUES



SP SCREEN PRINTING

BIC® MARK-IT PERMANENT MARKER

**BIC® MARK-IT
PERMANENT
MARKER**
1214



*Textured
rubberised
grip for more
precision and
control*

Decoration

**BIC® MARK-IT
PERMANENT MARKER**
1214

A/B SP: max. 3 col.

MOQ 250 units

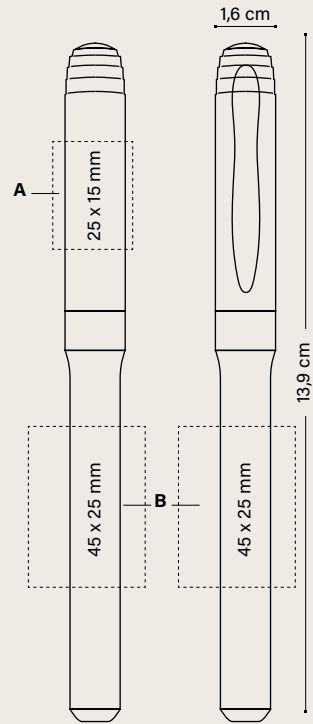

	Price (€)				
BIC® MARK-IT PERMANENT MARKER 1214	250- 499	500- 999	1000- 2499	2500- 4999	5000
SP	1,61	1,45	1,35	1,25	1,17

Additional imprint charge per colour & position

SP	0,17	0,14	0,14	0,14	0,13
----	------	------	------	------	------

Prices include one colour in screen printing in one position.

OPTIONAL SPECIAL PACKAGING



MARKING
SET

*You can have
it as a set!*



250 ± 2,8KG

+ INFO PAGES 222 TO 227

SPECIFICATIONS



MANUFACTURED AND
PRINTED IN BIC FACTORIES



REGULATORY
COMPLIANCE



RECYCLABLE



LOW ENVIRONMENTAL
IMPACT



RESISTANT
TIP

WRITING MODES



MARKER
MK

PRINTING TECHNIQUES



SCREEN PRINTING

BIC® PERMANENT MARKER ECOLUTIONS®



MADE FROM
51% RECYCLED MATERIAL*

Add the Möbius loop to your artwork at no additional charge. Please specify "Print the Möbius loop" on your order. (Möbius loop imprint defaults to left-hand hand corner.)



PHARMACEUTICAL
WASTE

BIC® PERMANENT MARKER ecolutions® 1210



02

●
Colour ink

02

●
Colour ink

Decoration

BIC® PERMANENT MARKER ecolutions® 1210

A SP: max. 1 col.

MOQ 250 units

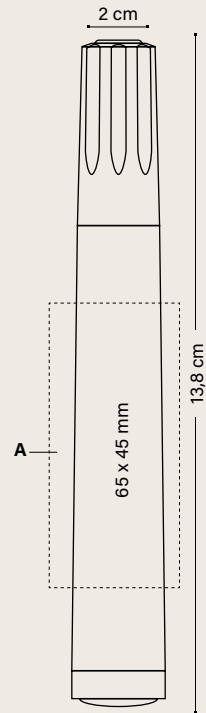

	Price (€)				
BIC® PERMANENT MARKER ecolutions® 1210	250-499	500-999	1000-2499	2500-4999	5000
SP	1,90	1,73	1,60	1,50	1,41

Prices include one colour in screen printing in one position.

EXTERNAL PACKAGING



SPECIFICATIONS



MANUFACTURED AND
PRINTED IN BIC FACTORIES

FABRIQUÉ
EN FRANCE



MADE IN
FRANCE



REGULATORY
COMPLIANCE



PHARMACEUTICAL
WASTE



RECYCLABLE



LOW ENVIRONMENTAL
IMPACT



RESISTANT
TIP



MARKER
MK

WRITING MODES

PRINTING TECHNIQUES



SCREEN PRINTING

* The percentage is calculated on total weight of product excluding ink system. Due to the recycled content of the raw materials used to make the product, we cannot guarantee that the colours shown in the catalogue or colours customised to order will always have the same colour and appearance. See page 233 for a detailed explanation of the icons





BIC[®] MECHANICAL PENCILS

A reference since 1993. Stay sharp with this first-class mechanical pencil!

It is solid and resistant, never needs sharpening and writes smoother and darker than ever!

BIC[®] Matic[®]

BIC[®] Media Clic Mechanical Pencil **54**

BIC[®] Media Clic Grip Mechanical Pencil **58**

ECO version and standard at the same price!

ecolutions®



MADE FROM 65% RECYCLED MATERIAL**

Add the Möbius loop to your artwork at no additional charge. Please specify it on your order. (Möbius loop imprint defaults to left-hand corner.)



PHARMACEUTICAL WASTE

BIC® MATIC®
1120 Opaque



01/05* 02/02 12/12* 03/03 07/07 01/01 100%

BIC® MATIC®
QUARTZ
1121 Opaque



51/07* 100%

BIC® MATIC®
ecolutions® 1E40 Opaque



06/8C* 04/8C* 100%

*While stocks last. **The percentage is calculated based on total weight of the product. Due to the recycled content of the raw materials used to make the product, we cannot guarantee that the colours shown in the catalogue or colours customised to order will always have the same colour and appearance.

Decoration

BIC® MATIC®
1120
ecolutions® 1E40

BIC® MATIC® QUARTZ

1121
A SP: max. 1 col.
(not available for
BIC® Matic® Quartz)
B/C SP: max. 2 col.

MOQ 500 units

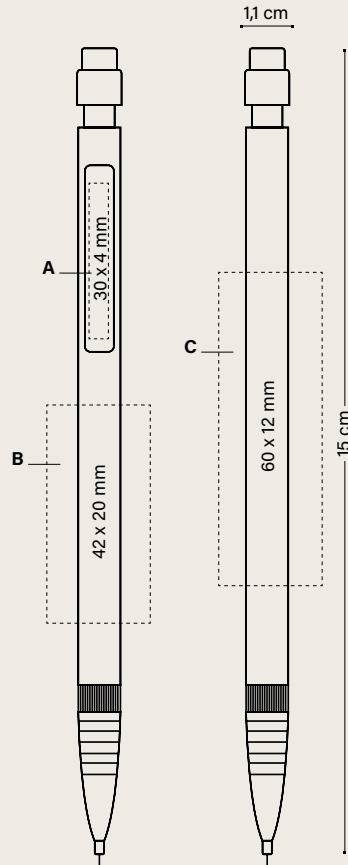

	500-999	1000-2499	2500-4999	5000
BIC® MATIC®				Price (€)
1120/ ecolutions® 1E40				
SP	0,82	0,77	0,71	0,67
1121				
SP	0,89	0,82	0,77	0,72
Additional imprint charge per colour & position				
SP	0,14	0,14	0,14	0,13

Prices include one colour in screen printing in one position.

OPTIONAL SPECIAL PACKAGING



PLASTIC
POUCH

+ INFO PAGES 222 TO 227

EXTERNAL PACKAGING



500 ± 3,1 KG

SPECIFICATIONS



MANUFACTURED
AND PRINTED IN
BIC FACTORIES



MADE IN FRANCE



REGULATORY
COMPLIANCE



IMPRIM'VERT®

ecolutions®



PHARMACEUTICAL
WASTE



RECYCLABLE



LOW ENVIRONMENTAL
IMPACT



SMOOTHER AND
DARKER WRITING



EASY TO
USE AND ERASE



2 LEADS 9 CM

**WRITING
MODES**



MECHANICAL PENCIL MP
Ø 0,7 MM

**PRINTING
TECHNIQUES**



SCREEN PRINTING

See page 233 for a detailed explanation of the icons.





BIC[®] PENCILS

A reference since 1993. Wood-free pencil made with recycled synthetic resin material, that will not splinter in the event of breaking. Ultra-resistant HB graphite lead.

Evolution[®] Ecolutions[®]

BIC® EVOLUTION® ECOLUTIONS®

Evolution® **ecolutions®**



THE SOLUTION FOR FULL COLOUR COMMUNICATION!



THE SOLUTION FOR FULL COLOUR COMMUNICATION!



Embossed iconic BIC® brand!

ecolutions®



MADE FROM 60% RECYCLED MATERIAL**



FRIDGES AND YOGURT POTS

ecolutions®



MADE FROM 52,7% RECYCLED MATERIAL**



FRIDGES AND YOGURT POTS

GRAPHITE PENCIL CUT END ecolutions® 1150

GRAPHITE PENCIL WITH ERASER ecolutions® 1151

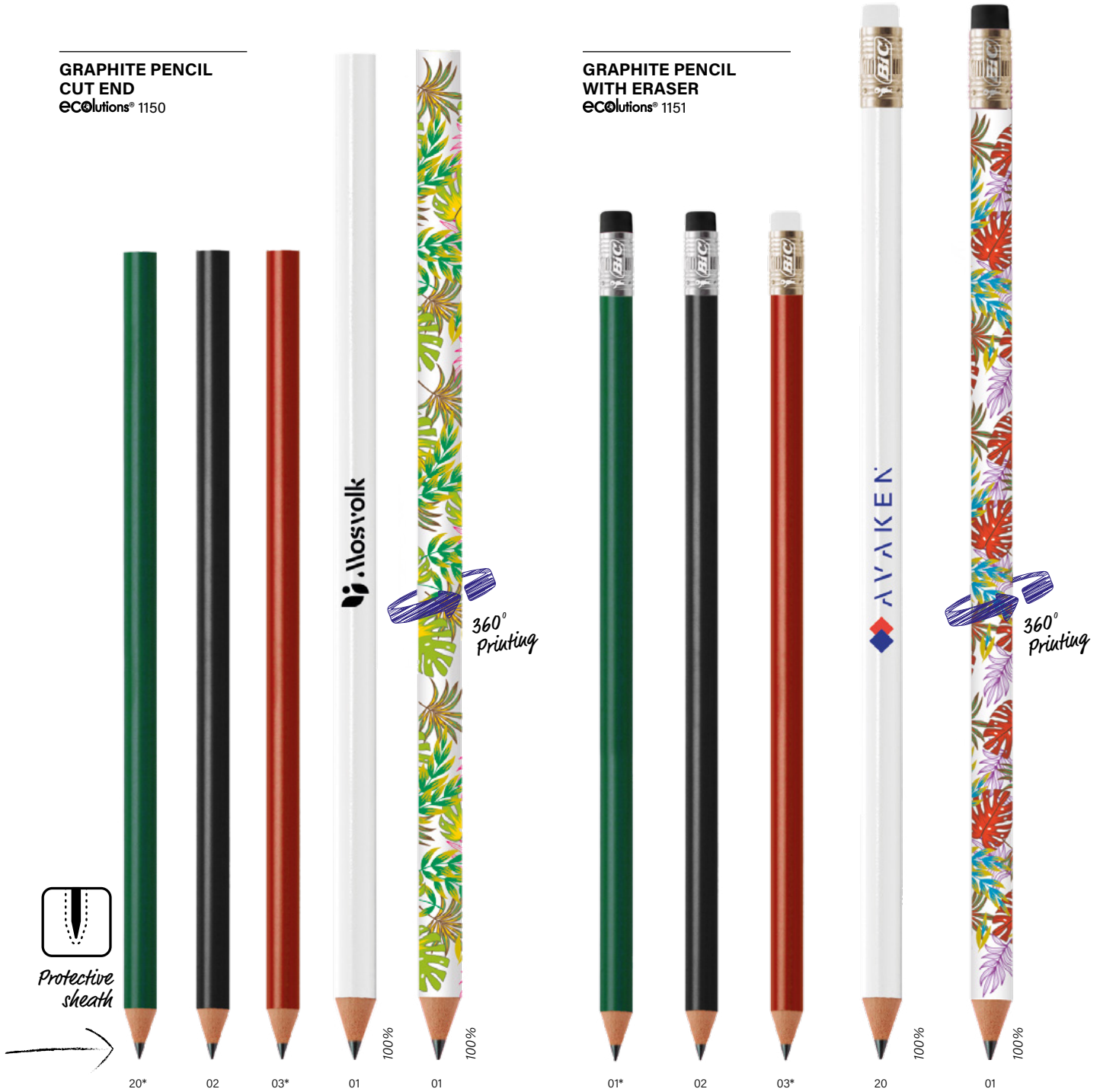

*While stocks last.

**The percentage is calculated based on total weight of the product. Due to the recycled content of the raw materials used to make the product, we cannot guarantee that the colours shown in the catalogue or colours customised to order will always have the same colour and appearance.

***48h not available in Digital finishes.

ecolutions®
 MADE FROM
 60% RECYCLED MATERIAL**



Add the Möbius loop to your artwork at no additional charge. Please specify it on your order. (Möbius loop imprint defaults to left-hand hand corner.)

GRAPHITE PENCIL

1150/1151

MOQ 500 units
 Standard colours combination



No extra charge

Eraser

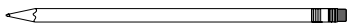

Opaque



Ferrule

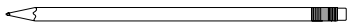

Opaque



Barrel



Opaque

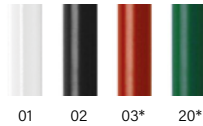

SPECIFICATIONS



MANUFACTURED AND PRINTED IN BIC FACTORIES



MADE IN FRANCE



REGULATORY COMPLIANCE



ecolutions®



RECYCLABLE



LOW ENVIRONMENTAL IMPACT



RESISTANT TIP



NO SPLINTER



PROTECTIVE SHEATH



EASY TO USE AND ERASE

WRITING MODES



PENCIL PC HB Ø 2,3MM

PRINTING TECHNIQUES



SCREEN PRINTING



DIGITAL

*While stocks last.



Decoration

BIC® EVOLUTION® ECOLUTIONS®
ecolutions® 1150 (Pencil cut end)

A SP: max. 1 col.

MOQ 500 units

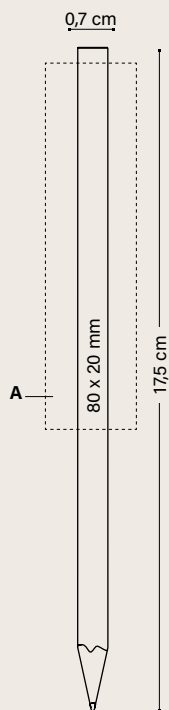

Decoration

BIC® EVOLUTION® ECOLUTIONS®
ecolutions® 1151 (Pencil with eraser)

MOQ 500 units

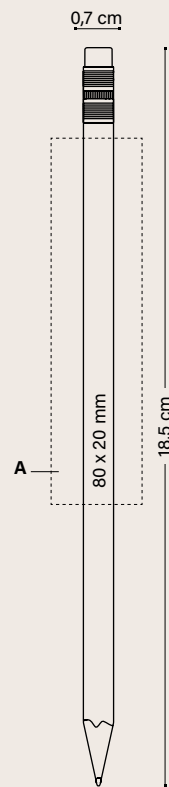

	Price (€)			
BIC® EVOLUTION® ecolutions®	500-999	1000-2499	2500-4999	5000
1150	<hr/>			
SP	0,49	0,46	0,43	0,41
1151	<hr/>			
SP	0,83	0,78	0,73	0,69

Prices include one colour in screen printing in one position.

OPTIONAL SPECIAL PACKAGING



PLASTIC
 POUCH
 (x 3 UNITS)

*Now you can
 have it as a set!*

+ INFO PAGES 222 TO 227

EXTERNAL PACKAGING



500 ± 3,5 KG

Decoration

BIC® EVOLUTION® ECOLUTIONS®
ecolutions® 1150 (Pencil cut end Digital)

A DG: full-colour (area for images)
B DG: full-colour (area for text)

MOQ 500 units

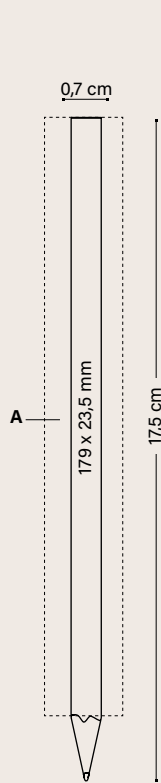

Decoration

BIC® EVOLUTION® ECOLUTIONS®
ecolutions® 1151 (Pencil with eraser Digital)

MOQ 500 units

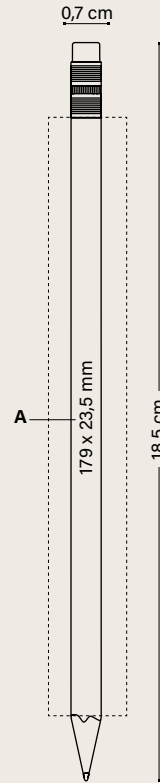

	Price (€)			
	500-999	1000-2499	2500-4999	5000
BIC® EVOLUTION® ecolutions®				
1150				
DG	0,76	0,73	0,68	0,63
1151				
DG	1,11	1,04	0,97	0,91

Prices include the digital imprint on the body.

OPTIONAL SPECIAL PACKAGING



PLASTIC POUCH (X 3 UNITS)

Now you can have it as a set!

+ INFO PAGES 222 TO 227

EXTERNAL PACKAGING



500 ± 3,5 KG

SPECIFICATIONS



MANUFACTURED AND PRINTED IN BIC FACTORIES



MADE IN FRANCE



REGULATORY COMPLIANCE



IMPRIM'VERT®
 ecolutions®



FRIDGES AND YOGURT POTS



100% RECYCLABLE



LOW ENVIRONMENTAL IMPACT



RESISTANT TIP



NO SPLINTER



PROTECTIVE SHEATH



EASY TO USE AND ERASE



PENCIL PC HB Ø 2,3MM



SCREEN PRINTING



DIGITAL

See page 233 for a detailed explanation of the icons.

SPROUT™ GRAPHITE PENCIL



The sustainable pencil that you can plant after use and grow into herbs, vegetables or flowers.

SPROUT™ GRAPHITE PENCIL
53062



Standard barrel

Customized barrels

Standard cardboard!



80%

Standard cardboard packaging

Customizable cardboard!



80%

Personalised cardboard packaging



Back



Graphite Lead

Once the pencil is too short to write with, plant the stub and watch your message turn into a pot of beautiful herbs, flowers or vegetables.

Choose between 8 different seeds!

- 1. Spruce
- 2. Sunflower
- 3. Daisy
- 4. Forget me not
- 5. Basil
- 6. Thyme
- 7. Sage
- 8. Cherry tomato

Decoration

SPROUT™ GRAPHITE PENCIL
53062

A LE
B DG

MOQ 100 units

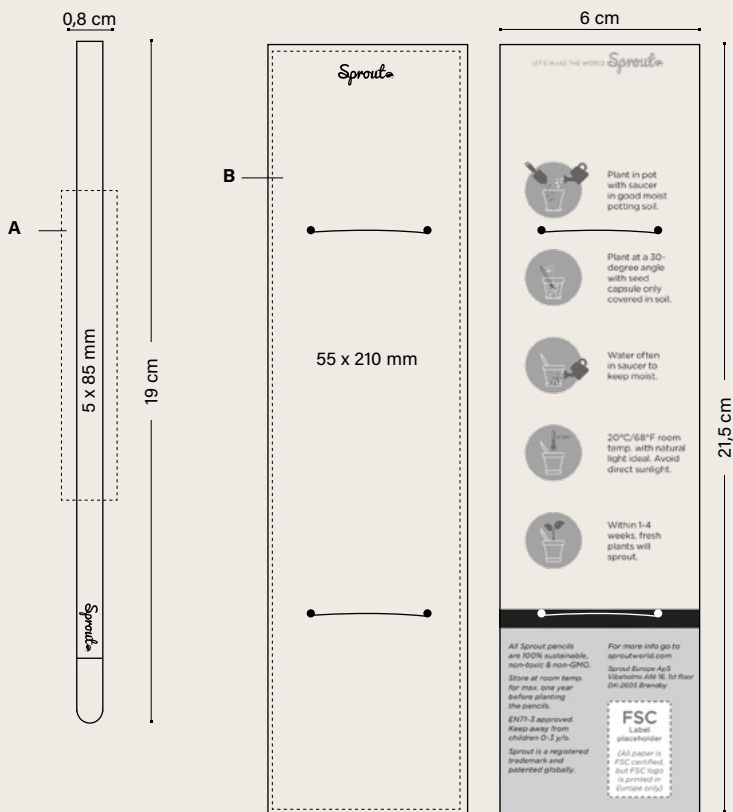

Planting instructions included on the back side. For customized cardboard, you can change the font and colours!

EXTERNAL PACKAGING



500 ± 2,5 KG (ONLY PENCIL)
± 5 KG (WITH CARDBOARD PACKAGING)

PACKAGING



SPECIFICATIONS



Sprouta



FSC AND RECYCLABLE CARDBOARD



RECYCLABLE

WRITING MODES



PENCIL PC HB
Ø 2,3MM

PRINTING TECHNIQUES



LASER



DIGITAL



CHECK OUT THE VIDEO

See page 233 for a detailed explanation of the icons.

Contents

02

OTHER WRITING INSTRUMENTS

PLASTIC PENS

Basic Pen	172
Click Pen	174
Striped Grip Pen	176

STYLUS PENS

Sleek Stylus Pen	178
------------------	-----

BASIC PEN

BASIC PEN

12010

Colour ink



Decoration

BASIC PEN 12010

A/B SP: max. 1 col.

MOQ 500 units

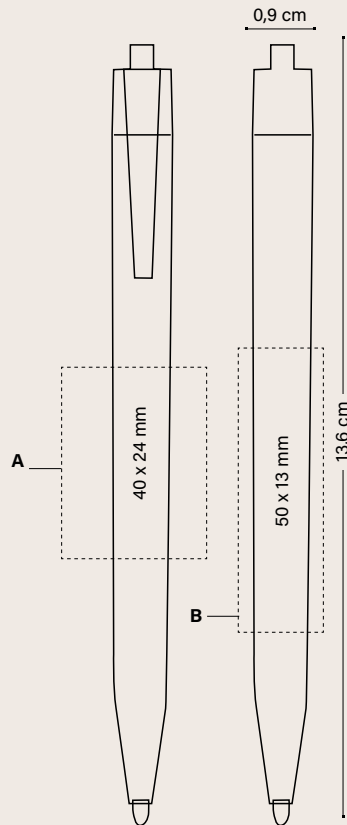

BASIC PEN 12010				Price (€)
	500-999	1000-2499	2500-4999	5000
Unimprinted	0,16	0,15	0,15	0,14
SP	0,65	0,51	0,44	0,40

Prices include one colour in screen printing in one position.

EXTERNAL PACKAGING



1000 ± 12,5 KG

SPECIFICATIONS



PRINTED IN
BIC FACTORIES



QUALITY & SAFETY
APPROVED



REGULATORY
COMPLIANCE



ISO
certified



IMPRIM'VERT®

WRITING MODES



BALLPEN M

PRINTING TECHNIQUES



SCREEN PRINTING

CLICK PEN

CLICK PEN

11748

Colour ink



Decoration

CLICK PEN

11748

A/B SP: max. 4 col.

C/D PD: max. 4 col.

MOQ 500 units

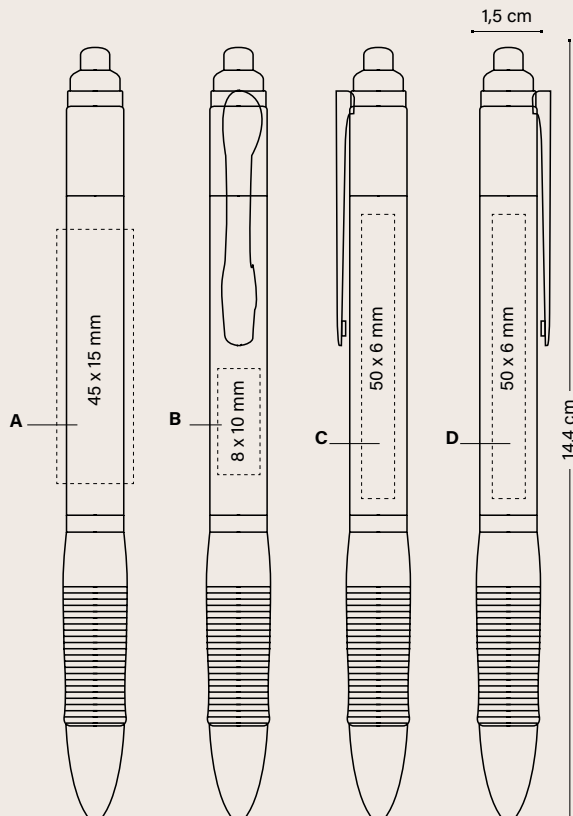

CLICK PEN 11748				Price (€)
	500-999	1000-2499	2500-4999	5000
Unimprinted	0,21	0,20	0,20	0,19
SP	0,63	0,51	0,44	0,41
PD	0,77	0,61	0,52	0,48

Additional imprint charge per colour & position

SP	0,14	0,14	0,14	0,13
PD	0,37	0,27	0,20	0,19

Prices include one imprint in one position according to specified technique.

EXTERNAL PACKAGING



SPECIFICATIONS



WRITING MODES



PRINTING TECHNIQUES



SCREEN PRINTING



PAD PRINTING

STRIPED GRIP PEN

STRIPED GRIP PEN

11243

Colour ink



10



03



24



8C



04
100%

Decoration

STRIPED GRIP PEN

11243

A SP: max. 2 col.

B PD: max. 1 col.

MOQ 500 units

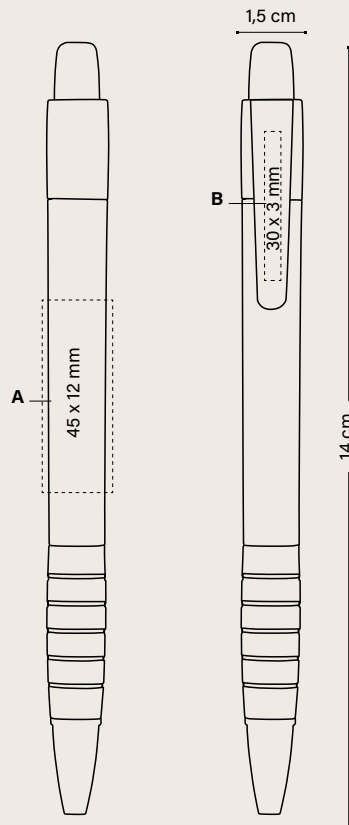

Price (€)

STRIPED GRIP PEN	500-999	1000-2499	2500-4999	5000
11243				
Unimprinted	0,33	0,32	0,32	0,30
SP	0,74	0,62	0,55	0,51
PD	0,81	0,72	0,63	0,58

Additional imprint charge per colour & position

SP	0,14	0,14	0,14	0,13
PD	0,37	0,27	0,20	0,19

Prices include one imprint in one position according to specified technique.

EXTERNAL PACKAGING



SPECIFICATIONS



WRITING MODES



PRINTING TECHNIQUES



SCREEN PRINTING



PAD PRINTING

SLEEK STYLUS PEN

SLEEK STYLUS PEN

11666

Colour ink



01

100%

SLEEK STYLUS MATT PEN

11747

Colour ink



47



04

100%

SLEEK STYLUS EXECUTIVE PEN

11976



26

Available in
blue ink



2N

Available in
black ink

100%

Decoration

SLEEK STYLUS PEN

11666

SLEEK STYLUS MATT PEN

11747

SLEEK STYLUS EXECUTIVE PEN

11976

A SP: max. 1 col.

B SP: max. 2 col.

C LE

MOQ 500 units (SP)

MOQ 100 units (LE)

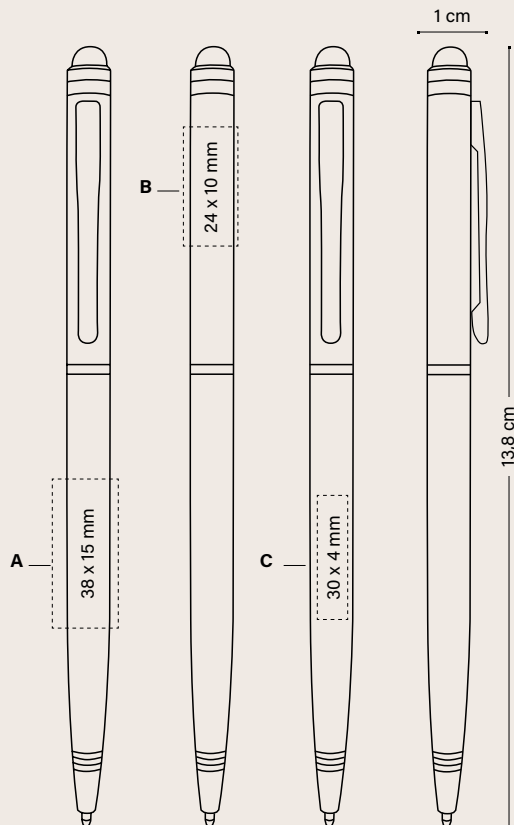

SLEEK STYLUS PEN	Price (€)					5000
	100-249	250-499	500-999	1000-2499	2500-4999	
11666						
Unimprinted	1,93	1,85	1,78	1,71	1,66	1,60
SP	-	2,55	2,34	2,15	2,09	1,94
LE	3,85	3,26	3,01	2,83	2,74	2,71

SLEEK STYLUS MATT PEN / EXECUTIVE PEN

11747 / 11976

Unimprinted	2,07	1,98	1,90	1,81	1,76	1,71
SP	-	2,68	2,46	2,26	2,19	2,05
LE	3,99	3,40	3,12	2,93	2,85	2,82

Additional imprint charge per colour & position

SP	-	0,39	0,34	0,23	0,23	①
LE	1,91	1,41	1,22	1,11	1,08	①

Prices include one imprint in one position according to specified technique.

① Price under request.

EXTERNAL PACKAGING



(11666)
900 ± 12,4 KG



(11747 / 11976)
800 ± 13 KG

SPECIFICATIONS



PRINTED IN BIC FACTORIES



QUALITY & SAFETY APPROVED



REGULATORY COMPLIANCE



ISO certified



IMPRIM'VERT®



BALLPEN M

WRITING MODES



STYLUS PEN

PRINTING TECHNIQUES



SP
SCREEN PRINTING



LE
LASER

See page 233 for a detailed explanation of the icons.

Contents

03

NOTEBOOKS

ROCKETBOOK®

Rocketbook® Core Executive A5	184
Rocketbook® Fusion Executive A5	186
Rocketbook® Core Mini A6	188



STUDIO BENCH

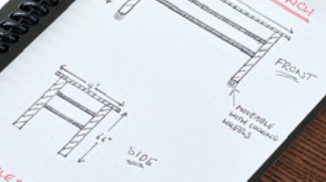

- * TABLE SURFACE IS PLY-WOOD
- * FELT-LINED SHELVES
- * ACETIC SURFACE THROU THE SHELVES
- * INDUSTRIAL GEAR WHEELS



Rocketbook
Beacons

STUDIO BENCH



- * TABLE SURFACE IS PLY-WOOD
- * FELT-LINED SHELVES
- * ACETIC SURFACE THROU THE SHELVES
- * INDUSTRIAL GEAR WHEELS



ROCKETBOOK®

Rocketbook® combines the freedom of a traditional pen and paper notebook with its app technology to send handwritten notes quickly and securely to the cloud folder of your choice. It is designed to be the last notebook you'll ever need. Follow the instructions included for a clean page that can be used endlessly. You can choose the Core for taking notes, making graphs and sketching, or go one step further with the Fusion for planning, making lists and setting goals.

Rocketbook® Core Executive A5

Rocketbook® Fusion Executive A5

Rocketbook® Core Mini A6



ROCKETBOOK® CORE EXECUTIVE A5



ROCKETBOOK® CORE EXECUTIVE A5
3728

POP Award Winner 2022 for
the best customisation



07
●
Navy Blue



01
○
White



02
●
Black

- Write
- Scan
- Share
- Reuse

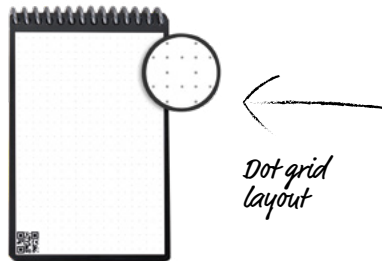

- The box always includes:
- Notebook
 - Pen
 - Cloth
 - Instructions

Decoration

ROCKETBOOK® CORE EXECUTIVE A5

3728

A SP: max. 1 col.

B BP: full-colour

C HS: max. 1 col.

36 pages

MOQ 50 units

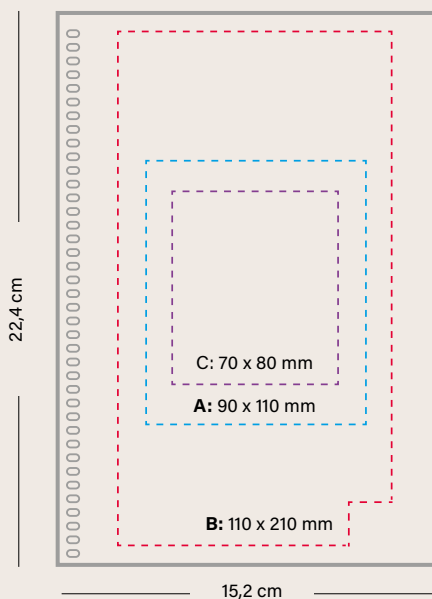

Price (€)

ROCKETBOOK® CORE EXECUTIVE A5	50-99	100-249	250-499	500-999	1000
3728					
SP	34,33	32,12	29,23	27,53	26,68
HS	34,92	32,52	29,50	27,76	27,11
BP	39,26	35,02	31,96	30,08	28,44

Prices include one imprint in one position according to specified technique.

SPECIAL PACKAGING ALWAYS INCLUDED



GIFT BOX CORE A5

EXTERNAL PACKAGING



50 ± 5,8 KG

SPECIFICATIONS



PRINTED IN BIC FACTORIES



REGULATORY COMPLIANCE



IMPRIM'VERT®

ROCKETBOOK® APP AVAILABLE IN:



PRINTING TECHNIQUES



SCREEN PRINTING



BRITEPIX™



HOT STAMPING



DOWNLOAD THE APP



HOW IT WORKS

See page 233 for a detailed explanation of the icons.

ROCKETBOOK® FUSION EXECUTIVE A5



ROCKETBOOK® FUSION EXECUTIVE A5
3726

POP Award Winner 2022 for
the best customisation



01
○
White



02
●
Black

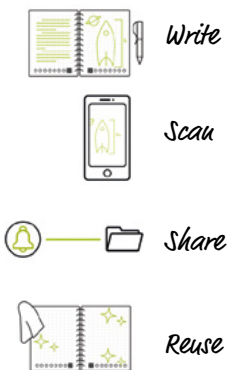

Seven page styles

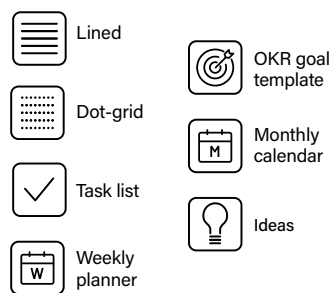

Customization visible in window cutout

The box always includes:

- Notebook
- Pen
- Cloth
- Instructions

Decoration

ROCKETBOOK® FUSION EXECUTIVE A5

3726

A SP: max. 1 col.

B BP: full-colour

C HS: max. 1 col.

42 pages

MOQ 50 units

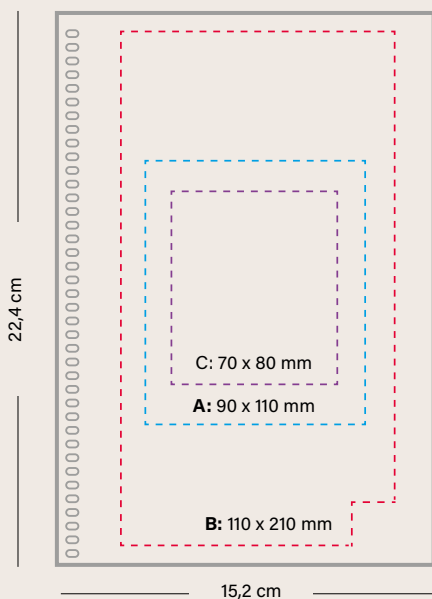

SPECIFICATIONS



PRINTED IN BIC FACTORIES



REGULATORY COMPLIANCE



IMPRIM'VERT®

ROCKETBOOK® APP AVAILABLE IN:



PRINTING TECHNIQUES



SCREEN PRINTING



BRITEPIX™



HOT STAMPING

	Price (€)				
ROCKETBOOK® FUSION EXECUTIVE A5	50-99	100-249	250-499	500-999	1000
3726					
SP	36,71	35,02	32,98	31,37	30,39
HS	37,30	35,41	33,30	31,58	30,59
BP	42,67	38,41	35,35	33,28	31,88

Prices include one imprint in one position according to specified technique.

SPECIAL PACKAGING ALWAYS INCLUDED

EXTERNAL PACKAGING



GIFT BOX FUSION A5



50 ± 5,8 KG



DOWNLOAD THE APP



HOW IT WORKS

See page 233 for a detailed explanation of the icons.

ROCKETBOOK® CORE MINI A6



ROCKETBOOK® CORE MINI A6
3727

POP Award Winner 2022 for
the best customisation



01
●
White



02
○
Black

- Write
- Scan
- Share
- Reuse

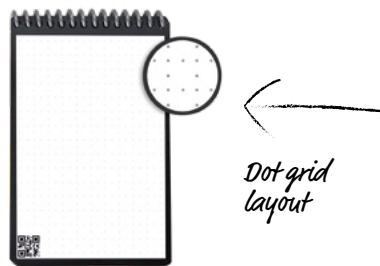

- The box always includes:
- Notebook
 - Pen
 - Cloth
 - Instructions

Decoration

ROCKETBOOK® CORE MINI A6

3727

A SP: max. 1 col.

B BP: full-colour

C HS: max. 1 col.

48 pages

MOQ 50 units

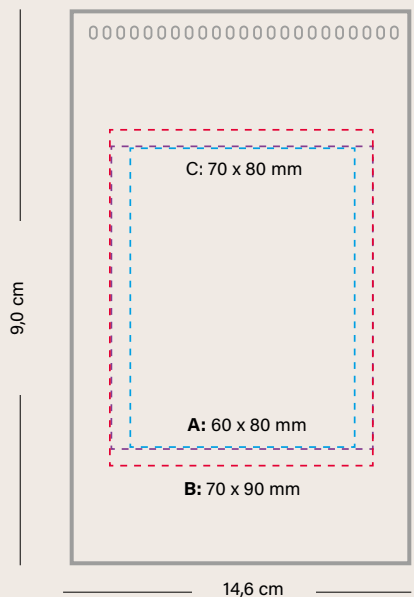

SPECIFICATIONS



PRINTED IN BIC FACTORIES



REGULATORY COMPLIANCE



IMPRIM'VERT®

ROCKETBOOK® APP AVAILABLE IN:



PRINTING TECHNIQUES



SCREEN PRINTING



BRITEPIX™



HOT STAMPING

	Price (€)				
ROCKETBOOK® CORE MINI A6	50-99	100-249	250-499	500-999	1000

3727

SP	18,99	17,68	15,97	14,64	14,23
HS	19,41	18,07	16,24	15,30	14,74
BP	23,93	21,07	17,68	16,23	15,51

Prices include one imprint in one position according to specified technique.

SPECIAL PACKAGING ALWAYS INCLUDED



GIFT BOX CORE A6

EXTERNAL PACKAGING



50 ± 2,6 KG



DOWNLOAD THE APP



HOW IT WORKS

See page 233 for a detailed explanation of the icons.

Contents

04

BIC® LIGHTERS AND CASES

LIGHTERS

BIC® J25 Lighter	196
BIC® J23 Lighter	200
BIC® J26 Lighter	204
BIC® J38 Lighter	208

LIGHTER CASES

BIC® Styl'it Luxury Case	212
BIC® Aluminium Flat Case	214
BIC® Clip Case	215
BIC® 3D Case	216

OTHER PRODUCTS

BIC® Pocket Ashtray	218
---------------------	-----



BIC® lighters.

Our quality, your safety.

All BIC® pocket lighters meet or exceed international standards and regulations requirements (ISO 9994, EN 13869, ASTM F400, US CPSC).

1/3 Less than 1/3 of the lighter models available in the European market MEET European safety standards¹.

3% Only 3% of the electronic lighter models available in Europe COMPLY with the EN 13869 Standard².

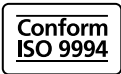

Flame height, resistance to drops, flame stability and flame extinction are some of the features tested by the ISO 9994 standard.

¹Source: Tests run by independent accredited laboratories from 2015 to 2018.



The EN 13869 Standard requires all pocket lighters sold within the EU to be effectively child-resistant throughout the life of the lighter.

²Source: SGS tests on 105 piezo models with vertical movement between April 2017 and June 2018.

A Child-resistant lighter is not a child proof lighter.

A Child-resistant lighter is a lighter that at least 85% of children under 51 months of age cannot operate. This means that up to 15% of children may still be able to operate such a lighter. Therefore, adults should always ensure that young children cannot get hold of lighters, even if they are Child-resistant.

CHOOSE WISELY! BIC® Pocket Lighters



BIC® J25 Digital lighter



BIC® J23 Digital lighter



BIC® J26 Digital lighter



BIC® J38 Digital lighter







BIC® LIGHTERS

The iconic, well-loved and time-honoured shapes of BIC® pocket lighters remain on trend!
Four different sizes and a wide range of colour combinations.

BIC® J25 Lighter

BIC® J23 Lighter

BIC® J26 Lighter

BIC® J38 Lighter

BIC® Styl'it Luxury Case

BIC® Aluminium Flat Case

BIC® Clip Case

BIC® 3D Case

BIC® Pocket Ashtray

BIC® J25 LIGHTER



Iconic BIC® Boy
and BIC® logo
engraved!

BIC® J25 LIGHTER

2360

2364 All Black



01 57 57 8G 03 11



59 24 04 25 25 06



90 84* 02 02 02 02

100%

Decoration



BIC® J25 LIGHTER

2360/2364

A/C SP: max. 4 col.

MOQ 300 units

BIC® J25 LIGHTER BRIPEPIX™

2360 / 2364

A/C BP: full-colour

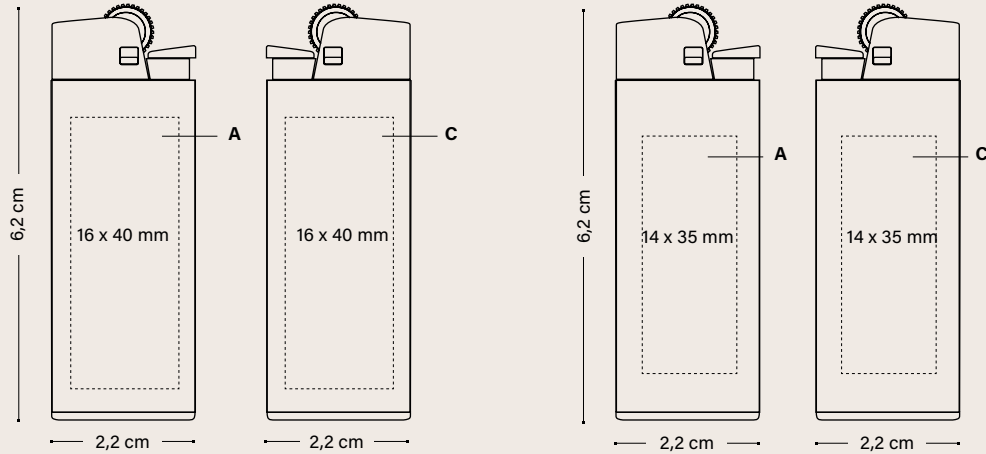

						Price (€)
BIC® J25 LIGHTER	300-599	600-1199	1200-2999	3000-5099	5100	
2360						
SP	1,43	1,26	1,19	1,16	1,13	
BP	1,69	1,51	1,43	1,39	1,34	
2364						
SP	1,63	1,51	1,42	1,32	1,25	
BP	1,91	1,75	1,64	1,54	1,46	
Additional imprint charge per colour & position						
SP	0,15	0,14	0,14	0,14	0,11	
BP	0,24	0,22	0,21	0,20	0,19	

Prices in screen printing include one colour in one position.
Prices in britePix™ include imprint on the body.

PACKAGING



STANDARD PACKAGING:
IN TRAY OF 50 UNITS

100% recycled!

EXTERNAL PACKAGING



600 ± 76 KG



FSC AND
RECYCLABLE
CARDBOARD

SPECIFICATIONS



MANUFACTURED
AND PRINTED
IN BIC FACTORIES



MADE
IN SPAIN



PASTEL
MADE IN FRANCE



REGULATORY COMPLIANCE



UP TO 1.450



100% OF ELECTRICITY
PRODUCED USING
RENEWABLE SOURCES



LOW ENVIRONMENTAL
IMPACT

**PRINTING
TECHNIQUES**



SCREEN PRINTING



BRIPEPIX™

See page 233 for a detailed explanation of the icons.

FINISHES

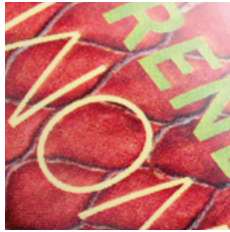

BR BRILLIANT



MT MATT

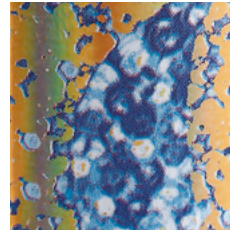

H HOLOGRAPHIC



P PUFFY

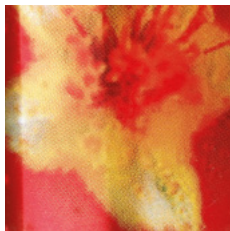

M METALLIC



UV UV



SA SANDY

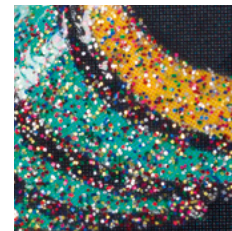

PG PUFFY GLITTER

BIC® J25 DIGITAL LIGHTER
2360



MT MATT
P PUFFY



BR BRILLIANT
P PUFFY



MT MATT
M METALLIC

360°
Printing

100%

Decoration

BIC® J25 DIGITAL LIGHTER

2360

A DG: full-colour

MOQ 600 units

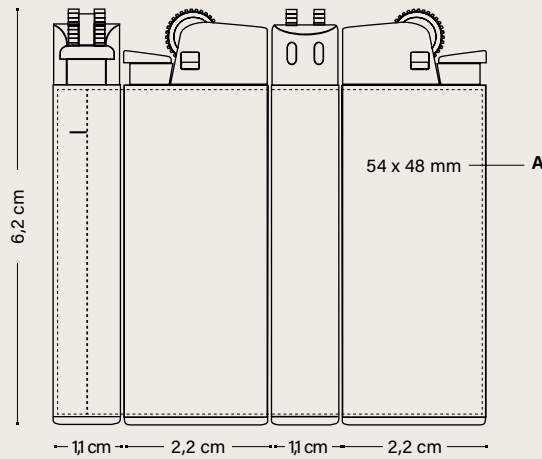

BIC® J25 DIGITAL LIGHTER	300-599	600-1199	1200-2999	3000-5099	5100	Price (€)
2360						
DG	-	1,88	1,76	1,66	1,56	

Additional charge for digital finishes						Minimum quantity		
BR	MT	Brilliant or Matt	Free			600 u.		
	H	Holographic	-	0,27	0,27	0,24	0,19	600 u.
	P	Puffy	-	-	-	0,24	0,19	3.000 u.
	M	Metallic	①					50.000 u.
	UV	UV	-	-	-	0,24	0,19	3.000 u.
	SA	Sandy	-	-	-	0,24	0,19	3.000 u.
	PG	Puffy Glitter	-	-	-	0,24	0,19	3.000 u.

Prices include the digital imprint on the body.

① Price under request.

PACKAGING



STANDARD PACKAGING:
IN TRAY OF 50 UNITS

100% recycled!

EXTERNAL PACKAGING



600 ± 7,6 KG



FSC AND RECYCLABLE CARDBOARD

SPECIFICATIONS



MANUFACTURED AND PRINTED IN BIC FACTORIES



MADE IN SPAIN



REGULATORY COMPLIANCE



UP TO 1450

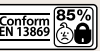

100% OF ELECTRICITY PRODUCED USING RENEWABLE SOURCES



LOW ENVIRONMENTAL IMPACT

PRINTING TECHNIQUES



DIGITAL

See page 233 for a detailed explanation of the icons.

BIC® J23 LIGHTER

 Iconic BIC® Boy
and BIC® logo
engraved!

BIC® J23 LIGHTER
2340



57



12



03



10

*Slim and fits
everywhere!*



05



04



25



02

Decoration

BIC® J23 LIGHTER

2340

A/C SP: max. 4 col.

MOQ 300 units

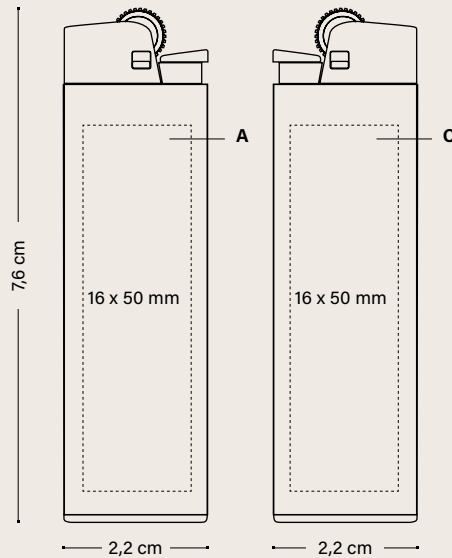

	Price (€)				
BIC® J23 LIGHTER	300-599	600-1199	1200-2999	3000-5099	5100
2340					
SP	1,56	1,43	1,34	1,26	1,22
Additional imprint charge per colour & position					
SP	0,15	0,14	0,14	0,14	0,11

Prices include one colour in screen printing in one position.

PACKAGING



STANDARD PACKAGING:
IN TRAY OF 50 UNITS

100% recycled!

EXTERNAL PACKAGING



600 ± 9,5 KG



FSC AND
RECYCLABLE
CARDBOARD

SPECIFICATIONS



MANUFACTURED
AND PRINTED
IN BIC FACTORIES



MADE IN FRANCE



REGULATORY
COMPLIANCE



UP TO 1.800



**PRINTING
TECHNIQUES**



SCREEN PRINTING

See page 233 for a detailed explanation of the icons.

FINISHES

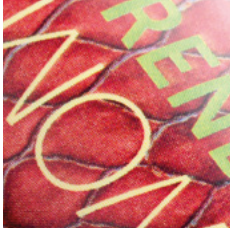

BR BRILLIANT

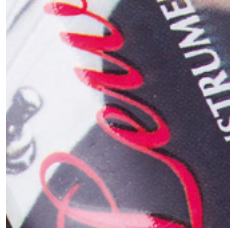

MT MATT

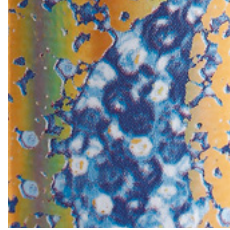

H HOLOGRAPHIC



P PUFFY

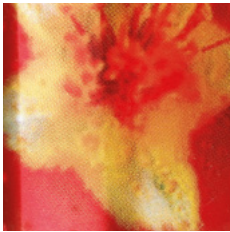

M METALLIC



UV UV



SA SANDY

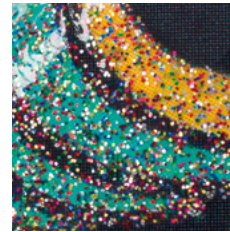

PG PUFFY GLITTER

BIC® J23 DIGITAL LIGHTER 2340



MT MATT

P PUFFY

UV UV



MT MATT

M METALLIC



BR BRILLIANT

P PUFFY

Decoration

BIC® J23 DIGITAL LIGHTER

2340

A DG: full-colour

MOQ 600 units

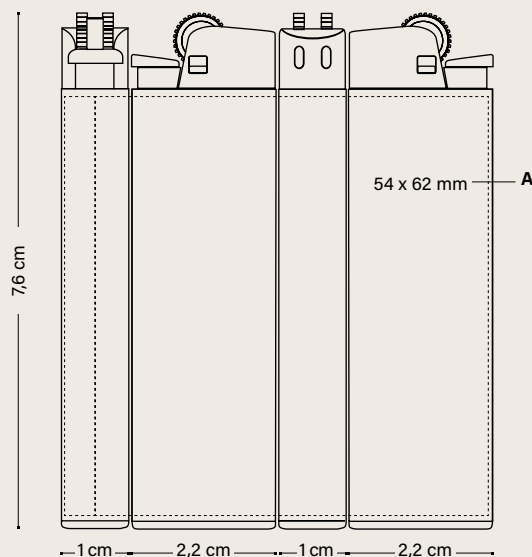

BIC® J23 DIGITAL LIGHTER	Price (€)				
	300-599	600-1199	1200-2999	3000-5099	5100
2340					
DG	-	2,04	1,93	1,84	1,74

Additional charge for digital finishes							Minimum quantity	
BR	MT	Brilliant or Matt	Free				600 u.	
	H	Holographic	-	0,27	0,27	0,24	0,19	600 u.
	P	Puffy	-	-	-	0,24	0,19	3.000 u.
	M	Metallic	①				50.000 u.	
	UV	UV	-	-	-	0,24	0,19	3.000 u.
	SA	Sandy	-	-	-	0,24	0,19	3.000 u.
	PG	Puffy Glitter	-	-	-	0,24	0,19	3.000 u.

Prices include the digital imprint on the body.
① Price under request.

PACKAGING



STANDARD PACKAGING:
IN TRAY OF 50 UNITS

100% recycled!

EXTERNAL PACKAGING



600 ± 9,5 KG



FSC AND
RECYCLABLE
CARDBOARD

SPECIFICATIONS



MANUFACTURED
AND PRINTED
IN BIC FACTORIES



MADE IN FRANCE



REGULATORY
COMPLIANCE



UP TO 1.800



LOW ENVIRONMENTAL
IMPACT

PRINTING TECHNIQUES



DIGITAL

See page 233 for a detailed explanation of the icons.

BIC® J26 LIGHTER

 Iconic BIC® Boy
and BIC® logo
engraved!

BIC® J26 LIGHTER
2320



01



57



8G



10



06

100%

*Extra long-
lasting: up to
3.000 lights!*

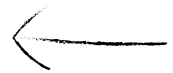

59



24



25



02



03

Decoration

BIC® J26 LIGHTER

2320

A/C SP: max. 4 col.

MOQ 300 units

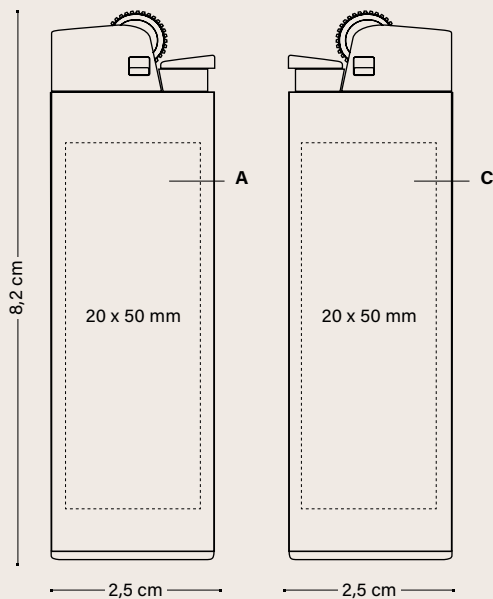

	Price (€)				
BIC® J26 LIGHTER	300-599	600-1199	1200-2999	3000-5099	5100
2320					
SP	1,85	1,63	1,54	1,47	1,40

Additional imprint charge per colour & position

SP	0,15	0,14	0,14	0,14	0,11
-----------	------	------	------	------	------

Prices include one colour in screen printing in one position.

PACKAGING



STANDARD PACKAGING:
IN TRAY OF 50 UNITS

100% recycled!

EXTERNAL PACKAGING



600 ± 15,1 KG



FSC AND
RECYCLABLE
CARDBOARD

SPECIFICATIONS



MANUFACTURED
AND PRINTED
IN BIC FACTORIES



MADE IN SPAIN



REGULATORY
COMPLIANCE



UP TO 3.000



Conform
ISO 9994



Conform
EN 13869 85%



IMPRIM'VERT®



100% OF ELECTRICITY
PRODUCED USING
RENEWABLE SOURCES



LOW ENVIRONMENTAL
IMPACT

**PRINTING
TECHNIQUES**



SCREEN PRINTING

FINISHES

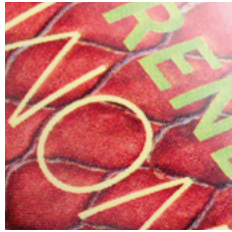

BR BRILLIANT



MT MATT

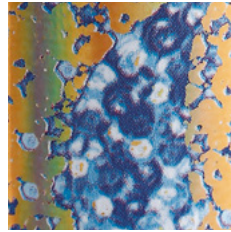

H HOLOGRAPHIC



P PUFFY

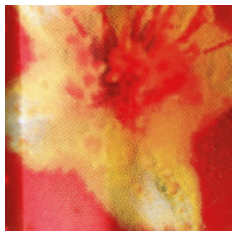

M METALLIC

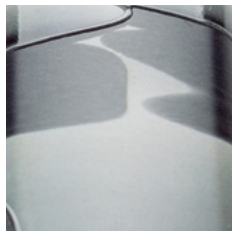

UV UV



SA SANDY

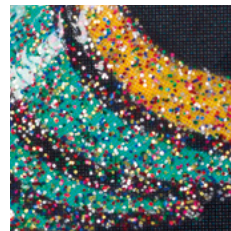

PG PUFFY GLITTER

BIC® J26 DIGITAL LIGHTER 2320



BR BRILLIANT

M METALLIC



MT MATT

M METALLIC

P PUFFY



BR BRILLIANT

UV UV

H HOLOGRAPHIC

Decoration

BIC® J26 DIGITAL LIGHTER

2320

A DG: full-colour

MOQ 600 units

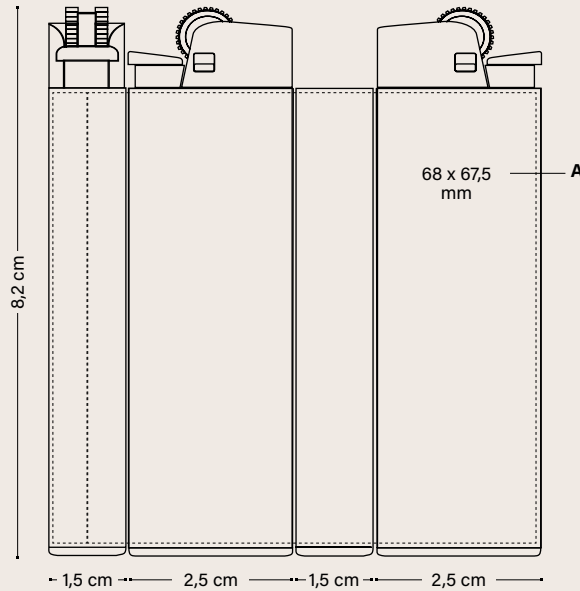

BIC® J26 DIGITAL LIGHTER 2320	Price (€)				
	300-599	600-1199	1200-2999	3000-5099	5100
DG	-	2,38	2,26	2,14	1,98

Additional charge for digital finishes						Minimum quantity		
BR	MT	Brilliant or Matt	Free			600 u.		
	H	Holographic	-	0,27	0,27	0,24	0,19	600 u.
	P	Puffy	-	-	-	0,24	0,19	3.000 u.
	M	Metallic	①					50.000 u.
	UV	UV	-	-	-	0,24	0,19	3.000 u.
	SA	Sandy	-	-	-	0,24	0,19	3.000 u.
	PG	Puffy Glitter	-	-	-	0,24	0,19	3.000 u.

Prices include the digital imprint on the body.
① Price under request.

PACKAGING



STANDARD PACKAGING:
IN TRAY OF 50 UNITS

100% recycled!

EXTERNAL PACKAGING



600 ± 15,1 KG



FSC AND RECYCLABLE
CARDBOARD

SPECIFICATIONS



MANUFACTURED
AND PRINTED
IN BIC FACTORIES



MADE
IN SPAIN



REGULATORY
COMPLIANCE



UP TO 3.000

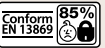

100% OF ELECTRICITY
PRODUCED USING
RENEWABLE SOURCES



LOW ENVIRONMENTAL
IMPACT

PRINTING
TECHNIQUES



DIGITAL

See page 233 for a detailed explanation of the icons.

BIC® J38 LIGHTER

 *Iconic BIC® Boy
and BIC® logo
engraved!*

BIC® J38 LIGHTER
2452



57



25



02



03

100%

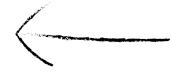

*Elegant and
comfortable
lighting!*

Decoration

BIC® J38 LIGHTER

2452

A/C SP: max. 4 col.

MOQ 300 units

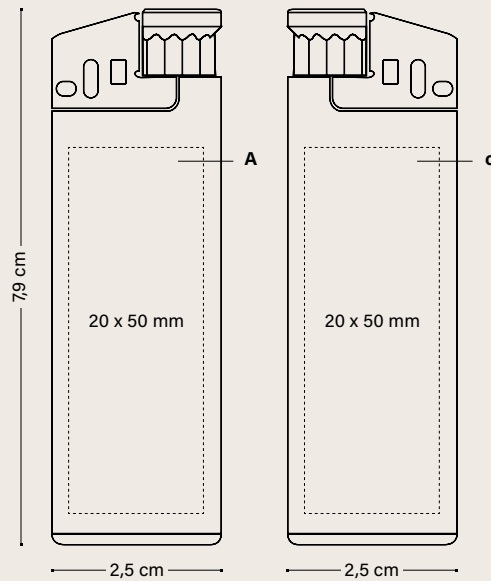

	300-599	600-1199	1200-2999	3000-5099	Price (€)
BIC® J38 LIGHTER					5100
2452					
SP	1,99	1,90	1,81	1,73	1,64

Additional imprint charge per colour & position

SP	0,15	0,14	0,14	0,14	0,11
----	------	------	------	------	------

Prices include one colour in screen printing in one position.

PACKAGING



STANDARD PACKAGING:
IN TRAY OF 50 UNITS

100% recycled!

EXTERNAL PACKAGING



600 ± 13,2 KG



FSC AND
RECYCLABLE
CARDBOARD

SPECIFICATIONS



MANUFACTURED
AND PRINTED
IN BIC FACTORIES



MADE IN SPAIN



REGULATORY
COMPLIANCE



UP TO 1.800



Conform
ISO 9994



Conform
EN 13869 85%



IMPRIM'VERT®



100% OF ELECTRICITY
PRODUCED USING
RENEWABLE SOURCES



LOW ENVIRONMENTAL
IMPACT

**PRINTING
TECHNIQUES**



SCREEN PRINTING

See page 233 for a detailed explanation of the icons.

FINISHES

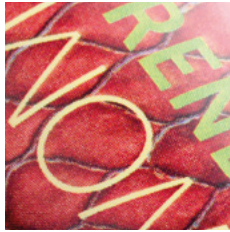

BR BRILLIANT



MT MATT

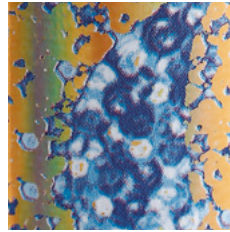

H HOLOGRAPHIC



P PUFFY

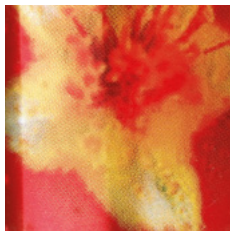

M METALLIC



UV UV



SA SANDY

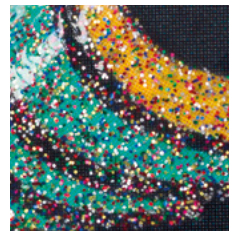

PG PUFFY GLITTER

BIC® J38 DIGITAL LIGHTER
2452



57

BR BRILLIANT

PG PUFFY GLITTER



57

BR BRILLIANT

SA SANDY



57

BR BRILLIANT

Decoration

BIC® J38 DIGITAL LIGHTER

2452

A DG: full-colour

MOQ 600 units

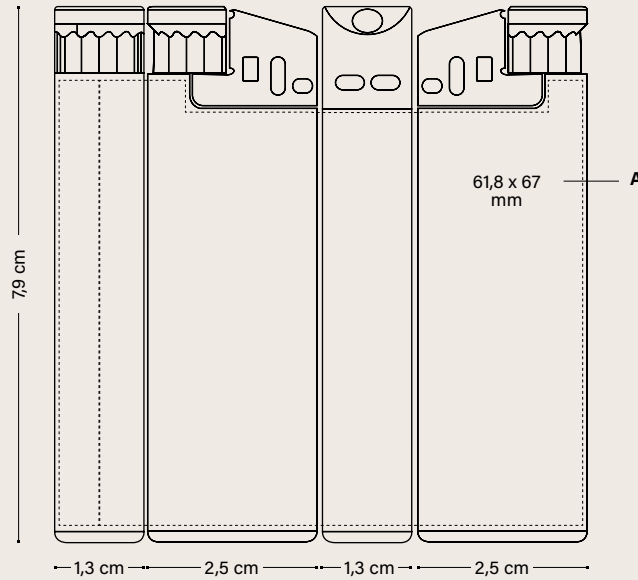

SPECIFICATIONS

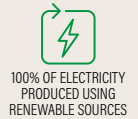

PRINTING TECHNIQUES



		Price (€)				
BIC® J38 DIGITAL LIGHTER	300-599	600-1199	1200-2999	3000-5099	5100	
2452						
DG	-	2,18	2,08	1,98	1,88	

Additional charge for digital finishes

						Minimum quantity		
BR	MT	Brilliant or Matt				Free	600 u.	
	H	Holographic	-	0,27	0,27	0,24	0,19	600 u.
	P	Puffy	-	-	-	0,24	0,19	3.000 u.
	M	Metallic				①		50.000 u.
	UV	UV	-	-	-	0,24	0,19	3.000 u.
	SA	Sandy	-	-	-	0,24	0,19	3.000 u.
	PG	Puffy Glitter	-	-	-	0,24	0,19	3.000 u.

Prices include the digital imprint on the body.
① Price under request.

PACKAGING



STANDARD PACKAGING:
IN TRAY OF 50 UNITS

100% recycled!

EXTERNAL PACKAGING



600 ± 13,2 KG



FSC AND RECYCLABLE CARDBOARD

*48h not available in Digital finishes.

BIC® STYL'IT LUXURY CASE

BIC® STYL'IT LUXURY CASE 2386 Neon

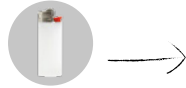

All cases are delivered with a white BIC® J25 lighter!



59*



1G*



5C*

100%

Decoration

BIC® STYL'IT LUXURY CASE 2386

MOQ 100 units
A/C LE

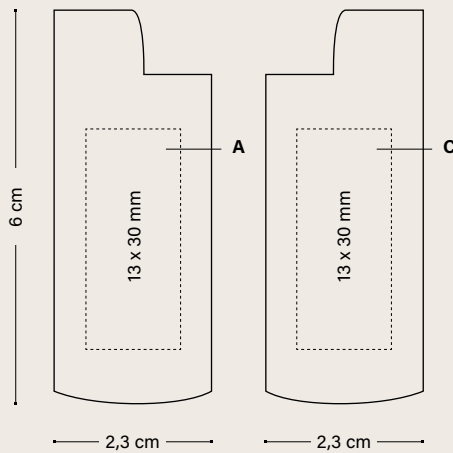

MOQ 100 units
A/C PD

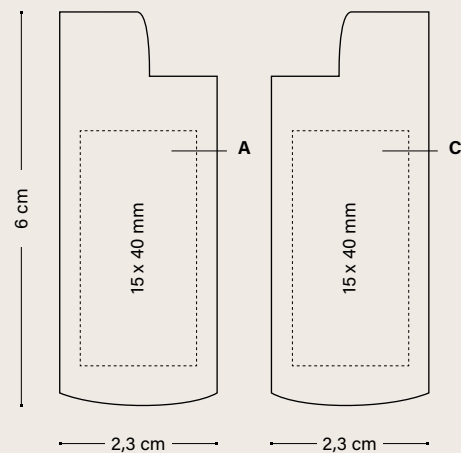

Price (€)

BIC® STYL'IT LUXURY CASE NEON	100-299	300-599	600-1199	1200-2999
2386				
PD	3,02	2,66	2,52	2,39
LE	4,31	4,11	3,85	3,72

Additional imprint charge per colour & position

PD	0,29	0,25	0,18	0,18
LE	1,21	1,09	0,96	0,96

Prices include one imprint in one position according to specified technique.

PACKAGING



STANDARD PACKAGING:
BOX FOR 10 UNITS

EXTERNAL PACKAGING



300 ± 6,1 KG



FSC AND
RECYCLABLE
CARDBOARD

SPECIFICATIONS



PRINTED IN BIC
FACTORIES



REGULATORY
COMPLIANCE



PRINTING TECHNIQUES



PAD PRINTING



LASER

BIC® STYL'IT LUXURY CASE
2153 Soft

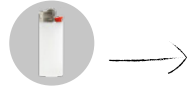

All cases are delivered with a white BIC® J25 lighter!



100%

47*

Decoration

BIC® STYL'IT LUXURY CASE

2153

A/C LE

MOQ 100 units

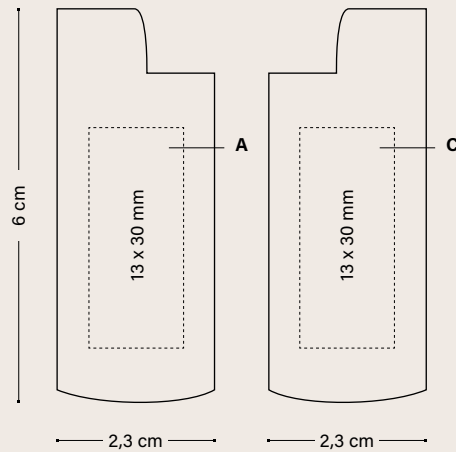

	Price (€)			
BIC® STYL'IT LUXURY CASE SOFT	100-299	300-599	600-1199	1200-2999
2153				
LE	4,52	4,37	4,18	4,02

Additional imprint charge per colour & position

LE	1,21	1,09	0,96	0,96
-----------	------	------	------	------

Prices include one laser engraving in one position.

PACKAGING



STANDARD PACKAGING:
BOX FOR 10 UNITS

EXTERNAL PACKAGING



300 ± 6,1 KG



FSC AND
RECYCLABLE
CARDBOARD

SPECIFICATIONS



PRINTED IN BIC
FACTORIES



REGULATORY
COMPLIANCE



PRINTING TECHNIQUES



LASER

*While stocks last. See page 233 for a detailed explanation of the icons.

BIC® ALUMINIUM FLAT CASE

BIC® ALUMINIUM FLAT CASE 2156



Decoration

BIC® ALUMINIUM FLAT CASE 2156

MOQ 100 units
A/C PD: max. 1 col.

MOQ 100 units
A/B/C BP: full-colour

MOQ 100 units
A/B/C LE

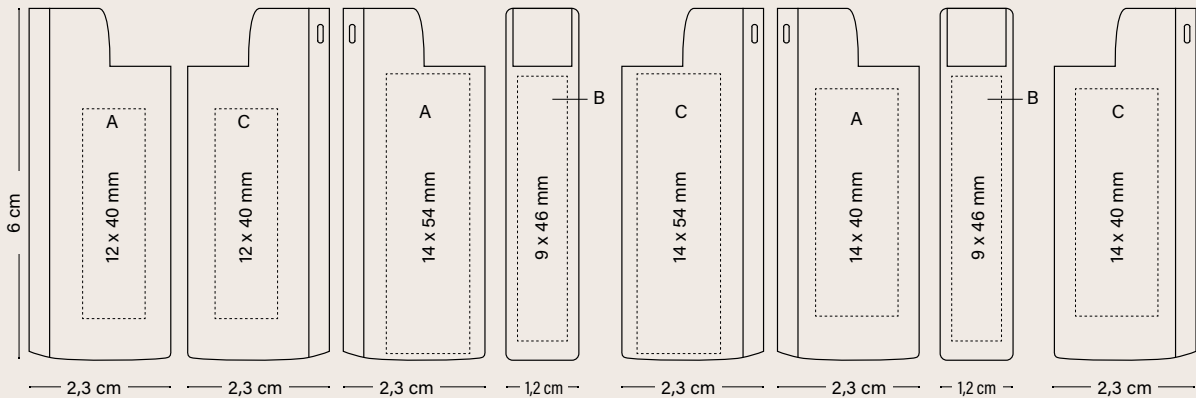

BIC® ALUMINIUM FLAT CASE 2156	Price (€)			
	100-299	300-599	600-1199	1200-2999
PD	1,93	1,85	1,76	1,67
BP	2,14	2,06	1,95	1,86
LE	3,10	2,93	2,71	2,63

Additional imprint charge per colour & position

PD	0,29	0,25	0,18	0,18
BP	0,25	0,22	0,20	0,19
LE	1,21	1,09	0,96	0,96

Prices include one imprint in one position according to specified technique.

PACKAGING



STANDARD PACKAGING:
BOX FOR 50 UNITS

EXTERNAL PACKAGING



300 ± 6,9 KG



FSC AND
RECYCLABLE
CARDBOARD

SPECIFICATIONS



PRINTED IN
BIC FACTORIES



REGULATORY
COMPLIANCE



PRINTING TECHNIQUES



PAD PRINTING



LASER



BRITEPIX™
BRITEPIX™ PERSONALISATION

BIC® CLIP CASE 2398



All cases are delivered with a white BIC® J25 lighter!



Decoration

BIC® CLIP CASE 2398

MOQ 100 units
A/C PD: max. 1 col.

MOQ 100 units
A/C BP: full-colour
BP Texture: full-colour

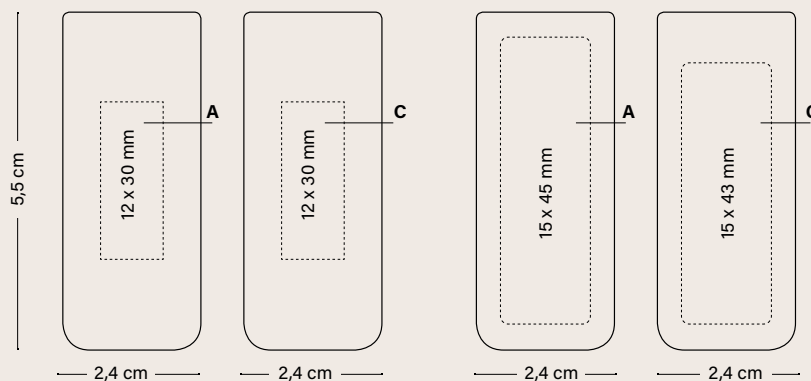

BIC® CLIP CASE 2398	Price (€)			
	100-299	300-599	600-1199	1200-2999
PD	1,55	1,44	1,32	1,29
BP	1,76	1,65	1,52	1,47

Additional imprint charge per colour & position

PD	0,29	0,25	0,18	0,18
BP	0,25	0,22	0,20	0,19
BP Texture	0,19	0,17	0,15	0,14

Prices include one imprint in one position according to specified technique.

PACKAGING



STANDARD PACKAGING:
BOX FOR 50 UNITS

EXTERNAL PACKAGING



300 ± 7,5 KG



FSC AND
RECYCLABLE
CARDBOARD

SPECIFICATIONS



PRINTED IN
BIC FACTORIES



REGULATORY
COMPLIANCE



PRINTING TECHNIQUES



PAD PRINTING



BRITEPIX™
BRITEPIX™ PERSONALISATION

BIC® 3D CASE

BIC® 3D CASE
2395



All cases are delivered with a white BIC® J25 lighter!

Convert your logo into a 3D shape!

Decoration

BIC® 3D CASE

2395

A/C 3D: max. 6 col.

MOQ 1.200 units

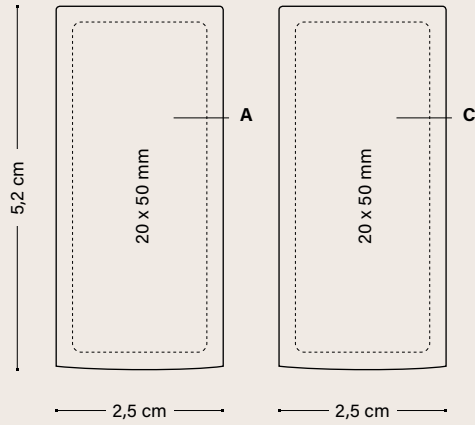

			Price (€)
BIC® 3D CASE	1200-2999	3000-5099	5100
2395			
3D	4,79	4,53	4,31
Additional imprint charge per colour & position			
3D Embossing on side C (1 colour)	0,17	0,15	0,15
Additional embossed colours	0,10	0,09	0,09

Prices include the 3D embossing in one colour in one position.

PACKAGING



STANDARD PACKAGING:
BOX FOR 50 UNITS

EXTERNAL PACKAGING



300 ± 7,5 KG



FSC AND
RECYCLABLE
CARDBOARD

SPECIFICATIONS



REGULATORY
COMPLIANCE



**PRINTING
TECHNIQUES**



EMBOSSING

BIC® POCKET ASHTRAY

BIC® POCKET ASHTRAY
3850

6 different flap shapes available!

Reusable and hermetic!



100%

Decoration

BIC® POCKET ASHTRAY
3850

A SP: max. 5 col. (max. 2 col. for orders under 20.000 pcs.)

MOQ 5.000 units

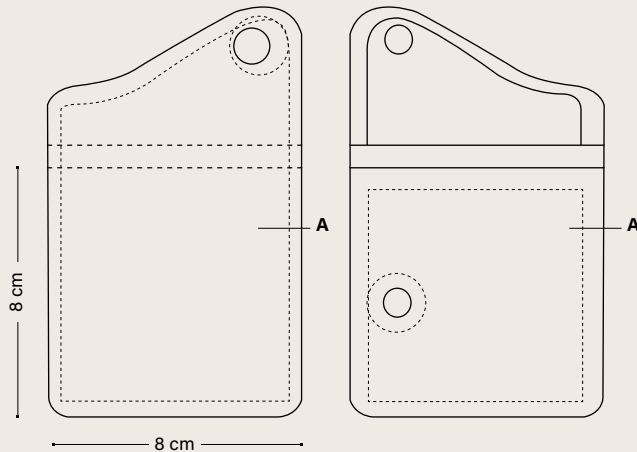

	Price (€)			
BIC® POCKET ASHTRAY	5000-9000	10000-24999	25000-49999	50000
3850				
SP	0,97	0,85	0,70	0,64

Additional imprint charge per colour & position

SP	0,04	0,03	0,03	0,03
-----------	------	------	------	------

Prices include one colour in screen printing in one position and the legal text.

PACKAGING



BOX FOR 10 UNITS EACH BIC® POCKET ASHTRAY COMES IN AN INDIVIDUAL CELLOPHANE PACKAGING

EXTERNAL PACKAGING



500 ± 5,5 KG

SPECIFICATIONS



REGULATORY COMPLIANCE

PRINTING TECHNIQUES



SCREEN PRINTING

BIC® POCKET ASHTRAY
3851 Kraft

Environmentally friendly image

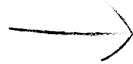

100%

Decoration

BIC® POCKET ASHTRAY KRAFT

3851 Kraft

A SP: max. 2 col.

MOQ 10.000 units

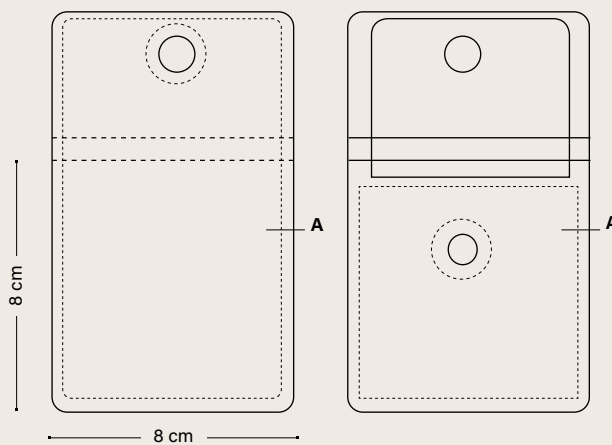

	Price (€)		
BIC® POCKET ASHTRAY	10000-24999	25000-49999	50000
3851			
SP	1,04	0,86	0,80

Additional imprint charge per colour & position

SP	0,03	0,03	0,03
-----------	------	------	------

Prices include one colour in screen printing in one position and the legal text.

PACKAGING

EXTERNAL PACKAGING



BOX FOR 10 UNITS EACH
BIC® POCKET ASHTRAY
COMES IN AN INDIVIDUAL
CELLOPHANE PACKAGING.



500 ± 5,5 KG

SPECIFICATIONS



REGULATORY
COMPLIANCE

PRINTING TECHNIQUES



SCREEN PRINTING

Contents

05

BIC® PACKAGING

BIC® Packaging Ecolutions®	222
BIC® Packaging	224

BIC® PACKAGING ECOLUTIONS®



BIC® COLLECTION BOX

FSC cardboard box, customizable on each side and offering large communication surfaces. Ideal for offering our iconic BIC® products as a collection. More than a pen, a great way to optimize your sales.

	100-249	250-499	500-999	1000-2499	2500-4999	Price (€) 5000
991212 1 unit	9,50	4,25	2,50	1,65	1,20	1,00
991213 2 units	12,20	6,25	3,75	2,50	2,20	1,85
991214 3 units	13,50	7,00	4,70	3,65	3,10	2,80

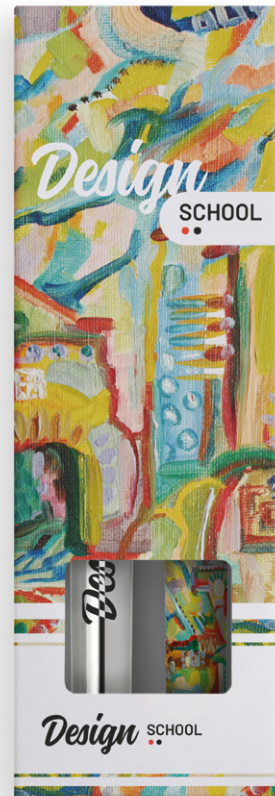

Special packaging for:



- BIC® 4 COLOURS®
- BIC® WIDE BODY™
- BIC® SUPER CLIP
- BIC® BRITELINER® GRIP
- BIC® GRIP ROLLER



BIC® ECO SLEEVE

985240

Special recycled sleeve for all BIC® writing instruments except graphite pencils.

Price (€)
0,24



Special packaging for pens with clip printed:



- BIC® MEDIA CLIC
- BIC® CLIC STIC
- BIC® SUPER CLIP
- BIC® WIDE BODY™
- BIC® INTENSITY® GEL CLIC
- BIC® XS FINE STYLE

BIC® WINDOW BOX

985241

Premium design packaging for all BIC® writing instruments except graphite pencils.

Price (€)
1,44



FSC AND
RECYCLABLE
CARDBOARD



Special packaging for:



BIC® METAL PENS

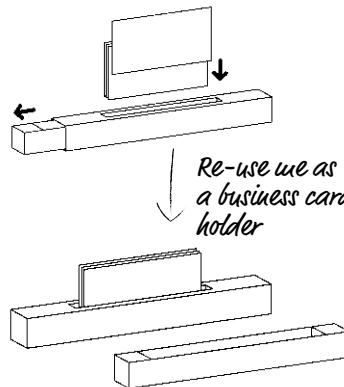

Re-use me as
a business card
holder

SPECIFICATIONS



MADE
IN SPAIN



REGULATORY
COMPLIANCE



ISO
certified

ecolutions®

BIC® PLASTIC POUCH

985242

Special design for this packaging which fits any writing instrument or 3 graphite pencils.

Price (€)
0,45



FSC AND
RECYCLABLE
CARDBOARD



RECYCLABLE
PLASTIC



Use me as
a bookmark



BIC® MARKING SET

985243

Packaging designed for all types of marker products.

Price (€)
0,71



FSC AND
RECYCLABLE
CARDBOARD



RECYCLABLE
PLASTIC

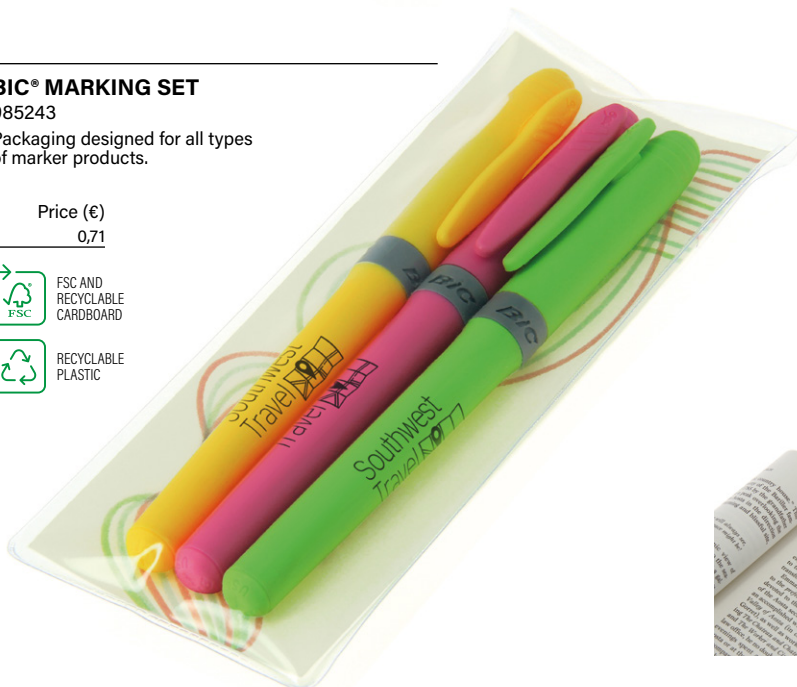

Special packaging for:



3 BIC® BRITE LINER® GRIP
3 BIC® MARK-IT



3 BIC® VELLEDA® GRIP
3 BIC® VELLEDA® FINE

Use me as
a bookmark



CHECK OUT
FREEDOM®
INITIATIVE

See page 233 for a detailed explanation of the icons.

BIC® CELLO WRAP

971634 / 971635 / 971636 / 971637

Packaging to wrap in a tough and transparent plastic material.



Cello wrap 1 unit



Cello wrap 2 units

BIC® CELLO WRAP		Price (€)
1 unit - 971634		0,18
2 units - 971635		0,35
3 units - 971636		0,50
4 units - 971637		0,68

Not available for graphite pencils or metal pens.

BIC® BLACK VELVET POUCH 1 ITEM

974216

Velvet exclusive packaging for 1 writing instrument.

Especially suitable for metal pens.

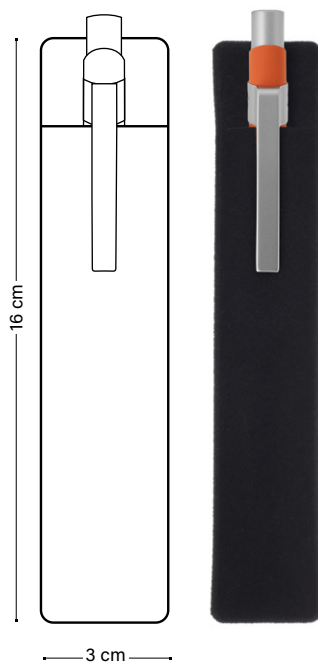

BIC® BLACK VELVET POUCH 1 ITEM		Price (€)
1 unit		0,51

Not available for graphite pencils and mechanical pencils.

**BIC® CARTON BLACK&SILVER
COLOUR GIFT BOX**

974218*

Box for all writing instruments, except graphite pencils.

Price (€)
0,35



BIC® FROSTED POUCH (FOR 1 OR 2 ITEMS)

971640*

Transparent packaging for 2 writing instruments.

A SP: max. 1 col.

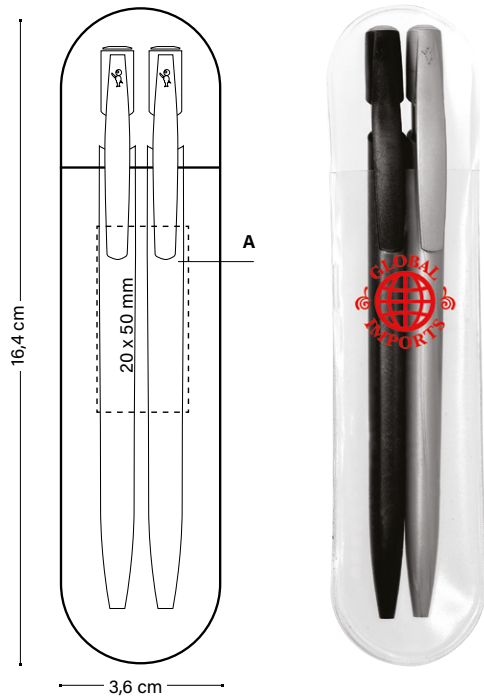

50%

BIC® FROSTED POUCH Price (€) 0,87

Additional imprint charge per colour & position

SP 0,47

Available for 1 or 2 slim writing instruments except graphite pencils.

PRINTING TECHNIQUES

SP SCREEN PRINTING

**BIC® SEE-THROUGH GIFT BOX
(FOR 1 OR 2 ITEMS)**

974599*

Box for all writing instruments, except graphite pencils, with special window.

Price (€)
1,97



30%

*While stocks last

BIC® PACKAGING

COUNT BOX

Small (for 25 BIC® Clic Stic)

Medium (for 50 BIC® Media Clic or writing instruments of similar size)

Large (only for 100 BIC® Evolution® Ecolutions®)

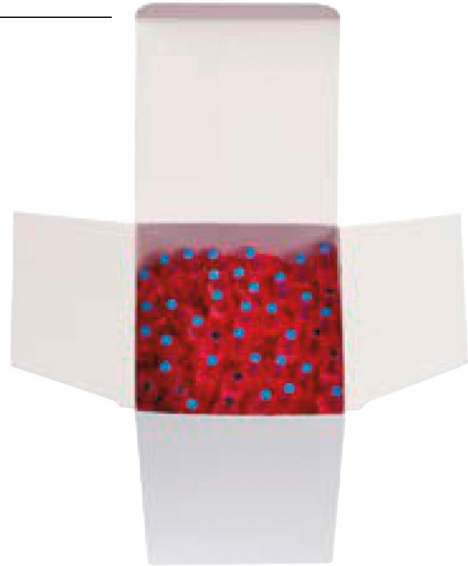

	Price (€)
Small	0,85
Medium	1,19
Big	1,64

PLASTIC BAG

Small (for 25 BIC® Media Clic or writing instruments of similar size)

Medium (for 50 BIC® Media Clic or writing instruments of similar size)

Large (for 100 BIC® Media Clic or writing instruments of similar size)



	Price (€)
Small	0,58
Medium	1,13
Big	1,69

TRAY OF 10 WRITING INSTRUMENTS



Price (€)
1,91

COUNT BOX 10U. CASES
976382



Price (€)
1,00

Available for BIC® J26,
BIC® J38, BIC® J23 and BIC® J25.

**COUNT BOX 10U.
CASES CHILD RESISTANT**
976403



Price (€)
1,00

Available for BIC® J26, BIC® J38, BIC® J23 and BIC® Luxury Case Family.

**COUNT BOX 10U.
J25 CHILD RESISTANT**
974635



Price (€)
0,78

Available for BIC® J25.

BOX OF 50U. METAL STYL'IT CASE
977852



Price (€)
4,48

Available for BIC® Clip Case, BIC® 3D Case and BIC® Flat Case.

BIC® OUTER BOXES

Special design for all the outer boxes for all writing instruments.



FSC AND RECYCLABLE CARDBOARD



MADE IN SPAIN

BIC® OUTER BOXES

Special design for lighters outer boxes.



FSC AND RECYCLABLE CARDBOARD



MADE IN SPAIN

TRAY OF 50 BIC® LIGHTERS



100% RECYCLED



Contents

GENERAL INFORMATION

Make it simple!	230
48-hour printing service	231
Symbols and abbreviations	232
General information	234
Product index	235
Colour table	236

SAVE TIME WHEN CALCULATING YOUR FINAL PRICE

LOOK AT THE QUANTITY COLUMN FOR THE PRICE AND THAT'S IT!

NO SET UP OR SCREEN CHARGES

PERSONALISATION INCLUDED

Price includes personalisation in one position.

CUSTOM MADE COLOURS FOR TRIM

- An "unlimited" choice of barrel and trim colours for orders over 10.000 units.
- A completely personalised pen in any colour you want.
- Available on an extensive range of products.
- A value added service with only a short additional lead time.
- Available for barrel and trims of: BIC® Round Stic®, BIC® Media Clic, BIC® Media Clic Grip*, BIC® Clic Stic, BIC® Super Clip, BIC® Wide Body™, BIC® XS Finestyle

*For personalised barrel and grip MOQ is 20.000 units

Set up charge per trim	1.080,00 €
Set up charge per trim (repeat orders)	645,00 €
Set up charge per trim from 100.000 units	Free

OTHER CHARGES

PRE-PRODUCTION ORDER (TRANSPORT NOT INCLUDED)	
> Available for BIC® Writing Instruments (10 units), BIC® Lighters (10 units)	140,00 €/order*
> Ink cartridge change when available (handling charge, cartridge not included)	0,15 €/unit
> Cancellations or changes to orders after artwork approval (Subject to BIC GRAPHIC EUROPE, S.A. acceptance).	
> Fixed cost per change (extra costs such as tooling, components or finished product to be added)	75,00 €/order
> britePix™ individual personalisation	70,00 €/order**

OTHER CHARGES

*Not available for digital lighters with Puffy, Puffy Glitter, Metallic, Sandy, Holographic and UV finishes.

**britePix™ individual personalisation allows you to change the texts and images of your artwork, giving you a personalised imprint for each of the products in your order. Both texts and information regarding image changes should be provided in an Excel file. Should you also require changes in the positioning of the texts and images there will be an additional charge.

Terms and conditions of sale apply, please refer to www.bicgraphic.com

FREE ON MORE THAN 100 BIC® PRODUCTS!

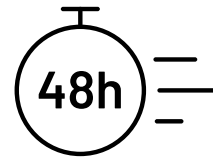

48H SERVICE REQUIREMENTS

WRITING INSTRUMENTS

1-colour imprint (For metal products only
Laser engraving available)

LIGHTERS

1-colour imprint

IMPRINT POSITION

1 standard position



MAXIMUM QUANTITY

Price End Column Quantity.

FOR ONLINE ORDERS

The promotional code 90000480 must be included in the keyword.

ELIGIBLE COUNTRIES

EU countries, UK, Switzerland and Norway.

ADDITIONAL PROGRAMME DETAILS

In the event that we are out of stock of the item ordered, an alternative item of equal or greater value will be offered. In this case the production lead time will be counted from when the customer has accepted the alternative item and also the new artwork approval.

ORDER REQUIREMENTS

Artwork approval must be received by BIC Graphic Europe by 12:00 p.m. GMT+1, Monday to Friday.

Weekends and local Spanish holidays are not considered as working days.

SHIPPING

BIC Graphic Europe cannot guarantee a specific delivery date; only shipping dates are guaranteed.

OTHER

Artwork Changes - Please allow additional time for artwork adjustments.

Accounts on credit hold are not eligible.

This promotion does not apply to orders delayed by forces or major events beyond BIC Graphic Europe's control.

SYMBOLS AND ABBREVIATIONS

PRINTING TECHNIQUES SYMBOLS



Puffy glitter
Coloured glitter texture.



Puffy
Highlighted personalisation giving a relief effect to your logo.



Brilliant
Brilliant finish.



Metallic
Create metallic effects on images and backgrounds.



Holographic
Create attractive gold or silver effects.



Matt
Matt finish.



UV
High gloss finish.



Sandy
Sandpaper effect with a granulated texture.



Hot Stamping
Tactile embossing



Print 360° ballpen



Print 360° lighter



Digital
High-definition 4-colour process. 360° degrees and full length of the barrel/body.



britePix™
Full-colour with photographic excellence, producing a durable imprint that ensures lasting impressions of your logo.



britePix™ Texture
britePix™ Texture is a fresh addition to our britePix™ concept: now you don't just see the full colour – you can feel it!



britePix™ Digital
The solution for full colour communication. Now on coloured barrels!



britePix™ personalisation
Personalise each unit within the same britePix™ order.



Screen printing



Laser



Pad printing



Digital



britePix™



Embossing

INK COLOURS

- Black
- Blue Pastel
- Light Blue
- Dark Blue
- Red
- Orange
- Yellow
- Yellow Pastel
- Light Green
- Green Pastel
- Apple Green
- Green Dark
- Fluo
- Coral Pink
- Pink
- Purple Pastel
- Purple

WRITING MODES



Ballpen | M Medium
F Fine



Mechanical Pencil MP



Pencil PC



Roller Ball R



Highlighter HL



Stylus Pen SP



Finestyle 0,7mm FS



Gel G



Marker MK



Resistant tip



No splinter



Easy to use and erase



Smoother and darker writing



Smoother, more flowing writing



Shock resistant



Will not dry out



Protective sheath



2 leads

GENERAL INFORMATION

FILE INFORMATION

Please submit your artwork in one of the following formats:

- Electronic file with the graphic design (artwork).
- Separate file for the text. For individual laser engraving please provide texts only in Excel® format (.xls)

ARTWORKS FEATURES

Please submit your artwork in one of the following formats:

- JPG / 350 dpi not compressed (only for images, no texts)
- PDF / outlined
- Illustrator® CC / outlined
- Photoshop® CC / with layers
- ZIP files

In order to facilitate a fluid order process and obtain an appropriate final result, it is important to provide us the information in one of the above listed formats. Should the customer's design not fit into our imprint area, we will modify it accordingly.

TYPEFACES:

All the typefaces must be converted to an artwork. Verify the minimum type sizes & line weights. Please, contact Customer Service for further information.

SPECIAL FOR WRITING PRODUCTS

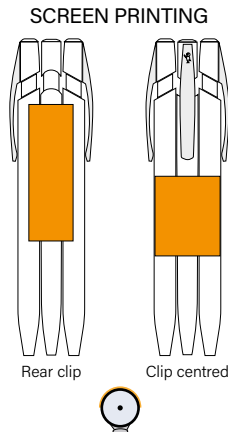

Available imprint area depends on required printing technique.

SPECIAL FOR DIGITAL LIGHTERS (J25, J23, J26 & J38)



If a direct exact colour is desired a fifth colour may be chosen from the aforementioned Guide for an additional charge. For more information on achieving the closest colour match for imprints on different products within our catalogue please contact our Customer Service Department

TECHNICAL PARAMETERS FOR EACH TYPE OF PRINTING

	DIGITAL / DIGITAL TRANSFER	
Minimum positive text	4 pt (1.4 mm)	4 Point text
Minimum negative text	7 pt (2.4 mm)	7 Point text
Minimum text for half tone	1.5 pt (0.5 mm)	7 Point text
Minimum thickness for positive lines	0.25 pt (0.08 mm)	—————
Minimum thickness for negative lines	0.5 pt (0.17 mm)	—————
Minimum thickness for lines in half tone	0.5 pt (0.17 mm)	—————
Minimum half tone values	C: 8% / M: 8% / Y: 12% / K: 8%	

	britePix™	
Minimum positive text	6 pt (2.1 mm)	6 Point text
Minimum negative text	7 pt (2.4 mm)	7 Point text
Minimum thickness for positive lines	0.4 pt (0.14 mm)	—————
Minimum thickness for negative lines	0.5 pt (0.17 mm)	—————
Minimum thickness for half tones	1 pt (0.35 mm)	—————
Percentage half tone		

	SCREEN PRINTING/ PAD PRINTING		HOT STAMPING / DEBOSSING		LASER ENGRAVING	
Minimum positive text	6 pt (2.1 mm)	6 Point text	10 pt (3.5 mm)	10 Point text	6 pt (2.1 mm)	6 Point text
Minimum negative text	9 pt (3.1 mm)	9 Point text	15 pt (5.25 mm)	15 Point	NOT RECOMENDED	
Minimum thickness for positive lines	0.4 pt (0.14 mm)	—————	1.5 pt (0.5 mm)	—————	0.3 pt (0.1 mm)	—————
Minimum thickness for negative lines	0,5 pt (0.176 mm)	—————	2 pt (0.706 mm)	—————	0.5 pt (0.17 mm)	—————
Minimum thickness for half tones	1.5 pt (0.5 mm)	—————	NOT POSSIBLE		NOT POSSIBLE	
Percentage half tone	50%	—————				

BIC® WRITING INSTRUMENTS

BIC® Style _____	38
BIC® Round Stic® _____	42
BIC® Round Stic® BGuard™ antibacterial _____	48
BIC® M10® Clic _____	50
BIC® Media Clic _____	52
BIC® Media Clic Grip _____	58
BIC® Media Clic BGuard™ antibacterial _____	63
BIC® Media Clic BGuard™ antimicrobial Ecolutions® _____	66
BIC® Media Clic Bio-Based Ecolutions® _____	68
BIC® Media Clic Bio-Based BGuard™ antibacterial _____	71
BIC® Media Clic Shine _____	73
BIC® Media Clic Glacé _____	74
BIC® Clic Stic _____	76
BIC® Clic Stic BGuard™ antibacterial _____	84
BIC® Clic Stic Stylus BGuard™ antibacterial _____	86
BIC® Super Clip _____	88
BIC® Super Clip BGuard™ antibacterial _____	94
BIC® Super Clip Advance _____	96
BIC® Super Clip Glacé _____	100
BIC® Super Clip Glacé Advance _____	100
BIC® Super Clip Soft _____	102
BIC® Super Clip Soft Advance _____	102
BIC® Super Clip Origin _____	104
BIC® Wide Body™ _____	106
BIC® Wide Body™ BGuard™ antibacterial _____	112
BIC® 4 Colours® _____	114
BIC® 4 Colours® Soft _____	118
BIC® 4 Colours® Wood Style _____	120
BIC® 4 Colours® Sun _____	122
BIC® 4 Colours® Fashion _____	124
BIC® 4 Colours® Shine _____	126
BIC® 4 Colours® Glacé _____	128
BIC® 4 Colours® Fine _____	130
BIC® 4 Colours® Fluo _____	131
BIC® 4 Colours® 3+1 ^{HB} _____	132
BIC® Metal Pro _____	134
BIC® Cristal® Re'New™ _____	138
BIC® Grip Roller _____	142
BIC® XS Finestyle _____	146
BIC® Intensity® Gel Clic _____	148
BIC® Brite Liner® Grip _____	152
BIC® Velleda® White Board Marker Fine _____	154
BIC® Velleda® White Board Marker Grip _____	155
BIC® Mark-It Permanent Marker _____	156
BIC® Permanent Marker Ecolutions® _____	157
BIC® Matic® _____	160
BIC® Evolution® Ecolutions® _____	164
Sprout™ Graphite Pencil _____	168

OTHER WRITING INSTRUMENTS

Basic Pen _____	172
Click Pen _____	174
Striped Grip Pen _____	176
Sleek Stylus Pen _____	178

NOTEBOOKS

Rocketbook® Core Executive A5 _____	184
Rocketbook® Fusion Executive A5 _____	186
Rocketbook® Core Mini A6 _____	188

BIC® LIGHTERS AND CASES

BIC® J25 Lighter _____	196
BIC® J23 Lighter _____	200
BIC® J26 Lighter _____	204
BIC® J38 Lighter _____	208
BIC® Styl'it Luxury Case _____	212
BIC® Aluminium Flat Case _____	214
BIC® Clip Case _____	215
BIC® 3D Case _____	216
BIC® Pocket Ashtray _____	218

BIC® PACKAGING

BIC® Packaging Ecolutions® _____	222
BIC® Packaging _____	224

 01 White	 1E White recycled	 57 Opaque white	 3C White pearl	 01BIO BIO white	 1T White polished	 51 Transparent	 69 Frosted white	 2E Frosted white recycled	 1R White clear	
 8D Yellow pastel	 8G Light yellow	 12 Yellow	 12W Yellow wood	 8T Yellow polished	 63 Frosted yellow	 6AW Natural wood	 012BIO BIO yellow	 4D Clear yellow	 6F Light brown	 07 Natural
 26 Gold	 76 Gold glacé	 1G Acid orange	 10 Orange	 6P Orange polished	 90 Orange pastel	 71 Frosted orange	 92 Clear orange			
 03 Red	 03G Red glacé	 03F Red soft	 3T Red polished	 8E Red recycled	 87 Clear red	 03BIO BIO red	 66 Frosted red	 08 Burgundy		
 14 Pink	 5C Pink fizz	 6T Pink polished	 1P Acid pink	 014G Pink glacé	 07 Gold Pink	 11 Pink				
 84 Purple pastel	 13 Violet	 39 Frosted Dark Purple	 7G Metallic purple	 2D Purple	 93 Clear Purple	 9T Polished purple				
 8C Lime	 68 Frosted green	 6C Grass green	 88 Clear light green	 59 Apple green	 5P Polished Light Green	 82 Frosted dark green	 72 Clear green	 5G Light green	 05G Green glacé	
 5T Green polished	 05 Green	 05W Green wood	 20 Dark green	 7E Dark green recycled	 88 Clear dark green	 05BIO BIO green	 3B Frosted jungle			
 83 Blue pastel	 3D Caribbean blue	 4T Caribbean blue polished	 86 Clear blue	 67 Frosted blue	 24 Light blue	 04BIO BIO blue	 04 Blue	 04G Blue glacé	 40 Frosted dark blue	
 34 Metallic Blue	 89 Clear dark blue	 25 Dark blue	 07 Navy blue	 07F Navy blue soft	 10E Navy blue recycled	 7T Navy Polished				
 35 Chrome	 47 Silver	 47G Silver glacé	 75 Metallic silver	 18 Metal	 06 Grey	 27 Dark grey	 8L Metal polished	 8H Clear dark grey	 7A Shadow grey	
 02BIO BIO black	 02W Black wood	 02F Black soft	 2T Black polished	 02 Black	 3E Black recycled	 2N Black matt				

