

High speed digital testing solutions

Edition 2018/03

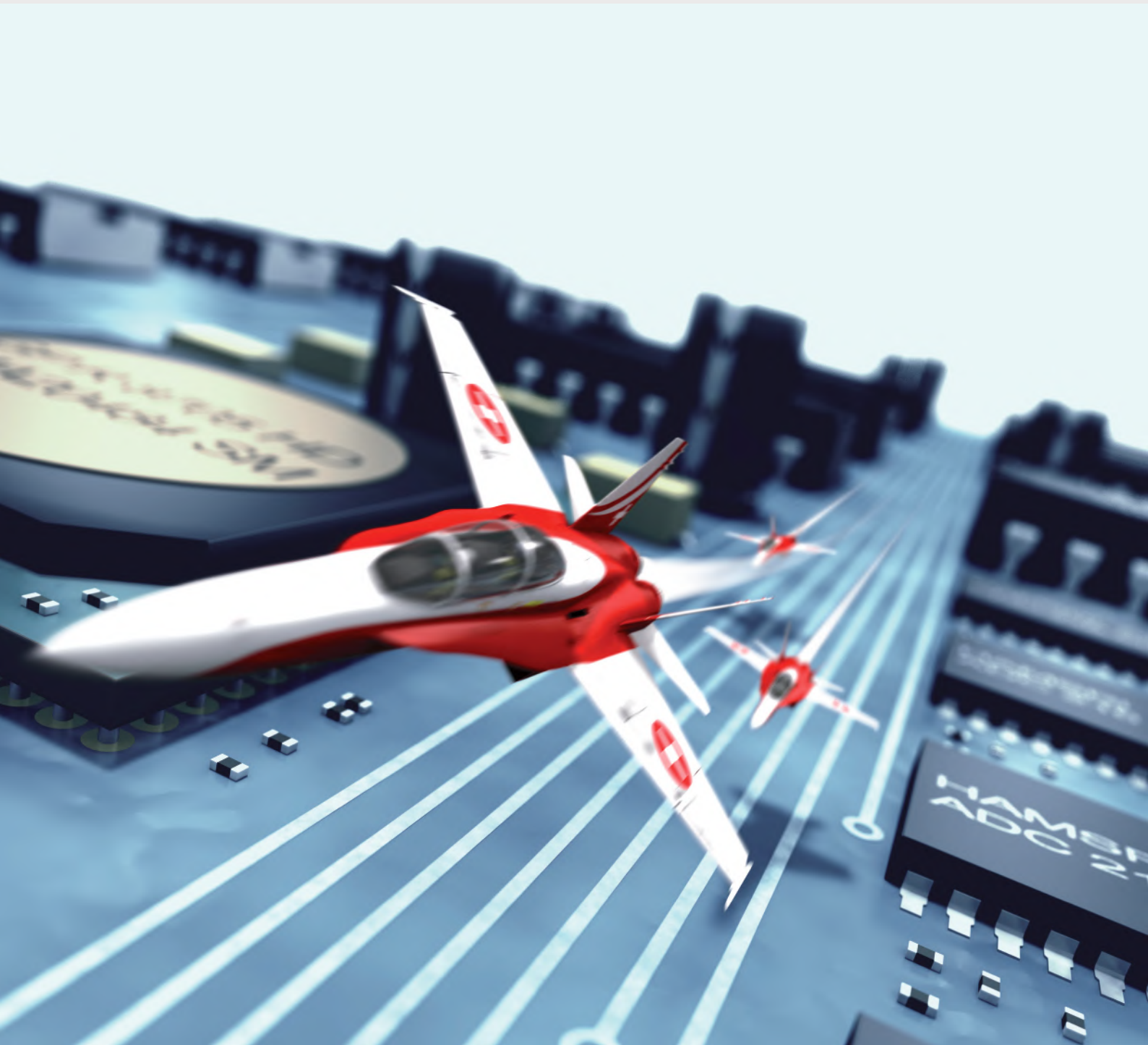

Maximise your signal integrity

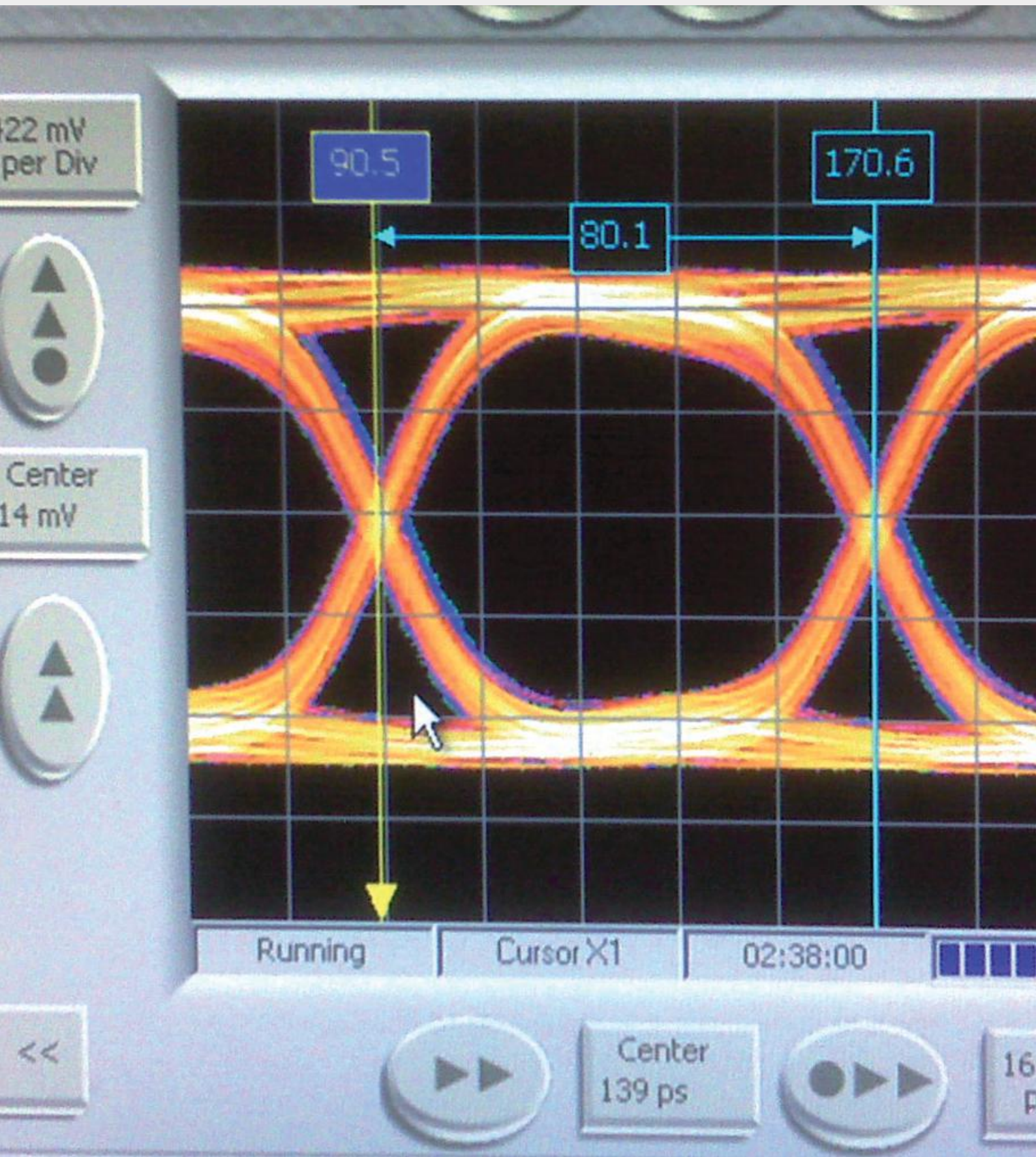



What high speed digital testing demands	4
HUBER+SUHNER digital solutions overview	6
Service and support	7
- 80 Gbps snap-on solution	8
MXP50 - 50 Gbps multicoax solution	16
MXP40 - 40 Gbps multicoax solution	28
MXP18 - 18 Gbps multicoax solution	34
Additional product details	38
Further HUBER+SUHNER products	50

80 Gbps

50 Gbps

40 Gbps

18 Gbps

Your partner for system solutions

HUBER+SUHNER is a leading international manufacturer and supplier of components and systems for electrical and optical connectivity. HUBER+SUHNER unites technical expertise in radio frequency technology, fiber optics and low frequency under one roof and offers a high-quality product range for the communication, transport and industrial markets.

The innovative high speed digital testing solution supplier

HUBER+SUHNER is offering a broad range of high end RF test components and assemblies developed and optimised for high speed digital testing. We stand for highest density, lowest loss and highest performance coaxial-to-PCB transitions and cabling solutions. Our solutions include extensive technical support, libraries of 3D files, electrical modelling data and customer specific optimised footprints.

What high speed digital testing demands

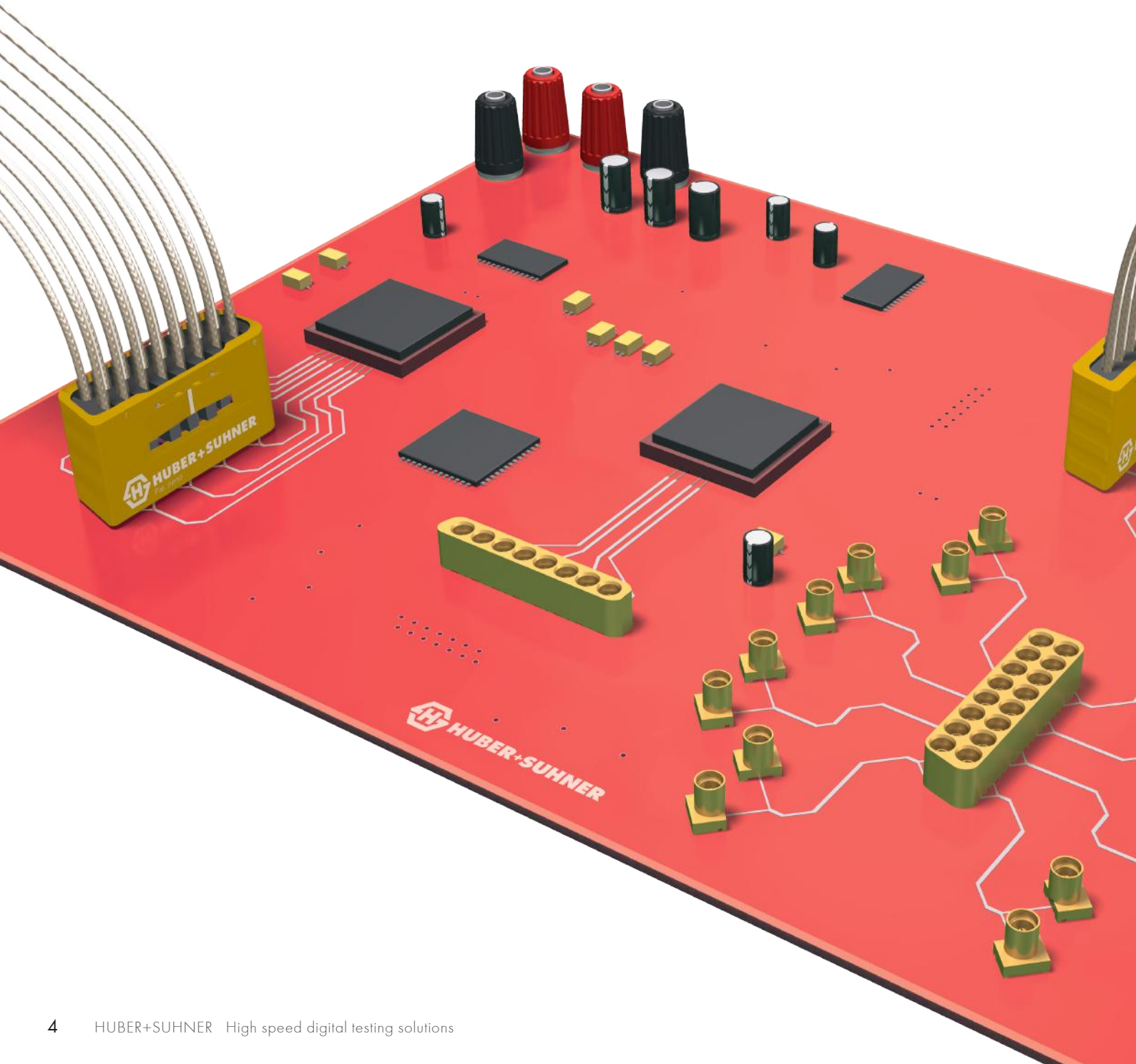

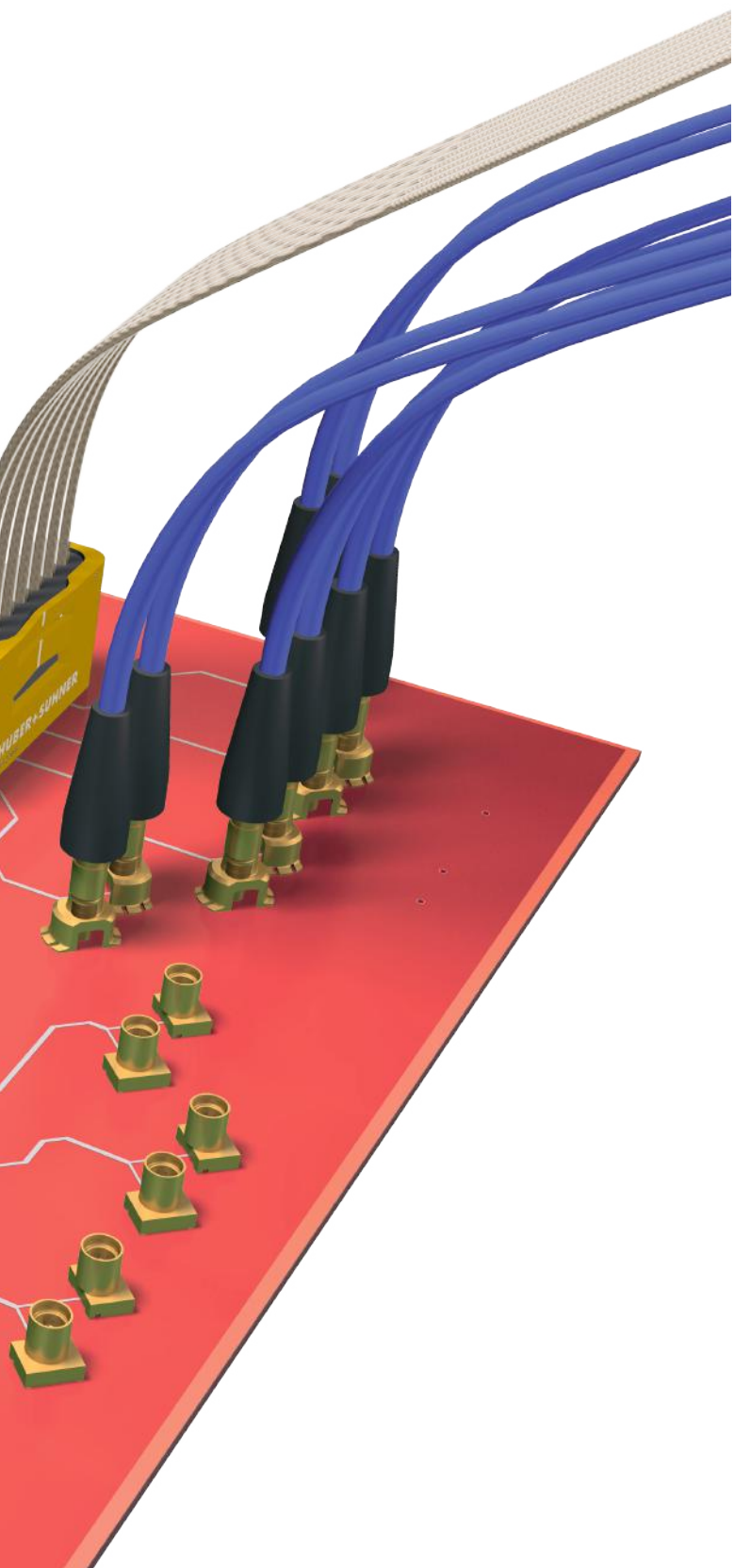

High speed digital chip verification – bench top testing

- Lowest loss from the device under test to the test equipment
- Best signal integrity performance
- Dense and space saving PCB connectivity solutions
- PCB connectivity closest to the device under test
- Proven and tested solutions and components

High speed digital hardware and system verification

Additional benefits regarding high speed digital systems

- Multicoax PCB edge mount and PCB panel mount solutions
- Multicoax interconnectivity between systems and modules with customised solutions

Automated test equipment

For internal and external interconnectivity of complex automated test equipment systems HUBER+SUHNER offers customer specific solutions based on

- Multicoax interfaces at up to 50 Gbps/50 GHz
- Snap-on interfaces at up to 80 Gbps/67 GHz
- RF cabling solutions optimised for highest data rates and frequencies, lowest loss, best phase matching and highest flexibility

HUBER+SUHNER high speed digital testing solutions overview

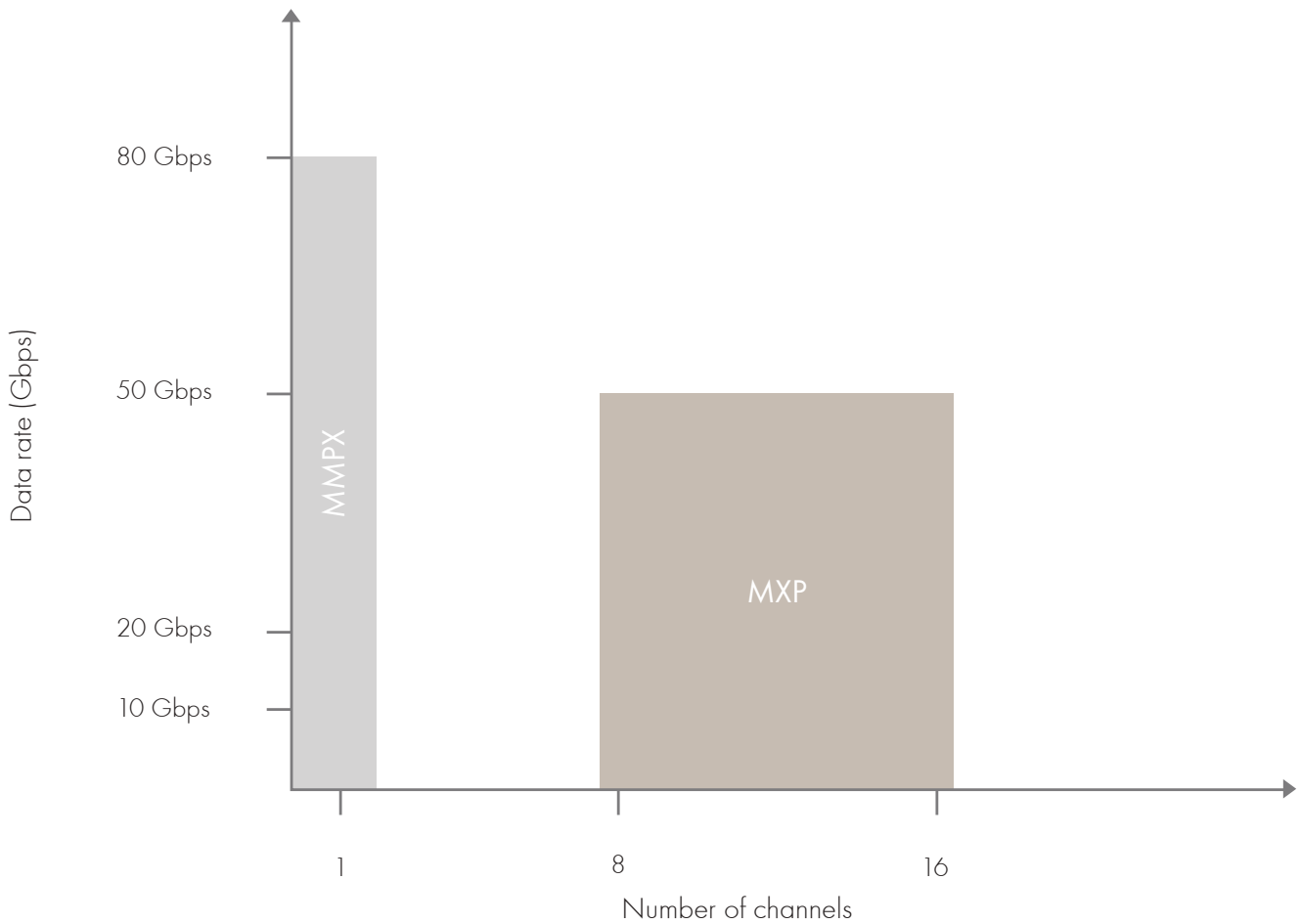

MMPX – 80 Gbps snap-on solution
for data rates at up to 80 Gbps and a maximum operating frequency of 67 GHz is based on

- MMPX connectors
- MULTIFLEX 86 HE and semi-rigid cable assemblies

MXP – 50 Gbps multicoax solution
for data rates at up to 50 Gbps and a maximum operating frequency of 50 GHz is based on

- MXP connectors
- MULTIFLEX 53-02 cable assemblies
- SUCOFLEX 100 cable assemblies

Service and support

Customised and optimised PCB footprints

HUBER+SUHNER is offering a professional design-in service for board connector footprints. By the use of three dimensional electromagnetic field simulators the optimal performance of the HUBER+SUHNER board connectors is provided to the customer.

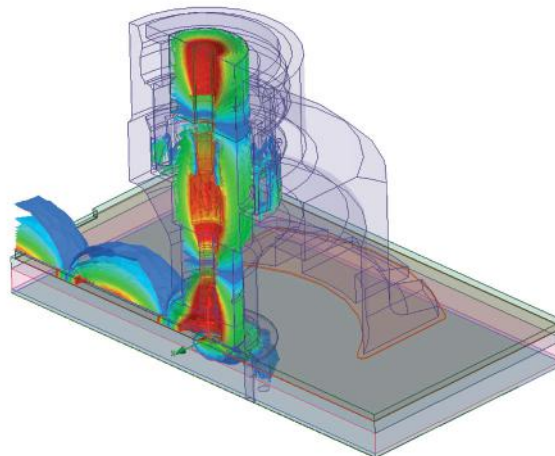

Comprehensive design data

HUBER+SUHNER provides comprehensive design data collections to their customers:

3D files

For the exchange of CAD models between various CAD systems, HUBER+SUHNER is providing 3D files in IGS or STEP data format.

S-parameter files

Measured S-parameters of the HUBER+SUHNER components are available on request, offering the customers the possibility to include these components into their electrical simulations.

Application notes

A bunch of application notes and technical design guidelines for the HUBER+SUHNER solutions are available on request.

Non standard connectors

Although our standard assortment is broad and miscellaneous, there are customer requirements which need a special solution. Thanks to capabilities and years of experience, HUBER+SUHNER is the ideal partner when customised solutions are demanded.

Repair service

HUBER+SUHNER is offering a retermination service for the professional replacement of defective channels. Your HUBER+SUHNER representative will guide you if you are in need of a repair and want to benefit from this opportunity.

MMPX – 80 Gbps snap-on solution

Key features

- True 67 GHz/80 Gbps coaxial-to-PCB transition
- Broadband characteristics from DC to 67 GHz
- Excellent return loss
- Excellent shielding, low cross talk
- Via-in-pad capable
- 5.08 mm pitch (0.2 inch)
- Mechanically robust design
- Extensive technical support

Benefits

• Future proof design

Thanks to the broadband characteristics, the excellent return loss and the true 67 GHz coaxial-to-PCB transition, MMPX helps in developing future proof RF systems.

• Quick and reliable mating

The MMPX snap-on mechanism is completely decoupled from the electrical path and therefore specifically optimised for quick and reliable mating.

• Space saving

The minimal pitch on boards of 5.08 mm (0.2 inch) saves expensive board material (40 % smaller SMD footprint than SMP).

• One connector for several applications

The unique electrical and mechanical performance as well as the compact form makes MMPX ideal for a variety of applications.

• Overall cost saving

The attractive pricing, the extensive technical support including footprint service and the HUBER+SUHNER one-stop shop approach, minimises the overall costs for design-ins and trade procedures.

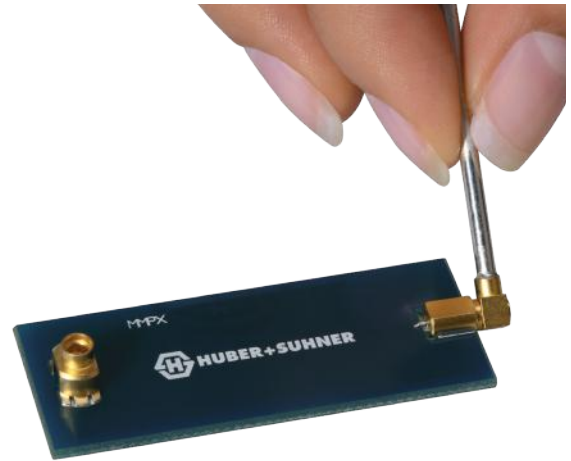

Benefits MULTIFLEX 86 HE cable

- Optimised regarding highest cut-off frequency, electrical loss and phase stability
- Flexible alternative to semi-rigid cables

minibend™ L

- Tight bending enabling easy access to PCB connectors in highly populated or limited clearance boards
- Better signal integrity through reduced losses

Comprehensive range of standard products

- Various PCB connector types (SMD)
- Adaptors between MMPX and PC 1.85 (1.85 mm standard) or SK (2.92 mm standard)
- Standard MULTIFLEX 86 HE cable assembly lengths with MMPX, PC 1.85 or SK (2.92 mm standard)
- Decoupling tools for easy and safe connector decoupling

MMPX – cable connectors/assemblies

Straight cable plugs (male)

- For semi-rigid cables
- Outer contact soldered
- Centre contact soldered

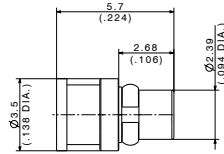

HUBER+SUHNER type	Item no.	Cable	Packaging	Notes
11_MMPX-50-2-1/111_NE	84022225	EZ 86, STORM SR 86	single	precision interface, air dielectric

- For semi-rigid, semi-flexible and flexible cables
- Outer contact soldered
- Centre contact plugged

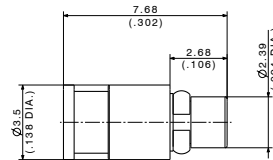

HUBER+SUHNER type	Item no.	Cable	Packaging	Notes
11_MMPX-50-1-4/111_NE	84122130	MULTIFLEX 53-02	single	for HUBER+SUHNER MULTIFLEX 53-02 cable
11_MMPX-50-2-2/111_NE	84022228	EZ 86, SUCOFORM 86, STORM SR 86	single	for semi-rigid and HUBER+SUHNER SUCOFORM cables
11_MMPX-50-2-3/111_NE	84089228	MULTIFLEX 86 HE	single	for HUBER+SUHNER MULTIFLEX 86 HE cable

- Straight cable plug (male) for minibend L assemblies
- Bend to the end cable entry
- Available as assembly only

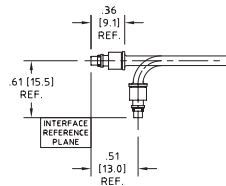

HUBER+SUHNER type	Item no.	Cable	Packaging	Notes
11_MMPX-50-0-1/19_NE		minibend L	single	

MMPX – cable connectors/assemblies

Right angle cable plugs (male)

- For semi-rigid, semi-flexible and flexible cables
- Outer contact soldered
- Centre contact plugged

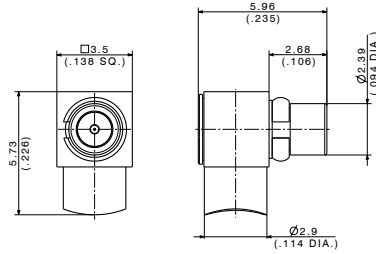

HUBER+SUHNER type	Item no.	Cable	Packaging	Notes
16_MMPX-50-1-1/111_NE	84122132	MULTIFLEX 53-02	single	for HUBER+SUHNER MULTIFLEX 53-02 cable
16_MMPX-50-2-1/111_NE	84022227	EZ 86, SUCOFORM 86, STORM SR 86	single	for semi-rigid and HUBER+SUHNER SUCOFORM cables
16_MMPX-50-2-2/111_NE	84067778	MULTIFLEX 86 HE	single	for HUBER+SUHNER MULTIFLEX 86 HE cable

Straight cable jacks (female)

- For semi-rigid and semi-flexible cables
- Outer contact soldered
- Centre contact soldered

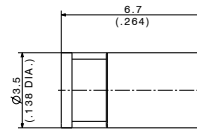

HUBER+SUHNER type	Item no.	Cable	Packaging	Notes
21_MMPX-50-2-1/111_NE	84022226	EZ 86, SUCOFORM 86, STORM SR 86	single	

MMPX – PCB connectors

Straight PCB jacks (female)

- Full surface mount (SMD)
- Decoupling tool 74_Z-0-0-491 or 74_Z-0-0-555 recommended

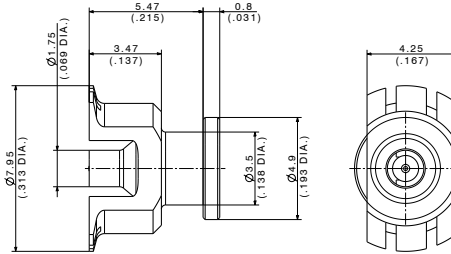

HUBER+SUHNER type	Item no.	Packaging	Notes
82_MMPX-S50-0-2/111_NM	84096711	tape	blister tape containing 10 pcs.
82_MMPX-S50-0-2/111_NM-1	84096752	tape and reel	blister tape containing 750 pcs.

Straight PCB jacks (female)

- Semi surface mount (Semi-SMD)
- Short print legs
- Decoupling tool 74_Z-0-0-491 or 74_Z-0-0-555 recommended

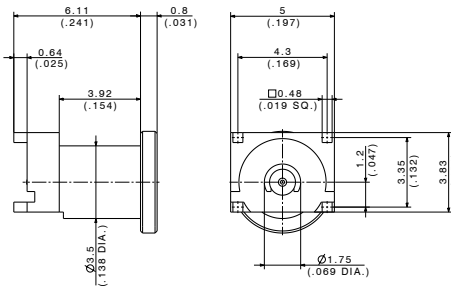

HUBER+SUHNER type	Item no.	Packaging	Notes
96_MMPX-50-0-2/111_NM-1	84093961	tape	blister tape containing 10 pcs.
96_MMPX-50-0-2/111_NM	84093966	tape and reel	blister tape containing 750 pcs.

Straight PCB jacks (female)

- Semi surface mount (Semi-SMD)
- Long print legs

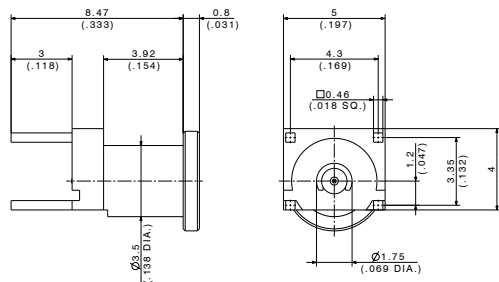

HUBER+SUHNER type	Item no.	Packaging	Notes
96_MMPX-50-0-3/111_NM-1	84099981	tape	blister tape containing 10 pcs.
96_MMPX-50-0-3/111_NM	84099988	tape and reel	blister tape containing 450 pcs.

MMPX – PCB connectors

Straight PCB jacks (female) edge-mount

- Full surface mount (SMD)
- PCB cut out required
- Decoupling tool 74_Z-0-0-491 or 74_Z-0-0-555 recommended

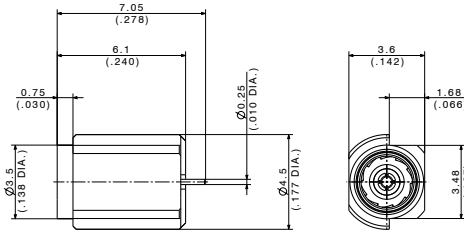

HUBER+SUHNER type	Item no.	Packaging	Notes
92_MMPX-S50-0-1/111_NM	84009138	tape	blister tape containing 10 pcs.
92_MMPX-S50-0-1/111_NM-1	84009140	tape and reel	blister tape containing 500 pcs.

- Full surface mount (SMD)
- PCB cut out required
- Extra shielded for EMF sensitive applications
- Operating range at up to 26.5 GHz
- Decoupling tool 74_Z-0-0-491 or 74_Z-0-0-555 recommended

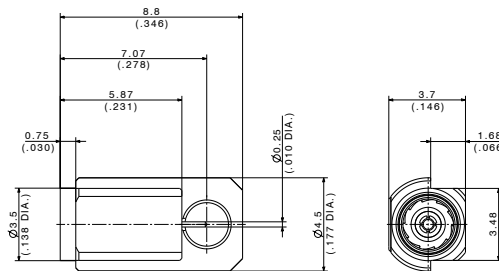

HUBER+SUHNER type	Item no.	Packaging	Notes
92_MMPX-S50-0-2/111_NE	84016110	single	

- Full surface mount (SMD)
- No PCB cut-out required
- Operating range at up to 15 GHz
- Decoupling tool 74_Z-0-0-491 or 74_Z-0-0-555 recommended

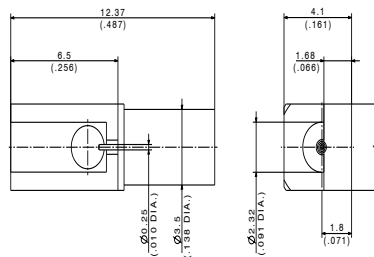

HUBER+SUHNER type	Item no.	Packaging	Notes
92_MMPX-S50-0-3/111_NM-1	84100614	tape	blister tape containing 10 pcs.
92_MMPX-S50-0-3/111_NM	84096563	tape and reel	blister tape containing 1750 pcs.

MMPX – decoupling tools

«All-round» decoupling tool

This decoupling tool is suitable for all kind of MMPX combinations.

HUBER+SUHNER type	Item no.
74_Z0-0-555	84020011

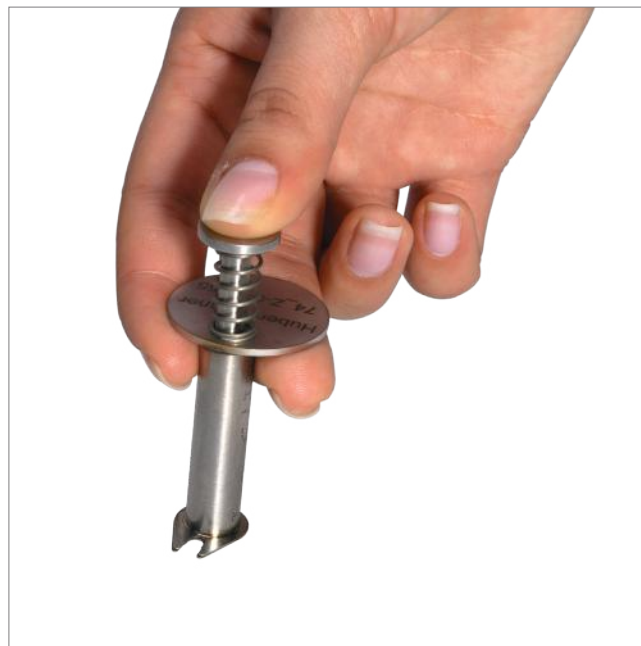
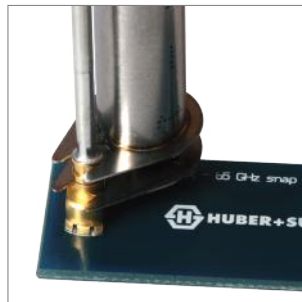
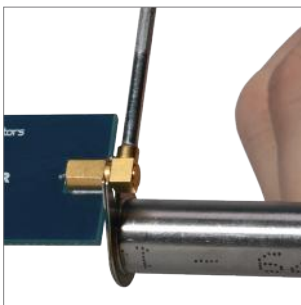

«PCB» decoupling tool

This high-end decoupling tool is especially suited for decoupling MMPX combinations when the PCB connectors are placed very close to each other. The anodised surface is non-conductive and helps to prevent short-cutting circuits on the PCB.

Note: Suitable for flexible cables only!

Possible combination of patterns

11_MMPX / 82_MMPX

11_MMPX / 92_MMPX

11_MMPX / 96_MMPX

16_MMPX / 82_MMPX

16_MMPX / 96_MMPX

HUBER+SUHNER type	Item no.
74_Z0-0-491	84114252

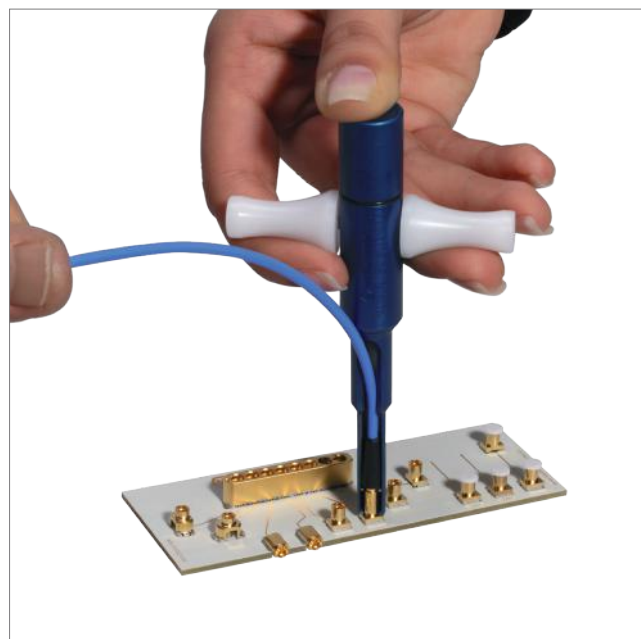

MMPX – phase matched standard assemblies (± 1 ps)

Cable	Connector interface		Item no.			
			Length mm (inches)			
MULTIFLEX 86 HE	Left	Right	152 (6)	305 (12)	610 (24)	914 (36)
	MMPX straight male	MMPX straight male	84072076	84040208	84111137	85009454
		MMPX r/a male	85009450	85009451	85009452	85009455
	MMPX r/a male	MMPX r/a male	84078830	84078831	85009453	85009456
	MMPX straight male	SMA male	84016478	84079180	85009201	85009460
		SMA female	84079175	85009457	85009458	85009461
	MMPX r/a male	SMA male	84079178	85009463	85009459	85009462
	MMPX straight male	SK (2.92 mm standard) male	84067183	84067182	85009464	84216671
		SK (2.92 mm standard) female	84067180	84078693	85009465	85009468
	MMPX r/a male	SK (2.92 mm standard) male	84078812	84078815	85009466	85009469
		SK (2.92 mm standard) female	84074084	84078814	85009467	84086484
	MMPX straight male	PC 1.85 male	84102504	84102505	84123731	85009492
		PC 1.85 female	85007768	85009502	85007769	85009497
	MMPX r/a male	PC 1.85 male	84082670	84086485	84121876	85009495
		PC 1.85 female	85009498	85009499	85012313	85009501
	minibend L	MMPX straight male	MMPX straight male	80376161	80376162	80376163
MMPX straight male		SK (2.92 mm standard) male	80376082	80376079	80376049	80376080
		SK (2.92 mm standard) female	80376083	80376008	80376050	80376081
MMPX straight male		PC 2.4 male	80375458	8037549	80375460	80375461
		PC 2.4 female	80375973	80375974	80375975	80375976

MMPX – evaluation kit

Set includes:

Adapters

- 2 × MMPX to PC 1.85

Assemblies

- 2 × MULTIFLEX 86 HE cable assemblies MMPX to PC 1.85 (152 mm/6")
- 2 × Semi-rigid 86 cable assemblies MMPX to PC 1.85 (152 mm/6")

PCB

- MMPX PCB connectors (pattern 82, 92 and 96, see pages 11 and 12)
- Material: Rogers RO3003
- Substrate thickness: 0.127 mm (5 mil)
- Dielectric constant ϵ_r : 2.3

USB stick

- S-parameters
- 3D files
- Datasheets

For further information, please contact the HUBER+SUHNER representative in your country.



MXP50 - 50 Gbps multicoax solution





Solution

The HUBER+SUHNER 50 Gbps multicoax solution is based on a triplex approach:

- MXP PCB connector
 - connect your PCB with **maximum density** and **highest performance**
- MULTIFLEX 53-02 breakout assembly
 - go off the PCB with **maximum flexibility**
- SUCOFLEX 100 cable assembly
 - connect your measurement equipment with **lowest loss**

Features

- Dense MXP connectors allow multicoax connectivity close to the device under test
- Short MULTIFLEX 53-02 breakout assemblies provide highest flexibility and easy channel management while still providing low loss
- SUCOFLEX offers lowest loss interconnectivity to the test equipment
- Quick and reliable interconnection thanks to the Quick Mate coupling nut and the ergonomic grip on the MULTIFLEX 53-02 breakout assembly
- No torque wrench required

Benefits

- Highest density - lowest loss
- Fast and reliable mating
- Reduces total cost of testing

MXP50 – 50 Gbps multicoax solution

Key features

- Operating range at up to 50 Gbps/50 GHz
- Standard absolute phase matching down to ± 2 ps
- Highest density – lowest loss
- Slide-on mating – no threading
- Highly flexible and ultra stable MULTIFLEX cable
- Extensive technical support

Benefits

- **Testing at the highest stage**
The broadband characteristics and the true 50 Gbps/50 GHz coaxial-to-PCB transition allow the design of evaluation boards (test set-ups) for the latest generation of semiconductor standards.
- **Space saving**
Due to the dense interface pitch, the PCB connectors take up less space on boards. This is advantageous, as expensive high-performance board material is essential for good signal integrity at high data rates.
- **Shorter transmission lines**
The compact design of the PCB connector allows it to be positioned directly adjacent to the DUT/chip. This helps to keep the transmission lines on the board short and the losses low.
- **Reliable push-on mating**
Thanks to the revolutionary slide-on interface design, assemblies can be replugged quickly and easily, while guaranteeing stable electrical values even after numerous mating cycles.
- **Easy channel handling**
The highly flexible MULTIFLEX cable in combination with a detailed numbering and coding system ensures easy channel handling without any degradation of the signal integrity.
- **Overall cost savings and service benefits**
Reduced cost of ownership compared to single interfaces thanks to lower outlay for PCB population and channel handling. 3D files, modelling data and customised footprints are available upon request.

Comprehensive range of standard products (1 × 8 and 2 × 8 ganged systems)

- 1 × 8 and 2 × 8 straight PCB connectors (SMD)
- 1 × 8 and 2 × 8 breakout assemblies MXP-to-PC 2.4
- 1 × 8 and 2 × 8 jumper assemblies MXP-to-MXP
- Loop back assembly
- 2 × 8 MXP-to-MXP board-to-board adaptor
- Standardised SUCOFLEX assembly lengths with different classes of phase matching
- Customised assemblies on request

MXP family – product combinations

General note: MXP50, MXP40 and MXP18 are mechanically compatible

MXP cable assemblies		Breakout to PC 2.4 mm MXP50	Breakout to SK (2.92 mm) MXP40	Breakout to SMA MXP18
MXP PCB connectors				
MXP50 marking on PCB connectors	MXP50	50 GHz	40 GHz	18 GHz
	MXP40	40 GHz	40 GHz	18 GHz
No specific MXP18 PCB connectors available	MXP18	-	-	-

MXP50 – technical data

Typical electrical data	Testing condition	Performance
Operating range/ data rate		up to 50 Gbps
Frequency range		DC up to 50 GHz
Impedance		50 Ω
Return loss	mated condition gated measurement: cable connector/ PCB transition PCB: Rogers RO3003 cable: HUBER+SUHNER MULTIFLEX 53-02	≥ 20 dB up to 22.5 GHz ≥ 15 dB up to 50 GHz
Insertion loss	MULTIFLEX 53-02	see page 38
Cross-talk	at PCB transition	≤ -40 dB up to 40 GHz ≤ -35 dB up to 50 GHz

Typical mechanical data	Testing condition	Requirements
Mating force (per single channel)		max. 3.4 N (typical 1.1 N)
Demating force (per single channel)		max. 3.4 N (typical 1.1 N)
Durability (matings)	MIL-PRF-39012, paragraph 4.7.12	> 500

Material data cable connector	Material	Coating
Center contact	copper beryllium	SUCOPRO® gold plating
Outer contact	brass	SUCOPRO® gold plating
Insulator	PTFE	n/a
Body	aluminium	gold anodised

Material data PCB connector	Material	Coating
Center contact	copper beryllium	SUCOPRO® gold plating
Outer contact	BZ4	SUCOPRO® gold plating
Body	brass	SUCOPRO® gold plating
Insulator	PEEK	n/a

Typical environmental data	Testing condition	Requirements
Temperature range		-55 to +85 °C
Thermal aging (mated condition)	IEC 60068-2-2, test B	120 °C / 260 h
Change of temperature	IEC 60068-2-14, test na	assembly: -55 to +85 °C PCB: -55 to +85 °C
Vibration	IEC 60068-2-6	on request
Mechanical shock (transport)	MIL-STD-202, method 213, condition I	100 g / 6 ms
Damp heat steady state	IEC 60068-2-78, test ca	40 °C / humidity 93 % / 96 h

MXP50 – technical data

Typical return loss for mated condition (PCB connector with MULTIFLEX 53-02 assembly, gated measurement)

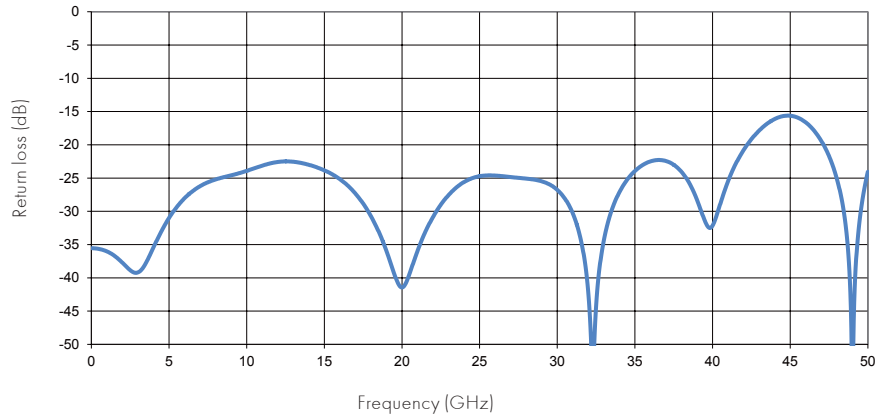

Typical measured cross-talk at PCB transition

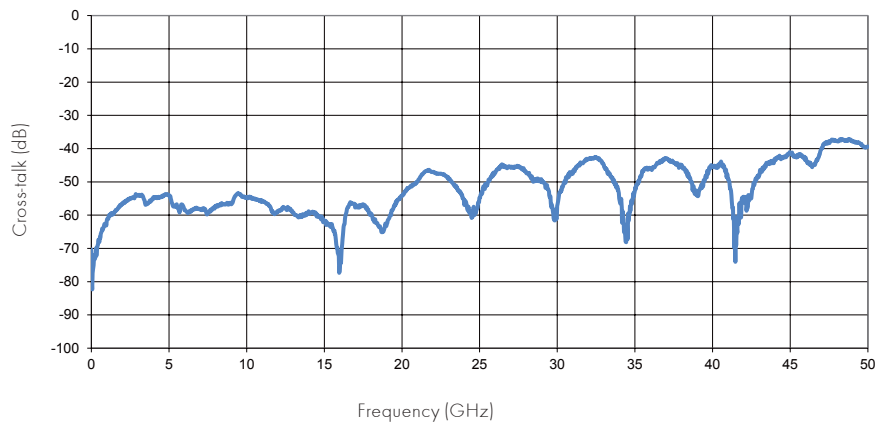

MXP50 – PCB connectors

- Pitch 4 mm (0.16")
- Via-in-pad capable
- 0.7 mm (0.028") pin size allows easy matching to smallest trace width
- SMD technology – ground pins for better mechanical stability of solder joint

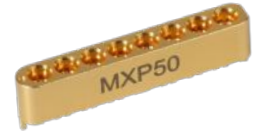
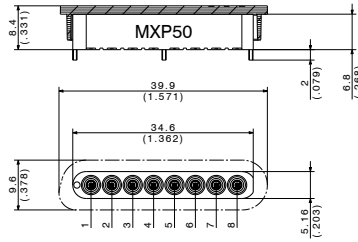

Type 1x8 ganged	Item no.	Packaging	Notes
1x8A_81_MXP-S50-0-3/111_NE	85022694	tape	symmetric design (non keyed)

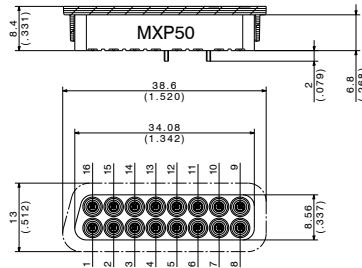

Type 2x8 ganged	Item no.	Packaging	Notes
2x8A_81_MXP-S50-0-4/111_NE	85023106	tape	asymmetric design (keyed) optimised grounding pin layout for differential pair routing

MXP50 – breakout to PC 2.4

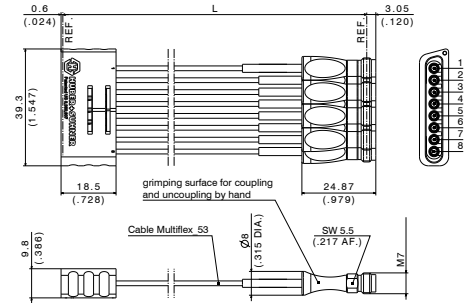

Type 1x8 ganged	Item no.	Length	Notes
MF53/1x8A_21MXP/21PC24_erg/152	85024118	152 mm (6")	single channels numbered with ergo grip on PC 2.4 side
MF53/1x8A_21MXP/21PC24_erg/229	85024116	229 mm (9")	
MF53/1x8A_21MXP/21PC24_erg/305	85024113	305 mm (12")	

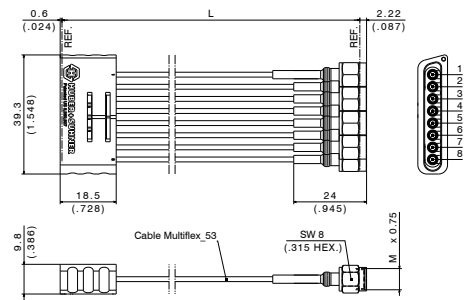

Type 1x8 ganged	Item no.	Length	Notes
MF53/1x8A_21MXP/11PC24/152	85025933	152 mm (6")	single channels numbered
MF53/1x8A_21MXP/11PC24/229	85025934	229 mm (9")	
MF53/1x8A_21MXP/11PC24/305	85025935	305 mm (12")	

MXP50 – breakout to PC 2.4

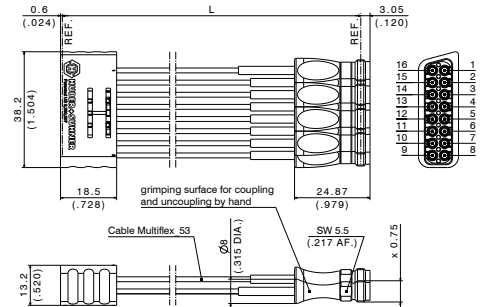

Type 2x8 ganged	Item no.	Length	Notes
MF53/2x8A_21MXP/21PC24_erg/152	85023135	152 mm (6")	single channels numbered with ergo grip on PC 2.4 side
MF53/2x8A_21MXP/21PC24_erg/229	85023167	229 mm (9")	
MF53/2x8A_21MXP/21PC24_erg/305	85023168	305 mm (12")	

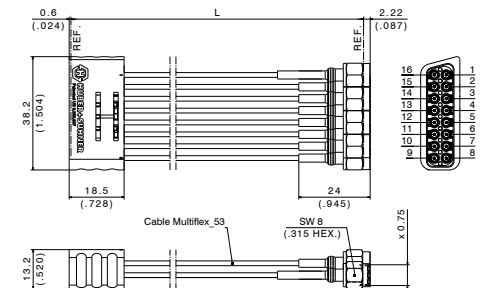

Type 2x8 ganged	Item no.	Length	Notes
MF53/2x8A_21MXP/11PC24/152	85025930	152 mm (6")	single channels numbered
MF53/2x8A_21MXP/11PC24/229	85025932	229 mm (9")	
MF53/2x8A_21MXP/11PC24/305	85025931	305 mm (12")	

50 Gbps

MXP50 – breakout to MMPX

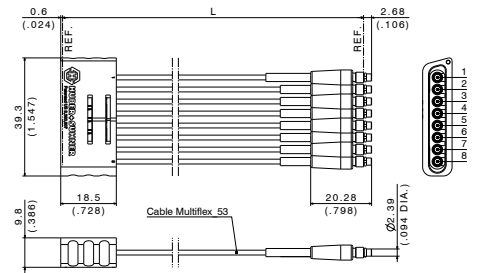

Type 1x8 ganged	Item no.	Length	Notes
MF53/1x8A_21MXP/11MMPX/152	85021537	152 mm (6")	single channels numbered
MF53/1x8A_21MXP/11MMPX/229	85018173	229 mm (9")	
MF53/1x8A_21MXP/11MMPX/305	85025640	305 mm (12")	
MF53/1x8A_21MXP/11MMPX/610	85025641	610 mm (24")	

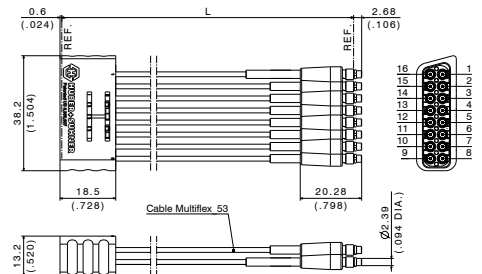

Type 2x8 ganged	Item no.	Length	Notes
MF53/2x8A_21MXP/11MMPX/152	85025642	152 mm (6")	single channels numbered
MF53/2x8A_21MXP/11MMPX/229	85024572	229 mm (9")	
MF53/2x8A_21MXP/11MMPX/305	85025643	305 mm (12")	
MF53/2x8A_21MXP/11MMPX/610	85006750	610 mm (24")	

MXP50 - jumper

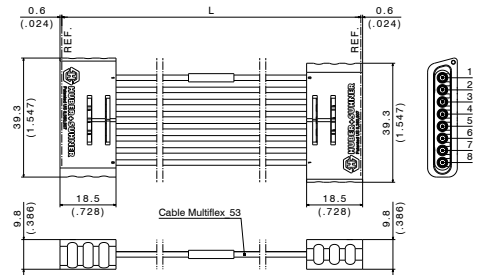

Type 1x8 ganged	Item no.	Length	Notes
MF53/1x8A_21MXP/21MXP/152	84129711	152 mm (6")	pin map: 1 to 8
MF53/1x8A_21MXP/21MXP/229	85009276	229 mm (9")	
MF53/1x8A_21MXP/21MXP/305	84099960	305 mm (12")	
MF53/1x8A_21MXP/21MXP/610	84100060	610 mm (24")	

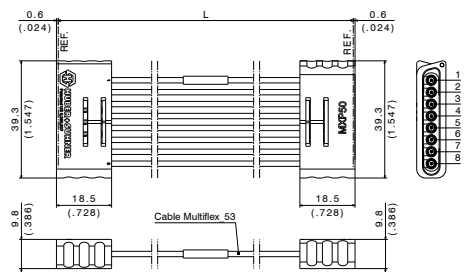

Type 1x8 ganged	Item no.	Length	Notes
MF53/1x8A_21MXP/21MXP/152_1	84129722	152 mm (6")	pin map: 1 to 1
MF53/1x8A_21MXP/21MXP/229_1	85009284	229 mm (9")	
MF53/1x8A_21MXP/21MXP/305_1	84099634	305 mm (12")	
MF53/1x8A_21MXP/21MXP/610_1	84099914	610 mm (24")	

50 Gbps

MXP50 - jumper

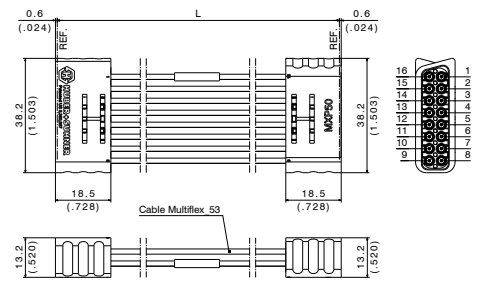

Type 2x8 ganged	Item no.	Length	Notes
MF53/2x8A_21MXP/21MXP/152	85009288	152 mm (6")	pin map: 1 to 16
MF53/2x8A_21MXP/21MXP/229	85009287	229 mm (9")	
MF53/2x8A_21MXP/21MXP/305	84099955	305 mm (12")	
MF53/2x8A_21MXP/21MXP/457	84131766	457 mm (18")	
MF53/2x8A_21MXP/21MXP/610	84099957	610 mm (24")	

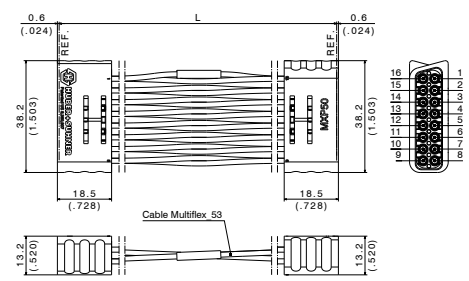

Type 2x8 ganged	Item no.	Length	Notes
MF53/2x8A_21MXP/21MXP/152_1	84116942	152 mm (6")	pin map: 1 to 1
MF53/2x8A_21MXP/21MXP/229_1	85009289	229 mm (9")	
MF53/2x8A_21MXP/21MXP/305_1	84099487	305 mm (12")	
MF53/2x8A_21MXP/21MXP/457_1	84150019	457 mm (18")	
MF53/2x8A_21MXP/21MXP/610_1	84099511	610 mm (24")	

MXP50 - loop back



Typical application

Channel bridging

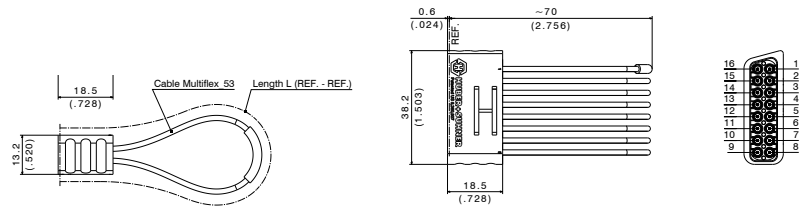

Type 2x8 ganged	Item no.	Length	Notes
MF53/2x8A_21MXP/152	84095097	152 mm (6")	loop back configuration Pin map: 1 to 16

MXP50 - board-to-board adaptor

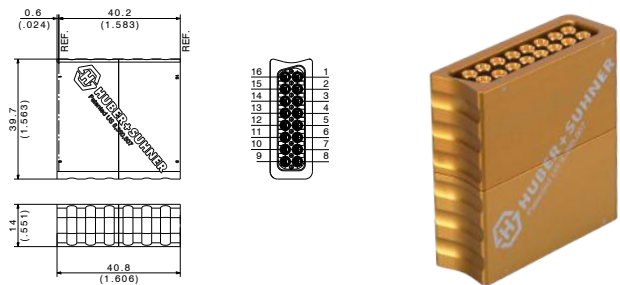

Type 2x8 ganged	Item no.	Height	Notes
2x8A_31_MXP-50-0-1	85022967	40 mm	limited misalignment tolerance

50 Gbps

MXP40 – 40 Gbps multicoax solution

Key features

- Operating range at up to 40 Gbps/40 GHz
- Standard absolute phase matching down to ± 2 ps
- Highest density – lowest loss
- Slide-on mating – no threading
- Highly flexible and ultra stable MULTIFLEX cable
- Extensive technical support

Benefits

• State-of-the-art-testing

The broadband characteristics and the true 40 Gbps/40 GHz coaxial-to-PCB transition allow the design of evaluation boards (test set-ups) for most of the existing semiconductor standards.

• Space saving

Due to the dense interface pitch, the PCB connectors take up less space on boards. This is advantageous, as expensive high-performance board material is essential for good signal integrity at high data rates.

• Shorter transmission lines

The compact design of the PCB connector allows it to be positioned directly adjacent to the DUT/chip. This helps to keep the transmission lines on the board short and the losses low.

• Reliable push-on mating

Thanks to the revolutionary slide-on interface design, assemblies can be replugged quickly and easily, while guaranteeing stable electrical values even after numerous mating cycles.

• Easy channel handling

The highly flexible MULTIFLEX cable in combination with a detailed numbering and coding system ensure easy channel handling without any degradation of the signal integrity.

• Overall cost savings and service benefits

Reduced cost of ownership compared to single interfaces thanks to lower outlay for PCB population and channel handling. 3D files, modelling data and customised footprints are free of charge.

Comprehensive range of standard products (1×8 and 2×8 ganged systems)

- 1×8 and 2×8 straight PCB connectors (SMD)
- 1×8 and 2×8 breakout assemblies MXP-to-SK (2.92 mm standard)
- Standardised SUCOFLEX assembly lengths with different classes of phase matchin
- Customised assemblies on request

MXP family – product combinations

General note: MXP50, MXP40 and MXP18 are mechanically compatible

MXP cable assemblies		Breakout to PC 2.4 mm MXP50	Breakout to SK (2.92 mm) MXP40	Breakout to SMA MXP18
MXP PCB connectors				
MXP50 marking on PCB connectors	MXP50	50 GHz	40 GHz	18 GHz
	MXP40	40 GHz	40 GHz	18 GHz
No specific MXP18 PCB connectors available	MXP18	-	-	-

MXP40 – technical data

Typical electrical data	Testing condition	Performance
Operating range/ data rate		up to 40 Gbps
Frequency range		DC up to 40 GHz
Impedance		50 Ω
Return loss	mated condition gated measurement: cable connector/ PCB transition PCB: Rogers RO3003 cable: HUBER+SUHNER MULTIFLEX 53-02	≥ 20 dB up to 22.5 GHz ≥ 12 dB up to 40 GHz
Insertion loss	Multiflex 53-02	see page 38
Cross-talk	at PCB transition	≤ -40 dB up to 40 GHz

Typical mechanical data	Testing condition	Requirements
Mating force (per single channel)		max. 3.4 N (typical 1.1 N)
Demating force (per single channel)		max. 3.4 N (typical 1.1 N)
Durability (matings)	MIL-PRF-39012, paragraph 4.7.12	> 500

Material data cable connector	Material	Coating
Center contact	copper beryllium	SUCOPRO® gold plating
Outer contact	brass	SUCOPRO® gold plating
Insulator	PTFE	n/a
Body	aluminium	black anodised

Material data PCB connector	Material	Coating
Center contact	copper beryllium	SUCOPRO® gold plating
Outer contact	BZ4	SUCOPRO® gold plating
Body	brass	SUCOPRO® gold plating
Insulator	PEEK	n/a

Typical environmental data	Testing condition	Requirements
Temperature range		-55 to +85 °C
Thermal aging (mated condition)	IEC 60068-2-2, test B	120 °C / 260 h
Change of temperature	IEC 60068-2-14, test na	assembly: -55 to +85 °C PCB: -55 to +85 °C
Vibration	IEC 60068-2-6	on request
Mechanical shock (transport)	MIL-STD-202, method 213, condition I	100 g / 6 ms
Damp heat steady state	IEC 60068-2-78, test ca	40 °C / humidity 93 % / 96 h

MXP40 – technical data

Typical return loss for mated condition (PCB connector with MULTIFLEX 53-02 assembly, gated measurement)

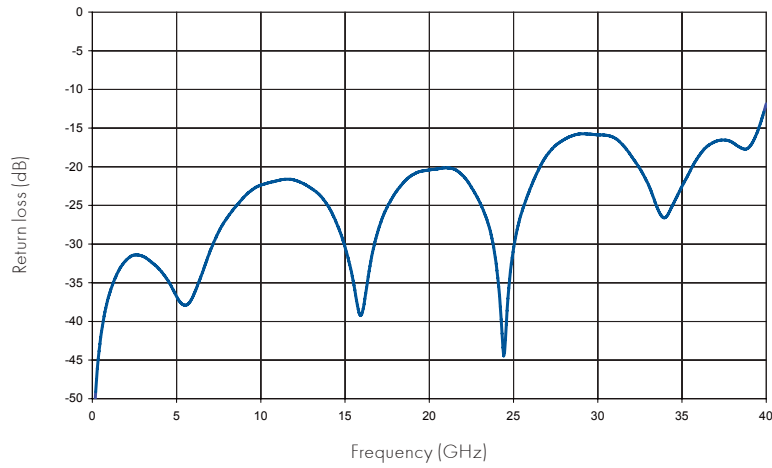

Typical measured cross-talk at PCB transition

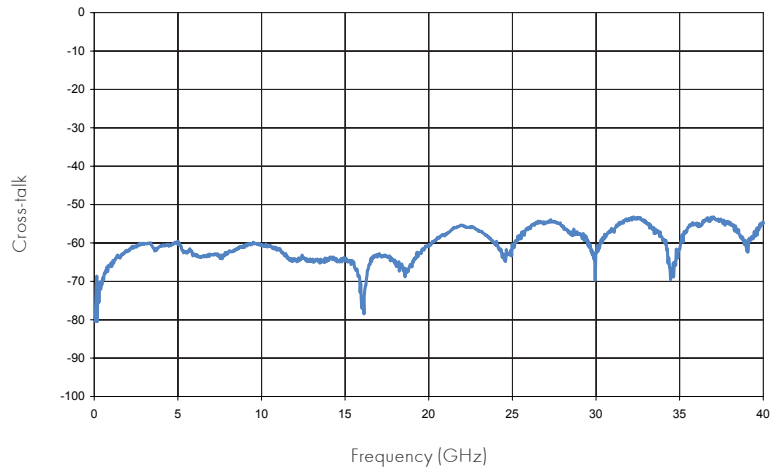

MXP40 – PCB connectors

- Pitch 4 mm (0.16")
- Via-in-pad capable
- 0.7 mm (0.028") pin size allows easy matching to smallest trace width
- SMD technology – ground pins for better mechanical stability of solder joint

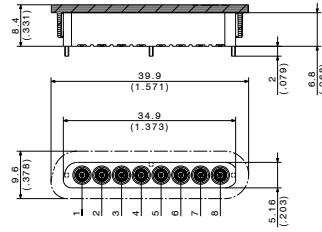

Type 1x8 ganged	Item no.	Packaging	Notes
1x8A_81_MXP-S50-0-1/111_NE	84091435	tape	asymmetric design (keyed)

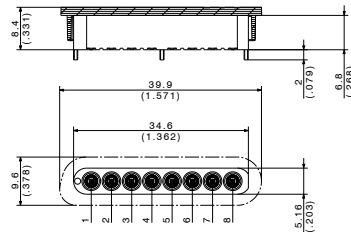

Type 1x8 ganged	Item no.	Packaging	Notes
1x8A_81_MXP-S50-0-2/111_NE	84091436	tape	symmetric design (non keyed)

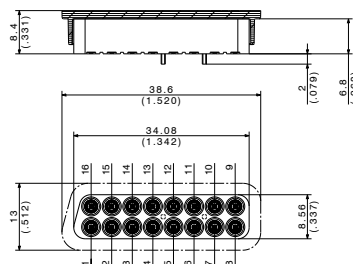
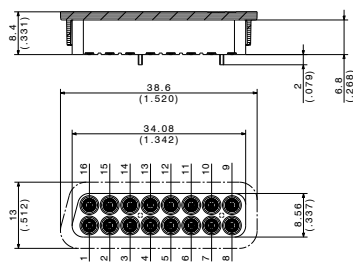
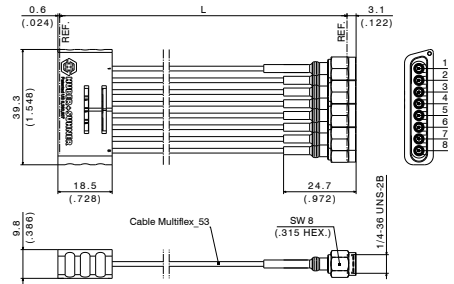

Fig. 1

Fig. 2

Type 2x8 ganged	Item no.	Packaging	Notes	Fig.
2x8A_81_MXP-S50-0-1/111_NE	84072058	tape	asymmetric design (keyed)	1
2x8A_81_MXP-S50-0-3/111_NE	85013397	tape	asymmetric design (keyed) optimised grounding pin layout for differential pair routing	2

MXP40 - breakout to SK



Type 1x8 ganged	Item no.	Length	Notes
MF53/1x8A_21MXP/11SK/152	84097196	152 mm (6")	single channels numbered
MF53/1x8A_21MXP/11SK/229	84099600	229 mm (9")	
MF53/1x8A_21MXP/11SK/305	84099607	305 mm (12")	
MF53/1x8A_21MXP/11SK/610	84123646	610 mm (24")	

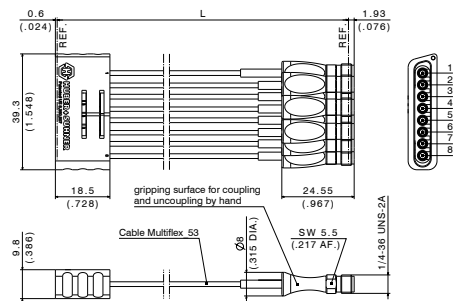

Type 1x8 ganged	Item no.	Length	Notes
MF53/1x8A_21MXP/21SK_ergo/152	84093980	152 mm (6")	single channels numbered with ergo grip on SK (2.92 mm standard) side
MF53/1x8A_21MXP/21SK_ergo/229	84098899	229 mm (9")	
MF53/1x8A_21MXP/21SK_ergo/305	84098900	305 mm (12")	
MF53/1x8A_21MXP/21SK_ergo/610	85009273	610 mm (24")	

MXP40 - breakout to SK

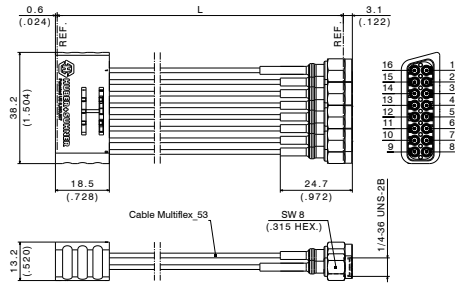

Type 2x8 ganged	Item no.	Length	Notes
MF53/2x8A_21MXP/11SK/152	84088950	152 mm (6")	single channels numbered
MF53/2x8A_21MXP/11SK/229	84098901	229 mm (9")	
MF53/2x8A_21MXP/11SK/305	84088954	305 mm (12")	
MF53/2x8A_21MXP/11SK/610	84089090	610 mm (24")	

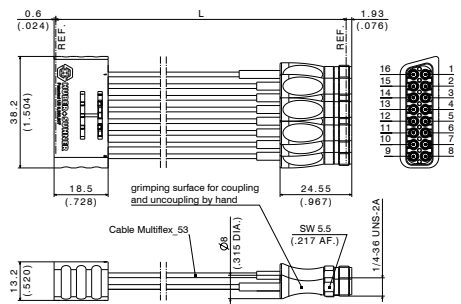

Type 2x8 ganged	Item no.	Length	Notes
MF53/2x8A_21MXP/21SK_ergo/152	84093901	152 mm (6")	single channels numbered with ergo grip on SK (2.92 mm standard) side
MF53/2x8A_21MXP/21SK_ergo/229	84098908	229 mm (9")	
MF53/2x8A_21MXP/21SK_ergo/305	84098902	305 mm (12")	
MF53/2x8A_21MXP/21SK_ergo/610	85009286	610 mm (24")	

40 Gbps

MXP18 – 18 Gbps multicoax solution

Key features

- Operating range at up to 18 Gbps/18 GHz
- Standard absolute phase matching down to ± 2 ps
- Highest density – lowest loss
- Slide-on mating – no threading
- Highly flexible and ultra stable MULTIFLEX cable
- Extensive technical support

Benefits

• Space saving

Due to the dense interface pitch, the PCB connectors take up less space on boards. This is advantageous, as expensive high-performance board material is essential for good signal integrity at high data rates.

• Shorter transmission lines

The compact design of the PCB connector allows it to be positioned directly adjacent to the DUT/chip. This helps to keep the transmission lines on the board short and the losses low.

• Reliable push-on mating

Thanks to the revolutionary slide-on interface design, assemblies can be replugged quickly and easily, while guaranteeing stable electrical values even after numerous mating cycles.

• Overall cost savings and service benefits

Reduced cost of ownership compared to single interfaces thanks to lower outlay for PCB population and channel handling. 3D files, modelling data and customised footprints are free of charge.

Comprehensive range of standard products (1×8 and 2×8 ganged systems)

- 1×8 and 2×8 breakout assemblies MXP-to-SMA
- Standardised SUCOFLEX assembly lengths with different classes of phase matching

MXP family – product combinations

General note: MXP50, MXP40 and MXP18 are mechanically compatible

MXP cable assemblies		Breakout to PC 2.4 mm MXP50	Breakout to SK (2.92 mm standard) MXP40	Breakout to SMA MXP18
MXP PCB connectors				
MXP50 marking on PCB connectors	MXP50	50 GHz	40 GHz	18 GHz
	MXP40	40 GHz	40 GHz	18 GHz
No specific MXP18 PCB connectors available	MXP18	n/a	n/a	n/a

MXP18 – technical data

Typical electrical data	Testing condition	Performance
Operating range/ data rate		up to 18 Gbps
Frequency range		DC up to 18 GHz
Impedance		50 Ω
Return loss	mated condition gated measurement: cable connector/ PCB transition PCB: Rogers RO3003 cable: HUBER+SUHNER MULTIFLEX 53-02	≥ 20 dB up to 18 GHz
Insertion loss	MULTIFLEX 53-02	see page 38
Cross-talk	at PCB transition	≤ -40 dB at 18 GHz

Typical mechanical data	Testing condition	Requirements
Mating force (per single channel)		max. 3.4 N (typical 1.1 N)
Demating force (per single channel)		max. 3.4 N (typical 1.1 N)
Durability (matings)	MIL-PRF-39012, paragraph 4.7.12	> 500

Material data cable connector	Material	Coating
Center contact	copper beryllium	SUCOPRO® gold plating
Outer contact	brass	SUCOPRO® gold plating
Insulator	PTFE	n/a
Body	aluminium	green anodised

Typical environmental data	Testing condition	Requirements
Temperature range		-55 to +85 °C
Thermal aging (mated condition)	IEC 60068-2-2, test B	120 °C / 260 h
Change of temperature	IEC 60068-2-14, test na	assembly: -55 to +85 °C PCB: -55 to +85 °C
Vibration	IEC 60068-2-6	on request
Mechanical shock (transport)	MIL-STD-202, method 213, condition I	100 g / 6 ms
Damp heat steady state	IEC 60068-2-78, test ca	40 °C / humidity 93 % / 96 h

Typical return loss value assembly

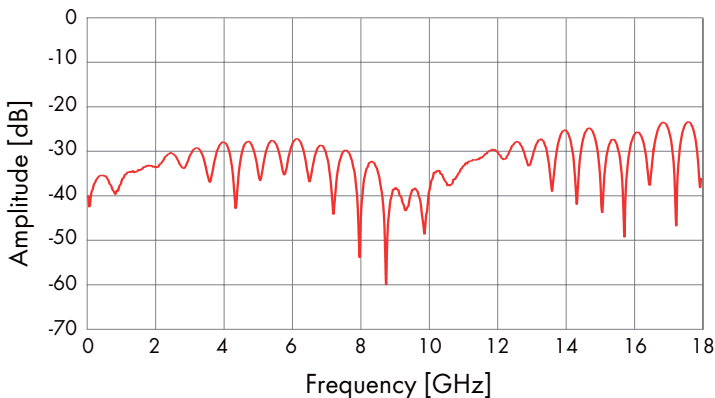

MXP18 – breakout to SMA

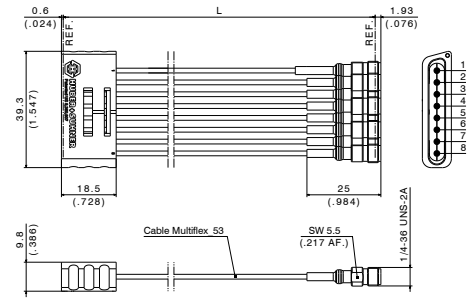

Type 1x8 ganged	Item no.	Length	Notes
MF53/1x8A_21MXP/21SMA/152	85014420	152 mm (6")	

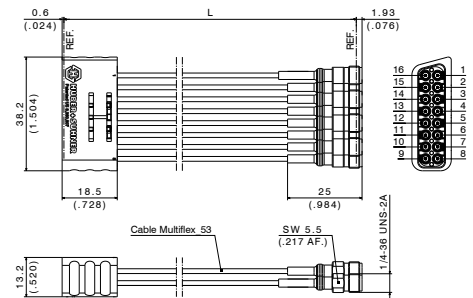

Type 2x8 ganged	Item no.	Length	Notes
MF53/2x8A_21MXP/21SMA/152	85022735	152 mm (6")	

MXP – evaluation kits

MXP40 set includes:

Assemblies

- MXP40 breakout assembly to SK (2.92 mm standard), 152 mm (6")
- Cable: HUBER+SUHNER MULTIFLEX 53-02

PCB

- MXP40 PCB connector
- Fan-out to MMPX* (adaptors to SK included)
- OST calibration area
- Material: Rogers RO3003
- Substrate thickness: 0.127 mm (5 mil)
- Dielectric constant ϵ_r : 3
- Stack up: microstrip



MXP50 set includes:

Assemblies

- MXP50 breakout assembly to PC 2.4, 152 mm (6")
- Cable: HUBER+SUHNER MULTIFLEX 53-02

PCB

- MXP50 PCB connector
- Fan-out to MMPX* (adaptors to PC 1.85 included)
- OST calibration area
- Material: Rogers RO3003
- Substrate thickness: 0.127 mm (5 mil)
- Dielectric constant ϵ_r : 3
- Stack up: grounded coplanar

*HUBER+SUHNER MMPX - 67 GHz precision snap connectors (patented), see page 8.



For further information, please contact the HUBER+SUHNER representative in your country.

MULTIFLEX 53-02 – technical data

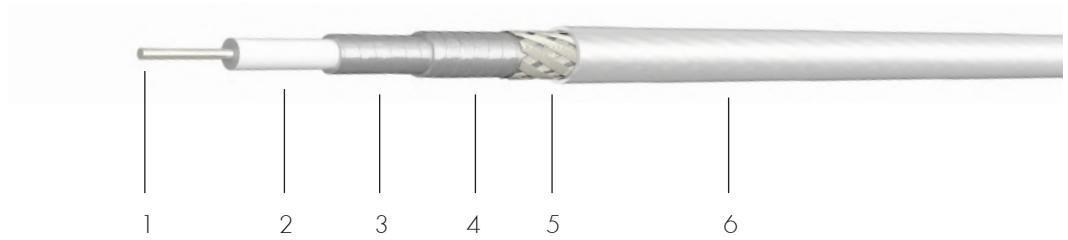

Technical data			
Construction	Material	Detail	Diameter
1 Center conductor	copper, silver plated	wire	
2 Dielectric	PTFE		
3 First outer conductor	copper, silver plated	wrapped tape	
4 Second outer conductor	copper, silver plated	wrapped tape	
5 Third outer conductor	copper, silver plated	braid	
6 Jacket	FEP	RAL 5015 - bl.	1.74 mm ± 0.05
Print	HUBER+SUHNER MULTIFLEX 53-02 (PA no.)		

Electrical data	
Impedance	50 Ω
Max. operating frequency	50 GHz
Capacitance	95 pF/m
Velocity of signal propagation	70 %
Signal delay	4.8 ns/m
Insulation resistance	≥ 1 × 10 ⁸ MΩm
Min. screening effectiveness	> 90 dB (at up to 18 GHz)
Max. operating voltage	0.75 kVrms (at sea level)
Test voltage	1.5 kVrms (50 Hz/1 min)

General cable data		
Temperature range	-55 to +165 °C	
Weight	0.85 kg/100 m	
Min. bending radius	static	3 mm
	dynamic	10 mm
2011/65/EC (RoHS)	compliant	

MULTIFLEX 86 HE - technical data

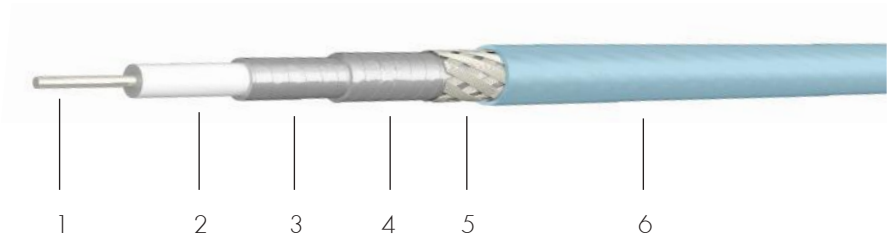

Technical data			
Construction	Material	Detail	Diameter
1 Centre conductor	solid copper, silver plated	wire	
2 Dielectric	solid PTFE	solid PTFE	
3 First outer conductor	copper, silver plated	wrapped tape	
4 Second outer conductor	copper, silver plated	wrapped tape	
5 Third outer conductor	copper, silver plated	braid	
6 Jacket	FEP	blue	2.65 mm

Electrical cable data			
Impedance		50 Ohm	
Operating frequency		67 GHz	
Capacitance		95 pF/m (29 pF/ft)	
Velocity of propagation		71 %	
Time delay		4.7 ns/m (1.4 ns/ft)	
Nom. attenuation*	coefficient a 0.71702	coefficient b 0.02892	
Max. attenuation*	coefficient a 0.75288	coefficient b 0.03037	
Max. operating voltage		1.5 kVrms	
Min. screening effectiveness at up to 18 GHz		90 dB	

*Attenuation calculation $\alpha_{25} = a \cdot \sqrt{f} \text{ (GHz)} + b \cdot f \text{ (GHz)}$ (dB/m)

General cable data			
Temperature range		- 65 to + 165 °C	
Weight		2.1 kg/100 m	
Min. bending radius	static	6 mm	
	dynamic	20 mm	
2011/65/EC (RoHS)		compliant	

minibend™ L – technical data



Technical data			
Construction	Material	Detail	Diameter
Center conductor	copper, silver plated	wire	
Dielectric	expanded PTFE		
Shield	silver plated copper	flat wire braid	
Binder	aluminum/polyimide	laminate tape	
Braid	stainless steel	round wire braid	
Jacket	FEP	transparent	2.64 mm

Electrical data	
Impedance	50 Ω ± 2 Ω
Max. operating frequency	50 GHz
Capacitance	90.2 pF/m
Velocity of signal propagation	76 %
Signal delay	4.36 ns/m
Insulation resistance	≥ 1 × 10 ⁶ MΩm
Min. screening effectiveness	> 100 dB (up to 18 GHz)
Max. operating voltage	2 kVrms (at sea level)

General cable data		
Temperature range	-55 to +165 °C	
Weight	1.56 kg/100 m	
Min. bending radius	static	5 mm
	dynamic	15 mm
2011/65/EC (RoHS)	compliant	

Cable comparison

Attenuation vs. frequency

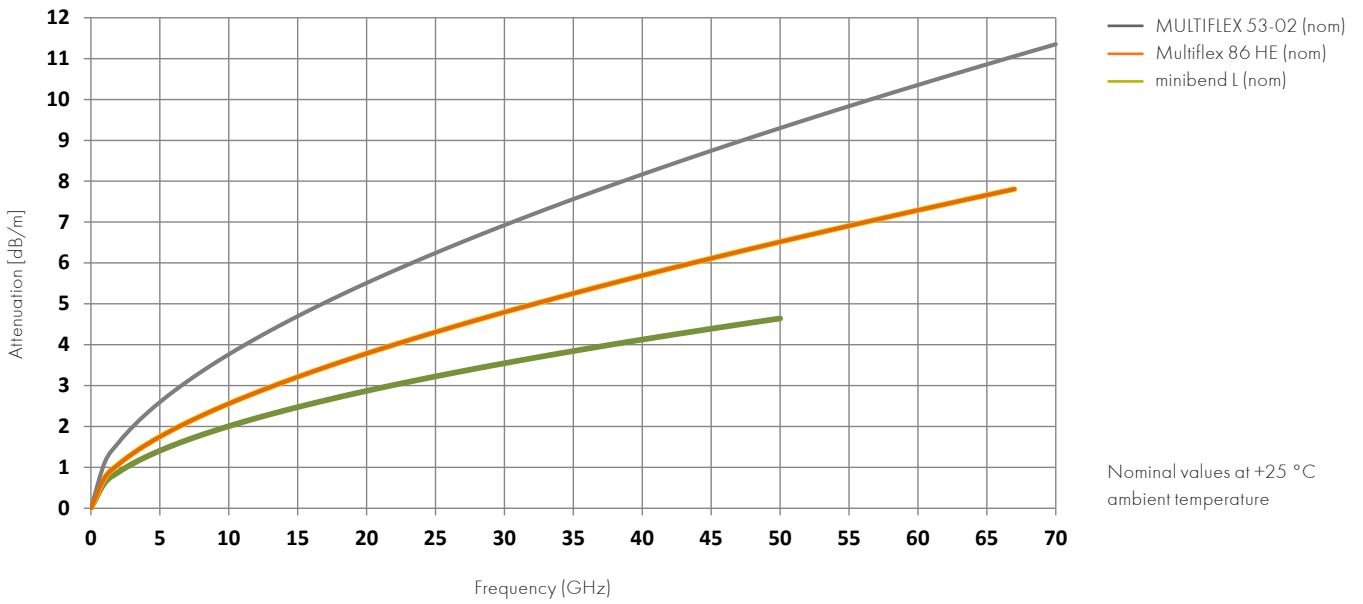

Phase change vs. temperature

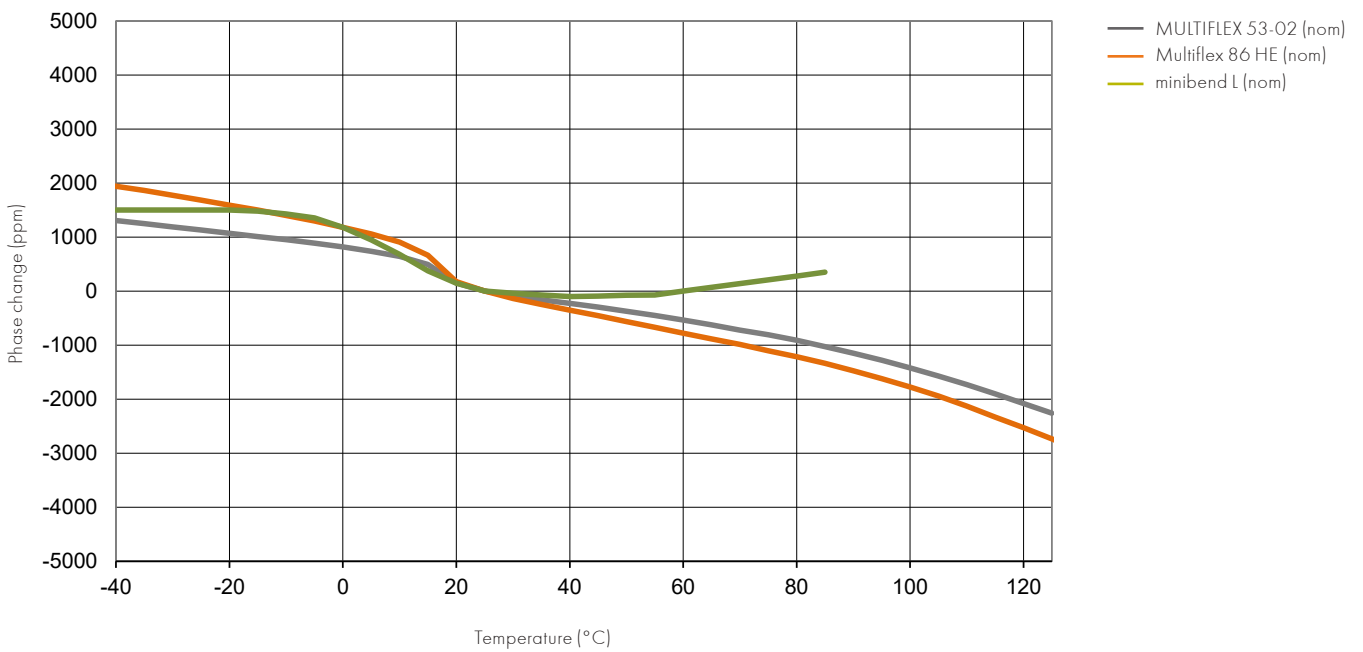

Semi-rigid – form-stable microwave cable

Product description

The semi-rigid cable is unique in that it is easily bent to finished shape and still maintains its set after bending. This property makes it ideal for use with automated bending equipment as well as hand forming by bending tools.

There are hundreds of proven applications which include: low-noise amplifiers, a full range of microwave components, aeronautical and space applications and a variety of high-performance laboratory instrumentation.

The semi-rigid cables provide greatly extended environmental parameters. The cables exhibit highly favourable electrical characteristics, particularly an impedance tolerance as low as 0.5 Ohm for a 0.141" diameter cable with nominal impedance of 50 Ohm.

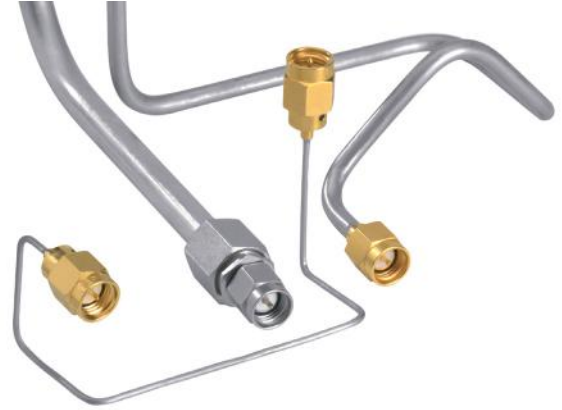

Features and benefits

- Excellent electrical performance: impedance tolerance as low as 0.5 Ohm; minimum VSWR, smooth attenuation vs. frequency curve; minimum change in impedance and attenuation
- Easy to form, strip and solder, making for convenient installation
- Small sizes permit use in high-density areas
- MIL-C-17 qualified

HUBER+SUHNER cable type	Item no.	Operating frequency (GHz)	Temperature range (°C)		Outer dia. (mm)	Nom. attenuation 18 GHz, 25°C (dB/m)	Bending radii	
			minimum	maximum			static (mm)	dyn. (mm)
SR_86_TP_LA	84016454	75	-40	+125	2.18	2.9	6.35	-
EZ_47_TP_M17	22810504	40	-40	+100	1.19	5.1	3.18	-
EZ_47_AL_TP	22810510	40	-40	+100	1.19	5.4	1.27	-
EZ_86_TP_M17	22810175	40	-40	+125	2.20	3.2	3.18	-
EZ_86_AL_TP_M17	22810167	40	-40	+125	2.20	3.3	1.78	-
EZ_118_TP	22810073	40	-40	+125	2.95	1.8	9.53	-
EZ_141_TP_M17	22810043	33	-40	+125	3.58	2.1	6.35	-
EZ_141_AL_TP_M17	22810015	33	-40	+125	3.58	2.2	3.18	-
EZ_250_TP_M17	22810705	18	-40	+90	6.35	1.5	9.52	-
EZ_250_AL_TP	22810708	18	-40	+90	6.35	1.5	6.35	-

SUCOFORM – handformable alternative to semi-rigid

Product description

SUCOFORM microwave coaxial cables offer distinct mechanical advantages over semi-rigid cables. They are based on the same design as the standard PTFE-insulated semi-rigid cables, but have a tin-soaked copper braid for the outer conductor, giving them outstanding hand-formability. These cables combine the excellent characteristics of semi-rigid cables with those of flexible coaxial cables. Thanks to their small bending radii, they allow space-saving routing and packaging.



Features and benefits

- Excellent properties: low loss, high screening effectiveness, high operating frequency, high temperature range
- Due to the high phase stability over every production run, SUCOFORM is especially suitable for delay lines
- Good flexibility: easy hand forming without tooling; fits into the smallest systems
- Comprehensive connector range; use of standard semi-rigid connectors
- Quick and easy assembly
- Available in long lengths and various versions

HUBER+SUHNER cable type	Operating frequency (GHz)	Temperature range (°C)		Outer dia. (mm)	Nominal attenuation 18 GHz, 25° C (dB/m)	Bending radii	
		minimum	maximum			static (mm)	repeat. (mm)
SUCOFORM_47_CU	40	-65	+165	1.20	5.4	3.18	-
SUCOFORM_86	40	-65	+165	2.10	3.4	6	20
SUCOFORM_141	33	-65	+165	3.58	2.2	8	40
SUCOFORM_141_CU	33	-65	+165	3.58	2.2	8	40
SUCOFORM_250-01	18	-65	+165	6.35	1.4	30	120

SUCOTEST 18 – highest standard of measurement

Product description

SUCOTEST 18 cable assemblies feature excellent electrical performance (low insertion loss combined with unique loss stability and excellent return loss).

SUCOTEST 18 is ideal for daily use in components and assembly shops, test labs and automatic test equipment applications

Outstanding features

- Applicable at up to 18 GHz
- Low insertion loss
- Excellent VSWR
- Unique loss stability
- There is no cable spring back during measurement procedures; the assembly stays in position.

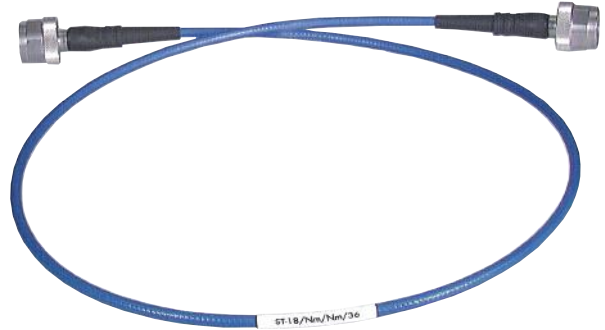

Product assortment	Item no
SUCOTEST_18/SMAm/SMAm/36"	84002061
SUCOTEST_18/Nm/Nm/36"	84002060
SUCOTEST_18/SMAm/Nm/36"	84004594
SUCOTEST_18/SMAm/SMAm/48"	84003373
SUCOTEST_18/Nm/Nm/48"	84003372
SUCOTEST_18/SMAm/Nm/48"	84004006
SUCOTEST_18/SMAm/SMAm/72"	84004007
SUCOTEST_18/Nm/Nm/72"	84004070
SUCOTEST_18/SMAm/Nm/72"	84004595

SUCOFLEX® 100 – high performance cable assemblies

Product description

SUCOFLEX 100 series flexible microwave cable assemblies offer superior electrical and mechanical performance for static and dynamic applications.

This series is a high-end product designed to provide optimal performance at up to 50 GHz, where stringent electrical requirements – in particular stability and low loss – are important. Their mechanical and climate resistance properties surpass those of standard flexible cables. This cable type is ideally suited to test and measurement applications (as test leads) and used in aerospace and defence systems.



Features and benefits

- The cable maintains stable electrical characteristics when exposed to bending and temperature, enabling reliable test results
- A balanced range of connectors is available, including types which feature NWA-specific interfaces
- Can be provided with various ruggedisations to protect the assembly against different environmental influences
- Available as assembly only

HUBER+SUHNER cable type	Operating frequency (GHz)	Temperature range		Outer dia. (mm)	Nominal attenuation 18 GHz, 25°C (dB/m)	Bending radii	
		minimum (°C)	maximum (°C)			static (mm)	dyn. (mm)
SUCOFLEX_101	50	-55	+125	3.65	2.0	11	20
SUCOFLEX_101_P	50	-55	+125	3.65	3.0	11	20
SUCOFLEX_101_PE	50	-40	+85	3.65	3.0	11	20
SUCOFLEX_102	46	-55	+125	4.00	1.7	12	20
SUCOFLEX_103	33	-55	+125	4.60	1.3	13	22
SUCOFLEX_104	26.5	-55	+125	5.50	1.1	16	25
SUCOFLEX_126	26.5	-55	+125	5.50	1.1	16	25
SUCOFLEX_126_E	26.5	-40	+85	5.50	1.1	16	25
SUCOFLEX_106	18	-55	+125	7.90	0.8	24	40
SUCOFLEX_118	18	-55	+125	7.90	0.8	24	40

SUCOFLEX 102 - technical data

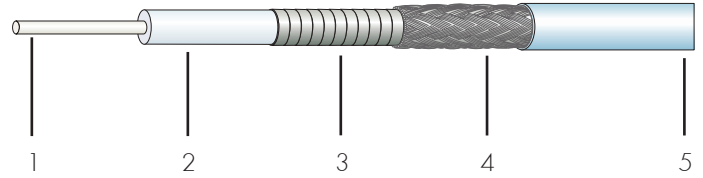

	Description	Diameter
1. Centre conductor	Solid silver-plated copper wire	
2. Dielectric	Low density PTFE	
3. First outer conductor	Silver-plated copper tape, wrapped	
4. Second outer conductor	Silver-plated copper braid	
5. Jacket	Fluoroethylenepropylene, blue	4.00 mm

Electrical cable data				
Impedance				50 Ohm
Operating frequency				46 GHz
Capacitance				87 pF/m (26.5 pF/ft)
Velocity of propagation				77 %
Time delay				4.3 ns/m (1.31 ns/ft)
Nom. attenuation*	coefficient a	0.3700	coefficient b	0.0071
Max. attenuation*	coefficient a	0.4070	coefficient b	0.0078
Max. operating voltage				1.4 kVrms
Min. screening effectiveness at up to 18 GHz				90 dB

*Attenuation calculation $l_{25} = a \cdot \sqrt{f} \text{ (GHz)} + b \cdot f \text{ (GHz)}$ (dB/m)

General cable data	
Temperature range	-55 to 125 °C
Weight	4.0 kg/100 m
Min. bending radius static	12 mm

SUCOFLEX 102 - technical data

Cable attenuation

Nominal values at +25 °C ambient temperature

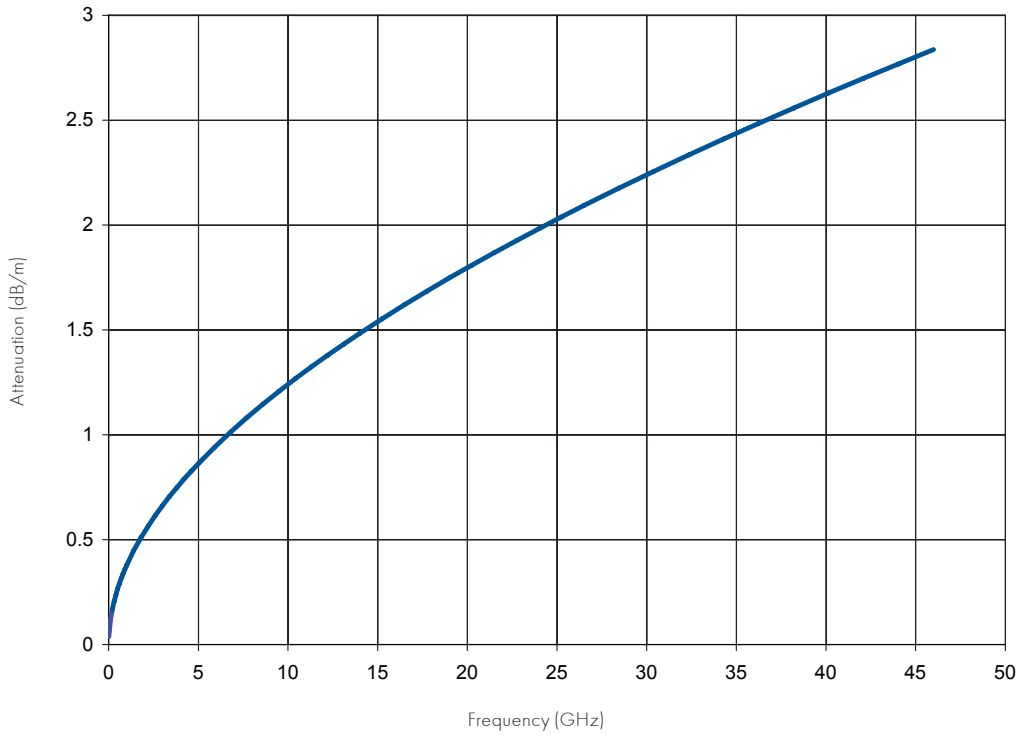

Phase change vs. temperature

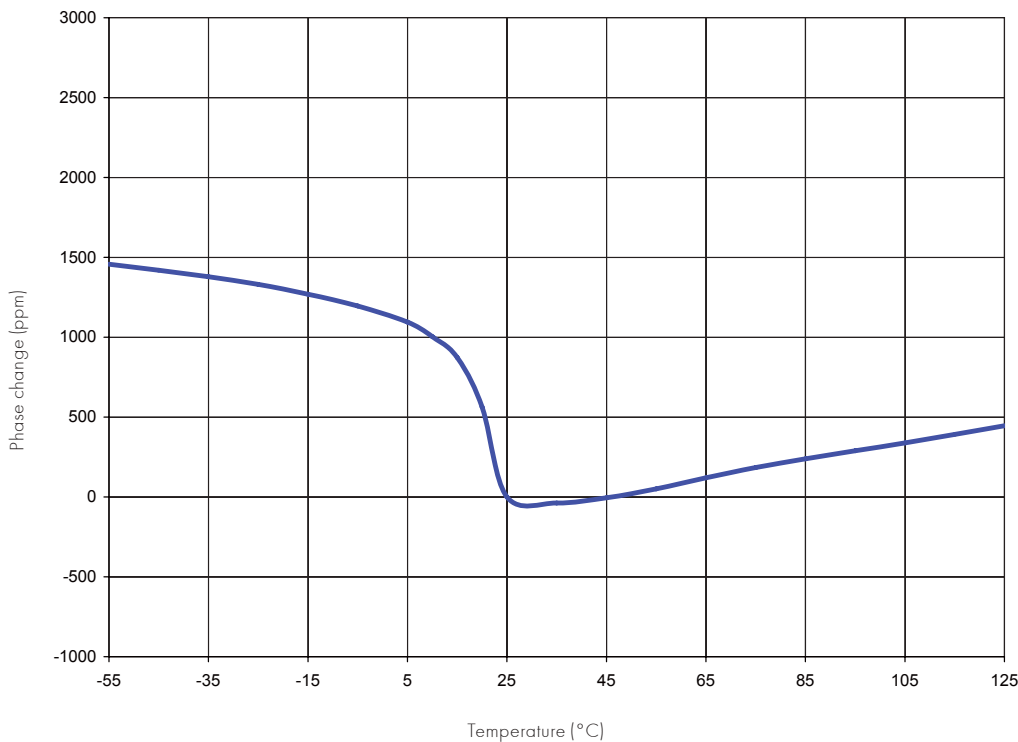

SUCOFLEX 102 – optional ruggedisation

«A» type for SUCOFLEX 102



Description

Consists of steel coil (flat wire), steel braid and polyurethane (TPU) jacket. At up to +85 °C, this ruggedisation offers excellent protection against compression, tension, torsion, abrasion and other mechanical forces acting upon the cable.

Typical applications

- Test and measurement cables
- Laboratory cables

SUCOFLEX 102 – Suitable connectors

Connector	Description	SUCOFLEX		Operating frequency (GHz)	Return loss ¹⁾ (dB)	VSWR
		102	102 A			
11_PC24_201	PC 2.4 plug (male)	•		46	-20	1.2
21_PC24_201	PC 2.4 jack (female)	•		46	-20	1.2
11_PC24_210	PC 2.4 plug (male)		•	46	-20	1.2
21_PC24_210	PC 2.4 jack (female)		•	46	-20	1.2
11_SK_252	SK (2.92 mm standard) plug (male)	•		40	-20	1.2
21_SK_252	SK (2.92 mm standard) jack (female)	•		40	-20	1.2
11_SK_258	SK (2.92 mm standard) plug (male)		•	40	-20	1.2
21_SK_257	SK (2.92 mm standard) jack (female)		•	40	-20	1.2
11_PC35_203	PC 3.5 plug (male)	•		26.5	-20	1.2
21_PC35_203	PC 3.5 jack (female)	•		26.5	-20	1.2

¹⁾ VSWR per connector at operating frequency

Phase matched standard assemblies

MULTIFLEX 53-02/SUCOFLEX 102

HUBER+SUHNER is offering a comprehensive range of phase matched standard assemblies for the MULTIFLEX 53-02, and SUCOFLEX 102 cables.

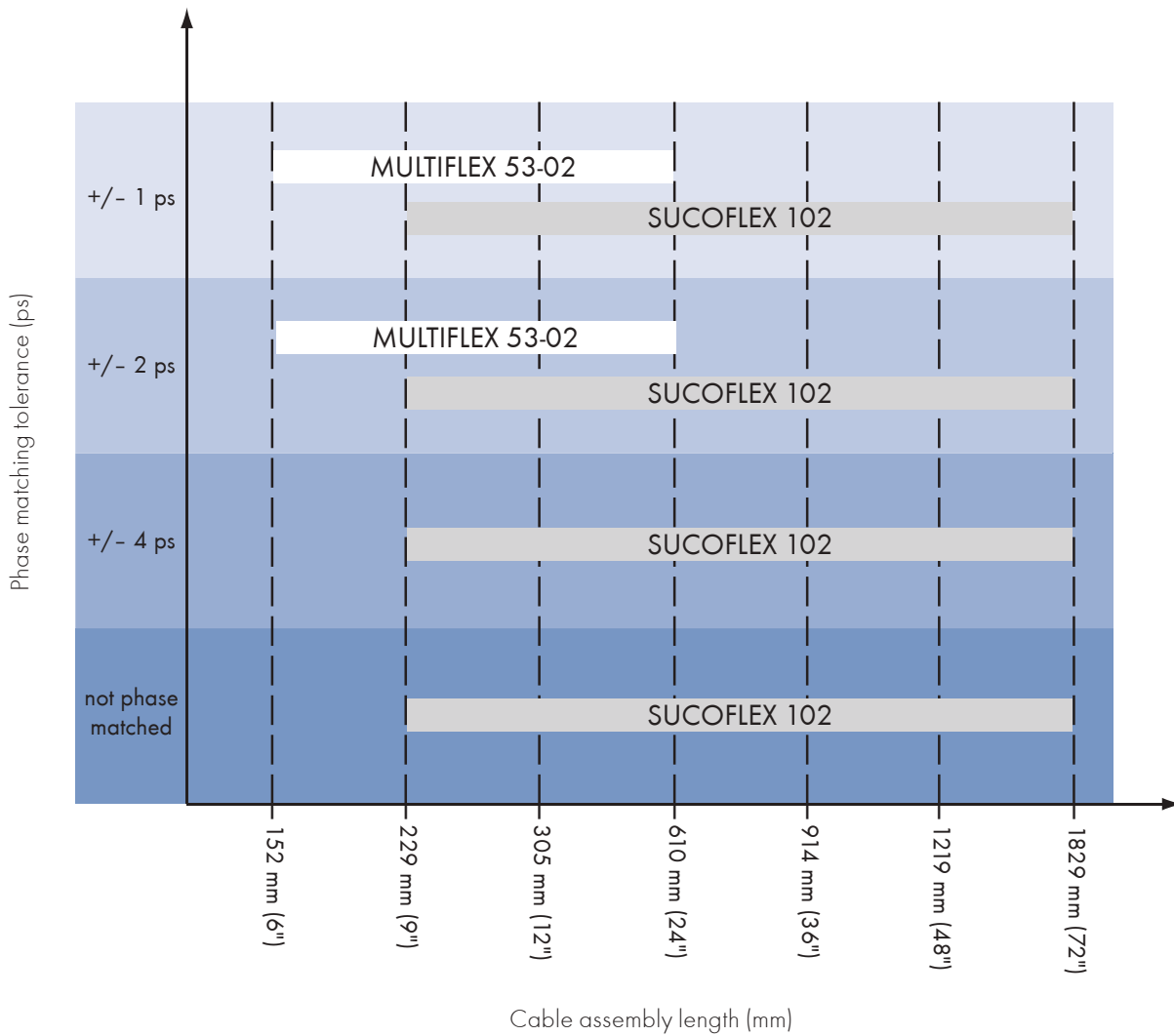

Your HUBER+SUHNER representative can provide you detailed information.

Further connector series

For several reasons, only the most popular HUBER+SUHNER connector series and the appropriate connectors for High Speed Digital Testing are mentioned in this brochure. Connector series such as SMA, PC 3.5 etc. belong also to the broad product range of HUBER+SUHNER and are listed below.

Series	Coupling mechanism	Frequency range	
MMCX	snap-on	6 GHz	
MCX	snap-on	6 GHz	
SMC	screw-on	10 GHz	
SMPX	snap-on	40 GHz	
PC 1.85 (1.85 mm)	screw-on	67 GHz	
PC 2.4 (2.4 mm)	screw-on	50 GHz	
SK (2.92 mm standard)	screw-on	40 GHz	
PC 3.5 (3.5 mm)	screw-on	26.5 GHz	
SMA	screw-on	18 GHz	
QMA	quick-lock	18 GHz	
N	screw-on	18 GHz	
QN	quick-lock	11 GHz	

Resistive components

Low power attenuators

Power	0.5 to 2 Watts
Connectors 50 Ω	BNC, N, PC 2.4, SK (2.92 mm standard), PC 7, QN, QMA, SMA, TNC
Connectors 75 Ω	BNC, N
Frequency range	from DC up to 50 GHz
Attenuation range	0 to 40 dB



Low power terminations

Power	0.5 to 2 Watts
Connectors 50 Ω	TNC, SMB, SMC, SMA, QN, QMA, QMA IP68, QLA, PC 7, SK (2.92 mm standard), PC 2.4, N, MMCX, MCX, C, BNC, BMA, 7/16, 1023
Connectors 75 Ω	TNC, N, BMA, BNC, MCX
Frequency range	from DC up to 50 GHz



DC blocks

Frequency (GHz)	Interface	Voltage max. (V)	Block type	H+S type	Item no.
18	SMA	200	inner	1100.19.0001	84107082
5	N	250	inner	1100.17.A	22550232
4	BNC	250	inner	1100.01.A	22550233
5	TNC	250	inner	1100.26.A	23001075



Resistive power divider

Interface	Frequency (GHz)	VSWR	Power max. (W)	H+S type	Item no.
BNC (fff)	2	1.15	1	4901.01.A	22550077
BNC (mff)	2	1.15	1	4901.01.B	22550078
TNC (mff)	2	1.15	1	4901.26.B	22550165
N (fff)	2	1.15	1	4901.17.A	22550252
TNC (fff)	2	1.15	1	4901.26.A	22640656
SMA (fff)	12.4	1.2	0.5	4901.19.A	22641657
N (mff)	2	1.15	1	4901.17.B	22643830



Note: BNC (mff) - all the tree port are BNC: male, female, female

Related HUBER+SUHNER products

Standard and precision adapters

		MMBX		MMCX		MCX		SMPX		PC 1.85	
		Plug	Jack	Plug	Jack	Plug	Jack	Plug	Jack	Plug	Jack
MMCX	Plug			84047711							
	Jack				22645960						
MCX	Plug					22653002					
	Jack	84014432 ¹⁾					22543558				
MMPX	Plug										84132754
	Jack									84132750	
SMPX	Plug							23021824			
	Jack										
PC 1.85	Plug									84132748	84019546
	Jack									84019546	84132746
PC 2.4	Plug										
	Jack										
SK (2.92 mm standard)	Plug										
	Jack										
PC 3.5	Plug										
	Jack										
SMA	Plug	23004934	23004935	22645967	22645969	22645486	22645488				
	Jack	23004937	23004933 84008370 ^{d)}	22645970	22645961 22658868 ^{d)}	22645487	22645485				
QMA	Plug										
	Jack		84076178 ^{d)}								
N	Plug					22543584 22651490 ²⁾	22543796 22649214 ²⁾				
	Jack		84027355 ^{e)} 84007990 ²⁾			22543586 22649216 ²⁾	22640172 22646217 ²⁾				
QN	Plug										
	Jack		84037845 ^{3) and d)}								

00000000 Standard adapters

00000000 Precision adapters for test+measurement high speed digital testing solutions applications

SK (2.92 mm standard)		PC 3.5		SMA		QMA		N			
Plug	Jack	Plug	Jack	Plug	Jack	Plug	Jack	Plug	Jack		
				22658202	22658203					Plug	MMCX
				22658204	22658201					Jack	
		22651600	22651594							Plug	MCX
		22651599	22651593							Jack	
	84071648									Plug	MMPX
84071696										Jack	
	23032847									Plug	SMPX
23021753	23021816									Jack	
23021792	23021817 ⁴⁾										
										Plug	PC 1.85
										Jack	
23004729	23004730								22650021	Plug	PC 2.4
23004731	84008075							22649932		Jack	
23004727	23004728									Plug	SK (2.92 mm standard)
23004728	23004726									Jack	
	84057235 ⁷⁾										
		22644361	22644362			23017489	23017467	22643957	22643958 22660363 ⁷⁾	Plug	PC 3.5
		22644362	22644360			23017488	23017468	22643959	22643960	Jack	
				22648730	22648731			22543916	22660181	Plug	SMA
				22640151	22641119						
				22648731	22648729			22660180 22543925	22660178 22645162 ⁷⁾	Jack	
				22641119	22640150						
					84014876 23022741 ⁷⁾	23023199	23023287		23023143	Plug	QMA
							84034347 ⁷⁾				
				84012204		23023287	23023171	23024265		Jack	
						84034347 ⁷⁾	84012029 ⁴⁾				
				22542399	22652905 23038869 ⁷⁾			22652113	22652114	Plug	N
								22542398	23014355		
				22640154 22660211 ⁵⁾	22542386 22642820 ⁶⁾			22652114	22652112	Jack	
								23014355	22542382		
			23033936		84018915				23036033	Plug	QN
								84016830 23040535 ⁶⁾		Jack	

- ¹⁾ NH = 100 pieces
- ²⁾ 75 Ω
- ³⁾ NY = variable industrial packing
- ⁴⁾ Additional type item no. 23021818
- ⁵⁾ Quick-Mate
- ⁶⁾ Bulkhead adapter
- ⁷⁾ Panel adapter, flange mount

Further catalogues



RF Coaxial Connectors

Item no. 644802



Microwave Cables and Assemblies

Item no. 23012500

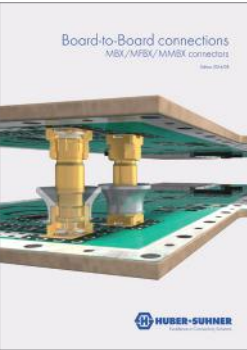

Board-to-Board Connections
MBX/MBX Connectors

Item no. 84104321



Resistive Components

Item no. 84068668



Test+Measurement

Item no. 84210252

HUBER+SUHNER AG
Radio Frequency Division
Degersheimerstrasse 14
9100 Herisau
Switzerland
Phone +41 71 353 4111
Fax +41 71 353 4444
hubersuhner.com

HUBER+SUHNER is certified according to EN (AS) 9100, ISO 9001, ISO 14001, ISO/TS 16949 and IRIS.

Waiver

Fact and figures herein are for information only and do not represent any warranty of any kind.