



The Display Handbook 22/23



A creative solution for every need

Create greater brand awareness to stand out from the crowd

Our extensive portfolio of display products includes everything from portable A-sign boards, roller banners and digital displays to custom built exhibition stands, helping brands to creatively capture the attention of their target audience across a variety of display solutions and vibrant printed graphics.



Best seller



Made in Europe



1 Year hardware guarantee



Use with fabric graphic



5 Year hardware guarantee



Use with PVC graphic



Comes with bag



Use with self-adhesive graphic



Illuminated product



Use with rigid panel graphic



Available for use outdoors



Direct printing onto hardware



Custom sizes available





Contents

Display Stands	6
Modulate™	9
Vector	20
Linear	40
Arena Structures	50
Hanging Structures	54
Arch	56
Display Backwalls	58
Illuminated pop-up backwalls	60
Non-illuminated pop-up backwalls	61
Non-illuminated fabric tube walls	66
Non-illuminated segmented frame walls	68
Non-illuminated tension Walls	72
Display Signs	74
Non-illuminated free-standing signs	76
Non-illuminated wall mounted signs	82
Illuminated wall mounted signs	84
Non-illuminated suspended signs	85
Strata	86
Display Banners	88
Lightboxes	90
Tension textile systems	93
Roller banners	95
Tension banners (X Banner)	102
Flag Banners	104
Free-standing flags	106
Free-standing flag bases	108
Post / wall mounted flags	112
Mobile flags	113
Tents	114
Pop-up tents	116
Inflatable tents	119
Counters	120
Non-illuminated promotional counters	122
Illuminated promotional counters	125
Barriers	126
Pedestrian control barriers	128
Queue management barriers	129
Ancillaries	130
Literature holders	132
Lighting	133
Lighting ancillaries	135
Portable transportation cases	136
Custom / made to measure graphics	139
Product Applications	140
Index	151



A solution for every requirement

Our comprehensive range of creative display solutions

Our goal is to offer a comprehensive range of innovative products for a variety of industries and applications, all from a single supplier. This collection contains our portfolio of creative display solutions including our latest new products.

01 Display Stands

Complete exhibition stand solutions, incorporating hanging structures, modular stands, towers and customised stands



02 Display Backwalls

Large format graphic backdrops which are ideal for conferences, promotional activities and events



03 **Display Signs**

Professional wall, floor and suspended signage solutions



04 **Display Banners**

Portable display options, ideal for temporary deployment



05 **Flag Banners**

Attract attention at a distance through movement with eye-catching flag solutions



06 **Tents**

Perfect outdoor temporary shelters, outdoor pop-up shops and market stalls



07 **Counters**

Adaptable and portable temporary counters for promotional, display and exhibition applications



08 **Barriers**

Convenient and easy barrier systems, to create temporary areas, manage queues and control crowds



09 **Ancillaries**

Accessories designed to increase the functionality of a chosen product range





Display Stands

Display stands are the perfect solution for an array of different applications. From exhibitions, conferences, events, retail event zones to window displays and product showrooms; their uses are unlimited. The perfect stand will showcase and increase the opportunity to interact with existing and potential customers by creating engaging, and innovative brand promotion and messaging.

Our Display range of products include hanging structures to attract interest from a distance, modular stand components and display towers that can be combined to create truly contemporary and captivating exhibition spaces. The collective modular systems; Modulate™, Formulate, Vector and Linear are all designed to work in unison, to deliver a re-usable and reconfigurable exhibition stand. In addition, stands from the modular range also all feature replaceable graphics, thus protecting the investment in hardware, whilst still being renewable by updating branding or marketing messages.

Creating an effective display stand that drives results is extremely straightforward with this collection of pre-configured solutions. Simply select a design for inspiration whilst considering floor size and parameters of price-point. For a more unique stand construction, the modular range can also be customised - incorporating precise requirements with all the benefits that modular exhibition systems offer for complete creative innovation.



Stand component systems

Modulate™

Modulate™ is the fusion between two of our original concepts: Formulate and Vector. The range is composed of various frames made of aluminium tubes, equipped with the patented magnet system: MagLink. Modulate™ provides a custom build solution through its hundreds of possible configurations using the various modules.

Vector

One of the simplest and most versatile communication solutions on the market. Vector is an aluminium frame system with a stretched fabric graphic that adapts to any environment. With a variety of different profiles, all applications are possible: suspended, wall-mounted, self-supporting, double-sided or illuminated.

Linear

A versatile POS and stand solution which enhances flexible and rigid PVC supports. Linear can either be a visible or invisible structure, where stands can be configured according to available space and the desired design.

Arena

A tubular aluminium gantry structure that is both extremely strong and light. The different sections can be assembled according to the space and can be covered with fabric or vinyl graphics.

Hanging Structures

Make your exhibition stands stand out with an eye catching Vector LED hanging structure. Vector LED are the perfect combination of our versatile Vector frames combined with a powerful LED system. Alternatively, select one of our lightweight Formulate hanging structures to compliment your stand design, which uses a lightweight 30mm tubular system that can be neatly wrapped in a fabric printed graphic.

Arch

The Formulate Arch offers a freestanding walkway solution created using our 30mm Formulate structure, which is lightweight and easy to build.

Considerations for exhibitions

Why exhibit at a trade show?

Trade shows remain the preferred communication channel for companies seeking to increase their reputation and promote their image.

The benefits of a trade show are vast and very attractive. They enable several actions to be carried out in a relatively short period of time:

- Brand positioning
- Prospecting
- Market research
- Launch of new products
- Building customer loyalty
- Business networking

The centrepiece: your stand

The success of any trade show depends on its cost vs quality and ROI for generating leads and meeting other sales / marketing objectives.

1. Location:

How much space? How many open sides?

2. The design:

Which media: textile, rigid, flexible panels?

Need to communicate in height: sign, extension or extension of storage room?

Do you need a storeroom to store equipment?

What kind of lighting?

3. Use:

How often?

Will it need to be scalable in shape and size?

What means of transport do you have?

Will the stand be reused in another environment i.e. customer showroom, inhouse events etc.?

4. The budget :

What is the budget for the stand?

Over how many shows will it pay for itself?

The keys to success

To have a successful trade fair, it is essential to :

- Set 3 to 5 objectives that will guide the marketing strategy of the event
- Ensure maximum visual impact with a quality stand that will enhance the company's image (openings, suspended communication, graphics, materials, etc.)
- Implement effective communication and promotion: before, during and after the event (emailing, invitation, social networks, stand promotion, etc.)

Why choose a modular stand?

- Lightweight and compact
- Reconfigurable
- Quick payback
- Durable
- Easy to assemble
- Standard or custom made
- Unlimited message renewal
- Ergonomic





Modulate

The best way to attract attention

Modulate™ is the result of the fusion of two original concepts that have proven successful in the exhibition and retail world; Formulate tubular solutions and the modularity of Vector frames.

Modulate™ is a collection of various frames made from aluminum tubes and covered with a printed textile cover. These frames can be easily connected to each other by means of powerful magnets placed inside each structure.

Based on this simple magnetic principle, it is possible to combine the different Modulate™ frames to create configurations for all communication areas: at the point of sale, at trade fairs, in exhibition areas, in shopping centres or simply within companies themselves.

MagLink connector, simple, fast and reconfigurable



Thanks to the exclusive MagLink magnetic system integrated into the structure, you can connect the frames to each other simply by bringing them together.

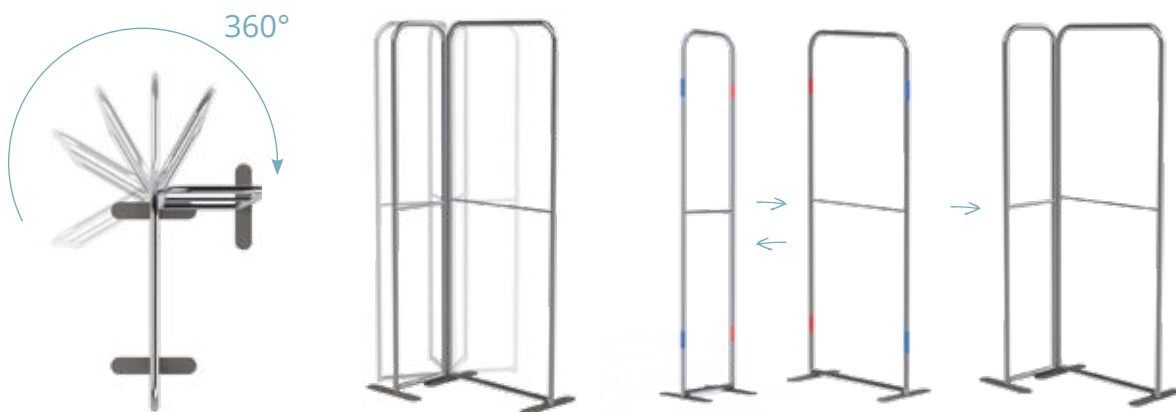

Optional 400 mm extension to change the height of the structures



MagLink connectors 360° in each post



Modulate™ carry bag with dedicated slots for feet and graphics



Intuitive marking on each section for easy assembly



Self-locking system with elastic posts and push-fit button



Rounded or straight corners with the reference MOD-SQ-ANGLE



2 Stabilising feet with Twist & Lock system, supplied with each frame



Central reinforcement bar (18 mm diameter)



Double-sided custom printed fabric graphic that zips closed

Tool-less assembly

Modulate™ structures are easy to assemble without tools. Each section is marked with numbers and colours and connected with push buttons. Once the structure is assembled, the Twist & Lock feet will rotate a quarter of a turn until they lock into a perfectly stable self-supporting frame. Finally pull-on the printed fabric graphic which perfectly fits to the contour of the frame.

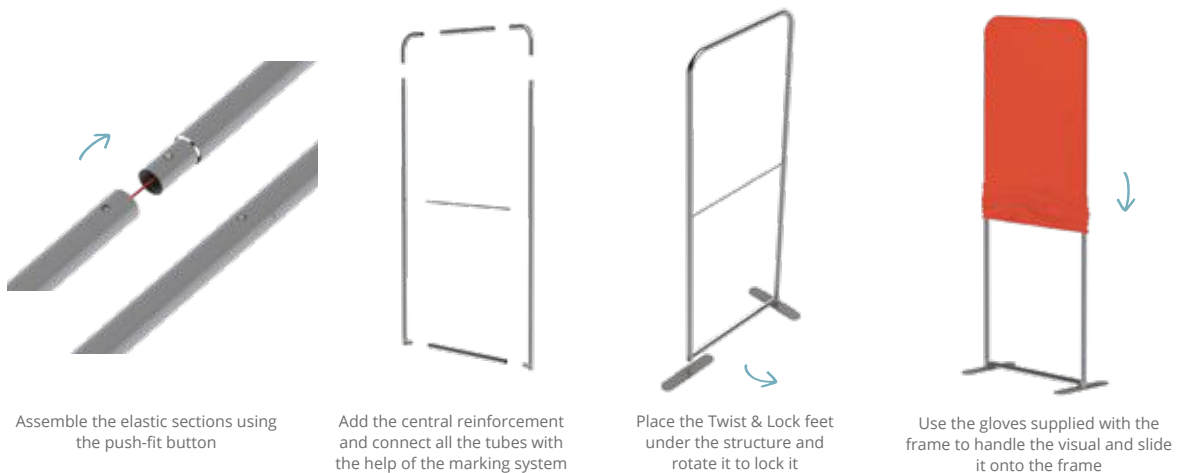

Twist & Lock Foot installation

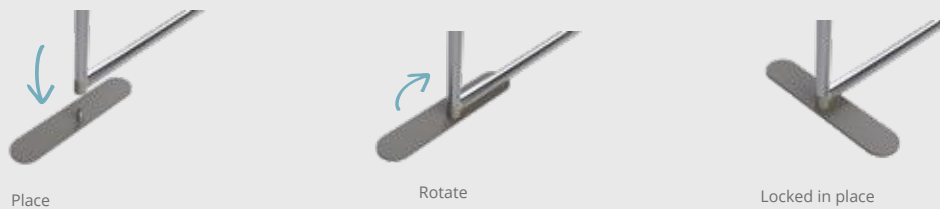

Structures with unique technological innovations!

To add versatility to Modulate™ structures, a 400 mm tubular extension can be added. With this extension, which is easily placed between two sections, you can use the same frame with two different heights.

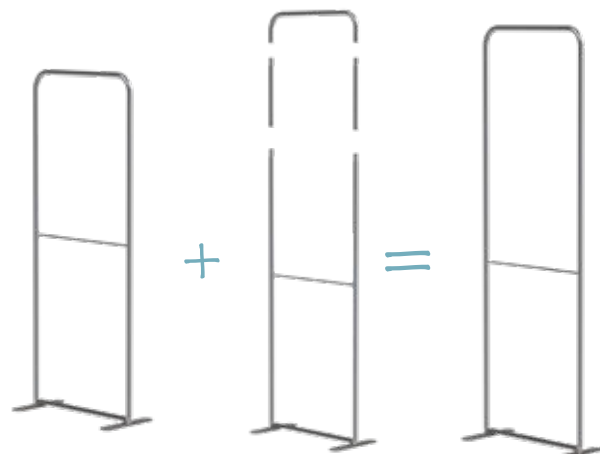

Standard Modulate™ Frames

Modulate™ is an innovative double-sided display system that consists of a set of lightweight aluminium frames covered with a custom printed tension fabric graphic. Frames connect together using powerful magnets encased inside each element and can be joined at any angle to create shaped displays or backwalls. Frames are completed with tension-fit fabric graphic pulls over the frame and zips at the base. Frames are available in various widths and two height options. Each frame is supplied with two stabilising feet which can be used if required for extra stability. The Modulate™ Straight frames can be used on their own or combined with other frames to create hundreds of configurations.

Material	Aluminium
Tube	30mm Ø
Assembly	Tool-free push-button connectors
Shape	Straight
Graphic area	Double-sided
Graphic attachment	Zipped tension-fit graphic
Application	Free-standing with feet (included)
Transport	Modulate™ carry bag with dedicated pockets for the feet and graphics

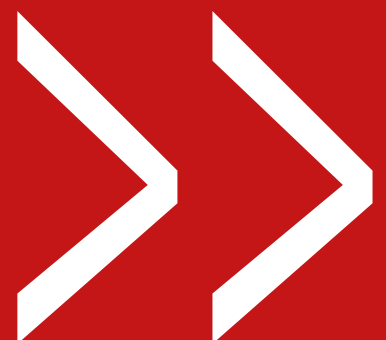

Modulate™ Straight

Modulate™ Straight 420, 424



Straight 420 rounded corners	MOD-S-420	Ⓜ 418(w) x 2000(h) x 400(d) mm
Straight 424 rounded corners	MOD-S-424	Ⓜ 418(w) x 2400(h) x 400(d) mm
Straight 420 square corners	MOD-S-420-SQ	Ⓜ 418(w) x 2000(h) x 400(d) mm
Straight 424 square corners	MOD-S-424-SQ	Ⓜ 418(w) x 2400(h) x 400(d) mm

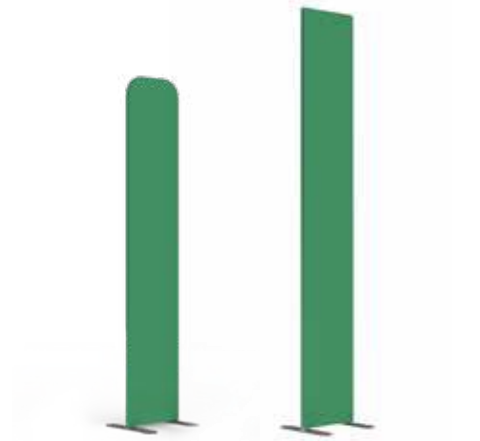

Modulate™ Straight 820, 824



Straight 810 rounded corners	MOD-S-810	Ⓜ 818(w) x 1000(h) x 400(d) mm
Straight 820 rounded corners	MOD-S-820	Ⓜ 818(w) x 2000(h) x 400(d) mm
Straight 824 rounded corners	MOD-S-824	Ⓜ 818(w) x 2400(h) x 400(d) mm
Straight 810 square corners	MOD-S-810-SQ	Ⓜ 818(w) x 1000(h) x 400(d) mm
Straight 820 square corners	MOD-S-820-SQ	Ⓜ 818(w) x 2000(h) x 400(d) mm
Straight 824 square corners	MOD-S-824-SQ	Ⓜ 818(w) x 2400(h) x 400(d) mm

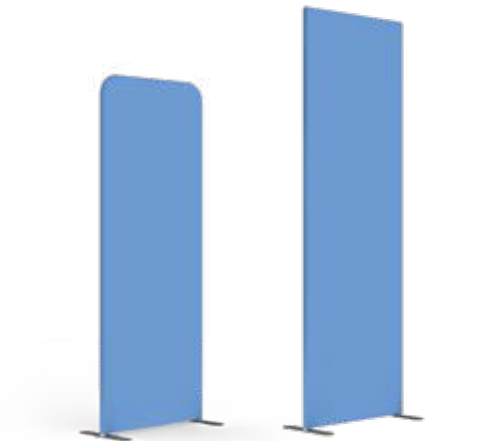

Modulate™ Straight 1020, 1024



Straight 1020 rounded corners	MOD-S-1020	1018(w) x 2000(h) x 400(d) mm
Straight 1024 rounded corners	MOD-S-1024	1018(w) x 2400(h) x 400(d) mm
Straight 1020 straight corners	MOD-S-1020-SQ	1018(w) x 2000(h) x 400(d) mm
Straight 1024 straight corners	MOD-S-1024-SQ	1018(w) x 2400(h) x 400(d) mm



Modulate™ Straight 1820, 1824



Straight 1820 rounded corners	MOD-S-1820	1818(w) x 2000(h) x 400(d) mm
Straight 1824 rounded corners	MOD-S-1824	1818(w) x 2400(h) x 400(d) mm
Straight 1820 square corners	MOD-S-1820-SQ	1818(w) x 2000(h) x 400(d) mm
Straight 1824 square corners	MOD-S-1824-SQ	1818(w) x 2400(h) x 400(d) mm

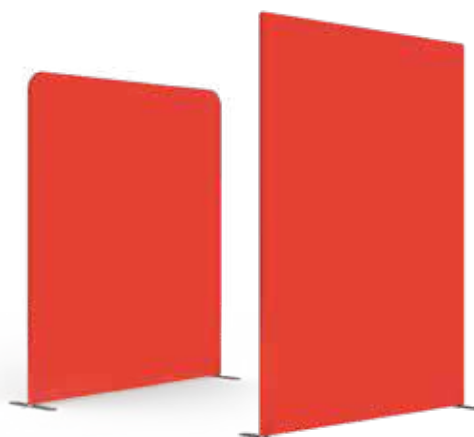

Modulate™ Straight 2020, 2024



Straight 2020 rounded corners	MOD-S-2020	2018(w) x 2000(h) x 400(d) mm
Straight 2024 rounded corners	MOD-S-2024	2018(w) x 2400(h) x 400(d) mm
Straight 2020 square corners	MOD-S-2020-SQ	2018(w) x 2000(h) x 400(d) mm
Straight 2024 square corners	MOD-S-2024-SQ	2018(w) x 2400(h) x 400(d) mm

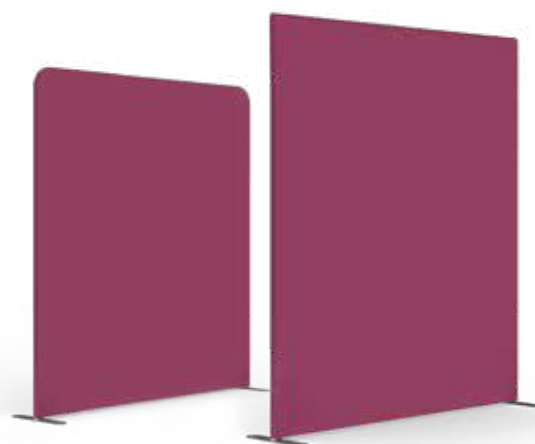

Modulate™ Slope

Modulate™ Slope



Material	Aluminium
Tube	30mm Ø
Assembly	Tool-free push-button connectors
Shape	Straight
Graphic area	Double-sided
Graphic attachment	Zipped tension-fit graphic
Application	Free-standing with feet (included)
Transport	Modulate™ carry bag with dedicated pockets for the feet and graphics

Slope 1	MOD-SS-824-01	818(w) x 2300(h) x 400(d) mm
Slope 2	MOD-SS-824-02	818(w) x 2400(h) x 400(d) mm



Slope 1

Slope 2

Modulate™ Door



The Modulate™ Door frame joins magnetically to other frames in the Modulate™ range and is tool-free in its design. Constructed from lightweight aluminium tubing with magnets held in the frames to join backwalls together. Complete with optional tension-fit fabric graphic, the door is ideal for store room areas or meeting rooms.

Material	Aluminium
Tube	30mm Ø
Assembly	Tool-free push-button connectors
Shape	Straight
Graphic area	Double-sided
Graphic attachment	Zipped tension-fit graphic
Application	Free-standing with feet (included)
Transport	Modulate™ carry bag with dedicated pockets for the feet and graphics

Modulate™ door Rounded corners	MOD-S-DOOR-820	800(w) x 2000(h) x 120(d) mm
	MOD-S-DOOR-824	800(w) x 2400(h) x 120(d) mm
Modulate™ door Square corners	MOD-S-DOOR-820-SQ	800(w) x 2000(h) x 120(d) mm
	MOD-S-DOOR-824-SQ	800(w) x 2400(h) x 120(d) mm

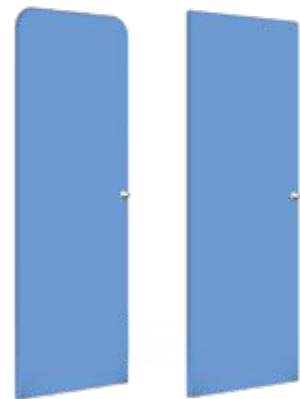

2 handles and 1 stop for Modulate™ Door MOD-S-DOOR-SP-01 included



2 Twist & Lock Square Feet MOD-FOOT-SQ-P included



An adjustable Foot Formulate FMLT-MOD-30-ADJ-F included



The Modulate™ Door can be used with either a left or right-hand handle

Modulate™ ancillaries

Modulate™ Half Feet (pair)

MOD-HALF-FOOT-P	80(w) x 6(h) x 215(d) mm
-----------------	--------------------------



Modulate™ Feet (pair)

MOD-FOOT-P	80(w) x 6(h) x 400(d) mm
------------	--------------------------



Modulate™ Bag

MOD-BAG	1020(w) x 225(h) x 100(d) mm
---------	------------------------------



Modulate™ 400mm Extension Kit

MOD-EXT400MM	3 tubes 400(h) x 30 (Ø) mm
--------------	----------------------------



Spotlight Clamp for Formulate / Modulate™ Tube

US903	48(w) x 32(h) x 50(d) mm
-------	--------------------------



Screen Holder for Modulate™ / Formulate Ø 30mm

LN136	900(w) x 1800(h) x 650(d) mm
-------	------------------------------



Pre-configured Modulate™ stand examples

This section showcases examples of various pre-configured Modulate™ Stands that can be achieved using the various Modulate™ hardware and ancillaries.

Modulate™ Stand 9m²



Material	Aluminium
Tube	30mm Ø
Assembly	Tool-free push-button connectors
Graphic area	Double-sided
Graphic attachment	Zipped tension-fit graphic

Straight 2024 right angles (x2)	MOD-S-2024-SQ
Straight 824 right angles (x3)	MOD-S-824-SQ
Door Modulate™	MOD-S-DOOR-824-SQ
Pair of half flat Feet (x2)	MOD-HALF-FOOT-P
Modulate™ counter	FORM-MOD-CNTR-01
Internal shelf	FORM-MOD-CNTR-02

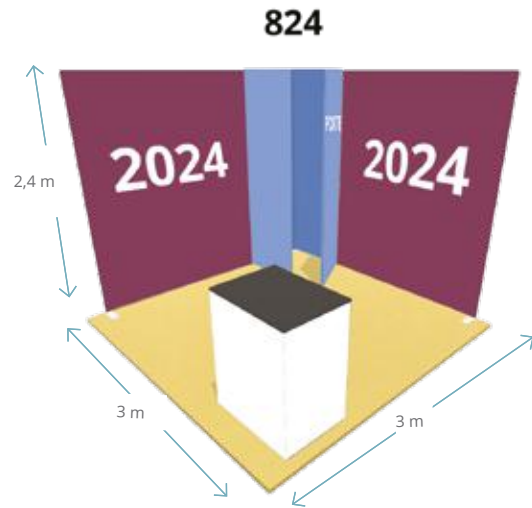

Modulate™ cupboard
perfect for storage

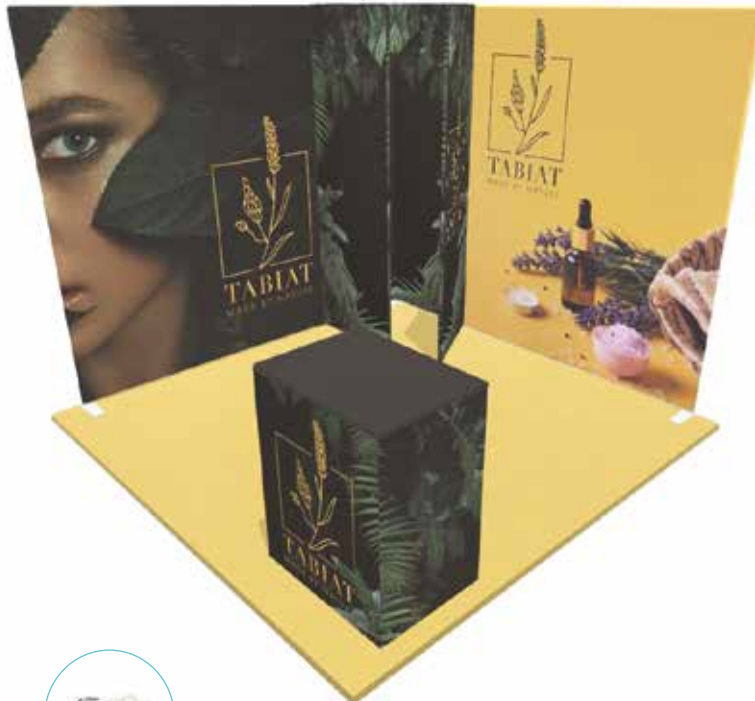

Optional Spot
LED-STRIP-ARM-BDLK



Clamp US903



Bag MOD-BAG

Modulate™ Stand 12m²



Material	Aluminium
Tube	30mm Ø
Assembly	Tool-free push-button connectors
Graphic area	Double-sided
Graphic attachment	Zippered tension-fit graphic

Straight 2024 right angles (x3)	MOD-S-2024-SQ
Straight 1024 right angles	MOD-S-1024-SQ
Straight 824 right angles (x4)	MOD-S-824-SQ
Modulate™ Door	MOD-S-DOOR-824-SQ
Pair of half flat feet x4	MOD-HALF-FOOT-P



Possibility to add PS950-1000 LED spotlights

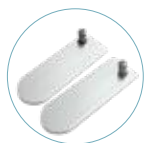

Half feet Twist & Lock MOD-HALF-FOOT-P grey



2 handles and 1 stop for Modulate™ Door MOD-S-DOOR-SP-01 included

Modulate™ Stand 15m²



Material	Aluminium
Tube	30mm Ø
Assembly	Tool-free push-button connectors
Graphic area	Double-sided
Graphic attachment	Zipped tension-fit graphic

Straight 2024 right angles (x3)	MOD-S-2024-SQ
Straight 1024 right angles	MOD-S-1024-SQ
Straight 824 right angles (x3)	MOD-S-824-SQ
Slope 2	MOD-SS-824-02
Door Modulate™	MOD-S-DOOR-824-SQ
Pair of half flat feet x4	MOD-HALF-FOOT-P
Modulate™ counter	FORM-MOD-CNTR-01
Internal shelf	FORM-MOD-CNTR-02

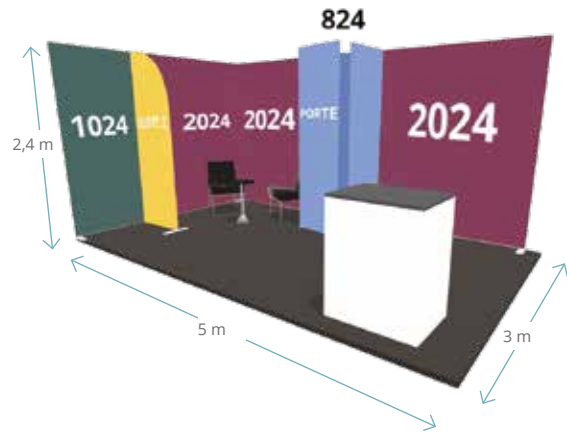

Configure the stand interior with additional Modulate™ frames



Possibility to add PS950-1000 LED spotlights



Half feet Twist & Lock MOD-HALF-FOOT-P



Accessorise with a Modulate™ counter

Modulate™ Stand 18m²



The Modulate™ range is ideal for the design of small and medium sized exhibition stands. The assembly of Modulate™ structures is simple, without tools and allows unlimited modularity and evolution of your configurations.

Material	Aluminium
Tube	30mm Ø
Assembly	Tool-free push-button connectors
Graphic area	Double-sided
Graphic attachment	Zippered tension-fit graphic

Straight 2024 right angles (x4)	MOD-S-2024-SQ
Straight 1024 right angles	MOD-S-1024-SQ
Straight 824 right angles (x4)	MOD-S-824-SQ
Door Modulate™	MOD-S-DOOR-824-SQ



Modulate™ cupboard - door with handle (without lock)



Modules join tool-free and without any connecting parts

The ease of assembly of the range allows for reconfigurable and reusable solutions: mix and match structures in an instant!



Vector

Visual marketing for every budget

Whether wall mounted, free-standing or backlit, the diverse range of Vector aluminium profiles provides a solution for every need and every budget.

They offer optimal visual impact and original designs that can be adapted to any event: showrooms, point of sale, exhibitions, museums and many others.

Anodised aluminium profiles

The Vector range includes 7 aluminium profile models that are perfect for all applications. Let our overview table guide you and make your choice easily.



Quick Fix 20 mm

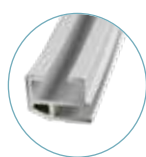

Slim 20 mm

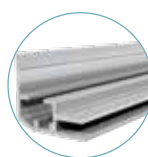

30 mm LED



50 mm

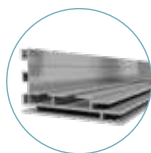

75 mm LED

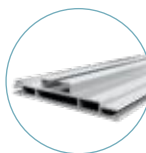

100 mm LED

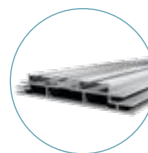

125 mm LED

Code	VECTOR	Wall mounted	Free-standing	Illuminated	Double-sided	Premium range	Various colours
VWQF-CUSTOM*	20 mm QF	x					x
VWF-CUSTOM	20 mm Slim	x					
VLB30-CUSTOM	30 mm LED	x		x		x	
VKF-CUSTOM*	50 mm		x		x	x	
VLB75-CUSTOM*	75 mm LED	x	x	x		x	x
VLB100-CUSTOM*	100 mm LED		x	x	x		
VLB125-CUSTOM	125mm LED		x	x	x	x	x

* Available in standard modules for stand application

Vector Modules

An ultra-compact solution

From free-standing textile walls to exhibition stands, the Vector range offers a versatile and adaptable solution for all your events. The Vector frame system with stretched fabric covering is one of the simplest communication solutions on the market, particularly in a stand environment. Scalable, reconfigurable, ultra-portable: go from a 9 to a 15 m² stand with ease. Easily create stands of all sizes and shapes and accessorise them with spotlights, counters, document holders, etc.

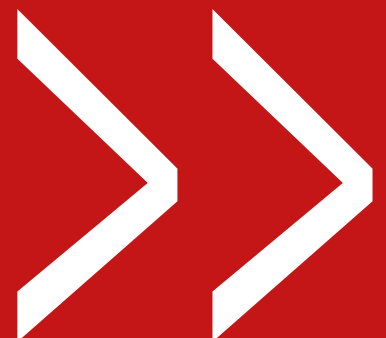

A compact solution for portability and optimised storage

Choose the Vector Modules:

- 50 mm aluminium profiles
- Different modules: walls, arches, LEDs, storage...
- Packaged in numbered sections of 1250 mm,
- Delivered in a cardboard box with assembly instructions, accompanied by the visual of your choice
- In stock all year round
- Each module is already perforated on 4 sides and equipped with the necessary screws: easily assemble different modules together, one Allen key is enough.
- Reconfigurable and reusable: store the stand at home in a small box (1350 x 400 x 300 mm)
- Excellent return on investment.

Go from a 3m² stand to a 15m² stand in the blink of an eye!



Vector Modules – Walls



Material	Aluminium
Profile width	50mm
Profile Colour Tube	Anodised
Assembly	Connectors assemble using Allen key
Graphic area	Single and double-sided
Graphic attachment	SEG 3mm

Module A	MODULE-VFF-A	Ⓞ 2950(w) x 2500(h) x 50(d) mm
Module B	MODULE-VFF-B	Ⓞ 1950(w) x 2500(h) x 50(d) mm
Module C	MODULE-VFF-C	Ⓞ 950(w) x 2500(h) x 50(d) mm
Module M	MODULE-VFF-M	Ⓞ 2850(w) x 2500(h) x 50(d) mm
Module N	MODULE-VFF-N	Ⓞ 1850(w) x 2500(h) x 50(d) mm
Module O	MODULE-VFF-O	Ⓞ 450(w) x 2500(h) x 50(d) mm
Module L	MODULE-VFF-L	Ⓞ 2800(w) x 2500(h) mm

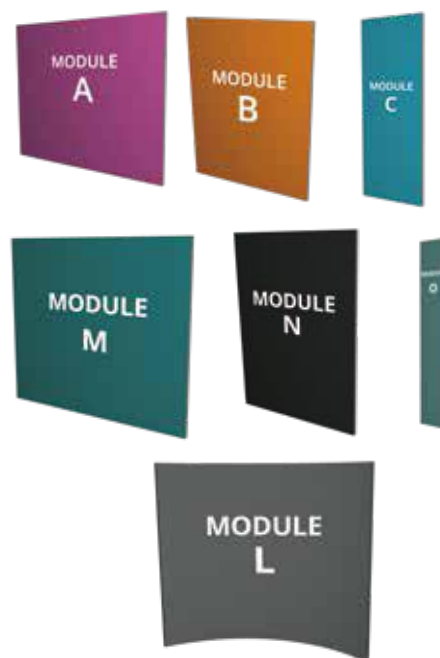

Vector Modules LED



Material	Aluminium
Profile width	75mm and 100mm
Profile Colour Tube	Anodised
Assembly	Connectors assemble using Allen key
Graphic area	Single and double-sided
Graphic attachment	SEG 3mm
LED System	Pre-installed LED lighting

Module I	MODULE-VFF-I	Ⓞ 950(w) x 2550(h) mm
Module J	MODULE-VFF-J	Ⓞ 950(w) x 2500(h) x 75(d) mm
Module P	MODULE-VFF-P	Ⓞ 1850(w) x 2500(h) x 100(d) mm

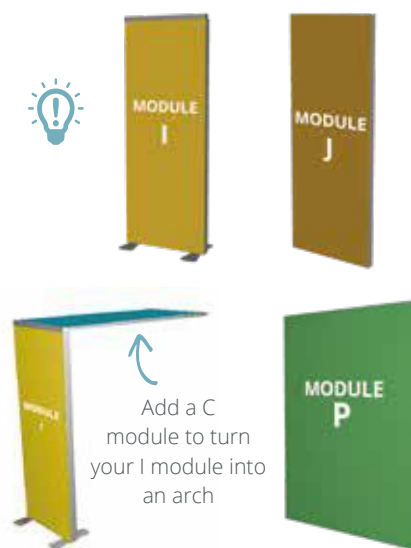

Post Module



Material	Aluminium
Profile width	50mm
Profile Colour Tube	Anodised
Assembly	Connectors assemble using Allen key, Screw-in strips

Post Module	Ⓞ 50(w) x 50(d) x 2500(h) mm
-------------	------------------------------



Vector Modules Extensions

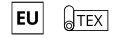

Material	Aluminium
Profile width	50mm
Profile Colour	Anodised
Assembly	Connectors assemble using Allen key
Graphic area	Single or double-sided
Graphic attachment	SEG 3mm

Module K	MODULE-VFF-K	⊙ 1050(w) x 1000(h) x 1050(d) mm
Module Q	MODULE-VFF-Q	⊙ 1850(w) x 1000(h) x 100(d) mm

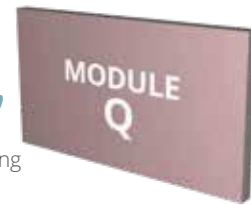

Consider adding
2 x 1000mm
square posts

Vector Modules Storage



Material	Aluminium
Profile width	50mm
Profile Colour	Anodised
Assembly	Connectors assemble using Allen key
Graphic area	Single and double-sided
Graphic attachment	SEG 3mm

Module F (door only) - Left handle	MODULE-VFF-FD-2	⊙ 940(w) x 1930(h) x 50(d) mm
Module F (door only) - Right handle	MODULE-VFF-FD-2R	⊙ 940(w) x 1930(h) x 50(d) mm



Vector standard stand designs

This section showcases examples of various pre-configured Vector Stands that can be achieved using the various Vector hardware and ancillaries.

Vector Stand 9m²



Material	Aluminium
Profile width	50mm
Profile Colour	Anodised
Assembly	Connectors assemble using Allen key
Graphic area	Single or double-sided
Graphic attachment	SEG 3mm

Module B (x2)	MODULE-VFF-B
Module G	MODULE-VFF-G-2
Pair of angled feet	SLF1P

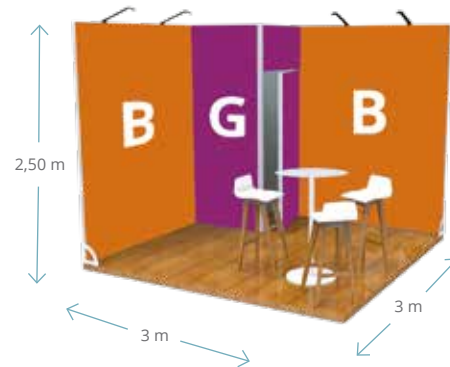

Scalable stands go from 9m² to 15m²

Screw together Module B to the corresponding post to form the desired configuration.



Possibility to add LED spotlights Exhibition Code : LED-EXHIB-ARM-BDLK



Angle foot Code: SLF1P



Return with lock and key set

Vector Stand 12m²- Design 1

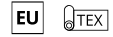

Material	Aluminium
Profile width	50mm
Profile Colour	Anodised
Assembly	Connectors assemble using Allen key
Graphic area	Single or double-sided
Graphic attachment	SEG 3mm

Module C (x2)	MODULE-VFF-C
Traverse 900 mm (x3)	LN605-900-L2
Module F	MODULE-VFF-F-2
Module V (x4)	MODULE-LN-V
Module L	MODULE-VFF-L
Module E (x2)	MODULE-VFF-E
Cross bar 950 mm (x12)	LN605-950-L2
Vector Curved Counter-top Black	VCCB-BK
Pair of angled feet	SLF1P

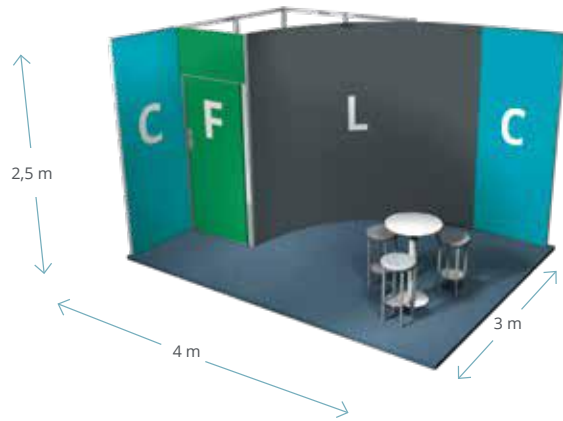

Possibility to add LED Flood spots
Code: LED-FLOOD-ARM-BDLK



Square post to create 90° angles



Return with lock and key set

Vector Stand 12m² - Design 2



Material	Aluminium
Profile width	50mm
Profile Colour	Anodised
Assembly	Connectors assemble using Allen key
Graphic area	Single or double-sided
Graphic attachment	SEG 3mm

Module C	MODULE-VFF-C
Module H	MODULE-VFF-H
Module G	MODULE-VFF-G3-2
Module B (x2)	MODULE-VFF-B
Pair of angled feet	SLF1P

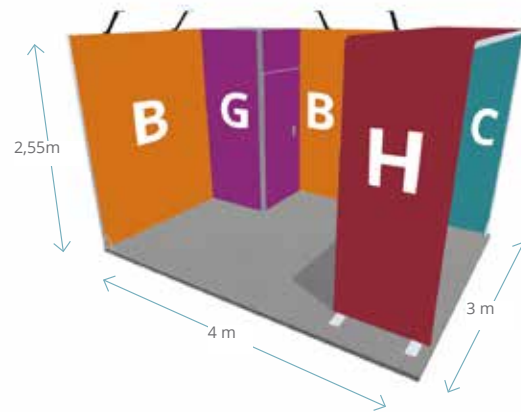

Vector graphic



Return with lock and key set



Spots Exhibition

Vector Stand 15m² - Design 1

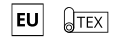

Material	Aluminium
Profile width	50mm
Profile Colour	Anodised
Assembly	Connectors assemble using Allen key
Graphic area	Single or double-sided
Graphic attachment	SEG 3mm

Module G3	MODULE-VFF-G3-2
Module B (x2)	MODULE-VFF-B
Vector Straight Wooden Counter-top	VSCB-BI
Pair of angled feet	SLF1P

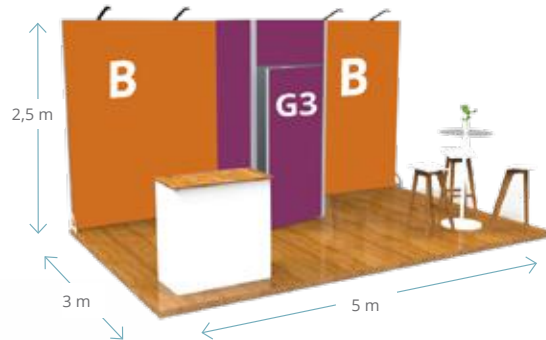

Scalable stands go from 9m² to 15m²



Square post to create 90° angles



Possibility to add LED spotlights Exhibition Code: LED-EXHIB-ARM-BDLK



Return with lock and key set

Vector Stand 15m² - Design 2



Material	Aluminium
Profile width	50mm
Profile Colour	Anodised
Assembly	Connectors assemble using Allen key
Graphic area	Single or double-sided
Graphic attachment	SEG 3mm

Module F	MODULE-VFF-F-2
Module B (x3)	MODULE-VFF-B
Module C (x3)	MODULE-VFF-C
Module J	MODULE-VFF-J
Module O	MODULE-VFF-O
Module E (x6)	MODULE-VFF-E
Module K	MODULE-VFF-K
Vector Counter Straight Black	VSCB-BK
Pair of angled feet	SLF1P

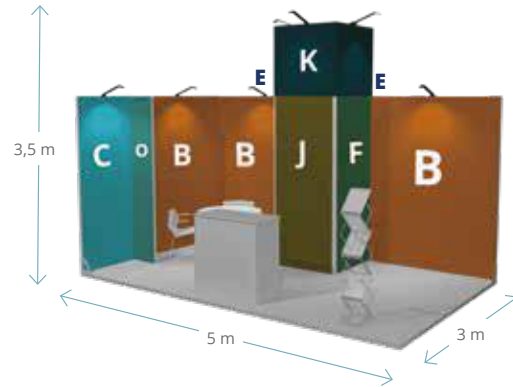

Module LED

Using a J-Module is a great way to add light to your stand and get noticed

Raise the backwall

Gain visibility and originality with this large reserve that can be personalised on all 4 sides



Square post to create 90° angles



Possibility to add LED spotlights Exhibition Code: LED-EXHIB-ARM-BDLK



Return with lock and key set

Vector Modules extensions

Vector Stand 15m² - Design 3

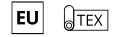

Material	Aluminium
Profile width	50mm
Profile Colour	Anodised
Assembly	Connectors assemble using Allen key
Graphic area	Single or double-sided
Graphic attachment	SEG 3mm

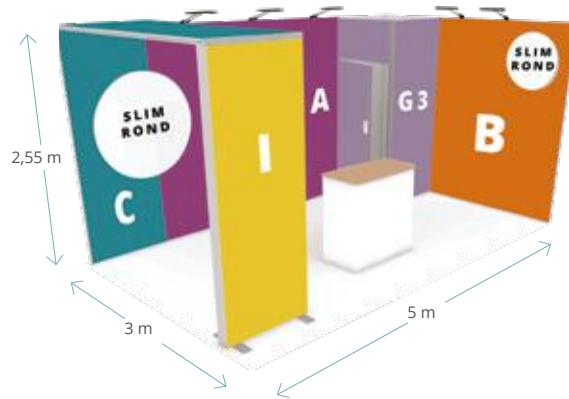

Module G3	MODULE-VFF-G3-2R
Module A	MODULE-VFF-A
Module B (x1)	MODULE-VFF-B
Module C (x2)	MODULE-VFF-C
Module I	MODULE-VFF-I
Vector LED sign	VLBH125-PAN-250
Pair of angled feet	SLF1P
Vector straight counter-top White	VSCB-WH
Slim round Ø1000mm	VWFC-1000
Slim round Ø400mm	VWFC-400

Spots LED-STRIP-ARM-BDLK

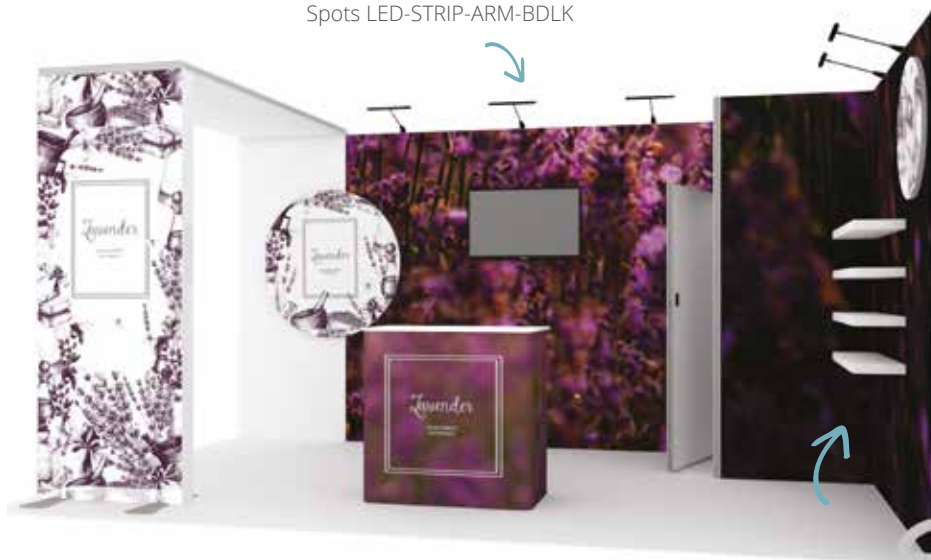

New shelves assemble tool-free



Vector graphic



Foot SLF1P



Spots LED-STRIP-ARM-BDLK

Vector Stand 18m²



Material	Aluminium
Profile width	50mm
Profile Colour	Anodised
Assembly	Connector with Allen key
Graphic area	Single or double-sided
Graphic attachment	SEG 3mm

Module G	MODULE-VFF-G-2
Module B (x3)	MODULE-VFF-B
Module C	MODULE-VFF-C
Module H	MODULE-VFF-H
Vector LED sign	VLBH125-PAN-250
Pair of angled feet	SLF1P
Vector Curved Counter-top Black	VCCB-BK

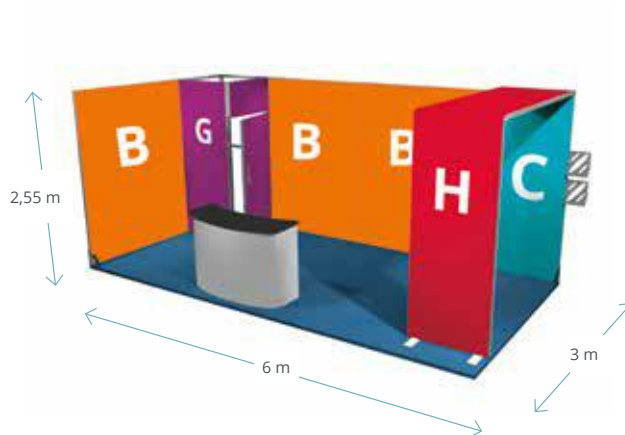

Rounded corner for a full graphic



Return with lock and key set



Literature holder

Vector Stand 24m²

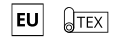

Material	Aluminium
Profile width	50mm
Profile Colour	Anodised
Assembly	Connectors assemble using Allen key
Graphic area	Single or double-sided
Graphic attachment	SEG 3mm

Module B (x2)	MODULE-VFF-B
Module N (x2)	MODULE-VFF-N
Module D (x2)	MODULE-VFF-D
Module C	MODULE-VFF-C
Module F	MODULE-VFF-F-2
Module E (x4)	MODULE-VFF-E
Module Q	MODULE-VFF-Q
Posts (x2) 1000 mm	LN616-CUSTOM-M
Pair of angled feet	SLF1P
Vector Straight Wooden Counter-top	VSCB-BI

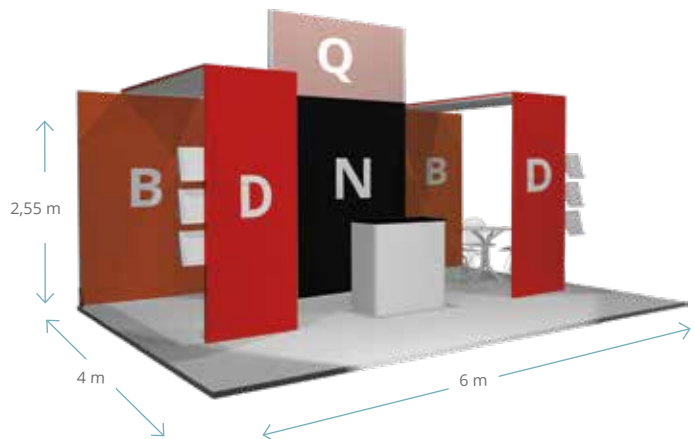

Square post to create 90° angles



Return with lock and key set



Literature holder

VECTOR

Vector free-standing module configurations and ancillaries

3m Wall



Material 50 mm aluminium profile frame
Graphic Fabric graphic with 3mm SEG

Module A (x1)	MODULE-VFF-A
Pair of half-moon feet	LN155



Ideal for creating large picture walls or partitions

6m Wall



Module A (x2)	MODULE-VFF-A
Flat feet (x4)	LN155



Enhance engagement!
 Attach LED spotlights to your free-standing frames to make graphics bright and eye-catching

Assemble several modules to create very large picture walls

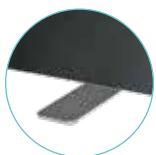

Stabilising feet
 For optimal stability of your structures, add feet at regular intervals.

Vector Modules ancillaries

Quick-fix Mounting Bracket

For hanging frames on shell schemes

Mounting bracket | LN134



Quarter Side Feet (pair)

SLF1P | 220(h) x 220(w) x 5(d) mm



Flat Foot for retail

Metal foot for free-standing frames
Available colour: ●

FX295 | 7(h) x 180(w) x 550(d) mm



Flat Foot

Metal foot for free-standing frames

LN155 | 7(h) x 75(w) x 450(d) mm



LCD Mounts

Mounts onto poles or crossbars

LN124A-01 | screens 32" x 55" (81 x 139 cm)



Custom Vector stands

The Vector range offers a versatile and adaptable solution for any event. The frame system is scalable and reconfigurable and are dressed with an optional custom printed stretched fabric graphic. The Vector range offers a versatile and adaptable solution for any event.

Vector Custom Stand 24m²

Material	Aluminium
Profile width	50mm
Profile Colour	Anodised
Assembly	Connectors assemble using Allen key
Graphic area	Single or double-sided
Graphic attachment	SEG 3mm

Add a touch of originality to your VECTOR stand by integrating FORMULATE



Vector Custom Stand 40m²

Material	Aluminium
Profile width	50mm
Profile Colour	Anodised
Assembly	Connectors assemble using Allen key
Graphic area	Single or double-sided
Graphic attachment	SEG 3mm



Vector Custom Stand 40m²

Material	Aluminium
Profile width	50mm
Profile Colour	Anodised
Assembly	Connectors assemble using Allen key
Graphic area	Single or double-sided
Graphic attachment	SEG 3mm



Vector Custom Stand 50m²

Material	Aluminium
Profile width	50mm
Profile Colour	Anodised
Assembly	Connectors assemble using Allen key
Graphic area	Single or double-sided
Graphic attachment	SEG 3mm



Vector Custom Stand 60m² - Design 1

Material	Aluminium
Profile width	50mm
Profile Colour	Anodised
Assembly	Connectors assemble using Allen key
Graphic area	Single or double-sided
Graphic attachment	SEG 3mm



Vector Custom Stand 60m² - Design 2

Material	Aluminium
Profile width	50mm
Profile Colour	Anodised
Assembly	Connectors assemble using Allen key
Graphic area	Single or double-sided
Graphic attachment	SEG 3mm

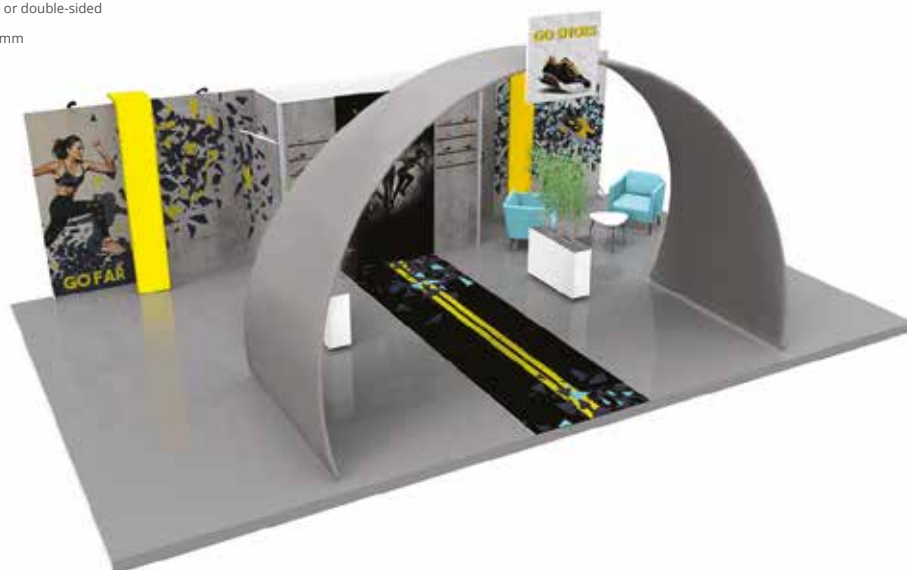

Vector Custom Stand 80m²

Material	Aluminium
Profile width	50mm
Profile Colour	Anodised
Assembly	Connectors assemble using Allen key
Graphic area	Single or double-sided
Graphic attachment	SEG 3mm

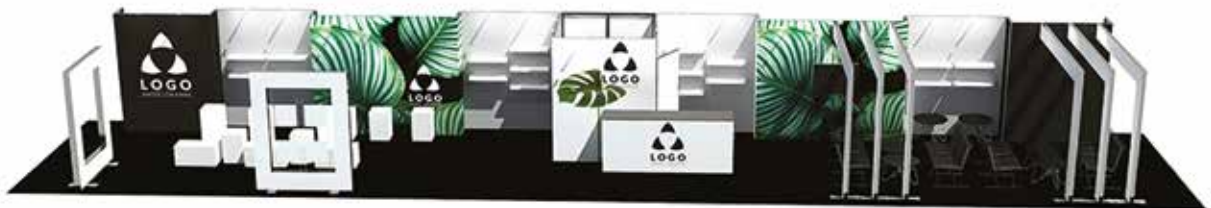
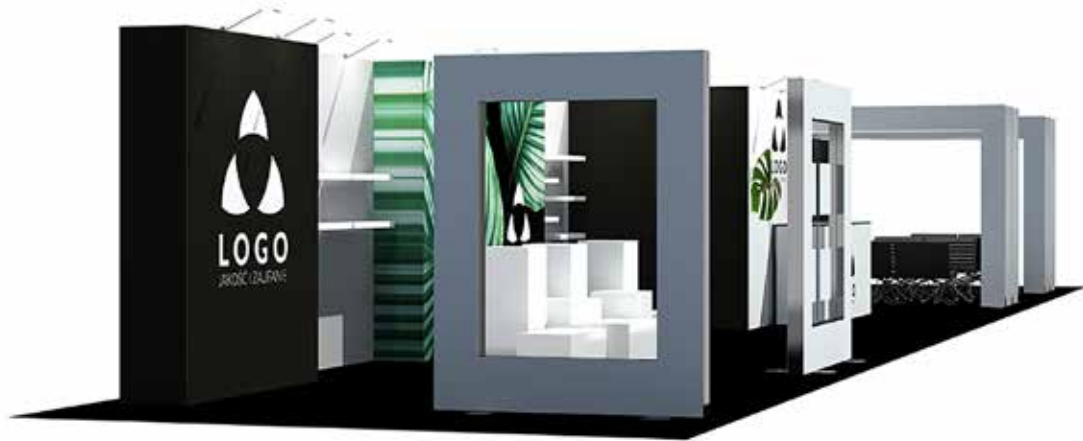

Vector Quick-fix Hanging Kit



The Vector Quick-fix Hanging Kit is a sleek 20mm low profile aluminium extrusion frame for optional SEG dye-sublimated fabric display graphics that simply push-fits into the frame's channel in a matter of seconds. Frames can be hung on a pre-built stand wall: a practical and economical way to decorate your stands.

Material	Anodised aluminium
Profile width	20mm
Profile Colour	Silver
Assembly	Assemble the post and crossbar by locking with an Allen key
Mounting	Connects to a shell scheme with bracket fixing
Graphic area	Single sided
Graphic attachment	SEG 3mm
Availability	Made to order

Hanging frame 2350 x 950 mm	VHQF-950-S	⊗ 950(w) x 2350(h) x 20(d) mm
Hanging frame 2350 x 1850 mm	VHQF-1850-S	⊗ 1850(w) x 2350(h) x 20(d) mm
Hanging frame 2350 x 2850 mm	VHQF-2850-S	⊗ 2850(w) x 2350(h) x 20(d) mm

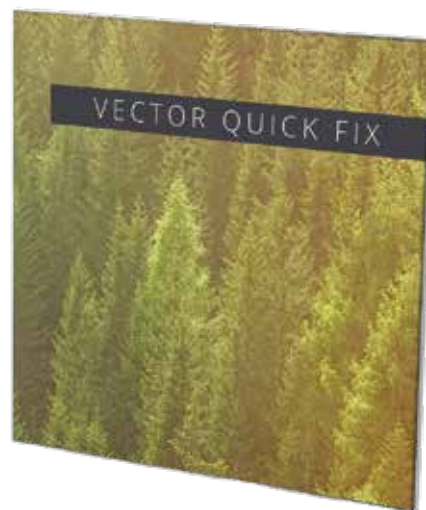

An economical and elegant way to dress up your stand

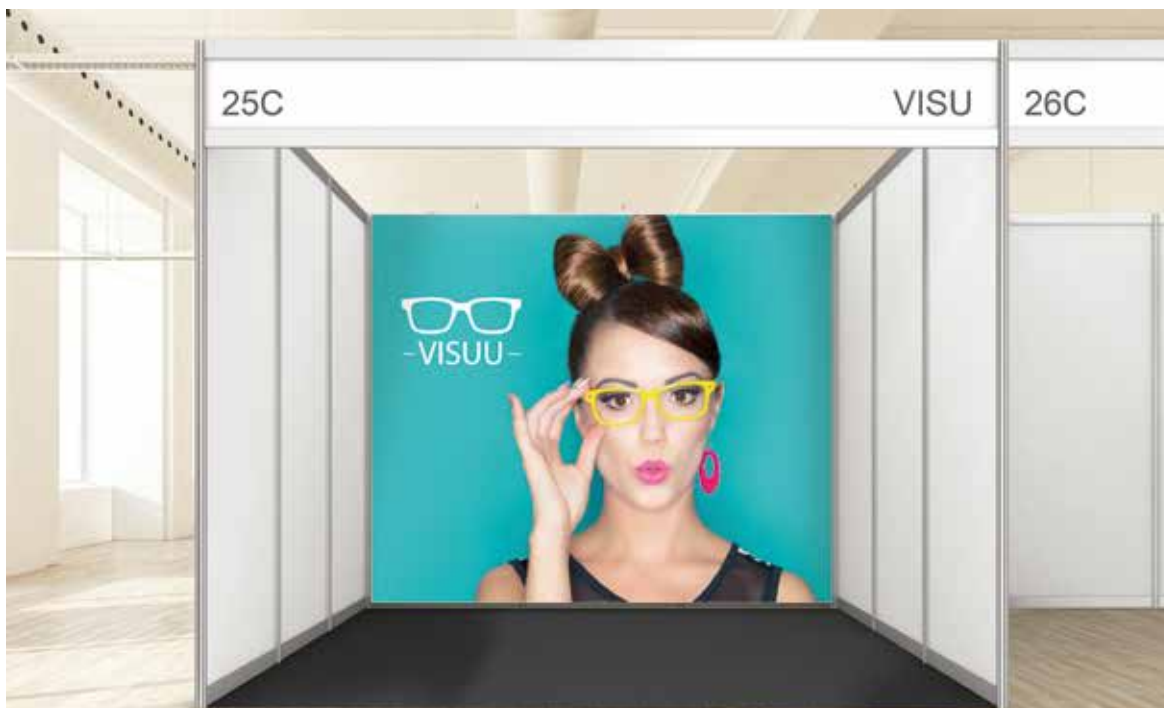

Vector Quick Fix



LN134 mounting bracket



Corners are assembled using brackets

A wide range of profiles



Linear

Versatility of profiles and print media

Linear assembly principles

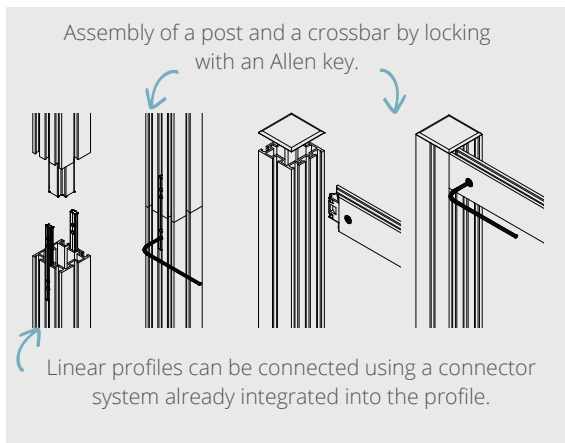

Graphic options for dressing structures

Whatever media you wish to use, you can choose to dress the structure entirely or partially.

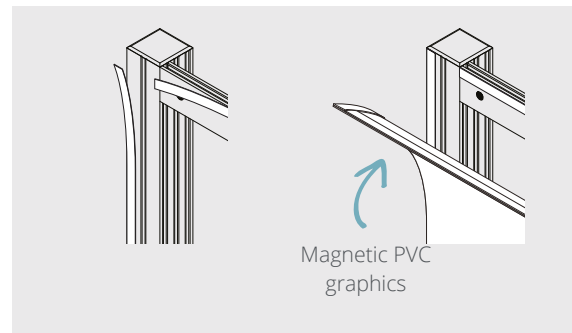

PVC (1mm) graphics require the use of an adhesive magnetic tape which will be positioned on the back of the graphic with a metal strip that adheres to the structure.

Channelled profiles and crosspieces in anodised aluminium:

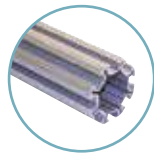

LN618 - Round post 50mm 8 connections

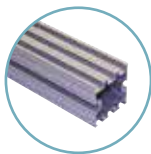

LN616 - Square post 50mm 8 connections

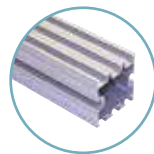

LN607 - Square post 75mm 8 connections

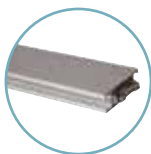

LN605 - Beam 45mm



LN619 - Oval Beam 50mm

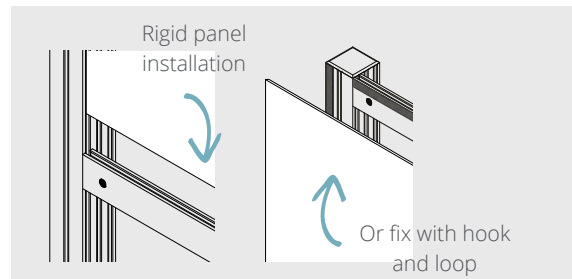

Rigid panel graphics (5mm) allow the panel to fit directly into the channel of the post. If you wish to cover the entire structure, male and female hook and loop fasteners are used on the back and on the structure.

Linear Modules

The Linear range is made up of different aluminium profiles and is intended to provide an alternative to fabric-covered structures. The construction of grooved poles and reinforcing crosspieces allows the structures to be fitted with flexible PVC or rigid panel graphics.

Linear Modules are made up of aluminium posts and cross beams cut into 1.25m sections and are available in five different shapes: connecting posts, straight walls, curved walls, and returns. Create stands of all sizes or shapes and accessorise them with spotlights, counters and literature holders.

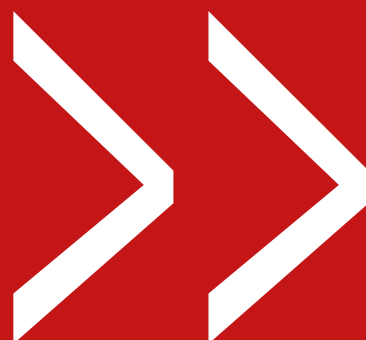

Linear Modules

The Linear range is available in 5 modules that can be combined to create different configurations.

Posts are cut into 1.25m sections, making them easy to transport and store. They are ready to be used with custom printed graphics.

Scalable solutions according to your needs and budget



Curved modules can be used in a concave or convex position

Module V

EU

2-part post of 1250 mm

Material	Aluminium
Profile width	50mm
Assembly	Connectors assemble using Allen key
Graphic option	Rollable PVC or rigid panel

Module V	MODULE-LN-V	Ⓞ 50(w) x 2500(h) x 50(d) mm
----------	-------------	------------------------------



Module W

EU

1 Post and 3 crossbeams

Material	Aluminium
Profile width	50mm
Assembly	Connectors assemble using Allen key
Graphic option	Rollable PVC or rigid panel

Module W 950mm	MODULE-LN-W	Ⓞ 950(w) x 2500(h) x 50(d) mm
----------------	-------------	-------------------------------



Module X

EU

1 Post and 3 crossbeams

Material	Aluminium
Profile width	50mm
Assembly	Connectors assemble using Allen key
Graphic option	Rollable PVC or rigid panel

Module X 1050mm	MODULE-LN-X	Ⓞ 1050(w) x 2500 (h) x 50(d) mm
-----------------	-------------	---------------------------------



Add beams for custom width sizes

Module Y

EU

Cupboard with lock and threshold bar included

Material	Aluminium
Profile width	50mm
Assembly	Connectors assemble using Allen key
Graphic option	Rollable PVC or rigid panel

Module Y	MODULE-LN-Y	Ⓞ 1000(w) x 2500(h) x 1000(d) mm
----------	-------------	----------------------------------



Module Z

EU

Crossbar set, (posts not included)

Material	Aluminium
Profile width	50mm
Assembly	Connectors assemble using Allen key
Graphic option	Rollable PVC or rigid panel

Module Z	MODULE-LN-Z	Ⓞ 950(w) x 2500(h) mm
----------	-------------	-----------------------



Linear standard stand designs

Linear Stand 9m²

EU

Material	Aluminium
Profile width	50mm
Assembly	Connectors assemble using Allen key
Graphic option	Rollable PVC or rigid panel

Module W (x6)	MODULE-LN-W
Module V	MODULE-LN-V
Square foot (pair)	SLF1P
Spots + fixations	PS950-1000-LED-BDLK (x3) + US-LINEAR (x6)

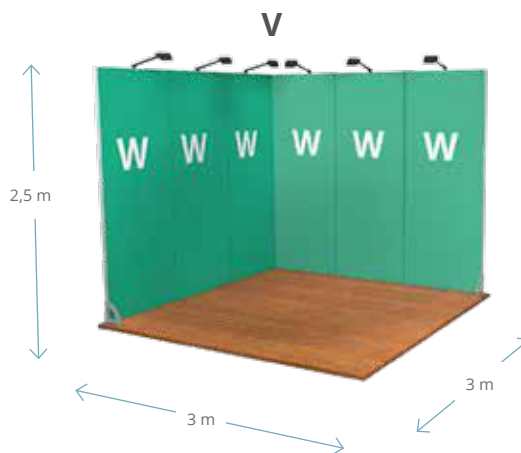

Use multiple graphics to create large format backwalls



Possibility to add LED spotlights
Code: LED-EXHIB-ARM-B



Quarter foot

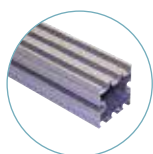

50mm square post
8 connections



Simple assembly

Linear Stand 15m²



Material	Aluminium
Profile width	50mm
Assembly	Connectors assemble using Allen key
Graphic option	Rollable PVC or rigid panel

Module W (x2)	MODULE-LN-W
Module V (x2)	MODULE-LN-V
Module Z (x2)	MODULE-LN-Z
Module Y	MODULE-LN-Y
Pair of angled feet	SLF1P
Spots + fixations	PS950-1000-LED-BDLK (x2) + US-LINEAR (x4)



Large format curved graphic



Possibility to add LED spotlights
Code: LED-EXHIB-ARM-B



Quarter foot



Curved crossbeams

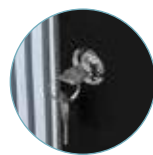

Secure closure

Linear Stand 18m²



Material Aluminium
 Profile width 50mm
 Assembly Connectors assemble using Allen key
 Graphic option Rollable PVC or rigid panel

Module V (x2)	MODULE-LN-V
Module W (x4)	MODULE-LN-W
Module X (x2)	MODULE-LN-X
Module Y	MODULE-LN-Y
Module Z	MODULE-LN-Z
Square foot (pair)	SLF1P
Spots + fixations	PS950-1000-LED-BDLK (x4) + US-LINEAR (x8)

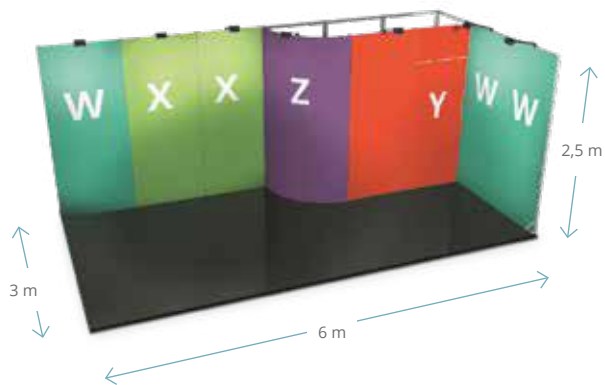

Possibility to add LED spotlights
 Code: LED-EXHIB-ARM-B

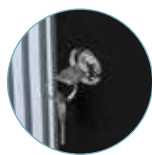

Secure closure



Simple assembly



Linear custom stand designs

Linear Custom Stand 16m²

Material	Aluminium
Profile width	50mm
Assembly	Connectors assemble using Allen key
Graphic option	Rollable PVC or rigid panel



Linear Custom Stand 24m²

Material	Aluminium
Profile width	50mm
Assembly	Connectors assemble using Allen key
Graphic option	Rollable PVC or rigid panel



Linear Custom Stand 36m²

Material	Aluminium
Profile width	50mm
Assembly	Connectors assemble using Allen key
Graphic option	Rollable PVC or rigid panel



Linear ancillaries

Dome Base (single)

LN102 (Foot) |  \varnothing 450 mm



Quarter Foot (single)

Weights: 1,2 kg

SLF1P |  220(w) x 220(h) x 5(d) mm



Flat Foot (single)

Metal for self-supporting frame

Weights: 1,75 kg

LN155 |  7(h) x 100(w) x 450(d) mm



LCD Screen Bracket

Mounting on post or crossbar

LN124A-01 |  Screen 32" - 55" (81 - 130 cm)

LN124-03 |  Screen 37" - 70" (94 - 177 cm)



Roll of magnetic tape

EM301 | Polarity A-30m x 12,7 mm



Steel tape

EM351 | 15m x 12,7 mm





Arena Structures

Arena Gantry structures for your stand

These 25mm diameter aluminium tubes have been assembled and welded into sections of various sizes to form the basis of an imposing and solid architecture.

A wide range of sections are available to make this solution compatible with your project requirements. With 14 components in various lengths and designs, you can create the right structure for you, and your chosen mode of transport.

Simple, tool-free assembly

Simple assembly - sections are connected using the supplied bolt and wing-nut fixings, and no tools are required. The double-sided graphics are attached to the gantry using a bungee cord. Create maximum brand visibility with up to 6m sections without the need for reinforcement.

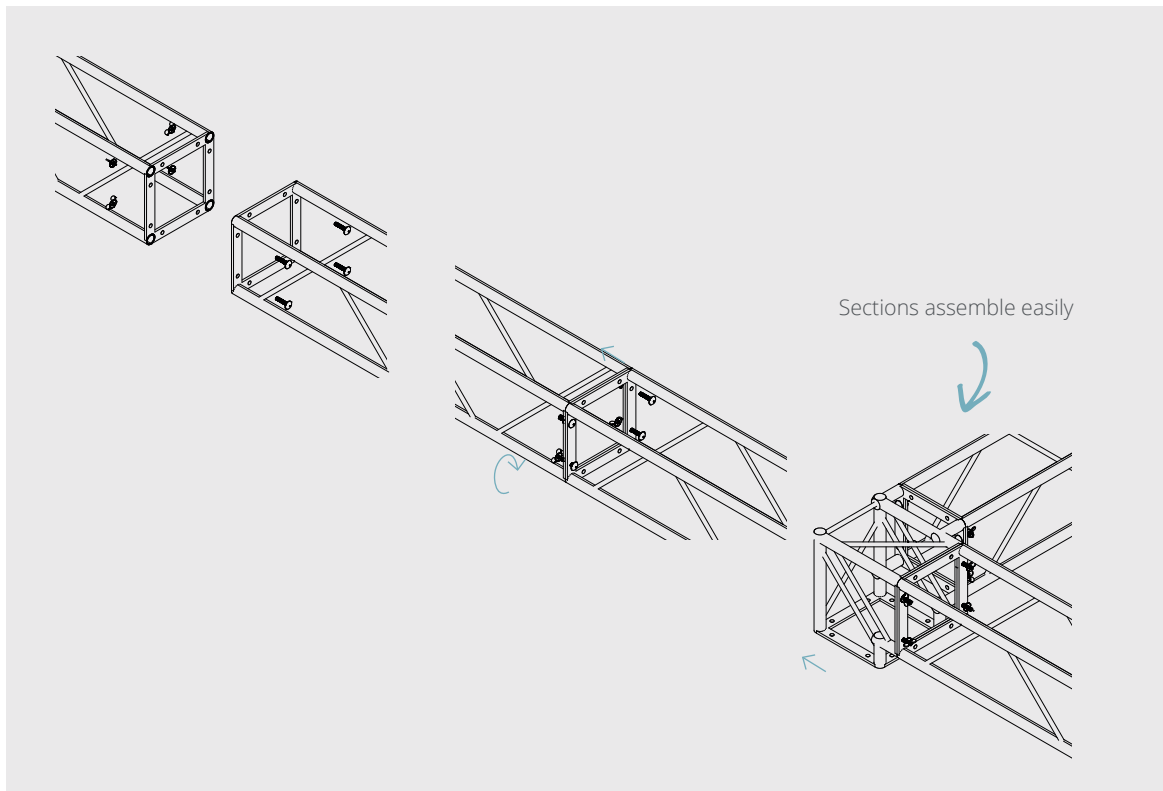

Arena components

Arena Straight Sections

The Arena Straight Sections are available in a variety of lengths, they are strong but lightweight with a natural silver grey finish. The system is quick and easy to assemble using bolt and wing-nut fixings. This aluminium tubular system is both modular and scalable, where different sections can be assembled and reused according to the needs of each project. The structure can then be dressed with interchangeable UV printed PVC graphics.

UT-S250	Section 250mm
UT-S500	Section 500mm
UT-S750	Section 750mm
UT-S1000	Section 1000mm
UT-S1250	Section 1250mm
UT-S1500	Section 1500mm
UT-S2000	Section 2000mm



Arena Junction Sections

The Arena Junction Sections are available in a variety of configurations from: 3-way T-junction, 4-way corner junction, 5-way corner junction, and 6-way junction. The choice of sections enables a custom build design for your application to create a modular and scalable system. The structure can then be dressed with interchangeable UV printed PVC graphics.



90° angle 2 connections
UT-C21



Corner connection
3 connections
UT-C30



T-junction 3 connections
UT-C35



T-junction 4 connections
UT-C40



4-way corner connector
UT-C41



Foot 250mm
UT-BS250



Foot triangle
UT-AF250

Arena Gantry stand designs

Arena Custom Stand 16m²

Material	Aluminium
Colour	Anodised
Graphic area	Single or double-sided
Graphic attachment	Bungee fixings
Graphic option	Vinyl



Arena Custom Stand 36m²

Material	Aluminium
Colour	Anodised
Graphic area	Single or double-sided
Graphic attachment	Bungee fixings
Graphic option	Vinyl



Arena Gantry free-standing design

Arena Custom Structure

Material	Aluminium
Colour	Anodised
Graphic area	Single or double-sided
Graphic attachment	Bungee fixings
Graphic option	Vinyl



Arena Hanging Structure



The Arena structure is a tubular aluminium stage structure used as a light bridge or suspended sign with 6m sides to draw attention to your brand.

Material	Aluminium
Colour	Anodised
Graphic area	Single or double-sided
Graphic attachment	Bungee fixings
Graphic option	Vinyl



Hanging Structures

Vector 125mm LED Hanging Structure

The robust 125mm Vector LED profile can support larger scale applications whilst still remaining sleek and eye-catching. The plug and play LED lighting system is linkable so it is great for standard and custom size displays. Perfectly suits vibrant SEG lightbox graphics which are available to order if required.

Material	Aluminium
Profile width	125 mm
Profile Colour	Anodised
Assembly	Connectors assemble using Allen key
Double-sided	Double-sided
Mounting	Sling (cables not included)
Graphic attachment	SEG 3mm
LED System	Pre-installed LED lighting

Vector 125 led 2,5m	VLBH125-PAN-250	⊖ 2500(w) x 1000(h) x 125(d) mm
Vector 125 led 3,5m	VLBH125-PAN-350	⊖ 3500(w) x 1000(h) x 125(d) mm
Vector 125 led 5m	VLBH125-PAN-500	⊖ 5000(w) x 1250(h) x 125(d) mm



Cable system



LED strip lighting



Mitred sections assemble with screw-in connectors

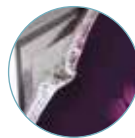

Graphic attaches with silicone edging (SEG)



Non-illuminated hanging structures

Formulate Square Hanging Structure



Formulate suspended signs have been specially designed to allow for easy and safe installation. The lightweight aluminium tubular structure makes them ideal for use on exhibition stands, in shopping arcades or in high traffic areas.

Material	Aluminium tubes
Tube	Ø 30 mm
Assembly	Push-fit button
Shape	Square
Graphic area	Double-sided
Graphic attachment	Zipped tension fabric graphic
Application	Suspended Pitons included, Slings not included
Availability	Basic range - in stock



Square Formulate 800	FORM-SQU-80	@ 1500(w) x 800(h) x 1500(d) mm
Square Formulate 1000	FORM-SQU-100	@ 3000(w) x 1000(h) x 3000(d) mm
Square Formulate 1500	FORM-SQU-150	@ 4500(w) x 1500(h) x 4500(d) mm

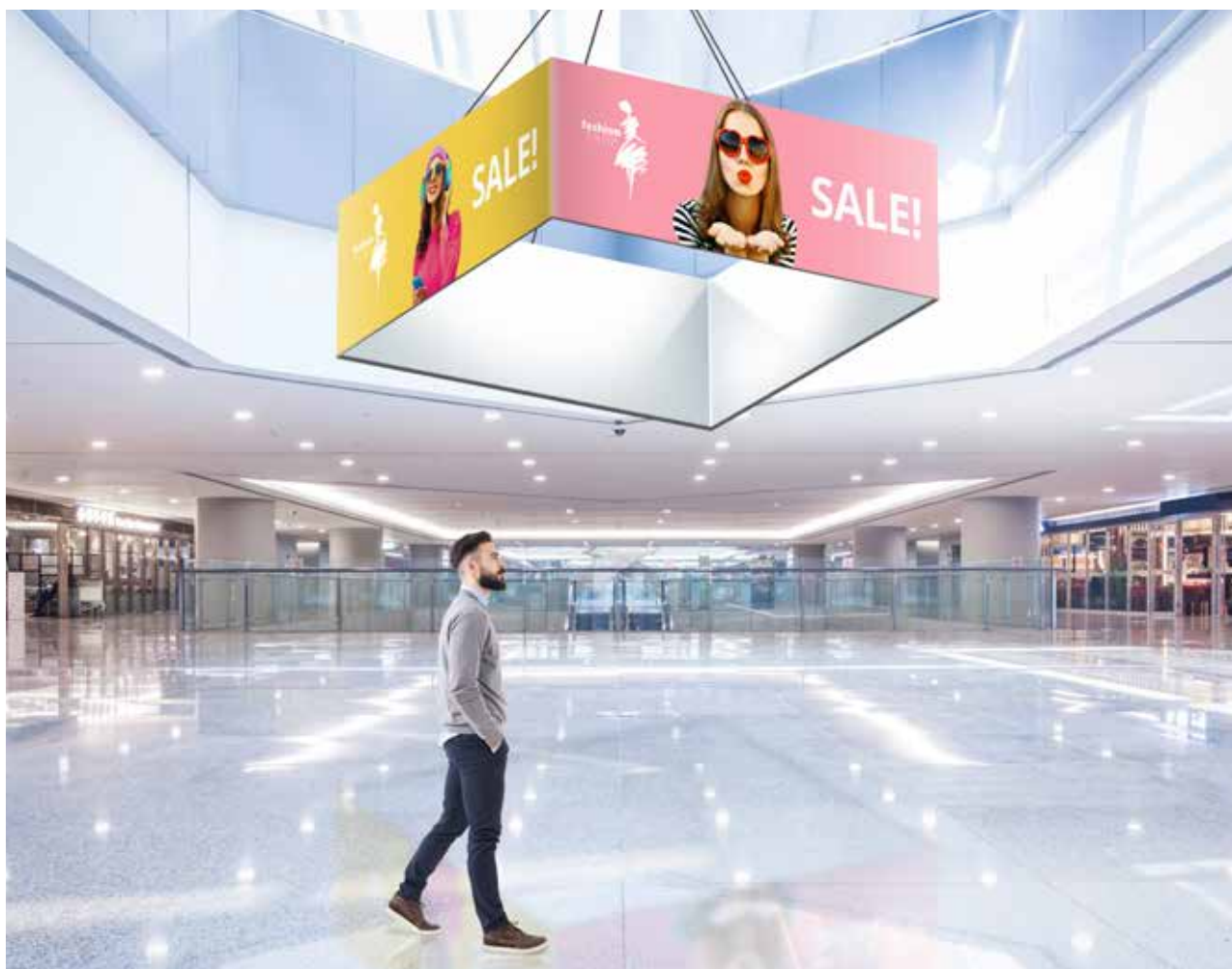

Arch

Formulate Arch



When display formats become common place and no longer stand out then choose something with an innovative shape! The Formulate range offers a variety of great shapes with clean lines, ideal for creating picture backwalls or defining areas in rooms by screening or zoning. The double-sided tension fabric graphics perfectly contour the shaped aluminium structures and maximise brand messaging.

Material	Aluminium
Tube	30mm Ø
Assembly	Tool-free push-button connectors
Shape	Arch
Graphic area	Double-sided
Graphic attachment	Zippered tension-fit graphic
Application	Free-standing

Formulate Arch	FORM-ARCH-01	Ⓞ 4000(w) x 3000(h) x 900(d) mm
----------------	--------------	---------------------------------

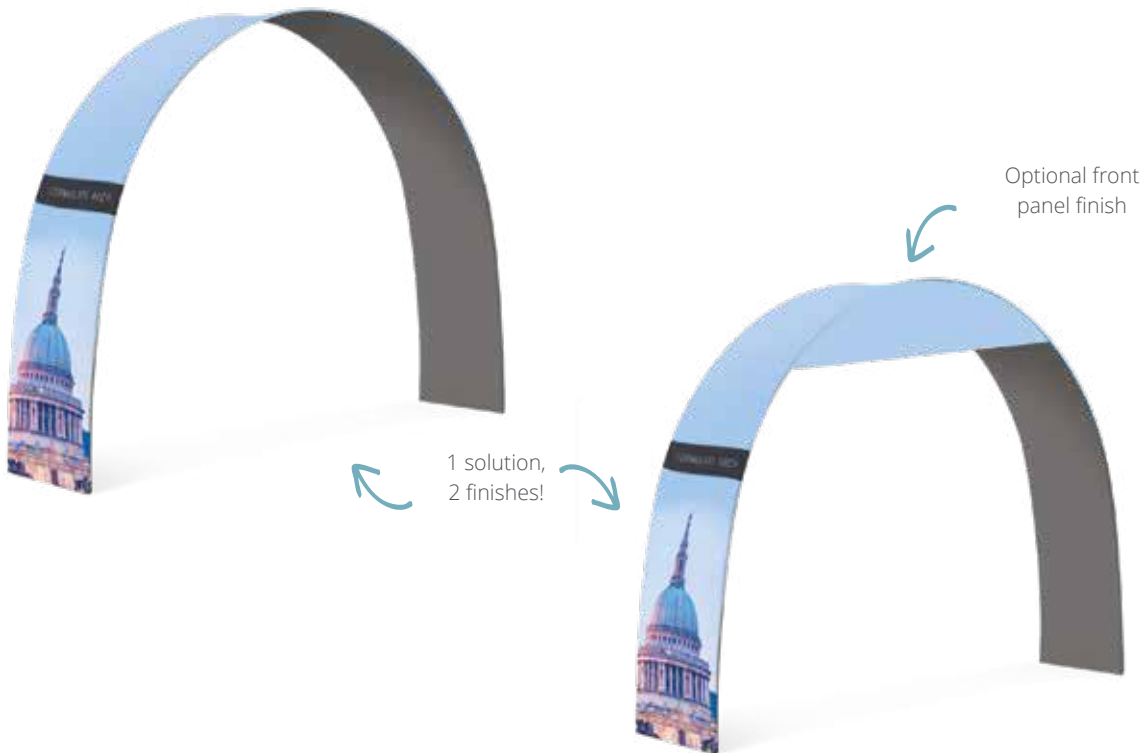

**TEST DRIVE NOW**



Display Backwalls

Display Backwalls create a dramatic backdrop to events, presentations, product demonstrations, pop-up shops or window displays. They are also ideal for smaller spaces, or as large static advertising boards in public spaces such as museums, reception areas, public transportation hubs and other large spaces.

Segmented Frame Walls are fully configurable, professional grade backwalls, where flexibility, ease of storage, reusing, portability and assembly are important. The pop-up display backwalls are constructed from lightweight aluminium scissor mechanisms, that are easy to transport, assemble and store, and are ideal for small exhibitions or events, as well as static displays. For a simple backdrop, the Pegasus tension walls offer a cost effective, easy solution to meet those needs. Configurable in both height and width, the tension wall is quick to assemble and makes an ideal backdrop to temporary or short-term presentations.

Display Backwalls

Our backwalls are available in several system configurations, depending on the application, with each offering a different method of construction, illumination and use.

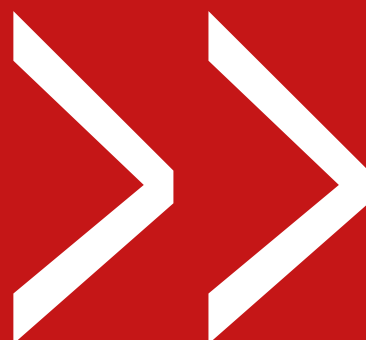

Illuminated pop-up backwalls

Embrace+



Bring drama and impact with large illuminated backwalls, U-shapes or seamless 90° corner walls using Embrace+; the premium portable LED tool-free system. Comes in a selection of sizes and is linkable so Embrace+ can fit and brighten-up any size event.

Material	Aluminium structure, plastic connectors
Assembly	Locking by clips, interlocking frame sections
Shape	Straight
Graphic area	Single-sided (with or without returns) or double-sided
Graphic attachment	Silicone Edged Gasket 3 mm (SEG)
Application	Free-standing
LED System	LED bar (optional)



Carrying bag included 

Embrace+ 3X1	EMB-PL-3X1-S	Ⓞ 774(w) x 2255(h) x 366(d) mm
Embrace+ 3X2	EMB-PL-3X2-S	Ⓞ 1508(w) x 2255(h) x 366(d) mm
Embrace+ 3X3	EMB-PL-3X3-S	Ⓞ 2242(w) x 2255(h) x 366(d) mm
Embrace+ 3X4	EMB-PL-3X4-S	Ⓞ 2974(w) x 2255(h) x 366(d) mm



Available with LED backlit 



Ancillaries :

Straight Clamp	EMB-PL-CL-STR	Ⓞ N/A
External Clamp	EMB-PL-CL-EXTOR	Ⓞ N/A
Internal Clamp	EMB-PL-CL-INTCOR	Ⓞ N/A



Feet are adjustable for stability on uneven flooring



Bungeed frame sections

Non-illuminated pop-up backwalls

Impact Pop-up Straight



A great entry level display backwall that is perfect for use at an exhibition, event or for a demonstration backdrop. Frames are available in a variety of widths, and are quick and easy to deploy using the self-locating locking arms. Magnetic tape attaches to the back of the graphic panels enabling them to be attached directly to the mag bars which are mounted to the frames.

Material	Aluminium structure, plastic connectors
Assembly	Magnetic connectors
Shape	Straight
Graphic area	Single-sided (with or without D-ends) / double-sided (optional)
Graphic attachment	Mag bars, hangers and kickers
Application	Free-standing

3x1 Straight	IMP-3X1S	Ⓞ 1240(w) x 2225(h) x 306(d) mm
3x2 Straight	IMP-3X2S	Ⓞ 1970(w) x 2225(h) x 306(d) mm
3x3 Straight	IMP-3X3S	Ⓞ 2700(w) x 2225(h) x 306(d) mm
3x4 Straight	IMP-3X4S	Ⓞ 3435(w) x 2225(h) x 306(d) mm
3x5 Straight	IMP-3X5S	Ⓞ 4160(w) x 2225(h) x 306(d) mm



Magnetic bars



Magnetic Locking arms



Hook-over graphic attachment

Impact Pop-up Straight Bundle



Impact Pop-up bundles are a great entry level display backwall kit that contains everything you will need to get you up and running at a show, event or demonstration - they even come with a counter and lighting!

Material	Aluminium structure, plastic connectors
Assembly	Magnetic connectors
Shape	Straight
Graphic area	Single-sided (with or without D-ends) / double-sided (optional)
Graphic attachment	Mag bars, hangers and kickers
Application	Free-standing

3x1 Straight	99-XX-105	Ⓞ 1240(w) x 2225(h) x 306(d) mm
3x2 Straight	99-XX-106	Ⓞ 1970(w) x 2225(h) x 306(d) mm
3x3 Straight	99-XX-107	Ⓞ 2700(w) x 2225(h) x 306(d) mm
3x4 Straight	99-XX-108	Ⓞ 3435(w) x 2225(h) x 306(d) mm
3x5 Straight	99-XX-109	Ⓞ 4160(w) x 2225(h) x 306(d) mm



Impact Pop-up Bundle

Impact Pop-up Kit



Carry bag



Straight or curved frame system



Hangers, kickers and mag bars



1x Roll of self-adhesive magnetic tape



Zenith transport case



Thermoformed table top in beech



2x PS950-1000 LED lights

Impact Pop-up Curved



A great entry level display backwall that is perfect for use at an exhibition, event or for a demonstration backdrop. Frames are available in a variety of widths, and are quick and easy to deploy using the self-locating locking arms. Magnetic tape attaches to the back of the graphic panels enabling them to be attached directly to the mag bars which are mounted to the frames.

Material	Aluminium structure, plastic connectors
Assembly	Magnetic connectors
Shape	Curved
Graphic area	Single-sided (with or without D-ends) / double-sided (optional)
Graphic attachment	Mag bars, hangers and kickers
Application	Free-standing

3x1 Curved	IMP-3X1C	Ⓞ 1240(w) x 2225(h) x 306(d) mm
3x2 Curved	IMP-3X2C	Ⓞ 1930(w) x 2225(h) x 485(d) mm
3x3 Curved	IMP-3X3C	Ⓞ 2540(w) x 2225(h) x 685(d) mm
3x4 Curved	IMP-3X4C	Ⓞ 3070(w) x 2225(h) x 960(d) mm
3x5 Curved	IMP-3X5C	Ⓞ 3430(w) x 2225(h) x 1225(d) mm



Magnetic bars



Magnetic Locking arms



Hook-over graphic attachment

Impact Pop-up Curved Bundle









Impact Pop-up bundles are a great entry level display backwall kit that contains everything you will need to get you up and running at a show, event or demonstration - they even come with a counter and lighting!

Material	Aluminium structure, plastic connectors
Assembly	Magnetic connectors
Shape	Curved
Graphic area	Single-sided (with or without D-ends) / double-sided (optional)
Graphic attachment	Mag bars, hangers and kickers
Application	Free-standing

3x2 Curved	99-XX-110	Ⓞ 1930(w) x 2225(h) x 485(d) mm
3x3 Curved	99-XX-071	Ⓞ 2540(w) x 2225(h) x 685(d) mm
3x4 Curved	99-XX-070	Ⓞ 3070(w) x 2225(h) x 960(d) mm
3x5 Curved	99-XX-111	Ⓞ 3430(w) x 2225(h) x 1225(d) mm



Impact Pop-up Bundle

Impact Pop-up Kit						
						
Carry bag	Straight or curved frame system	Hangers, kickers and mag bars	1x Roll of self-adhesive magnetic tape	Zenith transport case	Thermoformed table top in beech	2x PS950-1000 LED lights

Quick+ Straight Kit



The premium Quick+ Straight display backwall is a full magnetic system that can be used single or double-sided. Use with optional interchangeable, vibrant UV printed PVC graphics. Deploys tool-free in seconds straight out of the supplied padded protective bag giving you a brilliant backwall display for your event or shell scheme. Quick+ displays are also available in a curved display and come in five different sizes.

Material	Aluminium structure, plastic connectors
Assembly	Magnetic connectors
Shape	Straight
Graphic area	Single-sided (with or without D-ends) / double-sided (optional)
Graphic attachment	Mag bars, hangers and kickers
Application	Free-standing



3x1 Straight	WH221-S-CA	⊗ 1240(w) x 2225(h) x 306(d) mm
3x2 Straight	WH222-S-CA	⊗ 1970(w) x 2225(h) x 306(d) mm
3x3 Straight	WH223-S-CA	⊗ 2700(w) x 2225(h) x 306(d) mm
3x4 Straight	WH224-S-CA	⊗ 3435(w) x 2225(h) x 306(d) mm
3x5 Straight	WH225-S-CA	⊗ 4160(w) x 2225(h) x 306(d) mm



Square end magnetic bars



Magnetic Locking arms



Magnetic hanger

Quick+ Straight Bundle



The Premium Quick+ Straight Display Bundle includes the full magnetic display backwall kit which can be used single or double-sided, the unique Zenith transit case which converts to a counter and two PS950-1000 LED lights. Use with optional interchangeable, vibrant UV printed PVC graphics. Deploys tool-free in seconds, giving you a brilliant backwall display for your event or shell scheme. Quick+ displays are also available in a curved display bundle and come in five different sizes.

Material	Aluminium structure, plastic connectors
Assembly	Magnetic connectors
Shape	Straight
Graphic area	Single-sided (with or without D-ends) / double-sided (optional)
Graphic attachment	Mag bars, hangers and kickers
Application	Free-standing

3x1 Straight	99-XX-100Q	⊗ 1240(w) x 2225(h) x 306(d) mm
3x2 Straight	99-XX-101Q	⊗ 1970(w) x 2225(h) x 306(d) mm
3x3 Straight	99-XX-102Q	⊗ 2700(w) x 2225(h) x 306(d) mm
3x4 Straight	99-XX-103Q	⊗ 3435(w) x 2225(h) x 306(d) mm
3x5 Straight	99-XX-104Q	⊗ 4160(w) x 2225(h) x 306(d) mm



Quick+ Bundle

Quick+ Kit



Padded nylon carry bag



Quick+ Structure Straight / Curved



Hangers, kickers and mag bars



1x Roll of self-adhesive magnetic tape



Zenith transport case



Thermoformed table top in beech



2x PS950-1000 LED lights

Quick+ Curved Kit



The premium Quick+ Curved display backwall is a full magnetic system that can be used single or double-sided. Use with optional interchangeable, vibrant UV printed PVC graphics. Deploys tool-free in seconds straight out of the supplied protective padded bag giving you a brilliant backwall display for your event or shell scheme. Quick+ displays are also available in a Straight Display and come in five different sizes.

Material	Aluminium structure, plastic connectors
Assembly	Magnetic connectors
Shape	Curved
Graphic area	Single-sided (with or without D-ends) / double-sided (optional)
Graphic attachment	Mag bars, hangers and kickers
Application	Free-standing

3x1 Curved	WH221-C-CA	⊙ 1240(w) x 2225(h) x 306(d) mm
3x2 Curved	WH222-C-CA	⊙ 1930(w) x 2225(h) x 485(d) mm
3x3 Curved	WH223-C-CA	⊙ 2540(w) x 2225(h) x 685(d) mm
3x4 Curved	WH224-C-CA	⊙ 3070(w) x 2225(h) x 960(d) mm
3x5 Curved	WH225-C-CA	⊙ 3430(w) x 2225(h) x 1225(d) mm



Square end magnetic bars



Magnetic Locking arms



Magnetic hanger



Quick+ Curved Bundle



The Premium Quick+ Curved Display Bundle includes the full magnetic display backwall kit which can be used single or double-sided, the unique Zenith transit case which converts to a counter and two PS950-1000 LED lights. Use with optional interchangeable, vibrant UV printed PVC graphics. Deploys tool-free in seconds, giving you a brilliant backwall display for your event or shell scheme. Quick+ displays are also available in a straight display bundle and come in five different sizes.

Material	Aluminium structure, plastic connectors
Assembly	Magnetic connectors
Shape	Curved
Graphic area	Single-sided (with or without D-ends) / double-sided (optional)
Graphic attachment	Mag bars, hangers and kickers
Application	Free-standing

3x1 Curved	99-XX-015Q	⊙ 1240(w) x 2225(h) x 306(d) mm
3x2 Curved	99-XX-016Q	⊙ 1930(w) x 2225(h) x 485(d) mm
3x3 Curved	99-XX-017Q	⊙ 2540(w) x 2225(h) x 685(d) mm
3x4 Curved	99-XX-020Q	⊙ 3070(w) x 2225(h) x 960(d) mm
3x5 Curved	99-XX-021Q	⊙ 3430(w) x 2225(h) x 1225(d) mm



Quick+ Bundle

Quick+ Kit



Padded nylon carry bag



Quick+ Structure Straight / Curved



Hangers, kickers and mag bars



1x Roll of self-adhesive magnetic tape



Zenith transport case



Thermoformed table top in beech



2x PS950-1000 LED lights

Hop-up Impact Straight



Impact Hop-ups are simple lightweight interlocking frame structures that deploy in minutes. Complete with tension-fit graphics that can stay on even when packed away.

Material	Aluminium structure, plastic connectors
Assembly	Lock together with clips
Shape	Straight
Graphic area	Single-sided (with or without returns) or double-sided (optional)
Graphic attachment	Hook and loop
Application	Free-standing

3x1 quads	HUI3X1	Ⓞ 790(w) x 2260(h) x 295(d) mm
3x2 quads	HUI3X2	Ⓞ 1525(w) x 2260(h) x 295(d) mm
3x3 quads	HUI3X3	Ⓞ 2260(w) x 2260(h) x 295(d) mm
3x4 quads	HUI3X4	Ⓞ 2995(w) x 2260(h) x 295(d) mm
3x5 quads	HUI3X5	Ⓞ 3730(w) x 2260(h) x 295(d) mm



Graphics attach with hook and loop fastener



Plastic connectors



Easy to transport



Carry bag



Graphic stays on structure once packed down



Ancillaries :

Stabilising feet (pair)	ES508	Ⓞ N/A
Wheeled bag	HUB-001	Ⓞ N/A

Hop-up Impact Curved



Impact Hop-ups are simple lightweight interlocking frame structures that deploy in minutes. Complete with tension-fit graphics that can stay on even when packed away.

Material	Aluminium structure, plastic connectors
Assembly	Lock together with clips
Shape	Curved
Graphic area	Single-sided (with or without returns)
Graphic attachment	Hook and loop
Application	Free-standing

3x3 quads	HOP-2-3X3-C	Ⓞ 2310(w) x 2270(h) x 570(d) mm
3x4 quads	HOP-2-3x4-C	Ⓞ 2950(w) x 2260(h) x 810(d) mm

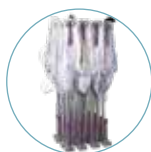

Easy to transport



Plastic connectors

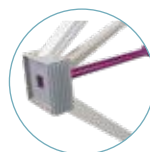

Graphics attach with hook and loop fastener

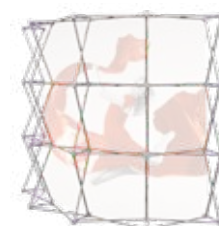

Non-illuminated fabric tube walls

Formulate Straight



Formulate Straight backwalls are constructed of lightweight 30mm diameter push-fit aluminium tubing for tool-free simple deployment. Complete with optional double-sided dye-sublimated tension-fit fabric graphics that zip at the base to perfectly contour the shaped aluminium structure and maximize your brand message. Formulate displays offer a variety of great shapes with clean lines, ideal for creating picture backwalls or defining areas in rooms by screening or zoning.

Material	Aluminium tubing
Tube	Ø 30 mm
Assembly	Push-fit / Allen key
Shape	Straight
Graphic area	Double-sided
Graphic attachment	Zipped tension fabric graphic
Application	Free-standing with feet (included)

2400 mm	FORM-STR-24	Ⓞ 2350(w) x 2380(h) x 400(d) mm
3000 mm	FORM-STR-30	Ⓞ 2950(w) x 2380(h) x 400(d) mm
4000 mm	FORM-STR-40	Ⓞ 3950(w) x 2380(h) x 400(d) mm
5000 mm	FORM-STR-50	Ⓞ 4950(w) x 2380(h) x 400(d) mm
6000 mm	FORM-STR-60	Ⓞ 5920(w) x 2380(h) x 400(d) mm

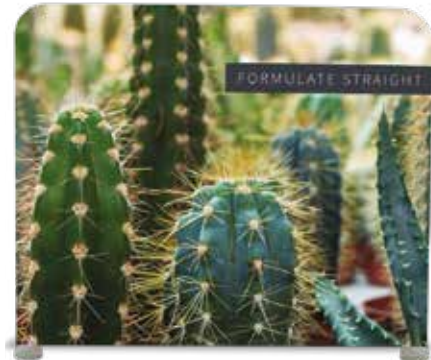

Feet included



Bungee tubes



Numbered system for easy assembly



Gloves included

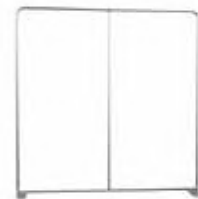

Formulate Horizontal Curve



Formulate Horizontal Curve displays are an eye-catching shape, constructed of lightweight 30mm diameter push-fit aluminium tubing, combine with a zipped tension-fit graphics for tool-free impressive backwalls. Formulate displays offer a variety of great shapes with clean lines, ideal for creating picture backwalls or defining areas in rooms by screening or zoning. The optional double-sided tension fabric graphics perfectly contour the shaped aluminium structures and maximise your brand message.

Material	Aluminium tubes
Tube	Ø 30 mm
Assembly	Push-fit button
Shape	Horizontal curve
Graphic area	Double-sided
Graphic attachment	Zipped tension fabric graphic
Application	Free-standing

2400 mm	FORM-CUR-24	Ⓞ 2350(w) x 2380(h) x 500(d) mm
3000 mm	FORM-CUR-30	Ⓞ 2950(w) x 2380(h) x 500(d) mm
6000 mm	FORM-CUR-60	Ⓞ 5950(w) x 2380(h) x 900(d) mm



Zipped tension fabric graphic



Bungee tubes



Numbered system for easy assembly



Possibility to add LED Spotlights and Ancillaries

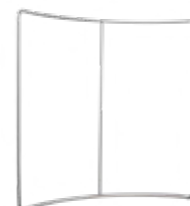

Formulate Meeting Pod



Formulate Meeting Pods are an eye-catching and functional way to create a simple break-out area from lightweight 30mm diameter push-fit aluminium tubing and optional zipped tension-fit graphics for tool-free impressive structure. Formulate displays offer a variety of great shapes with clean lines, ideal for creating shapes or defining areas in rooms by screening or zoning. The double-sided tension fabric graphics perfectly contour the shaped aluminium structures and maximise your brand message.

Material	Aluminium tubes
Tube	Ø 30 mm
Assembly	Push-fit button
Shape	Curved
Graphic area	Double-sided
Graphic attachment	Zipped tension fabric graphic
Application	Free-standing

Formulate Meeting Pod	FORM-MPOD-01	Ⓞ 2900(w) x 2100(h) x 2550(d) mm
-----------------------	--------------	----------------------------------



Zipped tension fabric graphic



Bungee tubes



Numbered system for easy assembly

Non-illuminated segmented frame walls

Vector 50mm Kit



Robust aluminium free-standing frame, packs down for ease of transportation and available in a wide range of sizes accommodating a SEG graphic creating the perfect look for any retail scenario.

Material	Aluminium
Profile width	50 mm
Profile colour	Anodised
Assembly	Push-button connector, Allen key
Graphic attachment	Silicone Edged Gasket 3 mm (SEG)
Graphic area	Single or double-sided
Application	Free-standing with flat feet (included)

Kit 2x1	VKF-2x1	📏 1000(w) x 2005(h) x 350(d) mm
Kit 2x2	VKF-2x2	📏 2000(w) x 2005(h) x 350(d) mm
Kit 2x3	VKF-2x3	📏 3000(w) x 2005(h) x 350(d) mm

Connect several kits together for larger displays

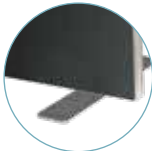

Flat foot included



Fabric graphic attaches with silicone edging (SEG)



Screw several frames together



Push-button assembly of corner sections

Baseline Panel and Pole Kits



Panel kits are easy to assemble, reconfigure and re-position. Baseline Panel and Pole kits can be positioned in multiple ways and come in two heights (600mm or 700mm) and two widths (900mm or 1000mm). Stabilising feet are included and kits are manufactured to order.

Material	PVC / Aluminium
Profile Colour	Grey
Finishes	Baseline board with grey PVC or aluminium frame / Baseline Plus board with grey PVC frame
Graphic area	Single or double-sided
Graphic attachment	Hook fixing
Graphic option	Felt coating * or optional Rigid replacement printed panels (3mm)
Application	Free-standing with stabilising feet (included)

4 Panel Kit - Aluminium	KK104A	⊙ 900(w) X 600(h) mm
4 Panel Kit - Baseline	KK104G	⊙ 900(w) X 600(h) mm
4 Panel Kit - Baseline Plus	KKP104-96G	⊙ 900(w) X 600(h) mm
6 Panel Kit - Aluminium	KK106A	⊙ 900(w) X 600(h) mm
6 Panel Kit - Baseline	KK106G	⊙ 900(w) X 600(h) mm
6 Panel Kit - Baseline Plus	KKP106-96	⊙ 900(w) X 600(h) mm
8 Panel Kit - Aluminium	KK108A	⊙ 900(w) X 600(h) mm
8 Panel Kit - Baseline	KK108G	⊙ 900(w) X 600(h) mm
8 Panel Kit - Baseline Plus	KKP108-96G	⊙ 900(w) X 600(h) mm
10 Panel Kit - Baseline	KK10G	⊙ 900(w) X 600(h) mm
10 Panel Kit - Baseline Plus	KKP110-96G	⊙ 900(w) X 600(h) mm

6 Panel - Baseline Plus	KKP106-107G	⊙ 700(h) x 1000(w) mm
8 Panel - Baseline Plus	KKP108-107G	⊙ 700(h) x 1000(w) mm
10 Panel - Baseline Plus	KKP110-107G	⊙ 700(h) x 1000(w) mm

Ancillaries :

Circular feet grey	LB913S-C	
Header panel	BH153G	⊙ 250mm x 600mm
Header panel	BH155G	⊙ 250mm x 900mm

Each panel can be assembled horizontally or vertically

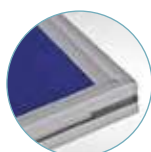
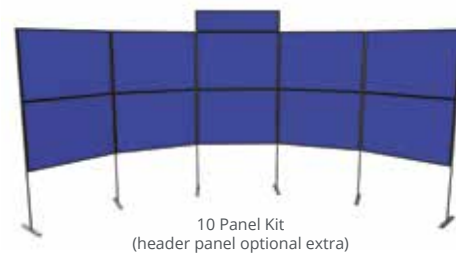
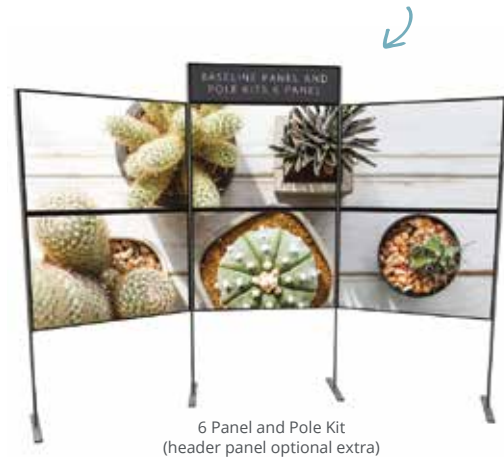

Baseline PVC
(thickness 18.2 mm)

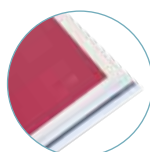

Baseline Plus PVC
(thickness 25 mm)

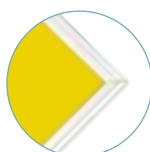

Aluminium baseline
(thickness 18.2 mm)

Baseline Jumbo Panel Kits



Baseline Jumbo Panel Kits are easy to assemble and are reconfigurable and re-positionable. Panels are hinged and free-standing. Position panels in multiple ways. Use to create a screen or office partition. Manufactured to order.

Material	PVC / Aluminium
Profile Colour	Grey
Finishes	Baseline board with grey PVC or aluminium frame / Baseline Plus board with grey PVC frame
Graphic area	Single or double-sided
Graphic attachment	Felt covered corrugated board
Graphic option	Felt coating * or optional Rigid replacement printed panels (3mm)
Application	Free-standing

3 Panel Kit - Baseline Aluminium	KK350A	⊗ 900(w) X 1800(h) mm
3 Panel Kit - Baseline Plus	KKP350G	⊗ 900(w) X 1800(h) mm
4 Panel Kit - Baseline Aluminium	KK351A	⊗ 900(w) X 1800(h) mm
4 Panel Kit - Baseline Plus	KKP351G	⊗ 900(w) X 1800(h) mm
3 Panel Kit - Baseline	KK350G	⊗ 900(w) X 1800(h) mm
4 Panel Kit - Baseline	KK351G	⊗ 900(w) X 1800(h) mm

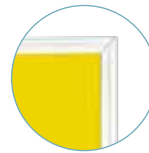

Aluminium baseline (thickness 18.2 mm)



Baseline Panel Kits



Baseline Panel Kits are easy to assemble and are reconfigurable and re-positionable. Panels are hinged and available in two heights (900mm and 1000mm) and two widths (600mm and 700mm). Position panels in multiple ways. Manufactured to order.

Material	PVC / Aluminium
Profile Colour	Grey
Finishes	Finish change to Baseline board with grey PVC or aluminium frame / Baseline Plus board with grey PVC frame
Graphic area	Single or double-sided
Graphic attachment	Hook fixing
Graphic option	Felt coating * or optional Rigid replacement printed panels (3mm)
Application	Free-standing

6 Panel Kit - Aluminium	KK117A	⊗ 600(w) x 900(h) mm
6 Panel Kit - Baseline	KK117G	⊗ 600(w) x 900(h) mm
6 Panel Kit - Baseline Plus	KKP117G	⊗ 600(w) x 900(h) mm
7 Panel Kit - Aluminium	KK114A	⊗ 600(w) x 900(h) mm
7 Panel Kit - Baseline	KK114G	⊗ 600(w) x 900(h) mm
7 Panel Kit - Baseline Plus	KKP114G	⊗ 600(w) x 900(h) mm
8 Panel Kit - Aluminium	KK120A	⊗ 600(w) x 900(h) mm
8 Panel Kit - Baseline	KK120G	⊗ 600(w) x 900(h) mm
8 Panel Kit - Baseline Plus	KKP120G	⊗ 600(w) x 900(h) mm
10 Panel Kit - Baseline	KK124G	⊗ 600(w) x 900(h) mm
10 Panel Kit - Baseline Plus	KKP124G	⊗ 600(w) x 900(h) mm

6 Panel - Baseline	KK317	⊗ 1000(h) x 700(w) mm
6 Panel - Baseline Plus	KKP317	⊗ 1000(h) x 700(w) mm
6 Panel - Aluminium	Call us	⊗ 1000(h) x 700(w) mm
7 Panel - Baseline	KK314	⊗ 1000(h) x 700(w) mm
7 Panel - Baseline Plus	KKP314	⊗ 1000(h) x 700(w) mm
7 Panel - Aluminium	Call us	⊗ 1000(h) x 700(w) mm
8 Panel - Baseline	KK320	⊗ 1000(h) x 700(w) mm
8 Panel - Baseline Plus	KKP320	⊗ 1000(h) x 700(w) mm
8 Panel - Aluminium	Call us	⊗ 1000(h) x 700(w) mm
10 Panel - Baseline	KK222	⊗ 1000(h) x 700(w) mm
10 Panel - Baseline Plus	KKP222	⊗ 1000(h) x 700(w) mm

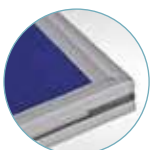

Baseline PVC (thickness 18.2 mm)



Baseline Plus PVC (thickness 25 mm)

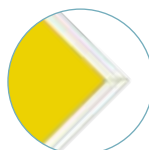

Aluminium baseline (thickness 18.2 mm)

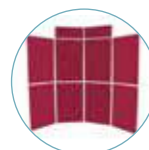

8-panel kit with 2x headers (included)

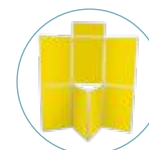

7-panel kit with header (included)

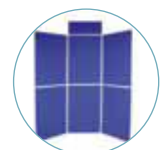

6-panel kit with header (included)

Baseline Tabletop Panel Kits



Baseline Tabletop Panel kits are part of our classic folding panel range of practical, durable and reconfigurable displays, ideally sized for counter-tops.

Material	PVC / Aluminium
Profile Colour	Grey
Finishes	Baseline board with grey PVC or aluminium frame
Graphic area	Single or double-sided
Graphic attachment	Hook fixing
Graphic option	Felt coating * or optional Rigid replacement printed panels (3mm)
Application	Free-standing

Junior kit - Baseline	KK102G	Ⓞ 600(w) x 450(h) mm
Junior kit - Baseline Aluminium	KK102A	Ⓞ 600(w) x 450(h) mm
Senior kit - Baseline	KK103	Ⓞ 900(w) x 600(h) mm
Senior kit - Baseline Aluminium	KK103A	Ⓞ 900(w) x 600(h) mm

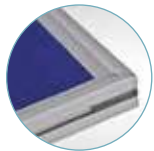

Baseline PVC
(thickness 18.2 mm)

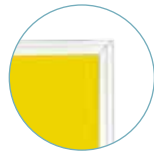

Aluminium baseline
(thickness 18.2 mm)



Baseline Wheeled Panel Kits



Baseline panels provide the perfect solution for any display or back drop requirement. Baseline Wheeled Panel Kits have lockable castors and are perfect as mobile displays or backdrops. They are also a practical screening solutions for temporarily zoning a space and are manufactured to order.

Kit 5 Baseline Plus - 1500 mm	KKPW5-156G	Ⓞ 600(w) x 1500(h) mm
Kit 5 Baseline Plus - 1800 mm	KKPW5-186G	Ⓞ 600(w) x 1800(h) mm
Kit 6 Baseline Plus - 1500 mm	KKPW6-156G	Ⓞ 600(w) x 1500(h) mm
Kit 6 Baseline Plus - 1800 mm	KKPW6-186G	Ⓞ 600(w) x 1800(h) mm
Kit 7 Baseline Plus - 1500 mm	KKPW7-156G	Ⓞ 600(w) x 1500(h) mm
Kit 7 Baseline Plus - 1800 mm	KKPW7-186G	Ⓞ 600(w) x 1800(h) mm

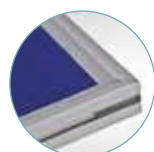

Baseline PVC
(thickness 18.2 mm)

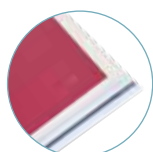

Baseline Plus PVC
(thickness 25 mm)

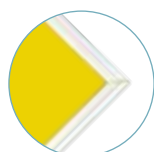

Aluminium baseline
(thickness 18.2 mm)

Non-illuminated tension walls

Horizon



Horizon is the ideal solution for large scale promotions. Use single-sided or double-sided to maximise the impact for brand displays. Link individual units together to form a display wall. Securely weighted by twin water filled bases for total stability.

Material	Aluminium, moulded grey plastic base
Pole	Adjustable height (1500-2400 mm)
Graphic area	Single or double-sided
Graphic attachment	Eyelets
Base capacity	28 litres per tank
Wind resistance	Up to 12 mph / 19 km/h

Horizon	UB203	Ⓞ 2500(w) x 1500/3000(h) x 800(d) mm
---------	-------	--------------------------------------



Telescopic pole for adjustable height



Graphic attaches with eyelets



Pegasus



The large-format Pegasus tension banner has telescopic poles and can adjust to 2.5m wide and tall - perfect for large format imagery and brand messaging. Tool-free assembly for quick and simple deployment, Pegasus packs down into a supplied carry bag, and is suitable for vinyl or fabric graphics with pole pockets.

Material	Aluminium
Assembly	Telescopic poles / screws
Shape	Straight
Graphic area	Single or double-sided
Graphic attachment	Pole pocket
Application	Free-standing with feet (included)

Pegasus	UB165-S	Ⓞ 1429/2540(w) x 1000/2515(h) x 442(d) mm
---------	---------	---

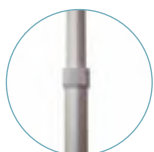

Telescopic poles



Poles slide into graphic pole pocket



Quick and easy installation



Pegasus 3m



The most compact 3m wide video wall! Ideal for large format photo calls for group meetings, political events or product launches.

Material	Aluminium
Assembly	Telescopic twist-lock poles
Shape	Straight
Graphic area	Single sided
Graphic attachment	Pole pocket
Application	Free-standing with feet (included)

Pegasus 3 m	UB167-S	📏 1845/3180(w) x 1835/2610(h) x 440(d) mm
-------------	---------	---



Quick and easy installation

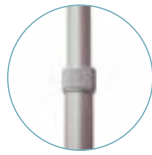

Telescopic poles



← from 1845 to 3180 mm →

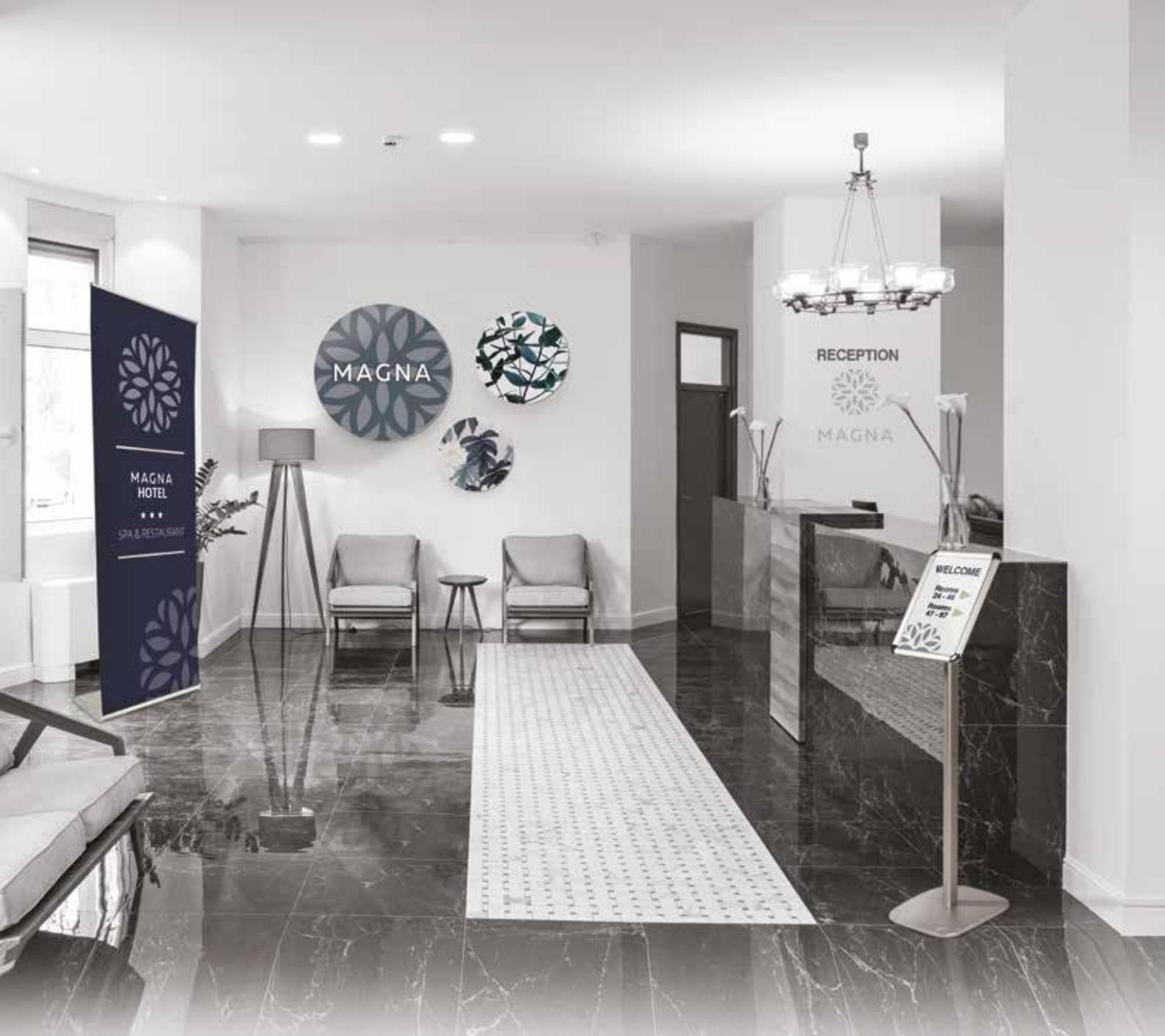

Display Signs

We provide a comprehensive range of professional display signage solutions for a variety of uses. From navigational signs to advertising, information, decorative and display needs.

Display signage solutions are versatile, reusable, durable, and reliable, ensuring investment in hardware is maximised, whilst allowing the flexibility to update marketing messages frequently.

Display Signs

With a wide choice of installation options such as wall, suspended or free-standing, as well as eye-catching illuminated lightbox versions, we are proud to offer one of the most comprehensive ranges on the market.

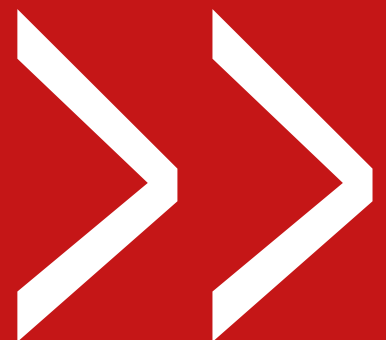

Non-illuminated free-standing signs

Wedge



Wedge is a weighted clamping banner base range that comes in 2 parts and is designed to hold a variety of rigid substrates for indoor or temporary outdoor usage. Available in four sizes from 300mm up to 1000mm Wedge can be used in tandem with a second pair of bases to create larger displays.

Material	Powder coated steel
Graphic area	Single or double-sided
Graphic attachment	Screwed to base
Graphic option	Rigid panel from 18-40mm thickness - optional extra 1500mm height max.
Application	Free-standing

Wedge 300 mm	UB102-300-S	Ⓞ 300(w) x 85(h) x 360(d) mm
Wedge 600 mm	UB102-600-S	Ⓞ 600(w) x 85(h) x 360(d) mm
Wedge 800 mm	UB102-800-S	Ⓞ 800(w) x 85(h) x 360(d) mm
Wedge 1000 mm	UB102-1000-S	Ⓞ 1000(w) x 85(h) x 360(d) mm



Sentry



Sentry is a handy and versatile way of imparting brand messaging or wayfinding information quickly and tool-free using the 'snap action' poster area which can be deployed either landscape or portrait. Comes in A3 and A4 sizes and the weighted base aids deployment in high foot-fall areas.

Material	25mm aluminium profile, clear PVC protection sheet
Colour	Anodised silver finish, chromed corners
Mounting	Free-standing
Graphic attachment	Snap rail
Graphic option	Suitable for substrates up to 420 microns
Positioning	Portrait or Landscape

Sentry A4	SL104	Ⓞ 245(w) x 1005(h) x 326(d) mm
Sentry A3	SL103	Ⓞ 245(w) x 1075(h) x 326(d) mm



Snap frame

Symbol



Symbol is constructed of robust weighted steel and angled for optimal viewing and reading for better engagement with prospective customers. Interchangeable graphics slide in to the recess channel and fix in place tool-free with a turnscrew.

Material	Steel
Profile Colour	Black
Assembly	Allen key and thumb screws
Graphic attachment	Thumbscrews
Graphic option	Rigid PVC and Dibond (3-5 mm thickness)
Weight	7.2 kg
Wind speed	18 mph

Symbol	IP01	420(w) x 1280(h) x 450(d) mm (A4) 480(w) x 1280(h) x 450(d) mm (A3)
--------	------	--



Content detail



Tool-free locking mechanism



Quick change graphic



Shield



The Shield sign is a fantastic alternative to the traditional A-board sign. Unlike A-boards the weighted tough rubber base prevents Shield from falling over and the sleek UV printed aluminium graphic panel has a professional enduring finish even in inclement weather. Ideal double-sided display for use in all weathers, as well as in high volume traffic settings.

Material	Recycled rubber base, aluminium panel (1.2 mm)
Graphic area	Double-sided
Graphic attachment	Bolts
Weight	6.5 kg
Wind resistance	Up to 18 mph / 29 km/h

Shield	UB108	465(w) x 800(h) x 450(d) mm
--------	-------	-----------------------------



Shield base



A-sign Board



Pavement signage is a marketing stalwart and no high street would be without one, and the A-sign Board is one of the best. Simple to use with double-sided 'snap-action' front loading frames complete with protective PVC sheeting to shield graphics which can be changed over and over again to keep up with your brand messaging or offers.



Material	Aluminium, steel, PVC sheet cover
Graphic area	Double-sided
Graphic attachment	Snap rail
Wind speed	18 mph
Weight	10.56 kg

A-sign Board A1	VF204-C	Ⓞ 638(w) x 1060(h) x 825(d) mm
-----------------	---------	--------------------------------



Snap frame



Street Sign



A durable outdoor double-sided sign frame with a standing height of 1135mm when deployed. There is a recessed area on each side of the frame that will accommodate a poster size graphic and is covered by a PET poster protection screen to protect the poster face. The unit is equipped with hinges attached to both sides of the frame to ensure stability once deployed. The sign frame folds flat to save space when storing and has an integrated wheel system on the base making it easy to reposition without the need for heavy lifting.



Material	Aluminium, steel, PVC sheet cover
Graphic area	Double-sided
Graphic attachment	Frame lock
Wind speed	18 mph
Weight	16.4 kg

Street sign	SS-24X36B	Ⓞ 690(w) x 1135(h) x 735(d) mm
-------------	-----------	--------------------------------



Open frame

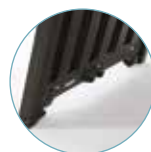

Integrated castors



Formulate Shadow



Formulate Shadow is a no mess, no fuss outdoor sign, that offers customers a viable alternative to traditional outdoor signs that typically rely on water or sand for stability.



Material	Steel
Assembly	Push-fit button/Allen key
Tube	32 mm
Graphic area	Double-sided
Graphic attachment	Zipped tension fabric graphic
Wind resistance	Up to 18 mph / 29 km/h
Weight	12.7 kg

Formulate Shadow	FORM-ODS	800(w) x 1174(h) x 420(d) mm
------------------	----------	------------------------------



Integrated castors



Base with handle



Monsoon



Monsoon is your perfect all-weather sturdy single or double-sided 'A' frame banner with bungeed PVC eyelet banner graphics - perfect for displaying brand messaging or wayfinding information.



Material	Aluminium tubes (25 mm), plastic connectors
Graphic area	Single or double-sided
Graphic attachment	Eyelets and looped bungee cords
Wind resistance	Up to 24 mph / 39 km/h

Monsoon 2500 mm	UB707-C	@ 2500(w) x 1000(h) x 640(d) mm
Monsoon 3000 mm	UB711-C	@ 3000(w) x 1250(h) x 795(d) mm
Bungee cords (pack of 12)	FX804-BX12	



Eyeletted graphic attaches to frames with bungee cord



Metal hinge



Interlocking sections



Stowaway



Make your brand messaging or wayfinding information literally pop with the Stowaway pop-out display banner that deploys in seconds for use either indoors or secured outside with pegs supplied.



Material	Sprung steel pole
Graphic area	Double-sided
Graphic attachment	Elasticated pole pocket
Ground fixing	4 pegs (included)
Transport	Carry bag included
Wind Speed	18 mph (when pegged)

Stowaway 1400 mm	UB736-03A	@ 1420(w) x 700(h) x 400/480(d) mm
Stowaway 2000 mm	UB736-01A	@ 2020(w) x 1000(h) x 400/480(d) mm



Internal hook and loop straps



Bora Column



The Bora Inflatable Column kit is a fantastic eye-catching visual advertisement and brand messaging tool that stands at almost 2.4 metres tall. Once deployed it can be left without the need for re-inflation leaving organisers free to attend to customers and visitors at events. Complete by choosing a vibrant optional custom graphic to display brand messaging.

Material	PVC column, plastic base
Graphic area	360°
Graphic attachment	Hook and loop
Ground fixing	4 pegs (included)
Wind resistance	Up to 24 mph / 39 km/h (if pegged)



Bora Column Kit	INFLCOL-220	📏 2390(h) x 460(Ø) mm
-----------------	-------------	-----------------------

Ancillaries :

Electric pump 600W	INFTA-PE4EU
Bag (column)	AB-INFLCOL



600W Electric pump (optional)



Gala Table



Portable and strong folding trestle table. Cover with an optional printed table cloth for a professional look, choose from traditional or fitted format.

Material	Polypropylene, metal
Assembly	Locking mechanism
Graphic area	360°

Gala 1.8m	FT-6A	📏 Open - 1805(w) x 730(h) x 740(d) mm
		📏 Closed - 900(w) x 80(h) x 740(d) mm

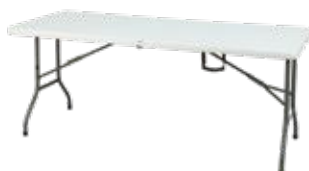

Gala table folds in half for ease of transportation



Central locking system



Gala table folds in half for ease of transportation

Two tablecloth finishes available

Non-illuminated wall mounted signs

Trappa Frame



The Trappa 'snap-action' Frame delivers a professional look and is quick to fix to a wall and easy to update. Posters can be changed, simply by opening the frame edges.

Material	25mm aluminium profile, clear PVC protection sheet
Colour	Anodised silver finish
Mounting	Wall*
Graphic attachment	Snap rail
Graphic option	Suitable for substrates up to 420 microns
Positioning	Portrait or Landscape



Trappa A4	AT401-C	⊘ 241(w) x 328(h) x 13(d) mm
Trappa A3	AT402-C	⊘ 328(w) x 451(h) x 13(d) mm
Trappa A2	AT403-C	⊘ 451(w) x 625(h) x 13(d) mm
Trappa A1	AT404-C	⊘ 625(w) x 872(h) x 13(d) mm
Trappa A0	AT405-C	⊘ 872(w) x 1220(h) x 13(d) mm



Trappa snap frame

* : Wall mounting screws not included

Vector Quick-fix Wall Kit



The Vector Quick Fix Wall Kit is a sleek 20mm low profile aluminium extrusion frame for optional SEG dye-sublimated fabric display graphics that simply push-fits into the frame's channel in a matter of seconds. Frames affix to walls in a fuss-free way by self-drilling.

Can be mounted directly on the wall without a bracket

Material	Anodised aluminium
Profile width	20mm
Profile Colour	Silver
Assembly	Angled connectors
Shape	Bevelled
Mounting	Wall mounted*
Graphic area	Single sided
Graphic attachment	SEG 3mm
Availability	Made to order

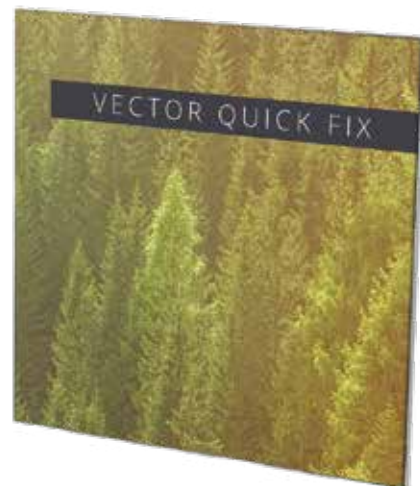

Vector Quick Fix A3	VWQF-A3	⊘ 420(w) x 297(h) x 20(d) mm
Vector Quick Fix A2	VWQF-A2	⊘ 594(w) x 420(h) x 20(d) mm
Vector Quick Fix A1	VWQF-A1	⊘ 841(w) x 594(h) x 20(d) mm
Vector Quick Fix A0	VWQF-A0	⊘ 1189(w) x 841(h) x 20(d) mm



Corners are assembled using brackets



Silicone edged (SEG) graphic

* : Wall mounting screws not included

Vector Slim Circular Wall Kit



Vector Slim Circular is a sleek circular 20mm aluminium profile wall frame which is completed with an optional interchangeable custom printed SEG tension fit fabric graphic. Frames are quick and easy to attach to walls by self-drilling, and SEG graphics attach in seconds by push-fitment into the frame channel.

Material	Aluminium
Profile width	20 mm
Profile Colour	Silver
Assembly	Screw-in connector
Shape	Bevelled
Mounting	Wall mounted
Graphic area	Single-sided
Graphic attachment	Silicone Edged Gasket 3 mm (SEG)
Availability	Made to order

Vector Slim Ø 400 mm	VWFC-400	⊘ 400(Ø) mm
Vector Slim Ø 700 mm	VWFC-700	⊘ 700(Ø) mm
Vector Slim Ø 1000 mm	VWFC-1000	⊘ 1000(Ø) mm



20mm slim aluminium profile



Silicone edged (SEG) graphic



Wall mount included



Illuminated wall mounted signs

Vector 75mm LED Kit



Large format wall mounted edge lit lightbox, creating even light across a wide area to illuminate your chosen graphic helping you stand out from the crowd.

Material	Aluminium
Profile width	75 mm
Profile Colour	Grey
Assembly	Screw-in bracket
Mounting	Wall mounted
Graphic area	Single-sided
Graphic attachment	Silicone Edged Gasket 3 mm (SEG)
LED System	Edge lit

Vector LED 75 – 2000 x 1000 mm	VLB75-2X1	Ⓞ 1000(w) x 2000(h) x 75(d) mm
Vector LED 75 – 2000 x 2000 mm	VLB75-2X3	Ⓞ 2000(w) x 2000(h) x 75(d) mm
Vector LED 75 - 2000 x 3000 mm	VLB75-2X2	Ⓞ 2000(w) x 3000(h) x 75(d) mm



Cable system



LED strip lighting



Numbered system for easy assembly

Non-illuminated suspended signs

Twista Lite



Twista Lite delivers a smart, modern poster display system that is quick and simple to deploy via the 'snap-action' rail. Versatile, as well as functional, it can be displayed single-sided on walls or double-sided when suspended from ceilings.

Material	Aluminium (rail), plastic (end caps, hooks)
Colour	Grey
Mounting	Wall / Ceiling
Graphic area	Single or double-sided
Graphic attachment	Snap rail

600 mm Kit	TWLHR-600	Ⓞ 600(w) x 31(h) x 12(d) mm
800 mm Kit	TWLHR-800	Ⓞ 800(w) x 31(h) x 12(d) mm
850 mm Kit	TWLHR-850	Ⓞ 850(w) x 31(h) x 12(d) mm
1000 mm Kit	TWLHR-1000	Ⓞ 1000(w) x 31(h) x 12(d) mm
3000 mm Kit	TWLHR-3000	Ⓞ 3000(w) x 31(h) x 12(d) mm
3100 mm (rail only)	TWLHR-3100	Ⓞ 3100(w) x 31(h) x 12(d) mm

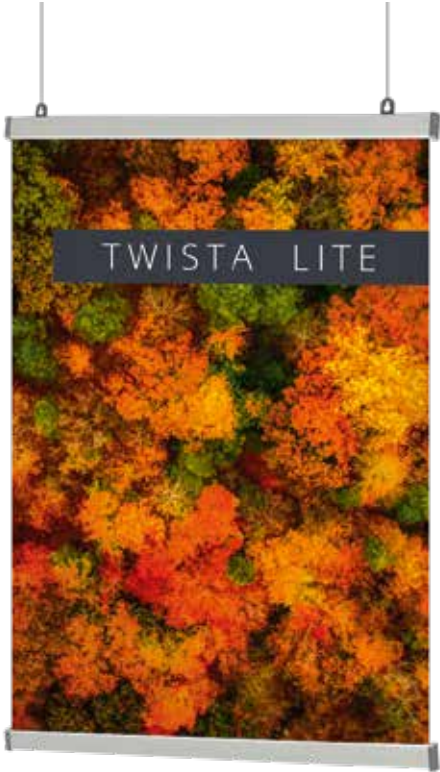

Snap rail clamps media securely



Top rail with hanging



Snap rail

Strata

Give perspective to your indoor display!

Strata is a versatile display system that can be fixed directly to the wall or on a cable, for an adjustable suspended display.

Ideal for a structured mechanism to display your materials including acrylic, plastic and wood. Often used for displaying properties for sale in estate agencies, case studies on an exhibition stand, or key messages on a backwall.

Strata



1 Stand-offs

- 11 mm diameter aperture is required in the substrate
- Screw fasteners
- 25 mm diameter compatible with 5 to 20 mm thick signs

Ø25 mm Stand-off	PO117
------------------	-------



Strata components



2 Acrylic Poster Holder

- Acrylic poster holders have wings to take panel support fixings
- Available landscape or portrait

Support A4	AH414L/P
------------	----------



3 Double Panel Support

- Double rotating fixture suitable for 7mm thick substrates and A1, A2 and A3 poster holders
- 7mm - 16mm diam. x 43mm with rotating feature for multi-angle fixing

PO121	⊗ 43(h) x 16 (Ø) mm
-------	---------------------



4 Panel Supports

- PO112 suitable for 4mm thick substrates and A4/A5 poster holders

PO112	⊗ 20.5(h) x 16 (Ø) mm
-------	-----------------------



5 Rotating Edge Stand-offs

- Eliminate the need for an aperture in the substrate
- Suitable for 2-10mm thick substrates in rail or screw options
- Distance from wall or ceiling 18.5mm approx.

PO119-S	⊗ 34(h) x 16 (Ø) mm
---------	---------------------



6 Compact Variable Cable Fixing

- 180° variable angle fixing
- Screw fixing
- Cannot be used with PO110 cable kit, use PO109

PO108 (Vis)	⊗ 25(h) x 16 (Ø) mm
-------------	---------------------



7 Adjustable Fixing Cable

- Supplied with rail fixings
- Can be fixed wall-to-wall, floor to ceiling, direct to wall - extra components required

PO109	⊗ 4000(w) x 1,5 (Ø) mm
-------	------------------------



8 Insert for Screw Fixing

- Suitable for PO109 Strata Cable Kits and Stand-off components

Screw mounting	PO116
----------------	-------



Display Banners

Portable display banners are ideal for a temporary but stable communications tool.

Our unique range of Display Banners are highly portable, quick to deploy and suitable for a broad range of applications. Choose from the economy range through to premium options for use indoors or select specifically designed solutions for outdoor applications.

Alternatively the fabric systems are a premium display solution, featuring aluminium tubing, with double-sided high-quality dye sublimated fabric graphics. Easy to deploy with tool-free assembly.

Display Banners

Affordable by nature, the roller banner range delivers a convenient, tool-free solution, with retractable graphics that deploy in seconds. Choose from a range of indoor or outdoor designs that best suits your application, with single or double-sided graphic options.

Tension banners are constructed of lightweight materials and offer the best value for money.

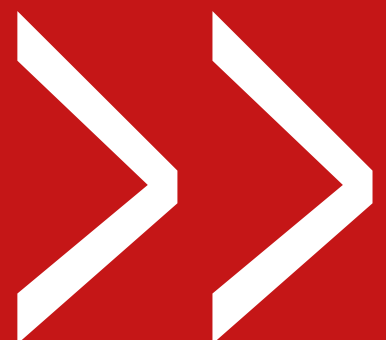

Lightboxes

Illumigo™ One



Illumigo™ One is a vibrant portable single-sided lightbox with the option to have a rear facing textile graphic unit. Standing 2000mm high and 850mm wide, the slim 60mm profile has a white powder coated finish and benefits from tool-free plug and play assembly due to an easy to follow numeric system, rollable LED panel and pre-assembled twist-out feet.



Material	Aluminium
Profile width	60 mm
Profile Colour	White
Assembly	Tool-free
Graphic area	Single-sided
Graphic attachment	Silicone Edged Gasket 3 mm (SEG)
Application	Self-supporting with pivoting feet fixed to the structure
Transport	Protective box with carry handle

Illumigo™ One	ILLGO-ONE	Ⓞ 850(w) x 2010(h) x 390(d) mm
---------------	-----------	--------------------------------



Tool-free assembly



Rollable LED panel



Single-sided frame



Optional Illumigo™ bag



Illumigo™



Illumigo™ is an innovative portable LED lightbox that comes in a protective compartmented box with handle for ease of transportation. Deploys tool-free in minutes thanks to pre-assembled LED lighting and push-fit optional dye-sublimated graphics.



Material	Aluminium
Profile width	100 mm
Profile Colour	White
Assembly	Tool-free
Graphic area	Double-sided
Graphic attachment	Silicone Edged Gasket 3 mm (SEG)
Application	Self-supporting with pivoting feet fixed to the structure
Transport	Protective box with carry handle

IllumiGo™ - 2x1	ILLGO-2X1	Ⓞ 1000(w) x 2000(h) x 400(d) mm
Illumigo™ bag	ILLGO-BAG	Ⓞ 460(w) x 1160(h) x 400(d) mm

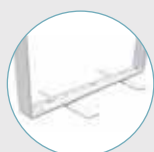

Supplied with twin twist-out feet

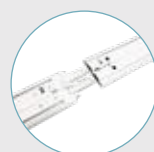

Numbered system for easy assembly

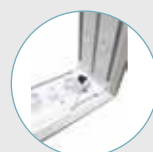

Pre-installed LED lights

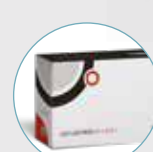

Branded protective compartmented box



Optional Illumigo™ bag

Illumigo™ Retail



Illumigo™ Retail is an innovative portable LED lightbox that is specifically designed for retail environments because of its size and stability. The 1600 x 600mm double-sided illuminated display comes in a protective compartmented box with handle for ease of transportation. Deploys tool-free in minutes thanks to pre-assembled LED lighting and push-fit optional dye-sublimated graphics.



Material	Aluminium
Profile width	100 mm
Profile Colour	White
Assembly	Tool-free
Graphic area	Double-sided
Graphic attachment	Silicone Edged Gasket 3 mm (SEG)
Application	Self-supporting with flat base fixed to the structure
Transport	Protective box with carry handle

Illumigo™ Retail	ILLGO-RETAIL	Ⓞ 600(w) x 1600(h) x 285(d) mm
------------------	--------------	--------------------------------



Pre-installed LED lights

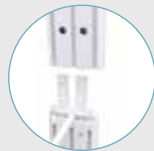

Connector



Branded protective compartmented box



Optional Illumigo™ bag



Illumigo™ 2x2



Illumigo™ is a complete portable 2x2m double-sided aluminium lightbox display system. Simple to deploy with tool-free assembly. Just remove from the box, twist out the feet from the base panel and use the matching numerical system to connect the remaining extrusions remembering to insert the horizontal bar. SEG graphics fit into the frame channel and the power cable inserts under the base panel. Plug and play in less than 10 minutes!



Material	Aluminium
Profile width	100 mm
Profile Colour	White
Assembly	Tool-free
Graphic area	Double-sided
Graphic attachment	Silicone Edged Gasket 3 mm (SEG)
Application	Self-supporting with pivoting feet fixed to the structure
Transport	Protective box with carry handle

Illumigo™ 2x2	ILLGO-2X2	Ⓞ 2000(w) x 2000(h) x 390(d) mm
---------------	-----------	---------------------------------



Metal straight connector



Numbered system for easy assembly



Vector 125mm LED Kit



Illuminate to communicate! This robust free-standing LED frame perfectly suits interior displays that need to be regularly updated to keep up with changing trends.



Material	Aluminium
Profile width	125mm
Profile Colour	Silver (White / black optional)
Assembly	Screw-in bracket, Allen key
Graphic area	Single-sided (one side printed with block-out rear) double-sided (both sides printed)
Graphic attachment	Silicone Edged Gasket 3 mm (SEG)
Application	Free-standing with flat retail feet (included)
LED System	Edge-lit

Kit 2x1 LED	VLB125-2X1	ⓐ 1000(w) x 2005(h) x 550(d) mm
Kit 2x2 LED	VLB125-2X2	ⓐ 2000(w) x 2005(h) x 550(d) mm
Kit 2x3 LED	VLB125-2X3	ⓐ 3000(w) x 2005(h) x 550(d) mm
Kit 2,5x3 LED	VLB125-25X30	ⓐ 3000(w) x 2505(h)x 550(d) mm

Available in standard and custom sizes

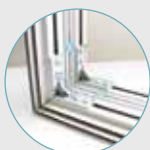

Mitred sections assemble with screw-in connectors

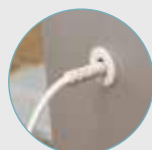

Cable system



LED strip lighting

Tension textile systems

Formulate Monolith



Monolith; the gentle giant, with weighted base for high traffic areas and practical, changeable fabric graphics for multiple brand messaging. This tall double-sided display banner comes in a variety of widths, from 600mm up to 1500mm, and is trusted for stability and easy deployment.

Material	Aluminium tubes, steel base
Tube	Ø 30 mm
Assembly	Push-fit button, Allen key
Graphic area	Double sided
Graphic attachment	Zipped tension fabric graphic
Application	Free-standing with metal base (included)
Transport	Padded with compartments

600 mm	FORM-MON-600	Ⓞ 600(w) x 2380(h) x 300(d) mm
900 mm	FORM-MON-900	Ⓞ 900(w) x 2380(h) x 300(d) mm
1200 mm	FORM-MON-1200	Ⓞ 1200(w) x 2380(h) x 300(d) mm
1500 mm	FORM-MON-1500	Ⓞ 1500(w) x 2380(h) x 300(d) mm

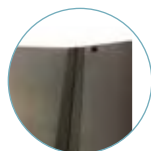

Hinged metal base (from sizes 900mm wide upward)



Bungee tubes



Formulate Monolith Eco



The Formulate Monolith Eco is an ideal alternative to roller banners as it provides a cost effective option for the budget conscious whilst delivering an uninterrupted double-sided stretch fabric display. It comes with powder-coated steel feet for increased stability that connect to the aluminium tubular frame. The tension graphic hugs the frame and is zipped at the base to hold it in place.

Material	Aluminium tubes, powder coated steel feet
Tube	25mm
Assembly	Push-fit, tool-free
Graphic area	Single or double-sided
Graphic attachment	Tension fabric graphic
Application	Free-standing with feet (included)
Transport	Simple carry bag

800 mm	FORM-MON-ECO-800	Ⓞ 800(w) x 2009(h) x 378(d) mm
1000 mm	FORM-MON-ECO-1000	Ⓞ 1000(w) x 2009(h) x 378(d) mm



Bungee tubes



Numbered system on tubes for easy assembly



Vector Media



Vector Media is a versatile display which accepts a variety of changeable media substrates; from SEG stretch fabric to rollable PVC. Each side of the frame has a channel for SEG fabrics, alternatively you can also use PVC with magnetic tape that magnetise to the inner frame profile.

Material	Aluminium
Profile width	35 mm
Profile Colour	Silver / Black
Assembly	Tool-free
Graphic area	Single or double-sided
Graphic attachment	For textile graphics: 3 mm SEG For PVC graphics: magnetic tape (included)
Application	Free-standing solid foot

Vector Media	VF-MEDIA-16X06	📏 600(w) x 1610(h) x 280(d) mm
--------------	----------------	--------------------------------

PVC or fabric graphic, the choice is yours!

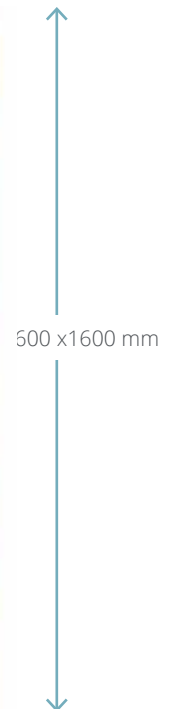

Fabric graphic with silicone edging (SEG)



PVC graphic with magnetic tape

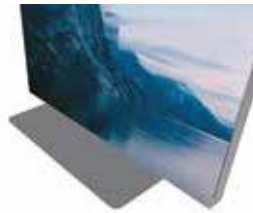

Roller banners (economy)

Wasp



The Wasp roller banner is an entry level product, ideal for short-term events or displays, where cost is a primary consideration. Despite its affordable price, Wasp is made to exacting quality standards and carries a full manufacturer's warranty, so you can be confident it will perform as expected.

Material	Aluminium, plastic end caps on rail and feet tips
Rail	Snap rail
Pole	Aluminium three-part bungee pole
Leader	Self-adhesive
Graphic area	Single-sided
Feet	Twin, twist-out feet
Transport	Simple nylon bag

600 mm	UB204-600-05	Ⓞ 615(w) x 1710/2080(h) x 320(d) mm
800 mm	UB204-800-03	Ⓞ 815(w) x 2080(h) x 320(d) mm
850 mm	UB204-850-03	Ⓞ 865(w) x 2080(h) x 320(d) mm
1000 mm	UB204-1000-03	Ⓞ 1015(w) x 2080(h) x 320(d) mm



Pole top



Pole bracket



Carry bag



Mantis



The Mantis roller banner is suitable for budget conscious users, who need a cost-effective roller banner with a little more durability for busier areas. With a weighted base, the unit provides enhanced stability over the unweighted banners in the range. Despite its economical price, Mantis is made to exacting quality standards and carries a full manufacturer's warranty, so you can be confident it will perform as expected.

Material	Aluminium, plastic end caps on rail
Rail	Snap
Pole	Bungee
Leader	Self-adhesive
Graphic area	Single-sided
Feet	Twin, twist-out feet
Transport	Padded nylon bag with side opening

800 mm	UB216-800-01	Ⓞ 818(w) x 2085(h) x 280(d) mm
850 mm	UB216-850-01	Ⓞ 868(w) x 2085(h) x 280(d) mm
1000 mm	UB216-1000-01	Ⓞ 1018(w) x 2085(h) x 280(d) mm



Pole top



Rigidising bracket in base for increased strength and longevity of banner



Mosquito



The Mosquito roller banner is an industry standard workhorse. This roller banner offers a blend of affordability, durability and robustness that is often copied, but never equalled. It is constructed from more robust componentry, allowing it to perform reliably in high traffic applications, or where there are likely to be repeated deployments of your roller banner.

Material	Aluminium and plastic
Rail	Snap rail
Pole	Aluminium three-part bungee pole
Leader	Self-adhesive
Graphic area	Single-sided
Feet	Twin, twist-out feet
Transport	Nylon bag with inner protection (double skin)

800 mm	UB197	⊗ 860(w) x 2105(h) x 285(d) mm
850 mm	UB196	⊗ 910(w) x 2105(h) x 285(d) mm
1000 mm	UB197-1000	⊗ 1060(w) x 2105(h) x 285(d) mm
1200 mm	UB197-1200	⊗ 1260(w) x 2105(h) x 285(d) mm
1500 mm	UB197-1500	⊗ 1560(w) x 2105(h) x 285(d) mm
2000 mm	UB197-2000	⊗ 2060(w) x 2105(h) x 285(d) mm



← Market favourite



Nylon bag with padded inner protection



Three-part bungee pole



Rigidising bracket in base for increased strength and longevity of banner

Grasshopper



The Grasshopper roller banner is an industry standard workhorse. A popular, classic-style lightweight economy banner with twin twist-out feet for stability. This roller banner offers a blend of affordability, durability and robustness.

Material	Aluminium and plastic
Rail	Adhesive Rail
Pole	Aluminium three-part bungee pole
Leader	Self-adhesive
Graphic area	Single-sided
Feet	Twin, twist-out feet
Transport	Nylon bag with inner protection (double skin)

800 mm	UB191	⊗ 860(w) x 2105(h) x 285(d) mm
850 mm	UB193	⊗ 910(w) x 2105(h) x 285(d) mm

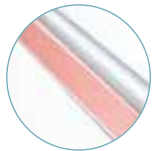

Self-adhesive rail

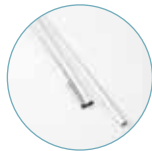

Three-part bungee pole



Rigidising bracket in base for increased strength and longevity of banner



Dragonfly 2



Economical and cost-effective double-sided roller banner with pole storage in base. Comes with padded nylon bag for ease of transportation.

Material	Aluminium, plastic end caps on rail
Rail	Snap rail with end caps
Pole	Aluminium three-part bungee pole
Leader	Self-adhesive
Graphic area	Double-sided
Feet	Twin, twist-out feet
Transport	Padded nylon bag

850 mm	UB199-850-01	⊗ 890(w) x 2105(h) x 395(d) mm
1000 mm	UB199-1000-01	⊗ 1040(w) x 2105(h) x 395(d) mm



Three-part bungee pole



Nylon padded carry bag included

Double-sided



Roller banners (standard)

Orient +



The Orient + is a trusted market leading roller banner that delivers stability whilst still being cost-effective. With its front-loading graphic that pulls up from the front of the base, the banner design ensures your brand message has maximum visibility from floor to top rail. It comes with our manufacturer's quality warranty, giving you peace of mind that it will perform every time.

Material	Aluminium and plastic
Rail	Patented Dual action self-adhesive and snap rail
Pole	Hybrid adjustable height telescopic pole
Leader	Self-adhesive or Hook and Loop
Graphic area	Single-sided
Feet	Adjustable
Transport	Padded nylon bag with side opening and foam reinforced ends

800 mm	WH353-800-003	⊗ 840(w) x 1595/2220(h) x 185(d) mm
850 mm	WH353-850-003	⊗ 890(w) x 1595/2220(h) x 185(d) mm
1000 mm	WH353-1000-003	⊗ 1040(w) x 1595/2220(h) x 185(d) mm
1200 mm	WH353-1200-003	⊗ 1240(w) x 1595/2220(h) x 185(d) mm
1500 mm	WH353-1500-003	⊗ 1540(w) x 1595/2220(h) x 185(d) mm
2000 mm	WH353-2000-003	⊗ 2040(w) x 1595/2220(h) x 185(d) mm



Hybrid telescopic pole



Pole top



Banner components



Delta Lite



The Delta Lite roller banner is highly stylish and has great stability thanks to the wide footprint aluminium base. This elegant banner has great design details including the chrome finished end covers. With adjustable levelling feet and telescopic pole, Delta Lite is excellent value for money. It comes with our manufacturer's quality warranty, giving you peace of mind that it will perform every time.

Material	Aluminium, chrome base end covers
Rail	Snap rail with end caps
Pole	Hybrid adjustable height telescopic pole
Leader	Self-adhesive
Graphic area	Single-sided
Feet	Adjustable
Transport	Padded nylon bag

850 mm	UB205-850-004	⊗ 903(w) x 1625/2224(h) x 203(d) mm
--------	---------------	-------------------------------------



Snap rail



Hybrid telescopic pole



Thunder 2



The Thunder 2 double-sided retractable roller banner is ideal for outdoor use as it is strong and durable yet very easy to assemble and transport. Standing 2m high, Thunder 2 will display your message on both sides for maximum viewing impact.

Material	Plastic, aluminium and steel
Pole	Three part bungee pole
Graphic area	Double-sided
Graphic attachment	Self-adhesive leader / top snap rail
Ground fixing	4 pegs (included)
Wind resistance	Up to 7 mph / 11 km/h (unpegged) up to 24 mph / 39 km/h (if pegged)
Transport	Padded bag

Thunder 2	UB185-850-01	884(w) x 2100(h) x 740(d) mm
-----------	--------------	------------------------------



Three-part bungee pole

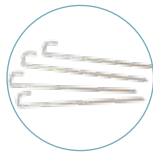

Ground pegs

Use outdoors



Roller banners (premium)

Merlin



Merlin is a sleek and elegant premium roller banner with an interchangeable graphic cassette which extends the life of the banner as graphics are quick and easy to change. The graphic cartridge is housed independently from the main base unit so it is simple to remove and replace with new graphics and old graphics can also be reused, just by swapping the cassette. A great value for money solution if the message or marketing campaign changes regularly. The Merlin roller banner comes with our manufacturer's quality warranty, giving you peace of mind that it will perform every time.

Material	Aluminium and plastic
Rail	Snap rail
Pole	Hybrid adjustable height telescopic pole
Leader	Cassette banner with adhesive leader
Graphic area	Single-sided
Feet	Adjustable
Transport	Padded nylon with side opening and foam reinforced ends

850 mm	UB160-850-01	⊗ 915(w) x 1655/2315(h) x 195(d) mm
--------	--------------	-------------------------------------



Interchangeable graphic cassette - swap messaging in seconds



Replacement cassette - 850 mm | UB175-850-01



Barracuda



The original best-selling premium Barracuda roller banner delivers a reliable, enduring display which is backed up by a life-time manufacturer's hardware warranty. The stylish anodised aluminium base has an elegant pinstripe detail on the front casing. Barracuda is height adjustable and has a large internal graphic housing and tensioner.

Material	Aluminium and plastic
Rail	Patented snap rail
Pole	Hybrid adjustable height telescopic pole
Leader	Self-adhesive slider
Graphic area	Single-sided
Feet	Adjustable
Transport	Padded nylon with side opening and foam reinforced ends

800 mm	WH321C-800A3	⊗ 860(w) x 1605/2210(h) x 200(d) mm
1000 mm	WH321C-1000A3	⊗ 1060(w) x 1605/2210(h) x 200(d) mm
1200 mm	WH321C-1200A3	⊗ 1260(w) x 1605/2210(h) x 200(d) mm
1500 mm	WH321C-1500A3	⊗ 1560(w) x 1605/2210(h) x 200(d) mm
2000 mm	WH321C-2000A3	⊗ 2060(w) x 1605/2210(h) x 200(d) mm
2400 mm	WH321C-2400A3	⊗ 2460(w) x 1605/2210(h) x 200(d) mm



Hybrid telescopic pole



Rail cap



Ratchet graphic tensioner



Roller banners (desktop)

Breeze



The Breeze mini roller banner is ideal for use on a tabletop, counter, or reception desk. Ultra-light and simple to assemble, it delivers a professional, smart display that is elegant and stylish.

Material	Aluminium, plastic end caps on rail
Rail	Self-adhesive
Pole	Aluminium
Leader	Self-adhesive
Graphic area	Single-sided
Transport	Padded nylon bag

Breeze A3	WH361	⊗ 238(w) x 335(h) x 80(d) mm
Breeze A4	WH360	⊗ 332(w) x 440(h) x 82(d) mm



Two-piece support pole



Liberty Mini



The 430mm wide Liberty Mini can be used as a full height (1600mm) roller banner or be located on a counter or tabletop and be deployed at 450mm. This is possible thanks to the optional extension pole. This makes the Liberty Mini a very versatile narrow-gauge solution.

Material	Aluminium, plastic end caps on rail
Rail	Snap rail
Pole	2 Part-pole, height 400 - 800mm Four Part pole, height 1200 - 1600mm
Leader	Self-adhesive
Graphic area	Single-sided
Transport	Padded nylon bag

Liberty Mini 400 mm	UB122-400	⊗ 430(w) x 450/850(h) x 125(d) mm
Extension pole	EP-MINI	⊗ 4 Part pole, height 1200 - 1600 mm



Non-padded carry bag



Tension banners (X Banner)

Beijing Lite



Basic X-banner. Ultra-light frame. Very easy to assemble and compact once packed down.

Material	Fibreglass
Graphic area	Single-sided
Graphic attachment	Eyelets
Application	Free-standing
Transport	Budget drawstring carry bag

800 mm	WH358-8X18-01	800(w) x 1800(h) x 650(d) mm
--------	---------------	------------------------------



Banner reverse



Graphic attaches with eyelets



Blizzard



Blizzard is a great all-rounder as it is ideal for all kinds of corporate, sporting and outdoor events. Its simple design makes it very easy to assemble on-site, and because it's adjustable, it can accommodate different graphic sizes to suit your application.



Material	Plastic and metal
Pole	Adjustable in width and height
Graphic area	Single-sided
Graphic attachment	Eyelets
Base capacity	12 litres
Wind resistance	Up to 18 mph / 29 km/h
Transport	Non-padded bag

Blizzard	UB701	600/800(w) x 1600/2100(h) x 540(d) mm
----------	-------	---------------------------------------



Non-padded bag included







Flag Banners

Draw attention to branding, products, services, or business premises with custom printed flags. Instantly noticeable due to their height, shape, and movement, our all-fibre flag poles are durable and flexible, easy to assemble and quick to deploy, making them an extremely effective means of advertising.

Choose from a range of free-standing, post / wall mounted, mobile and specialist hardware that can be used in a variety of applications such as car forecourts, festivals, and beach flags.

Alternatively, deploy taller or multiple flags to increase visibility and attention to branding. Our all-fibre flag poles are reusable with interchangeable graphics for greater return on investment. To protect this investment, it is recommended that flags be kept securely in place by selecting an appropriate base suitable for the desired application and location from the specifically designed range.

Flag Banners

Available as single or double-sided options and printed using hardy, UV resistant media, flag graphics can be utilised indoors or outside with standard or custom flag shapes.

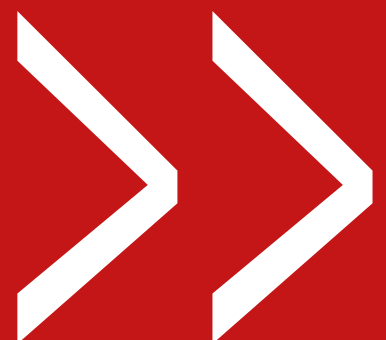

Free-standing flags

Zoom+ Quill / Feather Flag



Popular and versatile, lightweight flexible flag system, with black finish all fibre poles. Choose Feather or Quill shaped graphics. Ideal for advertising and used for all types of indoor and outdoor displays. Optional custom printed flag graphics are available in a range of sizes from small to extra-large and, with a choice of single or double-sided options (small, medium, and large). The eye-catching shape creates movement in the wind and is a great for attracting attention.

Material	GRP fibre glass pole
Graphic area	Single-sided or double-sided (double sided only available up to large)
Graphic attachment	Pole pocket
Wind resistance	Up to 18 mph / 29 km/h

Zoom + Small	UF-ZM-SM	Ⓞ 550/800(w) x 2100/2600(h) mm
Zoom + Medium	UF-ZM-ME	Ⓞ 600/900(w) x 2800/3200(h) mm
Zoom + Large	UF-ZM-LA	Ⓞ 800/1100(w) x 3500/4000(h) mm
Zoom + Extra large	UF-ZM-EXLA	Ⓞ 850/1200(w) x 4600/4900(h) mm

Ancillaries :

Bag (optional)	AB-ZML-01
----------------	-----------



Zoom+ Quill Flag



Zoom+ Feather Flag



Graphic attaches on to hook

Zoom+ Edge Flag



Popular and versatile, lightweight rectangular shaped flag system with black finish all-fibre poles. Ideal for all types of indoor and outdoor displays. Quick and easy to deploy and can withstand winds of approximately 13 -18m/h (21-29km/h). Optional custom printed flag graphic available in single and double-sided options (small, medium, and large), and all flag graphics have a printed pole pocket. The flag moves naturally in breezy/windy conditions and is ideal for attracting attention on car forecourts, at exhibitions and events, or outside a building or premises.

Material	Aluminium and GRP
Graphic area	Single-sided or double-sided (double sided only available up to large)
Graphic attachment	Pole pocket
Wind resistance	Up to 18 mph / 29 km/h



































Zoom + Edge Small	UF-ZME-SM	Ⓞ 750(w) x 2080(h) mm
Zoom + Edge Medium	UF-ZME-ME	Ⓞ 750(w) x 2900(h) mm
Zoom + Edge Large	UF-ZME-LA	Ⓞ 750(w) x 4000(h) mm
Zoom + Edge Extra large	UF-ZME-EXLA	Ⓞ 750(w) x 5000(h) mm



















































































Graphic attaches on to hook

Free-standing flag bases





























































Weighted bases - available in UK, Poland, Italy, Portugal and Spain

Base	Product	Code				Utilisation		Zoom + Quill				Zoom + Feather				Zoom + Edge			
						Int.	Ext.	S	M	L	XL	S	M	L	XL	S	M	L	XL
	Large water base	UF-ZMLWB	72.5 x 51 x 22.5 cm	0.9 kg															
	Stackable Water Base	UF-ZMSWB	64.2 x 64.2 x 27.7 cm	3.6 - 30 kg															

Metal and cement bases - available in UK, Poland, Italy, Portugal and Spain

Base	Product	Code			Utilisation		Zoom + Quill				Zoom + Feather				Zoom + Edge																	
					Int.	Ext.	S	M	L	XL	S	M	L	XL	S	M	L	XL														
	Zoom + Large cross base	UF-ZMLCB-01	240 x 400 x 400 mm	1.5 kg																												
	Zoom + Concrete base	UF-ZMCEM	∅ 45 x 35 mm	22.5 kg																												
	Zoom + Small square base 7,5 kg	UF-ZMLSQ-01	180 x 400 x 400 mm	7.5 kg																												
	Zoom + Drive on car foot	UF-ZMCF5-01	605 x 195 x 125 mm	1.7 kg																												

Spikes - available in UK, Poland, Italy, Portugal and Spain

Base	Product	Code			Utilisation		Zoom + Quill				Zoom + Feather				Zoom + Edge																	
					Int.	Ext.	S	M	L	XL	S	M	L	XL	S	M	L	XL														
	Zoom + Ground spike	UF-ZMGS-01	600 mm	1.16kg																												
	Zoom + Budget ground spike	UF-ZMBGS-01	600 mm	1kg																												



*Use with Weighting ring UB719-C



** Use with Heavy duty pegs FX620

Zoom+ Arch



The Zoom+ Arch stands out at any outdoor event or activity. With an overall height of 3m to the top of the graphic and a 4m width, it's perfect to use as a focal point or to attract attention. Simple and quick to assemble, it can be deployed in minutes and when used with the optional stackable bases, provides an extremely stable display that can be used in wind speeds of up to 20mph.

Material	GRP fibre glass pole - chrome steel end caps, plastic hook
Graphic area	Single-sided
Graphic attachment	Pole pocket
Wind resistance	Up to 19 km/h

Zoom+ Arch	ZOOM+ARCH	Ⓞ 4000(w) x 2500/3000(h) mm
Stackable base (optional) recommended that 2 bases either side are used	UF-ZMSWB	Ⓞ 162.5(h) x 642(w) mm



Supplied with 1 x 6-part bungee pole, 2 x base rods and hooks



Graphic attaches on to plastic hook



Water fillable base



Handle for easy transportation



Shimmer



A great value, free-standing, telescopic flag system, which includes the black water-fillable base. Adjustable to a height of up to 3m, the system comes with a base which can be filled with water or sand for optimum stability. Transport bags optional. Can be used indoor or outside and is quick and easy to deploy.

Material	Aluminium pole, plastic base
Pole	Telescopic (1540/2850 mm)
Graphic area	Single-sided
Graphic attachment	Printed pole pocket
Base capacity	14 litres
Wind resistance	Up to 18 mph / 29 km/h

Shimmer	WD102-01	Ⓞ 630(w) x 1620/3000(h) x 385(d) mm
---------	----------	-------------------------------------

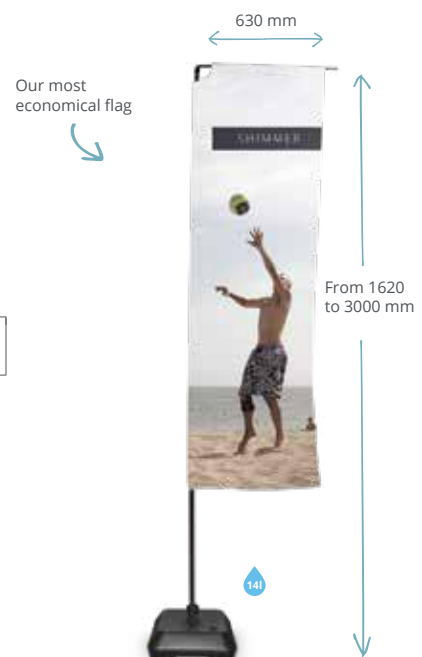

Wind Dancer



An imposing telescopic flag which stands 5m high when fully assembled and is certain to make an impact at any outdoor event. Wind Dancer comes complete with a base which can be filled with either water or sand. The 3.5m flag height makes an impressive statement when the flagpole is deployed at its full 5m height, and is particularly impactful when used in large crowded areas because of its dominating presence.

Material	Aluminium pole, plastic base
Pole	Telescopic
Graphic area	Single-sided
Graphic attachment	Eyelets
Base capacity	66 litres
Wind resistance	Up to 18 mph / 29 km/h

Wind Dancer	WD105	⊗ 1000(w) x 2900/5300(h) x 1000(d) mm
-------------	-------	---------------------------------------

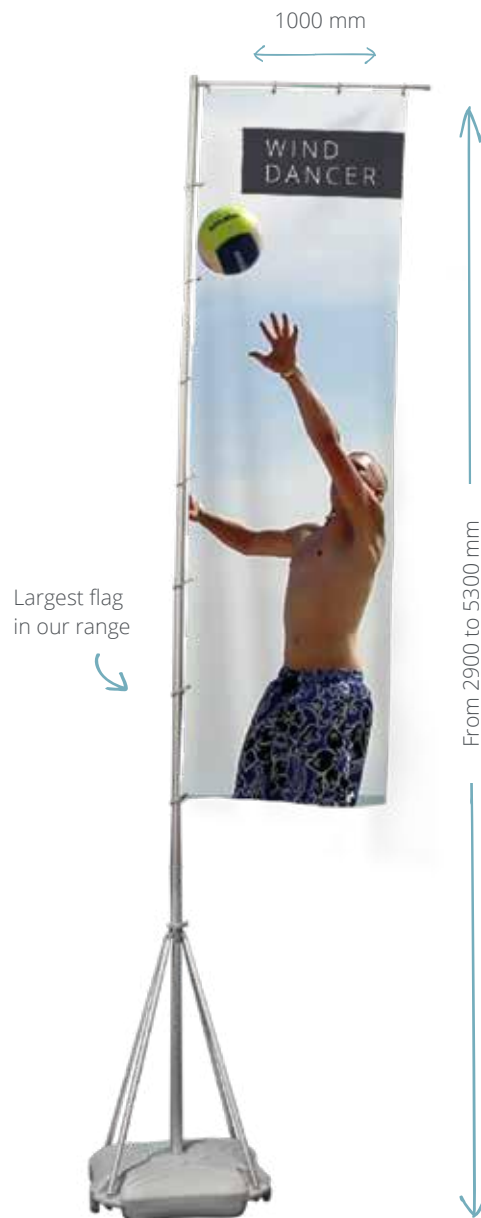



Post / wall mounted flags

Mistral



The Mistral is a fixed outdoor flag system designed for mounting to lampposts or building exteriors and is perfect for advertising or promoting a brand or event. The mechanism attaches directly to a pole, posts, or wall and can be moved to accommodate varying graphic heights. An eye-catching solution that can also be used for information and wayfinding. This flag is especially effective when repeated over a series of posts.

Material	Aluminium castings and GRP tubes
Tube	Height adjustable
Graphic area	Single-sided or double-sided
Graphic attachment	Pole pocket
Wind resistance	Up to 40 km/h

Mistral	UB725-01	890(w) x 2000(h) mm
---------	----------	---------------------

Can be fixed to a pole or wall



Post fixing

Mobile flags

Street Flag



The ideal advertising medium when on the move or when you want to attract attention in a crowded space! Perfectly suited to promote events, highlight your presence at trade shows or to organise a group of people on excursions! Rugged and lightweight the backpack can be used with four different flag shapes and come complete with fibre poles.

Material	Reinforced nylon backpack, fibre poles
Graphic area	Single-sided
Graphic attachment	Pole pocket or eyelets (X-banner)
Graphic shapes	Feather - Quill - Edge - X-banner

Street Flag	UF-ZMSTF-01	📏 310(w) x 540(h) x 80(d) mm
-------------	-------------	------------------------------

X-banner



One bag can be used with 4 flag shapes!

Feather



Quill



Edge



Zippered compartment to store graphics



Reinforced shoulder straps, adjustable strap and side mesh pocket



Storage for poles and rods



Tents

Take advantage of outdoor events with a temporary structure and create additional marketing opportunities. Offer customers protection and shelter from the weather by choosing custom-printed tents, that also provide an attractive brand marketing solution.

Conventional pop-up tents and gazebos are fantastic provisional outdoor or indoor structures which provide a unique way to advertise in a vibrant impactful manner with fully printed canopies and walls.

Constructed from robust steel or aluminium in a variety of sizes that are easy to transport, assemble, deploy and pack away, pop-up tents are ideal for short term events, fairs and exhibitions.

Tents

For a more unique and unconventional structure, choose the Bora Inflatable Tent. Simple to inflate for rapid deployment with an appealing eye-catching shape, the Bora, like pop-up tents, also offers optional printed canopies and walls. Customisable areas make highly effective brand messaging, ensuring maximum impact at events. As with all custom-printed graphics, they can easily be replaced, meaning you are also able to reuse your hardware, improving your return on investment.

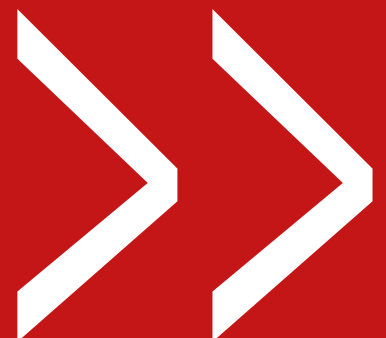

Pop-up tents

Zoom Tent Eco



The Zoom Tent Eco is the most cost-effective gazebo in our range. Quick and easy to deploy, the 3x3m tent can easily accommodate a 2.4m wide table making it a great solution for street markets, golf days or sporting events. Made from steel with a white powder coated finish, the frame easily shelters up to five people and folds completely into a portable wheeled carry bag. Custom fully printed canopy and walling available as an optional extra.



Material	Steel frame, plastic joins
Graphic area	Double-sided (wall) / single-sided (canopy)
Graphic attachment	Hook and loop
Ground fixing	Pegs and ropes (included)
Wind resistance	Up to 18 mph / 29 km/h
Transport	Wheeled standard

Zoom Tent Eco 3x3	FD33-SQF	Ⓞ 3310(w) x 3315/3510(h) x 3310(d) mm
-------------------	----------	---------------------------------------

Canopy	FD33-CTW	Colour : White
--------	----------	----------------



Locking post



Winder for opening and closing



Zoom Tent



Ensure your event's a success come rain or shine by using an easy to deploy vibrant lightweight aluminium pop-up tent frame system. The Zoom Tent folds out and returns in minutes with tool-free deployment. Dress with a custom full printed canopy, full and half walls. Available in a range of sizes.



Material	Aluminium frame, plastic joins
Graphic area	Double-sided (wall, half wall) / single-sided (canopy)
Graphic colours	White - Black (standard) / Full Graphic (optional)
Graphic attachment	Hook and loop / Pocket (half wall)
Ground fixing	Pegs and ropes (included)
Wind resistance	Up to 18 mph / 29 km/h
Transport	Wheeled Standard



2x2 frame	ZT22-XAF-01	2000(w) x 3160(h) x 2000(d) mm
3x3 frame	ZT33-XAF-01	2920(w) x 3160(h) x 2920(d) mm
3x4.5 frame	ZT345-XAF-01	4300(w) x 3160(h) x 2920(d) mm
3x6 frame	ZT36-XAF-01	5800(w) x 3160(h) x 2920(d) mm

Canopy	ZTXX-CTK/W	Colours : Black / White
Wall	ZTXX-FWK/W	Colours : Black / White
Half wall	ZTXX-HWK/W	Colours : Black / White

Ancillaries :

7.5 kg Weight	ZT-BASE
Half wall bar 2-3 m	ZT33-MTB

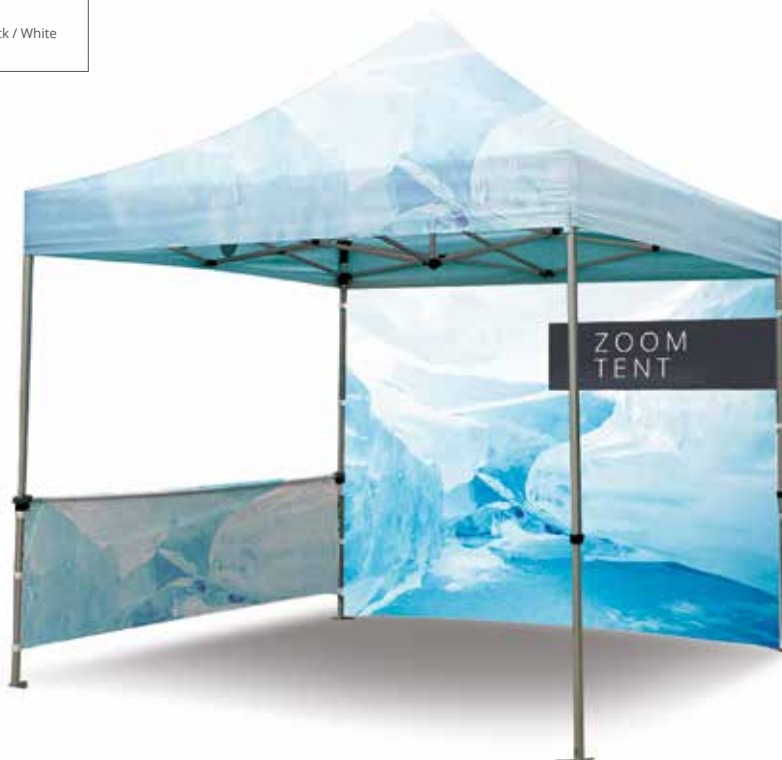

Pop-up frame



Tent weight (optional)



Automatic locking



Crank to tighten the canopy





Inflatable tents

Bora Tent



The Bora Inflatable Tent is a sturdy and attractive option for outdoor displays. Create shade and shelter for a registration desk, refreshment area or meeting point that fully shows off your brand. As one of the largest products in the range, there is plenty of print area on the canopy and backwalls (optional extra) for brand messaging. The backwalls zip in, so can be changed for a different message from the canopy if you wish. The Bora Tent uses trapped air technology: silent and free-standing once inflated.



Material	TPU, Polyester inner coat
Graphic area	Single-sided
Graphic attachment	Zip system (standard) / hook and loop (full graphic)
Ground fixing	Pegs (optional)
Wind resistance	Up to 24 mph / 39 km/h (if pegged)
Transport	Standard (included)

Bora Tent	INFT3-2Z	3200(w) x 2450(h) x 3200(d) mm
-----------	----------	--------------------------------

Canopy	INFT3-CZ-W/BL/B/R	Colours : White / Black / Blue / Red
Door	INFT3-WA-W/BL/B/R	Colours : White / Black / Blue / Red

Ancillaries :

Electric pump 600W	INFTA-PE4EU
--------------------	-------------



400W electric pump (optional)



Inflation valve



Carry bag included



Counters

Temporary counters add a professional touch to any exhibition, event, or retail environment. They provide a useful area for display or presentation space and, the ability to add a graphic, creates additional marketing opportunities as well as offering a convenient storage facility.

Our counters are available in a range of price points and shapes, depending on requirements. Add impact to a welcome desk or a reception area in a public space with an illuminated counter or choose an outdoor option to promote a product or service at an open-air event.

Counters

Counters are the perfect partner for a promotional display or event to complement a backdrop or add focus to an area and are the ideal companions for any marketing campaign.



Non-illuminated promotional counters

Pop-up Counta



A convenient lightweight pop-up counter that offers a substantial area to welcome guests yet packs down for easy transportation in a reinforced D-shaped wheeled trolley case. The counter comes with shelves for storage and a beech-coloured counter-top. Often used for exhibitions, in supermarkets as a demonstration unit and for events.

Material	Aluminium, plastic and MDF tabletop
Assembly	Self-locking magnetic
Collapsible	Yes
Counter top	Foldable - Beech colour
Shelves	4
Graphic attachment	Magnetic hangers, bars and tape (included). Suitable for 440 microns min. substrate (optional extra)
Transport	1 Wheeled trolley case

Pop-up 2x2	PUC22C-C	📏 985(h) x 1290(w) x 465(d) mm
------------	----------	--------------------------------



Structure



Magnetic fixing



Wheeled carry bag



Hop-up Counta



Durable lightweight hop-up counter, quick and easy to assemble with a single wrap around fabric graphic which stays on when collapsed and packed away. The unit is fitted with a beech effect counter top and provides a perfect welcome for guests.

Material	Aluminium, plastic, MDF tabletop and polycarbonate shelf
Assembly	Plastic locking arms
Collapsible	Yes
Counter top	Beech
Shelves	1
Graphic attachment	Hook and loop
Transport	One wheeled carry bag

Hop-up	HU301-001-C	📏 1020(h) x 1060(w) x 360(d) mm
--------	-------------	---------------------------------



Counter components



Plastic locking arm



Carry bag included



Modulate™ Counter



Modulate™ Counter consists of an innovative aluminium tubular frame, counter-top, and printed tension fabric graphic. Powerful magnets encased inside the frame enables two or more counters to connect using simple magnetic principles. The counter can be used on its own or combined to make a long reception or bar area. Modulate™ Counter can be deployed in minutes, thanks to the tool-less construction. The printed tension fabric graphic will either sit on or under the counter-top to suit the application.

PATENT PENDING **MODULATE™**



Use it on its own or combined, simply by using the integrated magnets!



2 possible finishes (with or without visible shelf)

Material	Ø 30mm Aluminium tubes, MDF tabletop/shelf
Assembly	Push-fit button
Collapsible	Yes
Counter top	Black
Shelves	1 (Optional)
Graphic attachment	Zip system
Transport	One padded carry bag, internal flap

Modulate™ Counter	FORM-MOD-CNTR	Ⓞ 1015(h) x 800(w) x 600(d) mm
-------------------	---------------	--------------------------------

Shelf	FORM-MOD-CNTR-02	Ⓞ 9(h) x 770(w) x 571(d) mm
-------	------------------	-----------------------------



Tabletop is held in place by plastic moulding underneath



Optional shelf

Basic Curved Counter



With a Double-D shape counter-top, the Basic Curved Counter delivers a functional and stylish look which is perfect to use for a reception desk or meeting point. The Counter is made from a rollable Corex tambour wrap to create the curved shape which push-fits into the thermoformed counter-top and base. A graphic can also be applied to the curved base to promote a message or brand. There is an opening for storage at the rear of the unit.

Material	MDF tabletop/base, Corex wrap
Assembly	Push-fit - Tool-free
Collapsible	Yes
Counter top	Beech / black
Transport	2 carry bags - included

Basics Curved Counter beech/black	PK922	Ⓞ 925(h) x 910(w) x 480(d) mm
Basics Curved Counter white/black	PK922-BLK	Ⓞ 925(h) x 910(w) x 480(d) mm



Interchangeable tabletops and bases

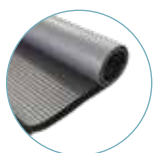

Grey counter wrap



Carry bag included

Counta



Lightweight portable indoor PVC demonstrator unit which includes header panel, poles and shelf supporting poles. Printed graphics can be applied as vinyl directly onto the base wrap. Available in white. Perfect for use in retail environments, one off events and promotions.

Material	PVC
Assembly	Push-fit - Tool-free
Collapsible	Yes
Counter top	No
Shelves	1
Graphic attachment	Self-adhesive
Transport	Carry bag

Counta	PC607	<ul style="list-style-type: none"> ⓐ Counter and front graphic - 2195(h) x 805(w) x 450(d) mm ⓑ Front graphic - 280(h) x 680(w) x 20(d) mm
--------	-------	--

Carrying bag included



Shelf for storage



Promotional counter, ideal for a retail



Tornado



Tornado is constructed from a lightweight frame with tambour graphic wrap, making it a very portable promotions counter. Additional features such as support poles and header panel give a brilliant finish and high visibility. The hollow base can be filled with water or sand to ensure it is stable and secure in outdoor environments.

Material	Moulded HDPE, PVC tambour
Assembly	Push-fit - Tool-free
Collapsible	Yes
Counter top	White
Shelves	No
Graphic attachment	Push-in
Transport	2 carry bags - optional extra

Tornado Base	PK410	ⓐ 1040(h) x 850(w) x 500(d) mm
Tornado Header	PK411	ⓑ 250(h) x 600(w) x 20(d) mm



Optional drum bag



Optional tabletop and base bag



Create extra brand visibility with a header



Base fills with water or sand for stability for outdoor use

Illuminated promotional counters

Embrace+ LED Counter



The Embrace+ Backlit Counter is a double-sided portable unit that can be quickly deployed and will add impact to any event or exhibition stand. The counter comprises of four main components: the collapsible white aluminium powder coated frame, the LED curtain lights, the counter-top and a set of optional SEG tension fabric graphics. The backlit LED curtain lights provide consistent illumination with no black spots and are powerful enough to illuminate both sides of the frame, without the need to add an additional LED curtain.



Material	Aluminium, plastic, metal locking arms, MDF tabletop
Assembly	Plastic locking arms
Collapsible	Yes
Counter top	White
Graphic attachment	Silicone Edged Gasket 3 mm (SEG)
Transport	Bag included
Accessories	LED lighting (included)

Embrace+ LED	EMB-PL-CNTR-LED-01	📏 1022(h) x 1040(w) x 310(d) mm
--------------	--------------------	---------------------------------



Fabric graphic attaches with silicone edging (SEG)



Light strip



Bag



Collapsible structure

Illumigo™ Counter



This versatile and quick to set-up double-sided counter lightbox is a great all-rounder not only at events but in retail environments from shopping centres to pop-up shops. Part of the Illumigo™ range, the Illumigo™ Counter is easy to assemble with a two-part counter-top that secures using a pair of twist out top locators and locking screws. Building the unit is intuitive and tool-free as all the parts are numbered and simply slot together. Two optional graphics complete the look to create an impactful counter ideal for attracting attention in retail, event or exhibition environments.

Material	Aluminium 100 mm, MDF table top
Assembly	Tool-free
Collapsible	Yes
Counter top	White
Graphic attachment	Silicone Edged Gasket 3 mm (SEG)
Transport	Protective box with carry handle
LED System	Led strips included

Illumigo™	ILLGO-COUNTER	📏 1045(h) x 1040(w) x 420(d) mm
Illumigo™ Bag	ILLGO-BAG	📏 1160(h) x 460(w) x 190(d) mm



Optional Illumigo™ bag

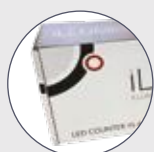

Protective compartmented box



Pre-assembled LEDs in the frame

Steel side feet for stability





Barriers

Barrier systems improve queue management and help with crowd control.

For pedestrian control, café barriers can be used to make an attractive, professional and functional barrier, creating a temporary space that can be easily reconfigured to suit your needs.

Café barriers are easy to store, assemble, deploy and move to suit your requirements. They are available in economy and premium solutions, depending on your application and budget.

Barriers

Queue management systems can be used to control queues, providing structured and manageable lanes to help marshal customers and are also suitable for indoor or outdoor use.



Pedestrian control standard barriers

Economy Café



A cost-effective way of defining areas outside restaurants, bars, shopping centre and coffee shops. A complete Café Barrier system requires two posts and bases. To secure the graphic, there are two options; dependent on budget and where the system is being deployed. If the Café Barrier is exposed to strong winds, we recommend a two-rail option ensuring the graphic is secured top and bottom to each post and base. If winds are not an issue but the budget is tight, then we suggest a single rail with two spring clips securing the bottom of the graphic. Rails are available in 1m, 1.5m and 2m sizes so it is quick and easy to calculate the number of café barriers required to define your space. To connect multiple barriers, add your choice of rails/spring clips plus one additional pole and base. All hardware components are finished in black. We can print vibrant graphics on PVC vinyl or recycled eco media.

Material	Stainless steel
Graphic area	Double-sided / or single-sided
Graphic attachment	Looped top rail. Looped bottom rail or spring clips
Weight	9.13 kg

Graphic Rail 1000 mm	UB214-1000	⊗ 1140(w) x 25(h) mm
Graphic Rail 1500 mm	UB214-1500	⊗ 1940(w) x 25(h) mm
Graphic Rail 2000 mm	UB214-2000	⊗ 2440(w) x 25(h) mm
Base	UB214B	⊗ 360 (Ø) mm
Post	UB214P	⊗ 960(h) mm
Spring clips (pair)	UB214-SC	

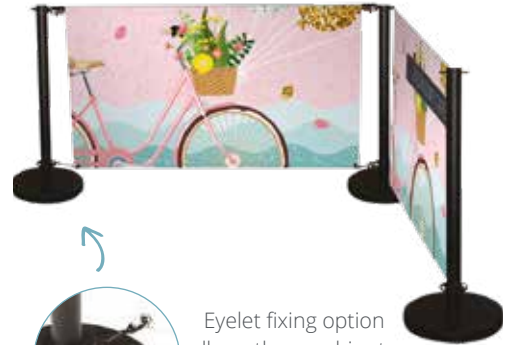

Eyelet fixing option allows the graphics to follow the movements of the wind



Spring clips for securing eyelet graphic



Graphic rail



Base and post

Pedestrian control premium barriers

Deluxe Café



With premium look and feel the modular Café Barrier system defines areas outside restaurants, bars, coffee shops, shopping centre and club houses. A complete Café Barrier system requires two posts and bases. To secure the graphic, there are two options; dependent on requirements and where the system is being deployed. If the Café Barrier is exposed to strong winds, we recommend a two-rail option ensuring the graphic is secured top and bottom to each post and base. If winds are not an issue and you want movement in the graphic, chose a single rail with two spring clips securing the bottom of the graphic. Rails are available in 1m, 1.5m and 2m sizes so it is quick and easy to calculate the number of café barriers required to define your space. To connect multiple barriers, add your choice of rails/spring clips plus one additional pole and base. All hardware components are finished in a premium chrome effect. We can print vibrant graphics on PVC vinyl or recycled eco media.



Material	Stainless steel chrome
Graphic area	Single / double sided
Graphic attachment	Looped top rail. Looped bottom rail or spring clips
Weight	8.63 kg



Graphic Rail 1000 mm	UB215-1000	⊘ 1140(w) mm
Graphic Rail 1500 mm	UB215-1500	⊘ 1940(w) mm
Graphic Rail 2000 mm	UB215-2000	⊘ 2440(w) mm
Base	UB215B	⊘ 360 (Ø) mm
Post	UB215P	⊘ 960(h) mm
Spring clips (pair)	UB215-SC	

Queue management standard barriers

Basic Leader



Basics range for retractable barrier system, ideal for use in retail outlets, post offices, cinemas, and airports. A complete system requires two sets of post and base. All hardware components are finished in black. Retractable webbing is available as a separate cassette that slots into the post and can be deployed at a length of up to 2m. Webbing colour is black.

Material	Steel, aluminium, plastic
Colour	Black (base and post) Black (webbing)

Basics Leader Retractable Belt	SP-803B
Basics Leader Post	SP-801B
Basics Leader Base	SP-913B



Retractable webbing cassette



Ancillaries

The range of ancillary products include literature holders, lighting solutions for various hardware ranges and transportation cases. These ancillaries offer flexibility and perfectly complement our product solutions.

Ancillaries

You can enhance your exhibition stand by selecting various supporting products from our range of ancillaries, that are often used to help promote your brand in a more impactful way, professionally display your latest literature, or add points of interest / making your stand more visible by using spot lights.



Literature holders (standard)

Zed-up Lite



A popular range of aluminium literature stands that are stylish and highly portable. Quick and easy to deploy Zed-up Lite is ideal for exhibitions and displays. Folds down for easy transportation in a heavy duty hard case.

Material	Acrylic and anodised aluminium
Colour	Silver
Documents sizes	A5 / A4 / A3
Pockets	6
Double-sided	Yes
Transport	Hard case (included)

A5 (6 pockets)	AS318-002	Ⓞ 210(w) x 1115(h) x 280(d) mm
A4 (6 pockets)	AS315-002	Ⓞ 256(w) x 1460(h) x 370(d) mm
A3 (6 pockets)	AS319-002	Ⓞ 470(w) x 1420(h) x 370(d) mm



Rigid carry case included



Linear Media Post



A robust, handy and very versatile information and promotional stand incorporating 3 literature holders. The post holds a rigid graphic which can be shaped to fit the display style; making it ideal for retail presentations.

Material	Anodised aluminium post, steel dome base
Colour	Silver
Documents sizes	A4
Pockets	3 - included
Double-sided	No
Graphic area	Optional extra - ideal with 5 mm foamed PVC
Transport	Carry bags (optional extra)
Availability	Made on request

Linear Media Post	LK026-001	Ⓞ 523(w) x 2060(h) x 450(d) mm
-------------------	-----------	--------------------------------



Lighting (standard)

Powerspot 950/1000 LED



Economical black LED spotlight particularly suitable for use with pop up stands.

Material	Aluminium and plastic
Positioning	270° - Straight arm
Watt output	12 watt (1400 lumens/5500 kelvins)
Watt consumption	12 Watt (1400 lumens/5500 Kelvins)
Linked lights	2 max
Double kit includes	2 spotlights + 2.5m linking lead + 1 transformer
Power lead UK & Euro	Yes (cross head screwdriver needed)



Double kit	PS950-1000-BDLK	ⓐ 103(w) x 425(h) x 29(d) mm
------------	-----------------	------------------------------



Transformer included

Lighting (premium)

LED Floodlight



The LED Floodlight is the new stylish and economical way to illuminate a range of exhibition stands including Pop-ups, Formulate and a range of modular systems. Don't let the compact design fool you, this small LED light is still capable of producing 1200 lumen but still only consuming a small amount of energy, making it far more efficient than the halogen equivalents. Link up to 5 lights together from one transformer, so no need for extra transformers just link them together with handy linking cables.

Material	Aluminium and plastic
Watt output	80 watt
Watt consumption	12 watt (1200 lumens/5631 Kelvin)
Linked lights	Link up to five to one transformer
Double kit includes	2 spotlights + 2.5m linking lead + 1 transformer
Power lead UK & Euro	Yes (cross head screwdriver needed)



Double kit	LED-FLOOD-ARM-BDLK	ⓐ 295(w) x 483(h) x 60(d) mm
------------	--------------------	------------------------------



Transportation box



Transformer included

Connection up to 5 lights with one transformer

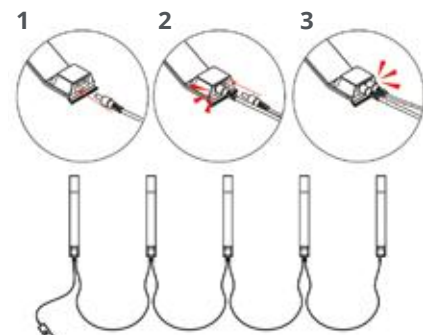

LED Strip Light



The LED Strip light is designed to work with a wide range of exhibition stands including, Pop-ups, Formulate and a range of modular stands. It has a unique wide head design feature, allowing for a wider spread of light, helping you illuminate more of your message. Link up to 5 lights together from one transformer, so no need for extra transformers just link them together with handy linking cables.

Material	Aluminium and plastic
Watt output	80 watt
Watt consumption	12 watt (1200 lumens/5631 Kelvin)
Linked lights	Link up to five to one transformer
Double kit includes	2 spotlights + 2.5m linking lead + 1 transformer
Power lead UK & Euro	Yes (cross head screwdriver needed)



Double kit	LED-STRIP-ARM-BDLK	100(w) x 520(h) x 35(d) mm
------------	--------------------	----------------------------



Transportation box



Transformer included

LED Exhibition Light



Specifically designed to work in conjunction with The Linear and Vector channel; this latest design requires no extra fitting, just plug in and switch on. Not only does the slick design make the LED Exhibition light stand out from the crowd, the clever design cast out of aluminium allows any heat to dissipate over the entire body of the light, stopping any localised heat, which allows for long use with no over heating. Link up to 5 lights together from one transformer, so no need for extra transformers just link them together with handy linking cables.

Material	Aluminium and plastic
Watt output	80 watt
Watt consumption	12 watt (1200 lumens/5631 Kelvin)
Linked lights	Link up to five to one transformer
Double kit includes	2 spotlights + 2.5m linking lead + 1 transformer
Power lead UK & Euro	Yes (cross head screwdriver needed)



Double kit	LED-EXHIB-ARM-BDLK	50(w) x 455(h) x 55(d) mm
------------	--------------------	---------------------------



Transportation box



Transformer included

Lighting ancillaries

Recommended fixings for lighting

Integrated fixing						
	Universal fixing kit US901-C	Vector fitting VLF	Linear fitting US-LINEAR	LED fitting for Quick+ US902-C	30mm Ø Tube clamp US903	
Compatible with :						
 Spot LED Flood LED-FLOOD-ARM-BDLK	> Aero > Quick + > Embrace	> Arena > Gear Edge Panels > Baseline Panels	> Vector	> Linear	> Quick Impact > Quick + > Hop Up > Xclaim	> Formulate > Modulate
 Spot LED Strip LED-STRIP-ARM-BDLK	> Aero > Quick + > Embrace	> Arena > Baseline Panels	> Vector	> Linear	> Impact > Quick + > Hop Up	> Formulate > Modulate
 Spot LED Exhibition LED-EXHIB-ARM-B	> Linear > Vector	/	/	/	/	/
 Powerspot 950-1000 LED PS950-1000-LED-BDLK	> Impact > Embrace > Quick + (except Quick+ tower) > Hop-up	> Arena	> Vector	> Linear	/	> Formulate > Modulate

Convert your UK plug into EU version



Unscrew



Lift the lid



Pull the plug to extract it

Portable transportation cases

Zenith



Tough moulded polyethylene Zenith case offer a multitude of features. Versatile ultra-portable transport solution with maximum storage for pop-ups, backwalls, roller banners and extrusions, they also double up as counters with optional extra graphic wrap and table top. The standard case will house a 3x5 pop-up system and graphics. Secure Internal dividers protect graphics and the case can be locked using padlocks (not supplied).

Material	Medium-density polyethylene (MDPE) / Metal
Wheels	2
Handle	1
Accessories	Beech table top / graphic wrap

Zenith	AC600	Ⓞ, (External dimensions) 600(w) x 956(h) x 400(d) mm
--------	-------	--

Ancillaries :

Tabletop (beech)	CO401-C	Ⓞ, 15(h) x 640 (l) x 420 (p) mm
------------------	---------	---------------------------------



With wheels for easy transportation



Zenith case thermoformed tabletop in beech



Foam protected lid holds two LED lights



Graphic wrap (optional)

Illumigo™ Bag



Wheeled bag for Illumigo™ 2x1, Retail, One or the Illumigo™ counter.

Material	Nylon and inner MDF
Colour	Black
Wheels	Yes
Handle	2

Illumigo™ bag	ILLGO-BAG	Ⓞ (Internal dimensions) 460(w) x 1160(h) x 190(d) mm
---------------	-----------	--



Wheeled bag



Inner compartment for graphic



Carry handle

Bag without tube



Nylon bag with shoulder strap for extra protection during transport.

Graphic up to 850(h) mm	AB120	Ⓞ 850(h) x 155 (Ø) mm
Graphic up to 1050(h) mm	AB120A	Ⓞ 1050(h) x 155 (Ø) mm
Graphic up to 1550(h) mm	AB120D	Ⓞ 1550(h) x 155 (Ø) mm







Custom and made to measure graphics

To guarantee quality visuals that are adaptable for multiple uses, we have selected a wide range of printing materials for you. From conception to finishing, we guarantee you a perfect fit and good quality vibrant printed custom graphics.

If you require a special format, or finish, we invite you to contact one of our advisers for a custom-made quote.

Below you will find some suggestions for frequently used formats.



Tablecloths
with hem



Cover for anti-theft security cover
Sleeve



Horizontal flag
Loop fastening with rings



Custom shapes available

Vertical flag
Straps and hook fastening



Other suggestions
Customised finish on request



Applications

We Provide creative display solutions that suit a multitude of industry applications.

Our display products are not only multi-functional and in many cases reconfigurable, but they can also be used for an array of different applications across a multitude of industries.

From retail or educational settings, outdoor sporting events to hospitality and corporate events; our creative display solutions are suitable for more than just exhibitions.

The following pages are a guide for where our popular products are often used to enhance brand messaging, in a vibrant and eyeing catching way.



Retail

In the age of digitalisation, the main challenge for retail is to consider the customer experience at the point of sale.

Window displays



Commercial events



Retail signage



Pop-up Store



Seasonal Campaigns



Sales



Shop openings



Click and collect



Car showroom



Leisure Activities

The leisure industry represents an important part of the economy. From hospitality through to galleries, promoting the benefits of improved well-being and quality of life is essential with innovative displays that catch the eye.



Interior signage



Outdoor signage



Posters



Music venues



Hospitality signage



Suspended signage



Fairs and markets



Cinema foyers



Art galleries





Cultural Events

Social events with a national or international scope involve a large audience and can have a huge impact. The organisation is often extremely complex and requires significant communication resources.

Award ceremonies



Award ceremonies



Professional sporting events



Amateur sporting events



Fundraising



Festivals



Military open days



Electoral campaigns



Fashion shoot



Corporate Events

Corporate events are essential for companies to maintain close relationships and partnerships with their customers, business partners or employees.



Product launches



Brand launches



Sales meetings



Outdoor corporate events



Corporate meetings



Corporate dinners



Gala events



Open days



Showrooms





University Events

Educational, artistic and cultural events offer encounters, projects and practical experiments. The aim is to ensure artistic and cultural educational coherence for all pupils.

Open days



Campus life



Graduation ceremonies



Fresher's week



Graduation shows



Career and job fairs



Ceremony staging



Student services



Gown hire



Conference

Preparing a conference is an excellent opportunity for brand exposure at high value-added events. Brand messaging should communicate exceptional, new, or informative and important information relating to your business.



Conferences



Seminars



Press conferences



Product launch



Concourse advertising



Roadshows



Networking



Trade fair



Annual General Meetings (AGMs)





Exhibitions

From planning to execution: give your brand the exposure it deserves with original, renewable and customised solutions.

Exhibition reception area



Exhibition shell system



Merchandising stand



Exhibition literature stand



Art gallery exhibition



Reconfigurable exhibition



Virtual exhibition



Reconfigurable stand



Exhibition - suspended



Outdoor

Custom printed flags, signage, and tents invigorate any outdoor activity and attract attention to help brands or businesses stand out.



Car dealerships



Sporting meets and races



Festivals



Sales



Museums



Outdoor music events



Clubs



Inflatable



Shelter



Notes

Notes

Product Index

A

3m Wall	33
6m Wall	33
Arena Components.....	51
Arena stand designs	52
A-sign Board	78

B

Bag without tube.....	137
Barracuda	100
Baseline Jumbo Panel Kits	70
Baseline Panel and Pole Kits.....	69
Baseline Panel Kits.....	70
Baseline Tabletop Panel kit	71
Baseline Wheeled Panel Kits	71
Basics Curved Counter	123
Basics Leader.....	129
Beijing Lite	102
Blizzard.....	102
Bora Column.....	81
Bora Tent	119
Breeze	101

C

Custom and made to measure graphics	139
Counta.....	124

D

Delta Lite	98
Deluxe Café.....	129
Dragonfly 2	97

E

Economy Café.....	128
Embrace+	60
Embrace+ LED Counter	125

F

Formulate Arch.....	56
Formulate Horizontal Curve	66
Formulate Meeting Pod	67
Formulate Monolith.....	93
Formulate Monolith Eco.....	93
Formulate Shadow.....	79
Formulate Square Hanging Structure.....	55
Formulate Straight.....	66

G

Gala Table	81
Grasshopper.....	97

H

Hop-up Counta.....	122
Hop-up Impact Curved.....	65
Hop-up Impact Straight.....	65
Horizon.....	72

I

Illumigo™.....	90
Illumigo™ 2x2	91
Illumigo™ Bag	137
Illumigo™ Counter	125
Illumigo™ One	90
Illumigo™ Retail.....	91
Impact Pop-up Curved	62
Impact Pop-up Curved Bundle ...	62
Impact Pop-up Straight	61
Impact Pop-up Straight Bundle..	61

L

LED Exhibition Light.....	134
LED Floodlight	133
LED Strip Light.....	134
Liberty Mini.....	101
Linear ancillaries	49
Linear Media Post	132
Linear Modules.....	42
Linear stand designs	43

M

Mantis.....	95
Merlin	100
Mistral.....	112
Modulate ancillaries	15
Modulate™ Counter.....	123
Modulate™ Slope	14
Modulate™ stand examples	16
Modulate™ Straight	12
Monsoon.....	80
Mosquito.....	96

O

Orient+	98
---------------	----

P

Pegasus	72
Pegasus 3m.....	73
Pop-up Counta	22
Powerspot 950/1000 LED.....	133

Q

Quick+ Curved Bundle.....	64
Quick+ Curved Kit	64
Quick+ Straight Bundle	63
Quick+ Straight Kit	63

S

Sentry	76
Shield.....	77
Shimmer.....	109
Stowaway.....	80
Strata components	87
Street Flag	113
Street Sign.....	78
Symbol.....	77

T

Thunder 2	99
Tornado.....	124
Trappa Frame	82
Twista Lite	85

V

Vector custom stands.....	35
Vector 50mm Kit	68
Vector 75mm LED Kit.....	84
Vector 125mm LED Hanging Structure.....	54
Vector 125mm LED Kit.....	92
Vector Media	94
Vector Modules	23
Vector Modules ancillaries.....	34
Vector stand designs	25
Vector Quick-fix Hanging Kit.....	39
Vector Quick-fix Wall Kit.....	82
Vector Slim Circular Wall Kit	83

W

Wasp.....	95
Wedge	76
Wind Dancer	110

Z

Zed-Up Lite	132
Zenith	136
Zoom+ Arch	109
Zoom+ Edge Flag.....	107
Zoom+ Quill / Feather Flag	106
Zoom Tent.....	117
Zoom Tent Eco	116

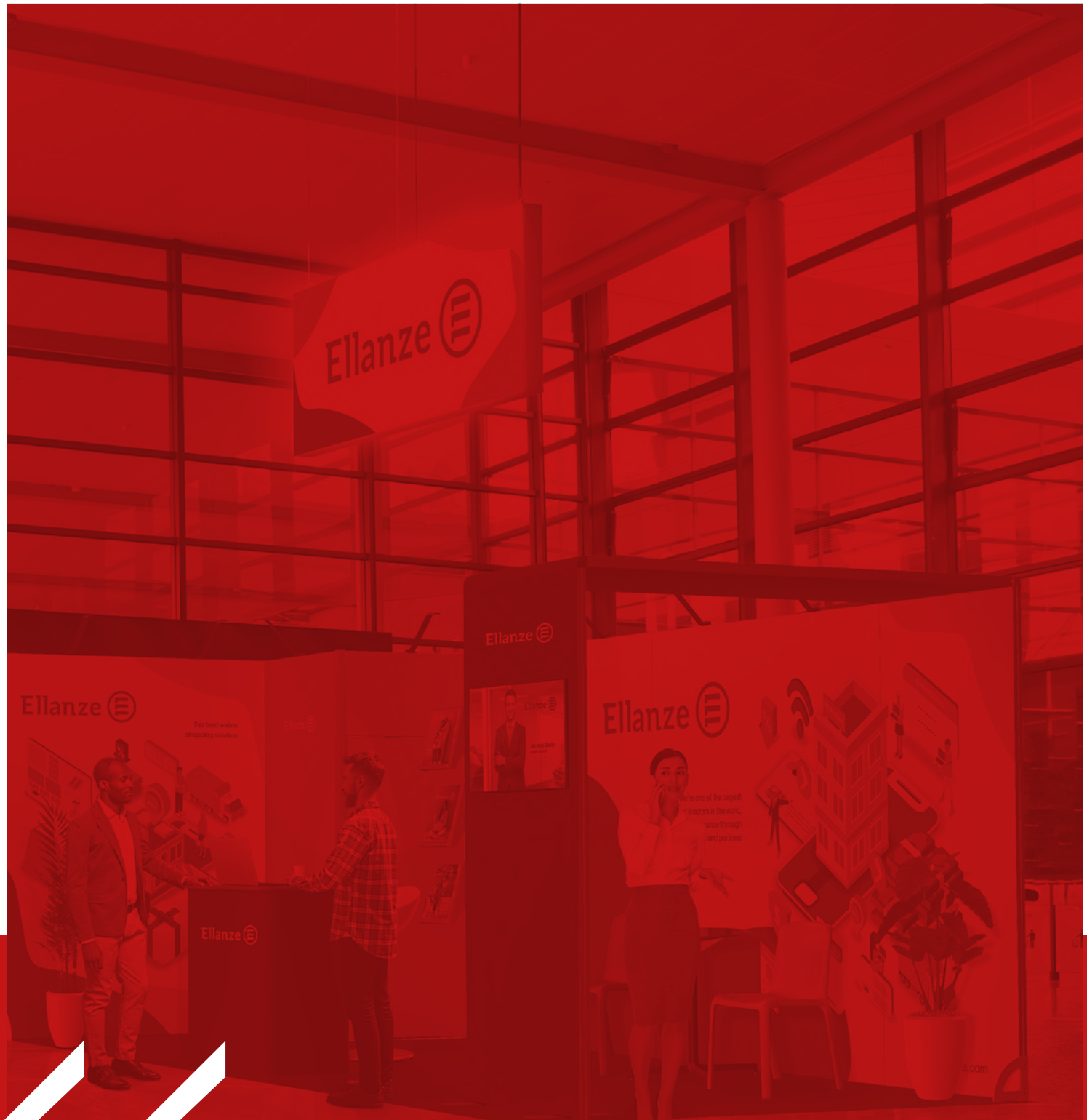

TERTZIA AB
Basteråsvägen 23
51172 FRITSLA

TEL 0320 749 00
E-post:info@reklamsaker.se

www.reklamsaker.se

HANU_EN_2022/23_V1