

KENRAY®

Perform Better



Vertical (VFFS)

KENRAY SNACKS FORMERS

The highly specialised range of KENRAY Snacks Formers have been specifically researched, designed and developed over several decades. Our expertise in this sector has been enhanced through our long-term partnership with some of the largest snacks organizations in the world.

CHARACTERISTICS OF A TYPICAL SNACK FORMER

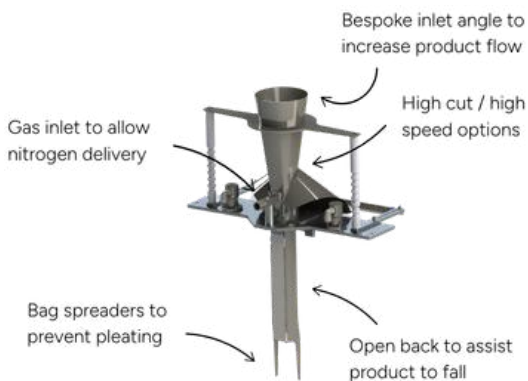

- > Significantly boosts production speed for high-volume lines
- > Ensures precise and consistent pouch filling every time
- > Reduces film usage and minimises material waste
- > Fully customisable to suit various snack types
- > Built with durable materials for long-term use



OUR SOLUTIONS

We have listened our customers' requirements and developed solutions which offer improved inlet speeds and performance for the competitive Snacks industry.

KENRAY's proven out-of-the-box solution offers total reassurance and reliability in an ever demanding market.

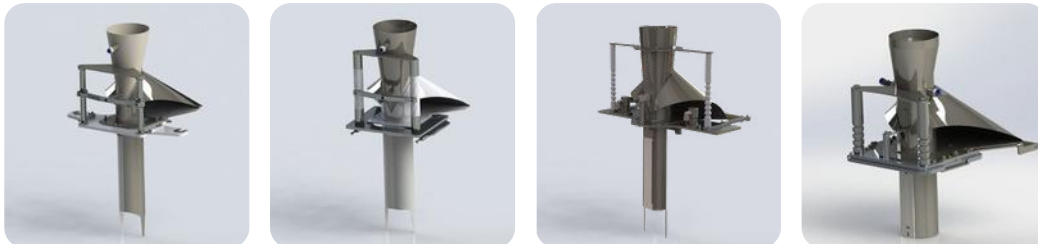

Kenray Forming Ltd (UK Headquarters)
Telford Way, Stephenson Industrial Estate
Coalville, Leicestershire LE67 3HE, UK

 perform@kenrayglobal.com

 +44 (0) 1530 400 100

Registered in England: **No 5097462**

Kenray Europe Sp. z o.o. (European Hub)
Lipie 71A, Głogów Małopolski (Woj. Podkarpackie)
36-060 Poland

 europe@kenrayglobal.com

 + 48 889 441 554

Registered in Poland: **No PL 8133899127**

KENRAY CEREALS FORMERS

Kenray Global's Cereal Packaging Solutions are designed to handle the unique challenges of packaging dry, free-flowing products such as breakfast cereals and granola. With a focus on efficiency, precision, and product protection, our forming sets ensure consistent, high-quality packaging that preserves freshness and reduces product breakage.

CHARACTERISTICS OF A TYPICAL CEREAL FORMER



- > Smooth product flow to prevent blockages and ensure consistent filling
- > Optimised film control for tight, secure seals and minimal material waste
- > Engineered to protect fragile cereals and prevent breakage
- > High-speed production performance without compromising efficiency
- > Durable construction for continuous operation in demanding environments



OUR SOLUTIONS

We work closely with leading cereal manufacturers to develop forming sets that optimise performance, minimise material waste, and maintain the integrity of fragile cereal products during the packaging process. With Kenray's expertise, you can ensure smooth operations and consistently well-formed, secure packs.



Kenray Forming Ltd (UK Headquarters)
Telford Way, Stephenson Industrial Estate
Coalville, Leicestershire LE67 3HE, UK

 perform@kenrayglobal.com
 +44 (0) 1530 400 100

Registered in England: **No 5097462**

Kenray Europe Sp. z o.o. (European Hub)
Lipie 71A, Głogów Malopolski (Woj. Podkarpackie)
36-060 Poland

 europe@kenrayglobal.com
 + 48 889 441 554

Registered in Poland: **No PL 8133899127**

KENRAY CONFECTIONERY FORMERS

Kenray Global's Confectionery Packaging Solutions are designed to handle the delicate nature of sweets, chocolates, and sugar-coated products while ensuring efficient, high-speed packaging. With a focus on precision and product protection, our forming sets help manufacturers maintain the quality and presentation of their confectionery products.

CHARACTERISTICS OF A CONFECTIONERY FORMER

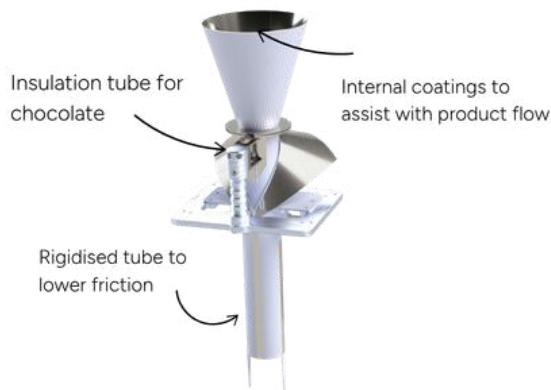

- > Gentle product handling to prevent breakage and maintain shape
- > Smooth film movement for precise bag formation
- > Supports high-speed production with secure and consistent seals
- > Customisable for pillow bags, gusseted pouches, and more
- > Built with durable materials for continuous, demanding use



OUR SOLUTIONS

From individually wrapped chocolates to multi-pack sweets, our forming sets are engineered to reduce breakage, minimise waste, and optimise seal integrity. With Kenray's expertise, you can achieve consistent, reliable packaging that enhances product appeal and extends shelf life.

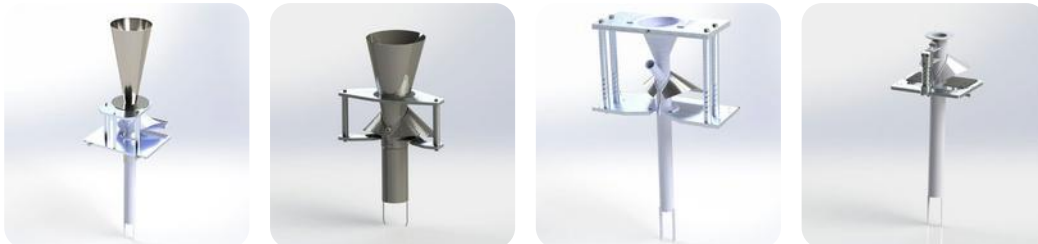

Kenray Forming Ltd (UK Headquarters)
Telford Way, Stephenson Industrial Estate
Coalville, Leicestershire LE67 3HE, UK

 perform@kenrayglobal.com

 +44 (0) 1530 400 100

Registered in England: **No 5097462**

Kenray Europe Sp. z o.o. (European Hub)
Lipie 71A, Głogów Małopolski (Woj. Podkarpackie)
36-060 Poland

 europe@kenrayglobal.com

 + 48 889 441 554

Registered in Poland: **No PL 8133899127**

KENRAY SALADS FORMERS

Kenray Global's Salad Packaging Solutions are specifically designed to meet the demands of packaging fresh salads and leafy greens, where delicate handling and precision are essential. Working closely with clients in the fresh produce industry, we've developed forming sets that address the challenges of packaging high-moisture, fragile products. Designed for efficiency, our solutions ensure smooth product flow, reduce blockages, and maintain the quality of leafy greens throughout the packaging process.

CHARACTERISTICS OF A TYPICAL FRESH SALAD FORMER

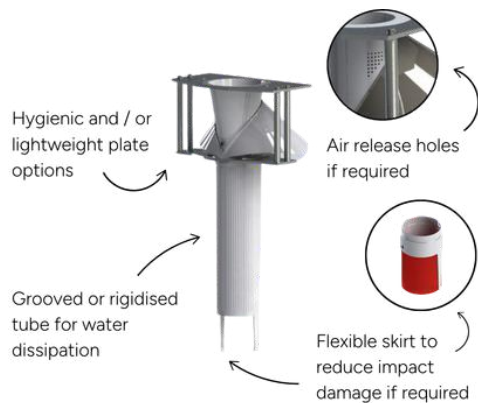

- > Smooth product handling for fragile, moisture-rich leaves
- > Efficient product flow to reduce blockages and improve speed
- > Enhanced film control for tightly packed, appealing bags
- > Minimised film wear to reduce waste during production
- > Durable design for high-demand environments



OUR SOLUTIONS

Over the years, our salad formers have consistently delivered exceptional results in production environments worldwide, combining durability, reliability, and precision. With Kenray's specialised designs, you can ensure consistent performance and maximise the efficiency of your packaging line.



Kenray Forming Ltd (UK Headquarters)
Telford Way, Stephenson Industrial Estate
Coalville, Leicestershire LE67 3HE, UK

 perform@kenrayglobal.com
 +44 (0) 1530 400 100

Registered in England: **No 5097462**

Kenray Europe Sp. z o.o. (European Hub)
Lipie 71A, Głogów Małopolski (Woj. Podkarpackie)
36-060 Poland

 europe@kenrayglobal.com
 + 48 889 441 554

Registered in Poland: **No PL 8133899127**

KENRAY AGRICULTURAL & AGGREGATES FORMERS

Kenray Agricultural & Aggregate Formers — Precision Forming Solutions for Bulk & Field-Crop Packaging.

CHARACTERISTICS OF A TYPICAL AGRICULTURAL & AGGREGATES FORMER



- > Create accurate, stable film tubes and bag shapes for bulk, loose, and free-flowing products such as grains, rice, seeds, pulses, animal feeds, and aggregate materials.
- > Ensure smooth product flow and distribution into the film tube, reducing bridging, hang-ups, and segregation
- > Handle large particulate and variable-sized product with minimal wear on components and consistent film control
- > Optimised for efficient material usage to reduce waste & production costs
- > Built for high-speed operation while ensuring precise, repeatable results



OUR SOLUTIONS

Kenray's Agricultural & Aggregate Formers are engineered forming sets and tooling solutions developed specifically for the unique demands of agricultural produce, grains, seeds, cereals, and bulk aggregate products. Drawing on over four decades of expertise in precision forming engineering, these formers are built to deliver consistent performance, robust reliability, and superior package integrity across high-speed vertical form-fill-seal (VFFS) packaging lines.

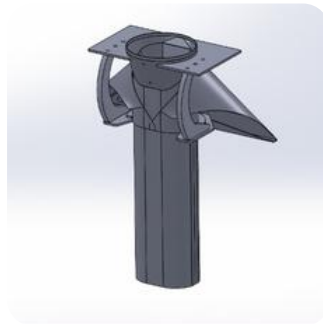

Kenray Forming Ltd (UK Headquarters)
Telford Way, Stephenson Industrial Estate
Coalville, Leicestershire LE67 3HE, UK

 perform@kenrayglobal.com
 +44 (0) 1530 400 100

Registered in England: **No 5097462**

Kenray Europe Sp. z o.o. (European Hub)
Lipie 71A, Głogów Malopolski (Woj. Podkarpackie)
36-060 Poland

 europe@kenrayglobal.com
 + 48 889 441 554

Registered in Poland: **No PL 8133899127**

KENRAY NUTS FORMERS

Kenray Global's Nuts Packaging Solutions are designed to meet the specific challenges of packaging nuts, seeds, and dried fruits. These products require precise handling to prevent breakage, maintain freshness, and ensure consistent portioning. Our forming sets are engineered for efficiency, durability, and high-speed performance to keep your production line running smoothly.

CHARACTERISTICS OF A TYPICAL NUT FORMER

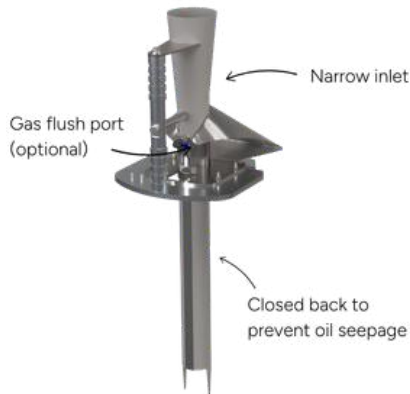

- > Smooth product flow to prevent blockages and ensure accurate filling
- > Optimised sealing to maintain freshness and extend shelf life
- > Engineered to handle various nut sizes and textures without damage
- > Built for high-speed production lines with minimal material waste
- > Durable construction for continuous operation in demanding environments



OUR SOLUTIONS

Whether packaging almonds, cashews, peanuts, or mixed seeds, our solutions provide optimal film control and secure sealing to maintain product quality and shelf life. With Kenray's expertise, manufacturers can achieve reliable, waste-reducing packaging that enhances product presentation.



Kenray Forming Ltd (UK Headquarters)
Telford Way, Stephenson Industrial Estate
Coalville, Leicestershire LE67 3HE, UK

 perform@kenrayglobal.com
 +44 (0) 1530 400 100

Registered in England: **No 5097462**

Kenray Europe Sp. z o.o. (European Hub)
Lipie 71A, Głogów Malopolski (Woj. Podkarpackie)
36-060 Poland

 europe@kenrayglobal.com
 + 48 889 441 554

Registered in Poland: **No PL 8133899127**

KENRAY PET FOOD FORMERS

Kenray Global's Pet Food Packaging Solutions are designed to meet the unique demands of packaging dry and moist pet food products. Whether packaging kibble, treats, or wet food pouches, our forming sets ensure efficient, reliable performance while maintaining product integrity and freshness.

CHARACTERISTICS OF A TYPICAL PET FOOD FORMER

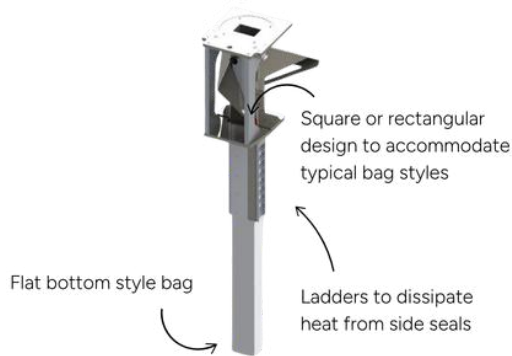

- > Smooth product handling to accommodate various kibble shapes and sizes
- > Optimised film control for airtight, secure seals, ensuring freshness
- > Durable design to withstand heavy loads and continuous operation
- > Customisable for pillow bags, stand-up pouches, and more
- > Engineered for high-speed performance while minimising material waste



OUR SOLUTIONS

With pet food packaging requiring strong, secure seals and durable materials, our forming sets are built to handle high-speed production lines while preventing product loss or contamination. By optimising material flow and seal integrity, Kenray's forming solutions help manufacturers maintain efficiency, reduce waste, and ensure consistently high-quality packaging.



Kenray Forming Ltd (UK Headquarters)
Telford Way, Stephenson Industrial Estate
Coalville, Leicestershire LE67 3HE, UK

 perform@kenrayglobal.com
 +44 (0) 1530 400 100

Registered in England: **No 5097462**

Kenray Europe Sp. z o.o. (European Hub)
Lipie 71A, Głogów Małopolski (Woj. Podkarpackie)
36-060 Poland

 europe@kenrayglobal.com
 + 48 889 441 554

Registered in Poland: **No PL 8133899127**

KENRAY POWDER, TEA & COFFEE FORMERS

Kenray Global's Powder, Tea & Coffee Packaging Solutions are designed to meet the complex demands of packaging fine, free-flowing powder-based products. These products require specialised forming sets to ensure precision filling, secure sealing, and minimal waste during the packaging process.

CHARACTERISTICS OF A POWDER, TEA & COFFEE FORMER



Requires an Auger to dose powder accurately

- > Precision-engineered for accurate dosing and controlled flow during filling
- > Optimised sealing to prevent leaks, spillage, and product contamination
- > Handles various packaging formats, including pouches and sachets
- > Anti-static and moisture-resistant features for improved powder handling
- > Durable construction to withstand continuous high-speed production



OUR SOLUTIONS

From powdered supplements and baking ingredients to sauces and liquid sachets, our forming sets provide optimal film control and leak-resistance.

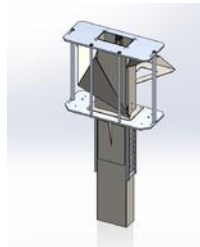

Kenray Forming Ltd (UK Headquarters)
Telford Way, Stephenson Industrial Estate
Coalville, Leicestershire LE67 3HE, UK

 perform@kenrayglobal.com

 +44 (0) 1530 400 100

Registered in England: **No 5097462**

Kenray Europe Sp. z o.o. (European Hub)
Lipie 71A, Głogów Małopolski (Woj. Podkarpackie)
36-060 Poland

 europe@kenrayglobal.com

 + 48 889 441 554

Registered in Poland: **No PL 8133899127**

KENRAY PRODUCE FORMERS

Kenray Global's Produce Packaging Solutions are expertly crafted to tackle the challenges of packaging fresh fruits and vegetables. With their irregular shapes, varying sizes, and delicate textures, produce requires forming sets that balance efficiency, precision and care.

CHARACTERISTICS OF A TYPICAL PRODUCE FORMER

Reinforced, sturdy framework to avoid excessive movement whilst sealing the back

Enhanced features may include rigidised tube to reduce friction

Carrot bottom to work in conjunction with product catchers



- > Allows smooth handling of produce with minimal bruising or damage
- > Accommodates varying sizes and shapes for flexible packaging options
- > Supports high-speed production without compromising product quality
- > Built for durability to handle heavy loads and continuous operation
- > Ensures secure sealing for extended freshness and shelf life



OUR SOLUTIONS

We work closely with clients in the fresh produce industry to design solutions that minimise product damage, optimise flow, and reduce blockages. Our forming sets are tailored to handle a wide variety of produce, from robust root vegetables to delicate berries, ensuring reliable performance across diverse applications.

Proven in production environments around the globe, Kenray's produce formers are built to withstand the demands of high-speed packaging lines. With a focus on durability and innovation, our designs deliver consistent results, helping you maintain efficiency and protect the quality of your products.



Kenray Forming Ltd (UK Headquarters)
Telford Way, Stephenson Industrial Estate
Coalville, Leicestershire LE67 3HE, UK

 perform@kenrayglobal.com

 +44 (0) 1530 400 100

Registered in England: **No 5097462**

Kenray Europe Sp. z o.o. (European Hub)
Lipie 71A, Głogów Małopolski (Woj. Podkarpackie)
36-060 Poland

 europe@kenrayglobal.com

 + 48 889 441 554

Registered in Poland: **No PL 8133899127**

- > Forming sets & Repairs
 - > Former coatings
- > Horizontal Flow Wrapper Toolings
- > Tube Closers & Product Strippers
 - > Cutting knives
 - > Flexible Chutes
 - > Sealing jaws
 - > Draw-down belts
 - > Former accessories
- > Training & Technical Service



The world's biggest brands and OEMs choose KENRAY formers for better performance and profit.

Shouldn't you?

KENRAY are recognised as the global authority on the development and manufacture of formers and solutions for the packaging industry.

Our key area of expertise is the innovative design in forming sets for vertical form fill and seal packaging machines. Renowned for value-added service, consistency of design, extensive testing procedures and accuracy in manufacturing, KENRAY are the partners of choice for companies around the world within the food and pharmaceutical packaging sector.

Our forward-thinking engineering ensures interchangeability and repeatability. It is this precision that continues to endorse KENRAY'S position as the Global Leader in this market today.

KENRAY. Perform Better.

KENRAY

