

Product Catalog 2026

The Nordic Selection



Ergonomic Dental
Instruments from Denmark

ErgoDenta™

From Denmark to dental clinics worldwide

ErgoDenta was founded with one clear purpose: to make daily clinical work easier with instruments designed for comfort, control, and reliability.

Designed in Denmark, our instruments are developed with a strong focus on ergonomics and everyday usability. We pay attention to the details that matter in practice — from grip and balance to finish and handling — so clinicians can work with greater comfort throughout the day.

In a short time, ErgoDenta has grown into a trusted partner for distributors and dental professionals across more than 25 countries. While our reach continues to grow, our approach remains the same: practical solutions, personal support, and instruments made with care.

Whether our products are used locally or internationally, the goal is always the same— to deliver dependable instruments that support better daily work.

2700+

Ergonomic Dental Instruments

30+

Distributors

25+

Countries supplied



Our first year

See how ErgoDenta started and what we built in 2025.

Scan to watch our story

ErgoDenta

- Fast dispatch from Denmark
- EU-based distribution
- Direct supply model
- No middlemen

4

Pillars of ErgoDenta

ErgoDenta is built on four key principles that shape our products and define the way we work.

Why we do it

We believe small improvements make a big difference. By focusing on ergonomics, balance, and consistent quality, ErgoDenta develops instruments that support clinicians in their daily work and long clinical hours.

Where we are going

Our vision is a dental workplace where instruments support the clinician, not strain them — with thoughtful design, consistent quality, and solutions that make dentistry more sustainable over a career.

Ergonomic Focus

Our instruments are developed to reduce hand fatigue and improve tactile control. Better comfort allows clinicians to work longer with greater precision throughout the day.

Global Compliance

Our products follow international regulatory requirements and include full documentation and traceability for clinics and partners.

Innovative Solutions

We create practical solutions for daily dentistry — from longer-lasting sharpness to replaceable tip systems that reduce waste and extend instrument life.

Danish Design

Designed in Denmark with focus on balance, precision, and everyday clinical use. Every instrument is developed with attention to detail, finish, and consistent quality.



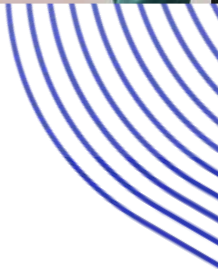

In 2025, ErgoDenta was introduced for the first time at IDS Cologne.

We arrived with a complete range — more than 2,500 instruments ready for the market. Visitors could pick up the instruments, feel the grip, and see the ergonomic design in real life.

Distributors showed strong interest and quickly recognized the potential of a new brand offering a full portfolio from day one. IDS became the starting point of our international journey.



FROM IDS



After IDS, the cooperation began.

Our partners started presenting the instruments in their local markets and introducing the range to their customers. Step by step, the instruments moved from the exhibition booth into everyday use around the world.

Today, ErgoDenta is present in many countries, and the network continues to grow through long-term partnerships. What started in Cologne now continues worldwide.

TO THE WORLD

Petter's 6 fav ErgoRazor Instruments



Highlights
Page 67



Kits by

DnD



Highlights
From page 109-111



Kits by
Dr. Iman



Highlights
From page 112-114



NEW
HIGHLIGHTS

Scalers & Curettes

Titanium

Highlights
Page 60



ErgoRazor®
Now Available in ErgoSteel Plus

Up to
3X
Longer
Sharpness

ErgoRazor® is a registered trademark of ErgoDentaria

Highlights
Page 75

→

Diamond
Grip Master

Upper Molars For Upper Wisdom Teeth
A08 CE 1539

Ergo Endo
Black

Highlights
From page 128

→

PC Plugger 0.5mm
100 701X

Orthodontic Pliers

Highlights
From page 113



ErgoTip Handles

Personal. Precise. Yours.

Identify by color. Work faster.

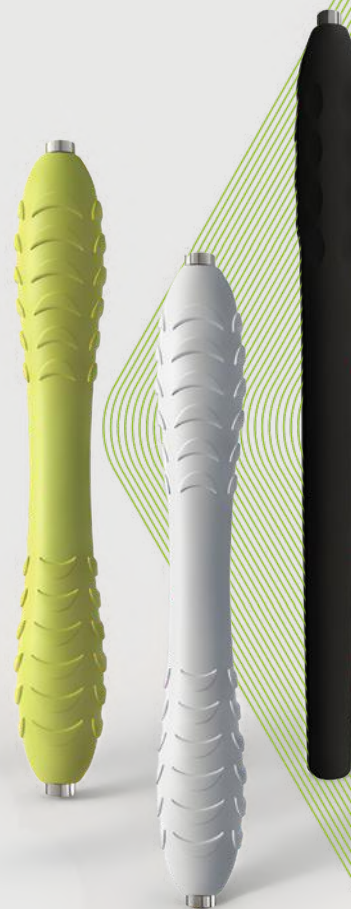

Highlights
Page 19



Ergo**X**[®]

Ergonomic Grip



Available in 15 Colors



Ergo**Steel**

Durability That Supports

Strong Classic Reliable



Ergo**Lite**

Daily Essentials

for your practice

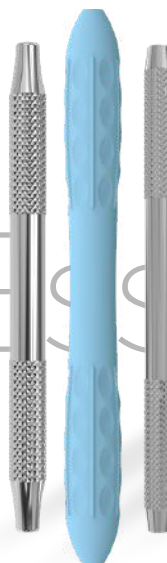

Scan to read more
about ErgoHandles



BRANDS

ErgoTip™

A smarter system where you replace only the tip – less waste, lower cost, and a handle that stays with you.

Page no 12-20



ErgoLite

Everyday dental instruments built for reliable clinical use.

Page no 21-28

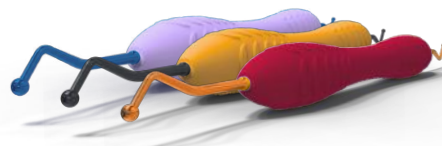
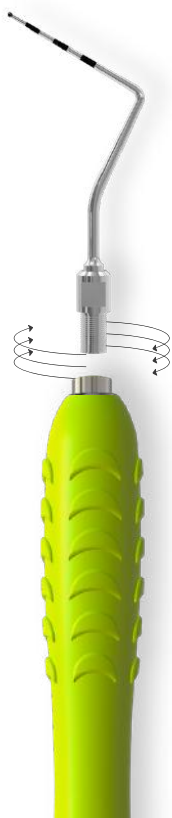

ErgoSlip

Non-stick restorative instruments available in gold, black, or blue for clear identification and precise composite placement.

Page no 48-53

Ergo Razor®

Up to 3× longer sharpness in periodontal scalers and curettes for efficient calculus removal.

Page no 61-66

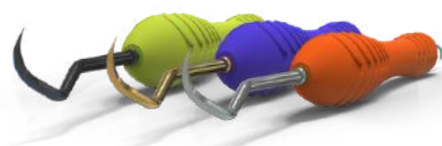

ErgoTrays

Fully autoclavable color-oriented plastic trays for organized instrument setups.

Page no 146-148



CONTENT

Diagnostics	29	Extraction	70
Explorers	30	Extraction Forceps	71
Periodontal Probes	30	Grip Master Diamond	75
Explorer & Probes	31	Luxating Elevators	77
Mirror Handles	33	Root Tip Elevators	79
Mouth Mirrors	35	X-Tool Elevators	82
Diagnostic kits	37		
		Surgery	83
Restoration	38	Scissors	84
Excavators	39	Needle Holders	90
Pluggers & Burnishers	41	Tweezers	94
Composite Spatulas	43	Retractor	98
Base Carriers	43	Syringes	100
Carvers	44	Crown Instruments	101
Condensers	45	Bone curettes	102
Filling instruments	45	Kits by DnD	107
Cord Packers	47	Kits by Dr Iman	110
Composite kits	53	Orthodontics	113
		Endodontics	128
		Implantology	140
Periodontics	54		
Gracey Curettes	55	Sterilize & Organize	143
Sickle Scalers	57	Sterilization trays	144
Universal Curettes	58	Instrument trays & holders	150
Hoe Scalers	59	Color-coded rings	152
Titanium Curettes & Scalers	60	ErgoTape	153
Perio kits	68	Diverse	154

ErgoTip

Every *practice* is unique.
Your *instrument* should be too.

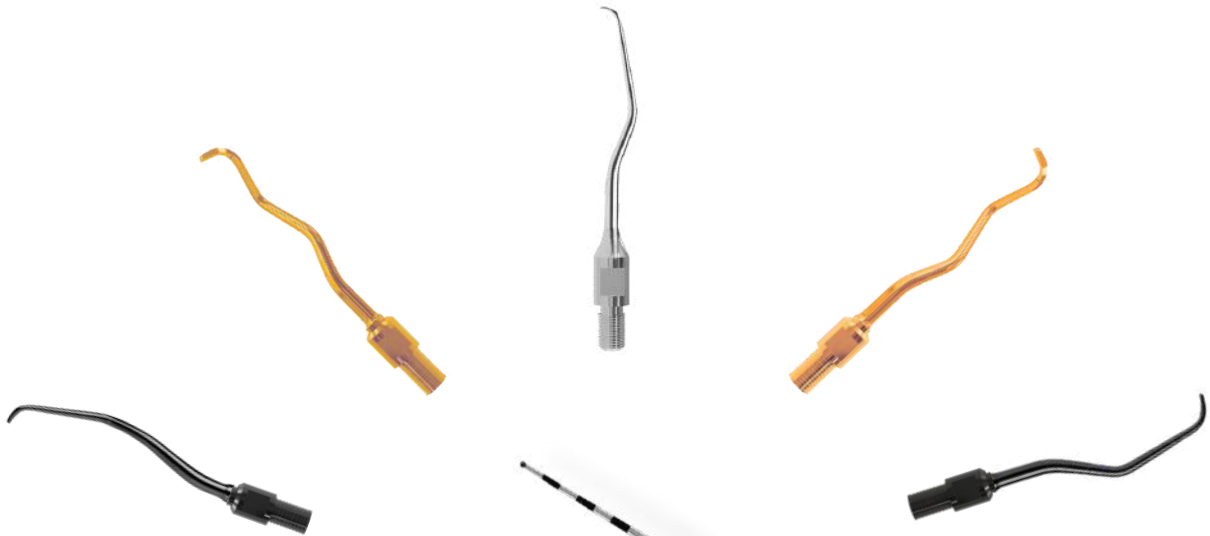

Use Replace Repeat

Personalize

Your Instruments

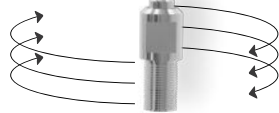

SCAN ME



Discover More Online
Scan the QR Code

Personal. Precise. Yours.

THE NEW ERGOTIP EXPLORER PROBE.

1.

Choose your **Handle**



2.

Choose your **Color**

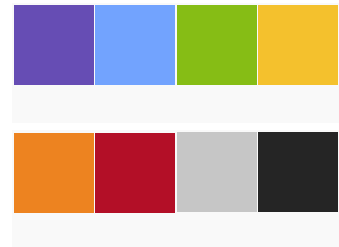

3.

Choose your **ErgoTips**

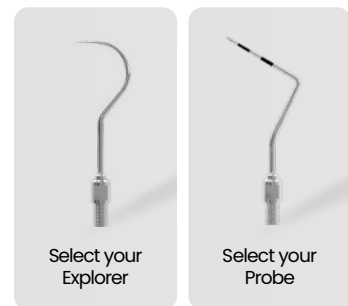

Your instrument
Your color, **Your style**

Diagnostics

Explorers

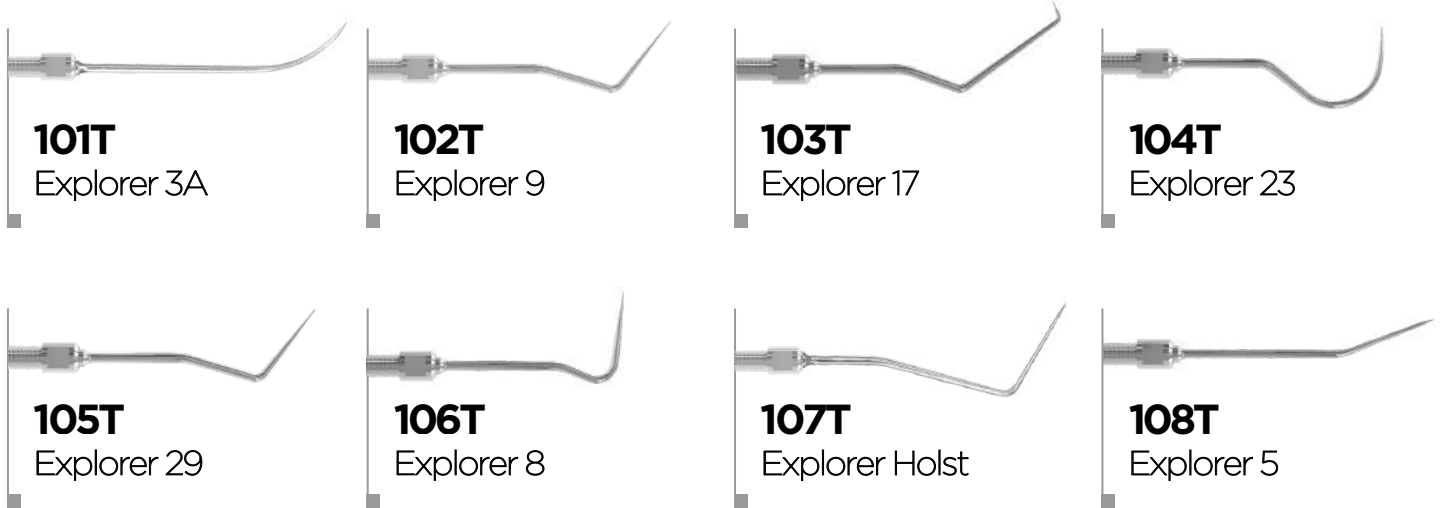

Probes

Color-coded and highly durable for lasting precision.



ErgoRazor® Tips

Personal. Precise. Yours.

Razor Gold

Razor

Razor Black



Up to

3X

Longer
Sharpness

Periodontics

Gracey Curettes

Gracey 1



Gracey 3



Gracey 5

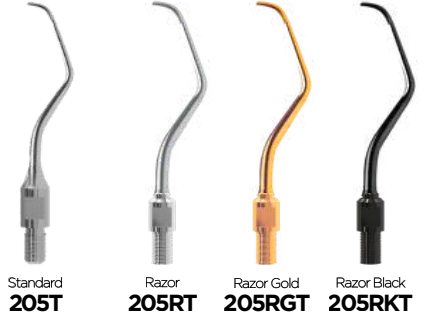

Gracey 2

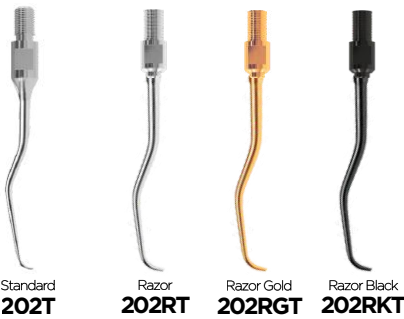

Gracey 4

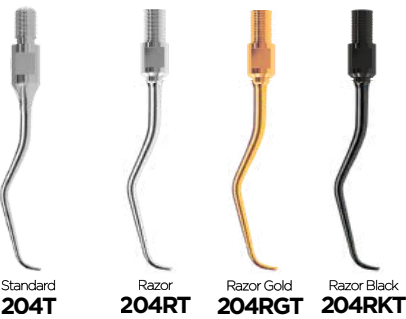

Gracey 6

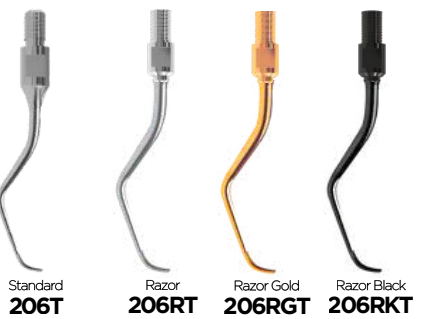

NEW

Gracey 7

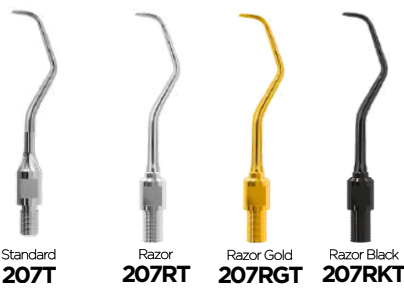

NEW

Gracey 9

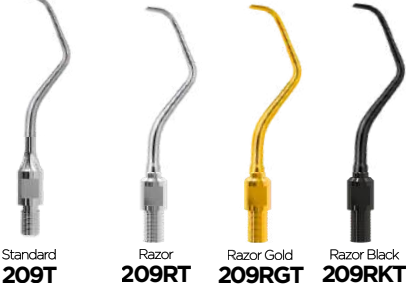

Gracey 11

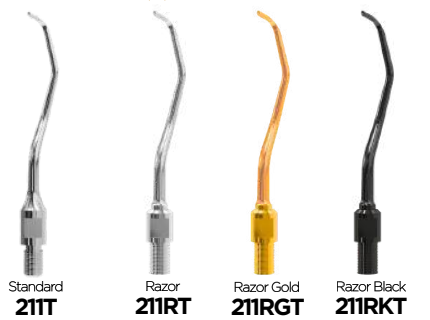

Gracey 8

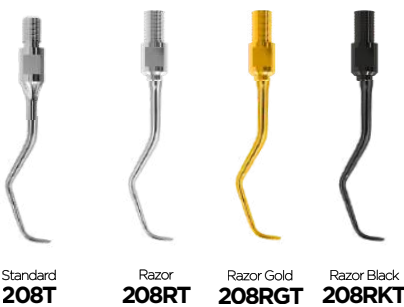

Gracey 10

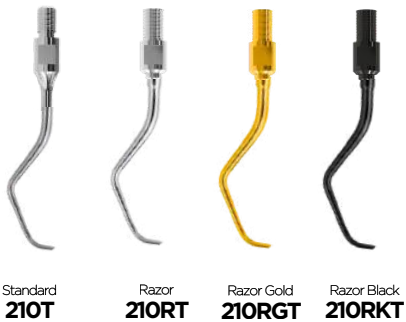

Gracey 12



NEW

Gracey 13



Gracey 15



Gracey 14

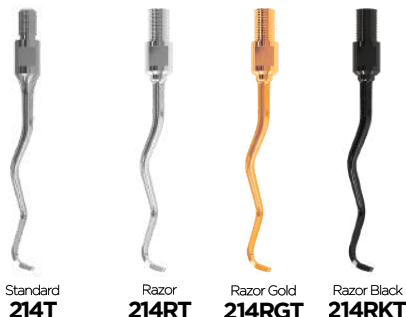

Gracey 16

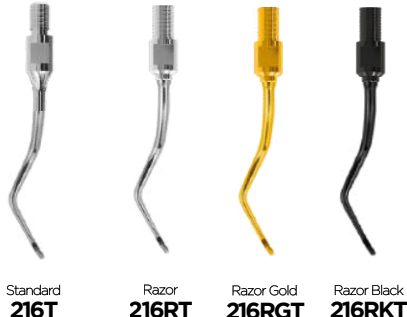

Did you know?

With ErgoTip, you can design your own perio instrument.



Mini Gracey Curettes

Mini Gracey 1

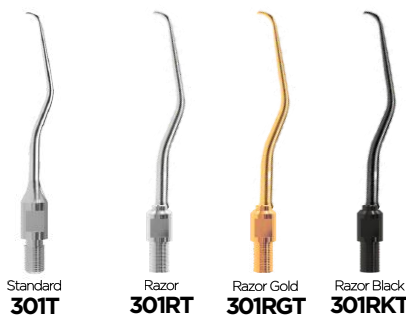

Mini Gracey 11

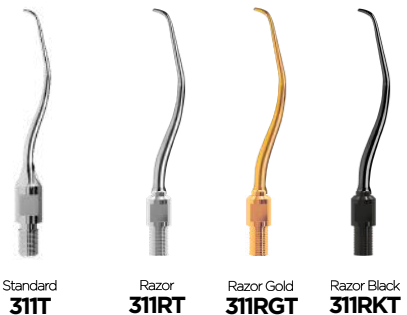

Mini Gracey 13

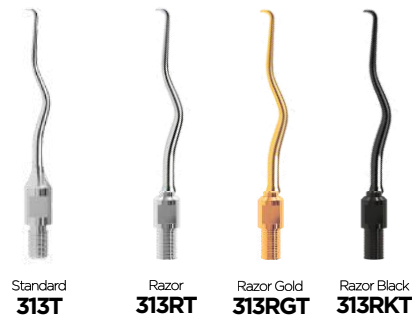

Mini Gracey 2



Mini Gracey 12



Mini Gracey 14



Sickle Scalers

Sickle Scaler 204S (A)



Sickle Scaler 204S (B)



Sickle Scaler 204SD (A)



Sickle Scaler 204SD (B)



Sickle Scaler M23 (A)



Sickle Scaler M23 (B)



Micro Sickie Scaler 01



Micro Sickie Scaler 02

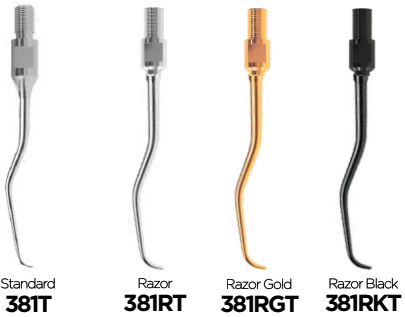

Mini Sickie Scaler 11



Mini Sickie Scaler 12

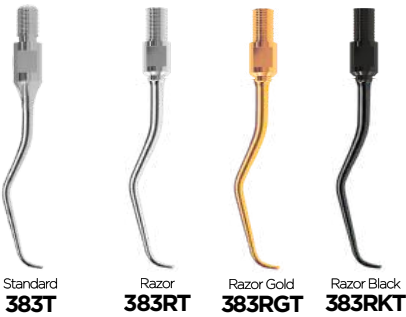

Sickle Scaler H6



Sickle Scaler H7



New ERGOTIP HANDLES

ErgoTip X & X Plus

Double-end



1451 X | XP
Magenta Blue



1452 X | XP
Aqua light



1453 X | XP
Lemon Green



1454 X | XP
Honey Brown



1455 X | XP
Citrus Orange



1456 X | XP
Ruby Pink



1457 X | XP
Misty Cyan



1458 X | XP
Pure Black

ErgoTip LX

Single-end



1451 LX
Magenta Blue



1452 LX
Aqua light



1453 LX
Lemon Green



1454 LX
Honey Brown



1455 LX
Citrus Orange



1456 LX
Ruby Pink



1457 LX
Misty Cyan



1458 LX
Pure Black



ErgoTip SS

Hollow Handles



Hollow handle design ensures a lighter weight, better balance, and improved tactile control during procedures.

Hollow 8 mm single-end handle with balanced feel and firm, comfortable grip.

Ø8mm

1491 SS
Ergo**Tip Single End**



Lightweight 8 mm hollow double-end handle offering control and reliable precision.



Ø8mm

1492 SS
Ergo**Tip Double End**



Wrench for ErgoTip
5757

Snap. Twist. Done.



ErgoLite

Daily Essentials for Your Practice

ErgoLite X

Ultra-lightweight color-coded handles at 14 g — covering a full assortment of scalers, curettes, and everyday instruments for efficient daily use.

ErgoLite S

Classic textured steel handles, solid or hollow — available across a wide range of scalers, curettes, and diagnostic instruments for reliable everyday performance.

ErgoLite Elevators

A complete tray-organised assortment of luxating elevators with plastic handles — straight, curved, contra, and dual-edge tips for atraumatic tooth and root loosening.

ErgoLite Mirror handles

Lightweight ergonomic handles in 11 vibrant colors, compatible with all SS socket mirrors and designed for both standard and cone socket configurations.



SCAN ME



Discover More Online
Scan the QR Code

Available in 11 colors

Lemon Green 9314C | 9314



Misty Cyan 9313C | 9313



Ruby Pink 9309C | 9309



Petal Pink 9308C | 9308



Citrus Orange 9307C | 9307



Honey Brown 9305C | 9305



Aqua Light 9306C | 9306



Sky Cyan 9304



Lilac Blue 9310



Magenta Blue 9302C | 9302



Also Available in
Cone Sockets



Pure Black

9315C | 9315
Cone socket SS socket

- Fits all SS & CS socket dental mirrors
- Suitable for Microscope & HD dental mirrors
- Now also available in cone socket

A lightweight, ergonomic mirror handle designed for Microscope and HD dental mirrors, compatible with all CS & SS socket mirrors. Offered in 11 vibrant colors. **Selected colors are also available with cone socket.**

ErgoLite

Mirror Handle

ErgoLite X

Light. Precise & Reliable.

Ultra-lightweight (11.5 mm, 14 g) ergonomic design reduces hand fatigue. Crafted from anti-rust stainless steel, fully autoclavable, with color coding and clear markings for quick identification and daily efficiency.

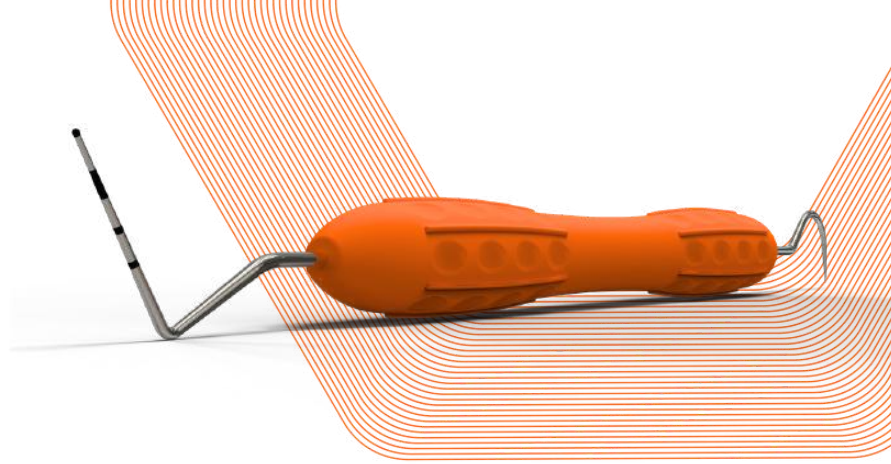

Explorer

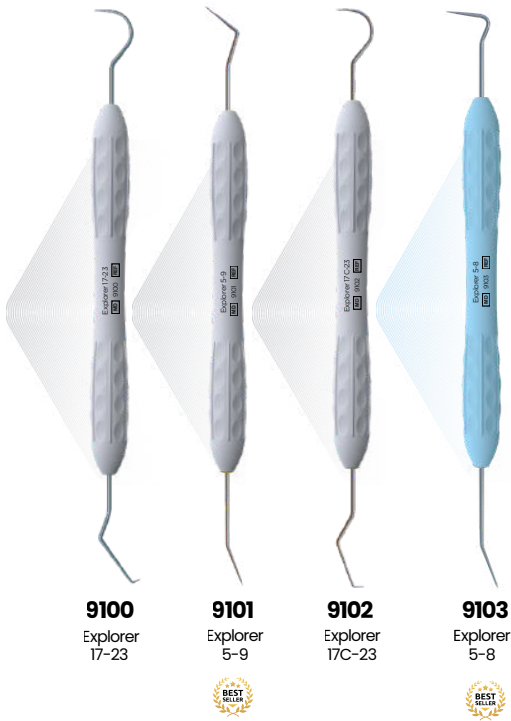

9100
Explorer
17-23

9101
Explorer
5-9

9102
Explorer
17C-23

9103
Explorer
5-8

Probes & Explorer

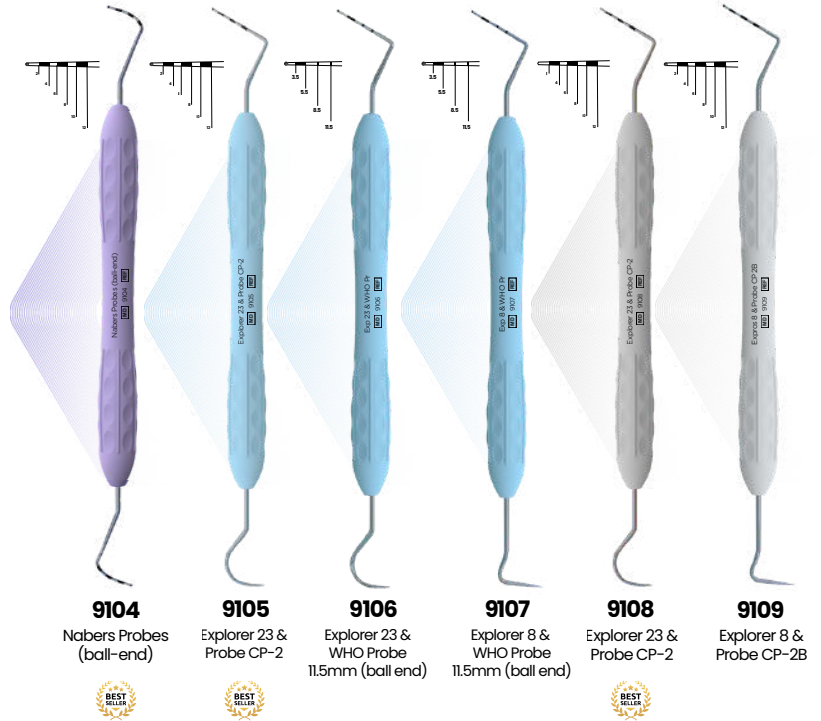

9104
Nabers Probes
(ball-end)

9105
Explorer 23 &
Probe CP-2

9106
Explorer 23 &
WHO Probe
11.5mm (ball end)

9107
Explorer 8 &
WHO Probe
11.5mm (ball end)

9108
Explorer 23 &
Probe CP-2

9109
Explorer 8 &
Probe CP-2B

Endodontics



9110
Root Canal
Explorer

9111
Endo
Plugger

Excavator



9112
Round
Excavator
1.0mm

9113
Round
Excavator
1.5mm

9114
Round
Excavator
2.0mm

9115
Action
Excavator
1.0mm

9116
Action
Excavator
1.5mm

9117
Action
Excavator
2.0mm

Filling Instruments



9118
Burnisher &
Plugger 1.5-
2.5mm

9119
Cord Packer
2.0mm

ErgoLite X

Light. Precise & Reliable.

Filling Instruments

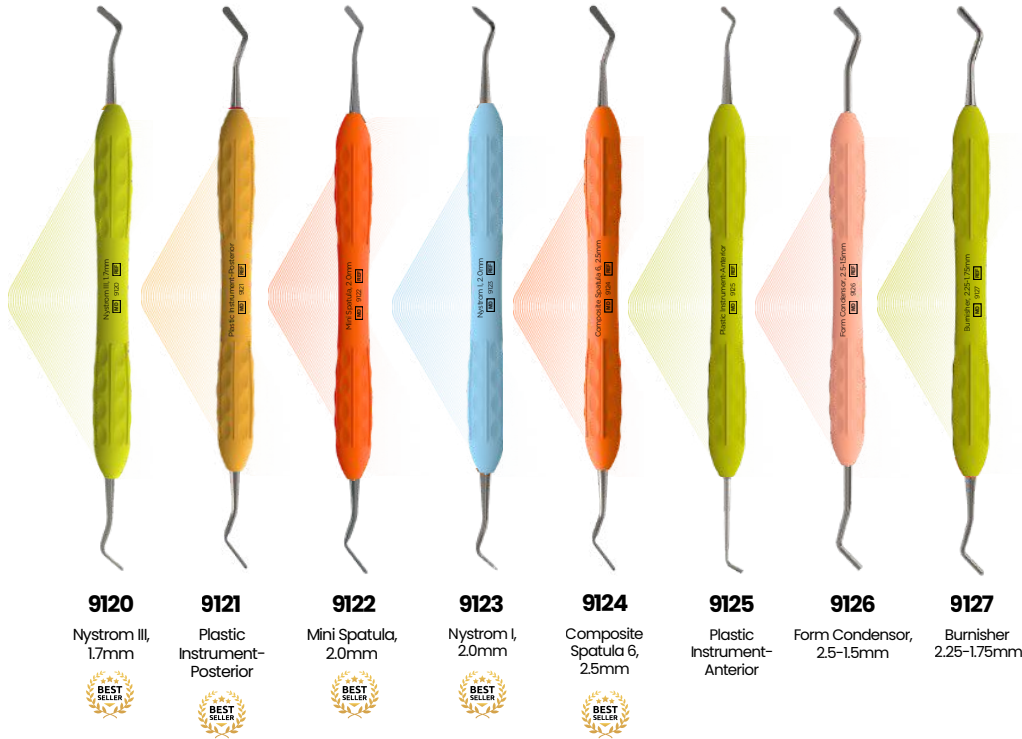

Gracey Curettes



Gracey Curettes



Sickle Scalers

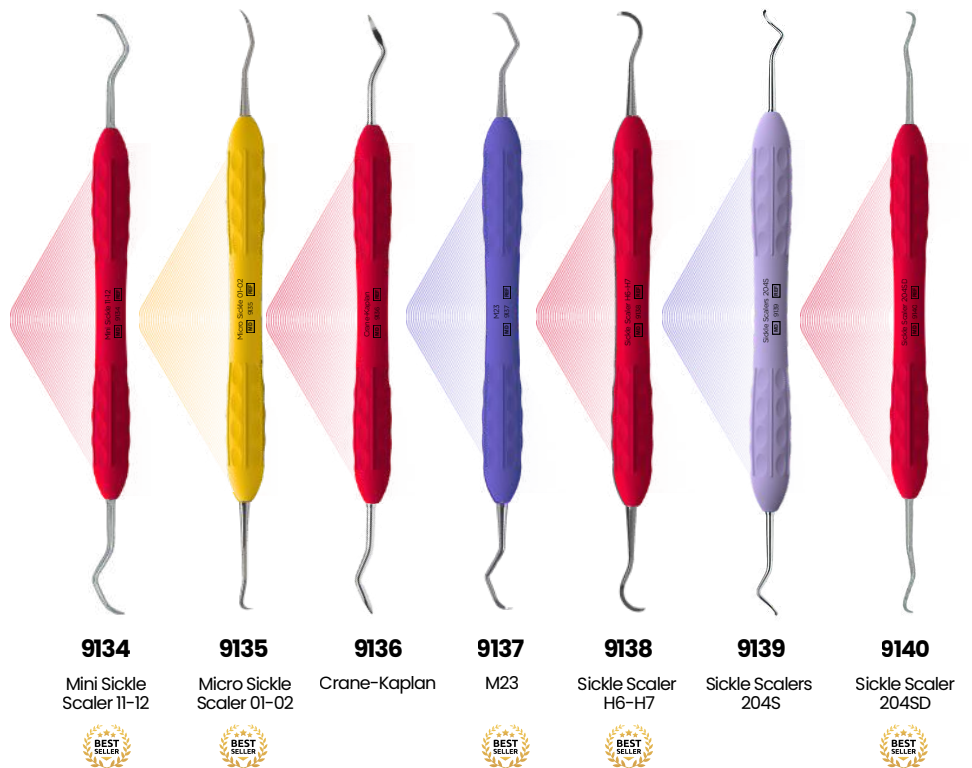

ErgoLite S

ErgoLite Steel offers two handle options solid steel for durability or a lightweight, ergonomic hollow handle for enhanced comfort. Both feature a classic textured design for a secure grip, ideal for reliable everyday use.

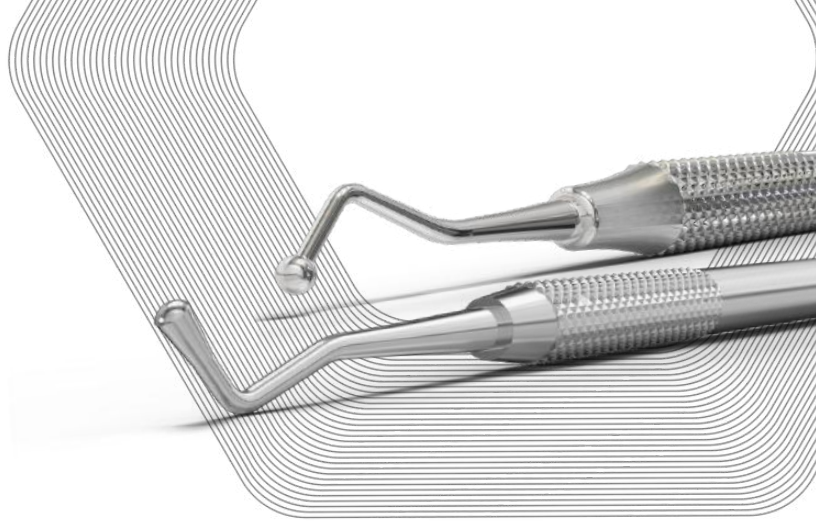

Diagnostics

Explorers

Single-end

Double-end

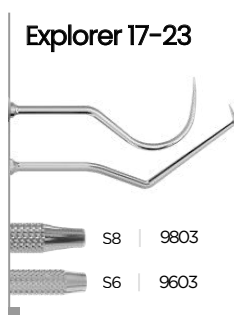
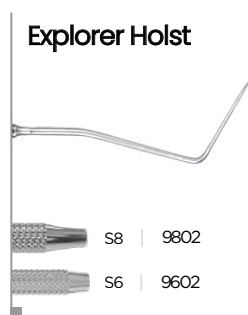

Probes

Single-end

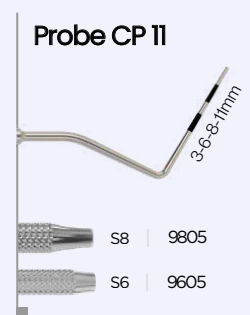
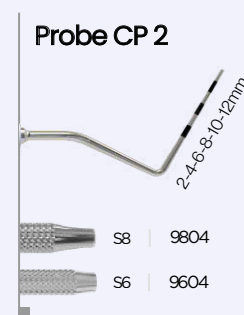

Explorer + Probes

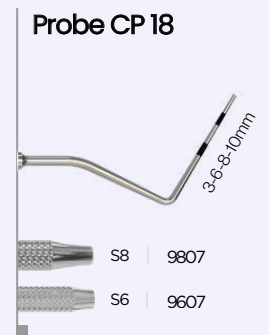
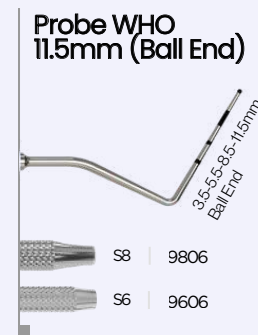
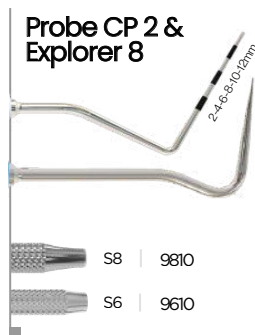
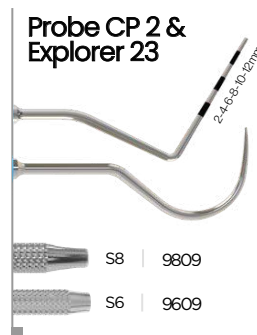
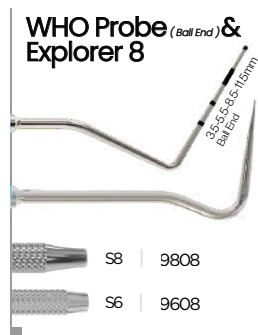

Restoration

Excavators

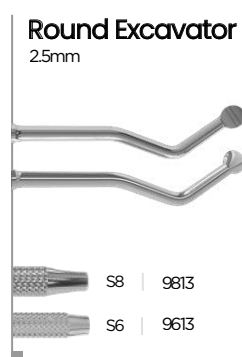
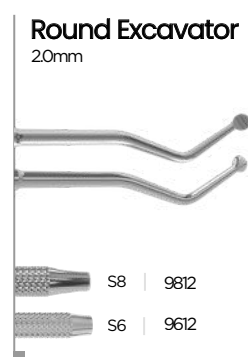
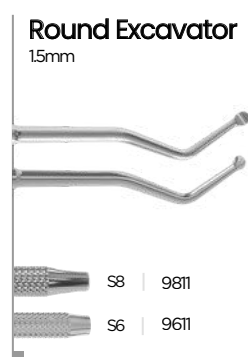

Filling instruments

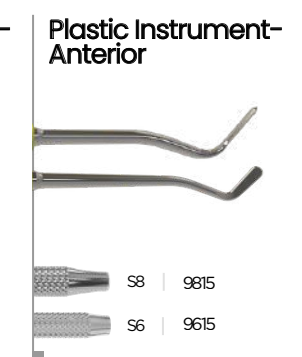
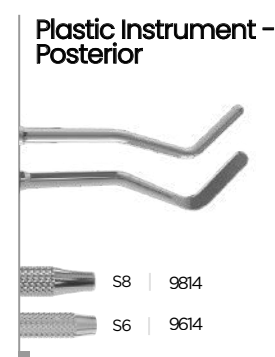

Restoration

Filling instruments

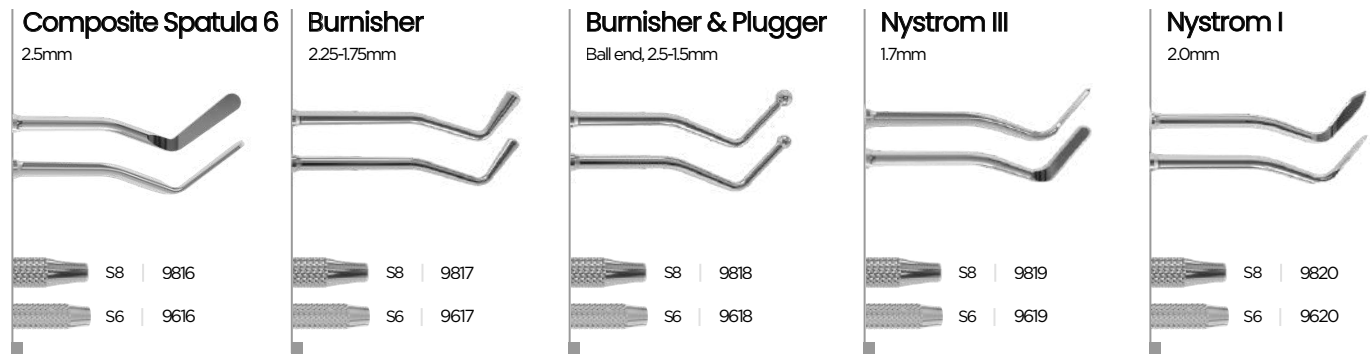

Periodontics

Gracey Curettes

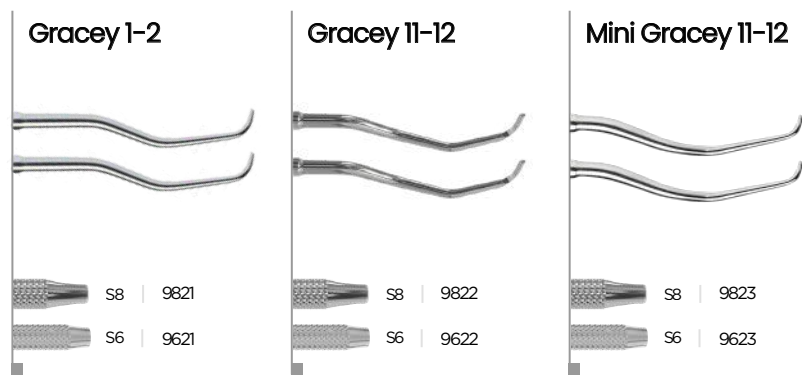

Sickle Scalers

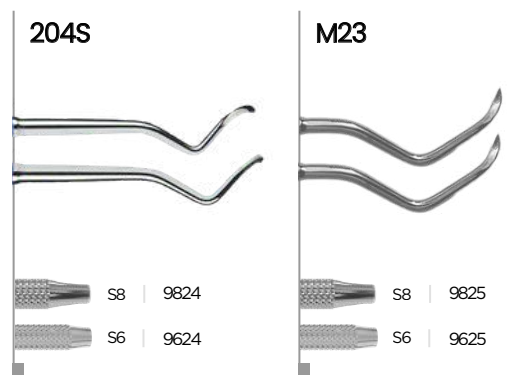

Bone Curette

Lucas

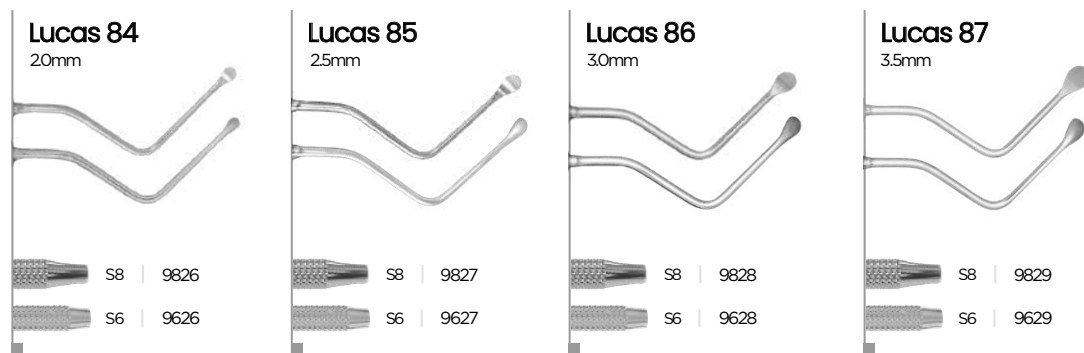

Hemmingway



Periosteal elevators

Molt

5mm-8mm

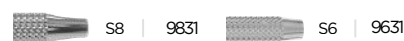

ErgoLite Elevator

A complete range of luxating elevators for atraumatic tooth and root loosening before extraction. Various tip sizes and patterns — straight, curved, contra and dual-edge — for different access situations.

Available in regular and gold versions.



Comfort
Grip

Ergonomic
Design

Built to
Last

ErgoLite Elevator

Each ErgoLite elevator is supplied in an autoclavable tray.

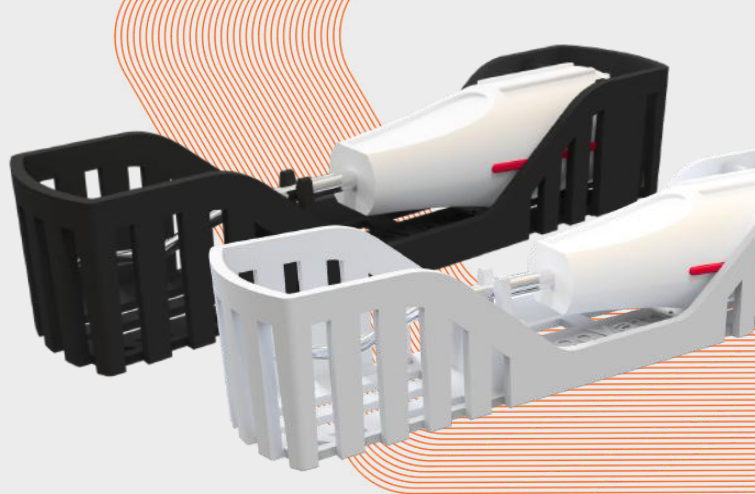

Straight



1mm

Regular 9204
Gold 9204G



2mm

Regular 9205
Gold 9205G



3mm

Regular 9206
Gold 9206G



5mm

Regular 9207
Gold 9207G

Inner Curved



3mm

Regular 9202
Gold 9202G

Dual edge



3mm-1.5mm

Regular 9208
Gold 9208G



5mm-3mm

Regular 9209
Gold 9209G

Curved

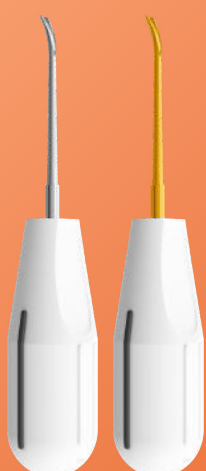

 3mm

Regular 9201
Gold 9201G



5mm

Regular 9203
Gold 9203G

Contra Curved



3mm

Regular 9210
Gold 9210G

Diagnosics

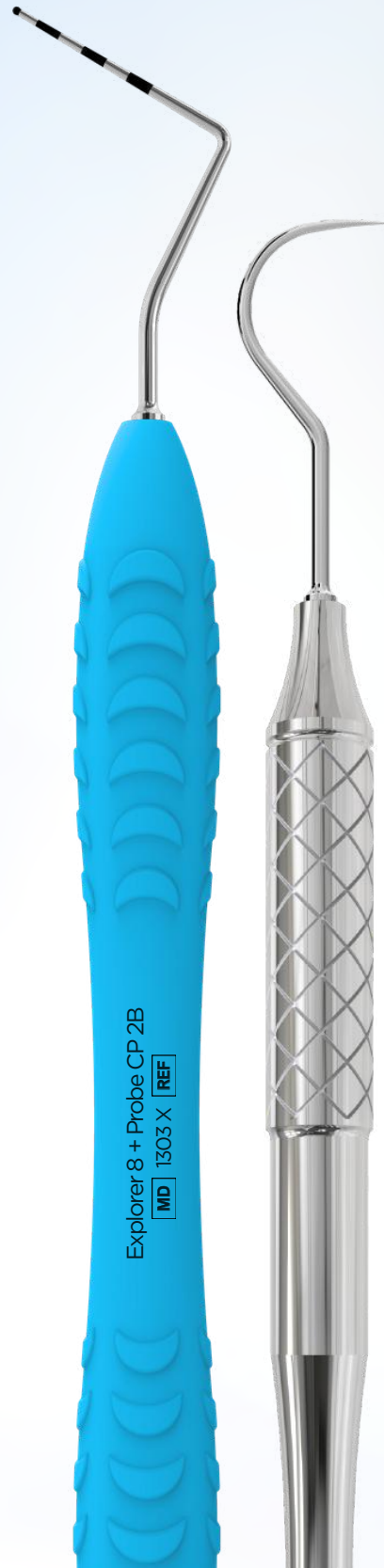

Explorer 8 + Probe CP 2B
MD 1303 X REF

Explorers

Designed for everyday use, these explorers help you check teeth surfaces easily. Available in single and double-end options with comfortable handles.

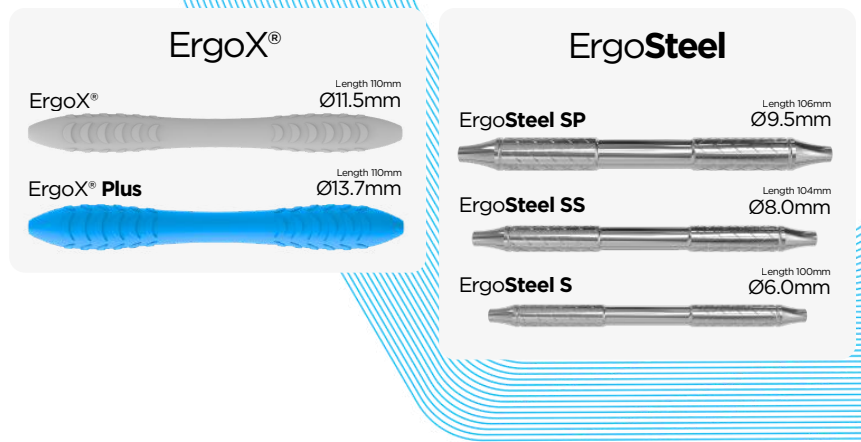

Single-Ended

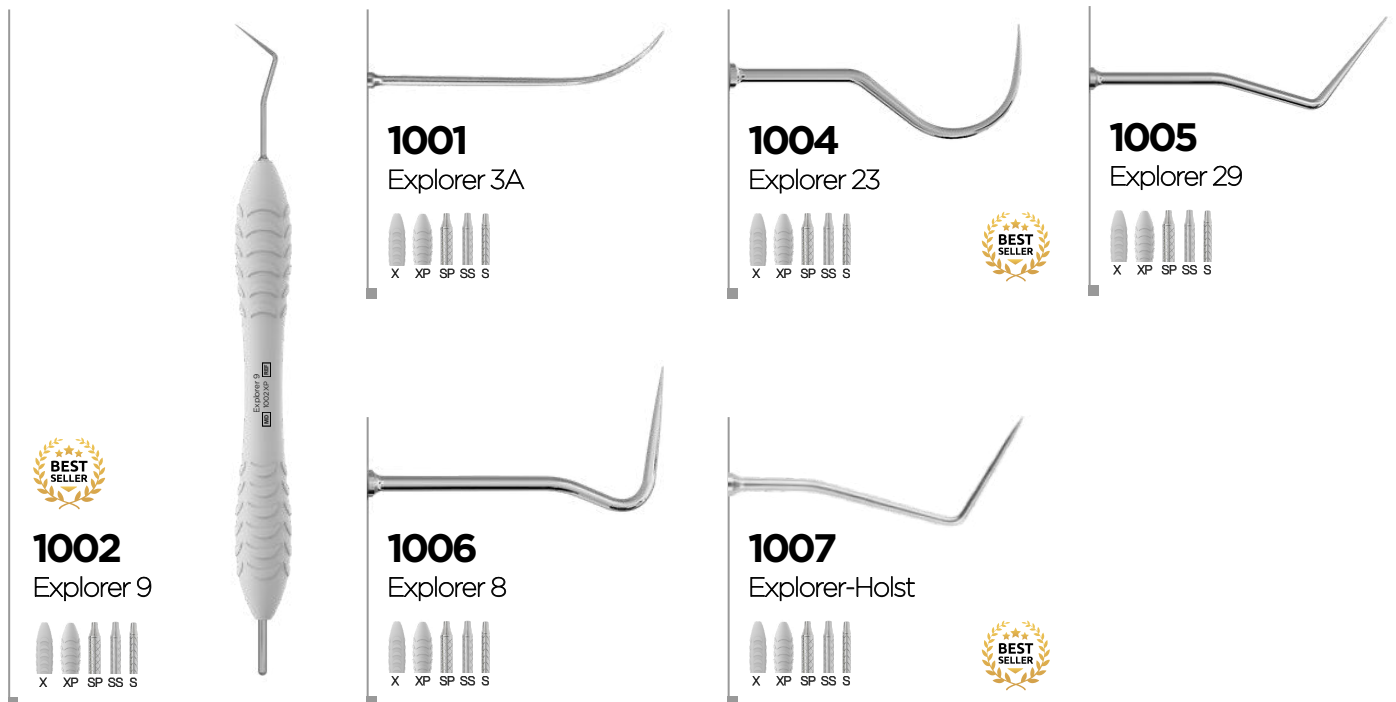

Double-Ended

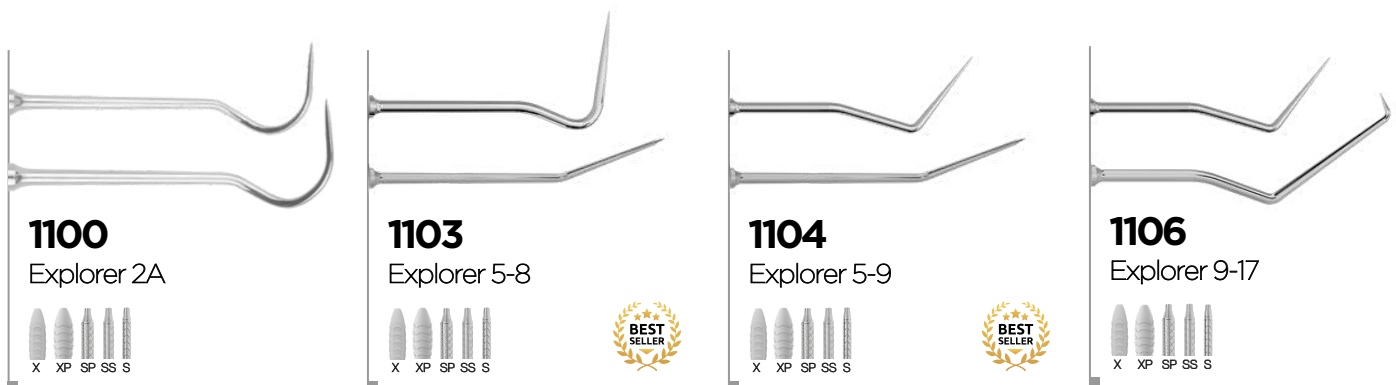

Explorers

Double-Ended

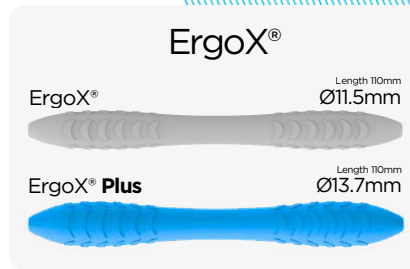

1107
Explorer 17-23



1108
Explorer 17C-23

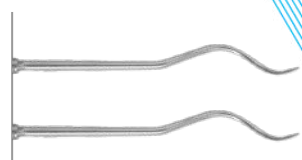

1111
Weston Explorer



Periodontal Probes

Single-Ended

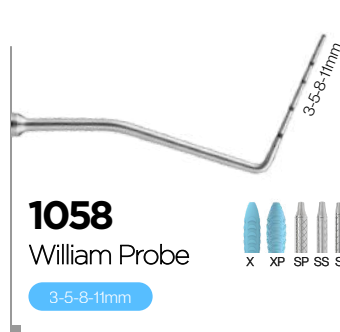
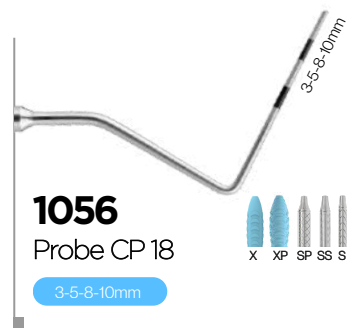
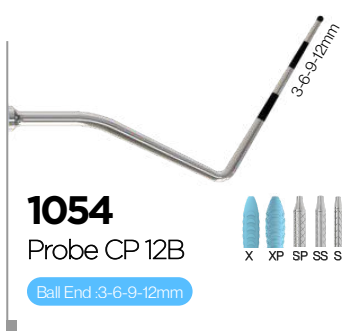
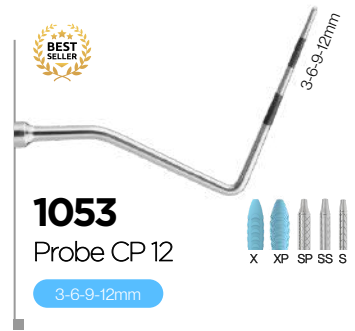
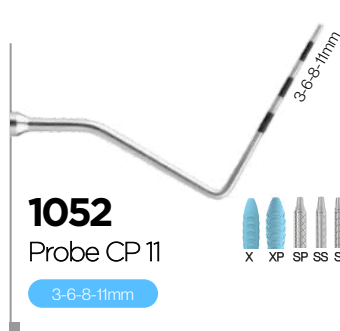

Periodontal Probes

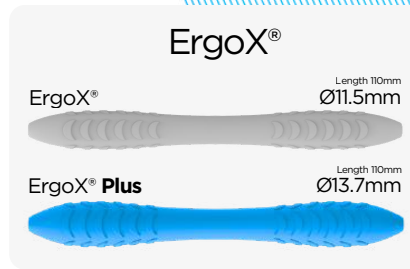

Double-Ended

<p>Explorer 8+ Probe CP 2B 1303 X [MP]</p>	<p>1300 Probe CP 2 & Explorer 6 2-4-6-8-10-12mm</p>	<p>1301 Probe CP 15 & Explorer 6L 1-15mm</p>	<p>1112 Probe William & Explorer Holst 3-5-8-11mm</p>	
	<p>BEST SELLER 1304 WHO Probe & Explorer 8 Ball End . 3.5-5.5-8.5-11.5mm</p>	<p>1305 Probe CP 15 & Explorer 8 1-15mm</p>	<p>1306 Probe CP 18 & Explorer 9 3-5-8-10mm</p>	
	<p>BEST SELLER 1303 Probe CP 2B & Explorer 8 2-4-6-8-10-12mm</p>	<p>BEST SELLER 1307 Probe CP 2 & Explorer 23 2-4-6-8-10-12mm</p>	<p>BEST SELLER 1308 Probe CP 2B & Explorer 23 2-4-6-8-10-12mm</p>	<p>BEST SELLER 1309 WHO Probe & Explorer 23 3.5-5.5-8.5-11.5mm</p>
	<p>1310 Probe CP 12 & Explorer 23 3-6-9-12mm</p>	<p>1311 Probe CP 12B & Explorer 23 3-6-9-12mm</p>	<p>BEST SELLER 1312 Probe CP 15 & Explorer 23 1-15mm</p>	<p>1313 Probe CP 18 & Explorer Holst 3-5-8-10mm</p>

Periodontal Probes

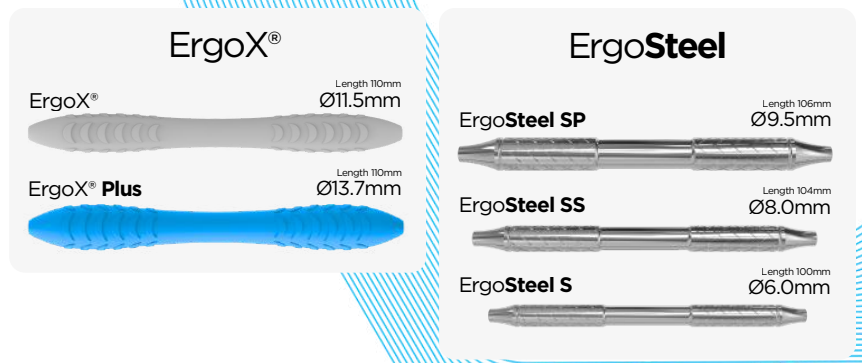

Double-Ended



1113

Furcation Probe

without measurements

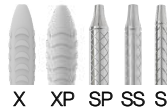

1200

Nabers Probe

2-4-6-8-10-12mm



Mirror Handles

ErgoSteel Mirror Handles

<p>ErgoSteel Mini Mirror handle</p>  <p>1450 S</p> <p>Ø 6mm Length 125mm</p> <p>BEST SELLER</p>	<p>ErgoSteel Standard Mirror handle</p>  <p>1450 SS</p> <p>Ø 8mm Length 125mm</p> <p>BEST SELLER</p>	<p>ErgoSteel Plus Mirror handle</p>  <p>1450 SP</p> <p>Ø 9.5mm Length 125mm</p>	<p>Chrome Plated Mirror handle</p>  <p>1453 SS</p> <p>Ø 8mm Length 135mm</p>
---	--	--	---

ErgoX[®]

Mirror handles

Find your perfect fit with our ergonomic mirror handles

NEW
Also available now
in cone socket.

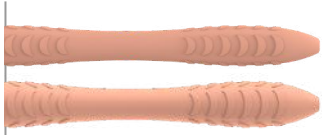
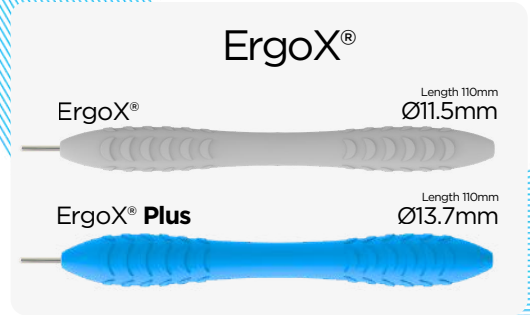

Peach Blush
1401
X | XP



Magenta Blue
1402
X | XP For Cone Socket C-X | C-XP



Deep Blue
1403
X | XP



Sky Cyan
1404
X | XP

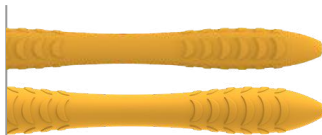

Honey Brown
1405
X | XP For Cone Socket C-X | C-XP

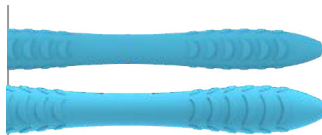

Aqua Light
1406
X | XP For Cone Socket C-X | C-XP



Citrus Orange
1407
X | XP For Cone Socket C-X | C-XP



Petal Pink
1408
X | XP



Ruby Pink
1409
X | XP For Cone Socket C-X | C-XP

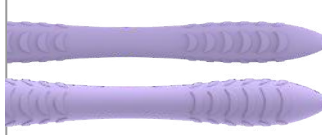

Lilac Blue
1410
X | XP



Earth Brown
1411
X | XP



Teal Deep
1412
X | XP



Misty Cyan
1413
X | XP For Cone Socket C-X | C-XP



Lemon Green
1414
X | XP For Cone Socket C-X | C-XP



Pure Black
1415
X | XP For Cone Socket C-X | C-XP





15
colors

2
Handles

BEST SELLER

Precision Vision for Endodontics

MICROSCOPIC MIRRORS

Size	Regular	Ultrathin
3mm	7091R	7091U 
5mm	7092R	7092U 
7mm	----	7095U 
2x7mm	7093R	----
3x6mm (Oval)	----	7093U 
3x6mm (WaterDrop)	----	7094U 
3x9mm	7094R	----



Ultrathin
0.7mm



Regular
1.5mm



36-layer coated, anti-glare mirror for clear visibility in microscope-assisted procedures. Available in two thicknesses: ultra-thin 0.7mm for maximum access and visibility, and standard 1.5mm for added durability. Sold with the ErgoLite mirror handle.

Sharper details

Confident Endo Work

Better Control

Front-Surface

No double image - the rhodium layer ensures a clear, single reflection. Suitable for all CS & SS-thread mirror handles

For SS (Simple Stem)

Size	Art nr.
NEW Ø10mm	1510F
NEW Ø12mm	1512F
NEW Ø14mm	1514F
No. 3 - Ø20mm	1503F
No. 4 - Ø22mm 	1504F
No. 5 - Ø24mm	1505F

For CS (Cone Socket)

Size	Art nr.
No. 3 - Ø20mm	1503FC
No. 4 - Ø22mm	1504FC
No. 5 - Ø24mm	1505FC

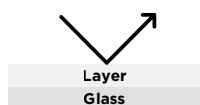

12pcs / box

Plane-Surface

Suitable for all CS & SS-thread mirror handles

For SS (Simple Stem)

Size	Art nr.
No. 3 - Ø20mm	1503P
No. 4 - Ø22mm 	1504P
No. 5 - Ø24mm	1505P

For CS (Cone Socket)

Size	Art nr.
No. 3 - Ø20mm	1503PC
No. 4 - Ø22mm	1504PC
No. 5 - Ø24mm	1505PC

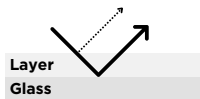

12pcs / box

HD Mirrors in box

Available in 4 colors and 2 sizes
Compatible with ErgoLite and ErgoSteel SS mirror handles

Note: Not suitable for ErgoX® or ErgoX® Plus mirror handles



Color	Ø22mm	Ø24mm
Black	1514HK	1515HK
Green	1514HG	1515HG
Blue	1514HB	1515HB
Pink	1514HP	1515HP

Sharpen your vision. Perfect your precision.

Anti Fog | **40%** Brighter than FS | **Ultra** Clear view



12pcs / box

Diagnostics Kits

Basic Diagnostic Kit

A practical starter set dentists love for everyday examinations, supplied in a sterilization cassette for organized storage, easy handling, and efficient sterilization.

9908

Available in



X XP SP

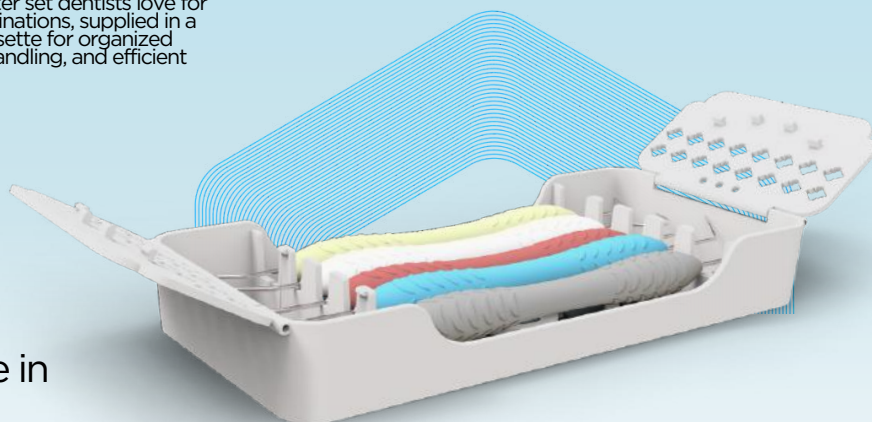

Instruments

ErgoX® Mirror handle
1401



Explorer 5-9
1104



Explorer 23 + WHO Probe
1309



Round Excavator, 1,5mm
2802



College Tweezer, Serrated 15cm
3627-1A



5 instruments + cassette

Super Diagnostic Kit

A complete instrument set for routine diagnostics and restorative procedures, organized in a sterilization cassette for efficient handling and sterilization.



9909

Available in



X XP SP

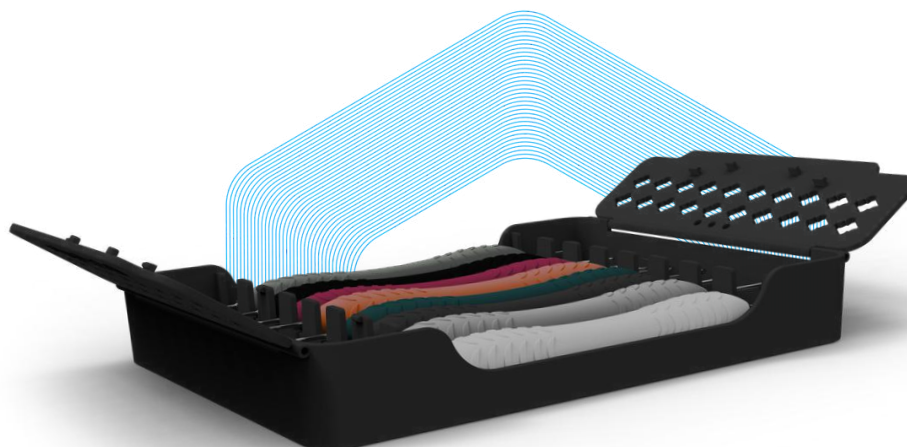

Instruments

ErgoX® Mirror handle, Peach Blush
1401



Explorer 17-23
1107



Explorer 9
1002



Probe CP-12 (3-6-9-12mm)
1053



Plastic Instrument-Posterior
2548



Nystrom III
2525



Round Excavator, 1,5mm
2802



Meriam Tweezer, 16 cm, TC
3636-2A



8 instruments + cassette

Restoration



Round Excavator 1.5mm
MD 2802 X REF

Carver Nys III
MD 2525 XP REF

Shaper Filling
MD 2576 SP REF

Excavators

Available in round, action, and spoon types with 5 handle options, designed for efficient removal of decayed tissue.

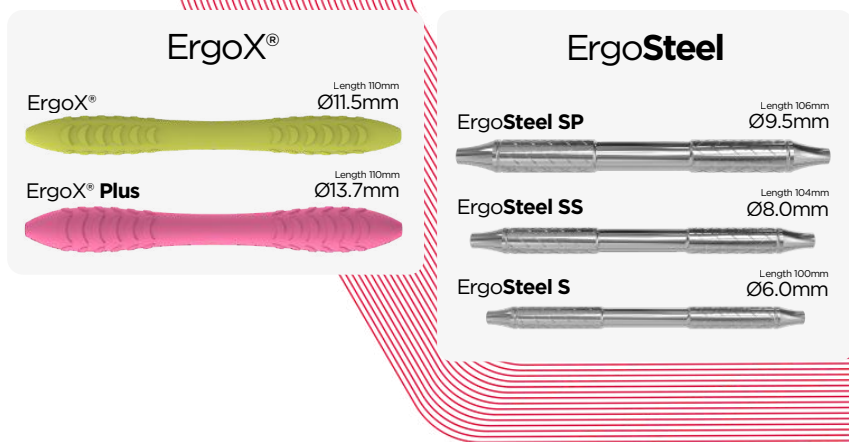

Round Excavators



Action Excavators



Spoon Excavators

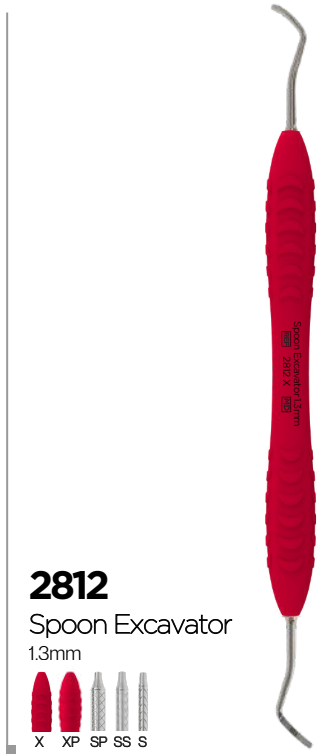
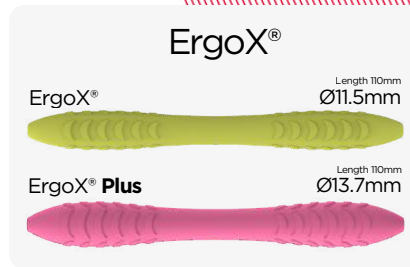

Know your Excavators

Our dental excavators are designed for safe, efficient decay removal

Action Excavator
Combines the benefits of spoon and round types for versatile, effective performance.



Round Excavator
Reaches tight curves for precise cleaning.

Spoon Excavator
Gently scoops out soft decay while preserving healthy tissue..

Composite & Filling instruments

Perfect for shaping, placing, and finishing composites and fillings. Available in various designs and handle options for easy handling and comfort.



Pluggers & Burnishers

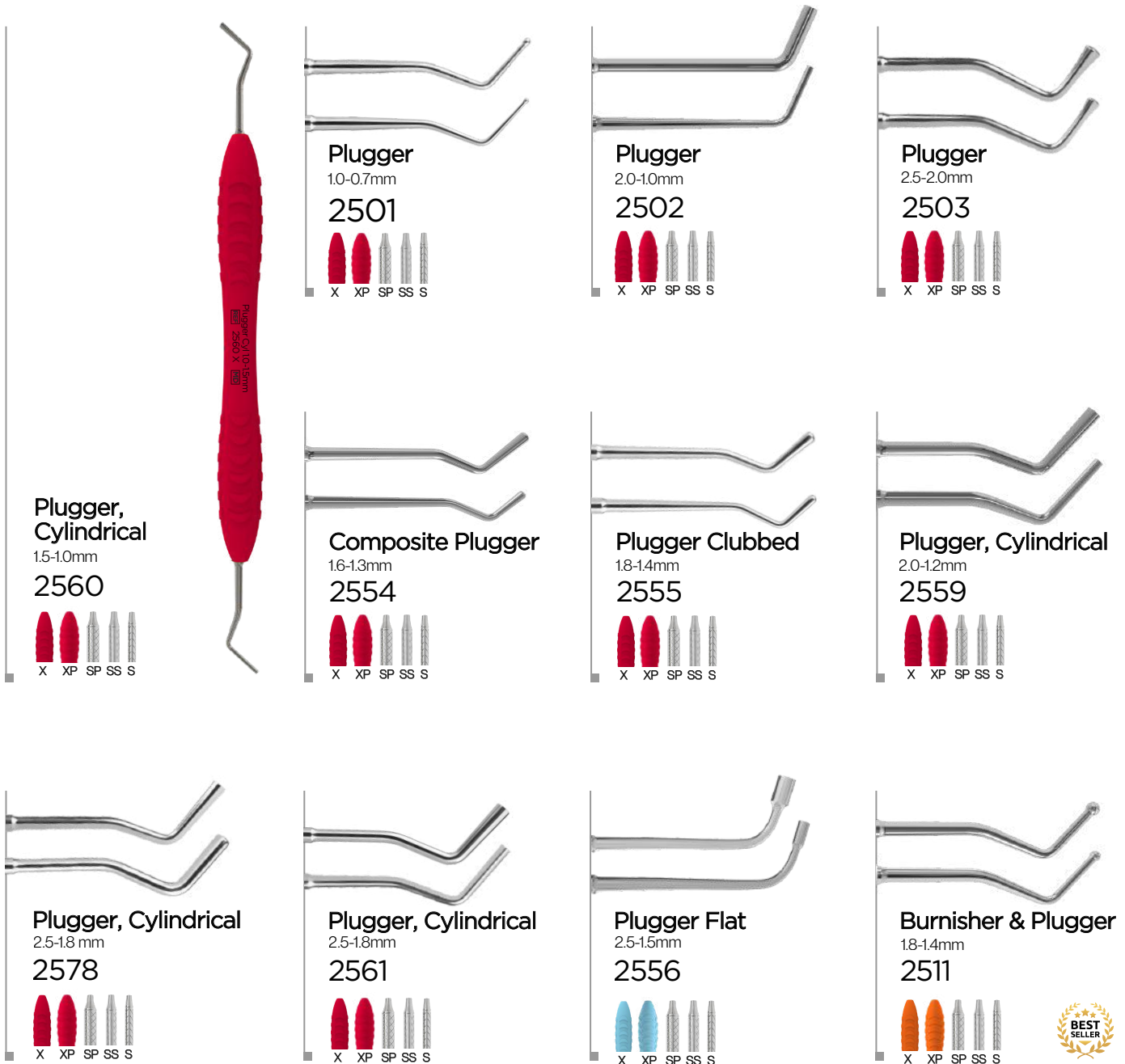

Pluggers & Burnishers

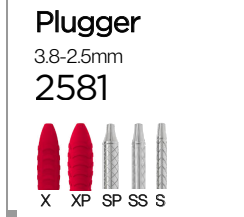
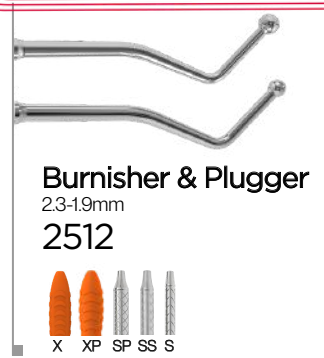
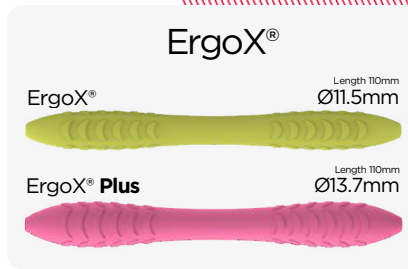

Cement & Composite Spatulas

ErgoX®

ErgoX® Length 110mm Ø11.5mm

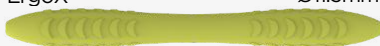

ErgoX® Plus Length 110mm Ø13.7mm



ErgoSteel

ErgoSteel SP Length 106mm Ø9.5mm



ErgoSteel SS Length 104mm Ø8.0mm



ErgoSteel S Length 100mm Ø6.0mm





Composite Spatula 6
2.5mm
2551

BEST SELLER



X XP SP SS S

Cement Spatula
5.0mm
2568



SP

Cement Spatula
6.0mm
2569





SP

Cement Spatula
7.0mm
2570





SP

Cement Spatel
2567



X XP SP SS S

Mini Spatula
2.0mm
2550

X XP SP SS S

Composite Instrument Posterior
2.5-2.2mm
2552

BEST SELLER

X XP SP SS S

Universal Spatula
1.5-2.0mm
2571



Uni Spatel 1.5-2.0mm
REF 2571 XP MD





BEST SELLER

X XP SP SS S



Base Carriers

Base Carrier - Rigid
0.9-06mm
2506



X XP SP SS S

Base Carrier - Condenser Malleable Tip
0.9mm
2507

X XP SP SS S

Base Carrier - Condenser Rigid
0.9mm
2508





X XP SP SS S

Carvers

ErgoX®

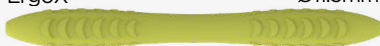
ErgoX® Length 110mm
Ø11.5mm



ErgoX® Plus Length 110mm
Ø13.7mm



ErgoSteel

ErgoSteel SP Length 106mm
Ø9.5mm



ErgoSteel SS Length 104mm
Ø8.0mm



ErgoSteel S Length 100mm
Ø6.0mm



Nystrøm I
2.0mm
2524



Carver Nys I
REF 2524 XP MD



BEST SELLER

X XP SP SS S

Nystrøm III
1.7mm
2525



Carver Nys III
REF 2525 XP MD



BEST SELLER

X XP SP SS S



Heidemann
2.0mm
2519



X XP SP SS S



Heidemann
2.5mm
2520



X XP SP SS S



Heidemann
3.0mm
2521



X XP SP SS S



Carver 5
2.5-2.0mm
2523



X XP SP SS S



Knife-Carver
2.0mm
2526



X XP SP SS S

Condensers

ErgoX®
Length 110mm
Ø11.5mm

ErgoX® Plus
Length 110mm
Ø13.7mm

ErgoSteel

ErgoSteel SP
Length 106mm
Ø9.5mm

ErgoSteel SS
Length 104mm
Ø8.0mm

ErgoSteel S
Length 100mm
Ø6.0mm

Amalgam Condenser
2.5-2.0mm
2505

Amalgam Condenser
1.5-1.0mm
2504

X XP SP SS S

Amalgam Condenser
2.5-2.0mm
2505

X XP SP SS S

Filling Contour
2.0mm
2564

X XP SP SS S

BEST SELLER

Condenser, Drop-Shaped
1.8-1.3mm
2572

X XP SP SS S

Form Condenser
2.5-1.5mm
2562

X XP SP SS S

BEST SELLER

Filling Flow 1
1.0mm
2563

X XP SP SS S

Filling instruments

Filling Remover
1.5-0.5mm
2547

X XP SP SS S

UP1 Plastic filling
1.6mm
2546

X XP SP SS S

Filling Instrument-C49
1.7-1.2mm
2589

X XP SP SS S

Filling Instrument-PFI 8A
1.7mm
2585

X XP SP SS S

Filling Instrument-PFI 6
1.5mm
2584

X XP SP SS S

Filling Instrument-PFI UP1
1.7mm
2583

X XP SP SS S

Filling Instrument-UP1
2.0-1.75mm
2582

X XP SP SS S

Filling instruments

ErgoX®

ErgoX® Length 110mm Ø11.5mm

ErgoX® Plus Length 110mm Ø13.7mm

ErgoSteel

ErgoSteel SP Length 106mm Ø9.5mm

ErgoSteel SS Length 104mm Ø8.0mm

ErgoSteel S Length 100mm Ø6.0mm

Special Filling Instrument

2.5-2.0mm

2542



Plastic Instrument-Posterior

2.0-1.4mm

2548



Plastic Instrument-Anterior

1.7-1.2mm

2549



Filling Applicator

1.5mm

2531



Filling Shaper

1/2.5mm-0.5/1mm

2534



Filling Condensor

14-0.7mm

2535



Goldfogel Composite Contouring

2595



Filling Twister

2532



Filling Contour Spatel

2533

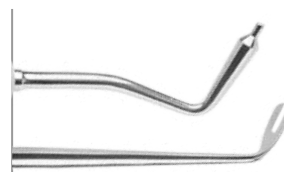

Filling Fork

2536



Filling Sculptor Posterior

2537



Filling instruments

ErgoX®

ErgoX® Length 110mm Ø11.5mm



ErgoX® Plus Length 110mm Ø13.7mm



ErgoSteel

ErgoSteel SP Length 106mm Ø9.5mm



ErgoSteel SS Length 104mm Ø8.0mm



ErgoSteel S Length 100mm Ø6.0mm







Filling Trimmer
2538

Filling Former
2539

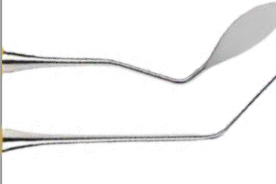
Filling Anterior
2540



Filling Posterior
2541



Cord Packers

Retraction Cord Paker-UP1
2.0mm
2545



Cord Paker-UP1
REF 2545 X MD



Cord Packer
2.0mm
2543



Cord Packer 2.0mm
REF 2543 XP MD



BEST SELLER

Cord Packer
2.6mm
2544



Cord Packer 2.6mm
REF 2544 SP MD



ErgoSlip

Non-stick composite
instruments



SCAN ME



Discover More Online
Scan the QR Code



No More
Sticking



Hygienic
and Easy



Available in Gold,
Black, Blue

Choose your ErgoSlip

Black

A low-glare black titanium coating that enhances contrast and visibility in the operative field. Delivers strong non-stick properties and is especially useful in deep cavities or aesthetic zones.

Blue

A durable blue titanium coating that provides reliable non-stick performance with a balanced feel. Ideal for everyday restorative work where smooth material handling and consistency are key.

Gold

A premium gold titanium coating designed to reduce composite sticking during restorative procedures. Offers smooth handling, high wear resistance, and excellent corrosion protection for long-lasting clinical performance.

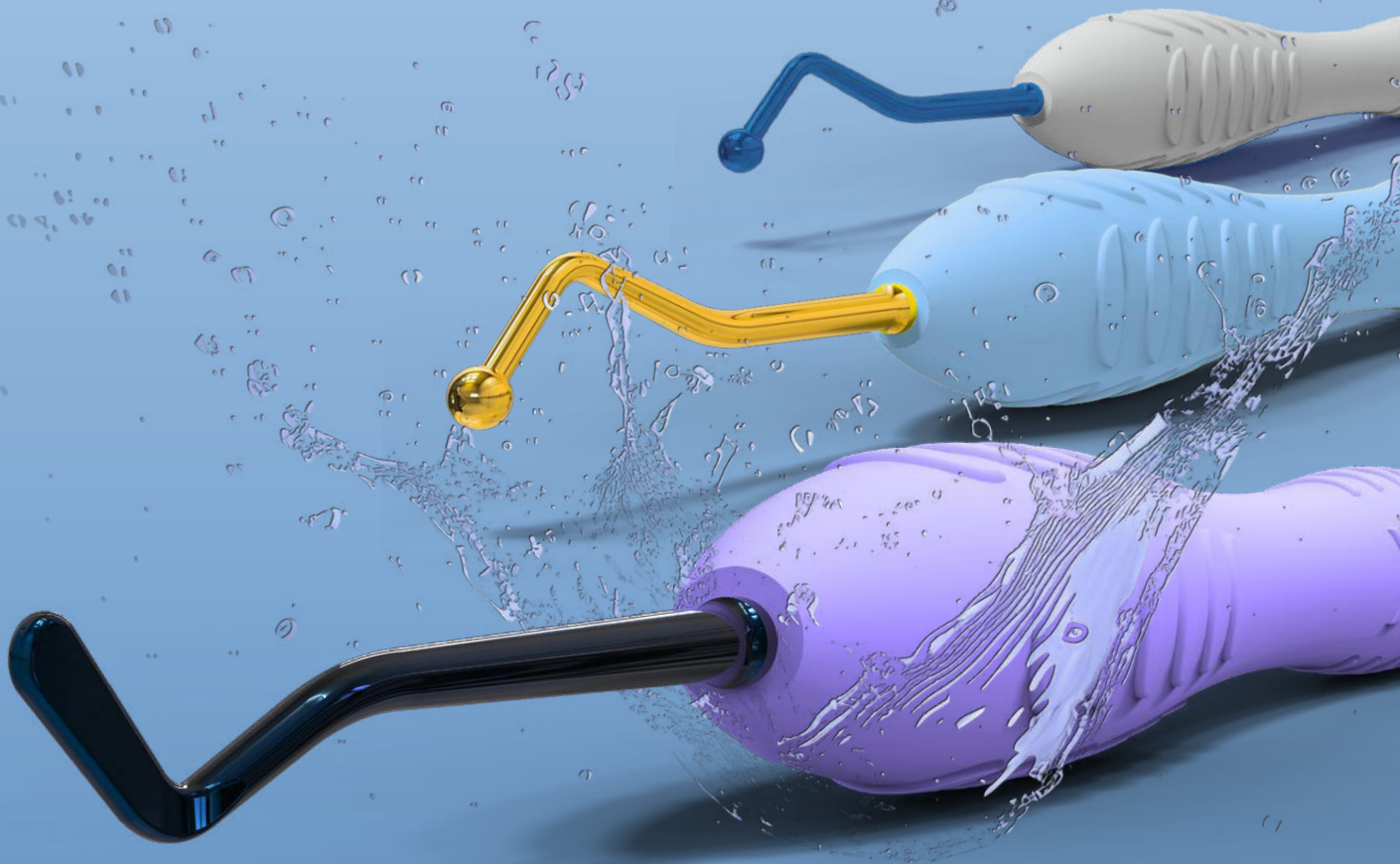

ErgoSlip

Available in blue, gold, and black coatings with ErgoX®, ErgoX® Plus, and ErgoSteel Plus handles. Each set includes an ErgoTray-1 for secure handling.

Perfect For: Composite placement, restorative procedures, and general dentistry.

Smoother Restorations, Every Time.

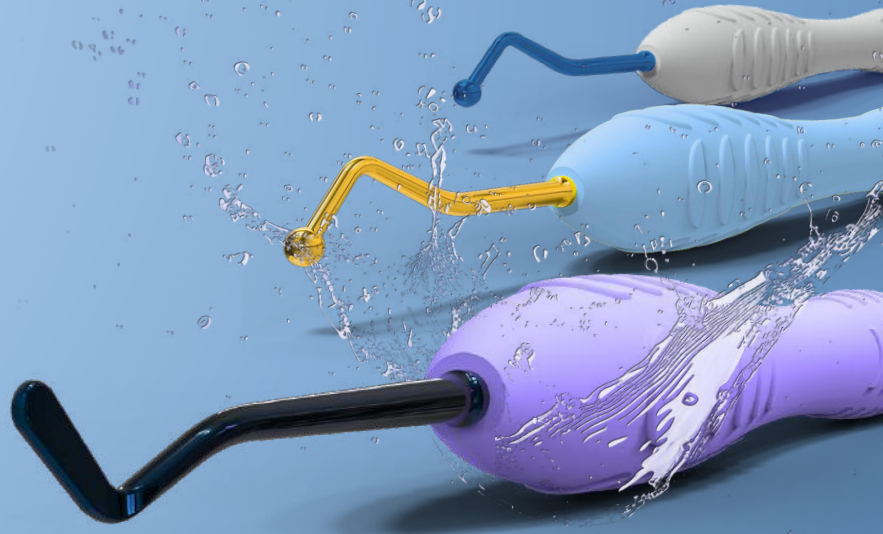

Each ErgoSlip comes with an ErgoTray-1.

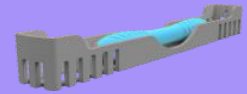

Plugger
1.2-1.0mm

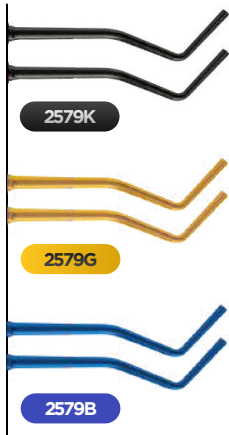

Plugger
1.6-1.4mm

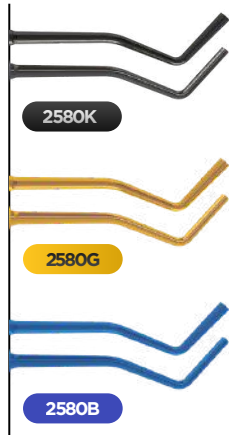

Plugger
3.8-2.5mm

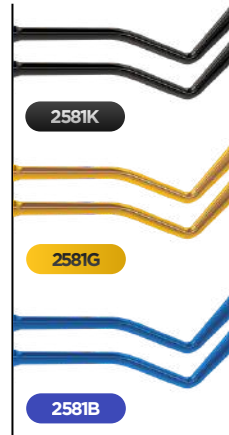

Plugger, Cylindrical
2.5-1.8mm

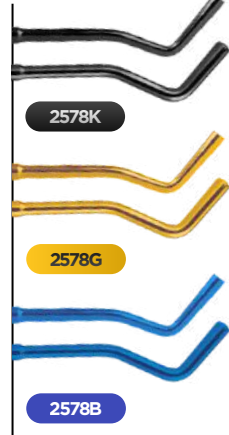

Burnisher
2.0-1.5mm

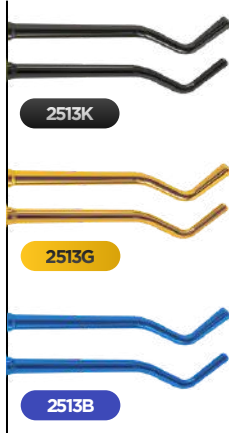

Burnisher & Plugger
Ball ended, 2.5-1.5mm

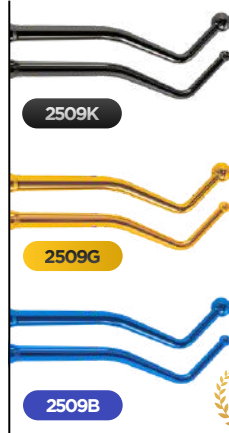

Shaper Filling,
3.0-2.5mm

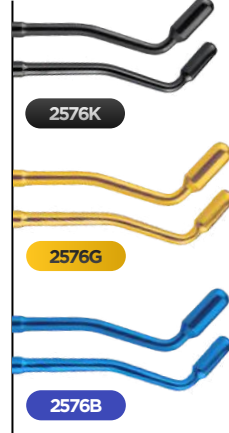

Shaper Filling Slim
2.5mm-2.0mm

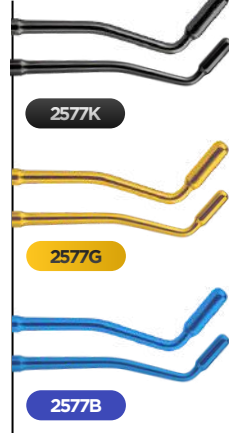

Filling Instrument-UP1
2.0-1.75mm



ErgoSlip

Smoother Restorations, Every Time.

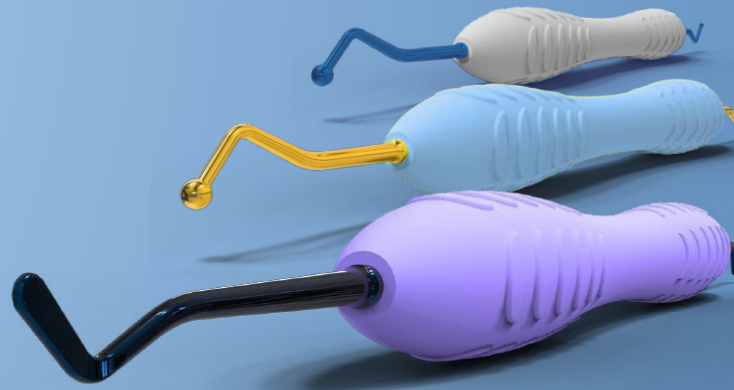

Filling Instrument-C49
1.7-1.2mm

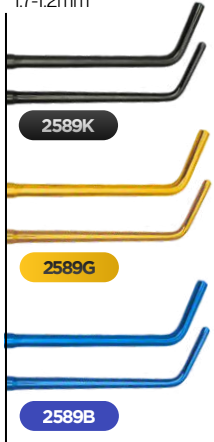

Filling Twister

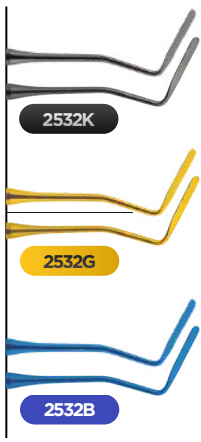

Universal Spatula
2.0-1.5mm



Mini Spatula
2.0mm



Condenser, Drop-Shaped
1.3-1.8mm



Plastic Instrument-Posterior
2.0-1.4mm



Filling Trimmer

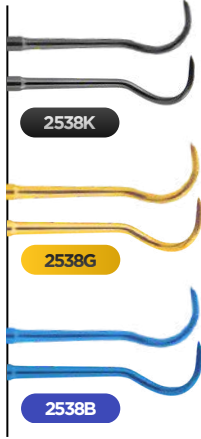

Filling Contour Spatula



Filling Sculptor Posterior

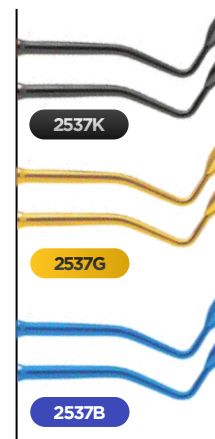

Plastic Instrument-Anterior
1.7mm-1.2mm



Filling Applicator
1.5mm

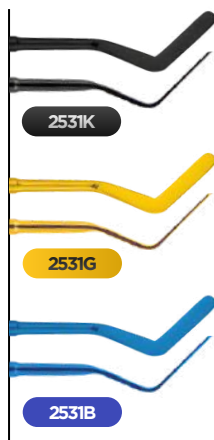

Filling Shaper
1.0-0.5 / 2.5-1.0mm

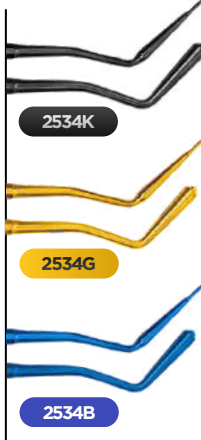

Filling Condensor
1.4-0.7mm

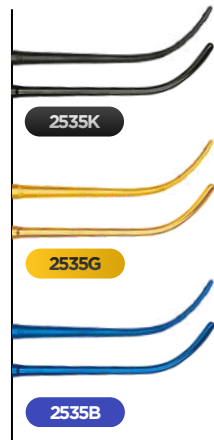

Filling Contour
2.0mm

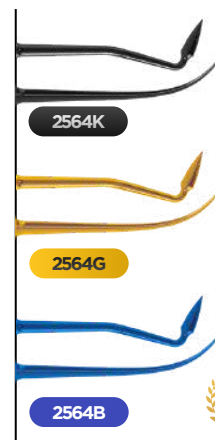

Filling Anterior

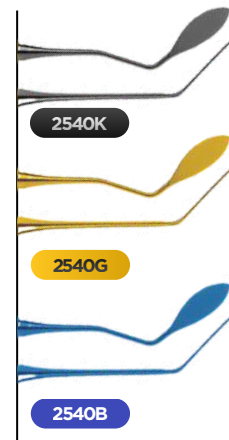

ErgoSlip

Smoother Restorations, Every Time.

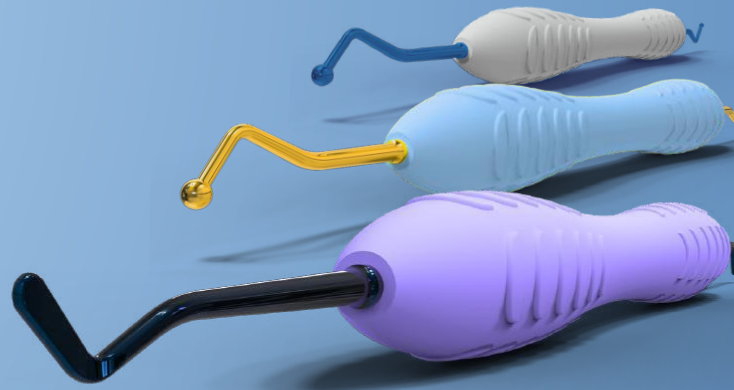

2536K

2536G

2536B

Filling Fork



Knife-Carver
2.0mm

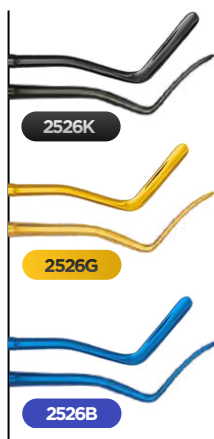

2526K

2526G

2526B

Filling Instrument-PFI
8A
1.7mm



2585K

2585G

2585B

Filling Instrument-PFI
6
1.5 mm

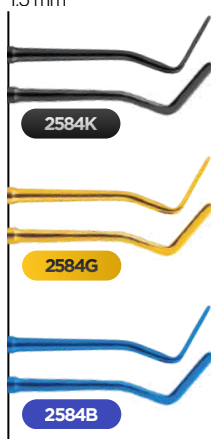

2584K

2584G

2584B

Filling Instrument-PFI
UP1
1.7 mm

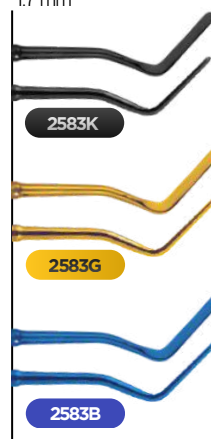

2583K

2583G

2583B

ErgoSlip All Round Compo Set

Used for easy placement, shaping, and finishing of composite materials. Blue non-stick coated tips help reduce sticking and improve control during restorative work. Supplied in a sterilization cassette.



9910

Available in



X XP SP

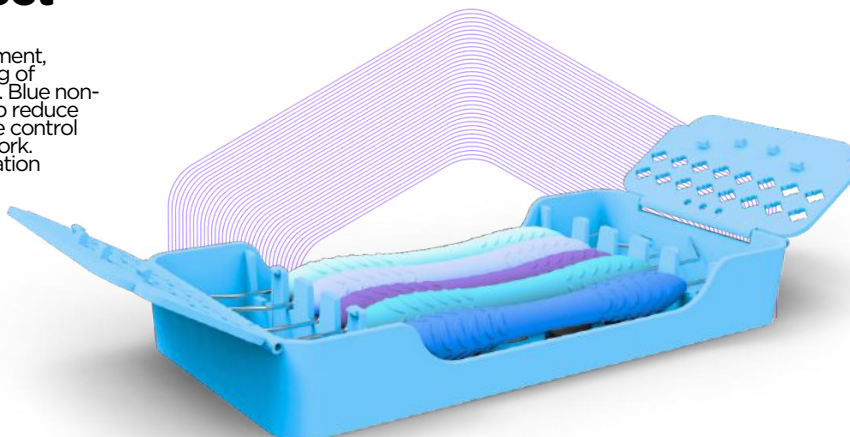

Instruments

Universal Spatula, 1.5-2.0mm
2571B



Mini Spatula, 2.0-2.0mm
2550B



Plastic Instrument-Anterior, 1.7-1.2mm
2549B



Burnisher, 2.0-1.5mm
2513B



Burnisher & Plugger, Ball ended, 2.5-1.5mm
2509B



5 instruments + cassette

Composite kits

Restoration Kits Compo Set 5

Used for precise placement, shaping, and finishing of composite restorations. A practical set of essential instruments for everyday restorative procedures, supplied in a sterilization cassette for organized storage and sterilization.

9911

Available in



X XP SP

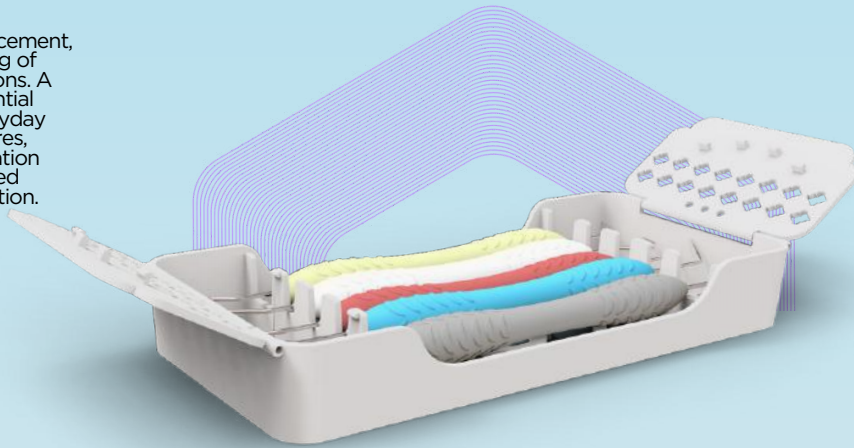

Instruments

Form Condenser, 2.5-1.5mm
2562



Mini Spatula, 2.0-2.0mm
2550



Plastic Instrument-Anterior, 1.7-1.2mm
2549



Filling Flow 1, 1.0mm
2563



Mini Sickle 11-12
2182



5 instruments + cassette

Super Restoration Kit

Used for efficient composite placement, contouring, and finishing during restorative procedures. A comprehensive set of essential instruments for daily restorative work, supplied in a sterilization cassette for organized storage and sterilization.

9912

Available in



X XP SP

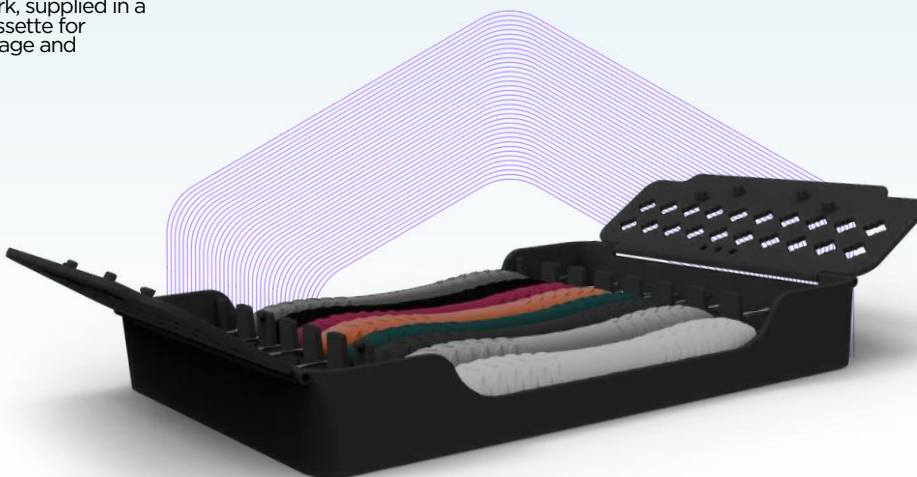

Instruments

ErgoX® Mirror handle, Peach Blush
1401



Explorer 23 + Probe CP-12B
1311

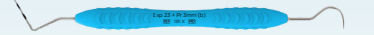

Round Excavator, 1.5mm
2802



Burn/Plug Ball 1.5-2.5mm
2509



Micro Sickle 01-02
2181



Mini Spatula, 2.0-2.0mm
2550



Form Condenser, 1.5-2.5mm
2562



Meriam Tweezer, 16 cm
3636-1A



8 instruments + cassette

Periodontics



Gracey curettes

ErgoDenta offers Gracey Curettes in Standard, Rigid, and Mini types, with ErgoX® and ErgoSteel handles for comfort and durability.

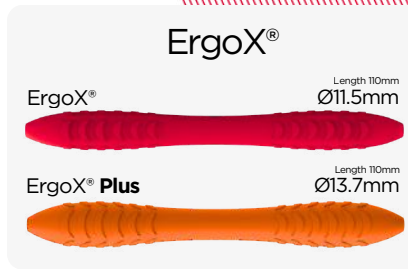

Gracey Curettes



<p>Gracey 1-2 2001</p> <p>BEST SELLER</p> <p>X XP SP SS S</p>	<p>Gracey 3-4 2002</p> <p>X XP SP SS S</p>	<p>Gracey 5-6 2003</p> <p>X XP SP SS S</p>	<p>Gracey 7-8 2004</p> <p>X XP SP SS S</p>	
	<p>Gracey 9-10 2005</p> <p>X XP SP SS S</p>	<p>Gracey 11-12 2006</p> <p>X XP SP SS S</p> <p>BEST SELLER</p>	<p>Gracey 13-14 2007</p> <p>X XP SP SS S</p> <p>BEST SELLER</p>	
	<p>Gracey 15-16 2008</p> <p>X XP SP SS S</p>	<p>Gracey 17-18 2009</p> <p>X XP SP SS S</p>	<p>Gracey 11-14 2010</p> <p>X XP SP SS S</p> <p>BEST SELLER</p>	<p>Gracey 12-13 2011</p> <p>X XP SP SS S</p>

Rigid Gracey Curettes

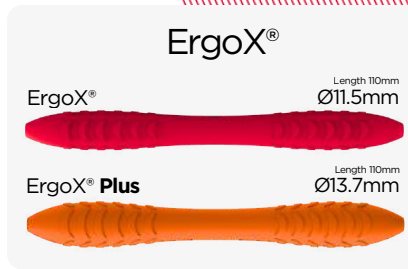

Rigid Gracey 11-12
2253

X XP SP SS S

Rigid Gracey 13-14
2254

X XP SP SS S

Gracey P3-P4
2014

X XP SP SS S

Mini Gracey Curettes



Mini Gracey 1-2
2101

X XP SP SS S

BEST SELLER

Mini Gracey 5-6
2102

X XP SP SS S

Mini Gracey 7-8
2103

X XP SP SS S

Mini Gracey 11-12
2104

X XP SP SS S

BEST SELLER

Mini Gracey 13-14
2105

X XP SP SS S

BEST SELLER

Mini Gracey 15-16
2106

X XP SP SS S

Mini Gracey 17-18
2107

X XP SP SS S

BEST SELLER

Sickle Scalers

ErgoX®
 ErgoX® Length 110mm Ø11.5mm
 ErgoX® Plus Length 110mm Ø13.7mm

ErgoSteel
 ErgoSteel SP Length 106mm Ø9.5mm
 ErgoSteel SS Length 104mm Ø8.0mm
 ErgoSteel S Length 100mm Ø6.0mm



Sickle Scaler H6-H7
2153



Sharp Jack Scaler
2154



Nebraska 128
2155



Sickle Scaler 204S
2156



Sickle Scaler 204SD
2157

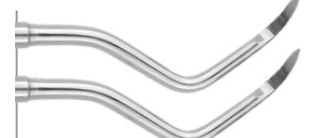

M23
2159

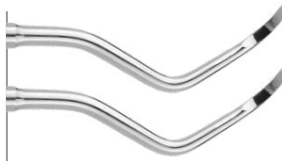

M23A
2161



Crane-Kaplan
2162



Micro Sickie 01-02
2181



Kirkland
2169 SP



Mini Sickie 11-12
2182



Furcator Scaler
2168

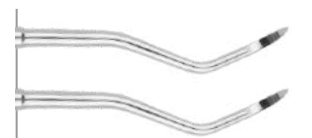

Mini Excess Scaler
2184



Universal Currettes

ErgoX
 ErgoX®
 Length 110mm
 Ø11.5mm



ErgoX® Plus
 Length 110mm
 Ø13.7mm



ErgoSteel

ErgoSteel SP
 Length 106mm
 Ø9.5mm



ErgoSteel SS
 Length 104mm
 Ø8.0mm



ErgoSteel S
 Length 100mm
 Ø6.0mm



Columbia 2L-2R
 REF: 2201 X MD

Columbia 2L-2R
 2201



Columbia 4L-4R
 2202



Columbia 13-14
 2203



Barnhart 1-2
 2204



Barnhart 5-6
 2205



Langer 1-2
 2206



Langer 3-4
 2207



Langer 5-6
 2208



Mini Langer 1-2
 2209



Mini Langer 3-4
 2210



Mini Langer 5-6
 2211



Mccall 13S-14S
 2212



Mini McCall 13S-14S
 2213





McCall 17-18
 2214

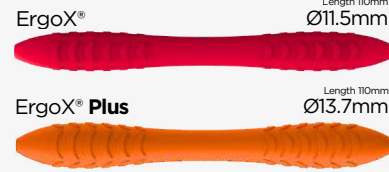

Universal Currettes

ErgoX®
 ErgoX® Length 110mm Ø11.5mm
 ErgoX® Plus Length 110mm Ø13.7mm



ErgoSteel
 ErgoSteel SP Length 106mm Ø9.5mm
 ErgoSteel SS Length 104mm Ø8.0mm
 ErgoSteel S Length 100mm Ø6.0mm



McCall 17S-18S
2215



Duplex Curette
2217



Mini Duplex Curette
2218



Duplex Anterior
2219



Mini Duplex Anterior
2220



Goldman-Fox 3
2221



Hoe Scalers



Hoe Scaler, Anterior
2281



Hoe Scaler, Lateral
2282



Hoe Scaler, Posterior
2283



NEW

Scalers & Curettes

Blue

Titanium

Titanium
Tips for Implant
Maintenance

Titanium working ends for implant maintenance. Clean effectively around implants and restorations while helping protect implant surfaces from scratching.

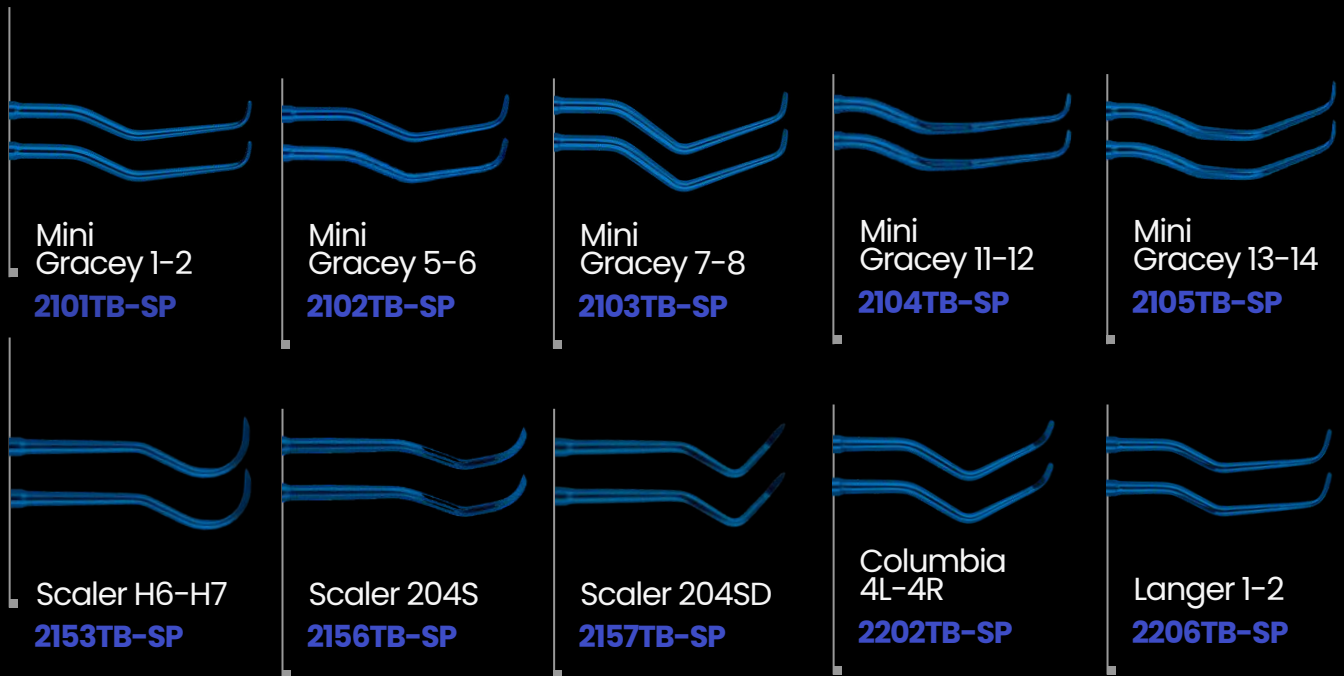

ErgoRazor[®]

Scalers & Cures

ErgoRazor[®] is a registered trademark of ErgoDenta



Up to

3X

Longer
Sharpness

SCAN ME



Discover More Online
Scan the QR Code

Choose your ErgoRazor

ErgoRazor® Black

Coated with a sleek black finish to minimize glare and enhance visibility. Ideal for deep periodontal pockets and precision-focused procedures.

ErgoRazor® Gold

Gold-coated for enhanced durability and smooth movement. Its corrosion resistance makes it a premium choice for clinicians who prioritize long-lasting performance.

ErgoRazor®

Made from high-quality stainless steel, this tip offers dependable performance for routine scaling. Trusted for its balance of strength and precision.

The World's First Perio Instruments Delivered in a Protective Tray

Every ErgoRazor® comes with ErgoTray-1 — protecting razor-sharp tips from damage, keeping instruments organized, and making handling and storage safer. Autoclaveable for full sterilization compatibility.



ErgoRazor®

Scalers & Currettes

ErgoRazor instruments deliver up to 3× longer-lasting sharpness for precise and efficient periodontal work.

Available with ErgoX® and ErgoX® Plus handles, in black or gold coating, or a silver finish without coating. Each ErgoRazor is supplied with ErgoTray-1 for safe handling and organized storage.

Upto **3X** longer sharpness



Each ErgoRazor comes with an ErgoTray-1.

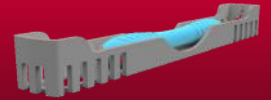

Gracey curettes

■ All Surface
 ■ Buccal-lingual
 ■ Mesial
 ■ Distal

Gracey 1-2	Gracey 3-4	Gracey 5-6	Gracey 7-8
 2001RK 2001RG 2001R	 2002RK 2002RG 2002R	 2003RK 2003RG 2003R	 2004RK 2004RG 2004R
	BEST SELLER		
	BEST SELLER		
Gracey 9-10	Gracey 11-12	Gracey 13-14	Gracey 15-16
 2005RK 2005RG 2005R	 2006RK 2006RG 2006R	 2007RK 2007RG 2007R	 2008RK 2008RG 2008R
	BEST SELLER		
		BEST SELLER	BEST SELLER

ErgoRazor®

Scalers & Curettes

Upto **3X** longer sharpness



Gracey 17-18

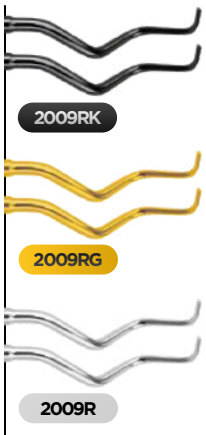

Gracey 11-14

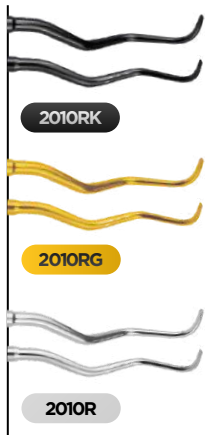

Gracey 12-13



Did you know?

Instrument sharpness plays a key role in effective periodontal treatment.

One of the key ideas behind ErgoRazor.



Upto **3X** longer sharpness

Mini Gracey Curettes



All Surface



Buccal-lingual



Mesial



Distal

2101RK

2101GK

2101K

Mini Gracey 1-2



Mini Gracey 7-8

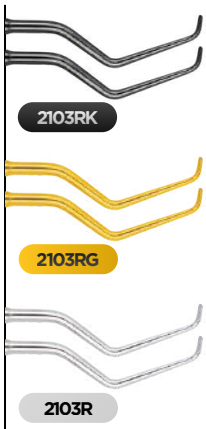

Mini Gracey 11-12

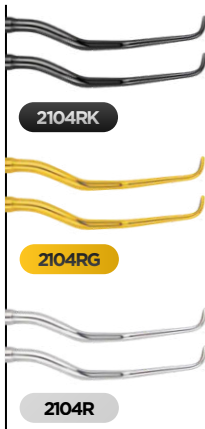

Mini Gracey 13-14



Mini Gracey 15-16

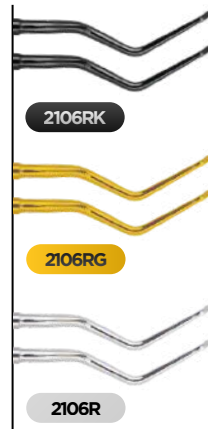

Mini Gracey 17-18

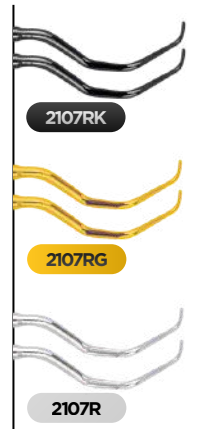

Upto **3X** longer sharpness



Sickle Scalers



2153RK **2153GK** 2153K

Sickle Scaler H6-H7



Sharp Jack Scaler

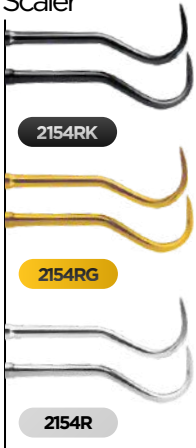

Nebraska 128



Sickle Scaler 204S

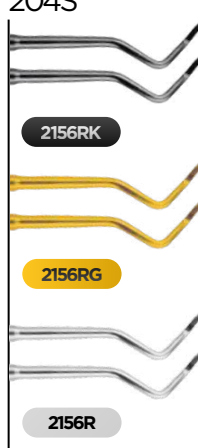

Sickle Scaler 204SD

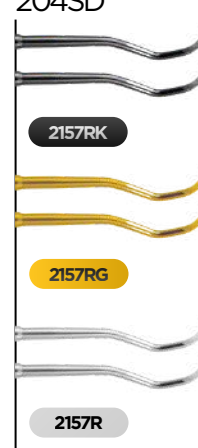

M23

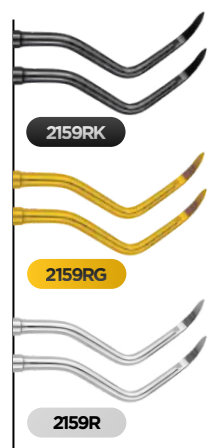

M23A



Crane-Kaplan

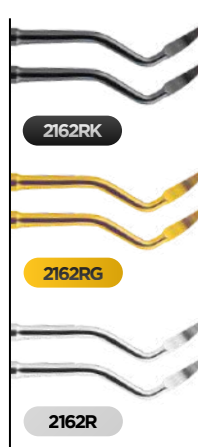

Mini Sickle Scaler 01-02



Mini Sickle Scaler 11-12

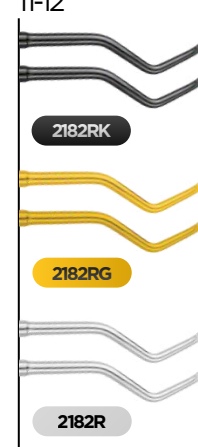

Upto **3X** longer sharpness



Universal Curettes

Columbia
2L-2R

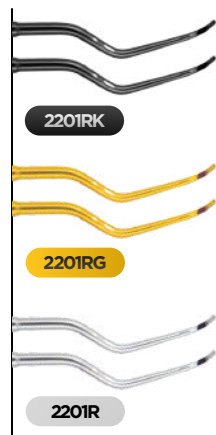

Columbia
4L-4R

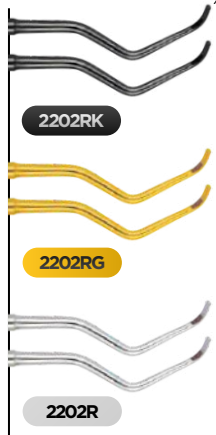

Columbia
13-14



Barnhart 1-2



Barnhart 5-6



Langer 1-2

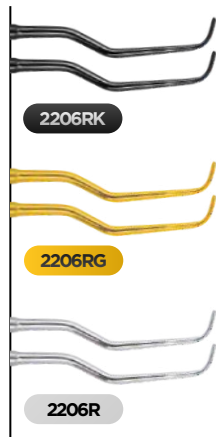

Mccall
13S-14S

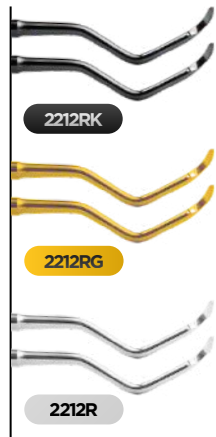

Mini McCall
13S-14S



McCall 17-18



McCall 17S-18S



Duplex Curette

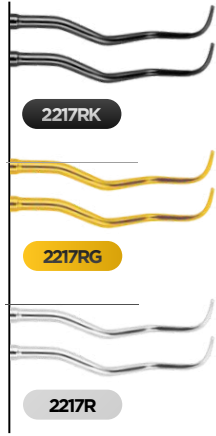

Mini Duplex
Curette

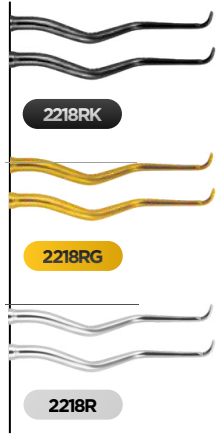

Duplex Anterior



Mini Duplex
Anterior

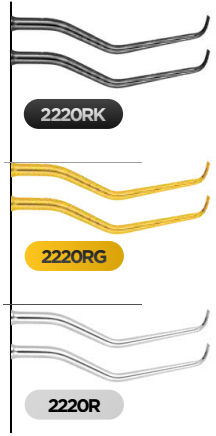

Goldman-Fox 3



Peter's 6 fav ErgoRazor Instruments

Mini Gracey 1-2

2101RG-X



Mini Gracey 11-12

2104RG-X



Mini Gracey 15-16

2106RG-X



Mini Gracey 7-8

2103RG-X



Mini Gracey 13-14

2105RG-X



Nebraska 128

2155RG-X

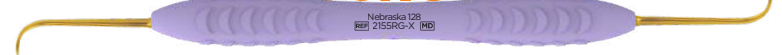

ErgoTray 8 - Black

5508K



“

I have been using instruments from ErgoDenta for some time and am very satisfied with the quality. We are especially pleased with the ErgoRazor series. The instruments offer solid quality at a reasonable price, and I warmly recommend ErgoDenta.

Petter Johnsen

Owner Dental Clinic, Studio Smile, Norway



Perio Kits

Basic Hygienist Kit

A practical set of essential instruments for routine periodontal examinations and scaling. Designed for everyday hygiene procedures and supplied in a sterilization cassette for organized storage and sterilization.



9905

Available in



X XP SP

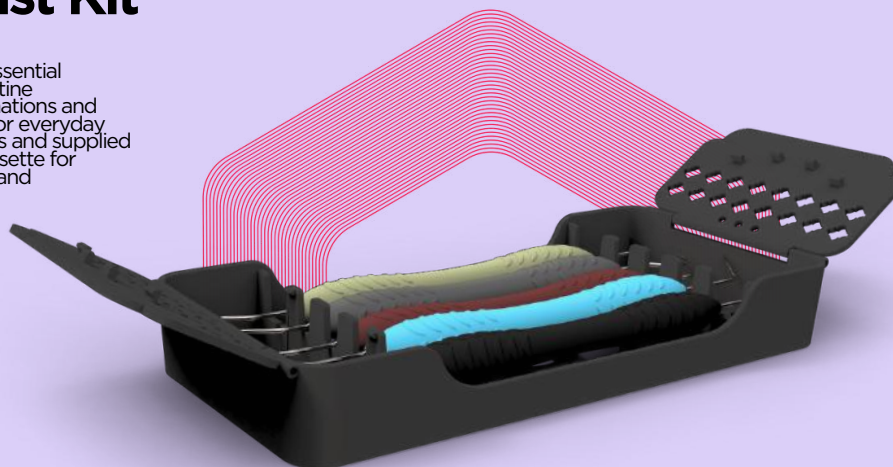

Instruments

ErgoX® Mirror handle, Peach Blush
1401



Explorer 17-23
1107



Mini McCall 13s-14s
2213



Probe CP-12 (3-6-9-12mm)
1053



Mini Sickle Scaler 11-12
2182



5 instruments + cassette

All Round Perio Set

A comprehensive set of essential periodontal instruments for scaling and root planing across different areas of the mouth. Supplied in a sterilization cassette for organized storage, easy handling, and efficient sterilization.

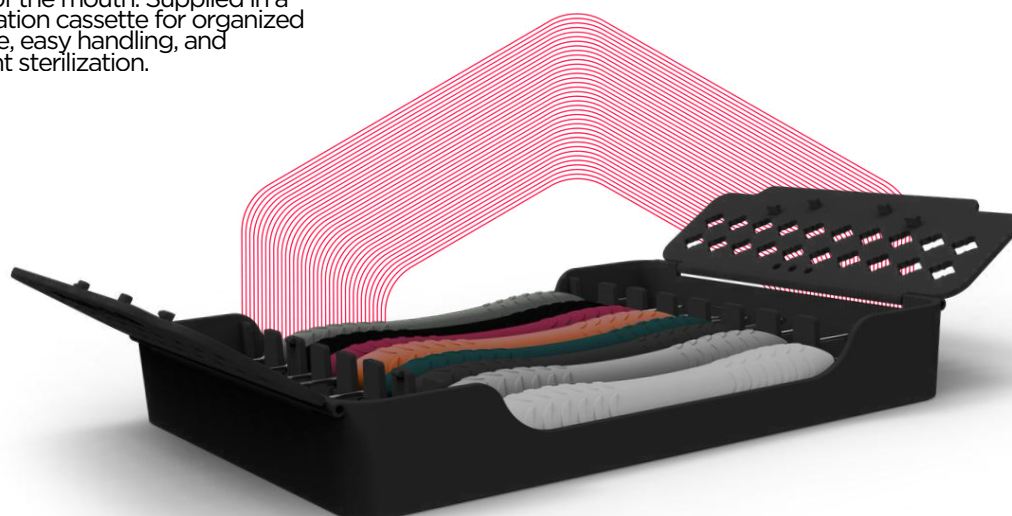

9903

Available in



X XP SP

Instruments

Mini Sickle Scaler 11-12
2182



Micro Sickle Scaler 01-02
2181



McCall 17-18
2214



Gracey 1-2
2001



Gracey 9-10
2005



Gracey 11-12
2006



Gracey 13-14
2007



Gracey 15-16
2008



8 instruments + cassette

Basic Perio Kit

A practical set of essential periodontal instruments for everyday scaling and root planing. Supplied in a sterilization cassette for organized storage, easy handling, and efficient sterilization.



9906

Available in



X XP SP

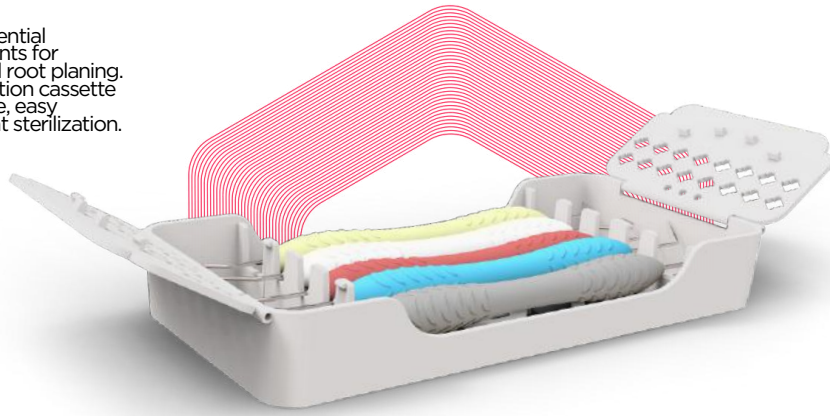

Instruments

Mini Sickle Scaler 11-12
2182



McCall 17-18
2214



Gracey 1-2
2001



Gracey 11-12
2006



Gracey 13-14
2007



5 instruments + cassette

Perio Diagnostic Kit

Each instrument is selected to support periodontal examination and basic scaling procedures. Supplied in a sterilization cassette for organized storage, easy handling, and efficient sterilization.

9907

Available in



X XP SP

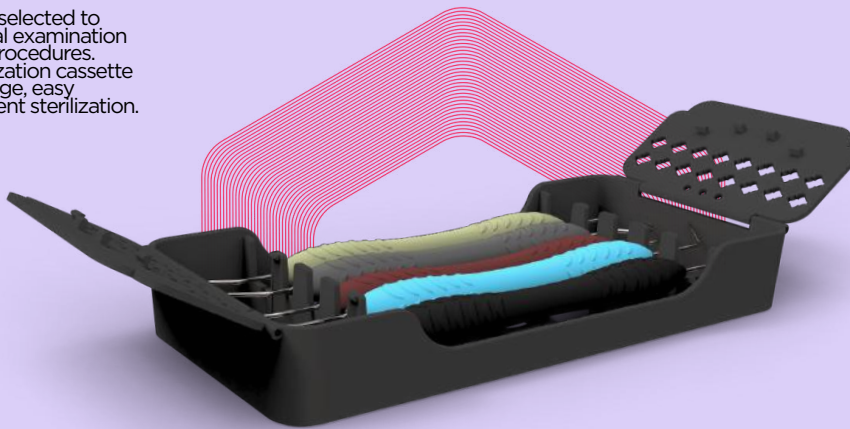

Instruments

ErgoX® Mirror handle, Peach Blush
1401



Crane-Kaplan
2162



Explorer 8 + Probe CP 2B
1303



Gracey 11-12
2006



Gracey 13-14
2007



5 instruments + cassette

Tartar Remover Set

A practical set designed for efficient tartar removal and routine scaling procedures. Supplied in a sterilization cassette for organized storage, easy handling, and efficient sterilization.

9904

Available in



X XP SP

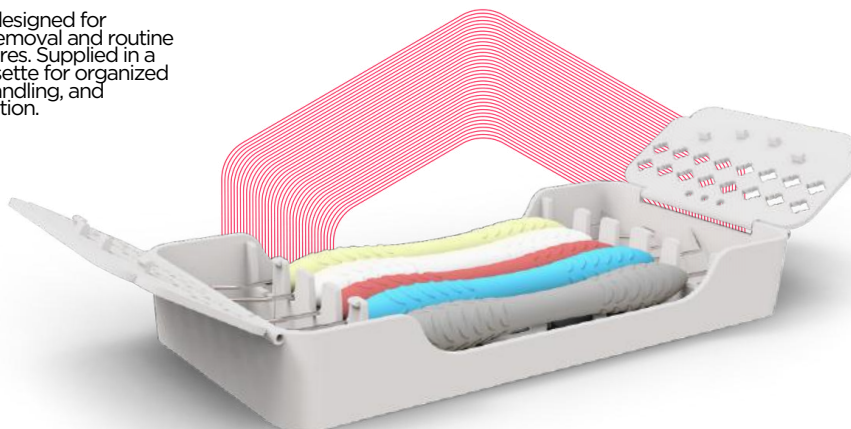

Instruments

ErgoX® Mirror handle, Peach Blush
1401



Sickle Scaler H6-H7
2153



Mini Sickle Scaler 11-12
2182



M23 Sickle Scaler
2159



Explorer 17-23
1107



5 instruments + cassette

Elevate, Grip & Extract

Extraction



Elevators and forceps for
smooth & controlled extractions.

Extraction Forceps

ErgoDenta offers Extraction Forceps in Diamond, Standard, Children Junior, and Grip Master variants, designed for precise and reliable tooth extraction.

Upper Incisors, molars,
Premolars & Roots



Fig.1
Upper Incisors
And Molars

5005-1 5025-1



5025-17
5005-17

Fig.17
Upper Molars, Right

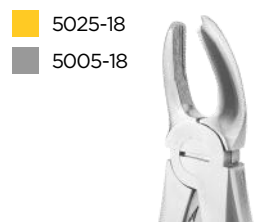

5025-18
5005-18

Fig.18
Upper Molars, Left

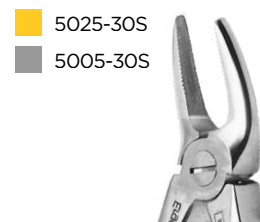

5025-30S
5005-30S

Fig.30S
Upper Front

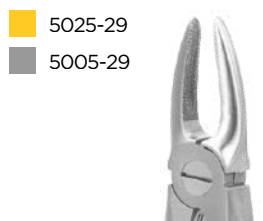

5025-29
5005-29

Fig.29
Upper Front

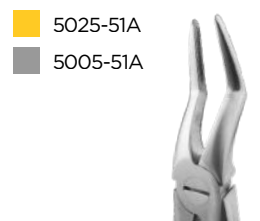

5025-51A
5005-51A

Fig.51A
Upper Roots

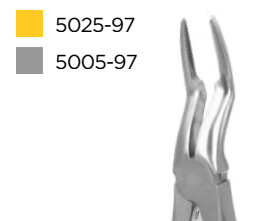

5025-97
5005-97

Fig.97
Upper Roots



Fig.7
Upper
Premolars

5005-7 5025-7



5025-41
5005-41

Fig.41
Upper Roots

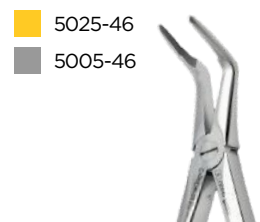

5025-46
5005-46

Fig.46
Upper Roots

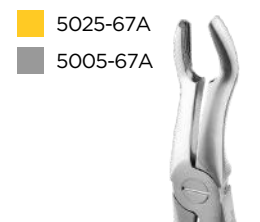

5025-67A
5005-67A

Fig.67A
Upper Molars for
Upper Wisdom Teeth

Upper Incisors, molars, Premolars & Roots



5005-OK

Fig.OK
Universal-Upper Roots
Extracting Forceps



5025-98

Fig.98
Witzel (Upper
roots)

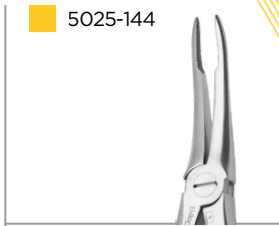

5025-144

Fig.144
Upper Roots



Lower Incisors, molars, Premolars & Roots



Fig.22
Lower Molars

5005-22 5025-22

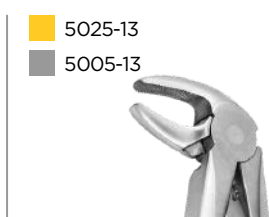

5025-13
5005-13

Fig.13
Lower Molars &
Premolars

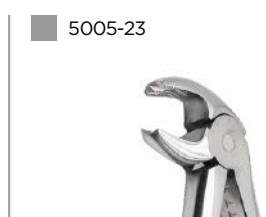

5005-23

Fig.23
Lower Molars,
Right



5005-24

Fig.24
Lower Molars,
Left

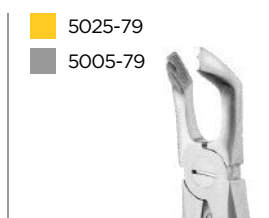

5025-79
5005-79

Fig.79
Lower Wisdom



5025-86A
5005-86A

Fig.86A
Lower Molars

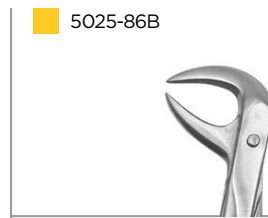

5025-86B

Fig.86B
Lower Molars

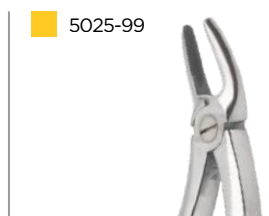

5025-99

Fig.99
Hertz (Lower
Molars)

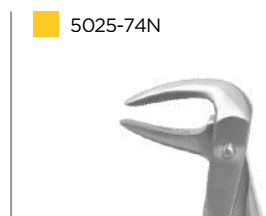

5025-74N

Fig.74N
Lower Roots



5005-UK

Fig.UK
Universal-Lower Roots

Lower Incisors, molars, Premolars & Roots

5005-87



Fig.87
Lower Molars



Junior Extraction Forceps

ErgoDenta's junior extraction forceps are designed for smaller anatomy and secure handling in younger patients. They provide controlled grip and reliable access for common pediatric extractions.



Fig.37
Incisors,
Upper Jaw
5015-37



Fig.13K
Premolars,
Lower Jaw
5015-13K



Fig.22K
Molars,
Lower Jaw
5015-22K



Fig.7K
Upper Jaw-
Molars & Incisors
5015-7K



Fig.38
Incisors & canines,
Lower Jaw
5015-38

Extraction Forceps Kit



Instruments in the kit

	Diamond	Standard
Fig. 1. Upper Incisors And Molars	5025-1	5005-1
Fig. 13. Lower Molars And Premolars	5025-13	5005-13
Fig. 17. Upper Molars, Right	5025-17	5005-17
Fig. 18. Upper Molars, Left	5025-18	5005-18
Fig. 22. Lower Molars	5025-22	5005-22
Fig. 33A. Lower Incisors, Premolars & Roots	5025-33A	5005-33A
Fig. 51A. Upper Roots	5025-51A	5005-51A
Fig. 67A. Upper Molars-Upper for Wisdom Teeth	5025-67A	5005-67A
Fig. 7. Upper Premolars	5025-7	5005-7
Fig. 79. Lower Wisdom Teeth	5025-79	5005-79

Diamond tip with a serrated pattern ensures a strong grip.



Forceps/box

10



Diamond extraction forceps set
5025



Standard extraction forceps set
5005

Available in regular & diamond

Extraction

Diamond Grip Master

ErgoDenta's GripMaster Extraction Forceps feature a diamond-coated beak surface, ensuring a secure hold with less grip strength required.

Maximum Grip.
Minimum Effort.



GRIP MASTER



D: 5040-2002
Upper Anterior



D: 5040-2074
Lower Anterior

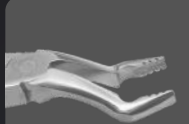

D: 5040-2067
Upper Molar



D: 5040-2079
Lower Molar

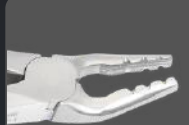

D: 5040-2007
Upper Universal

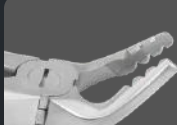

D: 5040-2021
Lower Universal

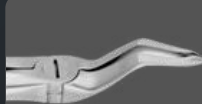

D: 5040-1251
Upper Spade root

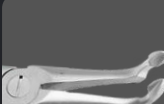

D: 5040-145
Lower Spade Roots



Child Extraction Forceps

ErgoDenta's pediatric extraction forceps offer safe and controlled handling for younger patients. Available in Diamond and Standard versions with an ergonomic grip. Diamond provides extra holding power, while Standard offers reliable grip for daily use.



Fig.3
Upper Molars

5020-3 5010-3

5020-137
5010-137



Fig.137
Upper Incisors

5020-139
5010-139



Fig.139
Upper Pre Molars

5020-51S
5010-51S



Fig.51S
Upper Roots

5020-6
5010-6



Fig.6
Lower Molars

5020-5
5010-5



Fig.5
Lower Incisors

5020-7
5010-7



Fig.7
Lower Roots

Child Extraction Forceps

Kit

Forceps/box

07



Diamond extraction forceps set
5020



Standard extraction forceps set
5010

All 7 child extraction forceps included in the kit. Available in Standard & Diamond.

Luxating Elevators

ErgoDenta's Luxating Elevators are available with Classic or Standard handles and Gold or Silver tips — so you can choose the combination that fits your style and workflow.

Gold Finish

- High contrast — better visibility
- Reduced friction while working
- Extra protection for the cutting edge
- Easy to identify on the tray
- Premium look

Silver Finish

- Classic stainless-steel look
- Durable for daily use
- Easy to clean and maintain
- Matches any instrument setup
- Professional, timeless style

Classic
Handle
8mm

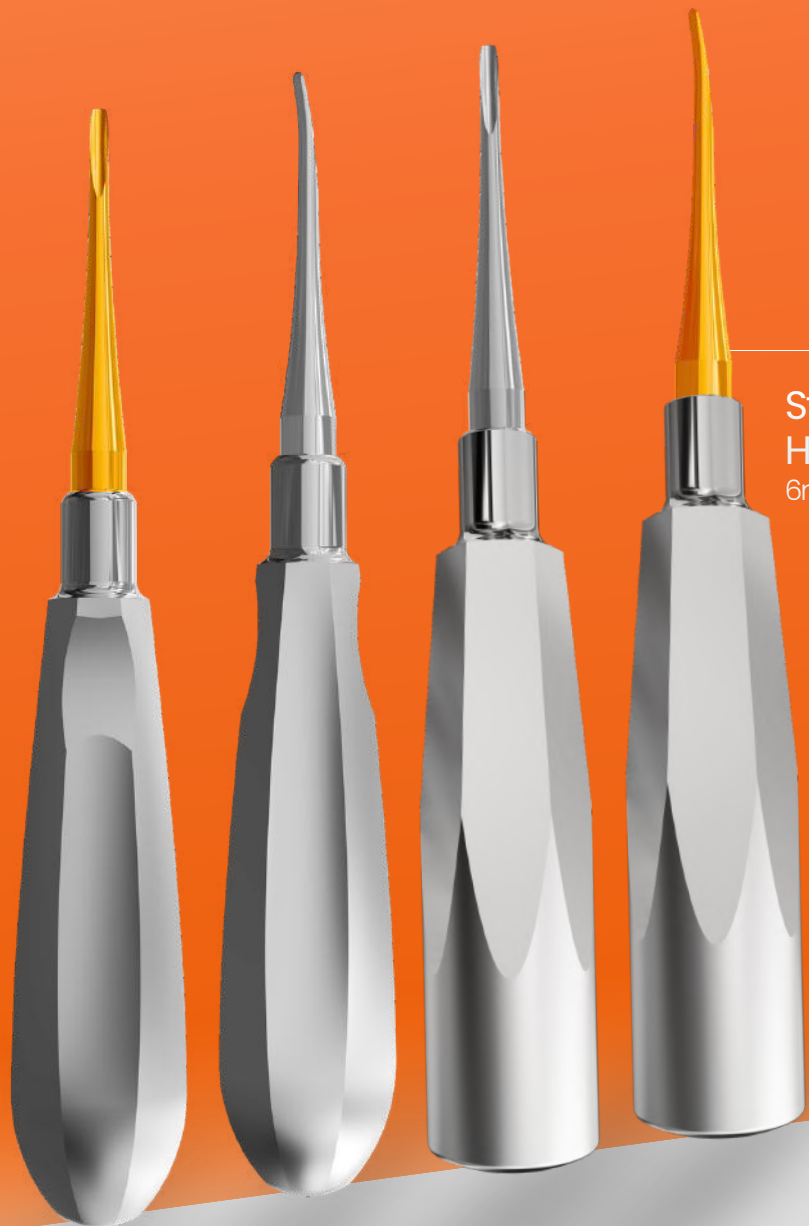

Standard
Handle
6mm

Atraumatic Extraction

Ergonomic Handle

Ultra-Thin, Sharp Tips

Gold or Silver

Straight



2.5mm

Standard Classic
6001-1 6002-1



3mm

Standard Classic
6001-2 6002-2



4mm

Standard Classic
6001-3 6002-3



5mm

Standard Classic
6001-4 6002-4

Straight Gold



2.5mm

Standard Classic
6001-1G 6002-1G



3mm

Standard Classic
6001-2G 6002-2G



4mm

Standard Classic
6001-3G 6002-3G



5mm

Standard Classic
6001-4G 6002-4G

Curved



2.5mm

Standard Classic
6001-5 6002-5



3mm

Standard Classic
6001-6 6002-6



4mm

Standard Classic
6001-7 6002-7



5mm

Standard Classic
6001-8 6002-8

Curved Gold



2.5mm

Standard Classic
6001-5G 6002-5G



3mm

Standard Classic
6001-6G 6002-6G



4mm

Standard Classic
6001-7G 6002-7G



5mm

Standard Classic
6001-8G 6002-8G

Luxating Elevators

Kit

Elevator/box

08

Silver



6001

Kit - 8 luxating elevators in standard handle



6002

Kit - 8 luxating elevators in classic handle

Gold



6001 G

Kit - 8 luxating Gold elevators in standard handle



6002 G

Kit - 8 luxating Gold elevators in classic handle



Root Tip Elevators

Lindo-Levian Elevators

Lindo-Levian Elevators allow gentle, controlled luxation in tight spaces.



Bein Root Elevators

Bein Root Elevators provide controlled elevation and secure leverage.



Flohr Elevators

Flohr Elevators support controlled luxation with stable leverage.



Hylin Root Elevators

Hylin Root Elevators provide controlled root elevation with secure leverage.



Berten Elevators

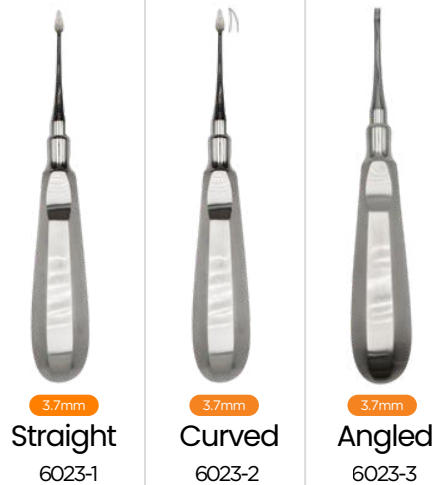

Bernard Elevators

Bernard Elevators provide controlled luxation with stable support.

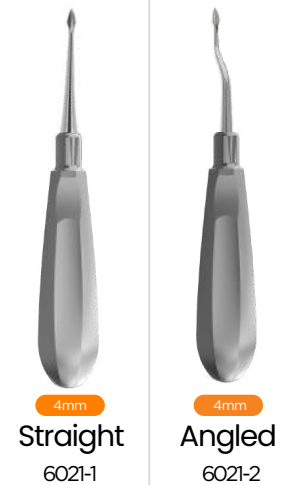

Winter Elevators

Winter Elevators deliver strong, controlled elevation of roots.



Root Tip Elevators

Apical Root Elevators

Apical Root Elevators allow precise elevation at the root apex.



2.5mm

Fig. 1

6046-1



3.5mm

Fig. 2

6046-2



2.3mm

Fig. 3

6046-3



11.2mm

Straight

6021-1



11.2mm

Angled

6021-2



3.7mm

Straight

6090



3.7mm

Curved

6091

Heiderbrink Elevators

Hilin Root Elevators provide controlled root elevation with secure leverage.



3.5mm

Fig. 1

6053-1



4.5mm

Straight

6053-2



4.5mm

Straight

6053-3



1.5mm

Straight

6220 S



1.5mm

Right

6221 S



1.5mm

Left

6222 S



2.5mm

Straight

6223 S



2.5mm

Right

6224 S



2.5mm

Left

6225 S

Root Tip Elevators

Appexo Elevators

Appexo Elevators are designed for gentle, precise luxation. Slim, sharp tips allow controlled movement around the tooth while helping protect surrounding tissue.

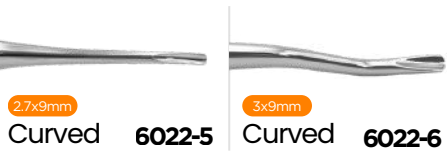

2.5x9mm

Straight
6022-1

Did you know?



Ergonomic elevators help improve grip and precision during extractions.

Root Tip Elevators

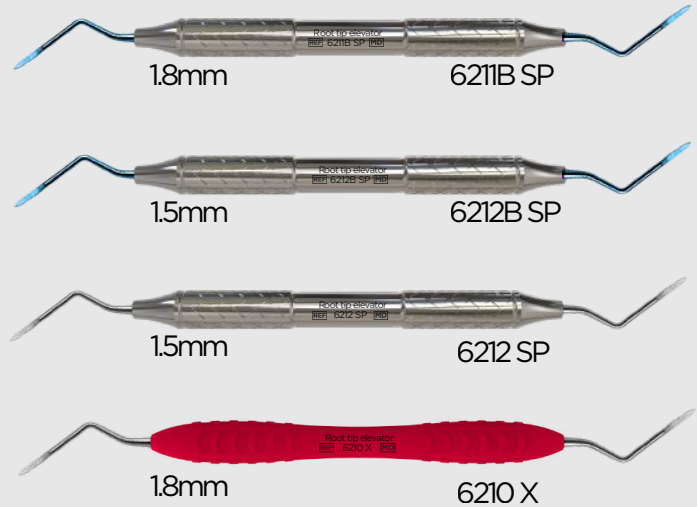

Kopp Elevators

Kopp Elevators offer gentle, precise luxation with slim, sharp tips designed for controlled movement around the tooth.



3.6mm

Upper Roots, Edge Sharp
6024-1

X-Tool Elevators

Extract with Ease

X-Tool Elevators are designed to make luxation smoother and more controlled. The titanium-coated tips reduce friction, improve wear resistance, and support gentle movement around the tooth — helping you work with confidence and less effort during extraction.



Distal, 2.6mm
6234



Mesial, 4.0mm
6237



Spade, 3.5mm
6233



Spade, 4.0mm
6236



Curved, 2.6mm
6232



Mesial, 2.6mm
6235



Straight, 2.6mm
6231

X Tool-Luxating Elevators Set

6230



Xtool & cassette

07

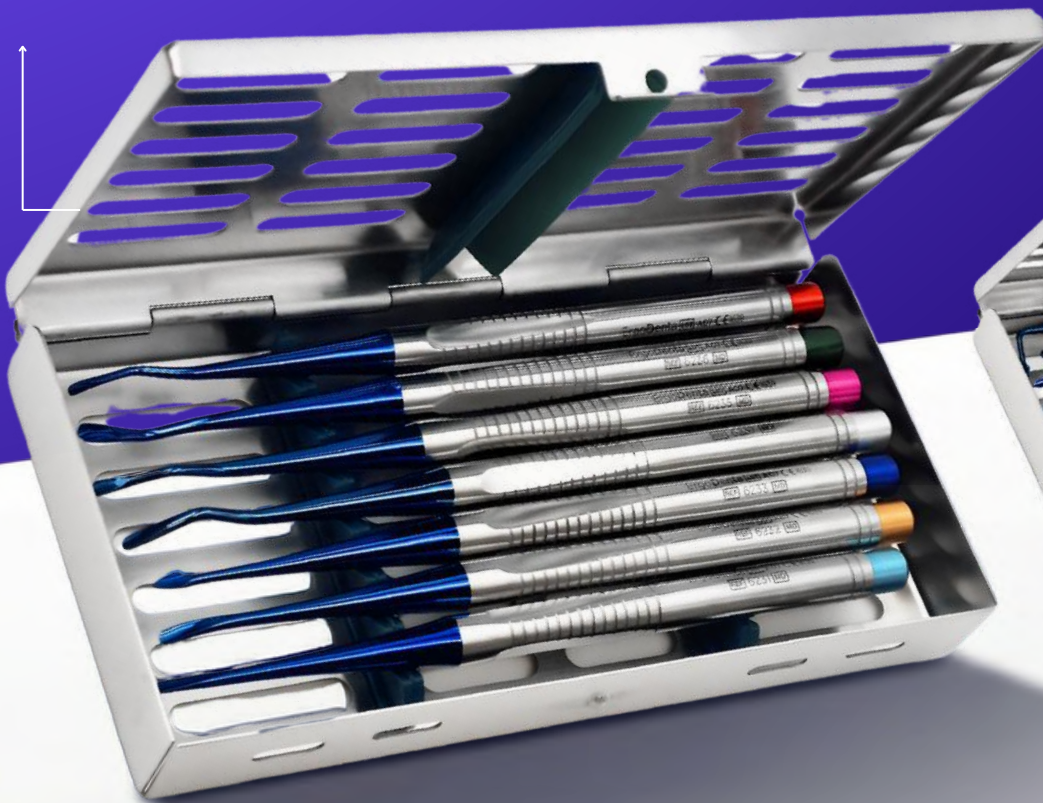

6250

X Tool-Bernard Spade Tip Elevators Set

6253
External Curved, 4.0mm



6252
Angled, Right, 4.0mm



6251
Angled, Left, 2.6mm



6257
Curved, 2.6mm



6254
Internal Curved, 2.6mm



6256
Curved, 3.5mm



6255
Straight 2.6mm



Cut, Hold & Retract

Surgery



Everyday essentials for
confident dental surgery

Scissors in Black

Experience **razor-sharp**, accurate cutting with Super-cut scissors featuring a durable black coating.



- Matte coating to reduce glare
- Optimized for surgical precision
- Easy to clean surface
- Long lasting sharpness
- Razor edge

TC

+

SC
Super Cut



Goldman Fox

13cm Straight 3007-4S
13cm Curved 3007-4C



La-Garange

11.5 cm Double Curved
3008-4D



Iris

11.5cm Straight 3002-4S
11.5 cm Curved 3002-4C



Metzenbaum
Stump

14.5cm Curved
3011-4C

Scissors

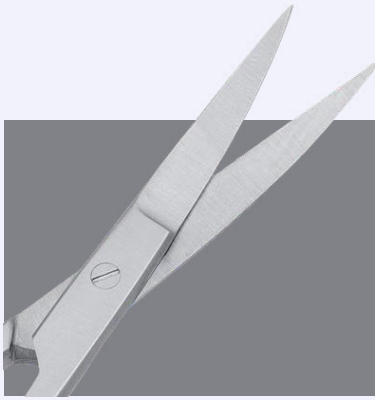

Standard

Reliable and versatile scissors for everyday cutting tasks.

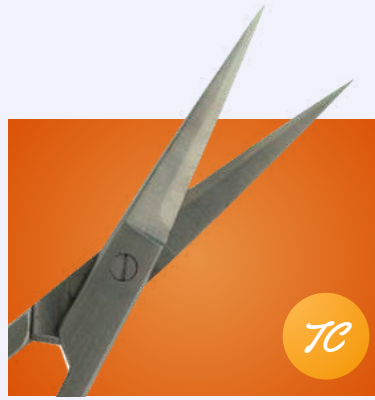

TC

Tungsten carbide inserts ensure precise and long-lasting sharpness for delicate oral procedures.



Super-cut

High-performance scissors with micro-serrated blades for precise and clean cuts.

IRIS



Straight	Curved
11.5 cm 3002-1S	11.5 cm 3002-1C
15 cm 3003-1S	15 cm 3003-1C



Straight	Curved
11.5 cm 3002-2S	11.5 cm 3002-2C
15 cm 3003-2S	15 cm 3003-2C



Straight	Curved
11.5 cm 3002-3S	11.5 cm 3002-3C



Angular
11.5 cm 3002-1A

La-Grange Scissors

Surgical scissors for controlled cutting of soft tissue and sutures, designed with double curved blades for improved access.

Curved

11.5 cm
3008-1D



Curved

11.5 cm
3008-2D



Curved

11.5 cm
3008-3D



Goldman-Fox Scissors

Fine periodontal scissors designed for precise trimming of gingival tissue and suture cutting, offering excellent control for delicate intraoral surgical procedures.

Straight

13 cm
3007-1S



Straight

13 cm
3007-2S



Straight

13 cm
3007-3S



Curved

13 cm
3007-1C

Curved

13 cm
3007-2C

Curved

13 cm
3007-3C

Scissors

Metzenbaum Stump Scissors



Straight 14.5 cm
3011-1S

Curved 14.5 cm
3011-1C



Straight 14.5 cm
3011-2S

Curved 14.5 cm
3011-2C

Metzenbaum Sharp Scissors



Straight 14.5 cm
3016-1S

Curved 14.5 cm
3016-1C



Straight 14.5 cm
3016-2S

Curved 14.5 cm
3016-2C

Kelly Scissors



Straight 16 cm
3026-1S

Curved 16 cm
3026-1C



Straight 16 cm
3026-2S

Curved 16 cm
3026-2C

Metzenbaum Fino Scissor

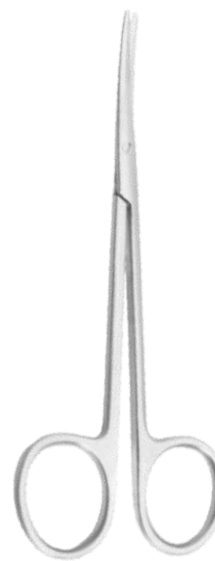

Straight 14.5 cm
3014-2S

Curved 14.5 cm
3014-2C

Metzenbaum Open Scissor



Straight 14.5 cm
3013-2S

Scissors

Classic Suture Scissors



Straight
11.5 cm
3009-1S

Curved
11.5 cm
3009-1C

13 cm
3010-1S

13 cm
3010-1C

Cooper Scissors



Straight
13 cm
3052-1S

16 cm
3058-1S

Spencer Scissors



Angled
11.5 cm
3037-1A

Mayo Scissors



Straight
14.5 cm
3031-1S

3031-2S

18 cm
3032-1S

3032-2S



Curved
14.5 cm
3031-1C

3031-2C

18 cm
3032-1C

3032-2C

Crown Scissor



Straight
13 cm
3045-1S

Curved
13 cm
3045-1C

Spencer Scissors



Straight
16 cm
3039-1S

Joseph Scissor



Straight
14.5 cm
3027-2S

Curved
14.5 cm
3027-2C

Kilner Scissor



Straight
12.5 cm
3029-1S

Perfect for small, delicate procedures

Micro Surgery Scissors



Noyes

Straight
15 cm
3107-1S

Curved
15 cm
3107-1C

Angled
15 cm
3107-1A

Barraquer Scissors

Straight
13 cm
3121-2S

Curved
15 cm
3122-2S

Micro Surgery

Straight
14.5 cm
3101-2S

Curved
14.5 cm
3101-2C

Needle Holders

Mayo Hegar



Straight 16 cm
3212-1S

Curved 16 cm
3212-1C



Straight 13 cm
3211-2S

16 cm
3212-2S

Crile-wood



Straight 15 cm
3226-2S

18 cm
3227-2S



Straight 15 cm
3226-1S

Fine Swedish



Straight 15 cm
3209-2S

Crile Ryde



Straight 15 cm
3238-2S

TC needle holders offer superior grip and durability, ensuring precise and reliable suturing in surgical procedures.

 A close-up photograph of a hand in a white surgical glove holding a TC needle holder. The hand is positioned to show the grip area of the handle. The background is a solid orange color.

Needle Holders

Mathieu



Straight
14 cm
3301-1S
17 cm
3302-1S

Curved
14 cm
3301-1C
17 cm
3302-1C



Straight
14 cm
3301-2S
17 cm
3302-2S

Curved
14 cm
3301-2C
17 cm
3302-2C

Olsen



Straight
17 cm
3312-2S



Lichtenberg



Straight
17 cm
3322-2S

Curved
17 cm
3322-2C



Castroviejo
Micro



Straight
16 cm
3343-2S

Curved
16 cm
3343-2C



Castroviejo



Straight
14 cm
3331-2S
16 cm
3333-2S
18 cm
3332-2S

Curved
14 cm
3331-2C
16 cm
3333-2C
18 cm
3332-2C

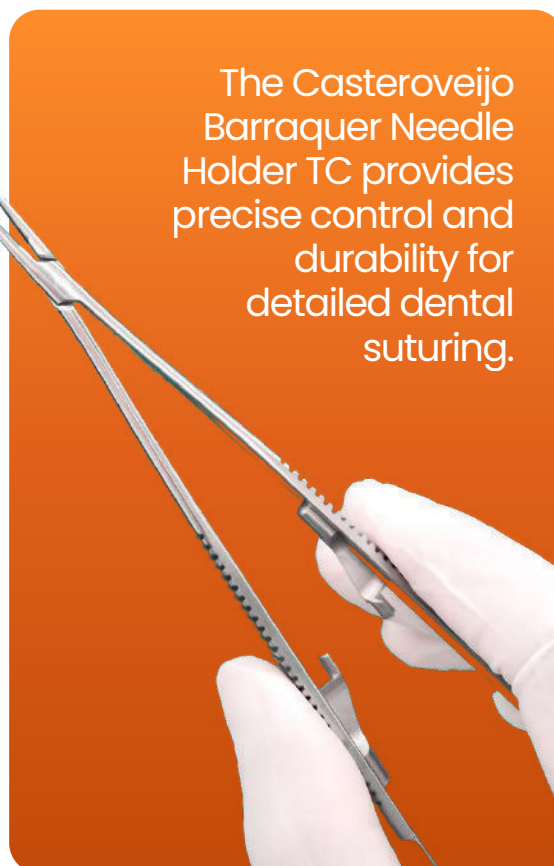

The Castroviejo Barraquer Needle Holder TC provides precise control and durability for detailed dental suturing.

Hemostatic Forceps

Halsted
Mosquito



Straight	Curved
12 cm 3406-1S	12 cm 3406-1C
14.5 cm 3407-1S	14.5 cm 3407-1C

Kocher



Straight	Curved
13 cm 3446-1SG	13 cm 3446-1CG
16 cm 3448-1SG	16 cm 3448-1CG

Pean



Straight	Curved
13.5 cm 3411-1S	13.5 cm 3411-1C
16.5 cm 3413-1S	16.5 cm 3413-1C

Crile



Straight	Curved
14 cm 3454-1S	14 cm 3454-1C

Stieglitz



Straight	Curved
13 cm 3456-1S	13 cm 3456-1A

Allis



Straight
15 cm 3432-1S

Adson



Straight	Curved
14 cm 3461-1S	14 cm 3461-1C
18 cm 3462-1S	18 cm 3462-1C

Kelly



Straight	Curved
14 cm 3441-1S	14 cm 3441-1C

Hemostatic Forceps

Backhaus



9 cm
3470
11 cm
3471

Hemostatic
Forceps



Straight
12 cm
3437-1S

Tohoku

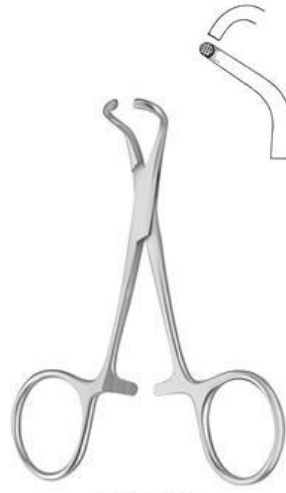

10 cm
3478

Micro-Mosquito



Straight	Curved
10 cm 3401-1S	10 cm 3401-1C
12 cm 3402-1S	12 cm 3402-1C

Bone Rongeurs

Friedmann
3mm
7301



Mini Friedmann
2mm
7304



Tweezers in Black

Experience precise, secure grip with Super-grip tweezers featuring a durable black coating.



Perry



3621-3C
13cm
Curved

Meriam Tweezer



3636-3A
16cm
Serrated, Fig 1.



3636-4A
16cm
Serrated, Fig 1. TC

College Tweezer



3627-3A
15cm
Serrated



3628-3A
15cm
Short Serrated



3630-3A
15cm
Serrated, with Lock

Micro Surgical Tweezer



3802-3G
18cm
Straight, 1-2



3802-3CG
18cm
Curved, 1-2



3802-3
18cm
Straight



3801-3G
15cm
Straight, 1-2

Gerald



3671-3G
17cm
Straight

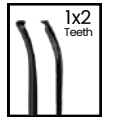

3671-3CG
17cm
Curved

Tweezers

Adson



12 cm
3606-2

12 cm
3606-1
15 cm
3608-1

Kocher
12 cm
3606-1G
15 cm
3608-1G

Kocher
15 cm
3608-1A



Designed for accuracy and ease of use, our tweezers support efficient handling in daily dental practice.

Perry



13 cm
3621-1C

Flagg



Half Serrated
16 cm
3616-1A

Anatomical



13 cm
3646-1
14.5 cm
3647-1
16 cm
3648-1



13 cm
3646-2

Miller



Straight
16 cm
3622-1

Curved
16 cm
3622-1C

Tweezers

Semken



12 cm
3656-1

12 cm
3656-1C

15 cm
3657-1



15 cm
3657-1G

15 cm
3657-1AG

15 cm
3657-1C

DeBakey



16 cm
3667-1A
Angled

16 cm
3667-1
Straight

Endo Tweezers



Cross hold

15 cm
3674-1A

With lock

15 cm
3676-1A

Endo
Tweezer

15 cm
3675-1A

Taylor

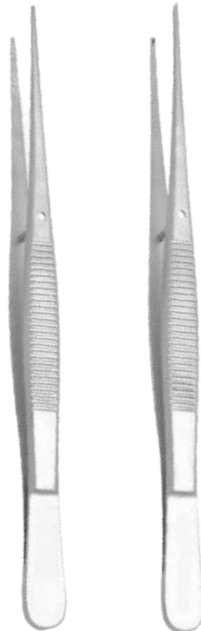

15 cm
3651-1

1x2

15 cm
3651-1G

Crane Kaplan



Left

15 cm
3662-1AG

Right

15 cm
3661-1AG

Tweezers

Micro surgical tweezers



Straight

15 cm
3801-1G
18 cm
3802-1G

Anatomical

18 cm
3802-1

Curved

18 cm
3802-1CG

Gerald



1x2

17 cm
3671-1G

Curved

17 cm
3671-1CG

Micro surgical plier



Curved

15 cm
3724-1C

College



Serrated

15 cm
3627-1A



Short Serrated, 13mm

15 cm
3628-1A



Serrated, with Lock

15 cm
3630-1A

Meriam



Serrated

16 cm
3636-1A



Serrated

16 cm
3636-2A

Surgical



Kocher 1x2

14.5 cm
3633-1G

Lip, cheek & mouth retractor

Sean-Miller

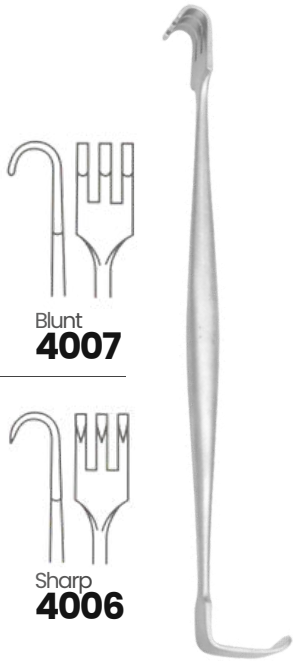

Obwegeser Internal

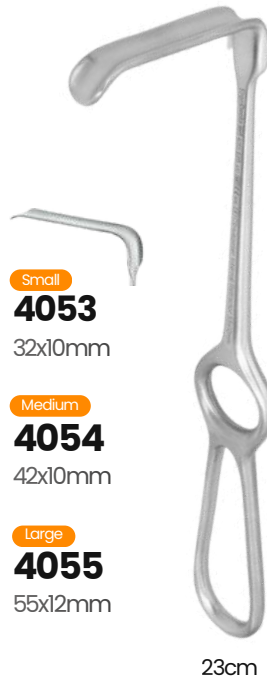

Obwegeser External



Wassmund



Langenbeck



Middeldorpf



Lip, cheek & mouth retractor



Minnesota
2cm x 14cm

4106



Universal cheek
retractor
16cm

4041

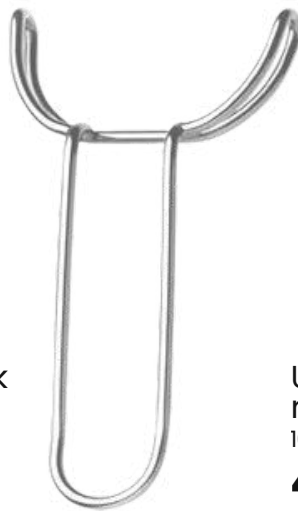

Universal cheek
retractor
16cm

4042



Bowdler Henry

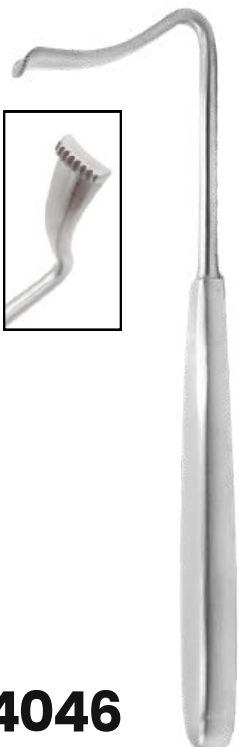

4046
16 cm



Tongue Holder
4129
15cm



S-Retractor
4103



Cawood-Minnesota
4127
2x16cm
15.5cm



Farabeuf
Fig. 1, 26 x 10 mm / 30 x 13 mm
Fig. 2, 30 x 10 mm / 34 x 13 mm
Set of 2 pieces
4101
12cm

Syringes

Self Aspirating Syringe



1.8 ml | 2.2 ml
3929 | **3930**



1.8 ml
3931

Cartridge Syringe



1.8 ml | 2.2 ml
3901 | **3902**



2.2 ml
3910



2.2 ml
3907

Self Aspirating Syringe



1.8ml
0.20 ml per click

3961

Spare-parts available

Pen model syringes



1.8ml
0.07 ml/ click

3968

Consists of three detachable components



1.8ml
0.07 ml/ click

3969

The offset/curved model syringe is versatile for use in both the upper and lower jaw.

Syringe holder



3999

Crown Instruments

Crown Scissors



Angled
3042-1A
12.5cm

Straight
3041-1S
11.5cm

Straight
3045-1S
13cm

Curved
3045-1C
13cm

Crown Spreader



Plier
2971
15cm

Elevator
2970
14cm

Crown remover Plier / forceps



Furrer Plier
2957
15cm

Lindblom Plier
2956
14cm

Wynman Forceps
2955
17cm, TC

Crown Remover

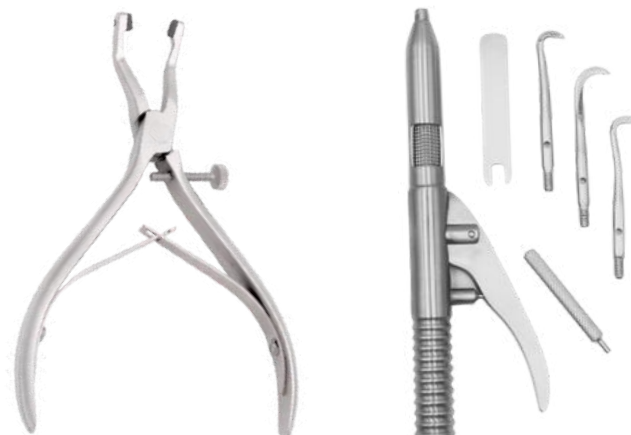

Crown Tractor Plier, 14cm
2953
With 20 extra pads

Automatic, 15cm
2951
incl. 3 tips, Wrench & accessory

Matrix retainers

Nystorm



2921
Right

2922
Left

Tofflemire



2912
Universal

2913
Senior

2911
Junior

Ivory



2901
15cm

Bone curettes

Lucas

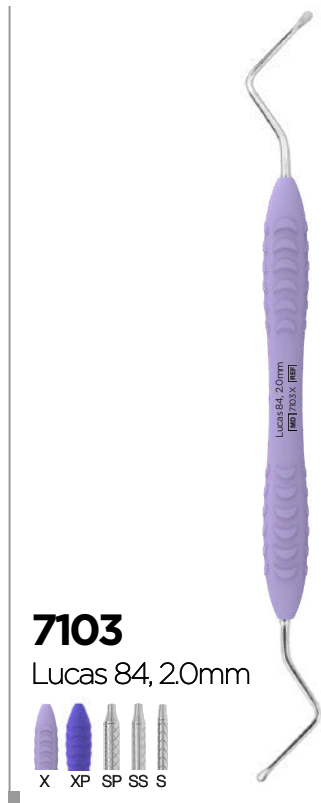

7103
Lucas 84, 2.0mm

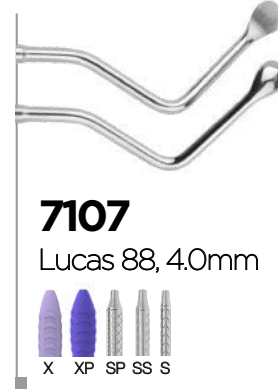

Lucas Serrated



7700
Micro serrated
Lucas Curette
1.8mm

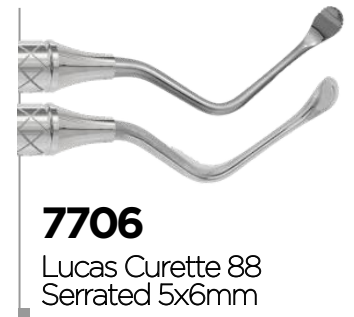

ErgoSteel



ErgoX

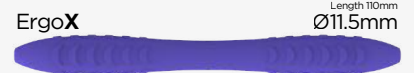

Hemingway



7110
Hemingway, 2mm

SP SS S



7112
Hemingway, 2-2.8mm

SP SS S

BEST SELLER



7113
Hemingway, 3, 3.5mm

SP SS S

7114
Hemingway Straight
2.8 - 3.5mm



Periosteal Elevators



7155 | **7156**
Molt | Molt
5-8mm | 4-7mm

SP | SP

BEST SELLER



7151
Buser
4mm

X XP SP SS S

BEST SELLER



7152
Freer
5mm

X XP SP SS S



7157
Zuchelli
3mm

X XP SP SS S



7158
Glickmann
4-4mm

X XP SP SS S



7160
Prichard
5-11mm

SP SS



7153
Micro Surgical Periosteal
elevator
18-28mm

X XP SP SS S



7154
Micro Surgical Periosteal
elevator
25-40mm

X XP SP SS S



6282-1
Periosteal Elevator
8mm



6280-2
Williger
16cm / 7mm

Bone curettes

Miller



7101

Miller 8
3.5mm



7166

Miller
3.0mm



7102

Miller 21
3.0mm



Surgery instruments

Bone files



7162

Bone scraper
3-5mm



7161

Miller 21
8.0-5.0mm



Periotome

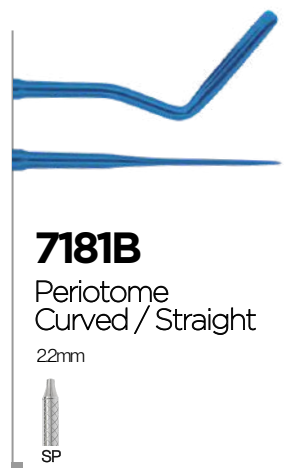

7181B

Periotome
Curved / Straight

22mm

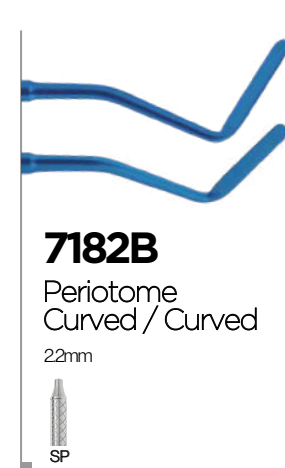

7182B

Periotome
Curved / Curved

22mm

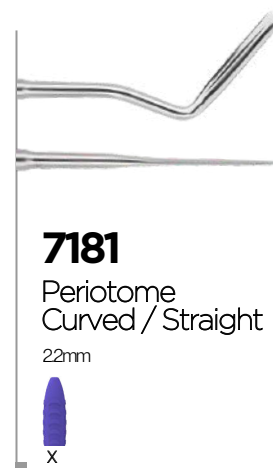

7181

Periotome
Curved / Straight

22mm



7182

Periotome
Curved / Curved

22mm



Tunneling Knife



7902 SP

Tunneling Knife 1, 3.5mm



7903 SP

Tunneling Knife 2 Micro, 2mm



7904 SP

Tunneling Knife 1 Micro, 2mm



7905 SP

Tunneling Knife 2, 3.5mm

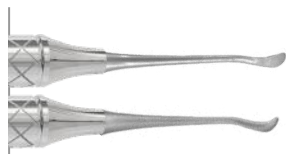

7906 SP

VISTA Tunneling 1



7907 SP

VISTA Tunneling 2



7901 SP

VISTA Tunneling 3



7908 SP

VISTA Tunneling 4



7909 SP

VISTA Tunneling 5



7902K-SP

Tunneling Knife 1, 3.5mm



7903K-SP

Tunneling Knife 2 Micro, 2mm



7904K-SP

Tunneling Knife 1 Micro, 2mm



7905K-SP

Tunneling Knife 2, 3.5mm

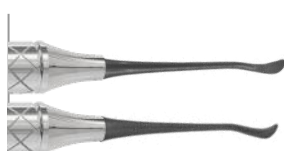

7906K-SP

VISTA Tunneling 1



7907K-SP

VISTA Tunneling 2



7901K-SP

VISTA Tunneling 3



7908K-SP

VISTA Tunneling 4



7909K-SP

VISTA Tunneling 5

Micro Surgery Kit

9914

What's Inside

- | | | | |
|----------------|--|----------------|---|
| 3008-4D | La Garange Scissor, Double Curved, 11.5 cm, Black, Super-cut, TC | 5664 | Scalpel Handles No:3 |
| 3122-2S | Barraquer/Gingiva Scissor, Straight, 15cm, TC | 1450 SP | ErgoSteel Plus, Mirror handle |
| 7151 SS | Buser, 4mm-4mm | 1504F | Front-Surface Mouth , Mirror, No. 4, 22mm |
| 7157 SS | Zucchelli 3mm-3mm | 7106 SP | Lucas 87, 3.5mm |
| 3332-2S | Castervejio Micro Needle Holder, Straight, 18cm, TC | 7156 SP | Nordberg Molt 4mm-7mm |
| 3802-1G | Micro Surgical Tweezer, Straight, 1-2, 18cm | 5513B | Removable lid, Sterilization cassette for 20, 280x180x35mm, Blue Silicone |
| 3802-1 | Micro Surgical Tweezer, Straight, 18cm | | |



Essential instruments for microsurgical procedures

A carefully selected set of essential instruments for delicate surgical procedures, designed to support precise tissue handling, better visibility, and efficient clinical workflow. Supplied in a 20-instrument sterilization cassette with removable lid for easy cleaning and handling.

ErgoDenta

&

NORDIC
DENTAL
ACADEMY

A collaboration between ErgoDenta and Nordic Dental Academy — as their official instrument partner, we co-developed dental instrument kits designed for their clinical training courses and trusted in everyday surgical practice.

Kits by

DnD

**Marcus
Dagnelid**

Specialist in
Prosthodontics

**Professor
Christer
Dahlin**

Oral Surgery and
Guided Bone
Regeneration

**Designed for education.
Built for daily practice**

Prosthetic kit by

DnD

Developed with

Professor Christer Dahlin
Dr. Marcus Dagnelid

This prosthetic kit brings together essential instruments for restorative and prosthetic procedures – carefully selected to support precise handling, good visibility, and an efficient clinical workflow.



9918

What's Inside

- 1311 XP** Explorer 23 + Probe CP 12B
- 1404 XP** ErgoX Plus Mirror handle, Sky Cyan
- 1504F** #4 Front-Surface Mirror Ø22mm (1 pc)
- 2551 X** Composite Spatula 6, 2.5mm-2.5mm
- 2543 X** Cord Packer 2.0 mm
- 2547 X** Filling Remover, 1.5-0.5mm
- 5508K** ErgoTray 8 - Black

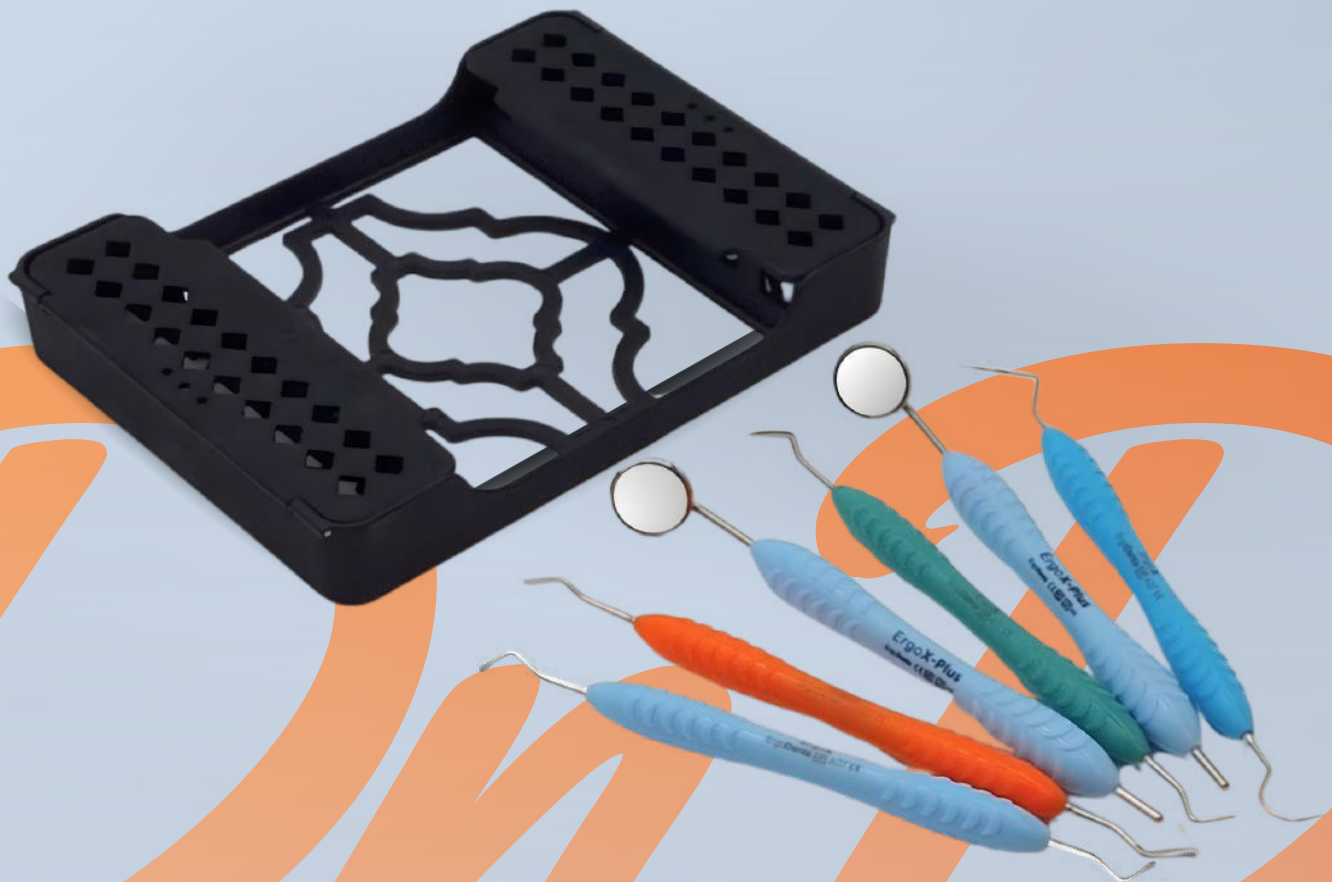

Surgery Kit by

DnD

Developed with
Professor Christer Dahlin
Dr. Marcus Dagnelid

This surgery kit brings together the essential instruments for predictable oral surgery and guided bone regeneration – organized for smooth, efficient clinical workflow.



9919

What's Inside

3226-2S	Crile-Wood Needle Holder, Straight, 15cm, TC	7106 SP	Lucas 87, 3.5mm
3003-2C	Iris Scissor, Curved, 15cm, TC	7156 SP	Nordberg Molt 4mm-7mm
3636-1A	Meriam Tweezer, Serrated, Fig 1, 16cm	7158 SP	Glickmann, 4mm-4mm
3606-1G	Adson Tweezer, 1x2, 12cm	7162 SP	Bone Scrapper, 3mm-5mm
4055	Obwegeser Internal Retractor, 55 x 12 mm, 23cm	5664	Scalpel handle no. 3
2159 SP	M23	3411-1C	Rochester Pean Forceps, Curved, 13.5cm
1310 SP	Explorer 23 + Probe CP 12	5593	Bowl 50*60*11mm
1450 SP	ErgoSteel Plus, Mirror handle	7218 SP	Sinus Lift Instrument, 4mm-4.3mm
1504F	#4 Front-Surface Mirror Ø22mm (1 pc)	5513B	Removable lid, Sterilization cassette for 20, Blue

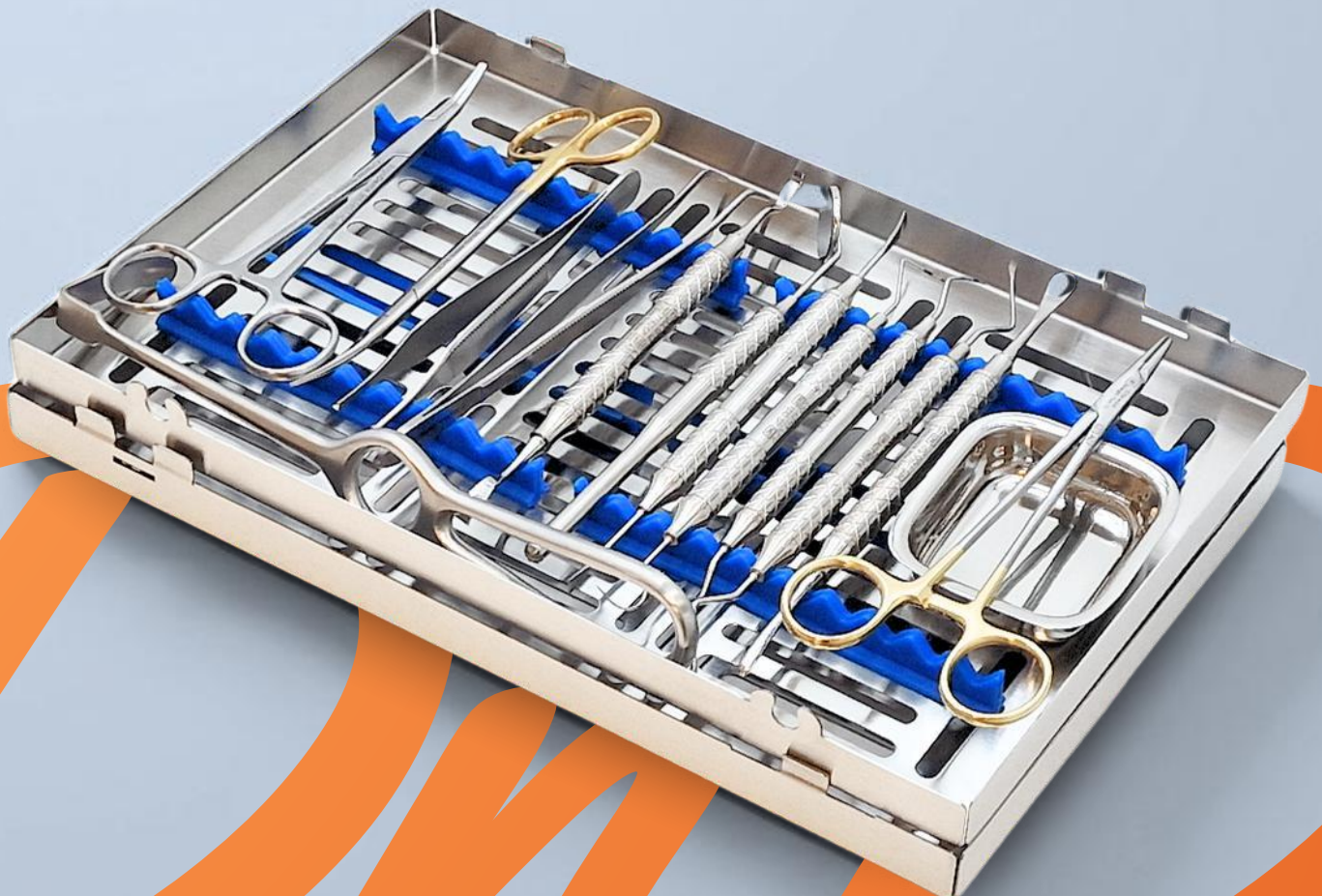

kits by *Dr.* **Iman**

ErgoDenta

Ideal for busy clinics performing everyday surgical procedures.

Dr. Iman Azarmehr

Oral & Maxillofacial Surgeon

Dr. Iman Azarmehr is an Oral & Maxillofacial surgeon practicing in Denmark and Sweden his main area of focus are advanced implant surgery, orthognathic surgery and treatment of temporomandibular joint diseases.

Together with the team of **ErgoDenta** he has put together a surgical kit that has been proven to be versatile, covering the need for most common procedures in private practice. This kit has now been tested and developed during 10 years.

**Efficient workflow
surgical kits**



Surgery kit by **Dr. Iman**

Developed with

Iman Azarmehr

Specialist in Oral and Maxillofacial Surgery

A compact, well-thought-out kit that covers the instruments you reach for in routine surgery. Easy to organize, easy to sterilize, and ideal for high-flow clinical environments.



Ideal for busy clinics performing everyday surgical procedures.

What's Inside

2547 SP	Filling Remover, 1.5–0.5mm	3007-4C	Goldman Fox, Curved, 13 cm, Black, Super-cut, TC
1310 SP	Explorer 23 + Probe CP 12	7102 SP	Miller 2I, 3.0mm
3629-1AD	College Tweezer, Diamond Tip, 15cm	3209-2S	Fine Swedish Needle Holder, Straight, 15cm, TC
1450 SP	ErgoSteel Plus, Mirror handle	3801-1G	Micro Surgical Tweezer, Straight, 1-2, 15cm
1504F	Front-Surface Mouth, Mirror, No. 4, 22mm	5594	Bowl 50x60x15mm
7156 SP	Nordberg Molt 4mm–7mm	5584	Perforated Instrument Tray 284x183x17mm
3437-1S	Hemostatic Forceps, Straight, 12cm	5555	Instrument Holder, 280mm
4014	Langenbeck Retractor, 42 x11 mm, 22cm		
7158 SP	Glickmann, 4mm–4mm		



Efficient workflow surgical kit

A practical kit built from clinical experience for everyday surgical procedures. The instruments are organized in a sterilization tray and rack, making preparation simple and improving workflow efficiency in busy clinics.

Kits by Dr. **Iman**

Ideal for busy clinics performing everyday surgical procedures.

Developed with

Iman Azarmehr

Specialist in Oral and Maxillofacial Surgery

A compact, well-thought-out kit that covers the instruments you reach for in routine surgery. Easy to organize, easy to sterilize, and ideal for high-flow clinical environments.



For more info visit **Page no 152**

Suture Silicone Training Pad Available

A practical solution for suturing practice and surgical training.



Mini Suture kit

9920

- 3007-4C** Goldman Fox, Curved, 13 cm, Black, Super-cut, TC
- 3209-2S** Fine swedish needle holder, 15 cm TC
- 3801-1G** Micro surgical tweezer, 1-2, 15cm
- 7158 SP** Glickman, 4mm-4mm
- 5664** Scalpal handle No:3
- 5512B** Sterilization cassette 10

A compact kit for everyday suturing and minor procedures. The instruments are organized in a sterilization cassette for easy preparation and efficient handling during treatment.



Sinus-lift kit

9921

- 7212B-SP** Sinus Lift Instrument, 3mm-3mm, Blue
- 7213B-SP** Sinus Lift Instrument, 4mm-4mm, Blue
- 7202B-SP** Currettes #2, 3mm-4mm, Blue
- 7218B-SP** Sinus Lift Instrument, 4mm-4.3mm, Blue
- 7222B-SP** Sinus Lift Mushroom, 2.5mm-3.2mm
- 5511B** Sterilization cassette 5

Set of 5 sinus-lift instruments in blue titanium coating, arranged in a sterilization cassette for organized handling and efficient preparation during sinus-lift procedures.

Align, Adjust & Adapt

Orthodontics



Essential instruments every
orthodontist trusts daily.

Orthodontics

Wire Cutters



4225
Distal End Cutter

12.5cm \varnothing 0.35mm / .014",
□ 0.55x0.64mm / .021"x.025"



4227
Distal End Cutter

13cm \varnothing 0.35mm / .014",
□ 0.55x0.64mm / .021"x.025"



4228
Distal End Cutter

15cm \varnothing 0.35mm / .014",
□ 0.55x0.64mm / .021"x.025"



4229
Distal End Cutter

15cm M Max. \varnothing 0.4mm / .016"



4601
Distal End Cutter

12.5cm \varnothing 0.35mm / .014",
□ 0.55x0.64mm / .021"x.025"



4602
Distal End Cutter

15cm \varnothing 0.35mm / .014",
□ 0.55x0.64mm / .021"x.025"



4603
Mini Distal End Cutter

12.5cm □ 0.41x0.56mm (.016 x .022)",
M .017 x.025"



4610
Flush Cutter

13cm □ 0.55x0.64mm / .021"x.025",
○ 0.4mm / .016"

Orthodontics

Wire Cutters

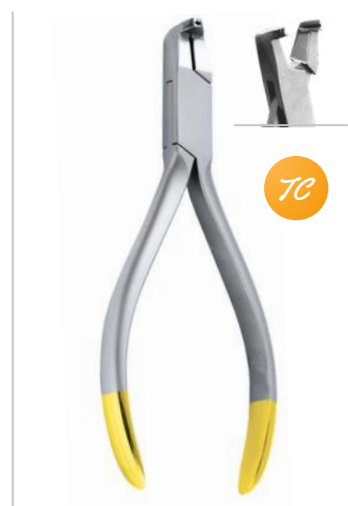

4611
Flush Cutter

13cm □ 0.41x0.55mm / .016x.021",
○ 0.3mm / .012"

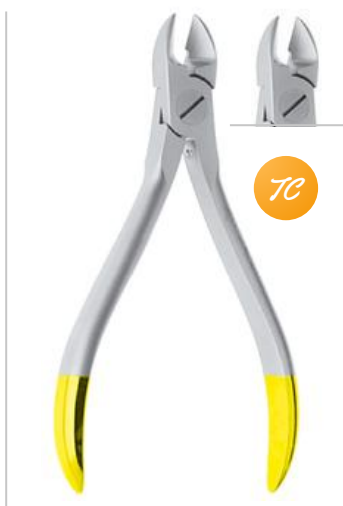

4616
Ligature Cutter

12cm ○ Max. \varnothing 0.7mm / .028"



4617
Mini Ligature Cutter

12cm ○ Max. \varnothing 0.3mm / .012"



4621
Angle Wire Cutter

13cm ○ Max. \varnothing 0.3mm / .012"



4622
Angle Wire Cutter

13cm ○ Max. \varnothing 0.3mm / .012"

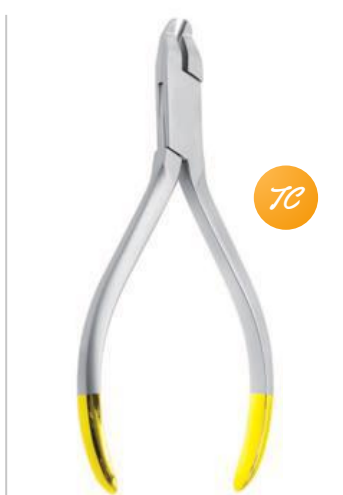

4626
Wire Cutting Forceps

13cm ○ Max. \varnothing 0.3mm / .014"

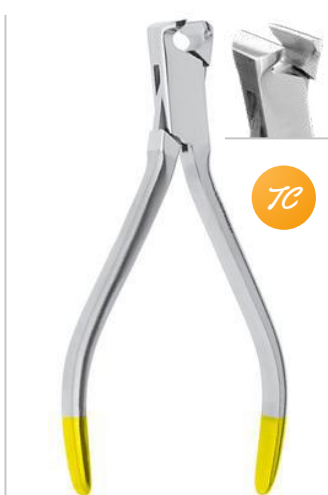

4627
Head Cutter for
hard wire

14.5cm ○ Max. \varnothing 1.0mm / .040"



4628
Side Cutter for
hard wire

15cm ○ Max. \varnothing 1.0mm / .040"

Wire Cutters



4320
Wire Cutter

15cm max Ø 1.0mm



4321
Wire Cutter, TC

12cm max Ø 0.6mm

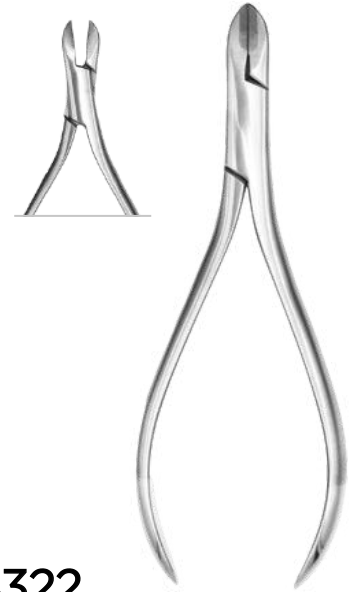

4322
Wire Cutter

12cm max Ø 0.6mm



4301
Pin & Ligature
Wirecutter, TC

13cm max Ø 0.5mm



4302
Pin & Ligature
Wirecutter

13cm max Ø 0.7mm



4303
Pin & Ligature
Wirecutter, TC

13cm max Ø 0.7mm

Aligner Plier

For accurate clear aligner adjustments. Durable stainless steel design ensures comfort and reliability.



Art no	Name	Size
4636	Horizontal Plier	12cm
4637	Vertical Plier	12cm
4745	Hole Punch Plier	12cm
4746	Tear Drop Plier	12cm
4747	Aligner Point Elevation Plier	12.5cm
4748	Aligner Reverse Plier	14cm



Hole Punch Plier



4638
For Non-TC

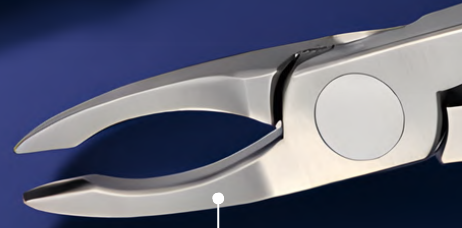

Aligner Reverse Plier



Aligner Point elevation plier

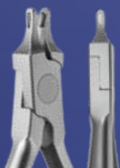

Tear Drop Plier



4639
For Non-TC

Horizontal Plier

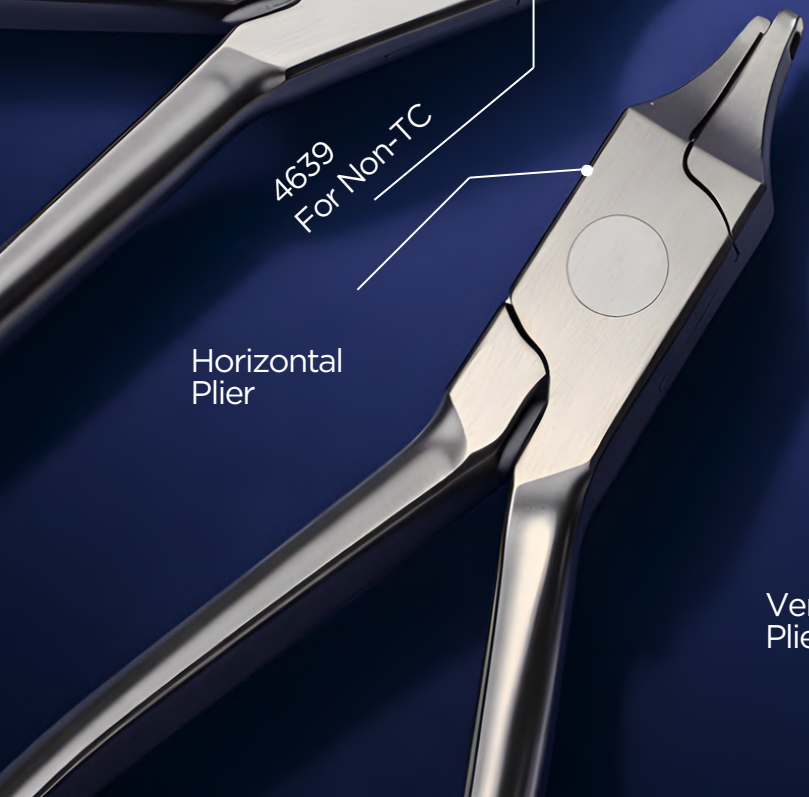

Vertical Plier

Wire Bending Pliers



4217
Young Loop and Arch Forming Plier
13cm ○ \varnothing 0.7mm / .028"



4232
HOW Plier Straight
14cm



4233
HOW Ligature Plier 45° angled
14cm



4295
Angle / Tweed, Arch Forming Plier
12.5cm ○ \varnothing 0.5mm / .028"



4296
ANGLE / TWEED, Arch Forming Plier
12.5cm ○ \varnothing 0.5mm / .028"



4312
Angle Wire Bending Plier
12.5cm ○ Max. \varnothing 0.7mm / .028"



4641
Angle Wire Bending Plier
12.5cm ○ Max. \varnothing 0.7mm / .028"



4642
Angle Wire Bending Plier, round
12.5cm ○ Max. \varnothing 0.7mm / .028"



4643
Adams Wire Bending Plier
12.5cm ○ Max. \varnothing 0.7mm / .028"

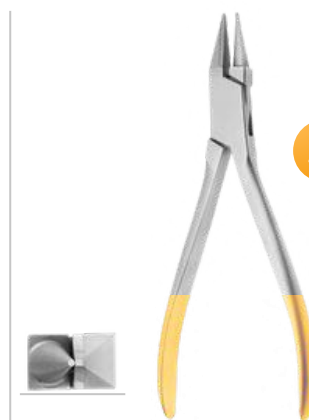

4644
Adams Wire and Arch Bending Plier No. 65
15cm



4650
Jarabac Wire Bending Plier
14cm ○ Max. \varnothing 0.7mm / .028"



4651
Wire Bending Plier
13cm ○ Max. \varnothing 0.5mm / .020"

Wire Bending Plier



4652
Wire Bending Plier
with grooves
13.5cm ○ Max. Ø 0.7mm / .028"



4653
Tweed Loop and
Arch Forming Plier
13.5cm ○ Ø 0.5mm / .020"



4654
Lightwire Bird Beak
Plier with Cutter
13.5cm ○ Max. Ø 0.6mm / .024"



4655
Lightwire Loop Forming
Plier with Cutter
13.5cm ○ Max. Ø 0.4mm / .016"



4656
Tweed Loop and
Arch Forming Plier
13.5cm ○ Ø 0.5mm / .020"



4657
Tweed Loop and
Arch Forming Plier
14cm ○ Ø 0.5mm / .020"



4658
Tweed Loop and
Arch Forming Plier
14cm ○ Ø 0.7mm / .028"



4666
Weingart Universal
Plier
14.5cm ○ Ø 0.7mm / .028"



4667
Weingart Delicate
Universal Plier
14cm ○ Ø 0.7mm / .028"



4668
Weingart Universal
Plier with short jaws
14cm ○ Ø 0.5mm / .020"



4669
Weingart Ultra Slim
Universal Plier
14.5cm ○ Ø 0.5mm / .020"



4670
Weingart Delicate
Universal Plier
14.5cm ○ Ø 0.5mm / .020"

TC

Wire Bending Plier



4676
Aderer Three-Finger-Plier
12.5cm \varnothing 0.7mm / .028"



4677
Aderer Three-Finger-Plier Strong Pattern
12.5cm \varnothing 0.9mm / .028"



4678
Aderer Three-Finger-Plier
11.5cm \varnothing 0.5mm / .020"



4679
Aderer Three Finger Plier
12.5cm \varnothing 0.3mm / .012"



4681
Aderer Band Removing Plier
13.5cm



4682
Aderer Band Removing Plier
13.5cm



4683
Oliver Band Removing Plier
14cm



4684
Bracket Removing Plier
13.5cm



4685
Bracket Removing Plier Angled 45°
13.5cm



4686
Removing Plier
12.5cm



4690
Schwarz Hollow Chop Plier
12.5cm \varnothing 0.7mm / .028"





4691
Schwarz Hollow Chop Plier
14cm \varnothing 0.7mm / .028"



Wire Bending Plier

4692
Johnson Contouring Plier
13.5cm 3mm

4693
Johnson Contouring Plier
13.5cm 4mm



4694
Andersen Hollow Chop Plier
13cm





4695
Gordon Contouring Plier
13.5cm

4696
DeLa ROSA Arch Contouring Plier with groove guides
12.5cm



4697
DeLa ROSA Arch Contouring Plier
12.5cm



4698
Lingual Arch Forming Plier
12.5cm \varnothing 0.7mm / .028"





4712
Step Bending Plier
13.5cm 1/2mm

4713
Step Bending Plier
13.5cm 3/4mm

4714
Step Bending Plier
13.5cm 1mm





4715
Nance Step Loop Bending Plier
13cm steps of 3, 4, 5 and 6mm enable exact and even bending



4716
V-Step Plier (places V-bends in arch wires)
13cm for wire up to .021 x .025"

Wire Bending Plier



4717
Crimpable Arch Wire Hook Plier

TC

14cm for surgical ball hooks straight



4718
Hammerhead Plier

for bending nickel-titanium arches/wires in the molar region

14cm \varnothing 0.018"



4719
Nance Arrow Clasp Forming Plier

12.5cm \varnothing 0.7mm / .028"



4720
Adams-Nance Clasp Bending Plier

15.5cm \varnothing 0.7mm / .028"



4721
SCHWARZ Arrow Clasp Forming Plier

13cm \varnothing 0.7mm / .028"



4722
Denta Wire Bending Plier, TC

TC

12.5cm



4280
Bracket Removal Plier, TC

TC



4736
Waldsachs Universal Plier

15cm \varnothing 0.7mm / .028"



4737
Universal Plier

15cm \varnothing 1.0mm / .040"



4738
Universal Plier

16cm \varnothing 1.0mm / .040"



4739
Flat Nose Plier

14cm both sides smooth



4740
Flat Nose Plier

14cm both sides serrated



4741
Flat Nose Plier, TC

14cm both sides serrated with TC Inserts



4742
Peeso Wire Bending Plier

13.5cm



4743
Langenbeck Round Plier

14cm



4744
Goslee Flat Nose Plier

14cm



4281
Bracket Removing Plier

12.5cm



1430
Ortho 0-25, Mirror Handle



4201E 1
Changeable Part for Adhesive Removal Plier, Teflon

4201E 2
Changeable Part for Adhesive Removal Plier, Blade

4201
Adhesive Removal Plier



4206E 1
Changeable Part for Posterior Band Removing Plier, Plastic Pad

4206
Posterior Band Remover Plier, TC

15cm Long, with Teflon/Plastic Tip



4780
Bracket Positioning Gauge
for .018 slot brackets



4781
Bracket Positioning Gauge
for .022 slot brackets



7071 X
Ortho Ligature Tucker



7072 X
Ortho Arch Wire Tucker



7073 X
Ligature 17C



7074 X
Ligature U15



4730
Smaha Ligature
Forceps

14cm



4733
Smaha Ligature
Forcep, Curved

14cm



4731
Smaha Ligature
Forceps

14cm delicate tips with groove



4732
Mathieu Ligature Forceps

14cm 5.0mm serration length



3301-1S
Mathieu Needle Holder,
Straight

14cm



3301-2S
Mathieu Needle Holder,
Straight, TC

14cm

TC



3302-1S
Mathieu Needle Holder,
Straight

17cm



3302-2S
Mathieu Needle Holder,
Straight, TC

17cm

TC



4370
Mathieu Ortho plier,
Delicate

14cm



4371
Mathieu Ortho plier,
Standard

14cm



2730
Elastic Separating Plier

15cm



4344
Langback Plier

12cm max Ø 0.8mm



4710

14cm

4711

Torquing Plier (Set) Set of Plier used to place a torque to square/rectangular archwire, TC



4230
Aderer Plier

12.5cm short max \varnothing 0.6mm



4231
Aderer Plier

13cm long max \varnothing 0.6mm



3692-1
Bracket Positioning
Tweezer

14cm



3694-1A
Bracket Tweezer

11cm



4252
Nose Plier, Short

15cm



4253
Nose Plier, Long

15cm

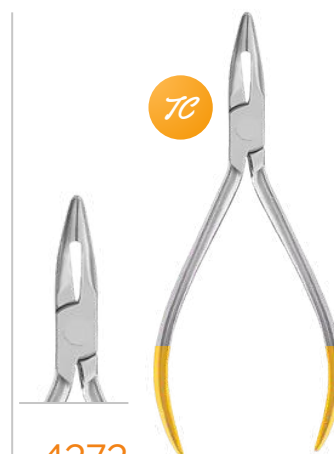

4272
Weingart Plier
Standard, TC

15cm for Dental Technic,



4273
Weingart Plier for
Dental Technic, TC

13.5cm

TC



4275
Ligature Cutter 15°
Angle, TC

12cm

TC



4290
Hard Wire Cutter, TC

14cm 10° Angle,



4292
Ribbon-Tweed
Arch, Short

15cm



4293
Ribbon-Tweed
Arch, Long

15cm



4310
Adams Plier, Lap joint

13cm max Ø 0.4mm



4266
Schwarz, Fig. 1,

13cm max Ø 0.4mm



4313
Angle Plier, Lap Joint

12.5cm max Ø 0.7mm



4223
Three beak Plier



4378
De la rosa band
contouring



4379
Micro ligature
cutter, TC



4294
Tweed Loop Plier

13cm

TC

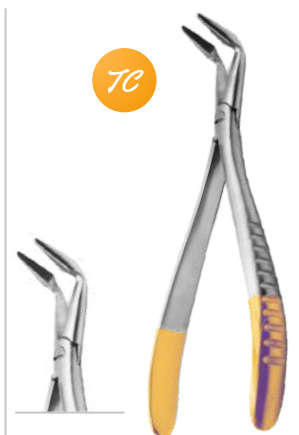

4382
Universal Plier, TC

4373
Measuring ruler,
0-60mm



0-60mm

4374
Measuring ruler,
0-80mm



0-80mm

4390B
Band seater, Blue



13cm

4372
Band Pusher



4375
Cinch Back



4376
Buccal Tube Holder



4377
Boon's Gauge with Lid



ErgoOrtho
is on the way

Our dedicated orthodontic catalog
will be released later in 2026.

Endodontic

Instruments

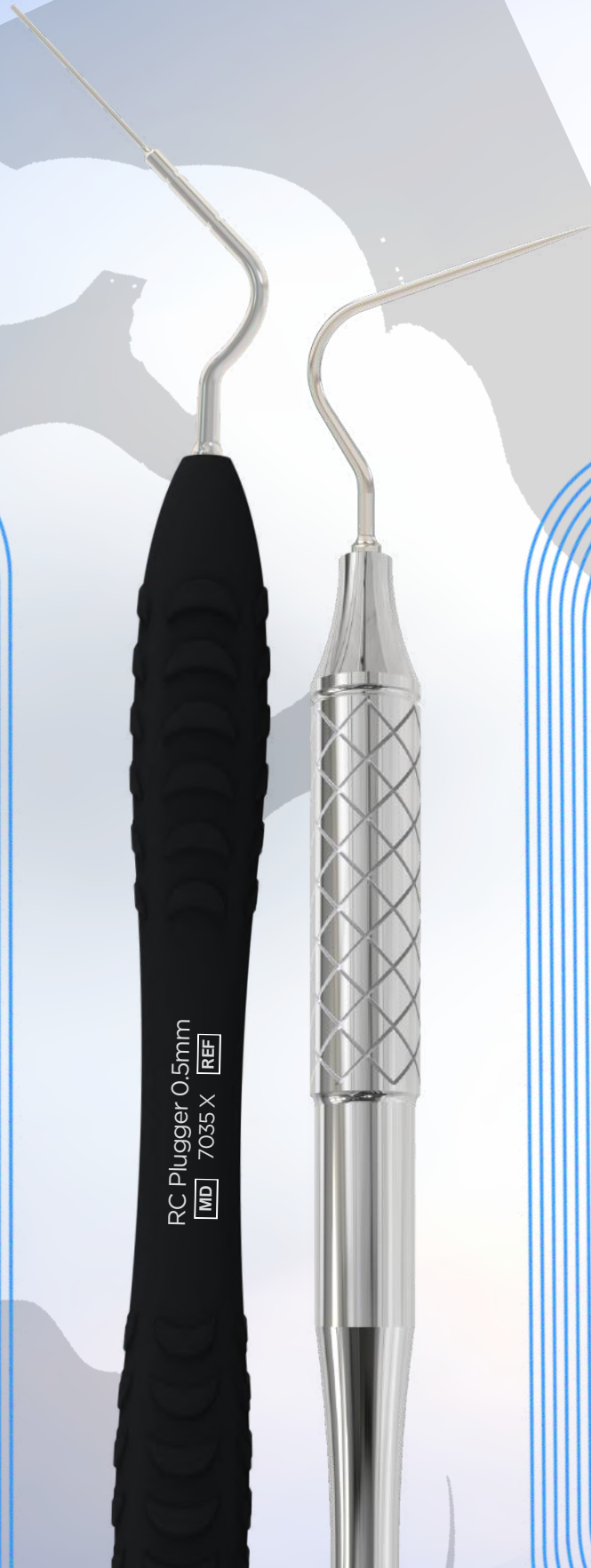

RC Plugger 0.5mm
MD 7035 X REF

Gutta-Percha Remover



Hook, Remove & Move On!

The ultra-thin 0.4 mm tip preserves canal walls. The double-ended design offers versatile hooks and easy retrieval from any angle, leaving no residue.

NEW

7001 X

Gutta Percha Remover, Up-Down, 0.4mm Hook



7002 X

Gutta Percha Remover, Left-Right, 0.4mm Hook



7001

Gutta Percha Remover, Up-Down, 0.4mm Hook



7002

Gutta Percha Remover, Left-Right, 0.4mm Hook



Black Endo Instruments



Endo Plugger

Used for condensing gutta-percha, providing a dense and secure canal filling.

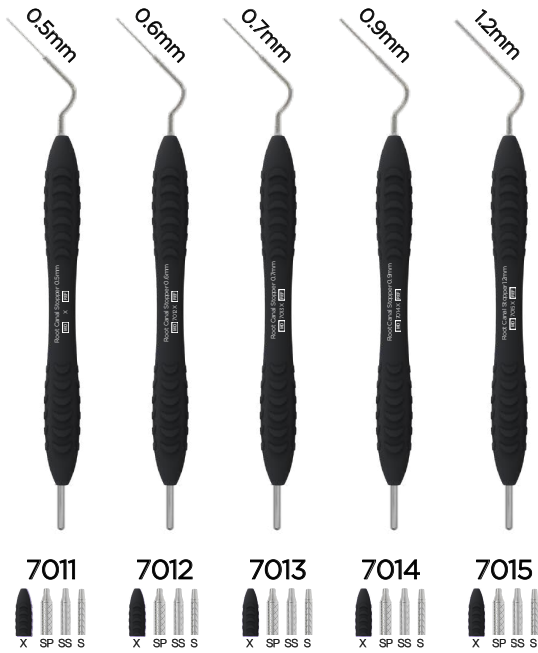

Single-end

NEW

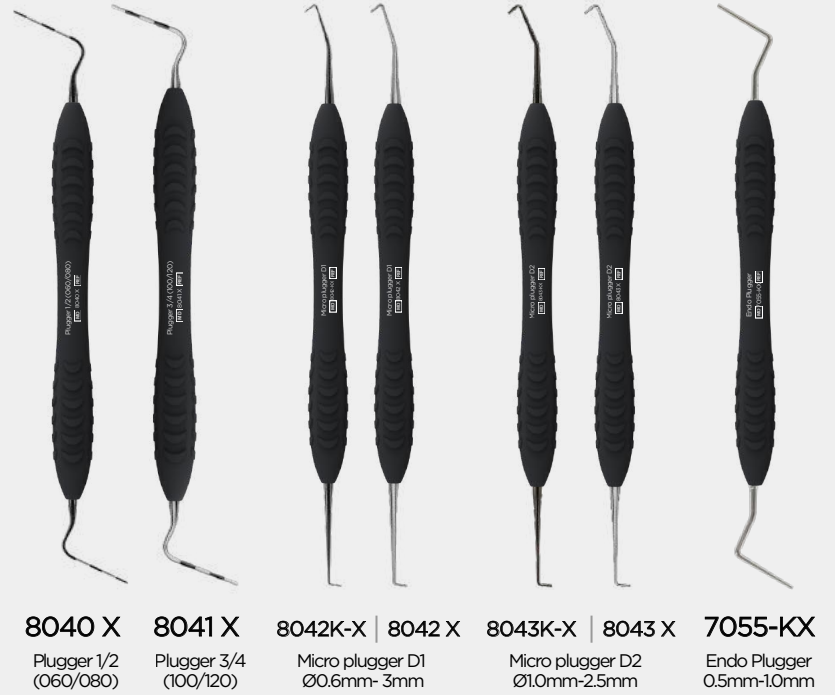

Endo Plugger

Used for condensing gutta-percha, providing a dense and secure canal filling.

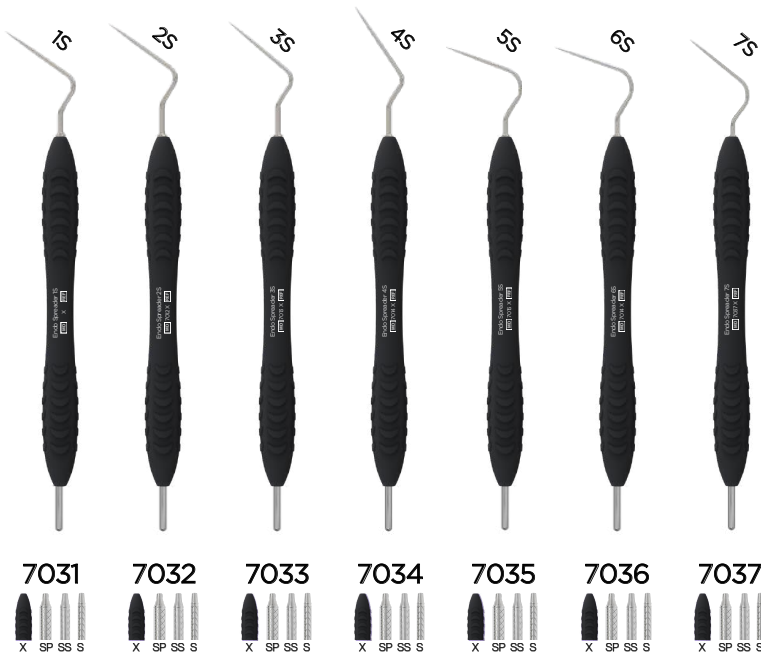

NEW



NEW

Black Endo Instruments



Excavator



8080K-X | 8080 X
Excavator
31L



8081K-X | 8081 X
Excavator
32L



8082K-X | 8082 X
Excavator
33L

Endo Spreader & Pluggers



7056-KX
Ø0.4mm &
Ø0.4mm



7057-KX
Ø0.4mm &
Ø0.6mm



7058-KX
Ø0.6mm &
Ø0.8mm



7059-KX
Ø0.6mm &
Ø1.0mm

Endo Explorer



8000K-X | 8042 X
Explorer
17/17L



8001K-X | 8041 X
Explorer KX1,
straight



8002K-X | 8042 X
Explorer KX2,
angled



7050-KX
Endo
Explorer



7051-KX
Root Canal
Explorer

Periodontal Probe



8020 X
Periodontal
CP 12-15

Mirror Handles



1715 X
Mirror Handles
Double End

Endo Instruments

Endo Spreader & Pluggers

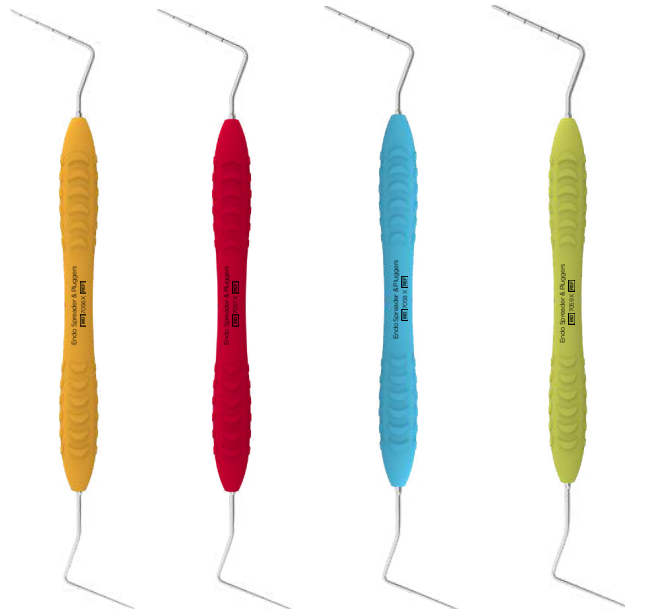

Ø0.4mm & Ø0.4mm
7056
 X SP SS S

Ø0.4mm & Ø0.6mm
7057
 X SP SS S

Ø0.6mm & Ø0.8mm
7058
 X SP SS S

Ø0.6mm & Ø1.0mm
7059
 X SP SS S

Endo Explorers & Pluggers



Endo Explorer
7050
 X XP SP

Root Canal Explorer
7051
 X XP SP

Endo Plugger, 0.5mm-1.0mm
7055
 X XP SP

NEW

Endo Curettes

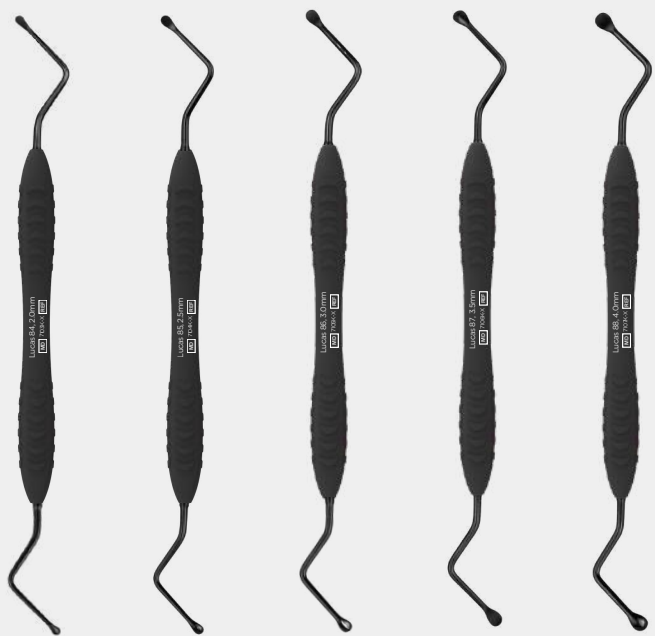

7103K-X
 Lucas 84, 2.0mm

7104K-X
 Lucas 85, 2.5mm

7105K-X
 Lucas 86, 3.0mm

7106K-X
 Lucas 87, 3.5mm

7107K-X
 Lucas 88, 4.0mm

ErgoEndo Black

A focused range for modern endodontic work, designed to support precision, comfort, and reliable daily performance.



View Online
Scan the QR Code



Rubberdam Clamps



Provide reduced *Glare* for
improved *Visibility* during procedures.

Rubberdam Clamps

ErgoDenta offers rubber dam clamps in four types:

- Gold
- Black
- Blue
- Standard



Anteriors

00	W00	6	9	9S	210	212	212SA
2701-00 K2701-00 G2701-00 B2701-00	2701-W00 K2701-W00 G2701-W00 B2701-W00	2701-6 K2701-6 G2701-6 B2701-6	2701-9 K2701-9 G2701-9 B2701-9	2701-9S K2701-9S G2701-9S B2701-9S	2701-210 K2701-210 G2701-210 B2701-210	2701-212 K2701-212 G2701-212 B2701-212	2701-212SA K2701-212SA G2701-212SA B2701-212SA
106R	106L	B4					
2701-106R K2701-106R G2701-106R B2701-106R	2701-106L K2701-106L G2701-106L B2701-106L	2701-B4 K2701-B4 G2701-B4 B2701-B4					

Upper Molars

4	W4	5	8				
2705-4 K2705-4 G2705-4 B2705-4	2705-W4 K2705-W4 G2705-W4 B2705-W4	2705-5 K2705-5 G2705-5 B2705-5	2705-8 K2705-8 G2705-8 B2705-8				
201	205	W8	26N				
2705-201 K2705-201 G2705-201 B2705-201	2705-205 K2705-205 G2705-205 B2705-205	2705-W8 K2705-W8 G2705-W8 B2705-W8	2705-26N K2705-26N G2705-26N B2705-26N				
30	31						
2705-30 K2705-30 G2705-30 B2705-30	2705-31 K2705-31 G2705-31 B2705-31						

Lower Molars

3	W3	7	7A				
2702-3 K2702-3 G2702-3 B2702-3	2702-W3 K2702-W3 G2702-W3 B2702-W3	2702-7 K2702-7 G2702-7 B2702-7	2702-7A K2702-7A G2702-7A B2702-7A				
26	28	202	W7				
2702-26 K2702-26 G2702-26 B2702-26	2702-28 K2702-28 G2702-28 B2702-28	2702-202 K2702-202 G2702-202 B2702-202	2702-W7 K2702-W7 G2702-W7 B2702-W7				
12A	W12A	13A					
2702-12A K2702-12A G2702-12A B2702-12A	2702-W12A K2702-W12A G2702-W12A B2702-W12A	2702-13A K2702-13A G2702-13A B2702-13A					

Pre molars

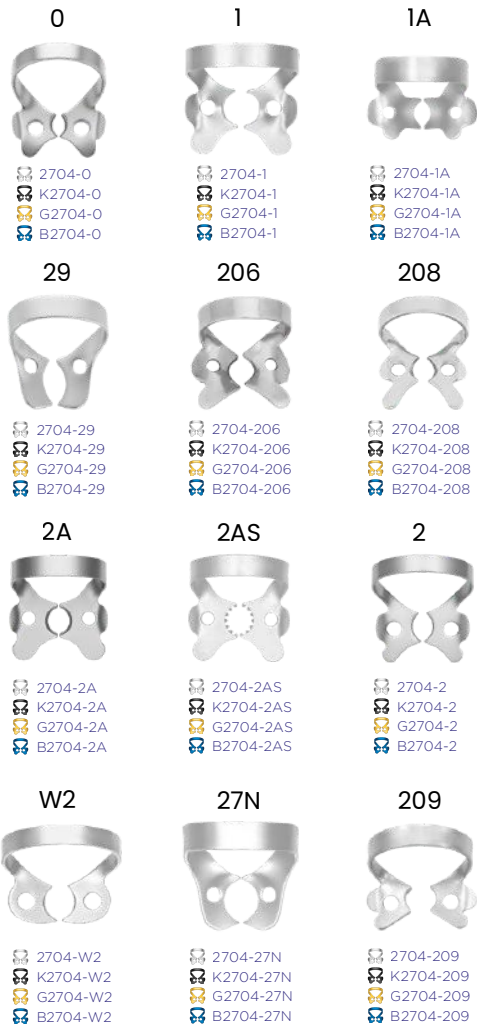

Using Rubber Dam Clamps Effectively

Successful rubber dam isolation depends on selecting and placing the correct clamp for each clinical situation. A properly fitted clamp provides stable tooth isolation, supports moisture control, and helps create a clear, dry working field.

Clamps should always be inspected before use and reprocessed according to standard sterilization protocols. Correct positioning below the tooth's height of contour ensures reliable retention throughout the procedure, while proper adaptation helps avoid unnecessary pressure on gingival tissues.

Choosing the right clamp design and size improves procedural efficiency, enhances visibility, and contributes to patient comfort during restorative and endodontic treatments.



Molars / Universal

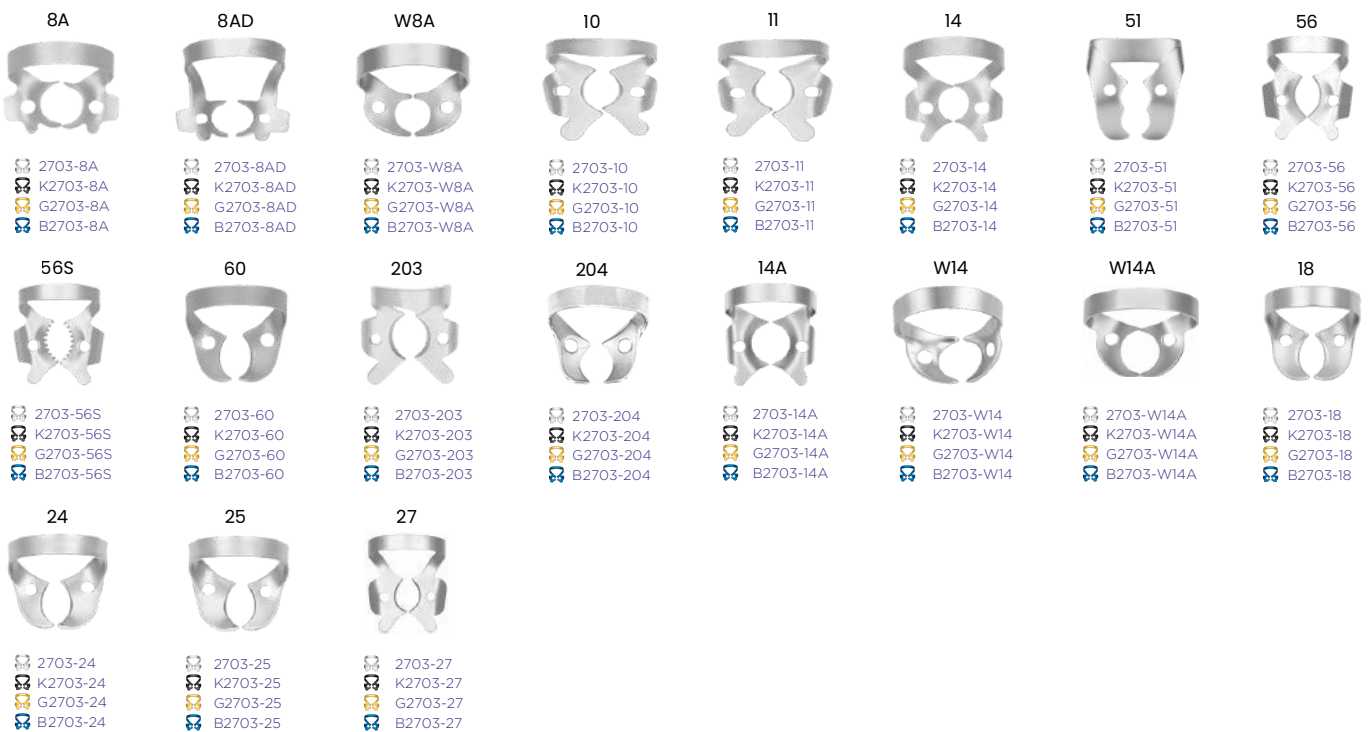

Rubber Dam Kit



9917
Standard



9917G
Gold



9917K
Black



9917B
Blue

Rubberdam clamps

2703-W8A	W8A - Molar (GENERAL)
2705-W8	W8 - Upper molar
2701-212	212 - Anterior
2701-9	9 - Anterior
2704-W2	W2 - Pre molar
2704-2	2 - Pre molar
2704-2A	2A - Pre molar
2702-W7	W7 - Lower molar
2701-00	00 - Anterior
2702-W3	W3 - Lower molar
2702-12A	12A - Lower molar
2705-30	30 - Upper molar

Rubberdam instruments & accessories

2740	Ivory Rubber Dam Punch, 16cm
2715	Rubber Dam Clamp Forceps Ivory, 17cm
2761	Steel Organizing Board for Rubber Dam Clamps
2750	Rubber Dam Stand, 9cm x 10cm
2753	Rubber Dam Stand, 10cm x 11cm
5513B	Sterilization cassette for 20, 280x180x35mm

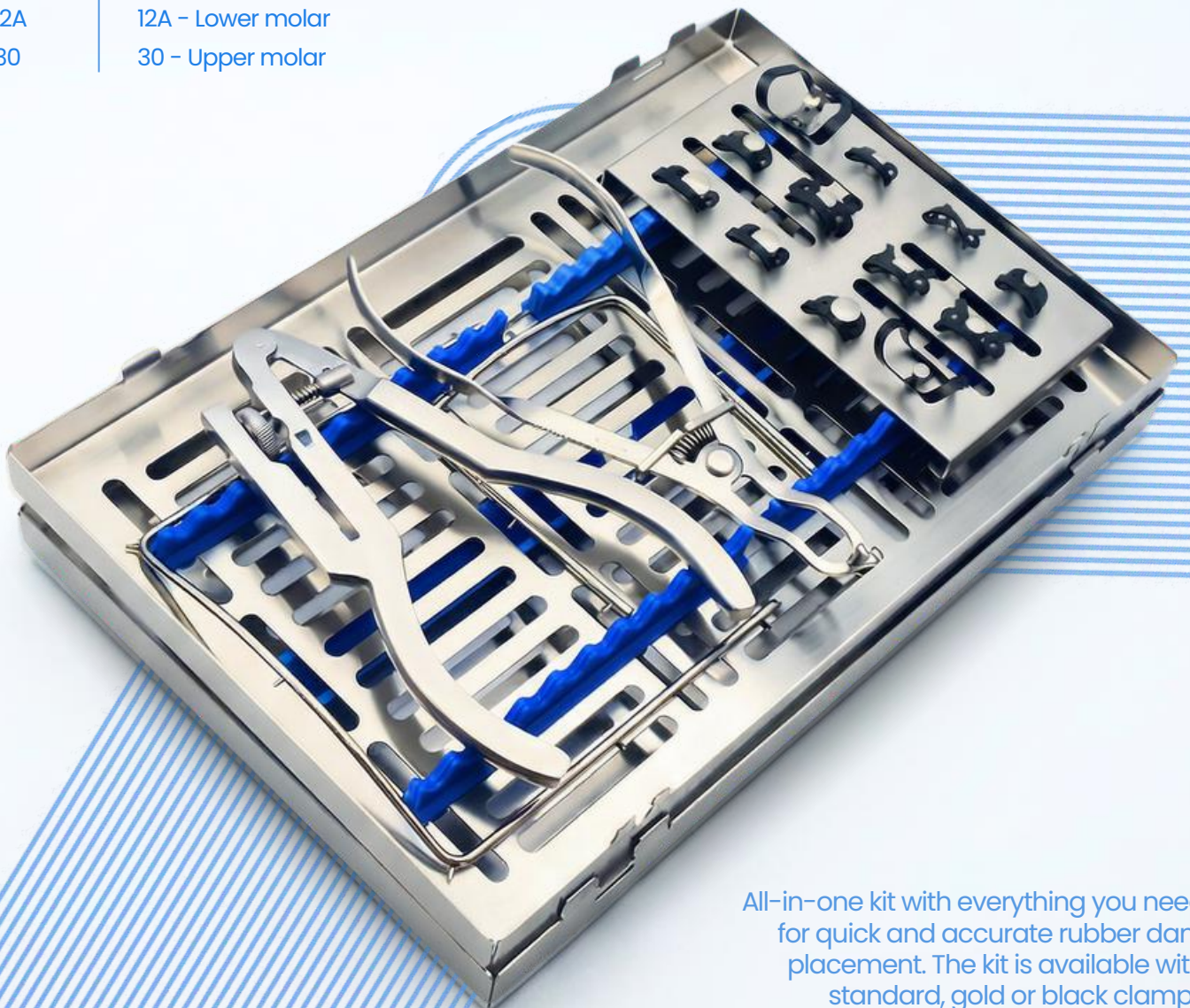

All-in-one kit with everything you need for quick and accurate rubber dam placement. The kit is available with standard, gold or black clamps

Rubberdam instruments



2711
Rubber Dam Clamp
Forceps Brewer
17cm



2712
Rubber Dam Clamp
Forceps Stockes
17cm



2713
Rubber Dam
Clamp Forceps
Washington
17cm



2714
Rubber Dam Clamp
Forceps White
17cm



2715
Rubber Dam Clamp
Forceps Ivory
17cm



2740
Ivory Rubberdam
Punch Forceps
16cm



2741 
Ainsworth Rubberdam
Punch Forceps



2750
Rubber Dam
Stand
9cm x 10cm

2753
Rubber Dam
Stand
10cm x 11cm



2761
Steel Organizing Board
for Rubber Dam Clamps

Endo Tweezers

— with lock —



3676-1A

Endo tweezers,
serrated handle
15cm, Curved



3677-1A

Endo tweezers
smooth handle
15cm, Curved



3667-1

DeBakey
Tweezers
16cm, Straight

Endodontic File Holder



7415

Endodontic
File Holder

Apicoectomy Retractor



45°
Angled

4180

Apicoectomy
retractor, toothed,
45° angled



90°
Angled

4181

Apicoectomy
retractor, toothed,
90° angled

Endo Forceps



7411

Angled Endodontic
Forceps, 14cm



60°
Angled

7416

Root Fragment
Forceps - Long 60°



3209-2S

Needle holder
Micro-Vascular with
TC inserts

Endo accessories

Fully autoclavable endo accessories available in various colors and sizes. View more on our website



Bur Disinfection box resistant to high temperature and Pressure, Blue
7458B



Translucent Bur disinfection box Square shape, 36 Holes, Blue
7454B



Gutta Percha Points Shaping Tip Cutter, Brown
7460N



Root Canal File Frame, 16 Holes, Blue
7459B



Endodontic block with memory holder, 5 holes, Orange
7462S



Gutta Percha Points Measuring Ruler, Black
7461K

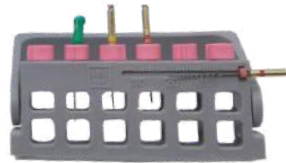

Root Canal File Frame, 6 holes, Grey
7463I



Root Canal File Frame, 8 holes, Sky Blue
7453S



Endo File Cleaner Round Shape, Sky Blue
7452S



Translucent Bur disinfection box Rectangle shape, 72 Holes, Blue
7455B

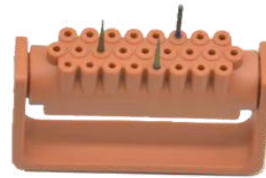

Opening Disinfection Frame Resistant to high temperature and pressure, 25 Holes, Orange
7457O



Equipment of high temperature and high pressure disinfection box, 4 Holes, Green
7456G

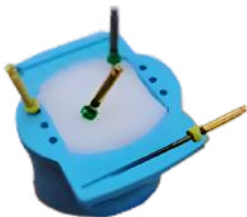

Wrist Endo Measuring Cleaner, Sky Blue
7451S



72 holes endo box for diamond bur, Purple
7464M

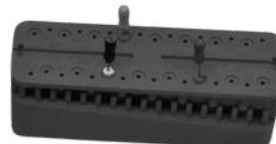

Gutta Percha Points Shaping Tip Cutter
7460K

File holder



Light Blue
7421I

Gray
7421B



Implantology

Sinus-lift instruments



7201 SP

Curettes #1
4mm-4mm



7202 SP

Curettes #2
3mm-4mm



7206 SP

Kramer-Nevins #1
4mm-7mm



7207 SP

Kramer-Nevins #2
4mm-7mm



7211 SP

Sinus Lift Instrument
4mm-4mm



7212 SP

Sinus Lift Instrument
3mm-3mm



7213 SP

Sinus Lift Instrument
4mm-4mm



7216 SP

Sinus Lift Instrument
4mm-4mm



7217 SP

Sinus Lift Instrument
4mm-4mm



7218 SP

Sinus Lift Instrument
4mm-4.3mm



7222 SP

Sinus Lift Mushroom
25mm-32mm

Hammers



4401

Mead
hammer
Ø26mm



4402

Solid head
hammer
17cm, Ø20mm



4403

Solid head
hammer
19cm, Ø19mm

NEW

Blue Titanium

Sinus Lift



7202B-SP

Currettes #2
3mm-4mm



7206B-SP

Kramer-Nevins #1
4mm-7mm

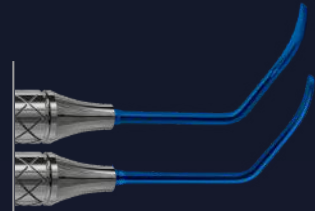

7207B-SP

Kramer-Nevins #2
4mm-7mm

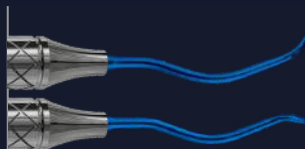

7211B-SP

Sinus Lift Instrument
4mm-4mm



7212B-SP

Sinus Lift Instrument
3mm-3mm



7213B-SP

Sinus Lift Instrument
4mm-4mm

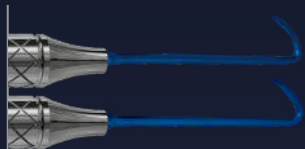

7216B-SP

Sinus Lift Instrument
4mm-4mm



7217B-SP

Sinus Lift Instrument
4mm-4mm



7218B-SP

Sinus Lift Instrument
4mm-4.3mm

7201B-SP

Currettes #1
4mm-4mm

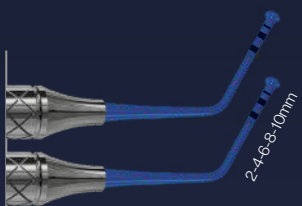

7222B-SP

Sinus Lift Mushroom
2.5mm-3.2mm

Blue titanium tips enhance visibility and control during sinus lift procedures while helping minimize surface trauma.

Blue Makes Your Edge Visible.



Implantology Kits

Osteotome

7260

Osteotome straight

Set of 5 including hammer & cassette

Osteotome size

2.7 mm
3.2 mm
3.7 mm
4.2 mm
5.0 mm



7270

Osteotome offset

Set of 5 including hammer & cassette

Osteotome size

2.7 mm
3.2 mm
3.7 mm
4.2 mm
5.0 mm

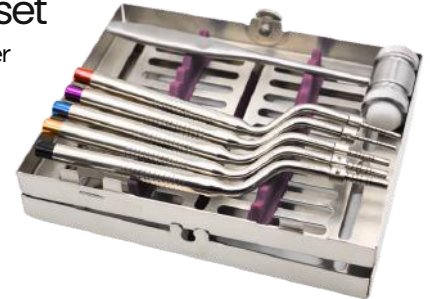

Condenser

The condenser kit ensures each tip fits the previous cavity, allowing safe depth measurement and matching standard implant lengths.

7280

Condenser straight

Set of 7 including hammer & cassette

A	B
2mm	2.7mm
2.5mm	3.2mm
2mm	3.7mm
3.5mm	4.2mm
4mm	4.7mm
4.5mm	5.2mm
5mm	5.7mm



7281

Condenser offset

Set of 7 including hammer & cassette

A	B
2mm	2.7mm
2.5mm	3.2mm
2mm	3.7mm
3.5mm	4.2mm
4mm	4.7mm
4.5mm	5.2mm
5mm	5.7mm



7282

Bone Spreader

Set of 6 including hammer & cassette

A	B
1.6mm	1.6mm
1.6mm	2.2mm
2.2mm	2.2mm



7250

Bone Splitting

Set of 8 including cassette

Straight	Curved
3mm	3mm
4mm	4mm
6mm	6mm
8mm	8mm



Impression Trays

- Perforated design for strong material retention
- Rim-Lock system for secure impression holding
- Fully autoclavable
- Available in 5 sizes: XS, S, M, L, XL

Perforated Impression Tray

Upper Jaw 

Art/no **Size**

4521-1	XS
4521-2	S
4521-3	M
4521-4	L
4521-5	XL

Lower Jaw 

Art/no **Size**

4501-1	XS
4501-2	S
4501-3	M
4501-4	L
4501-5	XL



Non Perforated Impression Tray

Upper Jaw 

Art/no **Size**

4571-1	XS
4571-2	S
4571-3	M
4571-4	L
4571-5	XL

Lower Jaw 

Art/no **Size**

4551-1	XS
4551-2	S
4551-3	M
4551-4	L
4551-5	XL



Half impression trays

Perforated

Right 4541-1 Left 4541-2



Non-Perforated

Right 4591-1 Left 4591-2



5 Upper & 5 Lower/Per



10

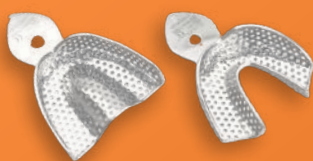

Perforated set
5U & 5L

4521



Non-perforated set
5U & 5L

4571

Clean, Sort & Store

Sterilize & Organize



Keeps You Organized
for Every Procedure.

Sterilization Cassettes with detachable lid

Detachable-lid stainless steel cassettes for better instrument visibility, easy handling, and space efficiency. Rust-free and fully autoclavable for both disinfection and sterilization. Available in five colors: red, blue, green, orange, and yellow for easy identification.

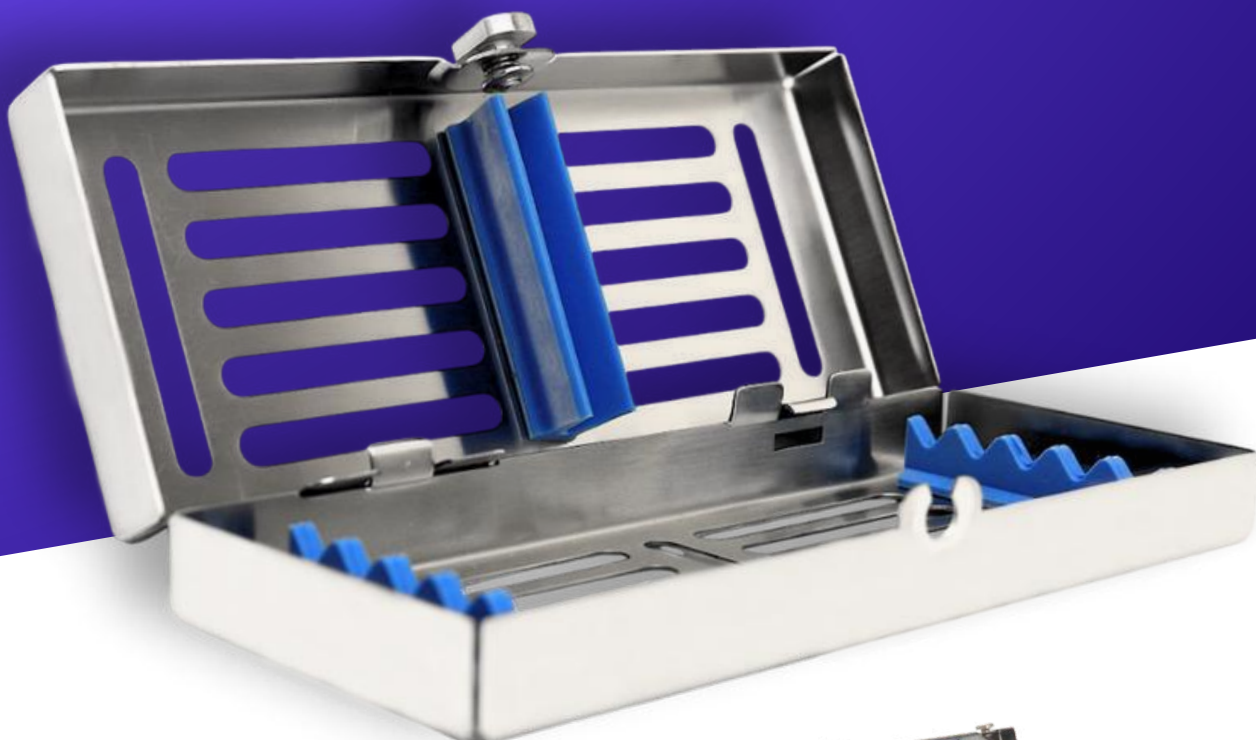

Sterilization cassette for 5 instruments

L:185mm X W:75mm X H:35mm

5511

5511B 5511G 5511R 5511O 5511Y



Sterilization cassette for 10 instruments

L:185mm X W:145mm X H:35mm

5512

5512B 5512G 5512R 5512O 5512Y



Sterilization cassette for 20 instruments

L:280mm X W:180mm X H:35mm

5513

5513B 5513G 5513R 5513O 5513Y

Standard Sterilization Cassettes

Simplify and reduce instruments processing time Disinfect & sterilization of instrument in one tray



Sterilization Cassette for 7

L:185mm X W:90mm X H:20mm

5532

5532B 5532G 5532R 5532O 5532Y



Sterilization cassette for 5 instruments

L:185mm X W:65mm X H:20mm

5531

5531B 5531G 5531R 5531O 5531Y



Sterilization cassette for 10 instruments

L:185mm X W:130mm X H:20mm

5533

5533B 5533G 5533R 5533O 5533Y



Sterilization cassette for 20 instruments

L:285mm X W:185mm X H:30mm

5534

5534B 5534G 5534R 5534O 5534Y

ErgoTrays

Organize with style



Discover More Online
Scan the QR Code

ErgoDenta

ErgoTray 5

The ErgoTray 5 is ideal for sterilizing up to five dental instruments. It has a secure lock and an ergonomic lid that prevent tip injuries and ensure thorough cleaning.

180 x 86 x 26 mm



Black

5505K

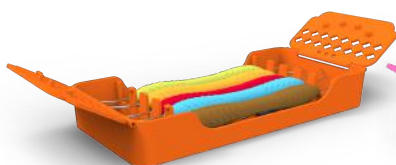

5505O
Orange



 5505P
Pink



5505R
Red



 5505N
Green

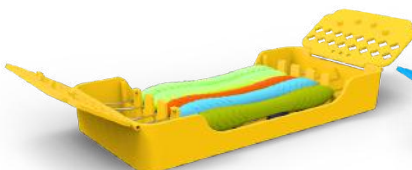

 5505Y
Yellow

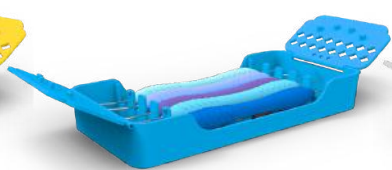

 5505B
Blue



 5505G
Grey



 5505E
Purple

ErgoTray 8

The ErgoTray 8 is ideal for sterilizing up to eight dental instruments. It has a secure lock and an ergonomic lid that prevent tip injuries and ensure thorough cleaning.

180 x 136 x 26 mm

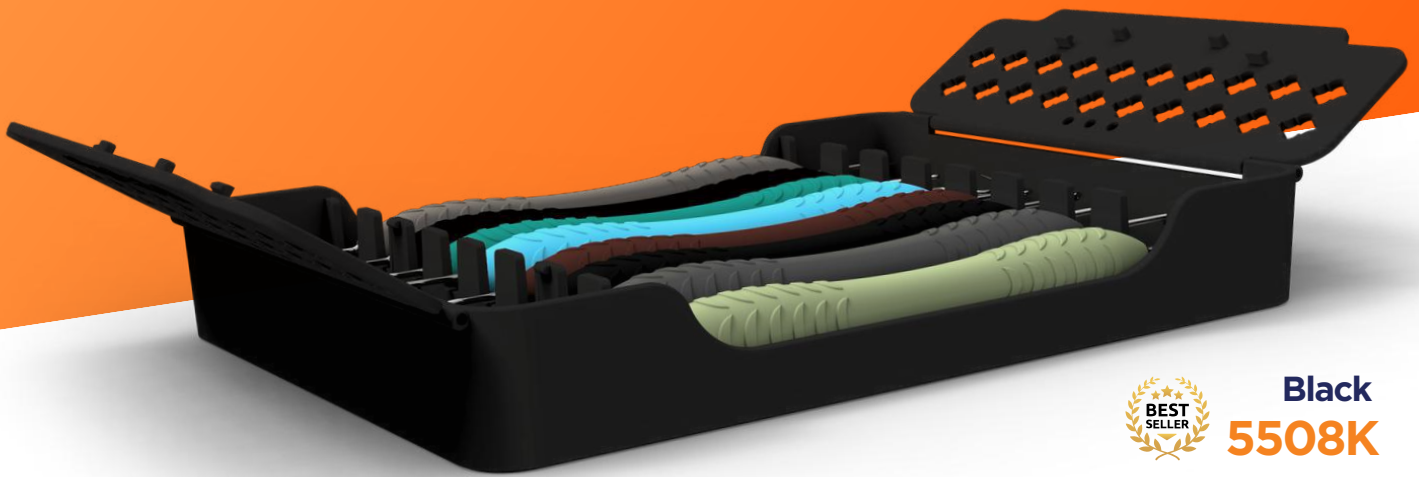

Black
5508K



5508O
Orange



5508P
Pink



5508R
Red



5508N
Green

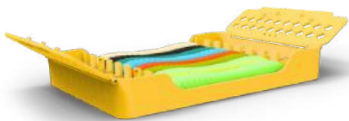

5508Y
Yellow

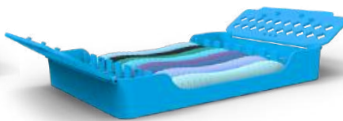

5508B
Blue

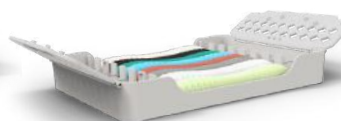

5508G
Grey



5508E
Purple

ErgoVator Tray

The ErgoVator tray is the perfect solution for managing your ErgoLite elevators. Each ErgoLite elevator is supplied with an ErgoVator tray included.

Grey
5502I

Black
5502K

ErgoTray 1

The ErgoTray single instrument holder helps keep your ErgoX and ErgoX Plus instruments organised and protected. Its special locking mechanism keeps the instrument securely in place. Included with all ErgoRazor and ErgoSlip instruments, it is fully autoclavable and reusable.

Grey
5501I

Black
5501K

Solid & Perforated trays



Solid Tray 5582
280x180mm (Incl. lid)



Perforated Tray 5583
280x180mm (Incl. lid)



Perforated Base Tray 5584
280x180mm (Incl. lid)



Perforated Instrument Tray with Rack 5510
284x183x17mm



Instrument Tray 5616
250x150x40mm



Shallow (Mayo) 5617
250x150x40mm



Scaler Tray 5618
200x100x20mm



Perforated Tray 5620
300x200mm

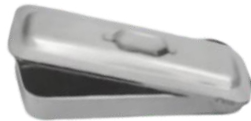

Catheter Tray 5621
220x120x50mm



Instrument Holder 5555
280mm

Storage Tubes/ Instrument Holder Ø 50x100mm
5585



Storage Tubes/ Instrument Holder Ø 50x170mm
5587

Storage Tubes/ Instrument Holder Ø 75x190mm
5588



Storage Tubes/ Instrument Holder Ø 90x210mm
5589

HOLDERS, BOXES & BOWLS



Instrument box with Lid 5590
100x200mm



Kidney Shape 5592
200mm



Bowl 5594
50x60x15mm

Bowl / Pots Ø 55 mm 5601
(65ml)



Bowl / Pots Ø 65 mm 5602
(130ml)

Bowl / Pots Ø 70 mm 5603
(190ml)



Round Box With Lid 5623
120x120mm



Glass (18cl) 5624
70x80mm



Instrument Tray With Lid 5622
220x120x50mm

Bowl / Pots Ø 70 mm 5604
(90ml)



Bowl / Pots Ø 90 mm 5605
(180ml)

Bowl / Pots Ø 110 mm 5606
(360ml)

Color Code Rings

Organize and identify instruments quickly with fully autoclavable, heat-resistant color-code rings. Available in two sizes: small for hand instruments and large for extraction forceps or wider handles.

Large

25 pieces per box per color

Small

50 pieces per box per color

Color	Large	Small
Blue	5641B	5651B
Green	5641G	5651G
Red	5641R	5651R
Yellow	5641Y	5651Y
Black	5641K	5651K
White	5641W	5651W
Purple	5641P	5651P
Light Blue	5641S	5651S



Large Mix
8 Colors (12 pcs each)
5641



Small Mix
8 Colors (25 pcs each)
5651



Fully autoclavable and heat-resistant

Available in **08** colors

ErgoTape



3x longer than regular tapes



Color	Code
Blue	5691B
Light Yellow	5691L
Red	5691R
Dark Yellow	5691Y
Black	5691K
White	5691W
Purple	5691M
Light Pink	5691P

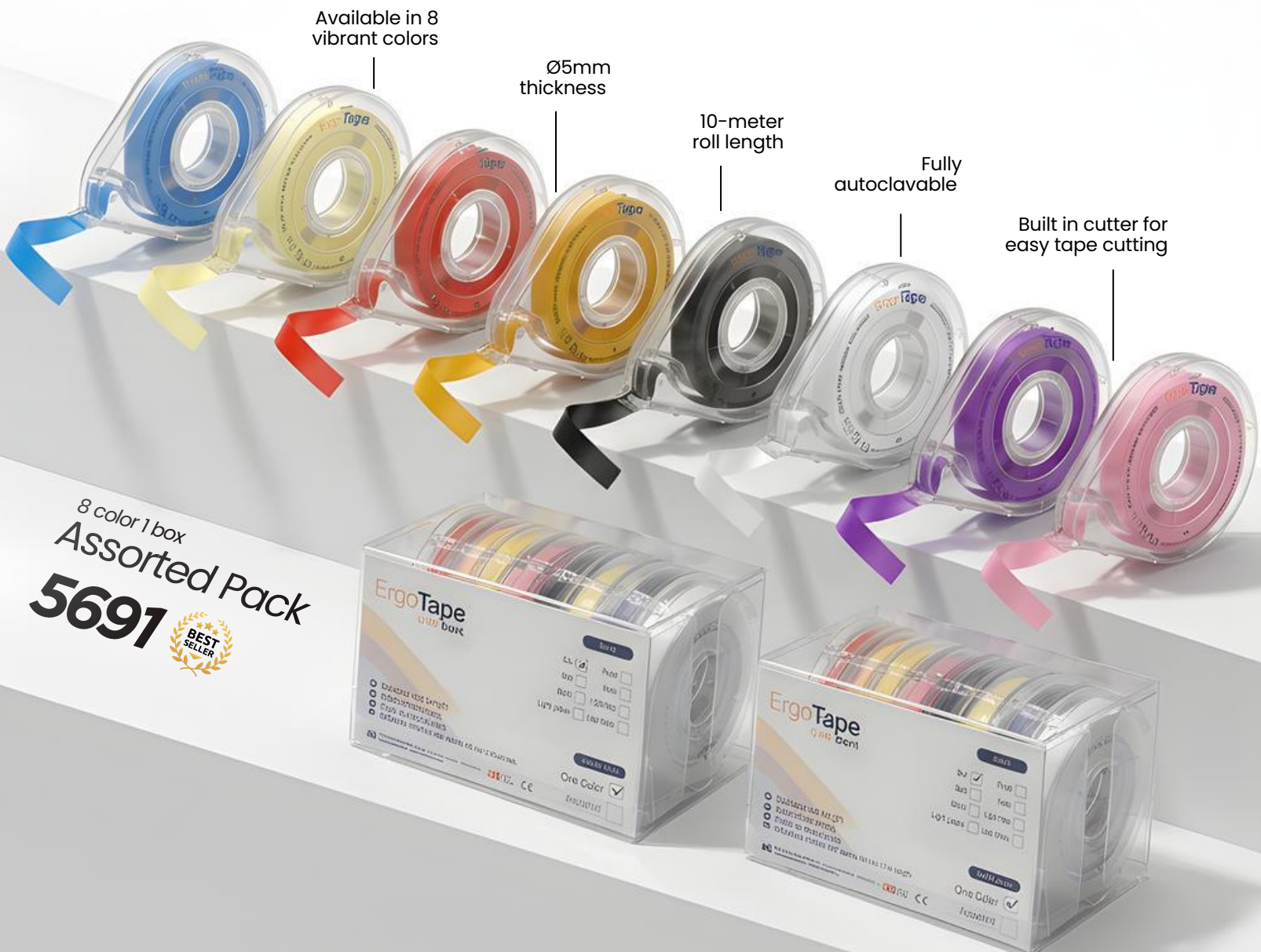

Available in 8 vibrant colors

Ø5mm thickness

10-meter roll length

Fully autoclavable

Built in cutter for easy tape cutting

8 color 1 box
Assorted Pack
5691



Scalpel Handles



5663
No:3 180°



5664
No:3



5665
No:3

Accessories



Silicone Suture Practice Pad, 14 shapes
175x120mm 5598



Silicone Suture Practice Pad, 17 shapes
175x120mm 5599



Rulers, 100mm
12 pcs per pack 5661



Rulers, 150mm
12 pcs per pack 5662



Napkin Holder
approx 44cm 5666

Calipers



5673
Sliding Calliper
0-125mm



5674
Iwanson
10mm



5667
Beerendonk Caliper
130mm



5668
Zuricher Caliper
130mm



5669
Boley Caliper
145mm

Bur Holders

These bur holders can hold 4, 8, or 12 burs and are suitable for any FG or latch type. The colored silicone holders are replaceable and come in 4 colors, helping to keep things organized easily.



For 4 Bur Holder

- 7381B
- 7381Y
- 7381R
- 7381G



For 8 Bur Holder

- 7382B
- 7382Y
- 7382R
- 7382G



For 12 Bur Holder

- 7383B
- 7383Y
- 7383R
- 7383G



Instrument Care & Maintenance

Keep your instruments performing at their best. Learn how to properly clean, disinfect, sterilize, and maintain dental instruments for long-lasting performance.

SCAN ME



Become a Distributor

Join our growing international network of distribution partners and offer ergonomic dental instruments designed in Denmark.

SCAN ME



Private Label Solutions

Create your own instrument brand with our complete private label service—from design and product selection to production and delivery.

SCAN ME



Follow us on



Find more information, practical guides, and partnership opportunities on our website.

Continue the Experience Online

Product Catalog 2026

The Nordic Selection

ErgoDenta

ErgoDenta ApS

 Hoerskaetten 14, 2630 Taastrup |  Denmark

 Tel. +45 5524 1100

 www.ergodenta.dk | info@ergodenta.dk

**VIEW
ONLINE**

