



kobi ®

**2024/25**

**KATALOG PRODUKTÓW**

PRODUCT CATALOGUE







**PRODUCENT OŚWIETLENIA**  
LIGHTING MANUFACTURER

## światło, które definiuje jakość

LIGHT THAT DEFINES QUALITY

WSZYSTKO ZACZYNA SIĘ OD ŚWIATŁA.  
TO PODSTAWOWA ENERGIA  
ŻYCIA, KOJARZĄCA SIĘ Z CIEPŁEM,  
BEZPIECZEŃSTWEM I NADZIEJĄ.

EVERYTHING BEGINS WITH LIGHT.  
IT IS THE FUNDAMENTAL ENERGY OF  
LIFE, ASSOCIATED WITH WARMTH,  
SAFETY, AND HOPE.

ŚWIATŁO WPŁYWA NA NASZE  
SAMOPOCZUCIE, ZDROWIE,  
EFEKTYWNOŚĆ PRACY I JAKOŚĆ  
ODPOCZYNKU. ODPOWIEDNIO  
DOBRAŃE OŚWIETLENIE MOŻE  
CAŁKOWICIE ODMIENIĆ CHARAKTER  
PRZESTRZENI, PODKREŚLAJĄC JEJ ATUTY  
I TWORZĄC WYJĄTKOWĄ ATMOSFERĘ.

LIGHT AFFECTS OUR WELL-BEING,  
HEALTH, WORK EFFICIENCY, AND THE  
QUALITY OF OUR REST. PROPERLY  
SELECTED LIGHTING HAS THE POWER  
TO COMPLETELY TRANSFORM A SPACE,  
HIGHLIGHTING ITS BEST FEATURES  
AND CREATING A TRULY UNIQUE  
ATMOSPHERE.

W KOBİ LIGHT DOSKONALE ROZUMIEMY  
SIŁĘ ŚWIATŁA, DLATEGO NASZE  
PRODUKTY SĄ PROJEKTOWANE Z MYŚLĄ  
O SPEŁNIANIU RÓŻNORODNYCH POTRZEB  
I OCZEKIWAŃ NASZYCH KLIENTÓW.

AT KOBİ LIGHT, WE DEEPLY UNDERSTAND  
THE PROFOUND IMPACT OF LIGHT,  
WHICH IS WHY OUR PRODUCTS ARE  
DESIGNED TO MEET THE DIVERSE NEEDS  
AND EXPECTATIONS OF OUR CLIENTS.

KATALOG, KTÓRY PAŃSTWO  
PRZEGLĄDACCIE, TO ZAPROSZENIE DO  
ŚWIATA KOBİ – PRZESTRZENI, GDZIE  
INNOWACJA SPOTYKA SIĘ Z ESTETYKĄ,  
A TECHNOLOGIA Z EKOLOGIĄ. JESTEŚMY  
DUMNI, ŻE MOŻEMY ZAPREZENTOWAĆ  
NASZE NAJNOWSZE ROZWIĄZANIA  
W DZIEDZINIE OŚWIETLENIA, POWSTAŁE  
NA BAZIE PONAD DWÓCH DEKAD  
BRANŻOWEGO DOŚWIADCZENIA.

THE CATALOG YOU ARE CURRENTLY  
BROWSING IS AN INVITATION INTO THE  
WORLD OF KOBİ – A SPACE WHERE  
INNOVATION MEETS AESTHETICS,  
AND TECHNOLOGY ALIGNS WITH  
SUSTAINABILITY. WE ARE PROUD  
TO PRESENT OUR LATEST LIGHTING  
SOLUTIONS, DEVELOPED FROM OVER  
TWO DECADES OF INDUSTRY EXPERTISE.







## DOSTARCZAMY KOMPLEKSOWE ROZWIĄZANIA OŚWIETLENIOWE: FUNKCJONALNE, TRWAŁE I DOSKONAŁE ZAPROJEKTOWANE.

WE DELIVER COMPREHENSIVE LIGHTING SOLUTIONS: FUNCTIONAL, ENDURING, AND IMPECCABLY DESIGNED.

**W Kobi Light wierzymy, że innowacyjność i estetyka mogą iść w parze. Dbamy o każdy detal: od projektu, przez produkcję, aż po dostarczenie gotowego produktu do klienta. W procesie tworzenia oświetlenia szczególnie inspiruje nas:**

1. Innowacyjność – wykorzystujemy najnowsze technologie, aby nasze produkty były energooszczędne, trwałe i wydajne. Stale inwestujemy w badania i rozwój, aby dostarczać rozwiązania, które spełniają najwyższe standardy.
2. Jakość – wysoka jakość asortymentu Kobi to wynik starannego doboru materiałów oraz rygorystycznych testów na każdym etapie produkcji. Nasze artykuły oświetleniowe są projektowane z myślą o długotrwałym, efektywnym użytkowaniu. Każda oprawa, lampa czy żarówka Kobi Light to gwarancja trwałości i niezawodności.
3. Ekologia – jesteśmy przekonani, że przyszłość oświetlenia leży w zrównoważonym rozwoju. Tworzymy nasze produkty z myślą o minimalizowaniu wpływu na środowisko naturalne, przy jednoczesnym maksymalnym wykorzystaniu zdobyczy technologicznych. Korzystamy z energooszczędnych technologii LED, sukcesywnie poszerzamy również ofertę modeli solarnych i hybrydowych.

**At Kobi Light, we believe that innovation and aesthetics can go hand in hand. We meticulously oversee every detail – from initial design through production to the final delivery to our clients. In our pursuit of creating exceptional lighting, we are guided by:**

1. Innovation – we use the latest technologies to ensure our products are energy-efficient, durable, and high-performing. We continually invest in research and development to provide solutions that meet the highest standards.
2. Quality – the high quality of Kobi's assortment is the result of carefully selected materials and rigorous testing at every stage of production. Our lighting products are designed for long-lasting, efficient use. Every fixture, lamp, or bulb from Kobi Light is a guarantee of durability and reliability.
3. Sustainability – We are convinced that the future of lighting lies in sustainable development. Our products are crafted with a commitment to minimizing environmental impact while maximizing technological innovation. We employ energy-efficient LED technologies and continually expand our selection of solar and hybrid models.

**W ODPOWIEDNIM OŚWIETLENIU KAŻDA PRZESTRZEŃ ZYSKUJE NOWY WYMIAR, PONIEWAŻ STARANNIE DOBRANE ŚWIATŁO POTRAFI PODKREŚLIĆ I WZMOCNIĆ JEJ FUNKCJONALNOŚĆ.**

THE RIGHT LIGHTING ELEVATES ANY SPACE, AS CAREFULLY CHOSEN LIGHT CAN ENHANCE AND AMPLIFY ITS FUNCTIONALITY.





**WŁAŚCIWIE DOPASOWANA BARWA ŚWIATŁA WSPIERA KONCENTRACJĘ, TWORZY PRZYTULNĄ ATMOSFERĘ, A TAKŻE PODKREŚLA GŁĘBIĘ KOLORÓW W ARANŻACJI WNĘTRZA.**

THE PROPER HUE OF LIGHT BOOSTS CONCENTRATION, CREATES A WELCOMING AMBIANCE, AND ACCENTUATES THE DEPTH OF COLORS IN INTERIOR DESIGN.



FIRMA / COMPANY

**KOBİ LIGHT**

**DLA KOMFORTU PRZEGLĄDANIA  
KATALOGU ZORGANIZOWALIŚMY  
NASZ ASORTYMENT W PRZEJRZyste  
GRUPY PRODUKTOWE.**

**Dziękujemy za zainteresowanie naszą ofertą  
i zapraszamy do odkrycia pełni możliwości, jakie oferują  
nasze produkty.** Mamy nadzieję, że ten katalog będzie  
dla Państwa nie tylko źródłem informacji, ale również  
inspiracją do tworzenia przestrzeni pełnych światła.

Jeśli po lekturze pojawiły się pytania lub potrzeba  
uzyskania dodatkowych informacji, nasz zespół jest do  
Państwa dyspozycji. Chętnie pomożemy w wyborze  
najlepszych rozwiązań oświetleniowych.

TO ENHANCE YOUR BROWSING  
EXPERIENCE, WE HAVE ORGANIZED OUR  
PRODUCT RANGE INTO CLEAR AND  
INTUITIVE CATEGORIES.

**Thank you for your interest in our product portfolio.**

We invite you to discover the full potential of our  
solutions, hoping this catalog serves not only as a source  
of information but also as an inspiration for creating  
spaces filled with light.

Should you have any questions or require additional  
information, our team is at your service. We are eager  
to assist in selecting the most fitting lighting solutions.



**ŹRÓDŁA ŚWIATŁA**  
LIGHT SOURCES  
26-69



**OPRAWY  
INWESTYCYJNE**  
INDUSTRIAL LIGHTING  
70-139



**ZEWNĘTRZNE OPRAWY  
INWESTYCYJNE**  
OUTDOOR INDUSTRIAL  
LIGHTING  
140-163



**OPRAWY DOMOWE**  
DOMESTIC LIGHTING  
164-197



**OPRAWY OGRODOWE**  
GARDEN LIGHTING  
198-225



**OŚWIETLENIE  
DO WZROSTU ROŚLIN**  
PLANT GROWTH LIGHTING  
226-235



**WENTYLATORY  
I TERMOWENTYLATORY**  
FANS AND FAN HEATERS  
236-243



**AKCESORIA I OSPRZĘT  
ELEKTRONICZNY**  
ACCESSORIES  
244-267



## NASZ KATALOG TO ŹRÓDŁO KOMPLEKSOWEJ WIEDZY O ASORTYMENTCIE KOBİ.

Każdy artykuł został dokładnie zobrazowany i opatrzony specyfikacją techniczną.

**Zachęcamy do zapoznania się z legendą symboli użytych w kartach katalogowych:**

## OUR CATALOG IS A COMPREHENSIVE GUIDE TO THE DIVERSE SELECTION OF KOBİ PRODUCTS.

Each item is presented with detailed visuals, complete with specifications and technical parameters.

**We encourage you to familiarize yourself with the symbols used throughout the catalog:**

	<b>zasilanie (np. 230V)</b> adjusted to voltage (e.g. 230V)		<b>wskaznik oddawania barw</b> color rendering index (CRI)
	<b>częstotliwość napięcia</b> voltage frequency		<b>temperatura pracy</b> working temperature
	<b>klasa ochronności przed porażeniem elektrycznym</b> protection class against electrocution		<b>czas nagrzewania lamp do 60% max. strumienia</b> lamp's heating time until 60% max. flux
	<b>klasa odporności na wnikanie pyłu i wilgoci</b> class of resistance against dust and humidity		<b>liczba cykli włącz / wyłącz</b> on/off cycles
	<b>sposób montażu</b> installation		<b>wyposażone we włącznik</b> with a switch
	<b>dopuszczalna moc</b> acceptable power		<b>nie stosować ze ściemniaczem</b> do not use with a dimmer
	<b>miejsce zastosowania</b> place of application		<b>można zastosować ze ściemniaczem</b> can be used with dimmer
	<b>rodzaj trzonka</b> holder types		<b>nieprzeznaczona do oświetlenia akcentowego</b> not intended for accent lighting
	<b>stosowane źródło światła</b> light source applied		<b>łatwy i szybki montaż</b> simple and quick installation
	<b>temperatura barwowa światła</b> color temperature		<b>diody rgb</b> rgb diodes
	<b>trwałość źródła światła</b> light source's life span		<b>stopień ochronności przed uderzeniami mechanicznymi</b> protection degree against mechanical damages
	<b>minimalna odległość od oświetlanego obiektu</b> minimum distance from illuminated object		<b>możliwość wymiany źródła światła LED jedynie przez wykwalifikowany personel</b> the LED light source can only be replaced by qualified personnel
	<b>rodzaj urządzenia stabilizacyjno-zapłonowego</b> ballast device type		<b>znak zgodności z dyrektywami Unii Europejskiej</b> a mark of conformity with European Union directives
	<b>współczynnik mocy lamp</b> lamp's power factor		



# ŹRÓDŁA ŚWIATŁA

## LIGHT SOURCES



LED GS 7W E27  
- 28 -



LED FGS 7W E27  
- 28 -



LED GS 7W E27 LED2B  
- 29 -



LED GS 8,5W E27  
LED2B  
- 29 -



LED GS 10W E27  
- 30 -



LED GS 10,5W E27  
LED2B  
- 30 -



LED FGS 11,5W E27  
- 31 -



LED GS 13W E27  
- 31 -



LED GS 15W E27  
- 32 -



LED GS 18W E27  
- 32 -



LED GS 9W LX E27  
PREMIUM  
- 33 -



SMART LED GS 9,5W  
E27 RGB WW WiFi  
- 34 -



LED GU10 1W  
- 35 -



LED GU10 3W  
PREMIUM  
- 35 -



LED GU10 5W  
- 36 -



LED GU10 5W  
PREMIUM  
- 36 -



LED GU10 7W  
- 37 -



LED GU10 7W  
PREMIUM  
- 37 -



LED GU10 9W  
PREMIUM  
- 38 -



LED MR11 4W GU10  
- 38 -



LED INSERT 5W MILKY  
- 39 -



LED INSERT 6,5W  
MILKY  
- 39 -



LED SW 3W E14  
- 40 -



LED FSW 4W E14  
- 41 -





LED FDE 4W E14  
- 41 -



LED SW 4,5W E14  
- 42 -



LED SW 6W E14  
- 42 -



LED SW 8,5W E14  
LED2B  
- 43 -



LED SW 9W E14  
PREMIUM - 43 -



LED SW 6W E27  
- 44 -



LED SW 8,5W E27  
LED2B  
- 45 -



LED SW 9W E27  
PREMIUM  
- 45 -



LED FMB 4W E14  
- 46 -



LED MB 4,5W E14  
- 47 -



LED MB 6W E14  
- 47 -



LED MB 8,5W E14  
LED2B  
- 48 -



LED MB 9W E14  
PREMIUM  
- 48 -



LED ST45 1W E27  
LED2B  
- 49 -



LED FMB 4W E27  
- 49 -



LED MB 4,5W E27  
- 50 -



LED MB 6W E27  
- 50 -



LED MB 8,5W E27  
LED2B  
- 51 -



LED MB 9W E27  
PREMIUM  
- 51 -



LED FG125 7W E27  
- 52 -



LED FST64 7W E27  
- 52 -



LED G120 24W E27  
- 53 -



LED R50 5W E14  
- 54 -



LED R63 8W E27  
- 54 -



LED G4 1,5W  
- 55 -



LED G4 2W  
- 55 -



LED G9 3W  
- 56 -





LED G9 4W  
- 57 -



LED G9 6W  
- 57 -



LED T 2W E14  
- 58 -



LED T 4,2W E14  
- 58 -



LED ES111 15W GU10  
- 59 -



LED J78 8W R7s  
- 60 -



LED J118 15W R7s  
- 60 -



LED NEXTUBE 18W  
120 cm  
- 61 -



LED NEXTUBE 24W  
150 cm  
- 62 -



LED T8 9W PREMIUM  
| 60 cm  
- 62 -



LED T8 18W PREMIUM  
| 120 cm  
- 63 -



LED T8 22W PREMIUM  
| 150 cm  
- 63 -



LED T8 9W LED2B  
60 cm  
- 64 -



LED T8 18W LED2B  
120 cm  
- 64 -



LED T8 22W LED2B  
150 cm  
- 65 -



LED T8 9W  
LED2B RED | 60 cm  
- 65 -



LED T8 18W  
LED2B RED | 120 cm  
- 66 -



LED T8 22W  
LED2B RED | 150 cm  
- 66 -



LED TRAMO 320  
COB IP20 5m  
- 67 -

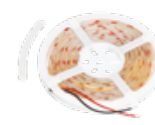

LED TRAMO 320  
COB IP65 5m  
- 68 -



LUMOS LED SET  
- 68 -



SMART LED SET  
RGB CCT WiFi  
- 69 -



LED PLAY SET RGB  
- 69 -



## OPRAWY INWESTYCYJNE INDUSTRIAL LIGHTING



LED ANICA 100W  
- 72 -



LED ANICA 150W  
- 72 -



LED ANICA 200W  
- 73 -



UCHWYT DO LED  
ANICA / HANDLE FOR  
A LED ANICA  
- 73 -



CZUJNIK RUCHU  
/ ZHAGA MOTION  
SENSOR  
- 74 -



PILOT DO CZUJNIKA  
RUCHU / ZHAGA  
REMOTE CONTROL  
- 74 -



LED NICO 120W  
- 75 -



LED RIO PRO 200W  
2CCT  
- 75 -



LED RIO PRO 100W  
- 76 -



LED RIO PRO 150W  
- 76 -



LED RIO PRO 200W  
- 77 -



UCHWYT DO LED RIO  
PRO / HANDLE FOR  
A LED RIO PRO  
- 77 -



LED NEXFORCE N2  
20W  
- 78 -



LED NEXFORCE N2  
36W  
- 78 -



LED NEXFORCE N2  
52W  
- 79 -



LED NEXFORCE N2  
70W  
- 79 -



HPL 1 PRO 30W  
- 80 -



HPL 1 PRO 45W  
- 80 -



HPL 1 PRO 60W  
- 81 -



HPL 1 PRO 75W  
- 81 -



HPL 2 PRO 60W  
- 82 -



HPL 2 PRO 90W  
- 82 -

















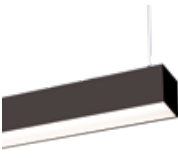







HPL 2 PRO 120W  
- 83 -



HPL 2 PRO 150W  
- 83 -



					
LED NEGRO 20W - 84 -	LED NEGRO 36W - 85 -	LED NEGRO 60W - 85 -	LED CORTEZ 2 60W - 86 -	LED CORTEZ 3 18W - 87 -	LED CORTEZ 3 36W - 87 -
					
LED CORTEZ 3 45W - 88 -	LED MIVRO 36W LED2B - 88 -	LED CORTEZ 18W LED2B - 89 -	LED CORTEZ 36W LED2B - 90 -	LED CORTEZ 48W LED2B - 90 -	LED KOLINE K1 20W - 91 -
					
LED KOLINE K1 40W - 92 -	LED BRISBANE 60x60 36W - 92 -	LED BRISBANE 30x120 36W - 93 -	LED CAPRI PRO 60x60 36W UGR<19 - 94 -	LED CAPRI PRO 30x120 36W UGR<19 - 94 -	LED CAPRI PRO 60x60 28W - 95 -
					
LED CAPRI PRO 60x60 36W - 96 -	LED CAPRI PRO 60x60 40W - 96 -	LED ORIO 60x60 26-32W - 97 -	LED ORIO 60x60 34-40W - 97 -	LED NELIO PRO 60x60 40W - 98 -	LED NELIO PRO 30x120 40W - 99 -
					
LED NELIO PREMIUM 30x60 28W - 99 -	LED NELIO PREMIUM 60x60 40W - 100 -	LED NELIO PREMIUM 30x120 40W - 100 -	LED CAMARO 60x60 40W LED2B - 101 -	KLIK RAMKA 45 mm DO PANELU LED / CLICK FRAME 45mm FOR LED PANEL - 102 -	KLIK RAMKA 63 mm DO PANELU LED / CLICK FRAME 63mm FOR LED PANEL - 102 -
					
LINKA DO PANELU LED / SUSPENSION WIRE - 103 -	UCHWYT DO KARTON-GIPS / CLASP FOR A DRYWALL - 103 -	ZASILACZ DALI 20W / DALI DRIVER 20W - 104 -	ZASILACZ DALI 44W / DALI DRIVER 44W - 104 -	LED ORBIS LX 10W - 105 -	LED DEFENDER 18W - 106 -



LED DEFENDER 24W  
- 106 -



LED DEFENDER 18W LX  
- 107 -



LED DEFENDER 24W LX  
- 107 -



LED NAIROS G2 12W  
- 108 -



LED NAIROS G2 18W  
- 109 -



LED NAIROS G2 24W  
- 109 -



LED NAIROS G2 36W  
- 110 -



LED NAIROS LX G2 12W  
- 110 -



LED NAIROS LX G2  
18W - 111 -



LED NAIROS LX G2  
24W - 112 -



LED NAIROS LX G2  
36W - 112 -



LED SOFI 13W LX  
PREMIUM - 113 -



LED SIGARO CIRCLE  
18W PREMIUM - 114 -



LED SIGARO CIRCLE  
24W PREMIUM - 114 -



LED SIGARO SQUARE  
18W PREMIUM - 115 -



LED SIGARO SQUARE  
24W PREMIUM - 115 -



LED NEXEYE NE1 15W  
- 116 -



LED NEXEYE NE1 20W  
- 117 -



LED NEXEYE NE1 30W  
- 117 -



LED SIGARO CIRCLE PT  
6W PREMIUM - 118 -



LED SIGARO CIRCLE PT  
12W PREMIUM - 118 -



LED SIGARO CIRCLE PT  
18W PREMIUM - 119 -



LED SIGARO CIRCLE PT  
24W PREMIUM - 119 -



TIGRA P 50W  
- 120 -



TIGRA P 100W  
- 120 -



TIGRA S 2x30W  
- 121 -



TIGRA S 2x50W  
- 121 -



NEXTRACK S-LINE  
- 122 -



SZYNOPRZEWODY  
/ TRACKS  
- 123 -



AKCESORIA MONTAŻOWE  
/ INSTALLATION  
ACCESSORIES  
- 123 -



ZESTAW DO  
ZAWIESZENIA  
/ A SET FOR HANGING  
- 124 -



RUTO  
- 125 -



WEGA PC  
- 125 -



SOMA PC 60 SIATKA  
METAL  
- 126 -



SOMA PC 100 SIATKA  
METAL  
- 126 -



SOMA PC 60 SIATKA  
PLASTIK  
- 127 -



SOMA PC 100 SIATKA  
PLASTIK  
- 127 -



ROMERO  
- 128 -



SAMIRA S  
- 129 -



SAMIRA B  
- 129 -



HERMETIC 1x120  
+ 1xLED T8 18W  
- 130 -



HERMETIC 2x60  
+ 2xLED T8 9W  
- 131 -



HERMETIC G2 2x120  
+ 2xLED T8 18W  
- 131 -



HERMETIC 1x60  
- 132 -



HERMETIC 1x120  
- 133 -



HERMETIC 1x150  
- 133 -



HERMETIC 2x60  
- 134 -



HERMETIC 2x120  
- 135 -



HERMETIC 2x150  
- 135 -



HERMIC 1x120  
- 136 -



HERMIC 2x120  
- 136 -



HERMES 2x120 LED2B  
- 137 -



DELFIGA 2x120  
- 138 -



ZEBRA 1x120  
- 139 -



ZEBRA 2x120  
- 139 -





## ZEWNĘTRZNE OPRAWY INWESTYCYJNE

OUTDOOR INDUSTRIAL LIGHTING



MASTER STREET S 35W  
- 142 -



MASTER STREET M  
80W  
- 143 -



MASTER STREET L  
120W  
- 143 -



LED VESPA PRO 40W  
- 144 -



LED VESPA PRO 60W  
- 145 -



LED VESPA PRO 100W  
- 145 -



LED VESPA PRO 150W  
- 146 -



LED VESPA PRO 200W  
- 146 -



LED CYOTO LX 50W  
- 147 -



LED CYOTO LX 100W  
- 147 -



HYBRID LED FUSION  
14W  
- 148 -



SOLAR LED STREET  
40W PREMIUM  
- 149 -



SOLAR LED STREET  
15W  
- 149 -



LED US 300W DIM  
- 150 -



LED US 500W DIM  
- 150 -



LED KOBI SEUL 50W  
- 151 -



LED KOBI SEUL 100W  
- 151 -



LED KOBI SEUL 150W  
- 152 -



LED KOBI SEUL 200W  
- 152 -



SOLAR LED NEW KOBI  
PHOENIX 13W  
- 153 -



SOLAR LED MHCS 30W  
2CCT PREMIUM  
- 154 -



SOLAR LED MHCS 10W PREMIUM  
- 154 -



SOLAR LED MHCS 30W PREMIUM  
- 155 -



SOLAR LED MHC 5W  
- 155 -



SOLAR LED MHC 10W  
- 156 -



SOLAR LED NCS 10W  
LED2B  
- 156 -



SOLAR LED NCS 20W  
LED2B  
- 157 -



SOLAR LED NCS 30W  
LED2B  
- 157 -



LED MH 10W LED2B  
RED  
- 158 -



LED MH 20W LED2B  
RED  
- 159 -



LED MH 30W LED2B  
RED  
- 159 -



LED MH 50W LED2B  
RED  
- 160 -



LED MH 100W LED2B  
RED  
- 160 -



LED MHC 10W LED2B  
RED  
- 161 -



LED MHC 20W LED2B  
RED  
- 161 -



LED MHC 30W LED2B  
RED  
- 162 -



LED MHC 50W LED2B  
RED  
- 162 -



LED NUMOS LX 7W  
- 163 -

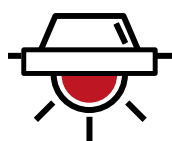

## OPRAWY DOMOWE DOMESTIC LIGHTING



LED LIZBONA 3,5W  
CCT  
- 166 -



LED TENUIX 14W  
LED2B  
- 167 -



LED TENUIX DUO 28W  
LED2B  
- 167 -



LED NOBLITE 7W  
LED2B  
- 168 -



LED VISUA DESK 5W  
LED2B  
- 168 -



ROLIG 1xE27  
- 169 -



ŚMIESZEK 1xE27  
- 170 -



AURIQ 1xE27  
LED2B  
- 170 -



AURIQ ST 1xE27  
LED2B  
- 171 -



LED PLAY SL 6W  
- 171 -



LED LUMIREFLECT 8W  
- 172 -



LED LUMIREFLECT 10W  
- 173 -



LED LUMIREFLECT 12W  
- 173 -



LED CLICK 1,5W CCT  
PREMIUM  
- 174 -



LED LUME-IQ 5W  
- 174 -



LED CORREA 3,4W  
- 175 -



LED WL 4W  
- 176 -



LED WL 8W  
- 176 -



LED WL 10W  
- 177 -



LED WL 14W  
- 177 -



LED HALO 5W  
- 178 -



OH14 | 1xGU10  
- 179 -



OH15 | 1xGU10  
- 179 -



OH21 | 1xGU10  
- 180 -



OH26N | 1xGU10  
- 181 -



OH27N | 1xGU10  
- 181 -

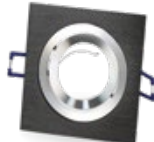

OH28 | 1xGU10  
- 182 -



OH29 | 1xGU10  
- 182 -



OH34 | 1xGU10  
- 183 -



OH36 S | 1xINSERT  
- 184 -



OH36 | 1xGU10  
- 185 -



OH36 L | 1xGU10  
- 185 -



OH37 S | 1xINSERT  
- 186 -



OH37 | 1xGU10  
- 186 -



KIVI | 1xGU10  
- 187 -



AQUARIUS ROUND  
1xGU10  
- 188 -



AQUARIUS SQUARE  
1xGU10  
- 189 -



LAHTI MINI 9W DIM  
- 189 -



LAHTI 10,5W DIM  
- 190 -



LAHTI 13,5W DIM  
- 191 -



LAHTI MINI 2x9W DIM  
- 191 -



BOHO BONN  
1xE27  
- 192 -





**BOHO BAKU S**  
1xE27  
- 193 -



**BOHO BAKU M**  
1xE27  
- 193 -



**BOHO BEIRUT**  
1xE27  
- 194 -



**BOHO BERN**  
1xE27  
- 194 -



**BOHO BRUGIA S**  
1xE27  
- 195 -



**BOHO BRUGIA M**  
1xE27  
- 195 -



**BOHO RENNES**  
1xE27  
- 196 -



**BOHO RIGA**  
1xE27  
- 197 -



**BOHO VERONA**  
1xE27  
- 197 -



## OPRAWY OGRODOWE FACADE AND GARDEN LIGHTING



**LED VENEZIA 10x0,8W**  
- 200 -



**MIMOSA LED SET**  
10m + 10x1W E27  
- 201 -



**MIMOSA LED SET**  
20m + 20x1W E27  
- 201 -



**BAJA LED SET**  
10m + 20x1W E27  
- 202 -



**BAJA LED SET**  
15m + 15x1W E27  
- 202 -



**MIMOSA 2 10m**  
10xE27  
- 203 -



**MIMOSA 10m**  
20xE27  
- 203 -



**MIMOSA 20m**  
20xE27  
- 204 -



**CRETE 5m**  
5m  
- 204 -



**CRETE PC**  
5m, 10m  
- 205 -



**CRETE LS M1 x5**  
- 206 -



**CRETE LS M2 x5**  
- 207 -



CRETE LS R1 x5  
- 207 -



CRETE LS D1 x5  
- 208 -



LED SOLARIS 2 5,5W  
- 208 -



LED SOLARIS 3 5,5W  
- 209 -



LED INDUO K 10W  
- 210 -



LED ENTERA 10W  
- 211 -



LED ENTERA P 10W  
- 211 -



QUAZAR 7  
2xGU10  
- 212 -



QUAZAR 11  
1xGU10  
- 213 -



QUAZAR 12  
1xGU10  
- 213 -

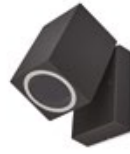

QUAZAR 15  
1xGU10  
- 214 -



QUAZAR 15 LX  
1xGU10  
- 215 -



QUAZAR 15S  
1xGU10  
- 215 -



QUAZAR 17  
1xGU10  
- 216 -



QUAZAR 18  
1xGU10  
- 216 -



QUERK 1 LED2B  
1xGU10  
- 217 -



QUERK 2 LED2B  
1xGU10  
- 217 -



QUERK 3 LED2B  
2xGU10  
- 218 -



QUERK 4 LED2B  
2xGU10  
- 219 -



QUERK 5 LED2B  
2xGU10  
- 219 -



LO 4101  
1xE27  
- 220 -



LO 4102  
1xE27  
- 221 -



LO 4105  
1xE27  
- 221 -



GARDEN BALL S  
1xE27  
- 222 -



GARDEN BALL M  
1xE27  
- 223 -



GARDEN BALL L  
1xE27  
- 223 -



BLAKE 2  
1xGU10  
- 224 -



ENTRADA 1  
1xGU10  
- 225 -



ENTRADA 2  
1xGU10  
- 225 -





## OŚWIETLENIE DO WZROSTU ROŚLIN

PLANT GROWTH LIGHTING



LED PLANTY FGS 8W  
E27  
- 228 -



LED PLANTY 9W E27  
- 229 -



LED PLANTY 24W E27  
- 229 -



LED PLANTY 40W E27  
- 230 -



PLANTY CLIP  
- 230 -



LED GROWLY 15W  
+ GROWLY PC 3m  
- 231 -



LED BLOOM 20W  
- 232 -



LED VERDI 5W  
- 232 -



LED VERDI 10W  
- 233 -



LED VITARO 3 CLIP  
10W  
- 233 -



LED VITARO 4 CLIP  
10W  
- 234 -



LED VITARO 3 ST MINI  
10W  
- 234 -



LED VITARO 4 ST MINI  
10W  
- 235 -



LED VITARO 4 ST 30W  
- 235 -





# WENTYLATORY I TERMOWENTYLATORY

## FANS AND FAN HEATERS



**VENLO 45W**  
- 238 -



**HOORN 45W**  
- 239 -



**VIENTO 40W**  
- 239 -



**VIENTO 45W**  
kolor / color: ● ○  
- 240 -



**VIENTO-R 45W**  
kolor / color: ● ○  
- 240 -



**VIENTO 100W**  
- 241 -



**MISTRAL 2000W**  
- 242 -



**ZEFIR 2000W**  
- 242 -



**SONDO 2000W TURBO**  
- 243 -



**YUGO-11 2500W**  
- 243 -



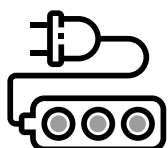

## AKCESORIA I OSPRZĘT ELEKTRONICZNY

### ACCESSORIES



LX01 CZUJNIK RUCHU  
/ MOTION SENSOR  
- 246 -



LX06 CZUJNIK RUCHU  
/ MOTION SENSOR  
- 246 -



LX39 CZUJNIK RUCHU  
/ MOTION SENSOR  
- 247 -



LX40 CZUJNIK RUCHU  
/ MOTION SENSOR  
- 247 -



LX41 CZUJNIK RUCHU  
/ MOTION SENSOR  
- 248 -



LX42 CZUJNIK RUCHU  
/ MOTION SENSOR  
- 248 -



LX501 CZUJNIK  
ZMIERZCHOWY / DUSK  
SENSOR  
- 249 -



LX701 CZUJNIK  
RUCHU / MOTION  
SENSOR  
- 249 -



KOBI PMM1  
PROGRAMATOR /  
TIMER  
- 250 -



KOBI PMM2  
PROGRAMATOR /  
TIMER  
- 251 -



KOBI PMM3  
PROGRAMATOR /  
TIMER  
- 251 -



SMART SOCKET WIFI  
- 252 -



PC 24  
PROGRAMATOR /  
TIMER  
- 253 -



CONNECTO 4-GN +  
4xUSB  
/ 4-SOCKETS + 4xUSB  
- 253 -



LINEA PRO 3-GN +  
5xUSB  
/ 3-SOCKETS + 5xUSB  
- 254 -



**LINEA FL**  
2-GNIAZDA + 4xUSB  
/ 2-SOCKETS + 4xUSB  
- 254 -



**LINEA PRO CUBE C**  
3-GNIAZDA + 4xUSB  
/ 3-SOCKETS + 4xUSB  
- 255 -



**LINEA PRO CUBE**  
3-GNIAZDA + 4xUSB  
/ 3-SOCKETS + 4xUSB  
- 255 -



**LINEA 3-GNIAZDA ZU**  
3-SOCKETS  
- 256 -



**LINEA 4-GNIAZDA ZU**  
4-SOCKETS  
- 257 -



**LINEA 5-GNIAZD ZU**  
5-SOCKETS  
- 257 -



**LINEA 3-GNIAZDA ZU+W**  
3-SOCKETS  
- 258 -



**LINEA 5-GNIAZD ZU+W**  
5-SOCKETS  
- 258 -



**STARTER DO LED T8**  
/ LED T8 STARTER  
- 259 -



**OPRAWKA CERAMICZNA**  
/ CERAMIC HOLDER G5.3  
- 260 -



**OPRAWKA GZ10**  
/ GZ10 HOLDER  
- 260 -



**ZASILACZ DO PANELU LED**  
/ DRIVER FOR LED PANEL 36W  
- 261 -



**ZASILACZ DO PANELU LED**  
/ DRIVER FOR LED PANEL 40W  
- 261 -



**ZASILACZ DESK**  
/ DESK TRANSFORMER  
- 262 -



**ZASILACZ INSTALACYJNY**  
/ INSTALLATION TRANSFORMER 10W  
- 262 -



**ZASILACZ INSTALACYJNY**  
/ INSTALLATION TRANSFORMER 20-60W  
- 263 -



**ZASILACZ INSTALACYJNY**  
/ INSTALLATION TRANSFORMER 80-200W  
- 263 -



**ZASILACZ MODUŁOWY**  
/ MODULE TRANSFORMER 6W  
- 264 -



**ZASILACZ MODUŁOWY**  
/ MODULE TRANSFORMER 25-350W  
- 264 -



**LED STEROWNIK**  
/ LED CONTROLLER ST06 FP  
- 265 -



**LED ŚCIEMNIACZ**  
/ LED DIMMER SC02 DP  
- 265 -



**LED WZMACNIACZ SYGNAŁU ST07 F**  
/ LED AMPLIFIER ST07 F  
- 266 -



**AKUMULATOR 18650**  
3,7V 3Ah  
- 266 -



**AKUMULATOR 18650**  
3,7V 7,2Ah  
- 267 -



**AKUMULATOR 18650**  
7,4V 5,4Ah  
- 267 -









## ŹRÓDŁA ŚWIATŁA

### LIGHT SOURCES

Nowoczesne rozwiązania oświetleniowe w technologii LED, która zapewniają efektywność energetyczną i długą żywotność – żarówki, świetlówki, żarówki ozdobne typu filament, taśmy LED oraz inteligentne źródła światła z linii KOBİ SMART HOME.

Modern lighting solutions with LED technology, providing energy efficiency and longevity – bulbs, fluorescent lamps, decorative filament bulbs, LED strips, and smart lighting from the KOBİ SMART HOME line.

STANDARD LINE LAMPY LED / LED LAMPS

# LED GS 7W E27

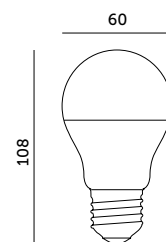

- ledowy zamiennik żarówki głównego szeregu,
- LED substitute for standard light bulbs,
- kąt rozsytu światła: 270 stopni.
- beam angle: 270 degrees.

MODEL	INDEKS	POBÓR MOCY [W]	BARWA ŚWIATŁA	STRUMIEŃ ŚWIETLNY [lm]	WAGA NETTO [kg]	PAKOWANIE [szt.]	KOD EAN
MODEL	INDEX	POWER [W]	LIGHT COLOR	LUMINOUS FLUX [lm]	NET WEIGHT [kg]	PACKING [pcs]	BARCODE
LED GS 7W E27 CB	KAGSE277CB24	7	CIEPŁOBIJAŁA WARM WHITE	600	0,03	100	5900605095287
LED GS 7W E27 NB	KAGSE277NB24	7	NEUTRALNA BIAŁA NEUTRAL WHITE	600	0,03	100	5900605095294
LED GS 7W E27 ZB	KAGSE277ZB24	7	ZIMNOBIJAŁA COOL WHITE	600	0,03	100	5900605095300



360 LINE LAMPY LED / LED LAMPS

# LED FGS 7W E27

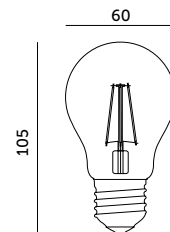

- wygląd i kształt wzorowany jest na tradycyjnych żarówkach wolframowych,
- appearance and shape is modeled on traditional tungsten lamps,
- kąt rozsytu światła: 360 stopni.
- beam angle: 360 degrees.

MODEL	INDEKS	POBÓR MOCY [W]	BARWA ŚWIATŁA	STRUMIEŃ ŚWIETLNY [lm]	WAGA NETTO [kg]	PAKOWANIE [szt.]	KOD EAN
MODEL	INDEX	POWER [W]	LIGHT COLOR	LUMINOUS FLUX [lm]	NET WEIGHT [kg]	PACKING [pcs]	BARCODE
LED FGS 7W E27 CB	KAFGSE277WCB	7	CIEPŁOBIJAŁA WARM WHITE	806	0,03	100	5902846016472
LED FGS 7W E27 NB	KAFGSE277WNB	7	NEUTRALNA BIAŁA NEUTRAL WHITE	806	0,03	100	5902846016960

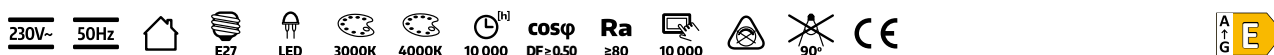

ECONOMIC BRAND LAMPY LED / LED LAMPS

**LED2B**

# LED GS 7W E27

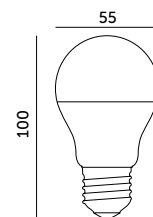

- ledowy zamiennik żarówki głównego szeregu,  
- kąt rozsytu światła: 240 stopni.

- LED substitute for standard light bulbs,  
- beam angle: 240 degrees.

MODEL	INDEKS	POBÓR MOCY [W]	BARWA ŚWIATŁA	STRUMIEN ŚWIETLNY [lm]	WAGA NETTO [kg]	PAKOWANIE [szt.]	KOD EAN
MODEL	INDEX	POWER [W]	LIGHT COLOR	LUMINOUS FLUX [lm]	NET WEIGHT [kg]	PACKING [pcs]	BARCODE
LED GS 7W E27 CB	KALGSE277C2	7	CIEPŁOBIAŁA WARM WHITE	600	0,03	100	5902846017424
LED GS 7W E27 NB	KALGSE277N2	7	NEUTRALNA BIAŁA NEUTRAL WHITE	600	0,03	100	5902846017455
LED GS 7W E27 ZB	KALGSE277Z2	7	ZIMNOBIAŁA COOL WHITE	600	0,03	100	5902846018766

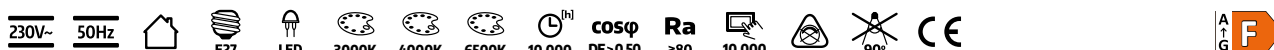

ECONOMIC BRAND LAMPY LED / LED LAMPS

**LED2B**

# LED GS 8,5W E27

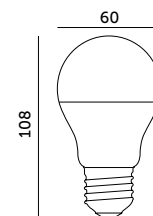

- ledowy zamiennik żarówki głównego szeregu,  
- kąt rozsytu światła: 200 stopni.

- LED substitute for standard light bulbs,  
- beam angle: 200 degrees.

MODEL	INDEKS	POBÓR MOCY [W]	BARWA ŚWIATŁA	STRUMIEN ŚWIETLNY [lm]	WAGA NETTO [kg]	PAKOWANIE [szt.]	KOD EAN
MODEL	INDEX	POWER [W]	LIGHT COLOR	LUMINOUS FLUX [lm]	NET WEIGHT [kg]	PACKING [pcs]	BARCODE
LED GS 8,5W E27 CB	KALGSE2785CB	8,5	CIEPŁOBIAŁA WARM WHITE	806	0,03	100	5902846015864
LED GS 8,5W E27 NB	KALGSE2785NB	8,5	NEUTRALNA BIAŁA NEUTRAL WHITE	806	0,03	100	5902846015871
LED GS 8,5W E27 ZB	KALGSE2785ZB	8,5	ZIMNOBIAŁA COOL WHITE	806	0,03	100	5902846015987

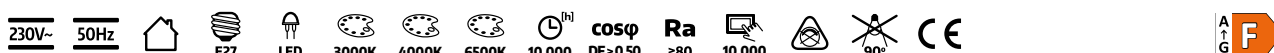

STANDARD LINE

LAMPY LED / LED LAMPS

# LED GS 10W E27

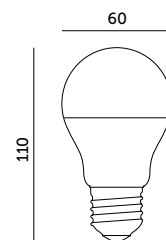

- ledowy zamiennik żarówki głównego szeregu,
- kąt rozsytu światła: 270 stopni.
- LED substitute for standard light bulbs,
- beam angle: 270 degrees.

MODEL	INDEKS	POBÓR MOCY [W]	BARWA ŚWIATŁA	STRUMIEŃ ŚWIETLNY [lm]	WAGA NETTO [kg]	PAKOWANIE [szt.]	KOD EAN
MODEL	INDEX	POWER [W]	LIGHT COLOR	LUMINOUS FLUX [lm]	NET WEIGHT [kg]	PACKING [pcs]	BARCODE
LED GS 10W E27 CB	KAGSE2710WCB	10	CIEPŁOBIĄŁA WARM WHITE	950	0,03	100	5900605094471
LED GS 10W E27 NB	KAGSE2710WNB	10	NEUTRALNA BIAŁA NEUTRAL WHITE	950	0,03	100	5900605094488
LED GS 10W E27 ZB	KAGSE2710WZB	10	ZIMNOBIĄŁA COOL WHITE	950	0,03	100	5900605094495



ECONOMIC BRAND

LAMPY LED / LED LAMPS

# LED GS 10,5W E27

LED2B

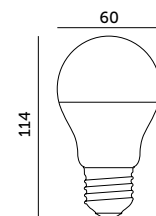

- ledowy zamiennik żarówki głównego szeregu,
- kąt rozsytu światła: 200 stopni.
- LED substitute for standard light bulbs,
- beam angle: 200 degrees.

MODEL	INDEKS	POBÓR MOCY [W]	BARWA ŚWIATŁA	STRUMIEŃ ŚWIETLNY [lm]	WAGA NETTO [kg]	PAKOWANIE [szt.]	KOD EAN
MODEL	INDEX	POWER [W]	LIGHT COLOR	LUMINOUS FLUX [lm]	NET WEIGHT [kg]	PACKING [pcs]	BARCODE
LED GS 10,5W E27 CB	KALGSE27105C	10,5	CIEPŁOBIĄŁA WARM WHITE	1055	0,03	100	5902201385977
LED GS 10,5W E27 NB	KALGSE27105N	10,5	NEUTRALNA BIAŁA NEUTRAL WHITE	1055	0,03	100	5902201385984
LED GS 10,5W E27 ZB	KALGSE27105Z	10,5	ZIMNOBIĄŁA COOL WHITE	1055	0,03	100	5902201384307





360 LINE LAMPY LED / LED LAMPS

# LED FGS 11,5W E27

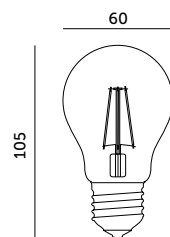

- wygląd i kształt wzorowany jest na tradycyjnych żarówkach wolframowych,
- kąt rozsytu światła: 360 stopni.
- appearance and shape is modeled on traditional tungsten lamps,
- beam angle: 360 degrees.

MODEL	INDEKS	POBÓR MOCY [W]	BARWA ŚWIATŁA	STRUMIEN ŚWIETLNY [lm]	WAGA NETTO [kg]	PAKOWANIE [szt.]	KOD EAN
MODEL	INDEX	POWER [W]	LIGHT COLOR	LUMINOUS FLUX [lm]	NET WEIGHT [kg]	PACKING [pcs]	BARCODE
LED FGS 11,5W E27 CB	KAFGSE27115C	11,5	CIEPŁOBIĄŁA WARM WHITE	1521	0,03	100	5902846016656
LED FGS 11,5W E27 NB	KAFGSE27115N	11,5	NEUTRALNA BIAŁA NEUTRAL WHITE	1521	0,03	100	5902846016663



STANDARD LINE LAMPY LED / LED LAMPS

# LED GS 13W E27

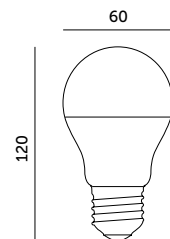

- ledowy zamiennik żarówki głównego szeregu,
- kąt rozsytu światła: 270 stopni.
- LED substitute for standard light bulbs,
- beam angle: 270 degrees.

MODEL	INDEKS	POBÓR MOCY [W]	BARWA ŚWIATŁA	STRUMIEN ŚWIETLNY [lm]	WAGA NETTO [kg]	PAKOWANIE [szt.]	KOD EAN
MODEL	INDEX	POWER [W]	LIGHT COLOR	LUMINOUS FLUX [lm]	NET WEIGHT [kg]	PACKING [pcs]	BARCODE
LED GS 13W E27 CB	KAGSE2713CB2	13	CIEPŁOBIĄŁA WARM WHITE	1350	0,04	100	5900605094501
LED GS 13W E27 NB	KAGSE2713NB2	13	NEUTRALNA BIAŁA NEUTRAL WHITE	1350	0,04	100	5900605094518
LED GS 13W E27 ZB	KAGSE2713ZB2	13	ZIMNOBIĄŁA COOL WHITE	1350	0,04	100	5900605094525



STANDARD LINE LAMPY LED / LED LAMPS

## LED GS 15W E27

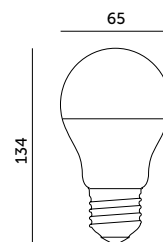

- ledowy zamiennik żarówki głównego szeregu,
- LED substitute for standard light bulbs,
- kąt rozsytu światła: 270 stopni.
- beam angle: 270 degrees.

MODEL	INDEKS	POBÓR MOCY [W]	BARWA ŚWIATŁA	STRUMIEŃ ŚWIETLNY [lm]	WAGA NETTO [kg]	PAKOWANIE [szt.]	KOD EAN
MODEL	INDEX	POWER [W]	LIGHT COLOR	LUMINOUS FLUX [lm]	NET WEIGHT [kg]	PACKING [pcs]	BARCODE
LED GS 15W E27 CB	KAGSE2715CB	15	CIEPŁOBIĄŁA WARM WHITE	1500	0,06	100	5900605095317
LED GS 15W E27 NB	KAGSE2715NB	15	NEUTRALNA BIAŁA NEUTRAL WHITE	1500	0,06	100	5900605095324
LED GS 15W E27 ZB	KAGSE2715ZB	15	ZIMNOBIĄŁA COOL WHITE	1500	0,06	100	5900605095331

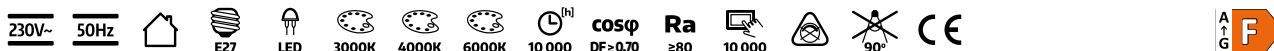

STANDARD LINE LAMPY LED / LED LAMPS

## LED GS 18W E27

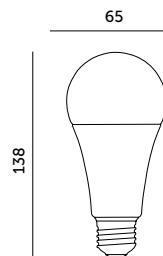

- ledowy zamiennik żarówki głównego szeregu,
- LED substitute for standard light bulbs,
- kąt rozsytu światła: 270 stopni.
- beam angle: 270 degrees.

MODEL	INDEKS	POBÓR MOCY [W]	BARWA ŚWIATŁA	STRUMIEŃ ŚWIETLNY [lm]	WAGA NETTO [kg]	PAKOWANIE [szt.]	KOD EAN
MODEL	INDEX	POWER [W]	LIGHT COLOR	LUMINOUS FLUX [lm]	NET WEIGHT [kg]	PACKING [pcs]	BARCODE
LED GS 18W E27 CB	KAGSE2718CB2	18	CIEPŁOBIĄŁA WARM WHITE	2000	0,07	100	5902846018681
LED GS 18W E27 NB	KAGSE2718NB2	18	NEUTRALNA BIAŁA NEUTRAL WHITE	2000	0,07	100	5902846018698
LED GS 18W E27 ZB	KAGSE2718ZB2	18	ZIMNOBIĄŁA COOL WHITE	2000	0,07	100	5902846018704





PREMIUM LAMPY LED / LED LAMPS

## LED GS 9W LX E27 PREMIUM

**3 LATA**  
GWARANCJI  
**3 YEARS**  
WARRANTY

DIODA LED  
**SAMSUNG**  
SAMSUNG  
LED DIODE

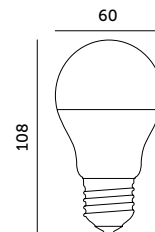

- ledowa żarówka z wbudowanym mikrofalowym czujnikiem ruchu i natężenia światła,
- tryb pracy: zaświeca się na 30 sekund przy natężeniu światła poniżej 20lx i wykryciu ruchu,
- kąt / zasięg detekcji: 170 stopni / max. 5 m,
- kąt rozsytu światła: 220 stopni,
- pobór mocy w trybie czuwania: 0,8W.

- LED bulb with built-in microwave motion sensor and light intensity sensor,
- operating mode: activates for 30 seconds when light intensity is below 20 lx and motion is detected,
- angle / range of detection: 170 degrees / max. 5 m,
- beam angle: 220 degrees,
- power consumption in standby mode: 0,8W.

MODEL	INDEKS	POBÓR MOCY [W]	BARWA ŚWIATŁA	STRUMIEN ŚWIETLNY [lm]	WAGA NETTO [kg]	PAKOWANIE [szt.]	KOD EAN
MODEL	INDEX	POWER [W]	LIGHT COLOR	LUMINOUS FLUX [lm]	NET WEIGHT [kg]	PACKING [pcs]	BARCODE
LED GS 9W LX E27 CB	KAGSE279WCPX	9	CIEPŁOBIĄŁA WARM WHITE	810	0,04	100	5902201302349
LED GS 9W LX E27 NB	KAGSE279WNPX	9	NEUTRALNA BIAŁA NEUTRAL WHITE	810	0,04	100	5902201304503
LED GS 9W LX E27 ZB	KAGSE279WZPX	9	ZIMNOBIĄŁA COOL WHITE	810	0,04	100	5902201304510





SMART HOME LAMPY LED / LED LAMPS

# SMART LED GS 9,5W E27 RGB WW WiFi

WSPÓŁPRACUJE Z  
WORKS WITH:



- inteligentne źródło światła, pozwalające na zdalną kontrolę poprzez aplikację TUYA (na Android i iOS),
- posiada możliwość ustawienia czasu włączenia i wyłączenia, ściemniania, zmiany kolorów, zmiany temperatury barwowej oraz tworzenia własnych scenariuszy,
- sterowanie z każdego miejsca na świecie,
- możliwość sterowania wieloma żarówkami jednocześnie poprzez grupowanie,
- zakres temperatury barwy białej: 2700-6500K,
- częstotliwość WiFi: 2,4GHz.

- smart light source, allowing remote control via the TUYA app (available on Android and iOS),
- features include setting on/off timers, dimming, adjusting color or color temperature, and creating custom scenes,
- control from anywhere in the world,
- control multiple bulbs simultaneously through grouping,
- white colour temperature range: 2700-6500K,
- WiFi frequency: 2.4GHz.

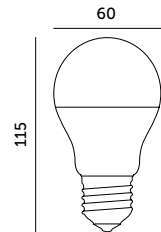

MODEL	INDEKS	POBÓR MOCY [W]	BARWA ŚWIATŁA	STRUMIEN ŚWIETLNY [lm]	WAGA NETTO [kg]	PAKOWANIE [szt.]	KOD EAN
MODEL	INDEX	POWER [W]	LIGHT COLOR	LUMINOUS FLUX [lm]	NET WEIGHT [kg]	PACKING [pcs]	BARCODE
SMART LED GS 9.5W E27 RGB WW WIFI	KAGSE2785RWW	9,5	RGB WW	806	0,06	50	5902201300376





STANDARD LINE LAMPY LED / LED LAMPS

# LED GU10 1W

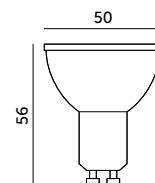

- kąt rozsytu światła: 120 stopni, - beam angle: 120 degrees,
- jednolitość barwy: 6 stopni, - color uniformity: 6 degrees.

MODEL	INDEKS	POBÓR MOCY [W]	BARWA ŚWIATŁA	STRUMIEŃ ŚWIETLNY [lm]	WAGA NETTO [kg]	PAKOWANIE [szt.]	KOD EAN
MODEL	INDEX	POWER [W]	LIGHT COLOR	LUMINOUS FLUX [lm]	NET WEIGHT [kg]	PACKING [pcs]	BARCODE
LED GU10 1W CB	KAGU1,0CB	1	CIEPŁOBIĄŁA WARM WHITE	90	0,02	100	5900605092767
LED GU10 1W NB	KAGU1,0NB	1	NEUTRALNA BIAŁA NEUTRAL WHITE	90	0,02	100	5900605098264
LED GU10 1W ZB	KAGU1,0ZB	1	ZIMNOBIĄŁA COOL WHITE	90	0,02	100	5900605093115



PREMIUM LAMPY LED / LED LAMPS

# LED GU10 3W PREMIUM

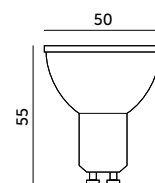

- kąt rozsytu światła: 80 stopni, - beam angle: 80 degrees,
- jednolitość barwy: 6 stopni, - color uniformity: 6 degrees.



MODEL	INDEKS	POBÓR MOCY [W]	BARWA ŚWIATŁA	STRUMIEŃ ŚWIETLNY [lm]	ŚWIATŁOŚĆ [cd]	WAGA NETTO [kg]	PAKOWANIE [szt.]	KOD EAN
MODEL	INDEX	POWER [W]	LIGHT COLOR	LUMINOUS FLUX [lm]	CANDLEPOWER [cd]	NET WEIGHT [kg]	PACKING [pcs]	BARCODE
LED GU10 3W CB	KAGU3,0CBPRE	3	CIEPŁOBIĄŁA WARM WHITE	270	255	0,03	100	5902201301960
LED GU10 3W NB	KAGU3,0NBPRE	3	NEUTRALNA BIAŁA NEUTRAL WHITE	270	255	0,03	100	5902201301977
LED GU10 3W ZB	KAGU3,0ZBPRE	3	ZIMNOBIĄŁA COOL WHITE	270	255	0,03	100	5902201301984



STANDARD LINE LAMPY LED / LED LAMPS

# LED GU10 5W

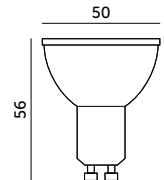

- kąt rozsytu światła: 120 stopni, - beam angle: 120 degrees,
- jednolitość barwy: 6 stopni, - color uniformity: 6 degrees.

MODEL	INDEKS	POBÓR MOCY [W]	BARWA ŚWIATŁA	STRUMIEN ŚWIETLNY [lm]	WAGA NETTO [kg]	PAKOWANIE [szt.]	KOD EAN
MODEL	INDEX	POWER [W]	LIGHT COLOR	LUMINOUS FLUX [lm]	NET WEIGHT [kg]	PACKING [pcs]	BARCODE
LED GU10 5W CB	KAGU5,0CB	5	CIEPŁOBIJAŁA WARM WHITE	400	0,02	100	5900605098295
LED GU10 5W NB	KAGU5,0NB	5	NEUTRALNA BIAŁA NEUTRAL WHITE	400	0,02	100	5900605098301
LED GU10 5W ZB	KAGU5,0ZB	5	ZIMNOBIAŁA COOL WHITE	400	0,02	100	5900605098318

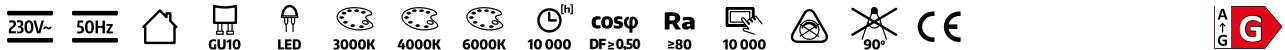

PREMIUM LAMPY LED / LED LAMPS

# LED GU10 5W PREMIUM

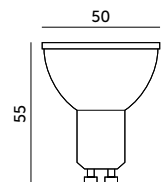

- kąt rozsytu światła: 80 stopni, - beam angle: 80 degrees,
- jednolitość barwy: 6 stopni, - color uniformity: 6 degrees.

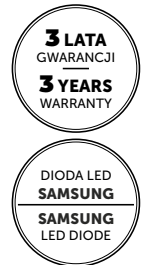

MODEL	INDEKS	POBÓR MOCY [W]	BARWA ŚWIATŁA	STRUMIEN ŚWIETLNY [lm]	ŚWIATŁOŚĆ [cd]	WAGA NETTO [kg]	PAKOWANIE [szt.]	KOD EAN
MODEL	INDEX	POWER [W]	LIGHT COLOR	LUMINOUS FLUX [lm]	CANDLEPOWER [cd]	NET WEIGHT [kg]	PACKING [pcs]	BARCODE
LED GU10 5W CB	KAGU5,0CBPRE	5	CIEPŁOBIJAŁA WARM WHITE	450	406	0,03	100	5902201300727
LED GU10 5W NB	KAGU5,0NBPRE	5	NEUTRALNA BIAŁA NEUTRAL WHITE	450	406	0,03	100	5902201300734
LED GU10 5W ZB	KAGU5,0ZBPRE	5	ZIMNOBIAŁA COOL WHITE	450	406	0,03	100	5902201300741

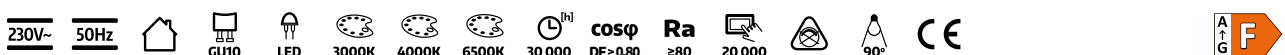

STANDARD LINE

LAMPY LED / LED LAMPS

# LED GU10 7W

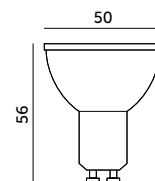

- kąt rozsytu światła: 120 stopni, - beam angle: 120 degrees,
- jednolitość barwy: 6 stopni. - color uniformity: 6 degrees.

MODEL	INDEKS	POBÓR MOCY [W]	BARWA ŚWIATŁA	STRUMIEN ŚWIETLNY [lm]	WAGA NETTO [kg]	PAKOWANIE [szt.]	KOD EAN
MODEL	INDEX	POWER [W]	LIGHT COLOR	LUMINOUS FLUX [lm]	NET WEIGHT [kg]	PACKING [pcs]	BARCODE
LED GU10 7W CB	KAGU7,0CBPOM	7	CIEPŁOBIĄŁA WARM WHITE	600	0,02	100	5900605093467
LED GU10 7W NB	KAGU7,0NB	7	NEUTRALNA BIAŁA NEUTRAL WHITE	600	0,02	100	5900605097717
LED GU10 7W ZB	KAGU7,0ZBPOM	7	ZIMNOBIĄŁA COOL WHITE	600	0,02	100	5900605093474

PREMIUM

LAMPY LED / LED LAMPS

# LED GU10 7W PREMIUM

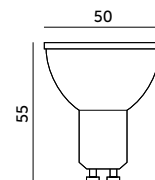

- kąt rozsytu światła: 80 stopni, - beam angle: 80 degrees,
- jednolitość barwy: 6 stopni. - color uniformity: 6 degrees.

MODEL	INDEKS	POBÓR MOCY [W]	BARWA ŚWIATŁA	STRUMIEN ŚWIETLNY [lm]	ŚWIATŁOŚĆ [cd]	WAGA NETTO [kg]	PAKOWANIE [szt.]	KOD EAN
MODEL	INDEX	POWER [W]	LIGHT COLOR	LUMINOUS FLUX [lm]	CANDLEPOWER [cd]	NET WEIGHT [kg]	PACKING [pcs]	BARCODE
LED GU10 7W CB	KAGU7,0CBPRE	7	CIEPŁOBIĄŁA WARM WHITE	630	536	0,03	100	5902846019107
LED GU10 7W NB	KAGU7,0NBPRE	7	NEUTRALNA BIAŁA NEUTRAL WHITE	630	536	0,03	100	5902846019114
LED GU10 7W ZB	KAGU7,0ZBPRE	7	ZIMNOBIĄŁA COOL WHITE	630	536	0,03	100	5902846019121

PREMIUM LAMPY LED / LED LAMPS

# LED GU10 9W PREMIUM

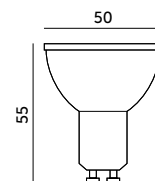

- ceramiczny korpus gwarantujący właściwe odprowadzenie ciepła,
- kąt rozsytu światła: 120 stopni,
- jednolitość barwy: 6 stopni.

- ceramic body that ensures proper heat dissipation,
- beam angle: 120 degrees,
- color uniformity: 6 degrees.

MODEL	INDEKS	POBÓR MOCY [W]	BARWA ŚWIATŁA	STRUMIEŃ ŚWIETLNY [lm]	WAGA NETTO [kg]	PAKOWANIE [szt.]	KOD EAN
MODEL	INDEX	POWER [W]	LIGHT COLOR	LUMINOUS FLUX [lm]	NET WEIGHT [kg]	PACKING [pcs]	BARCODE
LED GU10 9W CB	KAGU9CB	9	CIEPŁOBIJAŁA WARM WHITE	900	0,06	100	5902201305876
LED GU10 9W NB	KAGU9NB	9	NEUTRALNA BIAŁA NEUTRAL WHITE	900	0,06	100	5902201305883
LED GU10 9W ZB	KAGU9ZB	9	ZIMNOBIJAŁA COOL WHITE	900	0,06	100	5902201305890



STANDARD LINE LAMPY LED / LED LAMPS

# LED MR11 4W GU10

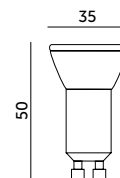

- ceramiczny korpus gwarantujący właściwe odprowadzenie ciepła,
- kąt rozsytu światła: 38 stopni,
- jednolitość barwy: 6 stopni.

- ceramic body that ensures proper heat dissipation,
- beam angle: 38 degrees,
- color uniformity: 6 degrees.

MODEL	INDEKS	POBÓR MOCY [W]	BARWA ŚWIATŁA	STRUMIEŃ ŚWIETLNY [lm]	ŚWIATŁOŚĆ [cd]	WAGA NETTO [kg]	PAKOWANIE [szt.]	KOD EAN
MODEL	INDEX	POWER [W]	LIGHT COLOR	LUMINOUS FLUX [lm]	CANDLEPOWER [cd]	NET WEIGHT [kg]	PACKING [pcs]	BARCODE
LED MR11 4W GU10 CB	KAM1GU4WCB	4	CIEPŁOBIJAŁA WARM WHITE	320	1183	0,03	100	5902846015895
LED MR11 4W GU10 NB	KAM1GU4WNB	4	NEUTRALNA BIAŁA NEUTRAL WHITE	320	1183	0,03	100	5902846015901
LED MR11 4W GU10 ZB	KAM1GU4WZB	4	ZIMNOBIJAŁA COOL WHITE	320	1183	0,03	100	5902846015918





STANDARD LINE LAMPY LED / LED LAMPS

# LED INSERT 5W MILKY

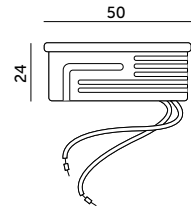

- ceramiczny korpus gwarantujący właściwe odprowadzenie ciepła,
- kąt rozsytu światła: 120 stopni,
- jednolitość barwy: 6 stopni.
- ceramic body that ensures proper heat dissipation,
- beam angle: 120 degrees,
- color uniformity: 6 degrees.

MODEL	INDEKS	POBÓR MOCY [W]	BARWA ŚWIATŁA	STRUMIEŃ ŚWIETLNY [lm]	WAGA NETTO [kg]	PAKOWANIE [szt.]	KOD EAN
MODEL	INDEX	POWER [W]	LIGHT COLOR	LUMINOUS FLUX [lm]	NET WEIGHT [kg]	PACKING [pcs]	BARCODE
LED INSERT 5W MILKY CB	KAIS5WCBML	5	CIEPŁOBIĄŁA WARM WHITE	450	0,05	100	5902846010685
LED INSERT 5W MILKY NB	KAIS5WNBML	5	NEUTRALNA BIAŁA NEUTRAL WHITE	450	0,05	100	5902846015802
LED INSERT 5W MILKY ZB	KAIS5WZBML	5	ZIMNOBIĄŁA COOL WHITE	450	0,05	100	5902846015819



STANDARD LINE LAMPY LED / LED LAMPS

# LED INSERT 6,5W MILKY

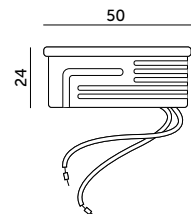

- ceramiczny korpus gwarantujący właściwe odprowadzenie ciepła,
- kąt rozsytu światła: 120 stopni,
- jednolitość barwy: 6 stopni.
- ceramic body that ensures proper heat dissipation,
- beam angle: 120 degrees,
- color uniformity: 6 degrees.

MODEL	INDEKS	POBÓR MOCY [W]	BARWA ŚWIATŁA	STRUMIEŃ ŚWIETLNY [lm]	WAGA NETTO [kg]	PAKOWANIE [szt.]	KOD EAN
MODEL	INDEX	POWER [W]	LIGHT COLOR	LUMINOUS FLUX [lm]	NET WEIGHT [kg]	PACKING [pcs]	BARCODE
LED INSERT 6,5W MILKY CB	KAIS7WCBML	6,5	CIEPŁOBIĄŁA WARM WHITE	600	0,05	100	5902846016724
LED INSERT 6,5W MILKY NB	KAIS7WNBML	6,5	NEUTRALNA BIAŁA NEUTRAL WHITE	600	0,05	100	5902846016731
LED INSERT 6,5W MILKY ZB	KAIS7WZBML	6,5	ZIMNOBIĄŁA COOL WHITE	600	0,05	100	5902846016748

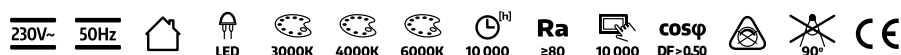



STANDARD LINE LAMPY LED / LED LAMPS

## LED SW 3W E14

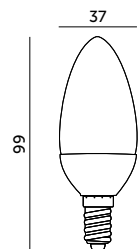

- ledowy zamiennik tradycyjnej  
żarówki świecowej,  
- kąt rozsytu światła: 200 stopni.

- LED substitute for a traditional  
candle bulb,  
- beam angle: 200 degrees.

MODEL	INDEKS	POBÓR MOCY [W]	BARWA ŚWIATŁA	STRUMIEŃ ŚWIETLNY [lm]	WAGA NETTO [kg]	PAKOWANIE [szt.]	KOD EAN
MODEL	INDEX	POWER [W]	LIGHT COLOR	LUMINOUS FLUX [lm]	NET WEIGHT [kg]	PACKING [pcs]	BARCODE
LED SW 3W E14 CB	KASWE143WCB2	3	CIEPŁOBIŁA WARM WHITE	250	0,02	100	5900605093801



360 LINE LAMPY LED / LED LAMPS

# LED FSW 4W E14

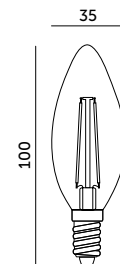

- wygląd i kształt wzorowany jest na tradycyjnych żarówkach wolframowych,  
- kąt rozsytu światła: 360 stopni.

- appearance and shape is modeled on traditional tungsten lamps,  
- beam angle: 360 degrees.

MODEL	INDEKS	POBÓR MOCY [W]	BARWA ŚWIATŁA	STRUMIEŃ ŚWIETLNY [lm]	WAGA NETTO [kg]	PAKOWANIE [szt.]	KOD EAN
MODEL	INDEX	POWER [W]	LIGHT COLOR	LUMINOUS FLUX [lm]	NET WEIGHT [kg]	PACKING [pcs]	BARCODE
LED FSW 4W E14 CB	KAFSWE144WCB	4	CIEPŁOBIĄŁA WARM WHITE	470	0,01	100	5900605095751

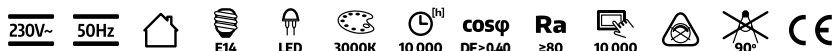

360 LINE LAMPY LED / LED LAMPS

# LED FDE 4W E14

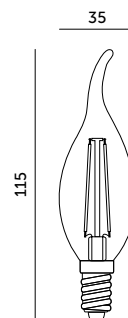

- wygląd i kształt wzorowany jest na tradycyjnych żarówkach wolframowych,  
- kąt rozsytu światła: 360 stopni.

- appearance and shape is modeled on traditional tungsten lamps,  
- beam angle: 360 degrees.

MODEL	INDEKS	POBÓR MOCY [W]	BARWA ŚWIATŁA	STRUMIEŃ ŚWIETLNY [lm]	WAGA NETTO [kg]	PAKOWANIE [szt.]	KOD EAN
MODEL	INDEX	POWER [W]	LIGHT COLOR	LUMINOUS FLUX [lm]	NET WEIGHT [kg]	PACKING [pcs]	BARCODE
LED FDE 4W E14 CB	KAFDEE144WCB	4	CIEPŁOBIĄŁA WARM WHITE	470	0,01	100	5900605095768

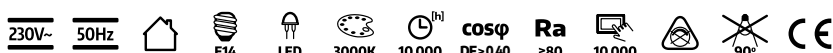

STANDARD LINE

LAMPY LED / LED LAMPS

# LED SW 4,5W E14

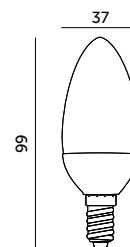

- ledowy zamiennik tradycyjnej żarówki świecowej,  
- kąt rozsytu światła: 200 stopni.

- LED substitute for a traditional candle bulb,  
- beam angle: 200 degrees.

MODEL	INDEKS	POBÓR MOCY [W]	BARWA ŚWIATŁA	STRUMIEŃ ŚWIETLNY [lm]	WAGA NETTO [kg]	PAKOWANIE [szt.]	KOD EAN
MODEL	INDEX	POWER [W]	LIGHT COLOR	LUMINOUS FLUX [lm]	NET WEIGHT [kg]	PACKING [pcs]	BARCODE
LED SW 4,5W E14 CB	KASWE1445CB2	4,5	CIEPŁOBIĄŁA WARM WHITE	420	0,02	100	5900605091319
LED SW 4,5W E14 NB	KASWE1445NB	4,5	NEUTRALNA BIAŁA NEUTRAL WHITE	420	0,02	100	5900605098066
LED SW 4,5W E14 ZB	KASWE1445ZB	4,5	ZIMNOBIĄŁA COOL WHITE	420	0,02	100	5900605097113



STANDARD LINE

LAMPY LED / LED LAMPS

# LED SW 6W E14

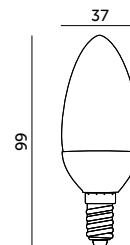

- ledowy zamiennik tradycyjnej żarówki świecowej,  
- kąt rozsytu światła: 200 stopni.

- LED substitute for a traditional candle bulb,  
- beam angle: 200 degrees.

MODEL	INDEKS	POBÓR MOCY [W]	BARWA ŚWIATŁA	STRUMIEŃ ŚWIETLNY [lm]	WAGA NETTO [kg]	PAKOWANIE [szt.]	KOD EAN
MODEL	INDEX	POWER [W]	LIGHT COLOR	LUMINOUS FLUX [lm]	NET WEIGHT [kg]	PACKING [pcs]	BARCODE
LED SW 6W E14 CB	KASWE146WCB2	6	CIEPŁOBIĄŁA WARM WHITE	470	0,02	100	5900605094112
LED SW 6W E14 NB	KASWE146WNB	6	NEUTRALNA BIAŁA NEUTRAL WHITE	470	0,02	100	5900605097526
LED SW 6W E14 ZB	KASWE146WZB	6	ZIMNOBIĄŁA COOL WHITE	470	0,02	100	5900605095539



**ECONOMIC BRAND** LAMPY LED / LED LAMPS

**LED2B**

# LED SW 8,5W E14

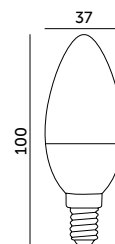

- ledowy zamiennik tradycyjnej żarówki świecowej,  
- kąt rozsytu światła: 180 stopni.

- LED substitute for a traditional candle lamp,  
- beam angle: 180 degrees.

MODEL	INDEKS	POBÓR MOCY [W]	BARWA ŚWIATŁA	STRUMIEŃ ŚWIETLNY [lm]	WAGA NETTO [kg]	PAKOWANIE [szt.]	KOD EAN
MODEL	INDEX	POWER [W]	LIGHT COLOR	LUMINOUS FLUX [lm]	NET WEIGHT [kg]	PACKING [pcs]	BARCODE
LED SW 8,5W E14 CB	KALSWE1485CB	8,5	CIEPŁOBIJAŁA WARM WHITE	806	0,02	100	5902201384246
LED SW 8,5W E14 NB	KALSWE1485NB	8,5	NEUTRALNA BIAŁA NEUTRAL WHITE	806	0,02	100	5902201384253
LED SW 8,5W E14 ZB	KALSWE1485ZB	8,5	ZIMNOBIJAŁA COOL WHITE	806	0,02	100	5902201384260



**PREMIUM** LAMPY LED / LED LAMPS

# LED SW 9W E14 PREMIUM

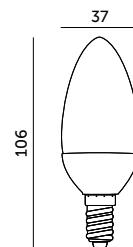

- ledowy zamiennik tradycyjnej żarówki świecowej,  
- ceramiczny korpus gwarantujący właściwe odprowadzenie ciepła,  
- kąt rozsytu światła: 200 stopni.

- LED substitute for a traditional candle bulb,  
- ceramic body that guarantees proper heat rejection,  
- beam angle: 200 degrees.

MODEL	INDEKS	POBÓR MOCY [W]	BARWA ŚWIATŁA	STRUMIEŃ ŚWIETLNY [lm]	WAGA NETTO [kg]	PAKOWANIE [szt.]	KOD EAN
MODEL	INDEX	POWER [W]	LIGHT COLOR	LUMINOUS FLUX [lm]	NET WEIGHT [kg]	PACKING [pcs]	BARCODE
LED SW 9W E14 CB	KASWE149WCB	9	CIEPŁOBIJAŁA WARM WHITE	900	0,05	100	5902846011200
LED SW 9W E14 NB	KASWE149WNB	9	NEUTRALNA BIAŁA NEUTRAL WHITE	900	0,05	100	5902846011217
LED SW 9W E14 ZB	KASWE149WZB	9	ZIMNOBIJAŁA COOL WHITE	900	0,05	100	5902846012979







STANDARD LINE LAMPY LED / LED LAMPS

## LED SW 6W E27

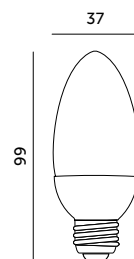

- ledowy zamiennik tradycyjnej  
zarówki świecowej,  
- kąt rozsytu światła: 200 stopni.

- LED substitute for a traditional  
candle lamp,  
- beam angle: 200 degrees.

MODEL	INDEKS	POBÓR MOCY [W]	BARWA ŚWIATŁA	STRUMIEN ŚWIETLNY [lm]	WAGA NETTO [kg]	PAKOWANIE [szt.]	KOD EAN
MODEL	INDEX	POWER [W]	LIGHT COLOR	LUMINOUS FLUX [lm]	NET WEIGHT [kg]	PACKING [pcs]	BARCODE
LED SW 6W E27 CB	KASWE276WCB2	6	CIEPŁOBIĄŁA WARM WHITE	470	0,02	100	5900605094129
LED SW 6W E27 NB	KASWE276WNB	6	NEUTRALNA BIAŁA NEUTRAL WHITE	470	0,02	100	5900605097533
LED SW 6W E27 ZB	KASWE276WZB	6	ZIMNOBIAŁA COOL WHITE	470	0,02	100	5900605095546



**ECONOMIC BRAND** LAMPY LED / LED LAMPS

**LED2B**

# LED SW 8,5W E27

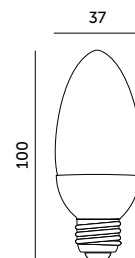

- ledowy zamiennik tradycyjnej żarówki świecowej,  
- kąt rozsytu światła: 180 stopni.

- LED substitute for a traditional candle lamp,  
- beam angle: 180 degrees.

MODEL	INDEKS	POBÓR MOCY [W]	BARWA ŚWIATŁA	STRUMIEN ŚWIETLNY [lm]	WAGA NETTO [kg]	PAKOWANIE [szt.]	KOD EAN
MODEL	INDEX	POWER [W]	LIGHT COLOR	LUMINOUS FLUX [lm]	NET WEIGHT [kg]	PACKING [pcs]	BARCODE
LED SW 8,5W E27 CB	KALSWE2785CB	8,5	CIEPŁOBIĄŁA WARM WHITE	806	0,02	100	5902201384277
LED SW 8,5W E27 NB	KALSWE2785NB	8,5	NEUTRALNA BIAŁA NEUTRAL WHITE	806	0,02	100	5902201384284
LED SW 8,5W E27 ZB	KALSWE2785ZB	8,5	ZIMNOBIĄŁA COOL WHITE	806	0,02	100	5902201384291



**PREMIUM** LAMPY LED / LED LAMPS

# LED SW 9W E27 PREMIUM

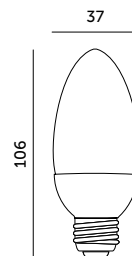

- ledowy zamiennik tradycyjnej żarówki świecowej,  
- ceramiczny korpus gwarantujący właściwe odprowadzenie ciepła,  
- kąt rozsytu światła: 200 stopni.

- LED substitute for a traditional candle bulb,  
- ceramic body that guarantees proper heat rejection,  
- beam angle: 200 degrees.

MODEL	INDEKS	POBÓR MOCY [W]	BARWA ŚWIATŁA	STRUMIEN ŚWIETLNY [lm]	WAGA NETTO [kg]	PAKOWANIE [szt.]	KOD EAN
MODEL	INDEX	POWER [W]	LIGHT COLOR	LUMINOUS FLUX [lm]	NET WEIGHT [kg]	PACKING [pcs]	BARCODE
LED SW 9W E27 CB	KASWE279WCB	9	CIEPŁOBIĄŁA WARM WHITE	900	0,05	100	5902846012085
LED SW 9W E27 NB	KASWE279WNB	9	NEUTRALNA BIAŁA NEUTRAL WHITE	900	0,05	100	5906340213740
LED SW 9W E27 ZB	KASWE279WZB	9	ZIMNOBIĄŁA COOL WHITE	900	0,05	100	5902846012986



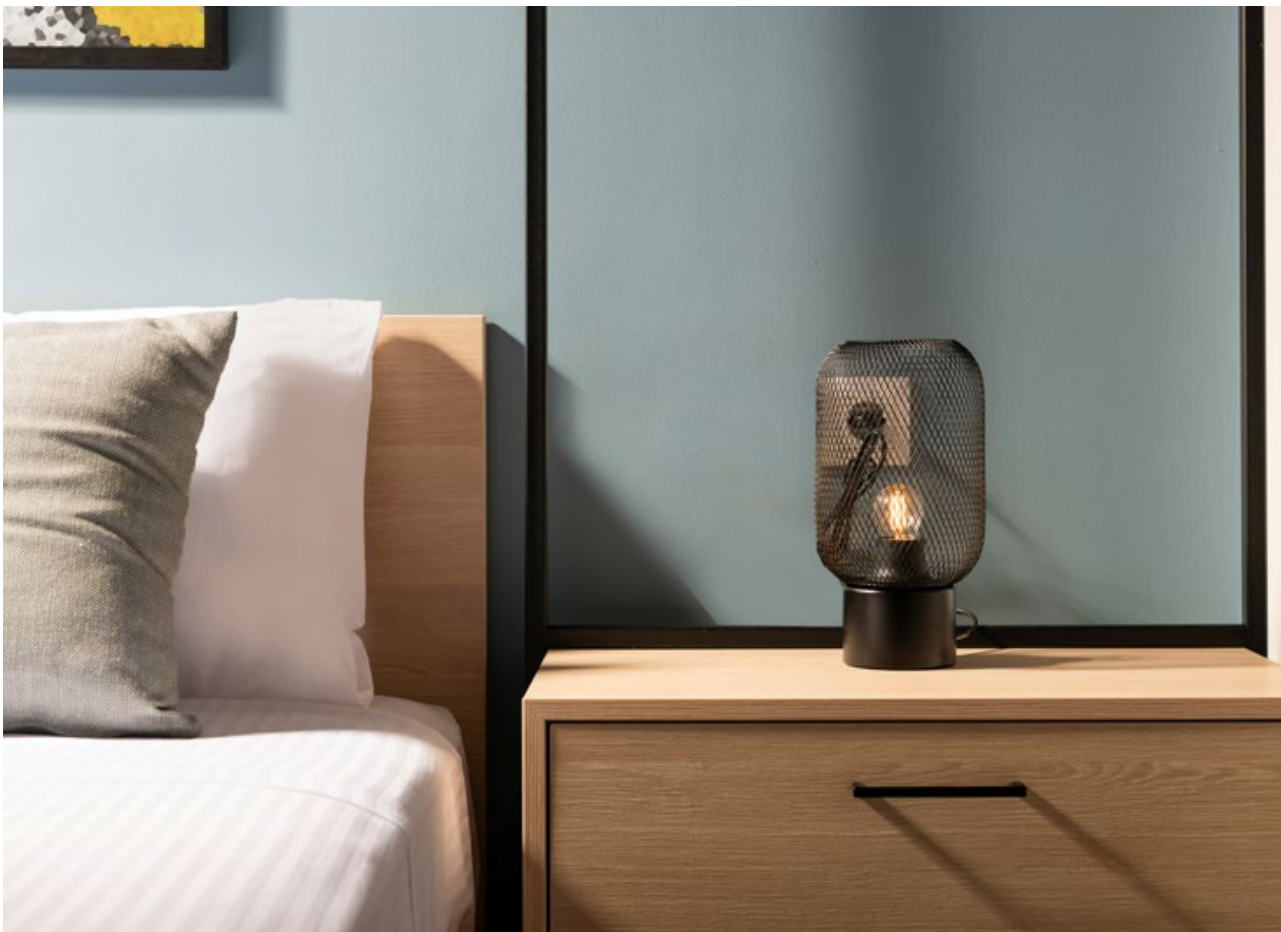

360 LINE

LAMPY LED / LED LAMPS

## LED FMB 4W E14

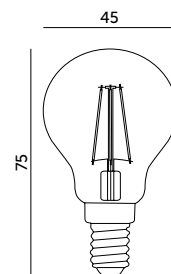

- wygląd i kształt wzorowany jest na tradycyjnych żarówkach wolframowych,  
- kąt rozsytu światła: 360 stopni.

- appearance and shape is modeled on traditional tungsten lamps,  
- beam angle: 360 degrees.

MODEL	INDEKS	POBÓR MOCY [W]	BARWA ŚWIATŁA	STRUMIEŃ ŚWIETLNY [lm]	WAGA NETTO [kg]	PAKOWANIE [szt.]	KOD EAN
MODEL	INDEX	POWER [W]	LIGHT COLOR	LUMINOUS FLUX [lm]	NET WEIGHT [kg]	PACKING [pcs]	BARCODE
LED FMB 4W E14 CB	KAFMBE144WCB	4	CIEPŁOBIŁA WARM WHITE	470	0,01	100	5902846010579



STANDARD LINE LAMPY LED / LED LAMPS

# LED MB 4,5W E14

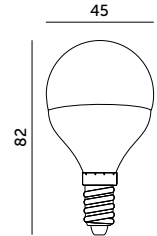

- ledowy zamiennik tradycyjnej żarówki kulistej,
- kąt rozsytu światła: 200 stopni.
- LED substitute for a traditional ball lamp,
- beam angle: 200 degrees.

MODEL	INDEKS	POBÓR MOCY [W]	BARWA ŚWIATŁA	STRUMIEŃ ŚWIETLNY [lm]	WAGA NETTO [kg]	PAKOWANIE [szt.]	KOD EAN
MODEL	INDEX	POWER [W]	LIGHT COLOR	LUMINOUS FLUX [lm]	NET WEIGHT [kg]	PACKING [pcs]	BARCODE
LED MB 4,5W E14 CB	KAMBE1445WCB	4,5	CIEPŁOBIĄŁA WARM WHITE	420	0,02	100	5900605091333
LED MB 4,5W E14 NB	KAMBE1445WNB	4,5	NEUTRALNA BIAŁA NEUTRAL WHITE	420	0,02	100	5902846013839
LED MB 4,5W E14 ZB	KAMBE1445WZB	4,5	ZIMNOBIAŁA COOL WHITE	420	0,02	100	5900605097090



STANDARD LINE LAMPY LED / LED LAMPS

# LED MB 6W E14

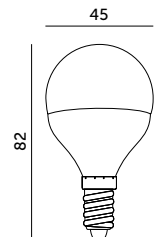

- ledowy zamiennik tradycyjnej żarówki kulistej,
- kąt rozsytu światła: 200 stopni.
- LED substitute for a traditional ball lamp,
- beam angle: 200 degrees.

MODEL	INDEKS	POBÓR MOCY [W]	BARWA ŚWIATŁA	STRUMIEŃ ŚWIETLNY [lm]	WAGA NETTO [kg]	PAKOWANIE [szt.]	KOD EAN
MODEL	INDEX	POWER [W]	LIGHT COLOR	LUMINOUS FLUX [lm]	NET WEIGHT [kg]	PACKING [pcs]	BARCODE
LED MB 6W E14 CB	KAMBE146WCB	6	CIEPŁOBIĄŁA WARM WHITE	470	0,02	100	5900605094136
LED MB 6W E14 NB	KAMBE146WNB	6	NEUTRALNA BIAŁA NEUTRAL WHITE	470	0,02	100	5900605097519
LED MB 6W E14 ZB	KAMBE146WZB	6	ZIMNOBIAŁA COOL WHITE	470	0,02	100	5900605095553

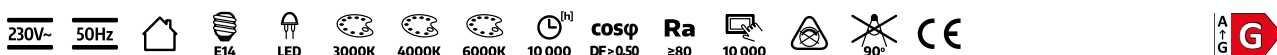

# LED MB 8,5W E14

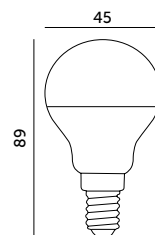

- ledowy zamiennik tradycyjnej żarówki kulistej,  
- kąt rozsytu światła: 180 stopni.

- LED substitute for a traditional ball lamp,  
- beam angle: 180 degrees.

MODEL	INDEKS	POBÓR MOCY [W]	BARWA ŚWIATŁA	STRUMIEŃ ŚWIETLNY [lm]	WAGA NETTO [kg]	PAKOWANIE [szt.]	KOD EAN
MODEL	INDEX	POWER [W]	LIGHT COLOR	LUMINOUS FLUX [lm]	NET WEIGHT [kg]	PACKING [pcs]	BARCODE
LED MB 8,5W E14 CB	KALMBE1485CB	8,5	CIEPŁOBIĄŁA WARM WHITE	806	0,02	100	5902201384185
LED MB 8,5W E14 NB	KALMBE1485NB	8,5	NEUTRALNA BIAŁA NEUTRAL WHITE	806	0,02	100	5902201384192
LED MB 8,5W E14 ZB	KALMBE1485ZB	8,5	ZIMNOBIĄŁA COOL WHITE	806	0,02	100	5902201384208



# LED MB 9W E14 PREMIUM

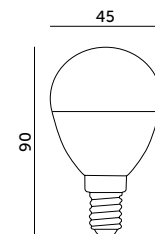

- ledowy zamiennik tradycyjnej żarówki kulistej,  
- ceramiczny korpus gwarantujący właściwe odprowadzenie ciepła,  
- kąt rozsytu światła: 200 stopni.

- LED substitute for a traditional ball lamp,  
- ceramic body that ensures proper heat dissipation,  
- beam angle: 200 degrees.

MODEL	INDEKS	POBÓR MOCY [W]	BARWA ŚWIATŁA	STRUMIEŃ ŚWIETLNY [lm]	WAGA NETTO [kg]	PAKOWANIE [szt.]	KOD EAN
MODEL	INDEX	POWER [W]	LIGHT COLOR	LUMINOUS FLUX [lm]	NET WEIGHT [kg]	PACKING [pcs]	BARCODE
LED MB 9W E14 CB	KAMBE149WCB	9	CIEPŁOBIĄŁA WARM WHITE	900	0,04	100	5902846011224
LED MB 9W E14 NB	KAMBE149WNB	9	NEUTRALNA BIAŁA NEUTRAL WHITE	900	0,04	100	5902846011231
LED MB 9W E14 ZB	KAMBE149WZB	9	ZIMNOBIĄŁA COOL WHITE	900	0,04	100	5902846012993





ECONOMIC BRAND LAMPY LED / LED LAMPS

**LED2B**

# LED ST45 1W E27

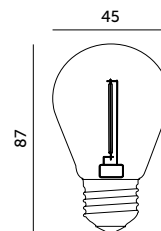

- bańka żarówki wykonana z tworzywa sztucznego,  
- kąt rozsytu światła: 220 stopni.

- bulb made of plastic,  
- beam angle: 220 degrees.

MODEL	INDEKS	POBÓR MOCY [W]	BARWA ŚWIATŁA	STRUMIEŃ ŚWIETLNY [lm]	WAGA NETTO [kg]	PAKOWANIE [szt.]	KOD EAN
MODEL	INDEX	POWER [W]	LIGHT COLOR	LUMINOUS FLUX [lm]	NET WEIGHT [kg]	PACKING [pcs]	BARCODE
LED ST45 1W E27 CB	KALFSTE271CB	1	CIEPŁOBIĄŁA WARM WHITE	50	0,01	100	5902201369892



360 LINE LAMPY LED / LED LAMPS

# LED FMB 4W E27

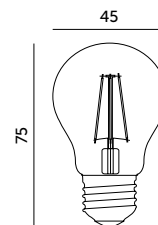

- wygląd i kształt wzorowany jest na tradycyjnych żarówkach wolframowych,  
- kąt rozsytu światła: 360 stopni.

- appearance and shape is modeled on traditional tungsten lamps,  
- beam angle: 360 degrees.

MODEL	INDEKS	POBÓR MOCY [W]	BARWA ŚWIATŁA	STRUMIEŃ ŚWIETLNY [lm]	WAGA NETTO [kg]	PAKOWANIE [szt.]	KOD EAN
MODEL	INDEX	POWER [W]	LIGHT COLOR	LUMINOUS FLUX [lm]	NET WEIGHT [kg]	PACKING [pcs]	BARCODE
LED FMB 4W E27 CB	KAFMBE274WCB	4	CIEPŁOBIĄŁA WARM WHITE	470	0,02	100	5902846010586

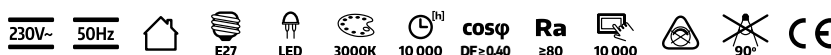

STANDARD LINE LAMPY LED / LED LAMPS

# LED MB 4,5W E27

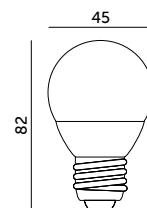

- ledowy zamiennik tradycyjnej żarówki kulistej.
- LED substitute for a traditional ball lamp.
- kąt rozsytu światła: 200 stopni.
- beam angle: 200 degrees.

MODEL	INDEKS	POBÓR MOCY [W]	BARWA ŚWIATŁA	STRUMIEŃ ŚWIETLNY [lm]	WAGA NETTO [kg]	PAKOWANIE [szt.]	KOD EAN
MODEL	INDEX	POWER [W]	LIGHT COLOR	LUMINOUS FLUX [lm]	NET WEIGHT [kg]	PACKING [pcs]	BARCODE
LED MB 4,5W E27 CB	KAMBE2745WCB	4,5	CIEPŁOBIJAŁA WARM WHITE	420	0,02	100	5900605091340
LED MB 4,5W E27 NB	KAMBE2745WNB	4,5	NEUTRALNA BIAŁA NEUTRAL WHITE	420	0,02	100	5902846015277
LED MB 4,5W E27 ZB	KAMBE2745WZB	4,5	ZIMNOBIAŁA COOL WHITE	420	0,02	100	5900605097106

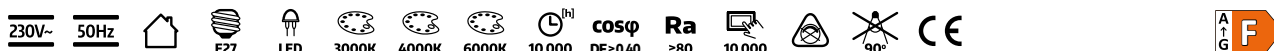

STANDARD LINE LAMPY LED / LED LAMPS

# LED MB 6W E27

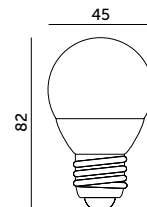

- ledowy zamiennik tradycyjnej żarówki kulistej.
- LED substitute for a traditional ball lamp.
- kąt rozsytu światła: 200 stopni.
- beam angle: 200 degrees.

MODEL	INDEKS	POBÓR MOCY [W]	BARWA ŚWIATŁA	STRUMIEŃ ŚWIETLNY [lm]	WAGA NETTO [kg]	PAKOWANIE [szt.]	KOD EAN
MODEL	INDEX	POWER [W]	LIGHT COLOR	LUMINOUS FLUX [lm]	NET WEIGHT [kg]	PACKING [pcs]	BARCODE
LED MB 6W E27 CB	KAMBE276WCB2	6	CIEPŁOBIJAŁA WARM WHITE	470	0,02	100	5900605094143
LED MB 6W E27 NB	KAMBE276WNB	6	NEUTRALNA BIAŁA NEUTRAL WHITE	470	0,02	100	5900605097540
LED MB 6W E27 ZB	KAMBE276WZB	6	ZIMNOBIAŁA COOL WHITE	470	0,02	100	5900605095560



ECONOMIC BRAND LAMPY LED / LED LAMPS

**LED2B**

# LED MB 8,5W E27

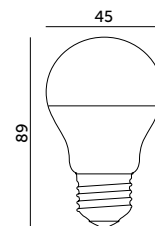

- ledowy zamiennik tradycyjnej żarówki kulistej,  
- kąt rozsytu światła: 180 stopni.

- LED substitute for a traditional ball lamp,  
- beam angle: 180 degrees.

MODEL	INDEKS	POBÓR MOCY [W]	BARWA ŚWIATŁA	STRUMIEŃ ŚWIETLNY [lm]	WAGA NETTO [kg]	PAKOWANIE [szt.]	KOD EAN
MODEL	INDEX	POWER [W]	LIGHT COLOR	LUMINOUS FLUX [lm]	NET WEIGHT [kg]	PACKING [pcs]	BARCODE
LED MB 8,5W E27 CB	KALMBE2785CB	8,5	CIEPŁOBIAŁA WARM WHITE	806	0,02	100	5902201384215
LED MB 8,5W E27 NB	KALMBE2785NB	8,5	NEUTRALNA BIAŁA NEUTRAL WHITE	806	0,02	100	5902201384222
LED MB 8,5W E27 ZB	KALMBE2785ZB	8,5	ZIMNOBIAŁA COOL WHITE	806	0,02	100	5902201384239



PREMIUM LAMPY LED / LED LAMPS

# LED MB 9W E27 PREMIUM

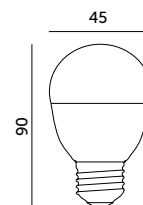

- ledowy zamiennik tradycyjnej żarówki kulistej,  
- ceramiczny korpus gwarantujący właściwe odprowadzenie ciepła,  
- kąt rozsytu światła: 200 stopni.

- LED substitute for a traditional ball lamp,  
- ceramic body that ensures proper heat dissipation,  
- beam angle: 200 degrees.

MODEL	INDEKS	POBÓR MOCY [W]	BARWA ŚWIATŁA	STRUMIEŃ ŚWIETLNY [lm]	WAGA NETTO [kg]	PAKOWANIE [szt.]	KOD EAN
MODEL	INDEX	POWER [W]	LIGHT COLOR	LUMINOUS FLUX [lm]	NET WEIGHT [kg]	PACKING [pcs]	BARCODE
LED MB 9W E27 CB	KAMBE279WCB	9	CIEPŁOBIAŁA WARM WHITE	900	0,06	100	5902846011248
LED MB 9W E27 NB	KAMBE279WNB	9	NEUTRALNA BIAŁA NEUTRAL WHITE	900	0,06	100	5902846011255
LED MB 9W E27 ZB	KAMBE279WZB	9	ZIMNOBIAŁA COOL WHITE	900	0,06	100	5902846013006



360 LINE

LAMPY LED / LED LAMPS

# LED FG125 7W E27



- ledowa ozdobna żarówka dekoracyjna, - decorative LED lamp,  
- kąt rozsytu światła: 360 stopni. - beam angle: 360 degrees.

MODEL	INDEKS	POBÓR MOCY [W]	BARWA ŚWIATŁA	STRUMIEŃ ŚWIETLNY [lm]	WAGA NETTO [kg]	PAKOWANIE [szt.]	KOD EAN
MODEL	INDEX	POWER [W]	LIGHT COLOR	LUMINOUS FLUX [lm]	NET WEIGHT [kg]	PACKING [pcs]	BARCODE
LED FG125 7W E27 CB	KAFG125E277C	7	CIEPŁOBIĄŁA WARM WHITE	800	0,10	50	5902846011958



360 LINE

LAMPY LED / LED LAMPS

# LED FST64 7W E27

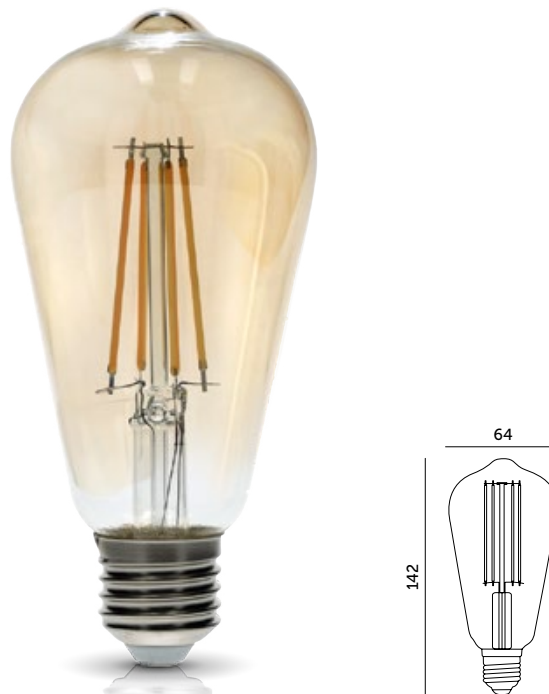

- ledowa ozdobna żarówka dekoracyjna, - decorative LED lamp,  
- kąt rozsytu światła: 360 stopni. - beam angle: 360 degrees.

MODEL	INDEKS	POBÓR MOCY [W]	BARWA ŚWIATŁA	STRUMIEŃ ŚWIETLNY [lm]	WAGA NETTO [kg]	PAKOWANIE [szt.]	KOD EAN
MODEL	INDEX	POWER [W]	LIGHT COLOR	LUMINOUS FLUX [lm]	NET WEIGHT [kg]	PACKING [pcs]	BARCODE
LED FST64 7W E27 CB	KAFST64E277C	7	CIEPŁOBIĄŁA WARM WHITE	800	0,04	100	5902846011965

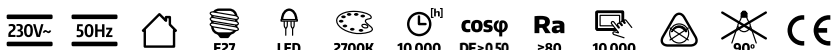



**STANDARD LINE** LAMPY LED / LED LAMPS

# LED G120 24W E27

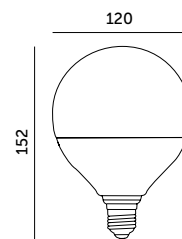

- ledowy zamiennik tradycyjnej domowej żarówki,  
- kąt rozsyłu światła: 270 stopni.

- LED substitute for a traditional lamp,  
- beam angle: 270 degrees.

MODEL	INDEKS	POBÓR MOCY [W]	BARWA ŚWIATŁA	STRUMIEN ŚWIETLNY [lm]	WAGA NETTO [kg]	PAKOWANIE [szt.]	KOD EAN
MODEL	INDEX	POWER [W]	LIGHT COLOR	LUMINOUS FLUX [lm]	NET WEIGHT [kg]	PACKING [pcs]	BARCODE
LED G120 24W E27 CB	KAG120E2724C	24	CIEPŁOBIĄŁA WARM WHITE	2600	0,24	24	5902846016816
LED G120 24W E27 NB	KAG120E2724N	24	NEUTRALNA BIAŁA NEUTRAL WHITE	2600	0,24	24	5902846016823





STANDARD LINE

LAMPY LED / LED LAMPS

# LED R50 5W E14

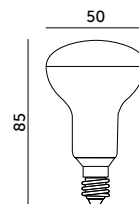

- ledowy zamiennik kierunkowej żarówki reflektorowej,  
- kąt rozsytu światła: 120 stopni,  
- jednolitość barwy: 6 stopni.

- LED substitute for a traditional directional reflector lamp,  
- beam angle: 120 degrees,  
- color uniformity: 6 degrees.

MODEL	INDEKS	POBÓR MOCY [W]	BARWA ŚWIATŁA	STRUMIEN ŚWIETLNY [lm]	ŚWIATŁOŚĆ [cd]	WAGA NETTO [kg]	PAKOWANIE [szt.]	KOD EAN
MODEL	INDEX	POWER [W]	LIGHT COLOR	LUMINOUS FLUX [lm]	CANDLEPOWER [cd]	NET WEIGHT [kg]	PACKING [pcs]	BARCODE
LED R50 5W E14 CB	KAR50E14SWCB	5	CIEPŁOBIĄŁA WARM WHITE	400	127	0,02	100	5900605095126
LED R50 5W E14 NB	KAR50E14SWNB	5	NEUTRALNA BIAŁA NEUTRAL WHITE	400	127	0,02	100	5900605097601



STANDARD LINE

LAMPY LED / LED LAMPS

# LED R63 8W E27

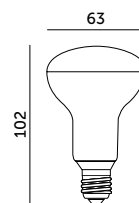

- ledowy zamiennik kierunkowej żarówki reflektorowej,  
- kąt rozsytu światła: 120 stopni,  
- jednolitość barwy: 6 stopni.

- LED substitute for a traditional directional reflector lamp,  
- beam angle: 120 degrees,  
- color uniformity: 6 degrees.

MODEL	INDEKS	POBÓR MOCY [W]	BARWA ŚWIATŁA	STRUMIEN ŚWIETLNY [lm]	ŚWIATŁOŚĆ [cd]	WAGA NETTO [kg]	PAKOWANIE [szt.]	KOD EAN
MODEL	INDEX	POWER [W]	LIGHT COLOR	LUMINOUS FLUX [lm]	CANDLEPOWER [cd]	NET WEIGHT [kg]	PACKING [pcs]	BARCODE
LED R63 8W E27 CB	KAR63E278WCB	8	CIEPŁOBIĄŁA WARM WHITE	700	207	0,04	100	5900605095133
LED R63 8W E27 NB	KAR63E278WNB	8	NEUTRALNA BIAŁA NEUTRAL WHITE	700	207	0,04	100	5900605098127
LED R63 8W E27 ZB	KAR63E278WZB	8	ZIMNOBIĄŁA COOL WHITE	700	207	0,04	100	5902846010432



STANDARD LINE LAMPY LED / LED LAMPS

# LED G4 1,5W

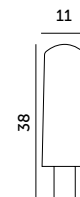

- ledowy zamiennik tradycyjnych  
żarówek halogenowych,  
- kąt rozsytu światła: 330 stopni.

- LED substitute for a traditional  
halogen lamps,  
- beam angle: 330 degrees.

MODEL	INDEKS	POBÓR MOCY [W]	BARWA ŚWIATŁA	STRUMIEŃ ŚWIETLNY [lm]	WAGA NETTO [kg]	PAKOWANIE [szt.]	KOD EAN
MODEL	INDEX	POWER [W]	LIGHT COLOR	LUMINOUS FLUX [lm]	NET WEIGHT [kg]	PACKING [pcs]	BARCODE
LED G4 1,5W CB	KAG41,5WCB	1,5	CIEPŁOBIĄŁA WARM WHITE	170	0,01	100	5902201307436
LED G4 1,5W NB	KAG41,5WNB	1,5	NEUTRALNA BIAŁA NEUTRAL WHITE	170	0,01	100	5902201307443



STANDARD LINE LAMPY LED / LED LAMPS

# LED G4 2W

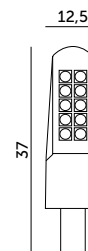

- ledowy zamiennik tradycyjnych  
żarówek halogenowych,  
- kąt rozsytu światła: 330 stopni.

- LED substitute for a traditional  
halogen lamps,  
- beam angle: 330 degrees.

MODEL	INDEKS	POBÓR MOCY [W]	BARWA ŚWIATŁA	STRUMIEŃ ŚWIETLNY [lm]	WAGA NETTO [kg]	PAKOWANIE [szt.]	KOD EAN
MODEL	INDEX	POWER [W]	LIGHT COLOR	LUMINOUS FLUX [lm]	NET WEIGHT [kg]	PACKING [pcs]	BARCODE
LED G4 2W CB	KAG42WCB	2	CIEPŁOBIĄŁA WARM WHITE	230	0,01	100	5902201305951
LED G4 2W NB	KAG42WNB	2	NEUTRALNA BIAŁA NEUTRAL WHITE	230	0,01	100	5902201305968

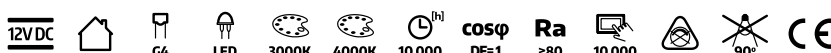



STANDARD LINE

LAMPY LED / LED LAMPS

# LED G9 3W

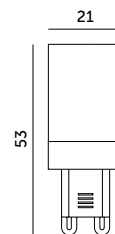

- ledowy zamiennik tradycyjnych żarówek halogenowych,  
- kąt rozsytu światła: 100 stopni.

- LED substitute for a traditional halogen lamps,  
- beam angle: 100 degrees.

MODEL	INDEKS	POBÓR MOCY [W]	BARWA ŚWIATŁA	STRUMIEN ŚWIETLNY [lm]	WAGA NETTO [kg]	PAKOWANIE [szt.]	KOD EAN
MODEL	INDEX	POWER [W]	LIGHT COLOR	LUMINOUS FLUX [lm]	NET WEIGHT [kg]	PACKING [pcs]	BARCODE
LED G9 3W CB	KAG93WCB	3	CIEPŁOBIĄŁA WARM WHITE	285	0,02	500	5902201364972
LED G9 3W NB	KAG93WNB	3	NEUTRALNA BIAŁA NEUTRAL WHITE	285	0,02	500	5902201364989
LED G9 3W ZB	KAG93WZB	3	ZIMNOBIAŁA COOL WHITE	285	0,02	500	5902201364996



STANDARD LINE LAMPY LED / LED LAMPS

# LED G9 4W

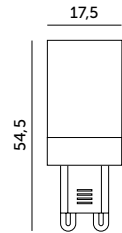

- ledowy zamiennik tradycyjnych  
żarówek halogenowych,  
- kąt rozsytu światła: 330 stopni.

- LED substitute for a traditional  
halogen lamps,  
- beam angle: 330 degrees.

MODEL	INDEKS	POBÓR MOCY [W]	BARWA ŚWIATŁA	STRUMIEŃ ŚWIETLNY [lm]	WAGA NETTO [kg]	PAKOWANIE [szt.]	KOD EAN
MODEL	INDEX	POWER [W]	LIGHT COLOR	LUMINOUS FLUX [lm]	NET WEIGHT [kg]	PACKING [pcs]	BARCODE
LED G9 4W CB	KAG94WCB360	4	CIEPŁOBIĄŁA WARM WHITE	380	0,01	100	5900605095720
LED G9 4W NB	KAG94WNB360	4	NEUTRALNA BIAŁA NEUTRAL WHITE	380	0,01	100	5900605097137
LED G9 4W ZB	KAG94WZB360	4	ZIMNOBIĄŁA COOL WHITE	380	0,01	100	5900605097144



STANDARD LINE LAMPY LED / LED LAMPS

# LED G9 6W

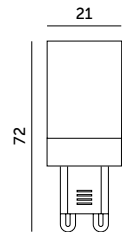

- ledowy zamiennik tradycyjnych  
żarówek halogenowych,  
- kąt rozsytu światła: 330 stopni.

- LED substitute for a traditional  
halogen lamps,  
- beam angle: 330 degrees.

MODEL	INDEKS	POBÓR MOCY [W]	BARWA ŚWIATŁA	STRUMIEŃ ŚWIETLNY [lm]	WAGA NETTO [kg]	PAKOWANIE [szt.]	KOD EAN
MODEL	INDEX	POWER [W]	LIGHT COLOR	LUMINOUS FLUX [lm]	NET WEIGHT [kg]	PACKING [pcs]	BARCODE
LED G9 6W CB	KAG96WCB2	6	CIEPŁOBIĄŁA WARM WHITE	600	0,02	200	5902201300888
LED G9 6W NB	KAG96WNB2	6	NEUTRALNA BIAŁA NEUTRAL WHITE	600	0,02	200	5902201300895
LED G9 6W ZB	KAG96WZB2	6	ZIMNOBIĄŁA COOL WHITE	600	0,02	200	5902201300901

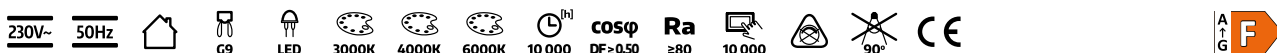

STANDARD LINE

LAMPY LED / LED LAMPS

# LED T 2W E14

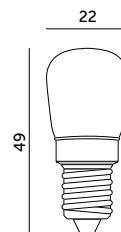

- żarówka przeznaczona do okapów oraz lodówek,  
- kąt rozsytu światła: 330 stopni.

- lamp designed for kitchen hoods and refrigerators,  
- beam angle: 330 degrees.

MODEL	INDEKS	POBÓR MOCY [W]	BARWA ŚWIATŁA	STRUMIEŃ ŚWIETLNY [lm]	WAGA NETTO [kg]	PAKOWANIE [szt.]	KOD EAN
MODEL	INDEX	POWER [W]	LIGHT COLOR	LUMINOUS FLUX [lm]	NET WEIGHT [kg]	PACKING [pcs]	BARCODE
LED T 2W E14 NB	KATE142WNB	2	NEUTRALNA BIAŁA NEUTRAL WHITE	200	0,01	100	5900605097564

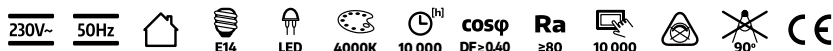

STANDARD LINE

LAMPY LED / LED LAMPS

# LED T 4,2W E14

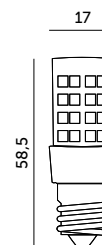

- żarówka przeznaczona do okapów oraz lodówek,  
- kąt rozsytu światła: 270 stopni.

- lamp designed for kitchen hoods and refrigerators,  
- beam angle: 270 degrees.

MODEL	INDEKS	POBÓR MOCY [W]	BARWA ŚWIATŁA	STRUMIEŃ ŚWIETLNY [lm]	WAGA NETTO [kg]	PAKOWANIE [szt.]	KOD EAN
MODEL	INDEX	POWER [W]	LIGHT COLOR	LUMINOUS FLUX [lm]	NET WEIGHT [kg]	PACKING [pcs]	BARCODE
LED T 4,2W E14 NB	KATE1442WNB	4,2	NEUTRALNA BIAŁA NEUTRAL WHITE	400	0,01	100	5902201301632

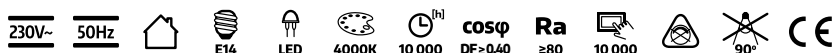





STANDARD LINE LAMPY LED / LED LAMPS

## LED ES111 15W GU10

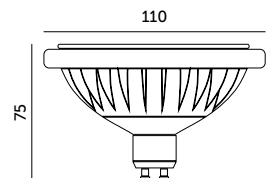

- ledowy zamiennik żarówek halogenowych,  
- kąt rozsytu światła: 40 stopni,  
- jednolitość barwy: 6 stopni.

- LED substitute for halogen bulbs,  
- beam angle: 40 degrees,  
- color uniformity: 6 degrees.

MODEL	INDEKS	POBÓR MOCY [W]	BARWA ŚWIATŁA	STRUMIEŃ ŚWIETLNY [lm]	ŚWIATŁOŚĆ [cd]	WAGA NETTO [kg]	PAKOWANIE [szt.]	KOD EAN
MODEL	INDEX	POWER [W]	LIGHT COLOR	LUMINOUS FLUX [lm]	CANDLEPOWER [cd]	NET WEIGHT [kg]	PACKING [pcs]	BARCODE
LED ES111 15W GU10 NB	KAES15WNB	15	NEUTRALNA BIAŁA NEUTRAL WHITE	1200	2079	0,12	100	5902846013709



STANDARD LINE LAMPY LED / LED LAMPS

# LED J78 8W R7s



- ledowy zamiennik tradycyjnych żarówek halogenowych,  
- kąt rozsytu światła: 330 stopni.

- LED substitute for a traditional halogen lamps,  
- beam angle: 330 degrees.



MODEL	INDEKS	POBÓR MOCY [W]	BARWA ŚWIATŁA	STRUMIEŃ ŚWIETLNY [lm]	WAGA NETTO [kg]	PAKOWANIE [szt.]	KOD EAN
MODEL	INDEX	POWER [W]	LIGHT COLOR	LUMINOUS FLUX [lm]	NET WEIGHT [kg]	PACKING [pcs]	BARCODE
LED J78 8W R7s CB	KAJ788WCB	8	CIEPŁOBIĄŁA WARM WHITE	900	0,03	24	5902201308334
LED J78 8W R7s NB	KAJ788WNB	8	NEUTRALNA BIAŁA NEUTRAL WHITE	900	0,03	24	5902201308341



STANDARD LINE LAMPY LED / LED LAMPS

# LED J118 15W R7s



- ledowy zamiennik tradycyjnych żarówek halogenowych,  
- kąt rozsytu światła: 330 stopni.

- LED substitute for a traditional halogen lamps,  
- beam angle: 330 degrees.

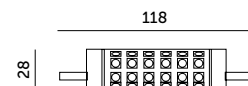

MODEL	INDEKS	POBÓR MOCY [W]	BARWA ŚWIATŁA	STRUMIEŃ ŚWIETLNY [lm]	WAGA NETTO [kg]	PAKOWANIE [szt.]	KOD EAN
MODEL	INDEX	POWER [W]	LIGHT COLOR	LUMINOUS FLUX [lm]	NET WEIGHT [kg]	PACKING [pcs]	BARCODE
LED J118 15W R7s CB	KAJ11815WCB	15	CIEPŁOBIĄŁA WARM WHITE	1700	0,06	24	5902201308228
LED J118 15W R7s NB	KAJ11815WNB	15	NEUTRALNA BIAŁA NEUTRAL WHITE	1700	0,06	24	5902201308235





PROFESSIONAL LINE LAMPY LED / LED LAMPS

# LED NEXTUBE 18W

**150**  
lm/W

**5 LAT**  
GWARANCJI  
**5 YEARS**  
WARRANTY



- nie zawierają szkodliwych substancji, które występują w standardowych świetlówkach,
- świetlówka uzyskuje pełną moc świecenia tuż po włączeniu,
- zasilana bezpośrednio z sieci,
- może pracować ze statecznikiem magnetycznym przy zastosowaniu startera KOBİ,
- wykonana ze szkła,
- kąt rozsyłu światła: 240 stopni,
- jednolitość barwy: 6 stopni.

- do not contain harmful substances found in standard fluorescent tubes,
- the tube reaches full brightness immediately after being switched on,
- powered directly from the mains (230V),
- can operate with a magnetic ballast when using the KOBİ starter,
- made of glass,
- beam angle: 240 degrees,
- color uniformity: 6 degree

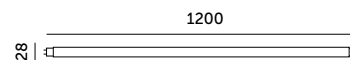

MODEL	INDEKS	POBÓR MOCY [W]	BARWA ŚWIATŁA	STRUMIEŃ ŚWIETLNY [lm]	WAGA NETTO [kg]	PAKOWANIE [szt.]	KOD EAN
MODEL	INDEX	POWER [W]	LIGHT COLOR	LUMINOUS FLUX [lm]	NET WEIGHT [kg]	PACKING [pcs]	BARCODE
LED T8 18W NB	01NST818WNB	18	NEUTRALNA BIAŁA NEUTRAL WHITE	2700	0,08	25	5902201304176

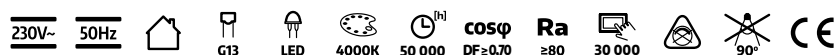

PROFESSIONAL LINE

LAMPY LED / LED LAMPS

# LED NEXTUBE 24W

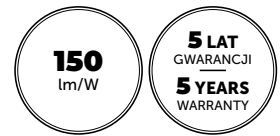

- nie zawierają szkodliwych substancji, które występują w standardowych świetłówkach,
- świetlówka uzyskuje pełną moc świecenia tuż po włączeniu,
- zasilana bezpośrednio z sieci,
- może pracować ze statecznikiem magnetycznym przy zastosowaniu startera KOBİ,
- wykonana ze szkła,
- kąt rozsytu światła: 240 stopni,
- jednolitość barwy: 6 stopni.

- do not contain harmful substances found in standard fluorescent tubes,
- the tube reaches full brightness immediately after being switched on,
- powered directly from the mains (230V),
- can operate with a magnetic ballast when using the KOBİ starter,
- made of glass,
- beam angle: 240 degrees,
- color uniformity: 6 degree

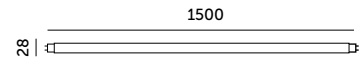

MODEL	INDEKS	POBÓR MOCY [W]	BARWA ŚWIATŁA	STRUMIEŃ ŚWIETLNY [lm]	WAGA NETTO [kg]	PAKOWANIE [szt.]	KOD EAN
MODEL	INDEX	POWER [W]	LIGHT COLOR	LUMINOUS FLUX [lm]	NET WEIGHT [kg]	PACKING [pcs]	BARCODE
LED T8 24W NB	01NST824WNB	24	NEUTRALNA BIAŁA NEUTRAL WHITE	3600	0,15	25	5902201304183



PREMIUM

LAMPY LED / LED LAMPS

# LED T8 9W PREMIUM



- nie zawierają szkodliwych substancji, które występują w standardowych świetłówkach,
- świetlówka uzyskuje pełną moc świecenia tuż po włączeniu,
- zasilana bezpośrednio z sieci,
- może pracować ze statecznikiem magnetycznym przy zastosowaniu startera KOBİ,
- wykonana ze szkła,
- kąt rozsytu światła: 240 stopni,
- jednolitość barwy: 6 stopni.

- do not contain harmful substances found in standard fluorescent tubes,
- the tube reaches full brightness immediately after being switched on,
- powered directly from the mains (230V),
- can operate with a magnetic ballast when using the KOBİ starter,
- made of glass,
- beam angle: 240 degrees,
- color uniformity: 6 degree

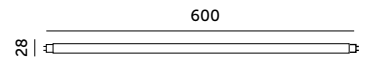

MODEL	INDEKS	POBÓR MOCY [W]	BARWA ŚWIATŁA	STRUMIEŃ ŚWIETLNY [lm]	WAGA NETTO [kg]	PAKOWANIE [szt.]	KOD EAN
MODEL	INDEX	POWER [W]	LIGHT COLOR	LUMINOUS FLUX [lm]	NET WEIGHT [kg]	PACKING [pcs]	BARCODE
LED T8 9W NB	KAT89WNB	9	NEUTRALNA BIAŁA NEUTRAL WHITE	1080	0,10	25	5902846016199
LED T8 9W ZB	KAT89WZB	9	ZIMNOBIAŁA COOL WHITE	1080	0,10	25	5902846016205



PREMIUM LAMPY LED / LED LAMPS

# LED T8 18W PREMIUM



- nie zawierają szkodliwych substancji, które występują w standardowych świetlówkach,
- świetlówka uzyskuje pełną moc świecenia tuż po włączeniu,
- zasilana bezpośrednio z sieci,
- może pracować ze statecznikiem magnetycznym przy zastosowaniu startera KOBİ,
- wykonana ze szkła,
- kąt rozsytu światła: 240 stopni,
- jednolitość barwy: 6 stopni.

- do not contain harmful substances found in standard fluorescent tubes,
- the tube reaches full brightness immediately after being switched on,
- powered directly from the mains (230V),
- can operate with a magnetic ballast when using the KOBİ starter,
- made of glass,
- beam angle: 240 degrees,
- color uniformity: 6 degree

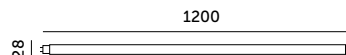

MODEL	INDEKS	POBÓR MOCY [W]	BARWA ŚWIATŁA	STRUMIEŃ ŚWIETLNY [lm]	WAGA NETTO [kg]	PAKOWANIE [szt.]	KOD EAN
MODEL	INDEX	POWER [W]	LIGHT COLOR	LUMINOUS FLUX [lm]	NET WEIGHT [kg]	PACKING [pcs]	BARCODE
LED T8 18W CB	KAT818WCBP	18	CIEPŁOBIAŁA WARM WHITE	2160	0,18	25	5902201359442
LED T8 18W NB	KAT818WNBP	18	NEUTRALNA BIAŁA NEUTRAL WHITE	2160	0,18	25	5902846016212
LED T8 18W ZB	KAT818WZBP	18	ZIMNOBIAŁA COOL WHITE	2160	0,18	25	5902846016229

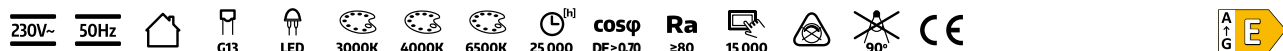

PREMIUM LAMPY LED / LED LAMPS

# LED T8 22W PREMIUM



- nie zawierają szkodliwych substancji, które występują w standardowych świetlówkach,
- świetlówka uzyskuje pełną moc świecenia tuż po włączeniu,
- zasilana bezpośrednio z sieci,
- może pracować ze statecznikiem magnetycznym przy zastosowaniu startera KOBİ,
- wykonana ze szkła,
- kąt rozsytu światła: 240 stopni,
- jednolitość barwy: 6 stopni.

- do not contain harmful substances found in standard fluorescent tubes,
- the tube reaches full brightness immediately after being switched on,
- powered directly from the mains (230V),
- can operate with a magnetic ballast when using the KOBİ starter,
- made of glass,
- beam angle: 240 degrees,
- color uniformity: 6 degree

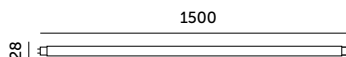

MODEL	INDEKS	POBÓR MOCY [W]	BARWA ŚWIATŁA	STRUMIEŃ ŚWIETLNY [lm]	WAGA NETTO [kg]	PAKOWANIE [szt.]	KOD EAN
MODEL	INDEX	POWER [W]	LIGHT COLOR	LUMINOUS FLUX [lm]	NET WEIGHT [kg]	PACKING [pcs]	BARCODE
LED T8 22W NB	KAT822WNBP	22	NEUTRALNA BIAŁA NEUTRAL WHITE	2640	0,24	25	5902846016236
LED T8 22W ZB	KAT822WZBP	22	ZIMNOBIAŁA COOL WHITE	2640	0,24	25	5902846016243

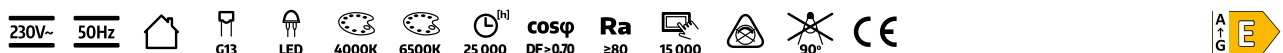



# LED T8 9W

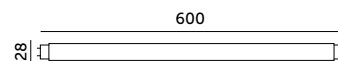

- nie zawierają szkodliwych substancji, które występują w standardowych świetlówkach,
- świetlówka uzyskuje pełną moc świecenia tuż po włączeniu,
- zasilana bezpośrednio z sieci,
- może pracować ze statecznikiem magnetycznym przy zastosowaniu startera KOB1,
- wykonana ze szkła,
- kąt rozsytu światła: 240 stopni,
- jednolitość barwy: 6 stopni.

- do not contain harmful substances found in standard fluorescent tubes,
- the tube reaches full brightness immediately after being switched on,
- powered directly from the mains (230V),
- can operate with a magnetic ballast when using the KOB1 starter,
- made of glass,
- beam angle: 240 degrees,
- color uniformity: 6 degree

MODEL	INDEKS	POBÓR MOCY [W]	BARWA ŚWIATŁA	STRUMIEŃ ŚWIETLNY [lm]	WAGA NETTO [kg]	PAKOWANIE [szt.]	KOD EAN
MODEL	INDEX	POWER [W]	LIGHT COLOR	LUMINOUS FLUX [lm]	NET WEIGHT [kg]	PACKING [pcs]	BARCODE
LED T8 9W NB	KALT89WNBS	9	NEUTRALNA BIAŁA NEUTRAL WHITE	900	0,08	25	5902846012825
LED T8 9W ZB	KALT89WZBS	9	ZIMNOBIAŁA COOL WHITE	900	0,08	25	5902846012832



# LED T8 18W

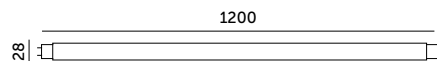

- nie zawierają szkodliwych substancji, które występują w standardowych świetlówkach,
- świetlówka uzyskuje pełną moc świecenia tuż po włączeniu,
- zasilana bezpośrednio z sieci,
- może pracować ze statecznikiem magnetycznym przy zastosowaniu startera KOB1,
- wykonana ze szkła,
- kąt rozsytu światła: 240 stopni,
- jednolitość barwy: 6 stopni.

- do not contain harmful substances found in standard fluorescent tubes,
- the tube reaches full brightness immediately after being switched on,
- powered directly from the mains (230V),
- can operate with a magnetic ballast when using the KOB1 starter,
- made of glass,
- beam angle: 240 degrees,
- color uniformity: 6 degree

MODEL	INDEKS	POBÓR MOCY [W]	BARWA ŚWIATŁA	STRUMIEŃ ŚWIETLNY [lm]	WAGA NETTO [kg]	PAKOWANIE [szt.]	KOD EAN
MODEL	INDEX	POWER [W]	LIGHT COLOR	LUMINOUS FLUX [lm]	NET WEIGHT [kg]	PACKING [pcs]	BARCODE
LED T8 18W NB	KALT818NB	18	NEUTRALNA BIAŁA NEUTRAL WHITE	1800	0,17	25	5902201305753
LED T8 18W ZB	KALT818ZB	18	ZIMNOBIAŁA COOL WHITE	1800	0,17	25	5902201305760



ECONOMIC BRAND LAMPY LED / LED LAMPS

**LED2B**

# LED T8 22W



- nie zawierają szkodliwych substancji, które występują w standardowych świetlówkach,
- świetlówka uzyskuje pełną moc świecenia tuż po włączeniu,
- zasilana bezpośrednio z sieci,
- może pracować ze statecznikiem magnetycznym przy zastosowaniu startera KOBi,
- wykonana ze szkła,
- kąt rozsytu światła: 240 stopni,
- jednolitość barwy: 6 stopni.

- do not contain harmful substances found in standard fluorescent tubes,
- the tube reaches full brightness immediately after being switched on,
- powered directly from the mains (230V),
- can operate with a magnetic ballast when using the KOBi starter,
- made of glass,
- beam angle: 240 degrees,
- color uniformity: 6 degree

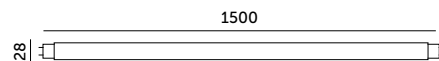

MODEL	INDEKS	POBÓR MOCY [W]	BARWA ŚWIATŁA	STRUMIEŃ ŚWIETLNY [lm]	WAGA NETTO [kg]	PAKOWANIE [szt.]	KOD EAN
MODEL	INDEX	POWER [W]	LIGHT COLOR	LUMINOUS FLUX [lm]	NET WEIGHT [kg]	PACKING [pcs]	BARCODE
LED T8 22W NB	KALT822WNB	22	NEUTRALNA BIAŁA NEUTRAL WHITE	2400	0,21	25	5902846016298
LED T8 22W ZB	KALT822WZB	22	ZIMNOBIAŁA COOL WHITE	2400	0,21	25	5902846016304



ECONOMIC BRAND LAMPY LED / LED LAMPS

**LED2B RED**

# LED T8 9W



- nie zawierają szkodliwych substancji, które występują w standardowych świetlówkach,
- świetlówka uzyskuje pełną moc świecenia tuż po włączeniu,
- zasilana bezpośrednio z sieci,
- może pracować ze statecznikiem magnetycznym przy zastosowaniu startera KOBi,
- wykonana ze szkła,
- kąt rozsytu światła: 240 stopni,
- jednolitość barwy: 6 stopni.

- do not contain harmful substances found in standard fluorescent tubes,
- the tube reaches full brightness immediately after being switched on,
- powered directly from the mains (230V),
- can operate with a magnetic ballast when using the KOBi starter,
- made of glass,
- beam angle: 240 degrees,
- color uniformity: 6 degree

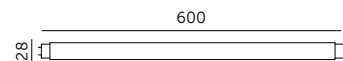

MODEL	INDEKS	POBÓR MOCY [W]	BARWA ŚWIATŁA	STRUMIEŃ ŚWIETLNY [lm]	WAGA NETTO [kg]	PAKOWANIE [szt.]	KOD EAN
MODEL	INDEX	POWER [W]	LIGHT COLOR	LUMINOUS FLUX [lm]	NET WEIGHT [kg]	PACKING [pcs]	BARCODE
LED T8 9W NB	KALT89WNBR	9	NEUTRALNA BIAŁA NEUTRAL WHITE	900	0,09	25	5902201365139
LED T8 9W ZB	KALT89WZBR	9	ZIMNOBIAŁA COOL WHITE	900	0,09	25	5902201365146





# LED T8 18W



- nie zawierają szkodliwych substancji, które występują w standardowych świetłówkach,
- świetlówka uzyskuje pełną moc świecenia tuż po włączeniu,
- zasilana bezpośrednio z sieci,
- może pracować ze statecznikiem magnetycznym przy zastosowaniu startera KOBI,
- wykonana ze szkła,
- kąt rozsytu światła: 240 stopni,
- jednolitość barwy: 6 stopni.

- do not contain harmful substances found in standard fluorescent tubes,
- the tube reaches full brightness immediately after being switched on,
- powered directly from the mains (230V),
- can operate with a magnetic ballast when using the KOBI starter,
- made of glass,
- beam angle: 240 degrees,
- color uniformity: 6 degree

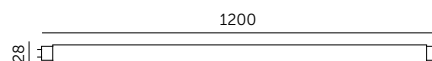

MODEL	INDEKS	POBÓR MOCY [W]	BARWA ŚWIATŁA	STRUMIEŃ ŚWIETLNY [lm]	WAGA NETTO [kg]	PAKOWANIE [szt.]	KOD EAN
MODEL	INDEX	POWER [W]	LIGHT COLOR	LUMINOUS FLUX [lm]	NET WEIGHT [kg]	PACKING [pcs]	BARCODE
LED T8 18W NB	KALT818WNBR	18	NEUTRALNA BIAŁA NEUTRAL WHITE	1800	0,18	25	5902201365153
LED T8 18W ZB	KALT818WZBR	18	ZIMNOBIAŁA COOL WHITE	1800	0,18	25	5902201365160



# LED T8 22W



- nie zawierają szkodliwych substancji, które występują w standardowych świetłówkach,
- świetlówka uzyskuje pełną moc świecenia tuż po włączeniu,
- zasilana bezpośrednio z sieci,
- może pracować ze statecznikiem magnetycznym przy zastosowaniu startera KOBI,
- wykonana ze szkła,
- kąt rozsytu światła: 240 stopni,
- jednolitość barwy: 6 stopni.

- do not contain harmful substances found in standard fluorescent tubes,
- the tube reaches full brightness immediately after being switched on,
- powered directly from the mains (230V),
- can operate with a magnetic ballast when using the KOBI starter,
- made of glass,
- beam angle: 240 degrees,
- color uniformity: 6 degree

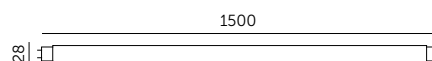

MODEL	INDEKS	POBÓR MOCY [W]	BARWA ŚWIATŁA	STRUMIEŃ ŚWIETLNY [lm]	WAGA NETTO [kg]	PAKOWANIE [szt.]	KOD EAN
MODEL	INDEX	POWER [W]	LIGHT COLOR	LUMINOUS FLUX [lm]	NET WEIGHT [kg]	PACKING [pcs]	BARCODE
LED T8 22W NB	KALT822WNBR	22	NEUTRALNA BIAŁA NEUTRAL WHITE	2400	0,23	25	5902201365177
LED T8 22W ZB	KALT822WZBR	22	ZIMNOBIAŁA COOL WHITE	2400	0,23	25	5902201365184





PREMIUM LINIOWE MODUŁY LED / LINEAR LED MODULES

# LED TRAMO 320 COB IP20 5m

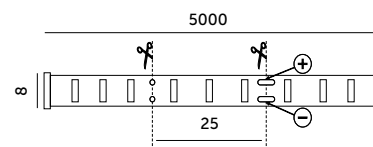

- dzięki zastosowaniu diod COB, taśma daje efekt płynnego świecenia na całej długości taśmy, bez widocznych punktów świetlnych,
- długość paska: 5 metrów,
- kąt rozsyłu światła: 180 stopni,
- produkt zasilany bezpiecznym napięciem 12V,
- wymaga zastosowania zasilacza,
- łączenie pasków możliwe poprzez lutowanie,
- możliwość dzielenia paska co 2,5 cm.

- due to the use of COB LEDs, the strip provides a smooth lighting effect along its entire length, without visible light points,
- strip length: 5 meters,
- beam angle: 180 degrees,
- powered by safe 12V voltage,
- requires a driver,
- strips can be connected by soldering,
- strip can be cut every 2,5 cm.

MODEL	INDEKS	POBÓR MOCY [W]	BARWA ŚWIATŁA	STRUMIEN ŚWIETLNY [lm]	WAGA NETTO [kg]	PAKOWANIE [szt.]	KOD EAN
MODEL	INDEX	POWER [W]	LIGHT COLOR	LUMINOUS FLUX [lm]	NET WEIGHT [kg]	PACKING [pcs]	BARCODE
LED TRAMO 320 COB IP20 CB	KBCOB320NCB	5W/0,5m	CIEPŁOBIAŁA WARM WHITE	460lm/0,5m	0,08	50	5902201371147
LED TRAMO 320 COB IP20 NB	KBCOB320NNB	5W/0,5m	NEUTRALNA BIAŁA NEUTRAL WHITE	500lm/0,5m	0,08	50	5902201371154
LED TRAMO 320 COB IP20 ZB	KBCOB320NZB	5W/0,5m	ZIMNOBIAŁA COOL WHITE	500lm/0,5m	0,08	50	5902201371161



PREMIUM

LINIOWE MODUŁY LED / LINEAR LED MODULES

# LED TRAMO 320 COB IP65 5m

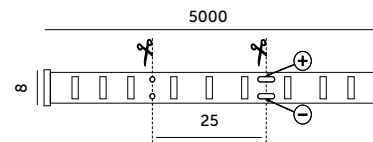

- dzięki zastosowaniu diod COB, taśma daje efekt płynnego świecenia na całej długości taśmy, bez widocznych punktów świetlnych,
- długość paska: 5 metrów,
- kąt rozsyłu światła: 180 stopni,
- produkt zasilany bezpiecznym napięciem 12V,
- wymaga zastosowania zasilacza,
- łączenie pasków możliwe poprzez lutowanie,
- możliwość dzielenia paska co 2,5 cm.

- due to the use of COB LEDs, the strip provides a smooth lighting effect along its entire length, without visible light points,
- strip length: 5 meters,
- beam angle: 180 degrees,
- powered by safe 12V voltage,
- requires a driver,
- strips can be connected by soldering,
- strip can be cut every 2,5 cm.

MODEL	INDEKS	POBÓR MOCY [W]	BARWA ŚWIATŁA	STRUMIEŃ ŚWIETLNY [lm]	WAGA NETTO [kg]	PAKOWANIE [szt.]	KOD EAN
MODEL	INDEX	POWER [W]	LIGHT COLOR	LUMINOUS FLUX [lm]	NET WEIGHT [kg]	PACKING [pcs]	BARCODE
LED TRAMO 320 COB IP65 CB	KBCOB320HCB	5W/0,5m	CIEPŁOBIĄŁA WARM WHITE	G 430lm/0,5m	0,11	50	5902201371178
LED TRAMO 320 COB IP65 NB	KBCOB320HNB	5W/0,5m	NEUTRALNA BIAŁA NEUTRAL WHITE	F 475lm/0,5m	0,11	50	5902201371185
LED TRAMO 320 COB IP65 ZB	KBCOB320HZB	5W/0,5m	ZIMNOBIĄŁA COOL WHITE	F 475lm/0,5m	0,11	50	5902201371192



STANDARD LINE

LINIOWE MODUŁY LED / LINEAR LED MODULES

# LUMOS LED SET

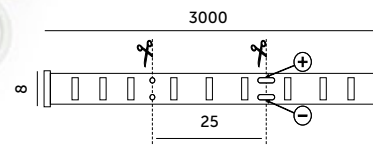

- w komplecie: taśma o długości 3 m + zasilacz z przewodem o długości ok. 1,9 m + wyłącznik z funkcją ściemniania,
- dzięki zastosowaniu diod COB, taśma daje efekt płynnego świecenia na całej długości taśmy, bez widocznych punktów świetlnych,
- możliwość cięcia taśmy co 2,5 cm,
- taśma zawiera źródła światła w klasie energetycznej F,
- krótkie naciśnięcie wyłącznika włącza lub wyłącza urządzenie, dłuższe naciśnięcie ściemnia lub rozjaśnia,
- kąt rozsyłu światła: 120 stopni,
- wymiary: zasilacz 40 x 70 x 70 mm; wyłącznik 22 x 11 x 300 mm.

- set includes: 3 m strip + power supply with a cable (approx. 1.9 m) + dimmer,
- due to the use of COB LEDs, the strip provides a smooth lighting effect along its entire length, without visible light points,
- strip can be cut every 2,5 cm,
- strip contains light sources energy efficiency class F,
- short press of the switch turns the device on or off, a long press dims or brightens the light,
- beam angle: 120 degrees,
- dimensions: driver 40 x 70 x 70 mm; switch 22 x 11 x 300 mm

MODEL	INDEKS	POBÓR MOCY [W]	BARWA ŚWIATŁA	STRUMIEŃ ŚWIETLNY [lm]	WAGA NETTO [kg]	PAKOWANIE [szt.]	KOD EAN
MODEL	INDEX	POWER [W]	LIGHT COLOR	LUMINOUS FLUX [lm]	NET WEIGHT [kg]	PACKING [pcs]	BARCODE
LUMOS LED SET CB	KBLSTN3MCB	25	CIEPŁOBIĄŁA WARM WHITE	2030	0,18	20	5902201359558
LUMOS LED SET NB	KBLSTN3MNB	25	NEUTRALNA BIAŁA NEUTRAL WHITE	2130	0,18	20	5902201359565





SMART HOME SMART HOME

# SMART LED SET RGB CCT WiFi

WSPÓŁPRACUJE Z  
WORKS WITH:



- inteligentne źródło światła, pozwalające na zdalną kontrolę poprzez aplikację TUYA (na Android i iOS),
- posiada możliwość ustawienia czasu włączenia i wyłączenia, ściemniania, zmiany kolorów, zmiany temperatury barwowej oraz tworzenia własnych scenariuszy,
- sterowanie z każdego miejsca na świecie,
- możliwość sterowania wieloma taśmami jednocześnie poprzez grupowanie,
- kąt rozsytu światła: 120 stopni.
- wymiary: zasilacz – 47 x 67 x 78 mm, kontroler – 203 x 23 x 10 mm, taśma – 12 x 5000 mm.

- smart light source, allowing remote control via the TUYA app (available on Android and iOS),
- features include setting on/off timers, dimming, adjusting color or color temperature, and creating custom scenes,
- control from anywhere in the world,
- control multiple LED strips simultaneously through grouping,
- beam angle: 120 degrees,
- dimensions: driver – 47 x 67 x 78 mm, controller – 203 x 23 x 10 mm, strip – 12 x 5000 mm.

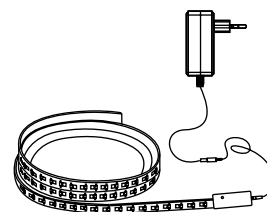

MODEL	INDEKS	POBÓR MOCY [W]	BARWA ŚWIATŁA	STRUMIEŃ ŚWIETLNY [lm]	WAGA NETTO [kg]	PAKOWANIE [szt.]	KOD EAN
MODEL	INDEX	POWER [W]	LIGHT COLOR	LUMINOUS FLUX [lm]	NET WEIGHT [kg]	PACKING [pcs]	BARCODE
SMART LED SET RGB CCT WiFi	KBZT2S5M2AH	4W/0,5 m	RGB + CCT	240 lm/0,5 m	0,32	20	5902201304565

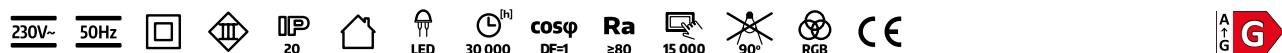

KOBI DESIGN SMART HOME

# LED PLAY SET

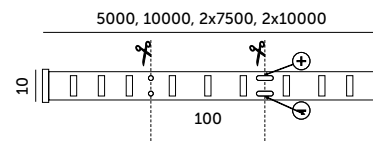

- inteligentne źródło światła pozwalające na zdalną kontrolę pilotem lub telefonem poprzez aplikację LOTUS LANTERN (na Android i iOS),
- posiada możliwość ustawienia czasu świecenia, ściemniania, zmiany kolorów, zmiany temperatury barwowej oraz możliwość ustawienia różnych trybów migania światła,
- aplikacja umożliwia również synchronizację światła w rytm muzyki,
- możliwość sterowania aplikacją wieloma urządzeniami jednocześnie,
- kąt rozsytu światła: 120 stopni.

- smart light source allowing remote control via remote or smartphone through the LOTUS LANTERN app (available on Android and iOS),
- features include setting lighting duration, dimming, adjusting color or color temperature, and various light flashing modes,
- the app enables synchronization of light with music rhythm,
- control multiple devices simultaneously through the app,
- beam angle: 120 degrees.

MODEL	INDEKS	POBÓR MOCY [W]	BARWA ŚWIATŁA	WAGA NETTO [kg]	PAKOWANIE [szt.]	KOD EAN
MODEL	INDEX	POWER [W]	LIGHT COLOR	NET WEIGHT [kg]	PACKING [pcs]	BARCODE
LED PLAY SET 5m	KDSN00000015	12,5	RGB	0,19	20	5902201376746
LED PLAY SET 10m	KDSN00000016	14	RGB	0,22	20	5902201376753
LED PLAY SET 15m	KDSN00000017	25,2	RGB	0,28	20	5902201376760
LED PLAY SET 20m	KDSN00000018	26	RGB	0,31	20	5902201376777



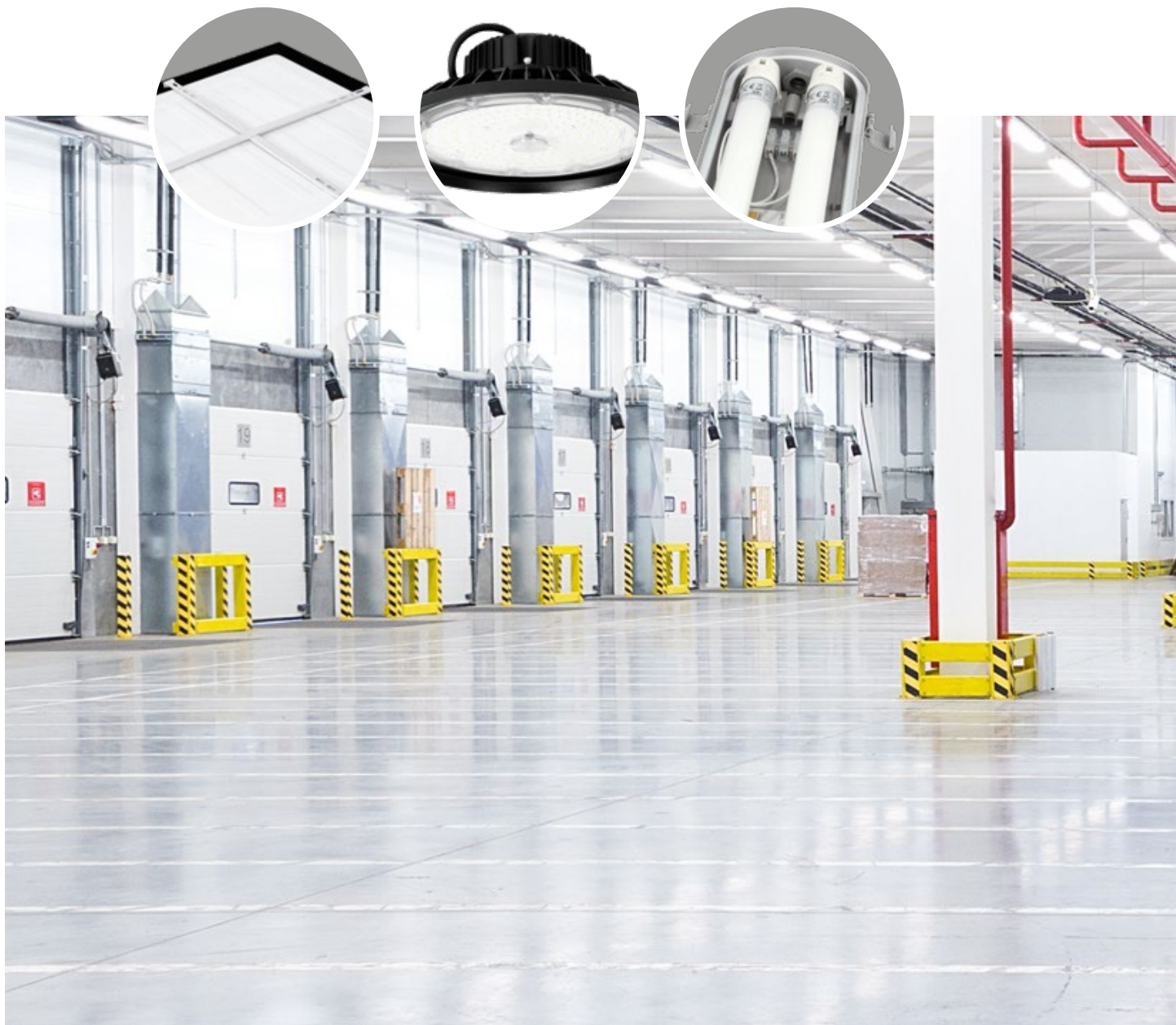



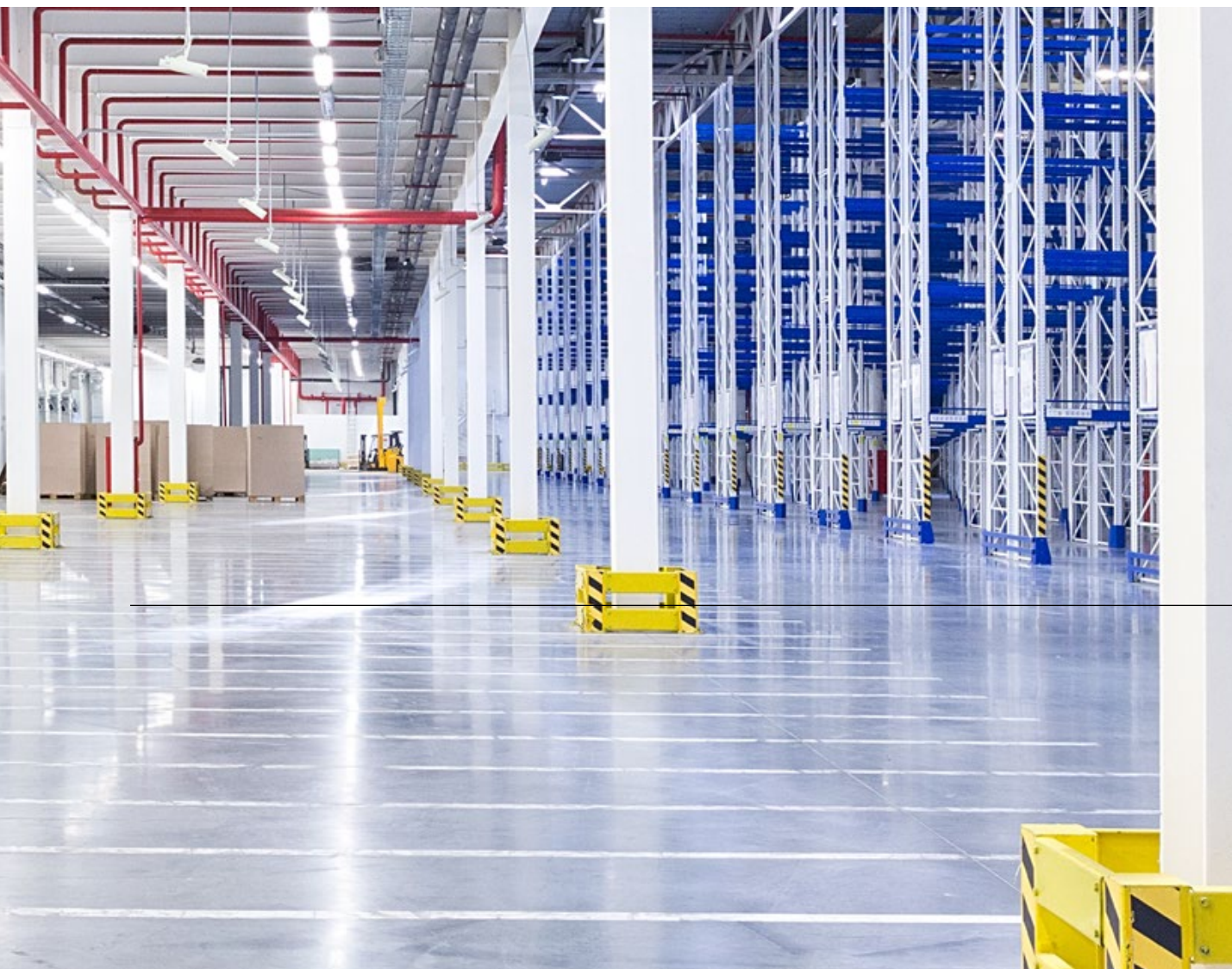

## OPRAWY INWESTYCYJNE INDUSTRIAL LIGHTING

Profesjonalne rozwiązania oświetleniowe, przeznaczone do zastosowań przemysłowych oraz innych przestrzeni, gdzie niezawodność i trwałość są kluczowe. Nasza oferta, skierowana w szczególności do projektów inwestycyjnych i komercyjnych, obejmuje również panele i plafony LED, a także oprawy liniowe, zaprojektowane z myślą o wnętrzach biurowych i sklepowych. Szeroki asortyment uwzględnia zróżnicowane potrzeby wnętrz wymagających komfortowego i funkcjonalnego oświetlenia.

Professional lighting solutions designed for industrial environments, warehouses, production halls, and other spaces where reliability and durability are paramount. Our range, tailored for investment and commercial projects, includes LED panels, ceiling lights, and linear fixtures specifically designed for office and retail interiors. This comprehensive assortment meets the diverse needs of spaces requiring both comfortable and functional lighting.

PROFESSIONAL LINE OPRAWY LED / LED FIXTURES

# LED ANICA 100W

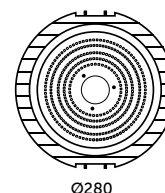
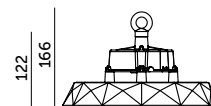
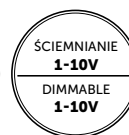

- ledowa oprawa przemysłowa o wydajności 180 lm/W,  
- obudowa wykonana z aluminium, przestona z poliwęglanu PC,  
- oprawa zawiera źródła światła o klasie energetycznej B,  
- możliwość wymiany źródła światła LED jedynie przez wykwalifikowany personel.

- LED industrial fixture with an efficacy of 180 lm/W,  
- housing made of aluminum, cover made of polycarbonate (PC),  
- fixture contains light sources with energy efficiency class B,  
- LED light source can only be replaced by qualified personnel.

MODEL	INDEKS	POBÓR MOCY [W]	KĄT ROZSYŁU ŚWIATŁA [°]	BARWA ŚWIATŁA	STRUMIEŃ ŚWIETLNY [lm]	WAGA NETTO [kg]	PAKOWANIE [szt.]	KOD EAN
MODEL	INDEX	POWER [W]	BEAM ANGLE [°]	LIGHT COLOR	LUMINOUS FLUX [lm]	NET WEIGHT [kg]	PACKING [pcs]	BARCODE
LED ANICA 100W 90°	KFAA10904	100	90	NEUTRALNA BIAŁA NEUTRAL WHITE	18000	2,50	1	5902201375954
LED ANICA 100W 120°	KFAA10124	100	120	NEUTRALNA BIAŁA NEUTRAL WHITE	18000	2,50	1	5902201375961



PROFESSIONAL LINE OPRAWY LED / LED FIXTURES

# LED ANICA 150W

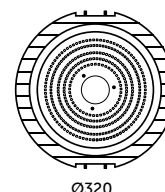
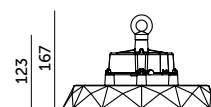
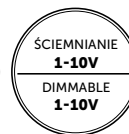

- ledowa oprawa przemysłowa o wydajności 180 lm/W,  
- obudowa wykonana z aluminium, przestona z poliwęglanu PC,  
- oprawa zawiera źródła światła o klasie energetycznej B,  
- możliwość wymiany źródła światła LED jedynie przez wykwalifikowany personel.

- LED industrial fixture with an efficacy of 180 lm/W,  
- housing made of aluminum, cover made of polycarbonate (PC),  
- fixture contains light sources with energy efficiency class B,  
- LED light source can only be replaced by qualified personnel.

MODEL	INDEKS	POBÓR MOCY [W]	KĄT ROZSYŁU ŚWIATŁA [°]	BARWA ŚWIATŁA	STRUMIEŃ ŚWIETLNY [lm]	WAGA NETTO [kg]	PAKOWANIE [szt.]	KOD EAN
MODEL	INDEX	POWER [W]	BEAM ANGLE [°]	LIGHT COLOR	LUMINOUS FLUX [lm]	NET WEIGHT [kg]	PACKING [pcs]	BARCODE
LED ANICA 150W 90°	KFAA15904	150	90	NEUTRALNA BIAŁA NEUTRAL WHITE	27000	2,90	1	5902201386240
LED ANICA 150W 120°	KFAA15124	150	120	NEUTRALNA BIAŁA NEUTRAL WHITE	27000	2,90	1	5902201386257



PROFESSIONAL LINE OPRAWY LED / LED FIXTURES

# LED ANICA 200W

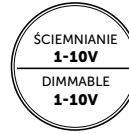

- ledowa oprawa przemysłowa o wydajności 180 lm/W,  
- obudowa wykonana z aluminium, przestona z poliwęglanu PC,  
- oprawa zawiera źródła światła o klasie energetycznej B,  
- możliwość wymiany źródła światła LED jedynie przez wykwalifikowany personel.

- LED industrial fixture with an efficacy of 180 lm/W,  
- housing made of aluminum, cover made of polycarbonate (PC),  
- fixture contains light sources with energy efficiency class B,  
- LED light source can only be replaced by qualified personnel.

MODEL	INDEKS	POBÓR MOCY [W]	KĄT ROZSYŁU ŚWIATŁA [°]	BARWA ŚWIATŁA	STRUMIEŃ ŚWIETLNY [lm]	WAGA NETTO [kg]	PAKOWANIE [szt.]	KOD EAN
MODEL	INDEX	POWER [W]	BEAM ANGLE [°]	LIGHT COLOR	LUMINOUS FLUX [lm]	NET WEIGHT [kg]	PACKING [pcs]	BARCODE
LED ANICA 200W 90°	KFAA20904	200	90	NEUTRALNA BIAŁA NEUTRAL WHITE	36000	3,60	1	5902201386264
LED ANICA 200W 120°	KFAA20124	200	120	NEUTRALNA BIAŁA NEUTRAL WHITE	36000	3,60	1	5902201386271



PROFESSIONAL LINE AKCESORIA DO LED ANICA / ACCESSORIES FOR LED ANICA

## UCHWYT DO LED ANICA

/ HANDLE FOR A LED ANICA



- przeznaczony do montażu sufitowego opraw LED ANICA 100W/150W/200W.

- designed for ceiling mounting of the LED ANICA 100W/150W/200W fixture.

MODEL	INDEKS	KOLOR	WAGA NETTO [kg]	PAKOWANIE [szt.]	KOD EAN
MODEL	INDEX	COLOR	NET WEIGHT [kg]	PACKING [pcs]	BARCODE
UCHWYT DO LED ANICA	KFAAU100	CZARNY BLACK	0,46	20	5902201376005

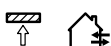



PREMIUM

CZUJNIKI RUCHU/MOTION DETECTORS

# CZUJNIK RUCHU ZHAGA HD06VCRH7C

**/ ZHAGA MOTION SENSOR HD06VCRH7C**

- detektor ruchu PIR, programowalny wyłącznie za pomocą pilota HD05R (brak w zestawie),
- możliwość programowania wielu czujników z jednego pilota,
- kompatybilny z gniazdem Zhaga Book 18 – dedykowany do opraw LED ANICA,
- max wysokość montażu: 12 m,
- kąt/zasięg detekcji: 120 stopni / max. 4 m,
- czułość detekcji: 100 %, 75 %, 50 %, 25 %,
- czas utrzymania pracy czujnika: 5 s, 30 s, 1 min, 3 min, 5 min, 10 min, 20 min, 30 min,
- moc w trybie czuwania –10 %, 20 %, 30 %, 50 %,
- długość trwania trybu czuwania-0 s, 10 s, 30 s, 1 min, 5 min, 10 min, 30 min, 60 min, nieograniczony.

- PIR motion sensor, programmable only with the HD05R remote control (not included),
- program multiple sensors with a single remote,
- compatible with Zhaga socket – dedicated to LED ANICA fixtures,
- max. mounting height: 12 m,
- detection angle/range: 120 degrees/max. 4 m,
- detection sensitivity: 100 %, 75 %, 50 %, 25 %,
- sensor hold time: 5 s, 30 s, 1 min, 3 min, 5 min, 10 min, 20 min, 30 min,
- standby power mode: 10 %, 20 %, 30 %, 50 %,
- standby duration: 0 s, 10 s, 30 s, 1 min, 5 min, 10 min, 30 min, 60 min, unlimited.

MODEL	INDEKS	KOLOR	WYMIARY [mm]	WAGA NETTO [kg]	PAKOWANIE [szt.]	KOD EAN
MODEL	INDEX	COLOR	SIZE [mm]	NET WEIGHT [kg]	PACKING [pcs]	BARCODE
CZUJNIK RUCHU ZHAGA HD06VCRH7C	KVLXZH	BIAŁY WHITE	Ø 47,9 x 43,1	0,03	1	5902201375985



PREMIUM

CZUJNIKI RUCHU/MOTION DETECTORS

# PILOT DO CZUJNIKA RUCHU ZHAGA HD05R

**/ REMOTE CONTROL FOR ZHAGA MOTION SENSOR HD05R**

- pilot dedykowany do czujnika ruchu ZHAGA HD06VCRH7C,
- pozwala na dostosowanie parametrów pracy czujnika, m.in. czułość detekcji, czas pracy po wykryciu ruchu, moc w trybie czuwania,
- umożliwia manualną regulację mocy świecenia w zakresie 10 % - 100 %,
- maksymalny zasięg pilota: 18 m,
- zasilany za pomocą baterii 2xAAA (2xLR03) (nieodłączony),
- w zestawie uchwyt do pilota.

- remote control dedicated to the ZHAGA HD06VCRH7C motion sensor,
- allows adjustment of detection sensitivity, duration of operation after motion detection, and standby power,
- allows adjustment of brightness from 10% to 100%,
- remote control range: max. 18 m,
- powered by 2xAAA batteries (2xLR03) (batteries not included),
- remote control holder included.

MODEL	INDEKS	KOLOR	WYMIARY [mm]	WAGA NETTO [kg]	PAKOWANIE [szt.]	KOD EAN
MODEL	INDEX	COLOR	SIZE [mm]	NET WEIGHT [kg]	PACKING [pcs]	BARCODE
PILOT CZUJNIKA RUCHU ZHAGA HD05R	KVLXRC	BIAŁY WHITE	140x58x22	0,08	1	5902201382907



PROFESSIONAL LINE OPRAWY LED / LED FIXTURES

# LED NICO 120W 60x90°

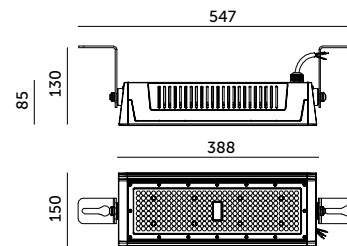
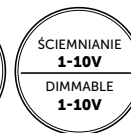

- ledowa oprawa przemysłowa o wydajności 170 lm/W,
- obudowa wykonana z aluminium, przestona z poliwęglanu PC,
- asymetryczny kąt rozsyłu światła: 60x90 stopni,
- oprawa zawiera źródła światła o klasie energetycznej C,
- możliwość wymiany źródła światła LED jedynie przez wykwalifikowany personel.

- industrial LED fixture with an efficacy of 170 lm/W,
- housing made of aluminium, diffuser made of polycarbonate (PC),
- asymmetric light distribution angle: 60x90 degrees,
- fixture contains light sources with energy efficiency class C,
- LED light source can only be replaced by qualified personnel.

MODEL	INDEKS	POBÓR MOCY [W]	KĄT ROZSYŁU ŚWIATŁA [°]	BARWA ŚWIATŁA	STRUMIEŃ ŚWIETLNY [lm]	WAGA NETTO [kg]	PAKOWANIE [szt.]	KOD EAN
MODEL	INDEX	POWER [W]	BEAM ANGLE [°]	LIGHT COLOR	LUMINOUS FLUX [lm]	NET WEIGHT [kg]	PACKING [pcs]	BARCODE
LED NICO 120W	KFNO12694	120	60x90	NEUTRALNA BIAŁA NEUTRAL WHITE	20400	3,00	1	5902201375978



PROFESSIONAL LINE OPRAWY LED / LED FIXTURES

# LED RIO PRO 2CCT 200W



- ledowa oprawa przemysłowa o wydajności 140 lm/W,
- obudowa wykonana z aluminium, przestona ze wzmocnionego poliwęglanu PC,
- możliwość montażu ściennego za pomocą uchwytu (nie dołączony do zestawu),
- możliwość przetężenia mocy na 150W i 100W,
- kąt rozsyłu światła: 120 stopni,
- oprawa zawiera źródła światła w klasie energetycznej D,
- możliwość wymiany źródła światła LED jedynie przez wykwalifikowany personel.

- led industrial fixture of the efficiency 140lm/W,
- aluminium housing, cover made of strengthened PC,
- can be installed on a wall (on a handle, not included in a set),
- adjustable power: 100W, 150W and 200W,
- beam angle: 120 degrees,
- fixture includes built-in light sources of D energy efficiency class,
- light sources can be replaced only by qualified personnel.

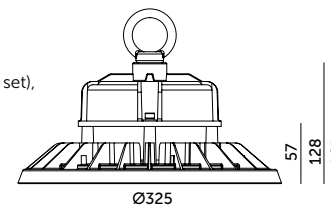

MODEL	INDEKS	POBÓR MOCY [W]	TEMPERATURA BARWOWA [K]	STRUMIEŃ ŚWIETLNY [lm]	WAGA NETTO [kg]	PAKOWANIE [szt.]	KOD EAN
MODEL	INDEX	POWER [W]	COLOR TEMPERATURE [K]	LUMINOUS FLUX [lm]	NET WEIGHT [kg]	PACKING [pcs.]	BARCODE
LED RIO PRO 2CCT 200W	KFRP200CCT	200	4000/5000	28000	2,63	1	5902201389050



PROFESSIONAL LINE OPRAWY LED / LED FIXTURES

# LED RIO PRO 100W / 120°

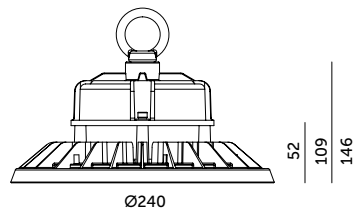

- ledowa oprawa przemysłowa o wydajności 140 lm/W,
- obudowa wykonana z aluminium, przestona ze wzmocnionego poliwęglanu PC,
- możliwość montażu ściennego za pomocą uchwyty (nieodłączony do zestawu),
- kąt rozsytu światła: 120 stopni,
- nie można wymieniać lamp w oprawie.

- LED industrial fixture with an efficacy of 140 lm/W,
- housing made of aluminum, cover made of reinforced polycarbonate (PC),
- wall mounting possible using a bracket (not included),
- beam angle: 120 degrees,
- lamps in the fixture cannot be replaced.

MODEL	INDEKS	POBÓR MOCY [W]	BARWA ŚWIATŁA	CAŁKOWITY STRUMIEN ŚWIETLNY [lm]	UŻYTKOWY STRUMIEN ŚWIETLNY (120°) [lm]	WAGA NETTO [kg]	PAKOWANIE [szt.]	KOD EAN
MODEL	INDEX	POWER [W]	LIGHT COLOR	TOTAL LUMINOUS FLUX [lm]	USEFUL LUMINOUS FLUX (120°) [lm]	NET WEIGHT [kg]	PACKING [pcs]	BARCODE
LED RIO PRO 100W	KFRP100NB	100	NEUTRALNA BIAŁA NEUTRAL WHITE	14000	11500	1,40	1	5902201369700

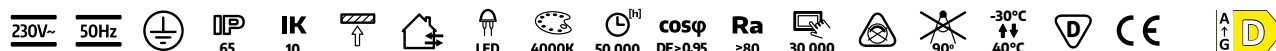

PROFESSIONAL LINE OPRAWY LED / LED FIXTURES

# LED RIO PRO 150W / 120°

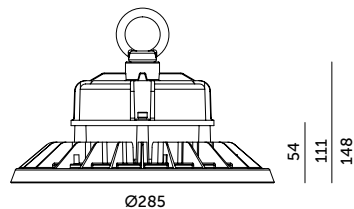

- ledowa oprawa przemysłowa o wydajności 140 lm/W,
- obudowa wykonana z aluminium, przestona ze wzmocnionego poliwęglanu PC,
- możliwość montażu ściennego za pomocą uchwyty (nieodłączony do zestawu),
- kąt rozsytu światła: 120 stopni,
- nie można wymieniać lamp w oprawie.

- LED industrial fixture with an efficacy of 140 lm/W,
- housing made of aluminum, cover made of reinforced polycarbonate (PC),
- wall mounting possible using a bracket (not included),
- beam angle: 120 degrees,
- lamps in the fixture cannot be replaced.

MODEL	INDEKS	POBÓR MOCY [W]	BARWA ŚWIATŁA	CAŁKOWITY STRUMIEN ŚWIETLNY [lm]	UŻYTKOWY STRUMIEN ŚWIETLNY (120°) [lm]	WAGA NETTO [kg]	PAKOWANIE [szt.]	KOD EAN
MODEL	INDEX	POWER [W]	LIGHT COLOR	TOTAL LUMINOUS FLUX [lm]	USEFUL LUMINOUS FLUX (120°) [lm]	NET WEIGHT [kg]	PACKING [pcs]	BARCODE
LED RIO PRO 150W	KFRP150NB	150	NEUTRALNA BIAŁA NEUTRAL WHITE	21000	17400	1,86	1	5902201369717

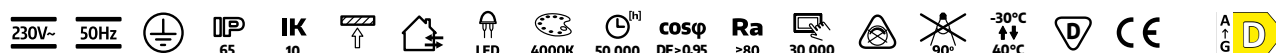

PROFESSIONAL LINE OPRAWY LED / LED FIXTURES

# LED RIO PRO 200W / 120°



- ledowa oprawa przemysłowa o wydajności 140 lm/W,
- obudowa wykonana z aluminium, przestona ze wzmocnionego poliwęglanu PC,
- możliwość montażu ściennego za pomocą uchwyty (niedotychczasony do zestawu),
- kąt rozsytu światła: 120 stopni,
- nie można wymieniać lamp w oprawie.

- LED industrial fixture with an efficacy of 140 lm/W,
- housing made of aluminum, cover made of reinforced polycarbonate (PC),
- wall mounting possible using a bracket (not included),
- beam angle: 120 degrees,
- lamps in the fixture cannot be replaced.

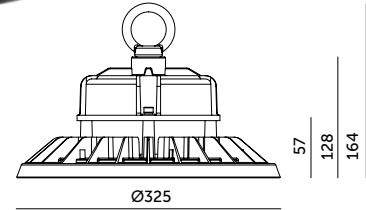

MODEL	INDEKS	POBÓR MOCY [W]	BARWA ŚWIATŁA	CAŁKOWITY STRUMIEN ŚWIETLNY [lm]	UŻYTKOWY STRUMIEN ŚWIETLNY (120°) [lm]	WAGA NETTO [kg]	PAKOWANIE [szt.]	KOD EAN
MODEL	INDEX	POWER [W]	LIGHT COLOR	TOTAL LUMINOUS FLUX [lm]	USEFUL LUMINOUS FLUX (120°) [lm]	NET WEIGHT [kg]	PACKING [pcs]	BARCODE
LED RIO PRO 200W	KFRP200NB	200	NEUTRALNA BIAŁA NEUTRAL WHITE	28000	23000	2,63	1	5902201369724

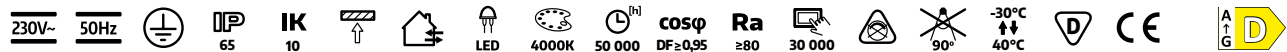

PROFESSIONAL LINE AKCESORIA DO LED RIO PRO / ACCESSORIES FOR LED RIO PRO

## UCHWYT DO LED RIO PRO

/ HANDLE FOR A LED RIO PRO

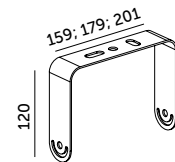

- przeznaczony do montażu sufitowego oprawy LED RIO PRO.

- intended for ceiling installation of LED RIO PRO fixtures.

MODEL	INDEKS	KOLOR	WAGA NETTO [kg]	PAKOWANIE [szt.]	KOD EAN
MODEL	INDEX	COLOR	NET WEIGHT [kg]	PACKING [pcs]	BARCODE
UCHWYT DO LED RIO PRO 100W	KFRPU100	CZARNY BLACK	0,22	54	5902201369731
UCHWYT DO LED RIO PRO 150W	KFRPU150	CZARNY BLACK	0,24	54	5902201369748
UCHWYT DO LED RIO PRO 200W	KFRPU200	CZARNY BLACK	0,25	36	5902201369755

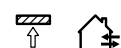

PROFESSIONAL LINE OPRAWY LED / LED FIXTURES

# LED NEXFORCE N2 20W

**5 LAT**  
GWARANCJI  
**5 YEARS**  
WARRANTY

OPRZEWDOWANIE  
**PRZELOTOWE**  
PASS-THROUGH  
WIRING

DO | UP TO  
**175**  
lm/W



zewewnętrzny przyłącz  
external connection

- oprawa hermetyczna z wbudowanymi diodami LED,
- obudowa i klosz mleczny wykonane z poliwęglanu,
- kąt rozsyłu światła: 120 stopni,
- można łączyć oprawy: max. 40 szt.,
- oprawa zawiera źródła światła o klasie energetycznej B,
- możliwość wymiany źródła światła LED jedynie przez wykwalifikowany personel.

- hermetic fixture with built-in LEDs,
- housing and milk-white lens made of polycarbonate,
- light distribution angle: 120 degrees,
- fixtures can be connected together: max. 40 pcs,
- fixture contains light sources with energy efficiency class B,
- LED light source can only be replaced by qualified personnel.

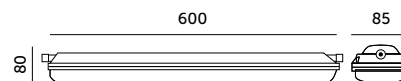

MODEL	INDEX	POBÓR MOCY [W]	BARWA ŚWIATŁA	STRUMIEŃ ŚWIETLNY [lm]	WAGA NETTO [kg]	PAKOWANIE [szt.]	KOD EAN
MODEL	INDEX	POWER [W]	LIGHT COLOR	LUMINOUS FLUX [lm]	NET WEIGHT [kg]	PACKING [pcs]	BARCODE
LED NEXFORCE N2 20W NB	KFNE220NB	20	NEUTRALNA BIAŁA NEUTRAL WHITE	3500	0,90	9	5902201387520

230V~
50Hz
IP66
IK08
LED
4000K
50 000
cosφ DF≥0,95
Ra ≥80
25 000
90°
-20°C / 40°C
D
CE

PROFESSIONAL LINE OPRAWY LED / LED FIXTURES

# LED NEXFORCE N2 36W

**5 LAT**  
GWARANCJI  
**5 YEARS**  
WARRANTY

OPRZEWDOWANIE  
**PRZELOTOWE**  
PASS-THROUGH  
WIRING

DO | UP TO  
**175**  
lm/W



zewewnętrzny przyłącz  
external connection

- oprawa hermetyczna z wbudowanymi diodami LED,
- obudowa i klosz mleczny wykonane z poliwęglanu,
- kąt rozsyłu światła: 120 stopni,
- można łączyć oprawy: max. 22 szt.,
- oprawa zawiera źródła światła o klasie energetycznej B,
- możliwość wymiany źródła światła LED jedynie przez wykwalifikowany personel.

- hermetic fixture with built-in LEDs,
- housing and milk-white lens made of polycarbonate,
- light distribution angle: 120 degrees,
- fixtures can be connected together: max. 22 pcs,
- fixture contains light sources with energy efficiency class B,
- LED light source can only be replaced by qualified personnel.

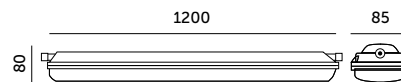

MODEL	INDEX	POBÓR MOCY [W]	BARWA ŚWIATŁA	STRUMIEŃ ŚWIETLNY [lm]	WAGA NETTO [kg]	PAKOWANIE [szt.]	KOD EAN
MODEL	INDEX	POWER [W]	LIGHT COLOR	LUMINOUS FLUX [lm]	NET WEIGHT [kg]	PACKING [pcs]	BARCODE
LED NEXFORCE N2 36W NB	KFNE236NB	36	NEUTRALNA BIAŁA NEUTRAL WHITE	6300	1,29	9	5902201386288

230V~
50Hz
IP66
IK08
LED
4000K
50 000
cosφ DF≥0,95
Ra ≥80
25 000
90°
-20°C / 40°C
D
CE



PROFESSIONAL LINE OPRAWY LED / LED FIXTURES

# LED NEXFORCE N2 52W



zewewnętrzny przyłącz  
external connection

- oprawa hermetyczna z wbudowanymi diodami LED,
- obudowa i klosz mleczny wykonane z poliwęglanu,
- kąt rozsyłu światła: 120 stopni,
- można łączyć oprawy: max. 17 szt.,
- oprawa zawiera źródła światła o klasie energetycznej B,
- możliwość wymiany źródła światła LED jedynie przez wykwalifikowany personel.

- hermetic fixture with built-in LEDs,
- housing and milk-white lens made of polycarbonate,
- light distribution angle: 120 degrees,
- fixtures can be connected together: max. 17 pcs,
- fixture contains light sources with energy efficiency class B,
- LED light source can only be replaced by qualified personnel.

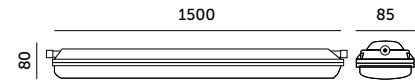

MODEL	INDEX	POBÓR MOCY [W]	BARWA ŚWIATŁA	STRUMIEN ŚWIETLNY [lm]	WAGA NETTO [kg]	PAKOWANIE [szt.]	KOD EAN
MODEL	INDEX	POWER [W]	LIGHT COLOR	LUMINOUS FLUX [lm]	NET WEIGHT [kg]	PACKING [pcs]	BARCODE
LED NEXFORCE N2 52W NB	KFNE252NB	52	NEUTRALNA BIAŁA NEUTRAL WHITE	9000	1,63	9	5902201386295

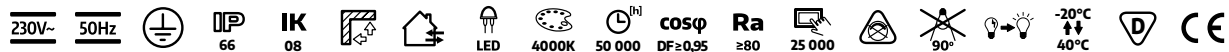

PROFESSIONAL LINE OPRAWY LED / LED FIXTURES

# LED NEXFORCE N2 70W



zewewnętrzny przyłącz  
external connection

- oprawa hermetyczna z wbudowanymi diodami LED,
- obudowa i klosz mleczny wykonane z poliwęglanu,
- kąt rozsyłu światła: 120 stopni,
- można łączyć oprawy: max. 11 szt.,
- oprawa zawiera źródła światła o klasie energetycznej B,
- możliwość wymiany źródła światła LED jedynie przez wykwalifikowany personel.

- hermetic fixture with built-in LEDs,
- housing and milk-white lens made of polycarbonate,
- light distribution angle: 120 degrees,
- fixtures can be connected together: max. 11 pcs,
- fixture contains light sources with energy efficiency class B,
- LED light source can only be replaced by qualified personnel.

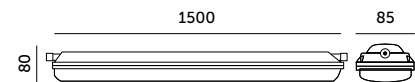

MODEL	INDEX	POBÓR MOCY [W]	BARWA ŚWIATŁA	STRUMIEN ŚWIETLNY [lm]	WAGA NETTO [kg]	PAKOWANIE [szt.]	KOD EAN
MODEL	INDEX	POWER [W]	LIGHT COLOR	LUMINOUS FLUX [lm]	NET WEIGHT [kg]	PACKING [pcs]	BARCODE
LED NEXFORCE N2 70W NB	KFNE270NB	70	NEUTRALNA BIAŁA NEUTRAL WHITE	12000	1,63	9	5902201386301

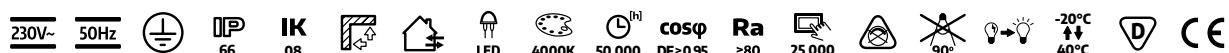

PROFESSIONAL LINE OPRAWY LED / LED FIXTURES

# HPL 1 PRO 30W

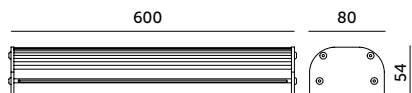

- oprawa z wbudowanymi diodami LED,
- obudowa wykonana z aluminium, przestona z poliwęglanu PC,
- typy montażu: zwieszany / sufitowy z regulacją kąta / ścienny z regulacją kąta,
- oprawa zawiera źródła światła w klasie energetycznej C,
- możliwość wymiany źródła światła LED jedynie przez wykwalifikowany personel.

- fixture with built-in LEDs,
- housing made of aluminum, diffuser made of polycarbonate (PC),
- mounting types: suspended / top with angle adjustment / side with angle adjustment,
- fixture contains light sources with energy efficiency class C,
- LED light source can only be replaced by qualified personnel.

MODEL	INDEKS	POBÓR MOCY [W]	KĄT ROZSYŁU ŚWIATŁA [°]	PRZESŁONA	TEMPERATURA BARWOWA (K)	STRUMIEŃ ŚWIETLNY [lm]	WAGA NETTO [kg]	PAKOWANIE [szt.]	KOD EAN
MODEL	INDEX	POWER [W]	BEAM ANGLE [°]	COVER	COLOR TEMPERATURE [K]	LUMINOUS FLUX [lm]	NET WEIGHT [kg]	PACKING [pcs]	BARCODE
HPL 1 PRO 30W 90°	02NSHL1309P	30	90	PRYZMATYCZNA PRISMATIC	4000	4041	1,83	1	5902846011774
HPL 1 PRO 30W 90°	02NSHL1309S	30	90	PRYZMATYCZNA PRISMATIC	5000	4041	1,83	1	5902846012092
HPL 1 PRO 30W 120°	02NSHL1301P	30	120	TRANSPARENTNA TRANSPARENT	4000	4650	1,83	1	5900605098837
HPL 1 PRO 30W 120°	02NSHL1301S	30	120	TRANSPARENTNA TRANSPARENT	5000	4650	1,83	1	5902846012337



PROFESSIONAL LINE OPRAWY LED / LED FIXTURES

# HPL 1 PRO 45W

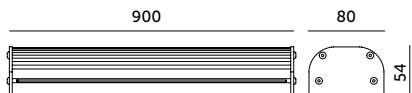

- oprawa z wbudowanymi diodami LED,
- obudowa wykonana z aluminium, przestona z poliwęglanu PC,
- typy montażu: zwieszany / sufitowy z regulacją kąta / ścienny z regulacją kąta,
- oprawa zawiera źródła światła w klasie energetycznej C,
- możliwość wymiany źródła światła LED jedynie przez wykwalifikowany personel.

- fixture with built-in LEDs,
- housing made of aluminum, diffuser made of polycarbonate (PC),
- mounting types: suspended / top with angle adjustment / side with angle adjustment,
- fixture contains light sources with energy efficiency class C,
- LED light source can only be replaced by qualified personnel.

MODEL	INDEKS	POBÓR MOCY [W]	KĄT ROZSYŁU ŚWIATŁA [°]	PRZESŁONA	TEMPERATURA BARWOWA (K)	STRUMIEŃ ŚWIETLNY [lm]	WAGA NETTO [kg]	PAKOWANIE [szt.]	KOD EAN
MODEL	INDEX	POWER [W]	BEAM ANGLE [°]	COVER	COLOR TEMPERATURE [K]	LUMINOUS FLUX [lm]	NET WEIGHT [kg]	PACKING [pcs]	BARCODE
HPL 1 PRO 45W 90°	02NSHL1459P	45	90	PRYZMATYCZNA PRISMATIC	4000	6062	2,74	1	5900605098493
HPL 1 PRO 45W 90°	02NSHL1459S	45	90	PRYZMATYCZNA PRISMATIC	5000	6062	2,74	1	5906340211371
HPL 1 PRO 45W 120°	02NSHL1451P	45	120	TRANSPARENTNA TRANSPARENT	4000	6975	2,74	1	5900605098486
HPL 1 PRO 45W 120°	02NSHL1451S	45	120	TRANSPARENTNA TRANSPARENT	5000	6975	2,74	1	5902846012344



PROFESSIONAL LINE OPRAWY LED / LED FIXTURES

# HPL 1 PRO 60W



- oprawa z wbudowanymi diodami LED,
- obudowa wykonana z aluminium, przestona z poliwęglanu PC,
- typy montażu: zwieszany / sufitowy z regulacją kąta / ścienny z regulacją kąta,
- oprawa zawiera źródła światła w klasie energetycznej C,
- możliwość wymiany źródła światła LED jedynie przez wykwalifikowany personel.

- fixture with built-in LEDs,
- housing made of aluminum, diffuser made of polycarbonate (PC),
- mounting types: suspended / top with angle adjustment / side with angle adjustment,
- fixture contains light sources with energy efficiency class C,
- LED light source can only be replaced by qualified personnel.

MODEL	INDEKS	POBÓR MOCY [W]	KĄT ROZSYŁU ŚWIATŁA [°]	PRZESŁONA	TEMPERATURA BARWOWA (K)	STRUMIEŃ ŚWIETLNY [lm]	WAGA NETTO [kg]	PAKOWANIE [szt.]	KOD EAN
MODEL	INDEX	POWER [W]	BEAM ANGLE [°]	COVER	COLOR TEMPERATURE [K]	LUMINOUS FLUX [lm]	NET WEIGHT [kg]	PACKING [pcs]	BARCODE
HPL 1 PRO 60W 90°	02NSHL1609P	60	90	PRYZMATYCZNA PRISMATIC	4000	8082	3,42	1	5900605098080
HPL 1 PRO 60W 90°	02NSHL16095P	60	90	PRYZMATYCZNA PRISMATIC	5000	8082	3,42	1	5900605097854
HPL 1 PRO 60W 120°	02NSHL2601P	60	120	TRANSPARENTNA TRANSPARENT	4000	9300	3,42	1	5900605098462
HPL 1 PRO 60W 120°	02NSHL16015	60	120	TRANSPARENTNA TRANSPARENT	5000	9300	3,42	1	5902846012108



PROFESSIONAL LINE OPRAWY LED / LED FIXTURES

# HPL 1 PRO 75W



- oprawa z wbudowanymi diodami LED,
- obudowa wykonana z aluminium, przestona z poliwęglanu PC,
- typy montażu: zwieszany / sufitowy z regulacją kąta / ścienny z regulacją kąta,
- oprawa zawiera źródła światła w klasie energetycznej C,
- możliwość wymiany źródła światła LED jedynie przez wykwalifikowany personel.

- fixture with built-in LEDs,
- housing made of aluminum, diffuser made of polycarbonate (PC),
- mounting types: suspended / top with angle adjustment / side with angle adjustment,
- fixture contains light sources with energy efficiency class C,
- LED light source can only be replaced by qualified personnel.

MODEL	INDEKS	POBÓR MOCY [W]	KĄT ROZSYŁU ŚWIATŁA [°]	PRZESŁONA	TEMPERATURA BARWOWA (K)	STRUMIEŃ ŚWIETLNY [lm]	WAGA NETTO [kg]	PAKOWANIE [szt.]	KOD EAN
MODEL	INDEX	POWER [W]	BEAM ANGLE [°]	COVER	COLOR TEMPERATURE [K]	LUMINOUS FLUX [lm]	NET WEIGHT [kg]	PACKING [pcs]	BARCODE
HPL 1 PRO 75W 90°	02NSHL1759P	75	90	PRYZMATYCZNA PRISMATIC	4000	10103	4,19	1	5900605098097
HPL 1 PRO 75W 90°	02NSHL17595P	75	90	PRYZMATYCZNA PRISMATIC	5000	10103	4,19	1	5900605097861
HPL 1 PRO 75W 120°	02NSHL1751P	75	120	TRANSPARENTNA TRANSPARENT	4000	11625	4,19	1	5902846010357
HPL 1 PRO 75W 120°	02NSHL17515P	75	120	TRANSPARENTNA TRANSPARENT	5000	11625	4,19	1	5902846012351



PROFESSIONAL LINE OPRAWY LED / LED FIXTURES

# HPL 2 PRO 60W



- oprawa z wbudowanymi diodami LED,
- obudowa wykonana z aluminium, przestona z poliwęglanu PC,
- typy montażu: zwieszany / sufitowy z regulacją kąta / ścienny z regulacją kąta,
- oprawa zawiera źródła światła w klasie energetycznej C,
- możliwość wymiany źródła światła LED jedynie przez wykwalifikowany personel.

- fixture with built-in LEDs,
- housing made of aluminum, diffuser made of polycarbonate (PC),
- mounting types: suspended / top with angle adjustment / side with angle adjustment,
- fixture contains light sources with energy efficiency class C,
- LED light source can only be replaced by qualified personnel.

MODEL	INDEKS	POBÓR MOCY [W]	KĄT ROZSYŁU ŚWIATŁA [°]	PRZESŁONA	TEMPERATURA BARWOWA (K)	STRUMIEŃ ŚWIETLNY [lm]	WAGA NETTO [kg]	PAKOWANIE [szt.]	KOD EAN
MODEL	INDEX	POWER [W]	BEAM ANGLE [°]	COVER	COLOR TEMPERATURE [K]	LUMINOUS FLUX [lm]	NET WEIGHT [kg]	PACKING [pcs]	BARCODE
HPL 2 PRO 60W 90°	02NSHL2609P	60	90	PRYZMATYCZNA PRISMATIC	4000	8082	3,66	1	5902846012238
HPL 2 PRO 60W 90°	02NSHL26095P	60	90	PRYZMATYCZNA PRISMATIC	5000	8082	3,66	1	5902846012245
HPL 2 PRO 60W 120°	02NSHL2601P	60	120	TRANSPARENTNA TRANSPARENT	4000	9300	3,66	1	5902846011699
HPL 2 PRO 60W 120°	02NSHL26015P	60	120	TRANSPARENTNA TRANSPARENT	5000	9300	3,66	1	5902846012269



PROFESSIONAL LINE OPRAWY LED / LED FIXTURES

# HPL 2 PRO 90W



- oprawa z wbudowanymi diodami LED,
- obudowa wykonana z aluminium, przestona z poliwęglanu PC,
- typy montażu: zwieszany / sufitowy z regulacją kąta / ścienny z regulacją kąta,
- oprawa zawiera źródła światła w klasie energetycznej C,
- możliwość wymiany źródła światła LED jedynie przez wykwalifikowany personel.

- fixture with built-in LEDs,
- housing made of aluminum, diffuser made of polycarbonate (PC),
- mounting types: suspended / top with angle adjustment / side with angle adjustment,
- fixture contains light sources with energy efficiency class C,
- LED light source can only be replaced by qualified personnel.

MODEL	INDEKS	POBÓR MOCY [W]	KĄT ROZSYŁU ŚWIATŁA [°]	PRZESŁONA	TEMPERATURA BARWOWA (K)	STRUMIEŃ ŚWIETLNY [lm]	WAGA NETTO [kg]	PAKOWANIE [szt.]	KOD EAN
MODEL	INDEX	POWER [W]	BEAM ANGLE [°]	COVER	COLOR TEMPERATURE [K]	LUMINOUS FLUX [lm]	NET WEIGHT [kg]	PACKING [pcs]	BARCODE
HPL 2 PRO 90W 90°	02NSHL2909P	90	90	PRYZMATYCZNA PRISMATIC	4000	12123	5,47	1	5902846010388
HPL 2 PRO 90W 90°	02NSHL29095P	90	90	PRYZMATYCZNA PRISMATIC	5000	12123	5,47	1	5902846012276
HPL 2 PRO 90W 120°	02NSHL2901P	90	120	TRANSPARENTNA TRANSPARENT	4000	13950	5,47	1	5900605098479
HPL 2 PRO 90W 120°	02NSHL29015P	90	120	TRANSPARENTNA TRANSPARENT	5000	13950	5,47	1	5902846012283



PROFESSIONAL LINE OPRAWY LED / LED FIXTURES

# HPL 2 PRO 120W

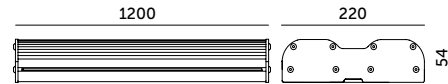

- oprawa z wbudowanymi diodami LED,
- obudowa wykonana z aluminium, przestona z poliwęglanu PC,
- typy montażu: zwieszany / sufitowy z regulacją kąta / ścienny z regulacją kąta,
- oprawa zawiera źródła światła w klasie energetycznej C,
- możliwość wymiany źródła światła LED jedynie przez wykwalifikowany personel.

- fixture with built-in LEDs,
- housing made of aluminum, diffuser made of polycarbonate (PC),
- mounting types: suspended / top with angle adjustment / side with angle adjustment,
- fixture contains light sources with energy efficiency class C,
- LED light source can only be replaced by qualified personnel.

MODEL	INDEKS	POBÓR MOCY [W]	KĄT ROZSYŁU ŚWIATŁA [°]	PRZESŁONA	TEMPERATURA BARWOWA (K)	STRUMIEŃ ŚWIETLNY [lm]	WAGA NETTO [kg]	PAKOWANIE [szt.]	KOD EAN
MODEL	INDEX	POWER [W]	BEAM ANGLE [°]	COVER	COLOR TEMPERATURE [K]	LUMINOUS FLUX [lm]	NET WEIGHT [kg]	PACKING [pcs]	BARCODE
HPL 2 PRO 120W 90°	02NSHL2129P	120	90	PRYZMATYCZNA PRISMATIC	4000	16164	6,85	1	5902846010371
HPL 2 PRO 120W 90°	02NSHL21295P	120	90	PRYZMATYCZNA PRISMATIC	5000	16164	6,85	1	5902846012290
HPL 2 PRO 120W 120°	02NSHL2121P	120	120	TRANSPARENTNA TRANSPARENT	4000	18600	6,85	1	5900605098011
HPL 2 PRO 120W 120°	02NSHL21215P	120	120	TRANSPARENTNA TRANSPARENT	5000	18600	6,85	1	5902846012306



PROFESSIONAL LINE OPRAWY LED / LED FIXTURES

# HPL 2 PRO 150W

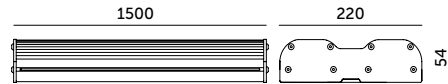

- oprawa z wbudowanymi diodami LED,
- obudowa wykonana z aluminium, przestona z poliwęglanu PC,
- typy montażu: zwieszany / sufitowy z regulacją kąta / ścienny z regulacją kąta,
- oprawa zawiera źródła światła w klasie energetycznej C,
- możliwość wymiany źródła światła LED jedynie przez wykwalifikowany personel.

- fixture with built-in LEDs,
- housing made of aluminum, diffuser made of polycarbonate (PC),
- mounting types: suspended / top with angle adjustment / side with angle adjustment,
- fixture contains light sources with energy efficiency class C,
- LED light source can only be replaced by qualified personnel.

MODEL	INDEKS	POBÓR MOCY [W]	KĄT ROZSYŁU ŚWIATŁA [°]	PRZESŁONA	TEMPERATURA BARWOWA (K)	STRUMIEŃ ŚWIETLNY [lm]	WAGA NETTO [kg]	PAKOWANIE [szt.]	KOD EAN
MODEL	INDEX	POWER [W]	BEAM ANGLE [°]	COVER	COLOR TEMPERATURE [K]	LUMINOUS FLUX [lm]	NET WEIGHT [kg]	PACKING [pcs]	BARCODE
HPL 2 PRO 150W 90°	02NSHL2159P	150	90	PRYZMATYCZNA PRISMATIC	4000	20205	8,37	1	5900605098004
HPL 2 PRO 150W 90°	02NSHL21595P	150	90	PRYZMATYCZNA PRISMATIC	5000	20205	8,37	1	5902846012313
HPL 2 PRO 150W 120°	02NSHL2150P	150	120	TRANSPARENTNA TRANSPARENT	4000	23250	8,37	1	5900605099278
HPL 2 PRO 150W 120°	02NSHL21515P	150	120	TRANSPARENTNA TRANSPARENT	5000	23250	8,37	1	5902846012320





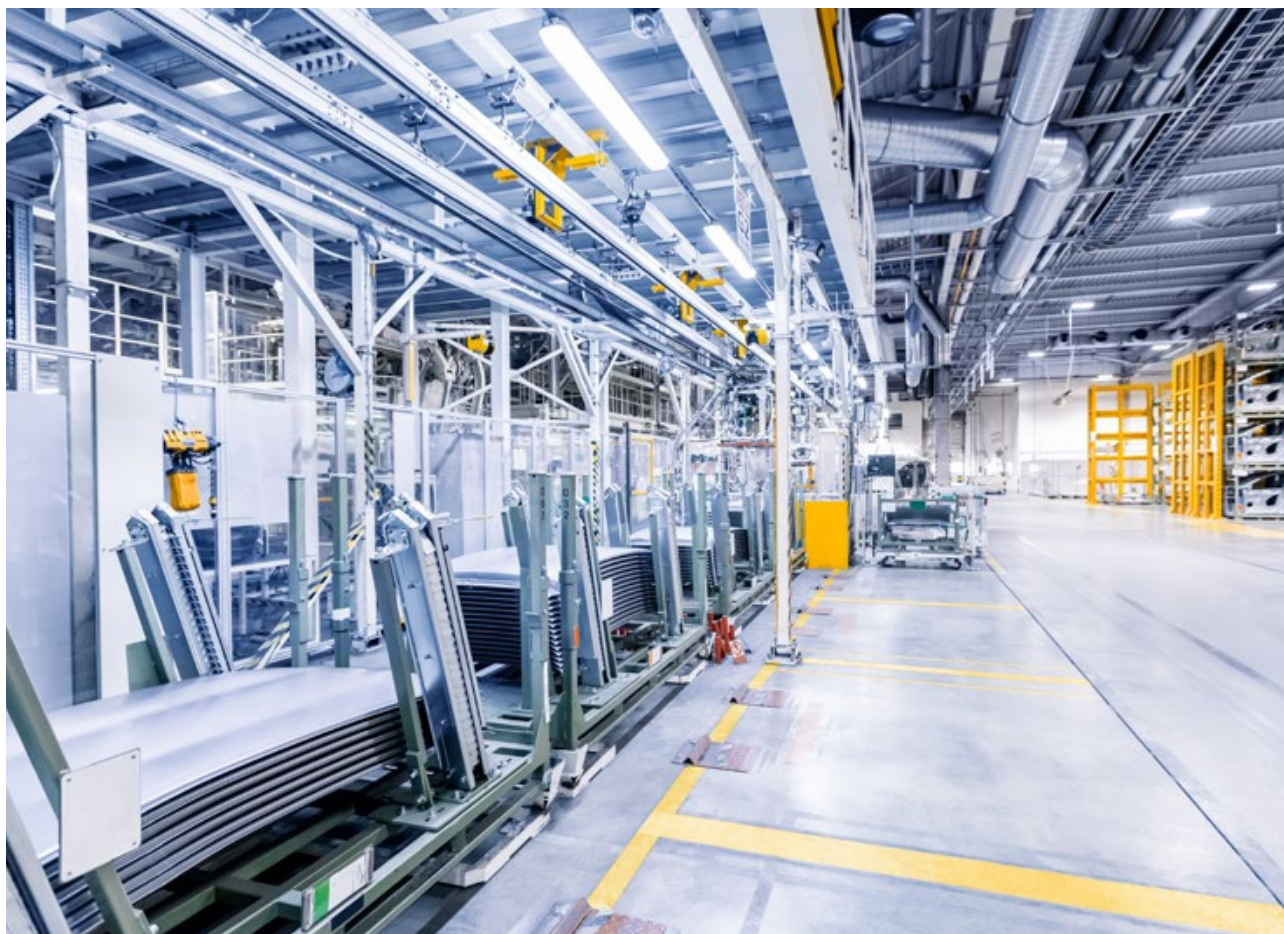

PREMIUM OPRAWY LED / LED FIXTURES

# LED NEGRO 20W



schowany przyłączy hermetyczny  
hidden hermetic connection

- hermetyczna oprawa nasufitowa z wbudowanymi diodami LED,
- podstawa i klosz wykonane z poliwęglanu,
- kąt rozsytu światła: 120 stopni,
- nie można wymieniać lamp w oprawie.

- hermetic ceiling fixture with built-in LEDs,
- base and cover made of PC,
- beam angle: 120 degrees,
- lamps in the fixture cannot be replaced.

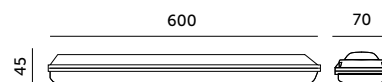

MODEL	INDEX	POBÓR MOCY [W]	BARWA ŚWIATŁA	STRUMIEN ŚWIETLNY [lm]	WAGA NETTO [kg]	PAKOWANIE [szt.]	KOD EAN
MODEL	INDEX	POWER [W]	LIGHT COLOR	LUMINOUS FLUX [lm]	NET WEIGHT [kg]	PACKING [pcs]	BARCODE
LED NEGRO 20W	KFNR20NB	20	NEUTRALNA BIAŁA NEUTRAL WHITE	2400	0,40	16	5902201369847



PREMIUM OPRAWY LED / LED FIXTURES

# LED NEGRO 36W



schowany przyłączy hermetyczny hidden hermetic connection



PRODUKT Z ATESTEM

- hermetyczna oprawa nasufitowa z wbudowanymi diodami LED,
- podstawa i klosz wykonane z poliwęglanu,
- kąt rozsyłu światła: 120 stopni,
- nie można wymieniać lamp w oprawie.

- hermetic ceiling fixture with built-in LEDs,
- base and cover made of PC,
- beam angle: 120 degrees,
- lamps in the fixture cannot be replaced.

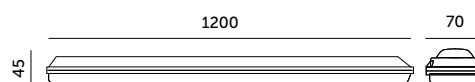

MODEL	INDEX	POBÓR MOCY [W]	BARWA ŚWIATŁA	STRUMIEŃ ŚWIETLNY [lm]	WAGA NETTO [kg]	PAKOWANIE [szt.]	KOD EAN
MODEL	INDEX	POWER [W]	LIGHT COLOR	LUMINOUS FLUX [lm]	NET WEIGHT [kg]	PACKING [pcs]	BARCODE
LED NEGRO 36W NB	KFNR36NB	36	NEUTRALNA BIAŁA NEUTRAL WHITE	4320	1,02	16	5902846016854
LED NEGRO 36W ZB	KFNR36ZB	36	ZIMNOBIAŁA COOL WHITE	4320	1,02	16	5902846016861

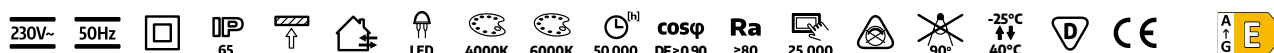

PREMIUM OPRAWY LED / LED FIXTURES

# LED NEGRO 60W



schowany przyłączy hermetyczny hidden hermetic connection

- hermetyczna oprawa nasufitowa z wbudowanymi diodami LED,
- podstawa i klosz wykonane z poliwęglanu,
- kąt rozsyłu światła: 120 stopni,
- nie można wymieniać lamp w oprawie.

- hermetic ceiling fixture with built-in LEDs,
- base and cover made of PC,
- beam angle: 120 degrees,
- lamps in the fixture cannot be replaced.

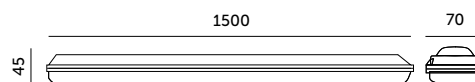

MODEL	INDEX	POBÓR MOCY [W]	BARWA ŚWIATŁA	STRUMIEŃ ŚWIETLNY [lm]	WAGA NETTO [kg]	PAKOWANIE [szt.]	KOD EAN
MODEL	INDEX	POWER [W]	LIGHT COLOR	LUMINOUS FLUX [lm]	NET WEIGHT [kg]	PACKING [pcs]	BARCODE
LED NEGRO 60W	KFNR60NB	60	NEUTRALNA BIAŁA NEUTRAL WHITE	7200	1,25	12	5902201369854





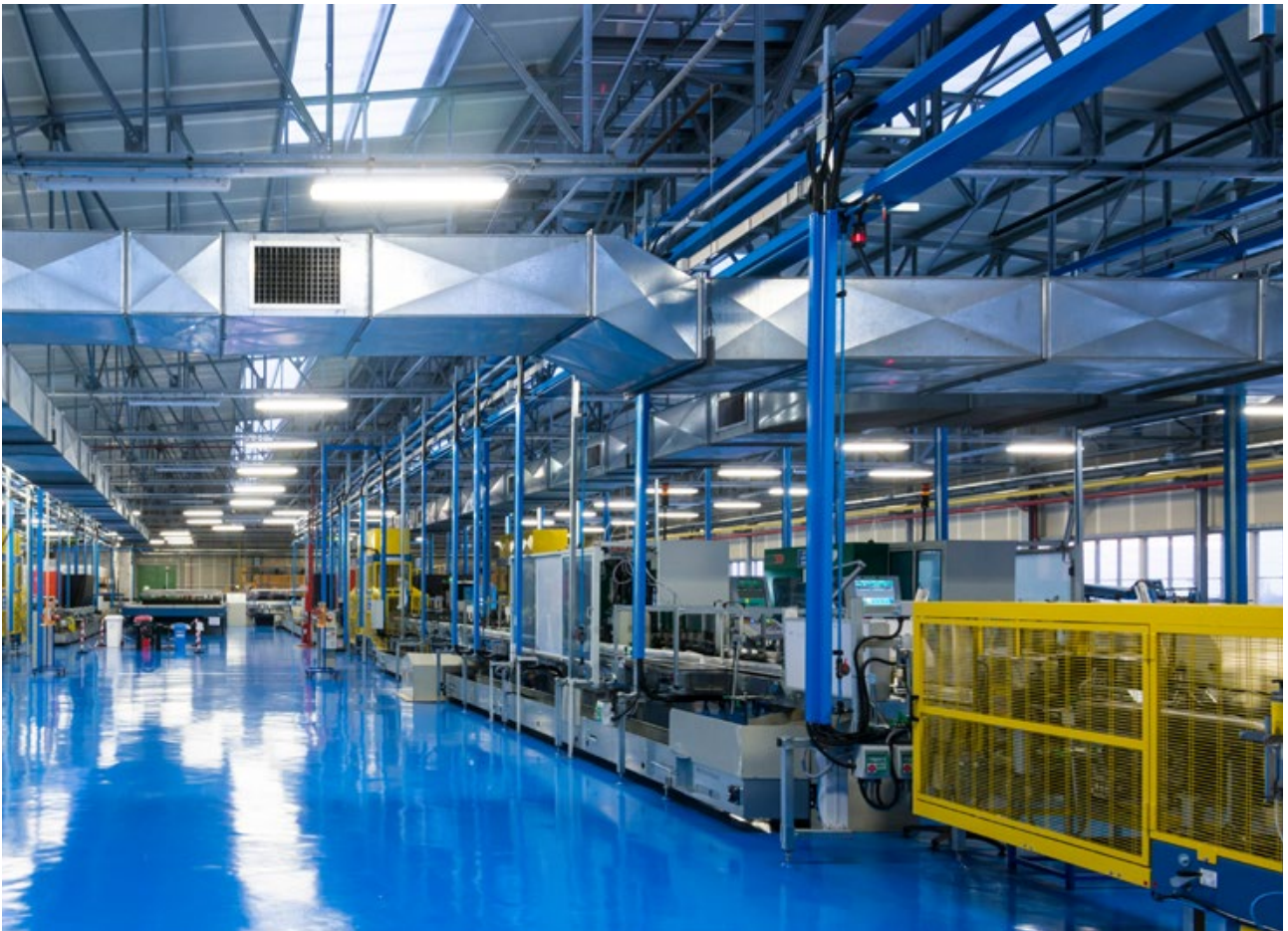

PREMIUM OPRAWY LED / LED FIXTURES

# LED CORTEZ 2 60W



- hermetyczna oprawa nasufitowa z wbudowanymi diodami LED,  
- kąt rozsytu światła: 120 stopni,  
- nie można wymienić lamp w oprawie.

- hermetic ceiling fixture with built-in LEDs,  
- beam angle; 120 degrees,  
- lamps in the fixture cannot be replaced.

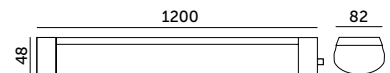

MODEL	INDEX	POBÓR MOCY [W]	BARWA ŚWIATŁA	STRUMIEŃ ŚWIETLNY [lm]	WAGA NETTO [kg]	PAKOWANIE [szt.]	KOD EAN
MODEL	INDEX	POWER [W]	LIGHT COLOR	LUMINOUS FLUX [lm]	NET WEIGHT [kg]	PACKING [pcs]	BARCODE
LED CORTEZ 2 60W NB	KFCZ260WNB	60	NEUTRALNA BIAŁA NEUTRAL WHITE	6000	0,54	10	5902846011804



STANDARD LINE OPRAWY LED / LED FIXTURES

# LED CORTEZ 3 18W



- hermetyczna oprawa nasufitowa z wbudowanymi diodami LED,
- obudowa i klosz mleczny wykonane z poliwęglanu,
- kąt rozsytu światła: 120 stopni,
- nie można wymienić lamp w oprawie.

- hermetic ceiling fixture with built-in LEDs,
- base and milky cover made of PC,
- beam angle: 120 degrees,
- lamps in the fixture cannot be replaced.

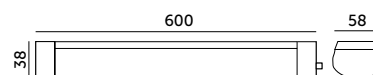

MODEL	INDEX	POBÓR MOCY [W]	BARWA ŚWIATŁA	STRUMIEŃ ŚWIETLNY [lm]	WAGA NETTO [kg]	PAKOWANIE [szt.]	KOD EAN
MODEL	INDEX	POWER [W]	LIGHT COLOR	LUMINOUS FLUX [lm]	NET WEIGHT [kg]	PACKING [pcs]	BARCODE
LED CORTEZ 3 18W NB	KFCZ318WNB	18	NEUTRALNA BIAŁA NEUTRAL WHITE	1800	0,17	20	5902201303360



STANDARD LINE OPRAWY LED / LED FIXTURES

# LED CORTEZ 3 36W



- hermetyczna oprawa nasufitowa z wbudowanymi diodami LED,
- obudowa i klosz mleczny wykonane z poliwęglanu,
- kąt rozsytu światła: 120 stopni,
- nie można wymienić lamp w oprawie.

- hermetic ceiling fixture with built-in LEDs,
- base and milky cover made of PC,
- beam angle: 120 degrees,
- lamps in the fixture cannot be replaced.

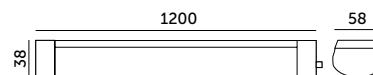

MODEL	INDEX	POBÓR MOCY [W]	BARWA ŚWIATŁA	STRUMIEŃ ŚWIETLNY [lm]	WAGA NETTO [kg]	PAKOWANIE [szt.]	KOD EAN
MODEL	INDEX	POWER [W]	LIGHT COLOR	LUMINOUS FLUX [lm]	NET WEIGHT [kg]	PACKING [pcs]	BARCODE
LED CORTEZ 3 36W NB	KFCZ336WNB	36	NEUTRALNA BIAŁA NEUTRAL WHITE	3600	0,27	20	5902201303377



STANDARD LINE OPRAWY LED / LED FIXTURES

# LED CORTEZ 3 45W



- hermetyczna oprawa nasufitowa z wbudowanymi diodami LED,  
- obudowa i klosz mleczny wykonane z poliwęglanu,  
- kąt rozsytu światła: 120 stopni,  
- nie można wymieniać lamp w oprawie.

- hermetic ceiling fixture with built-in LEDs,  
- base and milky cover made of PC,  
- beam angle: 120 degrees,  
- lamps in the fixture cannot be replaced.

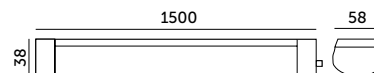

MODEL	INDEX	POBÓR MOCY [W]	BARWA ŚWIATŁA	STRUMIEŃ ŚWIETLNY [lm]	WAGA NETTO [kg]	PAKOWANIE [szt.]	KOD EAN
MODEL	INDEX	POWER [W]	LIGHT COLOR	LUMINOUS FLUX [lm]	NET WEIGHT [kg]	PACKING [pcs]	BARCODE
LED CORTEZ 3 45W NB	KFCZ345WNB	45	NEUTRALNA BIAŁA NEUTRAL WHITE	4500	0,40	20	5902846015970

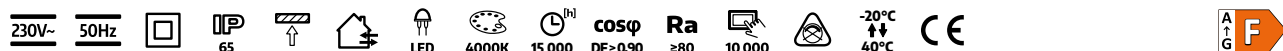

ECONOMIC BRAND OPRAWY LED / LED FIXTURES

# LED MIVRO 36W



- hermetyczna oprawa nasufitowa z wbudowanymi diodami LED,  
- obudowa i klosz mleczny wykonane z poliwęglanu,  
- kąt rozsytu światła: 120 stopni,  
- oprawa zawiera źródła światła w klasie energetycznej E,  
- możliwość wymiany źródła światła LED jedynie przez wykwalifikowany personel.

- ceiling fixture with LED diodes inside – hermetic,  
- base and milky cover made of PC;  
- beam angle: 120 degrees,  
- fixture includes built-in light sources in energy class E,  
- LED light sources can be replaced only by qualified personnel.

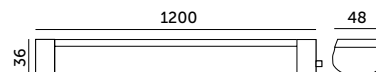

MODEL	INDEX	POBÓR MOCY [W]	BARWA ŚWIATŁA	STRUMIEŃ ŚWIETLNY [lm]	WAGA NETTO [kg]	PAKOWANIE [szt.]	KOD EAN
MODEL	INDEX	POWER [W]	LIGHT COLOR	LUMINOUS FLUX [lm]	NET WEIGHT [kg]	PACKING [pcs]	BARCODE
LED MIVRO 36W	KFLMO36WNB	36	NEUTRALNA BIAŁA NEUTRAL WHITE	3600	0,25	30	5902201378948







**ECONOMIC BRAND** OPRAWY LED / LED FIXTURES

## LED CORTEZ 3 18W

**LED2B**



- hermetyczna oprawa ledowa,
- obudowa i klosz mleczny wykonane z poliwęglanu,
- nie można łączyć opraw,
- kąt rozsytu światła: 120 stopni,
- oprawa zawiera źródła światła w klasie energetycznej E,
- możliwość wymiany źródła światła LED jedynie przez wykwalifikowany personel.

- hermetic LED fixture,
- housing and milky cover made of PC,
- fixtures cannot be connected together,
- beam angle: 120 degrees,
- fixture includes light sources of energy class E,
- light sources can be replaced only by qualified personnel.

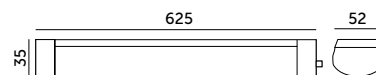

MODEL	INDEX	POBÓR MOCY [W]	BARWA ŚWIATŁA	STRUMIEN ŚWIETLNY [lm]	WAGA NETTO [kg]	PAKOWANIE [szt.]	KOD EAN
MODEL	INDEX	POWER [W]	LIGHT COLOR	LUMINOUS FLUX [lm]	NET WEIGHT [kg]	PACKING [pcs]	BARCODE
LED CORTEZ 18W NB	KFLCZ18WNB	18	NEUTRALNA BIAŁA NEUTRAL WHITE	2160	0,17	20	5902201387131



ECONOMIC BRAND OPRAWY LED / LED FIXTURES



# LED CORTEZ 3 36W



- hermetyczna oprawa ledowa,
- obudowa i klosz mleczny wykonane z poliwęglanu,
- nie można łączyć opraw,
- kąt rozsytu światła: 120 stopni,
- oprawa zawiera źródła światła w klasie energetycznej D,
- możliwość wymiany źródła światła LED jedynie przez wykwalifikowany personel.

- hermetic LED fixture,
- housing and milky cover made of PC,
- fixtures cannot be connected together,
- beam angle: 120 degrees,
- fixture includes light sources of energy class D,
- light sources can be replaced only by qualified personnel.

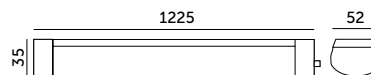

MODEL	INDEX	POBÓR MOCY [W]	BARWA ŚWIATŁA	STRUMIEŃ ŚWIETLNY [lm]	WAGA NETTO [kg]	PAKOWANIE [szt.]	KOD EAN
MODEL	INDEX	POWER [W]	LIGHT COLOR	LUMINOUS FLUX [lm]	NET WEIGHT [kg]	PACKING [pcs]	BARCODE
LED CORTEZ 36W NB	KFLCZ36WNB	36	NEUTRALNA BIAŁA NEUTRAL WHITE	4320	0,28	20	5902201387148



ECONOMIC BRAND OPRAWY LED / LED FIXTURES



# LED CORTEZ 3 45W



- hermetyczna oprawa ledowa,
- obudowa i klosz mleczny wykonane z poliwęglanu,
- nie można łączyć opraw,
- kąt rozsytu światła: 120 stopni,
- oprawa zawiera źródła światła w klasie energetycznej E,
- możliwość wymiany źródła światła LED jedynie przez wykwalifikowany personel.

- hermetic LED fixture,
- housing and milky cover made of PC,
- fixtures cannot be connected together,
- beam angle: 120 degrees,
- fixture includes light sources of energy class E,
- light sources can be replaced only by qualified personnel.

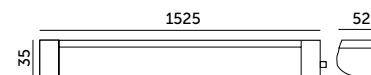

MODEL	INDEX	POBÓR MOCY [W]	BARWA ŚWIATŁA	STRUMIEŃ ŚWIETLNY [lm]	WAGA NETTO [kg]	PAKOWANIE [szt.]	KOD EAN
MODEL	INDEX	POWER [W]	LIGHT COLOR	LUMINOUS FLUX [lm]	NET WEIGHT [kg]	PACKING [pcs]	BARCODE
LED CORTEZ 48W NB	KFLCZ48WNB	48	NEUTRALNA BIAŁA NEUTRAL WHITE	5760	0,35	20	5902201387155





PROFESSIONAL LINE OPRAWY LED / LED FIXTURES

# LED KOLINE K1 20W



- oprawa nasufitowa z wbudowanymi diodami LED, z przestoną mleczną,
- obudowa wykonana z aluminium, przestona z poliwęglanu PC,
- możliwość łączenia opraw (maksymalnie do 20 szt.) – wariant dostępny na zamówienie,
- w komplecie zestaw do montażu zwieszanego na linkach (długość 1 m) i uchwyty do montażu natynkowego,
- kąt rozsyłu światła: 105 stopni,
- opcjonalnie: przestona pryzmatyczna ograniczająca efekt oślnienia,
- oprawa zawiera źródła światła w klasie energetycznej C,
- możliwość wymiany źródła światła LED jedynie przez wykwalifikowany personel.

- ceiling fixture with built-in LEDs and a milk-white cover,
- housing made of aluminum, lens made of polycarbonate (PC),
- can connect fixtures (up to 20 pcs) – variant available on request,
- includes a suspension kit with cables (1 m) and mounting brackets for surface mounting,
- beam angle: 105 degrees,
- optional: prismatic cover to reduce glare,
- fixture contains light sources with energy efficiency class C,
- LED light source can be replaced only by qualified personnel.

MODEL	INDEKS	KOLOR	POBÓR MOCY [W]	BARWA ŚWIATŁA	STRUMIEŃ ŚWIETLNY [lm]	WAGA NETTO [kg]	PAKOWANIE [szt.]	KOD EAN
MODEL	INDEX	COLOR	POWER [W]	LIGHT COLOR	LUMINOUS FLUX [lm]	NET WEIGHT [kg]	PACKING [pcs]	BARCODE
LED KOLINE K1 20W NB	KFKE20WNBB1	BIAŁY WHITE	20	NEUTRALNA BIAŁA NEUTRAL WHITE	2600	1,55	9	5902201368673
LED KOLINE K1 20W NB	KFKE20WNBCZ	CZARNY BLACK	20	NEUTRALNA BIAŁA NEUTRAL WHITE	2400	1,55	9	5902201368680



PROFESSIONAL LINE OPRAWY LED / LED FIXTURES

# LED KOLINE K1 40W



- oprawa nasufitowa z wbudowanymi diodami LED, z przestoną mleczną,
- obudowa wykonana z aluminium, przestona z poliwęglanu PC,
- możliwość łączenia opraw (maksymalnie do 20 szt.) – wariant dostępny na zamówienie,
- w komplecie zestaw do montażu zwieszanego na linkach (długość 1 m) i uchwyty do montażu natynkowego,
- kąt rozsyłu światła: 105 stopni,
- opcjonalnie: przestona pryzmatyczna ograniczająca efekt oślnienia,
- oprawa zawiera źródła światła w klasie energetycznej D,
- możliwość wymiany źródła światła LED jedynie przez wykwalifikowany personel.

- ceiling fixture with built-in LEDs and a milk-white cover,
- housing made of aluminum, lens made of polycarbonate (PC),
- can connect fixtures (up to 20 pcs) – variant available on request,
- includes a suspension kit with cables (1 m) and mounting brackets for surface mounting,
- beam angle: 105 degrees,
- optional: prismatic cover to reduce glare,
- fixture contains light sources with energy efficiency class D,
- LED light source can be replaced only by qualified personnel.

MODEL	INDEKS	KOLOR	POBÓR MOCY [W]	BARWA ŚWIATŁA	STRUMIEŃ ŚWIETLNY [lm]	WAGA NETTO [kg]	PAKOWANIE [szt.]	KOD EAN
MODEL	INDEX	COLOR	POWER [W]	LIGHT COLOR	LUMINOUS FLUX [lm]	NET WEIGHT [kg]	PACKING [pcs]	BARCODE
LED KOLINE K1 40W NB	KFKE40WNBBI	BIAŁY WHITE	40	NEUTRALNA BIAŁA NEUTRAL WHITE	5200	1,55	9	5902201368697
LED KOLINE K1 40W NB	KFKE40WNBZ	CZARNY BLACK	40	NEUTRALNA BIAŁA NEUTRAL WHITE	4800	1,55	9	5902201368703



PREMIUM PANELE LED / LED PANELS

# LED BRISBANE 60x60 36W



- oprawa do montażu natynkowego i podtynkowego,
- kąt rozsyłu światła: 120 stopni,
- oprawa zawiera źródła światła o klasie energetycznej D,
- możliwość wymiany źródła światła LED jedynie przez wykwalifikowany personel.

- panel designed for both surface and recessed installation,
- beam angle: 120 degrees,
- fixture includes light sources of energy class D,
- the LED light source can only be replaced by qualified personnel.

MODEL	INDEKS	KOLOR	POBÓR MOCY [W]	BARWA ŚWIATŁA	STRUMIEŃ ŚWIETLNY [lm]	WAGA NETTO [kg]	PAKOWANIE [szt.]	KOD EAN
MODEL	INDEX	COLOR	POWER [W]	LIGHT COLOR	LUMINOUS FLUX [lm]	NET WEIGHT [kg]	PACKING [pcs]	BARCODE
LED BRISBANE 60x60 36W	KFBE36NBB	BIAŁY WHITE	36	NEUTRALNA BIAŁA NEUTRAL WHITE	4320	1,35	6	5902201375541
LED BRISBANE 60x60 36W	KFBE36NBC	CZARNY BLACK	36	NEUTRALNA BIAŁA NEUTRAL WHITE	3960	1,35	6	5902201375558

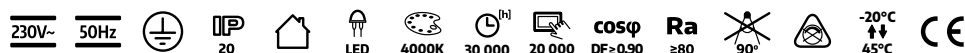



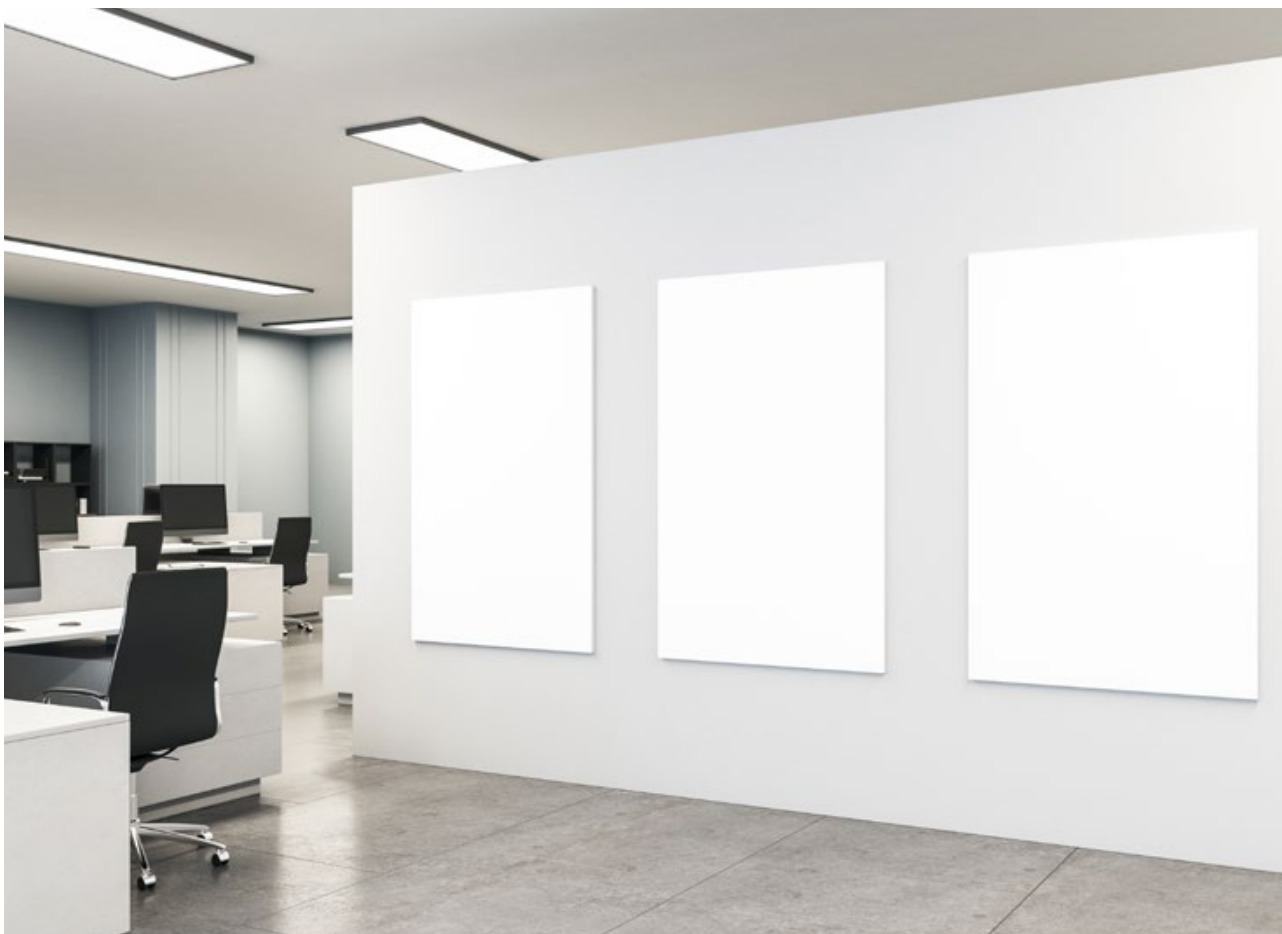

PREMIUM PANELE LED / LED PANELS

## LED BRISBANE 30x120 36W

**3 LATA**  
GWARANCJI  
**3 YEARS**  
WARRANTY



BIAŁY  
WHITE

CZARNY  
BLACK

- oprawa do montażu natynkowego i podtynkowego,
- kąt rozsytu światła: 120 stopni,
- oprawa zawiera źródła światła o klasie energetycznej D,
- możliwość wymiany źródła światła LED jedynie przez wykwalifikowany personel.

- panel designed for both surface and recessed installation,
- beam angle: 120 degrees,
- fixture includes light sources of energy class D,
- the LED light source can only be replaced by qualified personnel.

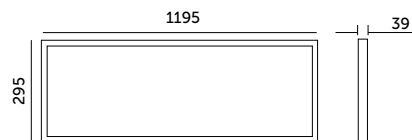

MODEL	INDEKS	KOLOR	POBÓR MOCY [W]	BARWA ŚWIATŁA	STRUMIEN ŚWIETLNY [lm]	WAGA NETTO [kg]	PAKOWANIE [szt.]	KOD EAN
MODEL	INDEX	COLOR	POWER [W]	LIGHT COLOR	LUMINOUS FLUX [lm]	NET WEIGHT [kg]	PACKING [pcs]	BARCODE
LED BRISBANE 30x120 36W	KFBEP36NBB	BIAŁY WHITE	36	NEUTRALNA BIAŁA NEUTRAL WHITE	4320	1,42	6	5902201375565
LED BRISBANE 30x120 36W	KFBEP36NBC	CZARNY BLACK	36	NEUTRALNA BIAŁA NEUTRAL WHITE	3960	1,42	6	5902201375572

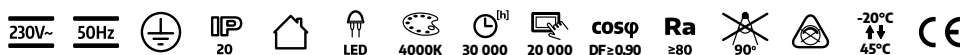



PROFESSIONAL LINE PANELE LED /LED PANELS

# LED CAPRI PRO 60x60

## 36W UGR<19

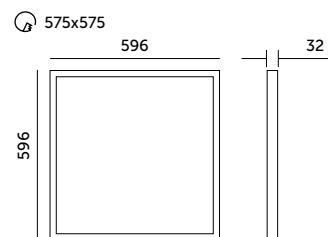

- ledowy zamiennik oprawy rastrowej,
- kąt rozsytu światła: 90 stopni,
- oprawa zawiera źródła światła o klasie energetycznej D,
- możliwość wymiany źródła światła LED jedynie przez wykwalifikowany personel.

- LED substitute for louver fitting,
- beam angle: 90 degrees,
- fixture includes light sources of energy class D,
- the LED light source can only be replaced by qualified personnel.

MODEL	INDEKS	POBÓR MOCY [W]	BARWA ŚWIATŁA	STRUMIEŃ ŚWIETLNY [lm]	WAGA NETTO [kg]	PAKOWANIE [szt.]	KOD EAN
MODEL	INDEX	POWER [W]	LIGHT COLOR	LUMINOUS FLUX [lm]	NET WEIGHT [kg]	PACKING [pcs]	BARCODE
LED CAPRI PRO 60X60 36W NB UGR<19	KFCP36NBU	36	NEUTRALNA BIAŁA NEUTRAL WHITE	4320	1,58	6	5902201364583



PROFESSIONAL LINE PANELE LED /LED PANELS

# LED CAPRI PRO 30x120

## 36W UGR<19

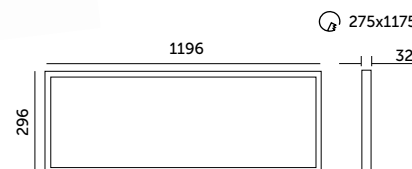

- ledowy zamiennik oprawy rastrowej,
- kąt rozsytu światła: 90 stopni,
- oprawa zawiera źródła światła o klasie energetycznej D,
- możliwość wymiany źródła światła LED jedynie przez wykwalifikowany personel.

- LED substitute for louver fitting,
- beam angle: 90 degrees,
- fixture includes light sources of energy class D,
- the LED light source can only be replaced by qualified personnel.

MODEL	INDEKS	POBÓR MOCY [W]	BARWA ŚWIATŁA	STRUMIEŃ ŚWIETLNY [lm]	WAGA NETTO [kg]	PAKOWANIE [szt.]	KOD EAN
MODEL	INDEX	POWER [W]	LIGHT COLOR	LUMINOUS FLUX [lm]	NET WEIGHT [kg]	PACKING [pcs]	BARCODE
LED CAPRI PRO 30x120 36W NB UGR<19	KFCP36PNBU	36	NEUTRALNA BIAŁA NEUTRAL WHITE	4320	1,58	6	5902201364569

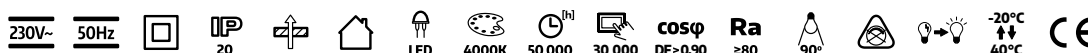



PROFESSIONAL LINE | PANELE LED / LED PANELS

# LED CAPRI PRO 60x60 28W

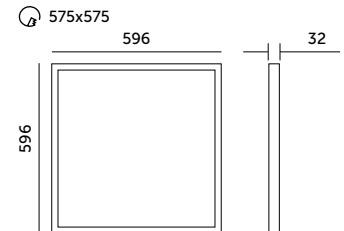

- ledowy zamiennik oprawy rastrowej,
- kąt rozsyłu światła: 120 stopni,
- oprawa zachowuje stopień ochrony IP44 w przypadku montażu podtynkowego,
- oprawa zawiera źródła światła o klasie energetycznej D,
- możliwość wymiany źródła światła LED jedynie przez wykwalifikowany personel.

- LED substitute for louver fitting,
- beam angle: 120 degrees,
- in case of recessed installation, fixture retains IP44 protection degree,
- fixture includes light sources of energy class D,
- the LED light source can only be replaced by qualified personnel.

MODEL	INDEKS	POBÓR MOCY [W]	BARWA ŚWIATŁA	STRUMIEN ŚWIETLNY [lm]	WAGA NETTO [kg]	PAKOWANIE [szt.]	KOD EAN
MODEL	INDEX	POWER [W]	LIGHT COLOR	LUMINOUS FLUX [lm]	NET WEIGHT [kg]	PACKING [pcs]	BARCODE
LED CAPRI PRO 60X60 28W NB	KFCP28NB44	28	NEUTRALNA BIAŁA NEUTRAL WHITE	3360	1,49	6	5902201364590

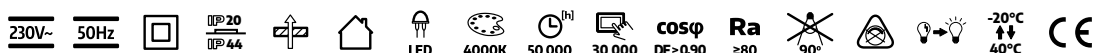

PROFESSIONAL LINE PANELE LED /LED PANELS

# LED CAPRI PRO 60x60 36W

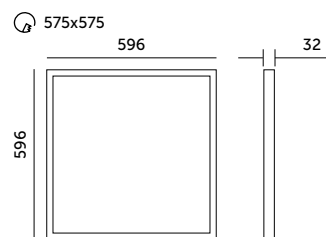

- ledowy zamiennik oprawy rastrowej,
- kąt rozsytu światła: 120 stopni,
- oprawa zawiera źródła światła o klasie energetycznej D,
- możliwość wymiany źródła światła LED jedynie przez wykwalifikowany personel.

- LED substitute for louver fitting,
- beam angle: 120 degrees,
- fixture includes light sources of energy class D,
- the LED light source can only be replaced by qualified personnel.

MODEL	INDEKS	POBÓR MOCY [W]	BARWA ŚWIATŁA	STRUMIEN ŚWIETLNY [lm]	WAGA NETTO [kg]	PAKOWANIE [szt.]	KOD EAN
MODEL	INDEX	POWER [W]	LIGHT COLOR	LUMINOUS FLUX [lm]	NET WEIGHT [kg]	PACKING [pcs]	BARCODE
LED CAPRI PRO 60x60 36W NB	KFCP36NB	36	NEUTRALNA BIAŁA NEUTRAL WHITE	4320	1,49	6	5902201364576



PROFESSIONAL LINE PANELE LED /LED PANELS

# LED CAPRI PRO 60x60 40W IP65

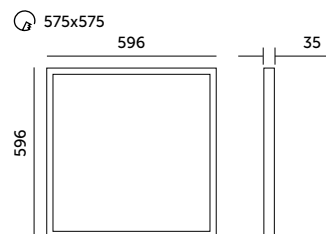

- ledowy zamiennik oprawy rastrowej,
- kąt rozsytu światła: 120 stopni,
- oprawa zawiera źródła światła o klasie E,
- możliwość wymiany źródła światła LED jedynie przez wykwalifikowany personel.

- LED substitute for louver fitting,
- beam angle: 120 degrees,
- fixture includes light sources of energy class E,
- the LED light source can only be replaced by qualified personnel.

MODEL	INDEKS	POBÓR MOCY [W]	BARWA ŚWIATŁA	STRUMIEN ŚWIETLNY [lm]	WAGA NETTO [kg]	PAKOWANIE [szt.]	KOD EAN
MODEL	INDEX	POWER [W]	LIGHT COLOR	LUMINOUS FLUX [lm]	NET WEIGHT [kg]	PACKING [pcs]	BARCODE
LED CAPRI PRO 60x60 40W IP65 NB	KFCP40NB65	40	NEUTRALNA BIAŁA NEUTRAL WHITE	4400	1,49	6	5902201364552

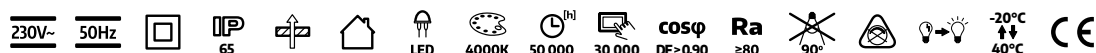

PROFESSIONAL LINE PANELE LED /LED PANELS

# LED ORIO 60x60 26-32W

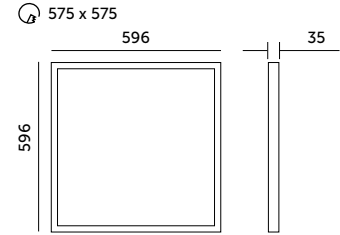
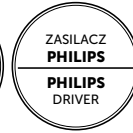

- 4-stopniowa regulacja mocy zasilacza,  
- kąt rozsytu światła: 120 stopni,  
- nie można wymienić lamp w oprawie.

- 4-step driver power adjustment,  
- beam angle: 120 degrees,  
- lamps in the panel cannot be replaced.

MODEL	INDEKS	POBÓR MOCY [W]	BARWA ŚWIATŁA	STRUMIEŃ ŚWIETLNY [lm]	WAGA NETTO [kg]	PAKOWANIE [szt.]	KOD EAN
MODEL	INDEX	POWER [W]	LIGHT COLOR	LUMINOUS FLUX [lm]	NET WEIGHT [kg]	PACKING [pcs]	BARCODE
LED ORIO 60X60 26W	02NSOO26WNB	26	NEUTRALNA BIAŁA NEUTRAL WHITE	3900	1,52	5	5902201307511
LED ORIO 60X60 28W	02NSOO28WNB	28	NEUTRALNA BIAŁA NEUTRAL WHITE	4200	1,52	5	5902201307528
LED ORIO 60X60 30W	02NSOO30WNB	30	NEUTRALNA BIAŁA NEUTRAL WHITE	4500	1,52	5	5902201307535
LED ORIO 60X60 32W	02NSOO32WNB	32	NEUTRALNA BIAŁA NEUTRAL WHITE	4800	1,52	5	5902201307542



PROFESSIONAL LINE PANELE LED /LED PANELS

# LED ORIO 60x60 34-40W

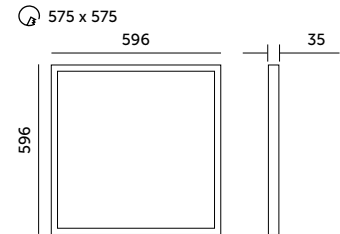
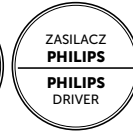

- 4-stopniowa regulacja mocy zasilacza,  
- kąt rozsytu światła: 120 stopni,  
- nie można wymienić lamp w oprawie.

- 4-step driver power adjustment,  
- beam angle: 120 degrees,  
- lamps in the panel cannot be replaced.

MODEL	INDEKS	POBÓR MOCY [W]	BARWA ŚWIATŁA	STRUMIEŃ ŚWIETLNY [lm]	WAGA NETTO [kg]	PAKOWANIE [szt.]	KOD EAN
MODEL	INDEX	POWER [W]	LIGHT COLOR	LUMINOUS FLUX [lm]	NET WEIGHT [kg]	PACKING [pcs]	BARCODE
LED ORIO 60X60 34W	02NSOO34WNB	34	NEUTRALNA BIAŁA NEUTRAL WHITE	5100	1,53	5	5902201307559
LED ORIO 60X60 36W	02NSOO36WNB	36	NEUTRALNA BIAŁA NEUTRAL WHITE	5400	1,53	5	5902201307566
LED ORIO 60X60 38W	02NSOO38WNB	38	NEUTRALNA BIAŁA NEUTRAL WHITE	5700	1,53	5	5902201307573
LED ORIO 60X60 40W	02NSOO40WNB	40	NEUTRALNA BIAŁA NEUTRAL WHITE	6000	1,53	5	5902201307580





PROFESSIONAL LINE PANELE LED / LED PANELS

# LED NELIO PRO 60x60 40W



- ledowy zamiennik oprawy rastrowej,
- ultrapiński: 10 mm,
- kąt rozsytu światła: 120 stopni,
- oprawa zawiera źródła światła o klasie energetycznej D,
- możliwość wymiany źródła światła LED jedynie przez wykwalifikowany personel.

- LED substitute for louver fitting,
- ultra-thin: 10 mm,
- beam angle: 120 degrees,
- fixture includes light sources of energy class D,
- the LED light source can only be replaced by qualified personnel.

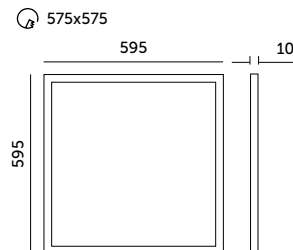

MODEL	INDEKS	POBÓR MOCY [W]	BARWA ŚWIATŁA	STRUMIEŃ ŚWIETLNY [lm]	WAGA NETTO [kg]	PAKOWANIE [szt.]	KOD EAN
MODEL	INDEX	POWER [W]	LIGHT COLOR	LUMINOUS FLUX [lm]	NET WEIGHT [kg]	PACKING [pcs]	BARCODE
LED NELIO 60X60 NB	KFNO3PT606NB	40	NEUTRALNA BIAŁA NEUTRAL WHITE	4400	2,44	5	5902846011743

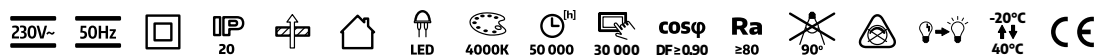



PROFESSIONAL LINE **PANELE LED /LED PANELS**

# LED NELIO PRO 30x120 40W

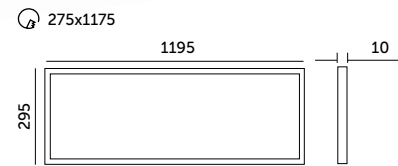

- ledowy zamiennik oprawy rastrowej,
- ultrapiński: 10 mm,
- kąt rozsytu światła: 120 stopni,
- oprawa zawiera źródła światła o klasie energetycznej D,
- możliwość wymiany źródła światła LED jedynie przez wykwalifikowany personel.

- LED substitute for louver fitting,
- ultra-thin: 10 mm,
- beam angle: 120 degrees,
- fixture includes light sources of energy class D,
- the LED light source can only be replaced by qualified personnel.

MODEL	INDEKS	POBÓR MOCY [W]	BARWA ŚWIATŁA	STRUMIEŃ ŚWIETLNY [lm]	WAGA NETTO [kg]	PAKOWANIE [szt.]	KOD EAN
MODEL	INDEX	POWER [W]	LIGHT COLOR	LUMINOUS FLUX [lm]	NET WEIGHT [kg]	PACKING [pcs]	BARCODE
LED NELIO 30X120 NB	KFNO3PT312NB	40	NEUTRALNA BIAŁA NEUTRAL WHITE	4400	2,47	5	5902846011750



PREMIUM **PANELE LED /LED PANELS**

# LED NELIO PREMIUM 30x60 28W

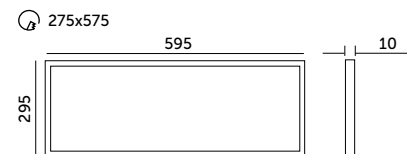

- ledowy zamiennik oprawy rastrowej,
- ultrapiński: 10 mm,
- kąt rozsytu światła: 120 stopni,
- oprawa zawiera źródła światła o klasie energetycznej D,
- możliwość wymiany źródła światła LED jedynie przez wykwalifikowany personel.

- LED substitute for louver fitting,
- ultra-thin: 10 mm,
- beam angle: 120 degrees,
- fixture includes light sources of energy class D,
- the LED light source can only be replaced by qualified personnel.

MODEL	INDEKS	POBÓR MOCY [W]	BARWA ŚWIATŁA	STRUMIEŃ ŚWIETLNY [lm]	WAGA NETTO [kg]	PAKOWANIE [szt.]	KOD EAN
MODEL	INDEX	POWER [W]	LIGHT COLOR	LUMINOUS FLUX [lm]	NET WEIGHT [kg]	PACKING [pcs]	BARCODE
LED NELIO 30X60 NB	KFNOP3060NB	28	NEUTRALNA BIAŁA NEUTRAL WHITE	3000	1,03	10	5902846011532



PREMIUM PANELE LED /LED PANELS

# LED NELIO PREMIUM 60x60 40W

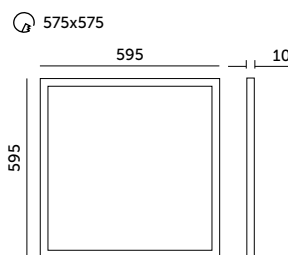

- ledowy zamiennik oprawy rastrowej,
- ultrapiński: 10 mm,
- kąt rozsytu światła: 120 stopni,
- oprawa zawiera źródła światła o klasie energetycznej D,
- możliwość wymiany źródła światła LED jedynie przez wykwalifikowany personel.

- LED substitute for louver fitting,
- ultra-thin: 10 mm,
- beam angle: 120 degrees,
- fixture includes light sources of energy class D,
- the LED light source can only be replaced by qualified personnel.

MODEL	INDEKS	POBÓR MOCY [W]	BARWA ŚWIATŁA	STRUMIEŃ ŚWIETLNY [lm]	WAGA NETTO [kg]	PAKOWANIE [szt.]	KOD EAN
MODEL	INDEX	POWER [W]	LIGHT COLOR	LUMINOUS FLUX [lm]	NET WEIGHT [kg]	PACKING [pcs]	BARCODE
LED NELIO 60X60 NB	KFNO2PT40NB	40	NEUTRALNA BIAŁA NEUTRAL WHITE	4300	1,83	5	5900605098028

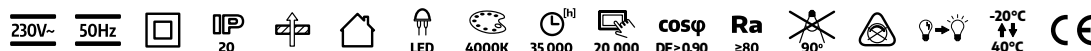

PREMIUM PANELE LED /LED PANELS

# LED NELIO PREMIUM 30x120 40W

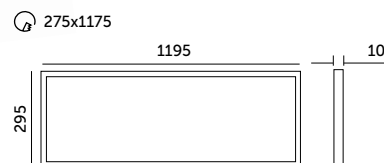

- ledowy zamiennik oprawy rastrowej,
- ultrapiński: 10 mm,
- kąt rozsytu światła: 120 stopni,
- oprawa zawiera źródła światła o klasie energetycznej D,
- możliwość wymiany źródła światła LED jedynie przez wykwalifikowany personel.

- LED substitute for louver fitting,
- ultra-thin: 10 mm,
- beam angle: 120 degrees,
- fixture includes light sources of energy class D,
- the LED light source can only be replaced by qualified personnel.

MODEL	INDEKS	POBÓR MOCY [W]	BARWA ŚWIATŁA	STRUMIEŃ ŚWIETLNY [lm]	WAGA NETTO [kg]	PAKOWANIE [szt.]	KOD EAN
MODEL	INDEX	POWER [W]	LIGHT COLOR	LUMINOUS FLUX [lm]	NET WEIGHT [kg]	PACKING [pcs]	BARCODE
LED NELIO 30X120 NB	KFNO2PT312NB	40	NEUTRALNA BIAŁA NEUTRAL WHITE	4300	2,10	5	5900605099414

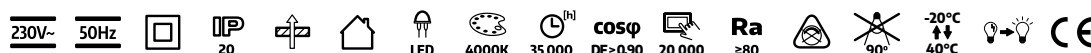



**ECONOMIC BRAND** PANELE LED /LED PANELS

# LED CAMARO 60x60 40W

**LED2B**

OPCJONALNIE  
**DALI**  
**DALI**  
OPTIONAL



575 x 575

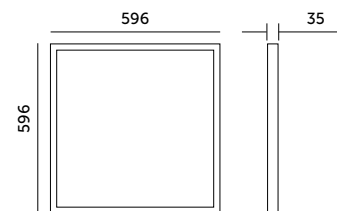

- ledowy zamiennik oprawy rastrowej,
- kąt rozsyłu światła: 120 stopni,
- oprawa zawiera źródła światła o klasie energetycznej E,
- możliwość wymiany źródła światła LED jedynie przez wykwalifikowany personel.

- LED substitute for louver fitting,
- beam angle: 120 degrees,
- fixture includes light sources of energy class E,
- the LED light source can only be replaced by qualified personnel.

MODEL	INDEKS	POBÓR MOCY [W]	BARWA ŚWIATŁA	STRUMIEŃ ŚWIETLNY [lm]	WAGA NETTO [kg]	PAKOWANIE [szt.]	KOD EAN
MODEL	INDEX	POWER [W]	LIGHT COLOR	LUMINOUS FLUX [lm]	NET WEIGHT [kg]	PACKING [pcs]	BARCODE
LED CAMARO 60X60 NB	KFLCO40NB	40	NEUTRALNA BIAŁA NEUTRAL WHITE	4230	0,94	6	5902201300628

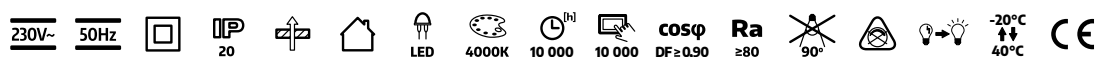

STANDARD LINE

AKCESORIA DO PANELU LED / ACCESSORIES FOR LED PANEL

# RAMKA 45mm DO PANELU LED KLIK

/ FRAME 45mm FOR LED PANEL CLICK

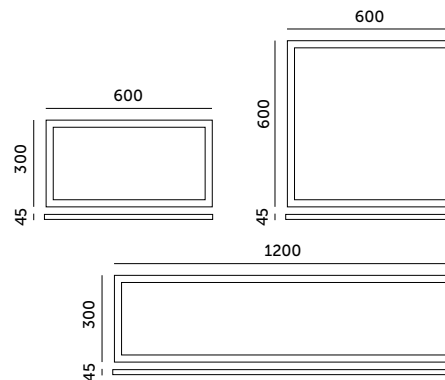

- wykonana z aluminium,
- malowana proszkowo na biało,
- przeznaczona do montażu natynkowego opraw LED NELIO.

- made of aluminium,
- powder painted – white,
- intended for surface-installation of LED NELIO panels.

MODEL	INDEKS	KOLOR	WAGA NETTO [kg]	PAKOWANIE [szt.]	KOD EAN
MODEL	INDEX	COLOR	NET WEIGHT [kg]	PACKING [pcs]	BARCODE
RAMKA DO PANELU LED 30X60 KLIK	KFNORK3060	BIAŁY WHITE	0,31	20	5902201304268
RAMKA DO PANELU LED 60X60 KLIK	KFNORK6060	BIAŁY WHITE	0,39	20	5900605096628
RAMKA DO PANELU LED 30X120 KLIK	KFNORK30120	BIAŁY WHITE	0,70	20	5902846013761

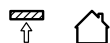

STANDARD LINE

AKCESORIA DO PANELU LED / ACCESSORIES FOR LED PANEL

# RAMKA 63mm DO PANELU LED KLIK

/ FRAME 63mm FOR LED PANEL CLICK

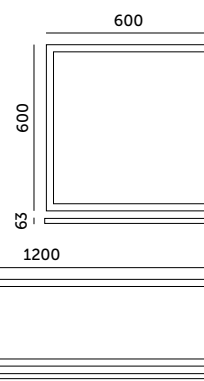
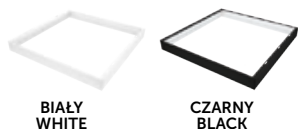

- wykonana z aluminium,
- malowana proszkowo,
- przeznaczona do montażu natynkowego paneli: LED NELIO, LED CAPRI, LED ARIEL i LED CAMARO.

- made of aluminium,
- powder painted,
- intended for surface-installation of LED NELIO, LED CAPRI, LED ARIEL and LED CAMARO panels.

MODEL	INDEKS	KOLOR	WAGA NETTO [kg]	PAKOWANIE [szt.]	KOD EAN
MODEL	INDEX	COLOR	NET WEIGHT [kg]	PACKING [pcs]	BARCODE
RAMKA DO PANELU LED 60X60 KLIK	KFNORC6060	BIAŁY WHITE	0,65	20	5902846018827
RAMKA DO PANELU LED 60X60 KLIK	KFNORC6060C	CZARNY BLACK	0,65	20	5902201364200
RAMKA DO PANELU LED 30X120 KLIK	KFNORC30120	BIAŁY WHITE	0,79	20	5902846018834

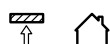

STANDARD LINE

AKCESORIA DO PANELU LED / ACCESSORIES FOR LED PANEL

# LINKA DO PANELU LED

/ SUSPENSION WIRE



- przeznaczona do zawieszenia paneli: LED NELIO, LED CAPRI, LED ARIEL i LED CAMARO, - długość linek: 1 m.

- intended for hanging LED NELIO, LED CAPRI, LED ARIEL and LED CAMARO panels, - wire's length: 1 m.

MODEL	INDEKS	KOLOR	WAGA NETTO [kg]	PAKOWANIE [szt.]	KOD EAN
MODEL	INDEX	COLOR	NET WEIGHT [kg]	PACKING [pcs]	BARCODE
LINKA DO PANELU LED (4 SZT.)	KFNOLA1	CHROM CHROME	0,10	200	5902846018872

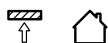

STANDARD LINE

AKCESORIA DO PANELU LED / ACCESSORIES FOR LED PANEL

# UCHWYT DO KARTON – GIPS

/ CLASP FOR A DRYWALL



- przeznaczone do montażu opraw: LED NELIO, LED CAPRI, LED ARIEL i LED CAMARO w płytach kartonowo-gipsowych.

- intended for drywall-installation of LED NELIO, LED CAPRI, LED ARIEL and LED CAMARO panels.

MODEL	INDEKS	KOLOR	WAGA NETTO [kg]	PAKOWANIE [szt.]	KOD EAN
MODEL	INDEX	COLOR	NET WEIGHT [kg]	PACKING [pcs]	BARCODE
UCHWYT DO KARTON GIPS 60X60 (4 SZT.)	KFNOUNKG	CHROM CHROME	0,06	250	5902846011361
UCHWYT DO KARTON GIPS 30X120 (6 SZT.)	KFNOUNG30	CHROM CHROME	0,09	250	5902846012221

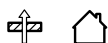



PROFESSIONAL LINE

OSPRZĘT LED / LED EQUIPMENT

# ZASILACZ DALI 20W

/ DALI DRIVER 20W



- możliwość ściemniania: 0-10V, DALI, PUSH,
- możliwość regulacji prądu wyjściowego w zakresie 250-500 mA (co 50 mA),
- napięcie wejściowe 220-240V AC (198-264V AC),
- napięcie wyjściowe 25-42V DC,
- temperatura składowania -30-80°C,
- standard DALI 2.0,
- zabezpieczenie przepięciowe: L-N 1 kV,
- kompatybilny z oprawami LED NEXEYE 15W i 20W.

- dimming options: 0-10V, DALI, PUSH,
- adjustable output current range: 250-500 mA (in 50 mA increments),
- input voltage: 220-240V AC (198-264V AC),
- output voltage: 25-42V DC,
- storage temperature: -30 to 80°C,
- DALI 2.0 standard,
- surge protection: L-N 1 kV,
- compatible with LED NEXEYE 15W and 20W fixtures.

MODEL	INDEKS	MAX. MOC [W]	WYMIARY [mm]	WAGA NETTO [kg]	PAKOWANIE [szt.]	KOD EAN
MODEL	INDEX	MAX. POWER [W]	SIZE [mm]	NET WEIGHT [kg]	PACKING [pcs]	BARCODE
ZASILACZ DALI 20W	KFZP0000003	20	107x70x29	0,13	1	5902201375619

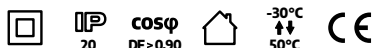

PROFESSIONAL LINE

OSPRZĘT LED / LED EQUIPMENT

# ZASILACZ DALI 44W

/ DALI DRIVER 44W



- możliwość ściemniania: 0-10V, DALI, PUSH,
- możliwość regulacji prądu wyjściowego w zakresie 550-1050 mA (co 50 mA),
- napięcie wejściowe 220-240V AC (198-264V AC),
- napięcie wyjściowe 25-42V DC,
- temperatura składowania -30-80°C,
- standard DALI 2.0,
- zabezpieczenie przepięciowe: L-N 1 kV,
- kompatybilny z oprawami LED CAPRI, LED NELIO, LED CAMARO, LED ORIO i LED NEXEYE 30W.

- dimming options: 0-10V, DALI, PUSH,
- adjustable output current range: 550-1050 mA (every 50 mA),
- input voltage: 220-240V AC (198-264V AC),
- output voltage: 25-42V DC,
- can be stored in a temperature: -30-80°C,
- DALI 2.0,
- overvoltage protection: L-N 1kV,
- compatible with fixtures LED CAPRI, LED NELIO, LED CAMARO, LED ORIO and LED NEXEYE 30W.

MODEL	INDEKS	MAX. MOC [W]	WYMIARY [mm]	WAGA NETTO [kg]	PAKOWANIE [szt.]	KOD EAN
MODEL	INDEX	MAX. POWER [W]	SIZE [mm]	NET WEIGHT [kg]	PACKING [pcs]	BARCODE
ZASILACZ DALI 44W	KFCPZD36	44	107x70x29	0,17	1	5902201364606

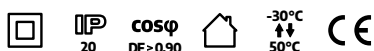

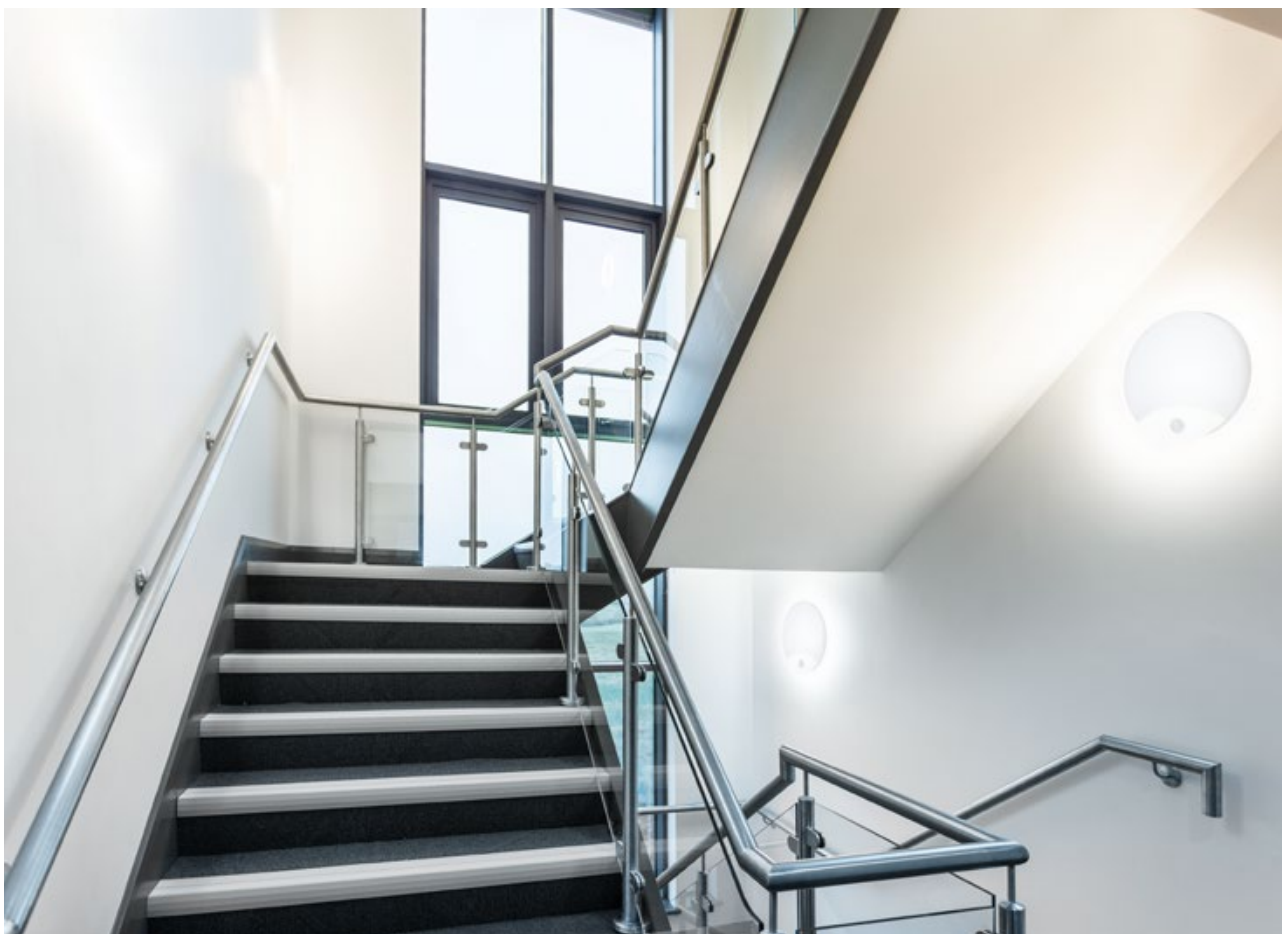

PROFESSIONAL LINE OPRAWY LED / LED FIXTURES

## LED ORBIS LX 10W

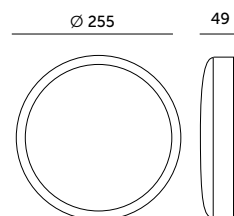

- oprawa ledowa z czujnikiem ruchu PIR o dwóch zakresach regulacji: natężenie światła i czas działania,
- natężenie światła: 3-2000 lx,
- czas działania: 10 sek. ± 3 sek. – 5 min ± 1 min,
- maksymalny zasięg detekcji: 9 m,
- kąt rozsytu światła: 120 stopni,
- podstawa i klosz mleczny wykonane z poliwęglanu,
- nie można wymieniać lamp w oprawie.

- LED fixture with a PIR motion sensor featuring adjustable light intensity and operating time,
- light intensity range: 3-2000 lx,
- operating time: 10 sec ± 3 sec – 5 min ± 1 min,
- max. detection range: 9 m,
- beam angle: 120 degrees,
- base and milky cover made of polycarbonate,
- lamps in the fixture cannot be replaced.

MODEL	INDEKS	POBÓR MOCY [W]	BARWA ŚWIATŁA	STRUMIEŃ ŚWIETLNY [lm]	WAGA NETTO [kg]	PAKOWANIE [szt.]	KOD EAN
MODEL	INDEX	POWER [W]	LIGHT COLOR	LUMINOUS FLUX [lm]	NET WEIGHT [kg]	PACKING [pcs]	BARCODE
LED ORBIS LX 10W NB	02NSOSX10WNB	10	NEUTRALNA BIAŁA NEUTRAL WHITE	1050	0,52	5	5902201305661

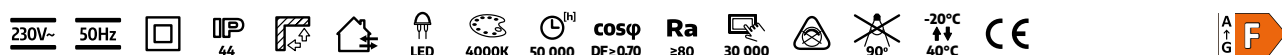

PROFESSIONAL LINE OPRAWY LED / LED FIXTURES

# LED DEFENDER 18W



- ścienno-sufitowa oprawa ledowa,
- podstawa wykonana z tworzywa sztucznego, klosz mleczny z poliwęglanu,
- kąt rozsyłu światła: 120 stopni,
- wysoki stopień hermetyczności: IP66,
- oprawa zawiera źródła światła o klasie energetycznej D,
- możliwość wymiany źródła światła LED jedynie przez wykwalifikowany personel.

- wall and ceiling LED fixture,
- base made of plastic, milky cover made of polycarbonate,
- beam angle: 120 degrees,
- high degree of ingress protection: IP66,
- fixture contains light sources with energy efficiency class D,
- LED light source can only be replaced by qualified personnel.

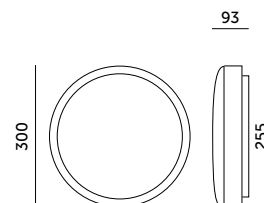

MODEL	INDEKS	POBÓR MOCY [W]	BARWA ŚWIATŁA	STRUMIEŃ ŚWIETLNY [lm]	WAGA NETTO [kg]	PAKOWANIE [szt.]	KOD EAN
MODEL	INDEX	POWER [W]	LIGHT COLOR	LUMINOUS FLUX [lm]	NET WEIGHT [kg]	PACKING [pcs]	BARCODE
LED DEFENDER 18W NB	KFDR18WNBBI	18	NEUTRALNA BIAŁA NEUTRAL WHITE	1800	0,82	4	5902201303780

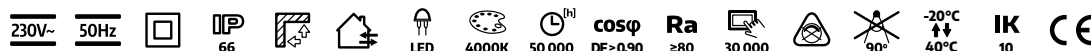

PROFESSIONAL LINE OPRAWY LED / LED FIXTURES

# LED DEFENDER 24W



- ścienno-sufitowa oprawa ledowa,
- podstawa wykonana z tworzywa sztucznego, klosz mleczny z poliwęglanu,
- kąt rozsyłu światła: 120 stopni,
- wysoki stopień hermetyczności: IP66,
- oprawa zawiera źródła światła o klasie energetycznej D,
- możliwość wymiany źródła światła LED jedynie przez wykwalifikowany personel.

- wall and ceiling LED fixture,
- base made of plastic, milky cover made of polycarbonate,
- beam angle: 120 degrees,
- high degree of ingress protection: IP66,
- fixture contains light sources with energy efficiency class D,
- LED light source can only be replaced by qualified personnel.

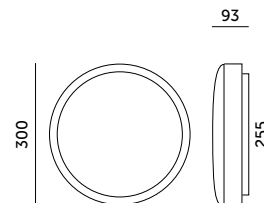

MODEL	INDEKS	POBÓR MOCY [W]	BARWA ŚWIATŁA	STRUMIEŃ ŚWIETLNY [lm]	WAGA NETTO [kg]	PAKOWANIE [szt.]	KOD EAN
MODEL	INDEX	POWER [W]	LIGHT COLOR	LUMINOUS FLUX [lm]	NET WEIGHT [kg]	PACKING [pcs]	BARCODE
LED DEFENDER 24W NB	KFDR24WNBBI	24	NEUTRALNA BIAŁA NEUTRAL WHITE	2400	0,85	4	5902201303803

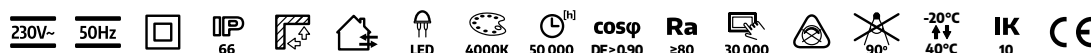

PROFESSIONAL LINE OPRAWY LED / LED FIXTURES

# LED DEFENDER 18W LX



- oprawa ledowa z mikrofalowym czujnikiem ruchu o trzech zakresach regulacji: czas działania, natężenie światła i czułość detekcji,
- czas działania: 5 sek, 1 min, 3 min, 10 min,
- natężenie światła: wyłączony lub do 30 lx,
- czułość detekcji: 100% i 50%,
- zasięg detekcji: max. 6 m,
- kąt rozsyłu światła: 120 stopni,
- podstawa wykonana z tworzywa sztucznego, klosz mleczny z poliwęglanu,
- wysoki stopień hermetyczności: IP66,
- oprawa zawiera źródła światła o klasie energetycznej D,
- możliwość wymiany źródła światła LED jedynie przez wykwalifikowany personel.

- LED fixture with a microwave motion sensor featuring three adjustable settings: operating time, light intensity, and detection sensitivity,
- operating time: 5 sec, 1 min, 3 min, 10 min,
- light intensity: off or up to 30 lx,
- detection sensitivity: 100% and 50%,
- detection range: max. 6 m,
- beam angle: 120 degrees,
- base made of plastic, milky cover made of polycarbonate,
- high degree of ingress protection: IP66,
- fixture contains light sources with energy efficiency class D,
- LED light source can only be replaced by qualified personnel.

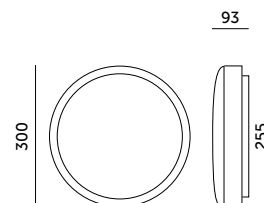

MODEL	INDEKS	POBÓR MOCY [W]	BARWA ŚWIATŁA	STRUMIEŃ ŚWIETLNY [lm]	WAGA NETTO [kg]	PAKOWANIE [szt.]	KOD EAN
MODEL	INDEX	POWER [W]	LIGHT COLOR	LUMINOUS FLUX [lm]	NET WEIGHT [kg]	PACKING [pcs]	BARCODE
LED DEFENDER 18W LX NB	KFDX18WNBBI	18	NEUTRALNA BIAŁA NEUTRAL WHITE	1800	0,82	4	5902201303797

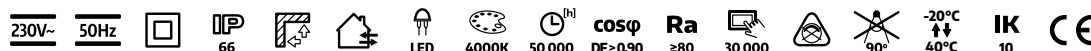

PROFESSIONAL LINE OPRAWY LED / LED FIXTURES

# LED DEFENDER 24W LX



- oprawa ledowa z mikrofalowym czujnikiem ruchu o trzech zakresach regulacji: czas działania, natężenie światła i czułość detekcji,
- czas działania: 5 sek, 1 min, 3 min, 10 min,
- natężenie światła: wyłączony lub do 30 lx,
- czułość detekcji: 100% i 50%,
- zasięg detekcji: max. 6 m,
- kąt rozsyłu światła: 120 stopni,
- podstawa wykonana z tworzywa sztucznego, klosz mleczny z poliwęglanu,
- wysoki stopień hermetyczności: IP66,
- oprawa zawiera źródła światła o klasie energetycznej D,
- możliwość wymiany źródła światła LED jedynie przez wykwalifikowany personel.

- LED fixture with a microwave motion sensor featuring three adjustable settings: operating time, light intensity, and detection sensitivity,
- operating time: 5 sec, 1 min, 3 min, 10 min,
- light intensity: off or up to 30 lx,
- detection sensitivity: 100% and 50%,
- detection range: max. 6 m,
- beam angle: 120 degrees,
- base made of plastic, milky cover made of polycarbonate,
- high degree of ingress protection: IP66,
- fixture contains light sources with energy efficiency class D,
- LED light source can only be replaced by qualified personnel.

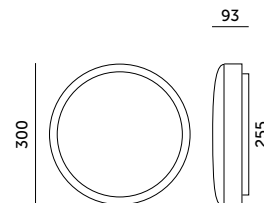

MODEL	INDEKS	POBÓR MOCY [W]	BARWA ŚWIATŁA	STRUMIEŃ ŚWIETLNY [lm]	WAGA NETTO [kg]	PAKOWANIE [szt.]	KOD EAN
MODEL	INDEX	POWER [W]	LIGHT COLOR	LUMINOUS FLUX [lm]	NET WEIGHT [kg]	PACKING [pcs]	BARCODE
LED DEFENDER 24W LX NB	KFDX24WNBBI	24	NEUTRALNA BIAŁA NEUTRAL WHITE	2400	0,85	4	5902201303810

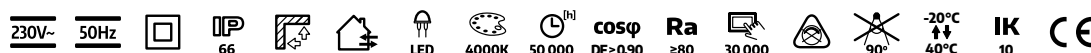



**PREMIUM** OPRAWY LED / LED FIXTURES  
**LED NAIROS G2 12W**

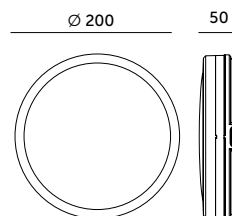

- sufitowa oprawa ledowa z możliwością zmiany barwy światła: ciepłobiała, neutralna lub zimnobiała,
- regulacja temperatury barwowej: 3000 K, 4000 K lub 6500 K za pomocą suwaka na spodzie oprawy,
- wykonana z polipropylenu PP,
- kąt rozsytu światła oprawy: 120 stopni,
- oprawa zawiera źródła światła o klasie energetycznej D,
- możliwość wymiany źródła światła LED jedynie przez wykwalifikowany personel.

- ceiling LED fixture with adjustable light color temperature: warm white, neutral white, or cool white,
- slider on the bottom of the fixture allows adjustment of light color temperature: 3000 K, 4000 K, or 6500 K,
- made of polypropylene (PP),
- beam angle: 120 degrees,
- fixture contains light sources with energy efficiency class D,
- LED light source can only be replaced by qualified personnel.

MODEL	INDEKS	KOLOR	POBÓR MOCY [W]	BARWA ŚWIATŁA	STRUMIEŃ ŚWIETLNY [lm]	WAGA NETTO [kg]	PAKOWANIE [szt.]	KOD EAN
MODEL	INDEX	COLOR	POWER [W]	LIGHT COLOR	LUMINOUS FLUX [lm]	NET WEIGHT [kg]	PACKING [pcs]	BARCODE
LED NAIROS G2 12W	KFN212WBI	BIAŁY WHITE	12	3000/4000/6500K	1260	0,40	20	5902201383829
LED NAIROS G2 12W	KFN212WCZ	CZARNY BLACK	12	3000/4000/6500K	1140	0,40	20	5902201383836





PREMIUM OPRAWY LED / LED FIXTURES

# LED NAIROS G2 18W



BIAŁY  
WHITE

CZARNY  
BLACK

- sufitowa oprawa ledowa z możliwością zmiany barwy światła: ciepłobiała, neutralna lub zimnobiała,
- regulacja temperatury barwowej: 3000 K, 4000 K lub 6500 K za pomocą suwaka na spodzie oprawy,
- wykonana z polipropylenu PP,
- kąt rozsyłu światła oprawy: 120 stopni,
- oprawa zawiera źródła światła o klasie energetycznej D,
- możliwość wymiany źródła światła LED jedynie przez wykwalifikowany personel.

- ceiling LED fixture with adjustable light color temperature: warm white, neutral white, or cool white,
- slider on the bottom of the fixture allows adjustment of light color temperature: 3000 K, 4000 K, or 6500 K,
- made of polypropylene (PP),
- beam angle: 120 degrees,
- fixture contains light sources with energy efficiency class D,
- LED light source can only be replaced by qualified personnel.

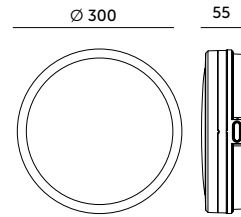

MODEL	INDEKS	KOLOR	POBÓR MOCY [W]	BARWA ŚWIATŁA	STRUMIEŃ ŚWIETLNY [lm]	WAGA NETTO [kg]	PAKOWANIE [szt.]	KOD EAN
MODEL	INDEX	COLOR	POWER [W]	LIGHT COLOR	LUMINOUS FLUX [lm]	NET WEIGHT [kg]	PACKING [pcs]	BARCODE
LED NAIROS G2 18W	KFN218WBI	BIAŁY WHITE	18	3000/4000/6500K	1890	0,70	10	5902201383867
LED NAIROS G2 18W	KFN218WCZ	CZARNY BLACK	18	3000/4000/6500K	1710	0,70	10	5902201383874



PREMIUM OPRAWY LED / LED FIXTURES

# LED NAIROS G2 24W



BIAŁY  
WHITE

CZARNY  
BLACK

- sufitowa oprawa ledowa z możliwością zmiany barwy światła: ciepłobiała, neutralna lub zimnobiała,
- regulacja temperatury barwowej: 3000 K, 4000 K lub 6500 K za pomocą suwaka na spodzie oprawy,
- wykonana z polipropylenu PP,
- kąt rozsyłu światła oprawy: 120 stopni,
- oprawa zawiera źródła światła o klasie energetycznej D,
- możliwość wymiany źródła światła LED jedynie przez wykwalifikowany personel.

- ceiling LED fixture with adjustable light color temperature: warm white, neutral white, or cool white,
- slider on the bottom of the fixture allows adjustment of light color temperature: 3000 K, 4000 K, or 6500 K,
- made of polypropylene (PP),
- beam angle: 120 degrees,
- fixture contains light sources with energy efficiency class D,
- LED light source can only be replaced by qualified personnel.

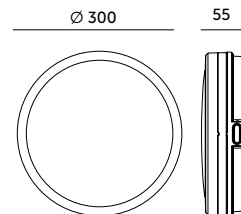

MODEL	INDEKS	KOLOR	POBÓR MOCY [W]	BARWA ŚWIATŁA	STRUMIEŃ ŚWIETLNY [lm]	WAGA NETTO [kg]	PAKOWANIE [szt.]	KOD EAN
MODEL	INDEX	COLOR	POWER [W]	LIGHT COLOR	LUMINOUS FLUX [lm]	NET WEIGHT [kg]	PACKING [pcs]	BARCODE
LED NAIROS G2 24W	KFN224WBI	BIAŁY WHITE	24	3000/4000/6500K	2520	0,70	10	5902201383904
LED NAIROS G2 24W	KFN224WCZ	CZARNY BLACK	24	3000/4000/6500K	2280	0,70	10	5902201383911



PREMIUM OPRAWY LED / LED FIXTURES

# LED NAIROS G2 36W

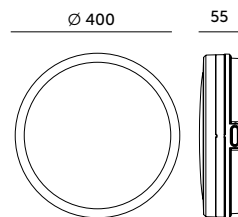

- sufitowa oprawa ledowa z możliwością zmiany barwy światła: ciepłobiała, neutralna lub zimnobiała,
- regulacja temperatury barwowej: 3000 K, 4000 K lub 6500 K za pomocą suwaka na spodzie oprawy,
- wykonana z polipropylenu PP,
- kąt rozsytu światła oprawy: 120 stopni,
- oprawa zawiera źródła światła o klasie energetycznej D,
- możliwość wymiany źródła światła LED jedynie przez wykwalifikowany personel.

- ceiling LED fixture with adjustable light color temperature: warm white, neutral white, or cool white,
- slider on the bottom of the fixture allows adjustment of light color temperature: 3000 K, 4000 K, or 6500 K,
- made of polypropylene (PP),
- beam angle: 120 degrees,
- fixture contains light sources with energy efficiency class D,
- LED light source can only be replaced by qualified personnel.

MODEL	INDEKS	KOLOR	POBÓR MOCY [W]	BARWA ŚWIATŁA	STRUMIEN ŚWIETLNY [lm]	WAGA NETTO [kg]	PAKOWANIE [szt.]	KOD EAN
MODEL	INDEX	COLOR	POWER [W]	LIGHT COLOR	LUMINOUS FLUX [lm]	NET WEIGHT [kg]	PACKING [pcs]	BARCODE
LED NAIROS G2 36W	KFN236WBI	BIAŁY WHITE	36	3000/4000/6500K	3780	1,20	10	5902201383942



PREMIUM OPRAWY LED / LED FIXTURES

# LED NAIROS LX G2 12W



- sufitowa oprawa ledowa z mikrofalowym czujnikiem ruchu i zmierzchowym o trzech zakresach regulacji: czas działania, natężenie światła i zasięg detekcji,
- sterowanie za pomocą pilota (bateria CR2025 w zestawie),
- z możliwością zmiany barwy światła: 3000 K, 4000 K lub 6500 K za pomocą suwaka na spodzie oprawy,
- czas działania po wykryciu ruchu: 5 sek, 1 min, 3 min, 10 min,
- natężenie światła czujnika: wyłączony lub 10 lx, 25 lx, 50 lx,
- zasięg detekcji czujnika: max. 6 m oraz 25%, 50%, 75%, 100%,
- kąt detekcji czujnika: 30-150 stopni,
- kąt rozsytu światła: 120 stopni,
- oprawa wykonana z polipropylenu PP,
- oprawa zawiera źródła światła o klasie energetycznej D,
- możliwość wymiany źródła światła LED jedynie przez wykwalifikowany personel.

- ceiling LED fixture with a microwave motion and dusk sensor featuring three adjustable settings: operating time, light intensity, and detection range,
- controlLED via remote (CR2025 battery included),
- slider on the bottom of the fixture allows adjustment of light color temperature: 3000 K, 4000 K, or 6500 K,
- operating time after detecting motion: 5 s, 1 min, 3 min, 10 min,
- sensor light intensity: off or 10 lx, 25 lx, 50 lx,
- sensor detection range: max. 6 m and 25%, 50%, 75%, 100%,
- sensor detection angle: 30-150 degrees,
- beam angle: 120 degrees,
- fixture made of polypropylene (PP),
- fixture contains light sources with energy efficiency class D,
- LED light source can only be replaced by qualified personnel.

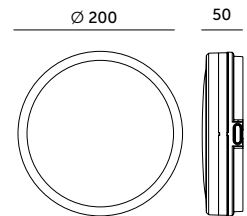

MODEL	INDEKS	KOLOR	POBÓR MOCY [W]	BARWA ŚWIATŁA	STRUMIEN ŚWIETLNY [lm]	WAGA NETTO [kg]	PAKOWANIE [szt.]	KOD EAN
MODEL	INDEX	COLOR	POWER [W]	LIGHT COLOR	LUMINOUS FLUX [lm]	NET WEIGHT [kg]	PACKING [pcs]	BARCODE
LED NAIROS G2 LX 12W	KFN2X12WBI	BIAŁY WHITE	12	3000/4000/6500K	1260	0,49	20	5902201383843
LED NAIROS G2 LX 12W	KFN2X12WCZ	CZARNY BLACK	12	3000/4000/6500K	1140	0,49	20	5902201383850



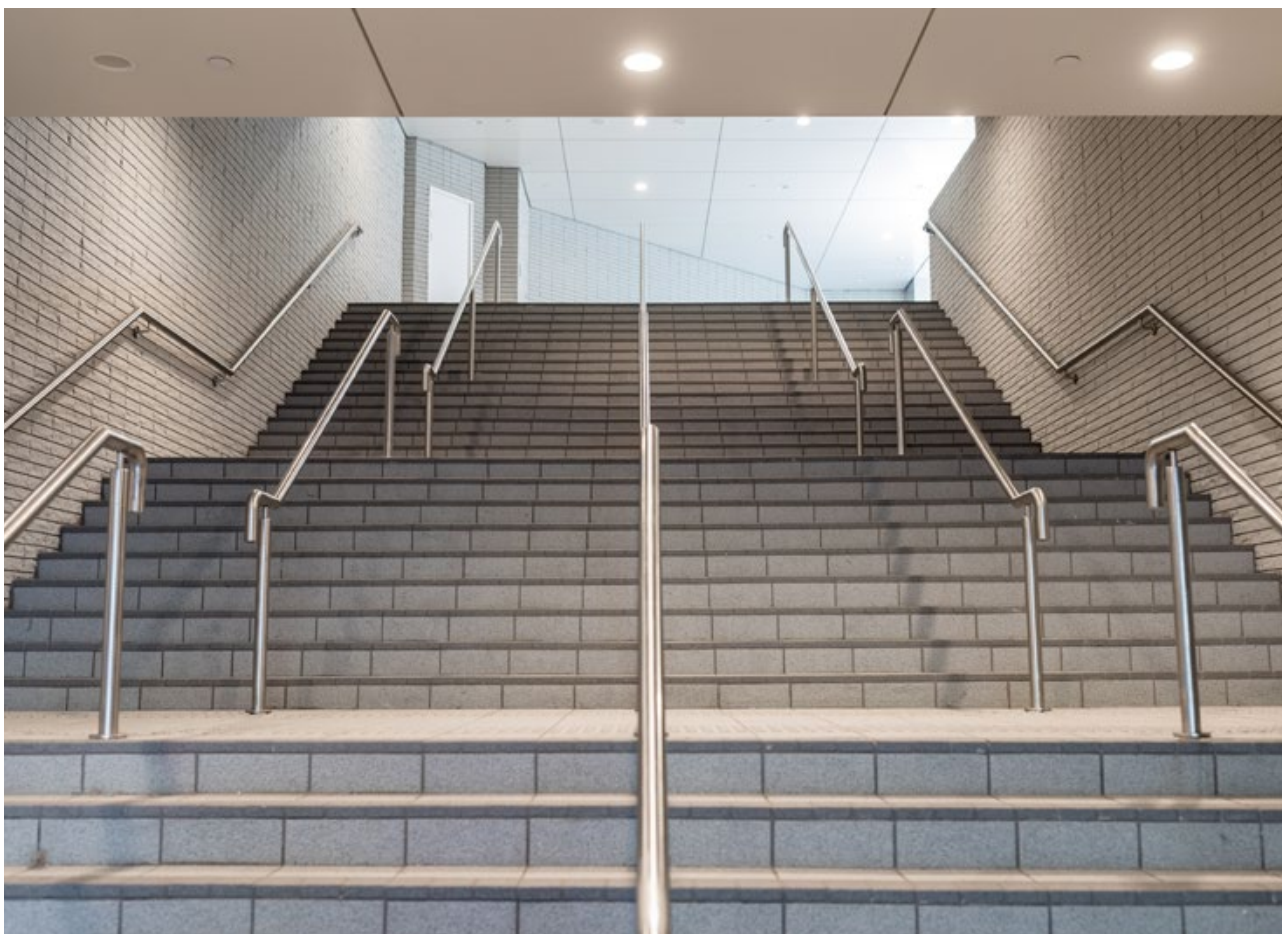

PREMIUM OPRAWY LED / LED FIXTURES

## LED NAIROS LX G2 18W

**3 LATA**  
GWARANCJI  
**3 YEARS**  
WARRANTY



BIAŁY  
WHITE



CZARNY  
BLACK



- sufitowa oprawa ledowa z mikrofalowym czujnikiem ruchu i zmierzchowym o trzech zakresach regulacji: czas działania, natężenie światła i zasięg detekcji,
- sterowanie za pomocą pilota (bateria CR2025 w zestawie),
- z możliwością zmiany barwy światła: 3000 K, 4000 K lub 6500 K za pomocą suwaka na spodzie oprawy,
- czas działania po wykryciu ruchu: 5 sek, 1 min, 3 min, 10 min,
- natężenie światła czujnika: wyłączony lub 10 lx, 25 lx, 50 lx,
- zasięg detekcji czujnika: max. 6m oraz 25%, 50%, 75%, 100%,
- kąt detekcji czujnika: 30-150 stopni,
- kąt rozsytu światła: 120 stopni,
- oprawa wykonana z polipropylenu PP,
- oprawa zawiera źródła światła o klasie energetycznej D,
- możliwość wymiany źródła światła LED jedynie przez wykwalifikowany personel.

- ceiling LED fixture with a microwave motion and dusk sensor featuring three adjustable settings: operating time, light intensity, and detection range,
- controlLED via remote (CR2025 battery included),
- slider on the bottom of the fixture allows adjustment of light color temperature: 3000 K, 4000 K, or 6500 K,
- operating time after detecting motion: 5 s, 1 min, 3 min, 10 min,
- sensor light intensity: off or 10 lx, 25 lx, 50 lx,
- sensor detection range: max. 6 m and 25%, 50%, 75%, 100%,
- sensor detection angle: 30-150 degrees,
- beam angle: 120 degrees,
- fixture made of polypropylene (PP),
- fixture contains light sources with energy efficiency class D,
- LED light source can only be replaced by qualified personnel.

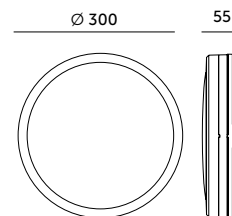

MODEL	INDEKS	KOLOR	POBÓR MOCY [W]	BARWA ŚWIATŁA	STRUMIEŃ ŚWIETLNY [lm]	WAGA NETTO [kg]	PAKOWANIE [szt.]	KOD EAN
MODEL	INDEX	COLOR	POWER [W]	LIGHT COLOR	LUMINOUS FLUX [lm]	NET WEIGHT [kg]	PACKING [pcs]	BARCODE
LED NAIROS G2 LX 18W	KFN2X18WBI	BIAŁY WHITE	18	3000/4000/6500K	1890	0,79	10	5902201383881
LED NAIROS G2 LX 18W	KFN2X18WCZ	CZARNY BLACK	18	3000/4000/6500K	1710	0,79	10	5902201383898



PREMIUM OPRAWY LED / LED FIXTURES

# LED NAIROS LX G2 24W



BIAŁY  
WHITE

CZARNY  
BLACK



- sufitowa oprawa ledowa z mikrofalowym czujnikiem ruchu i zmierzchowym o trzech zakresach regulacji: czas działania, natężenie światła i zasięg detekcji,
- sterowanie za pomocą pilota (bateria CR2025 w zestawie),
- z możliwością zmiany barwy światła: 3000 K, 4000 K lub 6500 K za pomocą suwaka na spodzie oprawy,
- czas działania po wykryciu ruchu: 5 sek, 1 min, 3 min, 10 min,
- natężenie światła czujnika: wyłączony lub 10 lx, 25 lx, 50 lx,
- zasięg detekcji czujnika: max. 6 m oraz 25%, 50%, 75%, 100%,
- kąt detekcji czujnika: 30-150 stopni,
- kąt rozsytu światła: 120 stopni,
- oprawa wykonana z polipropylenu PP,
- oprawa zawiera źródła światła o klasie energetycznej D,
- możliwość wymiany źródła światła LED jedynie przez wykwalifikowany personel.

- ceiling LED fixture with a microwave motion and dusk sensor featuring three adjustable settings: operating time, light intensity, and detection range,
- controlLED via remote (CR2025 battery included),
- slider on the bottom of the fixture allows adjustment of light color temperature: 3000 K, 4000 K, or 6500 K,
- operating time after detecting motion: 5 s, 1 min, 3 min, 10 min,
- sensor light intensity: off or 10 lx, 25 lx, 50 lx,
- sensor detection range: max. 6 m and 25%, 50%, 75%, 100%,
- sensor detection angle: 30-150 degrees,
- beam angle: 120 degrees,
- fixture made of polypropylene (PP),
- fixture contains light sources with energy efficiency class D,
- LED light source can only be replaced by qualified personnel.

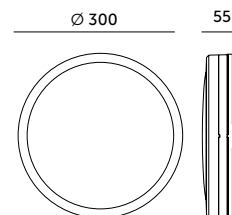

MODEL	INDEKS	KOLOR	POBÓR MOCY [W]	BARWA ŚWIATŁA	STRUMIEN ŚWIETLNY [lm]	WAGA NETTO [kg]	PAKOWANIE [szt.]	KOD EAN
MODEL	INDEX	COLOR	POWER [W]	LIGHT COLOR	LUMINOUS FLUX [lm]	NET WEIGHT [kg]	PACKING [pcs]	BARCODE
LED NAIROS LX G2 24W	KFN2X24WBI	BIAŁY WHITE	24	3000/4000/6500K	2520	0,79	10	5902201383928
LED NAIROS LX G2 24W	KFN2X24WCZ	CZARNY BLACK	24	3000/4000/6500K	2280	0,79	10	5902201383935



PREMIUM OPRAWY LED / LED FIXTURES

# LED NAIROS LX G2 36W



- sufitowa oprawa ledowa z mikrofalowym czujnikiem ruchu i zmierzchowym o trzech zakresach regulacji: czas działania, natężenie światła i zasięg detekcji,
- sterowanie za pomocą pilota (bateria CR2025 w zestawie),
- z możliwością zmiany barwy światła: 3000K, 4000K lub 6500K za pomocą suwaka na spodzie oprawy,
- czas działania po wykryciu ruchu: 5sek, 1min, 3min, 10min,
- natężenie światła czujnika: wyłączony lub 10lx, 25lx, 50lx,
- zasięg detekcji czujnika: max. 6m oraz 25%, 50%, 75%, 100%,
- kąt detekcji czujnika: 30-150 stopni,
- kąt rozsytu światła: 120 stopni,
- oprawa wykonana z polipropylenu PP,
- oprawa zawiera źródła światła o klasie energetycznej D,
- możliwość wymiany źródła światła LED jedynie przez wykwalifikowany personel.

- ceiling LED fixture with a microwave motion and dusk sensor featuring three adjustable settings: operating time, light intensity, and detection range,
- controlLED via remote (CR2025 battery included),
- slider on the bottom of the fixture allows adjustment of light color temperature: 3000 K, 4000 K, or 6500 K,
- operating time after detecting motion: 5 s, 1 min, 3 min, 10 min,
- sensor light intensity: off or 10 lx, 25 lx, 50 lx,
- sensor detection range: max. 6 m and 25%, 50%, 75%, 100%,
- sensor detection angle: 30-150 degrees,
- beam angle: 120 degrees,
- fixture made of polypropylene (PP),
- fixture contains light sources with energy efficiency class D,
- LED light source can only be replaced by qualified personnel.

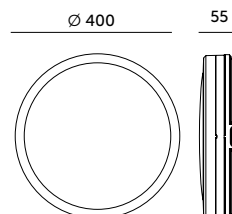

MODEL	INDEKS	KOLOR	POBÓR MOCY [W]	BARWA ŚWIATŁA	STRUMIEN ŚWIETLNY [lm]	WAGA NETTO [kg]	PAKOWANIE [szt.]	KOD EAN
MODEL	INDEX	COLOR	POWER [W]	LIGHT COLOR	LUMINOUS FLUX [lm]	NET WEIGHT [kg]	PACKING [pcs]	BARCODE
LED NAIROS LX G2 36W	KFN2X36WBI	BIAŁY WHITE	36	3000/4000/6500K	3780	1,29	10	5902201383959





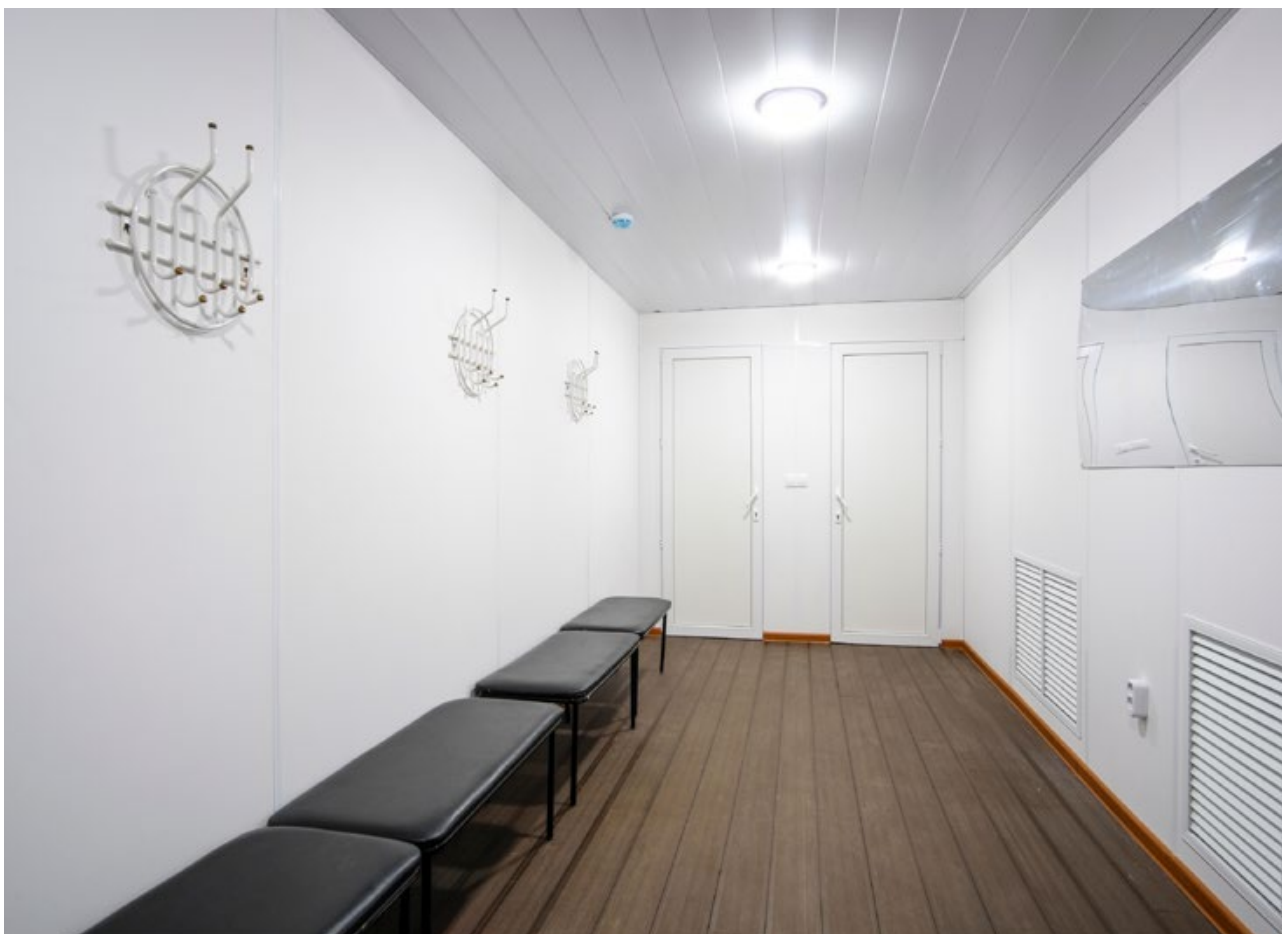

PREMIUM OPRAWY LED / LED FIXTURES

## LED SOFI 13W LX PREMIUM



- oprawa ledowa z mikrofalowym czujnikiem ruchu i natężenia światła,
- podstawa wykonana z blachy stalowej, klosz matowy z PMMA,
- tryb pracy: zaświeca się na 60 sekund przy natężeniu światła poniżej 50 lx i wykryciu ruchu,
- kąt / zasięg detekcji: 180 stopni / max. 6 m,
- kąt rozsytu światła: 115 stopni,
- optymalna wysokość montażu: 1,8-2,5 m,
- oprawa zawiera źródła światła o klasie energetycznej G,
- możliwość wymiany źródła światła LED jedynie przez wykwalifikowany personel.

- LED fixture with microwave motion sensor and light intensity sensor,
- base made of steel plate, matt cover made of PMMA,
- working mode: lights up for 60 seconds, if light intensity is lower than 50 lx and if motion is detected,
- angle/range of detection: 180 degrees/max. 6 m,
- beam angle: 115 degrees,
- optimal installation height: 1,8-2,5 m,
- fixture includes light sources of energy class G,
- the LED light source can only be replaced by qualified personnel.

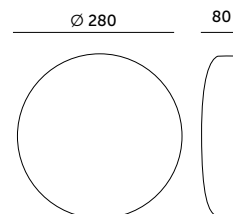

MODEL	INDEKS	POBÓR MOCY [W]	BARWA ŚWIATŁA	STRUMIEŃ ŚWIETLNY [lm]	WAGA NETTO [kg]	PAKOWANIE [szt.]	KOD EAN
MODEL	INDEX	POWER [W]	LIGHT COLOR	LUMINOUS FLUX [lm]	NET WEIGHT [kg]	PACKING [pcs]	BARCODE
LED SOFI LX 13W NB	KFSX13WNB	13	NEUTRALNA BIAŁA NEUTRAL WHITE	856	0,39	5	5900605090626





PREMIUM OPRAWY LED / LED FIXTURES

# LED SIGARO CIRCLE 18W PREMIUM

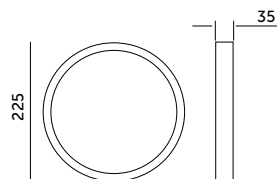
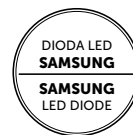

- ścienna-sufitowa oprawa ledowa,
- obudowa wykonana z ABS, klosz matowy z poliwęglanu PC,
- kąt rozsytu światła: 120 stopni,
- możliwość zdjęcia ramki i montażu podtynkowego,
- nie można wymieniać lamp w oprawie.

- wall and ceiling LED fixture,
- housing made of ABS, matt cover made of polycarbonate (PC),
- beam angle: 120 degrees,
- removable frame for recessed mounting,
- lamps in the fixture cannot be replaced.

MODEL	INDEKS	POBÓR MOCY [W]	BARWA ŚWIATŁA	STRUMIEŃ ŚWIETLNY [lm]	WAGA NETTO [kg]	PAKOWANIE [szt.]	KOD EAN
MODEL	INDEX	POWER [W]	LIGHT COLOR	LUMINOUS FLUX [lm]	NET WEIGHT [kg]	PACKING [pcs]	BARCODE
LED SIGARO CIRCLE 18W NB	KFSCNP18NB	18	NEUTRALNA BIAŁA NEUTRAL WHITE	1800	0,26	20	5902201301250

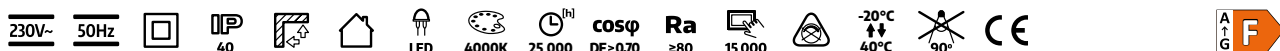

PREMIUM OPRAWY LED / LED FIXTURES

# LED SIGARO CIRCLE 24W PREMIUM

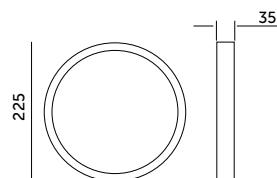
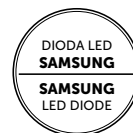

- ścienna-sufitowa oprawa ledowa,
- obudowa wykonana z ABS, klosz matowy z poliwęglanu PC,
- kąt rozsytu światła: 120 stopni,
- możliwość zdjęcia ramki i montażu podtynkowego,
- nie można wymieniać lamp w oprawie.

- wall and ceiling LED fixture,
- housing made of ABS, matt cover made of polycarbonate (PC),
- beam angle: 120 degrees,
- removable frame for recessed mounting,
- lamps in the fixture cannot be replaced.

MODEL	INDEKS	POBÓR MOCY [W]	BARWA ŚWIATŁA	STRUMIEŃ ŚWIETLNY [lm]	WAGA NETTO [kg]	PAKOWANIE [szt.]	KOD EAN
MODEL	INDEX	POWER [W]	LIGHT COLOR	LUMINOUS FLUX [lm]	NET WEIGHT [kg]	PACKING [pcs]	BARCODE
LED SIGARO CIRCLE 24W NB	KFSCNP24NB	24	NEUTRALNA BIAŁA NEUTRAL WHITE	2400	0,27	20	5902201301267

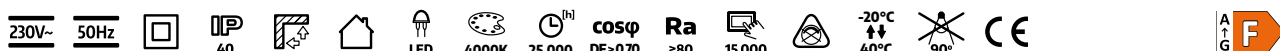

PREMIUM OPRAWY LED / LED FIXTURES

# LED SIGARO SQUARE 18W PREMIUM

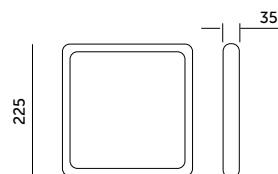
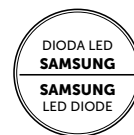

- ścienna-sufitowa oprawa ledowa,
- obudowa wykonana z ABS, klosz matowy z poliwęglanu PC,
- kąt rozsyłu światła: 120 stopni,
- możliwość zdjęcia ramki i montażu podtynkowego,
- w przypadku montażu podtynkowego otwór do wycięcia: 200 x 200 mm,
- nie można wymieniać lamp w oprawie.

- wall and ceiling LED fixture,
- housing made of ABS, matt cover made of polycarbonate (PC),
- beam angle: 120 degrees,
- removable frame for recessed mounting,
- cutout size for recessed mounting: 200 x 200 mm,
- lamps in the fixture cannot be replaced.

MODEL	INDEKS	POBÓR MOCY [W]	BARWA ŚWIATŁA	STRUMIEN ŚWIETLNY [lm]	WAGA NETTO [kg]	PAKOWANIE [szt.]	KOD EAN
MODEL	INDEX	POWER [W]	LIGHT COLOR	LUMINOUS FLUX [lm]	NET WEIGHT [kg]	PACKING [pcs]	BARCODE
LED SIGARO SQUARE 18W NB	KFSSNP18NB	18	NEUTRALNA BIAŁA NEUTRAL WHITE	1800	0,31	20	5902201301274

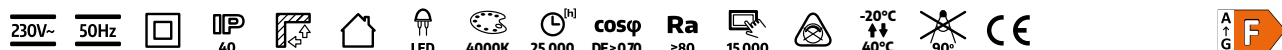

PREMIUM OPRAWY LED / LED FIXTURES

# LED SIGARO SQUARE 24W PREMIUM

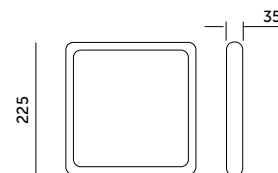
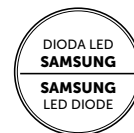

- ścienna-sufitowa oprawa ledowa,
- obudowa wykonana z ABS, klosz matowy z poliwęglanu PC,
- kąt rozsyłu światła: 120 stopni,
- możliwość zdjęcia ramki i montażu podtynkowego,
- w przypadku montażu podtynkowego otwór do wycięcia: 200 x 200 mm,
- nie można wymieniać lamp w oprawie.

- wall and ceiling LED fixture,
- housing made of ABS, matt cover made of polycarbonate (PC),
- beam angle: 120 degrees,
- removable frame for recessed mounting,
- cutout size for recessed mounting: 200 x 200 mm,
- lamps in the fixture cannot be replaced.

MODEL	INDEKS	POBÓR MOCY [W]	BARWA ŚWIATŁA	STRUMIEN ŚWIETLNY [lm]	WAGA NETTO [kg]	PAKOWANIE [szt.]	KOD EAN
MODEL	INDEX	POWER [W]	LIGHT COLOR	LUMINOUS FLUX [lm]	NET WEIGHT [kg]	PACKING [pcs]	BARCODE
LED SIGARO SQUARE 24W NB	KFSSNP24NB	24	NEUTRALNA BIAŁA NEUTRAL WHITE	2400	0,32	20	5902201301281

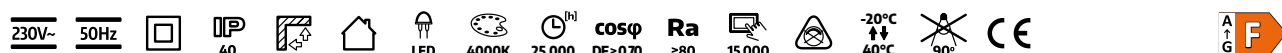



PROFESSIONAL LINE OPRAWY LED / LED FIXTURES

# LED NEXEYE NE1 15W



- oprawa ledowa do wbudowania w sufit,
- obudowa wykonana z aluminium, klosz mleczny z PMMA,
- kąt rozsytu światła: 110 stopni,
- oprawa zachowuje stopień ochrony IP44 w przypadku montażu podtynkowego,
- nie można wymieniać lamp w oprawie.

- recessed LED fixture,
- base made of aluminium, milky cover made of PMMA,
- beam angle: 110 degrees,
- in case of recessed installation, fixture retains IP44 protection degree,
- lamps in the fixture cannot be replaced.

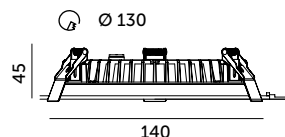

MODEL	INDEKS	KOLOR	POBÓR MOCY [W]	BARWA ŚWIATŁA	STRUMIEŃ ŚWIETLNY [lm]	WAGA NETTO [kg]	PAKOWANIE [szt.]	KOD EAN
MODEL	INDEX	COLOR	POWER [W]	LIGHT COLOR	LUMINOUS FLUX [lm]	NET WEIGHT [kg]	PACKING [pcs]	BARCODE
LED NEXEYE NE1 15W NB	O2NSNPN15NBT	BIAŁY WHITE	15	NEUTRALNA BIAŁA NEUTRAL WHITE	1600	0,34	24	5902201300796

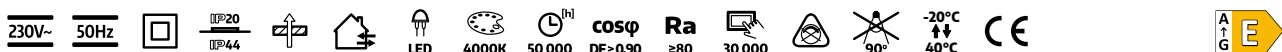

PROFESSIONAL LINE OPRAWY LED / LED FIXTURES

# LED NEXEYE NE1 20W



- oprawa ledowa do wbudowania w sufit,
- obudowa wykonana z aluminium, klosz mleczny z PMMA,
- kąt rozsyłu światła: 110 stopni,
- oprawa zachowuje stopień ochrony IP44 w przypadku montażu podtynkowego,
- nie można wymienić lamp w oprawie.

- recessed LED fixture,
- base made of aluminium, milky cover made of PMMA,
- beam angle: 110 degrees,
- in case of recessed installation, fixture retains IP44 protection degree,
- lamps in the fixture cannot be replaced.

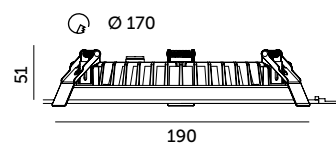

MODEL	INDEKS	KOLOR	POBÓR MOCY [W]	BARWA ŚWIATŁA	STRUMIEN ŚWIETLNY [lm]	WAGA NETTO [kg]	PAKOWANIE [szt.]	KOD EAN
MODEL	INDEX	COLOR	POWER [W]	LIGHT COLOR	LUMINOUS FLUX [lm]	NET WEIGHT [kg]	PACKING [pcs]	BARCODE
LED NEXEYE NE1 20W NB	02NSNNP20NBT	BIAŁY WHITE	20	NEUTRALNA BIAŁA NEUTRAL WHITE	2200	0,47	16	5902201300802



PROFESSIONAL LINE OPRAWY LED / LED FIXTURES

# LED NEXEYE NE1 30W



- oprawa ledowa do wbudowania w sufit,
- obudowa wykonana z aluminium, klosz mleczny z PMMA,
- kąt rozsyłu światła: 110 stopni,
- oprawa zachowuje stopień ochrony IP44 w przypadku montażu podtynkowego,
- nie można wymienić lamp w oprawie.

- recessed LED fixture,
- base made of aluminium, milky cover made of PMMA,
- beam angle: 110 degrees,
- in case of recessed installation, fixture retains IP44 protection degree,
- lamps in the fixture cannot be replaced.

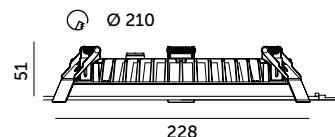

MODEL	INDEKS	KOLOR	POBÓR MOCY [W]	BARWA ŚWIATŁA	STRUMIEN ŚWIETLNY [lm]	WAGA NETTO [kg]	PAKOWANIE [szt.]	KOD EAN
MODEL	INDEX	COLOR	POWER [W]	LIGHT COLOR	LUMINOUS FLUX [lm]	NET WEIGHT [kg]	PACKING [pcs]	BARCODE
LED NEXEYE NE1 30W NB	02NSNNP30NBT	BIAŁY WHITE	30	NEUTRALNA BIAŁA NEUTRAL WHITE	3300	0,78	10	5902201300819



PREMIUM OPRAWY LED / LED FIXTURES

# LED SIGARO CIRCLE PT 6W PREMIUM

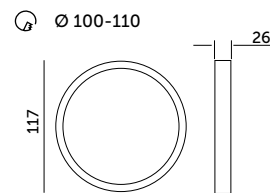
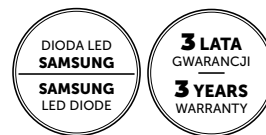

- oprawa ledowa do wbudowania w sufit,
- obudowa wykonana z ABS, klosz matowy z poliwęglanu PC,
- kąt rozsyłu światła: 120 stopni,
- nie można wymieniać lamp w oprawie.

- recessed LED fixture,
- housing made of ABS, matt cover made of PC,
- beam angle: 120 degrees,
- lamps in the fixture cannot be replaced.

MODEL	INDEKS	POBÓR MOCY [W]	BARWA ŚWIATŁA	STRUMIEŃ ŚWIETLNY [lm]	WAGA NETTO [kg]	PAKOWANIE [szt.]	KOD EAN
MODEL	INDEX	POWER [W]	LIGHT COLOR	LUMINOUS FLUX [lm]	NET WEIGHT [kg]	PACKING [pcs]	BARCODE
LED SIGARO CIRCLE PT 6W NB	KFSCPP6NB	6	NEUTRALNA BIAŁA NEUTRAL WHITE	600	0,05	40	5902201301212

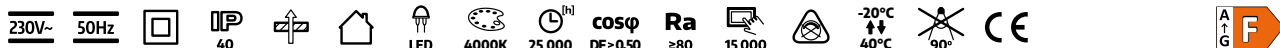

PREMIUM OPRAWY LED / LED FIXTURES

# LED SIGARO CIRCLE PT 12W PREMIUM

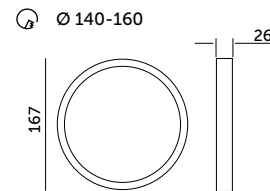
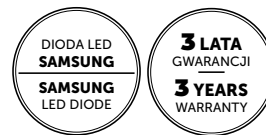

- oprawa ledowa do wbudowania w sufit,
- obudowa wykonana z ABS, klosz matowy z poliwęglanu PC,
- kąt rozsyłu światła: 120 stopni,
- nie można wymieniać lamp w oprawie.

- recessed LED fixture,
- housing made of ABS, matt cover made of PC,
- beam angle: 120 degrees,
- lamps in the fixture cannot be replaced.

MODEL	INDEKS	POBÓR MOCY [W]	BARWA ŚWIATŁA	STRUMIEŃ ŚWIETLNY [lm]	WAGA NETTO [kg]	PAKOWANIE [szt.]	KOD EAN
MODEL	INDEX	POWER [W]	LIGHT COLOR	LUMINOUS FLUX [lm]	NET WEIGHT [kg]	PACKING [pcs]	BARCODE
LED SIGARO CIRCLE PT 12W NB	KFSCPP12NB	12	NEUTRALNA BIAŁA NEUTRAL WHITE	1200	0,10	20	5902201301229

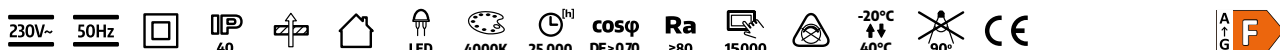



PREMIUM OPRAWY LED / LED FIXTURES

# LED SIGARO CIRCLE PT 18W PREMIUM

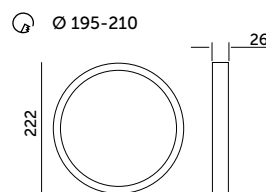
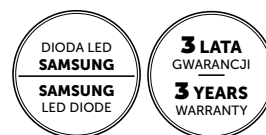

- oprawa ledowa do wbudowania w sufit,
- obudowa wykonana z ABS, klosz matowy z poliwęglanu PC,
- kąt rozsytu światła: 120 stopni,
- nie można wymieniać lamp w oprawie.

- recessed LED fixture,
- housing made of ABS, matt cover made of PC,
- beam angle: 120 degrees,
- lamps in the fixture cannot be replaced.

MODEL	INDEKS	POBÓR MOCY [W]	BARWA ŚWIATŁA	STRUMIEŃ ŚWIETLNY [lm]	WAGA NETTO [kg]	PAKOWANIE [szt.]	KOD EAN
MODEL	INDEX	POWER [W]	LIGHT COLOR	LUMINOUS FLUX [lm]	NET WEIGHT [kg]	PACKING [pcs]	BARCODE
LED SIGARO CIRCLE PT 18W NB	KFSCPP18NB	18	NEUTRALNA BIAŁA NEUTRAL WHITE	1800	0,23	20	5902201301236

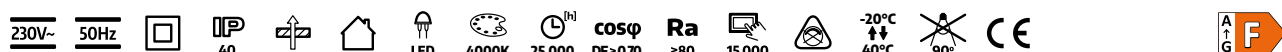

PREMIUM OPRAWY LED / LED FIXTURES

# LED SIGARO CIRCLE PT 24W PREMIUM

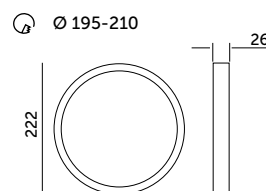
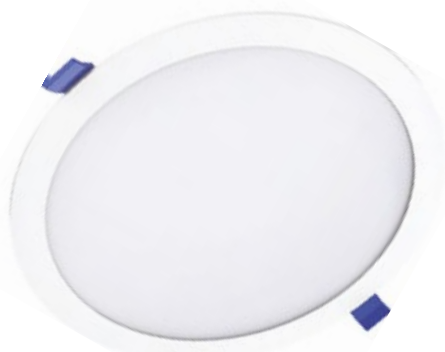
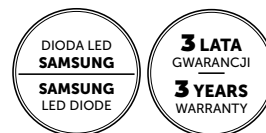

- oprawa ledowa do wbudowania w sufit,
- obudowa wykonana z ABS, klosz matowy z poliwęglanu PC,
- kąt rozsytu światła: 120 stopni,
- nie można wymieniać lamp w oprawie.

- recessed LED fixture,
- housing made of ABS, matt cover made of PC,
- beam angle: 120 degrees,
- lamps in the fixture cannot be replaced.

MODEL	INDEKS	POBÓR MOCY [W]	BARWA ŚWIATŁA	STRUMIEŃ ŚWIETLNY [lm]	WAGA NETTO [kg]	PAKOWANIE [szt.]	KOD EAN
MODEL	INDEX	POWER [W]	LIGHT COLOR	LUMINOUS FLUX [lm]	NET WEIGHT [kg]	PACKING [pcs]	BARCODE
LED SIGARO CIRCLE PT 24W NB	KFSCPP24NB	24	NEUTRALNA BIAŁA NEUTRAL WHITE	2400	0,25	20	5902201301243

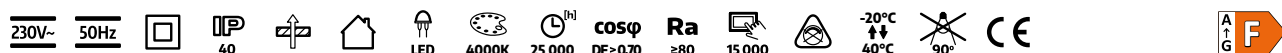

STANDARD LINE NAŚWIETLACZE LED / LED FLOODLIGHTS

# TIGRA P 50W

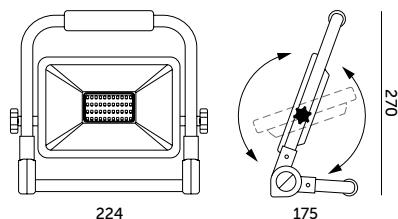

- przenośny naświetlacz ledowy,
- wykonany z aluminium i szkła hartowanego, konstrukcja ze stali,
- kąt rozsytu światła: 110 stopni,
- długość przewodu zasilającego: 1,3 m (H05RN-F 3x1 mm),
- wtyczka typu: uni-schuko,
- nie można wymieniać lamp w oprawie.

- portable LED floodlight,
- made of aluminium and tempered glass, steel stand,
- beam angle: 110 degrees,
- power cord length: 1.3 m (H05RN-F 3x1 mm),
- plug type: uni-schuko,
- lamps in the fixture cannot be replaced.

MODEL	INDEKS	POBÓR MOCY [W]	BARWA ŚWIATŁA	STRUMIEŃ ŚWIETLNY [lm]	WAGA NETTO [kg]	PAKOWANIE [szt.]	KOD EAN
MODEL	INDEX	POWER [W]	LIGHT COLOR	LUMINOUS FLUX [lm]	NET WEIGHT [kg]	PACKING [pcs]	BARCODE
TIGRA P 50W	KFNLP50NB	50	NEUTRALNA BIAŁA NEUTRAL WHITE	4000	1,00	8	5902201307979

STANDARD LINE NAŚWIETLACZE LED / LED FLOODLIGHTS

# TIGRA P 100W

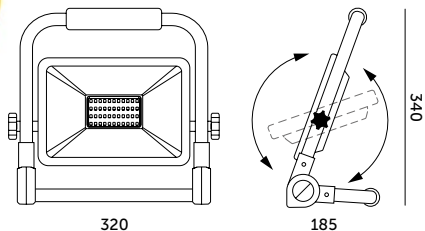

- przenośny naświetlacz ledowy,
- wykonany z aluminium i szkła hartowanego, konstrukcja ze stali,
- kąt rozsytu światła: 110 stopni,
- długość przewodu zasilającego: 1,3 m (H05RN-F 3x1 mm),
- wtyczka typu: uni-schuko,
- nie można wymieniać lamp w oprawie.

- portable LED floodlight,
- made of aluminium and tempered glass, steel stand,
- beam angle: 110 degrees,
- power cord length: 1.3 m (H05RN-F 3x1 mm),
- plug type: uni-schuko,
- lamps in the fixture cannot be replaced.

MODEL	INDEKS	POBÓR MOCY [W]	BARWA ŚWIATŁA	STRUMIEŃ ŚWIETLNY [lm]	WAGA NETTO [kg]	PAKOWANIE [szt.]	KOD EAN
MODEL	INDEX	POWER [W]	LIGHT COLOR	LUMINOUS FLUX [lm]	NET WEIGHT [kg]	PACKING [pcs]	BARCODE
TIGRA P 100W	KFNLP100NB	100	NEUTRALNA BIAŁA NEUTRAL WHITE	8150	1,74	4	5902201307986

STANDARD LINE NAŚWIETLACZE LED / LED FLOODLIGHTS

# TIGRA S 2x30W

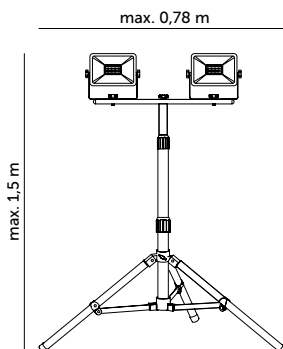

- dwa naświetlacze ledowe na statywie,
- wykonane z aluminium i szkła hartowanego, konstrukcja ze stali,
- kąt rozsytu światła: 110 stopni,
- długość przewodu zasilającego: 3 m (H05RN-F 3x1 mm),
- wtyczka typu: uni-schuko,
- nie można wymieniać lamp w oprawie.

- two LED floodlights on tripod,
- made of aluminium and tempered glass, steel stand,
- beam angle: 110 degrees,
- power cord length: 3 m (H05RN-F 3x1 mm),
- plug type: uni-schuko,
- lamps in the fixture cannot be replaced.

MODEL	INDEKS	POBÓR MOCY [W]	BARWA ŚWIATŁA	STRUMIEŃ ŚWIETLNY [lm]	WAGA NETTO [kg]	PAKOWANIE [szt.]	KOD EAN
MODEL	INDEX	POWER [W]	LIGHT COLOR	LUMINOUS FLUX [lm]	NET WEIGHT [kg]	PACKING [pcs]	BARCODE
TIGRA S 2x30W	KFNLS2X30NB	2x30	NEUTRALNA BIAŁA NEUTRAL WHITE	2x2340	3,37	4	5902201307993



STANDARD LINE NAŚWIETLACZE LED / LED FLOODLIGHTS

# TIGRA S 2x50W

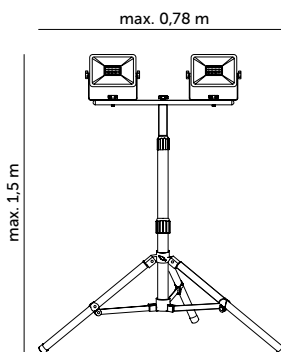

- dwa naświetlacze ledowe na statywie,
- wykonane z aluminium i szkła hartowanego, konstrukcja ze stali,
- kąt rozsytu światła: 110 stopni,
- długość przewodu zasilającego: 3 m (H05RN-F 3x1 mm),
- wtyczka typu: uni-schuko,
- nie można wymieniać lamp w oprawie.

- two LED floodlights on tripod,
- made of aluminium and tempered glass, steel stand,
- beam angle: 110 degrees,
- power cord length: 3 m (H05RN-F 3x1 mm),
- plug type: uni-schuko,
- lamps in the fixture cannot be replaced.

MODEL	INDEKS	POBÓR MOCY [W]	BARWA ŚWIATŁA	STRUMIEŃ ŚWIETLNY [lm]	WAGA NETTO [kg]	PAKOWANIE [szt.]	KOD EAN
MODEL	INDEX	POWER [W]	LIGHT COLOR	LUMINOUS FLUX [lm]	NET WEIGHT [kg]	PACKING [pcs]	BARCODE
TIGRA S 2x50W	KFNLS2X50NB	2x50	NEUTRALNA BIAŁA NEUTRAL WHITE	2x4000	3,49	4	5902201308006





**STANDARD LINE** OPRAWY DO NABUDOWANIA / BUILD-ON FIXTURES

# NEXTRACK S-LINE



BIAŁY  
WHITE



CZARNY  
BLACK

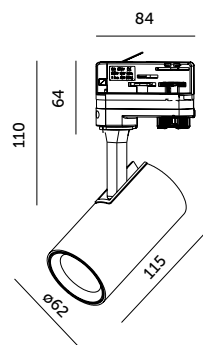

- zasilanie: 230V AC (poprzez adapter na szynę 3-fazową),
- kompatybilność z szynoprzewodami Global Trac, Unipro, itp.
- oprawa nie zawiera źródła światła.

- power: 230V AC (via adaptor for 3-phase track),
- compatible with various track systems such as Global Trac, Unipro, etc.
- light source not included.

MODEL	INDEKS	KOLOR	WAGA NETTO [kg]	PAKOWANIE [szt.]	KOD EAN
MODEL	INDEX	COLOR	NET WEIGHT [kg]	PACKING [pcs]	BARCODE
NEXTRACK S-LINE	KFNKSBI	BIAŁY WHITE	0,25	50	5902201359251
NEXTRACK S-LINE	KFNKSCZ	CZARNY BLACK	0,25	50	5902201359244

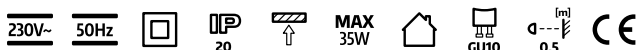

STANDARD LINE

AKCESORIA DO LED NEXTRACK / ACCESSORIES FOR LED NEXTRACK

# SZYNOPRZEWODY

/ TRACK SYSTEMS



BIAŁY  
WHITE

CZARNY  
BLACK

- 3-fazowe szynoprzewody typu GLOBAL track, Unipro itp.  
- wykonane z aluminium z miedzianym przewodem.

- 3 phase track of GLOBAL track, Unipro etc.  
- made of aluminium with copper wire.

MODEL	INDEKS	DŁUGOŚĆ [m]	KOLOR	WAGA NETTO [kg]	PAKOWANIE [szt.]	KOD EAN
MODEL	INDEX	LENGTH [m]	COLOR	NET WEIGHT [kg]	PACKING [pcs]	BARCODE
SZYNOPRZEWÓD BIAŁY 1m	NTTS1BP	1	BIAŁY WHITE	0,77	1	5902201301410
SZYNOPRZEWÓD BIAŁY 2m	NTTS2B1	2	BIAŁY WHITE	1,54	1	5902201301076
SZYNOPRZEWÓD CZARNY 1m	NTTS1CP	1	CZARNY BLACK	0,77	1	5902201300352
SZYNOPRZEWÓD CZARNY 2m	NTTS2C	2	CZARNY BLACK	1,54	1	5902846012801



STANDARD LINE

AKCESORIA DO LED NEXTRACK / ACCESSORIES FOR LED NEXTRACK

# AKCESORIA MONTAŻOWE

/ INSTALLATION ACCESSORIES



ŁĄCZNIK „F” ZEWNĘTRZNY  
EXTERNAL „F” CONNECTOR

ŁĄCZNIK „L” ZEWNĘTRZNY  
EXTERNAL „L” CONNECTOR

ŁĄCZNIK „T” ZEWNĘTRZNY  
EXTERNAL „T” CONNECTOR

ŁĄCZNIK „X” ZEWNĘTRZNY  
EXTERNAL „X” CONNECTOR

ŁĄCZNIK „I” ZEWNĘTRZNY  
EXTERNAL „I” CONNECTOR

ŁĄCZNIK „I” WEWNĘTRZNY  
INNER „I” CONNECTOR

ZASILANIE PRAWO  
RIGHT POWER SUPPLY

ZASILANIE LEWO  
LEFT POWER SUPPLY

ZASŁEPKA  
BLACK END CAP

MODEL	INDEKS [biały]	INDEKS [czarny]	WAGA NETTO [kg]	PAKOWANIE [szt.]	KOD EAN [biały]	KOD EAN [czarny]
MODEL	INDEX [white]	INDEX [black]	NET WEIGHT [kg]	PACKING [pcs]	BARCODE [white]	BARCODE [black]
ŁĄCZNIK „I” ZEWN.	NTTLIZB	NTTLIZC	0,10	50	5902846012719	5902846012726
ŁĄCZNIK „I” WEWN.	NTTLIWB	NTTLIWC	0,03	100	5902846012696	5902846012702
ŁĄCZNIK „L” ZEWN. LEWY	NTTLZB	NTTLZC	0,10	25	5902846012771	5902846012788
ŁĄCZNIK „L” ZEWN. PRAWY	NTTPZB	NTTPZC	0,10	25	5902201301694	5902201301182
ŁĄCZNIK „T” ZEWN.	NTTLTZB	NTTLTZC	0,15	25	5902846012757	5902846012764
ŁĄCZNIK „X” ZEWN.	NTTLXZB	NTTLXZC	0,21	10	5902846012733	5902846012740
ŁĄCZNIK „F” ZEWNĘTRZNY	NTTLFZB	NTTLFZC	0,15	25	5902846015246	5902846015239
ZASILANIE PRAWO	NTTZPB	NTTZPC	0,05	50	5902846012658	5902846012665
ZASILANIE LEWO	NTTZLB	NTTZLC	0,05	50	5902846012634	5902846012641
ZASŁEPKA	NTTZB	NTTZC	0,01	200	5902846012672	5902846012689





STANDARD LINE

AKCESORIA DO LED NEXTRACK / ACCESSORIES FOR LED NEXTRACK

# ZESTAW DO ZAWIESZENIA

/ A SET FOR HANGING

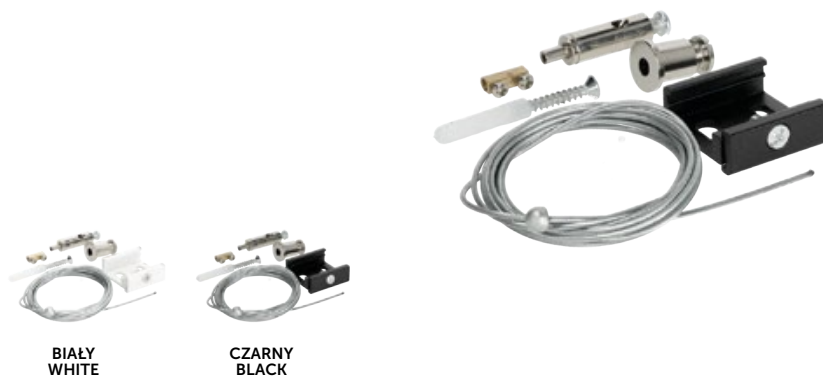

- zestaw do zawieszenia szynoprzewodów na linkach,  
- długość: max. 2 m.

- a set for hanging the tracks on wires,  
- length: max 2 m.

MODEL	INDEKS	KOLOR	WAGA NETTO [kg]	PAKOWANIE [szt.]	KOD EAN
MODEL	INDEX	COLOR	NET WEIGHT [kg]	PACKING [pcs]	BARCODE
ZESTAW DO ZAWIESZENIA	NTTZS2B	BIAŁY WHITE	0,05	100	5902846012795
ZESTAW DO ZAWIESZENIA	NTTZS2C	CZARNY BLACK	0,05	100	5902846018865

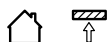

STANDARD LINE OPRAWY TECHNICZNE / TECHNICAL LIGHTING

# RUTO

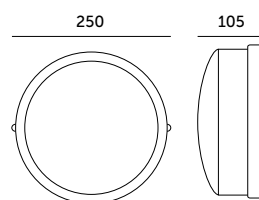

- podstawa z tworzywa sztucznego,  
- klosz wykonany ze szkła.

- base made of plastic,  
- cover made of glass.

MODEL	INDEKS	KOLOR	WAGA NETTO [kg]	PAKOWANIE [szt.]	KOD EAN
MODEL	INDEX	COLOR	NET WEIGHT [kg]	PACKING [pcs]	BARCODE
RUTO 100W	KKROB	BIAŁY WHITE	1,26	5	5906340215225



STANDARD LINE OPRAWY TECHNICZNE / TECHNICAL LIGHTING

# WEGA PC

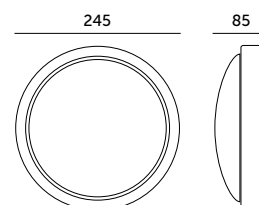

- podstawa wykonana z tworzywa sztucznego,  
- klosz wykonany z poliwęglanu.

- base made of plastic,  
- cover made of PC.

MODEL	INDEKS	KOLOR	WAGA NETTO [kg]	PAKOWANIE [szt.]	KOD EAN
MODEL	INDEX	COLOR	NET WEIGHT [kg]	PACKING [pcs]	BARCODE
WEGA PC	KKWA75WPC	BIAŁY WHITE	0,32	5	5900605092569



STANDARD LINE

OPRAWY TECHNICZNE / TECHNICAL LIGHTING

# SOMA PC 60 SIATKA METAL

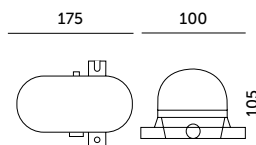

- podstawa wykonana z tworzywa sztucznego,  
ostona wykonana z metalu,  
- klosz wykonany z poliwęglanu.

- base made of plastic, cover made of metal,  
- shade made of PC.

MODEL	INDEKS	KOLOR	WAGA NETTO [kg]	PAKOWANIE [szt.]	KOD EAN
MODEL	INDEX	COLOR	NET WEIGHT [kg]	PACKING [pcs]	BARCODE
SOMA PC 60 SIATKA METAL	KKSA60SM	BIAŁY WHITE	0,20	12	5902846015734



STANDARD LINE

OPRAWY TECHNICZNE / TECHNICAL LIGHTING

# SOMA PC 100 SIATKA METAL

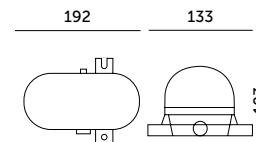

- podstawa wykonana z tworzywa sztucznego,  
ostona wykonana z metalu,  
- klosz wykonany z poliwęglanu.

- base made of plastic, cover made of metal,  
- shade made of PC.

MODEL	INDEKS	KOLOR	WAGA NETTO [kg]	PAKOWANIE [szt.]	KOD EAN
MODEL	INDEX	COLOR	NET WEIGHT [kg]	PACKING [pcs]	BARCODE
SOMA PC 100 SIATKA METAL	KKSA100SM	BIAŁY WHITE	0,22	10	5902846015758



STANDARD LINE OPRAWY TECHNICZNE / TECHNICAL LIGHTING

# SOMA PC 60 SIATKA PLASTIK

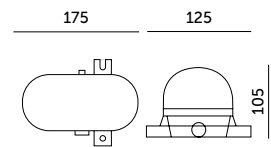

- podstawa i ostona wykonana z tworzywa sztucznego,  
- klosz wykonany z poliwęglanu.

- base and cover made of plastic,  
- shade made of PC.

MODEL	INDEKS	KOLOR	WAGA NETTO [kg]	PAKOWANIE [szt.]	KOD EAN
MODEL	INDEX	COLOR	NET WEIGHT [kg]	PACKING [pcs]	BARCODE
SOMA PC 60 SIATKA PLASTIK	KKSA60SP	BIAŁY WHITE	0,19	12	5902846015727



STANDARD LINE OPRAWY TECHNICZNE / TECHNICAL LIGHTING

# SOMA PC 100 SIATKA PLASTIK

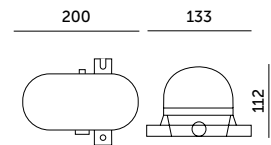

- podstawa i ostona wykonana z tworzywa sztucznego,  
- klosz wykonany z poliwęglanu.

- base and cover made of plastic,  
- shade made of PC.

MODEL	INDEKS	KOLOR	WAGA NETTO [kg]	PAKOWANIE [szt.]	KOD EAN
MODEL	INDEX	COLOR	NET WEIGHT [kg]	PACKING [pcs]	BARCODE
SOMA PC 100 SIATKA PLASTIK	KKSA100SP	BIAŁY WHITE	0,21	10	5902846015741







STANDARD LINE

OPRAWY TECHNICZNE / TECHNICAL LIGHTING

# ROMERO



CHROM  
CHROME



CZARNY  
BLACK

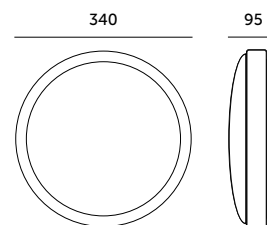

- podstawa wykonana z aluminium, klosz matowy z akrylu.

- base made of aluminium, matt cover made of acryl.

MODEL	INDEKS	KOLOR	WAGA NETTO [kg]	PAKOWANIE [szt.]	KOD EAN
MODEL	INDEX	COLOR	NET WEIGHT [kg]	PACKING [pcs]	BARCODE
ROMERO	KKRO	CHROM CHROME	0,65	10	5900605098813
ROMERO	KKROCZ	CZARNY BLACK	0,65	10	5902201301649





STANDARD LINE OPRAWY TECHNICZNE / TECHNICAL LIGHTING

# SAMIRA S

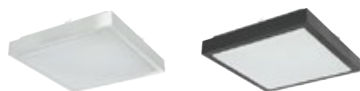

CHROM  
CHROME

CZARNY  
BLACK

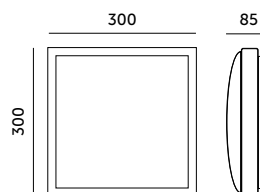

- podstawa wykonana z aluminium,  
klosz matowy z akrylu.

- base made of aluminium, matt cover  
made of acryl.

MODEL	INDEKS	KOLOR	WAGA NETTO [kg]	PAKOWANIE [szt.]	KOD EAN
MODEL	INDEX	COLOR	NET WEIGHT [kg]	PACKING [pcs]	BARCODE
SAMIRA S	KKSAS	CHROM CHROME	0,69	10	5900605098790
SAMIRA S	KKSASCZ	CZARNY BLACK	0,69	10	5902201301656



STANDARD LINE OPRAWY TECHNICZNE / TECHNICAL LIGHTING

# SAMIRA B

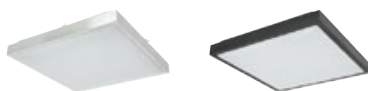

CHROM  
CHROME

CZARNY  
BLACK

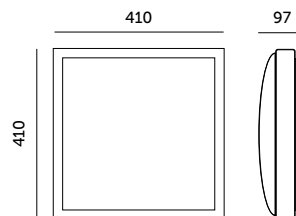

- podstawa wykonana z aluminium,  
klosz matowy z akrylu.

- base made of aluminium, matt cover  
made of acryl.

MODEL	INDEKS	KOLOR	WAGA NETTO [kg]	PAKOWANIE [szt.]	KOD EAN
MODEL	INDEX	COLOR	NET WEIGHT [kg]	PACKING [pcs]	BARCODE
SAMIRA B	KKSAB	CHROM CHROME	1,24	5	5900605098806
SAMIRA B	KKSABCZ	CZARNY BLACK	1,24	5	5902201301663





**STANDARD LINE** OPRAWY ŚWIETŁÓWKOWE / LED T8 FIXTURES

# ZESTAW HERMETIC 1x120 + 1xLED T8 18W

/ HERMETIC 1x120 SET + 1xLED T8 18W



- oprawa hermetyczna ze świetłówką LED T8 18W,
- świetłówka zamontowana w oprawie,
- obudowa wykonana z tworzywa sztucznego, klosz przezroczysty z polistyrenu (PS),
- w skład oprawy wchodzi lampy LED klasy F.

- hermetic fixture with LED T8 18W tubes,
- T8 tubes install inside the fixture,
- housing made of plastic, transparent cover made of polystyrene (PS),
- set includes LED lamps of energy efficiency class F.

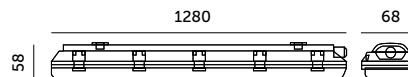

MODEL	INDEKS	POBÓR MOCY [W]	BARWA ŚWIATŁA	STRUMIEŃ ŚWIETLNY ŹRÓDŁA ŚWIATŁA [lm]	WAGA NETTO [kg]	PAKOWANIE [szt.]	KOD EAN
MODEL	INDEX	POWER [W]	LIGHT COLOR	LUMINOUS FLUX OF A LIGHT SOURCE [lm]	NET WEIGHT [kg]	PACKING [pcs]	BARCODE
ZESTAW HERMETIC 1x120 + T8 18W NB	KFHC118NB	1x18	NEUTRALNA BIAŁA NEUTRAL WHITE	1800	0,74	12	5902846015505

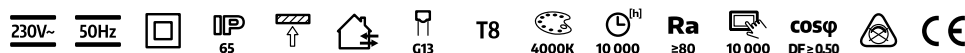

STANDARD LINE OPRAWY ŚWIETŁÓWKOWE / LED T8 FIXTURES

## ZESTAW HERMETIC 2x60 + 2xLED T8 9W

/ HERMETIC 2x60 SET + 2xLED T8 9W



- oprawa hermetyczna z dwiema świetłówkami LED T8 9W,
- świetłówki zamontowane w oprawie,
- obudowa wykonana z tworzywa sztucznego, klosz przezroczysty z polistyrenu (PS),
- w skład oprawy wchodzi lampy LED klasy F.

- hermetic fixture with two LED T8 9W tubes,
- T8 tubes installed inside the fixture,
- housing made of plastic, transparent cover made of polystyrene (PS),
- set includes LED lamps of energy efficiency class F.

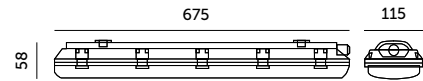

MODEL	INDEKS	POBÓR MOCY [W]	BARWA ŚWIATŁA	STRUMIEŃ ŚWIETLNY ŹRÓDŁA ŚWIATŁA [lm]	WAGA NETTO [kg]	PAKOWANIE [szt.]	KOD EAN
MODEL	INDEX	POWER [W]	LIGHT COLOR	LUMINOUS FLUX OF A LIGHT SOURCE [lm]	NET WEIGHT [kg]	PACKING [pcs]	BARCODE
ZESTAW HERMETIC 2x60 + 2xT8 9W NB	KFHC29NB	2x9	NEUTRALNA BIAŁA NEUTRAL WHITE	2x900	0,61	10	5902846015680

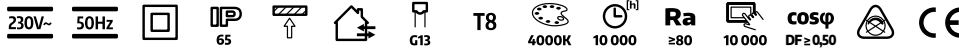

STANDARD LINE OPRAWY ŚWIETŁÓWKOWE / LED T8 FIXTURES

## ZESTAW HERMETIC G2 + 2xLED T8 18W

/ HERMETIC G2 SET + 2xLED T8 18W



- oprawa hermetyczna z dwiema świetłówkami LED T8 18W,
- świetłówki zamontowane w oprawie,
- obudowa wykonana z tworzywa sztucznego ABS, klosz przezroczysty z polistyrenu PS,
- można łączyć oprawy: max. 12 sztuk,
- kąt rozsyłu światła: 120 stopni,
- posiada 2 uchwyty do podtrzymania klosza w czasie montażu,
- w skład oprawy wchodzi lampy LED klasy E.

- hermetic fixture with two LED T8 18W tubes,
- T8 tubes already installed,
- housing made of ABS, transparent cover made of PS,
- fixtures can be connected: max. 12 pcs,
- beam angle: 120 degrees,
- has two clips that hold cover during installation,
- set includes LED lamps of energy efficiency class E.

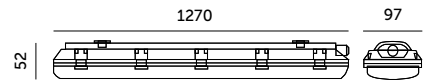

MODEL	INDEKS	POBÓR MOCY [W]	BARWA ŚWIATŁA	STRUMIEŃ ŚWIETLNY ŹRÓDŁA ŚWIATŁA [lm]	WAGA NETTO [kg]	PAKOWANIE [szt.]	KOD EAN
MODEL	INDEX	POWER [W]	LIGHT COLOR	LUMINOUS FLUX OF A LIGHT SOURCE [lm]	NET WEIGHT [kg]	PACKING [pcs]	BARCODE
HERMETIC G2 + 2xLED T8 18W NB	KFHC218NB2	2x18	NEUTRALNA BIAŁA NEUTRAL WHITE	2x2160	1,13	10	5902201387537
HERMETIC G2 + 2xLED T8 18W ZB	KFHC218ZB2	2x18	ZIMNOBIAŁA COOL WHITE	2x2160	1,13	10	5902201387544







**STANDARD LINE** OPRAWY ŚWIETŁÓWKOWE / LED T8 FIXTURES

# HERMETIC 1x60



- oprawa hermetyczna na świetłóWKi T8 LED z zasilaniem jednostronnym,
- obudowa wykonana z ABS, klosz przezroczysty z polistyrenu (PS),
- oprawa nie zawiera źródła światła.

- hermetic fixture for T8 LED tubes with single-sided power,
- housing made of ABS, transparent cover made of polystyrene (PS),
- light source not included.

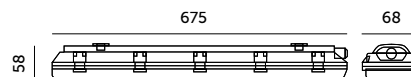

MODEL	INDEKS	WAGA NETTO [kg]	PAKOWANIE [szt.]	KOD EAN
MODEL	INDEX	NET WEIGHT [kg]	PACKING [pcs]	BARCODE
HERMETIC 1X60	KFHCE160	0,32	18	5900605099384



STANDARD LINE OPRAWY ŚWIETŁÓWKOWE / LED T8 FIXTURES

# HERMETIC 1x120



- oprawa hermetyczna na świetlówki T8 LED z zasilaniem jednostronnym,
- obudowa wykonana z ABS, klosz przezroczysty z polistyrenu (PS),
- oprawa nie zawiera źródła światła.

- hermetic fixture for T8 LED tubes with single-sided power,
- housing made of ABS, transparent cover made of polystyrene (PS),
- light source not included.

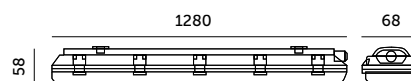

MODEL	INDEKS	WAGA NETTO [kg]	PAKOWANIE [szt.]	KOD EAN
MODEL	INDEX	NET WEIGHT [kg]	PACKING [pcs]	BARCODE
HERMETIC 1X120	KFHCE1120	0,56	12	5900605099391



STANDARD LINE OPRAWY ŚWIETŁÓWKOWE / LED T8 FIXTURES

# HERMETIC 1x150



- oprawa hermetyczna na świetlówki T8 LED z zasilaniem jednostronnym,
- obudowa wykonana z ABS, klosz przezroczysty z polistyrenu (PS),
- oprawa nie zawiera źródła światła.

- hermetic fixture for T8 LED tubes with single-sided power,
- housing made of ABS, transparent cover made of polystyrene (PS),
- light source not included.

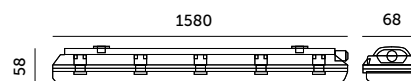

MODEL	INDEKS	WAGA NETTO [kg]	PAKOWANIE [szt.]	KOD EAN
MODEL	INDEX	NET WEIGHT [kg]	PACKING [pcs]	BARCODE
HERMETIC 1X150	KFHCE1150	0,68	12	5900605099407







**STANDARD LINE** OPRAWY ŚWIETŁÓWKOWE / LED T8 FIXTURES

# HERMETIC 2x60



- oprawa hermetyczna na świetlówki T8 LED z zasilaniem jednostronnym,
- obudowa wykonana z ABS, klosz przezroczysty z polistyrenu (PS),
- oprawa nie zawiera źródła światła.

- hermetic fixture for T8 LED tubes with single-sided power,
- housing made of ABS, transparent cover made of polystyrene (PS),
- light source not included.

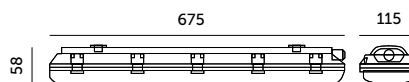

MODEL	INDEKS	WAGA NETTO [kg]	PAKOWANIE [szt.]	KOD EAN
MODEL	INDEX	NET WEIGHT [kg]	PACKING [pcs]	BARCODE
HERMETIC 2X60	KFHCE260	0,45	10	5900605099353



STANDARD LINE OPRAWY ŚWIETŁÓWKOWE / LED T8 FIXTURES

# HERMETIC 2x120



- oprawa hermetyczna na świetłóWKi T8 LED z zasilaniem jednostronnym,  
- obudowa wykonana z ABS, klosz przezroczysty z polistyrenu (PS),  
- oprawa nie zawiera źródła światła.

- hermetic fixture for T8 LED tubes with single-sided power,  
- housing made of ABS, transparent cover made of polystyrene (PS),  
- light source not included.

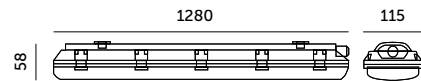

MODEL	INDEKS	WAGA NETTO [kg]	PAKOWANIE [szt.]	KOD EAN
MODEL	INDEX	NET WEIGHT [kg]	PACKING [pcs]	BARCODE
HERMETIC 2X120	KFHCE2120	0,74	10	5900605099360



STANDARD LINE OPRAWY ŚWIETŁÓWKOWE / LED T8 FIXTURES

# HERMETIC 2x150



- oprawa hermetyczna na świetłóWKi T8 LED z zasilaniem jednostronnym,  
- obudowa wykonana z ABS, klosz przezroczysty z polistyrenu (PS),  
- oprawa nie zawiera źródła światła.

- hermetic fixture for T8 LED tubes with single-sided power,  
- housing made of ABS, transparent cover made of polystyrene (PS),  
- light source not included.

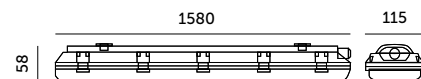

MODEL	INDEKS	WAGA NETTO [kg]	PAKOWANIE [szt.]	KOD EAN
MODEL	INDEX	NET WEIGHT [kg]	PACKING [pcs]	BARCODE
HERMETIC 2X150	KFHCE2150	0,97	8	5900605099377



STANDARD LINE

OPRAWY ŚWIETŁÓWKOWE / LED T8 FIXTURES

# HERMIC 1x120



- oprawa hermetyczna na świetlówki T8 LED z zasilaniem jednostronnym,
- obudowa wykonana z tworzywa sztucznego, klosz przezroczysty wykonany z polistyrenu,
- oprawa nie zawiera źródła światła.

- hermetic fixture for T8 LED tubes with one-sided power,
- housing made of plastic, transparent cover made of polystyrene,
- fixture without a light source.

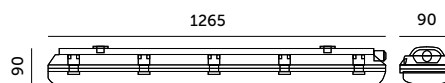

MODEL	INDEKS	WAGA NETTO [kg]	PAKOWANIE [szt.]	KOD EAN
MODEL	INDEX	NET WEIGHT [kg]	PACKING [pcs]	BARCODE
HERMIC 1X120	KFHCL1120	0,95	8	5900605096116



STANDARD LINE

OPRAWY ŚWIETŁÓWKOWE / LED T8 FIXTURES

# HERMIC 2x120



- oprawa hermetyczna na świetlówki T8 LED z zasilaniem jednostronnym,
- obudowa wykonana z tworzywa sztucznego, klosz przezroczysty wykonany z polistyrenu,
- oprawa nie zawiera źródła światła.

- hermetic fixture for T8 LED tubes with single-sided power,
- housing made of plastic, transparent cover made of polystyrene,
- fixture without a light source.

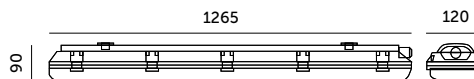

MODEL	INDEKS	WAGA NETTO [kg]	PAKOWANIE [szt.]	KOD EAN
MODEL	INDEX	NET WEIGHT [kg]	PACKING [pcs]	BARCODE
HERMIC 2X120	KFHCL2120	1,29	6	5900605096123







**ECONOMIC BRAND** OPRAWY ŚWIETŁÓWKOWE / LED T8 FIXTURES

**LED2B**

# HERMES 2x120



- oprawa hermetyczna na świetlówki T8 LED z zasilaniem jednostronnym,
- obudowa wykonana z ABS, klosz przezroczysty z polistyrenu (PS),
- oprawa nie zawiera źródła światła.

- hermetic fixture for T8 LED tubes with one-sided power,
- housing made of ABS, transparent cover made of polystyrene (PS),
- fixture without a light source.

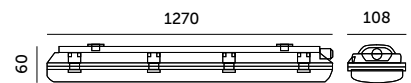

MODEL	INDEKS	WAGA NETTO [kg]	PAKOWANIE [szt.]	KOD EAN
MODEL	INDEX	NET WEIGHT [kg]	PACKING [pcs]	BARCODE
HERMES 2x120	KFHS2120	0,83	10	5902846017790





**STANDARD LINE** OPRAWY ŚWIETŁÓWKOWE / LED T8 FIXTURES

# DELFA 2x120



- ścienna-sufitowa oprawa na świetłówki LED T8 z zasilaniem jednostronnym,
- obudowa wykonana z blachy stalowej malowanej na biało i tworzywa sztucznego PS,
- klosz przezroczysty z poliwęglanu,
- oprawa nie zawiera źródła światła.

- wall and ceiling fixture for T8 LED tubes with single-sided power,
- housing made of steel sheet, painted white and plastic PS,
- transparent cover, made of PC,
- fixture without a light source.

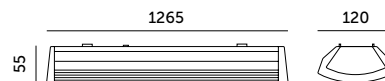

MODEL	INDEKS	WAGA NETTO [kg]	PAKOWANIE [szt.]	KOD EAN
MODEL	INDEX	NET WEIGHT [kg]	PACKING [pcs]	BARCODE
DELFA 2X120	KFDA2120	0,88	10	5902846010289





STANDARD LINE OPRAWY ŚWIETŁÓWKOWE / LED T8 FIXTURES

## ZEBRA 1x120



- ścienna-sufitowa oprawa na świetlówki LED T8 z zasilaniem jednostronnym,  
- obudowa wykonana z blachy stalowej malowanej na biało i tworzywa sztucznego ABS,  
- oprawa nie zawiera źródła światła.

- wall and ceiling fixture for T8 LED tubes with single-sided power,  
- housing made of steel sheet, painted white and plastic ABS,  
- fixture without a light source.

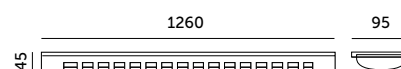

MODEL	INDEKS	WAGA NETTO [kg]	PAKOWANIE [szt.]	KOD EAN
MODEL	INDEX	NET WEIGHT [kg]	PACKING [pcs]	BARCODE
ZEBRA 1X120	KFZA1120	0,64	12	5902846010555



STANDARD LINE OPRAWY ŚWIETŁÓWKOWE / LED T8 FIXTURES

## ZEBRA 2x120



- ścienna-sufitowa oprawa na świetlówki LED T8 z zasilaniem jednostronnym,  
- obudowa wykonana z blachy stalowej malowanej na biało i tworzywa sztucznego ABS,  
- oprawa nie zawiera źródła światła.

- wall and ceiling fixture for T8 LED tubes with single-sided power,  
- housing made of steel sheet, painted white and plastic ABS,  
- fixture without a light source.

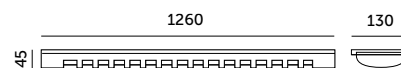

MODEL	INDEKS	WAGA NETTO [kg]	PAKOWANIE [szt.]	KOD EAN
MODEL	INDEX	NET WEIGHT [kg]	PACKING [pcs]	BARCODE
ZEBRA 2X120	KFZA2120	0,78	6	5902846010562







## ZEWNĘTRZNE OPRAWY INWESTYCYJNE OUTDOOR INDUSTRIAL LIGHTING

Nowoczesne oprawy uliczne, naświetlacze i oprawy LED to połączenie zaawansowanej technologii z wyjątkową energooszczędnością. Zapewniają jasne i równomierne oświetlenie, które poprawia bezpieczeństwo na drogach i w przestrzeniach publicznych. Dodatkowo, ich trwałość i niskie koszty eksploatacji sprawiają, że są idealnym rozwiązaniem dla nowoczesnych miast i osiedli.

Our modern street lights and LED floodlights combine cutting-edge technology with exceptional Energy efficiency. They deliver bright, uniform illumination that enhances safety on roads and in public spaces. Their durability and low operating costs make them the ideal choice for contemporary cities and communities.





PROFESSIONAL LINE OPRAWY ULICZNE / STREET LIGHTING

## MASTER STREET S 35W

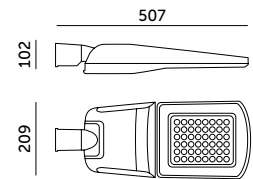

- obudowa lampy wykonana z aluminium, osłona z hartowanego szkła,
- możliwość pionowego lub poziomego montażu oprawy,
- możliwość regulacji oprawy o 15 stopni,
- montaż na słupach, wysięgnikach Ø60 mm,
- posiada gniazdo NEMA 5P, na które należy zamontować zaślepkę dołączoną do oprawy,
- możliwość regulacji mocy oprawy na zamówienie,
- oprawa zawiera źródła światła o klasie energetycznej B,
- możliwość wymiany źródła światła jedynie przez wykwalifikowany personel.

- lamp housing made of aluminum, cover made of tempered glass,
- suitable for vertical or horizontal mounting,
- fixture adjustable by 15 degrees,
- mountable on poles with a Ø60 mm diameter,
- equipped with a NEMA 5P socket, which should be covered with the provided cap,
- power adjustment available upon request,
- fixture includes light sources with energy efficiency class B,
- LED light source can only be replaced by qualified personnel.

MODEL	INDEKS	POBÓR MOCY [W]	KĄT ROZSYŁU ŚWIATŁA [°]	BARWA ŚWIATŁA	STRUMIEN ŚWIETLNY [lm]	WAGA NETTO [kg]	PAKOWANIE [szt.]	KOD EAN
MODEL	INDEX	POWER [W]	BEAM ANGLE [°]	LIGHT COLOR	LUMINOUS FLUX [lm]	NET WEIGHT [kg]	PACKING [pcs]	BARCODE
LED MASTER STREET S 35W MB	KFMS35MBNB	35	155x80	NEUTRALNA BIAŁA NEUTRAL WHIITE	5950	3,30	1	5902201371208
LED MASTER STREET S 35W WB	KFMS35WBNB	35	160x160	NEUTRALNA BIAŁA NEUTRAL WHIITE	5950	3,30	1	5902201371215





PROFESSIONAL LINE OPRAWY ULICZNE / STREET LIGHTING

# MASTER STREET M 80W



**5-7 LAT**  
GWARANCJI  
**5-7 YEARS**  
WARRANTY

**DALI 2**

**170**  
lm/W

576

119

209

- obudowa lampy wykonana z aluminium, osłona z hartowanego szkła,
- możliwość pionowego lub poziomego montażu oprawy,
- możliwość regulacji oprawy o 15 stopni,
- montaż na słupach, wysięgnikach Ø60 mm,
- posiada gniazdo NEMA 5P, na które należy zamontować zaślepkę dotaczoną do oprawy,
- możliwość regulacji mocy oprawy na zamówienie,
- oprawa zawiera źródła światła o klasie energetycznej B,
- możliwość wymiany źródła światła jedynie przez wykwalifikowany personel.

- lamp housing made of aluminum, cover made of tempered glass,
- suitable for vertical or horizontal mounting,
- fixture adjustable by 15 degrees,
- mountable on poles with a Ø60 mm diameter,
- equipped with a NEMA 5P socket, which should be covered with the provided cap,
- power adjustment available upon request,
- fixture includes light sources with energy efficiency class B,
- LED light source can only be replaced by qualified personnel.

MODEL	INDEKS	POBÓR MOCY [W]	KĄT ROZSYŁU ŚWIATŁA [°]	BARWA ŚWIATŁA	STRUMIEŃ ŚWIETLNY [lm]	WAGA NETTO [kg]	PAKOWANIE [szt.]	KOD EAN
MODEL	INDEX	POWER [W]	BEAM ANGLE [°]	LIGHT COLOR	LUMINOUS FLUX [lm]	NET WEIGHT [kg]	PACKING [pcs]	BARCODE
LED MASTER STREET M 80W MB	KFMS80MBNB	80	155x80	NEUTRALNA BIAŁA NEUTRAL WHITE	13600	4,15	1	5902201371222
LED MASTER STREET M 80W WB	KFMS80WBNB	80	160x160	NEUTRALNA BIAŁA NEUTRAL WHITE	13600	4,15	1	5902201371239



PROFESSIONAL LINE OPRAWY ULICZNE / STREET LIGHTING

# MASTER STREET L 120W



**5-7 LAT**  
GWARANCJI  
**5-7 YEARS**  
WARRANTY

**DALI 2**

**170**  
lm/W

623

120

245

- obudowa lampy wykonana z aluminium, osłona z hartowanego szkła,
- możliwość pionowego lub poziomego montażu oprawy,
- możliwość regulacji oprawy o 15 stopni,
- montaż na słupach, wysięgnikach Ø60 mm,
- posiada gniazdo NEMA 5P, na które należy zamontować zaślepkę dotaczoną do oprawy,
- możliwość regulacji mocy oprawy na zamówienie,
- oprawa zawiera źródła światła o klasie energetycznej B,
- możliwość wymiany źródła światła jedynie przez wykwalifikowany personel.

- lamp housing made of aluminum, cover made of tempered glass,
- suitable for vertical or horizontal mounting,
- fixture adjustable by 15 degrees,
- mountable on poles with a Ø60 mm diameter,
- equipped with a NEMA 5P socket, which should be covered with the provided cap,
- power adjustment available upon request,
- fixture includes light sources with energy efficiency class B,
- LED light source can only be replaced by qualified personnel.

MODEL	INDEKS	POBÓR MOCY [W]	KĄT ROZSYŁU ŚWIATŁA [°]	BARWA ŚWIATŁA	STRUMIEŃ ŚWIETLNY [lm]	WAGA NETTO [kg]	PAKOWANIE [szt.]	KOD EAN
MODEL	INDEX	POWER [W]	BEAM ANGLE [°]	LIGHT COLOR	LUMINOUS FLUX [lm]	NET WEIGHT [kg]	PACKING [pcs]	BARCODE
LED MASTER STREET L 120W MB	KFMS120MBNB	120	155x80	NEUTRALNA BIAŁA NEUTRAL WHITE	20400	4,72	1	5902201371246
LED MASTER STREET L 120W WB	KFMS120WBNB	120	160x160	NEUTRALNA BIAŁA NEUTRAL WHITE	20400	4,72	1	5902201371253







PROFESSIONAL LINE OPRAWY ULICZNE / STREET LIGHTING

# LED VESPA PRO 40W

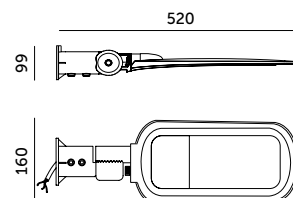

- obudowa lampy wykonana z aluminium, osłona z plastiku,
- możliwość pionowego lub poziomego montażu oprawy,
- możliwość regulacji oprawy o 180 stopni,
- montaż na słupach, wysięgnikach Ø60 mm,
- nie można wymieniać lamp w oprawie.

- lamp housing made of aluminum, cover made of plastic,
- suitable for vertical or horizontal mounting,
- fixture adjustable by 180 degrees,
- mountable on poles with a Ø60 mm diameter,
- lamps in the fixture cannot be replaced.

MODEL	INDEKS	POBÓR MOCY [W]	KĄT ROZSYŁU ŚWIATŁA [°]	BARWA ŚWIATŁA	STRUMIEŃ ŚWIETLNY [lm]	WAGA NETTO [kg]	PAKOWANIE [szt.]	KOD EAN
MODEL	INDEX	POWER [W]	BEAM ANGLE [°]	LIGHT COLOR	LUMINOUS FLUX [lm]	NET WEIGHT [kg]	PACKING [pcs]	BARCODE
LED VESPA PRO 40W	KFPV40NBAS	40	140x90	NEUTRALNA BIAŁA NEUTRAL WHITE	5600	1,60	6	5902201359343

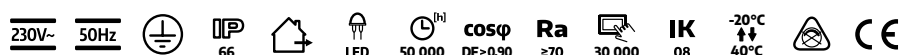



PROFESSIONAL LINE OPRAWY ULICZNE / STREET LIGHTING

# LED VESPA PRO 60W

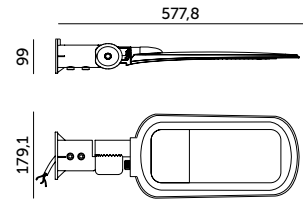

- obudowa lampy wykonana z aluminium, osłona z plastiku,
- możliwość pionowego lub poziomego montażu oprawy,
- możliwość regulacji oprawy o 180 stopni,
- montaż na słupach, wysięgnikach Ø60 mm,
- nie można wymieniać lamp w oprawie.

- lamp housing made of aluminum, cover made of plastic,
- suitable for vertical or horizontal mounting,
- fixture adjustable by 180 degrees,
- mountable on poles with a Ø60 mm diameter,
- lamps in the fixture cannot be replaced.

MODEL	INDEKS	POBÓR MOCY [W]	KĄT ROZSYŁU ŚWIATŁA [°]	BARWA ŚWIATŁA	STRUMIEŃ ŚWIETLNY [lm]	WAGA NETTO [kg]	PAKOWANIE [szt.]	KOD EAN
MODEL	INDEX	POWER [W]	BEAM ANGLE [°]	LIGHT COLOR	LUMINOUS FLUX [lm]	NET WEIGHT [kg]	PACKING [pcs]	BARCODE
LED VESPA PRO 60W	KFVP60NBAS	60	140x90	NEUTRALNA BIAŁA NEUTRAL WHITE	8400	1,90	6	5902201359350

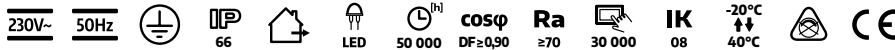

PROFESSIONAL LINE OPRAWY ULICZNE / STREET LIGHTING

# LED VESPA PRO 100W

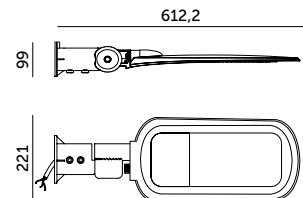

- obudowa lampy wykonana z aluminium, osłona z plastiku,
- możliwość pionowego lub poziomego montażu oprawy,
- możliwość regulacji oprawy o 180 stopni,
- montaż na słupach, wysięgnikach Ø60 mm,
- nie można wymieniać lamp w oprawie.

- lamp housing made of aluminum, cover made of plastic,
- suitable for vertical or horizontal mounting,
- fixture adjustable by 180 degrees,
- mountable on poles with a Ø60 mm diameter,
- lamps in the fixture cannot be replaced.

MODEL	INDEKS	POBÓR MOCY [W]	KĄT ROZSYŁU ŚWIATŁA [°]	BARWA ŚWIATŁA	STRUMIEŃ ŚWIETLNY [lm]	WAGA NETTO [kg]	PAKOWANIE [szt.]	KOD EAN
MODEL	INDEX	POWER [W]	BEAM ANGLE [°]	LIGHT COLOR	LUMINOUS FLUX [lm]	NET WEIGHT [kg]	PACKING [pcs]	BARCODE
LED VESPA PRO 100W	KFVP100NBAS	100	140x90	NEUTRALNA BIAŁA NEUTRAL WHITE	14000	2,43	6	5902201359367

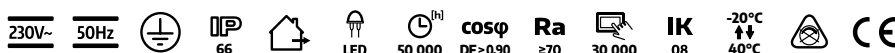

PROFESSIONAL LINE OPRAWY ULICZNE / STREET LIGHTING

# LED VESPA PRO 150W



- obudowa lampy wykonana z aluminium, ostona z plastiku,
- możliwość pionowego lub poziomego montażu oprawy,
- możliwość regulacji oprawy o 180 stopni,
- montaż na słupach, wysięgnikach Ø60 mm,
- nie można wymieniać lamp w oprawie.

- lamp housing made of aluminum, cover made of plastic,
- suitable for vertical or horizontal mounting,
- fixture adjustable by 180 degrees,
- mountable on poles with a Ø60 mm diameter,
- lamps in the fixture cannot be replaced.

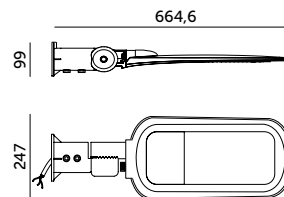

MODEL	INDEKS	POBÓR MOCY [W]	KĄT ROZSYŁU ŚWIATŁA [°]	BARWA ŚWIATŁA	STRUMIEN ŚWIETLNY [lm]	WAGA NETTO [kg]	PAKOWANIE [szt.]	KOD EAN
MODEL	INDEX	POWER [W]	BEAM ANGLE [°]	LIGHT COLOR	LUMINOUS FLUX [lm]	NET WEIGHT [kg]	PACKING [pcs]	BARCODE
LED VESPA PRO 150W	KFVP150NBAS	150	140x90	NEUTRALNA BIAŁA NEUTRAL WHITE	20250	2,80	4	5902201359374

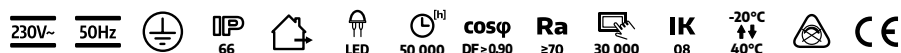

PROFESSIONAL LINE OPRAWY ULICZNE / STREET LIGHTING

# LED VESPA PRO 200W



- obudowa lampy wykonana z aluminium, ostona z plastiku,
- możliwość pionowego lub poziomego montażu oprawy,
- możliwość regulacji oprawy o 180 stopni,
- montaż na słupach, wysięgnikach Ø60 mm,
- nie można wymieniać lamp w oprawie.

- lamp housing made of aluminum, cover made of plastic,
- suitable for vertical or horizontal mounting,
- fixture adjustable by 180 degrees,
- mountable on poles with a Ø60 mm diameter,
- lamps in the fixture cannot be replaced.

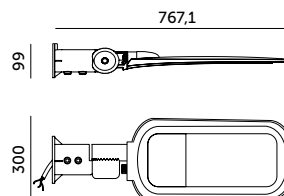

MODEL	INDEKS	POBÓR MOCY [W]	KĄT ROZSYŁU ŚWIATŁA [°]	BARWA ŚWIATŁA	STRUMIEN ŚWIETLNY [lm]	WAGA NETTO [kg]	PAKOWANIE [szt.]	KOD EAN
MODEL	INDEX	POWER [W]	BEAM ANGLE [°]	LIGHT COLOR	LUMINOUS FLUX [lm]	NET WEIGHT [kg]	PACKING [pcs]	BARCODE
LED VESPA PRO 200W	KFVP200NBAS	200	140x90	NEUTRALNA BIAŁA NEUTRAL WHITE	27000	3,69	4	5902201359381

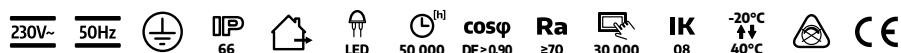



PREMIUM OPRAWY ULICZNE / STREET LIGHTING

# LED CYOTO LX 50W



- lampa uliczna z czujnikiem zmierzchu,
- czujnik zmierzchowy włącza lampę, gdy natężenie światła wynosi poniżej 30 lx, a wyłącza gdy natężenie światła wynosi powyżej 50 lx,
- obudowa wykonana z aluminium, przestona z poliwęglanu PC,
- możliwość pionowego lub poziomego montażu oprawy,
- możliwość regulacji oprawy w zakresie  $\pm 15$  stopni,
- montaż na słupach, wysięgnikach  $\varnothing 60$  mm,
- asymetryczny kąt rozsyłu światła: 75 x 130 stopni,
- oprawa zawiera źródła światła o klasie energetycznej F,
- możliwość wymiany źródła światła LED jedynie przez wykwalifikowany personel.

- LED streetlight with dusk sensor,
- dusk sensor activates the lamp when light intensity drops below 30 lx, turns off when light intensity exceeds 50 lx,
- housing made of aluminum, cover made of polycarbonate (PC),
- suitable for vertical or horizontal mounting,
- adjustable within a  $\pm 15$  degree range,
- mountable on poles with a  $\varnothing 60$  mm diameter,
- asymmetric light distribution angle: 75 x 130 degrees,
- fixture includes light sources with energy efficiency class F,
- LED light source can only be replaced by qualified personnel.

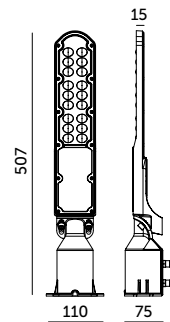

MODEL	INDEKS	POBÓR MOCY [W]	KĄT ROZSYŁU ŚWIATŁA [°]	BARWA ŚWIATŁA	STRUMIEN ŚWIETLNY [lm]	WAGA NETTO [kg]	PAKOWANIE [szt.]	KOD EAN
MODEL	INDEX	POWER [W]	BEAM ANGLE [°]	LIGHT COLOR	LUMINOUS FLUX [lm]	NET WEIGHT [kg]	PACKING [pcs]	BARCODE
LED CYOTO LX 50W	KFCX50NB	50	75x130	NEUTRALNA BIAŁA NEUTRAL WHITE	5000	0,85	10	5902201384413



PREMIUM OPRAWY ULICZNE / STREET LIGHTING

# LED CYOTO LX 100W



- lampa uliczna z czujnikiem zmierzchu,
- czujnik zmierzchowy włącza lampę, gdy natężenie światła wynosi poniżej 30 lx, a wyłącza gdy natężenie światła wynosi powyżej 50 lx,
- obudowa wykonana z aluminium, przestona z poliwęglanu PC,
- możliwość pionowego lub poziomego montażu oprawy,
- możliwość regulacji oprawy w zakresie  $\pm 15$  stopni,
- montaż na słupach, wysięgnikach  $\varnothing 60$  mm,
- asymetryczny kąt rozsyłu światła: 75x130 stopni,
- oprawa zawiera źródła światła o klasie energetycznej F,
- możliwość wymiany źródła światła LED jedynie przez wykwalifikowany personel.

- LED streetlight with dusk sensor,
- dusk sensor activates the lamp when light intensity drops below 30 lx, turns off when light intensity exceeds 50 lx,
- housing made of aluminum, cover made of polycarbonate (PC),
- suitable for vertical or horizontal mounting,
- adjustable within a  $\pm 15$  degree range,
- mountable on poles with a  $\varnothing 60$  mm diameter,
- asymmetric light distribution angle: 75x130 degrees,
- fixture includes light sources with energy efficiency class F,
- LED light source can only be replaced by qualified personnel.

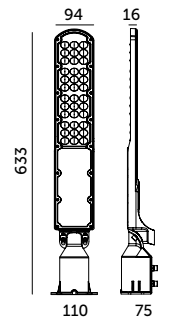

MODEL	INDEKS	POBÓR MOCY [W]	KĄT ROZSYŁU ŚWIATŁA [°]	BARWA ŚWIATŁA	STRUMIEN ŚWIETLNY [lm]	WAGA NETTO [kg]	PAKOWANIE [szt.]	KOD EAN
MODEL	INDEX	POWER [W]	BEAM ANGLE [°]	LIGHT COLOR	LUMINOUS FLUX [lm]	NET WEIGHT [kg]	PACKING [pcs]	BARCODE
LED CYOTO LX 100W	KFCX100NB	100	75x130	NEUTRALNA BIAŁA NEUTRAL WHITE	10000	1,18	5	5902201384420

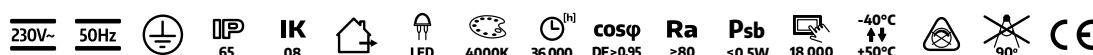





PROFESSIONAL LINE OPRAWY ULICZNE / STREET LIGHTING

# HYBRID LED FUSION 14W



- ledowa lampa hybrydowa (zasilanie solarne i sieciowe), po rozładowaniu akumulatora przechodzi na tryb sieciowy,
- oprawa z czujnikiem ruchu i zmierzchu - na pilota,
- 3 tryby świecenia, w tym świecenie ciągłe,
- kąt / zasięg detekcji czujnika: 90 stopni / 6 m,
- kąt rozsytu światła: 120 stopni,
- obudowa lampy wykonana z aluminium, przestona z poliwęglanu,
- możliwość regulacji oprawy o 60 stopni,
- montaż na słupach, wysięgnikach Ø60 mm,
- zawiera wymienny akumulator LiFe PO4 9,6V / 4500 mAh, oraz panel monokrystaliczny PV 15V 9W (gwarancja na akumulator: 2 lata),
- oprawa zawiera źródła światła o klasie energetycznej D,
- możliwość wymiany źródła światła LED jedynie przez wykwalifikowany personel.

- hybrid LED lamp (solar and mains power), switches to mains power after the battery is depleted,
- fixture with motion and dusk sensors, controlled by remote,
- 3 lighting modes, including continuous lighting,
- detection angle/range: 90 degrees / 6 m,
- beam angle: 120 degrees,
- housing made of aluminum, cover made of polycarbonate,
- fixture adjustable by 60 degrees,
- mountable on poles with a Ø60 mm diameter,
- includes a replaceable LiFePO4 9,6V / 4500 mAh battery, and a monocrystalline PV panel 15V 9W (battery warranty: 2 years),
- fixture includes light sources with energy efficiency class D,
- LED light source can only be replaced by qualified personnel

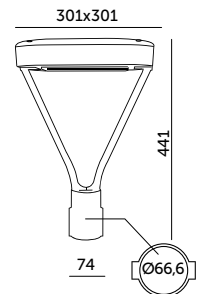

MODEL	INDEKS	POBÓR MOCY [W]	BARWA ŚWIATEŁA	STRUMIEŃ ŚWIETLNY [lm]	WAGA NETTO [kg]	PAKOWANIE [szt.]	KOD EAN
MODEL	INDEX	POWER [W]	LIGHT COLOR	LUMINOUS FLUX [lm]	NET WEIGHT [kg]	PACKING [pcs]	BARCODE
HYBRID LED FUSION 14W	KFHF14NB	14	NEUTRALNA BIAŁA NEUTRAL WHITE	2000	3,85	4	5902201374414







PREMIUM OPRAWY LED / LED FIXTURES

# SOLAR LED STREET 40W PREMIUM

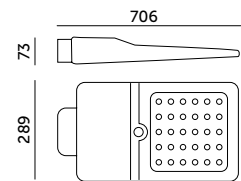

- ledowa oprawa solarna z czujnikiem ruchu i natężenia światła – na pilota,
- zasilana energią słoneczną,
- kąt / zasięg detekcji: 120 stopni / 8-12 m,
- kąt rozsyłu światła oprawy: X-140 stopni ; Y-70 stopni,
- zawiera wymienny akumulator LiFe P04 9,6V / 12000 mAh,
- nie można wymieniać lamp w oprawie.

- solar LED fixture with motion and light intensity sensors, controlled by remote,
- powered by solar energy,
- detection angle/range: 120 degrees / 8-12 m,
- beam angle: X-140 degrees; Y-70 degrees,
- includes a replaceable LiFePO4 9,6V / 12000 mAh battery,
- lamps in the fixture cannot be replaced.

MODEL	INDEKS	POBÓR MOCY [W]	BARWA ŚWIATŁA	STRUMIEŃ ŚWIETLNY [lm]	WAGA NETTO [kg]	PAKOWANIE [szt.]	KOD EAN
MODEL	INDEX	POWER [W]	LIGHT COLOR	LUMINOUS FLUX [lm]	NET WEIGHT [kg]	PACKING [pcs]	BARCODE
SOLAR LED STREET 40W	KFNSU40NB	40	NEUTRALNA BIAŁA NEUTRAL WHITE	4800	5,24	4	5902201304541



STANDARD LINE OPRAWY LED / LED FIXTURES

# SOLAR LED STREET 15W

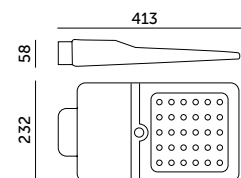

- ledowa oprawa solarna z czujnikiem ruchu i natężenia światła,
- zasilana energią słoneczną,
- kąt / zasięg detekcji: 120 stopni / 3-8 m,
- kąt rozsyłu światła oprawy: X-140 stopni; Y-70 stopni,
- zawiera wymienny akumulator litowo-jonowy 7,4V/5400 mAh,
- nie można wymieniać lamp w oprawie.

- solar LED fixture with motion and light intensity sensors,
- powered by solar energy,
- detection angle/range: 120 degrees / 3-8 m,
- beam angle: X-140 degrees; Y-70 degrees,
- includes a replaceable lithium-ion battery 7,4V / 5400 mAh,
- lamps in the fixture cannot be replaced.

MODEL	INDEKS	POBÓR MOCY [W]	BARWA ŚWIATŁA	STRUMIEŃ ŚWIETLNY [lm]	WAGA NETTO [kg]	PAKOWANIE [szt.]	KOD EAN
MODEL	INDEX	POWER [W]	LIGHT COLOR	LUMINOUS FLUX [lm]	NET WEIGHT [kg]	PACKING [pcs]	BARCODE
SOLAR LED STREET 15W	KFNSU15NB	15	NEUTRALNA BIAŁA NEUTRAL WHITE	1600	2,21	5	5902846015697



PROFESSIONAL LINE NAŚWIETLACZE LED / LED FLOODLIGHTS

# LED US 300W DIM

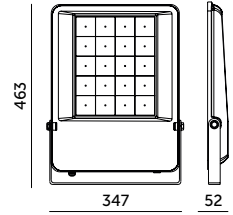

- profesjonalny naświetlacz ledowy,
- obudowa wykonana z aluminium, przestona z hartowanego szkła,
- kąt rozsyłu światła: 60 lub 90 stopni,
- oprawa zawiera źródła światła w klasie energetycznej: D,
- możliwość wymiany źródła światła LED jedynie przez wykwalifikowany personel.

- professional LED floodlight,
- housing made of aluminum, cover made of tempered glass,
- beam angle: 60 or 90 degrees,
- fixture includes light sources with energy efficiency class D,
- LED light source can only be replaced by qualified personnel.

MODEL	INDEKS	POBÓR MOCY [W]	KĄT ROZSYŁU ŚWIATŁA [°]	BARWA ŚWIATŁA	STRUMIEŃ ŚWIETLNY [lm]	WAGA NETTO [kg]	PAKOWANIE [szt.]	KOD EAN
MODEL	INDEX	POWER [W]	BEAM ANGLE [°]	LIGHT COLOR	LUMINOUS FLUX [lm]	NET WEIGHT [kg]	PACKING [pcs]	BARCODE
LED US 300W DIM 60°	KFUS30605SC	300	60	ZIMNOBIAŁA COOL WHITE	45200	4,20	1	5902201380729
LED US 300W DIM 90°	KFUS30905SC	300	90	ZIMNOBIAŁA COOL WHITE	45200	4,20	1	5902201364194



PROFESSIONAL LINE NAŚWIETLACZE LED / LED FLOODLIGHTS

# LED US 500W DIM

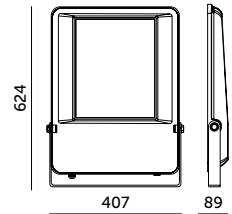

- profesjonalny naświetlacz ledowy,
- obudowa wykonana z aluminium, przestona z hartowanego szkła,
- kąt rozsyłu światła: 60 stopni,
- możliwość wymiany soczewki na 25 stopni lub 55 x 125 stopni,
- oprawa zawiera źródła światła o klasie energetycznej D,
- możliwość wymiany źródła światła LED jedynie przez wykwalifikowany personel.

- professional LED floodlight,
- housing made of aluminum, cover made of tempered glass,
- beam angle: 60 degrees,
- lens can be changed to 25 degrees or 55 x 125 degrees,
- fixture includes light sources with energy efficiency class D,
- LED light source can only be replaced by qualified personnel.

MODEL	INDEKS	POBÓR MOCY [W]	BARWA ŚWIATŁA	STRUMIEŃ ŚWIETLNY [lm]	WAGA NETTO [kg]	PAKOWANIE [szt.]	KOD EAN
MODEL	INDEX	POWER [W]	LIGHT COLOR	LUMINOUS FLUX [lm]	NET WEIGHT [kg]	PACKING [pcs]	BARCODE
LED US 500W DIM	KFUS50605SC	500	ZIMNOBIAŁA COOL WHITE	77500	12,50	1	5902201359589





PROFESSIONAL LINE NAŚWIETLACZE LED / LED FLOODLIGHTS

# LED KOBİ SEUL 50W

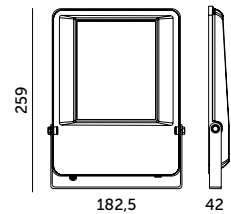

- profesjonalny naświetlacz ledowy,
- obudowa wykonana z aluminium, przestona z hartowanego szkła,
- kąt rozsytu światła: 120 stopni,
- oprawa zawiera źródła światła o klasie energetycznej E,
- możliwość wymiany źródła światła LED jedynie przez wykwalifikowany personel.

- professional LED floodlight,
- housing made of aluminum, cover made of tempered glass,
- beam angle: 120 degrees,
- fixture includes light sources with energy efficiency class E,
- LED light source can only be replaced by qualified personnel.

MODEL	INDEKS	POBÓR MOCY [W]	BARWA ŚWIATŁA	STRUMIEŃ ŚWIETLNY [lm]	WAGA NETTO [kg]	PAKOWANIE [szt.]	KOD EAN
MODEL	INDEX	POWER [W]	LIGHT COLOR	LUMINOUS FLUX [lm]	NET WEIGHT [kg]	PACKING [pcs]	BARCODE
LED KOBİ SEUL 50W NB	KFSL50NB	50	NEUTRALNA BIAŁA NEUTRAL WHITE	6500	1,20	10	5902201365009



PROFESSIONAL LINE NAŚWIETLACZE LED / LED FLOODLIGHTS

# LED KOBİ SEUL 100W

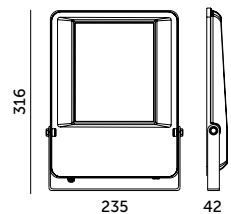

- profesjonalny naświetlacz ledowy,
- obudowa wykonana z aluminium, przestona z hartowanego szkła,
- kąt rozsytu światła: 120 stopni,
- oprawa zawiera źródła światła o klasie energetycznej E,
- możliwość wymiany źródła światła LED jedynie przez wykwalifikowany personel.

- professional LED floodlight,
- housing made of aluminum, cover made of tempered glass,
- beam angle: 120 degrees,
- fixture includes light sources with energy efficiency class E,
- LED light source can only be replaced by qualified personnel.

MODEL	INDEKS	POBÓR MOCY [W]	BARWA ŚWIATŁA	STRUMIEŃ ŚWIETLNY [lm]	WAGA NETTO [kg]	PAKOWANIE [szt.]	KOD EAN
MODEL	INDEX	POWER [W]	LIGHT COLOR	LUMINOUS FLUX [lm]	NET WEIGHT [kg]	PACKING [pcs]	BARCODE
LED KOBİ SEUL 100W NB	KFSL100NB	100	NEUTRALNA BIAŁA NEUTRAL WHITE	13000	1,90	5	5902201365016



PROFESSIONAL LINE NAŚWIETLACZE LED / LED FLOODLIGHTS

# LED KOBİ SEUL 150W

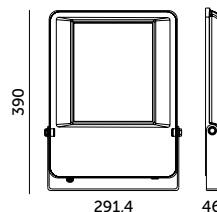

- profesjonalny naświetlacz ledowy,
- obudowa wykonana z aluminium, przestona z hartowanego szkła,
- kąt rozsytu światła: 120 stopni,
- oprawa zawiera źródła światła o klasie energetycznej E,
- możliwość wymiany źródła światła LED jedynie przez wykwalifikowany personel.

- professional LED floodlight,
- housing made of aluminum, cover made of tempered glass,
- beam angle: 120 degrees,
- fixture includes light sources with energy efficiency class E,
- LED light source can only be replaced by qualified personnel.

MODEL	INDEKS	POBÓR MOCY [W]	BARWA ŚWIATŁA	STRUMIEŃ ŚWIETLNY [lm]	WAGA NETTO [kg]	PAKOWANIE [szt.]	KOD EAN
MODEL	INDEX	POWER [W]	LIGHT COLOR	LUMINOUS FLUX [lm]	NET WEIGHT [kg]	PACKING [pcs]	BARCODE
LED KOBİ SEUL 150W NB	KFSL150NB	150	NEUTRALNA BIAŁA NEUTRAL WHITE	19500	2,90	4	5902201365023



PROFESSIONAL LINE NAŚWIETLACZE LED / LED FLOODLIGHTS

# LED KOBİ SEUL 200W

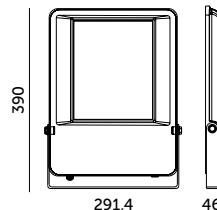

- profesjonalny naświetlacz ledowy,
- obudowa wykonana z aluminium, przestona z hartowanego szkła,
- kąt rozsytu światła: 120 stopni,
- oprawa zawiera źródła światła o klasie energetycznej E,
- możliwość wymiany źródła światła LED jedynie przez wykwalifikowany personel.

- professional LED floodlight,
- housing made of aluminum, cover made of tempered glass,
- beam angle: 120 degrees,
- fixture includes light sources with energy efficiency class E,
- LED light source can only be replaced by qualified personnel.

MODEL	INDEKS	POBÓR MOCY [W]	BARWA ŚWIATŁA	STRUMIEŃ ŚWIETLNY [lm]	WAGA NETTO [kg]	PAKOWANIE [szt.]	KOD EAN
MODEL	INDEX	POWER [W]	LIGHT COLOR	LUMINOUS FLUX [lm]	NET WEIGHT [kg]	PACKING [pcs]	BARCODE
LED KOBİ SEUL 200W NB	KFSL200NB	200	NEUTRALNA BIAŁA NEUTRAL WHITE	26000	2,90	4	5902201365030





**STANDARD LINE** NAŚWIETLACZE LED / LED FLOODLIGHTS

# SOLAR LED NEW KOBİ PHOENIX 13W

- ledowy naświetlacz solarny z czujnikiem ruchu z dwoma zakresami regulacji: natężenie światła i czas działania, zasilany energią słoneczną,
- posiada 2 tryby pracy:
  - 1) po wykryciu ruchu rozświetla się na 10-60 sekund, a następnie gaśnie,
  - 2) świeci na około 5% jasności, po wykryciu ruchu rozświetla się na 10-60 sekund, a następnie wraca do około 5% jasności,
- długość przewodu pomiędzy źródłem światła a modułem solarnym – 3 m,
- kąt / zasięg detekcji: 110 stopni / max. 10 m,
- kąt rozsyłu światła oprawy: 120 stopni,
- moc instalacji fotowoltaicznej: 3,5 Wp,
- optymalna wysokość do montażu: 1,8-2,5 m,
- łatwy montaż dzięki brakowi okablowania,
- zawiera niewymienny akumulator: litowo-jonowy 3,7V / 4000 mAh,
- nie można wymieniać lamp w oprawie.

- solar-powered LED floodlight with a motion sensor and two adjustable settings: light intensity and operating time,
- powered by solar energy,
- features 2 operating modes:
  - 1) lights up for 10-60 seconds upon motion detection, then turns off,
  - 2) operates at around 5% brightness, increases to full brightness for 10-60 seconds upon motion detection, then returns to 5%,
- 3 m cable connecting the light source and solar module,
- detection angle/range: 110 degrees / max. 10 m,
- beam angle: 120 degrees,
- photovoltaic system power: 3,5 Wp,
- optimal mounting height: 1,8-2,5 m,
- easy installation with no wiring required,
- includes a non-replaceable lithium-ion battery: 3,7V / 4000 mAh,
- lamps in the fixture cannot be replaced.

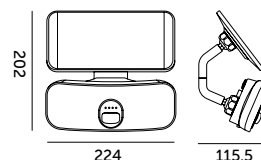

MODEL	INDEKS	POBÓR MOCY [W]	BARWA ŚWIATŁA	STRUMIEŃ ŚWIETLNY [lm]	WAGA NETTO [kg]	PAKOWANIE [szt.]	KOD EAN
MODEL	INDEX	POWER [W]	LIGHT COLOR	LUMINOUS FLUX [lm]	NET WEIGHT [kg]	PACKING [pcs]	BARCODE
SOLAR LED NEW KOBİ PHOENIX 13W	KFNSNPX13NB	13	NEUTRALNA BIAŁA NEUTRAL WHITE	1400	0,59	8	5902201381887





PREMIUM NAŚWIETLACZE LED / LED FLOODLIGHTS

# SOLAR LED MHCS 30W 2CCT

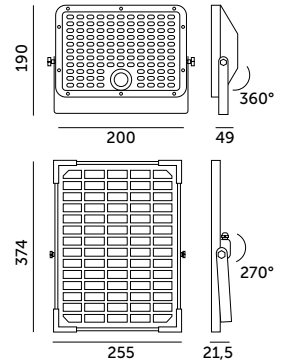

- ledowy naświetlacz solarny z czujnikiem ruchu i natężenia światła na pilota,
- zasilany energią słoneczną,
- posiada 2 tryby pracy: tryb z czujnikiem lub ciągłego świecenia (szereg opcji programowanych z pilota),
- 2 barwy światła: ciepłobiała i neutralna biała,
- długość przewodu pomiędzy źródłem światła a modułem solarnym – 5m,
- kąt / zasięg detekcji: 120 stopni / 8m,
- kąt rozsyłu światła oprawy: 120x60 stopni,
- moc instalacji fotowoltaicznej: 10,5Wp,
- łatwy montaż dzięki brakowi okablowania,
- zawiera wymienny akumulator: 6,4V / 6000mAh,
- optymalna wysokość montażu: 2-5m,
- nie można wymieniać lamp w oprawie.

- remote-controlled solar LED floodlight with motion and light intensity sensor,
- powered by solar energy,
- 2 operating modes: sensor mode or constant lighting mode (programmable via remote),
- 2 color temperatures: warm white and neutral white,
- cable length between the light source and the solar module – 5m,
- detection angle/range: 120 degrees/8m
- beam angle: 120x60 degrees,
- photovoltaic power: 10,5Wp,
- easy installation with no wiring required,
- includes a replaceable battery: 6,4V / 6000mAh,
- optimal installation height: 2-5m,
- lamps inside the fixture cannot be replaced.

MODEL	INDEKS	POBÓR MOCY [W]	BARWA ŚWIATŁA	STRUMIEŃ ŚWIETLNY [lm]	WAGA NETTO [kg]	PAKOWANIE [szt.]	KOD EAN
MODEL	INDEX	POWER [W]	LIGHT COLOR	LUMINOUS FLUX [lm]	NET WEIGHT [kg]	PACKING [pcs]	BARCODE
SOLAR LED MHCS 30W 2CCT	KFNCS302CCT	30	3000/4000	4800	1,89	8	5902201387117



PREMIUM NAŚWIETLACZE LED / LED FLOODLIGHTS

# SOLAR LED MHCS 10W PREMIUM

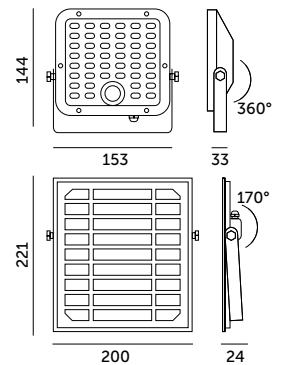

- ledowy naświetlacz solarny z czujnikiem ruchu i natężenia światła,
- zasilany energią słoneczną,
- posiada 2 tryby pracy: tryb z czujnikiem lub ciągłego świecenia (szereg opcji programowanych z pilota),
- długość przewodu pomiędzy źródłem światła a modułem solarnym – 5 m,
- kąt / zasięg detekcji: 120 stopni / 6 m,
- kąt rozsyłu światła oprawy: 120 x 60 stopni,
- moc instalacji fotowoltaicznej: 4,5Wp,
- łatwy montaż dzięki brakowi okablowania,
- zawiera wymienny akumulator: litowo-jonowy 3,7V / 3600mAh,
- nie można wymieniać lamp w oprawie.

- LED solar floodlight with motion sensor and light intensity sensor,
- powered by solar energy,
- 2 operating modes: sensor mode or constant lighting mode (programmable via remote),
- cable length between light source and solar module – 5 m,
- detection angle/range: 120 degrees / 6 m,
- light's beam angle: 120 x 60 degrees,
- photovoltaic power: 4,5Wp,
- easy installation with no wiring required,
- includes a replaceable lithium-ion battery 3,7V / 3600 mAh,
- lamps in the fixture cannot be replaced.

MODEL	INDEKS	POBÓR MOCY [W]	BARWA ŚWIATŁA	STRUMIEŃ ŚWIETLNY [lm]	WAGA NETTO [kg]	PAKOWANIE [szt.]	KOD EAN
MODEL	INDEX	POWER [W]	LIGHT COLOR	LUMINOUS FLUX [lm]	NET WEIGHT [kg]	PACKING [pcs]	BARCODE
SOLAR LED MHCS 10W NB	KFNRS10NB	10	NEUTRALNA BIAŁA NEUTRAL WHITE	1500	0,95	12	5902201359503





PREMIUM NAŚWIETLACZE LED / LED FLOODLIGHTS

# SOLAR LED MHCS 30W PREMIUM

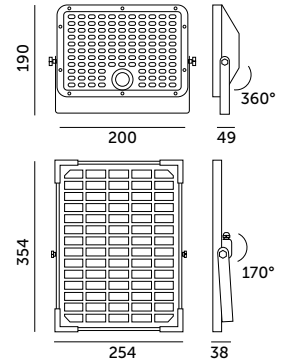

- ledowy naświetlacz solarny z czujnikiem ruchu i natężenia światła,
- zasilany energią słoneczną,
- posiada 2 tryby pracy: tryb z czujnikiem lub ciągłego świecenia (szereg opcji programowanych z pilota),
- długość przewodu pomiędzy źródłem światła a modułem solarnym – 5 m,
- kąt / zasięg detekcji: 120 stopni / 8 m,
- kąt rozsyłu światła oprawy: 120 x 60 stopni,
- moc instalacji fotowoltaicznej: 12,5Wp,
- łatwy montaż dzięki brakowi okablowania,
- zawiera wymienny akumulator: litowo-jonowy 6,4V / 6000mAh,
- nie można wymieniać lamp w oprawie.

- LED solar floodlight with motion sensor and light intensity sensor,
- powered by solar energy,
- 2 operating modes: sensor mode or constant lighting mode (programmable via remote),
- cable length between light source and solar module – 5 m,
- detection angle/range: 120 degrees / 8 m,
- light's beam angle: 120 x 60 degrees,
- photovoltaic power: 12,5Wp,
- easy installation with no wiring required,
- includes a replaceable lithium-ion battery 6,4V / 6000 mAh,
- lamps in the fixture cannot be replaced.

MODEL	INDEKS	POBÓR MOCY [W]	BARWA ŚWIATŁA	STRUMIEŃ ŚWIETLNY [lm]	WAGA NETTO [kg]	PAKOWANIE [szt.]	KOD EAN
MODEL	INDEX	POWER [W]	LIGHT COLOR	LUMINOUS FLUX [lm]	NET WEIGHT [kg]	PACKING [pcs]	BARCODE
SOLAR LED MHCS 30W NB	KFNCS30NB	30	NEUTRALNA BIAŁA NEUTRAL WHITE	4800	1,89	8	5902201359510



STANDARD LINE NAŚWIETLACZE LED / LED FLOODLIGHTS

# SOLAR LED MHC 5W



- ledowy naświetlacz solarny z czujnikiem ruchu i natężenia światła,
- zasilany energią słoneczną,
- każdy z 2 trybów pracy jest zaprogramowany tak, aby naświetlacz aktywował się po zmierzchu i dezaktywował o świcie,
- kąt / zasięg detekcji: 120 stopni / 6 m,
- kąt rozsyłu światła oprawy: 90 stopni,
- moc instalacji fotowoltaicznej: 2,3Wp,
- łatwy montaż dzięki brakowi okablowania,
- zawiera wymienny akumulator: litowo-jonowy 3,7V / 3000 mAh,
- nie można wymieniać lamp w oprawie.

- solar-powered LED floodlight with motion and light intensity sensors,
- powered by solar energy,
- each of the 2 operating modes is programmed to activate the floodlight at dusk and deactivate it at dawn,
- detection angle/range: 120 degrees / 6 m,
- beam angle: 90 degrees,
- photovoltaic power: 2,3Wp,
- easy installation with no wiring required,
- includes a replaceable lithium-ion battery: 3,7V / 3000 mAh,
- lamps in the fixture cannot be replaced.

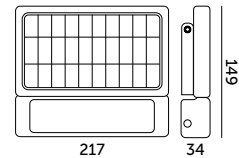

MODEL	INDEKS	POBÓR MOCY [W]	BARWA ŚWIATŁA	STRUMIEŃ ŚWIETLNY [lm]	WAGA NETTO [kg]	PAKOWANIE [szt.]	KOD EAN
MODEL	INDEX	POWER [W]	LIGHT COLOR	LUMINOUS FLUX [lm]	NET WEIGHT [kg]	PACKING [pcs]	BARCODE
SOLAR LED MHC 5W NB	KFNCS5NB	5	NEUTRALNA BIAŁA NEUTRAL WHITE	500	0,65	18	5902846013815



STANDARD LINE

NAŚWIETLACZE LED / LED FLOODLIGHTS

# SOLAR LED MHC 10W



- ledowy naświetlacz solarny z czujnikiem ruchu i natężenia światła,
- zasilany energią słoneczną,
- każdy z 3 trybów pracy jest zaprogramowany tak, aby naświetlacz aktywował się po zmierzchu i dezaktywował o świcie,
- kąt / zasięg detekcji: 180 stopni / 8 m,
- kąt rozsyłu światła oprawy: 90 stopni,
- moc instalacji fotowoltaicznej: 6Wp,
- łatwy montaż dzięki brakowi okablowania,
- zawiera wymienny akumulator: litowo-jonowy 3,7V / 7200 mAh,
- nie można wymieniać lamp w oprawie.

- solar LED floodlight with motion and light intensity sensors,
- powered by solar energy,
- each of operation modes is programmed so that the floodlight activates after dusk and deactivates during the dawn,
- detection angle/range: 180 degrees / 8 m,
- beam angle: 90 degrees,
- photovoltaic power: 6Wp,
- easy installation with no wiring required,
- contains replaceable lithium-ion battery: 3,7V / 7200 mAh,
- lamps in the fixture cannot be replaced.

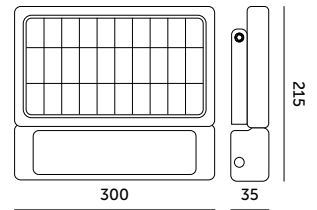

MODEL	INDEKS	POBÓR MOCY [W]	BARWA ŚWIATŁA	STRUMIEN ŚWIETLNY [lm]	WAGA NETTO [kg]	PAKOWANIE [szt.]	KOD EAN
MODEL	INDEX	POWER [W]	LIGHT COLOR	LUMINOUS FLUX [lm]	NET WEIGHT [kg]	PACKING [pcs]	BARCODE
SOLAR LED MHC 10W NB	KFNCS10NB	10	NEUTRALNA BIAŁA NEUTRAL WHITE	1080	1,40	8	5902846013822



ECONOMIC BRAND

NAŚWIETLACZE LED / LED FLOODLIGHTS

# SOLAR LED NCS 10W

LED2B



- ledowy naświetlacz solarny z czujnikiem ruchu,
- zasilany energią słoneczną,
- naświetlacz połączony z panelem za pomocą 2-metrowego przewodu,
- kąt / zasięg detekcji: 120 stopni / max. 10 m,
- kąt rozsyłu światła oprawy: 100 stopni,
- moc instalacji fotowoltaicznej: 3Wp,
- łatwy montaż dzięki brakowi okablowania,
- zawiera wymienny akumulator: litowo-jonowy 3,7V / 2200 mAh,
- nie można wymieniać lamp w oprawie.

- LED solar floodlight with motion sensor,
- powered by solar energy,
- floodlight is connected with panel through 2 meter wire,
- detection angle/range: 120 degrees / max. 10 m,
- light's beam angle: 100 degrees,
- photovoltaic power: 3Wp,
- easy installation due to no wires,
- includes replaceable lithium-ion battery: 3,7V / 2200 mAh,
- lamps in the fixture cannot be replaced.

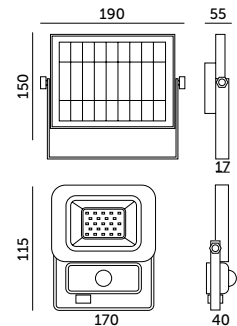

MODEL	INDEKS	POBÓR MOCY [W]	BARWA ŚWIATŁA	STRUMIEN ŚWIETLNY [lm]	WAGA NETTO [kg]	PAKOWANIE [szt.]	KOD EAN
MODEL	INDEX	POWER [W]	LIGHT COLOR	LUMINOUS FLUX [lm]	NET WEIGHT [kg]	PACKING [pcs]	BARCODE
SOLAR LED NCS 10W ZB	KFLNCS10ZB	10	ZIMNOBIAŁA COOL WHITE	700	1,05	12	5902201302127





**ECONOMIC BRAND** NAŚWIETLACZE LED / LED FLOODLIGHTS

**LED2B**

# SOLAR LED NCS 20W

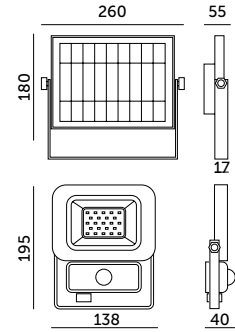

- ledowy naświetlacz solarny z czujnikiem ruchu,
- zasilany energią słoneczną,
- naświetlacz połączony z panelem za pomocą 2-metrowego przewodu,
- kąt / zasięg detekcji: 120 stopni / max. 10 m,
- kąt rozsyłu światła oprawy: 100 stopni,
- moc instalacji fotowoltaicznej: 6 Wp,
- łatwy montaż dzięki brakowi okablowania,
- zawiera wymienny akumulator: litowo-jonowy 3,7V / 4400 mAh,
- nie można wymienić lamp w oprawie.

- LED solar floodlight with motion sensor,
- powered by solar energy,
- floodlight is connected with panel through 2 meter wire,
- detection angle/range: 120 degrees / max.10 m,
- light's beam angle: 100 degrees,
- photovoltaic power: 6 Wp,
- easy installation due to no wires,
- includes replaceable lithium-ion battery: 3,7V / 4400 mAh,
- lamps in the fixture cannot be replaced.

MODEL	INDEKS	POBÓR MOCY [W]	BARWA ŚWIATŁA	STRUMIEŃ ŚWIETLNY [lm]	WAGA NETTO [kg]	PAKOWANIE [szt.]	KOD EAN
MODEL	INDEX	POWER [W]	LIGHT COLOR	LUMINOUS FLUX [lm]	NET WEIGHT [kg]	PACKING [pcs]	BARCODE
SOLAR LED NCS 20W ZB	KFLNCS20ZB	20	ZIMNOBIAŁA COOL WHITE	1400	1,34	10	5902201302134



**ECONOMIC BRAND** NAŚWIETLACZE LED / LED FLOODLIGHTS

**LED2B**

# SOLAR LED NCS 30W

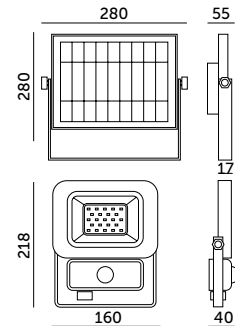

- ledowy naświetlacz solarny z czujnikiem ruchu,
- zasilany energią słoneczną,
- naświetlacz połączony z panelem za pomocą 2-metrowego przewodu,
- kąt / zasięg detekcji: 120 stopni / max. 10 m,
- kąt rozsyłu światła oprawy: 100 stopni,
- moc instalacji fotowoltaicznej: 9Wp,
- łatwy montaż dzięki brakowi okablowania,
- zawiera wymienny akumulator: litowo-jonowy 3,7V / 6600 mAh,
- nie można wymienić lamp w oprawie.

- LED solar floodlight with motion sensor,
- powered by solar energy,
- floodlight is connected with panel through 2 meter wire,
- detection angle/range: 120 degrees / max. 10 m,
- light's beam angle: 100 degrees,
- photovoltaic power: 9Wp,
- easy installation due to no wires,
- includes replaceable lithium-ion battery: 3,7V / 6600 mAh,
- lamps in the fixture cannot be replaced.

MODEL	INDEKS	POBÓR MOCY [W]	BARWA ŚWIATŁA	STRUMIEŃ ŚWIETLNY [lm]	WAGA NETTO [kg]	PAKOWANIE [szt.]	KOD EAN
MODEL	INDEX	POWER [W]	LIGHT COLOR	LUMINOUS FLUX [lm]	NET WEIGHT [kg]	PACKING [pcs]	BARCODE
SOLAR LED NCS 30W ZB	KFLNCS30ZB	30	ZIMNOBIAŁA COOL WHITE	2100	1,87	8	5902201302141







ECONOMIC BRAND NAŚWIETLACZE LED / LED FLOODLIGHTS



# LED MH 10W

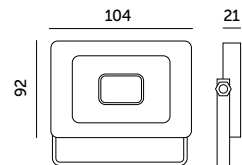

- praktyczny i ekonomiczny projektor oświetleniowy,
- obudowa wykonana z aluminium,
- kąt rozsytu światła: 120 stopni,
- nie można wymieniać lamp w oprawie.
- practical and economical LED floodlight,
- housing made of aluminum,
- beam angle: 120 degrees,
- lamps in the fixture cannot be replaced.

MODEL	INDEKS	KOLOR	POBÓR MOCY [W]	BARWA ŚWIATŁA	STRUMIEN ŚWIETLNY [lm]	WAGA NETTO [kg]	PAKOWANIE [szt.]	KOD EAN
MODEL	INDEX	COLOR	POWER [W]	LIGHT COLOR	LUMINOUS FLUX [lm]	NET WEIGHT [kg]	PACKING [pcs]	BARCODE
LED MH 10W NB	KFLNL10NBR	CZARNY BLACK	10	NEUTRALNA BIAŁA NEUTRAL WHITE	735	0,14	40	5902201380767
LED MH 10W ZB	KFLNL10ZBR	CZARNY BLACK	10	ZIMNOBIAŁA COOL WHITE	735	0,14	40	5902201380774

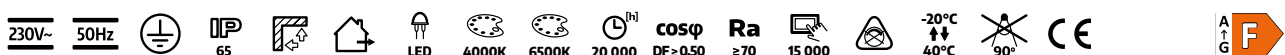





**ECONOMIC BRAND** NAŚWIETLACZE LED / LED FLOODLIGHTS



# LED MH 20W

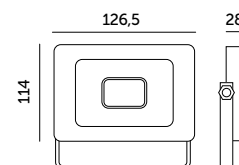

- praktyczny i ekonomiczny projektor oświetleniowy,
- obudowa wykonana z aluminium,
- kąt rozsyłu światła: 120 stopni,
- nie można wymieniać lamp w oprawie.
- practical and economical LED floodlight,
- housing made of aluminum,
- beam angle: 120 degrees,
- lamps in the fixture cannot be replaced.

MODEL	INDEKS	KOLOR	POBÓR MOCY [W]	BARWA ŚWIATŁA	STRUMIEN ŚWIETLNY [lm]	WAGA NETTO [kg]	PAKOWANIE [szt.]	KOD EAN
MODEL	INDEX	COLOR	POWER [W]	LIGHT COLOR	LUMINOUS FLUX [lm]	NET WEIGHT [kg]	PACKING [pcs]	BARCODE
LED MH 20W NB	KFLNL20NBR	CZARNY BLACK	20	NEUTRALNA BIAŁA NEUTRAL WHITE	1620	0,22	20	5902201380781
LED MH 20W ZB	KFLNL20ZBR	CZARNY BLACK	20	ZIMNOBIAŁA COOL WHITE	1620	0,22	20	5902201380798

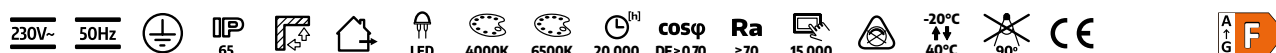

**ECONOMIC BRAND** NAŚWIETLACZE LED / LED FLOODLIGHTS



# LED MH 30W

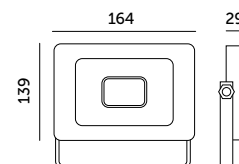

- praktyczny i ekonomiczny projektor oświetleniowy,
- obudowa wykonana z aluminium,
- kąt rozsyłu światła: 120 stopni,
- nie można wymieniać lamp w oprawie.
- practical and economical LED floodlight,
- housing made of aluminum,
- beam angle: 120 degrees,
- lamps in the fixture cannot be replaced.

MODEL	INDEKS	KOLOR	POBÓR MOCY [W]	BARWA ŚWIATŁA	STRUMIEN ŚWIETLNY [lm]	WAGA NETTO [kg]	PAKOWANIE [szt.]	KOD EAN
MODEL	INDEX	COLOR	POWER [W]	LIGHT COLOR	LUMINOUS FLUX [lm]	NET WEIGHT [kg]	PACKING [pcs]	BARCODE
LED MH 30W NB	KFLNL30NBR	CZARNY BLACK	30	NEUTRALNA BIAŁA NEUTRAL WHITE	2505	0,32	20	5902201380804
LED MH 30W ZB	KFLNL30ZBR	CZARNY BLACK	30	ZIMNOBIAŁA COOL WHITE	2505	0,32	20	5902201380811

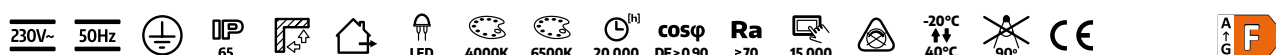

ECONOMIC BRAND

NAŚWIETLACZE LED / LED FLOODLIGHTS



# LED MH 50W

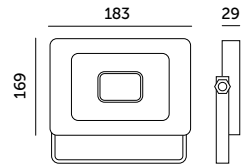

- praktyczny i ekonomiczny projektor oświetleniowy, - practical and economical LED floodlight,
- obudowa wykonana z aluminium, - housing made of aluminum,
- kąt rozsyłu światła: 120 stopni, - beam angle: 120 degrees,
- nie można wymieniać lamp w oprawie. - lamps in the fixture cannot be replaced.

MODEL	INDEKS	KOLOR	POBÓR MOCY [W]	BARWA ŚWIATŁA	STRUMIEN ŚWIETLNY [lm]	WAGA NETTO [kg]	PAKOWANIE [szt.]	KOD EAN
MODEL	INDEX	COLOR	POWER [W]	LIGHT COLOR	LUMINOUS FLUX [lm]	NET WEIGHT [kg]	PACKING [pcs]	BARCODE
LED MH 50W NB	KFLNL50NBR	CZARNY BLACK	50	NEUTRALNA BIAŁA NEUTRAL WHITE	4270	0,46	20	5902201380828
LED MH 50W ZB	KFLNL50ZBR	CZARNY BLACK	50	ZIMNOBIAŁA COOL WHITE	4270	0,46	20	5902201380835

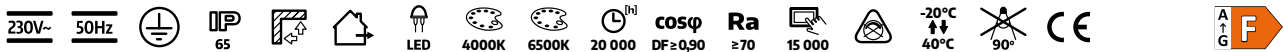

ECONOMIC BRAND

NAŚWIETLACZE LED / LED FLOODLIGHTS



# LED MH 100W

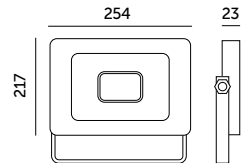

- praktyczny i ekonomiczny projektor oświetleniowy, - practical and economical LED floodlight,
- obudowa wykonana z aluminium, - housing made of aluminum,
- kąt rozsyłu światła: 120 stopni, - beam angle: 120 degrees,
- nie można wymieniać lamp w oprawie. - lamps in the fixture cannot be replaced.

MODEL	INDEKS	KOLOR	POBÓR MOCY [W]	BARWA ŚWIATŁA	STRUMIEN ŚWIETLNY [lm]	WAGA NETTO [kg]	PAKOWANIE [szt.]	KOD EAN
MODEL	INDEX	COLOR	POWER [W]	LIGHT COLOR	LUMINOUS FLUX [lm]	NET WEIGHT [kg]	PACKING [pcs]	BARCODE
LED MH 100W NB	KFLNL100NBR	CZARNY BLACK	100	NEUTRALNA BIAŁA NEUTRAL WHITE	8700	0,84	8	5902201380743
LED MH 100W ZB	KFLNL100ZBR	CZARNY BLACK	100	ZIMNOBIAŁA COOL WHITE	8700	0,84	8	5902201380750

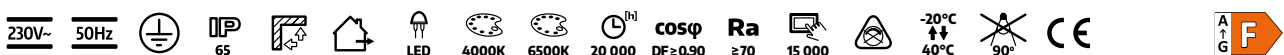



**ECONOMIC BRAND** NAŚWIETLACZE LED / LED FLOODLIGHTS



# LED MHC 10W

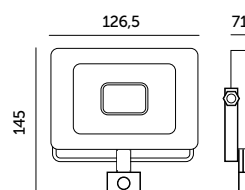

- projektor oświetleniowy z czujnikiem ruchu,
- czujnik ruchu z trzema zakresami regulacji: czas działania, natężenie oświetlenia i zasięg detekcji,
- czas działania: 7 s – 7 min,
- natężenie oświetlenia: 5-2000 lx,
- zasięg detekcji: 2-10 m,
- kąt rozsytu światła: 120 stopni,
- kąt detekcji: 120 stopni,
- nie można wymieniać lamp w oprawie.

- LED floodlight with motion sensor,
- motion sensor with three ranges of adjustment: working time, light intensity and detection range,
- working time: 7 s – 7 min,
- light intensity: 5-2000 lx,
- detection range: 2-10 m,
- beam angle: 120 degrees,
- detection angle: 120 degrees,
- lamps inside cannot be replaced.

MODEL	INDEKS	KOLOR	POBÓR MOCY [W]	BARWA ŚWIATŁA	STRUMIEN ŚWIETLNY [lm]	WAGA NETTO [kg]	PAKOWANIE [szt.]	KOD EAN
MODEL	INDEX	COLOR	POWER [W]	LIGHT COLOR	LUMINOUS FLUX [lm]	NET WEIGHT [kg]	PACKING [pcs]	BARCODE
LED MHC 10W NB	KFLNLC10NBR	CZARNY BLACK	10	NEUTRALNA BIAŁA NEUTRAL WHITE	735	0,25	20	5902201380842
LED MHC 10W ZB	KFLNLC10ZBR	CZARNY BLACK	10	ZIMNOBIAŁA COOL WHITE	735	0,25	20	5902201380859

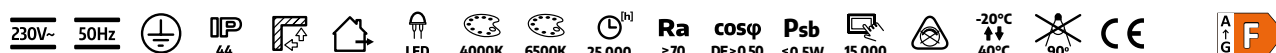

**ECONOMIC BRAND** NAŚWIETLACZE LED / LED FLOODLIGHTS



# LED MHC 20W

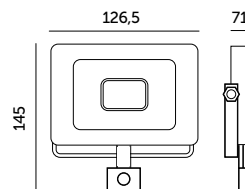

- projektor oświetleniowy z czujnikiem ruchu,
- czujnik ruchu z trzema zakresami regulacji: czas działania, natężenie oświetlenia i zasięg detekcji,
- czas działania: 7 s – 7 min,
- natężenie oświetlenia: 5-2000 lx,
- zasięg detekcji: 2-10 m,
- kąt rozsytu światła: 120 stopni,
- kąt detekcji: 120 stopni,
- nie można wymieniać lamp w oprawie.

- LED floodlight with motion sensor,
- motion sensor with three ranges of adjustment: working time, light intensity and detection range,
- working time: 7 s – 7 min,
- light intensity: 5-2000 lx,
- detection range: 2-10 m,
- beam angle: 120 degrees,
- detection angle: 120 degrees,
- lamps inside cannot be replaced.

MODEL	INDEKS	KOLOR	POBÓR MOCY [W]	BARWA ŚWIATŁA	STRUMIEN ŚWIETLNY [lm]	WAGA NETTO [kg]	PAKOWANIE [szt.]	KOD EAN
MODEL	INDEX	COLOR	POWER [W]	LIGHT COLOR	LUMINOUS FLUX [lm]	NET WEIGHT [kg]	PACKING [pcs]	BARCODE
LED MHC 20W NB	KFLNLC20NBR	CZARNY BLACK	20	NEUTRALNA BIAŁA NEUTRAL WHITE	1620	0,25	20	5902201380866
LED MHC 20W ZB	KFLNLC20ZBR	CZARNY BLACK	20	ZIMNOBIAŁA COOL WHITE	1620	0,25	20	5902201380873

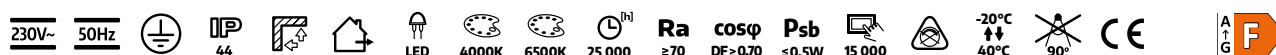

ECONOMIC BRAND

NAŚWIETLACZE LED / LED FLOODLIGHTS



# LED MHC 30W

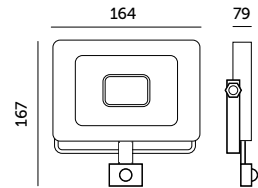

- projektor oświetleniowy z czujnikiem ruchu,
- czujnik ruchu z trzema zakresami regulacji: czas działania, natężenie oświetlenia i zasięg detekcji,
- czas działania: 7 s – 7 min,
- natężenie oświetlenia: 5-2000 lx,
- zasięg detekcji: 2-10 m,
- kąt rozsyłu światła: 120 stopni,
- kąt detekcji: 120 stopni,
- nie można wymieniać lamp w oprawie.

- LED floodlight with motion sensor,
- motion sensor with three ranges of adjustment: working time, light intensity and detection range,
- working time: 7 s – 7 min,
- light intensity: 5-2000 lx,
- detection range: 2-10 m,
- beam angle: 120 degrees,
- detection angle: 120 degrees,
- lamps inside cannot be replaced.

MODEL	INDEKS	KOLOR	POBÓR MOCY [W]	BARWA ŚWIATŁA	STRUMIEŃ ŚWIETLNY [lm]	WAGA NETTO [kg]	PAKOWANIE [szt.]	KOD EAN
MODEL	INDEX	COLOR	POWER [W]	LIGHT COLOR	LUMINOUS FLUX [lm]	NET WEIGHT [kg]	PACKING [pcs]	BARCODE
LED MHC 30W NB	KFLNLC30NBR	CZARNY BLACK	30	NEUTRALNA BIAŁA NEUTRAL WHITE	2505	0,37	20	5902201380880
LED MHC 30W ZB	KFLNLC30ZBR	CZARNY BLACK	30	ZIMNOBIAŁA COOL WHITE	2505	0,37	20	5902201380897

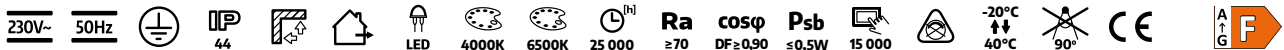

ECONOMIC BRAND

NAŚWIETLACZE LED / LED FLOODLIGHTS



# LED MHC 50W

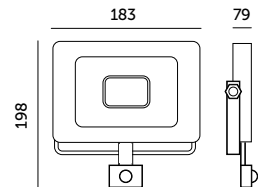

- projektor oświetleniowy z czujnikiem ruchu,
- czujnik ruchu z trzema zakresami regulacji: czas działania, natężenie oświetlenia i zasięg detekcji,
- czas działania: 7 s – 7 min,
- natężenie oświetlenia: 5-2000 lx,
- zasięg detekcji: 2-10 m,
- kąt rozsyłu światła: 120 stopni,
- kąt detekcji: 120 stopni,
- nie można wymieniać lamp w oprawie.

- LED floodlight with motion sensor,
- motion sensor with three ranges of adjustment: working time, light intensity and detection range,
- working time: 7 s – 7 min,
- light intensity: 5-2000 lx,
- detection range: 2-10 m,
- beam angle: 120 degrees,
- detection angle: 120 degrees,
- lamps inside cannot be replaced.

MODEL	INDEKS	KOLOR	POBÓR MOCY [W]	BARWA ŚWIATŁA	STRUMIEŃ ŚWIETLNY [lm]	WAGA NETTO [kg]	PAKOWANIE [szt.]	KOD EAN
MODEL	INDEX	COLOR	POWER [W]	LIGHT COLOR	LUMINOUS FLUX [lm]	NET WEIGHT [kg]	PACKING [pcs]	BARCODE
LED MHC 50W NB	KFLNLC50NBR	CZARNY BLACK	50	NEUTRALNA BIAŁA NEUTRAL WHITE	4270	0,46	20	5902201380903
LED MHC 50W ZB	KFLNLC50ZBR	CZARNY BLACK	50	ZIMNOBIAŁA COOL WHITE	4270	0,46	20	5902201380910

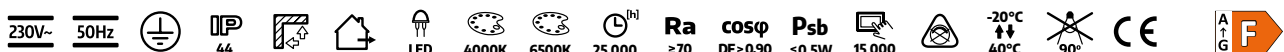



PROFESSIONAL LINE OPRAWY LED / LED FIXTURES

# LED NUMOS LX 7W

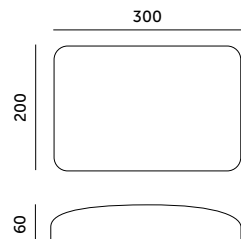
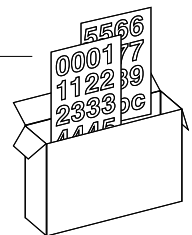

- oprawa ledowa z czujnikiem zmierzchowym,
- czujnik z możliwością regulacji natężenia światła w zakresie: 3-50 lux,
- kąt rozsytu światła: 120 stopni,
- podstawa i klosz mleczny wykonane z poliwęglanu,
- w zestawie naklejki z cyframi i literami,
- nie można wymieniać lamp w oprawie.

- LED fixture with dusk sensor,
- sensor with possibility of light intensity adjustment in a range: 3-50 lux,
- beam angle: 120 degrees,
- base and milky cover made of PC,
- the set includes stickers with numbers and letters,
- lamps in the fixture cannot be replaced.

MODEL	INDEKS	POBÓR MOCY [W]	BARWA ŚWIATŁA	STRUMIEŃ ŚWIETLNY [lm]	WAGA NETTO [kg]	PAKOWANIE [szt.]	KOD EAN
MODEL	INDEX	POWER [W]	LIGHT COLOR	LUMINOUS FLUX [lm]	NET WEIGHT [kg]	PACKING [pcs]	BARCODE
LED NUMOS LX 7W NB	02NSNSX7WNB	7	NEUTRALNA BIAŁA NEUTRAL WHITE	700	0,70	10	5902201305678









## **OPRAWY DOMOWE** DOMESTIC LIGHTING

Dzięki bogatemu wyborowi stylów i kształtów, oprawy domowe doskonale harmonizują z każdym wnętrzem, wprowadzając nowoczesny akcent. Oprawy LED oferują jasne i równomierne oświetlenie, które uwydatnia walory estetyczne pomieszczeń, jednocześnie zapewniając komfort użytkownikom.

With a diverse selection of styles and designs, our domestic lighting fixtures seamlessly integrate with any interior, adding a modern touch. Our LED fixtures provide bright, uniform lighting that highlights the aesthetic qualities of your spaces while ensuring maximum comfort.



PREMIUM

LAMPKI BIURKOWE / DESK LAMPS

## LED LIZBONA 3,5W CCT



CZARNY  
BLACK



BIAŁY  
WHITE

- bezprzewodowa, akumulatorowa i magnetyczna lampka ledowa, z 4 możliwościami instalacji,
- na podstawie – jako lampka biurkowa, do przykręcenia np. na ścianie, na klipsie i na zawieszce,
- w zestawie: kabel USB-C (około 1 m),
- lampka ma opcję regulacji o 360 stopni w każdym kierunku,
- trzy barwy światła do wyboru: ciepła, neutralna lub zimna – zmieniane przez przycisk na lampce,
- możliwość ściemniania poprzez dłuższe przytrzymanie przycisku,
- może być włączona już w czasie ładowania,
- zawiera niewymienny akumulator o pojemności 1800 mAh,
- ładowanie jest możliwe poprzez podłączenie przez USB-C w lampce – do komputera, powerbanku itp.

- wireless, rechargeable, and magnetic LED lamp with 4 installation options,
- can be used on a base, mounted on a wall, clipped on, or hung,
- includes a USB-C cable (approx. 1 m),
- lamp can be adjusted 360 degrees in any direction,
- three light colors: warm, neutral, or cool, selectable via a button on the lamp,
- dimmable by holding down the button,
- can be used while charging,
- includes a non-replaceable 1800 mAh battery,
- charges via USB-C connection to a computer, power bank, etc.



MODEL	KOLOR	INDEKS	POBÓR MOCY [W]	BARWA ŚWIATŁA	STRUMIEN ŚWIETLNY [lm]	WAGA NETTO [kg]	PAKOWANIE [szt.]	KOD EAN
MODEL	COLOR	INDEX	POWER [W]	LIGHT COLOR	LUMINOUS FLUX [lm]	NET WEIGHT [kg]	PACKING [pcs]	BARCODE
LED LIZBONA 3,5W CCT	CZARNY BLACK	KLLACZA	3,5	3000-6500K	220	0,79	12	5902201368246
LED LIZBONA 3,5W CCT	BIAŁY WHITE	KLLABIA	3,5	3000-6500K	220	0,79	12	5902201368253

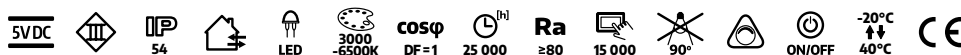





**ECONOMIC BRAND** LAMPKI BIURKOWE / DESK LAMPS

**LED2B**

# LED TENUIX 14W

CZARNY / BLACK

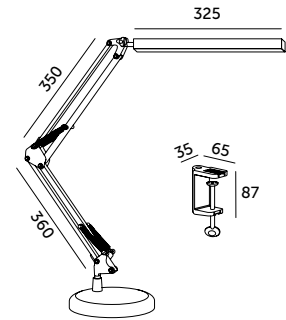

- ledowa lampka biurkowa z 2 możliwościami instalacji,
- na podstawie lub do przykręcenia np. do biurka,
- zasilanie poprzez przewód (około 1 m) zakończony portem USB-A,
- lampka ma podwójną opcję regulacji: o 180 stopni w pionie za pomocą pokręteł oraz regulację samego źródła światła,
- trzy barwy światła do wyboru: ciepła, neutralna lub zimna – zmieniane przez przycisk na przewodzie zasilającym,
- możliwość płynnego ściemniania poprzez dłuższe przytrzymanie przycisku i pojedynczym kliknięciem o 10%,
- kąt rozsyłu światła: 120 stopni,
- oprawa zawiera źródła światła o klasie energetycznej F,
- możliwość wymiany źródła światła LED jedynie przez wykwalifikowany personel.

- LED desk lamp with 2 installation options: use on a base or mount to a desk,
- powered by a USB-A cable (approx. 1 m),
- vertically adjustable within 180 degrees using knobs, with independent adjustment of the light source,
- three light colors: warm, neutral, or cool, selectable via a button on the power cable,
- dimmable by holding the button or in 10% increments with a single click,
- beam angle: 120 degrees,
- includes light sources with energy efficiency class F,
- LED light source can only be replaced by qualified personnel.

MODEL	INDEKS	POBÓR MOCY [W]	BARWA ŚWIATŁA	STRUMIEŃ ŚWIETLNY [lm]	WAGA NETTO [kg]	PAKOWANIE [szt.]	KOD EAN
MODEL	INDEX	POWER [W]	LIGHT COLOR	LUMINOUS FLUX [lm]	NET WEIGHT [kg]	PACKING [pcs]	BARCODE
LED TENUIX 14W	KLLTX14CZ	14	3000-6000K	800	1,57	16	5902201378184

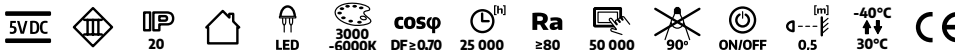

**ECONOMIC BRAND** LAMPKI BIURKOWE / DESK LAMPS

**LED2B**

# LED TENUIX DUO 28W

CZARNY / BLACK

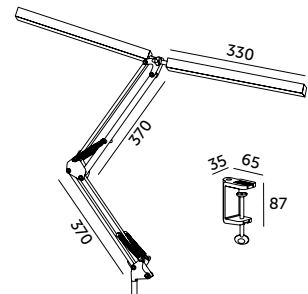

- ledowa lampka biurkowa z 2 elementami świecącymi,
- montaż poprzez przykręcenie np. do biurka,
- lampka ma podwójną opcję regulacji: o 180 stopni w pionie za pomocą pokręteł oraz regulację obu elementów świecących,
- trzy barwy światła do wyboru: ciepła, neutralna lub zimna – zmieniane przez przycisk na przewodzie zasilającym,
- możliwość płynnego ściemniania poprzez dłuższe przytrzymanie przycisku i pojedynczym kliknięciem o 10%,
- długość przewodu: około 1 m,
- kąt rozsyłu światła: 120 stopni,
- oprawa zawiera źródła światła o klasie energetycznej F,
- możliwość wymiany źródła światła LED jedynie przez wykwalifikowany personel.

- LED desk lamp with 2 light elements,
- mounts by screwing into a surface, e.g., a desk,
- vertically adjustable within 180 degrees using knobs, with independent adjustment of both light elements,
- three light colors: warm, neutral, or cool, adjustable via a button on the power cable,
- smooth dimming by holding the button, or in 10% increments with a single click,
- cable length: approx. 1 m,
- beam angle: 120 degrees,
- includes light sources with energy efficiency class F,
- LED light source can only be replaced by qualified personnel.

MODEL	INDEKS	POBÓR MOCY [W]	BARWA ŚWIATŁA	STRUMIEŃ ŚWIETLNY [lm]	WAGA NETTO [kg]	PAKOWANIE [szt.]	KOD EAN
MODEL	INDEX	POWER [W]	LIGHT COLOR	LUMINOUS FLUX [lm]	NET WEIGHT [kg]	PACKING [pcs]	BARCODE
LED TENUIX DUO 28W	KLLTX28CZ	28	3000-6000K	1400	0,77	16	5902201378191

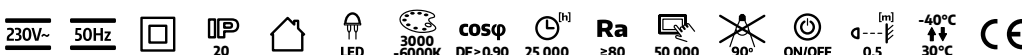

ECONOMIC BRAND LAMPKI BIURKOWE / DESK LAMPS

# LED NOBLITE 7W



CZARNY  
BLACK

BIAŁY  
WHITE

- lampka ledowa z możliwością ściemniania i zmiany barwy światła w zakresie 3000-6000 K,
- posiada dodatkowe światło nocne z obu stron podstawy,
- wyświetlacz z datą, godziną i temperaturą, zasilany baterią CR1632, która jest w zestawie,
- możliwość ustawienia alarmu i drzemki,
- lampka ma podwójną opcję regulacji: o 90° u podstawy i regulację elementu świecącego o 180°,
- posiada uchwyt na telefon wysuwany z podstawy lampki,
- posiada funkcję ładowania np. telefonu: przewodowo (z portu USB-A) oraz bezprzewodowo (Qi 10W),
- kąt rozsyłu światła: 120 stopni,
- długość przewodu; około 1 m,
- oprawa zawiera źródła światła o klasie energetycznej D,
- możliwość wymiany źródła światła LED jedynie przez wykwalifikowany personel.

- LED lamp with dimming and color temperature adjustment range of 3000-6000 K,
- includes an additional night light on both sides of the base,
- display shows date, time, and temperature,
- powered by a CR1632 battery (included),
- alarm and snooze functions,
- dual position adjustment: 90° at the base and 180° adjustment of the light element,
- features a phone holder that slides out from the lamp base,
- offers charging options for devices: wired (via USB-A port) and wireless (Qi 10W),
- beam angle: 120 degrees,
- cable length: approx. 1 m,
- includes light sources with energy efficiency class D,
- LED light source can only be replaced by qualified personnel.

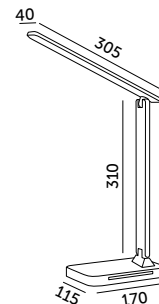

MODEL	INDEKS	KOLOR	POBÓR MOCY [W]	BARWA ŚWIATŁA	STRUMIEŃ ŚWIETLNY [lm]	WAGA NETTO [kg]	PAKOWANIE [szt.]	KOD EAN
MODEL	INDEX	COLOR	POWER [W]	LIGHT COLOR	LUMINOUS FLUX [lm]	NET WEIGHT [kg]	PACKING [pcs]	BARCODE
LED NOBLITE 7W	KLLNE7CZ	CZARNY BLACK	7	3000-6000K	460	0,59	18	5902201378238
LED NOBLITE 7W	KLLNE7BI	BIAŁY WHITE	7	3000-6000K	460	0,59	18	5902201378245

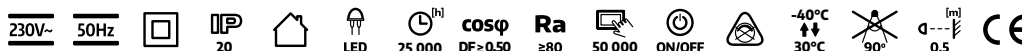

ECONOMIC BRAND LAMPKI BIURKOWE / DESK LAMPS

# LED VISUA DESK 5W



BIAŁY  
WHITE

CZARNY  
BLACK

MIĘTOWY  
MINT

SZARY  
GRAY

RÓŻOWY  
PINK

- bezprzewodowa, akumulatorowa lampka ledowa,
- w zestawie: kabel USB-A (około 1 m),
- lampka ma opcję regulacji o 360 stopni w każdym kierunku,
- trzy barwy światła do wyboru: ciepła, neutralna lub zimna – zmieniane przez przycisk na lampce,
- ściemnianie poprzez dłuższe przytrzymanie przycisku,
- może być włączona już w czasie ładowania,
- zawiera niewymienny akumulator o pojemności 1200 mAh,
- ładowanie jest możliwe poprzez podłączenie przez USB-A w lampce – do komputera, powerbanku itp.
- czas świecenia na pełnej jasności wynosi około 3 h,
- czas ładowania do pełnej pojemności:około 3 h.

- wireless, rechargeable LED lamp,
- includes a USB-A cable (approx. 1 m),
- can be adjusted 360 degrees in any direction,
- three light colors: warm, neutral, or cool, selectable via a button on the lamp,
- dimming by holding the button,
- can be used while charging,
- includes a non-replaceable 1200 mAh battery,
- charging is possible via USB-A connection to a computer, power bank, etc.,
- working time at full brightness is approx. 3 hours,
- charging time to full capacity: approx. 3 hours.

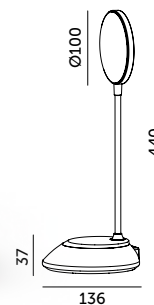

MODEL	INDEKS	KOLOR	POBÓR MOCY [W]	BARWA ŚWIATŁA	STRUMIEŃ ŚWIETLNY [lm]	WAGA NETTO [kg]	PAKOWANIE [szt.]	KOD EAN
MODEL	INDEX	COLOR	POWER [W]	LIGHT COLOR	LUMINOUS FLUX [lm]	NET WEIGHT [kg]	PACKING [pcs]	BARCODE
LED VISUA DESK 5W	KLLVD5BI	BIAŁY WHITE	5	3000-5000K	200	0,26	60	5902201378283
LED VISUA DESK 5W	KLLVD5CZ	CZARNY BLACK	5	3000-5000K	200	0,26	60	5902201378276
LED VISUA DESK 5W	KLLVD5MI	MIĘTOWY MINT	5	3000-5000K	200	0,26	60	5902201378306
LED VISUA DESK 5W	KLLVD5SZ	SZARY GRAY	5	3000-5000K	200	0,26	60	5902201378290
LED VISUA DESK 5W	KLLVD5RO	RÓŻOWY PINK	5	3000-5000K	200	0,26	60	5902201378313







STANDARD LINE LAMPKI BIURKOWE / DESK LAMPS

# ROLIG



CZARNY  
BLACK



BIAŁY  
WHITE

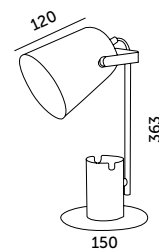

- lampka biurkowa z ruchomym kloszem,
- długość przewodu: około 1,5 m,
- posiada koszyk na długopisy,
- na spodzie lampki pianka, zabezpieczająca przed porysowaniem powierzchni,
- lampka nie zawiera źródła światła.

- desk lamp with an adjustable shade,
- cable length: approx. 1,5 m,
- features a pen holder,
- foam padding on the bottom of the lamp to prevent surface scratching,
- light source not included.

MODEL	INDEKS	KOLOR	WAGA NETTO [kg]	PAKOWANIE [szt.]	KOD EAN
MODEL	INDEX	COLOR	NET WEIGHT [kg]	PACKING [pcs]	BARCODE
ROLIG CZARNY	KLRG CZA	CZARNY BLACK	0,86	8	5902846015451
ROLIG BIAŁY	KLRG BIA	BIAŁY WHITE	0,86	8	5902846015468



STANDARD LINE

LAMPKI BIURKOWE / DESK LAMPS

# ŚMIESZEK



CZARNY BLACK    BIAŁY WHITE    RÓŻOWY PINK    CZERWONY RED    NIEBIESKI BLUE    ZIELONY GREEN    ŻÓŁTY YELLOW

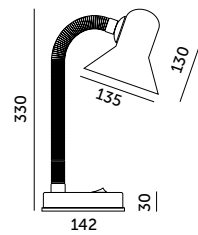

- lampka biurkowa z możliwością dowolnego ukierunkowania klosza,
- długość przewodu: 1,5 m,
- lampka nie zawiera źródła światła.
- desk lamp with a fully adjustable shade,
- cable length: approx. 1,5 m,
- light source not included.

MODEL	INDEKS	KOLOR	WAGA NETTO [kg]	PAKOWANIE [szt.]	KOD EAN
MODEL	INDEX	COLOR	NET WEIGHT [kg]	PACKING [pcs]	BARCODE
ŚMIESZEK KX3087	KLKXSMICZA	CZARNY BLACK	0,66	12	5906340216987
ŚMIESZEK KX3087	KLKXSMIBIA	BIAŁY WHITE	0,66	12	5900605097892
ŚMIESZEK KX3087	KLKXSMIROZ	RÓŻOWY PINK	0,66	12	5902201359190
ŚMIESZEK KX3087	KLKXSMICZE	CZERWONY RED	0,66	12	5906340218882
ŚMIESZEK KX3087	KLKXSMINIE	NIEBIESKI BLUE	0,66	12	5906340219599
ŚMIESZEK KX3087	KLKXSMIZIE	ZIELONY GREEN	0,66	12	5906340219131
ŚMIESZEK KX3087	KLKXSMIZOL	ŻÓŁTY YELLOW	0,66	12	5906340218875



ECONOMIC BRAND

LAMPKI BIURKOWE / DESK LAMPS

# AURIQ



CZARNY BLACK    BIAŁY WHITE

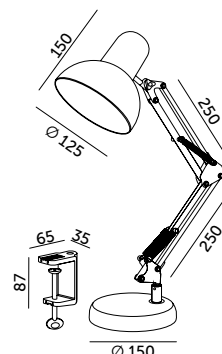

- lampka biurkowa z 2 możliwościami instalacji: na podstawie lub do przykręcenia np. do biurka,
- lampka ma opcję regulacji o 180 stopni w pionie oraz regulację klosza o 360 stopni,
- długość przewodu: około 1 m,
- lampka nie zawiera źródła światła.
- desk lamp with 2 installation options: use on a base or mount to a desk,
- vertically adjustable within 180 degrees, with 360-degree shade adjustment,
- cable length: approx. 1 m,
- light source not included.

MODEL	INDEKS	KOLOR	WAGA NETTO [kg]	PAKOWANIE [szt.]	KOD EAN
MODEL	INDEX	COLOR	NET WEIGHT [kg]	PACKING [pcs]	BARCODE
AURIQ CZARNY	KLLAQCZ	CZARNY BLACK	1,26	12	5902201378207
AURIQ BIAŁY	KLLAQBI	BIAŁY WHITE	1,26	12	5902201378214

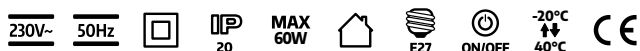



ECONOMIC BRAND LAMPY PODŁOGOWE / FLOOR LAMPS

# AURIQ ST

**LED2B**

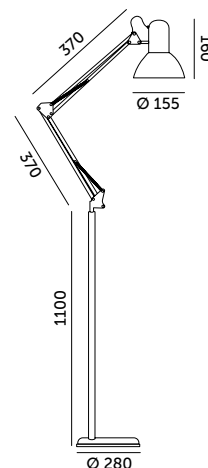

- lampa podłogowa o wysokości prawie 2 m,
  - lampa ma opcję regulacji o 180 stopni w pionie oraz regulację klosza o 360 stopni,
  - długość przewodu: około 1 m,
  - lampa nie zawiera źródła światła.
- floor lamp (approx. 2 m high),
  - vertically adjustable with in 180 degrees, with 360-degree shade adjustment,
  - cable length: approx. 1 m,
  - light source not included.

MODEL	INDEKS	KOLOR	WAGA NETTO [kg]	PAKOWANIE [szt.]	KOD EAN
MODEL	INDEX	COLOR	NET WEIGHT [kg]	PACKING [pcs]	BARCODE
AURIQ ST CZARNY	KLLATCZ	CZARNY BLACK	4,74	5	5902201378221

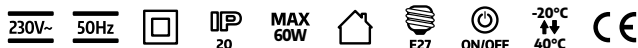

KOBI DESIGN SMART HOME

# LED PLAY SL 6W



- lampa podłogowa, dekoracyjna lub "rozrywkowa" pozwalająca na zdalną kontrolę pilotem lub telefonem poprzez aplikację MAGIC LANTERN (na Android i iOS),
  - posiada 7 kolorów w tym biały oraz 72 wielokolorowych programów dynamicznych (m.in. świecenie opadającymi odcinkami światła różnych kolorów czy wymiennianie kolorów naprzemiennie),
  - posiada możliwość ustawienia czasu świecenia, ściemniania, zmiany kolorów i zmiany prędkości w programach dynamicznych,
  - posiada tryb muzyczny – programy dynamiczne dostosowują się do rytmu włączonej muzyki pulsując w ten rytm,
  - możliwość sterowania aplikacją wieloma urządzeniami jednocześnie,
  - kąt rozsytu światła: 180 stopni,
  - lampa zasilana jest poprzez przewód zakończony złączem USB-A,
  - pilot zasilany za pomocą baterii CR2032 (dotychczasowa do zestawu).
- decorative floor lamp, controlled via remote or the MAGIC LANTERN app (available on Android and iOS),
  - features 7 colors, including white, and 72 dynamic multicolor programs (e.g., cascading light segments of various colors or alternating colors),
  - offers settings for light duration, dimming, color changes, and speed adjustments in dynamic programs,
  - includes a music mode – light synchronizes with the rhythm, pulsing to the beat,
  - allows control of multiple devices simultaneously via the app,
  - beam angle: 180 degrees,
  - powered by a cable ending in a USB-A connector,
  - remote powered by a CR2032 battery (included).

MODEL	INDEKS	POBÓR MOCY [W]	BARWA ŚWIATŁA	WAGA NETTO [kg]	PAKOWANIE [szt.]	KOD EAN
MODEL	INDEX	POWER [W]	LIGHT COLOR	NET WEIGHT [kg]	PACKING [pcs]	BARCODE
LED PLAY SL 6W	KDSN00000028	6	RGB	0,64	20	5902201378252





KOBİ DESIGN

OPRAWY MEBLOWE LED / CABINET FIXTURES

## LED LUMIREFLECT 8W

CZARNY/BLACK

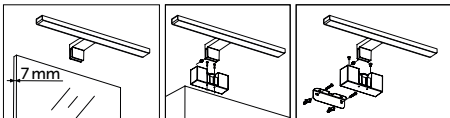

- ledowa lampa wykonana z aluminium,
- możliwość montażu na ścianie, na podłożu stałym od góry lub bezpośrednio np. do lustra (grubość lustra max. 7 mm),
- kąt rozsytu światła: 120 stopni,
- oprawa zawiera źródła światła o klasie energetycznej F,
- możliwość wymiany źródła światła jedynie przez wykwalifikowany personel.

- LED lamp made of aluminium,
- can be installed on a wall, on a solid surface, or directly on a mirror (max. mirror thickness 7 mm),
- beam angle: 120 degrees,
- fixture includes light sources with energy efficiency class F,
- LED light source can only be replaced by qualified personnel.

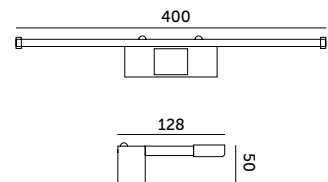

MODEL	INDEKS	POBÓR MOCY [W]	BARWA ŚWIATEŁA	STRUMIEŃ ŚWIETLNY [lm]	WAGA NETTO [kg]	PAKOWANIE [szt.]	KOD EAN
MODEL	INDEX	POWER [W]	LIGHT COLOR	LUMINOUS FLUX [lm]	NET WEIGHT [kg]	PACKING [pcs]	BARCODE
LED LUMIREFLECT 8W	KDSN00000030	8	NEUTRALNA BIAŁA NEUTRAL WHITE	560	0,27	20	5902201378399



KOBI DESIGN OPRAWY MEBLOWE LED / CABINET FIXTURES

# LED LUMIREFLECT 10W

CZARNY/BLACK

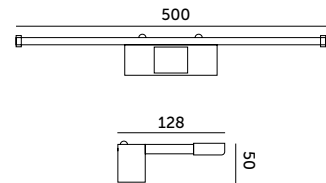
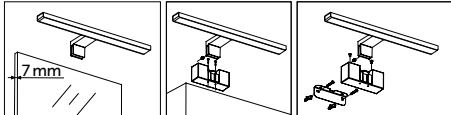

- ledowa lampa wykonana z aluminium,
- możliwość montażu na ścianie, na podłożu stałym od góry lub bezpośrednio np. do lustra (grubość lustra max. 7 mm),
- kąt rozsytu światła: 120 stopni,
- oprawa zawiera źródła światła o klasie energetycznej F,
- możliwość wymiany źródła światła jedynie przez wykwalifikowany personel.

- LED lamp made of aluminum,
- can be installed on a wall, on a solid surface, or directly on a mirror (max. mirror thickness 7 mm),
- beam angle: 120 degrees,
- fixture includes light sources with energy efficiency class F,
- LED light source can only be replaced by qualified personnel.

MODEL	INDEKS	POBÓR MOCY [W]	BARWA ŚWIATŁA	STRUMIEŃ ŚWIETLNY [lm]	WAGA NETTO [kg]	PAKOWANIE [szt.]	KOD EAN
MODEL	INDEX	POWER [W]	LIGHT COLOR	LUMINOUS FLUX [lm]	NET WEIGHT [kg]	PACKING [pcs]	BARCODE
LED LUMIREFLECT 10W	KDSN00000031	10	NEUTRALNA BIAŁA NEUTRAL WHITE	700	0,29	20	5902201378405



KOBI DESIGN OPRAWY MEBLOWE LED / CABINET FIXTURES

# LED LUMIREFLECT 12W

CZARNY/BLACK

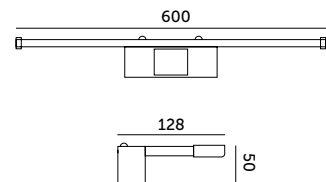
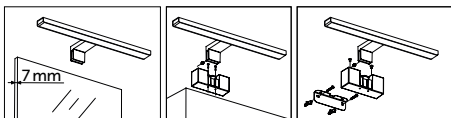

- ledowa lampa wykonana z aluminium,
- możliwość montażu na ścianie, na podłożu stałym od góry lub bezpośrednio np. do lustra (grubość lustra max. 7 mm),
- kąt rozsytu światła: 120 stopni,
- oprawa zawiera źródła światła o klasie energetycznej F,
- możliwość wymiany źródła światła jedynie przez wykwalifikowany personel.

- LED lamp made of aluminum,
- can be installed on a wall, on a solid surface, or directly on a mirror (max. mirror thickness 7 mm),
- beam angle: 120 degrees,
- fixture includes light sources with energy efficiency class F,
- LED light source can only be replaced by qualified personnel.

MODEL	INDEKS	POBÓR MOCY [W]	BARWA ŚWIATŁA	STRUMIEŃ ŚWIETLNY [lm]	WAGA NETTO [kg]	PAKOWANIE [szt.]	KOD EAN
MODEL	INDEX	POWER [W]	LIGHT COLOR	LUMINOUS FLUX [lm]	NET WEIGHT [kg]	PACKING [pcs]	BARCODE
LED LUMIREFLECT 12W	KDSN00000032	12	NEUTRALNA BIAŁA NEUTRAL WHITE	840	0,31	20	5902201378412





PREMIUM

OPRAWY MEBLOWE LED / CABINET FIXTURES

## LED CLICK 1,5W CCT PREMIUM

BIAŁY / WHITE

3 LATA  
GWARANCJI  
3 YEARS  
WARRANTY

- bezprzewodowa, akumulatorowa i magnetyczna lampka ledowa,
- w zestawie: kabel USB-C (około 25 cm), samoprzylepne mocowanie magnetyczne, oraz baza z kulką,
- samoprzylepne mocowanie magnetyczne (3 szt.) – z jednej strony taśma samoprzylepna, z drugiej magnetyczna,
- baza z kulką – z jednej strony taśma samoprzylepna, z drugiej magnetyczna kulka (można również ją zamontować na stałe za pomocą śrubek) – lampka ma wtedy opcję regulacji o 180 stopni w pionie,
- trzy barwy światła do wyboru: ciepła, neutralna lub zimna – zmieniane przez przycisk na obudowie,
- możliwość ściemniania poprzez dłuższe przytrzymanie przycisku,
- może być włączona już w czasie ładowania,
- zawiera niewymienny akumulator 3,7V/800 mAh,
- ładowanie jest możliwe poprzez podłączenie przez USB-C w lampce – do komputera, powerbanku itp.
- czas świecenia na pełnej jasności wynosi około 4 h,
- czas ładowania do pełnej pojemności: około 2 h.

- wireless, rechargeable magnetic LED lamp,
- set includes: USB-C cable (approx. 25 cm), adhesive magnetic mounts, and ball base,
- adhesive magnetic mounts (3 pcs) – adhesive tape on one side, magnetic on the other,
- ball base – adhesive tape on one side, magnetic ball on the other (can also be permanently mounted with screws), allowing 180-degree vertical adjustment,
- three light colors: warm, neutral, or cool, adjustable via a button on the housing,
- dimmable by holding the button,
- can be used while charging,
- includes a non-replaceable 3,7V / 800 mAh battery,
- charging is possible via USB-C connection to a computer, power bank, etc.,
- working time at full brightness: approx. 4 hours,
- charging time to full capacity: approx. 2 hours.

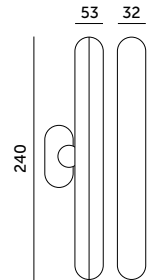

MODEL	INDEKS	POBÓR MOCY [W]	BARWA ŚWIATŁA	STRUMIEŃ ŚWIETLNY [lm]	WAGA NETTO [kg]	PAKOWANIE [szt.]	KOD EAN
MODEL	INDEX	POWER [W]	LIGHT COLOR	LUMINOUS FLUX [lm]	NET WEIGHT [kg]	PACKING [pcs]	BARCODE
LED CLICK 1,5W CCT PREMIUM	KOCP1,5W	1,5	3000-6500K	120	0,15	50	5902846015444



KOBİ DESIGN

OPRAWY MEBLOWE LED / CABINET FIXTURES

## LED LUME-IQ 5W

CZARNY / BLACK

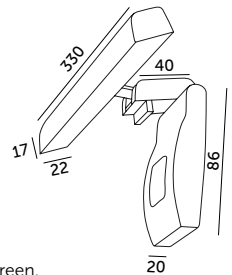

- lampka led do montażu na ekranie komputera,
- regulacja lampy pozwala na oświetlenie blatu lub klawiatury a nie ekranu,
- możliwość ściemniania i zmiany barwy światła w zakresie 3000-6000 K,
- zasilana za pomocą kabla USB-A o długości około 1 m, który można podpiąć do komputera, powerbanku itp.,
- w zestawie taśma samoprzylepna i przyssawka w celu dodatkowej stabilizacji lampy,
- wykonana z poliwęglanu PC,
- oprawa zawiera źródła światła o klasie energetycznej E,
- możliwość wymiany źródła światła LED jedynie przez wykwalifikowany personel.

- LED lamp for mounting on a computer screen,
- adjustable to light the desk or keyboard, not the screen,
- dimmable with adjustable color temperature (3000-6000 K),
- powered by a USB-A cable (approx. 1 m), connectable to a computer or power bank,
- made of polycarbonate (PC),
- includes light sources with energy efficiency class E,
- LED light source can only be replaced by qualified personnel.

MODEL	INDEKS	KOLOR	POBÓR MOCY [W]	BARWA ŚWIATŁA	STRUMIEŃ ŚWIETLNY [lm]	WAGA NETTO [kg]	PAKOWANIE [szt.]	KOD EAN
MODEL	INDEX	COLOR	POWER [W]	LIGHT COLOR	LUMINOUS FLUX [lm]	NET WEIGHT [kg]	PACKING [pcs]	BARCODE
LED LUME-IQ 5W	KDSN00000029	CZARNY BLACK	5	3000-6000K	230	0,50	20	5902201378320





**STANDARD LINE** OPRAWY MEBLOWE LED / CABINET FIXTURES

# LED CORREA 3,4W



- zasilana na baterie 4xAAA (LR03) – niedołączone do zestawu,
- 2 tryby pracy: świecenia ciągłego i automatycznego czujnika ruchu,
- czas świecenia automatycznego zaprogramowany na 25 sekund od wykrycia ruchu,
- klasa szczelności taśmy: IP65,
- klasa szczelności modułu zasilającego z czujnikiem: IP20,
- kąt rozsytu światła: 120 stopni,
- nie można wymieniać lamp w zestawie.

- powered by 4xAAA (LR03) batteries – not included,
- 2 working modes: constant lighting and automatic mode with motion sensor,
- automatic lighting time set to 25 seconds after motion detection,
- protection class of LED strip: IP65,
- protection class of the power module with sensor: IP20,
- beam angle: 120 degrees,
- lamps in the fixture cannot be replaced.



MODEL	INDEKS	POBÓR MOCY [W]	BARWA ŚWIATŁA	STRUMIEŃ ŚWIETLNY [lm]	WAGA NETTO [kg]	PAKOWANIE [szt.]	KOD EAN
MODEL	INDEX	POWER [W]	LIGHT COLOR	LUMINOUS FLUX [lm]	NET WEIGHT [kg]	PACKING [pcs]	BARCODE
LED CORREA 3,4W	KOCA	3,4	CIEPŁOBIĄŁA WARM WHITE	240	0,10	20	5902846013723



STANDARD LINE

OPRAWY MEBLOWE LED / CABINET FIXTURES

# LED WL 4W



- podstawa wykonana z tworzywa sztucznego, klosz mleczny z poliwęglanu,
- kąt rozsytu światła: 120 stopni,
- możliwość łączenia opraw w szereg (maksymalnie do 120W) bezpośrednio oprawa do oprawy lub za pomocą 20-centymetrowego łącznika dołączonego do zestawu,
- możliwość przymocowania oprawy na wkrętach lub za pomocą samoprzylepnej taśmy dwustronnej (oba warianty dołączone do zestawu),
- nie można wymieniać lamp w oprawie.

- housing made of plastic, milky cover made of PC,
- fixtures can be connected directly from fixture to fixture or using the 20 cm connector included in the set (up to 120W total),
- can be mounted with screws or double-sided adhesive tape (both included in the set),
- lamps in the fixture cannot be replaced.

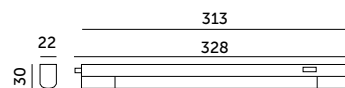

MODEL	INDEKS	POBÓR MOCY [W]	BARWA ŚWIATŁA	STRUMIEŃ ŚWIETLNY [lm]	WAGA NETTO [kg]	PAKOWANIE [szt.]	KOD EAN
MODEL	INDEX	POWER [W]	LIGHT COLOR	LUMINOUS FLUX [lm]	NET WEIGHT [kg]	PACKING [pcs]	BARCODE
LED WL 4W NB	KOWL4W	4	NEUTRALNA BIAŁA NEUTRAL WHITE	440	0,17	30	5902846016045

STANDARD LINE

OPRAWY MEBLOWE LED / CABINET FIXTURES

# LED WL 8W



- podstawa wykonana z tworzywa sztucznego, klosz mleczny z poliwęglanu,
- kąt rozsytu światła: 120 stopni,
- możliwość łączenia opraw w szereg (maksymalnie do 120 W) bezpośrednio oprawa do oprawy lub za pomocą 20-centymetrowego łącznika dołączonego do zestawu,
- możliwość przymocowania oprawy na wkrętach lub za pomocą samoprzylepnej taśmy dwustronnej (oba warianty dołączone do zestawu),
- nie można wymieniać lamp w oprawie.

- housing made of plastic, milky cover made of PC,
- fixtures can be connected directly from fixture to fixture or using the 20 cm connector included in the set (up to 120W total),
- can be mounted with screws or double-sided adhesive tape (both included in the set),
- lamps in the fixture cannot be replaced.

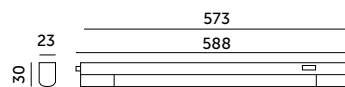

MODEL	INDEKS	POBÓR MOCY [W]	BARWA ŚWIATŁA	STRUMIEŃ ŚWIETLNY [lm]	WAGA NETTO [kg]	PAKOWANIE [szt.]	KOD EAN
MODEL	INDEX	POWER [W]	LIGHT COLOR	LUMINOUS FLUX [lm]	NET WEIGHT [kg]	PACKING [pcs]	BARCODE
LED WL 8W NB	KOWL8W	8	NEUTRALNA BIAŁA NEUTRAL WHITE	880	0,20	30	5900605096314

STANDARD LINE OPRAWY MEBLOWE LED / CABINET FIXTURES

# LED WL 10W



- podstawa wykonana z tworzywa sztucznego, klosz mleczny z poliwęglanu,
- kąt rozsytu światła: 120 stopni,
- możliwość łączenia opraw w szereg (maksymalnie do 120 W) bezpośrednio oprawa do oprawy lub za pomocą 20-centymetrowego łącznika dołączonego do zestawu,
- możliwość przymocowania oprawy na wkrętach lub za pomocą samoprzylepnej taśmy dwustronnej (oba warianty dołączone do zestawu),
- nie można wymieniać lamp w oprawie.

- housing made of plastic, milky cover made of PC,
- fixtures can be connected directly from fixture to fixture or using the 20 cm connector included in the set (up to 120W total),
- can be mounted with screws or double-sided adhesive tape (both included in the set),
- lamps in the fixture cannot be replaced.

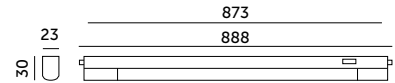

MODEL	INDEKS	POBÓR MOCY [W]	BARWA ŚWIATŁA	STRUMIEŃ ŚWIETLNY [lm]	WAGA NETTO [kg]	PAKOWANIE [szt.]	KOD EAN
MODEL	INDEX	POWER [W]	LIGHT COLOR	LUMINOUS FLUX [lm]	NET WEIGHT [kg]	PACKING [pcs]	BARCODE
LED WL 10W NB	KOWL10W	10	NEUTRALNA BIAŁA NEUTRAL WHITE	1100	0,24	30	5900605096321

STANDARD LINE OPRAWY MEBLOWE LED / CABINET FIXTURES

# LED WL 14W



- podstawa wykonana z tworzywa sztucznego, klosz mleczny z poliwęglanu,
- kąt rozsytu światła: 120 stopni,
- możliwość łączenia opraw w szereg (maksymalnie do 120 W) bezpośrednio oprawa do oprawy lub za pomocą 20-centymetrowego łącznika dołączonego do zestawu,
- możliwość przymocowania oprawy na wkrętach lub za pomocą samoprzylepnej taśmy dwustronnej (oba warianty dołączone do zestawu),
- nie można wymieniać lamp w oprawie.

- housing made of plastic, milky cover made of PC,
- fixtures can be connected directly from fixture to fixture or using the 20 cm connector included in the set (up to 120W total),
- can be mounted with screws or double-sided adhesive tape (both included in the set),
- lamps in the fixture cannot be replaced.

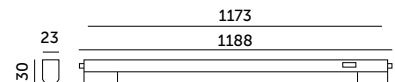

MODEL	INDEKS	POBÓR MOCY [W]	BARWA ŚWIATŁA	STRUMIEŃ ŚWIETLNY [lm]	WAGA NETTO [kg]	PAKOWANIE [szt.]	KOD EAN
MODEL	INDEX	POWER [W]	LIGHT COLOR	LUMINOUS FLUX [lm]	NET WEIGHT [kg]	PACKING [pcs]	BARCODE
LED WL 14W NB	KOWL14W	14	NEUTRALNA BIAŁA NEUTRAL WHITE	1540	0,27	30	5902846019244



STANDARD LINE OPRAWY LED / LED FIXTURES

# LED HALO 5W



- oprawa ledowa do wbudowania w sufit,
- obudowa wykonana z plastiku, klosz matowy z polistyrenu,
- 3 tryby świecenia zmieniane pojedynczym kliknięciem wyłącznika,
- kąt rozsytu światła: 120 stopni,
- nie można wymieniać lamp w oprawie.

- recessed led fixture,
- housing made of plastic, matt cover made of PS,
- 3 lighting modes operated by a switch,
- beam angle: 120 degrees,
- lamps in the fixture cannot be replaced.

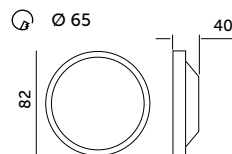

MODEL	INDEKS	POBÓR MOCY [W]	BARWA ŚWIATŁA	STRUMIEŃ ŚWIETLNY [lm]	WAGA NETTO [kg]	PAKOWANIE [szt.]	KOD EAN
MODEL	INDEX	POWER [W]	LIGHT COLOR	LUMINOUS FLUX [lm]	NET WEIGHT [kg]	PACKING [pcs]	BARCODE
LED HALO 5W CB	KQHO5CB	5	CIEPŁOBIĄŁA WARM WHITE	420	0,09	50	5902201305999
LED HALO 5W NB	KQHO5NB	5	NEUTRALNA BIAŁA NEUTRAL WHITE	420	0,09	50	5902201305708

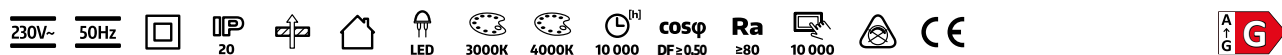



STANDARD LINE

PIERŚCIEN OZDOBNY DO OPRAW / DECORATIVE RING FOR FITTINGS

# OH14



MAT CZARNY MATT BLACK    BIAŁY WHITE    CHROM CHROME    MAT CHROM MATT CHROME    PATYNA VERDGRAS

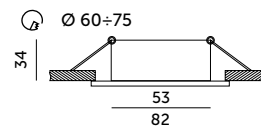

- pierścień ozdobny do opraw – nieruchomy,
- wykonany z wytłaczanej blachy stalowej,
- nie zawiera źródła światła,
- nie zawiera oprawki ceramicznej.

- decorative ring for recessed fittings – fixed,
- made of stamped steel sheet,
- light source not included,
- ceramic socket not included.

MODEL	INDEKS	KOLOR	WAGA NETTO [kg]	PAKOWANIE [szt.]	KOD EAN
MODEL	INDEX	COLOR	NET WEIGHT [kg]	PACKING [pcs]	BARCODE
OH14	KPOH14MCZ	MAT CZARNY MATT BLACK	0,04	50	5902201304879
OH14	KPOH14BI	BIAŁY WHITE	0,04	50	5906340210879
OH14	KPOH14CH	CHROM CHROME	0,04	50	5906340210824
OH14	KPOH14MCH	MAT CHROM MATT CHROME	0,04	50	5906340210862
OH14	KPOH14PA	PATYNA VERDGRAS	0,04	50	5906340216185

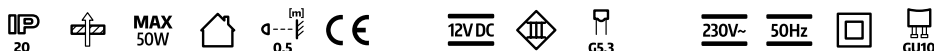

STANDARD LINE

PIERŚCIEN OZDOBNY DO OPRAW / DECORATIVE RING FOR FITTINGS

# OH15



MAT CZARNY MATT BLACK    BIAŁY WHITE    CHROM CHROME    MAT CHROM MATT CHROME    PATYNA VERDGRAS

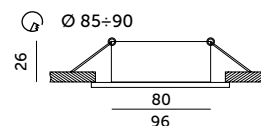

- pierścień ozdobny do opraw – ruchomy,
- wykonany z wytłaczanej blachy stalowej,
- nie zawiera źródła światła,
- nie zawiera oprawki ceramicznej.

- decorative ring for recessed fittings – adjustable,
- made of stamped steel sheet,
- light source not included,
- ceramic socket not included.

MODEL	INDEKS	KOLOR	WAGA NETTO [kg]	PAKOWANIE [szt.]	KOD EAN
MODEL	INDEX	COLOR	NET WEIGHT [kg]	PACKING [pcs]	BARCODE
OH15	KPOH15MCZ	MAT CZARNY MATT BLACK	0,08	50	5902201304886
OH15	KPOH15BI	BIAŁY WHITE	0,08	50	5906340210947
OH15	KPOH15CH	CHROM CHROME	0,08	50	5906340210893
OH15	KPOH15MCH	MAT CHROM MATT CHROME	0,08	50	5906340210930
OH15	KPOH15PA	PATYNA VERDGRAS	0,08	50	5906340217977

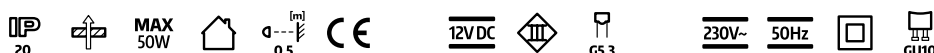



STANDARD LINE

PIERŚCIEN OZDOBNY DO OPRAW / DECORATIVE RING FOR FITTINGS

# OH21



CHROM  
CHROME

CZARNY  
BLACK

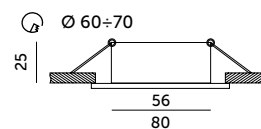

- pierścień ozdobny do opraw – nieruchomy,
- materiał: aluminium szczotkowane,
- nie zawiera Źródła światła,
- nie zawiera oprawki ceramicznej.

- decorative ring for recessed fittings – fixed,
- made of aluminum with a brushed black finish,
- light source not included,
- ceramic socket not included.

MODEL	INDEKS	KOLOR	WAGA NETTO [kg]	PAKOWANIE [szt.]	KOD EAN
MODEL	INDEX	COLOR	NET WEIGHT [kg]	PACKING [pcs]	BARCODE
OH21	KPOH21CH	CHROM CHROME	0,03	100	5900605092965
OH21	KPOH21CZ	CZARNY BLACK	0,03	100	5900605093641



MAX  
50W



0,5



12VDC



G5.3

230V~

50Hz



GU10



STANDARD LINE

PIERŚCIEŃ OZDOBNY DO OPRAW / DECORATIVE RING FOR FITTINGS

# OH26N



PRZEŻROCZYSTY  
TRANSPARENT

CZARNY  
BLACK

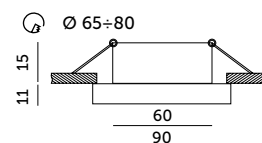

- pierścień ozdobny do opraw – nieruchomy,
- wykonany ze stopu aluminium i szkła,
- nie zawiera źródła światła,
- nie zawiera oprawki ceramicznej.

- decorative ring for recessed fittings – fixed,
- made of aluminium alloy and glass,
- light source not included,
- ceramic socket not included.

MODEL	INDEKS	KOLOR	WAGA NETTO [kg]	PAKOWANIE [szt.]	KOD EAN
MODEL	INDEX	COLOR	NET WEIGHT [kg]	PACKING [pcs]	BARCODE
OH26N	KPOH26NCL	PRZEŻROCZYSTY TRANSPARENT	0,11	50	5902846011262
OH26N	KPOH26NCZ	CZARNY BLACK	0,11	50	5902846011279

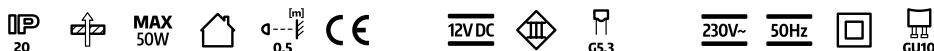

STANDARD LINE

PIERŚCIEŃ OZDOBNY DO OPRAW / DECORATIVE RING FOR FITTINGS

# OH27N



PRZEŻROCZYSTY  
TRANSPARENT

CZARNY  
BLACK

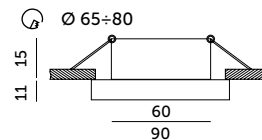
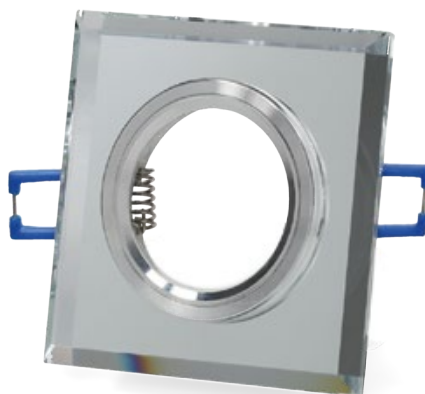

- pierścień ozdobny do opraw – nieruchomy,
- wykonany ze stopu aluminium i szkła,
- nie zawiera źródła światła,
- nie zawiera oprawki ceramicznej.

- decorative ring for recessed fittings – fixed,
- made of aluminium alloy and glass,
- light source not included,
- ceramic socket not included.

MODEL	INDEKS	KOLOR	WAGA NETTO [kg]	PAKOWANIE [szt.]	KOD EAN
MODEL	INDEX	COLOR	NET WEIGHT [kg]	PACKING [pcs]	BARCODE
OH27N	KPOH27NCL	PRZEŻROCZYSTY TRANSPARENT	0,14	50	5902846011286
OH27N	KPOH27NCZ	CZARNY BLACK	0,14	50	5902846011293



STANDARD LINE

PIERŚCIEŃ OZDOBNY DO OPRAW / DECORATIVE RING FOR FITTINGS

# OH28



MAT CZARNY  
MATT BLACK

CZARNY  
BLACK

MAT BIAŁY  
MATT WHITE

CHROM  
CHROME

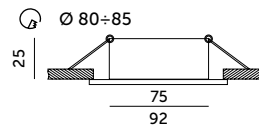
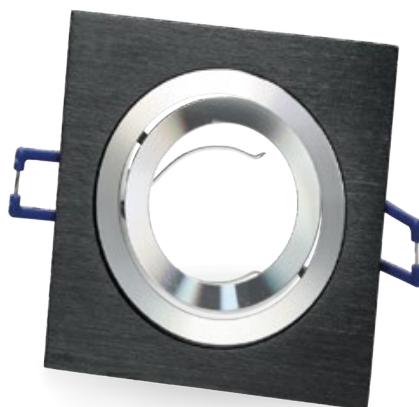

- pierścień ozdobny do opraw – ruchomy,
- materiał: aluminium szczotkowane,
- nie zawiera źródła światła,
- nie zawiera oprawki ceramicznej.

- decorative ring for recessed fittings – adjustable,
- made of aluminum with a brushed black finish,
- light source not included,
- ceramic socket not included.

MODEL	INDEKS	KOLOR	WAGA NETTO [kg]	PAKOWANIE [szt.]	KOD EAN
MODEL	INDEX	COLOR	NET WEIGHT [kg]	PACKING [pcs]	BARCODE
OH28	KPOH28MCZ	MAT CZARNY MATT BLACK	0,08	100	5900605097809
OH28	KPOH28CZ	CZARNY BLACK	0,08	100	5900605093580
OH28	KPOH28MBI	MAT BIAŁY MATT WHITE	0,08	100	5902201304916
OH28	KPOH28CH	CHROM CHROME	0,08	100	5900605093573

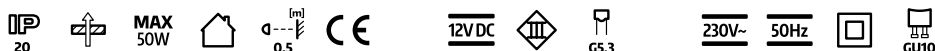

STANDARD LINE

PIERŚCIEŃ OZDOBNY DO OPRAW / DECORATIVE RING FOR FITTINGS

# OH29



MAT CZARNY  
MATT BLACK

CZARNY  
BLACK

MAT BIAŁY  
MATT WHITE

CHROM  
CHROME

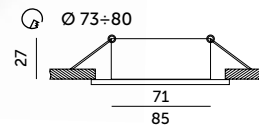

- pierścień ozdobny do opraw – ruchomy,
- materiał: aluminium,
- nie zawiera źródła światła,
- nie zawiera oprawki ceramicznej.

- decorative ring for recessed fittings – adjustable,
- made of aluminum,
- light source not included,
- ceramic socket not included.

MODEL	INDEKS	KOLOR	WAGA NETTO [kg]	PAKOWANIE [szt.]	KOD EAN
MODEL	INDEX	COLOR	NET WEIGHT [kg]	PACKING [pcs]	BARCODE
OH29	KPOH29MCZ	MAT CZARNY MATT BLACK	0,06	100	5902201305463
OH29	KPOH29CZ	CZARNY BLACK	0,06	100	5900605093603
OH29	KPOH29MBI	MAT BIAŁY MATT WHITE	0,06	100	5902201304923
OH29	KPOH29CH	CHROM CHROME	0,06	100	5900605093597







STANDARD LINE

PIERŚCIEŃ OZDOBNY DO OPRAW / DECORATIVE RING FOR FITTINGS

# OH34



MAT CZARNY  
MATT BLACK



MAT CHROM  
MATT CHROME

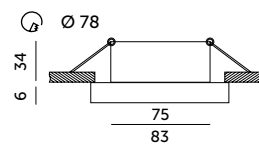

- pierścień ozdobny do opraw o podwyższonej hermetyczności – nieruchomy,
- wykonany ze stopu aluminium,
- nie zawiera źródła światła,
- nie zawiera oprawki ceramicznej.

- hermetic decorative ring for recessed fittings – fixed,
- made of aluminum alloy,
- light source not included,
- ceramic socket not included.

MODEL	INDEKS	KOLOR	WAGA NETTO [kg]	PAKOWANIE [szt.]	KOD EAN
MODEL	INDEX	COLOR	NET WEIGHT [kg]	PACKING [pcs]	BARCODE
OH34	KPOH34MCZ	MAT CZARNY MATT BLACK	0,12	50	5902201305470
OH34	KPOH34MC	MAT CHROM MATT CHROME	0,12	50	5900605096734



MAX  
50W



0,5



G5.3



GU10





STANDARD LINE

OPRAWY DO NABUDOWANIA / BUILD-ON FIXTURES

# OH36 S



CZARNY  
BLACK



BIAŁY  
WHITE

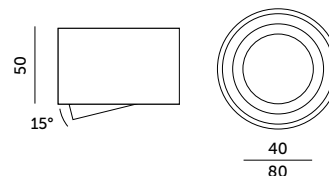

Dedykowane źródło światła  
Recommended light source  
**LED INSERT**

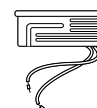

- sufitowa oprawa punktowa – ruchoma,
- wykonana z aluminium,
- jako źródło światła stosuje się żarówkę LED INSERT,
- oprawa nie zawiera źródła światła.

- ceiling spotlight – adjustable,
- made of aluminium,
- uses LED INSERT bulb as the light source,
- light source not included.

MODEL	INDEKS	KOLOR	WAGA NETTO [kg]	PAKOWANIE [szt.]	KOD EAN
MODEL	INDEX	COLOR	NET WEIGHT [kg]	PACKING [pcs]	BARCODE
OH36 S	KPOH36SCZ	CZARNY BLACK	0,15	20	5902846014379
OH36 S	KPOH36SBI	BIAŁY WHITE	0,15	20	5902846014362



STANDARD LINE OPRAWY DO NABUDOWANIA / BUILD-ON FIXTURES

# OH36



CZARNY  
BLACK



BIAŁY  
WHITE

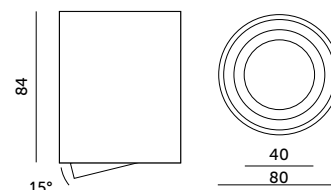

- sufitowa oprawa punktowa – ruchoma,
- wykonana z aluminium,
- jako źródło światła stosuje się żarówkę GU10,
- oprawka do źródła światła w zestawie,
- oprawka nie zawiera źródła światła.

- ceiling spotlight – adjustable,
- made of aluminium,
- uses GU10 bulb as the light source,
- ceramic socket included,
- light source not included.

MODEL	INDEKS	KOLOR	WAGA NETTO [kg]	PAKOWANIE [szt.]	KOD EAN
MODEL	INDEX	COLOR	NET WEIGHT [kg]	PACKING [pcs]	BARCODE
OH36	KPOH36CZ	CZARNY BLACK	0,20	20	5900605097670
OH36	KPOH36BI	BIAŁY WHITE	0,20	20	5900605096758

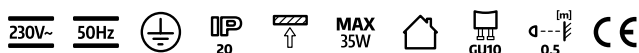

STANDARD LINE OPRAWY DO NABUDOWANIA / BUILD-ON FIXTURES

# OH36 L



CZARNY  
BLACK



BIAŁY  
WHITE

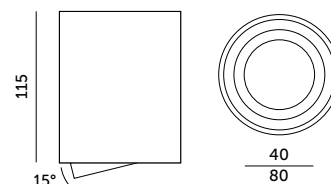

- sufitowa oprawa punktowa – ruchoma,
- wykonana z aluminium,
- jako źródło światła stosuje się żarówkę GU10,
- oprawka do źródła światła w zestawie,
- oprawka nie zawiera źródła światła.

- ceiling spotlight – adjustable,
- made of aluminium,
- uses GU10 bulb as the light source,
- ceramic socket included,
- light source not included.

MODEL	INDEKS	KOLOR	WAGA NETTO [kg]	PAKOWANIE [szt.]	KOD EAN
MODEL	INDEX	COLOR	NET WEIGHT [kg]	PACKING [pcs]	BARCODE
OH36L	KPOH36LCZ	CZARNY BLACK	0,28	20	5900605098714
OH36L	KPOH36LBI	BIAŁY WHITE	0,28	20	5900605098684



STANDARD LINE OPRAWY DO NABUDOWANIA / BUILD-ON FIXTURES

# OH37 S



CZARNY  
BLACK

BIAŁY  
WHITE

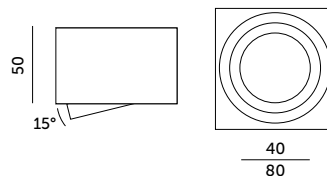
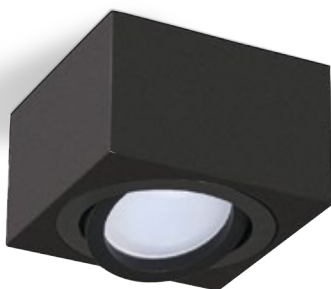

Dedykowane źródło światła  
Recommended light source  
**LED INSERT**

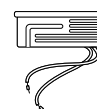

- sufitowa oprawa punktowa – ruchoma,
- wykonana z aluminium,
- jako źródło światła stosuje się żarówkę LED INSERT,
- oprawa nie zawiera źródła światła.

- ceiling spotlight – adjustable,
- made of aluminium,
- uses LED INSERT bulb as the light source,
- light source not included.

MODEL	INDEKS	KOLOR	WAGA NETTO [kg]	PAKOWANIE [szt.]	KOD EAN
MODEL	INDEX	COLOR	NET WEIGHT [kg]	PACKING [pcs]	BARCODE
OH37 S	KPOH37SCZ	CZARNY BLACK	0,32	20	5902846014409
OH37 S	KPOH37SBI	BIAŁY WHITE	0,32	20	5902846014393



STANDARD LINE OPRAWY DO NABUDOWANIA / BUILD-ON FIXTURES

# OH37

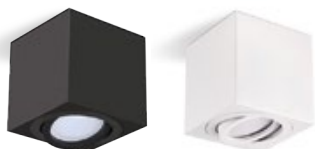

CZARNY  
BLACK

BIAŁY  
WHITE

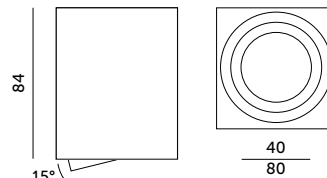

- sufitowa oprawa punktowa – ruchoma,
- wykonana z aluminium,
- jako źródło światła stosuje się żarówkę GU10,
- oprawka do źródła światła w zestawie,
- oprawa nie zawiera źródła światła.

- ceiling spotlight – adjustable,
- made of aluminium,
- uses GU10 bulb as the light source,
- ceramic socket included,
- light source not included.

MODEL	INDEKS	KOLOR	WAGA NETTO [kg]	PAKOWANIE [szt.]	KOD EAN
MODEL	INDEX	COLOR	NET WEIGHT [kg]	PACKING [pcs]	BARCODE
OH37	KPOH37CZ	CZARNY BLACK	0,54	20	5900605097694
OH37	KPOH37BI	BIAŁY WHITE	0,54	20	5900605096765





**STANDARD LINE** OPRAWY DO NABUDOWANIA / BUILD-ON FIXTURES

# KIVI



**CZARNY  
BLACK**



**CZARNO-ZŁOTY  
BLACK-GOLD**



**BIAŁY  
WHITE**



**BIAŁO-ZŁOTY  
WHITE-GOLD**

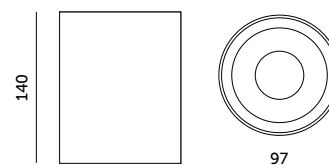

- sufitowa oprawa punktowa – nieruchoma,
- wykonana z aluminium,
- jako źródło światła stosuje się żarówki GU10,
- oprawka do źródła światła w zestawie,
- oprawa nie zawiera źródła światła.

- ceiling spotlight – fixed,
- made of aluminium,
- uses GU10 bulb as the light source,
- ceramic socket included,
- light source not included.

MODEL	INDEKS	KOLOR	WAGA NETTO [kg]	PAKOWANIE [szt.]	KOD EAN
MODEL	INDEX	COLOR	NET WEIGHT [kg]	PACKING [pcs]	BARCODE
KIVI	KPKIBL	CZARNY BLACK	0,54	20	5902846016502
KIVI	KPKIBLG	CZARNO-ZŁOTY BLACK-GOLD	0,54	20	5902846016175
KIVI	KPKIWH	BIAŁY WHITE	0,54	20	5902846016519
KIVI	KPKIWHG	BIAŁO-ZŁOTY WHITE-GOLD	0,54	20	5902846016182





STANDARD LINE OPRAWY DO NABUDOWANIA / BUILD-ON FIXTURES

# AQUARIUS ROUND



CZARNY  
BLACK



BIAŁY  
WHITE

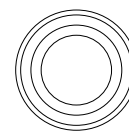
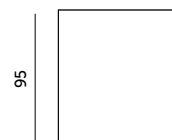

- sufitowa oprawa punktowa – nieruchoma,
- wykonana z aluminium,
- jako źródło światła stosuje się żarówkę GU10,
- oprawka do źródła światła w zestawie,
- oprawa nie zawiera źródła światła.

- ceiling spotlight – fixed,
- made of aluminium,
- uses GU10 bulb as the light source,
- ceramic socket included,
- light source not included.

MODEL	INDEKS	KOLOR	WAGA NETTO [kg]	PAKOWANIE [szt.]	KOD EAN
MODEL	INDEX	COLOR	NET WEIGHT [kg]	PACKING [pcs]	BARCODE
AQUARIUS ROUND	KPARCZ	CZARNY BLACK	0,23	20	5902846014584
AQUARIUS ROUND	KPARBI	BIAŁY WHITE	0,23	20	5902846014607





STANDARD LINE OPRAWY DO NABUDOWANIA / BUILD-ON FIXTURES

# AQUARIUS SQUARE



CZARNY  
BLACK

BIAŁY  
WHITE

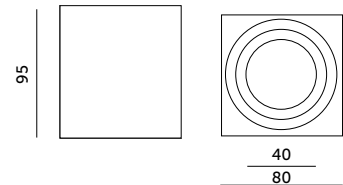

- sufitowa oprawa punktowa – nieruchoma,
- wykonana z aluminium,
- jako źródło światła stosuje się żarówkę GU10,
- oprawka do źródła światła w zestawie,
- oprawa nie zawiera źródła światła.

- ceiling spotlight – fixed,
- made of aluminium,
- uses GU10 bulb as the light source,
- ceramic socket included,
- light source not included.

MODEL	INDEKS	KOLOR	WAGA NETTO [kg]	PAKOWANIE [szt.]	KOD EAN
MODEL	INDEX	COLOR	NET WEIGHT [kg]	PACKING [pcs]	BARCODE
AQUARIUS SQUARE	KPASCZ	CZARNY BLACK	0,57	20	5902846014614
AQUARIUS SQUARE	KPASBI	BIAŁY WHITE	0,57	20	5902846014638



ART OF LIGHT OPRAWY SUFITOWE / CEILING LAMPS

# LAHTI MINI 9W DIM

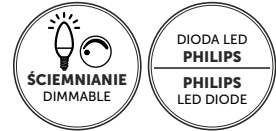

CZARNY  
BLACK

BIAŁY  
WHITE

- oprawa nasufitowa – ruchoma,
- materiał: aluminium,
- kąt rozsytu światła: 35 stopni,
- możliwość wymiany źródła światła LED jedynie przez wykwalifikowany personel,
- oprawa zawiera źródła światła o klasie energetycznej G,
- opcja ściemniania – konieczne zastosowanie ściemniacza niedotączonego do zestawu.

- ceiling fixture – adjustable,
- made of aluminium,
- beam angle: 35 degrees,
- the LED light source can only be replaced by qualified personel,
- fixture includes light sources with energy efficiency class G,
- dimming option available – requires a dimmer not included in the set.

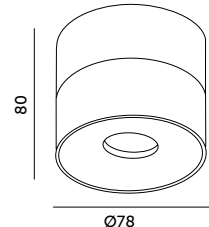

MODEL	INDEKS	KOLOR	POBÓR MOCY [W]	BARWA ŚWIATŁA	STRUMIEŃ ŚWIETLNY [lm]	WAGA NETTO [kg]	PAKOWANIE [szt.]	KOD EAN
MODEL	INDEX	COLOR	POWER [W]	LIGHT COLOR	LUMINOUS FLUX [lm]	NET WEIGHT [kg]	PACKING [pcs]	BARCODE
LAHTI MINI 9W DIM	KQLM9BD	CZARNY BLACK	9	CIEPŁOBIAŁA WARM WHITE	550	0,43	24	5902201305852
LAHTI MINI 9W DIM	KQLM9WD	BIAŁY WHITE	9	CIEPŁOBIAŁA WARM WHITE	550	0,43	24	5902201305869

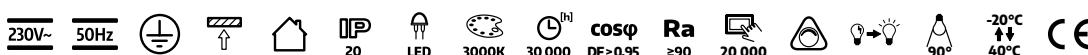



ART OF LIGHT OPRAWY SUFITOWE / CEILING LAMPS

# LAHTI 10,5W DIM

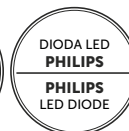

CZARNY  
BLACK



BIAŁY  
WHITE



- oprawa nasufitowa – ruchoma,
- materiał: aluminium,
- kąt rozsytu światła: 35 stopni,
- możliwość wymiany źródła światła LED jedynie przez wykwalifikowany personel,
- oprawa zawiera źródła światła o klasie energetycznej G,
- opcja ściemniania – konieczne zastosowanie ściemniacza niedołączanego do zestawu.

- ceiling fixture – adjustable,
- made of aluminium,
- beam angle: 35 degrees,
- the LED light source can only be replaced by qualified personnel,
- fixture includes light sources with energy efficiency class G,
- dimming option available – requires a dimmer not included in the set.

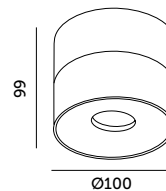

MODEL	INDEKS	KOLOR	POBÓR MOCY [W]	BARWA ŚWIATŁA	STRUMIEŃ ŚWIETLNY [lm]	WAGA NETTO [kg]	PAKOWANIE [szt.]	KOD EAN
MODEL	INDEX	COLOR	POWER [W]	LIGHT COLOR	LUMINOUS FLUX [lm]	NET WEIGHT [kg]	PACKING [pcs]	BARCODE
LAHTI 10,5W DIM	KQLI10BD	CZARNY BLACK	10,5	CIEPŁOBIŁA WARM WHITE	680	0,78	24	5902201305791
LAHTI 10,5W DIM	KQLI10WD	BIAŁY WHITE	10,5	CIEPŁOBIŁA WARM WHITE	680	0,78	24	5902201305807

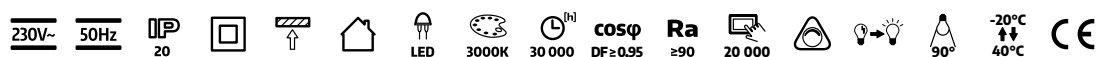



ART OF LIGHT OPRAWY SUFITOWE / CEILING LAMPS

# LAHTI 13,5W DIM

CZARNY / BLACK

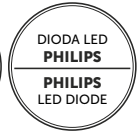

- oprawa nasufitowa – ruchoma,
- materiał: aluminium,
- kolor: czarny,
- kąt rozsyłu światła: 35 stopni,
- możliwość wymiany źródła światła LED jedynie przez wykwalifikowany personel,
- oprawa zawiera źródła światła o klasie energetycznej G,
- opcja ściemniania – konieczne zastosowanie ściemniacza niedołączonego do zestawu.

- ceiling fixture – adjustable,
- made of aluminium,
- beam angle: 35 degrees,
- the LED light source can only be replaced by qualified personnel,
- fixture includes light sources with energy efficiency class G,
- dimming option available – requires a dimmer not included in the set.

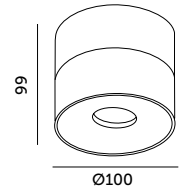

MODEL	INDEKS	POBÓR MOCY [W]	BARWA ŚWIATŁA	STRUMIEN ŚWIETLNY [lm]	WAGA NETTO [kg]	PAKOWANIE [szt.]	KOD EAN
MODEL	INDEX	POWER [W]	LIGHT COLOR	LUMINOUS FLUX [lm]	NET WEIGHT [kg]	PACKING [pcs]	BARCODE
LAHTI 13,5W DIM	KQLI13BD	13,5	CIEPŁOBIĄŁA WARM WHITE	850	0,79	24	5902201305814



ART OF LIGHT OPRAWY SUFITOWE / CEILING LAMPS

# LAHTI MINI 2x9W DIM

CZARNY / BLACK

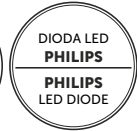

- oprawa nasufitowa – ruchoma,
- materiał: aluminium,
- kąt rozsyłu światła: 35 stopni,
- możliwość wymiany źródła światła LED jedynie przez wykwalifikowany personel,
- oprawa zawiera źródła światła o klasie energetycznej G,
- opcja ściemniania – konieczne zastosowanie ściemniacza niedołączonego do zestawu.

- ceiling fixture – adjustable,
- made of aluminium,
- beam angle: 35 degrees,
- the LED light source can only be replaced by qualified personnel,
- fixture includes light sources with energy efficiency class G,
- dimming option available – requires a dimmer not included in the set.

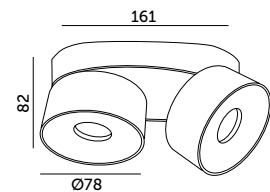

MODEL	INDEKS	POBÓR MOCY [W]	BARWA ŚWIATŁA	STRUMIEN ŚWIETLNY [lm]	WAGA NETTO [kg]	PAKOWANIE [szt.]	KOD EAN
MODEL	INDEX	POWER [W]	LIGHT COLOR	LUMINOUS FLUX [lm]	NET WEIGHT [kg]	PACKING [pcs]	BARCODE
LAHTI MINI 2x9W DIM	KQLM2X9BD	2x9	CIEPŁOBIĄŁA WARM WHITE	1050	0,86	12	5902201305838

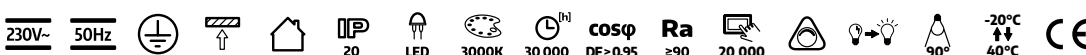



KOBI DESIGN

LAMPY WISZĄCE / HANGING LAMPS

# BOHO BONN

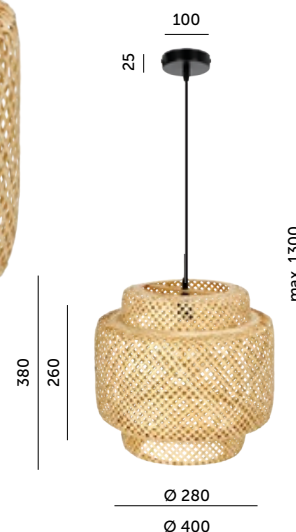

- lampa wisząca na 1 żarówkę, o tradycyjnym gwincie E27,
- klosz wykonany ze splecionego bambusa – materiału naturalnego,
- regulowana wysokość lampy: max. 130 cm,
- nie zawiera źródła światła.

- hanging lamp – 1 x E27,
- lampshade made of woven bamboo – a natural material,
- adjustable height – max. 130 cm,
- light source not included.

MODEL	INDEKS	KOLOR	WAGA NETTO [kg]	PAKOWANIE [szt.]	KOD EAN
MODEL	INDEX	COLOR	NET WEIGHT [kg]	PACKING [pcs]	BARCODE
BOHO BONN	KRBOBNNCZ	BEŻOWY BEIGE	1,00	1	5902201366297







KOBI DESIGN LAMPY WISZĄCE / HANGING LAMPS

# BOHO BAKU S



- lampa wisząca na 1 żarówkę, o tradycyjnym gwincie E27,
- klosz wykonany ze splecionego bambusa – materiału naturalnego,
- regulowana wysokość lampy: max. 120 cm,
- nie zawiera źródła światła.

- hanging lamp – 1 x E27,
- lampshade made of woven bamboo – a natural material,
- adjustable height – max. 120 cm,
- light source not included.

MODEL	INDEKS	KOLOR	WAGA NETTO [kg]	PAKOWANIE [szt.]	KOD EAN
MODEL	INDEX	COLOR	NET WEIGHT [kg]	PACKING [pcs]	BARCODE
BOHO BAKU S	KRBOBUSCZ	BEŻOWY BEIGE	0,80	1	5902201366273



KOBI DESIGN LAMPY WISZĄCE / HANGING LAMPS

# BOHO BAKU M



- lampa wisząca na 1 żarówkę, o tradycyjnym gwincie E27,
- klosz wykonany ze splecionego bambusa – materiału naturalnego,
- regulowana wysokość lampy: max. 120 cm,
- nie zawiera źródła światła.

- hanging lamp – 1 x E27,
- lampshade made of woven bamboo – a natural material,
- adjustable height – max. 120 cm,
- light source not included.

MODEL	INDEKS	KOLOR	WAGA NETTO [kg]	PAKOWANIE [szt.]	KOD EAN
MODEL	INDEX	COLOR	NET WEIGHT [kg]	PACKING [pcs]	BARCODE
BOHO BAKU M	KRBOBUMCZ	BEŻOWY BEIGE	0,99	1	5902201366280

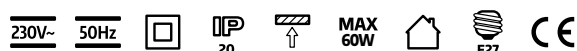



KOBI DESIGN

LAMPY WISZĄCE / HANGING LAMPS

# BOHO BEIRUT



- lampa wisząca na 1 żarówkę, o tradycyjnym gwincie E27,
- klosz wykonany ze splecionego bambusa – materiału naturalnego,
- regulowana wysokość lampy: max. 140 cm,
- nie zawiera źródła światła.

- hanging lamp – 1 x E27,
- lampshade made of woven bamboo – a natural material,
- adjustable height – max. 140 cm,
- light source not included.

MODEL	INDEKS	KOLOR	WAGA NETTO [kg]	PAKOWANIE [szt.]	KOD EAN
MODEL	INDEX	COLOR	NET WEIGHT [kg]	PACKING [pcs]	BARCODE
BOHO BEIRUT	KRBOBTCZ	BEŻOWY BEIGE	0,80	1	5902201366310



KOBI DESIGN

LAMPY WISZĄCE / HANGING LAMPS

# BOHO BERN



- lampa wisząca na 1 żarówkę, o tradycyjnym gwincie E27,
- klosz wykonany ze splecionego bambusa – materiału naturalnego,
- regulowana wysokość lampy: max. 128 cm,
- nie zawiera źródła światła.

- hanging lamp – 1 x E27,
- lampshade made of woven bamboo – a natural material,
- adjustable height – max. 128 cm,
- light source not included.

MODEL	INDEKS	KOLOR	WAGA NETTO [kg]	PAKOWANIE [szt.]	KOD EAN
MODEL	INDEX	COLOR	NET WEIGHT [kg]	PACKING [pcs]	BARCODE
BOHO BERN	KRBOBNCZ	BEŻOWY BEIGE	0,61	1	5902201366242





KOBI DESIGN LAMPY WISZĄCE / HANGING LAMPS

# BOHO BRUGIA S



- lampa wisząca na 1 żarówkę, o tradycyjnym gwincie E27,
- klosz wykonany ze splecionego bambusa – materiału naturalnego,
- regulowana wysokość lampy: max. 117 cm,
- nie zawiera źródła światła.

- hanging lamp – 1 x E27,
- lampshade made of woven bamboo – a natural material,
- adjustable height – max. 117 cm,
- light source not included.

MODEL	INDEKS	KOLOR	WAGA NETTO [kg]	PAKOWANIE [szt.]	KOD EAN
MODEL	INDEX	COLOR	NET WEIGHT [kg]	PACKING [pcs]	BARCODE
BOHO BRUGIA S	KRBOBISCZ	BEŻOWY BEIGE	0,90	1	5902201366259



KOBI DESIGN LAMPY WISZĄCE / HANGING LAMPS

# BOHO BRUGIA M



- lampa wisząca na 1 żarówkę, o tradycyjnym gwincie E27,
- klosz wykonany ze splecionego bambusa – materiału naturalnego,
- regulowana wysokość lampy: max. 117 cm,
- nie zawiera źródła światła.

- hanging lamp – 1 x E27,
- lampshade made of woven bamboo – a natural material,
- adjustable height – max. 117 cm,
- light source not included.

MODEL	INDEKS	KOLOR	WAGA NETTO [kg]	PAKOWANIE [szt.]	KOD EAN
MODEL	INDEX	COLOR	NET WEIGHT [kg]	PACKING [pcs]	BARCODE
BOHO BRUGIA M	KRBOBIMCZ	BEŻOWY BEIGE	1,20	1	5902201366266





KOBI DESIGN LAMPY WISZĄCE / HANGING LAMPS

## BOHO RENNES



- lampa wisząca na 1 żarówkę, o tradycyjnym gwincie E27,
- klosz wykonany ze splecionego rattanu – materiału naturalnego,
- regulowana wysokość lampy: max. 130 cm,
- nie zawiera źródła światła.

- hanging lamp – 1 x E27,
- lampshade made of woven rattan – a natural material,
- adjustable height – max. 130 cm,
- light source not included.

MODEL	INDEKS	KOLOR	WAGA NETTO [kg]	PAKOWANIE [szt.]	KOD EAN
MODEL	INDEX	COLOR	NET WEIGHT [kg]	PACKING [pcs]	BARCODE
BOHO RENNES	KRBORSZCZ	BEŻOWY BEIGE	0,55	1	5902201366372





KOBI DESIGN LAMPY WISZĄCE / HANGING LAMPS

# BOHO RIGA



- lampa wisząca na 1 żarówkę, o tradycyjnym gwincie E27,
- klosz wykonany ze splecionego rattanu – materiału naturalnego,
- regulowana wysokość lampy: max. 120 cm,
- nie zawiera źródła światła.

- hanging lamp – 1 x E27,
- lampshade made of woven rattan – a natural material,
- adjustable height – max. 120 cm,
- light source not included.

MODEL	INDEKS	KOLOR	WAGA NETTO [kg]	PAKOWANIE [szt.]	KOD EAN
MODEL	INDEX	COLOR	NET WEIGHT [kg]	PACKING [pcs]	BARCODE
BOHO RIGA	KRBORACZ	BEŻOWY BEIGE	0,60	1	5902201366228



KOBI DESIGN LAMPY WISZĄCE / HANGING LAMPS

# BOHO VERONA



- lampa wisząca na 1 żarówkę, o tradycyjnym gwincie E27,
- klosz wykonany z metalu i sznurka jutowego,
- regulowana wysokość lampy: max. 120 cm,
- nie zawiera źródła światła.

- hanging lamp – 1 x E27,
- lampshade made of metal and jute string,
- adjustable height – max. 120 cm,
- light source not included.

MODEL	INDEKS	KOLOR	WAGA NETTO [kg]	PAKOWANIE [szt.]	KOD EAN
MODEL	INDEX	COLOR	NET WEIGHT [kg]	PACKING [pcs]	BARCODE
BOHO VERONA	KRBOVACZ	BEŻOWY BEIGE	0,89	1	5902201366327











## OPRAWY OGRODOWE FACADE AND GARDEN LIGHTING

Eleganckie i funkcjonalne oświetlenie zewnętrzne stanowi kluczowy element aranżacji ogrodów i otoczenia budynków. Oprawy oferowane przez Kobi Light perfekcyjnie łączą estetykę z praktycznością, zapewniając odpowiednie oświetlenie i kreując wyjątkową przestrzeń.

Elegant and functional outdoor lighting is essential in designing gardens and building exteriors. Kobi Light's solutions effortlessly combine aesthetics with functionality, offering optimal illumination while creating a distinctive and inviting environment.

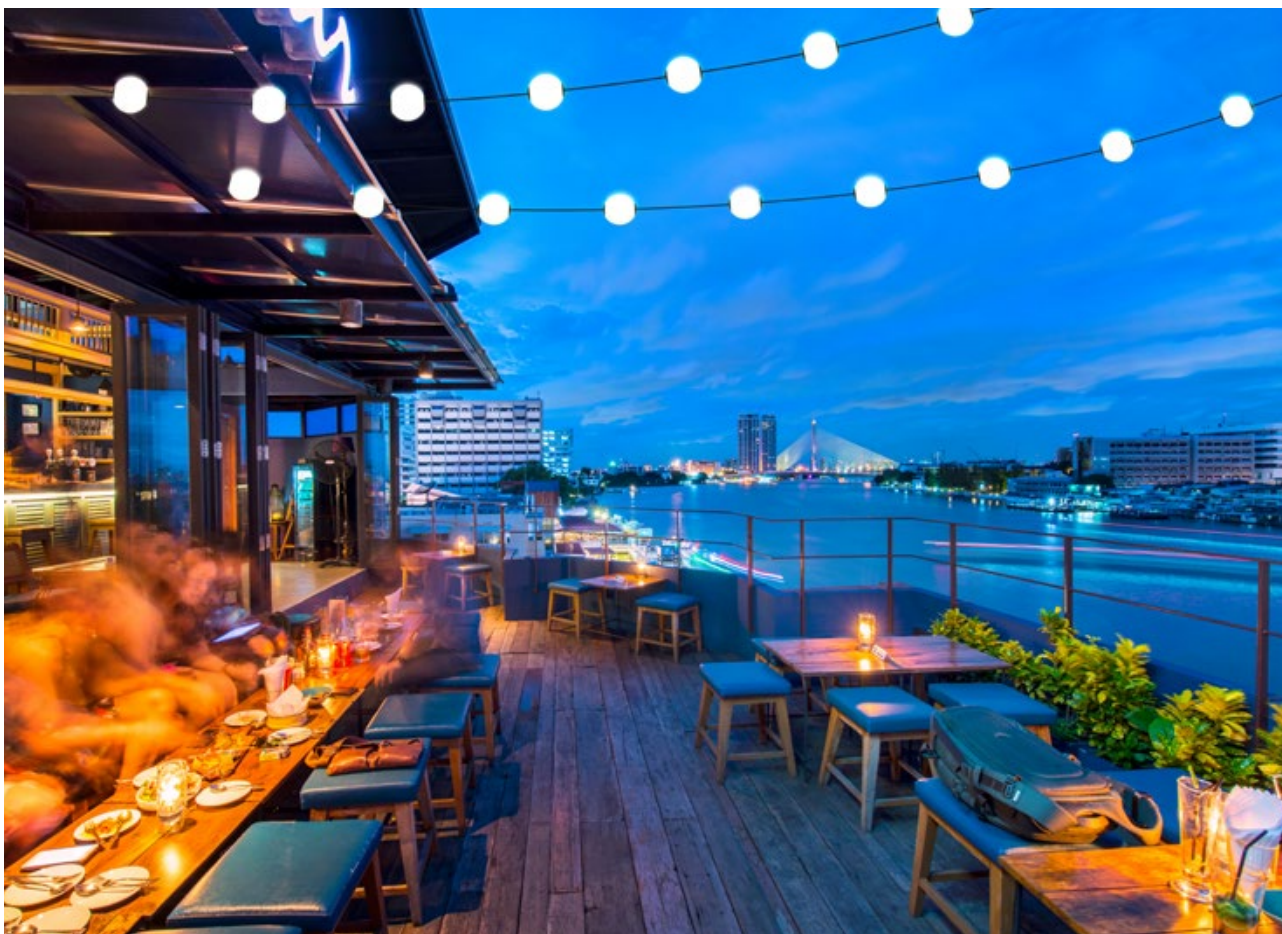

KOBI DESIGN LAMPY OGRODOWE / GARDEN LIGHTS

## LED VENEZIA 10x0,8W

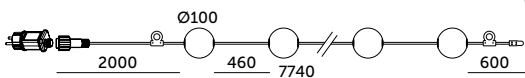

- girlanda o długości 7,74 m, posiadająca 10 kul świetlnych,
- do użytku również na zewnątrz,
- kąt rozsyłu światła: 280 stopni,
- zaleca się użycie opasek kablowych lub haczyków montażowych do zawieszenia girlandy,
- oprawa zawiera źródła światła o klasie energetycznej: G,
- możliwość wymiany źródła światła jedynie przez wykwalifikowany personel.

- 7,74 m garland with 10 lighting balls,
- can also be used outside,
- beam angle: 280 degrees,
- it is recommended to use cable ties or mounting hooks to hang the garland,
- garland includes light sources of G energy efficiency class,
- light sources can be changed by qualified personnel.

MODEL	INDEKS	POBÓR MOCY [W]	BARWA ŚWIATŁA	STRUMIEŃ ŚWIETLNY [lm]	WAGA NETTO [kg]	PAKOWANIE[szt.]	KOD EAN
MODEL	INDEX	POWER [W]	LIGHT COLOR	LUMINOUS FLUX [lm]	NET WEIGHT [kg]	PACKING [pcs]	BARCODE
LED VENEZIA 10X0,8W	KDSN00000004	10x0,8	CIEPŁOBIŁA WARM WHITE	10x70	1,68	8	5902201373639







STANDARD LINE LAMPY OGRODOWE / GARDEN LIGHTS

# MIMOSA LED SET 10m + 10x1W E27

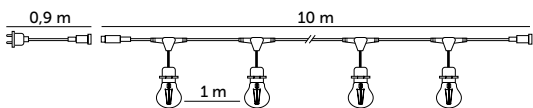
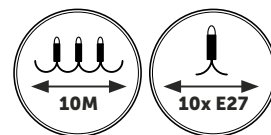

- girlanda 10-metrowa o rozmieszczeniu gniazd co 1 m,
- możliwość łączenia w szereg do maksymalnej mocy 1500W,
- źródła światła w zestawie: 1W na gwint E27 – 10 sztuk,
- kąt rozsytu światła: 220 stopni,
- przewód: H05RN-F 2 x 1 mm.

- 10 m garland with sockets spaced every 1 m,
- can be connected in series up to 1500W max.,
- light sources included: 1W E27 – 10 pcs,
- beam angle: 220 degrees,
- wire: H05RN-F 2 x 1 mm.

MODEL	INDEKS	KOLOR	WAGA NETTO [kg]	PAKOWANIE [szt.]	KOD EAN
MODEL	INDEX	COLOR	NET WEIGHT [kg]	PACKING [pcs]	BARCODE
MIMOSA LED SET 10M + 10X1W E27	KTMA10M10X1W	CZARNY BLACK	1,74	4	5902201374292



STANDARD LINE LAMPY OGRODOWE / GARDEN LIGHTS

# MIMOSA LED SET 20m + 20x1W E27

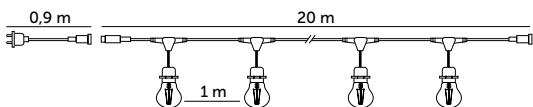
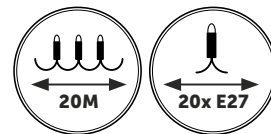

- girlanda 20-metrowa o rozmieszczeniu gniazd co 1 m,
- możliwość łączenia w szereg do maksymalnej mocy 1500W,
- źródła światła w zestawie: 1W na gwint E27 – 20 sztuk,
- kąt rozsytu światła: 220 stopni,
- przewód: H05RN-F 2 x 1 mm.

- 20 m garland with sockets spaced every 1 m,
- can be connected in series up to 1500W max.,
- light sources included: 1W E27 – 20 pcs,
- beam angle: 220 degrees,
- wire: H05RN-F 2 x 1 mm.

MODEL	INDEKS	KOLOR	WAGA NETTO [kg]	PAKOWANIE [szt.]	KOD EAN
MODEL	INDEX	COLOR	NET WEIGHT [kg]	PACKING [pcs]	BARCODE
MIMOSA LED SET 20M + 20X1W E27	KTMA20M20X1W	CZARNY BLACK	3,10	4	5902201374308



KOBI DESIGN LAMPY OGRODOWE / GARDEN LIGHTS

# BAJA LED SET 10m + 20x1W E27

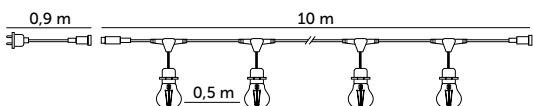
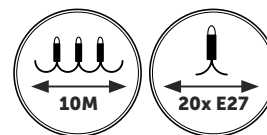

- girlanda 10-metrowa o rozmieszczeniu gniazd co 0,5 metra,
- możliwość łączenia w szereg do maksymalnej mocy 1500W,
- źródła światła w zestawie: 1W na gwint E27 – 20 sztuk,
- kąt rozsytu światła: 220 stopni,
- przewód: H05RN-F 2 x 1 mm.

- 10 m garland with sockets spaced every 0,5 m,
- can be connected in series up to 1500W max.,
- light sources included: 1W E27 – 20 pcs,
- beam angle: 220 degrees,
- wire: H05RN-F 2 x 1 mm.

MODEL	INDEKS	KOLOR	STRUMIEN ŚWIETLNY [lm]	WAGA [kg]	PAKOWANIE [szt.]	KOD EAN
MODEL	INDEX	COLOR	LUMINOUS FLUX [lm]	NET WEIGHT [kg]	PACKING [pcs]	BARCODE
BAJA LED SET 10M + 20X1W E27	KTBA10M20G1W	CZARNY BLACK	20X50	2,60	4	5902201369953

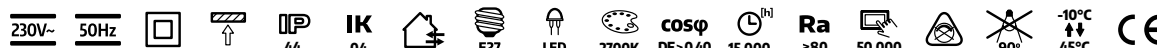

KOBI DESIGN LAMPY OGRODOWE / GARDEN LIGHTS

# BAJA LED SET 15m + 15x1W E27

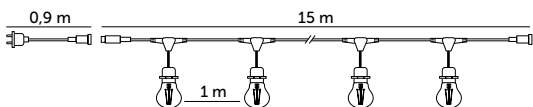
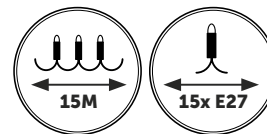

- girlanda 15-metrowa o rozmieszczeniu gniazd co 1 m,
- możliwość łączenia w szereg do maksymalnej mocy 1500W,
- źródła światła w zestawie: 1W na gwint E27 – 15 sztuk,
- kąt rozsytu światła: 220 stopni,
- przewód: H05RN-F 2 x 1 mm.

- 15 m garland with sockets spaced every 1 m,
- can be connected in series up to 1500W max.,
- light sources included: 1W E27 – 15 pcs,
- beam angle: 220 degrees,
- wire: H05RN-F 2 x 1 mm.

MODEL	INDEKS	KOLOR	STRUMIEN ŚWIETLNY [lm]	WAGA [kg]	PAKOWANIE [szt.]	KOD EAN
MODEL	INDEX	COLOR	LUMINOUS FLUX [lm]	NET WEIGHT [kg]	PACKING [pcs]	BARCODE
BAJA LED SET 15M + 15X1W E27	KTBA15M15G1W	CZARNY BLACK	15X50	2,55	4	5902201369960





STANDARD LINE LAMPY OGRODOWE / GARDEN LIGHTS

# MIMOSA 2 10M 10xE27

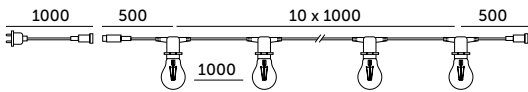
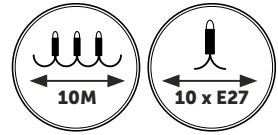

- girlanda 10-metrowa o rozmieszczeniu gniazd co 1 m,
- możliwość łączenia w szereg do maksymalnej mocy 2300W,
- nie zawiera źródła światła,
- przewód: HO5RN-F 2 x 1 mm.

- 10 m garland with socket every 1 m,
- can be connected in line up to 2300W,
- light source not included,
- wire: HO5RN-F 2 x 1 mm.

MODEL	INDEKS	KOLOR	WAGA NETTO [kg]	PAKOWANIE [szt.]	KOD EAN
MODEL	INDEX	COLOR	NET WEIGHT [kg]	PACKING [pcs]	BARCODE
MIMOSA 2 10M 10XE27	KTMA210M10G	CZARNY BLACK	1,51	8	5902201378177

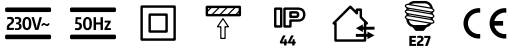

STANDARD LINE LAMPY OGRODOWE / GARDEN LIGHTS

# MIMOSA 10M 20xE27

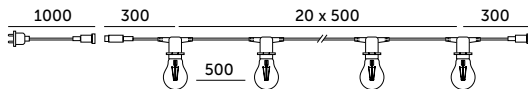
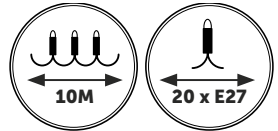

- girlanda 10-metrowa o rozmieszczeniu gniazd co 0,5 metra,
- możliwość łączenia w szereg do maksymalnej mocy 2300W,
- nie zawiera źródła światła,
- przewód: HO5RN-F 2 x 1 mm.

- 10 m garland with socket every 0,5 m,
- can be connected in line up to 2300W,
- light source not included,
- wire: HO5RN-F 2 x 1 mm.

MODEL	INDEKS	KOLOR	WAGA NETTO [kg]	PAKOWANIE [szt.]	KOD EAN
MODEL	INDEX	COLOR	NET WEIGHT [kg]	PACKING [pcs]	BARCODE
MIMOSA 10M 20xE27	KTMA10M20G	CZARNY BLACK	2,01	8	5902846019350

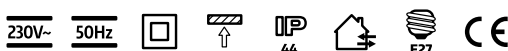



STANDARD LINE LAMPY OGRODOWE / GARDEN LIGHTS

# MIMOSA 20M 20xE27

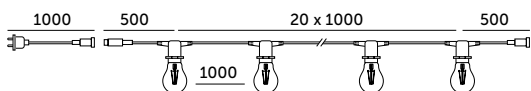
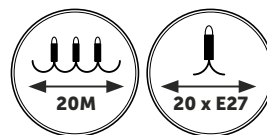

- girlanda 20-metrowa o rozmieszczeniu gniazd co 1 m,
- możliwość łączenia w szereg do maksymalnej mocy 2300W,
- nie zawiera źródła światła,
- przewód: HO5RN-F 2 x 1 mm.

- 20 m garland with socket every 1 m,
- can be connected in line up to 2300W,
- light source not included,
- wire: HO5RN-F 2 x 1 mm.

MODEL	INDEKS	KOLOR	WAGA NETTO [kg]	PAKOWANIE [szt.]	KOD EAN
MODEL	INDEX	COLOR	NET WEIGHT [kg]	PACKING [pcs]	BARCODE
MIMOSA 20M 20xE27	KTMA20M20G	CZARNY BLACK	2,83	8	5902846019367

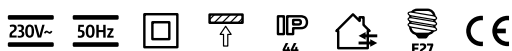

KOBI DESIGN LAMPY OGRODOWE / GARDEN LIGHTS

# CRETE 5m



- girlanda 5-metrowa o rozmieszczeniu gniazd co 1 m,
- przewód: HO5RN-F 2 x 1 mm,
- max. obciążenie: 500W.

- 5 m garland with socket every 1 m,
- cord: HO5RN-F 2 x 1 mm,
- max. load: 500W.

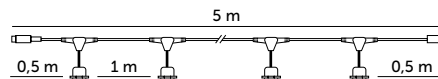

MODEL	INDEKS	KOLOR	WAGA NETTO [kg]	PAKOWANIE [szt.]	KOD EAN
MODEL	INDEX	COLOR	NET WEIGHT [kg]	PACKING [pcs]	BARCODE
CRETE 5M 5XE27	KDSN00000009	CZARNY BLACK	0,83	4	5902201373578





KOBI DESIGN

LAMPY OGRODOWE / GARDEN LIGHTS

## CRETE PC

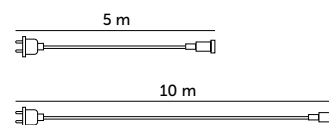

- przewód zasilający H05RN-F 2 x 1 mm o długości 5 lub 10 metrów,  
- max. obciążenie: 500W.

- power cord H05RN-F 2 x 1 mm of 5 m or 10 m length,  
- max. load: 500W.

MODEL	INDEKS	KOLOR	WAGA NETTO [kg]	PAKOWANIE [szt.]	KOD EAN
MODEL	INDEX	COLOR	NET WEIGHT [kg]	PACKING [pcs]	BARCODE
CRETE PC 5M	KDSN00000007	CZARNY BLACK	0,44	40	5902201373554
CRETE PC 10M	KDSN00000008	CZARNY BLACK	0,78	20	5902201373561





KOBI DESIGN

LAMPY OGRODOWE / GARDEN LIGHTS

# CRETE LS M1 x5

CZARNY / BLACK



- klosz do zestawu CRETE,  
- wykonany z metalu.

- lampshade for CRETE set,  
- made of metal.

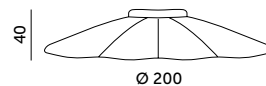

MODEL	INDEKS	KOLOR	WAGA NETTO [kg]	PAKOWANIE [szt.]	KOD EAN
MODEL	INDEX	COLOR	NET WEIGHT [kg]	PACKING [pcs]	BARCODE
CRETE LS M1 X5	KDSN00000010	CZARNY BLACK	0,72	20	5902201373585





**KOBI DESIGN** LAMPY OGRODOWE / GARDEN LIGHTS

# CRETE LS M2 x5

CZARNY / BLACK

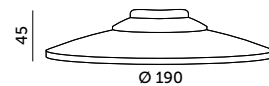

- klosz do zestawu CRETE,  
- wykonany z metalu.

- lampshade for CRETE set,  
- made of metal.

MODEL	INDEKS	KOLOR	WAGA NETTO [kg]	PAKOWANIE [szt.]	KOD EAN
MODEL	INDEX	COLOR	NET WEIGHT [kg]	PACKING [pcs]	BARCODE
CRETE LS M2 X5	KDSN00000011	CZARNY BLACK	0,72	20	5902201373592



**KOBI DESIGN** LAMPY OGRODOWE / GARDEN LIGHTS

# CRETE LS R1 x5



DREWNO / WOOD



CZARNY / BLACK

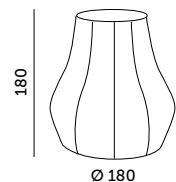

- klosz do zestawu CRETE,  
- wykonany z tworzywa.

- lampshade for CRETE set,  
- made of plastic.

MODEL	INDEKS	KOLOR	WAGA NETTO [kg]	PAKOWANIE [szt.]	KOD EAN
MODEL	INDEX	COLOR	NET WEIGHT [kg]	PACKING [pcs]	BARCODE
CRETE LS R1 X5	KDSN00000013	DREWNO WOOD	1,08	4	5902201373615
CRETE LS R2 X5	KDSN00000014	CZARNY BLACK	1,04	4	5902201373622



KOBI DESIGN LAMPY OGRODOWE / GARDEN LIGHTS

# CRETE LS D1 x5

CZARNY / BLACK

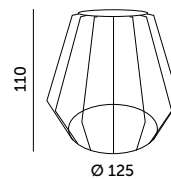

- klosz do zestawu CRETE,  
- wykonany z metalu.

- lampshade for CRETE set,  
- made of metal.

MODEL	INDEKS	KOLOR	WAGA NETTO [kg]	PAKOWANIE [szt.]	KOD EAN
MODEL	INDEX	COLOR	NET WEIGHT [kg]	PACKING [pcs]	BARCODE
CRETE LS D1 X5	KDSN00000012	CZARNY BLACK	0,25	20	5902201373608



STANDARD LINE SOLARNE LAMPY OGRODOWE / SOLAR GARDEN LAMPS

# LED SOLARIS 2 5,5W

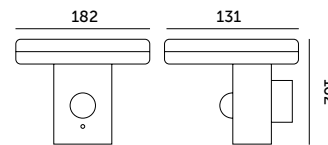

- ledowa lampa solarna z czujnikiem ruchu i natężenia światła,  
- zasilana energią słoneczną,  
- każdy z 3 trybów pracy jest zaprogramowany tak, aby lampa aktywowała się po zmierzchu i dezaktywowała o świcie,  
- możliwość pracy ciągłej,  
- kąt / zasięg detekcji: 120 stopni / 6 m,  
- kąt rozsyłu światła oprawy: 120 stopni,  
- moc instalacji fotowoltaicznej: 2 Wp,  
- łatwy montaż dzięki brakowi okablowania,  
- zawiera wymienny akumulator litowo-jonowy 3,7V / 2600 mAh,  
- nie można wymienić lamp w oprawie.

- LED solar lamp with motion and light intensity sensors,  
- powered by solar energy,  
- each of the 3 operating modes activates at dusk and deactivate at dawn,  
- optional continuous operation mode,  
- detection angle / range: 120 degrees / 6 m,  
- beam angle: 120 degrees,  
- photovoltaic power: 2 Wp,  
- easy installation with no wiring required,  
- includes a replaceable 3.7V / 2600 mAh lithium-ion battery,  
- lamps in the fixture cannot be replaced.

MODEL	INDEKS	POBÓR MOCY [W]	BARWA ŚWIATŁA	STRUMIEŃ ŚWIETLNY [lm]	WAGA NETTO [kg]	PAKOWANIE [szt.]	KOD EAN
MODEL	INDEX	POWER [W]	LIGHT COLOR	LUMINOUS FLUX [lm]	NET WEIGHT [kg]	PACKING [pcs]	BARCODE
LED SOLARIS 2 5,5W NB	KTLOS25WNBC	5,5	NEUTRALNA BIAŁA NEUTRAL WHITE	370	0,67	12	5902201301847







**STANDARD LINE** SOLARNE LAMPY OGRODOWE / SOLAR GARDEN LAMPS

# LED SOLARIS 3 5,5W

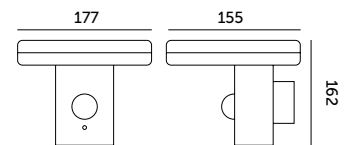

- ledowa lampa solarna z czujnikiem ruchu i natężenia światła,
- zasilana energią słoneczną,
- każdy z 3 trybów pracy jest zaprogramowany tak, aby lampa aktywowała się po zmierzchu i dezaktywowała o świcie,
- możliwość pracy ciągłej,
- kąt / zasięg detekcji: 120 stopni / 6 m,
- kąt rozsyłu światła oprawy: 120 stopni,
- moc instalacji fotowoltaicznej: 1,7Wp,
- łatwy montaż dzięki brakowi okablowania,
- zawiera wymienny akumulator litowo-jonowy 3,7V / 2600mAh,
- nie można wymieniać lamp w oprawie.

- LED solar lamp with motion and light intensity sensors,
- powered by solar energy,
- each of the 3 operating modes activates at dusk and deactivate at dawn,
- optional continuous operation mode,
- detection angle / range: 120 degrees / 6 m,
- beam angle: 120 degrees,
- photovoltaic power: 1,7 Wp,
- easy installation with no wiring required,
- includes a replaceable 3,7V / 2600 mAh lithium-ion battery,
- lamps in the fixture cannot be replaced.

MODEL	INDEKS	POBÓR MOCY [W]	BARWA ŚWIATŁA	STRUMIEŃ ŚWIETLNY [lm]	WAGA NETTO [kg]	PAKOWANIE [szt.]	KOD EAN
MODEL	INDEX	POWER [W]	LIGHT COLOR	LUMINOUS FLUX [lm]	NET WEIGHT [kg]	PACKING [pcs]	BARCODE
LED SOLARIS 3 5,5W NB	KTLOS35WNBC	5,5	NEUTRALNA BIAŁA NEUTRAL WHITE	350	0,66	12	5902201301861





**STANDARD LINE** LAMPY OGRODOWE / GARDEN LAMPS

# LED INDUO K 10W

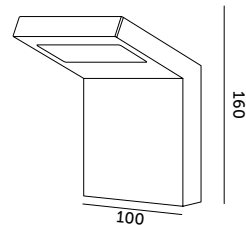

- ledowy kinkiet ścienny,
- wykonany z aluminium i poliwęglanu,
- kąt rozsytu światła: 95 stopni,
- oprawa zawiera źródła światła o klasie energetycznej C,
- możliwość wymiany źródła światła LED jedynie przez wykwalifikowany personel.

- LED wall lamp,
- made of aluminium and PC,
- beam angle: 95 degrees,
- includes light sources with energy efficiency class C,
- LED light source can only be replaced by qualified personnel.

MODEL	INDEKS	POBÓR MOCY [W]	BARWA ŚWIATŁA	STRUMIEŃ ŚWIETLNY [lm]	WAGA NETTO [kg]	PAKOWANIE [szt.]	KOD EAN
MODEL	INDEX	POWER [W]	LIGHT COLOR	LUMINOUS FLUX [lm]	NET WEIGHT [kg]	PACKING [pcs]	BARCODE
LED INDUO K 10W NB	KTIOK CZ	10	NEUTRALNA BIAŁA NEUTRAL WHITE	400	0,38	24	5902201359206





STANDARD LINE LAMPY OGRODOWE / GARDEN LAMPS

# LED ENTERA 10W

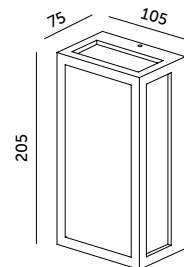

- ledowy kinkiet ścienny,
- wykonany z aluminium i poliwęglanu,
- kąt rozsytu światła: 125 stopni,
- oprawa zawiera źródła światła o klasie energetycznej D,
- możliwość wymiany źródła światła LED jedynie przez wykwalifikowany personel.

- LED wall lamp,
- made of aluminium and PC,
- beam angle: 125 degrees,
- includes light sources with energy efficiency class D,
- LED light source can only be replaced by qualified personnel.

MODEL	INDEKS	POBÓR MOCY [W]	BARWA ŚWIATŁA	STRUMIEŃ ŚWIETLNY [lm]	WAGA NETTO [kg]	PAKOWANIE [szt.]	KOD EAN
MODEL	INDEX	POWER [W]	LIGHT COLOR	LUMINOUS FLUX [lm]	NET WEIGHT [kg]	PACKING [pcs]	BARCODE
LED ENTERA 10W NB	KTEACZ	10	NEUTRALNA BIAŁA NEUTRAL WHITE	460	0,76	10	5902201359220



STANDARD LINE LAMPY OGRODOWE / GARDEN LAMPS

# LED ENTERA P 10W

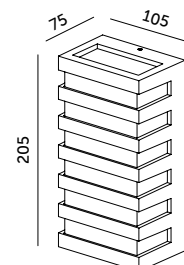
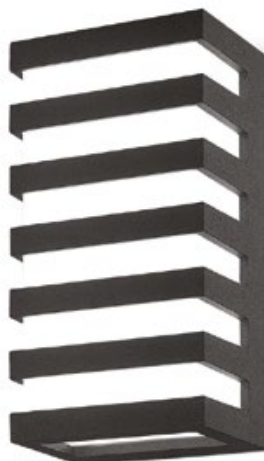

- ledowy kinkiet ścienny,
- wykonany z aluminium i poliwęglanu,
- kąt rozsytu światła: 125 stopni,
- oprawa zawiera źródła światła o klasie energetycznej D,
- możliwość wymiany źródła światła LED jedynie przez wykwalifikowany personel.

- LED wall lamp,
- made of aluminium and PC,
- beam angle: 125 degrees,
- includes light sources with energy efficiency class D,
- LED light source can only be replaced by qualified personnel.

MODEL	INDEKS	POBÓR MOCY [W]	BARWA ŚWIATŁA	STRUMIEŃ ŚWIETLNY [lm]	WAGA NETTO [kg]	PAKOWANIE [szt.]	KOD EAN
MODEL	INDEX	POWER [W]	LIGHT COLOR	LUMINOUS FLUX [lm]	NET WEIGHT [kg]	PACKING [pcs]	BARCODE
LED ENTERA P 10W NB	KTEAPCZ	10	NEUTRALNA BIAŁA NEUTRAL WHITE	220	0,86	10	5902201359237





STANDARD LINE LAMPY OGRODOWE / GARDEN LIGHTS

# QUAZAR 7



CZARNY  
BLACK



SZARY  
GREY

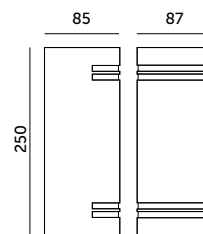

- kinkiet ścienny dwustronny,  
- wykonany z aluminium i tworzywa sztucznego.

- double-sided wall lamp,  
- made of aluminium and plastic.

MODEL	INDEKS	KOLOR	WAGA NETTO [kg]	PAKOWANIE [szt.]	KOD EAN
MODEL	INDEX	COLOR	NET WEIGHT [kg]	PACKING [pcs]	BARCODE
QUAZAR 7	KTLOQZ7CZ	CZARNY BLACK	0,83	12	5900605097366
QUAZAR 7	KTLOQZ7SZ	SZARY GREY	0,83	12	5900605097373





STANDARD LINE LAMPY OGRODOWE / GARDEN LIGHTS

# QUAZAR 11



CZARNY  
BLACK

SZARY  
GREY

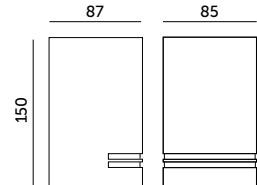

- kinkiet ścienny jednostronny,  
- wykonany z aluminium i tworzywa sztucznego.

- one-sided wall lamp,  
- made of aluminium and plastic.

MODEL	INDEKS	KOLOR	WAGA NETTO [kg]	PAKOWANIE [szt.]	KOD EAN
MODEL	INDEX	COLOR	NET WEIGHT [kg]	PACKING [pcs]	BARCODE
QUAZAR 11	KTLOQZ11CZ	CZARNY BLACK	0,55	16	5900605098325
QUAZAR 11	KTLOQZ11SZ	SZARY GREY	0,55	16	5900605098363

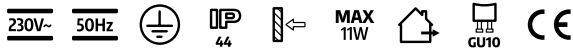

STANDARD LINE LAMPY OGRODOWE / GARDEN LIGHTS

# QUAZAR 12



CZARNY  
BLACK

SZARY  
GREY

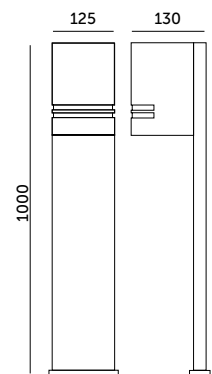

- lampa na słupku o nowoczesnym designie,  
- wykonana z aluminium, ze szklaną szybą,  
- lampa przeznaczona do montażu na stabilnym podłożu.

- bollard lamp with a modern design,  
- made of aluminium and glass,  
- designed for installation on a stable surface.

MODEL	INDEKS	KOLOR	WAGA NETTO [kg]	PAKOWANIE [szt.]	KOD EAN
MODEL	INDEX	COLOR	NET WEIGHT [kg]	PACKING [pcs]	BARCODE
QUAZAR 12	KTLOQZ12CZ	CZARNY BLACK	1,98	6	5900605098332
QUAZAR 12	KTLOQZ12SZ	SZARY GREY	1,98	6	5900605098370

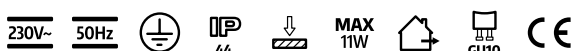



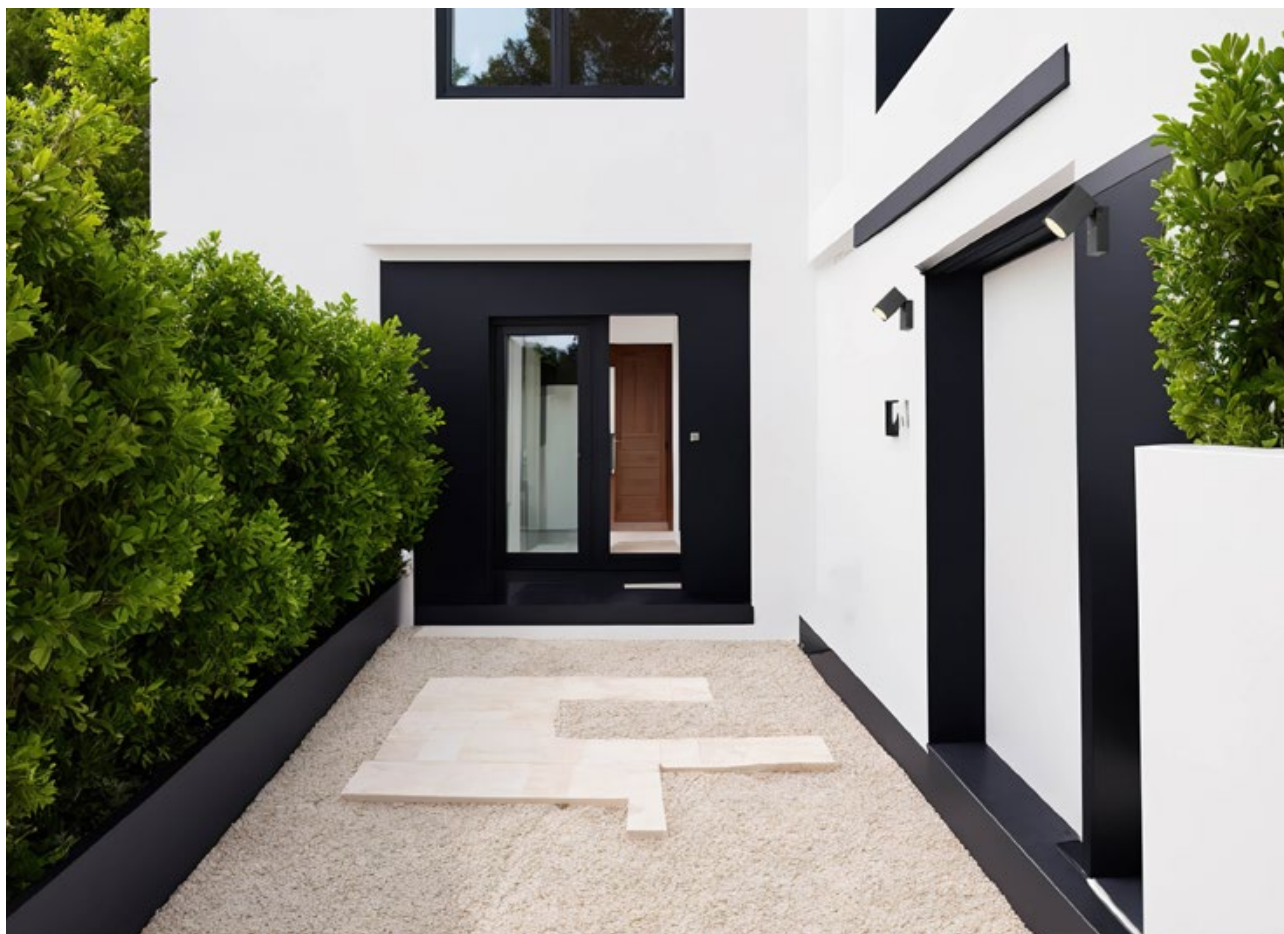

STANDARD LINE LAMPY OGRODOWE / GARDEN LIGHTS

# QUAZAR 15

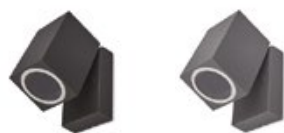

CZARNY  
BLACK

SZARY  
GREY

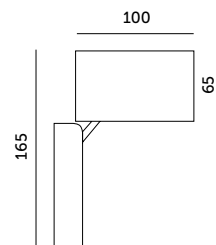

- kinkiet ścienny jednostronny,  
- wykonany z aluminium,  
- możliwość regulacji oprawy o 90 stopni.

- one-sided wall lamp,  
- made of aluminium,  
- a possibility of adjustable up to 90 degrees.

MODEL	INDEKS	KOLOR	WAGA NETTO [kg]	PAKOWANIE [szt.]	KOD EAN
MODEL	INDEX	COLOR	NET WEIGHT [kg]	PACKING [pcs]	BARCODE
QUAZAR 15	KTLOQZ15CZ	CZARNY BLACK	0,47	24	5902846011149
QUAZAR 15	KTLOQZ15SZ	SZARY GREY	0,47	24	5902846011156

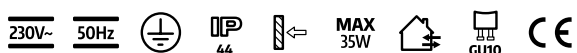



STANDARD LINE LAMPY OGRODOWE / GARDEN LIGHTS

# QUAZAR 15 LX

CZARNY / BLACK



CZARNY  
BLACK

SZARY  
GREY

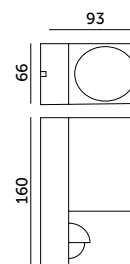

- kinkiet ścienny jednostronny z czujnikiem ruchu,
- wykonany z aluminium, ze szklaną szybką,
- czujnik ruchu z trzema zakresami regulacji: czas działania, zasięg detekcji i natężenie oświetlenia,
- kąt / zasięg detekcji: 90° / 2-8 m,
- czas pracy: min 10 s ± 5 s, max. 4 min ± 1 min,
- optymalna wysokość do instalacji: 1,8-2,5 m.

- single-sided wall lamp with motion sensor,
- made of aluminum with a glass,
- motion sensor with three adjustable settings: operating time, detection range, and light intensity,
- detection angle/range: 90° / 2-8 m,
- operating time: min. 10 s ± 5 s, max. 4 min ± 1 min,
- optimal installation height: 1,8-2,5 m.

MODEL	INDEKS	KOLOR	WAGA NETTO [kg]	PAKOWANIE [szt.]	KOD EAN
MODEL	INDEX	COLOR	NET WEIGHT [kg]	PACKING [pcs]	BARCODE
QUAZAR 15 LX	KTLOQZ15LXCZ	CZARNY BLACK	0,59	16	5902846013174
QUAZAR 15 LX	KTLOQZ15LXSZ	SZARY GREY	0,59	16	5902846013181

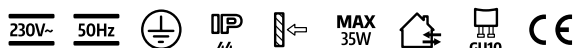

STANDARD LINE LAMPY OGRODOWE / GARDEN LIGHTS

# QUAZAR 15S



CZARNY  
BLACK

SZARY  
GREY

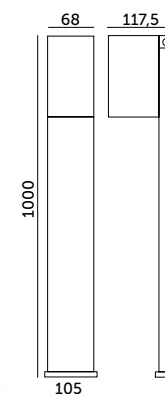

- lampa na słupku o nowoczesnym designie,
- wykonana z aluminium, ze szklaną szybką,
- lampa przeznaczona do montażu na stabilnym podłożu.

- bollard lamp with a modern design,
- made of aluminum and glass,
- designed for installation on a stable surface.

MODEL	INDEKS	KOLOR	WAGA NETTO [kg]	PAKOWANIE [szt.]	KOD EAN
MODEL	INDEX	COLOR	NET WEIGHT [kg]	PACKING [pcs]	BARCODE
QUAZAR 15S	KTLOQZ15SCZ	CZARNY BLACK	1,65	6	5902846013198
QUAZAR 15S	KTLOQZ15SSZ	SZARY GREY	1,65	6	5902846013204

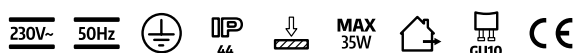

STANDARD LINE LAMPY OGRODOWE / GARDEN LIGHTS

# QUAZAR 17

SZARY / GREY

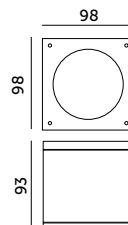

- sufitowa oprawa – nieruchoma,  
- wykonana z aluminium i szkła.

- ceiling lighting – fixed,  
- made of aluminium and glass.

MODEL	INDEKS	KOLOR	WAGA NETTO [kg]	PAKOWANIE [szt.]	KOD EAN
MODEL	INDEX	COLOR	NET WEIGHT [kg]	PACKING [pcs]	BARCODE
QUAZAR 17	KTLOQZ17SZ	SZARY GREY	0,39	24	5902201300437



STANDARD LINE LAMPY OGRODOWE / GARDEN LIGHTS

# QUAZAR 18

SZARY / GREY

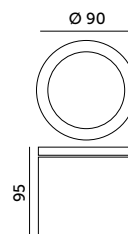

- sufitowa oprawa – nieruchoma,  
- wykonana z aluminium i szkła.

- ceiling lighting – fixed,  
- made of aluminium and glass.

MODEL	INDEKS	KOLOR	WAGA NETTO [kg]	PAKOWANIE [szt.]	KOD EAN
MODEL	INDEX	COLOR	NET WEIGHT [kg]	PACKING [pcs]	BARCODE
QUAZAR 18	KTLOQZ18SZ	SZARY GREY	0,28	24	5902201300451





**ECONOMIC BRAND** LAMPY OGRODOWE / GARDEN LIGHTS

**LED2B**

# QUERK 1

CZARNY / BLACK

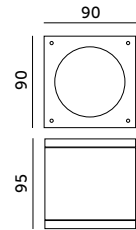

- sufitowa oprawa – nieruchoma,
- oprawa o podwyższonej odporności na wnikanie pyłu i wilgoci IP54,
- wykonana z aluminium i szkła,
- oprawa nie zawiera źródła światła w zestawie.

- ceiling fixtures – fixed,
- fixture with higher resistance to dust and moisture: IP54,
- made of aluminum and glass,
- light source not included.

MODEL	INDEKS	KOLOR	WAGA NETTO [kg]	PAKOWANIE [szt.]	KOD EAN
MODEL	INDEX	COLOR	NET WEIGHT [kg]	PACKING [pcs]	BARCODE
QUERK 1	KTLLQK01CZ	CZARNY BLACK	0,29	30	5902201373707



**ECONOMIC BRAND** LAMPY OGRODOWE / GARDEN LIGHTS

**LED2B**

# QUERK 2

CZARNY / BLACK

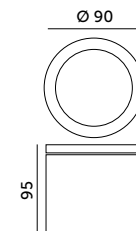

- sufitowa oprawa – nieruchoma,
- oprawa o podwyższonej odporności na wnikanie pyłu i wilgoci IP54,
- wykonana z aluminium i szkła,
- oprawa nie zawiera źródła światła w zestawie.

- ceiling fixtures – fixed,
- fixture with higher resistance to dust and moisture: IP54,
- made of aluminum and glass,
- light source not included.

MODEL	INDEKS	KOLOR	WAGA NETTO [kg]	PAKOWANIE [szt.]	KOD EAN
MODEL	INDEX	COLOR	NET WEIGHT [kg]	PACKING [pcs]	BARCODE
QUERK 2	KTLLQK02CZ	CZARNY BLACK	0,26	30	5902201373714





ECONOMIC BRAND LAMPY OGRODOWE / GARDEN LIGHTS



# QUERK 3

CZARNY / BLACK

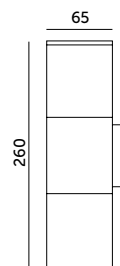

- kinkiet ścienny dwustronny,
- oprawa o podwyższonej odporności na wnikanie pyłu i wilgoci IP54,
- materiał: aluminium i szkło.
- oprawa nie zawiera źródła światła w zestawie.

- double-sided wall light,
- fixture with higher resistance to dust and moisture: IP54,
- made of aluminum and glass,
- light source not included.

MODEL	INDEKS	KOLOR	WAGA NETTO [kg]	PAKOWANIE [szt.]	KOD EAN
MODEL	INDEX	COLOR	NET WEIGHT [kg]	PACKING [pcs]	BARCODE
QUERK 3	KTLQK03CZ	CZARNY BLACK	0,48	10	5902201373721

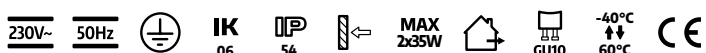





ECONOMIC BRAND

LAMPY OGRODOWE / GARDEN LIGHTS

**LED2B**

# QUERK 4

CZARNY / BLACK

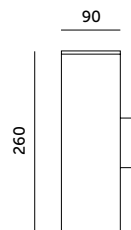

- kinkiet ścienny dwustronny,
- oprawa o podwyższonej odporności na wnikanie pyłu i wilgoci IP54,
- materiał: aluminium i szkło.
- oprawa nie zawiera źródła światła w zestawie.

- double-sided wall light,
- fixture with higher resistance to dust and moisture: IP54,
- made of aluminum and glass,
- light source not included.

MODEL	INDEKS	KOLOR	WAGA NETTO [kg]	PAKOWANIE [szt.]	KOD EAN
MODEL	INDEX	COLOR	NET WEIGHT [kg]	PACKING [pcs]	BARCODE
QUERK 4	KTLQK04CZ	CZARNY BLACK	0,79	10	5902201373738



ECONOMIC BRAND

LAMPY OGRODOWE / GARDEN LIGHTS

**LED2B**

# QUERK 5

CZARNY / BLACK

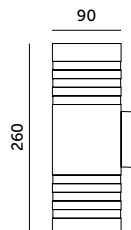

- kinkiet ścienny dwustronny,
- oprawa o podwyższonej odporności na wnikanie pyłu i wilgoci IP54,
- materiał: aluminium i szkło.
- oprawa nie zawiera źródła światła w zestawie.

- double-sided wall light,
- fixture with higher resistance to dust and moisture: IP54,
- made of aluminum and glass,
- light source not included.

MODEL	INDEKS	KOLOR	WAGA NETTO [kg]	PAKOWANIE [szt.]	KOD EAN
MODEL	INDEX	COLOR	NET WEIGHT [kg]	PACKING [pcs]	BARCODE
QUERK 5	KTLQK05CZ	CZARNY BLACK	0,58	10	5902201373745

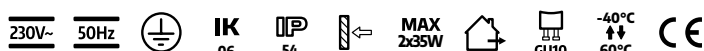



**STANDARD LINE** LAMPY OGRODOWE / GARDEN LIGHTS

# LO 4101



**CZARNY**  
BLACK

**ZŁOTY**  
GOLD

**BIAŁY**  
WHITE

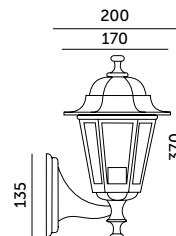

- stylowa lampa ogrodowa wykonana z aluminium, ze szklanymi szybami, - oprawa nie zawiera źródła światła.

- stylish garden luminaire made of aluminum with glass covers, - light source not included.

MODEL	INDEKS	KOLOR	WAGA NETTO [kg]	PAKOWANIE [szt.]	KOD EAN
MODEL	INDEX	COLOR	NET WEIGHT [kg]	PACKING [pcs]	BARCODE
LO 4101	KTLO4101CZAL	CZARNY BLACK	0,68	10	5906340214914
LO 4101	KTLO4101ZLAL	ZŁOTY GOLD	0,68	10	5906340214921
LO 4101	KTLO4101BIAL	BIAŁY WHITE	0,68	10	5902201382334





STANDARD LINE LAMPY OGRODOWE / GARDEN LIGHTS

# LO 4102



CZARNY  
BLACK

ZŁOTY  
GOLD

BIAŁY  
WHITE

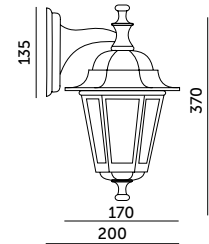

- stylowa lampa ogrodowa wykonana z aluminium, ze szklanymi szybkami, - oprawa nie zawiera źródła światła.

- stylish garden luminaire made of aluminum with glass covers, - light source not included.

MODEL	INDEKS	KOLOR	WAGA NETTO [kg]	PAKOWANIE [szt.]	KOD EAN
MODEL	INDEX	COLOR	NET WEIGHT [kg]	PACKING [pcs]	BARCODE
LO 4102	KTLO4102CZAL	CZARNY BLACK	0,68	10	5906340214853
LO 4102	KTLO4102ZLAL	ZŁOTY GOLD	0,68	10	5906340214860
LO 4102	KTLO4102BIAL	BIAŁY WHITE	0,68	10	5902201382327



STANDARD LINE LAMPY OGRODOWE / GARDEN LIGHTS

# LO 4105



CZARNY  
BLACK

ZŁOTY  
GOLD

BIAŁY  
WHITE

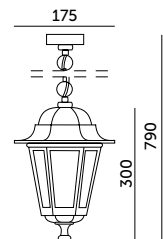

- stylowa lampa ogrodowa wykonana z aluminium, ze szklanymi szybkami, - oprawa nie zawiera źródła światła.

- stylish garden luminaire made of aluminum with glass covers, - light source not included.

MODEL	INDEKS	KOLOR	WAGA NETTO [kg]	PAKOWANIE [szt.]	KOD EAN
MODEL	INDEX	COLOR	NET WEIGHT [kg]	PACKING [pcs]	BARCODE
LO 4105	KTLO4105CZAL	CZARNY BLACK	0,69	10	5906340215034
LO 4105	KTLO4105ZLAL	ZŁOTY GOLD	0,69	10	5906340215041
LO 4105	KTLO4105BIAL	BIAŁY WHITE	0,69	10	5902201382341







STANDARD LINE LAMPY OGRODOWE / GARDEN LIGHTS

# GARDEN BALL S

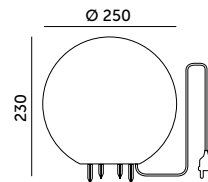

- świecąca kula ogrodowa,  
- wykonana z polietylenu (PE),  
- odporna na temperaturę i wilgoć,  
- długość przewodu: ok. 2 m.

- lighting garden ball,  
- made of polythene (PE),  
- resistant to temperature and moisture,  
- wire length: approx. 2 m.

MODEL	INDEKS	KOLOR	WAGA NETTO [kg]	PAKOWANIE [szt.]	KOD EAN
MODEL	INDEX	COLOR	NET WEIGHT [kg]	PACKING [pcs]	BARCODE
GARDEN BALL S	KTGBS	SZARY GREY	0,79	4	5902846011422



STANDARD LINE LAMPY OGRODOWE / GARDEN LIGHTS

# GARDEN BALL M



- świecąca kula ogrodowa,  
- wykonana z polietylenu (PE),  
- odporna na temperaturę i wilgoć,  
- długość przewodu: ok. 2 m.

- lighting garden ball,  
- made of polythene (PE),  
- resistant to temperature and moisture,  
- wire length: approx. 2 m.

MODEL	INDEKS	KOLOR	WAGA NETTO [kg]	PAKOWANIE [szt.]	KOD EAN
MODEL	INDEX	COLOR	NET WEIGHT [kg]	PACKING [pcs]	BARCODE
GARDEN BALL M	KTGBM	SZARY GREY	0,99	4	5902846011439

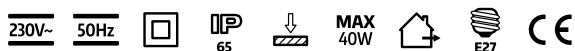

STANDARD LINE LAMPY OGRODOWE / GARDEN LIGHTS

# GARDEN BALL L



- świecąca kula ogrodowa,  
- wykonana z polietylenu (PE),  
- odporna na temperaturę i wilgoć,  
- długość przewodu: ok. 2 m.

- lighting garden ball,  
- made of polythene (PE),  
- resistant to temperature and moisture,  
- wire length: approx. 2 m.

MODEL	INDEKS	KOLOR	WAGA NETTO [kg]	PAKOWANIE [szt.]	KOD EAN
MODEL	INDEX	COLOR	NET WEIGHT [kg]	PACKING [pcs]	BARCODE
GARDEN BALL L	KTGBL	SZARY GREY	1,76	1	5902846011446

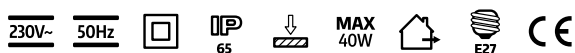





STANDARD LINE

LAMPY OGRODOWE / GARDEN LIGHTS

## BLAKE 2

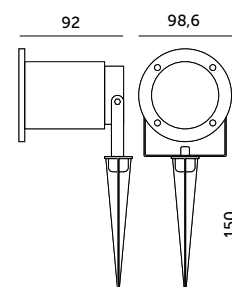

- lampa ogrodowa – reflektor,  
- wykonana z aluminium, ze szklaną szybką,  
- podwyższona szczelność: IP65,  
- przystosowana do żarówek z trzonkiem GU10.

- garden spotlight,  
- made of aluminum and glass,  
- high protection rating: IP65,  
- suitable for GU10 base bulbs.

MODEL	INDEKS	KOLOR	WAGA NETTO [kg]	PAKOWANIE [szt.]	KOD EAN
MODEL	INDEX	COLOR	NET WEIGHT [kg]	PACKING [pcs]	BARCODE
BLAKE 2	KTLOBE2CZ	CZARNY BLACK	0,42	24	5900605098110

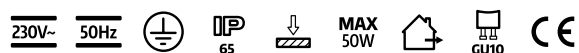



STANDARD LINE

OPRAWY DOGRUNTOWE / IN-GROUND LIGHTING FIXTURES

# ENTRADA 1

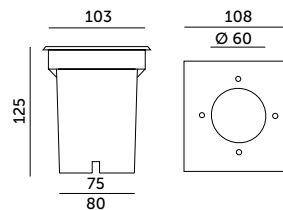

- korpus wykonany z plastiku, pierścień zewnętrzny wykonany ze stali nierdzewnej, klosz wykonany ze szkła hartowanego,  
- oprawa nie zawiera źródła światła w zestawie.

- body made of plastic, the outer ring made of stainless steel, cover made of tempered glass,  
- fixture does not include a light source.

MODEL	INDEKS	KOLOR	WAGA NETTO [kg]	PAKOWANIE [szt.]	KOD EAN
MODEL	INDEX	COLOR	NET WEIGHT [kg]	PACKING [pcs]	BARCODE
ENTRADA 1	KUEA1	CHROM CHROME	0,59	18	5900605095515

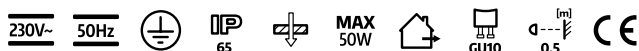

STANDARD LINE

OPRAWY DOGRUNTOWE / IN-GROUND LIGHTING FIXTURES

# ENTRADA 2

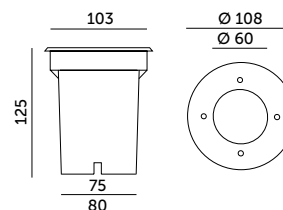

- korpus wykonany z plastiku, pierścień zewnętrzny wykonany ze stali nierdzewnej, klosz wykonany ze szkła hartowanego,  
- oprawa nie zawiera źródła światła w zestawie.

- body made of plastic, the outer ring made of stainless steel, cover made of tempered glass,  
- fixture does not include a light source.

MODEL	INDEKS	KOLOR	WAGA NETTO [kg]	PAKOWANIE [szt.]	KOD EAN
MODEL	INDEX	COLOR	NET WEIGHT [kg]	PACKING [pcs]	BARCODE
ENTRADA 2	KUEA2	CHROM CHROME	0,51	18	5900605095522









## OŚWIETLENIE DO WZROSTU ROŚLIN

### PLANT GROWTH LIGHTING

Badania potwierdzają skuteczność i korzyści płynące ze stosowania specjalistycznego oświetlenia dla roślin. Poznaj produkty Kobi Light, dedykowane roślinom domowym i zapewnij im idealne warunki do wzrostu.

Research confirms the effectiveness and benefits of using specialized lighting for plants. Discover Kobi Light products, designed specifically for houseplants, and provide them with the ideal conditions for growth.



KOBI DESIGN

LAMPY DO ROŚLIN / LAMP FOR PLANTS

## LED PLANTY FGS 8W E27



60

108

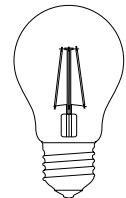

- żarówka LED wspomagająca wzrost roślin zwłaszcza w miejscach z niedoborami światła słonecznego,
- w żarówce zastosowano światło o 2 długościach fali:
  - a) 430-460 nm – wspomaga rozwój roślin głównie w początkowej fazie wzrostu,
  - a) 580-730 nm – wspomaga kwitnienie i owocowanie, połączenie tych 2 długości fal światła w żarówce daje światło zbliżone do naturalnego światła słonecznego,
- kąt rozsytu światła: 360 stopni,
- strumień fotonów fotosyntetycznych (PPF) – ilość światła użytecznego dla roślin, im więcej  $\mu\text{mol/s}$  tym lepiej dla roślin.

- LED bulb supporting plant growth, especially in places with lack of sunlight,
- the bulb emits light at two different wavelengths:
  - a) 430-460 nm – promotes plant development, especially during the early growth phase,
  - b) 580-730 nm – supports flowering and fruiting, the combination of these two wavelengths produces light that closely resembles natural sunlight.
- beam angle: 360 degrees,
- Photosynthetic Photon Flux (PPF) – the amount of light useful for plants; the higher value, the better.

MODEL	INDEKS	POBÓR MOCY [W]	TEMPERATURA BARWOWA [K]	PPF [ $\mu\text{mol/s}$ ]	WAGA NETTO [kg]	PAKOWANIE [szt.]	KOD EAN
MODEL	INDEX	POWER [W]	COLOR TEMPERATURE [K]	PPF [ $\mu\text{mol/s}$ ]	NET WEIGHT [kg]	PACKING [pcs.]	BARCODE
LED PLANTY FGS 8W E27	KDSN00000081	8	1200	10,984	0,04	50	5902201383164

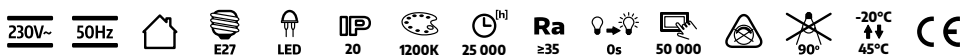





KOBI DESIGN LAMPY DO ROŚLIN / LAMP FOR PLANTS

# LED PLANTY 9W E27



CZARNY  
BLACK



BIAŁY  
WHITE

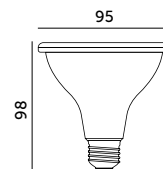

- żarówka LED wspomagająca wzrost roślin zwłaszcza w miejscach z niedoborami światła słonecznego,
- w żarówce zastosowano światło o 2 długościach fali:
  - a) 430-460 nm – wspomaga rozwój roślin głównie w początkowej fazie wzrostu,
  - a) 580-730 nm – wspomaga kwitnienie i owocowanie,
 połączenie tych 2 długości fal światła w żarówce daje światło zbliżone do naturalnego światła słonecznego,
- kąt rozsytu światła: 38 stopni,
- strumień fotonów fotosyntetycznych (PPF) – ilość światła użytecznego dla roślin, im więcej  $\mu\text{mol/s}$  tym lepiej dla roślin.

- LED bulb supporting plant growth, especially in places with lack of sunlight, the bulb emits light at two different wavelengths:
  - a) 430-460 nm – promotes plant development, especially during the early growth phase,
  - b) 580-730 nm – supports flowering and fruiting.
 the combination of these two wavelengths produces light that closely resembles natural sunlight.
- beam angle: 38 degrees,
- Photosynthetic Photon Flux (PPF) – the amount of light useful for plants; the higher value, the better.

MODEL	INDEKS	POBÓR MOCY [W]	KOLOR	TEMPERATURA BARWOWA [K]	PPF [ $\mu\text{mol/s}$ ]	WAGA NETTO [kg]	PAKOWANIE [szt.]	KOD EAN
MODEL	INDEX	POWER [W]	COLOR	COLOR TEMPERATURE [K]	PPF [ $\mu\text{mol/s}$ ]	NET WEIGHT [kg]	PACKING [pcs.]	BARCODE
LED PLANTY 9W E27	KDSN00000073	9	BIAŁY WHITE	1200	13	0,13	50	5902201382914
LED PLANTY 9W E27	KDSN00000074	9	CZARNY BLACK	1200	10,5	0,13	50	5902201382921

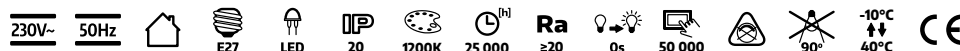

KOBI DESIGN LAMPY DO ROŚLIN / LAMP FOR PLANTS

# LED PLANTY 24W E27

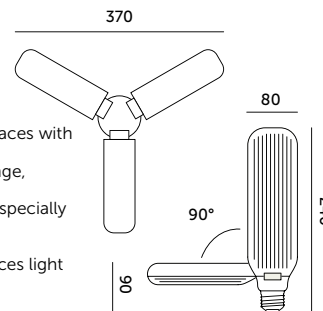

- żarówka LED wspomagająca wzrost roślin zwłaszcza w miejscach z niedoborami światła słonecznego,
- posiada 3 regulowane elementy świetlne w zakresie 90 stopni,
- w żarówce zastosowano światło o 2 długościach fali:
  - a) 430-460 nm – wspomaga rozwój roślin głównie w początkowej fazie wzrostu,
  - a) 580-730 nm – wspomaga kwitnienie i owocowanie,
 połączenie tych 2 długości fal światła w żarówce daje światło zbliżone do naturalnego światła słonecznego,
- kąt rozsytu światła: 120 stopni,
- strumień fotonów fotosyntetycznych (PPF) – ilość światła użytecznego dla roślin, im więcej  $\mu\text{mol/s}$  tym lepiej dla roślin.

- LED bulb supporting plant growth, especially in places with lack of sunlight,
- has 3 adjustable light elements in a 90-degree range,
- the bulb emits light at two different wavelengths:
  - a) 430-460 nm – promotes plant development, especially during the early growth phase,
  - b) 580-730 nm – supports flowering and fruiting.
 the combination of these two wavelengths produces light that closely resembles natural sunlight,
- beam angle: 120 degrees,
- Photosynthetic Photon Flux (PPF) – the amount of light useful for plants; the higher value, the better.

MODEL	INDEKS	POBÓR MOCY [W]	TEMPERATURA BARWOWA [K]	PPF [ $\mu\text{mol/s}$ ]	WAGA NETTO [kg]	PAKOWANIE [szt.]	KOD EAN
MODEL	INDEX	POWER [W]	COLOR TEMPERATURE [K]	PPF [ $\mu\text{mol/s}$ ]	NET WEIGHT [kg]	PACKING [pcs.]	BARCODE
LED PLANTY 24W E27	KDSN00000077	24	1200	35	0,26	50	5902201382952

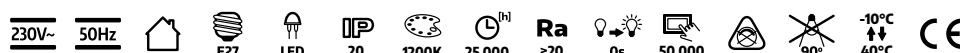

KOBI DESIGN LAMPY DO ROŚLIN / LAMP FOR PLANTS

# LED PLANTY 40W E27



- żarówka LED wspomagająca wzrost roślin zwłaszcza w miejscach z niedoborami światła słonecznego,
- posiada 5 elementów świetlnych w tym 4 regulowane w zakresie 90 stopni,
- w żarówce zastosowano światło o 2 długościach fali:
  - a) 430-460 nm – wspomaga rozwój roślin głównie w początkowej fazie wzrostu,
  - a) 580-730 nm – wspomaga kwitnienie i owocowanie, połączenie tych 2 długości fal światła w żarówce daje światło zbliżone do naturalnego światła słonecznego,
- kąt rozsytu światła: 120 stopni,
- strumień fotonów fotosyntetycznych (PPF) – ilość światła użytecznego dla roślin, im więcej μmol/s tym lepiej dla roślin.

- LED bulb supporting plant growth, especially in places with lack of sunlight,
- has 5 light elements including 4 adjustable ones in a 90-degree range,
- the bulb emits light at two different wavelengths:
  - a) 430-460 nm – promotes plant development, especially during the early growth phase,
  - b) 580-730 nm – supports flowering and fruiting.
- the combination of these two wavelengths produces light that closely resembles natural sunlight,
- beam angle: 120 degrees,
- Photosynthetic Photon Flux (PPF) – the amount of light useful for plants; the higher value, the better.

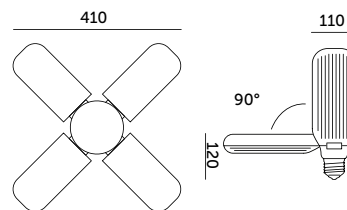

MODEL	INDEKS	POBÓR MOCY [W]	TEMPERATURA BARWOWA [K]	PPF [μmol/s]	WAGA NETTO [kg]	PAKOWANIE [szt.]	KOD EAN
MODEL	INDEX	POWER [W]	COLOR TEMPERATURE [K]	PPF [μmol/s]	NET WEIGHT [kg]	PACKING [pcs.]	BARCODE
LED PLANTY 40W E27	KDSN00000078	40	1200	59	0,40	25	5902201382969



KOBI DESIGN LAMPY DO ROŚLIN / LAMP FOR PLANTS

# PLANTY CLIP



CZARNY BLACK BIAŁY WHITE

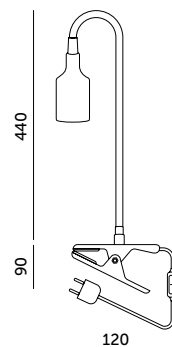

- lampka z mocowaniem na klips,
- z możliwością dowolnego ukierunkowania,
- długość przewodu: 1,7 m,
- lampka nie zawiera źródła światła.

- lamp with clip mounting,
- with the possibility of any orientation,
- cable length: 1,7 m,
- lamp does not include light source.

MODEL	INDEKS	KOLOR	WAGA NETTO [kg]	PAKOWANIE [szt.]	KOD EAN
MODEL	INDEX	COLOR	NET WEIGHT [kg]	PACKING [pcs]	BARCODE
PLANTY CLIP	KDSN00000075	BIAŁY WHITE	0,32	20	5902201382938
PLANTY CLIP	KDSN00000076	CZARNY BLACK	0,32	20	5902201382945

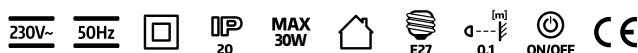



**KOBI DESIGN** LAMPY DO ROŚLIN / LAMP FOR PLANTS

# LED GROWLY 15W + GROWLY PC 3m

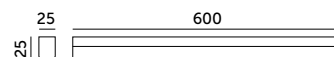

**LED GROWLY 15W:**

- lampa LED wspomagająca wzrost roślin zwłaszcza w miejscach z niedoborami światła słonecznego,
- podstawa i klosz przezroczyste wykonane z poliwęglanu,
- możliwość przymocowania oprawy na wkrętach lub za pomocą samoprzylepnej taśmy dwustronnej (wkręty dołączone do zestawu – taśma nie),
- możliwość łączenia opraw w szereg (maksymalnie 15 szt. do 180 W) bezpośrednio oprawa do oprawy za pomocą krótkiego łącznika (2 szt. w zestawie) lub za pomocą około 30-centymetrowego łącznika (1szt. w zestawie),
- kąt rozsyłu światła: 130 stopni,
- w żarówce zastosowano światło o 3 długościach fali:
  - a) 430-460 nm – wspomaga rozwój roślin głównie w początkowej fazie wzrostu,
  - a) 500-560nm – ma wpływ np. na lepszy rozwój today roślin,
  - c) 580-730nm – wspomaga kwitnienie i owocowanie,
 połączenie tych 3 długości fal światła w żarówce daje światło zbliżone do naturalnego światła słonecznego,
- strumień fotonów fotosyntetycznych (PPF) – ilość światła użytecznego dla roślin, im więcej  $\mu\text{mol/s}$  tym lepiej dla roślin.

**GROWLY PC 3 m:**

- przewód zasilający ze sterownikiem o długości 3 m,
- przewód H03VVH2-F (OMYp) 2 x 0,75 mm<sup>2</sup>,
- maksymalne obciążenie: 200W,
- na przewodzie sterownik, 3 możliwości ustawienia czasu świecenia:
  - a) 4 h włączona – 20 h wyłączona;
  - b) 8 h włączona – 16 h wyłączona;
  - c) 12 h włączona – 12 h wyłączona.

**LED GROWLY 15W:**

- LED lamp supporting plant growth, especially in places with lack of sunlight,
- base and clear cover made of PC,
- possibility of mounting the lamp with screws or double-sided adhesive tape (screws included in the set - tape not included),
- possibility of connecting fixtures in series (maximum 15 pcs. up to 180 W) directly fixture to fixture using a short connector (2 pcs. in the set) or using an approximately 30 cm connector (1 pc. in the set),
- beam angle: 130 degrees,
- the bulb emits light at three different wavelengths:
  - a) 430-460 nm – promotes plant development, especially during the early growth phase,
  - b) 500-560 nm – influences, e.g., better stem development in plants,
  - c) 580-730 nm – supports flowering and fruiting,
 the combination of these three wavelengths produces light that closely resembles natural sunlight,
- Photosynthetic Photon Flux (PPF) – the amount of light useful for plants; the higher value, the better.

**GROWLY PC 3 m:**

- 3m power cable with controller,
- cable H03VVH2-F (OMYp) 2 x 0,75mm<sup>2</sup>,
- maximum load: 200W,
- controller on the cable, 3 possibilities of lighting time settings:
  - a) 4 h on – 20 h off;
  - b) 8 h on – 16 h off;
  - c) 12 h on – 12 h off.

MODEL	INDEKS	KOLOR	POBÓR MOCY [W]	PPF [ $\mu\text{mol/s}$ ]	WAGA NETTO [kg]	PAKOWANIE [szt.]	KOD EAN
MODEL	INDEX	COLOR	POWER [W]	PPF [ $\mu\text{mol/s}$ ]	NET WEIGHT [kg]	PACKING [pcs.]	BARCODE
LED GROWLY 15W	KDSN00000079	BIAŁY WHITE	15	33	0,12	25	5902201382976
GROWLY PC 3M	KDSN00000080	BIAŁY WHITE	-	-	0,11	100	5902201382983

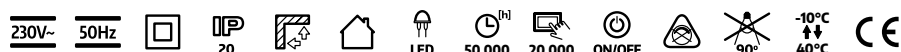

KOBI DESIGN LAMPY DO ROŚLIN / LAMP FOR PLANTS

# LED BLOOM 20W

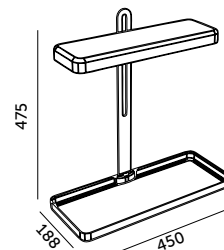

- lampa LED wspomagająca wzrost roślin, zwłaszcza w miejscach z niedoborami światła słonecznego,
- wysokość lampy można regulować,
- po włączeniu lampki, pracuje ona automatycznie w trybie oświetlania roślin przez 16 godzin, po czym wyłącza się na 8 godzin,
- kąt rozsytu światła: 110 stopni,
- zaleca się utrzymywać rośliny w odległości minimum 5 cm od źródła światła,
- zestaw nie zawiera doniczek,
- strumień fotonów fotosyntetycznych (PPF) – ilość światła użytecznego dla roślin, im więcej  $\mu\text{mol/s}$  tym lepiej dla roślin.

- LED lamp supporting plant growth, especially in places with sunlight deficiency,
- height can be adjusted,
- once turned on, the lamp operates automatically, illuminating plants for 16 hours and then turning off for 8 hours,
- beam angle: 110 degrees,
- it is recommended to keep plants at least 5 cm away from the light source,
- pots are not included in the set,
- Photosynthetic Photon Flux (PPF) – the amount of light useful for plants; the higher value, the better.

MODEL	INDEKS	POBÓR MOCY [W]	BARWA ŚWIATŁA	PPF [ $\mu\text{mol/s}$ ]	WAGA NETTO [kg]	PAKOWANIE [szt.]	KOD EAN
MODEL	INDEX	POWER [W]	LIGHT COLOR	PPF [ $\mu\text{mol/s}$ ]	NET WEIGHT [kg]	PACKING [pcs]	BARCODE
LED BLOOM 20W	KDSN00000025	20	CIEPŁOBIŁA WARM WHITE	20	1,34	10	5902201376821



KOBI DESIGN LAMPY DO ROŚLIN / LAMP FOR PLANTS

# LED VERDI 5W

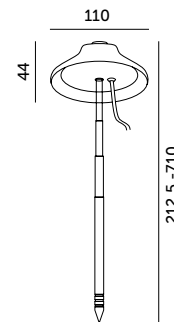

- teleskopowa lampa LED wspomagająca wzrost roślin, zwłaszcza w miejscach z niedoborami światła słonecznego,
- wysokość lampy można regulować,
- po włączeniu lampki, pracuje ona automatycznie w trybie oświetlania roślin przez 16 godzin, po czym wyłącza się na 8 godzin,
- kąt rozsytu światła: 110 stopni,
- zasilanie poprzez podłączenie portu USB-A w lampce,
- zaleca się utrzymywać rośliny w odległości minimum 5 cm od źródła światła,
- zestaw nie zawiera doniczki,
- strumień fotonów fotosyntetycznych (PPF) – ilość światła użytecznego dla roślin, im więcej  $\mu\text{mol/s}$  tym lepiej dla roślin.

- telescopic LED lamp supporting plant growth, especially in places with sunlight deficiency,
- height can be adjusted,
- once turned on, the lamp operates automatically, illuminating plants for 16 hours and then turning off for 8 hours,
- beam angle: 110 degrees,
- powered via USB-A,
- it is recommended to keep plants at least 5 cm away from the light source,
- pot is not included in the set,
- Photosynthetic Photon Flux (PPF) – the amount of light useful for plants; the higher value, the better.

MODEL	INDEKS	POBÓR MOCY [W]	BARWA ŚWIATŁA	PPF [ $\mu\text{mol/s}$ ]	WAGA NETTO [kg]	PAKOWANIE [szt.]	KOD EAN
MODEL	INDEX	POWER [W]	LIGHT COLOR	PPF [ $\mu\text{mol/s}$ ]	NET WEIGHT [kg]	PACKING [pcs]	BARCODE
LED VERDI 5W	KDSN00000026	5	CIEPŁOBIŁA WARM WHITE	4,6	0,14	20	5902201376838







KOBI DESIGN LAMPY DO ROŚLIN / LAMP FOR PLANTS

# LED VERDI 10W

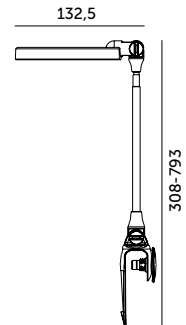

- teleskopowa lampa LED wspomagająca wzrost roślin, zwłaszcza w miejscach z niedoborami światła słonecznego,
- wysokość lampy można regulować,
- możliwość ustawienia czasu świecenia na 8 h, 12 h lub 16 h,
- pięciostopniowe ściemnianie kolejno: 100%, 80%, 60%, 40% i 20%,
- kąt rozsyłu światła: 110 stopni,
- zasilanie poprzez podłączenie portu USB-A w lampce,
- zaleca się utrzymywać rośliny w odległości minimum 5 cm od źródła światła,
- zestaw nie zawiera doniczki,
- strumień fotonów fotosyntetycznych (PPF) – ilość światła użytecznego dla roślin, im więcej  $\mu\text{mol/s}$  tym lepiej dla roślin.

- telescopic LED lamp supporting plant growth, especially in places with sunlight deficiency,
- height can be adjusted,
- lighting time can be set to 8 h, 12 h or 16 h,
- 5 step dimming: 100%, 80%, 60%, 40% i 20%,
- beam angle: 110 degrees,
- powered via USB-A,
- it is recommended to keep plants at least 5 cm away from the light source,
- pot is not included in the set,
- Photosynthetic Photon Flux (PPF) – the amount of light useful for plants; the higher value, the better.

MODEL	INDEKS	POBÓR MOCY [W]	BARWA ŚWIATŁA	PPF [ $\mu\text{mol/s}$ ]	WAGA NETTO [kg]	PAKOWANIE [szt.]	KOD EAN
MODEL	INDEX	POWER [W]	LIGHT COLOR	PPF [ $\mu\text{mol/s}$ ]	NET WEIGHT [kg]	PACKING [pcs]	BARCODE
LED VERDI 10W	KDSN00000027	10	CIEPŁOBIŁA WARM WHITE	6	0,17	20	5902201376845



KOBI DESIGN LAMPY DO ROŚLIN / LAMP FOR PLANTS

# LED VITARO 3 CLIP 10W

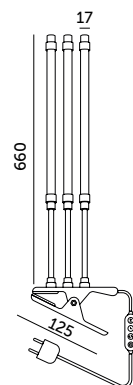

- lampka LED wspomagająca wzrost roślin zwłaszcza w miejscach z niedoborami światła słonecznego,
- mocowana na klips,
- posiada 3 elementy świecące regulowane w zakresie 360 stopni każdy i osobno,
- długość przewodu 1,7 m,
- na przewodzie sterownik z funkcją ściemniania i 3 możliwościami ustawienia czasu świecenia:
  - 3 h włączona – 21 h wyłączona,
  - 9 h włączona – 15 h wyłączona,
  - 12 h włączona – 12 h wyłączona,
- 3 barwy światła do wyboru: niebieska (400-500 nm) – stosowane głównie w początkowych fazach wzrostu, czerwona (600-700 nm) – wspomaga kwitnienie i owocowanie, oraz połączenie tych dwóch kolorów – światło zbliżone do naturalnego światła słonecznego,
- strumień fotonów fotosyntetycznych (PPF) – ilość światła użytecznego dla roślin, im więcej  $\mu\text{mol/s}$  tym lepiej dla roślin.

- LED bulb supporting plant growth, especially in places with lack of sunlight,
- clip mount
- has 3 lighting elements adjustable in the range of 360 degrees, each and separately,
- cable length: 1,7 m,
- controller on the cable with dimming function and 3 lighting time settings:
  - 3 h on- 21 h off,
  - 9 h on-15 h off,
  - 12 h on-12 h off,
- 3 light colours to choose from: blue (400-500 nm) – used mainly in the initial growth phases, red (600-700 nm) – supports flowering and fruiting, and a combination of these two colours – light similar to natural sunlight,
- Photosynthetic Photon Flux (PPF) – the amount of light useful for plants; the higher value, the better.

MODEL	INDEKS	POBÓR MOCY [W]	PPF [ $\mu\text{mol/s}$ ]	WAGA NETTO [kg]	PAKOWANIE [szt.]	KOD EAN
MODEL	INDEX	POWER [W]	PPF [ $\mu\text{mol/s}$ ]	NET WEIGHT [kg]	PACKING [pcs.]	BARCODE
LED VITARO 3 CLIP 10W	KDSN000000082	10	23	0,47	16	5902201383171



KOBI DESIGN

LAMPY DO ROŚLIN / LAMP FOR PLANTS

# LED VITARO 4 CLIP 10W



- lampka LED wspomagająca wzrost roślin zwłaszcza w miejscach z niedoborami światła słonecznego,
- mocowana na klips,
- posiada 4 elementy świecące regulowane w zakresie 360 stopni każdy i osobno,
- długość przewodu 1,7 m,
- na przewodzie sterownik z funkcją ściemniania i 3 możliwościami ustawienia czasu świecenia:
  - a) 3 h włączona – 21 h wyłączona
  - b) 9 h włączona – 15 h wyłączona
  - c) 12 h włączona – 12 h wyłączona,
- 3 barwy światła do wyboru: niebieska (400-500 nm) – stosowane głównie w początkowych fazach wzrostu, czerwona (600-700 nm) – wspomaga kwitnienie i owocowanie, oraz połączenie tych dwóch kolorów – światło zbliżone do naturalnego światła słonecznego,
- strumień fotonów fotosyntetycznych (PPF) – ilość światła użytecznego dla roślin, im więcej  $\mu\text{mol/s}$  tym lepiej dla roślin.

- LED bulb supporting plant growth, especially in places with lack of sunlight,
- clip mount
- has 4 lighting elements adjustable in the range of 360 degrees, each and separately,
- cable length: 1,7 m,
- controller on the cable with dimming function and 3 lighting time settings:
  - a) 3 h on – 21 h off,
  - b) 9 h on – 15 h off,
  - c) 12 h on – 12 h off,
- 3 light colours to choose from: blue (400-500 nm) – used mainly in the initial growth phases, red (600-700 nm) – supports flowering and fruiting, and a combination of these two colours – light similar to natural sunlight,
- Photosynthetic Photon Flux (PPF) – the amount of light useful for plants; the higher value, the better.

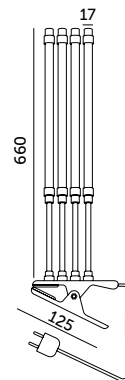
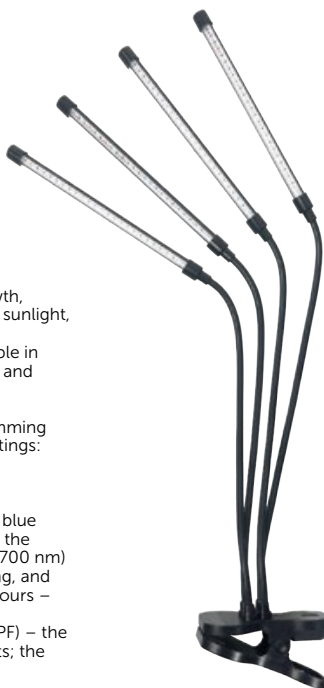

MODEL	INDEKS	POBÓR MOCY [W]	PPF [ $\mu\text{mol/s}$ ]	WAGA NETTO [kg]	PAKOWANIE [szt.]	KOD EAN
MODEL	INDEX	POWER [W]	PPF [ $\mu\text{mol/s}$ ]	NET WEIGHT [kg]	PACKING [pcs.]	BARCODE
LED VITARO 4 CLIP 10W	KDSN00000083	10	23	0,56	16	5902201383188



KOBI DESIGN

LAMPY DO ROŚLIN / LAMP FOR PLANTS

# LED VITARO 3 ST MINI 10W



- lampka LED wspomagająca wzrost roślin zwłaszcza w miejscach z niedoborami światła słonecznego,
- posiada 3 elementy świecące regulowane w zakresie 360 stopni każdy i osobno,
- długość przewodu 1,7 m,
- na przewodzie sterownik z funkcją ściemniania i 3 możliwościami ustawienia czasu świecenia:
  - a) 3 h włączona – 21 h wyłączona,
  - b) 9 h włączona – 15 h wyłączona,
  - c) 12 h włączona – 12 h wyłączona,
- 3 barwy światła do wyboru: niebieska (400-500nm) – stosowane głównie w początkowych fazach wzrostu, czerwona (600-700nm) – wspomaga kwitnienie i owocowanie, oraz połączenie tych dwóch kolorów – światło zbliżone do naturalnego światła słonecznego,
- strumień fotonów fotosyntetycznych (PPF) – ilość światła użytecznego dla roślin, im więcej  $\mu\text{mol/s}$  tym lepiej dla roślin.

- LED bulb supporting plant growth, especially in places with lack of sunlight,
- has 3 lighting elements adjustable in the range of 360 degrees, each and separately,
- cable length: 1,7 m,
- controller on the cable with dimming function and 3 lighting time settings:
  - a) 3 h on – 21 h off,
  - b) 9 h on – 15 h off,
  - c) 12 h on – 12 h off,
- 3 light colours to choose from: blue (400-500nm) – used mainly in the initial growth phases, red (600-700nm) – supports flowering and fruiting, and a combination of these two colours – light similar to natural sunlight,
- Photosynthetic Photon Flux (PPF) – the amount of light useful for plants; the higher value, the better.

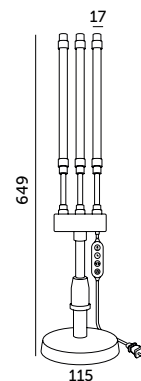

MODEL	INDEKS	POBÓR MOCY [W]	PPF [ $\mu\text{mol/s}$ ]	WAGA NETTO [kg]	PAKOWANIE [szt.]	KOD EAN
MODEL	INDEX	POWER [W]	PPF [ $\mu\text{mol/s}$ ]	NET WEIGHT [kg]	PACKING [pcs.]	BARCODE
LED VITARO 3 ST MINI 10W	KDSN00000084	10	23	0,59	16	5902201383195





KOBI DESIGN LAMPY DO ROŚLIN / LAMP FOR PLANTS

# LED VITARO 4 ST MINI 10W



- lampka LED wspomagająca wzrost roślin zwłaszcza w miejscach z niedoborami światła słonecznego,
  - posiada 4 elementy świecące regulowane w zakresie 360 stopni każdy i osobno,
  - długość przewodu 1,7 m,
  - na przewodzie sterownik z funkcją ściemniania i 3 możliwościami ustawienia czasu świecenia:
    - a) 3 h włączona – 21 h wyłączona,
    - b) 9 h włączona – 15 h wyłączona,
    - c) 12 h włączona – 12 h wyłączona,
  - 3 barwy światła do wyboru: niebieska (400-500nm) – stosowane głównie w początkowych fazach wzrostu, czerwona (600-700nm) – wspomaga kwitnienie i owocowanie, oraz połączenie tych dwóch kolorów – światło zbliżone do naturalnego światła słonecznego,
  - strumień fotonów fotosyntetycznych (PPF) – ilość światła użytecznego dla roślin, im więcej  $\mu\text{mol/s}$  tym lepiej dla roślin.
- LED bulb supporting plant growth, especially in places with lack of sunlight,
  - has 4 lighting elements adjustable in the range of 360 degrees, each and separately,
  - cable length: 1,7 m,
  - controller on the cable with dimming function and 3 lighting time settings:
    - a) 3 h on – 21 h off,
    - b) 9 h on – 15 h off,
    - c) 12 h on – 12 h off,
  - 3 light colours to choose from: blue (400-500nm) – used mainly in the initial growth phases, red (600-700nm) – supports flowering and fruiting, and a combination of these two colours – light similar to natural sunlight,
  - Photosynthetic Photon Flux (PPF) – the amount of light useful for plants; the higher value, the better.

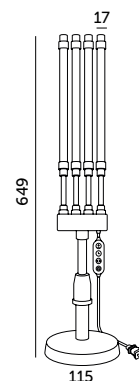

MODEL	INDEKS	POBÓR MOCY [W]	PPF [ $\mu\text{mol/s}$ ]	WAGA NETTO [kg]	PAKOWANIE [szt.]	KOD EAN
MODEL	INDEX	POWER [W]	PPF [ $\mu\text{mol/s}$ ]	NET WEIGHT [kg]	PACKING [pcs.]	BARCODE
LED VITARO 4 ST MINI 10W	KDSN00000085	10	23	0,78	16	5902201383201



KOBI DESIGN LAMPY DO ROŚLIN / LAMP FOR PLANTS

# LED VITARO 4 ST 30W



- lampka LED na statywie wspomagająca wzrost roślin zwłaszcza w miejscach z niedoborami światła słonecznego,
  - posiada 4 elementy świecące regulowane w zakresie 360 stopni każdy i osobno,
  - długość przewodu 2,5 m,
  - na przewodzie sterownik z funkcją ściemniania i 3 możliwościami ustawienia czasu świecenia:
    - a) 3 h włączona – 21 h wyłączona,
    - b) 9 h włączona – 15 h wyłączona,
    - c) 12 h włączona – 12 h wyłączona,
  - 3 barwy światła do wyboru: niebieska (400-500nm) – stosowane głównie w początkowych fazach wzrostu, czerwona (600-700nm) – wspomaga kwitnienie i owocowanie, oraz połączenie tych dwóch kolorów – światło zbliżone do naturalnego światła słonecznego,
  - strumień fotonów fotosyntetycznych (PPF) – ilość światła użytecznego dla roślin, im więcej  $\mu\text{mol/s}$  tym lepiej dla roślin.
- LED bulb supporting plant growth, especially in places with lack of sunlight,
  - has 4 lighting elements adjustable in the range of 360 degrees, each and separately,
  - cable length: 2,5 m,
  - controller on the cable with dimming function and 3 lighting time settings:
    - a) 3 h on – 21 h off,
    - b) 9 h on – 15 h off,
    - c) 12 h on – 12 h off,
  - 3 light colours to choose from: blue (400-500nm) – used mainly in the initial growth phases, red (600-700nm) – supports flowering and fruiting, and a combination of these two colours – light similar to natural sunlight,
  - Photosynthetic Photon Flux (PPF) – the amount of light useful for plants; the higher value, the better.

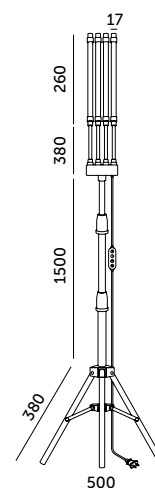

MODEL	INDEKS	POBÓR MOCY [W]	PPF [ $\mu\text{mol/s}$ ]	WAGA NETTO [kg]	PAKOWANIE [szt.]	KOD EAN
MODEL	INDEX	POWER [W]	PPF [ $\mu\text{mol/s}$ ]	NET WEIGHT [kg]	PACKING [pcs.]	BARCODE
LED VITARO 4 ST 30W	KDSN00000086	30	69	1,82	8	5902201383218









## WENTYLATORY I TERMOWENTYLATORY

### FANS AND FAN HEATERS

Nasze produkty zapewniają komfort termiczny i odpowiednią cyrkulację powietrza w domu lub biurze. Dostępne tradycyjne oraz nowoczesne wzornictwo i uniwersalna gama kolorystyczna pozwoli na dopasowanie urządzenia do aranżacji pomieszczenia.

Our products ensure thermal comfort and proper air circulation in homes and offices. Available in traditional and modern designs, and a universal color palette, our devices are crafted to complement any interior decor.



**KOBI DESIGN** WENTYLATORY / FANS

# VENLO 45W

CZARNY / BLACK



- 3-stopniowa regulacja mocy,
- zakres obrotu czaszy: 75 stopni,
- blokada nawiewu w jednym kierunku,
- cicha praca: 53 dB,
- długość przewodu: 1,5 m.

- 3-level power adjustment,
- oscillation range: 75 degrees,
- one-way airflow lock,
- silent operation: 53 dB,
- cable length: 1,5 m.

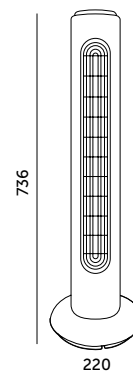

MODEL	INDEKS	POBÓR MOCY [W]	KOLOR	WAGA NETTO [kg]	PAKOWANIE [szt.]	KOD EAN
MODEL	INDEX	POWER [W]	COLOR	NET WEIGHT [kg]	PACKING [pcs]	BARCODE
VENLO 45W	KDSN000000003	45	CZARNY BLACK	1,80	1	5902201370744



**KOBI DESIGN** WENTYLATORY / FANS

# HOORN 45W

CZARNY / BLACK

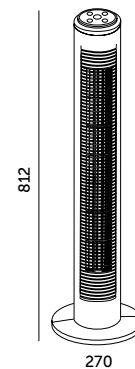

- wentylator kolumnowy z pilotem,
- 3-stopniowa regulacja mocy nawiewu,
- zakres obrotu: 75 stopni,
- blokada nawiewu w jednym kierunku,
- cicha praca: 57 dB,
- długość przewodu: 1,7 m,
- ustawienie czasu pracy 1-7,5 h co 0,5 godziny.

- tower fan with remote control,
- 3-level power adjustment,
- oscillation range: 75 degrees,
- one-way airflow lock,
- silent operation: 57 dB,
- cable length: 1,7 m,
- timer setting from 1 to 7,5 h in 0,5-h intervals.

MODEL	INDEKS	POBÓR MOCY [W]	KOLOR	WAGA NETTO [kg]	PAKOWANIE [szt.]	KOD EAN
MODEL	INDEX	POWER [W]	COLOR	NET WEIGHT [kg]	PACKING [pcs]	BARCODE
HOORN 45W	KDSN00000002	45	CZARNY BLACK	2,10	1	5902201370737

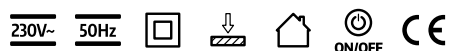

**WINDSTAR** WENTYLATORY / FANS

# VIENTO 40W

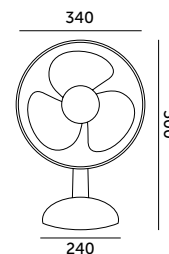

- 3-stopniowa regulacja mocy,
- zakres obrotu czaszy: 90 stopni,
- blokada nawiewu w jednym kierunku,
- cicha praca: 65 dB,
- przepływ powietrza: 35 m<sup>3</sup>/min.

- 3-level power adjustment,
- oscillation range: 90 degrees,
- one-way airflow lock,
- silent operation: 65 dB,
- airflow: 35 m<sup>3</sup>/min.

MODEL	INDEKS	POBÓR MOCY [W]	KOLOR	WAGA NETTO [kg]	PAKOWANIE [szt.]	KOD EAN
MODEL	INDEX	POWER [W]	COLOR	NET WEIGHT [kg]	PACKING [pcs]	BARCODE
VIENTO 40W	KZVVOS40WB	40W	BIAŁY WHITE	1,70	1	5902201301762

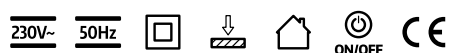

WINDSTAR WENTYLATORY / FANS

# VIENTO 45W



CZARNY  
BLACK



BIAŁY  
WHITE

- 3-stopniowa regulacja mocy,
- zakres obrotu czaszy: 90 stopni,
- blokada nawiewu w jednym kierunku,
- cicha praca: 55 dB,
- przepływ powietrza: 50 m<sup>3</sup>/min.

- 3-level power adjustment,
- oscillation range: 90 degrees,
- one-way airflow lock,
- silent operation: 55 dB,
- airflow: 50 m<sup>3</sup>/min.

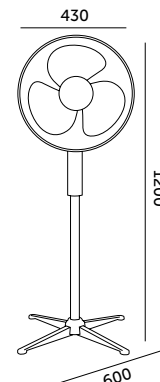

MODEL	INDEKS	POBÓR MOCY [W]	KOLOR	WAGA NETTO [kg]	PAKOWANIE [szt.]	KOD EAN
MODEL	INDEX	POWER [W]	COLOR	NET WEIGHT [kg]	PACKING [pcs]	BARCODE
VIENTO 45W	KZWWOP45WB	45	BIAŁY WHITE	2,42	1	5902201301731
VIENTO 45W	KZWWOP45WC	45	CZARNY BLACK	2,42	1	5902201301748

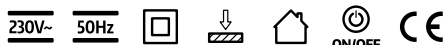

WINDSTAR WENTYLATORY / FANS

# VIENTO-R 45W

- wentylator stojący z pilotem,
- posiada funkcję pracy zwłocznej: ustawienia czasu pracy od 0,5 h do 7,5 h (co 0,5 h),
- posiada funkcję pracy częściowej – pracuje w zmiennym trybie mocy wentylatora w kilkusekundowych odstępach czasu,
- 3-stopniowa regulacja mocy,
- zakres obrotu czaszy: 90 stopni,
- blokada nawiewu w jednym kierunku,
- cicha praca: 55 dB,
- przepływ powietrza: 50 m<sup>3</sup>/min.

- standing fan with remote control,
- delayed start mode: timer setting from 0,5 h to 7,5 h (every 0,5 h),
- with a function of partial work – works in changeable mode of fan's power every few seconds,
- 3-level power adjustment,
- oscillation range: 90 degrees,
- one-way airflow lock,
- silent operation: 55 dB,
- airflow: 50 m<sup>3</sup>/min.

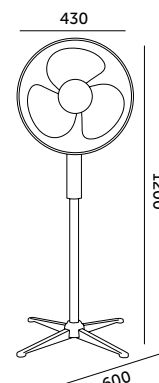

MODEL	INDEKS	POBÓR MOCY [W]	KOLOR	WAGA NETTO [kg]	PAKOWANIE [szt.]	KOD EAN
MODEL	INDEX	POWER [W]	COLOR	NET WEIGHT [kg]	PACKING [pcs]	BARCODE
VIENTO-R 45W	KZWVRP45WC	45	CZARNY BLACK	2,43	1	5902201301755

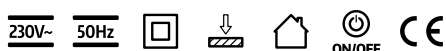





**WINDSTAR** WENTYLATORY / FANS

## VIENTO 100W

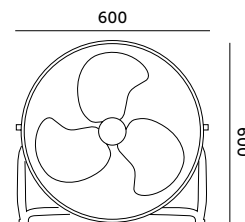

- 3-stopniowa regulacja mocy,
- wertykalny zakres obrotu czaszy: 120 stopni,
- poziomy hałas: 68 dB,
- przepływ powietrza: 105 m<sup>3</sup>/min,
- posiada uchwyt do przenoszenia.

- 3-level power adjustment,
- vertical rotation range: 120 degrees,
- noise level: 68 dB,
- airflow: 105 m<sup>3</sup>/min,
- with a handle that enables moving.

MODEL	INDEKS	POBÓR MOCY [W]	KOLOR	WAGA NETTO [kg]	PAKOWANIE [szt.]	KOD EAN
MODEL	INDEX	POWER [W]	COLOR	NET WEIGHT [kg]	PACKING [pcs]	BARCODE
VIENTO 100W	KZWVOP100WH	100	SREBRNY SILVER	4,25	1	5902201301779

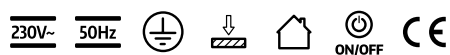

WINDSTAR

TERMOWENTYLATORY / FAN HEATERS

# MISTRAL 2000W



- termowentylator z 3 stopniami regulacji nawiewu: zimny, ciepły i gorący,
- wbudowany termostat,
- zabezpieczenie przed przegrzaniem,
- posiada uchwyt do przenoszenia,
- długość przewodu: ok. 1 m,
- produkt jest odpowiedni tylko do sporadycznego użytku lub do stosowania w dobrze izolowanych pomieszczeniach.

- fan heater with 3 airflow settings: cool, warm, and hot,
- built-in thermostat,
- overheat protection,
- carrying handle,
- cord length: approx. 1 m,
- product is only suitable for occasional use or for use in well-insulated rooms.

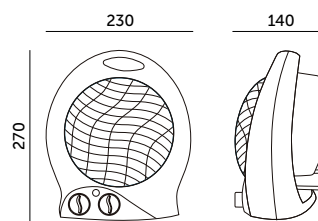

MODEL	INDEKS	KOLOR	POBÓR MOCY [W]	WAGA NETTO [kg]	PAKOWANIE [szt.]	KOD EAN
MODEL	INDEX	COLOR	POWER [W]	NET WEIGHT [kg]	PACKING [pcs]	BARCODE
TERMOWENTYLATOR MISTRAL	KGML	BIAŁY WHITE	1000/2000	0,85	8	5902201304817



WINDSTAR

TERMOWENTYLATORY / FAN HEATERS

# ZEFIR 2000W



- termowentylator z 3 stopniami regulacji nawiewu: zimny, ciepły i gorący,
- wbudowany termostat,
- zabezpieczenie przed przegrzaniem,
- posiada uchwyt do przenoszenia,
- długość przewodu: ok. 1 m,
- produkt jest odpowiedni tylko do sporadycznego użytku lub do stosowania w dobrze izolowanych pomieszczeniach.

- fan heater with 3 airflow settings: cool, warm, and hot,
- built-in thermostat,
- overheat protection,
- carrying handle,
- cord length: approx. 1 m,
- product is only suitable for occasional use or for use in well-insulated rooms.

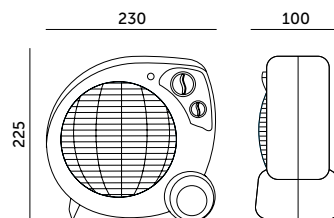

MODEL	INDEKS	KOLOR	POBÓR MOCY [W]	WAGA NETTO [kg]	PAKOWANIE [szt.]	KOD EAN
MODEL	INDEX	COLOR	POWER [W]	NET WEIGHT [kg]	PACKING [pcs]	BARCODE
TERMOWENTYLATOR ZEFIR	KGZR	BIAŁY WHITE	1000/2000	0,77	10	5902201304800

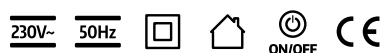



WINDSTAR TERMOWENTYLATORY / FAN HEATERS

# SONDO 2000W TURBO

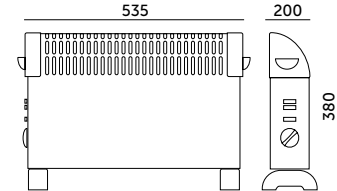

- grzejnik konwektorowy z 3 stopniami regulacji mocy: 750W, 1250W i 2000W,
- posiada funkcję NAWIEW TURBO, która znacząco przyspiesza proces nagrzewania pomieszczenia,
- wbudowany termostat,
- zabezpieczenie przed przegrzaniem,
- długość przewodu: ok. 1 m,
- produkt jest odpowiedni tylko do sporadycznego użytku lub do stosowania w dobrze izolowanych pomieszczeniach.

- convection heater with 3 power settings: 750W, 1250W, and 2000W,
- features TURBO FAN function, which significantly speeds up the heating process,
- built-in thermostat,
- overheat protection,
- cord length: approx. 1 m,
- product is only suitable for occasional use or for use in well-insulated rooms.

MODEL	INDEKS	KOLOR	POBÓR MOCY [W]	WAGA NETTO [kg]	PAKOWANIE [szt.]	KOD EAN
MODEL	INDEX	COLOR	POWER [W]	NET WEIGHT [kg]	PACKING [pcs]	BARCODE
SONDO 2000W TURBO	KGST	BIAŁO-CZARNY WHITE-BLACK	750/1250/2000	1,99	1	5902201308068



WINDSTAR TERMOWENTYLATORY / FAN HEATERS

# YUGO-11 2500W

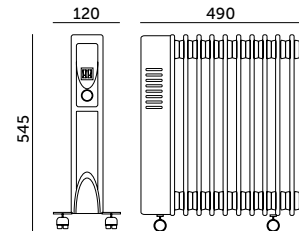

- grzejnik olejowy z 3 stopniami regulacji mocy: 1000W, 1500W i 2500W,
- ilość segmentów grzewczych: 11 żeberek,
- wbudowany termostat,
- zabezpieczenie przed przegrzaniem,
- wyposażony w kółka do łatwego przemieszczania,
- zasobnik na kabel zasilający,
- długość przewodu: ok. 1 m,
- produkt jest odpowiedni tylko do sporadycznego użytku lub do stosowania w dobrze izolowanych pomieszczeniach.

- oil heater with 3 power settings: 1000W, 1500W, and 2500W,
- number of heating fins: 11,
- built-in thermostat,
- overheat protection,
- equipped with wheels for easy mobility,
- cord storage handle,
- cord length: approx. 1 m,
- product is only suitable for occasional use or for use in well-insulated rooms.

MODEL	INDEKS	KOLOR	POBÓR MOCY [W]	WAGA NETTO [kg]	PAKOWANIE [szt.]	KOD EAN
MODEL	INDEX	COLOR	POWER [W]	NET WEIGHT [kg]	PACKING [pcs]	BARCODE
GRZEJNIK OLEJOWY YUGO-11	KGYO	SZARY GREY	1000/1500/2500	8,82	1	5902201304824









## **AKCESORIA I OSPRZĘT ELEKTRONICZNY** ACCESSORIES

Artykuły wspomagające do instalacji i użytkowania oświetlenia, m.in. czujniki, zasilacze, przedłużacze, sterowniki i gniazdka typu SMART. W tej kategorii znajdą Państwo szeroki wybór akcesoriów niezbędnych do kompleksowej obsługi systemów oświetleniowych.

Essential components for the installation and operation of lighting systems, including sensors, power supplies, extension cords, controllers, and SMART sockets. This category offers a wide range of accessories indispensable for the comprehensive management of lighting systems.

PREMIUM

CZUJNIKI RUCHU / MOTION SENSORS

# LX01



- detektor ruchu z dwoma zakresami regulacji: czas działania i natężenie oświetlenia,
- kąt / zasięg detekcji: 160 stopni / max. 9 m (<24°C),
- obciążenie: 1-800 W (dla źródeł żarowych), 1-400 W (dla źródeł ledowych i świetlówek kompaktowych),
- czas pracy: min. 10 s ±3 s, max. 7 min ±2 min,
- zakres natężenia światła: 10-2000 lux,
- wykrywana prędkość ruchu: 0,6-1,5 m/s,
- pobór mocy: 0,50 W (podczas pracy), 0,1 W (w trybie czuwania),
- optymalna wysokość do instalacji: 1-1,8 m.

- motion sensor with two adjustable settings: operating time and light intensity,
- detection angle/range: 160 degrees / max. 9 m (<24°C),
- load capacity: 1-800 W (for incandescent light sources), 1-400 W (for LED and compact fluorescent lamps),
- operating time: min. 10 s ±3 s, max. 7 min ±2 min,
- light intensity range: 10-2000 lux,
- detected motion speed: 0,6-1,5 m/s,
- power consumption: 0,50 W (while working), 0,1 W (in standby mode),
- recommended installation height: 1-1,8 m.

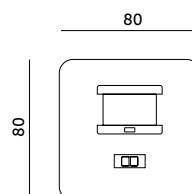

MODEL	INDEKS	KOLOR	WAGA NETTO [kg]	PAKOWANIE [szt.]	KOD EAN
MODEL	INDEX	COLOR	NET WEIGHT [kg]	PACKING [pcs]	BARCODE
LX01	KVLX01140ST	BIAŁY WHITE	0,09	100	5900605090589

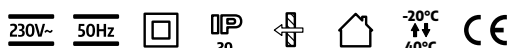

PREMIUM

CZUJNIKI RUCHU / MOTION SENSORS

# LX06



- detektor ruchu z trzema zakresami regulacji: czas działania, natężenie oświetlenia i czułość detekcji,
- kąt / zasięg detekcji: 360 stopni / max. 6 m (<24°C),
- obciążenie: 1-1200 W (dla źródeł żarowych), 1-300 W (dla źródeł ledowych i świetlówek kompaktowych),
- czas pracy: min. 10 s ±3 s, max. 8 min ±2 min,
- zakres natężenia światła: 3-2000 lux,
- wykrywana prędkość ruchu: 0,6-1,5 m/s,
- pobór mocy: 0,45 W (podczas pracy), 0,1 W (w trybie czuwania),
- optymalna wysokość do instalacji: 2,2-4 m.

- motion sensor with two adjustable settings: operating time and light intensity,
- detection angle/range: 360 degrees / max. 6 m (<24°C),
- load capacity: 1-1200 W (for incandescent light sources), 1-300 W (for LED and compact fluorescent lamps),
- operating time: min. 10 s ±3 s, max. 8 min ±2 min,
- light intensity range: 3-2000 lux,
- detected motion speed: 0,6-1,5 m/s,
- power consumption: 0,45 W (while working), 0,1 W (in standby mode),
- recommended installation height: 2,2-4 m.

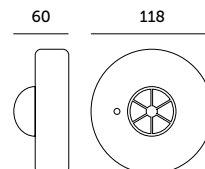

MODEL	INDEKS	KOLOR	WAGA NETTO [kg]	PAKOWANIE [szt.]	KOD EAN
MODEL	INDEX	COLOR	NET WEIGHT [kg]	PACKING [pcs]	BARCODE
LX06	KVLX06360ST	BIAŁY WHITE	0,14	50	5900605090572

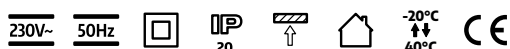

PREMIUM CZUJNIKI RUCHU / MOTION SENSORS

# LX39



CZARNY  
BLACK

BIAŁY  
WHITE



- detektor ruchu z dwoma zakresami regulacji: czas działania i natężenie oświetlenia,
- kąt / zasięg detekcji: 180 stopni / max. 12 m (<24°C),
- obciążenie: 1-1200 W (dla źródeł żarowych), 1-300 W (dla źródeł ledowych i świetlówek kompaktowych),
- czas pracy: min. 10 s ± 3 s, max. 8 min ± 2 min,
- zakres natężenia światła: 3-2000 lux,
- wykrywana prędkość ruchu: 0,6-1,5 m/s,
- pobór mocy: 0,5 W (podczas pracy), 0,1 W (w trybie czuwania),
- optymalna wysokość do instalacji: 1,8-2,5 m.

- motion sensor with two adjustable settings: operating time and light intensity,
- detection angle/range: 180 degrees / max. 12 m (<24°C),
- load capacity: 1-1200 W (for incandescent light sources), 1-300 W (for LED and compact fluorescent lamps),
- operating time: min. 10 s ± 3 s, max. 8 min ± 2 min,
- light intensity range: 3-2000 lux,
- detected motion speed: 0,6-1,5 m/s,
- power consumption: 0,5 W (while working), 0,1 W (in standby mode),
- recommended installation height: 1,8-2,5 m.

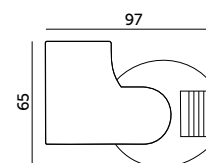

MODEL	INDEKS	KOLOR	WAGA NETTO [kg]	PAKOWANIE [szt.]	KOD EAN
MODEL	INDEX	COLOR	NET WEIGHT [kg]	PACKING [pcs]	BARCODE
LX39	KVLX39180SCZ	CZARNY BLACK	0,10	50	5906340218301
LX39	KVLX39180SBI	BIAŁY WHITE	0,10	50	5906340219285



PREMIUM CZUJNIKI RUCHU / MOTION SENSORS

# LX40



CZARNY  
BLACK

BIAŁY  
WHITE



- detektor ruchu z dwoma zakresami regulacji: czas działania i natężenie oświetlenia,
- kąt / zasięg detekcji: 180 stopni / max. 12 m (<24°C),
- obciążenie: 1-1200 W (dla źródeł żarowych), 1-300 W (dla źródeł ledowych i świetlówek kompaktowych),
- czas pracy: min. 10 s ± 3 s, max. 8 min ± 2 min,
- zakres natężenia światła: 3-2000 lux,
- wykrywana prędkość ruchu: 0,6-1,5 m/s,
- pobór mocy: 0,45 W (podczas pracy), 0,1 W (w trybie czuwania),
- optymalna wysokość do instalacji: 1,8-2,5 m.

- motion sensor with two adjustable settings: operating time and light intensity,
- detection angle/range: 180 degrees / max. 12 m (<24°C),
- load capacity: 1-1200 W (for incandescent light sources), 1-300 W (for LED and compact fluorescent lamps),
- operating time: min. 10 s ± 3 s, max. 8 min ± 2 min,
- light intensity range: 3-2000 lux,
- detected motion speed: 0,6-1,5 m/s,
- power consumption: 0,45 W (while working), 0,1 W (in standby mode),
- recommended installation height: 1,8-2,5 m.

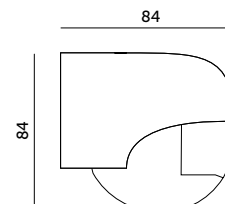

MODEL	INDEKS	KOLOR	WAGA NETTO [kg]	PAKOWANIE [szt.]	KOD EAN
MODEL	INDEX	COLOR	NET WEIGHT [kg]	PACKING [pcs]	BARCODE
LX40	KVLX40BIA	BIAŁY WHITE	0,14	50	5900605093849
LX40	KVLX40CZA	CZARNY BLACK	0,14	50	5900605093832



PREMIUM

CZUJNIKI RUCHU / MOTION SENSORS

# LX41



- detektor ruchu z dwoma zakresami regulacji: czas działania i natężenie oświetlenia,
- kąt / zasięg detekcji: 360 stopni / max. 6 m (<24°C),
- obciążenie: 1-1200 W (dla źródeł żarowych), 1-300 W (dla źródeł ledowych i świetlówek kompaktowych)
- czas pracy: min. 10 s ±3 s, max. 8 min ±2 min,
- zakres natężenia światła: 3-2000 lux,
- wykrywana prędkość ruchu: 0,6-1,5 m/s,
- pobór mocy: 0,5 W (podczas pracy), 0,1 W (w trybie czuwania),
- optymalna wysokość do instalacji: 2,2-4 m.

- motion sensor with two adjustable settings: operating time and light intensity,
- detection angle/range: 360 degrees / max. 6 m (<24°C),
- load capacity: 1-1200 W (for incandescent light sources), 1-300 W (for LED and compact fluorescent lamps),
- operating time: min. 10 s ±3 s, max. 8 min ±2 min,
- light intensity range: 3-2000 lux,
- detected motion speed: 0,6-1,5 m/s,
- power consumption: 0,5 W (while working), 0,1 W (in standby mode),
- recommended installation height: 2,2-4 m.

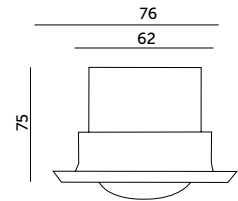

MODEL	INDEKS	KOLOR	WAGA NETTO [kg]	PAKOWANIE [szt.]	KOD EAN
MODEL	INDEX	COLOR	NET WEIGHT [kg]	PACKING [pcs]	BARCODE
LX41	KVLX41360STB	BIAŁY WHITE	0,07	50	5900605091531

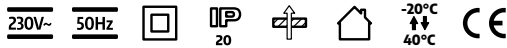

PREMIUM

CZUJNIKI RUCHU / MOTION SENSORS

# LX42



- detektor ruchu z dwoma zakresami regulacji: natężenie oświetlenia i czas działania,
- kąt / zasięg detekcji: 360 stopni / 6 m (<24°C),
- obciążenie: 1-100 W (dla źródeł żarowych, źródeł ledowych i świetlówek kompaktowych),
- czas pracy: 5 s, 30 s, 1 min, 3 min, 5 min, 8 min,
- optymalna wysokość do instalacji: 1,8-2,5 m,
- zakres natężenia światła: 10-2000 lux,
- wykrywana prędkość ruchu: 0,6-1,5 m/s,
- pobór mocy: 0,5 W (podczas pracy), 0,1 W (w trybie czuwania).

- motion sensor with two adjustable settings: operating time and light intensity,
- detection angle/range: 360 degrees / max. 6 m (<24°C),
- load capacity: 1-100 W (for LED and compact fluorescent lamps),
- operating time: min. 10 s ±3 s, max. 8 min ±2 min,
- light intensity range: 10-2000 lux,
- detected motion speed: 0,6-1,5 m/s,
- power consumption: 0,5 W (while running), 0,1 W (standby mode).

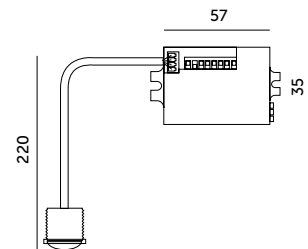

MODEL	INDEKS	KOLOR	WAGA NETTO [kg]	PAKOWANIE [szt.]	KOD EAN
MODEL	INDEX	COLOR	NET WEIGHT [kg]	PACKING [pcs]	BARCODE
LX42	KVLX42360STB	BIAŁY WHITE	0,04	100	5900605095225





STANDARD LINE CZUJNIKI ZMIERZCHOWE / DUSK SENSORS

# LX501



- czujnik zmierzchowy o zakresie natężenia światła 50-800 lux,
- dedykowany do oświetlenia ściemnianego 1-10V (np. LED ANICA, LED NICO),
- płynna regulacja przez czujnik w zakresie 10-100% mocy oprawy,
- kąt detekcji: 360 stopni,
- możliwość montażu natynkowego i podtynkowego.

- dusk sensor with light intensity range 50 - 800 lux,
- dedicated for dimmable lighting 1-10V (np. LED ANICA, LED NICO)
- smooth adjustment in a range 10-100% of fixture power,
- detection angle: 360 degrees,
- suitable for surface and recessed mounting..

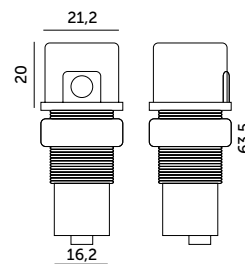

MODEL	INDEKS	KOLOR	WAGA NETTO [kg]	PAKOWANIE [szt.]	KOD EAN
MODEL	INDEX	COLOR	NET WEIGHT [kg]	PACKING [pcs]	BARCODE
LX501	KVLX501	BIAŁY WHITE	0,04	100	5902846017387



PROFESSIONAL LINE CZUJNIKI RUCHU / MOTION SENSORS

# LX701



- detektor mikrofalowy z trzema zakresami regulacji: czas działania, natężenie oświetlenia i czułość detekcji,
- kąt / zasięg detekcji: 360 stopni / max. 8 m (<24°C),
- obciążenie: 1-1200 W (dla źródeł żarowych), 1-300 W (dla źródeł ledowych i świetlówek kompaktowych),
- czas pracy: min. 10 s ±3 s, max. 12 min ±2 min,
- zakres natężenia światła: 3-2000 lux,
- wykrywana prędkość ruchu: 0,6-1,5 m/s,
- pobór mocy: 0,9 W (podczas pracy),
- typ czujnika: 5,8 GHz CW, pasmo ISM,
- optymalna wysokość do instalacji: 2-6 m.

- microwave motion sensor with three adjustable settings: operating time, light intensity, and detection sensitivity,
- detection angle/range: 360 degrees / max. 8 m (<24°C),
- load capacity: 1-1200 W (for incandescent light sources), 1-300 W (for LED and compact fluorescent lamps),
- operating time: min. 10 s ±3 s, max. 12 min ±2 min,
- light intensity range: 3-2000 lux,
- detected motion speed: 0,6-1,5 m/s,
- power consumption: 0,9 W (while working),
- sensor type: 5,8 GHz CW, ISM band,
- recommended installation height: 2-6 m.

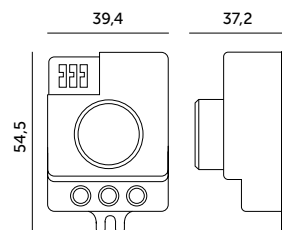

MODEL	INDEKS	KOLOR	WAGA NETTO [kg]	PAKOWANIE [szt.]	KOD EAN
MODEL	INDEX	COLOR	NET WEIGHT [kg]	PACKING [pcs]	BARCODE
LX701	KVLX70360ST	BIAŁY WHITE	0,04	100	5900605092347





STANDARD LINE PROGRAMATORY / TIMERS

# KOBI PMM1

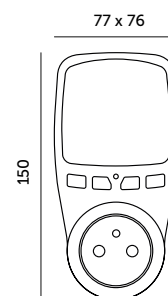

- miernik mocy, za pomocą którego zmierzmy:
  - a) zużycie energii elektrycznej podłączonego urządzenia,
  - b) emisję dwutlenku węgla CO<sub>2</sub> podłączonego urządzenia,
  - c) koszt energii elektrycznej podłączonego urządzenia,
- miernik pokazuje również parametry: napięcie [V], natężenie prądu [A], częstotliwość [Hz], współczynnik mocy [DF], pobór mocy [W] podłączonego urządzenia,
- minimalna moc mierzonego urządzenia: 2W,
- funkcja pamięci - ustawienia i dane zbiorcze zostaną zapisane dzięki 2 bateriom LR44 (AG13) które są w zestawie,
- funkcja przeciążenia – max. 3680W – można ustawić mniejszą wartość,
- przekroczenie przeciążenia sygnalizuje migotanie wyświetlacza,
- miernik posiada gniazdko z uziemieniem i wtyczkę unisichuko,
- gniazdko posiada przesłony torów prądowych (zabezpieczenie przed dziećmi).

- power meter that measures:
  - a) electric power consumption of the connected device,
  - b) CO<sub>2</sub> emission of the connected device,
  - c) electricity cost of the connected device,
- the meter shows parameters: voltage [V], current [A], frequency [Hz], displacement factor [DF], power consumption [W] of the connected device,
- minimum power of the measured device: 2W,
- memory function: settings and collective data will be saved thanks to 2 LR44 batteries – included in the set,
- overload function – max. 3680W – a lower value can be set,
- overload is signalled by display flickering,
- the meter has a grounded outlet and a unisichuko plug,
- has shutters for current circuits (child protection).

MODEL	INDEKS	KOLOR	WAGA NETTO [kg]	PAKOWANIE [szt.]	KOD EAN
MODEL	INDEX	COLOR	NET WEIGHT [kg]	PACKING [pcs]	BARCODE
KOBI PMM1	KWPM1B	BIAŁY WHITE	0,23	50	5902201383133



STANDARD LINE

PROGRAMATORY / TIMERS

# KOBI PMM2

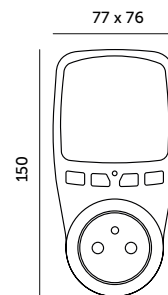

- miernik mocy, za pomocą którego zmierzmy:
  - zużycie energii elektrycznej podłączonego urządzenia,
  - emisję dwutlenku węgla CO<sub>2</sub> podłączonego urządzenia,
  - koszt energii elektrycznej podłączonego urządzenia,
- miernik pokazuje również parametry: napięcie [V], natężenie prądu [A], częstotliwość [Hz], współczynnik mocy [DF], pobór mocy [W] podłączonego urządzenia,
- wyświetlacz pokazuje zużycie, kWh dziennie, tygodniowo i miesięcznie,
- możliwość wpisania 2 taryf,
- minimalna moc mierzonego urządzenia: 2W,
- funkcja pamięci - ustawienia i dane zbiorcze zostaną zapisane dzięki 2 bateriom LR44 (AG13) które są w zestawie,
- funkcja przeciążenia – max. 3680W – można ustawić mniejszą wartość,
- przekroczenie przeciążenia sygnalizuje migotanie wyświetlacza,
- miernik posiada gniazdko z uziemieniem i wtyczkę unischnuko,
- gniazdko posiada przestony torów prądowych (zabezpieczenie przed dziećmi).

- power meter that measures:
  - electric power consumption of the connected device,
  - CO<sub>2</sub> emission of the connected device,
  - electricity cost of the connected device,
- the meter shows parameters: voltage [V], current [A], frequency [Hz], displacement factor [DF], power consumption [W] of the connected device,
- minimum power of the measured device: 2W,
- memory function: settings and collective data will be saved thanks to 2 LR44 batteries – included in the set,
- overload function – max. 3680W – a lower value can be set,
- overload is signalled by display flickering,
- the meter has a grounded outlet and a unischnuko plug,
- has shutters for current circuits (child protection).

MODEL	INDEKS	KOLOR	WAGA NETTO [kg]	PAKOWANIE [szt.]	KOD EAN
MODEL	INDEX	COLOR	NET WEIGHT [kg]	PACKING [pcs]	BARCODE
KOBI PMM2	KWPM2C	CZARNY BLACK	0,23	50	5902201383140



STANDARD LINE

PROGRAMATORY / TIMERS

# KOBI PMM3

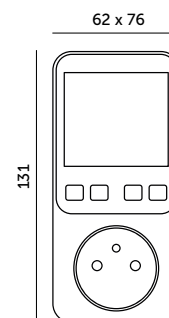

- miernik mocy, za pomocą którego zmierzmy:
  - zużycie energii elektrycznej podłączonego urządzenia,
  - koszt energii elektrycznej podłączonego urządzenia,
- miernik pokazuje również parametry: napięcie [V], natężenie prądu [A], częstotliwość [Hz], współczynnik mocy [DF], pobór mocy [W] podłączonego urządzenia,
- minimalna moc mierzonego urządzenia: 2W,
- funkcja pamięci - ustawienia i dane zbiorcze zostaną zapisane dzięki baterii CR2032 która jest w zestawie,
- funkcja przeciążenia – max. 3680W – można ustawić mniejszą wartość,
- przekroczenie przeciążenia sygnalizuje migotanie wyświetlacza i sygnał dźwiękowy,
- miernik posiada gniazdko z uziemieniem i wtyczkę unischnuko,
- gniazdko posiada przestony torów prądowych (zabezpieczenie przed dziećmi).

- power meter that measures:
  - electric power consumption of the connected device,
  - electricity cost of the connected device,
- the meter shows parameters: voltage [V], current [A], frequency [Hz], displacement factor [DF], power consumption [W] of the connected device,
- minimum power of the measured device: 2W,
- memory function: settings and collective data will be saved thanks to 2 CR2032 batteries – included in the set,
- overload function – max. 3680W – a lower value can be set,
- overload is signalled by display flickering and a sound signal,
- the meter has a grounded outlet and a unischnuko plug,
- has shutters for current circuits (child protection).

MODEL	INDEKS	KOLOR	WAGA NETTO [kg]	PAKOWANIE [szt.]	KOD EAN
MODEL	INDEX	COLOR	NET WEIGHT [kg]	PACKING [pcs]	BARCODE
KOBI PMM3	KWPM3B	BIAŁY WHITE	0,21	50	5902201383157



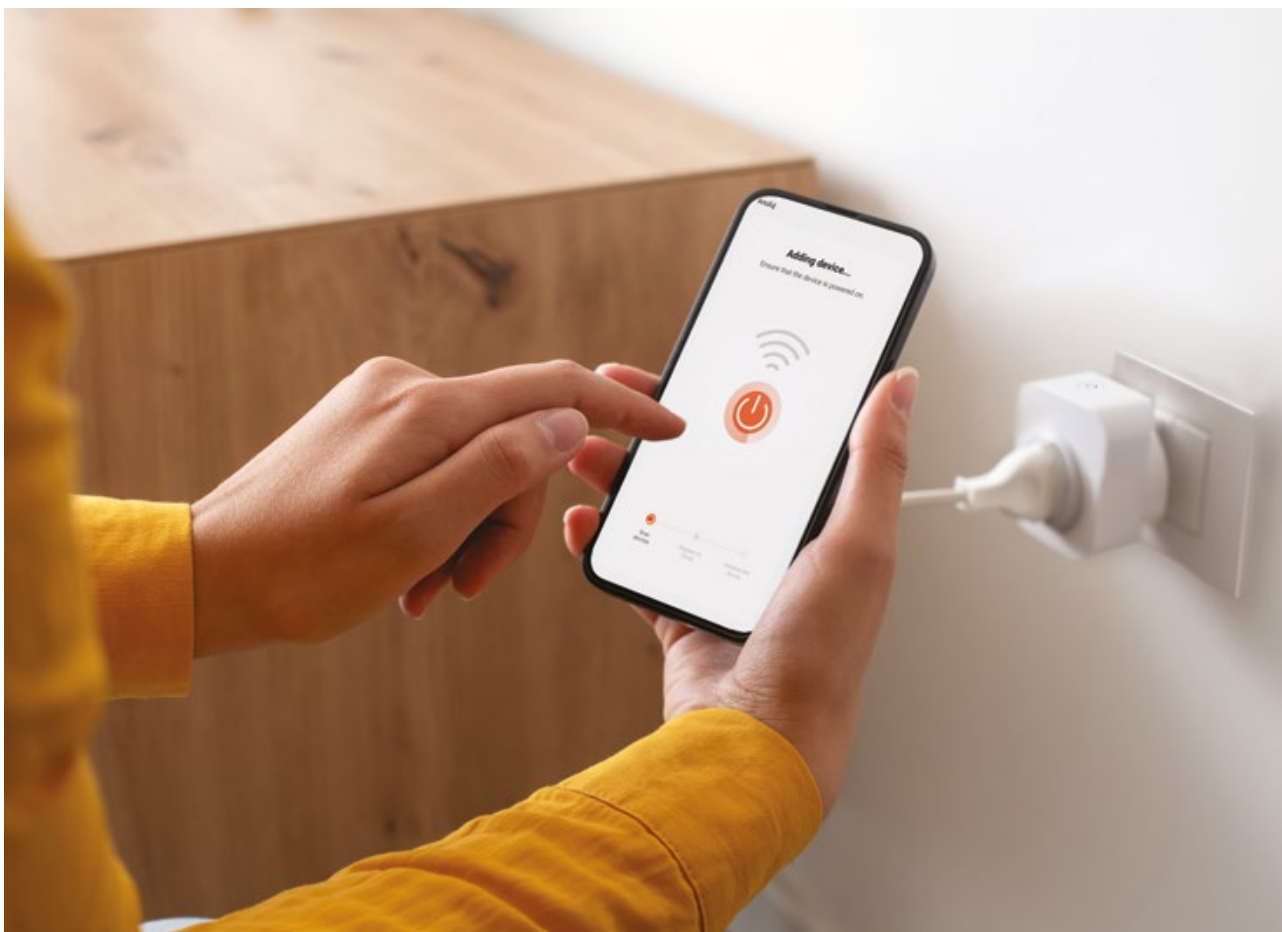

**SMART HOME** PROGRAMATORY / TIMERS  
**SMART SOCKET WiFi**

**WSPÓŁPRACUJE Z**  
 WORKS WITH:

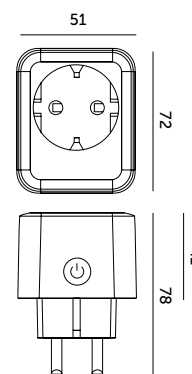

- inteligentne gniazdko sterowane, pozwala na zdalną kontrolę urządzeń poprzez aplikację TUYA (na Android i iOS),
- posiada możliwość ustawienia czasu włączenia i wyłączenia urządzenia oraz tworzenia własnych scenariuszy,
- sterowanie z każdego miejsca na świecie,
- możliwość sterowania wieloma gniazdami jednocześnie poprzez grupowanie,
- częstotliwość WiFi: 2,4GHz,
- wtyczka ma typ E/F (unischuko), gniazdo typ F (schuko),
- max. obciążenie: 16A / 3680W.

- smart socket, controlled via the TUYA app (available on Android and iOS),
- enables scheduling for turning devices on and off, and creating custom scenarios,
- control from anywhere in the world,
- control multiple sockets simultaneously through grouping,
- WiFi frequency: 2,4 GHz,
- plug type E/F (unischuko), socket type F (schuko),
- max load: 16A / 3680W.

MODEL	INDEKS	KOLOR	WAGA NETTO [kg]	PAKOWANIE [szt.]	KOD EAN
MODEL	INDEX	COLOR	NET WEIGHT [kg]	PACKING [pcs]	BARCODE
SMART SOCKET WIFI	KWSSW	BIAŁY WHITE	0,09	50	5902201300390





STANDARD LINE PROGRAMATORY / TIMERS

# PC 24

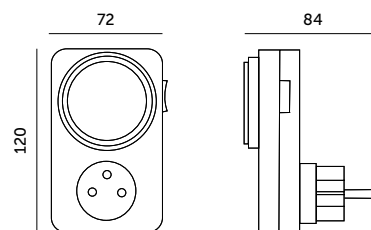

- mechaniczny programator czasowy, pracujący w trybie dobowym,  
- minimalny czas włączenia wynosi 15 minut,  
- max obciążenie: 16A / 3500W.

- mechanical timer operating in 24 h mode,  
- min. switch-on time: 15 minutes,  
- max. load: 16A / 3500W.

MODEL	INDEKS	KOLOR	WAGA NETTO [kg]	PAKOWANIE [szt.]	KOD EAN
MODEL	INDEX	COLOR	NET WEIGHT [kg]	PACKING [pcs]	BARCODE
PC 24	KWPC24	BIAŁY WHITE	0,14	12	5906340211883



KOBI DESIGN PRZEDŁUŻACZE / EXTENSION CORDS

# KOBI CONNECTO 4-GNIAZDA + USB

## KOBI CONNECTO 4-SOCKETS + USB



CZARNY  
BLACK



BIAŁY  
WHITE

- przedłużacz do użytku domowego, z uziemieniem i wyłącznikiem,  
- posiada 4 gniazda 230V, 3 gniazda USB-A (5V-2,1A) i 1 gniazdo USB-C (5V-2,1A),  
- maksymalne natężenie: 16A,  
- maksymalne obciążenie: 3250W,  
- przewód: H05VV-F 3 x 1,5 mm,  
- posiada przestory torów prądowych (zabezpieczenie przed dziećmi),  
- pakowany w folię z zawieszką.

- extension cord for home use, with grounding and switch,  
- features 4 x 230V sockets, 3 x USB-A ports (5V-2,1A), and 1 x USB-C port (5V-2,1A),  
- max. current: 16A,  
- max. load: 3250W,  
- cable: H05VV-F 3 x 1,5 mm,  
- with covers for power sockets (child protection),  
- packaged in a plastic bag with a hanger.



MODEL	INDEKS	ILOŚĆ GNIAZD	DŁUGOŚĆ PRZEWODU [m]	KOLOR	WAGA NETTO [kg]	PAKOWANIE [szt.]	KOD EAN
MODEL	INDEX	SOCKET QUANTITY	CABLE LENGTH [m]	COLOR	NET WEIGHT [kg]	PACKING [pcs]	BARCODE
KOBI CONNECTO 4GN ZU	KDSN00000020	4	1,5	BIAŁY WHITE	0,39	20	5902201376869
KOBI CONNECTO 4GN ZU	KDSN00000022	4	3	BIAŁY WHITE	0,55	20	5902201376883
KOBI CONNECTO 4GN ZU	KDSN00000024	4	5	BIAŁY WHITE	0,76	20	5902201376906
KOBI CONNECTO 4GN ZU	KDSN00000019	4	1,5	CZARNY BLACK	0,39	20	5902201376852
KOBI CONNECTO 4GN ZU	KDSN00000021	4	3	CZARNY BLACK	0,55	20	5902201376876
KOBI CONNECTO 4GN ZU	KDSN00000023	4	5	CZARNY BLACK	0,76	20	5902201376890

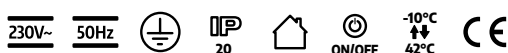

STANDARD LINE PRZEDŁUŻACZE / EXTENSION CORDS

# KOBI LINEA PRO 3-GNIAZDA + 5xUSB

KOBI LINEA PRO 3-SOCKETS + 5xUSB



CZARNY  
BLACK

BIAŁY  
WHITE

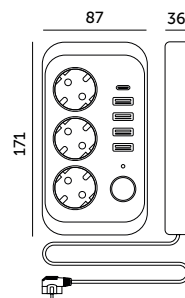

- przedłużacz do użytku domowego z uziemieniem typu schuko i wyłącznikiem,
- posiada 3 gniazda 230V, 4 gniazda USB-A i 1 gniazdo USB-C,
- maksymalne natężenie: 10A,
- maksymalne obciążenie: 2500W,
- przewód: H05VV-F 3x1,5 mm.

- extension cord for home use with schuko grounding and a switch,
- has 3 sockets 230V, 4 USB-A sockets and 1 USB-C socket,
- maximum current: 10A,
- maximum load: 2500W,
- wire: H05VV-F 3x1,5mm.

MODEL	INDEKS	ILOŚĆ GNIAZD	DŁUGOŚĆ PRZEWODU [m]	KOLOR	WAGA NETTO [kg]	PAKOWANIE [szt.]	KOD EAN
MODEL	INDEX	SOCKET QUANTITY	CABLE LENGTH [m]	COLOR	NET WEIGHT [kg]	PACKING [pcs]	BARCODE
KOBI LINEA PRO 3GN	KGLPZW3U5D1B	3	1,5	BIAŁY WHITE	0,36	20	5902201383027
KOBI LINEA PRO 3GN	KGLPZW3U5D3B	3	3	BIAŁY WHITE	0,52	20	5902201383041
KOBI LINEA PRO 3GN	KGLPZW3U5D5B	3	5	BIAŁY WHITE	0,73	20	5902201383065
KOBI LINEA PRO 3GN	KGLPZW3U5D1C	3	1,5	CZARNY BLACK	0,36	20	5902201383010
KOBI LINEA PRO 3GN	KGLPZW3U5D3C	3	3	CZARNY BLACK	0,52	20	5902201383034
KOBI LINEA PRO 3GN	KGLPZW3U5D5C	3	5	CZARNY BLACK	0,73	20	5902201383058

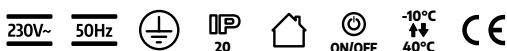

STANDARD LINE PRZEDŁUŻACZE / EXTENSION CORDS

# KOBI LINEA FL 2-GNIAZDA + 4xUSB

KOBI LINEA FL 2-SOCKETS + 4xUSB



CZARNY  
BLACK

BIAŁY  
WHITE

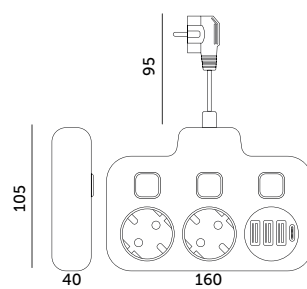

- rozgałęźnik do użytku domowego z uziemieniem typu schuko i 3 wyłącznikami,
- posiada 2 gniazda 230V, 3 gniazda USB-A i 1 gniazdo USB-C,
- maksymalne natężenie: 10A,
- maksymalne obciążenie: 2500W,
- przewód: H05VV-F 3x1,5 mm,
- posiada przestrony torów prądowych (zabezpieczenie przed dziećmi).

- splitter cord for home use with schuko grounding and 3 switches,
- has 2 sockets 230V, 3 USB-A sockets and 1 USB-C socket,
- maximum current: 10A,
- maximum load: 2500W,
- wire: H05VV-F 3x1,5mm,
- has shutters for current circuits (child protection).

MODEL	INDEKS	ILOŚĆ GNIAZD	DŁUGOŚĆ PRZEWODU [m]	KOLOR	WAGA NETTO [kg]	PAKOWANIE [szt.]	KOD EAN
MODEL	INDEX	SOCKET QUANTITY	CABLE LENGTH [m]	COLOR	NET WEIGHT [kg]	PACKING [pcs]	BARCODE
KOBI LINEA FL 2GN	KGLFZW2U4D2C	2	0,2	CZARNY BLACK	0,22	20	5902201383072
KOBI LINEA FL 2GN	KGLFZW2U4D2B	2	0,2	BIAŁY WHITE	0,22	20	5902201383089

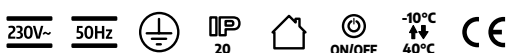

STANDARD LINE PRZEDŁUŻACZE / EXTENSION CORDS

# KOBI LINEA PRO CUBE C 3-GNIAZDA + 4xUSB

KOBI LINEA PRO CUBE C 3-SOCKETS + 4xUSB



- przedłużacz do użytku domowego z uziemieniem i wyłącznikiem,
- posiada 3 gniazda 230V, 3 gniazda USB-A i 1 gniazdo USB-C,
- maksymalne natężenie: 16A,
- maksymalne obciążenie: 3600W,
- przewód: H05VV-F 3x1 mm,
- posiada przestronny torów prądowych (zabezpieczenie przed dziećmi).

- extension cord for home use with grounding and a switch,
- has 3 sockets 230V, 3 USB-A sockets and 1 USB-C socket,
- maximum current: 16A,
- maximum load: 3600W,
- wire: H05VV-F 3x1 mm,
- has shutters for current circuits (child protection).

MODEL	INDEKS	ILOŚĆ GNIAZD	DŁUGOŚĆ PRZEWODU [m]	KOLOR	WAGA NETTO [kg]	PAKOWANIE [szt.]	KOD EAN
MODEL	INDEX	SOCKET QUANTITY	CABLE LENGTH [m]	COLOR	NET WEIGHT [kg]	PACKING [pcs]	BARCODE
KOBI LINEA PRO CUBE C 3GN	KGLCZW3U4D1C	3	1,5	CZARNY BLACK	0,33	50	5902201383102
KOBI LINEA PRO CUBE C 3GN	KGLCZW3U4D1B	3	1,5	BIAŁY WHITE	0,33	50	5902201383096

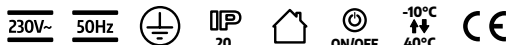

STANDARD LINE PRZEDŁUŻACZE / EXTENSION CORDS

# KOBI LINEA PRO CUBE 3-GNIAZDA + 4xUSB

KOBI LINEA PRO CUBE 3-SOCKETS + 4xUSB



- rozgałęźnik do użytku domowego z uziemieniem i wyłącznikiem,
- posiada 3 gniazda 230V, 3 gniazda USB-A i 1 gniazdo USB-C,
- maksymalne natężenie: 16A,
- maksymalne obciążenie: 3600W,
- posiada przestronny torów prądowych (zabezpieczenie przed dziećmi).

- splitter for home use with grounding and a switch,
- has 3 sockets 230V, 3 USB-A sockets and 1 USB-C socket,
- maximum current: 16A,
- maximum load: 3600W,
- has shutters for current circuits (child protection).

MODEL	INDEKS	ILOŚĆ GNIAZD	KOLOR	WAGA NETTO [kg]	PAKOWANIE [szt.]	KOD EAN
MODEL	INDEX	SOCKET QUANTITY	COLOR	NET WEIGHT [kg]	PACKING [pcs.]	BARCODE
KOBI LINEA PRO CUBE 3GN	KGLCZW3U4C	3	CZARNY BLACK	0,27	60	5902201383126
KOBI LINEA PRO CUBE 3GN	KGLCZW3U4B	3	BIAŁY WHITE	0,27	60	5902201383119

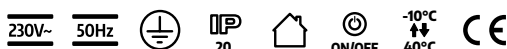



STANDARD LINE

PRZEDŁUŻACZE / EXTENSION CORDS

## LINEA 3-GNIAZDA ZU

LINEA 3-SOCKETS



- przedłużacz do użytku domowego z uziemieniem, na 3 gniazda,
- maksymalne natężenie: 10 A,
- maksymalne obciążenie: 2300 W,
- przewód: H05VV-F 3 x 1 mm,
- typ izolacji: PVC,
- posiada przestronny torów prądowych (zabezpieczenie przed dziećmi),
- pakowany w folię z zawieszka.

- extension cord for home use, with grounding, 3 sockets,
- max. current: 10 A,
- max. load: 2300 W,
- cable: H05VV-F 3 x 1 mm,
- insulation type: PVC,
- with covers for power sockets (child protection),
- packaged in a plastic bag with a hanger.

MODEL	INDEKS	ILOŚĆ GNIAZD	DŁUGOŚĆ PRZEWODU [m]	KOLOR	WAGA NETTO [kg]	PAKOWANIE [szt.]	KOD EAN
MODEL	INDEX	SOCKET QUANTITY	CABLE LENGTH [m]	COLOR	NET WEIGHT [kg]	PACKING [pcs]	BARCODE
LINEA 3GN 1,5M ZU	KGLAZ3G1,5M	3	1,5	BIAŁY WHITE	0,25	40	5902201308075
LINEA 3GN 3M ZU	KGLAZ3G3M	3	3	BIAŁY WHITE	0,36	30	5902201308082
LINEA 3GN 5M ZU	KGLAZ3G5M	3	5	BIAŁY WHITE	0,52	30	5902201308099





STANDARD LINE PRZEDŁUŻACZE / EXTENSION CORDS

# LINEA 4-GNIAZDA ZU

LINEA 4-SOCKETS



- przedłużacz do użytku domowego z uziemieniem, na 4 gniazda,
- maksymalne natężenie: 10 A,
- maksymalne obciążenie: 2300 W,
- przewód: H05VV-F 3 x 1 mm,
- typ izolacji: PVC,
- posiada przestronny torów prądowych (zabezpieczenie przed dziećmi),
- pakowany w folię z zawieszką.

- extension cord for home use, with grounding, 4 sockets,
- max. current: 10 A,
- max. load: 2300 W,
- cable: H05VV-F 3 x 1 mm,
- insulation type: PVC,
- with covers for power sockets (child protection),
- packaged in a plastic bag with a hanger.

MODEL	INDEKS	ILOŚĆ GNIAZD	DŁUGOŚĆ PRZEWODU [m]	KOLOR	WAGA NETTO [kg]	PAKOWANIE [szt.]	KOD EAN
MODEL	INDEX	SOCKET QUANTITY	CABLE LENGTH [m]	COLOR	NET WEIGHT [kg]	PACKING [pcs]	BARCODE
LINEA 4GN 1,5M ZU	KGLAZ4G1,5M	4	1,5	BIAŁY WHITE	0,28	40	5902201308105
LINEA 4GN 3M ZU	KGLAZ4G3M	4	3	BIAŁY WHITE	0,39	30	5902201308112
LINEA 4GN 5M ZU	KGLAZ4G5M	4	5	BIAŁY WHITE	0,54	30	5902201308129



STANDARD LINE PRZEDŁUŻACZE / EXTENSION CORDS

# LINEA 5-GNIAZD ZU

LINEA 5-SOCKETS



- przedłużacz do użytku domowego z uziemieniem, na 5 gniazd,
- maksymalne natężenie: 10 A,
- maksymalne obciążenie: 2300 W,
- przewód: H05VV-F 3 x 1 mm,
- typ izolacji: PVC,
- posiada przestronny torów prądowych (zabezpieczenie przed dziećmi),
- pakowany w folię z zawieszką.

- extension cord for home use, with grounding, 5 sockets,
- max. current: 10 A,
- max. load: 2300 W,
- cable: H05VV-F 3 x 1 mm,
- insulation type: PVC,
- with covers for power sockets (child protection),
- packaged in a plastic bag with a hanger.

MODEL	INDEKS	ILOŚĆ GNIAZD	DŁUGOŚĆ PRZEWODU [m]	KOLOR	WAGA NETTO [kg]	PAKOWANIE [szt.]	KOD EAN
MODEL	INDEX	SOCKET QUANTITY	CABLE LENGTH [m]	COLOR	NET WEIGHT [kg]	PACKING [pcs]	BARCODE
LINEA 5GN 1,5M ZU	KGLAZ5G1,5M	5	1,5	BIAŁY WHITE	0,37	40	5902201308136
LINEA 5GN 3M ZU	KGLAZ5G3M	5	3	BIAŁY WHITE	0,51	30	5902201308143
LINEA 5GN 5M ZU	KGLAZ5G5M	5	5	BIAŁY WHITE	0,73	30	5902201308150



STANDARD LINE

PRZEDŁUŻACZE / EXTENSION CORDS

# LINEA 3-GNIAZDA ZU+W

LINEA 3-SOCKETS



- przedłużacz do użytku domowego z uziemieniem i wyłącznikiem, na 3 gniazda,
- maksymalne natężenie: 10 A,
- maksymalne obciążenie: 2300 W,
- przewód: H05VV-F 3 x 1 mm,
- typ izolacji: PVC,
- posiada przestronny torów prądowych (zabezpieczenie przed dziećmi),
- pakowany w folię z zawieszka.

- extension cord for home use, with grounding and switch, 3 sockets,
- max. current: 10 A,
- max. load: 2300 W,
- cable: H05VV-F 3 x 1 mm,
- insulation type: PVC,
- with covers for power sockets (child protection),
- packaged in a plastic bag with a hanger.

MODEL	INDEKS	ILOŚĆ GNIAZD	DŁUGOŚĆ PRZEWODU [m]	KOLOR	WAGA NETTO [kg]	PAKOWANIE [szt.]	KOD EAN
MODEL	INDEX	SOCKET QUANTITY	CABLE LENGTH [m]	COLOR	NET WEIGHT [kg]	PACKING [pcs]	BARCODE
LINEA 3GN 3M ZU+W	KGLAZW3G3M	3	3	BIAŁY WHITE	0,39	30	5902201308167
LINEA 3GN 5M ZU+W	KGLAZW3G5M	3	5	BIAŁY WHITE	0,54	30	5902201308174



STANDARD LINE

PRZEDŁUŻACZE / EXTENSION CORDS

# LINEA 5-GNIAZD ZU+W

LINEA 5-SOCKETS



- przedłużacz do użytku domowego z uziemieniem i wyłącznikiem, na 5 gniazd,
- maksymalne natężenie: 10 A,
- maksymalne obciążenie: 2300 W,
- przewód: H05VV-F 3 x 1 mm,
- typ izolacji: PVC,
- posiada przestronny torów prądowych (zabezpieczenie przed dziećmi),
- pakowany w folię z zawieszka.

- extension cord for home use, with grounding and switch, 5 sockets,
- max. current: 10 A,
- max. load: 2300 W,
- cable: H05VV-F 3 x 1 mm,
- insulation type: PVC,
- with covers for power sockets (child protection),
- packaged in a plastic bag with a hanger.

MODEL	INDEKS	ILOŚĆ GNIAZD	DŁUGOŚĆ PRZEWODU [m]	KOLOR	WAGA NETTO [kg]	PAKOWANIE [szt.]	KOD EAN
MODEL	INDEX	SOCKET QUANTITY	CABLE LENGTH [m]	COLOR	NET WEIGHT [kg]	PACKING [pcs]	BARCODE
LINEA 5GN 3M ZU+W	KGLAZW5G3M	5	3	BIAŁY WHITE	0,53	30	5902201308181
LINEA 5GN 5M ZU+W	KGLAZW5G5M	5	5	BIAŁY WHITE	0,75	30	5902201308198





STANDARD LINE

AKCESORIA DO OPRAW ŚWIETŁÓWKOWYCH / ACCESSORIES FOR T8 FIXTURES

## STARTER DO LED T8

/ LED T8 STARTER

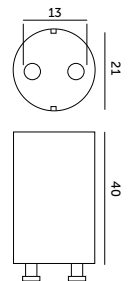

- starter służy do przystosowania opraw z zasilaczem magnetycznym do świetlówek T8 ledowych.

- the starter is used to adapt fixtures with a magnetic ballast for T8 LED tubes.

MODEL	INDEKS	KOLOR	WAGA NETTO [kg]	PAKOWANIE [szt.]	KOD EAN
MODEL	INDEX	COLOR	NET WEIGHT [kg]	PACKING [pcs]	BARCODE
STARTER DO LED T8	KYSLT8	BIAŁY WHITE	0,01	25	5902846018889



STANDARD LINE

AKCESORIA MONTAŻOWE / INSTALLATION ACCESSORIES

# OPRAWKA CERAMICZNA G5.3

/ CERAMIC HOLDER G5.3

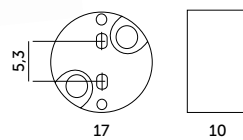

MODEL	INDEKS	RODZAJ TRZONKA	WAGA NETTO [kg]	PAKOWANIE [szt.]	KOD EAN
MODEL	INDEX	TYPE OF HOLDER	NET WEIGHT [kg]	PACKING [pcs]	BARCODE
K001	KXK001	G5.3	0,01	200	5906340210091



STANDARD LINE

AKCESORIA MONTAŻOWE / INSTALLATION ACCESSORIES

# OPRAWKA GZ10

/ GZ10 HOLDER

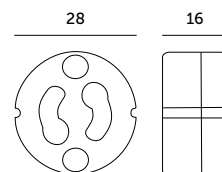

MODEL	INDEKS	WAGA NETTO [kg]	PAKOWANIE [szt.]	KOD EAN
MODEL	INDEX	NET WEIGHT [kg]	PACKING [pcs]	BARCODE
K002	KXK002*	0,02	50	5906340210107

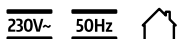

PROFESSIONAL LINE OSPRZĘT LED / LED EQUIPMENT

# ZASILACZ DO PANELU LED 36W

/ DRIVER FOR LED PANEL 36W



- prąd wyjściowy: 900 mA,
- napięcie wejściowe: 220-240V AC (198-264V AC),
- napięcie wyjściowe: 33-40V DC,
- temperatura składowania: -30-80°C,
- kompatybilny z panelami LED CAPRI 36W i LED ORIO 36W.

- output current: 900 mA,
- input voltage: 220-240V AC (198-264V AC),
- output voltage: 33-40V DC,
- storage temperature: -30 to 80°C,
- compatible with LED CAPRI 36W and LED ORIO 36W panels.

MODEL	INDEKS	MAX. MOC [W]	WYMIARY [mm]	WAGA NETTO [kg]	PAKOWANIE [szt.]	KOD EAN
MODEL	INDEX	MAX POWER [W]	SIZE [mm]	NET WEIGHT [kg]	PACKING [pcs]	BARCODE
ZASILACZ DO PANELU LED 36W	KFZP00000001	36	115x41x28	0,10	1	5902201375596

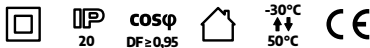

PROFESSIONAL LINE OSPRZĘT LED / LED EQUIPMENT

# ZASILACZ DO PANELU LED 40W

/ DRIVER FOR LED PANEL 40W



- prąd wyjściowy: 1000 mA,
- napięcie wejściowe: 220-240V AC (198-264V AC),
- napięcie wyjściowe: 33-40V DC,
- temperatura składowania: -30-80°C,
- kompatybilny z panelami LED CAPRI 40W, LED NELIO 40W, LED CAMARO 40W i LED ORIO 40W.

- output current: 1000 mA,
- input voltage: 220-240V AC (198-264V AC),
- output voltage: 33-40V DC,
- storage temperature: -30 to 80°C,
- compatible with LED CAPRI 40W, LED NELIO 40W, LED CAMARO 40W and LED ORIO 40W.

MODEL	INDEKS	MAX. MOC [W]	WYMIARY [mm]	WAGA NETTO [kg]	PAKOWANIE [szt.]	KOD EAN
MODEL	INDEX	MAX POWER [W]	SIZE [mm]	NET WEIGHT [kg]	PACKING [pcs]	BARCODE
ZASILACZ DO PANELU LED 40W	KFZP00000002	40	115x41x28	0,10	1	5902201375602

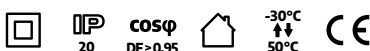



STANDARD LINE

OSPRZĘT LED / LED EQUIPMENT

# ZASILACZ DESK

/ DESK TRANSFORMER



- napięcie wejściowe: 230V,  
- napięcie wyjściowe: 12V,  
- materiał obudowy: tworzywo sztuczne,  
- długość przewodu 12V: minimum 1 m,  
- długość przewodu 230V: minimum 1 m,  
- wtyk DC 2,1 x 5,5.

- input voltage: 230V,  
- output voltage: 12V,  
- housing material: plastic,  
- 12V cable length: min. 1 m,  
- 230V cable length: min.1 m,  
- DC plug: 2,1 x 5,5.

MODEL	INDEKS	NAPIĘCIE [V]	NATĘŻENIE [A]	MAX. MOC [W]	WYMIARY [mm]	WAGA NETTO [kg]	PAKOWANIE [szt.]	KOD EAN
MODEL	INDEX	VOLTAGE [V]	CURRENT [A]	MAX POWER [W]	SIZE [mm]	NET WEIGHT [kg]	PACKING [pcs]	BARCODE
ZASILACZ LED 24W	KYZD24	12	2,0	24	92x52x31	0,16	1	5902201304589
ZASILACZ LED 30W	KYZD30W	12	2,5	30	120x55x33	0,22	1	5902201304190
ZASILACZ LED 36W	KYZD36W	12	3,0	36	115x55x33	0,24	1	5902201304206
ZASILACZ LED 42W	KYZD42W	12	3,5	42	120x55x33	0,24	1	5902201304596
ZASILACZ LED 60W	KYZD60W	12	5,0	60	120x55x33	0,24	1	5902201304220
ZASILACZ LED 72W	KYSDK72W	12	6,0	72	137x62x36	0,33	1	5900605096505
ZASILACZ LED 90W	KYSDK90WDESK	12	7,5	90	137x62x36	0,33	1	5900605096536
ZASILACZ LED 120W	KYSDK120WDES	12	10,0	120	137x62x36	0,36	1	5900605098035



STANDARD LINE

OSPRZĘT LED / LED EQUIPMENT

# ZASILACZ INSTALACYJNY 10W

/ INSTALLATION TRANSFORMER 10W



- napięcie wejściowe: 230V,  
- napięcie wyjściowe: 12V,  
- zabezpieczenia: zwarcioowe, przepięciowe,  
przeciążeniowe.

- input voltage: 230V,  
- output voltage: 12V,  
- protections: short-circuit,  
overvoltage, overload.

MODEL	INDEKS	NAPIĘCIE [V]	NATĘŻENIE [A]	MAX. MOC [W]	WYMIARY [mm]	WAGA NETTO [kg]	PAKOWANIE [szt.]	KOD EAN
MODEL	INDEX	VOLTAGE [V]	CURRENT [A]	MAX POWER [W]	SIZE [mm]	NET WEIGHT [kg]	PACKING [pcs]	BARCODE
ZASILACZ LED 10W IP67	KYZI12V10W	12	0,83	10	58 x 50 x 25	0,11	1	5902479642857



STANDARD LINE OSPRZĘT LED / LED EQUIPMENT

## ZASILACZ INSTALACYJNY 20-60W

/ INSTALLATION TRANSFORMER 20-60W



- napięcie wejściowe: 230V,  
- napięcie wyjściowe: 12V,  
- zabezpieczenia: zwarcziowe, przepięciowe,  
przeciążeniowe.

- input voltage: 230V,  
- output voltage: 12V,  
- protections: short-circuit, overvoltage, overload.

MODEL	INDEKS	NAPIĘCIE [V]	NATĘŻENIE [A]	MAX. MOC [W]	WYMIARY [mm]	WAGA NETTO [kg]	PAKOWANIE [szt.]	KOD EAN
MODEL	INDEX	VOLTAGE [V]	CURRENT [A]	MAX POWER [W]	SIZE [mm]	NET WEIGHT [kg]	PACKING [pcs]	BARCODE
ZASILACZ LED 20W IP67	KYKBS12-1671	12	1,7	20	129x31x21	0,13	1	5900605096420
ZASILACZ LED 30W IP67	KYKBA12-2501	12	2,5	30	134x31x21	0,14	1	5900605093351
ZASILACZ LED 50W IP67	KYCP12050A67	12	4,16	50	189x31x21	0,20	1	5900605096482
ZASILACZ LED 60W IP67	KYZI12V60W	12	5,0	60	228x31x21	0,25	1	5902479642864



STANDARD LINE OSPRZĘT LED / LED EQUIPMENT

## ZASILACZ INSTALACYJNY 80-200W

/ INSTALLATION TRANSFORMER 80-200W



- napięcie wejściowe: 230V,  
- napięcie wyjściowe: 12V,  
- zabezpieczenia: zwarcziowe, przepięciowe,  
przeciążeniowe.

- input voltage: 230V,  
- output voltage: 12V,  
- protections: short-circuit,  
overvoltage, overload.

MODEL	INDEKS	NAPIĘCIE [V]	NATĘŻENIE [A]	MAX. MOC [W]	WYMIARY [mm]	WAGA NETTO [kg]	PAKOWANIE [szt.]	KOD EAN
MODEL	INDEX	VOLTAGE [V]	CURRENT [A]	MAX POWER [W]	SIZE [mm]	NET WEIGHT [kg]	PACKING [pcs]	BARCODE
ZASILACZ LED 80W IP67	KYCP12080A67	12	6,67	80	207x57x18	0,34	1	5900605096512
ZASILACZ LED 100W IP67	KYSDKH100W	12	8,3	100	207x57x18	0,34	1	5900605092408
ZASILACZ LED 120W IP67	KYCP12120A67	12	10,0	120	207x57x18	0,35	1	5900605096383
ZASILACZ LED 150W IP67	KYKBA12-1252	12	12,5	150	224x71x26	0,65	1	5900605093337
ZASILACZ LED 200W IP67	KBA12-1672	12	16,7	200	218x71x26	0,69	1	5900605096413



STANDARD LINE OSPRZĘT LED / LED EQUIPMENT

# ZASILACZ MODUŁOWY 6W

/ MODULE TRANSFORMER 6W



- napięcie wejściowe: 230V,
  - napięcie wyjściowe: 12V,
  - temperatura pracy: -20 do +50°C,
  - temperatura składowania: -40 do +80°C,
  - zabezpieczenia: zwarciowe, przepięciowe, przeciążeniowe.
- input voltage: 230V,
  - output voltage: 12V,
  - operating temperature: -20 to +50°C,
  - storage temperature: -40 to +80°C,
  - protections: short-circuit, overvoltage, overload.

MODEL	INDEKS	NAPIĘCIE [V]	NATĘŻENIE [A]	MAX MOC [W]	WYMIARY [mm]	WAGA NETTO [kg]	PAKOWANIE [szt.]	KOD EAN
MODEL	INDEX	VOLTAGE [V]	CURRENT [A]	MAX POWER [W]	SIZE [mm]	NET WEIGHT [kg]	PACKING [pcs]	BARCODE
ZASILACZ LED 6W	KYSDK6W	12	0,5	6	56x42x22	0,03	1	5900605091838



STANDARD LINE OSPRZĘT LED / LED EQUIPMENT

# ZASILACZ MODUŁOWY 25-350W

/ MODULE TRANSFORMER 25-350W



- napięcie wejściowe: 230V,
  - napięcie wyjściowe: 12V,
  - temperatura pracy: -20 do +50°C,
  - temperatura składowania: -40 do +80°C,
  - zabezpieczenia: zwarciowe, przepięciowe, przeciążeniowe.
- input voltage: 230V,
  - output voltage: 12V,
  - operating temperature: -20 to +50°C,
  - storage temperature: -40 to +80°C,
  - protections: short-circuit, overvoltage, overload.

MODEL	INDEKS	NAPIĘCIE[V]	NATĘŻENIE [A]	MAX MOC [W]	WYMIARY [mm]	WAGA NETTO [kg]	PAKOWANIE [szt.]	KOD EAN
MODEL	INDEX	VOLTAGE [V]	CURRENT [A]	MAX POWER [W]	SIZE [mm]	NET WEIGHT [kg]	PACKING [pcs]	BARCODE
ZASILACZ LED 25W	KYSDK25WMONT	12	2,1	25	86x59x31	0,10	1	5900605099261
ZASILACZ LED 35W	KYSDK35WMONT	12	3,0	35	86x59x31	0,10	1	5900605096574
ZASILACZ LED 60W	KYSDK60WMONT	12	5,0	60	86x59x31	0,10	1	5900605099254
ZASILACZ LED 100W	KYSDK100WMOD	12	8,3	100	111x79x33	0,19	1	5900605096369
ZASILACZ LED 150W	KYSDK150WMON	12	12,5	150	160x99x41	0,37	1	5900605096390
ZASILACZ LED 200W	KYKB116.6A	12	16,6	200	160x99x41	0,45	1	5900605096406
ZASILACZ LED 250W	KYSDK250WMON	12	20,8	250	160x99x41	0,46	1	5900605096437
ZASILACZ LED 350W	KYSDK350WMON	12	29,0	350	200x99x41	0,58	1	5900605096451



STANDARD LINE OSPRZĘT LED / LED EQUIPMENT

# LED STEROWNIK ST06 FP

/ LED CONTROLLER ST06 FP



- sterownik do produktów RGB (komunikacja radiowa),
- umożliwia zmianę kolorów, programów oraz włączanie i wyłączenie oświetlenia RGB,
- posiada 43 programy dynamiczne, 10 poziomów szybkości, 5 poziomów jasności i 30 kolorów statycznych,
- wymiar sterownika: 50 x 15 x 7 mm; wymiar pilota: 87 x 36 x 8 mm.

- controller for RGB products (wireless communication),
- allows for changing colors, programs, and turning RGB lighting on and off,
- features 43 dynamic programs, 10 speed levels, 5 brightness levels, and 30 static colors,
- controller size: 50 x 15 x 7 mm; - remote size: 87 x 36 x 8 mm.

MODEL	INDEKS	NAPIĘCIE [V]	NATĘŻENIE [A]	WAGA NETTO [kg]	PAKOWANIE [szt.]	KOD EAN
MODEL	INDEX	VOLTAGE [V]	CURRENT [A]	NET WEIGHT [kg]	PACKING [pcs]	BARCODE
ST06FP	KYST06FP	5-24DC	3x2	0,03	10	5900605092828

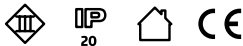

STANDARD LINE OSPRZĘT LED / LED EQUIPMENT

# LED ŚCIEMNIACZ SC02 DP

/ LED DIMMER SC02 DP



- sterownik do jednokolorowych produktów led (komunikacja radiowa),
- umożliwia zmianę jasności, programów oraz włączanie i wyłączenie oświetlenia,
- posiada 10 poziomów jasności, 10 poziomów szybkości i 8 programów dynamicznych,
- wymiar sterownika: 50 x 15 x 7 mm; wymiar pilota: 87 x 36 x 8 mm.

- controller for single-color LED products (wireless communication),
- allows for adjusting brightness, programs, and turning the lights on and off,
- features 10 brightness levels, 10 speed levels, and 8 dynamic programs,
- controller size: 50 x 15 x 7 mm; remote size: 87 x 36 x 8 mm.

MODEL	INDEKS	NAPIĘCIE [V]	NATĘŻENIE [A]	WAGA NETTO [kg]	PAKOWANIE [szt.]	KOD EAN
MODEL	INDEX	VOLTAGE [V]	CURRENT [A]	NET WEIGHT [kg]	PACKING [pcs]	BARCODE
SC02DP	KYSC02DP	5-24DC	6A	0,03	10	5900605092804

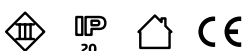

STANDARD LINE OSPRZĘT LED / LED EQUIPMENT

# LED WZMACNIACZ SYGNAŁU ST07 F

/ LED AMPLIFIER ST07 F



- trzykanałowy wzmacniacz sygnału led,
- produkt wymagany wszędzie tam, gdzie zastosowany jest długi odcinek instalacji oświetleniowej (np. Tramo),
- zapobiega spadkowi napięcia na dłuższych odcinkach instalacji oświetleniowej,
- wymiary: 33 x 12 x 5 mm.
- 3-channel led amplifier,
- the product is required wherever a long section of lighting installation is used (eg. Tramo),
- it prevents voltage drop on longer sections of lighting installation,
- size: 33 x 12 x 5 mm.

MODEL	INDEKS	NAPIĘCIE [V]	NATĘŻENIE [A]	WAGA NETTO [kg]	PAKOWANIE [szt.]	KOD EAN
MODEL	INDEX	VOLTAGE [V]	CURRENT [A]	NET WEIGHT [kg]	PACKING [pcs]	BARCODE
ST07F	KYST07F	5-24DC	3X2	0,01	15	5900605092835

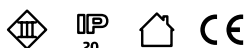

STANDARD LINE AKCESORIA DO LAMP SOLARNYCH / SOLAR LAMP ACCESSORIES

# AKUMULATOR 18650 3,7V 3Ah



- akumulator litowo-jonowy o napięciu 3,7V i pojemności 3Ah,
- dedykowany do oprawy SOLAR LED MHC 5W,
- konfiguracja elektryczna akumulatora: 1S2P,
- energia dostępna z akumulatora: 11,1 Wh.
- li-ion battery of voltage 3,7V and capacity 3Ah,
- deidcated to fixture SOLAR LED MHC 5W,
- electrical configuration of a battery: 1S2P,
- energy obtained from battery: 11,1 Wh.

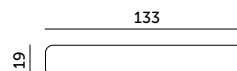

MODEL	INDEKS	KOLOR	WAGA NETTO [kg]	PAKOWANIE [szt.]	KOD EAN
MODEL	INDEX	COLOR	NET WEIGHT [kg]	PACKING [pcs]	BARCODE
AKUMULATOR 18650 3,7V 3Ah	KFN5C5BAT	NIEBIESKI BLUE	0,08	1	5902201302257





STANDARD LINE

AKCESORIA DO LAMP SOLARNYCH / SOLAR LAMP ACCESSORIES

# AKUMULATOR 18650 3,7V 7,2Ah



- akumulator litowo-jonowy o napięciu 3,7V i pojemności 7,2Ah,
- dedykowany do oprawy SOLAR LED MHC 10W i MHCS 10W,
- konfiguracja elektryczna akumulatora: 1S4P,
- energia dostępna z akumulatora: 26,64 Wh.

- li-ion battery of voltage 3,7V and capacity 7,2Ah,
- deidcated to fixture SOLAR LED MHC 10W and MHCS 10W,
- electrical configuration of a battery: 1S4P,
- energy obtained from battery: 26,64 Wh.

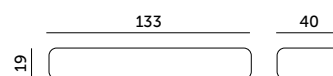

MODEL	INDEKS	KOLOR	WAGA NETTO [kg]	PAKOWANIE [szt.]	KOD EAN
MODEL	INDEX	COLOR	NET WEIGHT [kg]	PACKING [pcs]	BARCODE
AKUMULATOR 18650 3,7V 7,2Ah	KFNCS10BAT	NIEBIESKI BLUE	0,18	1	5902201302264



STANDARD LINE

AKCESORIA DO LAMP SOLARNYCH / SOLAR LAMP ACCESSORIES

# AKUMULATOR 18650 7,4V 5,4Ah

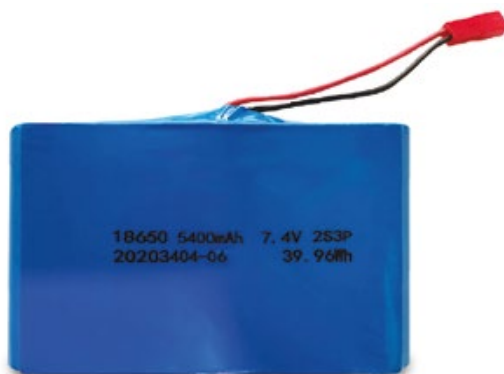

- akumulator litowo-jonowy o napięciu 7,4V i pojemności 5,4Ah,
- dedykowany do oprawy SOLAR LED STREET 15W,
- konfiguracja elektryczna akumulatora: 2S3P,
- energia dostępna z akumulatora: 39,96 Wh.

- li-ion battery of voltage 7,4V and capacity 5,4Ah,
- deidcated to fixture SOLAR LED STREET 15W,
- electrical configuration of a battery: 2S3P,
- energy obtained from battery: 39,96 Wh.

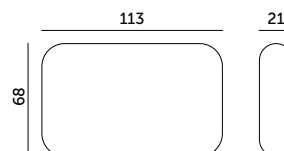

MODEL	INDEKS	KOLOR	WAGA NETTO [kg]	PAKOWANIE [szt.]	KOD EAN
MODEL	INDEX	COLOR	NET WEIGHT [kg]	PACKING [pcs]	BARCODE
AKUMULATOR 18650 7,4V 5,4Ah	KFNSU15BAT	NIEBIESKI BLUE	0,28	1	5902201302271



Zastrzegamy sobie prawo zmian konstrukcyjnych, zmian parametrów technicznych w produktach oświetleniowych zawartych w niniejszym katalogu lub wycofania produktów ze swojej oferty. Wygląd prezentowanego asortymentu może odbiegać od zdjęć i rysunków wskazanych w katalogu. Przedstawiona oferta produktowa ma wyłącznie charakter informacyjny, nie stanowi oferty handlowej w rozumieniu prawa.

We reserve the right to make structural changes or modify the technical parameters of the lighting products presented in this catalogue, as well as to withdraw products from our offer. The appearance of the products may differ from the photos and drawings shown in the catalogue. The product offer presented is for informational purposes only and does not constitute a trade offer in legal terms.



**kobi.pl**