

# MARCLIFF ENGINEERING CO. CATALOGUE

3rd Edition



HVAC  
Products



Brackets &  
Hardware



Plumbing  
Products



Electrical  
Products

41 Cawarra Road, Caringbah, NSW 2229

[WWW.MARCLIFF.COM.AU](http://WWW.MARCLIFF.COM.AU) | 02 9524 9123

# FOREWORD



- .QUALITY**
- .RELIABILITY**
- .DURABILITY**

Marcliff Engineering is the manufacturer of the ARROW and JANLIN product range. We provide a wide variety of pipe supports and general brackets for the building and construction industries.

Marcliff Engineering has been supplying the Australian markets since 1962 and continues to provide products of the highest quality at the shortest response times possible.

Strict control procedures are implemented to ensure high quality and reliability in all our products. With our continuous focus on optimising processing procedures, we endeavour to provide competitively priced and reliable products.

Our friendly sales staff are always ready to answer any queries, or help you with any specific needs.

Here at Marcliff Engineering we assure you of our best service and products and appreciate the support you have given us in the past.

Regards

A handwritten signature in black ink, appearing to read 'D Richardson', with a long horizontal line extending to the right.

.....  
Dale Richardson  
Managing Director

**CATALOGUE  
DISCOUNT  
30%**

# Index



<b>Content</b>	<b>Page</b>
Quick Reference	4 - 5
Pipe Sizing Chart	6
<b><u>Pipe Fasteners</u></b>	
Pipe Fasteners to Suit Copper Pipe	7 - 9
Pipe Fasteners to Suit Electrical Conduit	10 - 11
Pipe Fasteners to Suit PVC Pipe	12 - 14
Pipe Fasteners to Suit BSP Pipe	15 - 16
Stainless Steel Pipe Fasteners	17 - 18
Pipe Fasteners to Suit PVC Pressure Pipe	19
Pipe Fasteners Support Accessories	20
Mechanical & Industrial Services	21 - 39
Anti-Vibration Mounts	40 - 41
Cable Support Systems	42 - 46
Trunking	46
Fasteners & Tools	47 - 51
Consumables & Hose Clamps	52 - 53
<b><u>Pressure Pipe Fittings</u></b>	
Valve & Faucet Adaptor	Cat 2 & 3 54
Reducer Bushing	Cat 5 54
Caps	Cat 6 54
Coupling & Reducer Socket	Cat 7 & 8 55
45 Degree Elbow	Cat 10 55
90 Degree Elbow	Cat 13 & 15 56
Valve & Faucet Socket	Cat 17 & 18 56
Tee & Faucet Tee	Cat 19 & 21 57
Barrel Unions	Cat 22 57
Compression Coupling	58
Ball Valves	58 - 59
Spring Check Valve, PVC Swing Check Valve Slip x Slip and Screwed Bush CAT 24	58
Reducer Faucet Bushing, PVC Hose Barb and Screwed Plug Cat 23	59

# Index



Flanges & Solvent	60
Flanges, Rubber Gaslets, Roof Flashings	61
Pressure Pipe	62
Technical Specifications	63
<b><u>HVAC Supplies</u></b>	
Copper Pipe	64 - 65
Filters	66 - 74
Mflex Insulation	76 - 79
Foil Face Insulation	80
Solar Insulation	81
<b><u>Ventilation</u></b>	
Flexible Duct	82
Diffusers	83 - 84
Multidirectional Outlet	85
Reducing Neck for Multiflo	85
Grilles	85 - 87
Registers	87 - 89
Weatherproof Louvre	90
Fittings	91
Ventilation Products	91
Flow Control	91
Semi Rigid Ducting	91
<b>Izone Information</b>	92
Conditions of Sale	93

# Quick Reference



## Domestic Pipe Fasteners



Strap Hangers  
PVC Pg 12



Stand-Off Bracket  
Cu Pg 8, PVC Pg 12



Stand-Off Tee  
Pg 20



Clips Heads  
Cu Pg 7,  
PVC Pg 12



Twist Strap  
Pg 20



Full Saddles  
Cu Pg 8



Short Saddles  
Pg 13



Stand-Off  
Saddles Pg 13

## Commercial Pipe Fasteners



Pear Bands  
PVC Pg 13,  
BSP Pg 15



Welded Nut Hanger  
Copper Pg 7  
PVC Pg 14



Acoustic Hanger  
Copper Pg 7



Hanging Brackets  
PVC Pg 12



Single Sided  
Saddle  
Pg 10



Offset Hanger  
Pg 20



Blue Strapping  
Page 20

## Industrial Pipe Fasteners



Adjustable  
Hanger Pg 14



Heavy Bolted  
Hanger Pg 15



Welded Nut  
Hanger Cu Pg 7,  
PVC pg 14



Full Saddles  
Pg 16



Stainless Steel  
Clips Heads  
SS Pg 18



Offset Hanger  
Pg 20



Studding M10  
Clip  
Pg 16



Strut Nut  
Pg 14

## Mechanical Services Pipe Fasteners



Slotted Angle  
Pg 22

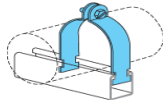

Channel Clips  
Pg 28-29



Cantilever  
Brackets Pg 22



Channel Sections  
Pg 21

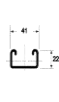

Channel Nuts  
Pg 24



Strut Accessories  
Pgs 21-39

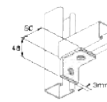

Anti-Vibration  
Mounts  
Pgs 40-41

**NEW**



Cable Trays  
Pg 42-46

## Pressure Pipe Fittings



90° Elbow  
Cat 13 Pg 55



45° Elbow  
Cat 10 Pg 55



Coupling  
Cat 7 Page 55



Caps  
Cat 6 Page 54



Valve Socket  
Cat 17 Pg 56



Barrel Union  
Cat 22 Pg 57



Ball Valve  
Cat 19 Pg 57



Bushing  
Cat 5 Page 54

# Quick Reference



## General Plumbing Supplies



Roof Flashing Pg 61



Rubber Insulation Pg 26



Wall Anchors Pg 50



Threaded Rod Pg 47



General Fasteners Pg 47-51



Tools - Spanners Pg 49



Multi-Way Saddles Pg 17



Purlin Hangers Pg 25

## HVAC Supplies



Cable Ties Pg 52



Copper Pipe Pg 64



Copper Fitting Pg 65



Filters Pg 66-74



FR Pipe Insulation Pg 76-79



Foil Face Insulation Pg 80



Solar Insulation Pg 81

## Ventilation



Flexible Duct Pg 82

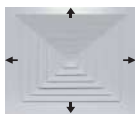

Diffusers Pg 83-84



Multi Directional Outlet Pg 85



Reducing Neck Pg 85



Grilles Pg 85-87



Registers Pg 87-89



Weatherproof Louvre Pg 90



Fittings Pg 90



Ventilation Products Pg 91



Semi Rigid Ducting Pg 91



# Pipe Sizing Chart



Nominal Metric Size (Commonly Known As)	Imperial Size	Actual PVC Pipe O.D Size	Actual Copper Pipe O.D Size	Actual BSP Pipe O.D Size	Actual Electrical Conduit O.D Size	Actual Pressure Pipe O.D Size	HDPE / PPR Pipe
5	3/16"		4.76				
6	1/4"		6.35				
8	5/16"		7.94				
10	3/8"		9.53				
15	1/2"	21.3	12.7	21.4		21.35	
18	5/8"		15.88				
20	3/4"	26.7	19.05	26.9	20	25.75	20
22	7/8"		22.22				
25	1"	33.5	25.4	34.1	25	33.55	25
30	1 1/8"		28.58		27		
32	1 1/4"	36.5	31.75	42.8	32	42.25	32
35	1 3/8"		34.92				
40	1 1/2"	43	38.1	48.4		48.25	40
42	1 5/8"		41.28				
45	1 3/4"		44.45				
50	2"	57.1	50.8	60.3	50	60.35	50
55	2 1/8"		53.97				
65	2 1/2"	69.8	63.5	76.2	63	75.35	63
80	3"	82.5	76.2	88.9	80 (Telc)	88.9	75
90	3 1/2"	90	88.9	101.6	89		90
100	4"	111.1	101.6	114.3	114/100 (Tel)	114.3	110
125	5"	136.5	127	140	140	140.2	
150	6"	161.9	152.4	168.1	160	160.25	
200	8"		203	219		225.3	
225	9"	250	228.6	244		250.35	
250	10"			273			
300	12"	315	303	324		315.45	
350	14"			356			
375	15"	400				400	

# Marcliff Engineering Co. Pty Ltd

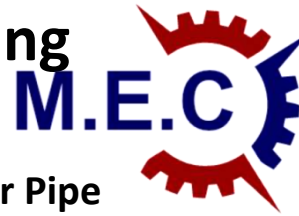

## Pipe Fasteners to Suit Copper Pipe

### Clip Heads

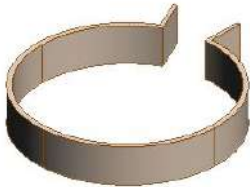

Nominal Size	Imperial Size	Powder Coated		Stainless Steel		Qty Pkt
		Code	\$/each	Code	\$/each	
15	1/2"	CCH050	0.34	CCH050S	3.21	20
18	5/8"	CCH062	2.30	CCH062S	5.41	20
20	3/4"	CCH075	0.36	CCH075S	3.48	20
25	1"	CCH100	0.38	CCH100S	3.70	20
32	1 1/4"	CCH125	0.47	CCH125S	4.04	20
40	1 1/2"	CCH150	0.53	CCH150S	4.06	20
50	2"	CCH200	0.61	CCH200S	4.74	20
65	2 1/2"	CCH250	0.71	CCH250S	11.76	20
80	3"	CCH300	1.02	CCH300S	6.80	20
100	4"	CCH400	1.24	CCH400S	7.48	20
125	5"	CCH500	4.09	CCH500S	11.16	20
150	6"	CCH600	1.70	CCH600S	8.18	20



### Hinged Welded Nut Hanger



Nom. Size	Imp. Size	Acoustic Lined		Qty Pkt
		Code	\$/each	
15	1/2"	CWA050	1.25	100
20	3/4"	CWA075	1.31	100
25	1"	CWA100	1.43	100
28.5	1 1/8"	CWA115	2.32	100
32	1 1/4"	CWA125	1.67	100
40	1 1/2"	CWA150	1.74	100
50	2"	CWA200	1.87	50
57.5	2 1/4"	PWA225	2.61	50
65	2 1/2"	CWA250	2.18	50
72.5	2 3/4"	PWA275	3.07	50
80	3"	CWA300	3.32	25
85	3 1/4"	PWA325	3.49	25
90	3 1/2"	PWA350	5.41	25
100	4"	CWA400	3.16	25
115	4 1/3"	PWA437	2.63	25

### Welded Nut Hanger



Nom. Size	Imp. Size	P/Coated Brown		Stainless Steel		Qty Pkt
		Code	\$/each	Code	\$/each	
15	1/2"			CWH050S	11.76	100
20	3/4"	CWH075	1.54	CWH075S	11.65	100
25	1"	CWH100	1.68	CWH100S	11.77	100
32	1 1/4"	CWH125	1.75	CWH125S	11.82	100
40	1 1/2"	CWH150	1.82	CWH150S	11.91	100
50	2"	CWH200	2.04	CWH200S	12.00	50
65	2 1/2"	CWH250	2.11	CWH250S	12.07	50
80	3"	CWH300	2.36	CWH300S	12.24	25
100	4"	CWH400	3.54	CWH400S	13.65	25
125	5"	CWH500	7.58	CWH500S	23.10	1
150	6"	CWH600	9.22	CWH600S	25.68	1

Ph: 02 9524 9123

Fax: 02 9540 2899

Email: orders@marcliff.com.au

Please note Prices in *Italic* made to order with minimum quantities required  
Please note all prices are GST exclusive

# Marcliff Engineering Co. Pty Ltd



## Pipe Fasteners to Suit Copper Pipe

### Stand-Off Brackets



Nominal Size	Imperial Size	Stainless Steel		Qty Pkt
		Code	\$/Each	
15	1/2"	CSB050S	11.81	1
20	3/4"	CSB075S	10.99	1
25	1"	CSB100S	12.60	1
32	1 1/4"	CSB125S	11.24	1
40	1 1/2"	CSB150S	11.70	1
50	2"	CSB200S	11.48	1
65	2 1/2"	CSB250S	15.52	1
80	3"	CSB300S	12.78	1
100	4"	CSB400S	13.21	1
125	5"	CSB500S	36.23	1
150	6"	CSB600S	30.98	1

### Metric Round U Bolts

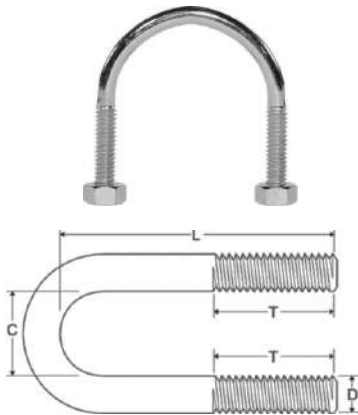

\*Please note that these items are made to order with minimum quantities required

Description	Hot Dip Galvanised		Qty Pkt
	Code	\$/Each	
HDG U-BLT KIT 15NB: M10 x 21	UBOLT021	1.93	50
HDG U-BLT KIT 20NB: M10 x 27	UBOLT027	2.09	50
HDG U-BLT KIT 25NB: M10 x 34	UBOLT034	2.19	50
HDG U-BLT KIT 32NB: M10 x 43	UBOLT043	2.39	50
HDG U-BLT KIT 40NB: M10 x 48	UBOLT048	2.49	50
HDG U-BLT KIT 40NB: M10 x 51	UBOLT051	2.59	50
HDG U-BLT KIT 50NB: M10 x 60	UBOLT060	2.79	50
HDG U-BLT KIT 65NB: M12 x 76	UBOLT076	4.18	25
HDG U-BLT KIT 80NB: M12 x 89	UBOLT089	4.58	25
HDG U-BLT KIT 90NB: M12 x 102	UBOLT102	5.77	25
HDG U-BLT KIT 100NB: M12 x 114	UBOLT115	6.27	10
HDG U-BLT KIT 125NB: M12 x 140	UBOLT140	6.88	10
HDG U-BLT KIT 150NB: M12 x 165	UBOLT165	7.25	10
HDG U-BLT KIT 150NB: M12 x 168	UBOLT168	7.86	10
HDG U-BLT KIT 200NB: M16 x 219	UBOLT219	15.72	10
HDG U-BLT KIT 250NB: M20 x 273	UBOLT273	39.69	10
HDG U-BLT KIT 300NB: M20 x 324	UBOLT324	41.76	1
HDG U-BLT KIT 350NB: M20 x 356	UBOLT356	47.90	1
HDG U-BLT KIT 400NB: M20 x 406	UBOLT406	51.59	1
HDG U-BLT KIT 450NB: M24 x 457	UBOLT457	71.24	1
HDG U-BLT KIT 500NB: M24 x 508	UBOLT508	81.07	1
HDG U-BLT KIT 600NB: M24 X 610	UBOLT610	88.44	1

### Plated Saddles



Nom. Size	Imp. Size	Zinc Plated		Black Zinc		Qty Pkt
		Code	\$/100	Code	\$/Each	
10	3/8"	ZPS037	17.53			100
15	1/2"	ZPS050	15.21	BS050	39.95	100
18	5/8"	ZPS062	11.70			100
20	3/4"	ZPS075	22.26	BS075	32.46	100
22	7/8"	ZPS087	42.20			100
25	1"	ZPS100	19.20	BS100	55.61	100
32	1 1/4"	ZPS125	37.50			20
40	1 1/2"	ZPS150	48.00			20
50	2"	ZPS200	75.00			20

Ph: 02 9524 9123

Fax: 02 9540 2899

Email: orders@marcliff.com.au

Please note all prices are GST exclusive

# Marcliff Engineering Co. Pty Ltd



## Pipe Fasteners to Suit Copper Pipe

### Coated Saddles



Nom. Size	Imp. Size	Galvanised Code	Powder Coated		Hot Dip Gal		Qty Pkt	
			\$/100	Code	Code	\$/100		
6	1/4"			PCS025	17.92		100	
8	5/16"			PCS031	23.04		100	
10	3/8"			PCS037	15.36		100	
15	1/2"	ZPS050	15.21	PCS050	9.78	GS050	18.92	200
18	5/8"			PCS062	10.57	GS062	26.71	200
20	3/4"			PCS075	12.23	GS075	18.15	200
25	1"			PCS100	17.98	GS100	23.10	200
32	1 1/4"	ZPS075	22.26	PCS125	35.71	GS125	70.12	20
40	1 1/2"			PCS150	42.90	GS150	54.45	20
50	2"	ZPS200	75.00	PCS200	45.71	GS200	74.25	20
65	2 1/2"			PCS250	386.98	GS250	156.60	20

### Copper Saddles

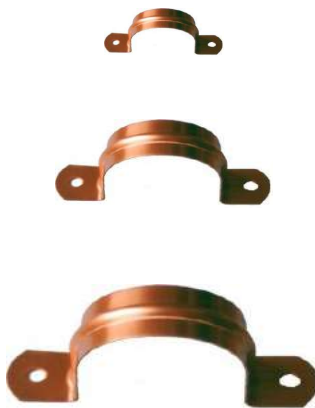

*\*Please note that these items  
are made to order with  
minimum quantities required*

Nom. Size	Imp. Size	Light Pattern		Heavy Pattern		Qty Pkt
		Code	\$/100	Code	\$/100	
6	1/4"	CSL025	20.45			100
8	5/16"	CSL031	25.60			100
10	3/8"	CSL037	25.71			100
15	1/2"	CSL050	25.24	CSH050	36.23	100
18	5/8"	CSL062	32.15	CSH062	42.93	100
20	3/4"	CSL075	34.59	CSH075	50.25	100
22	7/8"			CSH087	102.03	100
25	1"	CSL100	70.79	CSH100	92.86	100
32	1 1/4"			CSH125	132.06	20
40	1 1/2"			CSH150	196.33	20
50	2"			CSH200	244.25	20
65	2 1/2"			CSH250	854.28	1
80	3"			CSH300	976.99	1
100	4"			CSH400	1112.55	1
125	5"			CSH500	2369.72	1
150	6"			CSH600	2286.62	1

### Single Sided Saddles



Nom. Size	Imp. Size	Zinc Plated		Qty Pkt
		Code	\$/100	
5	3/16"	ZPC018	43.27	100
6	1/4"	ZPC025	43.52	100
8	5/16"	ZPC031	43.52	100
10	3/8"	ZPC037	28.94	100
15	1/2"	CON013	16.36	100
18	5/8"	CON016	14.63	100
20	3/4"	CON020	13.50	100
25	1"	CON025	16.88	100
32	1 1/4"	CON032	30.00	100
40	1 1/2"	CON040	42.00	100
50	2"	CON050	78.00	100

# Marcliff Engineering Co. Pty Ltd



## Pipe Fasteners to Suit Electrical Conduit

### Half Saddles - Single Sided

#### Heavy Pattern



Nom. Size	Descriptions	Zinc Plated		Hot Dipped Gal.		Stainless Steel		Qty Pkt
		Heavy Pattern		Code	\$/100	Code	\$/100	
		Code	\$/100					
5	Zinc Plated 5m hole	ZPC018	43.27					100
6	Zinc Plated 5m hole	ZPC025	43.52					100
8	Zinc Plated 5 m hole	ZPC031	43.52					100
10	Zinc Plated 5 m hole	ZPC037	28.94					100
13	Zinc Plated 6m hole	CON013	16.36			CON013S	94.50	100
16	Zinc Plated 6m hole	CON016	14.63			CON016S	101.25	100
20	Zinc Plated 6m hole	CON020	13.50	CON020G	28.80	CON020S	96.00	100
25	Zinc Plated 6m hole	CON025	16.88	CON025G	38.40	CON025S	121.50	100
32	Zinc Plated 6m hole	CON032	30.00	CON032G	56.40	CON032S	168.75	50
40	Zinc Plated 6m hole	CON040	42.00	CON040G	87.98	CON040S	209.25	50
50	Zinc Plated 6m hole	CON050	78.00	CON050G	121.13	CON050S	263.25	50

### Full Saddles



Nominal Size	Galvanised		Hot Dipped Gal.		Stainless Steel		Qty Pkt
	Code	\$/100	Code	\$/100	Code	\$/each	
6mm Cabling	ZPS025	11.69					100
8mm Cabling	ZPS031	15.82					100
10mm Cabling	ZPS037	17.53					100
13 Standard Conduit	ZPS050	15.21	GS050	18.92	SSS050	0.79	100
16 Standard Conduit	ZPS062	11.70	GS062	26.71	SSS062	1.28	100
20 Standard Conduit	ZPS075	22.26	GS075	18.15	SSS075	0.70	100
25 Standard Conduit	ZPS100	19.20	GS100	23.10	SSS100	0.88	100
20mm (27 OD) Telstra Conduit	GVS106	15.73	GS106	21.04	GS106S	1.59	100
32 Standard Conduit	ZPS125	37.50	GS125	70.12	SSS125	1.36	50
40 Standard Conduit	ZPS160	50.93	GS150	54.45	SSS150	2.22	50
32mm (43 OD) Telestra Conduit	GVS168	51.59	GS168	54.15	GS168S	2.64	50
50 Standard Conduit	ZPS200	75.00	GS200	<i>74.25</i>	SSS200	2.51	50
50mm (60 OD) Telstra Conduit	GVS237	65.76	GS237	71.29	GS237S	3.82	50
65mm (63 OD) Standard Conduit	ZPS250	103.95	GS250	<i>156.60</i>	SSS250	13.24	1
65mm (75 OD) Austel Conduit			GS315	373.97	GS315S	12.52	1
80mm (89 OD) Standard Conduit			GS350	399.68	GS350S	13.30	1
100mm (114 OD) Standard Conduit			GS450	515.37	GS450S	16.55	1
125mm (140 OD) Standard Conduit			GS550	<i>864.80</i>	GS550S	18.16	1
150mm (160 OD) Standard Conduit			GS600H	1,925.51	SSS600	POA	1

\*Please note Prices in *Italic* made to order with minimum quantities required

For more information visit: [www.meclec.net.au](http://www.meclec.net.au)

# Marcliff Engineering Co. Pty Ltd



## Pipe Fasteners to Suit Electrical Conduit

### Full Saddles



Description	Zinc Plated Heavy Pattern		Qty Pkt
	Code	\$/100	
12mm Full Zinc Conduit Saddle	ZCS050	12.07	100
16mm Full Zinc Conduit Saddle	ZCS062	11.69	100
20mm Full Zinc Conduit Saddle	ZCS085	22.26	100
25mm Full Zinc Conduit Saddle	ZCS100	30.21	100
32mm Full Zinc Conduit Saddle	ZCS125	40.90	50
40mm Full Zinc Conduit Saddle	ZCS160	53.76	50
50mm Full Zinc Conduit Saddle	ZCS200	60.77	20

### Plastic Full Saddles



### Plastic Stand-Off Clip Locks

Code	Plastic Saddle		Qty Pkt
	Code	\$/100	
PCON20		25.71	100
PCON25		34.29	100

### Girder Clips



Description	PVC Clip Lock		Qty Pkt
	Code	\$/100	
Girder Clip to Suit 8-13mm	EGC813	22.20	100
Girder Clip to Suit 16-20mm	EGC1620	28.29	100
Girder Clip to Suit 25-32mm	EGC2532	34.11	100

*\*Please note that these items are made to order with minimum quantities required*

For more information visit: [www.mecelc.net.au](http://www.mecelc.net.au)

# Marcliff Engineering Co. Pty Ltd



## Pipe Fasteners to Suit DWV & SWV PVC Pipe

### Clip Heads



Nominal Size	Imperial Size	Powder Coated	Stainless Steel		Qty Pkt	
		Code	\$/each	Code		\$/each
40	1 1/2"	PMC175	0.88	PMC175S	3.49	20
50	2"	PMC225	0.68	PMC225S	2.58	20
65	2 1/2"	PMC275	1.20	PMC275S	3.48	20
80	3"	PMC325	1.58			20
90	3 1/2"	PMC350	0.88	PMC350S	2.85	20
100	4"	PMC437	0.90	PMC437S	3.59	20
150	6"	PMC637	1.85	PMC637S	10.17	20

### Strap Hangers - 300mm Tails



Nominal Size	Imperial Size	Powder Coated	Stainless Steel		Qty Pkt	
		Code	\$/each	Code		\$/each
32	1 1/4"	PSH150	4.56	PSH150S	8.85	1
40	1 1/2"	PSH175	2.08	PSH175S	6.75	1
50	2"	PSH225	1.97	PSH225S	7.12	1
65	2 1/2"	PSH275	2.39	PSH275S	8.20	1
80	3"	PSH325	2.86	PSH325S	9.29	1
90	3 1/2"	PSH350	3.17	PSH350S	9.44	1
100	4"	PSH437	2.28	PSH437S	9.63	1

### Hanging Brackets - 450mm Tails

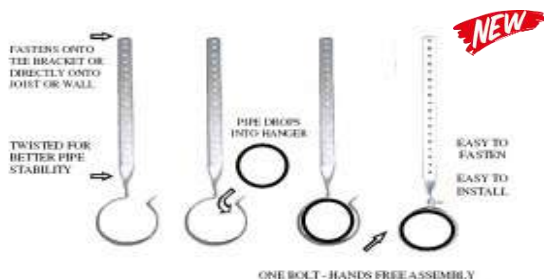

Nominal Size	Imperial Size	Galvanised	Stainless Steel		Qty Pkt	
		Code	\$/each	Code		\$/each
40	1 1/2"	PHB175	1.87	PHB175S	<i>8.40</i>	1
50	2"	PHB225	1.95	PHB225S	<i>8.40</i>	1
65	2 1/2"	PHB275	2.04	PHB275S	<i>9.25</i>	1
80	3"	PHB325	3.25	PHB325S	<i>10.11</i>	1
90	3 1/2"	PHB350	4.58	PHB350S	<i>10.40</i>	1
100	4"	PHB437	2.15	PHB437S	<i>10.05</i>	1

\*Please note Prices in *Italic* made to order with minimum quantities required

### Stand-Off Brackets

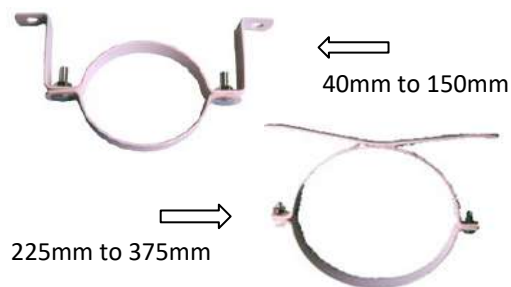

Nom. Qty	Imp. Size	Powder Coated	Stainless Steel		Qty Pkt	
		Code	\$/each	Code		\$/each
40	1 1/2"			PSB175S	10.08	1
50	2"	PSB225	3.82	PSB225S	9.76	1
65	2 1/2"			PSB275S	10.83	1
80	3"			PSB325S	11.29	1
100	4"	PSB437	2.63	PSB437S	9.98	1
150	6"	PSB637	5.65	PSB637S	21.73	1
225	9"	PSB985	27.61	PSB985S	<i>102.65</i>	1
300	12"	PSB1240	41.48	PSB1240S	<i>92.90</i>	1
375	15"	PSB1475	57.78	PSB1575S	<i>111.83</i>	1

\*Please note Prices in *Italic* made to order with minimum quantities required

# Marcliff Engineering Co. Pty Ltd



## Pipe Fasteners to Suit DWV & SWV PVC Pipe

### Saddles



Nom. Size	Imp. Size	Powder Coated		Stainless Steel		Qty Pkt
		Code	\$/each	Code	\$/each	
150	6"	PVS637	4.20	SSS637	21.39	1
225	9"	PVS985	17.27	SSS986	57.64	1
300	12"	PVS1275	28.97	SSS1240	90.98	1
375	15"	PVS1575	37.64	SSS1575	112.93	1

### Short Saddles for DWV Pipe



Nom. Size	Imp. Size	Powder Coated		Stainless Steel		Qty Pkt
		Code	\$/100	Code	\$/each	
40	1 1/2"	PS175	44.83	PS175S	1.20	100
50	2"	PS225	47.19	PS225S	1.43	100
65	2 1/2"	PS275	73.07			100
80	3"	PS325	71.94			100
90	3 1/2"	PS350	73.07	PS350S	2.59	50
90	3 1/2"	PS350H	231.12	HEAVY		50
100	4"	PS437	82.76	PS437S	2.57	50

### Stand-Off Saddles For DWV Pipe



Nom. Size	Imp. Size	Powder Coated		Stainless Steel		Qty Pkt
		Code	\$/100	Code	\$/each	
40	1 1/2"	PSS175	48.69	PSS175S	1.33	100
50	2"	PSS225	47.88	PSS225S	1.62	100
65	2 1/2"	PSS275	86.22			100
80	3"	PSS325	104.01			100
90	3 1/2"	PSS350	91.94	PSS350S	2.68	100
90	3 1/2"	PSS350H	225.83	HEAVY		50
100	4"	PSS437	115.59	PSS437S	4.37	50

### Pear Shaped Hangers



Nom. Size	Imp. Size	Galvanised		Powder Coated		Stainless Steel		Qty Pkt
		Code	\$/each	Code	\$/each	Code	\$/each	
25	1"	FBPH134V	0.57					100
32	1 1/4"	FBPH168V	0.65					100
40	1 1/2"	FBPH190V	0.69					100
50	2"	FBPH237V	0.93	PPH225	3.12	PPH225S	13.02	100
65	2 1/2"	FBPH300V	1.29					60
80	3"	FBPH350V	1.67					60
100	4"	FBPH450V	2.04	PPH437	2.24	PPH437S	10.47	60
150	6"	FBPH650V	3.75	PPH637	3.94	PPH637S	22.82	25
225	9"	FBPH862V	17.53	PPH985	20.12	PPH985S	73.26	1
300	12"			PPH1240	32.01	PPH1240S	117.11	1
375	15"			PPH1475	38.75	PPH1575S	135.98	1

### Acoustic Nut Hangers



Nom. Size	Rubber Lined		Qty Pkt
	Code	\$/each	
40	PWA175	1.82	100
50	PWA225	2.61	100
65	PWA275	3.07	50
80	PWA325	3.49	50
100	PWA437	2.63	50
150	PWA637	3.61	50

Ph: 02 9524 9123

Fax: 02 9540 2899

Email: orders@marcliff.com.au

New Stock

Old Stock

Please note all prices are GST exclusive

# Marcliff Engineering Co. Pty Ltd

## Pipe Fasteners to Suit PVC Pipe



### Adjustable Hangers



Nom. Size	Imp. Size	Powder Coated		Stainless Steel		Galvanised		Qty Pkt
		Code	\$/each	Code	\$/each	Code	\$/each	
100	4"	PAH437	1.58					1
150	6"	PAH637	2.86					1
225	9"	PAH985	23.79	PAH985S	115.77	PAH985G	40.91	1
300	12"	PAH1240	43.80	PAH1240S	139.28			1
375	15"	PAH1575	51.11					1

### Nut Clamps For PVC Pipes



Powder Coated  
Code - PWH



Stainless Steel



\*\*PWH225S, PWH437S &  
PWH637S -  
Stainless & Rubber lines\*\*

Nom. Size	Imp. Size	Powder Coated (PC)		Stainless Steel (SS)		Qty Pkt
		Code	\$/each	Code	\$/each	
40	1 1/2"	PWH175	1.77	PWH175S	<i>17.01</i>	100
50	2"	PWH225	2.20	PWH225S*	<i>6.90</i>	100
65	2 1/2"	PWH275	2.18	PWH275S	<i>14.58</i>	25
80	3"	PWH325	2.32	PWH325S	<i>15.12</i>	25
90	3 1/2"			PWH350S	<i>19.95</i>	25
100	4"	PWH437	3.41	PWH437S*	<i>7.90</i>	25
150	6"	PWH637	4.16	PWH637S*	<i>9.90</i>	25

\*Please note Prices in *Italic* made to order with minimum quantities required

### Strut Nut (M10 Thread)



Nom. Size	Code	\$/each	Qty Pkt
12-16	PRPE012	2.14	10
17-20	PRPE017	2.14	10
21-24	PRPE021	2.71	10
25-29	PRPE025	2.71	10
30-34	PRPE030	2.14	10
35-40	PRPE035	2.99	10
40-44	PRPE040	3.09	10
48-54	PRPE048	3.32	10
56-93	PRPE056	3.94	10
66-76	PRPE066	4.13	10
79-93	PRPE079	7.98	10
101-115	PRPE101	11.02	10
Spacer snap	PRPEOSPC	1.28	10
Strut nut	PRPEOSTNUT	1.14	10

**NEW**



The Strut Nut can either be snapped into a strut, or threaded onto a rod, without the use of extra hardware or tools. The pipe is simply snapped into the hanger and locked in place using the snug-fit size- adjusting lock arm.

# Marcliff Engineering

## Co. Pty Ltd

### Pipe Fasteners to Suit Steel Pipe (BSP)



#### Heavy Duty Bolted Hangers



Nom. Size	Imp. Size	Hot Dipped Gal.		Qty Pkt
		Code	\$/each	
15	1/2"	HBH084G	4.71	1
20	3/4"	HBH106G	4.93	1
25	1"	HBH134G	5.42	1
32	1 1/4"	HBH168G	5.82	1
40	1 1/2"	HBH190G	8.50	1
50	2"	HBH237G	8.66	1
65	2 1/2"	HBH300G	11.05	1
80	3"	HBH350G	10.54	1
90	3 1/2"	HBH375G	12.82	1
100	4"	HBH450G	13.87	1
125	5"	HBH550G	21.68	1
150	6"	HBH650G	21.88	1
200	8"	HBH862G	54.95	1
225	9"	HBH985G	60.28	1
250	10"	HBH1075G	60.54	1
300	12"	HBH1275G	65.20	1

#### Pear Shaped Hangers



Nom. Size	Imp. Size	Galvanised		8mm Hole		Qty Pkt
		Code	\$/each	Code	\$/each	
25	1"	FBPH134V	0.57			100
32	1 1/4"	FBPH168V	0.65			100
40	1 1/2"	FBPH190V	0.69	FBPH190X	1.04	100
50	2"	FBPH237V	0.93	FBPH237X	1.40	100
65	2 1/2"	FBPH300V	1.29			60
80	3"	FBPH350V	1.67			60
100	4"	FBPH450V	2.04			50
150	6"	FBPH650V	3.75			1
200	8"	FBPH862V	17.53			1

# Marcliff Engineering Co. Pty Ltd

## Pipe Fasteners to Suit Steel Pipe (BSP)



### Saddles



*\*Please note any Nom Size greater than 40 has a thickness of 3mm instead of a 1mm thickness*

Nom. Size	Imp. Size	Galvanised		Hot Dipped Gal.		Stainless Steel		Qty Pkt
		Code	\$/each	Code	\$/each	Code	\$/each	
15	1/2"	GVS084	0.16	GS084H	1.39	GS084S	1.44	100
20	3/4"	GVS106	0.16	GS106H	1.42	GS106S	1.59	100
25	1"	GVS134	0.21	GS134H	1.81	GS134S	1.94	100
32	1 1/4"	GVS168	0.52	GS168H	2.04	GS168S	2.64	50
40	1 1/2"	GVS190	0.55	GS190H	6.23	GS190S	3.31	50
50	2"	GVS237	0.66	GS237	0.71	GS237S	3.82	50
50	2"	HEAVY VERSION		GS280	2.76			1
65	2 1/2"			GS315	3.74	GS315S	12.52	1
80	3"			GS350	4.00	GS350S	13.30	1
100	4"			GS450	5.15	GS450S	16.55	1
125	5"			GS550	8.65	GS550S	18.16	1
150	6"			GS650	6.43	GS650S	18.16	1
200	8"			GS800	21.85			1
225	9"			GS862	23.97	GS862S	61.40	1
250	10"			GS1075	29.27	GS1075S	58.72	1
300	12"			GS1275	40.06	GS1275S	86.89	1
350	14"			GS1400	44.14	GS1400S	115.08	1

### Saddles (Heavy - 40 x 5 | 50 x 6)



Saddle Heavy

Nom. Size	Imp. Size	Hot Dipped Gal.		Qty Pkt
		Code	\$/each	
100	4"	GS450H	14.61	1
125	5"	GS600H	19.26	1
150	6"	GS650H	15.77	1
200	8"	GS862	23.97	1

### STUDDING M10 CLIP



Nom. Size	Code	\$/each	Qty Pkt
10	PRPS038	2.13	10
15	PRPS058	2.17	10
20	PRPS034	2.20	10
22	PRPS078	2.37	10
20-24	PRPS080	1.73	10
25	PRPS1	2.37	10
25-28	PRPS120	1.80	10
28	PRPS118	1.88	10
32	PRPS114	2.62	10
35	PRPS138	2.70	10
38	PRPS112	2.82	10
42	PRPS158	2.98	10
51	PRPS2	3.39	10
54	PRPS218	3.60	10



# Marcliff Engineering

## Co. Pty Ltd

### Stainless Steel Pipe Fasteners



#### Multi-Way Saddles



Stainless Steel 304 Grade		Price	Qty
Size	Code	\$/100	Pkt
6.4mm x 1 Way	MCS025-1S	35.28	100
8mm x 1 Way	MCS031-1S	47.91	100
8mm x 2 Way	MCS031-2S	69.08	100
8mm x 3 Way	MCS031-3S	70.02	100
8mm x 4 Way	MCS031-4S	70.91	100
10mm x 1 Way	MCS039-1S	39.73	100
10mm x 2 Way	MCS039-2S	67.78	100
10mm x 3 Way	MCS039-3S	81.81	100
10mm x 4 Way	MCS039-4S	86.48	100
12.7mm x 1 Way	MCS050-1S	51.42	100
12.7mm x 2 Way	MCS050-2S	79.47	100
12.7mm x 3 Way	MCS050-3S	87.65	100
12.7mm x 4 Way	MCS050-4S	92.32	100
14.3mm x 1 Way	MCS062-1S	68.95	100
14.3mm x 2 Way	MCS062-2S	85.31	100
14.3mm x 3 Way	MCS062-3S	97.37	100
14.3mm x 4 Way	MCS062-4S	103.82	100
17.5mm x 1 Way	MCS069-1S	116.87	100

#### Stainless Steel Saddles



Nom. Size	Imp. Size	For PVC Pipe		For Copper Pipe		For Suit Steel Pipe		Qty Pkt
		Code	\$/each	Code	\$/each	Code	\$/each	
6	1/4"			SSS025	0.78			100
8	5/16"			SSS031	0.98			100
10	3/8"			SSS037	0.85			100
15	1/2"			SSS050	0.79	GS084S	1.44	100
18	5/8"			SSS062	1.28			100
20	3/4"			SSS075	0.70	GS106S	1.59	100
25	1"			SSS100	0.88	GS134S	1.94	100
32	1 1/4"			SSS125	1.36	GS168S	2.64	20
40	1 1/2"			SSS150	2.22	GS190S	3.31	20
50	2"	SSS225	5.42	SSS200	2.51	GS237S	3.82	20
65	2 1/2"	SSS275	6.04	SSS250	13.24			1
80	3"	SSS325	7.10	SSS300	11.87			1
100	4"	SSS437	8.63	SSS400	11.05			1
150	6"	SSS637	21.39					1
225	9"	SSS986	57.64					1

# Marcliff Engineering Co. Pty Ltd

## Stainless Steel Pipe Fasteners



### Stand-Off Tees

Nom. Size	Stainless Steel		Qty Pkt
	Code	\$/each	
25 x 1	SOTS	4.64	1



### DWV & SWV Short Saddles

Nom. Size	Imp. Size	For PVC Pipe		Qty Pkt
		Code	\$/each	
40	1 1/2"	PS175S	1.20	100
50	2"	PS225S	1.43	100
65	2 1/2"	PS275S	2.98	50
80	3"	PS325S	2.98	50
90	3 1/2"	PS350S	2.59	50
100	4"	PS437S	2.57	50

### DWV & SWV Stand-Off Saddles



Nom. Size	Imp. Size	For PVC Pipe		Qty Pkt
		Code	\$/each	
40	1 1/2"	PSS175S	1.33	100
50	2"	PSS225S	1.62	100
90	3 1/2"	PSS350S	2.68	50
100	4"	PSS437S	4.37	50

### Stainless Steel Clip Heads



Nom. Size	Imp. Size	For PVC Pipe		For Cu Pipe		For Pressure Pipe		Qty Pkt
		Code	\$/each	Code	\$/each	Code	\$/each	
15	1/2"			CCH050S	3.21	PCH084S	5.73	20
18	5/8"			CCH062S	5.41			20
20	3/4"			CCH075S	3.48	PCH106S	3.23	20
25	1"			CCH100S	3.70	PCH134S	4.42	20
32	1 1/4"			CCH125S	4.04	PCH168S	6.13	20
40	1 1/2"	PMC175S	3.49	CCH150S	4.06	PCH190S	4.51	20
50	2"	PMC225S	2.58	CCH200S	4.74	PCH237S	4.74	20
65	2 1/2"	PMC275S	3.48	CCH250S	11.76			20
80	3"	PMC325S	3.74	CCH300S	6.80			20
90	3 1/2"	PMC350S	2.85					20
100	4"	PMC437S	3.59	CCH400S	7.48			20
150	6"	PMC637S	10.17	CCH600S	8.18			20

\*Please note Prices in *Italic* made to order with minimum quantities required

### Stand-Off Brackets



25mm to 150mm  
225mm to 375mm

Nom. Size	Imp. Size	For PVC Pipe		For Cu Pipe		Qty Pkt
		Code	\$/each	Code	\$/each	
15	1/2"			CSB050S	11.81	1
20	3/4"			CSB075S	10.99	1
25	1"	PSB132S	12.53	CSB100S	12.60	1
32	1 1/4"	PSB150S	10.68	CSB125S	11.24	1
40	1 1/2"	PSB175S	10.08	CSB150S	11.70	1
50	2"	PSB225S	9.76	CSB200S	11.48	1
65	2 1/2"	PSB275S	10.83	CSB250S	15.52	1
80	3"	PSB325S	11.29	CSB300S	12.78	1
100	4"	PSB437S	9.98	CSB400S	13.21	1
150	6"	PSB637S	21.73	CSB600S	30.98	1
225	9"	PSB985S	102.65			1
300	12"	PSB1240S	92.90			1
375	15"	PSB1575S	111.83			1

# Marcliff Engineering Co. Pty Ltd



## Pipe Fasteners to Suit PVC Pressure Pipe

### Pressure Pipe Full Saddles



Nom. Size	Galvanised		Powder Coated		Qty Pkt
	Code	\$/each	Code	\$/each	
15	GVS084	0.16	PPS084	0.41	100
20	GVS106	0.16	PPS106	0.42	100
25	GVS134	0.21	PPS134	0.46	100
32	GVS168	0.52	PPS168	0.72	20
40	GVS190	0.55	PPS190	0.78	20
40	Black		PPS190B	1.10	20
50	GVS237	0.66	PPS237	1.01	20
40	Black		PPS237B	1.17	20

### Pressure Pipe Stand-Off Brackets



Nom. Size	Powder Coated		Stainless Steel		Qty Pkt
	Code	\$/each	Code	\$/each	
15	PPSB075	3.56	PPSB084S	10.31	1
20	PPSB100	3.79	PPSB106S	9.94	1
25	PPSB125	3.45	PPSB134S	10.70	1

### Steel Pipe & Pressure Pipe Clip Heads



Nom. Size	Powder Coated		Qty Pkt
	Code	\$/each	
15	PCH084	2.91	20
20	PCH106	1.55	20
25	PCH134	1.57	20
40	PCH190	1.92	20
50	PCH237	2.00	20
65	PCH300	4.39	20
80	PCH350	4.64	20

### Pressure Pipe Half Saddles



Nom. Size	Zinc Plated	Hot Dipped Galvanised		Qty Pkt	
	Code	\$/each	Code		\$/each
13	CON013	0.16	CON013G	0.36	100
15	CON020	0.14	CON020G	0.29	100
20	CON025	0.17	CON025G	0.38	100
25	CON032	0.30	CON032G	0.56	100
32	CON040	0.42	CON040G	0.88	100
50	CON050	0.78	CON050G	1.21	100

### Pressure Pipe Welded Nut Clips



Nom. Size	Zinc Plated		Qty Pkt
	Code	\$/each	
65	BWH300	2.77	1
80	BWH350	3.12	1
100	BWH450	3.77	1
125	BWH550	11.59	1
150	BWH650	11.04	1

*\*Please note Prices in Italic made to order with minimum quantities required*

# Marcliff Engineering Co. Pty Ltd



## Pipe Fasteners Support Accessories

### Stand-Off Tees



Stainless Steel		Galvanised		Qty Pkt
Code	\$/each	Code	\$/each	
SOTS	4.64	SOTG	0.47	100

### Adjustable Tees



Galvanised		Qty Pkt
Code	\$/each	
SOTA	0.57	100

### Offset Hangers

25mm x 3mm



Galvanised		Stainless Steel		Hot Dipped Gal		Qty Pkt
Code	\$/each	Code	\$/each	Code	\$/each	
OHL25	1.07	OHL25S	7.22	OHL25G	2.38	1
		OHL40S	12.92			1



Code	Finish	\$/each	Qty Pkt
OHLM10	HDG	1.57	1
OHLM12	HDG	5.56	1
OHLM16	HDG	7.97	1
OHLM20	HDG	20.50	1

### Twist Straps



\*Also available M10 Offset Hanger

Nom. Size	Imp. Size	Galvanised		Stainless Steel		Qty Pkt
		Code	\$/each	Code	\$/each	
300	12	TS300	0.68	TS300S	8.28	50
450	18	TS450	2.66	TS450S	13.93	50
600	24	TS600	3.07	TS600S	12.19	50

### Twist Clip



Nom. Size	Code	Finish	\$/each	Qty Pkt
25	TWIST134	Pregal	1.45	1
32	TWIST168	Pregal	1.59	1
40	TWIST200	Pregal	1.70	1
50	TWIST237	Pregal	1.90	1
65	TWIST300	Pregal	2.04	1
80	TWIST350	Pregal	2.18	1

### Steel Strapping



Size	Galvanised		Stainless Steel		Qty Pkt
	Code	\$/each	Code	\$/each	
23x0.4x15m	FS415M	12.36			1
25x0.7x15m	FS715M	22.06	FS715S	139.74	1

\*Please note Prices in *Italic* made to order with minimum quantities required

# Marcliff Engineering Co. Pty Ltd

Mechanical & Industrial Services

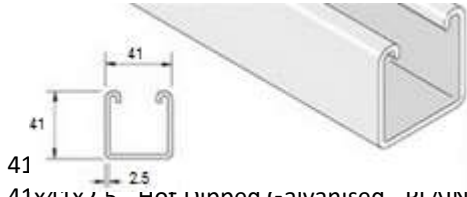

- 41  
41x41x2.5 - Hot Dipped Galvanised - PLAIN  
41x41x2.5 - Hot Dipped Galvanised - PLAIN  
41x41x2.5 - Hot Dipped Galvanised - SLOTTED  
41x41x2.5 - Hot Dipped Galvanised - SLOTTED  
41x41x2.5 - Pre-Galvanised - SLOTTED  
41x41x2.5 - Pre-Galvanised - SLOTTED  
41x41x2.5 - Stainless Steel 316 - PLAIN  
41x41x2.5 - Stainless Steel 316 - SLOTTED

## Channel Section - 1000 Series

Length m	Code	\$/per Length
6	C1001GP	186.04
3	C100GP3	58.83
6	C100GP6	90.00
3	C100GS3	49.67
6	C100GS6	91.43
3	C100S3	41.74
6	C100S6	75.62
6	C100SS316	491.97
6	C100TSS316	673.77



- 41x.  
41x21x2.5 - Hot Dipped Galvanised - SLOTTED  
41x21x2.5 - Stainless Steel 316 - PLAIN

## Channel Section - 3000 Series

Length m	Code	\$/per Length
3	C330GS3	37.09
6	C330GS6	66.31
6	C330SS316	372.99



- 41  
41x21x1.6 - Pre-Galvanised - SLOTTED  
41x21x1.6 - Pre-Galvanised - SLOTTED

## Channel Section - 4000 Series

Length m	Code	\$/per Length
6	C400P6	50.44
3	C400S3	22.84
6	C400S6	38.47



**1.6**

30x30x2.5 (11x18 hole)  
30x30x2.5 (11x18 hole)  
50x50x4.5 (14x30 hole)  
50x50x4.5 (14x30 hole)

**Slotted Angle**

Length	Finish	Code	\$/per
			Length
3	Zinc Plated	CASLT30	27.89
3	HDG	CASLT30G	33.37
3	Zinc Plated	CASLT50	57.49
3	HDG	CASLT50G	64.51

**Braced Cantilever Bracket**

Length	Finish	Code	\$/per
			Bracket
320	HDG	CAB320	23.33
470	HDG	CAB470	22.33
635	HDG	CAB635	27.97
780	HDG	CAB780	31.43
320	SS316	CAB320S	189.80
470	SS316	CAB470S	244.92
635	SS316	CAB635S	313.47
780	SS316	CAB780S	389.47

**Unbraced Cantilever Bracket**

Length	Finish	Code	\$/per
			Bracket
150	HDG	CA0150	12.87
300	HDG	CA0300	13.44
450	HDG	CA0450	16.68
600	HDG	CA0600	20.64
750	HDG	CA0750	25.23
900	HDG	CA0900	36.85
150	SS316	CA0150S	85.05
300	SS316	CA0300S	75.05
450	SS316	CA0450S	97.25
600	SS316	CA0600S	119.15
750	SS316	CA0750S	139.25
900	SS316	CA0900S	251.97



*\*A minimum order surcharge applies for less than 5 lengths*

# Marcliff Engineering Co. Pty Ltd

Mechanical & Industrial Services



**Back to Back Cantilever Bracket**

Length	Code	\$/per Bracket
300	CABB300	33.25
450	CABB450	44.72
600	CABB600	55.19
750	CABB750	61.77
900	CABB900	67.95



**Vertical**

**Mounting Plates**

Details	Zinc Plated		HDG		Stainless Steel		Qty
	Code	\$/each	Code	\$/each	Code	\$/each	
M10 Vertical Mounting Plate	MP10V	0.96	MP10VG	2.32	MP10VS	9.72	100
M12 Vertical Mounting Plate	MP12V	1.32	MP12VG	2.49	MP12VS	12.39	100
M10 Centre Mounting Plate	MP10C	0.92	MP10CG	2.32	MP10CS	9.72	100
M12 Centre Mounting Plate	MP12C	1.32	MP12CG	2.49	MP12CS	12.39	100
M10 Horizontal Mounting Plate	MP10H	0.96	MP10HG	2.32	MP10HS	9.72	100
M12 Horizontal Mounting Plate	MP12H	1.47	MP12HG	2.49	MP12HS	12.39	100



**Centre  
Mounting**



**Horizontal**

*\*A minimum order surcharge applies for less than 5 lengths*

# Marcliff Engineering Co. Pty Ltd

Mechanical & Industrial Services



## Cantilever Assembly Packs for Airconditioning Mounting

Code	Description	Price
<b>CABASS1</b>	<b>Pack Includes:</b> 4 x M10 Bolts, 4 x M10 Nuts, 4 x M10 Washers, 2 x Grey End CAPS	<b>6.73 Set</b>
<b>CABASS2</b>	<b>Pack Includes:</b> 4 x M10 Bolts, 4 x M10 Nuts, 4 x M10 Washers, 2 x Grey End CAPS, 4 x 50mm Square Rubber Pads	<b>12.93 Set</b>



M10



Short Spring

## Channel Nuts - Hot Dipped Galvanised

Details	Size	Short Spring	\$/each	Long Spring	\$/each	Plain	\$/each	Qty Pkt
		Code		Code		Code		
M6 Spring Nut	6	CNUT6SG	0.69	CNUT6LG	0.63	CNUT6NG	0.99	100
M8 Spring Nut	8	CNUT8SG	0.69	CNUT8LG	0.69	CNUT8NG	0.99	100
M10 Spring Nut	10	CNUT10SG	0.58	CNUT10LG	0.70	CNUT10NG	0.99	100
M12 Spring Nut	12	CNUT12SG	0.69	CNUT12LG	0.69	CNUT12NG	1.11	100
M16 Spring Nut	16					CNUT16NG	3.32	100

## Channel Nuts - Zinc Plated

Details	Size	Short Spring	\$/each	Long Spring	\$/each	Plain	\$/each	Qty Pkt
		Code		Code		Code		
M6 Spring Nut	6	CNUT6ST	0.69	CNUT6LZ	0.58	CNUT6NZ	0.57	100
M8 Spring Nut	8	CNUT8ST	0.69	CNUT8LZ	0.69	CNUT8NZ	0.69	100
M10 Spring Nut	10	CNUT10ST	0.58	CNUT10LZ	0.58	CNUT10NZ	0.58	100
M12 Spring Nut	12	CNUT12ST	0.69	CNUT12LZ	0.58	CNUT12NZ	0.67	100
M16 Spring Nut	16					CNUT16NZ	3.15	100



Long Spring

## Channel Nuts - Stainless Steel

Details	Size	Short Spring	\$/each	Long Spring	\$/each	Plain	\$/each	Qty Pkt
		Code		Code		Code		
M6 Spring Nut	6	CNUT6SS	5.19	CNUT6LSS	4.09	CNUT6PS	5.10	100
M8 Spring Nut	8	CNUT8SS	5.19	CNUT8LSS	4.21	CNUT8PS	5.10	100
M10 Spring Nut	10	CNUT10SS	5.39	CNUT10LSS	POA	CNUT10PS	5.30	100
M12 Spring Nut	12	CNUT12SS	6.01	CNUT12LSS	4.97	CNUT12PS	5.93	100



Plain Spring  
(No Spring)

## Rubber Lined EDPM Inserts & Channel Clips to Suit



Pipe Size	Code	\$/each	Qty Pkt
1/2"	CHR012	1.61	20
3/4"	CHR020	4.51	20
7/8"	CHR022	1.88	20
1	CHR025	4.71	20
1 1/8"	CHR028	2.20	20
1 1/4"	CHR032	5.28	20
1 3/8"	CHR035	2.54	20
1 1/2"	CHR038	6.61	20
2"	CHR050	7.26	20
2 1/2"	CHR060	13.42	20
3	CHR075	15.63	20
3 1/2"	CHR090	16.28	20
4	CHR110	11.99	20
5	CHR125	14.20	20
6	CHR150	16.68	20
8	CHR200	23.19	20

# Marcliff Engineering Co. Pty Ltd

Mechanical & Industrial Services

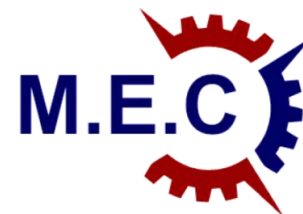

## Self Drilling Threaded Rod Hangers



Details	Code	\$/each	Qty Pkt
Concrete Vertigo 6mm (6.5mm x 32mm)	VVCH06	1.37	100
Concrete Vertigo 10mm (6.5mm x 38mm)	VVCH10	0.96	100
Steel Vertigo 6mm	VVSH06	1.39	100
Steel Vertigo 8mm With Nuts	VVSH08	1.33	100
Steel Vertigo 10mm With Nuts	VVSH10	0.81	100
Steel Vertigo (Side) 6mm	VSSH06	1.70	100
Steel Vertigo (Side) 8mm With Nuts	VSSH08	1.67	100
Steel Vertigo (Side) 10mm With Nuts	VSSH10	1.79	100
Steel Vertigo (Side) 12mm With Nuts	VSSH12	3.56	100
Wood Vertigo 6mm (1/4 x 50 Type 17)	VVWH06	1.50	100
Wood Vertigo 8mm (1/4 x 50 Type 17)	VVWH08	1.56	100
Wood Vertigo 10mm (1/4 x 50 Type 17)	VVWH10	0.96	100
Wood Vertigo 10mm x 50mm	VVWH1050	1.46	100
Wood Vertigo (Side) M10 (1/4 x 50 T17)	VSWH10	2.36	100
Universal (Metal/Wood) Socket (Red)	VUSOCK	13.74	100

## Purlin Hanger



Details	Code	\$/each	Qty
M10 Lipped Purlin Hanger	PUR10	0.93	100
M12 Lipped Purlin Hanger	PUR12	1.17	100
M8 Golden Nut Punched Zinc Plated	PYC08Z-NPG	1.93	100
M10 Golden Nut Punched Zinc Plated	PYC10Z-NPG	2.21	100
M12 Golden Nut Punched Zinc Plated	PYC12Z-NPG	2.81	100

## Wedge Nuts



Details	Code	\$/each	Qty
M10 Zn Wedge Nut	WNUTM10	0.46	100
M12 Zn Wedge Nut	WNUTM12	0.74	100

# Marcliff Engineering Co. Pty Ltd

## Mechanical & Industrial Services



### Beam Clamps



Details	Code	\$/each	Qty
M10 Zn Beam Clamp	BEAMHM10	2.90	1
M12 Zn Beam Clamp	BEAMHM12	5.71	1
M10 HDG Beam Clamp	BEAMHM10G	5.31	1
M12 HDG Beam Clamp	BEAMHM12G	7.74	1

### Closure Strips

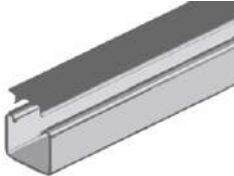

Details	Code	\$/each	Qty
Grey Plastic Closure Strip x 3 Mtrs	INSCLSR	12.10	1
White Plastic Closure Strip x 3 Mtrs	INSCLSRW	15.59	1

### End Caps



Details	Code	\$/each	Qty
Grey Plastic 1000 & 2000 Series Caps	END4141	0.75	1
Grey Plastic 3300 & 4000 Series Caps	END2141	0.75	1
Grey Plastic 5000 Series Caps	END5041	1.26	1

### Rubber Insulation



Details	Code	\$/m	Qty
Channel Rubber Insulation	INSRUB	2.66	m

### Ferrule Blocks - 19 & 25mm Wall Thickness

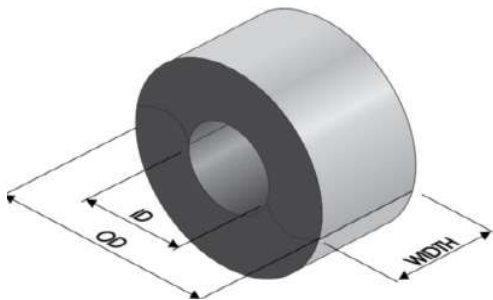

19mm FERRULE BLOCKS				25mm FERRULE BLOCKS				
ID	OD	Code	\$/each	ID	OD	Code	\$/each	Qty Pkt
6	46	FER006-46	3.38	6	57	FER006-57	3.43	1
9	49	FER009-49	3.54	9	60	FER009-60	3.61	1
13	51	FER013-51	2.75	13	63	FER013-63	3.38	1
16	57	FER016-57	2.75	16	67	FER016-67	3.68	1
20	57	FER020-57	2.78	20	70	FER020-70	3.85	1
22	60	FER022-60	2.78	22	73	FER022-73	3.96	1
25	63	FER025-63	3.31	25	76	FER025-76	4.06	1
27	67	FER027-67	3.61	27	76	FER027-76	4.25	1
32	70	FER032-70	3.78	32	83	FER032-83	4.68	1
34	73	FER034-73	3.90	34	83	FER034-83	4.69	1
38	76	FER038-76	4.14	38	89	FER038-89	5.51	1
42	79	FER042-79	4.58	42	89	FER042-89	5.68	1
48	86	FER048-86	4.72	48	98	FER048-98	5.84	1
51	89	FER051-89	5.11	51	102	FER051-102	6.60	1
54	89	FER054-89	5.23	54	102	FER054-102	6.99	1
60	98	FER060-98	5.73	60	110	FER060-110	7.36	1
64	102	FER064-102	6.08	64	114	FER064-114	8.42	1
67	102	FER067-102	6.09	67	114	FER067-114	8.53	1
76	114	FER076-114	7.03	76	127	FER076-127	8.64	1
89	127	FER089-127	8.08	89	140	FER089-140	8.94	1
102	140	FER102-140	9.25	102	152	FER102-152	12.06	1
115	152	FER115-152	10.89	115	165	FER115-165	12.13	1
127	165	FER127-165	11.93	127	178	FER127-178	14.70	1
140	178	FER140-178	11.93	140	203	FER140-203	15.46	1
154	203	FER154-203	16.25	154	203	FER154-203	16.25	1
168	203	FER168-203	17.93	168	220	FER168-220	18.13	1
203	250	FER204-250	23.13	203	250	FER204-250	23.13	1
219	250	FER219-250	22.94	219	275	FER219-275	26.36	1

*\*Indicates sizes that require specifically sized manufactured channel clips*

*\*Please note Prices in Italic made to order with minimum quantities required*

Ph: 02 9524 9123

Fax: 02 9540 2899

Email: orders@marcliff.com.au

Please note all prices are GST exclusive

# Marcliff Engineering Co. Pty Ltd

Mechanical & Industrial Services



Ferrule Blocks - 30 & 40mm Wall  
Thickness

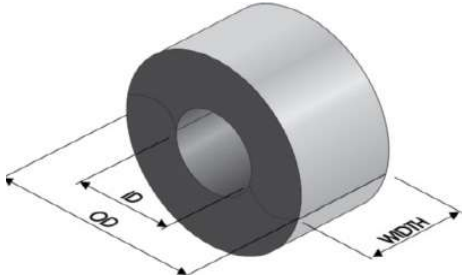

30mm FERRULE BLOCKS				40mm FERRULE BLOCKS			
ID	OD	Code	\$/each	ID	OD	Code	\$/each
16	76	FER016-76	4.58	13	92	FER013-92	5.50
20	80	FER020-80	4.62	16	98	FER016-98	5.50
22	83	FER022-83	4.86	20	102	FER020-102	5.50
25	86	FER025-86	5.33	22	102	FER022-102	5.81
27	89	FER027-89	5.43	25	102	FER025-102	6.19
32	89	FER032-89	5.68	27	111	FER027-111	6.87
34	98	FER034-98	5.88	32	111	FER032-111	7.03
38	98	FER038-98	5.87	34	114	FER034-114	7.02
42	102	FER042-102	6.22	38	114	FER038-114	7.03
				42	127	FER042-127	7.05
				48	127	FER048-127	8.07
				51	132	FER051-132	8.07
				54	132	FER054-132	8.07
				60	140	FER060-140	8.71
				64	140	FER064-140	9.39
				67	152	FER067-152	9.40
				76	152	FER076-152	11.05
				89	168	FER089-168	12.11
				102	178	FER102-178	11.72
				115	203	FER115-203	12.96
				127	203	FER127-203	14.34
				140	220	FER140-220	16.06
				154	250	FER154-250	17.99
				168	250	FER168-250	20.44
				203	283	FER204-283	26.99
				219	220	FER219-303	27.05
				254	250	FER254-355	30.66
				273	275	FER273-355	33.16
				305		FER305-375	39.19
				324		FER324-400	40.44
				355		FER355-400	41.69

*\*Indicates sizes that require specifically sized  
manufactured channel clips*

## Mechanical & Industrial Services

### Channel Clips

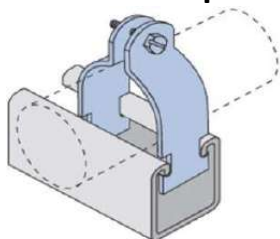

*\*Indicates Goods With Limited Stock Supplies*

*note Prices in Italic made to order with minimum quantities required*

Actual Size	Powder Coated		Galvanised		Hot Dipped Gal.		Stainless Steel		Qty
	Code	\$/each	Code	\$/each	Code	\$/each	Code	\$/each	
12.7			CH0127	0.84	CH0127G	1.39	CH0127S	3.75	100
16			CH01588	1.39					100
17.1			CH0171	1.01	CH0171G	1.60			100
19.1			CH0191	0.88	CH0191G	1.39	CH0191S	4.06	100
21			CH0214	0.82			CH0210S	6.07	100
21.3			CH0213	1.00	CH0213G	1.23			100
22			CH0220	1.04	CH0220G	1.23			100
24			CH0240	0.91	CH0240G	1.62			100
25.4			CH0254	1.09	CH0254G	1.62	CH0254S	4.44	100
27			CH0270	1.14	CH0270G	1.81	CH0270S	5.87	100
29.8			CH0298	1.27	CH0298G	1.78	CH0298S	5.57	100
31.8			CH0318	1.27	CH0318G	1.78	CH0318S	5.61	100
34.1			CH0341	1.39	CH0341G	1.85	CH0341S	5.91	100
38.1			CH0381	1.41	CH0381G	1.93	CH0381S	6.23	100
40			CH0400	1.46	CH0400G	2.32	CH0400S	4.75	100
42.8			CH0430	1.59	CH0430G	2.08	CH0430S	6.66	100
46.4			CH0464	2.73	CH0464G	3.55			50
48.4			CH0484	1.73	CH0484G	2.54	CH0484S	6.93	50
50.8			CH0508	1.82	CH0508G	2.48	CH0508S	9.25	50
57.1			CH0571	2.10	CH0571G	3.06			50
60.3			CH0603	1.96	CH0603G	2.86	CH0603S	9.95	50
63.5			CH0635	2.21	CH0635G	3.31	CH0635S	10.20	50
67			CH0670	2.27	CH0670G	2.27	CH0670S	16.33	50
69.8			CH0700	2.92	CH0700G	4.07	CH0700S	11.41	50
73			CH0730	2.54	CH0730G	2.54	CH0730S	18.34	50
76.2			CH0762	2.64	CH0762G	3.68	CH0762S	12.18	50
79			CH0790	2.68	CH0790G	4.25			50
82.5			CH0825	2.91	CH0825G	4.24	CH0825S	14.13	50

## Mechanical & Industrial Services

### Channel Clips

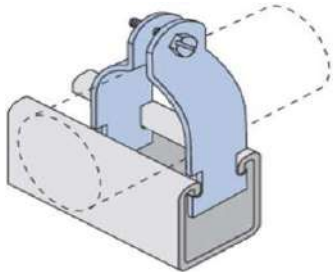

Actual Size	Powder Coated		Galvanised		Hot Dipped Gal.		Stainless Steel		Qty Pkt
	Code	\$/each	Code	\$/each	Code	\$/each	Code	\$/each	
86			CH0860	3.21	CH0860G	4.45			50
88.9			CH0889	2.82	CH0889G	3.96	CH0889S	15.07	50
98			CH0980	3.43	CH0980G	5.16			50
101.6			CH1016	3.58	CH1016G	5.66	CH1016S	14.77	25
102			CH1020G	14.06			CH1020S	14.06	25
111.1			CH1111	4.04	CH1111G	5.98	CH1111S		25
114.3			CH1143	3.77	CH1143G	5.98	CH1143S	17.61	25
127			CH1270	5.00	CH1270G	7.16	CH1270S	19.30	1
133					CH1320G	6.72			1
140			CH1400	5.22	CH1400G	7.49	CH1400S	20.64	1
152.4			CH1524	6.01	CH1524G	8.65	CH1524S	22.13	1
162			CH1620	6.33	CH1620G	8.13	CH1620S	22.88	1
165			CH1650	6.33	CH1650G	9.14	CH1650S	21.85	1
168			CH1681	7.84	CH1681G	8.54	CH1681S	24.02	1
178			CH1780	6.67	CH1780G	9.63	CH1780S	25.68	1
203			CH2300	8.23	CH2300G	11.94	CH2300S	31.75	1
219			CH2190	7.15	CH2190G	13.11	CH2190S	10.64	1
225			CH2250		CH2250G	27.36	CH2250S	30.40	1
228			CH2280	13.11	CH2280G	13.11			1
250			CH2500	8.68	CH2500G	14.73	CH2500S	34.15	1
275					CH2750G	13.83			1
283			CH2830	19.60					1
303			CH3030	11.71	CH3030G	16.14	CH3030S	39.09	1
315			CH3150	11.71	CH3150G	15.39	CH3150S	41.53	1
355			CH3550	24.47					1
375							CH3750S	47.88	1
400			CH4000	24.80			CH4000S	54.10	1

*\*Indicates Goods With Limited Stock Supplies*

*\*Please note Prices in Italic made to order with minimum quantities required*

# Marcliff Engineering Co. Pty Ltd



Mechanical & Industrial Services

**Square Washer**

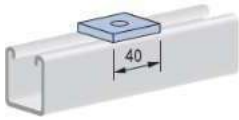

Hot Dipped Galvanised			
Code	Hold Dia	Cost	Alt Code
SY1062H	M8	1.22	P1062H
SY1063H	M10	1.28	P1063H
SX001	M12	0.70	P1064H
SY1964H	M16	1.53	P1964H
Stainless Steel			
SY1062S	M8	POA	P1062S
SX001S	M10	POA	P1063S
SY1064S	M12	POA	P1064S
SY1964S	M16	POA	P1964S

**Cross Flat Plate Fitting**

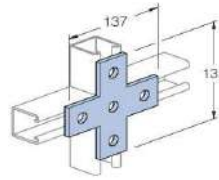

Hot Dipped Galvanised		
Code	Cost	Alt Code
SY1028H	31.92	P1028H

Details		
Width	Length	Holes
138	138	5

**T Flat Plate Fitting**

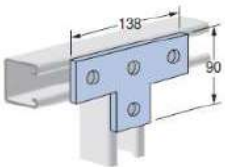

Hot Dipped Galvanised		
Code	\$/each	Alt Code
SX012	5.24	P1031H
Stainless Steel		
SY1031S	76.29	P1031S

Details		
Length	Height	Holes
138	90	4

**L Flat Plate Fitting**

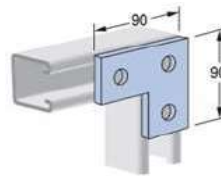

Hot Dipped Galvanised		
Code	\$/each	Alt Code
SX011	3.40	P1036H
Stainless Steel		
SY1036S	37.82	P1036S

Details		
Length	Height	Holes
90	90	3

**Flate Plate Fitting**



Hot Dipped Galvanised		
Code	\$/each	Alt Code
SX002	1.55	P1065H
Stainless Steel		
SY1065S	15.88	P1065S

Details		
Length	Height	Holes
90	40	2

**Flate Plate Fitting**



Hot Dipped Galvanised		
Code	\$/each	Alt Code
SX003	2.35	P1066H
Stainless Steel		
SY1066S	23.84	P1066S

Details		
Length	Height	Holes
138	40	3

**Flate Plate Fitting**

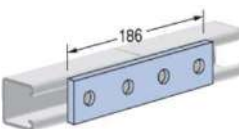

Hot Dipped Galvanised		
Code	\$/each	Alt Code
SX004	3.03	P1067H
Stainless Steel		
SY1067S	31.64	P1067S

Details		
Length	Height	Holes
186	40	4

**Flate Plate Fitting**

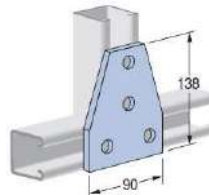

Hot Dipped Galvanised		
Code	\$/each	Alt Code
SX028	9.67	P1358H
Stainless Steel		
SY1358S	57.69	P1358S

Details		
Length	Height	Holes
90	138	4

# Marcliff Engineering Co. Pty Ltd

Mechanical & Industrial Services



Flate Plate Fitting

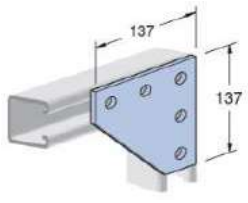

Hot Dipped Galvanised		
Code	\$/each	Alt Code
SY1941H	POA	P1941H

Details		
Length	Length	Holes
137	137	5

Flate Plate Fitting



Hot Dipped Galvanised		
Code	\$/each	Alt Code
SX005	4.43	P1873H

Details		
Length	Length	Holes
234	40	5

Flate Plate Fitting

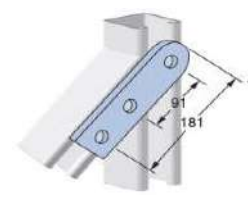

Hot Dipped Galvanised		
Code	\$/each	Alt Code
SY2324H	9.16	P2324H

Details		
Length	Length	Holes
181	40	3

Flate Plate Fitting

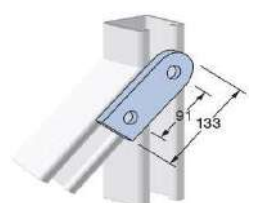

Hot Dipped Galvanised		
Code	\$/each	Alt Code
SY2325H	8.33	S2325H

Details		
Length	Length	Holes
133	40	2

Angle Fitting 90 Degrees

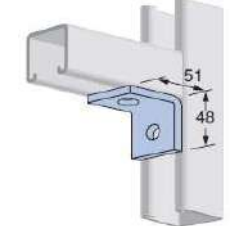

Hot Dipped Galvanised		
Code	\$/each	Alt Code
SX006	1.57	P1026H
Stainless Steel		
SY1026S	20.72	P1026S

Details		
51 x 48 x 6   2 Holes		

Flat Angle Plate

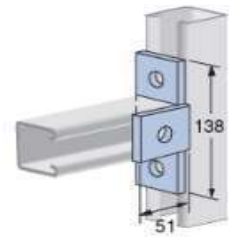

Hot Dipped Galvanised		
Code	\$/each	Alt Code
SY1033H	15.20	S1033H
Stainless Steel		
SY1033S	75.81	S1033S

Details		
40 x 51 x 138 x 6   3 Holes		

Angle Plate



Hot Dipped Galvanised		
Code	\$/each	Alt Code
SY1037H	9.21	S1037H
Stainless Steel		
SY1037S	33.62	S1037S

Details		
40 x 51 x 90 x 6   3 Holes		

Angle Fitting 90 Degrees



Hot Dipped Galvanised		
Code	\$/each	Alt Code
SY1068H	3.29	S1068H
Stainless Steel		
SY1068S	20.84	S1068S

Details		
41 x 57 x 6   2 Holes		

L Plate Angle Fitting

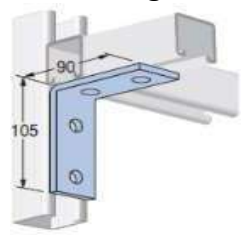

Hot Dipped Galvanised		
Code	\$/each	Alt Code
SX007	3.24	P1325H
Stainless Steel		
SY1325S	43.23	S1325S

Details		
90 x 105 x 6   4 Holes		

Angle Fitting 90 Degrees

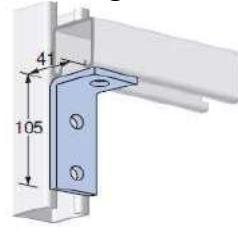

Hot Dipped Galvanised		
Code	\$/each	Alt Code
SY1326H	5.70	S1326H
Stainless Steel		
SY1326S	32.38	S1326S

Details		
41 x 105 x 6   3 Holes		

# Marcliff Engineering Co. Pty Ltd

## Mechanical & Industrial Services



**Angle Fitting  
Degrees**

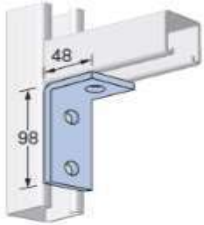

Hot Dipped Galvanised		
Code	\$/each	Alt Code
SX015	3.82	P1346H
Stainless Steel		
SY1346S	34.28	P1346S
Details		
48 x 98 x 6   3 Holes		

**Angle Fitting**

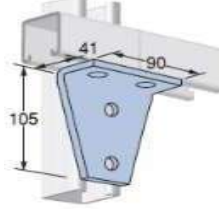

Hot Dipped Galvanised		
Code	\$/each	Alt Code
SX031	9.73	P1359H
Stainless Steel		
SY1359S	71.30	P1359S
Details		
41 x 90 x 105 x 6   4 Holes		

**Angle Fitting  
Degrees**

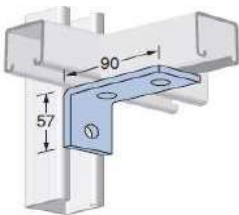

Hot Dipped Galvanised		
Code	\$/each	Alt Code
SY1458H	6.86	P1458H
Stainless Steel		
SY1458S	31.47	P1458S
Details		
90 x 57 x 6   3 Holes		

**45 Degree  
Plate  
Angle**

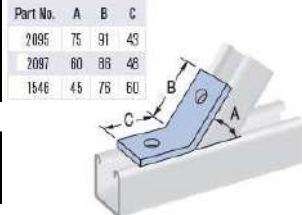

Part No.	A	B	C
2095	75	91	43
2097	80	88	48
1546	45	75	60

Hot Dipped Galvanised		
Code	\$/each	Alt Code
SX019	3.89	P1546H
Stainless Steel		
SY1546S	31.50	P1546S
Details		
76 x 60 x 6   2 Holes		

**45 Degree  
Angle Brace**



Hot Dipped Galvanised		
Code	\$/each	Alt Code
SY2452H	21.29	P2452H
Stainless Steel		
SY2452S	109.43	P2452S
Details		
346 x 346 x 422   2 Holes		

**L Plated  
Braced**

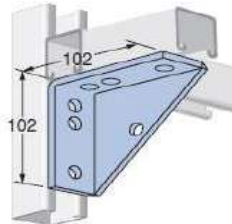

Hot Dipped Galvanised		
Code	\$/each	Alt Code
SX009	9.20	P2484H
Stainless Steel		
SY2484S	62.51	P2484S
Details		
102 x 102 x 6   6 Holes		

**LH Angle  
Plate**

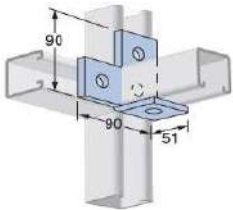

Hot Dipped Galvanised		
Code	\$/each	Alt Code
SX030	6.96	P1034H
Details		
40 x 90 x 90 x 51 x 6   4 Holes		

**RH Angle  
Plate**

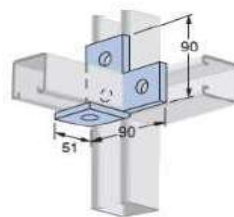

Hot Dipped Galvanised		
Code	\$/each	Alt Code
SX029	6.96	P1035H
Details		
40 x 90 x 90 x 51 x 6   4 Holes		

**Flat Angle  
Plate**

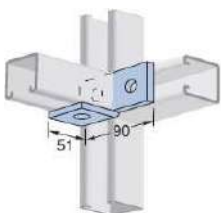

Hot Dipped Galvanised		
Code	\$/each	Alt Code
SY1038H	6.12	P1038H
Details		
40 x 51 x 90 x 6   3 Holes		

**45 Degree  
Angle Plate**

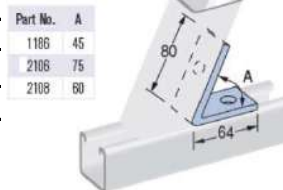

Part No.	A
1186	45
2106	75
2108	80

Hot Dipped Galvanised		
Code	\$/each	Alt Code
SY1186H	10.38	P1186H
Details		
40 x 63 x 80 x 6   2 Holes		

# Marcliff Engineering Co. Pty Ltd

Mechanical & Industrial Services



## Angle Fitting 75 Degrees

Part No.	A
1188	45
2106	75
2108	60

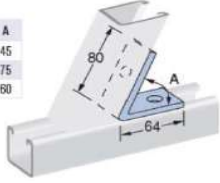

Hot Dipped Galvanised		
Code	\$/each	Alt Code
SY2106H	8.31	P2106H

Details
80 x 64 x 40 x 6   2 Holes

Hot Dipped Galvanised		
Code	\$/each	Alt Code
SY1357H	11.74	P1357H

Details
41 x 90 x 57 x 6   3 Holes

## Angle Fitting

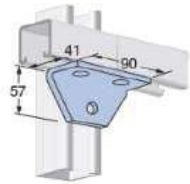

## Angle Fitting 60 Degrees

Part No.	A
1188	45
2106	75
2108	60



Hot Dipped Galvanised		
Code	\$/each	Alt Code
SY2108H	8.31	P2108H

Details
80 x 64 x 40 x 6   2 Holes

## Angle Fitting 90 Degrees

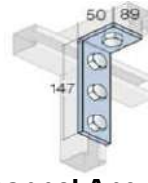

Hot Dipped Galvanised		
Code	\$/each	Alt Code
SY1474H	10.49	P1474H

Details
147 x 50 x 40 x 6   4 Holes

## Channel Angular Fitting 75 Degrees

Part No.	A	B	C
2095	75	91	43
2097	60	86	48
1546	45	75	60

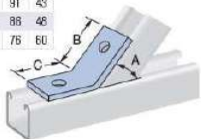

Hot Dipped Galvanised		
Code	\$/each	Alt Code
SY2095H	8.53	P2095H

Details
91 x 43 x 6   2 Holes

## Channel Angular Fitting 60 Degrees

Part No.	A	B	C
2095	75	91	43
2097	60	86	48
1546	45	75	60

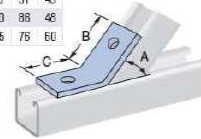

Hot Dipped Galvanised		
Code	\$/each	Alt Code
SY2097H	8.53	P2097H

Details
86 x 48 x 6   2 Holes

## 30 Degrees Angle Plate

Part No.	A	B
2101	30	68
2103	15	64

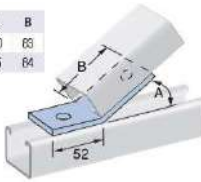

Hot Dipped Galvanised		
Code	\$/each	Alt Code
SY2101H	6.27	P2101H

Details
40 x 52 x 83 x 6   2 Holes

## 15 Degrees Angle Plate

Part No.	A	B
2101	30	68
2103	15	64



Hot Dipped Galvanised		
Code	\$/each	Alt Code
SY2103H	6.18	P2103H

Details
40 x 52 x 84 x 6   2 Holes

## Channel Fitting Single Pivot Arm

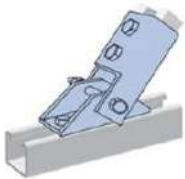

Hot Dipped Galvanised		
Code	\$/each	Alt Code
SY2815H	52.90	P2815H

Details
137 x 149 x 48mm

# Marcliff Engineering Co. Pty Ltd

Mechanical & Industrial Services

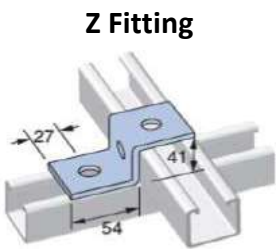

Z Fitting

Hot Dipped Galvanised		
Code	\$/each	Alt Code
SY1045H	7.60	P1045H

Details	
54 x 41 x 6   3 Holes	

Hot Dipped Galvanised		
Code	\$/each	Alt Code
SY1736H	9.07	P1736H

Details	
48 x 42 x 42 x 48   3 Holes	

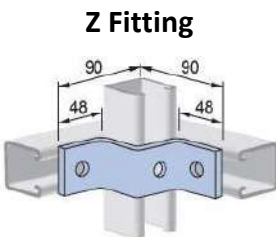

Z Fitting

Hot Dipped Galvanised		
Code	\$/each	Alt Code
SY5545H	8.25	P5545H

Details	
54 x 62 x 6   2 Holes	

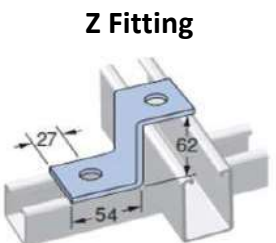

Z Fitting

Hot Dipped Galvanised		
Code	\$/each	Alt Code
SY1046H	10.60	P1046H

Details	
102 x 48 x 42 x 6   4 Holes	

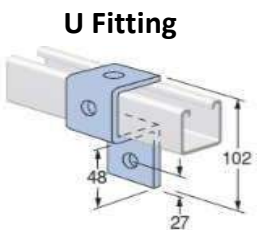

U Fitting

Hot Dipped Galvanised		
Code	\$/each	Alt Code
SX010	4.20	P1047H

Stainless Steel		
Code	\$/each	Alt Code
SY1047S	50.1228	P1047S

Details	
138 x 41 x 42 x 6   5 Holes ???	

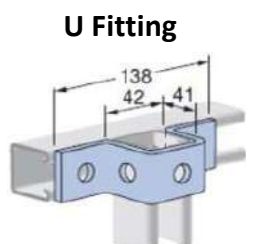

U Fitting

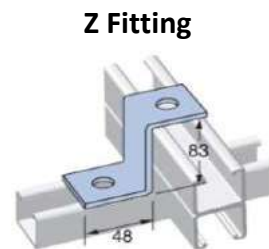

Z Fitting

Hot Dipped Galvanised		
Code	\$/each	Alt Code
SY1453H	8.99	P1453H

Details	
48 x 83 x 6   2 Holes	

Hot Dipped Galvanised		
Code	\$/each	Alt Code
SX016	4.17	P4045H

Details	
54 x 21 x 6   2 Holes	

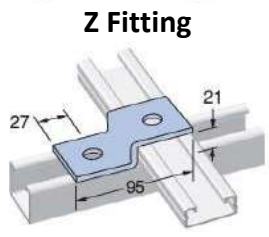

Z Fitting

Hot Dipped Galvanised		
Code	\$/each	Alt Code
SY1044H	8.79	P1044H

Details	
40 x 48 x 85 x 6   4 Holes	

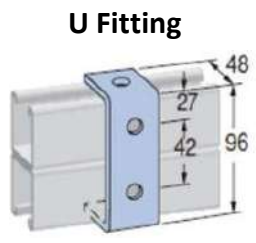

U Fitting

Hot Dipped Galvanised		
Code	\$/each	Alt Code
SY1376H	13.72	P1376H

Details	
41 x 90 x 6   2 Holes	

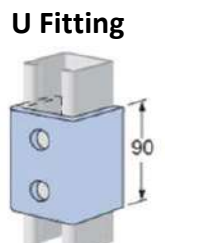

U Fitting

Hot Dipped Galvanised		
Code	\$/each	Alt Code
SY5547H	9.75	P5547H

Stainless Steel		
Code	\$/each	Alt Code
SY5547S	58.3443	S5547S

Details	
137 x 62 x 42 x 6   3 Holes	

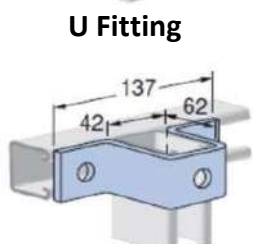

U Fitting

# Marcliff Engineering Co. Pty Ltd

## Mechanical & Industrial Services



**U Fitting**

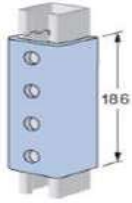

Hot Dipped Galvanised		
Code	\$/each	Alt Code
SY1377H	25.26	P1377H

Details		
41 x 186 x 6   4 Holes		

**U Fitting**

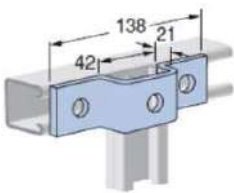

Hot Dipped Galvanised		
Code	\$/each	Alt Code
SX018	4.97	P4047H

Details		
138 x 21 x 42 x 6   2 Holes		

**U Fitting**

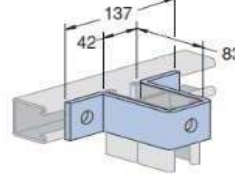

Hot Dipped Galvanised		
Code	\$/each	Alt Code
SY1737H	17.01	P1737H

Details		
137 x 83 x 42 x 6   3 Holes		

**U Fitting**

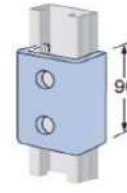

Hot Dipped Galvanised		
Code	\$/each	Alt Code
SY4376H	10.80	P4376H

Details		
41 x 21 x 90 x 6   3 Holes		

**Beam Clamp**



Hot Dipped Galvanised		
Code	\$/each	Alt Code
BEAMHM10G	5.31	BC10H
BEAMHM12G	7.7365	BC12H
Zinc		
BEAMHM10	2.8983	BC10Z
BEAMHM12	5.7147	BC12Z

**Beam Clamp**

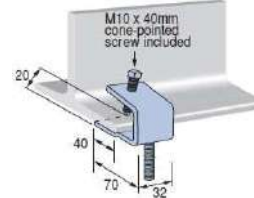

Hot Dipped Galvanised		
Code	\$/each	Alt Code
SY1270H	6.49	P1270H

Details		
70 x 20 x 32 x 6   M10 x 40		

**Beam Clamp**

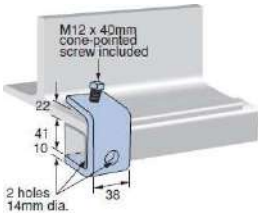

Hot Dipped Galvanised		
Code	\$/each	Alt Code
SY1271H	11.57	P1271H
Stainless Steel		
SY1271S	43.6023	P1271S

Details		
38 x 22 x 41 x 6   M12 x 40   2 Holes		

**Beam Clamp**



Hot Dipped Galvanised		
Code	\$/each	Alt Code
SY1272H	4.31	PY1272H
Stainless Steel		
SY1272S	28.4351	PY1272S

Details		
22 x 6   M10 x 40		

**Beam Clamp**

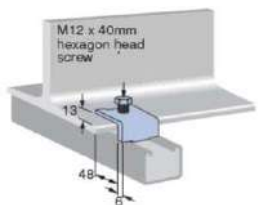

Hot Dipped Galvanised		
Code	\$/each	Alt Code
SX013	2.10	P1386H
Stainless Steel		
SY1386S	18.6827	PY1386S

Details		
48 x 13 x 6   M12 x 40		

**Beam Clamp  
1000 & 2000 S/C**

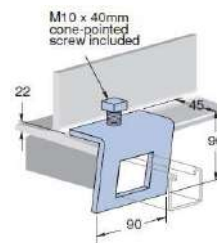

Hot Dipped Galvanised		
Code	\$/each	Alt Code
SX014	5.32	P1796H
Stainless Steel		
SY1796S	73.71	PY1796S

Details		
45 x 90 x 90 x 22 x 6   M10 x 40		

# Marcliff Engineering Co. Pty Ltd



## Mechanical & Industrial Services

**Beam Clamp**



Hot Dipped Galvanised		
Code	\$/each	Alt Code
SY2785H	10.04	PY2785H
Stainless Steel		
SY2785S	71.47	PY2785S
Details		
76 x 22 x 6   U Bolt		

**Column Clamp  
Pair**

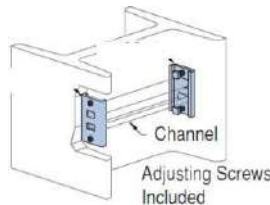

Hot Dipped Galvanised		
Code	\$/each	Alt Code
SY3087H	20.89	PY3087H
Stainless Steel		
SY3087S	68.607	PY3087S
Details		
100mm High   398kg Slip Load		

**Beam Clamp**

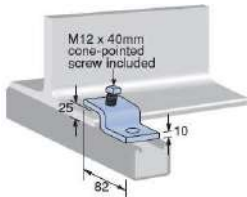

Hot Dipped Galvanised		
Code	\$/each	Alt Code
SY1379H	10.74	PY1379H
Details		
82 x 25 x 10 x 6   M12 x 40		

**Beam Clamp  
3300 & 4000 S/C**

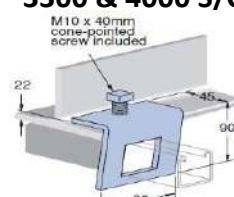

Hot Dipped Galvanised		
Code	\$/each	Alt Code
SY1796AH	8.90	PY1796AH
Details		
45 x 90 x 90 x 22 x 6   M10 x 40		

**Beam Clamp**

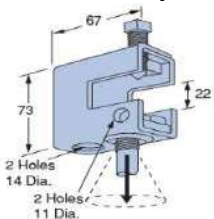

Hot Dipped Galvanised		
Code	\$/each	Alt Code
SY2675H	13.52	PY2675H
Details		
67 x 73 x 22   4 Holes   M10		

**Beam Clamp**

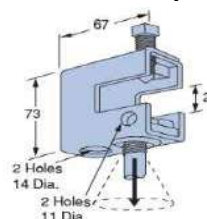

Hot Dipped Galvanised		
Code	\$/each	Alt Code
SY2676H	13.15	PY2676H
Details		
67 x 73 x 22   4 Holes   M12		

**Clevis Hanger**



Hot Dipped Galvanised		
Code	\$/each	Alt Code
SY2676-1H	6.46	PY2676-1H
Details		
Beam Clamp Swivel Extension   M12		

**Beam Clamp**



Hot Dipped Galvanised		
Code	\$/each	Alt Code
SY2786H	12.25	PY2786H
Details		
1001, 2001, & 5500 Series Channels		

**Base Plates**

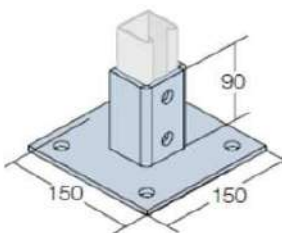

Hot Dipped Galvanised		
Code	\$/each	Alt Code
SY2072AH	32.91	PY2072AH
Stainless Steel		
SY2072AS	130.78	PY2072AS
Details		
150 x 150 x 90 x 6		

**Base Plates**

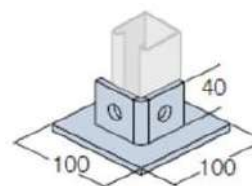

Hot Dipped Galvanised		
Code	\$/each	Alt Code
SY2072S1H	15.51	PY2072S1H
Stainless Steel		
SY2072S1S	60.1304	PY2072S1S
Details		
100 x 100 x 40 x 6		

# Marcliff Engineering Co. Pty Ltd

Mechanical & Industrial Services



**Base Plate**

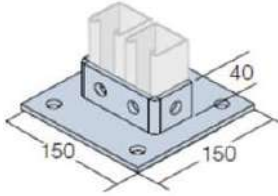

Hot Dipped Galvanised		
Code	\$/each	Alt Code
SY2073H	29.71	PY2073H
Stainless Steel		
SY2073S	114.534	PY2073S
Details		
150 x 150 x 42 x 6		

**Hinged Hole Connector**

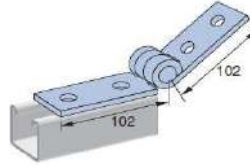

Hot Dipped Galvanised		
Code	\$/each	Alt Code
SY1354H	17.21	PY1354H
Stainless Steel		
SY1354S	58.9113	PY1354S
Details		
102 x 102   M12 x 4 Holes		

**Hinged Hole Connector**

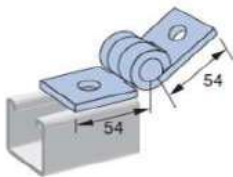

Hot Dipped Galvanised		
Code	\$/each	Alt Code
SY1843H	9.89	PY1843H
Stainless Steel		
SY1843S	38.7545	PY1843S
Details		
54 x 54   M12 x 2 Holes		

**Suspension Strut Channel Joiner**

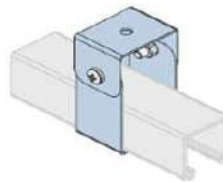

Zinc Plated		
Code	\$/each	Alt Code
SY2335Z	9.07	PY2335Z

Details		
Strut Lighting Fitting for Drop Rod		

**External Channel Hanger**

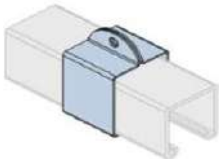

Zinc Plated		
Code	\$/each	Alt Code
SY2539Z	3.86	PY2539Z
Details		
42 x 44		

**External Channel Hanger**

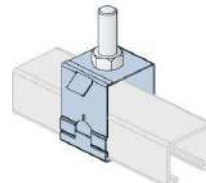

Zinc Plated		
Code	\$/each	Alt Code
SY2855Z	7.51	PY2855Z

Details		
M12 Hole		

**L Channel Joiner**

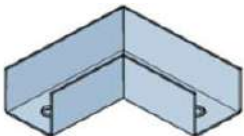

Zinc Plated		
Code	\$/each	Alt Code
SY1220Z	24.81	PY1220Z
Details		
160 x 160 x 40mm		

**T Channel Joiner**

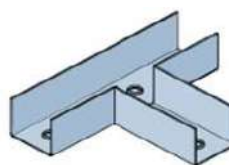

Zinc Plated		
Code	\$/each	Alt Code
SY1221Z	29.48	PY1221Z

Details		
225 x 160 x 40mm		

**X Channel Joiner**

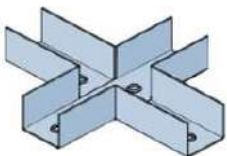

Zinc Plated		
Code	\$/each	Alt Code
SY1222Z	36.37	PY1222Z
Details		
225 x 225 x 40mm		

**External Channel Joiner**

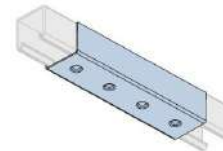

Zinc Plated		
Code	\$/each	Alt Code
SX023	4.50	P2377Z

Details		
Used for 1000 & 2000 Strut		

# Marcliff Engineering Co. Pty Ltd

Mechanical & Industrial Services



**Internal Channel  
Joiner**



Zinc Plated		
Code	\$/each	Alt Code
SY422Z	8.19	PY422Z

Details		
Used for 3300 & 4000 Strut		

**Internal Channel  
Joiner**



Zinc Plated		
Code	\$/each	Alt Code
SX024	5.65	P992J

Details		
Used for 1000 & 2000 Strut		

**Trolley Wheels**



Zinc Plated		
Code	\$/each	Alt Code
SX025	31.24	P2749Z

Details		
37 x 32 x 32   M7 Hole		

**Trolley Wheels**

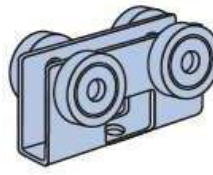

Zinc Plated		
Code	\$/each	Alt Code
SX026	45.33	P2750Z

Details		
37 x 75 x 32   M7 Hole		

**Trolley Wheels**



Zinc Plated		
Code	\$/each	Alt Code
SY2751Z	67.56	PY2751Z

Details		
43 x 32   Clevis 62 x 19 Dia		

**Trolley Wheels**

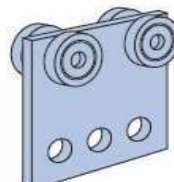

Zinc Plated		
Code	\$/each	Alt Code
SX027	51.35	P2950Z

Details		
87 x 90 x 32   3 Hole		

**Wing Fitting**

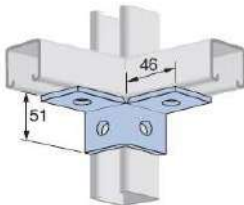

Hot Dipped Galvanised		
Code	\$/each	Alt Code
SY2223H	13.13	PY2223H

Details		
40 x 51 x 46 x 6   4 Holes		

**Wing Fitting**

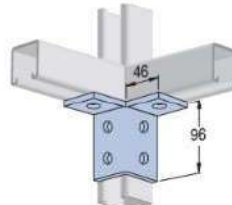

Hot Dipped Galvanised		
Code	\$/each	Alt Code
SY2224H	14.86	PY2224H

Details		
40 x 98 x 47 x 6   6 Holes		

**Wing Fitting**

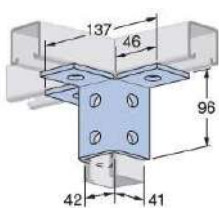

Hot Dipped Galvanised		
Code	\$/each	Alt Code
SY2228H	23.87	PY2228H

Details		
40 x 137 x 98 x 41 x 6   9 Holes		

**Wing Fitting**

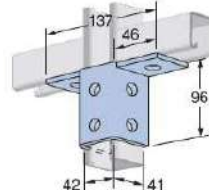

Hot Dipped Galvanised		
Code	\$/each	Alt Code
SX020	11.91	P2346H

Details		
40 x 98 x 137 x 41 x 6   8 Holes		

# Marcliff Engineering Co. Pty Ltd



## Mechanical & Industrial Services

Base Plate

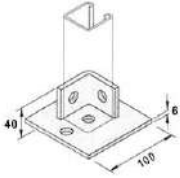

Hot Dipped Galvanised		Qty Pkt
Code	\$/each	
SX008	\$13.62	100
Details		
Width	Length	Thickness
40	126	5

4 Hole Post Base

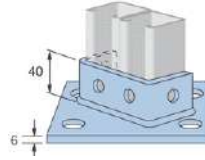

Hot Dipped Galvanised		Qty Pkt
Code	\$/each	
SX021	\$19.46	1
Details		
Width	Length	Thickness
40	137	6

Electrical Hanger Fitting

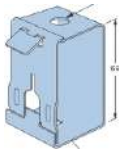

Hot Dipped Galvanised		Qty Pkt
Code	\$/each	
SX022	\$5.65	1
Details		
Width	Length	Thickness
40	69	6

Double Base Plate

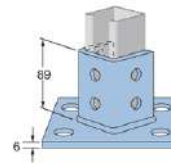

Hot Dipped Galvanised		Qty Pkt
Code	\$/each	
SX017	\$16.99	1
Details		
Width	Length	Thickness
40	89	6

41 x 41 Plastic End



For C1000/C2000 Series		Qty Pkt
Code	\$/each	
END4141	\$0.75	1
Details		
Width	Length	Thickness
41	41	2

21 x 41 Plastic End

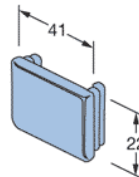

For C3000/C4000 Series		Qty Pkt
Code	\$/each	
END2141	\$0.75	1
Details		
Width	Length	Thickness
21	41	2

62 x 41 Plastic End

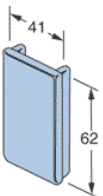

For C5000 Series		Qty Pkt
Code	\$/each	
END5041	\$1.26	1
Details		
Width	Length	Thickness
62	41	2

41 x 41 Plastic End  
White

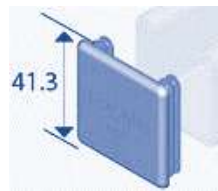

For C1000/C2000 Series		Qty Pkt
Code	\$/each	
END4141W	\$1.27	1
Details		
Width	Length	Thickness
41	41	2

21 x 41 Plastic End  
White

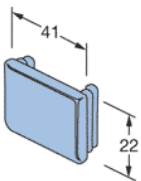

For C3000/C4000 Series		Qty Pkt
Code	\$/each	
END2141W	\$1.15	1
Details		
Width	Length	Thickness
21	41	2

# Marcliff Engineering Co. Pty Ltd

## Anti-Vibration Mounts

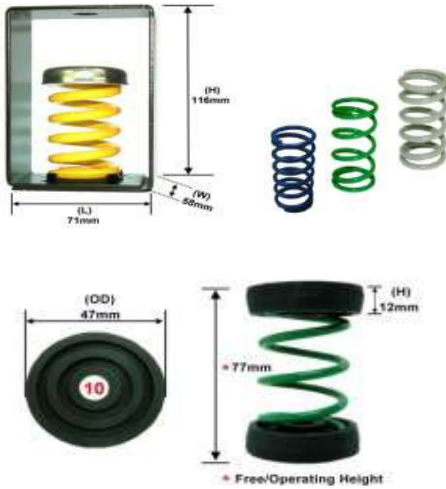

CODE	Details	\$/each	Qty Pkt
CCSC2020	Anti Vibration Spring Coil Blue 10-20 kg	4.71	1
CCSC2035	Anti Vibration Spring Coil Green 16-35kg	5.24	1
CCSC2050	Anti Vibration Spring Coil Grey 25-50kg	5.76	1
CCSC20115	Anti Vibration Spring Coil Black 55-115kg	6.60	1
CCSC20185	Anti Vibration Spring Coil Yellow 93-185kg	8.91	1
CCSH3865	Anti Vibration Hanger Bracket	9.86	1
CCSM3865	Anti Vibration Rubber Cup Mount M10	1.97	1

Anti-vibration devices are effective in isolating vibration & noise produced from suspended mechanical equipments such as in-line fans, exhaust fans and cabinet fans, etc or even water pipeworks and air ductworks.

### Mounting Block



Code	Size	\$/each	Qty Pkt
PDMBIV	450mm	10.83	1

### Rubber Condensor Stand PK4



Code	\$/pack	Qty Pkt
FRFSTD	14.33	4

### Cantilever Vibration Mount PK4



Size	\$/pack	Qty Pkt
CABASS3	13.39	4

### Cylindrical Mounts



Size	\$/each	Qty Pkt
CCSXM10	4.12	1

# Marcliff Engineering Co. Pty Ltd

## Anti-Vibration Mounts



**M10 Mounting Caps**



Code	Size	\$/each	Qty Pkt
CCSM3865	25mm   10mm hole	1.97	1

**1000x100 Waffle Strips**



Size	Code	\$/each	Qty Pkt
WAEP1000100	1000mm x 100mm x 10mm	12.32	1

**450x450 Waffle Pads**



Size	Code	\$/each	Qty Pkt
WAEPFM45458	450mm x 450mm	14.31	1

**50x60 Waffle Squares**



Size	Code	\$/each	Qty Pkt
WAEP5050	50mm x 50mm   13mm Hole	1.25	1

**100x150mm Sandwich Pad**

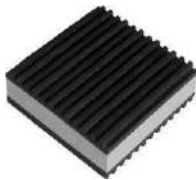

Size	Code	\$/each	Qty Pkt
FRFCSP	100mm x 150mm   25mm Thick	9.46	1

**100x100 Cork Waffle Sandwich**



Size	Code	\$/each	Qty Pkt
FRFCORK	100mm x 100mm	10.63	1

# Marcliff Engineering Co. Pty Ltd

## Cable Support Systems



### TRAY SYSTEMS LADDER TRAY

For more information visit: [www.mecstrut.com](http://www.mecstrut.com)

#### GENERAL DESCRIPTION

##### Information

T3 Ladder Tray System is designed for trapeze supported or surface mounted cable management and is ideally suited to small to medium size cables such as TPS, data comms and sub mains allowing for more tie off points as well as tighter radius bends and risers. T1 offers full integration with our T3 Ladder Tray System saving the installer from having to carrying two ranges of accessories.

- Material 0.65mm thick
- 3m length
- 50mm Sides
- 45mm cable laying depth
- 11mm tie off centres
- Site fabricated fittings
- Flat and peaked cover option

##### Available Finishes

- Galvabond
- Powder coated
- Zinc Passivated
- Stainless steel

##### Technical Information

Load and Deflection data is derived from tests performed in a NATA certified testing environment in accordance to NEMA VE1-2009 STANDARDS. ALL Ladders exceed the class designation that has been applied to the product. Load data is based on single spans resulting in worst case scenario. Deflections listed in our table are based on continuous spans, single span installation will result in increased deflection, for single spans multiply the corresponding deflection by 2.5 For further information regarding Nema VE 1-2009 Standards see technical information on page 2 of this catalogue.

#### LADDER TRAY

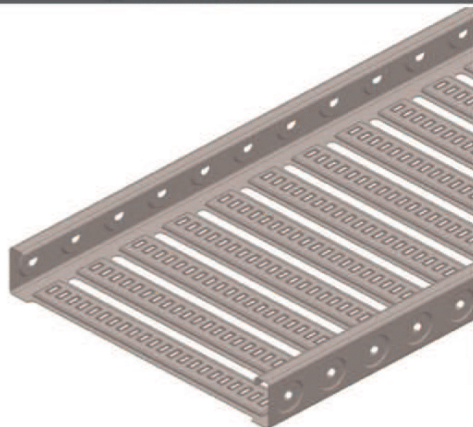

#### LADDER TRAY PROFILE

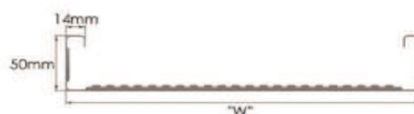

#### LADDER TRAY ORDERING INFORMATION

##### 1 PRODUCT CODE

CLSTD150	150 mm
CLSTD300	300 mm
CLSTD450	450 mm
CLSTD600	600 mm

##### 2 FINISH

<b>G</b>	Galvabond
<b>PC</b>	Powder Coated
<b>ZP</b>	Zinc Passivated

**EXAMPLE** 1 2  
CLSTD150ZP CLSTD150 ZP

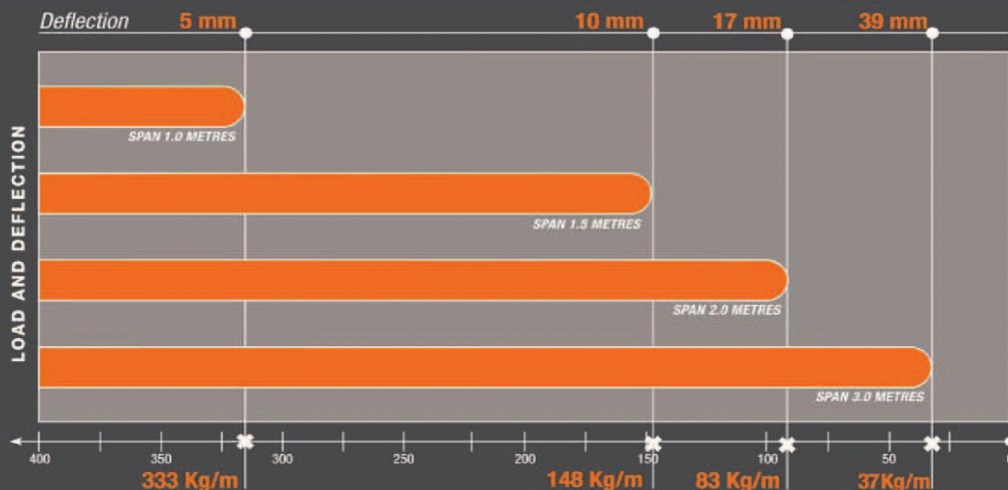

# Marcliff Engineering Co. Pty Ltd

## Cable Support Systems



For more information visit: [www.mecstrut.com](http://www.mecstrut.com)

### TRAY SYSTEMS LADDER TRAY ACCESSORIES



#### LADDER TRAY ACCESSORIES ORDERING INFORMATION

1 PRODUCT CODE		2 FINISH	
CLSTSG	Splice Plate	G	Galvabond
CLSTDRLG	Link Plate	H	Hot Dip Galv.
CLSTRPG	Radius Plate	PC	Powder Coated
CLSTDHDG	Hold Down Clamp	ZP	Zinc Passivated
<b>EXAMPLE</b> 1    2			
CLSTSG	CLSTSG	ZP	
CLSTNUT	Splice Nut	Z	Zinc
CLSTBOT	Splice Bolt	H	Hot Dip Galv.
<b>EXAMPLE</b> 1    2			
CLSTNUT	CLSTNUT	H	

## TRAY SYSTEMS ASSEMBLY INSTRUCTIONS

For more information visit: [www.mecstrut.com](http://www.mecstrut.com)

90 DEG INTERNAL RISER

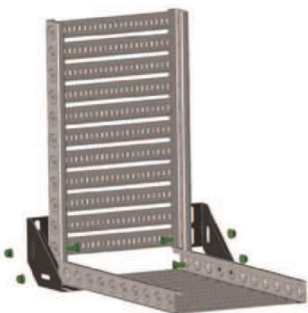

2 X TTX TEE & CROSS BRACKET 8 X TB TRAY BOLTS  
8 X TN TRAY NUTS - PER 90DEG RISER ASSEMBLY

90 DEG EXTERNAL RISER



2 X TTX TEE & CROSS BRACKET 8 X TB TRAY BOLTS  
8 X TN TRAY NUTS - PER 90DEG RISER ASSEMBLY

90 DEG RADIUSED INTERNAL RISER



6 X TLP RISER LINKS 12 X TB TRAY BOLTS  
12 X TN TRAY NUTS - PER 90DEG RISER ASSEMBLY

90 DEG RADIUSED EXTERNAL RISER

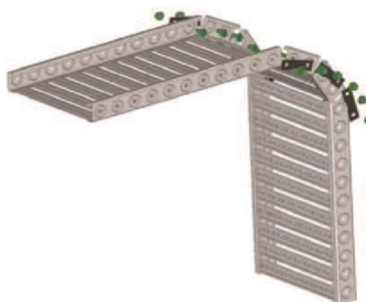

6 X TLP RISER LINKS 12 X TB TRAY BOLTS  
12 X TN TRAY NUTS - PER 90DEG RISER ASSEMBLY

90 DEG RADIUSED BEND



1 X TRP RADIUS PLATE 12 X TB TRAY BOLTS  
12 X TN TRAY NUTS - PER 90DEG BEND TRP RADIUS PLATE WILL  
COVER 2 BENDS IN 150MM & 300MM WIDTHS

TEE SECTION

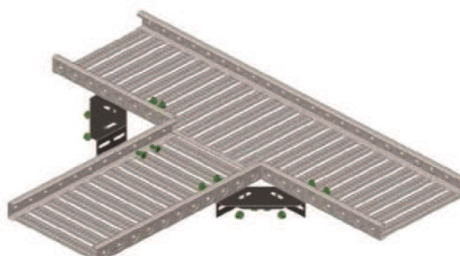

2 X TTX TEE & CROSS BRACKET 8 X TB TRAY BOLTS  
8 X TN TRAY NUTS - PER TEE, DOUBLE FOR CROSS SECTION

# Marcliff Engineering Co. Pty Ltd

## Cable Support Systems

### LT3 STD Laddertray & Accessories





LT3 STD Laddertray Galvanised	Nom. Size	Code:	Price	
			\$/each	QTY
	150mm	CLSTD150	\$32.10	1
	300mm	CLSTD300	\$39.45	1
	450mm	CLSTD450	\$54.50	1
	600mm	CLSTD600	\$64.48	1

LT3 Radius Plate	Nom. Size	Code:	Price	
			\$/each	QTY
	-	CLSTRPG	\$10.54	1

LT3 Splice	Nom. Size	Code	Price	
			\$/each	QTY
	-	CLSTSG	\$2.15	1

Splice Bolts and Nuts	Nom. Size	Code:	Price	
			\$/each	QTY
	-	CLSTNUTH	\$0.30	1

LT3 Hold Down	Nom. Size	Code:	Price	
			\$/each	QTY
	-	CLSTDHDG	\$1.01	1

LT3 Riser Link	Nom. Size	Code:	Price	
			\$/each	QTY
	-	CLSTDRLG	\$0.27	1

# Marcliff Engineering Co. Pty Ltd



## Cable Support Systems Cable Trays

Cable Tray	Nom. Size	Code	Price	QTY
			\$/each	
	75mm	CLGB75	\$15.17	1
	100mm	CLGB100	\$16.76	1
	150mm	CLGB150	\$18.56	1
	225mm	CLGB225	\$29.28	1
	300mm	CLGB300	\$48.45	1
	450mm	CLGB450	\$53.62	1
	600mm	CLGB600	\$78.71	1

Cable Tray Bend	Nom. Size	Code	Price	QTY
			\$/each	
	150mm	CLGBTB150	\$29.99	1

Cable Tray Tee	Nom. Size	Code	Price	QTY
			\$/each	
	150mm	CLGBTT150	\$31.03	1

## COLOUR BOND TRUNKING

CODE	SIZE	DESCRIPTION & COLOUR	\$/length	Qty
TRUNKB	2.4m	Trunking - Night Sky (Black)	\$31.69	1
TRUNKBA	2.4m	Trunking - Bassalt (Modern Grey)	\$31.69	1
TRUNKCOV	2.4m	Trunking - Cove (Medium Brown)	\$31.69	1
TRUNKCR	2.4m	Trunking - Classic Cream (Cream)	\$31.69	1
TRUNKDG	2.4m	Trunking - Ironstone (Dark Grey)	\$31.69	1
TRUNKDO	2.4m	Trunking - Deep Ocean (Dark Blue)	\$31.69	1
TRUNKDR	2.4m	Trunking - Manor Red (Dark Red)	\$31.69	1
TRUNKG	2.4m	Trunking - Dune (Light Grey)	\$31.69	1
TRUNKGL	2.4m	Trunking - Gaivanised	\$31.69	1
TRUNKGULLY	2.4m	Trunking - Gully (Light Grey)	\$31.69	1
TRUNKLG	2.4m	Trunking - Shale Grey (Light Grey)	\$31.69	1
TRUNKLW	2.4m	Trunking - Evening Haze (Off White)	\$31.69	1
TRUNKMB	2.4m	Trunking - Jasper (Medium Brown)	\$31.69	1
TRUNKMG	2.4m	Trunking - Cottage Green (Dark Green)	\$31.69	1
TRUNKNG	2.4m	Trunking - Monument (Grey)	\$31.69	1
TRUNKPB	2.4m	Trunking - Paper Bark (Off Pink)	\$31.69	1
TRUNKPG	2.4m	Trunking - Pale Eucalypt (Pale Green)	\$31.69	1
TRUNKTRN	2.4m	Trunking - Terrain (Wine Red)	\$31.69	1
TRUNKW	2.4m	Trunking - Surfist (White)	\$31.69	1
TRUNKWBY	2.4m	Trunking - Wallaby (Dune)	\$31.69	1
TRUNKWG	2.4m	Trunking - Woodland Grey (Dark Grey)	\$31.69	1
TRUNKWS	2.4m	Trunking - Windspray (Grey)	\$31.69	1

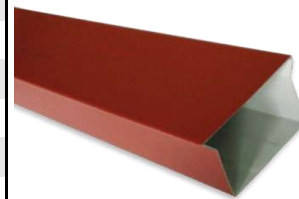

Ph: 02 9524 9123

Fax: 02 9540 2899

Email: orders@marcliff.com.au

Please note all prices are GST exclusive

# Marcliff Engineering Co. Pty Ltd Fasteners



**Threaded Rod - 3m Length**



Metric	Zinc Plated		Stainless Steel		Qty Pkt
	Code	\$/each	Code	\$/m	
M6	ROD06	3.64			25
M8	ROD08	6.02	ROD08S	5.71	20
M10	ROD10	5.40	ROD10S	8.02	10
M12	ROD12	7.71	ROD12S	13.89	10
M16	ROD16	25.78	ROD16S	21.60	5
M20	ROD20	37.81	ROD20S	35.49	5

**Metric Hex Set Screw**



Nuts & Bolts	Zinc Plated		Stainless Steel		Qty Pkt
	Code	\$/100	Code	\$/each	
4.6 Zn Plated Set Screw - M6 x 12mm	BOLTM06012	5.13	BOLTM0612S	0.08	200
4.6 Zn Plated Set Screw - M6 x 16mm	BOLTM06016	5.30	BOLTM0616S	0.09	200
4.6 Zn Plated Set Screw - M6 x 20mm	BOLTM06020	5.67	BOLTM0620S	0.11	200
4.6 Zn Plated Set Screw - M6 x 25mm	BOLTM06025	6.02	BOLTM0625S	0.12	200
4.6 Zn Plated Set Screw - M6 x 30mm	BOLTM06030	7.06	BOLTM0630S	0.13	200
4.6 Zn Plated Set Screw - M6 x 40mm	BOLTM06040	7.06	BOLTM0640S	0.17	200
4.6 Zn Plated Set Screw - M6 x 50mm	BOLTM06050	10.99	BOLTM0650S	0.24	200
4.6 Zn Plated Set Screw - M8 x 12mm	BOLTM08012	10.26	BOLTM0812S	0.18	200
4.6 Zn Plated Set Screw - M8 x 16mm	BOLTM08016	10.45	BOLTM0816S	0.18	200
4.6 Zn Plated Set Screw - M8 x 20mm	BOLTM08020	10.63	BOLTM0820S	0.21	200
4.6 Zn Plated Set Screw - M8 x 25mm	BOLTM08025	11.86	BOLTM0825S	0.23	200
4.6 Zn Plated Set Screw - M8 x 30mm	BOLTM08030	13.44	BOLTM0830S	0.26	200
4.6 Zn Plated Set Screw - M8 x 40mm	BOLTM08040	15.04	BOLTM0840S	0.32	200
4.6 Zn Plated Set Screw - M8 x 50mm	BOLTM08050	17.70	BOLTM0850S	0.37	200
4.6 Zn Plated Set Screw - M8 x 75mm	BOLTM08075	33.81			150
4.6 Zn Plated Set Screw - M10 x 16mm	BOLTM10016	17.70			150
4.6 Zn Plated Set Screw - M10 x 20mm	BOLTM10020	17.88	BOLTM1020S	0.36	150
4.6 Zn Plated Set Screw - M10 x 25mm	BOLTM10025	18.07	BOLTM1025S	0.43	150
4.6 Zn Plated Set Screw - M10 x 30mm	BOLTM10030	21.95	BOLTM1030S	0.45	150
4.6 Zn Plated Set Screw - M10 x 40mm	BOLTM10040	25.67	BOLTM1040S	0.56	150
4.6 Zn Plated Set Screw - M10 x 50mm	BOLTM10050	37.16	BOLTM1050S	0.60	75
4.6 Zn Plated Set Screw - M10 x 65mm	BOLTM10065	41.77	BOLTM1065S	0.75	75
4.6 Zn Plated Set Screw - M10 x 75mm	BOLTM10075	44.26	BOLTM1075S	0.77	75
4.6 Zn Plated Set Screw - M12 x 20mm	BOLTM12020	27.77			100
4.6 Zn Plated Set Screw - M12 x 25mm	BOLTM12025	30.86			100
4.6 Zn Plated Set Screw - M12 x 30mm	BOLTM12030	32.40	BOLTM1230S	0.71	100
4.6 Zn Plated Set Screw - M12 x 40mm	BOLTM12040	35.49	BOLTM1240S	0.83	100
4.6 Zn Plated Set Screw - M12 x 50mm	BOLTM12050	37.03			75
4.6 Zn Plated Set Screw - M12 x 75mm	BOLTM12075	54.00			75
4.6 Zn Plated Set Screw - M16 x 50mm	BOLTM16050	108.35			50

*All Fasteners Sold in Pack Quantities for Discounted Prices*

# Marcliff Engineering Co. Pty Ltd

## Fasteners



### Nuts



Details	Zinc Plated		Stainless Steel		Qty
	Code	\$/100	Code	\$/100	Pkt
M6 Hex Nut	NUT06	1.77	NUT06S	6.17	500
M8 Hex Nut	NUT08	3.43	NUT08S	9.26	500
M10 Hex Nut *(Come in Jar Qtys of 150)	NUT10	6.33	NUT10S	20.06	300
M12 Hex Nut	NUT12	9.93	NUT12S	27.77	200
M16 Hex Nut	NUT16	23.45	NUT16S	54.00	200
M20 Hex Nut	NUT20	56.82	NUT20S	181.69	100
M10 Nylon Insert	NUTNM10	13.52	NUTNM10S	28.45	200
M12 Nylon Insert	NUTNM12	20.64	NUTNM12S	42.62	200
M10 x 40 ZYP M/S Hex Coupler	HEXCZ10	40.92			100
M12 x 40 ZYP M/S Hex Coupler	HEXCZ12	62.20			100
M16 x 50 ZYP M/S Hex Coupler	HEXCZ16	122.77			100

### Washers



Details	Zinc Plated		Qty
	Code	\$/100	Pkt
M6 Zn Plated M/S Round Washer	WASHER06	1.54	500
M8 Zn Plated M/S Round Washer	WASHER08	2.82	500
M10 Zn Plated M/S Round Washer *(Come in Jar Qtys of 300)	WASHER10	4.90	600
M12 Zn Plated M/S Round Washer	WASHER12	6.90	200
M16 Zn Plated M/S Round Washer	WASHER16	12.88	200
M20 Zn Plated M/S Round Washer	WASHER20	15.39	200
M10 x 30 Zn Plated Large Washer	WASHER10LG	10.53	150
M10 x 40 Zn Plated Large Mud Washer	WASHER10LMG	12.17	50
M12 x 30 Zn Plated Large Washer	WASHER12LG	18.32	50

### Drop In Anchors



Anchor Details	Zinc Plated		Stainless Steel		Qty
	Code	\$/100	Code	\$/each	Pkt
M6 Wedge / Drop-In Anchor	ANCOM06	19.79	ANCOSM06	1.14	100
M8 Wedge / Drop-In Anchor	ANCOM08	24.05	ANCOSM08	2.08	50
M10 Wedge / Drop-In Anchor	ANCOM10	29.22	ANCOSM10	2.39	50
M12 Wedge / Drop-In Anchor	ANCOM12	60.15	ANCOSM12	4.32	50
M16 Wedge / Drop-In Anchor	ANCOM16	120.30	ANCOSM16	11.04	25
M20 Wedge / Drop-In Anchor	ANCOM20	240.63			25

### Strike Spikes

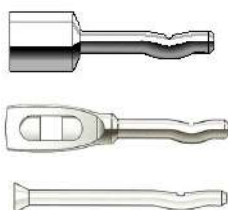

Anchor Details	Zinc Plated		Stainless Steel		Qty
	Code	\$/100	Code	\$/each	Pkt
Pipe Spike 5mm - 6mm Thread	PS56MM	100.63			100
Pipe Spike 6.5mm - 8mm Thread	PS658MM	113.79			100
Pipe Spike 6.5mm - 45mm M10 Pipe Dogleg Anc	PS6510MM	69.64			100
Mushroom Head Spike 5 x 25mm	ANCSPM525	51.04	ANCSPM525S	1.12	100
Mushroom Head Spike 5 x 32mm	ANCSPM532	54.49	ANCSPM532S	1.27	100
Mushroom Head Spike 5 x 38mm	ANCSPM538	55.95	ANCSPM538S	1.51	100
Mushroom Head Spike 5 x 50mm	ANCSPM550	64.18	ANCSPM550S	1.90	100
Mushroom Head Spike 6.5 x 25mm	ANCSPM625	65.21	ANCSPM625S	1.91	100
Mushroom Head Spike 6.5 x 38mm	ANCSPM638	78.30	ANCSPM638S	2.24	100
Mushroom Head Spike 6.5 x 50mm	ANCSPM650	86.91	ANCSPM650S	4.43	100
Mushroom Head Spike 6.5 x 75mm	ANCSPM675	111.66	ANCSPM675S	10.29	100
Mushroom Head Spike 6.5 x 102mm	ANCSPM6102	143.61	ANCSPM6102S	17.59	100

**All Fasteners Sold in  
Pack Quantities for  
Discounted Prices**

# Marcliff Engineering Co. Pty Ltd



## Fasteners

### Imperial Fasteners



Cup Head Set and Nut	Zinc Plated		Hot Dipped Gal.		Qty Pkt
	Code	\$/100	Code	\$/100	
4.6 Cup Head B/N Kit - M6 x 20mm	CUPZ0620	7.98	CUPMG06020	10.01	500
4.6 Cup Head B/N Kit - M6 x 25mm	CUPZ0625	8.14	CUPMG06025	10.01	200
4.6 Cup Head B/N Kit - M6 x 30mm	CUPZ0630	8.33			200
4.6 Cup Head B/N Kit - M6 x 40mm	CUPZ0640	12.23			200
4.6 Cup Head B/N Kit - M6 x 50mm	CUPZ0650	13.44			200
4.6 Cup Head B/N Kit - M6 x 65mm	CUPZ0665	15.24			150
4.6 Cup Head B/N Kit - M6 x 75mm	CUPZ0675	16.08			150
4.6 Cup Head B/N Kit - M8 x 20mm	CUPZ0820	12.81	CUPMG08020	16.30	150
4.6 Cup Head B/N Kit - M8 x 25mm	CUPZ0825	13.27	CUPMG08025	19.63	150
4.6 Cup Head B/N Kit - M8 x 30mm		POA	CUPMG08030	23.72	150
4.6 Cup Head B/N Kit - M8 x 75mm		POA	CUPMG08075	37.36	150
4.6 Cup Head B/N Kit - M10 x 20mm	CUPZ1020	25.13			150
4.6 Cup Head B/N Kit - M10 x 25mm	CUPZ1025	26.02			150
4.6 Cup Head B/N Kit - M10 x 30mm	CUPZ1030	28.14			150
4.6 Cup Head B/N Kit - M10 x 50mm	CUPZ1050	35.25			150
4.6 Cup Head B/N Kit - M10 x 90mm			CUPMG10090	63.03	150
4.6 Cup Head B/N Kit - M10 x 100mm			CUPMG100100	64.97	150
4.6 Cup Head B/N Kit - M10 x 110mm			CUPMG100110	66.92	150
4.6 Cup Head B/N Kit - M10 x 170mm			CUPMG10170	102.50	150

### Wallplugs



Details	Code	\$/100	Qty Pkt
White 25mm PVC Framed Wall Plug	PLUG0525	4.01	500
Red 38mm PVC Framed Wall Plug	PLUG0538	4.98	500
Green 25mm PVC Framed Wall Plug	PLUG0725	4.38	500
Green 30mm PVC Framed Wall Plug	PLUG0730	4.98	500
Green 38mm PVC Framed Wall Plug	PLUG0738	5.67	250
3m Roll Plastic Green Plugs	PLUGRLGREEN	488.57	1

\*Price for 1 x 3m Roll

*\*Please note Prices in Italic made to order with minimum quantities required*

### Tube Spanner - 6mm (1/4") Suit Stand-Off Bracket, Tee's Etc



Code	\$/each	Qty Pkt
TUBE	POA	1

### Drill Attachment Spanner Suit Stand-Off Bracket, Tee's Etc



Chrome Vanadium		Qty Pkt
Code	\$/each	
SOCK6	16.81	1

**All Fasteners Sold in Pack Quantities for Discounted Prices**

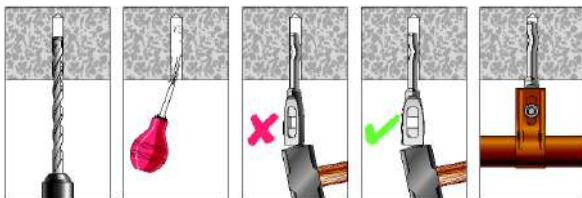

Using the proper diameter bit, drill a hole into the base material to a depth of at least one anchor diameter deeper than the embedment required.

Blow hole clean of dust and other material.

Place the anchor in the hole and align the Tie-Wire Spike head in the same direction as the pipe work. Drive the anchor into the hole until head is seated against the surface of the base material.

Attach pipe clamp.

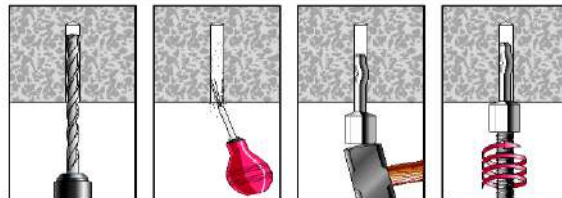

Using the proper diameter bit, drill a hole into the base material to a depth of at least one anchor diameter deeper than the embedment required.

Blow the hole clean of dust and other material.

Drive the anchor into the anchor hole until the head is firmly seated against the surface of the base material.

Screw in threaded rod.

# Marcliff Engineering Co. Pty Ltd

## Fasteners



### Zn Sleeve Anchors



Details	Zinc Plated		Stainless Steel		Qty Pkt
	Code	\$/100	Code	\$/100	
Hex Sleeve Anchor M6.5 x 35mm	ACHSL6036	13.11	ANC6806036	75.10	100
Hex Sleeve Anchor M6.5 x 55mm	ACHSL6055	16.97	ANC6806055	91.76	100
Hex Sleeve Anchor M8 x 40mm	ACHSL8040	18.51	ANC6808040	91.76	100
Hex Sleeve Anchor M8 x 65mm	ACHSL8065	23.14	ANC6808065	125.15	100
Hex Sleeve Anchor M8 x 85mm	ACHSL8085	30.86	ANC6808085	154.67	100
Hex Sleeve Anchor M10 x 40mm	ACHSL10040	30.09			100
Hex Sleeve Anchor M10 x 50mm	ACHSL10050	35.49	ANC6810050	171.86	50
Hex Sleeve Anchor M10 x 60mm	ACHSL10060	37.03			50
Hex Sleeve Anchor M10 x 75mm	ACHSL10075	41.66	ANC6810075	223.44	50
Hex Sleeve Anchor M10 x 95mm	ACHSL10095	49.37	ANC6810095	257.81	50
Hex Sleeve Anchor M10 x 120mm	ACHSL10120	57.09			50
Hex Sleeve Anchor M12 x 60mm	ACHSL12060	58.63	ANC6812060	292.18	50
Hex Sleeve Anchor M12 x 75mm	ACHSL12075	64.80	ANC6812075	317.04	50
Hex Sleeve Anchor M12 x 100mm	ACHSL12100	81.77	ANC6812100	412.48	50
Hex Sleeve Anchor M12 x 130mm	ACHSL12130	91.03			50
Hex Sleeve Anchor M16 x 65mm	ACHSL16065	95.66			50
Hex Sleeve Anchor M16 x 110mm	ACHSL16110	146.57			50
Hex Sleeve Anchor M16 x 145mm	ACHSL16145	177.43			50
Hex Sleeve Anchor M20 x 75mm	ACHSL20075	216.00			25
Hex Sleeve Anchor M20 x 105mm	ACHSL20105	246.86			25
Hex Sleeve Anchor M20 x 160mm	ACHSL20150	316.29			25

### Nylon Nail In Plugs



Details	Zinc Plated		Stainless Steel		Qty Pkt
	Code:	\$/100	Code	\$/100	
Nylon Anchor Round Head M5 x 25mm	ACHNYR525	7.39	ACHSR525	17.90	100
Nylon Anchor Round Head M5 x 40mm	ACHNYR540	10.32			100
Nylon Anchor Round Head M6.5 x 25mm	ACHNYR625	8.43	ACHSR626	21.14	100
Nylon Anchor Round Head M6.5 x 40mm	ACHNYR640	12.03	ACHSR638	25.92	100
Nylon Anchor Round Head M6.5 x 50mm	ACHNYR650	14.10			100

# Marcliff Engineering Co. Pty Ltd

## Fasteners



### Bugle Screws - Fine Thread



Drywall Into Steel Frames	Counter Sunk		Qty Pkt
	Code	\$/100	
Needle Bugle Fine ZY 6-18 x 25	SK0B0625	1.72	1000
Needle Bugle Fine ZY 6-18 x 32	SK0B0632	2.24	1000
Needle Bugle Fine ZY 6-18 x 41	SK0B0641	2.39	1000
Needle Bugle Fine ZY 6-18 x 45	SK0B0645	2.58	1000

### Bugle Screws - Coarse Thread



Drywall Into Wood Frames	Counter Sunk		Qty Pkt
	Code	\$/100	
Bugle Coarse ZY 6-9 x 20mm	SK9B20	1.72	1000
Bugle Coarse ZY 6-9 x 25mm	SK9B25	1.89	1000
Bugle Coarse ZY 6-9 x 32mm	SK9B32	2.24	1000

### Hex Washer Face Type 17 Screws



Hex Drive	Hex Drive		Qty Pkt
	Class 3 - Zinc Plated	Code	
T17 Hex Screw ZY 12-11 x 25	SK17ZY1225	6.02	1000
T17 Hex Screw ZY 12-11 x 50	SK17ZY1250	8.95	1000

### Hex Washer Face Type 17 Screws



Hex Drive	Hex Drive		Qty Pkt
	Class 4 - With Neoprene	Code	
T17 Hex C4 12-11 x 25 Neo	SK7GNEO1225	12.34	1000
T17 Hex C4 12-11 x 45 Neo	SK7GNEO1245	13.58	1000
T17 Hex C4 14-10 x 25 Neo	SK7GNEO1475	27.33	250
T17 Hex C4 14-10 x 50 Neo	SK7GNEO14100	40.21	250

### Hex Washer Face Head Self Drilling



Hex Drive	Hex Drive		Qty Pkt
	Class 3 - Zinc Plated	Code	
SD Hex Coarse ZY 10-16 x 16	SDSZ1016	3.80	900
SD Hex Coarse ZY 12-14 x 20	SDSZ1220	6.17	500

### Hex Washer Face Head Self Drilling



Hex Drive	Hex Drive		Qty Pkt
	Class 4 - With Neoprene	Code	
SD Hex Coarse C4 10-16 x 16 Neo	SDSGNEO1016	7.75	1000
SD Hex Coarse C4 12-14 x 45 Neo	SDSGNEO1245	16.16	1000
SD Hex Coarse C4 12-14 x 65 Neo	SDSGNEO1265	23.30	1000
SD Hex Coarse C4 12-14 x 75 Neo	SDSGNEO1275	37.18	500

### Button Head Needle Point



Flush Fit	Button Head		Qty Pkt
	Code	\$/100	
Needle Button ZY 8-15 x 12	SK21BB13	2.31	1000
Needle Button ZY 8-15 x 15	SK21BB16	2.58	1000
Needle Button ZY 8-15 x 20	SK21BB20	2.76	1000
Needle Button ZY 8-15 x 25	SK21BB25	3.28	1200
Needle Button ZY 8-15 x 32	SK21BB32	3.43	1000

### Button Head Self Drilling Screws



Flush Fit	Button Head		Qty Pkt
	Code	\$/100	
SD Button ZY 8-18 x 12	SD23TB0812	2.08	700
SD Button ZY 8-18 x 25	SD23TB0825	2.91	1000
SD Button ZY 8-18 x 32	SD23TB0832	3.80	1000

# Marcliff Engineering Co. Pty Ltd

## Consumables



### Duct Tape



### Silver Foil Tape



### Christmas Trees



### Standard Cable Ties



### HSS DRILL BITS



Description	Code	Price	Qty
		\$/each	Pkt
Grey Duct Tape 48mm x 75m	DUCTG	3.22	60
Black Duct Tape 48mm x 75m	DUCTB	3.22	60

Description	Code	Price	Qty
		\$/each	Pkt
Foil Tape 48mm	FOIL48	15.95	1
Foil Tape 72mm	FOIL72	22.49	1

Description	Zinc Plated		Qty
	Code	\$/100	Pkt
6mm Christmas Tree Plugs	ACHRIST	23.42	100
8mm Christmas Tree Plugs	ACHRIST8	22.89	100

Width	Details Length	Code	\$/100	Qty Pkt
2.5	100	CTIE100B	1.21	100
3.5	150	CTIE150B	2.57	100
4.7	200	CTIE200B	4.00	100
4.8	300	CTIE300B	6.29	100
4.8	370	CTIE370B	8.29	100
7.6	382	CTIE380B	15.57	100
7.6	540	CTIE540B	32.78	100
9	800	CTIE800B	54.29	100
9	900	CTIE1220B	88.57	100
9	1550	CTIE1550N	108.43	100

Description	Code	Price	Qty
		\$/each	Pkt
DRILLS025	HSS Drill Bit M2 METRIC Size: 2.5mm	2.86	1
DRILLS035	HSS Drill Bit M2 METRIC Size: 3.5mm	3.78	1
DRILLS045	HSS Drill Bit M2 METRIC Size: 4.5mm	POA	1
DRILLS055	HSS Drill Bit M2 METRIC Size: 5.5mm	6.67	1
DRILLS065	HSS Drill Bit M2 METRIC Size: 6.5mm	8.53	1
DRILLS085	HSS Drill Bit M2 METRIC Size: 8.5mm	16.80	1
DRILLS090	HSS Drill Bit M2 METRIC Size: 9mm	POA	1
DRILLS095	HSS Drill Bit M2 METRIC Size: 9.5mm	POA	1
DRILLS100	HSS Drill Bit M2 METRIC Size: 10mm	20.03	1
DRILLS105	HSS Drill Bit M2 METRIC Size: 10.5mm	POA	1
DRILLS110	HSS Drill Bit M2 METRIC Size: 11mm	24.93	1
DRILLS120	HSS Drill Bit M2 METRIC Size: 12mm	28.13	1
DRILLS130	HSS Drill Bit M2 METRIC Size: 13mm	35.20	1
<b>HSS 5% COBOLT M35 Double Ended Drill bit</b>			
Double Ended Drill Bit No. # 11 x 12.7mm Flute 4.85mm x 57m		15.24	20
Double Ended Drill Bit No. # 20 x 12.7mm Flute 4.09mm x 54mm		34.95	20
Double Ended Drill Bit No. # 30 x 12.7mm Flute 3.26mm x 51mm		26.77	20
<b>HSS M2 Double Ended Drill bit</b>			
Double Ended Drill Bit No. # 30 x 12.7mm Flute 3.26mm x 51mm		23.28	20

# Marcliff Engineering Co. Pty Ltd



## Consumables

### Ultra Thin Cutting Discs



Cutting Discs



Description	Code	Price	Qty
		\$/each	Pkt
CUTTING DISCS – 4" 100mm x 1.0mm x 16mm	GRWCMT100	1.92	25
CUTTING DISCS – 4.5", 115mm x 1.0mm x 22.23mm	GRWCMT114	3.15	25
CUTTING DISCS – 5", 125mm x 1.0mm x 22.23mm	GRWCMT125	3.46	25

Description	Code	Price	Qty
		\$/each	Pkt
230x22mm METALCUT-OFF WHEEL	GRWCM230	7.06	1
230x25mm METALCUT-OFF WHEEL	GRWCM250	3.33	1
355x3x25 L/S METAL C/O WHEEL	GRWCM355	6.60	1

### PPR ACCESSORIES



Description	Code	Price	Qty
		\$/box	Pkt
Disposable P2 Masks - Valved Standard	YRESP2	11.79	10
Disposable Ear Plugs Individually bagged - 200 box	YEPBPAIR200	POA	BX
Box Pack - 2 Clear & 1 Smoked Safety Glasses	YSG2C1S	POA	BX
Box Pack - 4 Clear & 2 Smoked Safety Glasses	YSG4C2S	POA	BX
Box Pack - 6 Clear Safety Glasses	YSGCLEAR6L	POA	BX
Box Pack - 6 Smoked Safety Glasses	YSGSMOKED 6	POA	BX

### LINEAR SPRINGS



Description	Code	Price	Qty
		\$/each	Pkt
Register Springs 10x75	LSPRINGR	0.66	100
Long Fixed Spring Round End	LSPRING	POA	100

### Hose Clamps | Zinc Plated



Description	Code	\$/each	Qty Pkt
9-12mm Galvanised Hose Clamp	HOSEC08	1.27	10
11-16mm Galvanised Hose Clamp	HOSEC10	1.37	10
15-20mm Galvanised Hose Clamp	HOSEC12	1.47	10
18-25mm Galvanised Hose Clamp	HOSEC18	1.49	10
22-32mm Galvanised Hose Clamp	HOSEC20	1.61	10
27-40mm Galvanised Hose Clamp	HOSEC30	1.65	10
40-55mm Galvanised Hose Clamp	HOSEC40	1.89	10
55-70mm Galvanised Hose Clamp	HOSEC50	2.05	10

# Marcliff Engineering Co. Pty Ltd



## Class 18 Pressure Pipe Fittings AS/NZS1477

**Valve Adaptor  
Cat. No. 2**



Nom. Size	Code	Individual	
		\$/each	Qty
15	SVA05	0.78	Each
20	SVA07	0.97	Each
25	SVA10	1.47	Each
32	SVA12	1.68	Each
40	SVA15	1.98	Each
50	SVA20	3.02	Each
80	SVA30	21.94	Each

**Faucet Adaptor  
Cat. No. 3**



Nom. Size	Code	Individual	
		\$/each	Qty
15	SFA05	1.28	Each
20	SFA07	1.51	Each
25	SFA10	1.78	Each
32	SFA12	2.56	Each
40	SFA15	4.55	Each
50	SFA20	5.31	Each

**Reducer Bushing (Slip x Slip)  
Cat. No. 5**



Nom. Size	Code	Individual	
		\$/each	Qty
20 x 15	SRB0750	0.45	Each
25 x 15	SRB1005	1.02	Each
25 x 20	SRB1007	0.97	Each
32 x 20	SRB1207	1.18	Each
32 x 25	SRB1210	1.52	Each
40 x 20	SRB1507	1.98	Each
40 x 25	SRB1510	1.54	Each
40 x 32	SRB1512	1.54	Each
50 x 25	SRB2010	2.41	Each
50 x 32	SRB2012	2.38	Each
50 x 40	SRB2015	1.58	Each
65 x 50	SRB2520	5.23	Each
80 x 50	SRB3020	5.04	Each
80 x 65	SRB3025	9.99	Each
100 x 50	SRB4020	12.69	Each
100 x 80	SRB4030	11.92	Each
150 x 100	SRB6040	41.78	Each
200 x 150	SRB8060	128.59	Each

**Cap (Slip x Slip)  
Cat. No. 6**



Nom. Size	Code	Individual	
		\$/each	Qty
15	SKS05	0.40	Each
20	SKS07	0.49	Each
25	SKS10	0.68	Each
32	SKS12	1.21	Each
40	SKS15	0.98	Each
50	SKS20	1.26	Each
65	SKS25	7.00	Each
80	SKS30	5.50	Each
100	SKS40	10.66	Each
150	SKS60	50.51	Each
200	SKS80	155.14	Each

# Marcliff Engineering Co. Pty Ltd



## Class 18 Pressure Pipe Fittings AS/NZS1477

**Coupling (Slip x Slip)  
Cat. No. 7**



Nom. Size	Code	Individual	
		\$/each	Qty
15	SCS05	0.31	Each
20	SCS07	0.38	Each
25	SCS10	0.57	Each
32	SCS12	1.05	Each
40	SCS15	0.84	Each
50	SCS20	1.37	Each
65	SCS25	4.94	Each
80	SCS30	4.92	Each
100	SCS40	10.31	Each
150	SCS60	42.57	Each
200	SCS80	121.05	Each
250	SCS100	292.66	Each

**Reducer Socket (Slip x Slip)  
Cat. No. 8**



Nom. Size	Code	Individual	
		\$/each	Qty
20x15	SRS0750	0.60	Each
25x15	SRS1005	0.89	Each
25x20	SRS1007	1.17	Each
32x20	SRS1207	1.37	Each
32x25	SRS1210	1.46	Each
40x20	SRS1507	1.59	Each
40x25	SRS1510	1.90	Each
40x32	SRS1512	2.42	Each
50x20	SRS2007	2.62	Each
50x25	SRS2010	2.64	Each
50x32	SRS2012	2.60	Each
50x40	SRS2015	2.58	Each
65x50	SRS2520	5.98	Each
80x50	SRS3020	5.31	Each
80x65	SRS3025	10.09	Each
100x50	SRS4020	11.67	Each
100x80	SRS4030	9.38	Each
150x100	SRS6040	36.89	Each
200x150	SRS8060	149.83	Each

**45 Degree Elbow (Slip x Slip)  
Cat. No. 10**



Nom. Size	Code	Individual	
		\$/each	Qty
15	SAS05	0.48	Each
20	SAS07	0.78	Each
25	SAS10	0.78	Each
32	SAS12	1.78	Each
40	SAS15	1.44	Each
50	SAS20	2.30	Each
65	SAS25	12.98	Each
80	SAS30	9.72	Each
100	SAS40	18.48	Each
150	SAS60	71.33	Each
200	SAS80	177.52	Each

## Class 18 Pressure Pipe Fittings AS/NZS1477

**90 Degree Elbow (Slip x Slip)**  
Cat. No. 13



Nom. Size	Code	Individual	
		\$/each	Qty
15	SLS05	0.46	Each
20	SLS07	0.52	Each
25	SLS10	0.80	Each
32	SLS12	1.41	Each
40	SLS15	1.50	Each
50	SLS20	3.20	Each
65	SLS25	11.21	Each
80	SLS30	9.34	Each
100	SLS40	17.28	Each
150	SLS60	72.39	Each
200	SLS80	255.15	Each

**90 Degree Faucet Elbow (Slip x FPT)**  
Cat. No. 15



Nom. Size	Code	Individual	
		\$/each	Qty
15	SLT05	0.65	50
20	SLT07	0.72	50
25	SLT10	1.10	50
40	SLT15	3.50	50
50	SLT20	18.26	50

**Valve Socket (Male Adapter)**  
Cat. No. 17



Nom. Size	Code	Individual	
		\$/each	Qty
15	SMT05	0.48	Each
20	SMT07	0.52	Each
25	SMT10	0.93	Each
32	SMT12	1.02	Each
40	SMT15	1.24	Each
50	SMT20	1.63	Each
65	SMT25	10.08	Each
80	SMT30	7.72	Each
100	SMT40	23.27	Each
150	SMT60	77.95	Each

**Faucet Socket (Female Adapter)**  
Cat. No. 18



Nom. Size	Code	Individual	
		\$/each	Qty
15	SFT05	0.62	Each
20	SFT07	0.76	Each
25	SFT10	1.08	Each
32	SFT12	1.45	Each
40	SFT15	1.76	Each
50	SFT20	2.42	Each
65	SFT25	15.54	Each
80	SFT30	9.47	Each
100	SFT40	14.04	Each
150	SFT60	74.14	Each

# Marcliff Engineering

## Co. Pty Ltd

### Class 18 Pressure Pipe Fittings AS/NZS1477



**Tee (Slip x Slip)**  
**Cat. No. 19**



Nom. Size	Code	Individual	
		\$/each	Qty
15	STS05	0.64	Each
20	STS07	0.72	Each
20x15	STS0705	1.09	Each
25	STS10	1.10	Each
25x15	STS1005	3.52	Each
25x20	STS1007	1.35	Each
32	STS12	1.96	Each
40	STS15	2.65	Each
40x20	STS1507	3.08	Each
50	STS20	4.08	Each
50x20	STS2007	4.10	Each
50x25	STS2010	4.25	Each
65	STS25	13.74	Each
80	STS30	16.93	Each
100	STS40	30.62	Each
150	STS60	112.66	Each
200	STS80	381.09	Each

**Faucet Tee (Slip x FPT)**  
**Cat. No. 21**



Nom. Size	Code	Individual	
		\$/each	Qty
20x15	STT0705	0.84	Each
25x15	STT1005	1.26	Each
25x20	STT1007	2.02	Each
40	STT15	5.66	Each
40x20	STT1507	5.06	Each
40x25	STT1510	5.06	Each
50	STT20	8.07	Each
50x25	STT2010	7.20	Each

**Barrel Unions (Slip x Slip)**  
**Cat. No. 22**



Nom. Size	Code	Individual	
		\$/each	Qty
15	SBU05	2.42	Each
20	SBU07	2.77	Each
25	SBU10	4.23	Each
32	SBU12	5.14	Each
40	SBU15	7.61	Each
50	SBU20	11.08	Each
65	SBU25	29.08	Each
80	SBU30	29.59	Each
100	SBU40	58.54	Each

# Marcliff Engineering Co. Pty Ltd

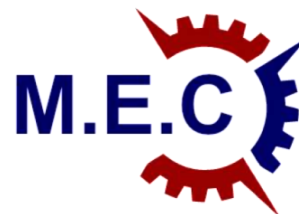

## Pressure Pipe Fittings

### Compression Coupling



Nom. Size	Code	Individual	
		\$/each	Qty
15	SCC05	2.65	Each
20	SCC07	3.85	Each
25	SCC10	4.97	Each
32	SCC12	6.82	Each
40	SCC15	8.02	Each
50	SCC20	10.42	Each
65	SCC25	28.00	Each
80	SCC30	41.87	Each
100	SCC40	60.44	Each
150	SCC60	114.95	Each

### Ball Check Valve - Solvent Weld



Nom. Size	Code	Individual	
		\$/each	Qty
20	SCBV07	9.97	Each
25	SCBV10	14.44	Each
32	SCBV12	41.53	Each
40	SCBV15	20.48	Each
50	SCBV20	28.53	Each

### PVC Swing Check Valve Slip x Slip Solvent Weld



Nom. Size	Code	Individual	
		\$/each	Qty
15	SCBSW05	27.86	Each
20	SCBSW07	22.08	Each
25	SCBSW10	35.07	Each
32	SCBSW12	48.91	Each
40	SCBSW15	37.67	Each
50	SCBSW20	45.47	Each
80	SCBSW30	120.74	Each
100	SCBSW40	169.49	Each

### 20x15mm Screwed Bush CAT 24



Inner Thread	Outer Thread	Code	\$/each
15	20	SCB0705	3.25
15	25	SCB1005	4.51
20	25	SCB1007	4.51
25	32	SCB1210	11.35
25	40	SCB1510	13.75
25	50	SCB2010	24.68

For more information visit:

# Marcliff Engineering

## Co. Pty Ltd

### Pressure Pipe Fittings



For more information visit: [www.pressurepipe.com.au](http://www.pressurepipe.com.au)

#### Ball Valves (Slip x Slip) Solvent Weld



Nom. Size	Code	Individual	
		\$/each	Qty
15	SBV05	2.66	Each
20	SBV07	3.42	Each
25	SBV10	5.18	Each
32	SBV12	7.26	Each
40	SBV15	9.30	Each
50	SBV20	13.48	Each
65	SBV25	54.41	Each
80	SBV30	44.63	Each
100	SBV40	91.96	Each

#### Ball Valves (FTP x FTP) BSP Threaded



Nom. Size	Code	Individual	
		\$/each	Qty
15	SBVF05	2.55	Each
20	SBVF07	3.24	Each
25	SBVF10	4.85	Each
32	SBVF12	7.14	Each
40	SBVF15	9.72	Each
50	SBVF20	12.75	Each
65	SBVF25	54.40	Each
80	SBVF30	43.99	Each
100	SBVF40	91.96	Each

#### PVC Hose Barb



Nom. Size	Code	Individual	
		\$/each	Qty
15	SCHB05	0.52	Each
20	SCHB07	0.85	Each
25	SCHB10	1.23	Each
32	SCHB12	POA	Each
40	SCHB15	POA	Each
50	SCHB20	5.21	Each
65	SCHB25	POA	Each
80	SCHB30	POA	Each
100	SCHB40	POA	Each

#### Screwed Plug Cat 23



Nom. Size	Code	Individual	
		\$/each	Qty
15	SCP05	1.81	Each
20	SCP07	2.28	Each
25	SCP10	3.90	Each
32	SCP12	POA	Each
40	SCP15	POA	Each
50	SCP20	POA	Each

# Marcliff Engineering

## Co. Pty Ltd

### Pressure Pipe Fittings



Type	Weight	Code	Individual	
			\$/each	Qty
CLEAR	100	SOL100	3.60	60
CLEAR	500	SOL500	11.86	12
BLUE	250	SOLB250	8.91	18
BLUE	500	SOLB500	16.61	12
GREEN	500	SOLG500	9.54	12
Clear PVC Glue Type P 500ml	500	SOLGN500	20.73	12
RED	500	SOLP500	7.08	12
PVC Clear Priming Fluid - 500ml	500	SOLPC500	7.08	12
CLEAR - 1 Litre Insulation Adhesive	1,000	SOLT1L	38.28	1
CLEAR - 520 Adhesive 500ml Insulation Glue	500	SOLT500	26.73	1

**PVC Solvent  
Pressure Pipe**



### Flange Loose Ring (Vanstones)



Nom. Size	Code	Individual	
		\$/each	Qty
50	VAN50	21.23	Each
80	VAN80	18.10	Each
100	VAN100	26.12	Each
150	VAN150	78.41	Each
200	VAN200	135.37	Each
250	VAN250	365.78	Each

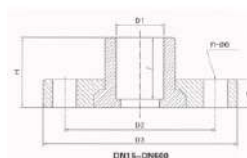

For more information visit:

# Marcliff Engineering Co. Pty Ltd



## Pressure Pipe Fittings

### Drilled Flanges (Fixed)

#### Cat. No. 16



Nom. Size	Code	Individual	
		\$/each	Qty
15	SFNG05	9.25	25
20	SFNG07	10.10	25
25	SFNG10	10.45	25
32	SFNG12	12.47	25
40	SFNG15	14.00	25
50	SFNG20	13.23	25
65	SFNG25	23.48	25

### Rubber Gaslets



Nom. Size	Code	Individual	
		\$/each	Qty
15	SRG05	2.66	20
20	SRG07	2.66	20
25	SRG10	3.31	20
32	SRG12	3.48	20
40	SRG15	3.89	20
50	SRG20	4.84	20
65	SRG25	5.51	20
80	SRG30	6.15	20
100	SRG40	7.55	20
150	SRG60	8.44	20
200	SRG80	10.17	20

### Roof Flashings



Size	Code	Individual	
		\$/each	Qty
6-60mm 120mm BASE	FLASH660	7.36	1
50-80mm 160mm BASE	FLASH5080	11.45	1
60-110mm 195mm BASE	FLASH60110	17.17	1
75-150mm 235mm BASE	FLASH75150	24.53	1

For more information visit: [www.pressurepipe.com.au](http://www.pressurepipe.com.au)

# Marcliff Engineering Co. Pty Ltd



## Pressure Pipe Fittings

For more information visit: [www.pressurepipe.com.au](http://www.pressurepipe.com.au)

### Ball Valves (Slip x Slip)

#### Double Union

Nom. Size	Code	Individual	
		\$/each	Qty
25	SBVDU25	24.91	1
40	SBVDU40	47.25	1
50	SBVDU50	56.21	1
80	SBVDU80	139.31	1
100	SBVDU100	195.18	1

#### Double Union



### Ball Valves FTP x FTP

#### BSP Threaded

Nom. Size	Code	Individual	
		\$/each	Qty
25	SBVDUT25	31.07	1
40	SBVDUT40	53.58	1
50	SBVDUT50	65.98	1
80	SBVDUT80	205.18	1
100	SBVDUT100	254.83	1

### Pressure Pipe



Nom. Size	Code	Pipe Length	Carton	
			\$/each	Qty
15	PD15ACR	4m	7.92	20
20	PD20ACR	4m	10.64	20
25	PD25ACR	4m	14.78	10
32	PD32ACR	4m	17.35	10
15	PD15CL12	6m	19.82	10
20	PD20CL12	6m	14.92	10
25	PD25CL12	6m	25.20	10
32	PD32CL12	6m	38.42	10
40	PD40CL12	6m	44.34	10
40	PD40CL9	6m	28.48	10
40	PD40CL18	6m	39.97	10
50	PD50CL9	6m	40.56	10
50	PD50CL12	6m	53.36	10
50	PD50CL18	6m	0.00	10
65	PD65CL12	6m	63.70	10
65	PD65CL18	6m	143.59	10
80	PD80CL9	6m	75.88	10
80	PD80CL12	6m	136.70	10
80	PD80CL18	6m	138.47	10
100	PD100CL9	6m	101.29	10
100	PD100CL12	6m	236.98	10
100	PD100CL18	6m	123.07	10
125	PD125CL12	6m	194.87	10
150	PD150CL9	6m	192.31	10
150	PD150CL12	6m	256.16	10
150	PD150CL18	6m	396.17	10
200	PD200CL9	6m	379.51	10
200	PD200CL12	6m	476.93	10
200	PD200CL18	6m	635.92	10
225	PD225CL12	6m	628.23	10
250	PD250CL12	6m	1015.41	10
300	PD300CL12	6m	1153.88	10

## CLASS 18 PRESSURE PIPE FITTINGS SPECIFICATIONS

### Technical Specifications

#### Physical Properties

The general physical properties of PVC are given in table below;

Property	Value
<b>Physical &amp; Mechanical</b>	
Specific Gravity	1.43 to 1.5
Effect on potable water - AS 4020	Complies
Hydrostatic design stress	Up to and including DN 150 = 11 Mpa above DN 150 = 12.3 MPa
Mean hoop stress at 20 Degrees Celcius extrapolated to 50 years AS/NZS 1462.6	Up to and including DN 150 = 23.6 Mpa Above DN 150 = 26 Mpa
Minimum notch hoop strength at 20 Degrees Celcius extrapolated to 50 years	24.5 Mpa
Flexual modulus - ISO 9969	3200 Mpa
Poisson's Ration	0.38 - 40
<b>Thermal</b>	
Coefficient of Linear thermal expansion	$70 \times 10^{-6}$ per degree celcius
Thermal conductivity	$0.138 \times 10^{-3}$ W/m.K
Specific Heat	1045 J/kg.K
Maximum practicable working temperature	50 Degree Celcius
<b>Fire resistance</b>	
Flammability	Will not support combustion
Ignitability - AS 1530	8
Smoke Development - AS 1530	7
Spread of Flame - AS 1530	0
Heat evolved - AS 1530	0
<b>Electrical</b>	
Volume resistivity	$10^{16}$ ohm.cm (60%RH)
Surface resistivity	$10^{13} - 10^{14}$ ohm
Power Factor	0.015 - 0.020 at 20 degree celcius
Dielectric Constant	3.4 - 3.6 at 25 degree celcius (60Hz)

# Marcliff Engineering Co. Pty Ltd

## HVAC Supplies



HARD DRAWN HVAC LENGTHS R410A		R410A Rated	OD (mm)	WT (mm)	L (M)	\$/each
Code:	Description					
CUSAC0621	Cu AC Length (6.35x0.81)x6M	YES	6.35	0.81	6	\$22.67
CUSAC1021	Cu AC Length (9.52x0.81)x6M	YES	9.52	0.81	6	\$36.86
CUSAC1221H	Cu AC Length (12.7x0.81)x6M	YES	12.7	0.81	6	\$48.86
CUSAC1619H	Cu AC Length (15.88x1.02)x6M	YES	15.88	1.02	6	\$77.47
CUSAC2019H	Cu AC Length (19.05x1.14)x6M	YES	19.05	1.14	6	\$104.18
CUSAC2217	Cu AC Length (22.23x1.40)x6M	YES	22.23	1.4	6	\$142.86
CUSAC2516	Cu AC Length (25.4x1.63)x6M	YES	25.4	1.63	6	\$188.08
CUSAC2814	Cu AC Length (28.58x1.83)x6M	YES	28.58	1.83	6	\$239.14
CUSAC3512	Cu AC Length (34.9x2.03)x6M	YES	34.9	2.03	6	\$329.57
CUSAC4213	Cu AC Length (41.28x2.41)x6M	YES	41.28	2.41	6	\$460.00

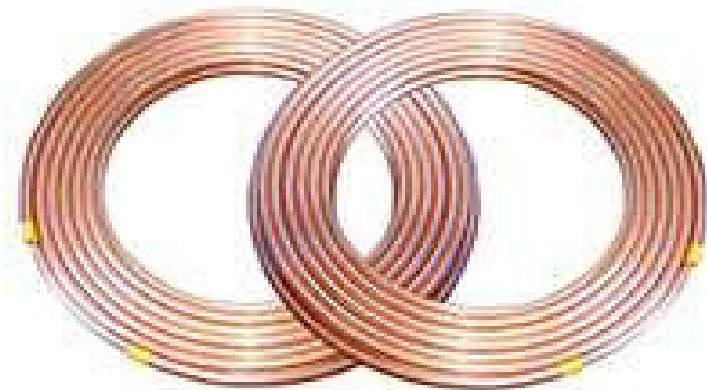

ANNEALED HVAC COILS R410A		R410A Rated	OD (mm)	WT (mm)	L (M)	\$/each
Code:	Description					
CUC1421P30	Cu Pancake (6.35x0.81)X30M	YES	6.35	0.81	30	\$111.39
CUC3821P	Cu Pancake (9.52x0.81)x18M	YES	9.52	0.81	18	\$107.94
CUC1221P	Cu Pancake (12.7x0.81)x18M	YES	12.7	0.81	18	\$146.95
CUC5819P	Cu Pancake (15.88x1.02)x18M	YES	15.88	1.02	18	\$226.15
CUC3419P	Cu Pancake (19.05x1.14)x18M	YES	19.05	1.14	18	\$317.65
CUC7817P	Cu Pancake (22.23x1.4)x18M R410	YES	22.23	1.4	18	\$456.02

PLEASE NOTE \$55 FREIGHT CHARGE APPLIES FOR SYDNEY METRO - OR PICKUP PRICING APPLIES  
PRICING SUBJECT TO CHANGE WITHOUT NOTICE - PRICING SUBJECT TO STOCK AVAILABILITY

Ph: 02 9524 9123

Fax: 02 9540 2899

Email: [orders@marcliff.com.au](mailto:orders@marcliff.com.au)

Please note all prices are GST exclusive

# Marcliff Engineering Co. Pty Ltd



## HVAC Supplies



PAIR COIL HVAC LENGTHS 20M R410A		R410A	SIZE	WT	L	\$/each
Code:	Description	Rated	(mm)	(mm)	(M)	
CUC1438PC	Cu Pair Coil(6.35x0.81+9.52x0.81)x20M	YES	1/4	3/8	20	\$210.82
CUC1412PC	Cu Pair Coil(6.35x0.81+12.7x0.81)x20M	YES	1/4	1/2	20	\$250.43
CUC1458PC	Cu Pair Coil(6.36x0.81+15.88x1.02)x20M	YES	1/4	5/8	20	\$344.35
CUC3858PC	Cu Pair Coil(9.52x0.81+15.88x1.02)x20M	YES	3/8	5/8	20	\$384.61
CUC3834PC	Cu Pair Coil(9.52x0.81+19.05x1.14)x20M	YES	3/8	3/4	20	\$472.86

Code	Description	\$/each
CUFE14D90	1/4 90 Degree Elbow R410A	1.30
CUFE38D90	3/8 90 Degree Elbow R410A	1.14
CUFE12D90	1/2 90 Degree Elbow R410A	0.91
CUFE58D90	5/8 90 Degree Elbow R410A	1.28
CUFE34D90	3/4 90 Degree Elbow R410A	2.56
CUFE78D90	7/8 90 Degree Elbow R410A	3.14
CUFE10D90	1 90 Degree Elbow R410A	4.48
CUFE118D90	1 1/8 90 Degree Elbow R410A	7.68
CUFE138D90	1 3/8 90 Degree Elbow R410A	13.44
CUFE158D90	1 5/8 90 Degree Elbow R410A	23.87

**90 DEG  
410a RATED ELBOW**



Code	Description	\$/each
CUFC14	1/4 Coupling R410A	0.48
CUFC38	3/8 Coupling R410A	0.59
CUFC12	1/2 Coupling R410A	0.99
CUFC58	5/8 Coupling R410A	0.88
CUFC34	3/4 Coupling R410A	1.68
CUFC78	7/8 Coupling R410A	1.81
CUFC10	1 Coupling R410A	2.40
CUFC118	1 1/8 Coupling R410A	4.59
CUFC138	1 3/8 Coupling R410A	9.18
CUFC158	1 5/8 Coupling R410A	10.93

**COUPLING  
410a RATED**



Code	Description	\$/each
CUFE38D45	3/8 45 Degree Elbow R410A	1.89
CUFE12D45	1/2 45 Degree Elbow R410A	2.75
CUFE58D45	5/8 45 Degree Elbow R410A	1.30
CUFE34D45	3/4 45 Degree Elbow R410A	4.94
CUFE78D45	7/8 45 Degree Elbow R410A	2.56
CUFE10D45	1 45 Degree Elbow R410A	6.98
CUFE118D45	1 1/8 45 Degree Elbow R410A	11.23
CUFE138D45	1 3/8 45 Degree Elbow R410A	13.71
CUFE158D45	1 5/8 45 Degree Elbow R410A	23.81

**45 DEG  
410a RATED ELBOW**



## HVAC Supplies

### G4/F4 CARDBOARD FILTERS

25mm (1") Cardboard Filters	Width mm	Height mm	Width mm	Height mm	Thick mm	Code	Pick-Up \$/each	Qty Pkt
	12	24	295	595	25	G4122425	\$10.18	12
	14	20	349	495	25	G4142025	\$11.93	12
	14	25	349	629	25	G4142525	\$11.93	12
	16	20	395	495	25	G4162025	\$11.93	12
	16	25	395	629	25	G4162525	\$14.31	12
	18	24	451	595	25	G4182425	\$3.66	12
	18	25	457	635	25	G4182525	\$13.47	12
	20	20	495	495	25	G4202025	\$15.26	12
	20	24	495	595	25	G4202425	\$18.93	12
	20	25	495	629	25	G4202525	\$17.41	12

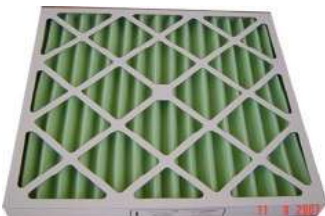
50mm (2") Cardboard Filters	Width mm	Height mm	Width mm	Height mm	Thick mm	Code	Pick-Up \$/each	Qty Pkt
 	10	20	254	495	50	G42544955	\$10.18	12
	12	12	295	295	50	G42952955	\$13.49	12
	12	14	295	349	50	G42953555	\$16.62	12
	12	16	295	395	50	G42953955	\$4.22	12
	12	20	295	495	50	G42954955	\$13.49	12
	12	24	295	595	50	G42955955	\$9.38	12
	13	14	320	349	50	G43203495	\$8.86	12
	14	15	349	375	50	G43493805	\$16.62	12
	14	17	349	430	50	G43494305	\$16.62	12
	14	20	349	495	50	G43494955	\$13.52	12
	14	24	349	595	50	G43495955	\$13.52	12
	14	25	349	629	50	G43496295	\$14.31	12
	15	20	375	495	50	G43754955	\$14.31	12
	16	16	395	395	50	G43953955	\$14.98	12
	16	18	395	460	50	G43954605	\$10.08	12
	16	20	395	495	50	G43954955	\$16.28	12
	16	24	395	595	50	G43955955	\$22.39	12
	16	25	395	629	50	G43956295	\$14.31	12
	18	20	451	495	50	G44514955	\$21.12	12
	18	24	451	595	50	G44515955	\$21.62	12
18	25	451	629	50	G44516295	\$18.60	12	
20	20	495	495	50	G44954955	\$20.86	12	
20	24	495	595	50	G45954955	\$25.19	12	
20	25	495	629	50	G44956295	\$22.69	12	
20	30	495	762	50	G44957625	\$22.90	12	
24	24	595	595	50	G45955955	\$13.83	12	
25	25	629	629	50	G46296295	\$23.69	12	
25	30	629	762	50	G46297625	\$29.57	12	

### G4/F4 CARDBOARD FILTERS

100mm (4") Cardboard Filters	Width mm	Height mm	Width mm	Height mm	Thick mm	Code	Pick-Up \$/each	Qty Pkt
	12	24	295	595	100	G4122495	\$16.85	6
	16	16	395	395	100	G4161695	\$22.90	6
	16	20	395	495	100	G4162095	\$16.72	6
	16	24	395	595	100	G4162495	\$18.41	6
	16	25	395	629	100	G4162595	\$27.51	6
	18	24	451	595	100	G4182495	\$29.57	6
	20	20	495	495	100	G4202095	\$24.80	6
	20	24	495	595	100	G4202495	\$26.39	6
	20	25	495	629	100	G4202595	\$32.91	6
	24	24	595	595	100	G4242495	\$28.62	6
	25	29	629	735	100	G4252995	\$30.64	6
	28	30	711	762	100	G4283095	\$37.03	6

### G4/ HIGH EFFICIENCY CARDBOARD FILTERS

High Efficiency Cardboard Filter	Width mm	Height mm	Width mm	Height mm	Efficiency En779	Code	Pick-Up \$/each	Qty Pkt
	24	24	594	594	F5	G5595595	POA	12
	12	24	290	594	F5	G5295595	POA	12
	24	24	594	594	F6	G6595595	POA	12
	12	24	290	594	F6	G6295595	POA	12
	24	24	594	594	F8	G8595595	POA	12
	12	24	290	594	F8	G8295595	POA	12
	24	24	594	594	F9	G9595595	\$14.31	12

CARBON FILTER	Width mm	Height mm	Width mm	Height mm	Thick mm	Code	Pick-Up \$/each	Qty Pkt
	24	24	595	595	50	G4C595595	\$14.31	12



### G4/ HIGH EFFICIENCY CARDBOARD FILTERS

G4 Cardboard Filters	Perimeter Size		Thick mm	Code	Pick-Up \$/each	Qty Pkt
		0	800	10	FILTER 800	POA
	800	1800	10	FILTER 1800	POA	1
	1800	2400	10	FILTER 2400	POA	1
	2400	3440	10	FILTER 3440	POA	1

N75 HIGH EFFICIENCY PANEL FILTER	Width mm	Height mm	Thick mm	Code	Pick-Up \$/each	Qty Pkt
		0	800	10	FILTER75N800	POA
	800	1800	10	FILTER75N1800	POA	1
	1800	2400	10	FILTER75N2400	POA	1
	2400	3440	10	FILTER75N3440	POA	1

N95 HIGH EFFICIENCY PANEL FILTER	Width mm	Height mm	Thick mm	Code	Pick-Up \$/each	Qty Pkt
		0	800	10	FILTER95N800	POA
	800	1800	10	FILTER95N1800	POA	1
	1800	2400	10	FILTER95N2400	POA	1
	2400	3440	10	FILTER95N3440	POA	1

### G4/F4 DISPOSABLE SERVICE PLEATS

50mm (2") Disposable Pleats	Width mm	Height mm	Width mm	Height mm	Thick mm	Code	Pick-Up \$/each	Qty Pkt
 	12	20	295	495	50	DSP295495	\$15.88	30
	12	24	295	595	50	DSP295595	\$16.69	30
	16	16	395	395	50	DSP395395	\$13.61	30
	16	20	395	495	50	DSP395495	\$6.60	30
	16	24	395	595	50	DSP395595	\$6.60	30
	16	25	395	629	50	DSP395629	\$15.94	30
	16	30	395	750	50	DSP395750	\$17.69	30
	20	12	495	295	50	DSP495295	\$10.31	30
	20	14.5	495	368	50	DSP495368	\$11.28	30
	20	16	495	395	50	DSP495395	\$11.67	30
	20	20	495	495	50	DSP495495	\$7.30	30
	20	24	495	595	50	DSP495595	\$7.30	30
	20	25	495	629	50	DSP495629	\$17.11	30
	20	30	495	750	50	DSP495750	\$19.64	30
	24	12	595	295	50	DSP595295	\$12.44	30
	24	16	595	395	50	DSP595395	\$13.03	30
	24	18	595	444	50	DSP595444	\$13.22	30
	24	20	595	495	50	DSP595495	\$13.61	30
	24	24	595	595	50	DSP595595	\$8.83	30
	24	30	595	750	50	DSP595750	\$22.51	30
	25	12	629	295	50	DSP629295	\$12.06	30
	25	16	629	395	50	DPS629395	POA	30
	25	20	629	495	50	DSP629495	\$14.00	30
	25	24	629	595	50	DSP629595	\$14.78	30
	25	30	629	762	50	DSP629762	\$16.92	30

100mm (4") Disposable Pleats	Width mm	Height mm	Width mm	Height mm	Thick mm	Code	Pick-Up \$/each	Qty Pkt
 	16	20	395	495	100	DSP16204	\$21.75	20
	16	24	395	595	100	DSP16244	\$23.50	20
	16	25	395	629	100	DSP16254	\$24.38	20
	20	12	495	295	100	DSP20124	\$18.03	20
	20	20	495	495	100	DSP20204	\$20.22	20
	20	24	495	595	100	DSP20244	\$21.53	20
	20	25	495	629	100	DSP20254	\$24.04	10
	24	12	595	295	100	DSP24124	\$21.85	10
	24	16	595	395	100	DSP24164	\$22.51	10
	24	24	595	595	100	DSP24244	\$27.97	10
	25	12	629	295	100	DSP25124	\$23.38	10
	25	20	629	495	100	DSP25204	\$25.79	10
	25	24	629	595	100	DSP25244	\$27.97	10
	25	30	629	595	100	DSP25304	\$30.38	10

# Marcliff Engineering Co. Pty Ltd



HVAC Supplies

## F4/G4 PRIMARY FILTERS

G4 Pad Filters	Width mm	Height mm	Depth mm	Code	\$/each	Qty Pkt
	300	500	25	P500300	\$5.74	1
	410	455	25	P455410	\$5.74	1
	510	455	25	P510455	\$5.74	1
	510	510	25	P510510	\$5.74	1
	510	590	25	P590510	\$5.74	1
	510	610	25	P610510	\$5.74	1
	595	595	25	P610510	\$5.74	1
	610	610	25	P610610	\$5.74	1

Bulk Media Rolls	Width mm	Height mm	Depth mm	Code	\$/each	Qty Pkt	Color
	2.1	18	65	MEDIAEC1	\$615.71	1	White
	21	18	20	MEDIAF4A	\$295.71	1	White
	1	10	20	MEDIAH12	\$222.22	1	White
	2.1	10	20	MEDIAH12	\$222.22	1	White
	2.1	10	20	MEDIAH12	\$222.22	1	Grey
	655	8		MEDIAF7	\$283.55	1	
	655	8		MEDIAF9	\$283.55	1	
	2.1	10	20	MEDIAH22	\$0.00	1	
	2.1	10	40	MEDIAH24	\$0.00	1	
	1	1		MEDIAMIS	\$396.97	1	

Grade: F4 Semi-Washable White

F4 Deep Bed Filters - Incl. Frame	Width mm	Height mm	Depth mm	Code	\$/each	Qty Pkt	
	595	595	570	DBF666	\$0.00	1	
	595	295	570	DBF636	\$0.00	1	
	595	595	350	DBF663	\$0.00	1	
	595	295	350	DBF633	\$0.00	1	
	Specifications						
	Width	Height	Depth	Pockets		L/S	
	595	595	945	570	3	945	
	595	295	470	570	2	470	
	595	595	945	350	3	945	
	595	295	470	350	2	470	

All F4 Filters Have A Sturdy Aluminium Frame

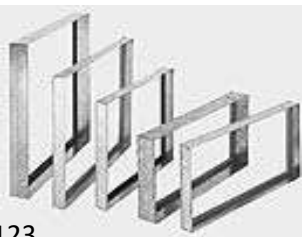
Galvanised Mounting Frames - Incl Gasket	Width mm	Height mm	Depth mm	Code	\$/each	Qty Pkt
	300	600	50	F600300	\$23.00	1
	305	610	50	F305610	\$21.36	1
	610	610	50	F610610	\$12.65	1
	600	600	50	F600600	\$24.30	1
	405	635	50	F405635	POA	1
	508	508	50	F508508	POA	1
	508	610	50	F508610	POA	1
	508	635	50	F508635	POA	1

Ph: 02 9524 9123

Fax: 02 9540 2899

Email: orders@marcliff.com.au

Please note all prices are GST exclusive

### MEDIUM EFFICIENCY FILTERS

F5 Medium Efficiency Pocket Filter	Width mm	Height mm	Depth mm	Code	Pockets	\$/each
	595	295	560	MF5636	3	\$29.75
	595	595	380	MF5663	6	\$39.23
	287	595	380	MF5363	3	POA
	595	295	380	MF5633	3	\$28.80
	595	595	560	MF56661	6	POA
	595	595	560	MF5666	8	\$65.88

F6 Medium Efficiency Pocket Filter	Width mm	Height mm	Depth mm	Code	Pockets	\$/each
	595	595	380	MF6663	6	\$52.29
	287	595	380	MF6363	3	POA
	595	295	380	MF6633		\$28.82
	595	595	560	MF66661	10	POA
	595	595	560	MF6666	8	\$26.37
	595	595	570	MF6636		\$16.51
	595	595	560	MF6666	8	\$26.37

F7 Medium Efficiency Pocket Filter	Width mm	Height mm	Depth mm	Code	Pockets	\$/each
	595	295	380	MF7633	3	\$14.61
	595	295	595	MF7636	6	\$26.92
	595	595	380	MF7663	6	\$24.22
	287	595	380	MF7363	3	POA
	595	595	560	MF76661	8	POA
	595	595	595	MF7666	8	\$67.44

# Marcliff Engineering Co. Pty Ltd



HVAC Supplies

## MEDIUM EFFICIENCY FILTERS

F8 Medium Efficiency Pocket Filter	Width mm	Height mm	Depth mm	Code	Pockets	\$/each
	595	595	380	MF8663	6	POA
	287	595	380	MF8363	3	POA
	595	595	560	MF86661	10	POA
	595	595	560	MF8666	8	POA

F9 Medium Efficiency Pocket Filter	Width mm	Height mm	Depth mm	Code	Pockets	\$/each
	295	595	560	MF9366	6	\$101.86

# Marcliff Engineering Co. Pty Ltd



HVAC Supplies

## HEPA FILTERS

Mini-Pleat HEPA Filter							
Width mm	Height mm	Width mm	Height mm	Depth mm	Efficiency En779	Code	\$/each
12	24	305	610	70	H11	MFHEPAH11-30561070	POA
24	24	610	610	70		MFHEPAH11-61061070	POA
36	24	915	610	70		MFHEPAH11-91561070	POA
48	24	1220	610	70		MFHEPAH11-122061070	POA
12	24	305	610	70	H13	MFHEPAH13-30561070	POA
24	24	610	610	70		MFHEPAH13-61061070	POA
36	24	915	610	70		MFHEPAH13-91561070	POA
48	24	1220	610	70		MFHEPAH13-122061070	POA
12	24	305	610	70	U15	MFHEPAU15-30561070	POA
24	24	610	610	70		MFHEPAU15-61061070	POA
36	24	915	610	70		MFHEPAU15-91561070	POA
48	24	1220	610	70		MFHEPAU15-122061070	POA



High Volume HEPA Filter							
Width mm	Height mm	Width mm	Height mm	Depth mm	Efficiency En779	Code	\$/each
24	24	610	610	292	MFHEPA4V	MFHEPAH11-610610292	POA
24	24	610	610	292	MFHEPA6V	MFHEPAH11-610610292	POA
12	24	305	610	292	MFHEPA3V	MFHEPAH11-305610292	POA
24	24	610	610	292	MFHEPA4V	MFHEPAH13-610610292	POA
24	24	610	610	292	MFHEPA6V	MFHEPAH13-610610292	POA
12	24	305	610	292	MFHEPA3V	MFHEPAH13-305610292	POA
24	24	610	610	292	MFHEPA4V	MFHEPAH14-610610292	POA
24	24	610	610	292	MFHEPA6V	MFHEPAH14-610610292	POA
12	24	305	610	292	MFHEPA3V	MFHEPAH14-305310292	POA



Ph: 02 9524 9123

Fax: 02 9540 2899

Email: orders@marcliff.com.au

Please note all prices are GST exclusive

# Marcliff Engineering Co. Pty Ltd



HVAC Supplies

## HVAC Filters

V-Type ASHRAE Filter							
Width mm	Height mm	Width mm	Height mm	Depth mm	Efficiency En779	Code	\$/each
12	24	305	610	292	F6	MFHVACF63V	POA
24	24	610	610	292		MFHVACF64V	POA
24	24	610	610	292		MFHVACF65V	POA
24	24	610	610	292		MFHVACF66V	POA
12	24	305	610	292	F7	MFHVACF73V	POA
24	24	610	610	292		MFHVACF74V	POA
24	24	610	610	292		MFHVACF75V	POA
24	24	610	610	292		MFHVACF76V	POA
12	24	305	610	292	F8	MFHVACF83V	POA
24	24	610	610	292		MFHVACF84V	POA
24	24	610	610	292		MFHVACF85V	POA
12	24	305	610	292		MFHVACF86V	POA



## M-Flex FR Insulation



9MM WALL			M-Flex FR	M-Flex FR ONE	
Product Code	WALL (mm)	ID (mm)	LENGTHS (per carton)	LENGTHS (per carton)	\$ PER 2M Length
TINS14	9	6	105	168	\$ 1.46
TINS38	9	10	84	130	\$ 1.72
TINS12	9	13	60	115	\$ 2.24
TINS58	9	15	50	90	\$ 2.45
TINS34	9	19	44	76	\$ 2.68
TINS78	9	22	40	70	\$ 3.18
TINS10	9	25	35	55	\$ 3.85
TINS118	9	28	28	55	\$ 4.47
TINS114	9	32			\$ 4.86
TINS138	9	35	45	36	\$ 4.87
TINS112	9	38			\$ 6.38
TINS158	9	42	36	30	\$ 6.44
TINS2	9	51			POA
TINS218	9	54			\$ 8.62
TINS238	9	60			\$ 10.11
TINS258	9	67			\$ 14.26

13MM WALL			M-Flex FR	M-Flex FR ONE	
Product Code	WALL (mm)	ID (mm)	LENGTHS (per carton)	LENGTHS (per carton)	\$ PER 2M Length
TFR13INS14	13	6	50	90	\$ 2.92
TFR13INS38	13	10	50	80	\$ 2.80
TFR13INS12	13	13	40	65	\$ 3.07
TFR13INS58	13	15	36	60	\$ 3.50
TFR13INS34	13	19	32	45	\$ 4.64
TFR13INS78	13	22	28	40	\$ 4.53
TFR13INS1	13	25	23	40	\$ 7.74
TFR13INS118	13	28	43	36	\$ 7.56

For more information visit: [www.mflex.com.au](http://www.mflex.com.au)

## M-Flex FR Insulation



13MM WALL			M-Flex FR	M-Flex FR ONE	
Product Code	WALL (mm)	ID (mm)	LENGTHS (per carton)	LENGTHS (per carton)	\$ PER 2M Length
TFR13INS114	13	32			\$ 8.53
TFR13INS138	13	35	33	30	\$ 8.22
TFR13INS112	13	38			\$ 10.32
TFR13INS158	13	42	24	25	\$ 9.86
TFR13INS178	13	48			POA
TFR13INS218	13	54			\$ 13.49
TFR13INS238	13	60			\$ 15.62
TFR13INS258	13	67			\$ 18.08
TFR13INS3	13	76			\$ 21.58

19MM WALL			M-Flex FR	M-Flex FR ONE	
Product Code	WALL (mm)	ID (mm)	LENGTHS (per carton)	LENGTHS (per carton)	\$ PER 2M Length
TFRINS14	19	6	54	48	\$ 5.31
TFRINS38	19	10	50	36	\$ 5.33
TFRINS12	19	13	42	30	\$ 5.75
TFRINS58	19	15	36	30	\$ 7.71
TFRINS34	19	19	36	25	\$ 7.70
TFRINS78	19	22	36	24	\$ 9.17
TFRINS1	19	25	30	20	\$ 10.51
TFRINS118	19	28	25	20	\$ 11.52
TFRINS114	19	32			\$ 14.32
TFRINS138	19	35	20	16	\$ 13.83
TFRINS112	19	38			\$ 20.42
TFRINS158	19	42	16	16	\$ 16.81
TFRINS178	19	48			POA
TFRINS218	19	54			\$ 21.36
TFRINS238	19	60			\$ 30.62
TFRINS258	19	67			\$ 28.29
TFRINS3	19	76			\$ 36.77
TFRINS318	19	80			\$ 37.41

## M-Flex FR Insulation



25MM WALL			M-Flex FR	M-Flex FR ONE	
Product Code	WALL (mm)	ID (mm)	LENGTHS (per carton)	LENGTHS (per carton)	\$ PER 2M Length
TFR25INS14	25	6	30	30	\$ 7.94
TFR25INS38	25	10	30	30	\$ 7.87
TFR25INS12	25	13	24	24	\$ 13.33
TFR25INS58	25	15	20	20	\$ 10.59
TFR25INS34	25	19	20	20	\$ 12.22
TFR25INS78	25	22	18	18	\$ 13.37
TFR25INS1	25	25	16	16	\$ 15.32
TFR25INS118	25	28	16	16	\$ 16.91
TFR25INS114	25	32			\$ 20.34
TFR25INS138	25	35	12	12	\$ 19.38
TFR25INS112	25	38			\$ 31.63
TFR25INS158	25	42	12	12	\$ 22.03
TFR25INS178	25	48			POA
TFR25INS218	25	54			\$ 29.23
TFR25INS238	25	60			\$ 39.52
TFR25INS258	25	67			\$ 38.03
TFR25INS3	25	76			\$ 53.73

## M-Flex FR Insulation



32MM WALL			M-Flex FR	M-Flex FR ONE	
Product Code	WALL (mm)	ID (mm)	LENGTHS (per carton)	LENGTHS (per carton)	\$ PER 2M Length
TFR32INS38	32	10	15	15	\$ 22.18
TFR32INS12	32	13	12	12	\$ 26.80
TFR32INS58	32	15	12	12	\$ 27.16
TFR32INS34	32	19	12	12	\$ 29.54
TFR32INS78	32	22	11	11	\$ 34.52
TFR32INS1	32	25	11	11	\$ 35.62
TFR32INS118	32	28	9	9	\$ 35.98
TFR32INS138	32	35	9	9	\$ 41.81
TFR32INS158	32	42	9	9	\$ 46.64
TFR32INS218	32	54	8	8	\$ 57.24

38MM WALL			M-Flex FR	M-Flex FR ONE	
Product Code	WALL (mm)	ID (mm)	LENGTHS (per carton)	LENGTHS (per carton)	\$ PER 2M Length
TFR38INS78	38	22	9	9	\$ 34.52
TFR38INS1	38	25	9	9	\$ 35.62
TFR38INS118	38	28	9	9	\$ 35.98
TFR38INS138	38	35	9	9	\$ 41.81
TFR38INS158	38	42	9	9	\$ 46.64



## FOIL Face Fire Rate Insulation

The Building Code of Australia (2005) provides a fire specification for fire testing of materials: Specification A2.4 (Fire Hazard Properties). This requires that materials are tested under the standard AS/NZS 1530.3, and meet stringent requirements for indices of both Spread-of-Flame and Smoke-Developed.



### Pipe Insulation 25mm Wall



Code	Description	mm	\$/Length	Box Qty
TFF25INS12	12mm Foil Pipe Insulation 25mm Wall-2m	12	\$12.72	1
TFF25INS58	16mm Foil Pipe Insulation 25mm Wall-2m	16	\$12.50	1
TFF25INS34	20mm Foil Pipe Insulation 25mm Wall-2m	20	\$14.51	1
TFF25INS78	22mm Foil Pipe Insulation 25mm Wall-2m	22	\$15.13	1
TFF25INS10	25mm Foil Pipe Insulation 25mm Wall-2m	25	\$15.77	1
TFF25INS118	28mm Foil Pipe Insulation 25mm Wall-2m	28	\$17.92	1
TFF25INS114	32mm Foil Pipe Insulation 25mm Wall-2m	32	\$18.50	1
TFF25INS138	34mm Foil Pipe Insulation 25mm Wall-2m	34	\$19.90	1
TFF25INS112	38mm Foil Pipe Insulation 25mm Wall-2m	38	\$20.40	1
TFF25INS158	42mm Foil Pipe Insulation 25mm Wall-2m	42	\$23.59	1
TFF25INS2	51mm Foil Pipe Insulation 25mm Wall-2m	51	\$25.53	1
TFF25INS215	60mm Foil Pipe Insulation 25mm Wall-2m	60	\$27.60	1
TFF25INS250	64mm Foil Pipe Insulation 25mm Wall-2m	64	\$27.65	1
TFF25INS3	76mm Foil Pipe Insulation 25mm Wall-2m	76	\$33.63	1
TFR25INS312	89 mm FR Pipe Insulation 25mm Wall-2m	89	\$55.79	1
TFR25INS378	101 mm FR Pipe Insulation 25mm Wall-2m	101	\$0.00	1
TFF25INS4	102mm Foil Pipe Insulation 25mm Wall-2m	102	\$45.46	1

## Armaflex® Solar UT

Armaflex® Solar UT is a highly flexible closed-cell pipe insulation for solar-water systems. Specifically designed and tested for the flow and return lines of solar hot water systems. Armaflex® Solar UT is ideal for high temperature applications (up to 150° C) and long-term outdoor exposure.



Armaflex® Solar UT 2m Tubes					
Product Code	Internal Diameter	Thickness	Tubes/Carton	\$/Length	\$/m
TSOLH1512	12mm (1/2")	15 mm	32	\$ 12.15	\$ 6.08
TSOLH1520	20 mm (3/4")	15 mm	20	\$ 6.42	\$ 3.21



Armaflex® Solar UT Continuous Tubes					
Product Code	Internal Diameter	Thickness	Coil Length	\$/ Carton	\$/Length
TSOLCIS12	12mm (1/2")	15 mm	25 m	\$ -	\$ 0.77
TSOLCIS20	20 mm (3/4")	15 mm	20 m	\$ -	\$ 8.02



Armaflex® Solar UT Accessories			
Product Code	Description	\$/Roll	Qty
TSOLCTP	Armaflex® Solar UT Tape	\$ 14.50	1

### Also Available:

Pipe Ferrules



Flat Insulation Sheets in 9, 19 &



Self Seal Insulation, 2m



# Marcliff Engineering Co. Pty Ltd



## Ventilation

### Flexible Duct

PRODUCT INFO			
Type	Thermaflex	Colour	Silver
Function	Air Diffusion	Material	Metallised Outer Sleeve
Mounting			Fire Rate to AS4254

Thermaflex R0.6					
	Product Code	Diamter Metric	Diameter Imperial	Length Metres	Price
	VTFP66	150	6	6	21.84
	VTFP86	200	8	6	24.22
	VTFP106	250	10	6	30.57
	VTFP126	300	12	6	33.97
	VTFP146	350	14	6	40.26
	VTFP166	400	16	6	46.03
	VTFP186	450	18	6	61.54
	VTFP206	500	20	6	71.89

Thermaflex R1.0					
	Product Code	Diamter Metric	Diameter Imperial	Length Metres	Price
	VRITFP66	150	6	6	24.69
	VRITFP86	200	8	6	28.05
	VRITFP106	250	10	6	34.77
	VRITFP126	300	12	6	42.65
	VRITFP146	350	14	6	47.55
	VRITFP166	400	16	6	52.03
	VRITFP186	450	18	6	76.42
	VRITFP206	500	20	6	85.02

PRODUCT INFO			
Type	Thermaflex Plain	Colour	Silver
Function	Ventilation and Exhaust	Material	Uninsulated Duct
Mounting			Fire Rated to AS4254 - 1995

Thermaflex Plain					
	Product Code	Diamter Metric	Diameter Imperial	Length Metres	Price
	VSBN66	150	6	6	10.76
	VSBN86	200	8	6	15.63
	VSBN106	250	10	6	19.37
	VSBN126	300	12	6	23.99
	VSBN146	350	14	6	28.36
	VSBN166	400	16	6	60.14

# Marcliff Engineering

## Co. Pty Ltd

### Ventilation



#### Lay-in Diffusers

PRODUCT INFO			
Type	Lay-in/Flush Face Diffusers	Varieties	2
Function	Supply Air	Colour	White Powder Coat
Mounting	Ceiling or Lay-in Grid	Material	Aluminium

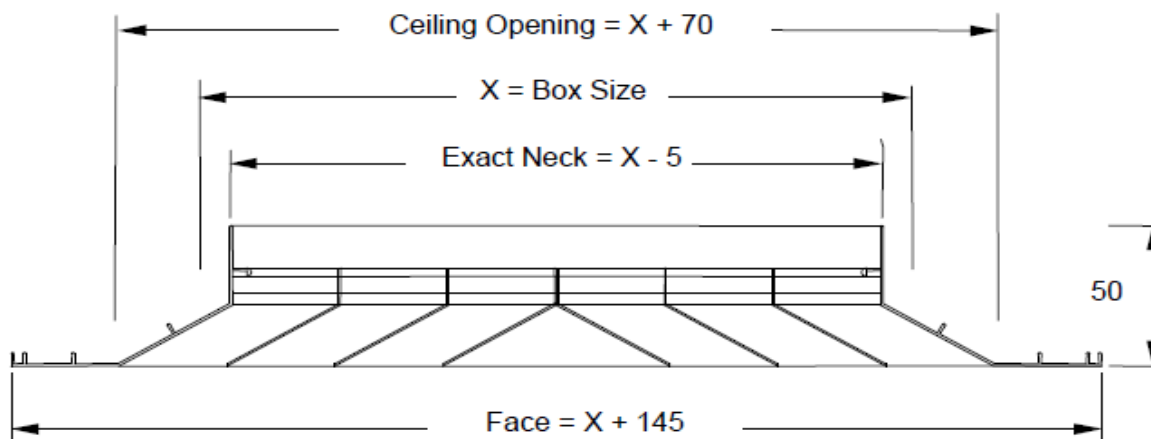

Lay-In 4-Way Blow Diffuser					
	Product Code	Face Size Metric	Nominal Size Metric	Pieces/Carton	Price
	VFFTBS	395 x 395 Face	250 x 250	8	\$ 52.45
	VFFTB	595 x 595 Face	450 x 450	10	\$ 40.56
*Grilles are aluminium powder coated white as standard					

#### Round Diffuser

PRODUCT INFO			
Type	Round Diffuser	Colour	White
Function	Supply Air	Material	ABS Polymer Snap Down Fixing Clip
Mounting	Ceiling		

UNIFLO Round Diffuser						
	Product Code	Nominal Neck Metric	Nominal Neck Imperial	Face Size Metric	Cut Out Size Metric	Price
	VRPD06	150	6	255	235	\$ 11.37
	VRPD8	200	8	320	285	\$ 13.93
	VRPD10	250	10	390	355	\$ 18.84
	VRPD12	300	12	435	410	\$ 18.84
*Grilles complete with snap down fixing clip & dual spring attachment						

For more information visit: [www.mecfans.com.au](http://www.mecfans.com.au)

Ph: 02 9524 9123

Fax: 02 9540 2899

Email: [orders@marcliff.com.au](mailto:orders@marcliff.com.au)

Please note all prices are GST exclusive

# Marcliff Engineering Co. Pty Ltd

## Ventilation



### Bevelled Edge Diffuser

PRODUCT INFO			
Type	Bevelled Edge Diffuser	Varieties	8
Function	Supply Air	Colour	Powder Coated White
Mounting	Ceiling	Material	Aluminium

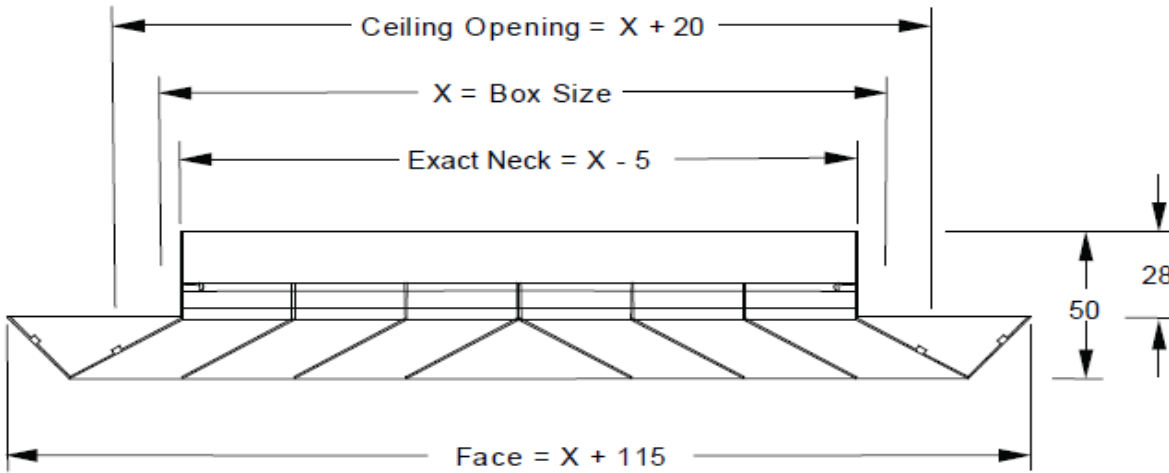

4 Way Bevelled Edge Diffuser					
	Product Code	Nominal Neck	Nominal Neck	Pieces/Carto	Price
	VBF4W66	150 x 150	6 x 6	10	37.34
	VBF4W99	225 x 225	9 x 9	10	46.38
	VBF4W1212	300 x 300	12 x 12	10	39.75
	VBF4W1515	375 x 375	15 x 15	10	51.11
	VBF4W1818	450 x 450	18 x 18	10	64.74
	VBF4W2121	525 x 525	21 x 21	10	99.49
	VBF4W2424	600 x 600	24 x 24	10	144.42
	*Grills are aluminium powder coated white as standard				

# Marcliff Engineering Co. Pty Ltd Ventilation



## Multi Directional Outlet

PRODUCT INFO			
<b>Type</b>	Multi Directional Outlet	<b>Colour</b>	White
<b>Function</b>	Supply Air	<b>Material</b>	ABS Polymer Multi Directional
<b>Mounting</b>	Ceiling		

Multi Directional Outlet					
	<b>Product Code</b>	<b>Nominal Neck Metric</b>	<b>Nominal Neck Imperial</b>	<b>Pieces/Carton</b>	<b>Price</b>
	VMDO99	225 x 225	6	10	19.26
	VMDO1212	300 x 300	8	110	16.20
	*Non-glare mottled white finish				

## Reducing Neck for Multiflo

PRODUCT INFO			
<b>Type</b>	Reducing Neck for Multiflo	<b>Colour</b>	White
<b>Design</b>	Butterfly Damper at Rear	<b>Material</b>	ABS Polymer

Poly Reducing Necks - c/w Damper to Suit Multiflo					
	<b>Product Code</b>	<b>Neck Size Metric</b>	<b>Neck Size Imperial</b>	<b>Spigot Size Metric</b>	<b>Price</b>
	VMDO998	225 x 225	9 x 9	200	31.30
	VMDO12128	300 x 300	12 x 12	200	27.08
	VMDO121210	300 x 300	12 x 12	250	3.16
	VMDO121212	300x 300	12 x 12	300	3.16
*All Reducing Necks are black as standard					

## Louvre Grille

PRODUCT INFO			
<b>Type</b>	Louvre Grille	<b>Colour</b>	White
<b>Function</b>	Exhaust or Intake Air	<b>Mount</b>	Ceiling or Wall
<b>Material</b>	ABS Polymer	<b>Design</b>	Connection to Duct

Louvre Grille					
	<b>Product Code</b>	<b>Nominal Neck</b>	<b>Nominal Neck</b>	<b>Pieces/Carton</b>	<b>Price</b>
	VLGF4	100	4	20	5.91
	VLGF5	125	5	20	3.73
	VLGF6	150	6	10	12.49
*Grilles are aluminium powder coated white as standard					

# Marcliff Engineering Co. Pty Ltd

## Ventilation



### Gravity Grille

PRODUCT INFO			
<b>Type</b>	Gravity Grille	<b>Colour</b>	White
<b>Function</b>	Exhaust or Intake Air	<b>Material</b>	Ceiling or Wall
<b>Material</b>	Abs Polymer	<b>Design</b>	Connection to duct

Gravity Grille					
	<b>Product Code</b>	<b>Nominal Neck Metric</b>	<b>Nominal Neck Imperial</b>	<b>Pieces/Carton</b>	<b>Price</b>
	VGG4	100	4	20	7.36
	VGG5	125	5	20	8.56
	VGG6	150	6	10	6.57
*Grilles are aluminium powder coated white as standard					

### Hinged EggCrate Grille with Filter

PRODUCT INFO			
<b>Type</b>	Hinged EggCrate Grille	<b>Colour</b>	White Powdercoat
<b>Function</b>	Return or Exhaust Air	<b>Material</b>	Ceiling or Wall
<b>Material</b>	Aluminium	<b>Design</b>	Hinged of Short Side

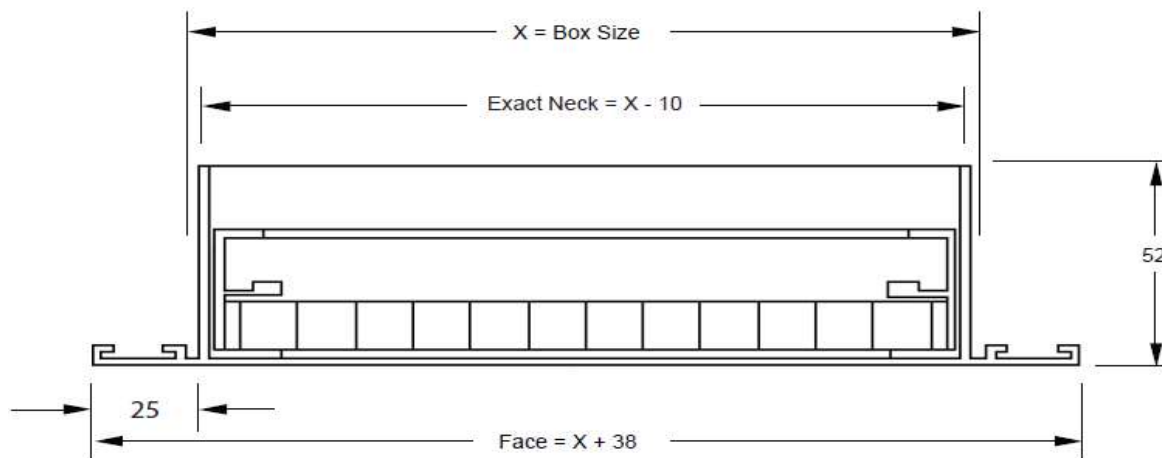

Hinged EggCrate Grille with Filter					
	<b>Product Code</b>	<b>Nominal Neck Metric</b>	<b>Nominal Neck Imperial</b>	<b>Pieces/Carton</b>	<b>Price</b>
	VECGF1212	300 x 300	12 x 12	2	32.45
	VECGF1612	400 x 300	16 x 12	2	26.01
	VECGF2412	600 x 300	24 x 12	2	36.34
	VECGF1414	350 x 350	14 x 14	2	43.48
	VECGF1616	400 x 400	16 x 16	2	43.48
	VECGF2016	500 x 400	20 x 16	2	35.77

# Marcliff Engineering Co. Pty Ltd

## Ventilation

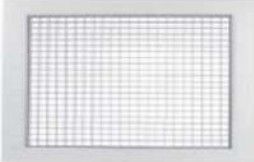

Hinged EggCrate Grille with Filter					
	Product Code	Nominal Neck Metric	Nominal Neck Imperial	Pieces/ arton	Price
		VECGF2416	600 x 400	24 x 16	2
VECGF2816		700 x 400	28 x 16	2	66.22
VECGF3016		750 x 400	30 x 16	2	69.70
VECGF3616		900 x 400	36 x 16	2	73.01
VECGF4016		1000 x 400	40 x 16	2	107.92
VECGF4816		1200 x 400	48 x 16	2	122.86
VECGF1818		450 x 450	18 x 18	2	49.32
VECGF2418		600 x 450	24 x 18	2	86.81
VECGF3018		750 x 450	30 x 18	2	77.13
VECGF3618		900 x 450	36 x 18	2	79.50
VECGF2020		500 x 500	20 x 20	2	56.79
VECGF2420		600 x 500	24 x 20	2	50.99
VECGF2820		700 x 500	28 x 20	2	69.70
VECGF3020		750 x 500	30 x 20	2	77.13
VECGF3220		800 x 500	32 x 20	2	65.98
VECGF3620		900 x 500	36 x 20	2	81.12
VECGF4020		1000 x 500	40 x 20	2	129.92
VECGF2422		600 x 550	24 x 22	2	106.23
VECGF2622		650 x 550	26 x 22	2	122.00
VECGF2822		700 x 550	28 x 22	2	81.90
VECGF3022		750 x 550	30 x 22	2	76.25
VECGF3622		900 x 550	36 x 22	2	94.10
VECGF2424		600 x 600	24 x 24	2	81.41
VECGF3024		750 x 600	30 x 24	2	128.79
VECGF3224		800 x 600	32 x 24	2	139.99
VECGF3624		900 x 600	36 x 24	2	97.57
VECGF4824		1200 x 600	48 x 24	2	105.94
VECGF3624		800 x 650	32 x 26	2	97.57
VECGF595595		595 x 595	550 X 50	2	60.03

### Fixed Core EggCrate Grille with Reducing Neck and Fixing Clip

Fixed Core EggCrate Grille with Reducing Neck and Fixing Clip					
	Product Code	Nominal Neck Metric	Nominal Neck Imperial	Spigot Size Metric	Price
		VEGN664	150 x 150	6 x 6	100
VEGN665		150 x 150	6 x 6	125	30.32
VEGN666		150 x 150	6 x 6	150	18.17
VEGN886		200 x 200	8 x 8	150	33.62
VEGN888		200 x 200	8 x 8	200	33.62
VEGN10108		250 x 250	10 x 10	200	43.59
VEGN101010		250 x 250	10 x 10	250	44.75
VEGN12128		300 x 300	12 x 12	200	52.17
VEGN121210		301 x 300	12 x 12	250	61.55
VEGN121212		302 x 300	12 x 12	300	52.17

# Marcliff Engineering Co. Pty Ltd Ventilation



## Removable Core Bar Grille

PRODUCT INFO			
Type	Removable Core Bar Grille	Colour	White Powdercoat
Function	Supply Air	Mount	Wall
Material	Aluminium	Design	Fixed Blades

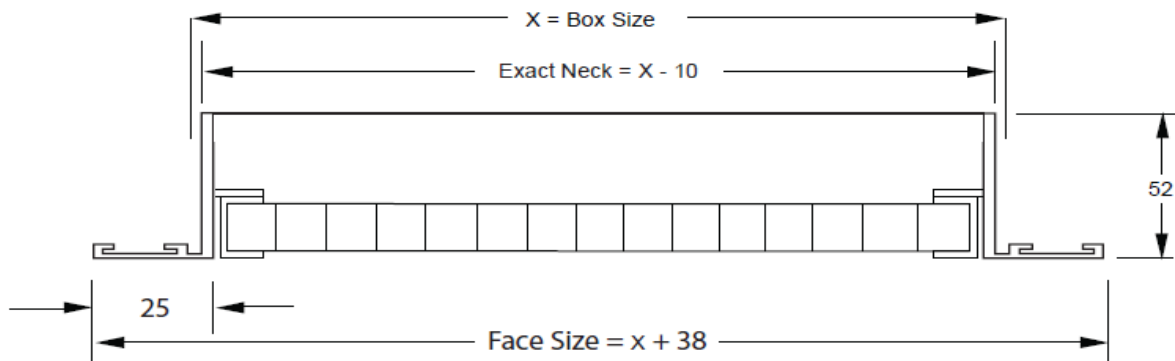

Removable Core Bar Grilles					
	Product Code	Nominal Neck Metric	Nominal Neck Imperial	Pieces/Carton	Price
	VRCBG164	400 x 100	16 x 4	10	37.02
	VRCBG244	600 x 100	24 x 4	10	42.06
	VRCBG324	800 x 100	32 x 4	10	46.22
	VRCBG146	350 x 1500	14 x 6	10	37.02
	VRCBG166	400 x 150	16 x 6	10	38.70
	VRCBG246	600 x 150	24 x 6	5	55.52

## Removable Core Double Deflection Register

PRODUCT INFO			
Type	Removable Double Deflection	Colour	White Powdercoat
Function	Supply Air	Mount	Wall or Duct
Material	Aluminium	Design	Adjustable Blades

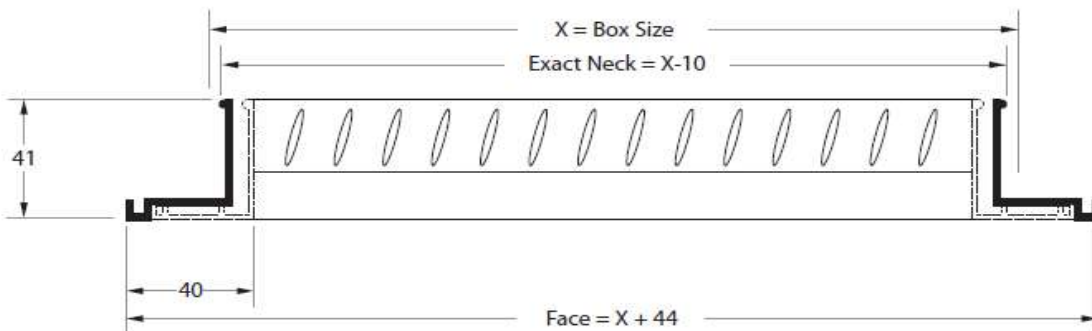

# Marcliff Engineering Co. Pty Ltd

## Ventilation



Removable Core Double Deflection Register					
	Product Code	Nominal Neck Metric	Nominal Neck Imperial	Pieces/ Carton	Price
	VSWR124RC	300 x 100	12 x 4	5	49.29
	VSWR144RC	350 x 100	14 x 4	5	41.14
	VSWR164RC	400 x 100	16 x 4	5	41.93
	VSWR184RC	450 x 100	18 x 4	5	54.31
	VSWR204RC	500 x 100	20 x 4	5	58.38
	VSWR244RC	600 x 100	24 x 4	5	59.06
	VSWR324RC	800 x 100	32 x 4	5	136.29

### Fixed Core Double Deflection Register

PRODUCT INFO			
Type	Fixed Double Deflection	Colour	White Powdercoat
Function	Supply Air	Mount	Wall or Duct
Material	Aluminium	Design	Adjustable Blades

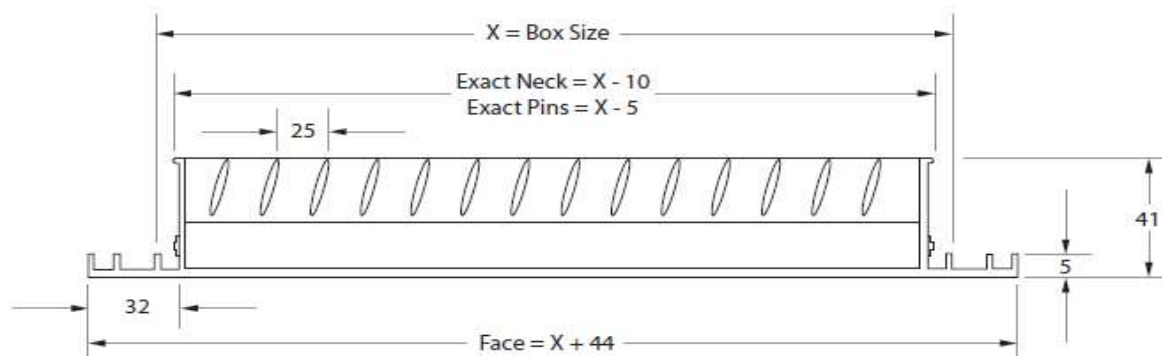

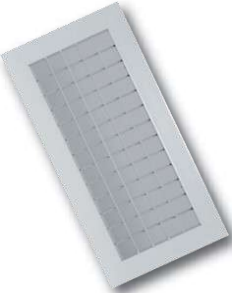
Fixed Core Double Deflection Register					
	Product Code	Nominal Neck Metric	Nominal Neck Imperial	Pieces/ Carton	Price
	VSWR104	200 x 100	8 x 4	5	30.32
	VSWR124	250 x 100	10 x 4	5	32.86
	VSWR144	300 x 100	12 x 4	5	34.41
	VSWR164	350 x 100	14 x 4	5	46.56
	VSWR184	400 x 100	16 x 4	5	41.07
	VSWR204	450 x 100	18 x 4	5	44.45
	VSWR244	500 x 100	20 x 4	5	48.84

# Marcliff Engineering Co. Pty Ltd Ventilation

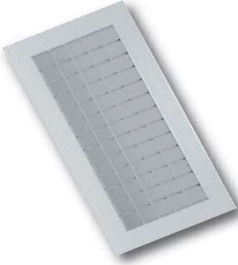

Fixed Core Double Deflection Register					
	Product Code	Nominal Neck Metric	Nominal Neck Imperial	Pieces/Carton	Price
	VSWR66	150 x 150	6 x 6	5	28.76
	VSWR86	200 x 150	8 x 6	5	29.10
	VSWR106	250 x 150	10 x 6	5	33.09
	VSWR126	300 x 150	12 x 6	5	14.99
	VSWR146	350 x 150	14 x 6	5	26.29
	VSWR166	400 x 150	16 x 6	5	38.68
	VSWR186	450 x 150	18 x 6	5	39.56
	VSWR206	500 x 150	20 x 6	5	41.53
	VSWR246	600 x 150	24 x 6	5	35.32
	VSWR306	750 x 150	30 x 6	5	81.61
	VSWR366	900 x 150	36 x 6	5	94.24
	VSWR88	200 x 200	8 x 8	5	31.85

## Weatherproof Louvre

PRODUCT INFO			
Type	Weatherproof Louvre	Colour	Anodised
Function	Exhaust or Air Intake	Mount	Wall
Material	Aluminium	Design	48mm Blade Spacing

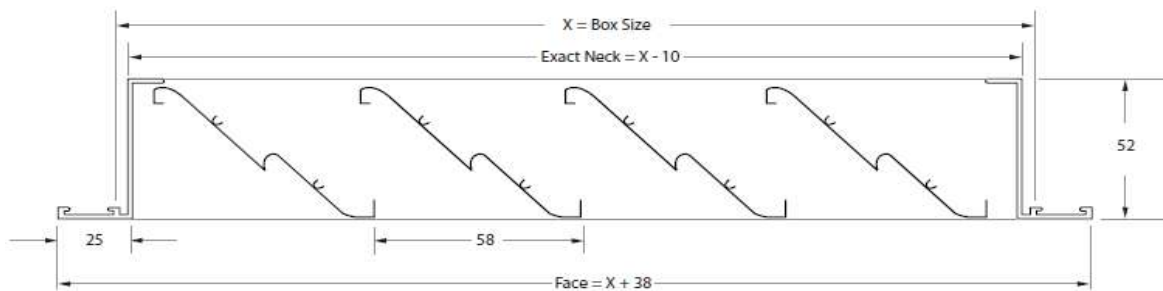

Weatherproof Louvre					
	Product Code	Nominal Neck Metric	Nominal Neck Imperial	Pieces/C	Price
	VOAL95	225 x 125	9 x 5	10	12.29
	VOAL66	150 x 150	9 x 6	10	8.63
	VOAL97	225 x 175	9 x 7	10	18.51
	VOAL88	200 x 200	8 x 8	10	23.85

# Marcliff Engineering Co. Pty Ltd

## Ventilation



### Fittings

### Ventilation Products

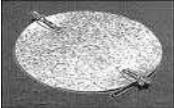
Damper Blade with Rapit Kits	Nom. Size	Product Code	\$/each	QTY
	150	VDBK6	6.81	1
	200	VDBK8	6.81	1
	250	VDBK10	6.81	1
	300	VDBK12	7.95	1
	350	VDBK14	9.09	1
	400	VDBK16	10.90	1

Zone Air 240v Metal Motorized	Nom. Size	Product Code	\$/each	QTY
	200mm	VDZ200	59.06	1
	250mm	VDZ250	67.01	1
	300mm	VDZ300	68.14	1
	350mm	VDZ350	71.55	1
	400mm	VDZ400	62.24	1

Inline Axial Fan	Nom. Size	Product Code	\$/each	QTY
	150	FANAX150	48.47	1
	200	FANAX200	68.87	1
	250	FANAX250	146.62	1

Zone Air 24v Metal Motorised	Nom. Size	Product Code	\$/each	QTY
	200mm	VDZIC200	POA	1
	250mm	VDZIC250	POA	1
	300mm	VDZIC300	POA	1
	350mm	VDZIC350	POA	1
	400mm	VDZIC400	91.54	1

### Flow Control

### Semi Rigid Ducting

Cable	Nom. Size	Product Code	\$/each	QTY
	10m	VDZCAB10	7.98	1
	15m	VDZCAB15	11.08	1

Semi Rigid Alu Duct	Nom. Size	Product Code	\$/each	QTY
	100mm x 3m	VSRD100	8.11	1
	125mm x 3m	VSRD125	23.85	1
	150mm x 3m	VSRD150	13.71	1

Touch Pad	Nom. Size	Product Code	\$/each	QTY
	150	VDZTP	26.60	1

Transformers	Nom. Size	Product Code	\$/each	QTY
	150	VDZTRANS	21.54	1

# Marcliff Engineering Co. Pty Ltd Izone



**imaxi** Better efficiency is better living



**iZone® App**  
The WiFi and 4G enabled iZone® App enables you to control your air conditioning system via your smart phone or tablet. The iZone® Worldwide service allows you greater control, giving you 4G access from anywhere, for even more

New generation iZone® climate control system works with Panasonic, Daikin, Toshiba, LG, Temperzone, Mitsubishi Electric, Fujitsu and Hitachi\* air conditioning brands and offers complete control over your ducted air conditioning system. iZone's intuitive touch screen interface is elegant, easy-to-use and exceptionally efficient.

iZone's touch screen technology gives you total temperature control of each room individually. Adjust the air distribution, temperature or airflow to any room.

Select up to 12 touch screen consoles or sensors – every room will be at the temperature you want, all the time. You can also direct airflow to only the rooms you choose for maximum efficiency



# Conditions of Sales



All special orders are to be in the form of written confirmation. Cancellation or return of special orders will not be accepted.

The Buyer will be deemed to have accepted the goods as being in accordance with its order unless a written notification is received within 7 days of receipt of goods.

Returns for credit will be subjected to a 15% surcharge. All goods must be in original condition.

Minimum invoice of \$80 otherwise an Administration Fee of \$10.00 is applicable.

Prices are subject to change without notice.

Trading Terms are strictly Nett 30 Days.

Title to *the Goods* shall remain vested in Marcliff Engineering Co. and shall not pass to *the Buyer* until the purchase price for *the Goods* has been paid in full and received by Marcliff Engineering Co. Until title to *the Goods* passes:

1. *Marcliff Engineering Co.* shall have authority to retake, sell or otherwise deal with and/or dispose of all or any part of *the Goods*;
2. *Marcliff Engineering Co.* and its agents and employees shall be entitled at any time and without the need to give notice enter upon any property upon which *the Goods* or any part are stored, or upon which *Marcliff Engineering Co.* reasonably believes them to be kept;
3. *The Buyer* shall store or mark *the Goods* in a manner reasonably satisfactory to *Marcliff Engineering Co.* indicating that title to *the Goods* remains vested in *Marcliff Engineering Co.*; and
4. *The Buyer* shall insure *the Goods* to their full replacement value, and arrange for *Marcliff Engineering Co.* to be noted on the policy of insurance as the loss payee.

Irrespective of whether title to *the Goods* remains vested in *Marcliff Engineering Co.*, risk in *the Goods* shall pass to *the Buyer* upon delivery.

All care was taken in preparing the information in this catalogue and is believed correct. It is subject to alteration without notice. No responsibility is taken for errors or omissions.

All warranties whether express or implied and whether statutory or otherwise with regard to the goods supplied by the company as to quality, fitness for purpose or any other matter are hereby excluded except insofar as any such warranties are incapable of exclusion at law.

Goods shall be delivered to the address as specified on the credit application unless otherwise agreed upon in writing between parties.

The company reserves the right to charge surcharges when goods purchased are less than minimum values (G.S.T Exclusive) *See below for further details.*

Delivery Charges: -

Metropolitan	Delivery Everyday Free in Store for Goods Over \$350. \$35.00 Surcharge Applicable for Goods Less than \$350. Long Length Surcharge (over 1.8m) \$100.
South Coast	Free in Store for Goods Over \$500. \$50.00 Surcharge Applicable for Goods Less than \$500. Long Length Surcharge (over 1.8m) Price on Application.
North Coast	Free in Store for Goods Over \$500. \$50.00 Surcharge Applicable for Goods Less than \$500. Long Length Surcharge (over 1.8m) Price on Application.

# Marcliff Engineering Co. Pty

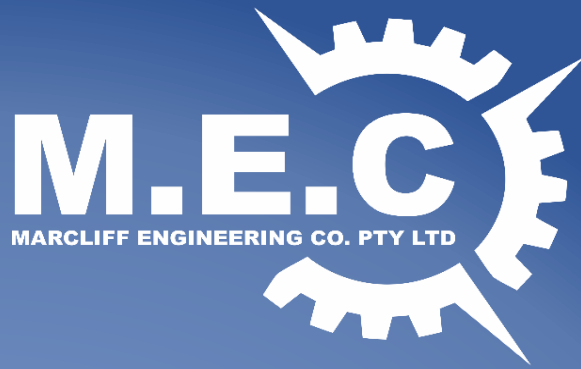

ABN: 48 078 484 143

39 - 41 Cawarra Road  
Caringbah NSW 2229  
Australia

Phone: (02) 9524 9123  
Fax: (02) 9540 2899

Email: [orders@marcliff.com.au](mailto:orders@marcliff.com.au)

Web: [www.marcliff.com.au](http://www.marcliff.com.au)

For more information on these products and  
other Marcliff Product lines please contact us, as  
per details above

## Authorised Distributor