

LEDProfile.it

Led light Solutions

INNOVATIVE LIGHTING

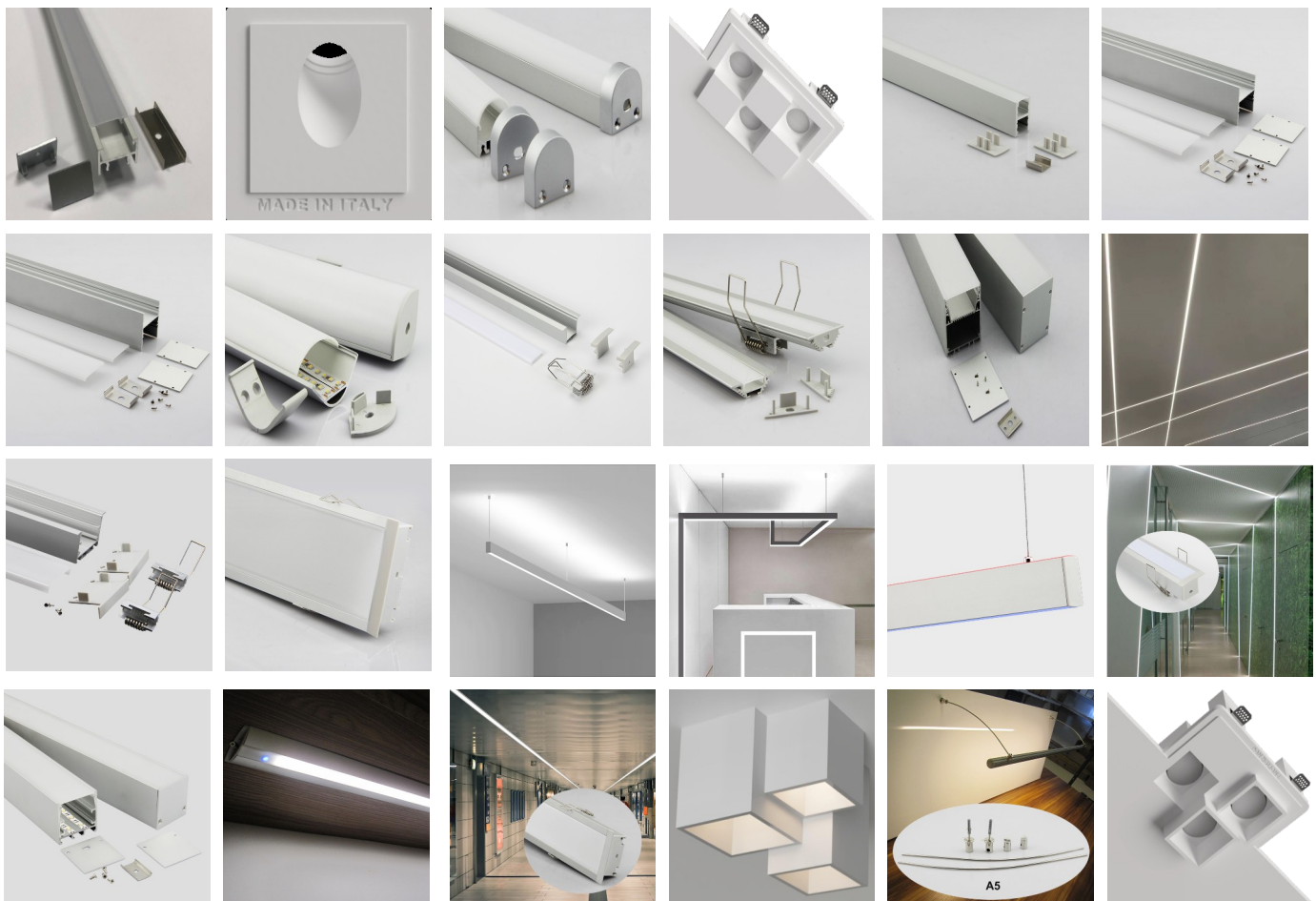

CATALOGO 2026
CATALOGUE 2026

INDICE / INDEX

LED PROFILE	PAG. 06 / 63
SILICONE TUBE	PAG. 65 / 73
ELETTRONICA / ELECTRONIC	PAG. 75 / 80
PROFILI GESSO / PLASTER LIGHT	PAG. 82 / 84
PORTA FARETTI	PAG. 86 / 124
SEGNAPASSI	PAG. 126 / 131
SOSPENSIONI	PAG. 133 / 144
PLAFONI	PAG. 146 / 163
LAMPADE A PARETE	PAG. 165 / 195
COPPE E ROSONI	PAG. 197 / 202
PUNTI LUCE	PAG. 204 / 206
ACCESSORI	PAG. 208 / 213

LEDProfile.it

Led light Solutions

ZERODUE LUX srl , una realtà con esperienza decennale nel mondo dell'illuminazione a Led. Siamo in grado di fornire le migliori soluzioni prodotte e realizzate in collaborazione con i nostri partner per poter soddisfare le svariate richieste e personalizzare ogni progetto secondo le richieste e necessità. Siamo in possesso della professionalità e dell'esperienza necessaria per sviluppare progetti globali , la nostra flessibilità produttiva e organizzativa coinvolge un gruppo di persone affiatate e strutturate con le proprie aziende proprio allo scopo di soddisfare tutte le esigenze che ci vengono sottoposte.

ZERODUE LUX srl, a company with many yaers of experience in the world of LED lighting. We can supply the best solutions produced and realized in collaboration with our partners to be able to satisfy the various requests and customize each project according to the requests and needs. We have the necessary professionalism and experience to develop global projects, our productive and organizational flexibility involves a group of close-knit people and structured with their own companies in order to satisfy all the needs that are submitted to us.



1

LED PROFILE

LEDProfile.it

Led light Solutions

I profili in alluminio anodizzato , trovano molteplici usi in molti settori . La loro installazione può essere in appoggio, incasso, a terra, a parete, all'interno di sistemi in gesso e custom per svariati utilizzi, ottenendo una finitura eccellente.

I diffusori o cover sono realizzati con materiali di prima qualità, sono di facile installazione a pressione e possono essere di diverse finiture , opaco, semi-opaco, trasparente, prismatico, fumè ecc. secondo la tipologia del profilo e del suo utilizzo.

I diffusori sono resistenti ai raggi UV grazie alla loro composizione molecolare, questo garantisce la longevità necessaria a sostenere i sistemi a led montati all'interno dei profili ed a mantenere un'accurata estetica nel tempo.

La base dei nostri profili è realizzata in lega di alluminio 6060/6063-T5 con anodizzazione da 15/20 micron.

Abbiamo lunghezze disponibili da 2, 3, 4, 6mt (in base al modello).

Gli accessori di montaggio e di terminazione sono di altissima qualità. I nostri profili sono realizzati e studiati con cura per garantire la massima efficienza termica e meccanica per la massima protezione ed efficienza dei sistemi Led montati al loro interno.

Anodized aluminum profiles find multiple uses in many sectors. Their installation can be free-standing, built-in, on the ground, on the wall, inside plaster systems and custom for various uses, obtaining an excellent finish.

The covers are made with top quality materials, are easy to install by pressing and can be of different finishes, opaque, semi-opaque, transparent, prismatic, smoked etc. according to the type of profile and its use.

The diffusers are resistant to UV rays thanks to their molecular composition, this guarantees the necessary longevity support the LED systems mounted inside the profiles and maintain an accurate aesthetic over time.

The base of our profiles is made of 6060/6063-T5 aluminum alloy with 15/20 micron anodization.

We have lengths available from 2, 3, 4, 6m (depending on the model).

The mounting and termination accessories are of the highest quality. Our profiles are made and designed with care to guarantee the maximum thermal and mechanical efficiency for maximum protection and efficiency of the LED systems mounted inside them.

Applicazioni - Applications:

Incassi per cucine e sotto pensili
Illuminazione lineare pavimento (con Led IP)
Incassi , soffitti , mensole , scaffali
Illuminazione per incassi soffitti in cartongesso
Arredamento e design Esposizioni
Illuminazione per interni

Kitchen units and under wall units
Linear floor lighting (with IP Led)
Recessed, ceilings, shelves, shelves
Lighting for recessed plasterboard ceilings
Furniture and design Exhibitions
Interior lighting

Colori disponibili Available colours

Standard	Option	Option	Option
AL 	WH 	BK 	CO 
Argento Silver	Bianco White	Nero Black	Corten Cortain

PARAMETRI COVER / COVER PARAMETERS

Materiale/Materials : PC o PPMA UL: UL94V-2

Colore / Colors : Milk, Opale, Semiopale,
Trasparente , Fumè – Milk , Opal, Semiopal,
Transparent , Black

Modello Microprismatico/ microprismatic : UGR<19

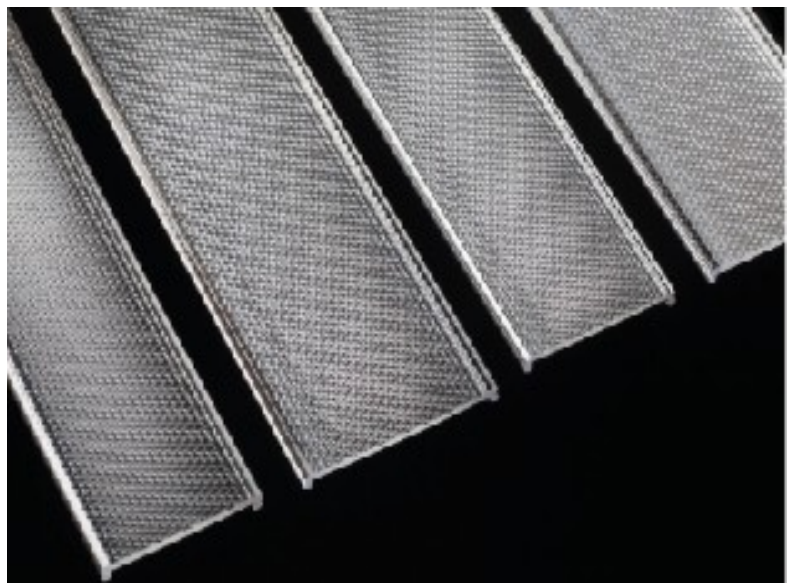

Profili ad incasso
Recessed profiles



AL-i7

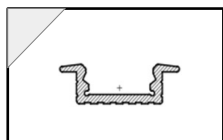

Pg.9

AL-i12

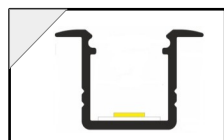

Pg.10

AL-i14

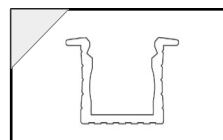

Pg.11

AL-i15

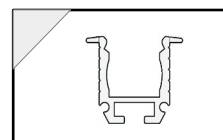

Pg.12

AL-CO

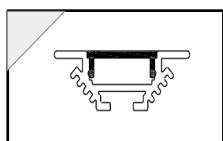

Pg.13

AL-i18

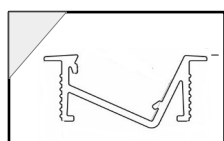

Pg.14

AL-i20

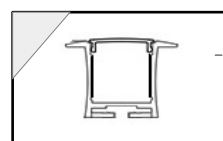

Pg.15

AL-i35

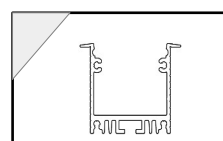

Pg.16

AL-i55

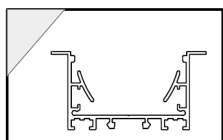

Pg.17

AL-i80

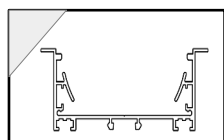

Pg.18

TERRA

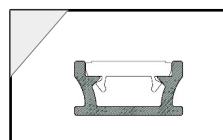

Pg.19

TERRA XL

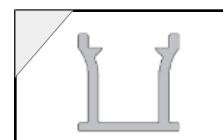

Pg.20

Profili appoggio/ Sospensione
Support/Suspension profiles



AL-E7

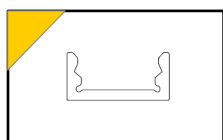

Pg.21

AL-E8

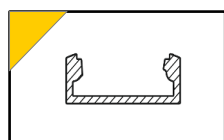

Pg.22

AL-FL

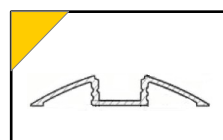

Pg.23

AL-E15

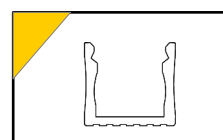

Pg.24

AL-TRKB

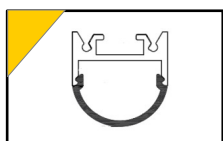

Pg.25

AL-TRKC

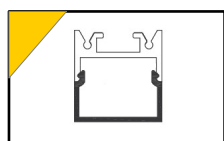

Pg.26

AL-TRKD

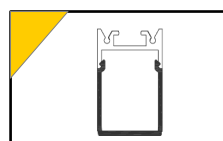

Pg.27

AL-E13

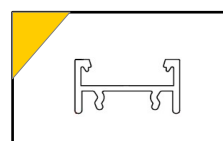

Pg.28

AL-E35

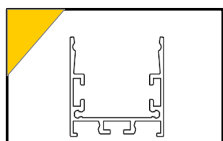

Pg.29

AL-E55

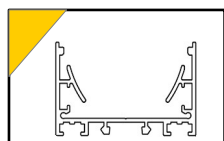

Pg.30

AL-E80

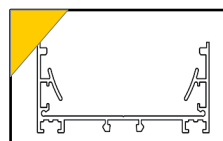

Pg.31

AL-5570

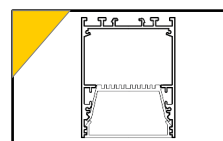

Pg.32

AL-D5570

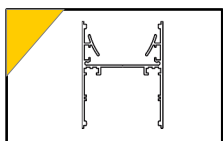

Pg.33

AL-B5570

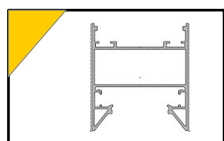

Pg.34

AL-D1732

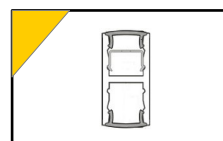

Pg.35

AL-ER

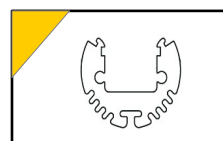

Pg.36

AL-R13

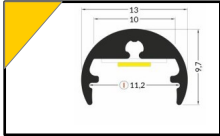

Pg.37

AL-R20



Pg.37

Profili angolari
Corner profiles



AL-AN

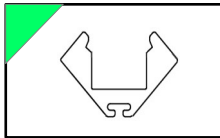

Pg.38

AL-ANV

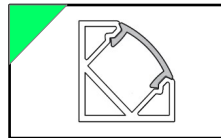

Pg.39

AL-3060

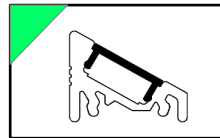

Pg.40

AL-ASY

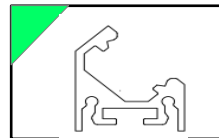

Pg.41

AL-A10

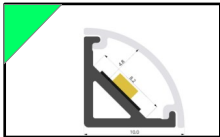

Pg.42

AL-A16

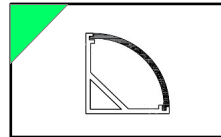

Pg.43

AL-B16

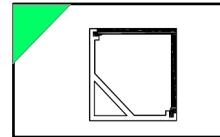

Pg.44

AL-A30

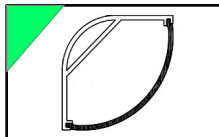

Pg.45

AL-B30

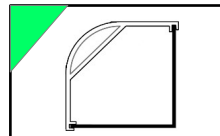

Pg.46

AL-2AN

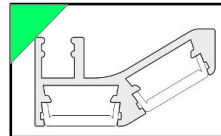

Pg.47

AL-A18

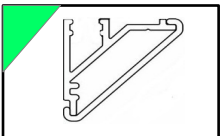

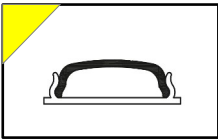
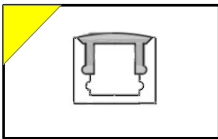
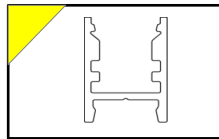
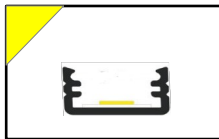
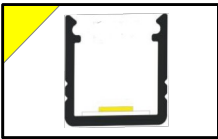
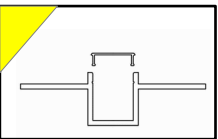
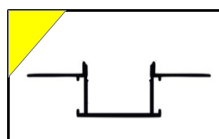
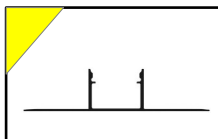
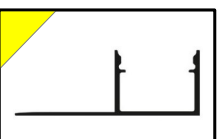
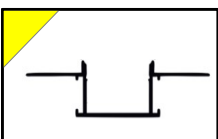
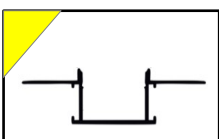
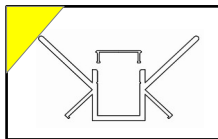
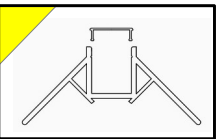
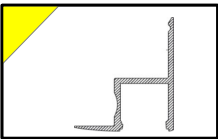
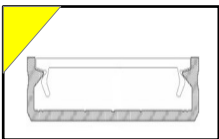
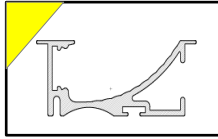
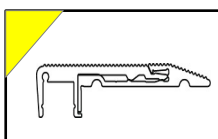
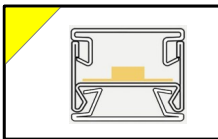
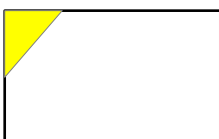
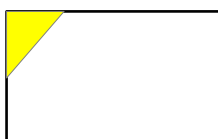

Pg.47

Profili Utilizzo particolare
Profiles special use

 AL-C1806 Pg.48	 AL-S10 Pg.49	 AL-SS Pg.50	 AL-S8 Pg.51
 AL-S12 Pg.52	 AL-GY13 Pg.53	 AL-GY17 Pg.54	 AL-GY17B Pg.55
 AL-GY17L Pg.56	 AL-GY20 Pg.57	 AL-GY30 Pg.58	 AL-GYANI Pg.59
 AL-GYANE Pg.56	 AL-CL Pg.57	 AL-E43 Pg.58	 AL-EWL Pg.59
 AL-STEP Pg.59	 AL-HOLE Pg.60	 AL-STEP Pg.60	 AL-HOLE Pg.61

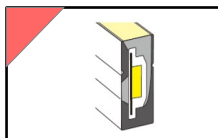
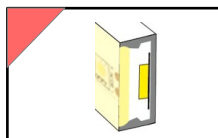
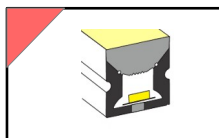
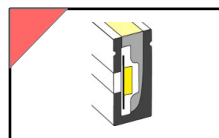
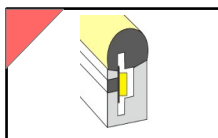
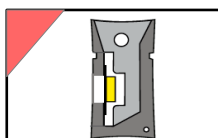
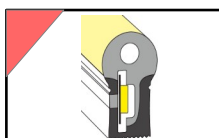
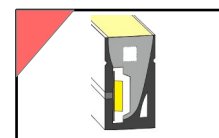
Tubo in silicone per Led IP67
Silicone tube for Leds IP67

 N0410 Pg.62	 N0513 Pg.63	 N1010 Pg.64	 N0612 Pg.65
 N0816 Pg.66	 N1020 Pg.67	 N1023 Pg.68	 N1220 Pg.69
 N1326 Pg.70			

Profili ad incasso Recessed profiles



Profilo in alluminio estruso per installazione ad incasso, in sistemi cartongesso e strutture in legno. Disponibile in varie finiture e con cover in policarbonato di prima qualità per meglio resistere nel tempo e per mantenere inalterata la qualità della luce emessa.

Extruded aluminum profile for installation recessed, in plasterboard systems and wooden structures. Available in various finishes and with a polycarbonate cover top quality to better withstand over time and for to maintain the quality of the light emitted.

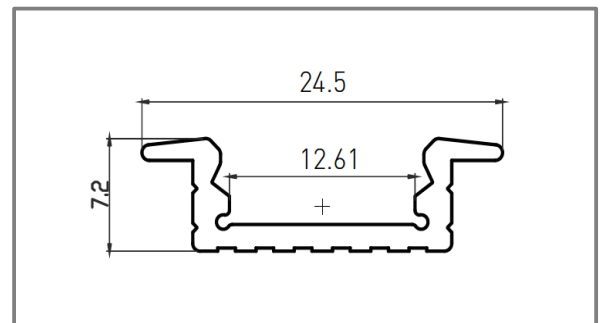

Dimensioni – Dimension
H7 x L24mm

Codice Profilo Code Profile	Lunghezza Length	Tipo Finitura Finish Type	Codice Cover Code Cover	Tipo Cover Cover Type	Lunghezza Length
AL-i7	-2 (2000mm)	AL Argento Silver	AB-E	-T Trasparente Transparent	-2 (2000mm)
	-3 (3000mm)	WH Bianco White		-O Opale Opal	-3 (3000mm)
	-4 (4000mm)	BK Nero Black		-S Semi-Opale Semi-Opal	-4 (4000mm)
		*CO Corten Cortain		-L40 Lente 40° Lens 40°	
			-F Fumè Fumè		

*a richiesta codice finitura - on request finishing code

Accessori Accessories	Codice Code	Descrizione Description
	EC-i7-SF	Tappo chiuso in alluminio senza foro/ End cap without hole
	EC-i7-CF	Tappo forato in alluminio per passaggio cavi/ End cap with hole
	EC-i7-K	Kit tappo chiuso e tappo forato in lega/ End cap kit – 1 with hole + 1 without

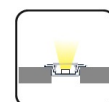

Profili ad incasso Recessed profiles







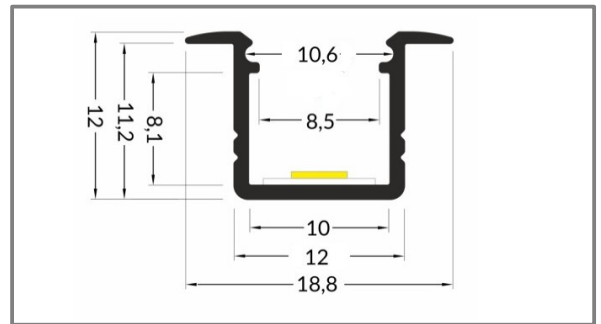

Profilo in alluminio estruso per installazione ad incasso, in sistemi cartongesso e strutture in legno. Disponibile in varie finiture e con cover in policarbonato di prima qualità per meglio resistere nel tempo e per mantenere inalterata la qualità della luce emessa.

Extruded aluminum profile for installation recessed, in plasterboard systems and wooden structures. Available in various finishes and with a polycarbonate cover top quality to better withstand over time and for to maintain the quality of the light emitted.



Dimensioni – Dimension
H12 x L18,8mm

Codice Profilo Code Profile	Lunghezza Length	Tipo Finitura Finish Type	Codice Cover Code Cover	Tipo Cover Cover Type	Lunghezza Length
AL-i12	-2 (2000mm)	AL  Argento Silver *WH  Bianco White *BK  Nero Black	AB-S	-T  Trasparente Transparent -O  Opale Opal -S  Semi-Opale Semi-Opal	-2 (2000mm)

*a richiesta codice finitura - on request finishing code

Accessori Accessories	Codice Code	Descrizione Description
	EC-i12-K	Kit Tappo chiuso e forato/ End cap with and without hole

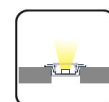

Profili ad incasso Recessed profiles



Profilo in alluminio estruso per installazione ad incasso, in sistemi cartongesso e strutture in legno. Disponibile in varie finiture e con cover in policarbonato di prima qualità per meglio resistere nel tempo e per mantenere inalterata la qualità della luce emessa.

Extruded aluminum profile for installation recessed, in plasterboard systems and wooden structures. Available in various finishes and with a polycarbonate cover top quality to better withstand over time and for to maintain the quality of the light emitted.

Dimensioni – Dimension
H15 x L24mm

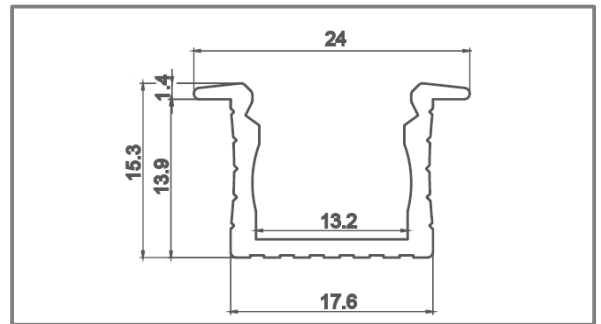

Codice Profilo Code Profile	Lunghezza Length	Tipo Finitura Finish Type	Codice Cover Code Cover	Tipo Cover Cover Type	Lunghezza Length
AL-i14	-2 (2000mm)	AL Argento Silver	AB-E-	-T Trasparente Transparent	-2 (2000mm)
	-3 (3000mm)	WH Bianco White		-O Opale Opal	-3 (3000mm)
	-4 (4000mm)	BK Nero Black		-S Semi-Opale Semi-Opal	-4 (4000mm)
		*CO Corten Cortain		-L40 Lente 40° Lens 40°	
			-F Fumè Fumè		

*a richiesta codice finitura - on request finishing code

Accessori Accessories	Codice Code	Descrizione Description
	EC-i14-K	Kit tappo chiuso e tappo forato in lega / End cap Kit 1 with hole + 1 without

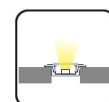

Profili ad incasso Recessed profiles



Profilo in alluminio estruso per installazione ad incasso, in sistemi cartongesso e strutture in legno. Disponibile in varie finiture e con cover in policarbonato di prima qualità per meglio resistere nel tempo e per mantenere inalterata la qualità della luce emessa.

Extruded aluminum profile for installation recessed, in plasterboard systems and wooden structures. Available in various finishes and with a polycarbonate cover top quality to better withstand over time and for to maintain the quality of the light emitted.

Dimensioni – Dimension
H19 x L24mm

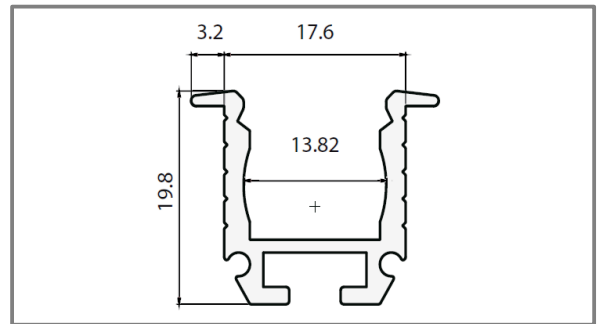



Codice Profilo Code Profile	Lunghezza Length	Tipo Finitura Finish Type	Codice Cover Code Cover	Tipo Cover Cover Type	Lunghezza Length
AL-i15	-2 (2000mm)	AL Argento Silver	AB-E-	-T Trasparente Transparent	-2 (2000mm)
	-3 (3000mm)	WH Bianco White		-O Opale Opal	-3 (3000mm)
	-4 (4000mm)	BK Nero Black		-S Semi-Opale Semi-Opal	-4 (4000mm)
		*CO Corten Corten		-L40 Lente 40° Lens 40°	
			-F Fumè Fumè		



*a richiesta codice finitura - on request finishing code

Accessori Accessories	Codice Code	Descrizione Description
	EC-i15-K	Kit tappo chiuso e tappo forato in lega / End cap Kit 1 with hole + 1 without
	MC-i15	Molla di montaggio per profilo da incasso/ Mounting spring for recessed profile
	LC01	Connettore lineare/ Linear connector
	LC02	Connettore angolare orizzontale/ Horizontal angle connector
	LC03	Connettore angolare verticale/ Vertical angle connector



LC01

LC02

LC03



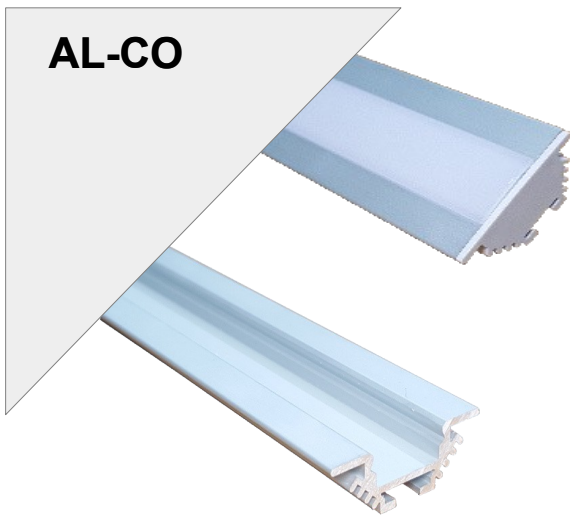

Profili ad incasso Recessed profiles

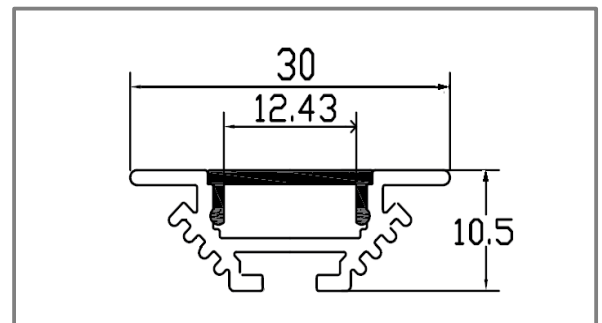

Profilo in alluminio estruso per installazione ad incasso, in sistemi cartongesso e strutture in legno. Disponibile in varie finiture e con cover in policarbonato di prima qualità per meglio resistere nel tempo e per mantenere inalterata la qualità della luce emessa.

Extruded aluminum profile for installation recessed, in plasterboard systems and wooden structures. Available in various finishes and with a polycarbonate cover top quality to better withstand over time and for to maintain the quality of the light emitted.





Dimensioni – Dimension
H10 x L30mm

Codice Profilo Code Profile	Lunghezza Length	Tipo Finitura Finish Type	Codice Cover Code Cover	Tipo Cover Cover Type	Lunghezza Length
AL-CO	-2 (2000mm)	AL Argento Silver	AB-E	-T Trasparente Transparent	-2 (2000mm)
	-3 (3000mm)	WH Bianco White		-O Opale Opal	-3 (3000mm)
	-4 (4000mm)	BK Nero Black		-S Semi-Opale Semi-Opal	-4 (4000mm)
		*CO Corten Corten		-L40 Lente 40° Lens 40°	
			-F Fumè Fumè		



*a richiesta codice finitura - on request finishing code

Accessori Accessories	Codice Code	Descrizione Description
	EC-CO-K	Kit tappo chiuso e tappo forato in lega / End cap Kit 1 with hole + 1 without
	MC-I15	Molla di montaggio per profilo da incasso/ Mounting spring for recessed profile
	LC01	Connettore lineare/ Linear connector
	LC02	Connettore angolare orizzontale/ Horizontal angle connector
	LC03	Connettore angolare verticale/ Vertical angle connector

LC01

LC02

LC03

Profili ad incasso Recessed profiles





Profilo in alluminio estruso per installazione ad incasso, in sistemi cartongesso e strutture in legno. Disponibile in varie finiture e con cover in policarbonato di prima qualità per meglio resistere nel tempo e per mantenere inalterata la qualità della luce emessa.

Extruded aluminum profile for installation recessed, in plasterboard systems and wooden structures. Available in various finishes and with a polycarbonate cover top quality to better withstand over time and for to maintain the quality of the light emitted.

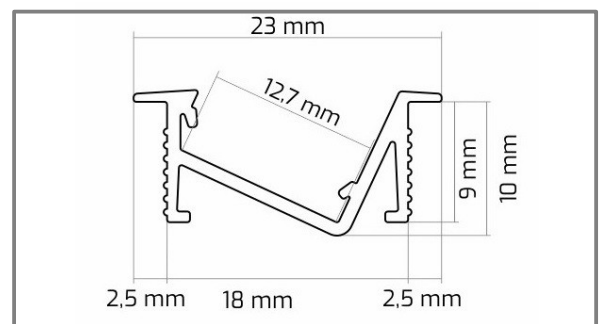
Dimensioni – Dimension
H20 x L53mm



Codice Profilo Code Profile	+ Lunghezza Length	+ Tipo Finitura Finish Type	Codice Cover Code Cover	+ Tipo Cover Cover Type	+ Lunghezza Length
AL-i18	-2 (2000mm)	AL  Argento Silver	AB-18	-O  Opale Opal	-2 (2000mm)
		*WH  Bianco White			

*a richiesta codice finitura - on request finishing code

Accessori Accessories	Codice Code	Descrizione Description
	EC-i18-K	Kit tappo chiuso e tappo forato in lega / End cap Kit 1 with hole + 1 without

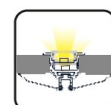

Profili ad incasso Recessed profiles

AL-i20





Profilo in alluminio estruso per installazione ad incasso, in sistemi cartongesso e strutture in legno. Disponibile in varie finiture e con cover in policarbonato di prima qualità per meglio resistere nel tempo e per mantenere inalterata la qualità della luce emessa.

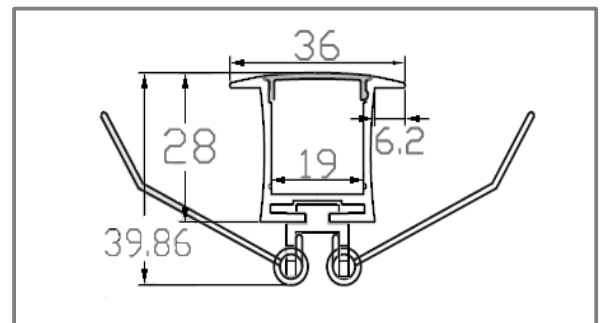

Extruded aluminum profile for installation recessed, in plasterboard systems and wooden structures. Available in various finishes and with a polycarbonate cover top quality to better withstand over time and for to maintain the quality of the light emitted.

Dimensioni – Dimension
H28 x L36mm



Codice Profilo Code Profile	Lunghezza Length	Tipo Finitura Finish Type	Codice Cover Code Cover	Tipo Cover Cover Type	Lunghezza Length
AL-i20	-2 (2000mm)	AL  Argento Silver *WH  Bianco White	AB-i20	-O  Opale Opal	-2 (2000mm)

*a richiesta codice finitura - on request finishing code

Accessori Accessories	Codice Code	Descrizione Description
	EC-i20-K	Kit tappo chiuso e tappo forato in lega / End cap Kit 1 with hole + 1 without
	MC-i15	Molla di montaggio per profilo da incasso / Mounting spring for recessed profile

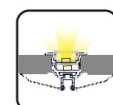

Profili ad incasso Recessed profiles

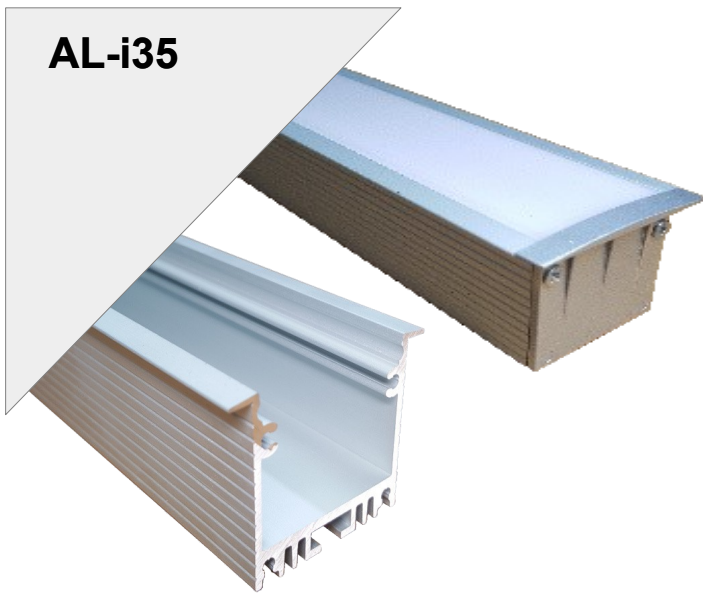

Profilo in alluminio estruso per installazione ad incasso, in sistemi cartongesso e strutture in legno. Disponibile in varie finiture e con cover in policarbonato di prima qualità per meglio resistere nel tempo e per mantenere inalterata la qualità della luce emessa.

Extruded aluminum profile for installation recessed, in plasterboard systems and wooden structures. Available in various finishes and with a polycarbonate cover top quality to better withstand over time and for to maintain the quality of the light emitted.

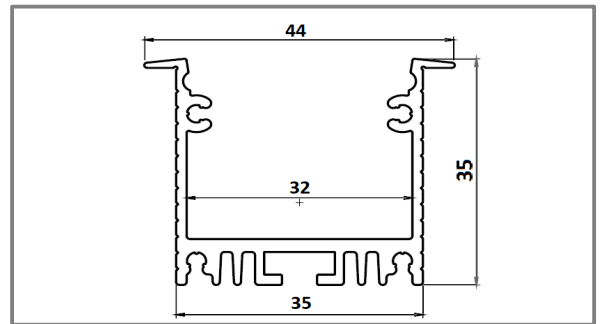



Dimensioni – Dimension
H35 x L44mm

Codice Profilo Code Profile	Lunghezza Length	Tipo Finitura Finish Type	Codice Cover Code Cover	Tipo Cover Cover Type	Lunghezza Length
AL-i35	-2 (2000mm)	AL Argento Silver	AB-35	-T Trasparente Transparent	-2 (2000mm)
	-3 (3000mm)	WH Bianco White		-O Opale Opal	-3 (3000mm)
	-4 (4000mm)	BK Nero Black		-PRI Prismatico Prismatic	-4 (4000mm)
		*CO Corten Corten			



*a richiesta codice finitura - on request finishing code

Accessori Accessories	Codice Code	Descrizione Description
	EC-I35-K	Kit tappo chiuso e tappo forato in lega / End cap Kit 1 with hole + 1 without
	MC-i35	Molla di montaggio per profilo da incasso / Mounting spring for recessed profile
	LC01	Connettore lineare / Linear connector
	LC02	Connettore angolare orizzontale / Horizontal angle connector
	LC03	Connettore angolare verticale / Vertical angle connector

LC01

LC02

LC03

Profili ad incasso Recessed profiles

AL-i55



Profilo in alluminio estruso per installazione ad incasso, in sistemi cartongesso e strutture in legno. Disponibile in varie finiture e con cover in policarbonato di prima qualità per meglio resistere nel tempo e per mantenere inalterata la qualità della luce emessa.



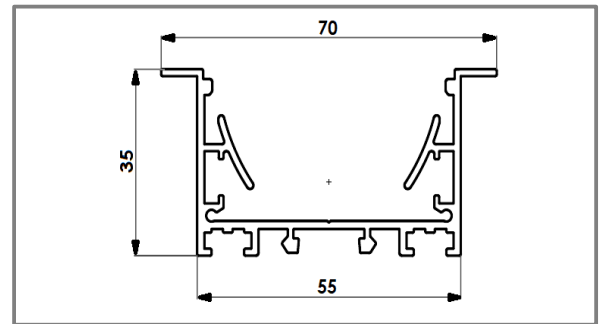

Extruded aluminum profile for installation recessed, in plasterboard systems and wooden structures. Available in various finishes and with a polycarbonate cover top quality to better withstand over time and for to maintain the quality of the light emitted.

Dimensioni – Dimension
H35 x L70mm



Codice Profilo Code Profile	Lunghezza Length	Tipo Finitura Finish Type	Codice Cover Code Cover	Tipo Cover Cover Type	Lunghezza Length
AL-i55	-2 (2000mm)	AL  Argento Silver	AB-55	-T  Trasparente Transparent	-2 (2000mm)
	-3 (3000mm)	WH  Bianco White		-O  Opale Opal	-3 (3000mm)
	-4 (4000mm)	BK  Nero Black		-PRI  Prismatico Prismatic	-4 (4000mm)
		*CO  Corten Corten			

*a richiesta codice finitura - on request finishing code

Accessori Accessories	Codice Code	Descrizione Description
	EC-i55-K	Kit terminali in lega / end Cap Kit
	MC-i55/80	Molla di montaggio per profilo da incasso/ Mounting spring for recessed profile
	LC01	Connettore lineare/ Linear connector
	LC02	Connettore angolare orizzontale/ Horizontal angle connector
	LLA-LC03	Connettore angolare verticale/ Vertical angle connector



LC01





LC02



LC03







Profili ad incasso Recessed profiles

AL-I80

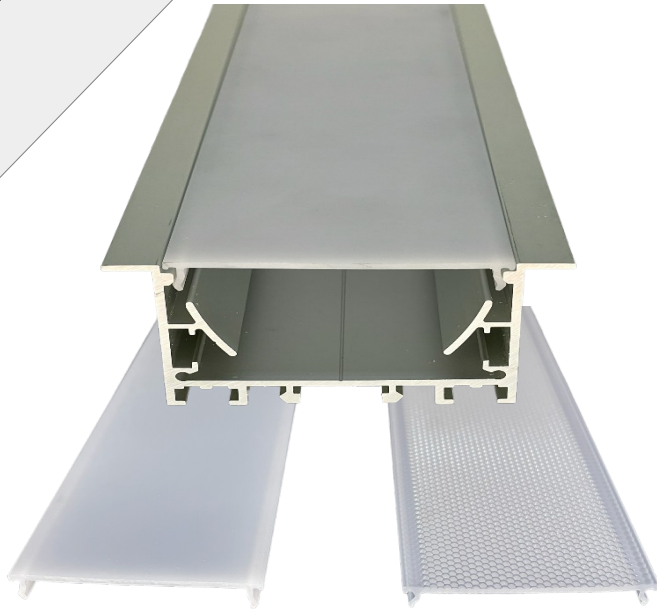

Dimensioni – Dimension
H35 x L97mm

Profilo in alluminio estruso per installazione ad incasso, in sistemi cartongesso e strutture in legno. Disponibile in varie finiture e con cover in policarbonato di prima qualità per meglio resistere nel tempo e per mantenere inalterata la qualità della luce emessa.

Extruded aluminum profile for installation recessed, in plasterboard systems and wooden structures. Available in various finishes and with a polycarbonate cover top quality to better withstand over time and for to maintain the quality of the light emitted.

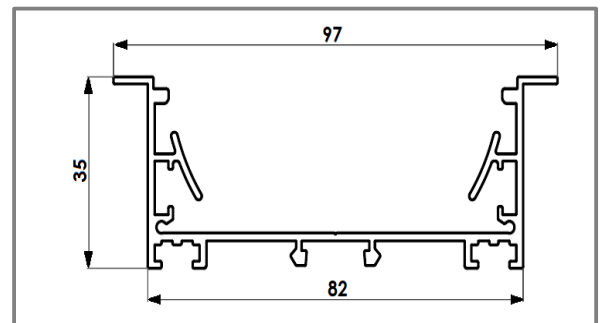



Codice Profilo Code Profile	Lunghezza Length	Tipo Finitura Finish Type	Codice Cover Code Cover	Tipo Cover Cover Type	Lunghezza Length
AL-i80	-2 (2000mm)	AL Argento Silver	AB-80	-T Trasparente Transparent	-2 (2000mm)
	-3 (3000mm)	WH Bianco White		-O Opale Opal	-3 (3000mm)
	-4 (4000mm)	BK Nero Black		-PRI Prismatico Prismatic	-4 (4000mm)
		*CO Corten Cortain			

*a richiesta codice finitura - on request finishing code

Accessori Accessories	Codice Code	Descrizione Description
	EC-i80-K	Kit terminali in lega / end Cap Kit
	MC-i55/80	Molla di montaggio per profilo da incasso/ Mounting spring for recessed profile
	LC01	Connettore lineare/ Linear connector
	LC02	Connettore angolare orizzontale/ Horizontal angle connector
	LLA-LC03	Connettore angolare verticale/ Vertical angle connector



LC01

LC02

LC03







TERRA



Profilo da incasso a terra Recessed floor profile

Profilo in alluminio estruso per l'installazione a terra, incassato.

Disponibile nelle finiture di colore alluminio anodizzato. Diffusore in policarbonato opale, con guarnizione per protezione antipolvere ed umidità.

Per l'alimentatore si richiede predisposizione del vano di alloggiamento durante la fase di progettazione.



Extruded aluminum profile for ground installation, recessed.

Available in anodised aluminum color finishes.

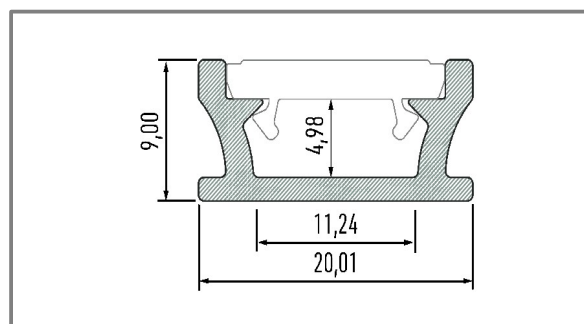
Opal polycarbonate diffuser, with gasket for protection against dust and humidity. For the power supply, the housing compartment must be prepared during the design phase.



Dimensioni – Dimension
H9 x L20mm

Codice Profilo Code Profile	Lunghezza Length	Tipo Finitura Finish Type	Codice Cover Code Cover	Tipo Cover Cover Type	Lunghezza Length
AL-TE	-2 (2000mm) -3 (3000mm)	AL  Argento Silver	AB-TE	-O  Opale Opal	-2 (2000mm) -3 (3000mm)

Guarnizione finalizzata a prevenire l'accesso di umidità e polvere
Gasket designed to prevent moisture and dust from entering

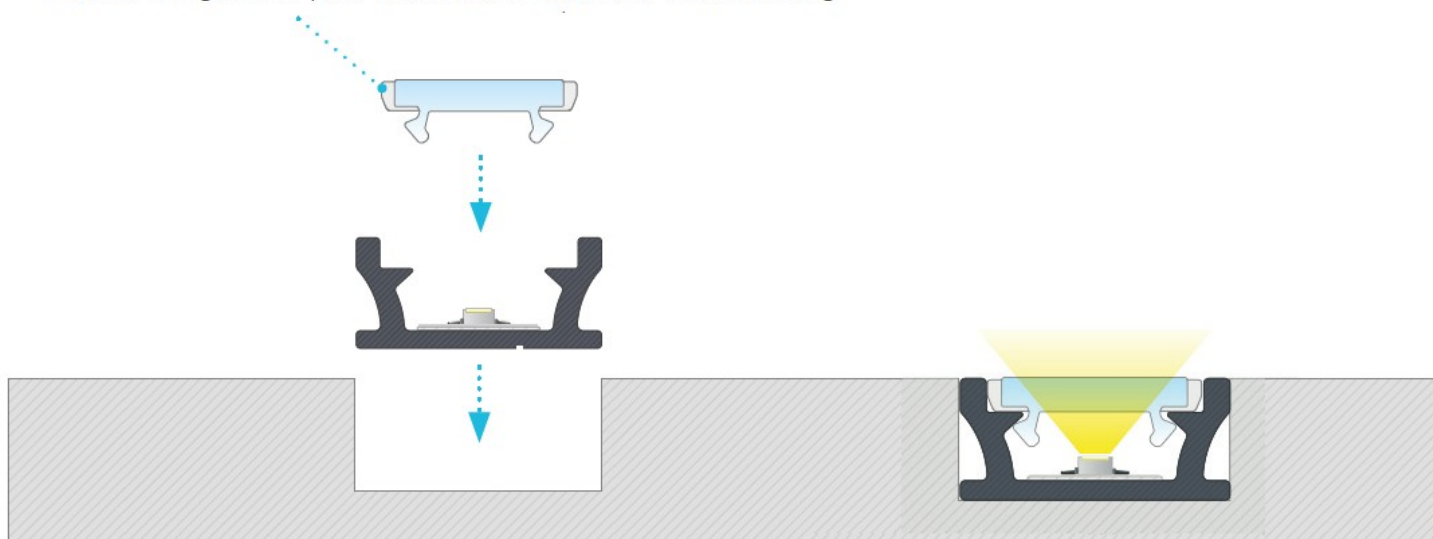

PROFILO CALPESTABILE DA PAVIMENTO CON COPERTURA COESTRUSA
DI POLICARBONATO AD ALTO SPESSORE E GOMMA AI LATI.







Profilo da incasso a terra Recessed floor profile

Profilo in alluminio estruso per l'installazione a terra, incassato.
Disponibile nelle finiture di colore alluminio anodizzato.
Diffusore in policarbonato opale, con guarnizione per protezione antipolvere ed umidità.
Per l'alimentatore si richiede predisposizione del vano di alloggiamento durante la fase di progettazione.

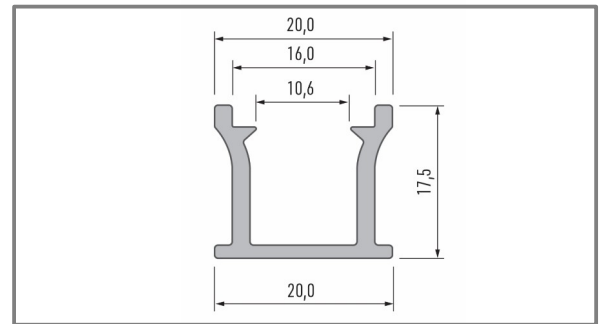
Extruded aluminum profile for ground installation, recessed.
Available in anodised aluminum color finishes.
Opal polycarbonate diffuser, with gasket for protection against dust and humidity. For the power supply, the housing compartment must be prepared during the design phase.



Dimensioni – Dimension
H17,5 x L20mm

Codice Profilo Code Profile	Lunghezza Length	Tipo Finitura Finish Type	Codice Cover Code Cover	Tipo Cover Cover Type	Lunghezza Length
AL-TE15	-2 (2000mm) -3 (3000mm)	AL  Argento Silver	AB-TE	-O  Opale Opal	-2 (2000mm) -3 (3000mm)

Profilo calpestabile da pavimento con copertura coestrusa di policarbonato ad alto spessore e gomma ai lati.

Architectural recessed profile - intended as an element of the floor and decorative lighting installation. Thanks to the sealing function of the dedicated cover, preventing the LED strip from getting wet, it can also be used in places exposed to the appearance of moisture.



Profili appoggio/parete Support/surface profiles

Profilo in alluminio estruso per l'installazione a parete. Disponibile nelle finiture di colore alluminio anodizzato, bianco, nero e corten. Diffusore in policarbonato opale, semiopale e trasparente.

Extruded aluminum profile for wall installation. Available in anodized aluminum color finishes, white, black and corten. Opal polycarbonate diffuser, semiopal and transparent.

AL-E7

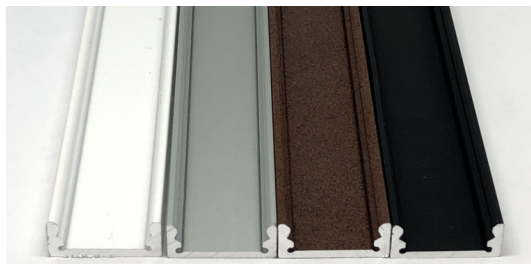
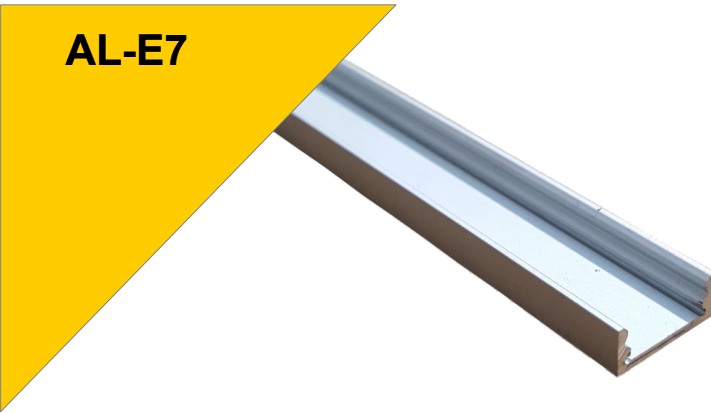

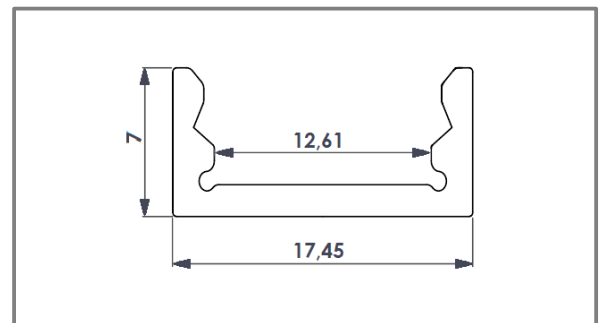

Dimensioni – Dimension
H7 x L17mm



Codice Profilo Code Profile	Lunghezza Length	Tipo Finitura Finish Type	Codice Cover Code Cover	Tipo Cover Cover Type	Lunghezza Length
AL-E7	-2 (2000mm)	AL  Argento Silver	AB-E	-T  Trasparente Transparent	-2 (2000mm)
	-3 (3000mm)	WH  Bianco White		-O  Opale Opal	-3 (3000mm)
	-4 (4000mm)	BK  Nero Black		-S  Semi-Opale Semi-Opal	-4 (4000mm)
		*CO  Corten Corten		-L40  Lente 40° Lens 40°	
			-F  Fumè Fumè		

*a richiesta codice finitura - on request finishing code

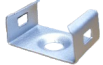
Accessori Accessories	Codice Code	Descrizione Description
	EC-E7-SF	Tappo chiuso in alluminio senza foro/ Closed aluminum cap without hole
	EC-E7-CF	Tappo forato in alluminio per passaggio cavi/ Perforated aluminum cap for cable passage
	EC-E7-K	Kit tappo chiuso e tappo forato in lega / End cap Kit 1 with hole + 1 without
	MC-E7-A	Supporto di fissaggio in acciaio per profilo a parete/ Fixing support in steel for wall profile

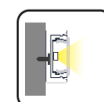

AL-E8

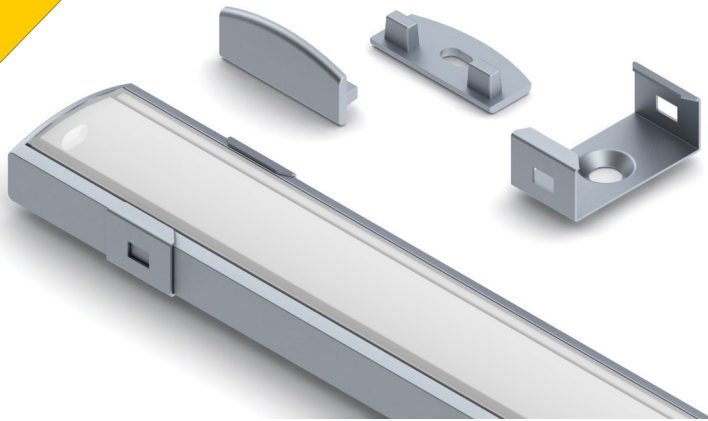

Dimensioni – Dimension
H8 x L22mm

Profili appoggio/parete Support/surface profiles

Profilo in alluminio estruso per l'installazione a parete. Disponibile nelle finiture di colore alluminio anodizzato, bianco, nero e corten. Diffusore in policarbonato opale, semiopale e trasparente.

Extruded aluminum profile for wall installation. Available in anodized aluminum color finishes, white, black and corten. Opal polycarbonate diffuser, semiopal and transparent.

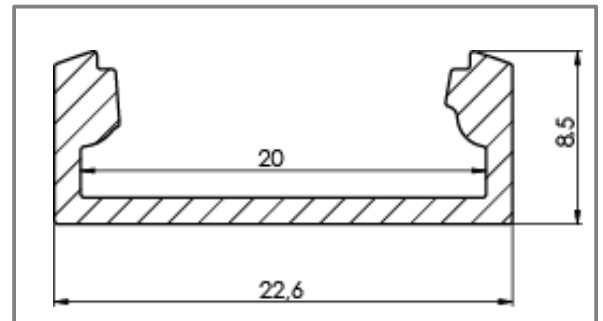

Codice Profilo Code Profile	Lunghezza Length	Tipo Finitura Finish Type	Codice Cover Code Cover	Tipo Cover Cover Type	Lunghezza Length
AL-E8	-2 (2000mm)	AL  Argento Silver	AB-E8	-T  Trasparente Transparent	-2 (2000mm)
	-3 (3000mm)	WH  Bianco White		-O  Opale Opal	-3 (3000mm)
	-4 (4000mm)	BK  Nero Black		-S  Semi-Opale Semi-Opal	-4 (4000mm)
		*CO  Corten Cortain			

*a richiesta codice finitura - on request finishing code

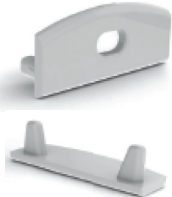
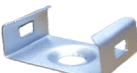
Accessori Accessories	Codice Code	Descrizione Description
	EC-E8-K	Kit tappo chiuso e tappo forato in lega / End cap Kit 1 with hole + 1 without
	MC-E8	Supporto di fissaggio in acciaio per profilo a parete / Fixing support in steel for wall profile



Profili appoggio/parete Support/surface profiles

Profilo in alluminio estruso per l'installazione a parete. Disponibile nelle finiture di colore alluminio anodizzato, bianco, nero e corten. Diffusore in policarbonato opale, semiopale e trasparente.

Extruded aluminum profile for wall installation. Available in anodized aluminum color finishes, white, black and corten. Opal polycarbonate diffuser, semiopal and transparent.



FLAT

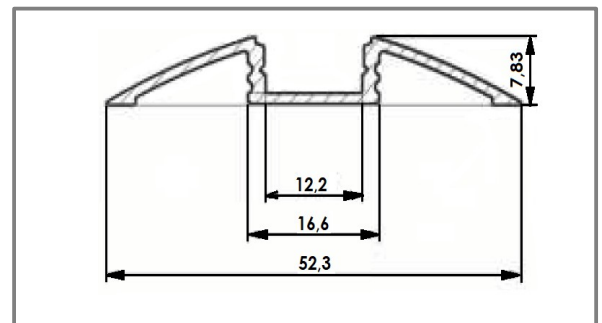

Dimensioni – Dimension
H9 x L55mm

Codice Profilo Code Profile	Lunghezza Length	Tipo Finitura Finish Type	Codice Cover Code Cover	Tipo Cover Cover Type	Lunghezza Length
AL-EF	-2 (2000mm)	AL Argento Silver	AB-E	-T Trasparente Transparent	-2 (2000mm)
	-3 (3000mm)	WH Bianco White		-O Opale Opal	-3 (3000mm)
	-4 (4000mm)	BK Nero Black		-S Semi-Opale Semi-Opal	-4 (4000mm)
		*CO Corten Cortain		-L40 Lente 40° Lens 40°	
			-F Fumè Fumè		

*a richiesta codice finitura - on request finishing code

Accessori Accessories	Codice Code	Descrizione Description
	EC-FL-SF	Tappo chiuso in alluminio senza foro/ Closed aluminum cap without hole
	EC-FL-CF	Tappo forato in alluminio/ Perforated cap aluminum
	EC-FL-K	Kit tappo chiuso e tappo forato in lega / End cap Kit 1 with hole + 1 without

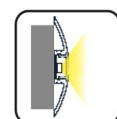

Profili appoggio/parete Support/surface profiles

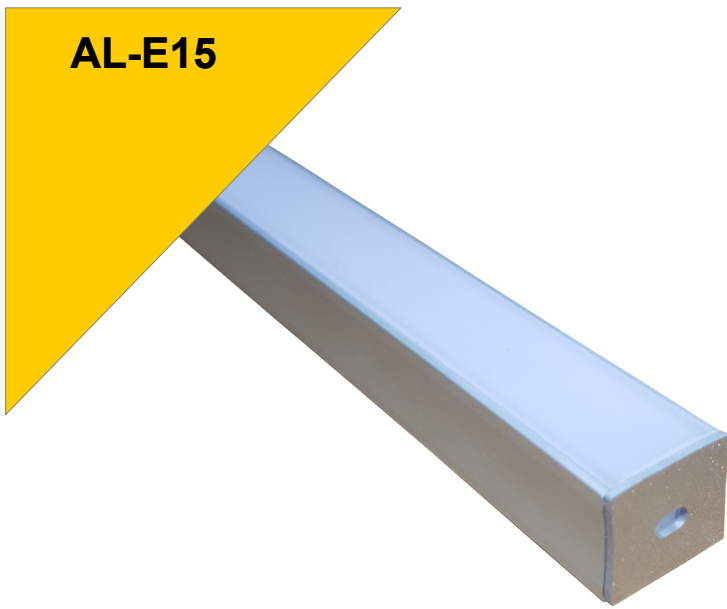



AL-E15

Profilo in alluminio estruso per l'installazione a parete. Disponibile nelle finiture di colore alluminio anodizzato, bianco, nero e corten. Diffusore in policarbonato opale, semiopale e trasparente.



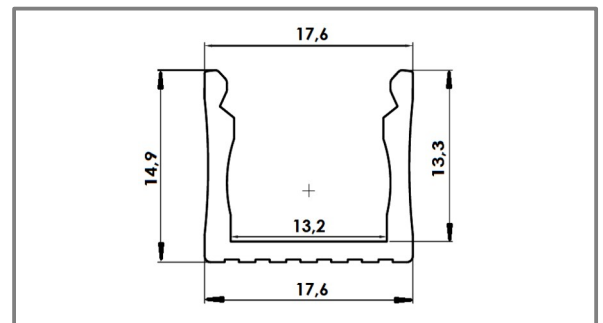

Extruded aluminum profile for wall installation. Available in anodized aluminum color finishes, white, black and corten. Opal polycarbonate diffuser, semiopal and transparent.

Dimensioni – Dimension
H15 x L17mm

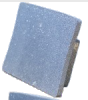

Codice Profilo Code Profile	+ Lunghezza Length	+ Tipo Finitura Finish Type	Codice Cover Code Cover	+ Tipo Cover Cover Type	+ Lunghezza Length
AL-E15	-2 (2000mm)	AL  Argento Silver	AB-E	-T  Trasparente Transparent	-2 (2000mm)
	-3 (3000mm)	WH  Bianco White		-O  Opale Opal	-3 (3000mm)
	-4 (4000mm)	BK  Nero Black		-S  Semi-Opale Semi-Opal	-4 (4000mm)
		*CO  Corten Cortain		-L40  Lente 40° Lens 40°	
			-F  Fumè Fumè		

*a richiesta codice finitura - on request finishing code

Accessori Accessories	Codice Code	Descrizione Description
	EC-E15-SF	Tappo chiuso in alluminio senza foro/ Closed aluminum cap without hole
	EC-E15-CF	Tappo forato in alluminio per passaggio cavi/ Perforated aluminum cap for cable passage
	EC-E15-K	Kit tappo chiuso e tappo forato in lega / End cap Kit 1 with hole + 1 without
	MC-E15	Supporto di fissaggio in acciaio per profilo a parete/ Fixing support in steel for wall profile



AL-TRB System



Profili appoggio/parete Support/surface profiles

Profilo in alluminio estruso per l'installazione a parete. Disponibile nelle finiture di colore alluminio anodizzato, bianco. Diffusore in policarbonato opale e trasparente.

Extruded aluminum profile for wall installation. Available in anodized aluminum color finishes, White. Opal polycarbonate diffuser and transparent.

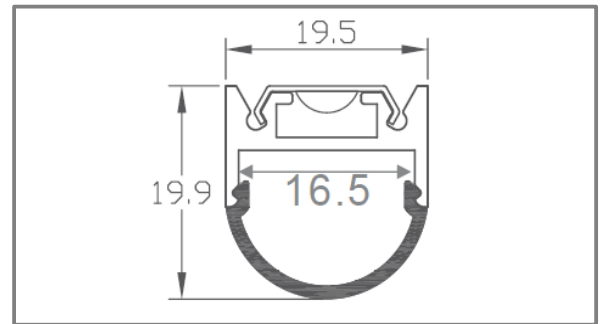

Dimensioni – Dimension
H20 x L20mm

Codice Profilo Code Profile	Lunghezza Length	Tipo Finitura Finish Type	Codice Cover Code Cover	Tipo Cover Cover Type	Lunghezza Length
AL-TR	-2 (2000mm)	AL Argento Silver	AB-TRB	-O Opale Opal	-2 (2000mm)
	-3 (3000mm)	WH Bianco White			-3 (3000mm)

Accessori Accessories

Codice Code

Descrizione Description



EC-TRB-K

Kit tappo chiuso e tappo forato in lega / End cap Kit 1 with hole + 1 without



MC-TR

Supporto di fissaggio in acciaio per profilo a parete/ Fixing support in steel for wall profile

LC01

Connettore lineare/ Linear connector

LC02

Connettore angolare orizzontale/ Horizontal angle connector

LC03

Connettore angolare verticale/ Vertical angle connector

MC-SOS-TR

Kit sospensione (2 cavi e 4 supporti)/ Suspension kit (2 cables and 4 supports)



MC-SOS-TR



LC01

LC02

LC03

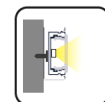

AL-TRC System

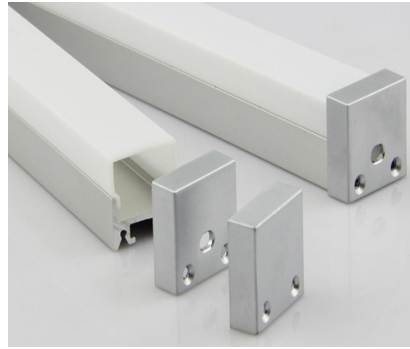

Profili appoggio/parete Support/surface profiles

Profilo in alluminio estruso per l'installazione a parete. Disponibile nelle finiture di colore alluminio anodizzato, bianco. Diffusore in policarbonato opale .

Extruded aluminum profile for wall installation. Available in anodized aluminum color finishes, White. Opal polycarbonate diffuser .

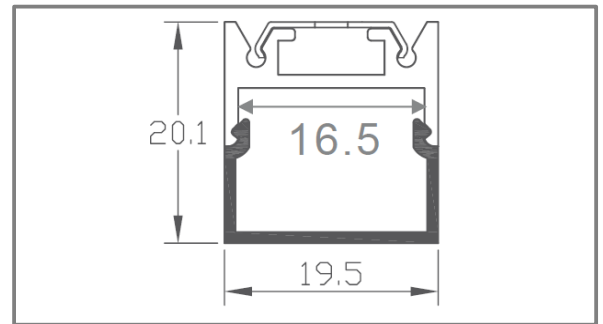

Dimensioni – Dimension
H20 x L20mm

Codice Profilo Code Profile	Lunghezza Length	Tipo Finitura Finish Type	Codice Cover Code Cover	Tipo Cover Cover Type	Lunghezza Length
AL-TR	-2 (2000mm)	AL Argento Silver	AB-TRC	-O Opale Opal	-2 (2000mm)
	-3 (3000mm)	WH Bianco White			-3 (3000mm)

Accessori Accessories

Codice Code

Descrizione Description



EC-TRC-K

Kit tappo chiuso e tappo forato in lega / End cap Kit 1 with hole + 1 without

MC-TR

Supporto di fissaggio in acciaio per profilo a parete/ Fixing support in steel for wall profile

LC01

Connettore lineare/ Linear connector

LC02

Connettore angolare orizzontale/ Horizontal angle connector

LC03

Connettore angolare verticale/ Vertical angle connector

MC-SS-TR

Kit sospensione (2 cavi e 4 supporti)/ Suspension kit (2 cables and 4 supports)



MC-SS-TR



LC01

LC02

LC03

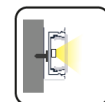

AL-TRD System





Profili appoggio/parete Support/surface profiles

Profilo in alluminio estruso per l'installazione a parete. Disponibile nelle finiture di colore alluminio anodizzato, bianco. Diffusore in policarbonato opale.

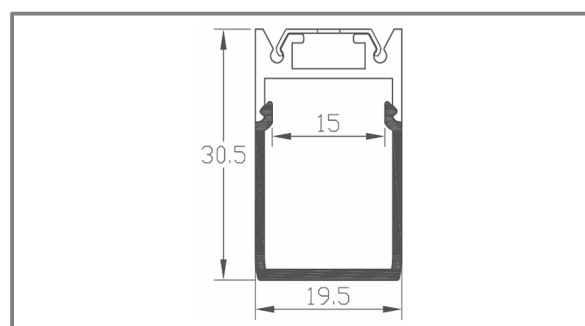
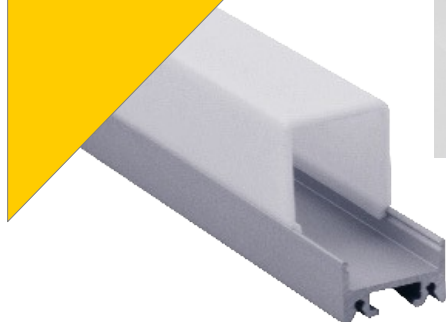
Extruded aluminum profile for wall installation. Available in anodized aluminum color finishes, White. Opal polycarbonate diffuser.



Dimensioni – Dimension
H30 x L20mm

Codice Profilo Code Profile	+ Lunghezza Length	+ Tipo Finitura Finish Type	Codice Cover Code Cover	+ Tipo Cover Cover Type	+ Lunghezza Length
AL-TR	-2 (2000mm)	AL  Argento Silver	AB-TRD	-O  Opale Opal	-2 (2000mm)
	-3 (3000mm)	WH  Bianco White			-3 (3000mm)

Accessori Accessories

Codice Code

Descrizione Description



EC-TRD-K

Kit tappo chiuso e tappo forato in lega / End cap Kit 1 with hole + 1 without

MC-TR

Supporto di fissaggio in acciaio per profilo a parete/ Fixing support in steel for wall profile

LC01

Connettore lineare/ Linear connector

LC02

Connettore angolare orizzontale/ Horizontal angle connector

LC03

Connettore angolare verticale/ Vertical angle connector

MC-SOS-TR

Kit sospensione (2 cavi e 4 supporti)/ Suspension kit (2 cables and 4 supports)



MC-SOS-TR



LC01

LC02

LC03

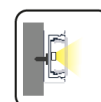

Profili appoggio/parete Support/surface profiles

AL-E13

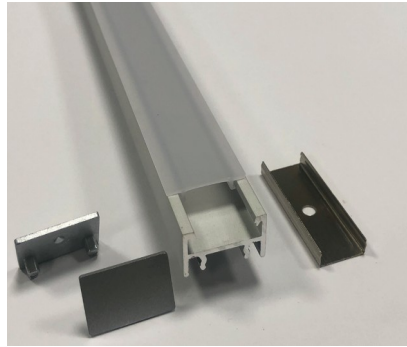



Profilo in alluminio estruso per l'installazione a parete. Disponibile nelle finiture di colore alluminio anodizzato, bianco. Diffusore in policarbonato opale e trasparente. Possibilità di customizzare corpi illuminanti su misura con le nostre strip LED inserite all'interno del profilo.

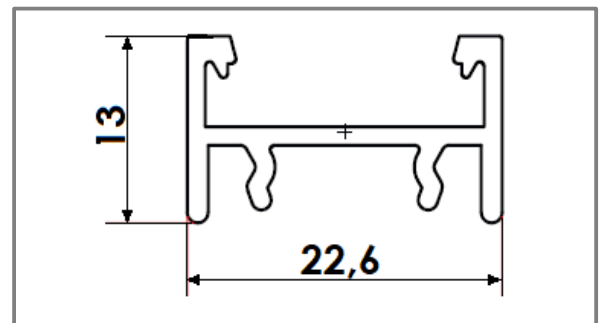

Extruded aluminum profile for wall installation. Available in anodized aluminum color finishes, White. Opal polycarbonate diffuser and transparent. Possibility of customizing bodies custom lighting with our LED strips inserted within the profile.



Dimensioni – Dimension
H13 x L22mm

Codice Profilo Code Profile	+ Lunghezza Length	+ Tipo Finitura Finish Type	Codice Cover Code Cover	+ Tipo Cover Cover Type	+ Lunghezza Length
AL-E13	-2 (2000mm)	AL  Argento Silver	AB-E13	-O  Opale Opal	-2 (2000mm)
	-3 (3000mm)	*WH  Bianco White			-3 (3000mm)
	-4 (4000mm)				-4 (4000mm)

*a richiesta codice finitura - on request finishing code

Accessori Accessories	Codice Code	Descrizione Description
	EC-E13-K	Kit tappo chiuso e tappo forato in lega / End cap Kit 1 with hole + 1 without
	MC-U	Supporto di fissaggio in acciaio per profilo a parete/ Fixing support in steel for wall profile



AL-E35N



Dimensioni – Dimension
H35 x L35mm

Profili appoggio/parete Support/surface profiles





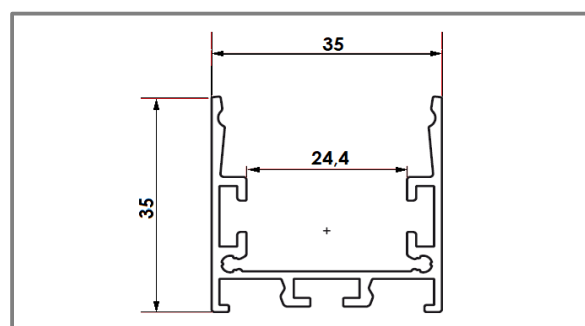





Profilo in alluminio estruso per l'installazione a parete. Disponibile nelle finiture di colore alluminio anodizzato, bianco, nero e corten. Diffusore in policarbonato opale, e trasparente.

Extruded aluminum profile for wall installation. Available in anodized aluminum color finishes, white, black and corten. Opal polycarbonate diffuser, and transparent.

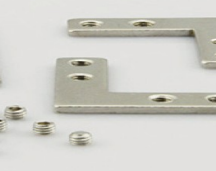

Codice Profilo Code Profile	+ Lunghezza Length	+ Tipo Finitura Finish Type	Codice Cover Code Cover	+ Tipo Cover Cover Type	+ Lunghezza Length
AL-E35N	-2 (2000mm)	AL  Argento Silver	AB-E35	-T  Trasparente Transparent	-2 (2000mm)
	-3 (3000mm)	WH  Bianco White		-O  Opale Opal	-3 (3000mm)
	-4 (4000mm)	BK  Nero Black		-PRI  Prismatico Prismatic	-4 (4000mm)
		*CO  Corten Corten		-F  Fumè	

*a richiesta codice finitura - on request finishing code

Accessori Accessories	Codice Code	Descrizione Description
	EC-E35-SF	Tappo senza foro in lega / End cap without hole
	EC-E35N-K	Kit tappo chiuso e tappo forato in lega / End cap Kit 1 with hole + 1 without
	LC01	Connettore lineare/ Linear connector
	LC02	Connettore angolare orizzontale/ Horizontal angle connector
	LC03	Connettore angolare verticale/ Vertical angle connector
	MC-U	Supporto di fissaggio in acciaio per profilo a parete/ Fixing support in steel for wall profile
	MC-SOS-35	Kit sospensione (2 cavi e 4 supporti)/ Suspension kit (2 cables and 4 supports)
	LC01	
	LC02	
	LC03	



AL-E55



Profili appoggio/parete Support/surface profiles

Profilo in alluminio estruso per l'installazione a parete. Disponibile nelle finiture di colore alluminio anodizzato, bianco, nero e corten. Diffusore in policarbonato opale, e trasparente.



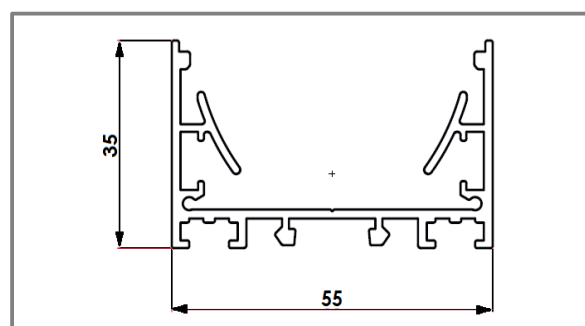



Extruded aluminum profile for wall installation. Available in anodized aluminum color finishes, white, black and corten. Opal polycarbonate diffuser, and transparent.



Dimensioni – Dimension
H35 x L55mm

Codice Profilo Code Profile	Lunghezza Length	Tipo Finitura Finish Type	Codice Cover Code Cover	Tipo Cover Cover Type	Lunghezza Length
AL-E55	-2 (2000mm)	AL  Argento Silver	AB-55	-T  Trasparente Transparent	-2 (2000mm)
	-3 (3000mm)	WH  Bianco White		-O  Opale Opal	-3 (3000mm)
	-4 (4000mm)	BK  Nero Black		-PRI  Prismatico Prismatic	-4 (4000mm)
		*CO  Corten Corten			

*a richiesta codice finitura - on request finishing code

Accessori Accessories	Codice Code	Descrizione Description
	EC-E55-K	Kit tappo chiuso lega / End cap without hole
	LC01	Connettore lineare/ Linear connector
	LC02	Connettore angolare orizzontale/ Horizontal angle connector
	LC03	Connettore angolare verticale/ Vertical angle connector
	MC-5580	Supporto di fissaggio in acciaio per profilo a parete/ Fixing support in steel for wall profile
	MC-SOS-5580	Kit sospensione (2 cavi e 4 supporti)/ Suspension kit (2 cables and 4 supports)
	LC01	
	LC02	
	LC03	



Profili appoggio/parete Support/surface profiles

AL-E80



Profilo in alluminio estruso per l'installazione a parete. Disponibile nelle finiture di colore alluminio anodizzato, bianco, nero e corten. Diffusore in policarbonato opale, e trasparente.

Extruded aluminum profile for wall installation. Available in anodized aluminum color finishes, white, black and corten. Opal polycarbonate diffuser, and transparent.





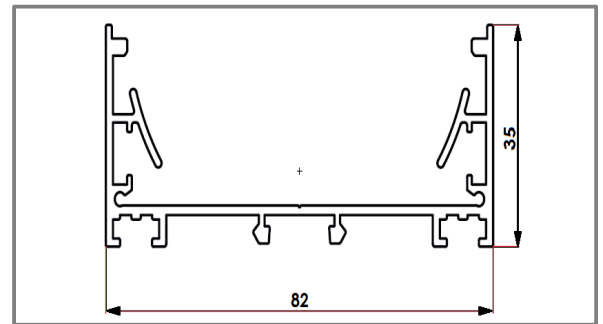



Dimensioni – Dimension
H35 x L80mm



Codice Profilo Code Profile	Lunghezza Length	Tipo Finitura Finish Type	Codice Cover Code Cover	Tipo Cover Cover Type	Lunghezza Length
AL-E80	-2 (2000mm)	AL  Argento Silver	AB-80	-T  Trasparente Transparent	-2 (2000mm)
	-3 (3000mm)	WH  Bianco White		-O  Opale Opal	-3 (3000mm)
	-4 (4000mm)	BK  Nero Black		-PRI  Prismatico Prismatic	-4 (4000mm)
		*CO  Corten Corten			

*a richiesta codice finitura - on request finishing code

Accessori Accessories	Codice Code	Descrizione Description
	EC-E80-K	Kit tappo chiuso in lega / End cap Kit without hole
	LC01	Connettore lineare/ Linear connector
	LC02	Connettore angolare orizzontale/ Horizontal angle connector
	LC03	Connettore angolare verticale/ Vertical angle connector
	MC-5580	Supporto di fissaggio in acciaio per profilo a parete/ Fixing support in steel for wall profile
	MC-SOS-5580	Kit sospensione (2 cavi e 4 supporti)/ Suspension kit (2 cables and 4 supports)
	LC01	
	LC02	
	LC03	



Profili appoggio/parete Support/surface profiles

AL-5570

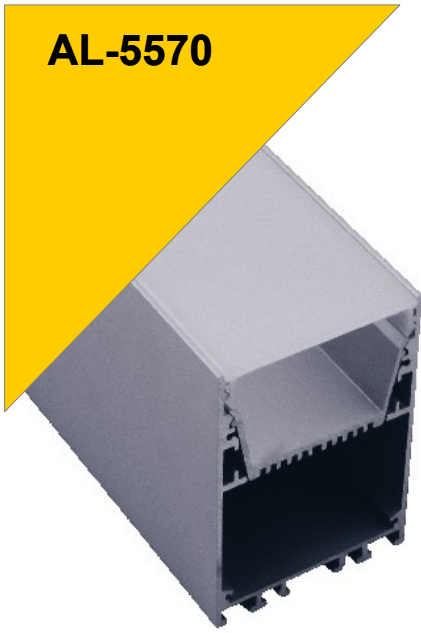

Dimensioni – Dimension
H70 x L55mm

Profilo in alluminio estruso per l'installazione a parete. Disponibile nelle finiture di colore alluminio anodizzato, bianco, nero e corten. Diffusore in policarbonato opale, e trasparente.

Extruded aluminum profile for wall installation. Available in anodized aluminum color finishes, white, black and corten. Opal polycarbonate diffuser, and transparent.

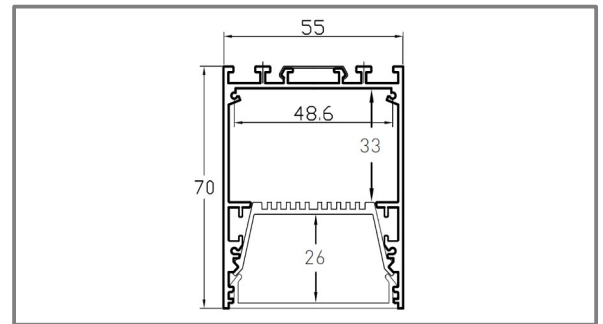

Codice Profilo Code Profile	Lunghezza Length	Tipo Finitura Finish Type	Codice Cover Code Cover	Tipo Cover Cover Type	Lunghezza Length
AL-5570	-2 (2000mm)	AL Argento Silver	AB-55	-T Trasparente Transparent	-2 (2000mm)
	-3 (3000mm)	WH Bianco White		-O Opale Opal	-3 (3000mm)
	-4 (4000mm)	BK Nero Black		-PRI Prismatico Prismatic	-4 (4000mm)
		*CO Corten Corten			

*a richiesta codice finitura - on request finishing code

Accessori Accessories	Codice Code	Descrizione Description
	EC-5570-SF	Tappo chiuso in alluminio senza foro/ Closed aluminum cap without hole
	LC01	Connettore lineare/ Linear connector
	LC02	Connettore angolare orizzontale/ Horizontal angle connector
	LC03	Connettore angolare verticale/ Vertical angle connector
	MC-5570	Supporto di fissaggio in acciaio per profilo a parete/ Fixing support in steel for wall profile
	MC-SOS-5570	Kit sospensione (2 cavi e 4 supporti)/ Suspension kit (2 cables and 4 supports)



MC-SOS-5580

LC01

LC02

LC03

Profili parete/bimissione Surface/bi-emission profiles

AL-D5570



Profilo in alluminio estruso per l'installazione a parete e sospensione mono o bi-emissione.
Disponibile nelle finiture di colore alluminio anodizzato, bianco, nero e corten. Diffusore in policarbonato opale, e trasparente.

Extruded aluminum profile for wall installation and single or double emission suspension.
Available in anodized aluminum color finishes, white, black and corten. Opal polycarbonate diffuser, and transparent.



Dimensioni – Dimension
H70 x L55mm

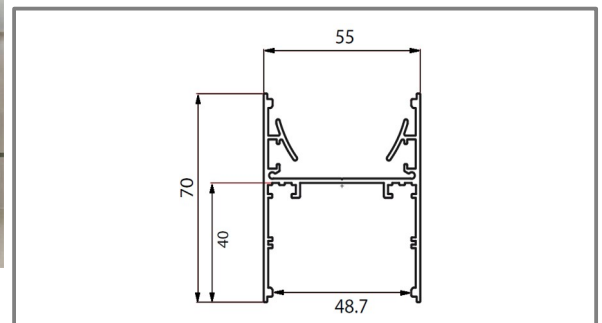

Codice Profilo Code Profile	Lunghezza Length	Tipo Finitura Finish Type	Codice Cover Code Cover	Tipo Cover Cover Type	Lunghezza Length
AL-D5570	-2 (2000mm)	AL Argento Silver	AB-55	-T Trasparente Transparent	-2 (2000mm)
	-3 (3000mm)	WH Bianco White		-O Opale Opal	-3 (3000mm)
	-4 (4000mm)	BK Nero Black		-PRI Prismatic Prismatic	-4 (4000mm)
		*CO Corten Corten			

*a richiesta codice finitura - on request finishing code

Accessori Accessories	Codice Code	Descrizione Description
	EC-D5570-K	Kit tappo chiuso in lega / End cap Kit without hole
	LC01	Connettore lineare Kit/ Linear connector Kit
	LC02	Connettore angolare orizzontale Kit/ Horizontal angle connector Kit
	LC03	Connettore angolare verticale/ Vertical angle connector
	MC-SOS-K	Kit sospensione (2 cavi e 4 supporti)/ Suspension kit (2 cables and 4 supports)

MC-SOS-K

LC01

LC-02

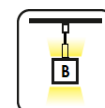

Profili biemissione biemission profiles

AL-B5570



Dimensioni – Dimension
H70 x L55mm

Profilo in alluminio estruso per l'installazione a sospensione mono o biemissione. Disponibile nelle finiture di colore alluminio anodizzato, bianco, nero e corten. Diffusore in policarbonato opale, e trasparente.

Extruded aluminum profile single or double emission suspension. Available in anodized aluminum color finishes, white, black and corten. Opal polycarbonate diffuser, and transparent.

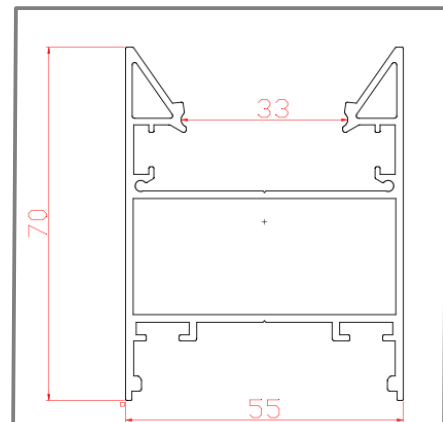

Codice Profilo Code Profile	+ Lunghezza Length	+ Tipo Finitura Finish Type	Codice Cover Code Cover	+ Tipo Cover Cover Type	+ Lunghezza Length
AL-B5570	-2 (2000mm)	AL  Argento Silver	AB-55	-O  Trasparente Transparent	-2 (2000mm)
	-3 (3000mm)	WH  Bianco White		-PRI  Opale Opal	-3 (3000mm)
	-4 (4000mm)	BK  Nero Black		 Prismatico Prismatic	-4 (4000mm)
		*CO  Corten Corten			

*a richiesta codice finitura - on request finishing code

Accessori Accessories	Codice Code	Descrizione Description
	EC-D5570-K	Kit tappo chiuso in lega / End cap Kit without hole
	LC01	Connettore lineare Kit/ Linear connector Kit
	LC02	Connettore angolare orizzontale Kit/ Horizontal angle connector Kit
	LC03	Connettore angolare verticale/ Vertical angle connector
	MC-SOS-K	Kit sospensione (2 cavi e 4 supporti)/ Suspension kit (2 cables and 4 supports)



MC-SOS-K

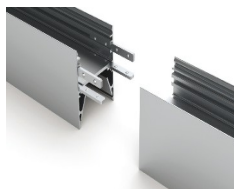

LC01

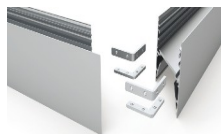

LC-02

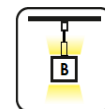

Profili sospensione/bimissione Suspension/bimission profiles

AL-1732





Profilo in alluminio estruso per l'installazione a sospensione mono o bimissione.
Disponibile nelle finiture di colore alluminio anodizzato, bianco. Diffusore in policarbonato opale, e trasparente.

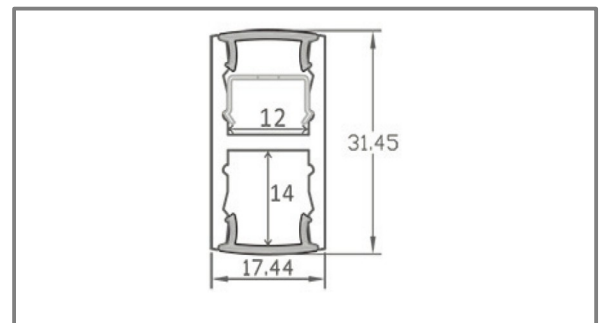

Extruded aluminum profile for suspension installation single or double emission.
Available in anodized aluminum color finishes, White. Opal polycarbonate diffuser, and transparent.



Dimensioni – Dimension
H32 x L17mm

Codice Profilo Code Profile	+ Lunghezza Length	+ Tipo Finitura Finish Type	Codice Cover Code Cover	+ Tipo Cover Cover Type	+ Lunghezza Length
AL-1732	-2 (2000mm)	AL  Argento Silver	AB-SL	-O  Opale Opal	-2 (2000mm)
	-3 (3000mm)	*WH  Bianco White			-3 (3000mm)

*a richiesta codice finitura - on request finishing code

Accessori Accessories	Codice Code	Descrizione Description
	EC-1732	Tappo chiuso in PVC senza foro/ Closed PVC cap without hole
	MC-1732	Supporto di fissaggio in acciaio per profilo a parete/ Fixing support in steel for wall profile
	MC-SOS-1732	Kit sospensione (2 cavi e 4 supporti)/ Suspension kit (2 cables and 4 supports)

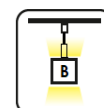

Profili appoggio/parete Support/surface profiles

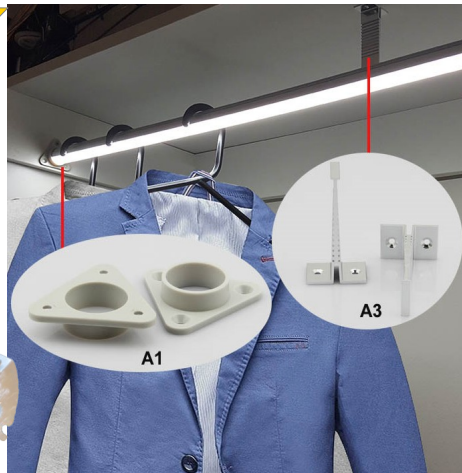

Profilo in alluminio estruso per vari tipi di installazione. Disponibile nelle finiture di colore alluminio anodizzato, bianco, nero e corten. Diffusore in policarbonato opale, trasparente.

Extruded aluminum profile. Available in anodized aluminum color finishes, white, black and corten. Opal polycarbonate diffuser, and transparent.

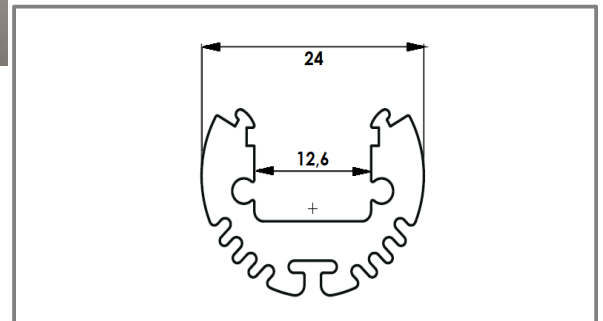

Dimensioni – Dimension
H24 x L24mm

Codice Profilo Code Profile	Lunghezza Length	Tipo Finitura Finish Type	Codice Cover Code Cover	Tipo Cover Cover Type	Lunghezza Length
AL-ER	-2 (2000mm)	AL Argento Silver	AB-ER	-T Trasparente Transparent	-2 (2000mm)
	-3 (3000mm)	WH Bianco White		-O Opale Opal	-3 (3000mm)
		BK Nero Black			
		*CO Corten Corten			

*a richiesta codice finitura - on request finishing code

Accessori Accessories	Codice Code	Descrizione Description
	EC-ER-K	Kit tappo chiuso e tappo forato in lega / End cap Kit 1 with hole + 1 without
	MC-A2	Supporto di montaggio (0-180°) ABS/ Mounting support (0-180°) ABS
	MC-SOS-R	Kit sospensione (2 cavi e 4 supporti)/ Suspension kit (2 cables and 4 supports)
	MC-A1	Supporto fissaggio laterale in PVC per armadio/ Side fixing support in PVC
	MC-A3	Supporto fissaggio sospensione in alluminio/ Suspension support fixed in aluminum

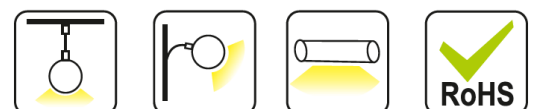

AL-R13



Dimensioni – Dimension
H13 x L13mm

Profili Round Round profiles

Profilo in alluminio estruso per carie installazioni
Disponibile nelle finiture di colore alluminio anodizzato,
bianco, nero. Diffusore in policarbonato opale,

Extruded aluminum profile .
Available in anodized aluminum color finishes,
white, black Opal polycarbonate diffuser,

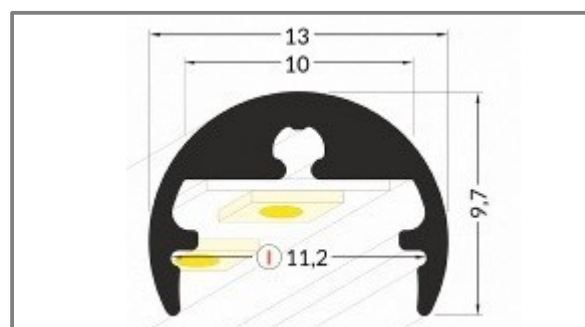

MC-R13
Supporti di montaggio
Mounting Clip

EC-R13-K
Kit di terminali
End Caps

Codice Profilo Code Profile	Lunghezza Length	Tipo Finitura Finish Type	Codice Cover Code Cover	Tipo Cover Cover Type	Lunghezza Length
AL-R13	-2 (2000mm)	AL Argento Silver	AB-R13	-O Opale Opal	-2 (2000mm)
	-3 (3000mm)	WH Bianco White			-3 (3000mm)
		BK Nero Black			

AL-R20



MC-R20
Supporti di montaggio
Mounting Clip

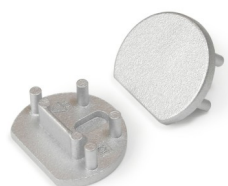

EC-R20-K
Kit di terminali
End Caps

Dimensioni – Dimension
H24 x L24mm

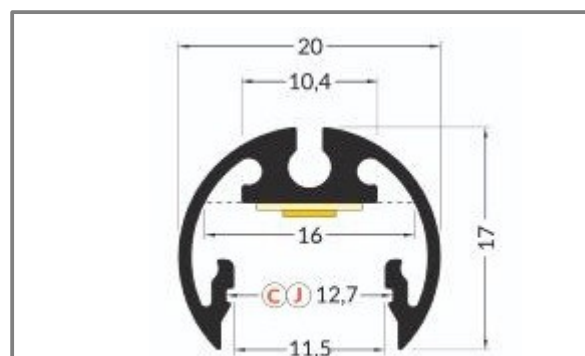

Codice Profilo Code Profile	Lunghezza Length	Tipo Finitura Finish Type
AL-R20	-2 (2000mm)	AL Argento Silver
	-3 (3000mm)	WH Bianco White
		BK Nero Black

MC-SOS-R

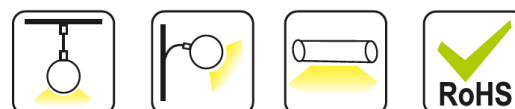

Profili appoggio/parete Support/surface profiles

Profilo in alluminio angolare per l'installazione a parete. Disponibile nelle finiture di colore alluminio anodizzato, bianco, nero e corten. Diffusore in policarbonato opale, semiopale e trasparente.

Extruded aluminum profile for wall installation. Available in anodized aluminum color finishes, white, black and corten. Opal polycarbonate diffuser, semiopal and transparent.

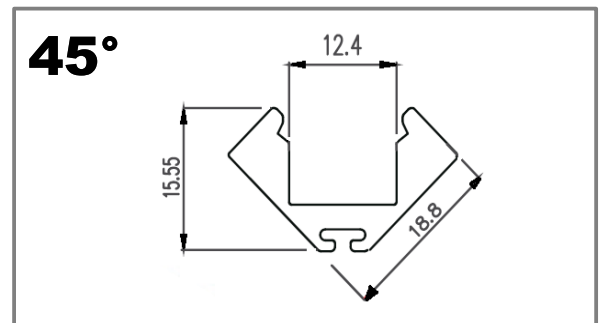
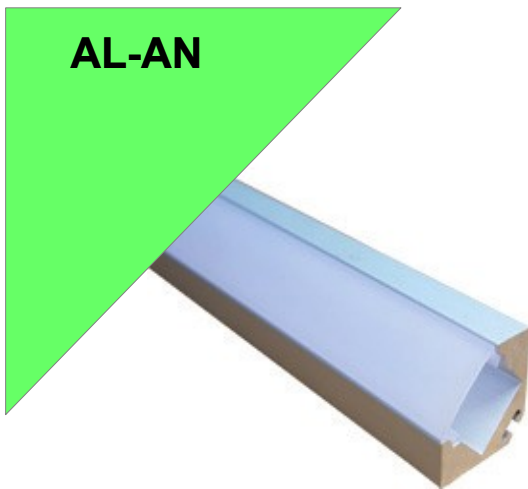

Dimensioni – Dimension
H19 x L19mm

Codice Profilo Code Profile	Lunghezza Length	Tipo Finitura Finish Type	Codice Cover Code Cover	Tipo Cover Cover Type	Lunghezza Length
AL-AN	-2 (2000mm)	AL Argento Silver	AB-E	-T Trasparente Transparent	-2 (2000mm)
	-3 (3000mm)	WH Bianco White		-O Opale Opal	-3 (3000mm)
	-4 (4000mm)	BK Nero Black		-S Semi-Opale Semi-Opal	-4 (4000mm)
		*CO Corten Cortain		-L40 Lente 40° Lens 40°	
			-F Fumè Fumè		

*a richiesta codice finitura - on request finishing code

Accessori Accessories	Codice Code	Descrizione Description
	EC-AN-K	Kit tappo chiuso e tappo forato in lega / End cap Kit 1 with hole + 1 without
	MC-AN-A	Supporto di fissaggio in acciaio per profilo a parete / Fixing support in steel for wall profile



Profili appoggio/parete Support/surface profiles

Profilo in alluminio angolare per l'installazione a parete. Disponibile nelle finiture di colore alluminio anodizzato, bianco, nero e corten. Diffusore in policarbonato opale, semiopale e trasparente.

Extruded aluminum profile for wall installation. Available in anodized aluminum color finishes, white, black and corten. Opal polycarbonate diffuser, semiopal and transparent.

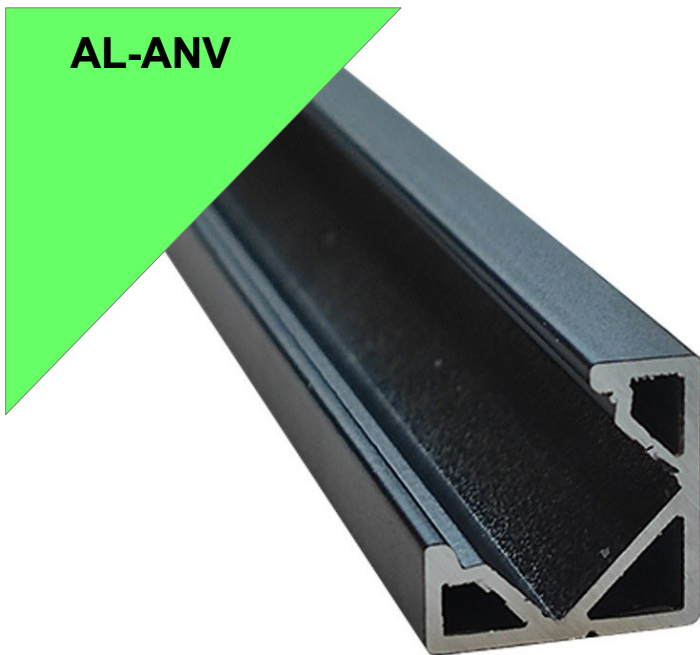

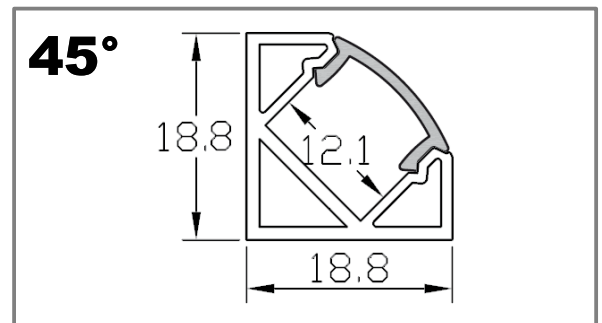

Dimensioni – Dimension
H19 x L19mm



Codice Profilo Code Profile	Lunghezza Length	Tipo Finitura Finish Type	Codice Cover Code Cover	Tipo Cover Cover Type	Lunghezza Length
AL-ANV	-2 (2000mm)	AL  Argento Silver	AB-E	-T  Trasparente Transparent	-2 (2000mm)
	-3 (3000mm)	WH  Bianco White		-O  Opale Opal	-3 (3000mm)
	-4 (4000mm)	BK  Nero Black		-S  Semi-Opale Semi-Opal	-4 (4000mm)
		*CO  Corten Corten		-L40  Lente 40° Lens 40°	
			-F  Fumè Fumè		

*a richiesta codice finitura - on request finishing code

Accessori Accessories	Codice Code	Descrizione Description
	EC-AN-K	Kit tappo chiuso e tappo forato in lega / End cap Kit 1 with hole + 1 without
	MC-AN	Supporto di fissaggio in acciaio per profilo a parete / Fixing support in steel for wall profile



Profili appoggio/parete Support/surface profiles

Profilo in alluminio angolare per l'installazione a parete. Disponibile nelle finiture di colore alluminio anodizzato, bianco, nero e corten. Diffusore in policarbonato opale, semiopale e trasparente.

Extruded aluminum profile for wall installation. Available in anodized aluminum color finishes, white, black and corten. Opal polycarbonate diffuser, semiopal and transparent.

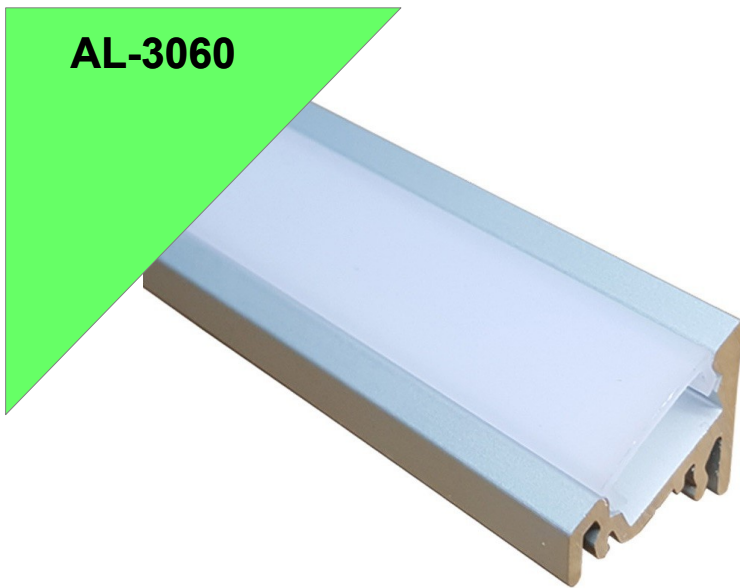

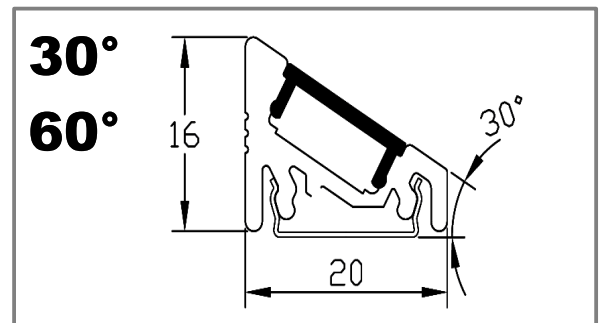

AL-3060

Dimensioni – Dimension
H16 x L20mm

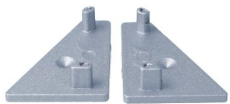

Codice Profilo Code Profile	Lunghezza Length	Tipo Finitura Finish Type	Codice Cover Code Cover	Tipo Cover Cover Type	Lunghezza Length
AL-3060	-2 (2000mm)	AL  Argento Silver	AB-E	-T  Trasparente Transparent	-2 (2000mm)
	-3 (3000mm)	WH  Bianco White		-O  Opale Opal	-3 (3000mm)
	-4 (4000mm)	BK  Nero Black		-S  Semi-Opale Semi-Opal	-4 (4000mm)
		*CO  Corten Corten		-L40  Lente 40° Lens 40°	
			-F  Fumè Fumè		

*a richiesta codice finitura - on request finishing code

Accessori Accessories	Codice Code	Descrizione Description
	EC-3060-K	Kit 2 terminali in lega / Kit of two End cap
	MC-3060	Supporto di fissaggio in acciaio per profilo a parete / Fixing support in steel for wall profile



Profili appoggio/parete Support/surface profiles

Profilo in alluminio angolare per l'installazione a parete. Disponibile nelle finiture di colore alluminio anodizzato, bianco, nero e corten. Diffusore in policarbonato opale, semiopale e trasparente, nero.

Extruded aluminum profile for wall installation. Available in anodized aluminum color finishes, white, black and corten. Opal polycarbonate diffuser, semiopal and transparent, black.



Dimensioni – Dimension
H16 x L20mm

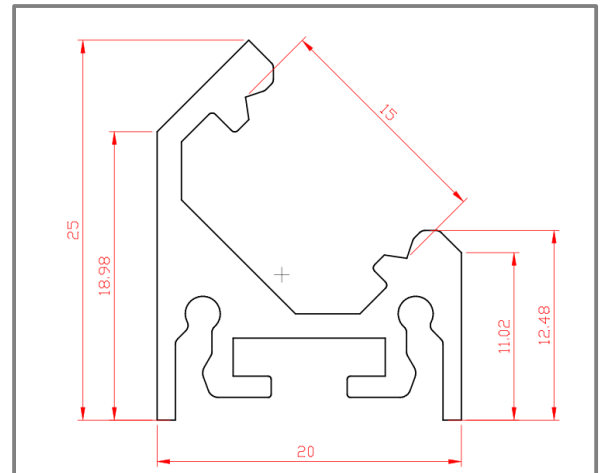

Codice Profilo Code Profile	Lunghezza Length	Tipo Finitura Finish Type	Codice Cover Code Cover	Tipo Cover Cover Type	Lunghezza Length
AL-ASY	-2 (2000mm)	AL Argento Silver	AB-E	-T Trasparente Transparent	-2 (2000mm)
	-3 (3000mm)	WH Bianco White		-O Opale Opal	-3 (3000mm)
		BK Nero Black		-S Semi-Opale Semi-Opal	
		*CO Corten Corten		-L40 Lente 40° Lens 40°	
			-F Fumè Fumè		

*a richiesta codice finitura - on request finishing code

Accessori Accessories	Codice Code	Descrizione Description
	EC-ASY-K	Kit 2 terminali in lega / Kit of two End cap
	MC-3060	Supporto di fissaggio in acciaio per profilo a parete / Fixing support in steel for wall profile



Profili appoggio/parete Support/surface profiles

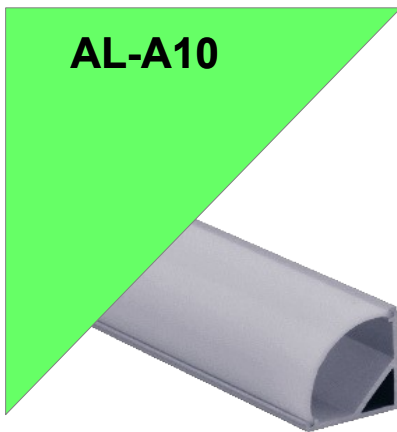

Profilo in alluminio angolare per l'installazione a parete.
Disponibile nelle finiture di colore alluminio anodizzato.
Diffusore in policarbonato opale,.

Extruded aluminum profile for wall installation.
Available in anodized aluminum Opal polycarbonate diffuser,

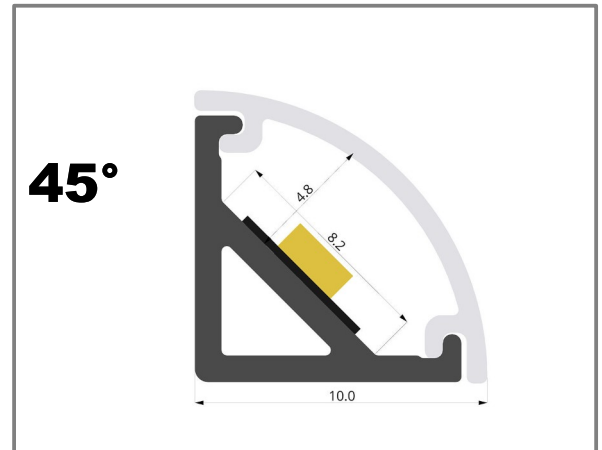

Dimensioni – Dimension
H10 x L10mm

Codice Profilo Code Profile	+ Lunghezza Length	+ Tipo Finitura Finish Type	Codice Cover Code Cover	+ Tipo Cover Cover Type	+ Lunghezza Length
AL-A10	-2 (2000mm)	AL Argento Silver	AB-A10	-O Opale Opal	-2 (2000mm)

*a richiesta codice finitura - on request finishing code

Accessori Accessories	Codice Code	Descrizione Description
	MC-A10-K	Kit tappo chiuso e tappo forato in ABS / End cap Kit 1 with hole + 1 without
	MC-A10	Supporto di fissaggio in acciaio per profilo a parete/ Fixing support in steel for wall profile



Profili appoggio/parete Support/surface profiles





Profilo in alluminio estruso per l'installazione a parete. Disponibile nelle finiture di colore alluminio anodizzato, Diffusore in policarbonato opale,

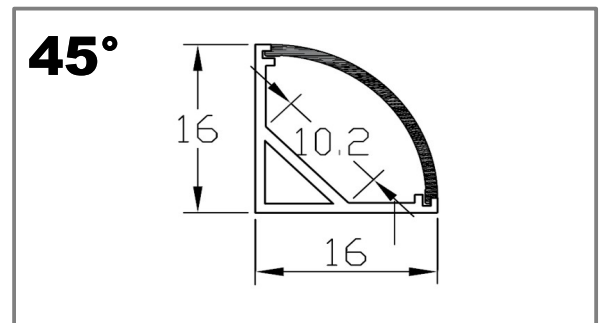

Extruded aluminum profile for wall installation. Available in anodized aluminum color finishes, white, black and corten. Opal polycarbonate diffuser, semiopal and transparent. Possibility of customizing bodies custom lighting with our LED strips inserted within the profile.



Dimensioni – Dimension
H16 x L16mm

Codice Profilo Code Profile	+ Lunghezza Length	+ Tipo Finitura Finish Type	Codice Cover Code Cover	+ Tipo Cover Cover Type	+ Lunghezza Length
AL-A16	-2 (2000mm) -3 (3000mm)	AL  Argento Silver	AB-A16	-O  Opale Opal	-2 (2000mm) -3 (3000mm)

*a richiesta codice finitura - on request finishing code

Accessori Accessories	Codice Code	Descrizione Description
	MC-A16-K	Kit tappo chiuso e tappo forato in ABS / End cap Kit 1 with hole + 1 without
	MC-A16-A	Supporto di fissaggio in acciaio per profilo a parete/ Fixing support in steel for wall profile



Profili appoggio/parete Support/surface profiles

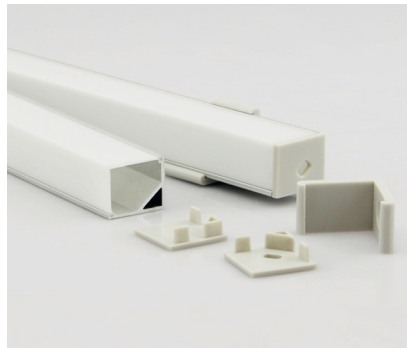



Profilo in alluminio estruso per l'installazione a parete. Disponibile nelle finiture di colore alluminio anodizzato, bianco, nero e corten. Diffusore in policarbonato opale, semiovale e trasparente.

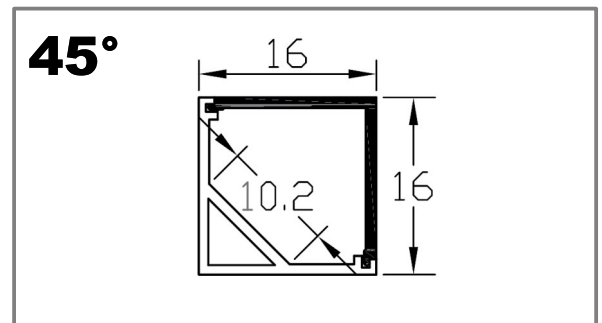

Extruded aluminum profile for wall installation. Available in anodized aluminum . Opal polycarbonate diffuser,



Dimensioni – Dimension
H16 x L16mm

Codice Profilo Code Profile	+ Lunghezza Length	+ Tipo Finitura Finish Type	Codice Cover Code Cover	+ Tipo Cover Cover Type	+ Lunghezza Length
AL-AN16	-2 (2000mm) -3 (3000mm)	AL  Argento Silver	AB-A16B	-O  Opale Opal	-2 (2000mm) -3 (3000mm)

*a richiesta codice finitura - on request finishing code

Accessori Accessories	Codice Code	Descrizione Description
	EC-A16B-K	Kit tappo chiuso e tappo forato in lega / End cap Kit 1 with hole + 1 without
	MC-A16	Supporto di fissaggio in acciaio per profilo a parete/ Fixing support in steel for wall profile





Profili appoggio/parete Support/surface profiles

Profilo in alluminio estruso per l'installazione a parete.
Disponibile nelle finiture di colore alluminio anodizzato,
Diffusore in policarbonato opale,

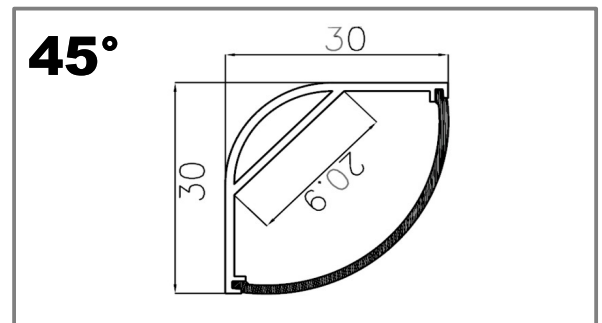

Extruded aluminum profile for wall installation.
Available in anodized aluminum color finishes,
white, black and corten. Opal polycarbonate diffuser,



Dimensioni – Dimension
H30 x L30mm

Codice Profilo Code Profile	+ Lunghezza Length	+ Tipo Finitura Finish Type	Codice Cover Code Cover	+ Tipo Cover Cover Type	+ Lunghezza Length
AL-AN30	-2 (2000mm) -3 (3000mm)	AL  Argento Silver	AB-A30A	-0  Opale Opal	-2 (2000mm) -3 (3000mm)

*a richiesta codice finitura - on request finishing code

Accessori Accessories	Codice Code	Descrizione Description
	EC-AN30A-K	Kit tappo chiuso e tappo forato in ABS / End cap Kit 1 with hole + 1 without
	MC-A30	Supporto di fissaggio per profilo a parete/ Fixing support for wall profile



Profili appoggio/parete Support/surface profiles

Profilo in alluminio estruso per l'installazione a parete.
Disponibile nelle finiture di colore alluminio anodizzato,
Diffusore in policarbonato opale,



Extruded aluminum profile for wall installation.
Available in anodized aluminum color finishes,



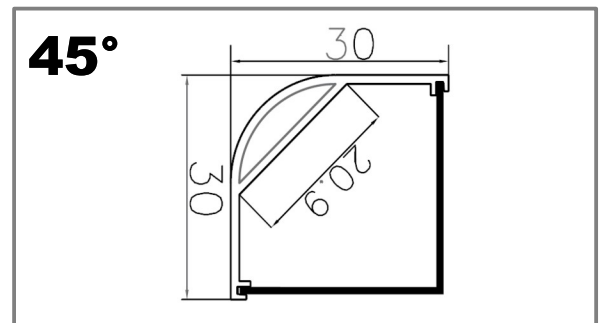

AL-B30

Dimensioni – Dimension
H30 x L30mm

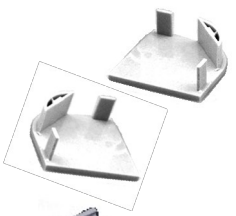

Codice Profilo Code Profile	+ Lunghezza Length	+ Tipo Finitura Finish Type	Codice Cover Code Cover	+ Tipo Cover Cover Type	+ Lunghezza Length
AL-A30	-2 (2000mm) -3 (3000mm)	AL  Argento Silver	AB-B30	-0  Opale Opal	-2 (2000mm) -3 (3000mm)

*a richiesta codice finitura - on request finishing code

Accessori Accessories	Codice Code	Descrizione Description
	EC-A30B-K	Kit tappo chiuso e tappo forato in lega / End cap Kit 1 with hole + 1 without
	MC-A30	Supporto di fissaggio per profilo a parete/ Fixing support for wall profile



Profili appoggio/parete Support/surface profiles

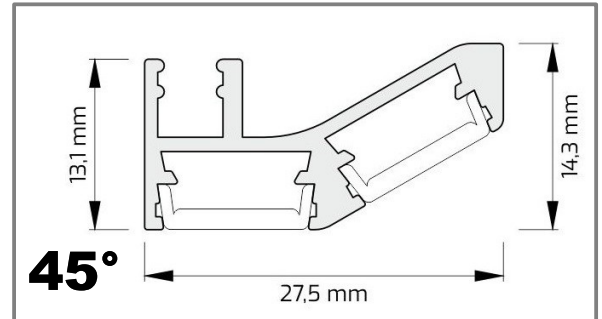

Profilo angolare in alluminio estruso per l'installazione a parete.
Disponibile nelle finiture di colore alluminio anodizzato,
Diffusore in policarbonato opale,

Extruded aluminum profile for wall installation.
Available in anodized aluminum color finishes,





Dimensioni – Dimension
H14 x L27mm

Kit Terminali / Kit end caps
EC-2AN-K

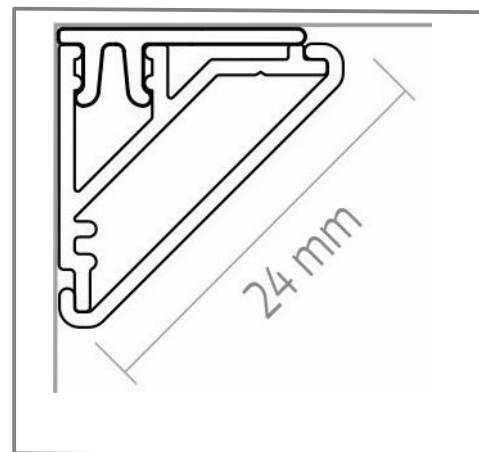
Codice Profilo Code Profile	+ Lunghezza Length	+ Tipo Finitura Finish Type	Codice Cover Code Cover	+ Tipo Cover Cover Type	+ Lunghezza Length
AL-2AN	-2 (2000mm)	AL  Argento Silver	AB-2AN	-O  Opale Opal	-2 (2000mm)
	-3 (3000mm)		AB-2AN		-3 (3000mm)



Codice Profilo Code Profile	+ Lunghezza Length	+ Tipo Finitura Finish Type	Codice Cover Code Cover	+ Tipo Cover Cover Type	+ Lunghezza Length
AL-A18		AL  Argento Silver	AB-A18	 Opale Opal	-2 (2000mm)
			AB-A18		-3 (3000mm)



AL-1806 System





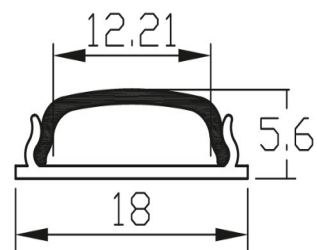

Profilo curvabile Bendable profile

Profilo in alluminio estruso per l'installazione a parete, curvabile.
Disponibile nelle finiture di colore alluminio anodizzato.
Diffusore in policarbonato opale.
Bendable extruded aluminum profile for wall installation.
Available in anodised aluminum color finishes. Opal polycarbonate diffuser.



Dimensioni – Dimension
H6 x L18mm

Codice Profilo Code Profile	+ Lunghezza Length	+ Tipo Finitura Finish Type	+ Tipo Cover Cover Type
AL-1806	-2 (2000mm) -3 (3000mm)	AL  Argento Silver	-O  Opale Opal

Accessori Accessories	Codice Code	Descrizione Description
	EC-1806-K	Kit tappo chiuso e tappo forato in lega / End cap Kit 1 with hole + 1 without
	MC-1806	Supporto di fissaggio/ Fixing support

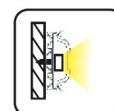

Profili Mini Slim Profiles Mini Slim

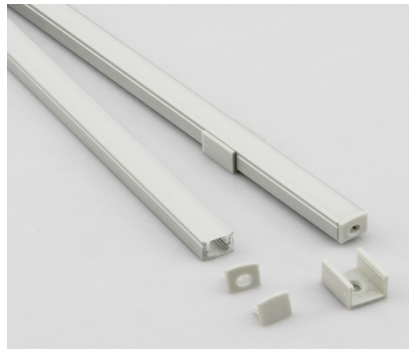



Profilo in alluminio estruso per l'installazione a parete.
Disponibile nelle finiture di colore alluminio anodizzato,
Diffusore in policarbonato opale,

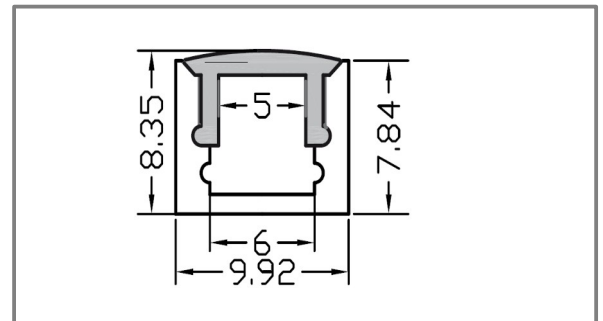

Extruded aluminum profile for wall installation.
Available in anodized aluminum color finishes,
Opal polycarbonate diffuser,



Dimensioni – Dimension
H8 x L10 mm

PCB: Max.6mm

Codice Profilo Code Profile	+ Lunghezza Length	+ Tipo Finitura Finish Type	Codice Cover Code Cover	+ Tipo Cover Cover Type	+ Lunghezza Length
AL-S10	-2 (2000mm) -3 (3000mm)	AL  Argento Silver	AB-S10	 Opale Opal	-2 (2000mm) -3 (3000mm)

Accessori Accessories	Codice Code	Descrizione Description
	EC-S10-K	Kit tappo chiuso e tappo forato in lega / End cap Kit 1 with hole + 1 without
	MC-S10	Supporto di fissaggio per profilo a parete/ Fixing support for wall profile



Profili Mini Slim Profiles Mini Slim

Profilo in alluminio estruso per l'installazione a parete.
Disponibile nelle finiture di colore alluminio anodizzato,
Diffusore in policarbonato opale,

Extruded aluminum profile for wall installation.
Available in anodized aluminum color finishes,
Opal polycarbonate diffuser,



**AL-SS
System**



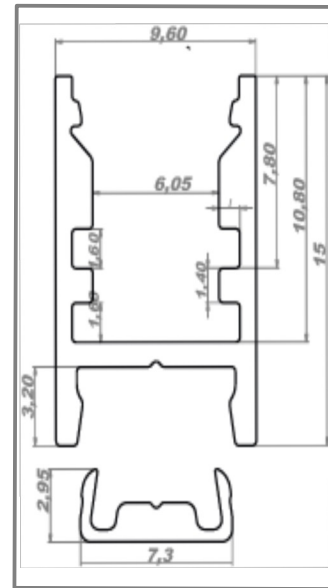

Dimensioni – Dimension
H10 x L10 mm



PCB: Max.6mm

Codice Profilo Code Profile	+ Lunghezza Length	+ Tipo Finitura Finish Type	Codice Cover Code Cover	+ Tipo Cover Cover Type	+ Lunghezza Length
AL-SS	-2 (2000mm) -3 (3000mm)	AL  Argento Silver	AB-SS-	 Opale Opal	-M2 (2000mm) -M3 (3000mm)

Accessori Accessories	Codice Code	Descrizione Description
	EC-SS-SF	Terminale senza foro / End Cap without hole
	EC-SS-CF	Terminale con foro / End Cap with hole
	MC-SS-BAS	Supporto di fissaggio per profilo a parete/ Fixing support wall profile

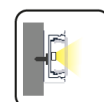

Profili Mini Slim Profiles Mini Slim

Profilo in alluminio estruso per l'installazione a parete.
Disponibile nelle finiture di colore alluminio anodizzato,
Diffusore in policarbonato opale,
Per l'alimentatore si richiede
predisposizione del vano di alloggiamento durante
la fase di progettazione.

Extruded aluminum profile for wall installation.
Available in anodized aluminum color finishes,
Opal polycarbonate diffuser,
For the feeder it is required provision of the housing
compartment during the planning phase.



AL-S8 System

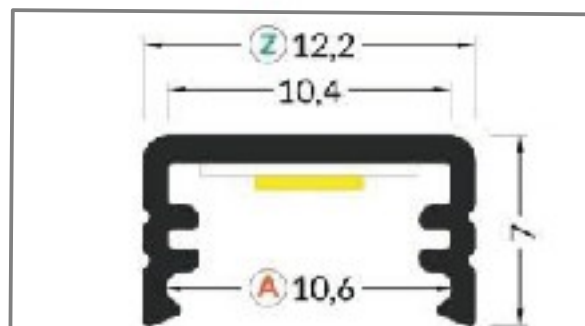

Dimensioni – Dimension
H7 x L12,2 mm



PCB: Max.6mm

Codice Profilo Code Profile	+ Lunghezza Length	+ Tipo Finitura Finish Type	Codice Cover Code Cover	+ Tipo Cover Cover Type	+ Lunghezza Length
AL-S8	-2 (2000mm)	AL  Argento Silver	AB-A-	 Opale Opal	-02 (2000mm)
	-3 (3000mm)				-03 (3000mm)

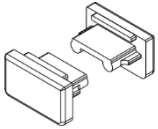
Accessori Accessories	Codice Code	Descrizione Description
	EC-S8-K	Kit Terminale con e senza foro / Kit End Cap with and without hole
	MC-SS-BAS	Supporto di fissaggio per profilo a parete/ Fixing support wall profile

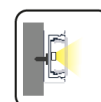

Profili Mini Slim Profiles Mini Slim

Profilo in alluminio estruso per l'installazione a parete.
Disponibile nelle finiture di colore alluminio anodizzato,
Diffusore in policarbonato opale,
Per l'alimentatore si richiede
predisposizione del vano di alloggiamento durante
la fase di progettazione.

Extruded aluminum profile for wall installation.
Available in anodized aluminum color finishes,
Opal polycarbonate diffuser,
For the feeder it is required provision of the housing
compartment during the planning phase.



AL-S12

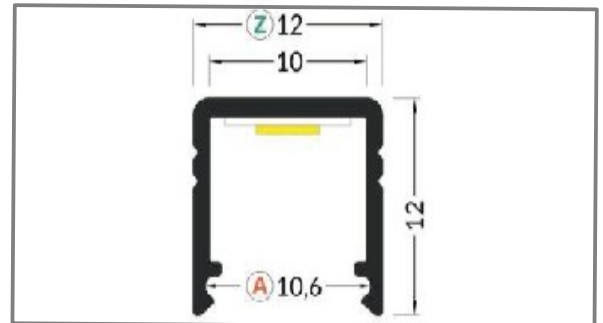

Dimensioni – Dimension
H12 x L12 mm



PCB: Max.6mm

Codice Profilo Code Profile	+ Lunghezza Length	+ Tipo Finitura Finish Type	Codice Cover Code Cover	+ Tipo Cover Cover Type	+ Lunghezza Length
AL-S12	-2 (2000mm) -3 (3000mm)	AL  Argento Silver	AB-A-	 Opale Opal	-02 (2000mm) -03 (3000mm)

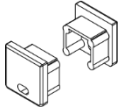
Accessori Accessories	Codice Code	Descrizione Description
	EC-S12-K	Kit Terminale con e senza foro / Kit End Cap with and without hole
	MC-S12	Supporto di fissaggio per profilo a parete/ Fixing support wall profile



Profili ad incasso Gesso Recessed gypsum profiles

Profilo in alluminio per incasso in cartongesso.
Copertura finitura opale. Fissaggio con viti e
successiva finitura a gesso.
Alimentatori da predisporre in alloggiamenti dedicati.

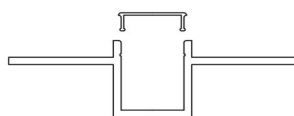
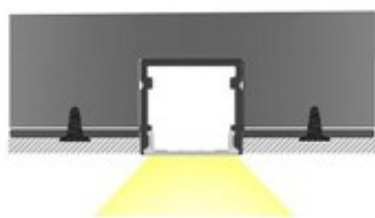

Aluminum profile for plasterboard recess mounting.
Opal finish cover. Fixing with screws and subsequent
plaster finishing. Power supplies to be set up in
dedicated housings.

AL-GY13

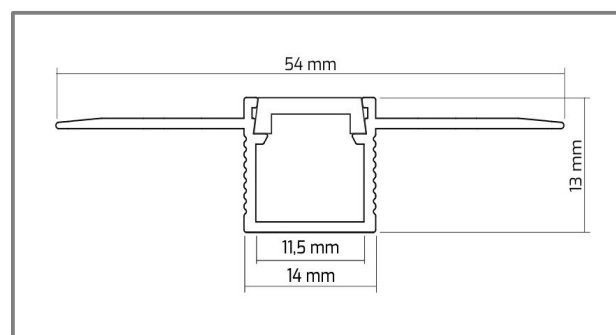

Dimensioni – Dimension
H14 x L54 mm



Codice Profilo Code Profile	+ Lunghezza Length	+ Tipo Finitura Finish Type	Codice Cover Code Cover	+ Tipo Cover Cover Type	+ Lunghezza Length
AL-GY13	-2 (2000mm)	AL  Argento Silver	AB-GY13	-0  Opale Opal	-2 (2000mm)

Accessori
Accessories

Codice
Code

Descrizione
Description



EC-GY13-K

Kit terminalii / End caps kit



Profili ad incasso Gesso Recessed gypsum profiles

AL-GY17

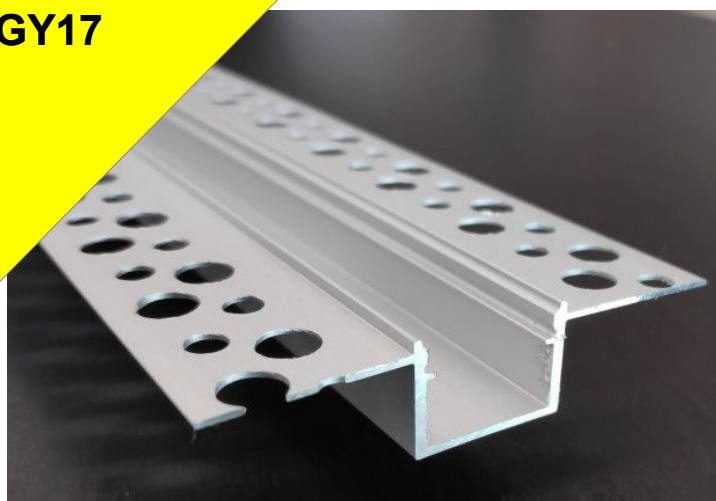

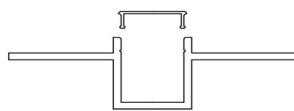
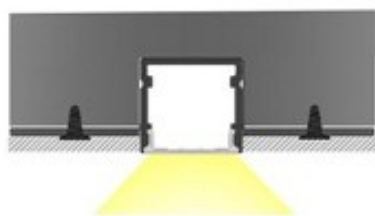

Profilo in alluminio per incasso in cartongesso.
Copertura finitura opale. Fissaggio con viti e
successiva finitura a gesso.
Alimentatori da predisporre in alloggiamenti dedicati.

Aluminum profile for plasterboard recess mounting.
Opal finish cover. Fixing with screws and subsequent
plaster finishing. Power supplies to be set up in
dedicated housings.

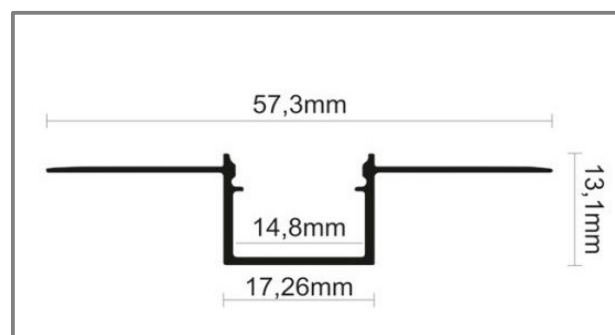

Dimensioni – Dimension
H17,26 x L13 mm



Codice Profilo Code Profile	+ Lunghezza Length	+ Tipo Finitura Finish Type	Codice Cover Code Cover	+ Tipo Cover Cover Type	+ Lunghezza Length
AL-GY17	-2 (2000mm)	AL  Argento Silver	AB-GY17	-0  Opale Opal	-2 (2000mm)

Accessori Accessories	Codice Code	Descrizione Description
	EC-GY17-K	Kit terminalii / End caps kit



Profili ad incasso Gesso Recessed gypsum profiles



Profilo in alluminio per incasso in cartongesso.
Copertura finitura opale. Fissaggio con viti e
successiva finitura a gesso.
Alimentatori da predisporre in alloggiamenti dedicati.

Aluminum profile for plasterboard recess mounting.
Opal finish cover. Fixing with screws and subsequent
plaster finishing. Power supplies to be set up in
dedicated housings.

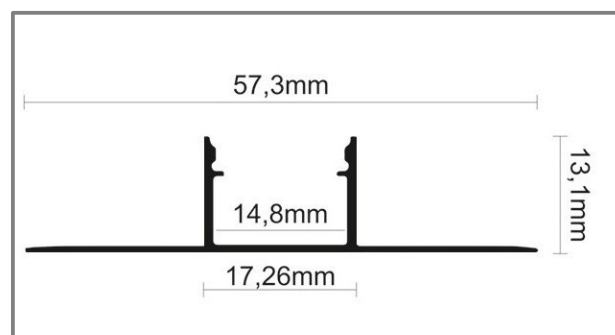
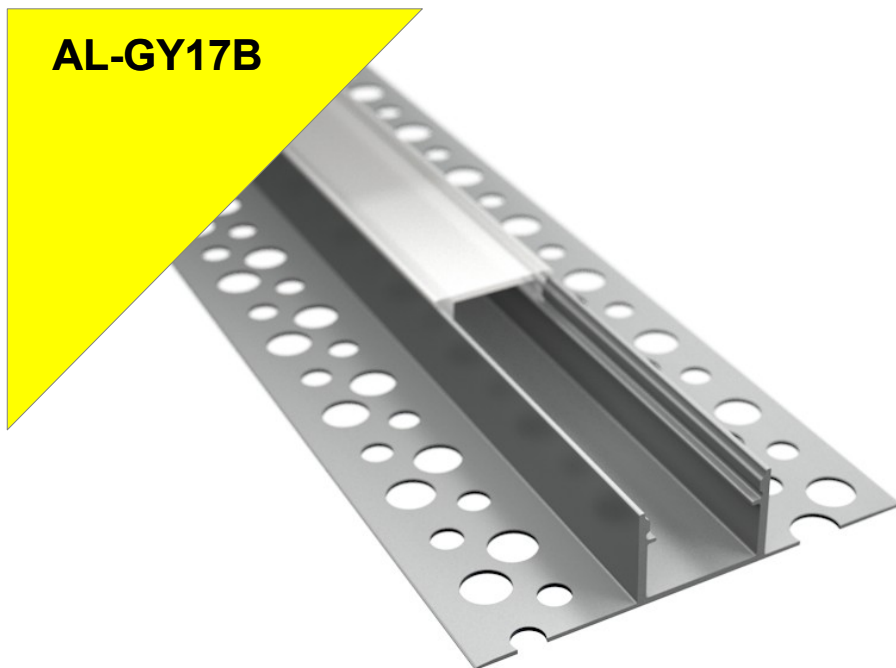
AL-GY17B



Dimensioni – Dimension
H113,1 x L57,3mm

Codice Profilo Code Profile	+ Lunghezza Length	+ Tipo Finitura Finish Type	Codice Cover Code Cover	+ Tipo Cover Cover Type	+ Lunghezza Length
AL-GY17B-O2	-2 (2000mm)	AL  Argento Silver	AB-GY30	-O  Opale Opal	-2 (2000mm)

Accessori Accessories	Codice Code	Descrizione Description
	EC-GY17B-K	Kit tappi chiusi / Closed caps kit





Profili ad incasso Gesso Recessed gypsum profiles

Profilo in alluminio per incasso in cartongesso.
Copertura finitura opale. Fissaggio con viti e
successiva finitura a gesso.
Alimentatori da predisporre in alloggiamenti dedicati.

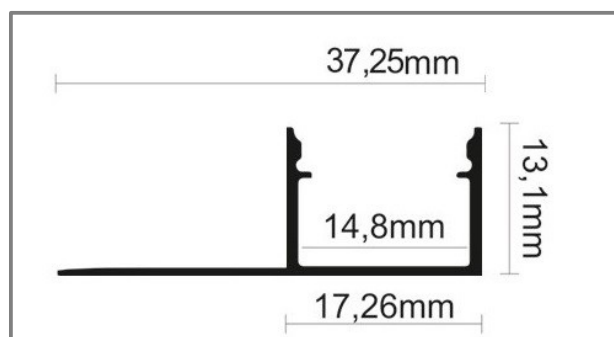
Aluminum profile for plasterboard recess mounting.
Opal finish cover. Fixing with screws and subsequent
plaster finishing. Power supplies to be set up in
dedicated housings.



Dimensioni – Dimension
H13,1 x L37,25 mm

Codice Profilo Code Profile	+	Lunghezza Length	+	Tipo Finitura Finish Type	Codice Cover Code Cover	+	Tipo Cover Cover Type	+	Lunghezza Length
AL-G1Y17L-02		-2 (2000mm)		AL  Argento Silver	AB-GY30		-O  Opale Opal		-2 (2000mm)

Accessori Accessories	Codice Code	Descrizione Description
	EC-GY30-K	Kit tappi chiusi / Closed caps kit

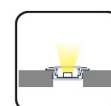

Profili ad incasso Gesso Recessed gypsum profiles

Profilo in alluminio per incasso in cartongesso.
Copertura finitura opale. Fissaggio con viti e
successiva finitura a gesso.
Alimentatori da predisporre in alloggiamenti dedicati.

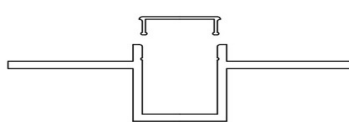
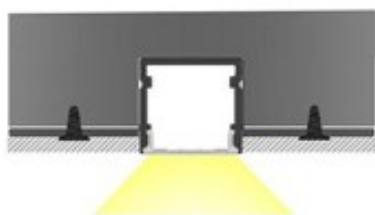

Aluminum profile for plasterboard recess mounting.
Opal finish cover. Fixing with screws and subsequent
plaster finishing. Power supplies to be set up in
dedicated housings.

AL-GY20

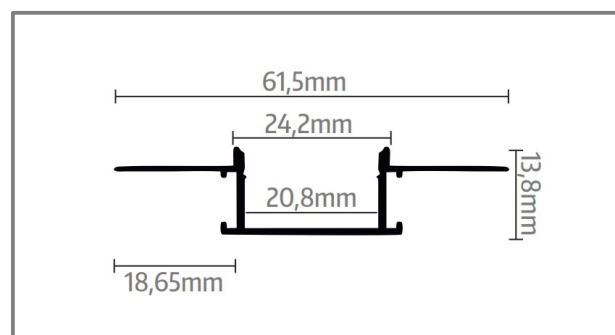

Dimensioni – Dimension
H13,8 x L61,5 mm



Codice Profilo Code Profile	+ Lunghezza Length	+ Tipo Finitura Finish Type	Codice Cover Code Cover	+ Tipo Cover Cover Type	+ Lunghezza Length
AL-GY20	-2 (2000mm)	AL  Argento Silver	AB-GY20	-0  Opale Opal	-2 (2000mm)

Accessori Accessories	Codice Code	Descrizione Description
	EC-GY20-K	Kit Terminali / End caps kit

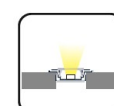

Profili ad incasso Gesso Recessed gypsum profiles

Profilo in alluminio per incasso in cartongesso.
Copertura finitura opale. Fissaggio con viti e
successiva finitura a gesso.
Alimentatori da predisporre in alloggiamenti dedicati.

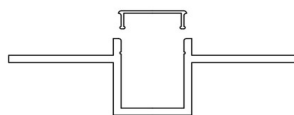
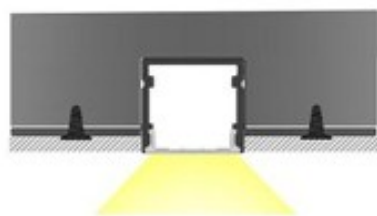

Aluminum profile for plasterboard recess mounting.
Opal finish cover. Fixing with screws and subsequent
plaster finishing. Power supplies to be set up in
dedicated housings.

AL-GY30

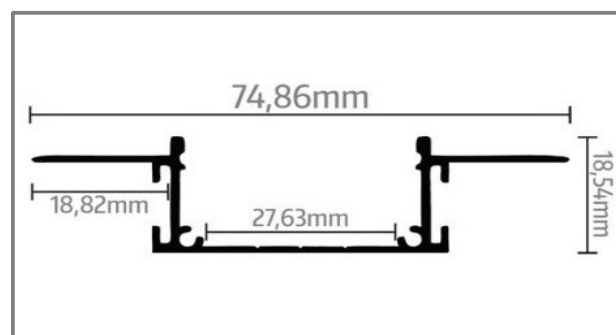

Dimensioni – Dimension
H18,5 x L74,9 mm



Codice Profilo Code Profile	+ Lunghezza Length	+ Tipo Finitura Finish Type	Codice Cover Code Cover	+ Tipo Cover Cover Type	+ Lunghezza Length
AL-GY30	-2 (2000mm)	AL  Argento Silver	AB-GY30	-0  Opale Opal	-2 (2000mm)

Accessori Accessories	Codice Code	Descrizione Description
	EC-GY30-K	Kit tappi chiusi / Closed caps kit

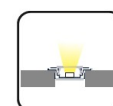

Profili ad incasso Gesso Recessed gypsum profiles

Profilo in alluminio per incasso in cartongesso.
Copertura finitura opale. Fissaggio con viti e
successiva finitura a gesso.
Alimentatori da predisporre in alloggiamenti dedicati.

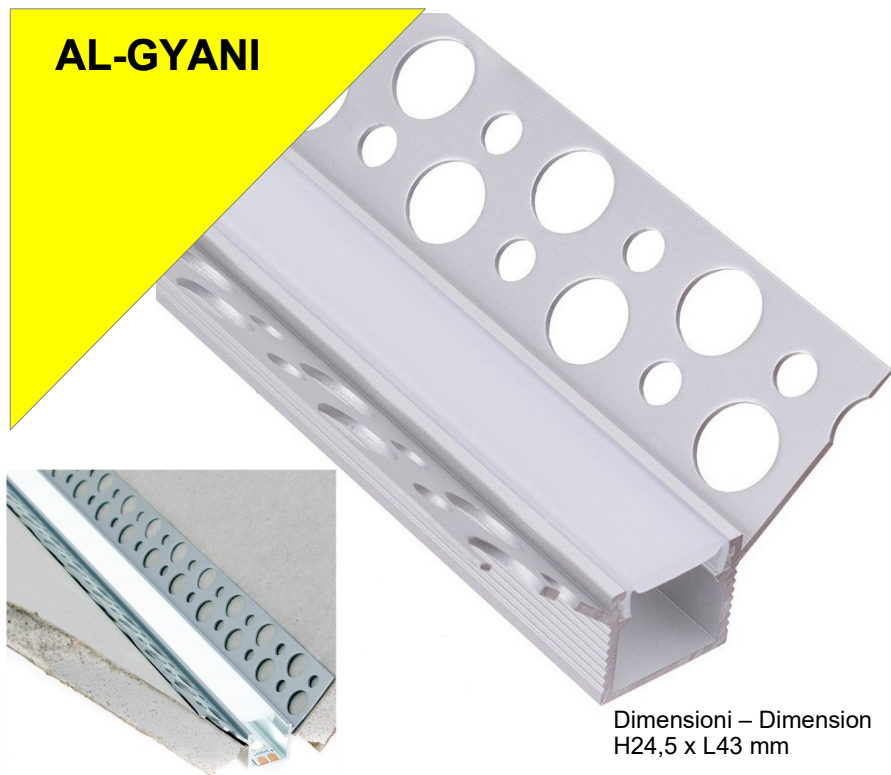

Aluminum profile for plasterboard recess mounting.
Opal finish cover. Fixing with screws and subsequent
plaster finishing. Power supplies to be set up in
dedicated housings.

AL-GYANI

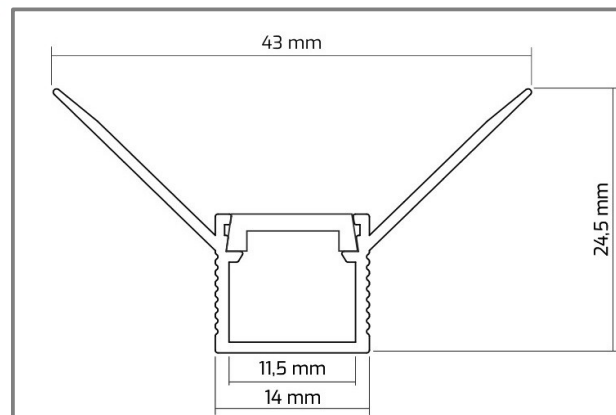

Dimensioni – Dimension
H24,5 x L43 mm



Codice Profilo Code Profile	+ Lunghezza Length	+ Tipo Finitura Finish Type	Codice Cover Code Cover	+ Tipo Cover Cover Type	+ Lunghezza Length
AL-GYANI	-2 (2000mm)	AL  Argento Silver	AB-GY14	-O  Opale Opal	-2 (2000mm)

Accessori Accessories	Codice Code	Descrizione Description
--------------------------	----------------	----------------------------



EC-GYANI-K

Kit Terminali / End caps kit

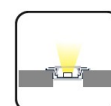

Profili ad incasso Gesso Recessed gypsum profiles

Profilo in alluminio per incasso in cartongesso.
Copertura finitura opale. Fissaggio con viti e
successiva finitura a gesso.
Alimentatori da predisporre in alloggiamenti dedicati.

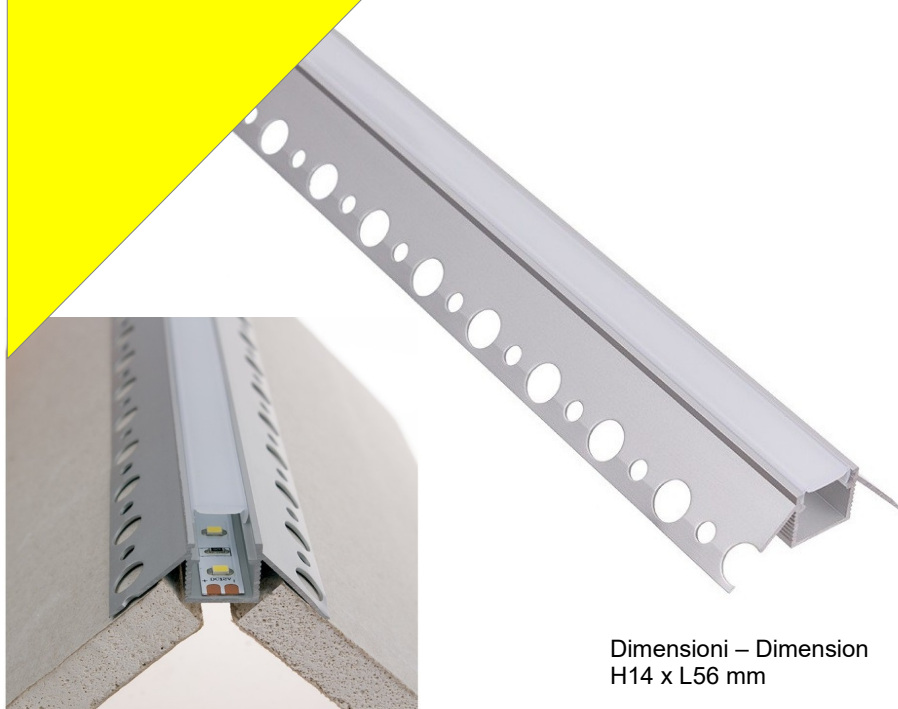

Aluminum profile for plasterboard recess mounting.
Opal finish cover. Fixing with screws and subsequent
plaster finishing. Power supplies to be set up in
dedicated housings.

AL-GYANE

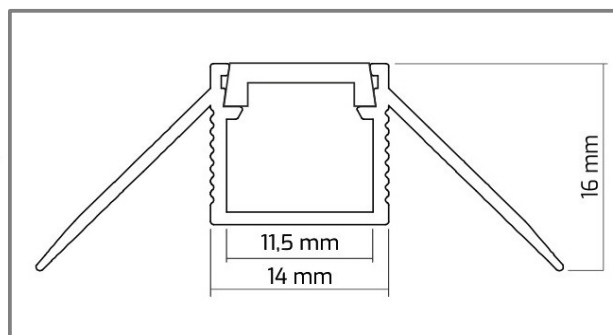

Dimensioni – Dimension
H14 x L56 mm



Codice Profilo Code Profile	+ Lunghezza Length	+ Tipo Finitura Finish Type	Codice Cover Code Cover	+ Tipo Cover Cover Type	+ Lunghezza Length
AL-GYANE	-2 (2000mm)	AL  Argento Silver	AB-GY14	-0  Opale Opal	-2 (2000mm)

Accessori
Accessories

Codice
Code

Descrizione
Description



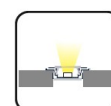

EC-GYANE-K

Kit Terminali / End caps kit



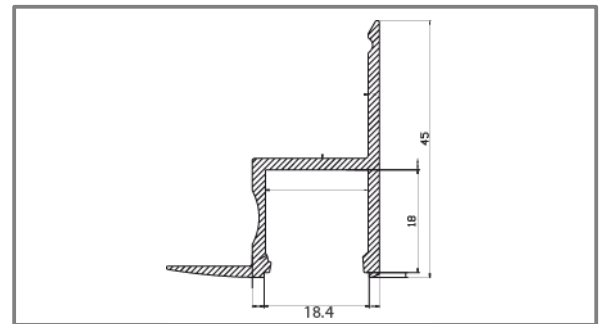
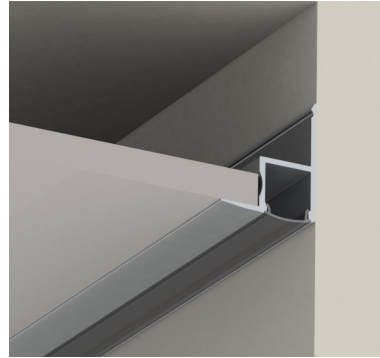
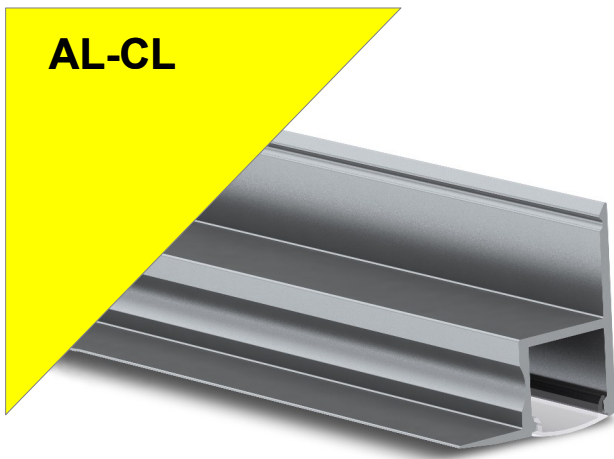

Profili ad incasso Recessed profiles

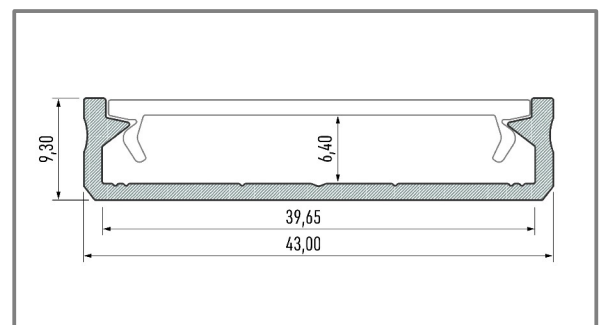

Codice Profilo Code Profile	Lunghezza Length	Tipo Finitura Finish Type	Codice Cover Code Cover	Tipo Cover Cover Type	Lunghezza Length
AL-CL	+ 2 (2000mm) + 3 (3000mm)	 Argento Silver	AB-E8	 Opale Opal	+ O2 (2000mm) + O3 (3000mm)



Codice Profilo Code Profile	Lunghezza Length	Tipo Finitura Finish Type	Codice Cover Code Cover	Tipo Cover Cover Type	Lunghezza Length
AL-E43	+ 2 (2000mm) + 3 (3000mm)	 Argento Silver	AB-E8	 Opale Opal	+ O2 (2000mm) + O3 (3000mm)

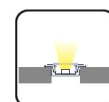

Profili ad incasso Recessed profiles

AL-EWL

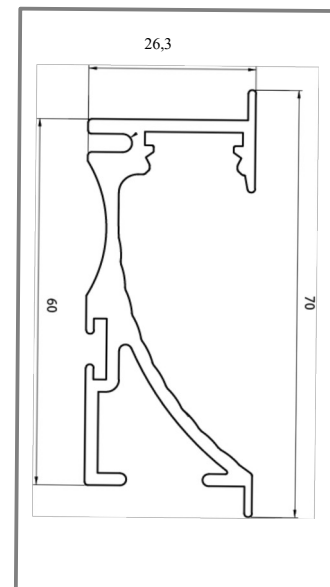
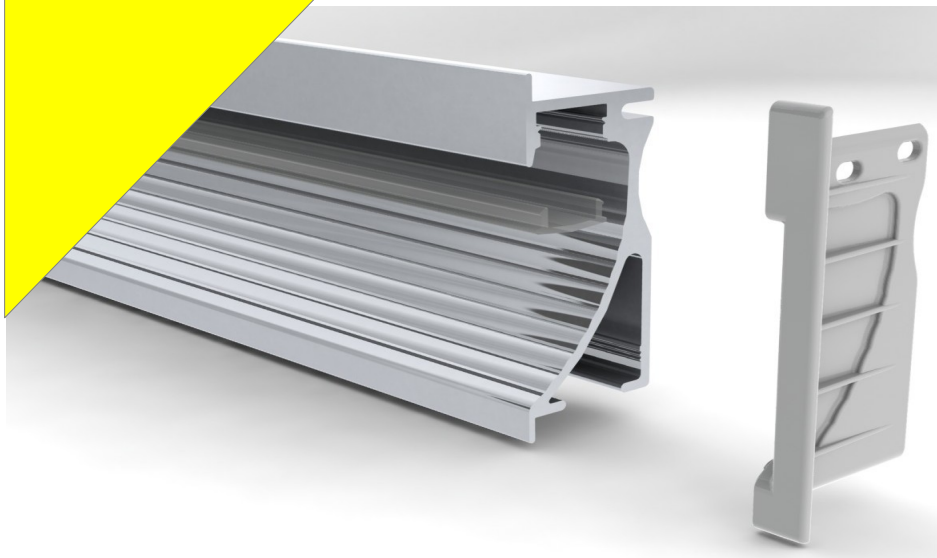

Codice Profilo Code Profile	Lunghezza Length	Tipo Finitura Finish Type	Codice Cover Code Cover	Tipo Cover Cover Type	Lunghezza Length
AL-EWL	-2 (2000mm)		AB-E	+ O Opale Opal	-2 (2000mm)
	-3 (3000mm)			+ T Trasparent Transparent	-3 (3000mm)

AL-STEP



Profili per gradini Stair profiles

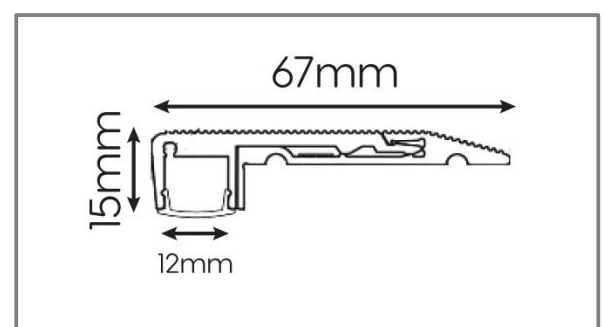

Codice Profilo Code Profile	Lunghezza Length	Tipo Finitura Finish Type	Codice Cover Code Cover	Tipo Cover Cover Type	Lunghezza Length
AL-STEP	-2 (2000mm)		AB-E-		O -2 (2000mm)
	-3 (3000mm)				O -3 (3000mm)

AL-HL



Profilo forato Perforated profiles

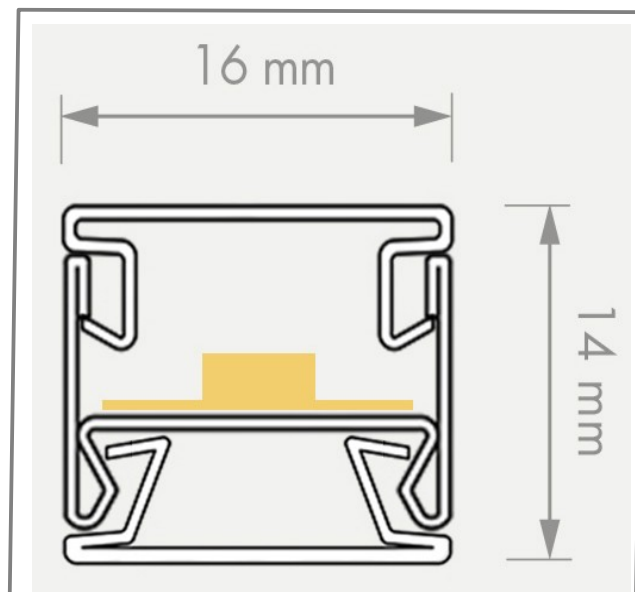

Codice Profilo Code Profile	Lunghezza Length	Tipo Finitura Finish Type	Codice Cover Code Cover	Tipo Cover Cover Type	Lunghezza Length
AL-HL	-2 (2000mm)	Argento Silver	AB-HLP	Argento Silver	-2 (2000mm)
	-3 (3000mm)	Bianco White		Bianco White	
		Nero Black		Nero Black	
		Oro Gold		Oro Gold	

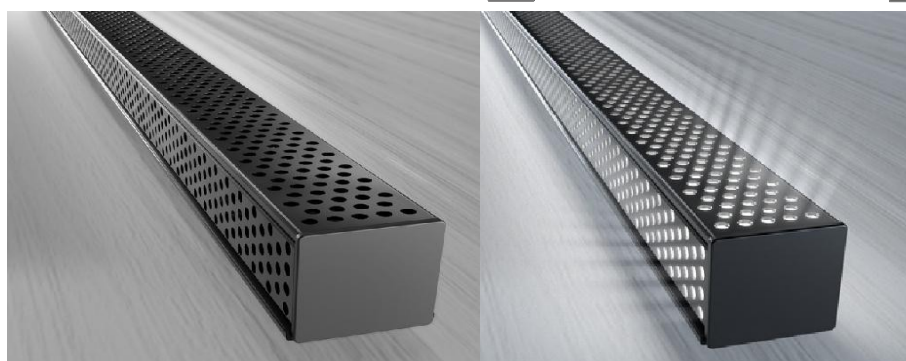

Profilo in alluminio perforato con direzione della luce su tre lati.

Perforated aluminum profile with three light directions

Codice Profilo Code Profile	Lunghezza Length	Tipo Finitura Finish Type	Codice Cover Code Cover	Tipo Cover Cover Type	Lunghezza Length
AL-HLP	-2 (2000mm)	Argento Silver	AB-HLP	Argento Silver	-2 (2000mm)
	-3 (3000mm)	Bianco White		Bianco White	
		Nero Black		Nero Black	
		Oro Gold		Oro Gold	

2 SILICONE TUBE

Tubo in silicone per Led IP67 Silicone tube for LEDs IP67

**N0410
System**

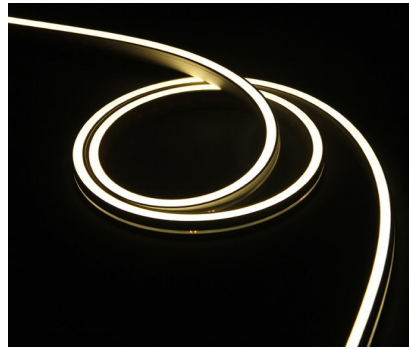
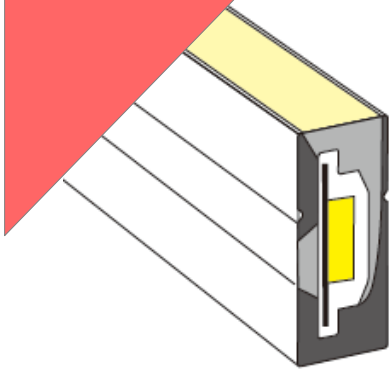

Tubi in silicone per l'installazione a parete.
Filo di traino interno per strip led. Protezione grado IP67.
Per l'alimentatore si richiede predisposizione del vano di alloggiamento durante la fase di progettazione.

Silicone tubes for wall installation. Internal towing wire for LED strip. Protection degree IP67.
The power supply is required predisposition of the housing compartment during the design phase

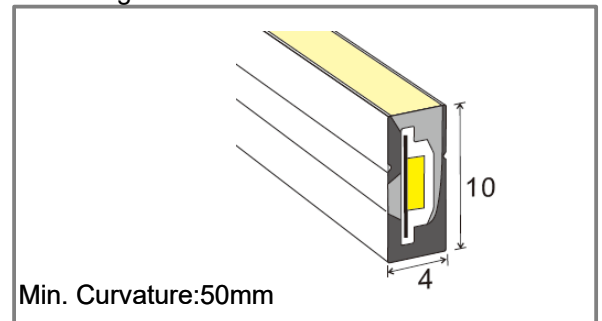

Emissione luce lato stretto diffusa 120°
Narrow light diffused emission 120°





WATERPROOF

PCB: Max.6mm

Dimensioni – Dimension
H10 x L4 mm

Codice Profilo Code Profile	+ Lunghezza * Length	Tipo Finitura Finish Type	Tipo Finitura Copertura Finish Type Cover
N0410	-1 (1mt.)	WH  Bianco White	FRO  Satinato Frosted

*Request 5-10-15-20 mt.

Accessori Accessories	Codice Code	Descrizione Description
	N0410-EC	Terminale chiuso in gomma /Closed rubber terminal
	N0410-ECH	Terminale con foro uscita cavo dritto /Terminal with straight cable exit hole
	MC-0410	Clip plastica di fissaggio 1mt. /Plastic fixing clip 1mt



Tubo in silicone per Led IP67 Silicone tube for LEDs IP67

N0513-System



Tubi in silicone per l'installazione a parete.
Filo di traino interno per strip led. Protezione grado IP67.
Per l'alimentatore si richiede predisposizione del vano di alloggiamento durante la fase di progettazione.

Silicone tubes for wall installation. Internal towing wire for LED strip. Protection degree IP67.
The power supply is required predisposition of the housing compartment during the design phase

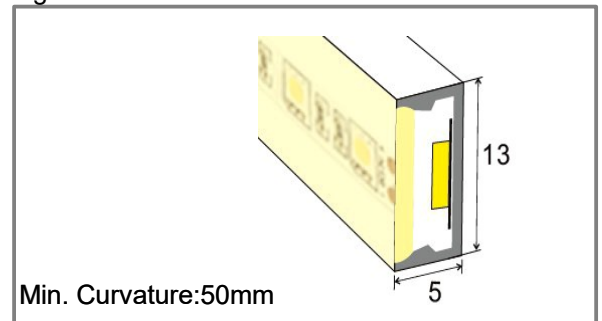

Emissione luce diffusa 120°
Light diffused emission 120°







WATERPROOF

PCB: Max. 10mm

Dimensioni – Dimension
H13 x L5 mm

Codice Profilo Code Profile	+ Lunghezza * Length	Tipo Finitura Finish Type	Tipo Finitura Copertura Finish Type Cover
N0513	-1 (1mt.)	WH  Bianco White	FRO  Satinato Frosted

*Request 5-10-15-20 mt.

Accessori Accessories	Codice Code	Descrizione Description
	N0513-EC	Terminale chiuso in gomma /Closed rubber terminal
	N0513-ECH	Terminale con foro uscita cavo dritto /Terminal with straight cable exit hole
	N0513-MC	Clip plastica di fissaggio 1mt. /Plastic fixing clip 1mt
	LTF-T-GLUE	Sigillante Glue Silicone 100ml /Glue Silicone Sealant 100ml



Tubo in silicone per Led IP67 Silicone tube for LEDs IP67

**N1010
System**

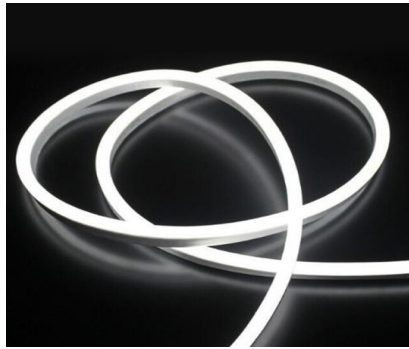

Tubi in silicone per l'installazione a parete.
Filo di traino interno per strip led. Protezione grado IP67.
Per l'alimentatore si richiede predisposizione del vano di alloggiamento durante la fase di progettazione.

Silicone tubes for wall installation. Internal towing wire for LED strip. Protection degree IP67.
The power supply is required predisposition of the housing compartment during the design phase

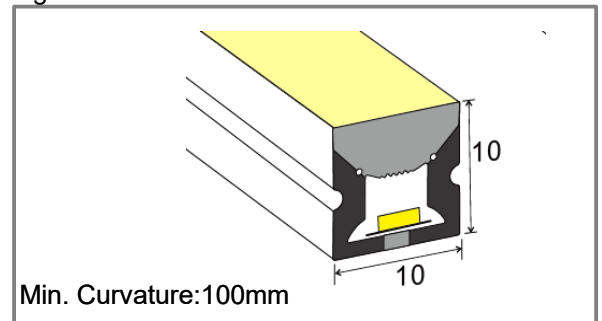

Emissione luce diffusa 150°
Light diffused emission 150°







WATERPROOF

PCB: Max.6mm

Dimensioni – Dimension
H10 x L10 mm

Codice Profilo Code Profile	+ Lunghezza * Length	Tipo Finitura Finish Type	Tipo Finitura Copertura Finish Type Cover
N1010	-1 (1mt.)	WH  Bianco White	FRO  Satinato Frosted

*Request 5-10-15-20 mt.

Accessori Accessories	Codice Code	Descrizione Description
	N1010-EC	Terminale chiuso in gomma /Closed rubber terminal
	N1010-ECH	Terminale con foro uscita cavo dritto /Terminal with straight cable exit hole
	N1010-ECHR	Terminale con foro uscita cavo destra/sinistra/sotto Terminal with right/left / down cable outlet hole
	MC-N1010	Supporto di montaggio in alluminio 30mm Fixing support for aluminum 30mm



Tubo in silicone per Led IP67 Silicone tube for LEDs IP67

**N0612
System**

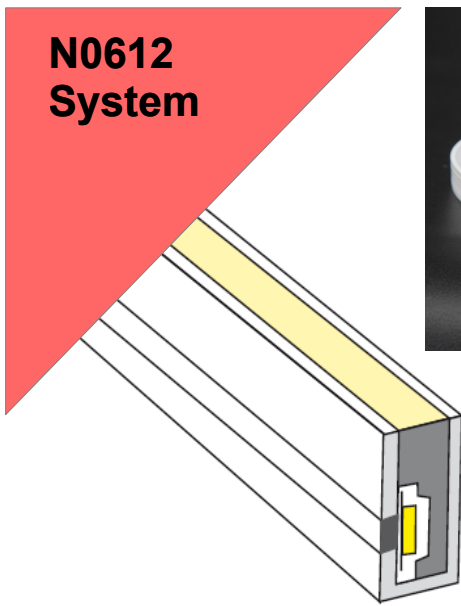

Tubi in silicone per l'installazione a parete.
Filo di traino interno per strip led. Protezione grado IP67.
Per l'alimentatore si richiede predisposizione del vano di alloggiamento durante la fase di progettazione.

Silicone tubes for wall installation. Internal towing wire for LED strip. Protection degree IP67.
The power supply is required predisposition of the housing compartment during the design phase

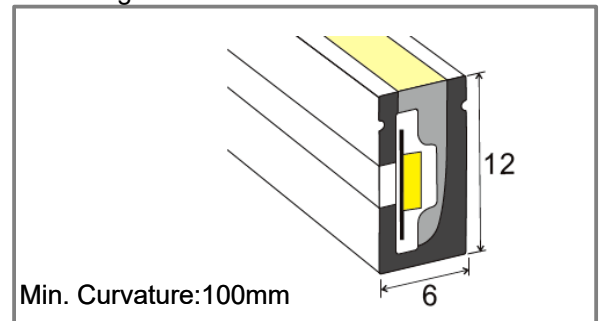

Emissione luce lato stretto diffusa 120°
Narrow light diffused emission 120°







WATERPROOF

PCB: Max.8mm

Dimensioni – Dimension
H12 x L6 mm

Codice Profilo Code Profile	+ Lunghezza * Length	Tipo Finitura Finish Type	Tipo Finitura Copertura Finish Type Cover
N0612	-1 (1mt.)	WH  Bianco White	FRO  Satinato Frosted

*Request 5-10-15-20 mt.

Accessori Accessories	Codice Code	Descrizione Description
	N01612-EC	Terminale chiuso in gomma /Closed rubber terminal
	N0612-ECH	Terminale con foro uscita cavo dritto /Terminal with straight cable exit hole
	N0612-ECHR	Terminale con foro uscita cavo destra/sinistra Terminal with right/left / cable outlet hole
	N0612-ECG90	Terminale con foro uscita cavo sotto 90° Terminal with down 90° cable outlet hole
	MC-N0612	Supporto di montaggio in alluminio 30mm Fixing support for aluminum 30mm



Tubo in silicone per Led IP67 Silicone tube for LEDs IP67

**N0816
System**

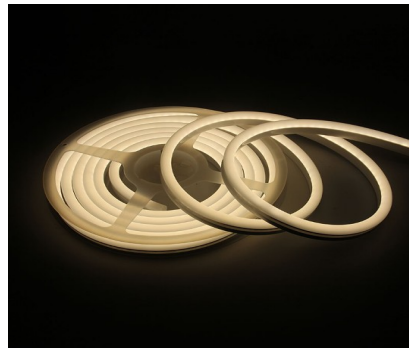
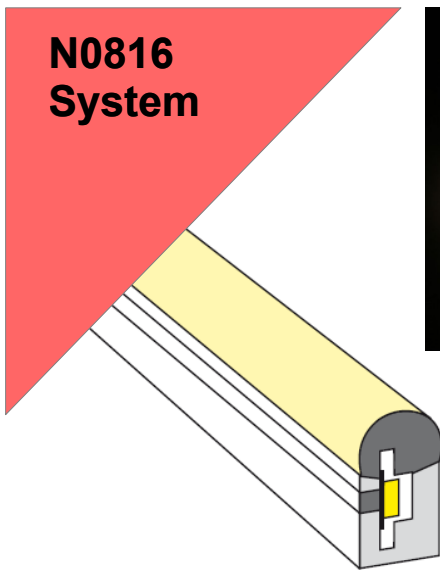

Tubi in silicone per l'installazione a parete.
Filo di traino interno per strip led. Protezione grado IP67.
Per l'alimentatore si richiede predisposizione del vano di alloggiamento durante la fase di progettazione.

Silicone tubes for wall installation. Internal towing wire for LED strip. Protection degree IP67.
The power supply is required predisposition of the housing compartment during the design phase

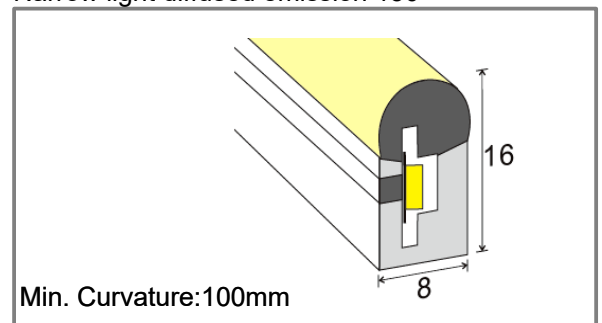

Emissione luce lato stretto diffusa 150°
Narrow light diffused emission 150°





WATERPROOF

PCB: Max. 10mm

Dimensioni – Dimension
H16 x L8 mm

Codice Profilo Code Profile	+ Lunghezza * Length	Tipo Finitura Finish Type	Tipo Finitura Copertura Finish Type Cover
N0816	-1 (1mt.)	WH  Bianco White	FRO  Satinato Frosted

*Request 5-10-15-20 mt.

Accessori Accessories	Codice Code	Descrizione Description
	N0816-EC	Terminale chiuso in gomma /Closed rubber terminal
	N0816-ECH	Terminale con foro uscita cavo dritto /Terminal with straight cable exit hole
	MC-N0816	Supporto di montaggio in alluminio 30mm Fixing support for aluminum 30mm



Tubo in silicone per Led IP67 Silicone tube for LEDs IP67

**N1020
System**

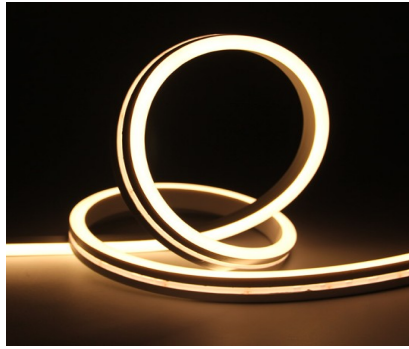
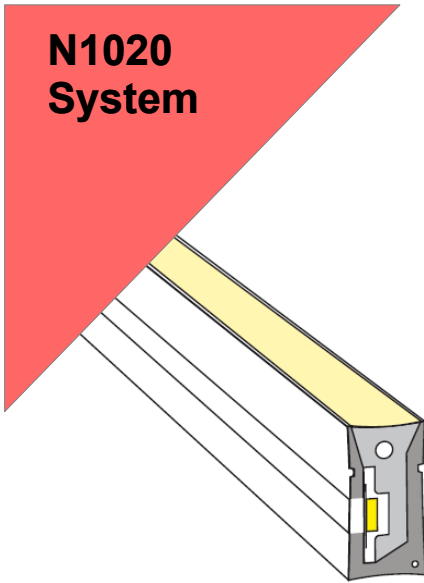

Tubi in silicone per l'installazione a parete.
Filo di traino interno per strip led. Protezione grado IP67.
Per l'alimentatore si richiede predisposizione del vano di alloggiamento durante la fase di progettazione.

Silicone tubes for wall installation. Internal towing wire for LED strip. Protection degree IP67.
The power supply is required predisposition of the housing compartment during the design phase

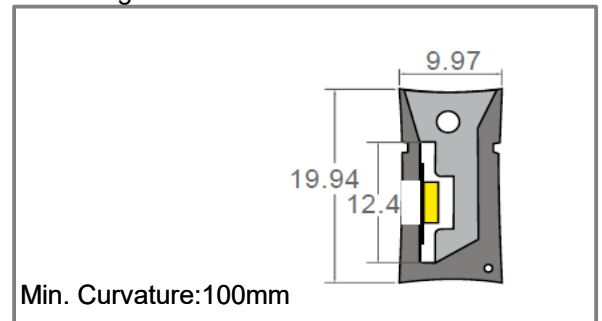

Emissione luce lato stretto diffusa 120°
Narrow light diffused emission 120°







WATERPROOF

PCB: Max. 10mm

Dimensioni – Dimension
H20 x L10 mm

Codice Profilo Code Profile	+ Lunghezza * Length	Tipo Finitura Finish Type	Tipo Finitura Copertura Finish Type Cover
N1020	-1 (1mt.)	WH  Bianco White	FRO  Satinato Frosted

*Request 5-10-15-20 mt.

Accessori Accessories	Codice Code	Descrizione Description
	N1020-EC	Terminale chiuso /Closed terminal
	N1020-ECHL	Terminale con foro uscita cavo sinistra /Terminal with straight cable exit left
	N1020-ECHR	Terminale con foro uscita cavo destra /Terminal with straight cable exit right
	N1020-ECHB	Terminale con foro uscita cavo basso /Terminal with straight cable exit down
	MC-N1020	Supporto di montaggio in alluminio Fixing support for aluminum



Tubo in silicone per Led IP67 Silicone tube for LEDs IP67

**N1023
System**

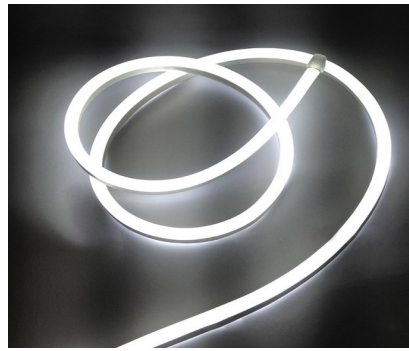
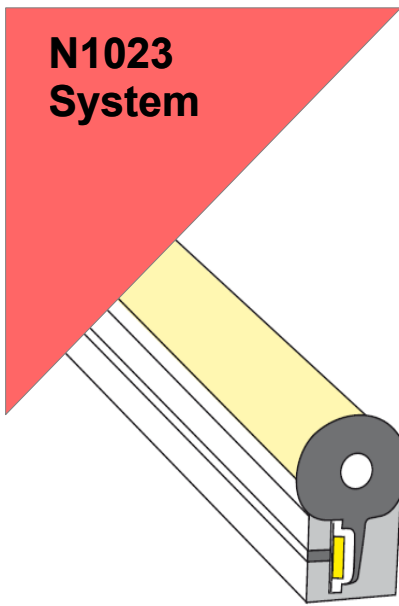

Tubi in silicone per l'installazione a parete.
Filo di traino interno per strip led. Protezione grado IP67.
Per l'alimentatore si richiede predisposizione del vano di alloggiamento durante la fase di progettazione.

Silicone tubes for wall installation. Internal towing wire for LED strip. Protection degree IP67.
The power supply is required predisposition of the housing compartment during the design phase

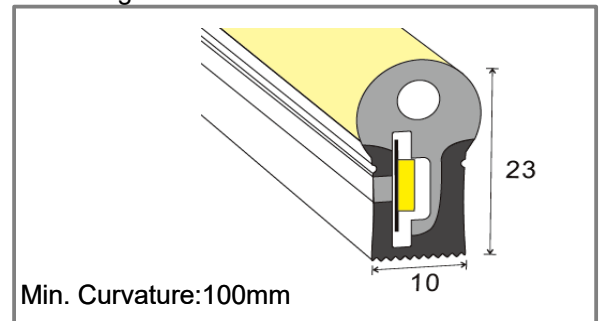

Emissione luce lato stretto diffusa 180°
Narrow light diffused emission 180°







WATERPROOF

PCB: Max.10mm

Dimensioni – Dimension
H23 x L10 mm

Codice Profilo Code Profile	+ Lunghezza * Length	Tipo Finitura Finish Type	Tipo Finitura Copertura Finish Type Cover
N1023	-1 (1mt.)	WH  Bianco White	FRO  Satinato Frosted

*Request 5-10-15-20 mt.

Accessori Accessories	Codice Code	Descrizione Description
	N1023-EC	Terminale chiuso / Closed terminal
	N1023-ECHL	Terminale con foro uscita cavo sinistra / Terminal with straight cable exit left
	N1023-ECHR	Terminale con foro uscita cavo destra / Terminal with straight cable exit right
	N1023-ECHB	Terminale con foro uscita cavo basso / Terminal with straight cable exit down
	MC-N1023	Supporto di montaggio in alluminio Fixing support for aluminum



Tubo in silicone per Led IP67 Silicone tube for LEDs IP67

**N1220
System**

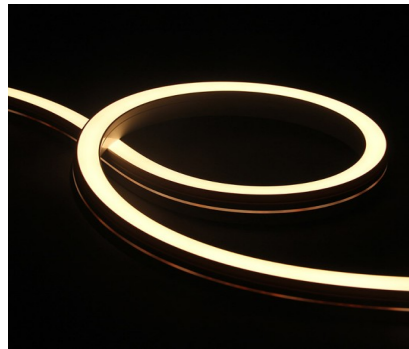
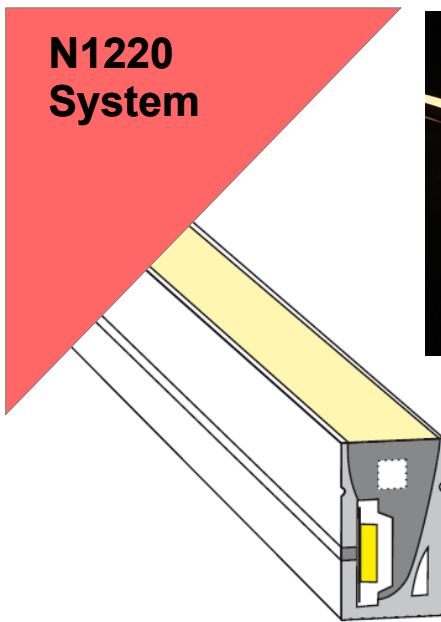

Tubi in silicone per l'installazione a parete.
Filo di traino interno per strip led. Protezione grado IP67.
Per l'alimentatore si richiede predisposizione del vano di alloggiamento durante la fase di progettazione.

Silicone tubes for wall installation. Internal towing wire for LED strip. Protection degree IP67.
The power supply is required predisposition of the housing compartment during the design phase

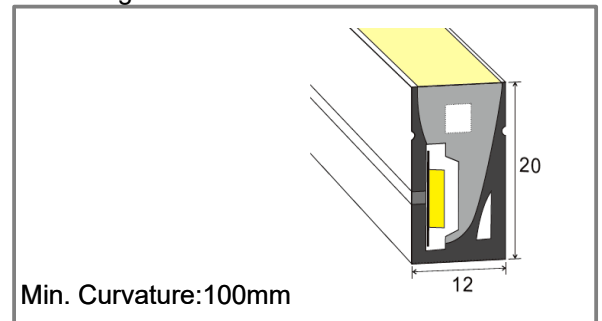

Emissione luce lato stretto diffusa 120°
Narrow light diffused emission 120°







WATERPROOF

PCB: Max. 10mm

Dimensioni – Dimension
H20 x L12 mm

Codice Profilo Code Profile	+ Lunghezza * Length	Tipo Finitura Finish Type	Tipo Finitura Copertura Finish Type Cover
N1020	-1 (1mt.)	WH  Bianco White	FRO  Satinato Frosted

*Request 5-10-15-20 mt.

Accessori Accessories	Codice Code	Descrizione Description
	N1020-EC	Terminale chiuso /Closed terminal
	N1220-ECL	Terminale con foro uscita cavo sinistra /Terminal with straight cable exit left
	N1220-ECR	Terminale con foro uscita cavo destra /Terminal with straight cable exit right
	N1220-ECB	Terminale con foro uscita cavo basso /Terminal with straight cable exit down
	MC-N1220	Supporto di montaggio in alluminio Fixing support for aluminum



Tubo in silicone per Led IP67 Silicone tube for LEDs IP67

**N1326
System**

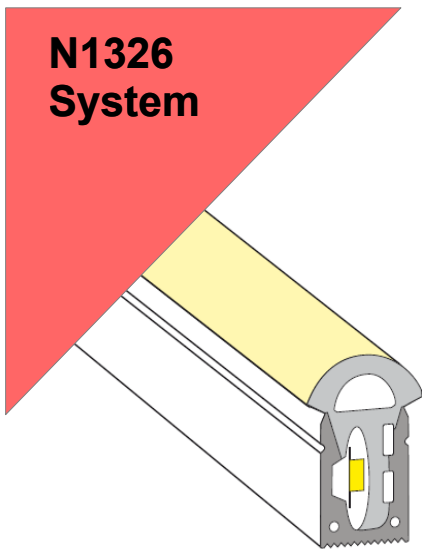

Tubi in silicone per l'installazione a parete.
Filo di traino interno per strip led. Protezione grado IP67.
Per l'alimentatore si richiede predisposizione del vano di alloggiamento durante la fase di progettazione.

Silicone tubes for wall installation. Internal towing wire for LED strip. Protection degree IP67.
The power supply is required predisposition of the housing compartment during the design phase

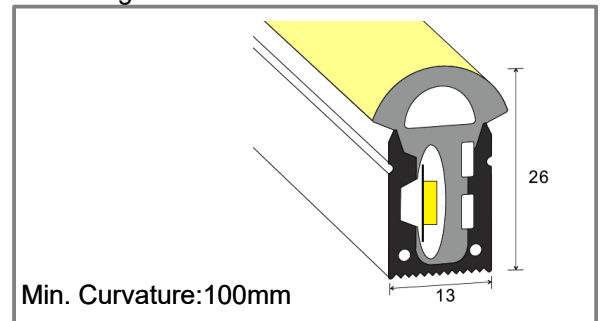

Emissione luce lato stretto diffusa 150°
Narrow light diffused emission 150°





WATERPROOF

PCB: Max.10mm

Dimensioni – Dimension
H26 x L13 mm

Codice Profilo Code Profile	+ Lunghezza * Length	Tipo Finitura Finish Type	Tipo Finitura Copertura Finish Type Cover
N1326	-1 (1mt.)	WH  Bianco White	FRO  Satinato Frosted

*Request 5-10-15-20 mt.

Accessori Accessories	Codice Code	Descrizione Description
	N1326-EC	Terminale chiuso in gomma /Closed rubber terminal
	N1326-ECH	Terminale con foro uscita cavo dritto /Terminal with straight cable exit hole
	MC-N1326	Supporto di montaggio in alluminio 30mm Fixing support for aluminum 30mm



3 ELECTRONICS

Elektronische Profili Led Electronic Led Profiles

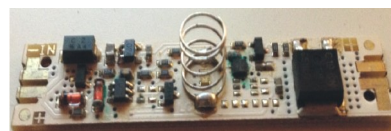

SCHEDA INTERRUTTORE E DIMMER CAPACITIVO SWITCH CARD AND CAPACITIVE DIMMER

Codice	Watt	Output VDC	Input VDC	Current Out Max.	Working Temp. Range Max	Dimensions	IP
SC-TDIM-M	12V-72W 24V-144W	12-24VDC	12-24VDC	6,0A	-20 ~ +45°C	50X10X5mm	20

Funzione OnOff con Dimmer e memoria ultimo stato. Attivazione capacitiva per applicazioni tecniche con luce di segnalazione.
OnOff function with Dimmer and memory last state. Capacitive activation for technical applications with signal light.



SCHEDA INTERRUTTORE E DIMMER RESISTIVO SWITCH CARD AND RESISTIVE DIMMER

Codice	Watt	Output VDC	Input VDC	Current Out Max.	Working Temp. Range Max	Dimensions	IP
SC-TLED	12V-60W 24V-120W	12-24VDC	6-48VDC	5,0A	-20 ~ +45°C	39X12X2mm	20

Funzione OnOff con Dimmer e memoria ultimo stato. Attivazione resistiva per applicazioni tecniche dietro superfici con luce di segnalazione.
OnOff function with Dimmer and memory last state. Resistive activation for technical applications behind surfaces with light of reporting.



SCHEDA INTERRUTTORE SENSORE DI PRESENZA PIR SWITCH PIR PRESENCE SENSOR CARD

Codice	Watt	Output VDC	Input VDC	Current Out Max.	Working Temp. Range Max	Dimensions	IP
SC-PIR	12V-60W 24V-120W	12-24VDC	12-24VDC	5,0A	-20 ~ +45°C	50X9,8X16mm	20

Funzione OnOff tramite sensore PIR. Attivazione con rilevamento movimento e presenza, temporizzato allo spegnimento.
OnOff function via PIR sensor. Activation with motion and presence detection, timed to switch off.

Elektronische Profili Led Electronic Led Profiles

SCHEDA INTERRUTTORE CREPUSCOLARE CREPUSCULAR SWITCH BOARD



Codice	Watt	Output VDC	Input VDC	Current Out Max.	Working Temp. Range Max	Dimensions	IP
SC-LIGHT	12V-96W 24V-192W	12-24VDC	12-24VDC	8,0A	-20 ~ +45°C	49X10X5mm	20

Funzione OnOff con sensore Luce. Attivazione crepuscolare con regolazione 2-60lx
OnOff function with Light sensor. Crepuscular activation with 2-60lx regulation

SCHEDA INTERRUTTORE CREPUSCOLARE E PIR CREPUSCULAR SWITCH BOARD AND PIR.



Codice	Watt	Output VDC	Input VDC	Current Out Max.	Working Temp. Range Max	Dimensions	IP
SC-PIRLIGHT	12V-96W 24V-192W	12-24VDC	6-48VDC	5,0A	-20 ~ +45°C	57X10X5+10mm	20

Funzione OnOff con sensore Luce. Attivazione crepuscolare con regolazione 2-60lx e sensore presenza PIR.
OnOff function with Light sensor. Twilight activation with 2-60lx regulation and PIR presence sensor.

SCHEDA INTERRUTTORE MAGNETICO MAGNETIC SWITCH BOARD



Codice	Watt	Output VDC	Input VDC	Current Out Max.	Working Temp. Range Max	Dimensions	IP
SC-MAG	12V-48W 24V-96W	12-24VDC	12-24VDC	4,0A	-20 ~ +45°C	51X10X5mm	20

Funzione OnOff tramite sensore Magnetico. Attivazione tramite magnete (NON INCLUSO)
OnOff function using Magnetic sensor. Activation by magnet (NOT INCLUDED)

Si prega di fare espressa richiesta per altri prodotti con caratteristiche diverse da quelle a catalogo. I prodotti sono in continua evoluzione.
Please make a specific request for other products with different characteristics from those in the catalog. The products are constantly evolving.

Elektronik Di Komando Command Electronics

INTERRUTTORE TOUCH DIMMER INCASSO BUILT-IN TOUCH DIMMER SWITCH



Codice	Watt	Output VDC	Input VDC	Current Out Max.	Working Temp. Range Max	Dimensions	IP
SE-PUSH-1BK SE-PUSH-1WH	12V-60W 24V-96W	12-24VDC	12-24VDC	4,0A	-20 ~ +45°C	d.cut 15,75mm d.ext. 22Mm Recessed 15mm	20

Funzione OnOff e Dimmer tramite touch. Colori disponibili Black – BK e Bianco - WH
OnOff and Dimmer function via touch. Available colors Black - BK and White - WH

SENSORE APERTURA ANTA E MOVIMENTO MANI 2 IN 1 LEAF OPENING SENSOR AND HANDS MOVEMENT 2 IN 1

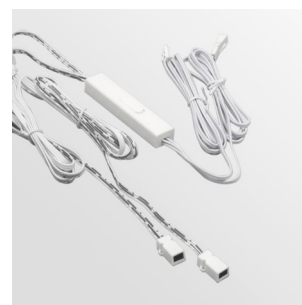

Codice	Watt	Output VDC	Input VDC	Current Out Max.	Working Temp. Range Max	Dimensions	IP
IR-011	12V-48W 24V-96W	12-24VDC	12-24VDC	4,0A	-20 ~ +45°C	d.13,5X55mm	20

Sensore apertura anta porta e movimento mani 2 in 1 automatico installazione da incasso o da superficie con mini connettore
Per mobili con sensore IR. Range 5-100mm
Door opening and hand movement sensor 2 in 1 automatic recessed or surface installation with mini connector
For furniture with IR sensor. Range 5-100mm

SENSORE APERTURA ANTA / INCASSO LEAF OPENING SENSOR / RECESSED



Codice	Watt	Output VDC	Input VDC	Current Out Max.	Working Temp. Range Max	Dimensions	IP
IR-009D	12V-48W 24V-96W	12-24VDC	12-24VDC	4,0A	-20 ~ +45°C	13X10X13mm	20
IR-008A (Recessed)	12V-48W 24V-96W	12-24VDC	12-24VDC		-20 ~ +45°C	d.13,5X30mm	20

Sensore apertura anta porta da esterno e incasso . Rilevamento area 100mm
Door opening sensor for external and built-in. 100mm area detection

Si prega di fare espressa richiesta per altri prodotti con caratteristiche diverse da quelle a catalogo. I prodotti sono in continua evoluzione.
Please make a specific request for other products with different characteristics from those in the catalog. The products are constantly evolving.

POWER TRACK -

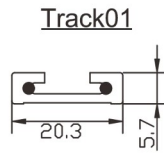

Track

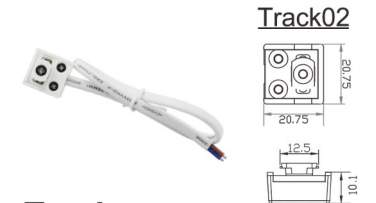

Tracker

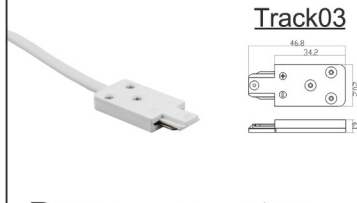

Power connector

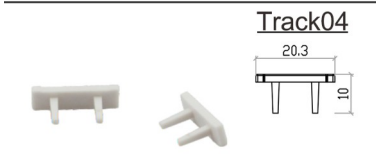

Endcap



Connector(Optional)

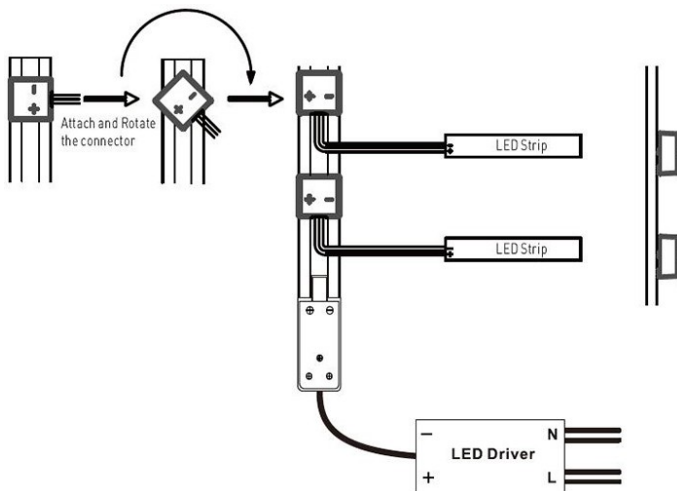

TRACK01

SURFACE MOUNTING DC POWER TRACK

- Item Type: Light track rail, Power track, DC power track
- Material: PC+Copper.
- Power: DC12V or 24V.
- Max. current rating: 25A.
- Strong double side tape at the back.
- Magnet tape at the back(optional)
- Standard Length: 2MT.
- Color: black and white.
- Operating environment: Indoor.
- Retrofit to existing wall or aisle Gondola shelving systems.
- Flexible and adaptable to a wide range of shelves.
- Convenient connection between shelve to shelve lighting with cable connector.
- Easy installation DC power track guarantees each layer lighting performance
- TRACK02(Connectors):
8A max with AWG#18 cable
4A max with AWG#22 cable

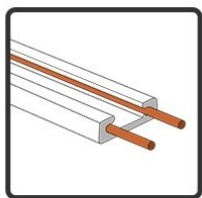

Best copper-excellent conductivity

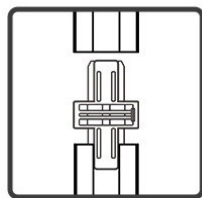

Special connector for join 2pcs track together

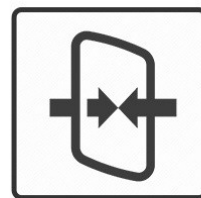

Ultra-thin design



Customized color acceptable.

POWER TRACK - STR002



STR002



STR001

The track is work with 12-24V power supply (customizable), which is convenient for installation and can be connected to the power supply after plugging in. According to the needs of different occasions, the space layout can be controlled arbitrarily. The metal panels, wood panels and glass panels can be freely combined. Max weight to hold up to 30 kg. With customized cabinet lights, the track shelf like will look more beau ful.



STR001

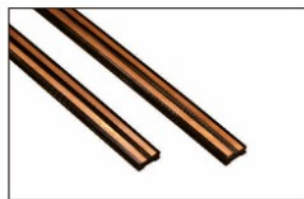

STR001-HT



STR001-AP



STR001-HP

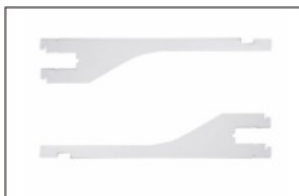

STR001-HM

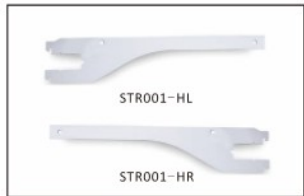

STR001-HL/HR



STR001-HG

POWER TRACK – MAGNETIC

Mini Magnet Power Track

Surface mounting on iron materials only.

Track: 25A max, DC12V–24V.

Connector: 8A max with VDE #18 cable.

Color: Black, white, customized color are available.



Track

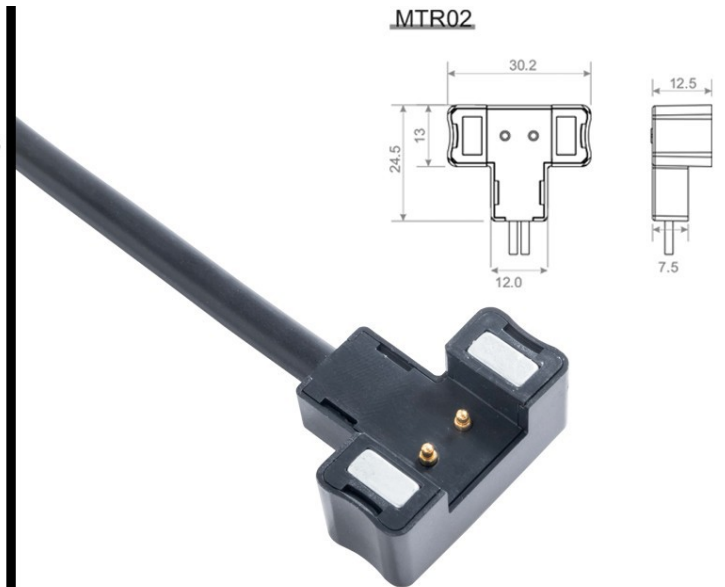

Track Connector



Power Connector

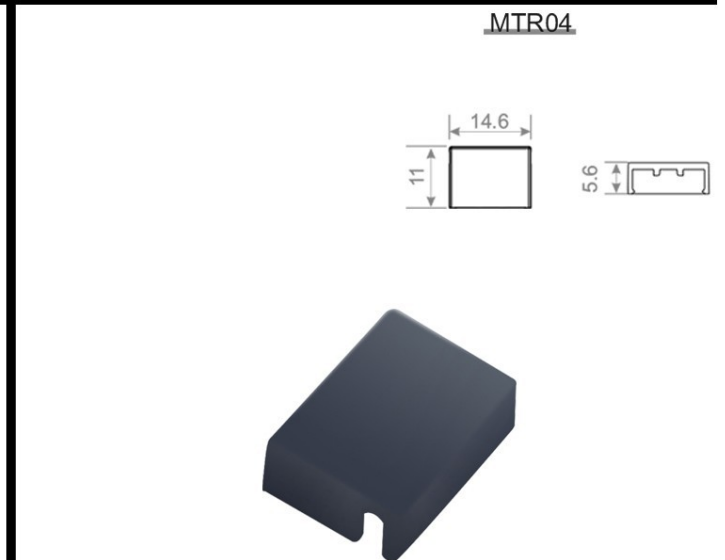

Endcap

ProfiLINE, la nostra esclusiva linea di profili in misto cartongesso e alluminio, è la soluzione ideale per alloggiare e proteggere le strisce led garantendo un'installazione impeccabile e una luce uniforme in ogni ambiente.

Il modello P1, offre un profilo lungo 200cm, con una larghezza di 12 cm e uno spessore di 1,3cm. Questo profilo è dotato di una spugna di protezione in dotazione, che permette di evitare sporcizie durante la fase di installazione e stuccatura. Grazie a questa spugna, non si formeranno residui di stucco che richiederebbero ulteriori operazioni di pulizia. La cover in policarbonato opale, inclusa nel kit, permette una diffusione omogenea della luce, creando un effetto morbido e piacevole all'occhio, mentre l'alluminio e il cartongesso assicurano la resistenza e la lavorabilità necessarie per una perfetta integrazione nel tuo progetto di illuminazione.

Per garantire una perfetta continuità estetica e funzionale, offriamo anche tre accessori di congiunzione.

Il P1L è un giunto angolare che consente di collegare in modo preciso due profili ad angolo retto, creando una transizione fluida tra le sezioni.

Il P1T è un giunto a tre incroci, ideale per unire tre profili in una disposizione a T.

Infine, il P1X è un giunto d'incrocio che permette di collegare quattro profili, offrendo infinite possibilità di configurazione per adattarsi alle esigenze specifiche del tuo progetto.

E' possibile anche acquistare un rotolo di 50mt do cover, per poter effettuare installazioni lineari senza giunzioni.

Questa combinazione offre un'ottima durata nel tempo e una facile lavorabilità per adattarsi a diverse superfici e design d'interni.

ProfiLINE, our exclusive line of mixed plasterboard and aluminum profiles, is the ideal solution for housing and protecting LED strips, ensuring flawless installation and uniform light in every environment.

The P1 model offers a 200cm long profile, with a width of 12cm and a thickness of 1.3cm. This profile is equipped with a sponge of protection supplied, which allows you to avoid dirt during the installation and grouting phase. Thanks to this sponge, no grout residues will form which would require further cleaning operations. The opal polycarbonate cover, included in the kit, it allows a homogeneous diffusion of light, creating a soft and pleasant effect on the eye, while the aluminum and plasterboard ensure the resistance and workability necessary for perfect integration into your lighting project.

To ensure perfect aesthetic and functional continuity, we also offer three connection accessories.

The P1L is a corner joint that allows you to precisely connect two profiles at right angles, creating a smooth transition between sections.

The P1T is a three-cross joint, ideal for joining three profiles in a T-shaped arrangement.

Finally, the P1X is a crossover joint that allows you to connect four profiles, offering infinite configuration possibilities to adapt to specific needs of your project.

It is also possible to purchase a 50m roll of cover, to be able to carry out linear installations without joints.

This combination offers excellent durability and easy workability to adapt to different surfaces and interior designs.

4 PROFILES



PROFILINE

ProfiLine

ProfiLine P1

Profilo in alluminio incassato in una sagoma pre-tagliata in cartongesso di spessore 13mm adatto all'installazione diretta in strutture di cartongesso nuove. All'interno della confezione viene data in dotazione, oltre alla cover opale di copertura, una spugna di lunghezza e larghezza adatte al binario in alluminio, la stessa svolgerà la funzione di protezione durante le operazioni di stuccatura. Il profilo ha lunghezza 2 metri e larghezza 12cm.

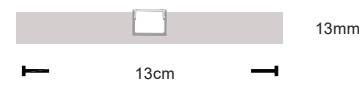
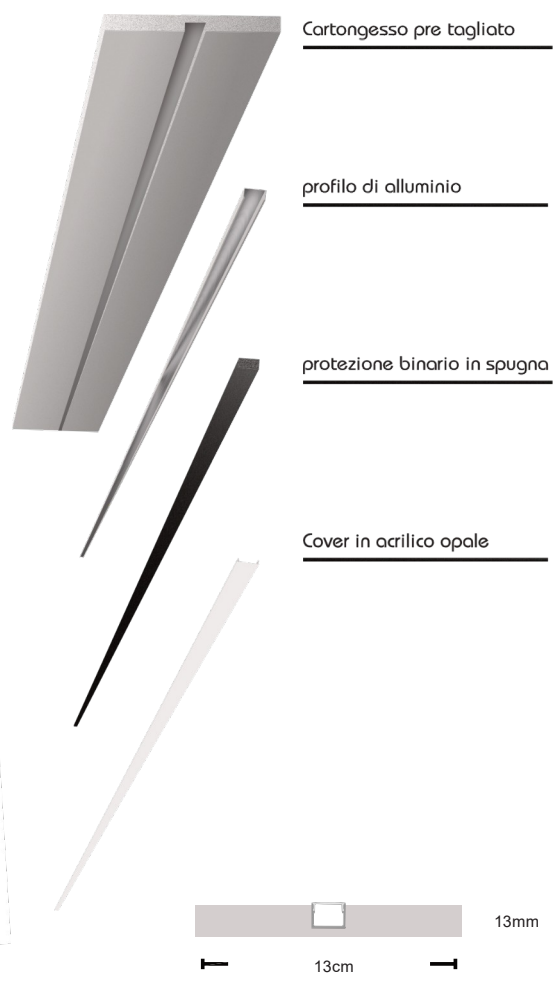
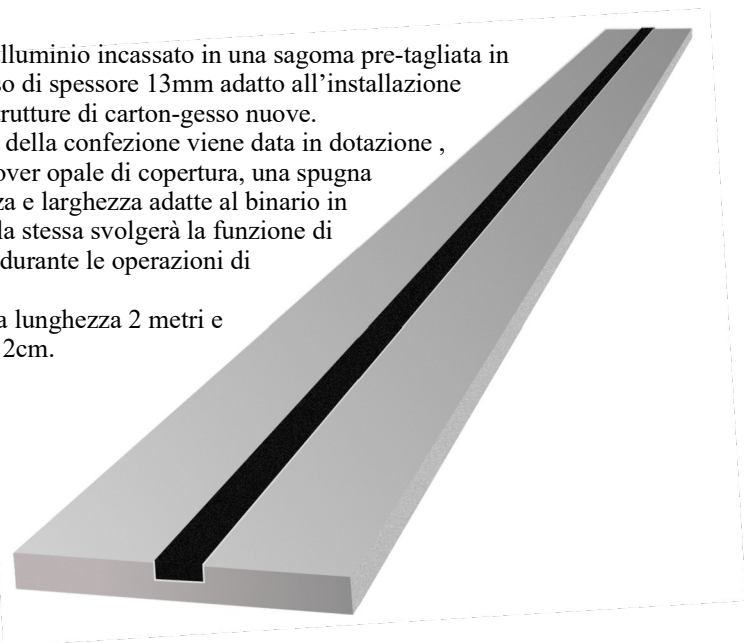

ProfiLine P1L

ProfiLine P1T

ProfiLine P1X

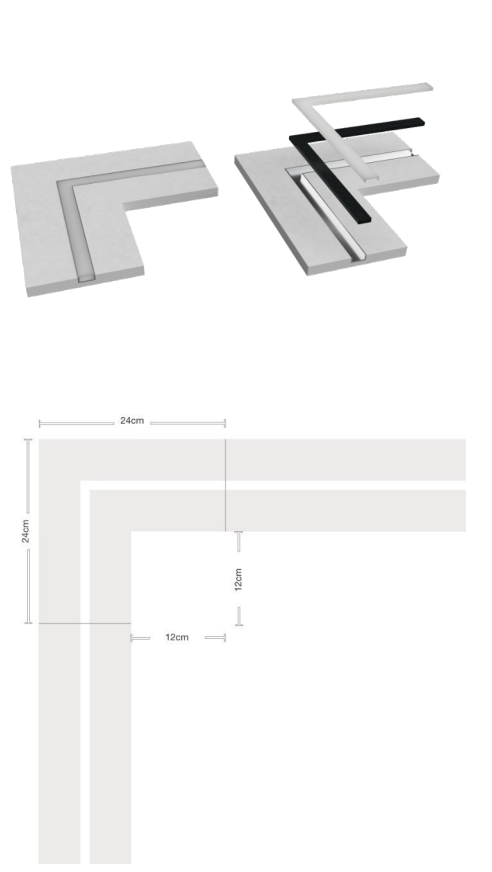

Spessore 13mm

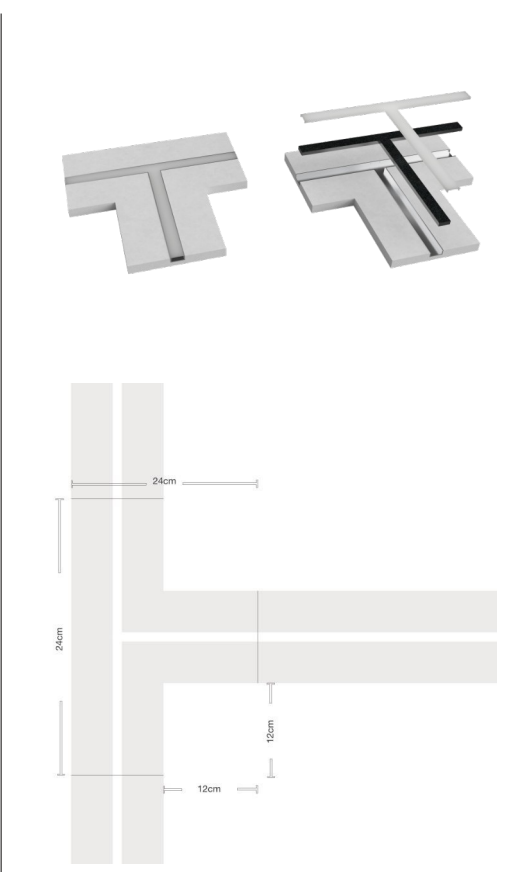

Spessore 13mm

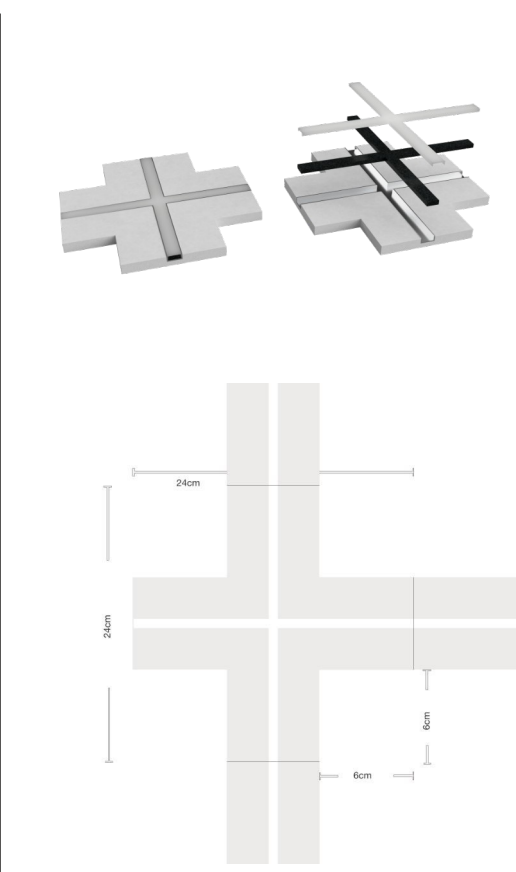

Spessore 13mm

Profilo in gesso ad incasso

Recessed ceramic plaster profile

LAVA

Profilo ad incasso in gesso ceramico a scomparsa totale completa di copertura opaca.

Recessed ceramic plaster profile disappearing. Complete with matte cover.

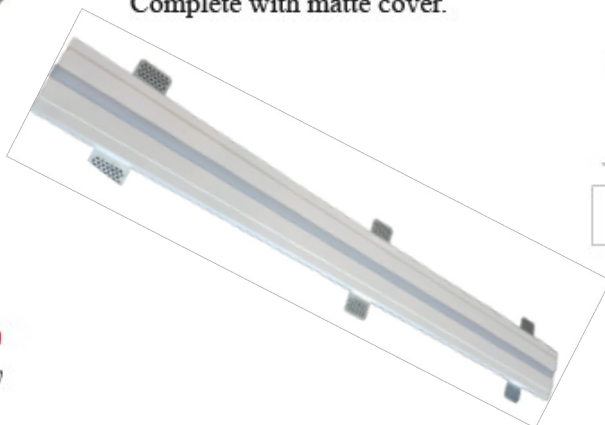

SCHEDA TECNICA/DATA SHEET

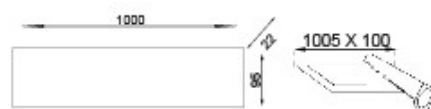

100%
Made in Italy

CE RoHS F IP20

Codice	Colore Luce	Misure	Unità di Taglio	Input Volt	Watt	CRI	Lumen	Classe Energetica	IP
G300	-	1000x95x22mm	-	-	-	-	-	A+	Ip20

ACCESSORI/ACCESSORIES



Codice	Colore Luce	Misure	Unità di Taglio	Input Volt	Watt	CRI	Lumen	Classe Energetica	IP
G305	-	140x140x22mm	-	-	-	-	-	A+	Ip20
G310	-	180x140x22mm	-	-	-	-	-	A+	Ip20
G315	-	180x180x22mm	-	-	-	-	-	A+	Ip20

C5

PORTA FARETTI

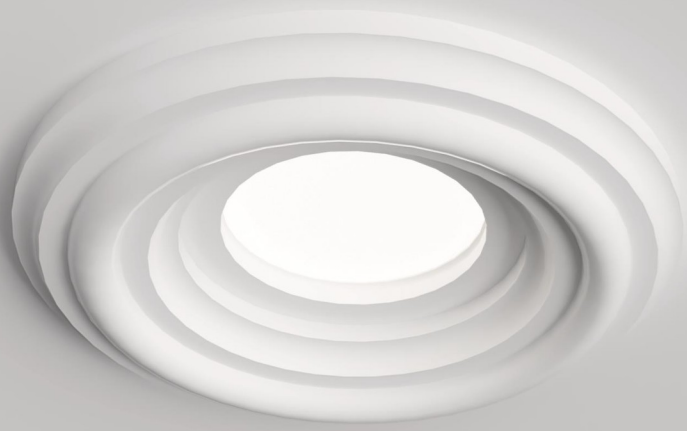

Portalamпада e molla di blocco inclusi - Lamp holder and lock spring included



Agua

1 x Gu10 max 35W

Codice FP1

180 x 180 mm

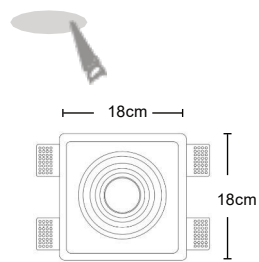

Salento

1 x Gu10 max 35W

Codice FP2

120 x 120 mm

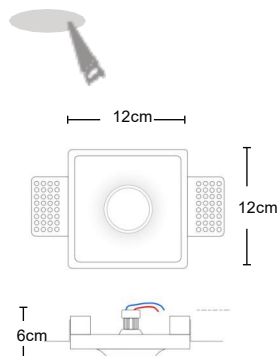

Como

1 x Gu10 max 35W

Codice 075

120 x 120 mm

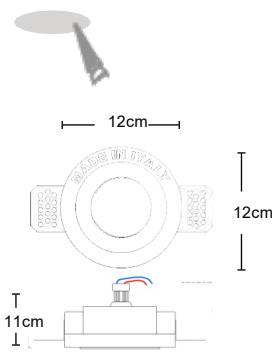

Lampadine non incluse



Portalamпада e molla di blocco inclusi - Lamp holder and lock spring included

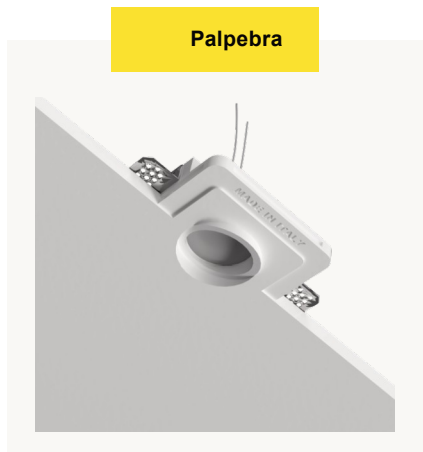

1 x Gu10 max 35W

Codice FP4

120 x 120 mm

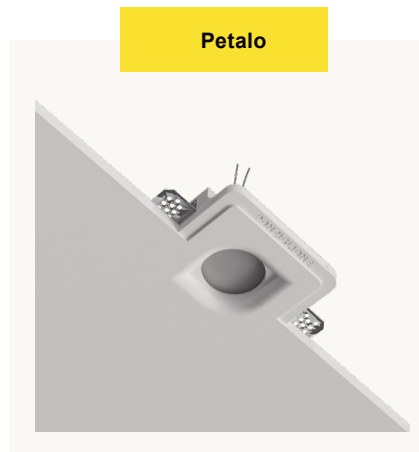
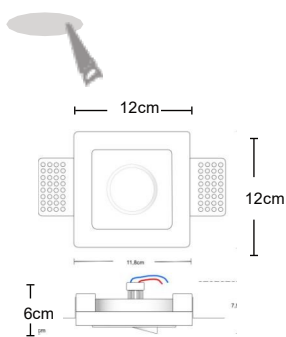

1 x Gu10 max 35W

Codice FP5

120 x 120 mm

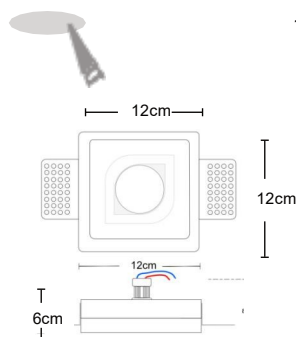

1 x Gu10 max 35W

Codice FP6

120 x 120 mm

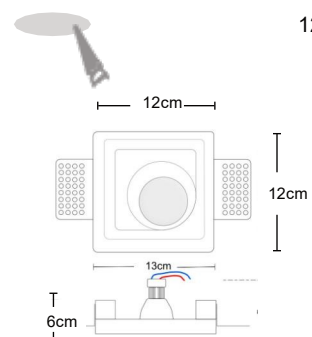

Lampadine non incluse



Portalamпада e molla di blocco inclusi - Lamp holder and lock spring included



Astro

Codice FP8

185 x 185 mm

1 x Gu10 max 35W

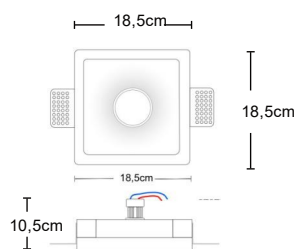

L'Astro è un faretto in gesso ceramico dalle dimensioni generose 18,5x18,5cm caratterizzato da una forma convessa con una curvatura morbida. Questo elegante faretto è progettato per offrire un'illuminazione di alta qualità e sofisticata. Compatibile con lampadine LED Gu10 (non incluse), fornisce una luce focalizzata e luminosa per creare l'atmosfera desiderata. Realizzato con materiali di alta qualità, l'Astro si integra perfettamente nell'ambiente grazie alla sua finitura in gesso ceramico, conferendo un tocco di stile contemporaneo. Sia che venga utilizzato in casa o in ambienti professionali, l'Astro garantisce un'illuminazione affidabile e un design raffinato.

Lampadine non incluse

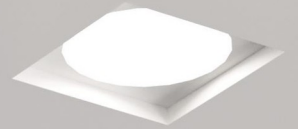
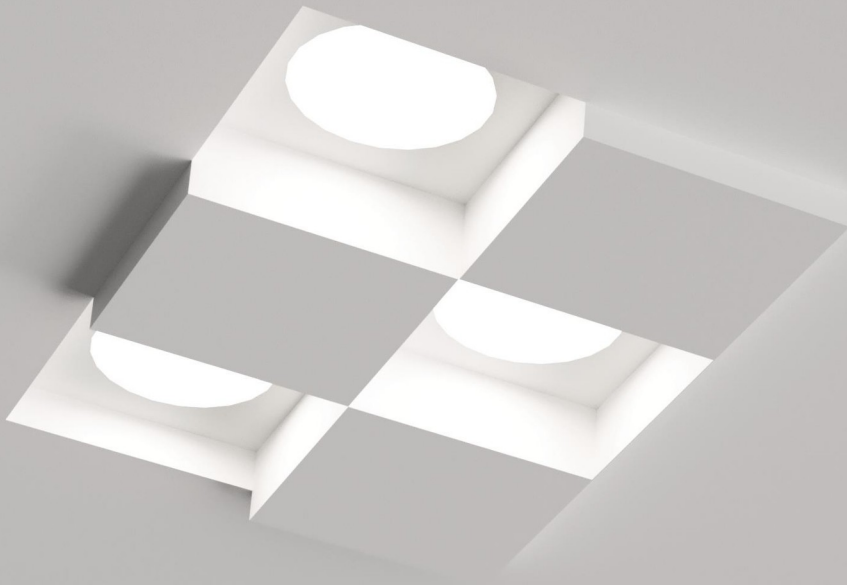

Porta lampada e molla di blocco inclusi - Lamp holder and lock spring included

Canyon

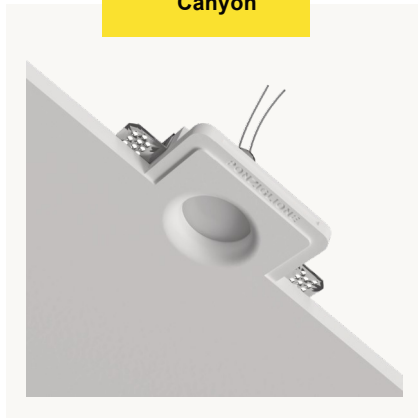

1 x Gu10 max 35W

Codice FP7

120 x 120 mm

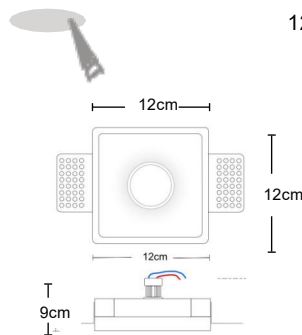

Scacchi

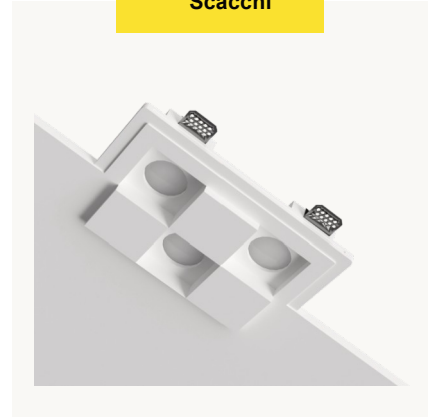

3 x Gu10 max 35W

Codice FP12

295 x 220 mm

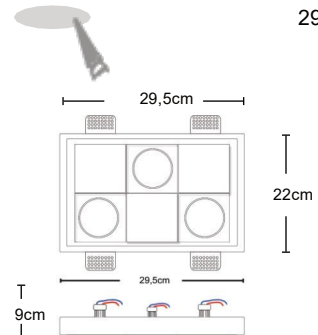



FILO SOFFITTO



AVERNO

Portalamпада e molla di blocco inclusi - Lamp holder and lock spring included

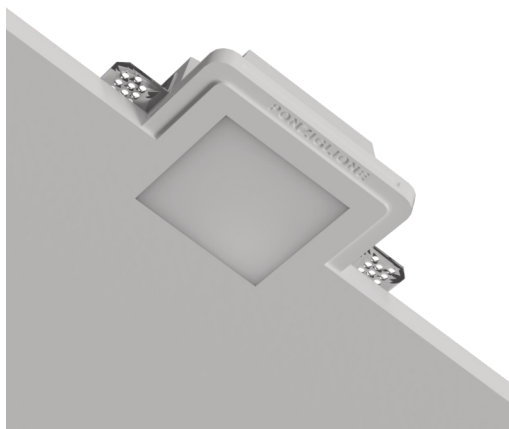

1 x Gu10 max 35W

Codice FP13

130 x 130 mm

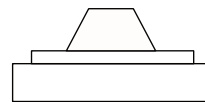

12cm

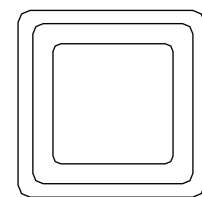

13cm

13cm

Il faretto ad incasso FP13 è una soluzione di illuminazione dal design elegante e minimalista, ideale per gli ambienti che richiedono un aspetto pulito e senza scalini. La sua particolarità risiede nella copertura in acrilico che si estende a filo soffitto, creando un effetto di continuità visiva senza interruzioni. Con il suo design senza scalini, il faretto FP13 si integra armoniosamente con qualsiasi tipo di soffitto, conferendo un tocco di modernità e raffinatezza all'ambiente. La copertura in acrilico diffonde la luce in modo uniforme, creando un'illuminazione piacevole e senza ombre indesiderate. L'installazione del faretto FP13 è semplice e discreta, grazie al suo incasso nel soffitto. Questo lo rende adatto a una varietà di ambienti, come salotti, camere da letto, cucine o uffici, dove si desidera un'elevata dose di minimalismo. Si consiglia di utilizzare lampadine compatibili con l'attacco del faretto FP13, come lampadine GU10 LED, per un'illuminazione efficiente ed energeticamente sostenibile. La scelta delle lampadine può essere personalizzata in base alle preferenze individuali e alle esigenze di illuminazione dell'ambiente.

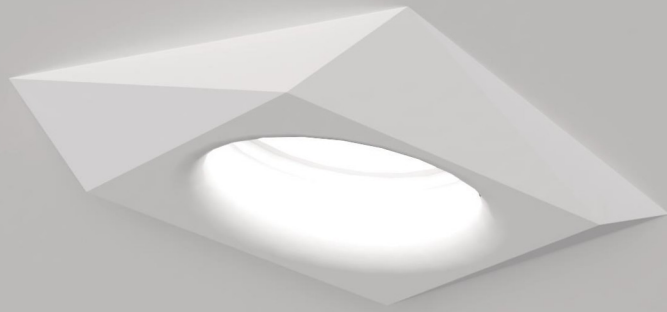

Diamante

Lieve

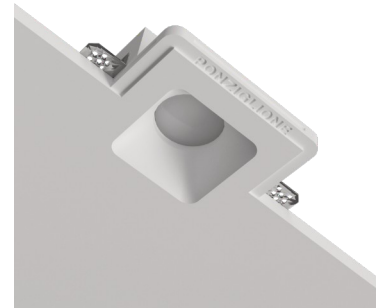

1 x Gu10 max 35W

Codice FP14

120 x 120 mm

1 x Gu10 max 35W

Codice FP35

140 x 140 mm

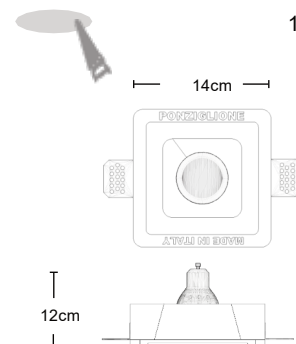
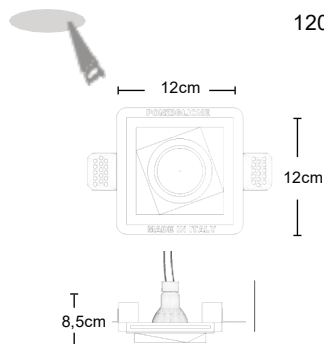

Portalamпада e molla di blocco inclusi - Lamp holder and lock spring included

Lampadine non incluse

ATTACCO GU10 PER LAMPADE MR11 MINI GU10



Gae

Codice FP15
100 x 100 mm

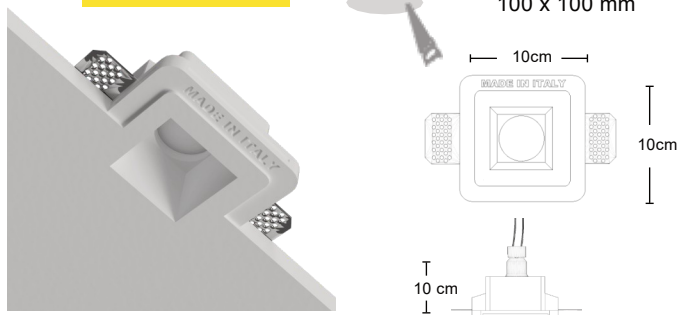

1 x Gu10 max 35W - Mr11 mini Gu10

Cini

Codice FP16
100 x 100 mm

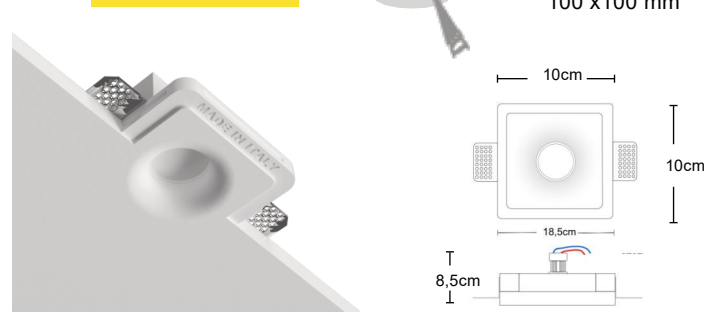

1 x Gu10 max 35W - Mr11 mini Gu10

Boeri

Codice FP17
100 x 100 mm

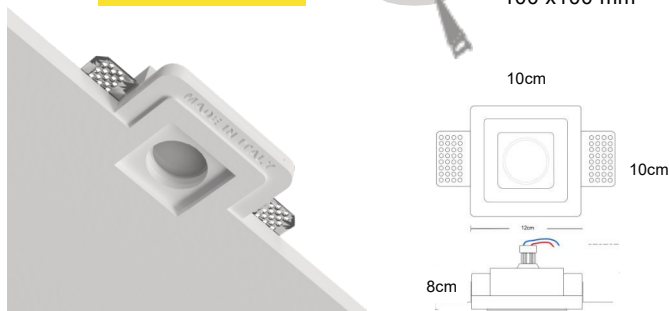

1 x Gu10 max 35W - Mr11 mini Gu10

Castiglioni

Codice FP18
100 mm

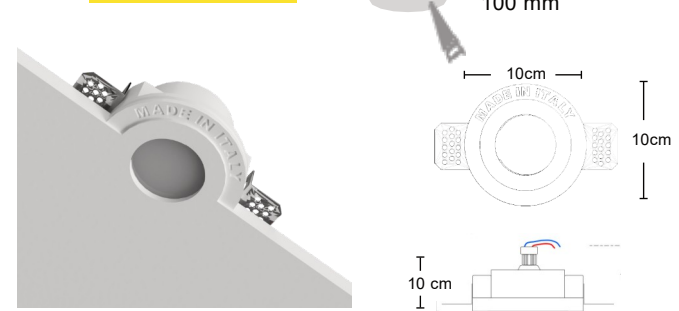

1 x Gu10 max 35W - Mr11 mini Gu10

Ponti

Codice FP19
100 x 100 mm

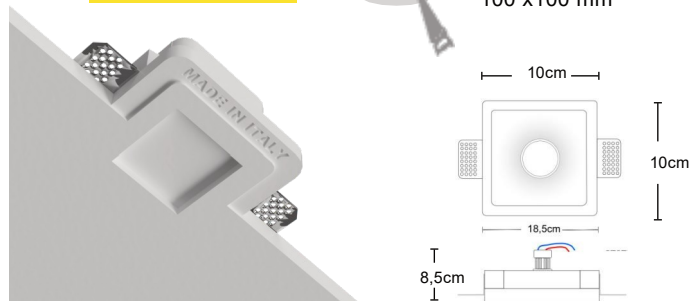

1 x Gu10 max 35W - Mr11 mini Gu10

Piano

Codice FP20
100 mm

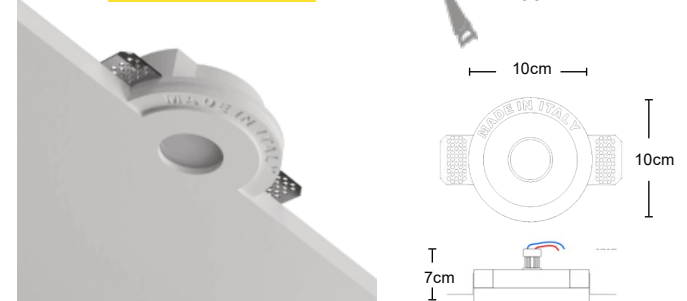

1 x Gu10 max 35W - Mr11 mini Gu10

Portalamпада e molla di blocco inclusi - Lamp holder and lock spring included

Lampadine non incluse

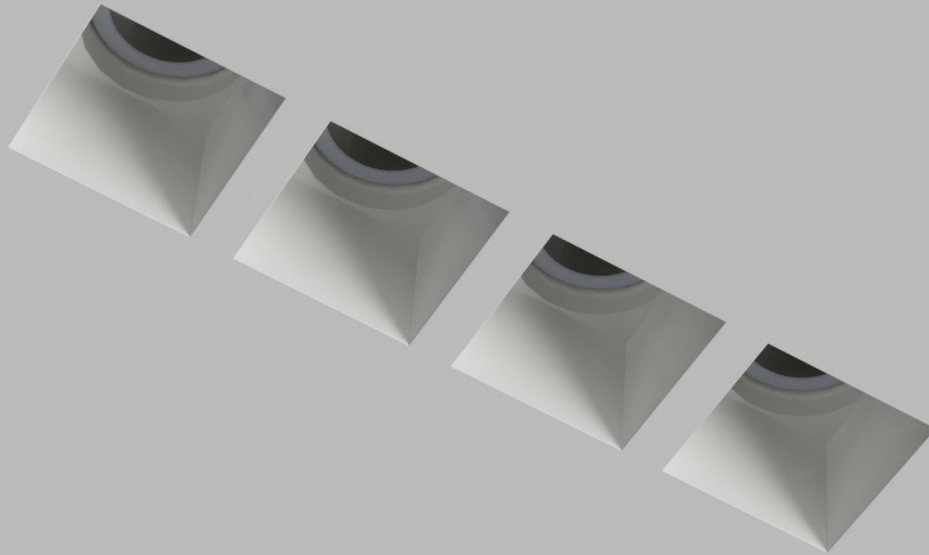

QUADRILATERO

Portalamпада e molla di blocco inclusi - Lamp holder and lock spring included

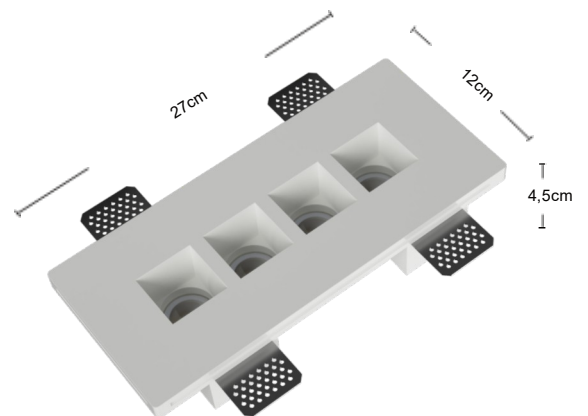
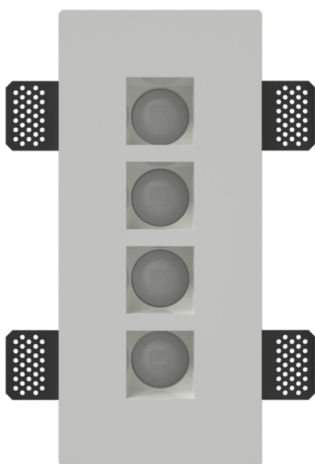

Lampadine non incluse

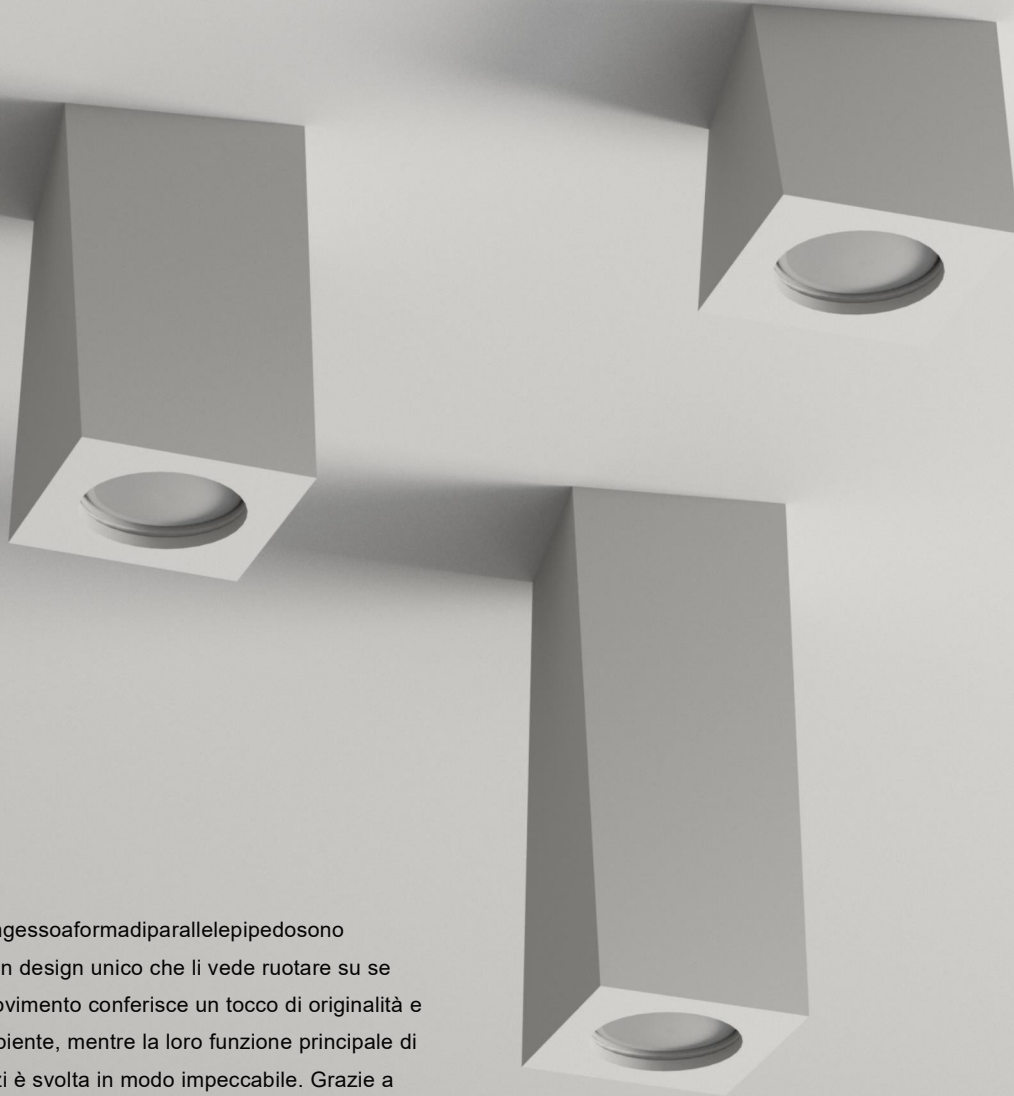

I nostri faretto in gesso a forma di parallelepipedo sono caratterizzati da un design unico che li vede ruotare su se stessi. Questo movimento conferisce un tocco di originalità e dinamicità all'ambiente, mentre la loro funzione principale di illuminare gli spazi è svolta in modo impeccabile. Grazie a questa particolare caratteristica, i nostri faretto donano un'atmosfera sobria e allo stesso tempo vivace, rendendo l'illuminazione degli ambienti un'esperienza esteticamente piacevole e funzionale. Scopri come i nostri faretto in gesso possono arricchire e personalizzare il tuo spazio abitativo o lavorativo.

REVERSE

Porta lampada e molla di blocco inclusi - Lamp holder and lock spring included

Codice FP32

Reverse 1



Codice FP33

Reverse 2



Codice FP34

Reverse 3

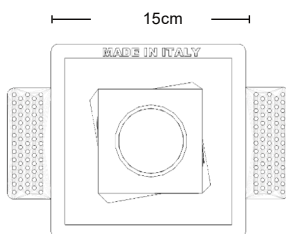
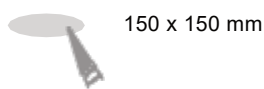

1 x Gu10 max 35W

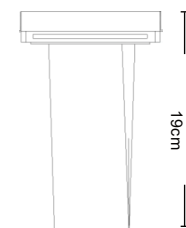
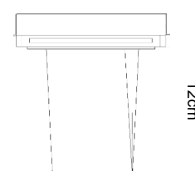

Porta faretto in gesso da incasso
 Alette di fissaggio in alluminio spesse
ATTACCO GU10

CE

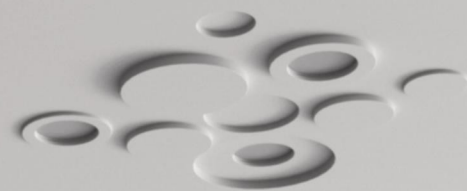
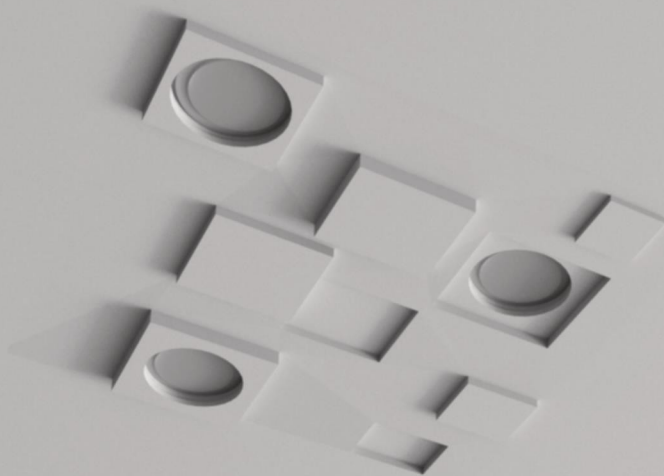

Ringo

Yellowstone

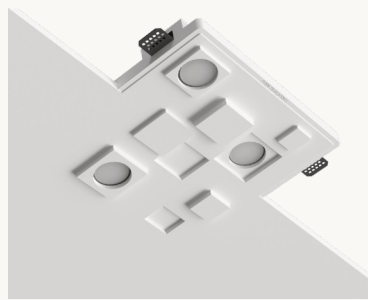

3 x Gu10 max 35W

Cod. FP45

3 x Gu10 max 35W

Cod. FP46

340 x 340 mm

340 x 340 mm

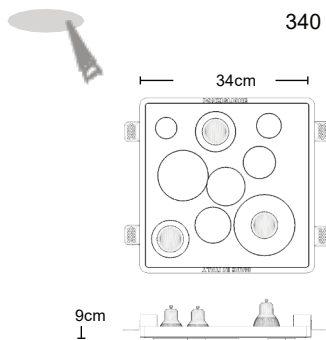
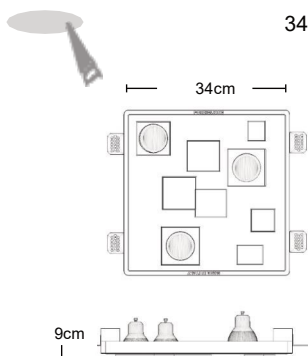

Portalamпада e molla di blocco inclusi - Lamp holder and lock spring included

Lampadine non incluse

Porta faretto in gesso da incasso
 Alette di fissaggio in alluminio spesse
ATTACCO GU10

CE

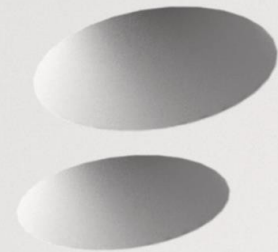

Crater

Crater D

Quadro

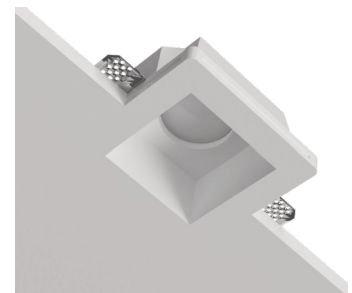
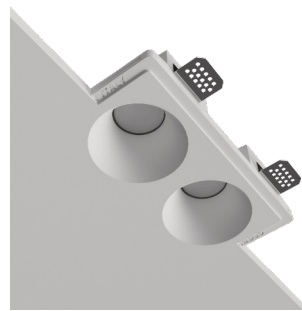
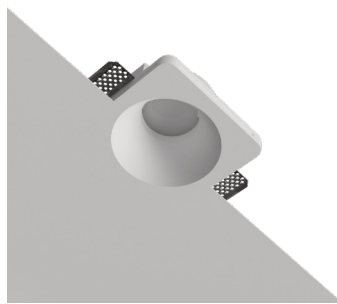

1 x Gu10 max 35W Cod. 060

2 x Gu10 max 35W Cod. 060D

1 x Gu10 max 35W Cod. 085

120 x 120 mm

240 x 130 mm

120 x 120 mm

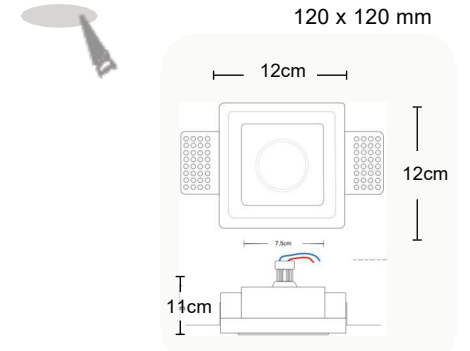
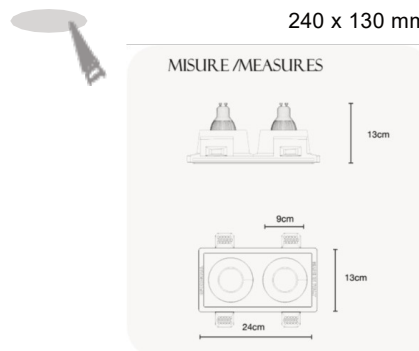
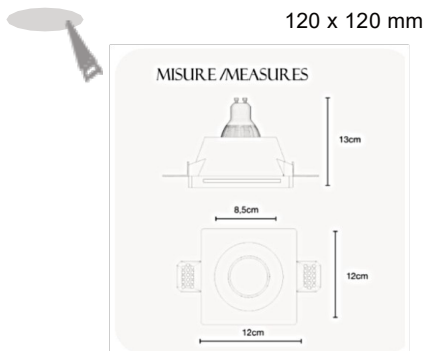

Portalamпада e molla di blocco inclusi - Lamp holder and lock spring included

Lampadine non incluse

Porta faretto in gesso da incasso
 Alette di fissaggio in alluminio spesse
ATTACCO GU10

CE



Quadro D

Brunelleschi

Brunelleschi D

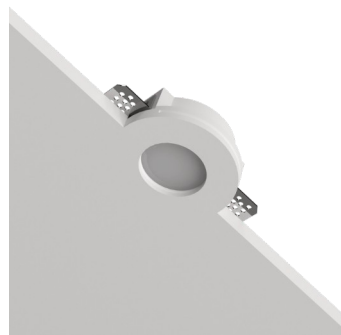
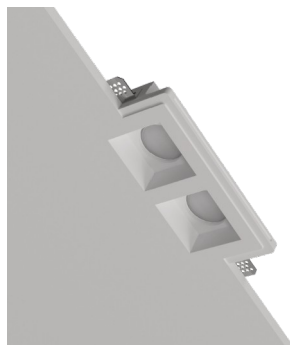

2 x Gu10 max 35W

Cod. 085D

1 x Gu10 max 35W

Cod. 010

2 x Gu10 max 35W

Cod. 010D

220 x 130 mm

100 mm

190 x 120 mm

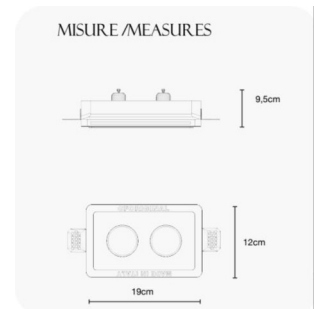
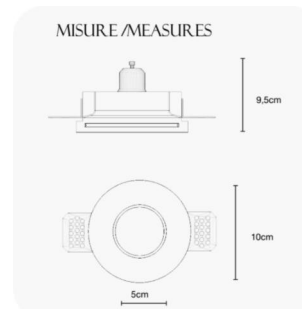
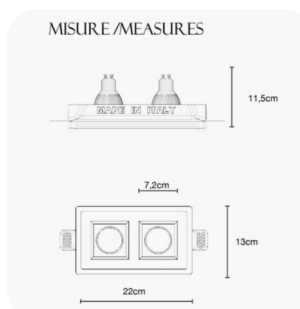

Portalamпада e molla di blocco inclusi - Lamp holder and lock spring included

Lampadine non incluse

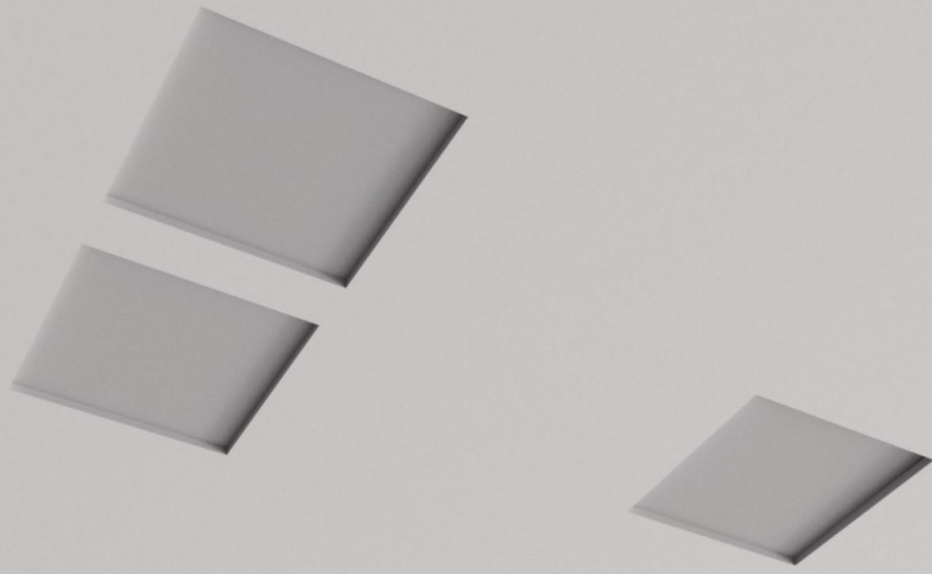

Portalamпада e molla di blocco inclusi - Lamp holder and lock spring included

Rosa

SLIM



1 x Gu10 max 35W

Cod. C13

120 x 120 mm

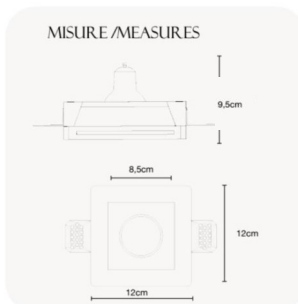

Rosa D

SLIM



2 x Gu10 max 35W

Cod. C13D

220 x 120 mm

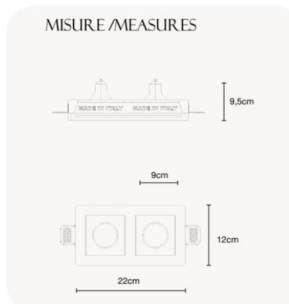

Tulip

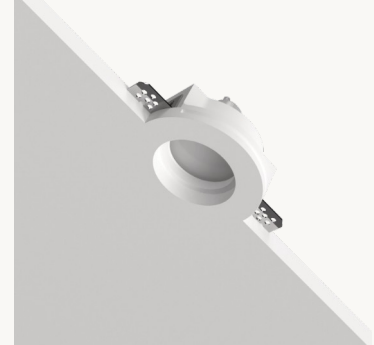

1 x Gu10 max 35W

Cod. 015

100 mm

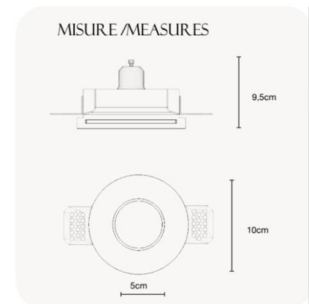



ATTACCO GU10



Ortensia

Cervino

Courmayeur

Portalamпада e molla di blocco inclusi - Lamp holder and lock spring included

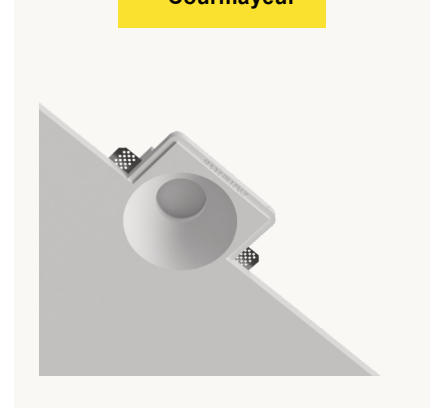
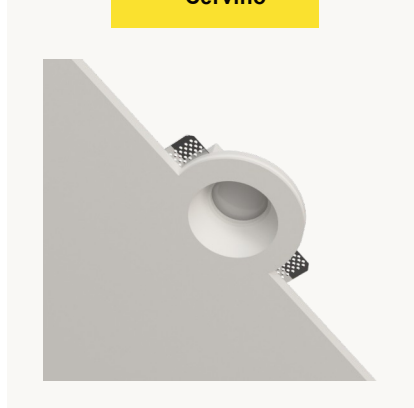
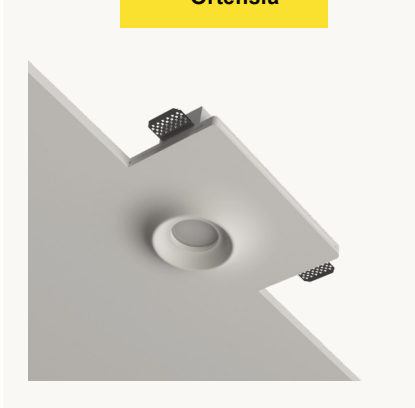

1 x Gu10 max 35W

Cod. 020

1 x Gu10 max 35W

Cod. 030

1 x Gu10 max 35W

Cod. 050

220 x 220 mm

125 mm

140 x 140 mm

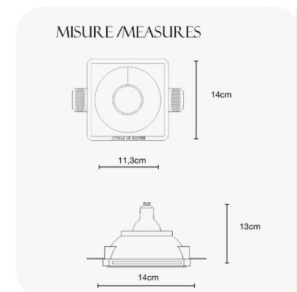
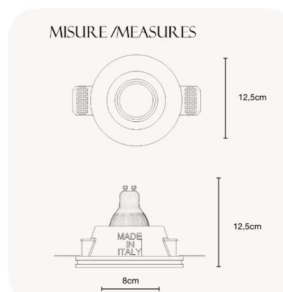
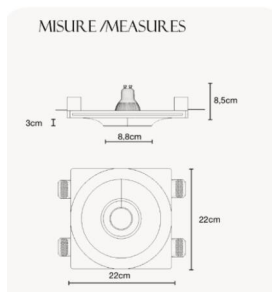



ATTACCO GU10

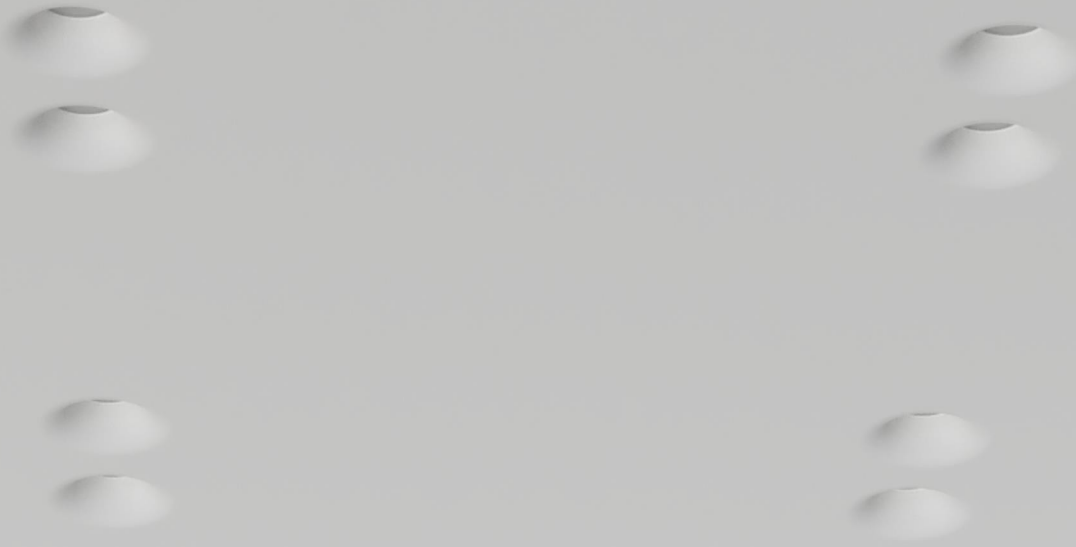

Bries

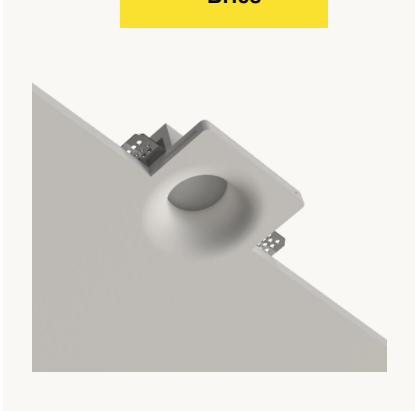

1 x Gu10 max 35W

Cod. 045

120 x 120 mm

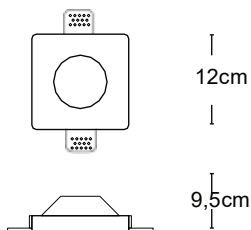

Desenzano

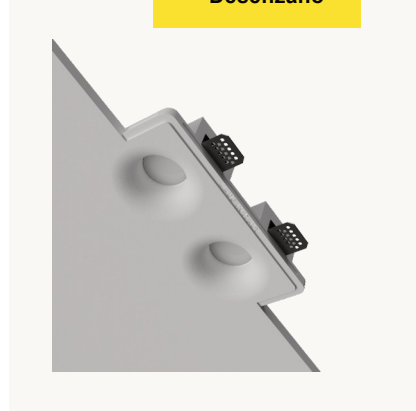

2 x Gu10 max 35W

Cod. 045D

260 x 130 mm

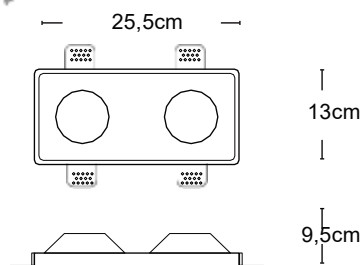

Porta lampada e molla di blocco inclusi - Lamp holder and lock spring included

Lampadine non incluse

Porta faretto in gesso da incasso / Recessed plaster spotlight holder

CE



ATTACCO GU10 PER LAMPADE MR11 MINI GU10

RIVER

Porta lampada e molla di blocco inclusi - Lamp holder and lock spring included

La serie "River" offre un'ampia varietà di elementi da incasso in gesso che permettono di creare percorsi luminosi suggestivi e personalizzati. Ogni parte della serie è progettata per adattarsi perfettamente alle altre, consentendo di combinare diverse forme e direzioni dell'illuminazione.

Le possibilità creative sono infinite: si possono creare percorsi luminosi che seguono le linee del soffitto, creando un'atmosfera unica e coinvolgente. In alternativa, si possono utilizzare le parti della serie per punti focali specifici, evidenziando particolari elementi architettonici o opere d'arte.

Lampadine non incluse

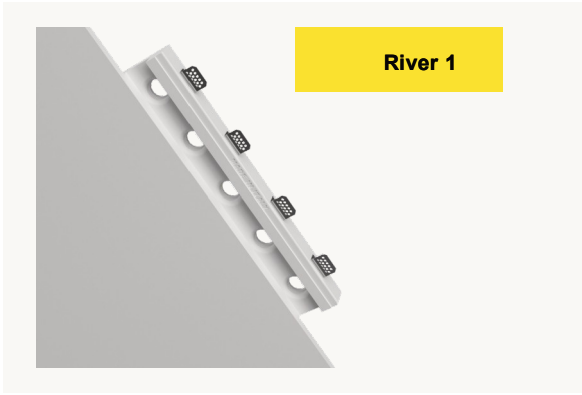

River 1

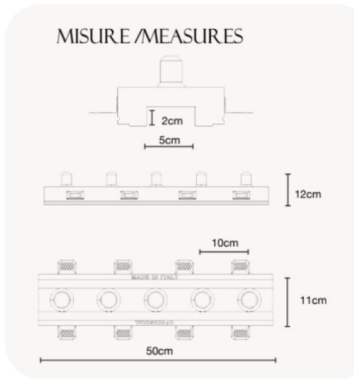

5 x Mini Gu10 max 35W



500 x 110 mm

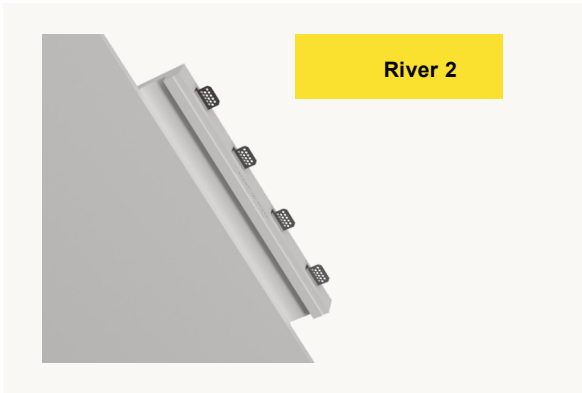

River 2

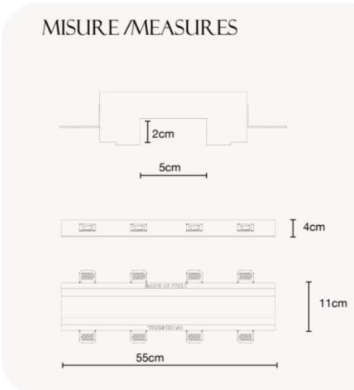

500 x 110 mm



River 3

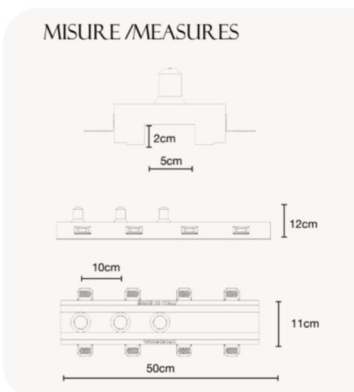

3 x Mini Gu10 max 35W



500 x 110 mm

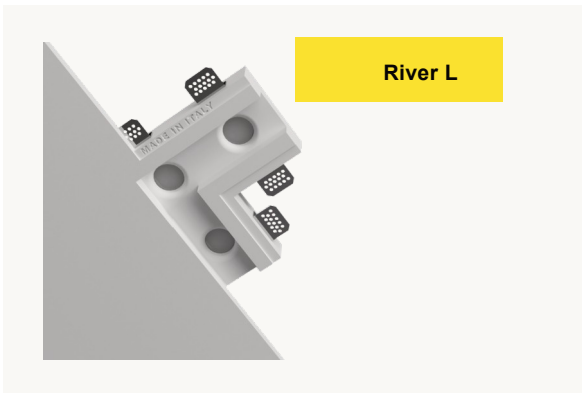

River L

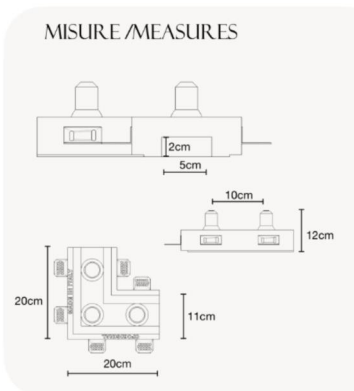

3 x Mini Gu10 max 35W



200 x 200 mm



River L1

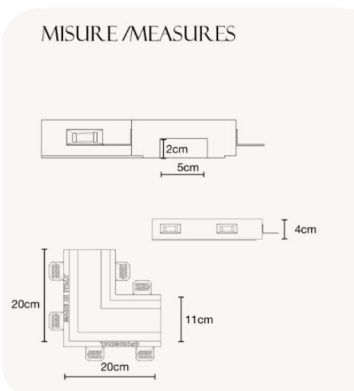

200 x 200 mm





ATTACCO GU10 PER LAMPADE MR11 MINI GU10



Pisa

Livorno

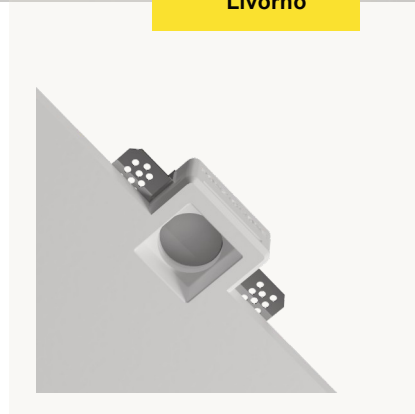
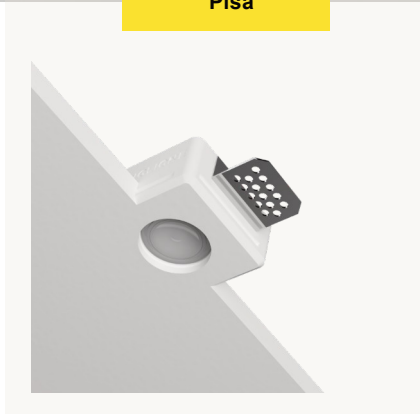

1 x Gu10 max 35W - Mr11 mini Gu10

1 x Gu10 max 35W - Mr11 Mini Gu10

70 x 70 mm

70 x 70 mm



MISURE / MEASURES

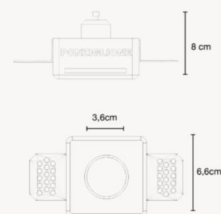

MISURE / MEASURES

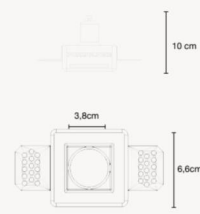

Portalamпада e molla di blocco inclusi - Lamp holder and lock spring included

Lampadine non incluse

ATTACCO GU10

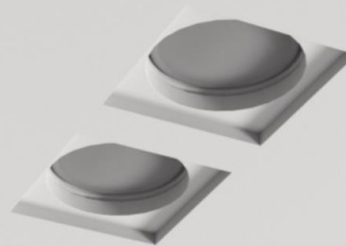
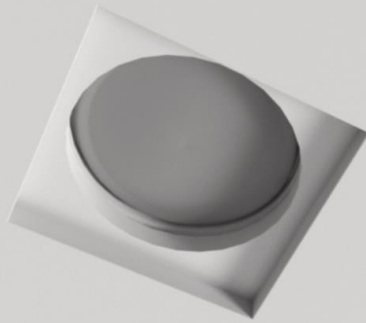

Grosseto

Grosseto D

Astroni

Porta lampada e molla di blocco inclusi - Lamp holder and lock spring included

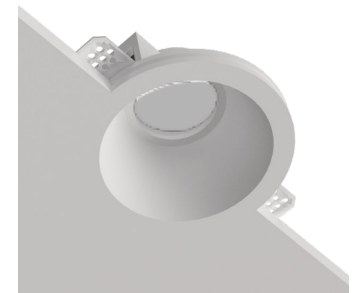
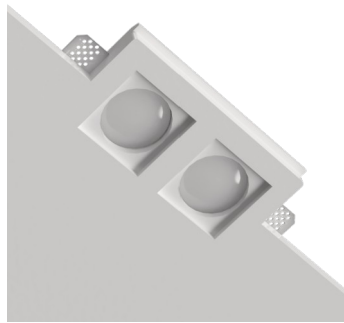
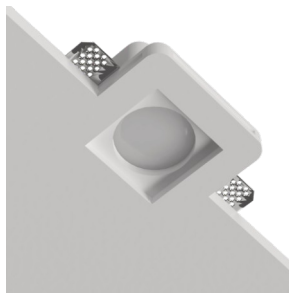

1 x Gu10 max 35W

Cod. 040

2 x Gu10 max 35W

Cod. 040D

1 x Gu10 max 35W

Cod. 065

100 x 100 mm

130 mm

130 mm

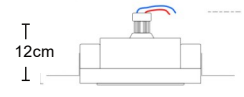
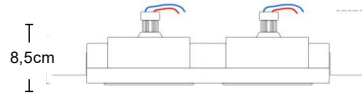
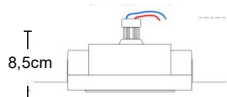
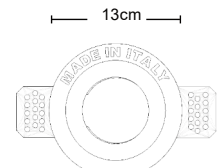
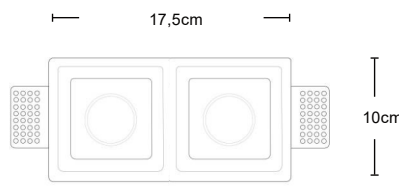
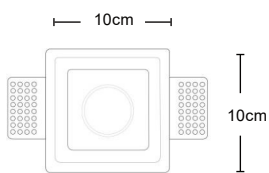

Lampadine non incluse



ATTACCO GU10

GHIERA IN METALLO

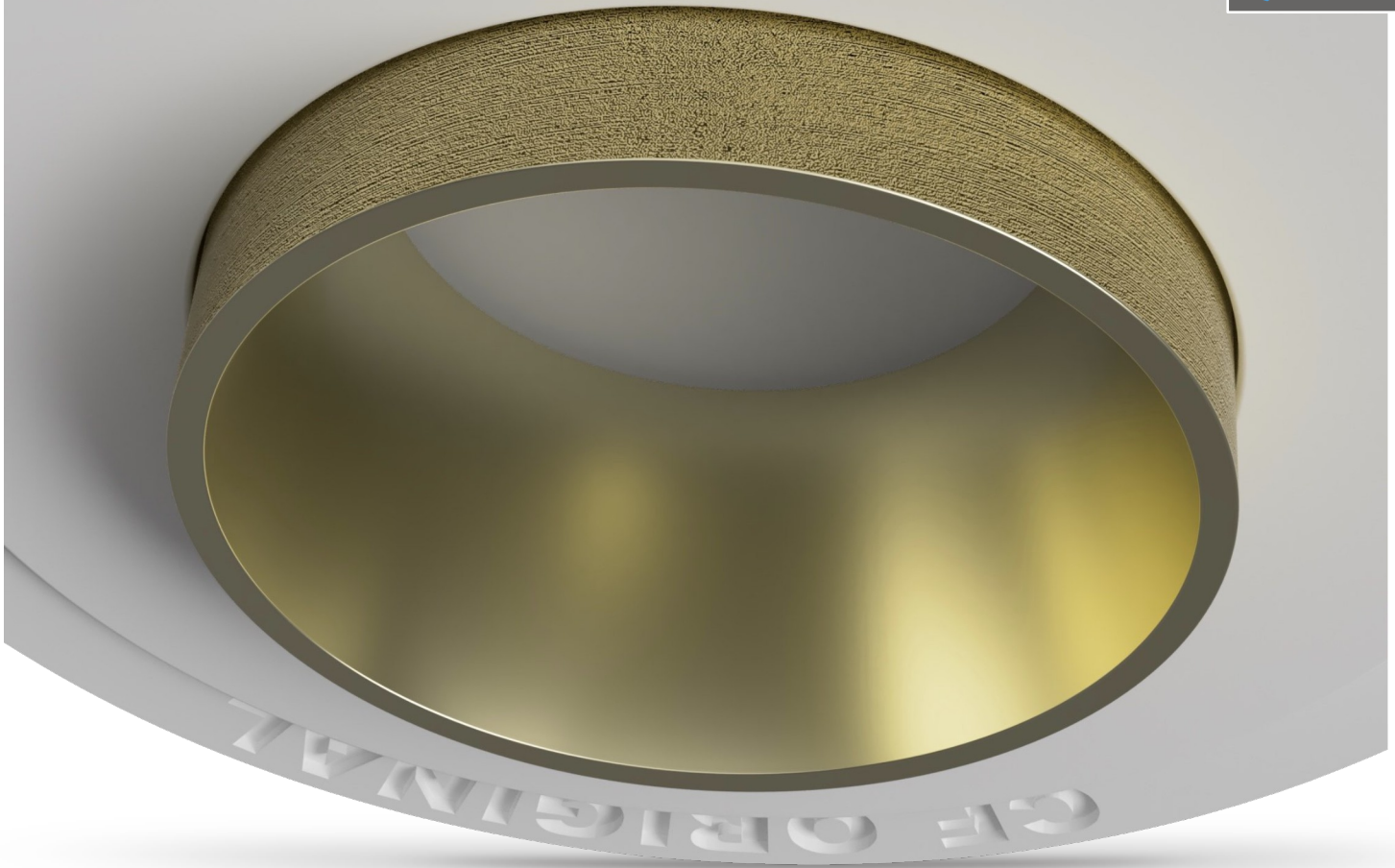

Porta lampada e molla di blocco inclusi - Lamp holder and lock spring included

Il faretto in gesso da incasso a scomparsa con ghiera in metallo è disponibile nelle finiture oro spazzolato, nero opaco e bianco opaco. La ghiera non solo aggiunge un tocco estetico, ma funge anche da blocco per la lampadina, garantendo una perfetta installazione.



Brion B
Bianco opaco



Brion G
Oro spazzolato



Brion N
Nero Opaco

Misure /measures

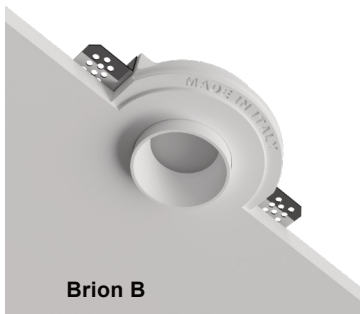
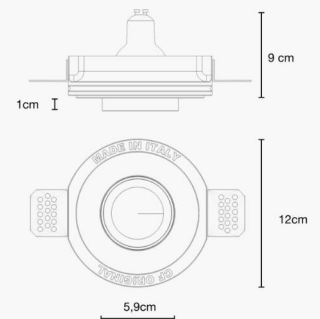

Brion B



Brion G



Brion N

1 x Gu10 max 35W



120 mm

1 x Gu10 max 35W



120 mm

1 x Gu10 max 35W



120 mm

Lampadine non incluse



IP20

Bianco opaco



Oro spazzolato



Nero Opaco

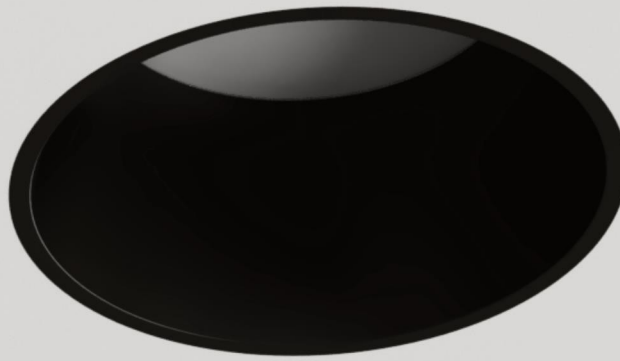

VENUS

GHIERA IN METALLO

ATTACCO GU10

Il faretto da incasso in gesso con ghiera filo soffitto è un'elegante soluzione di illuminazione per arricchire il tuo ambiente. La sua forma tonda dona un aspetto moderno e sofisticato, mentre la ghiera ad incasso, che si fonde con il soffitto, crea una finitura pulita e discreta. Disponibile in tre varianti di colore - bianco opaco, oro spazzolato e nero opaco. La ghiera ad incasso svolge anche una funzione pratica, fornendo una perfetta integrazione con il soffitto e garantendo un'installazione sicura e stabile

Misure /measures

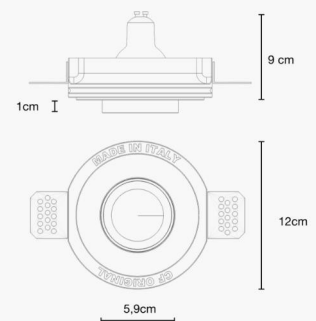

Portalamпада e molla di blocco inclusi - Lamp holder and lock spring included

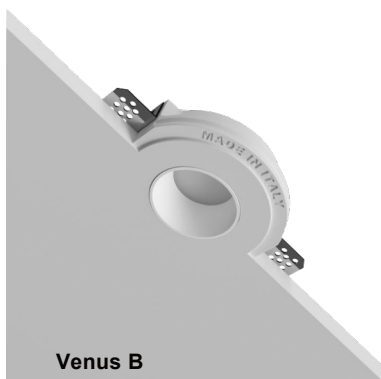

Venus B

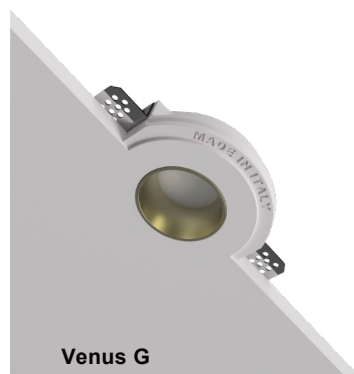

Venus G

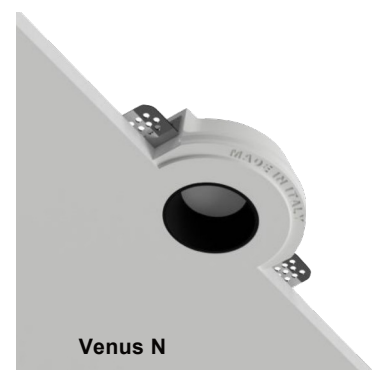

Venus N

1 x Gu10 max 35W



120 mm

1 x Gu10 max 35W



120 mm

1 x Gu10 max 35W



120 mm

Lampadine non incluse



ATTACCO GU10



Valley

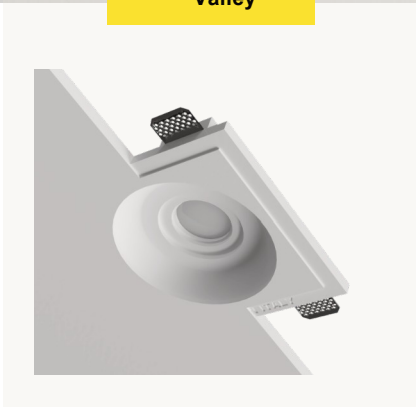

1 x Gu10 max 35W

Cod. 079

200 x 200 mm

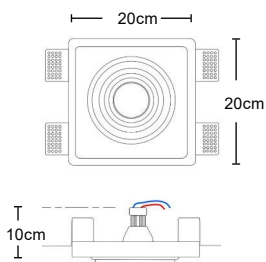

Stonehenge

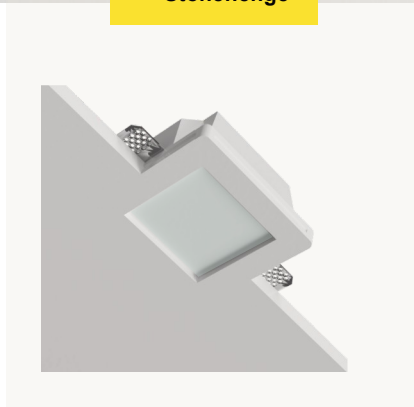

1 x Gu10 max 35W

Cod. 080

120 x 120 mm

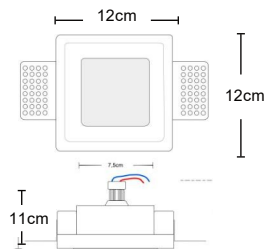

Deep

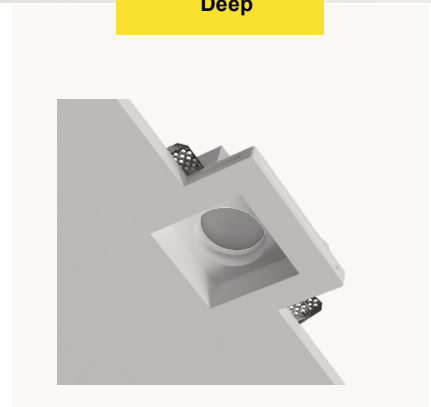

1 x Gu10 max 35W

Cod. 083

120 x 120 mm

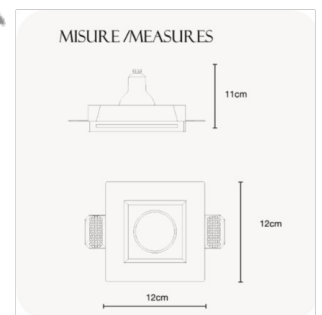

Portalamпада e molla di blocco inclusi - Lamp holder and lock spring included

Lampadine non incluse



ATTACCO GU10

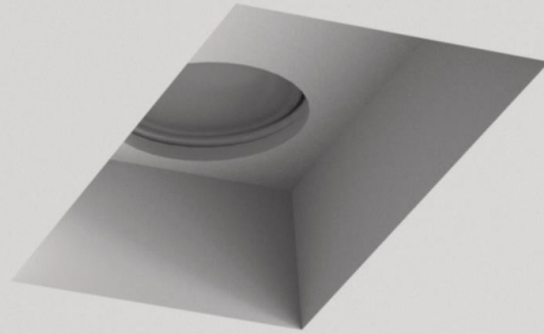
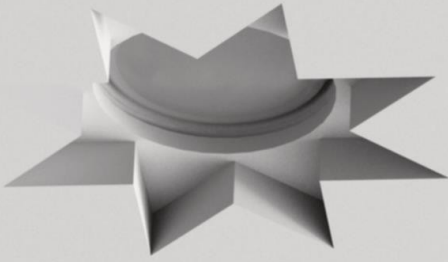

Portalamпада e molla di blocco inclusi - Lamp holder and lock spring included

Star

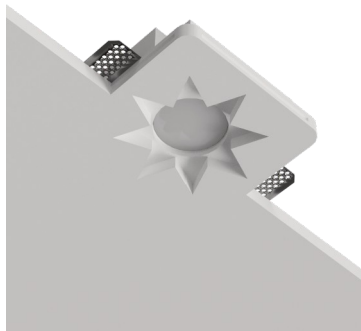

1 x Gu10 max 35W Cod. 088

170 x 170 mm

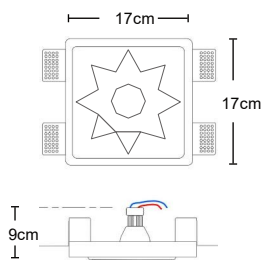

velletri



1 x Gu10 max 35W Cod. 090

150 x 150 mm

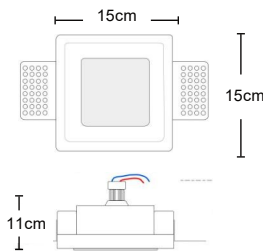

Big Hole

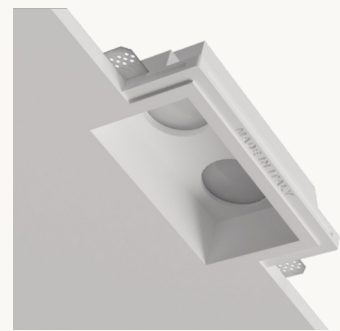

2 x Gu10 max 35W Cod. 096

200 x 200 mm

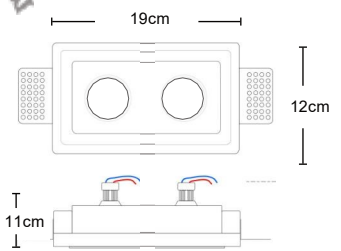

Lampadine non incluse



ATTACCO GU10

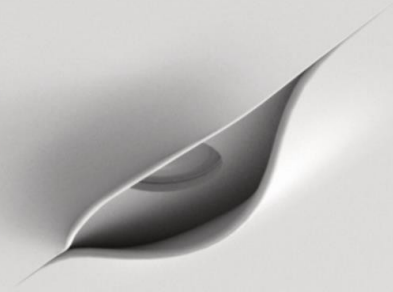

Lecco

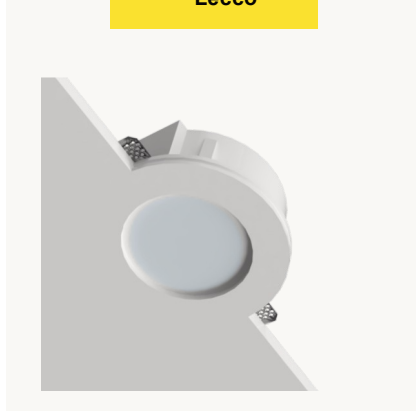

1 x Gu10 max 35W

Cod. 125

170 mm

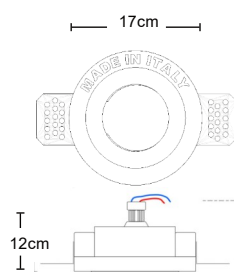

Istanbul

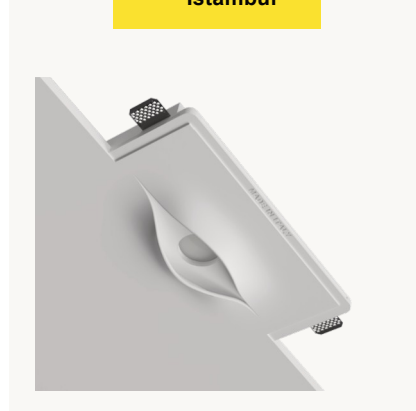

1 x Gu10 max 35W

Cod. 150

340 x 195 mm

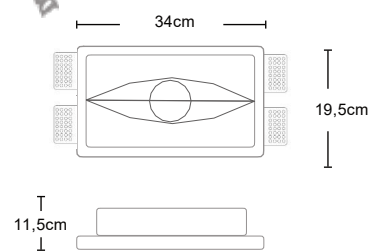

Porta lampada e molla di blocco inclusi - Lamp holder and lock spring included

Lampadine non incluse



ATTACCO GU10

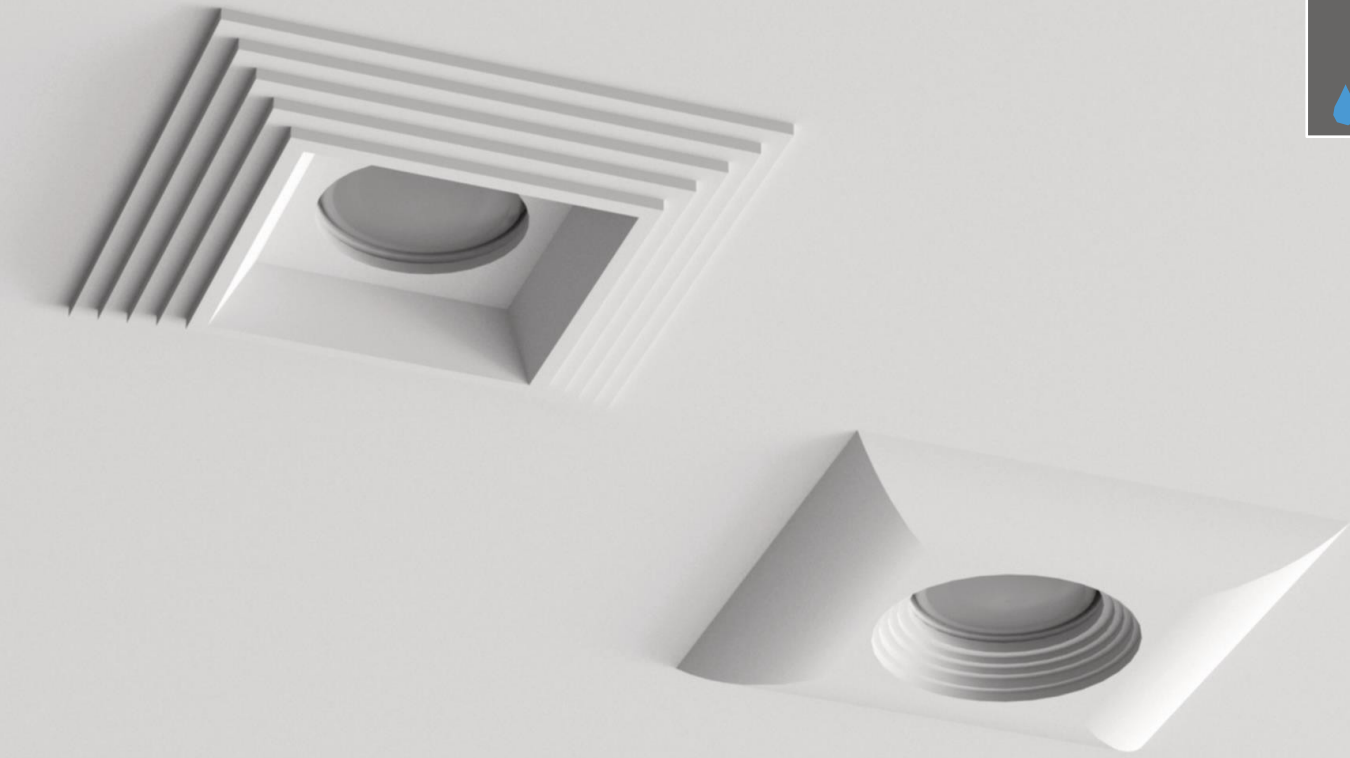

Brindisi



1 x Gu10 max 35W Cod. 210

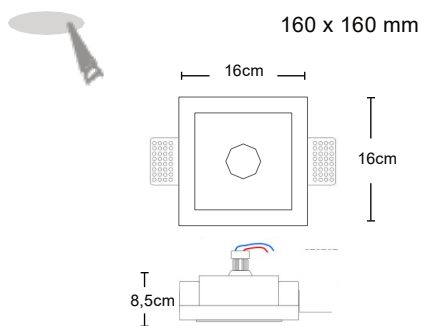

Olbia

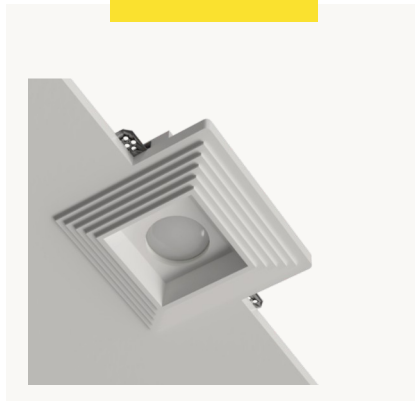

1 x Gu10 max 35W Cod. 220

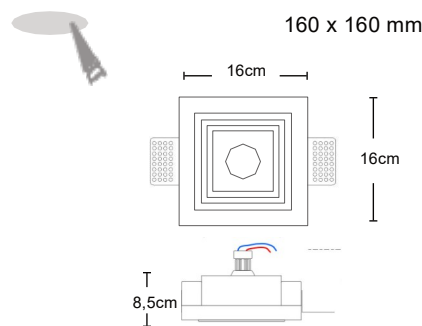

Paris



1 x Gu10 max 35W Cod. 387

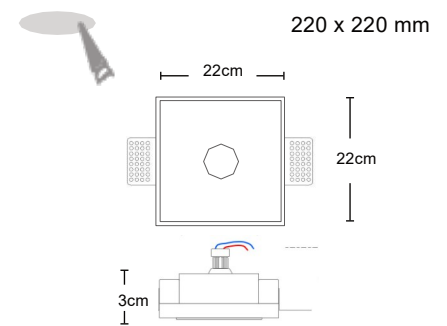

Portalamпада e molla di blocco inclusi - Lamp holder and lock spring included

Lampadine non incluse

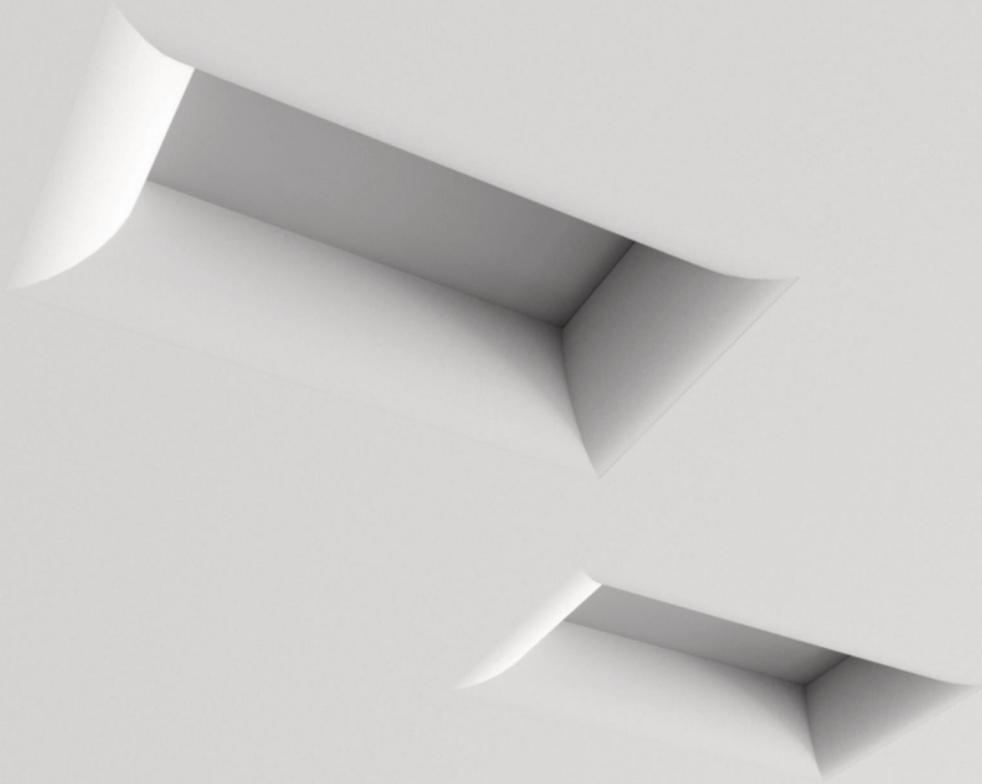

Incanto

Incanto D

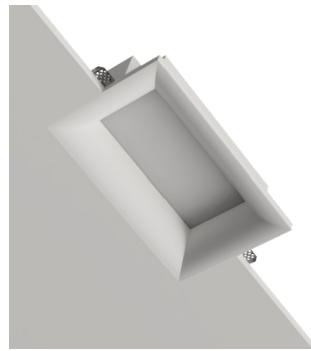

1 x Gu10 max 35W

Cod. 120

2 x Gu10 max 35W

Cod. 230

170 x 170 mm

270 x 180 mm

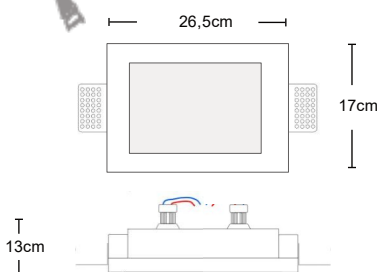
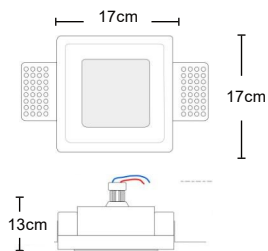

Portalamпада e molla di blocco inclusi - Lamp holder and lock spring included

Lampadine non incluse

Pendente in gesso fissaggio a soffitto
Tramite cavo elettrico. Prodotto verniciabile

ATTACCO GU10 PER LAMPADE MR11 MINI GU10

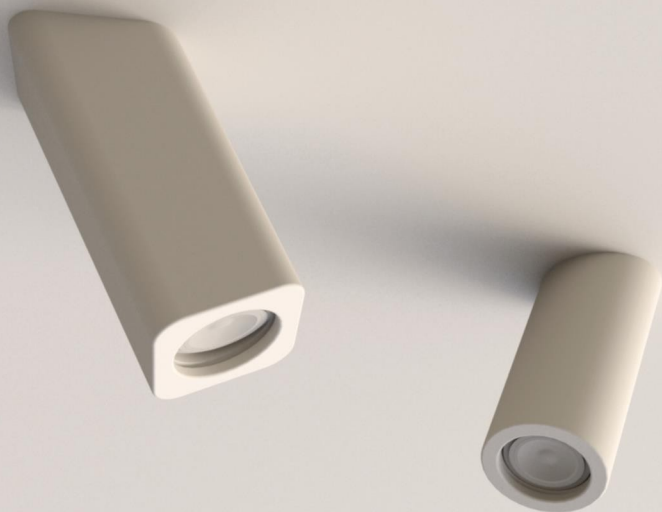

Porta faretto ad incasso con struttura inclinata di 15°
Lampadina adatta MR11 con attacco Mini Gu10

Foro 10cm

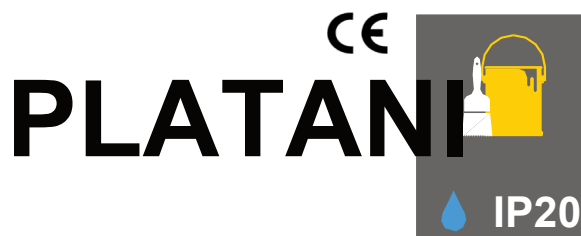

Platani-QS

Cod. CS10

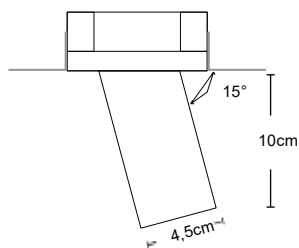

Platani TS

Cod. TS10

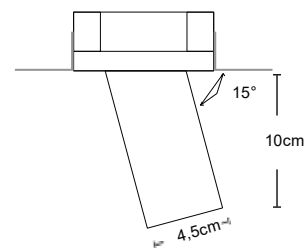

ATTACCO GU10 PER LAMPADE MR11 MINI GU10

Platani C

Cod. CD10

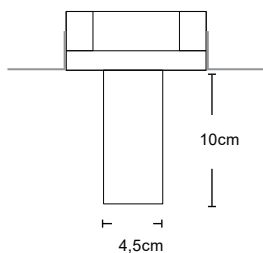

Platani D

Cod. TD10

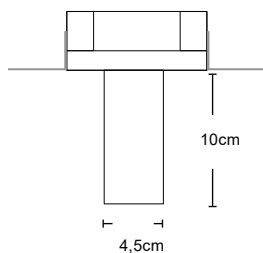

Portalampada e molla di blocco inclusi - Lamp holder and lock spring included

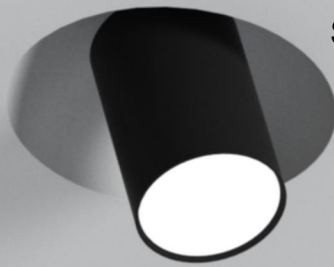

SUNRISE-N

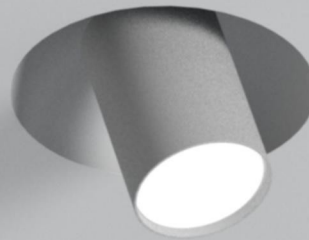

SUNRISE-B



SUNRISE-O

Portalamпада e molla di blocco inclusi - Lamp holder and lock spring included

Il faretto Sunrise è un'opzione versatile per l'illuminazione che combina eleganza e funzionalità. Questo faretto è composto da due parti: la prima parte è realizzata in gesso di alta qualità e va installata ad incasso completamente a scomparsa, creando un effetto pulito e discreto sul soffitto. All'interno della parte in gesso, è presente una cupola con un foro centrale, che offre la possibilità di inserire uno spot in metallo orientabile. Lo spot è disponibile in tre affascinanti colorazioni: nero opaco, bianco opaco e oro spazzolato. Questa scelta di colori permette di personalizzare l'aspetto del faretto per adattarlo al tuo stile e all'atmosfera desiderata.



BIANCO OPACO

ORO SPAZZOLATO

NERO OPACO

Foro 16,8x16,8cm

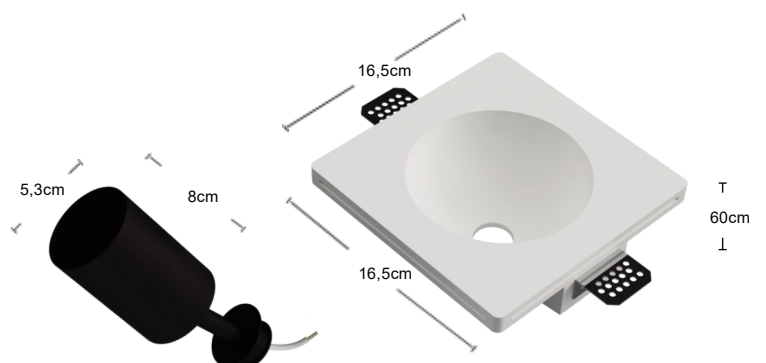

ATTACCO GU10

HYBRID

CE



prodotto ibrido, un perfetto connubio tra un faretto e un plafone: il Faretto/Plafone Hybrid. Questo innovativo dispositivo di illuminazione offre una soluzione versatile e dal design elegante per i tuoi ambienti. Il Faretto/Plafone Hybrid si adatta perfettamente alle controsoffittature, grazie al suo sistema di montaggio tramite foro e molle di blocco. Questo consente un'installazione facile e sicura, mantenendo il faretto saldamente fissato nel controsoffitto.

ATTACCO GU10

Portalamпада e molla di blocco inclusi - Lamp holder and lock spring included

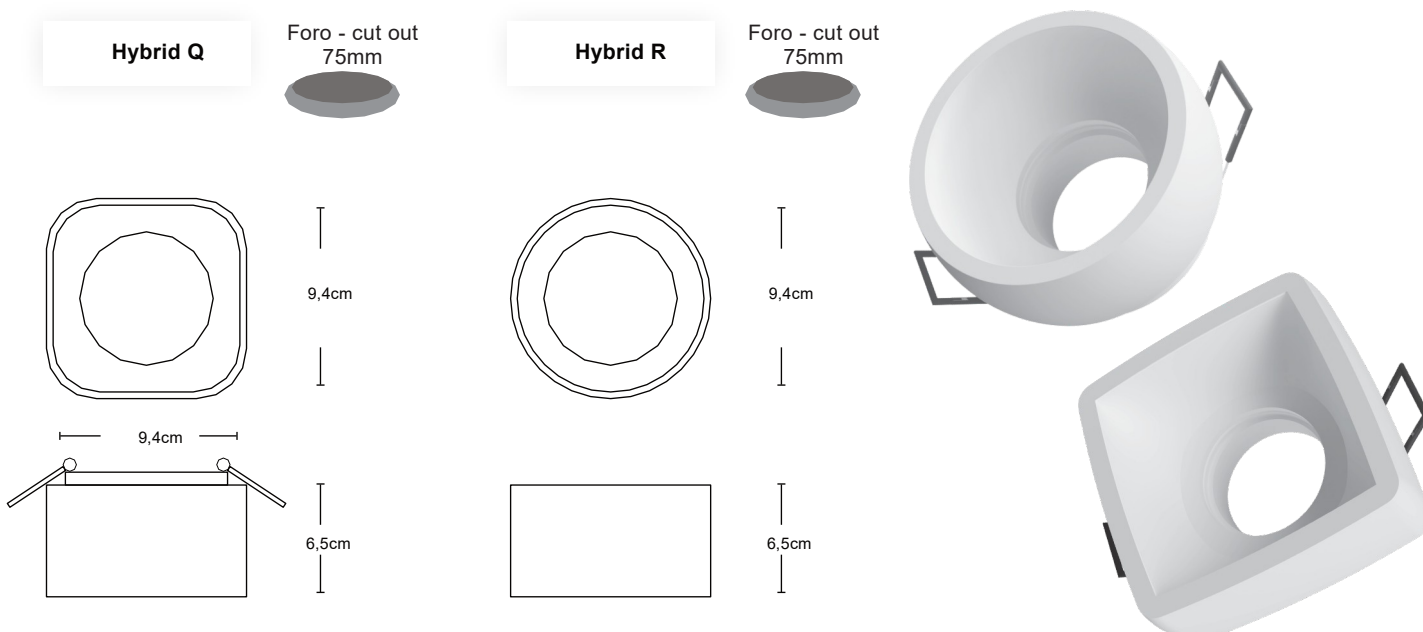

Lampadine non incluse

ATTACCO GU10

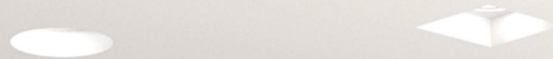

EYES

Faretto orientabile

La coppia di faretti EYES comprende un faretto tondo e uno squadrato, entrambi caratterizzati da un incavo verso l'interno che aggiunge un tocco di modernità e stile al tuo spazio. La loro forma distintiva li rende perfetti per essere utilizzati come punti focali nell'illuminazione, creando effetti luminosi unici e accattivanti. Entrambi i faretti EYES sono dotati di un alloggiamento orientabile, che ti consente di regolare l'angolazione della luce in base alle tue esigenze specifiche. Questo ti offre il controllo completo sull'illuminazione, consentendoti di dirigere i fasci luminosi verso aree specifiche o oggetti che desideri mettere in risalto.

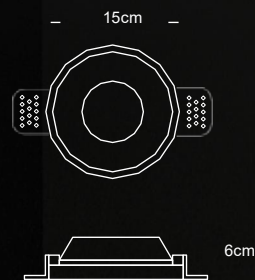

EYES-R

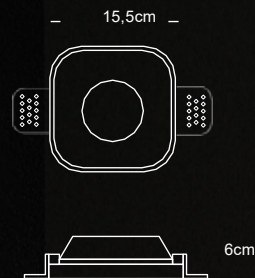
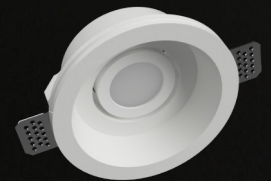

EYES-Q

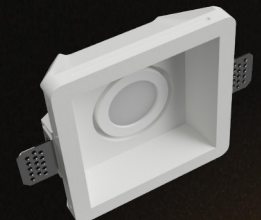

Porta lampada e molla di bloccaggio inclusi - Lamp holder and lock spring included

Lampadine non incluse



ATTACCO GX53

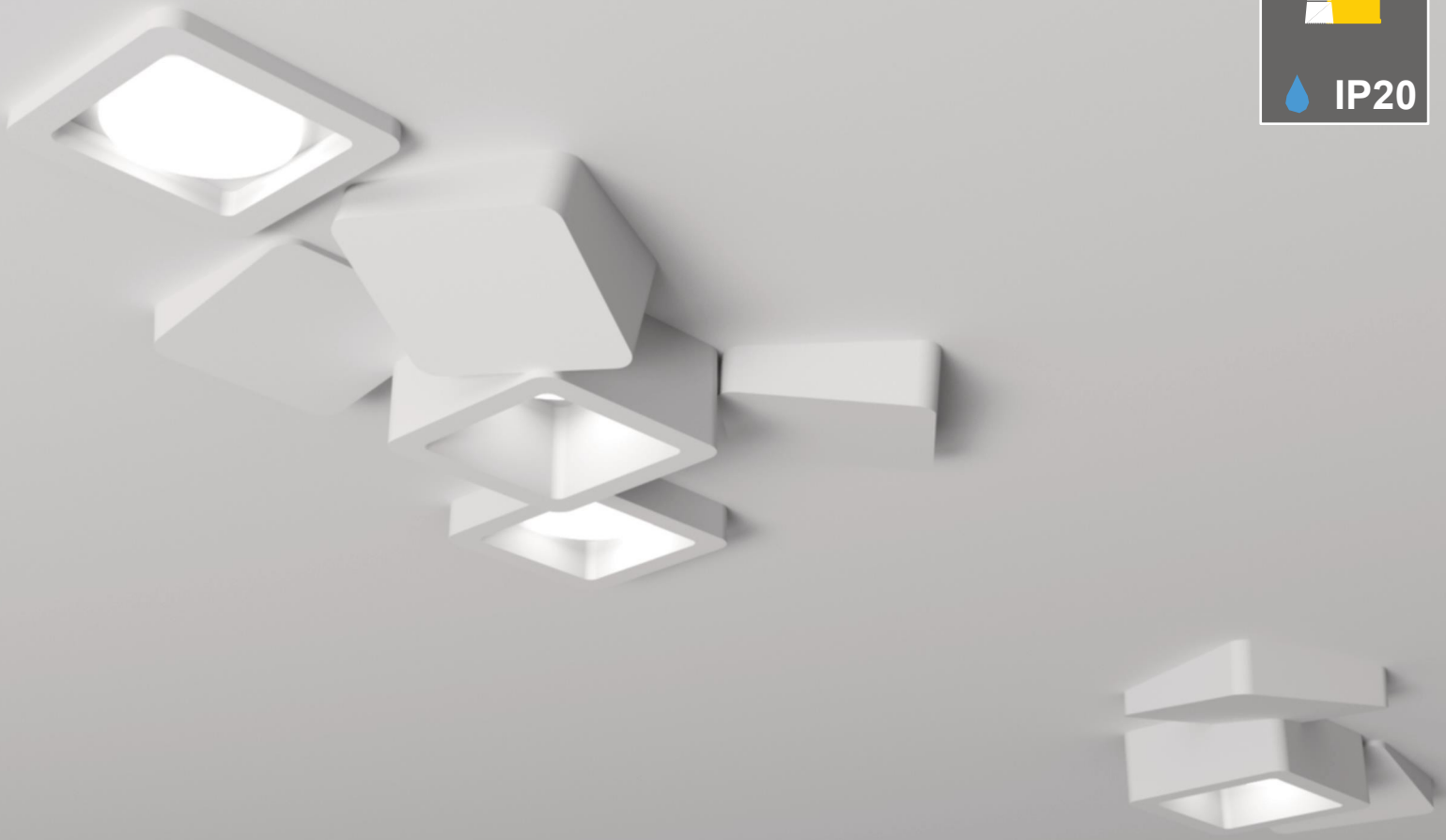

Portalamпада e molla di blocco inclusi - Lamp holder and lock spring included

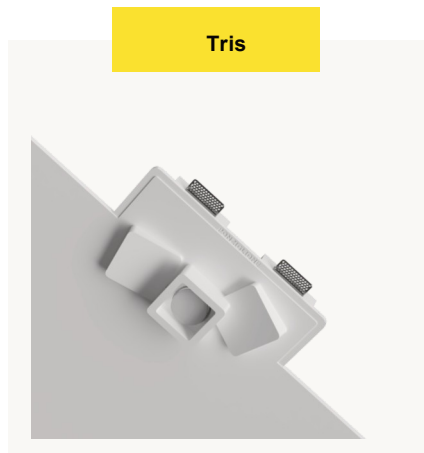

Tris

1 x Gx53 max 35W

Codice FP25

460 x 300 mm

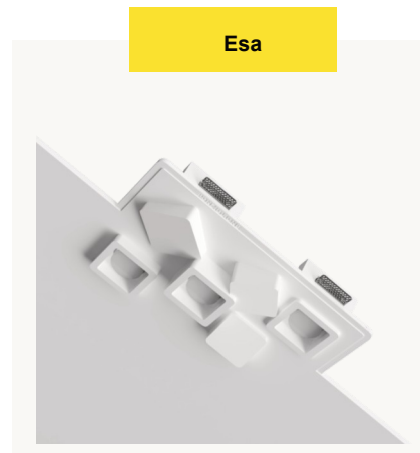
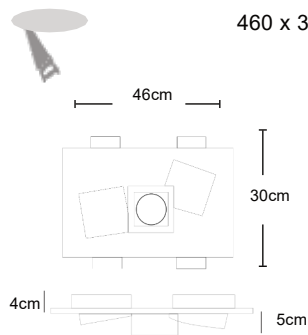

Esa

3 x Gx53 max 35W

Codice FP26

550 x 400 mm

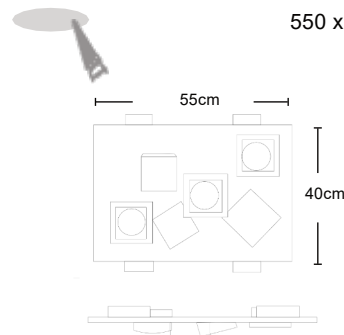



ATTACCO GX53



Portalamпада e molla di blocco inclusi - Lamp holder and lock spring included



Nasa

1 x Gx53 max 35W

Codice FP27

130 mm

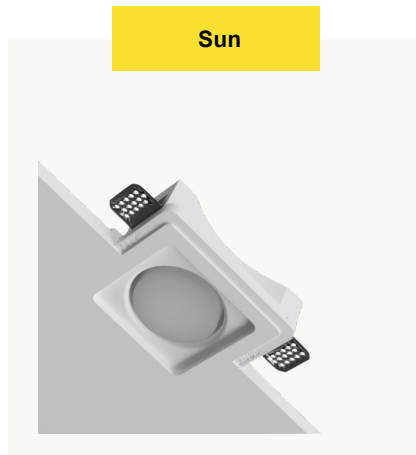
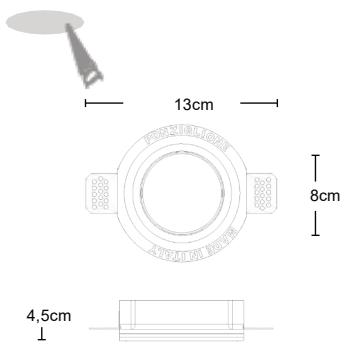

Sun

1 x Gx53 max 35W

Codice FP28

150 x 150 mm

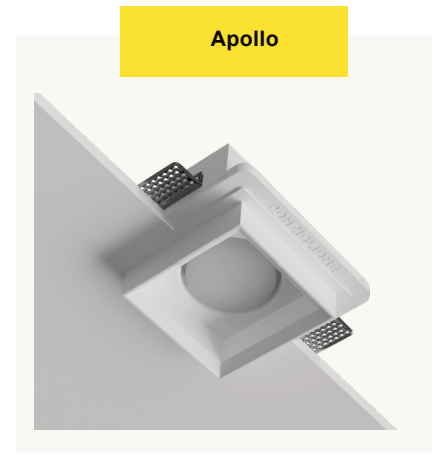
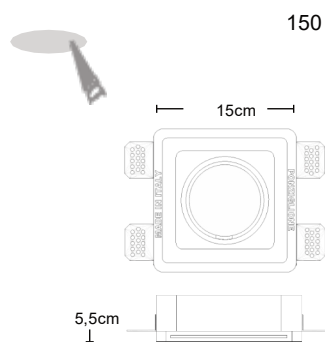

Apollo

1 x Gx53 max 35W

Codice FP29

150 x 150 mm

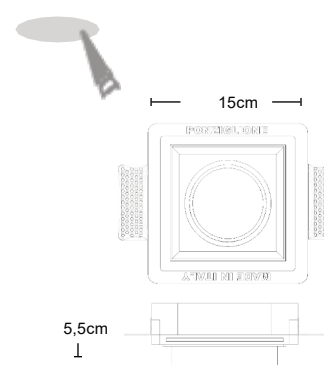

Lampadine non incluse



ATTACCO GX53



Crown

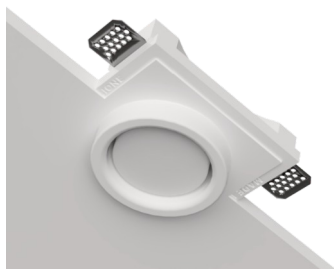

1 x Gx53 max 35W **Codice FP30**

150 x 150 mm

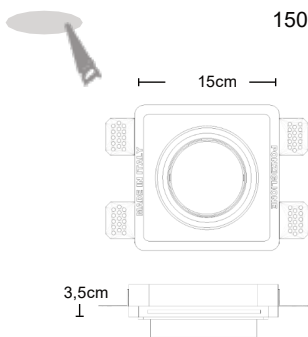

Cinta

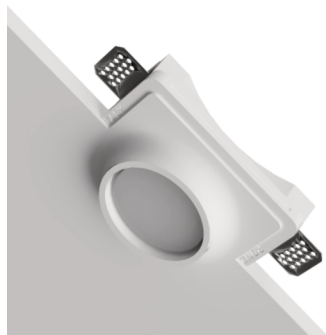

1 x Gx53 max 35W **Codice FP31**

150 x 150 mm

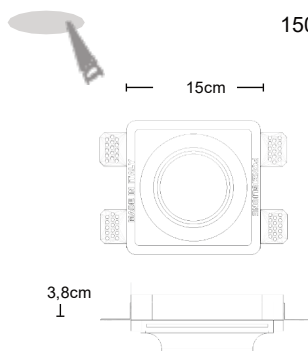

Level



1 x Gx53 max 35W **Codice FP41**

130 mm

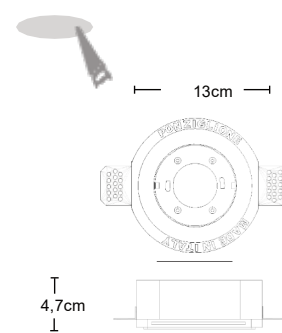

Portalamпада e molla di blocco inclusi - Lamp holder and lock spring included

Lampadine non incluse



ATTACCO GX53



Well

Pond

Soft

Portalamпада e molla di blocco inclusi - Lamp holder and lock spring included

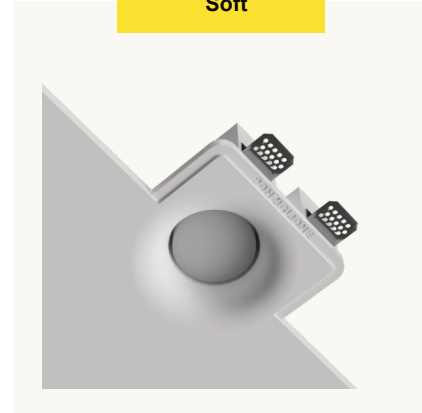
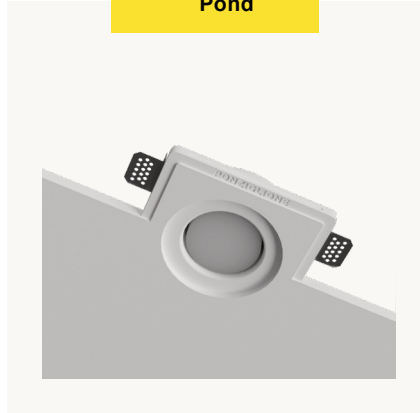

1 x Gx53 max 35W **Codice FP36**

1 x Gx53 max 35W **Codice FP37**

1 x Gx53 max 35W **Codice FP38**

150 x 150 mm

170 x 170 mm

170 x 170 mm

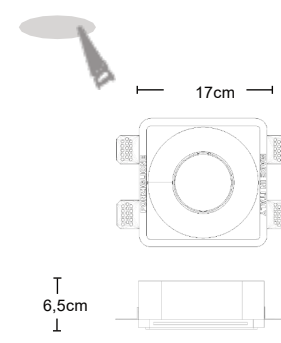
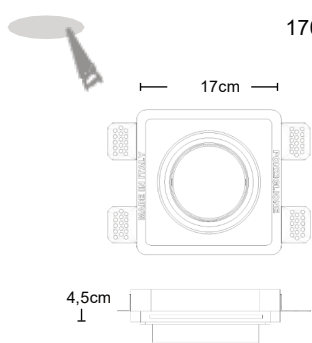
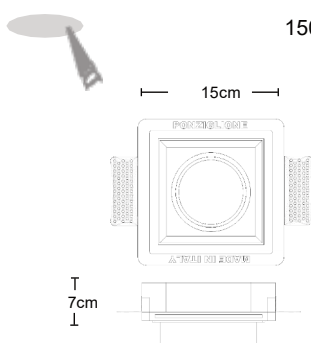

Lampadine non incluse



ATTACCO GX53



Gravity

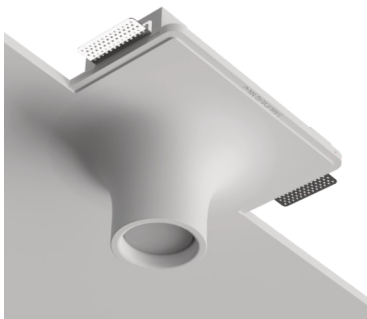

1 x Gx53 max 35W

Codice FP39

300 x 300 mm

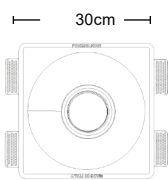

12,7cm



Cinetic

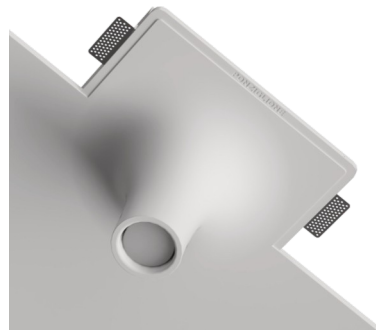

1 x Gx53 max 35W

Codice FP40

170 x 170 mm

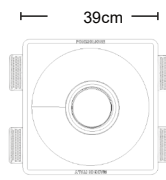

23cm

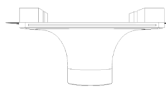

Portalamпада e molla di blocco inclusi - Lamp holder and lock spring included

Lampadine non incluse



ATTACCO GX53

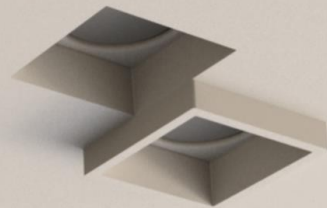
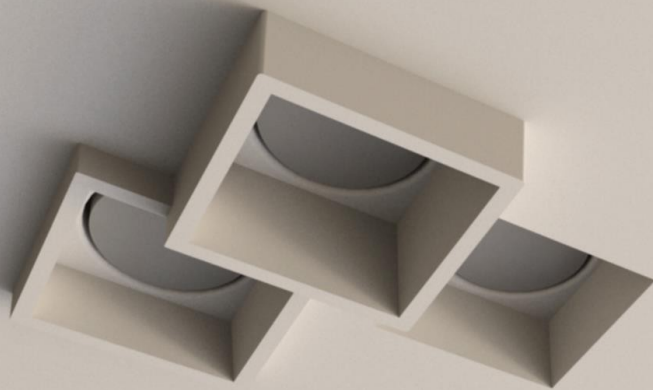

Cubo 2

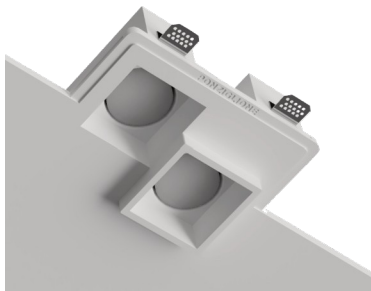

2 x Gx53 max 35W

Codice FP42

280 x 220 mm

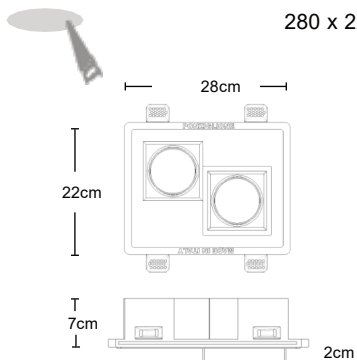

Cubo 3

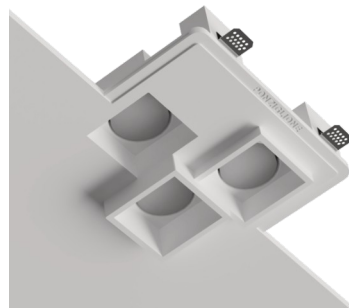

3 x Gx53 max 35W

Codice FP43

170 x 170 mm

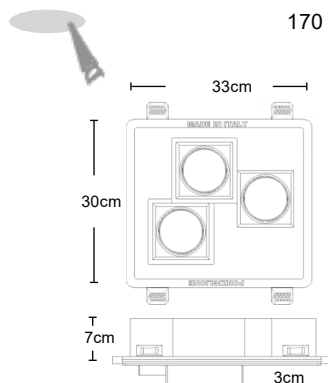

Portalamпада e molla di blocco inclusi - Lamp holder and lock spring included

Lampadine non incluse



UFFIZI



Bianco verniciabile



Oro spazzolato



Nero Opaco



Il faretto da incasso in gesso con copertura in acrilico e riquadratura in alluminio offre un'elegante soluzione per l'illuminazione focalizzata. Disponibile in tre varianti di design, puoi scegliere tra la sofisticata riquadratura in alluminio color oro spazzolato, l'aspetto moderno del nero opaco o l'eleganza minimalista del total white con il gesso a vista.

Uffizi B

Uffizi N

Uffizi G

ATTACCO GX53

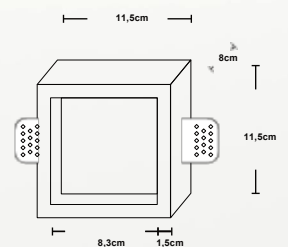
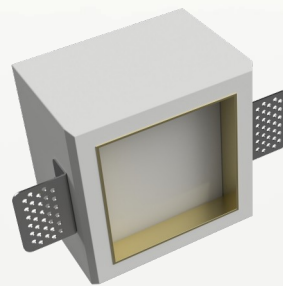
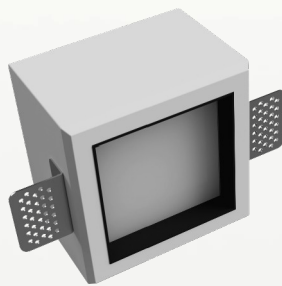
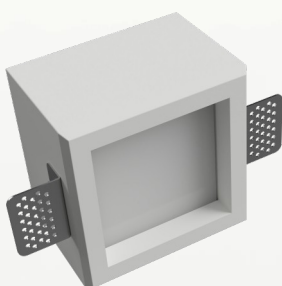

Portalampana e molla di blocco inclusi - Lamp holder and lock spring included

Lampadine non incluse



IP20

RING

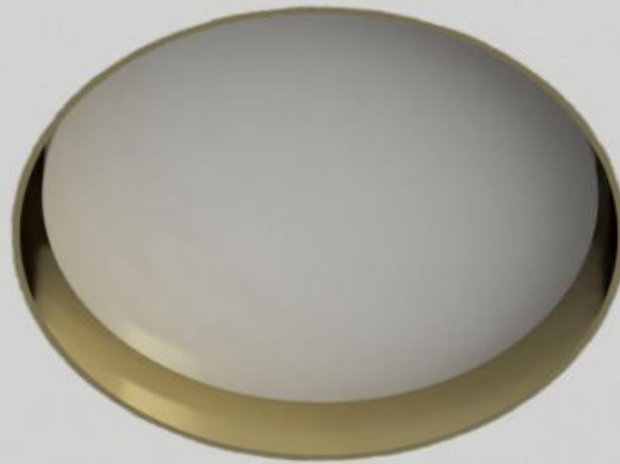

Oro spazzolato



Nero Opaco



ATTACCO GX53

1 x Gx53 max 35W



130 mm

GHIERA IN METALLO

Portalamпада e molla di blocco inclusi - Lamp holder and lock spring included

Il faretto da incasso in gesso con riquadratura in alluminio offre un'elegante soluzione per l'illuminazione focalizzata. La sua forma tonda dona un aspetto moderno e raffinato all'ambiente. Puoi scegliere tra due varianti di design, la riquadratura in alluminio color oro spazzolato o nero opaco, entrambe aggiungono un tocco di stile e definiscono il design complessivo del faretto. Dotato di un portalamпада interno con attacco GX53, che consente di utilizzare lampadine a LED ad alta efficienza energetica e una vasta scelta di tonalità di luce. La lampadina LED GX53 a vista crea un effetto moderno ed elegante, rendendo la sorgente luminosa un elemento decorativo in sé.

Ring G



Ring N

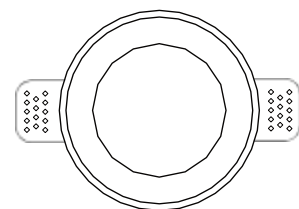

9,4cm



6,5cm

Porta faretto in gesso da incasso / Recessed plaster spotlight holder

CE



Porta lampada e molla di blocco inclusi - Lamp holder and lock spring included



Lampadine non incluse



ATTACCO E27

Porta faretto in gesso da incasso

Alette di fissaggio in alluminio spesse

Codice FP44

Cupolone

1 x E27 max 35W

400 x 400 mm

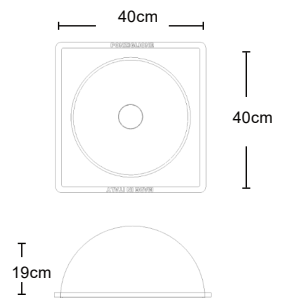

6

SEGNARE PASSI

Leonardo

Codice 035

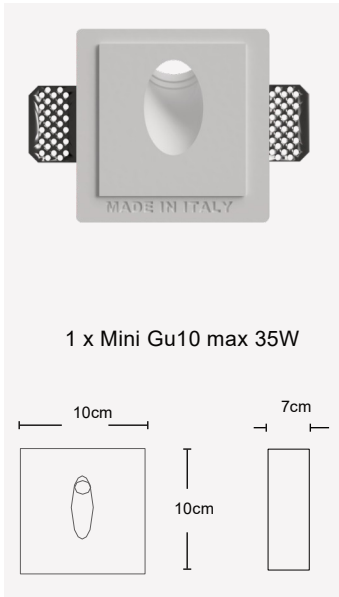

Michelangelo

Codice 036

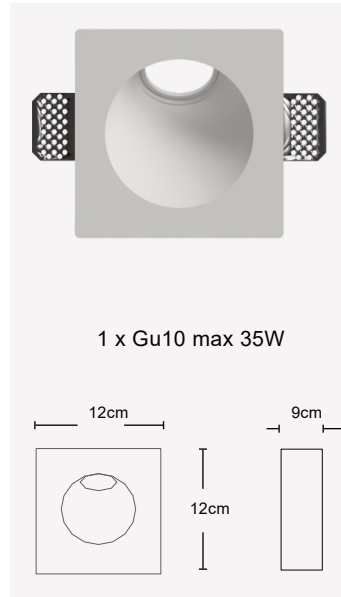

Bernini

Codice 070

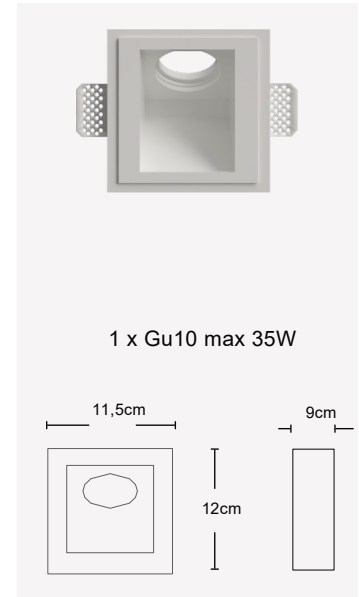

Rodin

Codice 037

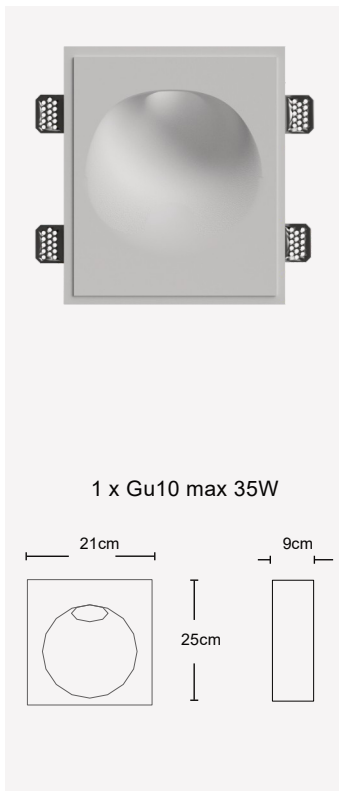

Verrocchio

Codice 370

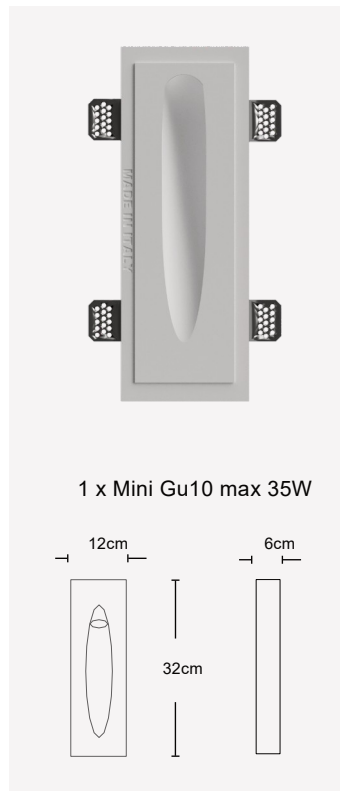

Jago

Codice 371

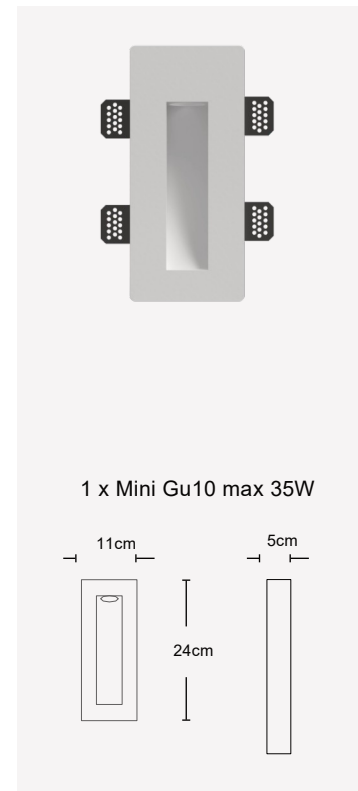

Portafaretti in gesso predisposte per lampadine led con attacco GU10

Le lampadine denominate Mini gu10 si riferiscono al modello Mr11 con attacco gu10 dimensione 35mm

Le lampadine denominte Gu10 (fanno riferimento alle classiche Gu10) sono le Mr16 con attacco Gu10

Chip led sostituibile. o

Supporti da incasso a parete

Alette laterali per il fissaggio in

equipaggiati con led di elevata qualità.

disponibile la cassa in lamiera per l'installazione in pareti di compatte



Raffaello

Codice SP2

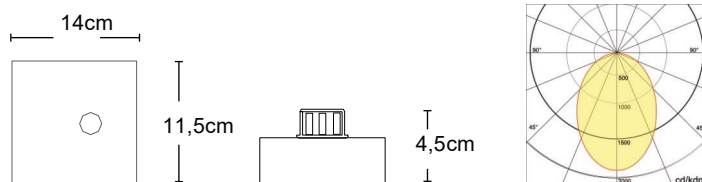

Codice/Code	Tipo di led/Led type	Potenza/Power	Voltaggio in ingresso/Input voltage	Flusso luminoso/LED flux	CCT	CRI
SP2-3C	COB Bridgelux	1x3W	350mA	400	3000k	90
SP2-3N	COB Bridgelux	1x3W	350mA	400	4000k	90



Perugino

Codice SP5

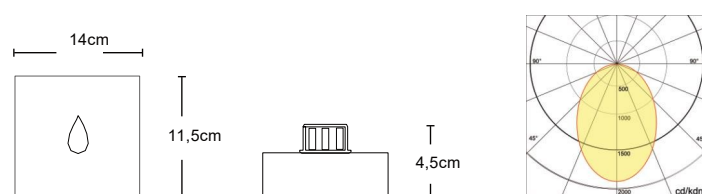

Codice/Code	Tipo di led/Led type	Potenza/Power	Voltaggio in ingresso/Input voltage	Flusso luminoso/LED flux	CCT	CRI
SP3-5C	COB Bridgelux	1x3W	350mA	400	3000k	90
SP3-5N	COB Bridgelux	1x3W	350mA	400	4000k	90



Canova

Codice SP4

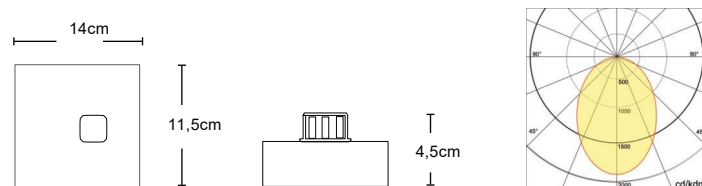

Codice/Code	Tipo di led/Led type	Potenza/Power	Voltaggio in ingresso/Input voltage	Flusso luminoso/LED flux	CCT	CRI
SP4-3C	COB Bridgelux	1x3W	350mA	400	3000k	90
SP4-3N	COB Bridgelux	1x3W	350mA	400	4000k	90

Punto luce in gesso ceramico
Light point in ceramic plaster



ATTACCO GU10 per lampade MR11 mini Gu10

Donatello

Codice SP6

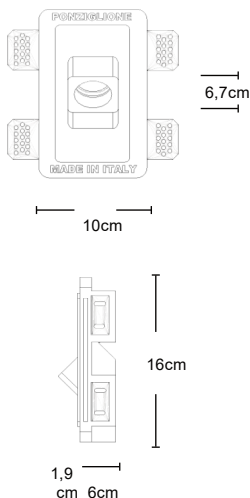
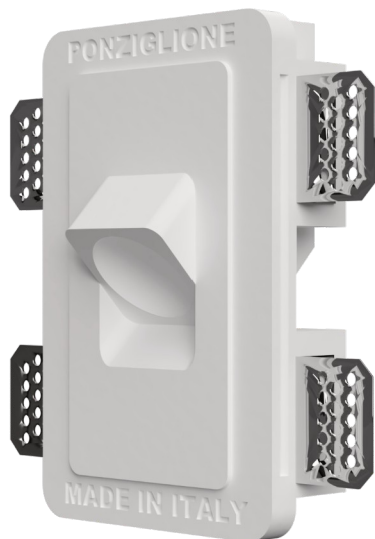

ATTACCO GU10 per lampade MR11 mini Gu10

Bramante

Codice SP7

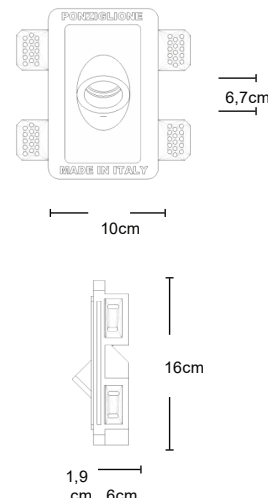
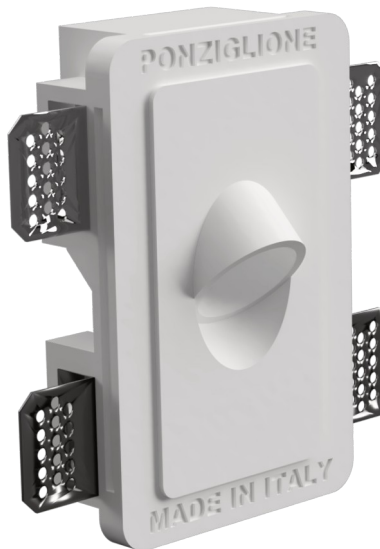

IT

Prodotto venduto privo d'illuminazione, adatto all'utilizzo di lampadine led MR11. Lampadine disponibili a pag.

EN

Product sold without lighting, suitable for use with MR11 LED bulbs. Light bulbs available on page.

Tiziano

Codice SP8

Prodotto venduto privo di parti elettriche e illuminazione
Product sold without electrical parts and lighting

ATTACCO G9 per lampade

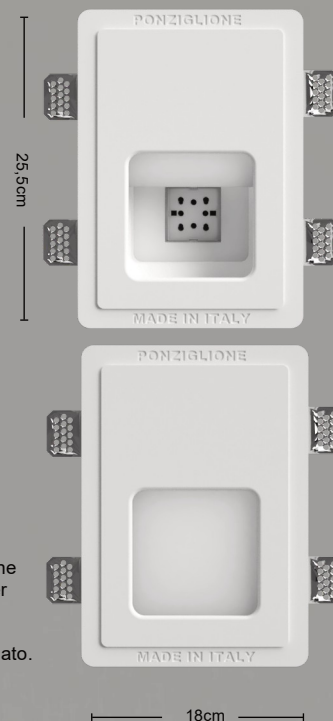

IT

Segna passi da incasso con predisposizione per lampadine led g9 e cassetta 2 posti per l'alloggio di prese, interruttori, comandi o bocchette dell'aspirapolvere. Sistema di chiusura in acrilico bianco satinato. Lampada G9 non inclusa



Chip led sostituibile. Attacco magnetico  

Caravaggio

Codice SP9

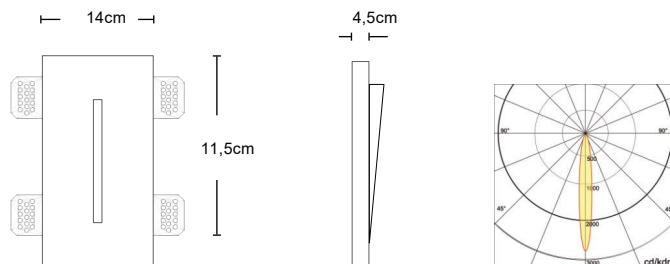

Codice/Code	Tipo di led/Led type	Potenza/Power	Voltaggio in ingresso/Input voltage	Flusso luminoso/LED flux	CCT	CRI
SP10-3C	COB EA led	1x1,3W	350mA	139	3000k	90
SP10-3N	COB EA led	1x1,3W	350mA	139	4000k	90
SP10-3C5	COB EA led	1x1,8W	500mA	190	3000k	90
SP10-3N5	COB EA led	1x1,8W	500mA	190	4000k	90

Botticelli

Codice SP10

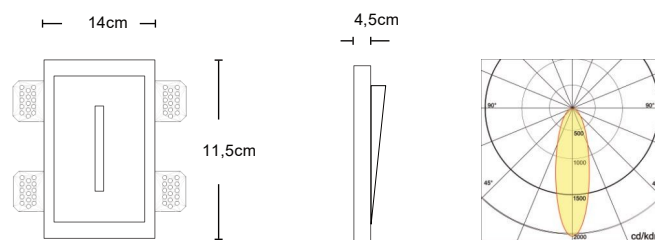

Codice/Code	Tipo di led/Led type	Potenza/Power	Voltaggio in ingresso/Input voltage	Flusso luminoso/LED flux	CCT	CRI
SP9-3C	COB EA led	1x1,3W	350mA	139	3000k	90
SP9-3N	COB EA led	1x1,3W	350mA	139	4000k	90
SP9-3C5	COB EA led	1x1,8W	500mA	190	3000k	90
SP9-3N5	COB EA led	1x1,8W	500mA	190	4000k	90

Giotto

Codice SP11

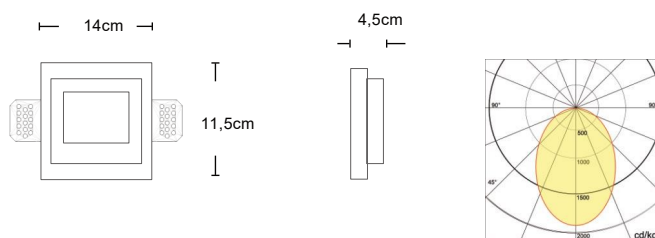

Codice/Code	Tipo di led/Led type	Potenza/Power	Voltaggio in ingresso/Input voltage	Flusso luminoso/LED flux	CCT	CRI
SP11-36C	COB EA led	1x3,6W	12V	661	3000k	90
SP11-36N	COB EA led	1x3,6W	12V	718	4000k	90

I segnapassi da incasso in gesso ceramico mateCOMP rappresentano la soluzione ideale per un'illuminazione senza alimentazione elettrica. Realizzati con il nostro esclusivo materiale gesso ceramico mateCOMP, questi segnapassi offrono una combinazione unica di durata e resistenza. Grazie al loro design senza alimentazione, sono estremamente versatili e possono essere posizionati in qualsiasi punto desiderato, senza la necessità di collegamenti elettrici. Sfruttando la luce naturale o l'illuminazione ambientale, i segnapassi in gesso ceramico mateCOMP diffondono una luce morbida e accogliente lungo i percorsi, creando un'atmosfera calda e invitante. Scegli i segnapassi in gesso ceramico mateCOMP per un'illuminazione senza complicazioni e di alta qualità.

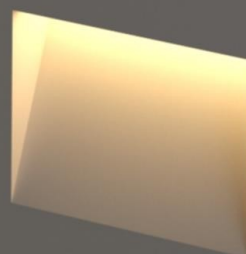



SOSPENSIONI

Pendente in gesso fissaggio a soffitto
Tramite cavo elettrico. Prodotto verniciabile

ATTACCO Gu10

CE



CHAMALEON



ORIENTABILE

Supporto in ORO SPAZZOLATO

La sospensione Chamaleon è un'illuminazione unica e sorprendente, che unisce l'eleganza del gesso alla robustezza del metallo. Il suo design si ispira all'occhio di un camaleonte, con una sfera centrale che funge da attacco per lampadine Gu10. La sospensione presenta una combinazione di materiali affascinante: la parte esterna è realizzata in metallo color oro spazzolato, che avvolge e sostiene l'occhio centrale. Questo supporto metallico conferisce alla lampada un aspetto sofisticato e una solida struttura.

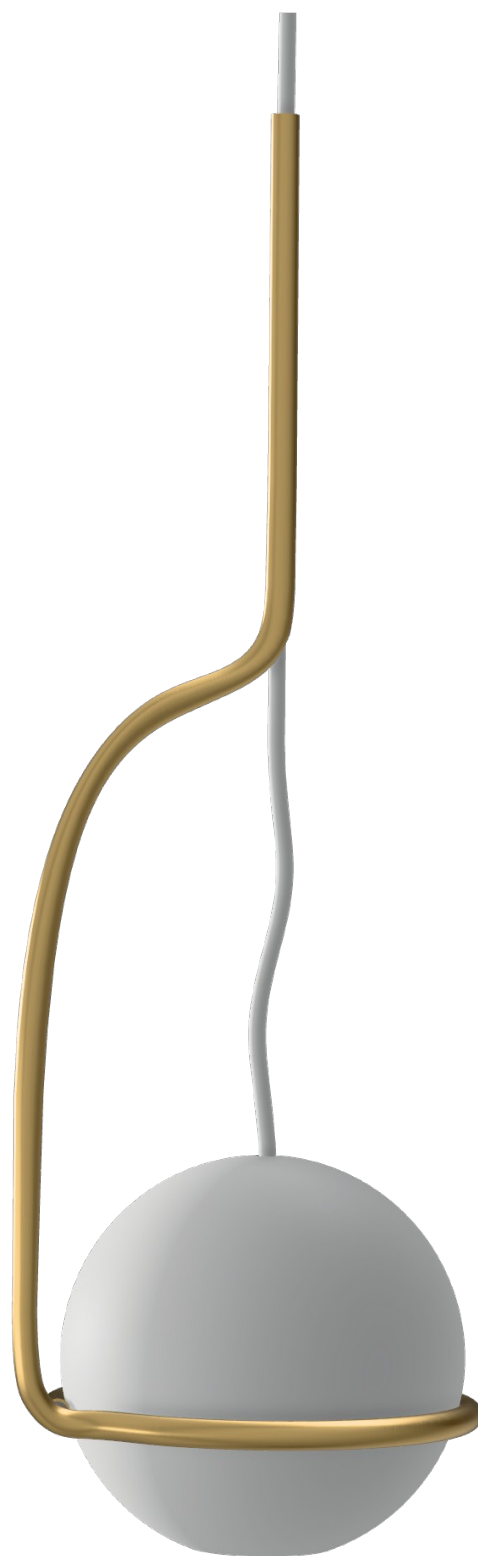
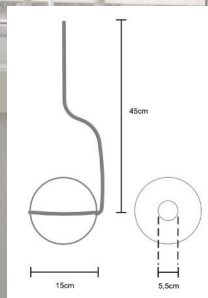
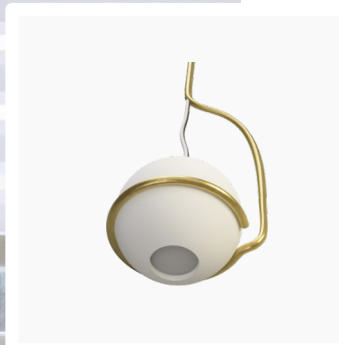

Pendente in gesso fissaggio a soffitto
Tramite cavo elettrico. Prodotto verniciabile

CE

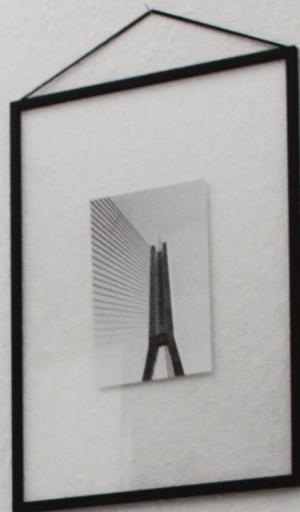

ATTACCO Gu10

PIRAMIDE

La caratteristica principale della sospensione Piramide è la sua forma unica, con la parte bassa e alta sfalsate rispetto alla geometria tradizionale. Questa sfalsatura crea un interessante effetto visivo e aggiunge dinamicità al design complessivo della lampada.

La sospensione è dotata di un attacco Gu10, che permette di utilizzare lampadine a LED con questa tipologia di attacco, offrendo un'illuminazione brillante ed efficiente dal punto di vista energetico. Il cavo trasparente che sostiene la lampada conferisce un aspetto leggero e sospeso, creando un'atmosfera eterea nell'ambiente circostante.

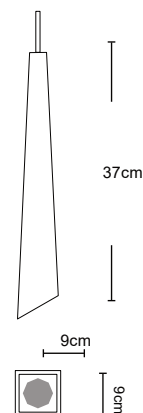

Lampadine non incluse

Portalampada e molla di blocco inclusi - Lamp holder and lock spring included

Pendente in gesso fissaggio a soffitto
Tramite cavo elettrico. Prodotto verniciabile



CE



ATTACCO Gu10

FUJI

La sospensione Fuji è un'opera d'arte illuminante che combina l'eleganza del gesso ceramico con un design unico ed accattivante. La sua forma a imbuto, con la parte inferiore sfalsata, conferisce a questa sospensione un aspetto distintivo e dinamico.

Realizzata con cura artigianale, la sospensione Fuji offre un attacco centrale per lampadine Gu10, consentendo di scegliere tra diverse opzioni di illuminazione. A seconda dell'orientamento della parte sfalsata, si possono creare effetti luminosi e sfumature differenti, rendendo la Fuji una scelta versatile per l'illuminazione di ambienti domestici o commerciali.

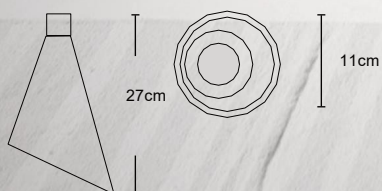

Lampadine non incluse

  IP20 
Portalamпада e molla di blocco inclusi - Lamp holder and lock spring included

Pendente in gesso fissaggio a soffitto
Tramite cavo elettrico. Prodotto verniciabile

CE



Stele e Obelisco sono due eleganti pendenti con attacco Gu10, disponibili in due forme: cubica e cilindrica. Realizzati con materiali di alta qualità, offrono un design semplice ed essenziale. La finitura liscia e duratura conferisce loro un aspetto sofisticato. Grazie alla versatilità dell'attacco Gu10, è possibile scegliere tra diverse lampadine per creare l'atmosfera desiderata. Stele e Obelisco sono soluzioni di illuminazione ideali per saloni, uffici e spazi commerciali, aggiungendo un tocco di eleganza e stile contemporaneo. Con il loro design senza tempo, sono perfetti per coloro che cercano una soluzione raffinata e moderna.



18cm

ATTACCO Gu10



7cm

Stele

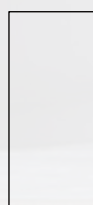

18cm

ATTACCO Gu10

7cm

Obelisco

Pendente in gesso fissaggio a soffitto
Tramite cavo elettrico. Prodotto verniciabile



IP20

10cm

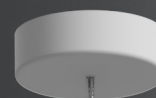

T
3cm
↓

120cm

DUPLICI

ATTACCO G9

Duplici è una lampada dall'estetica elegante e raffinata, composta da due sfere sovrapposte. La sfera superiore è realizzata in gesso, conferendo un tocco di calore e naturalezza all'ambiente circostante. La sfera inferiore è in vetro sabbato bianco, che diffonde una luce delicata e omogenea. Grazie all'attacco G9, è possibile utilizzare lampadine adatte per creare l'atmosfera desiderata. Duplici è una scelta ideale per soggiorni, camere da letto e spazi di accoglienza, aggiungendo un tocco di stile contemporaneo e un'illuminazione piacevole e confortevole.

T
10cm

T
10cm

↓



GESO

ACRILICO SATINATO

Lampadine non incluse

Portalampada e molla di blocco inclusi - Lamp holder and lock spring included

Pendente in gesso fissaggio a soffitto
Tramite cavo elettrico. Prodotto verniciabile

CE



COLUMN

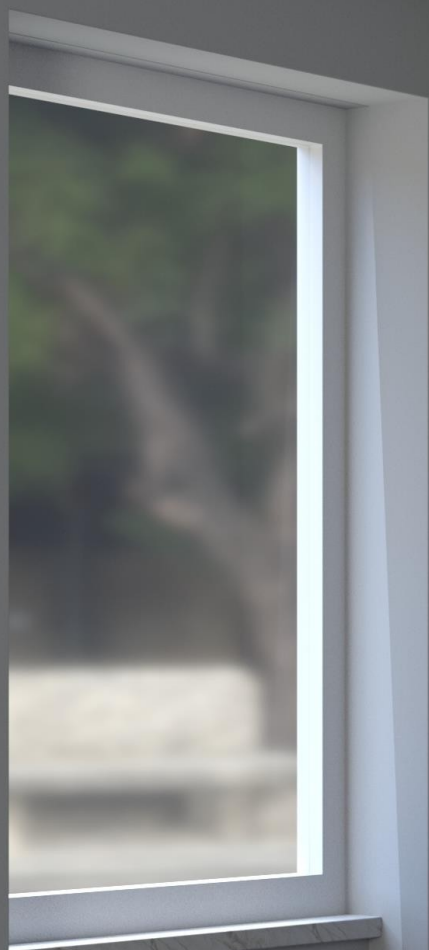

Attacco Gu10 per lampade Mini Gu10

Il pendente Column è un'elegante soluzione di illuminazione a sospensione realizzata interamente in gesso ceramico. Con la sua forma cilindrica, è perfetto per alloggiare lampade MR11 con attacco Gu10, offrendo una luce focalizzata e di qualità. La caratteristica distintiva di questo pendente è la possibilità di personalizzarlo completamente, grazie alla sua superficie in gesso che può essere dipinta con i colori di tua scelta. Con il pendente Column, puoi creare un'illuminazione unica e adattarla perfettamente al tuo stile e al tuo ambiente.

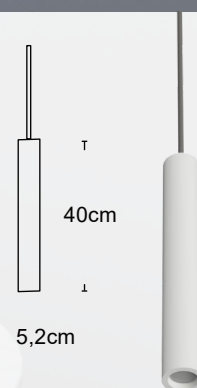

Lampadine non incluse

Portalampada e molla di blocco inclusi - Lamp holder and lock spring included

MARS



Attacco per lampadine led Gx53



Mars-N Placca in
nero opaco



Mars-G Placca in
Oro satinato

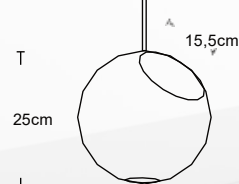

Mars è una lampada pendente caratterizzata da una forma sferica realizzata in gesso, che aggiunge un tocco di eleganza e modernità al tuo spazio. La lampada presenta un attacco inferiore Gx53, che consente l'utilizzo di lampadine compatibili per una luce calda e diffusa. Per un tocco di raffinatezza, Mars è dotata di una placca metallica disponibile in due varianti di colore: oro spazzolato o nero opaco. Questa placca conferisce un elemento di design distintivo e un contrasto visivo che valorizza ulteriormente la bellezza della lampada. Con Mars, puoi creare un'illuminazione accogliente e di classe in ambienti come soggiorni, sale da pranzo o camere da letto.

Pendenti in metallo a soffitto
Attacco lampada interno

MOON

Pendente con attacco Gu10



La lampada Moon è un'elegante sfera realizzata in alluminio, progettata per aggiungere un tocco di stile e illuminazione alla tua casa. Con la sua forma armoniosa e la superficie liscia, la lampada Moon si adatta perfettamente a qualsiasi ambiente. La parte inferiore della sfera è rimovibile, consentendo di inserire comodamente una lampadina Gu10 per creare l'atmosfera desiderata. Puoi scegliere tra diverse finiture per adattare la lampada al tuo stile: nero opaco per un look moderno e sofisticato, bianco opaco per un tocco di eleganza minimalista, o oro spazzolato per un effetto lussuoso e caldo. Con la lampada Moon, puoi illuminare i tuoi spazi con stile e versatilità.



Pendente in metallo
Attacco interno per lampadine led Gu10

NERO
OPACO

BIANCO
OPACO

ORO
SPAZZOLATO

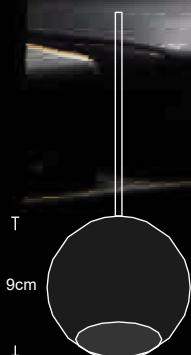

Moon-B



Moon-W



Moon-G

Pendente in gesso fissaggio a soffitto
Tramite cavo elettrico. Prodotto verniciabile

CE



STALATTITE

Pendente con attacco Gu10

Pendente in metallo

**NERO
OPACO**

**BIANCO
OPACO**

**ORO
SPAZZOLATO**

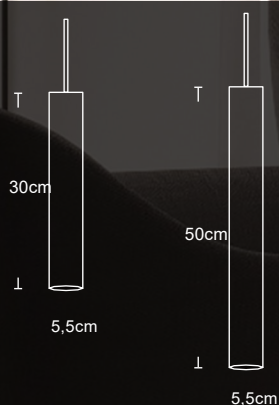

NS
Lunghezza 30cm

BS
Lunghezza 30cm

OS
Lunghezza 30cm

NL
Lunghezza 55cm

BL
Lunghezza 55cm

OL
Lunghezza 55cm

S L

Stalattite è un pendente dal design unico, caratterizzato da un tubolare metallico disponibile in due diverse dimensioni: 30 cm e 55 cm. Realizzato con cura artigianale, ogni pezzo è dipinto a fuoco per garantire una finitura di alta qualità e duratura.

Puoi scegliere tra tre affascinanti varianti di colore: bianco opaco, nero opaco e oro spazzolato. La lampada presenta un attacco inferiore Gu10, che ti permette di utilizzare lampadine compatibili per creare l'atmosfera desiderata. Con Stalattite, puoi aggiungere un tocco di stile contemporaneo e una sorgente luminosa focalizzata alle tue stanze, che sia in un ambiente domestico, in un ristorante o in uno spazio commerciale.

Lampadine non incluse

Portalampada e molla di blocco inclusi - Lamp holder and lock spring included

Pendente in gesso fissaggio a soffitto
Tramite cavo elettrico. Prodotto verniciabile

CE

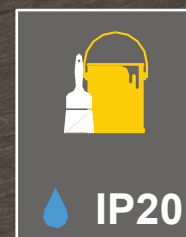

Sloping -AP
Pag.127

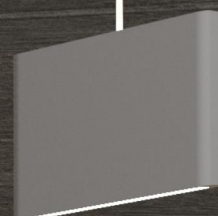

ATTACCO R7S SLOPING-P

La famiglia Sloping offre una selezione di lampade dal design moderno e sofisticato. Il pendente Sloping presenta una forma squadrata con profilo sottile e inclinato, mentre la lampada a parete Sloping mantiene la stessa forma distintiva. Entrambe le lampade sono realizzate in gesso ceramico di alta qualità e offrono la possibilità di personalizzare il colore per adattarsi all'ambiente circostante. Il pendente Sloping è dotato di un attacco R7S 118mm per lampade, fornendo una luce diretta e focalizzata. La lampada a parete Sloping offre un'opzione di illuminazione versatile per creare atmosfere accoglienti. Sia che si tratti del pendente o della lampada a parete, la famiglia Sloping unisce design elegante e funzionalità per illuminare gli ambienti con stile.

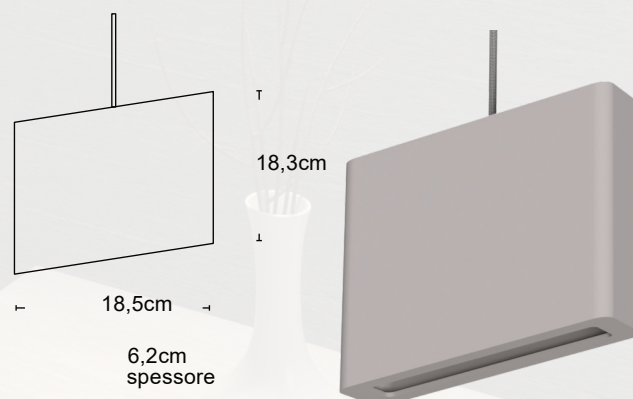

Lampadine non incluse

Portalampada e molla di blocco inclusi - Lamp holder and lock spring included

00 PLAFONI

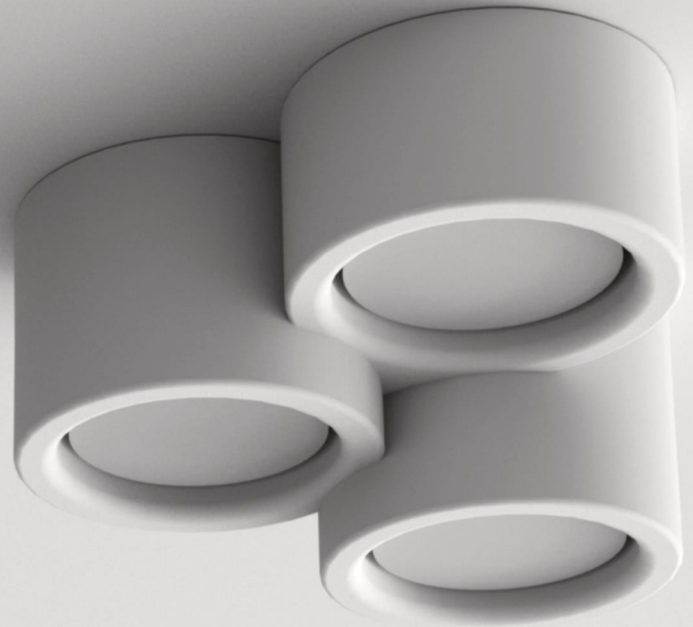

Codice PLAP1

Stand

1 x GX53 max 35W



11cm



Codice PLAP23

Stand long

1 x GX53 max 35W



11cm



Codice PLAP18

Stand 3

3 x GX53 max 35W

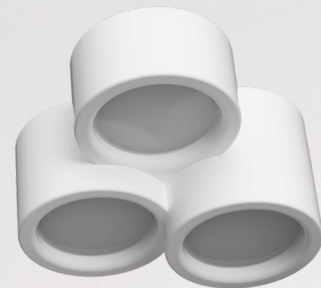

20cm



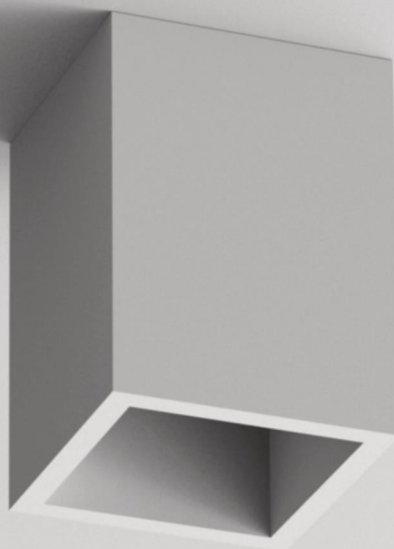
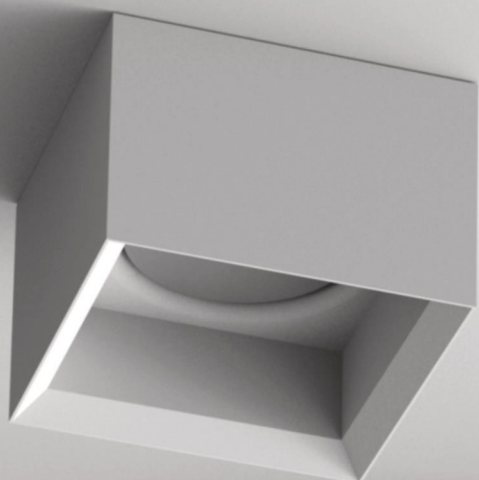
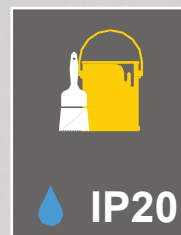

Codice PLAP2

Para 1

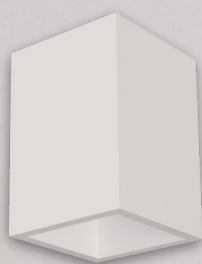

1 x GX53 max 35W

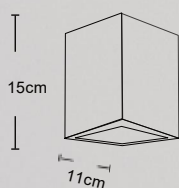

Codice PLAP3

Para 2



1 x GX53 max 35W

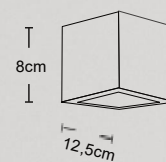

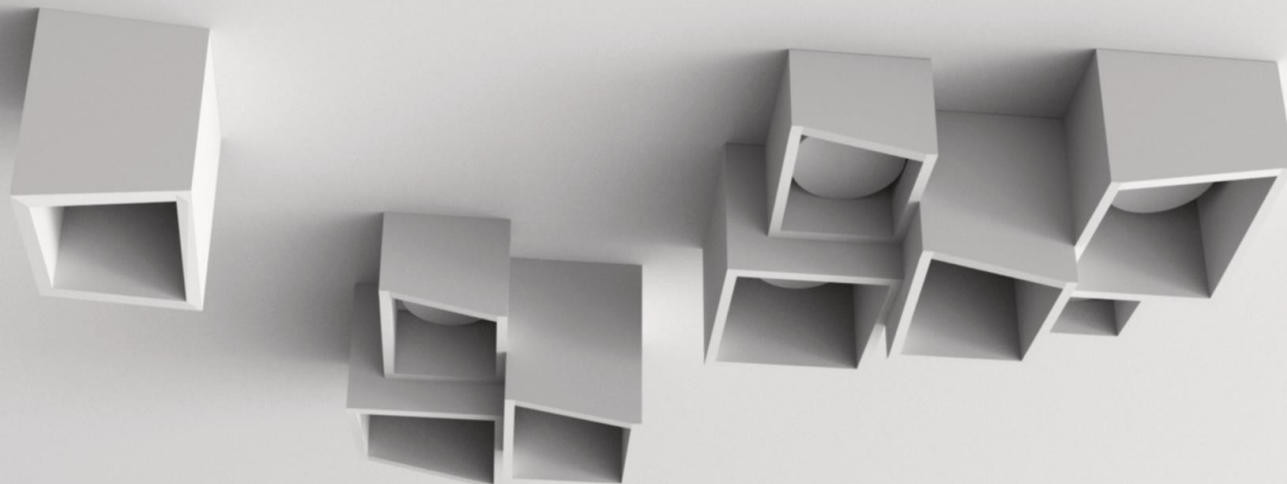
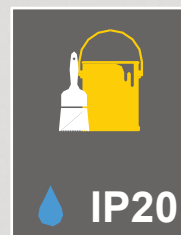

Codice PLAP4

Marsili 1

1 x GX53 max 35W

Codice PLAP5

Marsili 3

3 x GX53 max 35W

Codice PLAP6

Marsili 5

5 x GX53 max 35W

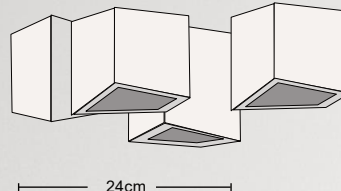
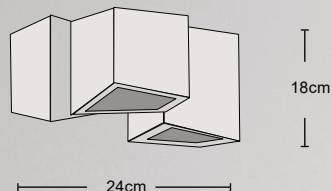
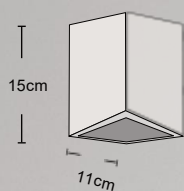
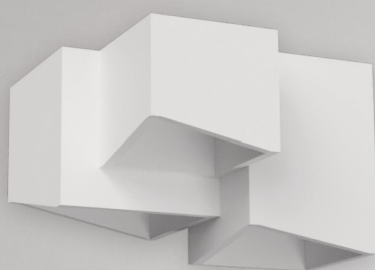

Plafoni in gesso fissaggio a soffitto
Prodotto verniciabile

CE

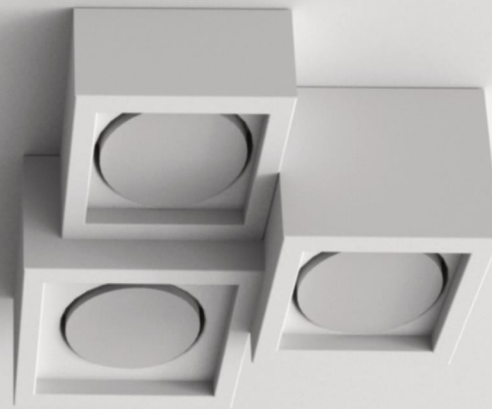

Codice PLAP7

Equo 1

Codice PLAP8

Equo 3

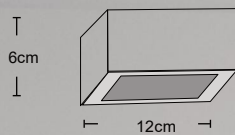
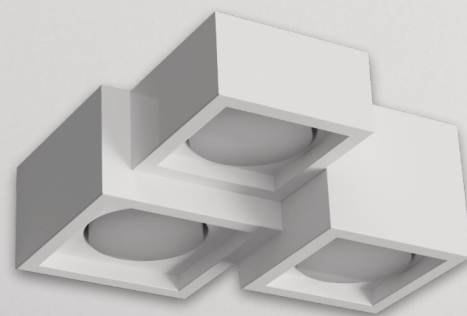
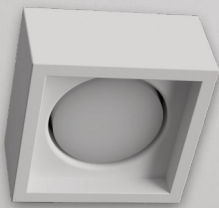

1 x GX53 max 35W

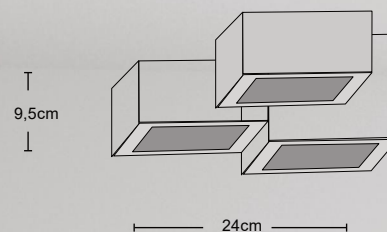

3 x GX53 max 35W

Lampadine non incluse

Portalampada e molla di blocco inclusi - Lamp holder and lock spring included

Plafoni in gesso fissaggio a soffitto
Prodotto verniciabile

CE



Codice PLAP9

Night

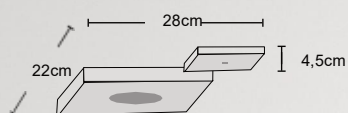
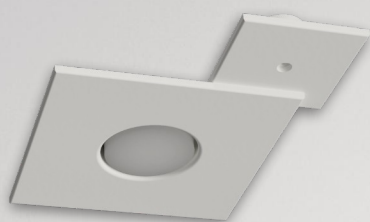

1 x GX53 max 35W

Codice PLAP10

Day

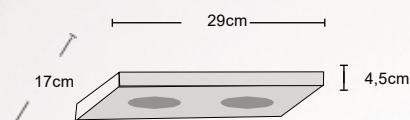

2 x GX53 max 35W

Lampadine non incluse

Portalampada e molla di blocco inclusi - Lamp holder and lock spring included

Plafoni in gesso fissaggio a soffitto
Prodotto verniciabile

CE



Codice PLAP11

Tao

Codice PLAP19

Ufo

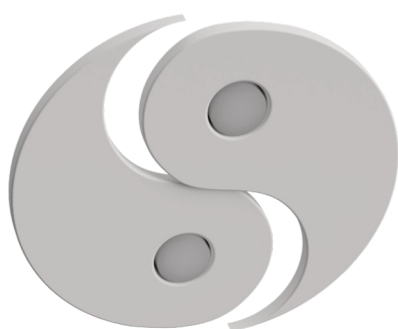

2 x GX53 max 35W

1 x GX53 max 35W

Lampadine non incluse

Portalampada e molla di blocco inclusi - Lamp holder and lock spring included

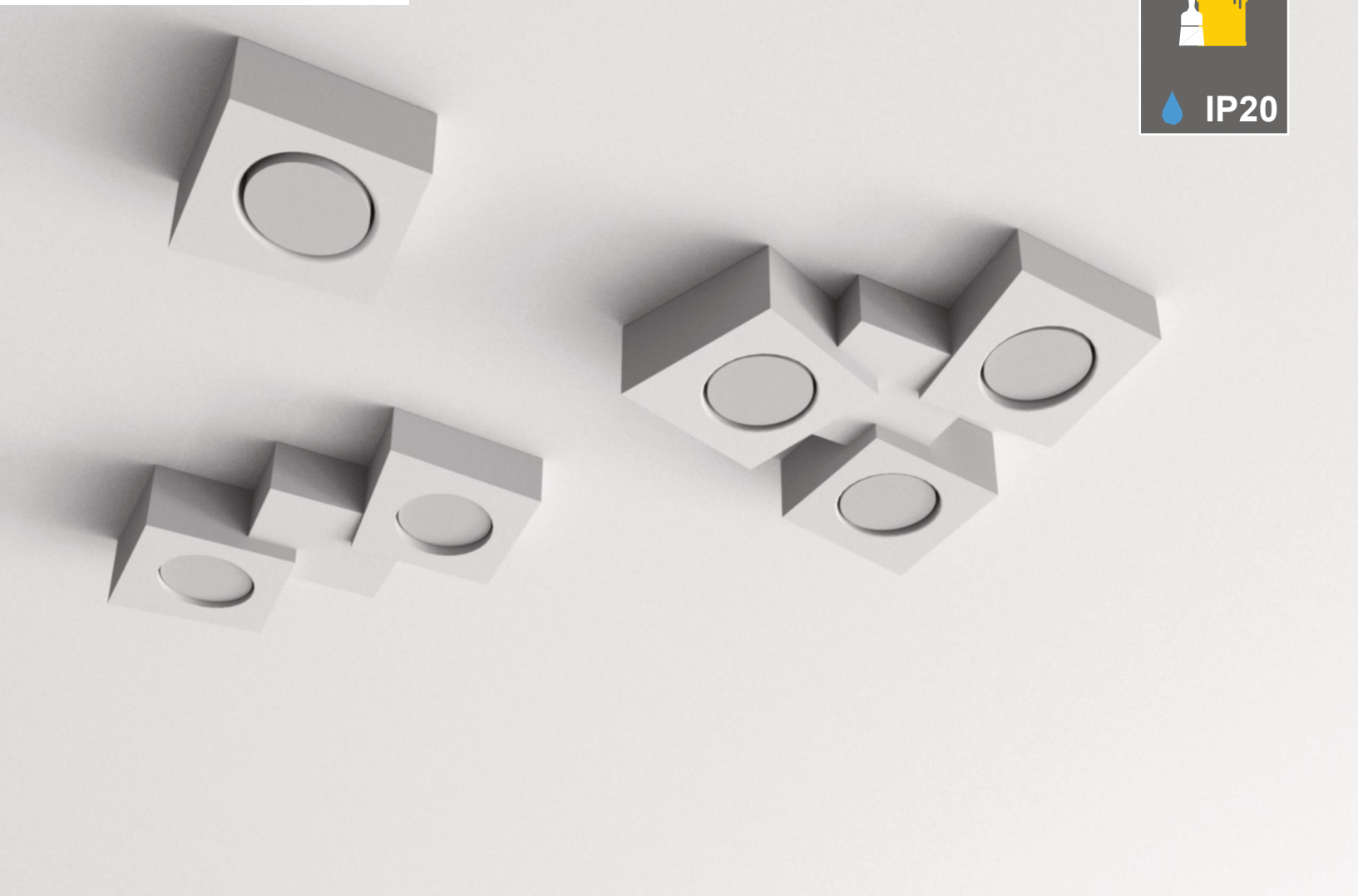

Codice PLAP12

Block 1

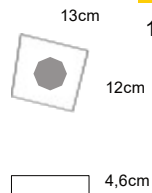

1 x GX53 max 35W

Codice PLAP13

Block 2

2 x GX53 max 35W

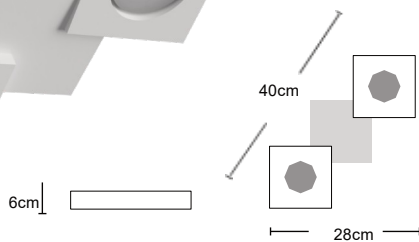
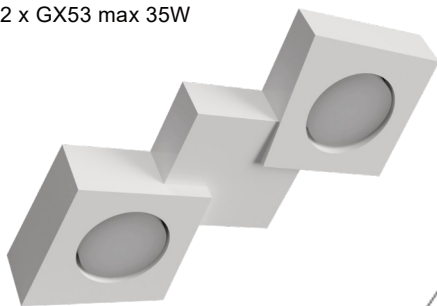

Codice PLAP14

Block 3

3 x GX53 max 35W

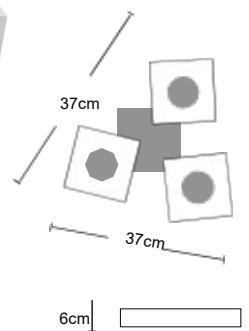
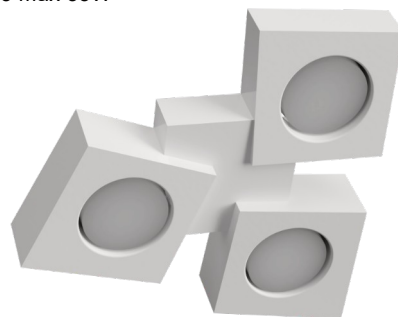



Squadro 1

1 x GX53 max 35W

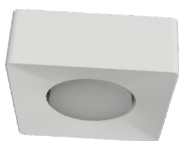

14cm

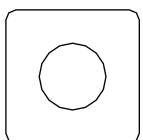

14cm



5,2cm

Squadro 2

2 x GX53 max 35W

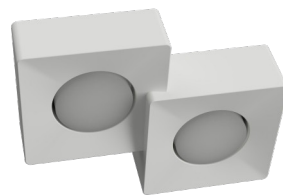

32cm

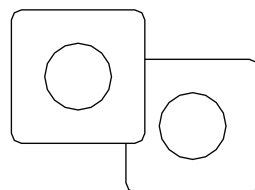

5,2cm

6,2cm

Squadro 3

3 x GX53 max 35W

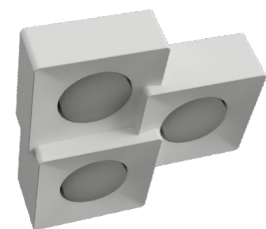

26cm

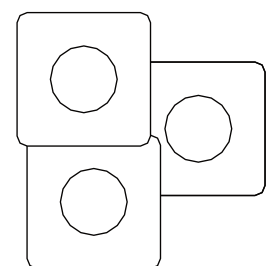

26,8cm

5,2cm

7,2cm

6,2cm

Plafoni in gesso fissaggio a soffitto
Prodotto verniciabile

CE

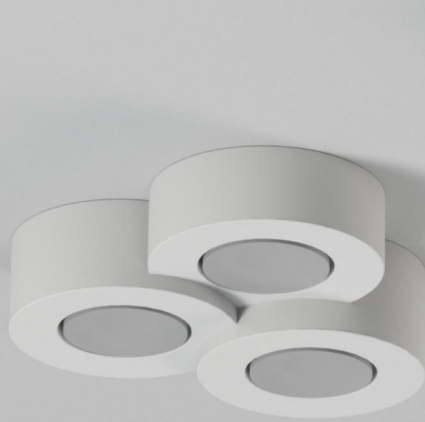

1 x GX53 max 35W

Eggs 1

2 x GX53 max 35W

Eggs 2

3 x GX53 max 35W

Eggs 3

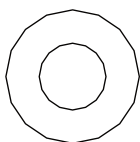
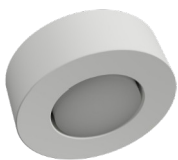

14cm



4,5cm

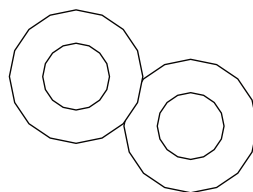
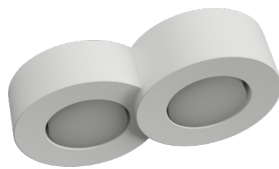

25cm

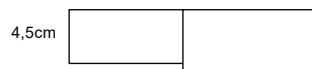

4,5cm

5,5cm

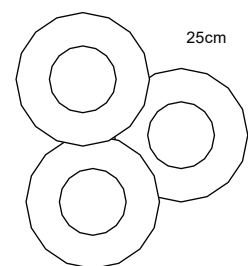
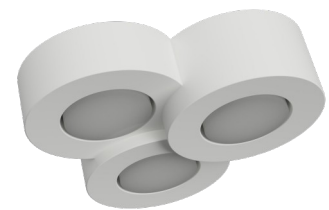

25cm



4,5cm

6,5cm

5,5cm

Lampadine non incluse

Portalampada e molla di blocco inclusi - Lamp holder and lock spring included



1 x GX53 max 35W

Sfera 1

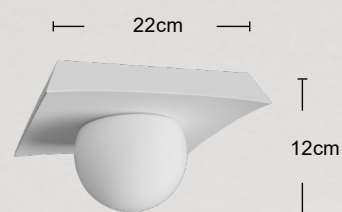

2 x GX53 max 35W

Sfera 2

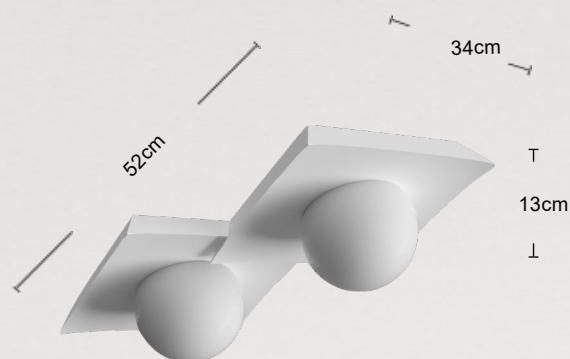
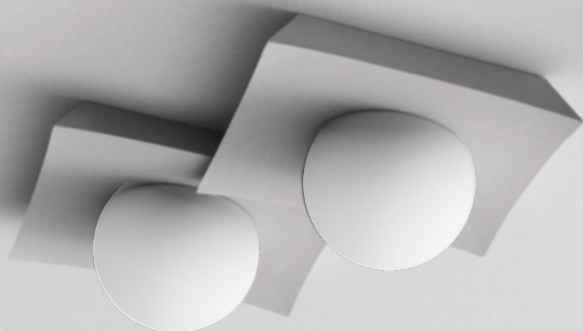

I plafoni quadrati con design affusolato sono un'aggiunta elegante e moderna per l'illuminazione degli ambienti. La parte inferiore presenta una sfera in vetro opale che diffonde una luce morbida e uniforme. Con l'attacco Gx53, puoi scegliere la lampadina più adatta alle tue esigenze di illuminazione (non inclusa). Disponibili in due versioni, singola luce e doppia luce, questi plafoni offrono opzioni flessibili per creare l'atmosfera desiderata. Realizzati con materiali di alta qualità, sono duraturi e resistenti nel tempo. Aggiungi un tocco di stile e funzionalità al tuo spazio con questi plafoni versatili.

Plafoni in gesso fissaggio a soffitto
Prodotto verniciabile

TUB x GX53 max 35W

CE

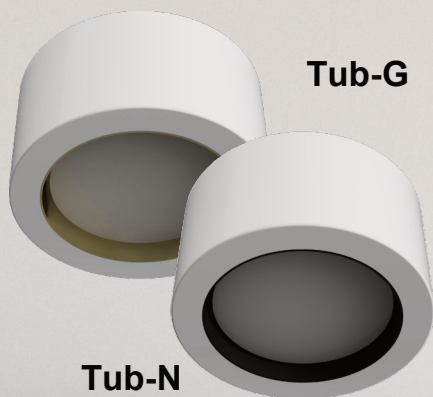

Tub-G

Tub-N

Tub-QB

Tub-QO



Tub-QN



Oro spazzolato



Nero Opaco

11cm



5,5cm



Oro spazzolato



Oro spazzolato



Nero Opaco

11cm

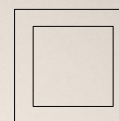

5,5cm



Con la loro forma cilindrica dal profilo basso di soli 5,5 cm, questi plafoni sono la scelta perfetta per chi desidera un'illuminazione discreta e sofisticata. L'attacco interno Gx53 offre una facile installazione delle lampadine, consentendoti di personalizzare l'illuminazione secondo le tue preferenze. Grazie alla cornice in metallo nero o oro spazzolato, questi plafoni aggiungono un tocco di raffinatezza e stile a qualsiasi ambiente. Scegli i nostri plafoni con cornice in metallo per creare un'atmosfera accogliente e luminosa, trasformando il tuo spazio in uno spazio di design.

Plafoni in gesso fissaggio a soffitto
Prodotto verniciabile

1 x Gu10 max 35WCE

TWIN SHORT



IP20



B



Bianco opaco

G



Oro spazzolato

N



Nero Opaco

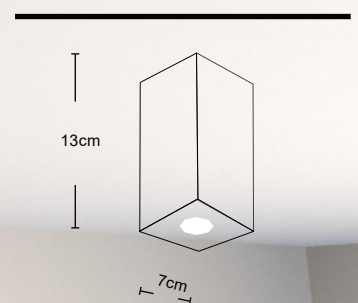
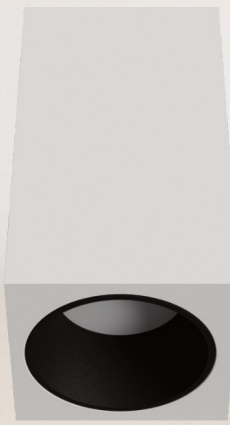

Con un'altezza di soli 13 cm, questi plafoni si distinguono per la loro eleganza compatta e raffinata. La ghiera in alluminio, disponibile nelle finiture nera opaca, bianca opaca e oro spazzolato, aggiunge un tocco di sofisticatezza al design, mentre l'attacco interno GU10 offre la possibilità di scegliere le lampadine che meglio si adattano alle tue esigenze. I plafoni Twin Small sono perfetti per creare un'atmosfera accogliente e contemporanea in ambienti dove l'altezza è limitata, senza rinunciare allo stile. Aggiungi un tocco di classe al tuo spazio con i plafoni Twin Short.

Lampadine non incluse

Portalamпада e molla di blocco inclusi - Lamp holder and lock spring included

Plafoni in gesso fissaggio a soffitto
Prodotto verniciabile

1 x Gu10 max 35WCE

TWIN LONG



IP20



B

G

N



Bianco opaco



Oro spazzolato



Nero Opaco

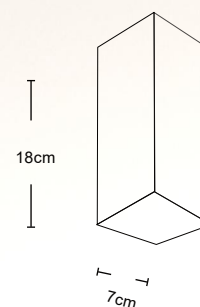

Con un'altezza di 18 cm, questi plafoni si distinguono per la loro presenza raffinata e sofisticata. La ghiera in alluminio, disponibile nelle finiture nera opaca, bianca opaca e oro spazzolato, aggiunge un tocco di classe al design, mentre l'attacco interno GU10 offre la flessibilità di scegliere le lampadine più adatte alle tue preferenze. I plafoni Twin Long sono perfetti per creare un'illuminazione d'impatto in ambienti con soffitti alti, aggiungendo un tocco di stile e raffinatezza. Rendi il tuo spazio unico con i plafoni Twin Long.

Lampadine non incluse

Portalamпада e molla di blocco inclusi - Lamp holder and lock spring included

Plafoni in gesso fissaggio a soffitto
Prodotto verniciabile

LEGO

 Mini Gu10 max 35W

CE



RUBIK

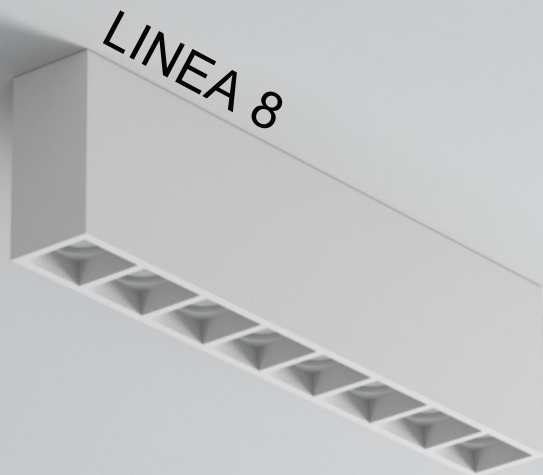

LINEA 8



LINEA 4

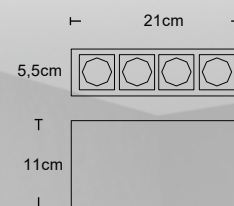
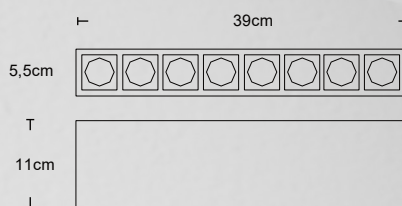
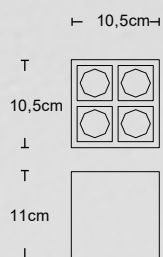

Benvenuti nella nostra eccezionale serie LEGO di plafoni, ispirata ai celebri mattoncini. Questi plafoni sono progettati per offrire un'illuminazione versatile e divertente, consentendoti di creare gruppi luminosi unici grazie alla loro speciale caratteristica di avvicinamento. La serie LEGO comprende tre modelli Rubik, caratterizzati da una forma quadrata e dotati di 4 luci ciascuno. Inoltre, abbiamo la linea 4, un modello lineare con 4 luci, e la linea 8, un modello lineare con 8 luci. Tutti i plafoni della serie LEGO sono compatibili con lampadine MR11 con attacco GU10, offrendo una luminosità ottimale e un'ampia scelta di temperature di colore. Scegli la serie LEGO e trasforma il tuo spazio con un tocco di originalità e creatività.

Lampadine MR11 mini gu10

Lampadine non incluse

Il marchio LEGO è registrato ed il copyright è di proprietà di LEGO Group. ©2022 The LEGO Group
Portalampada e molla di blocco inclusi - Lamp holder and lock spring included

PLAP 385

1 x Gu10 max 35W

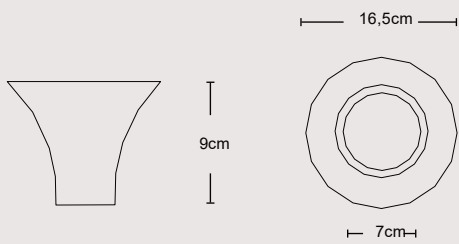

PLAP T100

1 x Gu10 max 35W

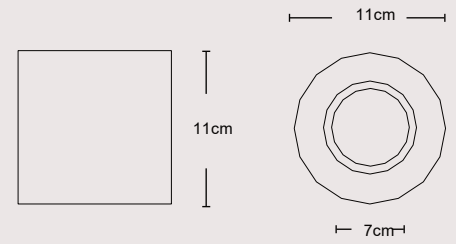

PLAP C100

1 x Gu10 max 35W

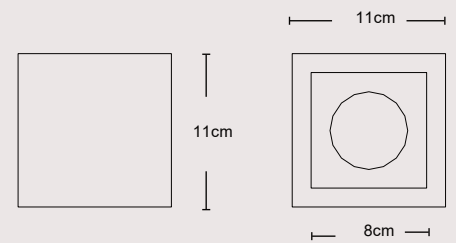
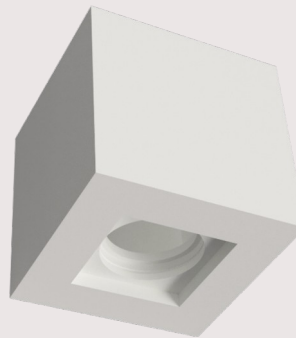

PLAP T8

PLAP T12

PLAP T18

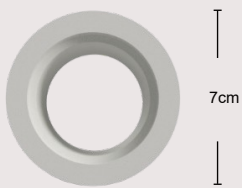

1 x Gu10 max 35W

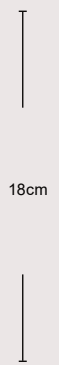
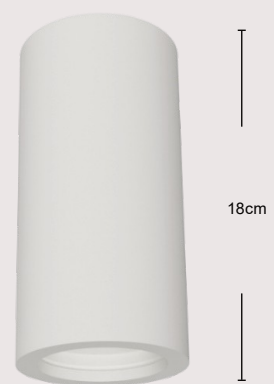
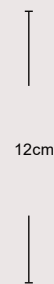
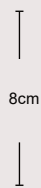

PLAP C8

PLAP C12

PLAP C18



1 x Gu10 max 35W

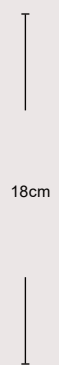
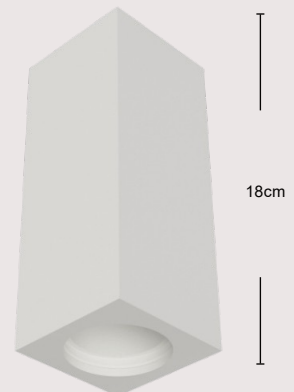
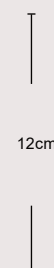
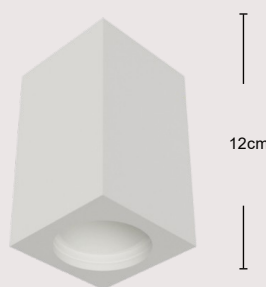
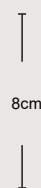
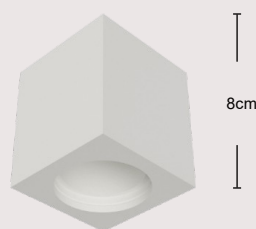

Plafoni in gesso fissaggio a soffitto
Prodotto verniciabile

CE

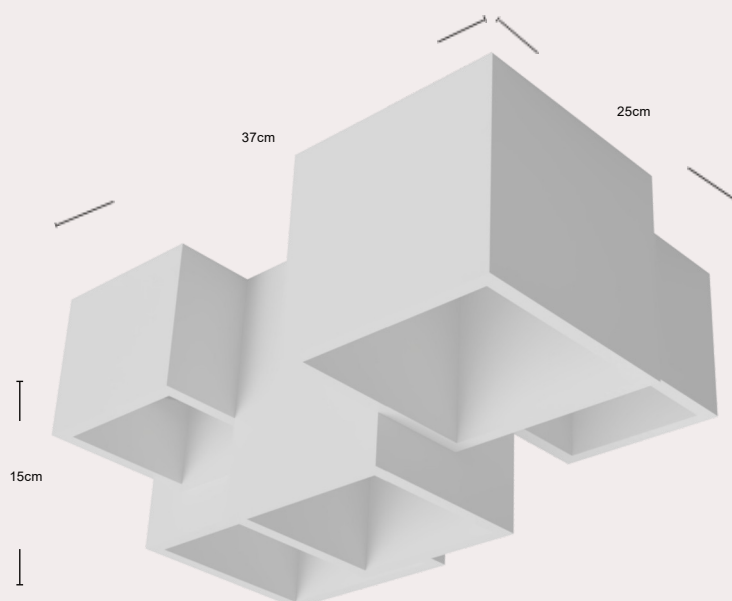
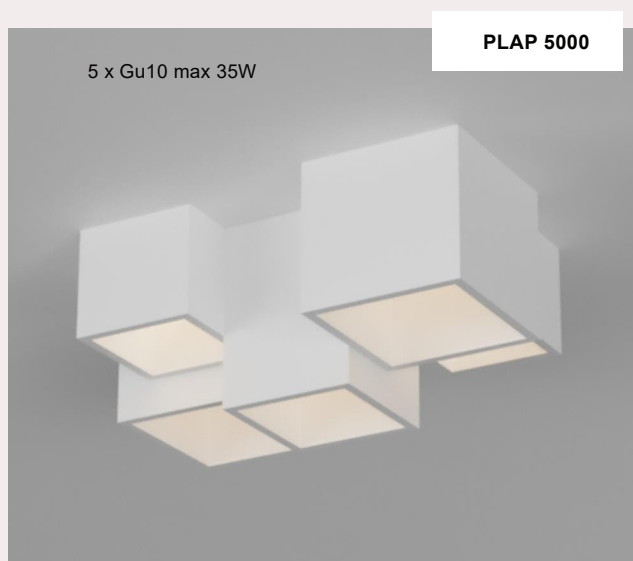
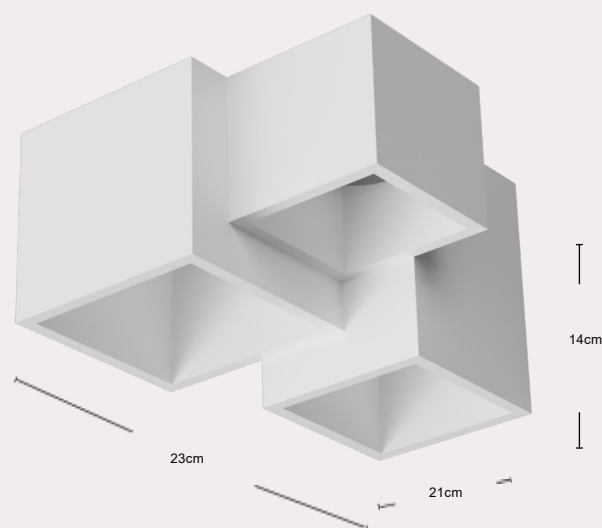
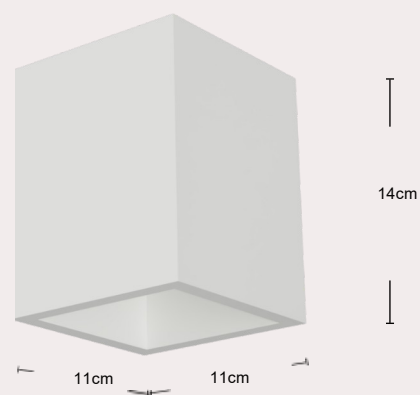
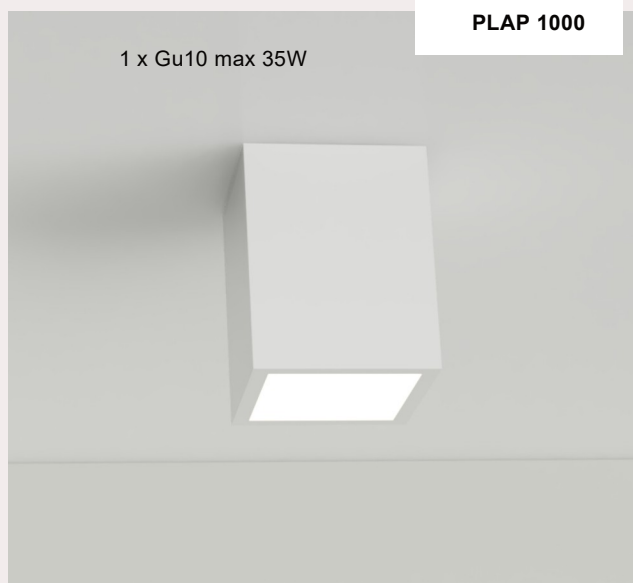

FIXED

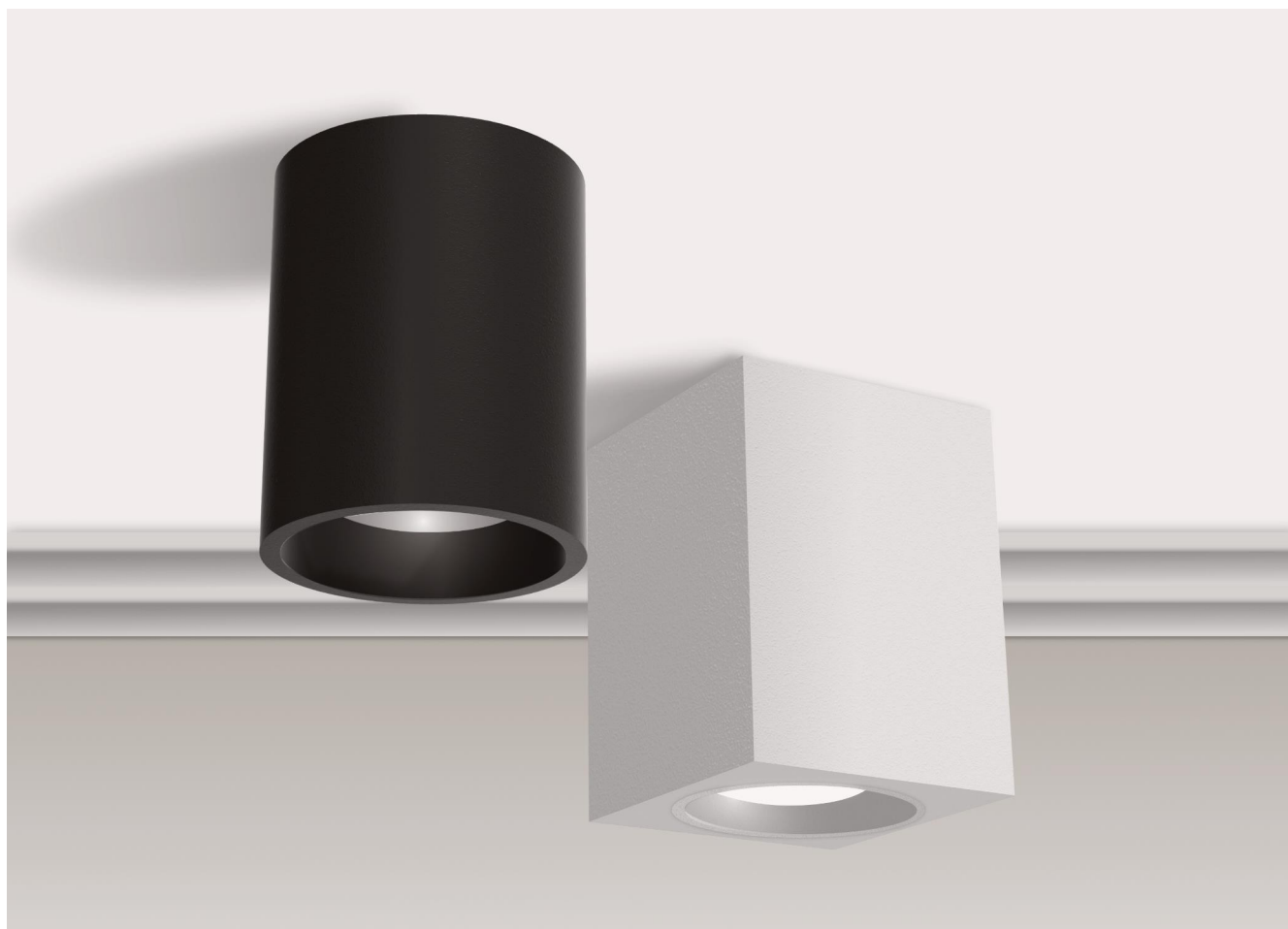

Il plafone cubico della linea FIXED è un'ottima scelta per un'illuminazione moderna e minimalista. Con la sua forma squadrata, si adatta perfettamente a una varietà di ambienti e stili di arredamento. Disponibile nelle eleganti colorazioni bianco opaco e nero opaco, questo plafone aggiunge un tocco di sofisticatezza all'ambiente. Il plafone cilindrico della linea FIXED, invece, offre un design più morbido e armonioso. La sua forma cilindrica si adatta bene a diversi spazi, dalla camera da letto al soggiorno. Anche questo modello è disponibile nelle affascinanti colorazioni bianco opaco e nero opaco, che si integrano perfettamente con l'arredamento esistente. Entrambi i plafoni della linea FIXED sono realizzati con materiali di alta qualità e offrono una luce diffusa e uniforme. L'installazione è semplice e veloce, garantendo una soluzione di illuminazione pratica e esteticamente piacevole. Si consiglia di utilizzare lampadine adatte alle proprie esigenze, come lampadine LED o alogene, per un'illuminazione efficiente ed energeticamente sostenibile.

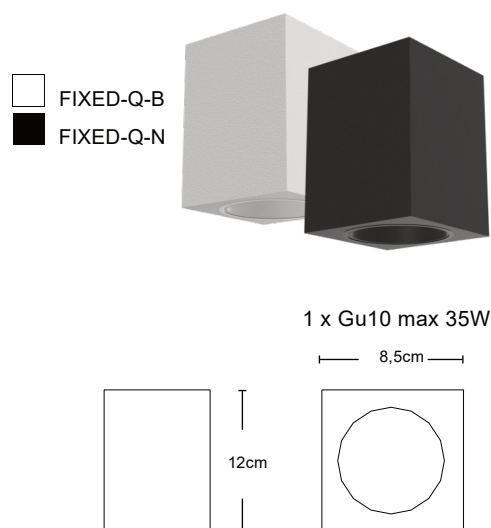
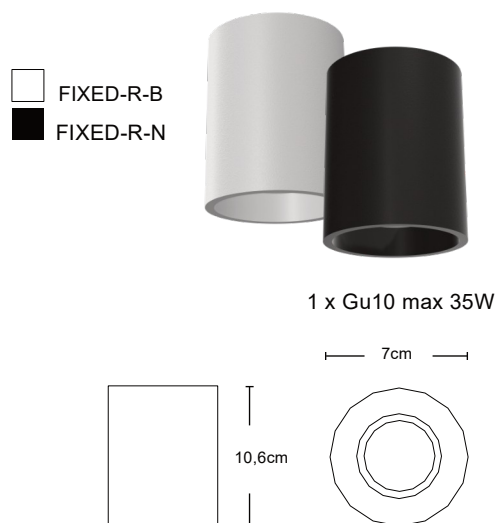

MATERA



Il plafone/applique Matera, realizzato in alluminio, si distingue per la sua completa orientabilità grazie allo speciale snodo centrale che consente di regolare l'angolazione della luce in un ampio raggio di 330°. Questa particolarità offre un elevato grado di flessibilità, consentendo di dirigere la luce esattamente dove desiderato.

Disponibile nelle eleganti finiture nero opaco e bianco opaco, il Matera si adatta con stile a qualsiasi ambiente, conferendo un tocco di raffinatezza e modernità. L'attacco interno Gu10 permette di scegliere tra diverse lampadine, offrendo la possibilità di personalizzare l'illuminazione secondo le proprie preferenze.

Si sottolinea che le lampadine non sono incluse nella confezione, consentendo così di selezionare le soluzioni luminose più adatte alle esigenze individuali. Grazie al suo design versatile e alla sua versatilità, il Matera garantisce un'illuminazione perfetta e una atmosfera accogliente in ogni ambiente.

MATERA-N

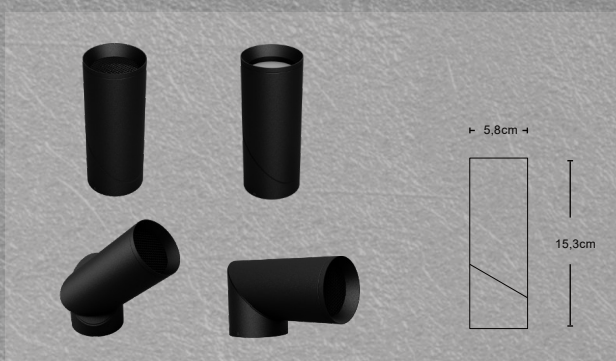

MATERA-B

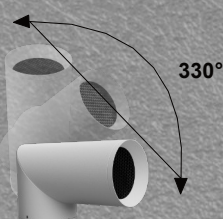
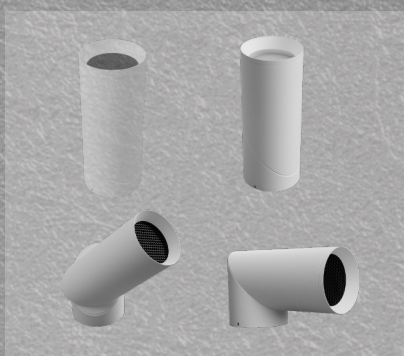

ORIENTABILE



9

LAMPADE A PARETE

Applique in gesso fissaggio a parete
Prodotto verniciabile

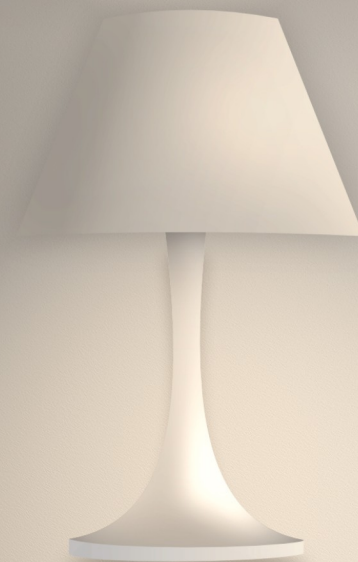

AP1 - con base
AP1-B senza base

AP6 - con base
AP6-B senza base

Portalamпада incluso
Lamp holder included

VIESTE LEVANTO

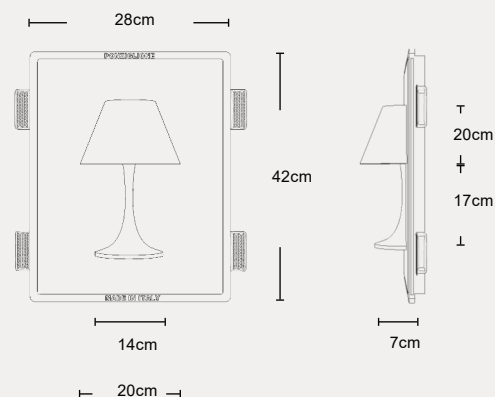
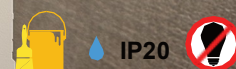

Le lampade Vieste e Levanto sono delle affascinanti soluzioni per l'illuminazione a parete. Con la loro forma di lumetto, queste lampade ad incasso in gesso aggiungono un tocco di eleganza e raffinatezza al tuo ambiente. Il modello Vieste presenta un paralume liscio, mentre il modello Levanto offre un paralume rigato, entrambi realizzati con grande attenzione ai dettagli. Con l'attacco G9, puoi utilizzare lampadine adatte alle tue preferenze di illuminazione. Inoltre, entrambi i modelli sono disponibili nelle varianti con o senza base da incasso. Nel caso della versione senza base, la lampada può essere facilmente incollata direttamente alla parete. Sia la lampada Vieste che Levanto aggiungeranno un tocco di stile e calore al tuo spazio, creando un'atmosfera accogliente e invitante.

Lampadine non incluse

Portalamпада incluso - Lamp holder included

Applique in gesso fissaggio a parete
Prodotto verniciabile



La lampada Noto è un'opzione moderna e sofisticata per l'illuminazione a parete. Con la sua forma squadrata e regolare, offre un design pulito e minimalista che si adatta a una varietà di stili di arredamento. Il profilo estremamente basso di soli 5 cm conferisce alla lampada un aspetto sottile e discreto. Dotata di due lampadine led G9, la lampada Noto offre una luce brillante e ben distribuita. L'acrilico posizionato sul fondo crea un effetto morbido e diffuso verso il basso, creando un'atmosfera accogliente e invitante. La lampada Noto è l'opzione perfetta per illuminare i tuoi spazi con eleganza e stile.

2xG9

NOTO

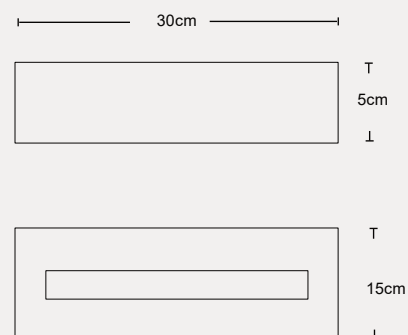
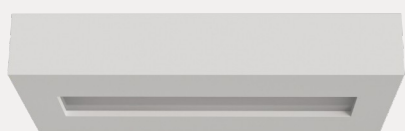

Lampadine non incluse

Portalamпада incluso - Lamp holder included

Appliche in gesso fissaggio a parete
Prodotto verniciabile

1xE27 + 1xG9



La lampada a parete da incasso Massa e Carrara offre due versioni che si distinguono per il loro stile unico. Entrambe le lampade presentano una forma di lume di due metri e un attacco E27 nel cappello, garantendo un'illuminazione versatile e di qualità. La differenza principale risiede nel gambo: Massa presenta un gambo liscio, mentre Carrara ha un gambo con delle piccole bombature classiche che aggiungono un tocco di raffinatezza e tradizione. Sia Massa che Carrara sono perfette per illuminare gli ambienti con stile e creare un'atmosfera accogliente e suggestiva.

AP4 - con base
AP4 -B senza base

CARRARA

AP3 - con base
AP3-B senza base

MASSA



Disponibili due varianti:

- Senza base di fissaggio MassaB e CarraraB pensate per l'incollaggio a parete

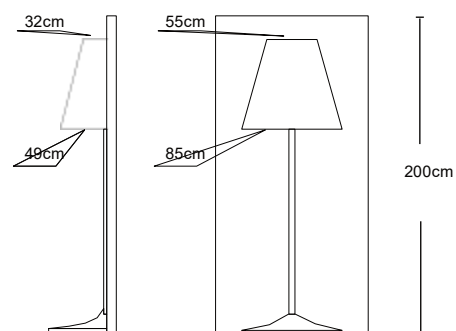

Applique in gesso fissaggio a parete
Prodotto verniciabile

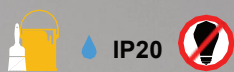

CONCA R7S

La parte superiore della lampada Conca è completamente aperta, consentendo alla luce di diffondersi in modo indiretto verso il soffitto. Questa distribuzione luminosa crea un'illuminazione soffusa e accogliente nell'ambiente circostante, conferendo una piacevole sensazione di calore e comfort.

Lampadine non incluse

Portalampada incluso - Lamp holder included

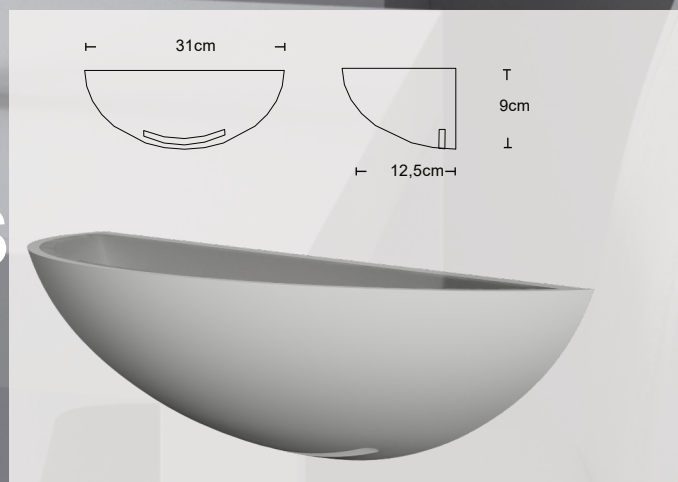

Applique in gesso fissaggio a parete
Prodotto verniciabile



ELBA

R7S

Cod.155

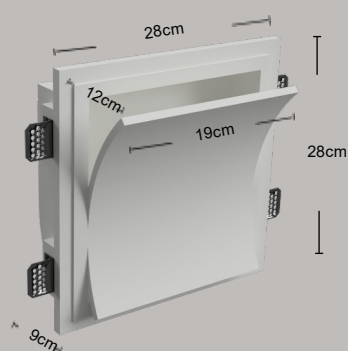

Lampadine non incluse

La lampada a parete da incasso completamente a scomparsa denominata Elba è un'opzione discreta ed elegante per illuminare il tuo ambiente senza compromettere l'estetica del tuo spazio. Questa lampada è progettata per essere completamente integrata nel muro, con l'unica parte a vista rappresentata da una doppia aletta asimmetrica.

Porta lampada incluso - Lamp holder included

Applique in gesso fissaggio a parete
Prodotto verniciabile



ALICUTI R7S



Cod.AP8

Il design attorcigliato della lampada Alicuti conferisce un aspetto dinamico e moderno, aggiungendo un tocco di originalità alla tua decorazione. La luce che si diffonde attraverso le parti vuote della lampada crea una sensazione di leggerezza e movimento, rendendo questa lampada un vero punto focale visivo.

Lampade a parete con attacco R7S.

Completa di staffa di fissaggio e portalampada R7S 118mm.

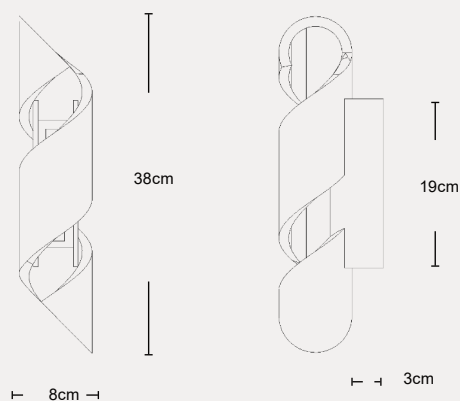

Applique in gesso fissaggio a parete
Prodotto verniciabile

Cod.AP9



Gu10

FILICUTI



L'effetto attorcigliato della lampada crea un interessante gioco di ombre e luci lungo la forma, aggiungendo profondità e movimento all'ambiente circostante. La doppia emissione di luce verso l'alto e il basso consente di illuminare in modo uniforme sia la parte superiore che quella inferiore della stanza, creando un'atmosfera accogliente e invitante.

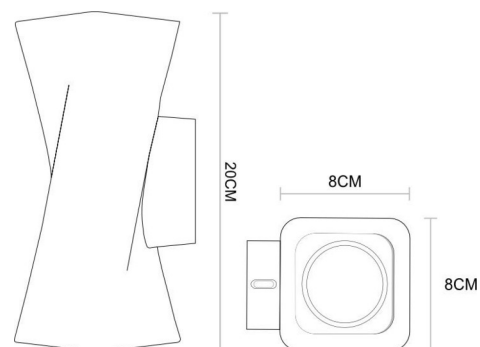

Lampade a parete con attacco Gu10
Completa di staffa di fissaggio e
doppio portalampada.

Lampadine non incluse

Portalampada incluso - Lamp holder included

Applique in gesso fissaggio a parete
Prodotto verniciabile



Cod.730



CE

IP20

La lampada a parete "Nisida" è un'opera d'arte illuminante che aggiungerà un tocco unico e suggestivo alle tue pareti. La sua forma è ispirata a una mensola che si distorce verso il centro fino a diventare parallela alla parete, creando un effetto visivo affascinante e dinamico.

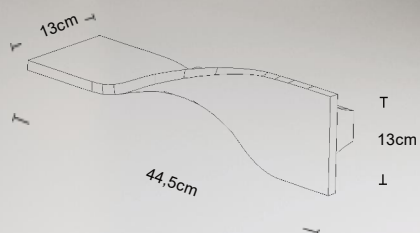

Lampadine non incluse

R7S
NISIDA

Portalampana incluso - Lamp holder included

Applique in gesso fissaggio a parete
Prodotto verniciabile

Cod.AP11

G9   IP20 

FOLIGNO

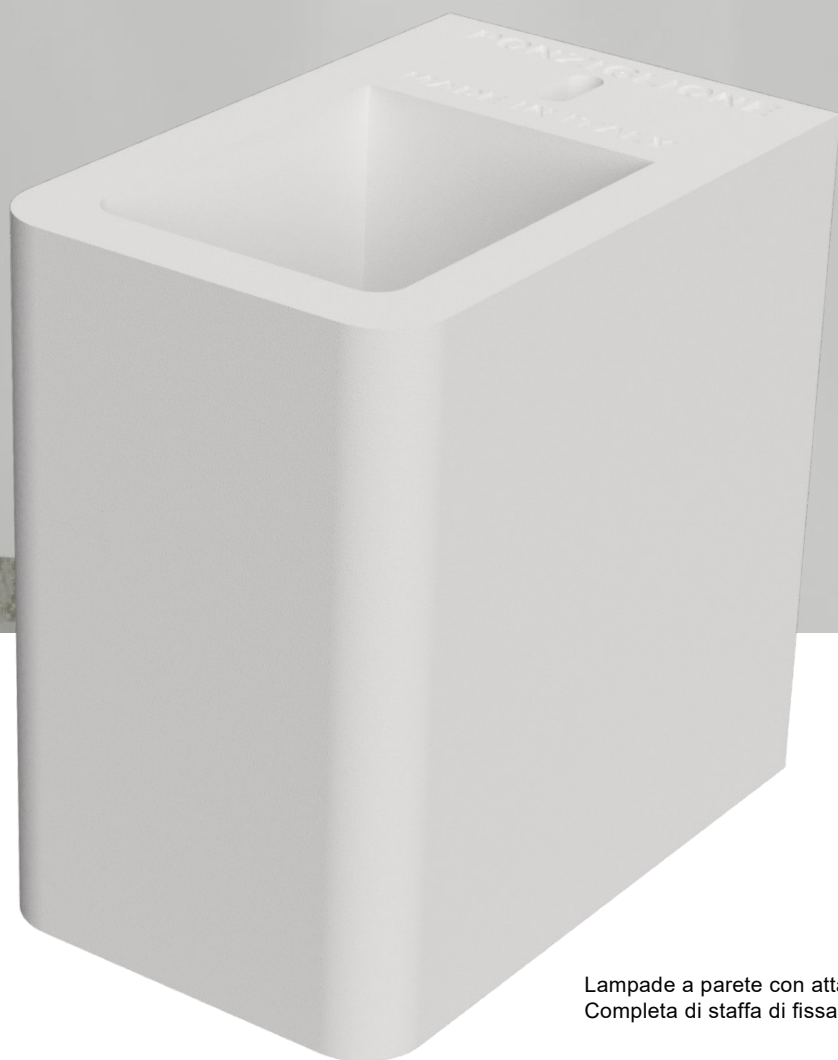

Dotata di un attacco per lampadine led G9, la lampada "Foligno" offre una soluzione luminosa efficiente ed ecologica. Le lampadine led G9 sono conosciute per la loro durata, efficienza energetica e brillantezza.

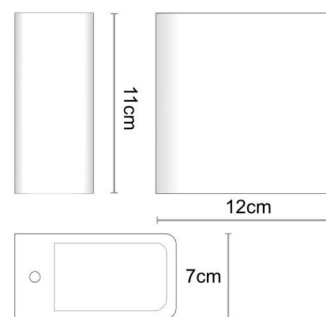

Lampade a parete con attacco G9
Completa di staffa di fissaggio e

Lampadine non incluse

Portalamпада incluso - Lamp holder included

Applique in gesso fissaggio a parete
Prodotto verniciabile



ORTIGIA

E27



Lampade a parete/soffitto con foro nel palmo
della mano per il passaggio dei cavi

Cod. AP1



Portalampada incluso
Lamp holder included

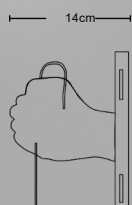
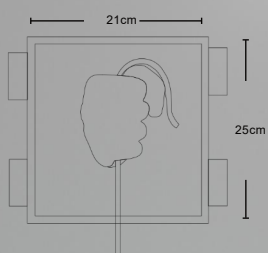

La caratteristica distintiva di "ORTIGIA" è il cavo che passa attraverso il palmo del pugno chiuso, creando un effetto visivo sorprendente. Alla base del pugno si trova un portalampada E27 che consente l'utilizzo di lampadine di diversi tipi, offrendo molteplici opzioni di illuminazione per creare l'atmosfera desiderata.

Lampadine non incluse

Portalampada incluso - Lamp holder included

Applique in gesso fissaggio a parete
Prodotto verniciabile



SIMIUS

E27 Cod.AP14



La lampada da parete "SIMIUS" è un pezzo unico che catturerà l'attenzione di tutti gli osservatori.

Realizzata in pregiato gesso ceramico, questa lampada si distingue per la sua forma sorprendente che ricrea l'avambraccio umano con la mano aperta rivolta verso l'alto.

Al centro della mano aperta si trova un portalampada E27, che consente di utilizzare diverse tipologie di lampadine, inclusi i modelli LED fino alla dimensione G95. Questo ti offre la possibilità di personalizzare l'illuminazione in base alle tue preferenze, creando l'atmosfera desiderata nella tua casa.

Applique in gesso fissaggio a parete
Prodotto verniciabile



PISA

Cod.AP15 Gu10

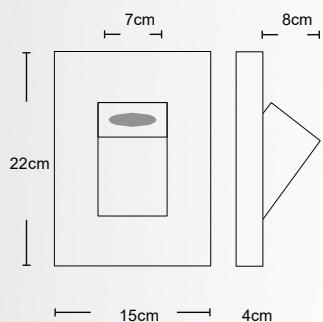

Lampade a parete con inclinazione
Montaggio verso il basso e verso l'alto

Lampadine non incluse



Portalamпада incluso - Lamp holder included

Applique in gesso fissaggio a parete
Prodotto verniciabile

Attacco G9

SATURNIA

Cod.AP20

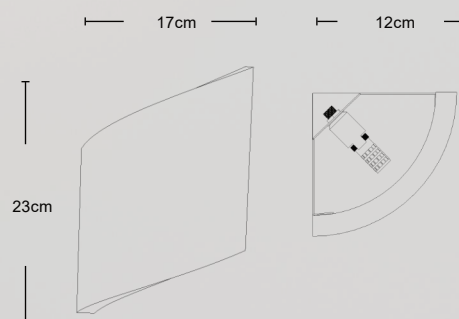
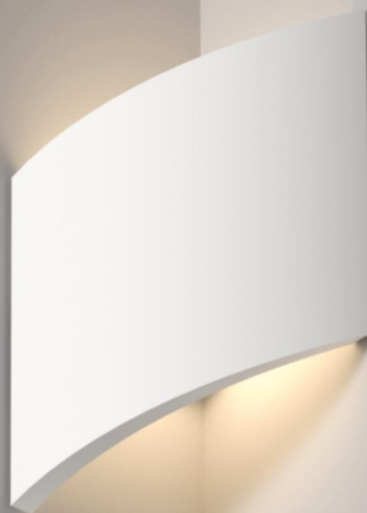

AP20

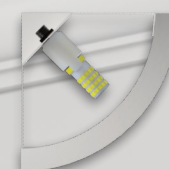

Grazie al suo design angolare, può essere facilmente installata negli angoli delle pareti, ottimizzando lo spazio disponibile. L'attacco G9 un'illuminazione brillante e omogenea.

Lampadine non incluse

Portalampada incluso - Lamp holder included

Applique in gesso fissaggio a parete
Prodotto verniciabile

Attacco G9



Jesi
Cod.AP16



Dotata di un attacco G9, questa applique consente l'utilizzo di lampadine compatibili, offrendo un'illuminazione brillante e uniforme. Grazie alle dimensioni compatte, può essere facilmente installata su pareti o superfici verticali, fornendo un'illuminazione focalizzata e accattivante.

Lampade a parete con cubo centrale con attacco G9

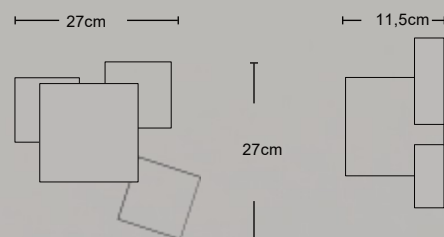

Camogli

Attacco G9
Cod.AP17



Dotata di un attacco G9, questa applique consente l'utilizzo di lampadine compatibili, offrendo un'illuminazione brillante e uniforme. Grazie alle dimensioni compatte, può essere facilmente installata su pareti o superfici verticali, fornendo un'illuminazione focalizzata e accattivante.

Lampadine non incluse

Portalamпада incluso - Lamp holder included

Applique in gesso fissaggio a parete
Prodotto verniciabile

Attacco R7S



OSCI

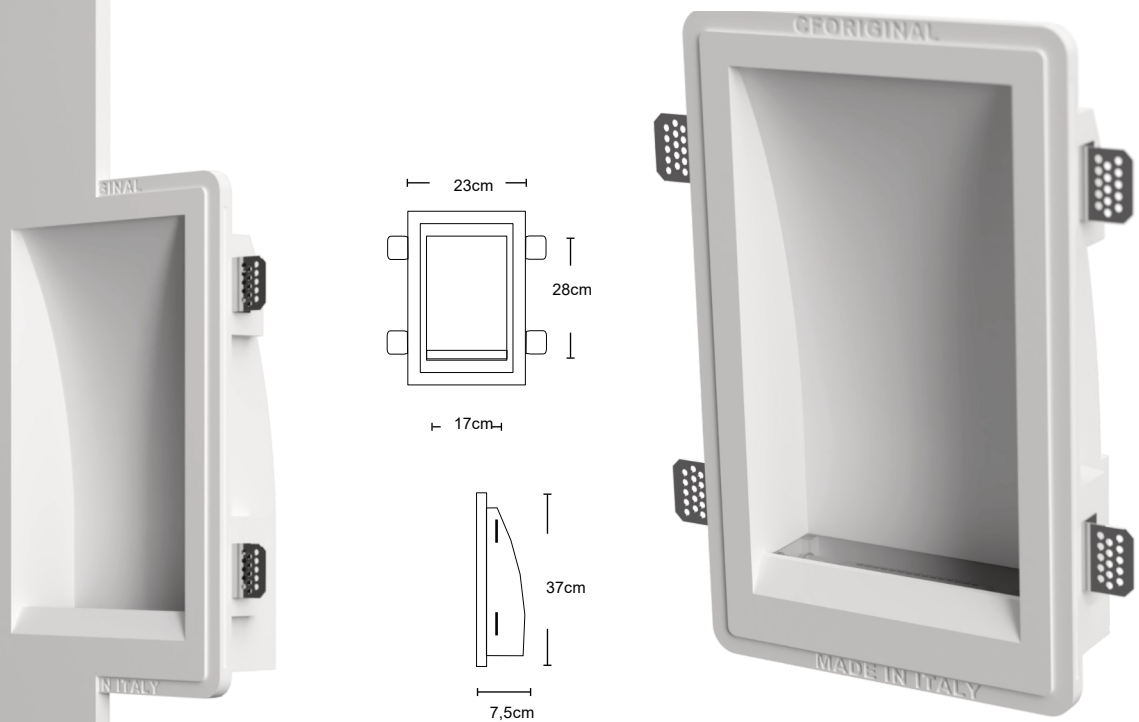

La lampada a parete da incasso nel muro con erogazione verso l'alto e attacco interno R7S è un prodotto di illuminazione di alta qualità che offre un'illuminazione diretta e potente verso l'alto. Grazie al suo design a incasso nel muro, questa lampada si integra perfettamente nell'ambiente circostante, creando un effetto luminoso elegante e discreto.



Lampadine non incluse

Portalamпада incluso - Lamp holder included

Applique in gesso fissaggio a parete
Prodotto verniciabile

Attacco 3 x Gu10

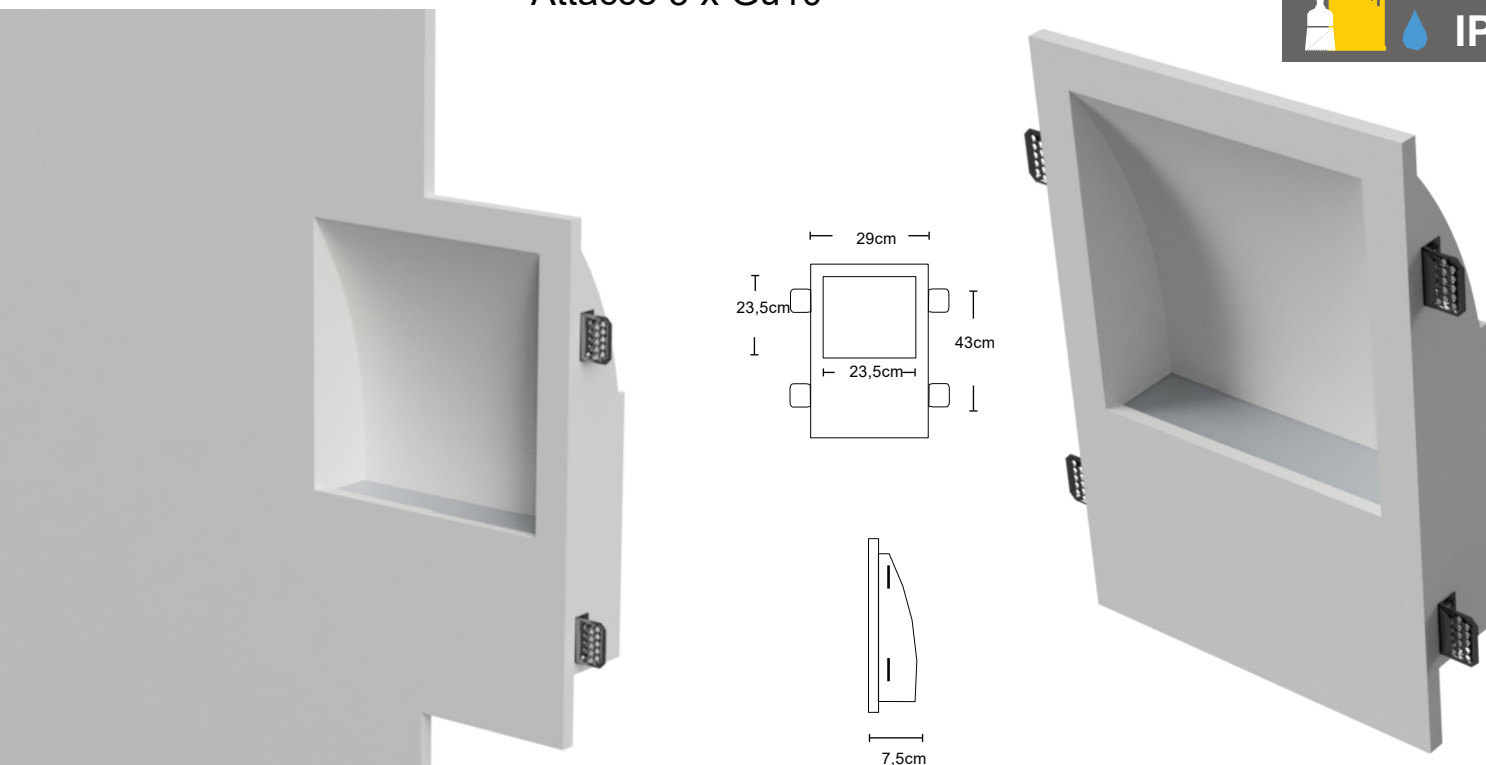

La lampada a parete da incasso nel muro con erogazione verso l'alto e attacco interno per 3 lampadine GU10 rappresenta una soluzione sofisticata e funzionale per l'illuminazione degli interni. Grazie alla sua tecnologia avanzata e al design discreto, questa lampada offre un'illuminazione di alta qualità e un tocco di eleganza all'ambiente.

Internamente la lampada è predisposta per l'alloggiamento di 3 lampadine led gu10 - lampadine NON fornite

SANNITA

Cod.057



Lampadine non incluse

Portalampada incluso - Lamp holder included

Applique in gesso fissaggio a parete
Prodotto verniciabile

Attacco GX53

QUADRO

LAMPADA MENSOLA CON SFERA
ATTACCO GX53



QU-SX

QU-DX

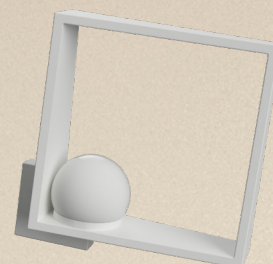
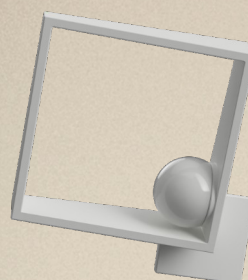

Applique in gesso ceramico di forma quadrata con attacco interno per lampadine led Gx53, la copertura della lampada è affidata ad una sfera in vetro bianco opale che irradia la luce a 360° rendendo l'effetto luminoso molto più accogliente e gradevole. Disponibile nei due versi sinistro e destro.



SFERA IN VETRO

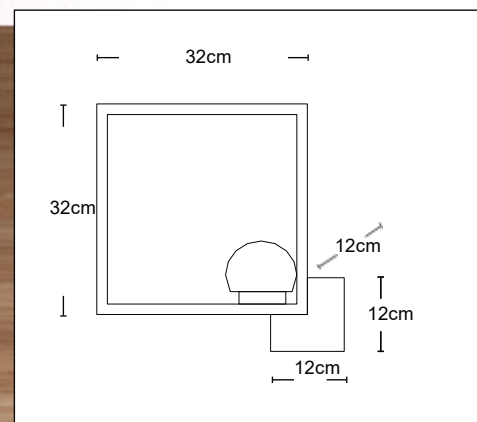

Lampadine non incluse

Portalamпада incluso - Lamp holder included

Applique in gesso fissaggio a parete
Prodotto verniciabile

Attacco GX53

POLIGNANO

LAMPADA MENSOLA CON SFERA IN VETRO
ATTACCO GX53



CE

IP20

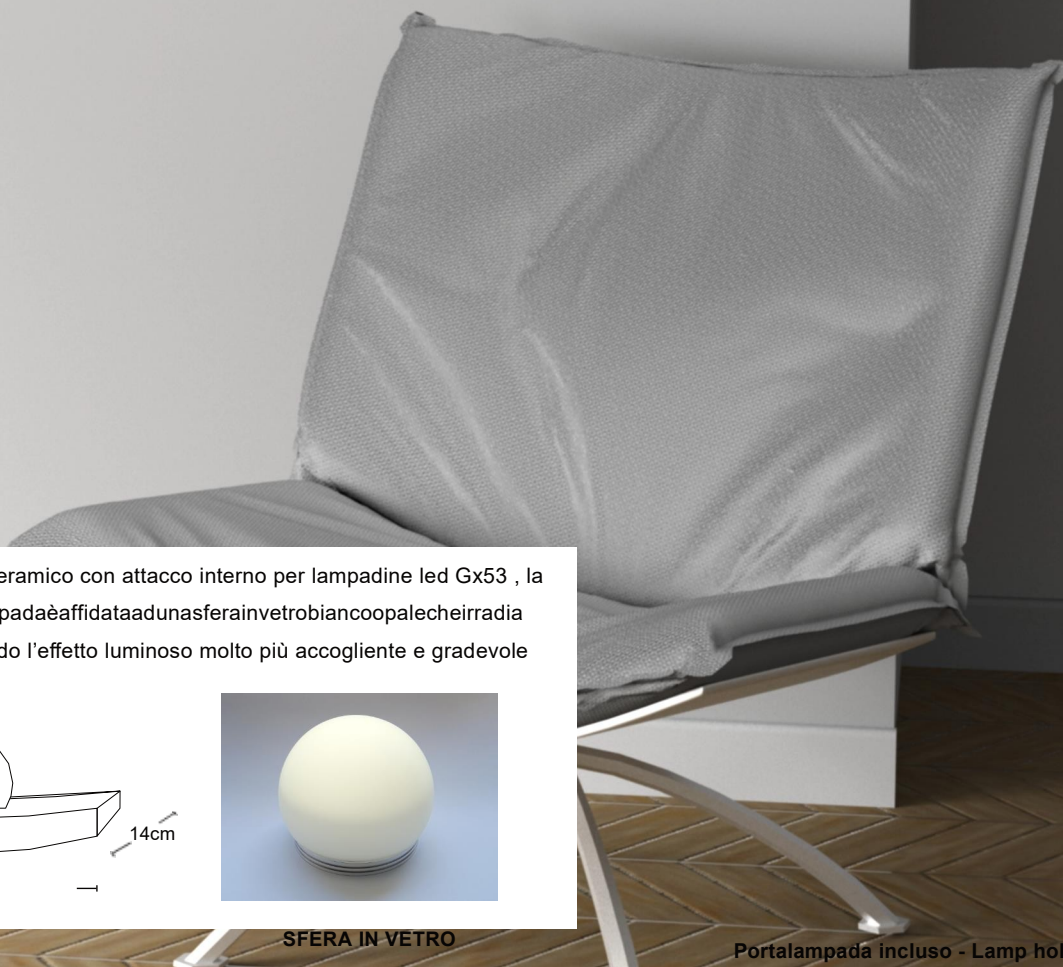

Applique in gesso ceramico con attacco interno per lampadine led Gx53 , la copertura della lampada è affidata ad una sfera in vetro bianco opale che irradia la luce a 360° rendendo l'effetto luminoso molto più accogliente e gradevole

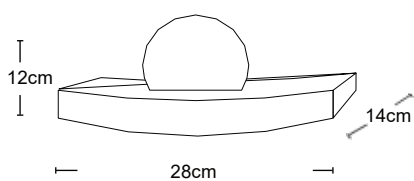

SFERA IN VETRO

Lampadine non incluse

Portalampada incluso - Lamp holder included

Applique in gesso fissaggio a parete
Prodotto verniciabile



Attacco 2 x GX53

PESCO COSTANZO

Applique in gesso ceramico con attacco interno per lampadine led Gx53 , la copertura della lampada è affidata ad una sfera in vetro bianco opale che irradia la luce a 360° rendendo l'effetto luminoso molto più accogliente e gradevole



SFERA IN VETRO

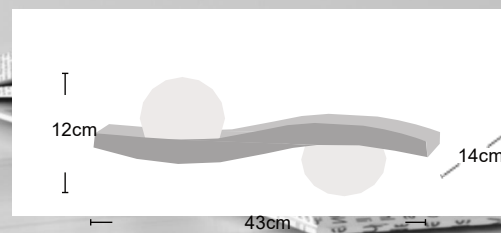

Portalampada incluso - Lamp holder included

Lampadine non incluse

Appliche in gesso fissaggio a parete
Prodotto verniciabile

Attacco R7S



PARTENOPE

DUE DIMENSIONI UN UNICO STILE



Chiaia

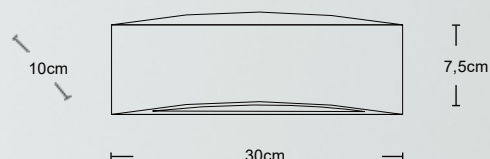

1 X R7S 118mm

Posillipo

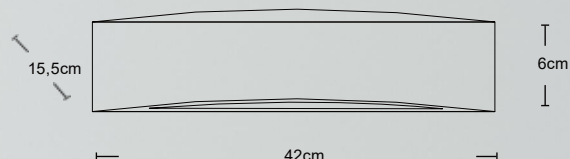

1 x R7S 118mm

La lampada da parete "Chiaia" della linea Partenope è caratterizzata da una forma allungata, con una parte posteriore piatta che si adatta perfettamente al muro e una parte anteriore stondata. Realizzata in pregiato gesso ceramico, questa lampada offre un design elegante e sofisticato per arricchire la tua decorazione d'interni. La particolarità delle lampade risiede nelle due aperture poste in alto e in basso. Attraverso queste aperture, la luce si diffonde in modo morbido e delicato, creando un'atmosfera calda e accogliente nella stanza. L'acrilico satinato posto sulla parte anteriore della lampada funge da protezione per le lampadine, diffondendo la luce in modo uniforme e creando un effetto luminoso gradevole.

Applique in gesso fissaggio a parete
Prodotto verniciabile

Attacco G9

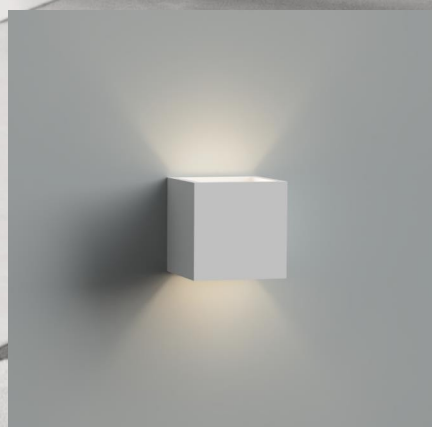
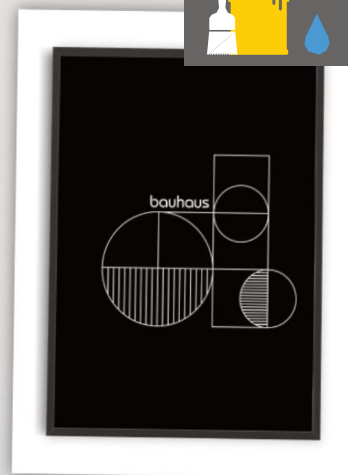

La lampada da parete "Cefalù" è un perfetto cubo liscio, realizzata in gesso ceramico di alta qualità. Le sue aperture sono strategicamente posizionate verso l'alto e il basso, consentendo alla luce di emergere in modo preciso e incisivo. L'attacco interno G9 offre la flessibilità di scegliere la lampadina più adatta alle tue esigenze di illuminazione.

Lampadine non incluse

Cod.110L
CEFALU'

LAMPADA A PARETE DI FORMA CUBICA
1 X G9

1 X G9 MAX 13W

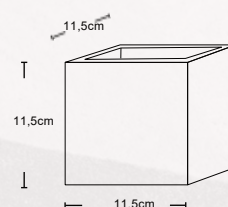

Portalampada incluso - Lamp holder included

Appliche in gesso fissaggio a parete
Prodotto verniciabile



LAMPADA A PARETE DI FORMA STONDATA

1 X G9 MAX 13W

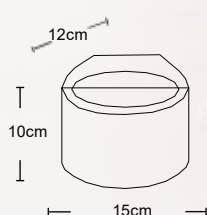

Cod.115

CUP

La lampada "CUP" è dotata di un attacco interno G9, che consente di utilizzare lampadine G9 (non incluse) per ottenere una luce intensa e ben distribuita attraverso le aperture. Grazie all'attacco interno, la lampada offre una soluzione compatta e discreta per l'illuminazione ambientale o accentuata

Lampadine non incluse

Portalamпада incluso - Lamp holder included

Applique in gesso fissaggio a parete
Prodotto verniciabile

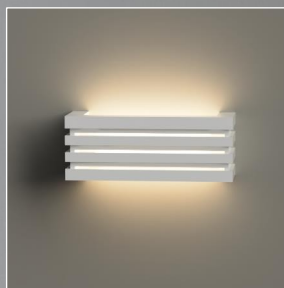

Attacco E27

Il suo design cubico e le aperture ben definite permettono una distribuzione ottimale della luce, mentre l'attenta selezione dei componenti assicura una resa luminosa efficace e duratura.

Cod.240

STRIPES

1 X E27 MAX 35W

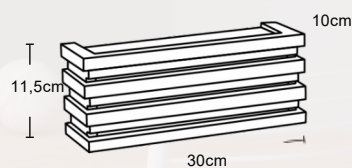

Aggiungi un tocco artistico e sofisticato alle tue pareti con la lampada "Gallery". Con la sua forma stondata, la distribuzione della luce verso l'alto e il basso e l'attacco G9, questa lampada ti offre la combinazione perfetta di estetica e funzionalità.

Cod.720

GALLERY

1 X G9 MAX 30W

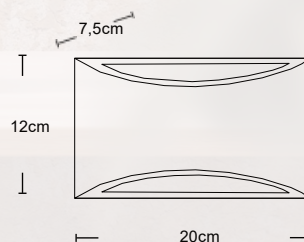

Lampadine non incluse

Portalampana incluso - Lamp holder included

Applique in gesso fissaggio a parete
Prodotto verniciabile



CE

IP20



PALATINO

Cod.550

Aggiungi un tocco di eleganza e stile alla tua parete con la lampada da parete "Palatino". La sua forma stondata e le aperture superiori e inferiori per la luce creano un'atmosfera suggestiva e accogliente, mentre il gesso ceramico MateCOMP assicura una qualità superiore. Sia che la utilizzi in ambienti domestici o commerciali, la lampada "Palatino" sarà sicuramente un punto focale di design e illuminazione.

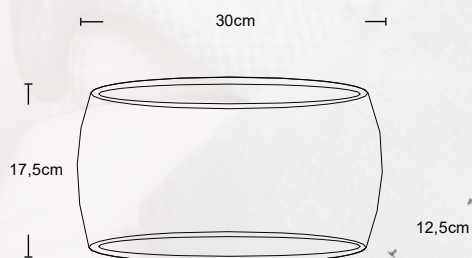

Attacco E27

Lampadine non incluse

Portalamпада incluso - Lamp holder included

Applique in gesso fissaggio a parete
Prodotto verniciabile



GIULIA Cod.1100

CASSIA Cod.1200



2 x Gu10 max 35W

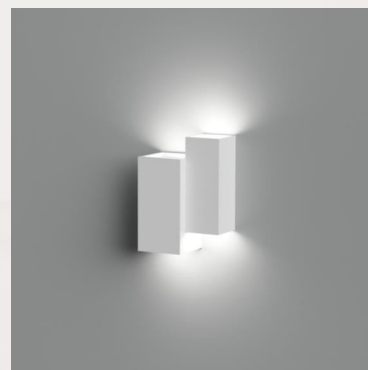
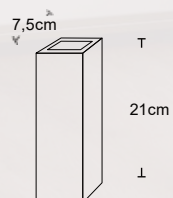

4 x Gu10 max 35W

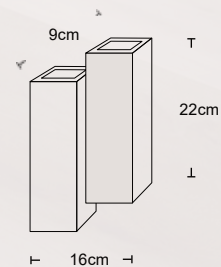

Lampadine non incluse

Portalamпада incluso - Lamp holder included



APPIA

Cod.1100A

Aggiungi uno stile contemporaneo e una fonte di illuminazione versatile alle tue pareti con queste eleganti lampade da parete in gesso ceramico. Sia che tu scelga la versione a singolo cilindro o a doppio cilindro, saranno un'aggiunta sofisticata al tuo spazio, offrendo luce direzionata e un tocco di design senza tempo.

FLAVIA

Cod.1200A



2 x Gu10 max 35W

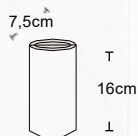

4 x Gu10 max 35W

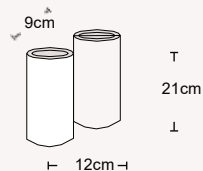

Applique in gesso fissaggio a parete
Prodotto verniciabile



Cod. 200

AMBO

2 x G9 max 13W

Lampada AMBO, un'illuminazione doppia che unisce design e funzionalità in modo armonioso. Questa lampada a parete presenta una forma unica, composta da due cubi affiancati e sfalsati di diverse dimensioni. Entrambi i cubi sono dotati di attacco interno G9, consentendo l'utilizzo di lampade G9 per creare l'effetto di illuminazione desiderato.

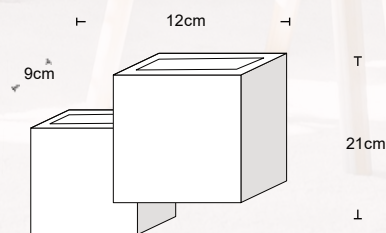
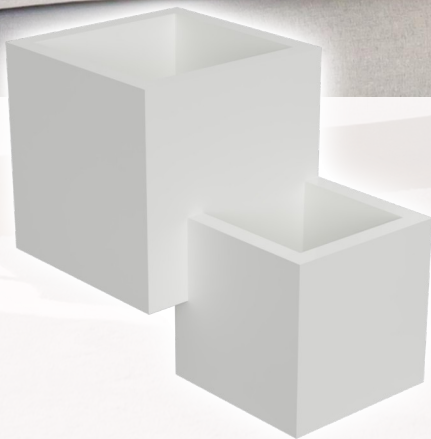

Applique in gesso fissaggio a parete
Prodotto verniciabile



CORNER



Il design della lampada presenta un lato frontale stondato a quarto di cerchio, che conferisce un tocco di eleganza e originalità al tuo ambiente. La superficie inferiore della lampada è dotata di un pannello di acrilico satinato, che copre in modo discreto le due lampade G9 (non incluse), offrendo una luce morbida e uniforme.

Lampadine non incluse

2 x G9 max 13W

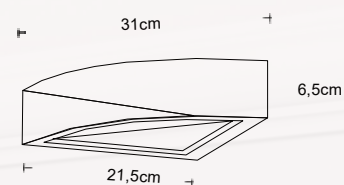

Chiusura inferiore in acrilico satinato

Portalamпада incluso - Lamp holder included

Applique in gesso fissaggio a parete
Prodotto verniciabile

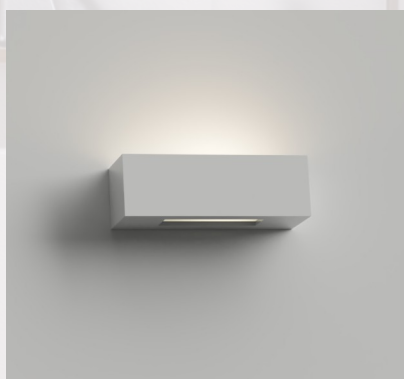

FOSCOLO

Cod.527

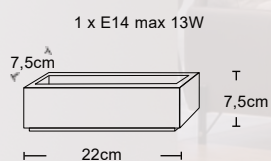

Realizzate in gesso di alta qualità, queste lampade offrono una superficie liscia e una finitura impeccabile. La forma rettangolare conferisce loro un design moderno e minimalista, che si integra armoniosamente con l'arredamento dei tuoi ambienti.



LEOPARDI

Cod.528

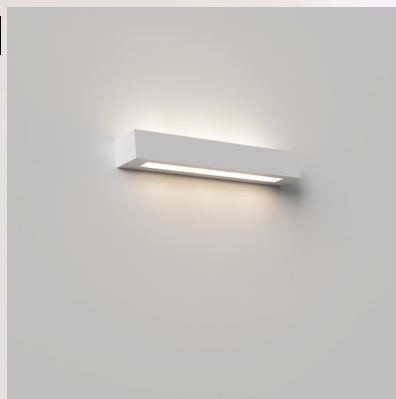
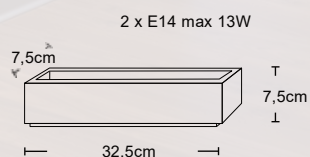

MANZONI

Cod.529

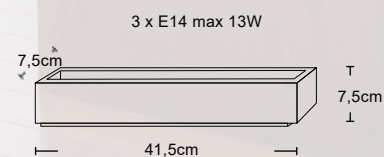

Lampadine non incluse

Portalamпада incluso - Lamp holder included

Applique in gesso fissaggio a parete
Prodotto verniciabile



Cod.C16

DANTE

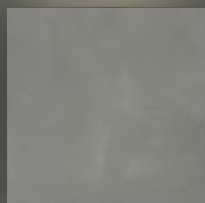

L'applique "Dante" proposta da Cforiginal.it è un'eccellente soluzione per illuminare i tuoi ambienti con eleganza e stile. Con la sua forma squadrata e il profilo basso, questa lampada a parete si integra perfettamente nelle tue pareti, donando un tocco di raffinatezza al tuo spazio. L'applique Dante è dotata di un attacco interno G9, che ti permette di selezionare le lampade compatibili che meglio si adattano alle tue esigenze luminose. Puoi scegliere tra diverse opzioni di potenza e tonalità di luce, garantendo un'illuminazione perfetta per il tuo ambiente.

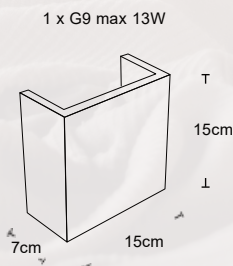

Lampadine non incluse

Portalamпада incluso - Lamp holder included

Applique in gesso fissaggio a parete
Prodotto verniciabile



Cod.AP19
1 x R7S

SLOPING-AP

Sloping è un'elegante lampada a parete caratterizzata da un profilo laterale sottile e una forma squadrata leggermente inclinata sul fronte e sul retro. Il design minimalista e moderno si fonde armoniosamente con qualsiasi stile di arredamento. All'interno della lampada, troverai un portalamпада R7S che consente l'utilizzo di lampadine adatte alle tue preferenze di illuminazione. La parte inferiore della lampada è corredata da un pannello in acrilico sabbato, che diffonde la luce in modo uniforme e crea un'atmosfera accogliente e rilassante. Sloping è la scelta perfetta per illuminare con stile soggiorni, sale da pranzo e ambienti moderni.

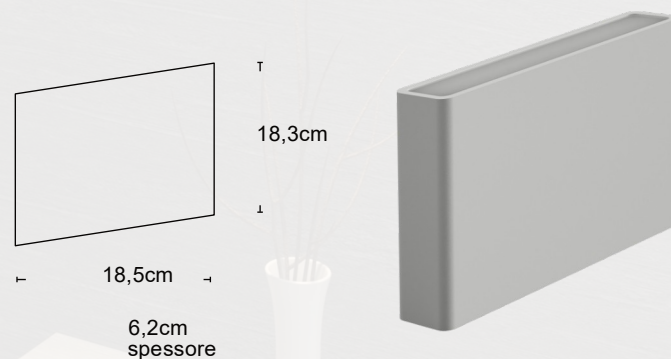

Lampadine non incluse

Portalamпада incluso - Lamp holder included

10

COPPE E ROSONI



Cod.SP1

Van Gogh

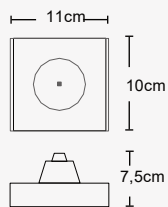

Cod.SP2

Picasso

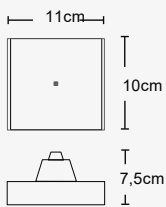

Cod.SP3

Monet

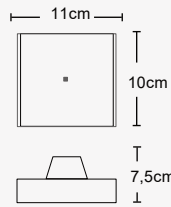
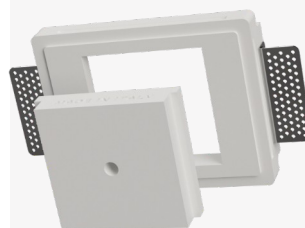

Cod.SP6

Dalì

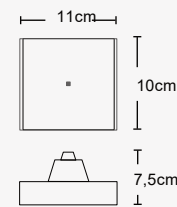
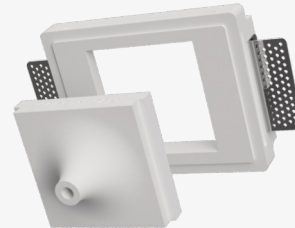

Particolare d'installazione

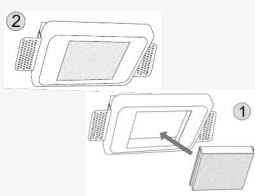

Ogni coppa a scomparsa è abbinata alla base di fissaggio BP1 in dotazione.

diametro 15mm

Base universale BP1 compresa

Coppe a scomparsa in gesso ceramico
cable pass point in ceramic plaster



Matisse

Cod.RP7

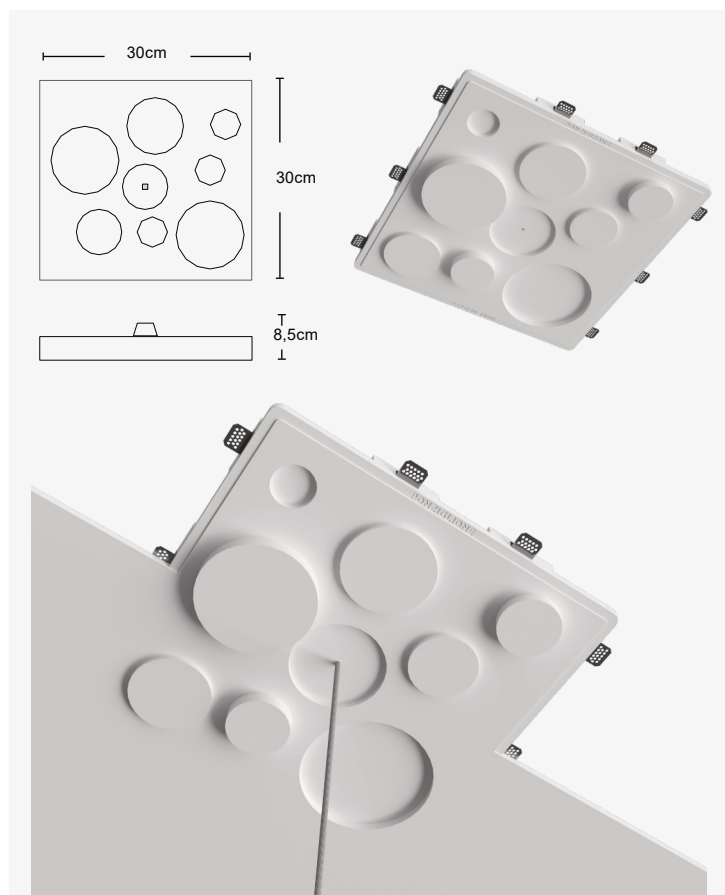
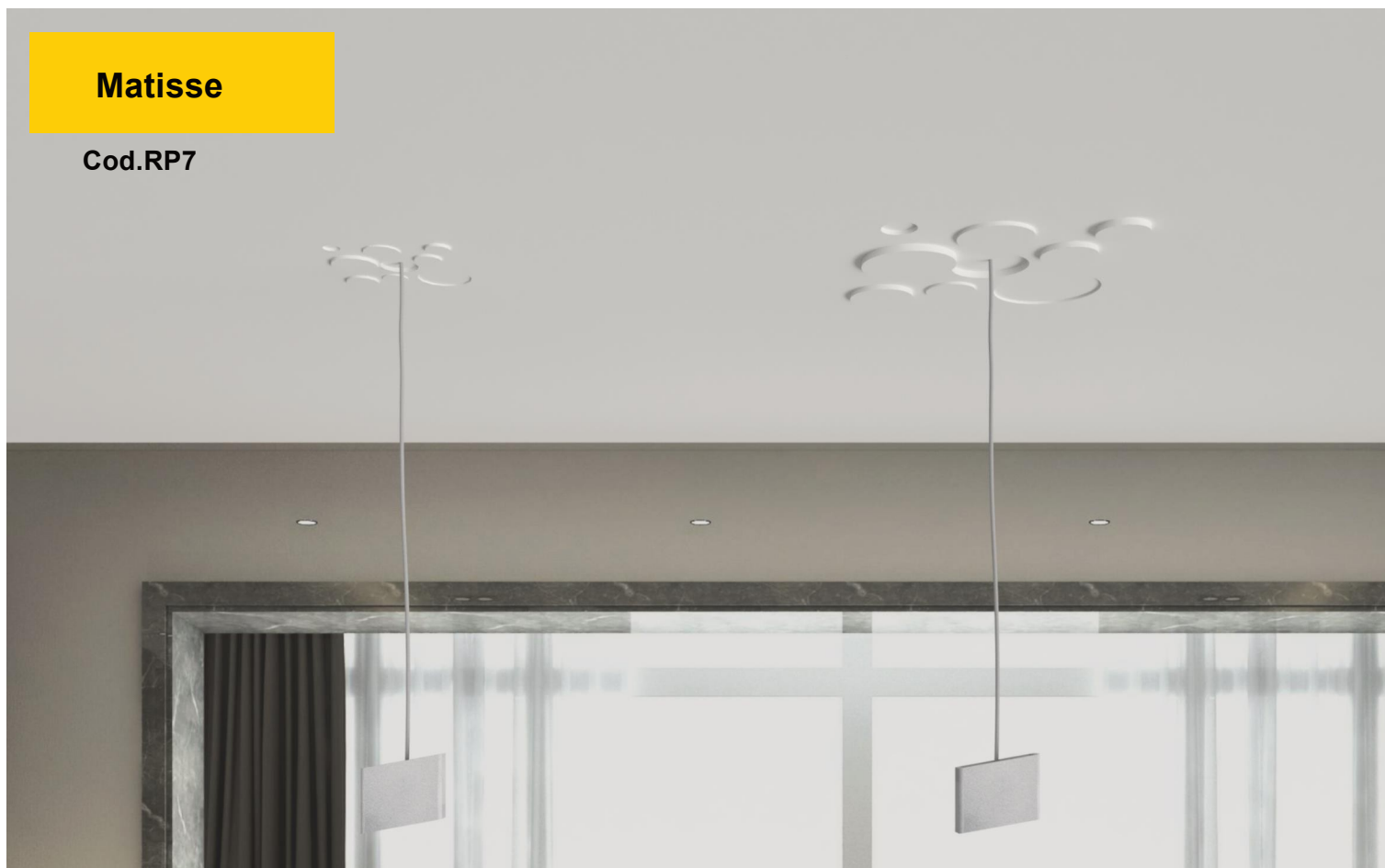

Lampadine non incluse

Coppe a scomparsa in gesso ceramico
 cable pass point in ceramic plaster



Pollok Cod.RP8

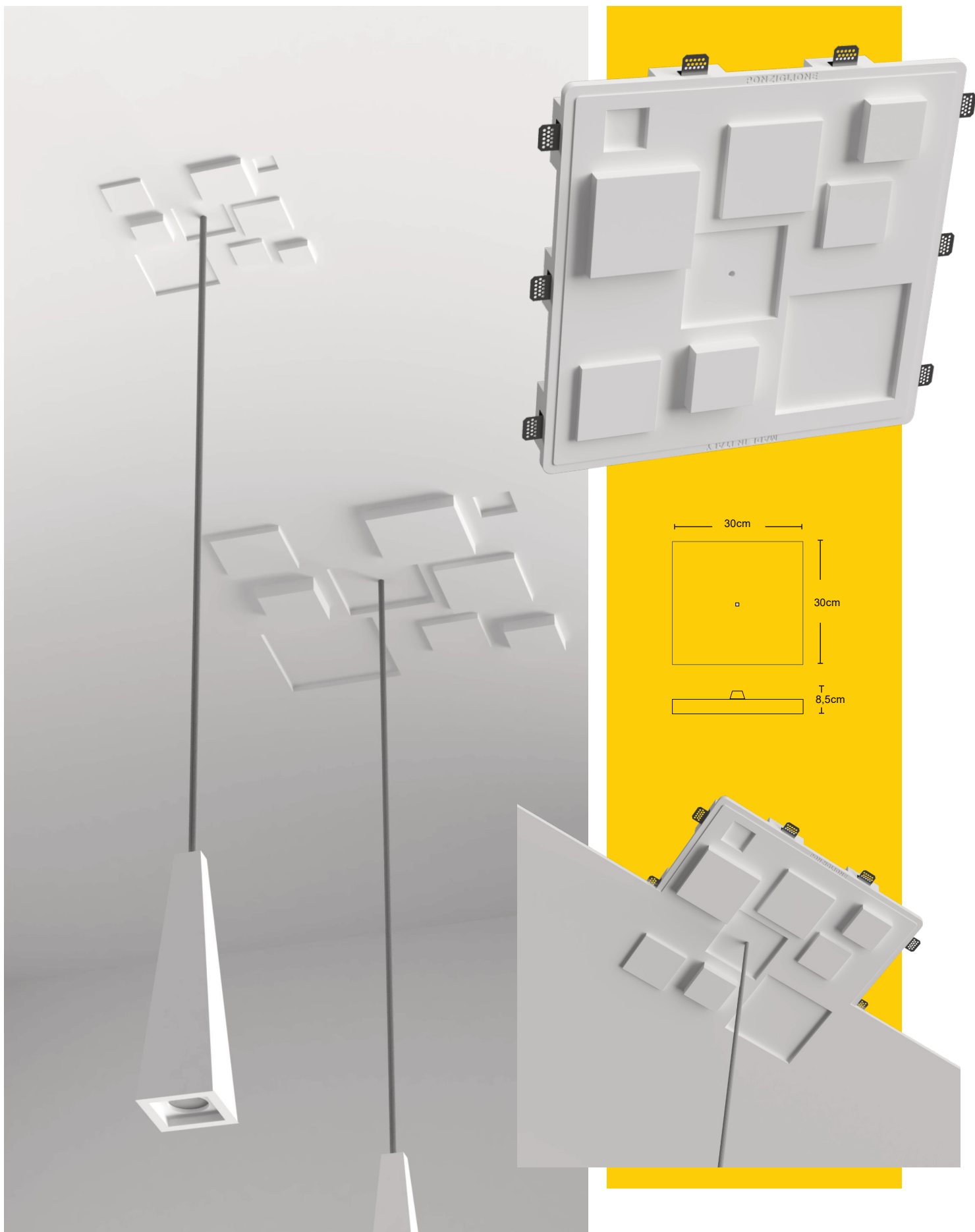

Lampadine non incluse



Coppe a scomparsa in gesso ceramico
cable pass point in ceramic plaster

Munch

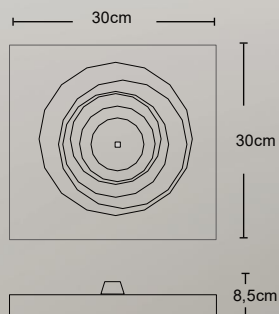
 Cod.RP9

Lampadine non incluse



CUPS

COPPA IN METALLO AD INCASSO



Foro - cut out
55mm

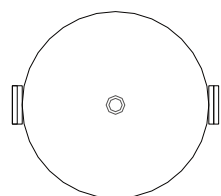

5cm

7cm



3cm



CP-01B

Bianco opaco

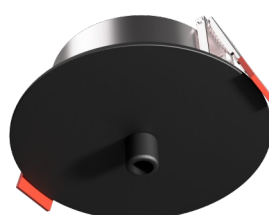

CP-01N

Nero opaco

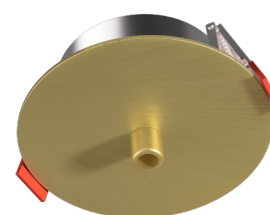

CP-01G

Oro spazzolato

1

1

PUNTI LUCE

Punti luce a scomparsa in gesso ceramico
Con led integrato

CE



IP20



Lampadina
non inclusa



Particolare d'installazione

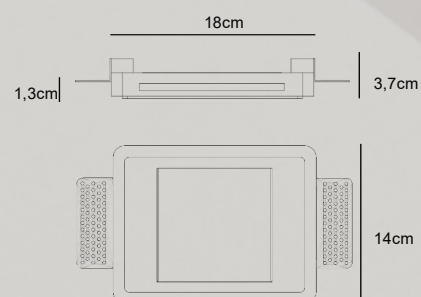
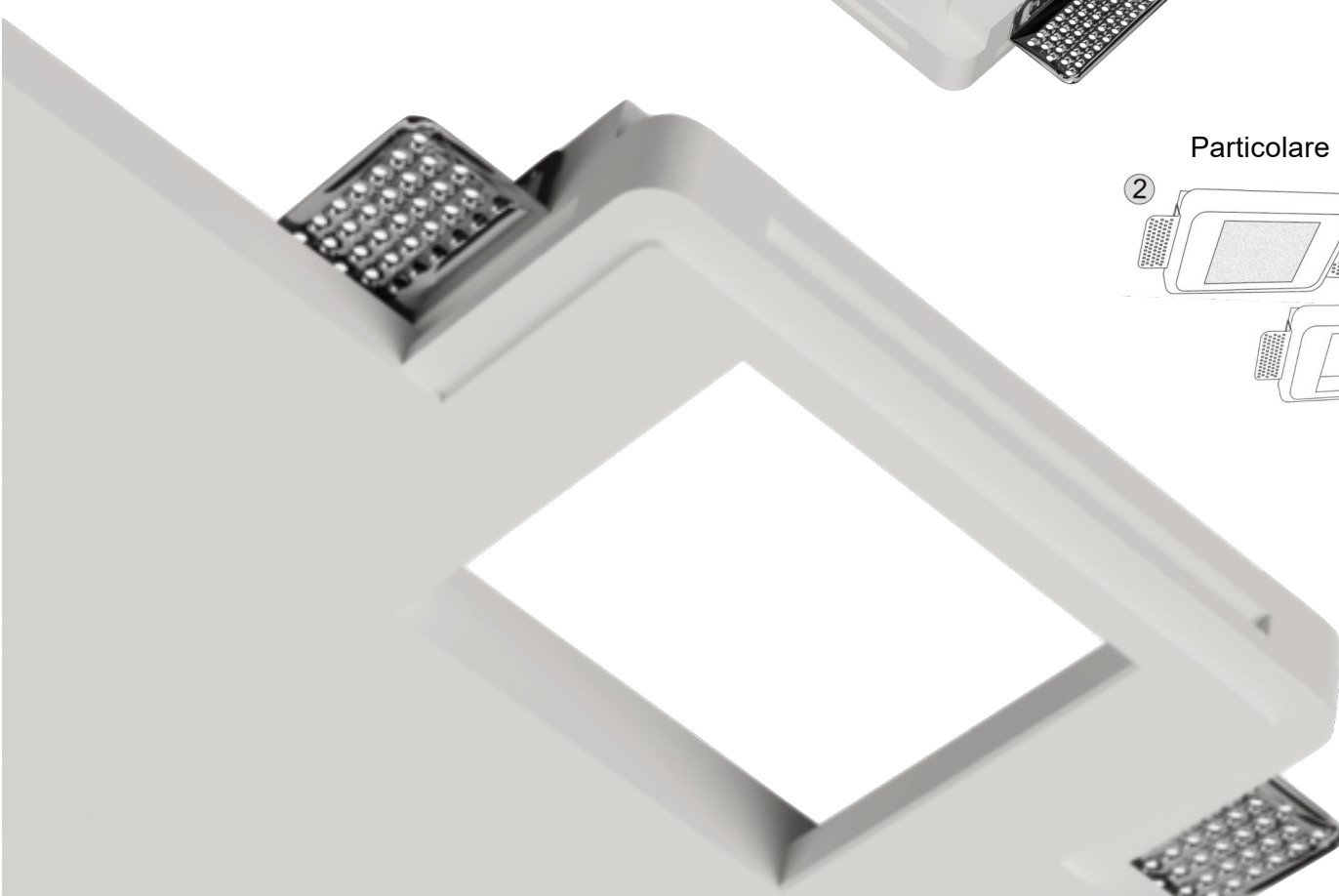
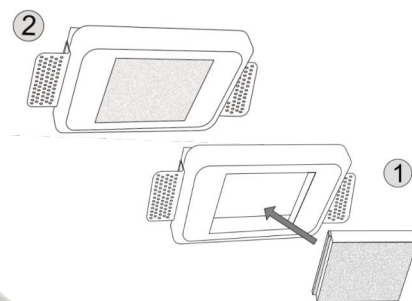

La base universale **BP1** ha una duplice funzione:

- botola d'ispezione e/o sostituzione tra i vari corpi.



Boccioni

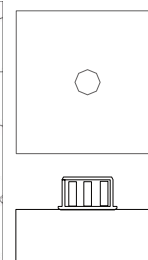
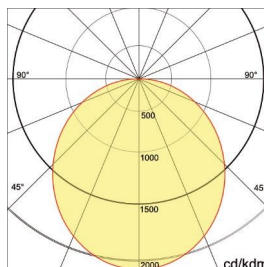

10cm

7cm

Codice/Code	Tipo di led/Led type	Potenza/Power	Voltaggio in ingresso/Input voltage	Flusso luminoso/LED flux	CCT	CRI
PLP1-3C	COB Bridgelux	1x3W	350mA	400	3000k	90
PLP1-3N	COB Bridgelux	1x3W	350mA	400	4000k	90
PLP1-7C	COB Bridgelux	1x7W	350mA	828	3000k	90
PLP1-7N	COB Bridgelux	1x7W	350mA	860	4000k	90
PLP1-7F	COB Bridgelux	1x7W	350mA	941	5000k	90



Balla

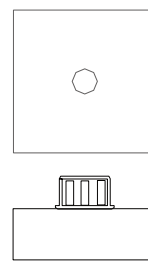
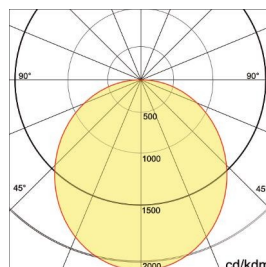

10cm

7cm

Codice/Code	Tipo di led/Led type	Potenza/Power	Voltaggio in ingresso/Input voltage	Flusso luminoso/LED flux	CCT	CRI
PLP4-3C	COB Bridgelux	1x3W	350mA	400	3000k	90
PLP4-3N	COB Bridgelux	1x3W	350mA	400	4000k	90
PLP4-7C	COB Bridgelux	1x7W	350mA	828	3000k	90
PLP4-7N	COB Bridgelux	1x7W	350mA	860	4000k	90
PLP4-7F	COB Bridgelux	1x7W	350mA	941	5000k	90



Severini

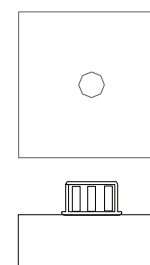
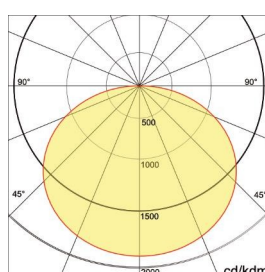

10cm

7cm

Codice/Code	Tipo di led/Led type	Potenza/Power	Voltaggio in ingresso/Input voltage	Flusso luminoso/LED flux	CCT	CRI
PLP5-3C	COB Bridgelux	1x3W	350mA	400	3000k	90
PLP5-3N	COB Bridgelux	1x3W	350mA	400	4000k	90
PLP5-7C	COB Bridgelux	1x7W	350mA	828	3000k	90
PLP5-7N	COB Bridgelux	1x7W	350mA	860	4000k	90
PLP5-7F	COB Bridgelux	1x7W	350mA	941	5000k	90

12

CORNICI HIPS

HIPSL4530

Cornice per illuminazione indiretta con LED

Dimensioni: 3 x 4,5 x 200 cm

Linea: Luxstyle

Sottolinea: Profili per illuminazione indiretta con LED

Materiale: HIPS Polistrutturato

Applicazioni: Elementi per parete Elementi per soffitto Elementi per LED

Stile: Moderno Liscio



HIPSL5535

Cornice per illuminazione indiretta con LED

Dimensioni: 3,5 x 5,5 x 200 cm

Linea: Luxstyle

Sottolinea: Profili per illuminazione indiretta con LED

Materiale: HIPS Polistrutturato

Applicazioni: Elementi per soffitto Elementi per LED

Stile: Moderno Liscio

HIPSL6024

Cornice per illuminazione indiretta con LED

Dimensioni: 2,4 x 6 x 200 cm

Linea: Luxstyle

Sottolinea: Profili per illuminazione indiretta con LED

Materiale: HIPS

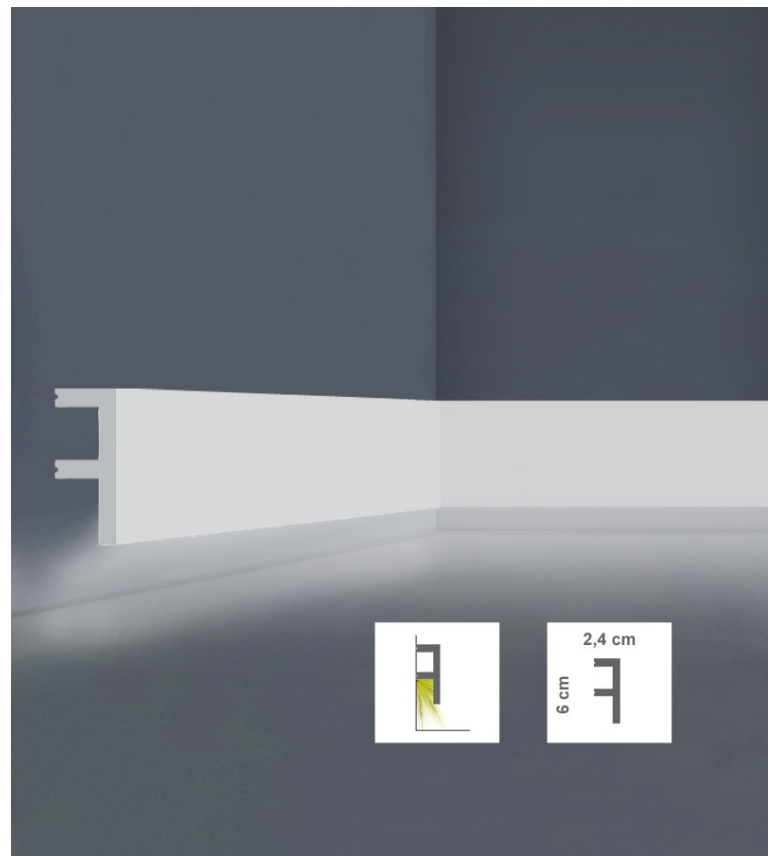
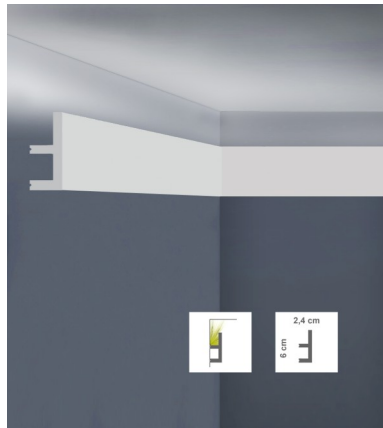

HIPSL6537

Cornice per illuminazione indiretta con LED

Dimensioni: 3,7 x 6,5 x 200 cm

Linea: Luxstyle

Sottolinea: Cornici per pareti e soffitti

Materiale: HIPS Polistrutturato

Applicazioni: Elementi per soffitto
Elementi per LED

Stile: Moderno Liscio

HIPSL7033

Cornice per illuminazione indiretta con LED

Dimensioni: 3,3 x 7 x 200 cm

Linea: Luxstyle

Sottolinea: Profili per illuminazione indiretta con LED

Materiale: HIPS Polistrutturato

Applicazioni: Elementi per soffitto
Elementi per LED

Stile: Moderno Classico

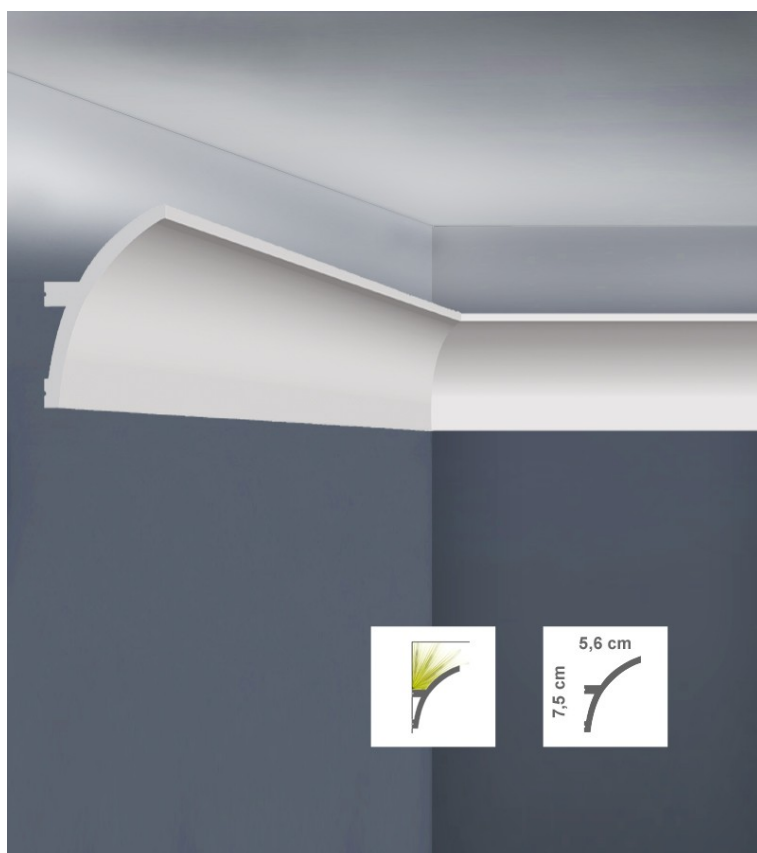
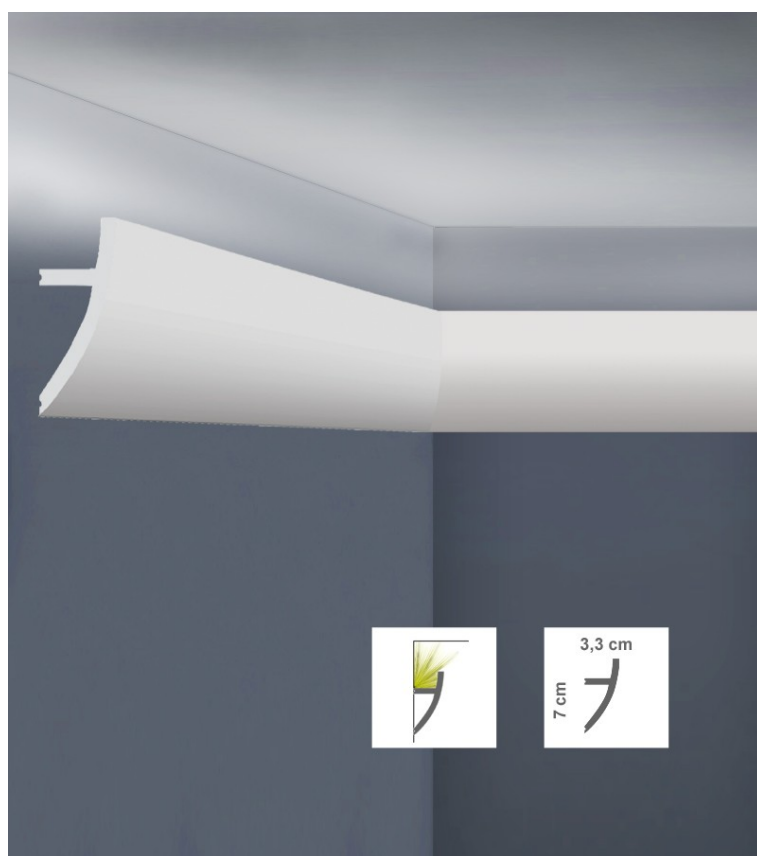

HIPSL7556

Cornice per illuminazione indiretta con LED

Dimensioni: 5,6 x 7,5 x 200 cm

Linea: Luxstyle

Sottolinea: Profili per illuminazione indiretta con LED

Materiale: HIPS Polistrutturato

Applicazioni: Elementi per soffitto
Elementi per LED

Stile: Moderno Liscio

HIPSL8585

Cornice per illuminazione indiretta con LED

Dimensioni: 8,5 x 8,5 x 200 cm

Linea: Luxstyle

Sottolinea: Profili per illuminazione indiretta con LED

Materiale: HIPS Polistrutturato

Applicazioni: Elementi per soffitto
Elementi per LED

Stile: Moderno Liscio

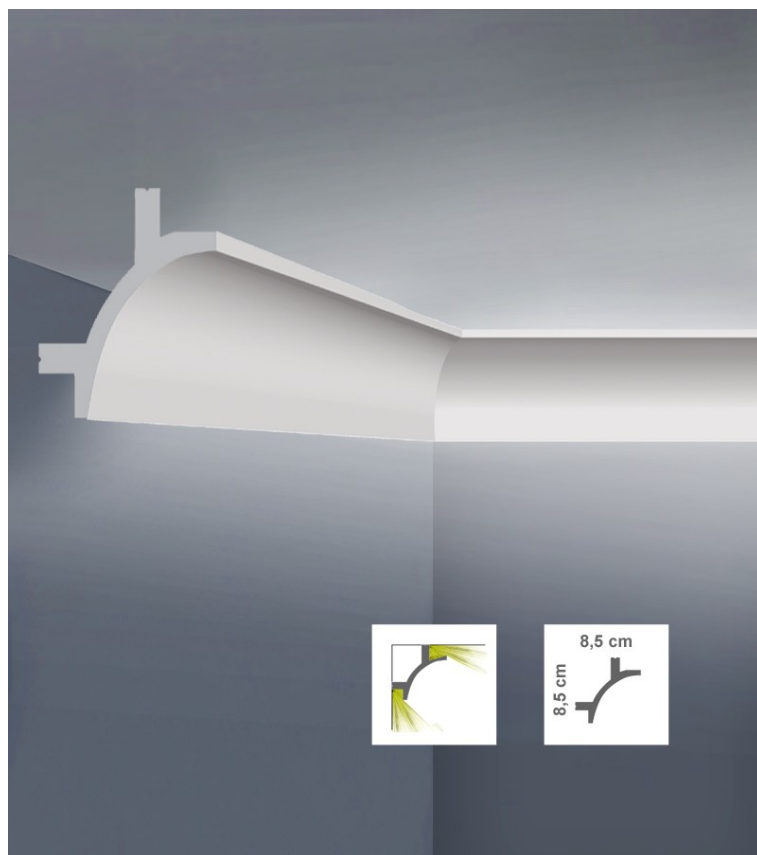

HIPSL9548

Cornice per illuminazione indiretta con LED

Dimensioni: 4,8 x 9,5 x 200 cm

Linea: Luxstyle

Sottolinea: Profili per illuminazione indiretta con LED

Materiale: HIPS Polistrutturato

Applicazioni: Elementi per soffitto
Elementi per LED

Stile: Moderno Liscio

HIPSL1818

Battiscopa e Profilo per parete

Dimensioni: 1,8 x 1,8 x 200 cm

Linea: Luxstyle

Sottolinea: Battiscopa

Materiale: HIPS Polistrutturato

Applicazioni: Elementi per parete Elementi per pavimento

Stile: Moderno Liscio

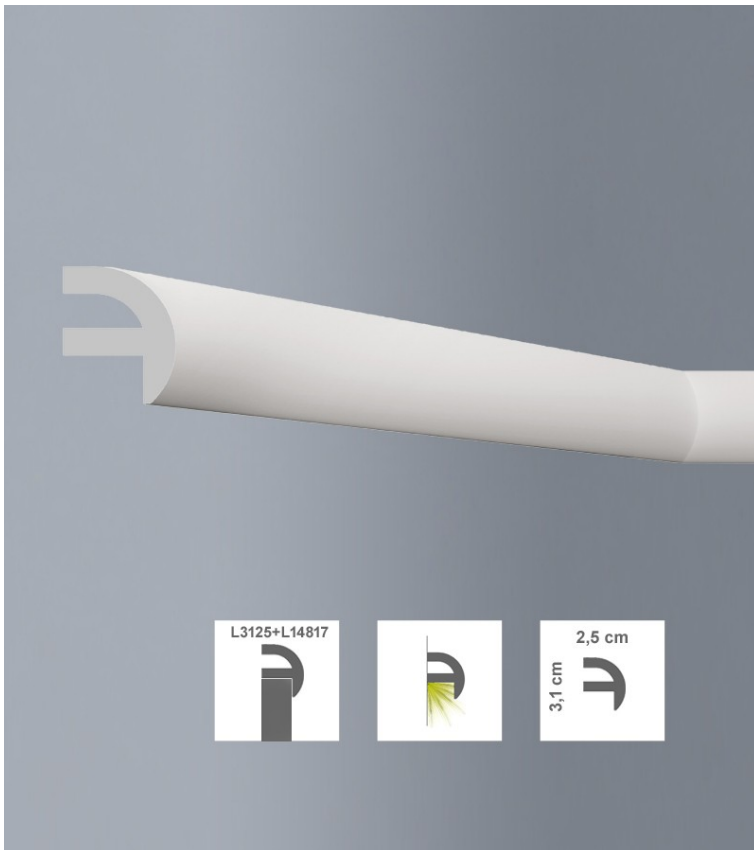
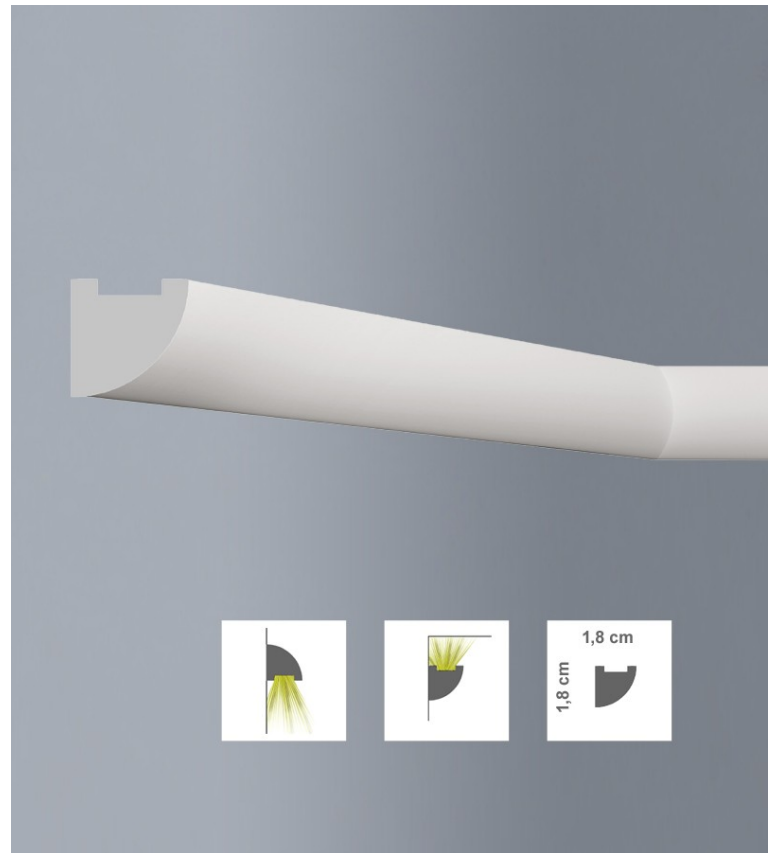

HIPSL3125

Battiscopa e Profilo per parete

Dimensioni: 2,5 x 3,1 x 200 cm

Linea: Luxstyle

Sottolinea: Battiscopa

Materiale: HIPS Polistrutturato

Applicazioni: Elementi per parete Elementi per pavimento

Stile: Moderno Liscio

HIPSL10014

Battiscopa e Profilo per parete

Dimensioni: 1,4 x 10 x 200 cm

Linea: Luxstyle

Sottolinea: Battiscopa

Materiale: HIPS Polistrutturato

Applicazioni: Elementi per parete Elementi per pavimento

Stile: Moderno Liscio



HIPSL10015

Battiscopa e Profilo per parete

Dimensioni: 1,5 x 10 x 200 cm

Linea: Luxstyle

Sottolinea: Battiscopa

Materiale: HIPS Polistrutturato

Applicazioni: Elementi per parete Elementi per pavimento

Stile: Moderno Liscio

HIPSL11014

Battiscopa e Profilo per parete

Dimensioni: 1,4 x 11 x 200 cm

Linea: Luxstyle

Sottolinea: Battiscopa

Materiale: HIPS Polistrutturato

Applicazioni: Elementi per parete Elementi per pavimento

Stile: Moderno Liscio



HIPSL11813

Battiscopa e Profilo per parete

Dimensioni: 1,3 x 11,8 x 200 cm

Linea: Luxstyle

Sottolinea: Battiscopa

Materiale: HIPS Polistrutturato

Applicazioni: Elementi per parete Elementi per pavimento

Stile: Moderno Liscio

HIPSL13016

Battiscopa e Profilo per parete

Dimensioni: 1,6 x 13 x 200 cm

Linea: Luxstyle

Sottolinea: Battiscopa

Materiale: HIPS Polistrutturato

Applicazioni: Elementi per parete Elementi per pavimento

Stile: Moderno Liscio

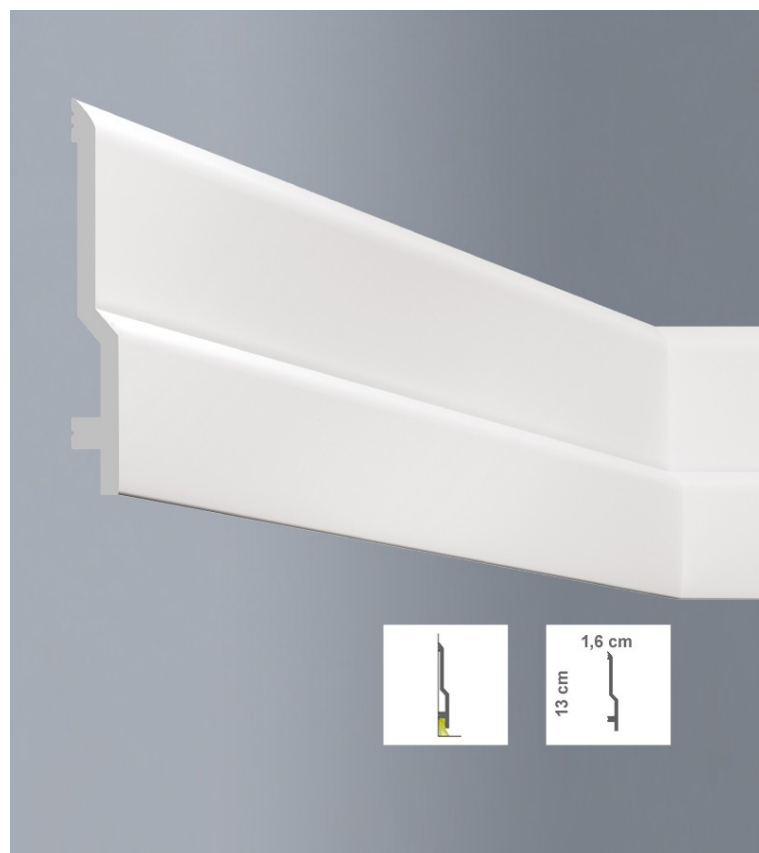

HIPSL15015

Battiscopa e Profilo per parete

Dimensioni: 1,5 x 15 x 200 cm

Linea: Luxstyle

Sottolinea: Battiscopa

Materiale: HIPS Polistrutturato

Applicazioni: Elementi per parete Elementi per pavimento

Stile: Moderno

13

ACCESSORI



MW LRS Series 12/24Vdc

Codice	Watt	Output Vdc	Input Vac	Current Out Max	Working Temp. Max	Dimensions	IP
LRS035-12	FG=	DC12V	90-264V	F%	-30 ~ +70°C	99X82X30	20
LRS035-24	FG=	DC24V	90-264V	1,5A	-30 ~ +70°C	99X82X30	20
LRS050-12	50W	DC12V	90-264V	4,2A	-30 ~ +70°C	99X82X30	20
LRS050-24	50W	DC24V	90-264V	2,2A	-30 ~ +70°C	99X82X30	20
LRS075-12	JG=	DC12V	90-264V	6A	-30 ~ +70°C	99X97X30	20
LRS075-24	JG=	DC24V	90-264V	3,2A	-30 ~ +70°C	99X97X30	20
LRS100-12	100W	DC12V	90-264V	8,5A	-30 ~ +70°C	129X97X30	20
LRS100-24	100W	DC24V	90-264V	4,5A	-30 ~ +70°C	129X97X30	20
LRS150-12	150W	DC12V	90-264V	12,5A	-30 ~ +70°C	160X100X30	20
LRS150-24	150W	DC24V	90-264V	6,5A	-30 ~ +70°C	160X100X30	20

Conformi ad EN60335-1 ed EN61558-1,-2-16

MW RSP Series 12/24Vdc

Codice	Watt	Output Vdc	Input Vac	Current Out Max	Working Temp. Max	Dimensions	IP	Cooling Fan
RSP200-12	200W	DC12V	90-264V	16,7A	-30 ~ +70°C	215X115X30	20	
RSP200-24	200W	DC24V	90-264V	8,4A	-30 ~ +70°C	215X115X30	20	
RSP320-12	320W	DC12V	90-264V	26,7A	-30 ~ +70°C	215X115X30	20	YES
RSP320-24	320W	DC24V	90-264V	13,4A	-30 ~ +70°C	215X115X30	20	YES
RSP500-12	500W	DC12V	90-264V	41,7A	-30 ~ +70°C	230X127X40	20	YES
RSP500-24	500W	DC24V	90-264V	21A	-30 ~ +70°C	230X127X40	20	YES

Conformi ad EN60335-1 ed EN61558-1,-2-16



RSP200



RSP320



RSP500

Si prega di fare espressa richiesta per altri prodotti con potenze e uscite diverse eventualmente disponibili.
Please make a specific request for other products with different powers and outputs that may be available.

Alimentatori LED Tensione Costante LED Power Supplies Constant Voltage



AcTEC UT Series 12/24Vdc Class II

Codice	Watt	Output Vdc	Input Vac	Current Out Max	Working Temp. Range Max	Dimensions	IP
UT12V6W	6W	DC12V	220-240V	0,5A	-20 ~ +50°C	98X46X11	20
UT24V6W	6W	DC24V	220-240V	0,25A	-20 ~ +50°C	98X46X11	20
UT12V12W	12W	DC12V	220-240V	1,0A	-20 ~ +50°C	128X50X13	20
UT24V12W	12W	DC24V	220-240V	0,5A	-20 ~ +50°C	128X50X13	20
UT12V20W	20W	DC12V	220-240V	1,67A	-20 ~ +50°C	128X50X13	20
UT24V20W	20W	DC24V	220-240V	0,83A	-20 ~ +50°C	128X50X13	20
UT12V30W	30W	DC12V	220-240V	2,5A	-20 ~ +50°C	155X53X16	20
UT24V30W	30W	DC24V	220-240V	1,25A	-20 ~ +50°C	155X53X16	20
UT12V50W	50W	DC12V	220-240V	4,16A	-20 ~ +50°C	185X64X22	20
UT24V50W	50W	DC24V	220-240V	2,1A	-20 ~ +50°C	185X64X22	20



MW APV Series 12/24Vdc Class II

Codice	Watt	Output Vdc	Input Vac	Current Out Max	Working Temp. Range Max	Dimensions	IP
APV08-12V	8W	DC12	90-264V	0,67A	-30 ~ +70°C	60X30X24	42
APV08-24V	8W	DC24	90-264V	0,34A	-30 ~ +70°C	60X30X24	42
APV12-12V	12W	DC12	90-264V	1,0A	-30 ~ +70°C	77X40X29	42
APV12-24V	12W	DC24	90-264V	0,5A	-30 ~ +70°C	77X40X29	42
APV16-12V	16W	DC12	90-264V	1,25A	-30 ~ +70°C	77X40X29	42
APV16-24V	16W	DC24	90-264V	0,67A	-30 ~ +70°C	77X40X29	42
APV25-12V	25W	DC12	90-264V	2,10A	-30 ~ +70°C	84X57X30	42
APV25-24V	25W	DC24	90-264V	1,05A	-30 ~ +70°C	84X57X30	42
APV35-12V	FG=	DC12	90-264V	3,0A	-30 ~ +70°C	84X57X30	42
APV35-24V	FG=	DC24	90-264V	1,5A	-30 ~ +70°C	84X57X30	42



Si prega di fare espressa richiesta per altri prodotti con potenze e uscite diverse eventualmente disponibili.
Please make a specific request for other products with different powers and outputs that may be available.

Alimentatori LED Tensione Costante LED Power Supplies Constant Voltage



AcTEC LT Series 12/24Vdc Class II (Ballast)

Codice	Watt	Output Vdc	Input Vac	Current Out Max	Working Temp. Range Max	Dimensions	IP
LT60-12V	60W	DC12V	220-240V	5,0A	-20 ~ +40°C	305X30X17	20
LT60-24V	60W	DC24V	220-240V	2,5A	-20 ~ +40°C	305X30X17	20
LT100-12V	100W	DC12V	220-240V	8,33A	-20 ~ +40°C	312X30X17	20
LT100-24V	100W	DC24V	220-240V	4,17A	-20 ~ +40°C	312X30X17	20
LT150-12V	150W	DC12V	220-240V	11A	-20 ~ +45°C	336X30X17	20
LT150-24V	150W	DC24V	220-240V	6,25A	-20 ~ +45°C	336X30X17	20



AcTEC Q3 Series 12/24Vdc Class II PFC - UL

Codice	Watt	Output Vdc	Input Vac	Current Out Max	Working Temp. Range Max	Dimensions	IP
Q3-50-12V	50W	DC12V	100-240V	4,2A	-20 ~ +50°C	184X61X33	20
Q3-50-24V	50W	DC24V	100-240V	2,0A	-20 ~ +50°C	184X61X33	20
Q3-75-12V	JG=	DC12V	100-240V	6,3A	-20 ~ +50°C	184X61X33	20
Q3-75-24V	JG=	DC24V	100-240V	3,15A	-20 ~ +50°C	184X61X33	20
Q3-100-12V	100W	DC12V	100-240V	8,3A	-20 ~ +50°C	184X61X33	20
Q3-100-24V	100W	DC24V	100-240V	4,16A	-20 ~ +50°C	184X61X33	20



Si prega di fare espressa richiesta per altri prodotti con potenze e uscite diverse eventualmente disponibili.
Please make a specific request for other products with different powers and outputs that may be available.

Alimentatori LED Tensione Costante LED Power Supplies Constant Voltage



AcTEC MINI Series 12/24Vdc IP65 Class II

Codice	Watt	Output Vdc	Input Vac	Current Out Max	Working Temp. Range Max	Dimensions	IP
MINI12V12W	12W	DC12V	220-240V	1,0A	-20 ~ +50°C	50X48X25	65
MINI24V12W	12W	DC24V	220-240V	0,5A	-20 ~ +50°C	50X48X25	65



AcTEC RS Series 12/24Vdc IP65 Class II

Codice	Watt	Output Vdc	Input Vac	Current Out Max	Working Temp. Range Max	Dimensions	IP
RS12V8W	8W	DC12V	220-240V	0,67A	-20 ~ +50°C	53X22	65
RS24V8W	8W	DC24V	220-240V	0,33A	-20 ~ +50°C	53X22	65



MW LPV Series 12/24Vdc IP67 Class II

Codice	Watt	Output Vdc	Input Vac	Current Out Max	Working Temp. Range Max	Dimensions	IP
LPV020-12	20W	DC12V	90-264V	1A	-30 ~ +70°C	118X35X26	67
LPV020-24	20W	DC24V	90-264V	0,5A	-30 ~ +70°C	118X35X26	67
LPV035-12	FG=	DC12V	90-264V	F%	-30 ~ +70°C	148X40X30	67
LPV035-24	FG=	DC24V	90-264V	1,5A	-30 ~ +70°C	148X40X30	67
LPV060-12	60W	DC12V	90-264V	G%	-30 ~ +70°C	162X42X32	67
LPV060-24	60W	DC24V	90-264V	2,5A	-30 ~ +70°C	162X42X32	67
LPV100-12	100W	DC12V	90-264V	8,5A	-25 ~ +70°C	190X52X37	67
LPV100-24	100W	DC24V	90-264V	4,5A	-25 ~ +70°C	190X52X37	67
LPV150-12	150W	DC12V	90-264V	12,5A	-25 ~ +70°C	190X63X37	67
LPV150-24	150W	DC24V	90-264V	6,5A	-25 ~ +70°C	190X63X37	67



Si prega di fare espressa richiesta per altri prodotti con potenze e uscite diverse eventualmente disponibili.
Please make a specific request for other products with different powers and outputs that may be available.

Alimentatori LED Tensione Costante LED Power Supplies Constant Voltage



MW ELG Series 24Vdc – DA (DALI) IP67 Class II

Codice	Watt	Output Vdc	Input Vac	Current Out Max	Working Temp. Range Max	Dimensions	IP
ELG075-24	75W	DC24V	100-305V	3,15A	-40 ~ +85°C	180X63X35,5	67
ELG075-24DA	75W	DC24V	100-305V	3,15A	-40 ~ +85°C	180X63X35,5	67
ELG100-24	100W	DC24V	100-305V	4A	-40 ~ +85°C	199X63X35,5	67
ELG100-24DA	100W	DC24V	100-305V	4A	-40 ~ +85°C	199X63X35,5	67
ELG150-24	150W	DC24V	100-305V	6,25A	-40 ~ +85°C	219X63X35,5	67
ELG150-24DA	150W	DC24V	100-305V	6,25A	-40 ~ +85°C	219X63X35,5	67
ELG200-24	200W	DC24V	100-305V	8,4A	-40 ~ +85°C	244X71X37,5	67
ELG200-24DA	200W	DC24V	100-305V	8,4A	-40 ~ +85°C	244X71X37,5	67
ELG240-24	240W	DC24V	100-305V	10A	-40 ~ +85°C	244X71X37,5	67
ELG240-24DA	240W	DC24V	100-305V	10A	-40 ~ +85°C	244X71X37,5	67







SELV IP65 IP67











MW HLG Series 12/24/36Vdc IP67 Class II

Codice	Watt	Output Vdc	Input Vac	Current Out Max	Working Temp. Range Max	Dimensions	IP
HLG040H-12	40W	DC12V	90-305V	3,33A	-40 ~ +70°C	171X61,5X36,8	67
HLG040H-24	40W	DC24V	90-305V	1,66A	-40 ~ +70°C	171X61,5X36,8	67
HLG060H-24	60W	DC24V	90-305V	2,5A	-40 ~ +70°C	171X61,5X36,8	67
HLG060H-36	60W	DC36V	90-305V	1,7A	-40 ~ +70°C	171X61,5X36,8	67
HLG080H-12	80W	DC12V	90-305V	5,0A	-40 ~ +60°C	195,6X61,5X38,8	67
HLG080H-24	80W	DC24V	90-305V	3,4A	-40 ~ +60°C	195,6X61,5X38,8	67
HLG100H-24	100W	DC24V	90-305V	4,0A	-30 ~ +60°C	220X68X38,8	67
HLG100H-36	100W	DC36V	90-305V	2,65A	-30 ~ +60°C	220X68X38,8	67
HLG120H-12	120W	DC12V	90-305V	10,0A	-40 ~ +70°C	220X68X38,8	67
HLG120H-24	120W	DC24V	90-305V	5,0A	-40 ~ +70°C	220X68X38,8	67
HLG150H-12	150W	DC12V	90-305V	12,5A	-30 ~ +60°C	228X68X38,8	67
HLG150H-24	150W	DC24V	90-305V	6,3A	-30 ~ +60°C	228X68X38,8	67
HLG185H-12	185W	DC12V	90-305V	13,0A	-40 ~ +70°C	228X68X38,8	67
HLG185H-24	185W	DC24V	90-305V	7,8A	-40 ~ +70°C	228X68X38,8	67
HLG240H-12	240W	DC12V	90-305V	16,0A	-40 ~ +70°C	244,2X68X38,8	67
HLG240H-24	240W	DC24V	90-305V	10,0A	-40 ~ +70°C	244,2X68X38,8	67
HLG320H-12	320W	DC12V	90-305V	22,0A	-40 ~ +70°C	252X90X43,8	67
HLG320H-24	320W	DC24V	90-305V	13,34A	-40 ~ +70°C	252X90X43,8	67







SELV IP65 IP67









Si prega di fare espressa richiesta per altri prodotti con potenze e uscite diverse eventualmente disponibili.
Please make a specific request for other products with different powers and outputs that may be available.

Alimentatori LED Corrente Costante LED Power Supplies Constant Current



MW APC Series 350mA-700mA

Codice	Watt	Output Vdc	Input Vac	Current Out Max	Working Temp. Range Max	Dimensions	IP
APC08-350	8W	11-23Vdc	90-264V	350mA	-30 ~ +70°C	60X30X24	42
APC08-700	8W	6-11Vdc	90-264V	700mA	-30 ~ +70°C	60X30X24	42
APC12-350	12W	9-36 Vdc	90-264V	350mA	-30 ~ +70°C	77X40X29	42
APC12-700	12W	9-18 Vdc	90-264V	700mA	-30 ~ +70°C	77X40X29	42
APC16-350	16W	12-48 Vdc	90-264V	350mA	-30 ~ +70°C	77X40X29	42
APC16-700	15W	9-24 Vdc	90-264V	700mA	-30 ~ +70°C	77X40X29	42
APC25-350	25W	25-70 Vdc	90-264V	350mA	-30 ~ +70°C	84X57X30	42
APC25-700	25W	11-36 Vdc	90-264V	700mA	-30 ~ +70°C	84X57X30	42
APC35-350	FG=	38-100 Vdc	90-264V	350mA	-30 ~ +70°C	84X57X30	42
APC35-700	FG=	15-50 Vdc	90-264V	700mA	-30 ~ +70°C	84X57X30	42



MW LCM Series MULTIPLE – STAGE CONSTANT CURRENT Dimmer Push/0...10V/DALI



Codice	Watt	Output Range Voltage	Input Vac	Current Out Range	Working Temp. Range Max	Dimensions	IP
LCM40-DA	40W	2-100Vdc	180-295V	350-1050mA	-30 ~ +60°C	123,5X81,5X23	20
LCM60-DA	60W	2-90Vdc	180-295V	500-1400mA	-30 ~ +60°C	123X81,5X23	20

IS 1869Par.26 e 13
R-416/2769



I _o	DIP S.W.					
	1	2	3	4	5	6
350mA	---	---	---	---	---	---
500mA	ON	---	---	---	---	---
600mA	ON	ON	---	---	---	---
700mA (Factory default)	ON	ON	ON	---	---	ON
900mA	ON	ON	ON	ON	---	ON
1050mA	ON	ON	ON	ON	ON	ON

PD-LCM40-DA

I _c	DIP S.W.					
	1	2	3	4	5	6
500mA	---	---	---	---	---	---
600mA	ON	---	---	---	---	---
700mA (Factory setting)	ON	ON	---	---	---	---
900mA	ON	ON	ON	---	---	ON
1050mA	ON	ON	ON	ON	---	ON
1400mA	ON	ON	ON	ON	ON	ON

PD-LCM60-DA

Si prega di fare espressa richiesta per altri prodotti con potenze e uscite diverse eventualmente disponibili.
Please make a specific request for other products with different powers and outputs that may be available.

Cavo elettrico in rame rivestito di tessuto.



Codice/Code	Model	Colore
RC01	2x0,75mm	Bianco



Codice/Code	Model	Colore
RC04	2x0,75mm	Nero



Codice/Code	Model	Colore
RC43	2x0,75mm	Tortora



Codice/Code	Model	Colore
RM36	3x0,75mm	Ruggine



Codice/Code	Model	Colore
RM05	2x0,75mm	Oro



Cavo elettrico in rame .



Codice/Code	Model	Colore
RC01	2x0,75mm	Rosso e Nero



CAVO 20# BIPOLARE
2x0.50MM ROSSO/NERO
IN ROTOLO DA 100MT

Codice/Code	Model	Colore
RC01	2x0,75mm	RGB



CAVO 22# RGB 4 POLI IN
ROTOLO DA 25MT

Codice/Code	Model	Colore
RC04	2x0,75mm	Bianco



CAVO PIATTO PVC
BIANCO 2x0.75MM 230V
IN ROTOLO DA 100MT

Codice/Code	Model	Colore
RC04	2x0,75mm	RGB+W



CAVO 22# RGBW 5 POLI
IN ROTOLO DA 25MT

Codice/Code	Model	Colore
RC43	2x0,75mm	Nero



CAVO PIATTO PVC
NERO 2x0.75MM 230V IN
ROTOLO DA 100MT

Codice/Code	Model	Colore
RC43	2x0,75mm	RGB+CCT



CAVO 22# RGB+CCT 6
POLI IN ROTOLO DA 25MT





Zerodeu Lux s.r.l

Zerodeu Lux srl
Via Edison 6/8
20054 Segrate (MI) Italy
www.ledprofile.it
info@ledprofile.it

Profili per illuminazione a **LED**