

CEMO

for safe storage



Innovative solutions
for Local authorities | Agriculture
Construction | Industry

Products 2025 | 2026

valid from 15/7/2025



Refuelling systems | Pumps | Storage of hazardous substances
Transportation and storage containers | Winter service | Spreaders

www.cemo-group.com

Moving forward **TOGETHER**

Innovative solutions and reliable service
for high demands.



1960

Erhard Mödinger set up a two-man business in Weinstadt, Germany for the production of grape vats and barrels made of glass fibre reinforced plastic (GRP) for viticulture and agriculture

1970

The second Chemo plant (called CEMO today) for the production of heating oil tanks was built on a 42,000 m² site in Schnellendorf (Bavaria)

1990

Development of an environmental protection range for the storage of water-polluting substances (GRP drip trays, used battery containers, pollutant collection stations)

2001

Market launch of the DWT tank – the first double-walled tank made of GRP in sandwich construction



CEMO plus points

Sustainability

Durable and well thought-out: In the development of our products, we take environmental protection as well as legal requirements into account.

Quality

Intelligent design and the highest quality manufacturing offer you efficient and economical solutions for safe storage.

Experience

Products with added value, expert technical advice, extensive training: With CEMO, you get everything from one source.

Moving forward together

Partnerships are more than just business relationships. They are connections built on trust, respect and common goals.

Together we can pool resources, exchange ideas and develop innovative solutions for tomorrow.



2013

Development of a new tank generation for diesel, AdBlue® and lubricants: CEMO CUBE

2019

Products for the storage and transport of lithium batteries, battery safety cabinets F90

2020

60 years of CEMO – full-range supplier for safe storage

2023

Expansion of the production facility at the plant in Schnelldorf, including new rotation moulding systems

2024

The new CEMO PROline product line offers the latest generation of safety storage cabinets



Made in Germany – and with over 60 years experience

Our products meet the highest quality standards and have been tried and tested in practice. They far exceed the required service life and are tested and approved by independent institutions.

Hazardous material management from one source

Our range of products includes everything you need to ensure safety during transportation and operation – from solutions for small containers and IBC bunds, mobile systems to suitable accessories.

Would you like some advice in choosing products or do you want to undergo training?

Our experts will be happy to assist you.

Simply contact us

Tel. +49 7151 9636-0

Fax +49 7151 9636-94

Mail export@cemo-group.com

CEMO Representation
Always close to you



**Reliable service.
Worldwide.**

CEMO INTERNATIONAL AREA SALES MANAGER +49 7151 9636-

Antonio Samarzija -1501
Daniel Bubeck -1502
Karsten Pflieger -1504
Tetyana Skypnyk -1503

 export@cemo-group.com



Antonio Samarzija
Export Director

DK, SI, HR, PL, RS, BA,
ME, MK, XK
+49 172 7045 617
asamarzija
@cemo-group.com



Daniel Bubeck
Deputy Export Director

CH, USA, Africa, Near &
Middle East, LATAM
+49 173 2762 221
dbubeck
@cemo-group.com



Karsten Pflieger
Senior Area Sales Manager

BeNeLux, Asia & Oceania,
Iceland
+49 172 7447 970
kpflieger
@cemo-group.com



Tetyana Skypnyk
Area Sales Manager

CZ, SK, PL, HU, UA
+49 152 2633 4570
tskrypnik
@cemo-group.com

CEMO INTERNATIONAL CUSTOMER SERVICE +49 7151 9636-

Renate Traub -1505
Uwe Kübler -1516
Franziska Abele -1508
Daniela Mayer -1509
Nora Offenhäuser -1510
Carmen Spießberger -1517

 export@cemo-group.com



Renate Traub
Team Leader



Uwe Kübler
Deputy Team Leader



Franziska Abele



Daniela Mayer



Nora Offenhäuser



Carmen Spießberger

CEMO INTERNATIONAL COUNTRY | REGIONAL MANAGER

AUSTRIA



Alexander Ohler
+43 664 2275 544
aohler@
cemo-group.com

UK & IRELAND



Geoff Miller
+44 7579 0032 27
gmiller@
cemo-group.com

IT/CZ/SK/H/RO/BG/MT



Giorgio Billio
+39 340 2942 007
gbillio@
cemo-group.com

SWEDEN/NORWAY



Frank Scharf
+46 73 2552 329
fscharf@
cemo-group.com

FINLAND/BALTICS



Jan Hägg
+358 45 3507 465
jhaegg@
cemo-group.com

NEW PRODUCTS

CEMO CUBE
3.500 L and 7.500 L
Stationary refuelling systems

Diesel

AdBlue®

18
24

101
102

CEMO DT-MOBIL EASY
470 L and 620 L
Mobile refuelling systems

CAS CORDLESS ALLIANCE SYSTEM

44
45

CEMO DT-MOBIL PRO hybrid
Mobile refuelling systems

54-
57

CEMO CUBE
Waste oil tank

81

CEMO KSS 130 L
Lubricant trolley

87

CEMO SW 180
Grit spreader

288

CEMO Environmental/HazMat rack with PE spill trays

181

CEMO PROline 6/20 and 12/20
Safety storage cabinets

204
205

for batteries

220

CEMO Battery storage and charging cabinets with explosion protection

lockEX inside

215-
217

REFUELLING SYSTEMS

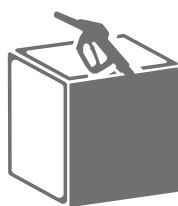

	PAGE
Stationary diesel refuelling systems and fuel dispensing areas, tank monitoring	10 – 34
Mobile diesel refuelling systems	35 – 64
Mobile diesel and heating oil refuelling systems for heaters and generators	65 – 67
Petrol refuelling systems, stationary and mobile	70 – 77
Refilling systems for lubricants, stationary and mobile	80 – 88
Mobile refilling systems for screenwash and radiator antifreeze	89
Refilling systems for AdBlue® (DEF) stationary and mobile	92 -111

PUMPS



Tank data management systems	115 – 116
Diesel dispensing pumps, CUBE pumps, diesel pumps and hose reels	117 – 128
Filters for diesel and petrol	124
Submersible pumps for diesel, AdBlue® and water	125 – 126
Hand pumps for diesel, lubricants and petrol	128
Petrol pumps and motorised pumps with petrol engine	129 – 130
Lubricant pumps, electric and pneumatic	131 – 133
AdBlue® and chemical pumps	134 – 139

AdBlue® is a registered trademark of the German Automotive Industry Association

ENVIRONMENTAL PROTECTION

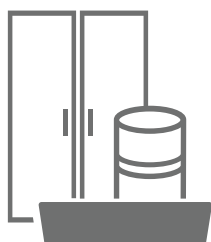

Spill pallets and spill trays made of GRP, PE and steel	145 – 164
Spill pallets and spill trays and refuelling systems made of GRP, PE and steel	165 – 171
Drum and hazardous material racks, environmental cabinets and safety containers	172 – 201
Secure cabinets fireproof F-SAFE, fireproof containers F-SAFE	202 – 209
Storage and charging of lithium batteries, battery secure cabinet F90	210 – 220
Transport of lithium batteries	221 – 224
Collection stations, drum depots, suction units, safety storage containers	225 – 231
Go-box for absorbents, portable drum bund, dispensing nozzle holder for drums	232
Filling funnels, bunds, Cemsorb absorbends	233 – 235

TRANSPORT AND STORAGE CONTAINERS



Tanks, GRP and PE, PE beverage tanks	240 – 251
Mobile irrigation systems, mobile cleaning systems	252 – 259
Water storage tanks PE	260 – 261
Rectangular containers	262 – 267
Transport containers CEMbox	268 – 271
Vehicle storage box, general purpose box GRP and steel, logistics box, Go-box	272 – 274
Boot cleaner, GRP rinsing trays	275

WINTER SERVICE / SPREADERS



GRP grit container, Go-Box, grit container loading frame	278 – 283
GRP snow shovel, snow plough, corrosion-resistant PP shovels	284 – 285
Spreaders with PE hopper and with composite frame	286
Grit and drop spreaders with PE hopper	287
Towable spreaders with steel and PE hopper, Spray Caddy	288 – 289

SERVICE AND MAINTENANCE INDEX

290
291

REFUELLING SYSTEMS FOR DIESEL





Stationary refuelling systems for diesel (p. 10 – 34)

DIESEL TANK GUIDE



Tank series	CUBE						UNI tanks	steel tanks
Capacity (L)	980	1,000 – 2,500	2,000	3,500	5,000	7,500	400 – 1,500	4,000 – 30,000
Outdoor	yes	yes	yes	yes	yes	yes	-	yes
Lockable	yes	yes	-	yes	yes	yes	-	-
Certification – stationary use	yes	yes	yes	yes	yes	yes	yes	yes
Transport certification according to ADR	optional	-	-	-	-	-	-	-
Forklifttable	yes	-	-	-	-	-	yes	-
Ergonomics								
working high (cm)	120	140	180	140	145	140	117 / 142 / 185	-
hose reel	optional	optional	-	optional	optional	optional	-	-
pump flow rate (L/min)	50	up to 72	50	up to 80	up to 80	up to 80	up to 50	up to 90
Revision dome / Cleaning opening	yes	yes	yes	yes	yes	yes	-	yes
Design	compact	compact	compact				compact	
Material combination			plastic / plastic				steel / plastic	steel / steel
Warranty (years)	10	10	10	10	10	10	5	10
Service + Maintenance	yes	yes	yes	yes	yes	yes	yes	yes

CEMO CUBE 980

- complete system Basic and Premium versions
- compact design, easy to operate
- all components at optimum working height



25

CEMO CUBE 2000 L Slimline diesel tank

- double-walled tank with visual leak detection



26

CEMO CUBE

- 1,000 – 15,000 L
- HDPE bunded tank
- installation in buildings and outdoors



from 12

CEMO UNI

- 400 – 4,500 L
- Double-wall tank comprising HDPE inner tank and galvanised sheet steel bund
- indoor installation
- does not require a bund, even in water-protected areas



from 27

CEMO steel tank

- 4,000 – 30,000 L
- above ground refuelling system
- steel double-wall



from 30



CEMO fuel dispensing areas

- outdoor
- Compact and Basic, indoor

from 32

CEMO tank monitoring

- Fuel level monitoring system, without and with remote monitoring for unpressurised tanks

34

Stationary refuelling systems for diesel

STATUTORY REQUIREMENTS FOR DIESEL REFUELLING SYSTEMS FOR OWN CONSUMPTION

The refuelling system is intended for the refuelling of the company's own vehicles. It is operated by the operator or by instructed persons appointed by the operator, and the total annual output is a maximum 100,000 L.

The self-consumption refuelling system consists of the storage tank and the refuelling system. A summary of the conditions to be met for a self-consumption refuelling system is provided below:

The ordinance on facilities for handling substances that are hazardous to water (AwSV) came into force on 1 August 2017. It harmonizes national requirements and replaces the 16 ordinances on facilities for handling substances that are hazardous to water (VAwS) of the individual German states. TRwS 781 (vehicle fuelling stations) will therefore also be regarded nationwide as the generally acknowledged technical regulation in accordance with Sec. 62 (2) of the Water Management Act (WHG). TRwS 781 defines the requirements for self-consumption refuelling systems.

A Storage facility

1. Storage containers with test mark or National Technical Certification, single-walled GRP containers up to 2,000 L without bund, but on a subsurface that is impervious to fluid with a 1 cm upstand (e.g. R1 sealing surface elements), also pertains to tank batteries up to 10,000 L; other double-walled containers or in a bund.
2. For installation in the open air, the storage tank must be certified for this purpose. This requirement is met by CEMO CUBE tanks, CEMO GRP tanks and double-walled steel tanks (cf. certification); PE tanks in sheet steel jackets only indoors.
3. Collision protection, for example: guard rails, large stones, high threshold or spray protection walls around the compact fuel dispensing area.
4. Automatic dispensing nozzle is required. Exception: Delivery from storage tanks < 1,000 L is also permitted using manually operated pumps with shut-off valve on the dispensing hose. This also applies to delivery with electrically operated pumps, if the pumps are disconnected from the power network by a manually operated switch during downtimes.
5. Permanently connected filling nozzles with tanker coupling.
6. Certified overfill prevention
7. A syphon lock on the pump is required.

8. No requirement for specialist assistance up to 10,000 L installation size.
9. Fire prevention regulations (distances, ventilation, design of walls and doors, etc.) must be met.

B Fuel dispensing area

1. Size of the fuel dispensing area: effective range of the nozzle, i.e. minimum hose length plus 1 m, livithable by walls or positively guided filler hose, e.g. compact fuel dispensing area.
2. The retention volume for the delivery devices is arrived at from the pump capacity in L/min x 3 min. For example, a pump with a volume flow of 50 L/min has a retention volume of 150 L. When filling the storage container, a retention volume for the fuel volume is required that will contain the volume of liquid that would be discharged at maximum flow, until the self-activating safety devices take effect. This results in a retention volume of $R = 0.1 \text{ m}^3$ when filling using a hose coupling, and a retention volume of $R = 0.9 \text{ m}^3$ when filling using devices with dead man's switch and emergency stop actuator.

Contrary to this, the maximum volume dispensing volume and thus the required retention volume may be reduced at owner-occupied refuelling systems by means of a non-replaceable restriction, e. g. by a smaller hose diameter.

3. Keep binding agents and fire extinguishers ready..

Obligations of the operator:

1. Register refuelling systems with more than 1,000 L with the water authorities below.
2. Inspection prior to commissioning by an expert in accordance with the Water Management Act (WHG) of refuelling systems with more than 1,000 L to 10,000 L. Periodic inspection (every 5 years) by an expert in accordance with the Water Management Act (WHG) of refuelling systems with more than 10,000 litres.
3. Obtain construction certification for refuelling systems with more than 5,000 L.



These principles apply to above-ground refuelling systems outside of water conservation areas. We will be happy to advise you for this purpose.

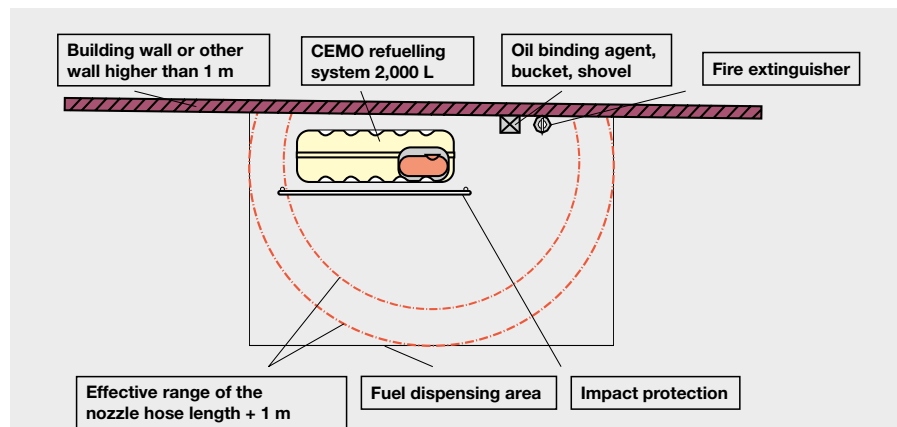

Example: Refuelling system for own consumption up to 2,000 L

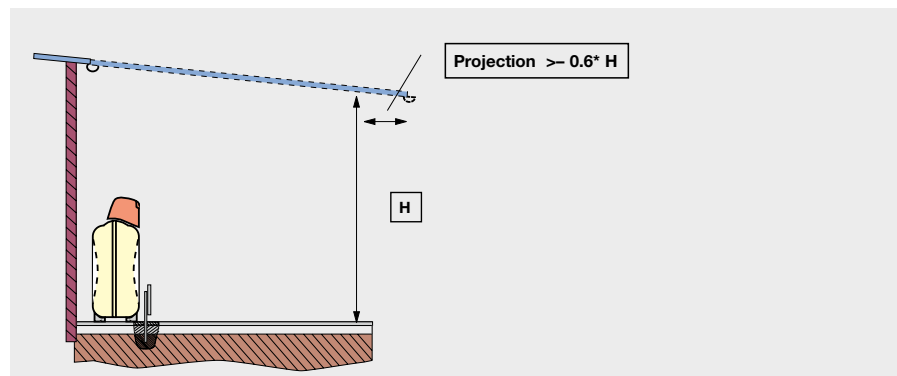

Roof for fuel dispensing areas

CEMO CUBE

Stationary refuelling systems for diesel

Most fuel stations available today have been adapted from oil storage tanks and often give the appearance of being cobbled together as best as possible. Perhaps now is the time to redesign from scratch and produce a purpose- designed fuel station better suited to today's user.

CEMO present the latest in security, function and design in the CUBE. We have introduced features with benefits, not compromises and jigs. The first dispensing station to be designed as a dispensing station with everything in its place, easily accessible and straightforward to use.

It's impressive – a great concept. Take a look and see if you agree.



Video
CUBE-Tank



ergonomic

All equipment is positioned so that it is easy to see and access at an optimum level over the bund.



always tidy

The automatic hose reel helps you keep 8 m of hose in order.

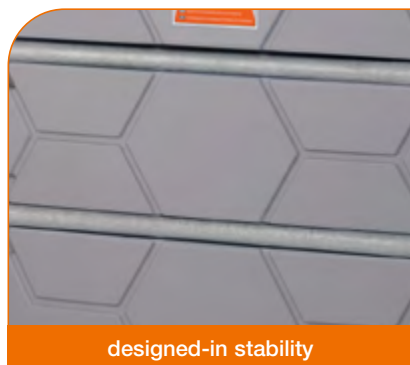

designed-in stability

The honeycomb structure (1,000, 1,500, 2,500, 3,500, 5,000, 7,500 L) and steel supports (1,000, 1,500, 2,500 L) result in superior robustness.



double protection

Integral 110 % bund gives added environmental protection.



electric connection access
integrated in lid

Cable duct allows easy connection to the electric pump.



**lighting**

Easy refueling even in the dark.

**large inspection hatch**

Hinged lid with 380 mm opening for tank inspection (5,000 and 7,500 L).

**cleanliness**

The integrated dispensing nozzle holder catches drops after filling.

**open on all sides**

When open, the lid gives unimpeded access to all components from three sides.

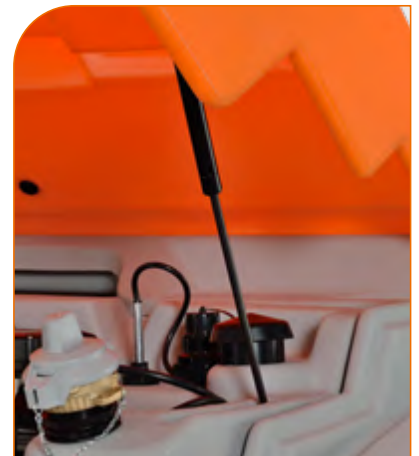
**robust, lockable lid**

Lockable lid secured by toggle latches. Opens upwards on supporting gas struts to allow access from three sides.

**wind damage prevention**

Four points for securing the tank to the ground to protect from strong wind damage (5,000 L version)

**easy to lift**

Connection points on the circumference for shackles or lifting eyes when being lifted from above (3,500, 5,000 and 7,500 L version)

CUBE diesel tank 5,000 L
Outdoor Premium

CEMO CUBE

Stationary refuelling systems for diesel PG 4

Diesel tank dispensing system, Basic and Premium

with general construction inspection certification no. Z-40.21-510

- comprising integrated bund
- visual bund alarm
- tanker coupling
- electronic overfill sensor
- vent
- analogue contents gauge
- suction hose
- 230 V pump 56 L/min (72 L/min on 2,500 L versions)
- 4 m delivery hose
- automatic nozzle with integral nozzle holder
- certified for outdoor installation with hinged lid (outdoor model)
- completely assembled

TOP SELLER

CEMO CUBE diesel tank 2,500 litre Outdoor Premium

- K33 mechanical flow meter
- filter with water separator
- hose reel with 8 m hose DN 19

Order no. 10299



CUBE diesel tank 1,500 L Outdoor

CUBE diesel tank 2,500 L Indoor Basic

CEMO CUBE DIESEL TANK

Description	Capacity L	External dimensions cm (w x d x h)	Weight approx. kg	Order no.
Indoor Basic 4 m dispensing hose DN 19, without hinged lid	1000	120 x 80 x 174	135	10420*
	1500	120 x 115 x 174	165	10292*
	2500	120 x 180 x 174	220	10293***
Outdoor Basic 4 m dispensing hose DN 19, with hinged lid	1000	120 x 80 x 180	150	10294*
	1500	120 x 115 x 180	180	10295*
	2500	120 x 180 x 180	235	10296***
Outdoor Premium K33 mechanical flow meter, cartridge filter with water separator, hose reel with 8 m hose DN 19, with hinged lid	1000	120 x 80 x 180	170	10297*
	1500	120 x 115 x 180	200	10298*
	2500	120 x 180 x 180	255	10299***
CUBE-Tank Extension I Indoor: CUBE-Tank with integrated bund, with visual bund alarm, filling connection with tanker coupling and overfill prevention sensor, vent, analogue contents gauge, suction hose with connection kit to first tank, completely assembled	1500	120 x 115 x 174	155	10776
	2500	120 x 180 x 174	210	10512
CUBE-Tank Extension I Outdoor: same as CUBE-Tank Extension I Indoor, incl. with hinged lid	1500	120 x 115 x 180	170	10774
	2500	120 x 180 x 180	225	10300
CUBE-Tank Extension II Indoor: same as CUBE-Tank Extension I Indoor, only with connection to CUBE-Tank Extension II	1500	120 x 115 x 174	155	10777
	2500	120 x 180 x 174	210	10544
CUBE-Tank Extension II Outdoor: same as CUBE-Tank Extension II Indoor, incl. with hinged lid	1500	120 x 115 x 180	170	10775
	2500	120 x 180 x 180	225	10545

* CON BOMBAS ELÉCTRICAS 56 l/min

*** CON BOMBAS ELÉCTRICAS 72 l/min (pump output in free advance. Please note that the pump output can fall sharply depending on the length and cross-sectional area of the hose.)

CEMO CUBE Outdoor PG 4 Premium Plus and Premium Plus SIM WITH TANK DATA MANAGEMENT SYSTEM "CMO 10" AND "CMO 20 SIM"

**Diesel tank dispensing system,
Outdoor Premium Plus 10
with general construction inspection
certification no. Z-40.21-510**

- comprising integrated bund
- visual bund alarm
- tanker coupling
- electronic overfill sensor
- vent
- analogue contents gauge
- suction hose
- pump 230 V
- meter with access control and tank data management system "CMO 10" for up to 250 users
- incl. 5 user keys and 1 master key
- hose reel with 8 m hose DN 19
- automatic nozzle with integral nozzle holder
- with hinged lid certified for outdoor installation
- completely assembled

Outdoor Premium Plus 20 SIM
features as for Outdoor Premium Plus 10,
and also:

- for up to 999 users
- access via PIN code
- mileage / operating hours input
- electronic contents gauge
- GPS function
- modem for tank data transmission



CUBE diesel tank 2,500 L Outdoor Premium Plus 20 SIM



- ① Meter with access control and tank data management system "CMO 10" for up to 250 users incl. 5 user and 1 master key
- ② Additional for Premium Plus 20 SIM: modem for tank data transfer, GPS function for up to 999 users

 Information on tank data management system see page 20.



CUBE diesel tank Outdoor Premium Plus 10

CEMO CUBE DIESEL TANK

Description	Capacity L	External dimensions cm (w x d x h)	Weight approx. kg	Order no.
Outdoor Premium Plus 10	1000	120 x 80 x 180	170	10780*
	1500	120 x 115 x 180	200	10778*
	2500	120 x 180 x 180	255	10736***
Outdoor Premium Plus 20 SIM	1000	120 x 80 x 180	170	11320*
	1500	120 x 115 x 180	200	11321*
	2500	120 x 180 x 180	255	11322***







* with electric pump 56 L/min

*** with electric pump 72 L/min (pump output in free flow. Please note that the pump output can fall sharply depending on the length and cross-sectional area of the hose.)

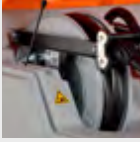
CEMO CUBE

Stationary diesel refuelling systems PG 4

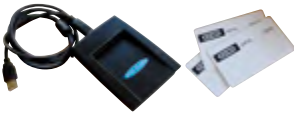
ACCESSORIES FOR CUBE DIESEL TANK 1,000, 1,500 AND 2,500 L

Description	Order no.
 <p>Hose reel with 8 m hose DN 19</p>	10375
 <p>K33 mechanical flow meter, 3-digit tank display</p>	10376
 <p>Filter with water separator</p>	10377
 <p>K 33 flow meter complete with filter and water separator</p>	10662
 <p>Meter with access control and "CMO 10" tank data management system for up to 250 users, incl. 5 user keys and 1 master key</p>	10745
 <p>Data transfer set with 3 data transfer cards and USB key reader for wireless data transfer to PC, incl. PC software</p>	10746
 <p>Key set with 5 user keys</p>	10747
 <p>LED instrument lighting with motion sensor and battery</p>	10378
<p>Hinged lid, orange, complete with supporting gas struts and mounting accessories</p>	10324



Accessory package
for placement
lengthwise

ACCESSORIES FOR CUBE DIESEL TANK SYSTEM 5,000 L

Description	Order no.
<p>Accessory package for placement lengthwise in connection of two CUBE diesel tanks 2,500 L with expansion unit I (see page 14) or CUBE diesel refuelling systems 5000 L (see page 17)</p>	10666

CEMO CUBE diesel refuelling system PG 4



CUBE diesel refuelling system, 5,000 L
Outdoor Premium



Filling the CUBE tank systems
is this easy.



Dispensing hose with connection to first tank and switching valves
included in the expansion kit.

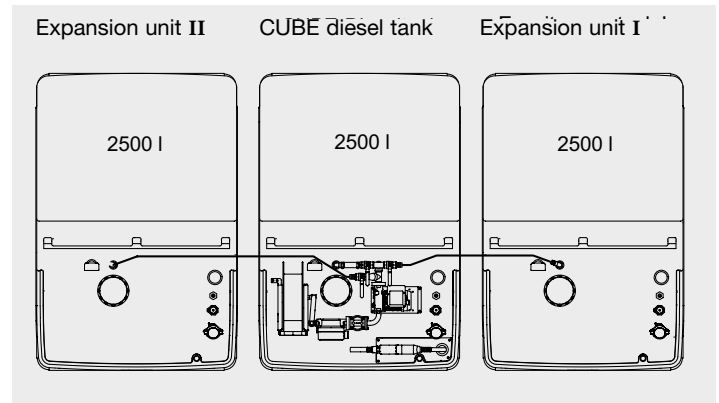

CUBE diesel refuelling system 7,500 L with expansion unit I and II

CUBE DIESEL REFUELLING SYSTEMS 5,000 L AND 7,500 L

Description	Comprising	Delivery rate L/min*	External dimensions cm (w x d x h)	Weight approx. kg	Order no.
5,000 L Indoor Basic	CUBE diesel refuelling system Indoor Basic (10293) and CUBE expansion unit I Indoor (10512)	72	250 x 180 x 174	430	10525
5,000 L Outdoor Premium	CUBE diesel refuelling system Outdoor Premium (10299) and CUBE expansion unit I Outdoor (10300)	72	250 x 180 x 180	480	10379
7,500 L Indoor Basic	CUBE diesel refuelling system Indoor Basic (10293), CUBE expansion unit I Indoor (10512) and CUBE expansion unit II Indoor (10544)	72	380 x 180 x 174	640	10546
7,500 L Outdoor Premium	CUBE diesel refuelling system Outdoor Premium (10299), CUBE expansion unit I Outdoor (10300) and CUBE expansion unit II Outdoor (10545)	72	380 x 180 x 180	705	10547

* Pump output in free flow. Please note that the pump output can fall sharply depending on the length and cross-sectional area of the hose.



Accessories see page 16.

CEMO CUBE diesel tank 3,500 L PG 4

NEW

- Diesel tank dispensing system, Basic and Premium with general construction inspection certification no. Z-40.21-565 (applied for)**
- integrated bund
 - visual bund alarm
 - filling connection with tanker coupling and overfill prevention sensor
 - vent
 - contents gauge
 - suction hose
 - pump 230 V, 72 L/min*
 - automatic nozzle with integral nozzle holder
 - with hinged lid, certified for outdoor installation
 - completely assembled



CUBE diesel tank 3,500 L, Outdoor Basic

CUBE diesel tank 3,500 L Outdoor Premium

- Capacity 3,500 L
- pump 230 V
- K33 mechanical flow meter,
- filter with water separator
- hose reel with 8 m hose,
- hinged lid



CUBE DIESEL TANK 3,500 L

Description	Capacity L	External dimensions cm (w x d x h)	Weight approx. kg	Order no.
Outdoor Basic 4 m dispensing hose DN19, with hinged lid	3,500	210 x 198 x 158	205	11976
Outdoor Premium K33 mechanical flow meter, cartridge filter with water separator, hose reel with 8 m hose DN19, with hinged lid			230	11977

CUBE-DIESEL TANK 3.500L FASTFILL

Description	Capacity L	External dimensions cm (w x d x h)	Weight approx. kg	Order no.
Outdoor fastfill Basic 4 m dispensing hose DN25, with hinged lid and automatic nozzle A80 fastfill, flow rate approx. 80 L/min*	3,500	210 x 198 x 158	205	11978

* with electric pump 72 L/min (pump output in free flow. Please note that the pump output can fall sharply depending on the length and cross-sectional area of the hose.)

 Accessories see page 21.

CEMO CUBE diesel tank 5,000 L PG 4

Diesel tank dispensing system, Outdoor Basic and Outdoor Premium with general construction inspection Z-40.21-565

- with integrated bund
- with visual bund alarm
- filling connection with tanker coupling and overfill prevention sensor
- vent
- contents gauge
- suction hose
- pump 230 V, 72 L/min*
- automatic nozzle with integral nozzle holder
- with hinged lid certified for outdoor installation
- completely assembled



CUBE diesel tank 5,000 L, Outdoor Basic



CUBE diesel tank 5,000 L, Outdoor Premium

CUBE diesel tank 5,000 L Outdoor Premium

- capacity 5,000 litre
- pump 230 V
- K33 mechanical flow meter, filter with water separator, hose reel with 8 m hose, with hinged lid

Order no. 11079

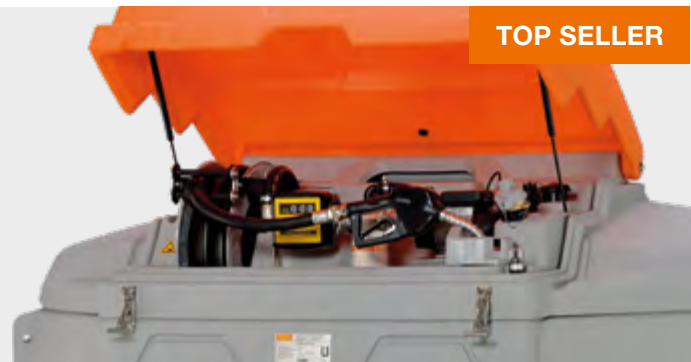

CUBE DIESEL TANK 5,000 L

Description	Capacity L	External dimensions cm (w x d x h)	Weight approx. kg	Order no.
<u>Outdoor Basic</u> 4 m dispensing hose DN25, with hinged lid	5,000	240 x 230 x 185	205	11078
<u>Outdoor Premium</u> K33 mechanical flow meter, cartridge filter with water separator, hose reel with 8 m hose DN25, with hinged lid			230	11079
<u>CUBE-Tank Extension I Outdoor</u> CUBE-Tank with integrated bund, with visual bund alarm, filling connection with tanker coupling and overfill prevention sensor, vent, contents gauge, suction hose with connection kit to first tank, completely assembled			201	11081
<u>CUBE-Tank Extension II Outdoor</u> same as CUBE-Tank Extension I Outdoor, only with connection to CUBE-Tank Extension II			201	11096

* Pump output in free flow. Please note that the pump output can fall sharply depending on the length and cross-sectional area of the hose.

★ Accessories see page 21.

CEMO CUBE diesel tank 5,000 L Outdoor Premium Plus and Premium Plus SIM PG 4

WITH TANK DATA MANAGEMENT SYSTEM "CMO 20"

Diesel tank dispensing system, Outdoor Premium Plus 20 with general construction inspection certification no. Z-40.21-565

- with integrated bund
- with visual bund alarm
- filling connection with tanker coupling and overfill prevention sensor
- vent
- contents gauge
- suction hose

- pump 230 V, 72 L/min *
- meter with access control and tank data management system "CMO20" for up to 999 users, incl. 5 user keys and 1 master key
- access via key or PIN code
- input of kilometre reading/operating hours
- hose reel with 8 m hose DN25
- automatic nozzle with integral nozzle holder

- with hinged lid certified for outdoor installation
- completely assembled

Outdoor Premium Plus 20 SIM*** same as Outdoor Premium Plus 20, additional with:

- electronic contents gauge
- GPS function
- modem for tank data transfer



CUBE Diesel tank 5,000 L, Outdoor Premium Plus 20 SIM



Meter with access control and tank data management system "CMO 20" for up to 999 user.
Additional for Premium Plus 20 SIM: modem for tank data transfer, GPS function

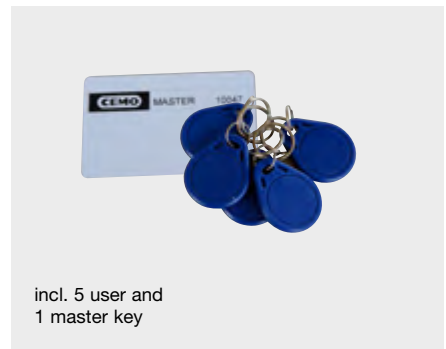

incl. 5 user and 1 master key

CUBE DIESEL TANK 5,000 L OUTDOOR PREMIUM PLUS AND PLUS SIM***

Description	Capacity L	External dimensions cm (w x d x h)	Weight approx. kg	Order no.
Outdoor Premium Plus 20	5000	240 x 230 x 185	212	11323
Outdoor Premium Plus 20 SIM***			212	11324

TANK SYSTEMS PREMIUM PLUS AND PLUS SIM*** WITH TANK DATA MANAGEMENT SYSTEM "CMO 20"

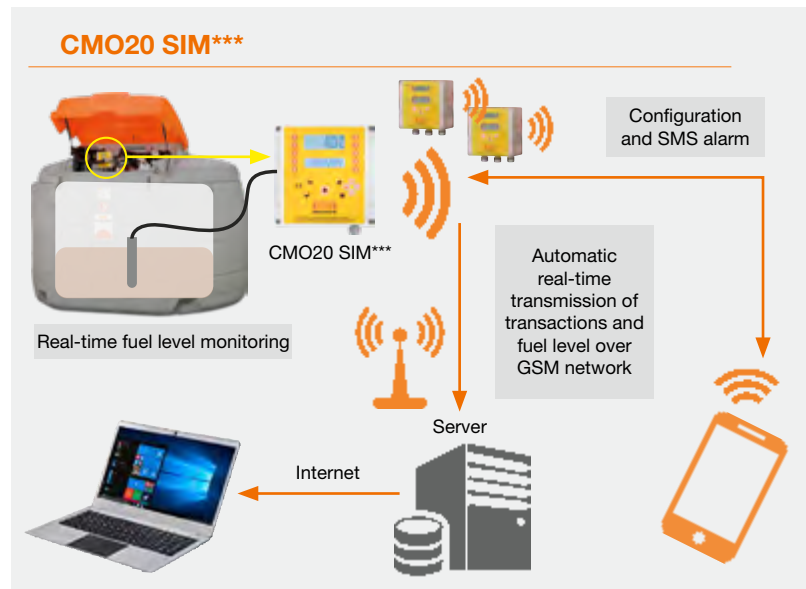

* Pump output in free flow. Please note that the pump output can fall sharply depending on the length and cross-sectional area of the hose.

*** SIM card is not included in scope of delivery.









Accessories see page 21.

CEMO CUBE diesel tank PG 4

ACCESSORIES OR CUBE DIESEL TANK 3,500 L (SUPPLIED AS COMPONENTS)

Description	Order no.
 <p>Filter with meter and water separator for CUBE tank 3500 L</p>	12080

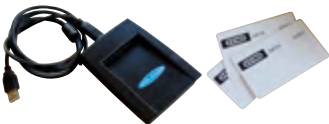
ACCESSORIES OR CUBE DIESEL TANK 5,000 L (SUPPLIED AS COMPONENTS)

Description	Order no.
 <p>Hose reel with 8 m hose DN25</p>	11092
 <p>K33 mechanical flow meter, 3-digit tank display</p>	10376
 <p>Cartridge filter with water separator</p>	11093
 <p>K33 mechanical flow meter complete with filter and water separator</p>	11094
 <p>Meter with access control and "CMO 10" tank data management system for up to 250 users, incl. 5 user keys and 1 master key</p>	10745
 <p>Data transfer set with 3 data transfer cards and USB key reader for wireless data transfer to PC, incl. PC software</p>	10746
 <p>Key set with 5 user keys</p>	10747
 <p>LED instrument lighting with motion sensor and battery</p>	10378
<p>Hinged lid, orange, complete with supporting gas struts and mounting accessories</p>	11095

CEMO CUBE diesel tank 5,000 L *fastfill* with high-performance submersible pump CENTRI SP 80 PG 4

Outdoor Basic and Outdoor Premium refuelling systems with general construction inspection certification no. Z-40.21-565

- bunded
- with visual leak indicator
- filling connection with tanker coupling and over-fill sensor
- mechanical contents gauge
- high-performance submersible pump CENTRI SP 80 AC, 230 V, 80 L/min*
- **NEW:** automatic nozzle A80 fastfill – for fast refuelling – also for passenger cars
- with lockable lid, certified for installation outdoors
- fully assembled, 5 m connection cable



Outdoor **Basic**

CEMO submersible pumps: the superior pumping principle for your refuelling system. Simple, fast and safe.

- Run time limitation: automatic switch-off after preset time
- easy start-up: stands on the tank bottom – no suction height
- submersible centrifugal pump Ø 130 mm, suitable for common tanks and IBCs
- voltage 230 V/50 Hz, power 800 W
- high dispensing volume
- motor thermally protected
- connection 1" IT without check valve



Outdoor **Premium**



HIGHER DISPENSING VOLUME FOR SHORTER REFUELLING STOPS – ALSO FOR PASSENGER CARS

CUBE DIESEL REFUELLING SYSTEMS 5,000 L FASTFILL

Description	External dimensions in cm (w x d x h)	Weight approx. in kg	Order no.
CUBE diesel tank 5,000 L Outdoor fastfill Basic, 4 m dispensing hose DN25	240 x 230 x 185	205	11649
CUBE diesel tank 5,000 L Outdoor fastfill Premium, mechanical flow meter K33, filter with water separator, hose reel with 8 m dispensing hose DN25	240 x 230 x 185	230	11650

* Pump output in free flow. Please note that the pump output can fall sharply depending on the length and cross-sectional area of the hose.



Accessories see page 21.

CEMO CUBE diesel tank system PG 4



CUBE diesel tank system 10,000 L
Outdoor Premium



Suction hose with connection to first tank and switching valves included in the expansion unit.

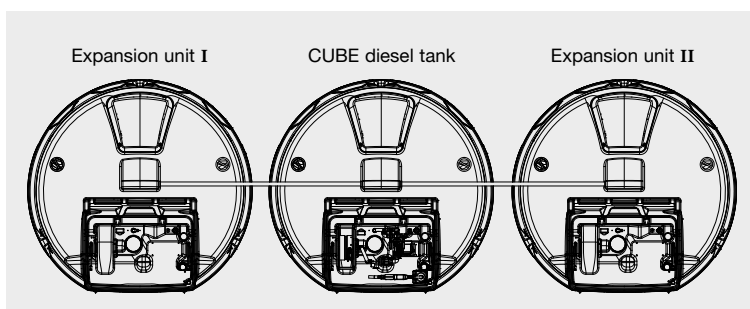

CUBE diesel refuelling system 15,000 L with expansion unit I and II

CUBE DIESEL REFUELLING SYSTEMS 10,000 L AND 15,000 L

Description	Comprising	Delivery rate L/min *	External dimensions cm (w x d x h)	Weight approx. kg	Order no.
10,000 L Outdoor Premium	CUBE diesel dispensing station Outdoor Premium (11079) and CUBE expansion unit I Outdoor (11081)	72	500 x 230 x 185	413	11097
15,000 L Outdoor Premium	CUBE diesel dispensing station Outdoor Premium (11079) and CUBE expansion unit I Outdoor (11081) and CUBE expansion unit II Outdoor (11096)	72	760 x 230 x 185	614	11098

* Pump output in free flow. Please note that the pump output can fall sharply depending on the length and cross-sectional area of the hose.



Accessories see page 21.

CEMO CUBE diesel tank 7,500 L *fastfill* with high-performance submersible pump CENTRI SP 80 PG 4

NEW

Diesel tank dispensing system, Basic and Premium

with general construction inspection certification no. Z-40.21-565 (applied for)

- bundled
- with leakage detector device (visual and acoustic)
- filling connection with tanker coupling, isolation valve and overflow prevention sensor
- pneumatic contents gauge
- digital flow meter K33 (Premium)
- suction hose
- cabinet fittings and brackets made of stainless steel
- inspection opening with hinged lid, aeration and ventilation
- quiet and powerful submersible pump CENTRI SP 80, 230 V, 80 L/min*
- **NEW:** automatic nozzle A80 fastfill for fast refuelling (also for passenger cars) with integral nozzle holder with automatic switch-off
- sturdy, lockable pump equipment cabinet
- comfortable and ergonomic operation
- certified for outdoor installation
- completely assembled

Higher flow rate
for shorter refuelling stops

fastfill
inside



CUBE diesel tank 7,500 L, Outdoor Premium



CUBE diesel tank 7,500 L, cross section

HIGHER DISPENSING VOLUME FOR SHORTER REFUELLING STOPS – ALSO FOR PASSENGER CARS

Other versions for brine and liquid fertilisers on request.

Description	Capacity L	External dimensions cm (l x w x h)	Weight approx. kg	Order no.
Outdoor fastfill Basic 6 m dispensing hose DN25 with hose holder, pump Centri SP 80, with equipment cabinet	7,500	295x245x225	400	12005
Outdoor fastfill Premium Mechanical flow meter K33, filter with water separator, swivel-mounted hose reel with 8 m hose DN 25, with equipment cabinet	7,500	295x245x225	430	12006

* Pump output in free flow.
Please note that the pump output can fall sharply depending on the length and cross-sectional pump equipment of the hose.

CEMO CUBE 980 L PG 4

Stationary refuelling systems for diesel

Complete station, Basic and Premium with general construction inspection certification no. Z-40.21-589

- compact design, easy to use
- all components at optimum working height
- bunded
- with visual leak indicator
- filling connection with tanker coupling and overflow sensor
- vent and breather
- contents gauge
- 1" suction hose
- pump 230 V, 56 L/min*
- automatic nozzle with dispensing nozzle holder
- with lockable lid, certified for installation outdoors (Outdoor versions)
- with forklift pockets for internal transport
- fully assembled
- for version with ADR certification see page 49



CUBE 980 L
Indoor Basic

CUBE 980 L
Outdoor Premium

BUNDED



tank with integral bund offers twice the safety



Indoor Basic
4 m dispensing hose DN19, without hinged lid



Outdoor Basic
4 m dispensing hose DN19, with hinged lid



Indoor Premium
mechanical flow meter K33, filter with water separator, hose reel with 8 m hose DN19, without hinged lid



Outdoor Premium
mechanical flow meter K33, filter with water separator, hose reel with 8 m hose DN19, with hinged lid

Description	External dimensions cm (l x w x h)	Weight approx. kg	Order no.
Indoor Basic 4 m dispensing hose DN19, without hinged lid	130 x 112 x 118	107	11628
Outdoor Basic 4 m dispensing hose DN19, with hinged lid	130 x 112 x 118	119	11629
Indoor Premium Mechanical flow meter K33, filter with water separator, hose reel with 8 m hose DN19, without hinged lid	130 x 112 x 118	130	11630
Outdoor Premium Mechanical flow meter K33, filter with water separator, hose reel with 8 m hose DN19, with hinged lid	130 x 112 x 118	141	11631

* Pump output in free flow.
Please note that the pump output can fall sharply depending on the length and cross-sectional area of the hose.

CEMO CUBE Slimline 2000 L PG 4 diesel tank

Outdoor safety package CUBE Slimline 2000 L with general construction inspection certification no Z-40.21-593

Double-walled tank with visual leak detection. Certified for outdoor installation without leak detection device, even in water protection areas!

- CUBE tank Slimline 2000 L (order no. 11664)
- Accessory pack for outdoor installation (order no. 7355)
- pump approx. 50 L/min, 230 V (self-priming)
- Mechanical flow meter
- Automatic nozzle
- 4 m extension hose DN 19
- installed within a protective housing (order no. 7354)

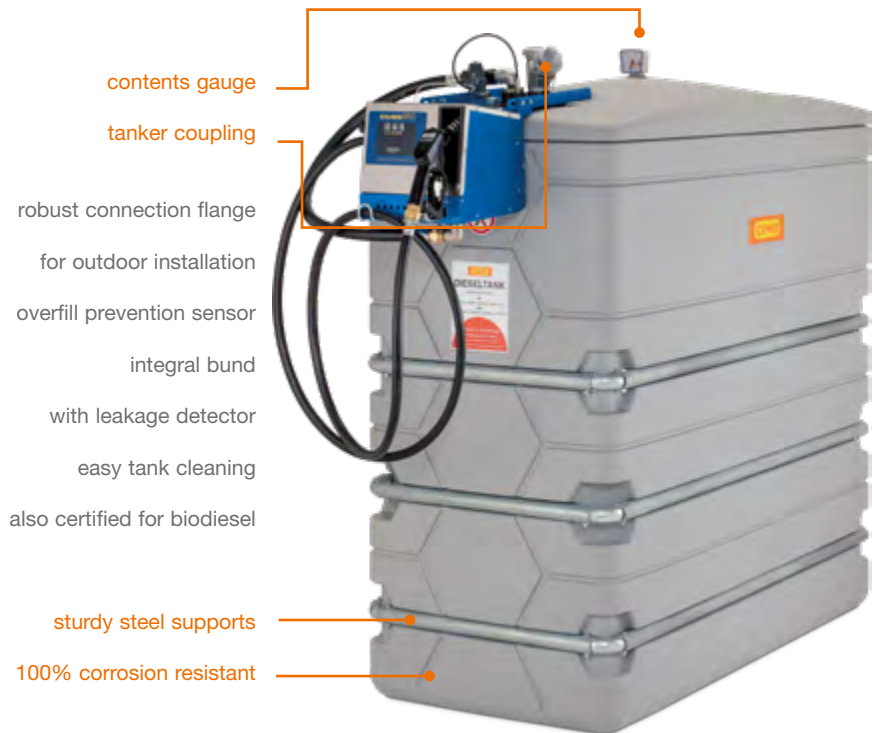





- robust connection flange for outdoor installation
- overfill prevention sensor
- integral bund with leakage detector
- easy tank cleaning
- also certified for biodiesel

Description	External dimensions cm (w x d x h)	Weight approx. kg	Order no.
Outdoor safety package CUBE Slimline 2000 L	86 x 212 x 211	210	11682

CUBE SLIMLINE 2000 L WITHOUT ACCESSORIES

Description	External dimensions cm (w x d x h)	Weight approx. kg	Order no.
CUBE Slimline 2000 L	86 x 180 x 180	180	11664

PUMPS AND ACCESSORIES, DESIGNED FOR CUBE SLIMLINE 2000 L

Description	Order no.
 <p>Accessory pack for indoor and outdoor installation (on single tank), consisting of: dome lid, vent cap, overfill prevention sensor, filling connection, suction hose with foot valve, installation instructions suitable for electric pump 50 L/min in protective box, order no. 7354</p>	7355
 <p>Pump approx. 50 L/min, 230 V (self-priming), mechanical flow meter, automatic nozzle with type certification, 4 m hose, in protective box</p>	7354
 <p>Extension hose DN 19 with 1" connection for electric pump approx. 50 L/min For additional hose lengths, see page 122</p>	2 m
	4 m
 <p>Dome lid steel with two angled threaded nipples 2", for filling and venting, 2 straight threaded nipples 2" and 1", TW coupling and vent cap</p>	1451
 <p>Tank heater type TH 370, 230 V, dia. 44 mm for electric heating of EL grade heating oil and diesel fuel power 0.22 kW, thermostatically controlled, prevents separation of paraffins at low temperatures</p>	8126

CEMO UNI diesel tank PG 4

Single tank

- from HDPE with integral galvanised sheet steel bund and base pallet
- standard accessories: contents gauge, visual leakage detector, integral carrying handles
- **no pump**
- or storage of diesel, biodiesel, without additional bund, even in water-protected areas*
- certified for installation indoors
- can be filled with dispensing nozzle (except Uni-Tank 1,500 L)
- **low overall height (up to 1,000 L), thus no step is necessary**

UNI tank 1,000 L



UNI-TANK

Capacity L	Dimensions cm (l x w x h)	Certification no.	Weight approx. kg	Order no.
400	73 x 70 x 117	Z-40.21-365	50	7979
750	98 x 77 x 142	Z-40.21-288	66	7379
1,000	128 x 77 x 142	Z-40.21-288	89	7380
1,500	163 x 77 x 185	Z-40.21-432	151	7881

Diesel refuelling system

with UNI-Tank 1,000 L or 1,500 L

Refuelling system comprising:

- UNI-Tank 1,000 L (7380) or 1500 L (7881), 1, 2 or 3 tanks
- filling connection with tanker coupling (7390)
- overfill prevention sensor (1437),
- extraction pipe and vent
- 240 V pump 50 L/min
- components not fitted to tank to avoid transport damage
- pump 230 V self-priming with automatic nozzle, dispensing nozzle holder, meter, 4 m dispensing hose and ventilation
- other lengths for dispensing hose optional, see page 122
- individual filling of the tanks via fixed tanker connection, extraction and venting via common lines



Accessories see page 29.



UNI-Tank 1,500 L with pump 230 V 50 L/min



Diesel tank system with 2 UNI-Tanks 1,500 L (Order no. 8822)

DIESEL TANKS SYSTEMS WITH UNI-TANK 1,000 L OR 1,500 L

Capacity L	Number of UNI tanks 1000 L	Delivery rate L/min	Dimensions cm (l x w x h)	Weight approx. kg	Order no.
1,000	1	50	166 x 77 x 159	114	10224
2,000	2	50	166 x 157 x 159	206	10225
3,000	3	50	166 x 237 x 159	298	10226

Capacity L	Number of UNI tanks 1500 L	Delivery rate L/min	Dimensions cm (l x w x h)	Weight approx. kg	Order no.
1,500	1	50	201 x 77 x 202	176	8821
3,000	2	50	201 x 157 x 202	330	8822
4,500	3	50	201 x 237 x 202	484	8823

* National installation laws and conditions must be observed.

CEMO UNI diesel tank PG 4

Basic package UNI tank 1.000 L

- UNI-Tank 1,000 L (order no. 7380)
- Pump 230 V, approx. 30 L/min effective (order no. 8639)
- 4 m connecting cable
- 6 m hose, may be sectioned into suction and dispensing hose
- Suction filter
- Automatic nozzle

Accessory:

- K24 digital flow meter (8644) see page 29



TOP SELLER

Articolo n. 8683

Basic package Premium 1,000 L

comprising:

- Diesel tank UNI 1,000 L (order no. 7380)
- Pump 230 V, self-priming, approx. 50 L/min (order no. 7768)
- Pump bracket (order no. 7631)
- Automatic nozzle
- 4 m connecting cable
- Suction hose with foot valve
- Nozzle holder
- Hose clamp (order no. 10252)

Accessory:

- K33 mechanical flow meter (order no. 7779 and 7984) see page 122
- Electric flow meter FMT 3/50 (order no. 7574) see page 29

















BASIC PACKAGES UNI-TANK

Description	Order no.
Basic package 1,000 L	8683
Basic package Premium 1,000 L	10239

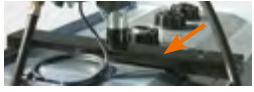
CEMO UNI/MULTI diesel tank PG 4

PUMPS AND ACCESSORIES SPECIALLY DESIGNED FOR UNI- AND MULTI-TANK

Description	Order no.				
 <p>Hand pump, flow rate up to 25 L/min suitable for UNI-/MULTI-Tank up to 1,000 L</p>	1452				
 <p>Pump 12 V, not self-priming, approx. 30 L/min effective, 4 m connecting cable with crocodile clips, 6 m hose, dispensing nozzle</p>	8640				
 <p>Pump 230 V, not self-priming, approx. 35 L/min effective, 4 m connecting cable, 6 m hose, dispensing nozzle</p>	8638				
 <p>Pump 12 V, not self-priming, approx. 25 L/min effective, 4 m connecting cable with crocodile clips, 6 m hose, automatic nozzle</p>	8641				
 <p>Pump 230 V, not self-priming, approx. 30 L/min effective, 4 m connecting cable, 6 m hose, automatic nozzle</p>	8639				
 <p>K24 digital flow meter can be calibrated, measuring range 10 – 120 L/min, 5-digit display, 6-digit total delivery display, inlet and outlet 1" external thread, with 1" steel coupling</p>	8644				
 <p>Dispensing hose for electric pump CENTRI Additional DN 19 hose, priced per meter (the standard 6 m hose is still included in the pump kit)</p>	11351				
 <p>Electric pump approx. 50 L/min suitable for UNI-/MULTI-Tank 750 L and 1,000 L, 230 V (self-priming), with foot valve, automatic nozzle, 4 m dispensing hose, pump bracket</p>	7573				
 <p>Electronic flow meter FMT 3/50 for electric pumps 50 L/min, display can be rotated in 90° steps</p>	7574				
 <p>Extension hose DN 19 *** (with 2 x 1" thread) for electric pump approx. 50 L/min</p>	<table border="0"> <tr> <td>2 m</td> <td>7071</td> </tr> <tr> <td>4 m</td> <td>7072</td> </tr> </table>	2 m	7071	4 m	7072
2 m	7071				
4 m	7072				
 <p>Fixed tanker coupling suitable for UNI-/MULTI-Tank 750 L, 1,000 L and 1,500 L with tanker coupling, vent pipe and overflow prevention sensor</p>	7857				
 <p>Pump bracket suitable for UNI-/MULTI-Tank 750 L and 1,000 L for mounting Cematic pumps</p>	7631				
 <p>230 V pump, approx. 50 L/min (self-priming) with flow meter, suction hose, automatic nozzle, nozzle holder, 4 m dispensing hose, mounted on the bracket and can be hung on the side of the UNI-/MULTI tank</p>	8162				
 <p>Tank heater type TH 370, 230 V, dia. 44 mm for electric heating of EL grade heating oil and diesel fuel power 0.22 kW, self-regulating, prevents separation of paraffins at low temperatures</p>	8126				
 <p>Hose bracket suitable for UNI-/MULTI-Tank 750 L, 1000 L and 1500 L</p>	10252				

*** For additional hose lengths see page 122.

CEMO diesel refuelling systems with steel tank PG 4

Above ground refuelling system

steel double-wall for outdoor installation, certified for the storage of diesel fuel and biodiesel

Construction:

- manufactured in accordance with DIN EN 12285-2 class B
- welded on saddle feet
- painted externally with primer and top coats
- ladder (5,000 L model no ladder due to low overall height)
- dip stick
- extraction pipe in dome lid
- anti-siphon device (model with mounted pump)
- bund alarm with liquid control
- overfill prevention sensor
- completely assembled
- factory test certificate

Options:

- paint schemes according to customer specification possible (additional charge)
- The standard containers are primed and painted. We offer a 10-year warranty against rusting through.



Steel tank fitted with optional bracket and suction hose for diesel dispensing pumps



STEEL TANK WITHOUT ACCESSORIES

REFUELLING SYSTEM AS DESCRIBED ABOVE

Capacity L	Dimensions cm (l x w x h)*	Tank ø cm	DIN EN	Weight approx. kg	Order no.
4000	233 x 178 x 233	160	12285-2 class B	1100	7580
5000	280 x 178 x 233	160	12285-2 class B	1500	11939
7500	409 x 178 x 233	160	12285-2 class B	1800	7377
10000	585 x 178 x 233	160	12285-2 class B	2200	7378
15000	782 x 178 x 233	160	12285-2 class B	3000	8140
20000	690 x 220 x 270	200	12285-2 class B	3800	8141
30000	991 x 220 x 270	200	12285-2 class B	5200	8142

* with ventilation pipe

STEEL TANK WITH BRACKET FOR DIESEL DISPENSING PUMPS

REFUELLING SYSTEM AS DESCRIBED ABOVE, ADDITIONALLY EQUIPPED WITH BRACKET AND EXTRACTION PIPE FOR DIESEL DISPENSING PUMPS (SEE PAGE 117), COMPLETELY MOUNTED. THE DIESEL DISPENSING PUMPS MUST BE ORDERED SEPARATELY.

Capacity L	Dimensions cm (l x w x h)*	Tank ø cm	DIN EN	Weight*** approx. kg	Order no.
4000	288 x 178 x 233	160	12285-2 class B	1100	8591
5000	335 x 178 x 233	160	12285-2 class B	1500	11940
7500	464 x 178 x 233	160	12285-2 class B	1800	8593
10000	640 x 178 x 233	160	12285-2 class B	2200	8594
15000	837 x 178 x 233	160	12285-2 class B	3000	8595
20000	745 x 220 x 270	200	12285-2 class B	3800	8596
30000	1046 x 220 x 270	200	12285-2 class B	5200	8597

* with vent pipe and bracket *** without dispensing pump

CEMO diesel refuelling systems with steel tank PG 4

Pump 230 V, CUBE 70 K33

- self-priming
- pump dispensing volume approx. 70 L/min
- flow meter with cumulative meter and single-use meter
- 4 m dispensing hose, automatic nozzle
- installed within a protective housing

Pump CUBE 70 MC50

- self-priming
- pump dispensing volume approx. 70 L/min
- electronic flow meter with 50 user codes
- 4 m dispensing hose, automatic nozzle
- installed within a protective housing



Pump 230 V, CUBE 70 K33
(details / accessories see page 119)



Pump 230 V, CUBE 70 MC50
(details / accessories see page 119)

STEEL TANK WITH PUMP CUBE 70 K33

REFUELLING SYSTEM AS DESCRIBED ON P. 30, ADDITIONALLY EQUIPPED WITH PUMP SYSTEM AND EXTRACTION PIPE, FULLY MOUNTED

Capacity L	Dimensions cm (l x w x h)*	Tank ø cm	DIN EN	Weight approx. kg	Order no.
4000	270 x 178 x 233	160	12285-2 class B	1100	7859
5000	317 x 178 x 233	160	12285-2 class B	1500	11941
7500	446 x 178 x 233	160	12285-2 class B	1800	7861
10000	622 x 178 x 233	160	12285-2 class B	2200	7862
15000	819 x 178 x 233	160	12285-2 class B	3000	8143
20000	727 x 220 x 270	200	12285-2 class B	3800	8144
30000	1028 x 220 x 270	200	12285-2 class B	5200	8145

* with ventilation pipe



STEEL TANK WITH PUMP CUBE 70 MC50

REFUELLING SYSTEM AS DESCRIBED ON P. 30, ADDITIONALLY EQUIPPED WITH PUMP SYSTEM AND EXTRACTION PIPE, FULLY MOUNTED

Capacity L	Dimensions cm (l x w x h)*	Tank ø cm	DIN EN	Weight approx. kg	Order no.
4000	270 x 178 x 233	160	12285-2 class B	1100	7863
5000	317 x 178 x 233	160	12285-2 class B	1500	11942
7500	446 x 178 x 233	160	12285-2 class B	1800	7865
10000	622 x 178 x 233	160	12285-2 class B	2200	7866
15000	819 x 178 x 233	160	12285-2 class B	3000	8146
20000	727 x 220 x 270	200	12285-2 class B	3800	8147
30000	1028 x 220 x 270	200	12285-2 class B	5200	8148

* with ventilation pipe

ACCESSORIES FOR DIESEL REFUELLING SYSTEMS WITH STEEL TANK

Description	Order no.
 <p>Level measurement unit, pneumatic, for retrofitting</p>	7565
 <p>Contents gauge OCIO for diesel, 230 V An innovative system for management of the liquid level in tanks at atmospheric pressure. Special features: continuous measurement, display of heights, volumes and refill percentages, minimum and maximum level alarms, high accuracy, simple installation, simple software configuration</p>	7795

CEMO fuel dispensing areas PG 9

Folding fuel dispensing area, for installation outdoors with general construction inspection approval no. Z-38.5-306

For the regulation-compliant, safe filling of your vehicles. Spilled fuel is held back and can be easily disposed of via a collecting channel when folded up. Patent protected.

The tray must lie on a level, stable surface. The folding mechanism must be anchored with the heavy load anchor included in the scope of delivery.

Special advantages:

- compact design
- only a small amount of space is needed for the fuel dispensing area when folded up
- simple operation using an electric chain hoist – Made in Germany
- can be set up and used in one day
- non-slip surface
- no suitability assessment required
- painted tray
- with spray protection wall
- navigable threshold on three sides

- 2x 2" pipe sockets integrated into fuel dispensing area, also making it suitable as a fuel dispensing area for filling of the storage tank by the tanker when using an emergency shutoff function ASS
- integrated protective box for control pendant
- integrated attachment points/eyes for lifting the parts
- integrated wind load protection for securing the floor tray in a vertical position
- tray and accessories are supplied separately, assembly not included



1. A 400 V power supply is required to operate the electric chain hoist.
2. The UV regulations of the professional associations stipulate that cranes/hoisting equipment must undergo an expert inspection before initial commissioning in accordance with DGUV Regulation 52 § 25 and DGUV Regulation 54 § 23. The inspection includes a load test (1.25 times the nominal load).



Folds up easily with the electrical chain block. This is how little space the fuel dispensing area needs!





Wind load protection



Box for protecting the control

Description	External dimensions cm (l x w x h)	Max. collection volume L	Wheel load kN	Weight approx. kg	Order no.
Folding fuel dispensing area, for installation outdoors, with electric chain hoist on column	500 x 284 x 316	300	50	930	10754

ACCESSORIES FOR DIESEL TANKS AND FUEL DISPENSING AREA FOR OUTDOOR INSTALLATION PG 4

Description	Order no.
 <p>ASS fitting complete with accessories According to TRwS 781 chapt. 6.2.2. If the CEMO fuel dispensing area (order no. 10754) is equipped with this fitting, can also be used to fill the tank system according to TRwS 781 chapt. 4.2.2.3. Scope of delivery consists of:</p> <ul style="list-style-type: none"> • ASS fitting G2" with automatic closure • refuelling system module for filler neck • wall fitting for conversion of an existing overfill prevention sensor to ASS version, product ID "diesel" IP 68 • 0.9 m earth cable • 1.9 m connecting cable between refuelling system module and wall fitting for overfill prevention sensor 	8693

CEMO fuel dispensing areas PG 9

Compact fuel dispensing area with general construction inspection approval no. Z-38.5-107

for approved and safe filling of your vehicles. Spilled fuel is contained and can be disposed of.

Particular advantages are:

- compact design
- mobile and transportable
- can be set up and used immediately
- accessible, anti-slip surfaces
- suitability assessment not required
- up to 50 tons wheel load
- limited operating range of the nozzle due to 1 m high splash protection wall (plug-in)
- accessible from three sides

Also see “Legal basics” on page 11.



Compact fuel dispensing area

Secure dispensing hose mounting with anti-kink device and length limiting

Basic fuel dispensing area with general construction inspection approval no. Z-38.5-107

(without splash protection wall and collision protection) for approved and safe filling of your vehicles. Spilled fuel is contained and can be disposed of.

- with two drive-over edge sills on the ends
- no splash protection wall (must be fitted by the customer, e.g. sheet metal board height 1 m at the wall)













Basic fuel dispensing area

Description	External dimensions cm (l x w x h)	Max. collection volume L	Wheel load kN	Weight approx. kg	Order no.
Compact fuel dispensing area	400 x 200 x 100	166	50	478	7827
Compact fuel dispensing area	500 x 250 x 100	266	50	712	8084
Basic fuel dispensing area	500 x 250 x 5	266	50	631	8124

CEMO tank monitoring PG 4

CONTENTS GAUGES AND TANK MONITORING UNITS WITH DATA TRANSFER FOR UNPRESSURISED TANKS

Description / Capacity L	Order no.
 <p>Contents gauge unit pneumatic, for diesel</p>	7565
 <p>Contents gauge unit pneumatic, for AdBlue®</p>	8020
 <p>Mechanical contents gauge with float for diesel and water. No free aperture on tank required.</p>	10717
 <p>Contents gauge Piusi OCIO for diesel, 230 V An innovative system for management of the liquid level in tanks at atmospheric pressure. Special features: continuous measurement, display of heights, volumes and refill percentages, minimum and maximum level alarms, high accuracy, simple installation, simple software configuration, PC connection possible</p>	7795
 <p>Contents gauge Piusi OCIO for oil, 230 V, IP55</p>	7796
 <p>Contents gauge Piusi OCIO for AdBlue®, 230 V, IP55</p>	10219
 <p>Contents gauge GOK SmartBox 1, 230 V, IP54, without sensor Displays fill level in millimeters, litres and percentage as well as free capacity in litres</p>	11172
<p>Analogue data transfer module 4 – 20 mA, for SmartBox</p>	8394
<p>Contents gauge GOK SmartBox 4, 230 V, IP54, without sensor Fill level displayed in millimetres, litres and per cent and free capacity in litres, data transfer via GSM as SMS or email, depending on provider, required SIM card not included. Event signal input, e.g. to report a system fault. 1 relay with make/break contact</p>	11173
 <p>GOK SmartBox 4 Pro display unit, 230 V, IP54, without probe Connection of up to four probes, otherwise 11173</p>	11174
<p>GOK SmartBox 4 LAN display unit, 230 V, IP30, without probe Fill level displayed in millimetres, litres and per cent and free capacity in litres, data transfer via LAN connection to a local network. Event signal input, e.g. to report a system fault. 1 relay with make/break contact</p>	11175
<p>GOK SmartBox 4 LAN Pro display unit, 230 V, IP30, without probe Connection of up to four probes, otherwise 11175</p>	11176
 <p>Pressure probe, stainless steel LC 0 – 250 mbar for SmartBox, 6 m cable, with mounting set, GKL 1 %</p>	11179
 <p>Cable junction box, IP66, breathable, for SmartBox Required when the indicator is installed more than 6 m from the bottom of the tank</p>	11180

Sensors for special media and other pressure ranges for the SmartBox available on request.
Additional interfaces for smart box can be optionally retrofitted e.g. B. 4 – 20 mA, 0 – 5 V, M-Bus, H-Protocol.

Mobile refuelling systems for diesel (p. 35 – 67)

Refuelling tanks

CEMO Diesel trolley
60 L + 100 L



from **38**

CEMO DT-MOBIL Easy
CEMO DT-MOBIL Easy COMBI
125 – 980 L



from **40**

CEMO CUBE MOBIL
980 L



49

Heavy duty refuelling systems

CEMO DT-MOBIL PRO hybrid
440, 980 L
CEMO DT-MOBIL PRO hybrid COMBI
850/100, 980/200 L

CEMO DT-MOBIL PRO ST
980 L
CEMO DT-MOBIL PRO ST COMBI
980/200 L



from **51**

CEMO DT-MOBIL
400 – 980 L



from **61**

CEMO DT-MOBIL horizontal
980 – 3,000 L



64

Generator tanks

CEMO MULTI TANK
400 – 1,500 L



65

CEMO DT-MOBIL Easy generator tank
210 – 980 L



66

Generator tanks
CEMO DT-MOBIL PRO hybrid 440 + 980 L
CEMO CUBE Mobil 980 L



67

CEMO diesel and heating oil trolley
60 L + 100 L



66

Mobile refuelling systems for diesel

Important legal regulations for mobile refuelling system

Legal basics

Mobile tank stations for diesel fuel and petrol are used in many businesses. The legal basics are governed in the ADR (European Agreement Concerning the International Carriage of Dangerous Goods by Road), the GGVSEB (German Regulation Concerning the Transport of Dangerous Goods by Road and Rail) and the GGBeFG (German Dangerous Goods Transportation Act). If the Contenedor is used as a fixed refuelling system, the refuelling system regulations for own consumption are applicable, see page 11.

Use of mobile diesel or petrol tank systems/IBC

According to the regulations on hazardous goods, mobile refuelling systems do not exist. They are so-called IBCs. The abbreviation IBC stands for Intermediate Bulk Contenedor. IBCs are used in various sectors for transport and storage, including the transport and storage of hazardous goods. They are filled with fluid or pourable products, but are also used for loose bulk products. This includes, for example, fuels for fueling machines, chemicals, waste products, dusts, but also food products, cosmetics and pharmaceutical products. IBCs contain a volume of up to 3,000 litres.

Exemptions in combination with the type of transport, subsection 1.1.3.1 c) ADR – Craftsman regulation –

If all exemption prerequisites according to 1.1.3.1 c) ADR are observed, complete exemption is granted in terms of hazardous goods regulations. In other words, the hazardous goods regulations are no longer applicable.

This lifts a great burden from agricultural, forestry, landscaping and crafts operations, because they no longer have to use the provisions otherwise applicable to the transport of hazardous goods.

These are:

- Use of design-tested packaging
- Non-observance of identification and tagging regulations
- Exemption from the obligation to carry fire-extinguishing equipment
- Exemption from the obligation to carry accompanying documentation (here: carriage document)

In practical terms, this arrangement represents a significant easement, because deliveries for direct consumption up to max. 450 litres are exempted from the ADR regulations as per RSEB 1-4.1 (German Implementation Guideline for Regulation Concerning the Transport of Dangerous Goods by Road and Rail). Transport for direct consumption means that up to 450 l can be driven to the machine, even in a car. This quantity must not be left there, but must be immediately filled into the consumers' tanks and consumed.

Please also observe our **checklist "Craftsman regulation", page 37.**

Test or examination

From the viewpoint of hazardous goods regulations, the mobile diesel refuelling systems are Intermediate Bulk Contenedors (IBC). The manufacturer uses different names for these diesel tank systems in some cases, e.g. Contenedor or tank. However, these terms, which are known from hazardous goods legislation, do not have anything to do with the actually applicable packaging definition under hazardous goods legislation, i.e. Intermediate Bulk Contenedors / IBC.

Unfortunately, tests and examinations are often not performed on the employed mobile tank systems by an inspection body certified by the German Federal Institute for Materials Testing (BAM) for Intermediate Bulk Contenedors (IBC).

Tests and examinations of this kind are specified by regulations and laws such as the ADR (Accord européen relatif au transport international des marchandises dangereuses par route), the GGVSEB and the GGBeFG (Regulations for the Transport of Dangerous Goods). The test or examination intervals are between 2 ½ and 5 years – from the date of manufacture.



Check the type plate of your mobile diesel tank system. If the last stamped test / examination was longer than 2½ years ago, you should have a test/examination performed by an authorised inspection body as soon as possible.



Example:
DT-Mobil Easy 460 L



Checklist

Transport of diesel fuel according to the craftsman regulation

Claim to the craftsman regulation [1.1.3.1 c) ADR]	yes	no *
Are the deliveries in question associated with the primary business activity?		
Quantities not exceeding 450 litres per package		
Do not exceed max. quantities according to the table 1.1.3.6 ADR – 1000-point rule – (diesel fuel = 1000 litres net)		
Measures taken to prevent leakage of the contents under normal transport conditions		
Load adequately secured		
Leak-proof and undamaged containment and closures of the packagings		
No adhesion of dangerous residues		
No transport for internal or external supply of the business. Exception: transport for direct consumption according to RSEB 1-4.1		
* Exemption cannot be claimed		
Additional regulations to be observed:		
Instruction given		



Example: DT-Mobil EASY for direct consumption

CEMO diesel trolley

Mobile fuelling on site used to be a tricky topic. Apart from the question of transport, smaller quantities of fuel were easily spilled, depending on whether tank connections, funnels or hoses were used. The new CEMO tank trolleys are a completely different story. They deliver up to 100 litres of diesel fuel or petrol on site in absolute safety and in accordance with regulations.



CAS battery

Totally mobile and cable free, independent of vehicle batteries.



integrated vent

The integrated vent system means that fuel can be dispensed continuously without the filler cap needing to be opened.



anti-kink protection + swivel joint + shut-off valve

The anti-kink protection and swivel joint provide the best possible protection for your delivery hose. The container can be completely closed with an isolation valve for transport.



nozzle holder

Integrated dispensing nozzle holder with lock.



recesses for lashing straps

Integrated guides for ratchet straps (100 L) provide safety for transport in the vehicle.

hose holder

Whether upright or horizontal – everything fits; no hose out of place.

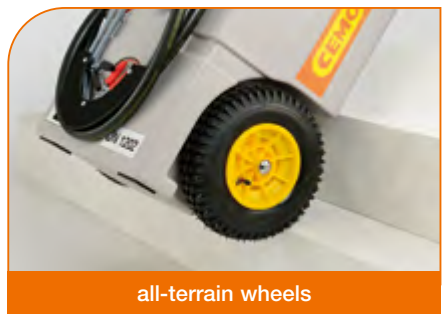

all-terrain wheels

Large tyres for easy handling on terrain and over stairs.

CEMO diesel trolley PG 4

Diesel trolley 60 L and 100 L

- suitable for use under ADR 1.1.3.1 c) for single-site refuelling by a person in the course of their primary business
- polyethylene container with integral hand grip and carry handles
- filler cap with integral vent and breather valve
- outlet connection with isolation valve
- trolley 100 L: 300 mm diameter pneumatic tyres, all-terrain trolley 60 L: 240 mm diameter plastic tyres
- internal baffle
- integral nozzle holder
- trolley 100 L: moulded recesses enabling strapping during transport

Mounted pump:

- crank pump 0,38 L per revolution with 3 m delivery hose DN 19 and nozzle
- self-priming pump CENTRI SP 30, 12 V, 30 L / min, extremely quiet, with 3 m dispensing hose DN 19 and 4 m fly leads or CAS battery

CEMO Diesel trolley 100L APready PG 3

approved for transport for direct consumption according to ADR 1.1.3.1 c)

- versatile mobile system. Handles, ratchet strap guides, baffle and vent/breather are integrated.
- 100 L tank made from lightweight PE plastic
- submersible pump CENTRI SP30, approx. 30 L/min
- 3 m dispensing hose with auto nozzle
- all-terrain large wheels with ø 300 mm
- pumping volume approx. 2,450 L with STIHL AP 500 S battery

★ Accessory: digital flow meter K24 for assembly between dispensing hose and automatic nozzle for the models with electric pump, see page 127.



CENTRI SP 30
EXTREMELY
QUIET



Diesel trolley 60 L with 12 V pump CENTRI SP 30



Diesel trolley 100 L with 18 V pump CENTRI SP 30 and CAS battery



Diesel trolley 100 L APready



Diesel trolley 60 L with crank pump



NEW

★ Accessories see page 48.

CEMO DIESEL TROLLEY

Description / Capacity	Dimensions in cm (l x w x h)	Weight approx. kg	Order no.
Diesel trolley 60 L, with crank pump and manual nozzle	90 x 53 x 38	15	11100
Diesel trolley 60 L, with submersible pump 12 V CENTRI SP 30 and automatic nozzle	90 x 53 x 38	15	11133
Diesel trolley 100 L, with crank pump and manual nozzle	100 x 59 x 43	20	11101
Diesel trolley 100 L, with submersible pump 12 V CENTRI SP 30 and automatic nozzle	100 x 59 x 43	20	11102

Description	Pump flow rate	Capacity of battery	Max. volume (litre) per battery charge	Dimensions in cm (l x w x h)	Order no.
Charger and battery included					
Diesel trolley 60 L, CENTRI SP 30	30 L/min	2 Ah	360	90 x 53 x 38	11597
Diesel trolley 100 L, CENTRI SP 30	30 L/min	4 Ah	720	100 x 59 x 43	11598
Supplied without charger or battery – use your own CAS battery					
Diesel trolley 60 L, CENTRI SP 30	30 L/min	-	-	90 x 53 x 38	11590
Diesel trolley 100 L, CENTRI SP 30	30 L/min	-	-	100 x 59 x 43	11591
Supplied without charger or battery – use your own STIHL AP battery					
Diesel trolley 100 L APready NEW	30 L/min	-	-	100x59x43	12059

CEMO DT MOBIL EASY

Innovative diesel refuelling systems offering a wealth of useful features.

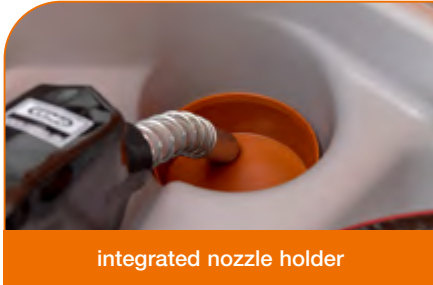

integrated nozzle holder

The integrated nozzle holder with drip cup (470 L, 620 L, 850 L/100 L and 980 L) ensures tidiness and cleanliness.



dispensing hose can be isolated

The isolation valve enables the container to be sealed off completely, thus adding to safety during transportation (125 L, 200 L, 200 L, 470 L, 620 L, 850/100 L and 980 L).



recesses for ratchet tie-down

Integral recesses (125 L, 200 L, 210 L, 440 L, 470 L and 620 L) and lashing eyes (470 L, 620 L, 850/100 L and 980 L) to allow immobilisation with a ratchet lashing strap during transportation.



integral forklift pockets

The integral forklift pockets make handling easier when the tank is full.



built-in ergonomic carry handles

The built-in carry handles enable the equipment to be handled easily during loading.

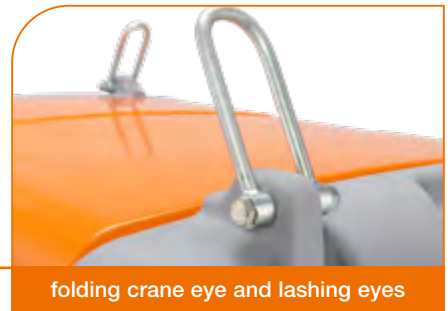

folding crane eye and lashing eyes

The folding crane and lashing eyes (470 L, 620 L, 850/100 L and 980 L) make it easier to secure the load in the prescribed manner, and serve at the same time as fastening eyes if the device is lifted by crane.

CEMO DT MOBIL Easy 125 L and 210 L PG 4

ACCORDING TO ADR 1.1.3.1 C)

DT-Mobil Easy

Certified for transport for immediate consumption according to ADR 1.1.3.1 c)

Container

- 125 L, 210 L, single-walled, polyethylene
- Integral dispensing nozzle holder
- Integral filler neck
- Integrated vent with pressure relief
- Integral forklift pockets and handles
- Integral recesses for ratchet straps during transport

Pre-fitted pump

- Self-priming pump, 12V or 24V, 40 L/min, with automatic nozzle, 4 m dispensing hose DN 19 and 4 m electric cable
- Submersible pump CENTRI SP 30, 30 L/min, extremely quiet, with automatic nozzle, 4 m dispensing hose DN 19 and 4 m electric cable or CAS battery
- Hand pump 25 L/min, 2.7 m dispensing hose DN 19 and manual nozzle



210 L with pump 12 V

210 L with 12V submersible CENTRI SP 30 12 V and hinged lid



210 L with pump 12 V



125 L with hand pump



210 L with CENTRI SP30 12 V and CAS battery



210 L with CENTRI SP30 18 V and CAS battery

***TOPSELLER**

DT-Mobil Easy 210 L with pump CENTRI SP 30

Packages:

without hinged lid order no. 10978

with hinged lid order no. 10981

★ Accessories see page 48.

DT-MOBIL EASY ACCORDING TO ADR 1.1.3.1 C)

Description	Capacity L	Dimensions in cm (l x w x h)	Weight approx. kg	Order no.
Hand pump and manual nozzle	125	80 x 60 x 45	22	8915
Pump CENTRI SP 30, 12 V, 30 L/min, automatic nozzle	125	80 x 60 x 45	20	10606
Pump CENTRI SP 30, 12 V, 30 L/min, automatic nozzle	210	78.5 x 59.5 x 68.5	19	10978*
Pump 12 V, 40 L/min, automatic nozzle	210	78.5 x 59.5 x 68.5	22	10980
Pump CENTRI SP 30, 12 V, 30 L/min, automatic nozzle, hinged lid	210	78.5 x 59.5 x 68.5	21	10981*
Pump 12 V, 40 L/min, automatic nozzle, hinged lid	210	78.5 x 59.5 x 68.5	23	10983
Pump 24 V, 40 L/min, automatic nozzle, hinged lid	210	78.5 x 59.5 x 68.5	23	11104

Description	Pump flow rate	Capacity of battery	Max. volume (litre) per battery charge	Dimensions in cm (l x w x h)	Order no.
Charger and battery included 					
DT-MOBIL EASY 210 L with hinged lid	30 L/min	4 Ah	720	78.5 x 59.5 x 68.5	11601
Supplied without charger or battery – use your own CAS battery					
DT-MOBIL EASY 210 L with hinged lid	30 L/min	-	-	78.5 x 59.5 x 68.5	11594

DT-MOBIL EASY APREADY ACCORDING TO ADR 1.1.3.1 C) PG 3

Description	Pump flow rate	Capacity of battery	Max. volume (litre) per battery charge with AP 500 S	Dimensions in cm (l x w x h)	Order no.
Supplied without charger or battery – use your own STIHL AP battery 					
CEMO DT Mobil Easy 210 L APready with hinged lid NEW	30 L/min	-	-	78.5 x 59.5 x 68.5	12060

CEMO DT MOBIL Easy pick-up 210 L PG 4

The perfect solution for transport by pick-up truck.

- overall height 45 cm. Fits under the load area cover.
- with recess for tie-down straps to secure tank in load area

DT-Mobil Easy certified for transport for immediate consumption under ADR 1.1.3.1 c).

Container:

- Pick-up 210 L, polyethylene, single wall
- integral nozzle holder
- integral filler neck
- filler cap with vent and breather valves
- integral forklift pockets and handles
- integral recesses for fastening with tie-down straps during transport

Pre-installed pump:

- self-priming pump, 12 V or 24 V, 40 L/min, with auto shut-off nozzle, 4 m dispensing hose DN 19 and 4 m electrical cable
- submersible pump CENTRI SP 30, 30 L/min, extremely quiet, with 4 m dispensing hose DN 19 and 4 m cable or CAS battery



210 L with submersible pump CENTRI SP 30 and hinged lid



Pick-up 210 L with submersible pump CENTRI SP 30 12 V



Pick-up 210 L with pump 12 V

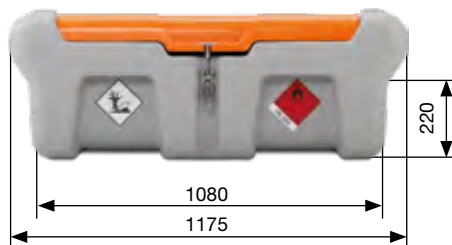

★ Accessories see page 48.



Pick-up 210 L with submersible pump CENTRI SP 30 18 V and CAS battery



Integral recesses for fastening with tie-down straps

DT-MOBIL EASY PICK-UP 210 L ACCORDING TO ADR 1.1.3.1 C)

Description	Dimensions in cm (l x w x h)	Weight approx. kg	Order no.
DT-Mobil Easy pick-up 210 L with submersible pump CENTRI SP 30, 12 V, 30 L/min, and auto shut-off nozzle	118 x 79 x 45	26	11248
DT-Mobil Easy pick-up 210 L with 12 V pump, 40 L/min, and auto shut-off nozzle	118 x 79 x 45	29	11249
DT-Mobil Easy pick-up 210 L with submersible pump CENTRI SP 30, 12 V, 30 L/min, auto shut-off nozzle and lid	118 x 79 x 45	30	11250
DT-Mobil Easy pick-up 210 L with pump 12 V, 40 L/min, auto shut-off nozzle and lid	118 x 79 x 45	34	11251
DT-Mobil Easy pick-up 210 L with pump 24 V, 40 L/min, auto shut-off nozzle and lid	118 x 79 x 45	34	11252

Description	Pump flow rate	Capacity of battery	Max. volume (litre) per battery charge	Dimensions in cm (l x w x h)	Order no.
Charger and battery included					
DT-Mobil EASY Pick-up 210 L with hinged lid	30 L/min	4 Ah	720	118 x 79 x 45	11627
Supplied without charger or battery – use your own CAS battery					
DT-Mobil EASY Pick-up 210 L with hinged lid	30 L/min	-	-	118 x 79 x 45	11626

CEMO DT MOBIL Easy 440 L

CEMO DT MOBIL Easy COMBI 440 / 50 L PG 4

ACCORDING TO ADR 1.1.3.1 C)

DT-Mobil Easy

container: 440 L and 440/50 L, description see page 42

EASY MOBIL COMBI

with additional tank for AdBlue®:

- with pump CENTRI SP30, 12 V
- 4 m dispensing hose DN19, automatic nozzle
- CAS Li-Ion 18 V battery system
- separate battery holder for each pump
- batteries and charger are not included with system and can be found with the accessories if required

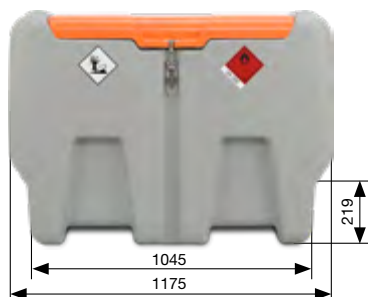

440 L and 440/50 L waisted for Pick-up

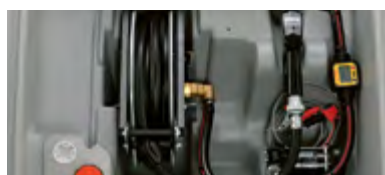

440 L Premium with automatic nozzle and meter



440/50 L COMBI with pump 18 V



440 L with quick coupling



440 L with pump 12 V

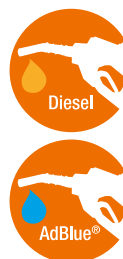

 Accessories see page 48.

DT-MOBIL EASY ACCORDING TO ADR 1.1.3.1 C)

Description	Capacity L	Dimensions in cm (l x w x h)	Weight approx. kg	Order no.
Quick coupling and hinged lid	440	118 x 80 x 71	35	11110
Submersible pump CENTRI SP 30 SP 30, 12 V, 30 L/min, extremely quiet, automatic nozzle	440	118 x 80 x 71	33	10984
Pump 12 V, 40 L/min, automatic nozzle	440	118 x 80 x 71	35	10985
Submersible pump CENTRI SP 30, 12 V, 30 L/min, extremely quiet, automatic nozzle, hinged lid	440	118 x 80 x 71	36	10987
Pump 12 V, 40 L/min, automatic nozzle, hinged lid	440	118 x 80 x 71	39	10988
Pump 24 V, 40 L/min, automatic nozzle, hinged lid	440	118 x 80 x 71	39	11105
Premium, pump 12 V, 40 L/min, digital flow meter K24, hose reel with 8 m hose DN 19, automatic nozzle, hinged lid	440	118 x 80 x 85	62	11107
Premium, pump 24 V, 40 L/min, digital flow meter K24, hose reel with 8 m hose DN 19, automatic nozzle, hinged lid	440	118 x 80 x 85	62	11108

Description	Pump flow rate	Capacity of battery	Max. volume (litre) per battery charge	Dimensions in cm (l x w x h)	Order no.
Charger and battery included					
DT-Mobil EASY 440 L with CENTRI SP30, 18V, with hinged lid	30 L/min	4 Ah	720	118 x 80 x 71	11603
DT-MOBIL EASY 440 L with Cematic 3000/18 V, with hinged lid	40 L/min	4 Ah	900	118 x 80 x 71	11687
Supplied without charger or battery – use your own CAS battery					
DT-Mobil EASY 440 L with CENTRI SP30, 18V, with hinged lid	30 L/min	-	-	118 x 80 x 71	11596
DT-MOBIL EASY 440 L with Cematic 3000/18 V, with hinged lid	40 L/min	-	-	118 x 80 x 71	11686

DT-MOBIL EASY APREADY ACCORDING TO ADR 1.1.3.1 C) PG 3

Description	Pump flow rate	Capacity of battery	Max. volume (litre) per battery charge with AP 500 S	Dimensions in cm (l x w x h)	Order no.
Supplied without charger or battery – use your own STIHL AP battery					
CEMO DT Mobil Easy 440 L APready NEW	30L/min	-	-	118 x 80 x 78	12061

DT-MOBIL EASY COMBI ACCORDING TO ADR 1.1.3.1 C)

Description	Capacity L	Dimensions in cm (l x w x h)	Weight approx. kg	Order no.
Submersible pump CENTRI SP 30, 12 V, 30 L/min, automatic nozzle, hinged lid	COMBI 440/50	118 x 80 x 85	51	10991
Pump 12 V, 40 L/min, automatic nozzle, hinged lid		118 x 80 x 85	54	10992
Pump 24 V, 40 L/min, automatic nozzle, hinged lid		118 x 80 x 85	54	11106
Pump 18 V, battery and charger NOT included. Please see pg. 48 for accessories if required; max. pumping volume per Ah of battery capacity 225 L (diesel) 150 L (AdBlue)	COMBI 440/50	118 x 80 x 85	52	11860

CEMO DT MOBIL Easy 200, 470 and 620 L PG 4

ADR CERTIFIED

NEW

IMDG&RID
ADR certified transport



DT-Mobil EASY with ADR certification certified for transport under ADR, examination every 2 ½ years according to ADR 6.5.4.4.1 b) and ADR 6.5.4.4.2 b).*** Completely assembled.

- Container:**
- 200 L, 470 L or 620 L polyethylene, single-walled
 - with hinged lid
 - with crane eyes (470 L and 620 L)
 - integral filler neck
 - filler cap with vent and breather valves
 - integral forklift pockets and handles
 - integral recesses (200 L) or loops (470 L and 620 L) for securing with ratchet straps during transport

- Pre-fitted pump:**
- self-priming, pump 12 V or 24 V DC, 40 L/min, with automatic nozzle, 4 m dispensing hose DN 19 and 4 m electrical cable
 - submersible pump CENTRI SP 30, 12 V, 30 L/min, extremely quiet, with automatic nozzle, 4 m dispensing hose DN 19 or DN25 (model 11919 and 11924) and 4 m cable
 - hand pump 25 L/min, 2.7 m dispensing hose DN 19 and manual nozzle

*** Transport certification for all plastic IBCs is limited to a life of 5 years. The 200 L model is therefore also certified for transport for direct consumption under ADR 1.1.3.1 c).

DT-Mobil EASY 620 L with electric pump, automatic nozzle and hinged lid



DT-Mobil EASY 200 L with electric pump, automatic nozzle and hinged lid



See catalogue page 163 for suitable steel bund SW 600/2



DT-MOBIL EASY WITH ADR CERTIFICATION

Description / capacity	Dimensions in cm (l x w x h)	Weight approx. kg	Order no.
200 L with hand pump, manual nozzle	80 x 62 x 61	26	10080
200 L with submersible pump CENTRI SP 30, extremely quiet, 12 V, 30 L/min, automatic nozzle	80 x 62 x 61	24	10735
200 L with pump 12 V, 40 L/min, automatic nozzle	80 x 62 x 61	28	10082
200 L with pump 24 V, 40 L/min, automatic nozzle	80 x 62 x 61	28	10112
470 L without pump, with quick coupling for vehicles with integrated suction pump	118 x 80 x 87	38	11917
470 L with pump 12 V, 40 L/min and automatic nozzle	118 x 80 x 87	45	11918
470 L with pump Cematic Duo 24/12V, 70/35 L/min and automatic nozzle	118 x 80 x 87	51	11919
620 L without pump, with quick coupling for vehicles with integrated suction pump	118 x 80 x 103	42	11922
620 L with pump 12 V, 40 L/min and automatic nozzle	118 x 80 x 103	48	11923
620 L with pump Cematic Duo 24/12V, 70/35 L/min and automatic nozzle	118 x 80 x 103	54	11924

★ Accessories see page 48.

*** Please note that ADR certification for all plastic IBCs is limited to a period of 5 years.

NEW

CEMO DT MOBIL Easy 470 and 620 L PG 4

ADR CERTIFIED AND CAS BATTERY SYSTEM

IMDG&RID

ADR certified transport



DT MOBIL Easy 470 L with 18V pump Cematic 3000/18 and CAS battery

DT-Mobil EASY with ADR certification certified for transport under ADR, examination every 2 ½ years according to ADR 6.5.4.4.1b) and ADR 6.5.4.4.2 b)..**

Completely assembled

- pump Cematic 3000/18, 18 V, 40 L/min or Cematic 56/18, 18 V, 60 L/min
- totally mobile and cable-free, independent of vehicle batteries
- very low self-discharge, no memory effect

- high intrinsic safety and integrated protection electronics
- charger 220 – 240 VAC, output 18 V – 3 A, included (11921+11926)
- with hinged lid
- 4 m dispensing hose

Description	Pump flow rate	Capacity of battery	Max. volume (litre) per battery charge	Dimensions in cm (l x w x h)	Order no.
Charger and battery included					
DT-MOBIL EASY 470 L with Cematic 3000/18	40 L/min	4 Ah	900	118 x 80 x 87	11921
DT-MOBIL EASY 620 L with Cematic 3000/18	40 L/min	4 Ah	900	118 x 80 x 103	11926
Supplied without charger or battery – use your own CAS battery					
DT-MOBIL EASY 470 L with Cematic 3000/18	40 L/min	-	-	118 x 80 x 87	11920
DT-MOBIL EASY 620 L with Cematic 3000/18	40 L/min	-	-	118 x 80 x 103	11925
DT-MOBIL EASY 620 L with Cematic 56/18	60 L/min	-	-	118 x 80 x 103	11933

*** Please note that ADR certification for all plastic IBCs is limited to a period of 5 years.

★ Accessories see page 48.

Battery systems, Li-Power-Block PG 4

SUITABLE FOR PUMPS WITH 12 VDC SUPPLY VOLTAGE

Lithium iron phosphate battery (LiFePO₄)

- totally mobile, independent of vehicle batteries
- 12.8 V nominal voltage, 3.3 Ah or 5.5 Ah capacity
- battery operating temperature range: -30 °C to + 80 °C
- very low self-discharge, no environmentally harmful heavy metals, no memory effect
- high intrinsic safety and integrated protection circuit, electrical protection class IP 67
- terminal protection caps protect against accidental short circuit
- easy to hang or carry due to rope handle
- includes charger 100 – 240 VAC, output 14.4 V – 3 A



Li-Power-Block with rope loop for easy hanging and carrying

LI-POWER-BLOCK

Description	Order no.
Li-Power-Block 12.8 V – 3.3 Ah with charger Discharge volume of approx. 300-380 litres on a single charge, without idling, depending on the pump, charging time approx. 66 min.	10749
Li-Power-Block 12.8 V – 5.5 Ah with charger Sufficient for an output volume of approx. 500 – 630 litres without idling, depending on the pump, charging time approx. 110 min.	10750



CEMO DT MOBIL Easy 980 L PG 4

ADR CERTIFIED

Certified for transport under ADR. Examination every 2 ½ years according to ADR 6.5.4.4.1 b) and ADR 6.5.4.4.2 b).*** Completely assembled.

Container:

- 980 L polyethylene, single-walled
- integral baffle
- integral dispensing nozzle holder
- integral filler neck
- filler cap with vent and breather valves
- integral forklift pockets
- integral handles
- with crane eyes
- with flap lid
- integral loops for securing the trolley with ratchet lashing strap during transport

Basic versions:

- with powerful electric pump
- 4 m dispensing hose DN25 / 6 m
- with CENTRI SP 80 (without hose reel, meter and filter) and automatic nozzle

Premium versions:

- with powerful electric pump
- hose reel with 8 m hose DN25
- flow meter
- filter with water separator and automatic nozzle

Pumps:

- pump Bipump 12 V, 500 W, approx. 85 L/min**
- pump Cematic Duo 24/12 V, 420 W, approx. 70/35 L/min*
- pump Cematic 72, 230 V, 500 W, approx. 72 L/min*
- submersible pump CENTRI SP80 AC**, 230 V, 8 L/min*
- hand pump 60 L/min*

IMDG&RID
ADR certified transport



Maintenance-free, high-performance submersible pump CENTRI SP80 AC, 230 V



DT-Mobil Easy 980



DT-Mobil EASY 980 without pump, with quick coupling



DT-Mobil Easy 980 Basic



DT Mobil Easy 980 Basic with CENTRI SP80



DT Mobil Easy 980 Premium with CENTRI SP80



DT-Mobil Easy 980 with hand pump

DT-MOBIL EASY 980 L WITHOUT PUMP OR WITH HAND PUMP

Description	Capacity L	External dimensions cm (l x w x h)	Weight approx. kg	Order no.
980 without pump, with quick coupling	980	127 x 107 x 112	95	10817
980 with hand pump 60 L/min, 4 m dispensing hose DN19, manual nozzle	980	127 x 107 x 112	100	11025

DT-MOBIL EASY 980 L DIESEL TANK

Description	Capacity L	External dimensions cm (l x w x h)	Weight approx. kg	Electric pump version			
				Bipump 12 V **	Cematic Duo 24/12 V	Cematic 230 V	CENTRI SP80 230 V**
				Order no.	Order no.	Order no.	Order no.
980 Basic	980	127 x 107 x 112	107	10818	10822	10826	11647
980 Premium	980	127 x 107 x 112	130	10819	10823	10827	11648

WITHOUT BATTERY AND CHARGER

	Capacity L	External dimensions cm (l x w x h)	Weight approx. kg	Order no.
980 Basic, without battery and charger, with pump Cematic 56/18 ** CAS CAS NEW	980	127 x 107 x 112	107	11932

* Pump output in free flow. Please note that the pump output can fall sharply depending on the length and cross-sectional area of the hose.

*** Please note that ADR certification for all plastic IBCs is limited to a period of 5 years.

** with automatic nozzle A80 fastfill for fast refuelling – also for passenger cars

CEMO DT MOBIL Easy COMBI 850 / 100 L PG 4 ADR CERTIFIED

Certified for transport under ADR.
Examination every 2 ½ years according to ADR 6.5.4.4.1 b) and ADR 6.5.4.4.2 b).***
Completely assembled.

Container:

- 850/100 L polyethylene, single-walled (diesel/AdBlue® tank)
- integral baffle
- integral dispensing nozzle holder
- integral filler neck
- filler cap with vent and breather valves
- integral forklift pockets
- integral handles
- with crane eyes
- integral loops for securing the trolley with ratchet lashing strap during transport



DT-Mobil Easy COMBI 850/100 Premium

Basic versions:

- with powerful electric pump
- 4 m dispensing hose DN25 (without hose reel, meter and filter)
- automatic nozzle

Premium versions:

- with powerful electric pump
- hose reel with 8 m hose DN25,
- flow meter
- filter with water separator
- automatic nozzle



IMDG&RID
ADR certified transport

DT-Mobil Easy COMBI 850/100 Premium



Pumps:

- Pump Bipump 12 V, 500 W, approx. 85 l/min**
- Pump Cematic Duo 24/12 V, 420 W, approx. 70/35 l/min*
- Pump Cematic 72, 230 V, 500 W, approx. 72 l/min*
- Pump CENTRI SP30 12 V, 220 W, approx. 25 l/min*
- Pompa manuale 60 l/min*

COMBI versions

with additional tank for AdBlue®:

- With submersible pump CENTRI SP30, 12 V,
- 5m dispensing hose DN 19
- Automatic nozzle

DT-MOBIL EASY COMBI 850/100 L DIESEL-/ADBLUE® TANK

Description	Capacity L	External dimensions cm (l x w x h)	Weight approx. kg	Electric pump version diesel (AdBlue®: CENTRI SP 30 12 V)		
				Bipump 12 V **	Cematic Duo 24/12 V	Cematic 230 V
				Order no.	Order no.	Order no.
850/100 Basic	850/100	127 x 107 x 112	121	10820	10824	10828
850/100 Premium	850/100	127 x 107 x 112	143	10821	10825	10829

























* Pump output in free flow. Please note that the pump output can fall sharply depending on the length and cross-sectional area of the hose.

*** Please note that transport certification for all plastic IBCs is limited to a period of 5 years.



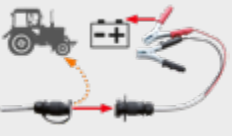

** with automatic nozzle A80 fastfill for fast refuelling – also for passenger cars

CEMO DT MOBIL Easy PG 4

ACCESSORIES

Description	Order no.
 Lid for DT-Mobil EASY 125 L and 200 L (from year of construction 2011)	8963
 Hinged lid lock for DT-Mobil EASY 125 L and 200 L, complete with two keys	10214
 Hinged lid for DT-Mobil EASY 210 L	11062
 Hinged lid for DT-Mobil EASY pick-up 210 L, 440 L and 440/50 L	11057
 Hinged lid for DT-Mobil EASY 430 L, 460 L, 600 L, 850/100 L and 980 L	8833
 K24 digital flow meter for 12 V and 24 V pumps, 40 L/min for DT-Mobil EASY 200 L	8832
 K24 digital flow meter for 12 V and 24 V pumps, 40 L/min for DT-Mobil EASY 430 L 460 L and 600 L	8908
 K24 digital flow meter for DT-Mobil EASY 210 L, Pick-up 210 L, 440 L and 440/50 L	11111
 K24 digital flow meter for DT-Mobil EASY 850/100 L and 980 L	10905
 K33 mechanical flow meter for DT-Mobil EASY 980 L with hand pump	11171
 K33 mechanical flow meter for DT-Mobil EASY 470 L and 620 L (flange ellbow unit order no. 11971 is required for for 11933)	11966
 Filter with water separator for DT-Mobil Easy 470 L and 620 L (flange ellbow unit order no. 11972 is required for for 11933)	11967
 Contents gauge for Easy Pick-up 210 L	11256
 Contents gauge for DT-Mobil Easy 440 L	11058
 Contents gauge for DT-Mobil Easy 440 L Premium, COMBI 440/50 L and Easy 470 L	11059
 Contents gauge for DT-Mobil Easy 850/100 L and 980 L (from year of construction 2021)	11503
 Contents gauge for DT-Mobil Easy 620 L	11957
 Contents gauge for DT-Mobil EASY 430 L and 460 L	8881
 Contents gauge for DT-Mobil EASY 600 L	10089
 Contents gauge for DT-Mobil EASY 850/100 L and 980 L (until year of manufacture 2020)	10830
 Anti-slip mat 120 x 80 cm for DT-Mobil Easy 125L, 200L, 210L, Pick-Up 210 L, 430 L, 440 L, 440/50L, 460 L, 600 L, oil and weather resistant	10953
  DIN 9680 plug, 3-pin, 6 – 24 V, max. 25 A, IP 54	10229
 DIN 9680 socket, 3-pin, 6 – 24 V, max. 25 A, IP 54	10230
 Adhesive label set for retrofitting to DT-Mobil EASY	10261

ACCESSORY FOR DT-MOBIL EASY WITH CAS BATTERY

 CAS <small>COMBRESS AIRLESS SYSTEM</small>	① Charger ASC55, 220 – 240 VAC, 3 A, CAS	11385
 ① Li-Power battery 18 V / 2.0 Ah CAS		11386
 Li-Power battery 18 V / 4.0 Ah CAS		11387
 Li-HD battery 18 V / 8.0 Ah CAS		11388

Mobile refuelling systems for diesel ADR CERTIFIED

CEMO CUBE mobil 980 L PG 4

IMDG&RID
ADR certified transport

Certified for transport according to ADR. Examination every 2 1/2 years according to ADR 6.5.4.4.1 b) and ADR 6.5.4.4.2 b).***
Certified as storage tank with general construction inspection certification no. Z-40.21-589

- compact design, easy to use
- with integral baffle
- with integral bund
- with visual leak indicator
- integral filler neck
- filler cap with vent and breather valves
- contents gauge
- 1" suction line with shut-off valve
- automatic nozzle with dispensing nozzle holder
- with lockable lid
- integral forklift pockets
- integral handles
- fully assembled

Basic version

with high-performance pump, 4 m dispensing hose DN25 (without hose reel, flow meter and filter) and automatic nozzle

Premium version

with high-performance pump, hose reel with 8 m hose DN25, flow meter, filter with water separator and automatic nozzle

Pumps

Bipump pump, 12 V, 500 W, approx. 85 L/min**

Cematic Duo pump, 24/12 V, 420 W, approx. 70/35 L/min*

Cematic 72 pump, 230 V, 500 W, approx. 72 L/min*



bunded tank offers twice the safety

ergonomic and compact

forkliftable

certified for storage and transport



CUBE Mobil 980 L Premium



Version without pump with quick coupling



Version with hand pump 60 L/min



Version Basic with Cematic Duo, 24/12 V



Version Premium with Bipump 12 V

CEMO CUBE MOBIL 980 L WITHOUT PUMP OR WITH HAND PUMP

Description	Capacity L	External dimensions cm (w x d x h)	Weight approx. kg	Order no.
980 without pump with quick coupling	980	130 x 112 x 118	102	11677
980 with hand pump 60 L/min, 4 m dispensing hose DN 19, manual nozzle	980	130 x 112 x 118	117	11678

CEMO CUBE MOBIL 980 L WITH ELECTRIC PUMP

Description	Capacity L	External dimensions cm (w x d x h)	Weight approx. kg	Electric pump version		
				Bipump 12 V **	Cematic Duo 24/12 V	Cematic 230 V
980 Basic	980	130 x 112 x 118	123	11632	11634	11636
980 Premium	980	130 x 112 x 118	145	11633	11635	11637

* Pump output in free flow. Please note that the pump output can fall sharply depending on the length and cross-sectional area of the hose
*** Please note that transport certification for all plastic IBCs is limited to a period of 5 years.
** with automatic nozzle A80 fastfill for fast refuelling – also for passenger cars

Water absorber for diesel PG 4

NEW

Avoid the repairs, machinery failure and costs resulting from the diesel bug or rust in the fuel system by removing the water that causes it from the diesel. A granulate in a bag absorbs free and dissolved water as well as microparticles.

- simple use in the tank
- non-toxic and environmentally friendly. Does away from the need for biocides and additives

- prevents the growth of bacteria and mould
- improves diesel quality and thus engine performance
- extends the shelf life of diesel and biodiesel
- particularly recommended when engines are not operated for longer periods of time, e.g. in boats, vintage cars or emergency power generators

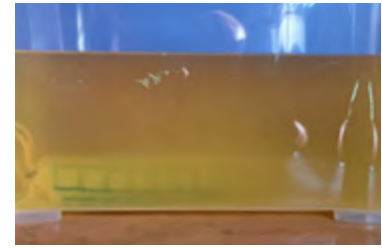

before



after

Water absorber S is recommended for vehicle tanks and filling stations up to 1,000 litres and fits through openings from 50 mm (2").

Size M fits through openings from 80 mm (3").

Description	Maximum absorption capacity in L	Dimensions (l x w) cm	Weight approx. kg	Order no.
Water absorber S	400	4.5 x 30	0.1	11969
Water absorber M	1,000	7.5 x 32	0.2	11970

Oil drip mat PG 4

The mobile filling area for refuelling at construction sites

- innovative absorption system for motor oil, petrol, diesel, hydrotreated vegetable oil (HVO) and hydraulic fluids (incl. bio)
- for indoor or outdoor use
- absorbs oil but repels water
- also usable in rainy conditions
- for refueling in accordance with regulations on the construction site and in the field



A clean solution: the innovative oil drip mat. Available in 3 sizes

Description	Maximum absorption capacity in L	Dimensions (l x w) cm	Weight approx. kg	Order no.
Oil drip mat M15	15	90 x 69	2	11638
Oil drip mat XL50	50	137 x 137	5	11639
Oil drip mat XXL80	80	218 x 137	8.5	11640

CEMO DT MOBIL PRO hybrid 440 L

CEMO DT MOBIL PRO hybrid 440/50 L PG 4

ACCORDING TO ADR 1.1.3.1 C)

DT-Mobil PRO hybrid and PRO hybrid COMBI

- outer bund made from 3 mm painted steel sheet, with lifting lugs, stackable, lockable
- with inner tank for diesel made from polyethylene
- with electronic overfill sensor

Basic version:

- powerful pump 12 V or 24 V, self-priming, 40 L/min
- 4 m dispensing hose DN 19
- automatic nozzle

Premium version:

- powerful 12 V or 24 V pumps, self-priming, 40 L/min
- hose reel with 8 m hose DN 19
- K24 digital flow meter
- automatic nozzle

COMBI version

with additional tank for AdBlue®:

- with submersible pump CENTRI SP 30, 12 V, 4 m dispensing hose DN 19 and automatic nozzle

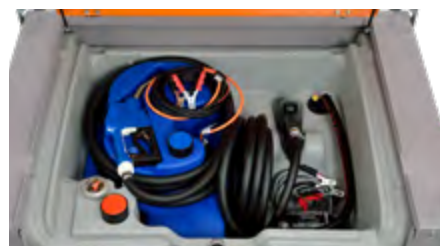
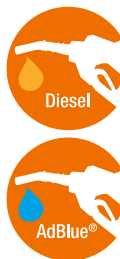

440/50 L COMBI Basic with pump 12 V

440/50 L COMBI Basic with pump 12 V



440 L without pump, with quick coupling



440 L Basic with 12 V pump



440 L Premium with 12 V pump

DT-MOBIL PRO PE 440 L AND PRO PE COMBI 440/50 L

Description	Capacity L	External dimensions cm (l x w x h)	Weight approx. kg	Order no.
PRO hybrid 440 L without pump, with quick coupling	440	125 x 87 x 107	196	11113
PRO hybrid 440 L Basic with 12 V pump	440	125 x 87 x 107	202	11115
PRO hybrid 440 L Basic with 24 V pump	440	125 x 87 x 107	203	11116
PRO hybrid 440 L Premium with 12 V pump	440	125 x 87 x 107	215	11117
PRO hybrid 440 L Premium with 24 V pump	440	125 x 87 x 107	216	11118
PRO hybrid COMBI 440/50 L Basic with 12 V pump	440/50	125 x 87 x 107	208	11119
PRO hybrid COMBI 440/50 L Basic with 24 V pump	440/50	125 x 87 x 107	209	11120

ACCESSORY

Description	Order no.
K24 digital flow meter for diesel	11111

Mobile COMBI refuelling systems for diesel and AdBlue®

Contractors want complete, time-saving and easy-to-use solutions for the combined filling of diesel and AdBlue® on site. The combination canister (petrol and oil) for petrol-driven saws is an example. CEMO has rigorously implemented the wishes of professionals with the DT-MobilCUBE COMBI.

- with ADR transport certification
- 980 L capacity, therefore below the exemption limit of 1,000 L according to ADR 1.1.3.6.3
- also ideally suited for biodiesel and diesel with increased biodiesel content
- versions with powerful 12 V, 24 V and 230 V pumps

- inner container with integrated equipment such as powerful pumps, hose reel (with hose DN25), meter and filter with water separator, dispensing nozzle holder, optional marquee heaters and power generators.
- DT-MobilCUBE COMBI with second inner tank in polyethylene, for AdBlue®, with CENTRI SP 30 electric pump
- bund volume of 110 %
- certified for use in water conservation areas
- The steel tanks are primed and painted. We provide a 5-year warranty against rusting through.

IMDG&RID
ADR certified transport



optional lifting frame

for crane hooks or grabs
Order no. 11112

optimal use of space

Cubic shape, hence optimal use of space.



high-quality coating

Outer container in painted 3 mm steel sheet** – high-quality coating.

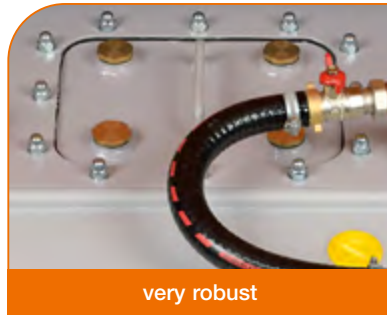

very robust

Inner container in painted 3 mm steel sheet, alternatively in polyethylene, with integrated baffle.



transport-friendly

Galvanised forklift pockets and stacking corners with crane eyes simplify transport and setup. Two tanks can be stacked one on top of the other when full.



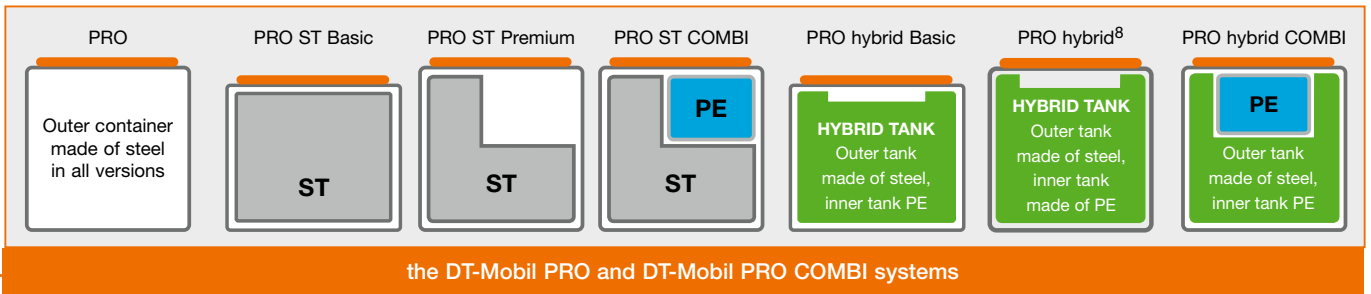

lockable

Lid has integrated bar lock to prevent theft. Lid can be locked with a padlock on DT MOBIL PRO ST and hybrid 980.



hose grommet

For routing hoses and cables.



easy to open

Gas struts simplify opening and closing of the lid.



tidies away nice and small

All fittings are on the inside and thus protected.

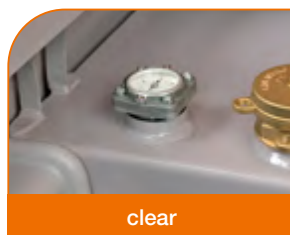

clear

contents gauge



double safety

bund alarm



DT-Mobil PRO ST COMBI 980/200 Premium Plus, with pump Bipump

* National installation laws and conditions must be observed. We will be happy to advise you.

** Outer container made of 2.5 mm sheet steel on DT MOBIL PRO ST 980 Basic.

The tank revolution – the new CEMO HYBRID-TANK

MOBILE TANK SYSTEMS MADE OF STEEL WITH INNER CONTAINER MADE OF PE

HYBRID TANK

outer tank steel – inner tank polyethylene

LIGHTER

130 kg less weight, less fuel consumption during transport

MORE SUSTAINABLE

climate-friendly manufacture, fewer CO2 emissions than for solid steel

LONGER CERTIFICATION

one of a kind: ADR certification for 8 years instead of just 5 years

REPLACEABLE PE INNER TANK

replacement service includes ADR test certificate

NEW

IMDG&RID

ADR certified transport



CEMO PRO mobil hybrid®

The first combination IBC in Germany to obtain ADR certification extended to 8 years.

CEMO PRO mobil hybrid Basic Model with lower overall height

Lighter than comparable double-walled steel IBCs for lower fuel consumption during transport.

CEMO PRO mobil hybrid Generator tank

Connections with quick-coupling for marquee heaters and power generators.

CEMO DT MOBIL PRO hybrid⁸ PG 4

ADR CERTIFICATION D/BAM 15151 WITH 8-YEAR VALIDITY

Diesel tank system DT MOBIL PRO hybrid⁸ with inner tank for diesel made of polyethylene****

Basic version:

- powerful electric pump
- 4 m dispensing hose DN25 (without hose reel, meter and filter)
- automatic nozzle

Premium version:

- powerful electric pump
- 8 m dispensing hose DN25
- mechanical flow meter K33
- filter with water separator
- automatic nozzle

Pumps:

- Bipump 12 V, 500 W, approx. 85 L/min****/**
- pump Cematic Duo 24/12 V, 420 W, approx. 70/35 L/min****
- pump Cematic 72, 230 V, 500 W, approx. 72 L/min****
- hand pump 60 L/min****

Examination every 2 ½ years (see ADR 6.5.4.4.1 b and ADR 6.5.4.4.2 b).



DT-Mobil PRO hybrid⁸ 980 Basic, with pump Cematic Duo

IMDG&RID
ADR certified transport



DT-Mobil PRO hybrid⁸ 980 Premium, with pump Cematic Duo



DT-Mobil PRO hybrid⁸ 980 with hand pump 60 L/min

DT MOBIL PRO hybrid⁸ Basic package

- capacity 980 L
- with inner tank for diesel made from polyethylene****
- 4 m dispensing hose DN25 (without hose reel, meter, filter)
- automatic nozzle
- 12 V Bipump, 500 W, approx. 85 L/min****

Order no. 10787

HYBRID TANK
Outer tank made of steel, inner tank PE

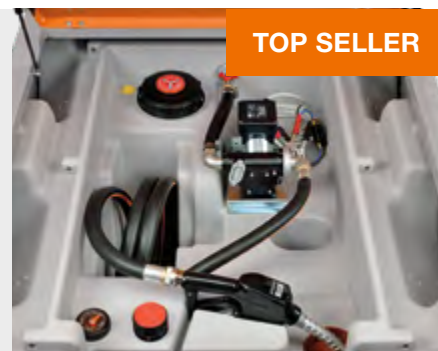

TOP SELLER

DT-MOBIL PRO HYBRID⁸ DIESEL TANK WITHOUT PUMP OR WITH HAND PUMP

Description	Capacity L	External dimensions cm (l x w x h)	Weight approx. kg	Order no.
DT MOBIL PRO hybrid ⁸ 980 without pump, with quick coupling	980	136 x 115 x 130	330	10937
DT MOBIL PRO hybrid ⁸ 980 with hand pump 60 L/min, 4 m dispensing hose DN 19, manual nozzle	980	136 x 115 x 130	335	11026

DT-MOBIL PRO HYBRID⁸ DIESEL TANK WITH ELECTRIC PUMP

Description	Capacity L	External dimensions cm (l x w x h)	Weight approx. kg	Electric pump version diesel Diesel		
				Bipump 12 V **	Cematic Duo 24/12 V	Cematic 72, 230 V
				Order no.	Order no.	Order no.
DT MOBIL PRO hybrid ⁸ 980 Basic	980	136 x 115 x 130	365	10787	10797	10807
DT MOBIL PRO hybrid ⁸ 980 Premium	980	136 x 115 x 130	385	10789	10799	10809

*** Pump output in free flow. Please note that the pump output can fall sharply depending on the length and cross-sectional area of the hose.

**** Please note that transport certification for all combination IBCs with plastic inner tanks for diesel – with exception of the hybrid8 model – is limited to a period of 5 years. After that, the inner tank must be replaced. We offer you this tank replacement service.

** with automatic nozzle A80 fastfill for fast refuelling – also for passenger cars

★ Accessories and accessory lifting frame see page 56.
Tank replacement service see page 60.

CEMO DT MOBIL PRO hybrid Basic PG 4

ADR CERTIFIED

NEW

Diesel tank DT MOBIL PRO hybrid Basic

- with inner tank for diesel made of polyethylene****
- powerful electric pump
- 4 m dispensing hose DN25 (without hose reel, meter and filter)
- automatic nozzle

HYBRID TANK
Outer tank made of steel, inner tank made of PE

Pumps:

- Bipump 12 V, 500 W, ca. 85 L/min**/**
- pump Cematic Duo 24/12 V, 420 W, approx. 70/35 L/min***
- pump Cematic 72, 230 V, 500 W, approx. 72 L/min***
- pump Cematic 56/18, 18 V, approx. 60 L/min***, max. volume per battery charge (4 Ah) 1,000 L; battery and charger see accessories.
- hand pump 60 L/min***

Examination every 2 ½ years (see ADR 6.5.4.4.1 b and ADR 6.5.4.4.2 b).

DT MOBIL PRO hybrid 980 Basic, with pump Cematic 72



IMDG&RID
ADR certified transport

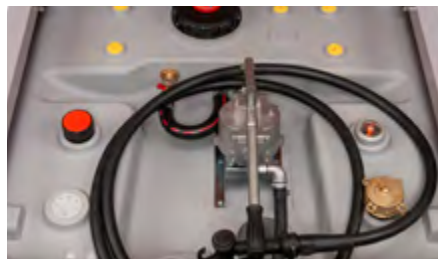

DT MOBIL PRO hybrid 980 with hand pump 60 L/min



DT MOBIL PRO hybrid Basic with pump Bipump 12 V



DT MOBIL PRO hybrid 980 Basic mit Pumpe Cematic DUO

DT MOBIL PRO HYBRID DIESEL TANK WITHOUT PUMP OR WITH HAND PUMP

Description	Capacity L	External dimensions cm (l x w x h)	Weight approx. kg	Order no.
DT MOBIL PRO hybrid 980 without pump, with quick coupling	980	136 x 115 x 118	280	11666
DT MOBIL PRO hybrid 980 with hand pump 60 L/min, 4 m dispensing hose DN19, manual nozzle	980	136 x 115 x 118	285	11667

DT MOBIL PRO HYBRID DIESEL TANK WITH ELECTRIC PUMP

Description	Capacity L	External dimensions cm (l x w x h)	Weight approx. kg	Electric pump version diesel			
				Bipump 12 V **	Cematic Duo 24/12 V	Cematic 72, 230 V	Cematic 56/18 **
				Order no.	Order no.	Order no.	Order no.
DT MOBIL PRO hybrid 980	980	136 x 115 x 118	315	11668	11669	11670	11931

DT MOBIL PRO HYBRID DIESEL TANK APready PG 3

Description	Pump flow rate	Capacity of battery APready	Max. volume (litre) per battery charge with AP 500 S	Dimensions in cm (l x w x h)	Order no.
CEMO DT MOBIL PRO hybrid 980 L Basic APready, 4 m dispensing hose with automatic nozzle A80 fastfill	56L/min	-	4,550	136x115x118	12062

ACCESSORIES DT MOBIL PRO HYBRID[®] AND HYBRID BASIC

Description	Order no.
Flow meter K 33 for DT MOBIL PRO hybrid [®] and hybrid Basic	11874
Overfill prevention sensor for DT MOBIL PRO hybrid [®] and hybrid Basic	11672
Lifting frame for crane hooks or grabs	11112
Adhesive label set for retrofitting	10261

CEMO DT MOBIL PRO hybrid COMBI PG 4

ADR CERTIFIED

DT-Mobil PRO hybrid COMBI

- with inner tank for diesel made of polyethylene****
- supply cable for both pumps

Basic version:

see DT-Mobil PRO hybrid

Premium version:

- see DT-Mobil PRO hybrid, exception:
- digital flow meter K24 in model DT-Mobil PRO hybrid COMBI 850/100 Premium

additional tank for AdBlue®:

- made of polyethylene
- submersible pump CENTRI SP30, 12 V
- 5 m dispensing hose DN 19
- automatic nozzle

Pumpen:

- Bipump 12 V, 500 W, approx. 85 L/min***/**
- pump Cematic Duo 24/12 V, 420 W, approx. 70/35 L/min***
- pump Cematic 72, 230 V, 500 W, approx. 72 L/min***
- submersible pump CENTRI SP30 12 V, 220 W, approx. 25 L/min*** (models 24 V and 230 V with voltage transformer)

IMDG&RID
 ADR certified transport

DT-Mobil PRO hybrid COMBI 850/100 Premium, with pump Cematic Duo

DT-Mobil PRO HYBRID COMBI 850/100 Basic, with pump Cematic Duo

 Examination every 2 ½ years
 (see ADR 6.5.4.4.1 b and ADR 6.5.4.4.2 b).

TOP SELLER

DT-Mobil PRO hybrid COMBI Basic package

- capacity 850/100 L
- with inner tank for diesel made from polyethylene****
- 4 m dispensing hose DN25 (without hose reel, meter, filter)
- automatic nozzle
- pump Bipump 12 V, 500 W, approx. 85 L/min***

Order no. 10792

additional tank for AdBlue® see below

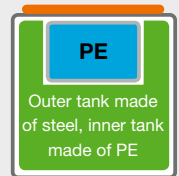

DT-MOBIL PRO HYBRID COMBI DIESEL-/ADBLUE®-TANK WITH ELECTRIC PUMP

Description	Capacity L	External dimensions cm (l x w x h)	Weight approx. kg	Electric pump version diesel (AdBlue: CENTRI SP30)		
				Bipump 12 V **	Cematic Duo 24/12 V	Cematic 72, 230 V
				Order no.	Order no.	Order no.
CEMO DT MOBIL PRO hybrid COMBI 850/100 Basic	850/100	136 x 115 x 130	360	10792	10802	10812
CEMO DT MOBIL PRO hybrid COMBI 850/100 Premium	850/100	136 x 115 x 130	380	10794	10804	10814

ACCESSORIES SUITABLE FOR DT-MOBIL PRO HYBRID AND DT-MOBIL PRO HYBRID COMBI

Description	Order no.
Digital flow meter K24 for DT-Mobil PRO hybrid and PRO hybrid COMBI for diesel	10905
Adhesive label set for retrofitting	10261

** with automatic nozzle A80 fastfill

*** Pump output in free flow. Please note that the pump output can fall sharply depending on the length and cross-sectional area of the hose.

 **** Please note that transport certification for all combination IBCs with plastic inner tanks for diesel – with exception of the hybrid⁸ model – is limited to a period of 5 years. After that, the inner tank must be replaced. We offer you this tank replacement service.

 Accessories and accessory lifting frame see page 56.
 Tank replacement service see page 60.

CEMO DT MOBIL PRO ST PG 4

ADR CERTIFIED

DT-Mobil PRO ST

- with inner tank for diesel made from painted 3 mm steel sheet
- ADR certification for unlimited time period

Basic version:

- powerful electric pump
- 4 m dispensing hose DN25 (without hose reel, meter and filter)
- automatic nozzle

Premium version:

- powerful electric pump
- hose reel with 8 m dispensing hose DN25
- K33 mechanical flow meter
- cartridge filter with water separator
- automatic nozzle

Premium Plus version:

- powerful electric pump
- hose reel with 8 m hose DN25
- meter with access control and tank data management system "CMO 10" for up to 250 users, incl. 5 user keys and 1 master key
- cartridge filter with water separator
- automatic nozzle

Premium Plus SIM version:

- same as Premium Plus, in addition:
- modem for data transfer
 - GPS function
 - electronic contents display

Tanks must be examined every 2 ½ years (see ADR 6.5.4.4.1 b and ADR 6.5.4.4.2 b).

IMDG&RID
ADR certified transport



DT-Mobil PRO ST 980 Premium, with pump Cematic 72

PRO ST Premium

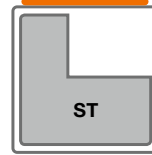

PRO ST Basic



Pumps:

- Bipump 12 V, 500 W, approx. 85 L/min^{***}/^{**}
- pump Cematic Duo 24/12 V, 420 W, approx. 70/35 L/min^{***}
- pump Cematic 72, 230 V, 500 W, approx. 72 L/min^{***}
- pump Cematic 56/18, 18 V, approx. 60 L/min^{***}, max. volume per battery charge (4 Ah) 1,000 L; battery and charger see accessories.
- hand pump 60 L/min^{***}



DT-Mobil PRO ST 980 Basic, with pump Cematic 72



DT-Mobil PRO ST 980 Basic, with hand pump 60 L/min

i
Information on **Premium Plus** and **Plus SIM** see page 60.



Including electronic overfill prevention sensor

DT-MOBIL PRO ST WITHOUT PUMP OR WITH HAND PUMP

Description	Capacity L	External dimensions cm (l x w x h)	Weight approx. kg	Order no.
DT-Mobil PRO ST 980 Basic without pump, with quick coupling	980	136 x 115 x 118	430	11425
DT-Mobil PRO ST 980 Basic with hand pump 60 L/min, 4 m dispensing hose DN19, manual nozzle	980	136 x 115 x 118	440	11426

DT-MOBIL PRO ST WITH ELECTRIC PUMP

Description	Capacity L	External dimensions cm (l x w x h)	Weight approx. kg	Electric pump version diesel			
				Bipump 12 V **	Cematic Duo 24/12 V	Cematic 72, 230 V	Cematic 56/18 **
				Order no.	Order no.	Order no.	Order no.
PRO ST 980 Basic	980	136 x 115 x 118	450	11369	11370	11371	11930
PRO ST 980 Premium	980	136 x 115 x 130	525	11402	11403	11404	-
PRO ST 980 Premium Plus	980	136 x 115 x 130	525	11405	11406	11407	-
PRO ST 980 Premium Plus SIM	980	136 x 115 x 130	525	11408	11409	11410	-

ACCESSORIES SUITABLE FOR DT-MOBIL PRO ST WITHOUT PUMP OR WITH HAND PUMP

Description	Order no.
Generator and heater connection set with quick couplings (1/2" flow and return braided hoses)	11506
K33 mechanical flow meter for DT MOBIL PRO ST with hand pump	11171
K33 mechanical flow meter for DT MOBIL PRO ST Basic	11423
Filter with water separator for DT-Mobil PRO ST Basic	11424

^{***} Pump output in free flow. Please note that the pump output can fall sharply depending on the length and cross-sectional area of the hose.

^{**} with automatic nozzle A80 fastfill

★ Accessories for **DT-MOBIL PRO ST** and **PRO ST COMBI** with electric pump see p. 59. Accessory lifting frame see p. 56.

CEMO DT MOBIL PRO ST COMBI PG 4

ADR CERTIFIED

DT-Mobil PRO ST COMBI

- with inner tank for diesel made from painted 3 mm steel sheet
- certification for unlimited period of time
- supply cable for both pumps

Basic version:

see DT-Mobil PRO ST

Premium version:

see DT-Mobil PRO ST

Premium Plus version:

see DT-Mobil PRO ST

Premium Plus SIM version:

see DT-Mobil PRO ST

additional tank for AdBlue®:

- made from polyethylene
- pump CENTRI SP30, 12 V
- 5 m dispensing hose DN 19
- automatic nozzle

Examination every 2 ½ years
(see ADR 6.5.4.4.1 b and ADR 6.5.4.4.2 b).

IMDG&RID
ADR certified transport



DT-Mobil PRO ST COMBI 980/200 Premium, with Bipump

Pumps:

- Bipump 12 V, 500 W, approx. 85 L/min^{***/**}
- pump Cematic Duo 24/12 V, 420 W, approx. 70/35 L/min^{***}
- pump Cematic 72, 230 V, 500 W, approx. 72 L/min^{***}
- submersible pump CENTRI SP30, 12 V, 220 W, approx. 25 L/min^{***} (for the 24 V and 230 V versions with voltage transformer)



DT-Mobil PRO ST COMBI 980/200 Premium Plus, with Bipump



Accessory: Generator and heater connection set complete with flow and return braided hoses and two sets of quick coupling 1/2" ET

PRO ST COMBI

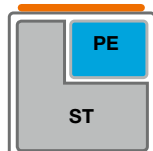

Including electronic overflow prevention sensor

DT-MOBIL PRO ST COMBI DIESEL & ADBLUE® TANK WITH ELECTRIC PUMP

Description	Capacity L	External dimensions cm (l x w x h)	Weight approx. kg	Electric pump version diesel (AdBlue: CENTRI SP30)		
				Bipump 12 V **	Cematic Duo 24/12 V	Cematic 72, 230 V
				Order no.	Order no.	Order no.
PRO ST COMBI 980/200 Basic	980/200	136 x 115 x 130	510	11411	11412	11413
PRO ST COMBI 980/200 Premium	980/200	136 x 115 x 130	535	11414	11415	11416
PRO ST COMBI 980/200 Premium Plus	980/200	136 x 115 x 130	535	11417	11418	11419
PRO ST COMBI 980/200 Premium Plus SIM	980/200	136 x 115 x 130	535	11420	11421	11422

ACCESSORIES SUITABLE FOR DT-MOBIL PRO ST AND DT-MOBIL PRO ST COMBI WITH ELECTRIC PUMP

Description	Order no.
K33 mechanical flow meter for DT-Mobil PRO ST COMBI with electric pump	10906
Adhesive label set for retrofitting (see page 61)	10261
Generator and heater connection set with quick couplings (1/2" flow and return braided hoses)	11506

*** Pump output in free flow. Please note that the pump output can fall sharply depending on the length and cross-sectional area of the hose.
** with automatic nozzle A80 fastfill

★ Accessory lifting frame see page 56.

CEMO tank replacement service and Complete Care Package for DT MOBIL PRO hybrid and PRO ST COMBI PG 100

ADR certification is limited to 5 years for all combination IBCs, such as our PRO mobil hybrid and PRO mobil hybrid COMBI.

hereafter, the inner tank for diesel must be renewed. We offer this tank replacement service including ADR test certificate.

This offers you the following advantages:

- The inspection by an officially recognized expert that is required after 5 years as per ADR 6.5.4.4.1 a) for all metal IBCs, all rigid plastic IBCs and all combination IBCs (cost approx. € 260) is included in the tank replacement service.
- Experts inspect the complete refuelling system.
- Any additional repair work required can be inexpensively performed at the same time.

We also offer a 10-year Complete Care Package.

The package includes the following services:

- inspection by experts after 2.5 and 7.5 years
- tank replacement service after 5 years
- scheduling of inspection dates



DT-Mobil PRO hybrid⁸ 980 Basic, with pump Cematic Duo



DT-Mobil PRO hybrid COMBI 850/100 Basic, with pump Cematic Duo

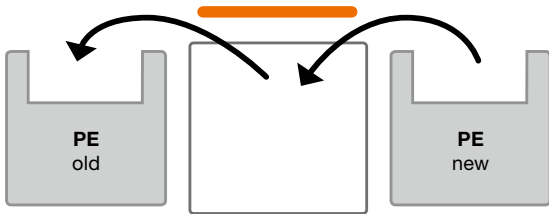

Replacement of inner tank



Ready for delivery

Description

Description	Order no.
Replacement of the inner tank of the PRO hybrid versions, including ADR test certificate	10874
Replacement of the inner tank of the PRO hybrid COMBI versions, including ADR test certificate	10875
10-year* Complete Care Package (including two expert inspections and container replacement according to ADR for version PRO hybrid)	11287
10-year* Complete Care Package (including two expert inspections and container replacement according to ADR for version PRO hybrid COMBI)	11288
Expert inspection (one-off maintenance) 5-year inspection according to ADR 6.5.4.4.1 a) and ADR 6.5.4.4.2 b)	NEW 11610

TANK SYSTEMS PREMIUM PLUS AND PLUS SIM*** WITH MANAGEMENT SYSTEM CMO10

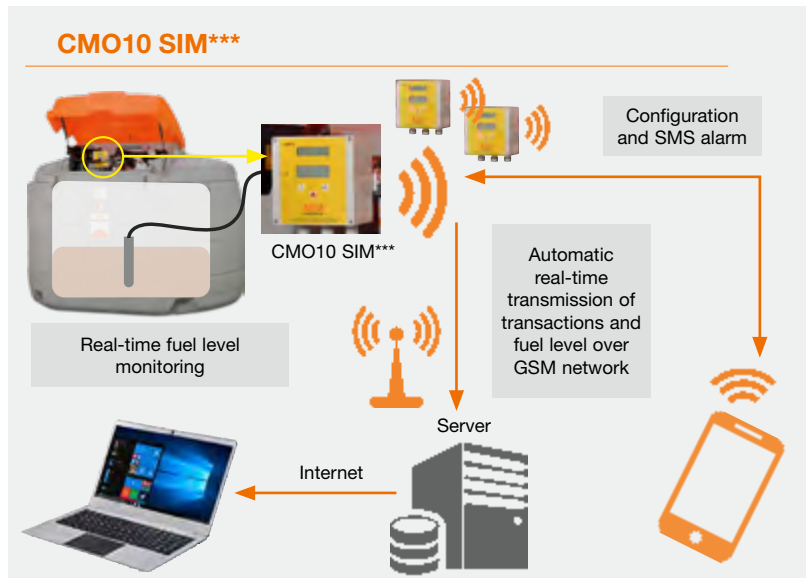
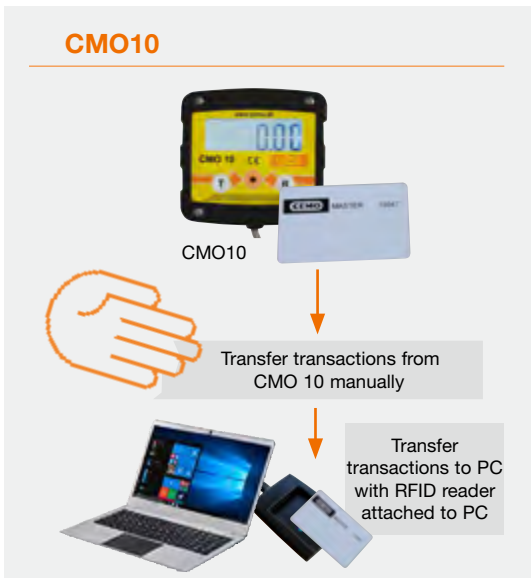

* valid from date of manufacture *** SIM card not included

CEMO DT MOBIL PG 4

Tank system

for mobile outdoor and indoor use

- indefinite certification period
- certified for transport under ADR
- capacity 400, 600 or 980 litre, i. e. lower than the permitted limit of 1000 litres as per ADR chapter 1.1.3.6.3.
- galvanised
- with two crane eyes and forklift pockets
- protection ring for pump system
- dip stick
- discharge line R 1", lockable
- vent pipe R 1½", lockable
- filling connection R 2", lockable
- DT 980 with overfill prevention sensor
- for orders of 5 or more, available in company colours

Double-wall model:

- also certified as a storage container according to DIN 6623
- certified for water-protected areas*
- with bund alarm

Single-wall model:

if used in water-protected areas, a bund is to be provided

Examination every 2 ½ years according to ADR 6.5.4.4.1 b and ADR 6.5.4.4.2 b.



TOP SELLER

Mobile package
Order no. 10287

IMDG&RID
ADR certified
transport

Pump cabinet model
double-wall, hot galvanised

Pump hood model, double-wall,
hot galvanised (see also
Mobile package 980 L)

MOBILE PACKAGE 980 L

Description

DT-Mobil980 L double-wall, galvanised, with lockable pump hood (Order no. 7386) and pump 12 V, 50 L/min, with automatic nozzle and 4 m dispensing hose (Order no. 7981)

Order no.

10287

DT-MOBIL SINGLE-SIDED, HOT GALVANISED

DIESEL REFUELLING SYSTEM AS DESCRIBED ABOVE

Certification no.: D/BAM 6167/31A (400 L and 600 l), D/BAM 5454/31A (980 L)

Double-sided hot galvanised model		Capacity L	Dimensions in cm (l x w x h)	Weight approx. kg	Order no.
A	with lockable pump hood, completely assembled (without pump etc.)	400	95 x 95 x 147	146	7316
		600	95 x 95 x 176	171,5	7314
		980	120 x 120 x 177	179,5	7233
B	with lockable pump cabinet, completely assembled (without pump etc.)	400	95 x 95 x 147	160	7746
		600	95 x 95 x 177	185	7747
		980	120 x 120 x 177	193	7748

DT-MOBIL DOUBLE-SIDED, HOT GALVANISED

DIESEL REFUELLING SYSTEM AS DESCRIBED ABOVE

Certification no.: D/BAM 6599/31A (400 L and 600 L galvanised), D/BAM 6600/31A (980 L galvanised)

Double-sided hot galvanised model		Capacity L	Dimensions in cm (l x w x h)	Weight approx. kg	Order no.
A	with lockable pump hood, completely assembled (without pump etc.)	400	96 x 96 x 150	216	7577
		600	96 x 96 x 177	258	7578
		980	121 x 121 x 181	305	7386
B	with lockable pump cabinet, completely assembled (without pump etc.)	400	96 x 96 x 150	229	7749
		600	96 x 96 x 177	271	7750
		980	121 x 121 x 181	318	7751

* National installation laws and conditions must be observed. We will be happy to advise you.

CEMO DT MOBIL PG 4

Tank system

for mobile outdoor and indoor use

indefinite certification period

- certified for transport under ADR
- capacity 980 litre, i. e. under the permitted limit of 1000 litres as per ADR chapter 1.1.3.6.3.
- painted
- with two crane eyes and forklift pockets
- protection ring for pump system
- dip stick
- discharge line R 1", lockable
- ventilation pipe R 1½", lockable
- filling connection R 2", lockable
- DT 980 with overfill prevention sensor
- for orders of 5 or more, available in custom colours.

Double-wall model:

- also certified as a storage container according to DIN 6623
- certified for water-protected areas*
- with bund alarm

Single-wall model:

if used in water-protected areas, a bund is to be provided

Examinations every 2½ years according to ADR 6.5.4.4.1 b and ADR 6.5.4.4.2 b.



Pump hood model double-wall, painted (see also mobile package 980 L)

IMDG&RID

ADR certified transport

TOP SELLER

Mobile package
Order no. 7216 + 7858

MOBILE PACKAGE 980 L

Description	Order no.
DT-Mobil980 L single-wall, painted, with lockable pump hood (Order no. 8587) and pump 12 V, 50 L/min, with automatic nozzle and 4 m dispensing hose (Order no. 7981)	7216
DT-Mobil980 L double-wall, painted, with lockable pump hood (Order no. 7384) and pump 12 V, 50 L/min, with automatic nozzle and 4 m dispensing hose (Order no. 7981)	7858

DT-MOBIL SINGLE-WALL, PAINTED DIESEL TANK SYSTEM AS DESCRIBED ABOVE

Certification no.: D/BAM 5454/31A (980 L)

also suitable for
Biodiesel
Vegetable oils

Painted model***	Capacity L	Dimensions in cm (l x w x h)	Weight approx. kg	Order no.
A without pump hood, fully assembled (without pump etc.)	980	120 x 120 x 126	175	8586
B with lockable pump hood, fully assembled (without pump etc.)	980	120 x 120 x 177	179,5	8587

DT-MOBIL DOUBLE-WALL, PAINTED DIESEL TANK SYSTEM AS DESCRIBED ABOVE

Certification no.: D/BAM 6600/31A (980 L painted)

also suitable for
Biodiesel
Vegetable oils















Painted model***	Capacity L	Dimensions in cm (l x w x h)	Weight approx. kg	Order no.
A without pump hood, fully assembled (without pump etc.)	980	122 x 122 x 141	300	7383
B with lockable pump hood, fully assembled (without pump etc.)	980	122 x 122 x 177	305	7384
Complete assembly of the DT-Mobil with pump				8379

* National installation laws and conditions must be observed. We will be happy to advise you.

*** For orders of 5 or more, available in custom colours.

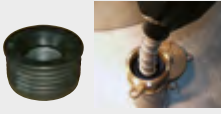
CEMO DT MOBIL PG 4

ACCESSORIES SUITABLE FOR SINGLE- AND DOUBLE-WALLED MOBILE DIESEL TANK SYSTEM PG 4PG 4

Description	Order no.
 <p>Lockable pump hood (included in model B)</p>	7219
 <p>Lockable pump cabinet with dispensing nozzle holder</p>	7763
 <p>Hand pump, 30 L/min, with manual nozzle and 4 m dispensing hose, Viton gaskets (suitable for pump cabinet with or without pump hood)</p>	11683
 <p>Pump 12 V, 50 L/min, with automatic nozzle and 4 m dispensing hose</p>	7981
 <p>Pump 24 V, 70 L/min, with automatic nozzle and 4 m dispensing hose (can also be operated at 12 V, in which case the pump dispensing volume is 35 L/min.) Reliably self-priming only for operation with 24 V.</p>	7982
 <p>Pump 18 V, 60 L/min, with automatic nozzle and 4 m dispensing hose CAS battery system, without battery and charger (see page 48) output rate per charging 4 Ah approx. 1,000 L</p>	<p>NEW</p>  <p>11952</p>
 <p>Pump 230 V, 50 L/min, with automatic nozzle and 4 m dispensing hose</p>	7222
 <p>Pump 230 V, 80 L/min, with truck automatic nozzle and 6 m dispensing hose DN25</p>	10689
 <p>K33 mechanical flow meter for hand pump and electric pump</p>	7753
 <p>Extension hose DN 19 for electric pump approx. 50 L/min</p>	<p>2 m, with 1" connection 7071</p> <p>4 m, with 1" connection 7072</p>
 <p>Splash guard insert for DT-Mobil dispensing nozzle filling A splash guard insert was developed to simplify the filling of mobile diesel tank systems using dispensing nozzles. This splash guard insert is simply inserted into the filler neck. It serves as a sealing element between the filler neck of the DT-Mobil and the outlet nozzle of the dispensing nozzle. After filling, the splash guard insert can remain in the filler neck.</p>	8272
 <p>Battery cable, 2.3 m, with 3-pin European standard socket</p>	8194
 <p>Ratchet tie-down 35 mm x 3 m, 2-piece with hooks</p>	8834
 <p>Adhesive label set for retrofitting der DT-Mobil and KS-MOBIL</p>	10261

 For additional hose lengths, see page 122.

CEMO DT MOBIL horizontal PG 4

Tank system for mobile outdoor and indoor use with general construction inspection certification no. PA-06-W 187

indefinite certification period

- certified for transport under ADR
- size 980 L certified as storage tank according to DIN 6624-2
- also ideally suited for biodiesel and diesel with increased biodiesel content
- certified for water-protected areas
- double-wall
- painted (for orders of 5 or more, available in company colours)
- two crane eyes and forklift pockets
- dip stick, overfill prevention sensor and bund alarm

Examinations every 2½ years according to ADR 6.5.4.4.1 b and ADR 6.5.4.4.2 b.

Robust cabinet

- lockable, tamper-resistant
- protection against pump system damage
- 2 x stacking of the system when full (size 980 L), tested to 4 x safety (6t)
- discharge pipe R 1", lockable
- vent pipe R 1½", lockable
- filling connection R 2", lockable

also suitable for
Biodiesel
Vegetable oils

IMDG&RID
ADR certified transport



980 L







3000 L

DT-MOBIL DOUBLE-WALL, HORIZONTAL

Description	Capacity L	Dimensions in cm (l x w x h)	Weight approx. kg	Order no.
980 L, double-wall horizontal	980	136 x 105 x 160	450	7765
2000 L, double-wall horizontal *	2000	190 x 130 x 185	650	8837
2500 L, double-wall horizontal *	2500	240 x 130 x 185	750	8838
3000 L, double-wall horizontal*	3000	170 x 165 x 220	780	8839

* built to order

ACCESSORIES

Description	Order no.
 Pump 12 V, 50 L/min, with automatic nozzle and 4 m dispensing hose	7981
 Pump 24 V, 70 L/min, with automatic nozzle and 4 m dispensing hose (can also be operated at 12 V, in which case the pump dispensing volume is 35 L/min.) Reliably self-priming only for operation with 24 V!	7982
 Pump 230 V, 50 L/min, with automatic nozzle and 4 m dispensing hose	7222
 Pump 230 V, 80 L/min, with truck automatic nozzle and 6 m dispensing hose DN25	10689
 K33 flow meter for electric pump	7753

 More accessories see page 63.

Reliable energy supply for mobile heaters and generators

Mobile diesel and heating oil tanks for fan heaters and power generators

Indoor and outdoor

Transport-friendly with tyres, forklift pockets or foot pallet

Capacities from 60 to 1,500 litres



CEMO Multi tank PG 4

Tank

- made of HDPE with integral galvanised sheet steel bund
- with rigidly connected sheet steel pallet for handling with a forklift or pallet truck from any of the four sides
- standard accessories: filling contents gauge, visual bund alarm, integral carrying handles
- no pump
- for storage of diesel, biodiesel without a bund, even in water-protected areas*
- certified for installation indoors

Particular advantages:

- certified for transport according to the ADR, but without a pump fitted – examination after 2½ years (see ADR 6.5.4.4.1 b and ADR 6.5.4.4.2 b).***
- lower centre of gravity increases stability and improves handling/transport

IMDG&RID
ADR certified transport



Base pallets with collision protection



Capacity L	Dimensions cm (l x w x h)	Certification no. for storage and transport	Weight approx. kg	Order no.
400	73 x 74 x 117	Z-40.21-365 / D/BAM6403/31 HA1	55	7536
750	98 x 80 x 146	Z-40.21-288 / D/BAM11580/31 HA1	82	7381
1000	128 x 80 x 147	Z-40.21-288 / D/BAM11581/31 HA1	100	7382
1500	164 x 80 x 191	Z-40.21-432 / D/BAM6404/31 HA1	165	7539

* National installation laws and conditions must be observed.
*** The transport certification for all plastic-IBC is limited to 5 years.

★ Accessories see page 29.

CEMO diesel and heating oil trolley PG 4

The mobile solution for supplying heating systems and generators.
The trolley can be used as an emergency supply when a heating oil tank is being replaced.

Diesel and heating oil trolley 60 L and 100 L

- suitable for use under ADR 1.1.3.1 c) for single site refuelling by a person in the course of their main business
- polyethylene container with integral hand grip and carry handles
- fill cap with integral breather valve
- flow connector with 3/8" quick-coupling with counterpart
- return connector with 3/8" quick-coupling with counterpart
- trolley 100 L: 300 mm diameter pneumatic tyres, air-filled, all-terrain
- trolley 60 L: 240 mm diameter plastic tyres
- interior baffle
- trolley 100 L: moulded recesses enabling strapping during transport



Description / Capacity	Dimensions in cm (l x w x h)	Weight approx. kg	Order no.
Diesel and heating oil trolley 60 L with quick couplings	90 x 53 x 38	12	10526
Diesel and heating oil trolley 100 L with quick couplings	100 x 59 x 43	17	10527

CEMO DT MOBIL EASY generator tank PG 4

The innovative diesel and heating oil tank with a wealth of useful features.
Transport-friendly thanks to rugged construction, ratchet strap recesses and forklift pockets.

DT-Mobil EASY generator tank

- 980 litre: certified for transport according to the ADR*
- 210 and 440 litre: certified for transport for immediate consumption according to ADR 1.1.3.1 c)
- integral filler neck
- filler cap with vent and breather valves
- integral forklift pockets and handles
- integral recesses (210 L and 440 L) or loops (980 L) for ratchet tie-downs during transport
- 980 litre: with hinged lid and contents gauge
- 210 and 440 litre: with hinged lid

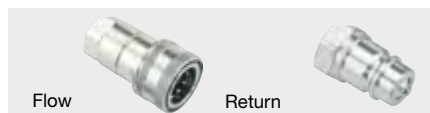

Flow and return braided hoses and two pairs of quick couplings 1/2" IT ideal for generators and heaters.



Description	Capacity L	Dimensions in cm (l x w x h)	Weight approx. kg	Order no.
210 generator tank	210	78.5 x 59,5 x 68.5	21	11374
440 generator tank	440	118 x 80 x 71	36	11375
980 generator tank	980	127 x 107 x 112	95	11376

* Please note that ADR certification for all combination IBCs with plastic inner tanks for diesel is limited to a period of 5 years.

CEMO DT MOBIL PRO hybrid generator tank PG 4

CEMO CUBE mobil generator tank PG 4

Our new DT-Mobil PRO tank is characterised by its extremely high strength due to the steel outer container with hot-dip galvanised steel forklift pockets and stacking corners with crane eyes. The new CUBE-Tank Mobile impresses with its PE sump due to its lower weight.

- certified for transport under ADR (980 L)
- with connections with quick-coupling for marquee heaters and power generators
- PRO mobil hybrid 440 generator tank: with inner tank for diesel made of polyethylene, ADR certified 1.1.3.1 c), with flow and return hoses with quick-coupling
- PRO mobil hybrid 980 generator tank: with inner tank for diesel made of polyethylene*** with flow and return hoses with quick-coupling (1 x flow, 1 x return)

- DT-Mobil PRO ST 980 generator tank: Certification for unlimited period of time, with inner tank for diesel made from painted 3 mm steel sheet, with 4 connections with quick-coupling (2 x flow, 2 x return)

- PRO mobil hybrid8 980 generator tank: with inner tank for diesel made of polyethylene***, with flow and return hoses with quick-coupling (1 x flow, 1 x return)
- CUBE Mobil generator tank 980: with inner tank and bund made of polyethylene***, with 2 connections with quick-coupling (1 x flow, 1 x return)

IMDG&RID
ADR certified transport

Examination every 2 ½ years (see ADR 6.5.4.4.1 b and ADR 6.5.4.4.2 b).

DT-Mobil PRO Outer container made of steel, inner container made of steel or PE

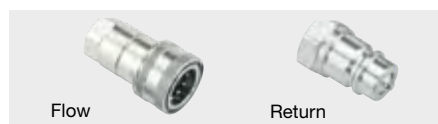

Delivery line with quick coupling set each with counterpart and 1/2" internal thread connection for flow and return line suitable for mobile oil heaters and generators



DT-Mobil PRO ST 980 generator tank



CUBE Mobil 980 generator tank with 2 connections



DT-Mobil PRO hybrid 980 generator tank with 2 connections



DT-Mobil PRO ST 980 Basic generator tank with 4 connections



Protected hose routing

Description	Capacity L	External dimensions cm (l x w x h)	Weight approx. kg	Order no.
DT MOBIL PRO hybrid 440 generator tank with 2 connections with quick-coupling (1 x flow, 1 x return)	440	125 x 87 x 107	196	11378
DT MOBIL PRO hybrid 980 generator tank with 2 connections with quick-coupling (1 x flow, 1 x return)	980	136 x 115 x 130	325	11377
PRO ST 980 generator tank with 4 connections with quick-coupling (2 x flow, 2 x return)	980	136 x 115 x 118	430	11373
DT MOBIL PRO hybrid 980 generator tank with 4 connections with quick-coupling (2 x flow, 2 x return)	980	136 x 115 x 118	280	11671
CUBE Mobil 980 generator tank with 2 connections with quick-coupling	980	130 x 112 x 118	100	11679

ACCESSORY

Description	Order no.
Generator and heater connection set (in tank) with quick couplings (½" flow and return braided hoses) for DT-Mobil PRO ST	11506

*** Please note that ADR certification is limited to 5 years for all combination IBCs with a plastic inner tank for diesel. The inner tank must be replaced after this time. We offer this tank replacement service..



TANK REPLACEMENT SERVICE see page 60.



Accessory lifting frame see page 56.



REFUELLING SYSTEMS FOR PETROL



Refuelling systems for petrol (page 72 – 77)

 Airfield tank systems on request



Canisters

- 5 L to 25 L
- model with explosion-proof filling
- models with nozzle pump

75



flashback arrester

CEMO petrol trolley

- 60 L + 95 L
- mobile tank system for petrol
- suitable for use under ADR 1.1.3.1 c) for single site refuelling by a person in the course of their main business
- container constructed from high density electrically conductive polyethylene to eliminate static
- flashback arrester
- large tyres, all-terrain

76



CEMO KS MOBIL Easy

- 120 L + 190 L + 330 L
- mobile tank system for petrol
- certified for transport according to ADR
- electrically conductive highly cross-linked polyethylene
- patented flame suppressant filling

76
77



Explosion pressure resistant

CEMO KS MOBIL

- 90 L – 300 L
- mobile tank system for petrol
- certified for transport under ADR
- explosion shock proof construction

74



CEMO KS MOBIL

- 400 L – 980 L
- mobile tank system for petrol
- certified for transport according to ADR, also in water-protected areas
- certified as a storage tank according to DIN 6623
- explosion shock proof construction

72

Refuelling systems for petrol

IMPORTANT LEGAL CONDITIONS FOR HANDLING PETROL

The requirements for handling petrol (H 224) are comparable to those of diesel fuel (H 226), but are somewhat stricter. The more stringent requirements are due to the usually higher water hazard classe in accordance with the German Water Management Act and to the lower flash point (extremely flammable liquid according to GHS) of petrol. The more stringent requirements are described below.

Storing petrol

There are many laws and regulations that must be complied with when storing petrol. Excerpts from the German Ordinance on Industrial Safety and Health (Betriebs-sicherheitsverordnung (BetrSichV)), the German Water Management Act (Wasser-haushaltsgesetz (WHG)), the German Technical Regulations for Hazardous Substances (Technische Regel Gefahrstoffe

(TRGS)) and the regulations related to garages in Germany (Garagenverordnung) are given here. These regulations clearly define the permissible storage quantities, storage site requirements, and the risk assessments required by the employer. This information has been clearly organised in the following table. For storage tanks with a capacity of 200 l or more, a restraining device is required if the tanks do not have a double-walled design.

Storage	Technical Regulations for Hazardous Substances (TRGS) 510	Ordinance on Industrial Safety and Health (BetrSichV)	Water Management Act (WHG)	Regulations on Garages (Garagenverordnung)
in homes	no			
in basements	not regulated			
in retail areas	not regulated			
in work areas	regulation for small quantities applies up to 10 L; quantities exceeding 10 L must be stored in an F90 safety cabinet or hazardous materials storage area	Risk assessment required due to risk of explosion	General duty of care under Section 5 and Duty of Care Principle Section 62	
in garages				20 L in small garages up to 100 m ² , not permitted in larger garages
outdoors	Active storage – distance of 10 m from building; passive storage up to 200 L – distance of 3 m; passive storage up to <1,000 L – distance of 5 m from building	Risk assessment required due to risk of explosion		

Transporting petrol

The following regulations must be observed when transporting petrol (see page 32). They go above and beyond the scope of requirements for transporting diesel fuel.

- Maximum quantity as defined in table 1.1.3.6 ADR (1000 point rule) is 333 L. For quantities greater than this, a dangerous goods driving licence is generally required and the German Craftsman Regulation in accordance with ADR 1.1.3.1 c) no longer applies.
- Mobile fuel refuelling systems with ADR certification require this for packaging groups II and III.

2. the probability of the existence or creation and the coming into effect of ignition sources, including electrostatic discharges, and
3. the extent of the effects to be expected from explosions.

The assessment must refer to the specific local and operating conditions. Note: More than 10 litres of contiguous explosive atmosphere in enclosed spaces must be viewed as a hazardous explosive atmosphere, regardless of the size of the space.

What does this mean for you in your day-to-day work?

In general, the transferring and filling of petrol must be done in well ventilated rooms or outdoors. According to the Ordinance on Industrial Safety and Health, you should only provide devices/equipment that are state of the art. In addition, you should pay special attention to the risk assessment when handling petrol. The best option for reducing the risk is never to allow a contiguous explosive atmosphere of more than 10 litres to form in the first place. The current state of the art only enables this to be achieved inside containers in use by means of explosion-suppressing inserts. Another option is to prevent the explosive atmosphere from being ignited by ignition sparks by placing flame arresters into the container openings.

If the container has an explosion-proof design, neither an explosion-suppressing insert nor a flame arrester is required up to a container size of 1000 L. As a rule, explosion-proof containers are made from thick-walled sheet steel, although they have the disadvantage of being very heavy.

Should you use equipment that is manufactured without explosion-suppressing inserts or flame arresters, the probability of the existence or creation and the coming into effect of ignition sources, including electrostatic discharges, is to be especially assessed. In practice, this is very difficult to achieve with changing types of work (forest, road, constructions sites or in the workshop). As a rule, the creation of sources of ignition and electrostatic charge cannot be fully prevented and therefore ruled out safely enough.

We therefore recommend using canisters or containers > 10 L, which are not designed to be explosion-proof, with explosion-suppressing inserts or flame arresters.

Important information related to risk assessments can be found in the operating instructions for CEMO petrol tank systems. This will make it easier for you to fulfil your obligations as an employer.

Transferring and filling petrol

The Ordinance on Industrial Safety and Health (BetrSichV) is the German implementation of European Directive 95/63/EC and regulates the provision of equipment by the employer. This also includes the risk assessment of the equipment, which in turn includes the assessment of the risk of explosion in accordance with TRBS 2152 Part 1. If the formation of hazardous, explosive atmospheres cannot be prevented with certainty, the employer is to assess the following:

1. the probability and duration of the occurrence of a hazardous, explosive atmosphere,

CEMO KS MOBIL PG 4

Refuelling systems for petrol, stationary and mobile

Tank system KS-MOBIL double-walled with certification no. D/BAM 6599/31A (400 L and 600 L), D/BAM 6600/31A (980 L)

- for mobile outdoor and indoor use
- indefinite certification period
- certified for transport under ADR, also in water-protected areas*
- certified as a storage tank according to DIN 6623
- certified for petrol
- capacity 400, 600 or 980 litre
- design approved as a complete system in all variations
- KS-MOBIL for bioethanol on request

IMDG & RID
ADR certified transport

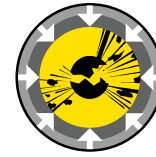

Explosion pressure resistant



Examinations every 2½ years según ADR 6.5.4.4.1 b and ADR 6.5.4.4.2 b.

Construction:





- double-walled steel container
- explosion shock proof construction
- with two crane eyes
- forklift pockets
- guard ring for pump system
- dip stick
- discharge line R 1", lockable
- ventilation pipe R 2", lockable
- filling connection R 2", lockable
- bund alarm and overfill prevention sensor
- long, removable ventilation pipe (3 m above ground)

Model with pump cabinet, double-walled, hot galvanised, design approved

KS-MOBIL DOUBLE-WALL

	Double sided hot galvanised model	Capacity L	Dimensions in cm (l x w x h)	Weight approx. kg	Order no.
1.	without pump hood, completely assembled (without pump etc.)	400	96 x 96 x 114	211	7754
		600	96 x 96 x 141	253	7755
		980	121 x 121 x 141	300	7756
2.	with lockable pump cabinet, completely assembled (without pump etc.)	400	96 x 96 x 150	229	7760
		600	96 x 96 x 177	271	7761
		980	121 x 121 x 181	318	7762

ACCESSORIES SUITABLE FOR MOBILE FUELING SYSTEMS



Description	Order no.
 Lockable pump cabinet with dispensing nozzle holder (included in model 2)	7763
 Dispensing hose for gasoline/petrol for extension or as a replacement, 4 m, coupling nut on one side, other side 1" outer thread	8521
 Automatic dispensing nozzle for petrol, EN13012, ATEX, with swivel joint 1" internal thread	10142
 Adhesive label set for DT-Mobiland KS-MOBIL retrofitting	10261

i According to TRbF (German Technical Regulations for Combustible Liquids), if actively storing petrol, a distance of 10 m between the container and building must be maintained, unless the building wall is constructed according to TRbF or there are fire-resistant components of sufficient width and height between the building and the container (e.g. F90 fire prevention store). According to health and safety regulations, all refuelling systems for petrol must have a permission (applicable when used as fixed refuelling system). We will be happy to advise.
Please note: The permitted max. amount for petrol is according to ADR chapter 1.1.3.6.3, 333 L (basic requirements, e.g. no dangerous good driving permit necessary).

* National installation laws and conditions must be observed. We will be happy to advise you.

Refuelling systems for petrol, stationary and mobile PG 4

PUMPS SUITABLE FOR PETROL TANK SYSTEMS

Description	Order no.
 <p>Hand pump, 30 L/min, with manual nozzle, 4 m dispensing hose, Viton gaskets</p>	11683
 <p>Pump, approx. 40 L/min, ATEX, 12 V, with automatic nozzle, 4 m dispensing hose</p>	10257
 <p>Pump, approx. 40 L/min, ATEX, 230 V, with automatic nozzle, 4 m dispensing hose</p>	10259
 <p>Pump, approx. 40 L/min, with meter, ATEX, 12 V, with automatic nozzle, 4 m dispensing hose</p>	10258
 <p>Pump, approx. 40 L/min, with meter, ATEX, 230 V, with automatic nozzle, 4 m dispensing hose</p>	10260
Complete assembly of the KS-MOBIL with pump	8379



i Electric pumps for petrol are supplied without connection cable. For matching accessories, see page 130. According to Directive 2009/104/EC (in Germany the Industrial Safety Ordinance BetrSichV) or other valid national regulations, the electrical connection must be carried out professionally and in accordance with the regulations according to a risk assessment performed by the local operator.



Accessory funnel with filter and water separator PG 4

Funnel with filter and water separator, suitable for aircraft fuelling
It is practically impossible to avoid dirt and water in fuels. That leads to blocked filters, corrosion, motor failure and even motor damage. The filter membrane of the funnel reliably holds back dirt and water. This settles on the bottom and can be easily disposed of.



Description	Order no.
 <p>Funnel with water separator and filter F3C, max. 13 L/min, electrically conductive</p>	10515
 <p>Funnel with water separator and filter F15C, max. 45 L/min, electrically conductive</p>	10516

CEMO KS MOBIL PG 4

ADR CERTIFIED

KS-MOBIL 90 L and 200 L
with general construction inspection
certification no. D/BAM 13136/31A (90 L),
D/BAM 13137/31A (200 L),
D/BAM 15331/31A (300 L)

- certified for transport under ADR
- individual refuelling systems for mobile use indoors and out
- explosion shock proof construction (TÜV-tested), therefore also suitable for petrol and oil / petrol mixtures
- single-wall steel container from 3 mm sheet steel, painted
- with handles that can also be used as crane eyes
- forklift pockets
- pump box lockable
- delivery line lockable
- filling connection 1½"
- dipstick

Pre-fitted pump:

- 25 L/min hand pump, 1.5 m dispensing hose (statically conductive) and manual nozzle
- self-priming pump 12 V, 25 L/min, ATEX-certified, automatic nozzle, 4 m dispensing hose (statically conductive) and 4.1 m electrical cable

Examinations every 2½ years
corresponding ADR 6.5.4.4.1 b and
ADR 6.5.4.4.2 b.



Pump cabinet (KS-MOBIL 300 L) with pump 12 V, 25 L/min, ATEX, hose reel (accessory) and automatic dispensing nozzle

Petrol and petrol mixes



Explosion pressure resistant



Pump cabinet (KS-MOBIL 200 L) with pump 12 V, 25 L/min, ATEX, 4 m discharge hose and automatic dispensing nozzle

IMDG&RID
ADR certified transport



KS-Mobil 200 l



KS-Mobil 90 l

Description / Capacity		Dimensions cm (l x w x h)	Weight approx. kg	Order no.
90 L	with hand pump 25 L/min	80 x 40 x 74	60	8840
200 L	with hand pump 25 L/min	80 x 60 x 95	77	10025
200 L	with pump 12 V, 25 L/min, ATEX and automatic nozzle	80 x 60 x 95	79	10755
300 L	with hand pump 25 L/min	120 x 60 x 108	110	10994
300 L	with pump 12 V, 25 L/min, ATEX and automatic nozzle	120 x 60 x 108	112	10995

ACCESSORY FOR KS-MOBIL 300 L

Description	Order no.
Hose reel with 10 m hose DN 19, electrically conductive, for petrol	10996

CEMO Canister PG 4

Ex0 Canister non-explosive

- ADR certified
- container made from HDPE
- patented explosion and shockproof insert
- fulfils the highest safety requirements
- child safety lock
- spout integrated in the canister
- fits commercially available canister holders
- stackable to save space



Ex0 canister, 20 L and 10 L

Canister 25 L with dispensing nozzle pump

- HD-PE container 25 L
- UN Certified for the transport of fuel
- handle for easy use
- nozzle with integral hand pump, up to 7.5 L/min, with locking latch on trigger guard
- 1.5 m flexible delivery hose



- ① Knurled nut for securing the locking cap
- ② Vent valve
- ③ Delivery nozzle holder



Canister 25 L with nozzle pump

Description / Capacity	Dimensions cm (l x w x h)	Weight approx. kg	Order no.
Ex0 Canister 10 L with explosion-proof filling	35 x 17 x 31	2	10268
Ex0 Canister 20 L with explosion-proof filling	35 x 17 x 49.5	3	10269
Canister 25 L with nozzle pump	36 x 24 x 43	2.1	11367



Important notice:

All petrol canisters must be labelled with safety and danger signs (10 x 10 cm) according to health and safety regulations.



Petrol trolley 53 L

- UN certified for the transport of fuel
- HD-PE container 53 L with wheel and handle for maneuverability
- dispensing nozzle pump, 7.5 L/min, with 3 m delivery hose and locking catch for the trigger guard
- baffle
- filling nozzles with integrated vent
- 2 shut-off valves for problem-free removal of the delivery hose
- integrated recesses for securing the trolley with ratchet lashing strap during transport



Description / Capacity	Dimensions cm (l x w x h)	Weight approx. kg	Order no.
Petrol trolley 53 L	87 x 42 x 33	9	10047

CEMO petrol trolley 60 and 95 L PG 4

- suitable for use under ADR 1.1.3.1 c) for single site refuelling by a person in the course of their main business
- container constructed from high density electrically conductive polyethylene to eliminate static
- flashback arrester
- integral grip and carry handles
- filling cap with integral breather valve
- delivery hose with stop valve
- handpump 25 L/min and nozzle
- with pump 12 V, 25 L/min, automatic nozzle, 4.1 m cable with battery terminals
- trolley 95 L: 300 mm diameter pneumatic tyres, air-filled, all-terrain; 3.2 m conductive dispensing hose
- trolley 60 L: 240 mm diameter plastic tyres; 2.7 m conductive dispensing hose
- internal baffle
- integral nozzle holder
- trolley 95 L: moulded recesses for strapping during transport



Flashback arrester



60 L with hand pump



95 L with hand pump



95 L with electric pump

Description		Dimensions in cm (l x w x h)	Weight approx. kg	Order no.
Petrol trolley Ex0*** 60 L, with hand pump		90 x 53 x 38	18	10507
Petrol trolley Ex0*** 95 L, with hand pump		100 x 59 x 43	20	10162
Petrol trolley Ex0*** 60 L, with electric pump		90 x 53 x 38	20	10508
Petrol trolley Ex0*** 95 L, with electric pump		100 x 59 x 43	22	10646

*** with flashback arrester

CEMO KS MOBIL Easy 120 and 190 L PG 4 ADR CERTIFIED

certified for transport according to ADR D/BAM 14341/31H2

Examinations every 2½ years corresponding ADR 6.5.4.4.1 b*** and ADR 6.5.4.4.2 b. Completely assembled.

Container:

- single-walled 120 L or 190 L
- electrically conductive highly cross-linked polyethylene
- patented flame suppressant filling
- dipstick for checking fill level
- integral dispensing nozzle holder
- integral filler neck
- integral vent and pressure relief
- integral forklift pockets
- integral handles
- integral recesses for ratchet straps during transport

Pre-fitted pump:

- 25 L/min hand pump, 2.7 m dispensing hose (statically conductive) and manual nozzle
- self-priming pump 12 V DC 25 L/min or 230 V AC 40 L/min, ATEX-certified, automatic dispensing nozzle, 4 m filling hose (statically conductive) and 5 m electrical cable (pump 230 V without cable)

KS-MOBIL Easy 190 L with hand pump and hinged lid



IMDG&RID
ADR certified transport



KS-MOBIL Easy 120 L with pump 12 V



Explosion-suppressing insert (patent protected), hence no explosive atmosphere inside the container (120 L and 190 L)

*** The transport certification for all plastic IBCs is limited to 5 years.

Mobile refuelling systems for petrol

CEMO KS MOBIL Easy 120 and 190 L PG 4

ADR CERTIFIED

Capacity / Description	Dimensions cm (l x w x h)	Weight approx. kg	Order no.
120 L with hand pump	80 x 60 x 45	23	10091
120 L with pump 12 V, 25 L/min, ATEX and automatic nozzle	80 x 60 x 45	33	11498
120 L with hand pump and hinged lid	80 x 60 x 47	26	10092
120 L with pump 12 V, 25 L/min, ATEX, automatic nozzle and hinged lid	80 x 60 x 47	36	11499
190 L with hand pump	80 x 60 x 59	25	10093
190 L with pump 12 V, 25 L/min, ATEX and automatic nozzle	80 x 60 x 59	35	11500
190 L with hand pump and hinged lid	80 x 60 x 61	28	10094
190 L with pump 12 V, 25 L/min, ATEX, automatic nozzle and hinged lid	80 x 60 x 61	38	11501

CEMO KS MOBIL Easy 330 L PG 4

Basic and Premium versions certified for transport under ADR D/BAM 15862/31H2

Examinations every 2½ years corresponding ADR 6.5.4.4.1 b*** and ADR 6.5.4.4.2 b.

- compact design, easy to use
- all components at optimum working height
- container made of electrically conductive, highly cross-linked polyethylene
- lockable lid with steel support stays
- flashback arrestor
- contents gauge
- integral dispensing nozzle holder
- integral filler neck
- filler cap with vent and breather valves
- integral baffle
- integral forklift pockets
- integral handles
- integral recesses for ratchet straps during transport
- with self-priming pump, 12 V DC, 25 L/min*, with ATEX certification, automatic nozzle and 5 m cable or 230 V AC pump, 40L/min*, with ATEX certification, auto nozzle and 1.8m electric cable with no plug
- fully assembled

IMDG&RID
ADR certified transport



KS-Mobil Easy 330 L **Premium** with hose reel and galvanised steel base

Petrol and petrol mixtures



flashback arrestor (330 L)

Basic version:
with 4 m dispensing hose DN 19, electrically conductive, 2 m earthing conductor with terminal clamp

Premium version
with hose reel with 10 m hose DN 19, electrically conductive, 10 m earthing conductor with terminal clamp with sturdy galvanised steel base, forkliftable from 4 sides



KS-Mobil Easy 330 L **Basic**

Description	External dimensions cm (w x d x h)	Weight (approx.) in kg	Order no.
KS Mobil Easy 330 L Basic with pump 12 V	118 x 79 x 57	42	11502
KS Mobil Easy 330 L Premium with pump 12 V	144 x 80 x 67	84	11361
KS Mobil Easy 330 L Basic with pump 230 V	118 x 79 x 57	43	12063
KS Mobil Easy 330 L Premium with pump 230 V	144 x 80 x 67	93	12064

ACCESSORIES

	Order no.
Digital flow meter K24 A ATEX for mounting between dispensing hose and automatic nozzle	10411

* Pump dispensing volume in free flow. Please note that the pump dispensing volume can fall sharply depending on the length and cross-sectional area of the hose. *** The transport certification for all plastic IBCs is limited to 5 years.



REFILLING SYSTEMS FOR LUBRICANTS



CEMO CUBE PG 4

Stationary refuelling system for lubricants

Dispensing station for lubricants,
Basic and Premium
with general construction inspection
certification no. Z-40.21-510

- bunded tank
- visual bund alarm
- tanker coupling
- electronic overfill sensor
- vent
- analogue contents gauge
- suction hose
- 230 V electric gear pump 9 L/min at 12 bar (cannot be calibrated)
- integral nozzle holder
- certified for outdoor installation with hinged lid (outdoor model)
- completely assembled

Electric pumps (technical data)

Pump 230 V (cannot be calibrated*).
Gear pump with a delivery rate of 9 l/min, suitable with engine, transmission and hydraulic oils up to SAE 140

* see information on weights and measures regulation on page 82



CUBE-Tank for lubricants
1,000 L Outdoor Premium

Fresh oil



230 V electric gear pump 9 L/min at 12 bar with digital handheld flow meter for lubricants (cannot be calibrated*)



CUBE-Tank for lubricants 1,500 L Outdoor Premium



Accessory LED instrument lighting



Accessory hose reel

Description	Capacity L	External dimensions cm (w x d x h)	Weight approx. kg	Order no.
CUBE-Tank Indoor Basic, 4 m dispensing hose, handheld digital flow meter, cannot be calibrated, without hinged lid	1000	120 x 80 x 174	140	10308
	1500	120 x 115 x 174	170	10309
CUBE-Tank Indoor Premium, hose reel with 15 m dispensing hose, handheld digital flow meter, cannot be calibrated, no lid	1000	120 x 80 x 174	160	10310
	1500	120 x 115 x 174	190	10311
CUBE-Tank Outdoor Premium, hose reel with 15 m dispensing hose, handheld digital flow meter, cannot be calibrated, with hinged lid	1000	120 x 80 x 180	175	10312
	1500	120 x 115 x 180	205	10313
	2500	120 x 180 x 180	260	10424

ACCESSORIES

Description	Order no.
Hinged lid, orange, complete with supporting gas struts and mounting accessories	10324
Hose reel with 15 m dispensing hose	10423
LED instrument lighting with motion sensor and battery	10378

CEMO CUBE Waste oil tank PG 4

Collection station for waste oil, indoor and outdoor

with general construction inspection certification no. Z-40.21-510 (1000 – 2500 L), Z-40.21-589 (980 L)

- bunded tank
- visual bund alarm
- integrated filling funnel with strainer
- integrated drainer for oil-contaminated parts, such as oil filters
- suction pipe with tanker coupling
- breather cap
- contents gauge
- additional 2x1" connections (1000 – 2500 L)
- with hinged lid, certified for installation outdoors (outdoor versions)
- completely assembled



CUBE waste oil tank 1000 L, Outdoor

Waste oil



CUBE waste oil tank 980 L, Outdoor

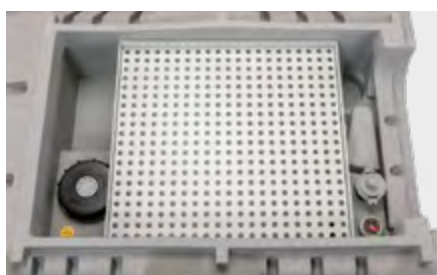

Filling funnel with strainer and drainer for oil-contaminated parts (980 L)



Integrated filling funnel with strainer and drainer for oil-contaminated parts, such as oil filters (1000 L – 2500 L)



Accessory overfill prevention sensor (only necessary when filling with fixed connection)

Description	Capacity L	External dimensions cm (w x d x h)	Weight approx. kg	Order no.
CUBE-Waste oil tank Indoor, without hinged lid	980	130 x 112 x 118	104	11861
	1000	120 x 80 x 174	125	10477
	1500	120 x 115 x 174	155	10478
	2500	120 x 180 x 174	210	10479
CUBE-Waste oil tank Outdoor, with hinged lid	980	130 x 112 x 118	116	11862
	1000	120 x 80 x 180	140	10480
	1500	120 x 115 x 180	170	10481
	2500	120 x 180 x 180	225	10482

ACCESSORY

Description	Order no.
Overfill prevention sensor, complete, supply voltage 230 V, comprising: level transmitter (sensor length 250 mm) with screwed connection R 1", display unit (alarm device) with signal light and buzzer.	10703

CEMO UNI PG 4 Stationary refilling systems for lubricants – electric

Tank from HDPE with integral galvanised sheet steel bund, standard accessories such as pallet base, filling contents gauge and visual bund alarm, suction kit, pump, dispensing hose and digital manual flow meter, with holder and drip tray.

Components delivered unmounted to prevent damage during transport. For storage of fresh and waste oil with a flash point > 55 °C and certified for use in water protected areas without a bund* when installed indoors.

Fresh oil



Electric pumps (technical data)

Pump 230 V (cannot be calibrated*). Gear pump with a delivery rate of 9 l/min, max. delivery pressure 12 bar, suitable for engine, transmission and hydraulic oils up to SAE 140



Pump 230 V (cannot be calibrated*) with a delivery rate of 9 L/min and max. delivery pressure of 12 bar

* see information on weights and measures regulation

IMPORTANT INFORMATION REGARDING THE WEIGHTS AND MEASURES REGULATION (EXTRACT)

Regulation on the putting into circulation and provision of measuring devices on the market and on their use and calibration (Weights and Measures Regulations – MessEV

§ 5

Uses exempt from the scope of application

- (1) **The Weights and Measures Act** and these regulations are not to be applied to measuring devices or readings that are used in normal commercial practice
6. **in businesses of the motor trade or at public refuelling systems for determining the volume or the mass of lubricating or transmission oil, brake fluid, refrigerant for air conditioners, anti-freeze or screenwash**

COMPACT LUBRICANT SYSTEM WITH ELECTRIC PUMP

Description / Capacity L	Dimensions cm (l x w x h)	Hose	Weight approx. kg	Order no.
UNI 750	108 x 77 x 167	4 m, hose holder	90	8251
UNI 750	108 x 77 x 187	15 m, open hose reel	108	8679
① UNI 1000	138 x 77 x 167	4 m, hose holder	114	8252
② UNI 1000	138 x 77 x 187	15 m, open hose reel	132	8680
③ UNI 1500*	187 x 77 x 210	4 m, hose holder	168	8681
④ UNI 1500*	212 x 77 x 210	15 m, open hose reel	188	8682

Complete assembly of the lubricant system ECO

10211

* incl. filling connection with TW coupling, breather cap and overfill protection

*** National installation laws and conditions must be observed. We will be happy to advise you.



Accessories see page 133

CEMO UNI | MULTI PG 4

Stationary refilling systems for lubricants

Tank from HDPE with general construction inspection certification
Individual tank with integral galvanised sheet steel bund, standard accessories such as filling contents gauge, visual leakage detector device, integral carrying handle, no pump.

For storage of fresh and waste oil with a flash point > 55 °C also certified for indoor installation and in water protection areas without a bund*.

Low overall height (up to 1,000 L), thus no steps are required when filling with waste oil.

UNI-Tank

Tank as described above with foot pallet.

MULTI-Tank

Tank as described above with integral sheet steel pallet for moving with a forklift or hand forklift from any of four sides.

Particular advantages:

- certified for transport according to ADR, but without a pump fitted. Examination after 2½ years (see ADR 6.5.4.4.1 b).***
- lower centre of gravity increases stability and improves handling/ transport.



Fresh and waste oil



MULTI-Tank series

Base pallets with collision protection

UNI-TANK

Capacity L	Dimensions cm (l x w x h)	Certification no.	Weight approx. kg	Order no.
400	73 x 70 x 117	Z-40.21-365	50	7979
750	98 x 77 x 142	Z-40.21-288	66	7379
1000	128 x 77 x 142	Z-40.21-288	89	7380
1500	163 x 77 x 185	Z-40.21-432	151	7881

MULTI-TANK

Capacity L	Dimensions cm (l x w x h)	Storage and transport Certification no.	Weight approx. kg	Order no.
400	73 x 74 x 117	Z-40.21-365 / D/BAM6403/31 HA1	55	7536
750	98 x 80 x 146	Z-40.21-288 / D/BAM11580/31 HA1	82	7381
1000	128 x 80 x 147	Z-40.21-288 / D/BAM11581/31 HA1	100	7382
1500	164 x 80 x 191	Z-40.21-432 / D/BAM6404/31 HA1	165	7539







* National installation laws and conditions must be observed. We will be happy to advise you.

*** The transport certification for all plastic-IBC is limited to 5 years.

CEMO Lubricant tanks PG 4

ACCESSORIES FOR UNI- AND MULTI-TANK

Fresh and
waste oil

Description	Order no.
 GRP filling funnel with sealable lid	7389
 Suction pipe with tanker coupling for UNI/MULTI-Tank up to 1,000 L	7390
 Suction pipe with tanker coupling for UNI/MULTI-Tank 1,500 L	8323
 Hand pump for engine oils up to SAE 50 for UNI/MULTI-Tank up to 1,000 L	1452
 Overfill prevention complete, supply voltage 230 V, comprising: level sender (probe) with reducer R 1" and 3/4", indicator (alarm arrangement) with alarm lamp and buzzer.	11452
 Leakage detector device 230 V, visual and acoustic, probe with 5 m cable, cable gland	7391

CEMO VISCOTROLL – mobile compact system PG 4

Mobile compact lubricant system is the ideal oil dispenser solution in all cases, where the drum may have to be moved anywhere within the workshop. Thanks to the electric power supply, connection to any type of socket is possible and no compressed air supply is needed. The unit has a self-priming gear pump, which guarantees a constant dispensing volume as well as even, pulsation- and noise-free flow. A flow meter with a display integrated into the nozzle enables exact metering and volume control of the dispensed liquid.

Pump technical data – see Viscomat lubricant pump 200/2 see page 132.

Wheeled drum trolley of tubular construction complete with nozzle holder, hose holder and drip tray, self-priming pump with connected 230 V AC asynchronous motor with self-ventilation (protection category IP 55), 1" suction hose with foot valve and filter, 4 m pressure hose 1/2", nozzle with flexible end, drop-free automatic valve.

Viscotroll 200/2 with flow meter pressure switch with incorporated safety valve available on request



Description	Weight approx. kg	Order no.
Viscotroll 200/2 with flow meter K 400	35	7910

CEMO CUBE Profitank 2000 L PG 4

Stationary refilling systems for lubricants, double walled

Successor to the legendary CEMO DWT tank with general construction inspection certification Z-40.21-593

- with two connection flanges
- also suitable for water protection areas
- certified for installation outdoors

- Extensive range of accessories such as sturdy steel dome lids for mounting pipeworks and pumps

Fresh and waste oil
Diesel / biodiesel
Antifreeze fluid



two connection flanges
(Ø 170 mm)
for up to
8 connection options

integral bund with
leakage detector

contents gauge

easy tank cleaning

100% corrosion resistant

sturdy steel supports





DOUBLE-WALLED –
therefore also certified for
water protection areas
without external bund!

Description	External dimensions cm (w x d x h)	Weight (approx.) in kg	Order no.
CUBE-Profitank 2000 L	86 x 180 x 180	180	11665

CEMO CUBE Profitank 2000 L PG 4

Stationary tank system for fresh and waste oil, double walled





ACCESSORIES FOR FRESH OIL TANK

Description	Order no.
 <p>Dome lid (steel) with 4 threaded pipe couplings (straight), 2" for filling, also 2", 1 1/2" and 1". Supplied with: a blanking cap for each pipe coupling 2", 1 1/2" and 1".</p>	1436
 <p>Dome lid (steel) with 2 threaded tubes (sloping welded), 1 x 2" for filling, 1 x 2" for vent and 2 threaded pipe couplings (straight) 2" and 1". Supplied with: Tanker coupling and ventilation cap.</p>	1451

ACCESSORIES FOR WASTE OIL TANK

Description	Order no.
 <p>Dome lid (steel) complete with suction pipe, with pipe couplings, respectively 1 x 2", 1 1/2" and 1". Supplied with: tanker coupling and a blanking cap for each pipe coupling 2", 1 1/2" and 1" for Profi-Tank 2000 L</p>	7332

ACCESSORIES GENERAL

Description	Order no.
 <p>Electronic overfill prevention, 230 VAC comprises evaluation unit and probe housing protection category IP 54, fitting 1" and 3/4", reduction 2" to 1", probe 500 mm</p>	11452
 <p>Contents gauge Piusi OCIO for oil, 230 V, IP55 An innovative system for management of the liquid level in tanks at atmospheric pressure. Special features: continuous measurement, display of heights, volumes and refill percentages, minimum and maximum level alarms, high accuracy, simple installation, simple software configuration, PC connection possible</p>	7796
 <p>Step, galvanised, step heights 20 cm and 40 cm</p>	3345
 <p>Tank heater type TH 370, 230 V, dia. 44 mm for electric heating of EL grade heating oil and diesel fuel power 0.22 kW, self-regulating, prevents separation of paraffins at low temperatures</p>	8126

CEMO lubricant trolley PG 4

CEMO lubricant trolley – now also available with a CAS battery system.

Professional system with longer battery life.

The practical solution for filling vehicles used on construction sites or in the field.

- for transport and independent filling of unused engine, gear and hydraulic oils (no dangerous goods as per ADR) with a viscosity of up to max. 2,000 cSt.
- polyethylene container with integral hand grip and carry handles











- filler cap with integral vent and breather valve
- outlet connection with isolation valve
- large all-terrain wheels
- equipped with 12 V, self-priming electric gear pump, 6 L/min, max. delivery pressure 5 bar
- 3,2 m dispensing hose (100 L)
- 2,7 m dispensing hose (60 L)

Lubricant trolley 100 L



Description	Battery capacity	Max. volume (litres) per battery charge	Dimensions cm (l x w x h)	Order no.
Including charger and battery				
Lubricant trolley 60 L	4 Ah	120	90 x 53 x 38	11869
Lubricant trolley 100 L	4 Ah	120	100 x 59 x 43	11867
Supplied without charger or battery – use your own CAS battery				
Lubricant trolley 60 L	-	-	90 x 53 x 38	11868
Lubricant trolley 100 L	-	-	100 x 59 x 43	11866

ACCESSORIES

		① Charger ASC55, 220 – 240 VAC, 3 A, CAS	11385	
		Li-Power battery 18 V / 2.0 Ah CAS	11386	
①		Li-Power battery 18 V / 4.0 Ah CAS	11387	
		Li-HD battery 18 V / 8.0 Ah CAS	11388	
		Electronic K400 meter, oval gear principle, 1 – 30 L/min, ½" inner thread, max. 70 bar, suitable for oil metering pistol and more	8574	

CEMO Transfer trolley KSS 130 L PG 4

NEW

How do you get the emulsion from mixer to machine?

This is how easy, safe and clean refilling can be.

- a clean emulsion every time. Closed, opaque polyethylene tank with handles
- large screw cap with vent/breather for simple refilling and cleaning
- lower centre of gravity and secure standing
- four large plastic steering castors, D = 125 mm, for easy manoeuvring. The two rear steering castors are fitted with a parking brake. The plastic wheels do not pick up any chips or shavings from the floor.

- pump sump with drain connector and ball valve for almost 100 % emptying.
- quiet submersible pump with a flow rate of approx. 30 L/min.
- 2 m hose with delivery nozzle. Removable drip tray in dispensing nozzle holder
- totally mobile. No cables or hoses on the ground that can be damaged by the forklift or pose a trip hazard. 4 Ah CAS battery sufficient for approx. five filling procedures.
- all materials resistant to cooling lubricant emulsion

Cooling lubricants



Description	Pump flow rate	Dimensions in cm (l x w x h)	Order no.
KSS 130 L with CAS , without battery and charger	30 L/min	50 x 75 x 101	11857
Accessories: digital flow meter K24, plastic, 6 – 100 L/min, 1" ET, coupling 1", stainless steel			8609

 Accessories see above

CEMO MOBIL Easy PG 4

Mobile refilling systems for lubricants

The solution for filling vehicles with clean engine, gear and hydraulic oils (no dangerous goods as per ADR) used on construction sites or in the field.



- Single-walled Contenedor made of polyethylene
- Recesses for tie-down straps
- Integral dispensing nozzle holder
- DN 100 filler neck with cap
- Vent with pressure relief
- Integral forklift pockets
- Integral handles
- Self-priming, 12 V electric gear pump, 10 L/min, max. delivery pressure 4 bar, 4 m connection cable with crocodile clips for oils with a viscosity up to max. 600 cSt
- Delivery hose 4 m
- Oil dispensing nozzle



Lubricant MOBIL Easy 200 L with 12 V pump and oil dispensing nozzle

Description	Dimensions cm (l x b x h)	Weight approx. kg	Order no.
200 L with pump 12 V and oil metering pistol	80 x 60 x 59	31	10752

ACCESSORIES

Description	Order no.
 <p>Electronic K400 flow meter, oval gear principle, 1-30 L/min, 1/2" inner thread, max. 70 bar, suitable for oil metering pistol and more</p>	8574
 <p>Lid for Lubricant Mobil Easy 200 L</p>	8963
 <p>Li-Power-Block 13,2 V – 5,5 Ah with charger (see page 45) The battery has the capacity to pump approximately 150 litres of lubricant on a single charge, depending on viscosity.</p>	10750



Li-Power-Block as accessory

Transfer trolley for oil 130 L PG 4

For transport and independent filling of fresh engine, gear and hydraulic oils in the workshop.

- totally mobile and cable-free
- 130 L container made of high-quality polyethylene, with integral handles
- low centre of gravity
- filler neck with integral ventilation
- with contents gauge
- integral pump sump allows the container to be emptied almost entirely
- equipped with four steering castors \varnothing 100 mm (two steering castors with rotation and swivel brake)
- integral dispensing nozzle holder

- equipped with self-priming gear pump, 2.5 L/min, max. delivery pressure 4 bar, with battery and charger, with oil dispensing nozzle and 2 m dispensing hose for oils with a viscosity up to max. 2,000 cSt



 **FILLING VEHICLES AND MACHINES IN THE WORKSHOP**

Description	Pump flow rate	Battery capacity 	Max. volume (litres) per battery charge	Dimensions in cm (l x w x h)	Order no.
130 L with pump, battery, charger and oil dispensing nozzle	6 L/min	4 Ah	120	50 x 75 x 101	11546
130 L without battery and charger	6 L/min	-	-	50 x 75 x 101	11676

ACCESSORIES TRANSFER TROLLEYS

- ① Charger ASC55, 220 – 240 VAC, 3 A, CAS
- ② Li-Power battery 18 V / 4.0 Ah CAS
- ③ Electronic flow meter K400, oval wheel principle, 1 – 30 L/min, 1/2" IT, max. 70 bar, suitable for oil dispensing nozzle and more



11385
11387
8574

Caddy for screenwash or radiator antifreeze PG 4

Mobile device for the simple filling of screenwash or radiator antifreeze. Optimal for the workshop or the vehicle fleet. Suitable for concentrate and water mixtures. Mixing can be done directly in the container.

- caddy with 60 L capacity
- markings for common mixing ratios 1:2, 1:1 and 2:1
- crank pump with 0.38 litres per revolution
- delivery valve with lock



Accessories: digital flow meter K24



Antifreeze fluid
Screenwash



Description	Dimensions cm (l x w x h)	Weight approx. kg	Order no.
60 L caddy for screenwash or radiator antifreeze, with crank pump, 2.9 m delivery hose and manual nozzle	90 x 53 x 38	14	10873

ACCESSORIES

Description	Order no.
Digital flow meter K24 plastic, 6 – 100 L/min, 1" internal thread, 90° elbow for direct attachment to the pump	10274



**REFILLING SYSTEMS
FOR ADBLUE® | DEF**



CEMO refilling systems for AdBlue® / DEF (p. 90 – 111)

CEMO CUBE 5,000 L

- 5,000 L
- everything fully integrated
- the new dimension of CEMO CUBE-Tanks



94



We also offer tanks and systems for co-generation plants and biogas plants. Please feel free to contact us.

CEMO CUBE „Outdoor“ and „Indoor“ Basic and Premium

- 1,500 L, 2,500 L
- expandable to 5,000 L
- everything packed into a small space



98

CEMO CUBE 3,500 and 7,500 L

- Basic and Premium



101

Trolley for AdBlue®

- All-terrain due to large wheels and integrated baffle.
- 60 L + 100 L
- no ADR certification is required for transport



106

Blue-Mobil Easy

The practical solution for filling vehicles when used on construction sites or in the field.

- 125 L – 980 L
- no ADR certification is required for transport



108

Refilling systems for AdBlue®

Basics and requirements for refilling systems for AdBlue®

Aqueous urea solution AUS 32 (trade name AdBlue®, for example) is a non-hazardous chemical substance as defined in the German Ordinance on Hazardous Substances.

AdBlue® must not be exposed to direct sunlight. The optimal storage temperature is between - 5 °C and +20 °C.

It freezes at -11 °C and should not be stored for longer periods above +30 °C, because vaporisation of ammonia increases with temperature and the urea concentration decreases.

All parts in contact with fluids must be made of stainless steel or certified plastics, because the urea solution is highly pure and must correspond to ISO 22241. CEMO tank systems meet this requirement.

AdBlue® is classified as a low hazard to water (water hazard class 1). Consequently, the relevant provisions of the laws pertaining to water and water-ways apply. These were summarised by the German Association for Water, Wastewater and Waste (DWA) in technical rule **TRwS 781-2**. It covers the filling of vehicles with aqueous urea solution from stationary storage tanks as well as mobile tanks used at a fixed location in refuelling systems for vehicles, both for public filling and private refuelling system.

The capacity constitutes the state of the art and is binding for all operating companies, both for existing tank systems as well as for new systems to be established



In all cases, contamination of the light oil separator or the sewer system by AdBlue® must be avoided.

Thus for filling storage tanks and fueling vehicles a filling area which is impermeable to fluids with an effective range according to TRwS 781: 4.1.2 is required.

Storage containers

- For volumes greater than 1,000 litres, the tank must be double-walled or a means of retention must be present. Please clarify the requirements which apply to your local water authorities. We will be happy to advise you.
- Storage tanks must be equipped with an certified overflow prevention system.
- Collision protection, for example as kerb, guard rail, large stones or similar.

Filling of vehicles with AdBlue®

- Nozzles with automatic shut-off must be used.
- The retention capacity of the necessary filling area must constitute 5 min of the maximum pump delivery rate and at least the maximum defined delivery volume with the use of an automatic pump.
- If this retention volume is not present without AdBlue® getting into the light oil separator or sewer system, then the requirement is considered met, only if the locking catch of the nozzle is removed and it is ensured that the dispensing hose cannot be run over.

Filling the storage tank

- For a filling area in the open, rainwater need not be considered in the calculation of retention volume when the area is covered.
- The necessary retention volume with the use of a dispensing hose safety system amounts to $R1 = 0.1 \text{ m}^3$; for filling using equipment with a safety button which must be held down while filling and an emergency shutoff function $R1 = 0.9 \text{ m}^3$
- The entire retention capacity present can be filled up to the oil separator if a closure is present at a suitable position before it, which can be closed during the filling of the large tank.



TIP:

No retention capacity is required if:

1. Dispensing hoses are in accordance with the German Technical Regulations for Flammable Liquids (TRbF) 50 Appendix B or Directive 97/23/EC are used and operated in accordance with Bulletin T 002 of the Employment Accident Insurance Fund of the Chemical Industry (BG Chemie)
2. Full hose delivery equipment with dry coupling is used
3. An immobiliser is used on the tank vehicle
4. Filling of the storage tanks takes place on a filling area compliant with TRwS 781
5. The dispensing hose cannot be run over (for example, automatic hose reel with spring return without pawl).

The points listed are abbreviated excerpts from the cited and general regulations in some cases with no guarantee of completeness.

CEMO CUBE 5,000 L

Stationary refilling systems for AdBlue®

The new CUBE-Tank series is the first generation of refilling systems to have been uncompromisingly developed as a complete system from the outset. With the 5,000 L size, CEMO is expanding this concept upwards. Everything has its place and nothing interrupts the filling process. Let us convince you of the advantages of this overall concept.



Video
CUBE-Tank



large access

Hinged lid with 300 mm inspection port.



ergonomically perfect

All components are clearly located at optimal height within the bund.



double protection

Integral 110 % bund gives added environmental protection.



wind load protection

Four fixing points on the floor for wind load protection.



easy to lift

Three attachment points around the circumference Ø 20 mm for shackles or hoists for lifting of the empty tank station from above.

AdBlue® is a registered trademark of the German Automotive Industry Association.

CEMO CUBE 5,000 L for AdBlue® PG 4

Refilling systems for AdBlue® Complete stations Basic and Premium with general construction inspection Z-40.21-565

- bunded tank
- hinged lid (Outdoor)
- visual bund alarm
- filling connection with 2" dry coupling
- electronic overfill prevention
- mechanical contents gauge
- pump 230 V, 35 L/min
- automatic nozzle with dispensing nozzle holder
- fitting heater 250 W (Outdoor)
- completely assembled
- all devices wired ready to connect into a terminal box



CUBE-Tank for AdBlue®,
Indoor Premium



CUBE-Tank for AdBlue®,
Indoor Basic

CUBE-TANK ADBLUE® FOR EXTERNAL FUEL MANAGEMENT SYSTEM

CUBE-Tank for AdBlue® for connection to an external Fuel Management System (not included)

- Features the same as CUBE-Tank for AdBlue®, however in addition:
- FMT 3 meter with pulsed output, 25 pulses per litre
 - dispensing nozzle contact
 - release relay 230 V
 - completely assembled



Meter FMT 3 with pulse output



Dispensing nozzle switch

Description	Capacity L	External dimensions cm (w x d x h)	Weight approx. kg	Order no.
<u>Indoor Basic</u> DN 19 dispensing hose 6 m	5,000	240 x 230 x 174	185	11140
<u>Indoor Premium</u> digital flow meter K24, DN 19 hose reel 8 m	5,000	240 x 230 x 174	200	11141
<u>Outdoor Basic</u> DN 19 dispensing hose 6 m	5,000	240 x 230 x 180	200	11028
<u>Outdoor Premium</u> digital flow meter K24, DN 19 hose reel 8 m	5,000	240 x 230 x 180	215	11029
<u>Outdoor Premium</u> fuel terminal	5,000	240 x 230 x 180	217	11165
<u>CUBE-Tank for AdBlue®</u> Outdoor storage and extension tank version as per Basic but without pump, dispensing hose, nozzle and nozzle holder. For connection set see accessories.	5,000	240 x 230 x 180	190	11352

AdBlue® is a registered trademark of the German Automotive Industry Association.

CEMO CUBE 5,000 L PG 4

Stationary refilling systems for AdBlue®

CUBE Tank for AdBlue® Outdoor Premium Plus with Tank Management System CMO 20

Specification the same as CUBE Tank for AdBlue® Outdoor Premium, additionally with:

- flow meter with access control and Tank

Data Management System “CMO 20” for up to 999 users, incl. 5 user key fobs and one Master Key fob

- access via key or PIN code
- input of kilometre reading/operating hours

Outdoor Premium Plus 20 SIM***

As Outdoor Premium Plus 20, additionally with:



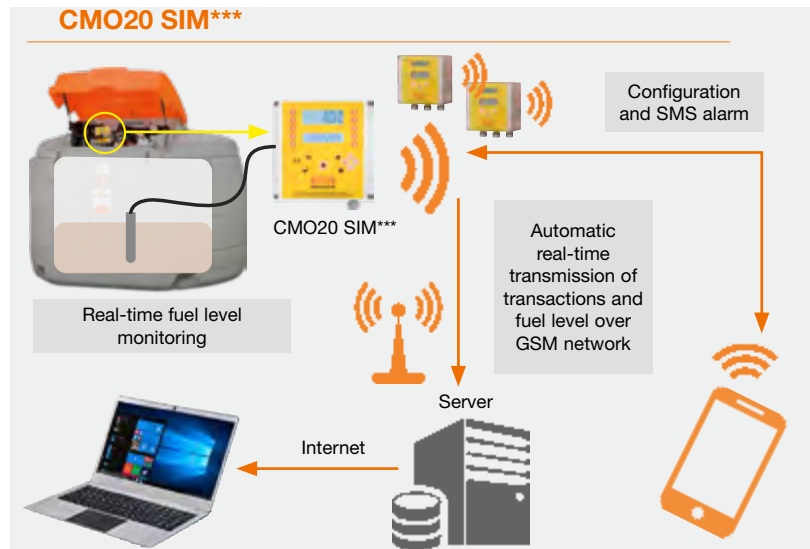





- electronic fill-level indicator
- GPS function
- modem for tank data transmission



CUBE-TANK FOR ADBLUE® OUTDOOR PREMIUM PLUS AND PLUS SIM

Description	Capacity L	External dimensions cm (w x d x h)	Weight approx. kg	Order no.
Outdoor Premium Plus 20	5,000	240 x 230 x 180	220	11339
Outdoor Premium Plus 20 sim	5,000	240 x 230 x 180	220	11340

ACCESSORIES (NOT FITTED)

Description	Order no.
 <p>Connection set between expansion tank and first tank. Consisting of connection pipe, hose, ball valves and connection fittings. Insulation or heating for pipe and hose not included.</p>	11353
 <p>Hose reel with 8 m of EPDM hose, DN19, including mounting fittings</p>	11168
 <p>Digital flow meter K24 plastic, 6 – 100 L/min, 1" internal thread, 90° elbow for direct attachment to the pump</p>	10274
 <p>LED instrument lighting with motion sensor and battery</p>	10378
 <p>Hinged lid blue, with gas struts and mounting fittings</p>	11142
 <p>Tank heater for AdBlue® 230 VAC/435 W, stainless steel, with 6 m connection cable Switching temperatures: Ton (-3) – (-5) °C, Toff (1 – 3) °C, size 700 mm x 47 mm. Suitable for retrofitting at any time. Two or more heaters can be installed for higher output requirements. We recommend insulating the installation surface of the tank system.</p>	10756
 <p>Data transfer set with 3 data transfer cards and USB key reader for wireless data transfer to PC, incl. PC software</p>	10746
 <p>Key fob with 5 user key fobs</p>	10747

AdBlue® is a registered trademark of the German Automotive Industry Association.

CEMO CUBE AdBlue® PG 4

Refilling system for AdBlue®

Basic and Premium

with general construction inspection certification no Z-40.21-510

- comprising integrated bund
- visual bund alarm
- 2" dry tanker coupling
- electronic overfill sensor
- analogue contents gauge
- 230 V pump 35 L/min
- automatic nozzle with integral nozzle holder
- completely assembled
- all devices wired ready to connect into a terminal box

CUBE-Tank for AdBlue® for connecting to an external fuel terminal

Specification as CUBE-Tank for AdBlue®, however in addition:

- FMT 3 meter with pulsed output, 25 pulses per litre
- dispensing nozzle contact
- release relay 230 V
- completely assembled



CUBE-Tank for AdBlue®
1,500 L, Indoor Basic



CUBE-Tank for AdBlue®
1,500 L, Indoor Premium

Integral forklift runners assists with loading and installation.



Moulded hexagonal matrix for integral polymer strength, supported by twin steel bands at the points of greatest load

Description	Capacity L	External dimensions cm (w x d x h)	Weight approx. kg	Order no.
CUBE-Tank for AdBlue®, Indoor Basic, 6 m dispensing hose, without hinged lid	1500	120 x 115 x 174	165	10301
	2500	120 x 180 x 174	220	10302
CUBE-Tank for AdBlue®, Indoor Premium, digital flow meter K24, hose reel with 8 m dispensing hose	1500	120 x 115 x 180	190	10434
	2500	120 x 180 x 180	250	10435
CUBE-Tank for AdBlue®, Outdoor Basic, 6 m dispensing hose, Winter Pack Mid-Europe 1, with hinged lid	1500	120 x 115 x 180	190	10303
	2500	120 x 180 x 180	250	10304
CUBE-Tank for AdBlue®, Outdoor Premium, digital flow meter K24, hose reel with 8 m dispensing hose, Winter Pack Mid-Europe 1, with hinged lid	1500	120 x 115 x 180	205	10305
	2500	120 x 180 x 180	265	10306
<u>Extension Indoor:</u> CUBE-Tank for AdBlue® with integrated bund, with visual bund alarm, filling connection with 2" dry tanker coupling, electronic overfill sensor, contents gauge, suction hose with connection kit to first tank, <u>completely assembled</u>	2500	120 x 180 x 180	220	10436
<u>Extension Outdoor:</u> CUBE-Tank for AdBlue® with integrated bund, with visual bund alarm, filling connection with 2" dry tanker coupling, electronic overfill sensor, contents gauge, suction hose with connection kit to first tank, Winter Pack Mid-Europe ¹ , with hinged lid, <u>completely assembled</u>	2500	120 x 180 x 180	235	10307
CUBE-Tank for AdBlue® Indoor Basic "fuel terminal"	2500	120 x 180 x 180	222	11036
CUBE-Tank for AdBlue® Outdoor Basic "fuel terminal"	2500	120 x 180 x 180	252	11037
CUBE-Tank for AdBlue® Outdoor Premium "fuel terminal"	1500	120 x 115 x 180	206	10466
	2500	120 x 180 x 180	266	11038

¹ Winter Pack Mid-Europe: includes heater 250 W for equipment area

CEMO CUBE PG 4

Stationary refilling systems for AdBlue®



CUBE-Tank for AdBlue®
1,500 L, Outdoor

CUBE-Tank for AdBlue®
1,500 L, Outdoor Premium



CUBE-Tank for AdBlue® Outdoor Premium

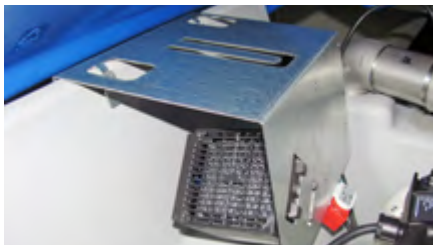

CUBE-Tank for AdBlue®
heating with thermostat



Sealing brush prevents cold ingress.



CUBE-Tank for AdBlue®
1,500 L, Outdoor Basic

CUBE-Tank for AdBlue® Outdoor Premium Plus with tank data management system CMT 10

Design as CUBE-Tank for AdBlue® Outdoor Premium, additionally with:

- meter with access control and tank data management system "CMT 10" with up to 250 users
- incl. 5 user keys and 1 master key
- completely assembled



CUBE tank for AdBlue®, Outdoor Premium, with meter with access control and "CMT 10" tank data management system as accessory



Accessories see page 99.

CUBE-TANK FOR ADBLUE® OUTDOOR PREMIUM PLUS WITH TANK DATA MANAGEMENT SYSTEM CMT 10

Description	Capacity L	External dimensions cm (w x d x h)	Weight approx. kg	Order no.
CUBE-Tank for AdBlue® Outdoor Premium Plus, meter with access control and tank data management system "CMT 10", user keys and master key	1500	120 x 115 x 180	206	11030
	2500	120 x 180 x 180	266	10920

AdBlue® is a registered trademark of the German Automotive Industry Association.

CEMO CUBE for AdBlue® PG 4



Accessory LED instrument lighting



Accessory hose reel





Accessory heater



Accessory K 24 digital flow meter

ACCESSORIES FOR CUBE-TANK FOR ADBLUE® (NOT ASSEMBLED)

Description	Order no.
Hose reel with 8 m EPDM hose, DN19	10431
Digital flow meter K24 plastic, 6 – 100 L/min, 1" internal thread, 90° elbow for direct attachment to the pump	10274
LED instrument lighting with motion sensor and battery	10378
Hinged lid blue, complete with gas strut and mounting fittings	10437
Tank heater for AdBlue® 230 VAC/435 W, stainless steel, with 6 m connection cable Switching temperatures: Ton (-3) – (-5) °C, Toff (1 – 3) °C, size 700 mm x 47 mm. Suitable for retrofitting at any time. Two or more heaters can be installed for higher output requirements. We recommend insulating the installation surface of the tank system	10756
 Data transfer set with 3 data transfer cards and USB key reader for data transfer to PC, incl. PC software	10746
 Key set with 5 user key fobs	10747



CUBE tank system 5,000 L for AdBlue®, comprising:

- CUBE-Tank 2,500 L for AdBlue®, Outdoor Premium (10306)
- Extension Outdoor 2,500 L (10307)

Mobile car AdBlue® refilling PG 4

Mobile refilling of passenger vehicles for the workshop

The rapidly-increasing number of diesel vehicles with AdBlue® introduces new challenges for workshops in refilling. CEMO presents the ideal solution for your business.

Bluefill PRO X

- chassis for 200 L and 60 L drums
- 230 V pump with 2 m dispensing hose
- dispensing volume preset
- dispensing volume automatic from 2 L/min to 15 L/min
- coupling for vehicle tank to ISO 22241
- self-cleaning sensor for automatic switch-off
- closed system between drum and vehicle tank, venting back into the drum
- with suction pipe for the drum and coupling type SEC
- the SEC coupling can be used for filling the drum or even connecting to an IBC for direct filling



Description	Dimensions cm (l x w x h)	Weight approx. kg	Order no.
Bluefill PRO X * 200 L or 60 L, car filling system with automatic shut-off	80 x 80 x 120	37	10868

Mobile refilling with AdBlue®

Blue-Mobil Easy, see page 108 – 110



CEMO CUBE 3,500 L for AdBlue® PG 4

**Refilling systems for AdBlue®,
Basic and Premium
with general construction inspection
certification no Z-40.21-565 (applied for)**

- with integrated bund
- sturdy lid made of GRP (Outdoor)
- visual bund alarm
- filling connection with 2" dry coupling
- electronic overfill sensor
- analogue contents gauge
- 230 V pump 35 L/min
- automatic nozzle
- fitting heater 250 W (Outdoor)
- completely assembled
- all devices wired ready to connect into a terminal box



CUBE-Tank for AdBlue® 3,500 L,
Outdoor Premium



CUBE-Tank for AdBlue® 3,500 L, Indoor Basic



CUBE-Tank for AdBlue® 3,500 L, Outdoor Basic

CUBE-TANK FOR ADBLUE®, 3,500 L

Description	Capacity L	External dimensions cm (w x d x h)	Weight approx. kg	Order no.
Indoor Basic 6 m dispensing hose	3,500	210 x 198 x 158	155	11953
Outdoor Basic 6 m dispensing hose	3,500	210 x 198 x 158	162	11954
Outdoor Premium digital flow meter K24, hose reel with 8 m dispensing hose	3,500	210 x 198 x 158	175	11955

CEMO CUBE 7,500 L for AdBlue® PG 4

NEW

Refilling systems for AdBlue®, Basic and Premium with general construction inspection certification no Z-40.21-565 (applied for)

- tank 7,500 L, polyethylene, banded
- equipment cabinet with lockable lid, simultaneous rain protection during operation
- electronic bund alarm
- filling connection with 2" dry coupling
- electronic overfill sensor

- analogue contents gauge
- 230 V pump 35 L/min
- automatic nozzle
- fitting heater 250 W (Outdoor)
- completely assembled
- all devices wired ready to connect into a terminal box
- dimensions (w x d x h) 245 x 295 x 225 cm

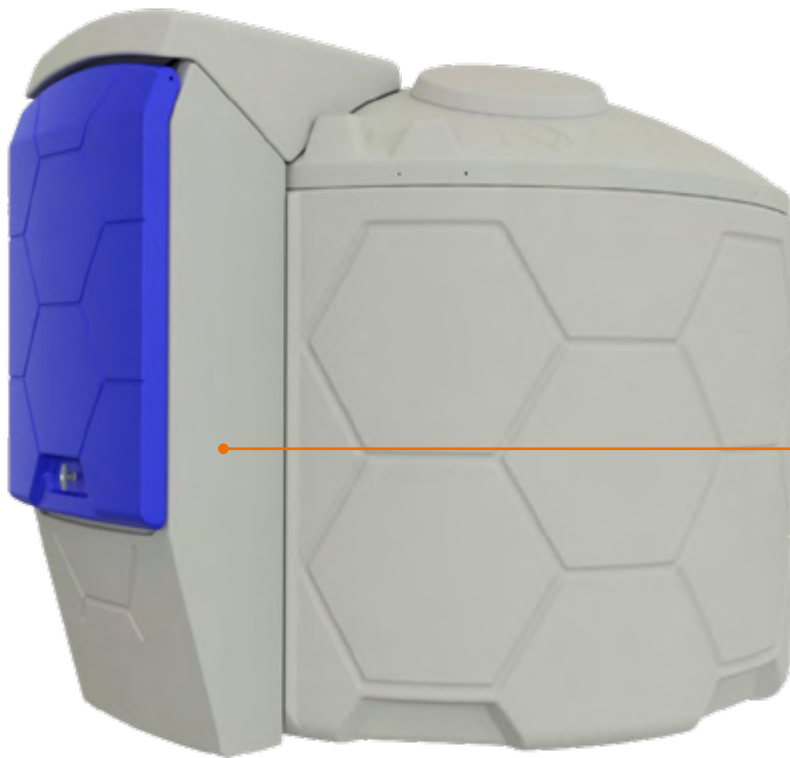

Hose reel (hose 8 m) at ergonomic height

lockable equipment cabinet



leak indicator (visual and acoustic)

CUBE-Tank for AdBlue® 7,500 L, Outdoor Premium

CUBE-TANK FOR ADBLUE® 7,500 LITER

Description	Capacity L	Dimensions in cm (l x w x h)	Weight (approx.) in kg	Order no.
Outdoor Premium Automatic nozzle, swivel-mounted hose reel with 8 m hose DN19, banded, lockable cabinet, 230V pump, 35 L/min, electronic bund alarm and overfill sensor, fitting heater 250 W	7,500	295 x 245 x 225	410	12007

★ Other versions for brine and liquid fertilisers on request.

CEMO stationary refilling systems for AdBlue® PG 4

With general construction inspection certification no. DIBt Z-40.21-241

- PE banded tank “Basic” made of high density polyethylene (HD-PE)
- horizontal bands
- four 2" internally threaded connections
- without accessories



PE banded tank “Basic”, without accessory

PE BANDED TANK “BASIC” WITHOUT ACCESSORIES

Capacity L (gross)	Dimensions cm (l x w x h)	Weight approx. kg	Order no.
5000	239 x 135 x 198	295	8259

CEMO CUBE BLUE Slimline 2000 L PG 4

CUBE Slimline 2000 L for AdBlue®

- Double-walled tank with visual leak detection
- Certified for outdoor installation without leak detection device, even in water protection areas!
- Screw holder for stainless steel dome cover

overflow protection sensor

for outdoor installation

integral bund with leakage detector

sturdy steel supports

100% corrosion resistant



CUBE BLUE SLIMLINE 2000 L WITHOUT ACCESSORY



Description	External dimensions cm (w x d x h)	Weight (approx.) in kg	Order no.
CUBE Slimline 2000 L	86 x 180 x 180	180	11858
CUBE Slimline 2,000 L with accessories, fully assembled Dome cover stainless steel, electronic overflow protection, vent cap, 2" dry coupling stainless steel with dust protection cap. Half sleeve 2" free for tap connection.	86 x 180 x 190	187	12079

ACCESSORY





Description	Order no.
 Dome cover DWT stainless steel, connections 2 x elbow 2" external thread, half socket 2", half socket 1"	8346

CEMO refilling systems for AdBlue® PG 4

ACCESSORIES FOR PE BUNDED TANK "BASIC"

Description	Order no.
 <p>Fixed tanker connection with filling pipe and 2" stainless steel dry coupling, vent with cartridge filter, mesh width 3 µm, replaceable cartridge</p>	8390
 <p>Suction kit, hose 2 m with foot valve, installation thread 2" ET, connection 1" IT</p>	8865
 <p>Pump cabinet for mounting to the wall, electric pump approx. 30 L/min with K 24 electronic flow meter, 4 m delivery hose with automatic delivery valve, complete in lockable metal cabinet, with foot valve as accessory, for further accessories, e.g. suction hose, see below</p>	10058













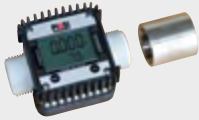

ACCESSORIES FOR REFILLING SYSTEMS FOR ADBLUE® / AUS 32, GENERAL

 <p>Dispensing hose EPDM, DN 19, 10 bar, per meter</p>	8248
 <p>Suction hose PVC, DN 19, with plastic spiral, per meter</p>	10757
 <p>Suction hose EPDM, DN 20, with wire spiral, per meter</p>	8387
 <p>Plastic foot valve with connection nozzle DN 19</p>	10661
 <p>Accessory hose clip, stainless steel</p>	8249
 <p>ELAFLEX ZVA nozzle for AdBlue® 8.0, with swivel joint 1" ET, with magnetic switch for "ELAFIX" magnetic adapter</p>	8019
 <p>Automatic dispensing nozzle SB325, plastic, with swivel joint, connection nozzle DN 19</p>	10190
 <p>Accessory stainless steel spout with misfilling system and magnetic adaptor for SB325, prevents from misfilling the diesel tank</p>	10452
 <p>Accessory solenoid adapter for AZV AdBlue® with solenoid switch</p>	10192
 <p>Automatic dispensing nozzle with swivel joint, made completely from plastic/stainless steel, connection nozzle DN 19</p>	10422
 <p>Accessory plastic hand dispenser, polypropylen (PP) body, stainless steel valve, Viton gaskets, connection port DN 19, stainless steel spout 19 mm</p>	8333
 <p>Accessory plastic manual dispensing nozzle, housing PA6, stainless steel, Viton gaskets, connection nozzle DN 19, outlet 19 mm, with lever lock</p>	11033

AdBlue® is a registered trademark of the German Automotive Industry Association.

Stationary refilling systems for AdBlue® PG 4

ACCESSORIES FOR REFILLING SYSTEMS FOR ADBLUE® / AUS 32, GENERAL

Description	Order no.
 <p>FMOGne electric flow meter with twin-pulse output, PEEK material, calibratable, 1" male thread both sides, inlet at top, pulse out of open collector, 5 – 24 VDC, 2 x 100 pulses per litre</p>	10049
 <p>Digital turbine meter FMT 3, Type open collector, pulse out 25 p/l, material POM, 5 – 120 L/min, ports 1" BSP male, horizontal flow direction</p>	10451
 <p>K 24 electric flow meter, plastic, 6 – 100 L/min, 1" external thread with socket 1" stainless steel</p>	8609
 <p>Digital flow meter K24 Pulse (87.73 pulses/L), plastic, 5 – 120 L/min, 1" ET, with 1" stainless steel socket</p>	11034
 <p>Plastic swivel joint, 1" external thread, matches K 24</p>	8610
 <p>Plastic 90° hose connector, DN19, matches K 24</p>	8611
 <p>Plastic 90° hose connector, 1" external thread on sleeve, DN19</p>	8612
 <p>DN19 hosetail with locknut</p>	8731
 <p>90°elbow with locknuts for K 24 meter</p>	8732
 <p>Connecting piece, straight with locknuts for K 24</p>	8733
 <p>Electronic overfill prevention, 230 VAC comprises evaluation unit and probe housing protection category IP 54, fitting 1" and 3/4", reduction 2" to 1", probe 500 mm</p>	11452
 <p>Dry coupling, 2" internal thread, stainless steel, with dust cap</p>	8389
 <p>Pneumatic filling contents gauge, display 0 – 100 %</p>	8020
 <p>Electronic contents gauge OCIO, 230 V, IP 55, 2 relay outputs</p>	10219

★ Pumps for AdBlue® see page 134.
Cematic Pumps for AdBlue® see page 135.

CEMO trolley for AdBlue® PG 4

Trolley 60 L for AdBlue®

- elegant blue container made from tested polyethylene with integrated handle and carry handles
- large wheels, dia. 240 mm, for simple handling on terrain and over stairs
- integrated sloshing baffle
- low centre of gravity

Trolley 100 L for AdBlue®

- blue container made from tested polyethylene with integrated handle and carry handles
- wheels, dia. 300, air-filled, all-terrain
- integrated sloshing baffle
- integrated recesses for securing with ratchet tie-downs during transport
- low centre of gravity

Version with crank pump

- solid construction for professional operation
- housing in stainless steel and technopolymer
- delivery rate 0.38 L per revolution
- with manual dispensing nozzle
- independent of electrical energy

Version with CENTRI SP 30

- electric submersible pump 12 V, max. 20 A
- delivery rate approx. 25 L/min
- 4 m cable with fuse, switch and crocodile clamps
- always self-priming, extremely quiet
- with lightweight automatic dispensing nozzle in plastic/stainless steel

Version with CENTRI SP 30 and CAS battery

- totally mobile and cable free, independent of vehicle batteries
- very low self-discharge, no environmentally harmful heavy metals, no memory effect
- high intrinsic safety and integrated protection circuit
- extremely quiet
- incl. charger 220 – 240 VAC, output 18 V – 3 A



Trolley 60 L for AdBlue® with crank pump



Trolley 60 L for AdBlue® with CENTRI SP 30 and CAS battery



CENTRI SP 30
EXTREMELY QUIET



Trolley 100 L for AdBlue® with CENTRI SP 30



Trolley 100 L for AdBlue® with crank pump



Trolley 100 L for AdBlue® with CENTRI SP 30 and CAS-battery

AdBlue® is a registered trademark of the German Automotive Industry Association.

CEMO trolley for AdBlue® PG 4





Description	Dimensions in cm (l x w x h)	Weight approx. kg	Order no.
60 L with crank pump, dispensing hose 2.9 m	90 x 53 x 38	13	11127
60 L with CENTRI SP 30, dispensing hose 2.9 m	90 x 53 x 38	14	11128
100 L with crank pump, dispensing hose 3.4 m	100 x 59 x 43	19	11130
100 L with CENTRI SP 30, dispensing hose 3.7 m	100 x 59 x 43	20	11131

Description	Pump flow rate	Battery capacity	Max. volume (litres) per battery charge	Dimensions in cm (l x w x h)	Order no.
Including charger and battery					
Trolley for AdBlue® 60 L	25 L/min	2 Ah	300	90 x 53 x 38	11599
Trolley for AdBlue® 100 L	25 L/min	4 Ah	600	100 x 59 x 43	11600
Supplied without charger or battery – use your own CAS battery					
Trolley for AdBlue® 60 L	25 L/min	-	-	90 x 53 x 38	11592
Trolley for AdBlue® 100 L	25 L/min	-	-	100 x 59 x 43	11593



Trolley for Adblue® 60 L

ACCESSORY

Description	Order no.
 K 24 digital flow meter, plastic, 6 – 100 L/min, 1" male thread, with two hose connecting pieces and sleeve for mounting at the hose or to the dispensing nozzle	10595
① Charger ASC55, 220 – 240 VAC, 3 A, CAS	11385 
② Li-Power battery 18 V / 2.0 Ah CAS	11386 
③ Li-Power battery 18 V / 4.0 Ah CAS	11387 
④ Li-HD battery 18 V / 8.0 Ah CAS	11388 



 **PRACTICAL AND ECONOMIC:**
ONE BATTERY FOR ALL
DEVICES. **CAS.**

AdBlue® is a registered trademark of the German Automotive Industry Association.

CEMO Blue-Mobil Easy for AdBlue® PG 4

Highly practical solution for refilling vehicles with Selective Catalytic Reduction (SCR) systems in the field.

Urea solution is not classed as hazardous, so no ADR certification needed!

- single-wall container constructed from polyethylene certified for AdBlue®
- moulded recesses for strapping during transport
- integral forklift pockets
- integral carry handles
- self priming 12 V chemical pump approx. 30 L/min, 4 m fly leads, with crocodile clips
- 4 m delivery hose DN 19
- automatic nozzle

③ Blue-Mobil Easy 620 l



NEW



⑤ Blue-Mobil Easy 980 L Premium, pump 12 V



⑥ Blue-Mobil Easy 980 L Premium, pump 230 V



② Blue-Mobil Easy 200 L

① Blue-Mobil Easy 125 L



④ Blue-Mobil Easy 980 L

BLUE-MOBIL EASY WITH DIAPHRAGM PUMP CEMATIC BLUE

Description	External dimensions cm (l x w x h)	Weight approx. kg	Order no.
125 L with pump 12 V	80 x 60 x 45	22	10195
① 125 L with pump 24 V			10196
125 L with pump 12 V, hinged lid			10314
200 L with pump 12 V	80 x 60 x 59	23	10197
② 200 L with pump 24 V			10198
200 L with pump 12 V, hinged lid			10315
620 L with pump 12 V, box with crane eyes and hinged lid	118 x 80 x 103	53	11927
③ 620 L with pump 24 V, box with crane eyes and hinged lid			11928
620 L with pump 230 V, box with crane eyes and hinged lid			11929
980 L with pump 12 V, box with crane eyes and hinged lid	127 x 107 x 112	105	10972
④ 980 L with pump 24 V, box with crane eyes and hinged lid			11164
980 L with pump 230 V, box with crane eyes and hinged lid			10973
⑤ 980 L Premium, pump 12 V, box with crane eyes, hinged lid, digital flow meter K24, hose reel 8 m, contents gauge			11146
⑥ 980 L Premium, pump 230 V, box with crane eyes, hinged lid, digital flow meter K24, hose reel 8 m, contents gauge		125	11147

AdBlue® is a registered trademark of the German Automotive Industry Association.

CEMO Blue-Mobil PRO PE 980 L for AdBlue® PG 4

Robust and professional, everything included!

Blue-MOBIL PRO PE 980 Premium

















- outer container made of 3 mm steel sheet, with high quality coating
- bidirectional forklift pockets and lifting eyes
- lockable lid with gas struts
- inner container 980 L from high quality polyethylene
- Cematic Blue pump, 230 V, 30 L/min
- K24 digital flow meter
- auto-rewind hose reel with 8 m of hose, manual nozzle

- Contents gauge
- Tank heater and equipment heater 230 V



Description	Dimension in cm (l x w x h)	Weight approx. kg	Order no.
Blue-Mobil PRO PE 980 Premium	130 x 115 x 130	380	11159

ACCESSORIES FOR BLUE-MOBIL EASY

Description	Weight approx. kg	Order no.
 <p>Li-Power-Block 12.8 V – 3.3 Ah with charger Sufficient for a dispensing volume of approx. 300 – 389 litres without idling, depending on the pump, charging time approx. 66 min.</p>	0.9	10749
 <p>Li-Power-Block 12.8 V – 5.5 Ah with charger Sufficient for a dispensing volume of approx. 500 – 630 litres without idling, depending on the pump, charging time approx. 110 min.</p>	1.2	10750
 <p>Charger 100 – 240 V, output 14.4 V – 3 A, with crocodile clips</p>	0.5	10759
 <p>Hinged lid for Blue-MOBIL Easy 125 L + 200 L, orange</p>	4	8963
 <p>Hinged lid for Blue-MOBIL Easy 430 L + 600 L, orange (can be hinged on right or left)</p>	13	8833
 <p>Contents gauge Blue-MOBIL Easy 440 L</p>	0.3	11148
 <p>Contents gauge Blue-MOBIL Easy 620 L</p>	0,4	11968
 <p>Contents gauge Blue-MOBIL Easy 980 L</p>	0.4	11149
 <p>Digital flow meter K24, plastic, 6 – 100 L/min, 1" internal thread, 90° elbow for direct attachment to the pump</p>	0.5	10274
 <p>K 24 digital flow meter, plastic, 6 – 100 L/min, 1" male thread, with two hose connecting pieces and sleeve for mounting at the hose or to the dispensing nozzle</p>	0.6	10595
 <p>Insulation pack for Blue-MOBIL Easy 125 L + 200 L, including CEMbox 400, grey/orange (order no. 10334), comprising 30 mm insulation panels on the walls and 20 mm on the floor. Space for battery (not included) for supplying power to the pump and the heating pad as needed.</p>	33	10008
 <p>Heating fabric 12 V, thermostatically controlled, approx. 80 W, 50 x 98 cm, IPX 4, cable 2 m with universal connector</p>	0.7	10266
 <p>Coupler cable 1 m, 2-wire, max. 8 A, battery crocodile clips + socket 12 V (SAE J563)</p>	0.3	10267
 <p>Charger ASC55, 220 – 240 VAC, 3 A, CAS</p>	1.3	11385
 <p>Li-Power battery 18 V / 2.0 Ah CAS</p>	0.5	11386
 <p>Li-Power battery 18 V / 4.0 Ah CAS</p>	0.7	11387
 <p>Li-HD battery 18 V / 8.0 Ah CAS</p>	1.0	11388

AdBlue® is a registered trademark of the German Automotive Industry Association.

CEMO Blue-Mobil Easy for AdBlue® PG 4

Specially adapted version of the Mobile Easy suitable for storing and dispensing urea solution AUS32 / DEF / AdBlue®. Highly practical solution for refilling vehicles with Selective Catalytic Reduction (SCR) systems in the field. Urea solution is not classed as hazardous, so no ADR certification needed!

- single-wall container constructed from polyethylene certified for AdBlue®

- moulded recesses for strapping during transport
- integral forklift pockets
- integral carry handles
- pump CENTRI SP 30, 12 V approx. 25 L/min, 4 m fly leads, with terminal clamp
- 4 m delivery hose DN 19
- automatic nozzle



CENTRI SP 30
EXTREMELY QUIET



125 L



210 L



210 L with CENTRI SP 30



210 L with CENTRI SP 30



CENTRI SP 30 submersible pump, 12V

CEMO BLUE-MOBIL EASY FOR ADBLUE®

Description	External dimensions cm (l x w x h)	Weight approx. kg	Order no.
125 L	80 x 60 x 45	20	10593
210 L	78.5 x 59.5 x 68.5	18.8	11143
210 L with hinged lid	78.5 x 59.5 x 68.5	20.5	11144
440 L with hinged lid	118 x 80 x 71	36.3	11145

Description	Pump flow rate	Battery capacity	Max. volume (litres) per battery charge	Dimensions in cm (l x w x h)	Order no.
Including charger and battery					
210 L with hinged lid	30 L/min	4 Ah	600	78.5 x 59.5 x 68.5	11602
Supplied without charger or battery – use your own CAS battery					
210 L with hinged lid	30 L/min	-	-	78.5 x 59.5 x 68.5	11595

AdBlue® is a registered trademark of the German Automotive Industry Association.

Transfer trolley Blue 130 L PG 4

- for safe, convenient indoor transfer of AdBlue® from the storage area to the vehicle
- totally mobile and cable-free
- 130 L container made of high-quality polyethylene, with integral handles
- low centre of gravity
- integral pump sump allows the container to be emptied almost entirely
- equipped with four swivel castors ø 100 mm (two castors with rotation and swivel brake)
- equipped with submersible pump, approx. 25 L/min, with LiFePO₄ battery, charger, 2 m dispensing hose and automatic nozzle

- suitable for commercial vehicles, construction and agricultural machinery and modern passenger cars. Not suitable for older passenger cars which can only be filled at a reduced dispensing volume. Please refer to the driver's manual for your vehicle for information about the maximum permissible dispensing volume.

★ **IN-HOUSE AND SAFE TRANSPORT OF ADBLUE®**



automatic nozzle

low centre of gravity



two swivel castors with rotation and swivel brake

★ Accessories Transfer-Trolley see page 89.

Description

Description	Pump dispensing volume	Battery capacity	Max. volume (litres) per battery charge	Dimensions in cm (l x w x h)	Order no.
130 L, with submersible pump, battery, charger and automatic nozzle	25 L/min	4 Ah	600	50 x 75 x 101	11545
130 L without battery and charger	25 L/min	-	-	50 x 75 x 101	11675

Transfer-Trolley Chem 130 L PG 4

- for safe, convenient indoor transfer of liquid chemicals from the storage area to the dispensing point
- totally mobile
- 130 L container made of high-quality polyethylene, with integral handles and nozzle holder
- translucent container features a fill-level scale
- low centre of gravity
- integral pump sump allows the container to be emptied almost entirely
- equipped with four swivel castors 100mm (two castors with rotation and swivel brake)
- The screw cap is positioned in the centre and has an opening with a 2" BSP internal thread, where an electric or manual drum pump with a length of 1,000 mm can be installed. Our drum pumps can be found on pages 134 – 138.



1,000 mm electric or manual drum pump can be installed (optional accessory)

Description	Dimensions cm (l x w x h)	Weight approx. kg	Order no.
130 L, without pump	50 x 75 x 101	20	11547

AdBlue® is a registered trademark of the German Automotive Industry Association.



PUMPS



The right pump for every application



Dispensing pumps

Recommended for easy filling of large annual diesel requirements where tank data management is a must

page
115 – 118

CUBE pumps

Recommended for an annual diesel consumption between 10,000 and 250,000 litres wherever easy filling is required

119

Cematic pumps

Recommended for an annual diesel consumption between 1,000 and 40,000 litres wherever easy filling is required without the need for integral tank data management

120 – 124



CENTRI SP 80

Submersible pump for diesel/biodiesel and heating oil, maintenance free

125

CENTRI SP 30

Compact submersible electric pump

125 – 126

CENTRI diesel pump

Electric fuel pumps – low-wearing pumps with a long service life

127

Hand pumps

For diesel and lubricating oils

128



ATEX/IECEX-certified pumps

For flammable liquids

129 – 130



Viscomat pumps

Up to SAE 140

131 – 133



Pump systems and pumps for AdBlue®

CENTRI SP30, ECO1 and Cematic Blue, Squalo 35

134 – 135, 138 – 139

Drum pumps and pumps for IBCs

For acids, lyes and aggressive chemicals

136 – 137

Hand pumps

Hand pumps for chemicals and urea solution AUS 32

139



Petrol-driven pumps

With a dispensing volume up to 500 L/min

130

All details stated for pressure and delivery volume assume unobstructed suction and dispensing without additional accessories, if not specified refer to effective dispensing volume.
AdBlue® is a registered trademark of the German Automotive Industry Association.

B.SMART PG 4

SIMPLE AND INTUITIVE – THE TANK DATA MANAGEMENT SYSTEM WITH ACCESS CONTROL VIA DEVICE USING BLUETOOTH.

- Everything under a single part number: fuel dispenser, access code for the web app, and licences for driver/user.
- No monthly or annual costs. No ongoing costs when upgrading your operating system. No separate software required.
- The device sends the fuel receipts to the Cloud. The administrator can track each refuelling operation in real time. It works on any device (PC, tablet, smartphone, etc.) and any operating system (Windows, Linux, iOS, etc).
- Any number of B.SMART systems can be monitored from anywhere.
- Suitable for all devices with iOS or Android operating system. The app is available free of charge from the App Store or Google Play Store.
- Data can be exported from the web app as a PDF or XLSX file.
- Drivers can work in the languages set on their smartphones. Drivers without smartphones can refuel using magnetic keys.



CUBE 70/90
with optional pedestal



Diesel dispensing
pump 70/100

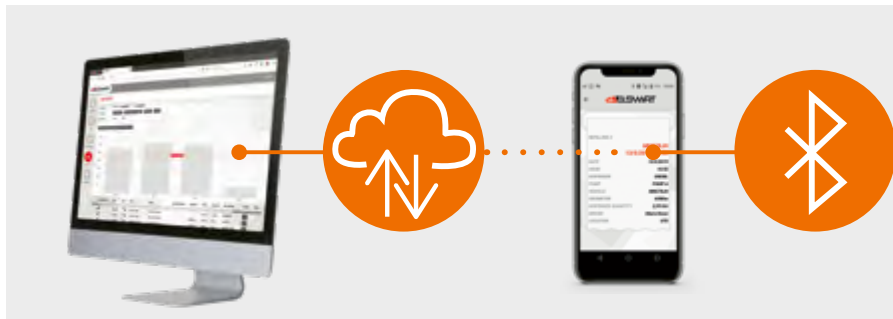

MC-Box-System





Description	Flow rate l/min	10 user Order no.
Diesel dispensing pump 70 B.SMART	70	11289
Diesel dispensing pump 100 B.SMART	90	11292
Dispensing pump for AdBlue® B.SMART	32	11295
MC-Box-System B.SMART	-	11298
MC-Box-System B.SMART for 2 pumps	-	11710
CUBE 70 B.SMART for Diesel	70	11301
CUBE 90 B.SMART for Diesel	90	11304

All devices for 230 V connection. Devices for 12 V or 24 V available on request.

B.SMART PG 4

TANK DATA MANAGEMENT SYSTEM WITH ACCESS CONTROL VIA DEVICE USING BLUETOOTH.

ACCESSORIES FOR B.SMART

Description	Order no.
10-User licence pack	11307
50-User licence pack	11309
B.SMART ADD-ON tank level indicator, 1-year period	11492
B.SMART ADD-ON tank level indicator, 3-years period	11493
B.SMART ADD-ON Tank level indicator, unlimited period	11494
 Pedestal for electric pump CUBE 70 MC 50, black	7888
 Key reader complete with USB interface	10878
 Single user key, yellow	10877
B.Smart ADD-ON Fuel Economy, 1-year period	11703
B.Smart ADD-ON Fuel Economy, 3-years period	11704
B.Smart ADD-ON Fuel Economy, unlimied period	11705
B.Smart ADD-ON tank level + Fuel Economy, 1-year period	11706
B.Smart ADD-ON tank level + Fuel Economy, 3-years period	11707
B.Smart ADD-ON tank level + Fuel Economy, unlimited period	11708
B.Smart Fuel Economy 45 QR-Codes	11709
 Level gauge OCIO 2.0 RS485, 230 V	91528

ADD-ON Fill level monitoring

- Management of the tank fill level
- Setting alarms and notifications
- Management of suppliers and prices
- Display of trends and ranges

ADD-ON Fuel Economy monitoring

- Fleet management
- Limit consumption per vehicle and/or driver
- Determine average consumption and costs
- Easy entry of external refuelling
- Vehicle recognition via QR code possible

Diesel dispensers PG 4 for diesel and biodiesel

Diesel dispensers 70 MC + 100 MC

- rotary vane pump 230 V
- up to 250 users
- diesel dispensing volume can be preset
- option of entering vehicle registration number and mileage
- management of date and time of dispensing
- PIN-code access control is standard
- local recording of the last 255 fuel dispensing events
- optional electronic key access control

- data transfer to the PC via electronic key, converter, LAN, W-LAN, 4G (optional)
- equipped with automatic dispensing, design approved in accordance with EN 13012
- 70 MC with passenger car outlet
- 100 MC with truck outlet
- 4 m dispensing hose, DN25
- filter 30 µm with water separator
- choice of 15 menu languages

CUBE 70 MC

- set up for 80 user
- suction vacuum approx. 0.3 bar, so not recommended for underground tanks
- Filter (accessories)

Diesel dispensers 70 K44 + 100 K44

- mechanical volumetric litre meter, 4 digit



Diesel dispensers 70 K44 + 100 K44



Diesel dispensers 70 MC + 100 MC



Electric pump CUBE 70 MC with pedestal (accessory)

DIESEL DISPENSERS

Description	Dispensing volume L/min	Dimensions cm (l x w x h)	Weight approx kg	Order no.
Diesel dispenser 70 MC Agilis	70	47 x 40 x 144	67	7930
Diesel dispenser 100 MC Agilis	90	47 x 40 x 144	75	8563
Diesel dispenser 70 K44	70	47 x 40 x 144	67	7931
Diesel dispenser 100 K44	90	47 x 40 x 144	75	8564
CUBE 70 MC Agilis	70	46 x 40 x 40	25	7853





We recommend that **assembly and commissioning be performed by trained service technicians.** We would be delighted to give you details of technicians near you.









Dispensers for vegetable oil and AdBlue® on request.

Diesel dispensers PG 4 for diesel and biodiesel

ACCESSORIES

Description	Order no.
 <p>Dispensing hose DN25 (with 2 x 1" external thread) diesel biodiesel resistant</p>	4 m 7933
	6 m 7934
	8 m 7935
	10 m 7936
 <p>Cartridge filter with water separator, max. 70 L/min, 30 µm, 1"-12 UNF, for dispensing pumps 70 MC/FM/K44 (1 piece) and 100 MC/FM/K44 to model year 10/09 (2 pieces)</p>	10031
 <p>Cartridge filter with water separator, max. 150 L/min, 30 µm, 1½"-16 UNF, for dispensing pumps 100 MC/FM/K44 (1 piece) from model year 11/09</p>	10032

ACCESSORIES SPECIALLY FOR DISPENSERS MC AND FM

Description	Order no.
 <p>PW-LAN data transmission interface requires PC-software see below</p>	11310
 <p>PW-WIFI data transmission interface requires PC-software see below</p>	11311
 <p>Converter without PC-software, for data transmission by means of a connection cable to the pump, USB interface, requires PC-software see below</p>	10876
 <p>Key set (1 master key, 10 user keys green yellow, key reader with USB interface) for wireless data transfer to the PC, for dispensers from model year 11/09 requires PC-software see below</p>	10879
 <p>Key reader complete with USB interface</p>	10878
 <p>Master key (1 pc.), red, for data transmission</p>	7826
<p>1 set of user keys (10 pcs.) green, for dispensers up to model year 10/09</p>	7825
 <p>Single user key, yellow</p>	10877
<p>1 set of user keys (10 pcs.) yellow, for dispensers from model year 11/09</p>	8705

Software SelfService Management Agilis

Newly-revised version of the tank data management system for SelfService MC, SelfService FM, MC Box and CUBE MC.

- contemporary control panel and intuitive operation
- simple data import from previous versions
- with drivers for key reader, converter, PW-LAN and PW-WiFi

- NEW** now with tank level management by calculation
- NEW** extended options for exporting tank data



Description	Order no.
Software SELF SERVICE MANAGEMENT Agilis – USB: USB stick with software, also acts as licence key	11909

CUBE pumps PG 4 for diesel and biodiesel

CUBE pumps

- light and robust construction
- simple handling due to low weight
- with anti-siphon device
- 4 m dispensing hose and automatic nozzle as standard
- all pumps are equipped with a meter
- weather-proof housing with integrated nozzle holder and lever switch for automatic pump shut-off
- suction vacuum approx. 0.3 bar, so not recommended for underground tanks



Electric pump CUBE 56 K 33



Electric pump CUBE 70 K 33

CUBE PUMPS

Description	Order no.
Pump CUBE 70 MC 50 (picture see page 119), 230 V, approx. 70 L/min (self-priming) with electric flow meter, 50 user codes, automatic nozzle, 4 m dispensing hose installed within a protective box, without suction hose	7853
Pump CUBE 56 K 33, 230 V, approx. 56 L/min (self-priming) with flow meter, automatic nozzle and 4 m dispensing hose DN 19, fitted in a protective housing, without suction hose	7776
Pump CUBE 70 K 33, 230 V, approx. 70 L/min (self-priming) with flow meter, automatic nozzle and 4 m dispensing hose DN 25, fitted in a protective housing, without suction hose	7887

 We recommend that **assembly and commissioning be performed by trained service technicians.** We would be delighted to give you details of technicians near you.

ACCESSORIES FOR CUBE PUMPS

Description	Order no.	
 Pedestal for electric pump CUBE, grey	7888	
 Wall-mounting bracket	7889	
 Quick coupling for barrels 2" x 1"	7781	
 PVC suction hose 1.6 m with foot valve and filter (with 1" external thread)	7783	
 Dispensing hose DN 25 (with 2 x 1" external thread) diesel biodiesel resistant	4 m	7933
	6 m	7934
	8 m	7935
	10 m	7936

 Dispensing hose DN 19 for CUBE 56 pump see page 122.

CEMATIC pumps PG 4 for diesel and biodiesel

Cematic pumps

- self-priming / rotary vane pump
- light and robust construction
- simple handling due to low weight
- with anti-siphon device
- 4 m dispensing hose is standard
- additional hose lengths from 6 to 10 m can be purchased at extra cost
- 2" connector for all commercially available tanks and drums
- connection cable for DC-pumps approx. 4 m long with catch and crocodile clips



All versions include: suction hose, dispensing hose, barrel mounting and angle bracket.

Description	Order no.
 <p>Pump Cematic 56 230 V, approx. 56 L/min (self-priming) with nozzle, 4 m dispensing hose, 1.6 m suction hose with foot valve and 2" quick coupling for barrels</p>	7766
 <p>Pump Cematic 56 AZ 230 V, approx. 56 L/min (self-priming) with automatic nozzle, nozzle holder, 4 m dispensing hose, 1.6 m suction hose with foot valve and 2" quick coupling for barrels</p>	7768
 <p>Pump Cematic 56 K33 AZ 230 V, approx. 56 L/min (self-priming) with flow meter, automatic nozzle, nozzle holder, 4 m dispensing hose, 1.6 m suction hose with foot valve and 2" quick coupling for barrels</p>	7769
 <p>Pump Cematic 3000/12 12 V, approx. 40 L/min (self-priming) with nozzle, 4 m dispensing hose, 1.6 m suction hose with foot valve and 2" quick coupling for barrels</p>	7770
 <p>Pump Cematic 3000/12 K33 AZ 12 V, approx. 40 L/min (self-priming) with K33 mechanical flow meter, automatic nozzle, nozzle holder, 4 m dispensing hose, 1.6 m suction hose with foot valve and 2" quick coupling for barrels</p>	7772
 <p>Pump Cematic 3000/24 24 V, approx. 40 L/min (self-priming) with nozzle, 4 m dispensing hose, 1.6 m suction hose with foot valve and 2" quick coupling for barrels</p>	7773
 <p>Pump Cematic 3000/24 AZ 24 V, approx. 40 L/min (self-priming) with automatic nozzle and flow meter, nozzle holder, 4 m dispensing hose, 1.6 m suction hose with foot valve and 2" quick coupling for barrels</p>	7774
 <p>Pump Cematic Duo 24/12 AZ, 24 V, approx. 70 L/min (self-priming only for use with 24 V) with automatic nozzle, nozzle holder, 4 m dispensing hose, 1.6 m suction hose with foot valve and 2" quick coupling for barrels (can also be operated at 12 V, in which case, the pump dispensing volume is 35 L/min.)</p>	8053

CEMATIC pumps PG 4 for diesel and biodiesel

Cematic pumps ① ② ③

- self-priming rotary vane pump
- suction height up to 2.5 m
- robust pump housing of cast steel
- Induction motor 230 V AC, protection category IP 55
- suitable for continuous operation, protected against thermal overload
- integral pressure relief bypass valve
- integral suction filter on Cematic 56 + 72
- 1" internal thread connection on suction and pressure sides

Cematic pumps DC ④ ⑤ ⑥

- self-priming rotary vane pump
- suction height up to 2 m
- robust pump housing of cast steel
- brush-type DC motor, protection category IP 55
- duty cycle max. 30 min.
- built-in excess pressure bypass valve

Cematic pumps UM ⑧

- 230 V, approx. 56 L/min
- self-priming
- flow meter
- suction hose
- automatic nozzle and nozzle holder
- 4 m dispensing hose
- mounted complete on a bracket that can be hung on the side of the UNI tank



230V pump Cematic 56



230V pump Cematic 90



12V/24V pump Cematic 3000/12 + 3000/24



12V pump Bipump



230V pump Cematic 72 + 85



24V/12V pump Cematic Duo Cematic 56, 12V



12V Diesel transfer set Cematic 12/40



















230V pump Cematic UM

Description	Order no.
① Pump Cematic 56, 230 V, 370 W, dispensing volume approx. 56 L/min, delivery pressure approx. 2 bar	8565
Pump Cematic 72, 230 V, 500 W, dispensing volume approx. 72 L/min, delivery pressure approx. 2 bar	8353
② Pump Cematic 85, 230 V, 700 W, dispensing volume approx. 90 L/min, delivery pressure approx. 2 bar	10764
③ Pump Cematic 90, 230 V, 750 W, dispensing volume approx. 90 L/min, delivery pressure approx. 1.5 bar	8354
Pump Cematic Duo, 24/12 V, 420 W, approx. 70/35 L/min, delivery pressure max. 1.5 bar, 1" internal thread connection on both sides, without cable	10148
④ 4 m cable with 30 A fuse and crocodile clips, for Cematic Duo 12V/24 V	11158
Pump Cematic 56, 12 V 300 W, max. 56 L/min, delivery pressure max. 1.5 bar, 1" internal thread connection on both sides, without cable	10548
4 m cable with 40 A fuse and crocodile clips, for Cematic 56 12 V	91021
Pump Cematic 3000/12, 12 V, 280 W, approx. 45 L/min, delivery pressure max. 1.5 bar, hoesetail DN19 suction side, 1" internal thread pressure side	10149
⑤ Pump Cematic 3000/12, 12 V, 280 W, 45 L/min, delivery pressure max. 1,5 bar, 90° bent spout on both sides DN 19, for e.g. DT-Mobil Easy 210 L and 440 L	91208
Pump Cematic 3000/24, 24 V, 280 W, approx. 45 L/min, delivery pressure max. 1.5 bar, hoesetail DN 19 suction side, 1" internal thread pressure side	10150
⑥ Diesel transfer set Cematic 12/40 In practical plastic case, 12 V pump, 4 m cable with battery pole terminals, dispensing volume approx. 30 L/min, 2 m suction hose with foot filter, 4 m dispensing hose, auto nozzle with swivel joint	10492
⑦ Bipump 12 V, max. 85 L/min 500 W, 1" internal threads , 4 m cable with crocodile clips, with switch	11160
⑧ Electric pump Cematic UM	8162

CEMATIC pumps PG 4









for diesel and biodiesel

ACCESSORIES

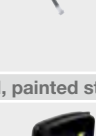

Description	Order no.	
 Self 3000 fuel pump nozzle (connection 1" internal thread)	7780	
 A 60 automatic dispensing nozzle with hose swivel joint, max. 60 L/min (1" internal thread connection), design approved in accordance with EN 13012	10028	
 A 60 automatic dispensing nozzle with hose swivel joint, max. 60 L/min (1" internal thread connection)	7983	
 Automatic dispensing nozzle, swivel joint with DN 19 hosetail	9705	
 Automatic dispensing nozzle A80 fastfill, EN13012, passenger car outlet 24 mm, with 1" internal thread hose swivel joint, 80 L/min	NEW 11910	
 A 80 automatic dispensing nozzle, truck outlet, max. 90 L/min, with 1" internal thread hose swivel joint	8355	
 A 80 automatic dispensing nozzle, design approved in accordance with EN 13012, truck outlet, max. 90 L/min, with 1" internal thread hose swivel joint	10026	
 Pump bracket for fitting Cematic pumps on UNI-/MULTI-tank 750 L and 1000 L	7631	
 Quick coupling for drums 2" x 1"(with 1" internal thread)	7781	
 K33 mechanical flow meter (connection 2 x 1" internal thread) 3-digit tank display	7779	
 Add-on kit for retrofitting K33 mechanical flow meter on Cematic pumps	7984	
 K24 digital flow meter, 10 – 120 L/min, 5-digit individual delivery display, 6-digit total delivery display, inlet 1" external thread, outlet 1" internal thread	8644	
 Digital flow meter K24 A, aluminium housing, 7 – 120 L/min, 5-digit display, total volume display 6-digit, 1" external thread, 1" internal thread, bi-directional flow	10157	
 1.6 m PVC suction hose with foot valve and filter (with 1" external thread, DN25)	7783	
 Dispensing hose DN 19 (with 2 x 1" external thread) diesel resistant	4 m	7899
	6 m	7900
	8 m	7901
	10 m	7902
 Dispensing nozzle holder suitable for 7780, 7258, 7983, etc. for installation on the pump foot or on the wall as required	8566	
O-ring for flange connection, with groove on one sides	10027	
Double O-ring for flange connection, with groove on both sides	8357	

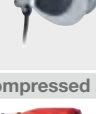
Automatic hose reels with spring return PG 4

FOR MOUNTING ON THE WALL, CEILING OR FLOOR

Description	Hose length m	Hose Ø mm	Order no.
Diesel, painted steel plate, with pivot arm			
 Hose reel open, Inlet 1" internal thread, outlet 1" male thread, max. 10 bar, Dimensions 475 x 460 x 246 mm	10	19	10557
 Hose reel open, Inlet 1" internal thread, outlet 1" male thread, max. 10 bar, Dimensions 475 x 460 x 246 mm	8	25	8734
 Hose reel open, Inlet 1" internal thread, outlet 1" male thread, max. 15 bar, Dimensions 512 x 470 x 322 mm	15	25	11161
Oil, painted steel plate			
 Hose reel closed, with fixed bracket Inlet and outlet ½" male thread, max. 60 bar Dimensions 516 x 491 x 160 mm	12	15	10558
 Hose reel open, with pivot arm Inlet and outlet ½" male thread, max. 60 bar Dimensions 475 x 462 x 150 mm	15	15	10559
AdBlue®, water			
 Hose reel open, painted steel plate Inlet with hoesetail 19 mm, outlet open, max. 10 bar Dimensions 475 x 460 x 196 mm	8	19	10560
 Hose reel open, painted steel plate Inlet with hoesetail 19 mm, outlet open, max. 10 bar Dimensions 475 x 460 x 246 mm	15	19	10561
Compressed air			
 Hose reel closed, impact-proof plastic, with swivelling wall bracket, 3/8" ET connections, max. 20 bar, dimensions 500 x 420 x 210 mm	15	15	10883
Cable			
 Cable reel closed, rugged plastic housing, cable oil and water proof, can be locked in any position. With swivel bracket for wall and ceiling installation. Power cable 1.5 m, with Schuko plug.	15	3 x 1,5 mm ²	10864









ACCESSORIES FOR HOSE REELS

Description	Order no.
 Pivotal wall bracket, narrow, painted steel plate, suitable for order code 10559, 10560	10563
 Pivotal wall bracket, wide, painted steel plate, suitable for order code 10557, 8734, 10561	8735













 Other versions and sizes on request.

Filter for fuels, diesel and biodiesel PG 4

Connection on both sides: 1" internal thread and flange with O-ring groove.

Description	Order no.
 Filter with transparent bowl max. 100 L/min, filter porosity 5 µm, pack contains 2 replaceable elements	10034
 Filter with transparent bowl max. 70 L/min, filter porosity 30 µm, with water separating function, pack contains 2 replaceable elements	10035
 Replacement element, max. 100 L/min, filter porosity 5 µm	10036
 Replacement element, max. 70 L/min, filter porosity 30 µm, with water separating function	10037
 Filter with cartridge 1" - 12 UNF, max. 70 L/min, 30 µm, with water separator	8122
 Cartridge filter with water separator, 1" - 12 UNF, 30 µm, max. 70 L/min	10031
 Filter with cartridge 1½" - 16 UNF u. 1 ¼" BSP, max. 100 L/min	10783
 Filter with cartridge with water separator, 1½" - 16 UNF, 30 µm, max. 150 L/min	10032
 Oil, diesel and fuel filter with cartridge, 10 µm, max. 60 L/min, max. 12 bar	10784

Diesel pumps accessories PG 4

 Quick-release brass hose coupling, leak-free coupling and uncoupling, 1" internal thread connection	10038
 Rubber suction hose DN 19, RME-resistant, with wire helix, sold by the metre	10039
 Rubber suction hose DN 25, RME-resistant, with wire helix, sold by the metre	10758
 PVC suction hose DN 19, RME-resistant, with plastic helix, sold by the metre	10757
 PVC suction hose DN 25, RME-resistant, with plastic helix, sold by the metre	10040
 Dispensing hose DN 19, PU/PVC, sold by the metre	11351
 Dispensing hose DN 25, PU/PVC, sold by the metre	11554
 Hosetail 1" external thread - 19 mm, brass, with O-ring	5522
 Hosetail 1" external thread - 25 mm, brass, with O-ring	10042
 Hose clamp 20 - 32 mm, 9 mm wide, galvanised	7030
 Hose clamp 32 - 50 mm, 9 mm wide, galvanised	10043
 Threaded ferrule compression coupling 1" ET for hose 19/4 mm, reusable	11555
Threaded ferrule compression coupling 1" ET for hose 25/6 mm, reusable	11556
Spring-loaded foot valve, brass, with filter, 1" internal thread	10044
Swivel joint, brass, ¾" external thread, 1" internal thread	11719
Swivel joint, brass, 1" external thread, 1" internal thread	10155
Swivel joint ¾" external thread - DN 19 hosetail, nickel-plated brass, Viton seal	11495

Submersible pump CENTRI SP 80 AC PG 4 for diesel/bio diesel and fuel oil

CEMO submersible pumps: the superior pump principle for your tank system. Simple, fast and safe.

- running time limitation: automatic switch-off after a preset time
- simple start-up: stands on the tank bottom – no suction height
- submersible centrifugal pump Ø 130 mm, suitable for common tanks and IBCs

- electrical supply 230 V/50 Hz, power 800 W
- high dispensing volume of 80 L/min
- motor thermally protected
- connection 1" internal thread without non-return valve
- connection cable 3 m without plug

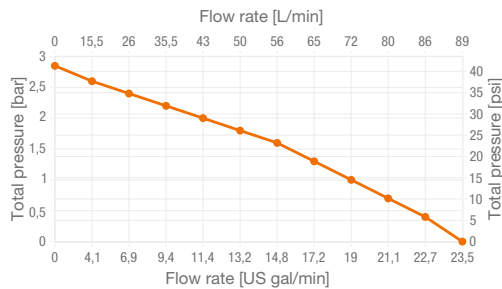

Dispensing volume submersible pump CENTRI SP80



MAINTENANCE FREE



Description	Max. dispensing volume in L/min	Max. delivery pressure in bar	Order no.
Submersible pump CENTRI SP 80 AC, 230 V/50 Hz	80	2.8	11644
Accessory Hosetail 1" M - DN25 with integrated check valve, o-ring	-	-	11964

Submersible pump CENTRI SP 30 PG 4

- low-cost entry-level solution
- low-wear centrifugal pump
- electric motor 12 V, max. 20 A
- version with power pack for 230 V
- self-priming as submersible pump on container bottom
- user-friendly

- compact, lightweight design
- dispensing volume approx. 30 L/min with automatic dispensing nozzle
- exterior pump dimensions: length 160 mm, dia. 56 mm
- extremely quiet

Diesel/biodiesel
AUS 32 (AdBlue®)
Fresh water
Antifreeze liquid



Large splash-proof cord switch



Container opening from e. g. 2" BSP and S70 x 6, Ø 56 mm

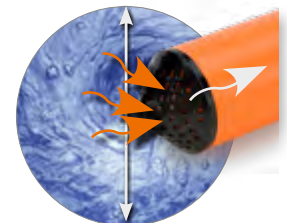

4 m cable with crocodile clips and blade fuse (versions 10488, 10489, 10490)

Bunghole adapter in NBR rubber

- suitable for 2" BSP and S 70 x 6
- hose and cable continuous, hence infinitely adjustable to any tank height
- simple to change from drum to drum without screws
- anti-kink sleeve for cable and hose
- integrated vent
- hose clamp for fixing



Cable connection directly on the 230 V power pack (variants 10590, 10591, 10592)

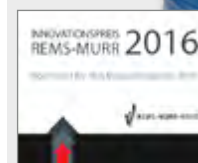

Submersible pump CENTRI SP 30 PG 4



Images with optional nozzle holder accessory









SUBMERSIBLE PUMP CENTRI SP 30

Description	Order no.
① Submersible pump CENTRI SP 30, 12 V, max. 18 A, max. 50 L/min, cable length 1.5 m, hose barb DN 19	91000
Submersible pump CENTRI SP 30, 18 V, max. 13 A, max. 50 L/min, cable length 1,2 m, hose barb DN 19, for CAS battery system	91646

PUMP KITS

② 12 V for AdBlue®, fresh water and antifreeze liquid 4 m cable with switch and crocodile clips, 4 m hose, automatic dispensing nozzle	10488
③ 12 V for diesel, 4 m cable with switch and crocodile clips, 4 m hose, automatic dispensing nozzle	10489
④ 12 V for AdBlue®, diesel, fresh water and antifreeze liquid 4 m cable with switch and crocodile clips, 4 m hose, dispensing nozzle	10490
⑤ 12 V for AdBlue®, fresh water and antifreeze liquid with power pack 230 V, 4 m hose, automatic dispensing nozzle	10590
⑥ 12 V for diesel, with power pack 230 V, 4 m hose, automatic dispensing nozzle	10591
⑦ 12 V for AdBlue®, diesel, fresh water and antifreeze liquid with power pack 230 V, 4 m hose, dispensing nozzle	10592

ACCESSORIES

Description	Order no.
 4 m fly lead with crocodile clips and 25 A fuse	91026
 In-line switch 16 A/250 V, two poles, black plastic	90958
 Li-Power-Block 12.8 V – 3.3 Ah with charger Sufficient for a volume of approx. 300 – 380 litres without idling, depending on the pump, charging time approx. 66 min	10749
 Li-Power-Block 12.8 V – 5.5 Ah with charger Sufficient for a volume of approx. 500 – 630 litres without idling, depending on the pump, charging time approx. 110 min	10750
 Power transformer 230 VAC/13.8 VDC, 20 A, cable 1m	10491
 For AdBlue®: digital flow meter K24, plastic, 6 – 100 L/min, 1" male thread, with two hose connecting pieces and sleeve for mounting at the hose or to the dispensing nozzle	10595
 Trolley for steel and plastic drums 200 L, 2 steering castors and 2 fixed castors, painted steel tube frame, with holder for dispensing nozzle, hose and cable	10607
 Dispensing nozzle holster for drums complete with clamping screws and drip container	11044

AdBlue® is a registered trademark of the German Automotive Industry Association.

Diesel pump CENTRI PG 4 non self-priming

- light and robust construction
- also for continuous operation
- simple handling due to low weight
- 2" connector and M 64 x 4 for all commercially available tanks and drums
- suction hose with foot filter
- integrated hand pump for priming







Submersible pump CENTRI 230 V



Submersible pump CENTRI 12 V with accessory digital flow meter K24

Diesel/biodiesel
Antifreeze liquid
Windshield cleaner

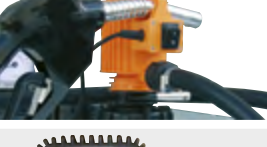
SUBMERSIBLE PUMPS CENTRI (EFFECTIVE OUTPUT)

Description	Order no.
 <p>Pump CENTRI, 12 V, approx. 30 L/min effective dispensing volume, 4 m connecting cable with terminals, 6 m hose, dispensing nozzle</p>	8640
 <p>Pump CENTRI, 12 V, approx. 25 L/min effective dispensing volume, 4 m connecting cable with terminals, 6 m hose, automatic dispensing nozzle</p>	8641
 <p>Pump CENTRI, 230 V, approx. 35 L/min effective dispensing volume, 4 m connecting cable, 6 m hose, dispensing nozzle</p>	8638
 <p>Pump CENTRI, 230 V, approx. 30 L/min effective dispensing volume, 4 m connecting cable, 6 m hose, automatic dispensing nozzle</p>	8639
 <p>K24 digital flow meter, can be calibrated, measuring range 10 – 120 L/min, 5-digit display, 6-digit total delivery display, inlet 1" external thread, outlet 1" internal thread, with 1" steel coupling</p>	8644
 <p>Dispensing hose for pump CENTRI, DN 19 other sizes available, price is per metre of hose (The standard hose is still included in the package)</p>	11351

Hand pumps for diesel and lubricants PG 4

- robust construction
- no energy source required
- low-cost
- 2" connector
- suction tube can be shortened as required

Diesel/biodiesel
Lubricants
Windshield cleaner
Fuels



Description	Order no.
<p>① Hand pump with 1.5 m discharge hose with outlet spout DN 19, suction pipe 1450 mm Pumping media: oil up to SAE 50, fuels, undiluted antifreeze, low viscosity mineral oils, heating oil EL/L, diesel, petroleum, biodiesel Dispensing volume: 15 L/min</p>	1452
<p>② Steel drum-pump with spout for drums 60/200/220 L, Telescopic suction pipe 480 – 900 mm Pumping media: oil up to SAE 90, self-lubricating, non-abrasive media, undiluted antifreeze, heating oil, diesel, petroleum Dispensing volume: 15 L/min</p>	7892
<p>③ Hand pump with curved spout and anti-drip nozzle for filling measuring cups, measuring buckets, canisters for drums 60/200/220 L, suction tube 840 mm, quick coupling for drums m 64 x 4 and 2" thread Pumping media: oil up to SAE 90, self-lubricating, non-abrasive media Dispensing volume: 10 L/min</p>	8577
<p>④ Aluminium rotary pump with curved spout 25 mm, for drums 60/200/220 L, threepart suction pipe 950 mm Pumping media: oil up to SAE 90, self-lubricating, non-abrasive media, undiluted antifreeze, heating oil, diesel, petroleum Dispensing volume: 20 L/min</p>	10010
<p>⑤ Aluminium rotary pump with curved spout 25 mm, for drums 60/200 L, three-part suction pipe 950 mm Pumping media: oil up to SAE 90, self-lubricating, non-aggressive media, heating oil, diesel, petroleum Dispensing volume: 25 L/min</p>	11162
<p>⑥ Hand pump with 1.5 m with conductive discharge hose with dispensing spout DN 19, telescopic suction pipe 470 – 925 mm Pumping media: fuels, undiluted antifreeze, low viscosity mineral oils, heating oil EL/L, diesel, petroleum, biodiesel Dispensing volume: 15 L/min</p>	11685

ACCESSORY FOR ALUMINIUM CRANK PUMP

Description	Order no.
 <p>Hose package 2 m, DN 25, with manual nozzle and pipe clamp, compatible with crank pump 10010</p>	10011

Petrol pumps PG 4 for fuels

ATEX/IECEx-certified pump Cematic 230/56 EX for flammable liquids

Complete set consisting of:

- pump 230 V, max. 56 L/min, with dispensing nozzle holder
- 2" drum adapter with coarse filter and check valve
- telescopic suction pipe max. 1100 mm
- cartridge filter 30 µm with water separating function
- 4 m dispensing hose, DN 19
- automatic dispensing nozzle with swivel joint

No connector cable is supplied with the pump. The electrical connection must be made by an expert technician after a risk assessment has been made.



Electric pump Cematic 230/56 EX



Pump set for drums Cematic 230/56 EX, flow meter available as accessory



i Petrol 2-stroke mixture
Avgas | Kerosene

Petrol pump Cematic 12/25 EX PG 4 for flammable liquids

- vane pump, 12 V, max. 25 L/min
- suction and pressure connection 3/4" internal thread
- motor thermally protected

- Ex dbh II A T4 Gb
- dry self-priming, max. 2 m
- 5 m cable with crocodile clips and cable switch



ATEX/CE-certified pump Cematic 12/30 EX for flammable liquids

- pump 12 V, approx. 30 L/min
- suction and pressure connection can be mounted on side or top
- compact design with carry handle
- thermally protected
- dry, self-priming, max. 1.5 m



Electric pump
Cematic 12/30 EX













Petrol transfer set Cematic 12/30 EX
in practical plastic case

PETROL PUMPS CEMATIC EX

Description	Dispensing volume L/min	Pressure (max) in bar	Order no.
① Cematic 230/56 EX, S1, 230 V 50 Hz, 56 L/min, 1.8 bar, ATEX (pump only)	56	1.8	12015
② Cematic 230/56 EX pump set, ATEX, 230 V, 56 L/min, filter, 4 m hose, automatic nozzle	56	1.8	12016
③ Cematic 12/30 EX, 12 V, 14 A, 220 W, 4.1 m cable with crocodile clips and earthing cable with crocodile clips, connection of both sides 3/4"	30	1.1	10647
④ Petrol transfer set Cematic 12/30 EX In practical plastic case, 12 V pump, 4.1 m cable with battery pole terminals and earthing terminal, dispensing volume approx. 25 L/min, 2 m suction hose with foot filter, 4 m dispensing hose, manual nozzle with swivel joint	25	1.1	10730
⑤ Cematic 12/25 EX, 12 V	25	0.7	11645

Petrol pumps PG 4

Accessories for petrol pumps Cematic EX

Description	Order no.
 K33 mechanical flow meter, upward flow, 20 – 120 L/min, ATEX	10236
 Retrofit kit for K33 ATEX flow meter, on Cematic 50 EX, Viton O-rings, flange	10410
 Digital flow meter K24 A ATEX/IECEX; II 2 G Ex ia IIB T4 Gb, aluminium housing, 7 – 120 L/min, 5-digit display, 6-digit total quantity display, 1" outer thread, 1" inner thread	10411
 Manual dispensing valve for fuels, outlet diameter 20 mm, with swivel joint 1" IT	90506
 Automatic nozzle for petrol, EN13012, ATEX, with swivel joint 1" internal thread	10142
 4 m dispensing hose, DN19, 1" external thread, electrically conductive, antistatic	10263
LC-Mix fuel hose, dia. = 19 mm, electrically conductive R < 10 MOhm	10731
 Cable gland 1/2" NPT for cable 7–12 mm, to Cematic 50 EX	10264
Cable gland 3/4" NPT ATEX, nickel-plated brass, ca. 10–17 mm compression coupling	12081
Connector cable, 3 x 2.5 mm ² , sold by the metre	10265
 Reducer 3/4" external thread x 1" internal thread	10659
Suction hose 3/4", conductive, sold by the metre	10660
 Plastic foot filter, hose connector 3/4"	10661
 Automatic rewind hose reel, open, for petrol, with swivel bracket/ Inlet 1" internal thread, outlet 1" external thread, max. 15 bar, hose 10 m DN19 antistatic, dimensions 495 x 460 x 246 mm	11041
 Automatic rewind cable reel, with 16 m earth cable 10 mm ² green/yellow, earthing clamp, feeder cable 1 m with open end	11042

Motorised pumps with petrol engine PG 8

Water

Motorised pump 500 L/min

with Honda petrol engine

- pump permanently installed
- 2" suction and pressure port
- DN 50 hose connections
- suction strainer
- max. 3 bar



Motorised pump 500 L/min with Honda petrol engine

Motorised pump with Honda petrol engine

- dispensing volume approx. 130 L/min
- pump capacity up to 3.5 bar
- 1" suction and pressure port
- DN25 hose connections
- suction strainer



Motorised pump 130 L/min with Honda petrol engine

Description	Dimensions cm (l x w x h)	Order no.
① Motorised pump with Honda petrol engine, dispensing volume approx. 500 L/min	47 x 35 x 39	8337
② Motorised pump with Honda petrol engine, dispensing volume approx. 130 L/min	33 x 25 x 40	8348

Lubricant pumps PG 4

Lubricants Vegetable oil

Lubricant pump Viscomat 70 and Viscomat 90

- rotary vane pump, thus high delivery volume flow at high pressure
- die cast aluminium pump body
- sintered steel rotor with resin vanes
- seal on the rotary shaft with access from the pump side
- bypass line integrated into the pump body
- suitable for oils up to 500 cSt, corresponding to approx. SAE 90 at 20 °C
- also suitable for vegetable oils e.g. cold pressed rape seed oil







Lubricant pump Viscomat 70 + 90



LUBRICANT AND VEGETABLE OIL PUMP VISCOMAT 70 AND VISCOMAT 90

Description	Dispensing volume L/min	Pressure (max) in bar	Order no.
Lubricant pump Viscomat 70, 230 V, self-priming, 750 W, 1" internal thread connection on both sides, without accessories	25	6	8727
① Viscomat 90, 230 V, self-priming, 1600 W, 2 m cable with connector, fixed bypass, 1" internal thread connection on both sides, without accessories	50	5	8070
Viscomat 90, 400 V, self-priming 2000 W, connection socket, adjustable bypass, 1" internal thread connection on both sides, without accessories	50	5	7985
Lubricant pump Viscomat 70, 230 V, self-priming, with nozzle, 4 m pressure hose, 1.6 m suction hose 1" with foot valve and quick coupling for drums	25	6	7928
② Lubricant pump Viscomat 70 K33, 230 V, self-priming, with nozzle, mechanical flow meter K33, 4 m pressure hose, 1.6 m suction hose 1", with foot valve, quick coupling for drums	25	6	7929

ACCESSORIES FOR VISCOMAT 70 + VISCOMAT 90

Description	Order no.	
 Self 3000 nozzle (connection 1" internal thread)	7780	
 Quick coupling for drums 2" x 1"(with 1" internal thread)	7781	
 1.6 m PVC suction hose with foot valve and filter, DN19, 1" external thread	7783	
 Mechanical flow meter K33 Oil, 20 – 120 L/min, 3-digit display, 1" internal thread on both sides	8728	
	4 m	7933
	6 m	7934
	8 m	7935
	10 m	7936

Lubricant pumps PG 4

Lubricant pump Viscomat 200/2

- gear pump design, thus high dispensing volume at high pressures, no pulsation, uniform flow
- die cast aluminium pump body
- sintered steel gears, with a specially designed internal profile
- mechanical seal on the engine shaft, accessible from the pump side
- bypass line integrated into the pump body
- suitable for oils up to 2000 cSt, corresponding to approx. SAE 140 at 20 °C



The pump principle:
gear pump design



Lubricant pump Visco-Flowmat 200/2

- like Viscomat 200/2, but with pressure switch
- pump switches on automatically when the nozzle is opened
- after delivery the pump continues to run for a few seconds to refill. Afterward it shuts off automatically.



LUBRICANT PUMPS VISCOMAT 200/2 AND VISCO-FLOWMAT

Description	Dispensing volume L/min	Pressure (max) / bar	Order no.
Lubricant pump Viscomat 200/2, 230 V, self-priming, with nozzle, 4 m pressure hose 1/2", 1.6 m suction hose 1" with foot valve and quick coupling for drums	9	12	7896
① Lubricant pump Viscomat 200/2 K400, 230 V, self-priming, with nozzle, flow meter K400, 4 m pressure hose 1/2", 1.6 m suction hose 1", with foot valve and quick coupling for drums	9	12	7897
② Lubricant pump Viscomat 200/2 230 V, 800 W, 1" internal thread connection on both sides, without accessories	9	12	8571
③ Lubricant pump Visco-Flowmat 200/2 with pressure switch, 230 V, 800 W, 1" internal thread connection on both sides, without accessories	9	12	8572

Compressed air diaphragm pump PG 4

- max. 60 L/min, self-priming
- aluminium housing and motor, NBR membrane
- inlet 3/4" IT, outlet 1/2" IT
- temperature range - 20 °C to + 90 °C (or briefly + 120 °C)
- particles up to 1.5 mm permissible
- max. 8 bar, air consumption 600 L/min
- explosion-proof (equipotential bonding on site)
- accessories, other versions and sizes on request











Waste oil
Lubricants
Antifreeze liquid
Windshield cleaner
Dirty water

Description	Order no.
Compressed air diaphragm pump, max. 60 L/min	10176

Lubricant pumps PG 4

ACCESSORIES FOR LUBRICANT PUMPS VISCOMAT 200/2, VISCO-FLOWMAT AND VISCOAIR

Description		Order no.
	Pressure hose ½" for oil, 2 m, both ends ½" inner thread, with union nuts Pressure hose ½" for oil, 4 m, both ends ½" outer thread Pressure hose ½" for oil, 6 m, one end ½" external thread, other end union nut and ½" double male connector Pressure hose ½" for oil, 10 m, one end ½" external thread, other end union nut and ½" double male connector	10697 8608 8351 8352
	Quick coupling for drums 2" x 1" (with 1" internal thread)	7781
	1.6 m PVC suction hose with foot valve and filter, DN25, 1" external thread	7783
	Oil dispensing nozzle with ½" swivel joint, fixed outlet with anti-drip nozzle. The K400 meter can be integrated between the handle and outlet.	8573
	Electronic K400 meter, oval wheel principle, 1 – 30 L/min, ½" inner thread, max. 70 bar, fits equipment including nozzle 8573	8574
	Oil dispensing nozzle K500, with electronic meter, ½" inner thread connection with swivel joint, 2-fold adjustable angle outlet with anti-drip nozzle, 1 – 30 L/min, max. 70 bar, with quantity pre-setting from 0.1 – 99.9 L. When the preset quantity is reached, the nozzle shuts off automatically.	8576
	Steel telescopic suction pipe, 1" male thread max. 1,100 mm	10748
	Suction pipe and hose set for drums 200 L, incl. wall bracket	10698
	Nozzle holster with drip tray	10696

Pump systems for AdBlue® PG 4

Compact refuelling systems for AdBlue®

AUS32 (AdBlue®)

- Low-cost entry-level solution
- self-priming as submersible pump on container bottom
 - electric pump approx. 25 L/min
 - external pump dimensions: length 160 mm, dia. 56 mm
 - extremely quiet



CENTRI SP 30
EXTREMELY QUIET

Bluetroll Mobile 12 V Battery not included.

★ Cost-effective entry-level solutions for drums including 12 V submersible pump CENTRI SP 30 and trolley see on page 126.



Description

	Order no.
① Pump set CENTRI SP 30 12 V, with power pack for 230 V, 4 m hose, automatic nozzle	10590
② Pump set CENTRI SP 30 with 4 m cable and battery crocodile clips, 4 m hose, automatic nozzle. With transport trolley for drums.	10781

Drum pump ECO-1 for AdBlue® PG 4

COMPLETE PUMP SET ECO-1 FOR AdBlue®

Pump kit ECO-1 for AdBlue®

- motor 230 V
- variable dispensing volume, 6 speeds can be selected
- sealless pump unit
- with bung adapter S 70 x 6
- 4 m filler hose



Accessory: digital flow meter K24



Drum pump set ECO-1 with manual nozzle



Drum pump set ECO-1 with automatic nozzle



Description

	Order no.
① Drum pump set ECO-1 with manual nozzle, max. 80 L/min	10869
② Drum pump set ECO-1 with automatic nozzle, max. 35 L/min	10870

ACCESSORIES

Description

	Order no.
③ K24 digital flow meter, with attachment screws and hose connector DN 19	10871

AdBlue® is a registered trademark of the German Automotive Industry Association.

CEMO Cematic Blue pump systems PG 4

Compact refuelling systems for AdBlue®

AUS32 (AdBlue®)

- high-quality diaphragm pump made of plastic, delivery rate approx. 30 L/min supply voltage 230 VAC
- pump self-priming
- dispensing hose 6 m
- automatic nozzle, plastic



Optional flow meter, see accessories



Accessory: long life 3D filter



Accessory: 3-piece suction pipe with coupling AF2



Accessory: digital flow meter K24



Accessory: 2-piece suction pipe for IBC and 220 L tanks



Accessory: coupling SEC



Drum not included in the system.

Description

	Description	Order no.
①	Cematic Blue pump system BASIC auto nozzle, with universal bracket for IBCs as described above, suction hose 1.5 m with SEC coupling	10215
②	Cematic Blue pump system for drums 220 L as described above, suction hose 0.5 m with AF2 coupling and adapted suction pipe	10276
③	Bluetroll Mobile, mobile tank system for drums, consisting of a painted chasis, with steering and fixed castors and the Cematic Blue pump system BASIC AZV and adapted suction pipe	10277

ACCESSORIES FOR CEMATIC PUMP SYSTEMS

Description

	Description	Order no.
④	AdBlue® long life 3D filter, replaceable cartridge, suitable for electric pump Cematic Blue and crank pump for AdBlue®	10782
	Replaceable cartridge for AdBlue® 3D filter, 70 µm	11915
⑤	3-piece suction pipe with coupling AF2, S 70 x 6 thread, external thread DN 19	10872
	3-piece suction pipe with coupling AF2, 2" BSP thread, external thread DN 19	11063
⑥	Digital flow meter K24, plastic, 6 – 100 L/min, 1" internal thread, 90° elbow for direct attachment to the pump	10274
⑦	2-piece suction pipe for IBC and 220 L tanks (can be shortened), suitable for SEC and CDS coupling, S 56 x 4 thread	10201
⑧	SEC coupling with elbow hoesetail DN 19	10256

AdBlue® is a registered trademark of the German Automotive Industry Association.

Electric drum and IBC pumps PG 4 for liquid chemicals

Complete pump sets for your liquid chemicals

- motor, 230 VAC
- ex-rated version available
- sealless pump unit with sturdy 8 mm driveshaft without guide tube
- robust, no dead space, easy to clean
- brief running on empty possible
- quick-lock coupling for super-fast connection with robust gear coupling, insensitive to soiling and aggressive environments
- contained in each set:
PP drum adapter, 2" outer thread and wall bracket for storage



① Basic set, for occasional use, can be used for diluted acids and lyes



② Allround set, for regular use, can be used for concentrated acids and lyes



③ Chemical set, for professional use, can be used for aggressive liquids



④ Ex-klusiv set, can be used for solvents and highly flammable liquids



Wall bracket



Drum adapter made from PP, 2" outer thread

ELECTRIC DRUM AND IBC PUMPS

Description / kit includes	technical data maximum values				for drum, immersion depth 1000 mm	for IBC, immersion depth 1200 mm
	Dispensing volume L/min	Pressure bar	Density kg/L	Viscosity mPas	Order no.	Order no.
① Basic set consisting of: Motor p310-A-230, 520 W, pump unit DL-PP-A-Niro, 2 m PVC hose reinforced DN 19, dispensing nozzle PP/FPM/Niro	100	0.6	1.3	300	10438	10442
② Allround set consisting of: Motor p400-A-230, 850 W, pump unit DL-PP-R-HC, 2 m PVC hose reinforced DN25, dispensing nozzle PP/FPM/HC DN25	100	2.0	1.8	700	10439	10443
③ Chemical set consisting of: Motor p400-A-230, 850 W, pump unit DL-PVDF-A-HC, 2 m hose universal chemical DN25, dispensing nozzle PVDF/ FEP 1 ¼"	110	0.8	2.0	800	10440	10444
④ Ex-klusive set consisting of: Motor EX700, 700 W, pump unit Niro-A, 2 m solvent hose DN25, hose connector MS 1 ¼", dispensing nozzle MS/PTFE, earth cable	110	0.7	1.8	600	10441	10445

Electric drum and IBC pumps PG 4 for liquid chemicals

Chemicals
AUS32 (AdBlue®)





Complete pump set ECO-1 for liquid chemicals

- motor 230 V
- six speed settings
- sealless pump unit
- easy to clean
- brief running on empty possible
- quick-lock coupling
- with S70x6 adapters in set for drums
- with 2" BSP adapter in set for IBCs



Description / kit includes	technical data maximum values				for drum, immersion depth 1000 mm	for IBC, immersion depth 1200 mm
	Dispensing volume L/min	Press bar	Density kg/L	Viscosity mPas	Order no.	Order no.
ECO-1 set, consisting of: Motor 230 V, 450 W; pump unit PP, shaft A2, seal Viton; 2 m PVC hose DN25, dispensing nozzle PP/ FPM/A2	140	1.0	1.8	200	10486	10487

ACCESSORIES FOR ELECTRIC DRUM AND IBC PUMPS

Description	Order no.
 Digital meter FMT 3 Material PP, 5 – 120 L/min, both side 1" outer thread	10450
 Installation kit (except ECO-1) for meter with 1" outer thread, PP	10446
 Screw lid DN 150 for IBC, with 2" inner thread, TPE seal	10447
 Threaded adapter of 2" fine (I) to 2" Mauser rough (A) S70 x 6	10448

THE FOLLOWING TABLE SHOWS A NUMBER OF TYPICAL LIQUIDS AND THEIR MATCHING PUMP SET.

Liquid	ECO-1-Set	Basic set	Allround set	Chemical set	Ex-klusive set
Acetone					x
AdBlue®	x	x	x	x	
Battery acid	x	x	x	x	x
Formic acid	x	x	x	x	x
Ammonia water	x	x	x	x	x
Petrol					x
Bleaching lye (sodium hypochlorite)				x	
Chlorine/chlorinated water				x	
Iron III chloride			x	x	
Acetic acid		x	x	x	
Ethanol					x
Ethyl acetate					x
Liquid fertilisers	x	x	x	x	
Anti-free agent (Antifrogen)	x	x	x	x	
Anti-free for radiators (ethylene glycol)	x	x	x	x	x
Cooling lubricants				x	x
Milking machine cleaner, alkali				x	
Milking machine cleaner, acidic	x	x	x	x	
Methanol					x
Caustic soda/sodium hydroxide	x	x	x	x	
Nitrocellulose thinner					x
Propionic acid				x	
Nitric acid		x	x	x	
Hydrochloric acid			x	x	
Foaming agent		x	x	x	x
Window cleaner	x	x	x	x	x
Sulphuric acid				x	
Turpentine					x
Water, (distilled/DI)	x	x	x		



Information on chemical resistance applies to a room temperature of 20 °C. A verification must be performed at much higher temperatures. At high concentrations, we recommend the use of the higher quality pump sets.

Can't find your liquid, or aren't sure? Then call representative responsible for your area:
www.cemo-group.com/locations/representation/international
We'd be pleased to assist.



AdBlue® is a registered trademark of the German Automotive Industry Association.

Pumps PG 4 for chemicals

Electric pump Cematic Blue

- or AUS 32 (AdBlue®), antifreeze fluid and windshield cleaner with flash point > 55 °C
- self-priming plastic diaphragm pump
- 1" external thread connection on both sides incl. DN19 hose connecting pieces with union nut
- OFF/ON switch
- can be installed in any orientation



Cematic Blue 230 V

AUS32 (AdBlue®)
Antifreeze fluid
Windshield cleaner
Water







Cematic Blue 12 V + 24 V

ELECTRIC PUMPS CEMATIC BLUE

Description	Dispensing volume L/min	Pressure (max) in bar	Order no.
① <u>Electric pump Cematic Blue</u> self-priming plastic diaphragm pump, 230 V, 370 W, 2800 rpm, 2 m cable with Schuko plug	35	1.5	8730
② <u>Electric pump Cematic Blue</u> self-priming plastic diaphragm pump, 12 V, 280 W, 2 m connecting cable with crocodile clips	35	1.5	10152
<u>Electric pump Cematic Blue</u> self-priming plastic diaphragm pump, 24 V, 280 W, 2 m connecting cable with crocodile clips	35	1.5	10153

ACCESSORIES FOR ELECTRIC PUMPS CEMATIC BLUE

Description	Order no.
 DN19 hosetail with 1" IT union nut with locknut	8731
 90° elbow with union nuts for K24 flow meter	8732
 Connecting piece, straight with union nuts for K24 flow meter	8733
 DN19 hosetail, 90° elbow with union nut	8611

 For other accessories such as hoses and meters, see pages 104.

Submersible pump Squalo 35

- submersible centrifugal pump ø 140 mm, suitable for common tanks and IBCs
- 230 V, 370 W
- Innovative pressure regulation system. Almost constant pressure and flow over the entire operating range.
- 1" connection with internal thread, with non-return valve
- 5 m connection cable without plug

AUS32 (AdBlue®)
Water



SUBMERSIBLE PUMP SQUALO 35

Description	Dispensing volume L/min	Pressure (max) in bar	Order no.
Submersible pump Squalo 35, 230 V/50 Hz, with timer approx. 6 min	35	2.0	11255

AdBlue® is a registered trademark of the German Automotive Industry Association.

Hand pumps PG 4 for chemicals

i Please read the datasheet for the chemical resistance of the medium to be conveyed, and decide for yourself on the basis of our material specification list!

Hand pumps for chemicals

- material: plastic, polypropylene and polyethylene
- food-safe
- double-action
- outlet tubes suitable for connecting a hose DN 25
- suitable for propionic acids, molasses, detergent, lubricants, AdBlue®, liquid fertilisers, liquid feeds, pesticides, etc.
- not suitable for highly flammable substances and strong solvents



Chemicals
AUS32 (AdBlue®)

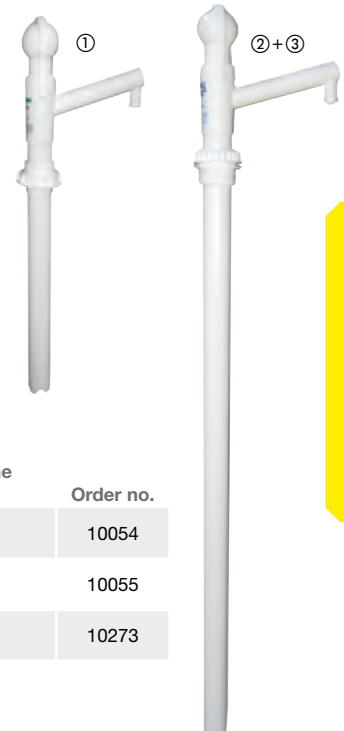

HAND PUMPS FOR CHEMICALS



Description	Dispensing volume L/min	Order no.
① Hand pump for canisters up to 30 L, inclusive of adapter C57 and C63, tube diameter 41 mm, max. immersion depth 420 mm	0.16	10054
② Hand pump for drums up to 220 L, inclusive of adapter S70x6, S56x4 and 2" BSP tube diameter 41 mm, max. immersion depth 930 mm	0.4	10055
③ Hand pump for IBC 1000 L, inclusive of adapter S56x4 and 2" BSP, tube diameter 41 mm, max. immersion depth 1185 mm, output connection 20 mm	0.4	10273

Rotary hand pump for AUS 32 (AdBlue®)

- solid construction for professional operation
- housing in stainless steel and technopolymer
- drum adapter with connection thread S56x4
- multi-part suction pipe 1 m, can be shortened as required
- PVC dispensing hose 3 m
- stainless steel outlet pipe 19 mm with protective cap



CRANK PUMP FOR AUS 32 (ADBLUE®) ANTI-FREEZE, WATER

Description	Dispensing volume L/min	Order no.
④ Crank pump for AdBlue® with PVC hose 3 m	25	10517
⑤ Crank pump for AdBlue® with PVC hose 3 m, mounting plate for IBC suction hose 1.5 m. For accessories see page 100	25	11163
 Accessory: plastic manual dispensing nozzle, with lever lock, polypropylene (PP) body, stainless steel valve, Viton gaskets, connection hosetail DN 19, stainless steel spout 19 mm	max. 80	8333
 Accessory: plastic manual dispensing nozzle, housing PA6, stainless steel, Viton gaskets, connection nozzle DN 19, outlet 19 mm, with lever lock	max. 80	11033

AdBlue® is a registered trademark of the German Automotive Industry Association.



WATER SAFETY

Sustainable system components



FIRE SAFETY

Fire resistance
F30 – F90

STORAGE OF HAZARDOUS SUBSTANCES



BATTERY SAFETY

Practical tip:
Charge and store lithium
batteries separately



The basics of hazardous material storage



When storing hazardous materials, various basic legal conditions must be observed. The essential relevant information is presented below.

Cause for concern principle:

Water is the most important foundation for life and is irreplaceable. This fact has always been true, and endangering the water supply is a threat to our future. This is why the so-called “cause for concern principle” is central to the (German federal) Water Resources Management Act. In the words of a lawyer: “Cause for concern exists not only when a harmful event is likely to occur but even as soon as a harmful event is not unlikely to occur.”

- ✓ Determine your water hazard class
- ✓ Note the classification of flammable liquids (see table on right)
- ✓ Observe the legal requirements
- ✓ Ensure that your collection trays are positioned correctly
- ✓ Check that your tray is made from a material that is resistant to the media held in it



Examples	WGK	GHS
Alcohol (ethanol), acetone	1	extremely flammable
Anti-freeze for radiators (glycol)	1	not flammable
AdBlue®	1	not flammable
Diesel fuel/heating oil	2	liquid with flash point > 55 resp. 60 °C
Normal petrol	3	highly flammable
Unused lubrication oils	2	not flammable
Old oil (known origin)*	3	liquid with flash point > 55 resp. 60 °C
Old oil (unknown origin)*	3	highly flammable
Coolant lubrication emulsion	3	not flammable
CKW (Tri, Per, etc.)	3	not flammable



The ABCs of hazardous materials

WATER POLLUTING CLASSES (WGK)

The German Water Management Act (WHG) sets out substances that are hazardous to water and how to handle them. According to an ordinance (AwSV) under the WHG, system operators are obliged to classify the substances and mixtures they use into one of three water pollution classes (WGK), for the purposes of handling these substances hazardous to water:

- WGK 3** Highly water-hazardous substances, e.g. petrolused oil, halogenated solvents
- WGK 2** Distinctly water-hazardous substances, e.g. diesel, lubricating oil, toluene
- WGK 1** Low water-hazardous substances, e.g. rapeseed methyl ester, AdBlue®, acetic acid

The classification is generally carried out by the manufacturer or distributing company. Operators can find the information on the water pollution classes in the safety data sheets of the products they use. The law does not prescribe a WGK label on the container packaging.

If you mix substances to create a mixture that is not yet classified, you must do so yourself in accordance with the AwSV (see AwSV appendix 1). There are rules concerning mixtures that can be used to derive the WGK of a mixture from the WGKs of the constituent substances. Available toxicity data may also be used in certain cases. **Document the self-classification carefully** (see AwSV appendix 2). The substance lists of hundreds of substances that have already been classified in the annexes of the now obsolete VwVwS provide a brief guide.

CLASSIFICATION OF FLAMMABLE LIQUIDS

After the German Ordinance on Industrial Safety (BetrSichV) replaced the previously valid ordinance on flammable liquids (VbF), the Technical Regulations for Handling Flammable Liquids (TRbF) ceased to be in force at the start of 2013. They were replaced with the Technical Regulations for Industrial Safety (TRBS) and the Technical Regulations for Hazardous Substances (TRGS). One particularly important element is TRGS 510 "Storage of hazardous substances in mobile containers", which substantiates the requirements of the Hazardous Materials Act, such as those concerning responsibilities, certifications, hazard assessments, operating instructions and briefings, warehouse configuration, transport routes, etc. The VbF also ended the classification of flammable liquids into the previous hazard classes A I to A III and B. Flammable liquids used to be classified according to the Hazardous Materials Act (GefStoffV) as follows:

- Extremely flammable (flash point < 0 °C)**
- Highly flammable (flash point < 21 °C)**
- Flammable (flash point 21 – 55 °C)**
- Liquids with a flash point > 55 °C**

Today, the GHS provides the following categories (see table for examples):

Extremely flammable liquids H224

Flashpoint < 23 °C

Boiling point ≤ 35 °C

Highly flammable liquids H225

Flashpoint < 23 °C

Boiling point > 35 °C

Flammable liquids H226

Flashpoint 23 °C – 60 °C

Liquids with a flash point above 100 °C are not considered flammable, e.g. lubrication oil.



Important note:

Since February 2021 the new TRGS 510 is valid and contains some changes! We will be happy to advise you.

Important legal provisions

- Water Resources Management Act (WHG)
- State Water Resources Management Act (LWG)
- Ordinance on installations handling water polluting substances (AwSV)
- Technical Regulations for Industrial Safety (TRBS)
- Technical Regulations for Hazardous Substances (TRGS)
- Health And Safety At Work Act (BetrSichV)
- Ordinance on Hazardous Substances (GefStoffV)
- European Agreement Concerning the International Carriage of Dangerous Goods by Road (ADR)
- GHS Globally Harmonized System of Classification and Labelling of Chemicals

We will be happy to advise you on this topic.

Collection volumes

General rule: The collection tray must be able to hold at least 10 % of the total storage volume or the contents of the largest container stored above it. The tray volume must therefore be equal to the largest of these two volumes. Special rules apply in water protection areas where it is necessary to guarantee a 100 % capture volume for the media stored.

Material resistance

Selection of tray material is dependent on the media stored. In most cases, the high resistance properties of GRP (see page 147) make it a suitable choice.

Certifications

According to the WHG, tanks and collection trays used for the storage of substances that are hazardous to water require a certificate of usability issued by the construction inspection authorities, e.g. a general construction inspection certification.



TIP:

A certified collection tray is not required for a total storage volume of < 220 L of liquid, water-hazardous substances.



Guidance for the storage of hazardous materials

The following questions should be addressed prior to purchase:

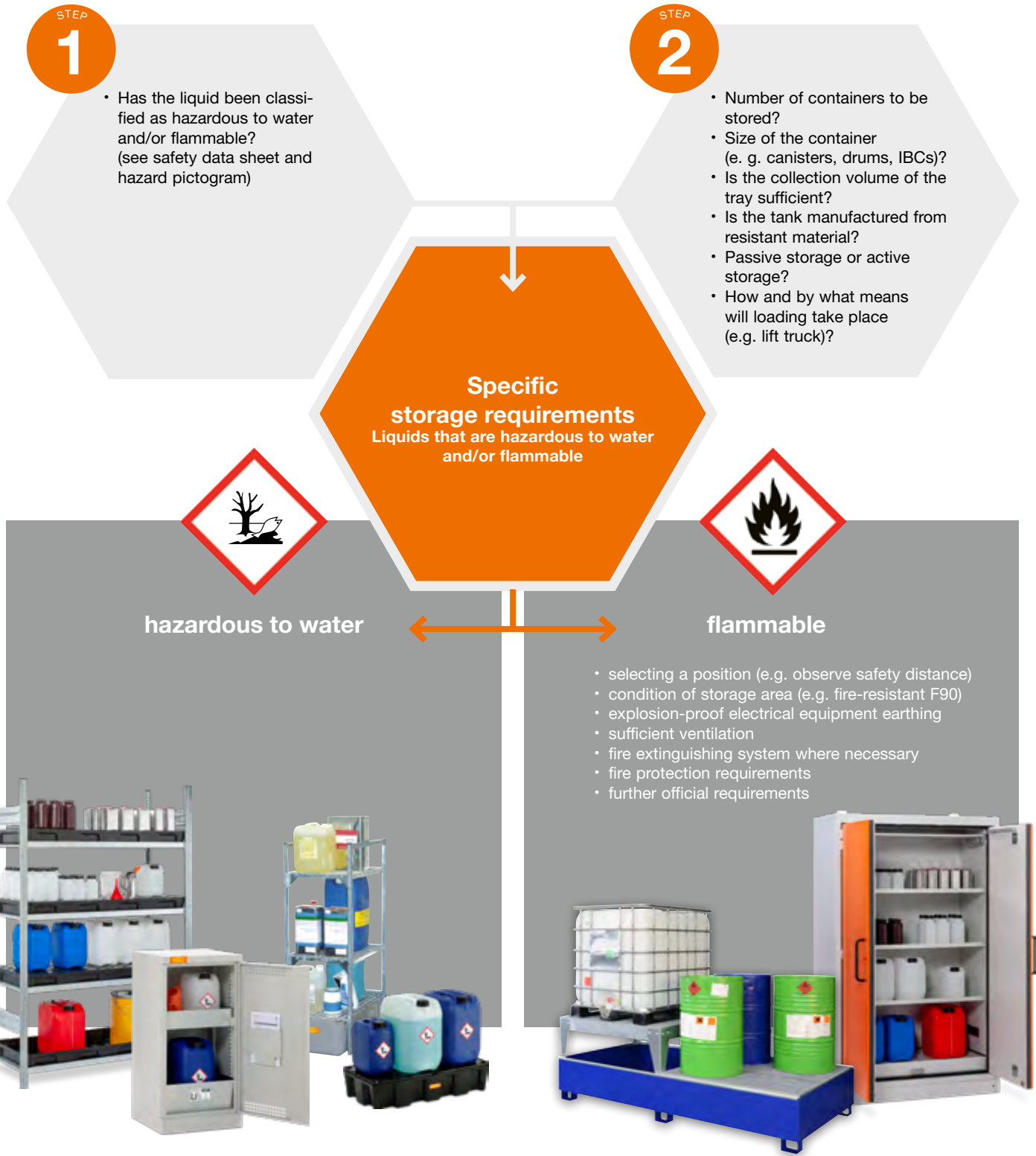
(Here using the example of the most frequently encountered hazard categories “hazardous to water” & “flammable”)

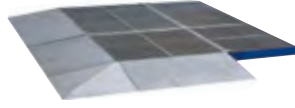

Collection trays

Spill trays	GRP	PE	steel
<p>Spill pallets / sumps for drums</p> 			
<p>IBC bunds</p> 			
<p>Workfloors/ground protection systems</p> 			
<p>HazMat racks and cabinets Bunds on several levels</p> 			

Collection trays in comparison

Characteristic	GRP	PE	steel
CORROSION RESISTANCE			
Trays must remain impervious to liquids during their entire service life.	No corrosion across entire service life.	No corrosion across entire service life.	Susceptible to corrosion: check regularly.
COMPULSORY CHECKS OF THE TRAY BASE			
The underside of the collection tray and the grating must be visually inspected every two years. The result must be recorded and presented to the responsible water authorities upon request.	No compulsory check, as material does not corrode.	No compulsory check, as material does not corrode.	Susceptible to corrosion: regular checking and recording compulsory.
CLEANING THE INSIDE OF THE TRAY			
The operator must carry out a visual inspection at least once a week to see whether any liquid has leaked out of the containers. Any liquid that has leaked out must be removed immediately.	Smooth inner surfaces make it easy to clean the tray if necessary.	Required reinforcements make cleaning harder.	Smooth inner surfaces enable simple cleaning.
TRAY STRENGTH			
The tray wall thickness must be such that the walls absorb the forces acting upon them. The trays may only be placed on suitable surfaces.	The material structure allows both high strength and low wall thickness.	High wall thicknesses and reinforcements are necessary for strength.	Required minimum wall thickness 3 mm.
TRAY HANDLING			
The handling characteristics depend heavily on the weight of the trays.	Low weight achieved through relatively low material thicknesses.	Higher material thicknesses have a negative effect on the tray weight.	Highest weight results in difficult handling, e.g. when checking the tray base.
TRAY MATERIAL DURABILITY			
The prescribed requirements for the trays remain fully valid across the entire service life.	The material characteristic does not change throughout the entire service life.	Strength is reduced as a result of the natural ageing process.	Corrosion impairs the required impermeability over a longer period.
CEMO recommendation for tray material:	Diesel, fresh and used oils, weak lyes and acids	Lyes and acids	Petrol, highly flammable liquids

Comparison of the suitability of sump/spill pallets made from different materials (confirmed by independent experts) used with various media typical in industrial concerns and workshops

Media stored	Waste oil of known origin (flammable, flash point > 55 °C)	Heating oil and diesel (flammable, flash point > 55 °C)	Petrol, nitro (extremely flammable, highly flammable)*	Lyes up to pH 8	Lyes over pH 8	Acids up to 10 % salt solutions pH 6-8 fixing baths	Acids up to 20 % battery acid 37%
Tray material							
GRP	●	●	–	●	–	●	●
Steel painted or galvanised	●	●	●	●	–	–	–
PE = polyethylene	–	–	–	●	●	●	●
● certified and resistant					– not certified / not resistant		
If necessary, please enquire about individual resistances.							

* Special storage location requirements are to be observed. (fire protection, explosion protection).

GRP sumps / spill pallets

GRP SUMPS ARE IDEAL FOR THE STORAGE OF ENVIRONMENTALLY HAZARDOUS SUBSTANCES.

GRP is a universally applicable material for the storage of environmentally hazardous substances. The thermosetting plastic base structure in conjunction with the glass fibre

reinforcement provide an advantageous fire performance and high chemical resistance. GRP sumps combine the properties of steel and plastic. Due to their absolute corrosion

resistance, GRP sumps can be placed directly on the ground. The low installation height facilitates easy handling in factories and workshops.



**EXTREMELY FAVOURABLE
PRICE/PERFORMANCE RATIO**



universal application
e.g. waste oil, lyes and acids

absolutely corrosion-resistant
(no welding seams)

low installation height, because no
ground clearances are required
(compare steel sumps/spill pallets)

smooth inner walls
ensure simple cleaning

minimal inspection requirements,
no additional inspection of
sump floor (compared to steel
sump/spill pallets)

Example:
GRP sump 220/2

Our PREMIUM product line GRP



Due to the excellent material properties created by reinforcing the three-dimensionally meshed duroplastic material with glass fibres, GRP has been used for decades to make high-performance products that are expected to have a long service life in tough environments and at the same time ensure high levels of safety.

GRP combines the positive properties of acero and plastic.

GRP sumps PG 9

GRP sumps with general construction inspection certification no. Z-40.12-227

- for the storage of products with high risk of water pollution

Mobile sump/spill pallets from GRP

- hot-dip galvanised grating
- hot-dip galvanised chassis with collision protection
- 2 steering and 2 fixed castors (castors dia. 12.5 cm) as well as a handle for trouble-free steering



Sump/spill pallet 220/2

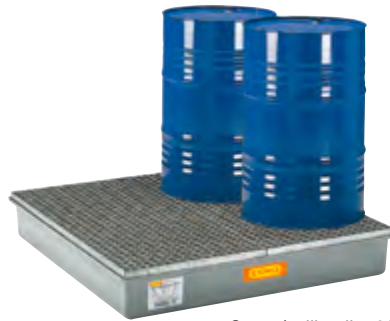

Sump/spill pallet 220/4



Sump/spill pallet 150 for Euro pallets



Mobile sump/spill pallets



Accessory: loading rails



Accessory: steel foot-frame, galvanised

★ Accessories see page 150

Sumps type RC PG 9

GRP sumps type RC without certification

- suitable as a collection tray for materials not hazardous to water or for uses for which no certification is required



Sump/spill pallet 220/3-RC

GRP sumps and RC sumps PG 9

Description / Type	External dimensions cm (l x w x h)	Collection volume L	Loading capacity kg	Quantity 200 L drums	Weight approx. kg	with general construction inspection certification	Type RC, without certification	
						Order no.	Order no.	
	GRP SUMP/SPILL PALLET 65							
	without grating	82 x 41 x 23	65	-	-	4	7086	10380
	with galvanised steel grating	82 x 42 x 24	65	40	-	9.5	7717	10381
	GRP SUMP/SPILL PALLET 150 FOR EURO PALLETES							
	without fixture	120 x 80 x 16.5	150	-	-	9	5113	10382
	with fixing pins	120 x 80 x 20.8	150	-	-	9	5114	10383
	with galvanised steel grating	120 x 80 x 19.0	140	250	-	25	7963	10384
	with fixing pins and galvanised steel grating	120 x 80 x 23.5	140	250	-	25	7970	10385
	GRP SUMP/SPILL PALLET 220/1							
	without grating	85 x 85 x 39	210	-	1	13	7867	10386
	with galvanised steel grating	85 x 85 x 40	210	400	1	27	7868	10387
	complete with GRP grating	85 x 85 x 40	210	400	1	20	7869	10388
	GRP SUMP/SPILL PALLET 220/2							
	without grating	128 x 85 x 27	220	-	1	13	6882	10389
	with galvanised steel grating	128 x 85 x 29	220	800	2	33	6875	10390
	complete with GRP grating	128 x 85 x 29	220	800	2	24	6886	10391
	GRP SUMP/SPILL PALLET 220/3							
	without grating	188 x 85 x 19	220	-	1	18	7085	10392
	with galvanised steel grating	188 x 85 x 20	220	1200	3	46	7083	10393
	complete with GRP grating	188 x 85 x 20	220	1200	3	36	7286	10394
	GRP SUMP/SPILL PALLET 220/4							
	without grating	128 x 128 x 18	220	-	1	18	6884	10395
	with galvanised steel grating	128 x 128 x 21	220	1300	4	46	6876	10396
	complete with GRP grating	128 x 128 x 20	220	1300	4	36	6943	10397

 Accessories see page 150

MOBILE SUMP/SPILL PALLETES GRP

Description / Type	External dimensions cm (l x w x h)	Height of loading area	Collection volume L	200 L drum items	Loading kg	Weight approx. kg	Order no.
 220/1-mobile	109 x 86 x 108	56	210	1	400	50	7870
220/2-mobile	152 x 86 x 108	44	220	2	800	60	7834



GRP sumps PG 9

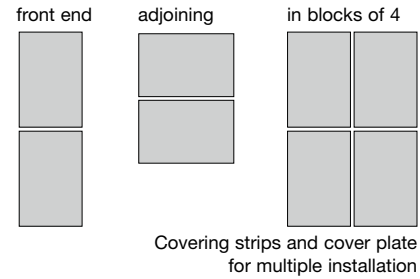
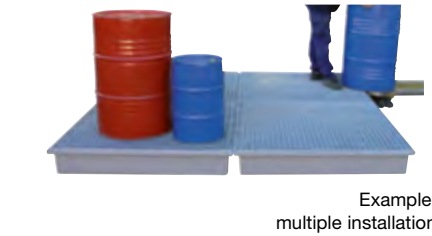
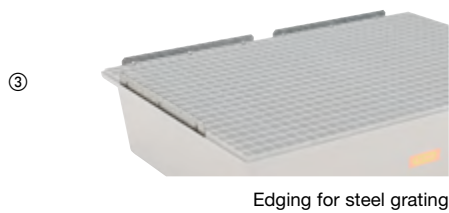
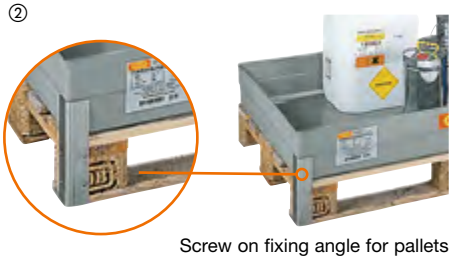

ACCESSORIES FOR GRP SUMP/SPILL PALLETTS

Description	External dimensions cm (l x w x h)	Weight approx. kg	Order no.
① Steel frame, galvanised (max. drive-under height 96 mm) only for GRP sump/spill pallet 220/2	117 x 78 x 14	15	6889
② Screw on fixing plate for pallets (2 off with screws) only for GRP pallet sump/spill pallet 150		0.5	5112
③ Edging (4-part), galvanised for sideways insertion in the steel grating, to stop storage material such as small containers, etc. from falling off			6990
④ Loading rails, galvanised (2 off), width inside 15 cm			6878

Description		External dimensions cm (l x w x h)	Weight approx. kg Steel / GRP	Galvanised steel	GRP
				Order no.	Order no.
Grating for GRP sump/spill pallet	65	80 x 40 x 3	6 / -	7641	-
	150	118 x 78 x 3	12.5 / -	8121	-
	220/1	83 x 83 x 3	14 / 7	8176	10601
	220/2	125 x 83 x 3	18 / 11	6883	6887
	220/3	185 x 83 x 3	28 / 18	7084	7338
	220/4	125 x 125 x 4	28 / 18	6885	6941

ACCESSORIES FOR MULTIPLE INSTALLATION

Type	Description	Number required			Order no.
		220/2	220/3	220/4	
Front end	Covering strip short	1	1	-	6967
adjoining	Covering strip long	1	-	1	6968
in blocks of 4	Cover plate	1	-	1	6969
	Covering strip short	2	-	-	6967
	Covering strip long	2	-	4	6968

PE sump/spill pallets

PE SUMP/SPILL PALLETS WITH AN IDEAL PRICE/PERFORMANCE RATIO

CEMO always offers a suitable solution when it comes to collecting water-polluting substances. Environmentally compatible, proper and safe storage of hazardous materials is important for every company.

Caustic or toxic substances require special care during handling and storage. For purposes of protection and a clean environment, we have developed a range of PE sump/spill pallets which offer great functionality and high resistance against

acids and lyes thanks to the wide choice of options OR various options which ensures an ideal price/performance ratio for you.



- ✓ high chemical resistance
- ✓ great functionality



various options:
with fixing pins,
feet, skids or castors

the tray can be placed directly
on the floor or a Euro pallet

Example: suitable
for Euro pallets



PE small container and rack trays



PE sump/spill pallet 120 x 80 mm
with a collection volume of 220 L



PE filling station
with a collection volume of 450 L

Euro PE sump/spill pallet 250/2 PG 9

Euro PE sump/spill pallet 250/2 with general construction inspection certification no. Z-40.22-420

- manufactured from high quality polyethylene (HDPE)
- high chemical resistance
- collection capacity without grating 250 L, with grating 224 L

- for storing drums up to 224 L
- high functionality
- tray can be positioned directly on the floor or on a Euro-pallet
- versions with locking pins (for Euro-pallets), feet, runners or castors

Euro PE sump/spill pallet 250/2 – RG without certification no.

- manufactured from high quality recycled polyethylene
- suitable as a collection tray for materials not hazardous to water or for uses for which no certification is required

★ Accessories see page 153



With 4 feet and PE grating



Integrated recessed handles for easy lifting



With 2 runners and steel grating



With steering castors



Description / Capacity L	External dimensions cm (l x w x h)	Capacity kg	Quantity 200 L drums	Weight approx. kg	with General Construction Inspection Certification Order no.	without certification 250/2 RG Order no.
EURO PE SUMP/SPILL PALLET 250/2						
without grating	120.5 x 80.5 x 33	600	1	16	8276	8424
with galvanised steel grating	120.5 x 80.5 x 33	600	2	29	8277	8425
EURO PE SUMP/SPILL PALLET 250/2 WITH 4 FEET						
without grating	120.5 x 80.5 x 43	600	1	18	8279	8427
with galvanised steel grating	120.5 x 80.5 x 43	600	2	31	8280	8428
EURO PE SUMP/SPILL PALLET 250/2 WITH 2 RUNNERS						
without grating	120.5 x 80.5 x 43	600	1	20	8282	8430
with galvanised steel grating	120.5 x 80.5 x 43	600	2	33	8283	8431
EURO PE SUMP/SPILL PALLET 250/2 MOBILE WITH STEERING AND FIXED CASTORS*						
without grating, with steel baseframe	129 x 80.5 x 104	400	1	26	8285	8433
with galvanised steel grating	129 x 80.5 x 104	400	2	37	8286	8434

Euro PE sump/spill pallet 250/2 PG 9

Canister rack system

The rack system is designed for the Euro PE sump/spill pallet 250/2 in versions: without feet or runners (8276 + 8277), with feet (8279 + 8280) and with runners (8282 + 8283).

Loading capacity per shelf: 100 kg.



Euro PE sump (8277), canister rack system base unit (8523) and extension unit (8627)



Accessory:
locking pins



Accessory:
sump/spill pallet attachment

CANISTER RACK SYSTEM FOR EURO PE SUMP/SPILL PALLET 250/2

Description	Overall dimensions * cm (l x w x h)	Heights of shelves in cm from the ground*	Weight approx. kg	Order no.
Canister rack system base unit for Euro PE sump/spill pallet 250/2, consisting of 4 push-on support elements and one steel grating (excludes sump)	120.5 x 80.5 x 81	33 / 81	19	8523
Canister rack system attachment unit for Euro PE sump/spill pallet 250/2, consisting of 4 push-on support elements and one steel grating (excludes sump)	120.5 x 80.5 x 129	129	19	8627

ACCESSORIES

Description	Order no.
Locking pins for fixing the Euro PE sump/spill pallet 250/2 onto a Euro pallet (4 pcs. incl. fittings)	8288
Steel grating, galvanised for PE sump/spill pallet 250/2	8324
Sump/spill pallet attachment (height 20.5 cm)	8358

PE sump/spill pallet 250 HD PG 9

HD = HIGH DENSITY

PE sump/spill pallet 250 HD with general construction inspection certification Z-40.22-548

- from polyethylene
- fully recyclable
- can be used with/without perforated plate
- non-slip plate surface
- easy to maintain
- trays can be connected to form a surface protection system, see page 168
- leakage indicator is included free of charge



PE sump/spill pallet 250^{HD}, with PE perforated plate

SUMP/SPILL PALLET 250 HD

Description	Overall dimensions cm (l x w x h)	Loading capacity kg	Collection volume L	Quantity 200 L drums	Weight approx. kg	Order no.
PE sump/spill pallet 250 ^{HD}	160 x 120 x 16.5	-	250	2	10,5	10712
PE sump/spill pallet 250 ^{HD} with PE grating	160 x 120 x 18	1000	250	5	25,7	10713

PE pallet sumps and PE drum bunds

The new generation of CEMO PE pallet sumps and PE drum bunds has arrived. The polyethylene (PE) sumps and bunds are highly resistant to chemicals. Thanks to the different sizes and versions, we have a solution for almost any application.

PE pallet sumps

- Matched to the size of a Euro pallet (120 x 80 cm) or an industrial pallet (120 x 120 cm).
- You can place the transport pallet directly on the bund or use a steel or PE grating as the deck surface.



Video
PE pallet sumps and PE drum bunds

**PRICE/
PERFORMANCE
WINNER**



Pallet sump 220/2
with wooden pallet

Pallet sumps 425/4
with steel grating



Pallet sump 220/4
with PE grating

PE drum bunds

- Grating dimensions match the size of 200 L drums
- no wasted space



Drum bund 220/3



Drum bund 220/4e

PE pallet sumps PG 9

PE pallet sumps with General Construction Inspection Certification Z-40.22-574 and Z-40.22-579

- made from high-quality polyethylene (PE)
- high chemical resistance
- Sumps can be placed directly on the floor
- with integral forklift pockets
- accessible from four sides (except tray for two 120 x 80 pallets lengthwise)
- ideal for Euro pallets (120 x 80) or industrial pallets (120 x 120), and for plastic pallets of similar sizes
- loaded pallets can be placed directly on the tray using a forklift or high-platform truck
- a steel or PE grating is not required, but can be used if desired



PE pallet sumps – RG, non-certified

- made from high-quality polyethylene regranulate
- suitable as sumps for non-water-hazardous substances or where certified products are not required



Description / Type	Overall dimensions cm (l x w x h)	Loading capacity kg	Collection volume L	Quantity pallets	Quantity 200 L drums	Weight approx. kg	with General Construction Inspection Certification	PE sumps RG non-certified
							Order no.	Order no.
① PE pallet sump 220/2 for 1 pallet 120 x 80								
without grating	123 x 83 x 36	600	220	1	2	13	11257	11484
with steel grating	123 x 83 x 36	600	220	1	2	25.4	11258	11485
with PE grating	123 x 83 x 39	600	220	1	2	21.5	11259	11486
② PE pallet sump 220/4 for 1 pallet 120 x 120								
without grating	123 x 123 x 26	1200	220	1	4	13.5	11260	11487
with steel grating	123 x 123 x 26	1200	220	1	4	43.5	11261	11488
with PE grating	123 x 123 x 29	1200	220	1	4	26	11262	11489
③ PE pallet sump 400/4 for 1 pallet 120 x 120								
without grating	129 x 129 x 48	1200	400	1	4	15.5	11276	-
with steel grating	129 x 129 x 48	1200	400	1	4	45.5	11277	-
with PE grating	129 x 129 x 50	1200	400	1	4	28	11278	-
④ PE pallet sump 425/4e for 2 pallets 120 x 80 lengthwise								
without grating	242 x 88 x 36	1200	425	2	4	17.5	11263	-
with steel grating	242 x 88 x 36	1200	425	2	4	42.3	11264	-
with PE grating	242 x 88 x 39	1200	425	2	4	34.5	11265	-
⑤ PE pallet sump 425/4 for 2 pallets 120 x 80 transverse								
without grating	167 x 127 x 36	1200	425	2	4	17	11266	-
with steel grating	167 x 127 x 36	1200	425	2	4	41.8	11267	-
with PE grating	167 x 127 x 39	1200	425	2	4	34	11268	-

ACCESSORIES FOR PE PALLET SUMPS

Description/Type	Overall dimensions cm (l x w x h)	Loading capacity kg	Weight approx. kg	Order no.
Steel grating for PE pallet sump 220/2, 425/4, 425/4e	120 x 80 x 3	600	12.4	11269
Steel grating for PE pallet sump 220/4, 400/4	120 x 120 x 3	1200	30	11270
PE grating for PE pallet sump 220/2, 425/4, 425/4e	120 x 80 x 6	600	8.5	11271
PE grating 60 x 60 (4 x) for PE pallet sump 220/4, 400/4	120 x 120 x 7	4 x 300	12.5	11281

PE drum bunds PG 9

PE drum bunds with General Construction Inspection Certification Z-40.22-579

- made from high-quality polyethylene (PE)
- high chemical resistance
- bund can be placed directly on the floor
- with integral forklift pockets
- accessible from two sides
- ideally suited for drums
- only one PE grating size for all versions

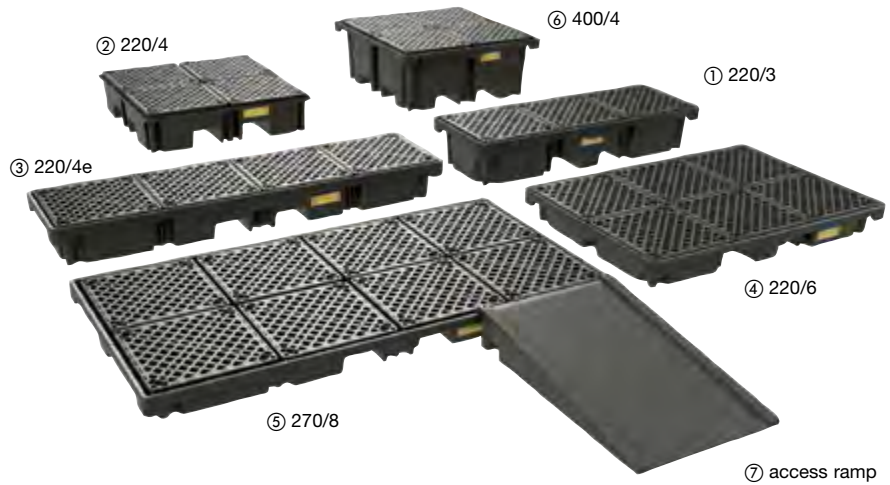

220/6



220/3



270/8

Description / Type	Overall dimensions cm (l x d x h)	Loading capacity kg	Collection volume L	Quantity PE grating	Quantity 200 L drums	Weight approx. kg	Order no.
① 220/3	186 x 66 x 33	900	215	3	3	23	11272
② 220/4	123 x 123 x 29	1200	220	4	4	26	11262
③ 220/4e	245 x 66 x 26	1200	215	4	4	24.5	11273
④ 220/6	186 x 126 x 20	1800	220	6	6	33	11274
⑤ 270/8	248 x 128 x 18	2400	270	8	8	44	11275
⑥ 400/4	129 x 129 x 50	1200	400	4	4	35.5	11278

ACCESSORIES FOR PE DRUM BUNDS

Description/Type	Overall dimensions cm (l x w x h)	Loading capacity kg	Weight approx. kg	Order no.
⑦ Access ramp for PE drum bunds 220/8	126 x 80 x 20	300	13	11282
PE grating 60 x 60	60 x 60 x 7	300	3.1	11283

Small PE container / laboratory trays HD PG 9

HD = HIGH DENSITY

Small PE container/laboratory trays with general construction inspection certification Z-40.22-548 and Z-40.22-549

- small container/laboratory trays in polyethylene
- fully recyclable
- can be used with/without perforated grating
- stackable for space-saving storage/transport
- non-slip grating surface
- low maintenance
- designed for Euro-pallets
- trays can be connected to form a surface protection system, see p. 168

PE Container/laboratory trays – RG without certification no.

- manufactured from high quality recycled polyethylene
- suitable as a collection tray for materials not hazardous to water or for when no certification is required



PE sump/spill pallet 25^{HD} with and without PE grating



PE sump/spill pallet 30^{HD} with and without PE grating



PE sump/spill pallet 60^{HD} with PE grating



PE sump/spill pallet 120^{HD} with PE grating



A significant plus in safety in the daily handling of hazardous liquids: the visual leakage indicator
If liquid has flowed unnoticed into the drip tray, then the visual leakage indicator free floats and becomes visible.

FREE
visual leakage indicator for every tray with PE grating



PE sump/spill pallet 25^{HD} with PE grating as laboratory tray

Description	Overall dimensions cm (l x d x h)	Loading capacity kg	Collection volume L	Weight approx. kg	with General Construction Inspection Certification	without certification PE-trays RG
					Order no.	Order no.
PE sump/spill pallet... 25 ^{HD}	60 x 40 x 16.5	-	25	1.8	10704	10884
... 25 ^{HD} with PE grating	60 x 40 x 18	125	25	3.7	10705	10885
... 35 ^{HD}	80 x 40 x 16.5	-	35	2.2	10706	10886
... 35 ^{HD} with PE grating	80 x 40 x 18	160	35	4.8	10707	10887
... 60 ^{HD}	80 x 60 x 16.5	-	60	3	10708	10888
... 60 ^{HD} with PE grating	80 x 60 x 18	250	60	6.8	10709	10889
... 120 ^{HD}	120 x 80 x 16.5	-	120	5.2	10710	10890
... 120 ^{HD} with PE grating	120 x 80 x 18	500	120	12.8	10711	10891
... 250 ^{HD}	160 x 120 x 16.5	-	250	10.5	10712	10892
... 250 ^{HD} with PE grating	160 x 120 x 18	1000	250	25.7	10713	10893
Accessory PE grating 60 x 40	60 x 40 x 17	125	-	1.9	10715	10894
Accessory PE grating 40 x 40	40 x 40 x 17	80	-	1.3	10716	10895

CEMO folding tray, PVCs PG 9

- available in 3 sizes, 19 L (4/4), 43 L (6/6) and 76 L (8/8)
- made of PVC with a special surface coating
- protects the environment from unexpected fluid leaks
- suitable for internal and external use
- easy to assemble, ready for use in seconds
- fibreglass rods at the sides ensure stability
- very space-saving when folded
- lightweight
- easy to use even in hard-to-reach areas



CEMO folding trays

Description	External dimensions cm (l x w x h)	Collection volume L	Weight approx. kg	Order no.
CEMO folding tray, PVC 4/4	40 x 40 x 12	19	0.6	12044
CEMO folding tray, PVC 6/6	60 x 60 x 12	43	0.75	12045
CEMO folding tray, PVC 8/8	80 x 80 x 12	76	1.2	12046

Folding tray 8/12 PG 9

This flexible, flat PVC tarpaulin can quickly and easily be turned into a resistant collection tray; it can be used as an emergency tray or as a transport and consignment container that can protect people and the environment against water-polluting liquids.

- multi-function container tray
- flexible collecting tray, extremely adaptable to different spaces
- built-in contents gauge
- space-saving when folded up
- ready for use in seconds
- impervious to liquid
- easy forklift access when empty
- resistant to oils, chemicals and technical fluids
- material: PES, surface-coated with PVC on both sides, blue



Description	External dimensions expanded cm (l x w)	External dimensions tray cm (l x w x h)	Package size cm (l x w x h)	Collection volume L	Weight approx. kg	Order no.
Folding tray 8/12 with carry bag	130 x 170	84 x 124 x 22.5	45 x 70 x 12	210	5.5	10179

Small containers and collection tray PE

PE collection tray 30-mobile PG 9



PE sump/spill pallet
40 L with frame



PE sump/spill pallet 40 L



Suitable for hazardous substance cabinet 13/20...



... drum racks 360, 540 and hazardous substances racks.

PE collection trays with general construction inspection certification no. Z-40.22-388

PE sump/spill pallet 30-mobile

- chassis galvanised with 2 steering and 2 fixed castors, dia. 100 mm, as well as a pushing handle for trouble-free maneuvering
- for carrying and storage of water-polluting substances such as cleaning agents, pesticides, used oil filters, oil-coated machine components
- PE collection tray can be removed for cleaning

PE sump/spill pallet 30-mobile



Description / Type	External dimensions cm (l x w x h)	Collection volume L	Loading capacity kg	Weight approx. kg	Order no.
PE collection tray 30	without grating	98 x 60 x 8.5	30	-	8076
	complete with steel grating	98 x 60 x 8.5	30	50	8077
PE collection tray 40	without grating	130 x 62 x 8	40	-	7871
	complete with steel grating	130 x 62 x 8	40	50	7872
PE collection tray 30-mobile	112 x 63 x 104	30	100	28	8166

ACCESSORIES FOR PE COLLECTION TRAYS AND PE COLLECTION TRAY 30-MOBILE

Description	Weight approx. kg	Order no.
Galvanised steel grating for PE collection trays 30 L	6	8167
Galvanised steel grating for PE collection trays 40 L	8	8168

★ More rack trays see page 180.

Canister filling stand PG 9

- facilitates emptying of canisters up to 60 L
- cage secures mounting of canisters
- precise measuring by swivelling of the canister
- made from highly resistant stainless steel – suitable for acids and lyes
- wall mounting possible



Canister filling stand for canisters up to 30 L

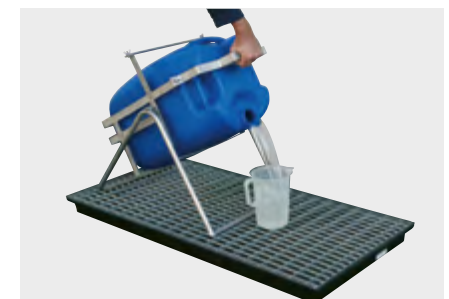

Canister filling stand for canisters up to 60 L

Description / Type	External dimensions cm (l x w x h)	max. canister dimensions cm (l x w x h)	Weight approx. kg	Order no.
Canister filling stand for canisters up to 30 L	67 x 39 x 74	31 x 29 x 48	5.4	8007
Canister filling stand for canisters up to 60 L	67 x 47 x 82	42 x 37 x 65	7.5	10100

Steel sump/spill pallets

SPILL PALLETS OFFERING EXCELLENT VALUE FOR MONEY

In the early days of the Environmental Protection Industry, spill pallets/sumps were made of steel. This material offers strength, rigidity and endurance. In the arena of professional manufacturing in a regulated industry, steel sumps emerged as a high-quality, premium sump for

hazardous materials. Before leaving the factory, every sump is tested for being leak-proof.

Companies should only implement products that conform to Water Resources Act standards, and have recognised certification.

All CEMO's steel bunds have the StawaR certification and are allowed to display the Ü mark.

IBC bunds

Designed for the storage of large containers such as KTC/IBC, ASF and ASP containers up to 1,000 litres.

Spill pallets

Our spill pallets come in various sizes and are available with or without hot-dip galvanised, removable grating (required for flammable liquids).

Forklift accessible for assembly and transport



Type SW2 galvanised without grating



Example application: Filling from a 60 litre drum. Spill pallet in combination with filling stand



Practical tip:

As a rule, CEMO generally recommends using spill pallets with galvanised grating. This provides the clear advantage of a level storage area for ease of loading and unloading. In addition, the full legally required collection volume is not reduced by drums placed directly in the spill pallet and therefore, the spill pallet will not overflow if the drums should leak.



Safety information:

When storing flammable liquids, please note that the German technical regulation TRGS 510 defines special fire protection and explosion prevention requirements applicable above a specific volume. These requirements can be met in practice by maintaining safety distances, earthing equipment and suitable storage spaces such as F90 containers and fire-resistant rooms, for example.



Surface protection system

The modular, matched elements of our surface protection system are also available in steel.



Mobile sump/spill pallet

Two steering and two fixed castors for easy manoeuvring and push handle for trouble-free positioning.



Small spill trays

For containers up to 30 litres. Highly versatile applications, such as decanting liquids on the workbench.



Spill pallet with and without grating



Painted spill pallet GS1a AB1 with filling area and filling stand



Drum rack type 540 with steel bund

Steel sump/spill pallets PG 9

Fireproof storage and safe transport
Steel bunds 3 mm thick ensure safe storage of water-hazardous and flammable substances. The product range offers many

options for a wide variety of applications for small containers, canisters and drums. Sump/spill pallets have 100 mm ground clearance.



for 60 L drums



Type SW65/2 painted without grating



Type SW65/4 painted without grating



Type SW65/2 painted with grating



Type SW65/4 painted with grating

for 200 L drums



Type SW6 painted without grating



Type SW2 galvanised without grating



Type SW1 painted without grating



Type SW2 painted with grating



Type SW3 painted with grating



Typ SW4 galvanised with grating



Type SW4e painted with grating



Type SW8 painted with grating



Type SW10 painted with grating

for mobile diesel tank systems



Type SW600/2 painted with grating (example with DT-Mobile Easy 600 L)

Steel sump/spill pallets PG 9

SUMP/SPILL PALLETES FOR 60 L DRUMS

Description / Type	External dimensions cm (l x w x h)	Collection volume L	Capacity / no. of 60 L drums on grating	Loading capacity kg	Weight approx. kg	Painted model	Galvanised model
						Order no.	Order no.
WITHOUT GRATING							
Type SW65/2 o. GR	82 x 41 x 32	65	one 60 L drum and small container	200	23	11473	11474
Type SW65/4 o. GR	80 x 80 x 23	65		400	27	11475	11476
WITH GRATING							
Type SW65/2	82 x 42 x 33	65	2 x 60 L drum	200	29,5	11477	11478
Type SW65/4	80 x 81 x 25	65	4 x 60 L drum	400	37	11479	11480

SUMP/SPILL PALLETES FOR 200 L DRUMS

Description / Type	External dimensions cm (l x w x h)	Collection volume L	Capacity / no. of 200 L drums on grating	Loading capacity kg	Weight approx. kg	Painted model	Galvanised model
						Order no.	Order no.
WITHOUT GRATING							
Type SW1 o. GR	80 x 80 x 44	200	one 200 L drum and small container	400	46	8529	8530
Type SW2 o. GR	120 x 80 x 36	220		800	50	7582	7680
Type SW3 o. GR	180 x 80 x 28	205		1200	61	10138	10139
Type SW4 o. GR	120 x 120 x 26.5	200		1600	56	7681	7682
Type SW4e o. GR	239 x 80 x 23.2	205		1600	71	7683	7684
Type SW6 o. GR	201 x 120 x 25.6	308		2400	87	10402	10403
Type SW8 o. GR	239 x 120 x 19.6	205		3200	92	7685	7686
Type SW10 o. GR	300.6 x 120 x 25.6	462		4000	125	10404	10405
WITH GRATING							
Type SW1	80 x 80.5 x 45	200	1 x 200 L drum	400	56	8531	8532
Type SW2	120 x 80.5 x 37	220	2 x 200 L drum	800	64	7583	7687
Type SW3	180 x 80.5 x 29	205	3 x 200 L drum	1200	90	10140	10141
Type SW4	120 x 120.5 x 27.5	200	4 x 200 L drum	1600	94	7688	7689
Type SW4e	239 x 80.5 x 24.2	205	4 x 200 L drum	1600	100	7690	7691
Type SW6	201 x 120.5 x 26.6	308	6 x 200 L drum	2400	122	10406	10407
Type SW8	239 x 120.5 x 20.6	205	8 x 200 L drum	3200	166	7692	7693
Type SW10	300.6 x 120.5 x 26.6	462	10 x 200 L drum	4000	175	10408	10409

SPILL PALLETES WITHOUT GROUND CLEARANCE

Description / Type	External dimensions cm (l x w x h)	Collection volume L	Loading capacity kg	Weight approx. kg	Painted model	Galvanised model
					Order no.	Order no.
WITHOUT GRATING						
Type SW2 o.F o.GR	120 x 80 x 26	220	800	47	11206	11207
Type SW4 o.F o.GR	120 x 120 x 16.5	200	1600	53	11208	11209
WITH GRATING						
Type SW2 o.F	120 x 80.5 x 27	220	800	49	11210	11211
Type SW4 o.F	120 x 120.5 x 17.5	200	1600	76	11212	11213

SPILL PALLETES FOR MOBILE TANK SYSTEMS FOR DIESEL UP TO 600 L

Description / Type	External dimensions cm (l x w x h)	Collection volume L	Loading capacity kg	Weight approx. kg	Painted model
					Order no.
WITHOUT GRATING					
Type SW 600/2 o. GR	120 x 81 x 81	640	800	96	11504
WITH GRATING					
Type SW 600/2	120 x 82 x 82	640	800	110	11505

Steel sumps / spill pallets PG 9

Mobile steel sump / spill pallets

- with hot-dip galvanised, removable gratings
- 2 steering and 2 fixed castors as well as a push handle for trouble-free steering
- collection volume 205 L
- loading height SW1-mobile 49 cm, loading height SW2-mobile 42 cm



SW1-mobile galvanised

SW2-mobile painted

MOBILE STEEL SUMP / SPILL PALLETS

Description / Type	External dimensions cm (l x w x h)	Dimensions without / with bracket cm (l x w x h)	200 L drum items	Loading capacity kg	Weight approx. kg	Order no.
SW1-mobile painted	98 x 81 x 113	80 x 80.5 x 53 /	1	300	62	7397
galvanised	98 x 81 x 113	980 x 80.5 x 106.5	1	300	62	7398
SW2-mobile painted	135 x 81 x 109	120 x 80.5 x 43.6 /	2	450	72	7399
galvanised	135 x 81 x 109	1380 x 80.5 x 106.5	1380 x 80.5 x 106.5	450	72	7400
Securing belt for safer transport, 25 mm x 4 m, one-piece						7420

Small steel collection trays PG 9

- extremely versatile use: e.g. for decanting on the workbench, placing on a pallet, etc.
- made liquid-tight from 3 mm steel
- certified according to German regulation StawaR
- for containers up to max. 30 litres



Steel spill tray Q30

Steel spill tray R30

Description / Type	External dimensions cm (l x w x h)	Collection volume L	Weight approx. kg	Order no.
Small steel collection trays Q30	46 x 43.5 x 17	30	11	11003
Small steel collection trays R30	90 x 44.5 x 9	30	16	11004
Perforated plate insert Q30	-	-	2.5	11060
Perforated plate insert R30	-	-	3.5	11061

Barrel support and drum pallet for GRP, PE and steel sump/spill pallets PG 9

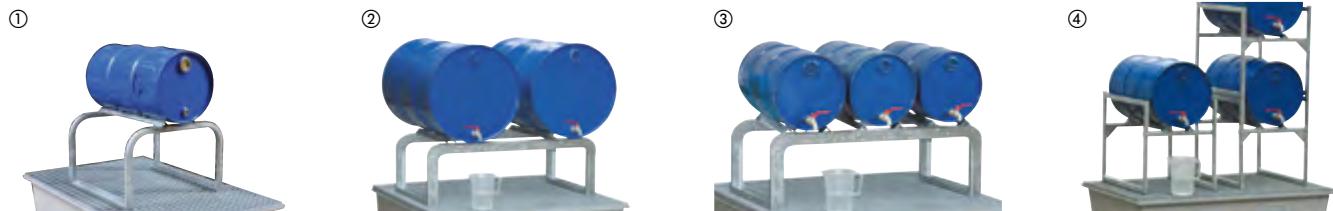

Description / Type	External dimensions cm (l x w x h)	Capacity	Weight approx. kg	Order no.
① Barrel support FB1	60 x 60 x 35	1 x 60 L or 1 x 200 L	15	7586
② Barrel support FB2	113 x 60 x 35	2 x 60 L or 2 x 200 L	21	7587
③ Barrel support FB3	120 x 60 x 40	3 x 60 L	17	7835
④ Barrel support, stackable	63 x 45 x 53	1 x 60 L	10	7741

IBC bunds steel PG 9

IBC bunds steel with design certification

- certified for the storage of water-hazardous and flammable substances
- designed for the storage of large containers such as IBC, ASF- and ASP containers up to 1000 litres
- with galvanised, removable grates
- 100 mm ground clearance for safe transport
- painted (RAL 5002, ultramarine blue) or galvanised



IBC bund GS2a galvanised with filling area



IBC bund GS1a painted with grating and filling area



IBC bund GS2 AB1 painted with filling area



IBC bund GS1a AB1 painted with filling stand and filling area

Description	External dimensions cm (l x w x h)	Collection volume L	Cont. à 1000 L item	Loading capacity kg	Weight approx. kg	Painted	Galvanised
						Order no.	Order no.
GS1	135 x 125.5 x 74.5	1000	1	2000	170	7392	7393
GS1a with filling area	160 x 125.5 x 65	1000	1	2000	179	10613	10614
GS1 AB1 with 1 filling stand	135 x 125 x 109.5	1000	1	2000	182	10849	10850
GS1a AB1 with 1 filling stand	160 x 125 x 100	1000	1	2000	191	10851	10852
GS2	268 x 125.5 x 44.5	1000	2	4000	238	7394	7395
GS2a with filling area	268 x 160.5 x 38.5	1000	2	4000	273	10615	10616
GS2 AB1 with 1 filling stand	268 x 125.5 x 79.5	1000	2	4000	247	10853	10854
GS2a AB1 with 1 filling stand and filling area	268 x 160.5 x 73.5	1000	2	4000	282	10855	10856
GS2 AB2 with 2 filling stands	268 x 125 x 79.5	1000	2	4000	256	10857	10858
GS2a AB2 with 2 filling stands and filling area	268 x 160 x 73.5	1000	2	4000	291	10859	10860

ACCESSORY FOR IBC STEEL BUNDS

Description	External dimensions cm (l x w x h)	Collection volume L	Cont. à 1000 L item	Loading capacity kg	Weight approx. kg	Order no.
Filling stand GS ZB galvanised	133 x 122 x 40	-	1	2000	49	7396

IBC bunds PE PG 9

IBC collecting trays in PE with National Technical Certification Z-40.22-564

- made from high-quality polyethylene
- high chemical resistance
- capacity 1,100 litre
- rugged PE support crossbar for high load-bearing capacity
- forkliftable with a forklift or manual lift truck (transport only when empty)
- can be stacked inside each other for transport



Video
IBC bunds made of PE



IBC bund 1100/1-PE with supporting crossbar and filling attachment



With the IBC extension bund 500/1-PE, the IBC bund 1100/2-PE can be extended on both sides.

The overflow function is patent-protected.



IBC extension bunds PG 9

NEW



IBC extension bund 500/1-PE with supporting crossbar



IBC extension bund 500/1-PE with steel grating



IBC extension bund 500/1-PE with PE perforated plate



IBC bund 1100/2-PE with galvanised steel grating



IBC bund 1100/1-PE with supporting crossbar



IBC bund 1100/1-PE with PE perforated plate



IBC bund 1100/1-PE with filling attachment and galvanised steel grating



Nestable for transport

IBC EXTENSION BUND

Description / Type	External dimensions cm (l x w x h)	Collection volume L	No. of 1000 L IBCs	Loading capacity kg	Weight approx. kg	Order no.
1100/1-PE	146 x 117 x 85	1100	1	1500	43	10938
1100/1-PE with galvanised steel grating	146 x 117 x 87	1100	1	1500	63	10947
1100/1-PE with PE perforated plate	146 x 117 x 88	1100	1	1500	53	10950
1100/1-PE with filling attachment	162 x 117 x 85	1100	1	1500	45	10939
1100/1-PE with filling attachment with galvanised steel grating	162 x 117 x 87	1100	1	1500	65	10948
1100/1-PE with filling attachment and PE perforated plate	162 x 117 x 88	1100	1	1500	55	10951
1100/2-PE	223 x 146 x 44	1100	2	3000	47	10940
1100/1-PE with galvanised steel grating	223 x 146 x 46	1100	2	3000	87	10949
1100/2-PE with PE perforated plate	223 x 146 x 47	1100	2	3000	67	10952
Extension bund 500/1-PE	146 x 124 x 48	500*	NEW 1	1500	34,5	11863
Extension bund 500/1-PE with galvanised steel grating	146 x 124 x 48	500*	NEW 1	1500	56	11864
Extension bund 500/1-PE with PE perforated plate	146 x 124 x 48	500*	NEW 1	1500	43	11865

PE ground protection systems HD with grating PE PG 9

PE ground protection systems with general construction inspection certification Z-40.22-548 and Z-40.22-549

- can be used as storage/filling station
- elements can be combined to cover a complete storage area
- connection components (accessories) permit the lining of surfaces of any size that are suitable as storage and transfilling stations

- can be combined in any way with the PE collection trays on page 157 of this catalogue
- rugged, removable PE grating
- sturdy PE access ramp with an integrated fixing bolt for connection to the PE grating, slight incline for easy loading of the floor elements
- PE grating and access ramp are non-slip
- with visual leak detector

PE ground protection systems – RG without certification

- manufactured from high quality recycled polyethylene
- suitable as a collection tray for materials not hazardous to water or when no certification is required



① Accessory access ramp



PE sump 120^{HD}
with PE grating



Can be combined in any way with the PE collection trays^{HD} on page 157



PE sump 250^{HD}
with PE grating

Description / Type	Overall dimensions cm (l x w x h)	Collection volume L	Ultimate load* kg	Weight approx. kg	with General Construction Inspection Certification	without certification PE-Systems ^{HD} RG
					Order no.	Order no.
PE sump 120 ^{HD} with PE grating	120 x 80 x 18	120	500	12.8	10711	10891
PE sump 250 ^{HD} with PE grating	160 x 120 x 18	250	1000	25.7	10713	10893

* with an evenly distributed load

ACCESSORIES FOR PE GROUND PROTECTION SYSTEMS^{HD}

Description	Overall dimensions cm (l x w x h)	Order no.
① Access ramp, load capacity 300 kg, weight approx 13 kg	126 x 80 x 20	10714
② Connecting rail, short	114 x 1.5 x 1.5	10721
③ Connecting rail, long	154 x 1.5 x 1.5	10722
Cross connector	11.5 x 11.5 x 3.5	10723

PE ground protection systems HD with galvanised grating PG 9

**PE ground protection system
with general building certification
Z-40.22-548 and Z-40.22-549**

- implemented as storage and filling station
- components can be combined into a floor-covering storage system
- robust, removable, galvanised steel grating with feet
- optional connecting rails make it possible to cover large surfaces that are suitable as storage and filling stations
- sturdy PE ramps with integrated locating bolts for docking on the grating, with a gentle slope for easy loading on the work floor
- perforated plate and access ramp are non-slip



① Accessory access ramp

Description / Type	Overall dimensions cm (l x w x h)	Collection volume L	Ultimate load kg	Wheel load kg	Weight approx. kg	Order no.
PE spill pallet 60 ^{HD} with galvanised steel grating	80 x 60 x 18	60	1000	150	16	11135
PE Spill pallet 120 ^{HD} with galvanised steel grating	120 x 80 x 18	120	1000	150	31	11136
PE Spill pallet 250 ^{HD} with galvanised steel grating	160 x 120 x 18	250	1000	150	63	11137

ACCESSORIES FOR PE GROUND PROTECTION SYSTEMS^{HD}

Description	Overall dimensions cm (l x w x h)	Order no.
① Access ramp, load capacity 300 kg, weight approx 13 kg	126 x 80 x 20	10714
② Connecting rail, short	114 x 1.5 x 1.5	11138
③ Connecting rail, long	154 x 1.5 x 1.5	11139

PE ground protection system 270/8 with PE grating PG 9

PE ground protection system with general building certification Z-40.22-579

- can be used as a storage/filling station
- elements can be connected to form a comprehensive storage system

- rugged, removable PE grating
- connection components (accessories) permit the lining of surfaces of any size that are suitable as storage and transfilling stations

- sturdy PE drive-on ramp with integrated angle bracket for docking onto the PE sump, low gradient for easy loading of the floor elements
- PE grating and access ramp are non-slip

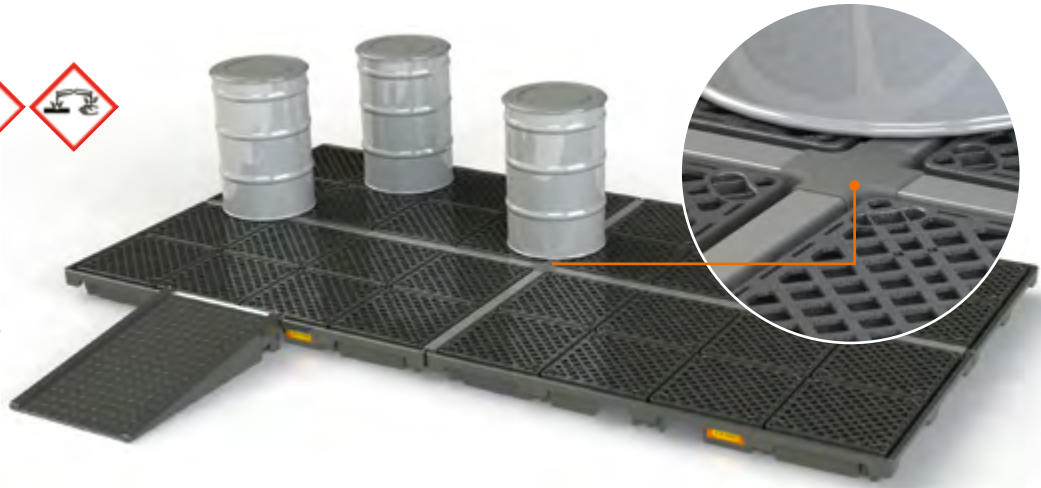

PE ground protection systems 270/8
Example consisting of
4x PE spill tray 270/8,
1x access ramp ①,
2x connecting rail, short ②,
2x connecting rail, long ③ and
1x cross connector ④





270/8

Description / Type	Overall dimensions cm (l x w x h)	Collection volume L	Ultimate load* kg	Weight approx. kg	with general building certification Order no.
PE ground protection systems 270/8 with PE grating	248 x 128 x 18	270	2400	44	11275

* with an evenly distributed load

ACCESSORIES FOR PE GROUND PROTECTION SYSTEMS 270/8

Description	Overall dimensions cm (l x w x h)	Order no.
① Access ramp for PE drum bunds 220/8	126 x 80 x 20	11282
②  ③ 	② Connecting rail, short for front connection ③ Connecting rail, long for longitudinal connection	11641 11642
④ 	Cross connector	11643

Ground protection systems made of steel PG 9

Safety when handling water hazardous and flammable substances.

Modular matching elements allow the lining of large surfaces, which are suitable as storage and transfer stations.

- suitable for storage of water-polluting and flammable substances
- modular, matched elements
- with galvanised, removable grating
- available painted (RAL 5002, ultramarine blue) or galvanised

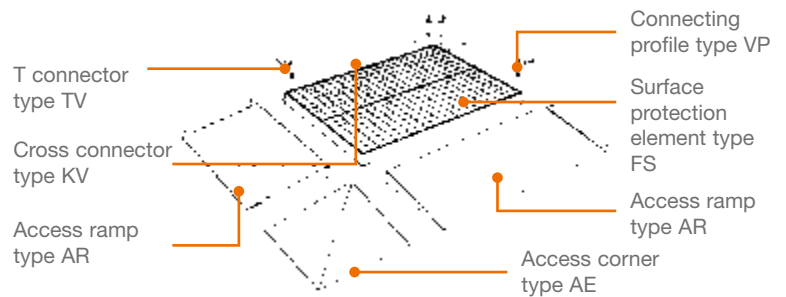

SYSTEM ELEMENTS

Description / Type		External dimensions cm (l x w)	Height cm	Collection volume L	Loading capacity kg/m ²	Wheel load kg	Weight approx. kg	Order no.
Ground protection	FS 55/13/13 galvanised	130 x 130	5.5	49	5000	450	106	11441
	FS 55/13/18 galvanised	130 x 180	5.5	69	5000	450	136	11442
	FS 55/13/28 galvanised	130 x 280	5.5	108	5000	450	223	11443
	FS 55/18/18 galvanised	180 x 180	5.5	96	5000	450	201	11444
	FS 108/13/13 galvanised	130 x 130	11	105	5000	450	112	11445
	FS 108/13/18 galvanised	130 x 180	11	146	5000	450	153	11446
	FS 108/13/28 galvanised	130 x 280	11	228	5000	450	233	11447
	FS 108/18/18 galvanised	180 x 180	11	220	5000	450	209	11448
Access ramps	AR13 galvanised	126 x 72	5.5				30	7407
	AR18 galvanised	176 x 72	5.5				42	7408
	AR28 galvanised	276 x 72	5.5				63	10619
	AE galvanised	72 x 72	5.5				21	7410
	AR13 galvanised	126 x 72	11				34	7411
	AR18 galvanised	176 x 72	11				46	7412
	AR28 galvanised	276 x 72	11				70	10620
	AE galvanised	72 x 72	11				23	7414

Manufactured to order. Delivery approx. 3-4 weeks.

FASTENING ELEMENTS

Description / Type		External dimensions mm (b x l)	Weight approx. kg	Order no.
VP13	galvanised	38 x 1280	2	7415
VP18	galvanised	38 x 1780	3	7416
VP28	galvanised	38 x 2780	5	10621
KV	galvanised	200 x 200	1	7418
TV	galvanised	200 x 100	1	7419

Manufactured to order. Delivery approx. 3-4 weeks.

Drum racks

Sump/spill pallets with general construction inspection certification no. Z-40.12-227 granted by DIBt-Berlin.

Drum racks for approved and spacesaving storage of barrels and other containers. All drum racks are completely hot-dip galvanised and have a corrosion free GRP

sump/spill pallet for long-term safe use. Due to their absolute corrosion resistance, GRP sump/spill pallets can be placed directly on the ground. The low installation height facilitates handling in the factory/ workshop. The different rack models permit filling over the projecting sump/spill pallet for a wide range

of barrels and containers. The rack ensures optimum matching to the actual operating conditions. Delivered in space-saving individual parts, easily and quickly assembled.



- ✓ quick and easy assembly
- ✓ universally applicable e.g. waste oil, lyes and acids
- ✓ corrosion-resistant
- ✓ heavy duty shelves
- ✓ minimum inspection requirements, no additional inspection of sump/spill pallet base (compare steel sump/spill pallets)



Example:
Drum rack type 540 has three grating shelves and six clip-in individual drum supports, which can be clipped in different positions in two shelves.

ACCESSORIES



Sump/spill pallet supports for secure standing on uneven ground and to make the drum rack forkliftable

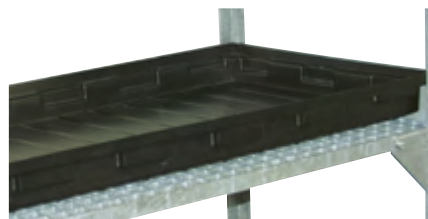

Accessory PE collection tray 40 L



Can holder for easy filling of small containers



Ball valve for quick and simple discharge



Rotating roller support for simple movement of drums



Drum supports for tilting drum for optimum emptying of 60 L drums

Drum racks type 120 PG 9

2 shelves for up to two 60 L barrels
or
2 shelves for small containers
or
1 shelf for one 60 L barrel and 1 shelf for small containers

GRP sump/spill pallet with 65 L collection volume

Model 3
Drum rack Type 120 with GRP sump/spill pallet

GRIP product PREMIUM







★ Accessories see page 177

drum supports

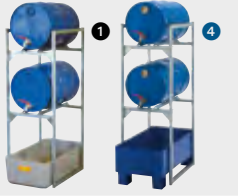
Application example: with steel grating for GRP sump/spill pallet as 3rd shelf

Application example: with stackable barrel support as an extra shelf for a 60 L drum

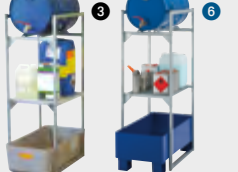
DRUM RACK TYPE 120 FOR SMALL CONTAINERS AND 60 L BARRELS

Description	Overall dimensions cm (l x w x h)	Heights of shelves in cm from ground	Weight approx. kg	Order no.
TYPE 1 SUMP/SPILL PALLET 65 L				
 Model 1 with GRP sump/spill pallet ① with drum supports for 2 x 60 L barrels	45 x 82 x 131	63 / 115	18	7081
 Model 1 with steel sump/spill pallet ④ with drum supports for 2 x 60 L barrels	45 x 82 x 131	63 / 115	37	11481
 Model 2 with GRP sump/spill pallet ② with grating support for small containers	45 x 82 x 131	60 / 112	21	7639
 Model 2 with steel sump/spill pallet ⑤ with grating support for small containers	45 x 82 x 131	60 / 112	40	11482
 Model 3 with GRP sump/spill pallet ③ with drum and grating support for 1 x 60 L barrel and small containers	45 x 82 x 131	60 / 112	19	7640
 Model 3 with steel sump/spill pallet ⑥ with drum and grating support for 1 x 60 L barrel and small containers	45 x 82 x 131	60 / 112	38	11483

Drum racks type 360 and type 540 PG 9



Drum rack type 360 with GRP sump/spill pallet
Application example: with can holder and steel grating as 3rd shelf



Drum rack type 540 with GRP sump/spill pallet
Application example: with can holder and steel grating as 4th shelf



Drum rack type 540 with steel sump/spill pallet*



DRUM RACKS TYPE 360 AND TYPE 540

Description	Overall dimensions cm (l x w x h)	Heights of shelves in cm from ground	Weight approx. kg	Order no.
DRUM RACK TYPE 360 FOR SMALL CONTAINERS AND UP TO 6 x 60 L BARRELS				
Drum rack type 360 with GRP sump/spill pallet 150 L (5113) with drum supports for 6 x 60 L barrels and/or small containers	132 x 80 x 130	69 / 117	60	7642
Drum rack type 360 with steel sump/spill pallet SW 2 (7583) with drum supports for 6 x 60 L barrels and/or small containers	132 x 80 x 130	36 / 69 / 117	115	10253
DRUM RACK TYPE 540 FOR SMALL CONTAINERS AND UP TO 12 x 60 L BARRELS				
Drum rack type 540 with GRP sump/spill pallet 150 L (5113) with drum supports for 6 x 60 L barrels and small containers	132 x 80 x 200	69 / 117 / 165	82	7734
Expansion unit for type 540 with GRP sump/spill pallet 150 L (5113) with drum supports for 6 x 60 L barrels and small containers	132 x 80 x 200	69 / 117 / 165	72	7855
Drum rack type 540 with steel sump/spill pallet SW 2 (7583) with drum supports for 6 x 60 L barrels and small containers	132 x 80 x 200	36 / 69 / 117 / 165	137	10254
Expansion unit for type 540 with steel sump/spill pallet SW 2 (7583) with drum supports for 6 x 60 L barrels and small containers	132 x 80 x 200	36 / 69 / 117 / 165	127	10255

* certified under StawaR



Combination of drum rack type 540 and expansion unit type 540



Combination of drum rack type 540 and hazardous substance rack 13/20 (see p. 182)

★ Accessories see page 177

Drum racks type 400 PG 9

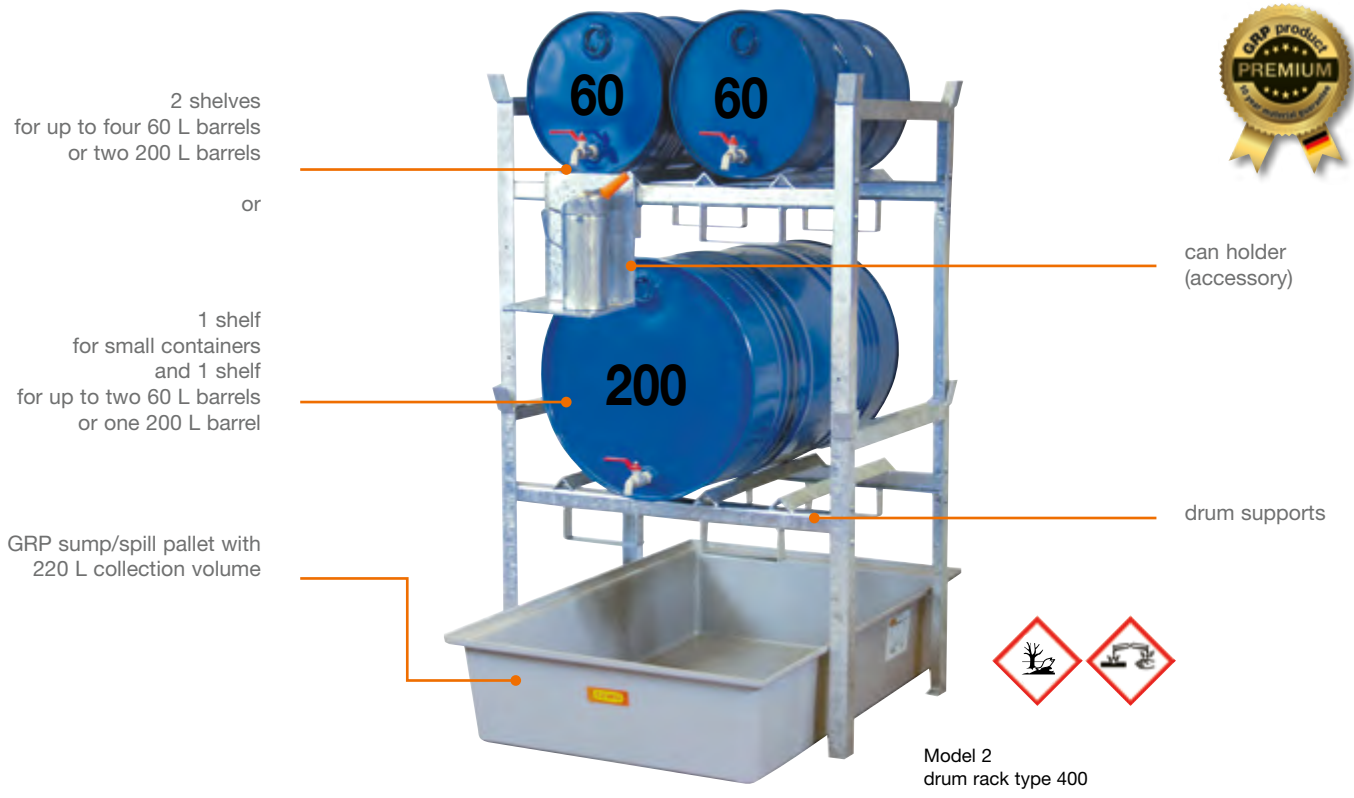

DRUM RACK TYPE 400 FOR SMALL CONTAINERS AND UP TO 4 x 60 L BARRELS

Description	Overall dimensions cm (l x w x h)	Heights of shelves in cm from ground	Weight approx. kg	Order no.	
TYPE 400 WITH GRP SUMP/SPILL PALLET 220 L (6882) 	Model 1 with barrel support for 2 x 60 L barrels or 1 x 200 L barrel	99 x 128 x 84	62	41	7663
	Model 2 with barrel support for 4 x 60 L barrels or 2 x 200 L barrels or 2 x 60 L drums and 1 x 200 L drum	99 x 128 x 162	62 / 140	70	7664
	Model 3 with barrel support for 2 x 60 L barrels or 1 x 200 L barrel and grating support for small containers	99 x 128 x 162	62 / 139	82	7665

★ Accessories see page 177

Drum rack type 800 PG 9

2 shelves
for up to six 60 L barrels
or four 200 L barrels

or

1 shelf for small
containers and
1 shelf
for barrels

or

1 shelf
for barrels

GRP sump/spill
pallet with 220 L
containment capacity



Model 3
Drum rack type 800

★ Accessories see
page 177

drum supports













can holder
(accessory)



DRUM RACK TYPE 800 FOR SMALL CONTAINERS AND UP TO 4 x 200 L BARRELS

Description	Overall dimensions cm (l x w x h)	Heights of shelves in cm from ground	Weight approx. kg	Order no.
TYPE 800 WITH GRP SUMP/SPILL PALLET 220 L (6884)				
Model 1 with barrel supports for 2 x 200 L barrels	141 x 128 x 84	62	51	7670
Model 2 with barrel supports for 4 x 200 L barrels	141 x 128 x 162	62 / 140	84	7671
Model 3 with barrel supports for 2 x 200 L barrels and 3 x 60 L barrels	141 x 128 x 162	62 / 140	87	7672
Model 4 for 2 x 200 L barrels and grating support for small containers	141 x 128 x 162	62 / 139	116	7673
Model 5 with drum supports for 3 x 60 L barrels	141 x 128 x 84	62	54	7674
Model 6 with drum supports for 6 x 60 L barrels	141 x 128 x 162	62 / 140	90	7675

Accessories for drum racks type 120 to type 800 PG 9

	for type	Description	Overall dimensions cm (l x d x h)	Heights of shelves in cm from ground	Weight approx. kg	Order no.
	400	Sump/spill pallet support (pair), sump/spill pallet forkliftable		15	7	7668
	800	Sump/spill pallet support (pair), sump/spill pallet forkliftable		15	10	7679
	400	Shelf for 1 x 200 L or 2 x 60 L drums	99 x 66 x 84	62	28	8326
	800	Shelf for 2 x 200 L drums	141 x 66 x 84	62	33	8328
	800	Shelf for 3 x 60 L drums	141 x 66 x 84	62	36	8329
	120	Steel grating for sump/spill pallet as 3 rd shelf	42 x 80 x 3	24	6	7641
	360 540	Steel grating as 3 rd (for type 360) or 4 th shelf (for type 540)	130 x 62 x 3	21	18	6817
	360 540	Steel tray 20 L as 3 rd (for type 360) or 4 th shelf (for type 540)	130 x 62 x 5	21	19	7799
	360 540	PE collection tray 40 L as insert tray (acid-/alkali resistant, see page 159)	130 x 62 x 8	22	5	7871
	120	Stackable drum support, for an extra shelf for a 60 L drum	63 x 45 x 53	167	10	7741
	400	Grating level for small containers	99 x 125 x 84	62	40	8327
	360 540	Drum supports 3 pcs. per shelf			1	7800
	360 540	Drum supports "raising" 3 pieces for one shelf for optimum emptying of the 60 L drums			1	8254
	400 800	Rotating roller support for 200 L barrel (pair)		66	6	7669
	360 400 540 800	Edge border (4-part), galvanised for sideways insertion in the steel grating for securing storage material such as small containers, etc. from falling off				6990
	120 360 540	Can holder, galvanised, bearing surface 23 x 11 cm (w x d)			2	5917
	400 800	Can holder, galvanised, bearing surface 18.5 x 11 cm (w x d)			2	7727
	all	Discharge ball valve 1/2", nickel plated brass, angled 90° [PG 8]			1	3775
	all	Discharge ball valve 3/4", nickel plated brass, angled 90° [PG 8]			1	3776

HazMat pallet racks with PE sumps PG 9

HazMat pallet racks

These racks are ideal for storing drums on Euro pallets or chemical pallets and for IBC storage. They comply with the legal requirements for the storage of water-hazardous substances.

PE collection trays with General Construction Inspection Certification Z-40.22-579

- several storage versions can be combined
- expandable
- simple plug-together assembly system
- suitable for storage of water-hazardous substances
- two shelves

HazMat pallet rack consisting of:

- 2 support frames
- 2 pairs of cross members
- 2 push-through prevention rails incl. bracket
- 1 PE rack floor tray

Add-on rack consisting of:

- 1 support frame
- 2 pairs of longitudinal members
- 2 push-through prevention rails incl. bracket
- 1 PE rack floor sump



HazMat pallet racks 18/405 and 27/1100, including optional PE suspended rack sumps 18/230 and 27/230, see page 179

HAZMAT PALLET RACKS AS A SET WITH PE RACK FLOOR TRAY

Description	Overall dimensions cm (l x w x h)	Shelf dimensions cm (w x d)	Shelf load kg	For number of pallets	Weight approx. kg	Collection volume L	Order no.
HazMat pallet rack 18/405 for drum storage	207 x 110 x 300	190 x 110	3850	2	132	405	11462
Add-on rack for HazMat pallet rack 18/405	199 x 110 x 300	190 x 110	3850	2	98	405	11463
HazMat pallet rack 22/520 for drum storage	247 x 110 x 300	230 x 110	3000	2	145	520	11464
Add-on rack for HazMat pallet rack 22/520	239 x 110 x 300	230 x 110	3000	2	111	520	11465
HazMat pallet rack 27/1100 for drum or IBC storage	287 x 110 x 300	270 x 110	3070	3	166	1100	11466
Add-on rack for HazMat pallet rack 27/1100	279 x 110 x 300	270 x 110	3070	3	132	1100	11467

ACCESSORIES HAZMAT PALLET RACK

Description	Order no.
 Rack collision guard	8202

HazMat pallet racks with PE sump PG 9

PE rack floor trays with General Construction Inspection Certification Z-40.22-579

- for retrofitting to convert existing rack systems into HazMat pallet racks
- made of high-quality polyethylene (PE)
- high chemical resistance
- sump can be placed directly on the floor
- with integral forklift pockets for loading the racks with pallets or IBCs



PE RACK FLOOR SUMPS

Description	Overall dimensions cm (l x d x h)	For number of pallets	Weight approx. kg	Collection volume L	Order no.
PE rack floor sump 18/405 for shelf dimensions 180 x 110 cm	178 x 132 x 28	2	18.2	405	11468
PE rack floor sump 22/520 for shelf dimensions 220 x 110 cm	218 x 132 x 28	2	22.5	520	11469
PE rack floor sump 27/1100 for shelf dimensions 270 x 110 cm	268 x 132 x 42	3	34	1100	11470

PE suspended rack sumps with General Construction Inspection Certification Z-40.22-579

- for retrofitting to convert existing rack systems into HazMat pallet racks
- made of high-quality polyethylene (PE)
- high chemical resistance
- the PE suspended rack sumps rest on the rack cross members and are held securely in place
- ideal for Euro pallets (120 x 80)
- loaded pallets can be placed directly on the sump
- a steel or PE grating is not required, but can be used if desired



PE suspended rack sump 18/230 for shelf dimensions 180 x 110 cm



PE suspended rack sump 27/230 for shelf dimensions 270 x 110 cm



PE SUSPENDED RACK SUMPS

Description	Overall dimensions cm (l x d x h)	Internal depth cm	Shelf load in kg	For number of pallets	Weight approx. kg	Collection volume L	Order no.
PE suspended rack sump 18/230 for shelf dimensions 180 x 110 cm	178 x 130 x 23	95	2 x 600	2	20	230	11471
PE suspended rack sump 27/230 for shelf dimensions 270 x 110 cm	262 x 130 x 16.5	95	3 x 600	3	27.5	230	11472

ACCESSORIES FOR PE SUSPENDED RACK TRAY

Description	Overall dimensions cm (l x d x h)	Loading capacity kg	Weight approx. kg	Order no.
Steel grating for PE suspended rack sump*	120 x 80 x 3	600	12.4	11269
PE grating for PE suspended rack sump*	120 x 80 x 6	600	8.5	11271

*two required for PE suspended rack tray 18/230 and three for suspended rack sump 27/230

PE shelf bunds for small containers PG 9

NEW

For the safe and proper storage of water and environmentally hazardous materials as per TRGS 510 in small containers and on shelves.

- with general construction inspection approval no. Z-40.22-601
- with/without PE grating
- manufactured from high-density polyethylene
- including visual leak indicator
- high resistance to acids and alkalis
- also for the separate installation of small containers
- multiple bunds enable single-type storage of the media
- the biggest variety of these bunds on the market – for 3 shelf depths and 2 lengths
- can also be retrofitted on shelves from other manufacturers
- for canisters of between 20 and 40 litres, depending on the size

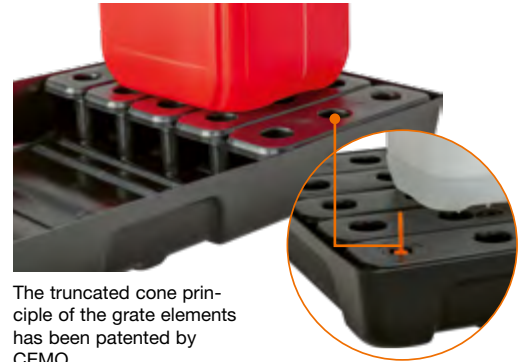

The truncated cone principle of the grate elements has been patented by CEMO.

The visual leak indicator allows leaks to be spotted quickly.



PE small container shelf bund 10/5 with PE grating



PE small container shelf bund 10/4



PE small container shelf bund 10/4, 10/5 and 10/6 with PE grating, stacked



PE small container shelf bund 13/4, 13/5 and 13/6 with PE grating, stacked



The bunds have been specially developed for small containers on shelving racks in 3 different depths – also ideal for retrofitting on shelves from other manufacturers.

PE SHELF BUNDS FOR SMALL CONTAINERS

Description / Type	for shelf depth cm	for shelf width cm	Dimensions bund			Collection volume L	Weight approx. kg	Order no.
			width	depth	height			
Shelf bunds for small containers 10/4	40	100	97.6	39.5	9.5	21	1.8	11729
Shelf bunds for small containers 10/4 with PE grating	40	100	97.6	39.5	9.5	21	3.9	11730
Shelf bunds for small containers 13/4	40	130	129.5	39.5	9.5	28	2.35	11735
Shelf bunds for small containers 13/4 with PE grating	40	130	129.5	39.5	9.5	28	5.15	11736
Shelf bunds for small containers 10/5	50	100	97.6	49.5	9.5	27	2.2	11731
Shelf bunds for small containers 10/5 with PE grating	50	100	97.6	49.5	9.5	27	4.7	11732
Shelf bunds for small containers 13/5	50	130	129.5	49.5	9.5	36	2.8	11737
Shelf bunds for small containers 13/5 with PE grating	50	130	129.5	49.5	9.5	36	6.14	11738
Shelf bunds for small containers 10/6	60	100	97.6	59.5	9.5	33	2.5	11733
Shelf bunds for small containers 10/6 with PE grating	60	100	97.6	59.5	9.5	33	5.68	11734
Shelf bunds for small containers 13/6	60	130	129.5	59.5	9.5	44	3.25	11739
Shelf bunds for small containers 13/6 with PE grating	60	130	129.5	59.5	9.5	44	7.49	11740

ACCESSORIES (FOR QUANTITY NEEDED, SEE GRAPHIC)

	Dimensions PE grating					
	width	depth	height	Collection volume L	Weight approx. kg	Order no.
PE grating 40 x 32 (1 piece) for bunds with a depth of 40 cm	40	32	9.5	-	0.7	11741
PE grating 50 x 32 (1 piece) for bunds with a depth of 50 cm	50	32	9.5	-	0.84	11742
PE grating 60 x 32 (1 piece) for bunds with a depth of 60 cm	60	32	9.5	-	1.06	11743

Shelf width 100 PE grating 3x Shelf width 130 PE grating 4x

Environmental/HazMat racks with PE bund PG 9

HazMat rack 10/5-PE and 13/5-PE with general construction inspection certification no Z-40.22-601

For storage of water-polluting substances in small containers up to 27 or 36 L capacity. The tray is completely galvanised and can be assembled without screws or tools. It has four shelf floors which can be

positioned in mounting points that have 25 mm spacing and four 27 or 36 L PE bunds.

Each level can support up to 200 kg.



Environmental/HazMat rack 13/5 with expansion rack 10/5 PE (For PE grating accessories, see page 180)

HAZMAT RACK 10/5-PE AND 13/5-PE

Description	External dimensions cm (l x w x h)	Usable floor area cm (l x w)	Features	Collection volume L	Base unit	Expansion rack
					Order no.	Order no.
① HazMat rack 10/5 PE with PE bund	106 x 53.5 x 200	100 x 50	4x PE bund	4 x 27	11943	11944
② HazMat rack 13/5 PE with PE bund	136 x 53.5 x 200	130 x 50	4x PE bund	4 x 36	11945	11946

Environmental / HazMat racks PG 9

Environmental/HazMat rack 10/20 with general construction inspection certification no. Z-40.22-388

For storage of water-polluting substances in small containers up to 30 L capacity. The tray is completely galvanised and can be assembled without screws or tools. It has 5 shelf floors which can be positioned in mounting points that have 25 mm spacing and two 30 L, PE collection trays. Each level can support up to 200 kg.

Environmental/HazMat rack 13/20

For storage of water-polluting substances in small containers up to 20 L capacity. It is completely hot-dip galvanised and equipped with a 20 L leak-tight spill tray base welded in accordance with StawaR (German guidelines for the requirements of steel container trays of capacity up to 1000 L) lowest shelf.





Environmental/HazMat rack 10/20 with expansion rack (PE sump/spill pallet, accessory)

ENVIRONMENTAL/HAZMAT RACK 10/20 FOR SMALL CONTAINERS

Description	Overall dimensions cm (l x w x h)	Weight approx. kg	Order no.
 <p>Environmental/HazMat rack 10/20 for small containers</p>	106 x 63 x 200	44	8091
 <p>Expansion rack for environmental/HazMat rack 10/20</p>	101 x 63 x 200	34	8092

ENVIRONMENTAL/HAZMAT RACK 13/20 FOR SMALL CONTAINERS

Description	Overall dimensions cm (l x w x h)	Heights of shelves in cm from ground	Weight approx. kg	Order no.
 <p>Environmental/HazMat rack 13/20 for small containers</p>	132 x 63 x 200	16/69/117/165	92	7820
 <p>Expansion rack for Environmental/HazMat rack 13/20</p>	132 x 63 x 200	16/69/117/165	82	7856

ACCESSORIES ENVIRONMENTAL/HAZMAT RACK 10/20 AND 13/20

for type	Description	Overall dimensions cm (l x w x h)	Weight approx. kg	Order no.
10/20	PE collection tray 30 L as insert tray (acid-/alkali resistant)*	98 x 60 x 8.5	4	8076
13/20	PE collection tray 40 L as insert tray (acid-/alkali resistant)*	130 x 62 x 8	5	7871
10/20	Additional shelf floor for environmental/HazMat rack 10/20	100 x 60 x 4	4	8093

* see page 159

Environmental/HazMat racks PG 9

Space-saving storage for substances in all water-pollution classes

- galvanised steel for racks, sumps and gratings
- accessible from both sides
- 200 kg weight limit per shelf
- 1600 kg floor wait limit per rack system
- height-adjustable shelves with grids of 25 mm

- additional wall fixing according to application (not essential)
- expandable storage capacity by increasing the base unit with expansion units
- quick plug-assembly of supplied components



Version with spill tray base:

- 4 shelves with spill tray base
- separated storage of different substances per shelf
- spill tray per shelf
- all shelves can have the full containment volume by using the removable grating (see accessories)



Environmental/HazMat rack 10/5 (base unit) and 13/5 (as expansion unit) with removable grating (see accessories)

Version with grating shelves:

- 4 shelves with grating
- 3 shelves with grating
- bottom shelf with spill tray
- bottom shelf can have the full containment volume by using a removable grating (see accessories)



Environmental/HazMat rack 13/5 (base unit) and 10/5 (expansion unit) with removable grating (see accessories)

ENVIRONMENTAL/HAZMAT RACK 10/5 AND 13/5

Description	External dimensions cm (l x w x h)	Usable floor area cm (l x w)	Features	Collection volume L	Base unit	Expansion unit
					Order no.	Order no.
10/5 with spill tray bases	106 x 53.5 x 200	100 x 50	4 x shelf tray, galvanised	4 x 25	11181	11182
13/5 with spill tray bases	136 x 53.5 x 200	130 x 50	4 x shelf tray, galvanised	4 x 33	11183	11184
10/5 with grating levels	106 x 53.5 x 200	100 x 50	1 x shelf tray, 3 x grating, galvanised	1 x 25	11185	11186
13/5 with grating levels	136 x 53.5 x 200	130 x 50	1 x shelf tray, 3 x grating, galvanised	1 x 33	11187	11188



Note: An expansion unit is supplied without a frame on one side and can only be used in conjunction with the base field.

ACCESSORIES FOR ENVIRONMENTAL/HAZMAT RACK 10/5 AND 13/5

Description	for type 10/5	for type 13/5
	Order no.	Order no.
Additional shelf spill tray	11189	11190
Additional grating as storage shelf	11191	11192
Reinforcing cross members (two) for shelf floor tray and grating as shelf	11365	11363
Removable grating for shelf tray	11193	11194
Wall fixing	11195	11195

Workshop trolley PG 9

Robust mobile workshop trolley for use in working and storage areas. Also ideal as a station for dispensing liquids and safely providing hazardous substances. Three versions are available.

- 3 mm thick steel spill trays tested according to German regulation StawaR
- available with lockable storage space
- push handle for simple manoeuvring
- four castors, including two braked steering castors
- top spill tray shelf positioned at an ergonomic working height of 92 cm
- optional third spill tray shelf can be positioned at half height
- high-quality powder coating in light grey and orange

Version 1: with spill tray shelves

- two spill tray shelves with 89 x 59 cm base area
- spill tray shelf can be fixed at half height as necessary
- includes 1 x perforated plate insert, can be used for both spill tray shelves

Version 2: with compartment

- two spill tray shelves with 44 x 59 cm base area
- lockable door
- height-adjustable shelf inside (42 x 58 cm base area)
- storage area on top with non-slip mat
- includes 1x perforated plate insert, can be used for both spill tray shelves

Version 3: with drawers

- two spill tray bases with 44 x 59 cm base area
- five drawers, jointly lockable
- storage area on top with non-slip mat
- includes 1 x perforated plate grating, can be used for both spill tray bases



Version 3
Workshop trolley with spill trays, drawers and additional spill tray base, 10 litres



Version 1
Workshop trolley with spill trays



Version 1
Workshop trolley with spill trays and additional spill tray base 20 litres



Version 2
Workshop trolley with spill trays, compartment and additional spill tray base 10 litres

Description	Overall dimensions cm (l x d x h)	Collection volume L	Weight approx. kg	Load capacity per level kg	Order no.
Workshop trolley with spill trays	99 x 61 x 92	2 x 20	58.8	75 / 150	11583
Workshop trolley with spill trays, compartment and anti-slip mat	99 x 61 x 92	2 x 10	56.2	75 / 180	11584
Workshop trolley with spill trays, drawers and anti-slip mat	99 x 61 x 92	2 x 10	86.2	75 / 180	11585

ACCESSORIES FOR WORKSHOP TROLLEY

Description	Overall dimensions cm (l x d x h)	Weight approx. kg	Order no.
Additional spill tray 10 L	45 x 60 x 6	7.8	11586
Additional spill tray 20 L	90.5 x 60 x 6	14.8	11587
Perforated plate for spill trays 10 L	44 x 59 x 5.5	2.2	11588
Perforated plate for spill trays 20 L	89.5 x 59 x 5.5	3.6	11589
Anti-slip mat (for compartments and drawers)	45 x 60 x 0.5	0.8	11358

Mobile hazardous material depot PG 9

For moving directly to the working location

- spill base according to German regulation StawaR
- shelf at the topmost position
- body made from sheet steel painted in grey (RAL 7035)
- smooth-running, lockable roller shutter
- side faces with perforations for tool holding system
- four castors, including two braked steering castors
- push handle for simple manoeuvring
- delivered fully assembled and ready for immediate use



Mobile hazardous material depot with shelf, extending tray and floor tray 33 L

Roller shutter, closed

Description	System includes	Overall dimensions cm (l x d x h)	Weight approx. kg	Load capacity per level kg	Order no.
Mobile hazardous material depot	1 x shelf, 1 x extending tray, 1 x floor tray 33 L (incl. perforated plate insert)	124 x 61 x 136	118	50	11394

ACCESSORIES

Floor tray 66 L (incl. perforated plate insert)	110 x 55 x 12	28	-	11400
Additional extending tray	108 x 51 x 9	11	-	11398
Additional spill tray base (incl. perforated plate insert)	111 x 55 x 5	12	-	11395
Non-slip mat, suitable for extending tray or shelf	-	0.5	-	11397

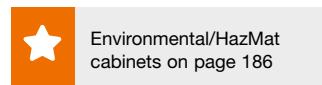

Hazardous material depot PG 9

For use in buildings and for outdoor installation

- vents in the door for natural ventilation
- lockable doors against unauthorised access
- slight roof pitch for rain drainage
- certified drip tray according to German regulation StawaR
- 2-drum version with partition wall in the centre
- hazard warning labels enclosed for identification as a hazardous materials storage facility
- Accessory height-adjustable shelves (grid 25 mm) allow storage of canisters and trays
- ground clearance for optimum forkliftability
- drums can be stored with pump or funnel fitted
- delivered fully assembled



Hazardous material depot compact 220 for 2 drums with perforated shelf (accessory)

Hazardous material depot compact 220 for 1 drum



Description	External dimensions cm (l x w x h)	Internal dimensions cm (l x w x h)	Containment volume L	Weight approx. kg	Order no.
Hazardous material depot compact 220 for 1 drum	85 x 70 x 200	82 x 67 x 144	220	99	11699
Hazardous material depot compact 220 for 2 drums	170 x 70 x 180	167 x 67 x 144	220	162	11700

ACCESSORY FOR HAZARDOUS MATERIAL DEPOT

Perforated shelf	81 x 66 x 3	-	-	4.2	11701
------------------	-------------	---	---	-----	-------

Environmental / HazMat cabinets PG 9

For the safe and proper storage of water-hazardous and environmentally hazardous substances in buildings pursuant to German technical regulation TRGS 510.

CEMO environmental cabinets are manufactured from quality sheet steel. All cabinets are certified according to the sump certification according to German Steel Sump Guideline (StawaR). Since the doors are lockable, access can be restricted to persons trained in handling hazardous substances. Also ideal for storage of pesticide. Not suitable for the storage of flammable substances in work areas.

The following applies to all environmental cabinets on this double page:

- floor bund conformant to StawaR in 3 mm-thick steel
- each shelf is a spill tray
- high-quality powder coating in grey (RAL 7035)
- lockable doors by means of a cylinder lock
- doors open to 180°
- vents in the doors for natural ventilation
- supplied fully assembled and ready for immediate use
- the cabinet top has a connection (NW75) for an external ventilation system
- hazard warning label included

Environmental cabinets 5/10, 10/10, 5/20 & 10/20 certified pursuant to StawaR

- floor bund 30 L
- 4 sizes for maximising space
- all shelves are manufactured as galvanised sumps
- height-adjustable shelves, additional shelves available separately
- document pouch on inside of door



Environmental/HazMat cabinet 10/10



Environmental/HazMat cabinet 5/10



Environmental/HazMat cabinet 10/20



Environmental/HazMat cabinet 5/20

ENVIRONMENTAL/HAZMAT CABINETS 5/10, 10/10, 5/20 AND 10/20

Description	System includes: Floor tray, shelf tray	Overall dimensions cm (l x d x h)	Load capacity per level kg	Weight approx. kg	Order no.
Environmental/HazMat cabinet 5/10	1 x 20 L 1 x 30 L	50 x 50 x 100	65	38	10999
Environmental/HazMat cabinet 10/10	1 x 20 L 1 x 30 L	95 x 50 x 100	65	54	11000
Environmental/HazMat cabinet 5/20	3 x 20 L 1 x 30 L	50 x 50 x 195	65	61	11001
Environmental/HazMat cabinet 10/20	3 x 20 L 1 x 30 L	95 x 50 x 195	65	88	11002

ACCESSORIES ENVIRONMENTAL/HAZMAT CABINETS 5/10, 10/10, 5/20 AND 10/20

Description	for type	Weight approx. kg	Order no.
Shelf tray (20 L)	5/10, 5/20	2.5	11005
Shelf tray (20 L)	10/10, 10/20	4	11006
Perforated plate insert for shelf tray (20 L)	5/10, 5/20	2.2	11007
Perforated plate insert for shelf tray (20 L)	10/10, 10/20	3.2	11008
Perforated plate insert for shelf tray (30 L)	5/10, 5/20	2.5	11060
Perforated plate insert for shelf tray (30 L)	10/10, 10/20	3.5	11061

Environmental/HazMat cabinets PG 9

① **Environmental cabinet with sliding door and certified under StawaR**

- ideal for tight spaces
- each sliding door is mounted on rollers and can therefore be operated with one hand
- all shelves are manufactured as spill trays
- height-adjustable shelves
- all spill trays galvanised



① Environmental/HazMat cabinet 15/20 with sliding doors



③ Canister cabinet 10/20 (canisters not included)



② **Environmental cabinet with fully extending drawers and certified under StawaR**

- removable galvanised shelf trays allow access to all stored containers and tanks
- with interlock protection as standard so that not more than one sliding shelf can be open simultaneously
- all trays galvanised



★ Fans on pages 208 – 209

💡 For mobile HazMat cabinets see HazMat depots on page 185.

③ **Environmental/HazMat cabinet designed as a canister cabinet and certified under StawaR**

- filling directly from the canister store (up to 15 canisters)
- the floor tray can be pulled out at the same time as the canister shelf to catch any spillage during filling
- the canister holder is suitable for most popular designs
- with interlock protection as standard so that the shelf tray cannot be open at the same time as more than one canister level
- all internals painted in RAL 7035
- shelf tray galvanised

② Environmental/HazMat cabinet 10/20 with fully extending drawers

Description	System includes	Overall dimensions cm (l x d x h)	Load capacity per level kg	Weight approx. kg	Order no.
① Environmental cabinet 10/20 with sliding doors	1 x Floor tray 30 L, 3 x Shelf tray à 20 L	100 x 50 x 195	65	95	11011
① Environmental cabinet 15/20 with sliding doors	2 x Floor tray à 30 L, 6 x Shelf tray à 20 L, centre divider	150 x 50 x 195	65	150	11012
② Environmental cabinet 10/20 with fully extending drawers	1 x Floor tray 30 L, 3 x Shelf tray à 20 L	95 x 50 x 195	70	108	11009
② Environmental cabinet 12/20 with fully extending drawers	1 x Floor tray 30 L, 3 x Shelf tray à 20 L	120 x 50 x 195	70	120	11010
③ Canister cabinet 10/20	1 x Floor tray 30 L, 1 x Lower shelf, 3 x Canister shelves	100 x 55 x 195	Canister shelf: 70 Lower shelf: 45	125	11014

Environmental/HazMat cabinet 13/20 PG 9

For the safe and proper storage of water-hazardous and environmentally hazardous, non-flammable substances in buildings pursuant to TRGS 510

The frame of this environmental cabinet is based on drum rack 540, forming a particularly sturdy overall package.

The cabinet is available in two versions.

- hot-dip galvanised frame and grating shelves
- high-quality powder coating in grey (RAL 7035)
- vents at the top and bottom of the doors for natural ventilation
- document pouch on inside of door
- hazard identification labels included
- load bearing capacity up to 200 kg per shelf
- 600 mm shelf depth allows horizontal storage of 60 L drums including tap for version 1



GRP sump with certification:



Version ① with GRP sump 150 L

Version ①: Environmental cabinet 13/20 with GRP sump

- collection volume 150 litres
- with General Construction Inspection Certification Z-40.12-227

Version ②: Environmental cabinet 13/20 with spill tray

- bottom shelf as seamlessly welded steel spill tray with 20 litre collection volume

The cabinet is delivered unassembled.

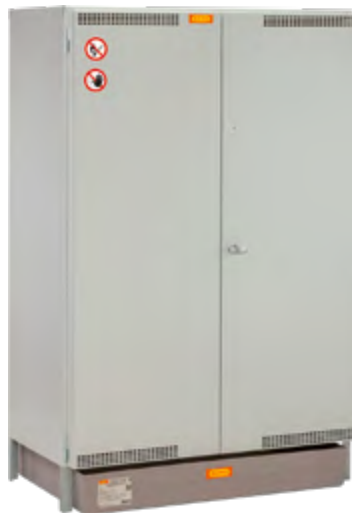

Version ① with GRP sump 150 L



Version ② with spill tray base 20 L

Description	Kit includes:	Overall dimensions cm (l x w x h)	Weight approx. kg	Order no.
① Environmental/HazMat cabinet 13/20 with GRP sump	4x gratings 1x GRP sump 150 L cabinet lining	132 x 80 x 200	202	7954
② Environmental/HazMat cabinet 13/20 with spill tray base	3x gratings 1x spill tray base 20 L cabinet lining	132 x 63 x 200	204	7956

ACCESSORIES

Description	Overall dimensions cm (l x w x h)	Weight approx. kg	Order no.
PE sump 40 L as insert tray (acid-/alkali resistant)*	130 x 62 x 8	5	7871
Three drum supports for one shelf for version 1	130 x 62 x 8	1	7800

* see page 159

Drum cabinet 14/20 PG 9

For the safe and proper storage of drums containing water-hazardous and environmentally hazardous, non-flammable substances in buildings according to German regulation TRGS 510

60 and 200 litre drums can be safely stored in this drum cabinet. The cabinet is large enough for you to work with a hand pump or handle the drums. The additional spill tray base at the top can accommodate small containers.

Drum cabinet 14/20

- high-quality powder coating in grey (RAL 7035)
- lockable doors by means of a cylinder lock
- vents in the doors for natural ventilation
- the cabinet top has a connection (NW75) for an external ventilation system
- document pouch on inside of door
- hazard warning label included

Version ① with large, certified collection tray:

- floor tray made of steel or PE, both with grating
- additional spill tray at top (height adjustable, 25 mm grid)
- supplied fully assembled and ready for immediate use

Version ② with drum rack type 360 and certified collection tray:

- base made of steel, PE or GRP
- with drum supports for 6 x 60 L drums
- optional third shelf using grating



Drum cabinet with steel base for upright 200 litre drums



Drum cabinet with drum rack type 360 inside for horizontal 60 litre drums, steel grating as as third shelf (see accessories), GRP base



Connection option (NW75) for external ventilation system

Description	System includes:	Overall dimensions cm (l x w x h)	Weight approx. kg	Order no.
① Drum cabinet 14/20 with steel sump	1 x spill tray 30 L, 1 x steel floor tray 210 L, incl. galvanised steel grating	140 x 84 x 195	150	11566
① Drum cabinet 14/20 with PE sump	1 x spill tray 30 L, 1 x PE floor tray 250 L, incl. PE grating	140 x 84 x 195	125	11571
① Drum cabinet 14/20 with PE sump	1 x spill tray 30 L, 1 x PE floor tray 250 L, incl. galvanised steel grating	140 x 84 x 195	128	11572
② Drum cabinet 14/20 with drum rack and steel sump	1 x drum rack type 360, incl. 6 x drum supports, 1 x steel floor tray 65 L	140 x 84 x 195	165	11569
② Drum cabinet 14/20 with drum rack and PE sump	1 x drum rack type 360, incl. 6 x drum supports, 1 x PE floor tray 120 L	140 x 84 x 195	145	11568
② Drum cabinet 14/20 with drum rack and GRP sump	1 x drum rack type 360 incl. 6 x drum supports, 1 x GRP sump 150 L	140 x 84 x 195	149	11567

ACCESSORIES

Description	Overall dimensions cm (l x w x h)	Weight approx. kg	Order no.
Steel grating as third shelf for drum rack type 360	130 x 62 x 3	18	6817
Three drum supports for steel grating for drum rack type 360	-	1	7800
Spill tray 30 L as additional shelf	132 x 46 x 5	8,5	11573

Pesticide cabinets PG 9

For the safe and proper storage of pesticides in buildings pursuant to TRGS 510

Pesticides are useful but, in the wrong hands or if released unintentionally, they can cause great harm to people and the environment due to the water hazard they pose. These substances can be safely stored behind locked doors and on trays in CEMO pesticide cabinets. The cabinets are suitable for the storage of non-flammable substances in work areas.

Pesticide cabinets 5/10, 10/10, 5/20 and 10/20

certified pursuant to StawaR:

- four sizes for different storage quantities
- high-quality powder coating in green (RAL 6011)
- floor tray (30 litres) pursuant to StawaR, made of 3 mm thick steel
- all shelves are manufactured as galvanised trays
- height-adjustable shelves (25 mm grid)
- see accessories for further spill tray bases as additional shelf
- lockable doors by means of a cylinder lock
- doors open to 135°
- vents in the doors for natural ventilation
- delivered fully assembled and ready for immediate use
- document pouch on inside of door
- hazard warning label included

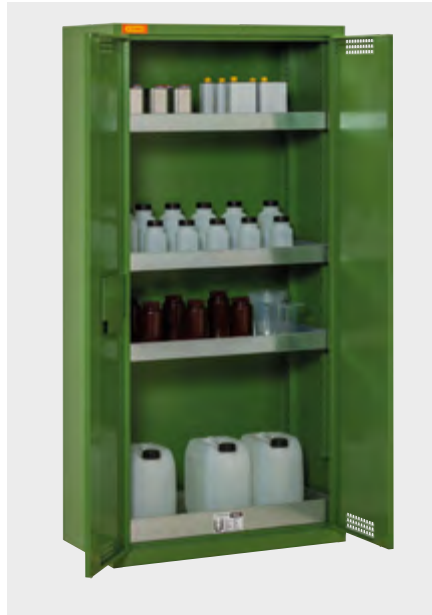

Pesticide cabinet 10/20



Pesticide cabinet 5/20



Pesticide cabinet 10/10



Pesticide cabinet 5/10 with perforated plate insert (see accessories)

Description	System includes: Spill tray base, floor tray	Overall dimensions cm (l x d x h)	Load capacity per shelf kg	Weight approx. kg	Order no.
Pesticide cabinet 5/10	1 x 20 L 1 x 30 L	50 x 50 x 100	50	29	11390
Pesticide cabinet 10/10	1 x 20 L 1 x 30 L	95 x 50 x 100	50	50	11391
Pesticide cabinet 5/20	3 x 20 L 1 x 30 L	50 x 50 x 195	50	56	11392
Pesticide cabinet 10/20	3 x 20 L 1 x 30 L	95 x 50 x 195	50	87	11393

ACCESSORIES

Description	for type	Weight approx. kg	Order no.
Spill tray base (20 litres)	5/10, 5/20	2.5	11005
Spill tray base (20 litres)	10/10, 10/20	4	11006
Perforated plate insert for spill tray base (20 litres)	5/10, 5/20	2.2	11007
Perforated plate insert for spill tray base (20 litres)	10/10, 10/20	3.2	11008
Perforated plate insert for floor tray (30 litres)	5/10, 5/20	2.5	11060
Perforated plate insert for floor tray (30 litres)	10/10, 10/20	3.5	11061

Gas cylinder store PG 9

NEW

For installation outdoors
For proper storage of gas cylinders as per TRGS 510

- ideal for the storage of propane gas cylinders
- sturdy welded sheet metal construction, galvanised and powder-coated, RAL 7035
- vents in the doors and side walls for natural ventilation
- inclined roof for optimal water run-off
- protects against unauthorised access, lockable with cylinder lock

- hazard sticker with warning symbol enclosed for identification as hazardous material storage
- delivered fully assembled

Single-door version:

- 1-leaf door, door hinge on right
- with a galvanised grating shelf and a removable intermediate shelf as additional deck surface
- for the storage of up to 8 gas cylinders of 11 kg each or 4 gas cylinders of 33 kg each

Two-door version:

- 2-leaf door, central partition, doors to be opened independently of each other
- with 2 galvanised grating shelves and 2 removable intermediate shelves as additional deck surfaces
- for the storage of up to 16 gas cylinders of 11 kg each or 8 gas cylinders of 33 kg each



Gas cylinder store, single door version



Gas cylinder store, two-door version

GAS CYLINDER STORE

Description	External dimensions cm (l x w x h)	Internal dimensions cm (l x w x h)	Quantity gas cylinder	Weight approx. kg	Order no.
Gas cylinder store, single door version	85 x 70 x 150	84 x 67 x 144	8 (11 kg), 4 (33 kg)	55	11878
Gas cylinder store, two-door version	170 x 70 x 150	169 x 67 x 144	16 (11 kg), 8 (33 kg)	105	11879

Storage of hazardous substances outdoors

It is not always possible for businesses to store hazardous substances indoors. Sometimes it is recommended to reduce risk by storing hazardous substances outdoors in suitable containers. One needs to distinguish between storage containers without fire protection features (Safety Storage Containers (SRC) and hazardous substance depots) and those with fire-resistant features (F90 fireproof container).

When storing flammable substances, EX-protective equipment is generally required due to the risk of explosion. In principle, the hazardous substances store should be fitted with a liquid-tight sump that should be certified.

The collection volume of a hazardous substance store must be capable of containing 10 % of the total volume of liquids stored, or the volume of the largest container (e.g. drum or IBC).

Please note: there are different regulations in water protection areas, if storage is permitted there

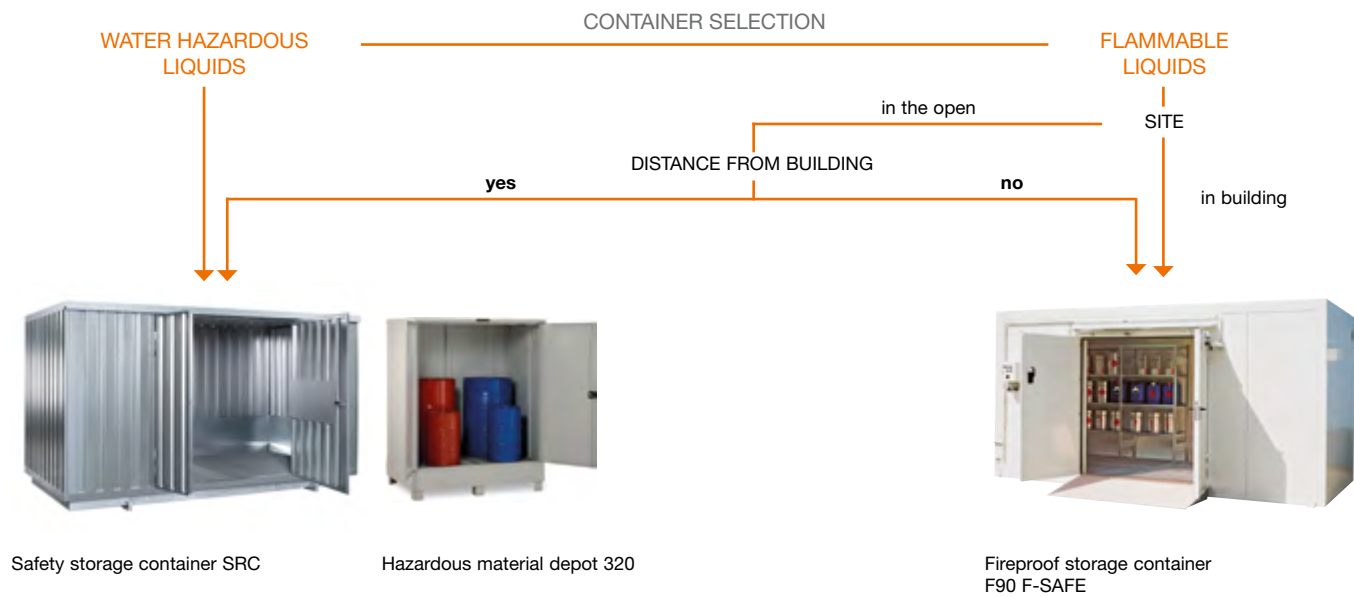

SAFE DISTANCES

When **flammable liquids** are not stored in a fireproof container, a safety distance must be maintained. This distance depends on the quantity to be stored in accordance with **TRGS (Technical Rule for Hazardous Substances) 510, Annex 5, Nr. 4, para. 2.:**

- Combined stored volume **less than 200 kg:** **3 metres**
- Combined stored volume **between 200 kg and 1,000 kg:** **5 metres**
- Active storage (see below) or combined stored volume **more than 1,000 kg:** **10 metres**

Alternatively, either fire-resistant building exterior walls (F90 in accordance with DIN 4102) or fire-resistant components between buildings and hazardous material storage in specified height and width would be sufficient, but in practice this occurs in very few cases. However, if a hazardous materials store is to be erected directly against a building, an F90 Fire proof container in fireproof material is required.

ACTIVE AND PASSIVE STORAGE OF FLAMMABLE LIQUIDS

1. Passive storage is when storage takes place in tightly closed containers. During the storage containers may not be emptied or filled and even opening for other purposes is prohibited. Generally natural ventilation is sufficient.
2. Active storage refers to those storage situations in which the containers are opened for dispensing or refilling. Mechanical ventilation is mandatory in these cases. An exception can be made for small hazardous substance stores (observe risk assessment).

Description	Passive storage	Active storage
Safety distance available	SRC (Depot) Natural ventilation (0.4 times air change)	SRC (Depot) Mechanical ventilation (5 times air change)
No safety distance possible	F 90 fireproof container Mechanical ventilation (5 times air change)	F 90 fireproof container Mechanical ventilation (5 times air change)

Hazardous material depot (steel) PG 9

- can be installed outdoors due to weather-resistant coating (similar to RAL7035)
- certified according to German regulation StawaR for the storage of water-hazardous (WGK 1 – 3) and flammable liquids (H224-226)
- cover can be held open as required by means of gas struts
- vents for natural ventilation
- doors can be locked
- forkliftable
- space to accommodate chemical and Euro pallets
- supplied fully-assembled
- hazard warning label included for identification as a hazardous material storage facility
- horizontal drum storage possible with installation of drum rack (optional accessory) with 2 shelves for 2 x 200 L or 3 x 60 L drums per shelf
- additional shelves for canisters etc. available with the small container rack (optional accessory)
- for the storage of flammable liquids please note the safety distances from buildings specified in the regulations TRGS 510, no. 12.4.1 (2).



Wide-opening doors for easy access



Hazardous material depot 400 with optional drum rack



Hazardous material depot 320 with optional small container rack

Description	Dimensions cm (l x w x h)	Collection volume L	Capacity	Weight approx. kg	Order no.
Steel hazardous material depot 320	150 x 120 x 189.5	320	2 x 200 L / 6 x 60 L	209	11015
Steel hazardous material depot 400	150 x 150 x 189.5	400	4 x 200 L / 9 x 60 L	250	11016

ACCESSORIES FOR STEEL HAZARDOUS MATERIAL DEPOT

Description	Dimensions cm (l x w x h)	Order no.
Drum shelf for steel hazardous material depot, horizontal drum storage, galvanised design, per shelf either 2 x 200 L drums or 3 x 60 L drums	135 x 52 x 90	11017
Small container shelf for steel hazardous material depot, 3 spill trays, galvanised design, up to 4 height-adjustable shelves	135 x 61 x 135	11018



For more hazardous material depots see page 177.

PE hazardous material depot PG 9

with General Construction Inspection Certification Z-40.22-591

- for use outdoors and indoors
- made of high-quality polyethylene (PE)
- high chemical resistance
- lockable with sturdy stainless steel bar lock
- with document pouch on inside of door
- with integral forklift pockets for loading with pallets or IBCs
- ideal for Euro pallets (120x80), industrial pallets (120x120), plastic pallets of similar size or IBCs
- loaded pallets or IBCs can be placed directly into the depot
- a steel or PE grating is not required, but can be used if required on PE hazardous material depot 220/2
- PE hazardous material depot 1100/1 is fitted with a separate, sturdy stand
- the stand is already integrated in the housing with PE hazardous material depot 220/2
- door opens to 270° for stand-alone installation
- door opens to approx. 180° for serial installation
- doors can be latched at increments of 90°
- integrated rain gutter at top of door opening
- domed roof withstands higher snow loads
- option for fitting interior lighting
- cable duct option on the rear wall



PE hazardous material depot 220/2 with Euro pallet and two drums



PE hazardous material depots 220/2 and 1100/1



PE hazardous material depot 220/1 with industry pallet and four drums

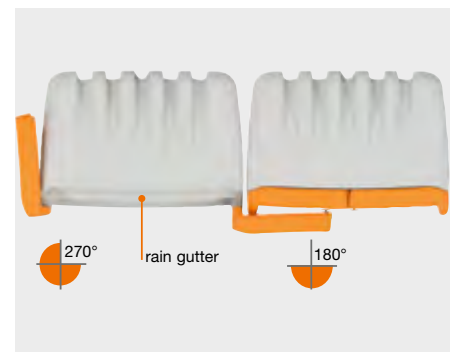

Door opening angle

Description	External dimensions cm (l x w x h)	Internal dimensions cm (l x w x h)	Loading capacity kg	Collection volume L	Quantity 200 L drums	Quantity IBCs	Weight approx. kg	Order no.
PE hazardous material depot 220/2	160 x 114 x 198	127 x 94 x 153	600	220	2	-	100	11550
PE hazardous material depot 1100/1	160 x 167 x 228	127 x 147 x 149	1500	1100	4	1	170	11551

PE hazardous material depot PG 9



PE hazardous material depot 1100/1 with IBC



Wind load protection



PE hazardous material depot 220/2 with drum rack type 360, steel grating as third shelf and steel grating as filling area

ACCESSORIES FOR PE HAZARDOUS MATERIAL DEPOT

Description	Overall dimensions cm (l x w x h)	Weight approx. kg	Order no.
Steel grating for PE hazardous material depot 220/2	120 x 80 x 3	12,4	11269
PE grating for PE hazardous material depot 220/2	120 x 80 x 6	8,5	11271
Drum rack type 360 for PE hazardous material depot 220/2	132 x 63 x 130	51	7643
Steel grating as third shelf for drum rack type 360	130 x 62 x 3	21	6817
Steel grating as filling area for PE hazardous material depot 220/2	150 x 27 x 3	3	11549
Interior lighting with motion sensor and battery (non-ex rated) for PE hazardous material depots 220/2 and 1100/1	-	-	10378
Wind load protection for PE hazardous material depot 220/2 and 1100/1	-	-	11360

HazMat collection station PG 9

Hazardous substance collection stations from glass fibre reinforced plastic (GRP) with General Construction Inspection Certification Z-40.12-228 granted by DIBt-Berlin

Offers centralised, safe storage for a variety of containers and liquids. The GRP sump

with splash protection wall is suitable for storage of liquids of all water-polluting classes.

The wide opening lockable lid with gas struts allows easy loading/unloading and allows outdoor use – station has galvanised floor frame with grating.



★ Accessory drum support see page 177

GRP HAZARDOUS SUBSTANCE COLLECTION STATION

Description	Surface area cm (l x w)	Height cm	Weight approx. kg	Order no.
Collection station with grating floor for outdoor installation (with lid), with 200 L containment volume	150 x 85	211	85	3412

Safety storage containers PG 9

This accessible container offers a compact solution for storage of a variety of hazardous materials.

By the modular principle, this can be supplied in a variety of sizes and can be tailored to individual demands on site.

Surface area coverage from 2 to 42 m²



SRC 5.1W with 2 swing doors fitted to long side



Storage for plant pesticide (example painted green)

- ✓ Fully-assembled model
- ✓ Galvanised sheet steel
 - Alternative: Galvanised and painted (RAL 5002 ultramarine blue, other colours available on request)
- ✓ Wall and roof elements from galvanised trapeze profile corrugated sheet steel
- ✓ Floor sections made as hot dipped galvanised steel sump floor.
 - resistant to chemicals according to Chemical compatibility guide DIN 6601
 - steel S235JR according to EN 10025
- ✓ 100 mm ground clearance
- ✓ Removable floor grating (load limit 1000 kg/m²)
- ✓ Large, single swing door (width 1240 mm)
- ✓ Traversable roof (designed to withstand 125 kg/m² snow load)
- ✓ drainage via interior gutters
- ✓ Spill guards on walls to protect against spills
- ✓ Door handles inside and outside



SRC 3.1W with door on narrow side

THE CORRECT CONFIGURATION FOR EVERY APPLICATION

Type series SRC-W		Storage of water-polluting liquids (WGK [water hazard class] 1-3)	<ul style="list-style-type: none"> ✓ Sump/spill pallet, walls and roof made of sheet steel 	Example storage situation: Chemicals, water-polluting liquids
Type series SRC-N		Storage of combustible and flammable liquids (WGK 1 – 3, H224-226)	<ul style="list-style-type: none"> ✓ Sump/spill pallet, walls and roof made of sheet steel ✓ Perforations for natural ventilation (min. 0.4 air changes guaranteed) 	Example storage situation: Fuel, petrol, oils, solvents
Type series SRC-TB		Storage of temperature-sensitive, water-polluting liquids (WGK [water hazard class] 1 – 3)	<ul style="list-style-type: none"> ✓ Sump/spill pallet made of sheet steel ✓ Walls and roof made of thermal insulation material (building material class B1: flame retardant) 	Example storage situation: Pesticides, cleaning agents, chemicals, housing for dosing systems
Type series SRC-TA		Storage of temperature-sensitive, flammable liquids (WGK 1 – 3, H224-226)	<ul style="list-style-type: none"> ✓ Sump/spill pallet made of sheet steel ✓ Walls and roof made of thermal insulation material (building material class A1: non-combustible) 	Example storage situation: Sensitive paints and varnishes

* Multi-module containers from size 4.x are delivered in individual modules

Safety storage containers PG 9

STORAGE OF SUBSTANCES HAZARDOUS TO WATER (WGK [WATER HAZARD CLASS] 1-3):

Safety storage containers can be installed both indoors and outdoors.
Observe official requirements for larger storage quantities, in particular for WGK 3 (highly hazardous to water).

STORAGE OF FLAMMABLE SUBSTANCES (H224-226):

Normal case: passive storage

Four fundamental specific features must be taken into account here:

- The prescribed safety distance between material and buildings is maintained
- Sufficient ventilation is guaranteed
- The electrical equipment is explosion-proof and the container is earthed
- For versions with thermal insulation: only type series TA

Special feature: active storage

e. g. decanting, removing, filling, etc. into and from drums, IBCs and small containers

In addition to the technical requirements for passive storage, the container must have mechanical ventilation (forced ventilation) for 5 times air exchanges. We also recommend exhaust air monitoring of the ventilation system for maximum safety.

i If the container location on the property does not permit a safety distance, an F90 fireproof storage unit with DIBt certification must be used. (see p. 202)

! See the detailed explanation of the regulations on page 196.

EQUIPMENT OPTIONS (STANDARD OR OPTIONAL)

Natural ventilation

Min. 0.4 times air change rate confirmed by expert. Micro-perforation protects against penetration by small animals and rodents.



Mechanical ventilation

Forced ventilation for 5 times air changes.



Thermal insulation

For protection against frost and cold. Dependent on the storage medium in building material A1 or B1. Frequently used in conjunction with heating and ventilation (accessories see p.198).



Grating

In addition to the standard grating, a closer-meshed grating with better lift truck access is also available if required.

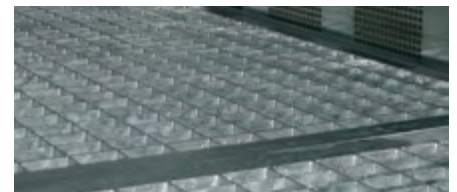

Single or double-wing doors

Single-wing door already in place creates an opening of 1240 cm (e.g. for chemical pallets), two-wing version provides significantly greater opening.



Sliding door

Convenient access. No slamming in the wind compared to winged doors. Not possible for thermo-insulated containers.



Safety storage containers PG 9

CONTAINER DESIGNATION: MODULAR DESIGN SYSTEM

FIGURE 1: Module depth or width of the basic size (rough guideline value)

FIGURE 2: Number of assembled modules

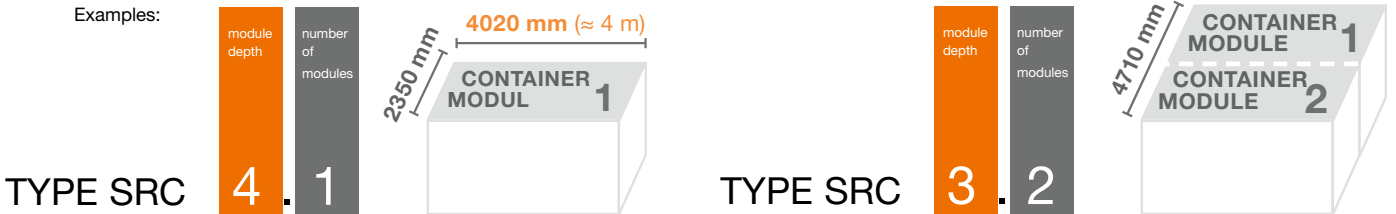

TYPE SERIES SRC W FOR WATER POLLUTING SUBSTANCES/HAZMAT

Description	External dimensions cm (l x w x h)	Weight approx .kg	Collection volume L	Galvanised model		Galvanised and painted	
				Position of door		Position of door	
				Long side Order no.	Narrow side Order no.	Long side Order no.	Narrow side Order no.
Typee SRC 1.1W	235 x 91.5 x 241	230	300	8043	–	8210	–
Typee SRC 2.1W	235 x 195 x 241	440	630	8044	8743	8211	8752
Typee SRC 3.1W	298.5 x 235 x 241	650	1000	8744	8045	8753	8212
Typee SRC 3.2W	471 x 298.5 x 241	1180	2 x 1000	8745	8209	8754	8213
Type SRC 3.3W	705 x 298.5 x 241	1710	3 x 1000	8746	8749	8755	8758
Type SRC 4.1W	402 x 235 x 241	830	1000	8747	8750	8756	8759
Type SRC 5.1W	505.5 x 235 x 241	980	1000	8748	8751	8757	8760
Type SRC 6.1W	609 x 235 x 241	1300	1000	10528	10529	10530	10531

Standard sizes 4.2, 5.2, 6.2 and 6.3 on request. | On delivery: Unloading of the goods by the customer



Exception:
Only in con-
junction with
technical
ventilation
(optional, see
accessories)

TYPE SERIES SRC TB FOR WATER POLLUTING SUBSTANCES/HAZMAT WITH THERMAL INSULATION

Description	External dimensions cm (l x w x h)	Weight approx .kg	Collection volume L	Galvanised model		Galvanised and painted	
				Position of door		Position of door	
				Long side Order no.	Narrow side Order no.	Long side Order no.	Narrow side Order no.
Type SRC 1.1TB	235 x 91.5 x 245	405	300	8214	–	8218	–
Type SRC 2.1TB	235 x 195 x 245	700	630	8215	8761	8219	8764
Type SRC 3.1TB	298.5 x 235 x 245	990	1000	8762	8216	8765	8220
Type SRC 3.2TB	471 x 298.5 x 245	1725	2 x 1000	8763	8217	8766	8221

All standard sizes of the SRC-W type series also with TB insulation. | On delivery: Unloading of the goods by the customer

TYPE SERIES SRC W ST WITH SLIDING DOOR FOR WATER POLLUTING SUBSTANCES/HAZMAT

Description	External dimensions cm (l x w x h)	Door position on wall side	Weight approx. kg	Collection volume L	Galvanised model		Galvanised and painted	
					Order no.		Order no.	
Type SRC 3.1W ST	298.5 x 237 x 241	298.5	700	1000	8767	8772	8772	
Type SRC 3.2W ST	473 x 298.5 x 241	298.5	1230	2 x 1000	8768	8773	8773	
Type SRC 3.3W ST	707 x 298.5 x 241	298.5	1760	3 x 1000	8769	8774	8774	
Type SRC 4.1W ST	402 x 237 x 241	402	880	1000	8770	8775	8775	
Type SRC 5.1W ST	505.5 x 237 x 241	505.5	1020	1000	8771	8776	8776	
Type SRC 6.1W ST	609 x 237 x 241	609	1350	1000	10532	10533	10533	

Further standard sizes on request. | On delivery: Unloading of the goods by the customer

Safety storage containers PG 9

TYPE SERIES SRC N WITH NATURAL VENTILATION



Description	External dimensions cm (l x w x h)	Weight approx. kg	Collection volume L	Galvanised model		Galvanised and painted	
				Position of door		Position of door	
				Long side Order no.	Narrow side Order no.	Long side Order no.	Narrow side Order no.
Type SRC 1.1N	235 x 91.5 x 241	230	300	10339	-	10340	-
Type SRC 2.1N	235 x 195 x 241	440	630	10341	10342	10343	10344
Type SRC 3.1N	298.5 x 235 x 241	650	1000	10345	10346	10347	10348
Type SRC 3.2N	471 x 298.5 x 241	1180	2 x 1000	10349	10350	10351	10352
Type SRC 3.3N	705 x 298.5 x 241	1710	3 x 1000	10353	10354	10355	10356
Type SRC 4.1N	402 x 235 x 241	830	1000	10357	10358	10359	10360
Type SRC 5.1N	505.5 x 235 x 241	980	1000	10361	10362	10363	10364
Type SRC 6.1N	609 x 235 x 241	1300	1000	10534	10535	10536	10537

Standard sizes 4.2, 4.3, 5.2, 5.3, 6.2 and 6.3 on request! | On delivery: Unloading of the goods by the customer.

TYPE SERIES SRC TA WITH THERMAL INSULATION FOR FLAMMABLE LIQUIDS



Description	External dimensions cm (l x w x h)	Weight approx. kg	Collection volume L	Galvanised model		Galvanised and painted	
				Position of door		Position of door	
				Long side Order no.	Narrow side Order no.	Long side Order no.	Narrow side Order no.
Type SRC 1.1TA	235 x 91.5 x 247	440	300	11215	-	11216	-
Type SRC 2.1TA	235 x 195 x 247	740	630	11217	11218	11219	11220
Type SRC 3.1TA	298.5 x 235 x 247	1050	1000	11221	11222	11223	11224
Type SRC 3.2TA	471 x 298.5 x 247	1820	2x1000	11225	11226	11227	11228

All standard sizes of the SRC-W type series also with TA insulation. | On delivery: Unloading of the goods by the customer

TYPE SERIES SRC N ST WITH SLIDING DOOR AND NATURAL VENTILATION



Description	External dimensions cm (l x w x h)	Door position on wall side	Weight approx. kg	Collection volume L	Galvanised	Galvanised and painted
					Order no.	Order no.
Type SRC 3.1N ST	298.5 x 237 x 241	298.5	700	1000	10365	10366
Type SRC 3.2N ST	473 x 298.5 x 241	298.5	1230	2 x 1000	10367	10368
Type SRC 3.3N ST	707 x 298.5 x 241	298.5	1760	3 x 1000	10369	10370
Type SRC 4.1N ST	402 x 237 x 241	402	880	1000	10371	10372
Type SRC 5.1N ST	505.5 x 237 x 241	505.5	1020	1000	10373	10374
Type SRC 6.1N ST	609 x 237 x 241	609	1350	1000	10538	10539

Further standard sizes on request. | On delivery: Unloading of the goods by the customer

Please make the most of the opportunity for a consultation:

- container size and media to be stored
- equipment options
- Door layout (long side or short side)
- option of unloading at point of use (as standard, unloading by customer)
- requirements for on-site preparation (e.g. foundation plan)



SRC 3.1 painted with single-leaf door (199.6 cm high, 130 cm wide) on long side, rack and translucent sheet (optional, see accessories)



SRC 4.1, galvanised and painted



















Please note size-related specifics:
e.g. centre supports, restrictions to the door position



We recommend taking out a **maintenance contract** for the annual safety inspection together with your purchase. Talk to us!



Accessories safety storage containers PG 9

Description	Weight approx. kg	Order no.
 Shelf short, for slotting into place, shelf dimensions 100 x 50 cm, 3 shelves (load 120 kg / shelf)	34	8046
	 Shelf long, for slotting into place, shelf dimensions 200 x 50 cm, 3 shelves (load 120 kg / shelf)	63
 Access ramp, (not suitable for models with sliding doors) max. wheel load 450 kg, 70 x 120 cm (w x d)		34
	Close-meshed grating	
 Double wing door, optional (199.6 cm high, door wing 125 cm wide, side wing 65 cm)		8222
	Double wing door insulated, optional (199.6 cm high, door wing 125 cm wide, side wing 65 cm)	
 PVC translucent sheet 90 x 200 cm to allow for daylight illumination		10270
  Fan for mechanical ventilation in explosion-proof model (EX)		8224
Exhaust air monitoring for mechanical ventilation		on request
  Finned tubular radiator 910 W with thermostat for safety storage container 1.1 T up to 3.1 T in ex model		8225
	Finned tubular radiator 1680 W with thermostat for safety storage container 3.2 T in EX model	
 Convector heater with temperature controller (non-ex, picture similar)	2 kW	10271
	3 kW	10272
  Linear luminaire 2 x 58 W in ex-proof version incl. switch (non-ex, located on outside of container)		8228
	Linear luminaire 2 x 58 W (non-ex) including switch (non-ex Linear luminaire 2 x 58 W (non-ex) including switch (non-ex located on outside of container))	
  LED diffuser luminaire in ex-proof version incl. switch (non-ex, located on outside of container)		11580
 Fuse box IP 54 (necessary for electrical equipment)		8230
 Set of 4 crane eyelets for up to 1 t total load for safety storage container SRC 1.1, SCR 2.1 and SRC 3.1		10070
 Set of 4 crane eyelets with bars for up to 3 t total load for safety storage container SRC 3.1, SCR 4.1, SRC 5.1 and SRC 6.1		10071

Delivery/shipping costs for a one-off delivery: Delivery ex works.

- When a delivery is made, the customer must provide a crane or forklift for unloading. Please note container weight!

- For crane unloading of container SRC x .1 with straps, the customer can also order crane lugs with our order no. 10070 or 10071 for the container.

- For crane unloading of containers SRC x .2 and SRC x .3, the customer must, in addition to the crane, order a crossbar that extends across the full width of the container.

Rack containers

These certified rack containers are always used when high storage capacities are required in the tightest space. The hazardous material storage facility can be set up for water-polluting or flammable liquids and can be individually adapted to the operational requirements.

- certified by the DIBt for the storage of water-polluting liquids (WGK 1 – 3). Flammable liquids (H224-226) are also included here (dependent on container version).

- storage capacity can be arranged at will thanks to different rack widths, 1-3 shelves and single or double rack width and depth.
- ideal for storing large quantities of drums and IBCs, dimensions match IBC, Euro and chemical pallets
- welded frame construction made of steel profiles
- adjustable levels thanks to removable, hot-dip galvanised gratings
- 100 mm ground clearance and therefore accessible for handling devices

The following versions are available:

- with wing door (single rack width) or sliding door (double rack width)
- wall model: either sheet metal (with or without natural ventilation) or thermal insulation in A1 or B1 model
- for vertical or horizontal drum storage or IBC storage
- accessible on one side (single rack depth) or both sides (double rack depth)
- extensive range of accessories (e. g. heating, mechanical ventilation, chemical-resistant model)

! Safety information: When storing flammable liquids, please pay attention to the outdoor setup and the required safety distance between liquids and buildings in accordance with TRGS 510. Safe alternative: F90 fireproof storage (see page 202)



Vertical drum storage in 3 shelves



IBC storage over 2 shelves



Vertical drum storage in 2 shelves

POSSIBLE CONFIGURATIONS

Description	Possible rack widths in m	Rack depths (single/double)	Rack heights according to shelves	Load	Order no.
horizontal drum storage	3.00	1.34 / 1.27	2 x 0.95 / 3 x 0.77	400 kg / drum support	on request
vertical drum storage	2.70 / 3.00 / 3.90	1.34 / 1.27	1 x 2.00 / 2 x 1.24 / 3 x 1.24	1000 kg/m ²	on request
IBC storage	2.70 / 3.38 / 3.90	1.34 / 1.27	1 x 2.00 / 2 x 1.50 / 3 x 1.50	1200 kg/m ²	on request

F90 walk-in fireproof storage F-SAFE

The standardized BLS fireproof storage units were developed with the expertise gained in hundreds of hazardous material storage facilities built to individual customer specifications.

The BLS storage units are fireproof inside and outside for up to 90 minutes as required by DIN 4102. They have integrated sumps and are suitable for both indoor and outdoor use.

Each BLS storage unit is a separate fire compartment.

- F90 fire protection inside and outside
- delivered ready for use
- sturdy, welded design
- thermally insulated with a high thermal insulation value
- with integrated sump made of galvanised sheet steel

- load-bearing surface with removable, galvanised steel gratings, 1000 kg/m²
- automatically closing doors with anti-panic function
- door optionally in the narrow or long side, single- or double-leaf
- low threshold, 160 mm
- corrosion protection via 2C paint in RAL 9002 grey-white



BLS 2460 with 2-leaf door on the long side with optional access ramp*



BLS 2460 with 1-leaf door on the narrow side (similar to image)

BLS interior view with optional small parts rack

BLS 24 WALK-IN, F90

Description / Type	External dimensions cm (l x w x h)	Internal dimensions cm (l x w x h)	Collection volume L	Storage capacity m ²	Weight to	Order no.
BLS 2420 DIBt	215 x 241.2 x 253	179 x 220 x 210	500	3.5	2.0	on request
BLS 2430 DIBt	315 x 241.2 x 253	279 x 220 x 210	780	5.5	2.1	on request
BLS 2440 DIBt	415 x 241.2 x 253	379 x 220 x 210	1060	7.6	2.4	on request
BLS 2450 DIBt	515 x 241.2 x 253	479 x 220 x 210	1340	9.7	2.9	on request
BLS 2460 DIBt	615 x 241.2 x 253	579 x 220 x 210	1620	11.8	3.2	on request
BLS 2470 DIBt	715 x 241.2 x 253	679 x 220 x 210	1880	13.9	4.1	on request
BLS 2480 DIBt	815 x 241.2 x 253	779 x 220 x 210	2100	15.9	4.7	on request

★ **Ex works – Please ask for freight rates!**

★ Other sizes, equipment versions and accessories such as technical ventilation, door retainer system with fire detection, heating, air-conditioning, stainless steel collection tray, access ramp, lighting, small parts racks, lightning protection, fire alarm system, fire extinguishing system, etc. upon request.

Secure cabinets FWF 30 and FWF 90 F-SAFE PG 9

Cabinets for proper storage of hazardous substances in work areas in accordance with DIN EN 14470-1 and TRGS 510 (Annex 1). The F-SAFE secure cabinets are design approved in accordance with DIN EN 14470-1 and comply with DIN EN 14727 (Laboratory Furniture Directive).

The cabinets are resistant to fire for 30 or 90 minutes.

Secure cabinet **PROline 12/20** from CEMO: developed, tested and manufactured to the latest standards

NEW

★ **NEW TO CEMO:**
TWO PRODUCT LINES TO CHOOSE FROM:



Type 12/20 with 3 spill trays and 1 x 44 L bottom tray

Collection volume

While the collection volume of 10 % of the total amount of stored liquids must be ensured when using collection trays, a different regulation applies in the case of secure cabinets: it must be possible to collect at least 110 % of the largest container.

Ventilation

A mechanical ventilation system (see page 208) with 10 air changes per hour has the advantage that, in normal operation with closed containers, no explosive atmosphere can occur outside the cabinet. Operation is also possible without mechanical ventilation. For this, however, the cabinet must be earthed via equipotential bonding to prevent electrostatic charging. If a secure cabinet is not connected to a mechanical ventilation system, this may also affect the explosion-proof zone. Zone

1 applies to the inside area, Zone 2 applies to the surrounding area within a radius of 2.5 m.

We generally recommend using technical ventilation (page 208 / 209).

Secure cabinets fwf 30

Secure cabinets with 90-minute fire resistance are considered to be “state of the art” in Germany. However, secure cabinets with 30-minute fire resistance may also be used with restrictions, pursuant to TRGS 510 (Annex 3).

The restrictions for FWF 30 cabinets are as follows:

1. only one cabinet is installed per separate building unit/fire (-fighting) compartment; if the area of the separate building unit/ fire (-fighting) compartment is greater than 100 m², one cabinet may be installed every 100 m², or

2. the building unit/fire (-fighting) compartment is protected by an automatic fire detection system and recognise plant fire brigade with a response time of at most 5 minutes from the alarm being raise, or an automatic extinguishing system is in place.

Exceptions in the case of extremely flammable liquids (H224):

Flammable liquids whose ignition temperature is below 200°C and which have been classified as “extremely flammable” (H224) may only be stored in FWF 90 secure cabinets with mechanical ventilation.

The newest generation of secure cabinets

CEMO PROline PG 9

NEW

With the new generation of PROline safety cabinets, CEMO sets new standards in terms of fire prevention, durability and user-friendliness. Developed for the safe storage of hazardous materials, our cabinets offer optimised protective mechanisms, well thought-out functions, and tested safety according to the latest standards.

Discover how technological innovation and practical design elevate fire-resistant storage cabinets to a new level.

90 min.

Cable duct

Innovative door lock at top and bottom

Adjustable locking mechanism

Bottom bund with perforated plate grating

Robust cabinet base

Magnetic lock

Maintenance opening

Height-adjustable feet from the inside

Greater safety and easy handling

- +** **Door closer/closing unit:** Permanently open – Permanently closed – You can choose to leave the door either permanently closed or permanently open as required without manual intervention.
- +** **Simplified adjustability:** For adjusting and levelling the safety cabinet, convenient adjustment is possible using levelling screws inside the cabinet body.

- +** **Robust transport protection:** Widened baseboards protect the levelling screws from damage during transport and installation.
- +** **Magnetic lock:** The magnetic lock ensures that the doors are fully locked and perfectly sealed. Good haptics when closed.
- +** **Maintenance opening:** Maintenance openings allow optimal and individual adjustment of the 2-bolt system to suit the on-site conditions.

CEMO PROline

Secure cabinet 6/20 and 12/20 type 90 PG 9

NEW

Complies with the newest version of DIN EN 14470-1

- 90 minutes fire resistance
- for containers up to 30 litres/60 litres (order no. 11975/12010)
- safe 2-point locking for optimal access protection
- locking mechanism activates automatically when closing the doors
- self-closing doors in the event of a fire
- door holding in an open condition as standard
- extra safety: load certification for fan centre of gravity on the top of the cabinet
- for connection to technical ventilation, diameter of ventilation opening DN75
- forkliftable, height-adjustable feet, removable base trim
- earthing point on the outside of the cabinet to avoid ignition hazards due to electrostatic charging
- optional: cable duct for installation of measuring equipment, for example
- cabinet body in grey, doors in RAL 2008/orange or in RAL 1023/traffic yellow (other colours on request)



PROline 12/20

PROline 6/20

Equipment

- 3x floor plates
- height-adjustable, load capacity 75 kg, grid dimension 32 mm
- 1x bottom bund with perforated plate grating



★ Matching fans for technical ventilation as accessories, see catalogue p. 208/209.



- ① storage of flammable liquids
- ② storage of containers up to 30 litres / 60 litres (11975)
- ③ removable base trim for forklift access



Description	Ext. dimensions cm (w x d x h)	Int. dimensions cm (w x d x h)	Collect. vol. in L	Weight (approx.) in kg	Order no.	
					Door orange	Door yellow
Safety cabinet PROline 12/20 type 90, double-wing door	120 x 60 x 195	105 x 49 x 166	33	450	11880	12009
stainless steel*					11991	-
Safety cabinet PROline 12/20 type 90, double-wing door	120 x 60 x 195	105 x 49 x 166	66	455	11975	12010
stainless steel*					11992	-
Safety cabinet PROline 6/20 type 90, door hinge left	63.5 x 60 x 195	49 x 49 x 166	33	265	11911	12011
stainless steel*					11989	-
Safety cabinet PROline 6/20 type 90, door hinge right	63.5 x 60 x 195	49 x 49 x 166	33	265	11916	12012
stainless steel*					11990	-

* Bottom bund and floor plates in stainless steel (V2A)

Secure cabinets FWF 30 PG 9

- with sign GS and CE
- 30 minute fire-resistance
- single-layer doors and walls in homogeneous full material
- in case of fire, self-closing vents on the top of the cabinet, DN 100 mm
- hydraulic door closer with integrated arrest system (thermally triggered) earthing to avoid the danger of ignition due to electrostatic discharge
- height-adjustable feet, can be aligned from inside
- with removable base trim so it can be driven under
- 3 height-adjustable, steel plate spill trays, powder-finished in RAL 7035, load bearing capacity 75 kg (grid size 32 mm)
- one steel plate bottom tray, powder-finished in RAL 7035 with a perforated plate insert
- fully-extending drawers for the storage of small containers, load bearing capacity 65 kg, or 11 kg for 28 L
- 6/20 with bottom tray 19 L
12/20 with bottom tray 44 L

30 min.

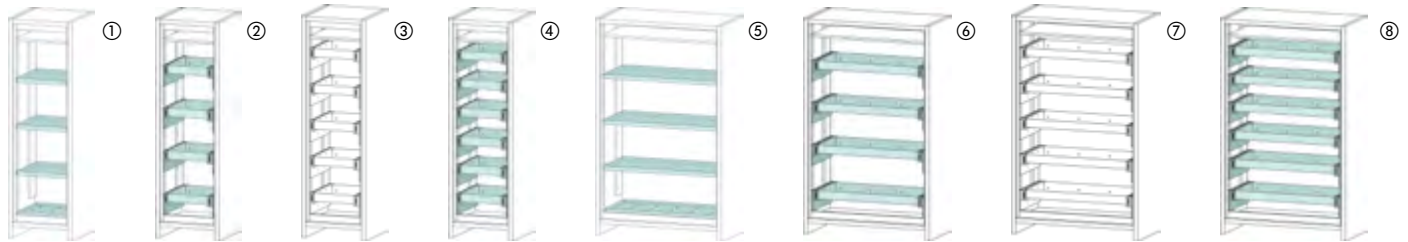

Description / Type	External dimensions cm (l x d x h)	Internal dimensions cm (l x d x h)	Weight approx. kg	Order no.
① 6/20 – FWF 30 3 spill trays, 1 bottom tray	59.5 x 59.5 x 196	47.5 x 51.5 x 160	147	8057
② 6/20 – FWF 30 4 full drawers	59.5 x 59.5 x 196	47.5 x 51.5 x 160	206	10622
③ 6/20 – FWF 30 5 full drawers	59.5 x 59.5 x 196	47.5 x 51.5 x 160	220	10623
④ 6/20 – FWF 30 6 full drawers	59.5 x 59.5 x 196	47.5 x 51.5 x 160	235	10624
⑤ 12/20 – FWF 30 3 spill trays, 1 bottom tray	119.5 x 59.5 x 196	107.5 x 51.5 x 160	226	8055
⑥ 12/20 – FWF 30 4 full drawers	119.5 x 59.5 x 196	107.5 x 51.5 x 160	291	10625
⑦ 12/20 – FWF 30 5 full drawers	119.5 x 59.5 x 196	107.5 x 51.5 x 160	308	10626
⑧ 12/20 – FWF 30 6 full drawers	119.5 x 59.5 x 196	107.5 x 51.5 x 160	324	10627

ACCESSORIES FOR SECURE CABINETS FWF 30 F-SAFE

Description	Order no.
Spill trays for secure cabinets 6/20 FWF 30 F-SAFE	11715
Spill trays for secure cabinets 12/20 FWF 30 F-SAFE	11716

Secure cabinets FWF 90 PG 9

90 min.



Secure cabinet FWF 90 under-table model:

- GS and CE conformity marks
- 90-minute fire resistance (EN 14470-1)
- single-layer doors and walls in homogeneous full material
- self-closing doors in case of fire
- vents on top of the cabinet, DN 100 mm
- adjustable metal feet on the underside of the cabinet
- earthing to prevent electrostatic charging

Version with fully-extending drawer

- smooth-running, fully-extending drawers for the storage of small containers, load bearing capacity 65 kg
- under-table cabinet with 49 L drawer with locking function
- rollers for easy movement
- locking status display
- includes certified pipe feed-through and earth terminal



Version with hinged doors



Version with fully-extending drawer (figure shows usage example)

Version with hinged doors

- for storage of small containers
- 24 L collection volume

Description / Type	External dimensions cm (l x d x h)	Internal dimensions cm (l x d x h)	Weight approx. kg	Order no.
11/6-FWF with hinged doors	110 x 50 x 67	101.5 x 35 x 53	185	8060
11/6-FWF with drawer	110 x 57 x 63	87 x 43 x 46.4	235	11024

CEMO PROline

Secure cabinet 6/20 and 12/20 type 90 PG 9

Complies with the newest version of DIN EN 14470-1

- 90 minutes fire resistance
- for containers up to 30 litres
- safe 2-point locking for optimal access protection

- locking mechanism activates automatically when closing the doors
- self-closing doors and drawers in the event of a fire
- for connection to technical ventilation, diameter of ventilation opening DN75
- forkliftable, height-adjustable feet, removable base trim
- earthing point on the outside of the cabinet to avoid ignition hazards due to electrostatic charging

- cabinet body in grey, doors in RAL 2008/ orange or in RAL 1023/traffic yellow (other colours on request)

Equipment

- 4 to 6 fully extending drawers (see table on page 15) with a load capacity of 75 kg per drawer 1x bottom bund

90 min.



PROline 12/20



PROline 6/20 with 4 fully extending drawers and bottom bund



PROline 12/20 with 4 fully extending drawers and bottom bund

Order no.

	Number of drawers	Ext. dimensions cm (w x d x h)	Int. dimensions cm (w x d x h)	Collect. vol. in L	Weight (approx.) in kg	Door orange	Door yellow
6/20 type 90, door hinge left	4	63.5 x 60 x 195	49 x 49 x 166	33	297	12017	12026
6/20 type 90, door hinge right	4	63.5 x 60 x 195	49 x 49 x 166	33	297	12018	12027
6/20 type 90, door hinge left	5	63.5 x 60 x 195	49 x 49 x 166	33	307	12019	12028
6/20 type 90, door hinge right	5	63.5 x 60 x 195	49 x 49 x 166	33	307	12020	12029
6/20 type 90, door hinge left	6	63.5 x 60 x 195	49 x 49 x 166	33	317	12021	12030
6/20 type 90, door hinge right	6	63.5 x 60 x 195	49 x 49 x 166	33	317	12022	12031
12/20 type 90, double-wing door	4	120 x 60 x 195	105 x 49 x 166	33	488	12023	12032
12/20 type 90, double-wing door	5	120 x 60 x 195	105 x 49 x 166	33	503	12024	12033
12/20 type 90, double-wing door	6	120 x 60 x 195	105 x 49 x 166	33	518	12025	12034

ACCESSORIES FOR PROLINE 6/20 AND 12/20 TYPE 90

Description	Collect. vol. in L	Dimensions cm (w x d x h)	Weight (approx.) in kg	Order no.
Additional floor plate 6/20	-	45 x 44 x 4	2.5	11912
Additional floor plate 12/20	-	105 x 44 x 4	6.5	11881
Cable duct 6/20 and 12/20 (in cabinet ceiling, for self-assembly)	-	-	-	11884
Accessory pack for active storage For active storage (decanting, filling of hazardous materials in the secure cabinet), the cabinet interior must be earthed.	-	-	-	12074
Bottom bund 6/20 with perforated plate grating	66	48.5 x 47 x 40	16	12041
Bottom bund 12/20 with perforated plate grating	66	105 x 47 x 17	18	12013

STAINLESS STEEL VERSION V2A

Additional floor plate 6/20 for PROline	-	45 x 44 x 4	2.5	11993
Additional floor plate 12/20 for PROline	-	105 x 44 x 4	6.5	11994
Bottom bund 6/20 with perforated plate grating for PROline	33	48.5 x 47.5 x 17.5	10.5	12042
Bottom bund 12/20 with perforated plate grating for PROline	33	105 x 47.5 x 9	15	12043
Bottom bund 12/20 with perforated plate grating for PROline	66	105 x 47 x 17	18	12014

Ventilation systems PG 9 for secure cabinets FWF 30 and FWF 90

Escaping vapours and hazardous gas-air mixtures are always possible when flammable liquids are stored in secure cabinets. These Ex-zones form not only inside a secure cabinet, but can also arise within a radius of several metres around it.

Suitable ventilation systems can remove escaping vapours and gases directly where they are produced, effectively preventing an explosive atmosphere forming. Subdivision into Ex-zones is no longer necessary.

There are two different ventilation systems:

- exhaust air fans, which discharge the extracted air to the outside through an exhaust line
- recirculation fans, which pass the extracted air through integrated filters and thereby render it harmless with regard to explosion hazard before discharging it into the environment



Note from TRGS 510, Appendix 1: Not only fire resistance class FWF 90 but also mechanical ventilation systems are required for extremely flammable liquids (H224).



The ventilation systems on pages 208 / 209 can be used for our environmental cabinets as well.

EXHAUST AIR FAN WITH AIRFLOW MONITORING

For placement on the secure cabinet and discharge of the extracted air into an external exhaust line

- sheet steel housing, powder-coated, light grey RAL7035
- floating output via DIN socket
- intake fitting diameter 75 mm
- output volume: 50 – 200 m³/h with volume flow monitoring
- sound pressure level Lp2A: 35 dB(A)
- voltage: 230 V
- frequency: 50 Hz
- power consumption: max. 0.45 A



Ready to go solutions
for extraction from Ex-zone 2
and installation in Ex-free zone
protection class: CE II _/3 G IIB T4

Description	External dimensions cm (l x w x h)	Weight approx. kg	Order no.
Exhaust air fan SST AL with adapter SST-P for FWF90	42.5 x 25 x 25.5	8	8739

RECIRCULATION FAN WITH ACTIVE CARBON FILTER

Plug&play recirculation fan with active carbon filter for discharging the exhaust air directly to outdoors.

- sheet steel housing, powder-coated, light grey RAL7035
- incl. active carbon, coarse and fine filters
- saturation level monitoring for filters
- floating output via DIN socket
- intake fitting diameter 75 mm
- output volume: 25 m³/h with volume flow monitoring
- sound pressure level: 38 dB(A)
- voltage: 230 V
- frequency: 50 Hz



Advantages:

- no exhaust pipe to outside required
- no wall opening required

Ready to go solutions
ATEX-compliant:
for extraction from Ex-zone 2
and installation in Ex-free zone
protection class: CE II _/3 G IIB T4

Description	External dimensions cm (l x w x h)	Weight approx. kg	Order no.
Recirculation fan SST UL with adapter SST-P for type FWF90	50 x 28.5 x 29.5	20	10963
Replacement filter set for recirculation fan SST UL	-	-	10964

Ventilation systems PG 9 for secure cabinets FWF 30 and FWF 90

RADIAL FAN 230 V

Model 1

made of flame retardant PPS

- with mounting bracket
- intake fitting diameter: 75 mm
- voltage: 230 V
- frequency: 50 Hz
- nominal current: 0.95 A
- output volume: 250 m³/h
- operating speed: 2850 rpm
- sound pressure level: 45 dB(A)



ATEX-compliant:

for extraction from Ex-zone 2
and installation in Ex-free zone
protection class:
CE II 2G Ex h IIB T3 Gc

Description	External dimensions cm (l x w x h)	Weight approx. kg	Order no.
Radial fan 230 V (model 1)	24.6 x 21.6 x 30	4	11431

RADIAL FAN 230 V

Model 2

made of flame retardant PPs-el

- with mounting bracket
- intake fitting diameter: 75 mm
- voltage: 230 V
- frequency: 50 Hz
- nominal current: 1.07 A
- output volume: 150 m³/h
- operating speed: 2800 rpm
- sound pressure level: 55 dB(A)



ATEX-compliant:

for extraction from zone 1 and
installation in zone 1
Motor: II 2G Ex eb IIC T4 Gb
Fan: II 2G Ex h IIB T4 Gb

Description	External dimensions cm (l x w x h)	Weight approx. kg	Order no.
Radial fan 230 V (model 2)	39 x 22 x 40.8	6	11432

RADIAL FAN 230 V

Model 3

made of flame retardant PPs-el

- with mounting bracket
- intake fitting diameter: 75 mm
- voltage: 3~ 230/400 V
- frequency: 50 Hz
- nominal current: 0,62 A
- output volume 150 m³/h
- operating speed: 2825 rpmn
- sound pressure level: 55 dB(A)



ATEX-compliant:

for extraction from zone 1 and
installation in zone 1
Motor: II 2G Ex eb IIC T4 Gb
Fan: II 2G Ex h IIB T4 Gb

Description	External dimensions cm (l x w x h)	Weight approx. kg	Order no.
Radial fan 380 V (model 3)	37.7 x 22 x 38	6	11433

ACCESSORIES FOR RADIAL FANS

Description	Order no.
Throttle valve, DN 75 mm, PPs	11434
Intake fitting, ND 100 – 75 mm, incl. clamp	11435
Sleeve extension, DN 75 mm	11436
Fitting extension, DN 75 mm	11437
Ventilation hose L = 750 mm, DN 75 mm, incl. two clamps	11438
Ventilation hose L = 2,000 mm, DN 75 mm, incl. two clamps	11439
T-piece, DN 75 mm	11440

Storage and charging of lithium batteries

The importance of lithium batteries is increasing constantly in our everyday lives. These powerful batteries are increasingly being used not only in small mobile devices or in bicycles (e-bikes) but, correspondingly sized, also in industrial appliances, vehicles and machines. Lithium batteries are powerful, but not without their hazards. Lithium batteries have long been classified as hazardous goods under transport law and are therefore subject to meticulous hazardous materials regulations which become stricter every 2 years. Lithium batteries require the utmost care during

transport and particularly during storage and handling. If damaged or if handled incorrectly, these batteries can quickly lead to dramatic consequences, usually in the form of a fire. One reason why storing lithium batteries poses a fire safety challenge is that they are not under constant observation, and a fire can spread quickly and unnoticed.

The typical incidence of damage involves the battery igniting and explosively emitting jets of flame and toxic smoke.

Summary of the possible causes of fire:

- mechanical damage (e.g. impact, fall)
- improper charging process
- deep discharging
- overheating due to high ambient temperature

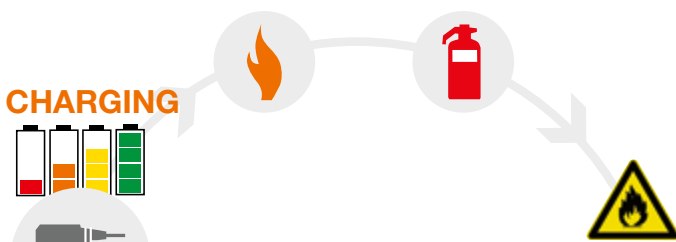

CHARGING

Most of the lithium battery-related fires studied in Germany occurred during the charging process. Safety specialists, fire brigades and property insurers are therefore paying closer attention to this threat.

Unfortunately, practical experience has shown us that there are many (deliberately or unintentionally) incorrect ways to charge batteries. Even a lithium battery which looks perfectly intact from the outside can already be damaged enough on the inside that adding electrical energy via the charger can cause a fire hazard. Charging stresses a lithium battery. Frequent charging, hard use and wear place a burden the battery to the point that any charging process could be the last one.

Charged lithium batteries pose a higher fire hazard (cause) and burn more intensely (effect). Therefore, the charging process must never be underestimated and must always take place under supervision at a designated location. Charging in the workplace therefore requires a risk assessment which takes into account the risk to employees and the environment, as well as the building layout. These findings should be included in the fire prevention plan.

Overheating due to causes such as direct sunlight or heat build-up during charging must also be avoided.

Practical tip:
Charge and store lithium batteries separately!

More Information: www.battery-secure.com

Important:
Lithium batteries are mentioned in German Regulation **TRGS 510**. Due to their higher hazard level, appropriate fire protection measures must be taken.

STORAGE

So far, there are no statutory regulations for the storage and supply of lithium batteries. Occupational safety obligations and, above all, insurance guidelines nevertheless mean that the information to be observed regarding the storage and operation of lithium batteries is just as comprehensive as that applicable to traditional hazardous materials storage.

VdS Guideline 3103 from the German Insurance Association (GDV) is a current source of important information about storing and supplying lithium batteries.

Storage also involves the danger of a nearby fire spreading to the lithium batteries. A small, extinguishable fire source can then become a major challenge to the fire brigade.

A risk assessment in combination with the right charging and storage solution effectively improves safety in the workplace. Not all lithium batteries are the same. Therefore, there is no "one size fits all" protection scheme. In addition, the information provided by the manufacturers of energy storage devices and battery-operated devices must be observed at all times. Suitable technical protective measures, such as tested transport containers, safety cabinets or even fire protection containers, always depend on the circumstances in the workplace.

CHARGING + STORAGE



Storage and charging of lithium batteries

CEMO safety note

Safety rules for charging

- Never charge in the storage area.
- Maintain a clearance of several metres from combustible objects.
- Never charge damaged or faulty batteries.
- Avoid heat build-up during charging.
- Use only the original charger.
- Immediately disconnect the battery from the mains after charging.
- Avoid charging overnight.
- Unsupervised charging poses a higher risk.

Fire extinguishing is still the most disputed topic regarding lithium batteries. Although small quantities of water can worsen the reactions of lithium-ion batteries, large quantities have a cooling effect and, in the ideal case, can interrupt the thermal runaway process. The fire brigade also fight fires with plenty of water, which at least prevents the flames spreading to the surroundings. It is therefore crucial to alert the fire brigade as soon as possible so they can extinguish the fire.

Safety rules for storage

- Protect against short circuit of the battery poles.
- Protect against mechanical damage.
- Separate storage, i.e. no mixed storage.
- When storing batteries inside buildings, maintain a distance of 2.5 m from other installations or store them in areas that are isolated in terms of fire prevention (e. g. fire protection containers, safety cabinets).
- Immediately dispose of damaged products properly, even in case of slight abnormalities.
- Do not expose directly and permanently to high temperatures.
- Train employees how to handle lithium batteries properly.
- Provide suitable fire extinguishers.

Damaged/defective batteries, prototypes or batteries for disposal require a hazard assessment and possibly additional protective measures.

Additional storage solutions for lithium batteries

STEEL CONSTRUCTION

F90 F-SAFE fire protection container
with DIBt certification



F90 F-SAFE fire protection container
with DIBt certification



Also available as
a shelf container



CONCRETE CONSTRUCTION

F90 F-SAFE fire protection storage cell



F90 F-SAFE fire protection storage
walk-in version





How to find the right product for your application:

Tool cabinet

PROline
6/20, 12/20

Battery storage cabinet **FMplus**
size US

Battery storage and charging cabinet **lockEX**
8/5, 8/10, 8/20

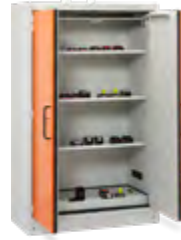

Safety class	Tool cabinet Simple sheet steel cabinet Protection against unauthorised access	+ Battery safety cabinet	++ Double-walled steel cabinet	+++ Fire-resistant fire prevention cabinet
Capacity			up to 1.1 kWh	up to 12 kWh
Explosion protection (battery fire testing)				
Protection: fire from inside				
Protection: fire from outside in minutes 0/30/60/90		90		30
BBT Index (Battery fire suitability)				
Certifications		 DIN EN14470-1	 TÜV NORD	 TÜV NORD + VDMA ¹⁾

¹⁾ VDMA standard sheet 24994:2024-08

What happens when lithium batteries catch fire?

A fire involving lithium batteries is more than the appearance of just a few flames; this is because the electrical energy is released in a burst of thermal energy and leads to a rapid increase in temperature. The thermal runaway of a cell and the spread of fire to other cells in the battery pack (thermal propagation) is described as explosive burning, which looks like an intense firework. Further observations include the emission of heavy smoke and particles being flung around like projectiles.

The greatest danger occurs during a gas explosion, when escaping battery vapours suddenly ignite, exerting an explosive pressure of several bar on cabinets or containers. If these are not designed to cope, the result can be the total failure of their intended protective effect.

This is why battery fire testing and induced gas explosions are so important as proof of performance for cabinets and battery safety products.



Extract from TRGS 510
Technical rules for hazardous materials in mobile containers

13 Combined storage, divided storage and separate storage

[...]

13.2 General principles

[...]

- (3) Instructions for a possible increase in danger [...] can arise from, for example, [...]
- 3. the product-specific hazards, such as, for example, the hazard posed by ignition sources due to a short-circuit involving lithium batteries.
- (5) To reduce hazards, divided storage within a storage compartment or separate storage may be required:
 - 1. Divided storage is achieved through sufficient distances or barriers (e.g. walls, cabinets made from non-flammable materials, [...])
 - 2. Separate storage is divided storage in different storage compartments with a fire rating of at least 90 min.

As at 2021

What does that mean for the use of cabinets and containers?

TRGS 510 provides only a recommendation for the minimum standard and can be replaced by more effective protective measures at any time.

The indicated fire rating of a cabinet or container plays a less important role, as these systems are assessed only at the test kiln and the assessment is therefore restricted only to fire and/or heat.

The most up-to-date qualification process therefore involves several real battery fire tests and induced gas explosions. This method makes it possible to demonstrate that the housing system remains intact and that the doors remain closed, even in an abnormal fire caused by lithium batteries. A gas explosion does not occur in every battery fire, but when it does, the consequences can be devastating.

Conclusion:

The actual product qualification is decisive. In the case of lithium batteries, focusing on the time indicated by the fire rating alone is therefore unhelpful. The battery cabinets from CEMO with a fire rating of 60 minutes (inside to outside) or the flame protection cabinets as lightweight fire protection products can therefore, with further qualification measures, be assessed as safer than other cabinet systems on the market that only have a fire rating of 90 minutes.

Which product qualification is recommended?

! TÜV Nord testing programme type tested in 2023 with TÜV NORD certification awarded

Please feel free to contact us.

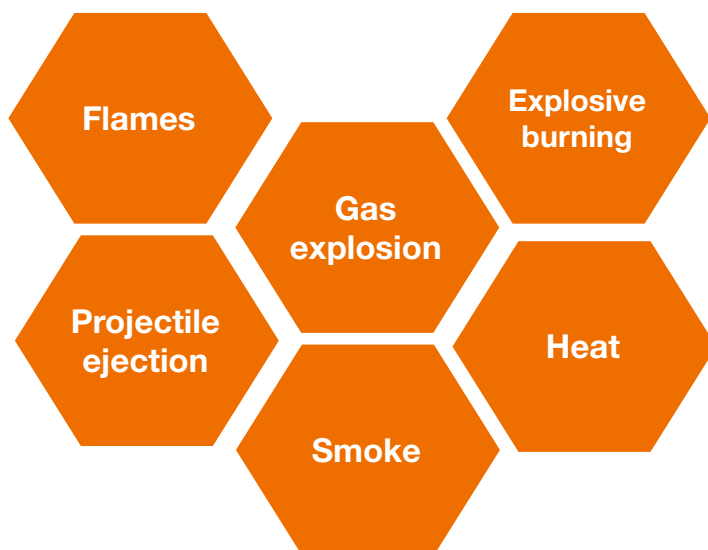

Battery flame protection cabinet FMplus PG 9

Leaving even a single lithium battery from a battery-powered device lying around in the open could be enough to ignite a fire. Based on the risk assessment, this double-walled steel cabinet can be used as a protective measure for new lithium batteries from devices such as power tools or garden equipment.

The cabinet is available in three sizes:

- sturdy, heat-insulating double-walled steel cabinet
- lockable door with three-point lock
- can be locked with a padlock if necessary (profile half cylinder lockable)
- Cold smoke seals help prevent smoke escaping the cabinet
- vent for proper connection to the exhaust pipe to the outdoors
- forklift access clearance (8 – 9 cm) for positioning and removal in the event of an incident
- equipped with smoke detector for audible alarms as standard
- powder coating body light grey (RAL 7035) and door light red orange (RAL 2008)
- includes warning labels and safety instructions

Based on the risk assessment, this double-walled steel cabinet can be used as a protective measure for new lithium batteries from devices such as power tools or garden equipment.

Safe and cost-effective storage: FMplus, the entry-level model.



US version with charger:

- 1 power socket per shelf
- battery-operated smoke alarm
- power disconnection in case of fire
- door contact switch for interrupting the charging current if the doors are open



FMplus US with charger



FMplus US

i From autumn 2023, the US version is also available with the latest certification from the TÜV NORD Group.



Accessories: Set of castors



Accessories: Cable duct



Accessories: Adapter for ventilation line

Description	Shelves	External dimensions in cm (w x d x h)	Internal dimensions in cm (w x d x h)	Weight approx. kg	Order no.
Battery storage cabinet FMplus US	2	43 x 43 x 56	35 x 35 x 46	27	11651
Battery charging cabinet FMplus US	2	43 x 43 x 56	35 x 35 x 46	30	11877
Battery storage cabinet FMplus S	3	59 x 46 x 89	51 x 38 x 79	47	11652
Battery storage cabinet FMplus L	4	60 x 46 x 165	52 x 38 x 154	83	11653

ACCESSORIES

Description	Order no.
Insert shelf for FMplus S battery storage cabinet	11655
Insert shelf for FMplus L battery storage cabinet	11656
Set of castors for FMplus battery storage cabinet	11657
Second smoke detector (can be networked with internal smoke detector)	11658
Padlock with profile half-cylinder NP 30 – 12 mm	11659
Cable duct for FMplus battery storage cabinet (e.g. for installation of in-house fire alarms)	11660
Adapter for ventilation line for FMplus battery storage cabinet	11661

Battery storage and charging cabinet PG 9

Fire protection is a high priority when storing and charging lithium batteries.

CEMO has been offering a safe solution since 2020, developing it further in line with the latest knowledge and obtaining the latest certifications. Equipped with important safety features, the fire consequences of these battery storage systems can be reduced to a minimum and operational safety significantly increased.

- Charging and/or storing multiple lithium batteries in the cabinet
- early alarm in case of damage
- all relevant safety regulations for charging lithium batteries are observed
- ideal for separating batteries on charge from stored units
- can also be used as an under-table cabinet under the workbench
- Tested with standardized, real battery fire tests according to VDMA standard sheet 24994 and TÜV Nord test program
- Withstands a battery fire, ensures no escape of flames and flames and sparks
- built using non-combustible, fire-resistant components

- Spring-based CEMO lockEX door locking for controlled pressure relief during explosions
- special fire prevention seals prevent flames escaping
- cold smoke-tight sealing system for openings
- transportable for positioning at the place of installation
- lockable double doors with sturdy lock and hinges
- doors painted orange, matching RAL 2004; body grey, matching RAL 7035

Type	Battery charging cabinet Basic	Battery charging cabinet Premium	Battery charging cabinet Premium Plus
Smoke alarms	●	●	●
Fan for charging heat dissipation	●	●	●
Charging stop when door is opened (door contact switch)	●	●	●
Currentless switching with heat development	●	●	●
De-energized circuit in case of smoke development		●	●
Connection option via potential-free contact to company-internal building management system		●	●
Remote alarm via per SMS			●
Remote alarm via App			●
Digital display on the outside			●

New test programme new state of technology

CEMO battery charging cabinets have been tested and already comply with the new state of technology according to VDMA standard sheet 24994 and TÜV Nord test program.



VDMA standard sheet
24994:2024-08

Certificates at
www.cemo-group.com/certificates

The 3 proofs of safety and quality

Test component of the new certification programme of the TÜV NORD Group.

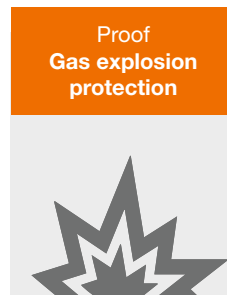

Battery storage and charging cabinet PG 9

Fire prevention meets explosion protection

CEMO now also has the solution for explosion protection.

Sequence of a battery fire:

An explosion can happen even before a thermal runaway occurs. If the cabinet housing gives way or the doors open, the protective effect can be instantly lost. There is then nothing to prevent the burning cells and battery packs being ejected into the area around the cabinet.

The solution:

CEMO lockEX is a spring-based mechanism in the door lock that effectively manages the explosive pressure of gases that ignite inside the cabinet. This NO-BANG technology guarantees that the protective effect is maintained.

RECOMMENDATION
max. capacity Li batteries



OPERATING PRINCIPLE OF THE LOCKEX LOCKING MECHANISM (PLAN VIEW)

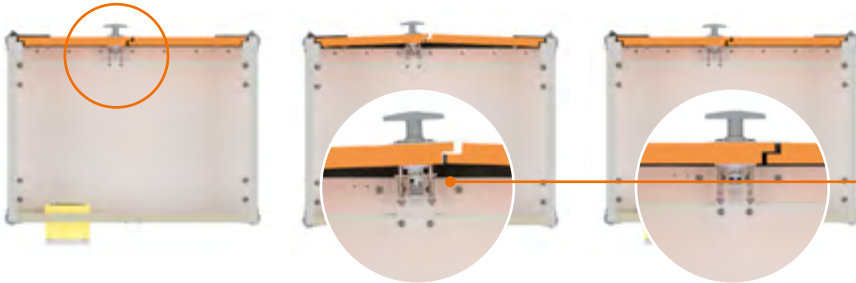

1. Battery failure begins, cells emit flammable vapours which spread throughout the cabinet.
2. An ignition source (possibly initiated by electrical sparks or the build-up of heat inside the battery itself) results in an explosion/ignition of the gas. The lockEX mechanism releases the explosive energy in a controlled way through a narrow gap.
3. The doors are locked again and the batteries can continue reacting without causing any danger. The cabinet system remains operational and protects the employees and the surroundings.

lockEX[®]
inside



Battery storage cabinet 8/5



Battery charging cabinet 8/10
Optionally with castors.

Battery storage cabinet 8/10
with 1 shelf as standard at half height. Optionally 2 more shelves possible (see accessories).

BATTERY STORAGE CABINETS

Description	External dimensions cm (l x w x h)	Internal dimensions cm (l x w x h)	Weight approx. kg	Order no.	
Battery storage cabinet 8/5	Two battery-operated audible smoke detectors - without power connection, without fan -	80 x 66 x 52	73 x 53 x 45	80	11890
	Additionally with stacking feet*	80 x 66 x 62	73 x 53 x 45	83	11891
Battery storage cabinet 8/10	With stacking feet*, two battery-operated audible smoke detectors - without power connection, without fan	80 x 66 x 111	73 x 53 x 91	132	11898
	With castors, two battery-operated audible smoke detectors - without power connection, without fan	80 x 66 x 115	73 x 53 x 91	144	11722
Battery storage cabinet 8/20	With feet, three battery-operated audible smoke detectors - without power connection, without fan	80 x 66 x 213	73 x 53 x 182	266	12047

* required when stacking the cabinets

Battery storage and charging cabinet PG 9

For all charging versions:

- heat dissipation by fan during charging
- charging current is interrupted if the doors are opened
- charging stops if a malfunction or accident occurs
- vents sealed with thermocouples
- 230V model with 1-phase power supply (3500W / 16A)
- 400V model with 3-phase power supply (2x3500W / 2x16A)

Battery charging cabinet 8/5

- power supplied by 9-socket power strip (3500 W, 16 A)
- up to 2 storage levels

Battery charging cabinet 8/10

- Charging versions with 2 horizontally arranged 9-socket power strip for power supply
- up to 4 storage levels

Akku-Ladeschrank 8/20

- Charging versions with 4 horizontally arranged 9-socket power strip for power supply
- 8 storage levels
- Fire compartment for subdividing the cabinet contents

NEW

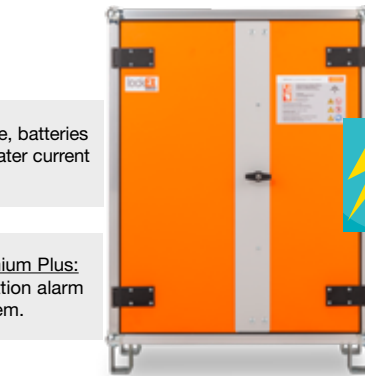
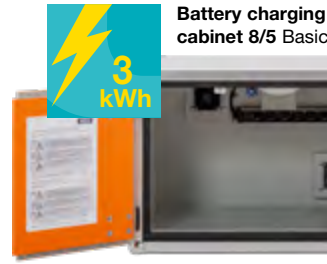

Battery charging cabinet 8/20 Premium



Battery charging cabinet 8/10 Premium Plus 3-phase

TIP: The 3-phase version is necessary if, for example, batteries are to be charged with fast chargers that have a greater current requirement than the 1-phase version can provide.

i All versions with audible alarm. Premium and Premium Plus: Now with improved connection option for combination alarm transmitter (12V) and connection to fire alarm system.

BATTERY CHARGING CABINETS

Description	Type	Ext. dimensions cm (l x w x h)	Int. dimensions cm (l x w x h)	Weight approx. kg	Order no.	
Battery charging cabinet Basic	8/5 1-phase	80 x 66 x 52	73 x 53 x 45	81	11892	
	8/5 with stacking feet* 1-phase	80 x 66 x 62	73 x 53 x 45	84	11893	
	8/10 with stacking feet* 1-phase	80 x 66 x 111	73 x 53 x 84	135	11899	
	8/10 with stacking feet* 3-phase	80 x 66 x 111	73 x 53 x 84	136	11900	
	8/10 with castors 1-phase	80 x 66 x 115	73 x 53 x 84	146	11723	
	8/10 with castors 3-phase	80 x 66 x 115	73 x 53 x 84	147	11726	
Battery charging cabinet Premium	8/20 with feet 1-phase	80 x 66 x 213	73 x 53 x 176	267	12048	
	8/20 with feet 3-phase	81 x 66 x 213	73 x 53 x 176	268	12049	
	<u>Modification to charging Basic:</u> electronic smoke detector	8/5 1-phase	89 x 66 x 52	73 x 53 x 45	82	11894
	<u>In addition to charging Basic:</u> Power disconnection also in case of smoke detection, audible warning tone, potential-free output for switching to fire alarm system on outside of cabinet, 12 V connection e.g. for accessory combination alarm (visual & audible)	8/5 with stacking feet* 1-phase	89 x 66 x 62	73 x 53 x 45	85	11895
		8/10 with stacking feet* 1-phase	89 x 66 x 111	73 x 53 x 88	135	11901
		8/10 with stacking feet* 3-phase	95 x 66 x 111	73 x 53 x 88	136	11902
8/10 with castors 1-phase		89 x 66 x 115	73 x 53 x 88	146	11724	
Battery charging cabinet Premium Plus	8/10 with castors 3-phase	95 x 66 x 115	73 x 53 x 88	147	11727	
	8/20 with feet 1-phase	89 x 66 x 213	73 x 53 x 176	267	12050	
Battery charging cabinet Premium Plus	8/20 with feet 3-phase	89 x 66 x 213	73 x 53 x 176	268	12051	
	8/5 1-phase	89 x 66 x 52	73 x 53 x 45	82	11896	
	8/5 with stacking feet* 1-phase	89 x 66 x 62	73 x 53 x 45	85	11897	
	8/10 with stacking feet* 1-phase	89 x 66 x 111	73 x 53 x 88	135	11903	
	8/10 with stacking feet* 3-phase	95 x 66 x 111	73 x 53 x 88	136	11904	
	8/10 with castors 1-phase	89 x 66 x 115	73 x 53 x 88	146	11725	
	8/10 with castors 3-phase	95 x 66 x 115	73 x 53 x 88	147	11728	

* required when stacking the cabinets

Special application for fire alarm systems

NEW

Battery cabinets for fire alarm systems:

The current battery cabinets from CEMO, available in the versions **Premium** and **Premium Plus**, are designed to send the alarm through to an in-house fire alarm system or internal warning device via the voltage-free contact. This means that it is not possible to create a permanent link to a fire alarm system with a direct connection to the fire service.

There are now special cabinet versions that are designed for the fire alarm equipment

to be installed in the cabinets by fire alarm specialists, which will be necessary depending on the requirements on site or the manufacturer-specific system compatibility.

Ask for our "Information sheet for battery cabinets for use with fire alarm systems" and talk to your fire alarm specialist.

Version for fire alarm system:

2x cable ducts for self-installation, for flexible installation of your individual fire alarm

equipment by a fire alarm specialist

Storage cabinet:

Two battery-operated audible smoke detectors

Charging cabinet:

Two battery-operated, audible smoke detectors, power supply in the cabinet with socket strip(s), technical ventilation, power disconnection in case of heat build-up or using a door contact switch

BATTERY CABINETS FOR FIRE ALARM SYSTEMS

Description	External dimensions cm (l x d x h)	Internal dimensions cm (l x d x h)	Weight approx. kg	Order no.
Battery storage cabinet 8/5 for fire alarm systems	83 x 66 x 52	73 x 53 x 45	82	11885
Battery storage cabinet 8/10 for fire alarm systems (with stacking feet)	83 x 66 x 111	73 x 53 x 91	137	11886
Battery charging cabinet 8/5 1-phase for fire alarm systems	83 x 66 x 52	73 x 53 x 45	85	11887
Battery charging cabinet 8/10 1-phase for fire alarm systems (with stacking feet)	83 x 66 x 111	73 x 53 x 84	139	11888
Battery charging cabinet 8/10 3-phase for fire alarm systems (with stacking feet)	83 x 66 x 111	73 x 53 x 84	140	11889

Modular system Battery storage and charging cabinets

NEW

Thanks to the **modular cabinet concept**, the secure storage space can grow with the needs of the business.

- Variable heights in 62 cm increments (8/5) or 111 cm (8/10)

- Variable subdivision of storage levels: One to four storage levels per 111 cm (8/10)
- Fire chamber-tested, stackable modular system for customised assembly
- Signals (Premium/Premium Plus model

- range) can be linked to several cabinets
- Assignment of task areas to dedicated battery cabinets possible
- Easy to move due to stacking at the installation site
- Simple assembly

COMBINATION OPTIONS BATTERY STORAGE AND CHARGING CABINETS

Combinations	K 8/22	K 8/19	K 8/17	K 8/12	8/10	8/5	8/5
Overall height cm	222	186	173	124	111	62	52
Models*	8/10 8/10	8/5 8/5 8/5	8/5 8/10	8/5 8/5	8/10	8/5	8/5
Max. number sockets	36	27	27	18	18	9	9
Max. number of storage levels	up to 8	up to 6	up to 6	up to 4	up to 4	up to 2	up to 2
Ext. dimensions** cm (l x d x h)	80 x 66 x 222	80 x 66 x 186	80 x 66 x 173	80 x 66 x 124	80 x 66 x 111	80 x 66 x 62	80 x 66 x 52
Overall weight** approx. kg	270	252	219	168	135	84	81

Information:

- battery storage cabinets 8/10 cannot be stacked on battery storage cabinets 8/5
- battery storage cabinets 8/5 may be stacked a maximum of three high
- battery storage cabinets 8/10 may be stacked a maximum of two high

*The Premium/Premium Plus 3-phase versions are 89 cm (8/5) and 95 cm (8/10) wide

**The Premium/Premium Plus 3-phase versions vary slightly in weight



For details on the individual modules see pages 216 and 217.

Battery storage and charging cabinet ACCESSORIES PG 9

- ① Extremely flexible, eg. for cabling of the in-house fire alarm system
- ② Stacking feet, set
- ③ Combination alarm unit (strobe light)
Visual and audible alarms if an accident occurs, enabling additional protective measures to be taken promptly
- ④ Set of two network-capable smoke alarms (audible). Included in "Storage" and "charging Basic" as standard.
- ⑤ Effective aerosol extinguishing agent for lithium batteries, for initial, rapid extinguishing and flame suppression, automatic pyrotechnical triggering, maintenance free
- ⑥ Ideal for making the best possible use of available space and enlarging the storage area for small-cell lithium batteries (bear in mind the total capacity of the lithium batteries in the event of a fire)
- ⑦ Simple relocation in the building and removal in the event of an accident; two of the four steering castors are fitted with an integral foot brake



Forkliftable for simple positioning and rapid removal to the outdoors in the event of a fire

⑧ Shelves can be adjusted to the ideal working height; cabinets can be loaded using a high-platform truck or forklift; including wall mounting materials



ACCESSORIES FOR BATTERY STORAGE AND CHARGING CABINETS

Description	Dimensions cm (l x w x h)	Weight approx. kg	Order no.
① Fireproof cable entry	14 x 2.5 x 14	1.3	11345
② Stacking feet, set (already included with cabinet size 8/10)	10 x 6 x 10	3	11368
③ Combination alarm unit, visual and audible alarm (100 dB) (only for charging Premium and charging Premium Plus)	7.3 x 4.3 x 12.2	-	11389
④ Wireless heat and smoke alarms, set of two, battery operated, network capable, incl. two magnetic plates	ø 12.5 x 4.8	-	11560
⑤ Aerosol extinguisher (0.25 m ³ extinguishing capacity)	ø 6.5 x 3.8	-	11561
⑥ Shelf insert (for floor level or as intermediate level)*	72 x 40 x 3.5	-	11508
⑦ Trolley, 240 kg load capacity, for up to two cabinets 8/5	80 x 60 x 15	11.3	11461
⑧ Rack, for up to two cabinets, including wall mounting (only in combination with stacking feet)	106 x 53.5 x 200	50	11562

Battery safety storage cabinets PROline 6/20 and 12/20 PG 9

For the storage of low-capacity lithium batteries

Complies with the newest version of DIN EN 14470-1

- 90-minute fire rating in accordance with DIN EN14470-1
- for the storage of new, low-capacity lithium batteries (<100 Wh, see VdS 3103)
- safe 2-point locking for optimal access protection
- locking mechanism activates when closing the doors
- self-closing doors in the event of a fire
- door holding in an open condition as standard
- extra safety: load certification for fan centre of gravity on the top of the cabinet

- height-adjustable spill tray shelves, load capacity 75 kg, grid dimension 32 mm
- for connection to technical ventilation, diameter of ventilation opening DN75
- forkliftable, height-adjustable feet, removable base trim
- earthing point on the outside of the cabinet to avoid ignition hazards due to electrostatic charging
- cabinet body in grey, doors in orange (other colours on request)
- door hinge right or left



Battery safety storage cabinet PROline12/20

Battery safety storage cabinet PROline 6/20

Description	External dimensions cm (l x d x h)	Internal dimensions cm (l x d x h)	Storage shelves	Weight approx. kg	Order no.
Battery safety storage cabinet 6/20 – door left	60 x 60 x 195	45 x 49 x 166	4	265	11959
Battery safety storage cabinet 6/20 – door right	60 x 60 x 195	45 x 49 x 166	4	265	11960
Battery safety storage cabinet 12/20	120 x 60 x 195	105 x 49 x 166	4	450	11961

Battery charging cabinet 12/20 FWF90-GS PG 9

for storage and charging of lithium batteries

Fire-resistant secure cabinet, specially developed **for the storage and charging of lithium-ion batteries, as well as for the storage of critical batteries.**

- tested fire rating of 90 minutes from inside to outside according to DIN EN 14470-1
- **maximum temperature rise inside the cabinet of no more than 100K at any temperature measurement point**
- tested fire rating of 90 minutes from inside to outside according to DIN EN 1363-2
- **GS symbol – tested as per testing principle EK5/AK4 22- 01**
- self-closing doors, tested for permanent function with profile cylinder lock

- suitable for the storage and charging of lithium-ion batteries
- **suitable for the storage of critical batteries (detection of deformations, escape of liquids, elevated temperature greater than 40°C)**
- **internal real fire test of a filled cabinet**
- **standard surface in CPL light grey, similar to RAL 7035, non-flammable plate with surface treatment, classified A2 – s1, d0**



NEW

Description	External dimensions mm (l x d x h)	Internal dimensions mm (l x d x h)	Equipment	Weight approx. kg	Order no.
Battery charging cabinet 12/20 FWF90-GS	1212 x 664 x 2250	1004 x 453 x 1687	4 grating shelves, bottom spill bund, 4 x 10 power outlets, control unit 230 V , 16 A	706	11962
	1212 x 664 x 2250	1004 x 453 x 1687	4 grating shelves, bottom spill bund, 4 x 10 power outlets, control unit 400 V , 16 A	706	11963

Transport of lithium batteries

Lithium batteries are classified as hazardous goods under transport law. UN certification of the container is not sufficient to ensure that all requirements for ADR-compliant transport of lithium batteries are satisfied in all cases.

We therefore advise our customers to familiarise themselves with this topic and to provide comprehensive training for their employees on how to use the containers in compliance with regulations. This includes

knowledge about the official packaging instructions (see table), marking as per ADR and implementing transport. It also covers appropriate handling of damaged lithium batteries, for example.

If transport containers are properly packed according to the hazardous materials regulations, they can often also be used for storage purposes at the company. It is nevertheless advisable to conduct a hazard assessment in line with the situation on site, additionally involving the plant safety officer and possibly the property insurer as well.



SPECIAL REGULATIONS AND PACKAGING INSTRUCTIONS

	Special regulations according to ADR	Packaging instructions according to ADR
Small, intact lithium batteries <100 Wh	SV188	-
Intact lithium batteries >100 Wh	SV230	P903
Prototypes	SV310	P910
Batteries for disposal/recycling	SV377	P909
Damaged/defective batteries	SV376	P908
Critically damaged/defective batteries (not safe to transport)	SV376	P911

	Certification of the packaging		Packaging instructions according to ADR				
	Packaging group	UN coding	Intact lithium batteries >100 Wh (usual case)	Prototypes	Batteries for disposal/recycling	Damaged/defective batteries	Critically damaged/defective batteries (not safe to transport)
			P903	P910	P909	P908	P911
Plastic collection container S	VG2	Y	✓	✓*	✓	✓*	✗
Plastic collection container L	VG2	Y	✓	✓*	✓	✓*	✗
Steel collection container for batteries	VG1	X	✓	✓	✓	✓	✗
Safety drum for batteries	VG1	X	✓	✓	✓	✓	✗
Safety container for batteries	VG2	Y	✓	✓	✓	✓	✗

Please always pay attention to compliant packaging and transport as well
* possible in principle but not recommended



Battery system fire protection box Li-SAFE PG 9



Video
Battery system fire protection box

- safe transport and storage system for lithium batteries
- special fire prevention lining made of non-combustible materials
- formable special pads prevent the batteries shifting inside the box (included)
- boxes are stackable and can be interconnected
- two sturdy latches
- two handles for ease of handling
- can be locked with a padlock (not included)
- made of durable, impact-resistant plastic
- including hazardous goods labels



stackable and interconnectable

handles



NEW

formable special pads

fire prevention lining

New size 2-L

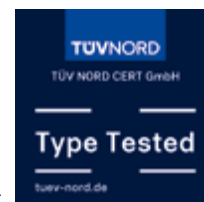

POSSIBLE APPLICATIONS:

- UN certification for lithium batteries in packaging group II and III
- for lithium battery weighing up to 5 kg
- transport possible on public roads in accordance with the regulations
- additionally usable as a stationary safety container for storage
- fire-protected storage for transport and on construction sites, for example
- Ideal for new and used batteries and for safe separation (e.g. faulty or quarantined batteries)



Faulty batteries must be transported safely during work.



With UN certification and Fire Safety lining.

Battery system fire protection box Li-SAFE PG 9

Development insights:

All boxes have been tested in battery fire tests with garden tool batteries, here the box 2-S

i Overview of ADR regulations see page 221



Essential if battery-powered devices are used in a company, because batteries can fail at any time (fire hazard).

Successful fire test: the CEMO fire prevention box withstands the flames.



Description	Permissible total weight in kg	External dimensions cm (l x w x h)	Internal dimensions cm (l x w x h)	Quantity of special pads	Weight approx. kg	Order no.
Battery system fire protection box Li-SAFE 2-S	10	40 x 30 x 21.5	30 x 19 x 9	2	4.5	11563
Battery system fire protection box Li-SAFE 3-S	12	40 x 30 x 34	30 x 19 x 21.5	3	6	11564
Battery system fire protection box Li-SAFE 2-L NEW	12	50 x 30 x 28	40 x 17 x 15	4	6.7	11872



In case of the loss or damage of pads or the filling of empty space



Multi-adapter plate for connecting with box systems of third-party manufacturers (e.g. Systainer, L-BOXX)



Shelf adapter plate for fixing the box in the required place, e.g. in a shelving system in a vehicle

ACCESSORIES

Description	Dimensions cm (l x w x h)	Weight approx. kg	Order no.
Special pads for battery system fire protection box	34 x 21 x 4	0.2	11565
Multi adapter plate NEW	44.5 x 30 x 5.5	0.74	11882
Shelf adapter plate NEW	39.5 x 29 x 2	0.46	11883

Further sizes on request

Battery safety barrel PG 9

- 60 litre clamping ring lidded drum
- special valve for pressure relief in the event of damage
- UN certification for hazardous goods belonging to packaging groups I, II or III
- for use with vermiculite as a buffer material
- 60 kg permissible total weight
- ideal for use as a storage bin for damaged batteries awaiting disposal
- certified for the transportation of lithium batteries (UN 3480 and UN 3090) weighing 0.5 – 5 kg

- Special ADR regulations apply for transportation (see special regulations and packaging instructions, p. 221).
- Please observe the enclosed packaging instructions!
- incl. one sack of vermiculite and plastic bags

Pressure relief in the event of damage in accordance with the pressure cooker principle



Ideal for the safe storage of defective batteries for eBikes, power tools, garden tools and much more.

Description	Dimensions cm (ø x height)	Storage capacity L	Weight when empty kg / maximum weight	Order no.
Battery safety barrel	38 x 66	60	4.9 / 60	11200

ACCESSORIES

Sack of vermiculite (corresponds to approx. 50 L)	-	-	4.5	11205
Lining bag for battery safety barrel	-	-	-	11232
Plastic bag for single battery	-	-	-	11233

Battery steel collection container PG 9

- 120 litre storage capacity
- ideal for use as a storage container for damaged batteries awaiting disposal
- robust, hot-dip galvanised steel container with sturdy closure buckles
- circumferential rubber seal protects against penetrating moisture
- lid can be opened easily and locked in place in a single step
- can be driven under, stacked and lifted by crane for easy handling
- for use with vermiculite or expanded glass granulate as a buffer material (see page 221)
- UN certification for hazardous solid goods belonging to packaging groups I, II and III

- Special ADR regulations apply for transportation (see special regulations and packaging instructions, p. 221), may only be carried out by qualified personnel.



Battery steel collection container



with vermiculite (see accessories)



Description	External dimensions cm (l x w x h)	Internal dimensions cm (l x w x h)	Storage capacity L	Weight when empty kg / maximum weight	Order no.
Battery steel collection container	71.5 x 71.5 x 58	58 x 58 x 39	120	54 / 170	11201

ACCESSORIES

Sack of expanded glass granulate ② (approx. 55 L)			12.5	11204
Sack of vermiculite ① (approx. 50 L)			4.5	11205
Lining bag for collection container				11231
Plastic bag for single battery				11233

Plastic collection container PG 9

Optimal storage and transport system

- UN-certified storage and transport system for solid hazardous goods (classified in packaging groups II and III)
- high-density, impact-resistant PE plastic (PE-HD)
- stackable and safe to transport
- ideal for collecting lithium batteries for recycling and disposal
- For reasons of fire prevention, use only in combination with suitable buffer material (e.g. vermiculite or expanded glass granulate).
- Observe packaging instructions (e.g. P909, p. 221) for ADR-compliant transport.
- delivery with lid and ratchet straps

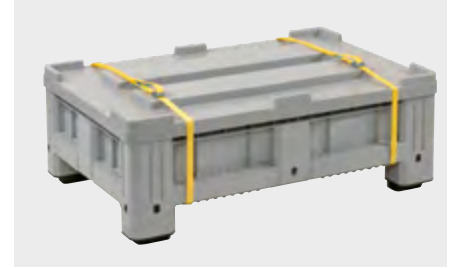

Plastic collection container S



Description	External dimensions cm (l x d x h)	Internal dimensions cm (l x d x h)	Collection volume L	Filling weight approx. kg	Order no.
Plastic collection container S	120 x 80 x 40	111.5 x 71.5 x 24.5	195	300	11202
Plastic collection container L	120 x 100 x 76	112 x 92 x 60	610	400	11203

ACCESSORIES

Sack of expanded glass granulate (corresponds to approx. 55 L)	12.5	11204
Sack of vermiculite (corresponds to approx. 50 L)	4.5	11205
Lining bag for plastic collection container S		11229
Lining bag for plastic collection container L		11230
Plastic bag for single battery		11233

CEMO Used battery collection box 16 L PG 9

The robust battery collection box is a sustainable solution for collecting, transporting and storing used batteries. The box can be reused in keeping with the concept of a circular economy (recyclable containers). It can be conveniently stacked on pallets, and special drop-in openings can also be used.

- impact-resistant box made of HDPE
- tested, guaranteed and certified raw material

- weatherproof and UV-resistant
- resistant to most acids and lyes
- stackable



Description	Capacity L	Dimensions in cm (l x w x h)	Weight (approx.) in kg	Order no.
CEMO Used battery collection box 16 L	16	40 x 30 x 24	1.5	12001

Buffer material for storage and transport

Expanded glass granulate and vermiculite

- not flammable
- high thermal insulation
- highly effective at absorbing escaping electrolyte
- not electrically conductive

Both materials have long been tried and tested buffers in hazardous goods packaging. Used carefully, these granulates can prevent flames from spreading from one cell to another. Expanded glass granulate is particularly suitable for lithium battery applications, because it forms a protective shielding layer around the cells in the event of a fire.



Expanded glass granulate Vermiculite



Description	Filling weight approx. kg	Order no.
Sack of expanded glass granulate (corresponds to approx. 55 L)	12.5	11204
Sack of vermiculite (corresponds to approx. 50 L)	4.5	11205

Collection containers for indoor storage PG 9

Battery disposal box

optimal storage and transport system

- high density PE plastic (HDPE)
- maximum acid resistance
- can be loaded up to 600 kg as individual box, up to 450 kg per box when stacked
- stackable up to 7 boxes
- for transporting old batteries (Rh 2807) in accordance with ADR 4.1.4.1 P801
- stackable and safe for transport
- equipped with three runners
- labelled with hazard warnings



Box 610 L

Box 300 L

Capacity L	External dimensions cm (l x w x h)	Weight approx. kg	Order no.
300 with four feet	100 x 63.5 x 64.5	14.3	11450
520 with two runners	120 x 80 x 79	29	11451
610 with three runners	120 x 100 x 76	37	8322

ACCESSORIES

Lid for box 300	103 x 65 x 7.5	5	10159
Lid for box 525	121.5 x 81.5 x 6	6	8614
Lid for box 610	121.5 x 101.5 x 6	7	8086

Fluorescent tube collection box PG 8

- grey/orange container made of high-quality PE
- for transporting and storing fluorescent tubes up to 155 cm long
- with optional side door
- stackable, with retaining cam
- with forklift pockets
- with integrated handles
- with lid opening restrictor
- with three toggle latches
- completely splash proof thanks to an all-round integrated seal

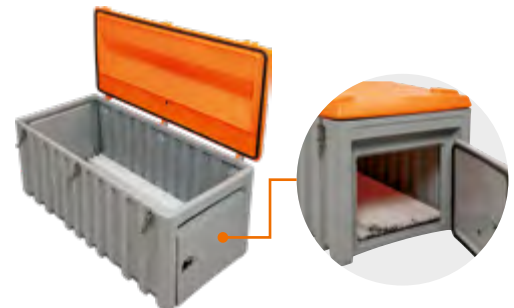

Description	Capacity L	External dimensions cm (l x w x h)	Internal dimensions cm (l x w x h)	Weight kg	Order no.
PE collection box 750, grey/orange, with side door	750	170 x 84 x 80	154 x 70 x 63	43	10336
PE collection box 750, grey/orange	750	170 x 84 x 80	156 x 70 x 63	42	10335

Collection containers for outdoor storage PG 9

Vehicle battery disposal container

- sturdy GRP model enables clean and safe storage for waste vehicle batteries
- certified for transport in accordance with ADR 4.1.4.1 P801
- two vents and a galvanised steel base frame for stable positioning
- all fittings are stainless steel
- removeable wooden grating forms a level base surface
- lid with hasp catch for padlock
- labelled with hazard warnings

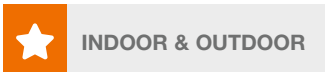

VEHICLE BATTERY DISPOSAL CONTAINER

Capacity L	External dimensions cm (l x w x h)	Weight approx. kg	Order no.
200	89 x 59 x 81	23	3396
400	120 x 80 x 81	37	3397
700	134 x 99 x 110	50	3983

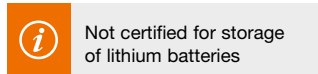

Mobile box for hazardous materials, certified PG 9

Mobile box

The robust design enables clean and safe storage of hazardous solid goods belonging to packing groups II or III and is also certified for transport according to ADR, RID and IMDG codes. The container (grey), with a capacity of 170 L or 250 L, and lid (coloured) are easy to handle, even when the container is full. The specially shaped lid enables storage in 2-layers. Up to 8 boxes can be safely stacked on a Euro pallet. The beading in the container wall enables emptying with a rotary forklift.

The mobile box is particularly suitable for the following applications:

- collection container for waste and materials such as oil binding agents, paint residues, etc.
- collection and transport container for recycling, cleaning cloths, etc.
- collection container for flammable and polluting substances



Up to 8 containers on a Euro pallet, two layer stackable



Lid with PU seal, fire-classified, light and air-tight for moisture-sensitive material, red lid version



Orange lid version



Green lid version



Red lid version



Blue lid version

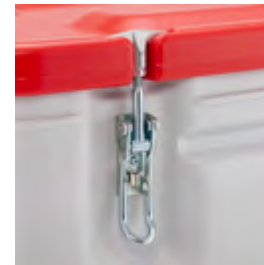

Lockable mechanism with metal bracket and locking spring

Description	Dimensions per packing unit cm (l x w x h)	Weight approx. kg	Order no. / lid			
			orange	red	green	blue
Mobile box 170 L	60 x 40 x 88	12	11453	11454	11455	11456
Mobile box 250 L	60 x 60 x 89	15	11457	11458	11459	11460

Aerosol spray can collection container PG 9

Mobile collection container for empty and partially empty aerosol spray cans. Tested safety via UN certification 1H2W/X150/S...

- certified for UN 1950 (waste aerosol containers)
- integrated opening to dispose of spray cans when the lid is closed
- lid with rubber seal and sturdy latch
- two integral vents for air circulation in the body

- manufactured in anti-static plastic for additional safety, therefore particularly suitable for installation in side buildings
- large wheels and a heat-treated steel axle for easy movement even when filled; maximum weight up to 150 kg
- grey body, orange lid
- delivery includes nonwoven pads (to absorb leaking fluids) and "UN1950" hazardous goods label
- Observe the relevant packaging instructions for transport under ADR.

Anti-static version:
Extra safety for workshop and industrial use

Important note:
Never dispose of empty spray cans as general waste or together with other waste.



Lid with rubber seal and latch



Volume 120 litres



Sturdy latch



Spray cans can be disposed of without opening the lid



Large wheels and integral vents



Including nonwoven pads



Video
Aerosol spray can collection container

Description	Dimensions cm (w x h x l)	Volume L	Weight kg	Order no.
Mobile collection container for aerosol spray cans	49.8 x 55.4 x 96	120	11	11346

Safety disposal container PG 9

Essential for every safety-conscious workshop and industrial building. Ideal for cleaning cloths saturated with flammable liquids, for example.

- tightly sealing lid is designed to prevent self-ignition by excluding oxygen
- self-closing due to maximum opening angle of 60°
- ventilation holes and clearance to the

- ground reduce the risk of overheating
- foot pedal for hygienic hands-free opening
- sturdy design made of painted sheet steel
- wear-free, durable mechanism
- light weight for simple handling and emptying
- suitable plastic bags available separately



Description	Capacity L	Dimensions cm (ø x h)	Weight approx. kg	Order no.
Safety disposal container	22.5	ø 36.5 x 39.5	5.6	11558

ACCESSORY

Plastic bags (50 pcs.)				11559
------------------------	--	--	--	-------

Mobile oil suction units PG 4

Pneumatic oil suction unit

Compressed-air operated mobile oil extractor. Ideal for quick oil changes on larger vehicles such as lorries, tractors, and cars, etc. A vacuum is generated in the tank with the aid of compressed air. The oil can then be decentrally extracted from the engines using the extraction probes, independently of a compressed-air connection. Ideal oil temperature 70 – 80 °C. Tank is drained by compressed air.

Technical data 8726 and 10145

- mobile 65 L or 90 L container with level indicator, vacuum indicator and 1-bar relief valve
- compressed-air connection ¼"
- removable tool tray
- extraction hose 2 m with probe adapter
- 7 different flexible and rigid probes; direct adapters for Mercedes, VW, BMW and Citroen
- drain hose 2 m
- max. extraction volume 52 L resp. 75 L
- maximum hopper height 188 cm (model 10145)

Technical data 10690 and 10691:

- mobile 80 L container with level indicator, vacuum indicator and relief valve
- compressed-air connection ¼"
- extraction hose 1.5 m with probe adapter
- 5 different flexible and rigid probes from 5 mm up to 8 mm
- drain hose



Oil suction unit 90 L with height-adjustable eccentric collection hopper

Oil suction unit 65 L

Pneumatic oil suction unit 80 L

Pneumatic oil suction unit 80 L, with collection hopper

OIL SUCTION UNITS PNEUMATIC

Description / Capacity L	Dimensions cm (l x w x h)	Weight approx. kg	Order no.
65 L	60 x 42 x 86	26.9	8726
90 L, with collection hopper	62 x 42 x 138	38.2	10145
80 L	44 x 49 x 77	24.5	10690
80 L, with collection hopper	58 x 49 x 173	27.5	10691

Electric oil suction unit

The mobile oil suction unit meets the growing requirement for sucking waste oil directly out of a car engine via the oil dipstick seating. An integral 12 L reservoir container can hold the removed waste oil directly. The oil suction unit has a special self-priming centrifugal pump which can produce very high vacuum pressures.

Technical data

- Mobile frame complete with:
- self-priming centrifugal pump, 230 V, delivery rate 2 to 10 L/min

- vacuum gauge for checking the pump's operation and for successful emptying
- suction hose with fast connection for the probes
- 4 different suction probes (semi-rigid probe dia. 6 x 800 mm, semi-rigid probe dia. 8 x 800 mm, rigid probe dia. 8 x 650 mm, rigid probe dia. 9 x 650 mm)
- removable probe holder with liquid-tight base for collection of any oil drops
- removable transparent collection container 12 L
- suitable for oils up to SAE 140



OIL SUCTION UNIT ELECTRIC

Description	Dimensions cm (l x w x h)	Weight approx. kg	Order no.
12 L	32 x 32 x 90	19,5	8253

Mobile extraction unit for fuels PG 4

EXTRACTION AND REFUELLING TROLLEY FOR PETROL

**2-stroke mixture and diesel
Used in the event of misfuelling,
accidents, vehicle returns, etc.**

- with flashback arrester in filler neck
- 2 m extraction hose DN 10 and 3.2 m delivery hose
- operated with 12 V electric pump
- 4.1 m connection cable and earthing cable with crocodile clips
- automatic dispensing nozzle, hose certified for petrol

- switch between extraction and dispensing via ball valves
- flexible probe dia. 8 mm/1.500 mm
- flexible probe dia. 12 mm/700 mm
- adapter for dia. 6 mm hose
- adapter for dia. 10 mm hose
- holder for probes and adapter (not mounted on trolley)



Description	Dimensions cm (l x w x h)	Weight approx. kg	Order no.
Electric extraction and dispensing trolley 95 L	100 x 56 x 48	23	10762

MOBILE EXTRACTION UNIT FOR FUELS

Petrol, diesel and oil

Unit suitable for vehicle and small tank extraction. Suitable for use in potentially explosive atmospheres. Compliant with the Occupational Safety Directive and the 1999/92/EG (ATEX 137) guidelines on workplace health and safety protection.

- complies with the Explosion Protection Directive ATEX 94/9
- 2 m extraction hose and 2 m drain hose
- operation with compressed air, including pressure reducer and maintenance unit
- load bearing surface of the transport trolley suitable for existing canisters or tanks up to 60 kg
- earth cable, 3 m with clip
- with suction lances Ø 8 mm and Ø 12 mm
- with adaptors for Ø 6/8/10 mm hoses



Description	Dimensions cm (l x w x h)	Weight approx. kg	Order no.
Mobile extraction unit for fuels, 2 stroke mix, diesel and oil	50 x 50 x 100	19,5	10090

Used oil collector PG 4

Mobile used oil collector 80 L

- with collection hopper and fill level display
- emptied using compressed air
- safety valve

Description	Dimensions cm (l x w x h)	Weight approx. kg	Order no.
Mobile used oil collector, 80 L	44 x 49 x 173	25	10692



Mobile used oil collector 80 L

MOBILE collecting and transport container for hazardous materials (HazMat) PG 4

Mobile hazardous substance collector GS-MOBILE for flammable liquids with general construction inspection certification no. D/BAM 6744/31A (400 L, 600 L) and D/BAM 6743/31A (980 L) indefinite certification period

The collection, storage and transport container for flammable liquids without a sump/spill pallet (e.g. waste oil of unknown origin, solvents, thinners and many more).

The integrated forklift pockets enable easy and safe transport. An integrated funnel with a dirt sieve and a fixed installed suction pipe with tanker coupling simplify filling and emptying. Can be used by anybody.

Design: explosion shock-proof



980 L



400 L

Filling funnel

Ventilation pipe 2" can be removed for transport

GS-MOBILE FOR A I TO A III AND B AS DESCRIBED ABOVE

Capacity L	Dimensions, cm (l x w x h) without ventilation pipe	Dimensions, cm (l x w x h) with ventilation pipe 2"	Weight approx. kg	Order no.
400	96 x 96 x 114	96 x 96 x 310	196	7713
600	96 x 96 x 141	96 x 96 x 300	250	7714
980	121 x 121 x 141	121 x 121 x 300	310	7715

Go-box for absorbents PG 9

- for granulates, absorbents, etc.
- for indoor and outdoor use and storage
- sturdy rubber wheels
- angled lid so that water runs off
- with eccentric stainless steel latch
- can be locked with a padlock (not included), see page 260
- user-friendly, ergonomic handle
- 70 L capacity
- lid locks open for loading/unloading
- easy to handle thanks to sophisticated balance
- easy to clean
- made of chemical-resistant PE – 100 % recyclable
- partition for insertion into the grooves of the Go-box as an accessory



Accessory: partition

Description / Capacity L	Dimension cm (h x w x d)	Weight approx. kg	Order no.
Go-box 70 for absorbents	107 x 59 x 39	10	11449

ACCESSORIES

Description	Dimension cm (h x w)	Order no.
Partition for Go-box 70	40 x 32	11286

Overpack drum PG 9

For securing a drum of up to 210 litres

- safety-tested to UN certification 1H2/X300/S...
- easy unscrewing of lid
- nestable storage in readiness for emergency
- made from high density polyethylene (HDPE) with high resistance to aggressive chemicals
- 300 kg load capacity
- interior dimensions: (top x bottom x height): 68.9 x 64.9 x 99



Description	Dimensions cm outside Ø x h	Collection volume L	Weight approx. kg	Order no.
Overpack drum	78.7 x 104.7	360	22.5	11023

Nozzle holder for 60 L and 200 L drum PG 4

Nozzle holder for 60 L and 200 L drum

- holder made from galvanised metal bracket with clamping screws and plastic holster for catching drops
- suitable for attaching to tight-head steel drums and L-ring plastic drums
- easy removal of holster for emptying and cleaning



ACCESSORY NOZZLE HOLDER FOR DRUMS

Description	Order no.
Nozzle holder for drums complete with clamping screws and drop holster	11044

Funnels / collection trays PG 9

GRP funnel

- with and without lid
- for placing on drums
- secure seating
- no risk of spillage

PE collection trays

- with swash edge to prevent content spillage
- pouring spout for transfilling
- robust carrying handles
- acid, chemical, oil and petrol resistant
- sizes 14 L provided
- version 65 L with 4 castors, drip tray and drain hose
- sizes 20 L and 55 L with a 4-chamber system for safe transportation and for emptying using the 4 edges with spouts

IBC filling funnel

- for mounting on commercially available IBCs
- Made of high-quality PE
- Integrated drip tray
- Drain opening with stainless steel conical sieve and integrated filler neck
- Optical overfill protection (optional)
- Storage compartment



Version with and without hinged lid available



GRP FUNNEL AND PE COLLECTION TRAYS

Description	Volume L	External dimension cm (l x w x h)	Weight approx. kg	Order no.
① GRP funnel without lid for 200 L drum	-	hight 15. ø 56	3	3342
② GRP funnel with hinged lid for 200 L drum	-	hight 18. ø 56	5	5348
③ GRP funnel without hinged lid for 60 L drum	-	hight 16. ø 39	2.5	5493
④ PE collection tray 16 L	16	59 x 47 x 15	1	91605
⑤ PE collection tray 20 L	20	69 x 44 x 10.5	1.3	6892
⑤ PE collection tray 55 L	55	101 x 73 x 12.5	2.8	6891
⑥ PE collection tray 14 L, sealable NEW	14	41 x 44 x 14.5	1.2	11973
⑦ PE drip tray 65 l, mobile NEW	65	110x70x20	17	12058
⑧ CEMO IBC filling funnel NEW	-	77 x 74 x 15	4	12054
⑨ CEMO IBC filling funnel with hinged lid NEW	-	77 x 74 x 24	5	12055

ACCESSORIES

⑩ Overfill protection, visual NEW	-	34 x 4 x 4	0.5	12056
Foam pipe, 1 m	-	105 x 5 x 5	1	12057

Cemsorb absorbents “Universal” and “Oil” PG 9

Cemsorb absorbents are high-performance absorbents to absorb accidentally discharged or spilled hazardous substances without delay or to prevent them from spreading.

The area of the accident or the workplace is soon ready to use again.

- Thanks to their high calorific value, they are well suited for thermal utilisation by incineration.

Cemsorb absorbent “Oil” blue

Cemsorb absorbent “Oil” was developed to absorb oil and oil derivatives. Cemsorb oil absorbent is hydroscopic; it does not absorb water.

Advantages:

- Cemsorb absorbents absorb up to 18 times their own weight in fluids.
- Cemsorb absorbents are simple and easy to use. Simply place them on the spilled fluid, and the fluid is quickly absorbed.

Cemsorb absorbent “Universal” grey

The Cemsorb absorbent “Universal” was developed to absorb all types of fluids. We do not recommend using it on water surfaces. Please use the Cemsorb absorbent “Universal” to absorb small quantities of different technical fluids.



Cemsorb cloths „Oil”



Cemsorb cloth roll “Oil”

Multiple Cemsorb cloth rolls “Universal”: both sides reinforced, lint-free and perforated



Cemsorb carpet “Oil”
Non-slip, dense, reinforced

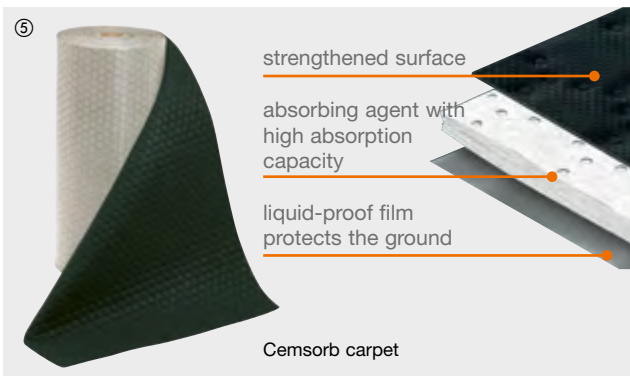

Cemsorb carpet



Cemsorb drum cover “Universal” with reinforced and lint-free surface



Cemsorb snake “Oil”

Description	Absorption in L / sales unit	Dimension cm	Area m ² / sales unit	Sales unit	Weight approx. kg / sales unit	Oil (blue or white)	Universal (grey)
						Order no.	Order no.
① Cemsorb cloths Heavy weight Perforated in width direction	113	40 x 50	20	100 cloths / carton	6	8793	8794
② Cemsorb cloth roll Heavy weight Transversely perforated	180	40 x 4000	32	2 rolls / carton	9.6	8795	8796
③ Cemsorb cloth roll Heavy weight Multiply perforated	48	40 x 2500	10	1 roll / dispenser carton	3.5	-	8797
④ Cemsorb carpet “Oil” Heavy weight Non-slip, dense, reinforced	41.3	80 x 120	9.5	10 carpets / carton	4.4	10412	-
⑤ Cemsorb carpet Heavy weight Non-slip, dense, reinforced	103	80 x 3000	24	1 carpet / carton	10.9	-	8798
⑥ Cemsorb pillow filled with flakes	80	Ø 7.5 x 120	-	20 snakes / carton	8	8799	8800
⑦ Cemsorb drum cover	31.5	Ø 56	6.15	25 items / plastic bag	2.1	-	8803

Cemsorb emergency sets PG 9



Use of the oil suction carpet from the Cemsorb emergency set Agrar



Cemsorb emergency set



Cemsorb emergency box "Universal"



Cemsorb emergency set Agrar



Cemsorb emergency trolley

Description	Capacity	Absorption in L / sales unit	Dimension cm (l x w x h)	Weight approx. kg / sales unit	Oil (blue)	Universal (grey)
					Order no.	Order no.
① Cemsorb emergency set Agrar	1 pair gloves, 2 disposal sacks, 22 oil absorbent cloths 30 x 30 cm white, 1 oil suction snake white 1.20 m x 7.5 cm, 5 wiping cloths, 2 yellow universal cloths 40 x 50 cm, 1 dense oil suction carpet 60 x 80 cm (brown surface)	20	32 x 32 x 16	2	10413	-
② Cemsorb emergency set	1 pair gloves, 2 disposal sacks, 32 cloths 30 x 30 cm, 1 snake 1.20 m x 7.5 cm, 5 wiping cloths	20	32 x 32 x 16	2	8804	8805
③ Cemsorb emergency trolley	1 sturdy PE box (10133), 100 item cloths Universal (8794), 20 snakes Universal (8800), 1 item emergency set Universal (8805)	197	80 x 60 x 53	32	-	10014
④ Cemsorb emergency box	1 sturdy PE box (8615), 100 item cloths Universal (8794), 20 snakes Universal (8800), 1 item emergency set Universal (8805)	197	120 x 60 x 54	35	-	8543



CONTAINERS FOR TRANSPORT AND STORAGE



Load securing – Responsibility

Experience shows that loads are often insufficiently or incorrectly secured. Securing the load properly makes a significant contribution to safety during transport, because insufficient load-securing measures cause damage to the cargo and may cause damage or injury to uninvolved third parties. It is therefore essential to know the relevant legal conditions and to be aware of the resulting responsibilities.

This summary is intended to give an overview with regard to responsibilities in the area of securing loads.

Under German law, the loader/sender (e.g. loadmaster of the sender), the haulier and the vehicle operator as well as the vehicle owner are assigned responsibilities in the area of securing loads. With regard to responsibility, a fundamental distinction must be made between civil responsibility and public responsibility.

1. Civil responsibility

1.1. Load made safe for conveyance (loader/sender):

he loader/sender must place the goods on the load surface, and has the obligation to secure the goods (by means of lashing straps, chains, chocks or other suitable aids) and to stow (load) them so that the goods are secured against falling over and moving around on the load surface as a result of dynamic influences during transport (e.g. knocks, vibrations, braking manoeuvres) as well as against falling from the vehicle.

1.2. Operationally secure loading (haulier):

The haulier is to provide a suitable vehicle with appropriate devices for securing the load (e.g. lashing points) and to ensure that operational safety is not impeded and that the vehicle is fully functional at all times. Furthermore, the haulier is responsible for adhering to the dimensions, axle loads and total weight as well as the load distribution plan.



IMPORTANT: If the haulier transfers the load to another vehicle during transport, the haulier shall be liable for this transfer. In this case, the haulier is liable for any insufficient securing of the load and possible loading errors that arise from the transfer procedure.

2. Public responsibility

The provisions of StVZO [German Road Vehicle Registration Regulation] and StVO [German Road Traffic Regulation] are of importance for securing loads that are subject to **statutory obligations**. **Anyone who does not wish to accept public responsibility in road traffic and does not comply with his/her duty to secure the load can be punished with fines or entries in the central register of traffic offenders and in the central commercial register. In case of negligence, or if regulations are intentionally ignored, criminal proceedings can also be initiated. This applies to the load / sender, haulier, vehicle operator and vehicle owner.**

Statutory regulation of load securing in the public domain:

2.1. Sec. 22 para. 1 StVO: Load

The load, including equipment for securing the load and loading devices, are to be stowed and secured so that they are unable to slide, fall over, roll around or fall off, even under full braking or sudden swerving, or produce avoidable noise. The recognised rules of the technology are to be observed. Responsible: Loader/sender and vehicle operator.

2.2. Sec. 23 para. 1 StVO: Other obligations of the vehicle operator

The vehicle operator is responsible for ensuring that his view and hearing are not impeded by the occupants, animals, load, equipment or condition of the vehicle. He/she must ensure that the vehicle, the tractor, the tractor-trailer combination and the load and the occupants are in compliance with regulations and that the road traffic safety of the vehicle is not impeded by the load or the occupants. He/she must also ensure that the prescribed labelling is always fully legible. Prescribed lighting equipment must be available on motor vehicles and their trailers as well as on bicycles, even during the day, and operationally ready, but otherwise only if it is anticipated that the vehicle is still in traffic when lighting is required (Sec. 17 para. 1).

2.3. Sec. 30 para. 1 StVZO: Condition of the vehicles

Vehicles must be manufactured and equipped so that
a) their usual operation in traffic does not harm anyone or endanger, obstruct or impede anyone more than unavoidable.

b) the occupants, especially during accidents, are as well protected as possible against injury and that the extent and consequences of injuries are kept to a minimum.

2.4. Sec. 31 para. 2 StVZO: Responsibility for operation of the vehicles

The vehicle owner is not to arrange or permit operation of the vehicle if he is or is required to be aware that the vehicle operator is not suitable to operate the vehicle independently or that the vehicle, the tractor, the tractor-trailer combination, the load or the occupants are not in accordance with regulations or that the road traffic safety of the vehicle is impeded by the load or the occupants.

3. Summary

The securing of loads is prescribed by Sec. 22 para. 1 StVO. A person who secures the load as a result of this is defined under civil law (see 1. Civil responsibility).

Responsibility for securing the load is transferred to the vehicle operator by Sec. 23 para. 1 StVO.

According to Sec. 30 para. 1 StVZO, the vehicle owner is to use a suitably equipped vehicle and to ensure (see 2.4. Principle Sec. § 31 para. 2 StVZO) that this equipment is sufficient for performing the transport in question.

The acknowledged rules of the technology (Sec. 22 para. 1 StVO; e.g. VDI guidelines 2700 and DIN EN standards) are to be observed when securing loads. The actual measures for securing the load must be carried out on the basis of these rules. Anyone wishing to delegate public responsibility for securing the load through agreements or instructions (e.g.: to the haulier) must observe the following:

- An explicit instruction / order must be available
- The instructed individual must be professionally suitable and technically able
- to perform random inspections in order to check the transferred obligations for proper execution.

The inspections are to be documented. If safety defects are found, measures are to be taken to eliminate these.

Importance for CEMO products

The fundamental health and safety requirements for CEMO products put into circulation or transport are complied with. Attention is paid during design and subsequent production to ensuring that the products are equipped with suitable devices for load securing (e.g. transport packaging, lashing points, sufficiently dimensioned contact areas etc.). In this way, risks caused by falling or ejected objects, risks from surfaces, sharp corners and edges as well as risks from loss of stability (e.g. from small contact areas) are avoided.

In this way, as long as the statutory conditions for securing loads are complied with, an uncontrolled change of position during transport and other general safety risks with regard to the conveyance are precluded.

1. Load securing for CEMO drums

1.1. Anti-slip mat (frictional connection)

Anti-slip mats are virtually standard these days as a means of securing loads. The frictional forces prevent the load from slipping and support all load securing measures. The coefficient of sliding friction μ is always less than 1. Example: The coefficient of sliding friction between metal and wet wood is generally about 0.2-0.25 μ . When using an anti-slip mat, the coefficient of friction increases to 0.6 μ . This corresponds to a load securing of 60% through friction alone! The consequence of this is that it may be possible to reduce the number of lashing straps.

We recommend placing anti-slip mats under the support runners on each side when loading CEMO drums, in order to increase the friction coefficient. If several mats are used, they are to be arranged so that no parts of the support runners remain in contact with the vehicle load surface.

1.2. Lashing straps (positive fit through lashing down)

Lashing straps, ropes and chains must be used in accordance with the manufacturer's instructions and discarded as necessary. In the case of lashing straps, the permissible tensile force of the strap material must not be confused with the pretension force of the ratchet when lashing down. The necessary indications on tensile force, manual force and clamping force can be found on the label of the lashing equipment.

For the purpose of supplementing the fixing methods in 1.1 and 1.3, the CEMO drum is to be additionally tied down with 2 lashing straps and fixed to the lashing points of the vehicle's load surface on both sides. In principle, the number of lashing straps is based on the weight of the load and the measures used according to 1.1 and 1.3.

1.3. Holder for tension chain (positive fit through direct lashing)

CEMO support rails are equipped as standard, or can be retrofitted, with holders for tension chains with a max. tensile force of 2000 daN. When using tension chains, the number of lashing straps can be reduced (see 1.2).

1.4. Locating surfaces (positive fit)

If possible, locating surfaces are also to be used for securing loads. The forward load space limit (front wall) can be used in addition to installed blocking devices, taking into consideration their strength and the vehicle-specific load distribution plan.

1.5 VDI (Association of German Engineers) guidelines

The following guidelines for securing loads are to be observed:

- VDI 2700 Securing loads on road vehicles
- VDI 2700a Evidence of qualification to secure loads
- VDI 2700 Sheet 1 Training and raining contents
- VDI 2700 Sheet 2 Lashing forces
- VDI 2700 Sheet 3.1 Instructions for using lashing equipment
- VDI 2700 Sheet 3.2 Equipment and aids for securing loads
- VDI 2700 Sheet 4 Load distribution plan

Guideline VDI 2700 Securing loads on road vehicles is the standard work that presents the principles and proven methods for securing loads.



Securing loads with anti-slip mats and lashing straps (lashing down) using the example of a 2000-litre mobile irrigation system

GRP tanks

CEMO tanks are manufactured from GRP (glass-fibre reinforced plastic) using state of the art technology. The vacuum injection method used enables rationalised manufacturing of widely varying sizes and tank shapes.

The finished products have smooth surfaces on both sides and a uniform wall

thickness. Both tank halves are joined together, by a smooth, absolutely leak-free laminate seam, into a single tank unit.

CEMO tanks thus guarantee an optimum quality standard, for safe use over many years.

large filling dome for efficient filling and transportation

resistant to chemicals, e.g. ammonia-nitrate-urea solution, pesticides

smooth inner walls, therefore easy to clean

durable - weather and corrosion resistant

translucent tank walls for easy level monitoring

up to 70 % lighter than steel tanks

GRP is easy to repair



Special drum version with air vent in the dome cover and filling connection with air gap

INDIVIDUAL ATTACHMENT AND INTEGRATION COMPONENTS WITH A WIDE RANGE OF FITTINGS



To ensure safer transport, CEMO tanks can also be equipped with baffles.



The CEMO 3-hole flange enables trouble-free mounting of a wide variety of fittings.

CEMO standard tanks are available in oval, trunk and box shapes for a very wide range of applications. From 200 L - 15500 L.



CEMO pasture water tanks have special light protection to prevent algae growth. They have an opaque colour and are thus particularly UV-resistant.



Intended specially for use on Unimog vehicles there are oval or trunk-shaped tanks of 1000 - 5000 L, high-speed versions with baffles also available.



For municipal use, CEMO offers mobile irrigation systems of 1000 - 6000 L with a variety of optional accessories.



Example of use: Sewage disposal from trains belonging to the Deutsche Bahn (German Railways).



GRP tanks oval PG 8

Oval tanks made from glass-fibre reinforced plastic, GRP

- for zero-pressure operation
- basic model: filling dome dia. 360 mm with quick closing lid or filling dome dia. 420 mm with flap lid
- vent valves fitted in the lid
- outlet opening with 3-hole flange connection
- fixed support runners attached (high pressure impregnated wood, above 7000 L – steel)
- high-speed model: additional baffles in the top and bottom tank halves

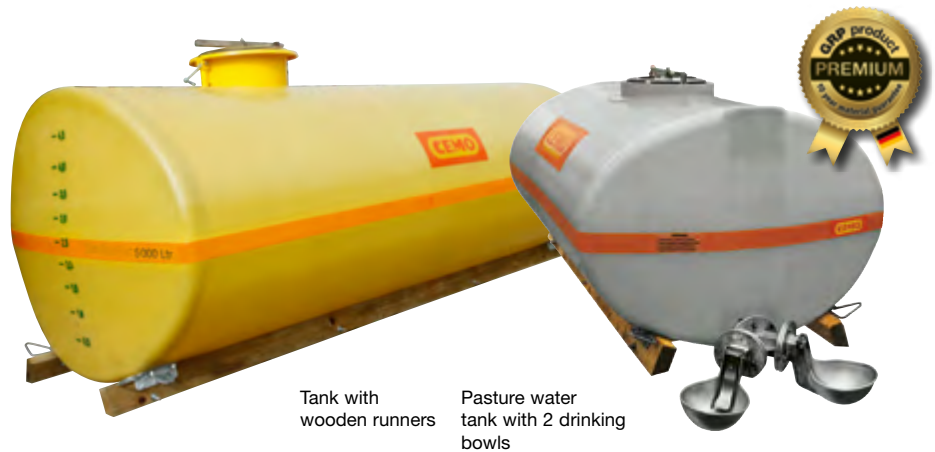

Tank with wooden runners

Pasture water tank with 2 drinking bowls

Capacity L	Dimensions cm (l x w x h) length incl. runners	Dome ø mm	Weight approx. kg	Order no. / dome		
				front	centre	rear*
2000	190 x 143 x 138	420	100	-	1824	-
3000	276 x 143 x 138	420	130	1059	-	1060*
4000	366 x 143 x 138	420	173	1061	-	1062*
5000	366 x 154 x 152	420	218	1063	-	1064*
6000	343 x 179 x 170	420	280	5101	-	5102*
7000	400 x 179 x 170	420	401	1025	-	1026*
8500	430 x 188 x 182	420	470	6674	-	6675*
10000	500 x 188 x 182	420	538	3083	-	3120*



Accessories for oval tanks (with 3-hole flange) see page 244-246

PASTURE WATERING TANKS IMPERMEABLE TO LIGHT AND COLOURED GREY TO PREVENT ALGAE GROWTH

Capacity L	Dimensions cm (l x w x h) length incl. runners	Dome ø mm	Weight approx. kg	Order no. / dome		
				front	centre	rear*
3000	276 x 143 x 138	420	130	2250	-	2219*
4000	366 x 143 x 138	420	173	2462	-	2218*
5000	366 x 154 x 152	420	218	2463	-	1848*
6000	343 x 179 x 170	420	280	5319	-	5654*
7000	400 x 179 x 170	420	401	1722	-	3179*
8500	430 x 188 x 182	420	470	6681	-	6682*
10000	500 x 188 x 182	420	538	3189	-	3679*

* Custom version, manufactured to order

ACCESSORIES FOR PASTURE WATER TANKS

Description	Order no.
 Drinking bowl single	for outlet DN 75
	for outlet DN 100
Mounting flange for 2 drinking bowls	5790

GRP tanks trunk-shaped PG 8



Trunk-shaped tanks

- made from glass-fibre reinforced plastic, GRP
- outlet opening with 3-hole flange connection
- steel support runners

Advantages of GRP tanks, trunk-shaped:

- optimal utilisation of the loading area
- more transport volume for permissible total weight compared to steel tanks
- remnants discharge

Tanks for Unimog, Multicar and Pfau:

- filling dome dia. 420 mm and flap lid
- compact shape with vaulted ends (top and bottom)
- baffles in top and bottom tank halves
- vent valves fitted onto the lid
- outlet opening with 3-hole flange connection
- intersecting baffles



Tank 13500 L



Example of tank application
Ratchet straps not included



Tank 1800 L











Tank 500 L

Capacity L		Dimensions cm (l x w x h) length incl. runners	Filling hole / Dome	Weight approx. kg	Order no.
500		105 x 95 x 71		41	5944
1000	with pump sump	147 x 101 x 99		58	2858
1800	Flap lid centrally mounted with baffles in upper and lower tank halves	154 x 148 x 128	Dome dia. 420 mm with flap lid	115	7696
3000	Flap lid displaced to the side, with transverse baffles	189 x 186 x 124		258	11039
3000	Flap lid displaced to the side, with intersecting baffles	189 x 186 x 124		285	10644
4000	Flap lid displaced to the side, with transverse baffles	191 x 188 x 153		287	11040
4000	Flap lid displaced to the side, with intersecting baffles	191 x 188 x 153		310	10645
5000	Flap lid displaced to the side, with intersecting baffles	231 x 198 x 169		320	6538
8000	Transport tank with baffles	376 x 220 x 179		780	11325
10000	Transport tank with baffles	376 x 220 x 200		810	11326
13500	Storage tank without baffles	506 x 220 x 195		870	8008
13500	Transport tank with baffles	506 x 220 x 195		950	8009
15500	Storage and transport tank with baffles	506 x 220 x 222	1,080	8270	

★ Accessories for trunk-shaped tanks (with 3-hole flange) see page 244-246













GRP tanks oval and trunk-shaped PG 8

ACCESSORIES FOR OVAL AND TRUNK-SHAPED GRP TANKS AND TRUNK-SHAPED PE TANKS

		GRP Tanks oval		GRP Tanks trunk shaped			PE Tanks		
		up to 1500 L	1600 L up to 10000 L	up to 1000 L	1800 L, 3000 L up to 5000 L	8000 L up to 15500 L	600 L up to 1000 L	2000 L up to 5000 L	
		Order no.	Order no.	Order no.	Order no.	Order no.	Order no.	Order no.	
	Lock plate (blank flange) for 3-hole flange ①	-	1367	1368	1367	1368	1368	1367*	1368*
		¾" ET	5954	5955	5954	5955	5955	5954*	5955*
		1" ET	1384	1385	1384	1385	1385	1384*	1385*
	Flange plate with threaded nipple for 3-hole flange ①	1 ¼" ET	1386	1387	1386	1387	1387	1386*	1387*
		1 ½" ET	1388	1542	1388	1542	1542	1388*	1542*
		2" ET	1389	1390	1389	1390	-	1389*	1390*
		3" ET	5614	1391	5614	1391	-	-	-
		4" ET	-	1392	-	1392	-	-	-
	Flange plate with threaded nipple ①	2" ET	-	-	-	-	8177	-	-
		3" ET	-	-	-	-	8178	-	-
		4" ET	-	-	-	-	11347	-	-
	Discharge valve ② with flange plate ①	¾" IT	1316	1317	1316	1317	-	1316*	1317*
		1" IT	1318	1319	1318	1319	-	1318*	1319*
		1 ¼" IT	1320	1321	1320	1321	-	1320*	1321*
		1 ½" IT	1322	1323	1322	1323	-	1322*	1323*
		2" IT	1324	1358	1324	1358	-	1324*	1358*
		3" IT	1325	1326	1325	1326	-	-	-
	Ball valve ② with flange plate ①	2" IT	-	-	-	-	8179	-	-
		3" IT	-	-	-	-	8180	-	-
		4" IT	-	-	-	-	11348	-	-
		1" IT	6447	6453	6447	6453	-	6447*	6453*
	Ball valve ③ with flange plate ①	1 ½" IT	6449	6455	6449	6455	-	6449*	6455*
		2" IT	6450	6456	6450	6456	-	6450*	6456*
		3" IT	6451	6457	6451	6457	-	-	-
	Ball valve ④ with flange plate ① (shatterproof version, recommended for liquid manure tanks)	1" IT	6442	6444	6442	6444	-	6442*	6444*
		1 ½" IT	1346	1347	1346	1347	-	1346*	1347*
		2" IT	1348	1349	1348	1349	-	1348*	1349*
	Ball valve ③ with flange plate ①	2" IT	-	-	-	-	8181	-	-
		3" IT	-	-	-	-	8182	-	-
	Ball valve ④ with flange plate ①	2" IT	-	-	-	-	8183	-	-
	* Installation kit for flange plate installation (required item)	-	-	-	-	-	-	8445	8445



① stainless steel ② nickel-plated brass ③ polyvinyl chloride (PVC) ④ polypropylene (PP) ⑤ painted ⑥ aluminium

ACCESSORIES FOR OVAL AND TRUNK-SHAPED GRP TANKS

Description		Thread	Order no.	
	Double nipple (PVC) with external thread	1"	1527	
		1 ½"	1529	
		2"	1530	
	Threaded nipple (PVC) with hose nozzle for hose	ø 60 mm	2"	1355
	Kamlok coupling for valves male connection	1 ½"	1356	
		2"	1359	
	Kamlok coupling female connection with hose nozzle for hose	inside diameter 40 mm for male connection:	1 ½"	1357
		inside diameter 60 mm for male connection:	2"	1360
	Kamlok sealing cap	for kamlok coupling, for male connection:	1 ½"	5266
		for kamlok coupling, for female connection:	2"	1361
	Fire hose coupling C, for valves 2" ET		2"	1340
	Plastic hose with helical reinforcement per m	40 mm I.D.		1363
		60 mm I.D.		1364
	Hose shut-off valve (plastic) for corrugated hose	60 mm I.D.	2"	1681
	Vent cap PVC (sealing cap for screw in / screw through nipples)		2"	1811
	T-piece (PVC) with internal thread		2"	1547
	90° angle, galvanised, IT and ET		2"	1338
	90° angle, PVC, IT		2"	1540
	Pipe coupling (PVC) loose, with internal thread		2"	1535
	Pipe coupling (PVC) laminated attachment, with internal thread	¾"	1752	
		1"	1753	
		1 ¼"	1754	
		1 ½"	1755	
		2"	1756	

GRP tanks oval and trunk-shaped PG 8

ACCESSORIES FOR OVAL AND TRUNK-SHAPED TANKS

Description	Order no.
 <p>C-filler coupling 2" with air break, complete with slider, including installation onto tank (factory made)</p>	5689
 <p>Filling sieve with intermediate ring for dome dia. 420 mm</p>	3080
<p>Filling sieve with intermediate ring for dome dia. 360 mm</p>	8241
<p>Filling sieve for dome dia. 380 mm (suitable for GRP tanks trunk-shaped 700 L and 1000 L without baffles)</p>	8628
 <p>1 kg repair pack, neutral pre-accelerated resin, hardener, glass-fibre, brush</p>	1617

Description	Nominal width	Order no.
	 <p>PVC-DIN flange laminated PN 10/16 comprising pipe socket (laminated to the tank) and loose flange made of PVC</p>	20
	25	1744
	32	1745
	40	1746
	50	1747
	65	1748
	80	1749
	100	1750
	125	2885
	150	2897
	200	2898

STEEL SUPPORT RUNNERS GALVANISED FOR OVAL TANKS, COMPLETE

Model for tank size	Dimensions mm		Weight approx. kg	
	Section	Length		
 <p>2000</p>	U 100 x 50 x 5	1900	40	surcharge
<p>3000</p>	U 100 x 50 x 5 (for order no. 1059, 1060, 2250, 2219)	2755	53	
<p>4000 + 5000</p>	U 100 x 50 x 5	3660	64	
<p>6000</p>	folded profile 3285 mm	3485	81	

CUSTOM EQUIPMENT FOR TANKS IS MADE TO ORDER

Description	Order no.
 <p>Dome dia. 420 mm with flap lid (factory-fitted) with 2 vent valves</p>	opposing dome dia. 360 mm
 <p>Baffles for fast vehicles in two tank halves</p>	for sizes up to 5000 L (2 off) for sizes 6000 – 7000 L (2 off) for sizes 8500 – 10000 L (4 off)

CUSTOM VERSIONS

Painting tanks in special colours (quote RAL no., colour similar to RAL, only for tanks manufactured by vacuum injection method)	surcharge on request
--	----------------------

PE tanks PG 8

PE beverage tanks







- in food-safe HD-PE
- low outlet with tap DN 19
- with screw cap, diameter 220 mm
- with 2 handles (for transporting when empty)
- sealing cap can be fitted instead of outlet tap
- optional adapter with 1" external thread or 1 ½" external thread (see accessory)



Description	Capacity L	Dimensions cm (l* x w x h*)	Weight approx. kg	Order no.
PE beverage tank 60	60	55 x 35 x 57	3.5	8886
PE beverage tank 100	100	63 x 42 x 67	5.5	8887
PE beverage tank 150	150	73 x 45 x 74	8.5	8888
PE beverage tank 200	200	84 x 48 x 81	11	8889
PE beverage tank 300	300	91 x 59 x 89	13.5	8890
PE beverage tank 500	500	106 x 73 x 103	21	8891

* Length with outlet tap, height with lid and sealing plug.

ACCESSORIES AND SPARE PARTS

Description	Order no.
 Screw cap, dia. 220 mm with sealing plug	8892
 Sealing plug	8893
 Outlet tap DN 19	8894
 Adapter with 1" external thread	8895
 Adapter with 1 ½" external thread	8896
 Outlet tap brass, nickel-plated with 1" internal thread	1304
 Outlet tap brass, nickel-plated with 1 ½" internal thread	1306

PE tanques rectangulares PG 8

- made of high quality, age-resistant and recyclable polyethylene.
- manufactured in one piece using centrifugal moulding
- space-saving, trunk-shaped design
- low centre of gravity
- footprint for the 600 L tank matched to Euro-pallet dimensions
- 2000 L tank fits across a Unimog load-bed

- 2" internal thread connection with indentation on the end
- discharge opening with 3-hole flange connection and indentation (in 600 – 2000 L tanks)
- 2" internal thread connection options on the long sides (2000 L + 3000 L tank)
- option of installing the proven CEMO 3-hole flange onto the 2000 L tank
- 1" internal thread fitting for complete drainage

- 380 mm diameter dome with swash baffle and hinged cover
- vent valve installed on the hinged cover
- handles and lugs for tensioning belts
- integral securing flange for direct mounting on the vehicle loadbed

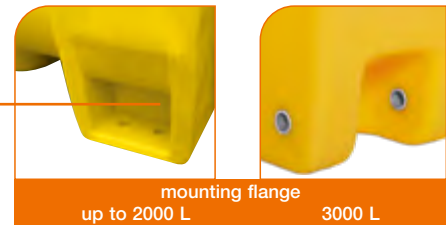

Valve available as an accessory

2000 L

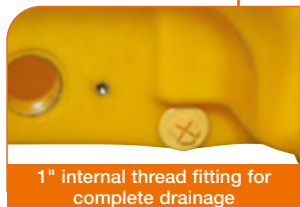

PE pasture watering tank, trunk-shaped, impermeable to light and coloured green to prevent algae growth.

PE TANKS TRUNK-SHAPED, COLOURED YELLOW

Capacity L	Dimensions cm (l x w x h)	Filling hole / dome ø mm	without baffles		with baffles	
			Weight approx. kg	Order no.	Weight approx. kg	Order no.
600	120 x 90 x 90	ø 380 with flap lid	35	8273	41	10921
1000	145 x 114 x 100		54	8274	62	10922
2000	190 x 135 x 117		82	8275	93	10923
3000	240 x 150 x 117		138	11510	166	11511
5000	310 x 197 x 136		264	12067	314	12068

PE PASTURE WATERING TANK TRUNK-SHAPED, IMPERMEABLE TO LIGHT AND COLOURED GREEN TO PREVENT ALGAE GROWTH

Capacity L	Dimensions cm (l x w x h)	Filling hole / dome ø mm	without baffles		with baffles	
			Weight approx. kg	Order no.	Weight approx. kg	Order no.
600	120 x 90 x 90	ø 380 with flap lid	35	8884	41	10924
1000	145 x 114 x 100		54	8885	62	10925
2000	190 x 135 x 117		82	8381	93	10926
3000	240 x 150 x 117		138	11512	166	11513
5000	310 x 197 x 136		264	12069	314	12070

* Accessory installation kit 8445 required (see page 244).

ACCESSORIES FOR PE TANKS, TRUNK-SHAPED















Description	Thread	Order no.
 PP adapter set (PP reducing nipple + PP reduction)	2" ET to ¾" ET	8406
 PP reducing nipple	2" x 1" ET	8407
	2" x 1 ½" ET	8408
 PP double male connector	2" ET	8409
 PP plug	2" ET	8410
 Filling sieve Ø 380 x H 330 mm		8628
 Drainage valve (brass, nickel plating) with internal thread on both sides	¾"	1303
	1"	1304
	1 ½"	1306
	2"	1307
 Plastic ball valve (PVC) with internal thread	1"	6426
	1 ½"	6428
	2"	6429
 Plastic ball valve (polypropylene, fibreglass-reinforced) with internal thread	1"	1310
	1 ½"	1312
	2"	1313
 C-filler port 1 ½" with air break, complete with gate valve, including assembly, for optional C-filler port 2" for PE tank 3000 L, see page 246		11045
 Galvanised steel frame, forklift accessible from four sides	for PE tank 600 L, trunk-shaped	11514
	for PE tank 1000 L, trunk-shaped	11515
	for PE tank 2000 L, trunk-shaped	11516
	for PE tank 3000 L, trunk-shaped	11517
	for PE tank 5000 L, trunk-shaped	12071

Fig. 11517

 Additional accessories see page 244.

ACCESSORIES FOR PE PASTURE WATERING TANK

Description	Order no.
 Single attached drinking trough *	600 L
	1000 L
	2000 L
 Mounting flange for 2 drinking troughs*	5790
 Example: In conjunction with the optional side outlets on the 2000 L PE tank, a maximum of 6 attached drinking troughs is possible with order no. 1056 and 5790. Frame with the minimum dimensions 149 x 120 x 16 cm (l x w x h) required (additional item).	

* Accessory installation kit 8445 required (see page 244).

Tanks box-shaped PG 8

Box-shaped tanks

made from glass-fibre reinforced plastic, GRP.

- flat bottom, so no support runners necessary
- strong, all-round gripping rim



GRP TANKS BOX-SHAPED

Description / Capacity L	Dimensions cm (l x w x h)	Filling hole / Dome ø in mm	Weight approx. kg	Order no.
Box-shaped tank, GRP, 200 L	87 x 57 x 57	Filling hole ø 190 mm	12	1043
Box-shaped tank, GRP, 400 L	122 x 62 x 72	with screw cap	19	1045

Tanks, trunk-shaped

made from high-quality, hard-wearing, recyclable polyethylene

- 125 L, 200 L, 450 L or 600 L
- manufactured in one piece using centrifugal moulding
- with S160 x 7 screw cap
- screw cap with integrated vent and pressure relief
- filling hole internal diameter 140 mm
- integrated recesses for securing with ratchet straps during transport
- integral forklift pockets and handles
- integral baffle with 450 L and 600 L models
- 2-tier stackable, with stacking cams
- ideal dimensions for transportation



Various sizes from 125 L to 450 L (600 L not illustrated)



With outlet tap accessory



Stackable, with stacking cams, integral forklift slots and handles

PE TANKS BOX-SHAPED, COLOURED YELLOW

Description / Capacity L	Dimensions cm (l x w x h)	Weight approx. kg	Order no.
Box-shaped tank, PE, 125 L	80 x 60 x 45	15	10095
Box-shaped tank, PE, 200 L	80 x 60 x 59	16	10096
Box-shaped tank, PE, 450 L	116 x 76 x 73	35	10097
Box-shaped tank, PE, 600 L	116 x 76 x 102	43	10098

ACCESSORIES FOR BOX-SHAPED TANKS, GRP AND PE

Description	Thread	without installation	with installation on the tank
		Order no.	Order no.
 <p>Screw through threaded connector* (brass) with external thread, 2 lock nuts</p>	¾"	1393	8843
	1"	1394	8844
	1 ¼"	1395	8845
	1 ½"	1396	8846
 <p>Screw in threaded connector* (brass, nickel-plated) with external thread, food safe</p>	¾"	1397	8847
	1"	1398	8848
	1 ¼"	1399	8849
	1 ½"	1500	8850
 <p>Screw in threaded connector *** (plastic) with external thread</p>	2"	1501	8851
	¾"	10910	10915
	1"	10911	10916
	1 ¼"	10912	10917
	1 ½"	10913	10918
 <p>Screw in threaded connector* (plastic) with external and internal threads</p>	2"	10914	10919
	ET 1" IT ½"	1515	8852
	ET 1 ¼" IT ¾"	1516	8853
	ET 1 ¼" IT 1"	1517	8854
	ET 2" IT 1 ½"	1518	8855
 <p>Discharge valve (brass, nickel-plated) with internal thread at both ends</p>	ET 2 ¾" IT 2"	1519	8856
	¾"	1303	
	1"	1304	
	1 ¼"	1305	
	1 ½"	1306	
 <p>Plastic ball valve (PVC) internally threaded</p>	2"	1307	
	1"	6426	
	1 ½"	6428	
	2"	6429	
 <p>Plastic ball valve (polypropylene, glass-fibre reinforced) internally threaded</p>	3"	6430	
	1"	1310	
	1 ½"	1312	
 <p>Spindle valves (plastic) with ET matched to screw in threaded connector</p>	2"	1313	
	½"	1314	
 <p>Spindle valves (plastic) with ET matched to screw in threaded connector</p>	¾"	1315	

* Not for PE trunk-shaped tank 125 L *** only for box-shaped tanks PE

ACCESSORIES FOR BOX-SHAPED TANKS, GRP

Description	Order no.
 <p>Screw cap dia. 190 mm compl. with screws (upgrade kit)</p>	6492

Description	Steel base frame for size	Weight approx. kg	Order no.
 <p>Steel base frame, galvanised, for safe support</p>	200	10	7784
	400	12	7785
	600	12	7787

Mobile irrigation system BWS 500 PG 8



Mobile irrigation system BWS 500 for vehicle load-beds or stationary operation

Oval tanks:

- made from glass-fibre reinforced plastic, GRP
- models above 4000 L with baffles
- with extended steel runners
- mounting bracket for pump installation
- stainless steel flange plate with threaded nipple 2"
- filling dome dia. 360 mm with quick closing lid, capacity up to 1500 L
- filling dome dia. 420 mm with flap lid above 2000 L
- vent valves fitted in the lid
- Example application:
Suitable for professional irrigation of large areas and parks and thus the ideal system for municipal or commercial users.



Example: foldable hose reel, ratchet straps not included in the kit

TANKS OVAL WITH EXTENDED STEEL RUNNERS AND PUMP BRACKET

Capacity L	Dimensions cm (l x w x h) length incl. runners	Dome ø mm	Weight approx. kg	Baffles, quantity	without hose reel, without pump
					Order no.
2000	247 x 143 x 138	420	205	-	7137
3000	325 x 143 x 138	420	267	-	7468
4000	418 x 143 x 138	420	310	2	7138
5000	418 x 154 x 155	420	356	2	8624
6000	395 x 179 x 170	420	410	2	7139

★ Special sizes on request



ADD-ON PARTS PUMPS AND HOSE REELS

DEPENDING ON THE APPLICATION, THE IRRIGATION TANK SYSTEMS CAN BE ASSEMBLED FROM THE COMPONENTS LISTED BELOW. THE EQUIPMENT TANK IS SUPPLIED COMPLETELY ASSEMBLED.

Description	suitable for equipment tanks	Order no.
① Motorized pump 500 L/min with petrol engine Integrated pump, with suction and pressure connections switchable using 3-way valves	all sizes	10540
② Pump 100 to 350 L/min (not self-priming), with hydraulic motor including flow control valve, permanently installed, with suction pressure connection, adjustable via 3-way valves		10541
③ Pump up to 60 L/min, 24 V / 19 A / DC, with switch and plug, pump permanently installed, with 1" suction and pressure connection, convertible via 3-way valve		10861
④ Swivel-mounted hose reel, vertically adjustable 145 mm (with connection hose to the pump) for 80 m water-hose ¾" or 35 m water hose 1" * (accessory)		10542
⑤ Automatic hose reel with spring-loaded retraction Painted steel, swivelling (with connecting hose to the pump), for 40 m water hose ¾" or for 30 m water hose 1" *(accessory)		10862
⑥ Foldable hose reel for high vehicles (without hose) securely mounted; for 80 m water-hose ¾" or 35 m water hose 1" *		10543

* Please note that the pump output can fall sharply depending on the length and cross-sectional area of the hose.

★ Other pumps on request. Further accessories see page 244 and 246.

ACCESSORIES FOR MOBILE IRRIGATION SYSTEM BWS 500

Description	suitable for equipment tanks	Order no.
Factory fitted	Forklift pockets with supports at the front and rear. Insertion profile 160 x 70 mm, distance between rail centres 700 – 1000 mm (empty tank)	1000 L up to 5000 L 7146
	C-filling coupling with free flowing path, complete with slider for tank filling (fig. page 246)	6000 L 7147
Supplied unassembled	PVC pressure hose, dia. 60 mm, length 3.5 m; C-coupling at both ends, can also be used to extend the suction hose	5689 5774
	PVC suction hose, dia. 60 mm, length 3.5 m; with strainer and C-coupling at one end	5775

Mobile irrigation system BWS 130 PG 8

Mobile irrigation system BWS 130

- made of glass fibre reinforced plastic, GRP
- light and robust construction
- simple handling due to low weight
- suitable for all oval tanks of 600 – 5000 L capacity
- hose reel can be swivelled through 135° (without hose) accepts 80 m water hose ¾" or 35 m water hose 1"
- pre-assembled unit**
- Example application:
Suitable for irrigating green spaces and parks. This system offers an optimum price-performance ratio for gardening and landscaping service providers as well as for many other service providers (e.g. building cleaning).



The displayed ratchet straps are not included in the system

 Accessories see page 246.

BWS 130 COMPLETE WITH TANK, ADD-ON PUMP AND HOSE REEL

Capacity L	Overall dimensions cm (l x w x h)	Total weight approx. kg	Order no. without baffles*
2000	260 x 143 x 138	175	7919
3000	346 x 143 x 138	205	7923
4000	436 x 143 x 138	248	7924
5000	436 x 154 x 152	296	7925

* baffles see page 246.

** 'mounted pump' is supplied separately as a pre-assembled unit including reel for self-assembly on the drum according to the enclosed instructions

ADD-ON PUMP WITH HOSE REEL (FOR RETROFITTING EXISTING TANKS)

Description	Dimensions cm (l ¹ x w x h)	Total weight approx. kg	Order no.
 <p>Add-on pump consisting of:</p> <ul style="list-style-type: none"> • Honda pump (petrol engine), self-priming, output rate approx. 130 L/min, • pump capacity up to 3.5 bar * • hose reel (without hose) • mounting bracket pre-assembled • Add-on pump is supplied separately as a pre-assembled module incl. reel for self-assembly on the drum according to the enclosed instructions 	70 x w ² x 96	75	7740

1 = increase in tank length 2 = maximum tank width

Mobile irrigation system BWS 130-PE PG 8

The irrigation system enables:

- irrigation: circuit with a safety inlet valve before the pump
- tank can be filled at a standpipe via the 3-way valve system (7 m hose included)
- mixing of optional additives possible using closed circuit in the tank (e.g. fertilisers, pesticides).

BWS 130-PE consisting of:

- frame and mounting surface made from galvanised steel (with mounting points)
- Honda pump with petrol engine 130 L/min* output rate
- pivotable hose reel (without hose) for 80 m water hose ¾" or 35 m water hose 1"
- pressure relief valve to protect the motorised pump
- ratchet straps
- frame with bi-directional forklift pockets
- version with optional baffles available, see below



BWS 130-PE
1000 L



Setup and securing of the ratchet strap

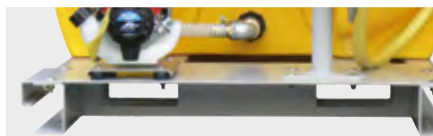

Bi-directional forklift pockets front and back



Forklift pockets at the side



Honda pump with petrol engine
130 L/min

MOBILE IRRIGATION SYSTEM BWS 130-PE WITH PETROL PUMP

Capacity L	Dimensions cm (l x w x h)	Filling hole / Dome ø in mm	without baffles		with baffles	
			Weight approx. kg	Order no.	Weight approx. kg	Order no.
600	184 x 90 x 96	ø 380 with flap lid	135	8684	141	10927
1000	208 x 114 x 104		160	8685	168	10928
2000	263 x 135 x 124		212	8686	223	10929
3000	291 x 150 x 127		308	11518	336	11519



Please note that the pump output can fall sharply depending on the length and cross-sectional area of the hose.



For the trunk-shaped PE tanks, see page 248.
Accessories see pages 249 and 255.
Further pumps on request.

Mobile irrigation system BWS 130-PE with electric pump PG 8

- version with pump 12 V or 24 V, 60 L/min
- the quiet alternative for mobile irrigation of plants in residential areas, parks and cemeteries
- optionally available with lithium-ion battery (charger incl.) for totally mobile, cable-free operation
- mixing of optional additives (e.g. fertiliser, pesticides) possible using closed circuit in the irrigation system
- galvanised steel frame forkliftable from four sides
- pivotable hose reel (without hose) for 80 m 3/4" water hose or 35 m 1" water hose
- version with optional baffles available, see below







BWS 130-PE
3000 L with pump 24 V
and Li-Ion battery

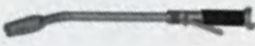

MOBILE IRRIGATION SYSTEM BWS 130-PE WITH ELECTRIC PUMP

Description	Dimensions cm (l x w x h)	Dome ø mm	without baffles		with baffles	
			Weight approx. kg	Order no.	Weight approx. kg	Order no.
600 L with pump 12 V	184 x 90 x 96	ø 380 with flap lid	130	11520	136	11532
600 L with pump 24 V	184 x 90 x 96		130	11521	136	11533
600 L with pump 24 V and Li-Ion battery	184 x 90 x 96		142	11522	148	11534
1000 L with pump 12 V	208 x 114 x 104		147	11523	155	11535
1000 L with pump 24 V	208 x 114 x 104		147	11524	155	11536
1000 L with pump 24 V and Li-Ion battery	208 x 114 x 104		159	11525	167	11537
2000 L with pump 12 V	263 x 135 x 124		205	11526	216	11538
2000 L with pump 24 V	263 x 135 x 124		205	11527	216	11539
2000 L with pump 24 V and Li-Ion battery	263 x 135 x 124		217	11528	228	11540
3000 L with pump 12 V	291 x 150 x 127		301	11529	329	11541
3000 L with pump 24 V	291 x 150 x 127		301	11530	329	11542
3000 L with pump 24 V and Li-Ion battery	291 x 150 x 127		313	11531	341	11543

ACCESSORIES FOR MOBILE IRRIGATION SYSTEM BWS 130, BWS 130-PE AND BWS 500 (SUPPLIED UNASSEMBLED)

Description	Order no.
 Spray lance with GEKA-coupling and lever valve	5826
 Watering shower head with rubber edge R 3/4", max. 80 L/min	10045
 Water hose per metre***	3/4" 5889
	1" 5855
 GEKA-coupling with hosetail	3/4" 10765
	1" 10766
Hose clamp 25 – 40 mm, stainless steel	8249

*** Available only in combination with a mobile irrigation system.

Mobile irrigation system BWS 25-Pro PE PG 8 for professional use

BWS 25-PRO PE comprising:

- PE tank box-shaped, with integrated baffles (see page 250)
- gear pump 12/24 V, IP 67, output rate 25 L/min*, delivery pressure 3 bar, with automatic switch-off function
- 4 m cable with crocodile clips
- quick coupling with water stop for Gardena irrigation system
- 10 m water hose 3/4"

Description	Capacity L	Dimensions cm (l x w x h)	Weight approx. kg	Order no.
BWS 25-PRO PE, 450 L	450	116 x 76 x 83	38	11332
BWS 25-PRO PE, 600 L	600	116 x 76 x 112	46	11333

ACCESSORIES

Description	Order no.
 Professional spray lance with spray head GEKA 20 – 35 L/min	11334



BWS 25-PRO PE with gear pump 12/24 V, GEKA quick coupling and professional spray lance (optional)

Mobile irrigation system BWS 30-PE PG 8 for personal use

- PE tank box-shaped, with integrated baffles (see page 250)
- submersible pump CENTRI SP 30, 12 V, output rate 30 L/min (free flow) *, delivery pressure 1 bar
- 4 m connection cable with crocodile clips
- quick coupling with water stop for Gardena irrigation system
- 10 m water hose 1/2"



BWS 30-PE, 450 L (spray lance not included, optional accessory)



CENTRI SP 30
EXTREMELY
QUIET



BWS 30-PE with submersible pump CENTRI SP 30 and quick coupling for Gardena irrigation system

Description	Capacity L	Dimensions cm (l x w x h)	Weight approx. kg	Order no.
BWS 30-PE, 12 L	125	80 x 60 x 45	17	11312
BWS 30-PE, 200 L	200	80 x 60 x 59	18	11313
BWS 30-PE, 450 L	450	116 x 76 x 73	37	10596
BWS 30-PE, 600 L	600	116 x 76 x 102	45	10597

ACCESSORY

Description	Order no.
Spray lance with watering shower head	10598

Aqua-Caddy PG 8

Aqua-Caddy 60 L

- made of translucent polyethylene
- submersible pump CENTRI SP 30, delivery pressure 1 bar
- Li-Ion CAS battery 18 V, 2 Ah with charger
- quick-coupling with water stop for Gardena irrigation system
- 6 m water hose 1/2"
- spray lance with spray head



CENTRI SP 30
EXTREMELY
QUIET

Aqua-Caddy 60 L for concrete drilling machines

- oscillating piston pump 230 V, duty cycle 100 %
- 6 m cable with switch
- 3 m dispensing hose with Gardena coupling

Description	Capacity L	Delivery rate pump	Capacity Battery	Delivery rate **	Dimensions cm (l x w x h)	Weight approx. kg	Order no.
with submersible pump, CAS battery and charger	60	12 L/min	2 Ah	300 L	90 x 52 x 37	15	10847
with submersible pump, without CAS battery and charger	60	12 L/min	-	-	90 x 52 x 37	15	11684
with oscillating piston pump	60	3,5 L/min	-	-	90 x 52 x 37	15	11032

* Please note that the pump output can fall sharply depending on the length and cross-sectional area of the hose.

** Max. range (litres) per battery charge

Transfer trolley Aqua 130 m PG 8

The practical solution for watering plants in administrative buildings, hotels and hospitals

- for transporting water and for independent watering of plants
- totally mobile and wireless
- no need to lug watering cans
- 130 L container made of high-quality translucent polyethylene, with integrated handles and fill-level scale
- low centre of gravity
- integral pump sump allows the container to be emptied almost entirely
- equipped with 4 swivel castors \varnothing 100 mm



① Version with electric pump:

- quick coupling with water stop for Gardena irrigation system
- hand sprayer with flow control
- equipped with self-priming pump, 11 L/min, with pressure switch, CAS battery and charger

② Version with hand pump

- hand pump, 0.4 L/stroke
- 2 m water hose
- manual nozzle

 MOBILE & CABLE-FREE

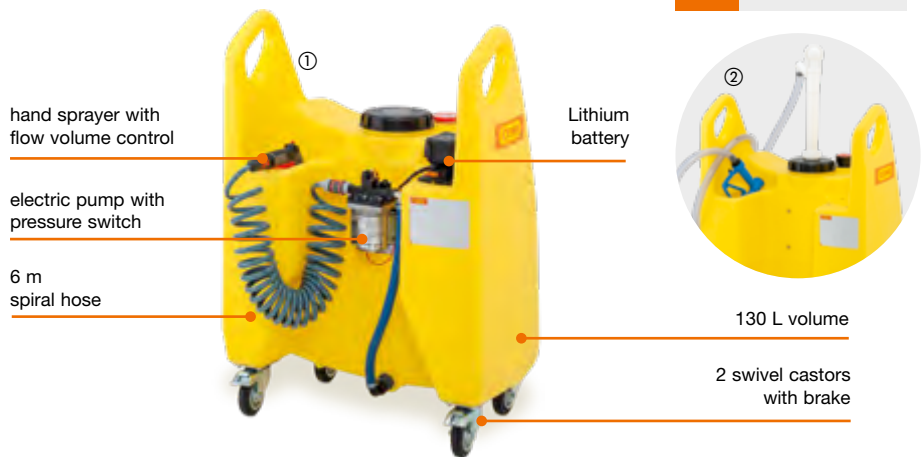

Description		Dimensions cm (l x w x h)	Weight approx. kg	Order no.
① 130 L with 12V pump, CAS battery, charger and hand sprayer		50 x 75 x 101	24	11544
130 L without CAS battery and charger		50 x 75 x 101	24	11674
② 130 L with hand pump and manual nozzle		50 x 75 x 114	22	11570

Mobile sprayers PG 8

Canister pump set, 230 V

Pump can be screwed directly onto canisters with DIN 61 thread. Spray lance with flat spray nozzle size 04, spray angle 110° approx. 950 mL/min, and flat spray nozzle size 02, spray angle 110°, approx. 690 mL/min output rate

Container sprayer, 230 V

Spray lance with flat spray nozzle size 04, spray angle 110°, approx. 1,040 – 1,370 mL/min, and flat spray nozzle size 02, spray angle 110°, approx. 800 – 1,000 mL/min output rate

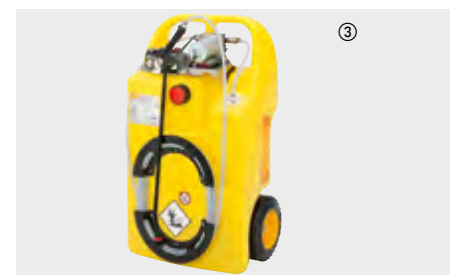

Spray caddy 60 L, 12 V

Battery capacity 3.3 Ah, suitable for approx. 60 L (with nozzle 03). Spray lance with flat spray nozzle size 03, spray angle 110°, approx. 1,150 mL/min, and flat spray nozzle size 02, spray angle 110°, approx. 800 mL/min output rate

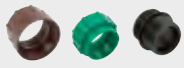

Description	Dimensions cm (l x w x h)	Order no.
① Canister pump set , 230 V, with 20 L PE canister and 5 m reinforced hose	29 x 25 x 57	7898
② Container sprayer , 230 V, 20 L container capacity, 5 m reinforced hose	56 x 21 x 38	11356
③ Spray caddy 60 L , pressure relief valve 0.3 – 5 bar, 8m reinforced hose, LiFePO ₄ battery with charger	90 x 52 x 37	11359

ACCESSORIES

	Adapter set for canister pump set Adapter to 2" thread, DIN 51 and DIN 71, and longer suction hose with foot filter	-	11362
	Spare battery for spray caddy 60 L Lithium-iron phosphate battery (LiFePO ₄), 12.8 V – 3.3 Ah	-	10602

Mobile cleaning and weed control system

MCS 1000 HD PG 8

The mobile cleaning and weed control system enables you to work independently of electricity and mains water. It consists of the following components:

- 600 L, 1000 L or 2000 L PE tank with baffle
- runners and frame made from galvanised steel (with mounting points)
- frame with integral forklift pockets on both sides and at the front
- ratchet straps
- heated Kärcher high-pressure module HDS 1000 De (diesel operation) with high-pressure gun
- hose reel with 20 m of high-pressure hose (optional)
- hose reel with 40 m of high-pressure hose (optional)
- cleaning gun
- with weed control attachment kit

- (temperature sensor). This ensures a constant water temperature of 98 °C at the outlet of the weed control lance
- weed control lance for weed removal without chemicals (optional)



MCS 1000 HD
with PE tank 1,000 L

MCS 1000 HD
2 in 1
mobile and effective

Weed control with hot water at 98 °C

High-pressure cleaning up to 200 bar



High-pressure module HDS 1000 De

Technical data for high-pressure module HDS 1000 De

Pressure	40 – 200/4 – 20 bar/MPa
Fuel oil consumption at full load	5.6 kg/h
Output rate	450 – 900 L/h
Engine power	6.8/9.3 kW/PS
Engine type	L 100 V diesel
Engine manufacturer	Yanmar
Max. temperature (supply temp.: 12 °C) for weed control	80 – 98 °C
Max. temperature (supply temp.: 12 °C) when operated with steam	up to 150 °C



High-pressure cleaning up to 200 bar



Weed control with weed lance WR 10



Before

After









MCS 1000 HD
with PE tank 1,000 L, with hose reel (accessory)
and weed control lance (accessory)

MOBILE CLEANING AND WEED CONTROL SYSTEM MCS 1000 HD

Capacity L	Dimensions cm (l x w x h)	Dome ø mm	Weight approx. kg	Order no.
600	203 x 113 x 96	ø 380 with lid	297	11314
1000	228 x 113 x 104		322	11315
2000	273 x 135 x 124		372	11316

ACCESSORIES

	Description	Dimensions cm (l x w x h)	Weight approx. kg	Order no.
	10 m of high-pressure hose DN 8 40 MPa	-	3.5	11355
	Hose reel with 20 m of high-pressure hose DN 8 40 MPa	45 x 19 x 46	20	11317
	Hose reel with 40 m of high-pressure hose DN 10 22 MPa	52 x 49 x 58	52	11318
	Weed control lance WR 50	24 x 50 x 26	1.6	11319
	Weed control lance WR 10	10 x 10 x 10	0.6	11509
	Pressure and flow regulator for cleaning gun MCS	-	-	11702
	Descaling agent RM 110, 1 litre	-	1.2	11552

Polyethylene storage tanks PG 8

- **Storage tanks and large reservoirs:** for above ground installation in the garden or for trade and industry
- can be used as water butts for garden watering
- protect water against subsequent dirt collection
- manufactured from high-quality polyethylene
- the green containers are opaque so as to limit algae growth
- can be completed by the addition of custom equipment so they fulfil particular purposes
- can also be installed as a tank battery (except storage tank 5000 L).
- **Storage tanks:** food safe (except storage tanks 1000 L and 5000 L) meet the requirements of the German Environment Agency for plastics in drinking water.
- **Large reservoirs:** are primarily for commercial water use, e. g. in market gardens, washing installations and industrial concerns, but are also suited to rain water storage in the domestic market.



Storage tank 750 L with 3 x 2" connections and 1 flange connection

Storage tank 1000 L with large inspection dome, 1 x 2" connection and 1 flange connection



Storage tanks with large inspection dome, 2 x 2" connections and flange connection (1100, 1500 and 2000 L with steel bands)



Large reservoir with large inspection dome, 1 x 2" connection and 2 flange connections (2000 and 3000 L)











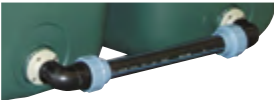

Storage tank 5000 L with 3 x 2" connections and 1 connection S 160 x 7

Description	Capacity L	Dimensions cm (l x w x h)	Inspection dome ø. mm	Weight approx. kg	Order no.
Storage tanks	750	74 x 74 x 164	140	25	7848
	1000	124 x 72 x 125	500 x 400	40	7649
	1100*	145 x 72 x 134	400	53	8315
	1500*	152 x 72 x 161	400	66	7650
	2000*	201 x 72 x 164	400	92	7651
	5000*	239 x 135 x 198	140	240	8317
Large reservoirs	2000	202 x 88 x 165	500 x 400	95	7652
	3000	263 x 88 x 165	500 x 400	130	7653

* with steel bands

STORAGE TANKS

ACCESSORIES FOR STORAGE TANKS 750 L UP TO 2000 L AND LARGE RESERVOIR

Description	suitable for							Order no.
	Storage tank					Large reservoir		
	750 L	1000 L	1100 L	1500 L	2000 L	2000 L	3000 L	
 <p>Flange with ball valve 1"</p>	X	X	X	X	X	X	X	7654
 <p>Mechanical filling level indicator</p>	X			X	X	X	X	7655
 <p>Screw connection for submersible pump</p>	X	X	X	X	X	X	X	7656
 <p>Connection line 2"</p>	X	X	X	X	X	X	X	7657
 <p>Floating extractor</p>			X	X	X	X	X	7658
 <p>Universal flange connector elbow 1"</p>	X	X	X	X	X	X	X	7659
 <p>Universal flange connector T-piece 1"</p>	X	X	X	X	X	X	X	7660
 <p>Universal flange connector elbow 2"</p>	X	X	X	X	X	X	X	7661
 <p>Universal flange connector T-piece 2"</p>	X	X	X	X	X	X	X	7662
 <p>Flange connection 1"</p>	X	X	X	X	X	X	X	7736
 <p>Flange connection 2"</p>	X	X	X	X	X	X	X	7737

 Other storage tanks for brine and liquid fertilisers on request.



 Accessories for storage tank 5000 L on request.

Rectangular containers, GRP

Rectangular containers made from glass-fibre reinforced plastic, GRP. For wherever transport and storage containers with particularly high strength, low weight and extreme resistance to corrosion are required.

- ✓ sizes 100 L to 2200 L
- ✓ reinforced handling rim
- ✓ corrosion resistant and extremely light
- ✓ very strong and rigid
- ✓ stackable
- ✓ UV-resistant
- ✓ smooth inside and outside surfaces for easy cleaning
- ✓ various transport accessories, e.g. removable foot and castor support frame with centering lugs



forkliftable

Integrated forklift pockets for pallet truck and forklift (200 L and 400 L).



stackable

Sideways stackable for space-saving storage and easy separation.

Can be stacked with closed stacking lid (200 L and 400 L).

Our PREMIUM product line GRP



Due to the excellent material properties created by reinforcing the three-dimensionally meshed duroplastic material with glass-fibres, GRP has been used for decades to make high-performance products that are expected to have a large service life in tough environments and at the same time ensure high levels of safety. GRP combines the positive properties of steel and plastic.

RECTANGULAR CONTAINERS



flat lid

GRP lids are available for each rectangular container ranging in size from 100 L to 2200 L.



smooth surfaces and reinforced handling rim

Less dirt thanks to smooth external walls (dirt not able to build up); no residues left behind after draining and easy to clean thanks to smooth internal walls in the container. The reinforced edge prevents any deformation and therefore a high-precision fit for the seal of the optional lid. It also guarantees excellent inherent rigidity, even with heavy contents.



screw-in threaded connector

Screw-in threaded connector and screw-through threaded connector as well as drain taps are available as accessories.



forklift pockets

The forklift pockets are mounted impervious to fluids and suitable for rotary forklifts.



castor frame

Accessory: castor frame with centering lugs.



steel base frame

Accessory: steel base frame with centering lugs.

Rectangular containers PG 8

Containers with forklift pockets:

- forklift pockets attached in a leak-proof manner using stainless steel coach bolts
- suitable for rotary forklifts, insertion dimension of forklift pockets 160 x 70 mm

Large containers:

- container (grey) in GRP
- for use as a storage and collection container
- chemical-resistant
- can be installed above ground as well as below ground level

- hot dip galvanised external braces for above ground installation
- stainless steel internal braces for installation in the ground



Rectangular container, for example with castor frame (accessory)



Capacity L		Internal dimensions cm top (l x w x h)	External dimensions cm top (l x w x h)	Weight approx. kg	Order no. green	Order no. grey	Order no. blue
100	Standard	80 x 50 x 28	88 x 58 x 29	5	1142	7165	7567
200	flat standard	115 x 55 x 36	122 x 62 x 37	8	1143	5671	7568
200	high standard	80 x 49 x 59	88 x 57 x 60	8	1144	1160	7569
300	Standard	110 x 62 x 52	118 x 70 x 53	14	1145	1161	7570
300	with forklift pockets	110 x 62 x 52	117 x 69 x 60	26	1204	7178	-
400	Standard	111 x 71 x 59	119 x 79 x 60	17	1146	1162	7571
400	with forklift pockets	111 x 71 x 59	119 x 79 x 67	30	1205	7179	-
500	flat standard	144 x 79 x 50	153 x 88 x 50	25	1156	7166	-
550	Standard	118 x 83 x 62	132 x 97 x 63	19	1147	1163	7995
550	with forklift pockets	118 x 83 x 62	132 x 97 x 70	34	1206	7180	-
700	Standard	118 x 83 x 80	132 x 97 x 81	23	1148	1164	7996
700	with forklift pockets	118 x 83 x 80	132 x 97 x 88	38	1207	2554	-
1100	Standard	148 x 105 x 80	162 x 119 x 81	36	1150	1165	7997
1100	with forklift pockets	148 x 105 x 80	162 x 119 x 88	57	1208	2555	-
1500	Standard	168 x 125 x 80	182 x 139 x 81	46	1151	1166	-
1500	with forklift pockets	168 x 125 x 80	182 x 139 x 88	64	1209	2642	-
2200	Standard	197 x 134 x 92	211 x 148 x 93	65	1152	1167	-
2200	with forklift pockets	197 x 134 x 92	211 x 148 x 100	90	1210	7181	-



Suitable steel feet or castor frame see page 265.

ACCESSORIES FLAT LID

Version for size		External dimensions cm (l x w x h)	Weight approx. kg	Order no.	
	100	89 x 59 x 4	2	1168	
	200	flat	123 x 64 x 4	2,5	1169
	200	high	89 x 59 x 4	2	1168
	300		120 x 72 x 4	3,5	1170
	400		120 x 80 x 4	4	1171
	500	flat	154 x 89 x 4	8	6956
	550		134 x 98 x 6	5,5	1172
	700		134 x 98 x 6	5,5	1172
	1100		163 x 120 x 6	6,5	1173
	1500		183 x 140 x 6	10,5	1174
	2200		212 x 149 x 6	15	1175

ACCESSORIES STEEL BASE FRAME (ALSO FOR GRIT CONTAINER)

Version for size		Weight approx. kg	Order no.	
	100		8	7784
	200	flat	12	7785
	200	high	10	7786
	300		12	7787
	400		12	7788
	550		16	7789
	700		16	7790
	1100		25	7591
	1500		42	8010
	2200		48	8011

galvanised steel base frame for more secure support

ACCESSORIES CASTOR FRAME (CASTOR = CA; ALSO FOR GRIT CONTAINER)

Version for size				Weight approx. kg	Order no.	
	100		(CA ø 100 mm)	PP	9	7812
	200	flat	(CA ø 100 mm)	PP	14	7813
	200	high	(CA ø 100 mm)	PP	9	7814
	300		(CA ø 100 mm)	PP	14	7815
	400		(CA ø 100 mm)	PP	14	7816
	550		(CA ø 125 mm)	PP	18	7817
	700		(CA ø 125 mm)	PP	18	7818
	1100		(CA ø 150 mm)	PA	25	8012
	1500		(CA ø 200 mm)	PA	42	8013
	2200		(CA ø 250 mm)	PA	48	8014

galvanised castor frame for mobile use

2 castors with additional turning and steering stops

Rectangular container forkliftable PG 8



Forkliftable rectangular container

- with integrated forklift pockets, suitable for pallet trucks and forklifts
- made of highly impact resistant, damage tolerant resin

Can be stacked with closed lid (stacking lid as accessory).





Can be driven under with pallet truck and forklift (stacking lid as accessory).

RECTANGULAR CONTAINER GRP, FORKLIFTABLE

Capacity L	Internal dimensions cm top (l x w x h)	External dimensions cm top (l x w x h)	Weight approx. kg	Order no. green	Order no. grey
200 high	80 x 50 x 54	87 x 57 x 64	9.7	10582	10584
400	112 x 72 x 50	119 x 79 x 60	15	10583	10585



ACCESSORIES



Description	Version for size	External dimensions cm top (l x w x h)	Capacity kg	Weight approx. kg	Order no.
 Stacking lid*	200 high	89 x 60 x 9	200	3	10586
	400	121 x 82 x 11	400	6.3	10587
 Insert plate	200 high	75 x 45 x 3	200	3	10739
	400	107 x 67 x 3	400	5.4	10740

* Stacking lid in grey on request.

Rectangular containers PG 8

ACCESSORIES

Description	Thread	without mounting	with mounting on the tank
		Order no.	Order no.
 <p>Screw through threaded connector (brass) with external thread, 2 lock nuts</p>	3/4"	1393	8843
	1"	1394	8844
	1 1/4"	1395	8845
	1 1/2"	1396	8846
	3/4"	1397	8847
 <p>Screw in threaded connector (brass, nickel-plated) with external thread, food safe</p>	1"	1398	8848
	1 1/4"	1399	8849
	1 1/2"	1500	8850
	2"	1501	8851
 <p>Screw in threaded connector (plastic) with external and internal threads</p>	ET 1" IT 1/2"	1515	8852
	ET 1 1/4" IT 3/4"	1516	8853
	ET 1 1/4" IT 1"	1517	8854
	ET 2" IT 1 1/2"	1518	8855
	ET 2 3/4" IT 2"	1519	8856

Description	Thread	Order no.
 <p>Discharge valve (brass, nickel-plated) with internal thread at both ends</p>	3/4"	1303
	1"	1304
	1 1/4"	1305
	1 1/2"	1306
	2"	1307
 <p>Plastic ball valve (PVC) internally threaded</p>	1"	6426
	1 1/2"	6428
	2"	6429
 <p>Spindle valves (plastic) with ext. thread matched to screw in threaded connector</p>	3/4"	1314
	1/2"	1315

Description	Order no.
 <p>1 kg repair pack, neutral pre-accelerated resin, hardener, glass-fibre, brush</p>	1617



Nestable while on their sides for space-saving storage and easy separation

One CEMbox – many benefits



stack-able

All models are moulded with lugs and recesses that allow them to be stacked safely and securely.

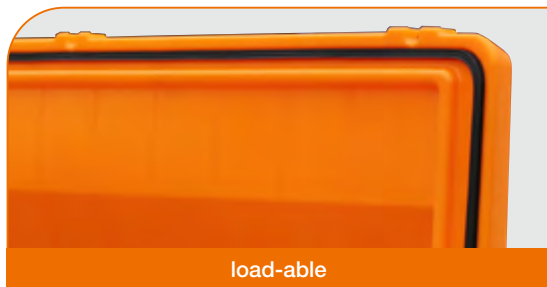

load-able

The lid is double-walled, therefore particularly stable and robust, and sealed to provide effective protection against the elements.



carry-able

With a CEMbox you have everything in hand. Ergonomically moulded carry handles allow for comfortable lifting by one or two people.



access-able

The 750 litre CEMbox with a side door offers easy and comfortable access from street level, when mounted on a vehicle.



transport-able

The CEMbox's robust design allows an impressive load bearing capacity of up to 400 kg. Except for the 150 litre box, moulded forklift pockets make handling easy.

The CEMO tool box for professionals

When you store your goods in transit in a CEMbox you can rest assured that they are safe and protected against outside influences. The CEMbox – the small, smart container for goods in transit.





crane-able

Crane frame with pivoting crane eyelets (for CEMbox 400 L and 750 L for use with cranes)

The CEMbox can be equipped with a frame to allow them to be suspended and lifted around a work site using a crane (except 150 L box).



lock-able

Adjustable toggle latches with padlock loops help prevent unwanted interference with the contents of your CEMbox.



roll-able

The trolley version of the 150 litre CEMbox provides a convenient solution for movement on site.



label-able

The 150 and 400 litre versions have a moulded recess to allow for marking and labelling.



adapt-able

A range of useful accessories allows the Cembox to be used in a variety of ways. Compartment dividers, installable and stackable trays, foam inserts and more provide for extensive individual adaptation.

CEMbox PG 8

CEMbox, PE

- grey/orange or yellow box made of high-grade PE
- for transport and storage of tools and small parts
- ideal length for shovels
- side door optional (750 L box)
- optimal dimensions for flatbed vehicles
- stackable, with locating lugs and recesses
- forklift pockets (except 150 L box)
- integrated handles

- cover stop
- 3 toggle latches (750 L box) or 2 toggle latches (150 L, 250 L or 400 L box) made of stainless steel
- space for label pocket (150 L and 400 L box)
- water ingress prevented by integral seal around entire lid
- partition that fits in the grooves of the toolbox as an accessory
- insert tray accessory for delicate tools (e.g. spirit level)

CEMbox suitable for use with cranes:

- reinforced design with crane lugs and sturdy crane frame (250 L, 400 L and 750 L box)



Video
CEMbox Trolley Offroad



CEMbox 750 L, anthracite



Other colours available on orders of more than 50 units.



CEMbox 750 L for use with cranes







CEMbox 250 L, yellow (other colours available for orders of 50 units or more)







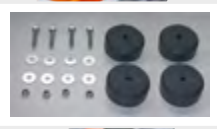

CEMbox trolley 150 L offroad, grey/orange

Description	Capacity L	External dimensions cm (l x w x h)	Internal dimensions cm (l x w x h)	Weight approx. kg	Individual load-bearing capacity in kg	Load-bearing capacity for double stacking in kg	Order no.
CEMbox 150, grey/orange	150	80 x 60 x 53	66 x 45 x 38	14	100	100	10330
CEMbox 150, yellow	150	80 x 60 x 53	66 x 45 x 38	14	100	100	10132
CEMbox Trolley 150, grey/orange	150	80 x 60 x 53	66 x 45 x 38	15	100	100	10331
CEMbox Trolley 150, yellow	150	80 x 60 x 53	66 x 45 x 38	15	100	100	10133
CEMbox Trolley 150 Offroad, grey/orange	150	88 x 73 x 61	66 x 45 x 38	19	60	-	11284
CEMbox 250, grey/orange	250	120 x 60 x 54	107 x 45 x 38	18	200	100	10332
CEMbox 250, yellow	250	120 x 60 x 54	107 x 45 x 38	18	200	100	8615
CEMbox 250, for use with cranes, grey/orange	250	124 x 60 x 57	107 x 45 x 38	33	100	100	10333
CEMbox 400, grey/orange	400	120 x 79 x 75	107 x 65 x 58	30	250	150	10334
CEMbox 400, for use with cranes, grey/orange	400	120 x 81 x 75	107 x 65 x 58	60	200	150	10961
CEMbox 750, anthracite	750	170 x 84 x 80	156 x 70 x 63	42	400	200	8490
CEMbox 750, grey/orange	750	170 x 84 x 80	156 x 70 x 63	42	400	200	10335
CEMbox 750, grey/orange, with side door 50 x 45 cm (w x h)	750	170 x 84 x 80	154 x 70 x 63	43	400	200	10336
CEMbox 750, for use with cranes, grey/orange	750	170 x 86 x 80	156 x 70 x 63	75	200	200	10337
CEMbox 750, for use with cranes, grey/orange, with side door	750	170 x 86 x 80	154 x 70 x 63	76	200	200	10338

ACCESSORIES FOR CEMBOX 150 L AND 250 L

Description	CEMbox 150 L		CEMbox 250 L	
	Dimensions cm (l x w x h)	Order no.	Dimensions cm (l x w x h)	Order no.
 Insert for delicate tools, long, PE	73 x 15 x 6	8955	113 x 15 x 6	8170
 Partition	54 x 37	8956	54 x 38	8171
 Insert, stackable	43 x 28 x 19	10016	43 x 28 x 19	10016
 Flatbed mounting kit	-	8666	-	8666
 Insert of polyurethane foam, cube size: 22 x 22 x 50 mm	66 x 48 x 40	10048	-	-
 Anti-slip mat, oil and weather resistant	80 x 120	10953	80 x 120	10953

ACCESSORIES FOR CEMBOX 400 L AND 750 L

Description	CEMbox 400 L		CEMbox 750 L	
	Dimensions cm (l x w x h)	Order no.	Dimensions cm (l x w x h)	Order no.
 Insert for delicate tools, long, PE	113 x 15 x 6	8170	160 x 15 x 6	8492
 Insert, metal	-	-	67 x 74 x 17	8688
 Rubber mat for metal insert	-	-	66 x 73	8689
 Partition	73 x 40	8957	76 x 60	8493
 Flatbed attachments	-	10111	-	8494
 Anti-slip mat, oil and weather resistant	80 x 120	10953	80 x 120	10953
 Set of wheels, consisting of 4 solid rubber wheels (Ø 125 mm) with rotation and swivel brake, includes mounting accessories, maximum load 200 kg	-	11491	-	11491

Vehicle storage box PG 8

- grey container made of PE
- for safe transport and storage of tools and building materials
- lockable
- stackable inside one another
- can be handled using a forklift or crane grab
- example application: construction industry, landscaping and handcraft

Easy loading and unloading with forklift pockets

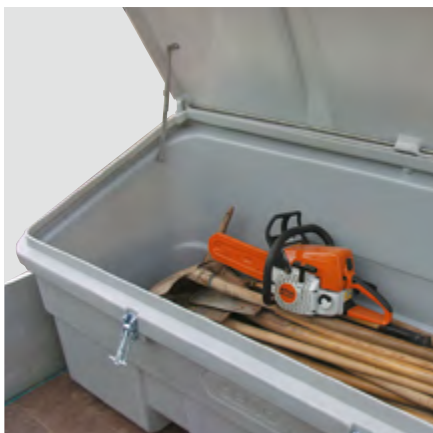

Secure storage of tools and building materials



Hinged steel lid stay

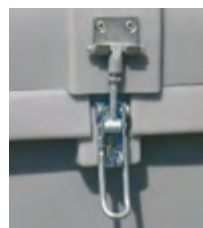

Lockable lid



Platform fastening (reinforcement)



Platform fastening

Description	Capacity L	Dimensions in cm (l x w x h)	Weight approx. kg	Order no.
Vehicle storage box	750	184 x 74 x 94	40	7841

ACCESSORIES

Description	Order no.
Platform fastening kit (for fastening on 2 corners)	7883

General-purpose box PG 8



- container and lid are made from glass-fibre reinforced plastic (GRP)
- weather-proof and durable
- lockable
- ideally suited for the storage of tools and small parts
- optional: with integrated forklift pockets, suitable for trucks and forklifts
- can be stacked with closed lid
- cover with gas struts
- flat internal base (in version with insert plate)

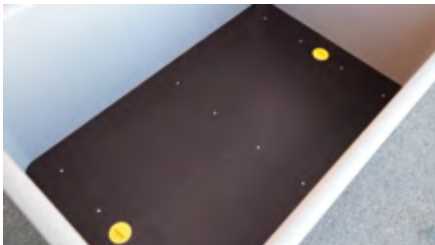

Level internal base thanks to insert plate

Description	Capacity L	External dimensions cm (l x w x h)	Internal dimensions cm (l x w x h)	Weight approx. kg	Order no.
General-purpose box 200 NEW	200	89 x 60 x 64	72 x 42 x 58	14	11913
General-purpose box 400 NEW	400	121 x 82 x 68	103 x 63 x 58	25	11914
General-purpose box 200 forklift pockets	200	89 x 60 x 69	75 x 45 x 51	16	10737
General-purpose box 400 forklift pockets	400	121 x 82 x 68	107 x 67 x 47	27	10738

ACCESSORIES

Description	Order no.
Padlock, galvanised	1490



NEW

GRP rectangular container 400 L, with or without integrated forklift pockets

Logistics box PG 8

- optimal storage and transport system
- PE plastic high density (HDPE)
- extremely acid-resistant
- stackable and safe for transport
- food safe



Food-safe design:
Container with foodstuff symbol as per Regulation (EU) No. 10/2011



Logistics box 300 L



Logistics box 520 L



Logistics box 610 L

Description / Capacity L	External dimensions cm (l x w x h)	Load-bearing capacity, individual, kg	Max. boxes stacked	Load-bearing capacity complete, stacked, kg	Weight approx. kg	Order no.
Logistics box 300, with 4 feet	100 x 63.5 x 64.5	150	5	750	14.3	10158
Logistics box 520, with 2 runners	120 x 80 x 79	350	8	2800	29	8613
Logistics box 610, with 3 runners	120 x 100 x 76	450	8	3600	37	8085

ACCESSORIES

Description	External dimensions cm (l x w x h)	Weight approx. kg	Order no.
Lid for box 300	103 x 65 x 7,5	5	10159
Lid for box 520	121.5 x 81.5 x 6	6	8614
Lid for box 610	121.5 x 101.5 x 6	7	8086

Go-Box PG 8

- for grit, sand, absorbents, etc.
- for indoor and outdoor use and storage
- sturdy rubber wheels
- angled lid so that water runs off
- with stainless steel toggle latch
- can be locked with a padlock (not included), see page 273
- user-friendly, ergonomic handle
- 70 L capacity
- lid in a vertical position for filling/emptying
- easy to handle thanks to sophisticated balance
- easy to clean
- made from chemical-resistant PE – 100 % recyclable
- partition for insertion into the grooves of the Go-box as accessories



Video
Go-Box

Accessory: partition



Description / Capacity L	Dimensions cm (h x w x d)	Weight approx. kg	Order no.
Go-Box 70	107 x 59 x 39	10	11285

ACCESSORY

Description	Dimensions cm (h x w)	Order no.
Partition for Go-Box 70	40 x 32	11286

BOOT CLEANER

Boot cleaner Premium PG 8

- made from high quality UV stabilised polyethylene
- equipped with three fixed brushes and one movable brush
- water connection ½"
- stainless steel fittings
- brush holder with integral hand washing function
- with integral sump for dirty water collection and run-off, optionally on the right or left

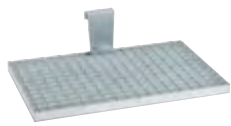

Accessory: scraper grate for coarse dirt



ground anchor kit

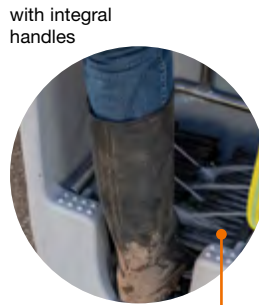

with integral handles

Integral sump to collect dirty water

Replacement brush set Premium for boot cleaner PE, Premium, and ECO available as an accessory



hand washing function



non-slip boot support surface while cleaning with hand brush

Description	Dimensions cm (l x w x h)	Weight approx. kg	Order no.
Boot cleaner Premium	53 x 49 x 88	13	11496
Accessory: scraper grate for coarse dirt	43 x 60 x 14.5	5	11497
Accessory: ground anchor kit	-	-	11507
Replacement brush set Premium for boot cleaner PE, Premium, and ECO	-	-	12008

Boot cleaner ECO PG 8

- frame made of stainless steel
- equipped with three fixed brushes
- ½" water connection (Gardena)
- stainless steel pipes
- with holder



Accessory: scraper grate for coarse dirt

Boot cleaner ECO



Description	Dimensions cm (l x w x h)	Weight approx. kg	Order no.
Boot cleaner ECO	33 x 33 x 82	5.6	10588
Accessory: Scraper grate for coarse dirt	28 x 40 x 4	1.1	10589

Rinsing tray PG 8

- from highly resistant GRP
- impact and scratch-proof, as well as resistant to high temperatures
- discharge with plug
- 1 ¼" with discharge connection



Description / Capacity L	Dimensions cm (l x w x h)	Order no.
Rinsing tray 75	80 x 55 x 30	1086
Rinsing tray 100	105 x 55 x 30	1087

ACCESSORIES

Description	Dimensions cm (l x w x h)	Order no.	
Wall bracket, galvanised, 46 cm wide	-	1088	
Floor frame in galvanised steel tube	for rinsing tray 75 L	83 x 56 x 81	1089
	for rinsing tray 100 L	108 x 56 x 81	1090
Drainage hose plastic with screw connector			1091



WINTER SERVICE | SPREADERS



CEMO grit bins

CEMO ensure that your grit is well protected in all weather and ready for action when needed.

- ✓ Material: GRP – durable, tough, rustproof, resistant to salt
- ✓ 20-year service life, 10-year warranty (!)
- ✓ Impact-resistant, able to withstand a blow from a hammer, and inherently robust
- ✓ Temperature- and UV-resistant
- ✓ Protected against water and humidity
- ✓ Well-conceived design for ease of use



smooth surfaces

Less dirt thanks to smooth external walls (dirt does not accumulate); no residues left behind after draining and easy to clean thanks to smooth internal walls in the container.



clean closing

Long-lasting, secure closure thanks to the moulded container edge and overhang which prevent the ingress of dirty water and moisture.



stackable

Sideways stackable for space-saving storage and easy separation.



vandalism-proof lid

Extremely impact-resistant and inherently robust material ("hammer test"), plus increased wall strength (for 550 L and 700 L containers).

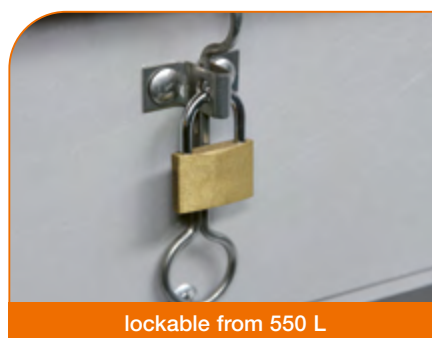

lockable from 550 L

Easy to open from outside and inside with a self-locking stainless steel spring closure. Lockable by means of a padlock (accessory)



Video
grit bin PLUS3

CEMO grit bin Plus3

The new grit bin generation **Plus3** adds **three** further plus points to the benefits of our GRP grit bins in terms of handling and assembly.

The additional benefits of the Plus3 grit bin:

- ① can be stacked with closed stacking lid
- ② forkliftable
- ③ lid can be removed without using tools



① stackable

Can be stacked with closed stacking lid.



② forkliftable

Can be lifted with pallet truck and forklift (version 200 L and 400 L).



tool-free removal

The lid can be removed without tools. It can be locked simply using removable support bar (400 L).



tool-free removal from 550 L

The lid can be removed without tools. It can be locked simply using removable retaining straps.

Grit bin Plus3 PG 8

As the market leader for grit bins, we receive extensive feedback and a large number of requests. For many local authorities, simple use and handling are paramount. The ability to move with a forklift and stack the containers makes it so much easier to move grit bins in and out of storage and saves time and space.

In addition, tool-free assembly of the very robust lid has been significantly simplified.

The new grit bin generation Plus3 adds three further plus points to the benefits of long-life GRP grit bins in terms of handling and assembly.

Grit bins Plus3

The additional benefits of the Plus3:

- forkliftable (optional)
- can be stacked with closed lid (optionally lockable with padlock, for accessories see page 282)
- lid can be removed without using tools
- with support strut for lid (400 L version)
- strong and robust lid shape



Yellow base and yellow lid version (200 L) without access chute



400 L forkliftable with access chute lockable with optional padlock



can be lifted with pallet truck and forklift



can be stacked with closed lid



GRIT BIN PLUS3

Capacity L	Dimensions in cm (l x w x h)	With or without chute	With or without forklift slots	Weight approx. kg	Container grey lid orange Order no.	Container green lid orange Order no.	Container yellow lid yellow Order no.
100	89 x 60 x 34	without	without	8.3	10564	10573	-
200	89 x 60 x 64	without	without	11.3	10565	10574	10974
200	89 x 60 x 64	with	without	12.5	10566	10575	-
200	89 x 60 x 69	without	with	12.8	10567	10576	-
200	89 x 60 x 69	with	with	14	10568	10577	-
400	121 x 82 x 67	without	without	21.4	10569	10578	10975
400	121 x 82 x 67	with	without	21.6	10570	10579	-
400	121 x 82 x 68	without	with	21.4	10571	10580	-
400	121 x 82 x 68	with	with	22.6	10572	10581	-

ACCESSORIES FOR FORKLIFTABLE GRIT BIN

Description	for size	External dimensions cm (l x w x h)	Capacity kg	Weight approx. kg	Order no.
 Floor plate	200	75 x 45 x 3	200	3	10739
	400	107 x 67 x 3	400	5.4	10740

 Capacity of the stacking lid see page 266.

GRIT BINS

Grit bin PG 8

- container and lid in glass-fibre reinforced plastic, GRP
- GRP grit bins are 100 % corrosion- and weather-proof
- stainless steel spring closure, self-closing
- simple opening from the outside and inside
- simple, safe handling
- space and time-saving to store and remove from storage (stackable)
- simple assembly, supplied with lid unassembled
- from 550 L - 700 L with removable retaining straps for lids
- from 1100 L to 2200 L (standard) with stainless steel locking lid stays



Colour combination grey/orange with chute



Colour combination green/orange with chute



GRIT BIN

Capacity L	Dimensions in cm (l x w x h)	with or without chute	Weight approx. kg	Container grey, lid orange	Container green, lid orange
				Order no.	Order no.
550	134 x 99 x 78	without	26	10833	10837
		with	28	10834	10838
700	134 x 99 x 96	without	30	10835	10839
		with	32	10836	10840
1100	163 x 121 x 101	without	50	7435	7441
		with	52	7436	7442
1500	184 x 143 x 104	without	70	7437	7443
		with	72	7438	7444
2200	213 x 152 x 124	without	92	7439	7445
		with	94	7440	7446

ACCESSORIES STEEL BASE FRAME GALVANISED, FOR STABLE FOOTING PG 8

Version for size		Weight approx. kg	Order no.
	100	8	7784
	200	10	7786
	400	12	7788
	550	16	7789
	700	16	7790
	1100	25	7591
	1500	42	8010
	2200	48	8011

ACCESSORIES CASTOR FRAME GALVANISED, FOR MOBILE USE (CASTOR = CA) PG 8 GALVANISED ROLLER STAND FOR MOBILE USE, 2 CASTORS WITH SWIVEL AND ROTATION BRAKE

Version for size		Weight approx. kg	Order no.
	100	(CA ø 100 mm) PP	9 7812
	200	(CA ø 100 mm) PP	9 7814
	400	(CA ø 100 mm) PP	14 7816
	550	(CA ø 125 mm) PP	18 7817
	700	(CA ø 125 mm) PP	18 7818
	1100	(CA ø 150 mm) PA	25 8012
	1500	(CA ø 200 mm) PA	42 8013
	2200	(CA ø 250 mm) PA	48 8014

Grit bin PG 8

GRP grit bin "V" with anti-vandalism lid

- particularly impact resistant and form-retaining material ("hammer test")
- increased wall thickness (for container sizes 400, 550 and 700 L)



GRIT BIN "V" WITH ANTI-VANDALISM LID

Capacity L	Dimensions in cm (l x w x h)	With or without chute	Weight approx. kg	Container grey, lid orange Order no.	Container green, lid orange Order no.
550	134 x 99 x 78	without	27	10896	10900
		with	29	10897	10901
700	134 x 99 x 96	without	31	10898	10902
		with	33	10899	10903

ANTI-VANDALISM LID FOR UPGRADING EXISTING GRP GRIT BINS WITH ROOF-SHAPED LID

For container size	Order no.
400 (not for Generation Plus 3 grit bins)	8087
550 and 700	10904

ACCESSORIES FOR GRP GRIT BIN PG 8

Description	Order no.	
Padlock, galvanised	1490	
Hinged steel lid stay, complete installation kit, for containers of 700 litres capacity. Note: lid can only be dismantled from container with tools, except for grit bin Plus3.	3212	
Sticker "Salt / Grit" (other language options upon request)	5 pcs.	8625
	10 pcs.	8626

GRIT BINS

Go-Box PG 8

- for grit, sand, absorbents, etc.
- for indoor and outdoor use and storage
- sturdy rubber wheels
- angled lid so that water runs off
- with stainless steel toggle latch
- can be locked with a padlock (not included)
- user-friendly, ergonomic handle
- 70 L capacity
- lid in a vertical position for filling/emptying
- easy to handle thanks to sophisticated balance
- easy to clean
- made from chemical-resistant PE – 100 % recyclable
- partition for insertion into the grooves of the Go-box as accessories



Accessories:
partition



Description / Capacity l	Dimensions in cm (h x w x d)	Weight approx. kg	Order no.
Go-Box 70	107 x 59 x 39	10	11285
Go-Box in yellow, see page 232	107 x 59 x 39	10	11449

ACCESSORIES

Description	Dimensions cm (h x d)	Order no.
Partition for Go-Box 70	40 x 32	11286

GRP Snow shovel PG 8



Test winner FAZ
(german magazine)
2023

GRP snow shovel

- high-quality GRP snow shovel
- solid aluminium edge (replaceable)
- absolutely resistant to corrosion
- smooth surface prevents snow from sticking
- high, strong raised sides
- double-arc'd shaft with D handle for ergonomic and efficient use

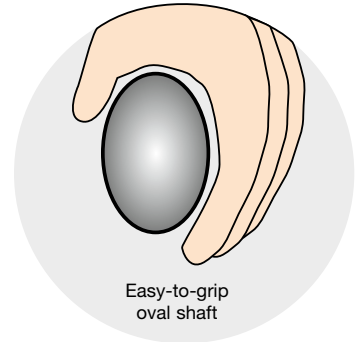

Solid aluminium edge (replaceable)



Description	Length with shaft cm	Dimensions of shovel cm (w x h)	Order no.
GRP snow shovel	152	56 x 36	10064
10 pack* of GRP snow shovels 10064			10066
Replacement aluminum edge for GRP snow shovel			10105



* 10 x snow shovel blades and 10 x snow shovel handles, packed in two cartons.

SHOVELS

Snow plough PG 8

With its adjustable-length handle, the snow plough lets you clear pavements and other areas of snow without straining your back..

- innovative snow clearing tool, "Made in Germany", with long service life
- solid, powder-coated steel tube construction
- ribbed stainless steel plough blade, cushioned with disc springs
- pneumatic wheels mounted on roller bearings, with lug tread dia. 260 mm adjustable blade position
- simple clearing angle adjustment without bending over

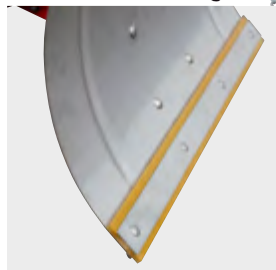

Replaceable stainless steel scrape rail or PU edge strip (accessories)



Control for three/five blade positions



Description	Dimensions cm (l x w x h)	Weight approx. kg	Order no.
Snow plough	110 x 74 x 90	12	10743

ACCESSORIES

Description	Order no.
PU edge strip	10744

PP shovels PG 8

- corrosion resistant shovels made of polypropylene (PP)
- ideal for handling corrosive materials such as grit used on the roads
- low weight
- high durability
- non-adhesive surface
- 100 % corrosion-proof
- UV-stabilised and virtually shatterproof material
- used in agriculture, municipalities and the food industry



PP01 PP02 PP03 PP04



Description	Shovel dimension cm (l x w x h)	Overall length cm	Weight approx. kg	Order no.
Hand scoop medium PP01	19 x 14 x 7.5	31	0.2	7964
Hand scoop large PP02	23 x 17 x 9	36	0.3	7965
General purpose shovel D-grip standard PP03	31.5 x 25 x 4	98	1.1	7966
General purpose shovel D-grip medium PP04	35 x 26 x 8	105	1.4	7967

Grit spreaders PG 8

Spreader with composite frame
The use of new composite plastics enables the integration of many functions into a single component.

- for use in domestic and commercial areas
- durable design
- composite frame and PE hopper
- stainless steel axles
- rugged transmission
- retractable support foot
- adjustable spreading quantity with fixed stop
- supplied in prefabricated assemblies

Retractable foot support



Spreader SW 20-C and SW 35-C

- for use in tough winter conditions
- for various spreading materials
- with robust agitator finger
- adjustable stainless steel dual handle with three height settings
- with adjustable spreading width limiter
- with strainer insert
- pneumatic rubber tyres with winter tread

Spreader SW 20-light

- for seeds and fertiliser
- adjustable galvanised steel dual handle with three height settings
- plastic wheels



SW 20-light



SW 35-C



Filling strainer (SW 20-C and SW 35-C)



Spreading quantity adjustable with fixed stop



Dual handle, three height settings

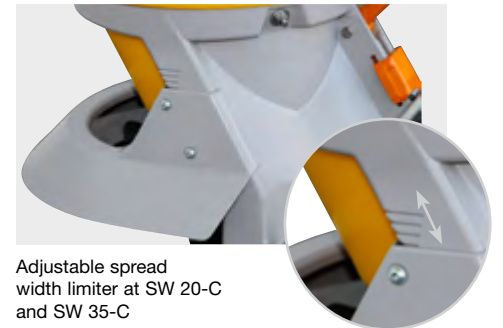



Adjustable spread width limiter at SW 20-C and SW 35-C

SPREADERS WITH COMPOSITE FRAME AND PE CONTAINER

Description	Capacity L	Spreading width m	Spreading steps	Weight approx. kg	Order no.
SW 20-light for medium spreading areas	20	1 to 4	6	9	10718
SW 20-C for medium spreading areas	20	1 to 4	6	10	10642
SW 35-C for medium spreading areas	35	1 to 4	6	11	10643

ACCESSORIES

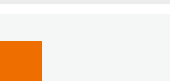
Description	Order no.
 Cover for SW 20-C and SW 20-light	7884
 Cover for SW 35-C	7885
 Spreading width limiter for SW 20-light	10720
 Eccentric agitator for slow-flowing salt and grit for SW 20-light, SW 20-C, SW 35-C and SW 50-E	10998

Grit spreaders PG 8

Spreader SW 50-E

- for commercial and domestic use
- suitable for a variety of gritting materials and spreading widths
- quick and easy assembly
- robust construction
- stainless steel axles
- stainless steel frame
- handle has three length adjustments and continuously adjustable in height
- hinged pedestal
- gearbox drive disengagement on wheel



SW 50-E

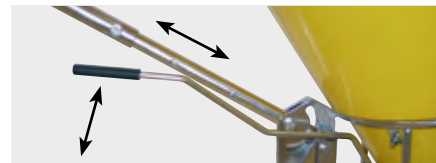

Volume adjustment lever and adjustable T-bar handle

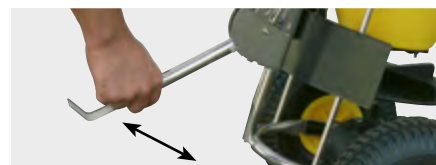

Hinged support foot



Additional anti-compression assembly



Wheel shutoff



Cover (accessory)

Drop spreader KS 35-E

- for domestic and commercial use
- for various types of spreading material such as salt, grit, sand, oil binding agents, seed or fertilizer with a grain size of between 2 and 4 mm
- accurate spread width of 60 cm
- quantity to be spread can be precisely and continuously adjusted via snail cam
- quick and easy assembly
- all parts that come into contact with media are made from stainless steel or plastic
- hopper made of corrosion-proof polyethylene
- powder-coated steel frame
- retractable support foot
- adjustable-length T-bar handle
- pneumatic rubber tyres with winter or rough terrain treads
- axle divided in the middle, moves around corners easily
- agitator vanes adjustable



Eccentric disk



Hopper attachment 25 L (accessory)



Rugged agitator shaft, axle divided in the middle



Adjustable length handle, large operating lever



Uniform scatter, accurate spread width, adjustable agitator vanes



Cover (accessory)

Description

SW 50-E, for medium spreading areas, 6 spreading steps, yellow plastic hopper, stainless steel tubular frame, pneumatic rubber tyres with winter tread, robust gearing, spreading quantity regulator, adjustable handle, additional anti-compression assembly, axle bearing suitable for lubrication and wheel shutoff . Supplied as pre-assembled modules.

	Capacity L	Spreading width m	Weight approx. kg	Order no.
SW 50-E	50	1 to 4	14	10742
KS 35-E drop spreader	35	0.6	16.5	8487

ACCESSORIES

Description

Cover for SW 50-E

Order no.

10021

Cover for KS 35-E

8495

Hopper attachment 25 L for KS 35-E

11043

SPREADERS

60 L Spray Caddy PG 8

60 L Spray Caddy for liquid de-icing products

- electric pump 12 V, approx. 6 L/min
- LiFePO₄ battery with charger
- flow-activated pump
- 8 m spiral hose
- spray lance with flat jet nozzle
- suitable for commercially available liquid, water-based de-icing products



Spiral hose, electric pump and battery with charger



Description	Capacity l	Dimensions cm (l x w x h)	Weight approx. kg	Order no.
Spray Caddy	60	90 x 52 x 37	15	10863

Grit spreaders PG 8

NEW

Spreader SW 180 with PE hopper

- for commercial and domestic use
- suitable for different gritting materials and spreading widths
- quick and easy assembly
- robust construction



Robust gearbox with aluminium housing, can be disabled







Stainless steel spreader disc, adjustable



SW 180

Description	Capacity L	Spreading width in m	Spreading steps	Weight approx. kg	Order no.
SW 180 for large spreading areas with robust gearbox with aluminium housing. Yellow plastic container with filling strainer, steel tube frame and spreading width limiter, painted, 16 x 6.5 cm rubber wheels with air-filled tyres, spreader quantity regulator and spreader disc made of stainless steel. Supplied as pre-assembled modules. System includes height-adjustable drawbar with 2" ball head coupling. Gearing disengageable. Max. speed 6 km/h.	180	bis 5	10	80	11947

ACCESSORIES

Description	Order no.
 Spreading width limiter made from stainless steel for SW 180	11948
 Towing eye for SW 180	11949
 Cover with inspection window for SW 180	11950
 Lighting kit for SW 180	11951

Towable grit spreaders PG 8

Towable spreader SW 200 and SW 300 with PE hopper

- for commercial and domestic use
- suitable for different gritting materials and spreading widths
- robust construction
- gearbox with aluminium housing, disengageable
- sturdy, greasable wheel bearings
- stainless steel frame
- all parts that come into contact with the media are stainless steel or plastic
- spreading amount, spreading direction and spreading width can all be set as required (optional)
- 16 x 6.5 wheels with pneumatic rubber tyres, winter profile

- parallel height-adjustable drawbar
- lighting with 7-pin plug
- supplied as pre-assembled modules



Anti-compression prevention bar



SW 200



Spreading quantity control



Disengageable gear



Stainless steel spreader disc, adjustable







Robust wheel bearing



SW 300

Description	Capacity L	Spreading width in m	Spreading steps	Weight approx. kg	Order no.
SW 200 for large spreading areas	200	up to 5	10	80	10205
SW 300 for large spreading areas	300	up to 5	10	85	10206

ACCESSORIES

Description	Order no.
 Spreading width limiter adjustable, galvanised, for SW 200 and SW 300	10207
 Remote control for spreaders SW 200 and SW 300 length of bowden cable: 2.0 m	10208
 Cover for SW 200 and SW 300	10210
 Ball coupling 2", galvanised, for SW 200 and SW 300	10209

Maintenance for safety cabinets, tank stations and drums

– on request –



Services for cabinets

- ✓ Individual inspection or maintenance contracts
- ✓ Competent support by our service technicians
- ✓ Inspection of all safety-relevant components
- ✓ Immediate repair of minor defects (major repairs are offered separately)
- ✓ Exhaust air test
- ✓ Preparation of service reports
- ✓ Attaching of an inspection sticker following successful maintenance
- ✓ Wear parts up to €10.00 per tested safety cabinet are included!

Inspection of filling stations after 2,5 and 5 years by experts in accordance with BAM-GGR 002

- ✓ Inspection of the external condition
- ✓ Verification of labelling
- ✓ Checking the function of the operating equipment, i.e. all fittings associated with the tank
- ✓ Leak test with overpressure
- ✓ Documentation of the periodic inspection
- ✓ Inspection certificate
- ✓ Inspection sticker
- ✓ Documentation of the test on the type plate
- ✓ Wear parts up to €20.00 per tested filling station are included!

Drum maintenance and inspection

Particularly in the case of mobile GRP tanks, initially-small cracks or impact points may lead to more extensive damage. Book our service and avoid leaving things until it's too late.

Optional:

We can also change the oil in your engine pump.

- ✓ Parts and supplies up to €20.00 per tested drum or irrigation system are included!

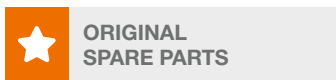

The CEMO safety concept guarantees you:

- the functional safety and longevity of your products
- legal certainty in the event of damages

Trust in the service of the specialist.

Our maintenance service will support you in complying with all current regulations. Maintenance service in accordance with DIN 31051.

 Would you like more advice?
Contact us at
service@cemo-group.com
or +49 7950 9803-2222

INDEX

A

Absorbents	234, 235
Access ramp	156, 168-171, 200
AdBlue®, refuelling systems	92-111
Adhesive label set	48, 56, 57, 59, 63, 72
Anti-slip mat	48, 184, 185, 271
Anti-vandalism lid	282
Aqua-Caddy	256
ASS fitting	32
Automatic hose reels	123

B

Baffles	246
Barrel support	164
Base frames	281
Battery cabinets for fire alarm systems	218
Battery disposal box	226
Battery storage cabinet FMplus	214
Battery storage/charging cabinets	214-220
Battery storage/charging cabinet, modular system	216-219
Battery systems	45, 48, 87
Battery system fire protection box	222, 223
Beverage tanks	247
Bluefill PRO X	100
Blue-Mobil Easy	108, 110
Bluetroll Mobil	134
Boot cleaner	275
Buffer material for storage and transport	225

C

Cable reel	123, 130
Caddy for screenwash or radiator antifreeze	89
Can holder	177
Canister	75
Canister cabinet	187
Canister filling stand	159
Canister rack system	153
CAS batteries	48, 87, 89, 107, 109
CAS charger	87
CEMbox	268-271
CEMbox trolley	270
Cemsorb absorbents	234
CENTRI SP pumps	125, 126, 134
Charger	48, 89, 109
Cleaning systems	258, 259
Collection box for used batteries	225
Collection container	225-228
Collection container for batteries	222-224
Collection trays	233
COMBI tanks for diesel/AdBlue®	43, 47, 51, 52, 57, 59, 60
Compressed air diaphragm pump	132
Container for hazardous materials	231
Container for transport	268-274
Contents gauge	105, 116
Cooling lubricants, transfer trolley	87
Couplings for containers	245
Cover	234, 286, 287, 289
CUBE for AdBlue®	99, 101-103
CUBE for diesel	12-26
CUBE for lubricants	80
CUBE for waste oil	81
CUBE heating oil tank	302
CUBE Slimline	26, 103

D

Data transfer set	16, 20, 21, 96, 99, 115, 116
Depot for HazMat	195
Diesel dispensers	30, 117, 118
Diesel pumps	119-128
Diesel refuelling systems with steel tank	30, 31
Diesel refuelling systems, mobile	35-67
Diesel refuelling systems, stationary	10-34
Diesel refuelling systems with STIHL APready battery	39, 41, 43, 56
Diesel transfer set	121
Diesel trolley	39
Discharge valve	177, 244, 247, 249, 251, 267
Dispensing hose	29, 72, 104, 118, 119, 122, 124, 127, 130, 131
Dispensing nozzle	104, 122, 131
Disposal container	228
Dome lid	26, 86, 103
Double walled tank	85
Drip mat	50
Drum depots	185, 189
Drum/IBC pumps	134, 136, 137
Drum racks	172-177
Drum supports	177, 188, 189
DT MOBIL PRO hybrid	54-57

E

Emergency sets	235
Environmental cabinets	186-188
Electric pumps for AdBlue®	135, 137, 138
Electric pumps for petrol	129
Electric pumps for chemicals	136-138
Electric pumps for diesel	119-127
Electric pumps for lubricants	131, 132
Exhaust air fan	208
Extensions for tanks	14, 16, 17, 19, 23, 97, 99

F

Fans	200, 208, 209
Filling funnels and trays	84, 233
Filling sieve for GRP tanks	246
Filling sieve for für PE tanks	249
Filling strainer for grit spreader	286
Filter	16, 21, 58, 73, 104, 124

Fireproof container	202
Fireproof/secure cabinets	203, 204
Flange plates	244
Flow meter	48, 77, 87, 89, 96, 99, 105, 107, 109, 126
Flow meter systems	16, 21, 48, 58, 63, 64, 122, 131
Foot filter	130
Food-safe containers	139, 247, 251, 260, 267, 274
Folding tray	158
Forklift pockets	25, 40-42, 44, 46, 47, 49, 52, 61, 62, 64-67, 72, 74, 76, 77, 88, 97, 108-110

F-SAFE fire prevention	202-209
Fuel dispensing areas	11, 32, 33
Funnel with water separator	73

G

Gas cylinder store	191
General-purpose box	273
Generator tanks, mobile	66, 67
Go-Box	232, 274, 283
GRP containers	262, 264, 266, 273
GRP tanks	240, 242, 243, 250, 252
Grating, PE	153, 155-157, 179, 180
Grating, Stahl	150, 153, 155, 159, 177
Grit bins	278, 279, 280, 281, 282
Grit spreaders	286-289
Ground protection systems	168-171

H

Hand pumps	84, 128, 139
Hazardous material storage, basic legal conditions	142-146
HazMat collection station	195
HazMat depots and cabinets	185-190
HazMat depots, mobile	185
HazMat pallet racks	178-183
HazMat storage, basic legal conditions	142
Hinged lid	16, 21, 48, 80, 88, 96, 99, 109
Hose reel	16, 21, 74, 80, 96, 99, 123, 130, 252
Hose with helical reinforcement	245

I

IBC bunds	165-167
IBC extension bund	167
IBC filling funnel	233
Indoor refuelling systems	14, 17, 25, 27, 28, 81, 95, 97, 101
Insert plate	266, 280
Insulation pack for Blue-Mobil Easy	109
Irrigation systems, mobile	252-257

K

Key set	16, 21, 96, 99, 118
KS Mobil	72-74
KS Mobil Easy	76, 77

L

Laboratory sumps/spill pallets	157
Leakage detector device	84
Level measurement unit	31, 34
Lifting frame	52, 56
Load securing	238, 239
Loading rails	150
Lubricants, compact systems	80
Lubricants, Mobil Easy	88
Lubricants, pumps	131-133
Lubricants, refuelling systems	80, 82-88
Lubricant trolley	87
Castor frames	265, 281
Wheels for CEMbox	271
Fluorescent tube collection box	226
Li-HD battery CAS	48, 87, 107, 109
Li-Power battery CAS	48, 87, 89, 107, 109
Li-Power-Block	45, 88, 109, 126
Li-SAFE battery safety	214-225
Perforated plate inserts	164, 186, 190
lockEX explosion protection	215-217
Logistics box	274

M

Master key	118
Meter	16, 21, 29, 51, 57, 59, 77, 87-89, 99, 105, 107, 109
Mobil-Box	227
Mobile irrigation systems	252-257
Mobile refilling, AdBlue®	100, 106-111
Mobile refilling, lubricants	87-89
Mobile refuelling, petrol	74-77
Mobile refuelling, diesel	35-67
Mobile sumps/spill pallets	149, 159, 164
Motorised pump with petrol engine	130
MULTI-Tank, diesel	29, 65
MULTI-Tank, lubricants	83

N

Nozzle holder	122, 126, 232
---------------	---------------

O

Oil suction units	229
Oil and fuel filter	124
Oil dispenser	84
Outdoor refuelling systems	14, 15, 17-20, 22-26, 80, 81, 95-98, 101, 102
Overflow prevention sensor	26, 56, 81, 84, 86, 105
Overpack drum	232

P

Padlock	214, 273, 282
Pallet racks	178, 179
Pasture water tanks	242, 248, 249
PE tanks	247-250
PE shelf bunds	180
PE gratings	153, 155-157, 179, 180, 195

PE tanks	260
Pesticide cabinets	190
Petrol, pumps	129, 130
Petrol transfer set	129
Petrol trolley	76
Pipe coupling	245
Pneumatic pumps	132
Power transformer	126
Profitank	85, 86
Pump cabinets	63, 72, 104
Pump hood	63
Pump sets	126, 134, 136, 137
Pump systems	134, 135
Pumps for AdBlue®	134-139
Pumps for chemicals	136-139
Pumps for diesel	119-128
Pumps for lubricants	131-133
Pumps for petrol	129

R

Rack containers	201
Rain water tanks	260, 261
Rectangular containers,	262, 264, 266, 267
Refuelling systems	151, 158, 168, 169, 170
Refuelling systems for fuels, KS mobil	72, 73
Refuelling systems for petrol	70-77
Remote control for spreaders	289
Repair pack for GRP	246, 267
Rinsing tray	275
Rotary pumps	128, 139

S

Safety storage containers	196-200
Screw lid	137, 247, 251
Secure cabinets	203-207
Secure cabinets CEMO PROline	204, 205
Secure cabinets CEMO PROline with extending drawers	207
Secure cabinets FWF 30	206
Showels	285
Small containers	157, 159, 164
Snow plough	285
Snow showels	284, 285
Spindle valves	251, 267
Spray caddy	257, 288
Spray lance	255, 256
Sprayers	257
Spreading quantity regulator	286, 288, 289
Stacking lid	266
Stationary refuelling systems	10-31, 80-85, 94-99, 101-105
Steel foot-frames	146, 150
Steel gratings	153, 155, 159, 177, 179, 189, 195
Steel tanks	27, 28, 29, 30
Steel sump/spill pallets	160-164
Storage container	262-274
Storage/charging of lithium batteries	211-213
Storage tanks, PE	260, 261
Submersible pump	125
Suction pipe	84, 133, 135
Suction hose	104, 119, 124, 130, 131, 133
Suction units	229, 230
Sumps, GRP	148
Sumps, PE	153-156, 178, 180, 181
Sumps/spill pallets for racks	159
Support runners	246

T

Tank data management	115, 116
Tank heater	26, 29, 86, 96, 99
Tank replacement service	60
Tanks, GRP	240-246, 250
Tanks, PE	247-249
Tanker coupling	29, 104
Tool box	268, 270, 272, 273
Transfer Trolley Aqua	257
Transfer Trolley Blue	111
Transfer Trolley Chem	111
Transfer Trolley KSS	87
Transfer Trolley Oil	89
Transport of lithium batteries	221
Trolley	38, 39, 66, 87, 106, 257
Trolley for AdBlue®	106, 107
Trolley for petrol	76
Trolley for diesel	38, 39, 66
Trolley for heating oil	66
Trolley for lubricants	87

U

UNI-Tank for diesel	82, 83
UNI-Tank for lubricants	82
Used oil collector	231
User key	16, 21, 96, 99, 116, 118

V

Vents	245
Ventilation systems	208, 209
Vehicle storage box	268, 270, 272

W

Water absorber for diesel	50
Water pumps	130, 138
Water storage tanks	260, 261
Watering shower head	255, 256
Weed control	258, 259
Workshop trolley	184
Winter service	276
W-SAFE water safety	145-201, 226-235

CEMO

for safe storage



**Innovative solutions
for Local authorities | Agriculture | Construction | Industry**



**Designed
and made in
Germany**

Right to change prices and technical specifications reserved. © CEMO 0007-en 06.25 000.5000.608

CEMO GmbH | In den Backenländern 5 | 71384 Weinstadt | Germany
Tel. +49 7151 9636-0 | Fax +49 7151 9636-98 | www.cemo-group.com