

Separation modes such as anion-exchange, ion-exclusion, and reversed-phase have been used in the analysis of organic acids by HPLC. In recent years, more and more cases have been analyzed using ion-exclusion modes with columns dedicated to organic acids.

However, in order to improve the separation in ion exclusion mode, it is necessary to lengthen the analysis time.

In this study, an ion exchange column was used.

Analyses were conducted using a combination of "ion exclusion mode" and "hydrophobic interaction mode" with a reversed-phase column. The use of two general-purpose-size columns with different separation modes (250 x 4.6 mm I.D.) enables the rapid simultaneous analysis of 8 components including phosphoric and organic acids.

Comparison with the previous report (Technical Note No. 1)

The data in Technical Note No. 1 showed that the separation of citric acid, tartaric acid, lactic acid, and formic acid was difficult, but improvement was made.

** Benefits **

1. Combining the ion exclusion mode with reversed-phase mode allows the separation of 8 organic acids!
2. Postlabelling with BTB (bromothymol blue) reagent eliminates contaminants!
3. Two columns of general purpose size (4.6 x 250 mm I.D.) are used for the separation, which is inexpensive and offers fast to analysis!

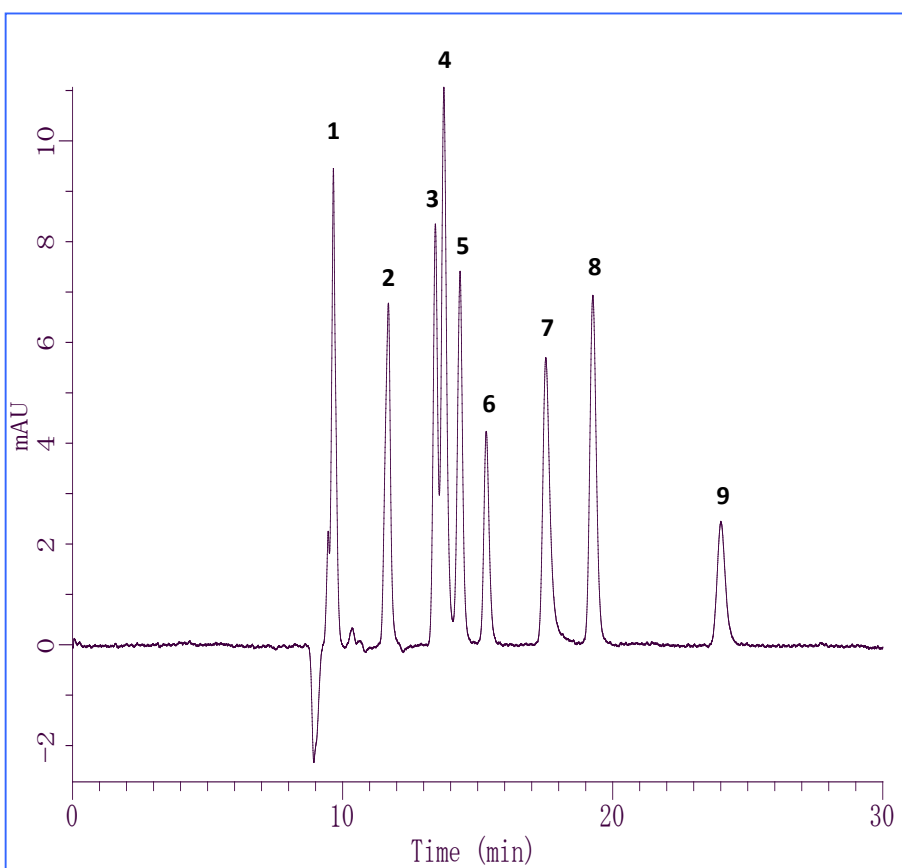

HPLC conditions

Mobile phase	: 3mM HClO ₄
Reaction solvent	: 0.1mM BTB + 30mM Na ₂ HPO ₄
Columns	: Inertsil Ph-3 (250 × 4.6 mm I. D.) + Inertsil CX (250 × 4.6 mm I. D.)
Mobile phase flow rate	: 0.5 mL / min
Reaction solvent flow rate	: 0.5 mL / min
Temperature	: 35 °C
Detector	: UV-Visible at 440 nm
Injection volume	: 10 μL

Sample (standard sample)

1. Phosphoric acid (phosphate)	(1 mg/mL)
2. Tartaric acid (tartaric acid)	(1mg/mL)
3. Malic acid (malate)	(1 mg/mL)
4. Formic acid (formic acid)	(1 mg/mL)
5. Citric acid (citric acid)	(1 mg/mL)
6. Lactic acid (lactic acid)	(1 mg/mL)
7. Acetic acid (acetic acid)	(1 mg/mL)
8. Succinic acid (succinate)	(1 mg/mL)
9. Pyroglutamic acid (pyroglutamic acid)	(1 mg/mL)

Detection Lower Limit and Calibration Curve

Compound	Concentration (μg/mL)	R ²
Phosphoric acid	12	0.998
Tartaric acid	16	1.000
Malic acid	13	0.999
Formic acid	10	0.999
Citric acid	15	1.000
Lactic acid	27	1.000
Acetic acid	19	0.995
Succinic acid	15	0.999
Pyroglutamic acid	43	0.999

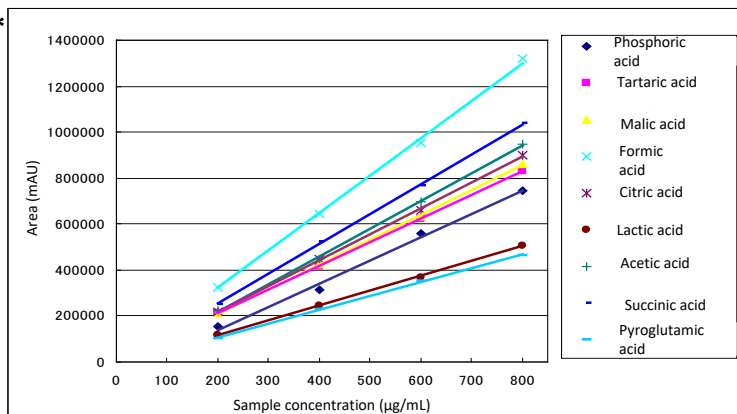

Features of organic acid analysis and introduction of analysis system

*Features

To reduce the total cost of organic acid analysis

The use of inexpensive silica columns reduces the cost of the separation columns.

High resolution

Inertsil CX is a silica gel-based column, the CX media has less diffusion with a greater number of theoretical plates per fixed volume than a polymer-based column.

Reducing the analysis time

The time required for a single analysis can be reduced to 25 minutes compared to the use of a typical organic acid-only column.

Silica-based columns with higher pressure resistance can be used to shorten the analysis time by increasing the flow rate.

Ion Exclusion Mode

● Neutral ⊖ weak acid ⊕ Strong acid

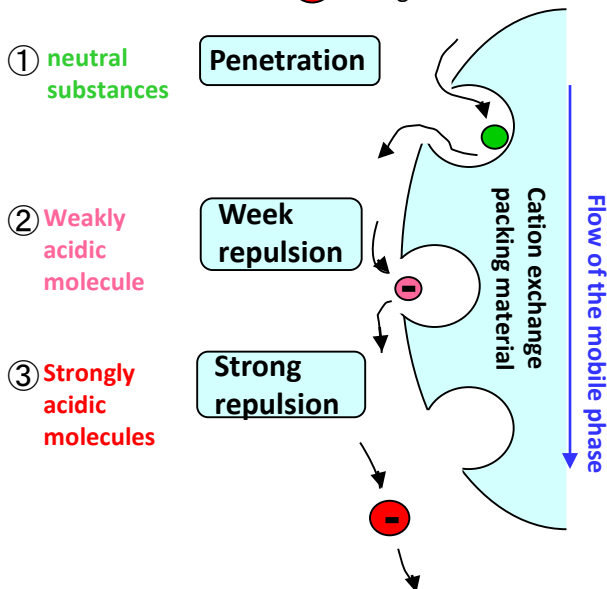

The ion exclusion mode uses the strong and weak repulsive force of the ion exchange group on the packing material to separate the target analytes on the basis of ionic strength.

Determinants of separation time

1. [Penetration into the pores]

The penetration power into the pore is determined by the size of the charge (pKa value).

Higher pKa = greater penetration

2. [Electrostatic exclusion due to the negative charge of the packing material]

Molecules with a large negative charge (small pKa) and are subject to large electrostatic exclusion and elute more quickly.

Small pKa = fast elution

Because molecules are separated by ionic strength,
The stronger the anionic strength, the faster the elution.
Elution order

BTB (bromothymol blue) method

Because detection using the BTB method is made using a visible wavelength at 440 nm, samples such as crops, dressings, and soy sauce, which contain many contaminants, can also be analyzed
See Technical note No. 1 - Highly Selective Assays

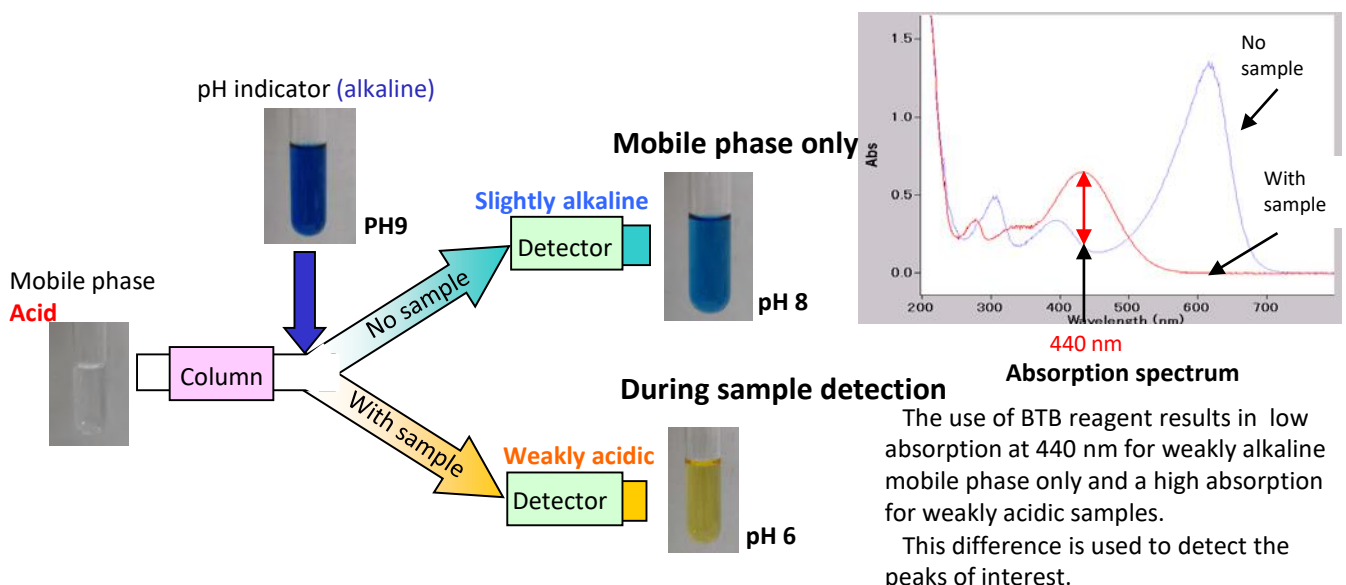

Example of Analysis

Organic acids absorb at UV 210 nm, but when brewed foods such as red wine and beer are analyzed at low wavelengths using UV 210 nm, many contaminants are detected, making it difficult to quantify only the target analyte.

However, the BTB method allows selective detection of organic acids because it shifts the detection wavelength to 440 nm.

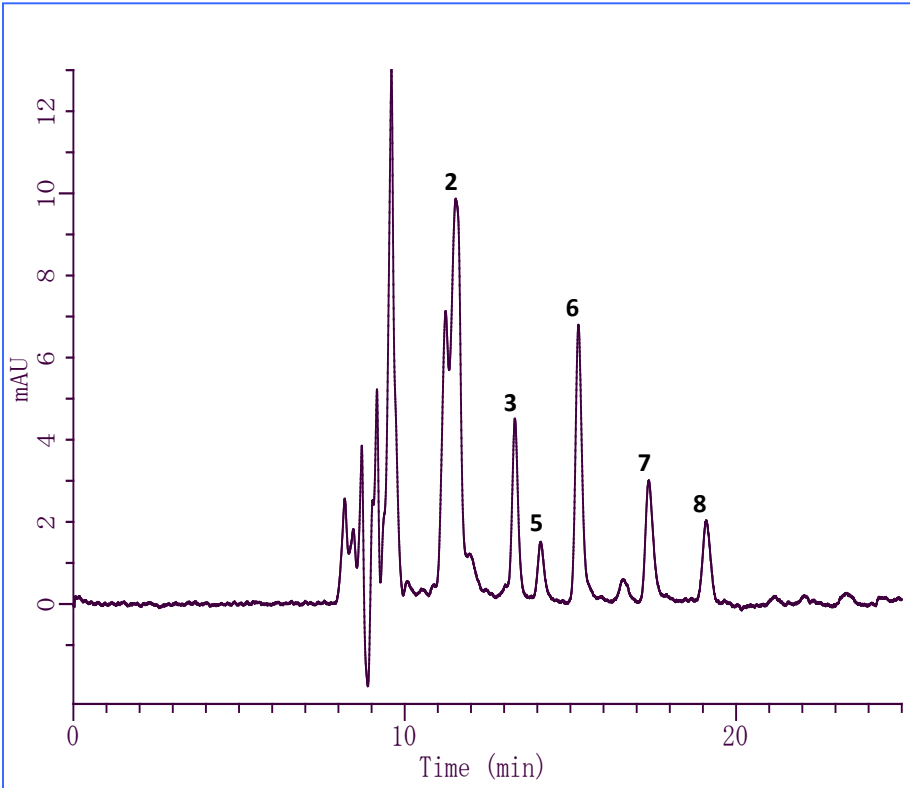

Organic Acid Analysis in Red Wine

Pretreatment

Sample

1 mL

Dilution

H₂O 10 mL

Filtration

0.45 μm GL Chromatodisk

HPLC

1. Phosphoric acid (phosphate)
2. Tartaric acid (tartaric acid)
3. Malic acid (malate)
4. Formic acid (formic acid)
5. Citric acid (citric acid)
6. Lactic acid (lactic acid)
7. Acetic acid (acetic acid)
8. Succinic acid (succinate)
9. Pyroglutamic acid (pyroglutamic acid)

Organic Acid Analysis in Beer

Pretreatment

Sample

1 mL

Dilution

H₂O 10 mL

Filtration

0.45 μm GL Chromatodisk

HPLC

1. Phosphoric acid (phosphate)
2. Tartaric acid (tartaric acid)
3. Malic acid (malate)
4. Formic acid (formic acid)
5. Citric acid (citric acid)
6. Lactic acid (lactic acid)
7. Acetic acid (acetic acid)
8. Succinic acid (succinate)
9. Pyroglutamic acid (pyroglutamic acid)

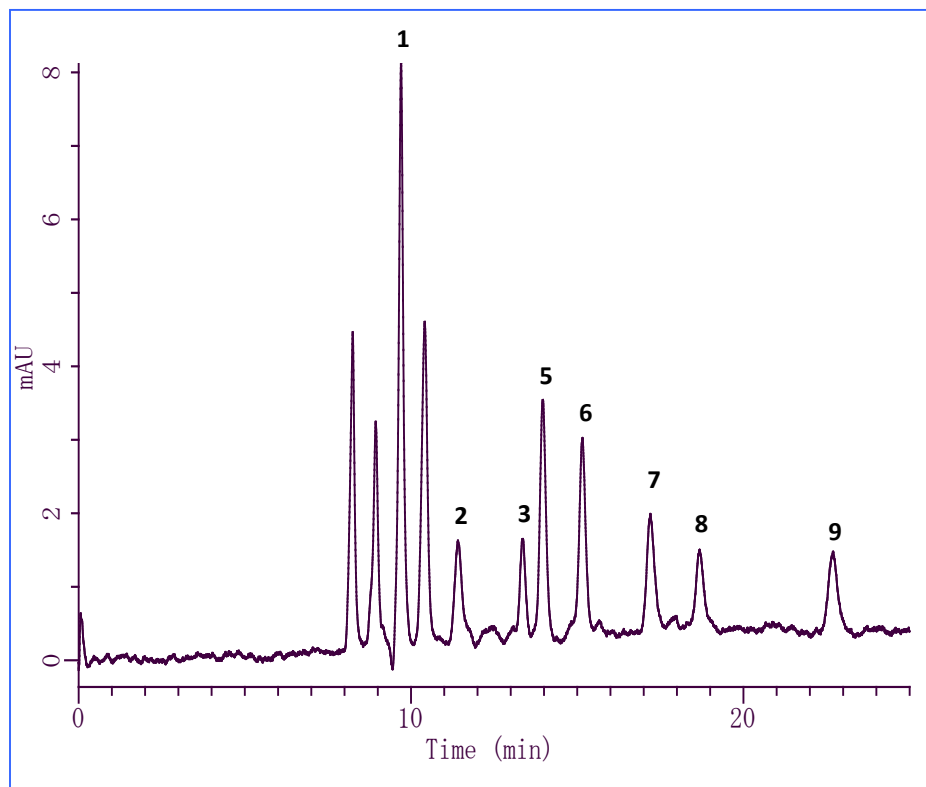

Flow diagram

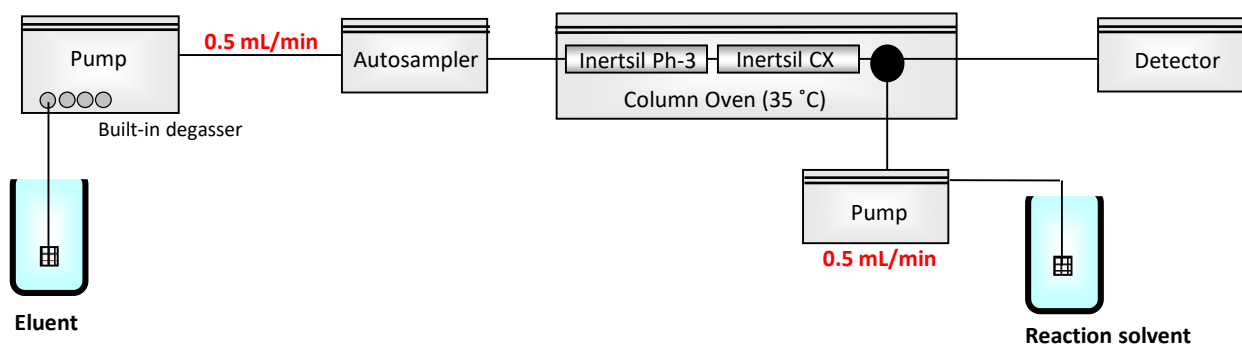

Analytical column

Inertsil Ph-3 5 μm 250 x 4.6 mm I.D.

Cat.No. 5020-01921

Inertsil CX 5 μm 250 x 4.6 mm I.D.

Cat.No. 5020-07146

	Product name	Maternal silica gel			Chemical Modification			
		Particle size	Surface area	Pore size	Bonded group	End-capping	Carbon load	Ion Change capacity
Ph	Inertsil Ph-3	5 μm	450 m^2/g	100 \AA	Phenyl group	Non	10 %	-
CX	Inertsil CX	5 μm	450 m^2/g	100 \AA	Benzenesulfonic group	Non	14 %	0.5 meqv/g

Aquatic 25A 0.45 μm filter
Cat. No. 5040-28512

GL Sciences disclaims any and all responsibility for any injury or damage which may be caused by this data directly or indirectly. We reserve the right to amend this information or data at any time and without any prior announcement.

GL Sciences, Inc. Japan

22-1 Nishishinjuku 6-Chome
Shinjuku-ku, Tokyo,
163-1130, Japan
Phone: +81-3-5323-6620
Fax: +81-3-5323-6621
Email: world@glsc.co.jp
Web: www.glsciences.com

GL Sciences B.V.

De Sleutel 9
5652 AS Eindhoven
The Netherlands
Phone: +31 (0)40 254 95 31
Email: info@glsciences.eu
Web: www.glsciences.eu

GL Sciences (ShangHai) Ltd.

Tower B, Room 2003,
Far East International Plaza,
NO,317 Xianxia Road,
Changning District.
Shanghai, China P.C. 200032
Phone: +86 (0)21-6278-2272
Email: contact@glsciences.com.cn
Web: www.glsciences.com.cn

GL Sciences, Inc. USA

4733 Torrance Blvd. Suite 255
Torrance, CA 90503
Phone: 310-265-4424
Fax: 310-265-4425
Email: info@glsciencesinc.com
Web: www.glsciencesinc.com

International Distributors

Visit our Website at www.glsciences.com/distributors