

Vitamin D in foods includes vitamin D2 (calciferol), which is found in vegetable foods such as mushrooms, and vitamin D3 (cholecalciferol), which is found in animal foods such as powdered milk, meat, rice, egg, and fish. Other active ingredients include the metabolites 25-hydroxyvitamin D3, 1 α , and 25-dihydroxyvitamin D3.

The vitamin D content in foods is small, typically several micrograms per 100 grams, which makes analysis difficult. Pretreatment requires removal of contaminants, hydrolysis to remove lipids, followed by solvent extraction. The extracts obtained as described in the Technical Note No33 are then concentrated and purified by preparative LC followed by a two stage HPLC analysis.

In this report, we have been able to purify samples after solvent extraction using size-exclusion chromatography (SEC) with an Inertsil Diol column, and then directly introducing the sample onto an analytical column using a heart-cut method. With this method samples can be analyzed in a single step without purification and concentration by LC separation.

(K. Kanno)

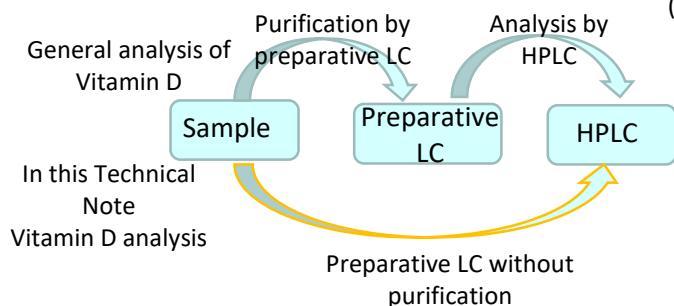

Structural Formula

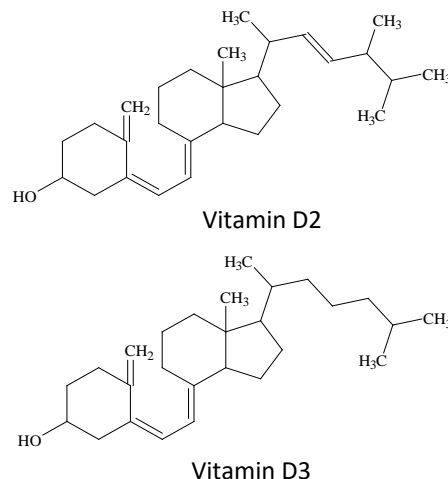

Structures are created using Chemistry 4-D Draw which is provided by ChemInnovation Software, Inc.

Examples: Analysis of vitamin D standards

After the sample is injected onto the pretreatment column for purification, the valve is switched at the time of elution of the vitamin D peak which is injected onto an ODS separation column using a heart-cut method.

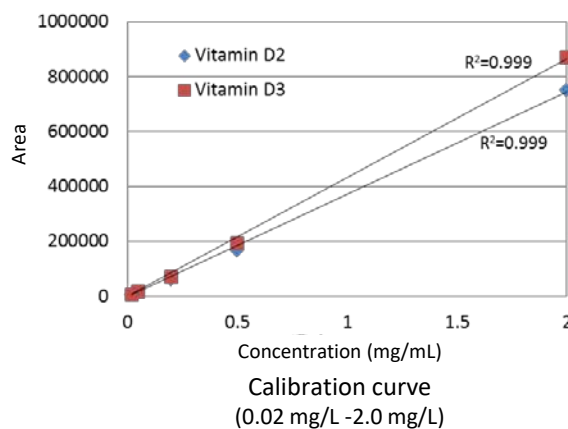
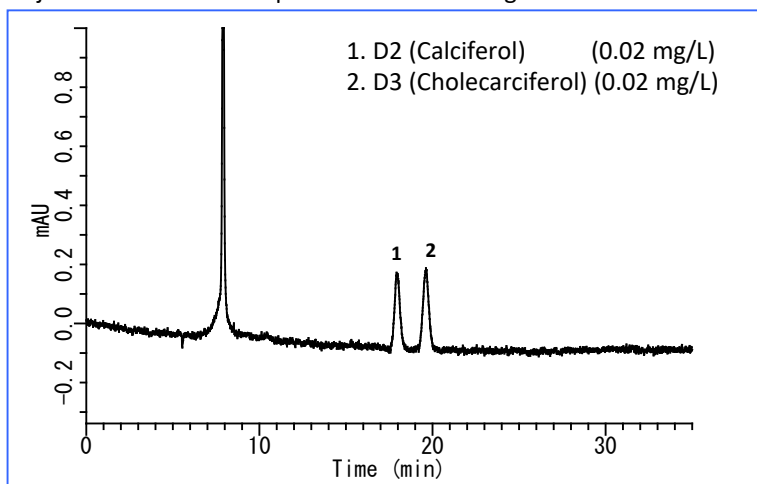
**HPLC conditions****Columns**

Analytical column :Inertsil ODS-P (5 μ m, 250 x 4.6 mm I.D.)
Pretreatment column :Inertsil Diol (5 μ m, 250 x 7.6 mm I.D.)

Temperature :40 °C

Detector :UV 265 nm

Injection volume :300 μ L

Flow rate

Main column :1.5 mL/min
Pretreatment column :1.5 mL/min (0-7 minutes, 25 minutes to)
0.5 mL/min (7-25 minutes)

Example of valve switching timing (depending on the pretreatment column)

0-5.5 minute position
5.5-6.3 minute position 1
6.3 minutes to position 0

Mobile phase

Pretreated column acetonitrile
Analytical column acetonitrile

Flow diagram

In the example below, the valve is switched between 5.5 minutes and 6.3 minutes* during which the vitamin D2 and D3 peaks elute from the pretreatment column, only during the elution of the target components are they injected onto the analysis column using a heart-cut method.

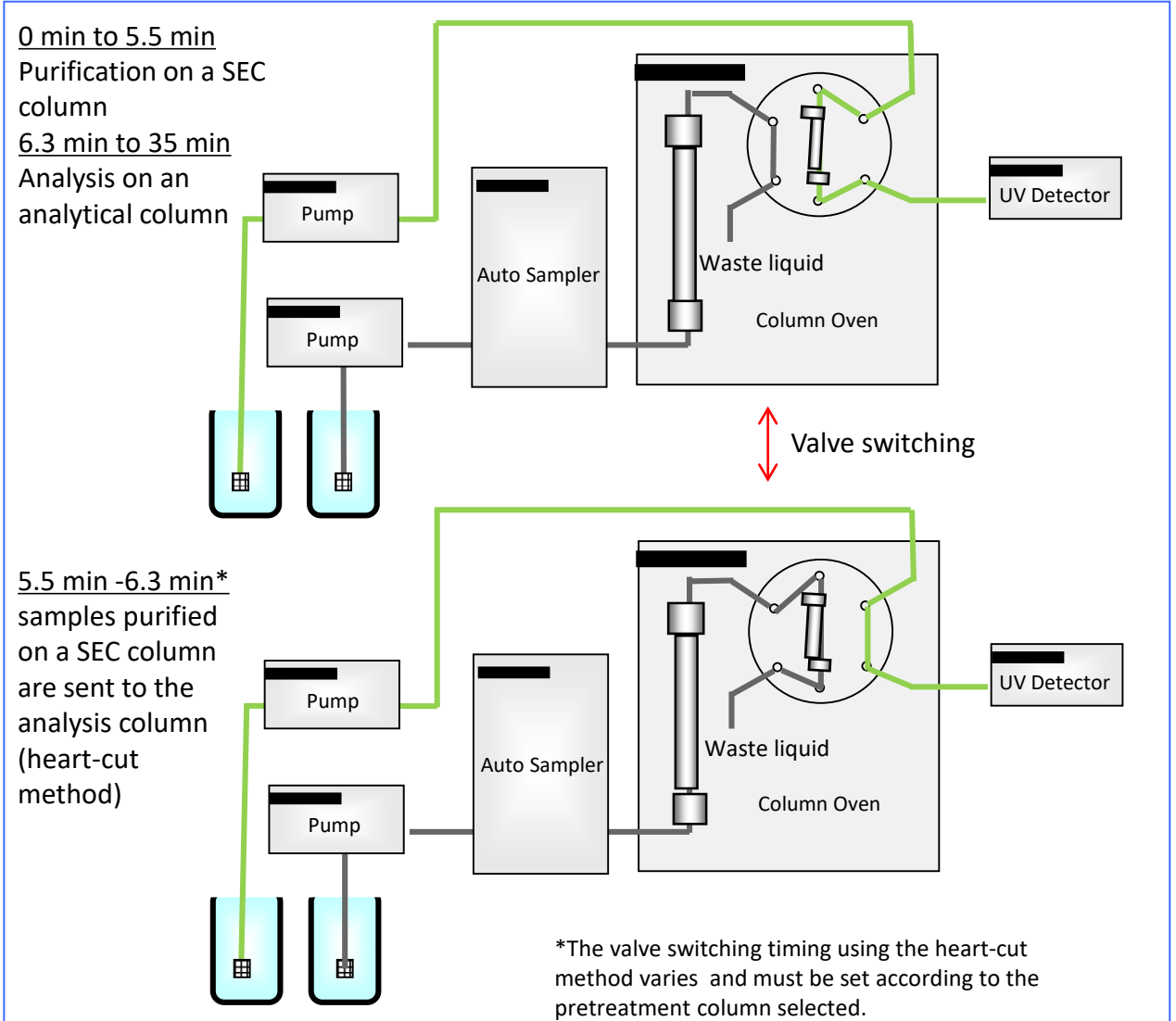

Using a heart-cut method, only the peaks eluting from 5.5 minutes to 6.3 minutes* were introduced onto the analysis column.

Chromatogram using a pretreatment column only

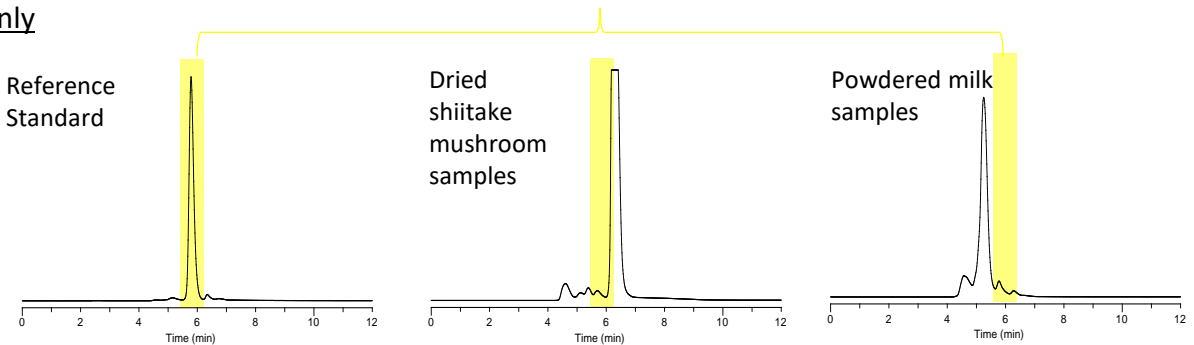

Examples of vitamin D pretreatment in foods

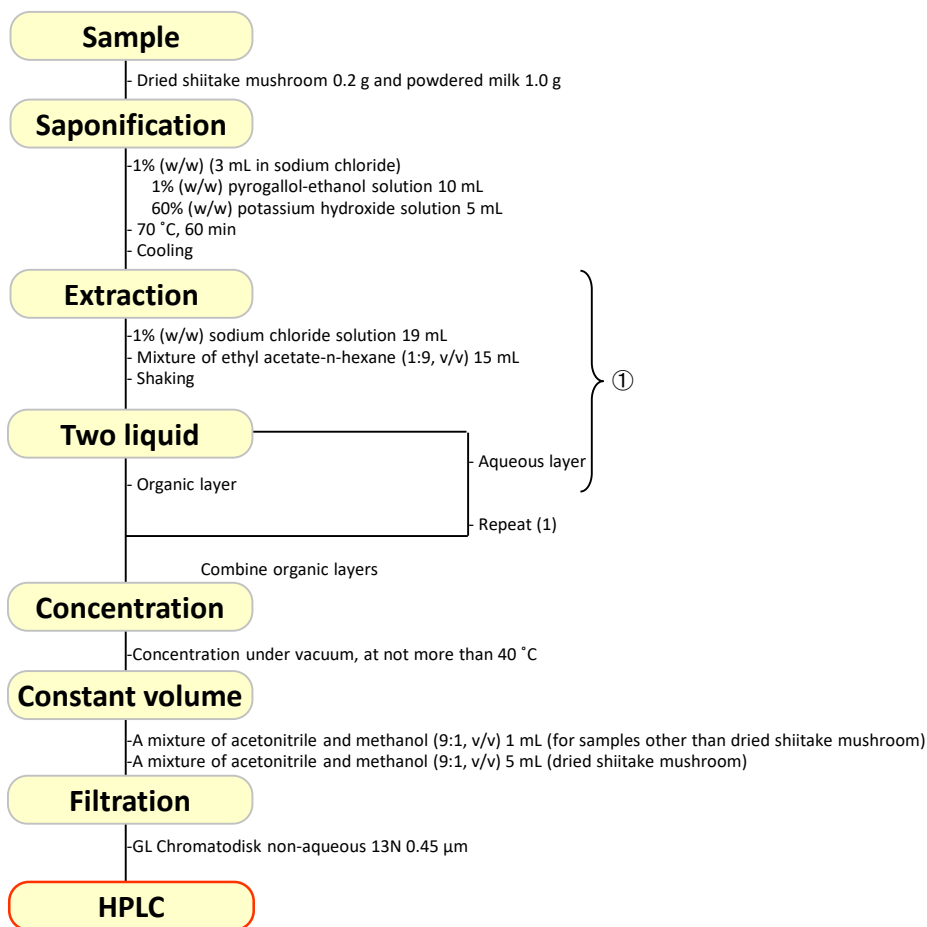

Example of real sample analysis

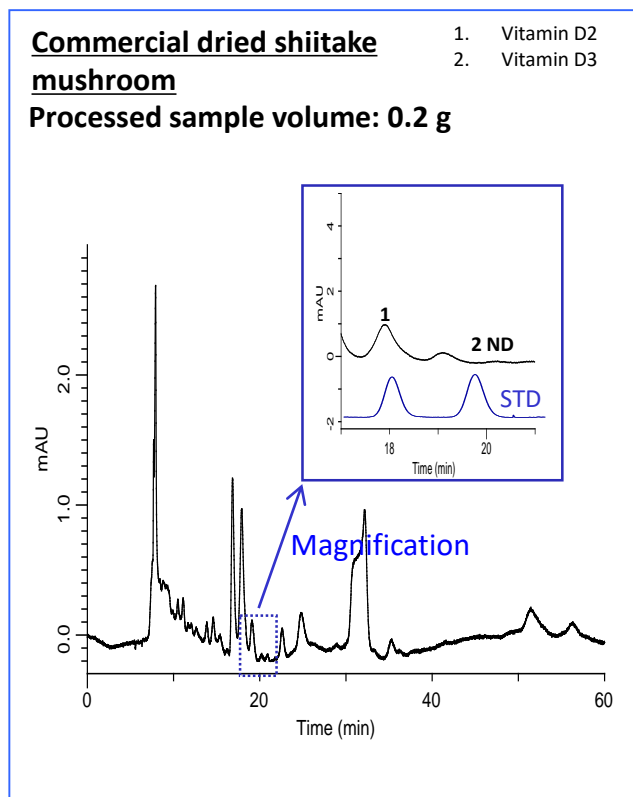
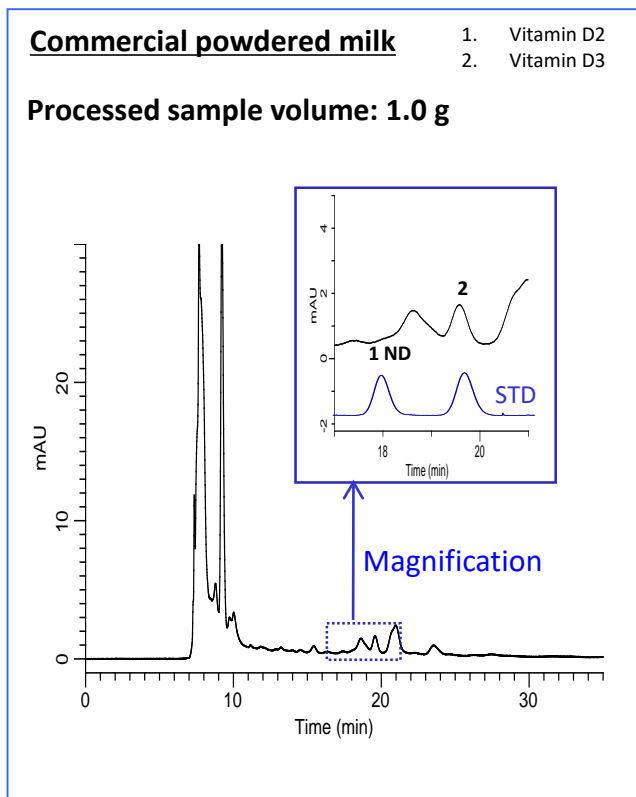

*For samples that are different from the samples detailed in Technical Note No 33.

*Some samples may not be able to separate from contaminants.

Pretreatment column

Inertsil Diol 5 μm , 250 x 7.6 mm I.D. Cat.No. 5020-05666

Columns for both water-based and organic solvent-based SEC. The molecular weight exclusion limit is about 10,000, which is suitable for the separation of compounds with molecular weights of several hundreds to several thousands.

Analytical column

Inertsil ODS-P 5 μm , 250 x 4.6 mm I.D. Cat.No. 5020-02002

Cap with vial/septum

1.5 mL screw cap vial (brown) set 9-425500 sets Cat. No. 1030-54247

1.5 mL screw cap vial (brown) set 9-425100 sets Cat.No. 1030-54128

GL Sciences disclaims any and all responsibility for any injury or damage which may be caused by this data directly or indirectly. We reserve the right to amend this information or data at any time and without any prior announcement.

GL Sciences, Inc. Japan

22-1 Nishishinjuku 6-Chome
Shinjuku-ku, Tokyo,
163-1130, Japan
Phone: +81-3-5323-6620
Fax: +81-3-5323-6621
Email: world@glsc.co.jp
Web: www.glsciences.com

GL Sciences B.V.

De Sleutel 9
5652 AS Eindhoven
The Netherlands
Phone: +31 (0)40 254 95 31
Email: info@glsciences.eu
Web: www.glsciences.eu

GL Sciences (ShangHai) Ltd.

Tower B, Room 2003,
Far East International Plaza,
NO,317 Xianxia Road,
Changning District.
Shanghai, China P.C. 200032
Phone: +86 (0)21-6278-2272
Email: contact@glsciences.com.cn
Web: www.glsciences.com.cn

GL Sciences, Inc. USA

4733 Torrance Blvd. Suite 255
Torrance, CA 90503
Phone: 310-265-4424
Fax: 310-265-4425
Email: info@glsciencesinc.com
Web: www.glsciencesinc.com

International Distributors

Visit our Website at www.glsciences.com/distributors