

GET SMART

# THE NNECTED SHOP

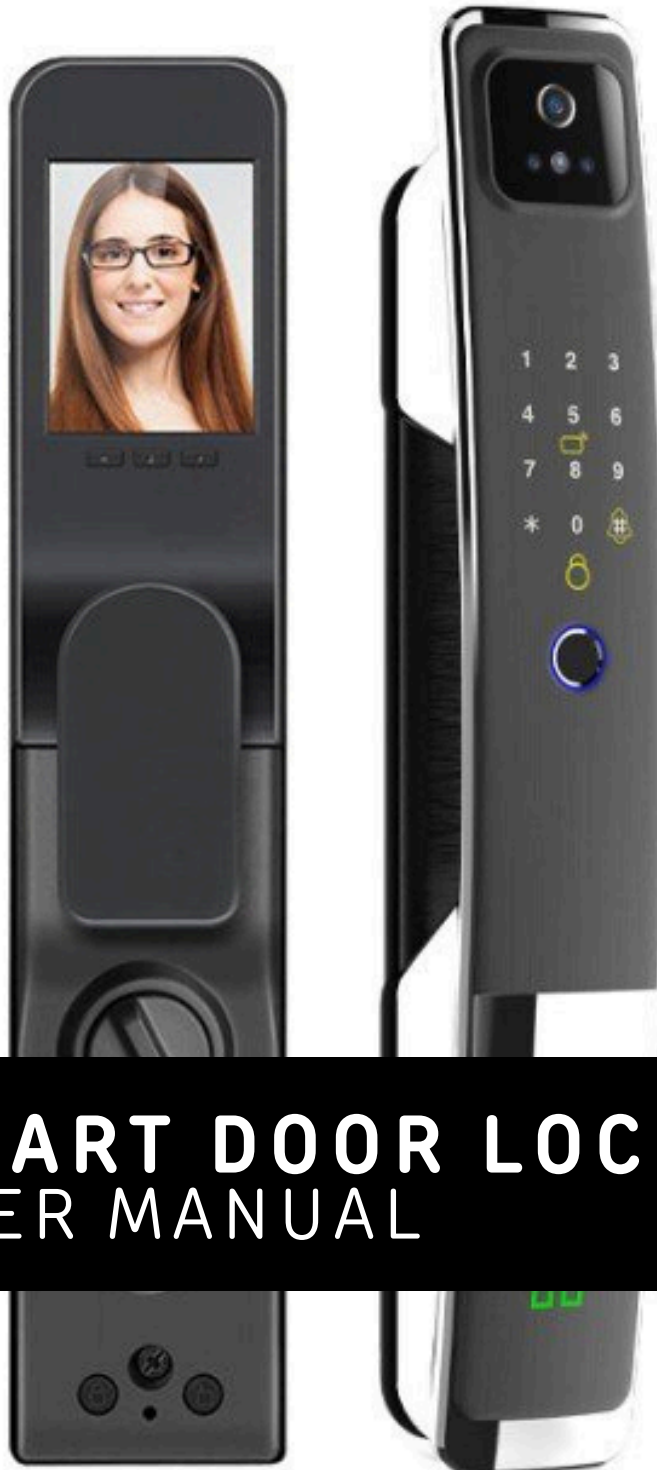

**SMART DOOR LOCK**  
USER MANUAL

Welcome to the 3D Face Recognition Smart Door Lock User Manual. This is your easy, step-by-step guide to installing, setting up, and connecting your 3D Face Recognition Smart Door Lock. The device is designed to be easy to use and to replace all modern door knobs—be it on the main door, bedroom door knobs, and so on— with the new, modern geek smart fingerprint door lock.



# SUMMARY

---

## I. Device Installation



1. Installation Guide
  - a) Installation Video

## II. Initialization



2. Initial State of your Smart Lock
  - a) Access Door Lock
  - b) Add Administrator
  - c) Delete Administrator
  - d) Add User
  - e) Delete User
  - f) Language Setting
  - g) Time and Date Settings
  - h) Volume Adjustment
  - i) Factory Reset

## III. Mobile App Connection



3. Registering on the Mobile App
  - a) Downloading the Mobile App
  - b) Logging In & Registering
  - c) Resetting your Password
  - d) Adding Locations
  - e) Adding Devices
  - f) Adding Members

## IV. Device Functions



### 4. Functions

- a) Remote Functions over Mobile App
- b) Dynamic Password
- c) Remote Unlock

## V. Additional Information



### 5. Other Notes

## PACKAGING DETAILS



1	Front Smart Lock Handle	6	Mechanical Keys
2	Mortise	7	Keyfobs/Cards
3	Metal Rod	8	Battery
4	Lock Screws	9	Key Cylinder
5	Back Smart Lock Handle		

# STEP BY STEP SMART LOCK INSTALLATION GUIDE



## 1. INSTALLATION

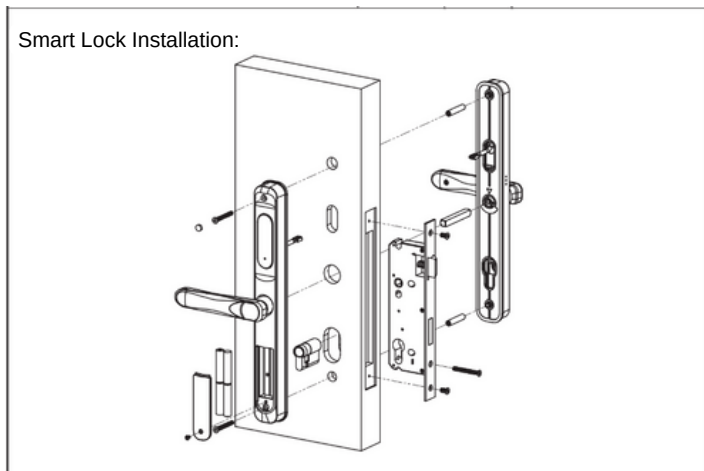

a. Start by removing your current lock. This is generally done by unscrewing the bolts and pulling out your current door knob.

b. Insert your new Mortise and Strike Plate into the door frame. Tighten the Mortise Screws on the top and bottom sides. Make sure the latch bolt is on the top side of the lock.

c. Insert the Lock Cylinder with the Cylinder Fixing Screws as shown in the diagram on the right.  
 d. Make sure the keyhole is facing the exterior side of the door. Insert and rotate the keyhole to make sure the bolt is retracted smoothly, and then fix the screw.

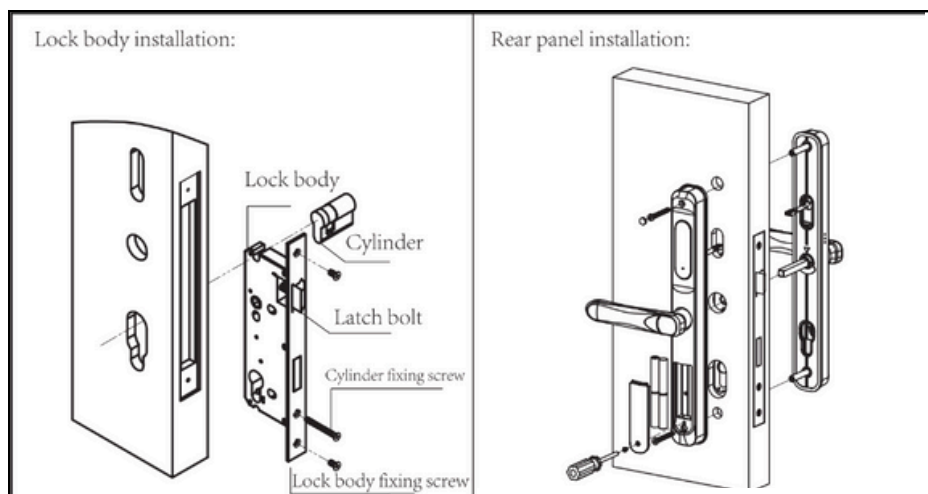

## 1. INSTALLATION



- e. Affix the Front Door Handle/Panel to the door. Insert the Metal Rod into the middle hole behind the handle/panel. Install the handle by passing the Metal Rod through the door with the use of the Lock Body Screws.
- f. Insert the power cord of the Front Panel through the door to connect it to the Back Door Handle/Panel.
- g. After both handles are fixed with the Screws, install the batteries in its compartment.





## 2. INITIAL STATE OF YOUR SMART LOCK



### Legend:



= to go back or return.



= to enter or confirm every time you input a code, and to request remote unlock and send a notification to your Tuya Smart app.

123456 = the default administrator information.

### Note:

Under the initial state, any fingerprint, keycard, and password can unlock or open the smart lock.

#### a) Access Door Lock

- Only an authorized fingerprint, passcode, and keycard can unlock the device, as well as through the mobile app or physical back-up key.
- Always remember to activate your Smart Lock first before entering your Administrator Information

## 2. INITIAL STATE OF YOUR SMART LOCK



### b) Add Administrator

- Activate your Smart Lock (Press '\*' and '#') and enter the initial Administrator Password (123456#)
- Follow the voice command. Press 1 for Administrator Settings and then press 1 again to add an administrator
  - Input the intended fingerprint 4 times
  - Input a 6-8 digit password 2 times
  - Input an Keycard 1 time
- To add a face ID, press 1 for User Setup and then press 2 for Normal Setup
- Follow the voice command to Add Normal and press 4 to Add Face

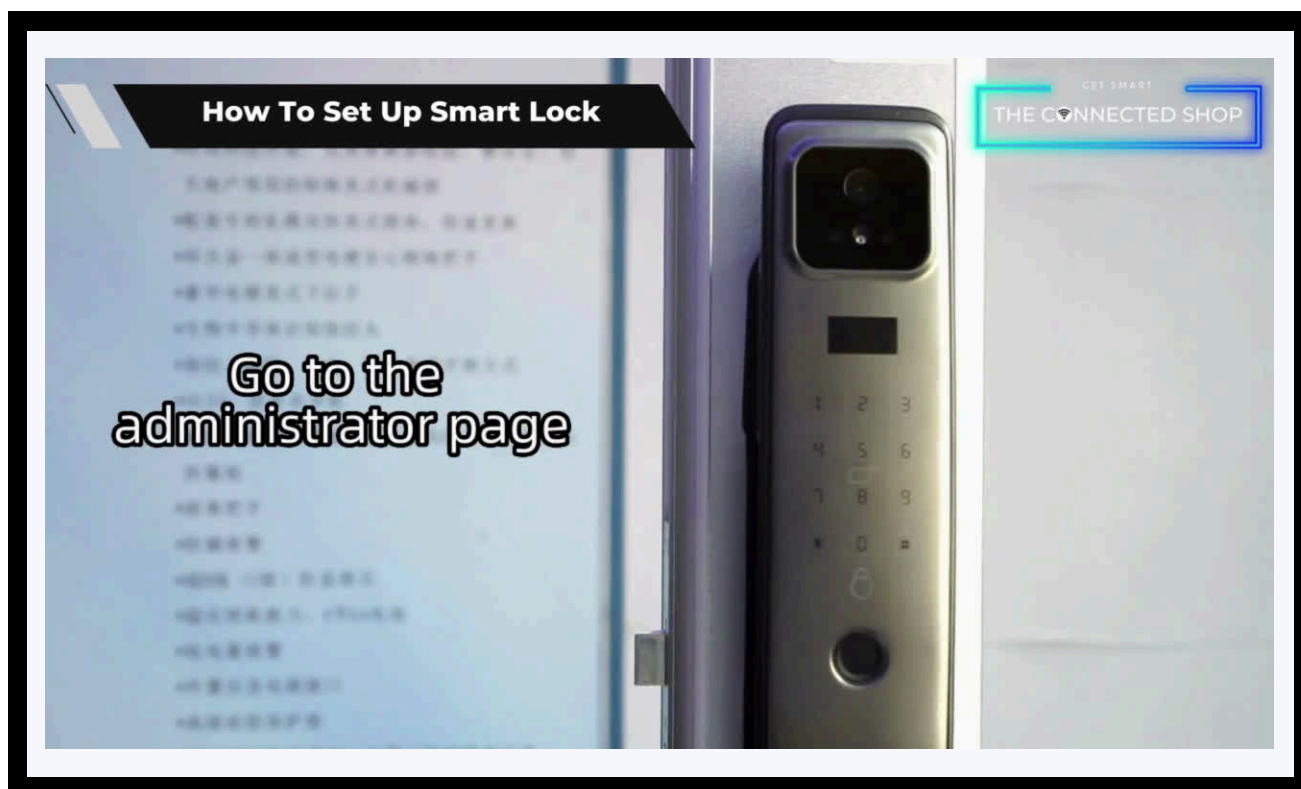

## 2. INITIAL STATE OF YOUR SMART LOCK



### c) Delete Administrator

- Activate your Smart Lock (Press '\*' and '#') and enter your Administrator Password
- Follow the voice command. Press 1 for User Setup to delete an administrator
- Enter the number of the Administrator you intend to delete
- Press '#' to confirm (e.g., 003 #)
- After the successful operation, press '\*' to continue to add an administrator or delete another administrator

## 2. INITIAL STATE OF YOUR SMART LOCK



### d) Add User

- Activate your Smart Lock and enter your Administrator details
- Then, press 1 to "Add User"
- Then, press 2 for User Setting
- Press 1 to add user
  - Input face ID 5 times
  - Input the intended fingerprint 4 times
  - Input a 4-10 digit password 2 times
  - Input an Keycard 1 time

## 2. INITIAL STATE OF YOUR SMART LOCK



### e) Delete User

- Activate your Smart Lock (Press '\*' and '#') and enter your Administrator Password
- Follow the voice command and press 1 for User Settings to delete a user
- Enter the number of the User you intend to delete
- Press '#' to confirm (e.g., 011 #)
- After the successful operation, press '\*' to continue to add a user or delete another user

## 2. INITIAL STATE OF YOUR SMART LOCK



### f) Language Setting

- Activate your Smart Lock (Press '\*' and '#') and enter your Administrator Password
- Follow the voice command and Press 2 for System Settings, and then press 1
- Follow the voice command and Press 2 for Language Settings
- Follow the voice prompts and Press 3 for English

## 2. INITIAL STATE OF YOUR SMART LOCK



### g) Time and Date Settings

- Activate your Smart Lock (Press '\*' and '#') and enter your Administrator Password
- Follow the voice command and Press 2 for System Settings, and then press 1
- Follow the voice command and Press 1 for Time Settings
- Follow the voice command to enter the Time and Date of the Smart Lock
- Modify based on the following format:
  - year / month / day / time (for example, today is December 04, 2022 11:03 so it should be: 2212041103)
- Press '#' to confirm

## 2. INITIAL STATE OF YOUR SMART LOCK



### h) Volume Adjustment

- Activate your Smart Lock (Press '\*' and '#') and enter your Administrator Password
- Follow the voice command and Press 2 for System Settings, and then press 1
- Follow the voice command and press 3 for Voice Settings
- Follow the voice command on how to increase and decrease volume



## 2. INITIAL STATE OF YOUR SMART LOCK



### i) Factory Reset

- Activate your Smart Lock (Press '\*' and '#') and enter your Administrator Password
- Follow the voice command and press 2 for System Setup
- Follow the voice command and press 4 to Factory Reset

### 3. MOBILE APP CONNECTION



#### a) Downloading the App

Download the application on the Google Play Store or Apple AppStore by searching “Tuya Smart” or by scanning the QR code below



#### b) Logging in and Registering

##### After Downloading the App

- Select the country from which you will be using the device, usually the app will prompt it automatically
- You will be redirected to register via email where a verification code will be sent and proceed to enter it on the app in the allotted time limit
- Once the verification code has been entered into the app, you will be asked to set your password
- You will then have full access to the Tuya Smart Platform

### 3. MOBILE APP CONNECTION

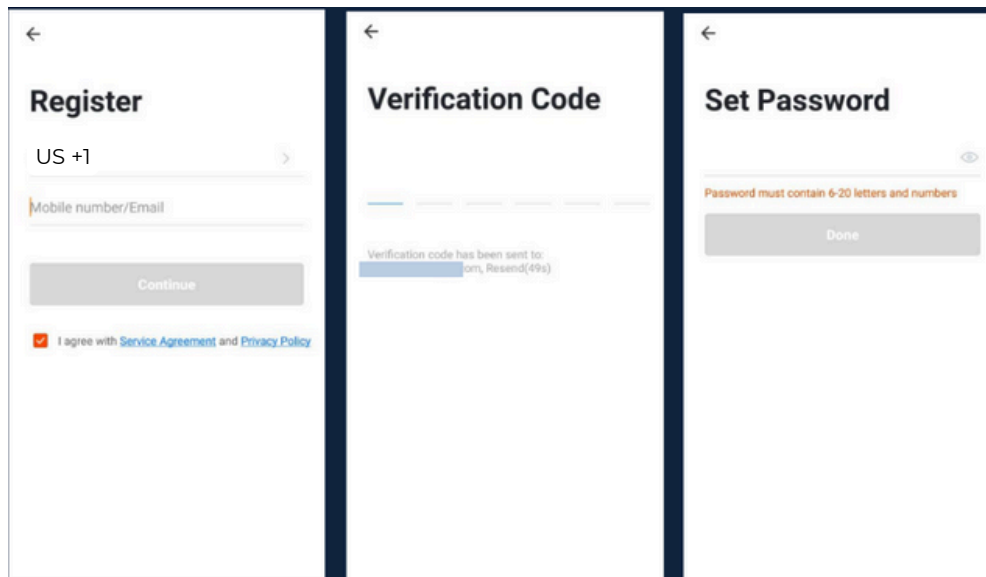

Should you be an existing user to the Tuya Smart Platform, log in using your email and password from the login page.

#### c) Resetting your Password

In case you have forgotten your password and need to reset it, please follow the steps below:

- On the Login Page, when prompted for your email & password, click “Forgot Password” button located below the “Login” button
- Select the country from which you will be using the device, usually the app will prompt it automatically

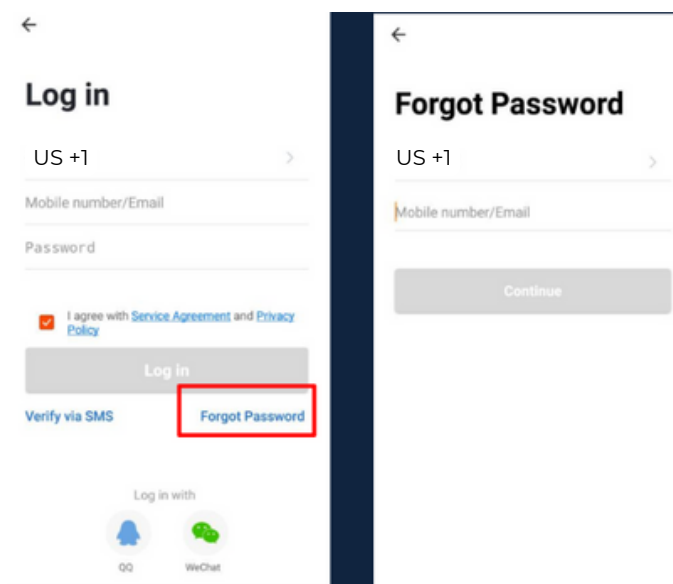

### 3. MOBILE APP CONNECTION



#### Verification Code

Verification code has been sent to: 86-15219500857,  
Resend(57s)

#### Set Password

👁️

Password must contain 6-20 letters and numbers

Done

- You will be prompted to enter the email where a verification code will be sent and proceed to enter it on the app in the allotted time limit
- Once the verification code has been entered into the app, you will be asked to set your new password
- You will then have full access to the Tuya Smart Platform

In the case that you would like to change your password from the app, please follow the steps below:

- Tap the 'Me' tab on the bottom right hand corner of your screen
- Click 'Change Login Password'
- You will be taken to the 'Account Verification' page and then tap 'Get Verification Code' button
- This will send a verification to your registered email
- Enter the code in the app
- Proceed to enter the new password

### 3. MOBILE APP CONNECTION

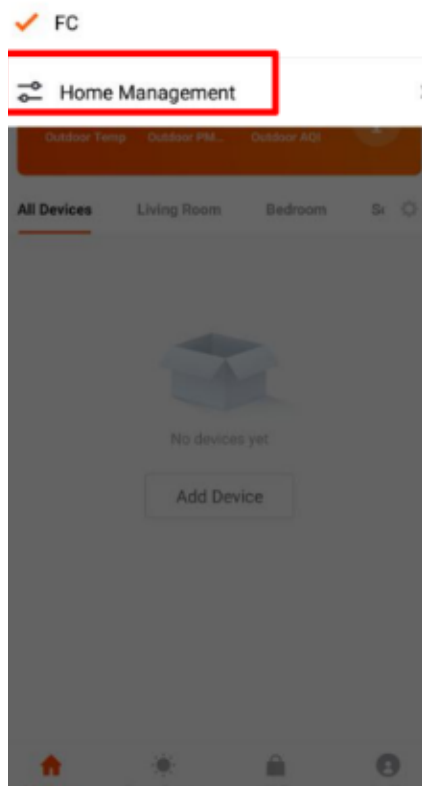

#### d) Adding Locations

- Tap the button on the top-left corner of the screen & select 'Home Management' from the dropdown list
  - One account can manage multiple locations at the same time. The user can operate multiple devices in a single location by selecting it from the drop-down menu

- If you already have a Home setup, simply click 'Join a Home'. Otherwise, click 'Create a home'
- Enter the details on the screen
- Click Confirm
  - Other Household members can also control the smart devices that are registered in this household, but will not be able to modify, add, or delete devices

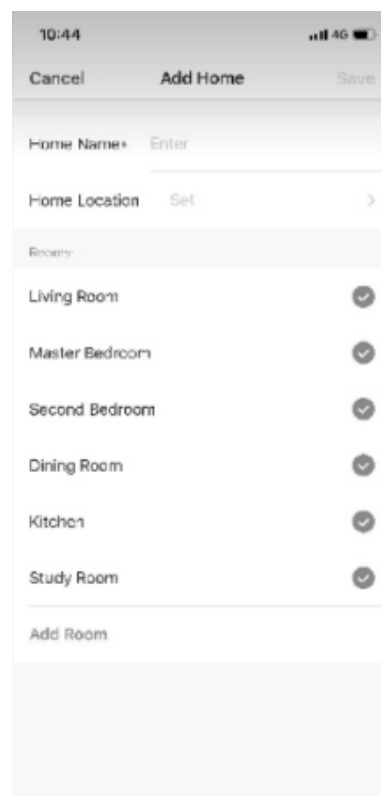

### 3. MOBILE APP CONNECTION



#### e) Adding Devices

To add devices on the app, please follow the instructions below. Your devices and phone must be connected to the same 2.4GHz Wi-Fi network in order for this to work.

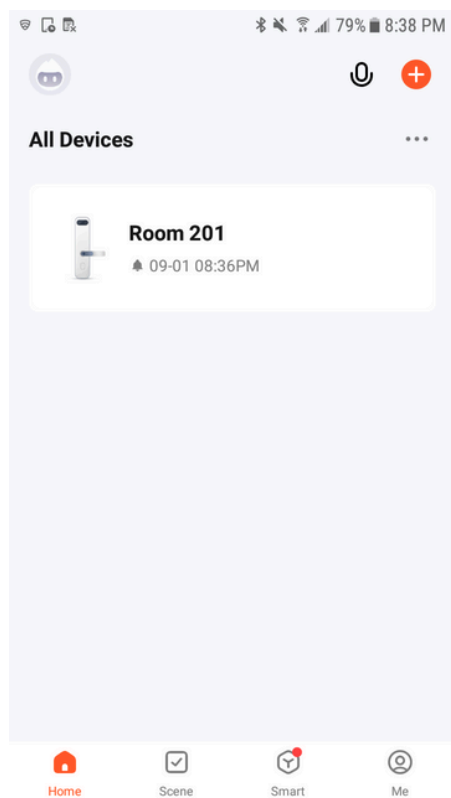

- To add a device, click the 'Add Device' or tap the 'Plus' button on the top-right corner of your screen and select 'Add Device'

- This will bring up a list of devices. Go to 'Camera & Lock' from the left side and then click 'Lock (Wi-Fi)' to select your Smart Lock device

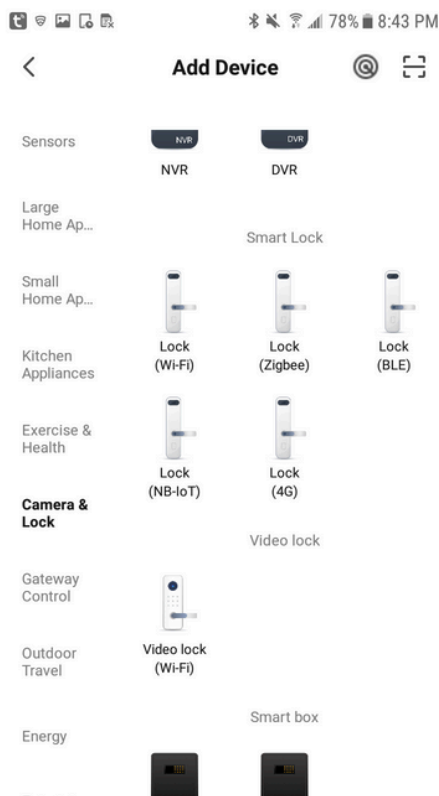

### 3. MOBILE APP CONNECTION



📶 🔒 🔋 78% 8:43 PM

✕

#### Select 2.4 GHz Wi-Fi Network and enter password.

If your Wi-Fi is 5GHz, please set it to be 2.4GHz.  
[Common router setting method](#)

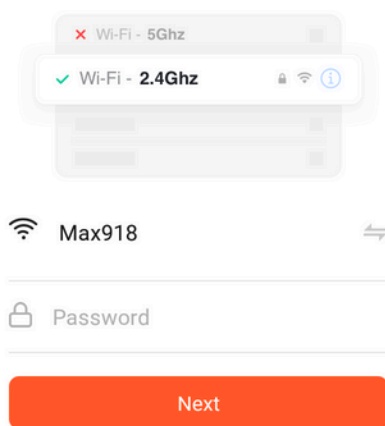

- Activate your smart lock by pressing the '\*' & '#' on your smart lock keypad to authenticate administrator identity and then press '1' to access administrator settings
- There will be a voice prompt to press '4' for network configuration
- Connect your phone to the 2.4 GHz Wi-Fi network and follow the onscreen instructions
- Shortcut: press '1' and '#', and then enter administrator information to enter into network-configuration state

- Check if the light indicator is blinking.
- Once you've tapped the 'Confirmation' button, you will be asked to select the current status of the light indicator. Options are AP Mode ("Access Point mode" or by default, uses access points like a Wi-Fi Hotspot) or EZ Mode ("Easy-connect mode" which is most compatible if you will directly connect your phone to the Wi-Fi router)
  - Should you select the AP mode, you will have to connect your phone to the device's hotspot before moving onto the next step
- Afterwards, the light should flash rapidly

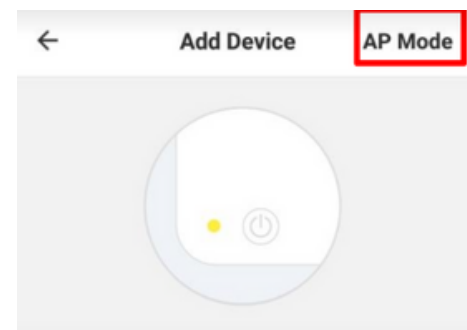

Power on the device and confirm that indicator light rapidly blinks

[How to make indicator rapidly blink](#)

Confirm indicator rapidly blink

### 3. MOBILE APP CONNECTION

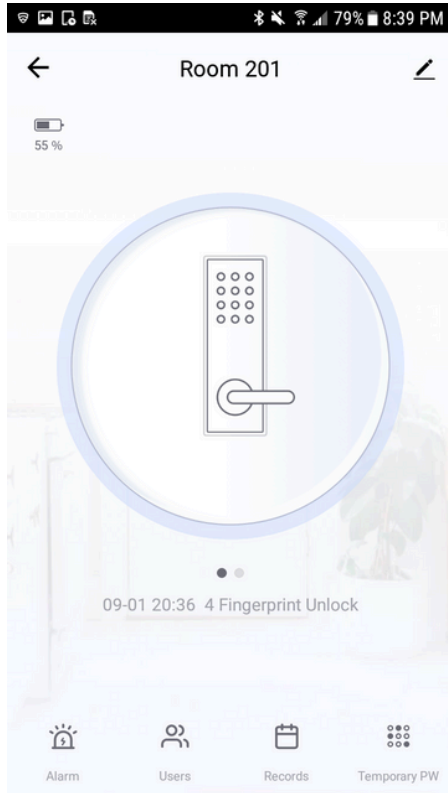

- Once you've completed these steps, make sure your phone and device are as close as possible. There will be a prompt from the lock and on the screen that pairing was a success

- Finish adding your device. Once this has been done successfully, you can go on to change the name of your device and control its functions

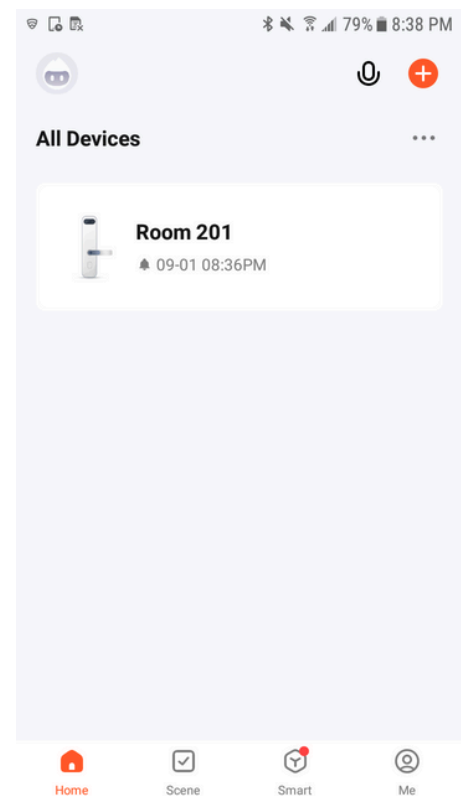



### 3. MOBILE APP CONNECTION



#### f) Adding Members

In order for others to gain access to a device, they will have to be added as members to the location/room.

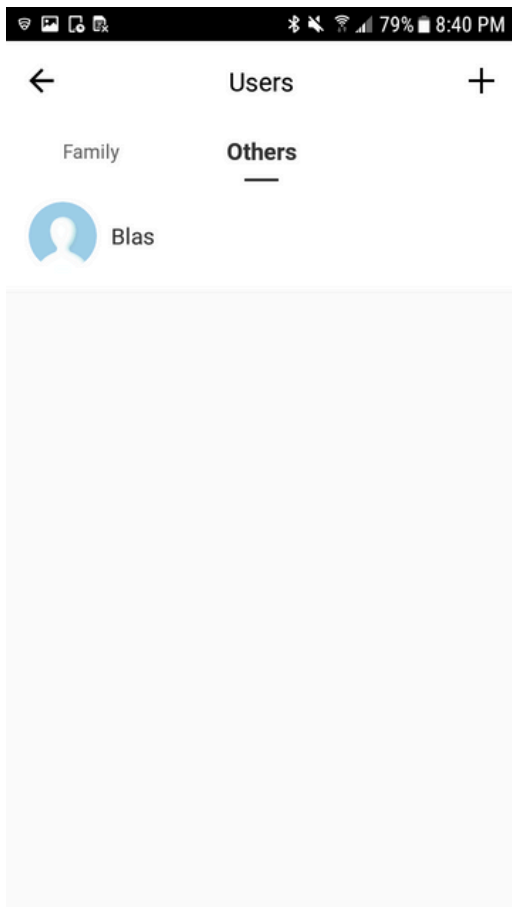

To add a member to the location, please follow the following steps:

- Tap the 'Me' tab at the bottom-right corner of your screen
- Click on 'Home Management'
- Select the location you would like to add the new member to
- Tap 'Add Member' and select how you would like to share the invitation to the new member

## 4. DEVICE FUNCTIONS



### a) Remote Functions via The Mobile App

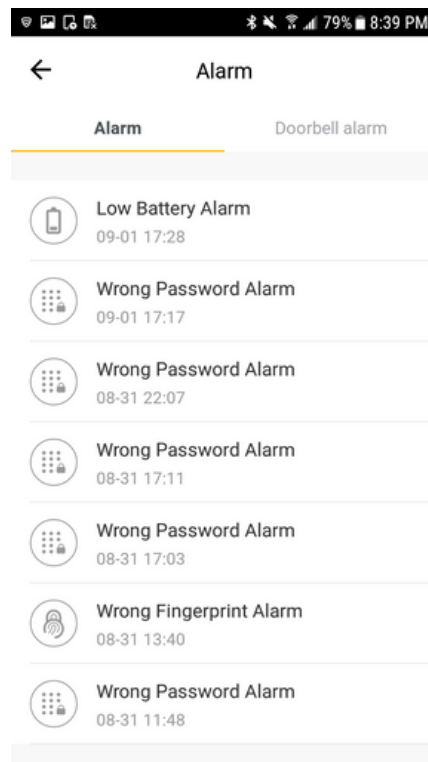
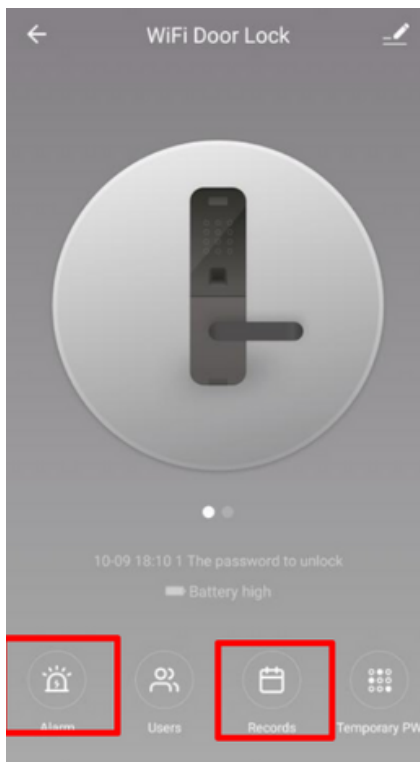

- Select the Smart Lock you would like to use from the Home Page
- Click 'Alarm' to check the battery state
- Click 'Records' to check the unlock records

## 4. DEVICE FUNCTIONS

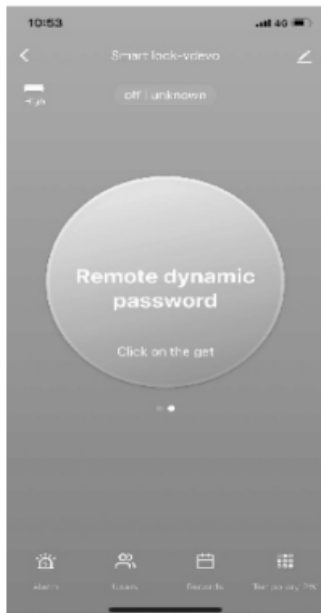

### b) Dynamic Password (optional)

- Click the 'Key' button on the phone screen to get your Dynamic Password (this is a short-term password that will last only for a few minutes)

- Enter the Dynamic Password to unlock the device

### c) Temporary Password (optional)

- On the Lock Screen tap the bottom-right 'Temporary PW' button

- Click 'Add'. Set your own Temporary Password, name of user, and the start and end date time. Make sure that the time on your mobile app and lock are synchronized

- Click 'Done' on the top-right corner to complete the operation

- Activate the lock pad and enter the code you've put in to activate the temporary-lock function and press '#' to confirm

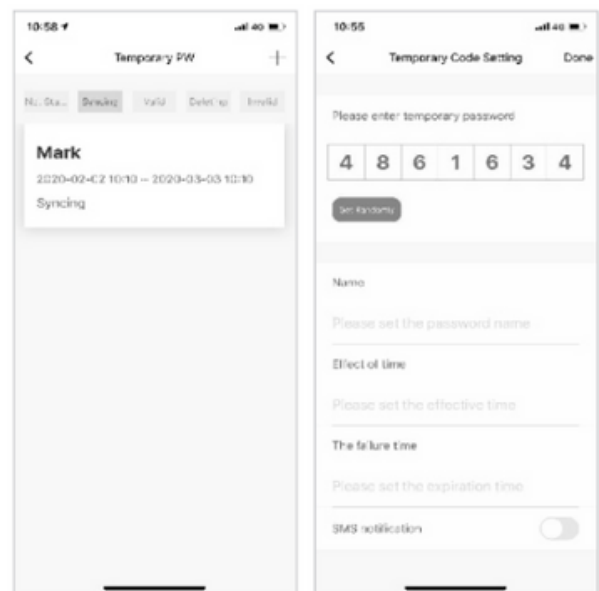

## 4. DEVICE FUNCTIONS



### d) Remote Unlock

- To grant access to someone when you are away, instruct them to press the doorbell symbol or '#' on the lock keypad. This will prompt a message or request on your mobile app to confirm remote unlocking.

## 5. OTHER NOTES

Created by Design Circle

- **To set up your network:** Press 1 for Admin Setting and 3 for Network Setting. Press 1 for Hotspot connection.
- To enable auto lock, activate your Smart Lock and enter your Administrator Passcode. Follow the voice command press 2 for System Setup, then press 2. Follow the voice command and press 3 to enable or disable the auto-lock feature.
- To reverse the direction of the handle, activate your Smart Lock and enter your Administrator Password. Follow the voice command and select 2 for System Setup. Input "888#" on the keypad and then press 1. Press # to enter and \* to return.

Congratulations!

You have successfully installed your very own 3D Face Recognition Smart Door Lock.

Thank you for being a valued customer of The Connected Shop.

[www.theconnectedshop.com](http://www.theconnectedshop.com)





# THE CONNECTED SHOP