

Product Catalog 2026

# The Nordic Selection



Ergonomic Dental  
Instruments from Denmark

ErgoDenta™

# From Denmark to dental clinics worldwide

ErgoDenta was founded with one clear purpose: to make daily clinical work easier with instruments designed for comfort, control, and reliability.

Designed in Denmark, our instruments are developed with a strong focus on ergonomics and everyday usability. We pay attention to the details that matter in practice — from grip and balance to finish and handling — so clinicians can work with greater comfort throughout the day.

In a short time, ErgoDenta has grown into a trusted partner for distributors and dental professionals across more than 25 countries. While our reach continues to grow, our approach remains the same: practical solutions, personal support, and instruments made with care.

Whether our products are used locally or internationally, the goal is always the same—to deliver dependable instruments that support better daily work.

# 2700+

Ergonomic Dental Instruments

# 30+

Distributors

# 25+

Countries supplied



## Our first year

See how ErgoDenta started and what we built in 2025.

Scan to watch our story

ErgoDenta

- Fast dispatch from Denmark
- EU-based distribution
- Direct supply model
- No middlemen

# 4

## Pillars of ErgoDenta

ErgoDenta is built on four key principles that shape our products and define the way we work.

### Why we do it

We believe small improvements make a big difference. By focusing on ergonomics, balance, and consistent quality, ErgoDenta develops instruments that support clinicians in their daily work and long clinical hours.

### Where we are going

Our vision is a dental workplace where instruments support the clinician, not strain them — with thoughtful design, consistent quality, and solutions that make dentistry more sustainable over a career.

### Ergonomic Focus

Our instruments are developed to reduce hand fatigue and improve tactile control. Better comfort allows clinicians to work longer with greater precision throughout the day.

### Global Compliance

Our products follow international regulatory requirements and include full documentation and traceability for clinics and partners.

### Innovative Solutions

We create practical solutions for daily dentistry — from longer-lasting sharpness to replaceable tip systems that reduce waste and extend instrument life.

### Danish Design

Designed in Denmark with focus on balance, precision, and everyday clinical use. Every instrument is developed with attention to detail, finish, and consistent quality.



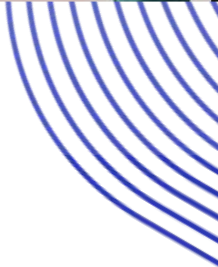
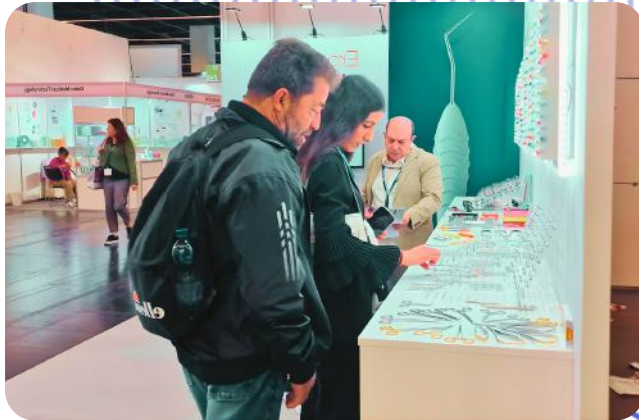

In 2025, ErgoDenta was introduced for the first time at IDS Cologne.

We arrived with a complete range — more than 2,500 instruments ready for the market. Visitors could pick up the instruments, feel the grip, and see the ergonomic design in real life.

Distributors showed strong interest and quickly recognized the potential of a new brand offering a full portfolio from day one. IDS became the starting point of our international journey.



# FROM IDS



**After IDS, the cooperation began.**

Our partners started presenting the instruments in their local markets and introducing the range to their customers. Step by step, the instruments moved from the exhibition booth into everyday use around the world.

Today, ErgoDenta is present in many countries, and the network continues to grow through long-term partnerships. What started in Cologne now continues worldwide.

# TO THE WORLD

# Petter's 6 fav ErgoRazor Instruments



Highlights  
Page 67



Kits by

# DnD



Highlights  
From page 109-111



Kits by  
**Dr. Iman**



Highlights  
From page 112-114



**NEW**  
HIGHLIGHTS

Scalers & Curettes

# Titanium

Highlights  
Page 60

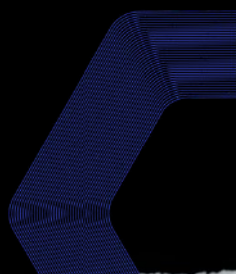

# ErgoRazor®

Now Available in ErgoSteel Plus

Up to

# 3X

Longer  
Sharpness

ErgoRazor® is a registered trademark of ErgoDent.



Highlights  
Page 75



Diamond

# Grip Master

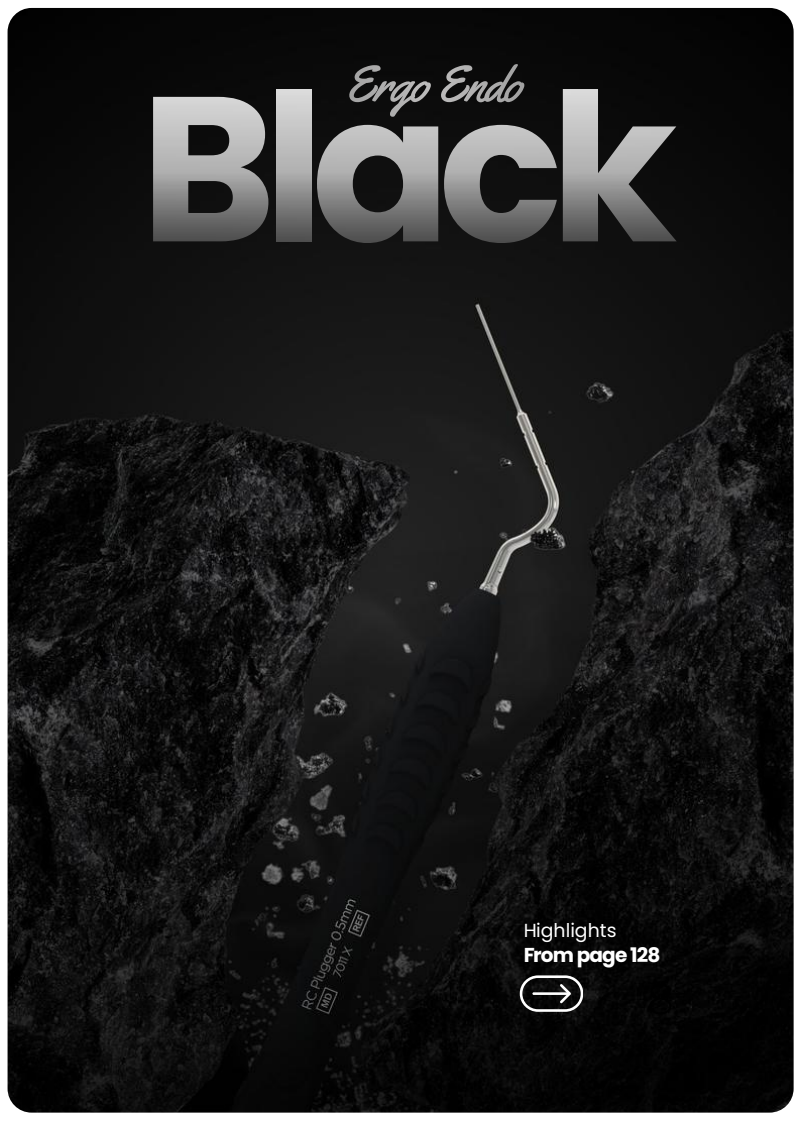

# Ergo Endo Black

Highlights  
From page 128



NEW  
HIGHLIGHTS

# Orthodontic Pliers

Highlights  
From page 113



# ErgoTip Handles

Personal. Precise. Yours.

Identify by color. Work faster.

Highlights  
Page 19



Ergo**X**<sup>®</sup>

# Ergonomic Grip



Available in 15 Colors



Ergo**Steel**

# Durability That Supports

Strong Classic Reliable



Ergo**Lite**

# Daily Essentials

for your practice

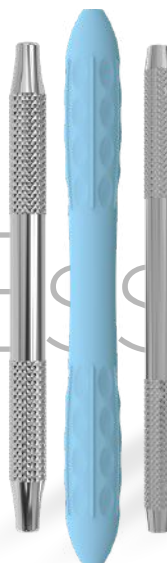

Scan to read more  
about ErgoHandles



# BRANDS

## ErgoTip™

A smarter system where you replace only the tip – less waste, lower cost, and a handle that stays with you.

Page no 12-20



## ErgoLite

Everyday dental instruments built for reliable clinical use.

Page no 21-28



## ErgoSlip

Non-stick restorative instruments available in gold, black, or blue for clear identification and precise composite placement.

Page no 48-53

## Ergo Razor®

Up to 3× longer sharpness in periodontal scalers and curettes for efficient calculus removal.

Page no 61-66



## ErgoTrays

Fully autoclavable color-oriented plastic trays for organized instrument setups.

Page no 146-148

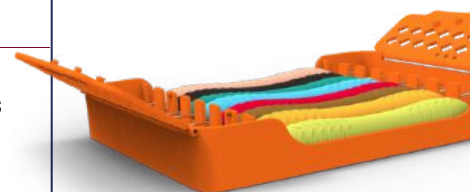

# CONTENT

<b>Diagnostics</b>	<b>29</b>	<b>Extraction</b>	<b>70</b>
Explorers	30	Extraction Forceps	71
Periodontal Probes	30	Grip Master Diamond	75
Explorer & Probes	31	Luxating Elevators	77
Mirror Handles	33	Root Tip Elevators	79
Mouth Mirrors	35	X-Tool Elevators	82
Diagnostic kits	37		
		<b>Surgery</b>	<b>83</b>
<b>Restoration</b>	<b>38</b>	Scissors	84
Excavators	39	Needle Holders	90
Pluggers & Burnishers	41	Tweezers	94
Composite Spatulas	43	Retractor	98
Base Carriers	43	Syringes	100
Carvers	44	Crown Instruments	101
Condensers	45	Bone curettes	102
Filling instruments	45	Kits by DnD	107
Cord Packers	47	Kits by Dr Iman	110
Composite kits	53	Orthodontics	113
		Endodontics	128
		Implantology	140
<b>Periodontics</b>	<b>54</b>		
Gracey Curettes	55	<b>Sterilize &amp; Organize</b>	<b>143</b>
Sickle Scalers	57	Sterilization trays	144
Universal Curettes	58	Instrument trays & holders	150
Hoe Scalers	59	Color-coded rings	152
Titanium Curettes & Scalers	60	ErgoTape	153
Perio kits	68	Diverse	154

# ErgoTip

Every *practice* is unique.  
Your *instrument* should be too.

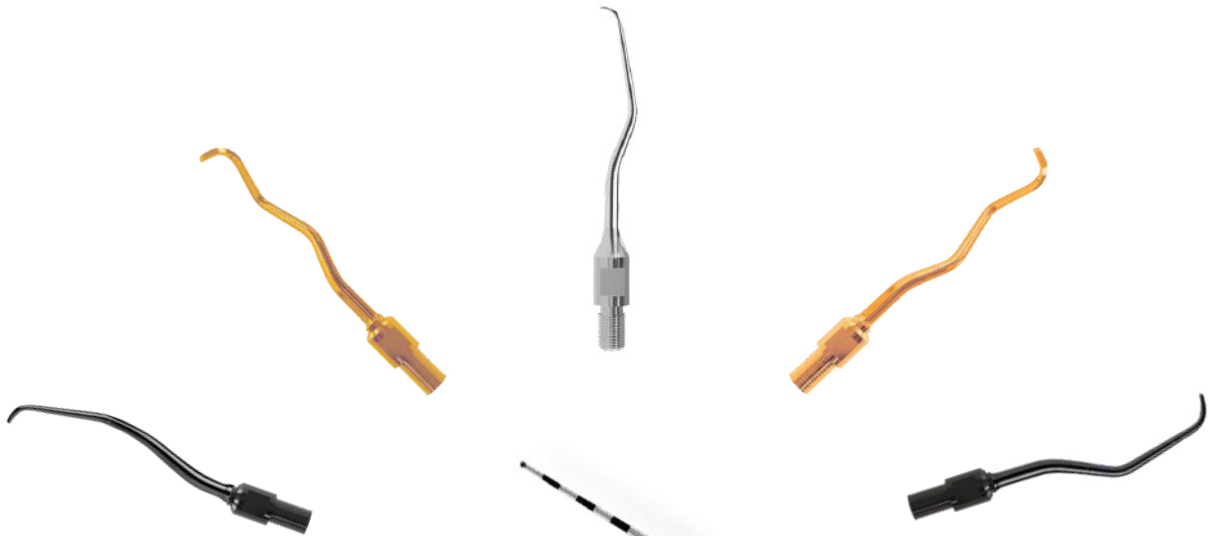

Use Replace Repeat

# Personalize

Your Instruments

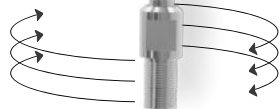

SCAN ME



Discover More Online  
Scan the QR Code

# Personal. Precise. Yours.

THE NEW ERGOTIP EXPLORER PROBE.

**1.**

Choose your **Handle**



**2.**

Choose your **Color**

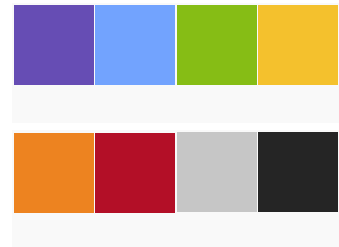

**3.**

Choose your **ErgoTips**

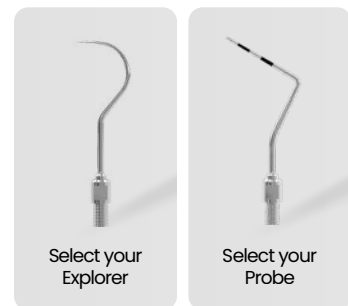

Your instrument  
Your color, **Your style**

# Diagnostics

## Explorers



## Probes

Color-coded and highly durable for lasting precision.

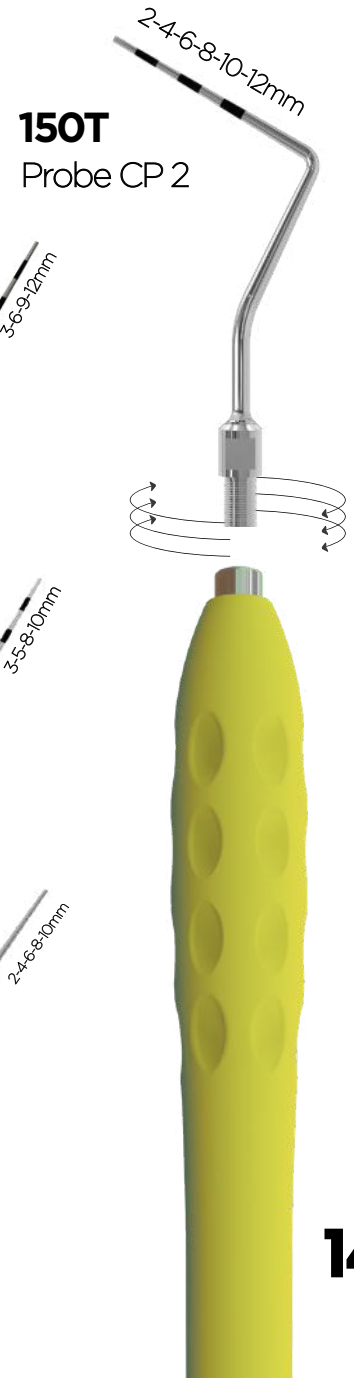
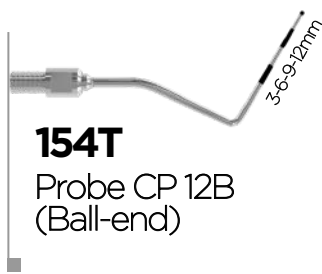
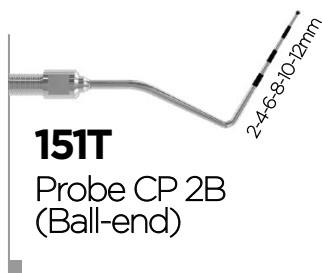

# ErgoRazor® Tips

*Personal. Precise. Yours.*

Razor Gold

Razor

Razor Black



Up to

**3X**

Longer  
Sharpness

# Periodontics

## Gracey Curettes

Gracey 1



Gracey 2

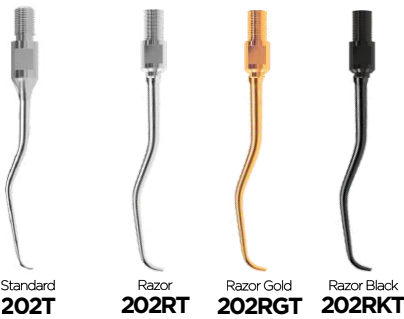

Gracey 3



Gracey 4

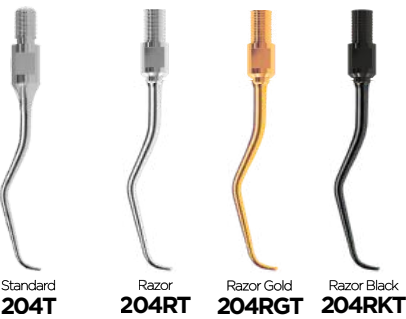

Gracey 5

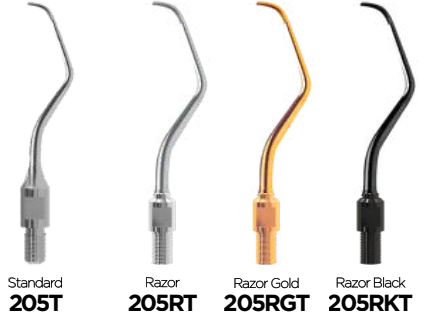

Gracey 6

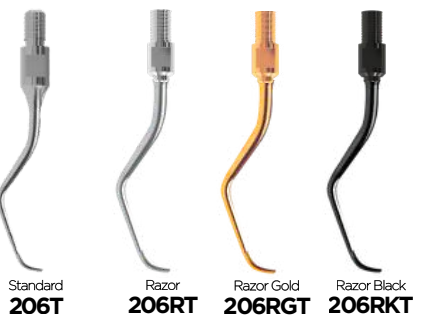

**NEW**

Gracey 7



Gracey 8

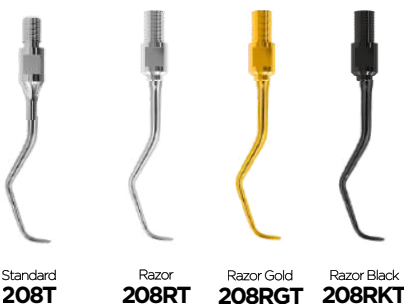

**NEW**

Gracey 9

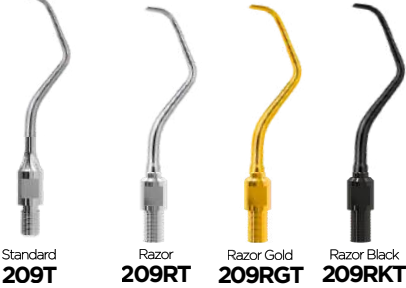

Gracey 10

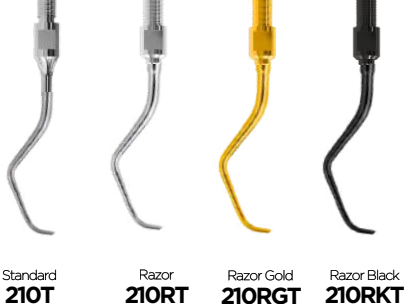

Gracey 11

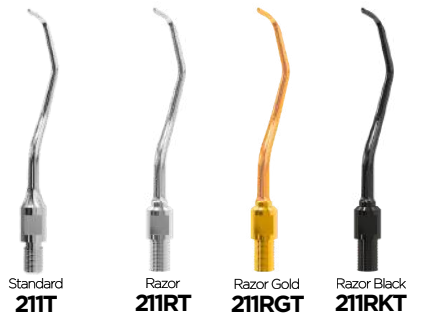

Gracey 12



**NEW**

### Gracey 13



### Gracey 15



### Gracey 14



### Gracey 16

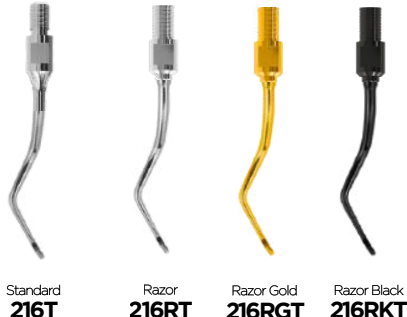

### Did you know?

With ErgoTip, you can design your own perio instrument.



## Mini Gracey Curettes

### Mini Gracey 1

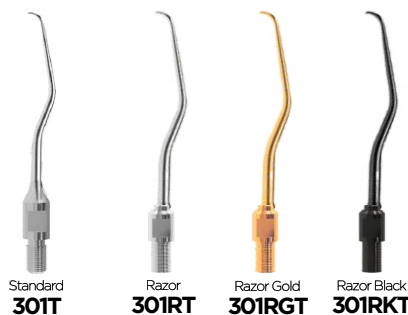

### Mini Gracey 11

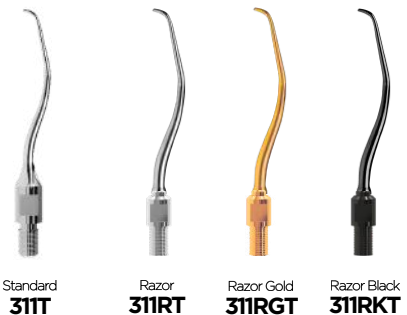

### Mini Gracey 13

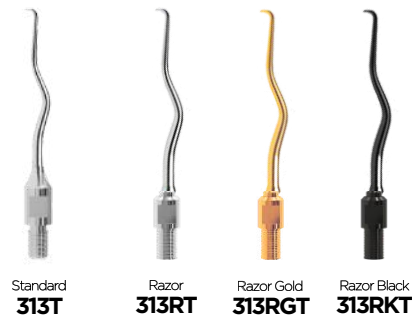

### Mini Gracey 2



### Mini Gracey 12



### Mini Gracey 14



# Sickle Scalers

## Sickle Scaler 204S (A)



## Sickle Scaler 204S (B)



## Sickle Scaler 204SD (A)



## Sickle Scaler 204SD (B)



## Sickle Scaler M23 (A)



## Sickle Scaler M23 (B)



## Micro Sickle Scaler 01



## Micro Sickle Scaler 02

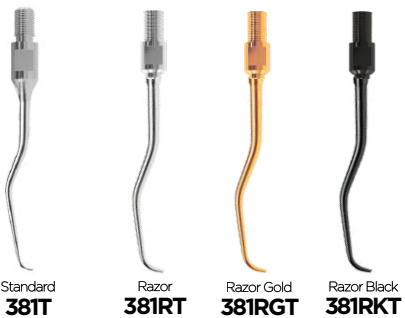

## Mini Sickle Scaler 11

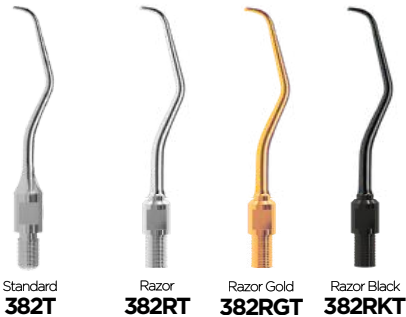

## Mini Sickle Scaler 12

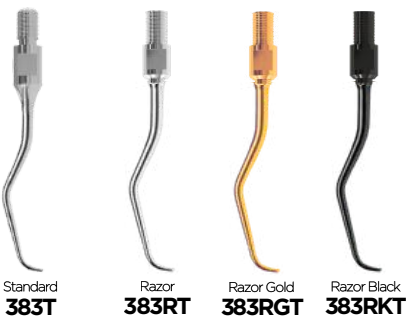

## Sickle Scaler H6



## Sickle Scaler H7



*New*  
**ERGOTIP HANDLES**

**ErgoTip X & X Plus**

Double-end



**1451** X | XP  
 Magenta Blue



**1452** X | XP  
 Aqua light



**1453** X | XP  
 Lemon Green



**1454** X | XP  
 Honey Brown



**1455** X | XP  
 Citrus Orange



**1456** X | XP  
 Ruby Pink



**1457** X | XP  
 Misty Cyan



**1458** X | XP  
 Pure Black

**ErgoTip LX**

Single-end



**1451 LX**  
 Magenta Blue



**1452 LX**  
 Aqua light



**1453 LX**  
 Lemon Green



**1454 LX**  
 Honey Brown



**1455 LX**  
 Citrus Orange



**1456 LX**  
 Ruby Pink



**1457 LX**  
 Misty Cyan



**1458 LX**  
 Pure Black



# ErgoTip SS

## Hollow Handles



Hollow handle design ensures a lighter weight, better balance, and improved tactile control during procedures.

Hollow 8 mm single-end handle with balanced feel and firm, comfortable grip.

Ø8mm

**1491 SS**  
Ergo**Tip Single End**



Lightweight 8 mm hollow double-end handle offering control and reliable precision.



Ø8mm

**1492 SS**  
Ergo**Tip Double End**



Wrench for ErgoTip  
5757

Snap. Twist. Done.



# ErgoLite

## Daily Essentials for Your Practice

### ErgoLite X

Ultra-lightweight color-coded handles at 14 g — covering a full assortment of scalers, curettes, and everyday instruments for efficient daily use.

### ErgoLite S

Classic textured steel handles, solid or hollow — available across a wide range of scalers, curettes, and diagnostic instruments for reliable everyday performance.

### ErgoLite Elevators

A complete tray-organised assortment of luxating elevators with plastic handles — straight, curved, contra, and dual-edge tips for atraumatic tooth and root loosening.

### ErgoLite Mirror handles

Lightweight ergonomic handles in 11 vibrant colors, compatible with all SS socket mirrors and designed for both standard and cone socket configurations.



Discover More Online  
Scan the QR Code

Available in 11 colors

Lemon Green 9314C | 9314



Misty Cyan 9313C | 9313



Ruby Pink 9309C | 9309



Petal Pink 9308C | 9308



Citrus Orange 9307C | 9307



Honey Brown 9305C | 9305



Aqua Light 9306C | 9306



Sky Cyan 9304



Lilac Blue 9310



Magenta Blue 9302C | 9302



Also Available in  
Cone Sockets



Pure Black

9315C | 9315  
Cone socket SS socket

- Fits all SS & CS socket dental mirrors
- Suitable for Microscope & HD dental mirrors
- Now also available in cone socket

A lightweight, ergonomic mirror handle designed for Microscope and HD dental mirrors, compatible with all CS & SS socket mirrors. Offered in 11 vibrant colors. **Selected colors are also available with cone socket.**

# ErgoLite

Mirror Handle

# ErgoLite X

Light. Precise & Reliable.

Ultra-lightweight (11.5 mm, 14 g) ergonomic design reduces hand fatigue. Crafted from anti-rust stainless steel, fully autoclavable, with color coding and clear markings for quick identification and daily efficiency.

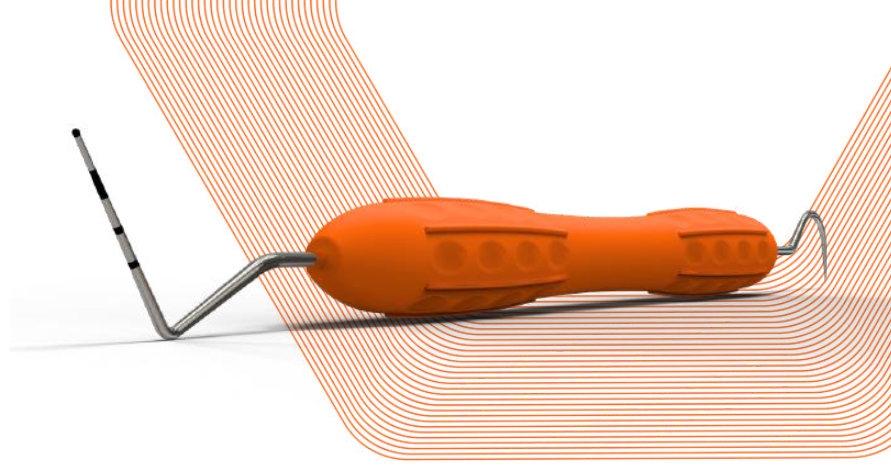

## Explorer

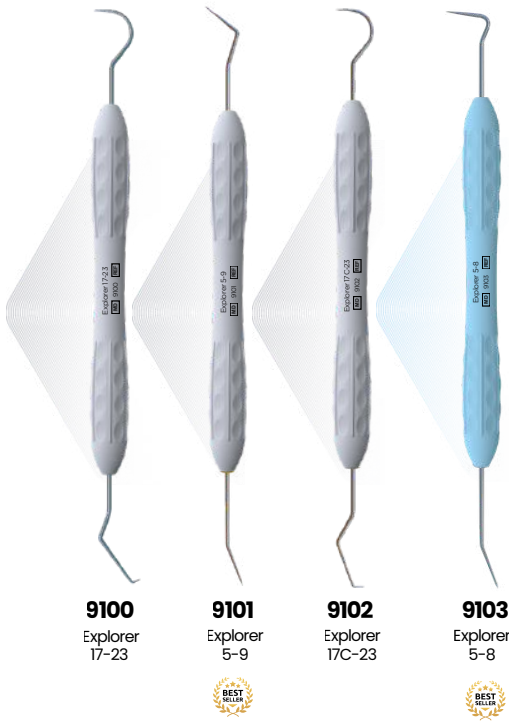

**9100**  
Explorer  
17-23

**9101**  
Explorer  
5-9

**9102**  
Explorer  
17C-23

**9103**  
Explorer  
5-8

## Probes & Explorer

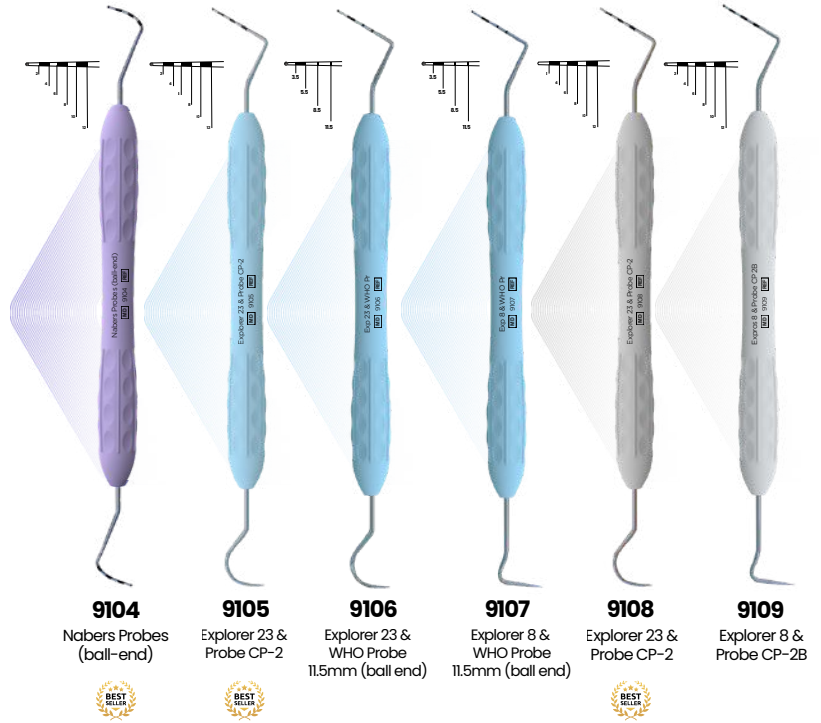

**9104**  
Nabers Probes  
(ball-end)

**9105**  
Explorer 23 &  
Probe CP-2

**9106**  
Explorer 23 &  
WHO Probe  
11.5mm (ball end)

**9107**  
Explorer 8 &  
WHO Probe  
11.5mm (ball end)

**9108**  
Explorer 23 &  
Probe CP-2

**9109**  
Explorer 8 &  
Probe CP-2B

## Endodontics



**9110**  
Root Canal  
Explorer

**9111**  
Endo  
Plugger

## Excavator



**9112**  
Round  
Excavator  
1.0mm

**9113**  
Round  
Excavator  
1.5mm

**9114**  
Round  
Excavator  
2.0mm

**9115**  
Action  
Excavator  
1.0mm

**9116**  
Action  
Excavator  
1.5mm

**9117**  
Action  
Excavator  
2.0mm

## Filling Instruments



**9118**  
Burnisher &  
Plugger 1.5-  
2.5mm

**9119**  
Cord Packer  
2.0mm

# ErgoLite X

Light. Precise & Reliable.

## Filling Instruments

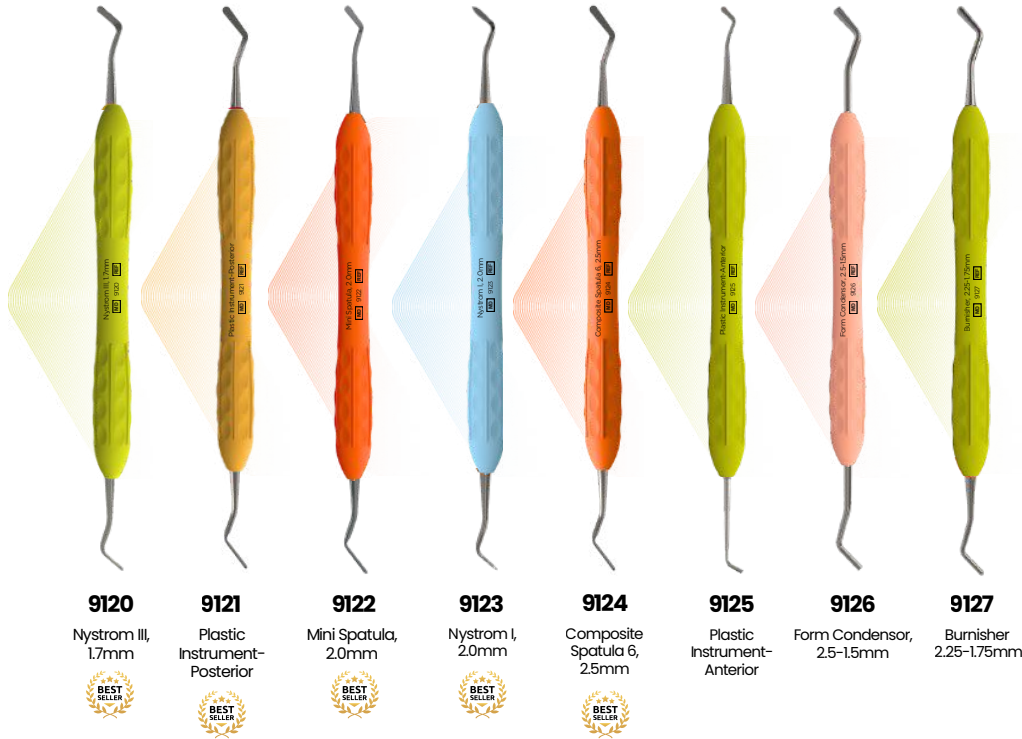

**9120**

Nystrom III,  
1.7mm



**9121**

Plastic  
Instrument-  
Posterior



**9122**

Mini Spatula,  
2.0mm



**9123**

Nystrom I,  
2.0mm



**9124**

Composite  
Spatula 6,  
2.5mm



**9125**

Plastic  
Instrument-  
Anterior



**9126**

Form Condensor,  
2.5-1.5mm



**9127**

Burnisher  
2.25-1.75mm



## Gracey Curettes



**9128**

Mini Gracey  
11-12



**9129**

Mini Gracey  
13-14



**9130**

Gracey  
1-2

## Gracey Curettes



**9133**

Gracey  
7-8



**9131**

Gracey  
11-12



**9132**

Gracey  
13-14



## Sickle Scalers



**9134**

Mini Sickle  
Scaler 11-12



**9135**

Micro Sickle  
Scaler 01-02



**9136**

Crane-Kaplan



**9137**

M23



**9138**

Sickle Scaler  
H6-H7



**9139**

Sickle Scalers  
204S



**9140**

Sickle Scaler  
204SD



# ErgoLite S

ErgoLite Steel offers two handle options solid steel for durability or a lightweight, ergonomic hollow handle for enhanced comfort. Both feature a classic textured design for a secure grip, ideal for reliable everyday use.

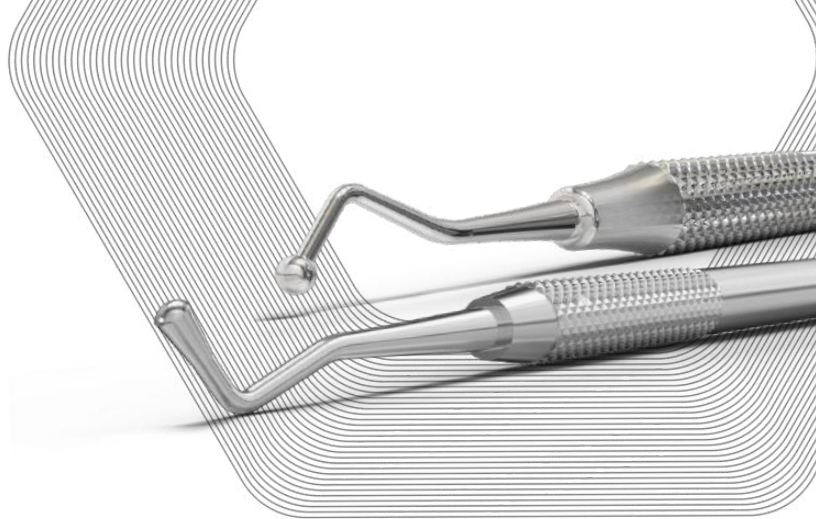

## Diagnostics

### Explorers

Single-end

Double-end

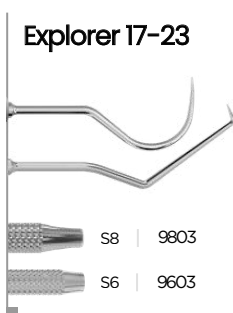
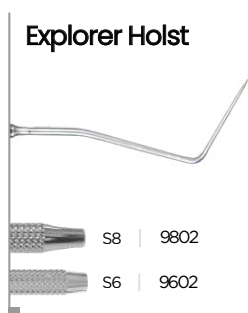

### Probes

Single-end

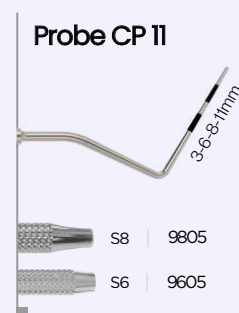
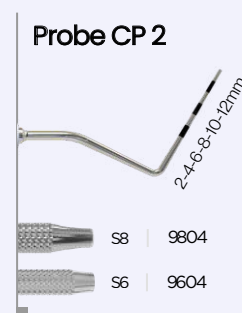

### Explorer + Probes

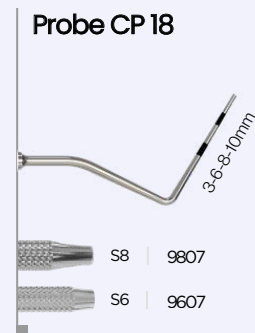
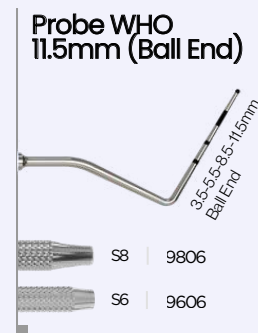
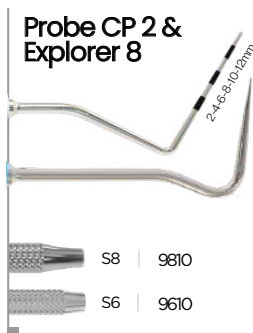
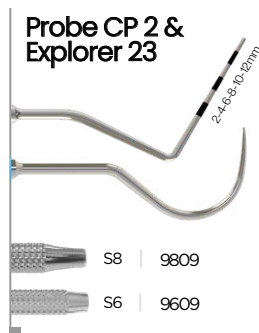
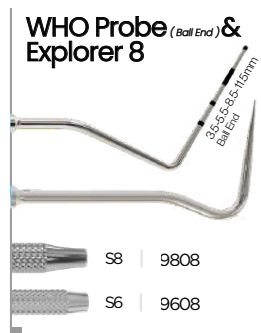

## Restoration

### Excavators

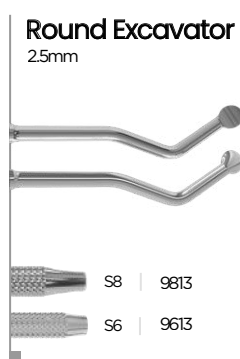
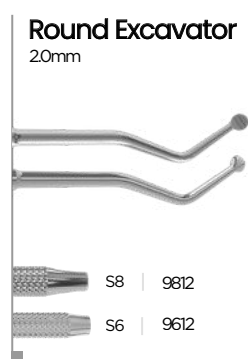
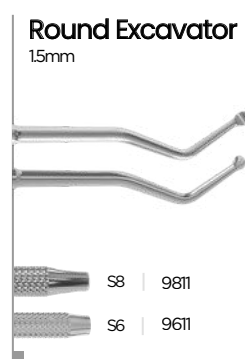

### Filling instruments



# Restoration

## Filling instruments

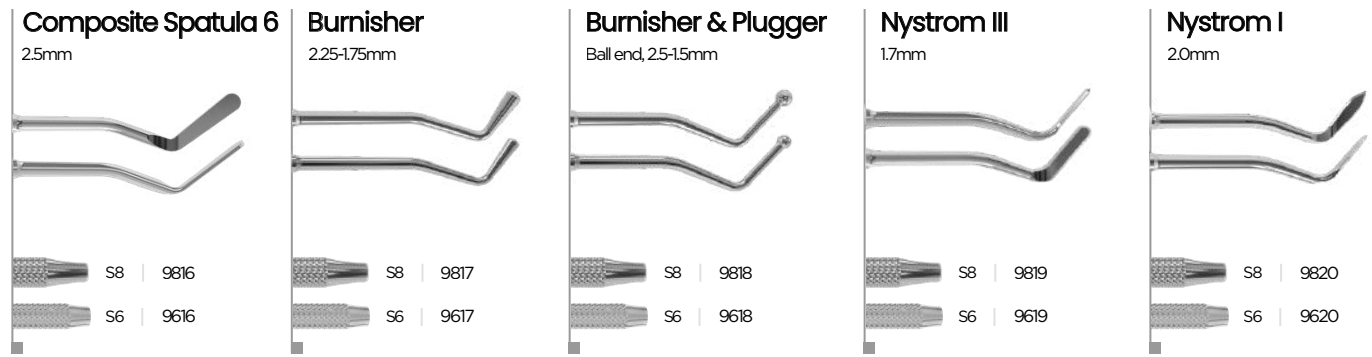

# Periodontics

## Gracey Curettes

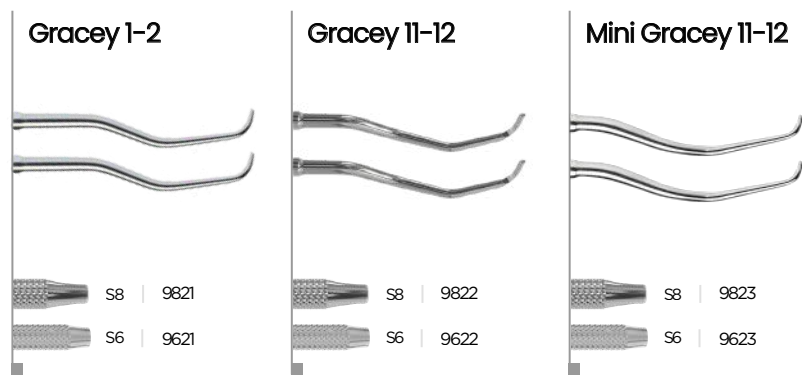

## Sickle Scalers

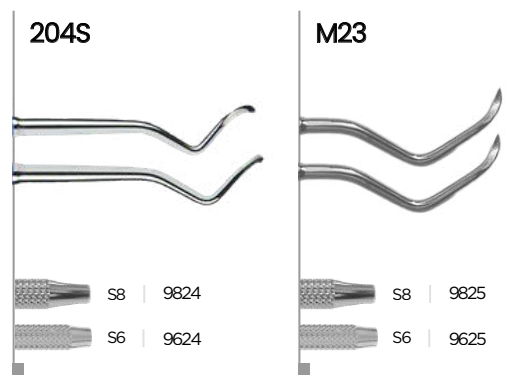

# Bone Curette

## Lucas

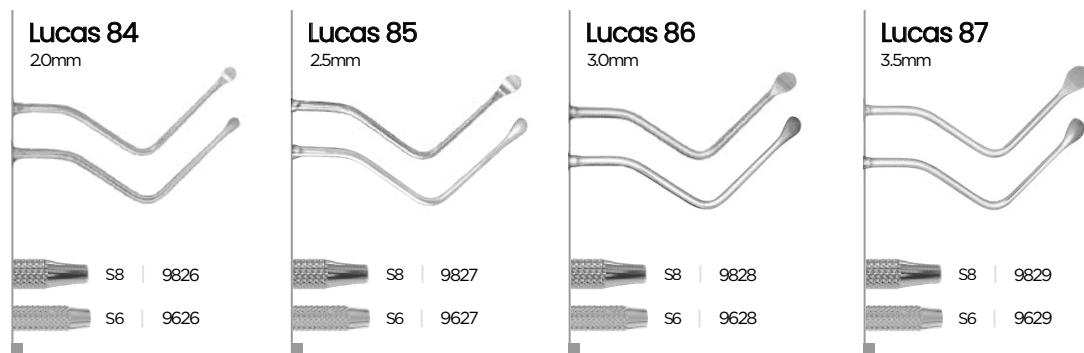

## Hemmingway



# Periosteal elevators

## Molt

5mm-8mm

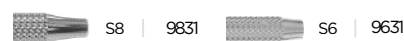

# ErgoLite Elevator

A complete range of luxating elevators for atraumatic tooth and root loosening before extraction. Various tip sizes and patterns — straight, curved, contra and dual-edge — for different access situations.

Available in regular and gold versions.



Comfort  
Grip

Ergonomic  
Design

Built to  
Last

# ErgoLite Elevator

Each ErgoLite elevator is supplied in an autoclavable tray.

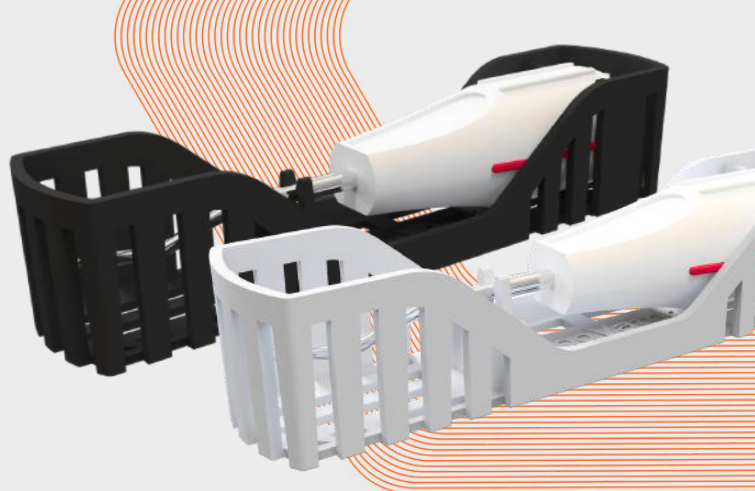

## Straight



1mm

Regular 9204  
Gold 9204G



2mm

Regular 9205  
Gold 9205G



3mm

Regular 9206  
Gold 9206G



5mm

Regular 9207  
Gold 9207G

## Inner Curved



3mm

Regular 9202  
Gold 9202G

## Dual edge



3mm-1.5mm

Regular 9208  
Gold 9208G



5mm-3mm

Regular 9209  
Gold 9209G

## Curved



 3mm

Regular 9201  
Gold 9201G



5mm

Regular 9203  
Gold 9203G

## Contra Curved



3mm

Regular 9210  
Gold 9210G

# Diagnosics

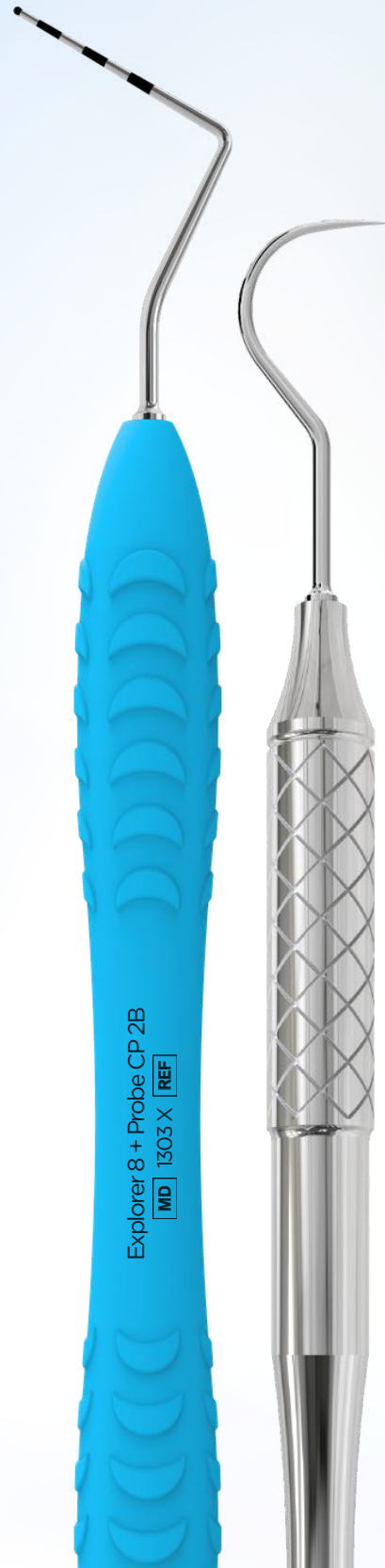

Explorer 8 + Probe CP 2B  
MD REF

# Explorers

Designed for everyday use, these explorers help you check teeth surfaces easily. Available in single and double-end options with comfortable handles.

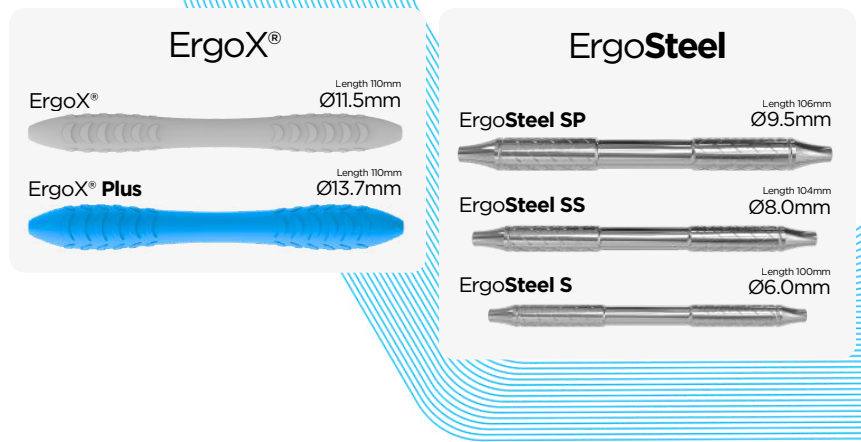

## Single-Ended

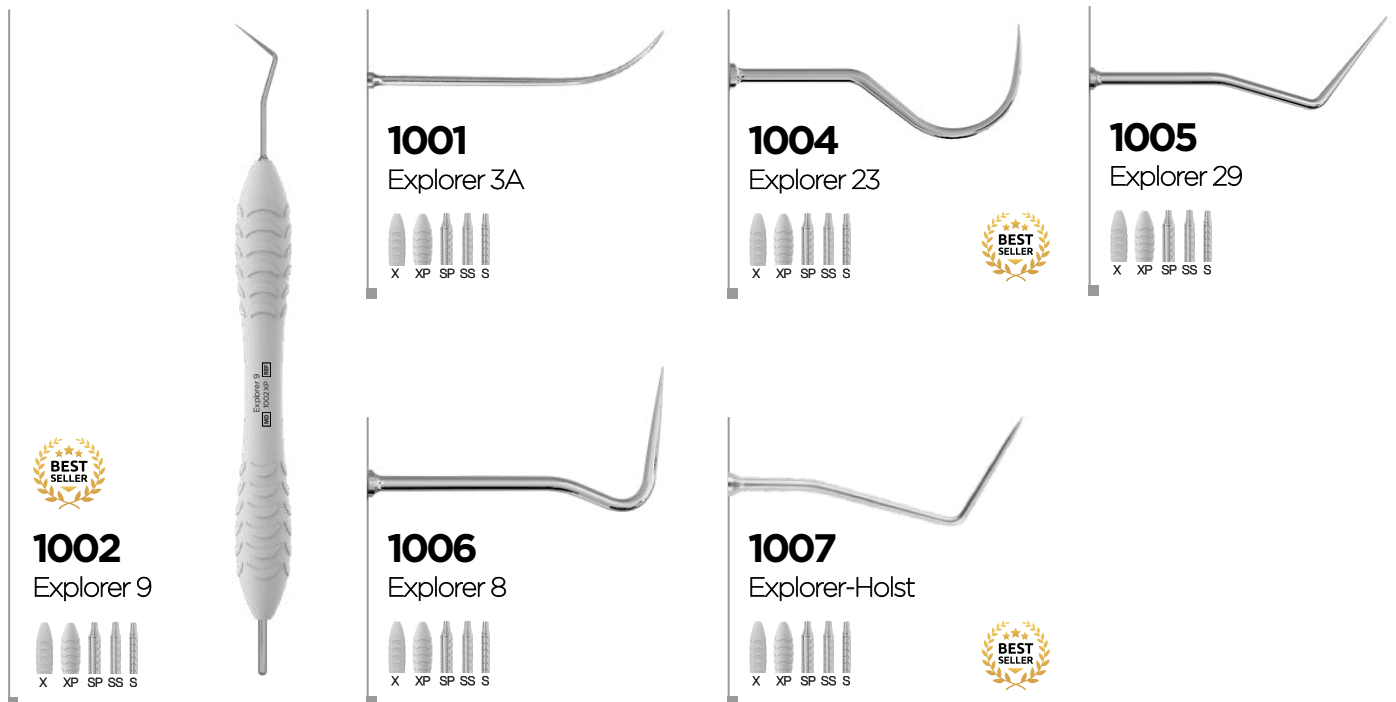

## Double-Ended

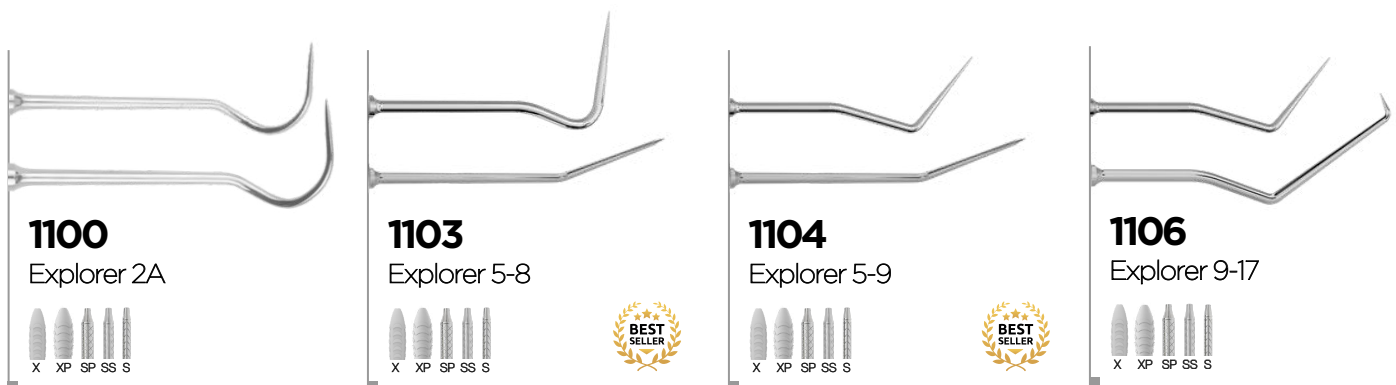

# Explorers

## Double-Ended

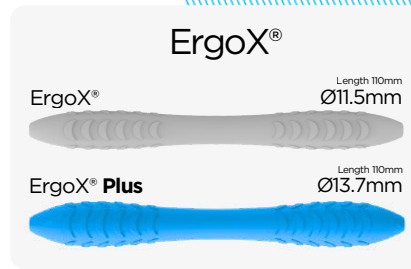

**1107**  
Explorer 17-23

X XP SP SS S

**BEST SELLER**

**1108**  
Explorer 17C-23

X XP SP SS S

**BEST SELLER**

**1111**  
Weston Explorer

X XP SP SS S

# Periodontal Probes

## Single-Ended

2-4-6-8-10-12mm

Probes CP 2  
1050 X

**BEST SELLER**

X XP SP SS S

**1050**  
Probe CP 2  
Ball End : 2-4-6-8-10-12mm

**BEST SELLER**

2-4-6-8-10-12mm

**1051**  
Probe CP 2B  
Ball End : 2-4-6-8-10-12mm

X XP SP SS S

**BEST SELLER**

3-6-8-11mm

**1052**  
Probe CP 11  
Ball End : 3-6-8-11mm

X XP SP SS S

**BEST SELLER**

3-6-9-12mm

**1053**  
Probe CP 12  
Ball End : 3-6-9-12mm

X XP SP SS S

**BEST SELLER**

3-6-9-12mm

**1054**  
Probe CP 12B  
Ball End : 3-6-9-12mm

X XP SP SS S

**BEST SELLER**

1-15mm

**1055**  
North Carolina & Probe CP 15  
Ball End : 1-15mm

X XP SP SS S

**BEST SELLER**

3-5-8-10mm

**1056**  
Probe CP 18  
Ball End : 3-5-8-10mm

X XP SP SS S

**BEST SELLER**

3-5-5.5-8.5-11.5mm

**1057**  
WHO Probe  
Ball End : 3-5-5.5-8.5-11.5mm

X XP SP SS S

**BEST SELLER**

3-5-8-11mm

**1058**  
William Probe  
Ball End : 3-5-8-11mm

X XP SP SS S

# Periodontal Probes

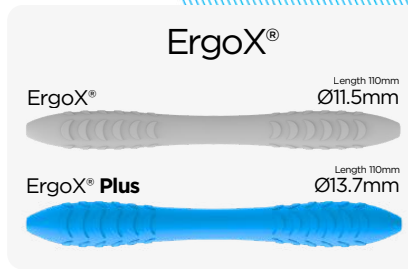

## Double-Ended

Explorer 8+ Probe CP 2B  
1303 X [MP]

<p><b>1300</b> Probe CP 2 &amp; Explorer 6 2-4-6-8-10-12mm</p> <p><b>1301</b> Probe CP 15 &amp; Explorer 6L 1-15mm</p> <p><b>1112</b> Probe William &amp; Explorer Holst 3-5-8-11mm</p>	<p><b>1304</b> WHO Probe &amp; Explorer 8 Ball End . 3.5-5.5-8.5-11.5mm</p> <p><b>1305</b> Probe CP 15 &amp; Explorer 8 1-15mm</p> <p><b>1306</b> Probe CP 18 &amp; Explorer 9 3-5-8-10mm</p>	<p><b>1303</b> Probe CP 2B &amp; Explorer 8 2-4-6-8-10-12mm</p> <p><b>1307</b> Probe CP 2 &amp; Explorer 23 2-4-6-8-10-12mm</p> <p><b>1308</b> Probe CP 2B &amp; Explorer 23 2-4-6-8-10-12mm</p> <p><b>1309</b> WHO Probe &amp; Explorer 23 3.5-5.5-8.5-11.5mm</p>	<p><b>1310</b> Probe CP 12 &amp; Explorer 23 3-6-9-12mm</p> <p><b>1311</b> Probe CP 12B &amp; Explorer 23 3-6-9-12mm</p> <p><b>1312</b> Probe CP 15 &amp; Explorer 23 1-15mm</p> <p><b>1313</b> Probe CP 18 &amp; Explorer Holst 3-5-8-10mm</p>
---	---	--	---

Legend: X, XP, SP, SS, S

Best Seller icons: BEST SELLER

# Periodontal Probes

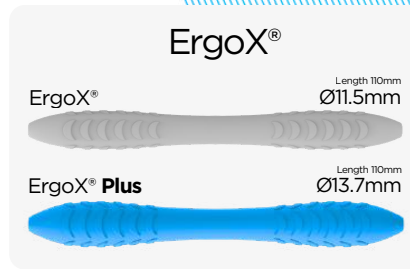

## Double-Ended



**1113**  
Furcation Probe

without measurements

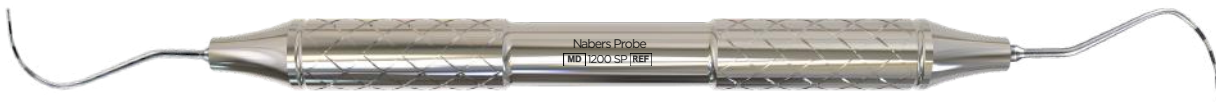
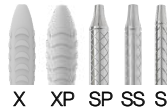

**1200**  
Nabers Probe

2-4-6-8-10-12mm



# Mirror Handles

## ErgoSteel Mirror Handles

ErgoSteel  
Mini  
Mirror handle



1450 S

Ø 6mm  
Length 125mm

ErgoSteel  
Standard  
Mirror handle



1450 SS

Ø 8mm  
Length 125mm

ErgoSteel  
Plus  
Mirror handle



1450 SP

Ø 9.5mm  
Length 125mm

Chrome  
Plated  
Mirror handle



1453 SS

Ø 8mm  
Length 135mm

# ErgoX<sup>®</sup>

## Mirror handles

Find your perfect fit with our ergonomic mirror handles

**NEW**  
Also available now  
in cone socket.

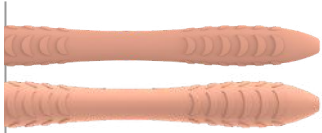
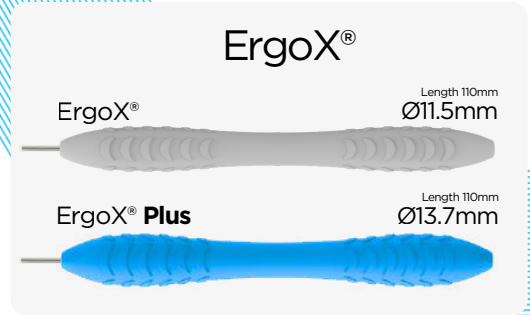

**Peach Blush**  
1401  
X | XP



**Magenta Blue**  
1402  
X | XP For Cone Socket C-X | C-XP



**Deep Blue**  
1403  
X | XP

**15**  
colors

**2**  
Handles

**BEST SELLER**

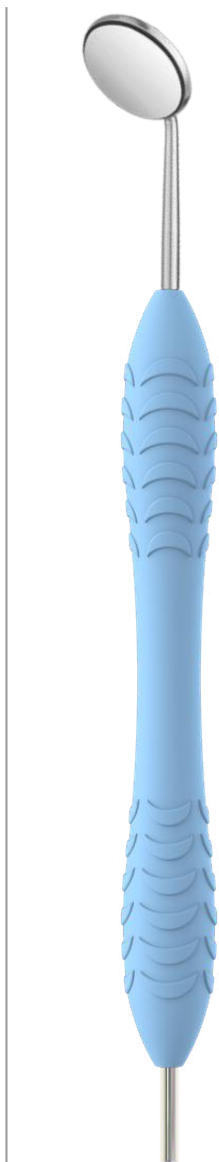

**Sky Cyan**  
1404  
X | XP

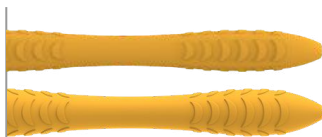

**Honey Brown**  
1405  
X | XP For Cone Socket C-X | C-XP

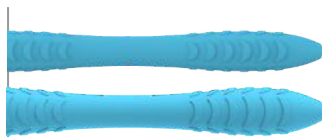

**Aqua Light**  
1406  
X | XP For Cone Socket C-X | C-XP



**Citrus Orange**  
1407  
X | XP For Cone Socket C-X | C-XP



**Petal Pink**  
1408  
X | XP



**Ruby Pink**  
1409  
X | XP For Cone Socket C-X | C-XP

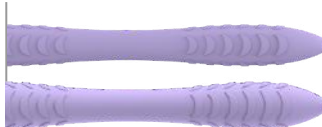

**Lilac Blue**  
1410  
X | XP



**Earth Brown**  
1411  
X | XP



**Teal Deep**  
1412  
X | XP



**Misty Cyan**  
1413  
X | XP For Cone Socket C-X | C-XP







**Lemon Green**  
1414  
X | XP For Cone Socket C-X | C-XP



**Pure Black**  
1415  
X | XP For Cone Socket C-X | C-XP

Precision Vision for Endodontics

# MICROSCOPIC MIRRORS

Size	Regular	Ultrathin
3mm	7091R	7091U 
5mm	7092R	7092U 
7mm	----	7095U 
2x7mm	7093R	----
3x6mm (Oval)	----	7093U 
3x6mm (WaterDrop)	----	7094U 
3x9mm	7094R	----



3x9mm 2x7mm 3x6mm 5mm 3mm

Ultrathin  
**0.7mm**



Regular  
**1.5mm**

36-layer coated, anti-glare mirror for clear visibility in microscope-assisted procedures. Available in two thicknesses: ultra-thin 0.7mm for maximum access and visibility, and standard 1.5mm for added durability. Sold with the ErgoLite mirror handle.

*Sharper details*

*Confident Endo Work*

*Better Control*

# Front-Surface

No double image - the rhodium layer ensures a clear, single reflection. Suitable for all CS & SS-thread mirror handles

For SS (Simple Stem)

Size	Art nr.
<b>NEW</b> Ø10mm	1510F
<b>NEW</b> Ø12mm	1512F
<b>NEW</b> Ø14mm	1514F
No. 3 - Ø20mm	1503F
No. 4 - Ø22mm 	1504F
No. 5 - Ø24mm	1505F

For CS (Cone Socket)

Size	Art nr.
No. 3 - Ø20mm	1503FC
No. 4 - Ø22mm	1504FC
No. 5 - Ø24mm	1505FC

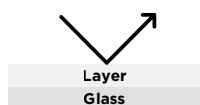

12pcs / box

# Plane-Surface

Suitable for all CS & SS-thread mirror handles

For SS (Simple Stem)

Size	Art nr.
No. 3 - Ø20mm	1503P
No. 4 - Ø22mm 	1504P
No. 5 - Ø24mm	1505P

For CS (Cone Socket)

Size	Art nr.
No. 3 - Ø20mm	1503PC
No. 4 - Ø22mm	1504PC
No. 5 - Ø24mm	1505PC

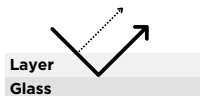

12pcs / box

# HD Mirrors in box

Available in 4 colors and 2 sizes  
Compatible with ErgoLite and ErgoSteel SS mirror handles

Sharpen your vision. Perfect your precision.

- Anti** Fog
- 40%** Brighter than FS
- Ultra** Clear view

**Note:** Not suitable for ErgoX® or ErgoX® Plus mirror handles



Color	Ø22mm	Ø24mm
Black	1514HK	1515HK
Green	1514HG	1515HG
Blue	1514HB	1515HB
Pink	1514HP	1515HP



12pcs / box

# Diagnostics Kits

## Basic Diagnostic Kit

A practical starter set dentists love for everyday examinations, supplied in a sterilization cassette for organized storage, easy handling, and efficient sterilization.

**9908**

Available in



X XP SP

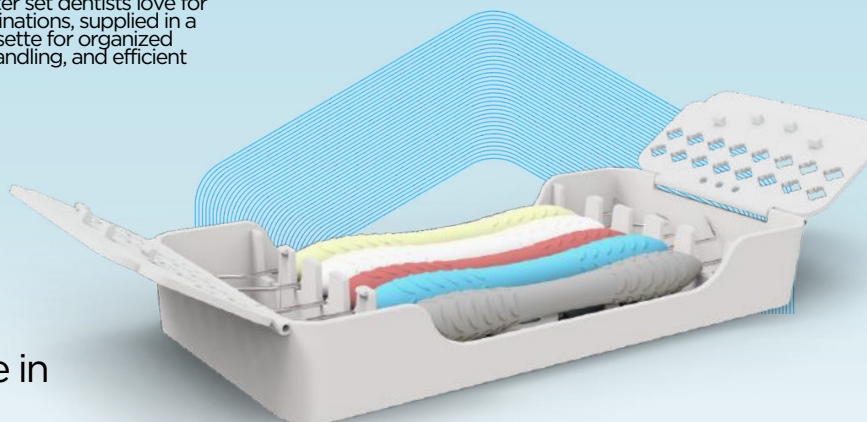

### Instruments

ErgoX® Mirror handle  
**1401**



Explorer 5-9  
**1104**



Explorer 23 + WHO Probe  
**1309**



Round Excavator, 1,5mm  
**2802**



College Tweezer, Serrated 15cm  
**3627-1A**



**5 instruments + cassette**

## Super Diagnostic Kit

A complete instrument set for routine diagnostics and restorative procedures, organized in a sterilization cassette for efficient handling and sterilization.



**9909**

Available in



X XP SP

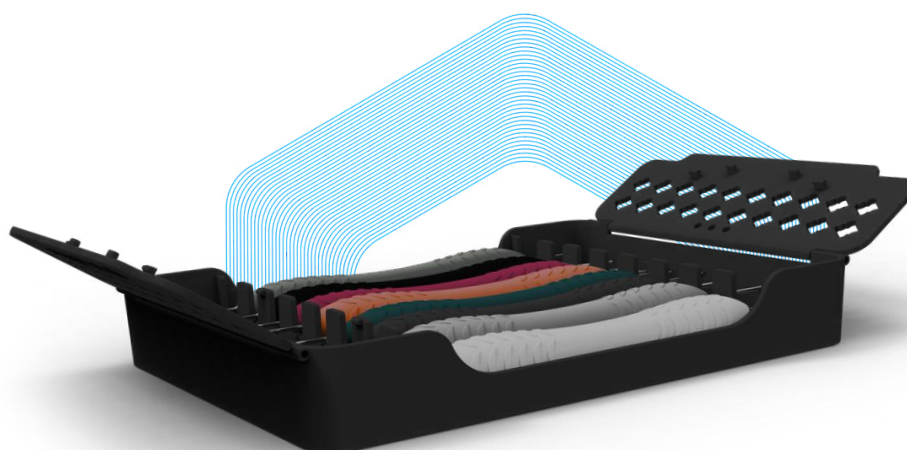

### Instruments

ErgoX® Mirror handle, Peach Blush  
**1401**



Explorer 17-23  
**1107**



Explorer 9  
**1002**



Probe CP-12 (3-6-9-12mm)  
**1053**



Plastic Instrument-Posterior  
**2548**



Nystrom III  
**2525**



Round Excavator, 1,5mm  
**2802**



Meriam Tweezer, 16 cm, TC  
**3636-2A**



**8 instruments + cassette**

# Restoration



Round Excavator 1.5mm  
MD 2802 X REF

Carver Nys III  
MD 2525 XP REF

Shaper Filling  
MD 2576 SP REF

# Excavators

Available in round, action, and spoon types with 5 handle options, designed for efficient removal of decayed tissue.

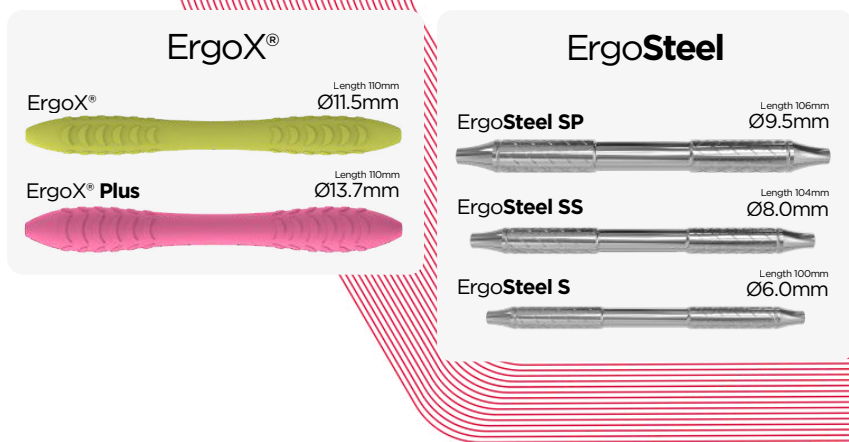

## Round Excavators



## Action Excavators



# Spoon Excavators

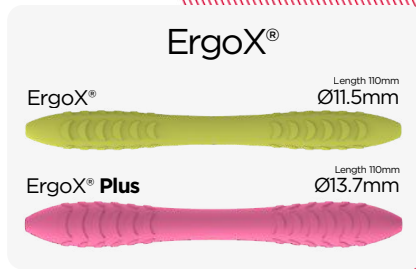

## Know your Excavators

Our dental excavators are designed for safe, efficient decay removal

**Action Excavator**  
Combines the benefits of spoon and round types for versatile, effective performance.

**Round Excavator**  
Reaches tight curves for precise cleaning.

**Spoon Excavator**  
Gently scoops out soft decay while preserving healthy tissue..



# Composite & Filling instruments

Perfect for shaping, placing, and finishing composites and fillings. Available in various designs and handle options for easy handling and comfort.

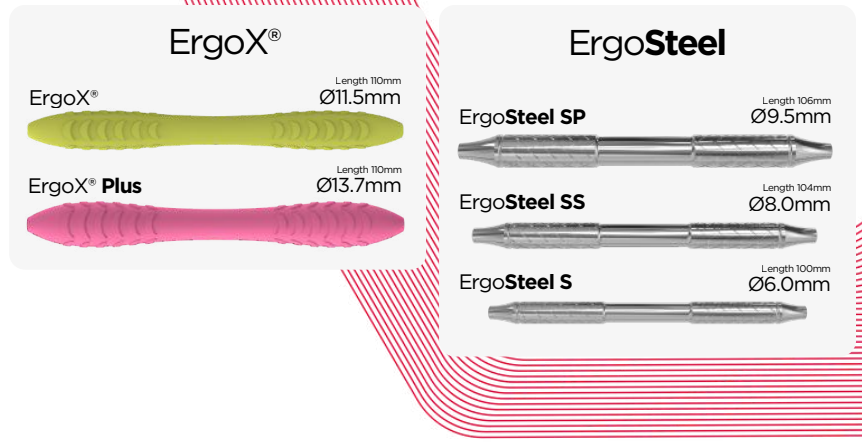

## Pluggers & Burnishers

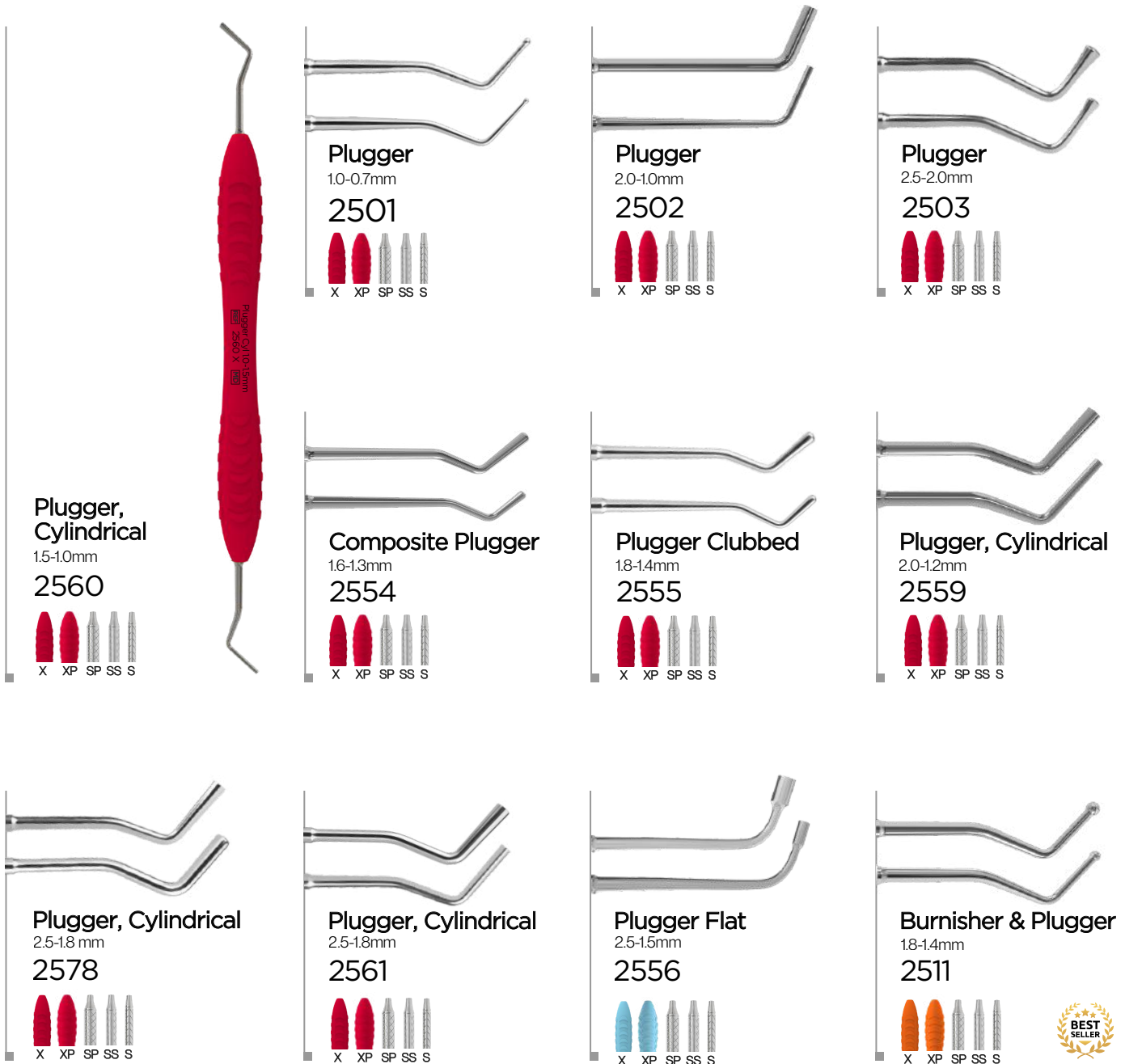

# Pluggers & Burnishers

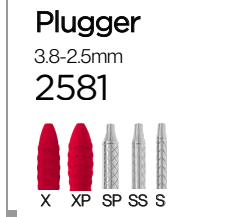
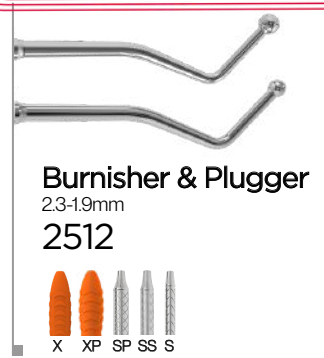
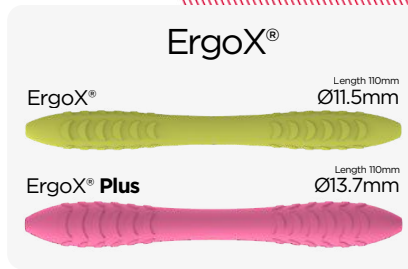

# Cement & Composite Spatulas



 <p><b>Composite Spatula 6</b> 2.5mm <b>2551</b></p> <p><b>BEST SELLER</b></p> <p>X XP SP SS S</p>	<p><b>Cement Spatula</b> 5.0mm <b>2568</b></p> <p>SP</p> <p><b>Cement Spatel</b> <b>2567</b></p> <p>X XP SP SS S</p>	<p><b>Cement Spatula</b> 6.0mm <b>2569</b></p> <p>SP</p> <p><b>Mini Spatula</b> 2.0mm <b>2550</b></p> <p>X XP SP SS S</p>	<p><b>Cement Spatula</b> 7.0mm <b>2570</b></p> <p>SP</p> <p><b>Composite Instrument Posterior</b> 2.5-2.2mm <b>2552</b></p> <p>X XP SP SS S</p> <p><b>BEST SELLER</b></p>
--	--	---	---

**Universal Spatula**  
1.5-2.0mm  
**2571**





Uni Spatel 1.5-2.0mm  
REF 2571 XP MD

X XP SP SS S

**BEST SELLER**

## Base Carriers

 <p><b>Base Carrier - Rigid</b> 0.9-06mm <b>2506</b></p> <p>X XP SP SS S</p>	 <p><b>Base Carrier - Condenser Malleable Tip</b> 0.9mm <b>2507</b></p> <p>X XP SP SS S</p>	 <p><b>Base Carrier - Condenser Rigid</b> 0.9mm <b>2508</b></p> <p>X XP SP SS S</p>
--	--	---

# Carvers

**ErgoX®**

ErgoX® Length 110mm Ø11.5mm

ErgoX® Plus Length 110mm Ø13.7mm

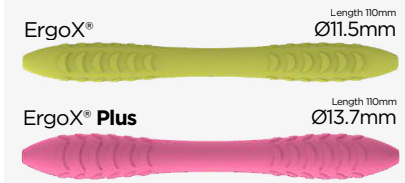

**ErgoSteel**

ErgoSteel SP Length 106mm Ø9.5mm

ErgoSteel SS Length 104mm Ø8.0mm

ErgoSteel S Length 100mm Ø6.0mm



**Nystrøm I**  
2.0mm  
2524

Carver Nys I  
REF 2524 XP MD

**BEST SELLER**



X XP SP SS S

**Nystrøm III**  
1.7mm  
2525

Carver Nys III  
REF 2525 XP MD

**BEST SELLER**



X XP SP SS S

**Heidemann**  
2.0mm  
2519



X XP SP SS S

**Heidemann**  
2.5mm  
2520



X XP SP SS S

**Heidemann**  
3.0mm  
2521



X XP SP SS S

**Carver 5**  
2.5-2.0mm  
2523



X XP SP SS S

**Knife-Carver**  
2.0mm  
2526



X XP SP SS S

# Condensers

**ErgoX®**  
Length 110mm  
Ø11.5mm

**ErgoX® Plus**  
Length 110mm  
Ø13.7mm

**ErgoSteel**

**ErgoSteel SP**  
Length 106mm  
Ø9.5mm

**ErgoSteel SS**  
Length 104mm  
Ø8.0mm

**ErgoSteel S**  
Length 100mm  
Ø6.0mm

**Amalgam Condenser**  
2.5-2.0mm  
**2505**

**Amalgam Condenser**  
1.5-1.0mm  
**2504**

**Filling Contour**  
2.0mm  
**2564**

**BEST SELLER**

**Condenser, Drop-Shaped**  
1.8-1.3mm  
**2572**

**Form Condenser**  
2.5-1.5mm  
**2562**

**BEST SELLER**

**Filling Flow 1**  
1.0mm  
**2563**

# Filling instruments

**Filling Remover**  
1.5-0.5mm  
**2547**

**UP1 Plastic filling**  
1.6mm  
**2546**

**Filling Instrument-C49**  
1.7-1.2mm  
**2589**

**Filling Instrument-PFI 8A**  
1.7mm  
**2585**

**Filling Instrument-PFI 6**  
1.5mm  
**2584**

**Filling Instrument-PFI UP1**  
1.7mm  
**2583**

**Filling Instrument-UP1**  
2.0-1.75mm  
**2582**

# Filling instruments

**ErgoX®**

ErgoX® Length 110mm Ø11.5mm

ErgoX® Plus Length 110mm Ø13.7mm

**ErgoSteel**

ErgoSteel SP Length 106mm Ø9.5mm

ErgoSteel SS Length 104mm Ø8.0mm

ErgoSteel S Length 100mm Ø6.0mm

## Special Filling Instrument

2.5-2.0mm

2542



## Plastic Instrument-Posterior

2.0-1.4mm

2548



## Plastic Instrument-Anterior

1.7-1.2mm

2549



## Filling Applicator

1.5mm

2531



## Filling Shaper

1/2.5mm-0.5/1mm

2534



## Filling Condensor

1.4-0.7mm

2535



## Goldfogel Composite Contouring

2595

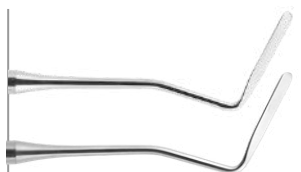

## Filling Twister

2532



## Filling Contour Spatel

2533

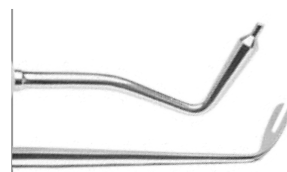

## Filling Fork

2536

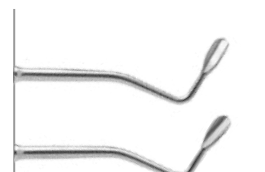

## Filling Sculptor Posterior

2537



# Filling instruments

**ErgoX®**

ErgoX® Length 110mm Ø11.5mm

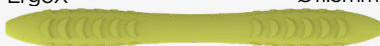

ErgoX® Plus Length 110mm Ø13.7mm



**ErgoSteel**

ErgoSteel SP Length 106mm Ø9.5mm



ErgoSteel SS Length 104mm Ø8.0mm



ErgoSteel S Length 100mm Ø6.0mm





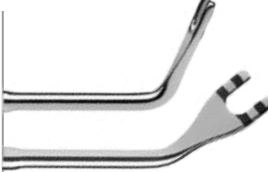

**Filling Trimmer**  
2538

**Filling Former**  
2539

**Filling Anterior**  
2540





**Filling Posterior**  
2541



# Cord Packers

**Retraction Cord Paker-UP1**  
2.0mm  
2545



Cord Paker-UP1  
REF 2545 X MD



**Cord Packer**  
2.0mm  
2543



Cord Packer 2.0mm  
REF 2543 XP MD



**BEST SELLER**

**Cord Packer**  
2.6mm  
2544



Cord Packer 2.6mm  
REF 2544 SP MD



# ErgoSlip

Non-stick composite  
instruments

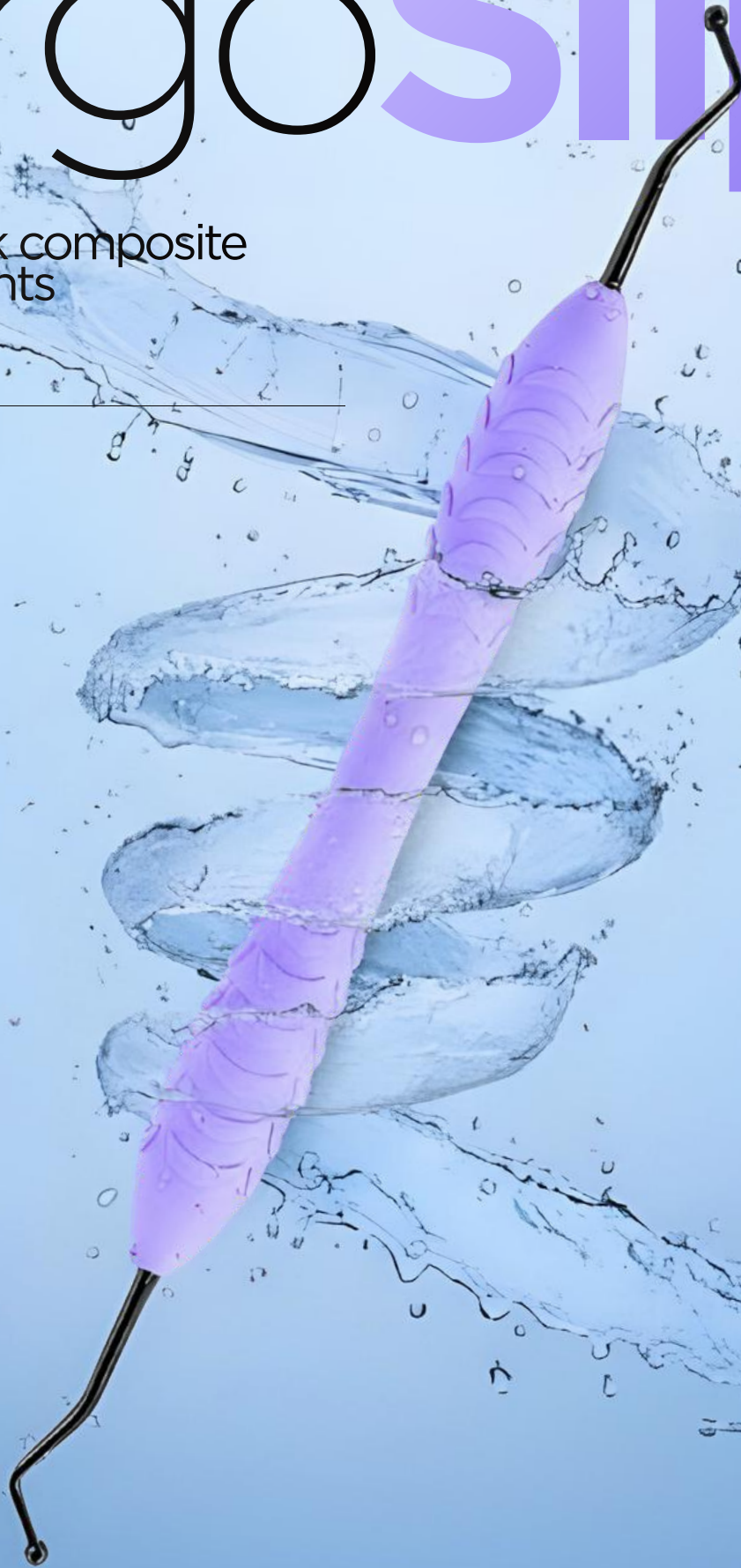

SCAN ME



Discover More Online  
Scan the QR Code



No More  
Sticking



Hygienic  
and Easy



Available in Gold,  
Black, Blue

# Choose your ErgoSlip

## Black

A low-glare black titanium coating that enhances contrast and visibility in the operative field. Delivers strong non-stick properties and is especially useful in deep cavities or aesthetic zones.

## Blue

A durable blue titanium coating that provides reliable non-stick performance with a balanced feel. Ideal for everyday restorative work where smooth material handling and consistency are key.

## Gold

A premium gold titanium coating designed to reduce composite sticking during restorative procedures. Offers smooth handling, high wear resistance, and excellent corrosion protection for long-lasting clinical performance.

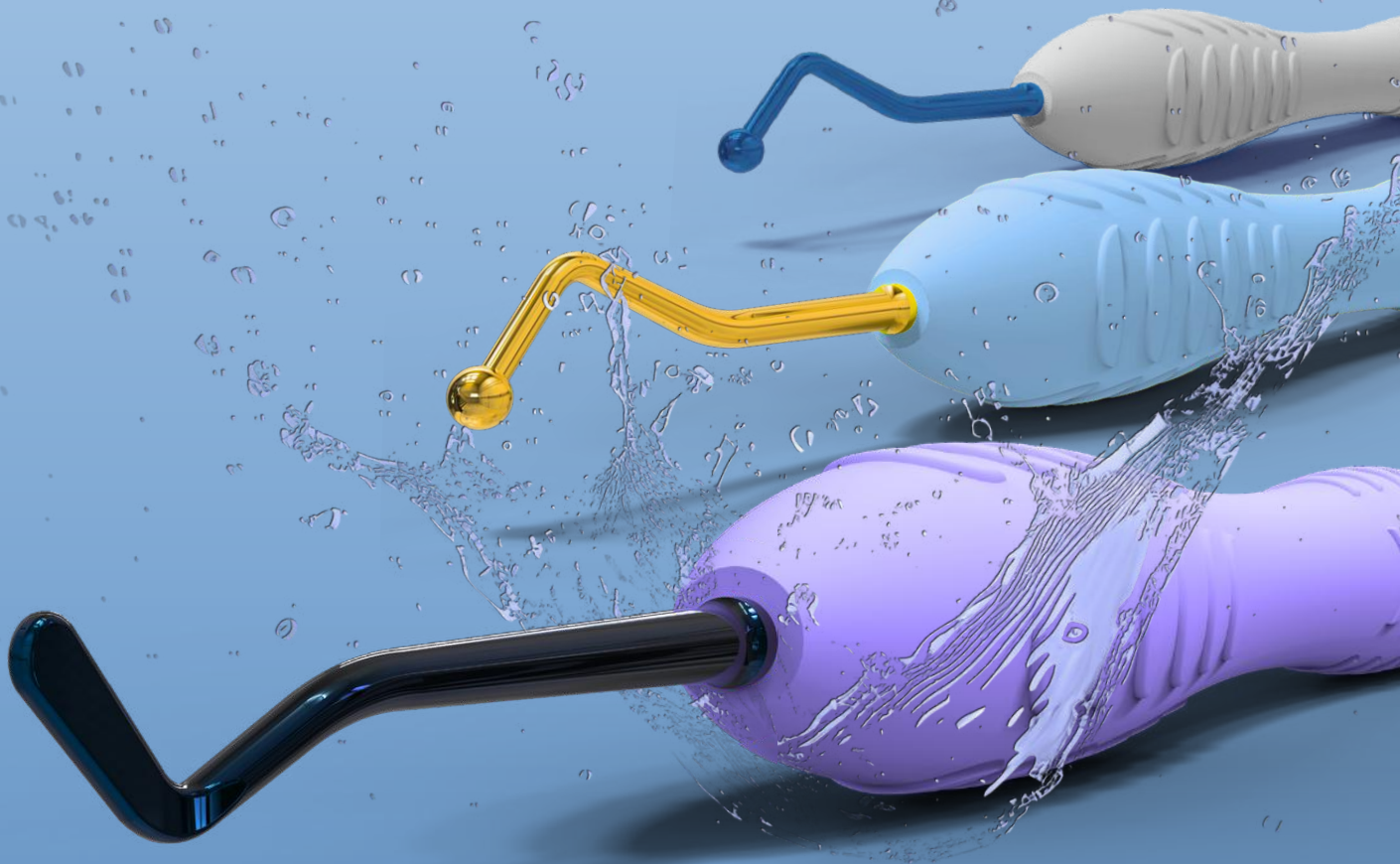

# ErgoSlip

Available in blue, gold, and black coatings with ErgoX®, ErgoX® Plus, and ErgoSteel Plus handles. Each set includes an ErgoTray-1 for secure handling.

Perfect For: Composite placement, restorative procedures, and general dentistry.

**Smoother Restorations, Every Time.**

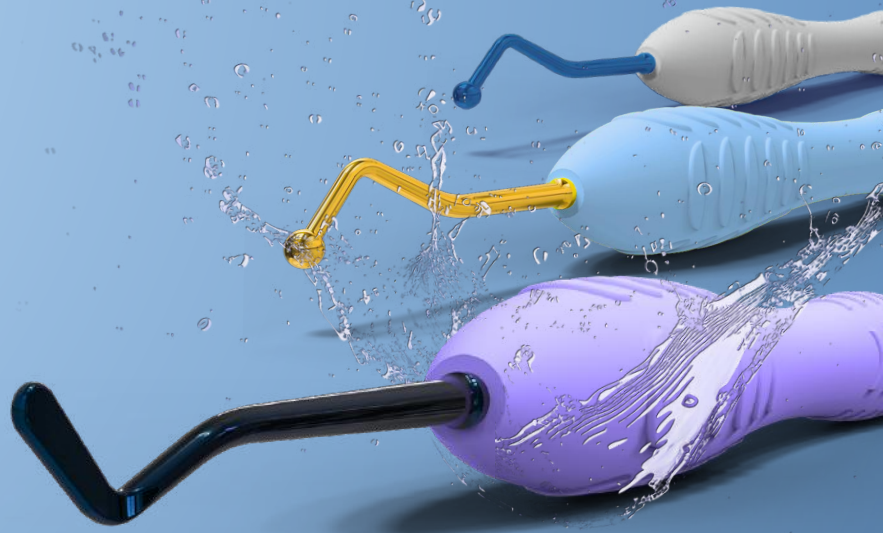

Each ErgoSlip comes with an ErgoTray-1.

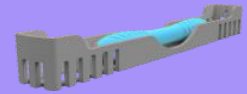

Plugger  
1.2-1.0mm

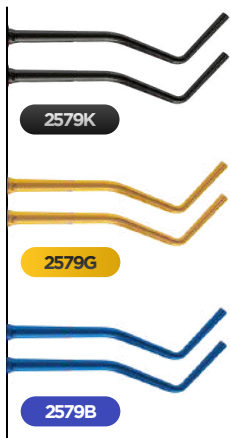

Plugger  
1.6-1.4mm

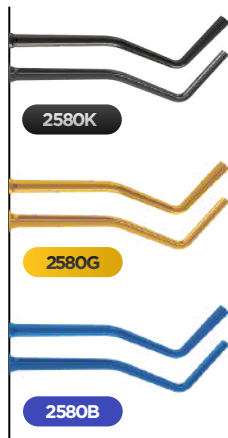

Plugger  
3.8-2.5mm

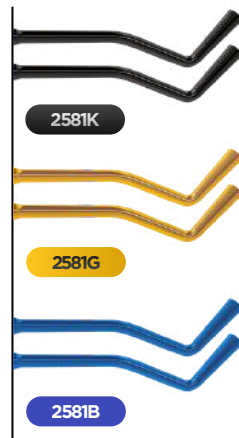

Plugger, Cylindrical  
2.5-1.8mm

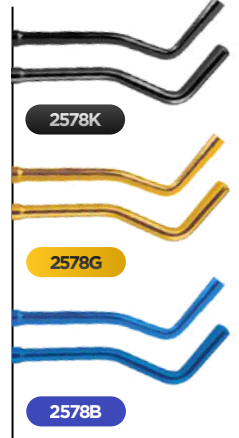

Burnisher  
2.0-1.5mm

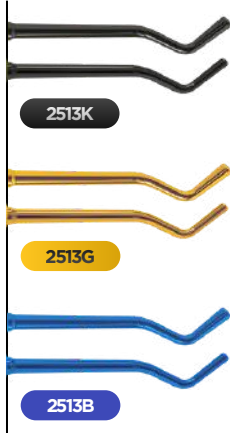

Burnisher & Plugger  
Ball ended, 2.5-1.5mm

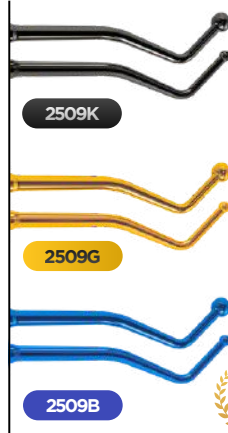

Shaper Filling,  
3.0-2.5mm

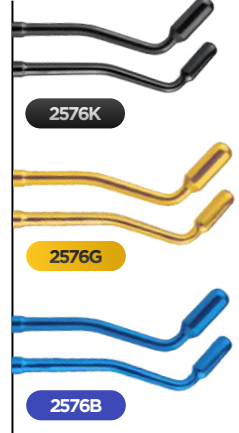

Shaper Filling Slim  
2.5mm-2.0mm

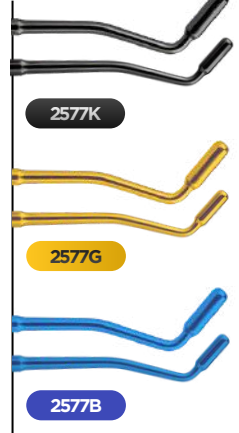

Filling Instrument-UP1  
2.0-1.75mm



# ErgoSlip

Smoother Restorations, Every Time.

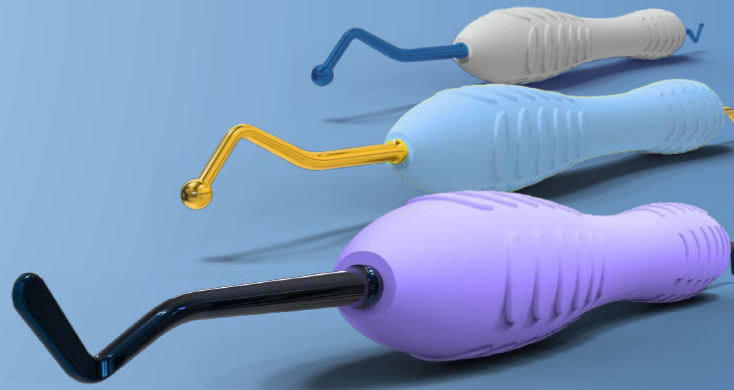

Filling Instrument-C49  
1.7-1.2mm



Filling Twister

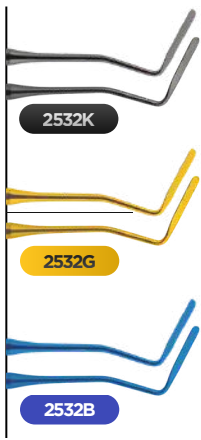

Universal Spatula  
2.0-1.5mm

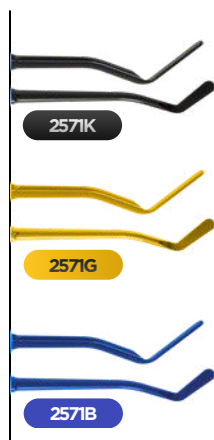

Mini Spatula  
2.0mm



Condenser, Drop-Shaped  
1.3-1.8mm

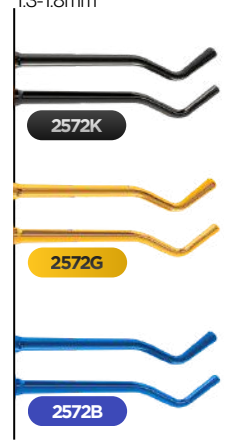

Plastic Instrument-Posterior  
2.0-1.4mm



Filling Trimmer

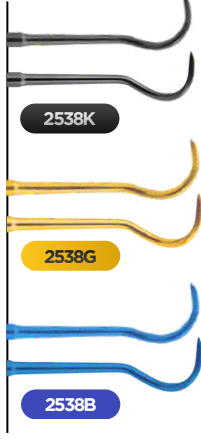

Filling Contour Spatula



Filling Sculptor Posterior

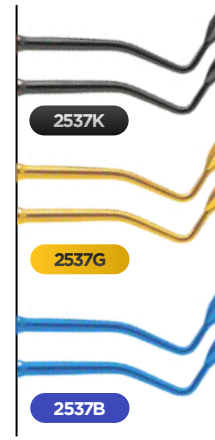

Plastic Instrument-Anterior  
1.7mm-1.2mm



Filling Applicator  
1.5mm

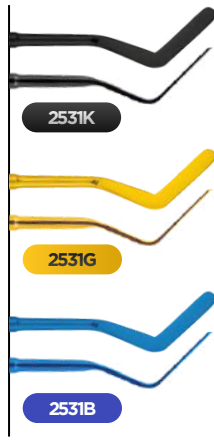

Filling Shaper  
1.0-0.5 / 2.5-1.0mm

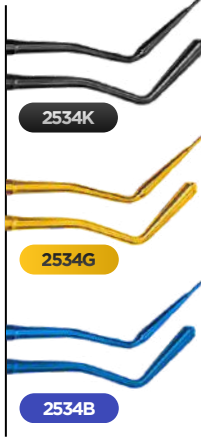

Filling Condensor  
1.4-0.7mm

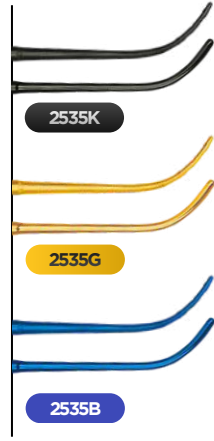

Filling Contour  
2.0mm

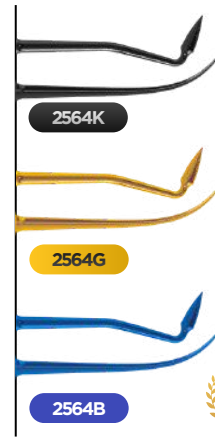

Filling Anterior



# ErgoSlip

Smoother Restorations, Every Time.

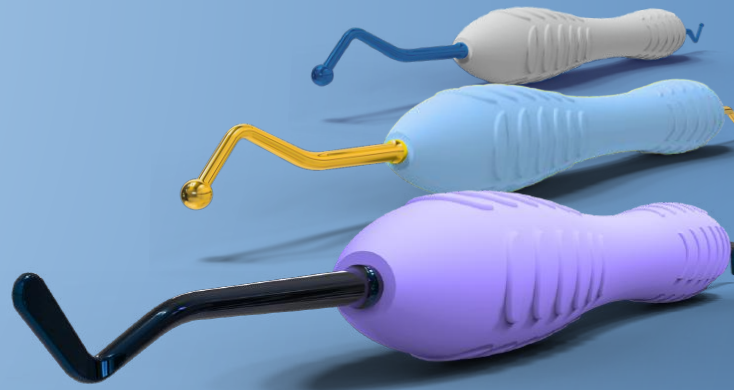

2536K

2536G

2536B

Filling Fork



Knife-Carver  
2.0mm

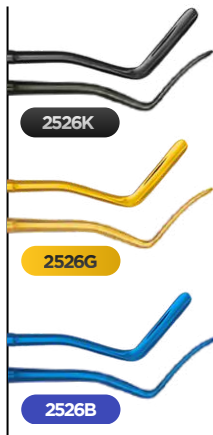

2526K

2526G

2526B

Filling Instrument-PFI  
8A  
1.7mm



2585K

2585G

2585B

Filling Instrument-PFI  
6  
1.5 mm

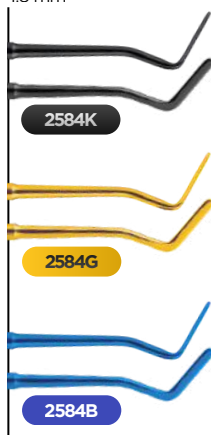

2584K

2584G

2584B

Filling Instrument-PFI  
UP1  
1.7 mm

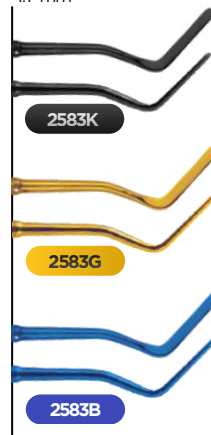

2583K

2583G

2583B

## ErgoSlip All Round Compo Set

Used for easy placement, shaping, and finishing of composite materials. Blue non-stick coated tips help reduce sticking and improve control during restorative work. Supplied in a sterilization cassette.



9910

Available in



X XP SP

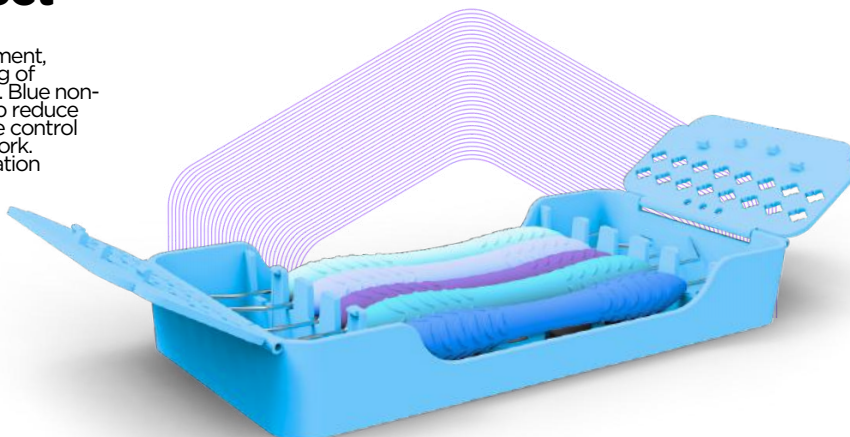

## Instruments

Universal Spatula, 1.5-2.0mm  
2571B



Mini Spatula, 2.0-2.0mm  
2550B



Plastic Instrument-Anterior, 1.7-1.2mm  
2549B



Burnisher, 2.0-1.5mm  
2513B



Burnisher & Plugger, Ball ended, 2.5-1.5mm  
2509B



5 instruments + cassette

# Composite kits

## Restoration Kits Compo Set 5

Used for precise placement, shaping, and finishing of composite restorations. A practical set of essential instruments for everyday restorative procedures, supplied in a sterilization cassette for organized storage and sterilization.

### 9911

Available in



X XP SP

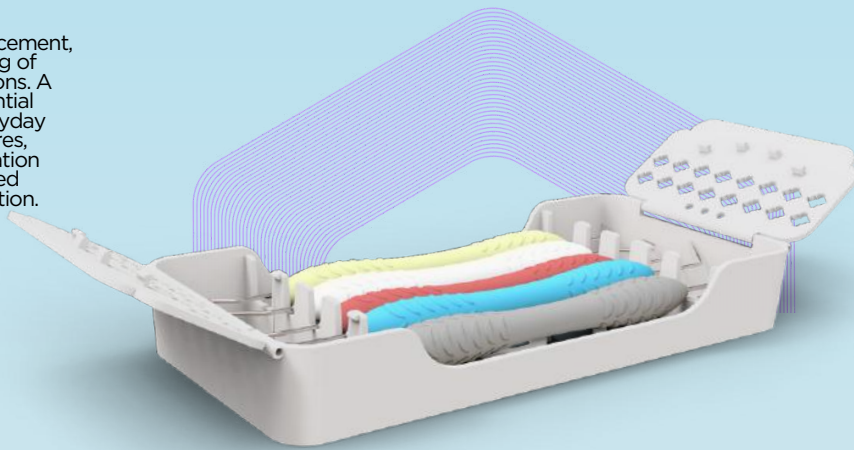

### Instruments

Form Condenser, 2.5-1.5mm  
**2562**



Mini Spatula, 2.0-2.0mm  
**2550**



Plastic Instrument-Anterior, 1.7-1.2mm  
**2549**



Filling Flow 1, 1.0mm  
**2563**



Mini Sickle 11-12  
**2182**



**5 instruments + cassette**

## Super Restoration Kit

Used for efficient composite placement, contouring, and finishing during restorative procedures. A comprehensive set of essential instruments for daily restorative work, supplied in a sterilization cassette for organized storage and sterilization.

### 9912

Available in



X XP SP

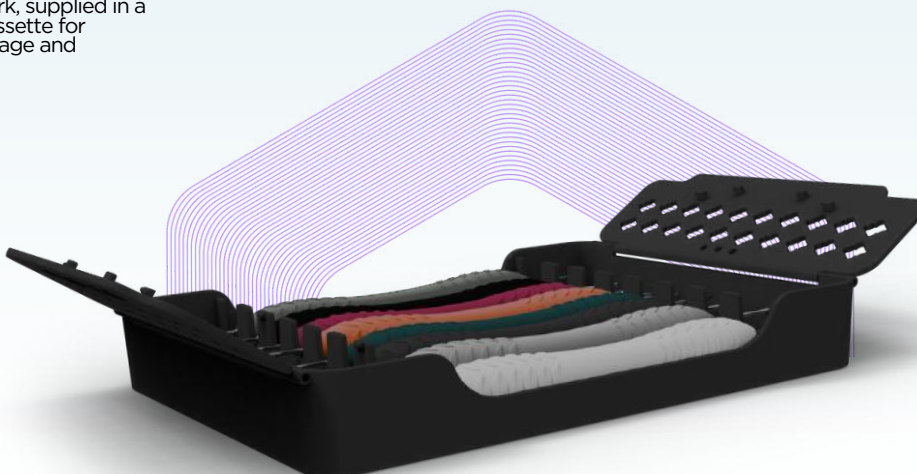

### Instruments

ErgoX® Mirror handle, Peach Blush  
**1401**



Explorer 23 + Probe CP-12B  
**1311**

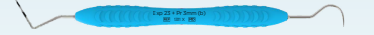

Round Excavator, 1.5mm  
**2802**



Burn/Plug Ball 1.5-2.5mm  
**2509**



Micro Sickle 01-02  
**2181**



Mini Spatula, 2.0-2.0mm  
**2550**



Form Condenser, 1.5-2.5mm  
**2562**



Meriam Tweezer, 16 cm  
**3636-1A**



**8 instruments + cassette**

# Periodontics



# Gracey curettes

ErgoDenta offers Gracey Curettes in Standard, Rigid, and Mini types, with ErgoX® and ErgoSteel handles for comfort and durability.

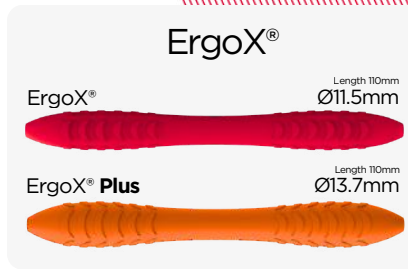

## Gracey Curettes



<p>Gracey 1-2 2001</p> <p><b>BEST SELLER</b></p> <p>X XP SP SS S</p>	<p><b>Gracey 3-4</b> 2002</p> <p>X XP SP SS S</p>	<p><b>Gracey 5-6</b> 2003</p> <p>X XP SP SS S</p>	<p><b>Gracey 7-8</b> 2004</p> <p>X XP SP SS S</p>	
	<p><b>Gracey 9-10</b> 2005</p> <p>X XP SP SS S</p>	<p><b>Gracey 11-12</b> 2006</p> <p>X XP SP SS S</p> <p><b>BEST SELLER</b></p>	<p><b>Gracey 13-14</b> 2007</p> <p>X XP SP SS S</p> <p><b>BEST SELLER</b></p>	
	<p><b>Gracey 15-16</b> 2008</p> <p>X XP SP SS S</p>	<p><b>Gracey 17-18</b> 2009</p> <p>X XP SP SS S</p>	<p><b>Gracey 11-14</b> 2010</p> <p>X XP SP SS S</p> <p><b>BEST SELLER</b></p>	<p><b>Gracey 12-13</b> 2011</p> <p>X XP SP SS S</p>

# Rigid Gracey Curettes

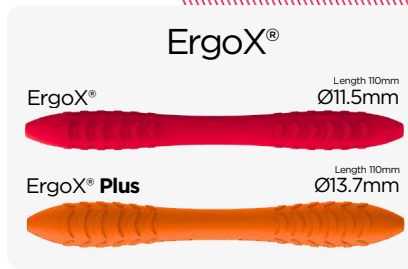

**Rigid Gracey 11-12**

2253



**Rigid Gracey 13-14**

2254



**Gracey P3-P4**

2014



# Mini Gracey Curettes



# Sickle Scalers

**ErgoX®**  
Length 110mm  
Ø11.5mm



**ErgoX® Plus**  
Length 110mm  
Ø13.7mm

**ErgoSteel**

**ErgoSteel SP**  
Length 106mm  
Ø9.5mm

**ErgoSteel SS**  
Length 104mm  
Ø8.0mm

**ErgoSteel S**  
Length 100mm  
Ø6.0mm



**Sickle Scaler H6-H7**  
2153



**Sharp Jack Scaler**  
2154

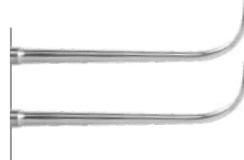

**Nebraska 128**  
2155



**Sickle Scaler 204S**  
2156



**Sickle Scaler 204SD**  
2157



**M23**  
2159



**M23A**  
2161



**Crane-Kaplan**  
2162



**Micro Sickie 01-02**  
2181



**Kirkland**  
2169 SP



**Mini Sickie 11-12**  
2182



**Furcator Scaler**  
2168



**Mini Excess Scaler**  
2184



# Universal Currettes

**ErgoX**  
 ErgoX®  
 Length 110mm  
 Ø11.5mm



ErgoX® Plus  
 Length 110mm  
 Ø13.7mm



**ErgoSteel**

ErgoSteel SP  
 Length 106mm  
 Ø9.5mm



ErgoSteel SS  
 Length 104mm  
 Ø8.0mm



ErgoSteel S  
 Length 100mm  
 Ø6.0mm



Columbia 2L-2R  
 REF: 2201 X MD

Columbia 2L-2R  
 2201



Columbia 4L-4R  
 2202



Columbia 13-14  
 2203



Barnhart 1-2  
 2204



Barnhart 5-6  
 2205



Langer 1-2  
 2206



Langer 3-4  
 2207



Langer 5-6  
 2208



Mini Langer 1-2  
 2209



Mini Langer 3-4  
 2210



Mini Langer 5-6  
 2211



Mccall 13S-14S  
 2212





Mini McCall 13S-14S  
 2213



McCall 17-18  
 2214

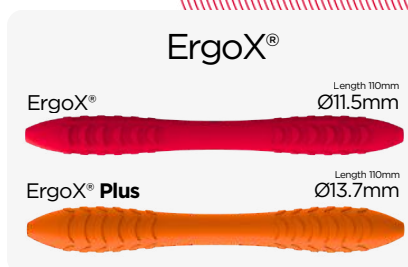

# Universal Currettes



McCall 17S-18S  
2215



Duplex Curette  
2217



Mini Duplex Curette  
2218



Duplex Anterior  
2219



Mini Duplex Anterior  
2220



Goldman-Fox 3  
2221



# Hoe Scalers



Hoe Scaler, Anterior  
2281



Hoe Scaler, Lateral  
2282



Hoe Scaler, Posterior  
2283



**NEW**

# Scalers & Curettes

*Blue*

# Titanium

Titanium  
Tips for Implant  
Maintenance

Titanium working ends for implant maintenance. Clean effectively around implants and restorations while helping protect implant surfaces from scratching.

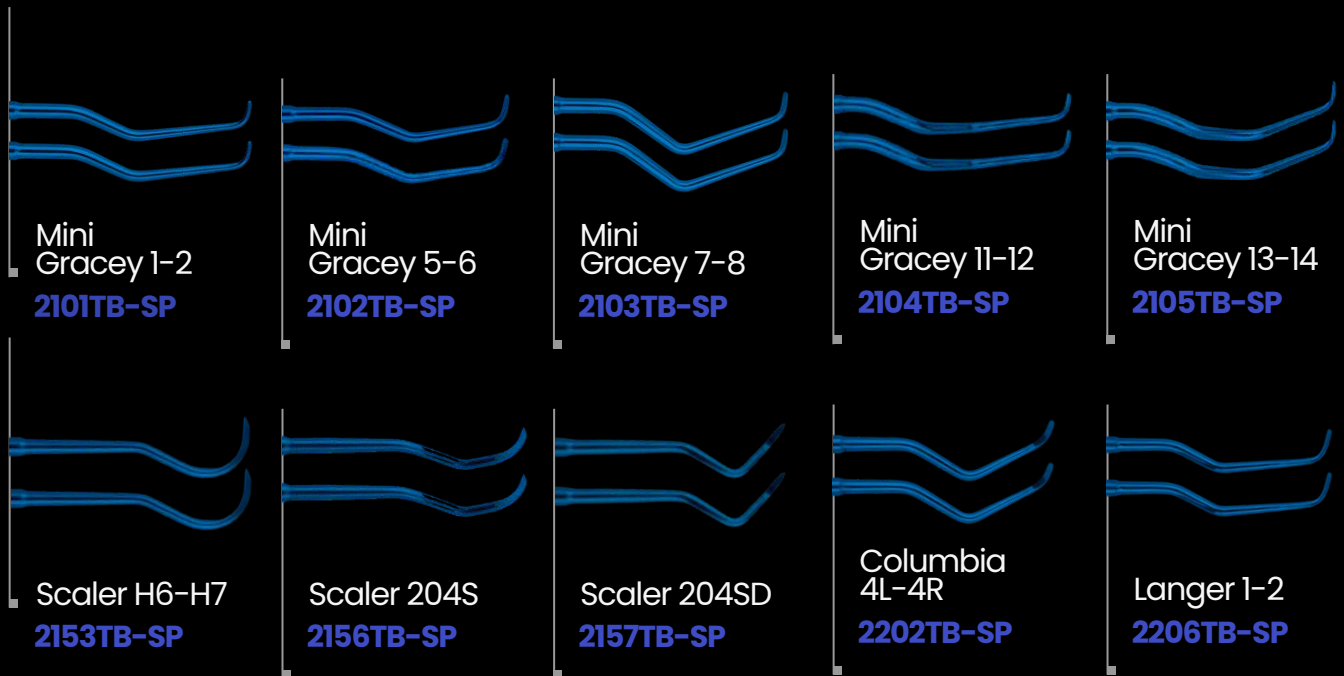

# ErgoRazor<sup>®</sup>

Scalers & Cures

ErgoRazor<sup>®</sup> is a registered trademark of ErgoDenta



Up to

**3X**

Longer  
Sharpness

SCAN ME



Discover More Online  
Scan the QR Code

# Choose your ErgoRazor

## ErgoRazor® Black

Coated with a sleek black finish to minimize glare and enhance visibility. Ideal for deep periodontal pockets and precision-focused procedures.

## ErgoRazor® Gold

Gold-coated for enhanced durability and smooth movement. Its corrosion resistance makes it a premium choice for clinicians who prioritize long-lasting performance.

## ErgoRazor®

Made from high-quality stainless steel, this tip offers dependable performance for routine scaling. Trusted for its balance of strength and precision.

## The World's First Perio Instruments Delivered in a Protective Tray

Every ErgoRazor® comes with ErgoTray-1 — protecting razor-sharp tips from damage, keeping instruments organized, and making handling and storage safer. Autoclaveable for full sterilization compatibility.



# ErgoRazor®

## Scalers & Currettes

ErgoRazor instruments deliver up to 3× longer-lasting sharpness for precise and efficient periodontal work.

Available with ErgoX® and ErgoX® Plus handles, in black or gold coating, or a silver finish without coating. Each ErgoRazor is supplied with ErgoTray-1 for safe handling and organized storage.

Upto **3X** longer sharpness



Each ErgoRazor comes with an ErgoTray-1.

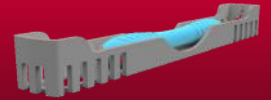

### Gracey curettes

■ All Surface   
 ■ Buccal-lingual   
 ■ Mesial   
 ■ Distal

Gracey 1-2	Gracey 3-4	Gracey 5-6	Gracey 7-8
   	 <b>BEST SELLER</b>  	   	   
Gracey 9-10	Gracey 11-12	Gracey 13-14	Gracey 15-16
 <b>BEST SELLER</b>  	  <b>BEST SELLER</b> 	  <b>BEST SELLER</b> 	   

# ErgoRazor®

Scalers & Curettes

Upto **3X** longer sharpness



## Gracey 17-18



2009RK

2009RG

2009R

## Gracey 11-14



2010RK

2010RG

2010R

## Gracey 12-13



2011RK

2011RG

2011R

## Did you know?

Instrument sharpness plays a key role in effective periodontal treatment.

One of the key ideas behind ErgoRazor.



Upto **3X** longer sharpness

## Mini Gracey Curettes



All Surface



Buccal-lingual



Mesial



Distal



Mini Gracey 1-2  
REF 2101R-SP MD



2101RK

2101GK

2101K

## Mini Gracey 1-2

## Mini Gracey 7-8

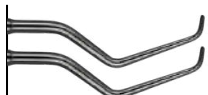

2103RK

2103RG

2103R

## Mini Gracey 11-12



2104RK

2104RG

2104R

## Mini Gracey 13-14



2105RK

2105RG

2105R

## Mini Gracey 15-16



2106RK

2106RG

2106R

## Mini Gracey 17-18



2107RK

2107RG

2107R

Upto **3X** longer sharpness



## Sickle Scalers



2153RK

2153GK

2153K

Sickle Scaler H6-H7

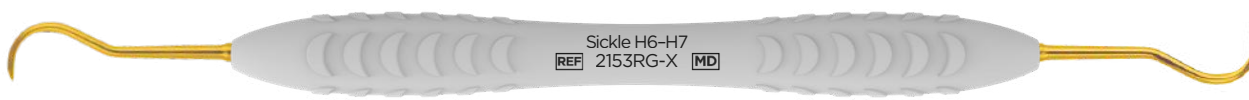

Sharp Jack Scaler

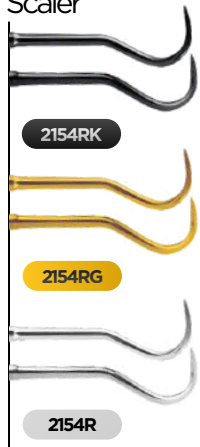

Nebraska 128

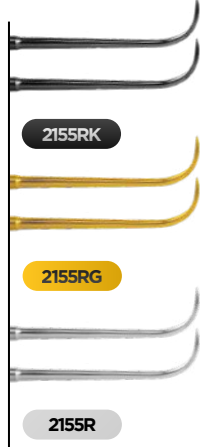

Sickle Scaler 204S

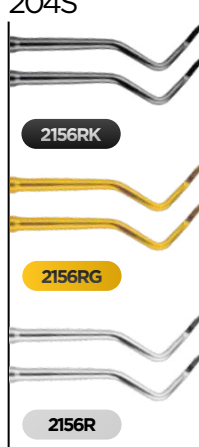

Sickle Scaler 204SD

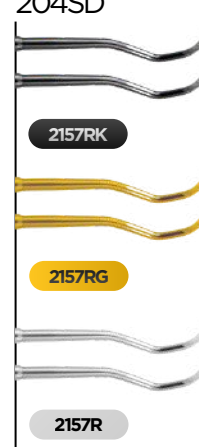

M23



M23A

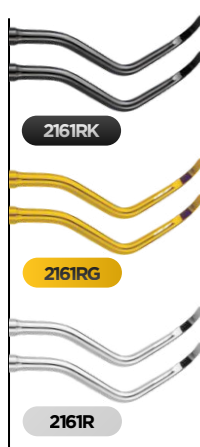

Crane-Kaplan

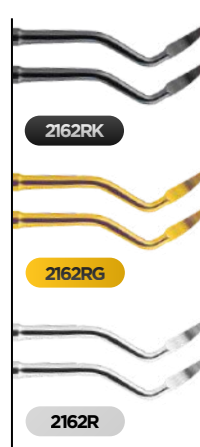

Mini Sickle Scaler 01-02



Mini Sickle Scaler 11-12

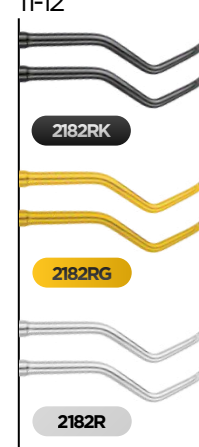

Upto **3X** longer sharpness



### Universal Currettes

Columbia  
2L-2R



Columbia  
4L-4R

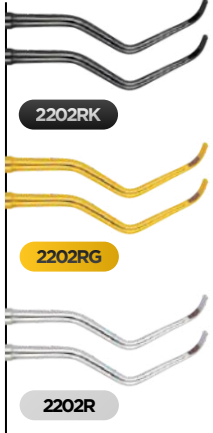

Columbia  
13-14



Barnhart 1-2

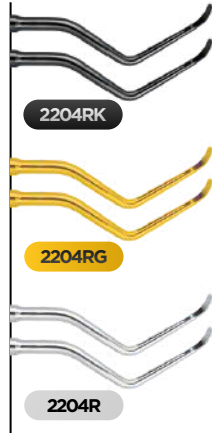

Barnhart 5-6

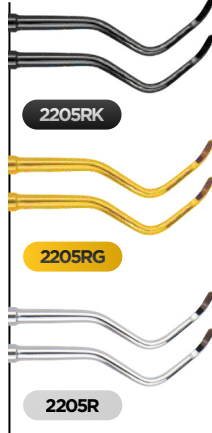

Langer 1-2

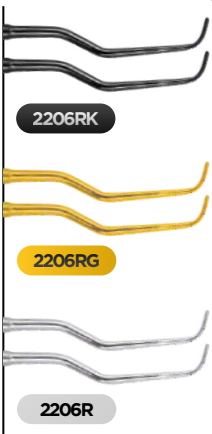

Mccall  
13S-14S



Mini McCall  
13S-14S



McCall 17-18



McCall 17S-18S



Duplex Curette

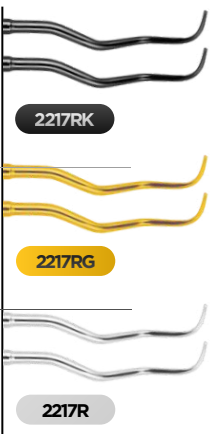

Mini Duplex  
Curette



Duplex Anterior



Mini Duplex  
Anterior

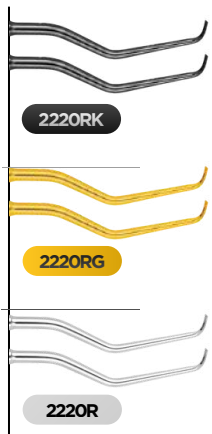

Goldman-Fox 3

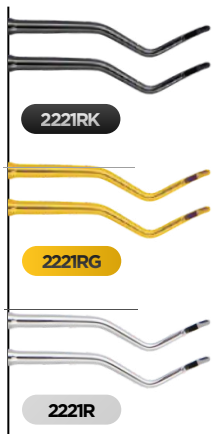

# Peter's 6 fav ErgoRazor Instruments

Mini Gracey 1-2

**2101RG-X**



Mini Gracey 11-12

**2104RG-X**



Mini Gracey 15-16

**2106RG-X**



Mini Gracey 7-8

**2103RG-X**



Mini Gracey 13-14

**2105RG-X**



Nebraska 128

**2155RG-X**

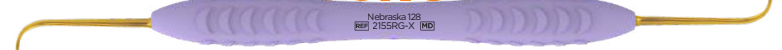

ErgoTray 8 - Black

**5508K**



“

I have been using instruments from ErgoDenta for some time and am very satisfied with the quality. We are especially pleased with the ErgoRazor series. The instruments offer solid quality at a reasonable price, and I warmly recommend ErgoDenta.

**Petter Johnsen**

Owner Dental Clinic, Studio Smile, Norway



# Perio Kits

## Basic Hygienist Kit

A practical set of essential instruments for routine periodontal examinations and scaling. Designed for everyday hygiene procedures and supplied in a sterilization cassette for organized storage and sterilization.



### 9905

Available in



X XP SP

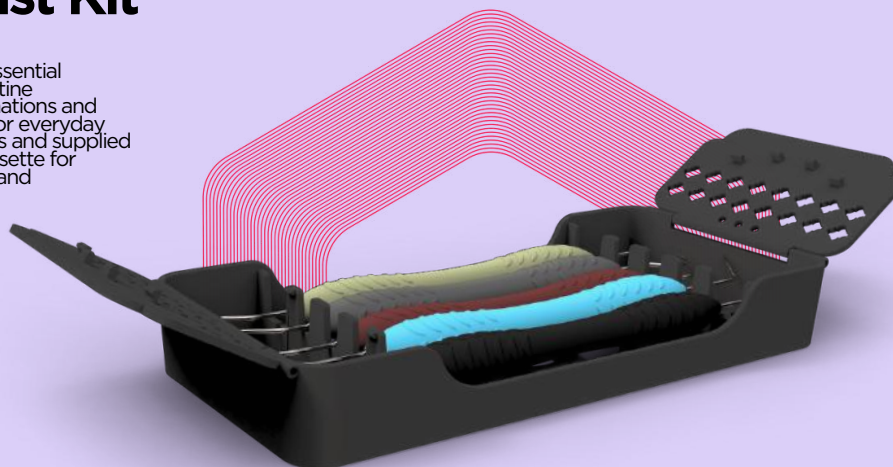

### Instruments

ErgoX® Mirror handle, Peach Blush  
1401



Explorer 17-23  
1107



Mini McCall 13s-14s  
2213



Probe CP-12 (3-6-9-12mm)  
1053



Mini Sickle Scaler 11-12  
2182



**5 instruments + cassette**

## All Round Perio Set

A comprehensive set of essential periodontal instruments for scaling and root planing across different areas of the mouth. Supplied in a sterilization cassette for organized storage, easy handling, and efficient sterilization.

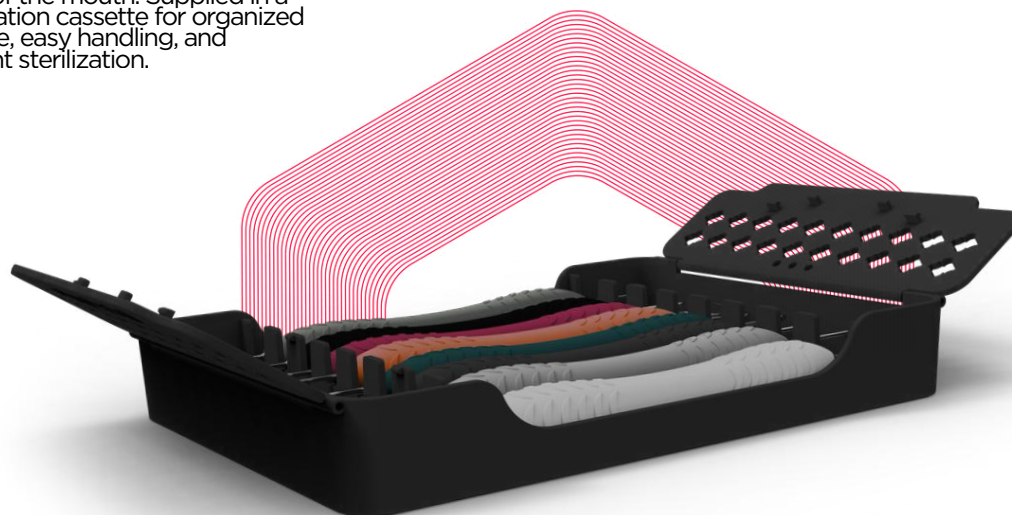

### 9903

Available in



X XP SP

### Instruments

Mini Sickle Scaler 11-12  
2182



Micro Sickle Scaler 01-02  
2181



McCall 17-18  
2214



Gracey 1-2  
2001



Gracey 9-10  
2005



Gracey 11-12  
2006



Gracey 13-14  
2007



Gracey 15-16  
2008



**8 instruments + cassette**

# Basic Perio Kit

A practical set of essential periodontal instruments for everyday scaling and root planing. Supplied in a sterilization cassette for organized storage, easy handling, and efficient sterilization.



**9906**

Available in



X XP SP

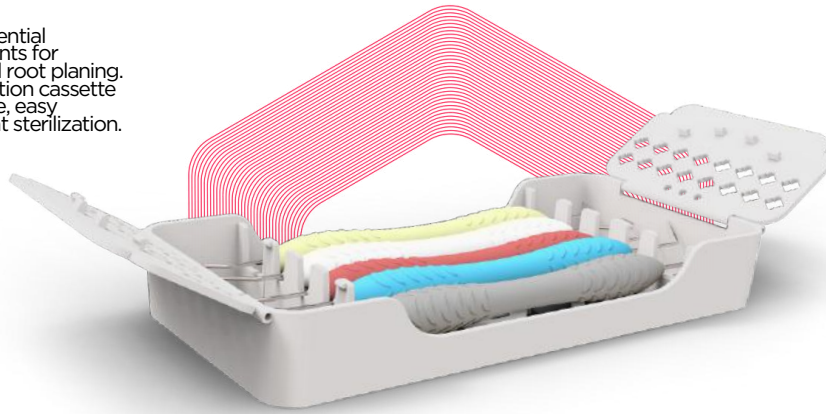

## Instruments

Mini Sickle Scaler 11-12  
**2182**



McCall 17-18  
**2214**



Gracey 1-2  
**2001**



Gracey 11-12  
**2006**



Gracey 13-14  
**2007**



**5 instruments + cassette**

# Perio Diagnostic Kit

Each instrument is selected to support periodontal examination and basic scaling procedures. Supplied in a sterilization cassette for organized storage, easy handling, and efficient sterilization.

**9907**

Available in



X XP SP

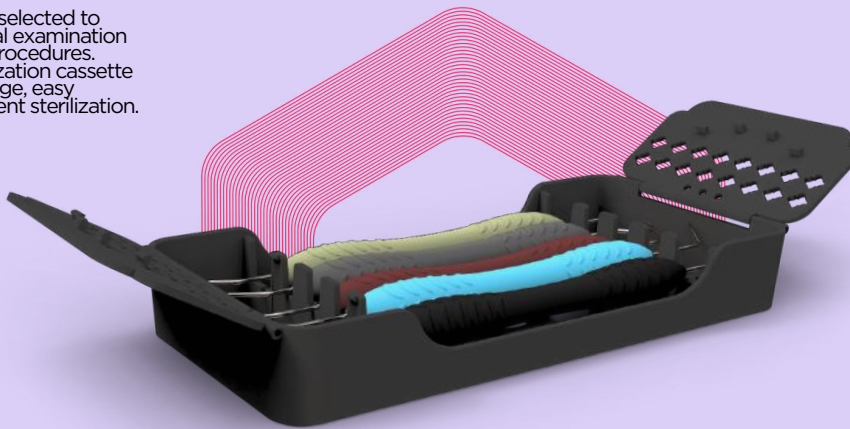

## Instruments

ErgoX® Mirror handle, Peach Blush  
**1401**



Crane-Kaplan  
**2162**



Explorer 8 + Probe CP 2B  
**1303**



Gracey 11-12  
**2006**



Gracey 13-14  
**2007**



**5 instruments + cassette**

# Tartar Remover Set

A practical set designed for efficient tartar removal and routine scaling procedures. Supplied in a sterilization cassette for organized storage, easy handling, and efficient sterilization.

**9904**

Available in



X XP SP

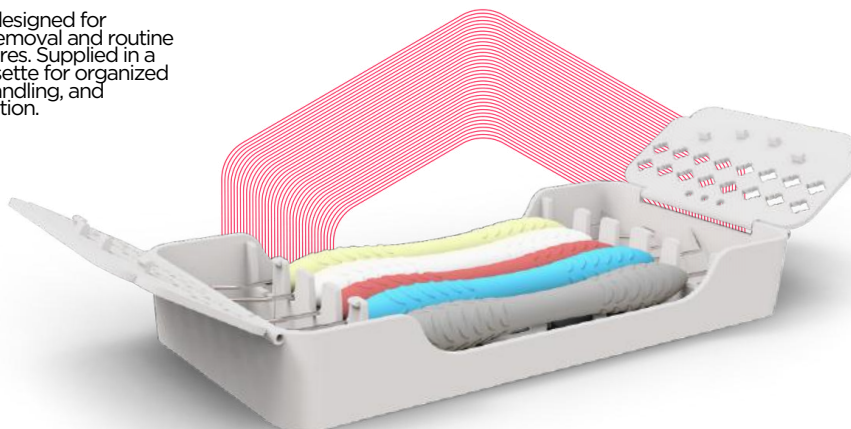

## Instruments

ErgoX® Mirror handle, Peach Blush  
**1401**



Sickle Scaler H6-H7  
**2153**



Mini Sickle Scaler 11-12  
**2182**



M23 Sickle Scaler  
**2159**



Explorer 17-23  
**1107**



**5 instruments + cassette**

Elevate, Grip & Extract

# Extraction



Elevators and forceps for  
smooth & controlled extractions.

# Extraction Forceps

ErgoDenta offers Extraction Forceps in Diamond, Standard, Children Junior, and Grip Master variants, designed for precise and reliable tooth extraction.

Upper Incisors, molars,  
Premolars & Roots



Fig.1  
Upper Incisors  
And Molars

5005-1 5025-1

5025-17  
5005-17



Fig.17  
Upper Molars, Right

5025-18  
5005-18



Fig.18  
Upper Molars, Left

5025-30S  
5005-30S



Fig.30S  
Upper Front

5025-29  
5005-29



Fig.29  
Upper Front

5025-51A  
5005-51A



Fig.51A  
Upper Roots

5025-97  
5005-97



Fig.97  
Upper Roots



Fig.7  
Upper  
Premolars

5005-7 5025-7

5025-41  
5005-41



Fig.41  
Upper Roots

5025-46  
5005-46



Fig.46  
Upper Roots

5025-67A  
5005-67A



Fig.67A  
Upper Molars for  
Upper Wisdom Teeth

## Upper Incisors, molars, Premolars & Roots

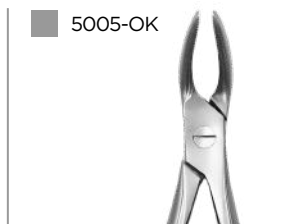

5005-OK

Fig.OK  
Universal-Upper Roots  
Extracting Forceps



5025-98

Fig.98  
Witzel (Upper  
roots)



5025-144

Fig.144  
Upper Roots



## Lower Incisors, molars, Premolars & Roots



Fig.22  
Lower Molars

5005-22 5025-22

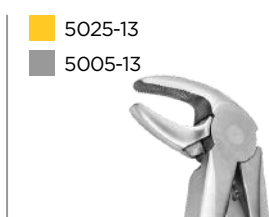

5025-13  
5005-13

Fig.13  
Lower Molars &  
Premolars

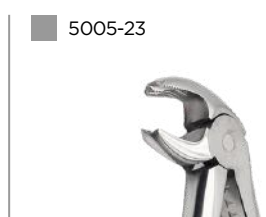

5005-23

Fig.23  
Lower Molars,  
Right



5005-24

Fig.24  
Lower Molars,  
Left

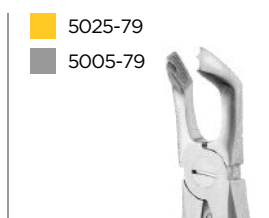

5025-79  
5005-79

Fig.79  
Lower Wisdom



5025-86A  
5005-86A

Fig.86A  
Lower Molars



5025-86B

Fig.86B  
Lower Molars

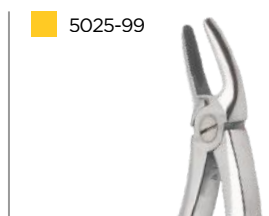

5025-99

Fig.99  
Hertz (Lower  
Molars)

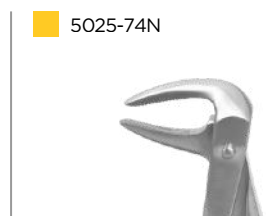

5025-74N

Fig.74N  
Lower Roots



5005-UK

Fig.UK  
Universal-Lower Roots

## Lower Incisors, molars, Premolars & Roots

5005-87



Fig.87  
Lower Molars



## Junior Extraction Forceps

ErgoDenta's junior extraction forceps are designed for smaller anatomy and secure handling in younger patients. They provide controlled grip and reliable access for common pediatric extractions.



Fig.37  
Incisors,  
Upper Jaw  
5015-37



Fig.13K  
Premolars,  
Lower Jaw  
5015-13K



Fig.22K  
Molars,  
Lower Jaw  
5015-22K



Fig.7K  
Upper Jaw-  
Molars & Incisors  
5015-7K



Fig.38  
Incisors & canines,  
Lower Jaw  
5015-38

# Extraction Forceps Kit



## Instruments in the kit

	Diamond	Standard
Fig. 1. Upper Incisors And Molars	5025-1	5005-1
Fig. 13. Lower Molars And Premolars	5025-13	5005-13
Fig. 17. Upper Molars, Right	5025-17	5005-17
Fig. 18. Upper Molars, Left	5025-18	5005-18
Fig. 22. Lower Molars	5025-22	5005-22
Fig. 33A. Lower Incisors, Premolars & Roots	5025-33A	5005-33A
Fig. 51A. Upper Roots	5025-51A	5005-51A
Fig. 67A. Upper Molars-Upper for Wisdom Teeth	5025-67A	5005-67A
Fig. 7. Upper Premolars	5025-7	5005-7
Fig. 79. Lower Wisdom Teeth	5025-79	5005-79

Diamond tip with a serrated pattern ensures a strong grip.



Forceps/box

# 10



 Diamond extraction forceps set  
5025



 Standard extraction forceps set  
5005

Available in regular & diamond

## Extraction

# Diamond Grip Master

ErgoDenta's GripMaster Extraction Forceps feature a diamond-coated beak surface, ensuring a secure hold with less grip strength required.

Maximum Grip.  
Minimum Effort.



## GRIP MASTER

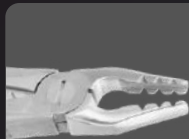

D: 5040-2002  
Upper Anterior



D: 5040-2074  
Lower Anterior

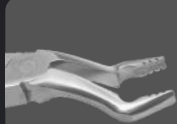

D: 5040-2067  
Upper Molar

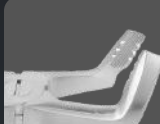

D: 5040-2079  
Lower Molar

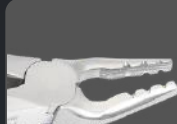

D: 5040-2007  
Upper Universal

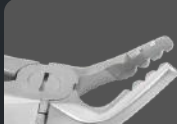

D: 5040-2021  
Lower Universal

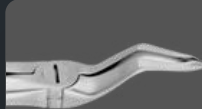

D: 5040-1251  
Upper Spade root



D: 5040-145  
Lower Spade Roots



# Child Extraction Forceps

ErgoDenta's pediatric extraction forceps offer safe and controlled handling for younger patients. Available in Diamond and Standard versions with an ergonomic grip. Diamond provides extra holding power, while Standard offers reliable grip for daily use.



Fig.3  
**Upper Molars**  
5020-3 5010-3

5020-137  
5010-137



Fig.137  
**Upper Incisors**

5020-139  
5010-139



Fig.139  
**Upper Pre Molars**

5020-51S  
5010-51S



Fig.51S  
**Upper Roots**

5020-6  
5010-6



Fig.6  
**Lower Molars**

5020-5  
5010-5



Fig.5  
**Lower Incisors**

5020-7  
5010-7



Fig.7  
**Lower Roots**

## Child Extraction Forceps

# Kit

Forceps/box

# 07



Diamond extraction forceps set  
5020



Standard extraction forceps set  
5010

All 7 child extraction forceps included in the kit. Available in Standard & Diamond.

# Luxating Elevators

ErgoDenta's Luxating Elevators are available with Classic or Standard handles and Gold or Silver tips — so you can choose the combination that fits your style and workflow.

## Gold Finish

- High contrast — better visibility
- Reduced friction while working
- Extra protection for the cutting edge
- Easy to identify on the tray
- Premium look

## Silver Finish

- Classic stainless-steel look
- Durable for daily use
- Easy to clean and maintain
- Matches any instrument setup
- Professional, timeless style

Classic  
Handle  
8mm

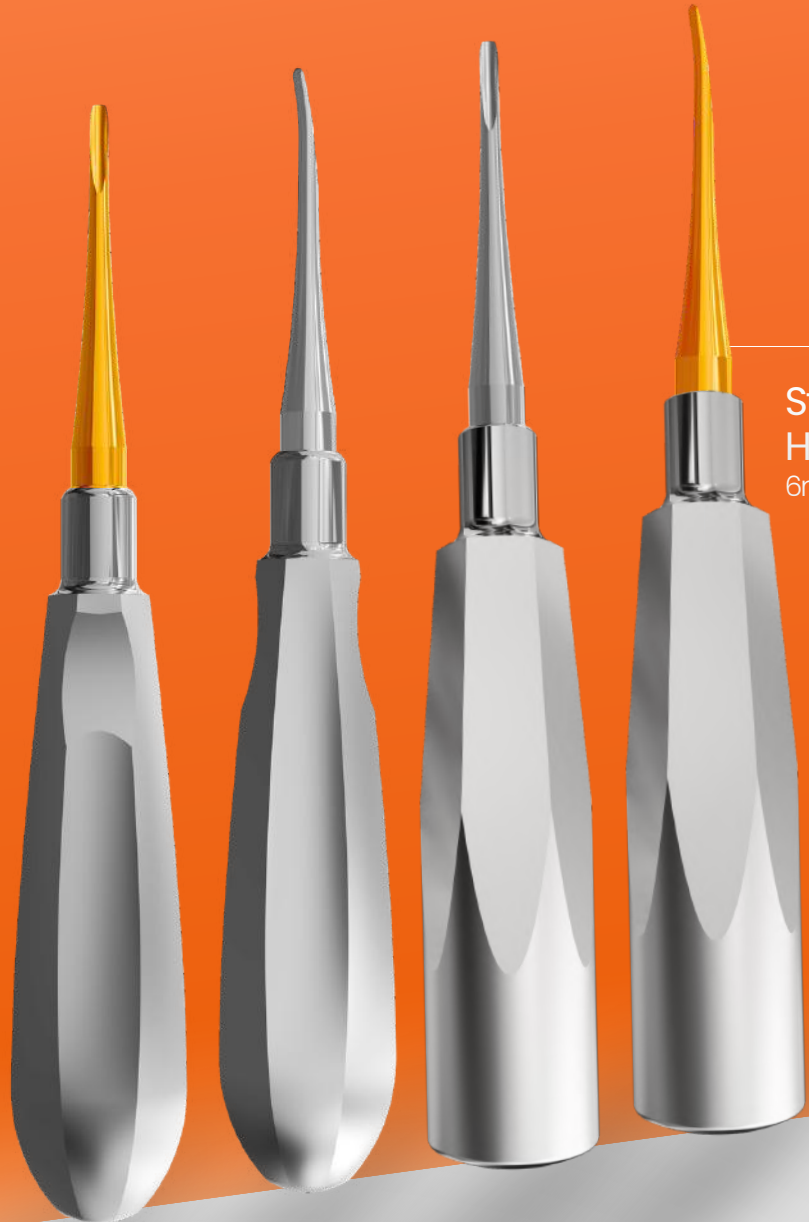

Standard  
Handle  
6mm

## Atraumatic Extraction

Ergonomic Handle

Ultra-Thin, Sharp Tips

Gold or Silver

## Straight



**2.5mm**

Standard Classic  
6001-1 6002-1



**3mm**

Standard Classic  
6001-2 6002-2



**4mm**

Standard Classic  
6001-3 6002-3



**5mm**

Standard Classic  
6001-4 6002-4

## Straight Gold



**2.5mm**

Standard Classic  
6001-1G 6002-1G



**3mm**

Standard Classic  
6001-2G 6002-2G



**4mm**

Standard Classic  
6001-3G 6002-3G



**5mm**

Standard Classic  
6001-4G 6002-4G

## Curved



**2.5mm**

Standard Classic  
6001-5 6002-5



**3mm**

Standard Classic  
6001-6 6002-6



**4mm**

Standard Classic  
6001-7 6002-7



**5mm**

Standard Classic  
6001-8 6002-8

## Curved Gold



**2.5mm**

Standard Classic  
6001-5G 6002-5G



**3mm**

Standard Classic  
6001-6G 6002-6G



**4mm**

Standard Classic  
6001-7G 6002-7G



**5mm**

Standard Classic  
6001-8G 6002-8G

## Luxating Elevators

# Kit

Elevator/box

# 08

Silver



**6001**

Kit - 8 luxating elevators in standard handle



**6002**

Kit - 8 luxating elevators in classic handle

Gold



**6001 G**

Kit - 8 luxating Gold elevators in standard handle



**6002 G**

Kit - 8 luxating Gold elevators in classic handle



# Root Tip Elevators

## Lindo-Levian Elevators

Lindo-Levian Elevators allow gentle, controlled luxation in tight spaces.



## Bein Root Elevators

Bein Root Elevators provide controlled elevation and secure leverage.



## Flohr Elevators

Flohr Elevators support controlled luxation with stable leverage.



## Hysin Root Elevators

Hysin Root Elevators provide controlled root elevation with secure leverage.



## Berten Elevators

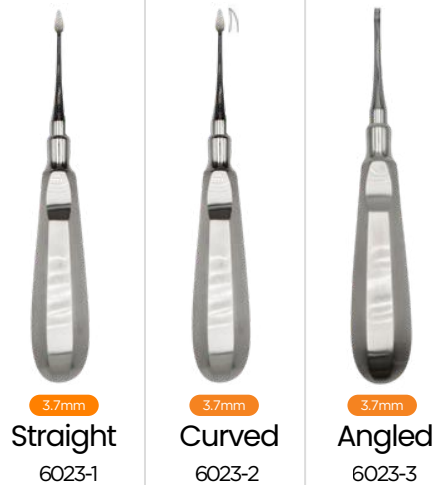

## Bernard Elevators

Bernard Elevators provide controlled luxation with stable support.

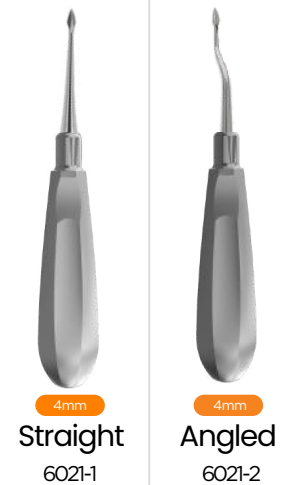

## Winter Elevators

Winter Elevators deliver strong, controlled elevation of roots.



# Root Tip Elevators

## Apical Root Elevators

Apical Root Elevators allow precise elevation at the root apex.



2.5mm

Fig. 1

6046-1



3.5mm

Fig. 2

6046-2



2.3mm

Fig. 3

6046-3



11.2mm

Straight

6021-1



11.2mm

Angled

6021-2



3.7mm

Straight

6090



3.7mm

Curved

6091

## Heiderbrink Elevators

Hilin Root Elevators provide controlled root elevation with secure leverage.



3.5mm

Fig. 1

6053-1



4.5mm

Straight

6053-2



4.5mm

Straight

6053-3



1.5mm

Straight

6220 S



1.5mm

Right

6221 S



1.5mm

Left

6222 S



2.5mm

Straight

6223 S



2.5mm

Right

6224 S



2.5mm

Left

6225 S

# Root Tip Elevators

## Appexo Elevators

Appexo Elevators are designed for gentle, precise luxation. Slim, sharp tips allow controlled movement around the tooth while helping protect surrounding tissue.



2.5x9mm

**Straight**  
**6022-1**



2.7x9mm

**Straight 6022-2**

3x9mm

**Straight 6022-3**

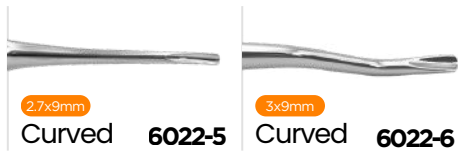

2.7x9mm

**Curved 6022-5**

3x9mm

**Curved 6022-6**



2.5mm

**Curved 6022-4**

## Root Tip Elevators

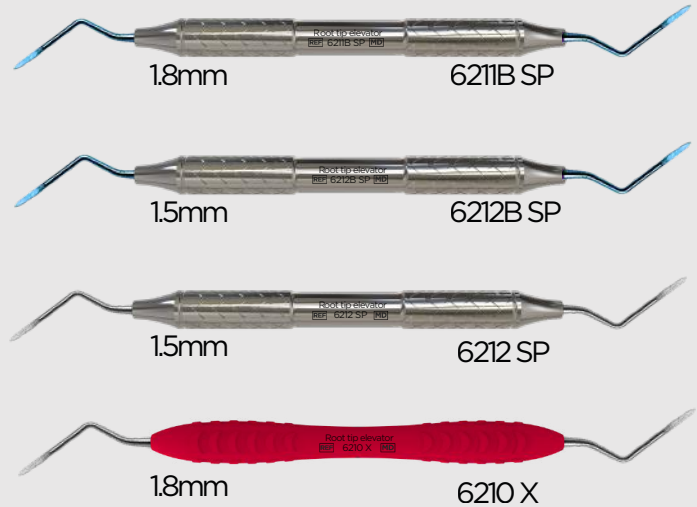

1.8mm

**6211B SP**

1.5mm

**6212B SP**

1.5mm

**6212 SP**

1.8mm

**6210 X**

## Kopp Elevators

Kopp Elevators offer gentle, precise luxation with slim, sharp tips designed for controlled movement around the tooth.

Did you know?



Ergonomic elevators help improve grip and precision during extractions.



4.2mm

**Lower Roots, Left 6024-5**

4.2mm

**Upper Roots, Right 6024-6**

3.6mm

**Upper Roots, Round Sharp 6024-2**

4.2mm

**Upper Roots, Edge Sharp 6024-3**

4.2mm

**Upper Roots, Round Sharp 6024-4**

3.6mm

**Upper Roots, Edge Sharp 6024-1**

# X-Tool Elevators

Extract with Ease

X-Tool Elevators are designed to make luxation smoother and more controlled. The titanium-coated tips reduce friction, improve wear resistance, and support gentle movement around the tooth — helping you work with confidence and less effort during extraction.



Distal, 2.6mm  
**6234**



Mesial, 4.0mm  
**6237**



Spade, 3.5mm  
**6233**



Spade, 4.0mm  
**6236**



Curved, 2.6mm  
**6232**



Mesial, 2.6mm  
**6235**



Straight, 2.6mm  
**6231**

## X Tool-Luxating Elevators Set

**6230**



Xtool & cassette

07

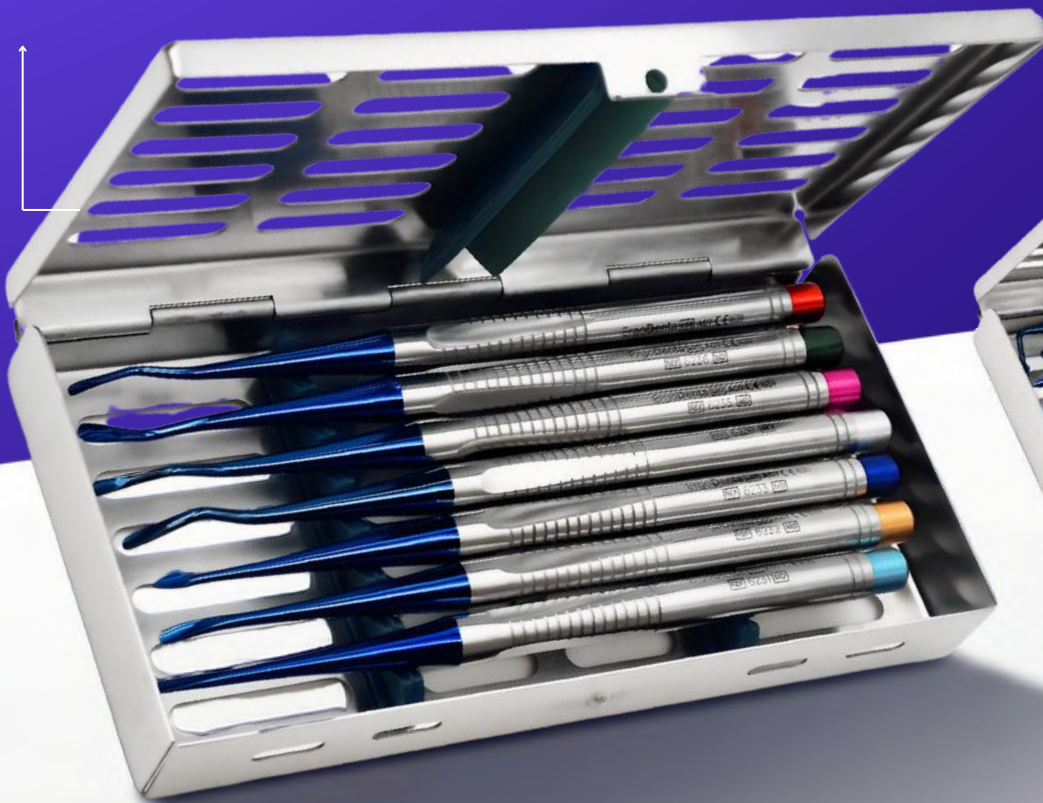

**6250**

X Tool-Bernard Spade Tip Elevators Set

**6253**  
External Curved, 4.0mm



**6252**  
Angled, Right, 4.0mm



**6251**  
Angled, Left, 2.6mm



**6257**  
Curved, 2.6mm



**6254**  
Internal Curved, 2.6mm



**6256**  
Curved, 3.5mm



**6255**  
Straight 2.6mm



Cut, Hold & Retract

# Surgery



Everyday essentials for  
confident dental surgery

# Scissors in Black

Experience **razor-sharp**, accurate cutting with Super-cut scissors featuring a durable black coating.



- Matte coating to reduce glare
- Optimized for surgical precision
- Easy to clean surface
- Long lasting sharpness
- Razor edge

TC

+

SC  
Super Cut



Goldman Fox

13cm Straight 3007-4S  
13cm Curved 3007-4C



La-Garange

11.5 cm Double Curved 3008-4D



Iris

11.5cm Straight 3002-4S  
11.5cm Curved 3002-4C



Metzenbaum Stump

14.5cm Curved 3011-4C

# Scissors

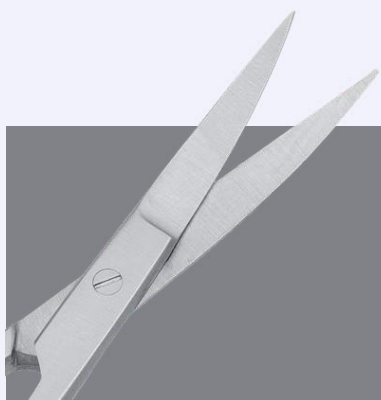

## Standard

Reliable and versatile scissors for everyday cutting tasks.



## TC

Tungsten carbide inserts ensure precise and long-lasting sharpness for delicate oral procedures.



## Super-cut

High-performance scissors with micro-serrated blades for precise and clean cuts.

## IRIS



Straight	Curved
11.5 cm <b>3002-1S</b>	11.5 cm <b>3002-1C</b>
15 cm <b>3003-1S</b>	15 cm <b>3003-1C</b>



Straight	Curved
11.5 cm <b>3002-2S</b>	11.5 cm <b>3002-2C</b>
15 cm <b>3003-2S</b>	15 cm <b>3003-2C</b>



Straight	Curved
11.5 cm <b>3002-3S</b>	11.5 cm <b>3002-3C</b>



Angular
11.5 cm <b>3002-1A</b>

# La-Grange Scissors

Surgical scissors for controlled cutting of soft tissue and sutures, designed with double curved blades for improved access.

Curved

11.5 cm  
**3008-1D**



Curved

11.5 cm  
**3008-2D**

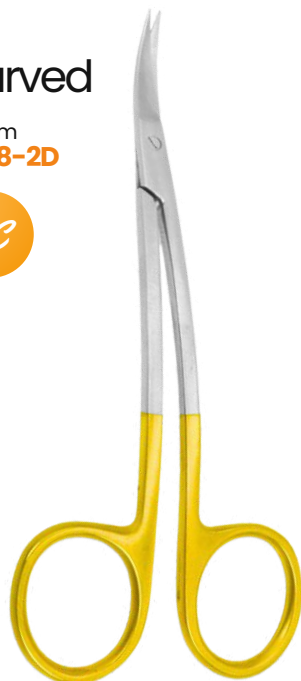

Curved

11.5 cm  
**3008-3D**



# Goldman-Fox Scissors

Fine periodontal scissors designed for precise trimming of gingival tissue and suture cutting, offering excellent control for delicate intraoral surgical procedures.

Straight

13 cm  
**3007-1S**



Straight

13 cm  
**3007-2S**



Straight

13 cm  
**3007-3S**



Curved

13 cm  
**3007-1C**

Curved

13 cm  
**3007-2C**

Curved

13 cm  
**3007-3C**

# Scissors

## Metzenbaum Stump Scissors



Straight 14.5 cm  
**3011-1S**

Curved 14.5 cm  
**3011-1C**



**TC**

Straight 14.5 cm  
**3011-2S**

Curved 14.5 cm  
**3011-2C**

## Metzenbaum Sharp Scissors



Straight 14.5 cm  
**3016-1S**

Curved 14.5 cm  
**3016-1C**



**TC**

Straight 14.5 cm  
**3016-2S**

Curved 14.5 cm  
**3016-2C**

## Kelly Scissors



Straight 16 cm  
**3026-1S**

Curved 16 cm  
**3026-1C**



**TC**

Straight 16 cm  
**3026-2S**

Curved 16 cm  
**3026-2C**

## Metzenbaum Fino Scissor

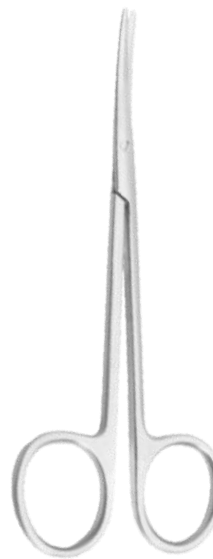

Straight 14.5 cm  
**3014-2S**

Curved 14.5 cm  
**3014-2C**

## Metzenbaum Open Scissor



**TC**

Straight 14.5 cm  
**3013-2S**

# Scissors

## Classic Suture Scissors



Straight	Curved
11.5 cm <b>3009-1S</b>	11.5 cm <b>3009-1C</b>
13 cm <b>3010-1S</b>	13 cm <b>3010-1C</b>

## Cooper Scissors



Straight

13 cm  
**3052-1S**

16 cm  
**3058-1S**

## Spencer Scissors



Angled

11.5 cm  
**3037-1A**

## Mayo Scissors



Straight

14.5 cm  
**3031-1S**

**3031-2S**

18 cm  
**3032-1S**

**3032-2S**



Curved

14.5 cm  
**3031-1C**

**3031-2C**

18 cm  
**3032-1C**

**3032-2C**

## Crown Scissor



Straight	Curved
13 cm <b>3045-1S</b>	13 cm <b>3045-1C</b>

## Spencer Scissors



Straight

16 cm  
**3039-1S**

## Joseph Scissor



Straight	Curved
14.5 cm <b>3027-2S</b>	14.5 cm <b>3027-2C</b>

## Kilner Scissor



Straight

12.5 cm  
**3029-1S**

Perfect for small, delicate procedures

# Micro Surgery Scissors



## Noyes

Straight  
15 cm  
**3107-1S**

Curved  
15 cm  
**3107-1C**

Angled  
15 cm  
**3107-1A**

## Barraquer Scissors

Straight  
13 cm  
**3121-2S**

Curved  
15 cm  
**3122-2S**

## Micro Surgery

Straight  
14.5 cm  
**3101-2S**

Curved  
14.5 cm  
**3101-2C**

# Needle Holders

## Mayo Hegar



Straight 16 cm  
**3212-1S**

Curved 16 cm  
**3212-1C**



Straight 13 cm  
**3211-2S**

16 cm  
**3212-2S**

## Crile-wood



Straight 15 cm  
**3226-2S**

18 cm  
**3227-2S**



Straight 15 cm  
**3226-1S**

## Fine Swedish



Straight 15 cm  
**3209-2S**

## Crile Ryde



Straight 15 cm  
**3238-2S**

TC needle holders offer superior grip and durability, ensuring precise and reliable suturing in surgical procedures.

 A close-up photograph of a hand in a white surgical glove holding a TC needle holder. The background is a solid orange color.

# Needle Holders

Mathieu



Straight  
14 cm  
**3301-1S**  
17 cm  
**3302-1S**

Curved  
14 cm  
**3301-1C**  
17 cm  
**3302-1C**



Straight  
14 cm  
**3301-2S**  
17 cm  
**3302-2S**

Curved  
14 cm  
**3301-2C**  
17 cm  
**3302-2C**

Olsen



Straight  
17 cm  
**3312-2S**



Lichtenberg



Straight  
17 cm  
**3322-2S**

Curved  
17 cm  
**3322-2C**



Castroviejo  
Micro



Straight  
16 cm  
**3343-2S**

Curved  
16 cm  
**3343-2C**



Castroviejo



Straight  
14 cm  
**3331-2S**  
16 cm  
**3333-2S**  
18 cm  
**3332-2S**

Curved  
14 cm  
**3331-2C**  
16 cm  
**3333-2C**  
18 cm  
**3332-2C**



The Castroviejo Barraquer Needle Holder TC provides precise control and durability for detailed dental suturing.

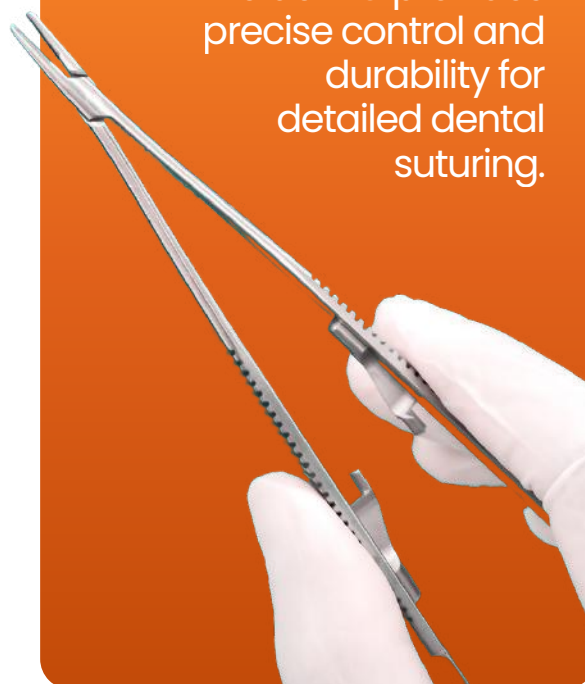

# Hemostatic Forceps

Halsted  
Mosquito



Straight	Curved
12 cm <b>3406-1S</b>	12 cm <b>3406-1C</b>
14.5 cm <b>3407-1S</b>	14.5 cm <b>3407-1C</b>

Kocher



Straight	Curved
13 cm <b>3446-1SG</b>	13 cm <b>3446-1CG</b>
16 cm <b>3448-1SG</b>	16 cm <b>3448-1CG</b>

Pean



Straight	Curved
13.5 cm <b>3411-1S</b>	13.5 cm <b>3411-1C</b>
16.5 cm <b>3413-1S</b>	16.5 cm <b>3413-1C</b>

Crile



Straight	Curved
14 cm <b>3454-1S</b>	14 cm <b>3454-1C</b>

Stieglitz



Straight	Curved
13 cm <b>3456-1S</b>	13 cm <b>3456-1A</b>

Allis



Straight
15 cm <b>3432-1S</b>

Adson



Straight	Curved
14 cm <b>3461-1S</b>	14 cm <b>3461-1C</b>
18 cm <b>3462-1S</b>	18 cm <b>3462-1C</b>

Kelly



Straight	Curved
14 cm <b>3441-1S</b>	14 cm <b>3441-1C</b>

# Hemostatic Forceps

Backhaus



9 cm  
**3470**  
11 cm  
**3471**

Hemostatic  
Forceps



Straight  
12 cm  
**3437-1S**

Tohoku

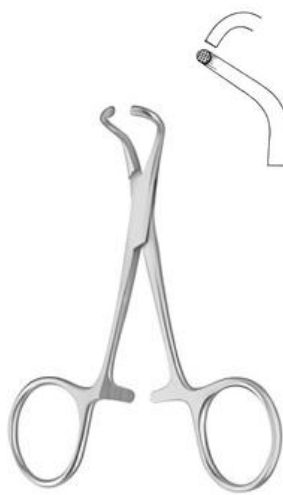

10 cm  
**3478**

Micro-Mosquito



Straight	Curved
10 cm <b>3401-1S</b>	10 cm <b>3401-1C</b>
12 cm <b>3402-1S</b>	12 cm <b>3402-1C</b>

## Bone Rongeurs

Friedmann  
3mm  
**7301**



Mini Friedmann  
2mm  
**7304**



# Tweezers in Black

Experience precise, secure grip with Super-grip tweezers featuring a durable black coating.



## Perry



**3621-3C**  
13cm  
Curved

## Meriam Tweezer



**3636-3A**  
16cm  
Serrated, Fig 1.



**3636-4A**  
16cm  
Serrated, Fig 1. TC

## College Tweezer



**3627-3A**  
15cm  
Serrated



**3628-3A**  
15cm  
Short Serrated



**3630-3A**  
15cm  
Serrated, with Lock

## Micro Surgical Tweezer



**3802-3G**  
18cm  
Straight, 1-2



**3802-3CG**  
18cm  
Curved, 1-2



**3802-3**  
18cm  
Straight



**3801-3G**  
15cm  
Straight, 1-2

## Gerald



**3671-3G**  
17cm  
Straight



**3671-3CG**  
17cm  
Curved

# Tweezers

## Adson



12 cm  
**3606-2**

12 cm  
**3606-1**  
15 cm  
**3608-1**

Kocher  
12 cm  
**3606-1G**  
15 cm  
**3608-1G**

Kocher  
15 cm  
**3608-1A**



Designed for accuracy and ease of use, our tweezers support efficient handling in daily dental practice.

## Perry



13 cm  
**3621-1C**

## Flagg



Half Serrated  
16 cm  
**3616-1A**

## Anatomical



13 cm  
**3646-1**  
14.5 cm  
**3647-1**  
16 cm  
**3648-1**



13 cm  
**3646-2**

## Miller



Straight  
16 cm  
**3622-1**

Curved  
16 cm  
**3622-1C**

# Tweezers

## Semken



12 cm **3656-1**    12 cm **3656-1C**    15 cm **3657-1**    15 cm **3657-1G**    15 cm **3657-1AG**    15 cm **3657-1C**

## DeBakey



16 cm **3667-1A** Angled    16 cm **3667-1** Straight

## Endo Tweezers



Cross hold    With lock    Endo Tweezer  
15 cm **3674-1A**    15 cm **3676-1A**    15 cm **3675-1A**

## Taylor

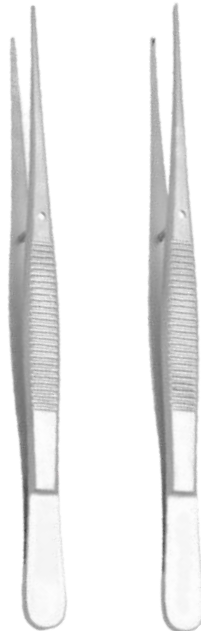

1x2  
15 cm **3651-1**    15 cm **3651-1G**

## Crane Kaplan



Left    Right  
15 cm **3662-1AG**    15 cm **3661-1AG**

# Tweezers

## Micro surgical tweezers



Straight

15 cm  
**3801-1G**

18 cm  
**3802-1G**

Anatomical

18 cm  
**3802-1**

Curved

18 cm  
**3802-1CG**

## Gerald

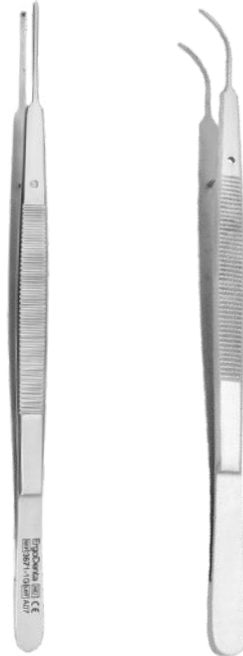

1x2

17 cm  
**3671-1G**

Curved

17 cm  
**3671-1CG**

## Micro surgical plier



Curved

15 cm  
**3724-1C**

## College



Serrated

15 cm  
**3627-1A**



Short  
Serrated, 13mm

15 cm  
**3628-1A**



Serrated,  
with Lock

15 cm  
**3630-1A**

## Meriam



Serrated

16 cm  
**3636-1A**



Serrated

16 cm  
**3636-2A**

## Surgical



Kocher 1x2

14.5 cm  
**3633-1G**

# Lip, cheek & mouth retractor

## Sean-Miller

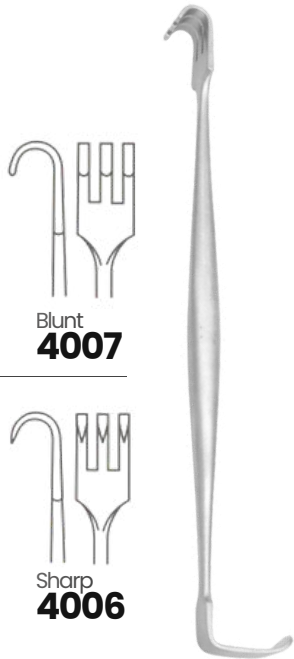

## Obwegeser Internal

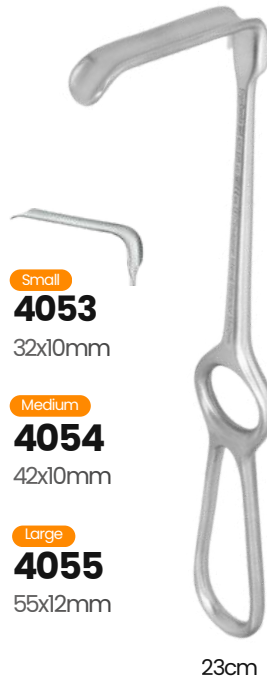

## Obwegeser External



## Wassmund



## Langenbeck



## Middeldorpf



# Lip, cheek & mouth retractor



Minnesota  
2cm x 14cm

**4106**



Universal cheek  
retractor  
16cm

**4041**

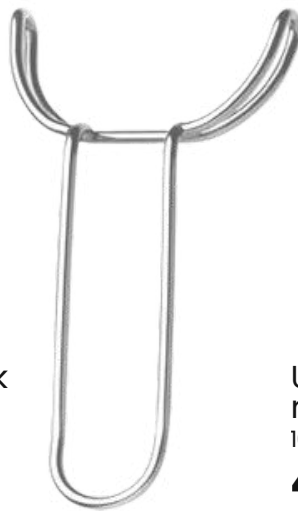

Universal cheek  
retractor  
16cm

**4042**



## Bowdler Henry

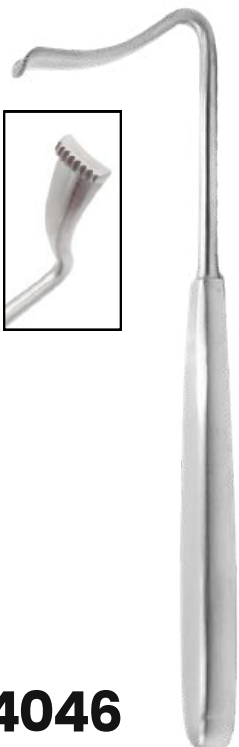

**4046**  
16 cm



Tongue Holder  
**4129**  
15cm



S-Retractor  
**4103**



Cawood-Minnesota  
**4127**  
2x16cm  
15.5cm



Farabeuf  
Fig. 1, 26 x 10 mm / 30 x 13 mm  
Fig. 2, 30 x 10 mm / 34 x 13 mm  
Set of 2 pieces  
**4101**  
12cm

# Syringes

## Self Aspirating Syringe



1.8 ml | 2.2 ml  
**3929** | **3930**



1.8 ml  
**3931**

## Cartridge Syringe



1.8 ml | 2.2 ml  
**3901** | **3902**



2.2 ml  
**3910**



2.2 ml  
**3907**

## Self Aspirating Syringe



1.8ml  
0.20 ml per click

**3961**

Spare-parts  
available

## Pen model syringes



1.8ml  
0.07 ml/ click

**3968**

Consists of three  
detachable  
components



1.8ml  
0.07 ml/ click

**3969**

The offset/curved  
model syringe is  
versatile for use in  
both the upper and  
lower jaw.

## Syringe holder



**3999**

# Crown Instruments

## Crown Scissors



Angled  
**3042-1A**  
12.5cm

Straight  
**3041-1S**  
11.5cm

Straight  
**3045-1S**  
13cm

Curved  
**3045-1C**  
13cm

## Crown Spreader



Plier  
**2971**  
15cm

Elevator  
**2970**  
14cm

## Crown remover Plier / forceps



Furrer Plier  
**2957**  
15cm

Lindblom Plier  
**2956**  
14cm

Wynman Forceps  
**2955**  
17cm, TC

## Crown Remover



Crown Tractor Plier, 14cm  
**2953**  
With 20 extra pads

Automatic, 15cm  
**2951**  
incl. 3 tips, Wrench & accessory

# Matrix retainers

## Nystorm



**2921**  
Right

**2922**  
Left

## Tofflemire



**2912**  
Universal

**2913**  
Senior

**2911**  
Junior

## Ivory



**2901**  
15cm

# Bone curettes

## Lucas

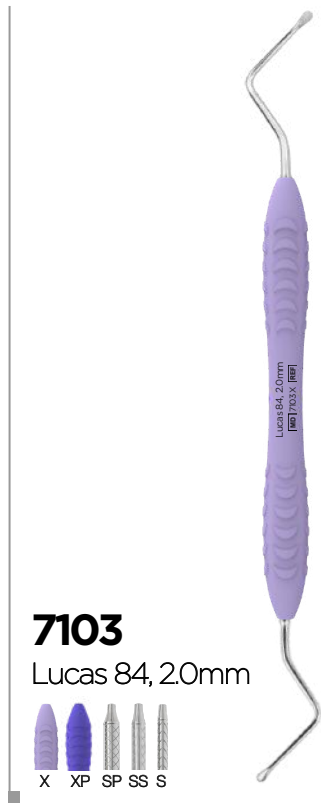

**7103**

Lucas 84, 2.0mm



## Lucas Serrated

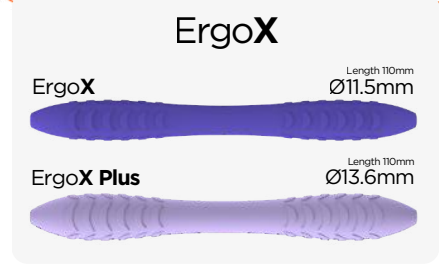
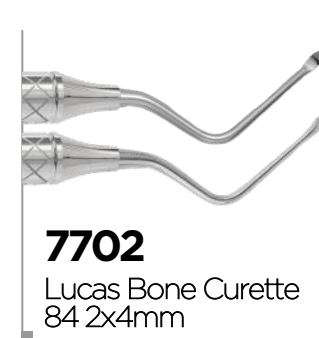

# Hemingway



# Periosteal Elevators

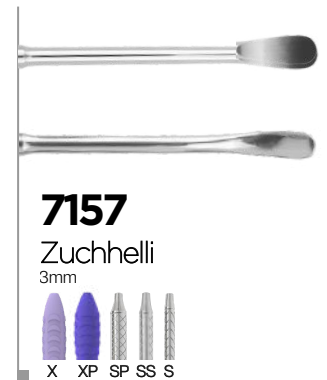

**6282-1**  
Periosteal Elevator  
8mm



**6280-2**  
Williger  
16cm / 7mm

# Bone curettes

## Miller



**7101**

Miller 8  
3.5mm



**7166**

Miller  
3.0mm



**7102**

Miller 21  
3.0mm



# Surgery instruments

## Bone files



**7162**

Bone scrapper  
3-5mm



**7161**

Miller 21  
8.0-5.0mm



## Periotome

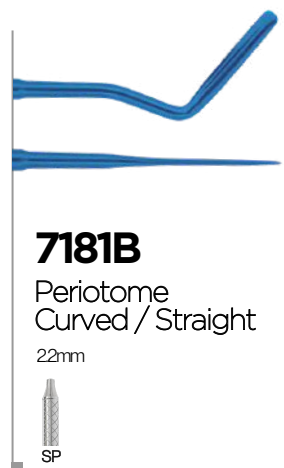

**7181B**

Periotome  
Curved / Straight

22mm

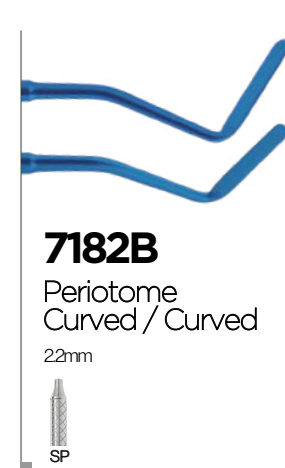

**7182B**

Periotome  
Curved / Curved

22mm



**7181**

Periotome  
Curved / Straight

22mm



**7182**

Periotome  
Curved / Curved

22mm



# Tunneling Knife



## 7902 SP

Tunneling Knife 1, 3.5mm



## 7903 SP

Tunneling Knife 2 Micro, 2mm



## 7904 SP

Tunneling Knife 1 Micro, 2mm



## 7905 SP

Tunneling Knife 2, 3.5mm

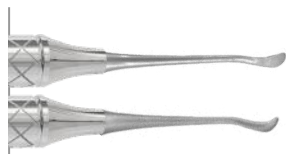

## 7906 SP

VISTA Tunneling 1

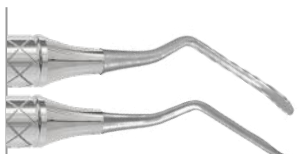

## 7907 SP

VISTA Tunneling 2



## 7901 SP

VISTA Tunneling 3



## 7908 SP

VISTA Tunneling 4



## 7909 SP

VISTA Tunneling 5



## 7902K-SP

Tunneling Knife 1, 3.5mm



## 7903K-SP

Tunneling Knife 2 Micro, 2mm



## 7904K-SP

Tunneling Knife 1 Micro, 2mm

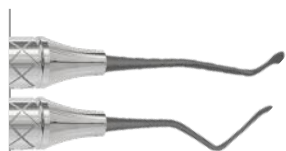

## 7905K-SP

Tunneling Knife 2, 3.5mm

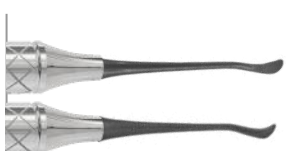

## 7906K-SP

VISTA Tunneling 1



## 7907K-SP

VISTA Tunneling 2



## 7901K-SP

VISTA Tunneling 3



## 7908K-SP

VISTA Tunneling 4



## 7909K-SP

VISTA Tunneling 5

# Micro Surgery Kit

# 9914

## What's Inside

- |                |  |                |   |
|----------------|--|----------------|---|
| <b>3008-4D</b> | La Garange Scissor, Double Curved, 11.5 cm, Black, Super-cut, TC | <b>5664</b>    | Scalpel Handles No:3  |
| <b>3122-2S</b> | Barraquer/Gingiva Scissor, Straight, 15cm, TC                    | <b>1450 SP</b> | ErgoSteel Plus, Mirror handle   |
| <b>7151 SS</b> | Buser, 4mm-4mm   | <b>1504F</b>   | Front-Surface Mouth , Mirror, No. 4, 22mm                                 |
| <b>7157 SS</b> | Zucchelli 3mm-3mm  | <b>7106 SP</b> | Lucas 87, 3.5mm   |
| <b>3332-2S</b> | Castervejio Micro Needle Holder, Straight, 18cm, TC              | <b>7156 SP</b> | Nordberg Molt 4mm-7mm   |
| <b>3802-1G</b> | Micro Surgical Tweezer, Straight, 1-2, 18cm                      | <b>5513B</b>   | Removable lid, Sterilization cassette for 20, 280x180x35mm, Blue Silicone |
| <b>3802-1</b>  | Micro Surgical Tweezer, Straight, 18cm                           |                |   |



## Essential instruments for microsurgical procedures

A carefully selected set of essential instruments for delicate surgical procedures, designed to support precise tissue handling, better visibility, and efficient clinical workflow. Supplied in a 20-instrument sterilization cassette with removable lid for easy cleaning and handling.

ErgoDenta

&

NORDIC  
DENTAL  
ACADEMY

A collaboration between ErgoDenta and Nordic Dental Academy — as their official instrument partner, we co-developed dental instrument kits designed for their clinical training courses and trusted in everyday surgical practice.

Kits by

*DnD*

**Marcus  
Dagnelid**

Specialist in  
Prosthodontics

**Professor  
Christer  
Dahlin**

Oral Surgery and  
Guided Bone  
Regeneration

**Designed for education.  
Built for daily practice**

Prosthetic kit by

*DnD*

Developed with

**Professor Christer Dahlin**  
**Dr. Marcus Dagnelid**

This prosthetic kit brings together essential instruments for restorative and prosthetic procedures – carefully selected to support precise handling, good visibility, and an efficient clinical workflow.



# 9918

## What's Inside

- 1311 XP** Explorer 23 + Probe CP 12B
- 1404 XP** ErgoX Plus Mirror handle, Sky Cyan
- 1504F** #4 Front-Surface Mirror Ø22mm (1 pc)
- 2551 X** Composite Spatula 6, 2.5mm-2.5mm
- 2543 X** Cord Packer 2.0 mm
- 2547 X** Filling Remover, 1.5-0.5mm
- 5508K** ErgoTray 8 - Black

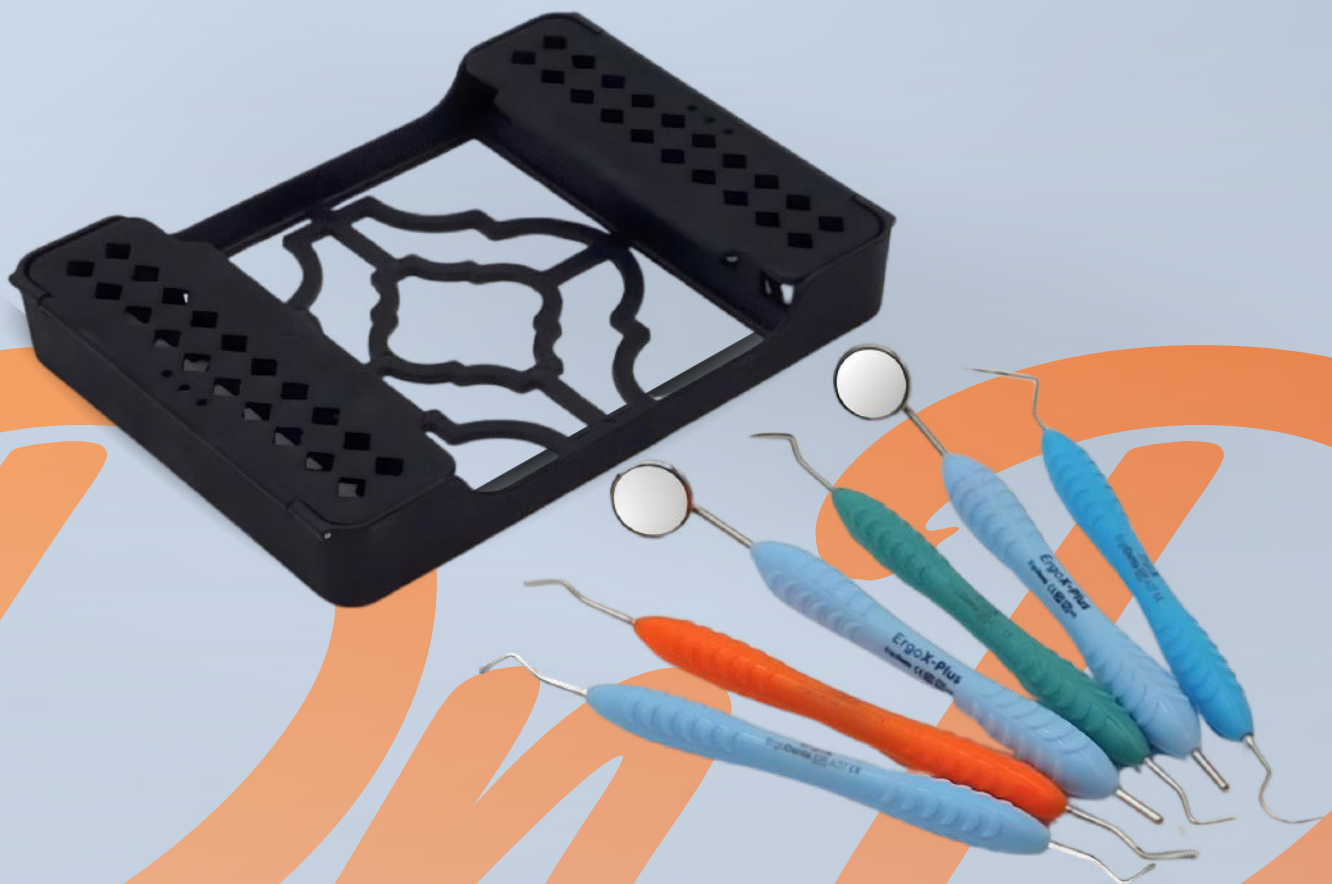

## Surgery Kit by

# DnD

# 9919

## What's Inside

<b>3226-2S</b>	Crile-Wood Needle Holder, Straight, 15cm, TC
<b>3003-2C</b>	Iris Scissor, Curved, 15cm, TC
<b>3636-1A</b>	Meriam Tweezer, Serrated, Fig 1, 16cm
<b>3606-1G</b>	Adson Tweezer, 1x2, 12cm
<b>4055</b>	Obwegeser Internal Retractor, 55 x 12 mm, 23cm
<b>2159 SP</b>	M23
<b>1310 SP</b>	Explorer 23 + Probe CP 12
<b>1450 SP</b>	ErgoSteel Plus, Mirror handle
<b>1504F</b>	#4 Front-Surface Mirror Ø22mm (1 pc)

<b>7106 SP</b>	Lucas 87, 3.5mm
<b>7156 SP</b>	Nordberg Molt 4mm-7mm
<b>7158 SP</b>	Glickmann, 4mm-4mm
<b>7162 SP</b>	Bone Scrapper, 3mm-5mm
<b>5664</b>	Scalpel handle no. 3
<b>3411-1C</b>	Rochester Pean Forceps, Curved, 13.5cm
<b>5593</b>	Bowl 50*60*11mm
<b>7218 SP</b>	Sinus Lift Instrument, 4mm-4.3mm
<b>5513B</b>	Removable lid, Sterilization cassette for 20, Blue

Developed with  
**Professor Christer Dahlin**  
**Dr. Marcus Dagnelid**

This surgery kit brings together the essential instruments for predictable oral surgery and guided bone regeneration – organized for smooth, efficient clinical workflow.

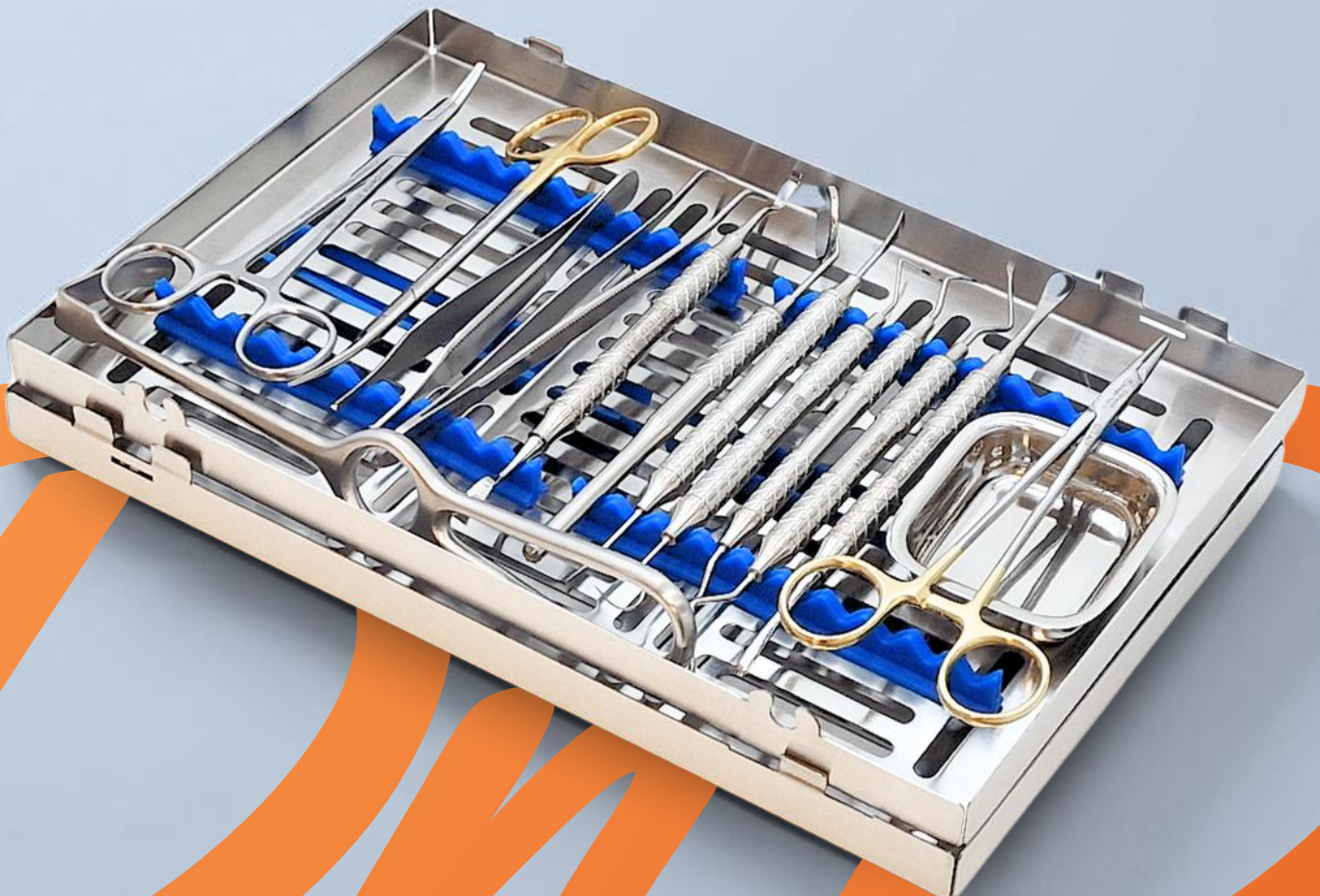

# kits by *Dr.* **Iman**

ErgoDenta

Ideal for busy clinics performing everyday surgical procedures.

## Dr. Iman Azarmehr

Oral & Maxillofacial Surgeon

**Dr. Iman Azarmehr** is an Oral & Maxillofacial surgeon practicing in Denmark and Sweden his main area of focus are advanced implant surgery, orthognathic surgery and treatment of temporomandibular joint diseases.

Together with the team of **ErgoDenta** he has put together a surgical kit that has been proven to be versatile, covering the need for most common procedures in private practice. This kit has now been tested and developed during 10 years.

**Efficient workflow  
surgical kits**



# Surgery kit by **Dr. Iman**

Developed with

**Iman Azarmehr**

Specialist in Oral and Maxillofacial Surgery

A compact, well-thought-out kit that covers the instruments you reach for in routine surgery. Easy to organize, easy to sterilize, and ideal for high-flow clinical environments.



Ideal for busy clinics performing everyday surgical procedures.

## What's Inside

**2547 SP** Filling Remover, 1.5–0.5mm

**1310 SP** Explorer 23 + Probe CP 12

**3629-1AD** College Tweezer, Diamond Tip, 15cm

**1450 SP** ErgoSteel Plus, Mirror handle

**1504F** Front-Surface Mouth, Mirror, No. 4, 22mm

**7156 SP** Nordberg Molt 4mm–7mm

**3437-1S** Hemostatic Forceps, Straight, 12cm

**4014** Langenbeck Retractor, 42 x11 mm, 22cm

**7158 SP** Glickmann, 4mm–4mm

**3007-4C**

**7102 SP**

**3209-2S**

**3801-1G**

**5594**

**5584**

**5555**

Goldman Fox, Curved, 13 cm, Black, Super-cut, TC

Miller 2I, 3.0mm

Fine Swedish Needle Holder, Straight, 15cm, TC

Micro Surgical Tweezer, Straight, 1-2, 15cm

Bowl 50x60x15mm

Perforated Instrument Tray 284x183x17mm

Instrument Holder, 280mm

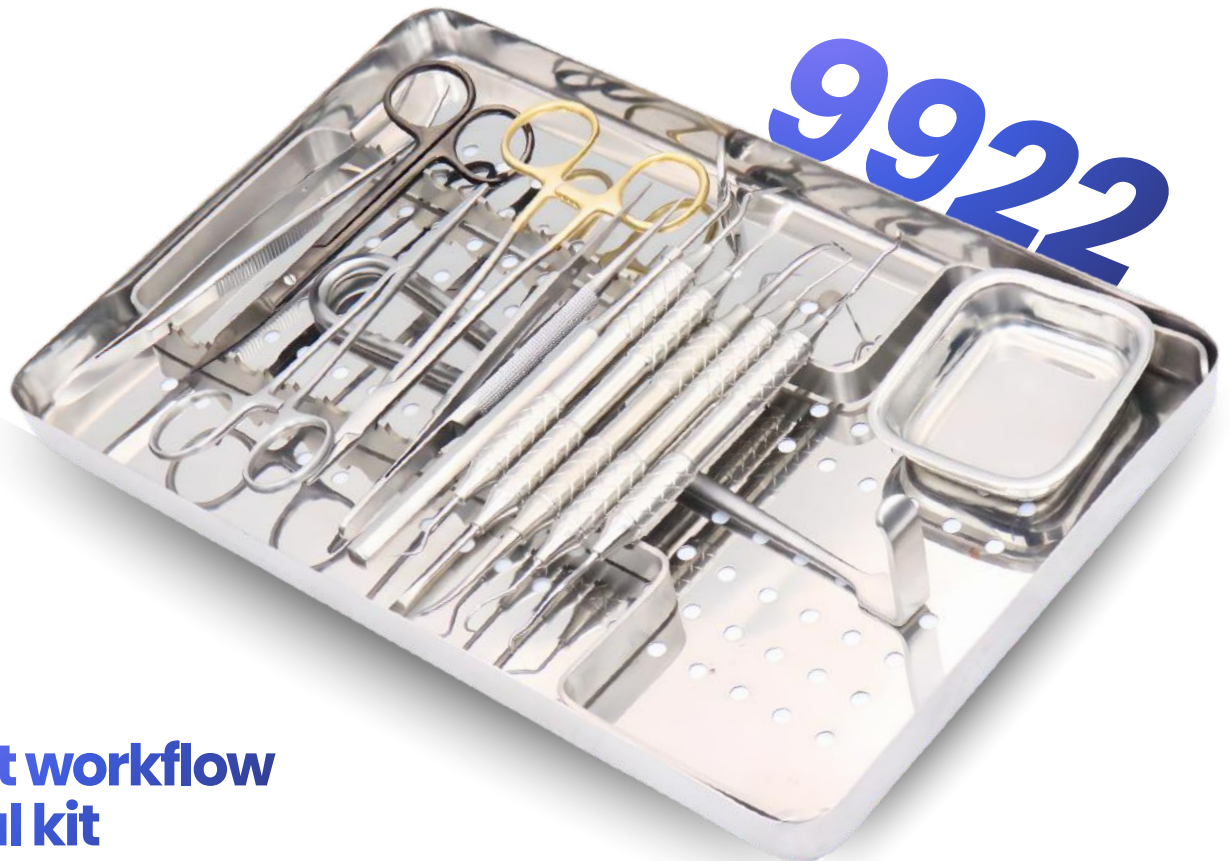

## Efficient workflow surgical kit

A practical kit built from clinical experience for everyday surgical procedures. The instruments are organized in a sterilization tray and rack, making preparation simple and improving workflow efficiency in busy clinics.

# Kits by Dr. **Iman**

Ideal for busy clinics performing everyday surgical procedures.

Developed with

**Iman Azarmehr**

Specialist in Oral and Maxillofacial Surgery

A compact, well-thought-out kit that covers the instruments you reach for in routine surgery. Easy to organize, easy to sterilize, and ideal for high-flow clinical environments.



For more info visit **Page no 152**

**Suture Silicone Training Pad Available**

A practical solution for suturing practice and surgical training.



## Mini Suture kit

# 9920

- 3007-4C** Goldman Fox, Curved, 13 cm, Black, Super-cut, TC
- 3209-2S** Fine swedish needle holder, 15 cm TC
- 3801-1G** Micro surgical tweezer, 1-2, 15cm
- 7158 SP** Glickman, 4mm-4mm
- 5664** Scalpal handle No:3
- 5512B** Sterilization cassette 10

A compact kit for everyday suturing and minor procedures. The instruments are organized in a sterilization cassette for easy preparation and efficient handling during treatment.



## Sinus-lift kit

# 9921

- 7212B-SP** Sinus Lift Instrument, 3mm-3mm, Blue
- 7213B-SP** Sinus Lift Instrument, 4mm-4mm, Blue
- 7202B-SP** Currettes #2, 3mm-4mm, Blue
- 7218B-SP** Sinus Lift Instrument, 4mm-4.3mm, Blue
- 7222B-SP** Sinus Lift Mushroom, 2.5mm-3.2mm
- 5511B** Sterilization cassette 5

Set of 5 sinus-lift instruments in blue titanium coating, arranged in a sterilization cassette for organized handling and efficient preparation during sinus-lift procedures.

Align, Adjust & Adapt

# Orthodontics



Essential instruments every  
orthodontist trusts daily.

# Orthodontics

## Wire Cutters



**4225**  
Distal End Cutter

12.5cm  $\varnothing$  0.35mm / .014",  
□ 0.55x0.64mm / .021"x.025"



**4227**  
Distal End Cutter

13cm  $\varnothing$  0.35mm / .014",  
□ 0.55x0.64mm / .021"x.025"



**4228**  
Distal End Cutter

15cm  $\varnothing$  0.35mm / .014",  
□ 0.55x0.64mm / .021"x.025"



**4229**  
Distal End Cutter

15cm M Max.  $\varnothing$  0.4mm / .016"



**4601**  
Distal End Cutter

12.5cm  $\varnothing$  0.35mm / .014",  
□ 0.55x0.64mm / .021"x.025"



**4602**  
Distal End Cutter

15cm  $\varnothing$  0.35mm / .014",  
□ 0.55x0.64mm / .021"x.025"



**4603**  
Mini Distal End Cutter

12.5cm □ 0.41x0.56mm (.016 x .022)",  
M .017 x.025"



**4610**  
Flush Cutter

13cm □ 0.55x0.64mm / .021x.025",  
○ 0.4mm / .016"

# Orthodontics

## Wire Cutters

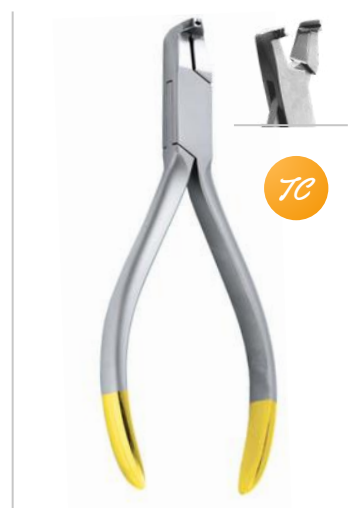

**4611**  
Flush Cutter

13cm □ 0.41x0.55mm / .016x.021",  
○ 0.3mm / .012"

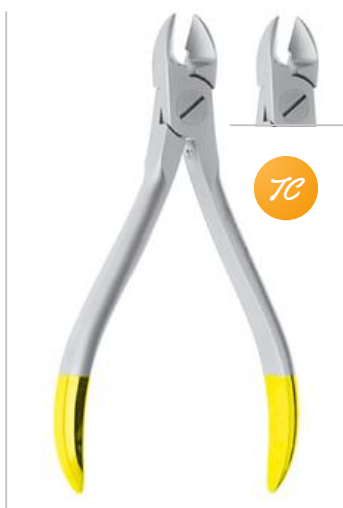

**4616**  
Ligature Cutter

12cm ○ Max.  $\varnothing$  0.7mm / .028"



**4617**  
Mini Ligature Cutter

12cm ○ Max.  $\varnothing$  0.3mm / .012"



**4621**  
Angle Wire Cutter

13cm ○ Max.  $\varnothing$  0.3mm / .012"

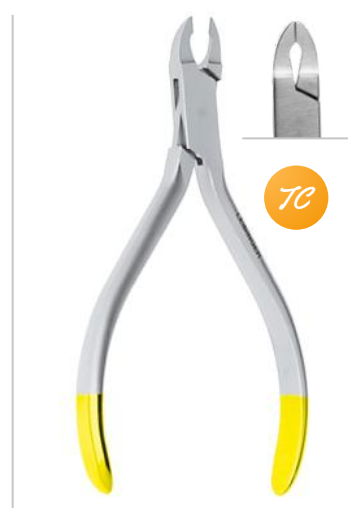

**4622**  
Angle Wire Cutter

13cm ○ Max.  $\varnothing$  0.3mm / .012"

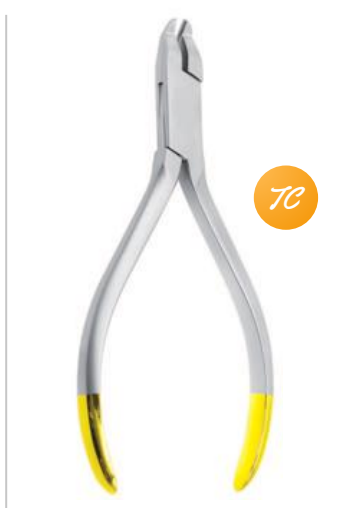

**4626**  
Wire Cutting Forceps

13cm ○ Max.  $\varnothing$  0.3mm / .014"



**4627**  
Head Cutter for  
hard wire

14.5cm ○ Max.  $\varnothing$  1.0mm / .040"



**4628**  
Side Cutter for  
hard wire

15cm ○ Max.  $\varnothing$  1.0mm / .040"

# Wire Cutters



**4320**  
Wire Cutter

15cm max Ø 1.0mm



**4321**  
Wire Cutter, TC

12cm max Ø 0.6mm

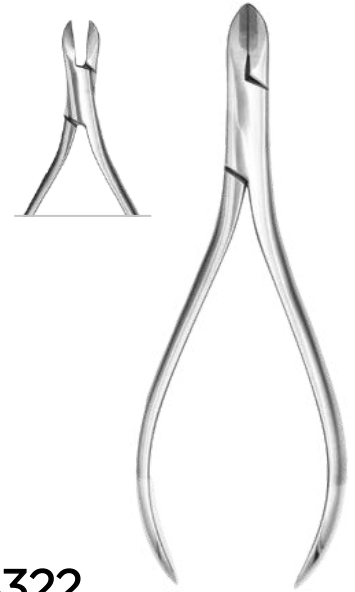

**4322**  
Wire Cutter

12cm max Ø 0.6mm



**4301**  
Pin & Ligature  
Wirecutter, TC

13cm max Ø 0.5mm



**4302**  
Pin & Ligature  
Wirecutter

13cm max Ø 0.7mm



**4303**  
Pin & Ligature  
Wirecutter, TC

13cm max Ø 0.7mm

# Aligner Plier

For accurate clear aligner adjustments.  
Durable stainless steel design ensures  
comfort and reliability.



Art no	Name	Size
4636	Horizontal Plier	12cm
4637	Vertical Plier	12cm
4745	Hole Punch Plier	12cm
4746	Tear Drop Plier	12cm
4747	Aligner Point Elevation Plier	12.5cm
4748	Aligner Reverse Plier	14cm



Hole Punch Plier



4638  
For Non-TC



Aligner  
Reverse Plier



Aligner Point  
elevation plier

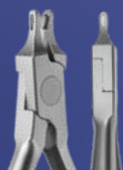

Tear Drop  
Plier



4639  
For Non-TC

Horizontal  
Plier

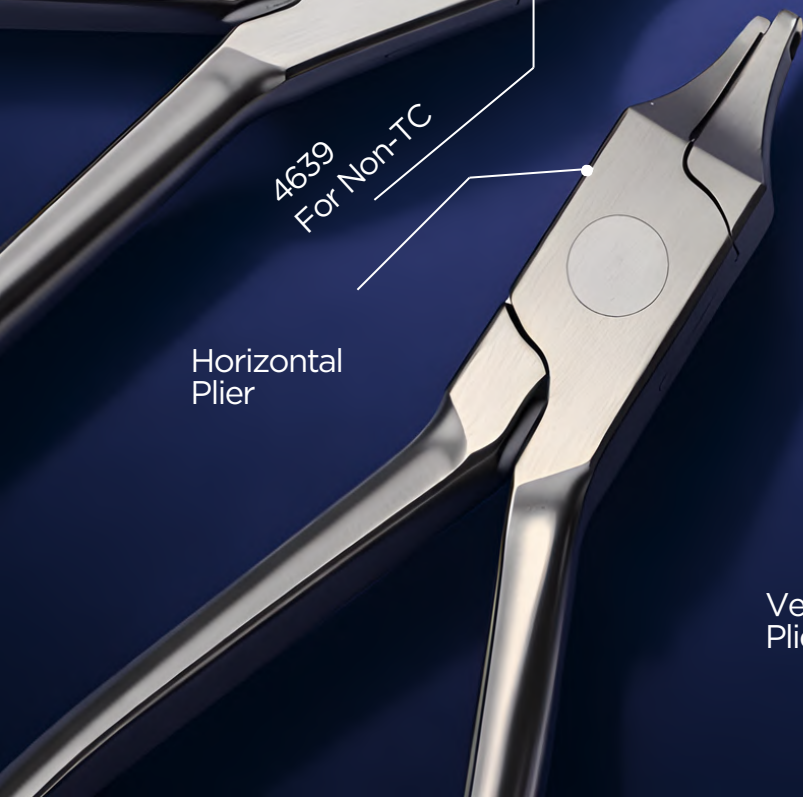

Vertical  
Plier

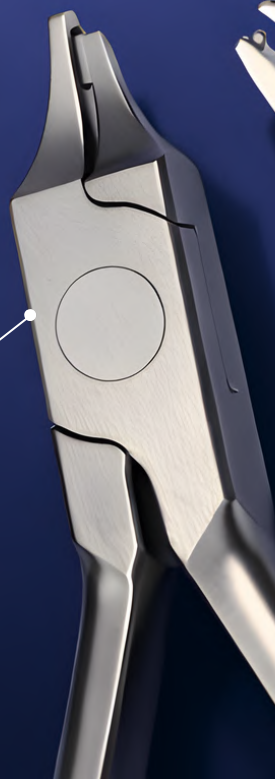

# Wire Bending Pliers



**4217**  
Young Loop and Arch Forming Plier  
13cm ○  $\varnothing$  0.7mm / .028"



**4232**  
HOW Plier Straight  
14cm



**4233**  
HOW Ligature Plier 45° angled  
14cm



**4295**  
Angle / Tweed, Arch Forming Plier  
12.5cm ○  $\varnothing$  0.5mm / .028"



**4296**  
ANGLE / TWEED, Arch Forming Plier  
12.5cm ○  $\varnothing$  0.5mm / .028"



**4312**  
Angle Wire Bending Plier  
12.5cm ○ Max.  $\varnothing$  0.7mm / .028"



**4641**  
Angle Wire Bending Plier  
12.5cm ○ Max.  $\varnothing$  0.7mm / .028"



**4642**  
Angle Wire Bending Plier, round  
12.5cm ○ Max.  $\varnothing$  0.7mm / .028"



**4643**  
Adams Wire Bending Plier  
12.5cm ○ Max.  $\varnothing$  0.7mm / .028"

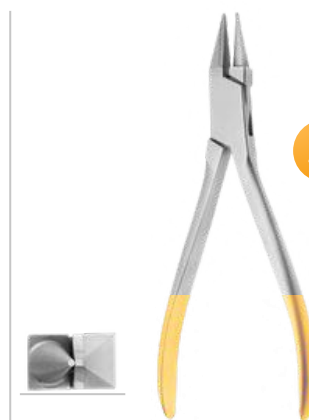

**4644**  
Adams Wire and Arch Bending Plier No. 65  
15cm



**4650**  
Jarabac Wire Bending Plier  
14cm ○ Max.  $\varnothing$  0.7mm / .028"



**4651**  
Wire Bending Plier  
13cm ○ Max.  $\varnothing$  0.5mm / .020"

# Wire Bending Plier

**4652**  
Wire Bending Plier with grooves  
13.5cm ○ Max. Ø 0.7mm / .028"

**4653**  
Tweed Loop and Arch Forming Plier  
13.5cm ○ Ø 0.5mm / .020"

**4654**  
Lightwire Bird Beak Plier with Cutter  
13.5cm ○ Max. Ø 0.6mm / .024"

**4655**  
Lightwire Loop Forming Plier with Cutter  
13.5cm ○ Max. Ø 0.4mm / .016"

**4656**  
Tweed Loop and Arch Forming Plier  
13.5cm ○ Ø 0.5mm / .020"

**4657**  
Tweed Loop and Arch Forming Plier  
14cm ○ Ø 0.5mm / .020"

**4658**  
Tweed Loop and Arch Forming Plier  
14cm ○ Ø 0.7mm / .028"

**4666**  
Weingart Universal Plier  
14.5cm ○ Ø 0.7mm / .028"

**4667**  
Weingart Delicate Universal Plier  
14cm ○ Ø 0.7mm / .028"

**4668**  
Weingart Universal Plier with short jaws  
14cm ○ Ø 0.5mm / .020"

**4669**  
Weingart Ultra Slim Universal Plier  
14.5cm ○ Ø 0.5mm / .020"

**4670**  
Weingart Delicate Universal Plier  
14.5cm ○ Ø 0.5mm / .020"



# Wire Bending Plier



**4676**  
Aderer Three-Finger-Plier  
12.5cm  $\varnothing$  0.7mm / .028"



**4677**  
Aderer Three-Finger-Plier Strong Pattern  
12.5cm  $\varnothing$  0.9mm / .028"



**4678**  
Aderer Three-Finger-Plier  
11.5cm  $\varnothing$  0.5mm / .020"



**4679**  
Aderer Three Finger Plier  
12.5cm  $\varnothing$  0.3mm / .012"



**4681**  
Aderer Band Removing Plier  
13.5cm



**4682**  
Aderer Band Removing Plier  
13.5cm



**4683**  
Oliver Band Removing Plier  
14cm



**4684**  
Bracket Removing Plier  
13.5cm



**4685**  
Bracket Removing Plier Angled 45°  
13.5cm



**4686**  
Removing Plier  
12.5cm



**4690**  
Schwarz Hollow Chop Plier  
12.5cm  $\varnothing$  0.7mm / .028"





**4691**  
Schwarz Hollow Chop Plier  
14cm  $\varnothing$  0.7mm / .028"

# Wire Bending Plier



**4692**  
Johnson Contouring Plier  
13.5cm 3mm



**4693**  
Johnson Contouring Plier  
13.5cm 4mm





**4694**  
Andersen Hollow Chop Plier  
13cm





**4695**  
Gordon Contouring Plier  
13.5cm

**4696**  
DeLa ROSA Arch Contouring Plier with groove guides  
12.5cm



**4697**  
DeLa ROSA Arch Contouring Plier  
12.5cm



**4698**  
Lingual Arch Forming Plier  
12.5cm  $\varnothing$  0.7mm / .028"





**4712**  
Step Bending Plier  
13.5cm 1/2mm

**4713**  
Step Bending Plier  
13.5cm 3/4mm



**4714**  
Step Bending Plier  
13.5cm 1mm





**4715**  
Nance Step Loop Bending Plier  
13cm steps of 3, 4, 5 and 6mm enable exact and even bending



**4716**  
V-Step Plier (places V-bends in arch wires)  
13cm for wire up to .021 x .025"

# Wire Bending Plier



**4717**  
Crimpable Arch Wire Hook Plier

TC

14cm for surgical ball hooks straight



**4718**  
Hammerhead Plier

for bending nickel-titanium arches/wires in the molar region

14cm ∅ 0.018"



**4719**  
Nance Arrow Clasp Forming Plier

12.5cm ∅ 0.7mm / .028"



**4720**  
Adams-Nance Clasp Bending Plier

15.5cm ∅ 0.7mm / .028"



**4721**  
SCHWARZ Arrow Clasp Forming Plier

13cm ∅ 0.7mm / .028"



**4722**  
Denta Wire Bending Plier, TC

TC

12.5cm

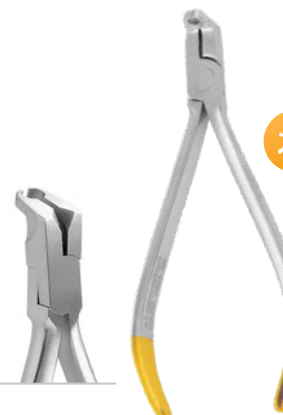

**4280**  
Bracket Removal Plier, TC

TC



**4736**  
Waldsachs Universal Plier

15cm ∅ 0.7mm / .028"



**4737**  
Universal Plier

15cm ∅ 1.0mm / .040"



**4738**  
Universal Plier

16cm ∅ 1.0mm / .040"



**4739**  
Flat Nose Plier

14cm both sides smooth



**4740**  
Flat Nose Plier

14cm both sides serrated



**4741**  
Flat Nose Plier, TC

14cm both sides serrated with TC Inserts



**4742**  
Peeso Wire Bending Plier

13.5cm



**4743**  
Langenbeck Round Plier

14cm



**4744**  
Goslee Flat Nose Plier

14cm



**4281**  
Bracket Removing Plier

12.5cm



**1430**  
Ortho 0-25, Mirror Handle



**4201E 1**  
Changeable Part for Adhesive Removal Plier, Teflon

**4201E 2**  
Changeable Part for Adhesive Removal Plier, Blade

**4201**  
Adhesive Removal Plier



**4206E 1**  
Changeable Part for Posterior Band Removing Plier, Plastic Pad

**4206**  
Posterior Band Remover Plier, TC

15cm Long, with Teflon/Plastic Tip



**4780**  
Bracket Positioning Gauge  
for .018 slot brackets



**4781**  
Bracket Positioning Gauge  
for .022 slot brackets



**7071 X**  
Ortho Ligature Tucker



**7072 X**  
Ortho Arch Wire Tucker



**7073 X**  
Ligature 17C



**7074 X**  
Ligature U15



**4730**  
Smaha Ligature  
Forceps

14cm

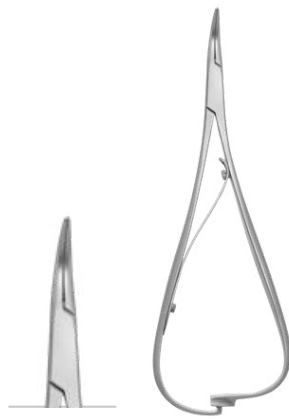

**4733**  
Smaha Ligature  
Forcep, Curved

14cm



**4731**  
Smaha Ligature  
Forceps

14cm delicate tips with groove



**4732**  
Mathieu Ligature Forceps

14cm 5.0mm serration length



**3301-1S**  
Mathieu Needle Holder,  
Straight

14cm



**3301-2S**  
Mathieu Needle Holder,  
Straight, TC

14cm

TC



**3302-1S**  
Mathieu Needle Holder,  
Straight

17cm



**3302-2S**  
Mathieu Needle Holder,  
Straight, TC

17cm

TC



**4370**  
Mathieu Ortho plier,  
Delicate

14cm



**4371**  
Mathieu Ortho plier,  
Standard

14cm



**2730**  
Elastic Separating Plier

15cm



**4344**  
Langback Plier

12cm max Ø 0.8mm



4710

14cm

4711

Torquing Plier (Set) Set of Plier used to place a torque to square/rectangular archwire, TC



4230  
Aderer Plier

12.5cm short max  $\varnothing$  0.6mm



4231  
Aderer Plier

13cm long max  $\varnothing$  0.6mm



3692-1  
Bracket Positioning  
Tweezer

14cm



3694-1A  
Bracket Tweezer

11cm



4252  
Nose Plier, Short

15cm



4253  
Nose Plier, Long

15cm

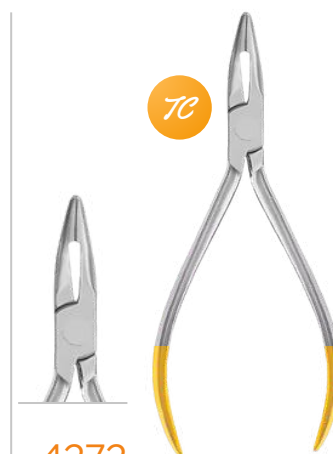

4272  
Weingart Plier  
Standard, TC

15cm for Dental Technic,



4273  
Weingart Plier for  
Dental Technic, TC

13.5cm



**4275**  
Ligature Cutter 15°  
Angle, TC  
12cm



**4290**  
Hard Wire Cutter, TC  
14cm 10° Angle,



**4292**  
Ribbon-Tweed  
Arch, Short  
15cm



**4293**  
Ribbon-Tweed  
Arch, Long  
15cm



**4310**  
Adams Plier, Lap joint  
13cm max Ø 0.4mm



**4266**  
Schwarz, Fig. 1,  
13cm max Ø 0.4mm



**4313**  
Angle Plier, Lap Joint  
12.5cm max Ø 0.7mm



**4223**  
Three beak Plier



**4378**  
De la rosa band  
contouring



**4379**  
Micro ligature  
cutter, TC



**4294**  
Tweed Loop Plier  
13cm



**4382**  
Universal Plier, TC

**4373**  
Measuring ruler,  
0-60mm



0-60mm

**4374**  
Measuring ruler,  
0-80mm



0-80mm

**4390B**  
Band seater, Blue



13cm

**4372**  
Band Pusher



**4375**  
Cinch Back



**4376**  
Buccal Tube Holder



**4377**  
Boon's Gauge with Lid



**ErgoOrtho**  
is on the way

Our dedicated orthodontic catalog  
will be released later in 2026.

# Endodontic

## Instruments

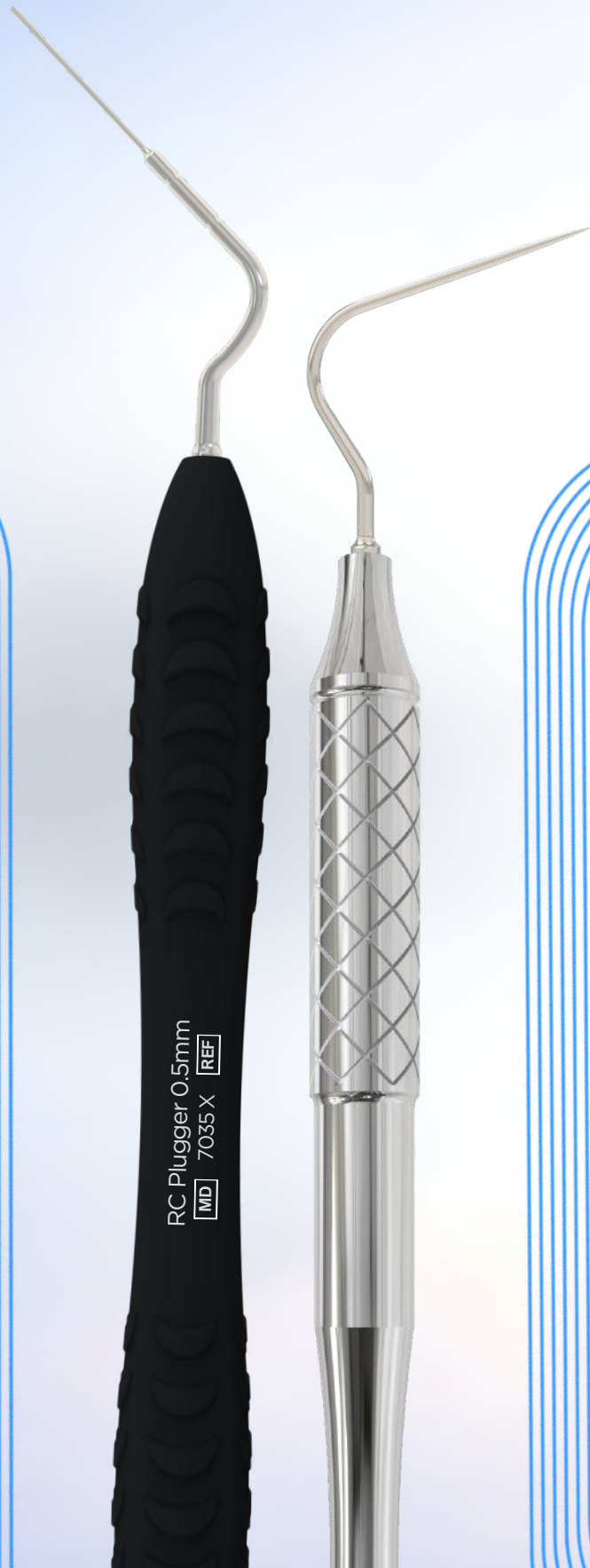

RC Plugger 0.5mm  
MD 7035 X REF

# Gutta-Percha Remover



Up

Down

Left

Right

## Hook, Remove & Move On!

The ultra-thin 0.4 mm tip preserves canal walls. The double-ended design offers versatile hooks and easy retrieval from any angle, leaving no residue.

**NEW**

### 7001 X

Gutta Percha Remover, Up-Down, 0.4mm Hook



### 7002 X

Gutta Percha Remover, Left-Right, 0.4mm Hook

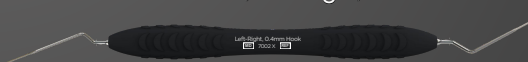

### 7001

Gutta Percha Remover, Up-Down, 0.4mm Hook



### 7002

Gutta Percha Remover, Left-Right, 0.4mm Hook



# Black Endo Instruments



## Endo Plugger

Used for condensing gutta-percha, providing a dense and secure canal filling.

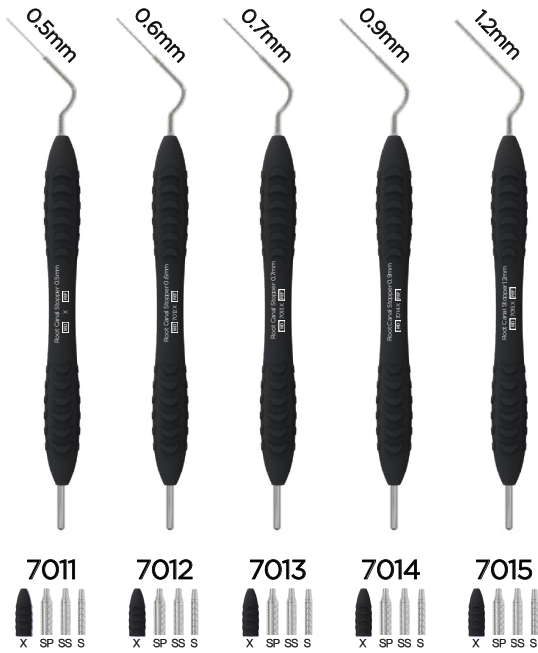

Single-end

**NEW**

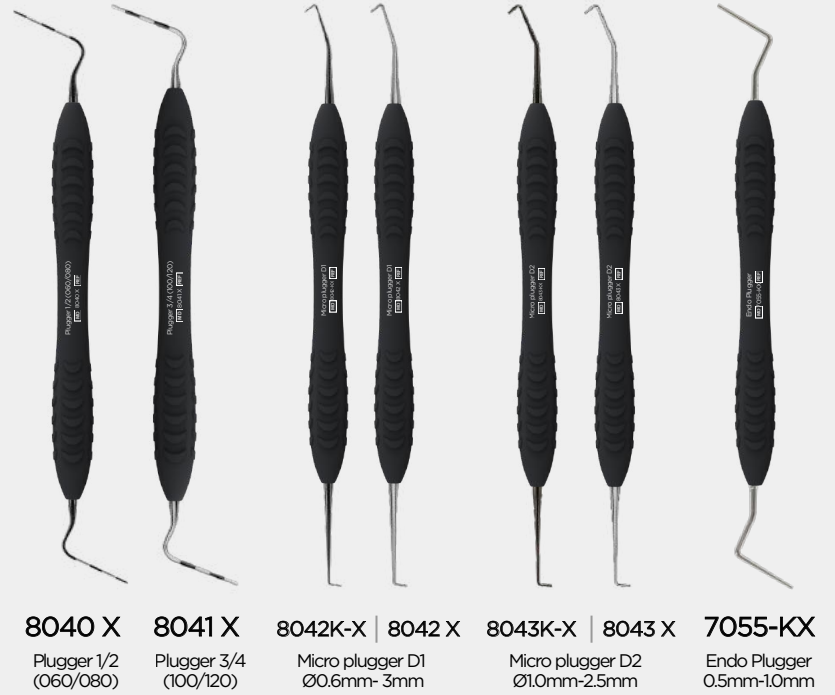

## Endo Plugger

Used for condensing gutta-percha, providing a dense and secure canal filling.

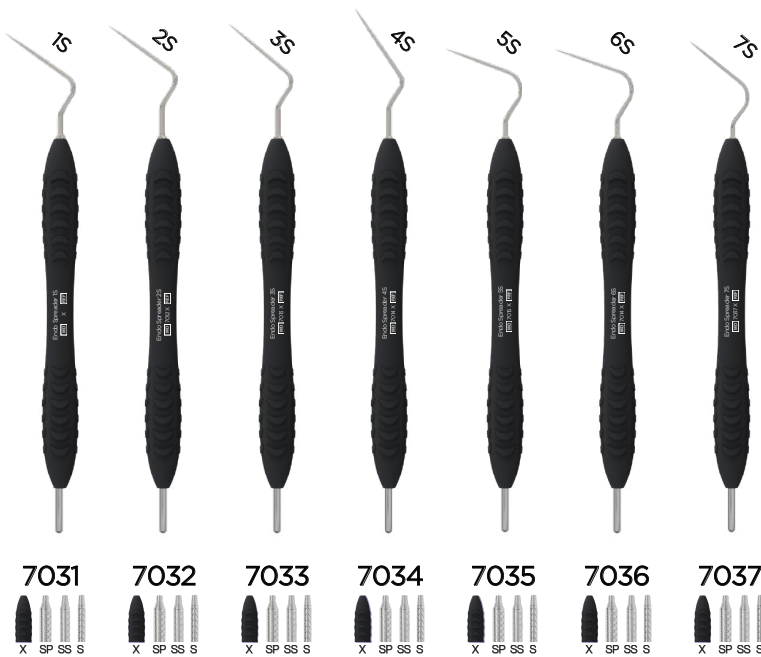

**NEW**



**NEW**

# Black Endo Instruments



## Excavator



8080K-X | 8080 X  
Excavator  
31L



8081K-X | 8081 X  
Excavator  
32L



8082K-X | 8082 X  
Excavator  
33L

## Endo Spreader & Pluggers



7056-KX  
Ø0.4mm &  
Ø0.4mm



7057-KX  
Ø0.4mm &  
Ø0.6mm



7058-KX  
Ø0.6mm &  
Ø0.8mm



7059-KX  
Ø0.6mm &  
Ø1.0mm

## Endo Explorer



8000K-X | 8042 X  
Explorer  
17/17L



8001K-X | 8041 X  
Explorer KX1,  
straight



8002K-X | 8042 X  
Explorer KX2,  
angled



7050-KX  
Endo  
Explorer



7051-KX  
Root Canal  
Explorer

## Periodontal Probe



8020 X  
Periodontal  
CP 12-15

## Mirror Handles



1715 X  
Mirror Handles  
Double End

# Endo Instruments

## Endo Spreader & Pluggers

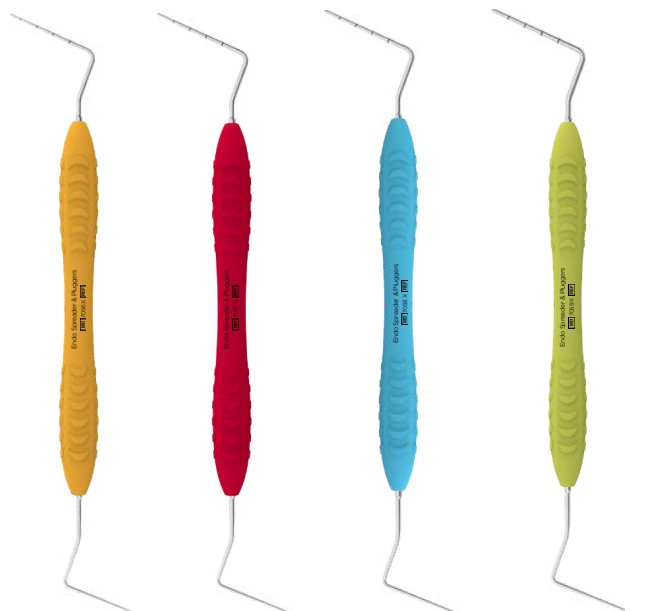

Ø0.4mm & Ø0.4mm

7056



Ø0.4mm & Ø0.6mm

7057



Ø0.6mm & Ø0.8mm

7058



Ø0.6mm & Ø1.0mm

7059



## Endo Explorers & Pluggers



Endo Explorer

7050



Root Canal Explorer

7051



Endo Plugger, 0.5mm-1.0mm

7055



**NEW**

## Endo Curettes

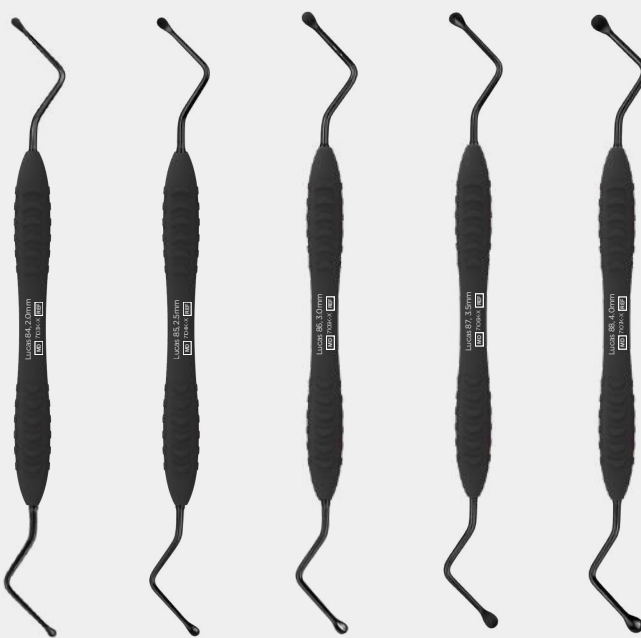

7103K-X  
Lucas 84,  
2.0mm

7104K-X  
Lucas 85,  
2.5mm

7105K-X  
Lucas 86,  
3.0mm

7106K-X  
Lucas 87,  
3.5mm

7107K-X  
Lucas 88,  
4.0mm

## ErgoEndo Black

A focused range for modern endodontic work, designed to support precision, comfort, and reliable daily performance.



View Online  
Scan the QR Code



# Rubberdam Clamps



Provide reduced *Glare* for  
improved *Visibility* during procedures.

# Rubberdam Clamps

ErgoDenta offers rubber dam clamps in four types:

- Gold
- Black
- Blue
- Standard



## Anteriors

00	W00	6	9	9S	210	212	212SA
2701-00 K2701-00 G2701-00 B2701-00	2701-W00 K2701-W00 G2701-W00 B2701-W00	2701-6 K2701-6 G2701-6 B2701-6	2701-9 K2701-9 G2701-9 B2701-9	2701-9S K2701-9S G2701-9S B2701-9S	2701-210 K2701-210 G2701-210 B2701-210	2701-212 K2701-212 G2701-212 B2701-212	2701-212SA K2701-212SA G2701-212SA B2701-212SA
106R	106L	B4					
2701-106R K2701-106R G2701-106R B2701-106R	2701-106L K2701-106L G2701-106L B2701-106L	2701-B4 K2701-B4 G2701-B4 B2701-B4					

## Upper Molars

4	W4	5	8
2705-4 K2705-4 G2705-4 B2705-4	2705-W4 K2705-W4 G2705-W4 B2705-W4	2705-5 K2705-5 G2705-5 B2705-5	2705-8 K2705-8 G2705-8 B2705-8
201	205	W8	26N
2705-201 K2705-201 G2705-201 B2705-201	2705-205 K2705-205 G2705-205 B2705-205	2705-W8 K2705-W8 G2705-W8 B2705-W8	2705-26N K2705-26N G2705-26N B2705-26N
30	31		
2705-30 K2705-30 G2705-30 B2705-30	2705-31 K2705-31 G2705-31 B2705-31		

## Lower Molars

3	W3	7	7A
2702-3 K2702-3 G2702-3 B2702-3	2702-W3 K2702-W3 G2702-W3 B2702-W3	2702-7 K2702-7 G2702-7 B2702-7	2702-7A K2702-7A G2702-7A B2702-7A
26	28	202	W7
2702-26 K2702-26 G2702-26 B2702-26	2702-28 K2702-28 G2702-28 B2702-28	2702-202 K2702-202 G2702-202 B2702-202	2702-W7 K2702-W7 G2702-W7 B2702-W7
12A	W12A	13A	
2702-12A K2702-12A G2702-12A B2702-12A	2702-W12A K2702-W12A G2702-W12A B2702-W12A	2702-13A K2702-13A G2702-13A B2702-13A	

# Pre molars

0	1	1A
<ul style="list-style-type: none"> <li> 2704-0</li> <li> K2704-0</li> <li> G2704-0</li> <li> B2704-0</li> </ul>	<ul style="list-style-type: none"> <li> 2704-1</li> <li> K2704-1</li> <li> G2704-1</li> <li> B2704-1</li> </ul>	<ul style="list-style-type: none"> <li> 2704-1A</li> <li> K2704-1A</li> <li> G2704-1A</li> <li> B2704-1A</li> </ul>
29	206	208
<ul style="list-style-type: none"> <li> 2704-29</li> <li> K2704-29</li> <li> G2704-29</li> <li> B2704-29</li> </ul>	<ul style="list-style-type: none"> <li> 2704-206</li> <li> K2704-206</li> <li> G2704-206</li> <li> B2704-206</li> </ul>	<ul style="list-style-type: none"> <li> 2704-208</li> <li> K2704-208</li> <li> G2704-208</li> <li> B2704-208</li> </ul>
2A	2AS	2
<ul style="list-style-type: none"> <li> 2704-2A</li> <li> K2704-2A</li> <li> G2704-2A</li> <li> B2704-2A</li> </ul>	<ul style="list-style-type: none"> <li> 2704-2AS</li> <li> K2704-2AS</li> <li> G2704-2AS</li> <li> B2704-2AS</li> </ul>	<ul style="list-style-type: none"> <li> 2704-2</li> <li> K2704-2</li> <li> G2704-2</li> <li> B2704-2</li> </ul>
W2	27N	209
<ul style="list-style-type: none"> <li> 2704-W2</li> <li> K2704-W2</li> <li> G2704-W2</li> <li> B2704-W2</li> </ul>	<ul style="list-style-type: none"> <li> 2704-27N</li> <li> K2704-27N</li> <li> G2704-27N</li> <li> B2704-27N</li> </ul>	<ul style="list-style-type: none"> <li> 2704-209</li> <li> K2704-209</li> <li> G2704-209</li> <li> B2704-209</li> </ul>

## Using Rubber Dam Clamps Effectively

Successful rubber dam isolation depends on selecting and placing the correct clamp for each clinical situation. A properly fitted clamp provides stable tooth isolation, supports moisture control, and helps create a clear, dry working field.

Clamps should always be inspected before use and reprocessed according to standard sterilization protocols. Correct positioning below the tooth's height of contour ensures reliable retention throughout the procedure, while proper adaptation helps avoid unnecessary pressure on gingival tissues.

Choosing the right clamp design and size improves procedural efficiency, enhances visibility, and contributes to patient comfort during restorative and endodontic treatments.



# Molars / Universal

8A	8AD	W8A	10	11	14	51	56
<ul style="list-style-type: none"> <li> 2703-8A</li> <li> K2703-8A</li> <li> G2703-8A</li> <li> B2703-8A</li> </ul>	<ul style="list-style-type: none"> <li> 2703-8AD</li> <li> K2703-8AD</li> <li> G2703-8AD</li> <li> B2703-8AD</li> </ul>	<ul style="list-style-type: none"> <li> 2703-W8A</li> <li> K2703-W8A</li> <li> G2703-W8A</li> <li> B2703-W8A</li> </ul>	<ul style="list-style-type: none"> <li> 2703-10</li> <li> K2703-10</li> <li> G2703-10</li> <li> B2703-10</li> </ul>	<ul style="list-style-type: none"> <li> 2703-11</li> <li> K2703-11</li> <li> G2703-11</li> <li> B2703-11</li> </ul>	<ul style="list-style-type: none"> <li> 2703-14</li> <li> K2703-14</li> <li> G2703-14</li> <li> B2703-14</li> </ul>	<ul style="list-style-type: none"> <li> 2703-51</li> <li> K2703-51</li> <li> G2703-51</li> <li> B2703-51</li> </ul>	<ul style="list-style-type: none"> <li> 2703-56</li> <li> K2703-56</li> <li> G2703-56</li> <li> B2703-56</li> </ul>
56S	60	203	204	14A	W14	W14A	18
<ul style="list-style-type: none"> <li> 2703-56S</li> <li> K2703-56S</li> <li> G2703-56S</li> <li> B2703-56S</li> </ul>	<ul style="list-style-type: none"> <li> 2703-60</li> <li> K2703-60</li> <li> G2703-60</li> <li> B2703-60</li> </ul>	<ul style="list-style-type: none"> <li> 2703-203</li> <li> K2703-203</li> <li> G2703-203</li> <li> B2703-203</li> </ul>	<ul style="list-style-type: none"> <li> 2703-204</li> <li> K2703-204</li> <li> G2703-204</li> <li> B2703-204</li> </ul>	<ul style="list-style-type: none"> <li> 2703-14A</li> <li> K2703-14A</li> <li> G2703-14A</li> <li> B2703-14A</li> </ul>	<ul style="list-style-type: none"> <li> 2703-W14</li> <li> K2703-W14</li> <li> G2703-W14</li> <li> B2703-W14</li> </ul>	<ul style="list-style-type: none"> <li> 2703-W14A</li> <li> K2703-W14A</li> <li> G2703-W14A</li> <li> B2703-W14A</li> </ul>	<ul style="list-style-type: none"> <li> 2703-18</li> <li> K2703-18</li> <li> G2703-18</li> <li> B2703-18</li> </ul>
24	25	27					
<ul style="list-style-type: none"> <li> 2703-24</li> <li> K2703-24</li> <li> G2703-24</li> <li> B2703-24</li> </ul>	<ul style="list-style-type: none"> <li> 2703-25</li> <li> K2703-25</li> <li> G2703-25</li> <li> B2703-25</li> </ul>	<ul style="list-style-type: none"> <li> 2703-27</li> <li> K2703-27</li> <li> G2703-27</li> <li> B2703-27</li> </ul>					

# Rubber Dam Kit



**9917**  
Standard



**9917G**  
Gold



**9917K**  
Black



**9917B**  
Blue

## Rubberdam clamps

2703-W8A	W8A - Molar (GENERAL)
2705-W8	W8 - Upper molar
2701-212	212 - Anterior
2701-9	9 - Anterior
2704-W2	W2 - Pre molar
2704-2	2 - Pre molar
2704-2A	2A - Pre molar
2702-W7	W7 - Lower molar
2701-00	00 - Anterior
2702-W3	W3 - Lower molar
2702-12A	12A - Lower molar
2705-30	30 - Upper molar

## Rubberdam instruments & accessories

2740	Ivory Rubber Dam Punch, 16cm
2715	Rubber Dam Clamp Forceps Ivory, 17cm
2761	Steel Organizing Board for Rubber Dam Clamps
2750	Rubber Dam Stand, 9cm x 10cm
2753	Rubber Dam Stand, 10cm x 11cm
5513B	Sterilization cassette for 20, 280x180x35mm

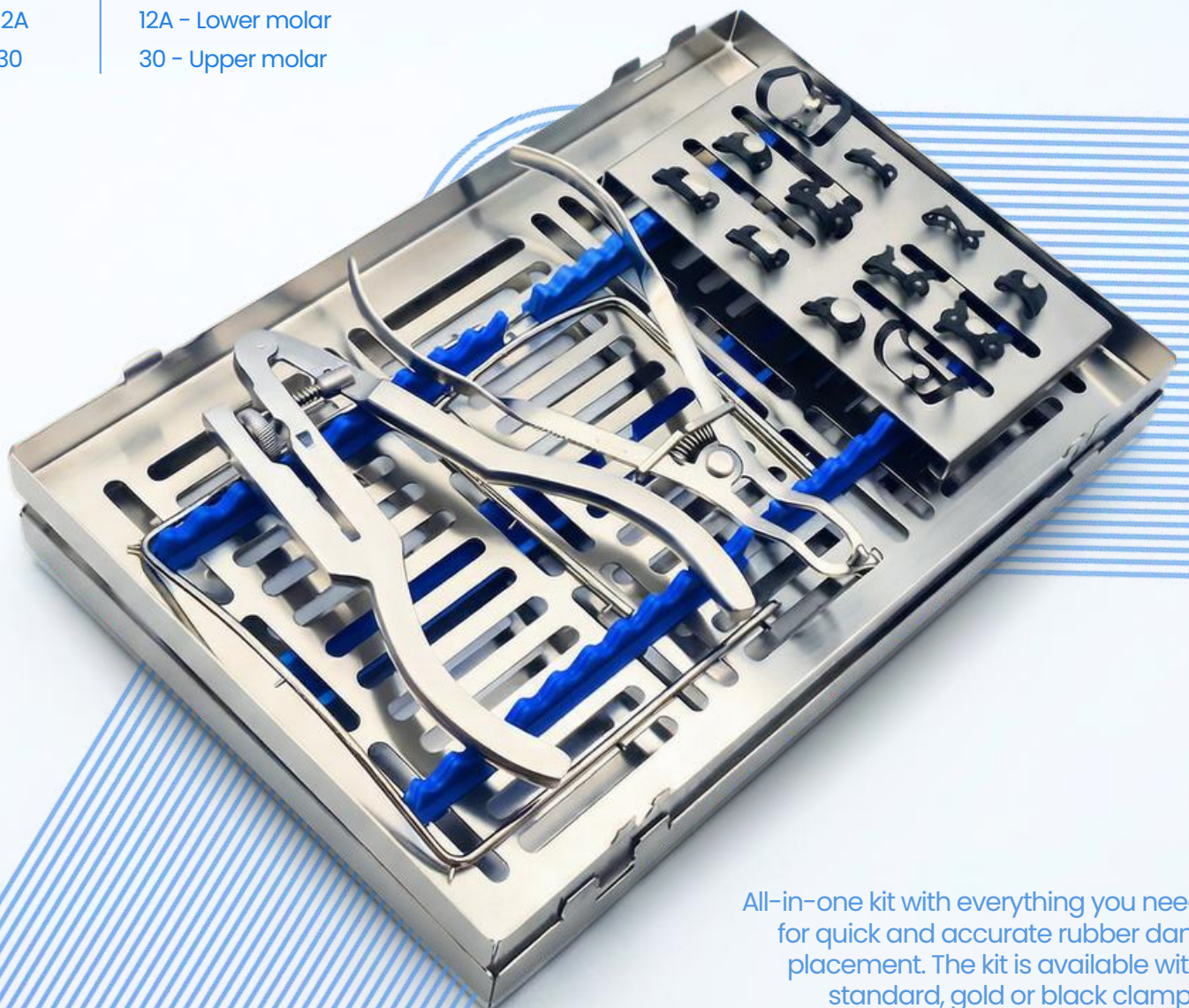

All-in-one kit with everything you need for quick and accurate rubber dam placement. The kit is available with standard, gold or black clamps

# Rubberdam instruments



**2711**  
Rubber Dam Clamp  
Forceps Brewer  
17cm



**2712**  
Rubber Dam Clamp  
Forceps Stockes  
17cm



**2713**  
Rubber Dam  
Clamp Forceps  
Washington  
17cm



**2714**  
Rubber Dam Clamp  
Forceps White  
17cm



**2715**  
Rubber Dam Clamp  
Forceps Ivory  
17cm



**2740**  
Ivory Rubberdam  
Punch Forceps  
16cm



**2741**   
Ainsworth Rubberdam  
Punch Forceps

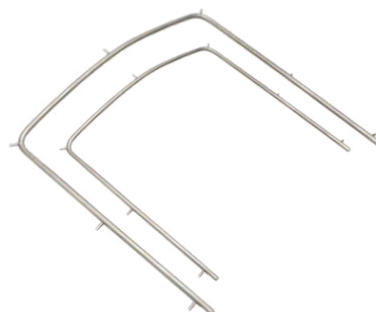

**2750**  
Rubber Dam  
Stand  
9cm x 10cm

**2753**  
Rubber Dam  
Stand  
10cm x 11cm



**2761**  
Steel Organizing Board  
for Rubber Dam Clamps

## Endo Tweezers

— with lock —



**3676-1A**

Endo tweezers,  
serrated handle  
15cm, Curved



**3677-1A**

Endo tweezers  
smooth handle  
15cm, Curved



**3667-1**

DeBakey  
Tweezers  
16cm, Straight

## Endodontic File Holder



**7415**

Endodontic  
File Holder

## Apicoectomy Retractor



**45°**  
Angled

**4180**

Apicoectomy  
retractor, toothed,  
45° angled



**90°**  
Angled

**4181**

Apicoectomy  
retractor, toothed,  
90° angled

## Endo Forceps



**7411**

Angled Endodontic  
Forceps, 14cm



**60°**  
Angled

**7416**

Root Fragment  
Forceps - Long 60°



**3209-2S**

Needle holder  
Micro-Vascular with  
TC inserts

# Endo accessories

Fully autoclavable endo accessories available in various colors and sizes. View more on our website



Bur Disinfection box resistant to high temperature and Pressure, Blue  
7458B



Translucent Bur disinfection box Square shape, 36 Holes, Blue  
7454B



Gutta Percha Points Shaping Tip Cutter, Brown  
7460N



Root Canal File Frame, 16 Holes, Blue  
7459B



Endodontic block with memory holder, 5 holes, Orange  
7462S



Gutta Percha Points Measuring Ruler, Black  
7461K

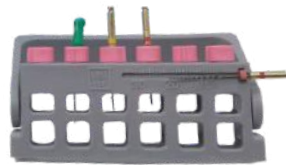

Root Canal File Frame, 6 holes, Grey  
7463I



Root Canal File Frame, 8 holes, Sky Blue  
7453S



Endo File Cleaner Round Shape, Sky Blue  
7452S



Translucent Bur disinfection box Rectangle shape, 72 Holes, Blue  
7455B

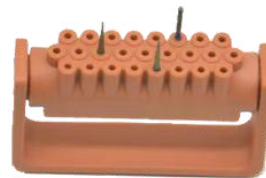

Opening Disinfection Frame Resistant to high temperature and pressure, 25 Holes, Orange  
7457O



Equipment of high temperature and high pressure disinfection box, 4 Holes, Green  
7456G

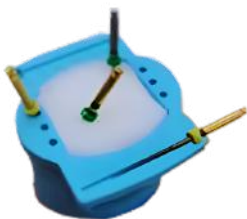

Wrist Endo Measuring Cleaner, Sky Blue  
7451S



72 holes endo box for diamond bur, Purple  
7464M

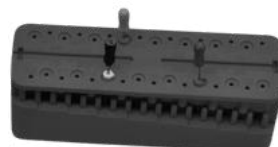

Gutta Percha Points Shaping Tip Cutter  
7460K

## File holder



Light Blue  
7421I

Gray  
7421B



# Implantology

## Sinus-lift instruments



### 7201 SP

Curettes #1  
4mm-4mm



### 7202 SP

Curettes #2  
3mm-4mm



### 7206 SP

Kramer-Nevins #1  
4mm-7mm



### 7207 SP

Kramer-Nevins #2  
4mm-7mm



### 7211 SP

Sinus Lift Instrument  
4mm-4mm



### 7212 SP

Sinus Lift Instrument  
3mm-3mm



### 7213 SP

Sinus Lift Instrument  
4mm-4mm



### 7216 SP

Sinus Lift Instrument  
4mm-4mm



### 7217 SP

Sinus Lift Instrument  
4mm-4mm



### 7218 SP

Sinus Lift Instrument  
4mm-4.3mm



### 7222 SP

Sinus Lift Mushroom  
2.5mm-3.2mm

## Hammers



### 4401

Mead  
hammer  
Ø26mm



### 4402

Solid head  
hammer  
17cm, Ø20mm



### 4403

Solid head  
hammer  
19cm, Ø19mm

NEW

Blue Titanium

# Sinus Lift



**7202B-SP**  
Currettes #2  
3mm-4mm



**7206B-SP**  
Kramer-Nevins #1  
4mm-7mm

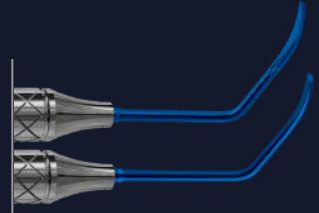

**7207B-SP**  
Kramer-Nevins #2  
4mm-7mm

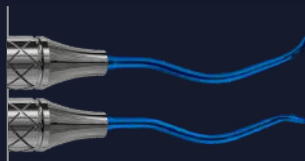

**7211B-SP**  
Sinus Lift Instrument  
4mm-4mm



**7212B-SP**  
Sinus Lift Instrument  
3mm-3mm



**7213B-SP**  
Sinus Lift Instrument  
4mm-4mm



**7216B-SP**  
Sinus Lift Instrument  
4mm-4mm



**7217B-SP**  
Sinus Lift Instrument  
4mm-4mm



**7218B-SP**  
Sinus Lift Instrument  
4mm-4.3mm

**7201B-SP**  
Currettes #1  
4mm-4mm

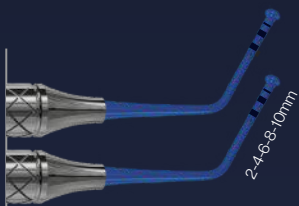

**7222B-SP**  
Sinus Lift Mushroom  
2.5mm-3.2mm

Blue titanium tips enhance visibility and control during sinus lift procedures while helping minimize surface trauma.

## Blue Makes Your Edge Visible.



# Implantology Kits

## Osteotome

### 7260

#### Osteotome straight

Set of 5 including hammer & cassette

Osteotome size

2.7 mm  
3.2 mm  
3.7 mm  
4.2 mm  
5.0 mm



### 7270

#### Osteotome offset

Set of 5 including hammer & cassette

Osteotome size

2.7 mm  
3.2 mm  
3.7 mm  
4.2 mm  
5.0 mm



## Condenser

The condenser kit ensures each tip fits the previous cavity, allowing safe depth measurement and matching standard implant lengths.

### 7280

#### Condenser straight

Set of 7 including hammer & cassette

A	B
2mm	2.7mm
2.5mm	3.2mm
2mm	3.7mm
3.5mm	4.2mm
4mm	4.7mm
4.5mm	5.2mm
5mm	5.7mm



### 7281

#### Condenser offset

Set of 7 including hammer & cassette

A	B
2mm	2.7mm
2.5mm	3.2mm
2mm	3.7mm
3.5mm	4.2mm
4mm	4.7mm
4.5mm	5.2mm
5mm	5.7mm



### 7282

#### Bone Spreader

Set of 6 including hammer & cassette

A	B
1.6mm	1.6mm
1.6mm	2.2mm
2.2mm	2.2mm



### 7250

#### Bone Splitting

Set of 8 including cassette

Straight	Curved
3mm	3mm
4mm	4mm
6mm	6mm
8mm	8mm



# Impression Trays

- Perforated design for strong material retention
- Rim-Lock system for secure impression holding
- Fully autoclavable
- Available in 5 sizes: XS, S, M, L, XL

## Perforated Impression Tray

Upper Jaw 

Art/no	Size
4521-1	XS
4521-2	S
4521-3	M
4521-4	L
4521-5	XL

Lower Jaw 

Art/no	Size
4501-1	XS
4501-2	S
4501-3	M
4501-4	L
4501-5	XL



## Non Perforated Impression Tray

Upper Jaw 

Art/no	Size
4571-1	XS
4571-2	S
4571-3	M
4571-4	L
4571-5	XL

Lower Jaw 

Art/no	Size
4551-1	XS
4551-2	S
4551-3	M
4551-4	L
4551-5	XL



## Half impression trays

Perforated



Non-Perforated



5 Upper & 5 Lower/Per



# 10

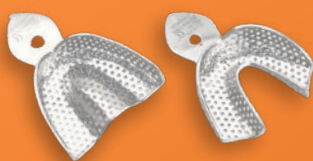

Perforated set  
5U & 5L

## 4521



Non-perforated set  
5U & 5L

## 4571

Clean, Sort & Store

# Sterilize & Organize



Keeps You Organized  
for Every Procedure.

# Sterilization Cassettes with detachable lid

Detachable-lid stainless steel cassettes for better instrument visibility, easy handling, and space efficiency. Rust-free and fully autoclavable for both disinfection and sterilization. Available in five colors: red, blue, green, orange, and yellow for easy identification.

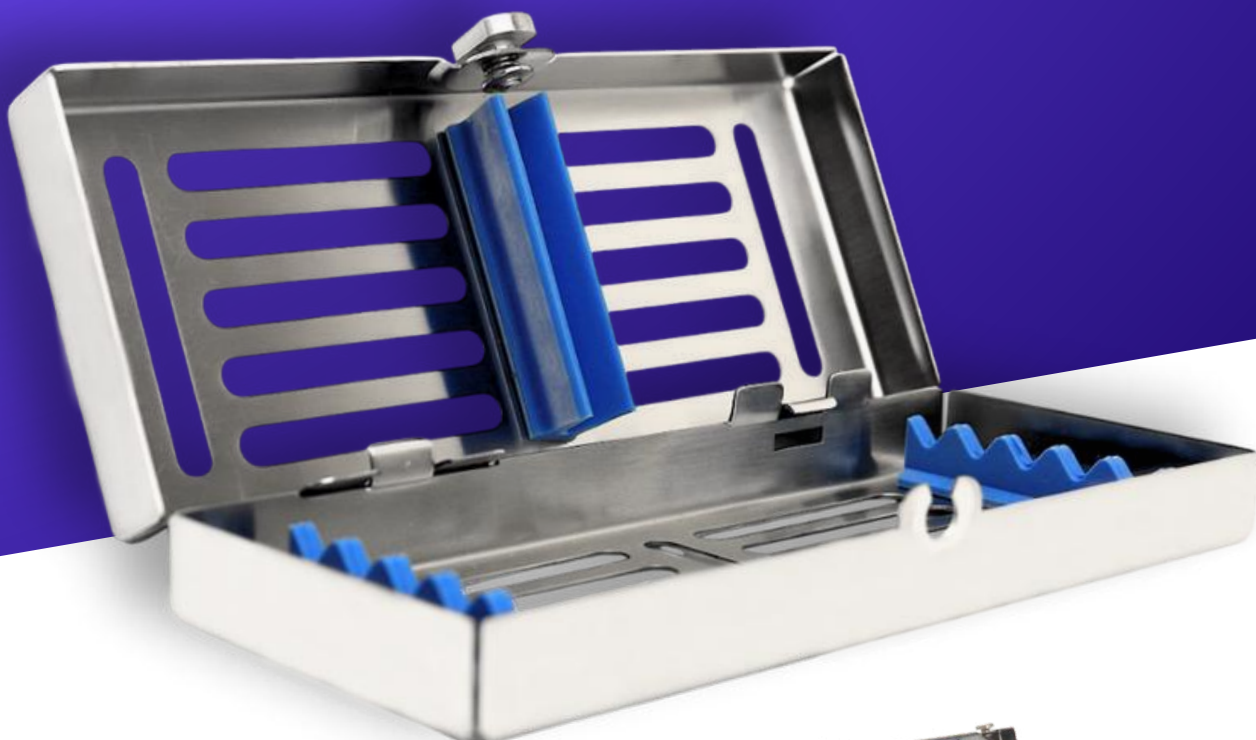

**Sterilization cassette for 5 instruments**

L:185mm X W:75mm X H:35mm

## 5511

5511B 5511G 5511R 5511O 5511Y



**Sterilization cassette for 10 instruments**

L:185mm X W:145mm X H:35mm

## 5512

5512B 5512G 5512R 5512O 5512Y



**Sterilization cassette for 20 instruments**

L:280mm X W:180mm X H:35mm

## 5513

5513B 5513G 5513R 5513O 5513Y

# Standard Sterilization Cassettes

Simplify and reduce instruments processing time Disinfect & sterilization of instrument in one tray



## Sterilization Cassette for 7

L:185mm X W:90mm X H:20mm

# 5532

5532B 5532G 5532R 5532O 5532Y



## Sterilization cassette for 5 instruments

L:185mm X W:65mm X H:20mm

# 5531

5531B 5531G 5531R 5531O 5531Y



## Sterilization cassette for 10 instruments

L:185mm X W:130mm X H:20mm

# 5533

5533B 5533G 5533R 5533O 5533Y



## Sterilization cassette for 20 instruments

L:285mm X W:185mm X H:30mm

# 5534

5534B 5534G 5534R 5534O 5534Y

# ErgoTrays

Organize with style



Discover More Online  
Scan the QR Code

ErgoDenta

# ErgoTray 5

The ErgoTray 5 is ideal for sterilizing up to five dental instruments. It has a secure lock and an ergonomic lid that prevent tip injuries and ensure thorough cleaning.

180 x 86 x 26 mm



**Black**  
**5505K**

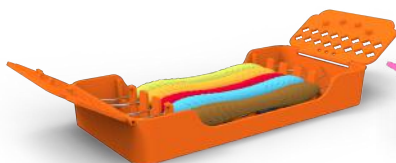

**5505O**  
Orange



 **5505P**  
Pink



**5505R**  
Red



**5505N**  
Green



 **5505Y**  
Yellow

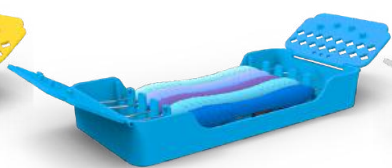

 **5505B**  
Blue



 **5505G**  
Grey



**5505E**  
Purple

# ErgoTray 8

The ErgoTray 8 is ideal for sterilizing up to eight dental instruments. It has a secure lock and an ergonomic lid that prevent tip injuries and ensure thorough cleaning.

180 x 136 x 26 mm

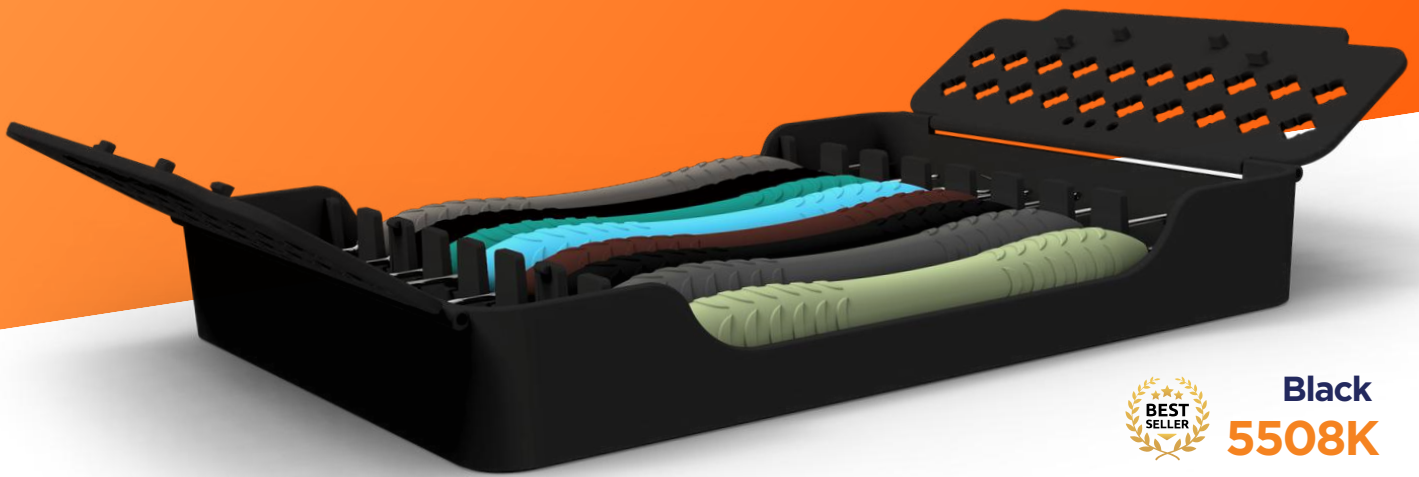

**Black**  
**5508K**



**5508O**  
**Orange**



**5508P**  
**Pink**



**5508R**  
**Red**



**5508N**  
**Green**

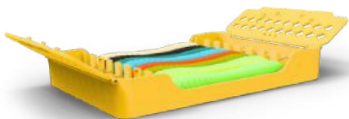

**5508Y**  
**Yellow**

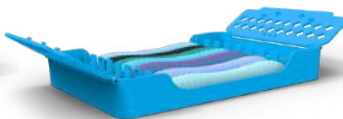

**5508B**  
**Blue**

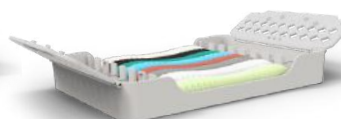

**5508G**  
**Grey**



**5508E**  
**Purple**

# ErgoVator Tray

The ErgoVator tray is the perfect solution for managing your ErgoLite elevators. Each ErgoLite elevator is supplied with an ErgoVator tray included.

Grey  
**5502I**

Black  
**5502K**

# ErgoTray 1

The ErgoTray single instrument holder helps keep your ErgoX and ErgoX Plus instruments organised and protected. Its special locking mechanism keeps the instrument securely in place. Included with all ErgoRazor and ErgoSlip instruments, it is fully autoclavable and reusable.

Grey  
**5501I**

Black  
**5501K**

# Solid & Perforated trays



**Solid Tray** 5582  
280x180mm (Incl. lid)



**Perforated Tray** 5583  
280x180mm (Incl. lid)



**Perforated Base Tray** 5584  
280x180mm (Incl. lid)



**Perforated Instrument Tray with Rack** 5510  
284x183x17mm



**Instrument Tray** 5616  
250x150x40mm



**Shallow (Mayo)** 5617  
250x150x40mm



**Scaler Tray** 5618  
200x100x20mm



**Perforated Tray** 5620  
300x200mm

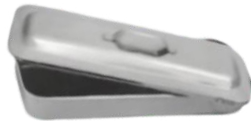

**Cathetar Tray** 5621  
220x120x50mm



**Instrument Holder** 5555  
280mm

Storage Tubes/  
Instrument Holder Ø  
50x100mm  
5585



Storage Tubes/  
Instrument Holder Ø  
50x170mm  
5587

Storage Tubes/  
Instrument Holder Ø  
75x190mm  
5588



Storage Tubes/  
Instrument Holder Ø  
90x210mm  
5589

# HOLDERS, BOXES & BOWLS



**Instrument box with Lid** 5590  
100x200mm



**Kidney Shape** 5592  
200mm



**Bowl** 5594  
50x60x15mm

Bowl / Pots Ø 55 mm  
5601  
(65ml)

Bowl / Pots Ø 65 mm  
5602  
(130ml)

Bowl / Pots Ø 70 mm  
5603  
(190ml)



**Round Box With Lid** 5623  
120x120mm



**Glass (18cl)** 5624  
70x80mm



**Instrument Tray With Lid** 5622  
220x120x50mm

Bowl / Pots Ø 70 mm  
5604  
(90ml)

Bowl / Pots Ø 90 mm  
5605  
(180ml)

Bowl / Pots Ø 110 mm  
5606  
(360ml)



# Color Code Rings

Organize and identify instruments quickly with fully autoclavable, heat-resistant color-code rings. Available in two sizes: small for hand instruments and large for extraction forceps or wider handles.

## Large

25 pieces per box per color

## Small

50 pieces per box per color

Color	Large	Small
Blue	5641B	5651B
Green	5641G	5651G
Red	5641R	5651R
Yellow	5641Y	5651Y
Black	5641K	5651K
White	5641W	5651W
Purple	5641P	5651P
Light Blue	5641S	5651S



**Large Mix**  
8 Colors (12 pcs each)  
**5641**



**Small Mix**  
8 Colors (25 pcs each)  
**5651**



Fully autoclavable and heat-resistant

Available in **08** colors

# ErgoTape



**3x** longer than regular tapes



Color	Code
Blue	5691B
Light Yellow	5691L
Red	5691R
Dark Yellow	5691Y
Black	5691K
White	5691W
Purple	5691M
Light Pink	5691P



Available in 8 vibrant colors

Ø5mm thickness

10-meter roll length

Fully autoclavable

Built in cutter for easy tape cutting

8 color 1 box  
Assorted Pack  
**5691**



# Scalpel Handles



5663  
No:3 180°



5664  
No:3



5665  
No:3

# Accessories



5598  
Silicone Suture Practice Pad, 14 shapes  
175x120mm



5599  
Silicone Suture Practice Pad, 17 shapes  
175x120mm



5661  
Rulers, 100mm  
12 pcs per pack



5662  
Rulers, 150mm  
12 pcs per pack



5666  
Napkin Holder  
approx 44cm

# Calipers



5673  
Sliding Calliper  
0-125mm



5674  
Iwanson  
10mm



5667  
Beerendonk Caliper  
130mm



5668  
Zuricher Caliper  
130mm



5669  
Boley Caliper  
145mm

# Bur Holders

These bur holders can hold 4, 8, or 12 burs and are suitable for any FG or latch type. The colored silicone holders are replaceable and come in 4 colors, helping to keep things organized easily.



For 4 Bur Holder

- 7381B
- 7381Y
- 7381R
- 7381G



For 8 Bur Holder

- 7382B
- 7382Y
- 7382R
- 7382G



For 12 Bur Holder

- 7383B
- 7383Y
- 7383R
- 7383G



## Instrument Care & Maintenance

Keep your instruments performing at their best. Learn how to properly clean, disinfect, sterilize, and maintain dental instruments for long-lasting performance.

SCAN ME



## Become a Distributor

Join our growing international network of distribution partners and offer ergonomic dental instruments designed in Denmark.

SCAN ME



## Private Label Solutions

Create your own instrument brand with our complete private label service—from design and product selection to production and delivery.

SCAN ME



Follow us on



Find more information, practical guides, and partnership opportunities on our website.

# Continue the Experience Online

Product Catalog 2026

# The Nordic Selection

**ErgoDenta**

ErgoDenta ApS

 Hoerskaetten 14, 2630 Taastrup |  Denmark

 Tel. +45 5524 1100

 [www.ergodenta.dk](http://www.ergodenta.dk) | [info@ergodenta.dk](mailto:info@ergodenta.dk)

**VIEW  
ONLINE**

