



BUTTI

RECYCLING E AGRICOLTURA
RECYCLING AND AGRICULTURE



INNOVAZIONI E SOLUZIONI INTEGRATE PER IL RECYCLING E L'AGRICOLTURA
INNOVATIONS AND INTEGRATED SOLUTIONS FOR RECYCLING AND AGRICULTURE

6 SCOPE AGRITHOR CON SPAZZOLE IN POLIPROPILENE
AGRITHOR BROOMS WITH POLYPROPYLENE BRUSHES



8 SCOPE INDUSTRIAL CON SPAZZOLE IN ACCIAIO
INDUSTRIAL BROOMS WITH STEEL BRUSHES



10 KIT "SISTEMA DI RIDUZIONE POLVERE"
KIT "DUST REDUCTION SYSTEM"



10 SCOPA PALA
BLADE BROOM



11 SCOPA RAGNO INDUSTRIAL CON SPAZZOLE IN ACCIAIO
INDUSTRIAL BROOM FOR POLYP GRAB



11 SCOPA RAGNO ECO STRONG CON SPAZZOLE IN POLIPROPILENE
ECO STRONG BROOM FOR POLYP GRAB



12 SCOPE UNIVERSAL CON SPAZZOLE IN ACCIAIO
UNIVERSAL BROOMS WITH STEEL BRUSHES



14 SCOPE ECO STRONG CON SPAZZOLE IN POLIPROPILENE
ECO STRONG BROOMS WITH POLYPROPYLENE BRUSHES



16 SCOPE ECO UNIVERSAL CON SPAZZOLE IN POLIPROPILENE
ECO STRONG UNIVERSAL WITH POLYPROPYLENE BRUSHES



18 SCOPE MAGNETICHE
MAGNETIC BROOMS



19 CESCOIE CAIMAN
CAIMAN SHEARS



20 VASCHE DI CONTENIMENTO IN POLIETILENE
POLYETHYLENE SPILL CONTAINMENT PALLETS



23 VASCHE DI CONTENIMENTO IN ACCIAIO
STEEL SPILL CONTAINMENT PALLETS



24 DEPOSITI PER ESTERNI
OUTDOOR CONTAINERS



26 FUSTI E CISTERNE
DRUMS AND TANKS



26 CHIAVI E TAGLIAFUSTI
KEY AND DRUMS DEHEADER



27 TRAMOGGIA PORTA "BIG-BAG"
"BIG-BAG" HOPPER



28 SACCO "BIG-BAG" OMOLOGATO
APPROVED "BIG-BAG"



28 DISPENSER DOSBAG PER LO SCARICO DEL "BIG-BAG"
DOSBAG DISPENSER FOR UNLOADING THE "BIG-BAG"



28 PORTA "BIG-BAG"
"BIG-BAG" CONTAINER



29 GANCI DI CARICO
LIFTING HOOKS FOR FORKLIFT



30 ASSORBENTI E KIT PRONTO INTERVENTO CARRELLATI
ABSORBENTS AND FIRST REACTION KIT WITH WHEELS



30 BIDONI CARRELLATI
WHEELED BINS



31 CONTAINER MULTIBENNA
MULTIBENNA CONTAINERS



32 CONTENITORI PER LIQUIDI MATERIALI PERICOLOSI
CONTAINERS FOR LIQUIDS AND HAZARDOUS MATERIALS



33 ARMADI DI SICUREZZA
SAFETY CABINETS



34 CONTENITORI RIBALTABILI "PERTUTTO"
TIPPING CONTAINERS "PERTUTTO"



38 CONTENITORI INDUSTRIALI
INDUSTRIAL CONTAINERS



42 SPARGISALE
SALT SPREADER



42 BENNA SABBIA
SAND BUCKET



BUTTI

PROGETTIAMO CON ESPERIENZA, COSTRUIAMO CON PROFESSIONALITÀ

Progettiamo e realizziamo attrezzature per movimentare e contenere ogni tipo di materiale, rendendo più veloce e sicuro il lavoro in vari settori. Possiamo proporre le soluzioni innovative che ci differenziano perché non ci siamo mai accontentati di limitarci a "produrre", ma abbiamo sempre dato grande importanza alla fase di progetto.

Il nostro catalogo non offre solo i prodotti che il mercato richiede, ma punta soprattutto a proporre soluzioni ad esigenze che ancora non hanno una risposta: la nostra forza è la continua innovazione, la costante ricerca di qualità, la grande flessibilità tecnica e commerciale che ci pone come interlocutore privilegiato per le aziende che cercano soluzioni efficaci ed immediate.

WE DESIGN WITH EXPERIENCE, WE BUILD WITH PROFESSIONALISM

We design and manufacture equipment to handle and contain all types of materials, making work faster and safer in various sectors.

We can propose innovative solutions that differentiate us because we have never contented ourselves with merely "producing", but we have always given great importance to the project phase.

Our catalogue does not only offer the products that the market requires, but aims above all to offer solutions to needs that do not have an answer yet: our strength is the continuous innovation, the constant research for quality, the great technical and commercial flexibility that makes us a privileged interlocutor for companies looking for effective and immediate solutions.

I NOSTRI CONTATTI / OUR CONTACTS

SEDE LEGALE E OPERATIVA / REGISTERED OFFICE AND OPERATIONAL HEADQUARTERS: Via Mayer 13 - 24034 Cisano Bergamasco (BG) - Italia

MAGAZZINO E RITIRO MERCI / WAREHOUSE AND GOODS COLLECTION: Via Zucallo 1 - 24034 Cisano Bergamasco (BG) - Italia

Tel. +39 035 787300 - +39 035 787005 - Fax +39 035 787322 - butti@butti.it - www.butti.it



35 ANNI DI ESPERIENZA

DUE MODERNI E AMPI STABILIMENTI SU UN'AREA DI 30.000 METRI QUADRI

TECNOLOGICO IMPIANTO DI VERNICIATURA INTERNO

REPARTO INTERNO RICERCA E SVILUPPO

MAGAZZINO CON PRODOTTI IN PRONTA CONSEGNA

REPARTO INTERNO DI LAVORAZIONE E REALIZZAZIONE PRODOTTI FINITI

REPARTO INTERNO MARKETING E COMUNICAZIONE

NORMATIVE DI RIFERIMENTO: D.LGS 81/2008 - EN 14502-1 - EN13155

RIFERIMENTI DEI NOSTRI COLORI RAL STANDARD:

BLU RAL 5010, ROSSO RAL 3000, VERDE RAL 6029, GRIGIO RAL 7011



Magazzino e ritiro merci
Warehouse and goods collection



Sede Legale e Operativa
Registered office and operational headquarters

Ci trovate tra Lecco e Bergamo, facilmente raggiungibili da Monza e Milano / You can find us between Lecco and Bergamo, easily reachable from Monza and Milan

IL NOSTRO LAVORO MIGLIORA IL VOSTRO LAVORO

Le tre linee di prodotto che proponiamo affrontano settori diversi – industria, edilizia, recycling – ma hanno in comune la necessità di strutture solide ed affidabili. La nostra trentennale esperienza ci consente di impostare le linee di produzione assicurando un costante controllo, dal progetto alla finitura. Per questo motivo i nostri prodotti non sono un costo per l'azienda, ma un investimento per migliorare sicurezza e produttività.

OUR WORK IMPROVES YOUR WORK

The three product lines we offer address different sectors - industry, construction, recycling - but they have in common the need of solid and reliable structures. Our thirty years of experience allow us to set up production lines ensuring constant control, from design to finishing. For this reason, our products are not a cost for the customer, but an investment to improve safety and productivity.



35 YEARS OF EXPERIENCE

TWO MODERN AND LARGE PLANT ON AN AREA OF 30,000 SQUARE METERS

TECHNOLOGICAL INTERNAL PAINTING PLANT

INTERNAL RESEARCH AND DEVELOPMENT DEPARTMENT

WAREHOUSE WITH PRODUCTS READY ON STOCK

INTERNAL DEPARTMENT FOR PROCESSING AND CONSTRUCTION OF FINISHED PRODUCTS

INTERNAL MARKETING AND COMMUNICATION DEPARTMENT

REFERENCE REGULATIONS: D.LGS 81/2008 - EN 14502-1 – EN13155

REFERENCES OF OUR STANDARD RAL COLORS:

BLUE RAL 5010, RED RAL 3000, GREEN RAL 6029, GRAY RAL 7011





SCOPA AGRITHOR CLASSIC CON RUOTE E BAFFO INCLINATO BREVETTATO
AGRITHOR BROOM CLASSIC WITH WHEELS AND PATENTED ANGLED BRUSH

MODELLO MODEL	DIMENSIONI / DIMENSIONS			N° DI FILI No. OF WIRES	FILE ROW	TARA TARE kg	SPAZZOLE BRUSHES
	L	P	H				
866AT0820	2000	920	500	34000	12 + baffo 12 + brush	200	Polipropilene di alta qualità High quality polypropylene

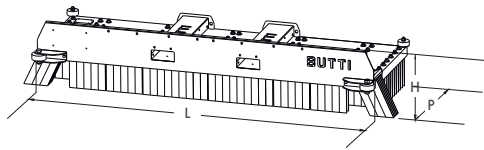

QUOTE SEDI FORCHE INTERNE
 INTERNAL FORK SEATS DIMENSIONS

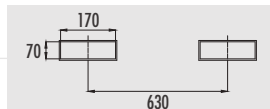

SCOPA AGRITHOR LARGE CON RUOTE E BAFFO INCLINATO BREVETTATO
AGRITHOR BROOM LARGE WITH WHEELS AND PATENTED ANGLED BRUSH

MODELLO MODEL	DIMENSIONI / DIMENSIONS			N° DI FILI No. OF WIRES	FILE ROW	TARA TARE kg	SPAZZOLE BRUSHES
	L	P	H				
866AT0825	2500	920	500	41000	12 + baffo 12 + brush	250	Polipropilene di alta qualità High quality polypropylene

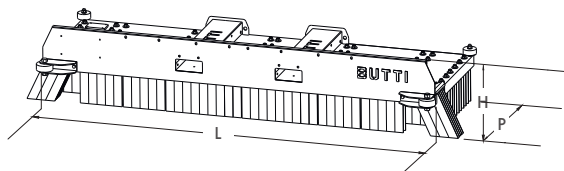

QUOTE SEDI FORCHE INTERNE
 INTERNAL FORK SEATS DIMENSIONS



SCOPA AGRITHOR EXTRA LARGE CON RUOTE E BAFFO INCLINATO BREVETTATO
AGRITHOR BROOM EXTRA LARGE WITH WHEELS AND PATENTED ANGLED BRUSH

MODELLO MODEL	DIMENSIONI / DIMENSIONS			N° DI FILI No. OF WIRES	FILE ROW	TARA TARE kg	SPAZZOLE BRUSHES
	L	P	H				
866AT0830	3000	920	500	48000	12 + baffo 12 + brush	320	Polipropilene di alta qualità High quality polypropylene

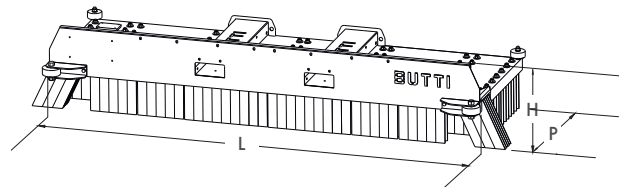

QUOTE SEDI FORCHE INTERNE
 INTERNAL FORK SEATS DIMENSIONS



KIT SPAZZOLE DI RICAMBIO IN POLIPROPILENE
REPLACEMENT KIT IN HIGH POLYPROPYLENE



FACILI E VELOCI DA SOSTITUIRE E MONTARE

Kit Butti con spazzole in PP di alta qualità per tutti i modelli di scope Butti. Su richiesta si producono kit di ricambio in PP di alta qualità per tutti i modelli di scope non prodotte dalla Butti. Le spazzole in polipropilene sono progettate per essere altamente resistenti, maneggevoli e per resistere nel tempo all'usura.

EASY AND FAST TO REPLACE AND MOUNT

Kit Butti in high quality PP brushes for every Butti's brooms model. Replacement brush kits in high quality PP on request for every brooms models not produced by Butti. PP brushes are designed to be sturdy and manageable and to resist for more time to mechanical stresses during the use.

TRASPORTO
TRANSPORT



Le scope Butti vengono spedite all'interno di un'apposita vasca zincata, progettata per proteggerle durante il trasporto e preservarne l'integrità fino alla consegna.

Butti brooms are shipped inside a dedicated galvanized steel container, designed to protect them during transport and preserve their integrity until delivery.

BAFFO INCLINATO
ANGLED BRUSH

I baffi inclinati presenti sulle scope sono composti da spazzole posizionate in verticale per la pulizia dei muretti delle autocatture.

The angled side brushes on the brooms are made of vertically positioned bristles designed to clean walls of cattle self-locking feed.



ATTACCO AD X
X-ATTACHMENT



Permette l'inclinazione automatica della scopa di 30 gradi a destra e a sinistra, senza dover scendere dal mezzo.

Allows the broom to tilt automatically by 30 degrees to the left and right, without leaving the vehicle.

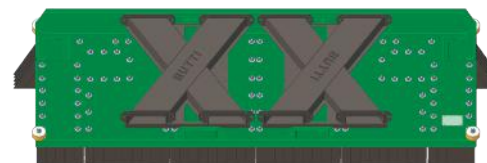

QUOTE SEDI FORCHE INTERNE
INTERNAL FORK SEATS DIMENSIONS



ATTACCHI PER TUTTI I MEZZI AGRICOLI
ATTACHMENT FOR ALL AGRICULTURAL VEHICLES



Diversi attacchi disponibili per tutti i mezzi agricoli su richiesta (ad esempio, trattori, escavatori e telescopici).

Various mounting options available on request for all types of agricultural machinery (e.g. tractors, excavators, and telehandlers).

RUOTE GUIDA E ASTE DI SEGNALAZIONE
GUIDE WHEELS AND SIGNAL RODS



Tutte le scope Agrithor sono dotate di quattro robuste ruote in Vulkolan che proteggono il telaio della scopa e le pareti della tua stalla durante le operazioni di pulizia. A richiesta sono applicabili, su tutti i modelli, due aste di segnalazione.

All Agrithor brooms are equipped with four sturdy Vulkolan wheels to protect both the broom frame and the barn walls during cleaning operations. On request, two signal rods can be added to all models.



SCOPE INDUSTRIAL COMPACT
INDUSTRIAL BROOM COMPACT

MODELLO MODEL	DIMENSIONI / DIMENSIONS			N° DI FILI No. OF WIRES	FILE ROW	TARA TARE kg	SPAZZOLE BRUSHES
	L	P	H				
863C20	2000	500	440	16800	6	212	Acciaio armonico di alta qualità High quality spring steel

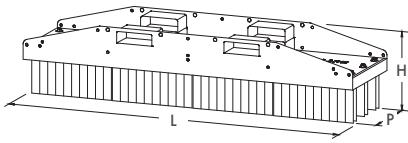

QUOTE SEDI FORCHE INTERNE
INTERNAL FORK SEATS DIMENSIONS

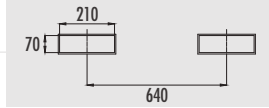

SCOPE INDUSTRIAL CLASSIC
INDUSTRIAL BROOM CLASSIC

MODELLO MODEL	DIMENSIONI / DIMENSIONS			N° DI FILI No. OF WIRES	FILE ROW	TARA TARE kg	SPAZZOLE BRUSHES
	L	P	H				
865C20	2000	1000	430	33600	12	380	Acciaio armonico di alta qualità High quality spring steel

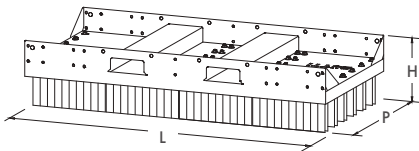

QUOTE SEDI FORCHE INTERNE
INTERNAL FORK SEATS DIMENSIONS

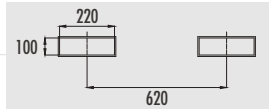

SCOPE INDUSTRIAL LARGE
INDUSTRIAL BROOM LARGE

MODELLO MODEL	DIMENSIONI / DIMENSIONS			N° DI FILI No. OF WIRES	FILE ROW	TARA TARE kg	SPAZZOLE BRUSHES
	L	P	H				
865C25	2500	1000	430	42000	12	476	Acciaio armonico di alta qualità High quality spring steel

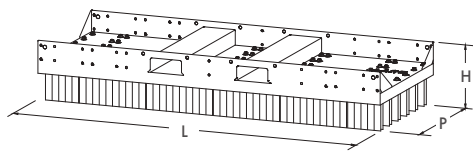

QUOTE SEDI FORCHE INTERNE
INTERNAL FORK SEATS DIMENSIONS

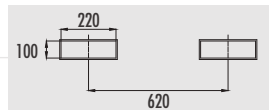

SCOPE INDUSTRIAL EXTRA LARGE
INDUSTRIAL BROOM EXTRA LARGE

MODELLO MODEL	DIMENSIONI / DIMENSIONS			N° DI FILI No. OF WIRES	FILE ROW	TARA TARE kg	SPAZZOLE BRUSHES
	L	P	H				
865C30	3000	1000	430	50400	12	566	Acciaio armonico di alta qualità High quality spring steel

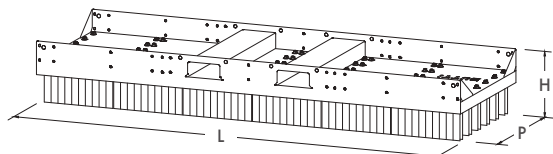

QUOTE SEDI FORCHE INTERNE
INTERNAL FORK SEATS DIMENSIONS

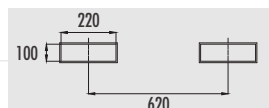

KIT SPAZZOLE DI RICAMBIO IN ACCIAIO ARMONICO
REPLACEMENT KIT IN HIGH QUALITY SPRING STEEL



FACILI E VELOCI DA SOSTITUIRE E MONTARE

Kit Butti con spazzole di lunghezza 50 cm in acciaio armonico di alta qualità adatte a tutti i modelli di scope Butti.

Su richiesta si producono kit di ricambio in acciaio armonico di alta qualità per tutti i modelli di scope non prodotte dalla Butti.

EASY AND FAST TO REPLACE AND MOUNT

Kit Butti with length 50 cm high quality brushes in spring steel for every Butti's brooms model.

Replacement brush kits in high quality steel are produced on request for every brooms models not produced by Butti.

TRASPORTO
TRANSPORT



Le scope Butti vengono spedite all'interno di un'apposita vasca zincata, progettata per proteggerle durante il trasporto e preservarne l'integrità fino alla consegna.

Butti brooms are shipped inside a dedicated galvanized steel container, designed to protect them during transport and preserve their integrity until delivery.

ATTACCO RAGNO
ATTACHMENT FOR POLYP GRAB

MODELLO MODEL	DIMENSIONI / DIMENSIONS mm		
	Ø disco antiscivolo anti-slip disc	Ø presa utile useful grip	H presa utile useful grip
868ARH3005B Compact	400	270	300
868ARH3010B Classic Large Extra Large	400	270	300

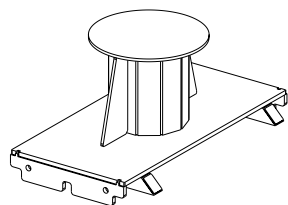

ATTACCO PER PALA GOMMATA
ATTACHMENT FOR WHEEL LOADER

868P0204



Composta da due sedi per gli attacchi alla pala gommata, due attacchi catene con fasce e cricchetto, due aste di segnalazione.

Composed of two mounts for wheel loader attachments, two chain connections with straps and ratchet, two signal rods.

ATTACCO FORCA PINZA IN ACCIAIO PER MODELLI CLASSIC, LARGE E EXTRA LARGE
STEEL FORK CLAMP ATTACHMENT FOR CLASSIC, LARGE AND EXTRA LARGE MODELS

MODELLO MODEL	DIMENSIONI / DIMENSIONS mm		
	L	P	H utile / useful
868F0750B	1150	925	600

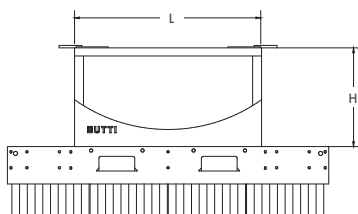

LAME REGOLABILI IN ACCIAIO PER SPINTA MATERIALI PER MODELLI CLASSIC, LARGE E EXTRA LARGE
ADJUSTABLE STEEL BLADES TO PUSH SCRAP FOR CLASSIC, LARGE AND EXTRA LARGE MODELS

REGOLABILI
ADJUSTABLE

MODELLO MODEL	DIMENSIONI / DIMENSIONS mm		SPESSORE THICKNESS mm
	L	H	
868LR420B 868LR420R	2000	400	10 15
868LR425B 868LR425R	2500	400	10 15
868LR430B 868LR430R	3000	400	10 15





KIT "SISTEMA DI RIDUZIONE POLVERE" - DRS PER SCOPE INDUSTRIAL MODELLI CLASSIC, LARGE E EXTRALARGE
KIT "DUST REDUCTION SYSTEM" - DRS FOR INDUSTRIAL BROOM MODEL CLASSIC, LARGE AND EXTRALARGE

MODELLO MODEL	VOLUME VOLUME	MODELLO SCOPE BROOM MODEL
868C0320	300	Industrial Classic
868C0325	300	Industrial Large
868C0330	300	Industrial Extra Large



Il sistema di riduzione polvere è un kit composto da una cisterna da 300 litri con rubinetto e raccordi in ottone, irrigatore in inox. Come protezione del sistema è previsto il montaggio di una lama regolabile spessore 10 mm.

The "dust reduction system" kit is composed of a 300 lt watertank with brass discharge valve and connection, stainless steel sprinkler. An adjustable blade is to be installed as a protection of the system 10 mm thickness.



SCOPA PALA UTILIZZABILE CON CARRELLO ELEVATORE CON PIASTRA ROTANTE PER FORCHE, RASCHIANTE INTERCAMBIABILE
BLADE BROOM USABLE WITH FORKLIFT ROTATING FORK CLAMP, INTERCHANGEABLE SCRAPER

MODELLO MODEL	DIMENSIONI / DIMENSIONS mm			N° DI FILI No. OF WIRES	FILE ROW	TARA TARE kg	SPAZZOLE BRUSHES
	L	P	H				
865SP20 Classic	2000	1000	1290	33600	12	675	Acciaio armonico di alta qualità High quality spring steel
865SP25 Large	2500	1000	1290	42000	12	835	Acciaio armonico di alta qualità High quality spring steel

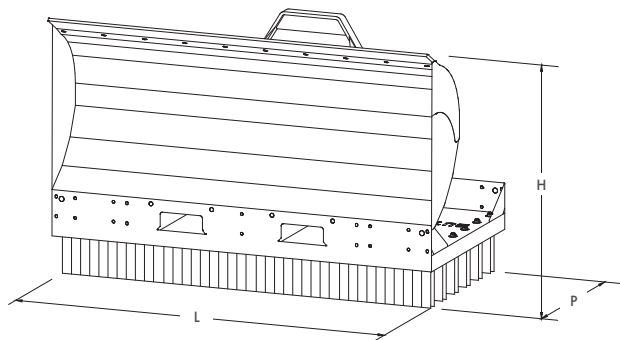

SCOPE RAGNO INDUSTRIAL
INDUSTRIAL BROOM FOR POLYP GRAB

MODELLO MODEL	DIMENSIONI / DIMENSIONS mm			N° DI FILI No. OF WIRES	FILE ROW	TARA TARE kg	SPAZZOLE BRUSHES
	L	P	H				
865C10AR	1000	1100	770	33600	24	500	Acciaio armonico di alta qualità High quality spring steel

*dimensioni presa - vedi cod. 868ARH3010B
*attachment socket dimensions- see cod. 868ARH3010B

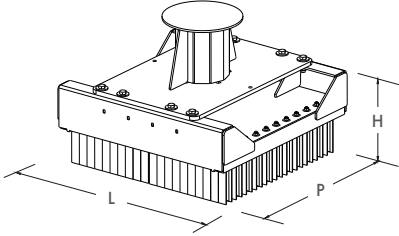

SCOPE RAGNO ECO STRONG
ECO STRONG BROOM FOR POLYP GRAB

MODELLO MODEL	DIMENSIONI / DIMENSIONS mm			N° DI FILI No. OF WIRES	FILE ROW	TARA TARE kg	SPAZZOLE BRUSHES
	L	P	H				
866S1010AR	1000	1100	770	28800	24	400	Acciaio armonico di alta qualità High quality spring steel

*dimensioni presa - vedi cod. 868ARH3010S
*attachment socket dimensions- see cod. 868ARH3010S

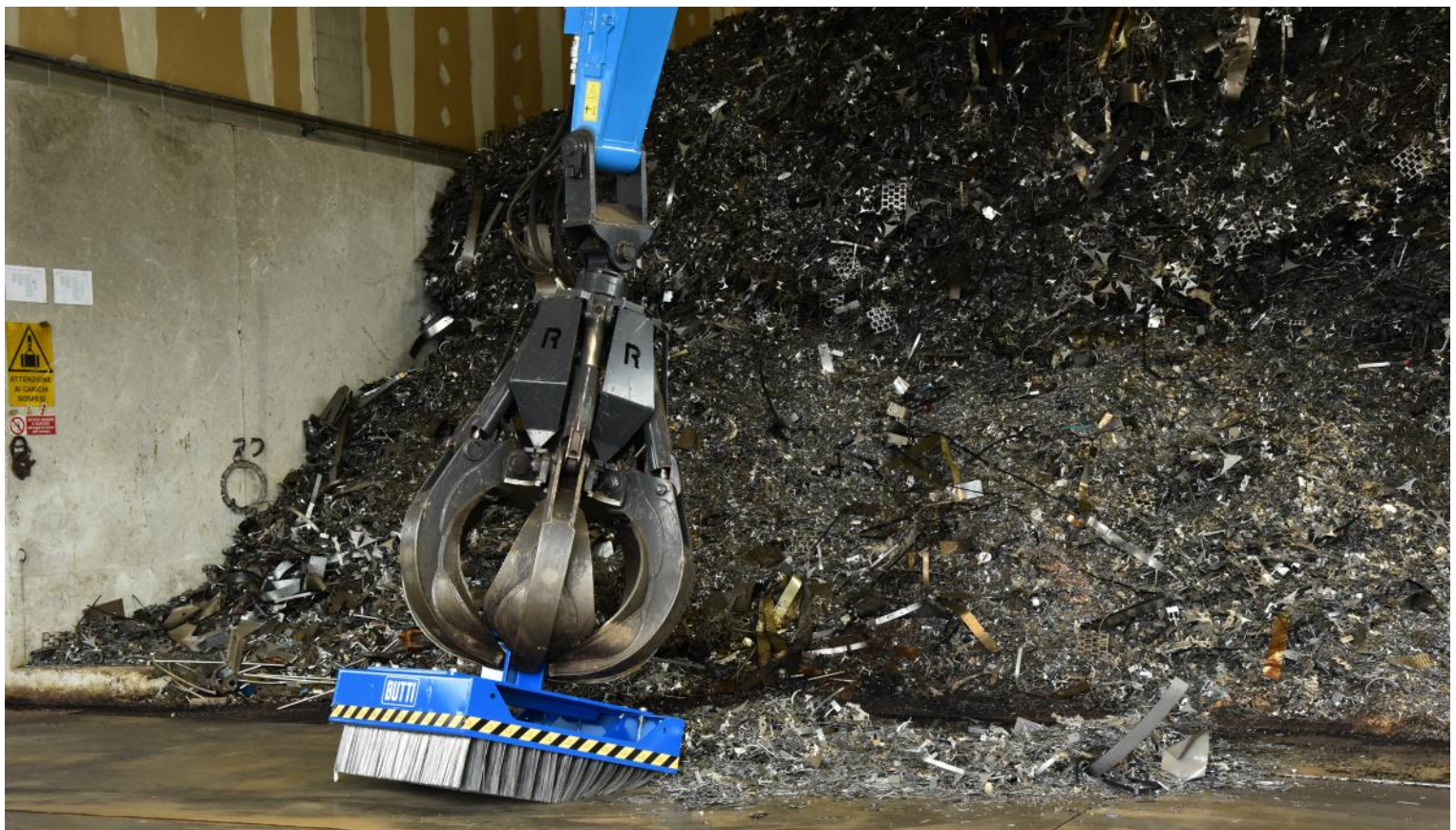
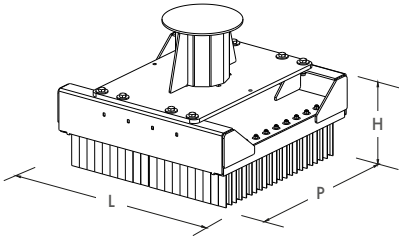



SCOPE UNIVERSAL COMPACT
UNIVERSAL BROOM COMPACT

MODELLO MODEL	DIMENSIONI / DIMENSIONS			N° DI FILI No. OF WIRES	FILE ROW	TARA TARE kg	SPAZZOLE BRUSHES
	L	P	H				
863UC20	2000	500	370	16800	6	161	Acciaio armonico di alta qualità High quality spring steel

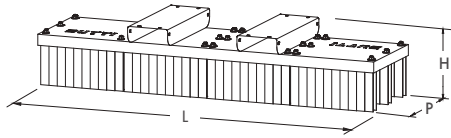

QUOTE SEDI FORCHE INTERNE
INTERNAL FORK SEATS DIMENSIONS

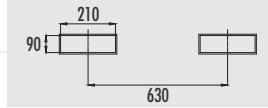

SCOPE UNIVERSAL CLASSIC
UNIVERSAL BROOM CLASSIC

MODELLO MODEL	DIMENSIONI / DIMENSIONS			N° DI FILI No. OF WIRES	FILE ROW	TARA TARE kg	SPAZZOLE BRUSHES
	L	P	H				
865UC20	2000	800	380	28000	10	268	Acciaio armonico di alta qualità High quality spring steel

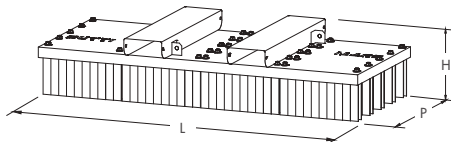

QUOTE SEDI FORCHE INTERNE
INTERNAL FORK SEATS DIMENSIONS

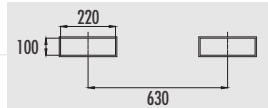

SCOPE UNIVERSAL LARGE
UNIVERSAL BROOM LARGE

MODELLO MODEL	DIMENSIONI / DIMENSIONS			N° DI FILI No. OF WIRES	FILE ROW	TARA TARE kg	SPAZZOLE BRUSHES
	L	P	H				
865UC25	2500	800	380	35000	10	318	Acciaio armonico di alta qualità High quality spring steel

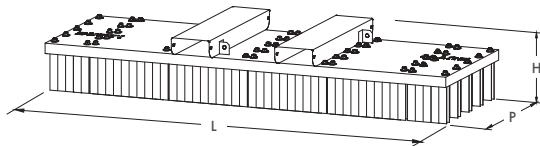

QUOTE SEDI FORCHE INTERNE
INTERNAL FORK SEATS DIMENSIONS

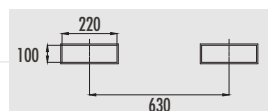

KIT SPAZZOLE DI RICAMBIO IN ACCIAIO ARMONICO
REPLACEMENT KIT IN HIGH QUALITY SPRING STEEL



FACILI E VELOCI DA SOSTITUIRE E MONTARE

Kit Butti con spazzole di lunghezza 50 cm in acciaio armonico di alta qualità adatte a tutti i modelli di scope Butti.

Su richiesta si producono kit di ricambio in acciaio armonico di alta qualità per tutti i modelli di scope non prodotte dalla Butti.

EASY AND FAST TO REPLACE AND MOUNT

Kit Butti with length 50 cm high quality brushes in spring steel for every Butti's brooms model.

Replacement brush kits in high quality steel are produced on request for every brooms models not produced by Butti.

TRASPORTO
TRANSPORT



Le scope Butti vengono spedite all'interno di un'apposita vasca zincata, progettata per proteggerle durante il trasporto e preservarne l'integrità fino alla consegna.

Butti brooms are shipped inside a dedicated galvanized steel container, designed to protect them during transport and preserve their integrity until delivery.

ATTACCO FORCA PINZA IN ACCIAIO PER MODELLI CLASSIC E LARGE
STEEL FORK CLAMP ATTACHMENT FOR CLASSIC AND LARGE MODELS

MODELLO MODEL	DIMENSIONI / DIMENSIONS mm		
	L	P	H utile / useful
868F0750U	1150	790	600

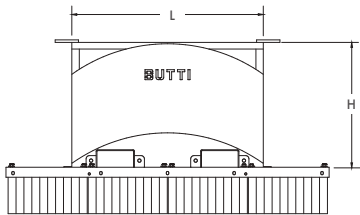

LAME REGOLABILI IN ACCIAIO PER SPINTA MATERIALI PER MODELLI CLASSIC E LARGE
ADJUSTABLE STEEL BLADES TO PUSH SCRAP FOR CLASSIC AND LARGE MODELS

MODELLO MODEL	DIMENSIONI / DIMENSIONS mm		SPESSORE THICKNESS mm
	L	H	
868LR420B	2000	400	10
868LR425B	2500	400	10



REGOLABILI
ADJUSTABLE

SCOPE ECO STRONG COMPACT
ECO STRONG BROOM COMPACT

MODELLO MODEL	DIMENSIONI / DIMENSIONS			N° DI FILI No. OF WIRES	FILE ROW	TARA TARE kg	SPAZZOLE BRUSHES
	L	P	H				
866S0520	2000	500	470	24000	5 x 2	146	Polipropilene di alta qualità High quality polypropylene

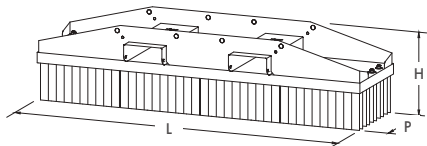

QUOTE SEDI FORCHE INTERNE
INTERNAL FORK SEATS DIMENSIONS

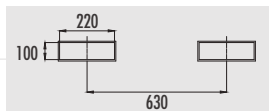

SCOPE ECO STRONG CLASSIC
ECO STRONG BROOM CLASSIC

MODELLO MODEL	DIMENSIONI / DIMENSIONS			N° DI FILI No. OF WIRES	FILE ROW	TARA TARE kg	SPAZZOLE BRUSHES
	L	P	H				
866S1020	2000	1000	500	43800	8 x 2	272	Polipropilene di alta qualità High quality polypropylene

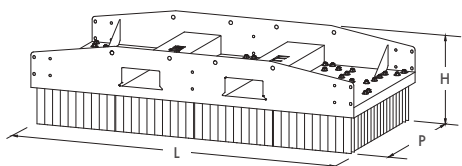

QUOTE SEDI FORCHE INTERNE
INTERNAL FORK SEATS DIMENSIONS

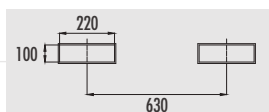

SCOPE ECO STRONG LARGE
ECO STRONG BROOM LARGE

MODELLO MODEL	DIMENSIONI / DIMENSIONS			N° DI FILI No. OF WIRES	FILE ROW	TARA TARE kg	SPAZZOLE BRUSHES
	L	P	H				
866S1025	2500	1000	500	53400	8 x 2	310	Polipropilene di alta qualità High quality polypropylene

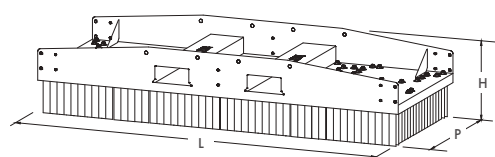

QUOTE SEDI FORCHE INTERNE
INTERNAL FORK SEATS DIMENSIONS

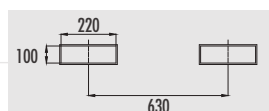

SCOPE ECO STRONG EXTRA LARGE
ECO STRONG BROOM EXTRA LARGE

MODELLO MODEL	DIMENSIONI / DIMENSIONS			N° DI FILI No. OF WIRES	FILE ROW	TARA TARE kg	SPAZZOLE BRUSHES
	L	P	H				
866S1030	3000	1000	500	64200	8 x 2	356	Polipropilene di alta qualità High quality polypropylene

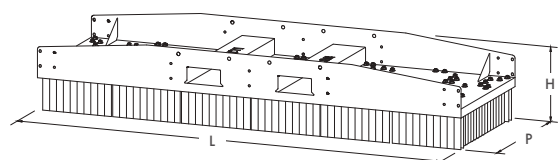

QUOTE SEDI FORCHE INTERNE
INTERNAL FORK SEATS DIMENSIONS

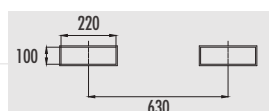

KIT SPAZZOLE DI RICAMBIO IN POLIPROPILENE
REPLACEMENT KIT IN HIGH POLYPROPYLENE



FACILI E VELOCI DA SOSTITUIRE E MONTARE

Kit Butti con spazzole in PP di alta qualità per tutti i modelli di scope Butti. Su richiesta si producono kit di ricambio in PP di alta qualità per tutti i modelli di scope non prodotte dalla Butti. Le spazzole montate sulla scopa Eco Strong sono in polipropilene di alta qualità e vengono montate trasversalmente per una migliore aderenza durante le operazioni di pulizia. Le spazzole sono inoltre progettate per essere altamente resistenti, maneggevoli e per resistere nel tempo all'usura.

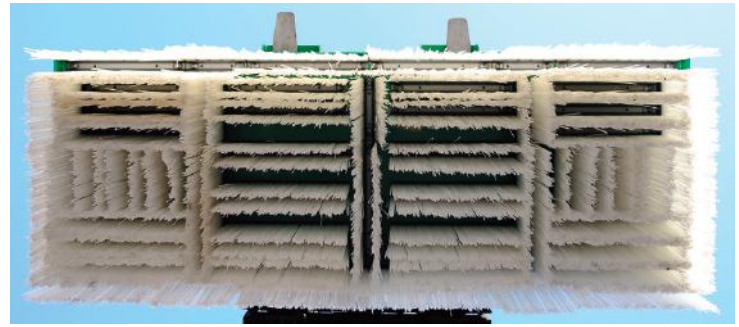

EASY AND FAST TO REPLACE AND MOUNT

Kit Butti in high quality PP brushes for every Butti's brooms model. Replacement brush kits in high quality PP on request for every brooms models not produced by Butti. The brushes mounted on the Eco Strong broom are made of high-quality polypropylene and are mounted transversely for better grip during cleaning operations. These are also designed to be sturdy and manageable and to resist for more time to mechanical stresses during the use.

ATTACCO RAGNO
ATTACHMENT FOR POLYP GRAB

MODELLO MODEL	DIMENSIONI / DIMENSIONS mm		
	Ø disco antisfilamento anti-slip disc	Ø presa utile useful grip	H presa utile useful grip
868ARH3005S Compact	400	270	300
868ARH3010S Classic Large Extra Large	400	270	300

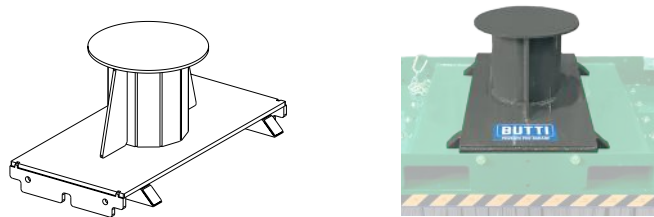

TRASPORTO
TRANSPORT



Le scope Butti vengono spedite all'interno di un'apposita vasca zincata, progettata per proteggerle durante il trasporto e preservarne l'integrità fino alla consegna.

Butti brooms are shipped inside a dedicated galvanized steel container, designed to protect them during transport and preserve their integrity until delivery.

ATTACCO FORCA PINZA IN ACCIAIO PER MODELLI CLASSIC, LARGE E EXTRA LARGE
STEEL FORK CLAMP ATTACHMENT FOR CLASSIC, LARGE AND EXTRA LARGE MODELS

MODELLO MODEL	DIMENSIONI / DIMENSIONS mm		
	L	P	H utile / useful
868F0750S	1150	900	600

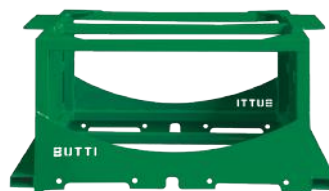
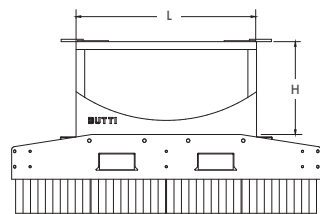

LAME REGOLABILI IN ACCIAIO PER SPINTA MATERIALI PER MODELLI CLASSIC, LARGE E EXTRA LARGE
ADJUSTABLE STEEL BLADES TO PUSH SCRAP FOR CLASSIC, LARGE AND EXTRA LARGE MODELS

MODELLO MODEL	DIMENSIONI / DIMENSIONS mm		SPESSORE THICKNESS mm
	L	H	
868LR420V 868LR420R	2000	400	10 15
868LR425V 868LR425R	2500	400	10 15
868LR430V 868LR430R	3000	400	10 15



REGOLABILI
ADJUSTABLE



SCOPE ECO UNIVERSAL COMPACT
ECO UNIVERSAL BROOM COMPACT

MODELLO MODEL	DIMENSIONI / DIMENSIONS			N° DI FILI No. OF WIRES	FILE ROW	TARA TARE kg	SPAZZOLE BRUSHES
	L	P	H				
866N0520	2000	500	370	14400	6	106	Polipropilene di alta qualità High quality polypropylene

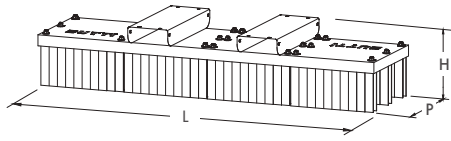

QUOTE SEDI FORCHE INTERNE
INTERNAL FORK SEATS DIMENSIONS

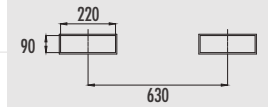

SCOPE ECO UNIVERSAL CLASSIC
ECO UNIVERSAL BROOM CLASSIC

MODELLO MODEL	DIMENSIONI / DIMENSIONS			N° DI FILI No. OF WIRES	FILE ROW	TARA TARE kg	SPAZZOLE BRUSHES
	L	P	H				
866N1020	2000	800	380	24000	10	176	Polipropilene di alta qualità High quality polypropylene

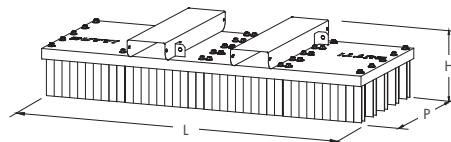

QUOTE SEDI FORCHE INTERNE
INTERNAL FORK SEATS DIMENSIONS

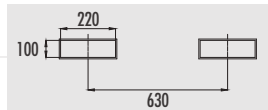

SCOPE ECO UNIVERSAL LARGE
ECO UNIVERSAL BROOM LARGE

MODELLO MODEL	DIMENSIONI / DIMENSIONS			N° DI FILI No. OF WIRES	FILE ROW	TARA TARE kg	SPAZZOLE BRUSHES
	L	P	H				
866N1025	2500	800	380	30000	10	213	Polipropilene di alta qualità High quality polypropylene

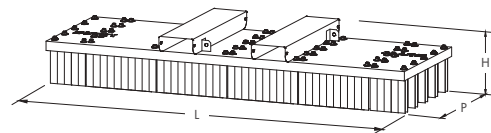

QUOTE SEDI FORCHE INTERNE
INTERNAL FORK SEATS DIMENSIONS

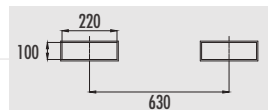

KIT SPAZZOLE DI RICAMBIO IN POLIPROPILENE
REPLACEMENT KIT IN HIGH POLYPROPYLENE



FACILI E VELOCI DA SOSTITUIRE E MONTARE

Kit Butti con spazzole in PP di alta qualità per tutti i modelli di scope Butti. Su richiesta si producono kit di ricambio in PP di alta qualità per tutti i modelli di scope non prodotte dalla Butti.

Le spazzole in polipropilene sono progettate per essere altamente resistenti, maneggevoli e per resistere nel tempo all'usura.

EASY AND FAST TO REPLACE AND MOUNT

Kit Butti in high quality PP brushes for every Butti's brooms model. Replacement brush kits in high quality PP on request for every brooms models not produced by Butti.

PP brushes are designed to be sturdy and manageable and to resist for more time to mechanical stresses during the use.

TRASPORTO
TRANSPORT



Le scope Butti vengono spedite all'interno di un'apposita vasca zincata, progettata per proteggerle durante il trasporto e preservarne l'integrità fino alla consegna.

Butti brooms are shipped inside a dedicated galvanized steel container, designed to protect them during transport and preserve their integrity until delivery.

LAME REGOLABILI IN ACCIAIO PER SPINTA MATERIALI PER MODELLI CLASSIC E LARGE
ADJUSTABLE STEEL BLADES TO PUSH SCRAP FOR CLASSIC ET LARGE MODELS

MODELLO MODEL	DIMENSIONI / DIMENSIONS mm		SPESSORE THICKNESS mm
	L	H	
868LR420V	2000	400	10
868LR425V	2500	400	10



REGOLABILI
ADJUSTABLE



SCOPA **MAGNETICA** MANUALE "EASY"
HAND HELD **MAGNETIC** BROOM "EASY"

MODELLO MODEL	DIMENSIONI / DIMENSIONS mm					FORZA MAGNETICA MAGNETIC FORCE kg
	L1	L2	P1	P2	H	
867M0210SM	1220	1070	850	250	1050	25/30

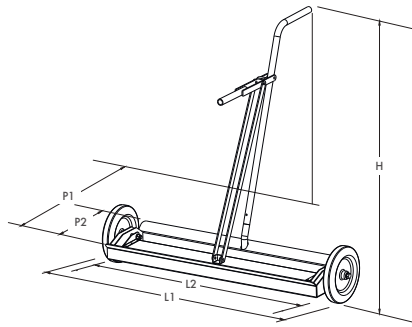

SCOPA **MAGNETICA**
MAGNETIC BROOM

MODELLO MODEL	DIMENSIONI / DIMENSIONS mm			FORZA MAGNETICA MAGNETIC FORCE kg
	L	P	H	
867M0515	1500	600	280	85/100

QUOTE SEDI FORCHE INTERNE
INTERNAL FORK SEATS DIMENSIONS

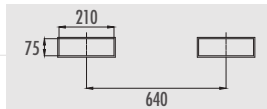

Sistema di apertura facilitato tramite leva in acciaio inox
Easy opening system with stainless steel lever

MODELLO MODEL	DIMENSIONI / DIMENSIONS mm			FORZA MAGNETICA MAGNETIC FORCE kg
	L	P	H	
867M0525	2500	600	300	145/160
867M0530	3000	600	300	175/190

QUOTE SEDI FORCHE INTERNE
INTERNAL FORK SEATS DIMENSIONS

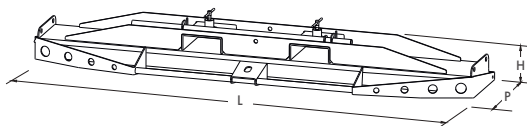
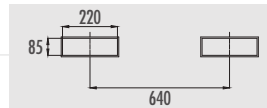

CESOIE CAIMAN PER IL TAGLIO DI METALLI DI RECUPERO
CAIMAN SHEARS TO CUT RECYCLABLE METALS

MODELLO MODEL	LUNGHEZZA LAMA BLADE LENGHT	MOTORE ELETTRICO ELECTRIC MOTOR	FORZA DI TAGLIO CUTTING STRENGHT	PREMI LAMIERA PLATE REHEARSAL	PRESSIONE PRESSURE	CICLO A VUOTO EMPTY CYCLES	CAPACITÀ SERBATOIO TANK LOAD	DIMENSIONI DIMENSIONS	PESO IN ORDINE DI LAVORO WEIGHT IN WORD ORDER	CAPACITÀ DI TAGLIO CUTTING CAPACITY			
										—	○	□	○
	mm	kw	ton		bar		lt	LxPxH mm	kg	S275JR	S275JR	S275JR	S275JR
869C150	150	3	17	idraulico/manuale hydraulic/manual	220	12	80	1100x800x1300	600	6x80	φ 25	20x20	φ 33 SP.4
869C250	250	4	50	idraulico hydraulic	180	15	120	1350x900x1300	700	10x100	φ 30	30x30	φ 42 SP.6
869C340	340	4	55	idraulico hydraulic	220	15	170	1500x1200x1340	1300	12x100	φ 35	35x35	φ 48 SP.8
869C500	500	7,5	94	idraulico hydraulic	250	15	170	1750x1280x1400	1600	12x150	φ 50	45x45	φ 70 SP.8
869C500X	500	7,5	120	idraulico hydraulic	240	13	200	1760x1280x1420	1650	12x150	φ 50	40x40	φ 70 SP.8
869C600	600	7,5	94	idraulico hydraulic	320	5	180	2000x1300x1500	1800	15x150	φ 55	50x50	φ 100 SP.6
869C600X	600	7,5	120	idraulico hydraulic	320	5	180	2000x1300x1500	1800	15x150	φ 55	50x50	φ 100 SP.6

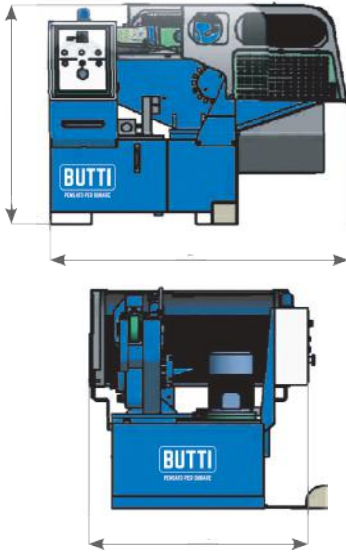

Doppia sicurezza: robusto piano di lavoro con fermo barra regolabile

Double safety: sturdy plan of work with adjustable bar to block the materials to cut

- Alimentazione elettrica: 400 V. 50 HZ
- Ciclo manuale
- Corsa controllabile tramite micro regolabili

- Power supply: 400 V. 50 HZ
- Manual cycle
- Easy opening system

CESOIE CAIMAN PER IL TAGLIO DI RUBINETTI E VALVOLE PER IL RECUPERO DI OTTONE E RAME
CAIMAN SCRAP SHEARS FOR BRASS AND COPPER RECOVERY FROM FAUCETS AND VALVES

MODELLO MODEL	MOTORE ELETTRICO ELECTRIC MOTOR	TAGLI AL MINUTO CUTS PER MINUTE	FORZA DI TAGLIO CUTTING STRENGHT	PREMI LAMIERA PLATE REHEARSAL	PRESSIONE PRESSURE	DIMENSIONI DIMENSIONS	PESO IN ORDINE DI LAVORO WEIGHT IN WORD ORDER
		massima corsa maximum stroke	ton		bar	LxPxH mm	kg
869CX70	4 kw 400 v. 50 hz	8	50	idraulico hydraulic	180	1450x880x1400	1300

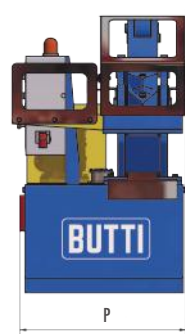
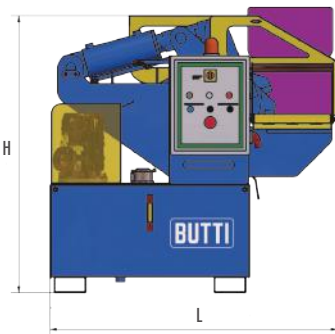

- Alimentazione elettrica: 400 V. 50 HZ
- Lame di taglio in acciaio speciale con 4 profili di taglio

- Power supply: 400 V. 50 HZ
- Special steel cutting blades with 4 cutting profiles

VASCHE IN POLIETILENE PER PICCOLI CONTENITORI
POLYETHYLENE TANKS FOR SMALL CONTAINERS

MODELLO MODEL	DIMENSIONI / DIMENSIONS mm			VOLUME VOLUME lt
	L	P	H	
83PL0045	630	590	175	45
83PL0280	1230	830	300	280

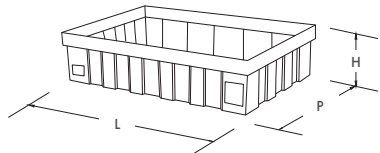

Il modello 83PL0280 è
pallettizzabile
Models 83PL0280 is
forklift pockets

VASCA DI CONTENIMENTO IN POLIETILENE PER FUSTI PER SOSTANZE ACIDE
POLYETHYLENE SPILL CONTAINMENT PALLET FOR DRUMS FOR ACID SUBSTANCES

MODELLO MODEL	DIMENSIONI / DIMENSIONS mm			PORTATA LOAD CAPACITY kg	CAPACITÀ DI STOCCAGGIO STORAGE CAPACITY	VOLUME VOLUME lt
	L	P	H			
8070V1FP	925	800	420	400 statico uniformemente distribuito static uniformly distributed	1 fusto da 200 lt su grigliato 1x200 lt drum on grid	225
83PL0305	1350	800	420	400+400 statico uniformemente distribuito static uniformly distributed	2 fusti da 200 lt su grigliato 2x200 lt drums on grid	305
824EP	1350	1350	490	1500 statico uniformemente distribuito static uniformly distributed	4 fusti da 200 lt su grigliato 4x200 lt drums on grid	500

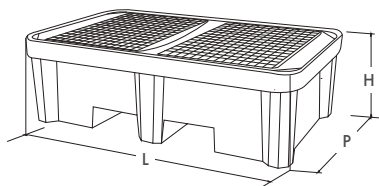

Ideale per sostanze acide
Ideal for acid substances

VASCA DI CONTENIMENTO IN POLIETILENE PER CISTERNETTA PER SOSTANZE ACIDE
POLYETHYLENE SPILL CONTAINMENT PALLET FOR TANK FOR ACID SUBSTANCES

MODELLO MODEL	DIMENSIONI / DIMENSIONS mm			PORTATA LOAD CAPACITY kg	CAPACITÀ DI STOCCAGGIO STORAGE CAPACITY	VOLUME VOLUME lt
	L	P	H			
826STQP	1350	1350	970	1500 statico uniformemente distribuito static uniformly distributed	1 cisternetta da 1000 lt su grigliato 1x1000 lt tank on grid	1050

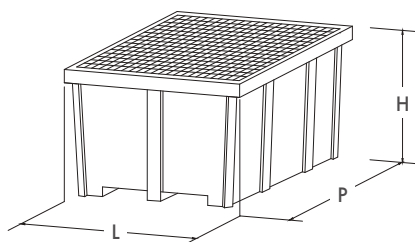

Ideale per sostanze acide
Ideal for acid substances

CISTERNETTA MULTIUSO
MULTI-PURPOSE TANK
614 - 614RI



POMPA PORTATA 40 LT
PUMP FLOW RATE 40 LT

915



RIDUZIONE IN ALLUMINIO CON RUBINETTO DA 1''
ALUMINIUM REDUCTION WITH 1" DISCHARGE VALVE
99C072



ACCESSORI
ACCESSORIES

VASCA DI CONTENIMENTO IN POLIETILENE PER 2 CISTERNETTE PER SOSTANZE ACIDE
POLYETHYLENE SPILL CONTAINMENT PALLET FOR 2 TANKS FOR ACID SUBSTANCES

MODELLO MODEL	DIMENSIONI / DIMENSIONS mm			PORTATA LOAD CAPACITY kg 3000 statico uniformemente distribuito static uniformly distributed	CAPACITÀ DI STOCCAGGIO STORAGE CAPACITY 2 cisternette da 1000 lt su grigliato 2x1000 lt tanks on grid	VOLUME VOLUME lt 1150
	L	P	H			
8070V2CP	2540	1370	650			



Ideale per sostanze acide
Ideal for acid substances

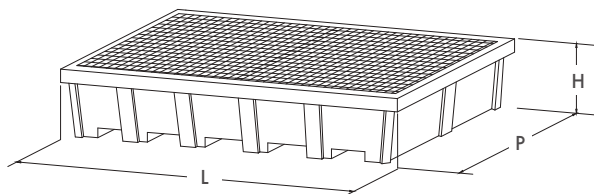

VASCA DI CONTENIMENTO IN POLIETILENE PER 2 CISTERNETTE CON TELO DI COPERTURA IN PVC
POLYETHYLENE SPILL CONTAINMENT PALLET FOR 2 TANKS WITH PVC COVER SHEET

MODELLO MODEL	DIMENSIONI / DIMENSIONS mm			CAPACITÀ DI STOCCAGGIO STORAGE CAPACITY 2 cisternette da 1000 lt su grigliato 2x1000 lt tanks on grid	VOLUME VOLUME lt 1140
	L	P	H		
8070V2CPT	2560	1350	2080		

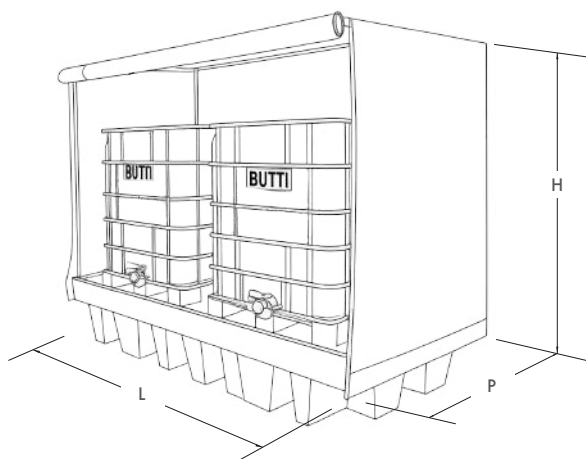

ACCESSORI
ACCESSORIES

CISTERNETTA MULTIUSO
MULTI-PURPOSE TANK
614 - 614RI



POMPA PORTATA 40 LT
PUMP FLOW RATE 40 LT

915



RIDUZIONE IN ALLUMINIO CON RUBINETTO DA 1"
ALUMINIUM REDUCTION WITH 1" DISCHARGE VALVE
99C072





La legge (rif. D.M. 392 del 16/05/1996 per oli e D.M. 18/05/1995 per depositi di soluzioni idroalcoliche, deliberazione del 27/07/1984) stabilisce che i bacini di contenimento devono contenere il maggiore tra:

The law (Ref D.M. 392 16/05/1996 for oils and D.M. 18/05/1995 for deposits of hydroalcoholic solutions, deliberation of 27/07/1984) says that the containment basins must contain the largest of:

IL VOLUME DEL CONTENITORE PIÙ GRANDE STOCCATO SULLA VASCA

THE VOLUME OF THE LARGEST CONTAINER STORED ON THE SPILL CONTAINMENT PALLET

E

AND

$\frac{1}{3}$ DEL LIQUIDO TOTALE STOCCATO

$\frac{1}{3}$ OF THE TOTAL OF THE LIQUID STORED

ESEMPIO 1
EXAMPLE 1

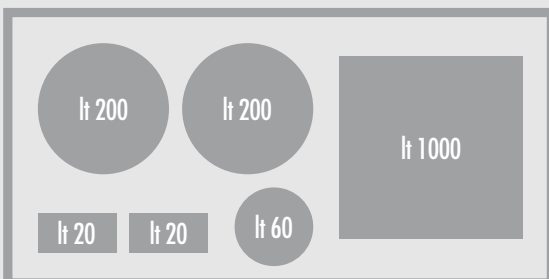

TOTALE LITRI STOCCATI: 1500. Quindi $1500 \times \frac{1}{3} = 500$ LITRI

CONTENITORE PIÙ GRANDE STOCCATO: 1000 LITRI
1000 lt > 500 lt

QUINDI LA VASCA **DOVRÀ CONTENERE 1000 LITRI**
in quanto è il risultato maggiore tra i due.

TOTAL LITERS STORED: 1500. Therefore $1500 \times \frac{1}{3} = 500$ LITERS

LARGEST CONTAINER STORED: 1000 LITER
1000 lt > 500 lt

THEREFORE THE SPILL CONTAINMENT PALLET **HAS TO CONTAIN 1000 LITERS** since it is the greater result between the two.

ESEMPIO 2
EXAMPLE 2

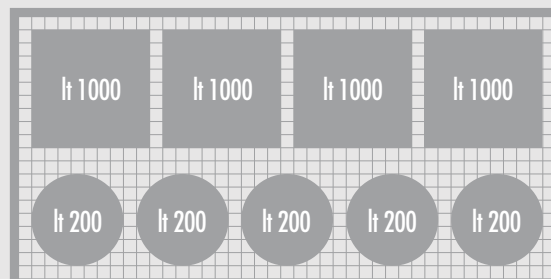

TOTALE LITRI STOCCATI: 5000. Quindi $5000 \times \frac{1}{3} = 1667$ LITRI

CONTENITORE PIÙ GRANDE STOCCATO: 1000 LITRI
1000 lt < 1667 lt

QUINDI LA VASCA **DOVRÀ CONTENERE 1667 LITRI**
in quanto è il risultato maggiore tra i due.

TOTAL LITERS STORED: 5000. Therefore $5000 \times \frac{1}{3} = 1667$ LITERS

LARGEST CONTAINER STORED: 1000 LITER
1000 lt < 1667 lt

THEREFORE THE SPILL CONTAINMENT PALLET **HAS TO CONTAIN 1667 LITERS** since it is the greater result between the two.

VASCA DI CONTENIMENTO IN ACCIAIO PER 1 FUSTO
STEEL SPILL CONTAINMENT PALLET FOR 1 DRUM

MODELLO MODEL	DIMENSIONI / DIMENSIONS mm			CAPACITÀ DI STOCCAGGIO STORAGE CAPACITY	VOLUME VOLUME lt
	L	P	H		
821E	850	850	400	1 fusto da 200 lt su grigliato 1x200 lt drum on grid	205
822E	1340	850	330	2 fusti da 200 lt su grigliato 2x200 lt drums on grid	230

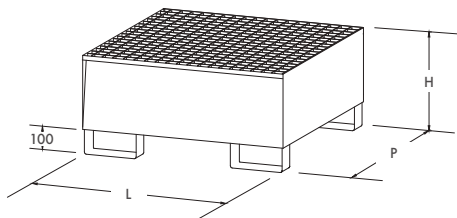

Grigliato zincato a caldo
Hot-dip galvanized grid

VASCA DI CONTENIMENTO IN ACCIAIO PER 4 FUSTI
STEEL SPILL CONTAINMENT PALLET FOR 4 DRUMS

MODELLO MODEL	DIMENSIONI / DIMENSIONS mm			CAPACITÀ DI STOCCAGGIO STORAGE CAPACITY	VOLUME VOLUME lt
	L	P	H		
824E	1340	1250	300	4 fusti da 200 lt su grigliato 4x200 lt drums on grid	280

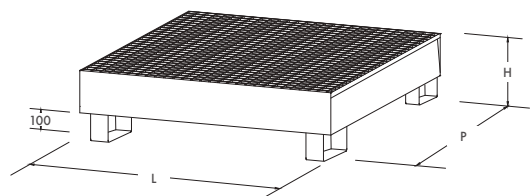

Grigliato zincato a caldo
Hot-dip galvanized grid

VASCA DI CONTENIMENTO IN ACCIAIO PER 1 CISTERNETTA
STEEL SPILL CONTAINMENT PALLET FOR 1 TANK

MODELLO MODEL	DIMENSIONI / DIMENSIONS mm			CAPACITÀ DI STOCCAGGIO STORAGE CAPACITY	VOLUME VOLUME lt
	L	P	H		
826STQ	1350	1650	640	1 cisternetta da 1000 lt su grigliato 1x1000 lt tank on grid	1000

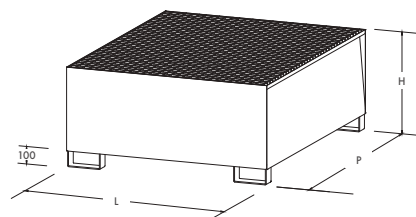

Grigliato zincato a caldo
Hot-dip galvanized grid

VASCA DI CONTENIMENTO IN ACCIAIO PER 2 CISTERNETTE
STEEL SPILL CONTAINMENT PALLET FOR 2 TANKS

MODELLO MODEL	DIMENSIONI / DIMENSIONS mm			CAPACITÀ DI STOCCAGGIO STORAGE CAPACITY	VOLUME VOLUME lt
	L	P	H		
807OV2C	2720	1650	350	2 cisternette da 1000 lt su grigliato 2x1000 lt tanks on grid	1100

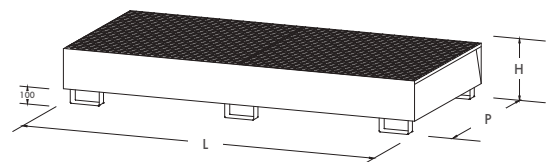

Grigliato zincato a caldo
Hot-dip galvanized grid

Profondità vasca maggiorata
Increased depth of the pallet



DEPOSITO IN ACCIAIO PER 2 O 4 FUSTI
OUTDOOR STEEL CONTAINER FOR 2 OR 4 DRUMS

Grigliato zincato a caldo
Hot-dip galvanized grid

MODELLO MODEL	DIMENSIONI / DIMENSIONS mm			CAPACITÀ DI STOCCAGGIO STORAGE CAPACITY	VOLUME VOLUME lt
	L	P	H		
822GB15	1430	930	1580	2 fusti da 200 lt su grigliato 2x200 lt drums on grid	230
824GB15	1420	1315	1490	4 fusti da 200 lt su grigliato 4x200 lt drums on grid	330

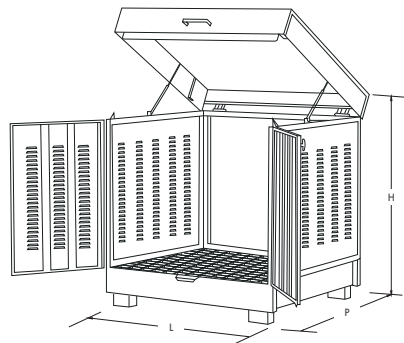

DEPOSITO IN ACCIAIO CON TETTO FISSO PER 2 O 4 FUSTI
OUTDOOR STEEL CONTAINER WITH FIXED ROOF FOR 2 OR 4 DRUMS

Grigliato zincato a caldo
Hot-dip galvanized grid

MODELLO MODEL	DIMENSIONI / DIMENSIONS mm			CAPACITÀ DI STOCCAGGIO STORAGE CAPACITY	VOLUME VOLUME lt
	L	P	H		
822GB18	1410	950	1810	2 fusti da 200 lt su grigliato 2x200 lt drums on grid	268
824GB18	1350	1260	1810	4 fusti da 200 lt su grigliato 4x200 lt drums on grid	340

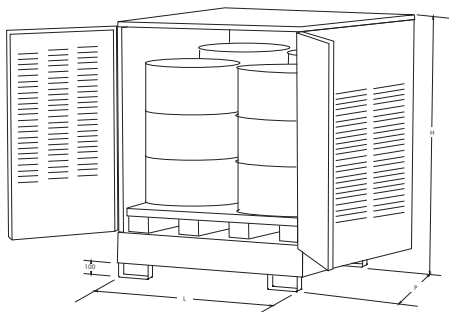

I DEPOSITI IN ACCIAIO CON TETTO FISSO SONO DISPONIBILI NELLE SEGUENTI VERSIONI
OUTDOOR STEEL CONTAINER WITH FIXED ROOF ARE AVAILABLE IN THE FOLLOWING VERSIONS

MODELLO MODEL	DIMENSIONI esterne / external DIMENSIONS mm			LUCE NETTA VANO CLEAR SPACE OF COMPARTMENT mm	CAPACITÀ DI STOCCAGGIO STORAGE CAPACITY	VOLUME VOLUME lt
	L	P	H			
	1410	950	1810	1290x1350	2 fusti da 200 lt su grigliato 2x200 lt drums on grid	268
	1350	1260	1810	1290x1350	4 fusti da 200 lt su grigliato 4x200 lt drums on grid	340
	1410	950	1810	1290x1350	1 fusto da 200 lt e 2 ripiani per piccoli contenitori 1 drum of 200 L and 2 shelves for small containers	230
	1350	1260	1810	1290x1350	4 ripiani per piccoli contenitori 4 shelves for small containers	280

FUSTI METALLICI CILINDRICI **OMOLOGATI**
HOMOLOGATED CYLINDRICAL METAL DRUMS



ACCESSORI
ACCESSORIES

DEPOSITO IN ACCIAIO PER UNA CISTERNETTA
OUTDOOR STEEL CONTAINER FOR ONE TANK

Grigliato zincato a caldo
Hot-dip galvanized grid

MODELLO MODEL	DIMENSIONI / DIMENSIONS mm			CAPACITÀ DI STOCCAGGIO STORAGE CAPACITY	PORTATA LOAD CAPACITY kg	VOLUME VOLUME lt
	L	P	H			
8080D1C18	1450	1760	1810	1 cisternetta da 1000 lt su grigliato 1x1000 lt tank on grid	1500	1000

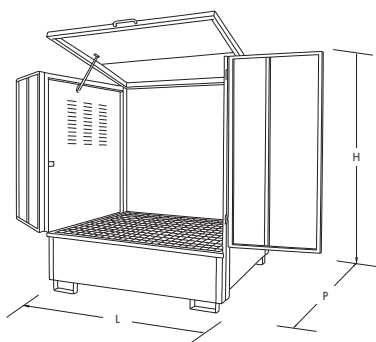

DEPOSITO IN ACCIAIO CON TETTO FISSO PER UNA CISTERNETTA
OUTDOOR STEEL CONTAINER WITH FIXED ROOF FOR ONE TANK

Grigliato zincato a caldo
Hot-dip galvanized grid

MODELLO MODEL	DIMENSIONI / DIMENSIONS mm			CAPACITÀ DI STOCCAGGIO STORAGE CAPACITY	VOLUME VOLUME lt
	L	P	H		
8080D1C	1350	1660	2535	1 cisternetta da 1000 lt su grigliato 1x1000 lt tank on grid	1100

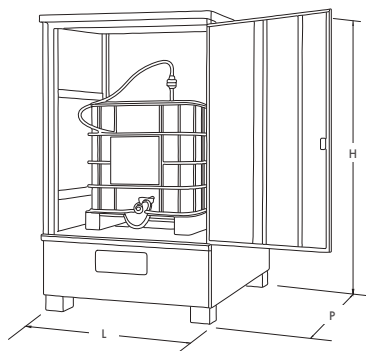

DEPOSITO IN POLIETILENE PER UNA CISTERNETTA
POLYETHYLENE OUTDOOR STEEL CONTAINER FOR ONE TANK

MODELLO MODEL	DIMENSIONI / DIMENSIONS mm			CAPACITÀ DI STOCCAGGIO STORAGE CAPACITY	PORTATA LOAD CAPACITY kg	VOLUME VOLUME lt
	L	P	H			
8080AP1C	1540	1600	2335	1 cisternetta da 1000 lt su grigliato 1x1000 lt tank on grid	2000	1350

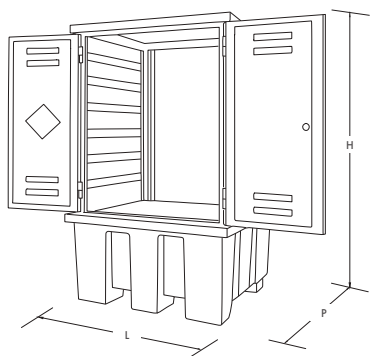

FUSTI METALLICI CILINDRICI **OMOLOGATI**
HOMOLOGATED CYLINDRICAL METAL DRUMS

MODELLO MODEL	TIPO TYPE	COPERCHIO COVER	TAPPI CAPS	VOLUME VOLUME lt
813FL217	Isocontainer senza corrugazioni <i>Isocontainer without corrugations</i>	Fisso <i>Fixed</i>	Uno da 2" e uno da 3/4" <i>One 2" and one 3/4"</i>	217
813FL217CM	Manto con corrugazioni <i>Mantle with corrugations</i>	Removibile <i>Removable</i>	Senza tappi <i>Without caps</i>	217



TAGLIAFUSTI PER LA RIMOZIONE COPERCHI DEI FUSTI METALLICI
DRUMS DEHEADER FOR THE REMOVAL OF METAL DRUM COVERS

MODELLO MODEL
925



CHIAVE PER FUSTI
KEY FOR DRUMS

MODELLO MODEL
99C394



CISTERNA MULTIUSO PER STOCCAGGIO ACQUA POTABILE O LIQUIDI VARI
MULTI-PURPOSE TANK FOR STORAGE OF DRINKABLE WATER OR VARIOUS LIQUIDS

MODELLO MODEL	DIMENSIONI / DIMENSIONS mm			TARA TARE kg	VOLUME VOLUME lt
	L	P	H		
614	1000	1200	1165	56	1000
614RI <i>rigenerata / regenerated</i>	1000	1200	1165	56	1000



Pallet in plastica
Plastic pallets

Possibilità di acquisto di modelli rigenerati
Possibility of purchasing regenerated models

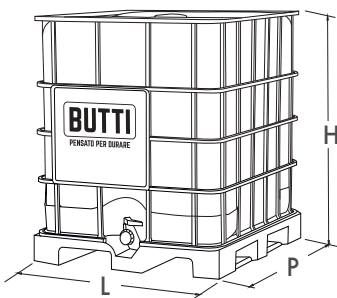

RIGENERATA
REGENERATED

CHIAVE E
TAGLIAFUSTI
KEY AND DRUMS
DEHEADER
99C394 - 925



POMPA
PORTATA 40 LT
PUMP FLOW
RATE 40 LT
915



RIDUZIONE IN
ALLUMINIO CON
RUBINETTO DA 1"
ALLUMINIUM
REDUCTION
WITH 1"
DISCHARGE
VALVE
99C072



SUPPORTO CISTERNA
MULTIUSO LT. 1000.
DIMENSIONI:
1150x955xH.700 MM
MULTI-PURPOSE
TANK STAND 1000 L.
DIMENSIONS:
1150x955xH.700 MM
614S



ACCESSORI
ACCESSORIES

TRAMOGGIA PORTA "BIG-BAG" SMONTABILE
REMOVABLE "BIG-BAG" HOPPER

MODELLO MODEL	DIMENSIONI / DIMENSIONS mm							PORTATA LOAD CAPACITY kg
	L1xP1	L2xP2	L3xP3 utile / useful	H1	H2	H3	H4	
873TB16	1600x1400	1675x1675	1440x1240	2330	2930	1530	2130	2000

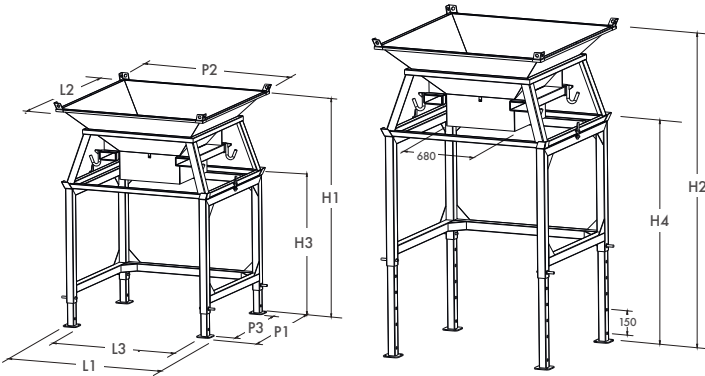

QUOTE SEDI FORCHE INTERNE
INTERNAL FORK SEATS DIMENSIONS

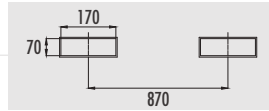

- Movimentazione facile
Easy handling
- Ampia bocca di carico
Wide insertion funnel
- Robusta struttura in acciaio
Sturdy steel structure
- Altezza regolabile con passi da 150 mm
Adjustable height with 150 mm steps
- Ganci saldati per fissare il "Big-Bag" agevolmente
Welded hooks to fix easily the "Big-Bag"
- 4 attacchi superiori sul bordo dell'imbuto per sollevamento con gru a vuoto
4 hooks for big-bag placed deeper on the funnel for lifting high
- Dimensioni bocca di scarico 680x680 mm
Discharge dimensions 680x680 mm

SACCO "BIG-BAG" OMOLOGATO
APPROVED "BIG-BAG"

MODELLO MODEL	DIMENSIONI / DIMENSIONS mm			PORTATA LOAD CAPACITY kg
	L	P	H	
99C300	900	900	1200	1000



DISPENSER DOSBAG PER LO SCARICO DEL "BIG-BAG"
DOSBAG DISPENSER FOR UNLOADING THE "BIG-BAG"

MODELLO MODEL	DIMENSIONI / DIMENSIONS mm		FLUSSO FLOW RATE kg/min
	Ø	P	
99C383	150	430	150 / 200



CONTENITORE PORTA "BIG-BAG" VERNICIATO
VARNISHED "BIG-BAG" CONTAINER

MODELLO MODEL	DIMENSIONI / DIMENSIONS mm			PORTATA LOAD CAPACITY kg
	L	P	H	
873PB15	1070	1070	1350	1000

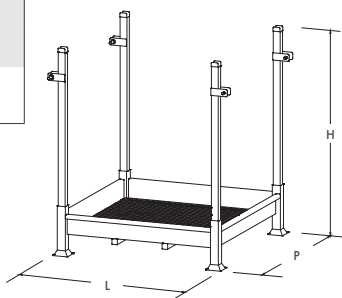

Con piantane smontabili
dotate di agganci
With removable planks with
hooks

CONTENITORE PORTA "BIG-BAG" ZINCATO
ZINC-COATED "BIG-BAG" CONTAINER

MODELLO MODEL	DIMENSIONI / DIMENSIONS mm			PORTATA LOAD CAPACITY kg
	L	P	H	
873PB15Z	1070	1070	1350	1000

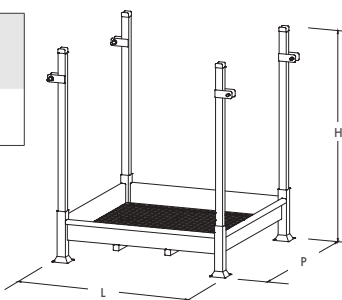

Con piantane smontabili
dotate di agganci
With removable planks with
hooks

CONTENITORE PORTA "BIG-BAG" CON VASCA
"BIG-BAG" CONTAINER WITH TANK

MODELLO MODEL	DIMENSIONI / DIMENSIONS mm			PORTATA LOAD CAPACITY kg
	L	P	H	
873VB15	1060	1060	1930	1000

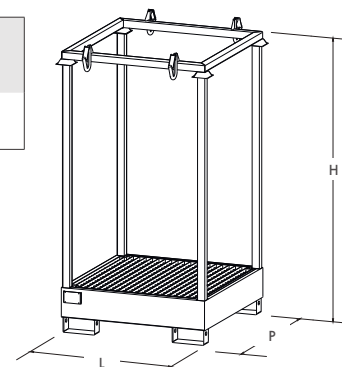

Con telaio e piantane
smontabili
With removable frame and
planks

Grigliato zincato a caldo
Hot-dip galvanized grid

CONTENITORE PORTA "BIG-BAG" EASY BAG
EASY BAG "BIG-BAG" CONTAINER

MODELLO MODEL	DIMENSIONI / DIMENSIONS mm		
	L	P	H
873EB	1100	1080	1450

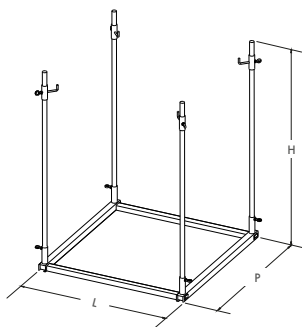

Pratico, leggero e veloce da
montare e smontare
Practical, light and quick to
assemble and disassemble
Ideale per la divisione dei
rifiuti in azienda
Ideal for waste separation in
the company sites

Si consiglia di utilizzare pallet
di supporto
It is recommended to use
support pallets

SACCO "BIG-BAG" OMOLOGATO
APPROVED "BIG-BAG"



ACCESSORI
ACCESSORIES

BILANCINO PORTA "BIG-BAG" CON SEDI FORCHE
 "BIG-BAG" LIFTING BEAM WITH FORK SEATS



MODELLO MODEL	DIMENSIONI esterne / external DIMENSIONS mm			PORTATA LOAD CAPACITY kg
	L	P	H	
564SBX	1160	1070	350	2000

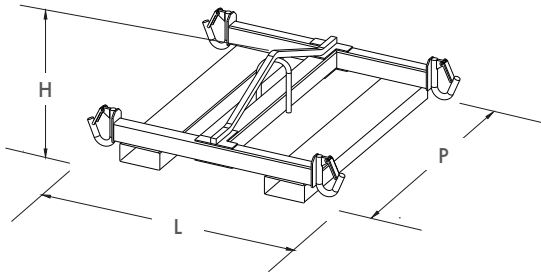

QUOTE SEDI FORCHE INTERNE
INTERNAL FORK SEATS DIMENSIONS

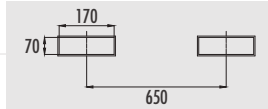

GANCIO DI CARICO
LIFTING HOOK



MODELLO MODEL	DIMENSIONI / DIMENSIONS mm			PORTATA LOAD CAPACITY kg
	L	P	H	
921	630	250	250	2000

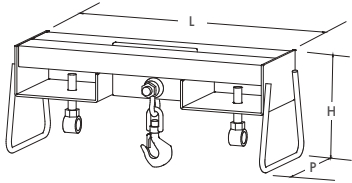

QUOTE SEDI FORCHE INTERNE
INTERNAL FORK SEATS DIMENSIONS

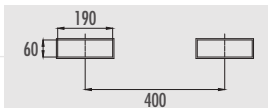

GANCIO DI CARICO
LIFTING HOOK



MODELLO MODEL	DIMENSIONI / DIMENSIONS mm			PORTATA LOAD CAPACITY kg
	L	P	H	
921Q40	1025	320	400	4000

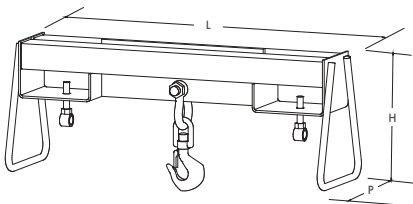

QUOTE SEDI FORCHE INTERNE
INTERNAL FORK SEATS DIMENSIONS

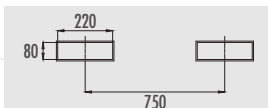

ASSORBENTE GRANULARE PER PRODOTTI LIQUIDI E OLEOSI
 GRANULAR ABSORBENT FOR LIQUID AND OILY PRODUCTS

MODELLO MODEL	CARATTERISTICHE FEATURES
909G0512	Granulare fine 12 Kg (secchio). Fine granular 12 Kg (bucket).



COMPOSTO GRANULARE ASSORBENTE E NEUTRALIZZANTE PER ACIDI
 GRANULAR ABSORBENT AND NEUTRALIZER FOR ACIDS

MODELLO MODEL	CARATTERISTICHE FEATURES
909P0805	Granulaira 6 kg (seau). Granular 6 kg (bucket).



KIT PRONTO INTERVENTO PER LIQUIDI UNIVERSALI
 FIRST REACTION KIT FOR ALL FLUIDS

MODELLO MODEL	DIMENSIONI / DIMENSIONS mm			CONTENUTO CONTENTS	ASSORBIMENTO ABSORPTION lt	VOLUME VOLUME lt
	L	P	H			
909KL120	480	550	950	50 panni - 50 rags 41x46cm 6 cuscini - 6 cushions 46x46cm 12 calze - 12 filters Ø 7,6x122cm 1 Kit Protect (whitesorb non incluso - not included)	124	120
909KL240	580	750	1100	150 panni - 150 rags 41x46cm 8 cuscini - 8 cushions 46x46cm 12 calze - 12 filters Ø 7,6x122cm 1 Kit Protect (whitesorb non incluso - not included)	265	240
909KL360	580	900	1100	200 panni - 200 rags 41x46cm 12 cuscini - 12 cushions 46x46cm 12 calze - 12 filters Ø 7,6x122cm 6kg WHITESORB-C + 1 Kit Protect	348	360



Può contenere liquidi universali come acqua, idrocarburi, liquidi organici e inorganici chimici, solventi antigelo
 It can contain universal liquids like water, hydrocarbon, chemical, organic and inorganic liquids, antifreezing solvents

KIT PRONTO INTERVENTO PER PRODOTTI CHIMICI
 FIRST REACTION KIT CHEMICAL PRODUCTS

MODELLO MODEL	DIMENSIONI / DIMENSIONS mm			CONTENUTO CONTENTS	ASSORBIMENTO ABSORPTION lt	VOLUME VOLUME lt
	L	P	H			
909KP120	480	550	950	50 panni - 50 rags 41x46cm 6 cuscini - 6 cushions 46x46cm 12 calze - 12 filters Ø 7,6x122cm 1 Kit Protect (acidsorb non incluso - not included)	124	120
909KP240	580	750	1100	150 panni - 150 rags 41x46cm 8 cuscini - 8 cushions 46x46cm 12 calze - 12 filters Ø 7,6x122cm 1 Kit Protect (acidsorb non incluso - not included)	265	240
909KP360	580	900	1100	200 panni - 200 rags 41x46cm 12 cuscini - 12 cushions 46x46cm 12 calze - 12 filters Ø 7,6x122cm 6kg ACIDSORB-C + 1 Kit Protect	348	360



Può contenere prodotti chimici
 It can contain chemical products

BIDONE CARRELLATO CON COPERCHIO PER RACCOLTA DIFFERENZIATA
 WHEELED RECYCLING BIN WITH LID

MODELLO MODEL	DIMENSIONI / DIMENSIONS mm			TARA TARA kg	CAPACITÀ DI CARICO LOAD CAPACITY kg	COLORI COLORS	VOLUME VOLUME lt
	L	P	H				
941L120-	480	550	930	9	60	 Giallo, blu, verde, rosso, marrone, grigio, bianco. Yellow, blue, green, red, brown, grey, white.	120
941L240-	580	730	1070	13	116		240



Ideali per la suddivisione dei rifiuti nelle industrie
 Ideal for the subdivision of waste in the industries
 Realizzati in polietilene ad alta densità
 Made of high-density polyethylene
 Con 2 ruote diametro 200 mm
 With 2 wheels of 200 mm diameter
 Dotati di una pratica maniglia per facilitarne la movimentazione
 Equipped with a practical handle for easy moving

A RICHIESTA: ANELLO FERMA SACCO
 ON DEMAND: BLOCKING BAG RING
 99C359 (120 lt) - 99C360 (240 lt)



A RICHIESTA: KIT COMPLETO ANELLO FERMA SACCO CON PEDALE
 ON DEMAND: BAG STOPPER RING SET COMPLETE WITH PEDAL



ACCESSORI
 ACCESSORIES

MULTIBENNA MINI
MULTIBENNA MINI

MODELLO MODEL	DIMENSIONI / DIMENSIONS mm						PORTATA LOAD CAPACITY kg	VOLUME VOLUME lit
	P1	L1	L2	L3	H1	H2		
641MC2	1100	2300	1200	1250	1210	825	3300	2000

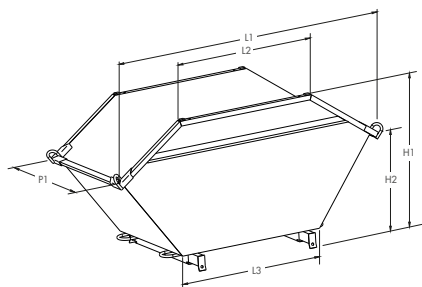

MULTIBENNA MAXI 5
MULTIBENNA MAXI 5

MODELLO MODEL	DIMENSIONI / DIMENSIONS mm						VOLUME VOLUME m ³
	P1	P2	P3	L1	H1	H2	
640MC5	1950	1720	750	3120	1250	850	5,5

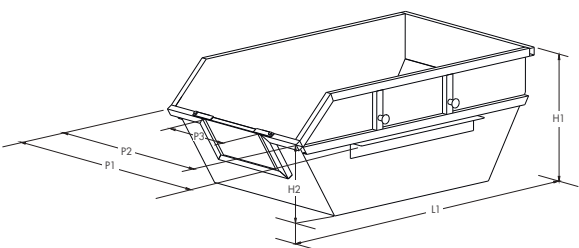

La multibenna 640MC5 presenta una sponda frontale amovibile per il carico con carriola

The 640MC5 multibenna has a removable front panel for loading with wheelbarrow

MULTIBENNA MAXI 7
MULTIBENNA MAXI 7

MODELLO MODEL	DIMENSIONI / DIMENSIONS mm					VOLUME VOLUME m ³
	P1	P2	L1	H1	H2	
640MC7	1950	1720	3620	1500	1000	7

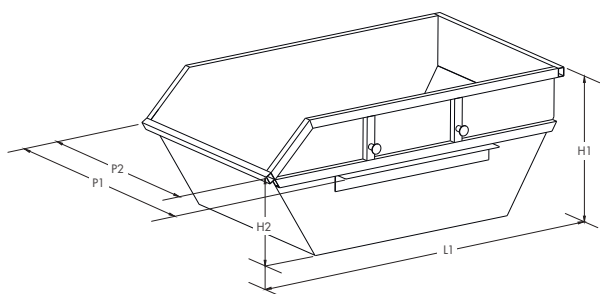

MULTIBENNA SUPERMAXI
MULTIBENNA SUPERMAXI

MODELLO MODEL	DIMENSIONI / DIMENSIONS mm					VOLUME VOLUME m ³
	P1	P2	L1	H1	H2	
640MC10	1950	1720	3870	1800	1250	10

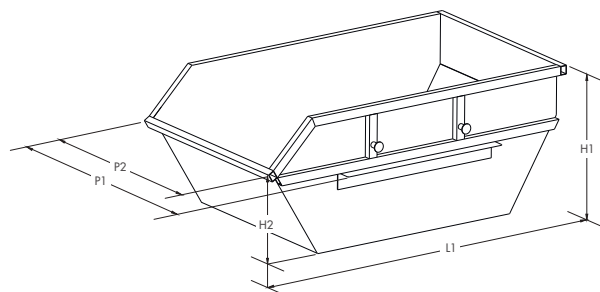

CONTENITORE PER OLI ESAUSTI (MINERALI, VEGETALI, IDRAULICI)
CONTAINER FOR WASTE OIL (MINERAL, VEGETABLE, HYDRAULIC)

MODELLO MODEL	DIMENSIONI / DIMENSIONS mm		CAPACITÀ CAPACITY lt
	Ø	H	
85PLO260	800	1100	260
85PLO500	1000	1330	500
85PL1200	1400	1485	1200



OLI MINERALI ESAUSTI
WASTE MINERAL OIL



OLI VEGETALI ESAUSTI
WASTE VEGETABLE OIL



OLI IDRAULICI ESAUSTI
WASTE HYDRAULIC OIL

VASSOIO SALVA GOCCE PER CONTENITORI PER OLI ESAUSTI
DRIP TRAY FOR USED OIL CONTAINERS

MODELLO MODEL	DIMENSIONI / DIMENSIONS mm	
	Ø	H
85VAS1	1000	150
85VAS2	1300	150



CONTENITORE PER BATTERIE ESAUSTE
CONTAINER FOR EXHAUSTED BATTERIES

MODELLO MODEL	DIMENSIONI esterne / external DIMENSIONS mm			VOLUME VOLUME lt
	L	P	H	
98CNT250P	950	700	800	250

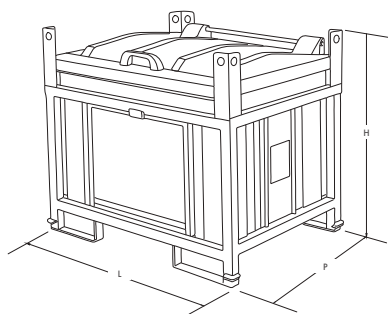

Vasca dotata di coperchio incernierato asportabile in polietilene

Tank equipped with removable hinged lid in polyethylene

Vasca alloggiata all'interno di una struttura metallica aperta verniciata anticorrosione

Tank housed inside an open metal structure painted anticorrosion

Portaforcine antiribaltamento per muletti o transpallet

Anti-tip fork holder for forklift or transpallet

Movimentazione e impilabilità sino a tre unità
Handling and stacking up to three units

Caratteristiche tecniche approvate dal consiglio di amministrazione COBAT
Technical characteristics approved by the COBAT board of directors

Conforme D.P.R. 915 - 10/09/1982
In compliance with D.P.R. 915 - 10/09/1982

CONTENITORE PER NEON ESAUSTI
CONTAINER FOR EXHAUSTED NEON

MODELLO MODEL	DIMENSIONI / DIMENSIONS mm			VOLUME VOLUME lt
	L	P	H	
98CNT900N	1870	920	1060	900

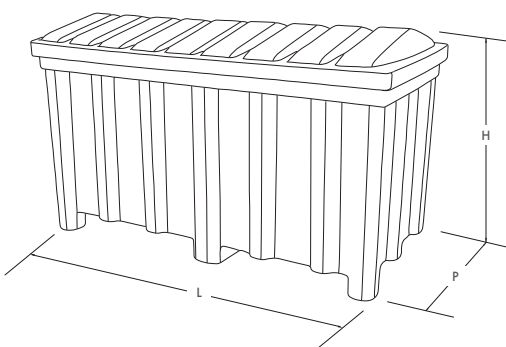

ARMADI DI SICUREZZA A 2 RIPIANI
SAFETY CABINETS WITH 2 SHELVES

MODELLO MODEL	UTILIZZO USE	DIMENSIONI / DIMENSIONS mm			VERNICIATURA PAINTING	PORTATA CAPACITY lt/kg	STOCCAGGIO TOTALE TOTAL STORAGE lt
		L	P	H			
98RARM12	Sostanze pericolose Dangerous substances	1000	460	1000	Giallo Yellow	2 ripiani di contenimento (6 LT/100 KG) 1 vasca di fondo (26 LT/100 kg) 2 storage shelves (6 liters/100 kg) 1 bottom tray (26 liters/100 kg)	111
98RARMF2	Fitosanitari Plant protection products	1000	460	1000	Verde Green	2 ripiani di contenimento (6 LT/100 KG) 1 vasca di fondo (26 LT/100 kg) 2 storage shelves (6 liters/100 kg) 1 bottom tray (26 liters/100 kg)	111
98RARM3C	Sostanze chimiche e corrosive Chemical and corrosive products	1075	500	1100	Blu RAL 5015 Epossipoliestere resistente a agenti chimici/corrosivi Blue RAL 5015 Epoxy-polyester resistant to chemical/corrosive agents	2 ripiani di contenimento (7 LT/100 KG) 1 vasca di fondo (27 LT/100 kg) 2 storage shelves (7 liters/100 kg) 1 bottom tray (27 liters/100 kg)	123

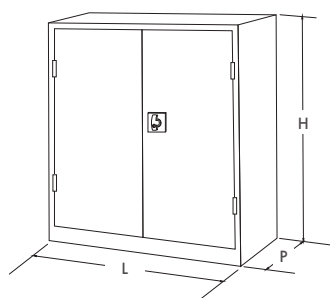

ARMADI DI SICUREZZA A 3 RIPIANI
SAFETY CABINETS WITH 3 SHELVES

MODELLO MODEL	UTILIZZO USE	DIMENSIONI / DIMENSIONS mm			VERNICIATURA PAINTING	PORTATA CAPACITY lt/kg	STOCCAGGIO TOTALE TOTAL STORAGE lt
		L	P	H			
98RARM13	Sostanze pericolose Dangerous substances	1000	460	1800	Giallo Yellow	3 ripiani di contenimento (6 LT/100 KG) 1 vasca di fondo (26 LT/100 kg) 3 storage shelves (6 liters/100 kg) 1 bottom tray (26 liters/100 kg)	132
98RARMF3	Fitosanitari Plant protection products	1000	460	1800	Verde Green	3 ripiani di contenimento (6 LT/100 KG) 1 vasca di fondo (26 LT/100 kg) 3 storage shelves (6 liters/100 kg) 1 bottom tray (26 liters/100 kg)	132
98RARM1C	Sostanze chimiche e corrosive Chemical and corrosive products	1075	500	1850	Blu RAL 5015 Epossipoliestere resistente a agenti chimici/corrosivi Blue RAL 5015 Epoxy-polyester resistant to chemical/corrosive agents	3 ripiani di contenimento (7 LT/100 KG) 1 vasca di fondo (27 LT/100 kg) 3 storage shelves (7 liters/100 kg) 1 bottom tray (27 liters/100 kg)	144

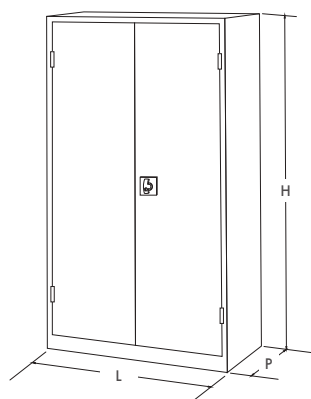

PERTUTTO
100% MADE IN ITALY **BUTTI**



LAVORARE IN SICUREZZA / WORK SAFELY



CILINDRO IDRAULICO HYDRAULIC CYLINDER "SECURE SYSTEM"

Dalla continua ricerca per la sicurezza negli ambienti di lavoro la Butti ha ideato il nuovo sistema "SECURE SYSTEM": cilindro idraulico, applicato a richiesta sui contenitori ribaltabili "Pertutto" per una maggiore sicurezza. Garantisce lunga vita ai cuscinetti dei montanti del carrello elevatore e ai contenitori stessi, permettendo un ribaltamento graduale e progressivo senza violenti contraccolpi o cadute accidentali. Il cilindro "Secure System" è montato nella parte sottostante del contenitore; la sua installazione non comporta ingombro nelle dimensioni.

From the ongoing search of safety in workplaces, Butti has devised the new system "SECURE SYSTEM": hydraulic cylinder, which can be applied on request to the tipping containers "Pertutto" to have more safety. It guarantees long lifespan both for forklifts and containers themselves by allowing a gradual and progressive tipping without violent backlashes and accidental falls. The "Secure System" cylinder is placed at the bottom of the container; its installation doesn't change the container dimensions.

////// FORNITI DI SERIE CON / STANDARD EQUIPMENT



Tappo di scarico a vite su
vasca di decantazione
*Draining screwplug on a
settling tank*



Ruote antirumore girevoli
con freno
*Rotating noiseless wheels
with brake*

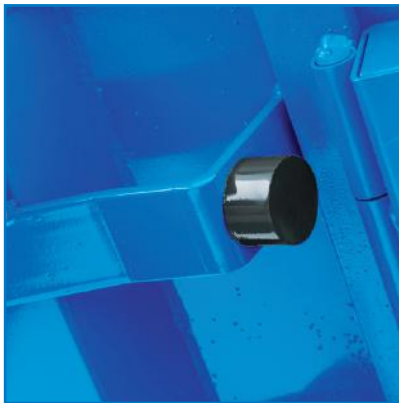

Tamponi in gomma
Rubber bumpers



Filtro in lamiera zincata
su vasca di decantazione
*Galvanized metal sheet
filter on a settling tank*



Dispositivo di sgancio
Release device



Targhetta di
identificazione
Identification plate



Mezzaluna in acciaio che agevola la chiusura del contenitore, salvaguardando le ruote
Half round steel support that facilitates the wheels during the closure of the tipping bucket

CONTENITORE RIBALTABILE "PERTUTTO"
TIPPING CONTAINERS "PERTUTTO"



MODELLO MODEL	DIMENSIONI / DIMENSIONS mm						PORTATA LOAD CAPACITY kg	VOLUME VOLUME lt
	P1	P2	L	H1	H2	H3		
748R	930	720	750	695	850	740	580	280

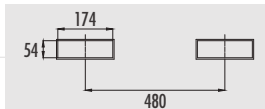
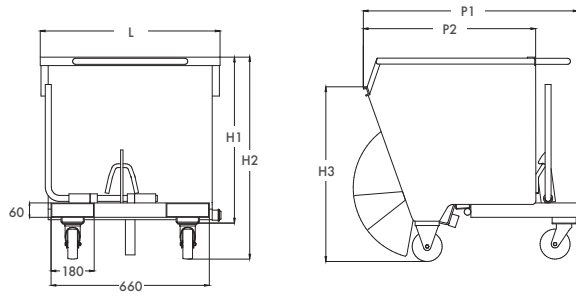

QUOTE SEDI FORCHE INTERNE
INTERNAL FORK SEATS DIMENSIONS



CONTENITORE RIBALTABILE "PERTUTTO"
TIPPING CONTAINERS "PERTUTTO"



MODELLO MODEL	DIMENSIONI / DIMENSIONS mm						PORTATA LOAD CAPACITY kg	VOLUME VOLUME lt
	P1	P2	L	H1	H2	H3		
750R	1250	1000	870	510	665	530	600	300

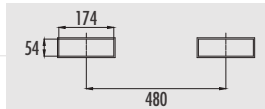
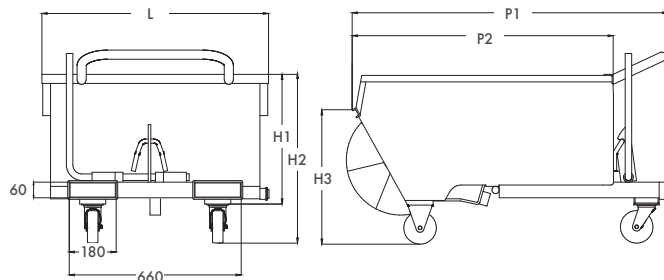

QUOTE SEDI FORCHE INTERNE
INTERNAL FORK SEATS DIMENSIONS



CONTENITORE RIBALTABILE "PERTUTTO"
TIPPING CONTAINERS "PERTUTTO"



MODELLO MODEL	DIMENSIONI / DIMENSIONS mm						PORTATA LOAD CAPACITY kg	VOLUME VOLUME lt
	P1	P2	L	H1	H2	H3		
751R	1490	1130	975	655	875	715	1000	500
752R	1575	1290	1070	745	965	770	1350	750
753R	1680	1400	1070	900	1140	940	1500	1000
754R	1680	1400	1320	900	1140	940	1800	1300

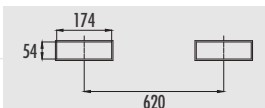
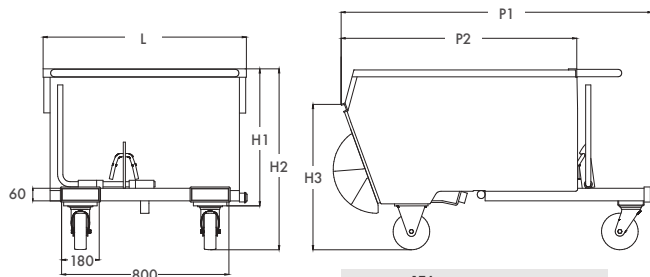

QUOTE SEDI FORCHE INTERNE
INTERNAL FORK SEATS DIMENSIONS



CILINDRO IDRAULICO SECURE SYSTEM
HYDRAULIC CYLINDER SECURE SYSTEM



COPERCHIO ASPORTABILE
REMOVABLE LID



ACCESSORI
ACCESSORIES

CONTENITORE RIBALTABILE "PERTUTTO" PER GRANDI VOLUMI
TIPPING CONTAINERS "PERTUTTO" FOR BIG VOLUMES



MODELLO MODEL	DIMENSIONI / DIMENSIONS mm						PORTATA LOAD CAPACITY kg	VOLUME VOLUME lt
	P1	P2	L	H1	H2	H3		
77B1800R	1630	1365	1065	920	1760	1160	900	1800
77B2200R	1630	1365	1230	920	1760	1160	1000	2200

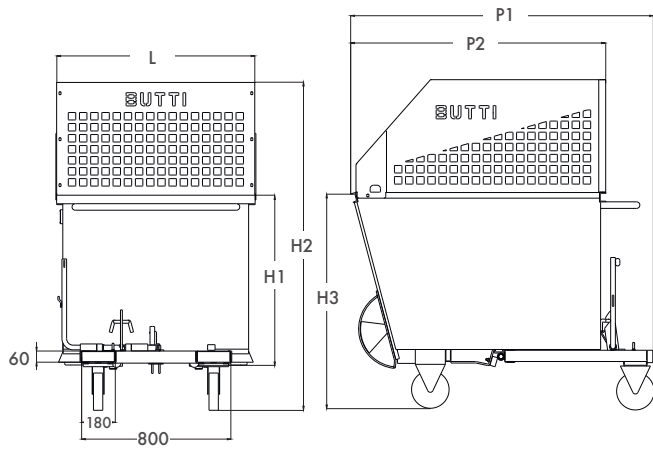

QUOTE SEDI FORCHE INTERNE
INTERNAL FORK SEATS DIMENSIONS



CONTENITORE RIBALTABILE "PERTUTTO" MAXI
TIPPING CONTAINERS "PERTUTTO" MAXI



MODELLO MODEL	DIMENSIONI / DIMENSIONS mm						PORTATA LOAD CAPACITY kg	VOLUME VOLUME lt
	P1	P2	L	H1	H2	H3		
756R	1780	1600	1785	1115	1490	1245	2000	2300

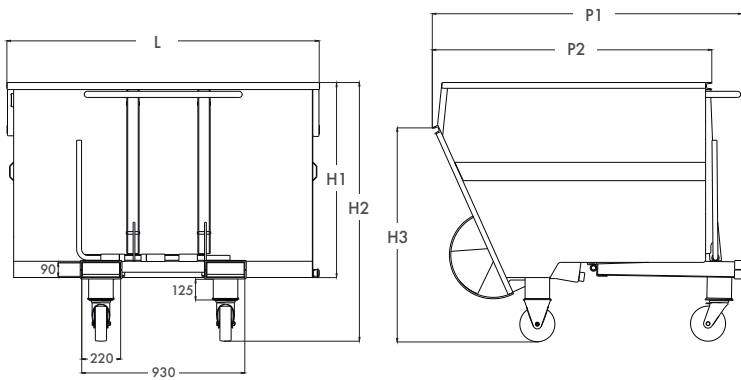

QUOTE SEDI FORCHE INTERNE
INTERNAL FORK SEATS DIMENSIONS



Ruote in vulkollan
Vulkollan wheels



SU RICHIESTA / ON DEMAND

Con pannelli in rete
With net sides



CONTENITORE IN METALLO
METAL CONTAINER

MODELLO MODEL	DIMENSIONI / DIMENSIONS					PESO PIENO CARICO TOTAL FULL LOAD WEIGHT	PORTATA LOAD CAPACITY
	L	P	H1	H2	H3		
621	700	650	450	150	60	630	600

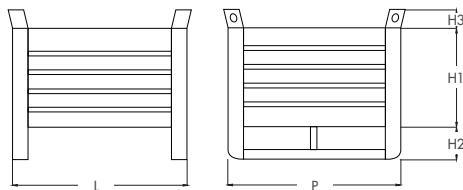

Sovrapposibilità statica
3 su 1 a pieno carico
Static overlap of 3 to 1 at
full load

CONTENITORE IN METALLO A BOCCA DI LUPO
METAL CONTAINER WITH FRONTAL OPENING

MODELLO MODEL	DIMENSIONI / DIMENSIONS					PESO PIENO CARICO TOTAL FULL LOAD WEIGHT	PORTATA LOAD CAPACITY
	L	P	H1	H2	H3		
622L	800	600	400	120	60	635	600

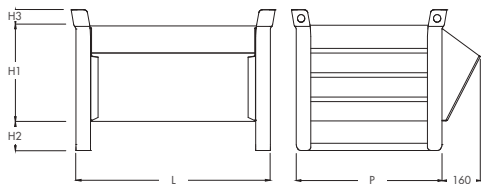

Sovrapposibilità statica
3 su 1 a pieno carico
Static overlap of 3 to 1 at
full load

CONTENITORE IN METALLO
METAL CONTAINER

MODELLO MODEL	DIMENSIONI / DIMENSIONS					PESO PIENO CARICO TOTAL FULL LOAD WEIGHT	PORTATA LOAD CAPACITY
	L	P	H1	H2	H3		
625	1000	800	650	150	100	2092	2000

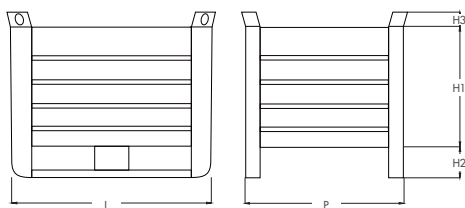

Sovrapposibilità statica
3 su 1 a pieno carico
Static overlap of 3 to 1 at
full load

CONTENITORE IN METALLO CON PORTELLO
METAL CONTAINER WITH DOOR

MODELLO MODEL	DIMENSIONI / DIMENSIONS					PESO PIENO CARICO TOTAL FULL LOAD WEIGHT	PORTATA LOAD CAPACITY
	L	P	H1	H2	H3		
625S	1000	800	650	150	100	2099	2000

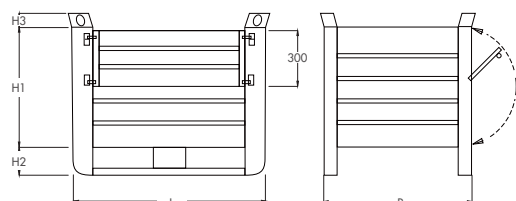

Sovrapposibilità statica
3 su 1 a pieno carico
Static overlap of 3 to 1 at
full load

CONTENITORE IN METALLO
METAL CONTAINER

MODELLO MODEL	DIMENSIONI / DIMENSIONS					PESO PIENO CARICO TOTAL FULL LOAD WEIGHT kg	PORTATA LOAD CAPACITY kg
	L	P	H1	H2	H3		
626	1200	800	650	150	60	1064	1000

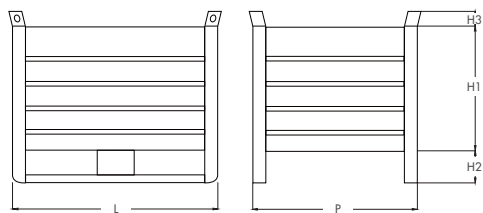

Sovrapposibilità statica
3 su 1 a pieno carico
Static overlap of 3 to 1 at
full load

CONTENITORE IN METALLO CON PORTELLO
METAL CONTAINER WITH DOOR

MODELLO MODEL	DIMENSIONI / DIMENSIONS					PESO PIENO CARICO TOTAL FULL LOAD WEIGHT kg	PORTATA LOAD CAPACITY kg
	L	P	H1	H2	H3		
626S	1200	800	650	150	60	1069	1000

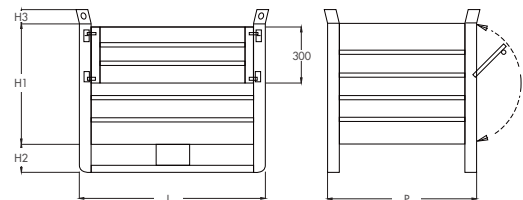

Sovrapposibilità statica
3 su 1 a pieno carico
Static overlap of 3 to 1 at
full load

CONTENITORE IN METALLO PESANTE CON FONDO E BORDO INFERIORE RINFORZATO
METAL CONTAINER WITH REINFORCED BOTTOM AND LOWER EDGE

MODELLO MODEL	DIMENSIONI / DIMENSIONS					PESO PIENO CARICO TOTAL FULL LOAD WEIGHT kg	PORTATA LOAD CAPACITY kg
	L	P	H1	H2	H3		
628I15XP	1500	800	750	150	100	1645	1500

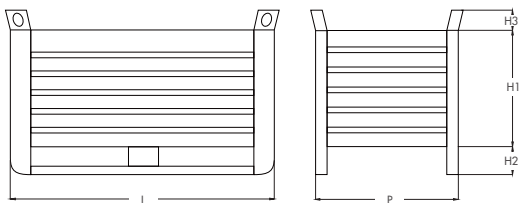

Sovrapposibilità statica
3 su 1 a pieno carico
Static overlap of 3 to 1 at
full load

CONTENITORE IN RETE
MESH CONTAINER

MODELLO MODEL	DIMENSIONI / DIMENSIONS					PESO PIENO CARICO TOTAL FULL LOAD WEIGHT kg	PORTATA LOAD CAPACITY kg
	L	P	H1	H2	H3		
624R	1000	800	650	150	60	1050	1000
626R	1200	800	650	150	60	1051	1000

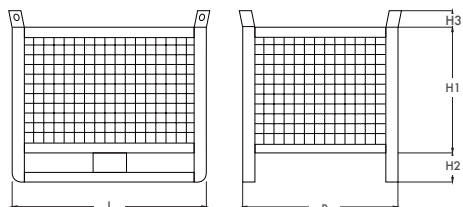

Sovrapposibilità statica
3 su 1 a pieno carico
Static overlap of 3 to 1 at
full load

CONTENITORE IN RETE CON PORTELLO
MESH CONTAINER WITH DOOR

MODELLO MODEL	DIMENSIONI / DIMENSIONS					PESO PIENO CARICO TOTAL FULL LOAD WEIGHT kg	PORTATA LOAD CAPACITY kg
	L	P	H1	H2	H3		
626RS	1200	800	650	150	60	1060	1000

Sovrapponibilità statica
3 su 1 a pieno carico
Static overlap of 3 to 1 at
full load

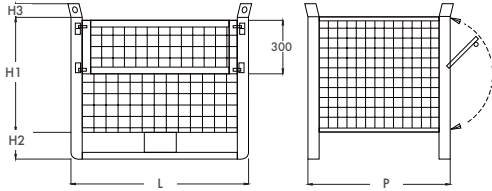

CONTENITORE IN RETE RIPIEGHEVOLE E SOVRAPPONIBILE
MESH COLLAPSIBLE OVERLAPPING CONTAINER

MODELLO MODEL	DIMENSIONI / DIMENSIONS			PORTATA LOAD CAPACITY kg
	L	P	H	
881B1ORSZ esterne / external	1200	800	980	1000
881B1ORSZ interne / internal	1120	730	810	1000
881B1ORSZ ripiegato / collapsed	1200	800	330	-



Sovrapponibilità statica 3 su 1 a
pieno carico con portello chiuso
Static overlap of 3 to 1 at full
load with closed door

A richiesta con 4 ruote,
2 fisse e 2 girevoli
On demand with 4 wheels,
2 fixed and 2 swiveling



CONTENITORE IN POLIETILENE
POLYETHYLENE CONTAINER

MODELLO MODEL	DIMENSIONI / DIMENSIONS			PORTATA LOAD CAPACITY kg
	L	P	H	
626POL	1200	800	800	500



COPERCHIO PER CONTENITORE IN POLIETILENE
LID FOR POLYETHYLENE CONTAINER



CONTENITORI A FONDO APRIBILE "COMPACT" ECO CON RUOTE
CONTAINERS WITH OPENABLE BOTTOM "COMPACT" ECO WITH WHEELS

MODELLO MODEL	DIMENSIONI / DIMENSIONS mm			PORTATA LOAD CAPACITY kg	VOLUME VOLUME lt
	L	P	H		
637L05C	1195	900	815	500	500
637L10C	1195	900	1265	600	1000

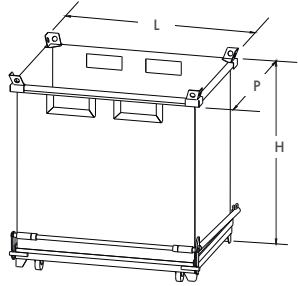

QUOTE SEDI FORCHE INTERNE
INTERNAL FORK SEATS DIMENSIONS

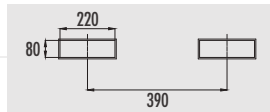

Impilabili a vuoto
Stackable empty

Pareti dritte
Straight sides

Con ruote
With wheels

CONTENITORE RIBALTABILE CON CARRELLO ELEVATORE A FORCHE ROTANTI
TIPPING CONTAINER FOR FORKLIFT WITH ROTATING FORKS

MODELLO MODEL	DIMENSIONI / DIMENSIONS mm			TARA TARE kg	PORTATA LOAD CAPACITY kg	VOLUME VOLUME lt
	L	P	H			
73B1345X	1280	1100	1180	180	1000	1345

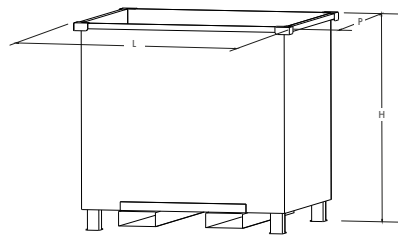

QUOTE SEDI FORCHE INTERNE
INTERNAL FORK SEATS DIMENSIONS

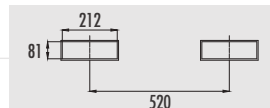

Inforcabile con carrello
elevatore a forche rotanti
Forkable with forklift with
rotating forks

Sovrapposibilità statica
2 su 1 a pieno carico
Static overlap of 2 to 1 at
full load

CONTENITORE IN LAMIERA PER PARABREZZA
SHEET METAL CONTAINER FOR WINDSHIELDS

MODELLO MODEL	DIMENSIONI / DIMENSIONS mm					TARA TARE kg	PORTATA LOAD CAPACITY kg
	L1	L2	P1	P2	H		
886BB15	2325	2400	1100	1175	760	210	1500

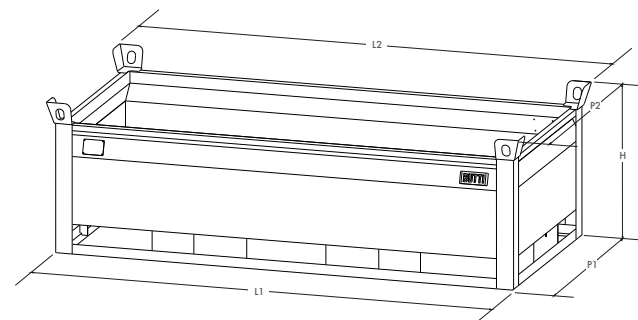

QUOTE SEDI FORCHE INTERNE
INTERNAL FORK SEATS DIMENSIONS

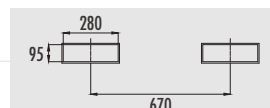

Sovrapposibilità statica
3 su 1 a pieno carico
Static overlap of 3 to 1 at
full load

▶ SPARGISALE PROFESSIONALE A MANO
PROFESSIONAL MANUAL SALT SPREADER

MODELLO MODEL	VELOCITÀ DI LAVORO WORKING SPEED km/h	PORTATA LOAD CAPACITY kg
876K25	1/4	25



▶ SPARGISALE PROFESSIONALE A MANO
PROFESSIONAL MANUAL SALT SPREADER

MODELLO MODEL	VELOCITÀ DI LAVORO WORKING SPEED km/h	PORTATA LOAD CAPACITY kg
876K50	1/4	50



▶ CARRELLO SPARGISALE PROFESSIONALE A TRAINO
PROFESSIONAL TOWING SALT SPREADER

MODELLO MODEL	VELOCITÀ DI LAVORO WORKING SPEED km/h	PORTATA LOAD CAPACITY kg
877K150	10/15	150



▶ BENNA SABBIA CON RIBALTAMENTO AUTOMATICO
SAND BUCKET WITH AUTOMATIC ROLL OVER

MODELLO MODEL	DIMENSIONI / DIMENSIONS				PESO PIENO CARICO TOTAL FULL LOAD WEIGHT kg	PORTATA LOAD CAPACITY kg	VOLUME VOLUME lit
	L	P1	P2	H			
310	1200	1450	950	700	1070	900	500

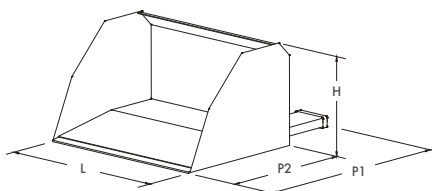

A richiesta:
SISTEMA DI RIBALTAMENTO
IDRAULICO

On demand:
HYDRAULIC TIPPING SYSTEM



CATALOGO RECYCLING E AGRICOLTURA BUTTI **BUTTI RECYCLING AND AGRICULTURE CATALOGUE**

Realizzazione:
Ufficio Tecnico BUTTI
Coordinamento:
Ufficio Marketing BUTTI
Documentazione fotografica:
Archivio Tecnico BUTTI

Produced by:
BUTTI Technical Department
Coordination:
BUTTI Marketing Department
Photographic documentation:
BUTTI Technical Archive

Le immagini e i dati tecnici illustrati sono stati aggiornati in occasione della presente edizione.
La ditta BUTTI, costantemente impegnata nell'evoluzione della propria produzione, si riserva la facoltà di modificare, in qualsiasi momento e senza alcun preavviso, le dimensioni e l'esecuzione dei prodotti qui illustrati.

Il presente catalogo non costituisce un documento contrattuale.

Le immagini e i dati tecnici del presente catalogo non possono essere utilizzati, in alcuna forma, intera o parziale, per altre pubblicazioni o produzioni, se non dopo esplicita autorizzazione scritta da parte di BUTTI SRL.

La responsabilità di eventuali errori di stampa non è da attribuire ad alcuno.

*The images and technical data shown have been updated for this edition.
BUTTI, constantly committed to the development of its production, reserves the right
to modify at any time and without notice the dimensions and execution of the products illustrated herein.*

This catalogue does not constitute a contractual document.

*The images and technical data in this catalogue may not be used in any form, in whole or in part,
for other publications or productions, unless expressly authorized in writing by BUTTI SRL.*

Responsibility for printing errors shall not be attributed to anyone.



INNOVAZIONE, EFFICIENZA, SICUREZZA

Soluzioni per la logistica industriale, progettate per durare nel tempo.

INNOVATION, EFFICIENCY, SAFETY

Solutions for recycling and agriculture, designed to last over time.



BUTTI srl - Via Mayer, 13 - 24034 Cisano Bergamasco (BG)
Tel. +39 035 787300 - butti@butti.it - www.butti.it

