



## L2 LOCKERS

### A system of modular locker cabinets

**Small storage lockers**, providing a variety of alternative choices. Locker cabinets are units of small compartments locked with a key or combination lock, with an optional paper slot drop. A practical solution to store personal belongings in offices, changing rooms or dining facilities. A well-thought out structure which enables limitless configurations and arrangements, but most of all, which permits an ergonomic design of even the tiniest space.

A perfect solution for open-plan offices. Ideal for large areas divided into work zones, rest areas, and dining facilities. Critical for those people who often stay outside of the office or are not "assigned" to one and the same desk. A large diversity of cabinet front and body colours allows to individually design the space in order to satisfy the needs of every interior.

#### Features and characteristics:

- a system of modular cabinets
- to be used in offices, dining facilities and changing rooms
- providing safe storage of clothing and personal items
- possibility to choose a locking mechanism - regular or combination locks
- possibility to drop correspondence through a paper slot drop – optional
- cabinets available in two width variants: single or double posts, with the height from 1 to 4OH
- possibility to mount a shelf in the top part of the compartment
- two kinds of pedestals to choose from: bottom panels or skid bases for single or double cabinets
- colours available according to Balma template; colours for cabinet fronts and bodies can be chosen independently

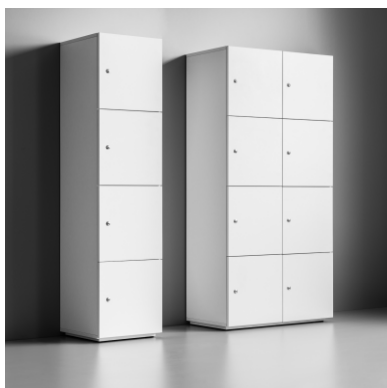

**Collection overview:**

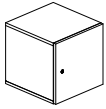

**L2-11** 40/40/H40

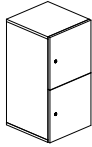

**L2-12** 40/40/H80

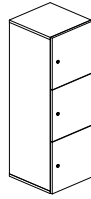

**L2-13** 40/40/H120

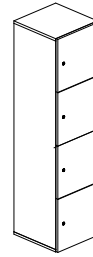

**L2-14** 40/40/H160

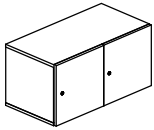

**L2-21** 80/40/H40

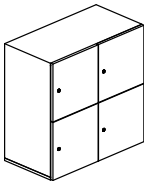

**L2-22** 80/40/H80

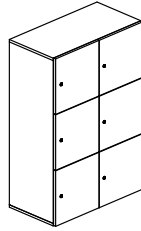

**L2-23** 80/40/H120

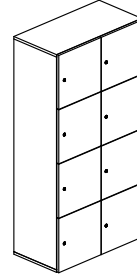

**L2-24** 80/40/H160

**Kinds of pedestals:**



\* skid bases

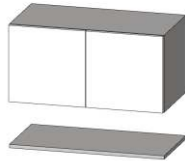

\* bottom panel

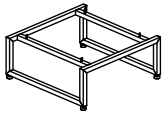

**L2-51** 40/40/H16,5

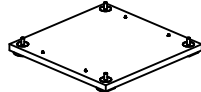

**L2-53** 36/36/H2,5

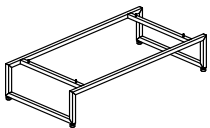

**L2-52** 80/40/H16,5

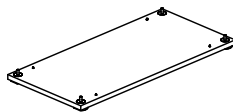

**L2-54** 76/36/H2,5

**Optional cabinet elements:**



combination lock

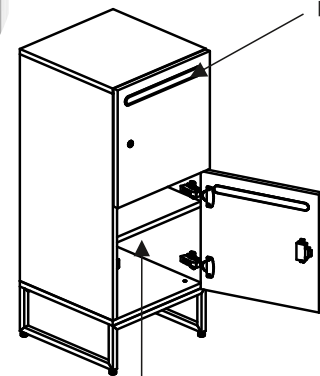

paper slot drop

shelf

