



NATURALS



Es liegt in der Natur der Sache, dass der Mensch sich gerne sicher und geborgen fühlt. Aus Sicht der Verbraucher werden somit die Themen Nachhaltigkeit und Umweltschutz immer weiter in den Fokus der Kaufentscheidung gerückt. Neben den Umwelt- und Sozialstandards interessiert sich der Verbraucher für die gesamte Wertschöpfungskette des Produktes und das verantwortungsvolle Handeln der Unternehmen. Vielleicht ist es gerade für die haptische Werbewelt entscheidend, dass ein tatsächlich in der Hand liegendes Produkt Vertrauen und Nachhaltigkeit transportiert.

Die uma Schreibgeräte Ullmann GmbH hat sich der Nachhaltigkeit buchstäblich verschrieben und es ist uns ein persönliches Anliegen für Mensch und Umwelt verantwortlich und pflichtbewusst zu handeln. Aus einem erfolgreichen, umweltbewussten Management entstehen so Produkte, die das Prädikat „Nachhaltig“ mehr als verdient haben.

Mit dem uma RECYCLED PET PEN zeigen wir, dass man aus PET Material einen sehr ansprechenden und sehr gut schreibenden recycelten Werbeträger erzeugen kann. Die uma RECYCLED PET PEN Schreibgeräte-Serie ist bereits Gewinner des Sustainability Awards, wurde nominiert zum Deutschen Nachhaltigkeitspreis und zuletzt 2021 ausgezeichnet mit dem German Innovation Award in Gold. Für uns sind das eindeutige Belege, dass eine Investition in Forschung und Entwicklung einen Mehrwert für unseren Planeten erzielen kann.

Alle uma Schreibgeräte stehen für langlebiges und erfolgreiches Werben. Deshalb ist ein Nachfüllen der Minen in allen Schreibgeräten selbstverständlich, sowie die Tatsache, dass alle eingesetzten Materialien recycelt werden können und erneuten Einsatz in unseren RECY-Modellen finden.

Mit den FSC®- und PEFC-zertifizierten uma Holzschreibgeräten tragen wir dazu bei, dass der Schwarzwald auch in Zukunft für die Nachwelt positiv erhalten bleibt.

Alle Modelle der uma Naturals-Serie werden klimaneutral produziert und am Standort in Fischerbach auf einer der weltweit modernsten Veredelungsstraßen für Werbeschreibgeräte auch zu 100% klimaneutral veredelt.

Mit den antimikrobiellen Schreibgeräten kombinieren wir Nachhaltigkeit und Hygiene. Damit beweisen wir nicht nur Innovationskraft sondern lösungsorientierte Ideen zum Schutz von Natur und Mensch.

Unternehmerische Gesellschaftsverantwortung vereint mit innovativen Produktideen und nachhaltigen Produktionsprozessen. Das ist die gelebte uma Philosophie für langfristiges, erfolgreiches und nachhaltiges Handeln.

Alexander Ullmann (CEO)





People generally like to feel safe and secure. So from the point of view of the consumer, purchasing decisions are being increasingly driven by questions of sustainability and environmental protection. Consumers want to know about a product's entire value creation chain and how the customer treats its staff and suppliers. A product needs to create a feeling not just of sustainability, but of trust.

The company of uma Schreibgeräte Ullmann is firmly committed to sustainability and to treat both people and the environment with respect. For uma, sustainability is more than just a label. The uma RECYCLED PET PEN writing instruments series has already won the Sustainability Award, was nominated for the German Sustainability Award, and most recently received the German Innovation Award in Gold in 2021. For us, these are clear evidence that an investment in research and development can achieve added value for our planet.

All uma writing instruments stand for long-lasting and successful advertising. That is why refilling the refills in all writing instruments becomes a matter of course, as well as the fact that all materials used can be recycled and used again in our RECY models.

With the FSC® and PEFC certified uma wooden writing instruments, we contribute to the positive preservation of the Black Forest for posterity in the future.

All models in the uma Naturals series are produced in a climate-neutral production process and are also finished in a 100% climate-neutral process at the Fischerbach site on one of the world's most modern finishing lines for promotional writing instruments.

With the antimicrobial writing instruments, we combine sustainability and hygiene. In this way, we demonstrate not only innovative strength but also solution-oriented ideas for the protection of nature and people.

Entrepreneurial responsibility combined with innovative product ideas and sustainable production processes. This is the philosophy that uma embodies, one of long-term, successful and sustainable action.

Alexander Ullmann (CEO)





Vorwort/Foreword	2 – 3
Verantwortung/Responsibility	6 – 7
Zertifizierungen/Certifications	8
Innovation/Innovation	9
Nachhaltigkeit/Sustainability	10 – 11
Natur-Materialien/Natural materials	12 – 13
Verpackung/Packaging	78



rPET-Modelle/rPET models	14 – 41
RECYCLED PET PEN STEP	16 – 17
RECYCLED PET PEN switch	18 – 19
RECYCLED PET PEN	20 – 21
RECYCLED PET PEN PRO	22 – 29
RECYCLED PET PEN PRO SI	30 – 31
RECYCLED PET PEN PRO F ocean	32 – 33
RECYCLED PET PEN PRO antibacterial	34 – 37
RECYCLED PET PEN PRO TOUCH	38 – 39
RECYCLED PET PEN ALUMA	40 – 41



GREEN-Modelle/GREEN models	42 – 47
PIXEL F GREEN	42 – 43
EFFECT GREEN	44 – 45
ICON GREEN	46 – 47



RECY-Modelle/RECY models	48 – 63
YES RECY	50
VITAN RECY	51
HAPPY RECY	52 – 53
ICONIC RECY	54 – 55
VANE RECY	56 – 57
POP RECY	57
ON TOP RECY	58



59	PIXEL RECY
60 – 61	CETA RECY
61	CHILL C SI RECY
62 – 63	ULTIMATE SI RECY



64 – 73	Holz-Modelle/Wooden models
66 – 67	TREE
67	LEAF
68	WOODY
68	WOODY B
68	CALIBRA S
69	FOREST
69	FOREST B
69	BEECH
70 – 71	TITAN WOOD
72 – 73	ELEGANCE WOOD



74	Bio-Modelle/Bio models
77	BIO PEN



75	Karton-Modelle/Cardboard models
76 – 77	PAPER PEN











## Wir übernehmen Verantwortung

Wir von uma stehen für ein verantwortliches Wirtschaften. Das bedeutet, dass bei uns Werte wie Qualität und Kundenzufriedenheit, wie auch die Einhaltung sozialer Verhaltensweisen und Aspekte der Nachhaltigkeit an oberster Stelle stehen.

Auch bei unseren Partnern legen wir höchsten Wert auf menschenwürdige und umweltverträgliche Arbeitsbedingungen, wie beispielsweise die Einhaltung von Arbeitnehmerrechten, das Verbot von Kinder- und Zwangsarbeit, sowie den verantwortungsbewussten Umgang mit der Natur und ihren Ressourcen. Für die Einhaltung dieser Ziele stehen wir mit unserem Namen.

Für unsere gesellschaftliche Verantwortung (CSR) wurden wir von EcoVadis mit der Bronzemedaille ausgezeichnet.

## We assume responsibility

For a company focused on the future, it almost goes without saying that quality, service and, by extension, customer loyalty, should always be maintained at the highest level.

The holistic view-point of any successful company must encompass seamless observance of social modes of behaviour in the daily conduct of its business. The scope of our sense of responsibility extends to the assurance of environmentally compliant working conditions that are truly worthy of our payroll staff. That translates into things like respect for employee rights, the prohibition of child labour and forced labour, as well as a responsible attitude towards our natural world and its resources. We put our name on the line when it comes to achievement of these objectives.

EcoVadis rewarded us with a bronze medal for our corporate social responsibility (CSR).

## umaSECRETS

In den umaSECRETS erfahren Sie mehr darüber, wie man bei uma Nachhaltigkeit und soziale Verantwortung nicht nur schreibt, sondern auch lebt. Fordern Sie ihre persönliche Broschüre an oder lesen Sie online im Downloadbereich auf [uma-pen.com](http://uma-pen.com).

## umaSECRETS

With our umaSECRETS you can find out how uma puts sustainability and social responsibility into practice. Order your personal brochure now, or download it online at [uma-pen.com](http://uma-pen.com).







## PEFC- und FSC®-Zertifizierung

Als Produzent aus dem Schwarzwald freut es uns, PEFC- und FSC®-zertifizierte Holzschreibgeräte garantieren zu können und somit zum Schutz von nachhaltigen Rohstoffen beizutragen. Für uns ist es eine Selbstverständlichkeit, an diesem Verfahren zur nachhaltigen Waldbewirtschaftung und zum Schutz eines wichtigen Rohstoffes teilzunehmen.

Die Zertifikate garantieren, dass Holz- und Papierprodukte aus nachhaltig bewirtschafteten Wäldern stammen. Mit einer Fläche von über 265 Millionen Hektar zertifizierter Waldfläche garantiert PEFC als größtes Waldzertifizierungssystem weltweit ausreichend Rohstoffmengen. Und rund 1,44 Millionen Hektar Wald sind in Deutschland FSC®-zertifiziert. Dank dieser Zertifizierungen übernehmen wir bei uma gesellschaftliche Verantwortung, denn wir unterstützen den verantwortungsbewussten Umgang mit Ressourcen und setzen uns somit für den aktiven Beitrag zum Erhalt der Wälder ein.

## PEFC and FSC® certification

As producer in the Black Forest we are happy to present and warranty you PEFC and FSC® certified pens made of wood and that we have a share in the prevention of enduring raw materials. For uma Schreibgeräte Ullmann GmbH it is self-evident to take part in the sustainable forest cultivation and for the safety of a very important resource.

These certifications guarantee that wood and paper products come from sustainably managed forests. With over 265 million hectares (655 million acres) of certified forests, PEFC is the world's largest forest certification system and guarantees sufficient quantities of raw materials. And about 1.44 million hectares German forests are FSC® certified. Thanks to this certifications, we at uma assume social responsibility by supporting responsible use of resources and being committed to making an active contribution to preserving forests.

## uma nachweislich zertifiziert

Die Grundprinzipien unserer Produktionsbedingungen sind klar: Wir sehen es als unternehmerische Verantwortung, menschenwürdige und umweltverträgliche Arbeitsbedingungen sicherzustellen. Somit haben das Einhalten von Arbeitnehmerrechten, sowie der verantwortungsbewusste Umgang mit der Natur und ihren Ressourcen oberste Priorität. Deshalb werden alle uma Produktionsstätten regelmäßig von externen Einrichtungen auditiert und unsere Ansprüche bei persönlichen Besuchen und Briefings den Zulieferern vermittelt. Die Zusammenarbeit mit diesen Produktionsstätten basieren auf jahrelangen und familiären Verbindungen, die ein zusätzliches Sicherheits- und Qualitätsniveau in allen Belangen sicherstellt.

## uma demonstrably certified

The basic principles of our production conditions are clear: We see it as our corporate responsibility to ensure humane and environmentally compatible working conditions. Respect for workers' rights and the responsible use of nature and its resources are therefore our top priorities. Therefore, all uma production sites are regularly audited by external institutions and our requirements are communicated to the suppliers during personal visits and briefings. The cooperation with these production sites is based on long-standing and family ties, which ensure an additional level of safety and quality in all matters.



SEDEX  
(Supplier Ethical  
Data Exchange)



FTA  
Foreign Trade Association

FTA  
(Foreign Trade  
Association)



The Mark of a Professional  
PPAI  
(Promotional Products  
Association International)



Trade with purpose  
BSCI  
(Business Social  
Compliance Initiative)



Gesamverband der  
Werbearbeitel-Wirtschaft e.V.  
GWV  
(German Association of  
the Promotional Products  
Industry)



asi/92469  
ASI  
(Advertising Specialty  
Institute)

## Tradition basiert auf ständigen Innovationen

Bei dem Innovationswettbewerb TOP 100 hat uma es nach 2019 auch in 2022 wieder unter die Besten geschafft. In einem unabhängigen Auswahlverfahren konnten wir besonders mit innovativen Prozessen und innovativem Management nachhaltig punkten. Dass sich zukunftssträchtiges Agieren auch in innovativen Produkten niederschlägt, konnte mit der uma RECYCLED PET PEN-Serie eindrucksvoll bewiesen werden. Der Einsatz alternativer Materialien und die Investition in neue Produktionsverfahren macht uma zu einem der TOP 100 Innovativsten Unternehmen des Deutschen Mittelstandes.



## Tradition is based on constant innovation

In the TOP 100 innovation competition, uma made it to the top again in 2022 after 2019. In an independent selection process, we scored particularly well with innovative processes and innovative management. With the uma RECYCLED PET PEN series, it was impressively demonstrated that future-oriented action is also reflected in innovative products. The use of alternative materials and the investment in new production processes make uma one of the TOP 100 most innovative companies in the German medium-sized sector.

## uma NATURALS Serie zu 100 % klimaneutral



Der Klimawandel ist aktuell eine der größten Herausforderungen. Wir wollen Verantwortung übernehmen und leisten einen konkreten Beitrag zum Klimaschutz: In Zusammenarbeit mit ClimatePartner haben wir die Emissionen unserer uma NATURALS Modelle berechnet und anschließend über regionale Klimaschutzprojekte ausgeglichen. Somit sind die ersten uma klimaneutralen Schreibgeräte Serien erhältlich.



Wir wären aber nicht uma, wenn wir uns nur auf ein Produkt konzentrieren würden. Aus diesem Grund haben wir die komplette Produktion in Fischerbach, im Herzen des Schwarzwaldes, auf klimaneutral gestellt. Wir freuen uns somit einen positiven Beitrag für die Umwelt leisten zu können.

## uma NATURALS series 100 % climate neutral



Climate change is currently one of the greatest challenges. We want to assume responsibility and make a concrete contribution to climate protection: In cooperation with ClimatePartner, we have calculated the emissions of our uma NATURALS series then offset them through regional climate protection projects. Thus the first uma climate-neutral writing instruments series are available.



But we wouldn't be uma if we only concentrated on one product. For this reason, we have set the complete production in Fischerbach, in the heart of the Black Forest, to climate-neutral. We are therefore pleased to be able to make a positive contribution to the environment.









## Wie schreibt man „nachhaltig“?

Nachhaltigkeit – ein Thema, das uma schon seit vielen Jahren bewegt. Dies spiegelt sich nicht nur in unserer generationsübergreifenden und zukunftsorientierten Firmengeschichte wider, sondern auch in den innovativen uma Produktideen.

Mit den uma RECYCLED PET PEN-Serien haben wir die erste tatsächlich nachhaltige Schreibgeräte-Serie entwickelt, die nicht nur in Haptik und Variationsmöglichkeit, sondern auch mit einer innovativen Recyclingidee überzeugt.

Und das ist zertifiziert mit dem Global Recycled Standard zertifiziert.



## How do you write 'sustainable'?

Sustainability – a topic that has been on umas' agenda for many years. This is reflected not only in our generation-spanning and future-oriented company history, but also in the innovative uma product ideas.

With the uma RECYCLED PET PEN series we have developed the first truly sustainable writing instrument series, which not only convinces in haptics and variation possibilities, but also with an innovative recycling idea.

And that's certified with the Global Recycled Standard.

## uma RECYCLED PET PEN – ausgezeichnet!

Mit der Einführung des uma RECYCLED PET PEN hat uma nicht nur seine Innovationskraft unter Beweis gestellt, sondern auch eine neue Idee in Sachen Nachhaltigkeit geschaffen. Dafür wurde die uma RECYCLED PET PEN-Serie mit dem PSI Sustainability Award 2017 ausgezeichnet.

Für die Erweiterung der uma RECYCLED PET PEN PRO Serie wurde uma zum Innovator of the Year Award nominiert und konnte den German Innovation Award 2021 mit der höchsten Auszeichnung GOLD gewinnen.

Mit der Nominierung zum Deutschen Nachhaltigkeitspreis 2019 wurde uma auch branchenextern bestätigt, zusätzlich zählt das Unternehmen zu den TOP 100 innovativsten Unternehmen im Deutschen Mittelstand.



2017  
Gewinner



## uma RECYCLED PET PEN – awarded!

With the introduction of uma RECYCLED PET PEN, uma has not only proven its innovative strength, it has also created a new idea in terms of sustainability. The uma RECYCLED PET PEN series was awarded the PSI Sustainability Award 2017.

For the expansion of the uma RECYCLED PET PEN PRO series, uma was nominated for the Innovator of the Year Award and was able to win the German Innovation Award 2021 with the highest award GOLD.

With its nomination for the German Sustainability Award 2019, uma was also confirmed outside the industry. In addition, the company ranks among the TOP 100 most innovative companies in the German medium-sized sector.

## Was bedeutet Nachhaltigkeit?

Nachhaltigkeit rückt immer stärker in das Bewusstsein der Menschen und gewinnt für Kaufentscheidungen von Produkten immer mehr an Bedeutung. Für uns bei uma Schreibgeräte bedeutet das, bei allem was wir heute tun, schon an die Zukunft zu denken. So sorgen wir dafür, dass Plastikflaschen zu Kugelschreibern recycelt werden und Bäume nur in der Anzahl gefällt werden, in der neue Bäume nachgepflanzt werden.



### rPET – recycelte PET-Flasche / rPET – recycled PET bottle

Für die Herstellung eines PET Kugelschreibers wird recyceltes PET verwendet. Das hierzu benötigte Granulat wird aus recycelten PET-Flaschen gewonnen. Eine 0,5 Liter PET-Flasche ergibt genau das Material, welches für die Herstellung eines Kugelschreibergehäuses benötigt wird – „Upcycling“ in seiner besten Form.



Recycled PET is used to manufacture a PET ballpoint pen. The required granulate is obtained from recycled PET bottles. A 0.5 litre PET bottle produces exactly the material required for the production of a ballpoint pen housing – “upcycling” in its best form.



### rABS – recycelter Kunststoff / rABS – recycled plastic

Recycelter ABS-Kunststoff wird aus den **Spritzgussresten** der eigenen Spritzgießerei gewonnen. Hierzu werden die Kunststoffabfälle gesammelt und dem Spritzgussprozess wieder zugeführt. Die gesammelten Kunststoffe können sortenrein und qualitätsbestimmt gesammelt werden. Durch das Aufbereiten der Kunststoffe kann aus diesen ein recyceltes Produkt gefertigt werden. Generell wird durch das Recyceln der Kunststoffe weniger Rohöl und Energie verbraucht.



Recycled ABS plastic is obtained from the **injection moulding** debris from our own injection moulding plant. For this, plastic waste is collected up and directed back into the injection moulding process. The collected plastics can be collected, graded and grouped by quality standard. These preparatory operations with plastics are the key to manufacturing a recycled product. Without exception, the recycling of plastics uses less crude oil and power.



### rPCP – recycelter Post Consumer Kunststoff / rPCP – recycled post consumer plastic

Recycelter Post-Consumer-Kunststoff (PCP) wird meist aus technischen (Haushalts-) Geräten oder sonstigen **Consumer Kunststoffabfällen** gewonnen. Hierzu werden die Kunststoffe gesammelt und sortenrein recycelt. Die sogenannten Post Consumer oder Post Industry Kunststoffe können nach der Aufbereitung in ein neues Produkt upgecycelt werden. Generell wird durch das Recyceln der Kunststoffe weniger Rohöl und Energie verbraucht.



POST-CONSUMER  
RECYCLED PLASTIC

For the most part, recycled post-consumer plastic (PCP) is obtained from technical (domestic) appliances or other forms of **plastic consumer waste**. This process involves collecting and grading plastics and recycling each grade separately. After the recycling process, a new product can be ‘upcycled’ from what are known as post-consumer or also post industry plastics. Without exception, the recycling of plastics uses less crude oil and power.

## What does sustainability really mean?

Sustainability is becoming increasingly important in the public consciousness and even more decisive in driving purchasing decisions. Here at uma, this means that, for everything that we do today, we think about how it impacts the future. It means that we recycle plastic bottles into ballpoint pens and that we don't cut down more trees than can be planted.



### Holz/wood

Für die uma Schreibgeräte aus Holz wird ausschließlich deutsches PEFC- und FSC®-zertifiziertes Buchenholz verwendet. Durch spezielle Bearbeitung des nachwachsenden Rohstoffs transportiert das Naturprodukt Ihre Werbebotschaft edel und formschön zum Kunden. Der Naturstoff Holz variiert sowohl in der Farbigkeit des Holzes als auch in der Struktur (Maserung).



Only german PEFC and FSC® certified beechwood is used for the uma writing utensils made of wood. Through special processing of the sustainable raw material, the natural product transports its advertising message in a refined and beautiful design to the customer. Wood is a natural material with a great variety of colours and textures (grain effect).



### Cellulose/cellulose acetate

Der aus der Natur gewonnene Rohstoff kann dieser ebenfalls wieder zugeführt werden. Das Celluloseacetat entspricht der DIN EN 13432:2000-12/ Zertifizierungsprogramm für Produkte aus kompostierbaren Werkstoffen. Die hierfür notwendige Cellulose wird aus europäischen Weichhölzern gewonnen.



The raw material gained from nature can also be returned to nature. The cellulose acetate complies with DIN EN 13432:2000-12/ certification program for products from compostable materials. The cellulose required for this is gained from European softwoods.



### recycelter Karton/recycled cardboard

Die Verwendung von bereits recycelter Kartonage bietet eine stabile und zugleich umweltverträgliche Grundlage für die Herstellung von Schreibgeräten. Das Material kann dem Recyclingprozess wieder zugeführt werden und trägt so zur Umweltschonung bei. Die Verwendung dieser besonderen Materialien unterliegt produktionstechnischen Schwankungen. Leichte Unterschiede in Farbe und Oberfläche sind daher möglich.

The use of cardboard that has already been recycled offers a stable and at the same time environmentally friendly basis for the production of writing utensils. The material can be returned to the recycling process again, thus contributing to helping the environment. The use of these special materials is subject to fluctuations in the production technology. As a result, slight differences in colour and surface are possible.



### Die uma RECYCLED PET PEN-Serie

Schreiben Sie mit der ersten in Europa gefertigten, komplett klimaneutralen, recycelten, nachhaltigen Schreibgeräte-Serie. Die uma RECYCLED PET PEN-Serie.

### Mit Innovationen Werben

Die verschiedenen Schreibsysteme, neben dem klassischen Kugelschreiber, basieren alle auf einem eigens entwickelten und innovativen Tintenleitsystem. Die Patronen können in allen Schreibgeräten ausgewechselt und nachgerüstet werden. Langlebiges Schreiben und Werben ist somit garantiert. Die Kombination aus Schreibsystemen und recyceltem PET Material macht die uma RECYCLED PET PEN-Serie zu einer Weltneuheit. Die erste nachhaltige Schreibgeräte-Serie aus recyceltem PET Material, die komplett klimaneutral produziert wird, verleiht den werbenden Unternehmen in der Kommunikation nicht nur Nachhaltigkeit, sondern auch geschriebene Innovation. Die nachhaltige Schreibgeräte-Familie, uma RECYCLED PET PEN, verspricht Werbekommunikation und Schreibvergnügen auf höchstem Niveau.



### The uma RECYCLED PET PEN series

Write with the first European, climate neutral, recycled and sustainable produced writing instrument series. The uma RECYCLED PEN series.

### Advertising with innovations

Along with the classic ballpoint pen, the various writing systems are all based on a specially developed and innovative ink flow system. The cartridges can be used and retrofitted. This guarantees long-lasting writing joy and appeal. The combination of writing systems and recycled PET material makes the uma RECYCLED PET PEN series a world first. The first sustainable writing series made from recycled PET material, which is produced completely climate-neutral, gives companies looking to communicate attractively sustainable and written innovation.

The sustainable uma RECYCLED PET PEN series guarantees promotional communication and an enjoyable writing experience of the highest quality.

### Nachhaltigkeit kombiniert mit innovativer Schreibtechnologie – Das uma Tintenleitsystem

Dank der innovativen Weiterentwicklung der uma RECYCLED PET PEN PRO-Serie ergeben sich zusätzliche Varianten von Schreibsystemen und Werbeoptionen für den Kunden. Neben dem klassischen Kugelschreiber können weitere Schreibsysteme im identischen Design, aus recyceltem PET-Material mit den gleichen, identischen Nachhaltigkeitsvorteilen umgesetzt werden.

### Sustainably combined with innovative writing technology – The uma ink flow system



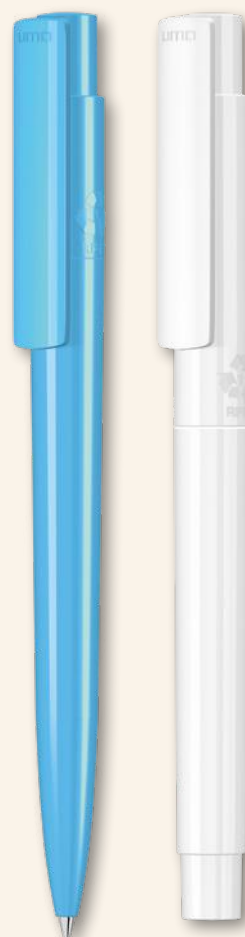



Thanks to the innovative further development of the uma RECYCLED PET PEN PRO series, additional types of writing system and promotional options have been created for customers. Along with the classic ballpoint pen, other identical writing systems made from recycled PET material can be used with the exact same sustainability benefits.



# Schreiben auch Sie Verantwortung! / Communicate your responsibility too!

Schreiben Sie: Die uma RECYCLED PET PEN-Serie mit folgenden Pro Argumenten

Communicate: The uma RECYCLED PET PEN series with the following pro arguments

 <ul style="list-style-type: none"> <li>• Weltneuheit: Erste in Europa gefertigte, recycelte, komplett klimaneutrale Schreibgeräte-Serie aus rPET Material</li> <li>• Ein Recyclingprozess wurde bereits durchlaufen.</li> <li>• World first: First recycled, fully climate-neutral writing series produced from rPET material and made in Europe</li> <li>• Already undergone a recycling process.</li> </ul>	 <ul style="list-style-type: none"> <li>• rPET Material zu 100 % aus recycelten PET Flaschen</li> <li>• Eine 0,5 L PET Flasche ergibt genau ein Schreibgerätegehäuse</li> <li>• Langlebiges, nachhaltiges Material – eignet sich zum Upcycling</li> <li>• rPET material made 100 % from recycled PET bottles</li> <li>• One 0,5 l PET bottle produces exactly one housing of a pen</li> <li>• Long-lasting, sustainable material – suitable for upcycling</li> </ul>
 <ul style="list-style-type: none"> <li>• Es werden ausschließlich PET Flaschen aus Europa verwendet (ausser Ocean Bound Plastic).</li> <li>• Made in Europe</li> <li>• Only PET bottles from Europe are used (excepted ocean-bound plastic).</li> <li>• Made in Europe</li> </ul>	 <ul style="list-style-type: none"> <li>• Optimaler CO<sub>2</sub>-Fußabdruck</li> <li>• Komplett klimaneutrale Produktion und Veredelung</li> <li>• Low carbon footprint</li> <li>• Fully climate-neutral production and processing</li> </ul>
 <ul style="list-style-type: none"> <li>• Alle Schreibgeräte sind mit dem international bekannten „rPET RECY-Zeichen“ versehen</li> <li>• Kann einem weiteren Recyclingprozess zugeführt werden</li> <li>• All stationery features the internationally recognised “rPET RECY logo”</li> <li>• Can be recycled further</li> </ul>	 <ul style="list-style-type: none"> <li>• Designs auch als antibakterielle und antivirale Variante erhältlich, zertifiziert nach ISO 22196 (antibakteriell) und nach ISO 21702 (antiviral)</li> <li>• #gesundbleiPEN – Hygiene- und Nachhaltigkeitskonzept werden mit einem Schreibgerät erfüllt</li> <li>• Designs also available as antibacterial an antiviral version, certified according to ISO 22196 (antibacterial) and to ISO 21702 (antiviral)</li> <li>• #antibacterial – hygiene and sustainability concept are fulfilled with one writing instrument</li> </ul>



- Einzigartige Gehäusefarbpalette, zusätzliche Einfärbung nach PMS und Mix & Match-Service
- Unique housing colour range, additional colouring based on PMS and Mix & Match service

Vier Schreibsysteme – ein Design

- **Kugelschreiber** mit Dokumental® Schreibpaste ●●
- **Rollerball** ●●●●●●●●
- **Highlighter** mit Dokumental® Highlighterpaste, EN-71-3, ASTM D4326 ●●●●●●●●
- **Fineliner** mit Dokumental® Finelinerpaste, EN-71-3, ASTM D4326 ●●●●●●●●●●●●●●



Four writing systems – one design

- **Ballpoint pen** with Dokumental® writing ink ●●
- **Rollerball** ●●●●●●●●
- **Highlighter** with Dokumental® highlighter ink, EN-71-3, ASTM D4326 ●●●●●●●●
- **Fineliner** with Dokumental® finelinerpaste, EN-71-3, ASTM D4326 ●●●●●●●●●●●●●●



- Geschlossener und kontrollierter Recycling- bzw. Produktionsprozess nach dem „Global Recycling Standard“ zertifiziert

- Zertifizierte und ausgezeichnete Idee

- Closed and controlled recycling and production process certified based on the “Global Recycling Standard”

- Certified and award-winning concept





Etui Empfehlung / Case suggestion  
 ETUI 0-0940 Cl rPET

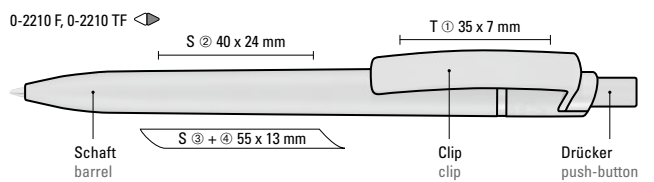



Farb-Code/Minen  
Colour code/Refills

RECYCLED PET PEN STEP F  
0-2210 F **new!**

RECYCLED PET PEN STEP frozen  
0-2210 TF **new!**

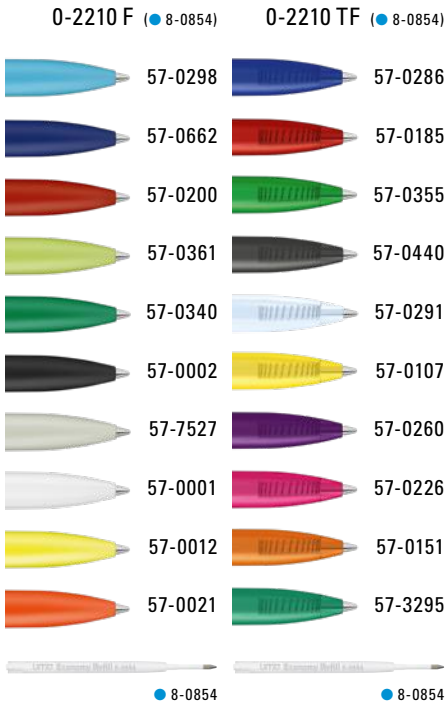

Das aus recycelten PET-Flaschen in Europa hergestellte rPET-Material eignet sich für einen langlebigen und nachhaltigen Werbeeinsatz. Dank der europäischen und klimaneutralen Produktion leistet der uma RECYCLED PET PEN STEP einen zusätzlichen nachhaltigen Beitrag zur Schonung der Umwelt. Aufgrund der Besonderheiten des Materials (recyceltes PET-Material) sind produktionstechnische Farbschwankungen gegeben.

The rPET material, which is produced in Europe from recycled PET bottles, is suitable for a durable and sustainable advertisement. Thanks to the European and climate-neutral production, the uma RECYCLED PET PEN STEP makes an additional sustainable contribution to the protection of the environment.

Due to the special nature of the material (recycled PET material) production-related variations are possible.



**Mix n' Match:** Ab 2.000 Stück kann das Modell farblich kombiniert werden.

0-2210 F: Druckkugelschreiber aus recyceltem PET-Material mit matt gedecktem Gehäuse, Clip und Drücker.

0-2210 TF: Druckkugelschreiber aus recyceltem PET-Material mit transparent gefrostetem Gehäuse, Clip und Drücker.

Mindestbestellmenge  
Werbeschlüssel

1.000 Stück  
Schaft S, Clip T

**Mix n' Match:** From 2,000 pieces, you can choose any colour combination.

0-2210 F: Retractable ballpoint pen made from recycled PET material with opaque matt housing, clip and push-button.

0-2210 TF: Retractable ballpoint pen made from recycled PET material with transparent frosted housing, clip and push-button.

Minimum quantity  
Advertising code

1,000 pieces  
barrel S, clip T

RECYCLED  
PET PEN switch transparent  
0-2240 T

RECYCLED  
PET PEN switch transparent KG  
0-2240 T KG

Farb-Code/Minen  
Colour code/Refills



0-2240 T (● 8-0866)	0-2240 T KG (● 8-0866)
57-0286 	57-0298 
57-0185 	57-0662 
57-0355 	57-0200 
57-0440 	57-7492 
57-0291 	57-0361 
57-0107 	57-0340 
57-0260 	57-0002 
57-0226 	57-7527 
57-0151 	57-0001 
57-3295 	57-0012 
● 8-0866 	57-0270 
	57-2607 
	57-0233 
	57-0021 
	57-7710 
	57-7500 
	● 8-0866 

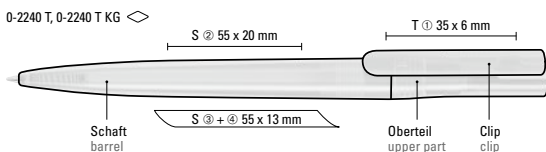

0-2240 T: Drehkugelschreiber aus recyceltem rPET-Material mit transparent glänzendem Gehäuse.

0-2240 T KG: Drehkugelschreiber aus recyceltem rPET-Material mit transparent glänzendem Gehäuse und gedeckt glänzendem Clip.

Mindestbestellmenge  
Werbeschlüssel

1.000 Stück  
Schaft S, Clip T

0-2240 T: Twist ballpoint pen made from recycled PET material with transparent housing.

0-2240 T KG: Twist ballpoint pen made from recycled PET material with transparent housing and opaque glossy clip.

Minimum quantity  
Advertising code

1,000 pieces  
barrel S, clip T

Farb-Code/Minen  
Colour code/Refills

RECYCLED  
PET PEN switch  
0-2240

RECYCLED  
PET PEN switch K transparent  
0-2240 KT

0-2240 (● 8-0866)      0-2240 KT (● 8-0866)



Das aus recycelten PET-Flaschen in Europa hergestellte rPET-Material eignet sich für einen langlebigen und nachhaltigen Werbeeinsatz. Dank der europäischen und klimaneutralen Produktion leistet der uma RECYCLED PET PEN switch einen zusätzlichen nachhaltigen Beitrag zur Schonung der Umwelt. Aufgrund der Besonderheiten des Materials (recyceltes PET-Material) sind produktionstechnische Farbschwankungen gegeben.

The rPET material, which is produced in Europe from recycled PET bottles, is suitable for a durable and sustainable advertisement. Thanks to the European and climate-neutral production, the uma RECYCLED PET PEN switch makes an additional sustainable contribution to the protection of the environment.

Due to the special nature of the material (recycled PET material) production-related variations are possible.

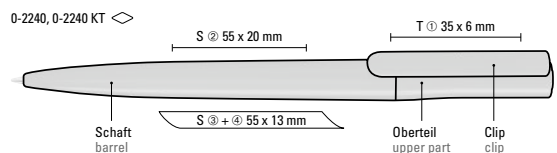

0-2240: Drehkugelschreiber aus recyceltem rPET-Material mit gedeckt glänzendem Gehäuse.

0-2240 KT: Drehkugelschreiber aus recyceltem rPET-Material mit gedeckt glänzendem Gehäuse und transparent glänzendem Clip.

Mindestbestellmenge  
Werbeschlüssel

1.000 Stück  
Schaft S, Clip T

0-2240: Twist ballpoint pen made from recycled PET material with opaque glossy housing.

0-2240 KT: Twist ballpoint pen made from recycled PET material with opaque glossy housing and transparent clip.

Minimum quantity  
Advertising code

1,000 pieces  
barrel S, clip T





0-2260 ◀, 0-2260 T, 0-2260 T SG ◇

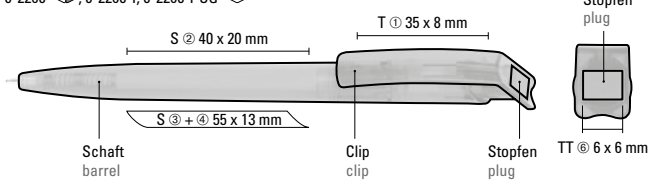

Farb-Code/Minen  
Colour code/Refills

RECYCLED  
PET PEN  
0-2260

RECYCLED  
PET PEN transparent  
0-2260 T

RECYCLED  
PET PEN transparent SG  
0-2260 T SG

0-2260 (● 8-0866)	0-2260 T (● 8-0866)
0-2260 T SG (● 8-0866)	
 57-0298	 57-0286
 57-0662	 57-0185
 57-0200	 57-0355
 57-7492	 57-0440
 57-0361	 57-0107
 57-0340	 57-0260
 57-0002	 57-0226
 57-7527	 57-0151
 57-0001	 57-3295
 57-0012	 ● 8-0866
 57-0270	
 57-2607	
 57-0233	
 57-0021	
 57-7710	
 57-7500	
 ● 8-0866	



Das aus recycelten PET-Flaschen in Europa hergestellte rPET-Material eignet sich für einen langlebigen und nachhaltigen Werbeeinsatz. Dank der europäischen und klimaneutralen Produktion leistet der uma RECYCLED PET PEN einen zusätzlichen nachhaltigen Beitrag zur Schonung der Umwelt. Aufgrund der Besonderheiten des Materials (recyceltes PET-Material) sind produktionstechnische Farbschwankungen gegeben.

The rPET material, which is produced in Europe from recycled PET bottles, is suitable for a durable and sustainable advertisement. Thanks to the European and climate-neutral production, the uma RECYCLED PET PEN makes an additional sustainable contribution to the protection of the environment.

Due to the special nature of the material (recycled PET material) production-related variations are possible.



**Mix n' Match:** Ab 2.000 Stück kann das Modell farblich kombiniert werden.

0-2260: Druckkugelschreiber aus recyceltem rPET-Material mit gedeckt glänzendem Gehäuse und Stopfen.

0-2260 T: Druckkugelschreiber aus recyceltem rPET-Material mit transparent glänzendem Gehäuse und gedecktem Stopfen.

0-2260 T SG: Druckkugelschreiber aus recyceltem rPET-Material mit klar transparent glänzendem Gehäuse und gedecktem Stopfen.

Mindestbestellmenge  
Werbeschlüssel

1.000 Stück  
Schaft S, Clip T, Stopfen TT

**Mix n' Match:** From 2,000 pieces, you can choose any colour combination.

0-2260: Retractable ballpoint pen made from recycled PET material with opaque glossy housing and plug.

0-2260 T: Retractable ballpoint pen made from recycled PET material with transparent housing and opaque glossy plug.

0-2260 T SG: Retractable ballpoint pen made from recycled PET material with clear transparent housing and opaque glossy plug.

Minimum quantity  
Advertising code

1,000 pieces  
barrel S, clip T, plug TT

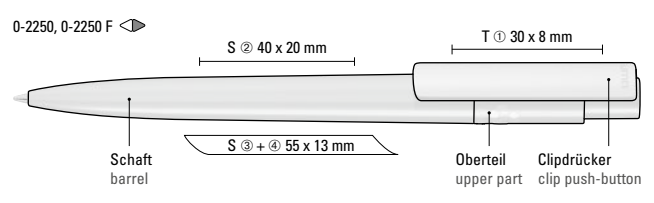



Farb-Code/Minen  
Colour code/Refills

RECYCLED PET PEN PRO  
0-2250

RECYCLED PET PEN PRO F  
0-2250 F

0-2250 (● 8-0854)  
0-2250 F (● 8-0854)



uma  
PRIME

Das aus recycelten PET-Flaschen in Europa hergestellte rPET-Material eignet sich für einen langlebigen und nachhaltigen Werbeeinsatz. Dank der europäischen und klimaneutralen Produktion leistet der uma RECYCLED PET PEN PRO einen zusätzlichen nachhaltigen Beitrag zur Schonung der Umwelt. Aufgrund der Besonderheiten des Materials (recyceltes PET-Material) sind produktionstechnische Farbschwankungen gegeben.

The rPET material, which is produced in Europe from recycled PET bottles, is suitable for a durable and sustainable advertisement. Thanks to the European and climate-neutral production, the uma RECYCLED PET PEN PRO makes an additional sustainable contribution to the protection of the environment.

Due to the special nature of the material (recycled PET material) production-related variations are possible.



**Mix n' Match:** Ab 2.000 Stück kann das Modell farblich kombiniert werden.

0-2250: Druckkugelschreiber aus recyceltem PET-Material mit gedeckt glänzendem Gehäuse und Clip.

0-2250 F: Druckkugelschreiber aus recyceltem PET-Material mit matt gedecktem Gehäuse und Clip.

Mindestbestellmenge  
Werbeschlüssel

1.000 Stück  
Schaft S, Clip T

**Mix n' Match:** From 2,000 pieces, you can choose any colour combination.

0-2250: Retractable ballpoint pen made from recycled PET material with opaque glossy housing and clip.

0-2250 F: Retractable ballpoint pen made from recycled PET material with opaque matt housing and clip.

Minimum quantity  
Advertising code

1,000 pieces  
barrel S, clip T

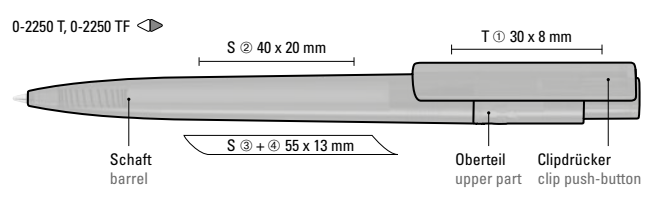

Farb-Code/Minen  
Colour code/Refills

RECYCLED PET PEN PRO transparent  
0-2250 T

RECYCLED PET PEN PRO frozen  
0-2250 TF

0-2250 T (● 8-0854)  
0-2250 TF (● 8-0854)



Etui Empfehlung/Case suggestion  
ETUI 0-0955 rPET  
Informationen unter [www.uma-pen.com](http://www.uma-pen.com)  
Information at [www.uma-pen.com](http://www.uma-pen.com)



UMA<sup>®</sup>  
PRIME



Das aus recycelten PET-Flaschen in Europa hergestellte rPET-Material eignet sich für einen langlebigen und nachhaltigen Werbeeinsatz. Dank der europäischen und klimaneutralen Produktion leistet der uma RECYCLED PET PEN PRO einen zusätzlichen nachhaltigen Beitrag zur Schonung der Umwelt. Aufgrund der Besonderheiten des Materials (recyceltes PET-Material) sind produktionstechnische Farbschwankungen gegeben.

The rPET material, which is produced in Europe from recycled PET bottles, is suitable for a durable and sustainable advertisement. Thanks to the European and climate-neutral production, the uma RECYCLED PET PEN PRO makes an additional sustainable contribution to the protection of the environment.

Due to the special nature of the material (recycled PET material) production-related variations are possible.



**Mix n' Match:** Ab 2.000 Stück kann das Modell farblich kombiniert werden.

0-2250 T: Druckkugelschreiber aus recyceltem PET-Material mit transparent glänzendem Gehäuse und Clip.

0-2250 TF: Druckkugelschreiber aus recyceltem PET-Material mit transparent gefrostetem Gehäuse und Clip.

Mindestbestellmenge  
Werbeschlüssel

1.000 Stück  
Schaft S, Clip T

**Mix n' Match:** From 2,000 pieces, you can choose any colour combination.

0-2250 T: Retractable ballpoint pen made from recycled PET material with transparent housing and clip.

0-2250 TF: Retractable ballpoint pen made from recycled PET material with transparent frosted housing and clip.

Minimum quantity  
Advertising code

1,000 pieces  
barrel S, clip T





Spüren Sie nachhaltigen Schreibgenuss auch mit dem uma Rollerball:

## RECYCLED PET PEN PRO Rollerball

Ein Rollerball für den besonders feinen Strich. In der uma RECYCLED PET PEN PRO-Serie gleich in 8 Schreibfarben erhältlich. Unterschriften für Verträge oder für ein einfach schönes Schreibgefühl ergeben weitere Werbeeinsatzmöglichkeiten.

Bringen Sie zukunftsorientierte Entwicklungen auf den Punkt mit dem uma Fineliner:

## RECYCLED PET PEN PRO Fineliner

Unterstreichen, hervorheben oder technisches Zeichnen, mit einem Fineliner kann der dünne Strich nicht nur präzise, sondern auch in Farbe umgesetzt werden. In der uma RECYCLED PET PEN PRO-Serie geht das mit 12 Standardfarben.

Experience the enjoyment of sustainable writing with the uma rollerball:

## RECYCLED PET PEN PRO Rollerball

A rollerball for a particularly fine line. Available in 8 writing colours in the uma RECYCLED PET PEN PRO series. Signing contracts or for a simply exquisite writing experience result in additional promotional opportunities.

Get to the heart of future-oriented developments with the uma fineliner:

## RECYCLED PET PEN PRO Fineliner

Emphasise, highlight or technical drawing – the thin streak of a fineliner can be precisely presented in colour format. 12 standard colours are available in the uma RECYCLED PET PEN PRO series.



0-2252 R, 0-2254 FL ◊

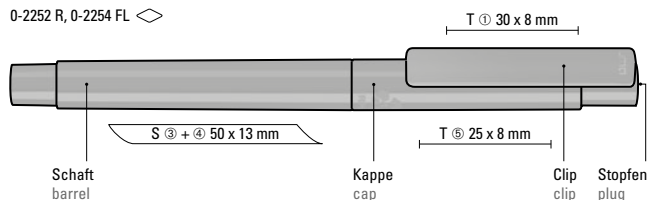

Farb-Code/Minen  
Colour code/Refills

RECYCLED PET PEN PRO R  
0-2252 R

RECYCLED PET PEN PRO FL  
0-2254 FL

0-2252 R

0-2254 FL



Tintenleitsystem/  
ink flow system

Tintenleitsystem/  
ink flow system

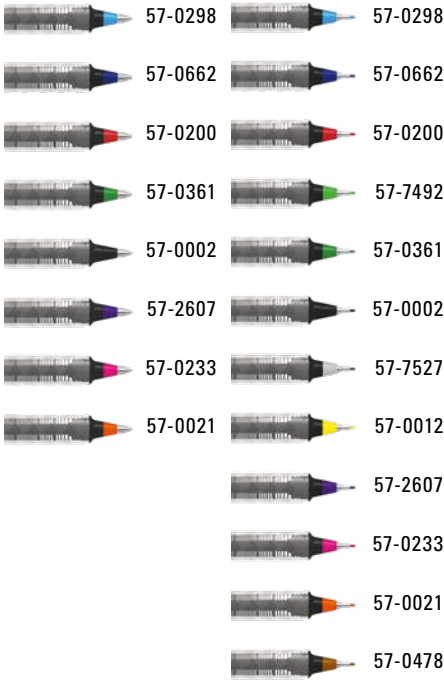

0-2252 R



0-2254 FL



Das aus recycelten PET-Flaschen in Europa hergestellte rPET-Material eignet sich für einen langlebigen und nachhaltigen Werbeeinsatz. Dank der europäischen und klimaneutralen Produktion leistet der uma RECYCLED PET PEN PRO einen zusätzlichen nachhaltigen Beitrag zur Schonung der Umwelt. Aufgrund der Besonderheiten des Materials (recyceltes PET-Material) sind produktionstechnische Farbschwankungen gegeben.

The rPET material, which is produced in Europe from recycled PET bottles, is suitable for a durable and sustainable advertisement. Thanks to the European and climate-neutral production, the uma RECYCLED PET PEN PRO makes an additional sustainable contribution to the protection of the environment.

Due to the special nature of the material (recycled PET material) production-related variations are possible.



0-2252 R: Rollerball mit Gehäuse aus recyceltem PET-Material in gedeckt glänzend weiß oder schwarz. Stopfen in den 8 möglichen Schreibfarben.

0-2254 FL: Fineliner mit Gehäuse aus recyceltem PET-Material in gedeckt glänzend weiß oder schwarz. Stopfen in den 12 möglichen Schreibfarben.

Mindestbestellmenge  
Werbeschlüssel

1.000 Stück  
Schaft S, Clip T, Kappe T

0-2252 R: Rollerball with opaque glossy housing in white or black made from recycled PET material. Plug in 8 possible writing colours.

0-2254 FL: Fineliner with opaque glossy housing in white or black made from recycled PET material. Plug in 12 possible writing colours.

Minimum quantity  
Advertising code

1,000 pieces  
barrel S, clip T, cap T



So schreiben Sie ab sofort Nachhaltigkeit auch mit dem uma Highlighter:

## RECYCLED PET PEN PRO LIQEO

Textmarker sind aus dem täglichen Bürobedarf nicht mehr wegzudenken. Somit sind die Highlighter in 6 Schreibfarben sowohl für den internen Gebrauch, aber auch für die Abgabe als Werbe- und Kommunikationstool perfekt. Auch im Bereich Schule, Ausbildungsmessen oder Mitarbeiterrekrutierung können diese Modelle optimal eingesetzt werden.

Now you can write sustainably with the uma highlighter:

## RECYCLED PET PEN PRO LIQEO

Text markers are an essential office item. Thus, the highlighters in 6 writing colours are suitable for office use and as an advertising and communication tool. These models can be optimally used in schools, at training fairs or employee recruitment.



0-2255 ◊

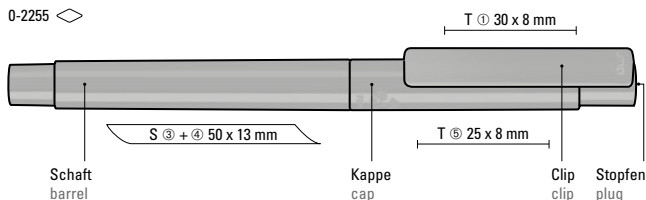



Farb-Code/Minen  
Colour code/Refills

RECYCLED PET PEN PRO LIQEO  
0-2255

0-2255



57-0002

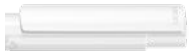

57-0001

Tintenleitsystem/  
ink flow system



57-0801



57-0802



57-0930



57-0814



57-0806



57-0804



0-2255



Das aus recycelten PET-Flaschen in Europa hergestellte rPET-Material eignet sich für einen langlebigen und nachhaltigen Werbeeinsatz. Dank der europäischen und klimaneutralen Produktion leistet der uma RECYCLED PET PEN PRO LIQEO einen zusätzlichen nachhaltigen Beitrag zur Schonung der Umwelt.

Der Highlighter ist ohne Pumpen oder Anstechen sofort einsatzfähig. Neues Flüssigtintenleitsystem – Bessere Schreibqualität – Höhere Leuchtkraft – Längere Schreibdauer – Umweltfreundlicher – Produziert nach EN-71, ASTM D-4236 – Flüssigtank austausch- bzw. nachfüllbar. Aufgrund der Besonderheiten des Materials (recyceltes PET-Material) sind produktionstechnische Farbschwankungen gegeben.

The rPET material, which is produced in Europe from recycled PET bottles, is suitable for a durable and sustainable advertisement. Thanks to the European and climate-neutral production, the uma RECYCLED PET PEN PRO LIQEO makes an additional sustainable contribution to the protection of the environment. Writes longer and more intensive as conventional highlighter, is without pumping or tapping operational immediately, supported in this way the sustainability concept. New liquid ink delivery system – better writing quality – greater luminance – longer writing time – ecologically superior – produced in acc. with EN-71, ASTM D-4236, liquid tank replaceable or refillable.

Due to the special nature of the material (recycled PET material) production-related variations are possible.



0-2255: Flüssig-Textmarker mit Gehäuse aus recyceltem PET-Material in gedeckt glänzend weiß oder schwarz. Stopfen in den 6 möglichen Schreibfarben.

Mindestbestellmenge  
Werbeschlüssel

1.000 Stück  
Schaft S, Clip T, Kappe T

0-2255: Liquid highlighter with opaque glossy housing in white or black made from recycled PET material. Plug in 6 possible writing colours.

Minimum quantity  
Advertising code

1,000 pieces  
barrel S, clip T, cap T

# RECYCLED PET PEN PRO SI

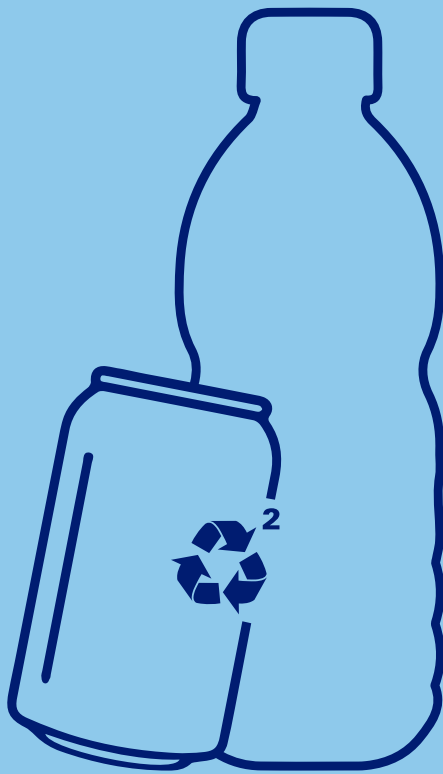

sustainable  
**RECYCLED<sup>2</sup>**  
 INNOVATIVE



Produkt-Video / product video  
 RECYCLED PET PEN PRO SI

## RECYCLED PET PEN PRO SI Recycled<sup>2</sup> – die nachhaltigste Kombination in einem Schreibgerät!

Recycelte PET-Getränke Flaschen treffen auf recycelte Aluminium Getränkedosen. Die uma rPET PRO-Serie ist eine der nachhaltigsten Schreibgeräteentwicklungen der Werbebranche. Eine 100 % klimaneutrale, europäische und nach Global Recycled Standard zertifizierte Produktion bilden die Basis für langlebiges und nachhaltiges Schreiben. Die neue Upcycling-Idee erweitert die bisher reine recycelte PET-Schreibgeräteserie um schicke Metallapplikationen. Aus einer recycelten Aluminium 150 ml Getränkedose entstehen 10 wertige Metallspitzen, die auf ein PET-Gehäuse einer recycelten 0,5 l PET-Flasche treffen. So schreiben Sie mit dem uma RECYCLED PET PEN PRO SI die nachhaltigste Kombination für die Umwelt – eben: uma Recycled<sup>2</sup>.

## RECYCLED PET PEN PRO SI Recycled<sup>2</sup> – the most sustainable combination in a writing instrument!

Recycled PET beverage bottles meet recycled aluminium beverage cans. The uma rPET PRO series is one of the most sustainable writing instrument developments in the promotional industry. A 100 % climate-neutral, European and Global Recycled Standard certified production built up the basics for long-lasting and sustainable writing. The new upcycling idea adds elegant metal applications to the previously pure recycled PET writing instrument series. A recycled aluminium 150ml beverage can is recycled into 10 valuable metal tips that meet a PET housing of a recycled 0.5 l PET bottle. So with the uma RECYCLED PET PEN PRO SI you write the most sustainable combination for the environment – just: uma Recycled<sup>2</sup>.



0-2250 F-SI, 0-2250 TF-SI

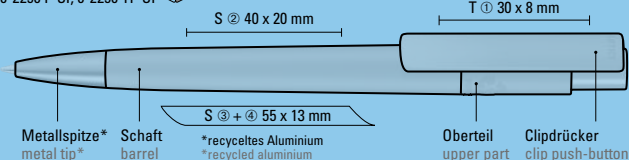

Farb-Code/Minen  
Colour code/Refills

RECYCLED PET PEN PRO F SI  
0-2250 F-SI **new!**

RECYCLED PET PEN PRO frozen SI  
0-2250 TF-SI **new!**

0-2250 F-SI (● 8-0855)



0-2250 TF-SI (● 8-0856)

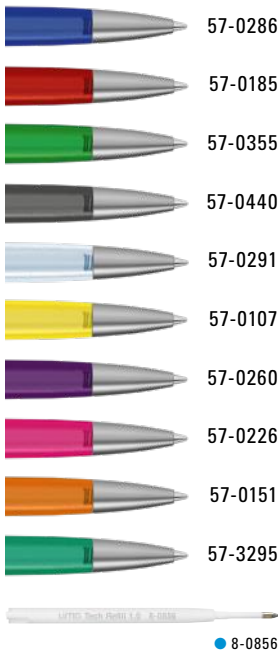

Die Gewinnung und Verarbeitung des rPET-Materials aus 100% recycelten PET-Flaschen sowie das rALU-Material aus 100% recycelten Aluminium-Getränkedosen findet in Europa statt. Die beiden Materialien eignen sich für einen langlebigen und nachhaltigen Werbeeinsatz.

Dank der europäischen und klimaneutralen Produktion leistet der uma RECYCLED PET PEN PRO einen zusätzlichen nachhaltigen Beitrag zur Schonung der Umwelt.

Aufgrund der Besonderheiten des Materials (recyceltes PET-Material) sind produktionstechnische Farbschwankungen gegeben.

The extraction and processing of the rPET material from 100% recycled PET bottles, as well as the rALU material from 100% recycled aluminium beverage cans takes place in Europe. Both materials are suitable for a durable and sustainable advertisement.

Thanks to the European and climate-neutral production, the uma RECYCLED PET PEN PRO makes an additional sustainable contribution to the protection of the environment.

Due to the special nature of the material (recycled PET material) production-related variations are possible.



**Mix n' Match:** Ab 2.000 Stück kann das Modell farblich kombiniert werden.

0-2250 F-SI: Druckkugelschreiber aus recyceltem PET-Material mit matt gedecktem Gehäuse und Clip sowie Metallspitze aus recyceltem Aluminium in silber matt.

0-2250 TF-SI: Druckkugelschreiber aus recyceltem PET-Material mit transparent gefrostetem Gehäuse und Clip sowie Metallspitze aus recyceltem Aluminium in silber matt.

Mindestbestellmenge  
Werbeschlüssel

1.000 Stück  
Schaft S, Clip T

**Mix n' Match:** From 2,000 pieces, you can choose any colour combination.

0-2250 F-SI: Retractable ballpoint pen made from recycled PET material with opaque matt housing and clip, metal tip made from recycled aluminium in matt silver.

0-2250 TF-SI: Retractable ballpoint pen made from recycled PET material with transparent frosted housing and clip, metal tip made from recycled aluminium in matt silver.

Minimum quantity  
Advertising code

1,000 pieces  
barrel S, clip T



# RECYCLED PET PEN PRO

# ocean



made from ocean-bound plastic



Produkt-Video/  
product video

0-2250 F OCEAN ◀

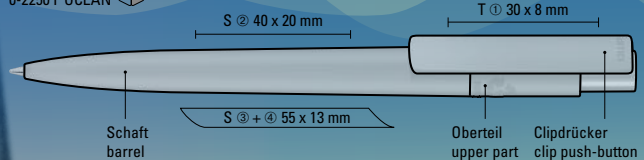

Farb-Code/Minen  
Colour code/Refills

RECYCLED PET PEN PRO F ocean  
0-2250 F OCEAN **new!**

0-2250 F OCEAN (● 8-0854)



Etui Empfehlung/Case suggestion  
ETUI 0-0940 CI  
Informationen unter [www.uma-pen.com](http://www.uma-pen.com)  
Information at [www.uma-pen.com](http://www.uma-pen.com)

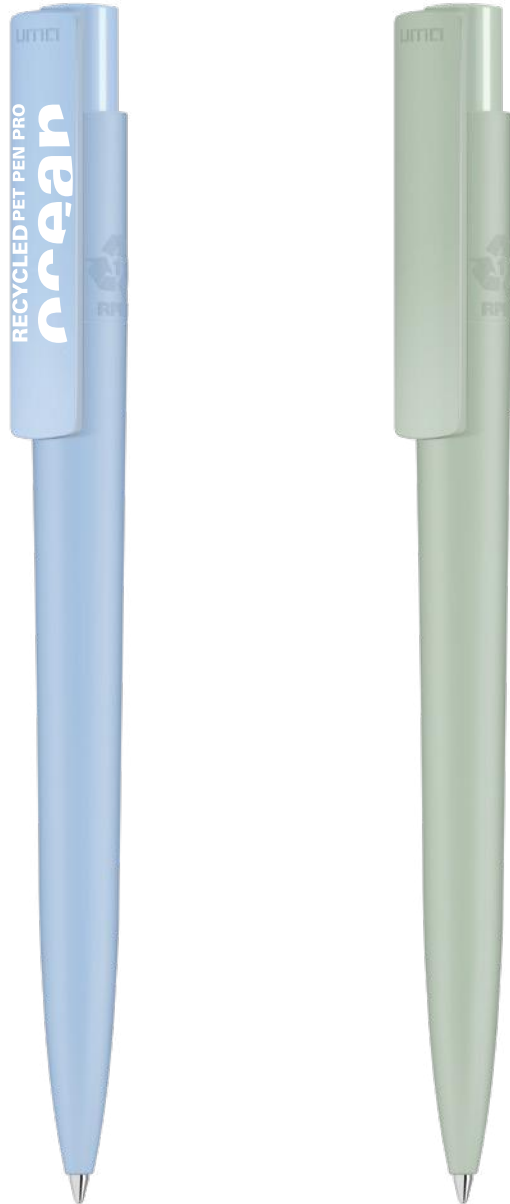

Das durch Plastic Bank gesammelte Ocean Bound Plastic, auch bekannt als Social Plastic®, wird in Europa zu einem recycelten PET Schreibgerät für einen langlebigen und nachhaltigen Werbeeinsatz upgecycelt.

Dank der europäischen und klimaneutralen Produktion leistet der uma RECYCLED PET PEN PRO ocean einen zusätzlichen nachhaltigen Beitrag zur Schonung der Umwelt.

Aufgrund der Besonderheiten des Materials (recyceltes PET-Material) sind produktionstechnische Farbschwankungen gegeben.

Ocean-bound plastic, also known as Social Plastic®, collected through Plastic Bank is upcycled in Europe into a recycled PET writing instrument for long-lasting and sustainable advertisement. Thanks to the European and climate-neutral production, the uma RECYCLED PET PEN PRO ocean makes an additional sustainable contribution to the protection of the environment. Due to the special nature of the material (recycled PET material) production-related variations are possible.

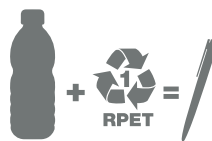

made from ocean-bound plastic



**Mix n' Match:** Ab 2.000 Stück kann das Modell farblich kombiniert werden.

0-2250 F OCEAN: Druckkugelschreiber aus recyceltem PET-Material aus Ocean Bound Plastic mit matt gedecktem Gehäuse und Clip.

Mindestbestellmenge  
Werbeschlüssel

1.000 Stück  
Schaft S, Clip T

**Mix n' Match:** From 2,000 pieces, you can choose any colour combination.

0-2250 F OCEAN: Retractable ballpoint pen made of ocean-bound PET material with opaque matt housing and clip.

Minimum quantity  
Advertising code

1,000 pieces  
barrel S, clip T



# Schützen Sie sich und die Umwelt mit dem einzigartigen **RECYCLED PET PEN PRO antibacterial**



## ANTIBAKTERIELL UND ANTIVIRAL

Der antimikrobielle Zusatz verleiht dem rPET eine antibakterielle und antivirale Wirkung.

Die antimikrobielle Wirkung ist für die gesamte Lebensdauer des Schreibgerätes gewährleistet und bietet somit einen dauerhaften Schutz.



## GEPRÜFT UND ZERTIFIZIERT

Die Haftung und Ansiedelung von Krankheitserregern auf der Oberfläche des Schreibgerätes wird nachweislich zu 99,99 % reduziert. Geprüft nach ISO 21702 (antiviral) und ISO 22196 (antibakteriell). Sowohl Bakterien als auch Viren (auch das Corona Virus) werden vernichtet.



## MADE IN EUROPE

Kurze und schnelle Lieferwege ermöglichen eine zuverlässige und kurzfristige Produktion und schaffen einen zusätzlichen Beitrag zum Erhalt der Umwelt.



## KLIMANEUTRAL

Die Schreibgeräte werden in Europa produziert und klimaneutral veredelt. Auf diese Weise wird ein zusätzlich positiver Beitrag für die Umwelt geleistet.



## RECYCEL T

Das Gehäuse wird zu 100 % aus recycelten PET-Flaschen hergestellt. Somit wurde bereits ein Recycling-Prozess umgesetzt und das Produkt kann wieder dem Recyclingzyklus zugeführt werden.



POS-Becher / Verpackungsoption  
POS-Cup / transport packaging  
**0-2220 RECYCLED PET CUP**

# Protect yourself and the environment with the unique

## RECYCLED PET PEN PRO antibacterial



### ANTIBACTERIAL AND ANTIVIRAL

It is made of antibacterial and antiviral plastic containing a special additive which releases silver ions that prevent bacteria from colonising the surface of the pen.



### TESTED AND CERTIFIED

Laboratory tests have shown that up to 99.99% of bacteria and pathogens on the surface of writing instruments are eliminated. Tested according to ISO 21702 (antiviral) and ISO 22196 (antibacterial) effect is guaranteed for the entire life of the writing instrument and thus offers lasting protection.



### MADE IN EUROPE

Short and fast delivery routes enable reliable and short-term production and create an additional contribution to the preservation to the environment.



### CLIMATE NEUTRAL

The writing instruments are produced in Europe and finished climate neutral in the Black Forest. In this way, an additional positive contribution to the environment is made.



### RECYCLED

The barrel is made of 100% recycled PET bottles. With the use of uma RECYCLED PET PENs we assure you that a recycling process has already been supported and that the writing instruments can be fed into further recycling cycles.



Etui Empfehlung / Case suggestion

#### 0-0940 CI ANTIBAC

Pappstecketui aus FSC®-zertifiziertem Pappkarton für ein Schreibgerät mit aufgedruckter Erklärung zum uma RECYCLED PET PEN PRO antibacterial, siehe [uma-pen.com](http://uma-pen.com)

Cardboard slip-in case made of FSC® certified cardboard for one writing instrument with printed declaration of uma RECYCLED PET PEN PRO antibacterial, see [uma-pen.com](http://uma-pen.com)



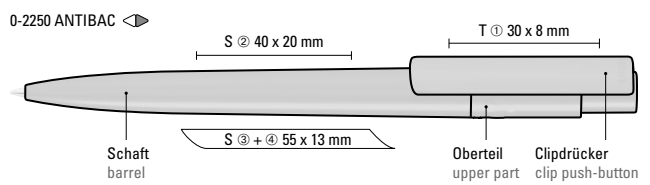

Farb-Code/Minen  
Colour code/Refills

RECYCLED PET PEN PRO antibacterial  
0-2250 ANTIBAC

0-2250 ANTIBAC (● 8-0854)



✓ **Wirkt gegen  
Corona - Viren**

- ANTIBAKTERIELL**
- ANTIVIRAL**
- RECYCLET**
- KLIMANEUTRAL**



Hinweis auf dem Schaft aufgedruckt:  
„antibacterial“ und „antiviral“  
Note printed on the barrel  
„antibacterial“ and „antiviral“

Das aus recycelten PET-Flaschen in Europa hergestellte rPET-Material eignet sich für langlebigen und nachhaltigen Werbeeinsatz. Der uma RECYCLED PET PEN PRO antibacterial bietet gleichzeitig mehrere Verkaufsargumente: recycelt, umweltverträglich, klimaneutral, antibakteriell und antiviral. Aufgrund der Besonderheiten des Materials (recyceltes PET-Material) sind produktionstechnische Farbschwankungen gegeben.

The rPET material, which is produced in Europe from recycled PET bottles, is suitable for a durable and sustainable advertisement. The uma RECYCLED PET PEN PRO antibacterial offers several sales arguments: recycled, environmentally friendly, climate-neutral, antibacterial and antiviral. Due to the special nature of the material (recycled PET material) production-related variations are possible.



**Mix n' Match:** Ab 2.000 Stück kann das Modell farblich kombiniert werden.

0-2250 ANTIBAC: Druckkugelschreiber aus recyceltem, antibakteriellem und antiviralem rPET in gedeckt glänzendem Gehäuse und Clip. Der nach ISO 22196 und ISO 21702 geprüfte antimikrobielle Zusatz verleiht dem rPET eine antibakterielle und antivirale Wirkung auch gegen Corona-Viren. Die Haftung und Ansiedlung von Bakterien oder Krankheitserregern auf der Oberfläche des Schreibgerätes wird um 99,99% verringert. Der in das rPET Material eingearbeitete antimikrobielle Zusatz kann nicht abgerieben oder abgegeben werden und wirkt über die gesamte Lebensdauer des Schreibgerätes. Eine dauerhafte Reduzierung von Krankheitserregern ist gegeben.

Mindestbestellmenge  
Werbeschlüssel

1.000 Stück  
Schaft S, Clip T

**Mix n' Match:** From 2,000 pieces, you can choose any colour combination.

0-2250 ANTIBAC: Retractable ballpoint pen made from recycled, antibacterial and antiviral recycled PET material with opaque glossy housing and clip. The ISO 22196 and ISO 21702 tested antimicrobial additive of silver ions gives the rPET material an antibacterial and antiviral effect that reduces the adhesion and settling of bacteria or pathogens on the surface of the writing instrument by 99.99%. The antimicrobial additive incorporated into the rPET material cannot be rubbed off or released and is effective over the entire life of the writing instrument. A permanent reduction of pathogens is given.

Minimum quantity  
Advertising code

1,000 pieces  
barrel S, clip T



0-2250 F TO ◊

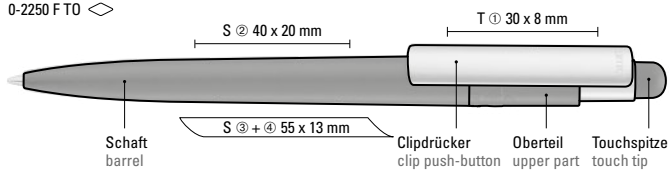

Farb-Code/Minen  
Colour code/Refills

RECYCLED PET PEN PRO F TOUCH  
0-2250 F TO **new!**

0-2250 F TO (● 8-0854)



57-0002



● 8-0854

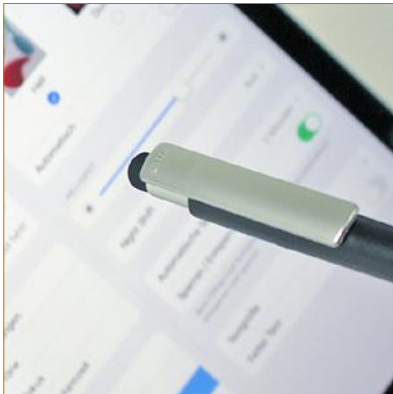

Das aus recycelten PET-Flaschen in Europa hergestellte rPET-Material eignet sich für einen langlebigen und nachhaltigen Werbeeinsatz. Dank der europäischen und klimaneutralen Produktion leistet der uma RECYCLED PET PEN PRO F TOUCH einen zusätzlichen nachhaltigen Beitrag zur Schonung der Umwelt.

Aufgrund der Besonderheiten des Materials (recyceltes PET-Material) sind produktionstechnische Farbschwankungen gegeben.

The rPET material, which is produced in Europe from recycled PET bottles, is suitable for a durable and sustainable advertisement. Thanks to the European and climate-neutral production, the uma RECYCLED PET PEN PRO F TOUCH makes an additional sustainable contribution to the protection of the environment.

Due to the special nature of the material (recycled PET material) production-related variations are possible.



0-2250 F TO: Druckkugelschreiber aus recyceltem PET-Material mit matt gedecktem Gehäuse und silbernem Clip, Drücker mit integrierter Touchscreensteuerung.

Mindestbestellmenge  
Werbeschlüssel

1.000 Stück  
Schaft S, Clip T

0-2250 F TO: Retractable ballpoint pen made from recycled PET material with opaque matt housing and silver clip, push-button with integrated touch screen control.

Minimum quantity  
Advertising code

1,000 pieces  
barrel S, clip T





## RECYCLED PET PEN ALUMA



Die Gewinnung und Verarbeitung des rPET Materials aus 100% recycelten PET-Flaschen sowie das rALU-Material aus 100% recycelten Aluminium-Getränkedosen findet in Europa statt. Die beiden Materialien eignen sich für einen langlebigen und nachhaltigen Werbeeinsatz. Dank der europäischen und klimaneutralen Produktion leistet der uma RECYCLED PET PEN ALUMA transparent einen zusätzlichen nachhaltigen Beitrag zur Schonung der Umwelt.

Aufgrund der Besonderheiten des Materials (recyceltes PET-Material) sind produktionstechnische Farbschwankungen gegeben.

The extraction and processing of the rPET material from 100% recycled PET bottles, as well as the rALU material from 100% recycled aluminium beverage cans takes place in Europe. Both materials are suitable for a durable and sustainable advertisement. Thanks to the European and climate-neutral production, the uma RECYCLED PET PEN ALUMA makes an additional sustainable contribution to the protection of the environment.

Due to the special nature of the material (recycled PET material) production-related variations are possible.

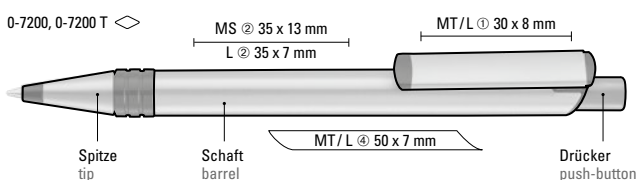

Farb-Code/Minen  
Colour code/Refills

RECYCLED PET PEN ALUMA  
0-7200 **new!**

RECYCLED PET PEN PRO ALUMA transparent  
0-7200 T **new!**

0-7200 (● 8-0855)  
0-7200 T (● 8-0856)



Die Modelle eignen sich für eine  
Laserung in weiß.  
The Models are suitable for  
laser engraving in white.



0-7200: Metall-Druckkugelschreiber mit Metallspitze,  
Metallschaft und Metallclip aus recyceltem Aluminium,  
Kunststoffteile aus recyceltem PET-Material in gedeckt schwarz  
und gedeckt farbigem Drücker.

0-7200 T: Metall-Druckkugelschreiber mit Metallspitze,  
Metallschaft und Metallclip aus recyceltem Aluminium,  
Kunststoffteile aus recyceltem PET-Material in klar transparent  
und gedeckt farbigem Drücker.

Mindestbestellmenge  
Werbeschlüssel

300 Stück  
Schaft MS/MT/L, Clip MT/L

0-7200: Metal retractable ballpoint pen with metal tip, metal  
barrel and metal clip made from recycled aluminium in matt  
silver, plastic parts made from recycled PET material in opaque  
glossy black and opaque coloured push-button.

0-7200 T: Metal retractable ballpoint pen with metal tip, metal  
barrel and metal clip made from recycled aluminium in matt  
silver, plastic parts made from recycled PET material in opaque  
clear transparent and opaque coloured push-button.

Minimum quantity  
Advertising code

300 pieces  
barrel MS/MT/L, clip MT/L

## Antibakterielle Schreibgeräte – sicher und langlebig

### WARUM GRÜN?



#### ANTIBAKTERIELL

Hergestellt aus antibakteriellem Kunststoff mit einem speziellen Zusatz, der Silberionen freisetzt, die die Bakterienbildung auf der Stiftoberfläche verhindern.



#### MADE IN EUROPE

Kurze und schnelle Lieferwege ermöglichen eine zuverlässige und kurzfristige Produktion und schaffen einen zusätzlichen Beitrag zum Erhalt der Umwelt.



#### KLIMANEUTRAL

Die Schreibgeräte werden in Europa produziert und klimaneutral veredelt. Auf diese Weise wird ein zusätzlich positiver Beitrag für die Umwelt geleistet.



#### WIRKLICH SICHER

Der verwendete Kunststoff erfüllt europäische und amerikanische FDA-Vorschriften für den Kontakt mit Lebensmitteln.



#### NATURFREUNDLICH

Die Schreibgeräte wurden aus nicht toxischem Kunststoff, für eine speziell lange Lebensdauer, entwickelt. Das Risiko, dass schädliche Substanzen in die Umwelt abgegeben werden, ist dadurch minimiert.

Eine möglichst lange Verwendung dieses Kugelschreibers hilft uns, die Umweltverschmutzung zu reduzieren und unterstreicht somit die Idee nachhaltiger Werbung.



#### VORAUSSCHAUEND

Hergestellt aus spielzeuggeeignetem Kunststoff (laut europäischer Norm EN 71, Teil 3 und US FDA-Vorschriften).



#### GRÜNE CHEMIE

Der Kunststoff enthält keine Dioxine, Phthalate, Bisphenol A, Antimo, Arsen, Barium, Cadmium, Chrom, Quecksilber, Blei, polybromierte Biphenyle (PCB), polybromierte Diphenylether oder Decabromdiphenylether und ist RoHS- und REACH-konform.



#### CLP-KONFORM

Ungefährlich gemäß der Verordnung zur Einstufung, Kennzeichnung und Verpackung von Stoffen und Gemischen.



Farb-Code/Minen  
Colour code/Refills

PIXEL F GREEN  
0-0017 F GREEN

0-0017 F GREEN (● 8-0866)



32-0001



● 8-0866



Hinweis im Schaft aufgedruckt:  
„antibacterial“  
Note printed on the barrel  
„antibacterial“

**NATUR-  
FREUNDLICH**

Antibakteriell, nicht toxisch,  
nachhaltig. Ein langlebiges  
Schreibgerät ist ein  
Schreibgerät, welches  
die Natur liebt.



Der nach ISO 22196:2011 geprüfte antimikrobielle Zusatz aus Silberionen verleiht dem Kunststoff eine antibakterielle Wirkung, die eine Haftung und Ansiedlung von Bakterien oder Krankheitserregern auf der Oberfläche des Schreibgerätes um 99,99% verringert. Der verarbeitete Kunststoff ist nicht nur antibakteriell, sondern auch schadstofffrei und umweltverträglich und entspricht den europäischen Lebensmittelrichtlinien, sowie der amerikanischen FDA.

The antimicrobial additive of silver ions, tested according to ISO 22196:2011, gives the plastic an antibacterial effect that reduces the adhesion and settling of bacteria or pathogens on the surface of the writing instruments by 99.99%. The processed plastic is not only antibacterial, but also pollutant-free and environmentally friendly and complies with European food as well as American FDA guidelines.

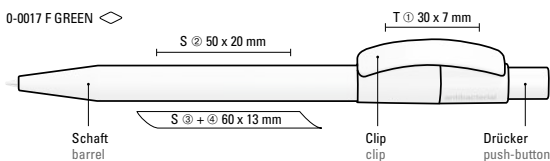

0-0017 F GREEN: Druckkugelschreiber mit antibakteriell wirkendem Kunststoffgehäuse in weiß matt, Bogenclip und Drücker.

Mindestbestellmenge  
Werbeschlüssel

1.000 Stück  
Schaft S, Clip T

0-0017 F GREEN: Retractable ballpoint pen with antibacterial plastic housing in white matt, curved clip and push-button.

Minimum quantity  
Advertising code

1,000 pieces  
barrel S, clip T



## Antibacterial writing utensils – save and long-lasting

### WHY GREEN?



#### ANTIBACTERIAL

It is made of antibacterial plastic containing a special additive which releases silver ions that prevent bacteria from colonising the surface of the pen.



#### MADE IN EUROPE

Short and fast delivery routes enable reliable and short-term production and create an additional contribution to the preservation to the environment.



#### CLIMATE-NEUTRAL

The writing instruments are produced in Europe and finished climate-neutral in the Black Forest. In this way, an additional positive contribution to the environment is made.



#### REALLY SAFE

The plastics employed are compliant with European and American FDA food contact regulations.



#### NATURE FRIENDLY

Made of non-toxic plastics, it has been designed to have a long life and to minimise the risk of harmful substances being released into the environment. Using a pen for as long as possible helps to reduce pollution and enables us to give full expression to the concept of promotion.



#### LOOKING TO THE FUTURE

Made of plastic suitable for toy manufacture (according to European standard EN 71-03 and U.S. FDA regulations).



#### GREEN CHEMICAL

It does not contain dioxin, phthalates, bisphenol A, antimony, arsenic, barium, cadmium, chrome, mercury, lead, polybrominated biphenyls (PBBs), polybrominated diphenyl ethers (PBDEs) or deca-BDE, and conforms to RoHS and REACH directives.



#### CLP COMPLIANT

It is rated as non hazardous pursuant to the Regulation on Classification, Labelling and Packaging.



0-0086 GREEN (● 8-0866)



Hinweis im Schaft eingelassen:  
„antibacterial/green chemical“  
Note embedded into the barrel  
„antibacterial/green chemical“



Der nach ISO 22196:2011 geprüfte antimikrobielle Zusatz aus Silberionen verleiht dem Kunststoff eine antibakterielle Wirkung, die eine Haftung und Ansiedlung von Bakterien oder Krankheitserregern auf der Oberfläche des Schreibgerätes um 99,99% verringert. Der verarbeitete Kunststoff ist nicht nur antibakteriell, sondern auch schadstofffrei und umweltverträglich und entspricht den europäischen Lebensmittelrichtlinien, sowie der amerikanischen FDA.

The antimicrobial additive of silver ions, tested according to ISO 22196:2011, gives the plastic an antibacterial effect that reduces the adhesion and settling of bacteria or pathogens on the surface of the writing instruments by 99.99%. The processed plastic is not only antibacterial, but also pollutant-free and environmentally friendly and complies with European food as well as American FDA guidelines.

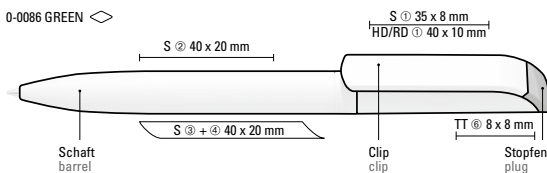

0-0086 GREEN: Drehkugelschreiber mit antibakteriell wirkendem Kunststoffgehäuse in gedeckt glänzend weiß mit farbiger Stopfen.

Mindestbestellmenge  
Werbeschlüssel

1.000 Stück  
Schaft S, Clip S/HD/RD, Stopfen TT

0-0086 GREEN: Twist ballpoint pen with antibacterial plastic housing in opaque glossy white with coloured plug.

Minimum quantity  
Advertising code

1,000 pieces  
barrel S, clip S/HD/RD, plug TT



EFFECT GREEN  
0-0086 GREEN



ICON GREEN  
0-0056 GREEN



PIXEL F GREEN  
0-0017 F GREEN



Etui Empfehlung/  
Case suggestion  
ETUI 0-0940 CI GREEN  
Informationen unter/  
Information at  
[www.uma-pen.com](http://www.uma-pen.com)



0-0056 GREEN (● 8-0866)



Hinweis im Schaft eingelassen:  
„antibacterial/green chemical“  
Note embedded into the barrel  
„antibacterial/green chemical“



## NATUR-FREUNDLICH

Antibakteriell, nicht toxisch,  
nachhaltig. Ein langlebiges  
Schreibgerät, welches  
die Natur liebt.



Der nach ISO 22196:2011 geprüfte antimikrobielle Zusatz aus Silberionen verleiht dem Kunststoff eine antibakterielle Wirkung, die eine Haftung und Ansiedlung von Bakterien oder Krankheitserregern auf der Oberfläche des Schreibgerätes um 99,99% verringert. Der verarbeitete Kunststoff ist nicht nur antibakteriell, sondern auch schadstofffrei und umweltverträglich und entspricht den europäischen Lebensmittelrichtlinien, sowie der amerikanischen FDA.

The antimicrobial additive of silver ions, tested according to ISO 22196:2011, gives the plastic an antibacterial effect that reduces the adhesion and settling of bacteria or pathogens on the surface of the writing instruments by 99.99%. The processed plastic is not only antibacterial, but also pollutant-free and environmentally friendly and complies with European food as well as American FDA guidelines.

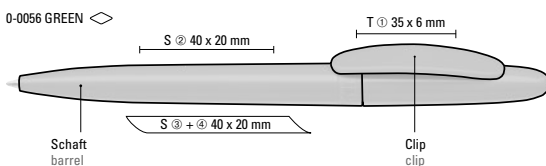

0-0056 GREEN: Drehkugelschreiber mit antibakteriell wirkendem Kunststoffgehäuse in gedeckt glänzend.

Mindestbestellmenge  
Werbeschlüssel

1.000 Stück  
Schaft S, Clip T

0-0056 GREEN: Twist ballpoint pen with antibacterial plastic housing and opaque glossy finish.

Minimum quantity  
Advertising code

1,000 pieces  
barrel S, clip T





## RECY-Modelle/RECY models

Das Gehäuse des HAPPY RECY wird aus recyceltem ABS Kunststoff hergestellt und ist mit dem rABS Logo gekennzeichnet.

The housing of the HAPPY RECY is made of recycled plastics (ABS) and is marked with the rABS logo.

HAPPY RECY  
0-0037 RECY



**rABS** – recycelter Kunststoff/  
**rABS** – recycled plastic

Recycelter ABS-Kunststoff wird aus den **Spritzgussresten** der eigenen Spritzgießerei gewonnen. Hierzu werden die Kunststoffabfälle gesammelt und dem Spritzgussprozess wieder zugeführt. Die gesammelten Kunststoffe können sortenrein und qualitätsbestimmt gesammelt werden. Durch das Aufbereiten der Kunststoffe kann aus diesen ein recyceltes Produkt gefertigt werden. Generell wird durch das Recyclen der Kunststoffe weniger Rohöl und Energie verbraucht.

Recycled ABS plastic is obtained from the **injection moulding** debris from our own injection moulding plant. For this, plastic waste is collected up and directed back into the injection moulding process. The collected plastics can be collected, graded and grouped by quality standard. These preparatory operations with plastics are the key to manufacturing a recycled product. Without exception, the recycling of plastics uses less crude oil and power.





## RECY-Modelle / RECY models



POST-CONSUMER  
RECYCLED PLASTIC

**rPCP** – recyclerter Kunststoff /  
**rPCP** – recycled plastic

Recyclerter Post-Consumer-Kunststoff (PCP) wird meist aus technischen (Haushalts-) Geräten oder sonstigen **Consumer Kunststoffabfällen** gewonnen. Hierzu werden die Kunststoffe gesammelt und sortenrein recycelt. Die sogenannten Post Consumer oder Post Industry Kunststoffe können nach der Aufbereitung in ein neues Produkt upgecyclt werden. Generell wird durch das Recyclen der Kunststoffe weniger Rohöl und Energie verbraucht.

For the most part, recycled post-consumer plastic (PCP) is obtained from technical (domestic) appliances or other forms of **plastic consumer waste**. This process involves collecting and grading plastics and recycling each grade separately. After the recycling process, a new product can be ‚upcycled‘ from what are known as post-consumer or also post industry plastics. Without exception, the recycling of plastics uses less crude oil and power.



Das Gehäuse des  
ICONIC RECY wird  
aus recyceltem  
Post-Consumer-  
Kunststoff (PCP)  
hergestellt und  
ist mit dem POST-  
CONSUMER-  
RECYCLED-  
PLASTIC-Logo  
gekennzeichnet.

The housing of the  
ICONIC RECY is  
made of recycled  
Post-Consumer  
plastics (PCP) and  
is marked with the  
POST-CONSUMER  
RECYCLED  
PLASTIC logo.

ICONIC RECY  
0-0057 RECY



0-0092 RECY (● 8-0854)

50-0301 

50-0340 

50-0002 

50-CG08 

50-0001 



● 8-0854



Das Modell ist mit dem Recyclingzeichen gekennzeichnet. Aufgrund der Besonderheit des Materials (ABS Recycled Plastic) sind produktionstechnische Farbschwankungen gegeben.

The model is labelled with the recycling mark. Due to the special nature of the material (ABS recycled plastic), colour variations may occur during the production process.



0-0092 RECY ◊

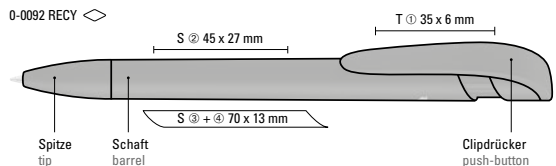

0-0092 RECY: Druckkugelschreiber mit gedeckt mattem Gehäuse, breitem Bogenclipdrücker und Spitze aus recyceltem Kunststoff.

0-0092 RECY: Retractable ballpoint pen with opaque matt housing, wide curved clip button and tip made from recycled plastic.

Mindestbestellmenge  
Werbeschlüssel

1.000 Stück  
Schaft S ◊, Clip T

Minimum quantity  
Advertising code

1,000 pieces  
barrel S ◊, clip T

1-0736 RECY (● 8-0877)

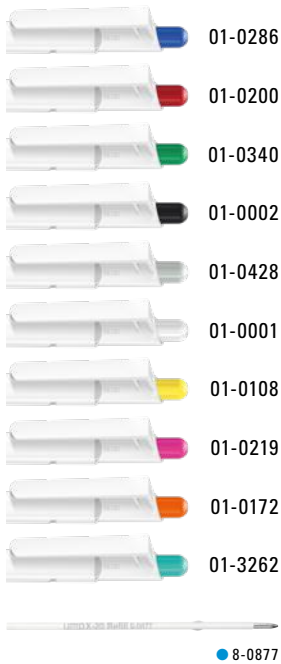

Das Modell ist mit dem Recyclingzeichen gekennzeichnet. Aufgrund der Besonderheit des Materials (ABS Recycled Plastic) sind produktionstechnische Farbschwankungen gegeben.

The model is labelled with the recycling mark. Due to the special nature of the material (ABS recycled plastic), colour variations may occur during the production process.

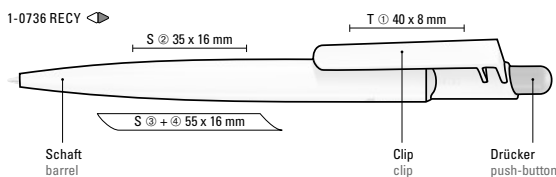

1-0736 RECY: Druckkugelschreiber mit gedeckt glänzendem Gehäuse aus 100% recyceltem Kunststoff und großem Clip an verstärkter Clipanbindung.

Mindestbestellmenge  
Werbeschlüssel

1.000 Stück  
Schaft S ○, Clip T

1-0736 RECY: Retractable ballpoint pen with opaque glossy body and large clip made from 100% recycled plastic.

Minimum quantity  
Advertising code

1,000 pieces  
barrel S ○, clip T



0-0037 RECY 

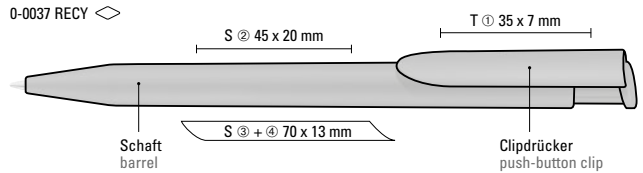



Farb-Code/Minen  
Colour code/Refills

HAPPY RECY  
0-0037 RECY

0-0037 RECY (● 8-0865)



Das Modell ist mit dem Recyclingzeichen gekennzeichnet. Aufgrund der Besonderheit des Materials (ABS Recycled Plastic) sind produktionstechnische Farbschwankungen gegeben.

The model is labelled with the recycling mark. Due to the special nature of the material (ABS recycled plastic), colour variations may occur during the production process.

 **Klimaneutral**  
Schreibgerät  
ClimatePartner.com/13223-2104-1001



0-0037 RECY: Druckkugelschreiber mit gedeckt mattem Gehäuse und Clipdrücker aus recyceltem Kunststoff.

Mindestbestellmenge  
Werbeschlüssel

1.000 Stück  
Schaft S ○, Clip T

0-0037 RECY: Retractable ballpoint pen with opaque matt housing and clip button made of recycled plastic.

Minimum quantity  
Advertising code

1,000 pieces  
barrel S ○, clip T



Etui Empfehlung / Case suggestion  
 ETUI 0-0940 RECY  
 Informationen unter [www.uma-pen.com](http://www.uma-pen.com)  
 Information at [www.uma-pen.com](http://www.uma-pen.com)

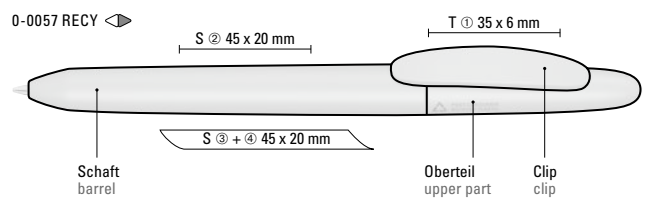

Farb-Code/Minen  
Colour code/Refills

ICONIC RECY  
0-0057 RECY

0-0057 RECY (● 8-0866)



Das Modell ist mit Recyclingzeichen gekennzeichnet. Aufgrund der Besonderheit des Materials (Post-Consumer Recycled Plastic) sind produktionstechnische Farbschwankungen gegeben.

The model is labelled with the recycling mark. Due to the special nature of the material (post-consumer recycled plastic) colour variations may occur during the production process.



**Mix'n Match:** Ab 2.000 Stück kann das Modell farblich kombiniert werden.

0-0057 RECY: Drehkugelschreiber mit gedeckt mattem Gehäuse aus 100% recyceltem Post-Consumer-Kunststoff.

Mindestbestellmenge  
Werbeschlüssel

1.000 Stück  
Schaft S, Clip T

**Mix'n Match:** From 2,000 pieces, you can choose any colour combination.

0-0057 RECY: Twist ballpoint pen with opaque matt housing made from 100% recycled post-consumer plastic.

Minimum quantity  
Advertising code

1,000 pieces  
barrel S, clip T

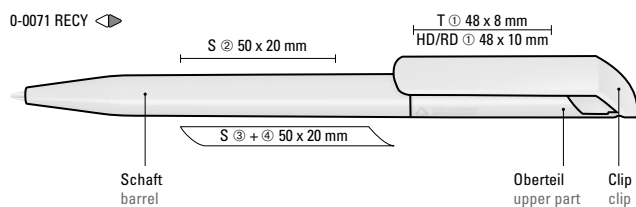
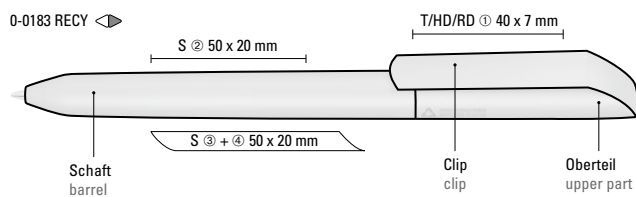

Farb-Code/Minen  
Colour code/Refills

VANE RECY  
0-0183 RECY

POP RECY  
0-0071 RECY

0-0183 RECY (● 8-0866)



0-0071 RECY (● 8-0866)



Die Modelle sind mit Recyclingzeichen gekennzeichnet. Aufgrund der Besonderheit des Materials (Post-Consumer Recycled Plastic) sind produktionstechnische Farbschwankungen gegeben.

The models are labelled with the recycling mark. Due to the special nature of the material (post-consumer recycled plastic) colour variations may occur during the production process.



**Mix'n Match:** Ab 2.000 Stück kann das Modell farblich kombiniert werden.

0-0183 RECY: Drehkugelschreiber mit gedeckt mattem Gehäuse und Clip aus 100% recyceltem Post-Consumer-Kunststoff.

0-0071 RECY: Drehkugelschreiber mit gedeckt glänzendem Gehäuse aus 100% recyceltem Post-Consumer-Kunststoff.

0-0183 RECY  
Mindestbestellmenge 1.000 Stück  
Werbeschlüssel Schaft S, Clip T/HD/RD

0-0071 RECY  
Mindestbestellmenge 1.000 Stück  
Werbeschlüssel Schaft S, Kappe T, Clip T/HD/RD

**Mix'n Match:** From 2,000 pieces, you can choose any colour combination.

0-0183 RECY: Twist ballpoint pen with opaque matt housing and clip made from 100% recycled post-consumer plastic.

0-0071 RECY: Twist ballpoint pen with opaque glossy housing made from 100% recycled post-consumer plastic.

0-0183 RECY  
Minimum quantity 1,000 pieces  
Advertising code barrel S, clip T/HD/RD

0-0071 RECY  
Minimum quantity 1,000 pieces  
Advertising code barrel S, cap T, clip T/HD/RD





- 0-0063 RECY (● 8-0866) Drücker/Stopfen ABS push-button/plug ABS
- 32-0534 ● 32-0292
- 32-0350 ● 32-2175
- 32-0432 ● 32-2147
- 32-0425 ● 32-0200
- 32-0428 ● 32-0382
- 32-0001 ● 32-0348
- 32-0466 ● 32-0343
- 32-7532 ● 32-0002
- 8-0866 ● 32-0428
- 32-0001
- 32-0115
- 32-2705
- 32-2685
- 32-0188
- 32-0203
- 32-0213
- 32-1585
- 32-0638
- 32-3262
- 32-0321
- 32-0468
- 32-7569
- 32-0469

0-0063 RECY: Drücker und Stopfen sind ab 2.000 Stück auch in allen glänzend gedeckten ABS Standardfarben erhältlich.

0-0063 RECY: From 2,000 units, push-buttons and plugs are available in all solid shiny ABS standard colours.

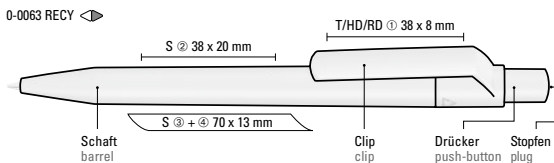

**Mix'n Match:** Ab 2.000 Stück kann das Modell farblich kombiniert werden.

0-0063 RECY: Druckkugelschreiber mit gedeckt matten Gehäuse, Clip, Drücker und Stopfen aus 100% recyceltem Post-Consumer-Kunststoff. Das Modell ist mit dem Recyclingzeichen gekennzeichnet. Drücker und Stopfen optional in verschiedenen gedeckt glänzenden Farben (Standard ABS) erhältlich. Aufgrund der Besonderheit des Materials (Post-Consumer Recycled Plastic) sind produktionstechnische Farbschwankungen gegeben.

Mindestbestellmenge  
Werbeschlüssel

1.000 Stück  
Schaft S, Clip T/HD/RD



**Mix'n Match:** From 2,000 pieces, you can choose any colour combination.

0-0063 RECY: Retractable ballpoint pen with opaque matt housing, clip, push-button and plug made of 100% recycled post-consumer plastic. The model is labelled with the recycling mark. Push-buttons and plugs optionally available in various opaque glossy colours (standard ABS). Due to the special nature of the material (post-consumer recycled plastic), colour variations may occur during the production process.

Minimum quantity  
Advertising code

1,000 pieces  
barrel S, clip T/HD/RD

Farb-Code/Minen  
Colour code/Refills

PIXEL RECY  
0-0017 RECY

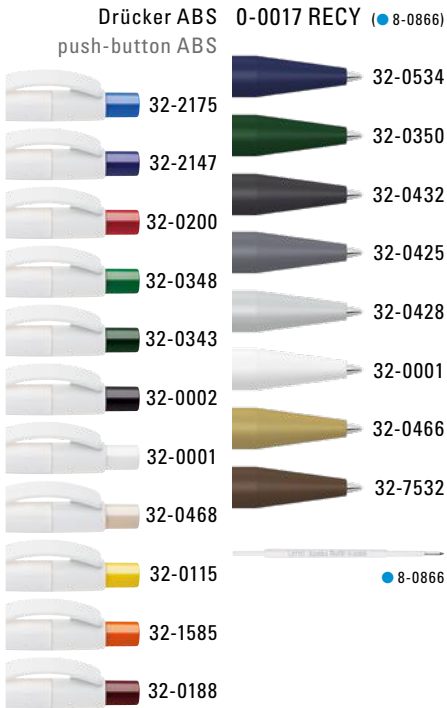

0-0017 RECY:  
Drücker sind ab 2.000 Stück  
auch in allen glänzend  
gedeckten ABS Standardfarben  
erhältlich.

0-0017 RECY:  
From 2,000 units, plugs are  
available in all solid shiny ABS  
standard colours.

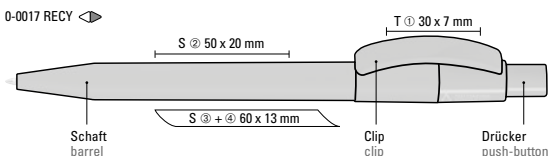

**Klimaneutral**  
Schreibgerät  
ClimatePartner.com/13223-2104-1001

POST-CONSUMER  
RECYCLED PLASTIC



**Mix'n Match:** Ab 2.000 Stück kann das Modell farblich kombiniert werden.

0-0017 RECY: Druckkugelschreiber mit gedeckt mattem Kunststoffgehäuse aus 100 % recyceltem Post-Consumer-Kunststoff, glänzendem Bogenclip und Drücker. Das Modell ist mit dem Recyclingzeichen gekennzeichnet. Drücker optional in verschiedenen gedeckt glänzenden Farben (Standard ABS) erhältlich. Aufgrund der Besonderheit des Materials (Post-Consumer Recycled Plastic) sind produktionstechnische Farbschwankungen gegeben.

Mindestbestellmenge  
Werbeschlüssel

1.000 Stück  
Schaft S, Clip T

**Mix'n Match:** From 2,000 pieces, you can choose any colour combination.

0-0017 RECY: Retractable ballpoint pen with matt plastic housing made from 100 % recycled post-consumer plastic, opaque glossy curved clip and push-button. The model is labelled with the recycling mark. Push-buttons available in various opaque glossy colours (standard ABS). Due to the special nature of the material (post-consumer recycled plastic), colour variations may occur during the production process.

Minimum quantity  
Advertising code

1,000 pieces  
barrel S, clip T

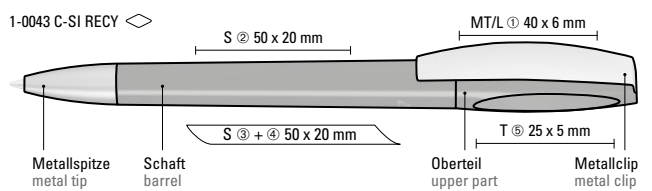
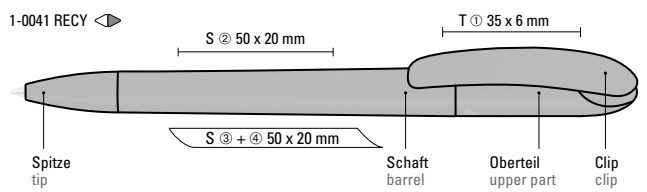

Farb-Code/Minen  
Colour code/Refills

CETA RECY  
1-0041 RECY

CHILL C SI RECY  
1-0043 C-SI RECY

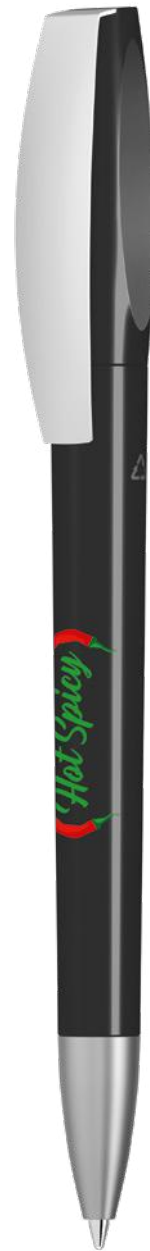
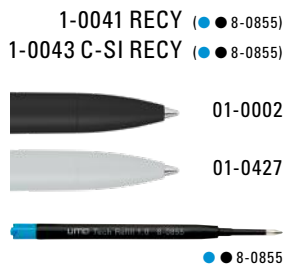

umaBlackForest  
*Pens*



Die Modelle sind mit Recyclingzeichen gekennzeichnet. Aufgrund der Besonderheit des Materials (Post-Consumer Recycled Plastic) sind produktionstechnische Farbschwankungen gegeben.

The models are labelled with the recycling mark. Due to the special nature of the material (post-consumer recycled plastic) colour variations may occur during the production process.



1-0041 RECY: Drehkugelschreiber mit gedeckt mattem Gehäuse aus 100% recyceltem Post-Consumer-Kunststoff.

1-0043 C-SI RECY: Drehkugelschreiber mit gedeckt glänzendem Gehäuse aus 100% recyceltem Post-Consumer-Kunststoff. Metallclip und schwere Metallspitze matt verchromt.

1-0041 RECY  
Minimum quantity 1.000 Stück  
Advertising code Werbeschlüssel Schaft S ○, Clip T

1-0043 C-SI RECY  
Minimum quantity 1.000 Stück  
Advertising code Werbeschlüssel Schaft S ○, Clip MT/L, Kappe T

1-0041 RECY: Twist ballpoint pen with opaque matt housing made from 100% recycled post-consumer plastic.

1-0043 C-SI RECY: Twist ballpoint pen with opaque glossy housing made from 100% recycled post-consumer plastic. Metal clip and heavy metal tip matt chromed.

1-0041 RECY  
Minimum quantity 1,000 pieces  
Advertising code barrel S ○, clip T

1-0043 C-SI RECY  
Minimum quantity 1,000 pieces  
Advertising code barrel S ○, clip MT/L, cap T

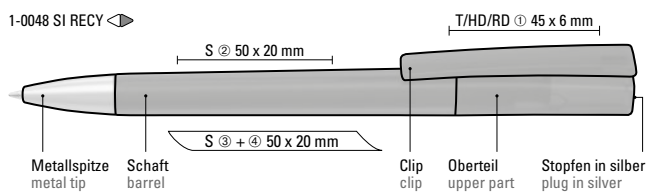



Farb-Code/Minen  
Colour code/Refills

ULTIMATE SI RECY  
1-0048 SI RECY



umaBlackForest  
*Pens*



Das Modell ist mit Recyclingzeichen gekennzeichnet. Aufgrund der Besonderheit des Materials (Post-Consumer Recycled Plastic) sind produktionstechnische Farbschwankungen gegeben.

The model is labelled with the recycling mark. Due to the special nature of the material (post-consumer recycled plastic) colour variations may occur during the production process.



1-0048 SI RECY: Drehkugelschreiber mit gedeckt mattem Gehäuse aus 100% recyceltem Post-Consumer-Kunststoff. Metallspitze matt verchromt. Stopfen optional in verschiedenen matt gedeckten Farben oder silber (Standard ABS) erhältlich.

Mindestbestellmenge  
Werbeschlüssel

1.000 Stück  
Schaft S O, Clip T/HD/RD

1-0048 SI RECY: Twist ballpoint pen with opaque matt housing made from 100% recycled post-consumer plastic. Metal tip matt chromed. Plugs optionally available in various matt colours or silver (standard ABS).

Minimum quantity  
Advertising code

1,000 pieces  
barrel S O, clip T/HD/RD







## PEFC- und FSC®- Zertifizierung

Holz: ein ganz besonderes Material voller Wärme und natürlich gewachsener Einzigartigkeit: Jeder Kugelschreiberschaft ist ein Unikat mit eigener Geschichte. Als führender Hersteller von Werbekugelschreibern legen wir bei uma großen Wert auf Individualität. Unsere Schreibgeräte aus Holz sind dabei so einzigartig wie der Baum, aus dem sie entstanden sind.

Als Produzent aus dem Schwarzwald freut es uns, PEFC- und auch FSC®-zertifizierte Holzschreibgeräte garantieren zu können und somit zum Schutz von nachhaltigen Rohstoffen beizutragen. Für uns ist es eine Selbstverständlichkeit, an diesem Verfahren zur nachhaltigen Waldbewirtschaftung und zum Schutz eines wichtigen Rohstoffes teilzunehmen.

Die Zertifikate garantieren, dass Holz- und Papierprodukte aus nachhaltig bewirtschafteten Wäldern stammen. Mit einer Fläche von über 265 Millionen Hektar zertifizierter Waldfläche garantiert PEFC als größtes Waldzertifizierungssystem weltweit ausreichend Rohstoffmengen. Und rund 1,44 Millionen Hektar Wald sind in Deutschland FSC®-zertifiziert. Dank dieser Zertifizierungen übernehmen wir bei uma gesellschaftliche Verantwortung, denn wir unterstützen den verantwortungsbewussten Umgang mit Ressourcen und setzen uns somit für den aktiven Beitrag zum Erhalt der Wälder ein.

Für die uma Schreibgeräte aus Holz wird ausschließlich deutsches PEFC- und FSC®-zertifiziertes Buchenholz verwendet. Durch spezielle Bearbeitung des nachwachsenden Rohstoffs transportiert das Naturprodukt Ihre Werbebotschaft edel und formschön zum Kunden. Der Naturstoff Holz variiert sowohl in der Farbigkeit des Holzes als auch in der Struktur (Maserung).



## PEFC and FSC® certification

Wood is a very special material, full of warmth and naturally grown uniqueness: every ballpoint pen barrel is unique and has its own history. As a leading manufacturer of promotional pens, we at uma attach great importance to individuality. Our wooden writing instruments are as unique as the trees they came from.

As a producer from the Black Forest, we are pleased to guarantee that our wooden writing instruments are PEFC and FSC® certified, and to contribute to the protection of sustainable raw materials in this way. It is natural for us to want to participate in this scheme for sustainable forest management and the protection of an important raw material.

These certifications guarantee that wood and paper products come from sustainably managed forests. With over 265 million hectares (655 million acres) of certified forests, PEFC is the world's largest forest certification system and guarantees sufficient quantities of raw materials. And about 1.44 million hectares German forests are FSC® certified. Thanks to this certifications, we at uma assume social responsibility by supporting responsible use of resources and being committed to making an active contribution to preserving forests.

Only german PEFC and FSC® certified beechwood is used for the uma writing utensils made of wood. Through special processing of the sustainable raw material, the natural product transports its advertising message in a refined and beautiful design to the customer. Wood is a natural material with a great variety of colours and textures (grain effect).





5-5400 ◊

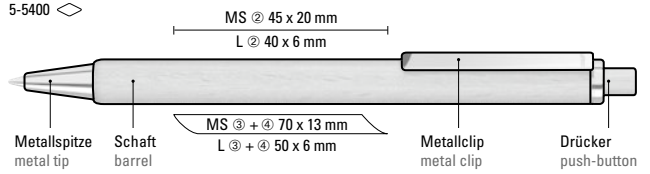

5-5900 ◊

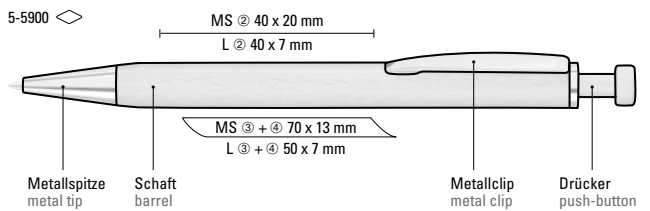

Farb-Code/Minen  
Colour code/Refills

TREE  
5-5400 **new!**

LEAF  
5-5900

5-5400 (● 8-0877)



08-W001



● 8-0877

5-5900 (● 8-0855)



37-W001



● 8-0855



Klimaneutral  
Schreibgerät  
ClimatePartner.com/13223-1907-1003



PEFC/04-31-3311



Das Zeichen für  
verantwortungsvolle  
Waldwirtschaft

Der Naturstoff Holz variiert sowohl in der Farbigkeit des Holzes als auch in der Struktur (Maserung).

Wood is a natural material with a great variety of colours and textures (grain effect).

5-5400: Holz-Druckkugelschreiber mit Holzdrücker, Metallclip und Metallspitze glanzverchromt. Schaft und Drücker aus schutzlackiertem PEFC-zertifiziertem Buchenholz.

5-5900: Holz-Druckkugelschreiber mit Holzdrücker, Metallclip und Metallspitze glanzverchromt. Schaft und Drücker aus schutzlackiertem FSC®-zertifiziertem Buchenholz.

5-5400: Wooden retractable ballpoint pen with wooden push-button, metal clip and metal tip chrome plated. Barrel and push-button made from PEFC-certified beechwood with protective varnish coating.

5-5900: Wooden retractable ballpoint pen with wooden push-button, metal clip and metal tip chrome plated. Barrel and push-button made from FSC® certified beechwood with protective varnish coating.

Mindestbestellmenge  
Werbeschlüssel

300 Stück  
Schaft MS/L

Minimum quantity  
Advertising code

300 pieces  
barrel MS/L



WOODY  
5-5600

WOODY B  
5-5607 B

CALIBRA S  
5-5100

Farb-Code/Minen  
Colour code/Refills



5-5600 (● 8-0855)  
5-5607 B (0,7mm)

05-W001 



● 8-0855

5-5100 (● 8-0888)

05-W001 



● 8-0888

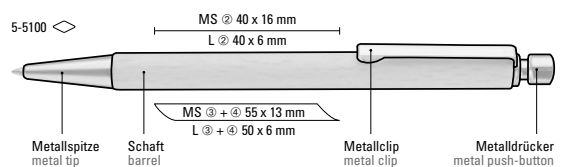
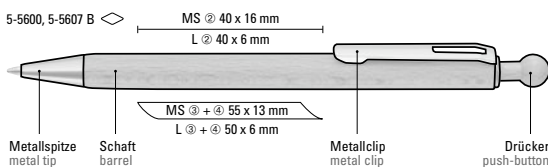

5-5600: Holz-Druckkugelschreiber mit Holz-Kugeldrücker, Metallclip und Metallspitze silber glänzend. Schaft und Drücker aus schutzlackiertem PEFC-zertifiziertem Buchenholz.

5-5607 B: Holz-Druckbleistift (0,7 mm) mit Holz-Kugeldrücker, Metallclip und Metallspitze silber glänzend. Schaft und Drücker aus schutzlackiertem PEFC-zertifiziertem Buchenholz.

5-5100: Holz-Druckkugelschreiber mit Metalldrücker, Metallclip und Metallspitze silber glänzend. Schaft aus schutzlackiertem PEFC-zertifiziertem Buchenholz.

Mindestbestellmenge  
Werbeschlüssel

300 Stück  
Schaft MS/L

5-5600: Wooden retractable ballpoint pen with wooden ball-button, metal clip and metal tip silver glossy. Barrel and push-button made from PEFC-certified beechwood with protective varnish coating.

5-5607 B: Wooden mechanical pencil (0.7 mm) with wooden ball-button, metal clip and metal tip silver glossy. Barrel and push-button made from PEFC-certified beechwood with protective varnish coating.

5-5100: Wooden retractable ballpoint pen with metal push-button, metal clip and metal tip silver glossy. Barrel made from PEFC-certified beechwood with protective varnish coating.

Minimum quantity  
Advertising code

300 pieces  
barrel MS/L

Farb-Code/Minen  
Colour code/Refills

FOREST  
5-5200

FOREST B  
5-5207 B

BEECH  
5-5800

5-5200 (● 8-0877)  
5-5207 B (0,7mm)



05-W001



● 8-0877

5-5800 (● 8-0855)



08-W001



● 8-0855

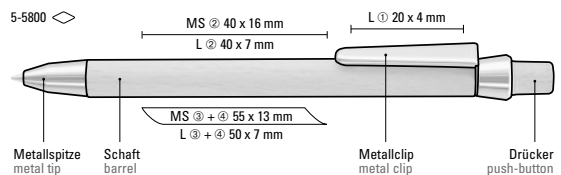
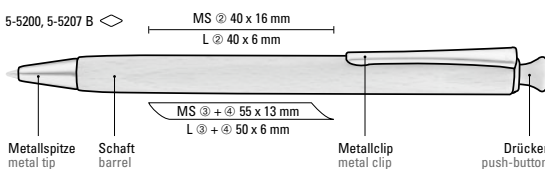

5-5200: Holz-Druckkugelschreiber mit Holzdrücker, Metallclip und Metallspitze silber glänzend. Schaft und Drücker aus schutzlackiertem PEFC-zertifiziertem Buchenholz.

5-5207 B: Holz-Druckbleistift (0,7mm) mit Holzdrücker, Metallclip und Metallspitze silber glänzend. Schaft und Drücker aus schutzlackiertem PEFC-zertifiziertem Buchenholz.

5-5800: Holz-Druckkugelschreiber mit Holzdrücker, Metallclip und Metallspitze glanzverchromt. Schaft und Drücker aus schutzlackiertem PEFC-zertifiziertem Buchenholz.

5-5200, 5207 B  
Mindestbestellmenge  
Werbeschlüssel

300 Stück  
Schaft MS/L

5-5800  
Mindestbestellmenge  
Werbeschlüssel

300 Stück  
Schaft MS/L, Clip L

5-5200: Wooden retractable ballpoint pen with wooden push-button, metal clip and metal tip silver glossy. Barrel and push-button made from PEFC-certified beechwood with protective varnish coating.

5-5207 B: Wooden mechanical pencil (0.7 mm) with wooden push-button, metal clip and metal tip silver glossy. Barrel and push-button made from PEFC-certified beechwood with protective varnish coating.

5-5800: Wooden retractable ballpoint pen with wooden push-button, metal clip and metal tip chrome plated. Barrel and push-button made from PEFC-certified beechwood with protective varnish coating.

5-5200, 5-5207 B  
Minimum quantity  
Advertising code

300 pieces  
barrel MS/L, clip L

5-5800  
Minimum quantity  
Advertising code

300 pieces  
barrel MS/L, clip L

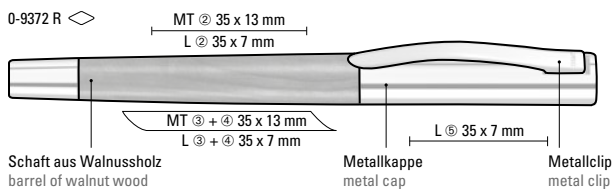
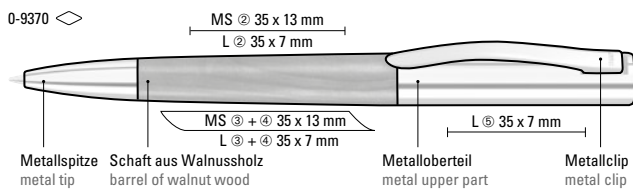

Farb-Code/Minen  
Colour code/Refills

TITAN WOOD  
0-9370

TITAN WOOD R  
0-9372 R

0-9370 (● 8-0888)



0-9372 R (● 8-0806)



Das Zeichen für verantwortungsvolle  
Waldwirtschaft



Der Naturstoff Holz variiert sowohl in der Farbigkeit des Holzes als auch in der Struktur (Maserung).

Wood is a natural material with a great variety of colours and textures (grain effect).

Etui Empfehlung/Case suggestion

ETUI 0-0944

Informationen unter [www.uma-pen.com](http://www.uma-pen.com)  
Information at [www.uma-pen.com](http://www.uma-pen.com)

0-9370: Metall-Drehkugelschreiber mit Schaft aus FSC®-zertifiziertem Walnussholz, Softdrehmechanik und gefedertem Clip. Oberteil, Clip und Spitze glanzverchromt.

0-9372 R: Metall-Rollerball mit Schaft aus FSC®-zertifiziertem Walnussholz und gefedertem Clip. Kappe und Clip glanzverchromt.

0-9370

Mindestbestellmenge  
Werbeschlüssel

100 Stück  
Schaft MS/L, Oberteil L

0-9372 R

Mindestbestellmenge  
Werbeschlüssel

100 Stück  
Schaft MT/L, Kappe L

0-9370: Metal twist ballpoint pen with barrel made from FSC® certified walnut wood, soft twist mechanism and spring-mounted clip. Upper part, clip and tip glossy chrome plated.

0-9372 R: Metal roller ball with barrel made from FSC® certified walnut wood, spring-mounted clip. Cap and clip glossy chrome plated.

0-9370

Minimum quantity  
Advertising code

100 pieces  
barrel MS/L, upper part L

0-9372 R

Minimum quantity  
Advertising code

100 pieces  
barrel MT/L, cap L



0-9190 WOOD 

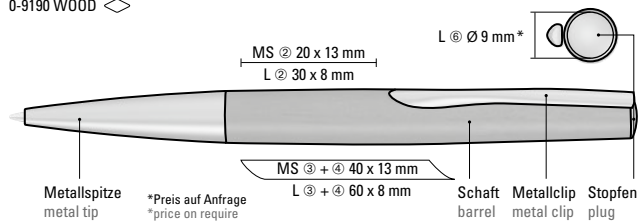



Farb-Code/Minen  
Colour code/Refills

ELEGANCE WOOD  
0-9190 WOOD

0-9190 WOOD (● 8-0888)



53-W001



LITKO Extra Class Refill 8-0888

● 8-0888



Das Zeichen für  
verantwortungsvolle  
Waldwirtschaft

Der Naturstoff Holz variiert sowohl in der Farbigkeit des Holzes als auch in der Struktur (Maserung).

Wood is a natural material with a great variety of colours and textures (grain effect).

0-9190 WOOD: Metall-Drehkugelschreiber mit Schaft aus FSC®-zertifiziertem Walnussholz, gefederter Metallclip, Metallstopfen, schwere Metallspitze matt verchromt und Softdrehmechanik.

Mindestbestellmenge  
Werbeschlüssel

100 Stück  
Schaft MS/L, Stopfen L

0-9190 WOOD: Metal twist ballpoint pen with FSC® certified walnut barrel, spring-mounted metal clip, plug, metal tip matt chrome-plated and soft twist mechanism.

Minimum quantity  
Advertising code

100 pieces  
barrel MS/L, plug L



## Bio-Modelle / Bio models

---

### Cellulose / cellulose acetate



Der aus der Natur gewonnene Rohstoff kann dieser ebenfalls wieder zugeführt werden. Das Celluloseacetat entspricht der DIN EN 13432:2000-12/Zertifizierungsprogramm für Produkte aus kompostierbaren Werkstoffen. Die hierfür notwendige Cellulose wird aus europäischen Weichhölzern gewonnen.

The raw material gained from nature can also be returned to nature. The cellulose acetate complies with DIN EN 13432:2000-12/certification program for products from compostable materials. The cellulose required for this is gained from European softwoods.

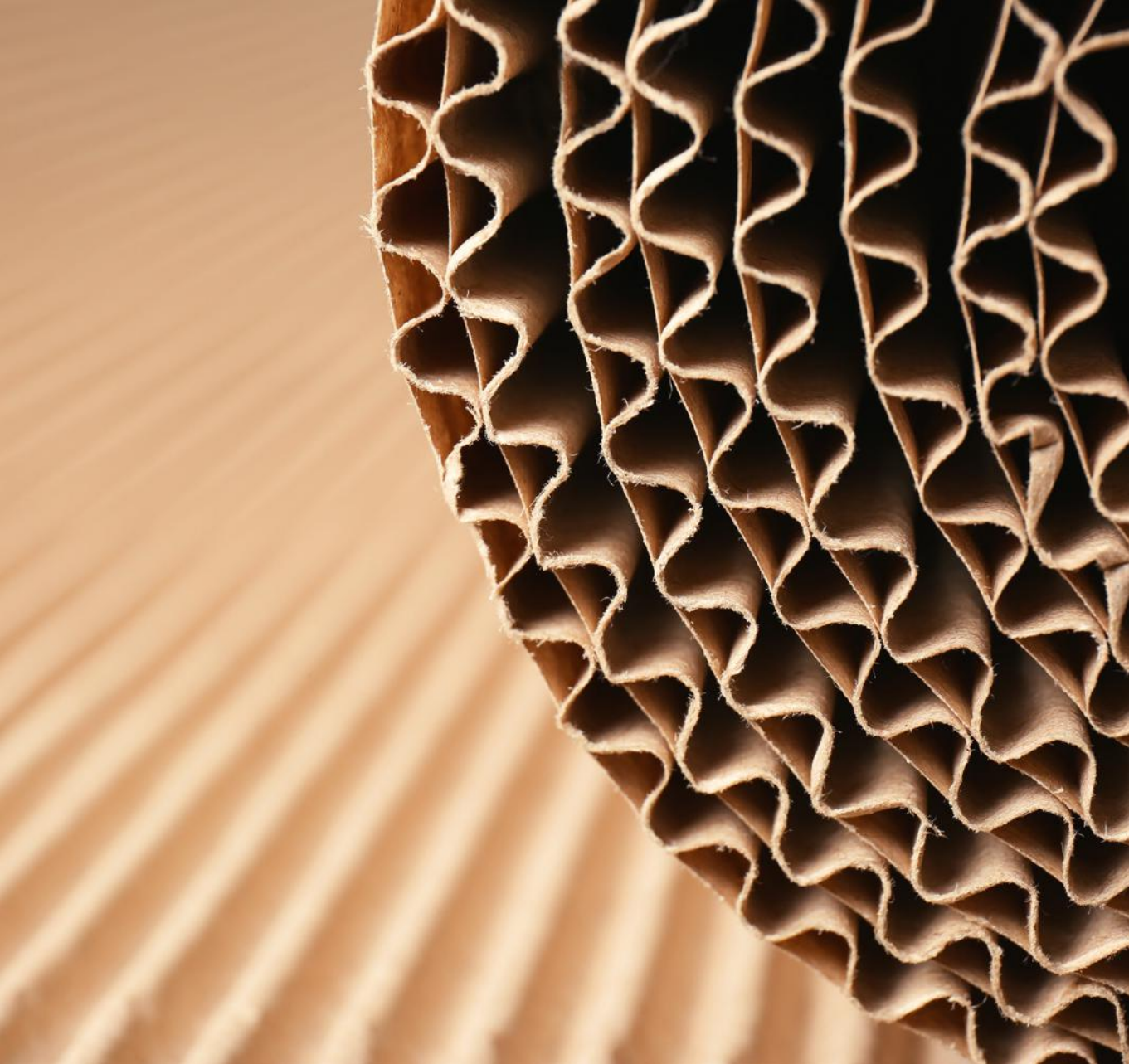

## Karton-Modelle/Cardboard models

---

### Recycelter Karton/recycled cardboard

Die Verwendung von bereits recycelter Kartonage bietet eine stabile und zugleich umweltverträgliche Grundlage für die Herstellung von Schreibgeräten. Das Material kann dem Recyclingprozess wieder zugeführt werden und trägt so zur Umweltschonung bei. Die Verwendung dieser besonderen Materialien unterliegt produktionstechnischen Schwankungen. Leichte Unterschiede in Farbe und Oberfläche sind daher möglich.

The use of cardboard that has already been recycled offers a stable and at the same time environmentally friendly basis for the production of writing utensils. The material can be returned to the recycling process again, thus contributing to helping the environment. The use of these special materials is subject to fluctuations in the production technology. As a result, slight differences in colour and surface are possible.





\*\*Die Herstellung der Clips und der Schäfte ist aufgrund des besonderen Materials produktionstechnischen Schwankungen unterlegen. Leichte Unterschiede in der Farbe und der Oberfläche (Schlierenbildung) sind möglich.

\*\* The production of the clips and barrels is subject to fluctuations due to the special material. Slight differences in colour and surface (smear formation) are possible.

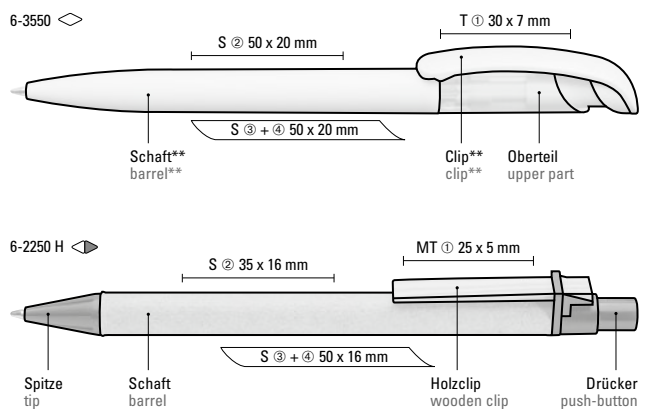



Farb-Code/Minen  
Colour code/Refills

BIO PEN  
6-3550

PAPER PEN  
6-2250 H

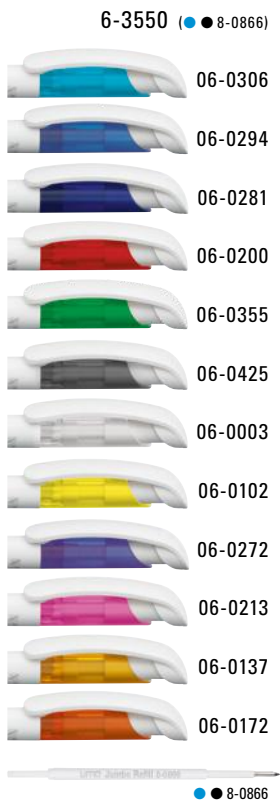

\* **06-7527 BIO-MIX:** Drücker und Spitze sind aus Bio-Material gefertigt. Der Werkstoff Celluloseacetat entspricht der DIN EN 13432:2000-12 und wird aus europäischen Weichhölzern gewonnen.

\* **06-7527 BIO-MIX:** Pushbutton and tip are made of bio material. This material – cellulose acetate – complies with DIN EN 13432:2000-12 and is derived from European softwoods.

6-3550: Druckkugelschreiber mit Gehäuse und Clip aus 100% nachwachsendem und kompostierbarem Material. Oberteil aus gefrostetem ABS Kunststoff.

6-2250 H: Druckkugelschreiber aus recycelter, naturfarbener Pappe. Spitze und Drücker unifarben aus recyceltem oder biologisch abbaubarem Kunststoff (\*06-7527 Bio-Mix) sowie Holzclip.

6-3550  
Mindestbestellmenge  
Werbeschlüssel  
6-2250 H  
Mindestbestellmenge  
Werbeschlüssel

1.000 Stück  
Schaft S ○, Clip T  
  
1.000 Stück  
Schaft S, Clip MT

6-3550: Retractable ballpoint pen with barrel and clip made from 100% renewable biodegradable material. Upper part made from transparent frosted ABS plastic.

6-2250 H: Retractable ballpoint pen made from recycled, natural-coloured cardboard. Tip and push-button uni-coloured made from recycled or biodegradable plastic (\*06-7527 Bio-Mix) as well as wooden clip.

6-3550  
Minimum quantity  
Advertising code  
6-2250 H  
Minimum quantity  
Advertising code  
1,000 pieces  
barrel S ○, clip T  
  
1,000 pieces  
barrel S, clip MT

## Unterverpackung

Für die Verpackung der Schreibgeräte verwenden wir ausschließlich Polybeutel aus 80 % recyceltem Material. Dies entspricht aktuell dem Maximalwert an recyceltem Material in Polybeuteln. Die Beutel können zu 100 % wieder dem Recycling Prozess zugeführt werden.

Wir weisen ausdrücklich darauf hin, dass wir bewusst auf den Einsatz von biologisch abbaubaren Materialien in den Polybeuteln verzichten. Diese Materialien können dem Recycling Prozess nicht zugeführt werden. Zudem stehen industrielle Kompostieranlagen bzw. Entsorgungsströme nicht zur Verfügung.

Zum Schutz der Schreibgeräte beim Transport und zur Vermeidung von voluminösem Kartonagenmüll empfehlen wir die Verpackung der Produkte in der uma LDPE-Bag.



## Reduced amounts of packaging

We only use polythene bags made of 80 % recycled material to pack our writing instruments. This currently equates to a maximum value of recycled material in polythene bags. 100 % of these bags can be returned to the recycling process.

We specifically wish to advise that we deliberately avoid the use of bio-degradable materials in these polythene bags. These materials cannot be directed to the recycling process. Furthermore, industrial composting facilities and/ or formal disposal mechanisms are not available.

To protect our writing instruments during transport, and to avoid high volumes of packaging waste, we recommend packing these products in an uma LDPE bag.



## Umverpackung

Die für den Transport verwendeten Umverpackungen der uma Produkte erfolgt in Kartons, die zu mehr als 85 % aus Altpapier bestehen und zertifiziert sind.



## Surrounding packaging

The cartons we use for the transport of the uma products comprise more than 85 % of used(old) paper and are certified.

## Versand

Auf Wunsch liefern wir Ihnen gerne die bestellte Ware klimaneutral. Gemeinsam mit UPS Carbon wird die CO<sub>2</sub>-Emission berechnet und in renommierten Klimaschutz-projekten ausgeglichen.

## Shipping

As an option, we would also be pleased to use climate-neutral packaging for the goods we send to you. Together with UPS Carbon, the CO<sub>2</sub> emission is calculated, and then balanced out in reputable climate protection projects.

ZUKUNFTSTRÄCHTIG

RECYCLINGIDEE

**VERANTWORTUNG**

**KLIMANEUTRAL**

**NACHHALTIGKEIT**

INNOVATIONEN

RECYCLED PET PEN

**AUSGEZEICHNET**

MENSCHENWÜRDIG

UMWELTVERTRÄGLICH

**PEFC-ZERTIFIZIERUNG**

ZUKUNFTSTRÄCHTIG

RECYCLINGIDEE

**HERAUSFORDERUNG**

**VERANTWORTUNG**

RECYCLED PET PEN

INNOVATIONEN

**KLIMANEUTRAL**

**NACHHALTIGKEIT**

MENSCHENWÜRDIG

**HERAUSFORDERUNG**

**PEFC-ZERTIFIZIERUNG**

UMWELTVERTRÄGLICH

**AUSGEZEICHNET**



Die Handschrift der Werbung

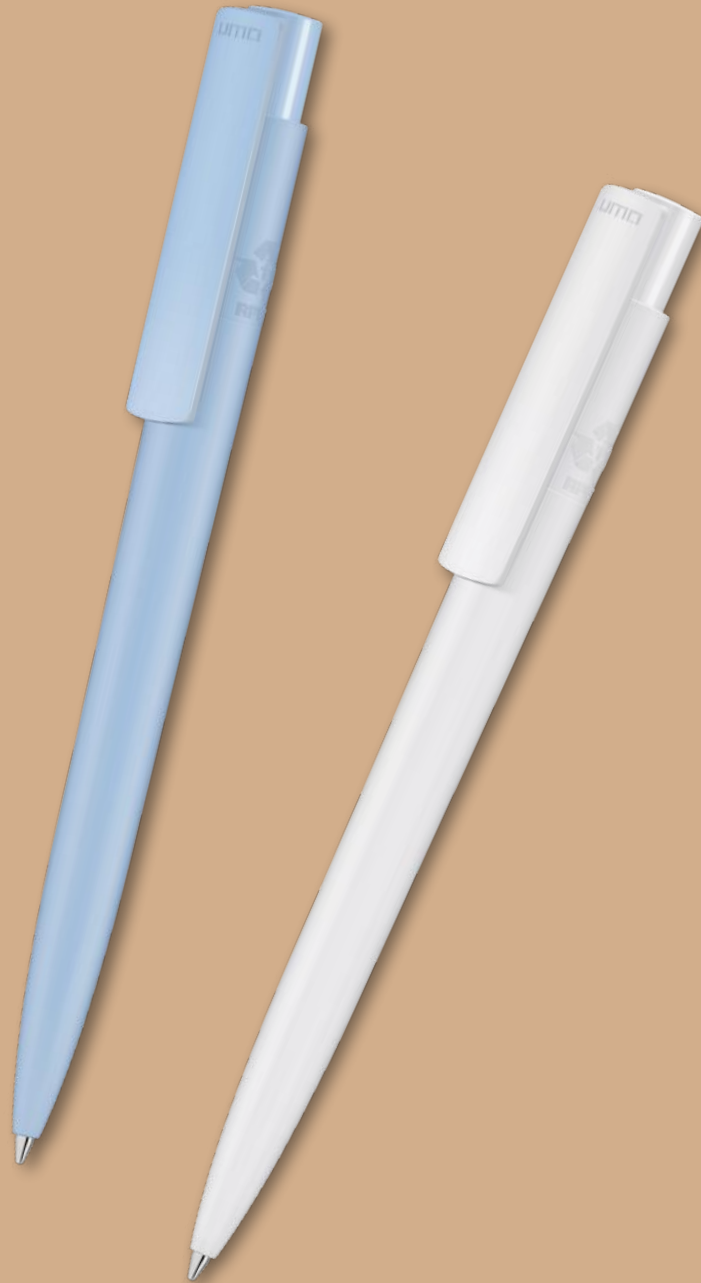

[www.uma-naturals.com](http://www.uma-naturals.com)