



ADRIANA HOYOS

HOSPITALITY



PRODUCT CATALOG
2024 - 2025



We specialize in providing pieces for commercial spaces that exude a unique and inviting ambiance, ensuring comfort and style in every setting.

LIVING ROOM | SALA

SOFAS & LOVESEATS
Sofás y loveseats

SECTIONALS
Seccionales

UPHOLSTERED CHAIRS
Poltronas

OTTOMANS
Otomanes

DAYBEDS
Daybeds

COCKTAIL TABLES
Mesas centrales

END TABLES
Mesas auxiliares

CONSOLES
Consolas



Referential photo. Some products, finishes or fabrics may no longer be available. /
Foto referencial. Algunos productos, acabados o telas podrían ya no estar disponibles.

ADRIANA HOYOS

SOFAS & LOVESEATS

sofás y loveseats



AH SIGNATURE SOFA 200/210
sofá ah signature 200/210



GALAPAGOS SOFA 100
sofá galápagos 100



H SOFA 500
sofá h 500



HOSPITALITY LOVESEAT 100
loveseat hospitality 100



LUA LOVESEAT 100
loveseat lua 100



LUA SOFA 100/110
sofá lua 100/110



LUA SOFA 200
sofá lua 200



RUMBA SOFA 100/110
sofá rumba 100/110



TEN SOFA / LOVESEAT 110
loveseat ten 110

Slight color variations may occur while printing tearsheets due to printers pixelation and quality. Product specifications are subject to change due to product development updates.
Ligeras variaciones de color pueden ocurrir en la impresión. Las especificaciones están sujetas a cambios debido a las necesidades del producto.
Dimensions are usually approximated to the nearest quarter inch that will correspond to its metric conversion.
Las medidas generalmente se dan de acuerdo a la conversión métrica correspondiente y con una medida aproximada.

AH SIGNATURE SOFA 200
sofá ah signature 200

AH12-200

w 96" D 40^{1/2"} H 32^{1/4"} SH 18^{1/2"}
244 cm 103 cm 82 cm 47 cm

sw 80^{1/4"} SD 23^{1/2"} AH 22"
204 cm 60 cm 56 cm

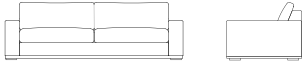
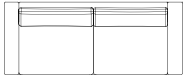

a:wood finish

AH SIGNATURE SOFA 210
sofá ah signature 210

AH12-210

w 118" D 40^{1/2"} H 32^{1/4"} SH 18^{1/2"}
300 cm 103 cm 82 cm 47 cm

sw 102^{1/4"} SD 23^{1/2"} AH 22"
260 cm 60 cm 56 cm

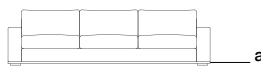
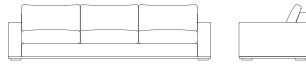
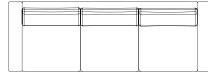

a:wood finish

Wood finish / Acabado madera



PIPING DETAIL / detalle ribete



Mixed filling with feathers and down. / Relleno combinado de plumas y plumón para garantizar mayor confort.
Feathers filling may cause wrinkles on the fabric. / El relleno de plumas puede causar arrugas en la tela.
Piping can be customized. / El ribete puede ser personalizado..

GALAPAGOS SOFA 100
sofá galápagos 100

GS12-100

w 102^{1/4"} d 46^{1/2"} *H 35^{1/2"} SH 17^{3/4"}
260 cm 118 cm 90 cm 45 cm

sw 102^{1/4"} sd 25^{1/2"}
260 cm 65 cm

Wood finish / Acabado madera

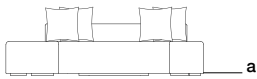
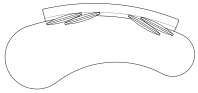

a: wood finish



BACK PILLOWS (X4) / cojines de espaldar (x4)

w 19^{3/4"} d 19^{3/4"}
50 cm 50 cm



Relaxed Comfort: the fixed seats are constructed with a premium combination of high-density foam and sinuous springs, providing excellent support, shock absorption, and softness. / Confort Relax: Los asientos fijos están fabricados con la mejor combinación de espuma de alta densidad y resortes sinuosos, que proporcionan un excelente soporte, absorción de impactos y suavidad.

Back pillows included. / Incluye cojines de espaldar.

(*H) Height may vary according to the inclination of the back pillows. / (H) La altura puede variar según la inclinación de los cojines del respaldo.



Referential photo. Some products, finishes or fabrics may no longer be available. /
Foto referencial. Algunos productos, acabados o telas podrían ya no estar disponibles.

ADRIANA HOYOS

H SOFA 500
sofá h 500

HS12-500

w 86^{1/2"} d 37^{1/2"} *H 33^{3/4"} SH 17^{3/4"}
220 cm 95 cm 86 cm 45 cm

sw 69^{1/4"} sd 25^{1/2"} AH 28"
176 cm 65 cm 71 cm

Wood finish / Acabado madera

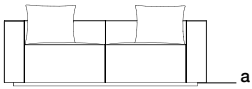
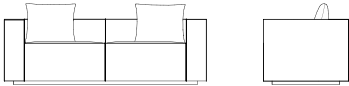
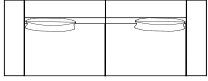

a: wood finish

BACK PILLOWS (X2) / COJINES DE ESPALDAR (X2)

w 19^{3/4"} d 19^{3/4"}
50 cm 50 cm

INVERTED SEAM / costura invertida



Back Pillows included. / Incluye cojines de espaldar.

(H) Height may vary according to the inclination of the back pillows. / (H) La altura puede variar según la inclinación de los cojines del respaldo.

**HOSPITALITY LEFT/RIGHT
LOVESEAT 100**
loveseat hospitality izq./der. 100

HT11-100 L/R

w 69^{1/4"} d 34^{1/4"} H 27^{1/2"} SH 17^{3/4"}
176 cm 87 cm 70 cm 45 cm

sw 63" sd 23^{1/2"}
160 cm 60 cm

Left | Izquierda

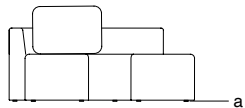
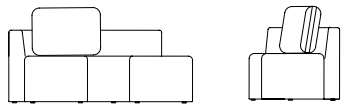
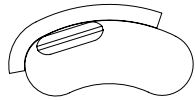

a:wood finish

Right | Derecha

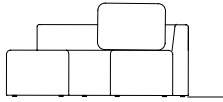
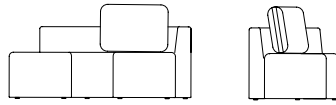
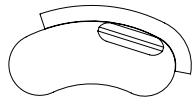

a:wood finish

BACK PILLOW / COJÍN DE ESPALDAR

w 20^{1/4"} H 17^{3/4"}
64 cm 45 cm



LUA LOVESEAT 100
loveseat lua 100

LU11-100

w 74^{3/4"} d 36^{1/2"} H 32" SH 17^{3/4"}
190 cm 93 cm 81 cm 45 cm

sw 74^{3/4"} sd 23^{1/2"}
190 cm 60 cm

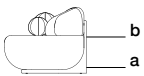
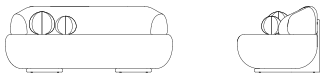
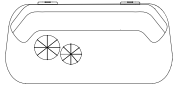

a:wood finish b:metal finish

Wood finish / Acabado madera



Metal finish / Acabado metal

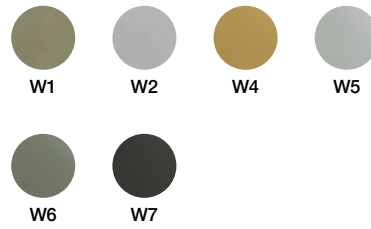

DECORATIVE PILLOW (X1) / cojín decorativo (x1)

DIAM 13"
33 cm

DECORATIVE PILLOW (X1) / cojín decorativo (x1)

DIAM 11"
28 cm



Relaxed Comfort: the fixed seats are constructed with a premium combination of high-density foam and sinuous springs, providing excellent support, shock absorption, and softness. / Confort Relax: Los asientos fijos están fabricados con la mejor combinación de espuma de alta densidad y resortes sinuosos, que proporcionan un excelente soporte, absorción de impactos y suavidad.

Decorative pillows included. / Incluye cojines decorativos.



Referential photo. Some products, finishes or fabrics may no longer be available. /
Foto referencial. Algunos productos, acabados o telas podrían ya no estar disponibles.

ADRIANA HOYOS

LUA SOFA 100
sofá lua 100

LU12-100

w 94^{1/2"} d 36^{1/2"} H 32" SH 17^{3/4"}
240 cm 93 cm 81 cm 45 cm

sw 94^{1/2"} sd 23^{1/2"}
240 cm 60 cm

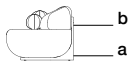
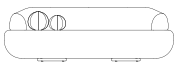
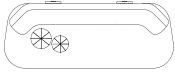

a:wood finish b:metal finish

DECORATIVE PILLOW (X1) / cojín decorativo (x1)

DIAM 13"
33 cm

DECORATIVE PILLOW (X1) / cojín decorativo (x1)

DIAM 11"
28 cm

LUA SOFA 110
sofá lua 110

LU12-110

w 110^{1/4"} d 36^{1/2"} H 32" SH 17^{3/4"}
280 cm 93 cm 81 cm 45 cm

sw 110^{1/4"} sd 23^{1/2"}
280 cm 60 cm

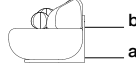

a:wood finish b:metal finish

Wood finish / Acabado madera



Metal finish / Acabado metal

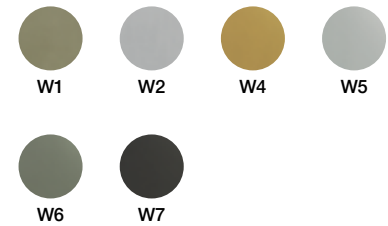

Relaxed Comfort: the fixed seats are constructed with a premium combination of high-density foam and sinuous springs, providing excellent support, shock absorption, and softness. / Confort Relax: Los asientos fijos están fabricados con la mejor combinación de espuma de alta densidad y resortes sinuosos, que proporcionan un excelente soporte, absorción de impactos y suavidad. Decorative pillows included. / Incluye cojines decorativos.

LUA SOFA 200
sofá lua 200

LU12-200

w 110^{1/4"} d 61" H 31^{1/2"} SH 17^{3/4"}
280 cm 155 cm 80 cm 45 cm

sw 110^{1/4"} SD 23^{1/2"}
280 cm 60 cm

Wood finish / Acabado madera

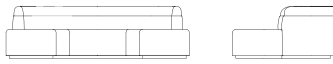

a:wood finish



Relaxed Comfort: the fixed seats are constructed with a premium combination of high-density foam and sinuous springs, providing excellent support, shock absorption, and softness. / **Confort Relax:** Los asientos fijos están fabricados con la mejor combinación de espuma de alta densidad y resortes sinuosos, que proporcionan un excelente soporte, absorción de impactos y suavidad.

RUMBA SOFA 100
sofá rumba 100

RM12-100

w 92^{1/2"} d 38^{1/4"} H 34^{1/4"} SH 17^{3/4"}
235 cm 97 cm 87 cm 45 cm

sw 73^{1/2"} sd 23^{1/2"}
187 cm 60 cm

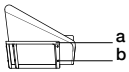
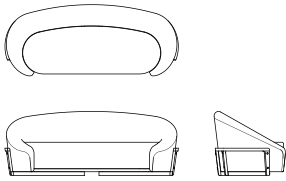

a:wood finish b:metallic button

RUMBA SOFA 110
sofá rumba 110

RM12-110

w 110^{1/4"} d 38^{1/4"} H 34^{1/4"} SH 17^{3/4"}
280 cm 97 cm 87 cm 45 cm

sw 91^{1/4"} sd 23^{1/2"}
232 cm 60 cm

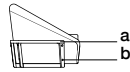
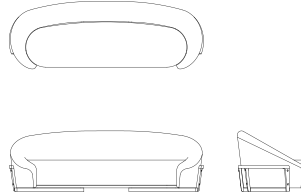

a:wood finish b:metallic button

Wood finish / Acabado madera



Metallic button / Botón metálico

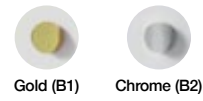

Relaxed Comfort: the fixed seats are constructed with a premium combination of high-density foam and sinuous springs, providing excellent support, shock absorption, and softness. /
Confort Relax: Los asientos fijos están fabricados con la mejor combinación de espuma de alta densidad y resortes sinuosos, que proporcionan un excelente soporte, absorción de impactos y suavidad.

TEN SOFA 110
sofá ten 110

TN12-110

W 94^{1/2"} D 35^{1/2"} H 35" SH 17^{3/4"}
240 cm 90 cm 89 cm 45 cm

SW 80^{1/4"} SD 23^{1/2"} AH 24^{3/4"}
204 cm 60 cm 63 cm

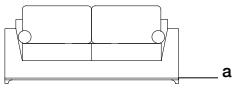
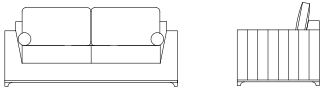

a:wood finish

TEN LOVESEAT 110
loveseat ten 110

TN11-110

W 74^{3/4"} D 35^{1/2"} H 35" SH 17^{3/4"}
190 cm 90 cm 89 cm 45 cm

SW 60^{3/4"} SD 23^{1/2"} AH 24^{3/4"}
154 cm 60 cm 63 cm

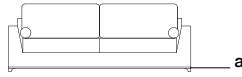
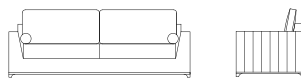
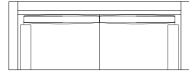

a:wood finish

Wood finish / Acabado madera



Bolster pillows included / Incluye cojines caramelo.





Referential photo. Some products, finishes or fabrics may no longer be available. /
Foto referencial. Algunos productos, acabados o telas podrían ya no estar disponibles.

ADRIANA HOYOS

SECTIONALS SECCIONALES



AH SECTIONAL
seccional ah



GALAPAGOS CURVED SECTIONAL
seccional curvo galápagos



H SECTIONAL
seccional h



LUA SECTIONAL
seccional lua

Slight color variations may occur while printing tearsheets due to printers pixelation and quality. Product specifications are subject to change due to product development updates.
Ligeras variaciones de color pueden ocurrir en la impresión. Las especificaciones están sujetas a cambios debido a las necesidades del producto.
Dimensions are usually approximated to the nearest quarter inch that will correspond to its metric conversion.
Las medidas generalmente se dan de acuerdo a la conversión métrica correspondiente y con una medida aproximada.

AH

SECTIONAL



AH14-200



AH14-210



AH13-210



AH13-200



AH16-200



AH47-200



AH70-200

**AH SIGNATURE
ARMLESS 2 SEAT 200**
módulo 2 pts. sin brazo
ah signature 200

AH14-200

w 70^{3/4"} d 40^{1/2"} H 32^{1/4"} SH 18^{1/2"}
180 cm 103 cm 82 cm 47 cm

sw 70^{3/4"} sd 23^{1/2"}
180 cm 60 cm

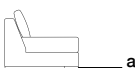

a: wood finish

**AH SIGNATURE HEXAGONAL
ARMLESS SEAT 200**
módulo hexagonal ah
signature 200

AH13-200

w 77^{1/4"} d 52^{1/4"} H 32^{1/4"} SH 18^{1/2"}
196 cm 133 cm 82 cm 47 cm

sw 59" sd 35^{1/2"}
150 cm 90 cm

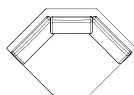

a: wood finish

Wood finish / Acabado madera



PIPING DETAIL / detalle ribete

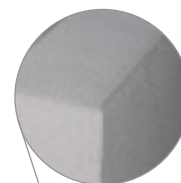

Mixed filling with feathers and down. / Relleno combinado de plumas y plumón para garantizar mayor confort.

Feathers filling may cause wrinkles on the fabric. / El relleno de plumas puede causar arrugas en la tela.

Piping can be customized. / El ribete es personalizable.

*For detailed dimensions, please refer to the cad block. / Para dimensiones detalladas ver el bloque del mueble.

SIGNATURE COLLECTION

**AH SIGNATURE ARMLESS
1 SEAT 210**
módulo 1 pt. sin brazo ah
signature 210

AH14-210

w 35^{1/2"} d 40^{1/2"} h 32^{1/4"} sh 18^{1/2"}
90 cm 103 cm 82 cm 47 cm

sd 23^{1/2"}
60 cm

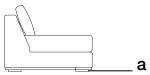
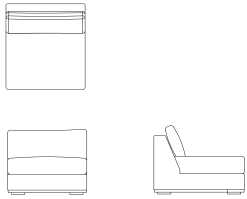

a: wood finish



**AH SIGNATURE ARMLESS
CHAISE LOUNGE 200**
chaise lounge sin brazo
ah signature 200

AH47-200

w 40^{1/2"} d 63" h 32^{1/4"} sh 18^{1/2"}
103 cm 160 cm 82 cm 47 cm

sw 40^{1/2"} sd 45^{1/4"}
103 cm 115 cm

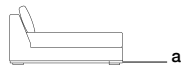
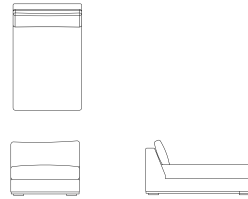

a: wood finish



Wood finish / Acabado madera



**AH SIGNATURE
LEFT/RIGHT ARM 200**
brazo ah signature
izq./der 200

AH70-200

w 7^{3/4"} d 40^{1/2"} h 22"
20 cm 103 cm 56 cm

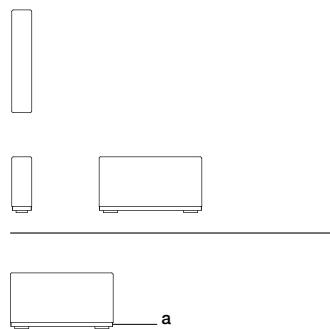

Mixed filling with feathers and down. / Relleno combinado de plumas y plumón para garantizar mayor confort.
Feathers filling may cause wrinkles on the fabric. / El relleno de plumas puede causar arrugas en la tela.
Piping can be customized. / El ribete es personalizable.
*For detailed dimensions, please refer to the cad block. / Para dimensiones detalladas ver el bloque del mueble.

**AH SIGNATURE
OTTOMAN 200**
otomán ah signature 200

AH16-200

W 35^{1/2"} D 40^{1/2"} H 18^{1/2"}
90 cm 103 cm 47 cm

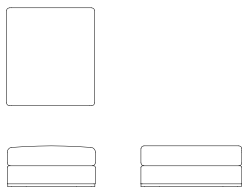

a:wood finish



**AH SIGNATURE
CORNER 210**
módulo esquinero
ah signature 210

AH13-210

W 40^{1/2"} D 40^{1/2"} H 32^{1/4"} SH 18^{1/2"}
103 cm 103 cm 82 cm 47 cm

SW 23^{1/2"} SD 23^{1/2"}
60 cm 60 cm



a:wood finish



Wood finish / Acabado madera



Build your own! | ¡Constrúyalo usted mismo!

Here you can find a suggested layout, but feel free to create a new one yourself.

Aquí encontrará combinaciones sugeridas, sin embargo le invitamos a que cree una nueva usted mismo.

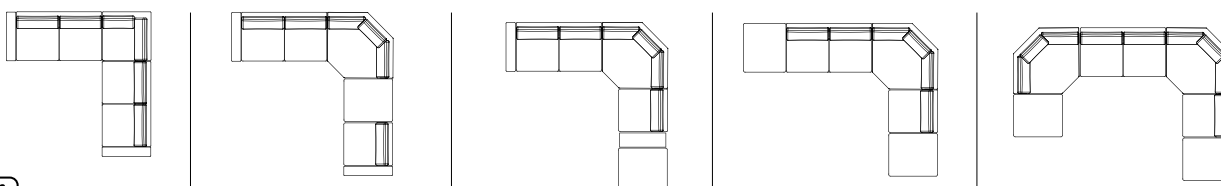
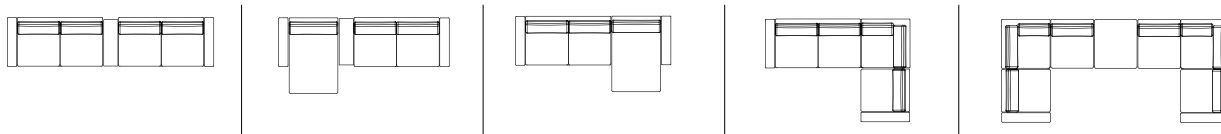

Mixed filling with feathers and down. / Relleno combinado de plumas y plumón para garantizar mayor confort.

Feathers filling may cause wrinkles on the fabric. / El relleno de plumas puede causar arrugas en la tela.

Piping can be customized. / El ribete es personalizable.

*For detailed dimensions, please refer to the cad block. / Para dimensiones detalladas ver el bloque del mueble.

GALAPAGOS CURVED

SECTIONAL



GS14-300



GS14-310



GS16-300

GALAPAGOS CURVED LEFT/RIGHT ARMLESS SOFA 300

módulo curvo izq./der. sin brazo galápagos 300

GS14-300 L/R

w 94^{1/2"} d 41^{1/4"} *H 35^{1/2"} SH 17^{3/4"}
 240 cm 105 cm 90 cm 45 cm

sw 94^{1/2"} *SD 25^{1/2"}
 240 cm 65 cm

BACK PILLOW (X3) /
 COJÍN DE ESPALDAR (X3)

w 19^{3/4"} H 19^{3/4"}
 50 cm 50 cm

Right | Derecha

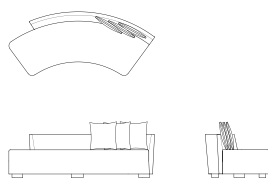

a:wood finish



Wood finish / Acabado madera



Left | Izquierda

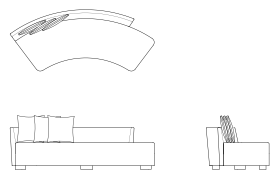

a:wood finish



Relaxed Comfort: the fixed seats are constructed with a premium combination of high-density foam and sinuous springs, providing excellent support, shock absorption, and softness. / Confort Relax: Los asientos fijos están fabricados con la mejor combinación de espuma de alta densidad y resortes sinuosos, que proporcionan un excelente soporte, absorción de impactos y suavidad.

Three back pillows included per set. / Incluye tres cojines de espalda por módulo.

* (H) Height may vary according to the inclination of the back pillows. / (H) La altura puede variar en función de la inclinación de los cojines de respaldo.

*For detailed dimensions, please refer to the cad block. / Para dimensiones detalladas ver el bloque del mueble.

GALAPAGOS
ARMLESS 1 SEAT 310
 módulo 1 pt.
 galápagos 310

GS14-310

w 51^{1/4"} d 32" H 27^{1/2"} SH 17^{3/4"}
 130 cm 81 cm 70 cm 45 cm

sw 33^{1/2"} sd 25^{1/2"}
 85 cm 65 cm

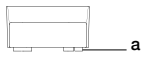
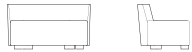

a:wood finish



GALAPAGOS OTTOMAN 300
 otomán galápagos 300

GS16-300

w 45^{3/4"} d 28" H 17^{3/4"}
 116 cm 71 cm 45 cm

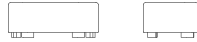

a:wood finish



Wood finish / Acabado madera



Build your own! ¡Constrúyalo usted mismo!

Here you can find a suggested layout, but feel free to create a new one yourself.
 Aquí encontrará combinaciones sugeridas, sin embargo le invitamos a que cree una nueva usted mismo.

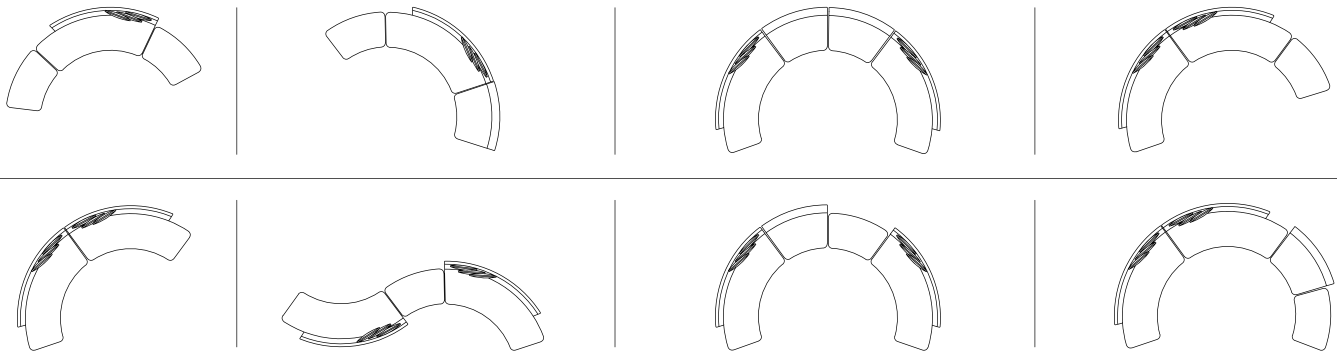

*For detailed dimensions, please refer to the cad block. / Para dimensiones detalladas ver el bloque del mueble.



Referential photo. Some products, finishes or fabrics may no longer be available. /
Foto referencial. Algunos productos, acabados o telas podrían ya no estar disponibles.

ADRIANA HOYOS



Referential photo. Some products, finishes or fabrics may no longer be available. /
Foto referencial. Algunos productos, acabados o telas podrían ya no estar disponibles.

ADRIANA HOYOS

H

SECTIONAL



HS14-510



HS13-510



HS70-500



HS16-500



HS20-500

H ARMLESS 1 SEAT 510
módulo 1 pt. sin brazo h 510

HS14-510

w 34^{3/4"} d 37^{1/2"} *H 35^{1/2"} SH 17^{3/4"}
88 cm 95 cm 90 cm 45 cm

sw 34^{3/4"} sd 19^{3/4"}
88 cm 50 cm

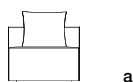
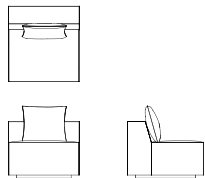

a:wood finish



H CORNER 510
módulo esquinero h 510

HS13-510

w 37^{1/2"} d 37^{1/2"} *H 35^{1/2"} SH 17^{3/4"}
95 cm 95 cm 90 cm 45 cm

sw 25^{1/2"} sd 19^{3/4"} AH 28"
65 cm 50 cm 71 cm

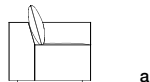
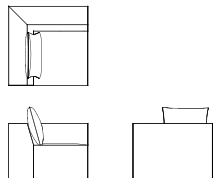

a:wood finish



Wood finish / Acabado madera



BACK PILLOW (1 PER SEAT) /
COJÍN DE ESPALDAR (1 POR MÓDULO)

w 19^{3/4"} d 19^{3/4"}
50 cm 50 cm

BACK PILLOW (1 PER SEAT) /
COJÍN DE ESPALDAR (1 POR MÓDULO)

w 19^{3/4"} d 19^{3/4"}
50 cm 50 cm



Back Pillows included. / Incluye cojines de espaldar.

* (H) Height may vary according to the inclination of the back pillows. / (H) La altura puede variar según la inclinación de los cojines del respaldo.

*For detailed dimensions, please refer to the cad block. / Para dimensiones detalladas ver el bloque del mueble.

H ARM LEFT/ RIGHT 500
brazo h izq./der. 500

HS70-500

w 8^{3/4"} d 37^{1/2"} *H 26^{1/2"}
22 cm 95 cm 67 cm

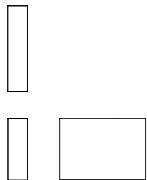

a:wood finish



H OTTOMAN 500
otomán h 500

HS16-500

w 34^{3/4"} d 34^{3/4"} *H 17^{3/4"}
88 cm 88 cm 45 cm

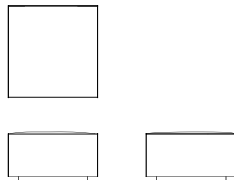

a:wood finish



Wood finish / Acabado madera



* (H) Height may vary according to the inclination of the back pillows. / (H) La altura puede variar según la inclinación de los cojines del respaldo.

*For detailed dimensions, please refer to the cad block. / Para dimensiones detalladas ver el bloque del mueble.

H END TABLE 500
 mesa auxiliar h 500

HS20-500

w 17^{3/4"} d 37^{1/2"} h 15^{3/4"}
 45 cm 95 cm 40 cm

Wood finish / Acabado madera

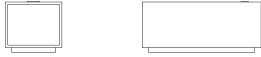

a: wood finish

CONNECTIVITY: | Conectividad:
 ELECTRIC & USB | Eléctrica & USB

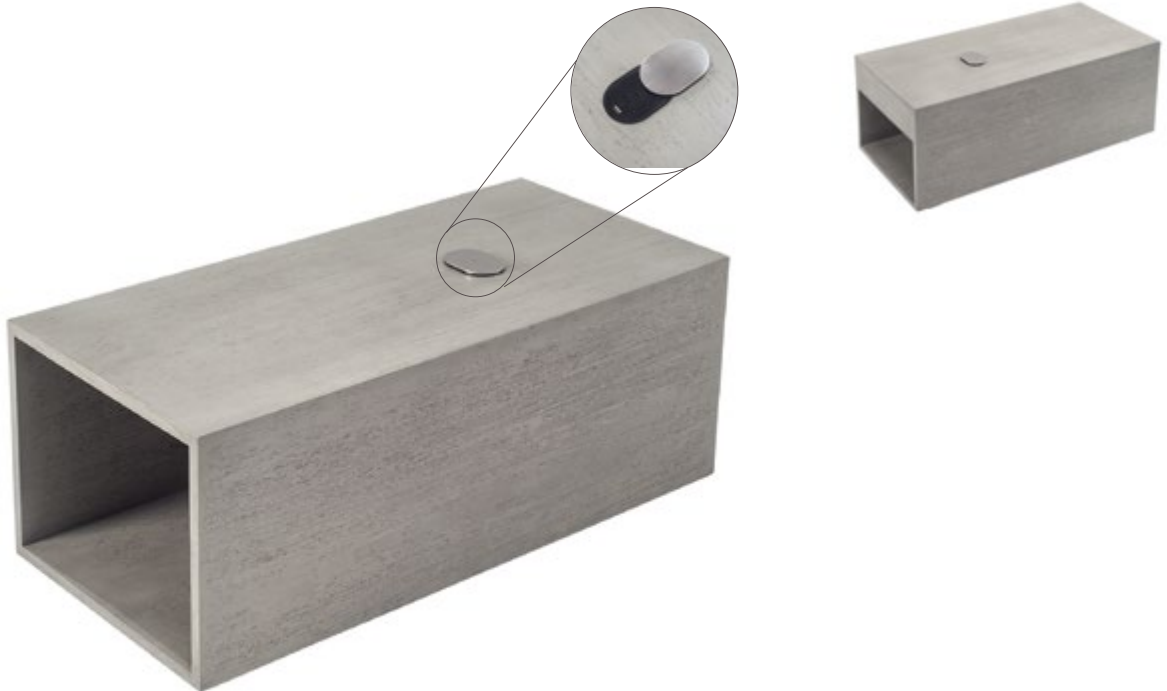

Build your own! | ¡Constrúyalo usted mismo!

Here you can find a suggested layout, but feel free to create a new one yourself.
 Aquí encontrará combinaciones sugeridas, sin embargo le invitamos a que cree una nueva usted mismo.

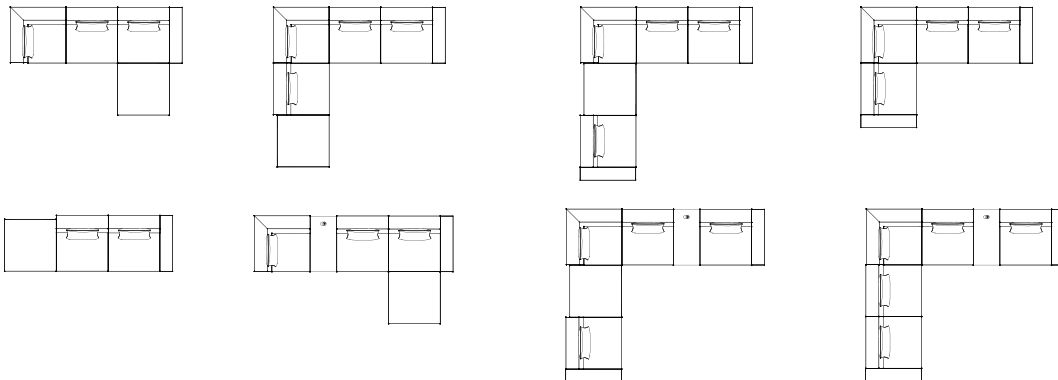

*Built-in electrical and USB connectivity. / Conectividad eléctrica y USB incorporada.

LUA

SECTIONAL



LU13-110 L/R



LU14-110 L/R



LU14-100



LU13-210



LU13-100



LU20-300

**LUA LEFT/RIGHT
CORNER 110**
módulo esquinero
izq./der. lua 110

LU13-110 L/R

w 44" d 37" H 32^{3/4}" SH 18"
112 cm 94 cm 83 cm 46 cm

sw 44" SD 24" AH 29^{1/2}"
112 cm 61 cm 75 cm

Right | Derecha

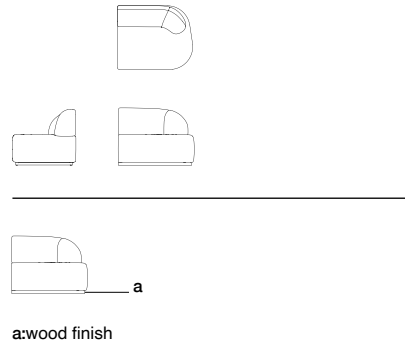

Wood finish / Acabado madera



Left | Izquierda

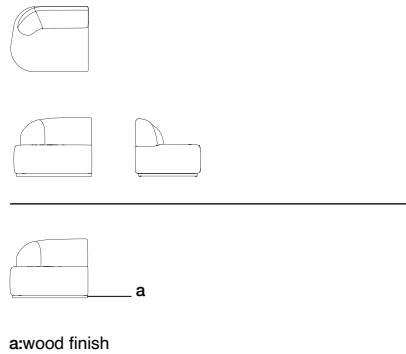

Relaxed Comfort: The fixed seat cushions are constructed with a premium combination of high-density foam and sinuous springs, providing excellent support, shock absorption, and softness. /
Relaxed Comfort: Los cojines fijos del asiento están fabricados con la mejor combinación de espuma de alta densidad y resortes sinuosos, que proporcionan un excelente soporte, absorción de impactos y suavidad.

*For detailed dimensions, please refer to the cad block. / Para dimensiones detalladas ver el bloque del mueble.

LUA LEFT/RIGHT 2 SEAT 110
módulo 2 pt.
izq./der. lua 110

LU14-110 L/R

w 74^{3/4"} D 42^{1/2"} H 32^{3/4"} SH 18"
190 cm 108 cm 83 cm 46 cm

sw 74^{3/4"} SD 24" AH 29^{1/2"}
190 cm 61 cm 75 cm

Right | Derecha

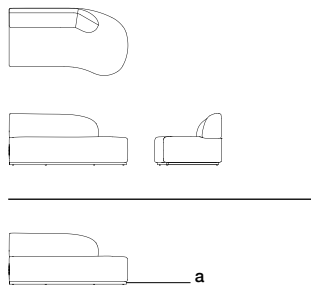

a:wood finish

Wood finish / Acabado madera



Left | Izquierda

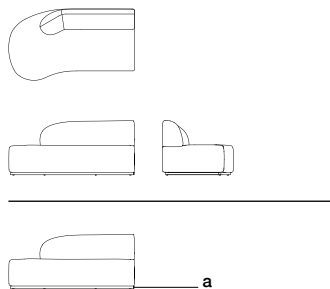

a:wood finish



LUA ARMLESS 1 SEAT 100
módulo 1 pt. sin brazo lua 100

LU14-100

w 47^{1/4"} D 37" H 32^{3/4"} SH 18"
120 cm 94 cm 83 cm 46 cm

sw 47^{1/4"} SD 24"
120 cm 61 cm

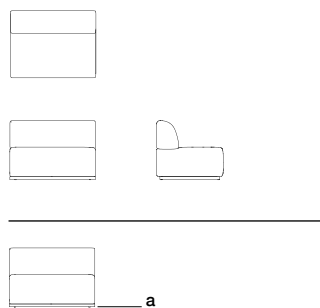

a:wood finish



Relaxed Comfort: The fixed seat cushions are constructed with a premium combination of high-density foam and sinuous springs, providing excellent support, shock absorption, and softness.
/ Relaxed Comfort: Los cojines fijos del asiento están fabricados con la mejor combinación de espuma de alta densidad y resortes sinuosos, que proporcionan un excelente soporte, absorción de impactos y suavidad.

*For detailed dimensions, please refer to the cad block. / Para dimensiones detalladas ver el bloque del mueble.

LUA COLLECTION

LUA CORNER 210
módulo esquinero lua 210

LU13-210

w 37" d 37" h 32^{3/4}" sh 18"
94 cm 94 cm 83 cm 46 cm

sw 24" sd 24" ah 32^{3/4}"
61 cm 61 cm 83 cm

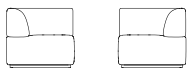

a:wood finish

LUA CURVED CORNER 100
módulo esquinero
curvo lua 100

LU13-100

w 52^{1/4}" D 39^{1/4}" H 32^{3/4}" SH 18"
133 cm 100 cm 83 cm 46 cm

sw 29^{1/2}" SD 24"
75 cm 61 cm

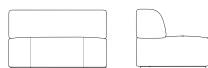

a:wood finish

Wood finish / Acabado madera



Relaxed Comfort: The fixed seat cushions are constructed with a premium combination of high-density foam and sinuous springs, providing excellent support, shock absorption, and softness. /
Relaxed Comfort: Los cojines fijos del asiento están fabricados con la mejor combinación de espuma de alta densidad y resortes sinuosos, que proporcionan un excelente soporte,
absorción de impactos y suavidad.

*For detailed dimensions, please refer to the cad block. / Para dimensiones detalladas ver el bloque del mueble.

LUA END TABLE 300
mesa auxiliar lua 300

LU20-300

w 25^{1/4"} d 37"
 64 cm 94 cm H 17^{3/4"}
 45 cm

Wood finish / Acabado madera

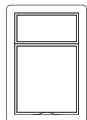

a: wood finish



Build your own! | ¡Constrúyalo usted mismo!

Here you can find a suggested layout, but feel free to create a new one yourself.
 Aquí encontrará combinaciones sugeridas, sin embargo le invitamos a que cree una nueva usted mismo.

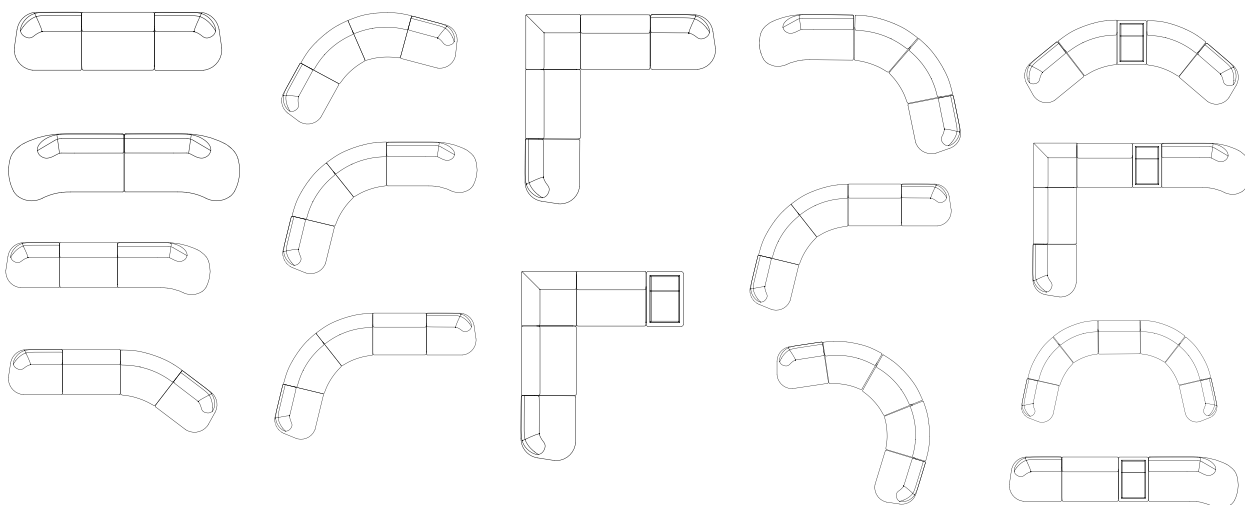

This piece has a storage space/ Esta pieza cuenta con un espacio de almacenamiento.



Referential photo. Some products, finishes or fabrics may no longer be available. /
Foto referencial. Algunos productos, acabados o telas podrían ya no estar disponibles.

ADRIANA HOYOS

UPHOLSTERED CHAIRS
poltronas



BOLERO UPHOLSTERED CHAIR 220
poltrona bolero 220



BOLERO UPHOLSTERED CHAIR 300
poltrona bolero 300



GEM UPHOLSTERED CHAIR 111
poltrona gem 111



GEM UPHOLSTERED CHAIR 121
poltrona gem 121



GEM UPHOLSTERED CHAIR 201
poltrona gem 201



GEM UPHOLSTERED CHAIR 301
poltrona gem 301



GALAPAGOS UPHOLSTERED CHAIR 101
poltrona galápagos 101



GALAPAGOS UPHOLSTERED CHAIR 200
poltrona galápagos 200



GALAPAGOS UPHOLSTERED CHAIR 300
poltrona galápagos 300



GALAPAGOS UPHOLSTERED CHAIR 400
poltrona galápagos 400



GALAPAGOS UPHOLSTERED CHAIR 900
poltrona galápagos 900



GALAPAGOS UPHOLSTERED CHAIR 911
poltrona galápagos 911



H UPHOLSTERED CHAIR 100
poltrona h 100



HOSPITALITY UPHOLSTERED CHAIR 900
poltrona icónica hospitality 900



LUA UPHOLSTERED CHAIR 401
poltrona lua 401



Slight color variations may occur while printing tearsheets due to printers pixelation and quality. Product specifications are subject to change due to product development updates.
Ligeras variaciones de color pueden ocurrir en la impresión. Las especificaciones están sujetas a cambios debido a las necesidades del producto.
Dimensions are usually approximated to the nearest quarter inch that will correspond to its metric conversion.
Las medidas generalmente se dan de acuerdo a la conversión métrica correspondiente y con una medida aproximada.

UPHOLSTERED CHAIRS poltronas



RUMBA UPHOLSTERED CHAIR 101
poltrona rumba 101



RUMBA UPHOLSTERED CHAIR 111
poltrona rumba 111



RUMBA UPHOLSTERED CHAIR 200
poltrona rumba 200



RUMBA UPHOLSTERED CHAIR 201
poltrona rumba 201



RUMBA UPHOLSTERED CHAIR 301
poltrona rumba 301



TEN UPHOLSTERED CHAIR 200
poltrona ten 200



TEN UPHOLSTERED CHAIR 210
poltrona ten 210



TEN UPHOLSTERED CHAIR 300
poltrona ten 300

Slight color variations may occur while printing tearsheets due to printers pixelation and quality. Product specifications are subject to change due to product development updates.
Ligeras variaciones de color pueden ocurrir en la impresión. Las especificaciones están sujetas a cambios debido a las necesidades del producto.
Dimensions are usually approximated to the nearest quarter inch that will correspond to its metric conversion.
Las medidas generalmente se dan de acuerdo a la conversión métrica correspondiente y con una medida aproximada.

BOLERO UPHOLSTERED CHAIR 220
 poltrona bolero 220

BR10-220

w 28 ^{3/4"}	d 34 ^{3/4"}	H 32"	SH 17 ^{3/4"}
73 cm	88 cm	81 cm	45 cm
sw 26"	SD 23 ^{1/4"}	AH 22"	
66 cm	59 cm	56 cm	

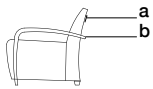
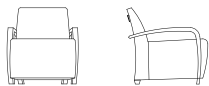

a:decorative hardware b:wood finish

Wood finish / Acabado madera



Decorative hardware / Herraje decorativo



**BOLERO UPHOLSTERED
CHAIR 300**
poltrona bolero 300

BR10-300

w 27^{1/2}" d 31^{1/2}" h 30" sh 17^{3/4}"
70 cm 80 cm 76 cm 45 cm

sw 22" sd 27^{1/4}"
56 cm 69 cm

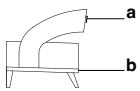
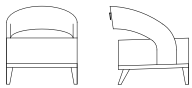

a:decorative hardware b:wood finish

Wood finish / Acabado madera



Decorative hardware / Herraje decorativo



GEM UPHOLSTERED CHAIR 111 (SWIVEL)
 poltrona gem 111 (giratoria)

GM10-111

w 36^{1/4"} d 30^{3/4"} H 32^{3/4"} SH 17^{3/4"}
 92 cm 78 cm 83 cm 45 cm

sw 25^{1/4"} sd 22" AH 25^{1/2"}
 64 cm 56 cm 65 cm

Wood finish / Acabado madera

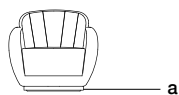
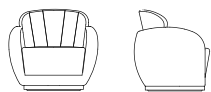

a: wood finish



**GEM UPHOLSTERED
CHAIR 121 (SWIVEL)**
poltrona gem 121
(giratoria)

GM10-121

w 36^{1/4"} d 30^{3/4"} H 32^{3/4"} SH 17^{3/4"}
92 cm 78 cm 83 cm 45 cm

sw 25^{1/4"} SD 22" AH 25^{1/2"}
64 cm 56 cm 65 cm

Wood finish / Acabado madera



a: wood finish



GEM UPHOLSTERED CHAIR 201 (SWIVEL)
 poltrona gem 201 (giratoria)

GM10-201

w 36^{1/4"} d 33" H 34^{3/4"} SH 17^{3/4"}
 92 cm 84 cm 88 cm 45 cm

sw 28" SD 20" AH 26^{3/4"}
 71 cm 51 cm 68 cm

Wood finish / Acabado madera

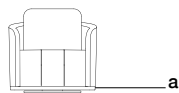

a: wood finish

BACK PILLOW (X1) / COJÍN DE ESPALDAR (X1)

w 19^{3/4"} d 1^{1/2"} H 23^{1/2"}
 50 cm 4 cm 60 cm



Back pillow included. / Incluye cojín de espaldar.

**GEM UPHOLSTERED
CHAIR 301 (SWIVEL)**
poltrona gem 301
(giratoria)

GM10-301

w 29^{1/2"} d 32^{1/4"} h 32^{1/2"} sh 17^{3/4"}
75 cm 82 cm 82 cm 45 cm

sw 31^{1/2"} sd 23^{1/4"}
80 cm 59 cm

Wood finish / Acabado madera

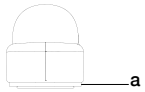
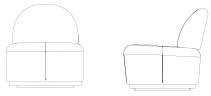

a: wood finish

PIPING DETAIL / detalle ribete



Piping can be customized. / El ribete puede ser personalizado.



Referential photo. Some products, finishes or fabrics may no longer be available. /
Foto referencial. Algunos productos, acabados o telas podrían ya no estar disponibles.

ADRIANA HOYOS

**GALAPAGOS
UPHOLSTERED CHAIR 101
(SWIVEL)**
poltrona galápagos 101
(giratoria)

GS10-101

w 23^{1/2}" d 29^{1/4}" h 30^{3/4}" sh 17^{3/4}"
60 cm 74 cm 78 cm 45 cm

sw 23^{1/2}" sd 21^{3/4}"
60 cm 55 cm

Wood finish / Acabado madera

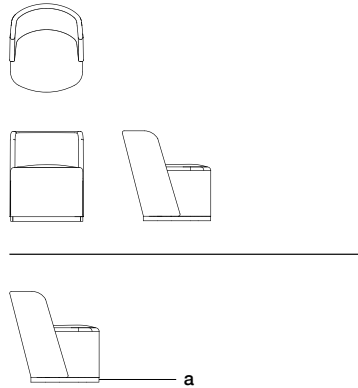

a: wood finish

PIPING DETAIL / detalle ribete



Piping can be customized. / El ribete puede ser personalizado.

GALAPAGOS
UPHOLSTERED CHAIR 200
 poltrona galápagos 200

GS10-200

w 27^{1/2"} d 27^{1/2"} H 29^{1/2"} SH 16^{1/2"}
 70 cm 70 cm 75 cm 42 cm

sw 23^{1/2"} SD 21^{3/4"} AH 25^{1/2"}
 60 cm 55 cm 65 cm

Wood finish / Acabado madera

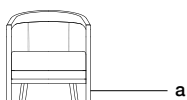
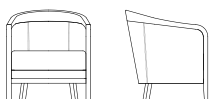

a: wood finish

PIPING DETAIL / detalle ribete



Piping can be customized. / El ribete puede ser personalizado.

GALAPAGOS
UPHOLSTERED CHAIR 300
 poltrona galápagos 300

GS10-300

w 37" d 31^{1/2"} h 33" SH 17"
 94 cm 80 cm 84 cm 43 cm

sw 26" sd 20^{1/2"} ah 24"
 66 cm 52 cm 61 cm

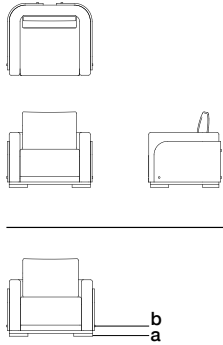

a: wood finish b: metallic button

BACK PILLOW (X1) / COJÍN DE ESPALDAR (X1)

w 16^{1/2"} d 3^{1/4"} h 23^{1/2"}
 42 cm 8 cm 60 cm

Wood finish / Acabado madera



Metallic button / Botón metálico

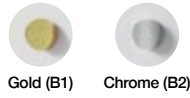

Relaxed Comfort: The fixed seat cushions are constructed with a premium combination of high-density foam and sinuous springs, providing excellent support, shock absorption, and softness.
 Confort Relax: Los cojines fijos del asiento están fabricados con la mejor combinación de espuma de alta densidad y resortes sinuosos, que proporcionan un excelente soporte, absorción de impactos y suavidad.

GALAPAGOS
UPHOLSTERED CHAIR 400
 poltrona galápagos 400

GS10-400

w 28" d 33¹/₂" H 32³/₄" SH 17³/₄"
 71 cm 85 cm 83 cm 45 cm

sw 22³/₄" SD 21³/₄" AH 24³/₄"
 58 cm 55 cm 63 cm

Wood finish / Acabado madera

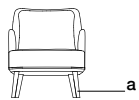

a: wood finish

BACK PILLOW (X1) / COJÍN DE ESPALDAR (X1)

w 19³/₄" d 1¹/₂" H 19³/₄"
 50 cm 4 cm 50 cm



PIPING DETAIL / detalle ribete



Piping can be customized. / El ribete puede ser personalizado.

Back pillow included. / Incluye cojín de espaldar.

*Sold separately. / Se venden por separado.



Referential photo. Some products, finishes or fabrics may no longer be available. /
Foto referencial. Algunos productos, acabados o telas podrían ya no estar disponibles.

ADRIANA HOYOS

**GALAPAGOS ICONIC
UPHOLSTERED CHAIR
900 (SWIVEL)**
poltrona icónica galápagos
900 (giratoria)

GS10-900

w 43^{1/4"} d 31" H 55^{1/2"} SH 17^{3/4"}
110 cm 79 cm 141 cm 45 cm

sw 32^{3/4"} sd 22"
83 cm 56 cm

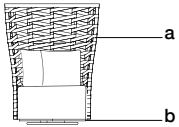
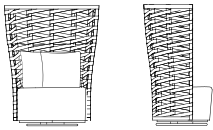

a:rope b:wood finish

**BACK PILLOWS (X2) /
COJINES DE ESPALDAR (X2)**

w 19^{3/4"} H 19^{3/4"}
50 cm 50 cm

Wood finish / Acabado madera



Rope / Reata

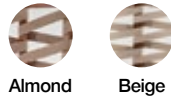

PIPING DETAIL / detalle ribete

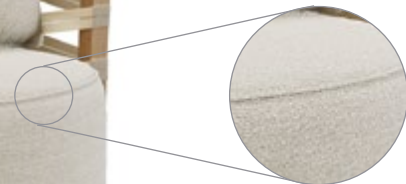

Piping can be customized. / El ribete puede ser personalizado.
Back pillows included. / Incluye cojines de espaldar.

**GALAPAGOS ICONIC
UPHOLSTERED CHAIR 911
(SWIVEL)**
poltrona icónica galápagos 911
(giratoria)

GS10-911

w 40^{1/4"} d 29^{1/2"} H 37"
102 cm 75 cm 94 cm SH 17^{3/4"}
45 cm

sw 32^{3/4"} sd 22"
83 cm 56 cm

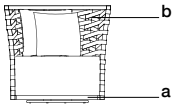
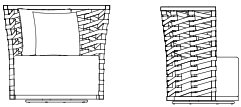

a: wood finish b: rope

BACK PILLOWS (X2) / COJINES DE ESPALDAR (X2)

w 19^{3/4"} d 19^{3/4"}
50 cm 50 cm

Wood finish / Acabado madera



Rope / Reata

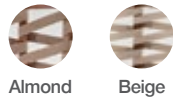

PIPING DETAIL / detalle ribete



Piping can be customized. / El ribete puede ser personalizado.
Back pillows included. / Incluye cojines de espaldar.

**H UPHOLSTERED
CHAIR 100**
poltrona h 100

HS10-100

w 26" d 29^{1/2"} h 28^{3/4"} sh 17^{3/4"}
66 cm 75 cm 73 cm 45 cm

sw 26" sd 20^{3/4"}
66 cm 53 cm

Wood finish / Acabado madera

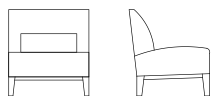
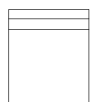

a: wood finish



**HOSPITALITY ICONIC
UPHOLSTERED CHAIR 900**
poltrona icónica hospitality 900

HT10-900

W 35^{3/4"} D 28" H 45^{1/4"} SH 17^{3/4"}
91 CM 71 CM 115 CM 45 CM

SW 31^{1/2"} SD 20^{3/4"}
80 CM 53 CM

Wood finish / Acabado madera

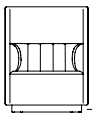
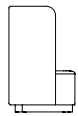
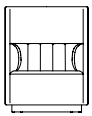

a: wood finish



LUA UPHOLSTERED CHAIR 401 (SWIVEL)
 poltrona lua 401
 (giratoria)

LU10-401

w 33" d 34^{3/4}" H 29^{1/2}" SH 17^{3/4}"
 84 cm 88 cm 75 cm 45 cm

sw 33" sd 22^{3/4}"
 84 cm 58 cm

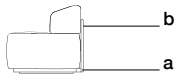
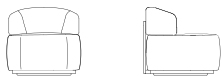

a:wood finish b:metal finish

Wood finish / Acabado madera



Metal finish / Acabado metal

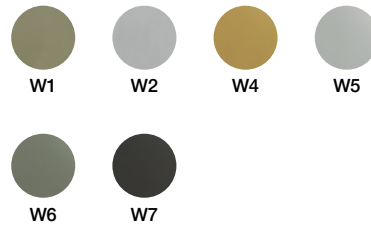

Relaxed Comfort: The fixed seat cushions are constructed with a premium combination of high-density foam and sinuous springs, providing excellent support, shock absorption, and softness.
Confort Relax: Los cojines fijos del asiento están fabricados con la mejor combinación de espuma de alta densidad y resortes sinuosos, que proporcionan un excelente soporte, absorción de impactos y suavidad.

*Sold separately. / Se venden por separado.

**RUMBA UPHOLSTERED
CHAIR 101 (SWIVEL)**
poltrona rumba 101
(giratoria)

RM10-101

w 31^{1/2"} d 28^{3/4"} h 31^{1/2"} sh 17^{3/4"}
80 cm 73 cm 80 cm 45 cm

sw 27^{1/2"} sd 21^{3/4"}
70 cm 55 cm

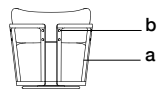
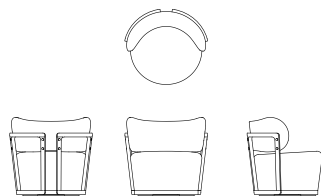

a: wood finish b:metallic button

Wood finish / Acabado madera



Metallic button / Botón metálico







Referential photo. Some products, finishes or fabrics may no longer be available. /
Foto referencial. Algunos productos, acabados o telas podrían ya no estar disponibles.

ADRIANA HOYOS

RUMBA UPHOLSTERED CHAIR 111 (SWIVEL)
 poltrona rumba 111 (giratoria)

RM10-111

w 31^{1/2"} d 28^{3/4"} H* 31^{1/2"} SH 17^{3/4"}
 80 cm 73 cm 80 cm 45 cm

sw 27^{1/2"} sd* 23^{1/2"}
 70 cm 60 cm

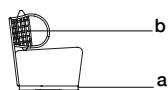
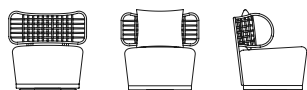

a:wood finish b:hand-woven back

BACK PILLOW (X1) / COJÍN DE ESPALDAR (X1)

w 19^{3/4"} H 19^{3/4"}
 50 cm 50 cm

Wood finish / Acabado madera



Hand-woven back / Espaldar tejido a mano



Back pillow included. / Incluye cojín de espaldar.

* (H) (SD) dimensions do not include back pillow. / (H) (SD) no incluye cojín de espaldar.

**RUMBA UPHOLSTERED
CHAIR 200**
poltrona rumba 200

RM10-200

w 36^{1/4"} d 35^{1/2"} H 32" SH 17^{3/4"}
92 cm 90 cm 81 cm 45 cm

sw 25^{1/2"} sd 21^{3/4"}
65 cm 55 cm

Metal finish / Acabado metal

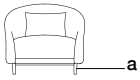
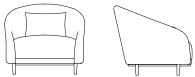
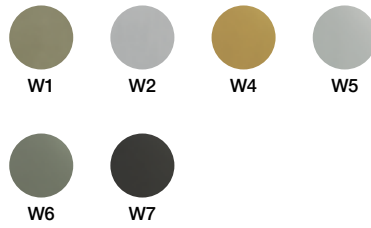

a:metal finish

LUMBAR PILLOW (X1) / COJÍN LUMBAR (X1)

w 19" H 13"
48 cm 33 cm



Lumbar pillow included. / Incluye cojín lumbar.

**RUMBA UPHOLSTERED
CHAIR 201 (SWIVEL)**
poltrona rumba 201
(giratoria)

RM10-201

w 36^{1/4"} d 35^{1/2"} h 32" SH 17^{3/4"}
92 cm 90 cm 81 cm 45 cm

sw 25^{1/2"} sd 21^{3/4"}
65 cm 55 cm

Wood finish / Acabado madera

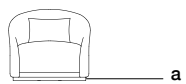
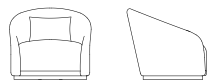

a: wood finish

LUMBAR PILLOW (X1) / COJÍN LUMBAR (X1)

w 19" h 13"
48 cm 33 cm



Lumbar pillow included. / Incluye cojin lumbar.

**RUMBA UPHOLSTERED
CHAIR 301 (SWIVEL)**
poltrona rumba 301
(giratoria)

RM10-301

w 32" d 30 1/4" H 28 3/4" SH 17 3/4"
81 cm 77 cm 73 cm 45 cm

sw 22 3/4" sd 21 3/4"
58 cm 55 cm

Wood finish / Acabado madera

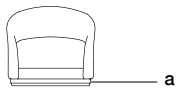
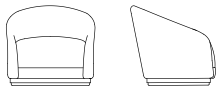

a: wood finish



**TEN UPHOLSTERED
CHAIR 200**
poltrona ten 200

TN10-200

w 30^{1/4"} d 32^{1/4"} H 39^{1/4"} SH 17^{3/4"}
77 cm 82 cm 100 cm 45 cm

sw 26^{1/2"} sd 21^{3/4"} AH 23^{1/2"}
67 cm 55 cm 60 cm

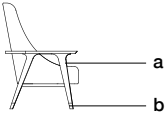
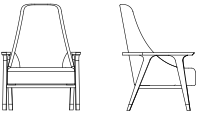

a:wood finish b:metal finish

Wood finish / Acabado madera



Metal finish / Acabado metal

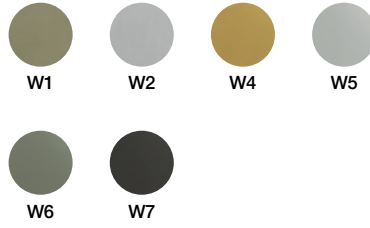

*Sold separately. / Se venden por separado.



Referential photo. Some products, finishes or fabrics may no longer be available. /
Foto referencial. Algunos productos, acabados o telas podrían ya no estar disponibles.

ADRIANA HOYOS

**TEN UPHOLSTERED
CHAIR 210**
poltrona ten 210

TN10-210

w 30^{1/4"} d 29^{1/2"} H 34^{3/4"} SH 17^{3/4"}
77 cm 75 cm 88 cm 45 cm

sw 26^{1/2"} SD 21^{3/4"} AH 23^{1/2"}
67 cm 55 cm 60 cm

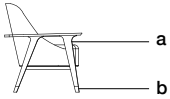
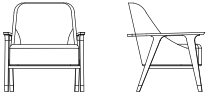

a:wood finish b:metal finish

Wood finish / Acabado madera



Metal finish / Acabado metal

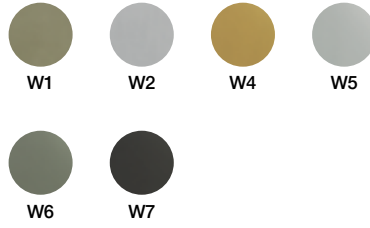

**TEN UPHOLSTERED
CHAIR 300**
poltrona ten 300

TN10-300

w 27^{1/2}" d 29^{1/2}" H 30^{3/4}" SH 17^{3/4}"
70 cm 75 cm 78 cm 45 cm

sw 24^{1/2}" sd 20^{3/4}"
62 cm 53 cm

Wood finish / Acabado madera

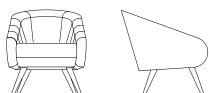

a: wood finish



OTTOMANS
otomanes



CHOCOLATE OTTOMAN 110
otomán chocolate 110



GEM OTTOMAN 101
otomán gem 101



GALAPAGOS FOOT STOOL 400
foot stool galápagos 400



GRAFITO OTTOMAN 110
otomán grafito 110



H OTTOMAN 300
otomán h 300



HOSPITALITY OTTOMAN 100
otomán hospitality 100



LUA OTTOMAN 100-110
otomán lua 100-110



LUA OTTOMAN 201
otomán lua 201



LUA OTTOMAN 210
otomán lua 210



LUA FOOT STOOL 300
foot stool lua 300



RUMBA OTTOMAN 100
otomán rumba 100



TEN OTTOMAN 200
otomán ten 200

Slight color variations may occur while printing tearsheets due to printers pixelation and quality. Product specifications are subject to change due to product development updates.
Ligeras variaciones de color pueden ocurrir en la impresión. Las especificaciones están sujetas a cambios debido a las necesidades del producto.
Dimensions are usually approximated to the nearest quarter inch that will correspond to its metric conversion.
Las medidas generalmente se dan de acuerdo a la conversión métrica correspondiente y con una medida aproximada.

CHOCOLATE OTTOMAN 110
otomán chocolate 110

CH16-110

W 23^{1/2"} D 23^{1/2"} H 17^{3/4"}
60 CM 60 CM 45 CM

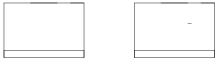

a:wood finish

Wood finish / Acabado madera





Referential photo. Some products, finishes or fabrics may no longer be available. /
Foto referencial. Algunos productos, acabados o telas podrían ya no estar disponibles.

ADRIANA HOYOS

GEM OTTOMAN 101 (SWIVEL)
otomán gem 101 (giratorio)

GM16-101

W 31^{1/2}" D 31^{1/2}" H 15^{3/4}"
80 CM 80 CM 40 CM

Wood finish / Acabado madera

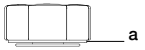

a: wood finish





Referential photo. Some products, finishes or fabrics may no longer be available. /
Foto referencial. Algunos productos, acabados o telas podrían ya no estar disponibles.

ADRIANA HOYOS

**GALAPAGOS FOOT
STOOL 400**
foot stool galápagos 400

GS16-400

W 25^{1/4"} D 19^{3/4"} H 16^{1/2"}
64 CM 50 CM 42 CM

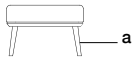

a:wood finish

Wood finish / Acabado madera



GRAFITO OTTOMAN 110
otomán grafito 110

GT16-110

w 20^{1/2}" d 20^{1/2}" H 19"
52 CM 52 CM 48 CM

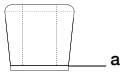
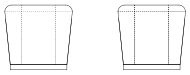

a:wood finish

Wood finish / Acabado madera



H OTTOMAN 300
otomán h 300

HS16-300

w 19^{3/4"} d 19^{3/4"} h 16^{1/2"}
50 CM 50 CM 42 CM

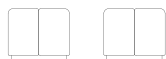

a: wood finish

Wood finish / Acabado madera



HOSPITALITY OTTOMAN 100
otomán hospitality 100

HT16-100

W 22" D 21^{1/4"} H 25^{2/4"} SH 19^{3/4"}
56 CM 54 CM 65 CM 50 CM

SW 20^{1/4"} SD 17^{3/4"}
53 CM 45 CM

Wood finish / Acabado madera

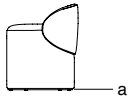
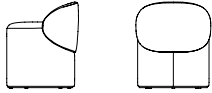

a:wood finish



LUA OTTOMAN 100
otomán lua 100

LU16-100

W 35^{1/2"} D 35^{1/2"} H 17"
90 CM 90 CM 43 CM

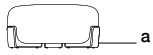
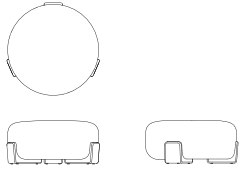

a:wood finish

LUA OTTOMAN 110
otomán lua 110

LU16-110

W 45^{1/4"} D 45^{1/4"} H 17"
115 CM 115 CM 43 CM

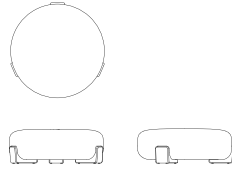

a:wood finish

Wood finish / Acabado madera



LUA OTTOMAN 201 (SWIVEL)
otomán lua 201 (giratorio)

LU16-201

DIA 35^{1/2"} H 17"
90 CM 43 CM

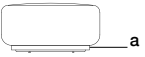
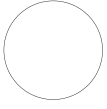

a:wood finish

Wood finish / Acabado madera



LUA OTTOMAN 210
otomán lua 210

LU16-210

DIA 45^{1/4"} H 17"
115 CM 43 CM

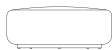
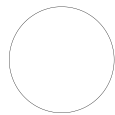

a:wood finish

Wood finish / Acabado madera



LUA FOOT STOOL 300
foot stool lua 300

LU16-300*

W 30^{1/4"} D 22^{1/2"} H 15^{1/4"}
77 CM 57 CM 39 CM

Wood finish / Acabado madera

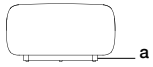
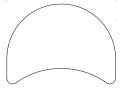

a:wood finish



*Sold separately. / Se venden por separado.

RUMBA OTTOMAN 100
otomán rumba 100

RM16-100

DIA 29^{1/2"} H 15^{3/4"}
75 CM 40 CM



a: wood finish

Wood finish / Acabado madera



TEN OTTOMAN 200
otomán ten 200

TN16-200

W 26^{3/4"} D 23^{1/2"} H 17^{3/4"}
68 CM 60 CM 45 CM

Wood finish / Acabado madera

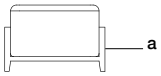
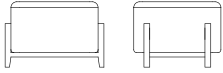
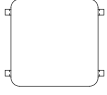

a: wood finish



*Sold separately. / Se venden por separado.

DAYBEDS
daybeds



BOLERO DAYBED 100
daybed bolero 100



CHOCOLATE DAYBED 100
daybed chocolate 100



GEM DAYBED 100
daybed gem 100



H DAYBED 310
daybed h 310



LUA DAYBED 100/110
daybed lua 100/110



LUA DAYBED 200/210
daybed lua 200/210



RUMBA DAYBED 100
daybed rumba 100



TEN DAYBED 100
daybed ten 100



TEN DAYBED 200
daybed ten 200

Slight color variations may occur while printing tearsheets due to printers pixelation and quality. Product specifications are subject to change due to product development updates.
Ligeras variaciones de color pueden ocurrir en la impresión. Las especificaciones están sujetas a cambios debido a las necesidades del producto.
Dimensions are usually approximated to the nearest quarter inch that will correspond to its metric conversion.
Las medidas generalmente se dan de acuerdo a la conversión métrica correspondiente y con una medida aproximada.

BOLERO DAYBED 100
daybed bolero 100

BR15-100

W 73^{1/2"} D 27^{1/2"} H 25^{1/2"} SH 17^{3/4"}
187 CM 70 CM 65 CM 45 CM

SW 63^{1/2"} SD 27^{1/2"} AH 25^{1/2"}
161 CM 70 CM 65 CM

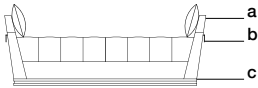
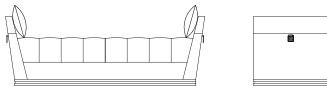
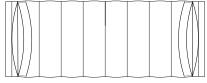

a:leather detail b:decorative hardware c:wood finish

Leather detail / Detalle cuero



Wood finish / Acabado madera



Decorative hardware / Herraje decorativo

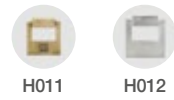

LUMBAR PILLOWS (X2) / COJINES LUMBARES (X2)

W 27^{1/2"} H 13^{3/4"}
70 CM 35 CM



Lumbar pillows included./ Incluye cojines lumbares.

CHOCOLATE DAYBED 100
daybed chocolate 100

CH15-100

W 82^{3/4"} D 33^{1/2"} H 25^{1/2"} SH 17^{3/4"}
210 CM 85 CM 65 CM 45 CM

SW 69^{1/4"}
176 CM

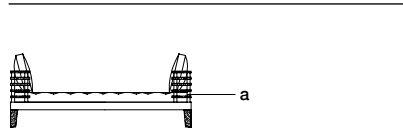
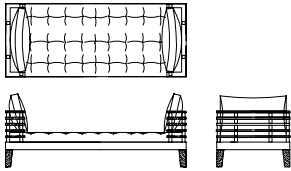

a:wood finish

CHOCOLATE DAYBED 120
daybed chocolate 120

CH15-120

W 67" D 27^{1/2"} H 25^{1/2"} SH 17^{3/4"}
170 CM 70 CM 65 CM 45 CM

SW 53^{1/2"}
136 CM

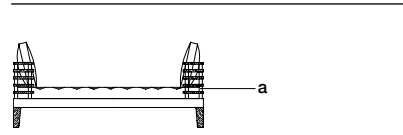
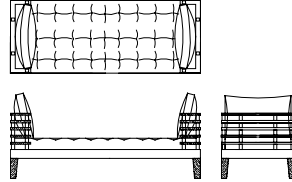

a:wood finish

Wood finish / Acabado madera



LUMBAR PILLOWS (X2) /
COJINES LUMBARES (X2)

W 29^{1/2"} H 15^{3/4"} D 3^{1/4"}
75 CM 40 CM 8 CM

LUMBAR PILLOWS (X2) /
COJINES LUMBARES (X2)

W 25^{1/2"} H 13^{3/4"} D 3^{1/4"}
65 CM 35 CM 8CM



Lumbar pillows included./ Incluye cojines lumbares.

GEM DAYBED 100
daybed gem 100

GM15-100

w 61" d 27^{1/2}" H 16^{1/2}"
155 CM 70 CM 42 CM

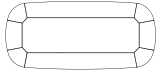

a:wood finish

Wood finish / Acabado madera



DOUBLE SEAM / pespunte doble

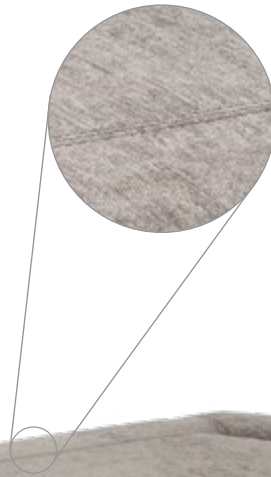

H DAYBED 310
daybed h 310

HS15-310

w 59" d 25 1/2" H 16 1/2"
150 CM 65 CM 42 CM

Wood finish / Acabado madera

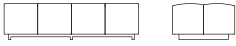

a:wood finish







Referential photo. Some products, finishes or fabrics may no longer be available. /
Foto referencial. Algunos productos, acabados o telas podrían ya no estar disponibles.

ADRIANA HOYOS

LUA DAYBED 100
daybed lua 100

LU15-100

w 59" d 21^{1/4"} h 17^{1/4"}
150 CM 54 CM 44 CM

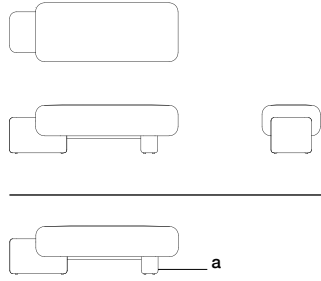

a:wood finish

LUA DAYBED 110
daybed lua 110

LU15-110

w 67" d 21^{1/4"} h 17^{1/4"}
170 CM 54 CM 44 CM

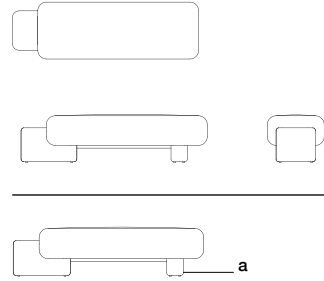

a:wood finish

Wood finish / Acabado madera



DOUBLE SEAM / pespunte doble

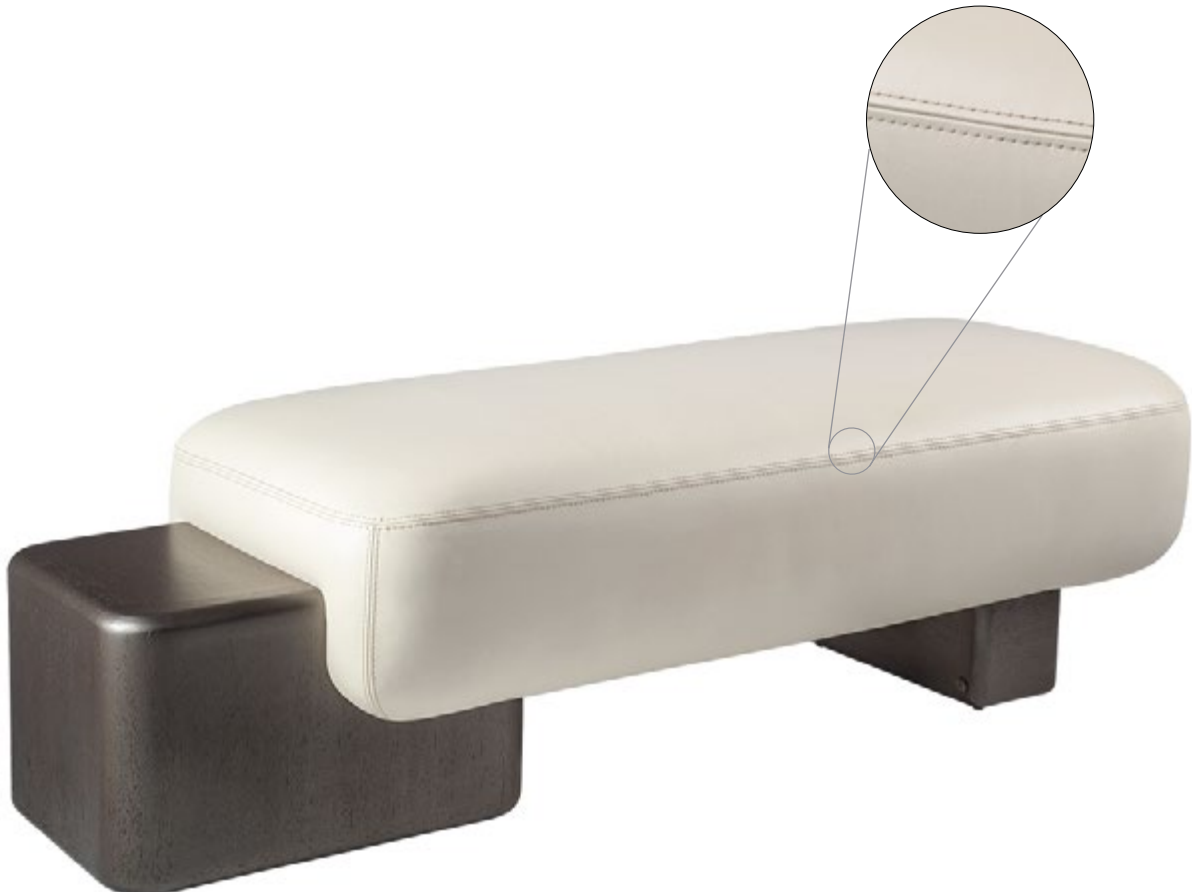

LUA DAYBED 200
daybed lua 200

LU15-200

W 47^{1/4"} D 20^{1/2"} H 16^{1/2"}
120 CM 52 CM 42 CM

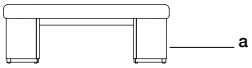
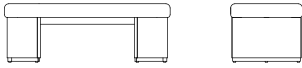

a:wood finish

LUA DAYBED 210
daybed lua 210

LU15-210

W 55" D 20^{1/2"} H 16^{1/2"}
140 CM 52 CM 42 CM

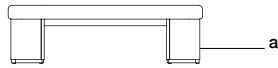
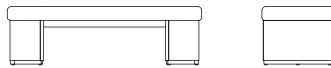

a:wood finish

Wood finish / Acabado madera



RUMBA DAYBED 100
daybed rumba 100

RM15-100

w 67" d 23^{1/2"} h 21^{3/4"} SH 17^{3/4"}
170 CM 60 CM 55 CM 45 CM

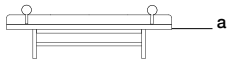
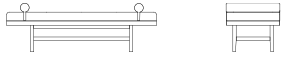

a: wood finish

BOLSTER PILLOWS (X2) / COJINES CARAMELO (X2)

d 23^{1/2"} h 2^{1/4"}
60 CM 6 CM

Wood finish / Acabado madera



Bolster pillows included. / Incluye cojines caramelo.



Referential photo. Some products, finishes or fabrics may no longer be available. /
Foto referencial. Algunos productos, acabados o telas podrían ya no estar disponibles.

ADRIANA HOYOS

TEN DAYBED 100
daybed ten 100

TN15-100

w 63" d 27^{1/2}" h 17^{3/4}"
160 CM 70 CM 45 CM

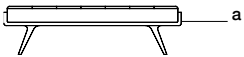

a: wood finish

Wood finish / Acabado madera



TEN DAYBED 200

daybed ten 200

TN15-200

w 59" d 23 1/2" h 17 3/4"
150 CM 60 CM 45 CM

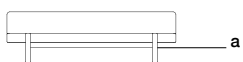
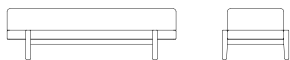

a: wood finish

Wood finish / Acabado madera



DOUBLE SEAM / pespunte doble







Referential photo. Some products, finishes or fabrics may no longer be available. /
Foto referencial. Algunos productos, acabados o telas podrían ya no estar disponibles.

ADRIANA HOYOS

COCKTAIL TABLES
mesas centrales



AFRICA COCKTAIL TABLES (LOW)
mesas centrales áfrica (bajas)



AFRICA COCKTAIL TABLES (HIGH)
mesas centrales áfrica (altas)



AH SIGNATURE COCKTAIL TABLE 100
mesa central ah signature 100



BOLERO COCKTAIL TABLE 200
mesa central bolero 200



GEM COCKTAIL TABLE 100
mesa central gem 100



GEM COCKTAIL TABLE 101
mesa central gem 101



GEM COCKTAIL TABLE 110
mesa central gem 110



GEM COCKTAIL TABLE 111
mesa central gem 111



GEM COCKTAIL TABLE 200
mesa central gem 200



GEM COCKTAIL TABLE 201
mesa central gem 201



GEM COCKTAIL TABLE 210
mesa central gem 210



GEM COCKTAIL TABLE 211
mesa central gem 211



GALAPAGOS COCKTAIL TABLE 100
mesa central galápagos 100



GALAPAGOS COCKTAIL TABLE 110
mesa central nesting galápagos 110



GALAPAGOS COCKTAIL TABLE 200
mesa central galápagos 200

Slight color variations may occur while printing tearsheets due to printers pixelation and quality. Product specifications are subject to change due to product development updates.
Ligeras variaciones de color pueden ocurrir en la impresión. Las especificaciones están sujetas a cambios debido a las necesidades del producto.
Dimensions are usually approximated to the nearest quarter inch that will correspond to its metric conversion.
Las medidas generalmente se dan de acuerdo a la conversión métrica correspondiente y con una medida aproximada.

COCKTAIL TABLES
mesas centrales



GALAPAGOS COCKTAIL TABLE 210
mesa central galápagos 210



GALAPAGOS COCKTAIL TABLE 300
mesa central galápagos 300



GALAPAGOS COCKTAIL TABLE 301
mesa central galápagos 301



GALAPAGOS COCKTAIL TABLE 310
mesa central galápagos 310



GALAPAGOS COCKTAIL TABLE 311
mesa central galápagos 311



GALAPAGOS COCKTAIL TABLE 401
mesa central galápagos 401



H COCKTAIL TABLE 200
mesa central h 200



H COCKTAIL TABLE 600
mesa central h 600



H COCKTAIL TABLE 601
mesa central h 601



LUA COCKTAIL TABLE 100
mesa central lua 100



LUA COCKTAIL TABLE 101
mesa central lua 101



LUA COCKTAIL TABLE 200/220
mesa central lua 200/220



LUA COCKTAIL TABLE 201/221
mesa central lua 201/221



LUA COCKTAIL TABLE
210/230
mesa central lua 210/230



LUA COCKTAIL TABLE 211/231
mesa central lua 211/231



RUMBA COCKTAIL TABLE
200
mesa central rumba 200

Slight color variations may occur while printing tearsheets due to printers pixelation and quality. Product specifications are subject to change due to product development updates.
Ligeras variaciones de color pueden ocurrir en la impresión. Las especificaciones están sujetas a cambios debido a las necesidades del producto.
Dimensions are usually approximated to the nearest quarter inch that will correspond to its metric conversion.
Las medidas generalmente se dan de acuerdo a la conversión métrica correspondiente y con una medida aproximada.

AFRICA COCKTAIL TABLE 501 (STONE TOP)
 mesa central áfrica 501 (top piedra)

AF19-501

w 35^{1/2"} D 35^{1/2"} H 11^{3/4"}
 90 CM 90 CM 30 CM

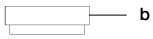
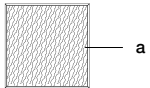

a: stone top b: wood finish

AFRICA COCKTAIL TABLE 531 (STONE TOP)
 mesa central áfrica 531 (top piedra)

AF19-531

w 59" D 23^{1/2"} H 11^{3/4"}
 150 CM 60 CM 30 CM

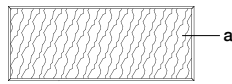
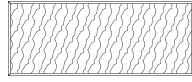

a: stone top b: wood finish

Stone top / Top piedra



Wood finish / Acabado madera



AFRICA COCKTAIL TABLE 500
 mesa central áfrica 500

AF19-500

w 35^{1/2"} D 35^{1/2"} H 11^{3/4"}
 90 CM 90 CM 30 CM



a: wood finish



Tables sold separately. / Las mesas se venden por separado.

Referential photo, refer to each code for product dimensions. / Foto referencial, consulte las dimensiones del producto en cada código.

**AFRICA COCKTAIL
TABLE 520**
mesa central áfrica 520

AF19-520

W 35^{1/2}" D 23^{1/2}" H 11^{3/4}"
90 CM 60 CM 30 CM



a: wood finish

**AFRICA COCKTAIL
TABLE 530**
mesa central áfrica 530

AF19-530

W 59" D 23^{1/2}" H 11^{3/4}"
150 CM 60 CM 30 CM



a: wood finish

Wood finish / Acabado madera

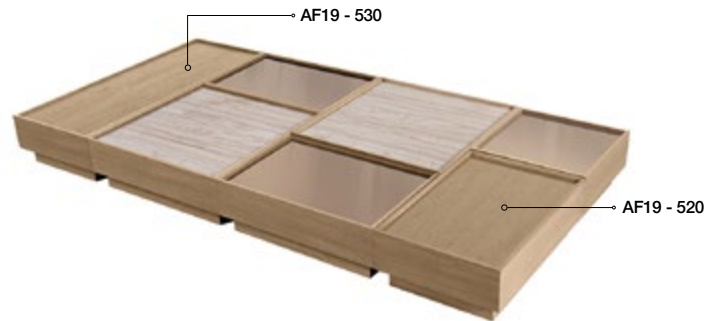

Tables sold separately. / Las mesas se venden por separado.

Referential photo, refer to each code for product dimensions. / Foto referencial, consulte las dimensiones del producto en cada código.

AFRICA COCKTAIL TABLE 525 (MIRROR TOP)
 mesa central áfrica 525
 (top espejo)

AF19-525

W 35^{1/2"} D 23^{1/2"} H 11^{3/4"}
 90 CM 60 CM 30 CM

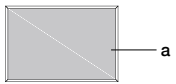

a:mirror top b:wood finish

AFRICA COCKTAIL TABLE 535 (MIRROR TOP)
 mesa central áfrica 535
 (top espejo)

AF19-535

W 59" D 23^{1/2"} H 11^{3/4"}
 150 CM 60 CM 30 CM



a:mirror top b:wood finish

Mirror top / Top espejo



Bronze

Fume

Wood finish / Acabado madera



Tables sold separately. / Las mesas se venden por separado.

Referential photo, refer to each code for product dimensions. / Foto referencial, consulte las dimensiones del producto en cada código.

AFRICA COCKTAIL TABLE 505 (MIRROR TOP)
 mesa central áfrica 505
 (top espejo)

AF19-505

W 35^{1/2}" D 35^{1/2}" H 11^{3/4}"
 90 CM 90 CM 30 CM

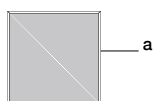
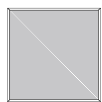

a:mirror top b:wood finish

AFRICA COCKTAIL TABLE 515 (MIRROR TOP)
 mesa central áfrica 515
 (top espejo)

AF19-515

W 23^{1/2}" D 23^{1/2}" H 11^{3/4}"
 60 CM 60 CM 30 CM

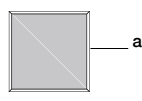
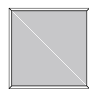

a:mirror top b:wood finish

Mirror top / Top espejo



Bronze

Fume

Wood finish / Acabado madera



R

T

P

A

K



B

L

J

E

N



Q

S

Y

Z

AFRICA COCKTAIL TABLE 510
 mesa central áfrica 510

AF19-510

W 23^{1/2}" D 23^{1/2}" H 11^{3/4}"
 60 CM 60 CM 30 CM

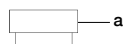

a:wood finish

AF19 - 510

AF19 - 505
 AF19 - 515



Tables sold separately. / Las mesas se venden por separado.

Referential photo, refer to each code for product dimensions. / Foto referencial, consulte las dimensiones del producto en cada código.

AFRICA COCKTAIL TABLE 600
 mesa central áfrica 600

AF19-600

W 35^{1/2"} D 35^{1/2"} H 17"
 90 CM 90 CM 43 CM

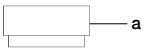

a:wood finish

AFRICA COCKTAIL TABLE 610
 mesa central áfrica 610

AF19-610

W 23^{1/2"} D 23^{1/2"} H 17"
 60 CM 60 CM 43 CM



a:wood finish

Wood finish / Acabado madera

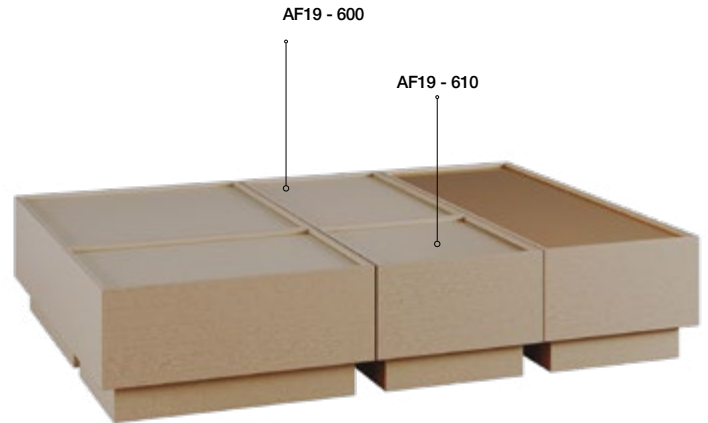

Tables sold separately. / Las mesas se venden por separado.

Referential photo, refer to each code for product dimensions. / Foto referencial, consulte las dimensiones del producto en cada código.

**AFRICA COCKTAIL
TABLE 620**
mesa central áfrica 620

AF19-620

W 35^{1/2}" D 23^{1/2}" H 17"
90 CM 60 CM 43 CM



a:wood finish

**AFRICA COCKTAIL
TABLE 630**
mesa central áfrica 630

AF19-630

W 59" D 23^{1/2}" H 17"
150 CM 60 CM 43 CM



a:wood finish

Wood finish / Acabado madera



AF19 - 620
AF19 - 630



Tables sold separately. / Las mesas se venden por separado.

Referential photo, refer to each code for product dimensions. / Foto referencial, consulte las dimensiones del producto en cada código.

AFRICA COCKTAIL TABLE 601 (STONE TOP)
 mesa central África 601 (top piedra)

AF19-601

W 35 1/2" D 35 1/2" H 17"
 90 CM 90 CM 43 CM

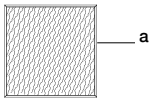
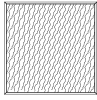

a:stone top b:wood finish

AFRICA COCKTAIL TABLE 631 (STONE TOP)
 mesa central África 631 (top piedra)

AF19-631

W 59" D 23 1/2" H 17"
 150 CM 60 CM 43 CM

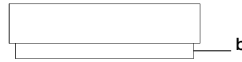
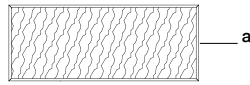
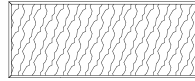

a:stone top b:wood finish

Stone top / Top piedra

marble/
mármol



L

granite/
granito



V

quartzite/
cuarcita



F



C



M

Wood finish / Acabado madera



R



T



P



A



K



B



L



J



E



N



Q



S



Y



Z

AF19 - 601
 AF19 - 631



Tables sold separately. / Las mesas se venden por separado.

Referential photo, refer to each code for product dimensions. / Foto referencial, consulte las dimensiones del producto en cada código.

AFRICA COCKTAIL TABLE 605 (MIRROR TOP)
 mesa central áfrica 605
 (top espejo)

AF19-605

W 35^{1/2}" D 35^{1/2}" H 17"
 90 CM 90 CM 43 CM

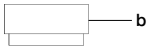
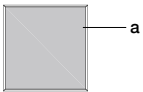

a:mirror top b:wood finish

AFRICA COCKTAIL TABLE 615 (MIRROR TOP)
 mesa central áfrica 615
 (top espejo)

AF19-615

W 23^{1/2}" D 23^{1/2}" H 17"
 60 CM 60 CM 43 CM

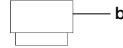
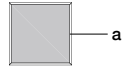

a:mirror top b:wood finish

Mirror top / Top espejo

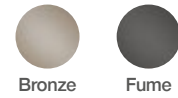

Wood finish / Acabado madera



AFRICA COCKTAIL TABLE 625 (MIRROR TOP)
 mesa central áfrica 625
 (top espejo)

AF19-625

W 35^{1/2}" D 23^{1/2}" H 17"
 90 CM 60 CM 43 CM

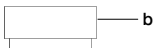

a:mirror top b:wood finish

AF19 - 605
 AF19 - 615



AF19 - 625



Tables sold separately. / Las mesas se venden por separado.

Referential photo, refer to each code for product dimensions. / Foto referencial, consulte las dimensiones del producto en cada código.





Referential photo. Some products, finishes or fabrics may no longer be available. /
Foto referencial. Algunos productos, acabados o telas podrían ya no estar disponibles.

ADRIANA HOYOS

**AFRICA COCKTAIL
TABLE 635 (MIRROR TOP)**
mesa central áfrica 635
(top espejo)

AF19-635

w 59" d 23 1/2" h 17"
150 cm 60 cm 43 cm



a:mirror top b:wood finish

Wood finish / Acabado madera



Mirror top / Top espejo



AF19 - 635



Build your own! | ¡Constrúyalo usted mismo!

Here you can find a suggested layout, but feel free to create a new one yourself.

Aquí encontrará combinaciones sugeridas, sin embargo le invitamos a que cree una nueva usted mismo.

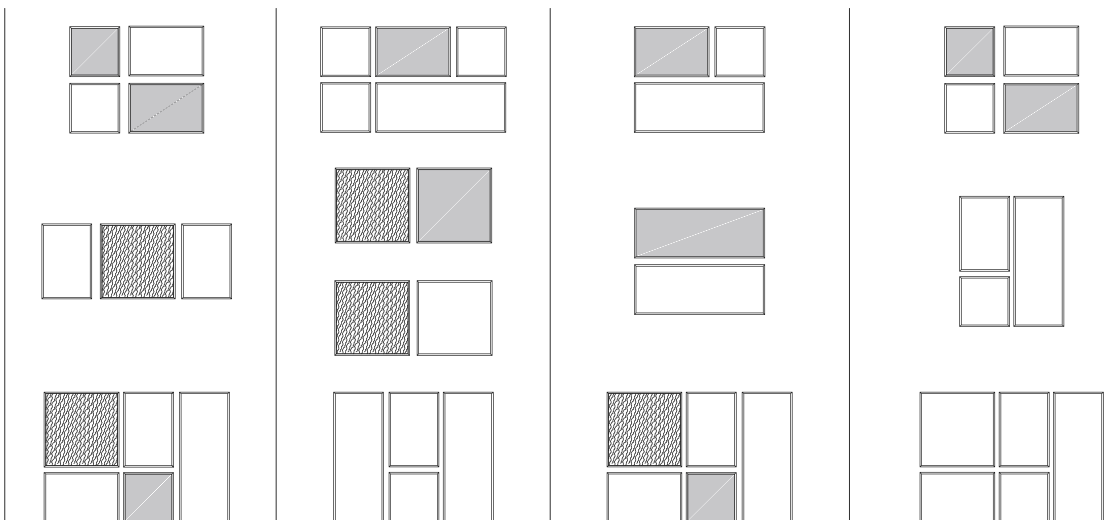

Tables sold separately. / Las mesas se venden por separado.

Referential photo, refer to each code for product dimensions. / Foto referencial, consulte las dimensiones del producto en cada código.

**AH SIGNATURE
COCKTAIL TABLE 100**
mesa central ah signature 100

AH19-100

DIA 50" H 16 1/2"
127 CM 42 CM

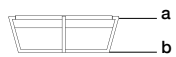
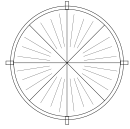

a:top finish b:base finish

Top finish / Acabado top
Base finish / Acabado base



BOLERO COCKTAIL TABLE 200
mesa central bolero 200

BR19-200

W 51^{1/4"} D 35^{1/2"} H 17"
 130 CM 90 CM 43 CM

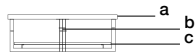
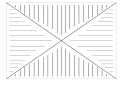

a:wood finish b:metal finish c:high gloss finish

COMBINATION OPTIONS / opción de combinaciones

Wood finish / Acabado madera

High gloss finish / Acabado high gloss

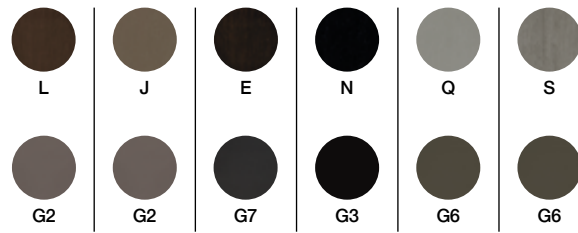
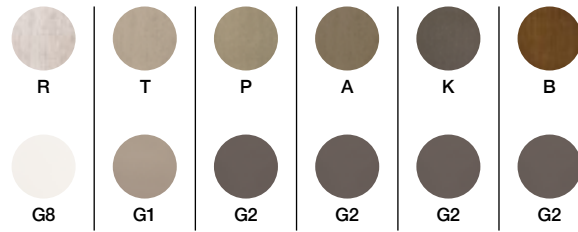

Metal finish / Acabado metal

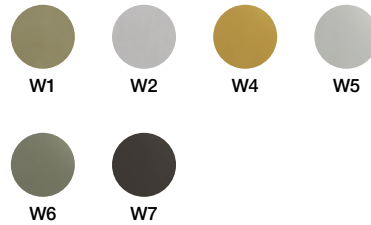

GEM COCKTAIL TABLE 100
mesa central gem 100

GM19-100

W 35^{1/2}" D 35^{1/2}" H 20^{3/4}"
 90 CM 90 CM 53 CM



a:top finish b:metal finish c:base finish

Top finish / Acabado top

Base finish / Acabado base



Metal finish / Acabado metal

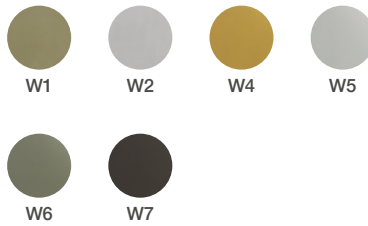

Tables sold separately. / Las mesas se venden por separado.
 One piece metallic structure. / Estructura de metal en una pieza.





Referential photo. Some products, finishes or fabrics may no longer be available. /
Foto referencial. Algunos productos, acabados o telas podrían ya no estar disponibles.

ADRIANA HOYOS

GEM COCKTAIL TABLE 101
(STONE TOP)
 mesa central gem 101
 (top piedra)

GM19-101

w 35^{1/2"} d 35^{1/2"} H 20^{3/4"}
 90 CM 90 CM 53 CM

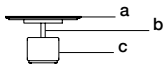

a:stone top b:metal finish c:wood finish

Stone top / Top piedra

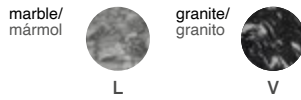

Metal finish / Acabado metal



Wood finish / Acabado madera



Tables sold separately. / Las mesas se venden por separado.
 One piece metallic structure. / Estructura de metal en una pieza.

GEM COCKTAIL TABLE 110
mesa central gem 110

GM19-110

W 43^{1/4"} D 43^{1/4"} H 18^{1/2"}
 110 CM 110 CM 47 CM

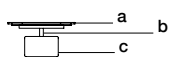

a:top finish b:metal finish c:base finish

Top finish / Acabado top
 Base finish / Acabado base



Metal finish / Acabado metal



One piece metallic structure. / Estructura de metal en una pieza.

GEM COCKTAIL TABLE 111
(STONE TOP)
 mesa central gem 111
 (top piedra)

GM19-111

W 43^{1/4"} D 43^{1/4"} H 18^{1/2"}
 110 CM 110 CM 47 CM

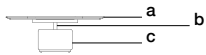

a:stone top b:metal finish c:wood finish

Stone top / Top piedra

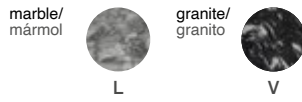

Metal finish / Acabado metal



Wood finish / Acabado madera



Tables sold separately. / Las mesas se venden por separado.
 One piece metallic structure. / Estructura de metal en una pieza.

GEM COCKTAIL TABLE 200
 mesa central gem 200

GM19-200

w 63" d 31 1/2" h 19"
 160 cm 80 cm 48 cm

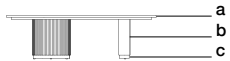
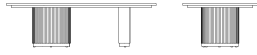

a:top finish top b:base finish c:wood detail

Top finish / Acabado top
 Base finish / Acabado base
 Wood detail / Detalle madera







Referential photo. Some products, finishes or fabrics may no longer be available. /
Foto referencial. Algunos productos, acabados o telas podrían ya no estar disponibles.

ADRIANA HOYOS

GEM COCKTAIL TABLE 201
(STONE TOP)
 mesa central gem 201
 (top piedra)

GM19-201

w 63" d 31 1/2" H 19"
 160 CM 80 CM 48 CM

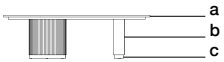
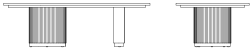
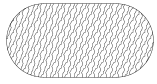

a:stone top b:wood finish c:wood detail

Stone top / Top piedra

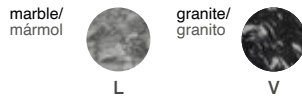

Wood finish / Acabado madera

Wood detail / Detalle madera



Tables sold separately. / Las mesas se venden por separado.

GEM COCKTAIL TABLE 210
 mesa central gem 210

GM19-210

w 63" D 31 1/2" H 16 1/2"
 160 CM 80 CM 42 CM

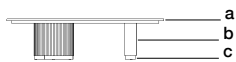
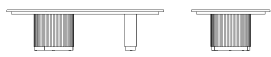

a:top finish b:base finish c:wood finish

Top finish / Acabado top
 Base finish / Acabado base
 Wood detail / Detalle madera



Tables sold separately. / Las mesas se venden por separado.

GEM COCKTAIL TABLE 211
(STONE TOP)
 mesa central gem 211
 (top piedra)

GM19-211

w 63" d 31 1/2" h 16 1/2"
 160 CM 80 CM 42 CM

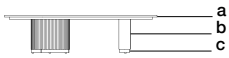
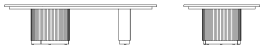
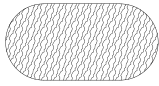

a:stone top b:wood finish c:wood finish

Stone top / Top piedra

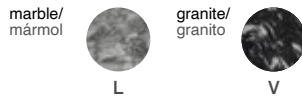

Wood finish / Acabado madera

Wood detail / Detalle madera



**GALAPAGOS COCKTAIL
TABLE 100 (GLASS TOP)**
mesa central galápagos 100
(top vidrio)

GS19-100

DIA 47^{1/4} H 13^{3/4}"
120 CM 35 CM

Wood finish / Acabado madera



a: wood finish



Tables sold separately. / Las mesas se venden por separado.
Glass top included / Incluye top de vidrio





Referential photo. Some products, finishes or fabrics may no longer be available. /
Foto referencial. Algunos productos, acabados o telas podrían ya no estar disponibles.

ADRIANA HOYOS

**GALAPAGOS NESTING
COCKTAIL TABLE 110**
mesa central nesting
galápagos 110

GS19-110

DIA 35^{1/2"} H 16^{1/2"}
90 CM 42 CM

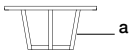

a: wood finish

Wood finish / Acabado madera



Tables sold separately. / Las mesas se venden por separado.

**GALAPAGOS COCKTAIL
TABLE 200**
mesa central galápagos 200

GS19-200

W 55" D 31 1/2" H 15 3/4"
140 CM 80 CM 40 CM

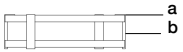
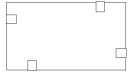

a: wood finish b: wood detail

Wood finish / Acabado madera
Wood detail / Detalle madera



GALAPAGOS COCKTAIL TABLE 210

mesa central galápagos 210

GS19-210

W 59" D 59" H 15^{3/4}"
150 CM 150 CM 40 CM

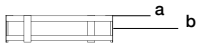
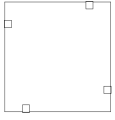

a: wood finish b: wood detail

Wood finish / Acabado madera
Wood detail / Detalle madera



**GALAPAGOS COCKTAIL
TABLE 300**
mesa central galápagos 300

GS19-300

W 63" D 35 1/2" H 13 3/4"
160 CM 90 CM 35 CM

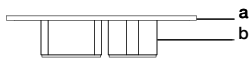
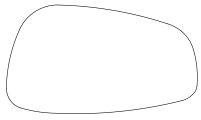

a:top finish b:base finish

Top finish / Acabado top
Base finish / Acabado base



GALAPAGOS COCKTAIL TABLE 301 (STONE TOP)
 mesa central galápagos 301 (top piedra)

GS19-301

w 63" d 35 1/2" h 13 3/4"
 160 CM 90 CM 35 CM

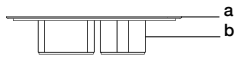
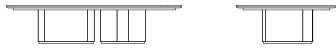
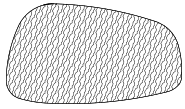

a:stone top b:wood finish

Stone top / Top piedra

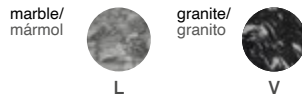

Wood finish / Acabado madera



Tables sold separately. / Las mesas se venden por separado.

**GALAPAGOS COCKTAIL
TABLE 310**
mesa central galápagos 310

GS19-310

W 47^{1/4"} D 23^{1/2"} H 16^{1/2"}
120 CM 60 CM 42 CM

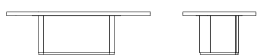

a:top finish b:base finish

Top finish / Acabado top
Base finish / Acabado base



Tables sold separately. / Las mesas se venden por separado.





Referential photo. Some products, finishes or fabrics may no longer be available. /
Foto referencial. Algunos productos, acabados o telas podrían ya no estar disponibles.

ADRIANA HOYOS

GALAPAGOS COCKTAIL TABLE 311 (STONE TOP)
 mesa central galápagos 311 (top piedra)

GS19-311

w 47^{1/4"} d 23^{1/2"} h 16^{1/2"}
 120 CM 60 CM 42 CM

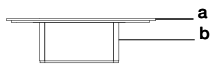
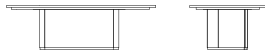
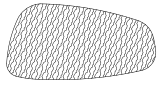

a:stone top b:wood finish

Stone top / Top piedra

marble/
mármol



L

granite/
granito



V

quartzite/
cuarcita



F



C



M

Wood finish / Acabado madera



R



T



P



A



K



B



L



J



E



N



Q



S



Y



Z



Tables sold separately. / Las mesas se venden por separado.

**GALAPAGOS COCKTAIL
TABLE 401 (STONE TOP)**
mesa central galápagos 401
(top piedra)

GS19-401

W 57" D 41 1/4" H 16 1/2"
145 CM 105 CM 42 CM

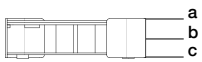
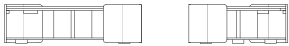
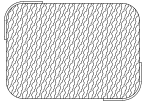

a:stone top b:wood finish c:high gloss finish

Stone top / Top piedra

marble/
mármol



L

granite/
granito



V

quartzite/
cuarcita



F



C



M

High gloss finish / Acabado high gloss



G1



G2



G3



G6



G7



G8

Wood finish / Acabado madera



R



T



P



A



K



B



L



J



E



N



Q



S



Y



Z



H COCKTAIL TABLE 200
 mesa central h 200

HS19-200

W 43^{1/4"} D 27^{1/2"} H 13^{3/4"}
 110 CM 70 CM 35 CM

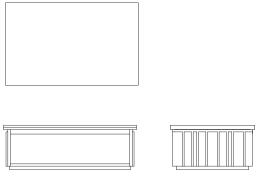

a: wood finish

Wood finish / Acabado madera



H COCKTAIL TABLE 600
mesa central h 600

HS19-600

W 44^{1/2"} D 35^{1/2"} H 15^{3/4"}
 113 CM 90 CM 40 CM

Diameter superior top /
 Diámetro top superior
 DIAM 29^{1/2"}
 75 CM
 Diameter lower top /
 Diámetro top inferior
 DIAM 35^{1/2"}
 90 CM

Table top finish / Acabado estructura superior
 Lower top finish / Acabado estructura inferior

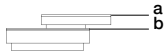
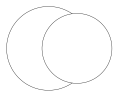

a: table top finish b: lower top finish



H COCKTAIL TABLE 601
(PORCELAIN TOP)
 mesa central h 601
 (top porcelanato)

HS19-601

W 44^{1/2"} D 35^{1/2"} H 15^{1/4"}
 113 CM 90 CM 39 CM

Diameter superior top /
 Diámetro top superior
 DIAM 29^{1/2"}
 75 CM
 Diameter lower top /
 Diámetro top inferior
 DIAM 35^{1/2"}
 90 CM

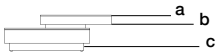
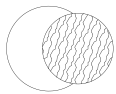

a:porcelain top b:table top c:lower top finish

Porcelain top* / Top porcelanato*

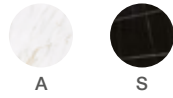

Table top finish / Acabado estructura superior
 Lower top finish / Acabado estructura inferior



*Only available on specific H Collection products. / Disponible únicamente para productos específicos de la Colección H



Referential photo. Some products, finishes or fabrics may no longer be available. /
Foto referencial. Algunos productos, acabados o telas podrían ya no estar disponibles.

LUA COCKTAIL TABLE 100
mesa central lua 100

LU19-100

W 48^{3/4"} D 48^{3/4"} H 13^{3/4"}
124 CM 124 CM 35 CM

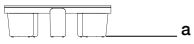

a:wood finish

Wood finish / Acabado madera



LUA COCKTAIL TABLE 101
(STONE TOP)
 mesa central lua 101
 (top piedra)

LU19-101

W 48^{3/4"} D 48^{3/4"} H 13^{3/4"}
 124 CM 124 CM 35 CM

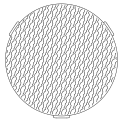

a:wood finish b:stone top

Wood finish / Acabado madera



Stone top / Top piedra

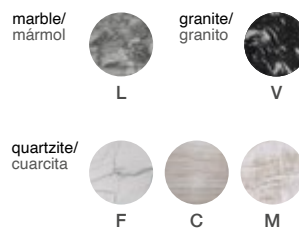

ROUNDED EDGE / canto redondeado



LUA COCKTAIL TABLE 200
 mesa central lua 200

LU19-200

W 45^{1/4"} D 22^{3/4"} H 13^{3/4"}
 115 CM 58 CM 35 CM

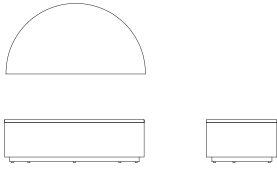

a:wood finish

LUA COCKTAIL TABLE 220
 mesa central lua 220

LU19-220

W 45^{1/4"} D 22^{3/4"} H 17"
 115 CM 58 CM 43 CM

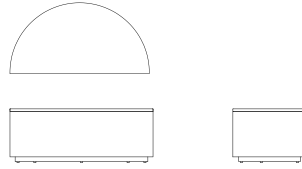

a:wood finish

Wood finish / Acabado madera



Tables sold separately. / Las mesas se venden por separado.

LUA COCKTAIL TABLE 210
 mesa central lua 210

LU19-210

W 45^{1/4"} D 23^{1/2"} H 13^{3/4"}
 115 CM 60 CM 35 CM

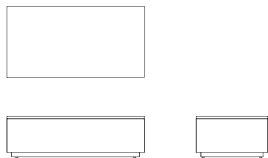

a:wood finish

LUA COCKTAIL TABLE 230
 mesa central lua 230

LU19-230

W 45^{1/4"} D 23^{1/2"} H 17"
 115 CM 60 CM 43 CM

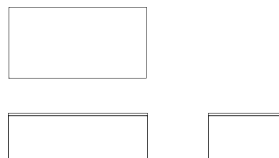

a:wood finish

Wood finish / Acabado madera



Tables sold separately. / Las mesas se venden por separado.

**LUA COCKTAIL TABLE 201
(STONE TOP)**
 mesa central lua 201
 (top piedra)

LU19-201

W 45^{1/4"} D 22^{3/4"} H 13^{3/4"}
 115 CM 58 CM 35 CM

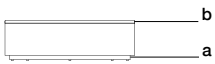
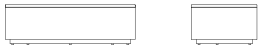
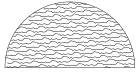

a:wood finish b:stone top

**LUA COCKTAIL TABLE 221
(STONE TOP)**
 mesa central lua 221
 (top piedra)

LU19-221

W 45^{1/4"} D 22^{3/4"} H 17"
 115 CM 58 CM 43 CM

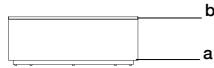
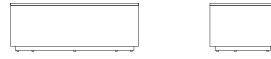
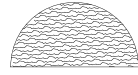

a:wood finish b:stone top

Wood finish / Acabado madera



Stone top / Top piedra

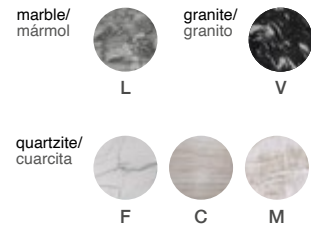

Tables sold separately. / Las mesas se venden por separado.

**LUA COCKTAIL TABLE 211
(STONE TOP)**
mesa central lua 211
(top piedra)

LU19-211

W 45^{1/4"} D 23^{1/2"} H 13^{3/4"}
115 CM 60 CM 35 CM

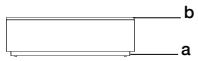
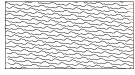

a:wood finish b:stone top

**LUA COCKTAIL TABLE 231
(STONE TOP)**
mesa central lua 231
(top piedra)

LU19-231

W 45^{1/4"} D 23^{1/2"} H 17"
115 CM 60 CM 43 CM

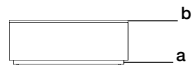
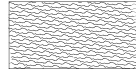

a:wood finish b:stone top

Wood finish / Acabado madera



Stone top / Top piedra

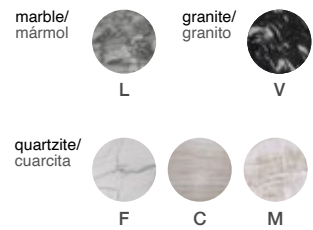

Tables sold separately. / Las mesas se venden por separado.

**RUMBA COCKTAIL
TABLE 200**
mesa central rumba 200

RM19-200

w 56^{3/4"} d 36^{1/4"} H 17^{1/4"}
144 CM 92 CM 44 CM

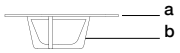

a:top finish b:base finish

Top finish / Acabado top
Base finish / Acabado base



END TABLES mesas auxiliares



GEM END TABLE 100
mesa auxiliar gem 100



GEM END TABLE 101
mesa auxiliar gem 101



GEM END TABLE 200
mesa auxiliar gem 200



GEM END TABLE 201
mesa auxiliar gem 201



GEM NESTING SIDE TABLE 300
mesa auxiliar nesting gem 300



GEM LOW BISTRO TABLE 401
mesa baja bistro gem 401



GALAPAGOS END TABLE 100
mesa auxiliar galápagos 100



GALAPAGOS END TABLE 200
mesa auxiliar galápagos 200



GALAPAGOS END TABLE 300
mesa auxiliar galápagos 300



GALAPAGOS END TABLE 301
mesa auxiliar galápagos 301



GALAPAGOS END TABLE 310
mesa auxiliar galápagos 310



GALAPAGOS END TABLE 311
mesa auxiliar galápagos 311



GALAPAGOS END TABLE 750
mesa auxiliar galápagos 750



H END TABLE 600
mesa auxiliar h 600



HOSPITALITY END TABLE 101
mesa auxiliar hospitality 101

Slight color variations may occur while printing tearsheets due to printers pixelation and quality. Product specifications are subject to change due to product development updates.
Ligeras variaciones de color pueden ocurrir en la impresión. Las especificaciones están sujetas a cambios debido a las necesidades del producto.
Dimensions are usually approximated to the nearest quarter inch that will correspond to its metric conversion.
Las medidas generalmente se dan de acuerdo a la conversión métrica correspondiente y con una medida aproximada.

END TABLES
mesas auxiliares



LUA END TABLE 100
mesa auxiliar lua 100



LUA END TABLE 101
mesa auxiliar lua 101



LUA END TABLE 200
mesa auxiliar lua 200



LUA END TABLE 201
mesa auxiliar lua 201

Slight color variations may occur while printing tearsheets due to printers pixelation and quality. Product specifications are subject to change due to product development updates.
Ligeras variaciones de color pueden ocurrir en la impresión. Las especificaciones están sujetas a cambios debido a las necesidades del producto.
Dimensions are usually approximated to the nearest quarter inch that will correspond to its metric conversion.
Las medidas generalmente se dan de acuerdo a la conversión métrica correspondiente y con una medida aproximada.

GEM END TABLE 100
mesa auxiliar gem 100

GM20-100

w 19^{3/4}" d 19^{3/4}" H 23^{1/2}"
 50 cm 50 cm 60 cm

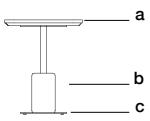

a:top finish b:base finish c:metal finish

Top finish / Acabado top

Base finish / Acabado base



Metal finish / Acabado metal

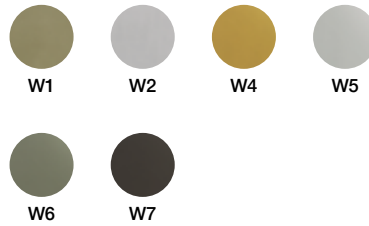

GEM END TABLE 101
(STONE TOP)
 mesa auxiliar gem 101
 (top piedra)

GM20-101

w 19^{3/4}" d 19^{3/4}" h 23^{1/2}"
 50 cm 50 cm 60 cm

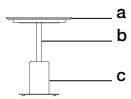

a:stone finish b:metal finish c:wood finish

Stone top / Top piedra



Metal finish / Acabado metal



Wood finish / Acabado madera



GEM END TABLE 200

mesa auxiliar gem 200

GM20-200

DIAM 19^{3/4"} H 21^{3/4"}
50 cm 55 cm

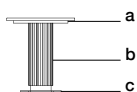

a:top finish b:base finish c:metal finish

Top finish / Acabado top

Base finish / Acabado base



Metal finish / Acabado metal

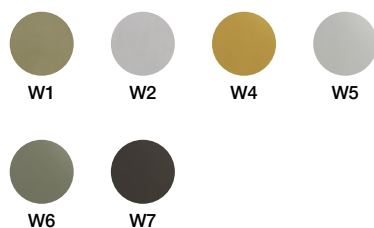



Referential photo. Some products, finishes or fabrics may no longer be available. /
Foto referencial. Algunos productos, acabados o telas podrían ya no estar disponibles.

ADRIANA HOYOS

GEM END TABLE 201
(STONE TOP)
 mesa auxiliar gem 201
 (top piedra)

GM20-201

DIAM 19^{3/4"} H 21^{3/4"}
 50 cm 55 cm

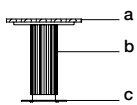
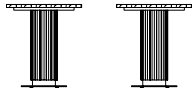

a:stone top b:wood finish c:metal finish

Stone top / Top piedra



Metal finish / Acabado metal

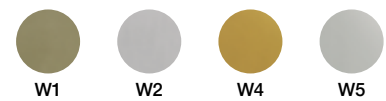

Wood finish / Acabado madera



**GEM NESTING SIDE
TABLE 300**
mesa auxiliar nesting
gem 300

GM20-300

w 13" D 19^{3/4}" H 20^{1/2}"
33 cm 50 cm 52 cm

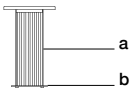

a:wood finish b:metal finish

Wood finish / Acabado madera



Metal finish / Acabado metal

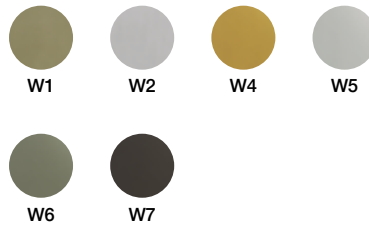

Maximum weight 3 kg (laptop). / Peso máximo 3 kg (laptop).

GEM LOW BISTRO
TABLE 401 (STONE TOP)
 mesa baja bistro gem 401
 (top piedra)

GM20-401

DIAM 31^{1/2"} W 26^{3/4"}
 80 cm 68 cm



a:stone top b:wood finish c:metal finish

Stone top / Top piedra



Metal finish / Acabado metal

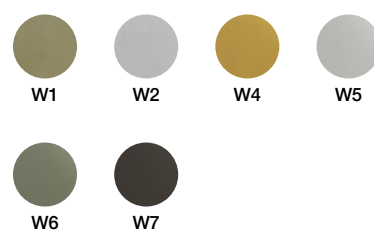

Wood finish / Acabado madera



GALAPAGOS END TABLE 100
(GLASS TOP)
mesa auxiliar galápagos 100
(top vidrio)

GS20-100

DIAM 23^{1/2"} H 25^{1/2"}
60 cm 65 cm

Wood finish / Acabado madera

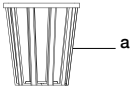

a:wood finish



Glass top included / Incluye top de vidrio

GALAPAGOS
END TABLE 200
mesa auxiliar
galápagos 200

GS20-200

w 19^{3/4}" d 19^{3/4}" h 25^{1/2}"
50 cm 50 cm 65 cm

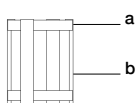
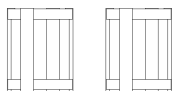

a:wood finish b:wood detail

Wood finish / Acabado madera

Wood detail / Detalle madera



GALAPAGOS END
TABLE 300
mesa auxiliar
galápagos 300

GS20-300

w 17^{3/4}" d 17^{3/4}" H 21^{3/4}"
45 cm 45 cm 55 cm

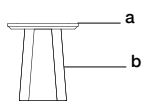

a:top finish b:base finish

Top finish / Acabado top
Base finish / Acabado base



GALAPAGOS END TABLE 301
(STONE TOP)
 mesa auxiliar galápagos 301
 (top piedra)

GS20-301

w 17^{3/4}" d 17^{3/4}" h 21^{3/4}"
 45 cm 45 cm 55 cm

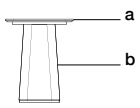

a:stone top b:wood finish

Stone top / Top piedra



Wood finish / Acabado madera



GALAPAGOS END
TABLE 310
 mesa auxiliar
 galápagos 310

GS20-310

w 19^{3/4"} d 19^{3/4"} d 24^{1/2"}
 50 cm 50 cm 62 cm

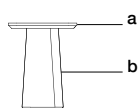

a:stone top b:base finish

Top finish / Acabado top
 Base finish / Acabado base



Tables sold separately. / Las mesas se venden por separado.



Referential photo. Some products, finishes or fabrics may no longer be available. /
Foto referencial. Algunos productos, acabados o telas podrían ya no estar disponibles.

ADRIANA HOYOS

**GALAPAGOS END
TABLE 311
(STONE TOP)**
mesa auxiliar galápagos 311
(top piedra)

GS20-311

w 19^{3/4"} d 19^{3/4"} h 24^{1/2"}
50 cm 50 cm 62 cm

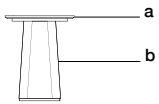

a:stone top b:wood finish

Stone top / Top piedra

marble/
mármol



L

granite/
granito



V

quartzite/
cuarcita



F



C



M

Wood finish / Acabado madera



R



T



P



A



K



B



L



J



E



N



Q



S



Y



Z



**GALAPAGOS END
TABLE 750**
mesa auxiliar
galápagos 750

GS20-750

w 43^{1/4"} d 11^{3/4"} h 21^{3/4"}
110 cm 30 cm 55 cm

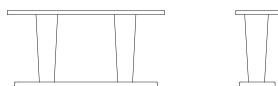

a: wood finish

Wood finish / Acabado madera



H END TABLE 600
mesa auxiliar h 600

HS20-600

w 17^{3/4}" d 17^{3/4}" h 21^{3/4}"
45 cm 45 cm 55 cm

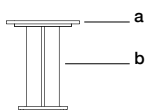

a:top finish b:base finish

Top finish / Acabado top
Base finish / Acabado base



HOSPITALITY END TABLE 101
(PORCELAIN TOP)
 mesa auxiliar hospitality 101
 (top porcelanato)

AH12-100

DIAM 19^{3/4"} H 21^{3/4"}
 50 cm 55 cm

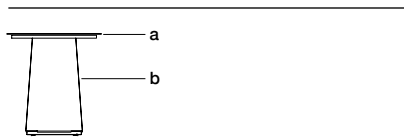
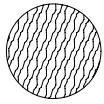

a:Porcelain top b:wood finish

Porcelain top / Top porcelanato

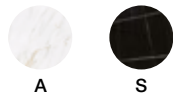

Wood finish / Acabado madera



LUA END TABLE 100
mesa auxiliar lua 100

LU20-100

DIAM 19^{3/4"} H 21^{3/4"}
 50 cm 55 cm

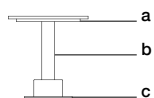

a:top finish b:base finish c:metal finish

Top finish / Acabado top

Base finish / Acabado base



Metal finish / Acabado metal

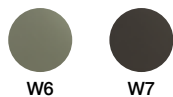

**LUA END TABLE 101
(STONE TOP)**
 mesa auxiliar lua 101
 (top piedra)

LU20-101

DIAM 19^{3/4"} H 21^{3/4"}
 50 cm 55 cm

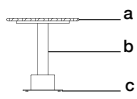

a:stone top b:wood finish c:metal finish

Stone top / Top piedra

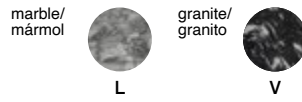

Metal finish / Acabado metal



Wood finish / Acabado madera



ROUNDED EDGE / canto redondeado



LUA END TABLE 200
mesa auxiliar lua 200

LU20-200

w 20" d 13^{3/4}" H 23^{1/2}"
51 cm 35 cm 60 cm

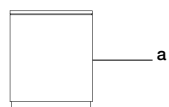
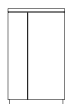

a:wood finish

Wood finish / Acabado madera



LUA END TABLE 201
(STONE TOP)
 mesa auxiliar lua 201
 (top piedra)

LU20-201

w 20" d 13^{3/4}" h 23^{1/2}"
 51 cm 35 cm 60 cm

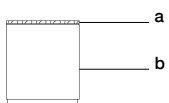

a:stone top b:wood finish

Stone top / Top piedra

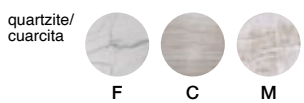

Wood finish / Acabado madera



CONSOLES

consolas



GEM CONSOLE 101/111
consola gem 101/111



GEM CONSOLE 110
consola gem 110



GALAPAGOS CONSOLE 100
consola galápagos 100



GALAPAGOS CONSOLE 101
consola galápagos 101



GALAPAGOS CONSOLE 200
consola galápagos 200



GALAPAGOS CONSOLE 201
consola galápagos 201



H CONSOLE 110
consola h 110



H CONSOLE 500
consola h 500



H CONSOLE 501
consola h 501



LUA CONSOLE 100/110
consola lua 100/110

Slight color variations may occur while printing tearsheets due to printers pixelation and quality. Product specifications are subject to change due to product development updates.
Ligeras variaciones de color pueden ocurrir en la impresión. Las especificaciones están sujetas a cambios debido a las necesidades del producto.
Dimensions are usually approximated to the nearest quarter inch that will correspond to its metric conversion.
Las medidas generalmente se dan de acuerdo a la conversión métrica correspondiente y con una medida aproximada.

GEM CONSOLE 101
(STONE TOP)
 consola gem 101
 (top piedra)

GM34-101

W 61^{1/2"} D 19^{3/4"} H 33^{3/4"}
 156 CM 50 CM 86 CM

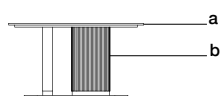
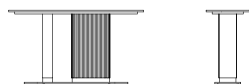

a:stone top b:wood finish

GEM CONSOLE 111
(STONE TOP)
 consola gem 111
 (top piedra)

GM34-111

W 70^{3/4"} D 20^{1/2"} H 33^{3/4"}
 180 CM 52 CM 86 CM

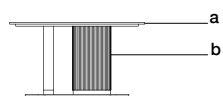
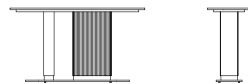
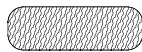

a:stone top b:wood finish

Stone top / Top piedra



Wood finish / Acabado madera



GEM CONSOLE 110
consola gem 110

GM34-110

w 70^{3/4"} d 19^{3/4"} h 33^{3/4"}
180 CM 50 CM 86 CM

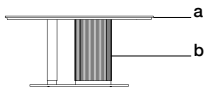
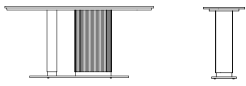

a:top finish b:base finish

Top finish / Acabado top
Base finish / Acabado base



GALAPAGOS CONSOLE 100
consola galápagos 100

GS34-100

W 63" D 21 3/4" H 33 1/2"
160 CM 55 CM 85 CM

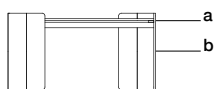
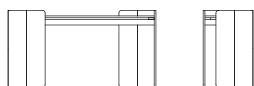

a:top finish b:base finish

Top finish / Acabado top
Base finish / Acabado base







Referential photo. Some products, finishes or fabrics may no longer be available. /
Foto referencial. Algunos productos, acabados o telas podrían ya no estar disponibles.

ADRIANA HOYOS

**GALAPAGOS CONSOLE 101
(STONE TOP)**
consola galápagos 101
(top piedra)

GS34-101

W 63" D 21 3/4" H 33 1/2"
160 CM 55 CM 85 CM

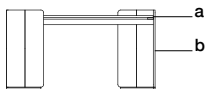
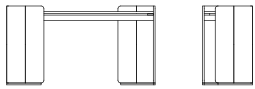
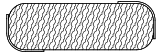

a:stone top b:wood finish

Stone top / Top piedra



Wood finish / Acabado madera



GALAPAGOS CONSOLE 200
consola galápagos 200

GS34-200

w 67" d 19^{3/4}" h 33^{3/4}"
170 CM 50 CM 86 CM

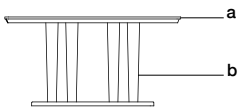
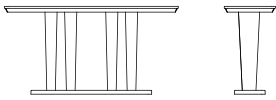

a:top finish b:base finish

Top finish / Acabado top
Base finish / Acabado base





Referential photo. Some products, finishes or fabrics may no longer be available. /
Foto referencial. Algunos productos, acabados o telas podrían ya no estar disponibles.

ADRIANA HOYOS

GALAPAGOS CONSOLE 201
(STONE TOP)
 consola galápagos 201
 (top piedra)

GS34-201

W 67" D 19^{3/4"} H 33^{3/4"}
 170 CM 50 CM 86 CM

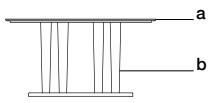
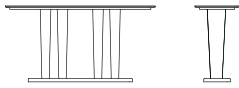
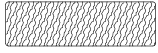

a:stone top b:wood finish

Stone top / Top piedra



Wood finish / Acabado madera



H CONSOLE 110
consola h 110

HS34-110

W 51^{1/4"} D 13^{3/4"} H 32^{1/4"}
130 CM 35 CM 82 CM

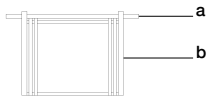
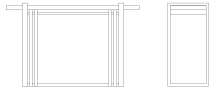

a:top finish b:base finish

Top finish / Acabado top

Base finish / Acabado base



H CONSOLE 500
consola h 500

HS34-500

W 51^{1/4"} D 13^{3/4"} H 30"
130 CM 35 CM 76 CM

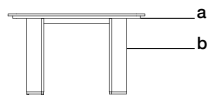
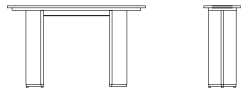

a:top finish b:base finish

Top finish / Acabado top
Base finish / Acabado base



H CONSOLE 501
(PORCELAIN TOP)
 consola h 501
 (top porcelanato)

HS34-501

W 51^{1/4"} D 13^{3/4"} H 30"
 130 CM 35 CM 76 CM

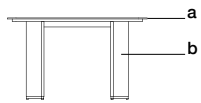
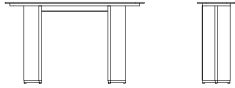

a:porcelain top b:wood finish

Porcelain top* / Top porcelanato*

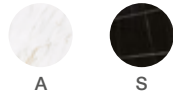

Wood finish / Acabado madera



*Only available on specific H Collection products. / Disponible únicamente para productos específicos de la Colección H.

LUA CONSOLE 100
consola lua 100

LU34-100

W 63" D 17^{3/4}" H 23^{1/2}"
160 CM 45 CM 60 CM

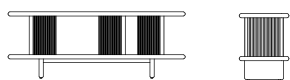

a:wood finish

LUA CONSOLE 110
consola lua 110

LU34-110

W 78^{3/4}" D 17^{3/4}" H 23^{1/2}"
200 CM 45 CM 60 CM

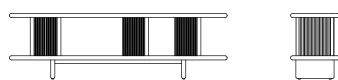

a:wood finish

Wood finish / Acabado madera



DINING ROOM | COMEDOR

DINING TABLES
Mesas de comedor

DINING CHAIRS
Sillas de comedor

BAR & COUNTER STOOLS
Bar y counter stools



DINING TABLES

mesas de comedor



HOSPITALITY DINING TABLE 101
mesa comedor hospitality 101



HOSPITALITY DINING TABLE 111
mesa comedor hospitality 111



HOSPITALITY DINING TABLE 121
mesa comedor hospitality 121



HOSPITALITY DINING TABLE 531
mesa comedor hospitality 531

Slight color variations may occur while printing tearsheets due to printers pixelation and quality. Product specifications are subject to change due to product development updates.
Ligeras variaciones de color pueden ocurrir en la impresión. Las especificaciones están sujetas a cambios debido a las necesidades del producto.
Dimensions are usually approximated to the nearest quarter inch that will correspond to its metric conversion.
Las medidas generalmente se dan de acuerdo a la conversión métrica correspondiente y con una medida aproximada.

**HOSPITALITY DINING TABLE
101 (PORCELAIN TOP)**
mesa comedor hospitality 101
(top porcelanato)

HT04-101

DIAM 47^{1/4"} H 29^{1/2"}
120 cm 75 cm

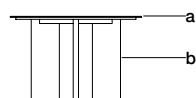
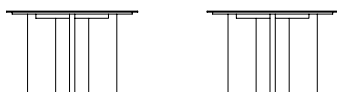
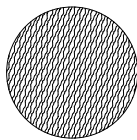

a:Porcelain top b:wood finish

Porcelain top / Top porcelanato

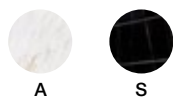

Wood finish / Acabado madera



**HOSPITALITY DINING TABLE
101 (PORCELAIN TOP)**
mesa comedor hospitality 111
(top porcelanato)

HT04-111

w 46^{3/4"} d 35"
119 cm 89 cm H 29^{1/2"}
75 cm

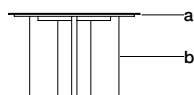
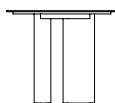
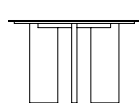
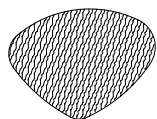

a:Porcelain top b:wood finish

Porcelain top / Top porcelanato

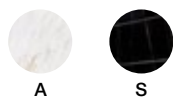

Wood finish / Acabado madera



**HOSPITALITY DINING TABLE
121 (PORCELAIN TOP)**
mesa comedor hospitality 121
(top porcelanato)

HT04-121

w 43^{1/4"} d 43^{1/4"} h 29^{1/2"}
110 cm 110 cm 75 cm

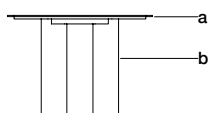
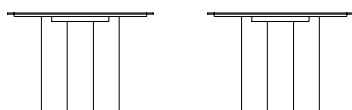
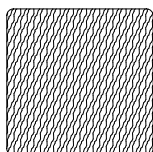

a: Porcelain top b:wood finish

Porcelain top / Top porcelanato

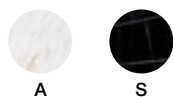

Wood finish / Acabado madera



**HOSPITALITY DINING TABLE
531 (PORCELAIN TOP)**
mesa comedor hospitality 531
(top porcelanato)

HT04-531

w 30^{3/4"} d 30^{3/4"} H 30"
78 cm 78 cm 76 cm

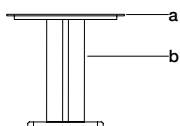
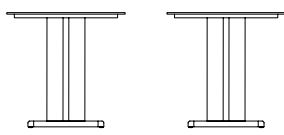
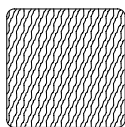

a: Porcelain top b: wood finish

Porcelain top / Top porcelanato

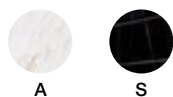

Wood finish / Acabado madera



DINING CHAIRS

sillas de comedor



BOLERO SIDE CHAIR 210
silla sin brazo bolero 210



CHOCOLATE SIDE CHAIR 120
silla sin brazo chocolate 120



CHOCOLATE ARM CHAIR 120
silla con brazo chocolate 120



CARAMELO SIDE CHAIR 740
silla sin brazo caramelo 740



GEM SIDE CHAIR 100
silla sin brazo gem 100



GEM SIDE CHAIR 200
silla sin brazo gem 200



GEM ARM CHAIR 100
silla con brazo gem 100



GEM ARM CHAIR 200
silla con brazo gem 200



GALAPAGOS CHAIR 100
silla galápagos 100



GALAPAGOS SIDE CHAIR 110
silla sin brazo galápagos 110



GALAPAGOS CASTER DINING CHAIR 203
silla galápagos 203 con ruedas



GRAFITO SIDE CHAIR 200
silla sin brazo grafito 200



GRAFITO ARM CHAIR 200
silla con brazo grafito 200



H SIDE CHAIR 100
silla sin brazo h 100



H SIDE CHAIR 300
silla sin brazo h 300

Slight color variations may occur while printing tearsheets due to printers pixelation and quality. Product specifications are subject to change due to product development updates.
Ligeras variaciones de color pueden ocurrir en la impresión. Las especificaciones están sujetas a cambios debido a las necesidades del producto.
Dimensions are usually approximated to the nearest quarter inch that will correspond to its metric conversion.
Las medidas generalmente se dan de acuerdo a la conversión métrica correspondiente y con una medida aproximada.

DINING CHAIRS
sillas de comedor



H ARM CHAIR 300
silla con brazo h 300



H SIDE CHAIR 500
silla sin brazo h 500



RUMBA SIDE CHAIR 210
silla sin brazo rumba 210



RUMBA SIDE CHAIR 410
silla sin brazo rumba 410



TEN CHAIR 100
silla ten 100



TEN SIDE CHAIR 110
silla sin brazo ten 110



TEN SIDE CHAIR 220
silla sin brazo ten 220

Slight color variations may occur while printing tearsheets due to printers pixelation and quality. Product specifications are subject to change due to product development updates.
Ligeras variaciones de color pueden ocurrir en la impresión. Las especificaciones están sujetas a cambios debido a las necesidades del producto.
Dimensions are usually approximated to the nearest quarter inch that will correspond to its metric conversion.
Las medidas generalmente se dan de acuerdo a la conversión métrica correspondiente y con una medida aproximada.

BOLERO SIDE CHAIR 210
silla sin brazo bolero 210

BR01-210

W 23^{1/4"} D 26^{1/2"} H 39^{1/4"} SH 19^{3/4"}
59 CM 67 CM 100 CM 50 CM

SW 19^{1/4"} SD 20"
49 CM 51 CM

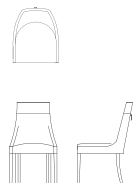

a:leather detail b:decorative hardware c:wood finish

Leather detail / Detalle cuero



Wood finish / Acabado madera



Decorative hardware / Herraje decorativo

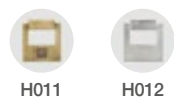

CHOCOLATE SIDE CHAIR 120

silla sin brazo chocolate 120

CH01-120

W 21^{3/4"} D 24^{3/4"} H 39^{3/4"} SH 19^{3/4"}
55 CM 63 CM 101 CM 50 CM

SW 21^{3/4"} SD 19^{1/4"}
55 CM 49 CM

Wood finish / Acabado madera

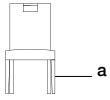
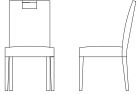

a:wood finish



**CHOCOLATE ARM
CHAIR 120**
silla con brazo chocolate 120

CH02-120

W 24" D 24^{3/4}" H 39^{3/4}" SH 19^{3/4}"
61 CM 63 CM 101 CM 50 CM

SW 21^{3/4}" SD 19^{1/4}" AH 24^{3/4}"
55 CM 49 CM 63 CM

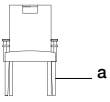
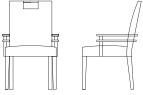

a:wood finish

Wood finish / Acabado madera



CARAMELO SIDE CHAIR 740
silla sin brazo caramelo 740

CM01-740

W 22^{3/4"} D 28^{3/4"} H 41^{1/4"} SH 19^{3/4"}
58 CM 73 CM 105 CM 50 CM

SW 19" SD 20"
48 CM 51 CM

Wood finish / Acabado madera

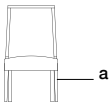
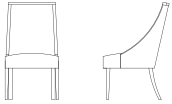

a: wood finish



GEM SIDE CHAIR 100
silla sin brazo gem 100

GM01-100

w 20" d 24^{1/2"} H 34^{3/4"} SH 19^{3/4"}
51 CM 62 CM 88 CM 50 CM

sw 20" SD 19^{1/4"}
51 CM 49 CM

Wood finish / Acabado madera



a: wood finish

PIPING DETAIL / detalle ribete



Piping can be customized using leather or fabric. / El ribete puede personalizarse en tela y cuero.





Referential photo. Some products, finishes or fabrics may no longer be available. /
Foto referencial. Algunos productos, acabados o telas podrían ya no estar disponibles.

ADRIANA HOYOS

GEM SIDE CHAIR 200
silla sin brazo gem 200

GM01-200

W 22^{1/2}" D 25^{1/2}" H 32^{1/4}" SH 19^{3/4}"
57 CM 65 CM 82 CM 50 CM

SW 20" SD 19^{3/4}"
51 CM 50 CM

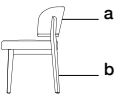
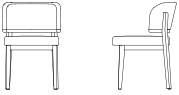

a:wood finish b:metallic button

Wood finish / Acabado madera



Metallic button / Botón metálico

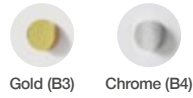

PIPING DETAIL / detalle ribete



Piping can be customized using leather or fabric. / El ribete puede personalizarse en tela y cuero.



Referential photo. Some products, finishes or fabrics may no longer be available. /
Foto referencial. Algunos productos, acabados o telas podrían ya no estar disponibles.

ADRIANA HOYOS

GEM ARM CHAIR 100
silla con brazo gem 100

GM02-100

W 24^{1/2"} D 25^{1/2"} H 34^{3/4"} SH 19^{3/4"}
62 CM 65 CM 88 CM 50 CM

SW 21^{3/4"} SD 19^{3/4"} AH 26
55 CM 50 CM 66 CM

Wood finish / Acabado madera

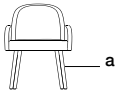

a: wood finish

PIPING DETAIL / detalle ribete



Piping can be customized using leather or fabric. / El ribete puede personalizarse en tela y cuero.

GEM ARM CHAIR 200
silla con brazo gem 200

GM02-200

W 24" D 25 1/2" H 32 1/4" SH 19 3/4"
61 CM 65 CM 82 CM 50 CM

SW 20" SD 19 3/4" SD 25 1/4"
51 CM 50 CM 64 CM

Wood finish / Acabado madera



Metallic button / Botón metálico

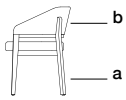
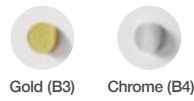

a: wood finish b: metallic button

PIPING DETAIL / detalle ribete



Piping can be customized using leather or fabric. / El ribete puede personalizarse en tela y cuero.

GALAPAGOS CHAIR 100
silla galápagos 100

GS01-100

W 23^{1/2}" D 26^{1/2}" H 34^{1/4}" SH 19^{3/4}"
60 CM 67 CM 87 CM 50 CM

SW 19^{3/4}" SD 20" AH 26"
50 CM 51 CM 66 CM

Wood finish / Acabado madera

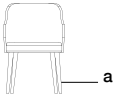
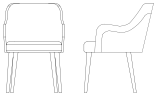

a: wood finish



**GALAPAGOS SIDE
CHAIR 110**
silla sin brazo galápagos 110

GS01-110

W 22^{3/4"} D 26^{1/2"} H 34^{1/4"} SH 19^{3/4"}
58 CM 67 CM 87 CM 50 CM

SW 19^{3/4"} SD 20"
50 CM 51 CM

Wood finish / Acabado madera

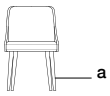
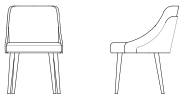

a: wood finish



**GALAPAGOS CASTER
DINING CHAIR 203**
silla galápagos 203
con ruedas

GS01-203

W 23^{1/2"} D 26^{3/4"} H 35^{1/2"} SH 19^{3/4"}
60 CM 68 CM 90 CM 50 CM

SW 23^{1/2"} SD 19^{3/4"}
60 CM 50 CM

Wood finish / Acabado madera

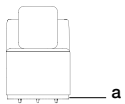
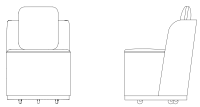

a: wood finish

PIPING DETAIL / detalle ribete

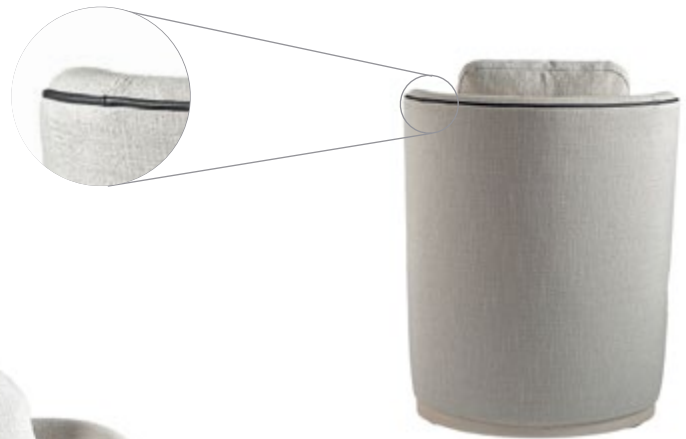

DECORATIVE PILLOW (X1) / COJÍN DECORATIVO (X1)

W 15^{1/2"} D 1^{1/2"} H 15^{1/2"}
39 CM 4 CM 39 CM



Piping can be customized using leather or fabric. / El ribete puede personalizarse en tela y cuero.
Decorative pillow included. / Incluye cojines decorativos.

GRAFITO SIDE CHAIR 200
silla sin brazo grafito 200

GT01-200

W 19^{3/4"} D 26"
50 CM 66 CM

H 37"
94 CM

SH 19^{3/4"}
50 CM

SW 19^{3/4"} SD 19^{3/4"}
50 CM 50 CM

Wood finish / Acabado madera

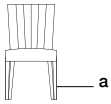
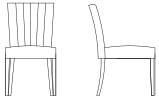

a: wood finish



GRAFITO ARM CHAIR 200

silla con brazo grafito 200

GT02-200

W 23 ^{1/2} "	D 26"	H 37"	SH 19 ^{3/4} "
60 CM	66 CM	94 CM	50 CM
SW 19 ^{3/4} "	SD 19 ^{3/4} "	AH 26"	
50 CM	50 CM	66 CM	

Wood finish / Acabado madera



a: wood finish



H SIDE CHAIR 100
silla sin brazo h 100

HS01-100

W 19" D 23^{1/2}" H 37^{1/2}" SH 19^{3/4}"
48 CM 60 CM 95 CM 50 CM

SW 19" SD 19"
48 CM 48 CM

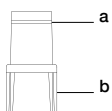
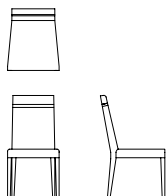

a:leather detail b:wood finish

Leather detail / Detalle cuero



Wood finish / Acabado madera



LEATHER DETAIL / detalle cuero

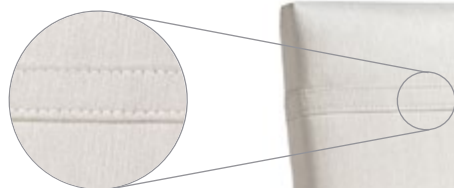

H SIDE CHAIR 300
silla sin brazo h 300

HS01-300

W 19" D 24^{3/4"} H 35^{1/2"} SH 19^{3/4"}
48 CM 63 CM 90 CM 50 CM

SW 19" SD 19"
48 CM 48 CM

Wood finish / Acabado madera

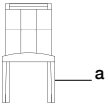
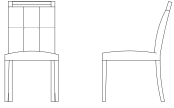

a: wood finish



H ARM CHAIR 300
silla con brazo h 300

HS02-300

W 22^{1/2}" D 24^{3/4}" H 35^{1/2}" SH 19^{3/4}"
57 CM 63 CM 90 CM 50 CM

SW 18" SD 19" AH 24^{3/4}"
46 CM 48 CM 63 CM

Wood finish / Acabado madera

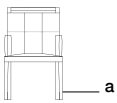
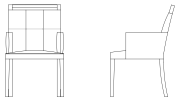

a: wood finish





Referential photo. Some products, finishes or fabrics may no longer be available. /
Foto referencial. Algunos productos, acabados o telas podrían ya no estar disponibles.

ADRIANA HOYOS

H SIDE CHAIR 500

silla sin brazo h 500

HS01-500

W 20" D 24 1/2" H 37 1/2" SH 19 3/4"
 51 CM 62 CM 95 CM 50 CM

SW 20" SD 19"
 51 CM 48 CM

Wood finish / Acabado madera

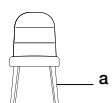
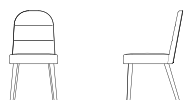

a: wood finish

PIPING DETAIL / detalle ribete

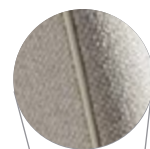

Piping can be customized using leather or fabric. / El ribete puede personalizarse en tela y cuero.

RUMBA SIDE CHAIR 210
silla sin brazo rumba 210

RM01-210

W 20^{1/2"} D 24^{1/2"} H 34^{1/4"} SH 19^{3/4"}
52 CM 62 CM 87 CM 50 CM

SW 20^{1/2"} SD 20^{1/2"}
52 CM 52 CM

Wood finish / Acabado madera

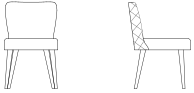

a: wood finish

PIPING DETAIL / detalle ribete



RUMBA SIDE CHAIR 410
silla sin brazo rumba 410

RM01-410

W 23^{1/2}" D 28" H 39^{1/4}" SH 19^{3/4}"
60 CM 71 CM 100 CM 50 CM

SW 20^{1/2}" SD 21^{1/4}" SD 22"
52 CM 54 CM 56 CM

Wood finish / Acabado madera

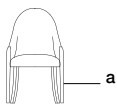
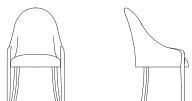

a: wood finish



TEN CHAIR 100
silla ten 100

TN01-100

W 22^{3/4"} D 25^{1/2"} H 33^{1/2"} SH 19^{3/4"}
58 CM 65 CM 85 CM 50 CM

SW 20^{1/2"} SD 20" AH 28"
52 CM 51 CM 71 CM

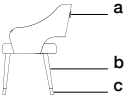
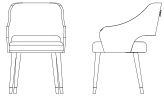

a:decorative hardware b:wood finish c:metal finish

Wood finish / Acabado madera



Metal finish / Acabado metal



Decorative hardware / Herraje decorativo





Referential photo. Some products, finishes or fabrics may no longer be available. /
Foto referencial. Algunos productos, acabados o telas podrían ya no estar disponibles.

ADRIANA HOYOS

TEN SIDE CHAIR 110
silla sin brazo ten 110

TN01-110

W 19^{3/4"} D 25^{1/2"} H 33^{1/2"} SH 19^{3/4"}
50 CM 65 CM 85 CM 50 CM

SW 19^{3/4"} SD 20"
50 CM 51 CM

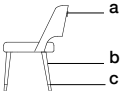
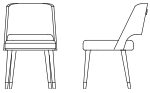

a:decorative hardware b:wood finish c:metal finish

Wood finish / Acabado madera



Metal finish / Acabado metal

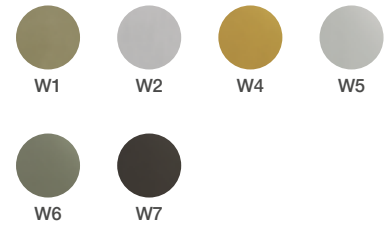

Decorative hardware / Herraje decorativo





Referential photo. Some products, finishes or fabrics may no longer be available. /
Foto referencial. Algunos productos, acabados o telas podrían ya no estar disponibles.

ADRIANA HOYOS

TEN SIDE CHAIR 220
silla sin brazo ten 220

TN01-220

W 19^{3/4"} D 24" H 31^{1/2"} SH 19^{3/4"}
50 CM 61 CM 80 CM 50 CM

SW 18^{1/2"} SD 19^{1/4"}
47 CM 49 CM

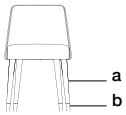

a:wood finish b:metal finish

Wood finish / Acabado madera



Metal finish / Acabado metal

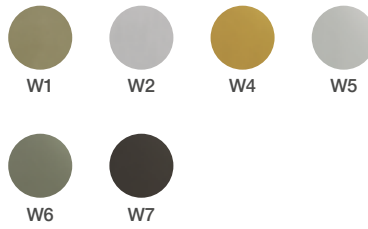

PIPING DETAIL / detalle ribete



Piping can be customized using leather or fabric. / El ribete puede personalizarse en tela y cuero.

BAR & COUNTER STOOLS

bar y counter stools



Slight color variations may occur while printing tear sheets due to printers pixelation and quality. Product specifications are subject to change due to product development updates.
Ligeras variaciones de color pueden ocurrir en la impresión. Las especificaciones están sujetas a cambios debido a las necesidades del producto.
Dimensions are usually approximated to the nearest quarter inch that will correspond to its metric conversion.
Las medidas generalmente se dan de acuerdo a la conversión métrica correspondiente y con una medida aproximada.

**CHOCOLATE
BAR STOOL 120**
bar stool chocolate 120

CH03-120

w 20^{3/4"} d 22^{3/4"} h 41^{1/4"} sh 30"
53 cm 58 cm 105 cm 76 cm

sw 20^{3/4"} sd 18^{1/2"}
53 cm 47 cm

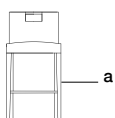
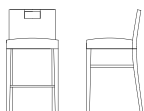

a:wood finish

**CHOCOLATE
COUNTER STOOL 120**
counter stool chocolate 120

CH05-120

w 20^{3/4"} d 22^{3/4"} h 35^{1/2"} sh 26"
53 cm 58 cm 90 cm 66 cm

sw 20^{3/4"} sd 18^{1/2"}
53 cm 47 cm

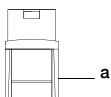
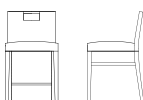

a:wood finish

Wood finish / Acabado madera



High traffic resistance finish available for foot-bar only / Acabado de alto tráfico está disponible únicamente para la barra de pie inferior.

CHOCOLATE COLLECTION

**GEM BAR STOOL 100
(SWIVEL*)**
bar stool gem 100
(mecanismo giratorio*)

GM03-100

w 19^{1/4}" d 22" H 41" SH 30"
49 cm 56 cm 104 cm 76 cm

sw 19^{1/4}" sd 17^{3/4}"
49 cm 45 cm

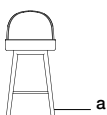

a:wood finish

GEM COUNTER STOOL 100*
(SWIVEL*)
counter stool gem 100*
(mecanismo giratorio*)

GM05-100

w 19^{1/4}" d 22" H 37" SH 26"
49 cm 56 cm 94 cm 66 cm

sw 19^{1/4}" sd 17^{3/4}"
49 cm 45 cm

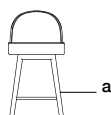

a:wood finish

Wood finish / Acabado madera



PIPING DETAIL / detalle ribete

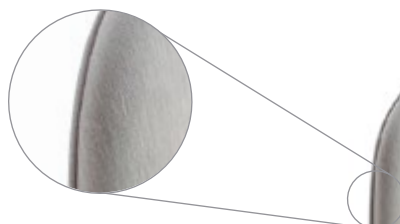

*Memory-Return Swivel / Mecanismo giratorio con memoria de retorno.

Piping can be customized / El ribete puede personalizarse.

High traffic resistance finish available for foot-bar only / Acabado de alto tráfico está disponible únicamente para la barra de pie inferior.

LUA COUNTER STOOL 100

counter stool lua 100

LU05-100

w 17" d17" H 26"
43 cm 43 cm 66 cm

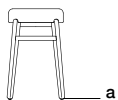
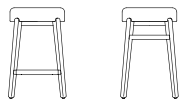

a:wood finish

Wood finish / Acabado madera



Product includes two stainless steel plates, which have a predetermined finish. / El producto incluye dos placas de acero inoxidable, con un acabado predeterminado.

LUA COLLECTION

**RUMBA BAR
STOOL 100 (SWIVEL*)**
bar stool rumba 100
(giratorio*)

RM03-100

w 22" d 22" H 40^{1/4}" SH 30"
56 cm 56 cm 102 cm 76 cm

sw 19^{3/4}" SD 19^{3/4}"
50 cm 50 cm

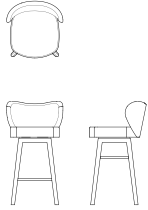

a:wood finish

**RUMBA COUNTER
STOOL 100 (SWIVEL*)**
counter stool rumba 100
(giratorio*)

RM05-100

w 22" d 22" H 35^{1/2}" SH 26"
56 cm 56 cm 90 cm 66 cm

sw 19^{3/4}" SD 19^{3/4}"
50 cm 50 cm

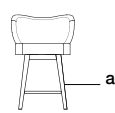
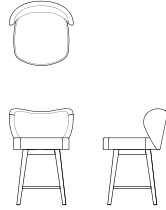

a:wood finish

Wood finish / Acabado madera



PIPING DETAIL / detalle ribete

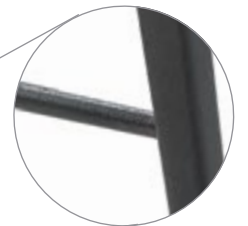

*Memory-Return Swivel / Mecanismo giratorio *

Piping can be customized / El ribete puede per

High traffic resistance finish available for foot-bar only / Acabado de alto tráfico está disponible únicamente para la barra de pie inferior.

RUMBA COLLECTION

TEN BAR STOOL 100 (SWIVEL*)
bar stool ten 100 (giratorio*)

TN03-100

w 20^{1/2"} d 23^{1/2"} H 41^{1/4"} SH 30"
52 cm 60 cm 105 cm 76 cm

sw 20^{1/2"} sd 19^{1/4"}
52 cm 49 cm

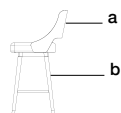

a:decorative hardware b:wood finish

TEN COUNTER STOOL 100 (SWIVEL*)
counter stool ten 100 (giratorio*)

TN05-100

w 20^{1/2"} d 23^{1/2"} H 37^{1/2"} SH 26"
52 cm 60 cm 95 cm 66 cm

sw 20^{1/2"} sd 19^{1/4"}
52 cm 49 cm

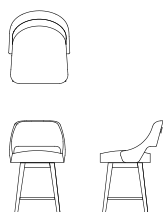

a:decorative hardware b:wood finish

Wood finish / Acabado madera



Decorative hardware / Herraje decorativo



*Memory-Return Swivel / Mecanismo giratorio con memoria de retorno.

High traffic resistance finish available for foot-bar only / Acabado de alto tráfico está disponible únicamente para la barra de pie inferior.

TEN COLLECTION

TEN BAR STOOL 200
(SWIVEL*)
 bar stool ten 200
 (giratorio)

TN03-200

w 20^{1/2"} d 23^{1/2"} H 41^{1/4"} SH 30"
 52 cm 60 cm 105 cm 76 cm

sw 20^{1/2"} sd 19^{1/4"}
 52 cm 49 cm

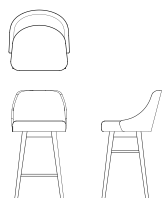

a:wood finish

TEN COUNTER STOOL 200
(SWIVEL*)
 counter stool ten 200
 (giratorio)

TN05-200

w 20^{1/2"} d 23^{1/2"} H 35^{1/2"} SH 26"
 52 cm 60 cm 90 cm 66 cm

sw 20^{1/2"} sd 19^{1/4"}
 52 cm 49 cm

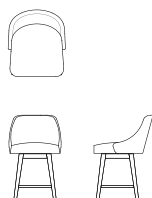

a:wood finish

Wood finish / Acabado madera



PIPING DETAIL / detalle ribete



*Memory-Return Swivel / Mecanismo giratorio con memoria de retorno.

Piping can be customized / El ribete puede personalizarse.

High traffic resistance finish available for foot-bar only / Acabado de alto tráfico está disponible únicamente para la barra de pie inferior.





Referential photo. Some products, finishes or fabrics may no longer be available. / Foto referencial.
Algunos productos, acabados o telas podrían ya no estar disponibles.

BEDROOM | DORMITORIO

BEDS
Camas



Referential photo. Some products, finishes or fabrics may no longer be available. / Foto referencial.
Algunos productos, acabados o telas podrían ya no estar disponibles.

BEDS camas



AFRICA BED 500/501/502
cama áfrica 500/501/502



AFRICA BED 510/511/512
cama áfrica 510/511/512



GEM UPHOLSTERED BED WITH PANELS
100/101/102
cama tapizada con paneles gem 100/101/102



GEM UPHOLSTERED BED 110/111/112
cama tapizada gem 110/111/112



GEM UPHOLSTERED BED WITH PANELS
200/201/202
cama tapizada con paneles gem 200/201/202



GEM UPHOLSTERED BED 210/211/212
cama tapizada gem 210/211/212



H UPHOLSTERED BED 100/101
cama h tapizada 100/101



H BED 200/201
cama h 200/201



H BED 400/401
cama h 400/401



H BED 500/501
cama h 500/501



H WITH PANELS BED 510/511
cama con paneles h 510/511



H BED 600/601
cama h 600/601



RUMBA UPHOLSTERED BED 211
cama tapizada rumba 211



RUMBA BED 400/401/402
cama rumba 400/401/402



RUMBA UPHOLSTERED BED 410/411/412
cama tapizada rumba 410/411/412

Slight color variations may occur while printing tear sheets due to printers pixelation and quality. Product specifications are subject to change due to product development updates.
Ligeras variaciones de color pueden ocurrir en la impresión. Las especificaciones están sujetas a cambios debido a las necesidades del producto.
Dimensions are usually approximated to the nearest quarter inch that will correspond to its metric conversion.
Las medidas generalmente se dan de acuerdo a la conversión métrica correspondiente y con una medida aproximada.

**AFRICA KING/QUEEN BED
(WOOD SIDE RAILS &
FOOTBOARD)**
cama king/queen áfrica
(larguero y piccero de madera)

US STANDARD

AF26-501K

platform

W 85" D 84^{1/4}" H 63"
216 CM 214 CM 160 CM

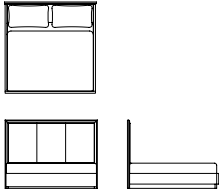

AF26-501Q

platform

W 69^{1/4}" D 84^{1/4}" H 63"
176 CM 214 CM 160 CM

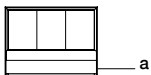
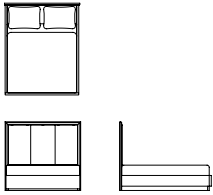

a:wood finish

US STANDARD BOX SPRING

AF26-502K

requires box spring

W 85" D 84^{1/4}" H 63"
216 CM 214 CM 160 CM

AF26-502Q

requires box spring

W 69^{1/4}" D 84^{1/4}" H 63"
176 CM 214 CM 160 CM

ECUADOR STANDARD

AF26-500K

W 85" D 84^{1/4}" H 63"
216 CM 214 CM 160 CM

AF26-500Q

W 69^{1/4}" D 84^{1/4}" H 63"
176 CM 214 CM 160 CM

Wood finish / Acabado madera





Referential photo. Some products, finishes or fabrics may no longer be available. / Foto referencial.
Algunos productos, acabados o telas podrían ya no estar disponibles.

ADRIANA HOYOS

**AFRICA KING/QUEEN BED
(UPHOLSTERED SIDE
RAILS & FOOTBOARD)**
cama king/queen áfrica
(larguero y piecero tapizado)

US STANDARD BOX SPRING

AF26-512K

requires box spring

W 85" D 84^{1/4}" H 63"
216 CM 214 CM 160 CM

US STANDARD

AF26-511K

platform

W 85" D 84^{1/4}" H 63"
216 CM 214 CM 160 CM

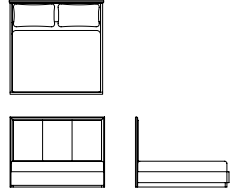

AF26-511Q

platform

W 69^{1/4}" D 84^{1/4}" H 63"
176 CM 214 CM 160 CM

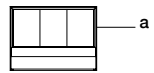
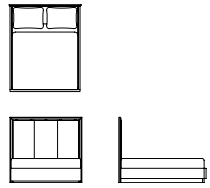

a: wood finish

AF26-512Q

requires box spring

W 69^{1/4}" D 84^{1/4}" H 63"
176 CM 214 CM 160 CM

ECUADOR STANDARD

AF26-510K

W 85" D 84^{1/4}" H 63"
216 CM 214 CM 160 CM

AF26-510Q

W 69^{1/4}" D 84^{1/4}" H 63"
176 CM 214 CM 160 CM

Wood finish / Acabado madera



**GEM KING/QUEEN
UPHOLSTERED BED
WITH PANELS (LOW)**
cama king/queen tapizada
con paneles gem (baja)

US STANDARD

GM26-101K

platform

W 167^{3/4"} D 87^{1/2"} H 47^{1/4"}
426 CM 222 CM 120 CM

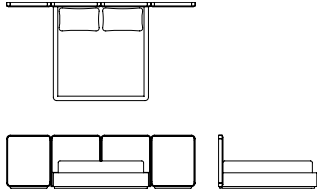

GM26-101Q

platform

W 152" D 87^{1/2"} H 47^{1/4"}
386 CM 222 CM 120 CM

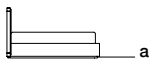
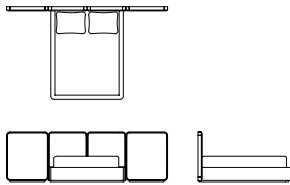

a: wood finish

US STANDARD BOX SPRING

GM26-102K

requires box spring

W 167^{3/4"} D 87^{1/2"} H 47^{1/4"}
426 CM 222 CM 120 CM

GM26-102Q

requires box spring

W 152" D 87^{1/2"} H 47^{1/4"}
386 CM 222 CM 120 CM

ECUADOR STANDARD

GM26-100K

W 167^{3/4"} D 87^{1/2"} H 47^{1/4"}
426 CM 222 CM 120 CM

GM26-100Q

W 152" D 87^{1/2"} H 47^{1/4"}
386 CM 222 CM 120 CM

Wood finish / Acabado madera



BW: box width | BD: box depth / BW: ancho de box | BD: profundidad de box

**GEM KING/QUEEN
UPHOLSTERED BED (LOW)**
cama king/queen tapizada
gem (baja)

US STANDARD

GM26-111K

platform

W 89" D 87^{1/2}" H 47^{1/4}"
226 CM 222 CM 120 CM

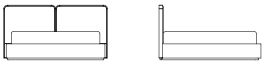
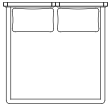

GM26-111Q

platform

W 73^{1/4}" D 87^{1/2}" H 47^{1/4}"
186 CM 222 CM 120 CM

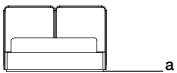
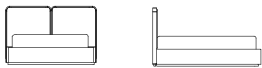
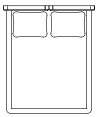

a: wood finish

US STANDARD BOX SPRING

GM26-112K

requires box spring

W 89" D 87^{1/2}" H 47^{1/4}"
226 CM 222 CM 120 CM

GM26-112Q

requires box spring

W 73^{1/4}" D 87^{1/2}" H 47^{1/4}"
186 CM 222 CM 120 CM

ECUADOR STANDARD

GM26-110K

W 89" D 87^{1/2}" H 47^{1/4}"
226 CM 222 CM 120 CM

GM26-110Q

W 73^{1/4}" D 87^{1/2}" H 47^{1/4}"
186 CM 222 CM 120 CM

Wood finish / Acabado madera



**GEM KING/QUEEN
UPHOLSTERED BED
WITH PANELS (HIGH)**
cama king/queen tapizada
con paneles gem (alta)

US STANDARD

GM26-201K

platform

W 167^{3/4"} D 87^{1/2"} H 63"
426 CM 222 CM 160 CM

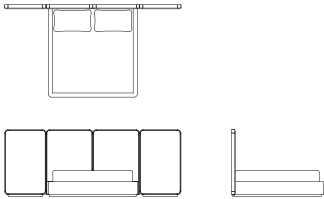

GM26-201Q

platform

W 152" D 87^{1/2"} H 63"
386 CM 222 CM 160 CM

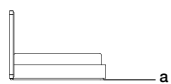
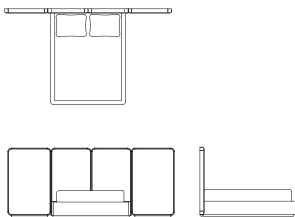

a: wood finish

US STANDARD BOX SPRING

GM26-202K

requires box spring

W 167^{3/4"} D 87^{1/2"} H 63"
426 CM 222 CM 160 CM

GM26-202Q

requires box spring

W 152" D 87^{1/2"} H 63"
386 CM 222 CM 160 CM

Wood finish / Acabado madera



ECUADOR STANDARD

GM26-200K

W 167^{3/4"} D 87^{1/2"} H 63"
426 CM 222 CM 160 CM

GM26-200Q

W 152" D 87^{1/2"} H 63"
386 CM 222 CM 160 CM





Referential photo. Some products, finishes or fabrics may no longer be available. / Foto referencial.
Algunos productos, acabados o telas podrían ya no estar disponibles.

ADRIANA HOYOS

**GEM KING/QUEEN
UPHOLSTERED BED (HIGH)**
cama king/queen tapizada
gem (alta)

US STANDARD

GM26-211K

platform

W 89" D 87^{1/2}" H 63"
226 CM 222 CM 160 CM

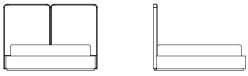

GM26-211Q

platform

W 73^{1/4}" D 87^{1/2}" H 63"
186 CM 222 CM 160 CM

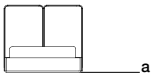
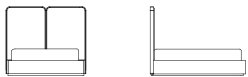
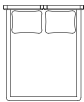

a:wood finish

US STANDARD BOX SPRING

GM26-212K

requires box spring

W 89" D 87^{1/2}" H 63"
226 CM 222 CM 160 CM

GM26-212Q

requires box spring

W 73^{1/4}" D 87^{1/2}" H 63"
186 CM 222 CM 160 CM

ECUADOR STANDARD

GM26-210K

W 89" D 87^{1/2}" H 63"
226 CM 222 CM 160 CM

GM26-210Q

W 73^{1/4}" D 87^{1/2}" H 63"
186 CM 222 CM 160 CM

Wood finish / Acabado madera



**H KING/QUEEN
UPHOLSTERED BED**
cama king/queen tapizada h

US STANDARD

HS26-101K

platform

W 80" D 85^{3/4}" H 47^{1/4}"
203 CM 218 CM 120 CM

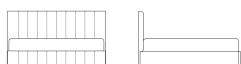
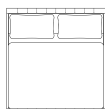

HS26-101Q

platform

W 63^{3/4}" D 85^{3/4}" H 47^{1/4}"
162 CM 218 CM 120 CM

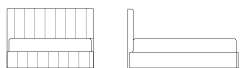
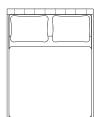

a:wood finish

ECUADOR STANDARD

HS26-100K

W 82^{3/4}" D 85^{3/4}" H 47^{1/4}"
210 CM 218 CM 120 CM

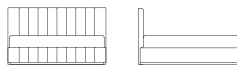
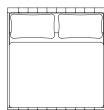

HS26-100Q

W 67" D 85^{3/4}" H 47^{1/4}"
170 CM 218 CM 120 CM

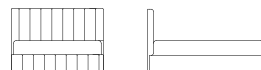
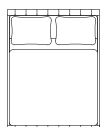

Wood finish / Acabado madera



H KING/QUEEN BED

cama king/queen h

US STANDARD

HS26-201K

platform

W 80" D 84^{1/4"} H 51^{1/4"}
203 CM 214 CM 130 CM

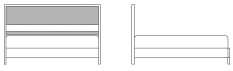

HS26-201Q

platform

W 63^{3/4"} D 84^{1/4"} H 51^{1/4"}
162 CM 214 CM 130 CM

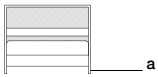
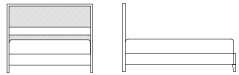
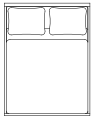

a:wood finish

ECUADOR STANDARD

HS26-200K

W 82^{3/4"} D 84^{1/4"} H 51^{1/4"}
210 CM 214 CM 130 CM

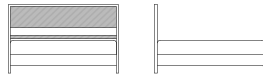
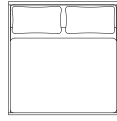

HS26-200Q

W 67" D 84^{1/4"} H 51^{1/4"}
170 CM 214 CM 130 CM

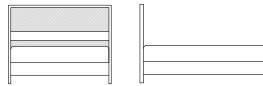
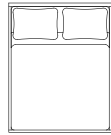

Wood finish / Acabado madera



**H KING/QUEEN
UPHOLSTERED BED**
cama king/queen tapizada h

US STANDARD

HS26-401K

platform

W 84^{3/4"} D 92^{1/4"} H 39^{1/4"}
215 CM 234 CM 100 CM

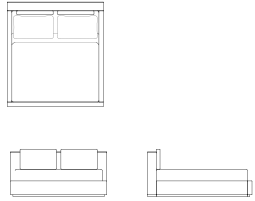

HS26-401Q

platform

W 68^{1/2"} D 92^{1/4"} H 39^{1/4"}
174 CM 234 CM 100 CM

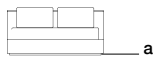
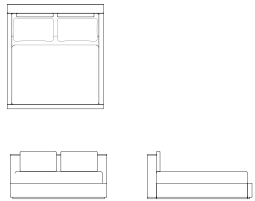

a:wood finish

ECUADOR STANDARD

HS26-400K

W 87^{1/2"} D 92^{1/4"} H 39^{1/4"}
222 CM 234 CM 100 CM

HS26-400Q

W 71^{3/4"} D 92^{1/4"} H 39^{1/4"}
182 CM 234 CM 100 CM

Wood finish / Acabado madera



H KING/QUEEN BED
cama king/queen h

US STANDARD

HS26-501K

platform

W 82^{3/4}" D 84^{1/4}" H 47^{1/4}"
210 CM 214 CM 120 CM

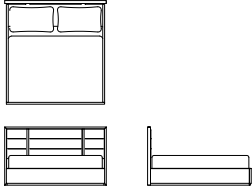

HS26-501Q

platform

W 67" D 84^{1/4}" H 47^{1/4}"
170 CM 214 CM 120 CM

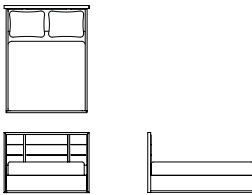

a: wood finish

ECUADOR STANDARD

HS26-500K

W 82^{3/4}" D 84^{1/4}" H 47^{1/4}"
210 CM 214 CM 120 CM

HS26-500Q

W 67" D 84^{1/4}" H 47^{1/4}"
170 CM 214 CM 120 CM

Wood finish / Acabado madera



H KING/QUEEN BED WITH PANELS
 cama king/queen con paneles h

US STANDARD

HS26-511K
 platform

W 145^{3/4"} D 84^{1/4"} H 47^{1/4"}
 370 CM 214 CM 120 CM

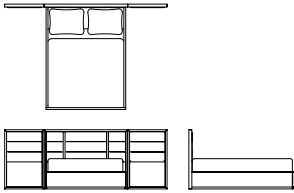

HS26-511Q
 platform

W 130" D 84^{1/4"} H 47^{1/4"}
 330 CM 214 CM 120 CM

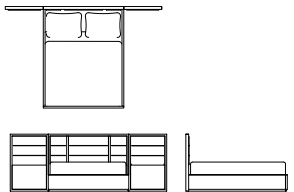

a: wood finish

ECUADOR STANDARD

HS26-510K

W 145^{3/4"} D 84^{1/4"} H 47^{1/4"}
 370 CM 214 CM 120 CM

HS26-510Q

W 130" D 84^{1/4"} H 47^{1/4"}
 330 CM 214 CM 120 CM

Wood finish / Acabado madera







Referential photo. Some products, finishes or fabrics may no longer be available. / Foto referencial.
Algunos productos, acabados o telas podrían ya no estar disponibles.

ADRIANA HOYOS

**H KING/QUEEN
UPHOLSTERED BED**
cama king/queen tapizada h

US STANDARD

HS26-601K

platform

W 89" D 89^{3/4}" H 47^{1/4}"
226 CM 228 CM 120 CM

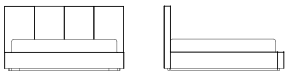
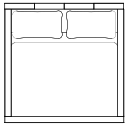

HS26-601Q

platform

W 73^{1/4}" D 89^{3/4}" H 47^{1/4}"
186 CM 228 CM 120 CM

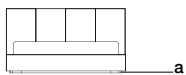
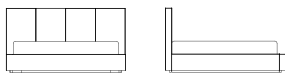
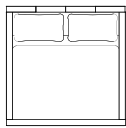

a: wood finish

ECUADOR STANDARD

HS26-600K

W 89" D 89^{3/4}" H 47^{1/4}"
226 CM 228 CM 120 CM

HS26-600Q

W 73^{1/4}" D 89^{3/4}" H 47^{1/4}"
186 CM 228 CM 120 CM

Wood finish / Acabado madera



**RUMBA KING/QUEEN BED
(UPHOLSTERED SIDE
RAILS & FOOTBOARD)**
cama king/queen rumba
(larguero y piecero tapizado)

US STANDARD

RM26-211K

platform

W 82^{3/4"} D 84^{1/4"} H 69^{3/4"}
210 CM 214 CM 177 CM

Wood finish / Acabado madera

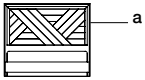
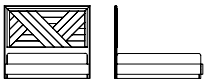

a: wood finish



**RUMBA KING/QUEEN BED
(WOOD SIDE RAILS
& FOOTBOARD)**
cama king/queen rumba
(larguero y piecero de madera)

US STANDARD

RM26-401K

platform

W 85" D 84^{1/4}" H 63"
216 CM 214 CM 160 CM

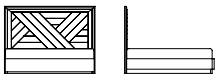

RM26-401Q

platform

W 69^{1/4}" D 84^{1/4}" H 63"
176 CM 214 CM 160 CM

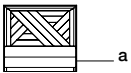
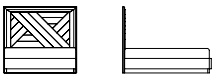

a: wood finish



US STANDARD BOX SPRING

RM26-402K

requires box spring

W 85" D 84^{1/4}" H 63"
216 CM 214 CM 160 CM

RM26-402Q

requires box spring

W 69^{1/4}" D 84^{1/4}" H 63"
176 CM 214 CM 160 CM

ECUADOR STANDARD

RM26-400K

W 85" D 84^{1/4}" H 63"
216 CM 214 CM 160 CM

RM26-400Q

W 69^{1/4}" D 84^{1/4}" H 63"
176 CM 214 CM 160 CM

Wood finish / Acabado madera



**RUMBA KING/QUEEN BED
(UPHOLSTERED SIDE
RAILS & FOOTBOARD)**
cama king/queen rumba
(larguero y piecero tapizado)

US STANDARD

RM26-411K

platform

W 85" D 84^{1/4}" H 63"
216 CM 214 CM 160 CM

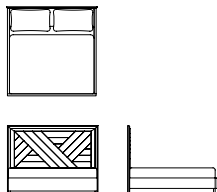

RM26-411Q

platform

W 69^{1/4}" D 84^{1/4}" H 63"
176 CM 214 CM 160 CM

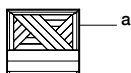
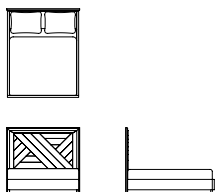

a: wood finish

US STANDARD BOX SPRING

RM26-412K

requires box spring

W 85" D 84^{1/4}" H 63"
216 CM 214 CM 160 CM

RM26-412Q

requires box spring

W 69^{1/4}" D 84^{1/4}" H 63"
176 CM 214 CM 160 CM

ECUADOR STANDARD

RM26-410Q

W 69^{1/4}" D 84^{1/4}" H 63"
176 CM 214 CM 160 CM

RM26-410K

W 85" D 84^{1/4}" H 63"
216 CM 214 CM 160 CM

Wood finish / Acabado madera



MATERIALS

Wood Finishes | acabados de madera

High Gloss Finishes | acabados high gloss

Metal Finishes | acabados mate

Natural Stones | piedras naturales

Dekton | dekton

Porcelain | porcelanato

Metal Finishes | acabados de metal

Leather Options | opciones de cuero

Decorative Hardware | herraje decorativo

Pull | tiraderas

Metallic Buttons | botones metálicos

Decorative Plates | placas decorativas

Mirrors | espejos

WOOD FINISHES

Acabados de madera



ARENA (R)



TAUPE (T)



CHAMPAGNE (P)



NATURAL (A)



MINK (K)



BAHÍA (B)



PALMA (L)



JAMA (J)



ESPRESSO (E)



CHARCOAL (N)

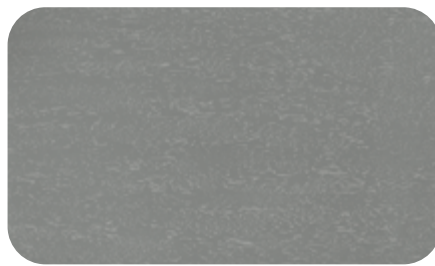

PLATINUM (Q)

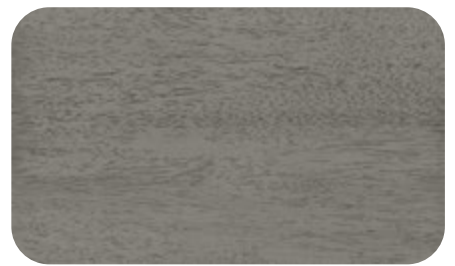

ASH GREY (S)

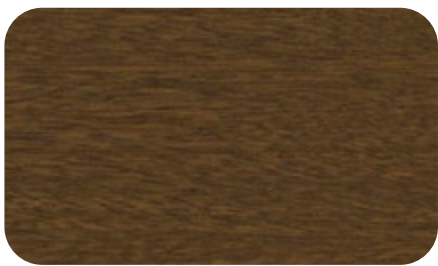

TERRA (Z)



CHARDONNAY (Y)

Slight color variations may occur while printing tearsheets due to printers pixelation and quality / Ligeras variaciones de color pueden ocurrir en la impresión.



HIGH GLOSS FINISHES

Acabados high gloss



CHAMPAGNE HIGH GLOSS (G1)



MINK HIGH GLOSS (G2)



GRAFITO HIGH GLOSS (G3)



PLATINUM HIGH GLOSS (G6)

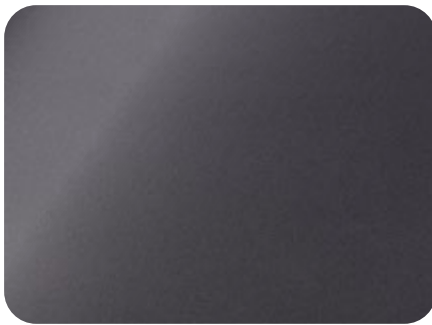

GUN METAL HIGH GLOSS (G7)



OFF WHITE HIGH GLOSS (G8)

MATTE FINISHES

Acabados mate

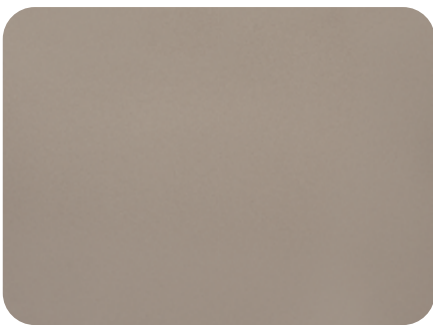

CHAMPAGNE MATTE (M1)



PLATINUM MATTE (M6)



GUN METAL MATTE (M7)



OFF WHITE MATTE (M8)

Slight color variations may occur while printing tearsheets due to printers pixelation and quality / Ligeras variaciones de color pueden ocurrir en la impresión.



NATURAL STONES

Piedras naturales

STONE 1

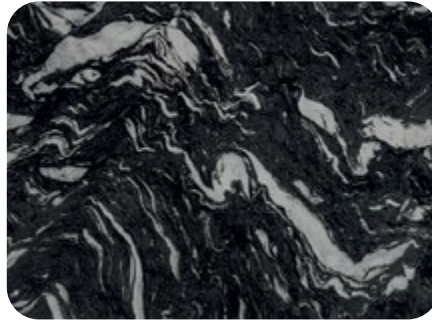

LAVA GRANITE (V)

STONE 2

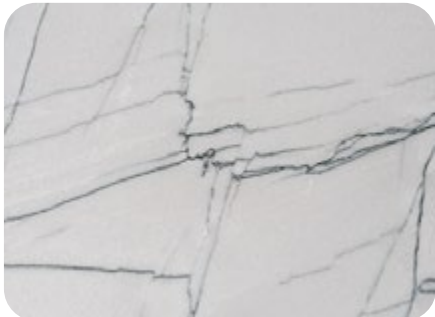

WHITE FOG QUARTZITE (F)



MOCCA QUARTZITE (C)



MACADAMIA QUARTZITE (M)

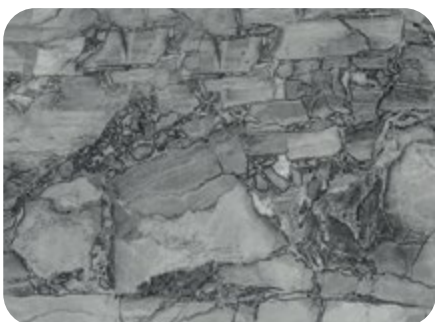

LUNAR MARBLE (L)

Slight color variations may occur while printing tearsheets due to printers pixelation and quality / Ligeras variaciones de color pueden ocurrir en la impresión.

DEKTON*

Dekton*



BERGEN DEKTON (B)



KHALO DEKTON (H)



TAGA DEKTON (T)



LAURENT DEKTON (U)



LUCID DEKTON (D)



MARMORIO DEKTON (O)

PORCELAIN**

Porcelanato**



CALACATTA WHITE PORCELAIN (A)
STONE 1

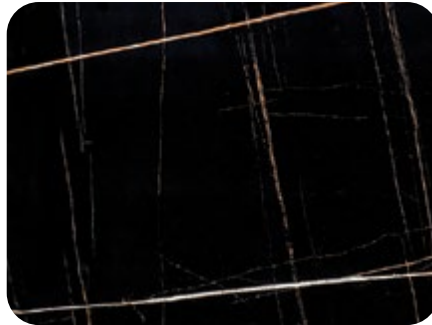

BLACK SAINT PORCELAIN (S)
STONE 1

*These dektions are only available for certain pieces / Estos dektion están disponibles únicamente para piezas específicas

**Only available for HS products / Disponible únicamente para productos HS.

Slight color variations may occur while printing tearsheets due to printers pixelation and quality / Ligeras variaciones de color pueden ocurrir en la impresión.

METAL FINISHES

Acabados de metal



BRONZE (W1)



SILVER (W2)



SATIN GOLD (W4)



CHROME (W5)



PLATINUM (W6)



GUN METAL (W7)

LEATHER OPTIONS

Opciones de cuero



OYSTER MILAN PORTOFINO **1-CR002**



BEIGE ASPEN **RE027**



BROWN MILAN PORTOFINO **RE045**



CAMEL MILAN PORTOFINO **RE049**

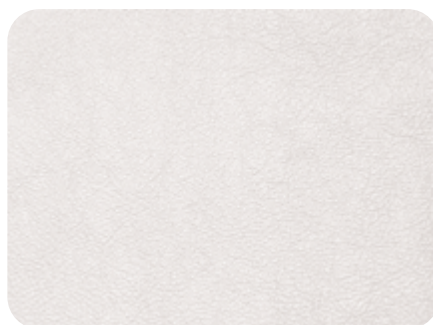

WHITE MILAN PORTOFINO **RE057**



LIGHT GRAY MILAN PORTOFINO **RE061**

The leathers are applicable only in specific details / Estos cueros son aplicables únicamente en detalles específicos
Slight color variations may occur while printing tearsheets due to printers pixelation and quality / Ligeras variaciones de color pueden ocurrir en la impresión.

LEATHER OPTIONS

Opciones de cuero



SILVER GRAY MILAN PORTOFINO **RE064**

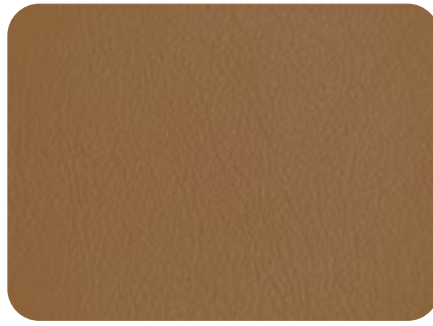

LIGHT CAMEL MILAN PORTOFINO **RE069**



GUN METAL MILAN PORTOFINO **RE070**

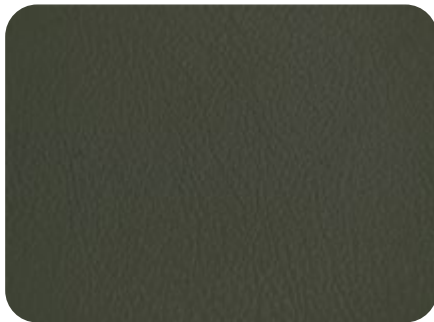

OLIVE GREEN MILAN PORTOFINO **RE071**



OFF WHITE MILAN PORTOFINO **RE072**

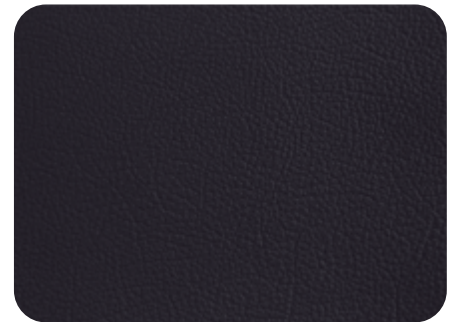

PURE BLACK MILAN PORTOFINO **RE073**

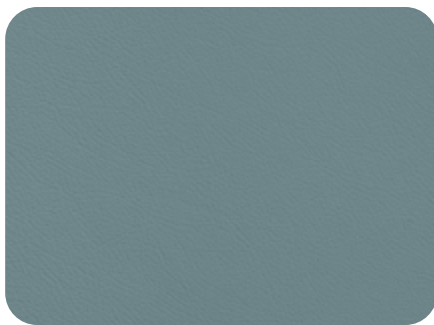

POWDER BLUE MILAN PORTOFINO **RE075**

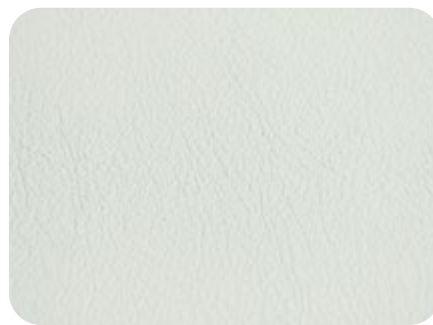

ICE MILAN PORTOFINO **RE077**



LIGHT TAUPE MILAN PORTOFINO **RE078**

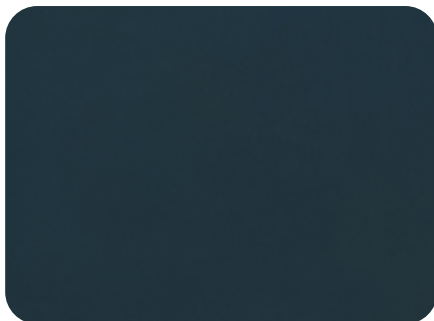

EMERALD BLUE MILAN PORTOFINO **RE079**

The leathers are applicable only in specific details / Estos cueros son aplicables únicamente en detalles específicos

Slight color variations may occur while printing tearsheets due to printers pixelation and quality / Ligeras variaciones de color pueden ocurrir en la impresión.



DECORATIVE HARDWARE

Herrajes decorativos



H-011



H-012



H-036



H-037

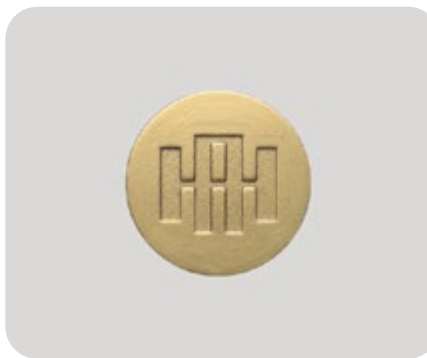

H-038

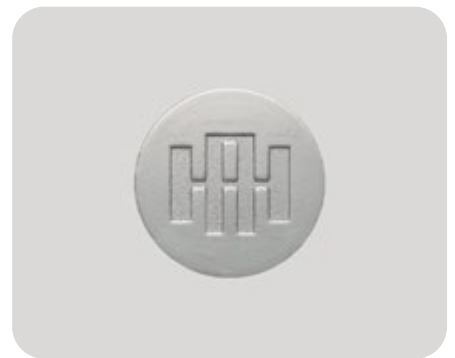

H-039



H-040

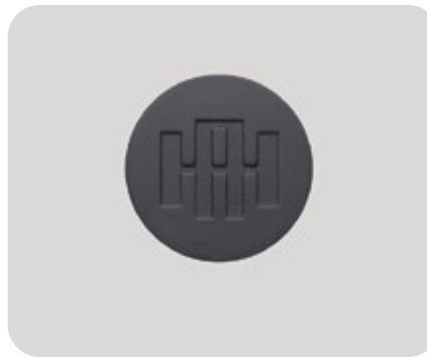

H-041

PULLS

Tiraderas



H-001



H-016



H-017



H-018



H-019



H-020



H-021



H-022



H-023



H-024



H-030



H-031

Slight color variations may occur while printing tearsheets due to printers pixelation and quality / Ligeras variaciones de color pueden ocurrir en la impresión.

PULLS

Tiraderas



H-032

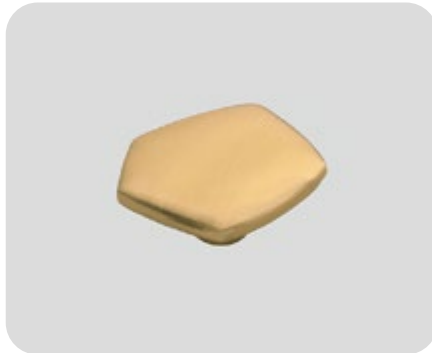

H-033



H-034



H-035



H-036



H-037



H-038

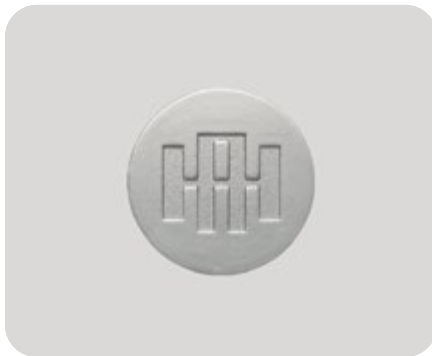

H-039



H-040

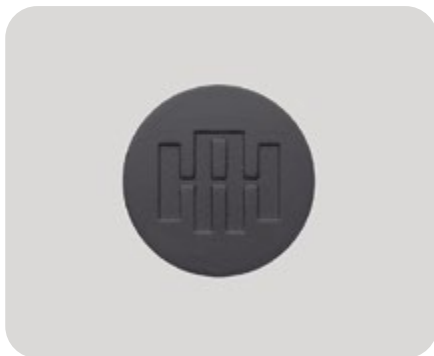

H-041



H-042



H-043

Slight color variations may occur while printing tearsheets due to printers pixelation and quality / Ligeras variaciones de color pueden ocurrir en la impresión.

METALLIC BUTTONS

Botones metálicos



GOLD (B1)
3/4" | 2cm



CHROME (B2)
3/4" | 2cm



GOLD (B3)
1/2" | 1,4cm



CHROME (B4)
1/2" | 1,4cm

DECORATIVE PLATES

Placas decorativas



BRONZE



SILVER

Slight color variations may occur while printing tearsheets due to printers pixelation and quality / Ligeras variaciones de color pueden ocurrir en la impresión.

MIRRORS

Espejos



BRONZE



FUME

To check our latest materials, please refer to our web page.

Para consultar nuestros últimos materiales, consulte nuestra página web.

OUR TEARSHEET

NUESTRA TEARSHEET

PRODUCT NAME
Nombre del producto

AVAILABLE PRODUCT FINISHES
Acabados disponibles

PRODUCT CODE
Código de producto

PRODUCT DIMENSIONS
Dimensiones del producto
(inches and centimeters)
(pulgadas y centímetros)

LINE DRAWING

PRODUCT NAME
Nombre del producto

AVAILABLE PRODUCT FINISHES
Acabados disponibles

PRODUCT CATEGORY
Categoría de producto

SECONDARY PRODUCT VIEW
Vista secundaria del producto

IMPORTANT DETAILS
Detalles importantes

PRODUCT CODE
Código de producto

GS10-310

PRODUCT DIMENSIONS
Dimensiones del producto
(inches and centimeters)
(pulgadas y centímetros)

w 37" d 31 1/2" h 33" sh 17"
94 cm 80 cm 84 cm 43 cm

sw 26" sd 20 1/2" ah 24"
66 cm 52 cm 61 cm

LINE DRAWING

WOOD FINISH / ACABADO MADERA

R	T	P	A
K	B	L	J
E	N	Q	S

LEATHER BACK / CUERO CASCO

CR012	RE040	RE048	RE057
RE061	RE064	RE069	RE070
RE071	RE072	RE073	RE075
RE077	RE078	RE079	

METALLIC BUTTON / BOTÓN METÁLICO

Gold Chrome

BACK PILLOW (X) / COJÍN DE ESPALDA (X)

w 16 1/2" d 3 1/4" h 23 1/2"
42 cm 8 cm 60 cm

PRODUCT NOTES
Notas del producto

COMFORT SEAT: The fixed seat cushions are constructed with a premium combination of high-density foam and sinuous springs, providing excellent support, shock absorption, and softness.
CONFORT SEAT: Los cojines fijos del asiento están fabricados con la mejor combinación de espuma de alta densidad y resortes sinuosos, que proporcionan un excelente soporte, absorción de impactos y suavidad.

LIVING ROOM | SALA **GALAPAGOS COLLECTION** **ADRIANA HOYOS**

17

GENERAL CATEGORY
Categoría general de producto

COLLECTION NAME
Nombre de la colección

DISCOVER OUR HOSPITALITY PROJECTS

Explore spaces thoughtfully crafted to
inspire and elevate hospitality experiences.
Scan the QR code to view our portfolio.



