



AS CUATRO, S.A

MÀQUINES PNEUPORTÀTILS

































CATÀLEG GENERAL
SETEMBRE 2022



ÍNDEX

Clavadores	2 - 5	Pistoles de pintar	24
Grapadores	6 - 12	Reblanadores	24
Claus i grapes	13 - 15	Varis	25
Trepants / Cargoladores	16 - 18	Espirals i mànegues	26
Fregadores	19 - 20	Enrotlladors	27
Claus d'impacte / carraca	21	Connexions	28 - 31
Cisells / Moles	22 - 23	Regulació i filtratge d'aire	32 - 34

PICTOGRAMES ESPECIFICACIONS TÈCNiques

 AGULLA	 PVP SENSE IMPOSTOS	 PLAT VELCRO	 DOBLE MARTELL
 CLAU	 VELOCITAT	 PLAT ADHESIU	 CARRERA
 GRAPA	 REVOLUCIONS PER MINUT	 PLAT PINÇA	 MESURA REBLÓ
 GRAPA CABLE	 LITRES PER MINUT CFM del fabricant passat a L/Min	 BASE PAPER VIDRE RODONA	 DIPÒSIT
 XAPA CF	 PORTABROQUES AUTOMÀTIC	 BASE PAPER VIDRE QUADRADA	 Ø BOQUILLA
 GRAPA FLX, FUW, FLAX	 PORTABROQUES CLAU	 BANDA PAPER VIDRE	 MÀNEGA
 PES	 REVERSIBLE	 QUADRAT	 ASPIRACIÓ
 MIDES	 PARELL COLLAMENT (Nw)	 PINÇA ESMOLADORES	 NO ASPIRACIÓ
 PRESSIÓ D'US (bar)	 DECIBELS [dB(A)]	 COPS PER MINUT	
 ROSCA ENTRADA D'AIRE	 ÒRBITA DE GIR	 HEXAGONAL / CARRERA	

PICTOGRAMES D'APLICACIONS

 TAPISSERIA	 EMBALATGE DE CARTRÓ	 PANELLS	 BRICOLATGE
 PÀLETS	 TAPETES	 MARCS DE QUADRES	 CABLE EIÈCTRIC / FIBRA ÒPTICA
 CASES / TEULADES DE FUSTA	 JOGUINES DE FUSTA	 MOQUETA	
 TANQUES	 SÓCOLS	 MOBLES	
 EMBALATGE DE FUSTA	 TARIMA	 LLISTONETS FINESTRES	

CLAVADORES

HP 2330

Ref. M030500

PT 635

Ref. M030900

LMF 32 AC

Ref. M020002



T 6,6 mg
T 12, 15, 18, 22, 25, 30 mm
Kg 1 kg
 230x190x50 mm
 5-6 bar
PVP 224,53 €

T 6,6 mg
T 15, 18, 22, 25, 30, 35 mm
Kg 0,9 kg
 200x180x40 mm
 5-6 bar
PVP 235,87 €

T 8 mg
T 15, 18, 20, 25, 30 mm
Kg 1,2 kg
 200x240x60 mm
 5-6 bar
PVP 197,32 €



84324721001766



84324721004231



84324721000421

LMF 40 AC

Ref. M020001

LMF 40 LAC

Ref. M021000

P850

Ref. M020600



T 8 mg
T 12, 15, 18, 20, 25, 30, 35, 40 mm
Kg 1,2 kg
 220x240x60 mm
 5-6 bar
PVP 230,20 €

T 8 mg
T 12, 15, 18, 20, 25, 30, 35, 40 mm
Kg 1,4 kg
 230x245x60 mm
 5-6 bar
PVP 247,21 €

T 8,8 mg
T 20,25,30,35,40,45,50mm
Kg 1,45 kg
 250x220x50 mm
 6 bar
PVP 318,65 €



84324721000059



84324721002749



84324721004459

CLAVADORES

LNF 32 AC

Ref. M060001

LNF 50AC

Ref. M080100

LU 50 F

Ref. M080400



T 12
T 16, 20, 25, 30, 32 mm
Kg 1,2 kg
 240x200x60 mm
 6 bar
PVP 153,09 €

T 12
T 16, 20, 25, 30, 35, 40, 45, 50 mm
Kg 1,4 kg
 220x240x60 mm
 6 bar
PVP 200,72 €

T 12
T 20 → 50 mm
T 90
T 20 - 40 mm
Kg 1,4 kg
 220x240x60 mm
 6 bar
PVP 271,03 €



LT 50 AC

Ref. M140000

LNF 50 E

Ref. M140200

LT 1650 AC

Ref. M140001



T 14 i acer 1.8
T 20, 25, 30, 35, 40, 45, 50 mm
Kg 1,4 kg
 240x220x60 mm
 6 bar
PVP 271,03 €

T 12 / 15°
T 25, 32, 38, 45, 50 mm
Kg 1,2 kg
 270x300x60 mm
 6 bar
PVP 269,89 €

T 14 i acer 1.8
T 20, 25, 30, 35, 40, 45, 50 mm
Kg 1,8 kg
 290x280x80 mm
 6 bar
PVP 359,48 €



CLAVADORES

LT 1664 AC

Ref. M110001

LHT 64

Ref. M120001

PTS 8400

Ref. M140500



T 14 i acer 1.8
|| 20, 25, 30, 35, 40, 45, 50, 60, 63 mm
Kg 1,9 kg
 300x290x80 mm
 6 bar
PVP 401,44 €

T TN
|| 25, 32, 38, 45, 50, 60, 64 mm
Kg 2,7 kg
 300x290x80 mm
 6-7 bar
PVP 412,78 €

T Ø 2,1 - 2,3
|| 25 → 57 mm
Kg 1 kg
 140x140x90 mm
 6-7 bar
PVP 188,24 €



DA 64

Ref. M130000

NP 50

Ref. M120900 **DESCLAVADORA**



T 14 / 34°
|| 25, 32, 38, 45, 50, 64 mm
Kg 2,1 kg
 330x340x100 mm
 6 bar
PVP 538,65 €

Kg 1 kg
 250x230x70 mm
 6-7 bar
PVP 294,84 €









CLAVADORES

CN 57E

Ref. M120300



-  Ø 2,0 → 2,2 mm - 15°
-  30 → 55 mm
-  2,5 kg
-  290x280x140 mm
-  6-7 bar
-  PVP 908,33 €









8 432472 0002763

CN 70E

Ref. M120100



-  Ø 2,5 → 2,9 - 15°
-  45 → 70 mm
-  3,6 kg
-  320x318x125 mm
-  7 bar
-  PVP 967,30 €









8 432472 0014211

AN 130 21E

Ref. M121900



-  Ø 3,33 → 4,19 - 21°
-  90, 100, 130 mm
-  5,4 kg
-  590x450x190 mm
-  7 bar
-  PVP 1.769,04 €









8 432472 0003173

CN 90.1L

Ref. M120500



-  Ø 2,5 → 3,3 - 15°
-  50 → 90 mm
-  3,74 kg
-  347x365x142 mm
-  7 bar
-  PVP 1.188,00 €



8 432472 0005016

GRAPADORES

LU 8016 F

Ref. M150400



LU 8016 AC

Ref. M150100



LU 8016 LAC

Ref. M150200



80
6 → 16 mm
0,9 kg
220x140x40 mm
5-6 bar
PVP 171,23 €



80
6 → 16 mm
1 kg
220x160x40 mm
5-6 bar
PVP 163,30 €



80
6 → 16 mm
1,1 kg
220x220x45 mm
5-6 bar
PVP 212,06 €



LU 8025 AC

Ref. M160200



LU 7116 F

Ref. M170200



LU SJK 16

Ref. M170300



80
10 → 25 mm
1,1 kg
220x220x60 mm
5-6 bar
PVP 176,90 €



71
6 → 16 mm
0,9 kg
220x140x40 mm
5-6 bar
PVP 188,24 €



SJK 16
6 → 16 mm
0,9 kg
220x140x40 mm
5-6 bar
PVP 212,06 €



GRAPADORES

LU 9816 F

Ref. M170400



LU 9716 F

Ref. M210200



LU 9725 AC

Ref. M210100



98
 8 → 16 mm
 1 kg
 220x160x40 mm
 5-6 bar
 PVP 188,24 €



97
 8 → 16 mm
 1 kg
 220x160x40 mm
 5-6 bar
 PVP 188,24 €



97
 10 → 25 mm
 1,2 kg
 220x200x60 mm
 6 bar
 PVP 153,09 €



LU 9025 AC

Ref. M180100

LU 9225 AC

Ref. M200100

LU G 25 AC

Ref. M200200



90
 10 → 25 mm
 1,2 kg
 220x200x60 mm
 6 bar
 PVP 153,09 €



92
 10 → 25 mm
 1,2 kg
 220x200x60 mm
 6 bar
 PVP 153,09 €



SG 44
 10 → 25 mm
 1,2 kg
 220x200x60 mm
 6 bar
 PVP 172,37 €



GRAPADORES

LU G40 LM

Ref. M252000



-  **SG 44**
-  12 → 40 mm
-  1,4 kg
-  223, 246, 58 mm
-  6 bar
-  PVP 352,67 €









8 432472 1002824



LU 9240 HAC

Ref. M250001



-  **92**
-  20 → 40 mm
-  1,7 kg
-  270x270x70 mm
-  6-7 bar
-  PVP 352,67 €





8 432472 1000202



LU 9040 KT

Ref. M190200



-  **90**
-  20 → 40mm
-  1,2 kg
-  300x260x70 mm
-  6-7 bar
-  PVP 352,67 €





8 432472 1004255



LU 851 LC

Ref. M231100



-  **14**
-  25 → 50 mm
-  2,2 kg
-  380x280x70 mm
-  6-7 bar
-  PVP 506,90 €



8 432472 1003838









GRAPADORES

LU 16/851 F

Ref. M230100



-  14
-  25 → 50 mm
-  2,9 kg
-  340x300x100 mm
-  6-7 bar
-  PVP 525,04 €









8 432472 1000219



LU 16/864

Ref. M230200



-  14
-  25 → 60 mm
-  2,9 kg
-  343x307x246 mm
-  6-7 bar
-  PVP 525,04 €



8 432472 1001414



LU 16/964

Ref. M230600



-  16 NC
-  25 → 60 mm
-  2,9 kg
-  343x307x97 mm
-  6-7 bar
-  PVP 565,87 €



8 432472 1002886



LU 1068/38 (WS)

Ref. M230300



-  1068 (WS)
-  25 → 38mm
-  2,3 kg
-  356x290x95 mm
-  6-7 bar
-  PVP 538,65 €



8 432472 1002442



GRAPADORES

CF 15 AA

Ref. M240000

CF 15 MS

Ref. M240200



- CF**
- 10, 13, 15 mm
- 2,7 kg
- 286x312x94 mm
- 6-7 bar
- PVP 589,68 €

- MINI CF**
- 9, 12 mm
- 2,4 kg
- 286x312x94 mm
- 6-7 bar
- PVP 589,68 €



FL 1000

Ref. M980001

LV15EH

Ref. M982000



- FLX**
- 7, 10, 12, 15 m
- 24 kg
- 450X600X450 mm
- 6 bar
- PVP A CONSULTAR

- FLAX**
- 7, 10, 12, 15 m
- 1,3 kg
- 240x200x60 mm
- 6 bar
- PVP 424,12 €



GRAPADORES

CN 32

Ref. M290500

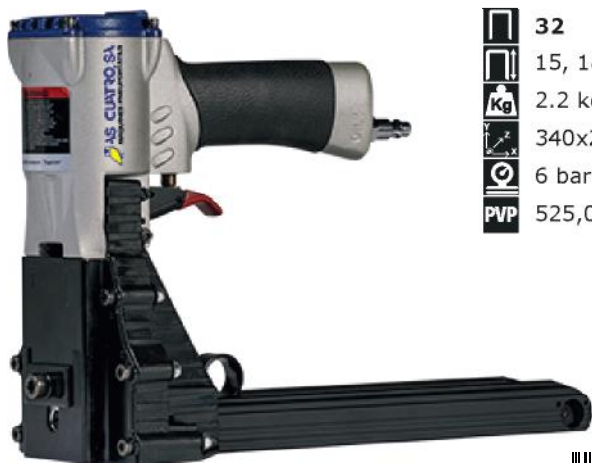

- 32**
- 15, 18 mm
- 2.2 kg
- 340x210x110 mm
- 6 bar
- PVP** 525,04 €



8 432 472 004 194



CN 33

Ref. M290200



- 33 (35)**
- 15, 18 mm
- 2.2 kg
- 340x210x110 mm
- 6 bar
- PVP** 525,04 €



8 432 472 000 1605



CN 33/22

Ref. M290400

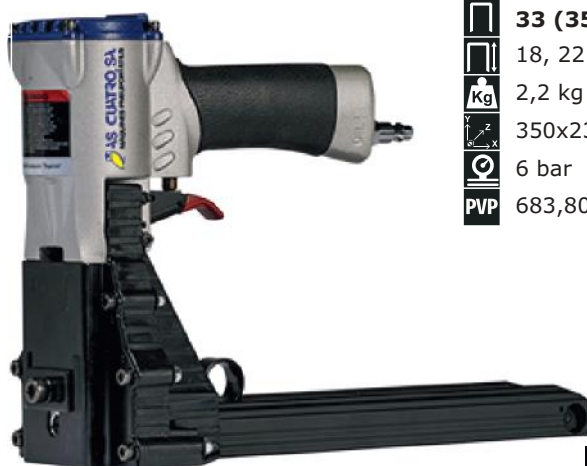

- 33 (35)**
- 18, 22 mm
- 2,2 kg
- 350x230x111 mm
- 6 bar
- PVP** 683,80 €



8 432 472 004 217



CM 32

Ref. M290700



- 32**
- 15, 18 mm
- 1,9 kg
- 350x270x110 mm
- PVP** 259,69 €



8 432 472 000 4200



CM 33

Ref. M290100



- 33 (35)**
- 15, 18 mm
- 1,9 kg
- 350x270x110 mm
- PVP** 259,69 €



8 432 472 000 1599



GRAPADORES

AL 16

Ref. M270038



Vr16, A16, A18, A20
Kg 0,2 kg
PVP 37,42 €



AL 18 C

Ref. M270039



A18
Kg 0,4 kg
PVP 100,93 €



AHT 11

Ref. M270020



140
Kg 0,9 kg
 300x60x40 mm
PVP 49,90 €



AHT 14

Ref. M270021



140
Kg 1 kg
 300x90x40 mm
PVP 100,93 €



FG 5310

Ref. M270006



530, 13
Kg 0,3 kg
 160x100x30 mm
PVP 12,47 €



FG 5314

Ref. M270007



530, 13
Kg 0,5 kg
 180x120x40 mm
PVP 21,55 €



FG 2811

Ref. M270022



28
Kg 0,9 kg
 190x160x30 mm
PVP 61,24 €



FG 3614

Ref. M270023



36
Kg 0,9 kg
 190x160x30 mm
PVP 61,24 €



FG 530

Ref. M270024



530
Kg 0,5 kg
 150x90x30 mm
PVP 23,81 €



FG 140

Ref. M270025



140
Kg 0,9 kg
 190x180x30 mm
PVP 23,81 €



FG 2608

Ref. M270004



26
Kg 0,3 kg
 170x80x30 mm
PVP 29,48 €



FG 7312

Ref. M270005



73
Kg 0,5 kg
 180x90x20 mm
PVP 58,97 €



IDENTIFICAR CLAUS I GRAPES

Per poder identificar el clau o grapa que necessita, cal saber:
 En els claus el diàmetre del fil i en els claus de bobina la inclinació són bàsics.
 En les grapes, les mides A i B són determinants.

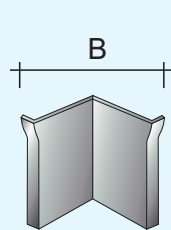

GRAPA FLAX

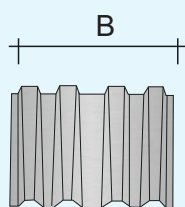

GRAPA CF CORRUGADA

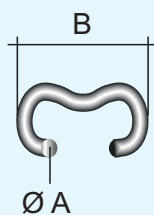

GRAPA OMEGA

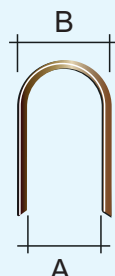

GRAPA CABLE



GRAPA

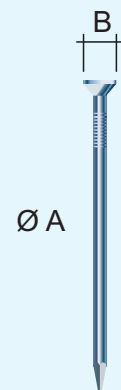

CLAU

Clau	6	6 mg	8	8 mg	I	12	14
Ø A mm	0.64	0.64	0.84	0.84	1x1.25	1x1.25	1.4x1.6
Ø B Cap	no	0.82	no	1.40	no	1.90	2.70
Inclinació	no	no	no	no	no	no	no

Clau	Acer	DA	A	TN	Bobina	Bobina	Ristra
Ø A mm	1.83	1.85	1x1.25	2.20	2.0-2.5	2.8	3.3
Ø B Cap	3.05	3.00	1.90	7.00	5-6.5	7.0	8.5
Inclinació	no	34°	15°	no	15°	15°	21°

Grapa	80	SJK	71	97	98	90	92
mm	0.70x0.90	0.60x0.70	0.60x0.70	0.70x0.90	0.7x0.90	1x1.25	1x1.25
A	11.30	2.70	7.70	3.00	6.40	3.50	6.50
B	12.70	3.90	8.90	4.00	7.80	5.50	8.50

Grapa	SG44	94	14	16NC	18NC	CF	Mini CF
mm	1x1.25	1x1.25	1.4x1.6	1.4x1.6	1.6x1.9	0.5	0.5
A	7.70	11.20	7.85	9.30	9.30	no	no
B	9.70	13.20	10.70	12.10	12.50	25.00	18.50

Grapa	33/35	30/32	1068	FLX	FLAX	OMEGA VR	OMEGA A
mm	0.9x2.3	0.9x1.9	1.4x1.6	0.39	0.39	1.6	2.0
A	33	30	22.0	no	no	1.6	2.0
B	35	32	24.8	10.5	11	16	16, 18, 20

Grapa	530	130	28	36	140	26	73
mm	0.45x0.65	0.50x0.75	0.6x1.0	0.6x1.0	0.45x1.25	0.45x0.5	1x1.25
A	10.2	9.5	4.9	6.4	9.4	11.7	10.2
B	11.3	10.5	6.2	7.8	10.7	12.8	11.3

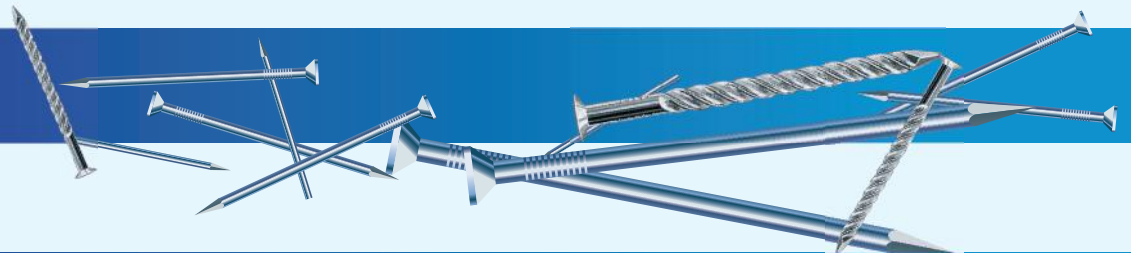

Model	mm	€/miler	Model	mm	€/miler	Model	mm	€/miler
Clau Pin 6			Clau Pin I			Clau Acer 1.8 bicro		
C960610	10	1,57	C960115	15	2,22	C961018	18	12,68
C960612	12	1,57	C960120	20	2,48	C961020	20	12,68
C960615	15	1,70	C960125	25	2,87	C961025	25	12,68
C960618	18	1,96	C960130	30	3,14	C961030	30	18,95
C960622	22	2,35	Clau 12			C961035	35	20,52
C960625	25	2,61	C961215	15	2,74	C961040	40	22,22
C960628	28	3,14	C961216	16	2,74	C961045	45	23,78
C960630	30	3,27	C961220	20	2,48	C961050	50	25,35
C960631 Inox.	30	a.c.	C961225	25	2,61	Clau TN 2.2		
C960635	35	4,57	C961230	30	3,27	C960225	25	14,24
C960640	40	5,23	C961232	32	3,40	C960232	32	15,03
C960650	50	7,06	C961235	35	3,66	C960238	38	18,16
Clau Pin 6 mg			C961238	38	3,92	C960245	45	18,95
C960712	12	2,09	C961240	40	4,18	C960250	50	19,73
C960715	15	2,22	C961245	45	4,57	C960260	60	21,43
C960718	18	2,35	C961250	50	4,97	C960264	64	22,22
C960722	22	2,48	Consultar preus inox clau 12			Clau TN 2.2 Acer		
C960725	25	2,74	Clau 14			C960226	25	17,64
C960730	30	3,01	C961420	20	4,18	C960239	38	21,82
C960735	35	3,79	C961425	25	4,97	Clau bobina 15° roscat		
C960740	40	4,05	C961430	30	5,75	C962335	35	17,12
C960750	50	5,23	C961435	35	6,53	C962341	40	17,12
Clau Pin 8			C961438	38	7,06	C962245	45	17,12
C960815	15	1,96	C961440	40	7,32	C962251	50	18,56
C960818	18	2,09	C961445	45	8,10	C962551	50	18,56
C960821	21	2,22	C961450	50	8,76	C962561	60	21,43
C960825	25	2,48	C961455	55	9,80	C962571	70	24,18
C960830	30	2,74	C961460	60	10,72	C962871	70	27,05
C960835	35	3,14	C961463	63	11,11	C962876	75	29,93
C960840	40	3,27	Clau A			C962881	80	31,36
C960845	45	4,70	C961625	25	5,23	altres mesures a consultar		
C960850	50	4,70	C961632	32	7,32			
Clau Pin 8 mg			C961638	38	7,97			
C960910	10	1,83	C961645	45	9,02			
C960912	12	1,83	C961650	50	10,06			
C960915	15	1,83	Clau DA					
C960918	18	2,09	C961725	25	13,20			
C960921	21	2,22	C961732	32	15,03			
C960925	25	2,61	C961738	38	16,73			
C960930	30	3,01	C961745	45	18,43			
C960935	35	3,40	C961750	50	19,47			
C960940	40	3,79	C961764	64	23,65			
C960945	45	4,84						
C960950	50	5,23						

GRAPES

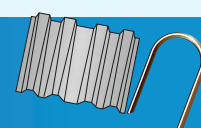
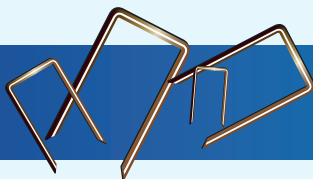

Model mm €/miler Model mm €/miler Model mm €/miler Model mm €/mil.

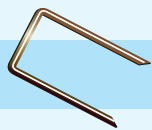

Grapa 80

G988004	04	1,05
G988006	06	1,18
G988008	08	1,31
G988010	10	1,44
G988012	12	1,57
G988014	14	1,70
G988016	16	1,83
G988020	20	2,49
G988025	25	3,40

Consultar estoc en inox.

Grapa 97

G989710	10	2,22
G989712	12	2,48
G989714	14	2,74
G989716	16	3,14
G989720	20	3,79
G989725	25	4,05

Grapa SJK

G987208	08	1,83
G987210	10	1,83
G987212	12	1,96
G987214	14	2,09
G987216	16	2,35

Grapa 71 (S3G)

G987106	06	1,18
G987108	08	1,31
G987110	10	1,44
G987112	12	1,57
G987114	14	1,70
G987116	16	1,96

Grapa 98

G989808	08	1,96
G989810	10	1,96
G989812	12	2,22
G989814	14	2,35
G989816	16	2,87
G989820	20	3,14
G989825	25	3,92

Grapa 90

G989012	12	4,18
G989015	15	4,44
G989018	18	4,97

G989020	20	5,49
G989025	25	6,01
G989030	30	6,80
G989035	35	7,19
G989040	40	8,36

Consultar estoc en inox.

Grapa 92

G989212	12	4,31
G989215	15	4,57
G989220	20	5,49
G989225	25	6,14
G989230	30	6,93
G989235	35	7,84
G989240	40	8,62

Consultar estoc en inox.

Grapa 94

G989410	10	4,57
G989415	15	5,49
G989420	20	6,40
G989425	25	7,32
G989430	30	8,62
G989435	35	9,67
G989440	40	10,85

Grapa SG 44

G984412	12	4,84
G984415	15	5,10
G984420	20	6,14
G984425	25	6,93
G984430	30	7,84
G984435	35	8,76
G984438	38	9,15
G984440	40	9,93

Grapa 14

G981420	20	8,36
G981425	25	9,67
G981430	30	11,11
G981435	35	12,55
G981440	40	13,98
G981445	45	15,16
G981450	50	16,47
G981460	60	19,21

Grapa 16NC

G981625	25	11,63
G981630	30	13,33
G981635	35	14,90
G981640	40	15,81
G981650	50	18,03

G981660	60	23,00
---------	----	-------

Grapa 32

G983115	15	8,23
G983118	18	8,76

Grapa 33

G983315	15	8,23
G983318	18	8,76
G983322	22	11,24

Grapa 1068

G986812	12	8,62
G986816	16	9,28
G986820	20	10,45
G986825	25	11,63
G986830	30	12,15
G986832	32	13,07
G986835	35	13,85
G986838	38	14,77

Grapa 140

G981006	06	2,22
G981008	08	2,74
G981010	10	3,27
G981012	12	3,53
G981014	14	3,79

Grapa 13

G983706	06	2,48
G983708	08	2,74
G983710	10	3,27
G983712	12	3,66
G983714	14	3,92

Grapa 530

G985304	4	1,83
G985306	6	1,96
G985308	8	2,09
G985310	10	2,48
G985312	12	2,87
G985314	14	2,87

Grapa 73

G987310	10	2,35
G987312	12	2,74

Grapa 26

G982606	06	1,07
G982608	08	1,23



Grapa 28

G987711	10	4,70
---------	----	------

Grapa 36

G983610	10	4,18
G983612	12	4,44
G983614	14	4,84



Grapa Omega

G980016	Vr16	6,01
G980017	A16	8,36
G980018	A18	9,28
G980020	A20	11,76



Xapa Puntiflex

G980315	15	10,32
G980515	15	14,37

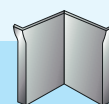

Xapa FLX, FUW o FLAX

G989907	07	11,50
G989910	10	11,50
G989912	12	11,50
G989915	15	11,50

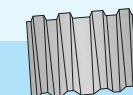

Xapa CF

G981310	10	27,31
G981313	13	37,11
G981315	15	41,82

Xapa Mini CF

G981209	09	43,26
G981212	12	47,70

TREPANTS

TP 75-7500-02

Ref. M362000



Revers.
 Progressiu
 83 dB(A)
 2.000 r.p.m.
 10 mm
 113 l/min
 0,5 hp
 1,0 kg
 170x160x40 mm
 6,2 bar
 PVP 108,57 €



TP 819

Ref. M360001



Revers.
 800 r.p.m.
 13 mm
 113 l/min
 1,4 kg
 220x150x40 mm
 6,2 bar
 PVP 165,17 €



TP 75-7251-03

Ref. M361100



Revers.
 83 dB(A)
 1.800 r.p.m.
 10 mm
 113 l/min
 1,3 kg
 180x160x40 mm
 6,2 bar
 PVP 211,37 €



SM 78-7284PR02

Ref. M361300



Revers.
 83 dB(A)
 2.800 r.p.m.
 6 mm
 150 l/min
 0,6 kg
 160x130x40 mm
 6,2 bar
 PVP 210,21 €



TP 807

Ref. M400000



2.600 r.p.m.
 10 mm
 150 l/min
 1,0 kg
 220x40x50 mm
 6,2 bar
 PVP 124,74 €



TP 824 R

Ref. M410000



Revers.
 1.500 r.p.m.
 10 mm
 150 l/min
 1,8 kg
 210x110x50 mm
 6,2 bar
 PVP 170,94 €



TP 824

Ref. M400001



1.900 r.p.m.
 10 mm
 150 l/min
 1,1 kg
 200x100x50 mm
 6,2 bar
 PVP 152,46 €



SM 79 8423R

Ref. M361200



Revers.
 85 dB(A)
 1.400 r.p.m.
 10 mm
 113 l/min
 1,2 kg
 200x100x50 mm
 6,2 bar
 PVP 195,20 €



CARGOLADORES

SD 83-7251

Ref. M371000

SD 83-7500

Ref. M370100

SD 83-7251 F

Ref. M381000



83 dB(A)
800 r.p.m.
3 → 11 Nm
113 l/min
1,4 kg
210x160x50 mm
6,2 bar
PVP 222,92 €



83 dB(A)
800 r.p.m.
3 → 11 Nm
113 l/min
1,2 kg
210x150x40 mm
6,2 bar
PVP 154,77 €



83 dB(A)
800 r.p.m.
5 → 10 Nm
113 l/min
1,4 kg
120x160x50 mm
6,2 bar
PVP 228,69 €



SD 163

Ref. M370000

SD 162

Ref. M370001

SD 165

Ref. M380000



800 r.p.m.
3 → 11 Nm
113 l/min
1,3 kg
210x150x50 mm
6,2 bar
PVP 135,14 €



1.800 r.p.m.
3 → 8 Nm
113 l/min
1,1 kg
190x150x40 mm
6,2 bar
PVP 129,36 €



800 r.p.m.
Max. 16 Nm
113 l/min
1,3 kg
200x160x50 mm
6,2 bar
PVP 325,71 €



CARGOLADORES

SM 83 8423F

Ref. M370200



Ajustable externament

- Revers.
- 83 dB(A)
- 800 r.p.m.
- 5 → 10 Nm
- 113 l/min
- 1,4 kg
- 270x40x60 mm
- 6,2 bar
- 289,91 €



SD 843

Ref. M370003



- Revers.
- 800 r.p.m.
- 3 → 11 Nm
- 113 l/min
- 1,2 kg
- 270x40x70 mm
- 6,2 bar
- 198,66 €



SD 842

Ref. M370002



- Revers.
- 1.800 r.p.m.
- 3 → 8 Nm
- 113 l/min
- 1,1 kg
- 270x40x70 mm
- 6,2 bar
- 159,39 €



SD 863

Ref. M380002



- Revers.
- 800 r.p.m.
- 5 → 16 Nm
- 150 l/min
- 1,2 kg
- 270x40x70 mm
- 6,2 bar
- 269,12 €



SD 140 Q

Ref. M350000



- Revers.
- 1.500 r.p.m.
- 1 → 3 Nm
- 150 l/min
- 0,6 kg
- 230x30x50 mm
- 6,2 bar
- 174,41 €



SI 161

Ref. M390000



- Revers.
- 7.000 r.p.m.
- 1,1 → 16 Nm
- 170 l/min
- 1,1 kg
- 230x50x70 mm
- 6,3 bar
- 285,29 €



SI 165

Ref. M390001



- Revers.
- 7.000 r.p.m.
- 1,1 → 16 Nm
- 170 l/min
- 1,2 kg
- 200x170x60 mm
- 6,2 bar
- 285,29 €



FREGADORES

SM 66-6133 C

Ref. M481000

-  Asp.
-  76 dB (A)
-  5 mm
-  12.000 r.p.m.
-  Ø150 mm
-  57 l/min
-  0,8 kg
-  200x80x150 mm
-  6,2 bar
-  PVP 241,40 €



Base Ø150 aspiració 6 forats velcro Ref. R480239

PVP 27,49 €

Base Ø150 aspiració 15 forats velcro Ref. R480245











PVP 53,95 €

Els codigs iniciats per la lletra R ,tenen el descompte de recanvis

SM 66-6233 C

Ref. M481500

ESPECIAL AUTOMOCIÓ

-  Asp.
-  76 dB (A)
-  2,5 mm
-  12.000 r.p.m.
-  Ø150 mm
-  57 l/min
-  0,8 kg
-  200x80x150 mm
-  6,2 bar
-  PVP 241,40 €



SM 63-6133

Ref. M481300

-  No Asp.
-  76 dB (A)
-  5 mm Orb.
-  12.000 r.p.m.
-  Ø75 mm
-  57 l/min
-  0,7 kg
-  130x80x100 mm
-  6,2 bar
-  PVP 271,43 €



SM 65-6133 C

Ref. M481400

-  Asp.
-  76 dB (A)
-  5 mm Orb.
-  12.000 r.p.m.
-  Ø125 mm
-  57 l/min
-  0,8 kg
-  190x80x125 mm
-  6,2 bar
-  PVP 241,40 €



Base Ø 75 velcro

Ref. R481334









PVP 21,60 €

Base Ø125 aspiració velcro Ref. R481446

PVP 28,08 €

SM 64-6321



Ref. M490100

-  No Asp.
-  80 dB (A)
-  3.200 r.p.m.
-  Ø75 mm
-  91 l/min
-  0,7 kg
-  116x120x30 mm
-  6,2 bar
-  PVP 222,92 €



SG 0402

Ref. M490200

-  Asp.
-  18.000 r.p.m.
-  Ø74, 110, 140 mm
-  125 l/min
-  1,2 kg
-  200x150x40 mm
-  6,2 bar
-  PVP 73,92 €



Base Ø 75 velcro

Ref. R480133

PVP 19,44 €

FREGADORES

SA 325

Ref. M450000



- No Asp.
- 20.000 r.p.m.
- 100x110
- 280 l/min
- 0,5 kg
- 6,2 bar
- 130x110x80 mm
- 181,34 €



SA 324

Ref. M460000



- No Asp.
- 15.000 r.p.m.
- 74x83
- 280 l/min
- 0,4 kg
- 6,2 bar
- 150x70x70 mm
- 165,17 €



CY 374 D

Ref. M451000



- Asp.
- 3 mm orb.
- 9.000 r.p.m.
- 73x140
- 200 l/min
- 0,9 kg
- 6,2 bar
- 180x70x100 mm
- 309,54 €



SA 420

Ref. M470103



- No Asp.
- 5 mm orb.
- 10.000 r.p.m.
- Ø150
- 150 l/min
- 1,8 kg
- 6,2 bar
- 240x190x150 mm
- 95,87 €



ZK 1201

Ref. M470000



- No Asp.
- 8.000 r.p.m.
- 73x145
- 150 l/min
- 1,8 kg
- 6,2 bar
- 170x90x120 mm
- 91,25 €



SM 6W 6100

Ref. M470200



- No Asp.
- 20.000 r.p.m.
- 10x330 mm
- 200 l/min
- 0,9 kg
- 6,2 bar
- 207x70x100 mm
- 247,17 €



LB 620

Ref. M470102



- No Asp.
- 16.000 r.p.m.
- 20x520 mm
- 400 l/min
- 1,5 kg
- 6,2 bar
- 250x70x100 mm
- 377,69 €



CLAUS D'IMPACTE-CARRACA

SM 43 4134P K3

Ref. M630301

Kit estoig



1/2	x 3
	x 2
	92,8 dB(A)
	8.000 r.p.m.
	68→786 Nm. Max. 1.112 Nm
	113 l/min
	1,9 kg
	180x160x60 mm
	6,2 bar
	315,32 €



AW 050H

Ref. M630500

Kit estoig



1/2	3/8
	x 3
	x 2
	83 dB(A)
	9.000 r.p.m.
	122→542 Nm. Max. 813 Nm
	113 l/min
	1,4 kg
	102x170x60 mm
	6,2 bar
	288,75 €



SM 45 4154P

Ref. M630400



3/4	x 3
	x 2
	94 dB(A)
	5.500 r.p.m.
	271→1.627 Nm. Max. 2034 Nm
	198 l/min
	3,5 kg
	220x220x85 mm
	6,2 bar
	586,74 €



SM 34 3023

Ref. M672100



1/2	
	79 dB(A)
	150 r.p.m
	14→68 Nm. Max. 68 Nm
	113 l/min
	1,2 kg
	260x40x40 mm
	6,2 bar
	136,29 €



Treball continuat.
Coixinets de boles.
Regulador d'aire.

LC 30

Ref. M671000



3/8	
	200 r.p.m
	50 Nm
	120 l/min
	1,1 kg
	260x40x40 mm
	6.2 bar
	83,16 €



LC 31

Ref. M672000

1/2	
	200 r.p.m
	50 Nm
	120 l/min
	1,1 kg
	260x40x40 mm
	6.2 bar
	83,16 €



LC 735

Ref. M673000



1/2	
	150 r.p.m
	90 Nm
	150 l/min
	2,0 kg
	350x50x50 mm
	6.2 bar
	211,37 €



CISELLS - MOLES

ZK 101 kit

Ref. M630015

ZK 106 kit

Ref. M630003

SH 2110

Ref. M630009

Kit estoig

Kit estoig



T_{xm} 5.000
Ø 42 mm
LPM 120 l/min
Kg 1,4 kg
Y_xZ_x 150x150x50 mm
Ø 6,2 bar
PVP 80,85 €



T_{xm} 3.200
Ø 66 mm
LPM 200 l/min
Kg 1,60 kg
Y_xZ_x 180x150x50 mm
Ø 6,2 bar
PVP 101,64 €



T_{xm} 3.000
Ø 19 x Ø 3 mm
LPM 120 l/min
Kg 1,35 kg
Y_xZ_x 180x150x50 mm
Ø 6,2 bar
PVP 271,43 €



SM 108 HK

Ref. M631000.



Kit estoig.

Coixinets amortidors dobles que absorbeixen el cop i la vibració per reduir el cansament.

Cilindre d'acer d'alta qualitat que proporciona més força.

Pistó reforçat d'acer que proporciona un cop més fort per rendibilitzar al màxim l'impacte.

Canviador ràpid de cisell.

T_{xm} 2.500
Ø 73 mm
LPM 51 l/min
Kg 2,6 kg
Y_xZ_x 232x180x50 mm
Ø 6,2 bar
PVP 284,13 €



SM 51 3011BK

Ref. M620004

SM 5F 3011B

Ref. M620005

FR 516

Ref. M674000



Kit estoig.
 Regulador d'aire incorporat.

Sortida d'aire posterior amb silenciador.

SM 51 3011B

SM 5F 3011B

dB(A) 79 dB(A)
RPM 20.000 r.p.m.
Ø 6 i 3 mm
LPM 113 l/min
Kg 0,7 kg
Y_xZ_x 180x40x40 mm
Ø 6,2 bar
PVP 155,93 €



dB(A) 79 dB(A)
RPM 20.000 r.p.m.
Ø 6 mm
LPM 113 l/min
Kg 1,35 kg
Y_xZ_x 348x40x40 mm
Ø 6,2 bar
PVP 155,93 €



RPM 56.000 r.p.m.
Ø 3 mm
LPM 45 l/min
Kg 0,1 kg
Y_xZ_x 140x20x20 mm
Ø 6,2 bar
PVP 137,45 €



CISELLS - MOLES

SM 5C 6192 PS 115

Ref. M620011

**Limitador de velocitat.
9 posicions del protector.
Discs de 6 a 8 mm.
Botó de bloqueig per desmuntar el disc.
Motor 0,9 HP.
Sortida d'aire posterior.**

Ø 115 mm
83 dB(A)
12.000 r.p.m.
Eix M14 x 2.0
113 l/min
1,9 kg
290x100x220 mm
6,2 bar
PVP 303,77 €



SM 5D 6192 PS 125

Ref. M620012

**Limitador de velocitat.
9 posicions del protector.
Discs de 6 a 8 mm.
Botó de bloqueig per desmuntar el disc.
Motor 0,9 HP.
Sortida d'aire posterior.**

Ø 125mm
83 dB(A)
12.000 r.p.m.
Eix M14 x 2.0
113 l/min
1,9 kg
290x100x220 mm
6,2 bar
PVP 303,77 €



SM 6N 6661

Ref. M490300

**Botó de bloqueig per desmuntar el disc.
Sortida d'aire posterior.
Gatell amb seguretat.
*Cobertor de llana no inclòs.**

Ø 125mm
83 dB(A)
2.500 r.p.m.
Eix M14 x 2.0
113 l/min
1,9 kg
300x100x180 mm
6,2 bar
PVP 309,54 €



SM 5J 3011B

Ref. M620007

Regulador d'aire incorporat.

Sortida d'aire posterior amb silenciador.

Ø 75mm
79 dB(A)
20.000 r.p.m.
113 l/min
0,8 kg
241x80x40 mm
6,2 bar
PVP 121,28 €



REBLANADORES

CCP 200

Ref.M510000

Tracció 725 Kg



- 14→30 mm
- 2.5, 3.0, 4.0, 4.8
- 2 L X
- 2,0 kg
- 225x260x75 mm
- 5 bar
- PVP 143,22 €



CCP 500

Ref.M511000

Tracció 1.000 Kg



- 15→65 mm
- 2.5, 3.0, 4.0, 4.8, 6
- 2 L X
- 2,3 kg
- 250x285x80 mm
- 5 bar
- PVP 287,60 €



CCP RF 410

Ref. M513000

Tracció 1219 Kg



M4,M5,M6
tots els materials.
M8,M10 no acer inox.

- 6,5 mm
- M4,M5,M6,M8,M10
- 2 L X
- 1,5 kg
- 160x300x75 mm
- 5 bar
- PVP 334,95 €



PISTOLES DE PINTAR

HC W 77S

Ref. M682001

3 regulacions:

- Caudal d'aire
- Caudal de líquid
- Ventall de sortida



- 1.000 cc
- Ø 1.5 - Ø 2.5
- 200 l/min (3 bar boquilla 1,5)
- 1,1 kg
- 400x110x160 mm
- 6 bar
- PVP 99,33 €



HC W 98 G

3 regulacions:

- Caudal d'aire
- Caudal de líquid
- Ventall de sortida



- 500 cc
- 160 l/min (3 bar boquilla 1,4)
- 0,9
- 300x100x200 mm
- 3 → 5 bar
- PVP 84,32 €

Ref. M682002
Ø 1,7



Ref. M682003
Ø 1,4



Ref. M682004
Ø 2,0



VARIS

VD

Ref. M540005

VI

Ref. M540004

VILL

Ref. M540006



Max. 50 Kg

PVP 58,91 €



Max. 30 Kg

PVP 21,95 €



Max. 5 Kg

PVP 16,17 €



kit boquillas

Ref. E021212

DG 10-3

Ref. M960001

T-G3

Ref. M630007



PVP 10,40 €



Boq.Inflar

Ref. E020906



PVP 4,97 €

Kg 0,1 kg
PVP 11,76 €



Kg 0,3 kg
PVP 23,10 €



Hd20

Ref. M370900

KS-10

Ref. M960000

SB

- 2 T10
- 4 T20
- 2 Ph1
- 5 Ph2
- 2 Pz1
- 5 Pz2



PVP 18,48 €

Kg 0,1 kg
PVP 10,40 €



Recorregut cable 1.4 m

SB 5000

Ref. M540001

2,5 → 5 Kg

PVP 84,32 €



SB 3000

Ref. M540002

1,5 → 3 Kg

PVP 72,77 €



SB 2000

Ref. M540003

1 → 2 Kg

PVP 49,67 €



ESPIRALS I MÀNEGUES

MÀNEGA

Ref. E208103 / E208106

Termocautxú reforçat tèxtil



50 m
 Ø 8x15 mm
 max. 20 bar
 PVP 150,15 €



50 m
 Ø 10x17 mm
 max. 20 bar
 PVP 234,47 €



MÀNEGA

Ref. E208105

PVC Alta resistència
 Connexions 1/4 "



15 m
 Ø 8x15 mm
 max. 20 bar
 PVP 57,96 €



TUB RILSAN PA 12



	Ø mm	€ x m
Ref. E020850	2x4	0,97
Ref. E020851	4x6	1,51
Ref. E020852	6x8	2,20
Ref. E020853	8x10	2,75
Ref. E020854	10x12	3,44

MÀNEGA

Ref. E208101

Connector USA 113
 Termocautxú tèxtil



10 m
 Ø 8x12 mm
 max. 20 bar
 PVP 57,96 €



ESPIRALS DE POLIURETÀ 98A

Temperatura de treball de -40° a 60°.

Connexions giratòries 1/4".

Possibilitat muntades amb ràcords.



Ref. E100450	3 m	Ø 5x8 mm	14,49 €
Ref. E100650	6 m	Ø 5x8 mm	20,53 €
Ref. E100850	8 m	Ø 5x8 mm	22,94 €
Ref. E100865	8 m	Ø 6,5x10 mm	33,81 €
Ref. E101265	12 m	Ø 6,5 x10mm	42,26 €
Ref. E101212	12 m	Ø 12x15 mm	77,28 €

TUB POLIURETÀ 98A

Temperatura de treball de -40° a 60°.



B Blau
 C Cristall
 V Vermell
 G Groc
 N Negre

	Ø mm	color	Max. bar	€ x m
Ref. E980254	2,5x4	B	13	0,63 €
Ref. E980406	4x6	B	11	1,14 €
Ref. E980608	6x8	B	8	1,76 €
Ref. E980609	6x8	C	8	1,76 €
Ref. E980610	6x8	V	8	1,76 €
Ref. E980611	6x8	G	8	1,76 €
Ref. E980612	6x8	N	11	1,76 €
Ref. E980651	6,5x10	B	11	3,14 €
Ref. E980652	6,5x10	C	11	3,14 €
Ref. E980653	6,5x10	V	11	3,14 €
Ref. E980654	6,5x10	G	11	3,14 €
Ref. E980655	6,5x10	N	11	3,14 €
Ref. E980812	8x12	B	10	4,52 €

ENROTLLADORS

ENROTLLADOR

Ref. E206511

Carcassa metall
Connexions 1/4
Poliuretà reforçat



- 10 m
- Ø 6,5 x 10 mm
- 8 kg
- 345x325x120 mm
- 15 bar
- PVP 225,23 €



ENROTLLADOR

Ref. E206515

Carcassa metall
Connexions 1/4
Poliuretà reforçat



- 15 m
- Ø 6,5 x 10 mm
- 9 kg
- 345x325x120 mm
- 15 bar
- PVP 248,33 €



ENROTLLADOR

Ref. E206505

Carcassa plàstic
Endoll ràpid
Connector USA 113
Poliuretà reforçat



- 10 m
- Ø 6,5 x 10 mm
- 9 kg
- 360x360x140 mm
- 10 bar
- PVP 133,98 €



ENROTLLADOR

Ref. E208513

Enrotllador manual
Connexions 1/4
Poliuretà reforçat



- 30 m
- Ø 8x12 mm
- 7,5 kg
- 325x360x260 mm
- 15 bar
- PVP 199,82 €



ENROTLLADOR

Ref. E208514

Enrotllador manual
Connexions 1/4
Poliuretà reforçat



- 40 m
- Ø 8x12 mm
- 9 kg
- 325x360x260 mm
- 15 bar
- PVP 242,55 €



ENROTLLADOR

Ref. E208515

Enrotllador manual
Connexions 1/4
Poliuretà reforçat



- 20 m
- Ø 6,5x10 mm
- 5 kg
- 325x360x260 mm
- 15 bar
- PVP 151,31 €



ENROTLLADOR

Ref. E208516

- 30 m
- Ø 6,5x10 mm
- 6 kg
- 325x360x260 mm
- 15 bar
- PVP 172,10 €



CONNEXIONS

1/8"± Ø 9,90 mm

1/4"± Ø13,24 mm

3/8"± Ø16,73 mm

1/2"± Ø20,73 mm

3/4"± Ø25,97 mm

1"± Ø32,98 mm



115/1FU Universal

E020712	1/8	10,25 €
E010000	1/4	9,55 €
E020713	3/8	10,25 €
E020714	1/2	11,07 €



115/1U Universal

E020715	1/8	9,70 €
E020716	1/4	9,70 €
E020717	3/8	9,70 €
E020718	1/2	11,07 €



115/RU Universal

E020867	6	11,45 €
E020868	8	11,45 €
E020869	10	11,45 €



113P USA

E020004	6	2,37 €
E020005	8	2,37 €
E020006	10	2,37 €



113M USA

E020689	1/8	1,93 €
E020000	1/4	1,49 €
E020690	3/8	1,93 €
E020691	1/2	2,63 €



113F USA

E020676	1/8	2,79 €
E020003	1/4	1,46 €
E020677	3/8	2,79 €



115/1FD EUR

E030001	1/4	10,25 €
E030008	3/8	10,85 €
E030009	1/2	11,93 €



115/PD EUR

E030010	8	11,50 €
E020034	10 1/4	2,43 €
E030011	10	11,50 €



113PD EUR

E030006	8	2,39 €
E030012	10	2,39 €



113MD EUR

E030002	1/4	1,63 €
E030013	3/8	1,93 €
E030014	1/2	3,51 €



113FD EUR

E030003	1/4	1,64 €
E030015	3/8	2,18 €
E030016	1/2	3,28 €



3603

E020012	6-6	1,81 €
E020008	8-8	2,45 €
E020035	10-10	3,20 €



3602

E020016	6 1/4	2,25 €
E020013	8 1/4	2,25 €
E020034	10 1/4	2,43 €
E020889	10 3/8	2,56 €



3601

E020593	6 1/8	1,11 €
E020007	6 1/4	1,38 €
E020594	7 1/8	1,11 €
E020595	7 1/4	1,65 €
E020596	8 1/8	1,17 €
E020001	8 1/4	1,59 €
E020597	8 3/8	1,93 €
E020598	9 1/8	1,26 €
E020599	9 1/4	1,59 €
E020600	9 3/8	1,81 €
E020601	10 1/8	1,11 €
E020002	10 1/4	1,56 €
E020602	10 3/8	1,81 €
E020603	12 1/4	1,53 €
E020604	12 3/8	1,81 €
E020605	12 1/2	2,78 €
E020606	14 3/8	1,93 €
E020607	14 1/2	2,78 €
E020608	17 3/8	1,93 €
E020609	17 1/2	2,78 €
E020610	20 1/2	3,33 €



3500 conic.

E020466	1/8	1,11 €
E020467	1/4	1,38 €
E020468	3/8	2,09 €
E020469	1/2	2,49 €
E020470	3/4	4,43 €
E020871	1	10,66 €



3521 cilin.

E020486	M5 1/8	0,85 €
E020487	1/8 1/8	0,85 €
E020488	1/8 1/4	1,20 €
E020489	1/8 3/8	1,82 €
E020490	1/4 1/4	1,20 €
E020032	1/4 3/8	1,87 €
E020491	1/4 1/2	3,26 €
E020492	3/8 3/8	1,82 €
E020493	3/8 1/2	3,13 €
E020494	1/2 1/2	3,26 €



3520 conic.

E020477	1/8 1/4	1,38 €
E020478	1/8 3/8	1,93 €
E020479	1/4 1/4	1,53 €
E020480	1/4 3/8	2,09 €
E020481	1/4 1/2	3,47 €
E020482	3/8 3/8	2,09 €
E020483	3/8 1/2	3,47 €
E020484	1/2 1/2	3,60 €
E020485	1/2 3/4	5,47 €



3501 cilin.

E020514	M5	0,70 €
E020515	1/8	0,98 €
E020015	1/4	1,22 €
E020516	3/8	1,81 €
E020517	1/2	2,78 €
E020518	3/4	4,99 €



3511 cilin.

E020502	M5 1/8	0,98 €
E020503	1/4 1/8	1,38 €
E020504	3/8 1/8	1,65 €
E020031	3/8 1/4	1,65 €
E020505	1/4 1/2	2,49 €
E020506	3/8 1/2	2,63 €
E020507	1/2 3/4	4,43 €



3510 conic.

E020471	1/8 1/4	1,09 €
E020472	1/8 3/8	1,44 €
E020473	1/4 3/8	1,58 €
E020474	1/4 1/2	2,16 €
E020475	3/8 1/2	2,29 €
E020476	1/2 3/4	3,37 €
E020870	3/4 1	8,91 €



3530 conic.

E020495	1/4 1/8	0,98 €
E020496	3/8 1/8	1,26 €
E020497	3/8 1/4	1,11 €
E020498	1/2 1/8	2,49 €
E020499	1/2 1/4	2,21 €
E020500	1/2 3/8	1,93 €
E020501	3/4 1/2	3,94 €



3611C conic.

E020550	1/8	0,62 €
E020551	1/4	0,89 €
E020552	3/8	1,17 €
E020553	1/2	1,81 €
E020554	3/4	3,47 €
E020555	1	5,54 €



3543

E020556	M5	0,70 €
E020557	1/8	0,98 €
E020033	1/4	1,46 €
E020558	3/8	2,49 €
E020559	1/2	3,60 €
E020560	3/4	5,41 €



3531 cilin.

E020519	1/8 M5	0,83 €
E020520	1/4 1/8	1,11 €
E020521	3/8 1/8	1,38 €
E020030	3/8 1/4	1,26 €
E020522	1/2 1/8	2,37 €
E020523	1/2 1/4	2,37 €
E020524	3/8 1/2	2,37 €
E020525	3/4 1/2	4,02 €

CONNEXIONS



3553 conic

E020561	M5 1/8	1,38 €
E020562	1/4 1/8	1,38 €
E020563	3/8 1/8	2,09 €
E020564	1/8 1/2	3,47 €
E020565	1/4 3/8	2,37 €
E020566	1/4 1/2	3,33 €
E020567	3/8 1/2	3,33 €
E020872	1/2 3/4	4,77 €



3612 allen

E020568	M5	0,70 €
E020569	1/8	0,83 €
E020570	1/4	0,98 €
E020571	3/8	1,26 €
E020572	1/2	1,81 €



3611 cilin.

E020526	M5	0,50 €
E020527	1/8	0,70 €
E020041	1/4	0,98 €
E020528	3/8	1,46 €
E020529	1/2	1,93 €
E020530	3/4	2,97 €
E020531	1	5,54 €



3613

E020589	1/8	0,83 €
E020590	1/4	1,11 €
E020591	3/8	1,81 €
E020592	1/2	2,49 €



5020

E020545	M5	1,81 €
E020546	1/8	1,81 €
E020547	1/4	2,78 €
E020548	3/8	4,15 €
E020549	1/2	6,92 €



5010

E020625	1/8	1,82 €
E020626	1/4	2,49 €
E020627	3/8	3,88 €
E020628	1/2	6,24 €



5013

E020532	1/8	2,21 €
E020533	1/4	3,88 €
E020534	3/8	5,54 €
E020535	1/2	8,31 €



5060

E020540	M5	2,37 €
E020541	1/8	2,49 €
E020542	1/4	4,15 €
E020543	3/8	6,92 €
E020544	1/2	10,38 €



5070

E020577	1/8	2,63 €
E020578	1/4	4,71 €
E020579	3/8	6,92 €
E020580	1/2	11,07 €



5050

E020536	1/8	2,63 €
E020537	1/4	4,84 €
E020538	3/8	6,92 €
E020539	1/2	10,66 €



5003

E020611	1/8	3,05 €
E020011	1/4	5,84 €
E020612	3/8	7,62 €
E020613	1/2	11,07 €



5090

E020618	1/8	2,45 €
E020619	1/4	3,74 €
E020620	3/8	6,92 €
E020621	1/2	9,70 €



5080

E020581	1/8	2,37 €
E020582	1/4	3,88 €
E020583	3/8	6,09 €
E020584	1/2	9,70 €



5040

E020614	1/8	2,63 €
E020615	1/4	4,15 €
E020616	3/8	5,54 €
E020617	1/2	9,70 €



5043

E020622	1/8	2,63 €
E020010	1/4	3,80 €
E020623	3/8	4,84 €
E020624	1/2	8,31 €



5033

E020573	1/8	4,15 €
E020574	1/4	6,92 €
E020575	3/8	9,42 €
E020576	1/2	16,62 €



5033/1

E020585	1/8	4,15 €
E020586	1/4	6,92 €
E020587	3/8	9,70 €
E020588	1/2	16,62 €



3525

E020508	1/8 22	1,26 €
E020509	1/8 42	3,47 €
E020510	1/8 51	4,71 €
E020511	1/4 35	2,37 €
E020512	1/4 45	2,49 €
E020513	1/4 51	3,47 €



1035 doble

E020641	1/4 1/8	2+2	19,32 €
E020642	1/4 1/8	3+3	23,27 €
E020643	1/4 1/8	4+4	27,08 €
E020644	1/4 1/8	5+5	31,20 €
E020645	3/8 1/4	2+2	23,27 €
E020646	3/8 1/4	3+3	28,70 €
E020647	3/8 1/4	4+4	33,94 €
E020648	3/8 1/4	5+5	39,69 €
E020649	1/2 1/4	3+3	37,72 €
E020650	1/2 1/4	4+4	42,60 €
E020651	1/2 1/4	5+5	46,45 €

CONNEXIONS



1034 individual

E020633	1/4 1/8	2	16,45 €
E020634	1/4 1/8	3	19,37 €
E020635	1/4 1/8	4	21,29 €
E020636	1/4 1/8	5	23,93 €
E020637	3/8 1/4	2	20,33 €
E020638	3/8 1/4	3	24,46 €
E020639	3/8 1/4	4	28,20 €
E020640	3/8 1/4	5	32,45 €



1033

E020652	1/8	5,65 €
E020653	1/4	9,70 €
E020654	3/8	15,24 €
E020655	1/2	16,62 €



108F

E020671	7	1,59 €
E020672	8	1,98 €
E020673	10	1,98 €
E020674	12	3,69 €



108

E020658	1/4	1,59 €
E020669	1/4	1,59 €

108/1

E020658	1/4	1,59 €
E020669	1/4	1,59 €



RA/1 conic.

E020050	4 1/8	2,78 €
E020051	4 1/4	2,91 €
E020052	6 1/8	2,91 €
E020053	6 1/4	3,05 €
E020054	8 1/8	3,25 €
E020055	8 1/4	3,33 €
E020056	10 1/4	3,74 €
E020057	10 3/8	3,88 €
E020058	10 1/2	5,54 €
E020059	12 3/8	5,82 €
E020060	12 1/2	6,24 €



RA/1 COR cilin.

E020079	4 1/8	2,91 €
E020080	4 1/4	3,60 €
E020081	6 1/8	3,05 €
E020082	6 1/4	3,05 €
E020083	8 1/8	3,33 €
E020084	8 1/4	3,33 €
E020085	10 1/4	3,88 €
E020086	10 3/8	4,43 €
E020087	10 1/2	5,54 €
E020088	12 3/8	5,82 €
E020089	12 1/2	6,24 €



RA/2

E020090	4 1/8	4,02 €
E020091	6 1/8	4,02 €
E020092	6 1/4	4,71 €
E020093	8 1/8	4,71 €
E020094	8 1/4	5,12 €
E020095	10 1/4	6,24 €
E020096	10 3/8	6,64 €



RA/3

E020097	4	5,54 €
E020098	6	5,54 €
E020099	8	6,64 €
E020100	10	7,20 €
E020101	12	8,86 €



RA/4

E020061	4	7,62 €
E020062	6	7,90 €
E020063	8	8,73 €
E020064	10	10,38 €
E020065	12	12,46 €



RA/6

E020066	4	4,84 €
E020067	6	4,99 €
E020068	8	5,69 €
E020069	10	7,20 €
E020070	12	9,97 €



RA/5 G conic.

E020111	4 1/8	4,99 €
E020112	4 1/4	5,12 €
E020113	6 1/8	5,12 €
E020114	6 1/4	5,26 €
E020115	8 1/8	5,69 €
E020116	8 1/4	5,69 €
E020117	8 3/8	7,34 €
E020118	10 1/4	6,92 €
E020119	10 3/8	8,31 €
E020120	10 1/2	8,73 €
E020121	12 3/8	9,70 €
E020122	12 1/2	10,38 €



RA/5 GOR cilin.

E020123	4 1/8	4,97 €
E020124	4 1/4	5,82 €
E020125	6 1/8	5,26 €
E020126	6 1/4	5,41 €
E020127	8 1/8	5,69 €
E020128	8 1/4	6,09 €
E020129	8 3/8	7,20 €
E020130	10 1/4	7,20 €
E020131	10 3/8	7,62 €
E020132	10 1/2	9,70 €
E020133	12 3/8	10,25 €
E020134	12 1/2	11,35 €



RA/8 G conic.

E020165	4 1/8	6,92 €
E020166	6 1/8	6,92 €
E020167	6 1/4	7,20 €
E020168	8 1/8	8,31 €
E020169	8 1/4	8,59 €
E020170	10 1/4	11,63 €
E020171	10 3/8	11,63 €
E020172	10 1/2	12,05 €
E020173	12 3/8	13,00 €
E020174	12 1/2	13,85 €



RA/8 GOR cilin.

E020175	4 1/8	7,08 €
E020176	6 1/8	7,08 €
E020177	6 1/4	7,34 €
E020178	8 1/8	8,17 €
E020179	8 1/4	8,59 €
E020180	8 3/8	9,29 €
E020181	10 1/4	10,53 €
E020182	10 3/8	11,23 €
E020183	10 1/2	11,51 €
E020184	12 3/8	14,54 €
E020185	12 1/2	14,54 €



RA/7 G conic.

E020143	4 1/8	6,92 €
E020144	6 1/8	6,92 €
E020145	6 1/4	6,92 €
E020146	8 1/8	8,31 €
E020147	8 1/4	8,45 €
E020148	8 3/8	9,42 €
E020149	10 1/4	10,66 €
E020150	10 3/8	11,51 €
E020151	10 1/2	12,05 €
E020152	12 3/8	13,16 €
E020153	12 1/2	13,72 €



RA/7 GOR cilin.

E020154	4 1/8	7,08 €
E020155	6 1/8	7,20 €
E020156	6 1/4	7,34 €
E020157	8 1/8	8,17 €
E020158	8 1/4	8,45 €
E020159	8 3/8	9,29 €
E020160	10 1/4	10,38 €
E020161	10 3/8	11,23 €
E020162	10 1/2	11,51 €
E020163	12 3/8	13,85 €
E020164	12 1/2	15,24 €

CONNEXIONS



RA/8 conic.

E020071	4 1/8	5,82€
E020072	6 1/8	5,97 €
E020073	6 1/4	6,09 €
E020074	8 1/8	6,92 €
E020075	8 1/4	6,92 €
E020076	8 3/8	8,86 €
E020077	10 3/8	9,29 €
E020078	12 3/8	11,79 €



RA/9

E020186	4	6,64 €
E020187	6	6,80 €
E020188	8	8,03 €
E020189	10	10,25 €
E020190	12	13,16 €



RA/5 conic.

E020102	4 1/8	3,88 €
E020103	6 1/8	4,15 €
E020104	6 1/4	4,43 €
E020105	8 1/8	4,84 €
E020106	8 1/4	4,84 €
E020107	8 3/8	7,62 €
E020108	10 1/4	5,97 €
E020109	10 3/8	7,62 €
E020110	12 3/8	8,31 €



RA/7 conic.

E020819	4 1/8	5,69 €
E020135	6 1/8	5,69 €
E020136	6 1/4	5,82 €
E020137	8 1/8	6,92 €
E020138	8 1/4	6,92 €
E020139	8 3/8	7,62 €
E020140	10 1/4	8,86 €
E020141	10 3/8	9,01 €
E020142	12 3/8	11,79 €



Brida roscada

E021101	8/16 mm	1,20 €
---------	---------	--------



Conector per espirals

E020710	5*8mm	5,12 €
E020711	6.5*10 mm	5,12€



RA/5 GOR P cilin.

E030123	4 1/8	2,63 €
E030124	4 1/4	3,42 €
E030125	6 1/8	2,63 €
E030126	6 1/4	2,83 €
E030127	8 1/8	3,32 €
E030128	8 1/4	3,32 €
E030129	8 3/8	4,19 €
E030130	10 1/4	4,19 €
E030131	10 3/8	5,26 €
E030132	10 1/2	6,24 €
E030133	12 3/8	5,26 €
E030134	12 1/2	6,29 €



RA/7 G P conic.

E030143	4 1/8	4,59 €
E030144	6 1/8	4,88 €
E030145	6 1/4	5,17 €
E030146	8 1/8	5,46 €
E030147	8 1/4	5,65 €
E030148	8 3/8	6,34 €
E030149	10 1/4	7,02 €
E030150	10 3/8	7,70 €
E030151	10 1/2	8,68 €
E030152	12 3/8	8,38 €
E030153	12 1/2	9,26 €



RA/9 P T

E030186	4	2,95 €
E030187	6	3,13 €
E030188	8	3,41 €
E030189	10	3,85 €
E030190	12	5,36 €



RA/5 G P conic.

E030111	4 1/8	2,63 €
E030112	4 1/4	3,42 €
E030113	6 1/8	2,63 €
E030114	6 1/4	2,83 €
E030115	8 1/8	3,21 €
E030116	8 1/4	3,32 €
E030117	8 3/8	4,09 €
E030118	10 1/4	4,19 €
E030119	10 3/8	5,26 €
E030120	10 1/2	6,24 €
E030121	12 3/8	5,26 €
E030122	12 1/2	6,92 €



RA/5F GOR P cilin.

E030502	4 1/8	3,39 €
E030503	4 1/4	3,45 €
E030504	6 1/8	3,39 €
E030505	6 1/4	3,65 €
E030506	8 1/8	3,45 €
E030507	8 1/4	3,77 €
E030508	8 3/8	4,40 €
E030509	10 1/4	5,51 €
E030510	10 3/8	5,70 €
E030511	10 1/2	7,53 €
E030512	12 3/8	7,84 €
E030513	12 1/2	7,98 €



RA/8 G P conic.

E030165	4 1/8	5,94 €
E030166	6 1/8	6,24 €
E030168	8 1/8	7,22 €
E030169	8 1/4	7,40 €
E030170	10 1/4	8,97 €
E030171	10 3/8	9,55 €
E030172	10 1/2	10,43 €
E030173	12 3/8	10,82 €
E030174	12 1/2	11,41 €



Y

E030220	4	3,21 €
E030221	6	3,41 €
E030222	8	3,71 €
E030223	10	4,19 €
E030224	12	5,84 €



RA/3 P

E030097	4	2,44 €
E030098	6	2,54 €
E030099	8	2,73 €
E030100	10	3,71 €
E030101	12	4,00 €



RA/3 RP

E030210	6-4	2,51 €
E030211	8-6	2,77 €
E030214	10-8	3,26 €
E030212	12-10	3,89 €



RA/6 P

E030066	4	2,44 €
E030067	6	2,54 €
E030068	8	2,73 €
E030069	10	3,90 €
E030070	12	4,19 €



PZA 4

E030585	4	5,54 €
E030586	6	5,82 €
E030587	8	6,09 €
E030588	10	6,92 €
E030589	12	7,62 €



Y Reduació

E030230	6-4	3,41 €
E030231	8-6	3,71 €
E030232	10-8	4,19 €
E030233	12-10	5,86 €

REGULACIÓ I FILTRATGE D'AIRE

201 Válvula seguretat



E020727	1/8 8bar	6,53 €
E020728	1/4 8bar	6,53 €
E020729	3/8 8bar	8,31 €
E020730	1/2 8bar	9,70 €
E020882	3/8 10bar	9,70 €
E020883	1/4 10bar	9,70 €

116 Válvula purga



E020749	1/8	1,93 €
E020750	1/4	1,93 €
E020751	3/8	2,21 €
E020752	1/2	2,78 €

202 Válvula retenció



E020739	3/8MF	11,63 €
E020740	1/2MF	13,85 €
E020887	3/8MM	15,24 €
E020888	1/2MM	17,99 €

RO 5 Cotze compressor



E020268	1/4 TU 10	5,28 €
E020269	3/8 TU 10	5,28 €
E020270	1/2 TU 10	5,28 €

Filtre compressor



E020901	3/8	6,92 €
---------	-----	--------

1205 Secant



F000500	1/4	19,32 €
---------	-----	---------

1204 Lubricador



F000700	1/4	13,28 €
---------	-----	---------

Tefló



E020790	1/2 12 M	0,80 €
---------	----------	--------

213



213/50 1/4

E020794	P 6	9,70 €
E020795	P 12	9,70 €

213/40 1/8

E020797	P 6	9,70 €
E020798	P 12	9,70 €

213



213/63 1/4

E020799	P 6	16,62 €
E020800	P 12	16,62 €
E020801	P 20	16,62 €
E020802	R 6	16,62 €
E020803	R 12	16,62 €
E020804	R 20	16,62 €

P rosca posterior
R rosca radial

214



214/63 glic. 1/4

E020816	P 6	23,86 €
E020805	P 12	23,86 €
E020806	P 25	23,86 €
E020807	R 6	23,86 €
E020808	R 12	23,86 €
E020809	R 25	23,86 €

altres combinacions
a consultar

214



214/100 glic. 1/2

E020810	P 6	62,79 €
E020811	P 12	62,79 €
E020812	P 25	62,79 €
E020813	R 6	62,79 €
E020814	R 12	62,79 €
E020815	R 25	62,79 €

Pressostat



Pressostat

E020736	4v mono	36,01 €
E020737	4v trifàsic	45,69 €

Pressostat



Pressostat

E020884	Trifàsic 6/10 A	119,30 €
E020885	Trifàsic 10/16 A	119,30 €

REGULACIÓ I FILTRATGE D'AIRE

217 Válvula unidireccional



E020753	1/8	5,54 €
E020754	1/4	6,92 €
E020755	3/8	9,70 €
E020756	1/2	16,62 €

217/1 Válvula unidireccional



E020772	1/8	5,54 €
E020773	1/4	8,31 €

218 Válvula corredera



E020757	1/8	17,99 €
E020758	1/4	20,77 €
E020759	3/8	26,31 €

6.000 Regulador cabal



E020774	1/8	17,99 €
E020775	1/4	22,16 €
E020776	3/8	48,46 €
E020777	1/2	48,46 €

40 FF



E020857	1/4	11,07 €
E020826	3/8	11,79 €
E020827	1/2	13,16 €

45 MF



E020828	1/4	13,16 €
E020829	3/8	13,85 €
E020830	1/2	15,24 €

2.003 FF



E020834	1/8	9,70 €
E020835	1/4	9,70 €
E020836	3/8	11,07 €
E020837	1/2	13,85 €

2.003 MF



E020874	1/8	9,70 €
E020875	1/4	9,70 €
E020876	3/8	11,07 €
E020877	1/2	13,85 €

2.002 MF



E020878	1/4	11,07 €
E020879	3/8	11,07 €
E020880	1/2	13,85 €

2.002 FF



E020831	1/4	11,07 €
E020832	3/8	11,07 €
E020833	1/2	13,85 €

118 F Unidireccional



E020702	1/8	8,31 €
E020703	1/4	8,31 €

6.901 Silenciador



E020760	1/8	2,21 €
E020761	1/4	2,63 €
E020762	3/8	4,15 €
E020763	1/2	5,54 €
E020764	3/4	10,38 €
E020765	1	17,99 €

6.961 Silenciador



E020784	1/8	3,88 €
E020785	1/4	3,88 €
E020786	3/8	6,92 €
E020787	1/2	6,92 €
E020788	3/4	23,53 €
E020789	1	23,53 €

6.921 Silenciador



E020778	1/8	2,78 €
E020779	1/4	3,47 €
E020780	3/8	6,36 €
E020781	1/2	9,70 €
E020782	3/4	15,24 €
E020783	1	24,92 €

6.931 Silenciador



E020766	1/8	2,78 €
E020767	1/4	4,15 €
E020768	3/8	6,92 €
E020769	1/2	9,01 €
E020770	3/4	17,99 €
E020771	1	27,69 €

REGULACIÓ I FILTRATGE D'AIRE

1.706 RN Regulador



F000900 1/4 4,59 €

209 Regulador



E020734 1/4 15,07 €

205 Regulador



E020733 1/4 28,88 €

208 Regulador



E020741 3/8 47,80 €
E020747 1/2 62,29 €

R 200



F000800 1/4 42,26 €
F000801 3/8 54,34 €
F000802 1/2 54,34 €

FR 200



Filtratge 40 µm
10 cc
F001005 1/4 57,96 €

FRL 300



Filtratge 40 µm
40cc
Lubri 75cc
F000400 1/4 117,13 €
F000401 3/8 117,13 €
F000402 1/2 117,13 €
altres mesures consultar

FR 300



altres mesures consultar

Filtratge 40 µm
40cc

F001000 1/4 70,04 €
F001001 3/8 70,04 €
F001002 1/2 70,04 €

GL 300 Lubricador



F000701 1/4 42,26 €
F000702 3/8 42,26 €
F000703 1/2 42,26 €

GA 300/400 Purgador aut.



F001020 3/8 53,13 €
F001021 1/2 66,83 €

GA 1/8 MINI Purgador man.



F000596 1/8 34,50 €



Pol. Ind. Pla de la Bruguera
c/Segarra, 6
08211 - Castellar del Vallès
(BARCELONA)
T. 937 150 613
www.ascuatro.cat
info@ascuatro.cat