

TECHNICAL RESCUE ARB CLIMBER WILDERNESS SAR ACCESS & RESCUE

BUYERS GUIDES

Water Rescue

Comprehensive free MARKET GUIDE
to all of the key and less well-known
products with specifications.

Updated with new data and
products monthly.



DRAFTING
COMPLETION

SONAR EMILY

- Easy Operation based Humminbird SONAR
- Real-time imagery for search and recovery missions
- Light weight (17 kg)
- Line of Sight technology
- GPS Accurate Mapping
- Navigation Lights for Night Missions
- Side scan, downward imaging and bathymetry
- SD cards for recording and post-processing
- Autonomy through easy waypoint entry
- SARHAWK Post Mission Processing Software

SWIFT WATER RESCUE EMILY

- Line of sight technology
- Battery powered, jet boat
- Fast and durable, 40 km/h
- Navigation Lights for Night Missions
- Easy to deploy off riverbanks, piers, bridges
- Self-righting technology for strong currents



For UK: info@emilyrobotuk.co.uk
For US: info@hydronalix.com

BUYERS GUIDES

Water Rescue Equipment



OTHER EQUIPMENT FOR WATER RESCUERS.....

Ropes, descenders & carabiners are in **Rope Equipment**

Helmets, headtorches, med-packs, spine-care & stretchers are in **PPE & CasEvac**

'Black' tactical and theatre/film rope, hardware & access items are in **'Black' Equipment**

Larger cases, area lighting, tripods & high directional are in **USAR/Extrication**

CONTENTS

in grey= in a later supplement

PPE

- 04 Rescuer PFDs
- 14 Dog/Animal PFDs
- 20 Water Rescue Helmets
- 28 Drysuits
- 36 Ice Rescue Suits
- 40 Water Rescue Boots
- 46 Fins
- 52 Gloves

WATERCRAFT

- 54 Inflatable Paths/Platforms
- 60 Inflatable Open-back Sleds
- 72 Inflatable Rafts
- 84 Short Boards (Sleds)
- 94 Inflatable Rescue Boats
- 128 RWCs
- 138 Rescue Hovercraft
- 142 Rescue Airboats

ROPE EQUIPMENT

- 216 Water-Specific Hardware
- 222 Water Rescue Ropes
- 230 Throwbags

SOFTWARE

- 236 Water-tight Bags

TECHNOLOGY

- 246 Waterproof Aerial UAVs
- 250 Subsea ROVs
- 260 Surface Drones
- 370 Underwater Cameras
- 280 Sonar Systems/Arrays

TOOLS/ACCESORIES

- 290 Water Rescue Knives
- 304 Underwater Lighting
- 324 Hard-cases -Small
- 330 Water Training Mankins

Welcome to our **BUYERS GUIDES**. These are free to all as a page-turning pdf or you can download a regular PDF by clicking on the cloud icon. Many of these GUIDES originally appeared in our print magazines so have been updated and will continue to be updated every month. The same link that you used this time can be used anytime to see the latest version. New Guides and those appearing in forthcoming magazines will also be incorporated into the relevant **BUYERS GUIDES** building into an amazingly comprehensive guide to the best products on the market.

The tabulated data in our GUIDES is non-subjective although the comprehensive introductions do have subjective comment and pick out key and interesting products.

MANUFACTURERS can contact us at any time to update the information on a product(s).
admin@rescuemagazines.com.

Copyright TECHNICAL RESCUE Ltd -All rights reserved
BUYERS GUIDES are free to pass on in their published, unmodified form

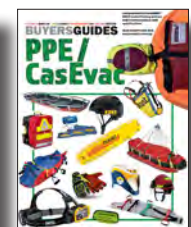

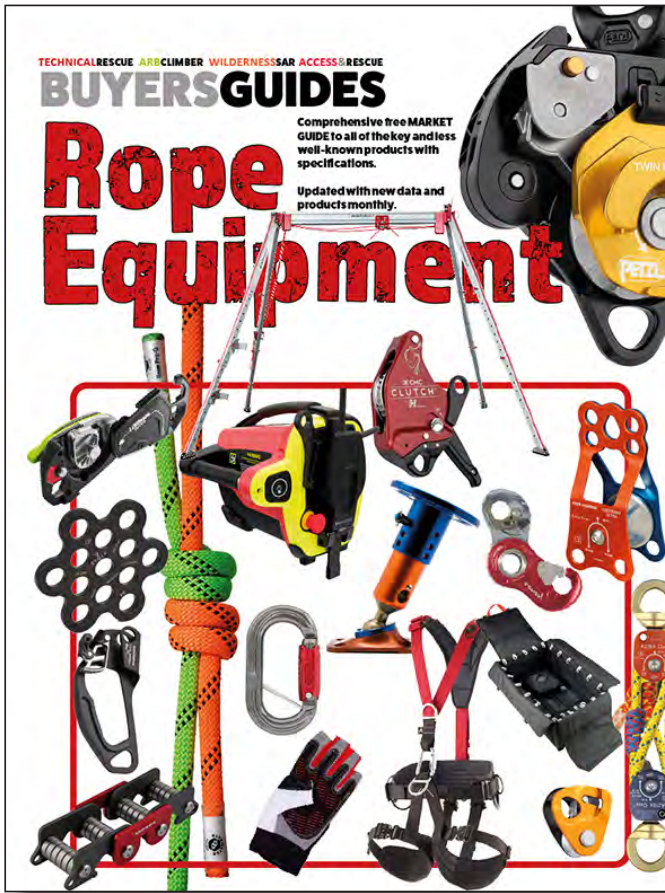

CONTENTS

=New /Coming Soon
 =Updating or
 Still Compiling

HARDWARE

- 6 Locking Carabiners
- 44 **Captive Eye Carabiners**
- 46 Scaffold/Firefighter Hooks
- 48 AutoLock Descenders
- 68 Escape/Mini Descenders
- 80 Harness Tool Hooks
- 86 Rigging Plates
- 106 Swivels

ASCENDING/HAULING

- 112 Swivel Pulleys
- 118 Carabiner Pulleys
- 122 Pulleys
- 143 Knot Passing Pulleys
- 144 Tandem Pulleys & Trolleys
- 150 Chest/Hand Ascenders/Grabs
- 188 Handled Ascenders
- 204 Mini Hauling Kits
- 210 Progress Capture Pulleys
- 222 Power Ascenders/winches
- 236 Back Up Devices
- 242 High Directionals/Tripods

SOFTWARE

- 262 Abseil/Rappel Gloves
- 272 Transport Packs
- 286 Duffle/Duffel Bags
- 290 Rope/Tackle Bags
- 310 Tool Bags/Pouches
- 368 Slings & Daisy Chains
- 316 Adj Anchor Straps

ROPE & ACCESSORIES

- 320 **9-13mm Ropes**
- 354 EscapeRopes
- 370 Prusik Cord
- 382 Edge Protectors
- PPE**
- 390 Rescue Harnesses
- 420 **Dog 'Lift' Harnesses**

CONTENTS

'BLACK = not only military and tactical equipment but also film/theatre. This may simply be that the product is black or camouflaged but there are also specialist tactical and theatrical rigging products in here

PPE

- 2 Tactical & Black Helmets
- 16 Sit Harnesses
- 28 Chest Harnesses
- 36 Full Body Harnesses
- 42 Stage/Theatre Harnesses
- 48 Gloves & Goggles
- 56 Water PFDs
- 60 Drysuits/Wetsuits

ROPE HARDWARE

- 85 Carabiners
- 96 Pulleys
- 100 Rigging Plates
- 142 Swivels/SwivelHardware
- 153 Chest Ascenders
- 170 Hand Ascenders/Grabs

- 192 Handled Ascenders
- 200 Foot Ascenders
- 208 Descenders
- 216 Tactical Anchors

ROPE

- 230 Tac Rope
- 246 Cord

SPECIALIST

- 270 Power Ascenders
- 278 Access Ladders
- 282 Hooks & Poles
- 290 Forced Entry Tools
- 300 Line Launchers
- 310 UAV accessories
- 320 Film/Theatre Rigging

TOOLS & LIGHTING

- 340 Headtorches
- 348 Tac Lights
- 358 MultiTools
- 364 Knives/Combi-Knives

WATER RESCUE pt2

In Feb/March 2025 we will add the following product groups to this BUYERS GUIDE:

- Hovercraft
- Air Boats
- RWCs (JetBikes)
- Inflatable Rescue Boats

Check out our other BUYERS GUIDES

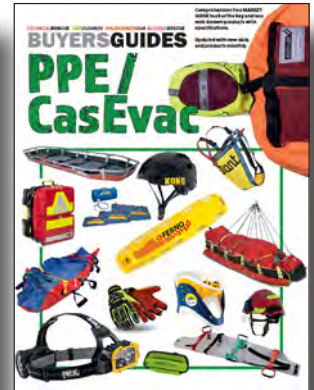

KEY TO TABLES:

Across all of our BUYERS GUIDE tables, some of the data entries are quite complex in appearance and you do need to refer to the individual keys to fully understand the information in the tables. Note that in the print magazine we have tended to round down lbf (pounds force) from KiloNewtons as a straight 2.2lb:1kg conversion but these GUIDES use the actual lbf to KN conversion which is a little higher at almost 225lbf:1kN

Cyan blue is always a variant of the main model shown. data relating specifically to that version will be **highlighted** in cyan blue or any squares or circles may be outlined in cyan blue ■■■●●● the cyan blue outline is admittedly difficult to spot on the green square or circle.

□□□○○○ An outline square or circle of any colour = an OPTION, not part of, or present, in the data shown

●● a solid circle indicates that the usage or feature indicated is OK but not ideal. It may be a usage that is not intended but it can function in that role like a descender being used as an ascender

🇺🇸🇹🇼 The main flags shown are the origin of the company listed but there may be a smaller inset flag like this Taiwan flag, indicating that the country of manufacture is different.

£\$€ Prices shown in **burnt orange** are currency conversions only. They do not reflect the additional import costs like shipping, import duty and local taxes so are a very rough guide only

Page corners are colour coded to common groups of equipment eg. Watercraft are in **blue**, rope is in **lime green**. Rope related equipment is in **red**. tools, knives and hand-tools are in **orange** Technology/drones/UAVs is in **berry** and safety/PPE is in **green**.

FOAM PFDs

PERSONAL

INTRODUCTION

Personal Floatation differs from a 'Life-Jacket' in that it uses foam to provide permanent floatation rather than a water or person-activated inflatable vest. A PFD is much bulkier to wear and therefore tends to be worn by active water rescuers with a much higher likelihood of entering the water whereas a lifejacket is a precaution should the wearer enter water unexpectedly. There are also some hybrids which provide a less bulky degree of floatation which is subsequently enhanced on entry to the water by an inflatable chamber or two but hybrids tend not to be active rescuer PFDs once the chambers are inflated - once this occurs the PFDs are effectively passive floatation aimed at keeping the wearer afloat, not inflated during an active rescue.



BUOYANCY

ranges from 50 to 275Newtons equivalent to supporting an in-water body mass of ...

Of the permanent floatation models there are broadly three designs of rescue PFD -

1) the Kayak style like the *SRE/NDiver Evo* left which tends to be shorter in the body, cut-away at the shoulders and often donned over-the-head.

2) The full torso jackets, often quite heavily adorned with pockets, pouches, accessory eyes, lanyards and closures like the *Force 6* models or the *Palm 800* left. Or it may be more simply fitted out like the US Coastguard Vests from Mustang Survival right. Both of these full-cut versions may have leg straps to ensure the vest stays down on water-entry rather than trying to float off over the wearer's head.

3) a more slimline cut, less bulky floatation rescue swimmer vests like the *Force 6 Ops* vest in the title picture or Mustang MRV170 right. These still has provision for the attachment of kit and accessories (and helo winch attachment in the case of the *Force 6*) but is otherwise less inhibited for active swimming.



KEY to TABLES

USES BUOYANCY

WEIGHT

COST: basic model. As always, expect lower cost for multiple purchases or reduced specifications. Prices INCLUDE VAT or local taxes. £\$€ in Orange are a CURRENCY CONVERSION ONLY and do not include import tax, shipping etc.

ORIGIN: Not necessarily where the PFD is made. It refers to the company's country of origin and even this may be misleading if the company is a subsidiary. For instance Mustang Survival would normally be listed as Canadian but is now owned by US group, Safariland.

SIZING:

MATERIALS:

FRONT FASTENING

LEGLOOPS

QUICK RELEASE

INTEGRAL POCKETS

OPTIONAL POCKETS

ATTACHMENT EYES

WHISTLE

MOLLE

KNIFE POUCH

LIGHTING POUCH

STANDARDS

OTHER COLOURS

REFLECTIVE/SOLAS: Counter to the interests of tactical operators but reflective tape is a feature of most rescue drysuits, usually on the wrists and/or arms but may also be in the form of piping which is less obvious until a light is shone near it

COLOURS: We've listed combination colours with a forward slash/. Similar proportion colours begin with a capital letter and minority colours with a lower case letter. Most, though not all, suits have some element of black and this is often from the waist down while the top half is in a higher visibility colour like red, yellow or orange. Obviously, most tactical-oriented suits stick to all black or dark blue and lack reflective tape which is counter-productive when trying to avoid snipers or sentries!

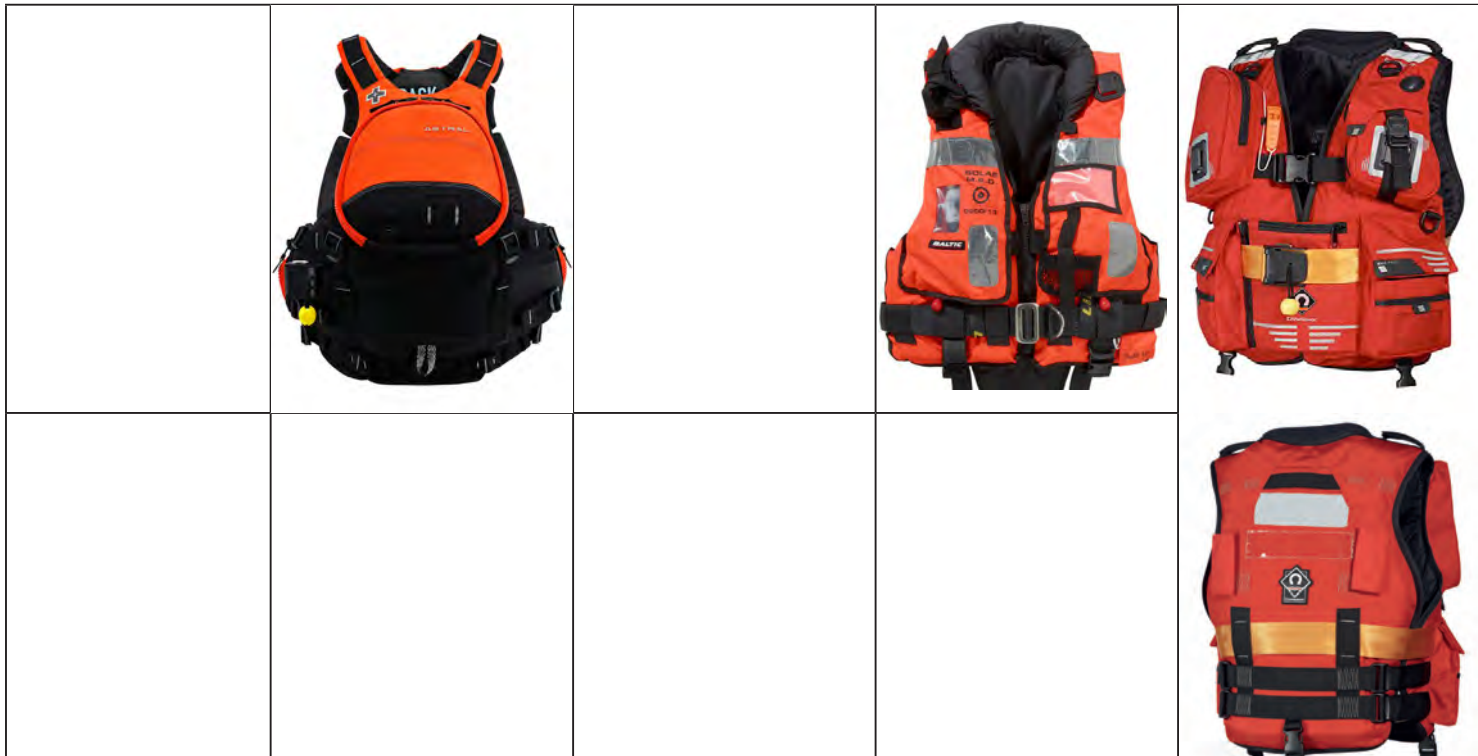

MANUFACTURER	ASTRAL	AQUATEK	BALTIC	CREWSAVER/SURVITEC
MODEL VARIANT	Greenjacket Rescue	00	00	00
PRODUCT CODE	MRV150 02	MV1254 T3	MV3128..T2...22	MD3040
ORIGIN				
USES BUOYANCY				
COST	£650 \$00 €00	£00 \$00 €00	£235 \$00 €00	£250 \$00 €00
WEIGHT				
SIZES				
MATERIALS	00	00		00
FRONT FASTENING	00	00		00
LEGLOOPS	00	00		00
QUICK RELEASE	00	00		00
INTEGRAL POCKETS				
OPTIONAL POCKETS				
ATTACHMENT EYES				
WHISTLE				
MOLLE				
KNIFE POUCH				
LIGHTING POUCH				
REFLECTIVE SOLAS				
STANDARDS				
OTHER COLOURS				
NOTES				Designed for Aircraft Carrier deck crew allows full range of arm motion.
WEBSITE	pro.mustangsurvival.com	pro.mustangsurvival.com	pro.mustangsurvival.com	pro.mustangsurvival.com

FOAM RESCUE PFDs

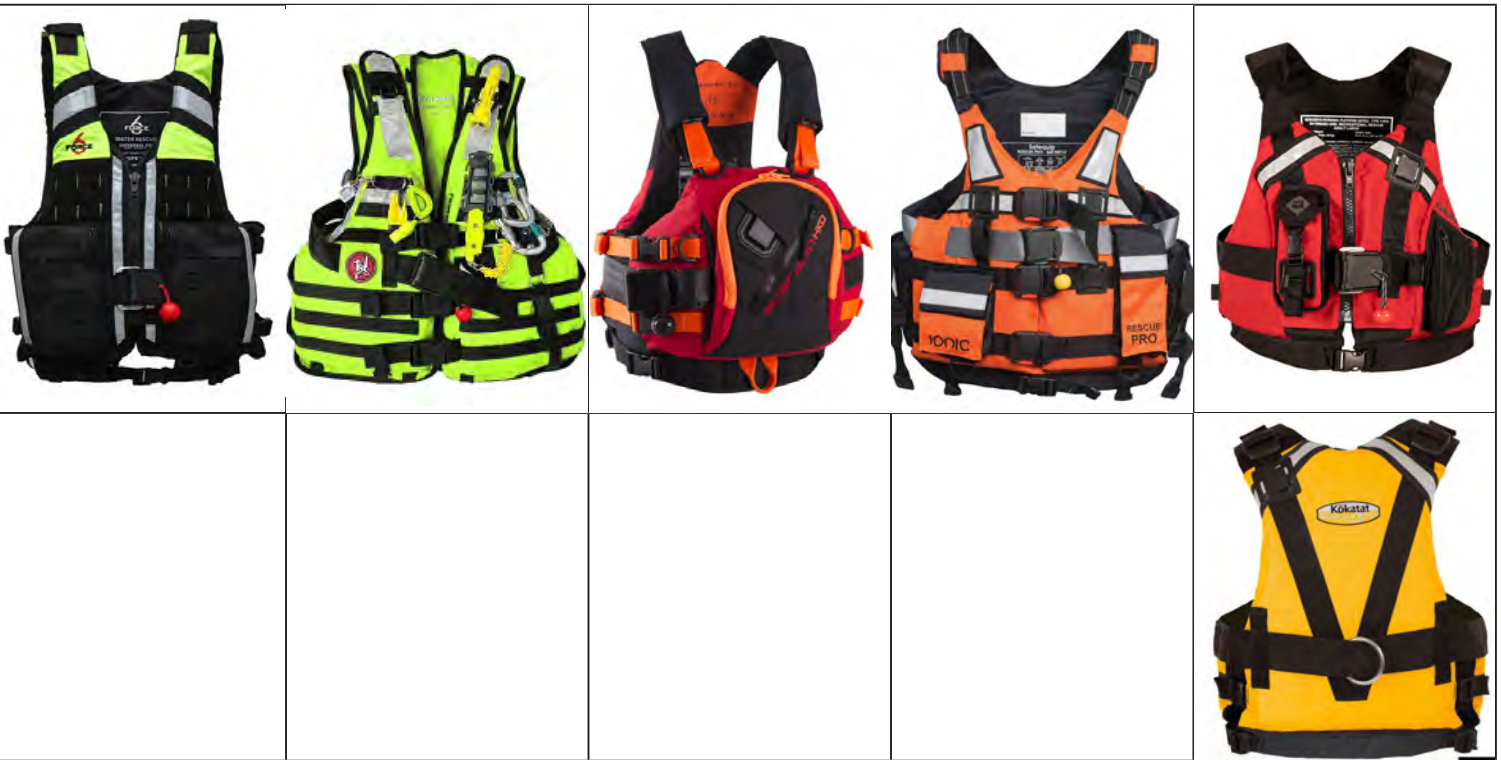

FORCE6	FORCE6	HIKO	IONIC	KOKATAT
00	00	Guardian 3D	Rescue Pro	Guide Rescue
MV1254.. T1...22...34	MRV050WR	MV5606	MRV150 02	MRV170
£250 \$00 €00	£250 \$00 €00	£00 \$00 €00	£650 \$00 €00	£250 \$00 €00
00 00 00 00	00 00 00 00		00 00 00 00	00 00 00 00
pro.mustangsurvival.com	pro.mustangsurvival.com	pro.mustangsurvival.com	pro.mustangsurvival.com	pro.mustangsurvival.com



MANUFACTURER	MUSTANG SURVIVAL			
MODEL VARIANT	Classic Industrial	Hi-Viz Industrial Mesh Vest	4-Pocket Flotation Vest USCG/Aux	USN Mk1 Flight Deck
PRODUCT CODE	MRV150 02	MV1254 T3	MV3128..T2...22	MD3040
ORIGIN				
USES	BUOYANCY			
COST	£650 \$00 €00	£00 \$00 €00	£235 \$00 €00	£250 \$00 €00
WEIGHT				
SIZES				
MATERIALS	00	00		00
FRONT FASTENING	00	00		00
LEGLOOPS	00	00		00
QUICK RELEASE	00	00		00
INTEGRAL POCKETS				
OPTIONAL POCKETS				
ATTACHMENT EYES				
WHISTLE				
MOLLE				
KNIFE POUCH				
LIGHTING POUCH				
REFLECTIVE SOLAS STANDARDS				
OTHER COLOURS				
NOTES				Designed for Aircraft Carrier deck crew allows full range of arm motion.
WEBSITE	pro.mustangsurvival.com	pro.mustangsurvival.com	pro.mustangsurvival.com	pro.mustangsurvival.com



MUSTANG SURVIVAL Industrial Mesh Vest USCG/Aux	MUSTANG SURVIVAL Ops Support Water Rescue Vest	MUSTANG SURVIVAL SAR Vest	MUSTANG SURVIVAL Universal	MUSTANG SURVIVAL Rescue Swimmer Vest
MV1254.. T1...22...34	MRV050WR	MV5606	MRV150 02	MRV170
£250 \$00 €00	£250 \$00 €00	£00 \$00 €00	£650 \$00 €00	£250 \$00 €00
00 00 00 00	00 00 00 00		00 00 00 00	00 00 00 00
pro.mustangsurgical.com	pro.mustangsurgical.com	pro.mustangsurgical.com	pro.mustangsurgical.com	pro.mustangsurgical.com



MANUFACTURER	NDIVER SRE	NDIVER SRE	NDIVER SRE	NDIVER SRE
MODEL VARIANT	Rescue 900	EVO X Rescue	Arctic Survivor Evo Pro 5	Arctic Survivor Evo Pro 6
PRODUCT CODE				
ORIGIN				
USES	BUOYANCY			
COST	£60 \$00 €00	£134 \$00 €00	£138 \$00 €00	£162 \$00 €00
WEIGHT				
SIZES				
MATERIALS	00	00		00
FRONT FASTENING	00	00		00
LEGLOOPS	00	00		00
QUICK RELEASE	00	00		00
INTEGRAL POCKETS				
OPTIONAL POCKETS				
ATTACHMENT EYES				
WHISTLE				
MOLLE				
KNIFE POUCH				
LIGHTING POUCH				
REFLECTIVE SOLAS				
STANDARDS				
OTHER COLOURS		■		
NOTES				
WEBSITE	ndiver-rescue.com	ndiver-rescue.com	ndiver-rescue.com	ndiver-rescue.com

FOAM RESCUE PFDs



NRS RESCUE	NRS RESCUE	NRS RESCUE	NRS RESCUE	NRS RESCUE	NRS RESCUE
Zen Rescue	Big Water Guide	Ninja Pro	Rapid Responder	Rapid Rescuer	Ninja Pro

£00 \$230 €00	£00 \$145 €00	£00 \$230 €00	£00 \$240 €00	£00 \$264 €00	
00 00 00 00	00 00 00 00		00 00 00 00	00 00 00 00	
nrs.com/rescue	nrs.com/rescue	nrs.com/rescue	nrs.com/rescue	nrs.com/rescue	nrs.com/rescue



MANUFACTURER	PALM EQUIPMENT	PALM EQUIPMENT	PALM EQUIPMENT	PALM EQUIPMENT
MODEL VARIANT	Universal	Rescue 800	Rescue 850	Rescue Extrem
PRODUCT CODE		11621	10392	
ORIGIN				
USES BUOYANCY				
COST	£235 \$00 €00	£200 \$00 €00	£235 \$00 €00	£245 \$00 €00
WEIGHT				
SIZES				
MATERIALS	00	00	00	00
FRONT FASTENING	00	00	00	00
LEGLOOPS	00	00	00	00
QUICK RELEASE	00	00	00	00
INTEGRAL POCKETS				
OPTIONAL POCKETS				
ATTACHMENT EYES				
WHISTLE				
MOLLE				
KNIFE POUCH				
LIGHTING POUCH				
REFLECTIVE SOLAS				
STANDARDS				
OTHER COLOURS				■
NOTES				
WEBSITE	palm.equipment	palm.equipment	palm.equipment	palm.equipment



PALM EQUIPMENT	POSSESS SEA IND CO	POSSESS SEA IND CO	POSSESS SEA IND CO	POSSESS SEA IND CO
Rescue Hybrid	Rescue PFD 1	Rescue PFD 2	Rescue PFD 3	Rescue PFD 4
12644				
	150N / 34lb	150N / 34lb	100N / 22lb	100N / 22lb
£250 \$00 €00	£00 \$00 €00	£00 \$00 €00	£00 \$00 €00	£00 \$00 €00
00 00 00 00	INVISTA 500D Cordura 00 00 00	1680D Nylon 00 00 00	INVISTA 500D Cordura Auto-Lock, YKK® VISLON® 10VF zip 00 UTX-Duraflex / ITW-Nexus buckle (UL / ISO Cert)	420D Nylon 00 00 00
palm.equipment	en.drysuit.cn	en.drysuit.cn	en.drysuit.cn	en.drysuit.cn



MANUFACTURER	SECUMAR	STOHLQUIST	STEARNS	STOHLQUIST
MODEL VARIANT	Swift Pro	Descent	Universal	Descent
PRODUCT CODE		11621		11621
ORIGIN				
USES BUOYANCY	50N / 00lb			
COST	£202 \$00 €00	£00 \$325 €00	£235 \$00 €00	£00 \$325 €00
WEIGHT				
SIZES		S/M, L/XL, XXL		S/M, L/XL, XXL
MATERIALS	Cordura	00	00	00
FRONT FASTENING	00	00	00	00
LEGLOOPS	00	00	00	00
QUICK RELEASE	■	00	00	00
INTEGRAL POCKETS				
OPTIONAL POCKETS				
ATTACHMENT EYES				
WHISTLE				
MOLLE				
KNIFE POUCH				
LIGHTING POUCH				
REFLECTIVE SOLAS				
STANDARDS				
OTHER COLOURS		■ ■		■ ■
NOTES				
WEBSITE	palm.equipment	stohlquist.com	palm.equipment	stohlquist.com

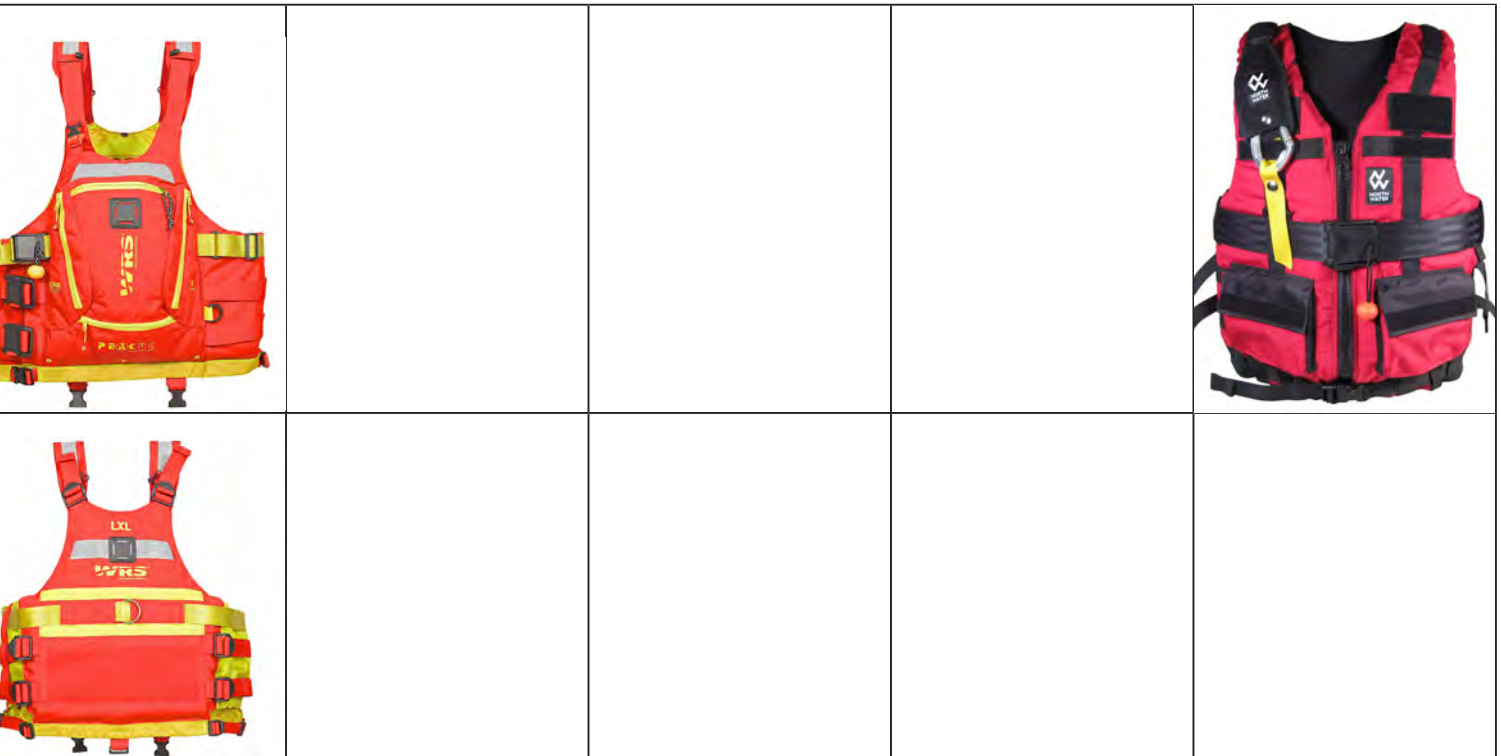

WRSi	YAK			NORTHWATER
Rescue Hybrid	Rescue PFD 1	Rescue PFD 2	Rescue PFD 3	Rescue PFD 4
12644				
	150N / 34lb	150N / 34lb	100N / 22lb	100N / 22lb
£250 \$00 €00	£00 \$00 €00	£00 \$00 €00	£00 \$00 €00	£00 \$00 €00
00 00 00 00	INVISTA 500D Cordura 00 00 00	1680D Nylon 00 00 00	INVISTA 500D Cordura Auto-Lock, YKK® VISLON® 10VF zip 00 UTX-Duraflex / ITW-Nexus buckle (UL / ISO Cert)	420D Nylon 00 00 00
.com	en.drysuit.cn	en.drysuit.cn	en.drysuit.cn	en.drysuit.cn



Universal Swift Water
Rescue Vest



RESCUE | SECURE | PROTECT

**PROTECTING PROFESSIONALS
LIKE YOU**

For over 45 years, we've been researching and developing personal protective equipment for fire fighters, water rescue, law enforcement and SAR professionals who rely on durable high quality lifesaving solutions for saving lives and protecting their own.

Through each stage of development, our products are rigorously field-tested by leading professionals in the water rescue community. Your feedback drives our innovation.

View our full line of solutions for water rescue professionals at:
www.mustangsurvival.com/professional

WALKING THE WALK. OUR PRODUCT DEVELOPMENT ENGINEER TAKES A LOCAL WATER RESCUE TRAINING COURSE AND PUTS OUR NEW SENTINEL™ WATER RESCUE DRY SUIT TO THE TEST.

OUR SENTINEL™ SERIES DRY SUITS OFFER A LARGE RANGE OF SEMI-CUSTOM SIZES AND PROVIDE FIELD-REPAIR CAPABILITIES.



Water Rescue & Water Safety **RESCUEDOG PFD**



Above: Alp Design's Delphinus harness and in action on an Italian Swim-Rescue Newfoundland. top : Alp Design's Turtle
Middle: Julius K9's 3in1

Unlike our previous Guide to Rope Rescue/Access Dog Harnesses the majority of companies making Dog PFDs are not from the rescue sector. Some are specialist marine-safety companies like **Baltic** and **Crewsaver** and some are specialist dog-harness companies like **Ray Allen Mfg**, **Julian K9**, **Non-Stop** and **Ruffwear**. The exception to this is Italian Caving and rescue specialist **ALP Design**, now part of **Kong** (the climbing company not the dog-ball manufacturer although they too have a basic pet dog flotation harness that we haven't included). Their two models are both specialist swim-vests with lift capability. Aside from 4 models suitable for swim-rescue, the rest are Pet Flotation Devices, an acronym we've made up and not to be confused with human Personal Flotation Devices. These are technically NOT life jackets which have an inflatable element to orientate the wearer head-up if unconscious. PFDs are for rescue dogs unexpectedly working around water and also for in-water swim-training like the Norwegian Non-Stop harness pictured on the right. Buoyancy doubles as thermal protection for ground work in colder climates but is otherwise a cumbersome prospect for a non-water dog. Perhaps the most versatile is **Ray Allen's Modular LLC** which is a webbing and mesh 'shell' into which you can mount or swap a flotation jacket, cooling pads and stab/bullet protection and/or kevlar belly shield against sharp terrain. The **Julius K9 3in1** is also a

versatile option because it allows float pads to be inserted into or removed from a neoprene jacket. The newest addition to this genre is the *UnderDog* (below) which comes from a source you might have thought already had such products - **MUSTANG SURVIVAL**. This is one of the best names in professional water safety and having used their gear professionally for decades we we have a high degree of confidence in their products.



Most rescue dogs would wear a life jacket in exactly the same circumstances as their handler - as a precaution against falling into water - perhaps when searching around water or over water in a boat in the case of cadaver dogs but there are some dedicated water rescue dogs whose job it is to enter the water, swim to a struggling human and provide a tow back to safety or perhaps assist a human rescuer. These would use dedicated float harnesses with the **ALP Design** models the only options to have strategically located side handles for a victim or rescuer to hold onto. All other floatation vests in this GUIDE are intended solely for the safety of the dog should it fall into water. Unlike a smaller rescue dog with a 'personal' floatation harness, direct contact or tow-rescue dogs like the Newfoundland in the title picture are large, powerful dogs that can resist being 'swamped' by a panicking in-water casualty. In the title picture a tow strap is attached to the top eye which a struggling swimmer can grab to deploy and then be assisted back to shore or the boat. In-water rescue dogs require a degree of self reliance on the part of the casualty to perform a 'rescue'. Think of them more as an in-water version of a sight-assistance dog.

It is a little surprising that only the **ALP Design's 278/Turtle** and the **Ray Allan Modular LLC** have rear leg straps or the option to add them because they provide much greater security in terms of harness retention. As with the hoist-capable harnesses discussed in the previous issue, there can be a danger that the dog can pull backwards out of all other harnesses in this GUIDE

perhaps when scared, exhausted and someone is trying to pull them to safety or when connected to a tether and unwilling to be pulled wherever you intend them to go. Admittedly, this may be a peripheral concern and some like the **Julius K9** and **NRS** models would argue that their body wrap design with additional tensioning should negate this but it really depends on whether the dog has been secured into the harness because it is *definitely* entering the water or *just in case* it might fall into water. In the case of the latter the harness may be fitted less firmly to allow for comfort and fur/undercoat that is much bulkier when dry than it is when wet. Once the dog has entered the water the fur inevitably reduces in volume and the harness may be looser than the optimum fit. The **Delphinus** harness has two quick securing Velcro straps (with reflective strips) that mean the dog is at least partially secure within seconds even if the two buckle straps fail to be secured before the dog is swamped. These also mean the harness can be more quickly tightened should winching or lifting be required though it is the buckled straps that provide the true lift/hoist capability.

Much simpler in design, and representative of many of the harnesses in this GUIDE is the **NRS CFD** Harness. Effectively a one piece harness that can be slipped over the dog's head and secured around the chest/neck and under the belly which

RESCUE DOG PFDs

needs plenty of padding because a wet dog sees a huge increase in weight which the padding and lift handle needs to be able to cope with. The eye on the top is for a tether NOT for lifting. Remember that such harnesses also function well in providing thermal insulation on dry land in colder months. Even though companies like **NRS**, **Crewsaver** and **Baltic** are professional water-safety companies, theirs and some of the brands not associated with military or law enforcement are intended more for pet animals than they are for professional rescue dogs



NRS CFD harness



Julius K9's 3in1

although **Baltic's** most extensive range of dog PFDs includes one listed as suitable for rescue - the **Special**. Nevertheless, the principle for providing buoyancy and therefore safety for the dog when in water remains the same



and quality of production with these and the specialist dog companies **Julius K9** and **Ruffwear** provide peace of mind for the handler. There are a considerable number of 'dog lifejackets' available online through Amazon and Ali Baba etc. and some of these may well be OK but, as with all

equipment used in the professional rescue sector, if you are not familiar with the manufacturer and unsure of its track record, don't risk it. Expect to pay hundreds for the professional brands while renown pet brands may cost upwards £\$€40. Anything less than this and you will need to check stitching, design and components to satisfy yourself that it will perform its task of keeping your dog safe - it's fair to say that it is rarely worth basing a safety equipment purchase on the lowest price.

Sewn attachments for D-Ring, web eye and handles are very prone to degradation due to water and UV and in particular salt water. They need to be well cleaned after each use and you need to specifically inspect the stitching and integrity of the webbing itself - sometimes this may not be easy if other fabric components are covering it, which, of course, can also be a good thing if it's providing some protection to the stitching. Look for strong bar tacking which are three or four relatively thick parallel lines of stitching or a robust box stitch which is a square with an X stitched to each corner. Salt water corrosion will also be an issue to look out for with metal components, again, ensure that the harness is washed down with fresh water and properly dried after each use. Store in a well ventilated area to avoid mould.

IN THE FOLLOWING TABLES.....

A circle ●● in the 'USE' columns indicates that the feature is OK for that purpose but not ideal.

COST: a rough guide only - includes local taxes. Varies with exchange rates, extra taxes etc. We usually round up to the nearest Pound£/US Dollar\$/Euro€. Larger sizes often cost more. **£\$€ in orange is a currency conversion** figure NOT an accurate import price with taxes etc which is shown in black.

SIZES: Given as generic sizing **S, M, L** etc. which varies wildly between models. Colour-coded to the weight/girth to read more easily but some are universally adjustable. We have tried to include the weight of dog to give an accurate idea for the flotation required but many only provide measurements.

USES: All of these harnesses can be used to provide a degree of floatation in water but one or two may only provide this as a consequence of using foam padding for comfort or thermal protection in which case they will have a diamond in the **BUOYANCY** column.

SWIM-RESCUE refers to the ability of the harness to assist not only the dog in staying afloat but also in assisting either a rescuer or a casualty while in the water. Usually this will be via extra handles on the body of the harness for a person to grab onto and is only present in the two ALP Design models.



SUSPENSION means the harness is capable of being hoisted or lowered vertically. This is usually via a bridle to spread the dog's weight evenly front-to back for hoisting into a helicopter, on or off a ship or up/down a cliff or wall. A single robust top eye does NOT constitute hoist-capable even if it will easily take the dog's weight because it is not even close to being safe - the dog may slip out and/or suffer compression of the thorax or neck. In our previous **GUIDE GROUND** referred to long-duration search, patrol and/or tracking and manoeuvring over boulders etc. requiring freedom of movement and no heavy panels that might rub against legs. In this **GUIDE** it refers only

to the ability to add a lead or tether and use the harness on dry land for a period of time. The ALP Design specialist water rescue harnesses for instance, is shown with a diamond rather than full square because they can have a lead attached but the dog would not be comfortable for long distances on land.

MATERIALS: The main fabric of the body panel containing the foam is shown in **black**. Webbing type is shown in **green** and the hard fittings (buckles & D rings) are shown in **burnt orange**.

WEIGHT/GIRTH of DOG: is the weight of dog that is intended to use the harness. Body mass is a more accurate indication for floatation requirements but girth measurement provides more accurate fitting. **BUOYANCY** provided by the harness is only given by a few manufacturers. It is NOT the same as the weight of dog it will support - a 27kg dog would only need 3 or 4kg of buoyancy to support its weight

Images NOT to scale N/A = Not Available/not given COST: Approx & inc.local tax/ VAT £\$€ in orange =currency conversion USES: ●●=OK BUT NOT IDEAL USES/FEATURES: ■= Option		MODEL	COMPANY	ORIGIN	COST Inc tax/ VAT	SUSPENSION	GROUND	SWIM RESCUE	MATERIALS: 'JACKET' WEBBING INTEGRAL 'HARDWARE'
		TURTLE 278	ALP DESIGN		£190 \$265 €220	■	■	■	Cordura Polyester 7x double-D buckles 1x D-ring
		Delphinus	ALP DESIGN		£220 \$300 €250	■	■	■	Cordura 2x Velcro straps Polyester 7x double-D buckles 1xRing +4xSml Rings
		Maja (Cat Harness)	BALTIC		£28 \$38 €34	-	■	■	Cellu cushion float Polyester 3x plastic fast clips 1 metal D ring
		Mascot	BALTIC		£25-33 \$32-43 €29-39	-	■	■	Cellu cushion float Polyester 3x plastic fast clips 1x metal D-ring

because the water is supporting much of the load. There is a huge difference between the quality of components in a pet-shop dog harness and a professional dog's lift harness. Unusually for us, this GUIDE contains non-rescue professional designs that are mostly NOT intended for hoisting so the Minimum Breaking Strength/Load - **MBS** (in **burnt orange**) is only provided by one or two. We list the precise weights and sizes in metric with the imperial figures rounded up or down because it's a less precise measurement anyway! We dispensed with the **COMFORT / PADDING** column used in the previous GUIDE to *Hoist-Capable Harnesses* because ALL of these are padded to some degree. **INTEGRAL/ADD-ON FLOTATION** most of these harnesses have integrated flotation indicated by a black square but some can have extra flotation pads added to a neoprene jacket like the JuliusK9 3in1 or to a webbing frame like the Ray Allen Modular LLC. This allows quite a bit of flexibility and is indicated by an orange square ■. Those with minimal buoyancy are indicated by a black circle● meaning OK but not ideal

SECURE: The straps and attachment points which secure the dog in the PFD and you to the dog!

GIRTH/BELLY: a strap that can be adjusted for length on the underside of the dog. The **girth** strap is behind the front legs and the **belly** strap is further back towards the rear legs. For most of these float harnesses the buckles are plastic push-fit (Fastex,Nexus or DuraFlex) but some like the NRS use a plastic ladderlock where you simply pull the web tail to tighten and some, like ALP DESIGN use alloy double D buckles because they are designed for hoisting as well as swimming.

LENGTH: refers to adjustment for length from front to back and is usually a buckle on the top at the shoulders or on the back near the back legs. Only one or two of these harnesses have that

capability.

NECK: indicates that the front or breast strap that encircles the neck can be adjusted for size.

We have omitted the Front eye/Handle column that we had in the last GUIDE to Dog Harnesses because none of these PFDs has that feature but it is an option on the K9 Storm harness.

TOP EYE, TOP HANDLE: Mostly a metal ring or D-ring but can be a reinforced sewn eye. Sewn eyes are indicated by an asterisk and details in the NOTES column. In professional models the top eye(s) may constitute part of a lift/hoist capability indicated in the **SUSPENSION** column. Otherwise assume that all of these are simply lead/tether eyes. The handle, will always be capable of lifting the full weight of the dog but this is simply for assisting out of the water or over an obstacle NOT for hoisting off the ground.

ACCESSORIES:

POUCH, VELCRO, LIGHT ATTACH: A pouch or pocket which can be for accessories like lift straps or dog supplies or the harness itself when not in use. **VELCRO** refers to strips of loop velcro onto which you can add badges, reflection, panniers etc. a key feature of 'tactical' harnesses. **LIGHT ATTACH** refers to elastic or Velcro-secured straps intended to hold a chemical light stick, strobe or torch/flashlight.

HI-VIZ REFLECTIVE MOLLE: **HI-VIZ** is a High visibility colour option like yellow or red. **REFLECTIVE** refers to smaller panels or badges or piping rather than the entire jacket. Often an optional badge and easily applied to harnesses with Velcro. **MOLLE** or PALS is military-style attachment webbing.

















Any item that is an option is shown as an outline square □□□



















































































COLOUR: Primary colour of Jacket or panel or webbing if it's a web-only harness. Secondary or web colours are shown in the square's outline frame.

SIZE	WEIGHT of PFD	WEIGHT of DOG	GIRTH of DOG (&/or LENGTH of VEST)	SECURE		TOP /SIDE EYE(S) HANDLES	POUCH/VELCRO-ATTACH LIGHT	HI-VIZ MOLLE REFLECTIVE	COLOURS	WEBSITE	WWW.
				GIRTH BELLY	NECK LENGTH						
S/M L	1.2kg/2.6lb 1.5kg/3.3lb	25-40kg/55-88lb 45-65kg/18-143lb	55cm/22" 65cm/25.6"	■ ■	■ ■	1 4*	■ ■	■ ■	■	Full flotation swim harness. *2 handles on flanks	alpdesign.it
S M L	800g/2lb 1kg/2.2lb 1.3kg/2.9lb	20-25kg/44-55lb 25-40kg/55-88lb >40kg/>88lb	- -	■ ■	■ ■	1 6*	■ ■	■ ■	■ ■	Full flotation swim harness with zipped pouch. *2 handles on flanks. 2x rings on each side are options.	alpdesign.it
S M L	178g/6oz 200g/7oz 220g/8oz	0-3kg/0-6.6lb 3-7kg/6.6-15.4lb 7-10kg/15.4-22lb	- -	■ ■	■ ■	1 1	■ ■	■ ■	■	Specifically designed for cats but could suit small dogs or animals?	Baltic.se
XS S M L XL XXL	170g/6oz 208g/7.3oz 248g/8.7oz 412g/14.5oz 470g/16.7oz 530g/19oz	0-3kg/0-6.6lb 3-8kg/6.6-17.6lb 8-15kg/17.6-33lb 15-40kg/33-88lb >40kg/>88lb	- -	■ ■	■ ■	1 1	- -	■ ■	■ ■ ■ ■		Baltic.se

<p>Images <u>NOT</u> to scale N/A = Not Available/not given COST: Approx & inc local tax/ VAT £\$€ in orange =currency conversion USES: ●●=OK BUT NOT IDEAL USES/FEATURES: ■■= Option</p>		MODEL	COMPANY	ORIGIN	COST inc tax/ VAT	D SUSPENSION	S SWIM RESCUE	MATERIALS: 'JACKET' WEBBING INTEGRAL 'HARDWARE'
		Pluto	BALTIC		£20-28 \$24-38 €24-34	-	■	Cellu cushion float Polyester 3x plastic fast clips
		Special	BALTIC		£65 \$105 €96	-	●	Cellu cushion float Polyester 3x plastic fast clips 2x metal D-rings 2x plastic D-rings
		Zorro	BALTIC		£39 \$47 €43	-	■	Cellu cushion float Polyester Top Zipper 1 ladderlock buckle 1 plastic D-ring
		Petfloat	CREWSAVER		£58 \$76 €68	-	■	3x plastic fast clips 1x plastic D-ring
		Dog Flotation Device, Micro DFD	EZYDOG		£37-73 \$49-96 (£29) (\$38)	-	■	Polyester/Neoprene Nylon 3x plastic fast clips 1x St. steel D-ring 1x nylon D-ring
		X2 Boost	EZYDOG		£49-73 \$65-96 €57-85	-	■	1680D Nylon/ Neoprene Nylon 3x plastic fast clips 1x alloy D-ring
		Multifunctional/ IDC 3in1 Dog Vest	JULIUS-K9		£82-120 \$120-164 €110-150	●	■	Neoprene Nylon 2x plastic fast clips 3x metal D-rings
		SAR Std/ Aerial Insertion Std	K9 STORM		£2179* \$2699* €2520*	■	■	Ballistic Nylon & Kevlar Mil-Spec Nylon 3x alloy fast clips 2x plastic fast clips
		Underdog	MUSTANG SURVIVAL		£56 \$70 €65	●	■	Cordura & Mesh covered foam Nylon 3x plastic fast clips

SIZE	WEIGHT of PFD	WEIGHT of DOG	GIRTH of DOG (&/or LENGTH of VEST)	SECURE				COLOURS	NOTES	WEBSITE
				GIRTH BELLY	NECK LENGTH	TOP /SIDE HANDLE(S)	POUCH/VELCRO ATTACH LIGHT			
XS S M L XL XXL	133g/4.7oz 133g/4.7oz 175g/6oz 308g/11oz 347g/12oz 407g/14oz	0-3kg/0-6.6lb 3-8kg/6.6-17.6lb 8-15kg/17.6-33lb 15-40kg/33-88lb >40kg/>88lb	- - - - - -	■ ■ ■ ■ ■ ■	■ ■ ■ ■ ■ ■	1 1 1 1 1 1	■ ■ ■ ■ ■ ■	■ ■ ■ ■ ■ ■	Baltic.se	
S M L XL XXL	292g/10.3oz 434g/15.3oz 730g/25.7oz 800g/28.2oz 858g/30.2oz	0-8kg/0-17.6lb 8-15kg/17.6-33lb 15-40kg/33-88lb >40kg/>88lb >40+kg/>88+lb	- - - - -	■ ■ ■ ■ ■	■ ■ ■ ■ ■	2 1 1 1 1	■ ■ ■ ■ ■	■ ■ ■ ■ ■	2 side-mounted d-rings can take side handholds Baltic.se	
XS S M L	133g/4.7oz 133g/4.7oz 133g/4.7oz 133g/4.7oz	2-5kg/4.4-11lb 5-10kg/11-22lb 10-25kg/22-55lb >25kg/>55lb	- - - -	■ ■ ■ ■	- - - -	0 1 1 1	■ ■ ■ ■	■ ■ ■ ■	Zips along the top. Weights of harness provided by Baltic must mean that increased air volume alone is the difference in the size of dog supported. Baltic.se	
XS S M L XL	300g/10.6oz 375g/13.2oz 450g/15.6oz 525g/18.5oz 600g/21.1oz	-	24-30cm/9-12" 28-35cm/12-14" 35-45cm/14-18" 45-55cm/18-22" 55-65cm/22-26"	■ ■ ■ ■ ■	■ ■ ■ ■ ■	1 1 1 1 1	■ ■ ■ ■ ■	■ ■ ■ ■ ■	crewsaver.com	
XS S M L XL	(214g/7.5oz) 317g/11.2oz 389g/13.7oz 508g/18oz 593g/21oz 670g/23.6oz	(<7kg/<15.4lb) 7-11kg/15-24lb 9-20kg/20-44lb 18-27kg/40-60lb 27-41kg/60-90lb >41kg/>90lb	(25-34 30-50cm/10-13 12-20") 25-33 48-81cm/10-13 19-32" 33-41 53-89cm/13-16 21-35" 38-50 64-99cm/15-20 25-39" 43-61 69-112cm/17-24 27-44" 51-66 76-122cm/20-26 30-48"	■ ■ ■ ■ ■ ■	■ ■ ■ ■ ■ ■	1 1 1 1 1 1	■ ■ ■ ■ ■ ■	■ ■ ■ ■ ■ ■	Micro DFD is a variant for small dogs/animals ezydog.co.uk	
XS S M L XL	300g/10.6oz 350g/12.3oz 400g/14.1oz 450g/15.9oz 500g/17.6oz	7-11kg/15-24lb 9-20kg/20-44lb 18-27kg/40-60lb 27-41kg/60-90lb >41kg/>90lb	30-45 45-55cm/12-18 18-22" 35-50 56-65cm/14-20 22-26" 40-55 66-75cm/16-22 26-29" 45-60 76-85cm/18-24 30-33" 50-65 86-105cm/20-26 35-41"	■ ■ ■ ■ ■	■ ■ ■ ■ ■	2* 1 1 1 1	■ ■ ■ ■ ■	■ ■ ■ ■ ■	* one is a sewn web eye ezydog.co.uk	
S M L XL	g lb	15-25kg/33-55lb 24-40kg/53-88lb 40-60kg/88-132lb	40 44-64cm/16 17-25" 46 55-72cm/18 22-28" 51 65-82cm/20 26-32" 57 75-92cm/22 29-36"	■ ■ ■ ■	■ ■ ■ ■	2 1 1 1	■ ■ ■ ■	■ ■ ■ ■	Flotation panels can be removed *reflective seams julius-k9.com	
Custom*	average 907g/2lb	Custom*	Custom*	■ ■ ■ ■	■ ■ ■ ■	1 3 1 1	■ ■ ■ ■	■ ■ ■ ■	3 versions , Aerial Insertion, SWAT & SAR. All have #2 ballistic protection & buoyancy. *Customised for dog's wt, size & breed. *+3xMulti-Camo colours k9storm.com	
XS S M L XL	-	0.9-5.4kg/2-12lb 5.4-11kg/12-24lb 11-27kg/24-60lb 27-41kg/60-90lb 41-54kg/90-120lb	31-46cm/12-18" 46-61cm/18-24" 61-76cm/24-30" 69-91cm/27-36" 84-112cm/33-44"	■ ■ ■ ■ ■	■ ■ ■ ■ ■	1 1 1 1 1	■ ■ ■ ■ ■	■ ■ ■ ■ ■	*Light attach by virtue of the buckle adjustment web-ends velcro down mustangsurvival.com	

<p>Images NOT to scale N/A = Not Available/not given COST: Approx & inc local tax/ VAT £/\$ in orange =currency conversion USES: ●=OK BUT NOT IDEAL USES/FEATURES: ■= Option</p>		MODEL	COMPANY	ORIGIN	COST inc tax/ VAT	US GROUND SUSPENSION	SWIM RESCUE	MATERIALS: 'JACKET' WEBBING INTEGRAL 'HARDWARE'
		Safe Life Jacket 2.0	NON-STOP DOGWEAR		£87-100 \$98-118 €88-107	●	■	PU-coated 210D Polyester Oxford/ 8mm TPE C/S1800 padding, Nylon 2x plastic fast clips* 3x metal D-rings
		Protector	NON-STOP DOGWEAR		£109-125 \$120-140 €110-135	●	■	PU-coated 210D Polyester Oxford/ HexiVent mesh,8mm TPE C/S1800 padding, Nylon 2x plastic fast clips* 2x Lateral web loops
		CFD Dog Life jacket	NRS		£49 \$60 €56	-	■	420D Rip-Stop Nylon Nylon 2x plastic fast clips 1x plastic ladderlock 1x metal D-ring
		Modular LLC with Flotation	RAY ALLEN MANUFACTURING		£176* \$210 €96	-	■	Ballistic Nylon Nylon 2 GT Cobra buckles, 1 Roll Bar buckle, 2x Fastex, 6x G-Hooks, 1x metal D-ring
		Dog Buoyancy Aid	RED		£65-90 \$85-120 €76-105	-	●	Cordura 3x plastic fast clips 1x metal D-ring
		Pet Buoyancy Aid	RIBER		£23 \$30 €26	-	■	3x plastic fast clips 1x Ladderlock buckle 2x metal D-rings
		FloatCoat	RUFFWEAR		£95 \$80 €82	-	●	1000D Cordura PE 'NylIKE' 4x 3-bar buckles 1x double-D buckle 4x length adjusters
		Auxilium	SPÜR HUNDE SCHULE		£51-61 \$64-77 €58-70	-	■	300D Cordura Nylon 3x plastic fast clips 1 metal D-ring
		K9 AquaFloat	WEST COAST HYDRA-THERAPY		£60-70 \$79-92 €70-81	-	●	3x plastic fast clips 3x Length Adjusters

SIZE	WEIGHT of PFD	WEIGHT of DOG	GIRTH of DOG (&/or LENGTH of VEST)	SECURE GIRTH BELLY	SECURE NECK LENGTH	TOP/SIDE EYE(S) HANDLERS	POUCH/VELCRO ATTACH LIGHT	HI-VIZ MOLLE REFLECTIVE	COLOURS	NOTES	WEBSITE
XS S M L XL XXL	169g/6oz 192g/6.8oz 312g/11oz 473g/17oz 619g/22oz 688g/24oz	1.5-7kg/3.3-15.4lb 2.5-10kg/5.5-22lb 5-20kg/11-44.1lb 10-30kg/22-66lb 15-40kg/33-88.2lb 20-50kg/44-110lb	20cm/8" 25cm/10" 30cm/12" 36cm/14" 42cm/17" 51cm/20"	 	 	1 2 1	 	  		2 side-mounted d-rings can take side handholds * Duraflex	nonstopdogwear.com
XS S M L XL XXL	169g/6oz 192g/6.8oz 312g/11oz 473g/17oz 619g/22oz 688g/24oz	1.5-7kg/3.3-15.4lb 2.5-10kg/5.5-22lb 5-20kg/11-44.1lb 10-30kg/22-66lb 15-40kg/33-88.2lb 20-50kg/44-110lb	20cm/8" 25cm/10" 30cm/12" 36cm/14" 42cm/17" 51cm/20"	 	 	1 2 1	 	  		2 side-mounted d-rings can take side handholds * Duraflex	nonstopdogwear.com
XS S M L XL	181g/6.4oz 233g/8.2oz 320g/11.3oz 374g/13.2oz 428g/15.1oz	<5kg/<12lb 6-11kg/13-24lb 11-27kg/25-59lb 27-36kg/60-79lb >36kg/>80lb	35-53cm/14-21" 51-66cm/20-26" 64-79cm/25-31" 76-91cm/30-36" 89-104cm/35-41"	 	 	1 1	-	  	 	Bouyancy= 1.2kg/2.7lb 1.5kg/3.4 lb 2.2kg/4.9lb 2.9kg/6.4lb 3.6kg/7.9lb	nrs.com
Uni	408g/0.9lb +flotation panels	all	68-80cm/26-31.5" + extension strap for larger dogs	 	 	2 1	  	  	  +	Flotation panels can be removed *price for modular harness + add-on 100N flotation	rayallen.com
XS S M L XL	-	-	33-48cm/13-19" 46-64cm/18-25" 61-81cm/24-32" 76-94cm/30-37" 89-114cm/35-45	 	 	1 4*	 	  	  	2 dorsal + 1 running each side from shoulder to chest (black strap that leads to fast clip buckle)	red-equipment.co.uk
M L	-	-	33-55cm/13-22" 40-70cm/21-27" 46-76cm/18-30"	 	 	2 1	 	  			riberproducts.com
XXS XS S M L XL	.2kg/0.4lb .25kg/0.55lb .34kg/0.75lb .43kg/0.95lb .5kg/1.1lb .6kg/1.35lb	-	33-43cm/13-17" 43-56cm/17-22" 56-69cm/22-27" 69-81cm/27-32" 81-91cm/32-36" 91-107cm/36-42"	 	 	2* 1	 	  	 	*1 eye is a webbing eye	ruffwear.com
M L XL	0.4kg/0.88lb	-	40-60cm/21-24" 60-80cm/24-32" 80-100cm/32-39" 100-140cm/39-55"			1 2		 		100N of buoyancy	spuerhundeschule.de
XS S M L XL XXL	3.9kg/8.7lb	-	51-61cm/20-24" 54-63cm/21-25" 57-67cm/22-26" 65-80cm/26-31" 73-93cm/29-37" 87-104cm/34-41" 87-107cm/34-42"			3* 1		 		*all are webbing eyes	westcoasthydrotherapy.co.uk



OceanidTM

WATER RESCUE CRAFT





RDC@Oceanid.com
(208) 322-3600



SURFACE DRYSUITS

INTRODUCTION

This Guide is focused on rescue drysuits that are suitable for use out of and in-water but distinct from purely dive suits which will be a separate Guide. There are some dive suits included here that are used for surface rescue and there are some dedicated ice rescue suits that would be too bulky and hot for general surface rescue work so they have separate category rows in our tables. It's quite difficult to get consensus on the true history of drysuit development because there was much experimentation in the 30's and 40's and hard to know when a suit truly kept the body dry. Everyone over the age of 30 will be familiar with the term 'frogman' which was combat diving largely developed by a specialist Italian Navy team and subsequently taken up with gusto by British Commandos during WWII. Their 'Top-Secret' suits were primarily membrane rubber as distinct from thicker neoprene so in this respect they were certainly on their way to being drysuits. Sometime during the 40s and 50s suits evolved to provide a dry body and the ability to use thermal layering - so-called baggy suits rather than skin-tight wet suits. In the absence of the NASA invented dryzips original drysuits were rubber and had to be stretched over the head (in the case of an early Pirelli model) via an enlarged opening which was subsequently made watertight with a hood drape or a metal ring for a hood or the suit was accessed via an 'umbilical' tube that was then rolled up to create a watertight seal (in the case of a British Seibe Gorman model). Companies like Viking in Norway who were working on drysuits at the request of the Norwegian Navy and Poseidon in Sweden were producing viable drysuits in the 50's but it wasn't until the space race caused the development of an airtight zip for space suits that divers' drysuits truly evolved into the versatile, multi-agency tool that it is today. Some of the companies involved haven't changed much in the past few decades except that they now have several dozen competitors. This is mostly due to sports demands but there are also a lot of commercial dive suits and military models available. **We have only included companies actively producing RESCUE-oriented models.** So we haven't included otherwise worthwhile models from folk like *Gul, Holis, Kokotat, O'Three, Stohlquist, Seatec* in Australia or the aptly named '*Waterproof*' in Sweden. Even the companies we have included may have many more models that are worth a look. Often these only differ from a 'rescue' model by dint of high vis colours and some reflective tape but for the purposes of this GUIDE they will have been shown to be fit for the purpose of rescue.

Of those not in our Guide, *Bell Avon* still exist as part of *Zodiac* inflatable boats, *Solent* still make wetsuits and associated products and *Nokia* presumably branched out big time into more lucrative areas.



Wearing a DUI USCG drysuit a rescue swimmer deploys from a MH-65C Dolphin rescue helicopter U.S. Coast Guard photo by Petty Officer 2nd Class Levi Read

Main Image: U.S. Coast Guard Ice Rescue training photo by Petty Officer 2nd Class Lauren Jorgensen
Inset Left: MFC-International Drysuit.
Inset right: Mustang Survival's Sentinel D624

You can see from early development that there was a time when drysuits were just for divers or at least for underwater use. Water rescue, as the traditional domain of beach lifeguards, helicopter PJs or rescue boat crews, meant wet suits. They're called 'wet' because the user relies on a layer of water warmed from being sandwiched between spongy neoprene and the skin, to maintain a functioning body temperature. The suit prevents heat being stripped from naked skin by cold water or cold air but also relies on a degree of self-heating through activity to work efficiently. Once the user becomes inactive or the water becomes more frigid this principle doesn't work so well and this is where drysuits capable of being used over thermal layers excel in rescue work.

In the past few decades drysuits have become more like the ultimate in waterproof overalls than a dive suit and in fact many aren't now even suitable or capable of being used under water or even for swimming and are simply a means of protecting the rescuer against the elements while on or near water and for simple wading in floods. They should keep you mostly dry should you fall in and then egress immediately but are not intended for in-water use. NB: Our row in the **USES** section of the tables headed **IMMERSION** indicates that the suit will keep you dry if you fall in or are completing an in-water task- **it does NOT mean immersion in the sense of long term in-water survival.** Equally a full dive suit is not generally the



best thing to wear as a surface rescue suit. Aside from being more expensive it may be too restrictive with tighter seals and features like inflation and exhaust (purge) valves that just get in the way. 'Surface' suits are now a specialised and commonplace item in their own right. Rescuers are able to don them quickly at a water rescue incident and are provided with a good degree of thermal protection as well as counter-contamination. At their most bulky are the dedicated ice rescue suits like the Stearns DriFlex, Imperial IR1500 and Mustang Ice Commander with insulating neoprene and integral hoods and gloves. But many other suits are substantial enough to be used for ice rescue providing they have enough room for insulating layers. At the other end of the spectrum, some drysuits are relatively thin waterproof nylon for short term use only, some are even disposable - small and light enough to be stored in a response bag or in the vehicle. An interesting long-duration variation on lightweight is the Survitec/Multifabs 601 a long duration drysuit light enough and comfortable enough to be worn all day beneath regular rescue clothing which opens up a number of possibilities for use of specialist rescue clothing and equipment when exposed to the risk of cold-water immersion.

For swiftwater and flood rescuers something more substantial is called for because fast moving water requires more efficient seals and drysuits should have clean lines so that there is

less possibility of snagging. Their water resistance capabilities and strength of outer fabric are often much higher than for a surface or disposable suit. Cordura or heavy gauge nylon are now as common as more traditional Butyl, rubber and neoprene though they are most often used as part of a layered fabric - Bi or Tri-Laminates. The other specialised drysuit that requires exemplary in-water performance is the pararescue or rescue swimmer suit. Used primarily by helicopter crews it may or may not have fire-retardant qualities but it is going to be amongst the best drysuits available because the PJ or winchman role can be unforgiving and would soon highlight any shortcomings in drysuit performance. Boat suits are not necessarily designed for regular in-water use but tend to have a tougher outer fabric like Cordura simply because it is regularly knocking against hard and rough surfaces; they're more of a working suit.

KEY TO TABLES

COST

basic model. As always, expect lower cost for multiple purchases or reduced specifications. Prices INCLUDE VAT or local taxes. £\$€ in Orange are a CURRENCY CONVERSION ONLY and do not

include import tax, shipping etc.

ORIGIN: Not necessarily where the suit is made. It refers to the company's country of origin and even this may be misleading if the company is a subsidiary. For instance Mustang Survival would normally be listed as Canadian but is now owned by US group, Safariland.

FEMALE VERSION: With apologies for the stereotypical pink but it stands out well in the tables! All membrane suits are going to be far more forgiving of shape than a skin-tight neoprene suit so female sized versions aren't necessarily vital for all facets of rescue work. Nevertheless, some manufacturers do offer an off-the-peg female fit with appropriate relief zip (if fitted) while the rest should at least be looking at an option for the 51% of the population that need a properly fitting suit as well!

MATERIALS: Traditionally drysuits have fallen into two types of construction, **MEMBRANE** which is baggy and **NEOPRENE** which is a tighter fit. Most rescue suits are 'membrane suits' and utilise a wide range of materials. Simple nylon or Cordura which can be lightweight, inexpensive and used in temporary use or 'disposable' suits. Or it can be thicker and tougher and a more durable option. Either way it is non-breathable. In combination with other materials or multiple layers, nylon becomes a far more durable suit though still not breathable which is the domain of GoreTex or similar specialist materials. Breathable suits are particularly suited to surface or out-of-water use when overheating could be an issue. Some that are quoted as breathable may only be breathable on the top section. The vast majority of drysuits in this list are Bi or Tri-Laminate where two or three materials are sandwiched together. Often this will be Nylon, Butyl or to a lesser extent neoprene and a more complex material like Goretex with a comfortable liner or facing material which aids in wicking moisture away from the body. Goretex may also be used in

conjunction with Nomex for fire retardancy in drysuits used in aviation. High tenacity Nylon and Cordura tend to offer the best protection from wear while Butyl, Neoprene and similar rubber compounds offer good insulation as well as a better degree of wear resistance than *GoreTex* and breathable materials alone. More complex suits, usually intended for diving, may incorporate a special inner suit to provide better fit, comfort and warmth than the outer alone. This is donned as a single, integrated drysuit for example Whites Fusion as distinct from the more usual separate drysuit and undersuit. This article is large enough as it is so we haven't been able to go into too much detail on the individual materials but it's worth you doing some extra research in this regard once you've narrowed down your selection.

REINFORCED AREAS: As distinct from 'Padded Areas' this refers to the addition of extra layers or a more robust material in areas of high wear. Mostly this is in the contact areas of the knees, elbows and seat (buttocks) but may also be on the shoulders and around the waist where the rescuer's suit is in contact with load-bearing harness straps and scuba, SCBA or CABA tanks.

PADDED AREAS: Usually applies to the knees where thickened 'comfort' padding is used in addition to reinforcement to alleviate wear and abrasion. Padded areas provide comfort on hard, sharp and angular surfaces as well as resistance to penetration. They will often have drainage built in so that the suit doesn't retain excess water on land or when hoisted out of water. Some provide external pads that can be inserted into knee and/or elbow auto-draining pouches.

ENTRY: Once waterproof zips were invented, dive suits followed the space suit initiative with a horizontal zip across the shoulders. This kept a vital component away from any frontal assault but it wasn't long before those less concerned with underwater zip integrity looked at easier and quicker ways to don a drysuit. A front zip was found to be easiest with most being diagonal but there are also shoulder to shoulder (yoke) and 'J' configurations as well as a full spiral such as on the Multifabs 106.

SIZE ADJUST: Usually just a fabric extension of the outer material at the wrist, ankle and/or neck and often intended to be seal protection but with velcro they enable you to tighten the material. This lessens your profile and makes the seals more efficient while allowing you to slacken off for comfort when out of water. Necks and ankles may also be adjusted by zip or elasticated cord and toggles.

SEALS: what used to be rubber is now more often than not latex but can also be silicone which tends to be more expensive or it may be neoprene which many find more comfortable. Either way, with tight rubber-like seals at the neck, wrist and ankle water is prevented from entering the suit. In many cases there will be an integral hood protecting the head and sealing on the face. There will also be either waterproof seals at the ankle or integral socks, booties or boots. Booties shown as  in our tables, are usually a cross between a flexible sock and the sole of a boot. Socks or an ankle seal enables the wearer to use any suitable boot they wish. Swiftwater rescuers in particular like to have a more tactile boot to provide better traction and mobility on rocks and as can be seen from our title shot, studded boots are much better on ice than standard sole boots.

Where integrated boots are offered they tend to be tough and steel toe capped and/or rubber wellingtons particularly for boat suits. Drysuits with dive capability and especially in contaminated water may have fixed rings at the wrist to enable connection of gloves to keep the hands dry.

At the neck things have changed in recent years with an adjustable neck seal option providing very improved levels of comfort for the surface rescuer and rescue swimmers. The great Jim Segerstrom used a Mustang suit with this feature for swiftwater rescue and swore by it. I too have this excellent drysuit but keep miscalculating how tight to draw in the neck to withstand immersion. If your face is not red, it isn't tight enough!

POCKETS Most suits can have pockets custom-fitted but standard fittings vary. Generally speaking swiftwater oriented suits will not have pockets as standard because they may be a snag hazard. In aviation suits there may be low profile pockets on the top of the thighs and for more general purpose rescue and USAR there may be bellows style cargo pockets. Some have shoulder pockets with pen holders and some have D-rings or even lanyards which enable you to secure items on a length of cord or elastic so that they can be used but safely retained. Lash Tabs also known as Matrix Base Plates offer a means of attaching pockets or accessories using webbing.

REFLECTIVE: Counter to the interests of tactical operators but reflective tape is a feature of most rescue drysuits, usually on the wrists and/or arms but may also be in the form of piping which is less obvious until a light is shone near it

BRACES/SUSPENDERS: Are mounted internally and help to improve fit so that the legs don't sag in relation to the torso -especially useful for shorter individuals wearing a standard fit suit. Also used to keep up the legs when the top part of the suit is unhinged when on a break (away from the water).

ADJUSTABLE WAIST: to lessen that Pooh Bear look and give a firmer fit around the waist. Negated to some extent by those wearing a PFD. Some suits have a telescoping torso which allows good height adjustment.

RELIEF ZIP: If you are used to a wet suit don't forget that you've switched to a drysuit or there could be some unsavoury sealed in liquids and odours. A relief zip is a great feature if you're likely to be in a suit for long periods without the option to disrobe for a latrine break. Our table indicates the male option but some offer a zipped drop-down seat option for females. Dive oriented companies also offer a urine valve .

PURGE/INFLATE VALVE: A necessity for dive suits along with an inflation port so the presence of a valve usually discerns dive from the surface suits BUT air purge is a great feature on any drysuit even if you don't dive because it allows rapid release of pent up air without having to perform the neck-pull-squat while inflate allows a big increase in buoyancy.

COLOURS: We've listed combination colours with a forward slash/. Similar proportion colours begin with a capital letter and minority colours with a lower case letter. Most, though not all, suits have some element of black and this is often from the waist down while the top half is in a higher visibility colour like red, yellow or orange. Obviously, most tactical-oriented suits stick to all black or dark blue and lack reflective tape which is counter-productive when trying to avoid snipers or sentries!

RESCUE DRYSUITS



NRS
RESCUE

SWIFTWATER RESCUE EQUIPMENT

- Dry suits • Wetsuits • Footwear • Gloves • Helmets
- Life Jackets • Rescue hardware and more...

nrsrescue.com | rescue@nrs.com



WRS WATER RESCUE BOOT



The WRS Water Rescue Boot is designed to give the user both **confidence** and **protection** in this **difficult environment**.

- Synthetic leather and Neoprene upper
- Nitrile rubber sole for added grip on wet smooth surfaces
- Multi directional tread pattern for slippery terrain
- Boa Lace System for a secure and quick fit.
- Fibreglass safety toe cap.
- Anti-perforation midsole
- Drainage holes
- Oil resistant sole
- Bright colour for under water identification
- Reflective detail on tongue
- Certified: EN ISO 20345: 2011 SIP SRC
- Sizes 36- 48

CONTACT

Krommebeekstraat 44
8930 Menen, Belgium
+32 56 21 38 62
contact@wrsinternational.com
www.wrsinternational.com

WRS[®]
INTERNATIONAL

UPDATING to NEW LAYOUT Q1 '25

Images NOT to Scale
COST: Approx, INC local tax/VAT. £/\$/€=currency conversion only
USES/ FEATURES:
 ● = partial feature&/or OK but not ideal
 □/■ = Option
 N/A = Info Not Available
VALVES PRV=Pressure Relief Valve



MANUFACTURER	AQUATEK	AQUATEK	AQUATEK	COLLINS NET	COLLINS NET	COLLINS NET	COLLINS NET	
MODEL VARIANT	X480R	X350R	S200R	First Responder	Rescue	Technical Rescue	Patrol	
ORIGIN								
COST	£00 \$00 €00	£00 \$00 €00	£00 \$00 €00	£00 \$00 €00	£00 \$00 €00	£00 \$00 €00	£00 \$00 €00	
USES	SURFACE IMMERSION	■	NO	■	■	NO	■	
	SWIFTWATER FLOOD	■						
	CONTAMINANTS DIVE							
	BOAT CREW AVIATION							
	ICE/EXTREME COLD TACTICAL							
	SIZES							
	to fit HEIGHT CHEST							
	MATERIALS	TOP /BREATHABLE	00	00	00	00	00	00
		LEGS/ BREATHABLE	00	00	00	00	00	00
		REINFORCEMENT AREAS	00	00	00	00	00	00
SEALS NECK/WRIST SOCKS BOOTS SEALS		00 ■			00 ■ □			
FEATURES	FEMALE FIT OPTION				■			
	ZIP ENTRY							
	INTEGRAL SIZE ADJ							
	POCKETS							
	REFLECTIVE SOLAS							
	INTERNAL BRACES							
	ELASTIC ADJUST WAIST							
	RELIEF ZIP FEMALE							
	PURGE INFLATE VALVE	--	--	--	--	--	--	
	STORAGE BAG							
OTHER COLOURS			■ ■ ■	■ ■ ■ ■ ■				
NOTES								
WEBSITE www. .com	aquatekdrysuits.co.uk	aquatekdrysuits.co.uk	aquatekdrysuits.co.uk	collinsnet.co.uk	collinsnet.co.uk	collinsnet.co.uk	collinsnet.co.uk	



NET	CREWSAVER (SURVITEC)	DUI	DUI	DUI	FIRST WATCH	HAMMOND DRYSUITS	HAMMOND DRYSUITS	HAMMOND DRYSUITS
	Atacama Pro	--	--	--	Ice Rescue RS10021005-HV-U	--	--	--
	£00 \$00 €00	£00 \$00 €00	£00 \$00 €00	£00 \$00 €00	£00 \$780 €00	£00 \$00 €00	£00 \$00 €00	£00 \$00 €00
	■			■				
	●							
	■							
	-							
	■							
	-				■			
	-							
	S,M,L,XL,XXL 168-198cm 5'6"-6'6" 86-122cm 34-48cm				5'-6'4" 4'6"-5'8"			
	TriLaminate ■	00	00	00	00	00	00	00
	Cordura	00	00	00	00	00	00	00
	PU	00	00	00	00	00	00	00
	Knees/Seat	00	00	00	Knee/Elbow	00	00	00
	Neoprene □ ■							
	Front Diag				Front Vertical			
	Wrists							
	1 leg				2x Ice Awl			
	■							
	■				■			
	■							
	-							
	-				-	-	-	-
	■				■			
				■				
	Integral wellingtons have steel toe and mid-shank							
o.uk	crewsaver	dui-online	dui-online	dui-online	firstwatchgear	hammond-drysuits.co.uk	hammond-drysuits.co.uk	hammond-drysuits.co.uk

UPDATING to NEW LAYOUT Q1'25

Images NOT to Scale
COST: Approx, INC.local tax/VAT. £\$€=currency conversion only
USES/ FEATURES:
 ● = partial feature&/or OK but not ideal
 □ □ □ = Option
 N/A = Info Not Available
VALVES PRV=Pressure Relief Valve



MANUFACTURER	HANSEN PROTECTION	HANSEN PROTECTION	HANSEN PROTECTION	HANSEN PROTECTION	HANSEN PROTECTION	HIKO	ICE RESCUE SYSTEM	
MODEL VARIANT	SeaRescue Tactical	SeaRescue II	SeaRescue III	SeaSwim MSAD III	SeaRescue Neoprene	Rescue-	Hybrid	
ORIGIN								
COST						£00 \$00 €911	£00 \$890 €00	
USES	SURFACE				■		■	
	IMMERSION				■	■	●	
	SWIFTWATER						-	
	FLOOD						■	
	CONTAMINANTS						■	
	DIVE				●		-	
	BOAT CREW						■	
	AVIATION						-	
	ICE/EXTREME COLD					■	■	
	TACTICAL						-	
SIZES					XS,S,M,L,XL,XXL		S,M-L,XL	
MATERIALS	TOP /BREATHABLE	00	00	00	00	5mm Neoprene	00	200D Nylon
	LEGS/ BREATHABLE	00	00	00	00	5mm Neoprene	00	Cordura
	REINFORCEMENT AREAS	00	00	00	00	PU	00	1000D Nylon
	SEALS NECK/WRIST SOCKS BOOTS SEALS	00	00	00	00	Neoprene	00	Thigh/Seat/V
FEATURES	FEMALE FIT OPTION				/	Neoprene ■/■		Neoprene/L ■
	ZIP ENTRY	Front Diagonal	Front Diagonal	Front Diagonal	Front Diagonal	Front Diagonal	Front Diagonal	Front Diagonal
	INTEGRAL SIZE ADJ							
	POCKETS					Chest,pen,radio		Ice Awl
	REFLECTIVE SOLAS					■		■
	INTERNAL BRACES							■
	ELASTIC ADJUST WAIST							-
	RELIEF ZIP FEMALE							-
	PURGE INFLATE VALVE	--		--	--	■	--	--
	STORAGE BAG							-
OTHER COLOURS								
NOTES	Survitech Company	Survitech Company		Adjustable Neck	Detachable hood & gloves		Sizes termed Universal Large and O size. Also Custom size. WT: 16lb	
WEBSITE www. .com	hansenprotection.no	hansenprotection.no	hansenprotection.no	hansenprotection.no	hansenprotection.no		icerescuesystem.com	



	IMPERIAL	MFC INTERNATIONAL	MUSTANG SURVIVAL	MUSTANG SURVIVAL	MUSTANG SURVIVAL	MUSTANG SURVIVAL	MUSTANG SURVIVAL	
	Ice Rescuer IR1500	--	Ice Commander IC9001	Sentinel MSD576	Sentinel MSD624	Sentinel Rescue Swimmer MSD660	Sentinel Light Boat Crew MSD636	
	£00 \$1300 €00	£00 \$00 €00	£00 \$00 €00	£00 \$00 €00	£00 \$00 €00	£00 \$00 €00	£00 \$00 €00	
	■	■	■					
	●	●						
	■	■						
	-	-						
	■	■	■					
	-	-						
	-	-	■					
	-	-						
	S,M,L,XL,XXL 168-198cm 5'6"-6'6" 86-122cm 34-48cm	S,M,L,XL,XXL 168-198cm 5'6"-6'6" 86-122cm 34-48cm						
■	TriLaminate Cordura PU Knees/Seat	TriLaminate Cordura PU Knees/Seat	00 00 00 00	00 00 00 00	00 00 00 00	00 00 00 00	00 00 00 00	
Latex	Neoprene □ ■	Neoprene □ ■						
onal	Front Diagonal Wrists 1 leg ■Wrists	Front Diagonal Wrists 1 leg ■Wrists						
	■	■						
	■	■						
	- -	- -						
	- -	- -	- -	- -	- -	- -	- -	
	■	■						
iver- Over- om.	Survitech Company	Integral wellingtons have steel toe and mid-shank				Available as Aviation or Naval versions	MSD637=Rear Drop Relief Panel	
ems		mfc-international	pro.mustangsuvival	pro.mustangsuvival	pro.mustangsuvival	pro.mustangsuvival	pro.mustangsuvival	

UPDATING to NEW LAYOUT Q1 '25

Images NOT to Scale
COST: Approx, INC local tax/VAT. £\$€=currency conversion only
USES/ FEATURES:
 ● = partial feature&/or OK but not ideal
 □ ◻ ◻ = Option
 N/A = Info Not Available
VALVES PRV=Pressure Relief Valve



MANUFACTURER	MUSTANG SURVIVAL	MUSTANG SURVIVAL	MUSTANG SURVIVAL	NDIVER RESCUE	NDIVER RESCUE	NDIVER RESCUE	NDIVER RESCUE
MODEL VARIANT	Sentinel TacOps MSD674	Sentinel Light SpecOps MSD676	Sentinel Aviation MSD697	Responder MOD2	Storm Force	Arctic Survivor	FEM
ORIGIN							
COST	£00 \$00 €00	£00 \$00 €00	£00 \$00 €00	£360 \$00 €00	£725 \$00 €00	£675 \$00 €00	£Custom \$00 €00
USES	SURFACE						
	IMMERSION	■			■		
	SWIFTWATER						
	FLOOD						
	CONTAMINANTS						
	DIVE						
	BOAT CREW						
	AVIATION						
	ICE/EXTREME COLD						
	TACTICAL						
SIZES	to fit HEIGHT CHEST						
MATERIALS	TOP /BREATHABLE	00	00	00	00	00	00
	LEGS/ BREATHABLE	00	00	00	00	00	00
	REINFORCEMENT AREAS	00	00	00	00	00	00
	SEALS NECK/WRIST SOCKS BOOTS SEALS						
FEATURES	FEMALE FIT OPTION						
ZIP ENTRY							
INTEGRAL SIZE ADJ							
POCKETS							
REFLECTIVE SOLAS							
INTERNAL BRACES							
ELASTIC ADJUST WAIST							
RELIEF ZIP FEMALE							
PURGE INFLATE VALVE	--	--	--	--	--	--	--
STORAGE BAG							
OTHER COLOURS	■			■			
NOTES							
WEBSITE www. .com	pro.mustangsurvival	pro.mustangsurvival	pro.mustangsurvival	ndiver-rescue	ndiver-rescue	ndiver-rescue	ndiver-rescue

UPDATING to NEW LAYOUT Q1 '25

Images NOT to Scale
COST: Approx, INC local tax/VAT. £/\$/€=currency conversion only
USES/ FEATURES:
 ● = partial feature&/or OK but not ideal
 □/□/□ = Option
 N/A = Info Not Available
VALVES PRV=Pressure Relief Valve



MANUFACTURER	OS SYSTEMS	OS SYSTEMS	OS SYSTEMS	OS SYSTEMS	OS SYSTEMS	POSSESS SEA IND CO	POSSESS SEA IND CO
MODEL VARIANT	DSRTFE	SPLB SROB	SPLLB SRBEC	SPLB SRO	SPLB SREC	Rescue 082101	Rescue 082102
ORIGIN							
COST	£650 \$00 €00	£00 \$00 €00	£00 \$00 €00	£00 \$00 €00	£00 \$00 €00		
USES	SURFACE						
	IMMERSION	■			■		
	SWIFTWATER						
	FLOOD						
	CONTAMINANTS						
	DIVE						
	BOAT CREW						
	AVIATION						
SIZES	ICE/EXTREME COLD						
	TACTICAL						
	to fit HEIGHT						
	CHEST						
MATERIALS	TOP /BREATHABLE	00	00	00	00	00	
	LEGS/ BREATHABLE	00	00	00	00	00	
	REINFORCEMENT AREAS	00	00	00	00	00	
FEATURES	SEALS NECK/WRIST						
	SOCKS BOOTS SEALS						
	FEMALE FIT OPTION						
	ZIP ENTRY						
	INTEGRAL SIZE ADJ						
	POCKETS						
	REFLECTIVE SOLAS						
	INTERNAL BRACES						
OTHER	ELASTICADJUSTWAIST						
	RELIEF ZIP FEMALE						
	PURGEINFLATEVALVE			--	--	--	
STORAGE BAG							
OTHER COLOURS	■			■			
NOTES							
WEBSITE www. .com	osystems.com	osystems.com	osystems.com	osystems.com	osystems.com	en.drysuit.cn	en.drysuit.

Images NOT to Scale
COST: Approx, INC local tax/VAT. £/\$/€=currency conversion only
USES/ FEATURES:
 ● = partial feature&/or OK but not ideal
 □/□/□ = Option
 N/A = Info Not Available
VALVES PRV=Pressure Relief Valve



MANUFACTURER	TYPHOON	TYPHOON	TYPHOON	TYPHOON	TYPHOON	TYPHOON	TYPHOON
MODEL VARIANT							
ORIGIN							
COST	£00 \$00 €00	£00 \$00 €00	£00 \$00 €00	£00 \$00 €00	£00 \$00 €00	£00 \$00 €00	£00 \$00 €00
USES	SURFACE						
	IMMERSSION						
	SWIFTWATER						
	FLOOD						
	CONTAMINANTS						
	DIVE						
	BOAT CREW						
	AVIATION						
	ICE/EXTREME COLD						
	TACTICAL						
SIZES							
to fit HEIGHT							
CHEST							
MATERIALS	TOP /BREATHABLE	00	00	00	00	00	00
	LEGS/ BREATHABLE	00	00	00	00	00	00
	REINFORCEMENT	00	00	00	00	00	00
	AREAS	00	00	00	00	00	00
SEALS NECK/WRIST							
SOCKS BOOTS SEALS							
FEATURES	FEMALE FIT OPTION						
ZIP ENTRY							
INTEGRAL SIZE ADJ							
POCKETS							
REFLECTIVE SOLAS							
INTERNAL BRACES							
ELASTIC ADJUST WAIST							
RELIEF ZIP FEMALE							
PURGE INFLATE VALVE	--	--	--	--	--	--	--
STORAGE BAG							
OTHER COLOURS	■	■	■	■	■	■	■
NOTES							
WEBSITE www. .com	typhoon-int.co.uk	typhoon-int.co.uk	typhoon-int.co.uk	typhoon-int.co.uk	typhoon-int.co.uk	typhoon-int.co.uk	typhoon-int.co.uk

YOU DON'T HAVE TIME TO

... about the quality of your equipment. You have to know it works because, for you, saving lives also means keeping yourself alive.

At Mustang Survival, you can trust us to provide you with a complete range of water rescue solutions.

NEXT GENERATION OF WATER RESCUE SOLUTIONS

Three years of research and development bring you new swift water rescue dry suits, specifically designed for water rescue professionals:

- New features for improved mobility, comfort & durability
- Innovative Rapid Repair Technology™ allows for the repair of seals and minor leaks on site
- Improved sizing delivers the best fitting suits on the market

View our range of solutions at: mustangsurvival.com/SAR



THINK...



WE SAVE LIVES FOR A LIVING
mustangsurvival.com



INFLATABLE PONTOONS & PATHS

images not to scale



This GUIDE to inflatable platforms could be divided into what we will call 'passive' and 'dynamic' products.

The next guide is 'dynamic' inflatables which are open-backed sleds designed to be powered or paddle driven through water or they can be pushed, towed or 'punted' over ice/mud/sand in order to reach a person in difficulties. Such craft have an inflatable gunwale or side-walls and an open back that allows easier ingress into or egress out of the water. These are 'wet' craft and not to be confused with inflatable boats and rafts which are designed to keep the occupants dry-ish. Inflatable sleds and open backed-rafts require the occupants to be fully kitted for potential water entry. Sleds and even tow-boards can duplicate some of the work of the paths in this GUIDE and we have included some flat sleds that function well as 'passive' platforms but they are primarily intended for rescue in moving water, be it a broad flood or complex swiftwater.

This GUIDE concerns passive platforms which are mobile and can be pushed, pulled or leapfrogged into position on water, ice, mud or sand in order to access and extract a person or

animal in difficulties. Other than one or two that have a raised 'lip' these platforms are flat mats which can be walkways across water and unstable surfaces and/or work platforms from which to perform the rescue. Some of these models are not the same flat surface on the bottom as they are on the top - some have a catamaran style base. We haven't included inflatable stretchers unless they are flat top and can be used as an impromptu work platform or access method over water and unstable surfaces. The *WRS Evac* below is an interesting oddity because it's a box-like stretcher but the sides fold down to create a flat platform.

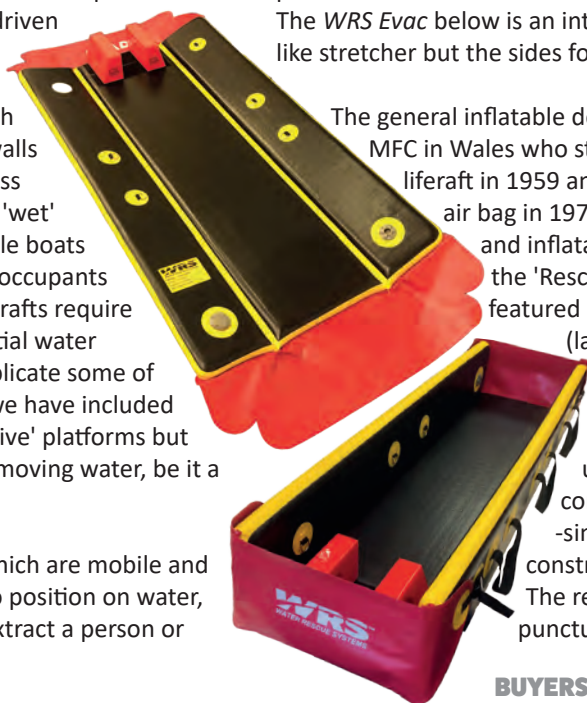

The general inflatable design we see now, originated with MFC in Wales who started in rescue with lifejackets and liferaft in 1959 and went on to invent the pneumatic air bag in 1971. The technology for both airbags and inflatable platforms is quite similar so the 'Rescue Path' was born in the 80's. This featured a very tough rubber and neoprene (later Hyperlon) outer fabric, reinforced internally with a fabric mesh and held flat, rather than ballooning into a ball, by judicious use of retaining string or cords connecting the top to the bottom -similar to mattress springs, this construction they called 'drop-stitch'. The result is a very tough, virtually puncture-proof (but we'll call it puncture-

INFLATABLE PONTOONS & PATHS

resistant) mat a few inches thick that can be transported in a back-pack-sized package and inflated in minutes on-scene using compressed air or in dozens of minutes using a hand or foot pump. Having the option of both is most useful to ensure that you are not wholly reliant on a properly charged compressed air cylinder that hasn't been quietly leaking air all the way to the incident.

One amazing feature of this class of rescue products is that manufacturing hasn't strayed much outside of the UK with only one made in North America. *MFC* are still the granddaddy of inflatables though they have some younger competitors to contend with these days so the UK still produces most models of inflatable platforms - from the original *MFC* to *WRS* (*Water Rescue Systems*) and *SIT Ltd* (*Specialist Inflatable Technology*) and latterly *Northern Diver* as well as the other Brit, *Checkmate Flexible Engineering* (making the *IC.Brindle* models) *WRS* have actually now relocated to Belgium as *WRS International*. We then saw *Savatech* in Slovakia (although they are now hard to find and may have been discontinued under *Trelleborg*) and *VETTER* in Germany expanding into inflatable paths because they, like *MFC*, were already producing pneumatic air bags. In fact *VETTER* took things a step further and are the only commercial rescue producer of high-fall air bags - giant inflatables that can save a person falling from height. Another company in Slovakia that we weren't familiar with is *Nexis* which has a single 5.1m/11' path in a fetching white with red trim and is almost certainly rebadged from a *Duletai* product.

We saw a lot of Chinese inflatable platforms while researching this GUIDE but only *Duletai* with their *Durainflate* series seemed to be aimed at the professional market and indeed imported into Europe and the US by a number of reputable companies. We always hesitate to include Chinese products in our GUIDES, not because they are poor products - we always say that the Chinese can produce to whatever quality they are asked including the very best, but because so many products are counterfeit copies. We can't say that of *Duletai* because their range is unlike the others. They have incorporated a double air chamber where a smaller safety chamber of 30-50% of total air capacity is surrounded and protected by the main

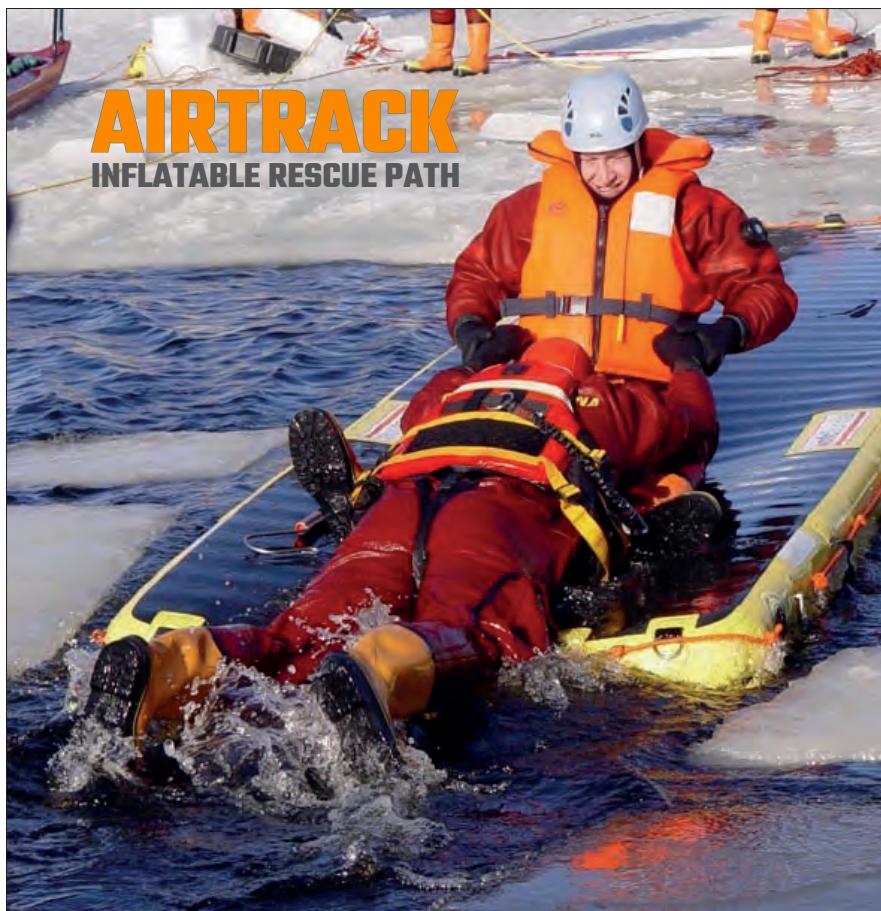

MFCInternational
by RESPIREX

ENGINEERED INFLATABLE PRODUCT SOLUTIONS

- Catamaran design with twin sponsons for water, mud and ice rescues
- Excellent stability
- Lengths from 2 to 15m
- Available in Hypalon or TPU materials
- Can be customised to your specific needs
- Manufactured in the UK

W: mfc-international.com

T: +44 (0)1443 433 075

E: sales@mfc-international.com

chamber. Should the main chamber develop a serious leak you still have a useful degree of floatation. We can't say for sure that this makes them fit for purpose having not used them but the design, materials and spec look promising, they even quote a DIN-compliant figure for tenacity and cohesion strength of the fabric and laminate bonding of the top surface and the sidewall of, respectively: 2600x5000 (+/-150) Newtons per 5cm, 150x150 (+/-10) Newtons per 5cm & 3000x3000 (+/-200) Newtons per 5cm, 100x100 (+/-10) Newtons per 5cm. We haven't seen these kinds of figures quoted by others so *Duletai* are obviously keen to be transparent assuming the figures are accurate.

It's interesting to note that some designs have tried to address one problem that can occur with a broad, flat surface in contact with wet mud and sand - suction. It can be difficult to lift and move these mats so a number of designs have a catamaran-style base mentioned earlier and shown in this *Checkmate* model that lifts the mat clear of the surface to negate that suction. Being much higher they also afford a little more protection in water but of course that height can make loading on board the platform more difficult than mats that are only a few inches high. *WRS* took a different approach and have incorporated a forced curve to their mats (shown here in the original colourway) such that it lays flat when there is weight on it but is curved to sit only on its longer outer edges when empty- genius!



HYPALON VS PVC *Hypalon* is a *DuPont* tradename though, like *Hoover*, it seems to have become a more generic term for the tougher, more UV, abrasion and chemical-resistant material of the two. Consequently, it's heavier, more expensive and with less colour options. *Hypalon* is also more resilient in extreme cold and heat but as a rough guide both materials can operate in temperatures from around -25 to +60°C (-13 to 140°F) but should be stored in cool dark places around 15 degrees give or take 10 degrees either way and obviously never in direct sunlight or adjacent any solvents or chemicals. These things are basically modified lifting air-bags with a drop-stitch construction where a thread, cord or fabric ties the upper and lower surfaces together to stop then path becoming a balloon.

FEATURES of INFLATABLE PATHS

INFLATION & VALVES

All of these rescue-oriented models are inflated by BA style compressed air cylinders which suits fire services nicely. Most can also be inflated by high capacity hand or foot pumps or even an electric inflation pump - preferably something that is a step up from those cigarette lighter lilo inflators or you'll be there for quite some time. Compressed Air (CABA) inflation is the preferred option for speed because it inflates in seconds to a few minutes rather than several minutes. Most companies can provide the most compatible pressure reducer and hoses for your services

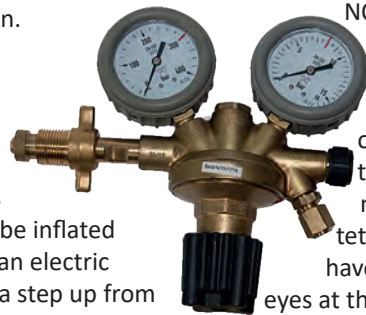

air cylinders. Over-pressure is not an issue since they all have a safety valve that will purge air (SAFETY PRV). Pressures need to be high to provide the rigid surface capable of taking around 100kg/220lb per square metre of path. In some cases there is a separate 'dump' or purge valves for rapid deflation often doubling as the safety valve. A speedy deflation can also be achieved by using a suction pump on the inflation point. Once inflated, these things are rock-hard and tough as old boots but they don't have a limitless capacity for being squashed - under high load they will deflect and maybe crease in water but on a harder, more resistant surface like mud or sand they would either rupture or, in most cases the safety or over-pressure valve would save the day and expel air rather than rupture a seam. Typical load capacities are around 100kg per square metre give or take several kg so with most paths being about a metre wide you can gauge their capacity by the length - a 3m path will take 3 or 4 people or one horse, a 10 metre might take a dozen people or a small herd of sheep but good luck keeping any live and frisky animal on-board. For animal rescue, platforms can be useful for physically hauling and sliding

an animal out of mud or water but they tend to be used more for the human rescuers to carry out a rescue around a trapped animal (or human) - frequently in mud, sometimes sand where the platform either allows easy access and deployment of air lances to free a mud-entrapment or can be used as a base for a lifting tripod being careful NOT to exceed the per square metre or foot load rating.

'LOAD-BEARING' EYES

Virtually all designs have towing or connection eyes, either as metal rings or webbing eyes on the ends or close to the ends on the top. These can be used to connect paths together and create much larger working areas or to tow the paths into position/ back from a rescue; the UK Coastguard Mud Rescue Teams have provision for a powered winch to drag their rescue sled back to dry land after a rescue but this principle can extend to paths that have strong enough towing eyes. Such attachment points can also be used as tether points for holding position in flowing water but NONE are intended as vertical lift eyes for hoisting with weight on the platform. Only the inflatable stretchers are properly equipped for hoisting as noted in the NOTES section of one or two in this list. Some models have different sizes of D-rings and while there are no figures given it is likely that the smaller D-Rings are intended to have less load applied - these are often around the circumference or side walls with the perimeter cord running through so load is shared more equally between them that the larger towing/ tethering eyes. One or two, like the *Checkmate* models have connection hooks on one wne and connecting eyes at the opposite end.

HANDLES

There are carry handles on most models, these are intended for transport and positioning NOT for lifting stretcher style though that is possible with one or two of the paths with a

high 'freeboard', the *SIT* models for example are nearly double the height of the *Vetter* paths. Some handles are bespoke, ergonomic grips while others may simply be the perimeter cord with a smaller gap between anchor points.

PERIMETER CORD

There is cord or webbing running around the top surface or all the way around the sides of most paths. This tends to be on the rectangular models which are long and thin rather than the smaller square models. Cord is fastened to the top surface or the sidewalls of the path at intervals and can be used to aid positioning of the path, for in-water casualties that won't fit on top to hold onto or to fasten equipment or throwbags etc. anywhere along the path's length and ensure you don't lose anything during the rescue mêlée. On longer models this can add a kilo to the weight as it tends to be 7 to 10 mm in diameter for easier grasping.



MFC's Animal Rescue Path seems to be the original Rescue Path that we used to deploy for just about everything from mud and ice to quicksand and even trench rescue but is now re-purposed as an animal rescue platform. It's still a great and probably more cost-effective, general option for mud/ice/sand rescue but with less frills and a slicker surface. In the image below, the sheer scale of effort required to rescue a cow from mud can be seen, plus the necessity for a slick surface in sliding the cow out. Here it's all hands to the pump in Hampshire, UK as the Animal Rescue Team, Water Rescue Team, local fire crew, farmer and vet all get involved. The slick surface, as distinct from the now more common tactile surface, enables rescuers to drag the animal out and is made easier in dry weather with liberal application of a bucket of water.

NON-SLIP TOP SURFACE

A slick rubber surface might be good for sliding animals on but



it is something of a liability for anyone stood on it or trying to walk across it so most have some form of extra grip - this can be a textured or dimpled surface across its entirety like EVA foam or it may be a series of ribs. Most use a tactile surface like this *NDiver* model (right) which is noticeably matt and grippy in appearance but some have a surface that is not immediately distinct from a non-textured surface yet still flat and grippy. There are times when a tactile surface is more of hindrance than a help - trying to slide a trapped animal onto the platform for instance and when it comes to cleaning/decontamination but on the whole - greater traction is more useful to rescuers.

INFLATABLE PONTOONS & PATHS

IN THE FOLLOWING TABLES.....

Any use, feature, accessory or component that is inherent in the product is shown as a solid coloured square ■■■■

If it's an option it is shown as an outline square □□□□

A circle ● in the 'USE' columns indicates that this feature is only partially present and/or is OK for that purpose but not ideal.

ORIGIN: The 'manufacturer's country, not necessarily the country of manufacture indicated by an inset flag.

COST: a rough guide only - includes local taxes/VAT. Varies with exchange rates, extra taxes etc. Like our other GUIDE in this issue, hardly anyone is prepared to give a price, WRS, Northern Diver and IC Brindle have no problem passing on prices so you can get a rough idea from these of the cost of similar sized paths from other manufacturers. We usually round up to the nearest Pound\$/US Dollar\$/Euro€. We have started to quote a US\$ figure in orange which is simply a currency conversion to give an idea of price, it is not the selling price in the US which may have import duties etc to add.

TOTAL LOAD CAPACITY or kg/sqm: Most companies will quote a maximum figure which is much lower than its true capabilities - the Animal path in the picture below-left is quoted as having a max total load of 200kg but that cow looks a little heavier than that! If in doubt, work on 100kg per square metre or 67.2 pounds per square foot.

DIMENSIONS: Length by width by depth/height from ground. The stored dimensions may be the bag rather than the rolled or folded platform but close enough.

AIR CAPACITY: The volume of air needed to fill the path to working pressure. This doesn't necessarily correlate to the dimensions (which are external measurements) and vary with different thicknesses of material, resistance, internal components etc.

MAX WORKING PRESSURE: the pressure at which the path is pumped up and workable, exceeding of which will purge via the safety valve.

INFLATION TIME: Mostly via compressed air which is two or three times quicker than an electric pump which, in turn may be twice as fast as hand or foot inflation. All of these times are approximate and depend on the temperature and how well the path has been unpacked/unrolled. One or two of the figures given here seem mightily optimistic.

TOW/CONNECT EYES: metal D-rings and/or web straps and sometime hooks. This can be tricky because some components can easily do the job of both but generally speaking the connecting eyes can be weaker than towing eyes but neither is designed to hold a loaded path in suspension.

SAFETY/DUMP VALVE: The safety valve or purge valve allows excess air to vent as a result of over-inflation or an excessive compressive load. Dump valve refers to the ability to empty air quickly or even to actively suck air out with a pump.

COLOUR: Primary colour of shell/frame with an outline secondary colour to indicate trim colour.



images NOT to Scale

□□□ = Option

● = Partial Feature &/or OK but not ideal

COST: Approx. INC local tax/VAT

£ US\$ € = currency conversions only

INFLATION: Hand Pump/ Electric Pump
Compressed Air

VALVES PRV=Pressure Relief Valve

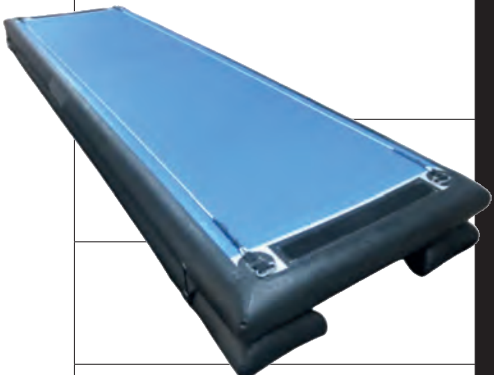
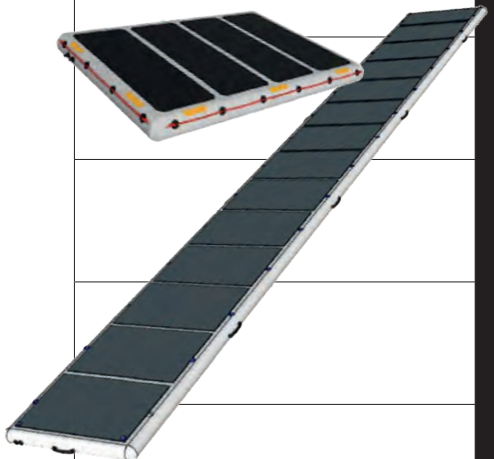
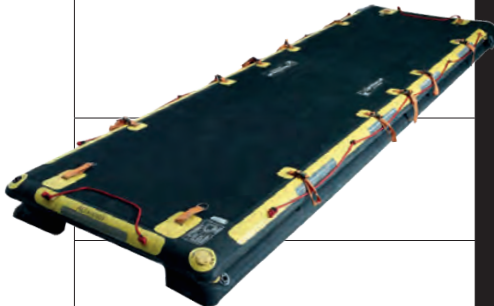

MODEL	COMPANY	ORIGIN	COST inc tax / VAT	WEIGHT	LOAD CAPACITY &/or Kg/Sq M lb/Sq Ft	DIMENSIONS L x Wx H/D PACKED convert cm to m " to '
2m Rescue Walkway	CHECKMATE FLEXIBLE ENGINEERING	UK	N/A	24kg 52.8lb	200kg 440lb >100kg >67.2lb	2 x 1.4 x 0.25m 78.7 x 55 x 10" 1.7 x 0.5 x 0.3m 67 x 19.7 x 13.7"
5m Rescue Walkway	CHECKMATE FLEXIBLE ENGINEERING	UK	N/A	36kg 61.6lb	500kg 1100lb >100kg >67.2lb	5 x 1.4 x 0.25m 197 x 55 x 10" 1.7 x 0.5 x 0.35m 67 x 19.7 x 13.7"
10m Rescue Walkway	CHECKMATE FLEXIBLE ENGINEERING	UK	N/A	46kg 101.2lb	1000kg 2200lb >100kg >67.2lb	10 x 1.4 x 0.25m 254 x 55 x 10" 1.7 x 0.5 x 0.4m 67 x 19.7 x 15.7"
2m Rescue Walkway 520017	DULETAI	China	N/A	14kg 30.8lb	800kg 1760lb	2 x 1.37 x 0.2m 78.7 x 53.9 x 8" 0.82 x 0.35 x 0.45m 32.2 x 13.7 x 17.7"
5m Rescue Walkway 520018	DULETAI	China	N/A	27kg 59.4lb	800kg 1760lb	5 x 1.37 x 0.2m 197 x 53.9 x 8" 1.15 x 0.35 x 0.45m <45.2 x 13.8 x 17.7"
10m Rescue Walkway 520019	DULETAI	China	N/A	55kg 121lb	1300kg 2860lb	10 x 1.37 x 0.2m 254 x 53.9 x 8" 115 x 35 x 45m 45.2 x 13.8 x 17.7"
15m Rescue Walkway 520020	DULETAI	China	N/A	90kg 198lb	3000kg 6600lb	15 x 1.37 x 0.2m 590 x 53.9 x 8" 1.8 x 1 x 0.85m 70.8 x 40 x 33.4"
2m Fast Path	IC BRINDLE	UK	£1620 \$1688	23kg 50.6lb	250kg 550lb	2 x 1.3 x 0.3m 78.7 x 51 x 12" 1.7 x 0.5 x 0.3m 67 x 19.7 x 13.7"
5m Fast Path	IC BRINDLE	UK	£2736 \$3358	35kg 77lb	625kg 1375lb	5 x 1.3 x 0.3m 197 x 51 x 12" 1.7 x 0.5 x 0.35m 67 x 19.7 x 13.7"
10m Fast Path	IC BRINDLE	UK	£4776 \$5865	45kg 99lb	1250kg 2750lb	1000x130x30m 393 x 51 x 12" 170 x 50 x 40m 67 x 19.7 x 15.7"
2m Airtrack Rescue Path WR0011 WRW0011/01	MFC INTERNATIONAL	UK	\$2600	12kg 26.4lb	200kg 440lb	200x137x25m 00 x 00 x 00" 82x48x24m 00 x 00 x 00"
3m Airtrack Rescue Path WR0012 WRW0012/01	MFC INTERNATIONAL	UK	N/A	17kg 37.4lb	300kg 660lb	300x137x25m 87x48x28m
4m Airtrack Rescue Path WR0013 WRW0013/01	MFC INTERNATIONAL	UK	N/A	22kg 48.4lb	400kg 880lb	400x137x25m 87x48x32m











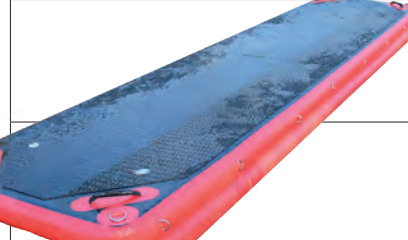



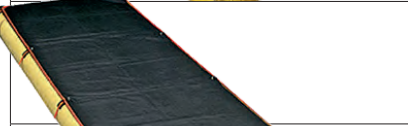





INFLATABLE PONTOONS & PATHS

AIR CAPACITY	MAX PRESSURE	INFLATION OPTIONS & TIMES HAND ELECTRIC HP/CABA	MATERIALS:	TOP SURFACE GRIP	INFLATION CHAMBERS	REGULATOR / HOSE	SAFETY PRV/ DUMP VALVE	MANUAL/POWER PUMP	HANDLES / GRAB CORD	TOW / CONNECT EYES	REPAIR KIT / POCKETS	CARRY BAG/VALISE	REFLECTIVE	COLOUR OPTIONS	NOTES	WWW.
*840 L 29.7cuft	0.55 BAR 8 PSI	■ ■ ■	Neoprene coated nylon	■	3	□ □	■ ■	□ □	■ ■	10 4	- □	■ ■	■ ■	■	* approximate figures	checkmateflex.com
*1700 L 60cuft	0.55 BAR 8 PSI	■ ■ ■	Neoprene coated nylon	■	3	□ □	■ ■	□ □	■ ■	10 4	- □	■ ■	■ ■	■	* approximate figures	checkmateflex.com
*3500 L 123.6cuft	0.55 BAR 8 PSI	■ ■ ■	Neoprene coated nylon	■	3	□ □	■ ■	□ □	■ ■	10 4	- □	■ ■	■ ■	■	* approximate figures	checkmateflex.com
800 L 28.25cuft	0.5 BAR 7.25 psi	■ ■40 sec ■	PVC coated Polyester. EVA foam upper	■	2	- -	- ■	□ ■	■ ■	20 0	□ ■	■ ■	■ ■	□ □		durainflate.com
1600 L 56.5cuft	0.5 BAR 7.25 psi	■ ■1min ■	PVC coated Polyester. EVA foam upper	■	2	- -	- ■	□ ■	■ ■	20 0	□ ■	■ ■	■ ■	□ □		durainflate.com
3200 L 113cuft	0.5 BAR 7.25 psi	■ ■4mins ■	PVC coated Polyester. EVA foam upper	■	2	- -	- ■	□ ■	■ ■	24 6	□ ■	■ ■	■ ■	□ □		durainflate.com
5570 L 196.7cuft	0.5 BAR 7.25 psi	■ ■6mins ■	PVC coated Polyester. EVA foam upper	■	2	- -	- ■	□ ■	■ ■	30 10	□ ■	■ ■	■ ■	□ □		durainflate.com
*840 L 29.7cuft	0.55 BAR 8 PSI	■ ■ ■	PVC	■	3	□ □	■ ■	□ □	■ ■	0	□ ■	□ ■	□ ■	■	* approximate figures	icbrindle.com
*1700 L 60cuft	0.55 BAR 8 PSI	■ ■ ■	PVC	■	3	□ □	■ ■	□ □	■ ■	0	□ ■	□ ■	□ ■	■	* approximate figures	icbrindle.com
*3500 L 123.6cuft	0.55 BAR 8 PSI	■ ■ ■	PVC	■	3	□ □	■ ■	□ □	■ ■	0	□ ■	□ ■	□ ■	■	* approximate figures	icbrindle.com
640 L 22.6cuft	0.7 BAR 10 Psi	■ ■1min ■	Hypalon Neoprene/TPU	■	3	□ □	■ ■	□ □	■ ■	8 4	2 ■	■ ■	■ ■	■	comes with throwline with rubber quoit	mfc-international.com
960 L 33.9 L	0.7 BAR 10 Psi	■ ■ ■	Hypalon Neoprene/TPU	■	3	□ □	■ ■	□ □	■ ■	8 4	2 ■	■ ■	■ ■	■	comes with throwline with rubber quoit	mfc-international.com
1280 L 45.2cuft	0.7 BAR 10 Psi	■ ■3mins ■	Hypalon Neoprene/TPU	■	3	□ □	■ ■	□ □	■ ■	8 4	2 ■	■ ■	■ ■	■	comes with throwline with rubber quoit	mfc-international.com

<p>images NOT to Scale □□□= Option ●= Partial Feature &/or OK but not ideal COST: Approx, <u>INC</u> local tax/VAT £ US\$ € = currency conversions only INFLATION: Hand Pump/ Electric Pump Compressed Air VALVES PRV=Pressure Relief Valve</p>	MODEL	COMPANY	ORIGIN	COST inc tax / VAT	WEIGHT	LOAD CAPACITY &/or Kg/Sq M lb/Sq Ft	DIMENSIONS L x Wx H/D PACKED convert cm to m " to '
	5m Airtrack-Rescue Path WR0014 WRW0014/01	MFC INTERNATIONAL		£000 \$4900 €000	28kg 61.6lb	500kg 1100lb	5 x 1.37 x 0.25m 197 x 54 x 9.8" 0.87 x 0.48 x 0.35m 34.2 x 19 x 13.8"
	10m Airtrack-Rescue Path WR0015 WRW0015/01	MFC INTERNATIONAL		N/A	55kg 121lb	1000kg 2200lb	10 x 1.37 x 0.25m 394 x 54 x 9.8" 0.89 x 0.73 x 0.5m 35 x 28.7 x 19.7"
	15m Airtrack-Rescue Path WR0016 WRW0016/01	MFC INTERNATIONAL		N/A	00kg 00lb	2000kg 4400 lb	15 x 1.37 x 0.25m 590 x 54 x 9.8" 0.91 x 0.73 x 0.5m 36 x 28.7 x 19.7"
	5m Animal Rescue Path WR0195 WRW0195	MFC INTERNATIONAL		N/A	15.5kg 34.1lb	600kg 1320 lb 200kg	5 x 1.34 x 0.67m 197 x 53 x 2.6" 0.66 x 0.34 x 0.25m 26 x 13.4 x 9.8"
	10m Animal Rescue Path WR0197 WRW0197	MFC INTERNATIONAL		N/A	40kg 88 lb	1200kg 2640 lb	10 x 1.34 x 0.67m 39.4 x 5.3 x 2.6" 0.7 x 0.45 x 0.3m 27.6 x 17.7 x 12"
	Inflatable Stretcher WR0196 WRW0196	MFC INTERNATIONAL		N/A	7kg 15.4lb 6kg 13.2lb	150kg 330 lb	2.04 x 0.66 x 0.67m 80.3 x 26 x 2.6" 0.35 x 0.35 x 0.18m 13.8 x 13.8 x 7"
	RPH Lifeline	NIXUS		N/A	28.5kg 62.7lb	800kg 1760lb	5.1 x 1.37 x 0.16m 200 x 54 x 6.3" <1.15 x 0.35 x 0.45m <45.2 x 13.8 x 17.7"
	1m Air Track	NORTHERN DIVER		£177 \$218 €000	5kg 11lb	60kg 132lb	1 x 1 x 0.8m 39 x 39 x 3.15" 1.10 x 0.35 x 0.1m 43.3 x 35 x 4"
	2m Air Track	NORTHERN DIVER		£369 \$453 €000	10.5kg 23.1lb	120kg 264lb	2 x 1 x 0.8m 39 x 3.15" 110 x 35 x 15m 43.3 x 13.8 x 6"
	5m Air Track	NORTHERN DIVER		£1310 \$1608 €0000	35.5kg 78.1lb	420kg 924lb	5 x 1 x 0.8m 19.7 x 39 x 3.15" 1.4 x 0.35 x 0.3m 55 x 13.8 x 12"
	8m Air Track	NORTHERN DIVER		£1662 \$2041 €0000	46kg 101.2lb	672kg 1478lb	8 x 1 x 0.8m 315 x 39 x 3.15" 1.4 x 0.35 x 0.35m 55 x 13.8 x 13.8"
	10m Air Track	NORTHERN DIVER		£1916 \$2352 €0000	41kg 90.2lb	840kg 1848lb	10 x 1 x 0.8m 394 x 39 x 3.15" 1.4 x 0.35 x 0.38m 55 x 13.8 x 13.8"
	2m Walkway	NORTHERN DIVER		£956 \$1174 €0000	300kg 660lb	250kg 550lb	2 x 1.2 x 0.3m 79 x 47.2 x 12" <1.4 x 0.5 x 0.35m <55 x 19.7 x 13.8"

INFLATABLE PONTOONS & PATHS

AIR CAPACITY	MAX PRESSURE	INFLATION OPTIONS & TIMES HAND ELECTRIC HP/CABA	MATERIALS:	TOP SURFACE GRIP	INFLATION CHAMBERS	REGULATOR / HOSE	SAFETY PRV/ DUMP VALVE	MANUAL/POWER PUMP	HANDLES / GRAB CORD	TOW / CONNECT EYES	REPAIR KIT / POCKETS	CARRY BAG/VALISE	REFLECTIVE	COLOUR OPTIONS	NOTES	WWW.
				■	3	■ □	■ □	■ □	■ □	■ □	■ □	■ □	■ □	■ □		
1600 L 56.5cuft	0.7 BAR 10 Psi	■ 3-4mins ■	Hypalon Neoprene/TPU	■	3	■ □	■ □	■ □	■ 0	8 4	2 ■	■	■	■	comes with throwline with rubber quoit	mfc-international.com
3200 L 113cuft	0.7 BAR 10 Psi	■ 6-7mins ■	Hypalon Neoprene/TPU	■	3	■ □	■ □	■ □	■ 0	12 4	2 ■	■	■	■	comes with throwline with rubber quoit	mfc-international.com
4800 L 169cuft	0.7 BAR 10 Psi	■ 8-10mins ■	Hypalon Neoprene/TPU	■	3	■ □	■ □	■ □	■ 0	16 4	2 ■	■	■	■	comes with throwline with rubber quoit	mfc-international.com
455 L 16cuft	0.2 BAR 3 Psi	■ 30sec ■	Hypalon Neoprene/TPU	NO	1	■ □	■ □	■ □	■ 6	0 0	- ■	■	NO	■	Hypalon version in Yellow/Black, TPU version in Orange/black	mfc-international.com
910 L 32.1cuft	0.2 BAR 3 Psi	■ 2mins ■	Hypalon Neoprene/TPU	NO	1	■ □	■ □	■ □	■ 6	0 0	- ■	■	NO	■	Hypalon version in Yellow/Black, TPU version in Orange/black	mfc-international.com
100 L 3.5cuft	0.2 BAR 3 Psi	■ 30secs ■	Hypalon Neoprene/TPU	NO	1	■ □	■ □	■ □	NO 6	0 0	- ■	■	NO	■		mfc-international.com
1600 L 56.5cuft	0.5 BAR 7.25 psi	■ 2mins ■	PVC coated Polyester. EVA foam upper	■	2	-	-	■ □	■ 20	0 0	■ □	■	■	■ □		nixus2protect.com
80 L 2.8cuft	0.7 BAR 10 Psi	■ 23secs ■	DWF/PVC	■	1	■ □	■ □	■ □	■ 2	■ □	- ■	■	■	■ □	*Inflation time calculated at 50 pump strokes per minute	ndiver-rescue.com
160 L 5.6cuft 54secs	0.7 BAR 10 Psi	■ ■ ■	DWF/PVC	■	1	■ □	■ □	■ □	■ 2	■ □	- ■	■	■	■ □	*Inflation time calculated at 50 pump strokes per minute	ndiver-rescue.com
560 L 19.8cuft 3.1mins	0.7 BAR 10 Psi	■ ■ ■	DWF/PVC	■	1	■ □	■ □	■ □	■ 4	■ □	- ■	■	■	■ □	*Inflation time calculated at 50 pump strokes per minute	ndiver-rescue.com
896 L 31.6cuft 5mins	0.7 BAR 10 Psi	■ ■ ■	DWF/PVC	■	1	■ □	■ □	■ □	■ 4	■ □	- ■	■	■	■ □	*Inflation time calculated at 50 pump strokes per minute	ndiver-rescue.com
1120 L 39.6cuft 6.2mins	0.7 BAR 10 Psi	■ ■ ■	DWF/PVC	■	1	■ □	■ □	■ □	■ 4	■ □	- ■	■	■	■ □	*Inflation time calculated at 50 pump strokes per minute	ndiver-rescue.com
360 L 12.7cuft 2mins*	0.7 BAR 10 Psi	■ ■ ■	DWF/PVC	■	3	■ □	■ □	■ □	■ 4	■ 12	- ■	■	■	■ □	*Inflation time calculated at 50 pump strokes per minute	ndiver-rescue.com

<p>images NOT to Scale □□□ = Option ● = Partial Feature &/or OK but not ideal COST: Approx. <u>INC</u> local tax/VAT £ US\$ € = currency conversions only INFLATION: Hand Pump/ Electric Pump Compressed Air VALVES PRV=Pressure Relief Valve</p>	MODEL	COMPANY	ORIGIN	COST inc tax / VAT	WEIGHT	LOAD CAPACITY &/or Kg/Sq M lb/Sq Ft	DIMENSIONS L x Wx H/D PACKED convert cm to m " to '
	3m Walkway	NORTHERN DIVER		£1318 \$1618 €0000	35kg 77lb	450kg 990lb	3 x 1.2 x 0.3m 118 x 47.2 x 12" <1.4 x 0.5 x 0.35m <55 x 19.7 x 13.8"
	5m Walkway	NORTHERN DIVER		£2084 \$2559 €0000	42kg 92.4lb	750kg 1650lb	500 x 120 x 30cm 197 x 47.2 x 12" 140 x 50 x 35cm <55 x 19.7 x 13.8"
	10m Walkway	NORTHERN DIVER		£3873 \$4755 €0000	85kg 187lb	1500kg 3300lb	1000 x 120 x 30cm 394 x 47.2 x 12" 140 x 60 x 40cm
	RR2	NORTHERN DIVER		£970 \$1191 €0000	23.7kg 52.1lb	300kg 660lb	300 x 100 x 15cm 118 x 39 x 4" 0 x 0 x 0cm
	5m Rescue Walkway ATP5	SAVATECH (TRELLEBORG)		N/A	34kg 74.8lb	1000kg 2200lb 200kg 440lb	500 x 165 x 15cm 197 x 65 x 6" n/a
	10m Rescue Walkway ATP10	SAVATECH (TRELLEBORG)		N/A	66kg 145.2lb	2000kg 2205lb 200kg 440lb	1000 x 165 x 15cm 394 x 65 x 6" n/a
	15m Rescue Walkway ATP15	SAVATECH (TRELLEBORG)		N/A	100kg 220lb	3000kg 4409lb 200kg 440lb	1500 x 165 x 15cm 590 x 65 x 6" n/a
	ResQ Path 3000 SIT38050	SIT Ltd		N/A	15kg 33lb	350kg 770lb	300 x 145 x 15cm 118 x 57 x 4" 70 x 40 x 40cm 27.5 x 15.7 x 15.7"
	ResQ Path 5000 SIT38050	SIT Ltd		£0000 \$6397 €6074	25kg 55lb	650kg 1430lb	500 x 145 x 15cm 197 x 57 x 4" 70 x 44 x 40cm 27.5 x 17.3 x 15.7"
	ResQ Path 10000 SIT38050	SIT Ltd		£0000 \$8718 €8278	45kg 99lb	1200kg 2640lb	1000 x 145 x 15cm 394 x 57 x 4" 70 x 70 x 70cm 27.5 x 27.5 x 27.5"
	LifeRamp 10' 6601-10	TULMAR SAFETY		£00 \$6075 €00	12.7kg 28lb	499kg 1100lb 145kg 30 lb	1.2 x 3.1 x 0.2m 3.8 x 10 x 0.7' 1.2 x 0.46 x 0.3m 4 x 1.5 x 1'
	LifeRamp 15' 6601-15	TULMAR SAFETY		£00 \$6945 €00	19.1kg 42lb	762kg 1679lb 145kg 30 lb	1.2 x 4.5 x 0.2m 3.8 x 15 x 0.7' 1.2 x 0.46 x 0.3m 4 x 1.5 x 1'
	LifeRamp 30' 6601-30	TULMAR SAFETY		£00 \$9220 €00	35.4kg 78lb	1543kg 3400lb 145kg 30 lb	1.2 x 9 x 0.2m 3.8 x 30 x 0.7' 1.2 x 0.61 x 0.46m 4 x 2 x 1.5'

INFLATABLE PONTOONS & PATHS

AIR CAPACITY	MAX PRESSURE	INFLATION OPTIONS & TIMES HAND ELECTRIC HP/CABA	MATERIALS:	TOP SURFACE GRIP	INFLATION CHAMBERS	REGULATOR / HOSE	SAFETY PRV/ DUMP VALVE	MANUAL/POWER PUMP	HANDLES / GRAB CORD	TOW / CONNECT EYES	REPAIR KIT / POCKETS	CARRY BAG/VALISE	REFLECTIVE	COLOUR OPTIONS	NOTES	WWW.
540 L 19cuft 3mins*	0.7 BAR 10 Psi	■ ■ ■	DWF/PVC	■	3	□ □	- ■	□ ■	■ 4	4 12	- ■	■ ■	□ □	■ ■	*Inflation time calculated at 50 pump strokes per minute	ndiver-rescue.com
900 L 31.8cuft 5mins*	0.7 BAR 10 Psi	■ ■ ■	DWF/PVC	■	3	□ □	- ■	□ ■	■ 4	4 12	- ■	■ ■	□ □	■ ■	*Inflation time calculated at 50 pump strokes per minute	ndiver-rescue.com
1800 L 63.6cuft 10mins*	0.7 BAR 10 Psi	■ ■ ■	DWF/PVC	■	3	□ □	- ■	□ ■	■ 4	4 12	- ■	■ ■	□ □	■ ■	*Inflation time calculated at 50 pump strokes per minute	ndiver-rescue.com
310 L 11cuft <1min	0.7 BAR 10 Psi	■ ■ ■	DWF/PVC	■	1	□ □	- ■	□ ■	■ 11	5 14	- ■	■ ■	□ □	■ ■	Primarily a sled so comes with twin-blade paddle	ndiver-rescue.com
1860 L 66cuft 1min	0.5 BAR 7.25 psi	■ ■ ■	Hypalon	■	1	□ □	■ ■	□ ■	■ *	14 0	- □	■ ■	■ ■	■ ■	May be discontinued *Perimeter cord provides the carrying handles	trelleborgslovenija.com
3720 L 131cuft 1.4min	0.5 BAR 7.25 psi	■ ■ ■	Hypalon	■	1	□ □	■ ■	□ ■	■ *	24 0	- □	■ ■	■ ■	■ ■	May be discontinued *Perimeter cord provides the carrying handles	trelleborgslovenija.com
5570 L 197cuft 10+min	0.5 BAR 7.25 psi	■ ■ ■	Hypalon	■	1	□ □	■ ■	□ ■	■ *	34 0	- □	■ ■	■ ■	■ ■	May be discontinued *Perimeter cord provides the carrying handles	trelleborgslovenija.com
650 L 23cuft 1min	0.5 BAR 7.25 psi	■ ■ ■	Hypalon	■	1	□ □	■ ■	□ ■	■ 4*	4* 4*	■ ■	□ □	□ □	■ ■	Updated range will not now include the original 2m version. *All fitments subject to change due to series redesign/update	sitltd.co.uk
1080 L 38.1cuft 2mins	0.5 BAR 7.25 psi	■ ■ ■	Hypalon	■	1	□ □	■ ■	□ ■	■ 6*	4* 4*	■ ■	□ □	□ □	■ ■	*All fitments subject to change due to series redesign/update Also branded as SAFEQUIP	sitltd.co.uk
2160 L 76.3cuft 4mins	0.5 BAR 7.25 psi	■ ■ ■	Hypalon	■	1	□ □	■ ■	□ ■	■ 10*	4* 4*	■ ■	□ □	□ □	■ ■	*All fitments subject to change due to series redesign/update Also branded as SAFEQUIP	sitltd.co.uk
<1min	0.2 BAR 3 psi	■ ■ ■	Neoprene/ PVC	NO	2	■ □	- ■	□ -	■ -	2 0	■ ■	■ ■	NO NO	■ ■		tulmar.com
<1min	0.2 BAR 3 psi	■ ■ ■	Neoprene/PVC	NO	2	■ □	- ■	□ -	■ -	2 0	■ ■	■ ■	NO NO	■ ■		tulmar.com
<1min	0.2 BAR 3 psi	■ ■ ■	Neoprene/PVC	NO	2	■ □	- ■	□ -	■ -	2 0	■ ■	■ ■	NO NO	■ ■		tulmar.com

images NOT to Scale
 □□□ = Option
 ● = Partial Feature &/or OK but not ideal
COST: Approx, INC local tax/VAT
 £ US\$ € = currency conversions only
INFLATION: Hand Pump/ Electric Pump
 Compressed Air
VALVES PRV=Pressure Relief Valve



LifeRamp 50'
6601-50

TULMAR SAFETY



£00
\$13430
€00

40.9kg
90lb

2586kg
5700lb
145kg
30 lb

1.2 x 15.5 x 0.2m
3.8 x 50 x 0.7'
1.2 x 0.91 x 0.76m
4 x 3 x 2.5'

LifeRamp 80'
6601-80

TULMAR SAFETY



£00
\$19680
€00

86.2kg
190lb

4151kg
9150lb
145kg
30 lb

1.2 x 24.8 x 0.2m
3.8 x 80 x 0.7'
1.2 x 1.1 x 1.1m
4 x 3.5 x 3.5'

6m Walkway
1530008502

VETTER



N/A

25kg
77.2lb

800kg
1760 lb
95kg
2255 lb

6 x 1.4 x 0.1m
236 x 55 x 4"
1.65 x 0.35 x 0.25m
65 x 14 x 10"

10m Walkway
1530008602

VETTER



N/A

57.5kg
126.8lb

1330kg
2926 lb
95kg
2255 lb

10 x 1.4 x 0.1m
394 x 55 x 4"
1.65 x 0.45 x 0.3m
65 x 14 x 10"

15m Walkway
1530008702

VETTER



N/A

81.5kg
179.7lb

1995kg
4390 lb
95kg
2255 lb

1500 x 140 x 10m
590 x 55 x 4"
1.65 x 0.6 x 0.45m
65 x 14 x 10"

2m Rescue Pathway

WRS INTERNATIONAL



£00
\$2667
€2667

7.4kg
16.3lb

220kg
484lb

2. x 1 x 0.15m
79 x 39 x 6"

3m Rescue Pathway

WRS INTERNATIONAL



£00
\$3046
€2682

13.3kg
29.3lb

390kg
858lb

3 x 1.4 x 0.15m
118 x 55 x 6"

5m Rescue Pathway

WRS INTERNATIONAL



£00
\$3696
€3253

23kg
50.6lb

650kg
1430lb

5 x 1.4 x 0.15m
197 x 55 x 6"

Evac Sled

WRS INTERNATIONAL



£00
\$2073
€2682

8.5kg
18.7lb

160kg
352lb

3 x 1.4 x 0.15m
118 x 55 x 6"

10m Walkway
1530008602

ZODIAC MILPRO



N/A

57.5kg
126.8lb

1330kg
2926 lb
95kg
2255 lb

10 x 1.4 x 0.1m
394 x 55 x 4"
1.65 x 0.45 x 0.3m
65 x 14 x 10"

10m Walkway
1530008602

ZODIAC MILPRO



N/A

57.5kg
126.8lb

1330kg
2926 lb
95kg
2255 lb

10 x 1.4 x 0.1m
394 x 55 x 4"
1.65 x 0.45 x 0.3m
65 x 14 x 10"

NEW- Insert Inflation options

www.rescuemagazines.com

INFLATABLE PONTOONS & PATHS

AIR CAPACITY	MAX PRESSURE	INFLATION OPTIONS & TIMES HAND ELECTRIC HP/CABA	MATERIALS:	TOP SURFACE GRIP	INFLATION CHAMBERS	REGULATOR / HOSE	SAFETY PRV/ DUMP VALVE	MANUAL/POWER PUMP	HANDLES / GRAB CORD	TOW / CONNECT EYES	REPAIR KIT / POCKETS	CARRY BAG/VALISE	REFLECTIVE	COLOUR OPTIONS	NOTES	WWW.
	0.2 BAR 3 psi	■ ■ ■ <1min	Neoprene/PVC	NO	2	■ □	- ■	■ -	■ -	2 0	■ ■	■ ■	NO			tulmar.com
	0.2 BAR 3 psi	■ ■ ■ 2-3mins	Neoprene/PVC	NO	2	■ □	- ■	■ -	■ -	2 0	■ ■	■ ■	NO			tulmar.com
1321 L 47cuft	0.5 BAR 7.25 psi	■ ■ 2.9mins	PVC	■*	1	□ □	■ ■	- ■	■ 6	4 4	- -	■ ■	■	■	* Grip provides by strips at intervals along the top	vetter.de
2196 L 78cuft	0.5 BAR 7.25 psi	■ ■ 4.9mins	PVC	■*	1	□ □	■ ■	- ■	■ 8	4 4	- -	■ ■	■	■	* Grip provides by strips at intervals along the top	vetter.de
3360 L 119cuft 7.4mins	0.5 BAR 7.25 psi	■ ■	PVC	■*	1	□ □	■ ■	- ■	■ 10	4 4	- -	■ ■	■	■	* Grip provides by strips at intervals along the top	vetter.de
450 L 15.9cuft <1min	0.7 BAR 10 Psi	■ ■	PVC	NO	1	□ □	- ■	- ■	NO □	□ □	- ■	■ ■	□	■		wrsinternational.com
650 L 23cuft 1-2mins	0.7 BAR 10 Psi	■ ■	TPU	NO	1	□ □	- ■	- ■	■ 4	8 -	- ■	■ ■	□	■		wrsinternational.com
1000 L 32.5cuft >2mins	0.7 BAR 10 Psi	■ ■	TPU	NO	1	□ □	- ■	- ■	■ 4	12 -	- ■	■ ■	□	■		wrsinternational.com
350 L 12.4cuft 1min	0.7 BAR 10 Psi	■ ■	TPU	NO	1	□ □	- ■	- ■	NO 6	- -	- ■	■ ■	□	■	Folds flat to create a platform for easy loading	wrsinternational.com
2196 L 78cuft 4.9mins	0.5 BAR 7.25 psi	■ ■	PVC	■*	1	□ □	■ ■	- ■	■ 8	4 4	- -	■ ■	■	■	* Grip provides by strips at intervals along the top	zodiacmilpro.com
2196 L 78cuft 4.9mins	0.5 BAR 7.25 psi	■ ■	PVC	■*	1	□ □	■ ■	- ■	■ 8	4 4	- -	■ ■	■	■	* Grip provides by strips at intervals along the top	zodiacmilpro.com

INFLATABLE OPEN-ENDED SLEDS & WATERCRAFT

Oceanid RDC. Invented in 1996 in Washington State in response to a request for a specialist ice-rescue craft, the Oceanid RDC has lately spawned many copies. This image shows the optional transom for mounting an outboard which a number of larger sleds/rafts also offer.



This GUIDE covers the more 'dynamic' rescue sleds, and open-transom rafts. Some of these are described as 'sleds' some as 'rafts' but in all cases they will have an open ended stern or water-entry opening in the case of the *Oceanid RDC* style rafts. These can be powered though that generally requires some modification like the *RDC* above since the stern is open on all the models in this GUIDE. More often they are paddled as with the *MFC Sled* on the left or pushed/towed/'punted' over water, ice, mud or sand in order to reach a person in difficulties. Such craft have inflatable sponsons or side-walls and an open back that allows easier ingress into or egress out of the water. These are 'wet' craft and not to be confused with inflatable boats or rafts which are designed to keep the occupants dry-ish. Inflatable sleds and open backed-rafts require the occupants to be fully kitted for potential water entry. Materials were discussed in part 1 and these sleds/rafts are the same materials and construction - incredibly robust welded PVC/TPU or glued Hypalon, often as a Double Wall Fabric (DWF) and drop stitched on the most robust part of these craft, the floor/hull. Given the abuse these things get from ice, gravel, flooded wire fences and brick walls etc. some have extra reinforcing strip along the underside of sponsons like the *NRS* craft. Failing that, all craft come with a repair kit. As with most things in life, you get what you pay for, so consider the materials, construction warranty and pedigree of the manufacturer and craft before committing to a purchase.

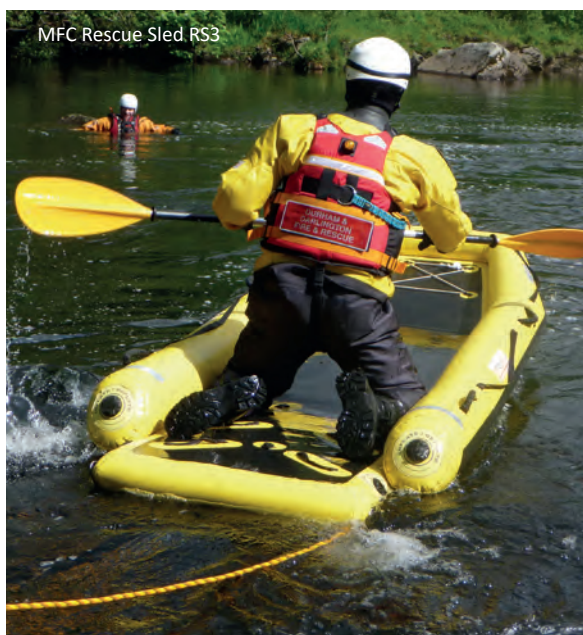

MFC Rescue Sled RS3

The point of the open stern of these sleds is to enable easy loading of a rescuer and/or a casualty and human kick-power if necessary so there is some duplication of the work of the paths we featured in the last GUIDE especially in the larger sizes which are more appropriate for flood evacuation than they are swiftwater. However, unlike flat platforms, sleds have a degree of occupant protection from their sponsons and are designed to be used in fast moving flood water, broad slow-moving flood water and /or complex swiftwater and most can negotiate quite narrow channels. This style of craft may sit between the passive platforms and inflatable boats but it actually evolved last and as a consequence

of adding a protective sponson like a RIB collar to an inflatable base and in most cases, raising the bow profile slightly. In its simplest form, you can see that this *CheckRaft* has a 3-sided sponson ratcheted to the deck of the same platform we listed in last issue's GUIDE. Indeed a market leader that rarely gets a mention outside of the manufacturers boardrooms is *Henshaw Inflatables*, which is yet another UK pioneer that, since the 70's had been making rib collars/sponsons rather than entire boats. *Henshaw* either supply their collars or assist in conjoining the two products but you won't see an entire *Henshaw* boat or craft. They are however, now part of the *Wing Group*, *Bill Wing's* inflatable raft company and they certainly DO make water craft.

images in this article
not to scale

www.rescuemagazines.com



ABOVE: The IRB-style WRS Mega Sled

The two original and distinctly different boat designs in this Guide evolved on opposite sides of the Atlantic - *MFC* in Wales evolved their open-stern Sleds from their inflatable paths while Kris Walker at *Oceanid* in Washington State modified the classic whitewater raft to create the narrow, double-ended *RDC* much lauded by our old mate, the late, great, co-founder of *Rescue3* and water rescue oracle Jim Segerstrom. Having been unopposed in the market for at least 15 of its 25 year history, the *RDC* is now copied by most of the major players in inflatables - high praise indeed although Chinese company Yushan Yijia using the trade name *EJIA* have some nerve in not only copying and calling their own model an *RDC* they even use *Oceanid's* traditional sunburst advert template and other manufacturer's photos implying it's their product! We haven't included *EJIA* craft but their range is represented by some companies here and as always, Chinese, Taiwanese and Vietnamese manufacture can be as good as any, they just need to cut out the blatant copying. *RDC*-Style craft are on p48/49.

The red *WRS* model above demonstrates the most obvious hybrid between a platform and an inflatable rescue boat with sponsons/gunwales that are much larger than the *MFC sleds* and with a bow tapered like a boat - contrast this with *CheckRaft's* and *Sit Ltd's ResQRaft's* rather less hydrodynamic square 'bow' and you can tell which craft is designed for faster flowing water and which are flat-water evacuation craft. Because the sponsons are quite sizeable on all these craft the inner working space is severely restricted in comparison to the uncluttered surface of a platform so the 51"/120cm width of a *2Tinga RIT* for instance equates to only 20"/51cm of working deck width.

The narrower beam sleds like the pioneering *MFC Rescue Sled* and the *WRS X-Sled* opposite



not only work well in fast moving rivers they are excellent in flooded urban streets and alleyways.

The last style of craft to note is the *Tip-Board* (overleaf) which we have included in the *RDC*-style craft table because it can be tipped to approach the casualty as all *RDC*-style craft can and especially for ice rescue. The *TipBoard* could be said to be a true water 'sled' because it has hybridised a flat platform with an *IRB* sponsons which are sharply angled at the stern to create what, on snow, would be sled/akja push handles or, if driving a

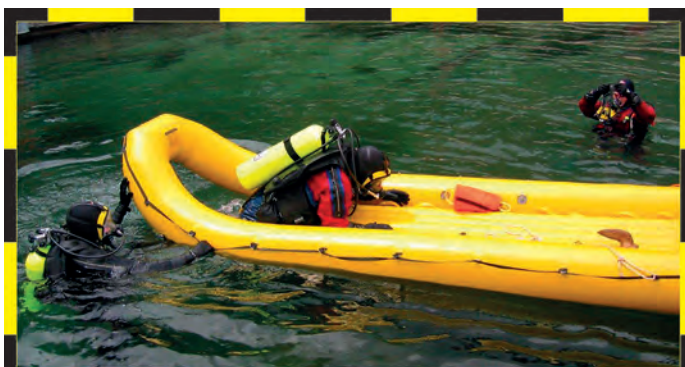

+1 (208) 322 3600

oceanid.com

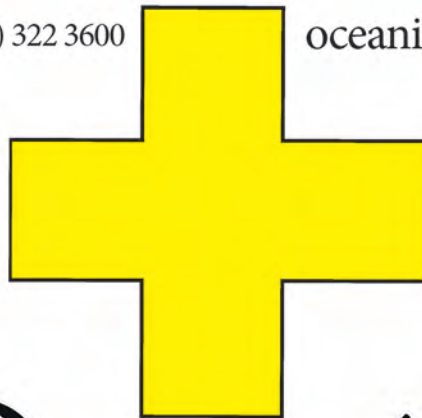

Oceanid™

WATER RESCUE CRAFT





dog sled team, handles with which to hang on for dear life. During the rescue of an incapacitated or severely weakened in-water victim, the stern can be tipped backward over the head and shoulders to facilitate easier loading while the rescuer has handy foot recesses from which to perform the lift. As the casualty comes out of the water the rescuer can simply 'fall' back into the craft with the levelling of the craft acting like a lever to assist with the lift or in this case, on ice or mud, a colleague can assist by levering down the bow to help pull the casualty inboard. We see a lot of these rescue design concepts by technical students in particular but they don't often seem

to reach it to market so it's good to that Dutch safety company Honor have taken this on. Of course in this case, the casualty extraction process is very similar to the Oceanid RDC albeit that the bow is not often fully tipped during loading. Most sled loading is like a seal or penguin getting onto an ice flow only without their degree of momentum. The casualty can assist by swim-kicking at the same time as the rescue hauls them on-board as can be seen in the 2Tinga pic right.



NRS ASR 155

The shallow rake we see on sleds helps deal with waves but the higher rake we see on craft like the RDC, the ASR155 on the left and the Tip-Board above can also allow the craft to negotiate fast flowing water without having tons of water washing over the bow but that's obviously not the case with the open bow beneath the raked bow of the RDC designed to allow water through and rescuers to position over an in-water casualty or to slip more easily into the water direct from the floor of craft. The rake also allows the craft to be pushed up against obstacles and in the image below the face of a low-head dam/weir can be searched for an entrapment and the open bow decreases the pressure trying to force the craft away as it instead washes over the craft's floor.

High-rake craft will also 'bend' a little at the change of angle to provide an extra few inches of proximity to the target and in the absence of a hole with which to funnel an in-water casualty, the



NRS ASR 155



raked solid bow is less inclined to smash an in-water casualty in the head as the two approach each other, possibly closing at speed in a high flow.

VALVES

All of these craft inflate through a valve which may only allow air flow inwards (inlet check valve) so you don't lose air pressure should the valve cap not be in place or the pump/cylinder hose come off during inflation. We have differentiated four types in our tables: Safety or Pressure Relief Valves, 1-Way, 2-Way and Dump valves but for this GUIDE they are mostly 2-Way and PR Valves. Safety or **Pressure Relief Valves** like the Leaffield A6 refers to its ability to purge air should you OVER-inflate (Northern Diver 2-Way and PR Valves shown in the image above). This can be



the case particularly with compressed air cylinders so the safety valve will allow air to force its way out of the valve rather than bursting the seams of the craft. A **2-way** valve allows inflation and deflation - as in the valve on the left in the image above. Some, like the Leaffield A/B/C7 and Halkey-Roberts valve, have a cap and then an interior sleeve that you rotate a quarter or



half turn to alternate between inflate and deflate while others have a second screw-off collar beneath a non-return inflation section. When unscrewed, this allows air to exit freely. Deflation needs to be fast so that the craft can be rolled and stowed or moved ASAP ready for the next task so these 2-way valves are

doubling as Dump or rapid air expulsion valves which tend not to be present on most sleds, boats and rafts. True dump valves, in the diving sense, can of course be a push button affair but this is obviously not the case for inflatable craft where they are regular screw-top release if they are present at all. Bear in mind that most craft have more than one chamber so deflation can be a more time consuming process than inflation. Craft like the Polar75, 2Tinga and Wing Ice Skiff have one-way baffles between chambers that means a single inflation point inflates all chambers. Many craft have both sets of

INFLATABLE OPEN-ENDED SLEDS/WATERCRAFT



valves sometimes next to each as with the *TIPBoard* and *WRS* and sometimes separate as with the *MFC Sleds* and *2Tinga Craft* where the inflate-deflate valves are located on the ends of each sponson and on the floor. Most valves are designed to use manual pumps and BA cylinders, but some, and especially the dump valves are large enough to use a powered blower or even a vacuum cleaner in reverse. Professional battery blowers are an excellent idea because they have numerous other uses including cleaning/drying the craft. They are also unlikely to inflate beyond the pressure limit of the seams because they will struggle to push against over-pressure resistance. Basic dump valves can be used for large-bore pipe/hose inflation but air will escape while you try to screw the cap back on. *2Tinga's* accessory pack shown above, includes a repair kit but also a pressure valve so that you can check the air pressure of your craft exactly and a very useful trigger-gun adapter for a BA line, This goes over the inflation valve and provides very precise start-stop during inflation rather than the more imprecise screwing/unscrewing of a cylinder valve.

LOAD CAPACITIES

Typical load capacities are the same as flat platforms at around 100kg/220lb per square metre on water (more on ice/mud) so for craft about a metre wide you can again gauge their capacity by the length - a 3m sled will take approximately 3 or 4 people. Bear in mind that some have a deeper floor; 6" drop thread instead of 4" and this provides greater capacity per floor area.

'LOAD-BEARING' EYES

Virtually all designs have connection rings that vary in size and strength of attachment depending on their purpose. One or two, like the *TipBoard*, have high strength LIFTING eyes (shown in green in our tables) that enable the entire sled with casualty to be lifted vertically. In some cases handles rather than rings can serve the same purposes. Most craft have medium-size/strength eyes that can be used for towing or positioning of the craft (shown as an orange number) and most have ancillary eyes that are intended for smaller loads such as connecting two craft or attaching equipment. The tow-strength eyes can also be used as tether points for holding position in flowing water.

GRAB / LIFT HANDLES

There are lift or carry handles on most of these models (shown in orange in our tables), these are intended for transport and positioning while the craft

is empty rather than for lifting stretcher style though that is possible with one or two of these sleds like the *Oceanid RDC* and we have indicated this in the NOTES. Unlike the RDC-style rafts, most of the sleds have bespoke handles as distinct from perimeter cord doubling as a handle. Some handles are flat tape, some have solid tubes of ergonomic rubber-like material. Inboard handles (shown in black in our tables) on the floor are to assist in getting on board or for human outboard propulsion as with the *MFC Sled* on the title page.

FLIP TAB/GRAB CORD

Rather than a solid handle some sleds and most RDC-Style rafts have a cord, rope or webbing that runs around the sponson or, in the case of *SIT's ResQraft*, down the length of the floor. Cord or webbing is fastened at intervals to provide a something to grab or attach equipment to during the rescue mêlée. On longer models this can add a kg or more to the weight as it tends to be 7 to 10 mm in diameter for better grip and is heavier when wet.

A **Flip Tab** is a section of webbing or a handle on the underside of the craft to enable it to be more easily righted should it capsize. This tends to be on the broader craft where the sponsons would be out of reach of rescuers in the water but this slimmer RR4 Sled by Northern Diver also has one.

We removed the 'Tactile surface' column that we had for inflatable platforms, not because the sled versions don't have tactile surfaces but because we wanted to expand upon the valves for this GUIDE and sleds tend not to be walked on in the same way as a platform although rescuers still may need to stand up to pull a casualty on-board. Sleds tend to be paddled Canadian-style, knelt down. The tactile surface of most flat platforms provides grip when standing up and to lessen the chance of people and things sliding off the top. Sleds are more of a mixture because, while standing and pulling requires better traction it tends to be by wedging your feet against the sponson than by traction so some have slick surfaces to make it easier to slide a casualty onto the craft.

It is important to reference the key on the next page in order to fully understand the categories and symbols used in the following tables.



The WRS X-Sled (right) was the first to introduce a 'stacked' bow where the rake of the sponsons sit above the solid floor providing enhanced protection from water over the bow while increasing protection of the hull in this vulnerable area. WRS are among two or three to have increased deck height from 4 to 6" but they also managed to decrease weight over similar models by 'fusing' rather than gluing the layers.

KEY to ALL INFLATABLE CRAFT TABLES.....

Any use, feature, accessory or component that is **inherent** in the product is shown as a **solid coloured square** ■■■■

If it's an **OPTION** it is shown as an **outline square** □□□□

A circle ● in the 'USE' columns indicates that this feature is only partially present and/or is OK for that purpose but not ideal.

ORIGIN: The 'manufacturer's country, not necessarily the country of manufacture, If we know it's made in a different country there will be a smaller inset flag eg. these three for Vietnam, South Africa and Taiwan 

COST: a rough guide only - **includes** local taxes/VAT. Varies with exchange rates, extra taxes etc. Unlike our other GUIDE in this issue, most companies here have given a rough price but in the current economic climate (2022) with so many factors affecting product costs, these prices may be subject to quite radical changes. We usually round up to the nearest Pound£/US Dollar\$/Euro€. We have started to quote a US\$ figure in orange which is simply a currency conversion to give an idea of price, it is not the selling price in the US which may have import duties etc. to add.

LOAD CAPACITY: Often quoted as a person load where 4 persons is roughly 750lb but a quite imprecise way to describe load. Most companies will quote a maximum figure which is much lower than its true capabilities especially if used on mud or ice. If you work on 100kg per square metre or 67.2 pounds per square foot you won't tax any of these models. [Note that some don't give a load capacity or indeed air capacity or inflation time citing differences in user expertise, pumps etc. Since even a vague figure would be a useful guide to readers we have included some approximate Volume figures for comparative purposes in italics].

DIMENSIONS: Length by external width by depth/height from ground. This does not include the kick of an angled bow or stern. Height is often the width of sponson tube as many floors are suspended rather than having the tube sat on top.

Internal/Usable Width is the floor width available to use.

The **PACKED** dimensions may be size of the bag rather than the rolled or folded sled but it's close enough.

AIR CAPACITY: The volume of air needed to fill the path to working pressure. This doesn't necessarily correlate to the dimensions (which are external measurements) and vary with different thicknesses of material, resistance, internal components and in particular, temperature. *Figures in italics are our own approximation and could be out by a few hundred Liters.*

MAX WORKING PRESSURE: the pressure at which the path is pumped up and workable, exceeding of which will purge via the safety valve or burst the seams! The base tends to be a higher pressure (avge 5-10psi) compared to the tubes at 2-4psi.

INFLATION TIME: The quickest time is via **compressed air** and where chambers are linked so can inflate from one valve. **CA** is 2-3 times quicker than **electric pump** which may be twice as fast as **hand/foot inflation**. All times are approximate and depend on the temp and how well the path has been packed/unrolled. Times in *italics* are our own estimate based on volume

MATERIALS: Mostly trade names which are variants of treated polyester, PVC and/or Polyurethane in a range of construction layering. Imperial figures showing oz is per square foot eg. 44 and 66oz materials.

CA INFLATION CHAMBERS: Whether the craft can be inflated using **Compressed Air cylinder** and the total number of separate inflation **chambers** including the floor. If the floor is NOT inflatable this will be indicated in the NOTES.

THWARTS or BOLSTERS are tubular seats, supports or partitions separately inflated and not included in the number of chambers figure above. Note that thwarts can increase the outside width of a raft by a few inches as it pushes out from the inside.

GRAB/LIFT HANDLES: **LIFT** Handles shown in **Orange** are on the sponsons and for lifting/shifting as well as holding onto. **GRAB** Handles are in-board and are to self-assisted boarding or for in-water swim propulsion.

FLIP TAB/HANDLE GRAB CORD/WEB FLIP tab or cord to help with righting a capsized craft. **GRAB CORD** is perimeter webbing or more commonly cord or lengths of cord for holding on to or attaching equipment and may be pre-installed or self-tied.

HD-TOW/LT DUTY EYES: metal D-rings and/or web straps and sometime hooks. **LT DUTY** eyes are D-Rings we described in previous GUIDES as 'Link'; eyes which are used to clip in gear, connect rafts together or for threading grab lines etc. but some are easily strong enough for control lines and maybe towing but generally the **LIGHT (LT) DUTY** or connecting eyes are weaker than **TOWing** eyes. **HEAVY DUTY-TOW** eyes can be used for towing, positioning in high-flows and lifting the **EMPTY** craft if positioned appropriately. For any live-load lifting, these are best used with a sling passing through the side-mounted rings and beneath the hull of the raft but this would be a rare event because of the risk of buckling if not sufficiently supported along the hull/floor. Double check the manufacturer's definition of 'lift' when referring to rings and handles; most actually mean lifting an **EMPTY** craft into water, for instance off a dock, before starting the rescue.

PRESSURE RELIEF VALVE: (PRV) This safety, pressure relief or auto-purge valve allows excess air to vent as a result of over-inflation or an excessive compressive load. You may have initially inflated the craft to its limit and then have a temperature or load increase that could rupture the seams if air could not escape

1-WAY CHECK /2-WAY: A one way inlet valve that doesn't allow air to escape. A **2-way** valve is a joint inflation-deflation valve like the Leafield C7 and D7 valves. Usually requiring a twist or unscrewing of a top section to switch between inflation and deflation. A 'wrench' is often required (and supplied) in preference to being able to open by hand.

ACC = ACCESSORIES

CARRY BAG: All of these come with a carry or storage bag but one or two like the WRS can have an enhanced 'pro' bag.

PADDLES - self explanatory!

WARRANTY: Not really an accessory! Shown as manufacturer's warranty but fabric warranty may be separate and approx 5yrs. Shown in **YEARS** and usually subject to conditions. Some raft suppliers have shorter warranty for commercial users as distinct from recreational users. This is aimed at commercial rafting using rafts day in day out and shouldn't really apply to rescue - worth asking for a retail warranty.

SELF BAILING: any water that enters the raft will drain away through holes or gaps in the floor or between the floor and the tubes/sponsons.

VIZ =VISUAL ATTRIBUTES

CUSTOM: Customised Team/Service/Dept decals or printing

REFLECTIVE: As standard ■, or as an option □

OTHER COLOURS: Primary colour of shell/frame with an

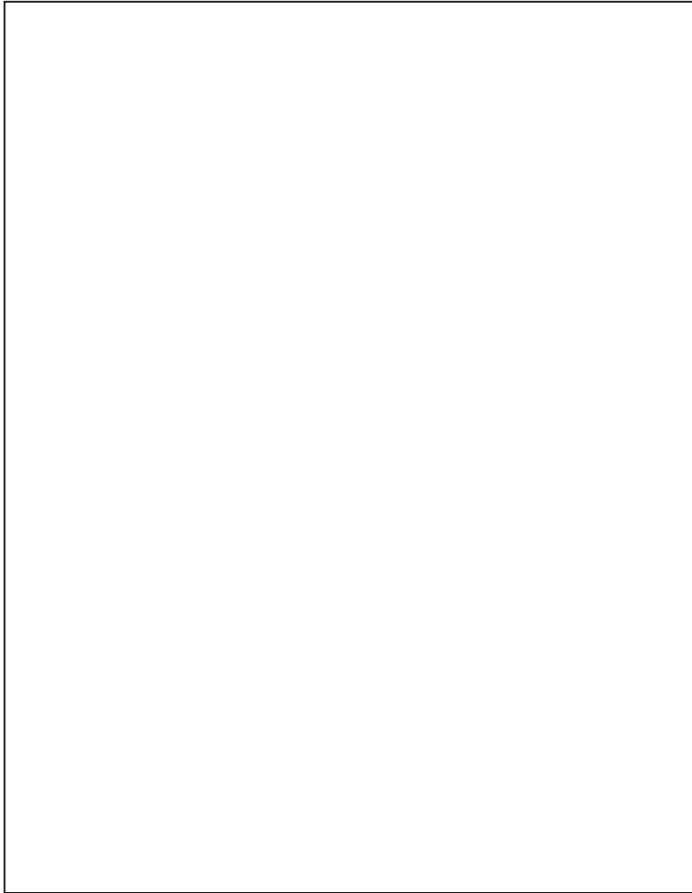

SWIFTWATER RESCUE EQUIPMENT

- Dry suits • Wetsuits • Footwear • Gloves • Helmets
- Life Jackets • Rescue hardware and more...

nrsrescue.com | rescue@nrs.com



RESCUE SLED

INFLATABLE WATER RESCUE CRAFT



MFCInternational
by RESPIREX
ENGINEERED INFLATABLE PRODUCT SOLUTIONS

- Lightweight & easy to manoeuvre
- Excellent stability
- 3, 5, 6, 10 & 15 Person Capacities
- Can be used in very shallow water (5cm or more)
- Available in Hypalon or TPU materials
- Extremely tough & durable
- Highly customisable
- Manufactured in the UK

W: mfc-international.com
T: +44 (0)1443 433 075
E: sales@mfc-international.com

Images NOT to Scale
 □ □ □ = Option
 ● = PARTIAL FEATURE and/or OK BUT NOT IDEAL
COST: Approx, INC local tax/VAT
N/A = info Not Available/not given
INFLATION TIME: Hand Pump/ Compressed Air
VALVES PRV=Pressure Relief Valve

MODEL	COMPANY	ORIGIN	COST inc tax / VAT	WEIGHT	LOAD CAPACITY Kg/Sq Metre lb/Sq Foot	DIMENSIONS L x W x H EXTERNAL INTERNAL/USABLE WIDTH	PACKED SIZE
	RIT Craft 2-TINGA		\$3600	27.3kg 60lb	682kg 1500lb	3.7 x 1.2 x 0.48m 144 x 48 x 19" 0.51m 20"	46 x 36 x 50 18 x 14 x 20
	Craft-Boat Conversion CHECKMATE FLEXIBLE ENGINEERING		N/A	28kg 61.6lb	500kg 1100lb >100kg >67.2lb	5 x 1.4 x 0.25m 197 x 55 x 10" 1.06m 55"	90 x 42/50 35cm 35.4 x 19.7 13.7"
	Rescue Sled WRW001/01 MFC INTERNATIONAL		>£1350 >£999 >\$1755 >\$1300	15/17kg 33/ 37.4lb	240kg 528lb	2.16 x 1.17 x 0.4m 101 x 46 x 16" 0.7m 28"	88 x 35 x 30 36 x 14 x 10
	Rescue Sled WRW002/01 MFC INTERNATIONAL		>£1699 >£1100 >\$2210 >\$1430	17.5/ 19.5kg 38.6/ 43lb	400kg 882lb	3.31 x 1.17 x 0.4m 130 x 46 x 16" 0.7m 28"	88 x 48 x 30 35 x 14 x 10
	Rescue Sled RW0169/01 MFC INTERNATIONAL		>£1900 >£1300 >\$2470 >\$1690	18.5/ 20.5kg 38.6/ 45.1lb	480kg 1056lb	3.97 x 1.17 x 0.4m 156 x 46 x 16" 0.7m 28"	88 x 48 x 30 35 x 14 x 10
	Rescue Sled WRW003/01 MFC INTERNATIONAL		>£3800 >\$2500 >\$5000 >\$3250	31/ 35kg 38.6/ 68.2lb	800kg 1764lb	4 x 1.9 x 0.56m 158 x 47/75 x 22" 1.2m 47"	88 x 55 x 30 35 x 22 x 10
	Rescue Sled WRW005/01 MFC INTERNATIONAL		>£4200 >£2900 >\$5500 >\$3780	45/ 50kg 99/ 110lb	1200kg 2646lb	5 x 2.31 x 0.77m 197 x 63/91 x 30" 1.6m 63"	88 x 70 x 50 35 x 28 x 20
	RR3 NORTHERN DIVER		£1069 £1489 £1691	22kg 48.4lb	650kg 1430lb	3 x 1.16 x 0.3m 118 x 28/46 x 12" 0.7m 28"	90 x 40 x 30 35.4 x 15.8 x 10
	RR4 NORTHERN DIVER		£1096 £1765 £1885	31kg 68.2lb	750kg 1650lb	3.6 x 1.16 x 3.8m 142 x 46 x 15" 0.7m 28"	95 x 50 x 50 37.4 x 19.7 19.7"
	RR Max Raft NORTHERN DIVER		£1836 €2326	37kg 81.4lb	1000kg 2200lb	3 x 2 x 0.38m 118 x 51/79 x 15" 1.3m 51"	130 x 60 x 40 51 x 23.6 x 10

INFLATABLE OPEN-ENDED SLEDS/WATERCRAFT

	AIR CAPACITY INFLATION TIME	MAX WORKING PRESSURE	MATERIALS: TUBES/SPONSONS FLOOR/DECK	INFLATION		LOADING		VALVES		EXTRAS		VIZ		NOTES	WWW.		
				CA INFLATION CHAMBERS	REGULATOR / HOSE	MANUAL/POWERPUMP	GRAB/LIFT HANDLES	FLIP TAB / GRAB CORD	TOW/HD-LIFT/LINK EYES	SAFETY PRV / DUMP	1-WAY / 2-WAY	CARRY BAG / PADDLES	REPAIR KIT/ WARRANTY			REFLECTIVE/ CUSTOM	COLOUR OPTIONS
6cm 2"	1132 L 40cuft 1-3mins	0.2 BAR 3 PSI	PVC. drop-stitch deck	3 ■	■	-	8 0	■	2 4 3	-	■	10 ■	□	-	Note 2Tinga have a flat platform called a RIT-Sled but is not a 'sled' as defined in this article	2tinga.ca	
0 x 7 x	1700 L 60cuft 3-4mins	0.55 BAR 8 PSI	Neoprene coated nylon. drop-thread deck	3 ■	□	□	0 0	-	6 - 4	-	■	N/A ■	□	-	* 6 of these eyes are for joining to another raft or platform NOT towing	checkmateflex.com	
0cm 2"	530 L 18.7cuft 2-3mins	0.2 & 0.4 BAR 3.25 & 6 PSI	Hypalon TPU drop-thread deck	2 ■	■	□	5 6	■	8 - 4	-	■	2 ■	2 ■	□	■	comes with throwline with rubber quoit. Leafield Valves. Optional rear bolster and storage pockets	mfc-international.com
2cm 2"	670 L 23.7cuft 3mins	0.2 & 0.4 BAR 3.25 & 6 PSI	Hypalon TPU drop-thread deck	2 ■	■	□	5 6	■	8 - 4	-	■	2 ■	2 ■	□	■	comes with throwline with rubber quoit. Leafield Valves. Optional rear bolster and storage pockets	mfc-international.com
5cm 4"	710 L 25cuft 3mins	0.2 & 0.4 BAR 3.25 & 6 PSI	Hypalon TPU drop-thread deck	2 ■	■	□	5 6	■	8 - 4	-	■	2 ■	2 ■	□	■	comes with throwline with rubber quoit. Leafield Valves. Optional rear bolster and storage pockets	mfc-international.com
5cm 4"	2000 L 70.6cuft 3mins	0.2 & 0.4 BAR 3.25 & 6 PSI	Hypalon TPU drop-thread deck	5 ■	■	□	5 12	■	8 - 4	-	■	2 ■	2 ■	□	■	comes with throwline with rubber quoit. Leafield Valves. Optional rear bolster and storage pockets	mfc-international.com
2cm 11"	3800 L 134.2cuft 3mins	0.2 & 0.4 BAR 3.25 & 6 Psi	Hypalon TPU drop-thread deck	5 ■	■	□	5 16	■	8 - 4	-	■	2 ■	2 ■	□	■	comes with throwline with rubber quoit. Leafield Valves. Optional rear bolster and storage pockets	mfc-international.com
0cm 12"	approx 630 L 22.2cuft 1 - 3mins*	0.35 & 0.7 BAR 5 & 10 PSI	1.2mm PVC or Orca Hypalon drop-stitch deck	3 ■	□	□	4 6	-	4 - 7	-	■	■	2 ■	□	■	*Power pump to Hand Inflation time calculated at 50 pump strokes per minute	ndiver-rescue.com
0cm 7 x	approx 800 L 28.3cuft 1- 3-4mins*	0.35 & 0.7 BAR 5 & 10 PSI	1.2mm PVC or Orca Hypalon drop-stitch deck	3 ■	□	□	4 9	-	4 - 15	-	■	■	2 ■	□	■	* Power pump to Hand Inflation time calculated at 50 pump strokes per minute	ndiver-rescue.com
0cm 5.8"	1550 L 54.7cuft 1.5-5min	0.35 & 0.7 BAR 5 & 10 PSI	1.2mm PVC drop-thread deck	4 ■	□	□	5 4	■	13 - ?	-	■	■	1 ■	□	■	*Power pump to Hand Inflation time calculated at 50 pump strokes per minute	ndiver-rescue.com

Images NOT to Scale
 □ □ □ = Option
 ● = PARTIAL FEATURE and/or OK BUT NOT IDEAL
COST: Approx, INC local tax/VAT
N/A = info Not Available/not given
INFLATION TIME: Hand Pump/ Compressed Air
VALVES PRV=Pressure Relief Valve

	MODEL	COMPANY	ORIGIN	COST inc tax / VAT	WEIGHT	LOAD CAPACITY Kg/Sq Metre lb/Sq Foot	DIMENSIONS L x W x H EXTERNAL INTERNAL/USABLE WIDTH	PACKED SIZE
	X-Sled 115	NRS		\$2495	30.5kg 67lb	480kg 1056lb	3.66 x 1.22 x 0.36m 144 x 48 x 14" 0.71m 28"	85 x 35 x 30 33.5 x 13.8 x 12
	Ionic Extreme Sled	SAFEQUIP		£1700 \$2380 €2040	23.8kg 52.4lb	650kg 1430lb	3 x 1.2 x 0.35m 118 x 47 x 14" 0.7m 27.6"	90 x 30 x 30 35.4 x 12 x 12
	Ionic Titan Sled SAF38070	SAFEQUIP		£2160 \$3025 €2590	25kg 55lb	500kg 1100lb	370* x 1.2 x 0.35m 146 x 47 x 14" 0.7m 27.6"	95 x 30 x 30 37.4 x 12 x 12
	Ionic Xcel X-Raft	SAFEQUIP		£3600 \$5040 €4320	42kg 92.4lb	1000kg 2200lb	3.2 x 2.2 x 0.38m 126 x 87 x 15" 1.44m 57"	100 x 70 x 40 39 x 27.6 x 16
	ResQSLED 3 ResQSLED5 ResQSLED10	SIT Ltd		N/A	23.8kg 52.4lb	650kg 1430lb	3. x 1.2 x 0.35m 118 x 47 x 14" 0.7m 27.6"	90 x 30 x 30 35.4 x 12 x 12
	ResQRAFT10 ResQRAFT15	SIT Ltd		N/A	42kg 92.4lb	1000kg 2200lb	3.2 x 2.2 x 0.38m 126 x 87 x 15" 1.2m 47"	90 x 30 x 30 35.4 x 12 x 12
	Mega Sled	WRS INTERNATIONAL		£ \$2667 €2667	7.4kg 16.3lb	220kg 484lb	2 x 1 x 0.35cm 79 x 39 x 14" 00m 00"	120 x 60 x 30 47 x 23.6 x 12
	X Sled	WRS INTERNATIONAL		£2147 \$2300 €2553	20kg 44lb	350- 580kg 770- 1276lb	3.55 x 1.2 x 0.24m 118 x 55 x 6" 00m 00"	100 x 50 x 40 39.4 x 19.7 x 15.75"

INFLATABLE OPEN-ENDED SLEDS/WATERCRAFT

	AIR CAPACITY INFLATION TIME	MAX WORKING PRESSURE	MATERIALS: TUBES/SPONSONS FLOOR/DECK	INFLATION		LOADING			VALVES		EXTRAS		VIZ		NOTES	WWW.	
				CA INFLATION CHAMBERS	REGULATOR / HOSE	MANUAL/POWERPUMP	GRAB/LIFT HANDLES	FLIP TAB / GRAB CORD	TOW/HD-LIFT/LINK EYES	SAFETY PRV / DUMP	1-WAY / 2-WAY	CARRY BAG / PADDLES	REPAIR KIT/ WARRANTY	REFLECTIVE/ CUSTOM			OTHER COLOURS
0cm 12"	710 L 25 cuft <2mins	0.3 & 0.7 BAR 4 & 10 Psi	PVC drop-stitch deck	3 ■	□	□	-	-	-	-	■	■	3	□	-	Design being changed. Armoured underside to sponsons. Leaffield valves. * Height does not include 20" rise of the angled bow	nrs.com
0cm 12"	860 L 30.4cuft <1min	0.2 & 0.4BAR 3 & 6 psi	'Orca' Hypalon 6" drop-thread deck	3 ■	□	□	7	4	4	-	■	■	5	□	■	Leaffield valves. Height does not include angled bow	safequip.co.uk
0cm 12"	920 L 34.5cuft <2mins	0.2 & 0.4BAR 3 & 6 psi	'Orca' Hypalon 6" drop-thread deck	3 ■	□	□	10	4	4	-	■	■	5	□	■	* length inc 45cm/18" deck extension. Leaffield valves. Height does not include angled bow	safequip.co.uk
5cm 18"	1550 L 54.7cuft <2mins	0.2 & 0.4BAR 3 & 6 psi	'Orca' Hypalon 6" drop-thread deck	5 ■	□	□	8	2	2	-	■	■	5	□	■	Leaffield valves. 6" Deck. * D-Ring under deck can provide flip tab	safequip.co.uk
0cm 12"	860 L 30.4cuft <1min	0.2 & 0.4BAR 3 & 6 psi	'Orca' Hypalon Neoprene-coated 6" drop-thread deck	3 ■	□	□	7	4	4	-	■	■	2	□	■	Leaffield valves	sitltd.co.uk
0cm 12"	1550 L 54.7cuft >2mins	0.2 & 0.4BAR 3 & 6 psi	'Orca' Hypalon 6" drop-thread deck	5 ■	□	□	8	2	2	-	■	■	2	□	■	Leaffield valves. * D-Ring under deck can provide flip tab. Inboard stowage loops	sitltd.co.uk
5cm 14"	450 L 15.9cuft <1min	0.3 & 0.6BAR 3.6 & 9 psi	PVC. 6" drop-stitch deck	3 ■	□	-	2	11	11	-	■	■	?	□	-	Leaffield valves. Flap at stern can be lifted to form a 'transom' style water barrier. 8x Velcro loop stow points	wrsinternational.com
0cm x	700 L 24.7cuft >2mins	0.25 & 0.6BAR 3.6 & 9 psi	PVC. 6" drop-stitch deck	3 ■	□	-	0	-	5	-	■	■	?	□	-	* Height does not include 54cm/21" rise of the angled bow. Leaffield valves. EVA floor friction pads	wrsinternational.com

<p>Images NOT to Scale</p> <p>☐☐☐= Option</p> <p>●= PARTIAL FEATURE and/or OK BUT NOT IDEAL</p> <p>COST: Approx, <u>INC</u> local tax/VAT</p> <p>N/A = info Not Available/not given</p> <p>INFLATION TIME: Hand Pump/ Compressed Air</p> <p>VALVES PRV=Pressure Relief Valve</p>	MODEL	COMPANY	ORIGIN	COST inc tax / VAT	WEIGHT	LOAD CAPACITY Kg/Sq Metre lb/Sq Foot	DIMENSIONS L x W x H EXTERNAL INTERNAL/USABLE WIDTH	PACKED SIZE
	Rescue Tip Board	HONOR-SAFETY		N/A	22kg 48.4lb	500kg 1100lb	2.7 x 1.3 x 0.7m 106 x 57 x 15.7" 0.55m 20"	90 x 50 x 40 35.4 x 19.7 15.7"
	Lifeboat	LANCO		?	25kg 55lb	900kg 1980lb	4.67 x 1.12 x 0.00m 00 x 00 x 00" 00m 00"	70 x 70 x 40 28 x 28 x 15
	RSW Rescue Sled WR0244	MFC INTERNATIONAL		£2500 \$3250	31.5kg 69.3lb	850kg 1870lb	5 x 1.2 x 0.45m 197 x 47 x 17.7" 0.75m 30"	80 x 40 x 30 31.5 x 15.7 x 11.8"
	Polar 75	NAUTIC&ART (CHARGEK inc)		\$7800	32kg 70.4lb	1045kg 2299lb	4.4 x 1.3 x 0.36m 173 x 51 x 14" 0.58m 23"	152 x 152 152cm 60 x 60 x 60
	RR5	NORTHERN DIVER		£1621 \$3000	42kg 92.6lb	850kg 1873lb	4.7 x 1.4 x 0.35m 105 x 55 x 13.8" 0.7m 28"	110 x 60 x 40 43x24x15.7"
	ASR 155	NRS		\$2995	39.5kg 87lb	850kg 1873lb	4 x 1.25 x 0.3m 185 x 49 x 12** 0.64m 25"	122 x 78 x 30 48 x 31 x 11.8"
	RDC Rapid Deployment Craft	OCEANID		\$4900	22.7kg 50lb	>909kg >2000lb	4.68 x 1.22 x 0.3m 184 x 48 x 12" 0.56m 22"	91.2 x 61 x 30 36 x 24 x 11.8"
	Ionic Explorer Sled	SAFEQUIP		£2250 \$3150 €2700	22kg 48.4lb	>500kg >1100lb	4.6 x 1.42 x 0.3cm 181 x 56 x 12" 0.82m 32"	80x40x25 31.5x16x10
	ResQsled Endurance SIT38042	SIT Ltd		N/A	20kg 44lb	>500kg >1100lb	4.6 x 1.42 x 0.3cm 181 x 56 x 12" 0.82m 32"	80x40x25 31.5x16x10
	SKF-ICE	WING INFLATABLES		\$10000	27.3kg 60lb	909kg 2000lb	4.72 x 1.22 x 0.3cm 186 x 48 x 12** 0.61m 24"	81 x 38 x 40 32x15x16

INFLATABLE OPEN-ENDED RDC-STYLE RAFTS

	AIR CAPACITY INFLATION TIME	MAX WORKING PRESSURE	MATERIALS: TUBES/SPONSONS FLOOR/DECK	INFLATION		LOADING			VALVES		EXTRAS		VIZ		NOTES	WWW.
				CA INFLATION CHAMBERS	REGULATOR/HOSE	MANUAL/POWER PUMP	GRAB/LIFT HANDLES	FLIP TAB / GRAB CORD	TOW/HD-LIFT/LINK EYES	SAFETY PRV / DUMP	1-WAY / 2-WAY	CARRY BAG/ PADDLES	REPAIR KIT/ WARRANTY	REFLECTIVE/ CUSTOM		
0cm 7' x	570 L 20cuft 15-30sec	N/A	N/A drop-stitch deck	?	<input type="checkbox"/>	<input checked="" type="checkbox"/>	11	<input checked="" type="checkbox"/>	4	-	-	?	<input type="checkbox"/>	-	Can be purchased with an electric SeaBob hand-held waterjet * with BA cylinder	honor-safety.com
0cm .7"	?	?	PVC-coated polyester	3	<input type="checkbox"/>	<input type="checkbox"/>	40	<input checked="" type="checkbox"/>	21	-	?	?	<input type="checkbox"/>	?	*20 external grab handles (via rope) can be used as lift ponts	lanco.eu
5cm 14"	2000 L 70.6cuft 3mins	0.2 & 0.4 BAR 3.25 & 6 Psi	Hypalon TPU drop-thread deck	3	<input type="checkbox"/>	<input type="checkbox"/>	10	<input checked="" type="checkbox"/>	8	-	<input checked="" type="checkbox"/>	2	2	<input type="checkbox"/>	comes with throwline with rubber quoit. Leafield Valves	mfc-international.com
x 0"	1100 L 40cuft 20sec*	0.24 & 0.8BAR 3.5 & 12 Psi	40oz Hypalon. drop-thread deck	3	<input type="checkbox"/>	<input type="checkbox"/>	6	<input checked="" type="checkbox"/>	-	-	<input checked="" type="checkbox"/>	5	<input type="checkbox"/>	-	opening=81x46cm *Single inflation point. Height does not include 73° rake	nacorp.ca
0cm 7"	1000 L 35cuft 1- 3-4mins*	0.35 & 0.7 BAR 5 & 10 Psi	DWF/PVC drop-stitch deck	3	<input type="checkbox"/>	<input type="checkbox"/>	6	<input checked="" type="checkbox"/>	-	-	<input checked="" type="checkbox"/>	1	<input type="checkbox"/>	-*	*Power pump to Hand Inflation time calculated at 50 pump strokes per minute. *Custom colours	ndiver-rescue.com
3cm 3"	960 L 34cuft 1-2mins	0.3 & 0.7 BAR 4 & 10 Psi	PVC drop-stitch deck	5	<input type="checkbox"/>	<input type="checkbox"/>	32	<input checked="" type="checkbox"/>	16	-	<input checked="" type="checkbox"/>	3	<input type="checkbox"/>	-	* Height does not include 24" rise of the angled bow and stern. Armoured underside to sponsons. Can be hoisted under load. Leafield valves	nrs.com
30cm 2"	1133 L 40cuft <1min	0.2 BAR 3 Psi	35 oz. PU/PVC coated Polyester (Dacron). Drop-thread deck	3	<input type="checkbox"/>	<input type="checkbox"/>	0*	<input checked="" type="checkbox"/>	26	-	<input checked="" type="checkbox"/>	12	<input type="checkbox"/>	-	Halkey Roberts & Incept PR Valves. Can be suspended/hoisted while loaded. *Perimeter cord 'handles' load=>2500lb/1136kg access hole = 22x40"	oceanid.com
cm 0"	860 L 30cuft >1min	0.2 & 0.6BAR 3 & 9 psi	'Orca' Hypalon 6" drop-thread deck	3	<input type="checkbox"/>	<input type="checkbox"/>	12	<input checked="" type="checkbox"/>	14	-	<input checked="" type="checkbox"/>	2	<input type="checkbox"/>	<input checked="" type="checkbox"/>	Leafield valves	safequip.co.uk
cm 0"	860 L 30cuft >1min	0.2 & 0.6BAR 3 & 9 psi	'Orca' Hypalon. 6" drop-thread deck	3	<input type="checkbox"/>	<input type="checkbox"/>	12	<input checked="" type="checkbox"/>	14	-	<input checked="" type="checkbox"/>	2	<input type="checkbox"/>	<input checked="" type="checkbox"/>	Leafield valves	sitltd.co.uk
1cm 5"	950 L 33.5cuft >1min	0.3 BAR 4.5 psi	33oz polyester scrim Polyurethane. drop-thread deck	5	<input type="checkbox"/>	<input type="checkbox"/>	0	<input checked="" type="checkbox"/>	-	-	<input checked="" type="checkbox"/>	5	<input type="checkbox"/>	-	Price includes Motor transom. *rise of bow/stern =30". Chambers linked to Inflate as 1 *Grab cord rigged to act as lift and shift handles. Custom colours	inflatable-solutions.com

Inflatable NON-POWERED RAFTS

MAIN PIC: Mustang Survival's MRR130 raft made by specialist raft company Wing Inflatables. This is a craft specifically made for rescue from a swiftwater rafting origin unlike most of the UK models (like the MFC sled below which forms the basis of their fully enclosed raft) are much more 'work-boat' oriented and redesigned for rescue from that perspective. Unlike North America the UK doesn't have a huge swiftwater rafting community or indeed the vast lengths of whitewater rapids to support it. It does however, have masses of much narrower, fast moving channels that can and do become raging torrents in the blink of an eye during storms.

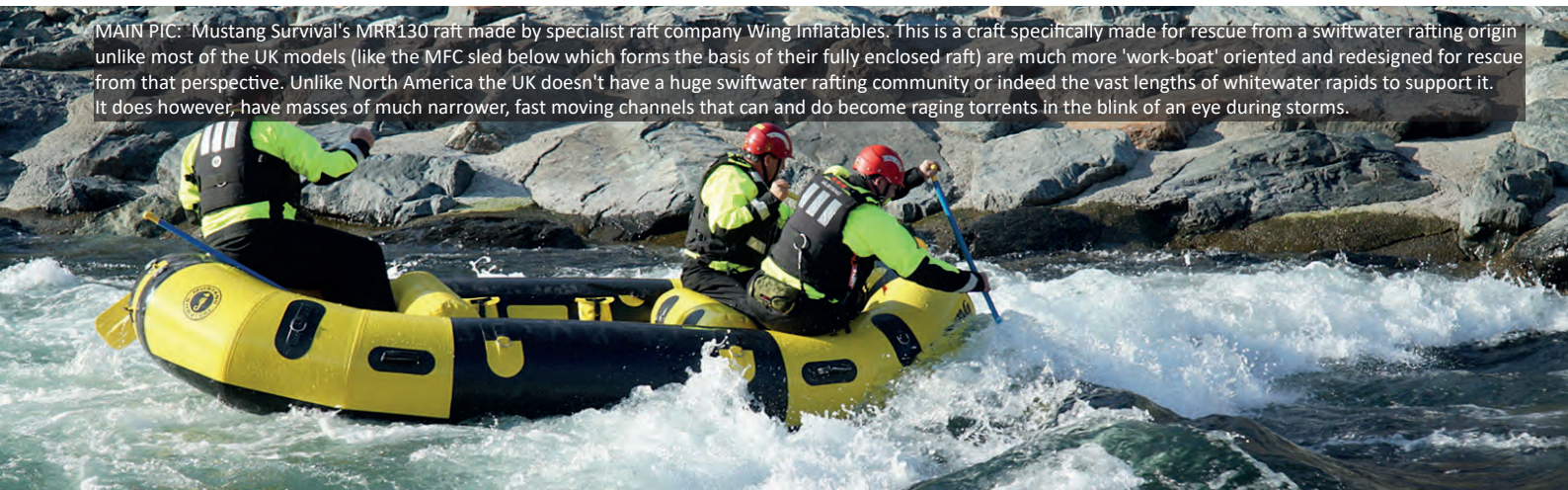

After covering the open-backed/stern sleds and rafts in TECHNICAL RESCUE#82 we've switched to WSAR for this one because non-powered rafts evolved with wilderness teams working true swiftwater on their patch. 'Evolved' is not the correct word because the craft in use are very close to the recreational models aside from reinforcements and extra handles and rings and it's more accurate to say that the open-ended sleds (as exemplified by the MFC model in the picture on the right) and Oceanid-style rafts (as shown in the ad far right) evolved out of these 'puffier' swiftwater-style rafts. While the majority of rescue agencies have moved towards the sled and Oceanid styles, there is still a big place for conventional rafts in a rescue inventory either because there are swiftwater risks in or near your response area or because they are used for casualty rescue and evacuation in the event of flooding. This is because rafts, with larger sponsons completely surrounding the deck, provide better protection for the raft occupants. We have only listed models that are marketed to or used by rescue agencies and that do not have an inherent ability to mount an outboard because those will be included in our GUIDE to Powered IRBs.

However, those GUIDES will not include rafts and catarafts that can be retrofitted with a frame capable of mounting an engine - there would be just too many to mention. Back to the sponsons on swiftwater rafts and while they provide greater protection than open ended craft, they won't necessarily keep everyone bone-dry because many, especially if they have an I-beam

RAFT VS SMALL OPEN-STERN SLED/RAFT

- Both Self bail,
- Raft has more stability so better for bigger water,
- Raft with larger tubes is more forgiving so less training to keep upright.
- Raft has larger carrying capacity,
- Sled is lighter to carry in,
- Sled easier to self rescue after capsiz,
- Sled easier to load victim from water into boat,
- Sled can be paddled solo so less rescuers at risk.

RAFT VS LARGER OPEN-STERN RAFT

- Raft heavier than equivalent open-stern version,
- Rafts offer more rear protection from falling out so more suitable for bigger or higher risk water where you don't want people falling out at all!
- Both offer good stability (raft would be slightly more stable due to added weight, but marginal)
- Open-Stern better for wading wide spread floods and getting on & off the boat
- Raft are generally self-bailing so contaminated water will enter the raft through the floor. (This is a Flood Rescue Consideration)
- Open Stern Raft offers easier water victim access
- Open-Stern easier to climb into after capsiz.



rather than drop-thread or drop-stitch floor, are self baling which means that water can enter and drain through gaps around the union between the floor and the sponsons. **Any craft in this GUIDE not shown as self-bailing are better suited to slow moving flood or still water rather than swift or rough water.** Indeed, Safequip in the UK actually call theirs an 'urban' evacuation raft indicating its true design purpose and while 'urban' is perhaps too limiting for some of the non-self-bailing models, particularly from UK companies, they are certainly designed for a different role to the North American models that can be dealing with epic whitewater conditions as well as general flooding.

One of the differences between true swiftwater and broader

Images in this article
not to scale

www.rescuemagazines.com

remit rescue is that hardcore whitewater rafts tend to have the softer and deeper I-beam inflatable floor but rescue tends more towards a drop-thread floor because it is generally tougher, thinner and more stable to work on bearing in mind that such craft tend to be used more in flood than whitewater.

These rafts are the same materials and construction as the platforms and sleds covered in TECHNICAL RESCUE GUIDES to INFLATABLE CRAFT ie. - incredibly robust welded PVC/TPU or Hypalon, often as a Double Wall Fabric (DWF) and drop stitched on the most robust part of these craft, the floor/hull. Welded is more resilient than glued seams and all inflatables have pressure differentials due to heat increases that can test the seams if over-inflated and overloaded. Some, like WRS and Rocky Mountain Rafts offer drop-stitch or I-beam floors. Given the abuse these things get from ice, gravel, flooded wire fences and brick walls etc. some have extra reinforcing strips along the underside of sponsons like the NRS craft. Failing that, most craft come with a repair kit. As with most things in life, you get what you pay for, so consider the materials, construction warranty and pedigree of the manufacturer and craft before committing to a purchase.

The Mustang/Wing MRR130 model above demonstrates the most obvious difference between a conventional 'whitewater' style raft and the open-ended sleds/rafts covered in TR82 like the yellow MFC sled- the sponsons extend all the way around the craft and because they are quite large the inner working space is more restricted in comparison to the uncluttered surface of a platform or narrow-sponson sled. It's clear that the specialist rescue rafts like the South African ARK range that have been developed from whitewater rafts rather than actually being a whitewater raft with extras, are much narrower. Most of the sleds designed to be used in fast moving water (as well as flooded urban streets and alleyways) were also narrow beamed and it seems that this profile suits many rescue agencies since the ARK range for instance has been designed in conjunction with the Queensland Fire Service in Australia.

The shallow rake we see on sleds helps deal with waves but the higher rake we see on fully enclosed -size rafts like the NRS raft below, allows the craft to negotiate fast flowing water without having tons of water washing over the bow. The rake also allows the craft to be pushed up against obstacles such as mid-stream boulders and low-head dam/weir faces which can be more easily searched or a stranded taken on board because high-rake craft 'bend' a little at the change of angle to provide an extra few inches of proximity to the target. In the absence of an opening in the bow (as per the Oceanid-style craft) with which to funnel an in-water casualty, the raked, solid bow is

less inclined to smash an in-water casualty in the head as the two approach each other, possibly closing at speed in a



Hull of an NRS Raft

WRS[®]
INTERNATIONAL

High Volume Bow and Rocker - With a raised bow height the X-Sled is able to handle tethers in swift water whilst reducing the risk of the bow diving when loaded. The increased volume maintains stability when occupied by a casualty or rescuer.

WRS[®]
INTERNATIONAL

Water Rescue X-Sled
The original and best since 2014, designed in the UK.

www.wrsinternational.com

A CHECKLIST to BUYING AN APPROPRIATE RAFT

by **Mike Croslin**

In discussing boat handling in the rescue environment, the rescuer must first examine the types of boats to be utilized in river rescues and should closely examine the maneuvers those boats can perform in contrast to the total number of river rescue methods for which all river rescue boats are capable of.

Consider all of the pointers below in order to arrive at the most economically feasible and the most efficient type of rescue craft for your specific locality, type and number of incidents and ability to attain and maintain training for your craft in your conditions. It has been observed that manufacturers across the world have, in the past, marketed various kinds of craft as the "ultimate ** answer for river rescue. River teams and individuals should be cautious when considering such claims and perhaps consult other teams that may have similar conditions in their response area.

Generally there are 3 boats teams may have in their cache:

- River Rescue Boats, inflatable.
- IRB style with transom motorized
- Cataraft IRB with transom. Motorized

Motor-capable IRBs are the workhorse of flood and disaster response, flood evacuations, wide flooding areas with no road access, can ascend against the current to approach from downstream, bridge abutments, rocks, trees, can function in waves, strong currents and obstacles with expert training. Can be Zodiac/Avon style or cataracts. Full spectrum, rigid-hull rescue boats are too heavy to surf in choppy, stout currents and have limited capability in class3 and above or inside tree lines at flood stage. Crews must train for motor failure and must carry paddles to R2. Registered swiftwater teams generally have one or two IRBs or motorized cataracts/oar combos in cache in the USA and operators require extensive training annually to stay competent and build experience. Such craft are not useful in remote canyons or rocky, shallow rivers and have significant risk of engine failure, or swamping in big volume or steep gradient rivers. Excellent for wide, flood plain deployment and up to class 3. Again, a great flood evacuation workhorse.

Non-motorized, human powered inflatables

1. The self-bailing "basket" boats. A new variation on the commercial recreational market that have lashed in inflatable floors allowing immediate draining of water and enhanced performance downriver in up to class 5. Medium weight, 100-150lbs or more. Tube size varies depending upon CFS navigating, a Grand Canyon NPS boat will have larger tubes than a Yosemite cataract based on size of waves, hydraulics etc. A USFS river patrol ranger would on the Tuolumne would run

a SOTAR downriver or a Wing as a choice based on support for operations and loads carrying duty, but they are not the best in rescue mode that may require surfing under technical rope control,

2. Framed cataract oar powered or a frameless cataract R2 paddle. If you choose to train and expand boat operators skillsets beyond your local watersheds in the standard R2 paddle format, the frameless cataracts that have immediate rapid floor flush meet the essential high performance criteria in terms of weight, portability, speed, side stability, to both perform as a rescue boat with R2 as a chase boat, or pickoff boat launched with experienced R2 paddlers that are capable of broaching, crossing powerful stout channels to pull victims into a soft protected compartment and exit downriver safely. Some teams use framed cataracts of various sizes, if they have the talent base to row. Many do and this is important on many technical rivers and they make excellent platforms, but they have frames and large oars, which prevent dynamic pickoffs safely and can be traumatic if flipped onto inexperienced passengers or victims...only an issue if experience is lacking.. So for lightness and speed of deployment and downriver chase boat and pickoff capability and maneuverability, the frameless cataracts are superior for rescue crews training in paddle power only...which is faster performance in these excellent maneuvering and forgiving boats.

Because most teams lack the training to safely use a motorized or non-motorized inflatable at the scene of a significant flood or swiftwater event with rescuers on board it is essential that rope based control systems be learned and practiced with the best performing inflatable under shore control with ropes. If its an evac off a car roof in a flooded creek with slight gradient, and the channel has trees and wood galore within range of a short unexpected swim, this is a major event, for even the most experienced operators. These technical rope based systems we use are capable of placing a boat precisely where it is needed safely, with or without rescuers on board, and if you choose to use rescuers, whomever goes is a function of experience and strong swimmer status, not paper/scissors/rock. The rescuer on the boat is in charge of the controllers. He can feel the boat, and guide it better, and I hope at this point we can collectively agree that if he was trained well he or she would choose the lightest, most stable, self bailing platform to control from shore AND to navigate to safety should it be necessary. By my logic and experience this is the most important purchase decision a top tier team will make. It HAS to be the lightest but toughest, boat that is best across all formats of control and is fast under R-2 paddle for chase function safety as well, and in boat pickoff, broaching, grabbing victims into a central closed, self bailing compartment with instant drainage mesh, or lashed inflatable flooring..These criteria will insure best protection for rescuers and if delivering an empty evacuation boat in high risk flows, the best chance of bringing those trapped to safety. My best advice is to use a high performing design that is light, frameless and selfbailing with a reputation for running class 4-5, then add handles and attachments to carry or hold onto into the

interior, including foot braces. Make team members study R2 paddle techniques and practice regularly even if its just in a swimming pool, this alone is the minimal standard for R2 rescuers being sent, they must be drown-proofed and capable of navigating the boat to safety on their own. If a boat can be placed precisely and victims are capable of putting on a PFD, and exiting onto a stable platform, they should be allowed to do so, especially if competent control of the boat in an emergency exit is in question.

COMPARISONS AND CONTRASTS

Once the river rescue team has discovered all of the various types of boats capable of performing river rescues, they then have to make some comparisons between the ability of these boats to perform in their local environment. The river rescue team first has to analyze and determine which kind of boat will be suitable for their particular situation. They must ask themselves the following questions:

1. Are you working in a flat river or waves, currents and rapids?
2. Is your river averaging fairly deep water or shallow areas?
3. Is your river wide or narrow?
4. What is the immediate access to the river.
5. Are there numerous boat launches or are you going to be forced to put their boat into the water through brush, walls, fences and other obstacles?
6. Are there a number of in-water hazards such as strainers, low head dams/weirs, class 3 or above rapids in your response area?
7. What is the ease or difficulty of operation of the type of rescue craft that you are choosing and how well can you train and maintain training of personnel?
8. What is the potential for flipping, broaching, or otherwise turning the boat over within the rescue environment?
9. What types of rescues are usually undertaken on your stretch of river?
10. Will the boat be used for other purposes besides rescue, aka dive platform, body recoveries?
11. Will the boat be suitable for deployment to other areas?
12. What is the available budget?
13. Which of the following rescue maneuvers will the boat be capable of:
 - Pick up rescuers in current
 - Pick up victims entrapped on top of rocks, houses, vehicles, caught in class 3 flood-stage water or higher
 - Effectively maneuver downstream to broach onto an object in order to pick up victims
 - Light enough to suspended on a rope rescue system in the middle of the river
 - Move upstream through class 3 water or better
 - Make effective crossing in current
 - Carry several victims, extremely stable

Mitch Sasser says...

A recent successful rescue from a mid-stream vehicle using a non-powered raft by the Santa Barbara Fire Dept with inflatable raft highlighted the need to ensure your craft is properly inflated, in the rush to deploy to a casualty in difficulties it is all too easy to cut corners leaving you open to swamping and buckling if the casualty numbers or conditions change during the rescue.

Self Bailers are the design to go with BUT...for whitewater and fast flowing/rough water, the self bailing should be via holes all they way around the floor. Some designs only have drain holes punched through the floor material along both sides with the floor being glued to the outer tubes in these designs. I prefer a floor that is laced in and provides drainage 360 degrees around the boat. Without this you risk sudden weight change when taking on water flushing through the self bailing system and without drainage in the bow and/or stern the water accumulation can cause overloading, snapping control lines or ripping lines out of rescuers grip. Having drain holes around the entire raft also helps in self rescue if a flip occurs. Naturally, the larger the tube diameter the more difficult it is to climb on top and right the raft again.

Those who have experience with flips and recovery will note the hand hold and grab options that a laced-in floor provides even at the bow and stern for the rescuer to quickly get up on top of the upside down boat. Some teams may be using pre-rigged flip lines to avoid having to climb up on top of the craft for correcting it. In summary, if the floor and tubes/sponsons are properly inflated with weight properly distributed and with full circumference self bailers, the boats will plane better. My choice in fast-moving water is a cataraft first option, then raft as a second option.

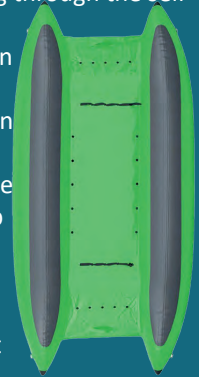

high flow. Also notice that the larger-diameter tubes/sponsons on the whitewater-style rafts mean that the deck may be suspended clear of the water as it is in most catarafts which improves speed and manoeuvrability.

VALVES

All of these craft inflate through a valve which may only allow air flow inwards (inlet check valve) so you don't lose air pressure should the valve cap not be in place or the pump/cylinder hose come off during inflation. We have differentiated three types in our tables: Safety or Pressure Relief Valves, 1-Way, 2-Way and Dump valves but for this GUIDE they are mostly 2-Way and Pressure relief valves. **Pressure Relief Valves** refers to its ability to purge air should you OVER-inflate. This can be the case particularly with compressed air cylinders so the safety valve will allow air to force its way out of the valve rather than bursting the seams of the craft. A **2-way** valve allows inflation and deflation. Some, like the *Leaffield A/B/C* and now *D7* (pic below) and *Halkey-Roberts* valve, have a cap and then an interior sleeve that you rotate a quarter or half





turn to alternate between inflate and deflate while others have a second screw-off collar beneath a non-return inflation section. When unscrewed, this allows air to exit freely. Deflation needs to be fast so that the craft can be rolled and stowed or moved ASAP ready for the next task so these 2-way valves are doubling as Dump or rapid air expulsion valves which tend not to be present on most sleds, boats and rafts. True dump valves, in the diving sense, can of course be a push button affair but this is obviously not the case for inflatable craft where they are regular screw-top release if they are present at all. Bear in mind that most craft have more than one chamber so deflation can be a more time consuming process than inflation. Some rafts have one-way baffles between chambers that means a single inflation point inflates all chambers which is much faster to inflate and deflate than inflating/deflating chambers one after the other - this is more the case with specialist rescue craft than it is with purist swiftwater rafts. Many craft have both sets of valves sometimes next to each other as with the *WRS* and sometimes separated as with *MFC* and *ARK* Craft where the inflate-deflate valves are located on the ends of each sponson and on the floor. Most valves are designed to use manual pumps and BA cylinders, but some are large enough to use a powered blower or even a vacuum cleaner in reverse. Professional battery blowers are an excellent idea because they have numerous other uses including cleaning/drying the craft. They are also unlikely to inflate beyond the pressure limit of the seams because they will struggle to push against over-pressure resistance. Basic dump valves can use large-bore pipe/hose inflation but air will escape while you try to screw the cap back on.

THWARTS/BOLSTERS/SEATS

The narrower raft can be paddled Canadian-style, knelt down but conventional, wider models are paddled from each side,

usually while sitting on one of the soft, inflatable thwarts or bolsters that act as seats as well as increasing buoyancy.

In some models, these are detachable and can be used as makeshift in-water buoyancy aids in the event of a person-overboard situation. The 'fatter' tubes on rafts enable paddlers/rescuers to wedge feet into the deck-union to gain purchase and help in maintaining balance and integrity within the raft.

At least one craft, the Wing Inflatable at the top of this page has augmented the inflatable floor chamber with an additional 'flat' chamber for kneeling, this not only reinforces the deck it enhances comfort when paddling for long periods. Two of the craft in this GUIDE,

the *ARK Croc-Rescue* (above) and

the German *RTB1*

have flat seating. The Ark has a vinyl strip which can also act as a forward restraint when leant against during knelt paddling while the *RTB1* has wooden seats indicating tasking aimed at flood evacuation in slow-moving water rather than swiftwater or waves.



FOOT CUPS

A useful feature of some whitewater rafts that crosses over well into

rescue rafts is the incorporation of low profile foot restrain cups attached to the deck. These are a flap of material that will sit flat when not in use or with a person/kit sat on them. In some cases these might double as paddle stowage but the more overt models like the *NRS* above are large enough to insert a good





portion of booted foot and help keep you in the boat in rough water as well as providing purchase from which to gain more paddling power going forwards and more reach when leaning back to help steering in strong current. Some thwarts also allow feet to be wedged beneath for extra purchase in rough water/waves.

NON-STANDARD DESIGNS

Another design much favoured in the North America is the cataraft, a twin sponson hull, invariably 'pointed' at the ends and joined by a two or three transverse sponsons that, in a standard raft would be separately inflated thwarts or bolsters. Our own swiftwater rescue co-editor Mitch Sasser swears by them because of their manoevrability, speed and stability but they offer far less floor space so clearly not so much use in flood evacuations and very much a tool for the specialists. Nevertheless, in the right hands these are a potent swiftwater rescue craft. There aren't as many in this GUIDE as you might expect because many are equipped with a rigid transom to take a motor and will therefore be in the separate Powered Craft GUIDES. *Rapid Approach Rescue's* cataraft (above) can also be retrofitted for a motor with an aluminium frame costing around \$275 and is one of only two in this particular GUIDE but there are a number of comparable craft that would suit rescue agencies that are not currently used or marketed as such. This *RAR* model incorporates a reinforced ramp on one end to ease hauling casualties on board - in this case up to 4 plus two rescuers.

MFC's RSBER (right) is typical of some rescue-specific models that have been born out of rescue and not rafting. Theirs is basically the same as their sled (and platform) but with sponsons all around that are narrower than their swiftwater counterparts. They are not self-bailing and are intended for evacuation and searching on relatively flat water and slower moving flood water. Such craft are perfectly capable in faster moving water but without self bailing water coming in adds to the weight and discomfort so is best avoided. You can also see two inside pouches for throw cord or strobe etc and a tied-down panel to safely stow equipment or extra PPE. Some raft have internal paddle stowage points.

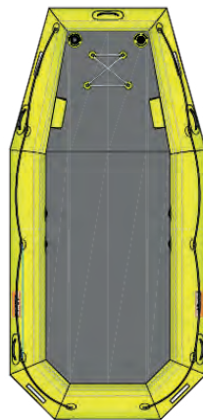

Finally a word about the *Mustang MRR130* model in the title picture which has been custom built by Wing Inflatables so you know it will be good. It's a dedicated rescue craft with enhanced features like ultra high visibility and more D-rings than you could possibly find uses for but it's one of only a handful that offers this range of rescue specificity in a raft design. **IMPORTANT: REFER to KEY to TABLES on page 64**

Side Scan Sonar

The ideal tool to locate drowning victims and missing evidence



JW Fishers Mfg., Inc.
(800)822-4744
info@jwfishers.com
jwfishers.com



Images NOT to Scale
 □□□ = Option
 ● = PARTIAL FEATURE and/or OK BUT NOT IDEAL
COST: Approx, INC local tax/VAT
 N/A = info Not Available/not given
INFLATION TIME: Hand Pump/ Compressed Air
VALVES PRV=Pressure Relief Valve

Image	MODEL	COMPANY	ORIGIN	approx COST inc tax / VAT	WEIGHT	LOAD CAPACITY Kg/sq Metre lb/Sq Foot	DIMENSIONS L x W x H EXTERNAL INTERNAL/USABLE WIDTH	PACKED SIZE
	Croc Rescue CRR 375	ARK		£592 \$706 €662	23kg 50.6lb	170kg 375lb	3.75 x 1.05 x 0.36m 12.3 x 3.4 x 1.16' 0.33m 13"	75 x 50 x 5 30 x 20 x 2
	Ark Angel ARR 420	ARK		£1424 \$1697 €1593	28kg 110lb	350kg 750lb	4.2 x 1.18 x 0.37m 13.75 x 3.9 x 1.2' 0.44m 17"	95 x 50 x 5 37.4 x 20 x 2
	Nile KN365	ARK		£1797 \$2142 €2010	35kg 68.2lb	425kg 937lb	3.65x 1.75 x 0.52m 11.9 x 5.75 x 1.7' 0.71m 28"	98 x 56 x 5 38.6 x 22 x 2
	Res-Q-Raft 400	CPI Rescue Products		N/A	50kg 44lb	950kg 2090lb	3.02 x 2.31 x 0.56m 9.9 x 7.6 x 1.8' 1.2m 478"	N/A
	Personal Paddle Boat	DEMAREE (D.I.B.)		?	28kg 60lb	272kg 600lb	3.48 x 1.52 x 0.48m 11.4 x 5 x 1.6' 1.2m 478"	?
	Rapid Response Boat	DEMAREE (D.I.B.)		?	40.9kg 90lb	454kg** 1000lb	3.7 x 1.8 x 0.6m 12 x 6 x 2' 1.2m 478"	71 x 45.7 x 35 28 x 18 x 2
	430RR Rescue Raft	INMAR		£3000 \$3500* €3200	72.7kg 160lb	1023kg 2250lb	4.27x 1.98 x 0.51m 168 x 78 x 20" 1.47m 58"	140 x 84 x 6 55 x 33 x 2
	Fat Boy	JPW inc		£4100 \$4444 €4300	32.7kg 72lb	400kg 882lb	3.05 x 1.65 x 0.50m 120x 65x 19.5" 0.66m 26"	100 x 86 x 6 40 x 34 x 2
	Rescue Raft RS8ER WR0212	MFC INTERNATIONAL		N/A	26kg 57.2lb	820kg 1804lb	3.5 x 1.9 x 0.56*m 137 x 75 x 22" 1.34m 52.7"	88 x 50 x 3 35 x 19.7 x 2
	Rescue Raft RS10ER WR0214	MFC INTERNATIONAL		N/A	35kg 77lb	950kg 2090lb	4 x 2.3 x 0.56*m 158 x 91 x 22" 1.9m 75"	88 x 55 x 3 35 x 22 x 2

INFLATABLE NON-POWERED RAFTS

	approx. AIR CAPACITY INFLATION TIME (Hand) (Powered or CA)	MAX WORKING PRESSURE FLOOR/DECK	MATERIALS: TUBES/SPONSONS FLOOR/DECK	INFLATE		LOADING			VALVES		ACC		VIZ		NOTES	WWW.	
				SELF-BAILING	CHAMBERS / THWARTS	MANUAL/POWERPUMP	GRAB/LIFT HANDLES	FLIP TAB / GRAB CORD	HD-TOW / LT DUTY EYES	PRESSURE RELIEF VALVE	1-WAY / 2-WAY VALVE	CARRY BAG / PADDLES	REPAIR KIT / WARRANTY	REFLECTIVE / CUSTOM			OTHER COLOURS
0cm 20"	600 L 21.2cuft 8-12mins	0.24-0.28BAR 3.5-4.5 Psi * BAR * Psi	1055g PVC closed-cell foam floor	■ *	2	□	2	■	6	-	■	□	3	□	■	*No bolsters, seating is a PVC strip. *Floor is solid foam (not inflatable). *Via bailing sock which can be closed.	arkinfloatables.com
0cm 20"	1200 L 42.4cuft 12-15mins	0.24-0.28BAR 3.5-4.5 Psi 0.55 BAR 8 Psi	1450g PVC 8cm/3" drop- thread deck	■	2 4	□	12 8	■	8	-	■	□	3	□	■	60cm bow & stern kick. Additional rear PVC band seat.	arkinfloatables.com
0cm 20"	1648 L 58.2cuft 12-15mins	0.24-0.28BAR 3.5-4.5 Psi 0.17 BAR 2.5 Psi	1450g PVC I-beam deck	■	2 5	□	8 0	■	10 10	-	■	□	3	□	■	70cm bow & stern kick	arkinfloatables.com
	1900 L 67 cuft 4-10mins	N/A	32oz PVC 40oz Evaloy- drop-thread deck	■	0 ?	□	0 10	■	14 6	■	■	□	1	□	□	This raft being updated or discontinued. Removable inflatable floor	cpewaterresqproducts.com
	1300 L 46 cuft <2->10mins	?	30oz vulcanized/ neoprene-coated fabric. Mil-C-17415 type 9A	■	* 3	□	6 0*	■	2 6	■	■	□	1	□	□	*+2x Foot stirrups **design load = 272kg 600lb. *No bolsters, fore and aft transverse sponsons act as thwarts.	dibboats.com
5.5cm 14"	1700 L 53 cuft <3->12mins	?	30oz vulcanized/ neoprene-coated fabric. Mil-C-17415 type 9A	■	* 4	□	6 0*	■	2 6	■	■	□	1	□	□	*+4x Foot stirrups Inflatable transom will take 10HP outboard. *No bolsters, fore and aft transverse sponsons act as thwarts.	dibboats.com
51cm 24"	2400 L 85 cuft 10-15mins	0.16-0.2 BAR 2.8-3 Psi 0.6-0.7 BAR 9-10 Psi	1.2mm Hypertex, polyester, dual coated	■	2 5	□	6 0	■	6 4	■	■	□	1/ 3	□	■	*Rescue Agencies=\$2995	inmarboats.com
50cm 24"	1600 L 56.5 cuft <15mins	0.17 BAR 2.5 Psi 0.17 BAR 2.5 Psi	32/42oz PVC coated Polyester drop-thread deck	■	2 8	□	0 2	■	4 0	■	■	□	5- 10	■	■	10" bow kick. Removable drop-stitch floor. Foot thwarts. Rescue Celubra is power - capable so will be in the powered craft GUIDE	jpwinc.com
3cm 13"	1815 L 64cuft 3mins	0.2 BAR 3.25 Psi 0.4 BAR 6 Psi	Hypalon TPU 12cm/5" drop- thread deck	NO	- 3	□	7 0	■	0 3	■	■	□	2 2	□	■	*Height is not tube diameter hence low volume Leafield Valves. Optional rear bolster and storage pockets	mfc-international.com
5cm 14"	2000 L 70.6cuft 3mins	0.2 BAR 3.25 Psi 0.4 BAR 6 Psi	Hypalon TPU 12cm/5" drop- thread deck	NO	- 3	□	4 0	■	0 3	■	■	□	2 2	□	■	*Height is not tube diameter hence low volume Leafield Valves. Optional rear bolster and storage pockets	mfc-international.com

Images NOT to Scale
 □□□ = Option
 ● = PARTIAL FEATURE and/or OK BUT NOT IDEAL
COST: Approx, INC local tax/VAT
 N/A = info Not Available/not given
INFLATION TIME: Hand Pump/
 Compressed Air
VALVES PRV=Pressure Relief Valve

MODEL	COMPANY	ORIGIN	approx COST inc tax / VAT	WEIGHT	LOAD CAPACITY Kg/sq Metre lb/Sq Foot	DIMENSIONS L x W x H EXTERNAL INTERNAL/USABLE WIDTH	PACKED SIZE
 MRR130	MUSTANG SURVIVAL (WING INFLATABLES)		N/A	50kg 110lb	909kg 2000lb	3.96 x 1.96 x 0.53cm 156 x 77 x 21" 0.89m 35"	96.5 x 111.25cm 38 x 45 x 4
 2.4m Raft	NORTHERN DIVER		£606 \$800 €700	25kg 55.1lb	400kg 882lb	2.4 x 1.3 x 0.35m 94.5 x 55 x 14" 0.6m 23"	92 x 67 x 23.6cm 36.2 x 26.4 x 9.2
 CBS6	NORTHERN DIVER		£1260 \$1600 €1550	62kg 136.7lb	700kg 1543lb	380 x 80/170 x 45cm 150x31.5/67 x17.7" 0.6m 24"	120 x 60 x 47cm 47 x 24 x 19
 CBS8	NORTHERN DIVER		£1460 \$1850 €1750	70kg 154.3lb	900kg 1984lb	420x100/200x50cm x39.4/x 19.7" 0.6m 24"	135 x 68 x 53cm 53 x 27 x 21
 R120	NRS		£2550 \$3095 €3250	54.5kg 120lb	N/A	371 x 71/163 x 46cm 146 x 40/76 x 18" 0.6m 24"	114 x 66 x 45cm 45 x 26 x 18
 R130	NRS		£2800 \$3395 €3550	60.5kg 133lb	N/A	396 x 71/163 x 46cm 156 x 37/74 x 18" 0.6m 24"	125 x 66 x 49cm 49 x 26 x 19
 R140	NRS		£3500 \$3695 €3850	76kg 167lb	N/A	430x109/221x 56cm 169 x 43/87 x 22" 0.6m 24"	125 x 66 x 49cm 49 x 26 x 19
 Slice XL Cataraft	NRS/STAR		£1950 \$2195 €1766	30-36kg 66-79lb	900kg 1980lb	361 x 66/178x56cm 142 x 26/70x 22" 0.6m 24"	152 x 76 x 60cm 60 x 30 x 24
 Rescue Cat	RAPID APPROACH RESCUE		£2000 \$2150 €2100	34kg 75lb	900kg 1980lb	358 x 61/173 x 56cm 141 x 24/68 x 22" 0.6m 24"	115 x 81 x 45cm 45 x 32 x 18
 12' Rescue Raft Self bailing version	ROCKY MOUNTAIN RAFTS		£2600 \$3150 €2750	54.5kg 120lb	>800kg >1760lb	366 x 66/158 x 46cm 144 x 26/62 x 18" 0.6m 24"	117 x 76 x 46cm 46 x 30 x 18

INFLATABLE NON-POWERED RAFTS

	approx. AIR CAPACITY INFLATION TIME (Hand) (Powered or CA)	MAX WORKING PRESSURE FLOOR/DECK	MATERIALS: TUBES/SPONSONS FLOOR/DECK	INFLATE		LOADING			VALVES		ACC		VIZ		NOTES	WWW.	
				SELF-BAILING	CHAMBERS / THWARTS	MANUAL/POWERPUMP	GRAB/LIFT HANDLES	FLIP TAB / GRAB CORD	HD-TOW / LT DUTY EYES	PRESSURE RELIEF VALVE	1-WAY / 2-WAY VALVE	CARRY BAG / PADDLES	REPAIR KIT / WARRANTY	REFLECTIVE / CUSTOM			OTHER COLOURS
4 x 9"	2350 L 83 cuft <i><2/>5mins</i>	0.24 BAR 3.5Psi 0.31 BAR 4.5 Psi	33oz PU-coated Polyester. I-beam floor	■	2 5	- □	6 0	■	32 2* 16	■	■	□	1	-	■	Federal Aviation specification reflective panels 10" bow kick *2x3" Tow Eyes + 16x2" eyes. Flip cord/web housed in internal pouches	mustangsurvival.com
5cm x 9.8"	692 L 24.4 cuft <i><1 - 3.8mins*</i>	0.35 BAR 5Psi 0.7 BAR 10 Psi	1.2mm PVC 8cm/3" drop-thread DWF/PVC Floor	NO	- 3	□ ■	0 6	■	0 0	■	-	2 2	2	□	■	*Power pump to Hand Inflation time calculated at 50 pump strokes/min. NB the 2.7 and 3.3 raft are power-capable so will be in the powered craft GUIDE	ndiver-rescue.com
40cm x 16"	1753 L 62cuft <i>1-10mins*</i>	0.35 BAR 5Psi 0.7 BAR 10 Psi	1.2mm PVC 8cm/3" drop-thread DWF/PVC Floor	NO	0 5	□ ■	8 0	■	0 12	■	-	2 2	2	□	■	UK DEFRA/Flood Approved * Power pump to Hand Inflation time calculated at 50 pump strokes/minute. NB the 2.7 and 3.3 raft are power-capable so will be in the next GUIDE	ndiver-rescue.com
45cm x 18"	2397 L 85cuft <i>2- 13mins*</i>	0.35 BAR 5Psi 0.7 BAR 10 Psi	1.2mm PVC 8cm/3" drop-thread DWF/PVC Floor	NO	0 5	□ ■	8 0	■	0 12	■	-	2 2	2	□	■	UK DEFRA/Flood Approved * Power pump to Hand Inflation time calculated at 50 pump strokes/minute. NB the 2.7 and 3.3 raft are power-capable so will be in the next GUIDE	ndiver-rescue.com
38cm x 15"	1600 L 56.5cuft <i>1- <5mins</i>	0.28 BAR 4Psi 0.55- 0.7 BAR 8-10 Psi	2000D PVC 10cm/4" drop-thread deck	■	2 5	□ ■	6 6	- □	0 16	■	■	□	3	□	■	Foot retention pouches on deck +3 toe-holds under each thwart. Armoured underside to sponsons & hull. Leafield C7 & D7 valves. * Height does not include 29" kick of the angled bow	nrs.com
40cm x 14"	1800 L 63.6cuft <i>1- <6mins</i>	0.28 BAR 4Psi 0.55- 0.7 BAR 8-10 Psi	2000D PVC 10cm/4" drop-thread deck	■	2 5	□ ■	8 6	- □	0 18	■	■	□	3	□	■	Foot retention pouches on deck +3 toe-holds under each thwart. Armoured underside to sponsons & hull. Leafield C7 & D7 valves. 30" bow kick	nrs.com
56cm x 16"	2700 L 95cuft <i>>2/ >15mins</i>	0.28 BAR 4Psi 0.55- 0.7 BAR 8-10 Psi	2000D PVC 10cm/4" drop-thread deck	■	3 5	□ ■	8 8	- □	0 22	■	■	□	3	□	■	Foot retention pouches on deck +3 toe-holds under each thwart. Armoured underside to sponsons & hull. Leafield C7 & D7 valves. * Height does not include 30" kick of the angled bow	nrs.com
40cm x 16"	2300 L 81cuft <i><2/ >10mins</i>	0.2 BAR 3 Psi 0.55 BAR 8 Psi	44oz/1000D PVC 8cm/3" Drop-thread deck	■	1* 5	□ □	0 8	- □	10 0	■	■	□	3/ 5	□	■	*1x detachable bolster + two integral, transverse bolsters/chambers. 2x Self-draining zipped compartments.+2 toe-holds under each thwart.Leafield C7 & D7 valves. 30" Bow/stern kick	nrs.com
56cm x 16"	2250 L 79cuft <i><2/ >10mins</i>	0.2 BAR 3 Psi 0.2 BAR 3 Psi	2000 Denier - 44 oz PVC 60oz Deck	■	* 4	□ □	0 6	- -	4 10	■	■	□	5	□	■	*2 of the 4 chambers are integrated transverse 'thwarts'. Transom frame available. Leafield D7 valves	rapidapproachrescue.com
34cm x 14"	1650 L 58cuft <i>1/ <5mins</i>	0.17 BAR 2.5 Psi 0.14 BAR 2 Ps	44oz/3000 Denier Rockshield PVC. 66oz drop-stitch floor	□	3 5	□ ■	6 0	■	0 12	■	■	□	2/ 6	□	■	Also 13 and 14' models. Leafield D7 valves. *Also non-'rescue' colours: green, grey, Blue, Torquoise, Beige, purple. Also Self-bailing with I-beam deck 27" Bow rise	rockymountainrafts.com

Images NOT to Scale
 □□□ = Option
 ● = PARTIAL FEATURE and/or OK BUT NOT IDEAL
COST: Approx, INC local tax/VAT
 N/A = info Not Available/not given
INFLATION TIME: Hand Pump/
 Compressed Air
VALVES PRV=Pressure Relief Valve

MODEL	COMPANY	ORIGIN	approx COST inc tax / VAT	WEIGHT	LOAD CAPACITY Kg/sq Metre lb/Sq Foot	DIMENSIONS L x W x H EXTERNAL INTERNAL/USABLE WIDTH	PACKED SIZE
 6' Rescue Ra drop-Stitch Deck	ROCKY MOUNTAIN RAFTS		£3300 \$3800 \$4550 €3550	88.6kg 195lb	>1350kg >3000lb	4.88 x 2.34 x 0.56m 192 x 92 x 22" 1.22m 48"	152 x 76 x 4 60 x 30 x 1
 Phat Cat PC120	ROCKY MOUNTAIN RAFTS		£1500 \$1650 €1750	23-29kg 51-63lb	>180kg >400lb	3.58 x 1.73 x 0.56m 141 x 68 x 22" 0.61m 24"	76 x 56 x 3 30 x 22 x 1
 Ionic Urban Raft	SAFEQUIP		£3600 \$5040 €4320	42kg 92.4lb	1000kg 2200lb	3.2 x 2.2 x 0.38m 126 x 87 x 15" 1.44m 57"	100 x 70 x 4 39 x 27.6 x 1
 WWR3700 SIT38040	SIT Ltd		N/A	37kg 81.4lb	300kg 660lb	3.7 x 1.75 x 0.45m 146 x 69 x 18" 0.85m 33.5"	80 x 80 x 5 31.5 x 31.5 19.7"
 WWR4300 SIT38006	SIT Ltd		N/A	60kg 132lb	450kg 990lb	4.3 x 2 x 0.5m 169 x 79 x 19.5" 100m 39.4"	90 x 90 x 5 35.4 x 35.4 19.7"
 RTB1 SEB	SURVITEC/ DSB gmbH/ IC BRINDLE		£3995 €4550	43kg 94.6lb	600kg 1320lb	3 x 1.2 x 0.4m 118 x 47 x 15.8" 0.4m 15.8"	105 x 50 x 3 41.3 x 19.7 x 1
 IBS	WING INFLATABLES		\$13000	49kg 108lb	612kg 1350lb	3.66 x 1.65 x 0.43m 144 x 65 x 17" 0.79m 31"	117 x 86 x 4 46 x 34 x 2
 LifeRamp 6601-10/15	TULMAR SAFETY		\$6073	12.7kg 28lb 19.1kg 42lb	?	3.14.6 x 00 x 00m 1015 x 00 x 00" 0.00m 00"	?
 3.6m Raft	WRS INTERNATIONAL		£3900 \$5000 €4366	55kg 122lb	700kg 1544lb	3.6 x 1.8 x 0.48m 142 x 71 x 18.9" 0.84m 33"	120 x 60 x 4 47.2 x 23.6 23.6"
 4m Raft	WRS INTERNATIONAL		£5210 \$6500 €5900	60kg 122lb	1000kg 2200lb	4 x 1.85 x 0.52m 157.5 x 73 x 20.5" 0.8m 31.5"	100 x 100 x 4 39 x 39 x 2

INFLATABLE NON-POWERED RAFTS

	approx. AIR CAPACITY INFLATION TIME (Hand) (Powered or CA)	MAX WORKING PRESSURE FLOOR/DECK	MATERIALS: TUBES/SPONSONS FLOOR/DECK	INFLATE		LOADING			VALVES		ACC		VIZ		NOTES	WWW.
				SELF-BAILING	CHAMBERS / THWARTS	MANUAL/POWER/CA	GRAB/LIFT HANDLES	FLIP TAB / GRAB CORD	HD-TOW / LT DUTY EYES	PRESSURE RELIEF VALVE	1-WAY / 2-WAY VALVE	CARRY BAG / PADDLES	REPAIR KIT / WARRANTY	REFLECTIVE / CUSTOM		
41cm x 16"	3200 L 113cuft >15mins	0.17 BAR 2.5 Psi 0.14 BAR 2 Psi	44oz/3000-denier RockShield PVC. 66oz PVC I-Beam lace-in floor	■	2-4 5	□	8 0	-	2-4 12-14	■	□	3/5	□	■ ■ ■ □	Also 13 and 14' models. Leafield D7 valves. Also non-'rescue' colours: Green, Grey, Blue, Torquoise, Beige, Purple. *Option as non-self bailing-drop-thread deck. 31" bow rise	rockymountainrafts.com
6cm x 14"	2300 L 81cuft >10mins	0.17 BAR 2.5 Psi 0.14 BAR 2 Psi	44oz/2000-denier RockShield PVC. 66oz PVC floor	■	0* 4	□	0 0	-	12 8	■	□	3/6	□	■ ■ ■ □	*two integral, transverse bolsters/chambers. Leafield D7 valves. Also non-'rescue' colours: Green, Grey, Blue, Torquoise, Beige, Purple. Splash net & foot cups	rockymountainrafts.com
15cm x 18"	1550 L 54.7cuft <2/>10mins	0.2BAR 3 Psi 0.4BAR 6 Psi	'Orca' Hypalon. 6" drop-thread deck	NO	1 5	□	8 2	■	2 8*	■	■	5	□	■ ■ ■	Leafield valves. 6" Deck. * D-Ring under deck can provide flip tab	safequip.co.uk
10cm x 5 x	1740 L 61.4cuft <1/<8m	0.2BAR 3 Psi 0.4BAR 6 Psi	Neoprene-coated Hypalon. 6" drop-thread deck	■	2 5	□	7 4	-	4 5	■	■	2 2	□	■ ■ ■	Leafield valves	sitltd.co.uk
10cm x 4 x	2480 L 87.6cuft >2/>10mins	0.2BAR 3 Psi 0.4BAR 6 Psi	Neoprene-coated Hypalon. 6" drop-thread deck	■	3 5-6	□	8 2	■	0 14	■	■	2 2	□	■ ■ ■	Larger WWR5000 also available. Leafield valves.	sitltd.co.uk
38cm x 14"	1000 L 35.3cuft <1/<4mins	0.2BAR 3 Psi 0.4BAR 6 Psi	Hypalon/Neoprene coated polyester. 6" drop-thread deck	NO	0* 4	□	0 0	■	4 8	■	■	2 4	□	■ □	* 2x Wooden seats SEB=quick inflation version with CA cylinder	icbrindle.com
61cm x 24"	1415 L 50cuft 3-10mins	0.31 BAR 4.5Psi 0.31 BAR 4.5 Psi	40oz Polyurethane. drop-thread deck	NO	2 6	□	0 *	■	0 0	■	■	5	□	-	*Perimeter cord acts as lift/grab handles	inflatable-solutions.com
	? <1/<6mins	?	?	NO	0 2	□	0 0	■	18 4	■	■	?	-	-	For longer lengths 30,50&80ft see Paths/Walkways Guide	tulmar.com
60cm x 6 x	1900 L 67cuft <2/>8min	0.3 BAR 3.6 Psi 0.1 BAR 1.5 Psi	PVC/PU. 15cm I-Beam deck*	■	2 5	-	6 0	□	0 12	■	■	3	□	-	Leafield C7 7 A6 valves. *Available as non-self bailing with drop-thread deck.	wrsinternational.com
60cm x 3.6"	2200 L 78cuft <2/>10min	0.3 BAR 3.6 Psi 0.1 BAR 1.5 Psi	PVC/PU. 15cm I-Beam deck	■	3 5	-	6 4	□	0 5	■	■	3	□	-	Leafield C7 7 A6 valves. 6 x Foot retaining cups/loops.	wrsinternational.com

INFLATABLE & SOLID 'SHORT' RESCUE BOARDS

'Short' as distinct from the numerous long boards and basically modified surf boogie or body boards. These short boards are often called 'sleds' in North America because they are huge compared to a standard sport body board. Most derive from the surf community but in rescue terms it is probably the Carlson Board from the 80's that steered the entire water rescue and swiftwater community towards use of short boards for water entry rescue (as distinct from towing). High-speed towing is now where you see most short boards - on the back of a PWC/RWCs both as a rescue measure in surf, flood and swiftwater and for general transport of a surfer to or from the hairy wave face on a surf beach. Be aware though that just because a board/sled has forward-mounted D-rings, doesn't mean it can be towed by an RWC - these exert a degree of force through acceleration that surfers long ago realised needed to be mitigated by additional elastic connections or strengthened fixings. Of course you could bypass the RWC altogether and power the board itself which is what the ASAP 156 jet-board on the right does. With an average 50minute run-time this is an exciting, if rather more expensive option! The 156 does have a forward towing option but more for recovery than deployment. Swiftwater rescue boards either have no tow eyes because they're intended for swimmers or the eyes are more for control lines and hauling, neither of which involves fast acceleration. True surf-oriented boards are also more able to cope with large waves that can bend or snap boards not designed for that environment. Some, like the Peruvian Suntech boards are reinforced - in their case with a longitudinal aluminium I-beam.

Another offshoot has been ice rescue which has spawned a few quite odd designs like the *Angel-Guard* but in principle the main players like *Ice Rescue Systems RTS* and *MARSARS sled* above, are modified boards, longer than most RWC boards but not quite a lifeguard's long board. They are however, considerably more complex than simply a flotation aid. Both are

rectangular with numerous integrated slings and the *MARSARS sled* has a 4:1 hauling mechanism built into the centre of the board that helps haul an in-water victim on board the sled via a set of forearm straps- there are even two rollers in the end to facilitate easier victim movement onto the sled.



We see a definite difference between boards with a US surf background like *Extractor*, *P2P* and *Lifesled* (better known in surf circles as *Wahoo International*) and those from a European water rescue background like *WRSMFC*, *WRS* and *NDiver*. These latter boards and indeed most inflatable short boards are better suited to 'flat' or flood water (and ice or mud) than they are to rough water like surf or swiftwater. They can however be deflated and stored in a considerably smaller space than a solid board although deployment times are also considerably longer. In general, the inflatable boards are the domain of multi-discipline rescue agencies not necessarily using them on every call or with simply no more space on the truck for any more kit. We have dealt with the specifics of inflatable craft in the previous guides to watercraft so no need to discuss that further here - the same rules apply, the materials are the same, the valves are the same only the sheer size and volume and therefore the time to inflate (a couple of minutes even with a hand pump) are different. Beach rescue and standby rescue teams are more likely to go for a solid board

and for some boards storage as a flat- one piece can sometimes be easier to fit on or around a rescue vehicle than a plump bag of deflated board.

Something that all 'short' boards have in common is a plethora of handles and all go to great lengths to ensure that they are strongly fixed to the deck. In the case of inflatables it is exactly the same as all inflatable watercraft with glued or preferably

'SHORT' RESCUE BOARDS/SLEDS



welded seams having a considerable track record. Solid boards (which aren't necessarily solid as we'll see shortly) can be a bit trickier because the plastic or foam 'shell' that they have to be fixed into can have inherent localised weakness. So most overcome this by spreading the load either by broadening the rivet bed as you can see on the *MARSARS* or by running the handles as a continuous length into and out of the body of the board as you see with the *Lifesleds*.

Extractor mould the threaded receiver into the HDPE shell and claim a 7000lb/3181kg test pull which is quite impressive and likely one of the strongest options. P2P have neoprene covered solid rubber handles while NRS has low-profile flat straps.

Some have a 'last-chance' handle right at the back and some even have a last chance sling/cord hanging off the back. Apart from the special purpose boards all of the towable boards have a curved 'stern' both in terms of smoothing off the roughly 4"/100mm side profile and the crescent shape which accommodates the shape of a 'casualty' who is hanging on for grim death more comfortably and safely than a square back edge.

In the case of the title picture opposite from *Lifesled* the rescuer is using the board as an in-water access tool and is knelt on it while assisting the casualty that has just been hot-loaded after having his hand grabbed by the RWC driver. He will then be swung back to the waiting rescuer who ensures he has a firm handhold for the journey back to shore.

For inland swiftwater and floods the use of the not-so-short, short board was pioneered for rescue by Robert Carlson after using a regular surf boogie board for sport riverboarding or river sledging as its sometimes called since the early 70s. The Carlson Board took the standard boogie design, added a slick, hardened plastic base and deep crescent curve to the rear as well as four handles, none of which had been seen on rescue boards before. These days the board's curved body channel has evolved into two 'limb' channels that retain the forearms better



when grasping the handles. The boards still have their original vivid green base as well as a curved profile nose to tail.

The NRS board opposite shows a textured, padded surface common to most boards that offers a tactile surface to help grip the body, *ExtractorX Sled* for instance has a 3/8" thick dimpled PVC layer while some like *Extractor* and *Carlson* have scallops in the top surface to better hug the body arms. In fast moving water and particularly on the back of a fast moving RWC any slight turn can make it hard to hang on and virtually impossible on a slick



NRS

RESCUE

SWIFTWATER RESCUE EQUIPMENT

- Dry suits • Wetsuits • Footwear • Gloves • Helmets
- Life Jackets • Rescue hardware and more...

nrsrescue.com | rescue@nrs.com

The WRS Rapid D inflatable board



top-surface. This sideways skid at higher speeds is mitigated in some models like *Extractor's River X* and *JetRescue's Newk* by use of strakes or channels in the underside that keep the board in line - much as you see on RIBs.

We mentioned earlier that the non-inflatable sleds are not necessarily 'solid', some like the *Extractor* range are expanded foam but have differing densities and are hollow. Some are solid 'polystyrene' but it may surprise some to learn that regular polystyrenes (EPS more-so than EPP) will absorb some water - perhaps up to 7% of total board volume. Talking of volumes, the relative board sizes is not immediately apparent in our tables

as the images are NOT to scale but the difference between a river board/body board compared to one intended to be towed by an RWC can be huge. The *Extractor River X Extreme* above middle is 4'8" long and approximately 130L in volume while the *WRS* on the left is 6'4" long and around 180L and the *NDiver* on the right is 6'8" long and 280L. Make sure you read the dimensions and volumes to get an accurate idea of size.

KEY to TABLES.....

Any use, feature, accessory or component that is **inherent** in the product is shown as a **solid coloured square** ■■■■

If it's an **OPTION** it is shown as an **outline square** □□□□

A circle ● in the 'USE' columns indicates that this feature is only partially present and/or is OK for that purpose but not ideal.

ORIGIN: The 'manufacturer's country, not necessarily the country of manufacture, If we know it's made in a different country there will be a smaller inset flag. 🇵🇪 = Peru 🇬🇷 = Greece

COST: a rough guide only - **includes** local taxes/VAT. Varies with exchange rates, extra taxes etc. We usually round up to the nearest Pound£/US Dollar\$/Euro€. We now give a **currency conversion** figure in orange £\$€ which is simply to give an idea of price, it is not the selling price which will have import duties and bulk shipping etc. to add.

LOAD BUOYANCY VOLUME: These are all linked but all manufacturers show it differently. **LOAD** capacity in terms of the weight of person that the board is designed to carry or more importantly that the connecting D-Rings can cope with. **BUOYANCY** of the board, like a PFD or lifejacket is directly related to the weight it can carry whereas **VOLUME** is more an indication of the sheer size of the board usually correlating with load capacity - - the greater the volume the greater the load capacity. As with inflatable platforms, you can work on roughly 100kg per square metre or 67.2 pounds per square foot.

DIMENSIONS: Length by width by depth/thickness.

MATERIALS: (and type of construction) for the board itself,

for the top surface and for the bottom which is often the same as the entire board if it is rotomoulded or a solid foam.

EPS=Expanded Polystyrene. EPP=Expanded Polypropylene
HANDLES TETHER POINTS: Tether points are the attachment D-Rings or in some cases simple thru-board holes that can be used for towing, hauling, securing and directional control but NOT NECESSARILY high speed towing by an RWC - see the next category for clarification.

RWC TOWING: whether or not the board can be towed at high speed by an RWC/PWC or similar high speed watercraft.

NOSEGUARD VALVE PLUG: NOSEGUARD or Bump protection - this can be a separate plastic or rubber nose, sometimes detachable as with the P2P Rescue Sled or it may be protection offered by a continuation up the side of a hull protection as with the WRS board. VALVE for inflatable boards - usually a combined inflate/deflate valve, some have an additional PRV or Pressure Release Valve in case of over-inflation. **PLUG** is present on some hollow boards as a drainage measure but can also be used to add ballast or extra floatation (expanded foam) .

SURF/SWIFTFLAT WATERICE: Surf and swiftwater are not necessarily the same as you can get fast moving water with virtually no wave-forms. Here we mean operating in sea waves/surf and fast moving water *with* waves where point loading on the crest or in the dip of a wave can snap or fold if not designed for the purpose. Flat water is flood, lakes and mud where the load is evenly distributed but this can also be 'calmer' swiftwater. **ICE** Any board/sled can be used if you're careful but true ice design requires a longer board, tougher materials (not usually inflatable) and provision for dragging, ice awls, etc.



OceanidTM

WATER RESCUE CRAFT

Proudly made in the USA and New Zealand
Backed up with a **12-year warranty**, four times the industry average.

Pick Your Rescue Package

Everything you need for your next call out.



On the scene and in action, *fast!*

Whether it's ice, water, snow or mud, successful rescues depend on the coordination and skill of first responders, as well as the availability of the right equipment to handle each situation. See the RDC in action, [visit our video gallery](#).

Easy-to-order parts and accessories

Our online form makes it easy to customize your order. Select from our six Rescue Packages, or update your current equipment with replacement parts and accessories. We'll review the details of your order and email you an invoice at the time we ship your product(s).

Exceptional quality and endurance

The RDC is built to withstand the stresses incurred in demanding, water-related rescue situations. Our products are proudly made in the USA and New Zealand and come with a **12-year warranty**, four times the coverage that is typical in the industry.





SEE OUR NEW WEBSITE

Images NOT to Scale
COSTS: £\$€ in burnt orange are currency conversions only- excludes shipping, import duty and tax
USES/ FEATURES:
 ● = PARTIAL FEATURE and/or OK BUT NOT IDEAL
 □□□ = Option
INFLATION TIME: 300L= 1-2mins with manual/electric pump
VALVES PRV=Pressure Relief Valve



MANUFACTURER	ASAP	AQUACENTER	CARLSON	EXTRACTOR SLED	EXTRACTOR SLED
MODEL VARIANT	Rescue 156	Jet Ski Rescue	Carlson River Rescue -	Mega	Pro
ORIGIN					
COST	£7421 \$9040 €8600	€565 \$700 €650	£405 \$500 €470	£1940 \$2400 €2250	£1724 \$2100 €1990
WEIGHT	30kg 66lb	13.6kg 30lb	5.7kg 12lb 9oz	31.8kg 70lb	27kg* 55lb*
INFLATABLE SOLID HOLLOW	■	■	■	■	■
LOAD BUOYANCY VOLUME	60kg 132lb 230L		75kg 165lb 120L	270kg 600lb 310L	180kg 397lb 160L
DIMENSIONS height x width x Depth	145 x 60 x 28cm 4'9" x 2' x 11"		142 x 61 x 10cm 4'8" x 2' x 4"	206 x 104 x 14cm 6'9" x 3'6" x 5.5"	160-170 x 95x10cm 5'3"-5'7" x 3'1.5" x <
MATERIALS: CORE	HD EPP	Drop-Stitch PVC	Closed cell polyethylene foam	HDPE & 10-13mm LDPE inner	HDPE & 10-13mm LDPE inner
EXTERIOR - Top	?	UV-safe Mil-Rubber	-	3/8" PVC deck pad	3/8" PVC deck pad
EXTERIOR - Bottom	?	hard plastic 'sheet'	hard plastic 'sheet'	hard plastic 'sheet'	HDPE
HANDLES TETHER POINTS	11+2* 3 (rear)	14 3	4 -	10 3	8or10 3
RWC TOWABLE	NO	■	NO	■	■
NOSE-GUARD VALVES PLUG	- - -	- 1 -	- - -	■ - 1	□ - 1
SURF/SWIFT FLAT-WATER ICE	■ ■	■ ■	■ ■	■ ■	■ ■
OTHER COLOURS				■ ■ ■	■ ■ ■ ■ ■
NOTES	A water-Jet-propelled board 16kmh/. Price includes battery charger. *2 'pilot' handles	Includes handpump and repair kit		Range of RWC connection option packages	*Wt includes all option extras. Tail buoyancy reduced for easier loading and incline ride when towed. Optional Nose bumper
WEBSITE	asapwatercrafts.com	aquacenter.gr	carlsonriverboard.com	extractorsled.com	extractorsled.com

'SHORT' RESCUE BOARDS/SLEDS

					
					
EXTRACTOR SLED	EXTRACTOR SLED	EXTRACTOR SLED	HSA	ICE RESCUE SYSTEMS	JETRESCUE
River X Rescue	RWCiD Pro	RWCiD Mega	Standard/Tow	RTS RaipdTransit-Sled (Ice)-	Newks SLSA
					
£905 \$1100 €1045	-	-	£1940 \$2400 €2250 \$2600	£2300 \$2800 €2660	£789 \$978 €915
8.2kg 18lb	11kg 24lb	16kg 35lb		12.7kg 28lb	12kg 26.4lb
■	■	■		■	■
54.5kg 120lb 130L	approx 200L	>260L	114kg 250lb 200L 160kg 350lb 300L	310L	approx 120L
142 x 61 x 15cm 4'8" x 2' x 6"	185 x 107 x 10cm 6'1" x 3'6" x 4"	229 x 109 x 10cm 7'6" x 3'7" x 4"	173x211x96 107x13cm 5'8"6'11x3'26"x5"	158 x 127 x 15.4cm 5'2" x 4'2" x 6"	150 x 90 x 9cm 4'11" x 3' x 3.5"
Rotomoulded PE ¾" Textured PVC PE	Coated Drop-Stitch PVC Chemical welding Grooved PVC pad PE	Coated Drop-Stitch PVC Chemical welding Grooved PVC pad PE		HD Polyethylene Foam deck pad HD Polyethylene	Heat Laminated PE Soft Deck Pad Hard skin
6 7*	8 3	11-12 5	1113 3	6 4	10 3
NO	■	■	□	NO	■
□ - 1	■ HalkeyRoberts+PRV -	■ HalkeyRoberts+PRV -		- - -	■ - -
■ ■	■ ■	■ ■	■ ■	■ ■ ■	■ ■
					■
Elbow recesses in deck. Base-Pic shows optional HDPE ice rails	DISCONTINUED inc pump with pressure gauge & bag. Optional Reflective strips	DISCONTINUED There was also a 16ft long 'TEAM' model to carry up to 10 people	PWC Mount kit NOT included. Also a larger 'Fish'-board with 180/400lb buoyancy.	Ice Awl pouches.	
extractorsled.com	extractorsled.com	extractorsled.com	highsurfrescue.com	icerescuesystems.com	jetrescue.com















Images NOT to Scale
COSTS: £\$€ in burnt orange are currency conversions only- excludes shipping, import duty and tax
USES/ FEATURES:
 ● = PARTIAL FEATURE and/or OK BUT NOT IDEAL
 □□□ = Option
INFLATION TIME: 300L= 1-2mins with manual/electric pump
VALVES PRV=Pressure Relief Valve



MANUFACTURER	LIFESLED WAHOO INTERNATIONAL	LIFESLED WAHOO INTERNATIONAL	LIFESLED WAHOO INTERNATIONAL	MARSARS	MFC INTERNATIONAL
MODEL VARIANT	LS1	LS2	LS Inflatable	Ice Rescue Sled	Jet-Ski Board WR0213/001
ORIGIN					
COST	£1700 \$2100 €1970	£2100 \$2600 €2440	£805 \$995 €935	?	£2100 \$2700 €2500
WEIGHT	15.5kg 34lb	19kg 42lb	13.6kg 30lb	?	9kg 20lb
INFLATABLE SOLID HOLLOW	■	■	■	■	■
LOAD BUOYANCY VOLUME	approx 170L	approx 200 L	approx 160 L	240lb 350 L	150kg/330lb 300
DIMENSIONS <small>height x width x Depth</small>	160 x 95 x 12cm 5'3" x 3'1" x 4"	188 x 104.1 x 10cm 6'2" x 3'5" x 4"	107 x 96 x 15.25cm 5'6" x 3'2" x 6"	195 x 104.1 x 18cm 6'5" x 2'3" x 7"	160 x 95 x 12.5cm 5'3" x 3'1" x 5"
MATERIALS: CORE	Composite	Composite	V-Drop-Stitch	HD Polyethylene	Glued Hypalon
EXTERIOR - Top	-	-	UV-safe Mil-Rubber	HD Polyethylene	or Welded TPU
EXTERIOR - Bottom	-	-	-	HD Polyethylene	- Double-Skin
HANDLES TETHER POINTS	10 3	12 3	12 3	8 3	10 3
RWC TOWABLE	■	■	■	NO	■
NOSE-GUARD VALVES PLUG	■ --	■ --	■ 1 -	---	- 1x Leaffield -
SURF/SWIFT FLAT-WATER ICE	■ ■	■ ■	- ■	■ ■	■ ■
OTHER COLOURS			-		■
NOTES			Includes pump, transport bag & repair kit	integrated 4:1 haul system & rollers within the board to pull victims on-board. Ice Awl pouches.	Inflation Pressure=0.866 Includes Repair kit & Ca Bag
WEBSITE	lifesled.com	lifesled.com	lifesled.com	marsars.com	mfc-international.com

'SHORT' RESCUE BOARDS/SLEDS

						
						
AL	N DIVER	NRS	P2P RESCUE	P2P RESCUE	P2P RESCUE	P2P RESCUE
	Rescue Life Board V2	Rescue Board	Rescue Sled	Inflatable Sled	Lg Inflatable Sled	Responder
						
00	£627 \$777 €728	£400 \$495 €465	£1780 \$2200 €2065	£767 \$950 €890	£805 \$995 €935	£2660 \$3295 €3090
	14kg 30.9lb	18.2kg 11lb	14.5kg 32lb	9kg 20lb	10.5kg 23lb	18.2kg 40lb
	■	■	■	■	■	■
L	200kg 441lb 280L	135L	100L	approx 160L	approx 200L	135 L
n	185 x 105 x 15cm 6'1" x 3'5" x 5.9"	145x 63.5 x 10cm 4'9" x 2'1" x 4"	167.6 x 91.5 x 10cm 5'6" x 3' x 4"	167.6 x 91.4 x 10cm 5'6" x 3'3" x 4"	182.9 x 106.7 x 10cm 6' x 3'6" x 4"	213.3 x 86.3 x 10cm 7' x 34" x 4"
	PVC Drop Stitch or Hypalon Non-slip EVA PVC/EVA	PVC Drop Stitch - -	EPP High Density Plastic Multi-layer skin	- Neoprene Multi-layer skin	- Neoprene Multi-layer skin	EPS/Fibreglass - -
	12 7	6 2	9 3	12 5	14 3	11 3
	■	■	■	■	■	■
	- 1x Leaffield -	- Leaffield 1xD7 1x PRV -	■ - -	- 1 -	- 1 -	■ - -
	■ ■	■ ■	■ ■ ■	■ ■ ■ ■	■ ■ ■	■ ■
			■ ■ ■	■ ■ ■ ■ ■	■ ■ ■	
Bar erry	Inc Hand-pump, bag & repair kit.	Includes pump and repair kit	Replaceable Nose Cone	Includes pump, transport bag & repair kit	Includes pump, transport bag & repair kit	Plastic protection nose-skid
m	ndiver.com	nrs.com	p2prescue.com	p2prescue.com	p2prescue.com	p2prescue.com

<p>Images NOT to Scale COSTS: £\$€ in burnt orange are currency conversions only- excludes shipping, import duty and tax USES/ FEATURES: ● = PARTIAL FEATURE and/or OK BUT NOT IDEAL □□□ = Option INFLATION TIME: 300L= 1-2mins with manual/electric pump VALVES PRV=Pressure Relief Valve</p>					
					
MANUFACTURER	PPC FOILING	SEA EAGLE	SUNTECH	SUNTECH	SUNTECH
MODEL VARIANT		Rescue	5859" Rescue Sled	62" Rescue Sled	66" Rescue Sled
ORIGIN					
COST	£1010 \$1290 €1220	£245 \$300 €285	£735 \$909 €853	£760 \$939 €881	£810 \$999 €940
WEIGHT	0kg 0lb	7kg 15lb	9kg 20lb	10.8kg 23.8lb	13kg 28.6lb
INFLATABLE SOLID HOLLOW	■	■	■	■	■
LOAD BUOYANCY VOLUME	approx 200L	105kg 231lb 105 L	93/124L	131L	139L
DIMENSIONS _{height x width x Depth}	184 x 106 x 11cm 6'1" x 3'3" x 4.4"	152 x 74 x 13cm 5' x 2'5" x 5"	148 x 89 x 11cm 4'10/11" x 2'11" x 4.4"	158 x 92 x 11cm 5'1" x 3' x 4.4"	168 x 92 x 11cm 5'6" x 3' x 4.4"
MATERIALS: CORE EXTERIOR - Top EXTERIOR - Bottom	Moulded Foam EVA traction top triple layer PVC	Glued 1000Denier Non-Slip EVA pad Multi-layer skin	EPS & Alu stringers non-slip. Anti- Delamination Vinyl 0.6-0.9mm vinyl	EPS & Alu stringers non-slip. Anti- Delamination Vinyl 0.6-0.9mm vinyl	EPS & Alu stringe non-slip. Anti- Delamination Vinyl 0.6-0.9mm vinyl
HANDLES TETHER POINTS	8 3	4(+6cord) 11	14 3	14 3	14 3
RWC TOWABLE	■	■	■	■	■
NOSE-GUARD VALVES PLUG	■ 1 -	- 1-	■ - 1	■ - 1	■ - 1
SURF/SWIFT FLAT-WATER ICE	■ ■	■	■ ■	■ ■	■ ■
OTHER COLOURS					
NOTES	Foam core is moulded not CNC cut.	DISCONTINUED Pack size 6x14x32" 15x36x81cm Inflate <30seconds HiVis Reflective strips. Inc Pump, Bag & Repair kit	Alu stringer is an H-profile aluminium bar running thru centre line	Alu stringer is an H-profile aluminium bar running thru centre line	Alu stringer is an H-profile aluminium bar running thru centre line
WEBSITE	ppcfoiling.com	rescue.seaeagle.com	suntechboard.com	suntechboard.com	suntechboard.com

'SHORT' RESCUE BOARDS/SLEDS

					
					
SUNTECH	TIKI FACTORY	TIKI FACTORY	TIKI FACTORY	TIKI FACTORY	WRS
72" Rescue Sled	Rescue Rocket	Rescue Swammer	Rescue Sled	Rescue Plan 205*	Rapid D
					
£840 \$1039 €975	£80 \$100 €92	£140 \$171 €160	£560 \$700 €650	£1076 \$1335 €1250	£860 \$1120 €985
0kg 0lb	2kg 4.4lb	3kg 6.6lb	8kg 17.6lb	7.5kg 15.5lb	13.5kg 30lb
■	■	■	■	■	■
162L	38L	70L	160L	150L	180L
181 x 99 x 11cm 6'1" x 3'3" x 4.4"	98 x 43 x 10cm 3'2" x 1'5" x 4"	110 x 70 x 10cm 3'8" x 2'4" x 4"	168 x 99 x 10cm 5'6" x 3'3" x 4"	205 x 70 x 10cm 5'6" x 2'4" x 4"	160 x 95 x 12cm 6.3 x 3.7 x 4.7"
EPS & Alu stringers non-slip. Anti-Delamination Vinyl 0.6-0.9mm vinyl	Drop-Stitch PVC Tactile EVA pad PVC	Drop-Stitch PVC Tactile EVA pad PVC	Drop-Stitch PVC Tactile EVA pad Extra PVC half layer	Drop-Stitch PVC Tactile EVA pad Extra PVC half layer	Drop-Stitch PVC Non-Slip EVA pad Polymer clad
14 3	4 0	2 10	12 3	6 0	10 3
■	NO	NO	■	NO	■
■ - 1	- 1 -	- 1 -	- 1 -	- 1 -	■ 2x Leaffield -
■ ■	■ ■	■ ■	■ ■	■ ■	■
Alu stringer is an H-profile aluminium bar running thru centre line	Alternative to the lifeguard can or torpedo. Inflation in <1min pack size 40x27x10cm	Inflation in 1min Optional, detachable stabilising fins (for hull) pack size 70x15x15cm	Inflation in 3mins or <1min with CO cylinder pack size 70x50x20cm	*also a 215cm version with inflatable side walls see WATER RESCUE BUYERS GUIDE Inflation in 3mins or <30sec with CO cylinder pack size 70x27x18cm	Pack size 100x55x15cm
suntechboard.com	rescue.tiki-factory.com	rescue.tiki-factory.com	rescue.tiki-factory.com	rescue.tiki-factory.com	wrsinternational.com

Powered, Inflatable IRBs/ RESCUE BOATS

<16ft/4.9m



Inflatable Rescue Boats or IRBs can be fully deflated and rolled up for compact storage/transport so this guide does not include any rigid-hull versions and also does not include inflatable craft that need to be retro-fitted with a transom or frame in order to use a motor. Many white water rafts and catarafts including the WING IBS, Oceanids WRC and RDC, RAR's Rescue Cat etc. can all accommodate an outboard engine with modification of the basic craft making them extremely versatile craft. This GUIDE is concerned only with straight-out-of-the bag inflatable rescue boats with a transom on which to mount an outboard as exemplified by the original Zodiac and Avon ERBs (Avon now owned by Zodiac).

Such craft pre-date the specialist open-ended inflatable craft we looked at in our first 'boats' GUIDE but have developed alongside the white-water style rafts. These IRBs are the kind of boats long-favoured by beach rescue and lifeguard teams, in Australia affectionately called rubber duckies, by inshore rescue teams and coastguards operating in near-coastal and inland waters and by fire-rescue departments operating on inland waterways and in floods. They are typically a U or V shape with two side sponsons terminated by a cone or dome cap and then joined across the stern by a transom which keeps the water out and provides a solid mount for an outboard engine. They are the smaller sized rescue boats, less than 4.5 metres/13-15 feet able to manoeuvre in small spaces and with a shallow draft that can drive easily onto a beach or shoreline and operate in shallow water (remembering to lift the outboard where necessary). The smaller boats are easier and faster to deploy or from a package or roll and can fit more easily into a rescue truck compartment or even the back of 4WD or pick-up.

Our cut-off for the length of craft is largely dictated by the manufacturers but whether a 4.2 is considered a good size for a rescue boat but a 4.7m is too long is arbitrary but we had to set a limit somewhere.

Matt Carlin of Australia's **Surf Life-Saving Tasmania** gives some background to the types of usage and specific differences between Rescue Boats and swiftwater rafts:

Rescue services worldwide have adapted techniques from various disciplines, continually modifying and improving methods to enhance outcomes for both rescuers and victims. Flood and swiftwater rescue techniques integrate marine, cliff, fire, and whitewater rafting and kayaking industry practices. Over the last 50 years, advancements in rescue techniques, equipment, personal protective equipment, and training have significantly reduced fatalities for both victims and rescuers. This chapter highlights the evolution of these techniques and equipment, primarily derived from the commercial whitewater rafting industry and surf rescue services, and how continuous learning and adaptation from different industries are crucial to providing the best outcomes in flood and swiftwater environments.

HISTORICAL PERSPECTIVE

Humans have been rescuing victims from floodwaters for hundreds of years, initially using simple tools and methods such as throwing something to hold onto and trying to pull the victim to safe ground. Techniques have evolved, equipment has been designed to suit specific purposes, and some form of training has been conducted within organisations or communities. Fast forward to the twentieth century, with urbanisation, vehicles, infrastructure, increased and concentrated populations, altering of natural watercourses, and intensified rainfall, all resulting in water behaving very differently and impacting larger areas and populations. With greater impact on our communities, governments have attempted to solve this problem by identifying organisations to take responsibility, funding them to provide rescue services, and educating the public on how to avoid the dangers.

Formalised rescue services bring together a broad range of

POWERED INFLATABLE RESCUE BOATS

www.rescuemagazines.com

people to train and develop techniques that improve the safety of rescuers and increase the success of rescuing victims. However, “you don’t know what you don’t know.” Looking outside your lived experiences, organisation, industry, or country will help you learn and improve on what you do. Surf Life Saving Tasmania (Australia)

In 2016, Tasmania experienced some of the worst flooding in living memory. Whole communities and towns were flooded and cut off. Emergency services requested the assistance of Surf Life Saving Tasmania (SLST) in using surf rescue inflatable rescue boats (IRBs) to access flood victims and assist with welfare checks, evacuations, and rescue of people impacted by floodwaters. Volunteers from many surf clubs mobilised and assisted using and adapting boats and equipment throughout the rescue efforts over a couple of weeks. Upon reflection, SLST undertook a review of the rescue efforts, examining what worked, what didn’t work, and what should be done next time. The first step was to look at other organisations in other states of Australia, followed by reaching out to the international life-saving community. Surf Life Saving Great Britain (SLSGB) had been involved in flood and swiftwater rescue for more than ten years, learning from international organisations and incorporating those lessons into their operations. This informed SLST on risk management, operational procedures, rescue equipment, rescue techniques, structures of rescue training, rescue teams, and effective personal protective equipment (PPE) for rescuers (2). SLST continues to work closely with SLSGB, adopting similar learnings into their operational framework and now sharing this knowledge with other states in Australia through the Centre of Excellence: Flood and Swiftwater Rescue and Surf Life Saving Australia.

PHASES OF FLOODING

Flooding occurs through four phases:

1. Preparation: Monitoring weather forecasts, utilising prediction models, and ensuring rescue workers and volunteers are prepared to respond if the rainfall event is extreme enough to result in flooding.
2. Flash Flooding: Heavy rainfall in a localised area resulting in increased speeds and volume of water in natural waterways and channels that cannot handle the volume of water (stormwater channels, roads, canals). This phase is sudden and can put lives at risk in a very short period.
3. Broadwater Flooding: The overtopping of river channels, dams, lakes, and the expansion of water into open territory, inundating towns, farmland, roads, and transport networks. This phase can last for an extended period, usually trapping people, cutting off towns and cities, and disrupting services such as power, water, sewage, and communications.
4. Recovery: The receding of floodwaters, clean-up, rehousing of affected people, reinstating services, and supporting affected communities with transport, accommodation, food, water, clothing, and other basic needs.

Flood and swiftwater rescue operates in all four phases but primarily in Phases 2 and 3. During Phase 2: Flash Flooding, rescuers help people who may be trapped by rapidly rising water. People often underestimate the forces of water when

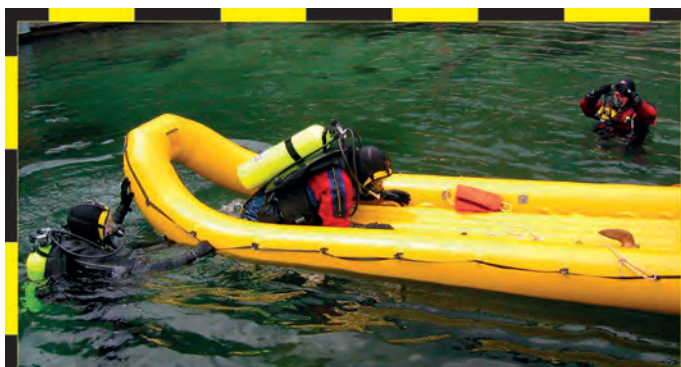

+1 (208) 322 3600

oceanid.com

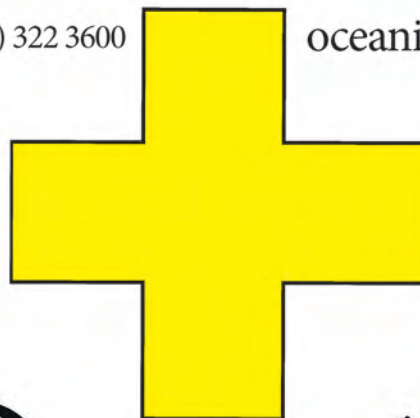

Oceanid™

WATER RESCUE CRAFT



attempting to cross a swollen waterway, resulting in trouble and an inability to get out of the water. Phase 3: Broadwater Flooding inundates communities for weeks, cutting people off from basic needs. Large numbers of volunteers (surge capacity) are needed to support those communities, conducting welfare checks, supplying food and water, or evacuating people to alternative accommodation. This usually involves the use of boats to access people as roads become impassable.

ADAPTATION AND TRAINING

Surf Life Saving has become involved in flood rescue through extensive experience in the use of IRBs. The organisation can mobilise hundreds of IRBs, drivers, and crew to assist in broadwater flooding disasters. Standard surf rescue IRBs are currently suitable for broadwater flooding environments, and with targeted training and suitable PPE, volunteers are well equipped to handle the demands of broadwater flood response.

The use of IRBs in swiftwater is an emerging area of flood rescue. Organisations worldwide use modified IRBs in swiftwater to rescue victims in various situations. Surf Life Saving Tasmania has been training with SLSGB for over six years, developing skills, training courses and materials, rescue equipment, risk management, and operational procedures around IRBs in swiftwater. More recently, SLST has been working with several organisations in Australia that use IRBs in swiftwater rescues. One of the challenges of adapting to a new rescue environment is ensuring the equipment is fit for the task. Current IRB manufacturers in Australia produce craft similar to those used in surf rescue or the military. Manufacturers often only make modifications based on feedback from users. If rescue organisations do not look beyond their organisation, state, or country, they may miss advancements in techniques, equipment, and training that could inform necessary modifications to IRBs.

SLST recently examined the commercial whitewater rafting industry and IRB manufacturers in Great Britain and the United States. A guideline in the commercial whitewater rafting industry is that there should be no ropes, lines, or equipment on a raft that could entrap a person's limbs. Perimeter lines are tight, bow and stern lines are coiled and secured to the boat with small loops, and equipment tied onto a raft has no loose straps, loops, or holes (1). Unfortunately, these lessons were learned through client and guide deaths during the 1970s and 1980s when the industry was emerging.

Standard surf rescue IRBs have loose perimeter lines, loosely coiled tow ropes inside the boat, a rescue tube strapped inside the boat with potential loops that could entrap a person, a fuel line running from the bow to the stern with only three attachment points (leaving loops on the boat floor), the motor secured to the transom with a wire safety cable (3) (which cannot be cut and released if the motor comes off the transom), and paddles that are not rated for swiftwater. While these guidelines suit the surf zone, they are unsuitable for swiftwater. Swiftwater is continuous and forceful, pushing people and boats into objects that can entrap them and quickly

carry them into more danger. The nature of the water and potential hazards should dictate the design modifications to rescue equipment.

Several IRB manufacturers worldwide have addressed some of these safety issues, such as tight perimeter ropes, stern-mounted fuel cells (no long, loose fuel lines), and rated rescue rings positioned around the outside for rope-tethered rescue systems. However, rescue organisations must ensure that other equipment on these IRBs meets minimum standards, is tested in different situations, and is included in training courses to ensure rescuers know how and why something is attached a particular way and how to access it quickly. Rescue organisations need to continually ask the "what if" questions:

- What if the boat overturns?
- What if the motor is disabled?
- What if the IRB is pushed against a bridge pylon/car/rock and overturned?

The next series of questions revolves around what equipment on board can assist the crew to respond effectively (rollover rope easily accessible, strong paddles, no limb entrapment points, knives on life jackets to cut rope, motor that can be cut away if wedged in a strainer). Training of rescuers must include drills using these techniques to ensure quick responses in emergencies.

CONCLUSION

Rescue agencies worldwide are being asked by governments to respond to new rescue challenges. When an agency decides to tackle a new challenge or a different form of rescue (fire to water), it faces many new challenges and costs. Sometimes, budget constraints can lead to shortcuts in equipment, training, and professional development of rescuers. However, you are not the first—there is another organisation that has done this, made mistakes, learned, evolved, and continues to modify and train to ensure the safety of rescuers and victims. Reach out to similar organisations nationally and internationally. Research how other countries set up their operating standards, rescue team typing, PPE standards for operating in contaminated floodwaters (International Life Saving Federation standards), and training programs. Consult with people and organisations with experience in similar fields. The broader you search, the more people you consult, and the more you involve in the research stage, the greater the diversity of ideas generated.

REFERENCES

1. Worksafe New Zealand. White Water Rafting: Guidance for Commercial Rafting Operators. Published June 2020. ISBN: 978-1-98-856768-6. Worksafe NZ
2. International Life Saving Federation. Lifesaving Position Statement – LPS 23: Flood Disaster Rescuer Responder Personal Protection Equipment (PPE). 2023.
3. International Life Saving Federation. Equipment Specification Inflatable Rescue Boat (IRB). 2015.

Abbreviations:

- SLST: Surf Life Saving Tasmania
- SLSGB: Surf Life Saving Great Britain
- PPE: Personal Protective Equipment
- IRB: Inflatable Rescue Boat
- ILS: International Life Saving Federation

POWERED INFLATABLE RESCUE BOATS

SPEED/PERFORMANCE TUBES

are additional lines of narrow tubing that run along the bottom of the side-sponsons and effectively carve a line through the water and limit the resistance of the wider sponsons:

IN THE FOLLOWING TABLES:

Use common data notes from the GUIDE to RAFTS on page __. These are the IRB-unique definitions.....

In the previous inflatable guides we referenced the inflation methods as hand pump, electric pump or CABA for compressed air. In IRBs this latter may be described as HPP for High Pressure Air and may be a different model to the same craft inflated by hand or electric pump Zodiac for example offer the ERB models as either a fully rigid craft, a roll-up which inflates with hand or electric pump or HPP which is permanently inflated or inflated on-scene with high pressure compressed air.



WRS[®]
INTERNATIONAL

High Volume Bow and Rocker - With a raised bow height the X-Sled is able to handle tethers in swift water whilst reducing the risk of the bow diving when loaded. The increased volume maintains stability when occupied by a casualty or rescuer.

WRS[®]
INTERNATIONAL



Water Rescue X-Sled
The original and best since 2014, designed in the UK.

www.wrsinternational.com

Images NOT to Scale □□□ = Option ●● = Partial Feature/ OK but not ideal COST: £\$€ Approx, inc local tax/VAT £\$€=currency conversion only N/A = info Not Available/not given INFLATION TIME: Hand Pump/CABA VALVES PRV=Pressure Relief Valve		MODEL	COMPANY	ORIGIN	COST inc tax / VAT	WEIGHT	LOAD CAPACITY Kg/Sq Metre lb/Sq Foot	DIMENSIONS L x int/ext Wx H/D PACKED
			CPI Rescue Products		£ \$ €	50kg 44lb	950kg lb	0 x 0/0 x 0cm 119 x 47/91 x 22" 0 x 0 x 0cm 0 x 0 x 0"
	430-SR-HD 430-SR-HYP	INMAR		£ \$3896 €7996	kg 195lb	3kg 0lb	0 x 0/0 x 0cm 150 x 37/77 x 20" 0 x 0 x 0cm 55 x 33 x 24"	
	380-SR-HD 380-SR-HYP	INMAR		£ \$3696 €6996	kg 185lb	kg 1750lb	0 x 0/0 x 0cm 150 x 37/77 x 20" 0 x 0 x 0cm 52 x 34 x 20"	
			JPW inc		£ \$4444 €	32.7kg 72lb	400kg 882lb	0 x 0/0 x 0cm 120x65 x 19.5" 0 x 0 x 0cm 0 x 0 x 0"
			MFC INTERNATIONAL		£ \$ €	26kg 57.2lb	820kg lb	350x134/190x56cm 137 x 52.7/75 x 22" 88 x 50 x 33cm 35 x 19.7 x 13"
	RC4000	MFC INTERNATIONAL		£ \$ €	53kg 00lb	800kg lb	400x0/200 x84cm 0 x 0/0 x 0" 140 x 50 x 35cm 0 x 0 x 0"	
	DS400	NORTHERN DIVER		£1330 \$ €	25kg 55.1lb	400kg 882lb	240 x 60/130 x 35cm 94.5 x 23.6/55 x 14" 92 x 67 x 25cm 36.2 x 26.4 x 9.8"	
	DS420	NORTHERN DIVER		£1480	62kg 136.7lb	700kg 1543lb	380 x 80/170 x 45cm 0 x 0/0 x 0" 120 x 60 x 40cm 0 x 0 x 0"	
	DS520	NORTHERN DIVER		£1530	62kg 136.7lb	700kg 1543lb	380 x 80/170 x 45cm 0 x 0/0 x 0" 120 x 60 x 40cm 0 x 0 x 0"	

POWERED INFLATABLE RESCUE BOATS

AIR CAPACITY INFLATION TIME	MAX WORKING PRESSURE MAX ENGINE HP	INFLATION OPTIONS & TIMES HAND ELECTRIC HP/CABA	MATERIALS TRANSOM	INFLATION				LOADING			EXTRAS			VIZ		NOTES	WWW.
				INFLATION	REGULATOR / HOSE	MANUAL/POWERPUMP	SAFETY PRV / DUMP	INFLATABLE/ HARD DECK	HANDLES	FLIP TAB / GRAB CORD	TOW/HD/LIT DUTY EYES	POUCHES / BOW BAG	CARRY BAG/ PADDLES	REPAIR KIT/ WARRANTY	REFLECTIVE/ CUSTOM		
?	?		32oz PVC 40oz Evaloy- drop-thread deck	0	<input type="checkbox"/>	<input type="checkbox"/>	<input type="checkbox"/>	-	14			<input type="checkbox"/>	1	<input type="checkbox"/>	<input type="checkbox"/>		cpiwaterresqproducts.com
?	?		1.2mm Mehler, Orca Hypalon Welded seams Fiberglass	0	<input type="checkbox"/>	<input type="checkbox"/>	<input type="checkbox"/>	<input type="checkbox"/>	11	<input type="checkbox"/>	<input type="checkbox"/>	<input type="checkbox"/>	1*	<input type="checkbox"/>	<input type="checkbox"/>	Shown with fold-up Aluminium Floor/deck	inmarboats.com
?	?		1.2mm Mehler, Orca Hypalon Welded seams Fiberglass	0	4	<input type="checkbox"/>	<input type="checkbox"/>	6	11	<input type="checkbox"/>	<input type="checkbox"/>	<input type="checkbox"/>	1*	<input type="checkbox"/>	<input type="checkbox"/>	Shown with inflatable floor/deck	inmarboats.com
?	?		32/42oz PVC coated Polyester drop-thread deck	?	?	<input type="checkbox"/>	<input type="checkbox"/>	-	4			-	10	-	<input type="checkbox"/>		jpwinc.com
1815 L cuft 3mins	0.2 & 0.4 BAR 3.25 & 6 Psi		Hypalon TPU drop-thread deck	?	?	<input type="checkbox"/>	<input type="checkbox"/>	7	-				2	2	<input type="checkbox"/>		mfc-international.com
3000 L 0cuft 0mins	0.2 & 0.4 BAR 3.25 & 6 Psi		Hypalon TPU drop-thread deck	?	?	<input type="checkbox"/>	<input type="checkbox"/>	4	-				2	2	<input type="checkbox"/>		mfc-international.com
? L ?cuft -3mins*	0.35 & 0.7 BAR 5 & 10 Psi		1.2mmPVC 8cm drop-stitch DWF/PVC Floor	?	?	<input type="checkbox"/>	<input type="checkbox"/>	-	-				2	2	<input type="checkbox"/>	add £20 for Alu Deck	ndiver-rescue.com
? L ?cuft 1-3 & 4mins*	0.35 BAR 5 Psi		1.2mm PVC 8cm drop-stitch DWF/PVC Floor	?	?	<input type="checkbox"/>	<input type="checkbox"/>	8	-				2	<input type="checkbox"/>	<input type="checkbox"/>		ndiver-rescue.com
? L ?cuft 1-3 & 4mins*	0.35 BAR 5 Psi		1.2mm PVC 8cm drop-stitch DWF/PVC Floor	?	?	<input type="checkbox"/>	<input type="checkbox"/>	8	-				2	<input type="checkbox"/>	<input type="checkbox"/>		ndiver-rescue.com

<p>Images NOT to Scale □□□ = Option ●● = Partial Feature/ OK but not ideal COST: £\$€ Approx, <u>inc</u> local tax/VAT £\$€=currency conversion only N/A = info Not Available/not given INFLATION TIME: Hand Pump/CABA VALVES PRV=Pressure Relief Valve</p>	MODEL	COMPANY	ORIGIN	COST <u>inc tax /</u> <u>VAT</u>	DRY WEIGHT	LOAD PERSON CAPACITY Kg/Sq M lb/Sq Ft	DIMENSIONS L x int/ext Wx H/D PACKED
	DS400	NORTHERN DIVER		£1850	62kg 136.7lb	700kg 1543lb	380 x 80/170 x 45cm 0 x 0/0 x 0" 120 x 60 x 40cm 0 x 0 x 0"
	DS420	NORTHERN DIVER		£1960	62kg 136.7lb	700kg 1543lb	380 x 80/170 x 45cm 0 x 0/0 x 0" 120 x 60 x 40cm 0 x 0 x 0"
	DS460	NORTHERN DIVER		£1260	62kg 136.7lb	700kg 1543lb	380 x 80/170 x 45cm 0 x 0/0 x 0" 120 x 60 x 40cm 0 x 0 x 0"

REALISTIC WATER RESCUE TRAINING OPENED SPRING 2023



FAYETTEVILLE
TECHNICAL COMMUNITY COLLEGE

Fayetteville Technical Community College
 2201 Hull Rd,
 Fayetteville, NC 28303
 Tel +1 (910) 678-8400
 www.faytechcc.edu



POWERED INFLATABLE RESCUE BOATS

AIR CAPACITY INFLATION TIME	MAX WORKING PRESSURE MAX ENGINE HP	INFLATION OPTIONS & TIMES HAND ELECTRIC HP/CABA	HULL FORM MATERIALS TRANSOM	INFLATION				LOADING			EXTRAS		VIZ		NOTES	WWW.
				INFLATION	REGULATOR / HOSE	MANUAL/POWERPUMP	SAFETY PRV / DUMP	INFLATABLE/ HARD DECK	HANDLES	FLIP TAB / GRAB CORD	TOW/HD/LT DUTY EYES	POUCHES / BOW BAG	CARRY BAG/ PADDLES	REPAIR KIT/ WARRANTY		
? L ? cuft 1- 3 & 4mins*	0.35 BAR 5 Psi	■ ■ ■	1.2mm PVC 8cm drop-stitch DWF/PVC Floor	? ? ?	? ?	□ ■	■ ■	8 -	- -	12	■	2	□	■	add £15 for Alu Deck	ndiver-rescue.com
? L ? cuft 1- 3 & 4mins*	0.35 BAR 5 Psi	■ ■ ■	1.2mm PVC 8cm drop-stitch DWF/PVC Floor	? ? ?	? ?	□ ■	■ -	8 -	- -	12	■	2	□	■		ndiver-rescue.com
? L ? cuft 1- 3 & 4mins*	0.35 BAR 5 Psi	■ ■ ■	1.2mm PVC 8cm drop-stitch DWF/PVC Floor	0 5	■ □	□ ■	■ -	8 -	- -	12	■	2	□	■		ndiver-rescue.com
		HAND														

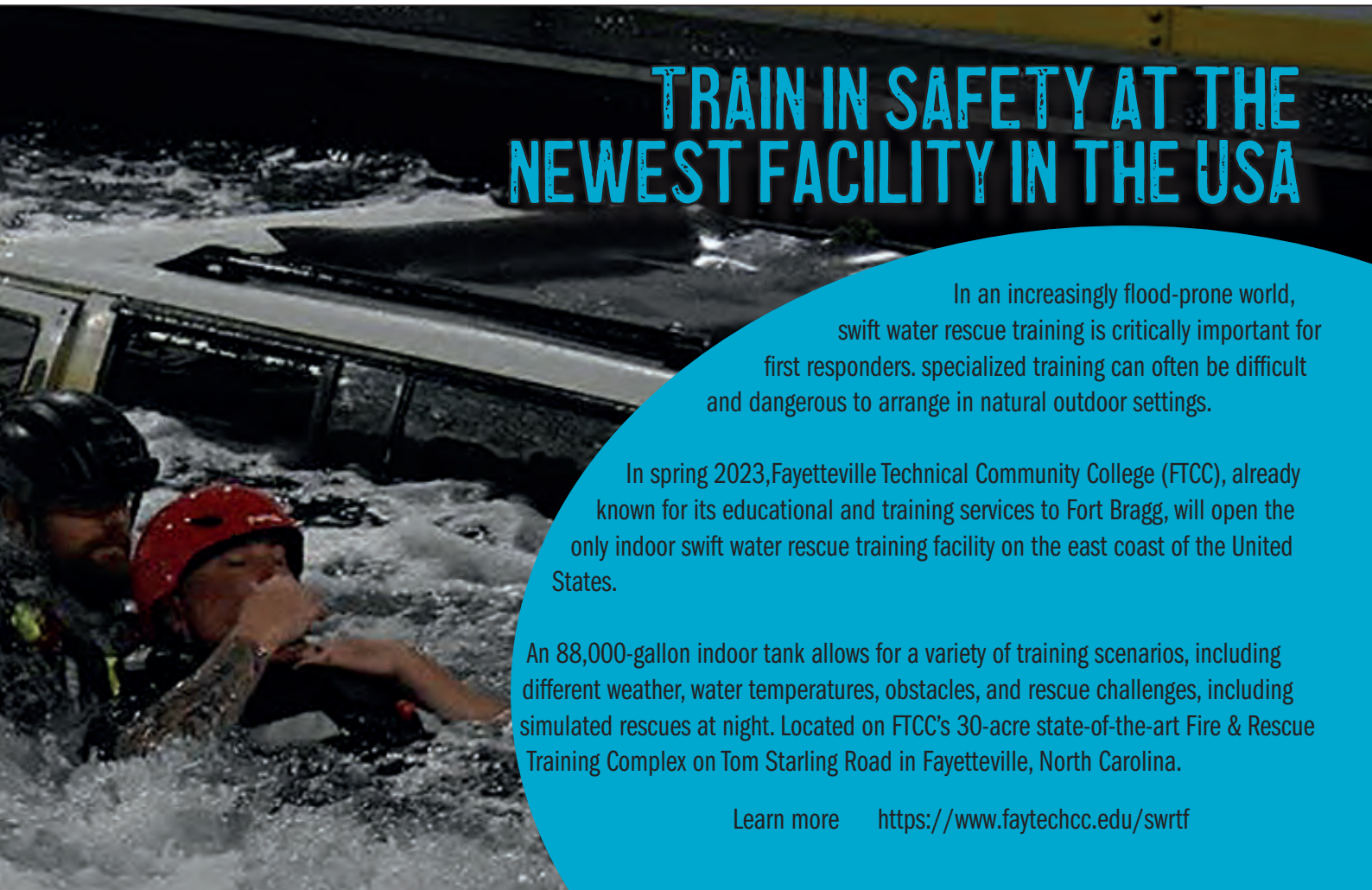

TRAIN IN SAFETY AT THE NEWEST FACILITY IN THE USA

In an increasingly flood-prone world, swift water rescue training is critically important for first responders. Specialized training can often be difficult and dangerous to arrange in natural outdoor settings.

In spring 2023, Fayetteville Technical Community College (FTCC), already known for its educational and training services to Fort Bragg, will open the only indoor swift water rescue training facility on the east coast of the United States.

An 88,000-gallon indoor tank allows for a variety of training scenarios, including different weather, water temperatures, obstacles, and rescue challenges, including simulated rescues at night. Located on FTCC's 30-acre state-of-the-art Fire & Rescue Training Complex on Tom Starling Road in Fayetteville, North Carolina.

Learn more <https://www.faytechcc.edu/swrtf>

Images NOT to Scale □□□ = Option ●● = Partial Feature/ OK but not ideal COST: £\$€ Approx, inc local tax/VAT £\$€=currency conversion only N/A = info Not Available/not given INFLATION TIME: Hand Pump/CABA VALVES PRV=Pressure Relief Valve		MODEL	COMPANY	ORIGIN	COST inc tax / VAT	DRY WEIGHT	LOAD PERSON CAPACITY Kg/Sq M lb/Sq Ft	DIMENSIONS L x int/ext Wx H/D PACKED
			SAFEQUIP	UK	£3600 \$5040 €4320	42kg 92.4lb	1000kg 2200lb	320 x144/220 x 38cm 126 x 57/87 x 15" 100 x 70 x45cm 39 x 27.6 x 18"
		ResQCraft3800 SIT38040	SIT Ltd	UK	£ \$ €6074	23.8kg 52.4lb	650kg 1430lb	300 x 70/120x35cm 118 x27.6/47 x 14" 90 x 30 x 30cm 35.4 x 12 x 12"
		ResQCraft4000 SIT38006	SIT Ltd	UK	£ \$ €	42kg 92.4lb	1000kg 2200lb	320 x 120/220 x 38cm 126 x 47/87 x 15" 80 x 60 x40cm 31.5 x 23.6 x 15.75"
			SURVITEC/ DSB gmbH IC BRINDLE		£3994	00kg 00lb		00 x 00/000 x 00cm 00 x00/x00" 00 x 00 x 00cm 00 x 00 x00"
		P4.2 RESCUE	WING INFLATABLES	USA	\$	77.3kg 170lb	952kg 00lb	420x81/173x45.7cm x/x" 63.5 x 74 x 122cm xx"
		ZMSR 380 (Surf Rescue)	ZODIAC	FR	£ \$ €	81kg 00lb	6 617kg 00lb	381 x 00/168 x 00cm 00 x00/x00" 120 x 60 x 40cm 00 x 00 x00"
		ERB310 Roll-Up HPP Rigid	ZODIAC MILPRO	FR	£ \$ €	74kg 00lb	7 700kg 00lb	393x??/168x45.7cm x/x" 140 x 30 x 72cm xx"
		ERB380 Roll-Up HPP Rigid	ZODIAC	FR		00kg 00lb		00 x 00/000 x 00cm 00 x00/x00" 00 x 00 x 00cm 00 x 00 x00"
		ERB400 Roll-Up HPP Rigid	ZODIAC	FR		00kg 00lb		00 x 00/000 x 00cm 00 x00/x00" 00 x 00 x 00cm 00 x 00 x00"

POWERED INFLATABLE RESCUE BOATS

AIR CAPACITY INFLATION TIME	MAX WORKING PRESSURE MAX ENGINE HP	INFLATION OPTIONS & TIMES HAND ELECTRIC HP/CABA	HULL FORM MATERIALS TRANSOM	INFLATION					LOADING			ACC			VIZ		NOTES	WWW.	
				CHAMBERS / SEATS	REGULATOR / HOSE	MANUAL/POWERPUMP	SAFETY PRV / DUMP	INFLATABLE/ HARD DECK	HANDLES	FLIP TAB / GRAB CORD	TOW/HD/LIGHT EYES	POUCHES / BOW BAG	CARRY BAG/ PADDLES	REPAIR KIT/ WARRANTY	REFLECTIVE/ CUSTOM	COLOUR OPTIONS			
1550 L 4.7cuft <2mins	0.2 & 0.4BAR 3 & 6 psi 0HP	■ ■ ■	'Orca' Hypalon 6" drop-thread deck	5	□ □	□ □	- ■		8 2	■ ■	2 -	8* -	■ ■	■ ■	5	□ ■	■ ■ ■ ■	Leaffield valves. 6" Deck. * D-Ring under deck can provide flip tab	safequip.co.uk
860 L 0.4cuft <1min	0.2 & 0.4BAR 3 & 6 psi 0HP	■ ■ ■	'Orca' Hypalon Neoprene-coated 6" drop-thread deck	3	□ □	□ □	- ■		7 4	■ ■	4 -	5 -	■ ■	■ ■	2	□ ■	■ ■ ■ ■	Leaffield valves	sitltd.co.uk
1550 L 4.7cuft >2mins	0.2 & 0.4BAR 3 & 6 psi 0HP	■ ■ ■	'Orca' Hypalon 6" drop-thread deck	5	□ □	□ □	- ■		8 2	■ ■	2 -	8* -	■ ■	■ ■	2	□ ■	■ ■ ■ ■	Leaffield valves. * D-Ring under deck can provide flip tab. Inboard stowage loops	sitltd.co.uk
0 L 00cuft >0>min	00BAR 00psi 30HP	■ ■ ■																markus.bolay@sur- vitecgroup.com	icbrindle.com
0 L 00cuft >0>min	00BAR 00psi 30HP	■ ■ ■	Polyurethane. drop-thread deck. Composite	3	□ ■	□ ■	- ■		4 -	■ -	- -	3 -	■ ■	□ ■	- ■	□ ■	■ ■ ■ ■	also available with composite hard deck	inflatable solu- tions.com
0 L 00cuft >0>min	00BAR 00psi 30HP	■ ■ ■	V Polyurethane. drop-thread deck. Composite																
0 L 00cuft >0>min	00BAR 00psi 30HP	■ ■ ■																	
0 L 00cuft >0>min	00BAR 00psi 30HP	■ ■ ■																	
0 L 00cuft >0>min	00BAR 00psi 30HP	■ ■ ■																	

HAND-PORTABLE SUB-SEA ROVS



We should first define the acronym that we're using here - ROV or Remote Operated Vehicle - further defined by the term SubSea because an ROV could just as easily be your kids toy car. There are other terms - UUV is Underwater Unmanned Vehicle and AUV is an Autonomous Underwater Vehicle which is not directly controlled by an operator but rather preprogrammed to carry out a specific task via a specified route and mode - these don't use a tether and are not usually utilised by rescue teams. As far as ROVs are concerned, there is a fine line between a mini or hand-portable underwater Remote Operated Vehicle that rescue agencies would or could use and the smaller end of the scientific and oilfield ROVs defined as Work-Class ROVs that look like a block of flats with arms. The difference of course is the ability for your average search team to be able to carry and deploy it and their ability to buy it in the first place. All of the models in this guide cost less than a fire truck - some of them cost less than a set of tyres for your Off Road vehicle but those big boxy exploration and maintenance ROVs are 5 and 6 figure sums or they weigh the same as a small elephant at their smallest! Take this Oceaneering OmniMaxx on the right - it looks a lot like some of the models in our guide if you look at this picture in isolation, but it's 1.3m/50" long and over a quarter of a tonne and don't even bother about asking the cost. They know you can't afford it, rescue/emergency response isn't mentioned once in their blurb. Most of the big ROV manufacturers don't mention rescue or



search & recovery in their list of possible taskings and industries served. They are all about inspection and maintenance of pipelines, subsea comms cables, ships and submarines - you can see where all the money is - oil, gas, shipping and the military.... rescue, not so much. So even though ROV's like that Omni Maxx might be the kind of vehicle that a dive team would crave, it is, to all intents and purposes, 'out of your league'.

As we said earlier, it's a fine line between the most 'recreational' ROV and the cheapest Search and/or Rescue ROV but cost is often the first consideration. Emergency responders and Government agencies not related to defence are unlikely to have money to burn and for most, an ROV is a luxury. It will be tempting to look at some of the numerous Chinese 'recreational' models costing only a few hundred up to a thousand or two on the basis that any capability is better than nothing? Or is it? Once you rock up to a scene with expectations of a capability in underwater search and maybe light-recovery you effectively have a duty of care to perform that task to a level of professionalism expected of any emergency service. Deploying an ROV that looks like your kids skillfully constructed it using one of those month by month publications that builds into a complete ROV might leave you with egg on your face. Because, despite the fact it worked fine in the practice pool, when it came to deployment at an actual incident with time pressing, weather rubbish and the incident commander waiting for you to perform, the video graphics looked sketchy, the tether ran out 20feet short of the target and the battery packed up after 7 minutes because the water is pretty chilly. Not buying 'cheap' is a broad concept that you could apply to any technological kit used for rescue but ROVs - whether aerial or subsea - are a relatively new phenomenon with many new companies vying for your attention and most don't have the kind of track

record that you might otherwise look for in selecting equipment. That's certainly true of aerial ROVs but in fact, subsea ROVs do have some specialists from our sector. Regular readers of **TECHNICAL RESCUE** magazine will be familiar with *JW Fishers* who have been featuring for the past 30 years and this century we have seen Canadian company *DeepTrekker* and US company *VideoRay* targeting the rescue, inspection and research sectors. It's fair to say that *Deeptrekker* and *VideoRay* represent perhaps the more technological end of things - reliable modern complex subsea robotics with a range of vehicles that include an absolute maze of mission possibilities. Compared to the many Chinese models available (which may or may not be good) *Deeptrekker*, *VideoRay* and *JW Fishers* have skin in the game, a track record in rescue that you can hang your hat on. *JW Fishers* represents the bombproof, more traditional end of robotics. Their *Sea Lion* and slightly more basic *Sea Otter* are perhaps the most robust in this sector with a simple cylinder modified to take the lighting units, thrusters and manipulators common to all ROV's. We often think of them in terms of that great (and probably urban myth) analogy that retells how NASA engineers were proud of their latest innovation after thousands of hours of research and design and hundreds of thousands of dollars - a pen that could write in any orientation, underwater, in zero gravity, in freezing temperatures or extreme heat to which the Soviets replied that they too has such an innovation - they called it a pencil. Whether this is true or not, and we doubt it, the point of the analogy is that simple is often the best option. With ROVs being operated in an alien environment by rescuers who rarely get level of use and experience that deep-sea explorers and maintenance workers get but who may be operating under critical time and environmental constraints, the less to go wrong the better.

POWER/BATTERIES

All of these ROVs are electrically driven but not all have an independent on-board battery system. Some can only operate via hardwire connection to a top-side power source usually housed in a Pelican style hardcase like this Video-Ray power-case

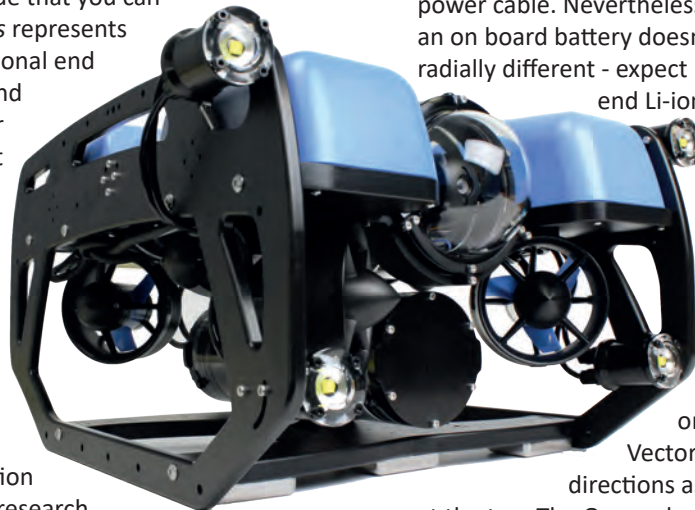

(right). With transformers, many can use other top-side power sources like vehicle batteries or even mains supplies. Many fuel-driven generators on rescue trucks have AC power sockets which some, like *Video-Ray's Defender*, can use. But for the most part, in rescue we're talking independent battery power.

The top-side systems provide much greater longevity and easier power monitoring and management than autonomous on-board batteries and, since a tether is usually used for retrieval, control and live feed, it is not a stretch to add a power cable. Nevertheless a tether adds bulk and drag which an on board battery doesn't but work/search durations are radically different - expect 1 to 4 hours with an on-board high end Li-ion or polymer. The *BlueRov2* above quotes 2hours for heavy use up to 6 hours with 'light' use. A tether may allow up to 8 hours from a top-side powerpack.

CONTROL of THRUSTERS

In terms of controlling your ROV this relies on thrusters, basically impellers that can have variable orientation but are more usually fixed.

Vector thrusters are paired in opposing directions as you can see in the *Fishers Sea Lion* at the top, The *Oceanobotics* model in the titles and the *Blue ROV* above with additional vertical thrusters for lift. Variable thrusters can be rotated to give infinite directional control. The way you control might be via a simple thumb toggle or, taking a leaf out of military UAVs, the *Play Station*-style controller is seen by many under 50 year-olds as an easier means to control the ROV. The control systems and imaging options are often pre-mounted into a *Peli*-style hard case with the monitor handily located in the lid and ready for use when you open the case like the *Fisher* system top for their *Sea Lion2*. Lighter weight, out-of-the-box controllers are also available like the *Deeptrekker* system above left used to control its *DTG3* ROV and *Video-Ray's Expeditionary* controller above using a tablet with add-ons from the main control box. Lap top computers are another common interface to provide video and sonar viewing.

SENSORS

On-board sensors can provide data on temperature, depth, direction/orientation, size of and proximity to objects.

Exact location of your ROV has to be achieved via transponders **rather than GPS because satellite-based systems only work in the surface layers of water**. A little easier to work out is orientation of the ROV in terms of whether it is upside down etc and this is achieved with an onboard gyroscope or gimbal relaying attitude to the system. This is all important information that affects the ability of the ROV to perform and enable the controller to carry out specific tasks. Some ROVs have these sensors as standard, most can be added to a package. At a minimum, rescuers will want the option of temperature because the colder it is, the shorter time your battery will last and a navigation package. Navigation in terms of directing the ROV where to go is usually undertaken with **USBL** tracking which uses the surface boat (if you are using one) as its reference GPS. There are also computer analytics that use DVL or Doppler Velocity Log (speed relative to the seabed) and distance from mother-ship figures to calculate location. Usually, DVL just give you an accurate speed.



majority of dive and surface water rescue teams are using their ROVs as a search tool so it is the video capability and/or acoustic/sonar imaging that are most important. And these are elements that can really rack up the bill on your ROV. Imaging sonar will triple the price of a US\$10K ROV. it's always the add-ons that get you but these add-ons can be crucial. High Definition video aided by high intensity white light LEDs with images relayed by a hard-wire (fibre-optic) tether offer the most reliable way to get the best quality images to the controller on top though there are WiFi telemetry systems that will undoubtedly improve in the coming years. This may not be quite as useful

VIDEO, IMAGING & LIGHTING

Getting your Remotely Operated Vehicle to the underwater scene is only one part of the package requirements, in fact, by itself is of no use whatsoever. The ROVs need to be able to do something tangible and this means at least the ability to scan an area with Sonar or IR etc or film and illuminate a scene and to relay that back in real time to the team on top. There they will view data and control the ROV from a mobile 'command-Post' like the Fishers model above. Real-time visuals include video and higher resolution stills and these generally need to be well illuminated. All ROVs have on-board lighting - arrays of LEDs these days offering differing lighting levels and types of beam from long range spot to short range wide-area flood.

Something that doesn't require lighting is Sonar. Sonar is the most often used asset by rescue agencies and this is a complex field in itself with most ROVs designed to accommodate a specific brand/model of multi-beam rather than scanning or side-scansonar (see our separate GUIDE to SONAR). The image below is via a Kongsberg Flexview sonar which can be retrofitted to many ROVs and in this case has picked out the outline of a bicycle but humans can be far less distinct and it takes a skilled operator with lots of experience to discern a bone-fide target from all the other clutter than may be adorning a lake, bay or river bed.

Your ROV may be equipped with a manipulator arm that can either grab and retrieve objects (to a very specified weight) or perform other manipulation and or cutting tasks but the vast

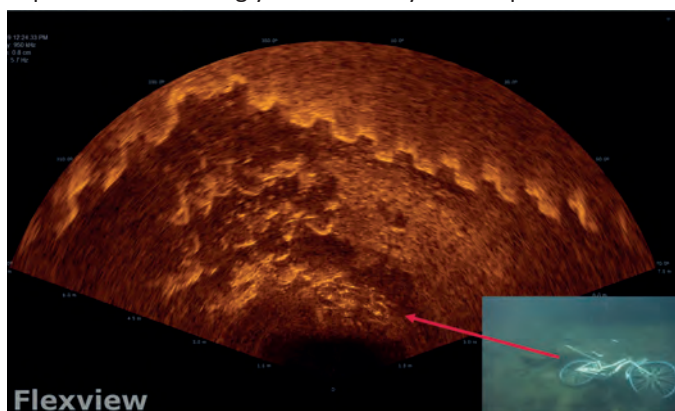

a development as you might think because virtually all ROV deployments would use a tether to the surface anyway in order to deploy, recover or find your ROV should it shut-down and become lost or entrapped. The downfall of video is that it relies on fairly clear water and this is often not what you're dealing with in inclement weather which is why acoustic imaging or sonar is a more favoured function - it not only 'sees' through the murk, it does so over distance of 100s of feet. It is sonar which sets apart the more serious ROV packages.

MORE TECHNICAL INFO on Cameras VIDEO & IMAGING

TETHERS

Technically a tether is simply the load-capable connection between your ROV and top-side that enables you to drag it back should it lose power. Once you add a power cable and data transmission cable (fibre-optics) your tether is actually an umbilical providing and receiving vital power and/or data as well as being the distance restrain and haul-back line. Power

Make Searching Open Waters Safer & Easier with JW Fishers Underwater Equipment

Hand Held Underwater Metal Detectors

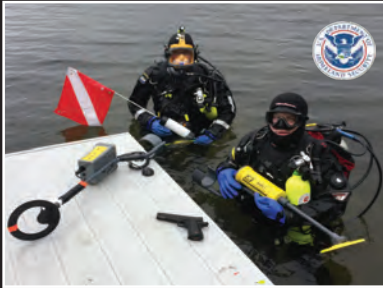

Pulse 8X

- Detects ALL metals on land & underwater
- Audio and Visual output
- Commercial construction
- Ideal for evidence recovery
- Rated #1 by US Homeland Security

SAR-1

- "Snareless" design with VIBRATING handle
- Bright red LED display
- Specialized for low visibility environments
- 200' depth rating

Side Scan Sonar

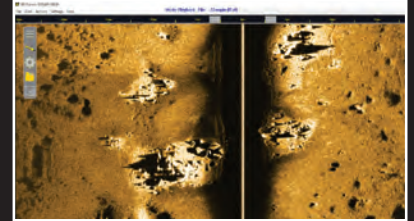

* Simulated Drowning Victim



600kHz - CW

- Simple to operate
- Up to 225' (75m) range on each side
- Displays images on laptop or tablet
- Commercial construction
- Works in all waters, regardless of clarity
- In use by public safety dive teams

450kHz / 900 kHz - CHIRP

- Fully digital
- Up to 495' (150m) range on each side
- Breaks down for easy transport (case included)
- Commercial construction
- Low cost and easy operation
- Complete turnkey system

Remote Operated Vehicle with Sector Scanning Sonar



SeaLion-3

- 7 vectored, thruster system
- Front and rear 1080p HD cameras
- Two monitors for viewing and control
- Picture in picture (PIP) functionality
- Easily transportable
- Commercial construction
- 1,000' depth capability

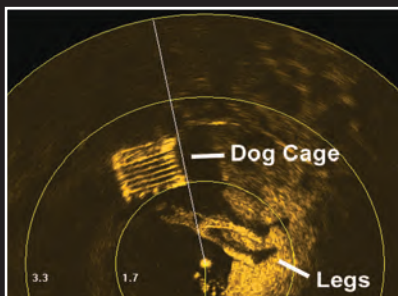

SCAN-650

- Target sizing capability
- 360° sweep pattern
- High resolution imagery
- User friendly software
- Commercial construction
- ROV, pole or tripod mountable
- Starting at \$6,995



PHONE: (508) 822-7330
 info@jwfishers.com
 jwfishers.com

transmission cables like the Video-Ray Expedition Reel below, may not be as long as a simple tether cord or cord & fibre-optic tether which is only limited in length by the capabilities of your ROV and sheer weight and bulk of log tether lengths. Your ROV will have a depth rating which is related to water pressure and what the casing can withstand. This can be anything from 5metres/16feet to 2000m/6560ft. Two things to note here - 1) you might think 5metres - what the hell use is that? But if you are a inland water rescue or dive team it is highly likely that the vast majority of your incidents will involve water depths of less than 30ft so size isn't everything. 2) Equally, do not think that if your ROV has a limit of say 100feet, you only need 100 feet of tether or umbilical. Again, it's not about depth, it's about lateral searching. JWfisher's tether option for the 1000ft rated Seal Lion is 1500ft, not so that you can run it so far beyond 1000feet that you might break it but so that you can move up to 1500ft laterally from your control position - it might only ever be 15ft deep. Of course you then have concerns about the battery life and in particular if you are fighting a current or water flow. That's when that tether might become even more crucial as it allows you to run your ROV out to the max and then manually haul it back rather than operating on only half the limit because you are guiding it back under power before passing the PONR.

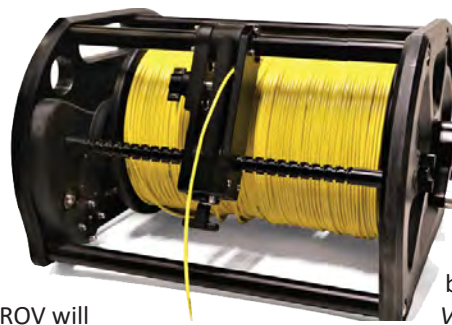

single axis arms that only move up and down or left and right. Some don't move at all and are 'grabbers' or other tools that connect direct to the ROV body. Manipulators like the set sported by Video-Ray's Defender below, can operate in all axis directions, swivelling at the union and articulating at the elbow and 'wrist'. The best option might be a modular arrangement that allows you to quickly remove or attach a **MANIPULATOR ARM** or a head (connecting directly to an ROV without the articulated arm) and if that also allowed you the choice of **GRAB** jaws, hydraulic **CUTTER** or even a **LASER** so much the better. But as an inherent feature that you specify at the time of purchase, these are extra expenses, complications to electronics and snag hazards that could trip you up if you are only using them infrequently. Blueprint make a generic series of manipulator arms and tools (pic right) that are used by *Boxfish* and *Video-Ray* among others.



In terms of retrieval of an object or body by grabbing it with jaws, the grip strength is not the same as the ROV's load capacity. You must remember that a strong grip closure can damage an item or disintegrate a cadaver so your control needs to be finite and accurate. You have the advantage that the load capacity is significantly increased by the buoyancy of water - a 10kg/22lb payload may just be enough to move an adult weighing 100kg/220lb under the water. *DeepTrekker*, *Video-Ray* and *Boxfish* offer a **LASER** (scaler) which is not a James Bond villain cutting tool but a rangefinder or incredibly accurate measuring device using two beams.

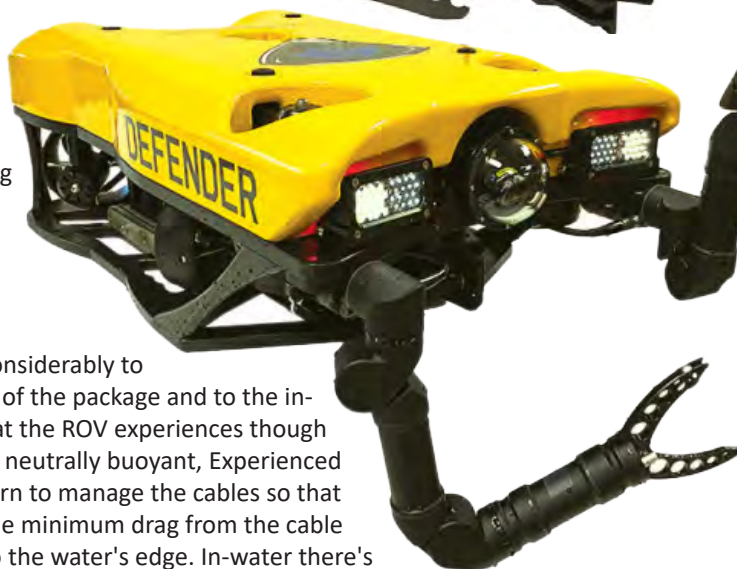

Tethers add considerably to the air weight of the package and to the in-water drag that the ROV experiences though they are often neutrally buoyant, Experienced controllers learn to manage the cables so that they impart the minimum drag from the cable reel or pack to the water's edge. In-water there's not too much you can do other than avoid changes of direction after obstacles or even seaweed wracks that will conspire to add drag and limit the endurance time of your ROV.

MANIPULATION ARM, GRABS & TOOLS

Other add-ons include the ubiquitous grasping jaws that you see in every deep-sea film but for rescuers, it's not so common even though it can prove immensely useful. Some are more versatile than others, the simplest, cheapest options are

KEY to TABLES.....

Any use, feature, accessory or component that is **inherent** in the product is shown as a **solid coloured square** ■■■■■
 If it's an **OPTION** it is shown as an **outline square** □□□□□
 A circle ● in the 'USE' columns indicates that this feature is only partially present and/or is OK for that purpose but not ideal.
ORIGIN: The 'manufacturer's country, not necessarily the country of manufacture, If we know it's made in a different country there will be a smaller inset flag.
COST: a rough guide only - **includes** local taxes/VAT. Varies with exchange rates, extra taxes etc. We usually round up to the nearest Pound£/US Dollar\$/Euro€. We now give a currency conversion figure in orange £\$€ which is simply to give an idea of price, it is not the selling price which will have import duties and bulk shipping etc. to add.
WEIGHT (with cable/tether) Weight of the ROV only - this does not include the control system usually housed in a waterproof case like Pelican - such systems can add 15-25kg/33-55lb to the weight of the ROV and tether as an entire system
DIMENSIONS height x width x Depth: of the ROV only
DEPTH RATING
ROV LIFT/GRAB CAPACITY
SUPPLIED OPTIONAL TETHER
SPEED OPERATING TEMP
POWER- BATTERY TETHER

ONBOARD BATTERY DURATION

TEMP SONAR GPS DIRECTION GPS = TRANSPONDER that can be interrogated for position because satellite GPS only functions in shallow water. BAE's POSYDEN system seeks to have acoustic buoys across the world to provide a bat-like response to a known location to provide GPS style data.

METAL DETECTION LASER RF

MANIPULATOR GRAB CUTTER

VECTOR/VERT/VARIABLE THRUSTERS

CAMERA(S)

RESOLUTION

B W COLOUR PAN TILT

LID LAPTOP HAND MONITOR

DIRECTIONAL LIGHTING

CASE SD/STORAGE

WARRANTY

SLOW FAST FLOW/CURRENT: Conditions under which the ROV can reasonably operate - dictated by the engine/thruster power. All will operate in still, slow moving water and a current that a person could remain standing in.

Fill in explanations

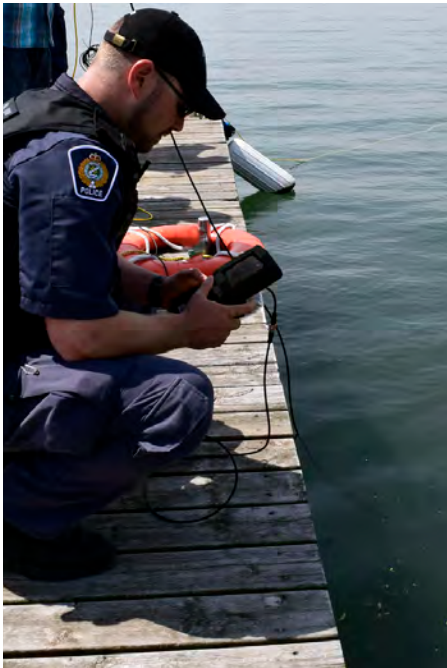

Rapid response underwater search & recovery ROVs

 **DEEP TREKKER™**

deeptrekker.com

Images NOT to Scale



MANUFACTURER

BLUE ROBOTICS

BOXFISH

DEEPTREK

MODEL VARIANT

BlueROV2 Alu-frame

ROV +

Revoluti

ORIGIN



COST

£0
\$4650/4940*
€0

£0
\$0
€0

£0
>\$40,000
€0

WEIGHT (with cable/tether)

11 12kg
24 27lb

24kg*
53lb

35kg
75lb

DIMENSIONS height x width x Depth

45.7 x 33.8 x 25.4cm
28 x 17 x 14"

71.4 x 43.5 x 35.1cm
28 x 17 x 14"

71.7 x 0 x 0
0 x 0 x 0

DEPTH RATING

100300m 328984ft

500/1000m 1640/3300ft

305m 1000ft

ROV LIFT/GRAB CAPACITY

1.2-1.4kg/2.6-3.1lb

??

32kg/70lb

SUPPLIED OPTIONAL TETHER

100m/330ft 300m/984ft

350m/1150ft
3000m/10000ft

300m/984ft
<2000m/6561ft

SPEED OPERATING TEMP

3knots

-10to45°C/ 14-113°F

-10to50°C/ 14-122°F

POWER= BATTERY TETHER

Lithium Polymer 21.6v ■

21.6v ■

ONBOARD BATTERY DURATION

2-6hrs

4-14hrs

3hrs

TEMP SONAR GPS DIRECTION

□ □ □

□ □ □

METAL DETECTION LASER RF

□

□

□

MANIPULATOR GRAB CUTTER

□

□ ■ ■ rotat

VECTOR/VERTVARITHRUSTERS

4 +2 Vertical

8

6

CAMERA(S)

1 main
1080p
■ +-90°

1main + 2 fore/aft NavCams
4K
■

1x front
4K HD 1920x1080
■

RESOLUTION OPTION

B W COLOUR PAN TILT

LID LAPTOP HAND MONITOR

17"

DIRECTIONAL LIGHTING

2 or 4x 0 to 1500 lumen

2 x 0 to 8500 lumen
1 rear light

1000 lumen (option)

CASE(S) SD/STORAGE

■

■ ■

WARRANTY

1 year

1 year

SLOW FAST FLOW/CURRENT

■

■

■

NOTES

*Price excludes controllers, montor etc.

*Weight includes salt water ballast.
5hrs Battery mains Recharge or
1.5hrs Field recharge.
Auto RTB if comms are lost
Blueprint Oculus and tool compatible

Field-changeable to

WEBSITE

bluerobotics.com

boxfish.nz

deeptrek.com

NOTES: **COST:** Approx, INCLUDES local tax/VAT **£\$€=**Currency conversion only - exc duty, shipping etc. **USES/ FEATURES:** ● = PARTIAL FEATURE



	DEEPTREKKER	DEEPTREKKER	DEEPTREKKER
Model	Pivot	Photon	DTG3
Country			
Price	£0 \$17600 €0	£0 \$0 €0	£0 \$8500 €0
Weight	20kg 45lb	11.6kg 25.6lb	8.5kg 18lb
Dimensions	57.6 x 36 x 31.3cm 0 x 0 x 0"	57.6 x 36 x 31cm 0 x 0 x 0"	27.9 x 32.5 x 25.8cm 11 x 12.8 x 10.2"
Depth	305m 1000ft	120-305m 400-1000ft	200m 656ft
Operating Depth	100-150m/328-492ft <2000m/6560ft	<2000m/6560ft	75m/246ft 200m/656ft
Temperature	-10to50°C/ 14-122°F	-10to50°C/ 14-122°F	
Battery Voltage	19.2v	19.2v	
Runtime	1.5hrs	2.5hrs	1.5hrs
Connectivity	<input type="checkbox"/> <input type="checkbox"/> <input type="checkbox"/>	<input type="checkbox"/> <input type="checkbox"/> <input type="checkbox"/>	<input type="checkbox"/> <input type="checkbox"/>
Camera	<input type="checkbox"/>	<input type="checkbox"/>	
Rotation	<input type="checkbox"/> <input checked="" type="checkbox"/> <input checked="" type="checkbox"/> rotates 97°	<input type="checkbox"/> <input type="checkbox"/> <input type="checkbox"/> rotates 0°	<input type="checkbox"/> <input type="checkbox"/> <input type="checkbox"/> rotates 180°
Ports	6	6	3
Camera	1x front 4K HD 1920x1080, 30FPS	1x front 4K HD 1920x1080, 30FPS	1x front 4K HD 1920x1080, 30FPS
Display		178 mm (7") Wide-Angle LCD	
Lighting	1000 lumen (option 1-4000lmn)	1000 lumen (option 1-4000lmn)	1000 lumen (option 1-4000lmn)
Warranty	<input checked="" type="checkbox"/> <input checked="" type="checkbox"/>	<input checked="" type="checkbox"/> <input checked="" type="checkbox"/>	<input checked="" type="checkbox"/> <input checked="" type="checkbox"/>
Warranty	1 year	1 year	1 year
Warranty	<input checked="" type="checkbox"/>	<input checked="" type="checkbox"/>	
Prop heads.			
Website	deeptrekker.com	deeptrekker.com	deeptrekker.com

and/or OK BUT NOT IDEAL = Option N/A = info Not Available/not given

NEW - COMPILING Q4-24

Images NOT to Scale



MANUFACTURER	HSE	HSE	JW FISHERS
MODEL VARIANT	M2	M2Pro	Sea Otter
ORIGIN			
COST	£0 \$0 €0	£0 \$0 €0	£0 \$21000 €0
WEIGHT (with cable/tether)	0kg 0lb	0kg 0lb	0kg 0lb 0oz
DIMENSIONS height x width x Depth	0 x 0 x 0cm 0 x 0 x 0"	0 x 0 x 0cm 0 x 0 x 0"	0 x 0 x 0cm 0 x 0 x 0"
DEPTH RATING			152m 500'
ROV LIFT/GRAB CAPACITY			
SUPPLIED OPTIONAL TETHER			250ft 1500'
SPEED			4mph
POWER= BATTERY via TETHER	<input checked="" type="checkbox"/>	<input checked="" type="checkbox"/>	<input type="checkbox"/>
ONBOARD BATTERY DURATION			
TEMP SONAR GPS DIRECTION	<input checked="" type="checkbox"/>	<input checked="" type="checkbox"/>	<input checked="" type="checkbox"/> <input type="checkbox"/> <input checked="" type="checkbox"/>
METAL DETECTION LASER RF			<input type="checkbox"/>
MANIPULATOR GRAB CUTTER		<input checked="" type="checkbox"/>	<input checked="" type="checkbox"/>
VECTOR/VERTVARITHRUSTERS			4
CAMERA(S) RESOLUTION			1x Front 1x Rear
B W COLOUR PAN TILT			<input checked="" type="checkbox"/> <input type="checkbox"/> <input type="checkbox"/>
LID LAPTOP HAND MONITOR			<input type="checkbox"/> <input type="checkbox"/> <input type="checkbox"/> 10.5"
LIGHTING DIRECTIONAL			<input checked="" type="checkbox"/> 2200 Lumen LED Ring - R
CASE(S) SD/STORAGE			2 <input checked="" type="checkbox"/> <input type="checkbox"/>
WARRANTY			2 years
SLOW FAST FLOW/CURRENT	<input checked="" type="checkbox"/>		<input checked="" type="checkbox"/>
NOTES			
WEBSITE	hse-uav.com	hse-uav.com	jwfishers.com

NOTES: COST: Approx, INCLUDES local tax/VAT £\$€=Currency conversion only - exc duty, shipping etc. USES/ FEATURES: ● = PARTIAL FEATURE







	JW FISHERS	THOR ROBOTICS	THOR ROBOTICS
	Sea Lion II	TrenchRover 110	TrenchRover 200H
	£0 \$30,000 €0	£0 \$0 €0	£0 \$0 €0
	0kg 0lb	4.2kg 9.25lb	15kg 9.25lb
	0 x 0 x 0cm 0 x 0 x 0"	36 x 20 x 20cm 14.2 x 7.9 x 7.9"	50 x 34 x 28cm 19.7 x 13.4 x 11"
Depth	305m 1000ft	5-30m 16-98ft	30m 98ft
Speed	250ft 1500ft 4mph	30m 1.5kn 2.8kmh	30m 2kn 3.7kmh
Battery		12v 3Ah NiMH or 5Ah LiPo	12v 3Ah NiMH or 5Ah LiPo
Lighting	<input type="checkbox"/> <input type="checkbox"/> <input type="checkbox"/>		<input checked="" type="checkbox"/>
Propellers	<input type="checkbox"/>		
Wheels	<input type="checkbox"/>		
Engines	4	4 x 8000rpm	8 x 8000rpm
Colour	<input checked="" type="checkbox"/> <input type="checkbox"/> <input type="checkbox"/> 15" Colour		<input checked="" type="checkbox"/> <input type="checkbox"/> <input type="checkbox"/>
LED - Front	<input checked="" type="checkbox"/> 2200 Lumen LED - Front	2x 300 lumen	2x 300 lumen
LED - Rear	<input type="checkbox"/> LED Ring - Rear		
Warranty	2 <input checked="" type="checkbox"/> <input type="checkbox"/>	<input checked="" type="checkbox"/> <input type="checkbox"/>	<input checked="" type="checkbox"/> <input type="checkbox"/>
Warranty	2 years	2 years	2 years
Warranty	<input checked="" type="checkbox"/>	<input checked="" type="checkbox"/>	<input checked="" type="checkbox"/>
Notes	Has a power-boost option to counter sudden current/flow change	Wireless version available. NB: uses proprietry battery <u>not</u> supplied	Wireless version available. NB: uses proprietry battery <u>not</u> supplied
Website	jwfishers.com	thorrobotics.com	thorrobotics.com

and/or OK BUT NOT IDEAL = Option N/A = info Not Available/not given

Images NOT to Scale
 NOTES: **COST:** Approx, **IN-**
CLUDES local tax/VAT £\$€=Cur-
 rency conversion only **USES/**
FEATURES: ● = OK BUT NOT
 IDEAL ■■■ = Option



MANUFACTURER	VIDEO RAY	VIDEO RAY	VIDEO RAY
MODEL VARIANT	Pro4 ip65 Ultra	Pro5	Mission Specialist
ORIGIN			
COST	£0 \$0 €0	£0 \$0 €0	£0 \$0 €0
WEIGHT (with cable/tether)	6.1kg 13.5lb	11.8 36.6kg 26 80.9lb	17.2 32kg 38 71.6lb
DIMENSIONS height x width x Depth	37.5 x 28.9 x 22.3cm 14.75 x 11.4 x 8.75"	51.6 x 33 x 25.7cm 20.3 x 13 x 10.1"	71.1 x 39.4 x 22.9cm 28.8 x 15.5 x 9.0"
DEPTH RATING	305m 1000ft	305m 1000ft	1000m 3280ft
ROV LIFT/GRAB CAPACITY		11.3 22.6kg 25 50lb	11.3- 22.6kg 25 50lb
SUPPLIED OPTIONAL TETHER		76m/250ft 550m/1804ft	76m/250ft 550m/1804ft
SPEED		4.4 kn	4.4 kn
POWER= BATTERY via TETHER		48vDC NiMH or Li-ion & 48vDC	48vDC NiMH or Li-ion
ONBOARD BATTERY DURATION			NIMH 1-2hrs, Li-ion 2hrs
TEMP SONAR GPS DIRECTION	■ □ □ □	■ □ □ ■	■ □ □
METAL DETECTION LASER RF	□	□	□
MANIPULATOR GRAB CUTTER	□	□ □ □	■ □ □
VECTOR/VERTVARITHRUSTERS		2 + 1 vertical	4 + 3 vertical
CAMERA(S) RESOLUTION B W COLOUR PAN TILT		1x Front 13mp still. 16x digital zoom ■ ■ ■	1x Front 1x 13mp still. 16x dig ■ ■ ■
LID LAPTOP HAND MONITOR	■ □ 15" Colour	■ □ □ 15-21" Colour	■ □ □ 15-21"
LIGHTING DIRECTIONAL		2x7600 Lumen spot & flood on both LED arrays	2x7600 Lum spot & flood on bot
CASE(S) SD/STORAGE	2 ■ ■	3 ■ ■	3 ■ ■
WARRANTY	2 years	2 years	2 years
SLOW FAST FLOW/CURRENT	■	■	■
NOTES	Ultra a simpler system with lighter control system (8.4kg) but doesn't accept most accessories including sonar and does not operate in fast flow/ currents.	Sonar options include Teledyne, Trittech and Blueprint systems. Blueprint Oculuus systems offer 5 to 120m/394ft ranges.	Sonar options include Teledyne, Trittech and Blueprint systems. Blueprint Oculuus systems offer 5 to 120m/394ft ranges.
WEBSITE	videoray.com	videoray.com	videoray.com

			
AY	OCEANBOTICS	OCEANBOTICS	
t Defender	SRV-8	SRV-8X Optimus ATS	
			
	£0 \$0 €0	£0 \$0 €0	
g lb	6.1kg 13.5lb	6.1kg 13.5lb	
3.8cm 10.4"	37.5 x 28.9 x 22.3cm 14.75 x 11.4 x 8.75"	37.5 x 28.9 x 22.3cm 14.75 x 11.4 x 8.75"	
30ft	305m 1000ft	305m 1000ft	
5 50lb			
/1804ft			
on & 48vDC			
-4hrs 1-8.5hr			
■	■ □ □ □	■ □ □ □	
	□	□	
	■ □ □	■ □ □	
cal			
Rear igital zoom			
" Colour	■ □ 15" Colour	■ □ 15" Colour	
nen h LED arrays			
	2 ■ ■	2 ■ ■	
	2 years	2 years	
	■	■	
ne, Tritech and Blue- plus systems offer 5 anges..	Ultra a simpler system with lighter control system (8.4kg) but doesn't accept most accessories including sonar and does not operate in fast flow/ currents.	ATS is a specialist 'ping' detector option with a sensitive acoustic (sonar) detection system for locating downed craft. Also an MDV Mine Disposal Vehicle for remote detonation of undersea mines	
om	oceanbotics.com	oceanbotics.com	

DRY BAGS

Unlike the gear bags in our Arborist and Rope Equipment BUYERS GUIDES which contain many waterproof bags, these bags go one step further and are water tight. That means that you could theoretically, use them as a water container and indeed we often do with the smaller bags anyway. Dry bags will keep the contents entirely dry even if the bag were somehow submerged. Not an easy proposition given the degree of buoyancy so unless it was being jettisoned from a submarine hatch, we'll go with inundation, it will keep your gear dry even in the event of prolonged inundation.

To achieve this, the seams are welded or glued and welded instead of sewn although they could be sewn if they were then patch welded over the entire seam. The main players in this category of bags tend not to be the same as the main players in rope and tackle bags because the market is more specialised along with the manufacturing processes.

Some have taken a leaf out of drysuit technology and use high grade waterproof zips while the majority use rolled lids that are then buckled together to complete the seal

, see the **ROPE EQPT BUYERSGUIDE**. There will also be separate guides for **THROWLINE BAGS/BOXES** in this **BUYERSGUIDE** but check out Palmu's squarerope bag which looks like a throwline cube but is a full strength rope bag. **TRAUMA PACKS** are in the **MEDEVAC/PPE BUYERSGUIDE** and watertight **WATER RESCUE BAGS** ARE in the **WATERRESCUEBUYERSGUIDE**. This introduction and the KEY to the tables covers *all* organiser bags. A separate KEY to Duffles and basic rope/gear bags with fewer data rows is on pages **368 & 372**.

IN THE FOLLOWING TABLES:.....

A large, modern transport pack is quite sophisticated with a whole load of different features that are not always apparent from simply looking at it.

COST: Approximate. Includes local taxes but can vary due to exchange rates, other taxes etc. We generally round up the cost to the nearest Pound£, US Dollar\$ or Euro€. **Simple currency conversions are shown in orange** for reference - they are lower than the actual price because it does not take into account import duty, shipping or tax.

ORIGIN: Is the country of the company selling the item, not necessarily the same as the origin of the product itself which is shown as an inset flag where we know.

STYLE/FUNCTION: The bags in this guide can be defined as one or two of the following

- **BUCKET/ROPE BAG** - an upright, top-feeder that holds its shape to allow rope to be fed in or out.
- **BACKPACK:** two shoulder straps and maybe a waist belt but



either way- carried on the back giving both hands free to carry even more stuff. Often a combo with a rope bucket.

- **DUFFLE/DUFFEL:** a horizontally carried bag with handles on the top. May also has hidden rucksack straps in the base to convert to vertical orientation.
- **TRANSPORTER:** a multi-compartmented pack - usually a rucksack style - that will either present the equipment in a cabinet style or will open out entirely on the ground to show everything in pockets/pouches or attached.

VOLUME: in Litres/liters /US Gallons (20% less than UK Gallon)
Market Origin: Bags are either specifically designed for arborists (Pro Arb), or for the Rope Access and/ore rescue markets - both requiring tough equipment. Sport can be equally tough if its caving and canyoning but tends not to be used all day every day.

NOMINAL/INTENDED ROPE CAPACITY: As provided by the manufacturer but varies with the diameter. In organiser packs, rope storage may only be part of the overall volume whereas it may be all of the internal volume in a dedicated rope bag/duffel.
 46m/150ft x 12.7mm/1/2" = 76m/250' x 11mm 7/16" = 91m/300' x 9mm 3/8"

WEIGHT: empty with no optional extras included

MAX DIMENSIONS: Height and the width and maybe depth front-to-back. These figures are for the body of the bag and do not include extraneous handles or external pouches that are stuffed to bursting. Most bags will end up much wider!

2xBACK STRAPS=rucksack style carrying straps

1xSHOULDER=a single strap for slinging over your shoulder

WAIST BELT=rucksack style waist belt to keep the pack tight to your body when walking any distance

[PADDED]=in brackets[] indicates straps padded for comfort.

BACK/LUMBAR PADDING=padding on the pack itself rather than straps, again for improved comfort carrying a heavy load.

Lumbar is lower back, behind the waist belt if there is one.

DETACH/STOW CARRY STRAPS: refers to rucksack style straps that can either be ditched entirely or can be stuffed into an integral pocket so that no straps are exposed to snagging.

REINFORCED SIDES (Free-standing)=the pack has stiffened panels or bars that keep the bag upright during rope feed.

CARRY HANDLES WLL ENDS SIDE dedicated carrying handles with ergonomic adjuncts to make carrying a heavy weight more comfortable. Mounted on the top or for duffle-style side-carry. Can also be used to clip on kit. **WLL**=the max weight you can carry via these handles or an additional haul eye.....

ADDITIONAL HAUL WLL SEWN EYES RINGS Top handles can be used for hauling but there is often a sewn loop between the top of shoulder straps or there may be metal eyes around the top.

BAG OPENS FLAT to DISPLAY KIT The whole bag unzips or unbuckles to expose the interior. Can also include organisers with detachable, opening display panels/boards.

HELMET [SAW] POCKET/POUCH CORD Designated for use with a helmet or saw but can obviously be used for anything that will fit. Climbers packs often use bungee cord on the outside front or top of the pack but some have a separated helmet pocket on the top as it should be the first thing you put on. **INTERNAL PARTITION** a means to divide internal space eg. for 2 ropes or to keep clothes dry-not just a pocket. Some packs come with their own **ROPE TOOL BAG** or are an option ☐.

GEAR (individual) EYES EXTERNAL INTERNAL These can be daisy chain eyes, Molle eyes or individual plastic eyelets but all are intended to clip one carabiner and/or clippable hardware

GEAR LOOPS [STRAPS] EXTERNAL INTERNAL harness-style larger semi-circles of cord or plastic that allow multiple items to be clipped into the same loop. All handles could be used as a gear loop! **[STRAPS]** [in brackets] is securing web with buckles

TOTAL POCKETS EXTERNAL INTERNAL The total number of closable pockets and open pouches outside and **inside** the bag. This does not include saw pockets/pouches listed separately.

of which.. MESH/CLEAR EXTERNAL INTERNAL of the total number of pockets those which are clear plastic or open mesh allowing free drainage but more importantly visibility of the contents. Mesh makes the bag lighter than a full, heavy duty enclosure.

CLOSURES Velcro POP Zipped Draw-Cord Buckle Referring ONLY to the outside pockets - a colour square indicates the type of closure and the number is the pockets that have that specific closure.

WATERPROOF VENT HOLES DRAIN HOLES All of these packs are water resistant to a degree unless they have mesh panels but some are more waterproof than others and particularly so if they have a roll-top closure. The most water resistant are

marked with a blue square ■, less water resistant - usually because there are a drawcord closure, is marked with a ● Being waterproof does not preclude having vent and drain holes as the term 'waterproof' refers to rain from the top not complete submersion. See our **WATER RESCUE BUYERS GUIDE** for completely waterproof bags.

LID POP ZIPPED DRAW-CORD BUCKLE ROLL-TOP Referring ONLY to the top lid and compartment doors if it is an organiser type pack.

LOCKABLE: the main compartment(s) can be locked with a small padlock (not usually supplied). Usually needs a chunky YKK style zip large enough to clip in a padlock clasp but may be a tougher, bespoke element like the *FTC-Tree Koompsonia*.

ID PANEL: a small-see-through rectangle for a luggage style label or large enough for an inventory or risk assessment sheet.

END/SIDE STRAPS: in addition to the carry straps these are adjustable webbing straps on the sides that can either act to compress the bag to a smaller size if it's not fully filled or you can secure items behind them. Side straps are often set above open pouches that can house a saw, pole or spikes or **end** straps can be used to secure a hank of rope or a tarpaulin etc.

REFLECTIVE TRIM: not seen as much on arb packs as they are on rescue packs- light reflective to provide high visibility.

TARPAULIN: a separate or integral ground sheet. ☐=if an option

RAINCOVER: a separate cap or complete cover. ☐=if an option

MATERIALS: just the main body panel materials

OTHER COLOURS: colours available *OTHER* than the colour shown in the product image at the top of the column.

Images NOT to Scale
 £\$€ any price in 'burnt-orange' is a **Currency conversion only**-exc shipping, duties,taxes etc.
Backstraps &/or Waist Belts in square brackets []= padded
HAUL EYES = can carry the entire weight of the bag & contents eg. for hauling or attaching to harness. May double as handles shown as 1/1
POP= Popper or press stud
BUCKLE ROLL TOP= all roll tops are closed with a push-fit/Fastex buckle
 ●●●●● =Partial feature or OK but not ideal
 □□□□□ = Option



MANUFACTURER	
MODEL litres/liters VARIANT	
ORIGIN	
COST (inc Tax/VAT) Currency conversion only	
VOLUME L/US Gallon intended market	
LOAD CAPACITY	
WEIGHT empty	
DIMENSIONS	
BACK STRAPS HANDLES WAIST BELT	
POCKETS Ext/Int EYES/LOOP Ext/Int EXT MESH	
ID-PANEL DRAIN/VENT HAUL EYE(S)	
LID VELCRO POP ZIPPED DRAW-CORD BUCKLE ROLL-TOP	
OUTER MATERIALS REFLECTIVE TRIM	
OTHER COLOURS	
NOTES	
WEBSITE	









Images NOT to Scale
 £\$€ any price in 'burnt-orange' is a **Currency conversion only**-exc shipping, duties,taxes etc.
Backstraps &/or Waist Belts in square brackets []= padded
HAUL EYES = can carry the entire weight of the bag & contents eg. for hauling or attaching to harness. May double as handles shown as 1/1
POP= Popper or press stud
BUCKLE ROLL TOP= all roll tops are closed with a push-fit/Fastex buckle
 ●●●●● =Partial feature or OK but not ideal
 □□□□□ = Option









MANUFACTURER	KONG
MODEL litres/liters VARIANT	RopeBag 28
ORIGIN	
COST (inc Tax/VAT) Currency conversion only	£0 \$0 €0
VOLUME L/US Gallon intended market	28L/7.4gal Pro
LOAD CAPACITY	0m 0'
WEIGHT empty	0kg 0lb
DIMENSIONS	0 x 0 x 0cm 0 x 0 x 0"
BACK STRAPS HANDLES WAIST BELT	---
POCKETS Ext/Int EYES/LOOP Ext/Int EXT MESH	---
ID-PANEL DRAIN/VENT HAUL EYE(S)	---
LID VELCRO POP ZIPPED DRAW-CORD BUCKLE ROLL-TOP	---
OUTER MATERIALS REFLECTIVE TRIM	--
OTHER COLOURS	
NOTES	-
WEBSITE	Kong.it

MANUFACTURER	KONG	KONG	KONG	KONG
MODEL litres/liters VARIANT	RopeBag 28	Genius II 30	Linnhà 40 982522000KK	RopeBag 43
ORIGIN				
COST (inc Tax/VAT) Currency conversion only	£0 \$0 €0	£0 \$0 €0	£0 \$0 €0	£0 \$0 €0
VOLUME L/US Gallon intended market	28L/7.4gal Pro	30L/7.9gal Pro	40L/10.6gal Canyoning	43L/11.4gal Pro Access
LOAD CAPACITY	0m 0'	0m 0'	0m 0'	0m 0'
WEIGHT empty	0kg 0lb	0.85kg 0lb	0kg 0lb	0kg 0lb
DIMENSIONS	0 x 0 x 0cm 0 x 0 x 0"	0 x 0 x 0cm 0 x 0 x 0"	0 x 0 x 0cm 0 x 0 x 0"	0 x 0 x 0cm 0 x 0 x 0"
BACK STRAPS HANDLES WAIST BELT	---	---	---	---
POCKETS Ext/Int EYES/LOOP Ext/Int EXT MESH	---	---	---	---
ID-PANEL DRAIN/VENT HAUL EYE(S)	---	---	---	---
LID VELCRO POP ZIPPED DRAW-CORD BUCKLE ROLL-TOP	---	---	---	---
OUTER MATERIALS REFLECTIVE TRIM	--	PVC	--	--
OTHER COLOURS				
NOTES	-	-	-	-
WEBSITE	Kong.it	kong.it	Kong.it	Kong.it

ROPE/GEAR BAGS

					
			HUSQVARNA	KONG	
			Xplorer Backpack 596 93 63-11	RopeTube 17 98252500KK	
					
				£0 \$0 €0	
				17L/4.5gal Pro	
			0m 0'	0m 0'	
			0kg 0lb	155g 0oz	
			0 x 0 x 0cm 0 x 0 x 0"	0 x 0 x 0cm 0 x 0 x 0"	
			---	---	
			---	---	
			---	---	
			---	---	
			---	---	
			-	-	
			husqvarna.com	Kong.it	
					
KONG	KONG				
WorkBag 50 982528N00KK	OmniBag 60				
					
£0 \$0 €0	£0 \$0 €0				
13.2gal Pro Access	60L/15.8gal Pro Access				
0m 0'	0m 0'				
0kg 0lb	0kg 0lb				
0 x 0 x 0cm 0 x 0 x 0"	0 x 0 x 0cm 0 x 0 x 0"				
---	---				
---	---				
---	---				
---	---				
PVC	--				
Being phased out	-				
Kong.it	Kong.it				

<p>Images NOT to Scale £\$€ any price in 'burnt-orange' is a Currency conversion only-exc shipping, duties,taxes etc. Backstraps &/or Waist Belts in square brackets []= padded HAUL EYES = can carry the entire weight of the bag & contents eg. for hauling or attaching to harness. May double as handles shown as 1/1 POP= Popper or press stud BUCKLE ROLL TOP= all roll tops are closed with a push-fit/Fastex buckle ●●●●●=Partial feature or OK but not ideal □□□□□= Option</p>						
MANUFACTURER			ORTLEIB	ORTLEIB	ORTLEIB	
MODEL litres/liters VARIANT						
ORIGIN						
COST (inc Tax/VAT) Currency conversion only						
SPECIFICATIONS	VOLUME L/US Gallon intended market					
	LOAD CAPACITY					
	WEIGHT empty					
	DIMENSIONS					
FEATURES	BACK STRAPS HANDLES WAIST BELT					
	POCKETS Ext/Int EYES/LOOP Ext/Int EXT MESH					
	ID-PANEL DRAIN/VENT HAUL EYE(S)					
	LID VELCRO POP ZIPPED DRAW-CORD BUCKLE ROLL-TOP					
OUTER MATERIALS REFLECTIVE TRIM						
OTHER COLOURS						
NOTES						
WEBSITE						
<p>Images NOT to Scale £\$€ any price in 'burnt-orange' is a Currency conversion only-exc shipping, duties,taxes etc. Backstraps &/or Waist Belts in square brackets []= padded HAUL EYES = can carry the entire weight of the bag & contents eg. for hauling or attaching to harness. May double as handles shown as 1/1 POP= Popper or press stud BUCKLE ROLL TOP= all roll tops are closed with a push-fit/Fastex buckle ●●●●●=Partial feature or OK but not ideal □□□□□= Option</p>						
MANUFACTURER		ORTLEIB	ORTLEIB	ORTLEIB	PETZL	
MODEL litres/liters VARIANT					Bucket 15	
ORIGIN						
COST (inc Tax/VAT) Currency conversion only					£41 \$50 €42	
SPECIFICATIONS	VOLUME L/US Gallon intended market				15L/4gal Pro Access	30
	LOAD CAPACITY				50kg 45m x11mm 88'x½"	50
	WEIGHT empty				465g 1lb	
	DIMENSIONS				30 x 25cm 11.8 x 9.8"	
FEATURES	BACK STRAPS HANDLES WAIST BELT				-21	
	POCKETS Ext/Int EYES/LOOP Ext/Int EXT MESH				11 -2 -	
	ID-PANEL DRAIN/VENT HAUL EYE(S)					
	LID VELCRO POP ZIPPED DRAW-CORD BUCKLE ROLL-TOP					
OUTER MATERIALS REFLECTIVE TRIM					TPU (PVC-free)	
OTHER COLOURS						
NOTES					*two loops intended for tieo=ing in the rope ends.	* ti
WEBSITE						

Images NOT to Scale
 £\$€ any price in 'burnt-orange' is a **Currency conversion only**-exc shipping, duties,taxes etc.
Backstraps &/or Waist Belts in square brackets []= padded
HAUL EYES = can carry the entire weight of the bag & contents eg. for hauling or attaching to harness. May double as handles shown as 1/1
POP= Popper or press stud
BUCKLE ROLL TOP= all roll tops are closed with a push-fit/Fastex buckle
 ●●●●● =Partial feature or OK but not ideal
 □□□□□ = Option



MANUFACTURER	SEALINE	SEALINE	SEALINE	SEALINE
MODEL litres/liters VARIANT	Discovery View 5	Discovery View 10	Discovery View 20	Discovery View 30
ORIGIN				
COST (inc Tax/VAT) Currency conversion only	£0 \$0 €0	£0 \$0 €0	£0 \$0 €0	£0 \$0 €0
VOLUME L/US Gallon intended market	0L/0gal Pro & Exped	0L/0gal Pro & Exped	0L/0gal Pro & Exped	0L/0gal Pro & Exped
LOAD CAPACITY	0m 0'	0m 0'	0m 0'	0m 0'
WEIGHT empty	0kg 0lb	0kg 0lb	0kg 0lb	0kg 0lb
DIMENSIONS	0 x 0 x 0cm 0 x 0 x 0"	0 x 0 x 0cm 0 x 0 x 0"	0 x 0 x 0cm 0 x 0 x 0"	0 x 0 x 0cm 0 x 0 x 0"
BACK STRAPS HANDLES WAIST BELT	---	---	---	---
POCKETS Ext/Int EYES/LOOP Ext/Int EXT MESH	---	---	---	---
ID-PANEL DRAIN/VENT HAUL EYE(S)	---	---	---	---
LID VELCRO POP ZIPPED DRAW-CORD BUCKLE ROLL-TOP	---	---	---	---
OUTER MATERIALS REFLECTIVE TRIM	--	--	--	--
OTHER COLOURS				
NOTES	-	-	-	-
WEBSITE	sealinegear.com	sealinegear.com	sealinegear.com	sealinegear.com

Images NOT to Scale
 £\$€ any price in 'burnt-orange' is a **Currency conversion only**-exc shipping, duties,taxes etc.
Backstraps &/or Waist Belts in square brackets []= padded
HAUL EYES = can carry the entire weight of the bag & contents eg. for hauling or attaching to harness. May double as handles shown as 1/1
POP= Popper or press stud
BUCKLE ROLL TOP= all roll tops are closed with a push-fit/Fastex buckle
 ●●●●● =Partial feature or OK but not ideal
 □□□□□ = Option

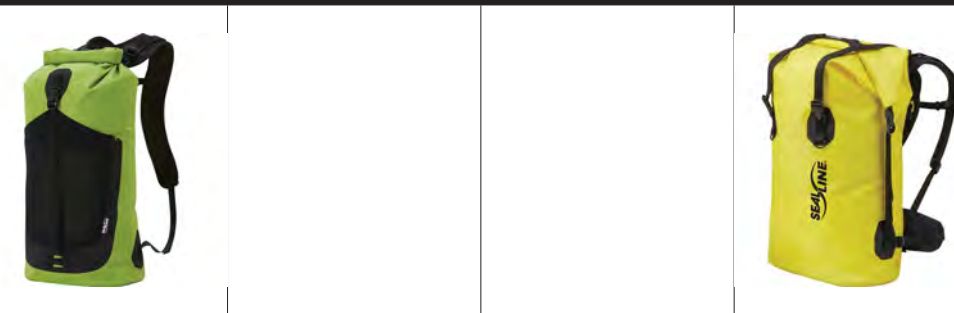

MANUFACTURER	SEALINE	SEALINE	SEALINE	SEALINE
MODEL litres/liters VARIANT	Skylake 18	Pro Dry Pack 40	Pro Dry Pack 40	Black Canyon 65
ORIGIN				
COST (inc Tax/VAT) Currency conversion only	£0 \$0 €0	£0 \$0 €0	£0 \$0 €0	£0 \$0 €0
VOLUME L/US Gallon intended market	0L/0gal Pro & Exped	0L/0gal Pro & Exped	0L/0gal Pro & Exped	0L/0gal Pro & Exped
LOAD CAPACITY	0m 0'	0m 0'	0m 0'	0m 0'
WEIGHT empty	0kg 0lb	0kg 0lb	0kg 0lb	0kg 0lb
DIMENSIONS	0 x 0 x 0cm 0 x 0 x 0"	0 x 0 x 0cm 0 x 0 x 0"	0 x 0 x 0cm 0 x 0 x 0"	0 x 0 x 0cm 0 x 0 x 0"
BACK STRAPS HANDLES WAIST BELT	---	---	---	---
POCKETS Ext/Int EYES/LOOP Ext/Int EXT MESH	---	---	---	---
ID-PANEL DRAIN/VENT HAUL EYE(S)	---	---	---	---
LID VELCRO POP ZIPPED DRAW-CORD BUCKLE ROLL-TOP	---	---	---	---
OUTER MATERIALS REFLECTIVE TRIM	--	--	--	--
OTHER COLOURS				
NOTES	-	-	-	-
WEBSITE	sealinegear.com	sealinegear.com	sealinegear.com	sealinegear.com

					
SEALINE	SEALINE	SEALINE	SEALINE		
Blocker Compression 5	Blocker Compression 10	Blocker Compression 20	Blocker Compression 30		
					
£0 \$0 €0	£0 \$0 €0	£0 \$0 €0	£0 \$0 €0		
0L/0gal Pro & Exped	30L/0gal Pro & Exped	40L/0gal Pro & Exped	70L/0gal Pro & Exped		
0m 0'	0m 0'	0m 0'	0m 0'		
0kg 0lb	0kg 0lb	0kg 0lb	0kg 0lb		
0 x 0 x 0cm 0 x 0 x 0"	0 x 0 x 0cm 0 x 0 x 0"	0 x 0 x 0cm 0 x 0 x 0"	0 x 0 x 0cm 0 x 0 x 0"		
---	---	-61	-61		
---	---	-- 10--	-- 10--		
---	---	---	---		
---	---	---	---		
--	--	--	--		
					
-	-	-	-		
sealinegear.com	sealinegear.com	sealinegear.com	sealinegear.com		
					
SEALINE	SEALINE	SEALINE	SEALINE	SEALINE	
Black Canyon 115	Bigfork Daypack 30	Pro Zip Duffel 40	Pro Zip Duffel 70	Pro Zip Duffel 100	
					
£0 \$0 €0	£0 \$0 €0	£0 \$0 €0	£0 \$0 €0	£0 \$0 €0	
0L/0gal Pro & Exped	30L/0gal Pro & Exped	40L/0gal Pro & Exped	70L/0gal Pro & Exped	100L/0gal Pro & Exped	
0m 0'	0m 0'	0m 0'	0m 0'	0m 0'	
0kg 0lb	0kg 0lb	0kg 0lb	0kg 0lb	0kg 0lb	
0 x 0 x 0cm 0 x 0 x 0"	0 x 0 x 0cm 0 x 0 x 0"	0 x 0 x 0cm 0 x 0 x 0"	0 x 0 x 0cm 0 x 0 x 0"	0 x 0 x 0cm 0 x 0 x 0"	
---	---	-61	-61	-61	
---	---	-- 10--	-- 10--	-- 10--	
---	---	---	---	---	
---	---	---	---	---	
--	--	--	--	--	
					
-	-	-	-	-	
sealinegear.com	sealinegear.com	sealinegear.com	sealinegear.com	sealinegear.com	

<p>Images NOT to Scale £\$€ any price in 'burnt-orange' is a Currency conversion only-exc shipping, duties,taxes etc. Backstraps &/or Waist Belts in square brackets []= padded HAUL EYES = can carry the entire weight of the bag & contents eg. for hauling or attaching to harness. May double as handles shown as 1/1 POP= Popper or press stud BUCKLE ROLL TOP= all roll tops are closed with a push-fit/Fastex buckle ●●●●● =Partial feature or OK but not ideal □□□□□ = Option</p>					
MANUFACTURER		SINGING ROCK	SINGING ROCK	SINGING ROCK	SINGING ROCK
MODEL litres/liters VARIANT		Drybag 40	Drybag 40	Dry Duffel 40 C0046BB70	Dry Duffel 60 C0046BB90
ORIGIN					
COST (inc Tax/VAT) Currency conversion only		£0 \$0 €0	£0 \$0 €0	£0 \$0 €0	£0 \$0 €0
SPECIFICATIONS	VOLUME L/US Gallon intended market	40L/10gal Pro Access	40L/10gal Pro Access	40L/10.6gal Pro Access	60L/15.8gal Pro Access
	LOAD CAPACITY	0m 0'	0m 0'	0kg 0lb	0kg 0lb
	WEIGHT empty	0kg 0lb	0kg 0lb	0kg 0lb	0kg 0lb
	DIMENSIONS	0 x 0 x 0cm 0 x 0 x 0"	0 x 0 x 0cm 0 x 0 x 0"	0 x 0 x 0cm 0 x 0 x 0"	0 x 0 x 0cm 0 x 0 x 0"
FEATURES	BACK STRAPS HANDLES WAIST BELT	---	---	---	-- 6
	POCKETS Ext/Int EYES/LOOP Ext/Int EXT MESH	---	---	---	---
	ID-PANEL DRAIN/VENT HAUL EYE(S)	---	---	---	---
	LID VELCRO POP ZIPPED DRAW-CORD BUCKLE ROLL-TOP	---	---	---	---
OUTER MATERIALS REFLECTIVE TRIM		---	---	---	---
OTHER COLOURS					
NOTES		-	-	-	-
WEBSITE		singingrock.com	singingrock.com	singingrock.com	singingrock.com
<p>Images NOT to Scale £\$€ any price in 'burnt-orange' is a Currency conversion only-exc shipping, duties,taxes etc. Backstraps &/or Waist Belts in square brackets []= padded HAUL EYES = can carry the entire weight of the bag & contents eg. for hauling or attaching to harness. May double as handles shown as 1/1 POP= Popper or press stud BUCKLE ROLL TOP= all roll tops are closed with a push-fit/Fastex buckle ●●●●● =Partial feature or OK but not ideal □□□□□ = Option</p>					
MANUFACTURER		TYPHOON	TYPHOON	TYPHOON	TYPHOON
MODEL litres/liters VARIANT		Osea Backpack 20 C0046BB90	Osea Backpack 40 C0046BB90	Osea Duffel 40 360340	Osea Duffel 60 360360
ORIGIN					
COST (inc Tax/VAT) Currency conversion only					
SPECIFICATIONS	VOLUME L/US Gallon intended market				
	LOAD CAPACITY				
	WEIGHT empty				
	DIMENSIONS				
FEATURES	BACK STRAPS HANDLES WAIST BELT				
	POCKETS Ext/Int EYES/LOOP Ext/Int EXT MESH				
	ID-PANEL DRAIN/VENT HAUL EYE(S)				
	LID VELCRO POP ZIPPED DRAW-CORD BUCKLE ROLL-TOP				
OUTER MATERIALS REFLECTIVE TRIM		250D Tarp	250D Tarp	500D Tarp	500D Tarp
OTHER COLOURS		■			
NOTES					
WEBSITE		typhoon-int.co.uk	typhoon-int.co.uk	typhoon-int.co.uk	typhoon-int.co.uk

					
TYPHOON Mersea 8 C0046BB90	TYPHOON Mersea 12 C0046BB90	TYPHOON Mersea 15 C0046BB90	TYPHOON Osea Backpack 20 C0046BB90	TYPHOON Osea Cool Bag 12 C0046BB90	TYPHOON Seaton 20 C0046BB90
					
					
500D tarp	500D tarp	500D tarp	250D Tarp	500D tarp	250D tarp
typhoon-int.co.uk	typhoon-int.co.uk	typhoon-int.co.uk	typhoon-int.co.uk	typhoon-int.co.uk	typhoon-int.co.uk
	ZULUPACK	ZULUPACK	ZULUPACK	ZULUPACK	ZULUPACK
					
	zulupack.com	zulupack.com	zulupack.com	zulupack.com	zulupack.com

WATER RESCUE TRAINING MANIKINS

Ruth Lee's Man-Overboard manikin is given low-visibility clothing in it's Search & Rescue variant to make finding it harder. No reflective tape or bright colours.



In its simplest form, an in-water training manikin hasn't necessarily changed much in the past 50 years - a bunch of yacht fenders tied together for arms and legs and stuffed into overalls with more shoved into the chest area to make the torso and finished off with a crab-fishing marker buoy as the head. Simple. But rescuers soon got tired of the lack of realism that a fully floating and relatively light dummy provided and started to improvise by drilling and filling with sand or water

for weight and adding extra layers of clothing. The Dacon Dummy on the left is the modern incarnation of these early fender-style manikins. These also worked OK on dry land and in fact many a fire service had their own versions of dummies made out of tyres, fenders and fire hoses stuffed with material. Even though medical sector companies like Simulaids were producing trauma manikins or bits of manikins

as long ago as the 60's we didn't really start seeing more realistic full-weight manikins that could be thrown and dragged around in any rescue scenario until the 80's when we had the iconic lifelike rubber/plastic/metal *Rescue Randy* from

Simulaids costing a small fortune and the more amorphous but distinctly more affordable *Ruth Lee* filled fabric manikins. There were others of course producing both realistic and amorphous dummies alongside these early market leaders like the Swedish SRP (right) and ELJI Sport models but as you'll see from our tables - none have quite the scope of these two brands that have tried to corner the market by covering every type of rescue. Water rescue seemed to take a back seat for a while because early development of more realistic training manikins centred on the needs of land-based fire & Rescue services and medical responders. These 'land' manikins could be used short term for water rescue but it quickly became apparent that your hugely expensive and definitely submerged, *Rescue Randy* with metal components didn't last so long in salt water and chlorinated water submersions. Similarly a lot of the fabric models quickly succumbed to mould, disintegration of fibres and some truly unwelcome smells. They all needed materials and constructions more suited to us in water and even today, there is a specific delineation of tasking between land and water manikins - water can do land tasks (but not fire involved training) but land can't do water unless you're treating them as semi-disposable. One very amorphous model, the *Fibrilight BOB* is effectively a giant, shaped dry bag where you fill with whatever weight of water you can deal with and roll the top closed as with any dry bag.

Simulaids (right) were always oriented towards patient



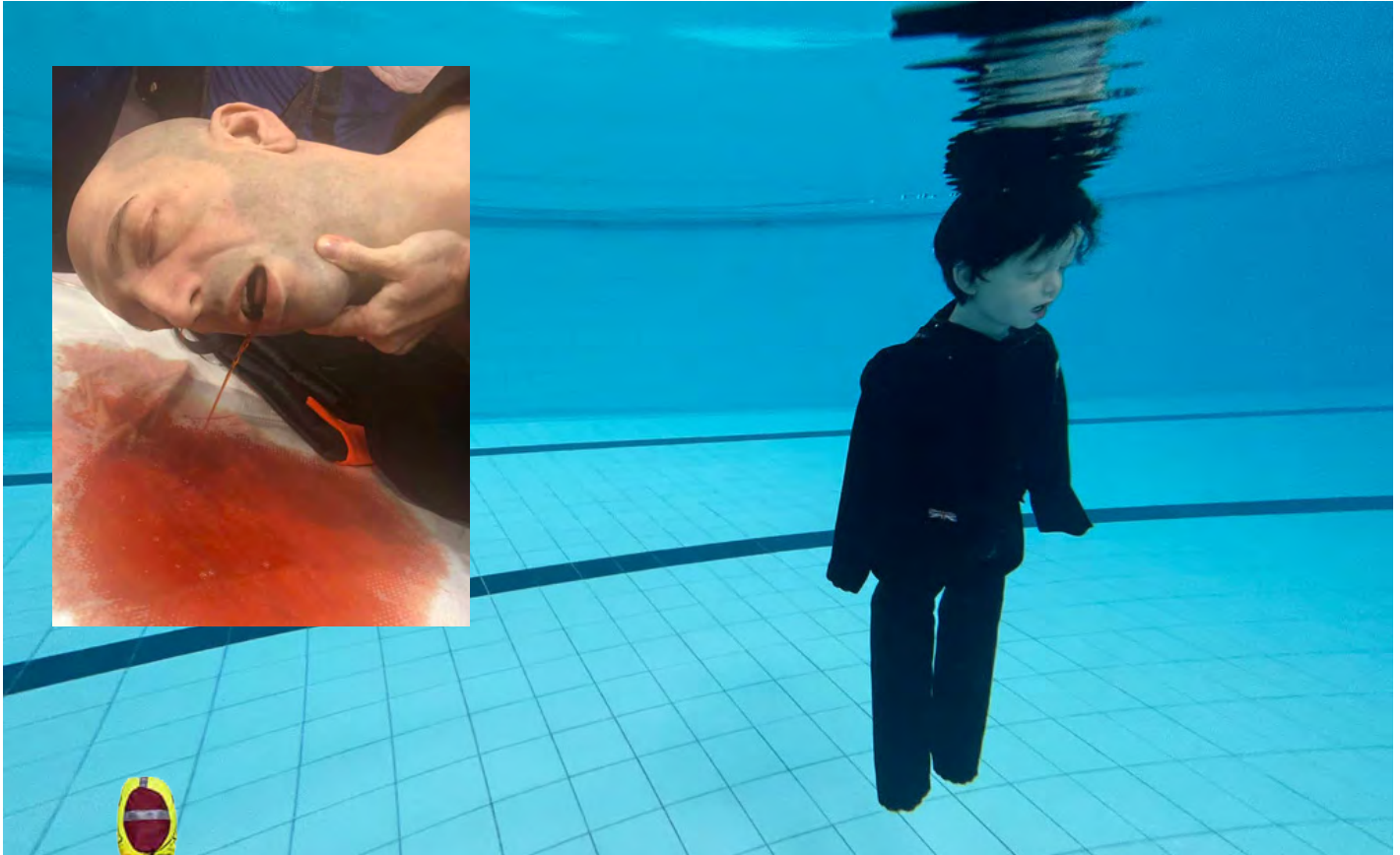

ABOVE: The future should be hyper-realistic manikins like these Lifecast/RuthLee adult and juvenile models with full CPR/Airway management interaction but fiscal prudence will mean that more traditional designs will always have a place.



Dave Halliwell and his company *Lifecast body simulation* (lifecastbodysim.com) producing the most scarily realistic manikin heads and torsos in the world. Hollywood-quality medical manikins

in fact that are now termed 'hyper-realistic' and include full size and fully featured babies and toddlers - scary stuff. We have to confess that we consider Dave as one of our own here at TECHNICAL RESCUE as he's been a local paramedic and ALS trainer for decades as many of our own Unit personnel going back to the early nineties can attest. However, we don't blow smoke without good cause and Dave/Lifecast literally lead the world in this stuff. We featured some of his work in TECHNICAL RESCUE#81 including the ability (inset-top-left) for their advanced water manikin to aspirate foamy, pinkish water during and after CPR in about the most realistic post-drowning resus training currently available. What *Ruth Lee* did was to come up with a rugged outer-skin that attached

treatment so they always had a more realistic head for *Rescue Randy* that allowed rescuers to at least try mouth-to-mouth on a mouth rather than a sword fencing face shield but *Ruth Lee* manikins were more about handling and rough handling at that. Despite their amorphous, Squid-Games appearance, they offered softer limbs and body than the human-replicants and were/are perhaps more realistic to handle than they look especially for those models with some kind of skeletal-like inserts that mimic human bone in the way it maintains rigidity of limbs and torso. Ultimately of course this arms race between the realism of a very human-looking manikin and the more utilitarian fabric and fender manikins collided with *Ruth Lee's* collaboration with the Silicon-meister himself

Half page ad



securely to the hyper-realistic torso (above) and provided the correct orientation, weight and durability for water rescue training. It ain't cheap but at the moment, this is



the gold-standard for water rescue - something that provides the physical needs of handling a victim in-water together with proper medical intervention.

Meanwhile back in the original realistic replicant world and *Rescue Randy* was modified and had some offspring. He was given rust-proof joints and salt/chlorine tolerant skin before immaculately and miraculously conceiving three youngsters all of whom were sent off to work in water. Simulaids and other plastic body'd manikins had the advantage of being able to easily alter the weight and orientation by adding/removing water or sand in some models. Simulaids have ports and valves (below) that mean you don't have to suffer the firefighters curse of having to drag your heavy-ass manikin hundreds of yards across all kinds of terrain and up or down stairs and ladders to set up your training scenario. You could empty your manikin for storage or transport and fill it up on-site. As a readily available and heavy filling, water is perfect for changing the weight and orientation of the manikin from full floating to full sinking (with some clothes on and possibly a dive weight). The valves allow filling and rapid draining.



KEY to TABLES.....

Any use, feature, accessory or component that is **inherent** in the product is shown as a **solid coloured square** ■■■■

If it's an **OPTION** it is shown as an **outline square** □□□□

A circle ● in the 'USE' columns indicates that this feature is only partially present and/or is OK for that purpose but not ideal.

ORIGIN: The 'manufacturer's country, not necessarily the country of manufacture, If we know it's made in a different country there will be a smaller inset flag.

COST: a rough guide only - **includes** local taxes/VAT. Varies with exchange rates, extra taxes etc. We usually round up to the nearest Pound£/US Dollar\$/Euro€. We now give a **currency conversion** figure in orange £\$€ which is simply to give an idea of price, it is not the selling price which will have import duties and bulk shipping etc. to add.

AMORPHOUS HUMAN FACE: Amorphous is a general representative shape. HUMAN closely resembles a human in the head and upper torso and will always have a realistic face. Some amorphous manikins have a human face to enhance realism and/or allow CPR actions but not necessarily actual CPR

SPINAL RESISTANCE WAISTNECK: Generally a reinforcing strip, alloy, plastic or carbon-fibre that runs up the spine. It keeps the manikin in-line rather than completely bending at the waist or the neck but not fully rigid - will allow limited bend under pressure.

ARTICULATE ELBOW SHOULDER: The arm will bend at these points. Shoulder joints often rotate as well as hinge.

ARTICULATE KNEE WAIST NECK: The legs will bend at the knee

and hip. The head will 'flop' forward or backward unless it has a spinal resistance insert.

LIFTING ATTACHMENTS: To suspend the full weight of the manikin out of water for drying

CPR AIRWAY CAPABLE: CPR has a mouth into which you can breath or entrain air/oxygen and will have a torso that can resist compressions. **AIRWAY** is a much more advanced feature allowing realistic intubation

ADVANCED FEATURES: D

VARIABLE WEIGHT: You can make the manikin heavier or lighter either by removing/adding internal weight packs or by adding external weight packs or replacing limbs/components with lighter/heavier options.

REDISTRIBUTE WEIGHT: The orientation and buoyancy of the manikin can be adjusted by manipulating the weight distribution with the dummy eg. weight shift from upper torso to upper legs to orient into a more upright stance in the water.

SOLAS REFLECTIVE: SOLAS is the international maritime approval/standard for quality reflective tape but there are non-SOLAS reflective materials and some may want the manikin to be low vis in order to test search capabilities!

IN WATER ORIENTATION: How the manikin sits in water, most will be head-up with the body and legs at an angle or upright as if treading water. Most will also be semi-submerged with the help of saturated material covers but some may sink.

Body recovery manikins sink but of course a drowning victim that may still be alive and able to be resuscitated may also be underwater depending on their attire.

WITH REPLACEABLE BOOTS: May be integrated and difficult to remove/replace - others are usually slip-on/off rubber wellies.



A WORLD FIRST FOR WATER RESCUE ADVANCED WATER RESCUE MANIKIN



An exciting collaboration between the experts at Ruth Lee Ltd and Lifecast Body Simulation creating **a world-first for water rescue.**

The most realistic water rescue manikin in the world. From rescue to resuscitation with advanced life support features.

Available world-wide through a network of distributors in more than 40 countries.















☎ +44 (0) 1490 413 282 ✉ SALES@RUTHLEE.CO.UK 🌐 WWW.RUTHLEE.COM



MANUFACTURER	CQC FIBRELIGHT	CQC FIBRELIGHT	DACON	ELJI SPORT	ELJI SPORT
MODEL VARIANT	BoB	BoB+	Rescue Dummy	Water Rescue Woman	Water Rescue Man
ORIGIN					
COST	£00 \$00 €00	£00 \$00 €00	£0 >\$40,000 €0	£0 \$00 €0	£0 \$0 €0
DRY WEIGHT	1-30kg 2.2-66lb	1.2-55kg 2.6-121lb	22-85kg 49-187lb	30kg 66lb	30kg 66lb
HEIGHT	1.74m 5'8"	1.74m 5'8"	1.9m 6'2"	1.5m 5'	1.7m 5'7"
MATERIALS OUTER INNER	Coated Polyester Foam + Water	Coated Polyester + Polyurethane Liner Foam + Water	PVC/ Stainless Steel Air/Water	PVC, Polyester, Rubber ?	PVC, Polyester Rubber ?
AMORPHOUS HUMAN FACE	■	■	■	■ ■	■ ■
SPINAL RESISTANCE WAIST NECK					■
ARTICULATE ELBOW SHOULDER	□ □*	□ □*	■ ■	■ ■	■ ■
ARTICULATE KNEE WAIST NECK	□ □ □*	□ □ □*	■ ■ ■	■ ■	■ ■
LIFTING ATTACHMENTS			Rear lifting eye		
CPR AIRWAY CAPABLE					
ADVANCED FEATURES					
VARIABLE WEIGHT	Water	Water			
REDISTRIBUTE WEIGHT	No	No			
SOLAS REFLECTIVE	No	No	■	■	■
IN WATER ORIENTATION	FLOAT/NEUTRAL	FLOAT/NEUTRAL	SINK* FLOAT 90-180°		
WITH REPLACEABLE BOOTS	No	No	□ □ □	□ □ □	□ □ □
STORAGE BAG HARD-CASE			■	■	■
WARRANTY			1 year	1 year	1 year
OTHER COLOURS					
NOTES	*All extremities can bend depending on how much water is put in.	Will retain 80% of start weight on land after 3hrs. *All extremities can bend depending on how much water is put in.	Extremely robust, can be dropped from height * negative buoyancy version available for body-recovery training		
WEBSITE	cqc.co.uk	cqc.co.uk	daconrescue.com	eljisport.com	deeptrekker.com

NOTES: **COST:** Approx, **INCLUDES** local tax/VAT **USES/ FEATURES:** = PARTIAL FEATURE and/or OK BUT NOT IDEAL = Option

WATER RESCUE MANIKINS

					
ELJI SPORT	PAX	RUTH LEE	RUTH LEE	RUTH LEE	RUTH LEE
Water Rescue Child	Water Rescue	MOB II Adult	MOB Youth	MOB Toddler	MOB Toddler
					
£0 \$8500 €0	£0 \$00 €1250	£0 \$800 €0	£0 \$0 €0	£0 \$0 €0	£0 \$0 €0
10kg 22lb 1m 3'3"	45kg 99lb 1.82m 6'	40kg 88lb 1.8m 5'11"	20kg 44lb 1.3m 4'3"	8kg 17.6lb 0.9m 2'11"	5kg 11lb 0.7m 2'4"
PVC, Polyester, Rubber ?		Nylon Mesh/ Reinforced PVC Polypropylene plastic /non-absorbant (1 Day <0.1%) closed cell foam	Nylon Mesh/ Reinforced PVC Polypropylene plastic /non-absorbant (1 Day <0.1%) closed cell foam	Nylon Mesh/ Reinforced PVC Polypropylene plastic /non-absorbant (1 Day <0.1%) closed cell foam	Nylon Mesh/ Reinforced PVC Polypropylene plastic /non-absorbant (1 Day <0.1%) closed cell foam
■ ■	■	■	■	■	■
		■ ■	■ ■	■ ■	■ ■
■ ■ ■ ■					
		rear web loop	rear web loop	rear web loop	rear web loop
		Foam pads	Foam pads		
■	■	■	■	■	■
		FLOAT 45-90°	FLOAT 45-90°	FLOAT 45°	FLOAT 45°
□ □	■	■	■	■	■
■ 1 year		■	■	■	■
	■ ■	■	■	■	■
	includes solid foam lifejacket DISCONTINUED				
deeptrekker.com	pax-bags.com	ruthlee.com.com	ruthlee.com.com	ruthlee.com.com	ruthlee.com.com











N/A = info Not Available/not given INFLATION TIME: Hand Pump/ Compressed Air VALVES PRV=Pressure Relief Valve

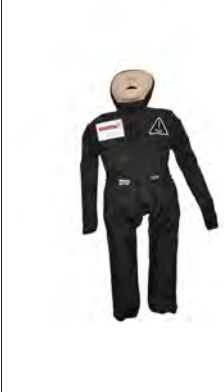

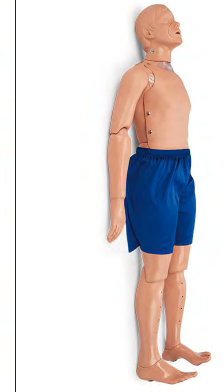
MANUFACTURER	RUTH LEE	RUTH LEE	RUTH LEE	RUTH LEE	RUTH LEE
MODEL VARIANT	Surf Adult	Pool Adult	Pool Youth	Advanced Adult	Advanced Toddler
ORIGIN					
COST	£0 \$0 €0	£0 \$1400 €0	£0 \$900 €0	£0 \$0 €0	£0 \$0 €0
DRY WEIGHT	20kg 44lb	30kg 66lb	16kg 35.3lb	0kg 0lb	12kg 26.4lb
HEIGHT	1.5m 5'	1.3m 4'3"	1.1m 3'7"	1.9m 6'2"	0.95m
MATERIALS OUTER	Nylon Mesh/ Reinforced PVC	Nylon Mesh/ Reinforced PVC	Nylon Mesh/ Reinforced PVC	Nylon Mesh/ Reinforced PVC	Nylon Mesh/ Reinforced PVC
INNER	Polypropylene plastic /non-absorbant (1 Day <0.1%) closed cell foam	Polypropylene plastic /non-absorbant (1 Day <0.1%) closed cell foam	Polypropylene plastic /non-absorbant (1 Day <0.1%) closed cell foam	Polypropylene plastic /non-absorbant (1 Day <0.1%) closed cell foam	Polypropylene plastic /non-absorbant (1 Day <0.1%) closed cell foam
AMORPHOUS HUMAN FACE	■	■ ■	■ ■	■ ■	■
SPINAL RESISTANCE WAIST/NECK					
ARTICULATE ELBOW SHOULDER		■	■	■	■
ARTICULATE KNEE WAIST/NECK					
LIFTING ATTACHMENTS	rear web loop	rear web loop	rear web loop		
CPR AIRWAY CAPABLE				■ ■	■ ■
ADVANCED FEATURES				Lung fluid/foam	Lung fluid/foam
VARIABLE WEIGHT					
REDISTRIBUTE WEIGHT					
SOLAS REFLECTIVE	■	■	■	■	■
IN WATER ORIENTATION	FLOAT 90°	SINK/NEUTRAL BUOY-	SINK/NEUTRAL BUOY-	FLOAT 45°	FLOAT 45°
WITH REPLACEABLE BOOTS	-	-	-	■	■
STORAGE BAG HARD-CASE					
WARRANTY					
OTHER COLOURS	■	■	■	■	■
NOTES	Arms loped above head for in-water pick-up			<i>lifecastbodysim.com</i>	<i>lifecastbodysim.com</i>
WEBSITE	ruthlee.com.com	ruthlee.com.com	ruthlee.com.com	ruthlee.com.com	ruthlee.com.com

NOTES: **COST:** Approx, **INCLUDES** local tax/VAT **USES/ FEATURES:** = PARTIAL FEATURE and/or OK BUT NOT IDEAL = Option

WATER RESCUE MANIKINS

						
	RUTH LEE	RUTH LEE	RUTH LEE	RUTH LEE	SIMULAIDS	SIMULAIDS
Model	Heli-Winch	Body Recovery Adult	Body Recovery Youth	Body Recovery Toddler	Water Rescue Adult	Water Rescue CPR Adult
Origin						
Price	£0 \$0 €0	£0 \$0 €0	£0 \$0 €0	£0 \$0 €0	£1260 \$985 €1665	£1446 \$0 €2261
Weight	40kg 88lb	50kg 110lb	30kg 66lb	10kg 22lb	20kg 44lb	20kg 44lb
Height	1.8m 5'11"	1.8m 5'11"	1.3m 4'3"	0.9m 2'11"	1.65m 5'5"	1.65m 5'5"
Material	Nylon Mesh/ Reinforced PVC Polypropylene plastic /non-absorbant (1 Day <0.1%) closed cell foam	Nylon Mesh/ Reinforced PVC Polypropylene plastic /non-absorbant (1 Day <0.1%) closed cell foam	Nylon Mesh/ Reinforced PVC Polypropylene plastic /non-absorbant (1 Day <0.1%) closed cell foam	Nylon Mesh/ Reinforced PVC Polypropylene plastic /non-absorbant (1 Day <0.1%) closed cell foam	Vinyl/ Stainless Steel Air/Water	Vinyl/ Stainless Steel Air/Water
Features	■	■ ■	■ ■	■ ■	■ ■	■ ■
Additional Features	■ ■	■ ■	■ ■	■ ■	■ ■	■ ■
Other Features					■ ■	■ ■
Material					■ ■	■ ■
Environment		rear web loop	rear web loop	rear web loop		
Material					Water	Water
Other Features	■	■	■	■		
Floatation	FLOAT 45°	SINKS	SINKS	SINKS	FLOAT 90°	FLOAT 45°
Other Features	■	■	■	-	-	-
Warranty	■	■	■	■	3 Years	3 Years
Notes	Shorter legs and different weight distribution to MOB version. Lifetec-Australia version shown.	Includes hair. Can withstand drop height into water of 5-6m	Includes hair. Can withstand drop height into water of 5-6m	Includes hair. Can withstand drop height into water of 5-6m	Arms loped above head for in-water pick-up	
Website	ruthlee.com.com	ruthlee.com.com	ruthlee.com.com	ruthlee.com.com	ruthlee.com.com	ruthlee.com.com

N/A = info Not Available/not given INFLATION TIME: Hand Pump/ Compressed Air VALVES PRV=Pressure Relief Valve

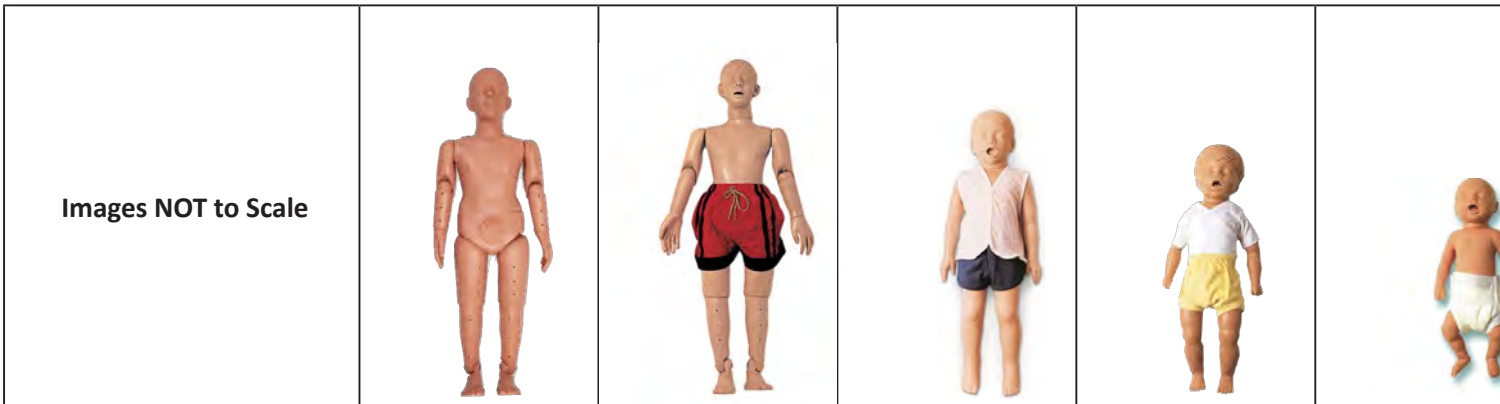

MANUFACTURER	SIMULAIDS				
MODEL VARIANT	Water Rescue Adolescent	Water Rescue CPR Adolescent	Water Rescue Timmy	Water Rescue Billy	Water Rescue C
ORIGIN					
COST	£1065 \$840 €1412	£1542 \$0 €2190	£323 \$273 €0	£317 \$267 €0	£285 \$252 €0
DRY WEIGHT	9kg 19.8lb	5kg 11lb	5kg 11lb	40kg -12lb	2.3kg 5lb
HEIGHT	1.25m	0.7m 2'4"	0.7m 2'4"	1.8m 5'11"	0.5m 20"
MATERIALS OUTER INNER	Vinyl/ Stainless Steel Air/Water	Vinyl/ Stainless Steel Air/Water	Vinyl/ Stainless Steel Air/Water	Vinyl/ Stainless Steel Air/Water	Nylon Mesh/ Reinforced PV Polypropylene pl /non-absorbant Day<0.1%) closed foam
AMORPHOUS HUMAN FACE					
SPINAL RESISTANCE WAIST NECK					
ARTICULATE ELBOW SHOULDER					
ANKLE KNEE WAIST NECK					
LIFTING ATTACHMENTS					rear web loop
CPR AIRWAY CAPABLE					
ADVANCED FEATURES					
VARIABLE WEIGHT	Water	Water	Water		
REDISTRIBUTE WEIGHT					
SOLAS REFLECTIVE					
IN WATER ORIENTATION	FLOAT	FLOAT	FLOAT	FLOAT	SINKS
WITH REPLACEABLE BOOTS	-				
STORAGE BAG HARD-CASE					
WARRANTY	3 Years	3 Years	3 Years	3 Years	3 Years
OTHER COLOURS					
NOTES			3 Years old	6-9 month old	baby
WEBSITE	simulaids.com	simulaids.com	simulaids.com	simulaids.com	simulaids.com

NOTES: **COST:** Approx, **INCLUDES** local tax/VAT **USES/ FEATURES:** = PARTIAL FEATURE and/or OK BUT NOT IDEAL = Option

						
	SRP	SRP	SRP	SRP		
Category	Water CPR	Water Floating 15-9161F	Water Sinking 15-9161S	Water Sinking Child 15-9161SB		
						
Price	£285 \$252 €0	£00 \$00 €00	£00 \$00 €00	£00 \$00 €00		
Weight	40kg 88lb	40kg 88lb	40kg 88lb	18kg 39.6lb		
Height	1.8m 5'11"	1.8m 5'11"	1.8m 5'11"	1m 3'3"		
Material	PVC	PVC				
Cell	■	■	■	■		
Features	■ ■	■ ■	■ ■	■ ■		
Additional Features	■ ■ ■	■ ■ ■	■ ■ ■	■ ■ ■		
Other	■					
Search		Heat bar for FLIR searching				
Search	■	■	■	■		
Float/Sink	FLOAT	FLOAT	SINKS	SINKS		
Other	□	□	□	□		
Other			■	■		
Search		Heat bar for FLIR searching				
Website	srp.se	srp.se	srp.se	srp.se		

N/A = info Not Available/not given INFLATION TIME: Hand Pump/ Compressed Air VALVES PRV=Pressure Relief Valve