

Surgical Instruments Catalogue

- Surgery
- Chirurgie
- Cirugía
- Chirurgie
- Chirurgia



SURGICAL SOURCES INDUSTRIES

We are manufacturer and supplier of Surgical & Dental instruments



M. Rizwan Bajwa
Marketing Directors

Surgical Sources feels great honor introducing itself to be one of the leading manufacturing company of surgical & dental instruments. Professional always prefer **Surgical Sources** instruments, which is our pride.

Our all instruments are manufactured by the high quality stainless steel made on our requirements, every instrument is hand crafted with the highest workmanship available in the industry. Through heat treatment, the instruments are hardened and tempered for proper functioning and long life. All instruments are polished electrolytically and manually for maximum resistance to corrosion and long life.

Surgical Sources pays special attention to the needs of doctors, with innovative designs to meet the needs of professionals. The wide assortment of standard patterns and exclusive **Surgical Sources** designs gives you the most desirable range of surgical and dental instruments.

Over the several years, we have earned the reputation of for maintaining highest quality standards of quality and service. To manufacture instruments that meet with your changing demands is our achievement. Our highly skilled staff of professionals will continue to serve your needs and will try their outmost to uplift the standards which we have set in the past.

With your co-operation and guidance, **Surgical Sources** will continue serving surgical and dental instruments in future.

Management of **Surgical Sources**



Sr. #		Page #	Page #
10	ENT Surgery	290 to 323	
11	Neurosurgery	324 to 339	
12	Intestinal & Rectal Instruments	340 to 351	
13	Gynecology / Obstetrics	352 to 380	
14	Urology Instruments	381 to 390	
15	Hollow Wares	391 to 399	
16	Index	400 to 408	

Sr. #		Page #	Page #
01	Diagnostic Instruments	01 to 14	
02	Trocars, Suction Tubes & Cannulas	15 to 21	
03	Scalpel Handle, Scalpel Blades, Dissecting Knives & Saws	22 to 29	
04	General Operating Scissors	30 to 66	
05	Dressing & Tissue Forceps	67 to 88	
06	Haemostatic Forceps	89 to 123	
07	Needle Holders	124 to 158	
08	Retractors	159 to 210	
09	Bone Surgery Instruments	211 to 289	



DIAGNOSTIC INSTRUMENTS





BASIC METHODS FOR HANDLING AND CARE OF SURGICAL AND DENTAL INSTRUMENTS

Dear Customers:

We have received some questions concerning staining, pitting or rusting in stainless steel instruments. So, we took great honour and pleasure in guiding our respected customers to eliminate the problems about staining or rusting etc. The points are as follows:-

- 1) Rinse the instruments as soon as possible after use to remove blood and serum.
- 2) Dry the instruments after cleaning or before wrapping and storing, if not so, moisture left can cause rust and corrosion.
- 3) Do not leave instruments in cold sterilization solution for a long period, as the solution may lead the instrument to be corrosive.
- 4) Never use caustic cleaners, use those specified for cleaning surgical instruments.
- 5) Avoid cleaning instruments with steel wool; if want to clean with hand, use detergent soap and a soft brush and finally treat with distilled water.
- 6) You should check your autoclave; Iron, calcium, sodium or copper in water can cause rusting, staining or corrosion.
- 7) Leaving of instruments for a long time in the following solutions can also cause corrosion.
 - i) Phenol or Iodine.
 - ii) Aluminium, Barium or Calcium.
 - iii) Any Acid, Mercury or Potassium solution.
- 8) Try your utmost not to sterilize stainless steel instrument with chrome plated bras instruments, as any break in chrome surface may cause pitting or rusty surface in instruments.
- 9) Muslin wraps should be rinsed sufficiently by the laundry, so that all chlorine bleach may remove, which can cause corrosion or custing during autoclaving.

We hope that by acting on the above instructions, your problems relating to rusting, staining or pitting would abolish and the age of your instrument would increase.

MANAGEMENT



STETHOSCOPES

Stethoskope | Estetoscopios
Stéthoscopes | Stetoscopi



DUPLEX, Stethoscope
F1-001
super lightweight



DUPLEX-BABY
Stethoscope
F1-002
super lightweight

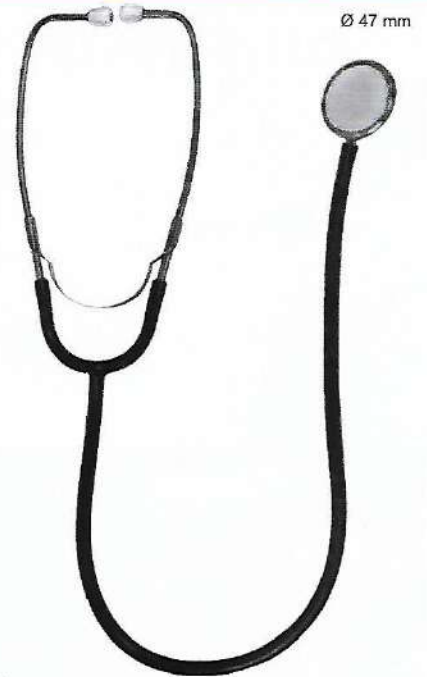

ANAESTOPHON
Stethoscope
F1-003
super lightweight



PINARD WOODEN
Stethoscope
F1-004
18 cm, 7"



PINARD ALUMINIUM
Stethoscope
F1-005
15 cm, 6"



WEBER
Aesthesiometer
F1-006
9.0 cm, 3 1/2"

PERCUSSION HAMMERS

Perkussionshämmer | Martillos de percusión
 Marteaux-percuteurs | Martelli percussori

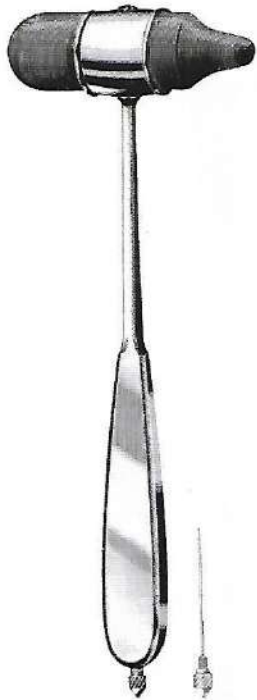

NEURO-DUOFLEX Hammer
 F1-007 22 cm, 8 3/4"



DEJERINE Hammer
 F1-008 20 cm, 8"

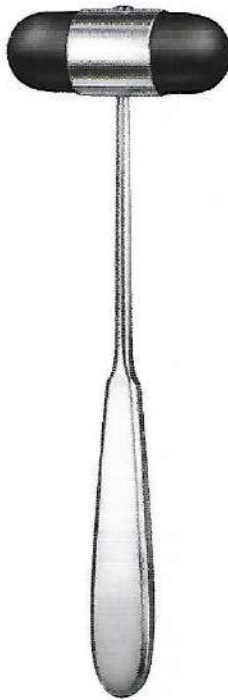

DEJERINE Hammer
 F1-009 20 cm, 8"



TROEMNER Hammer
 F1-010 145 g
 F1-011 175 g
 F1-012 235 g
 24.5 cm, 9 1/2"
 spare rubber



TROEMNER-SIMPLEX Hammer
 F1-013 21 cm, 8 1/4"



BUCK Hammer
 F1-014 18.5 cm, 7 1/4"



BUCK Hammer
 F1-015 18 cm, 7"



TAYLOR Hammer
 F1-016 18 cm, 7"
 F1-017 20 cm, 8"



TAYLOR Hammer
 F1-018 18 cm, 7"



PERCUSSION HAMMERS

Perkussionshämmer | Martillos de percusión

Marteaux-percuteurs | Martelli percussori

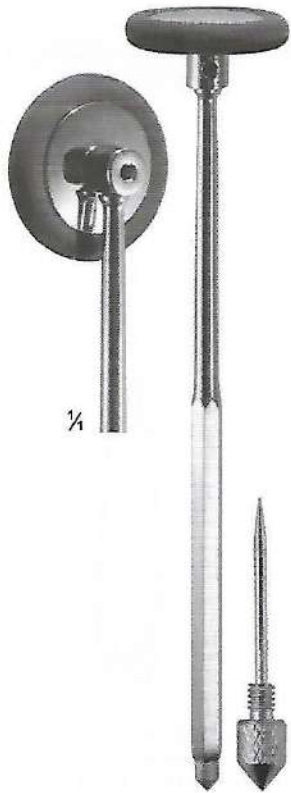

BABINSKY Hammer
F1-019 22 cm, 8 ¾"
Ø 40mm

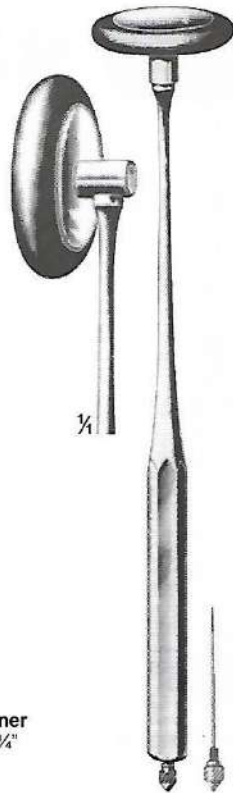

BABINSKY Hammer
F1-020 22 cm, 8 ¾"
Ø 40mm

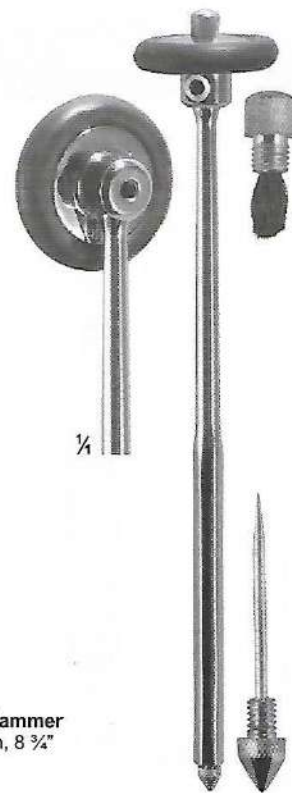

RABINER Hammer
F1-021 23 cm, 9"
Ø 40mm
with needle & brush



BERLINER Hammer
F1-022 20.0 cm, 8"

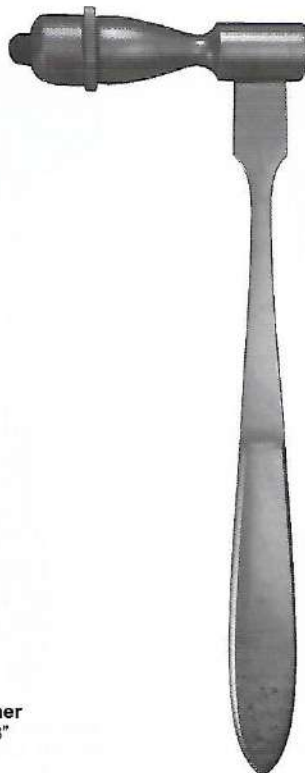

TRAUBE Hammer
F1-023 16 cm, 6 ¼"



**WARTENBERG
Pinwheel**
F1-024 19 cm, 7 ½"

CATHETER FORCEPS



Katheterzangen

Pinzas para catéteres

Pinzas para sondes

Pinze per cannule

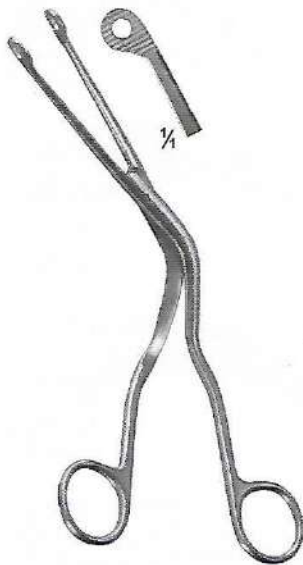

MAGILL
Catheter Intubating
Forcep
F1-025 16 cm, 6 1/4"

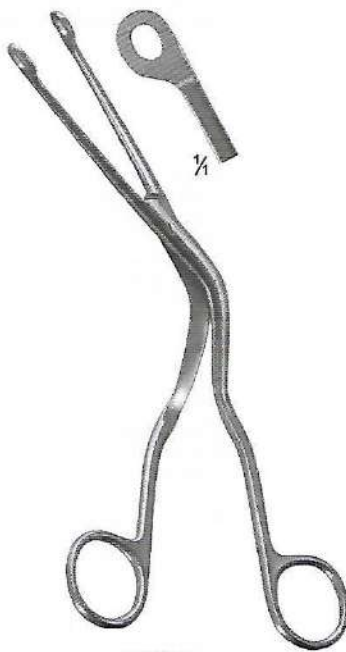

MAGILL
Catheter Intubating
Forcep
F1-026 20 cm, 8"

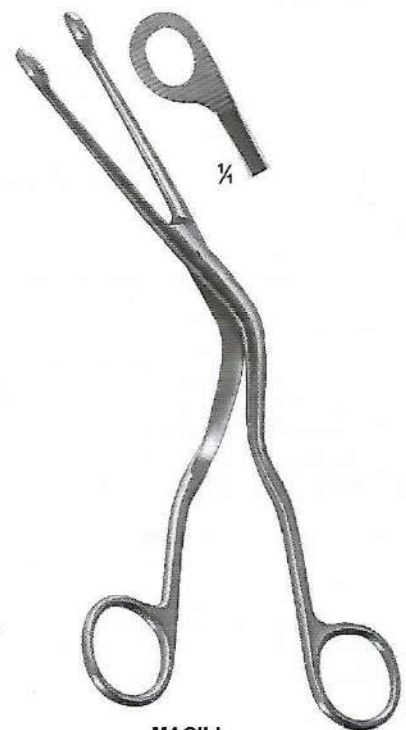

MAGILL
Catheter Intubating
Forcep
F1-027 25 cm, 10"



MAGILL Catheter Intubating Forcep GOLD
F1-028 6.5" (2.5" shaft) , Infant , hole (dia 2.00 mm)
F1-029 7.5" (3" shaft) , Infant , hole (dia 2.30 mm)
F1-030 7.5" (4" shaft) , Infant , hole (dia 2.60 mm)



MAGILL Catheter Intubating Forcep GOLD
F1-031 8" (4" shaft) , Child , hole (dia 3.00 mm)
F1-032 8" (4" shaft) , Child , oval tip (5.38 mm X 4.15 mm)
F1-033 9" (5" shaft) , Adult , oval (6.80 mm x 5.00 mm)
F1-034 10" (5" shaft) , Adult , oval (9.60 mm x 7.70 mm)



LARYNGOSCOPES

Laryngoskope | Laringoscopios
Laryngoscopes | Laringoscopi

MC-INTOSH FIBER OPTIC LARYNGOSCOPE BLADE (English Pattern)

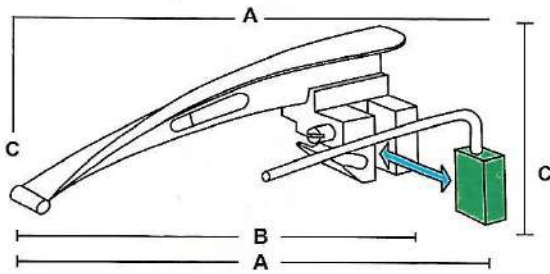

BLADE

Size	A	B	C	Working Length
0	77mm	53mm	14mm	55mm
1	95mm	72mm	43mm	70mm
2	111mm	86mm	44mm	78mm
3	133mm	109mm	44mm	108mm
4	151mm	129mm	44mm	133mm

Mc-Intosh Laryngoscope Fiber Optic
Halogen illumination. Manufactured from AISI 304 Stainless-Steel. Halogen illumination 2.5 V. The Bulb is inside the handle in order to simplify the sterilization of the blades. All blades and handles are interchangeable with other leading manufacturer. All sets can be combined as per your request, and delivered in Green plastic case.

Blades Availability:

- ★ Matt Finish
- ★ Mirror Finish
- ★ Sand Blast Finish
- ★ Pls, confirm in your order list



Laryngoscope Battery
Handle for Adult
C type 2 batteries

MC-INTOSH FIBER OPTIC LARYNGOSCOPE SET HALOGEN ILLUMINATION

**F1-035
PEDIATRIC SET**
Set of 0,1,2
Blades
Supplied in
Green plastic case

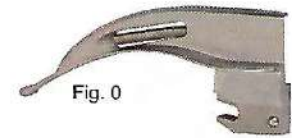

Fig. 0



Fig. 1

**F1-036
STANDARD SET**
Set of 1,2,3
Blades
Supplied in
Green plastic case



Fig. 2



Fig. 3

**F1-037
ADULT SET**
Set of 1,2,3,4
Blades
Supplied in
Green plastic case

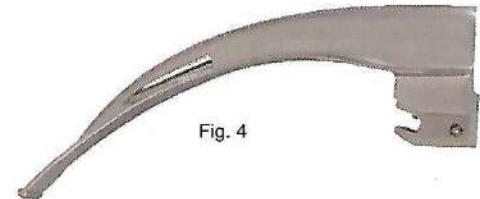

Fig. 4



Mc-Intosh Fiber Optic Laryngoscope Set
Halogen Illumination
Manufactured by AISI:
304 Stainless Steel Material

LARYNGOSCOPES

Laryngoskope | Laringoscopios
Laryngoscopes | Laringoscopi



MC-INTOSH LARYNGOSCOPE

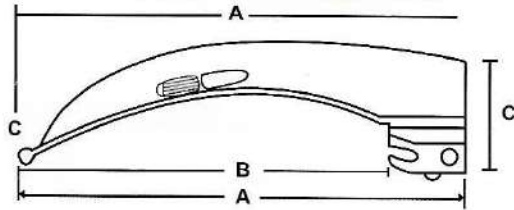

BLADE

Size	A	B	C	Working Length
0	80mm	58mm	30mm	55mm
1	97mm	76mm	36mm	70mm
2	111mm	88mm	36mm	78mm
3	133mm	112mm	36mm	108mm
4	154mm	131mm	38mm	133mm

Mc-Intosh Laryngoscope

Plastic case, Standard illumination. Manufactured from AISI 304 Stainless Steel Matt Type, Standard Illumination 2.5 V. All blades and handles are interchangeable with other leading manufacturer. All sets can be combined as per your request, and delivered in Gray plastic case.

Blades Availability:

- * Matt Finish
- * Mirror Finish
- * Sand Blast Finish
- * Pls, confirm in your order list

Conventional Laryngoscope Set

Mc-INTOSH LARYNGOSCOPE SET STANDARD ILLUMINATION

AVAILABLE SETS
WITH
BATTERY HANDLE

**F1-038
PEDIATRIC SET**
Set of 0,1,2
Blades
Supplied in
Gray plastic case

**F1-039
STANDARD SET**
Set of 1,2,3
Blades
Supplied in
Gray plastic case

**F1-040
ADULT SET**
Set of 1,2,3,4
Blades
Supplied in
Gray plastic case

Fig. 0

Fig. 1

Fig. 2

Fig. 3

Fig. 4



Laryngoscope Battery
Handle for Adult
C type 2 Batteries



With two Spare
Bulbs



Mc-Intosh Laryngoscope Set
Standard Illumination
Manufactured From
Stainless Steel Material



LARYNGOSCOPES

Laryngoskope | Laringoscopios
Laryngoscopes | Laringoscopi

LARYNGOSCOPE MILLER

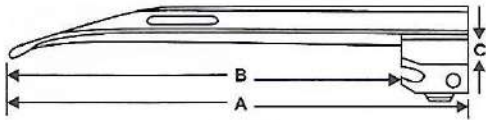

BLADE

Size	A	B	C	Working Length
0	75mm	53mm	26mm	55mm
1	111mm	80mm	26mm	80mm
2	151mm	134mm	28mm	130mm
3	188mm	167mm	28mm	170mm
4	203mm	180mm	28mm	180mm

Mc-Intosh Laryngoscope

Plastic case, Standard illumination.
Manufactured from AISI 304 Stainless Steel.
All blades and handles are interchangeable
with other leading manufacturer. All sets
can be combined as per your request, and
delivered in Blue plastic case.

Blades Availability:

- * Matt Finish
- * Mirror Finish
- * Sand Blast Finish
- * Pls, confirm in your order list

Conventional Laryngoscope Set

LARYNGOSCOPE SET OF CONVENTIONAL MILLER STANDARD ILLUMINATION

AVAILABLE SETS WITH BATTERY HANDLE

F1-041 PEDIATRIC SET
Set of 0,1,2
Blades
Supplied in Blue plastic case

F1-042 STANDARD SET
Set of 1,2,3
Blades
Supplied in Blue plastic case

F1-043 ADULT SET
Set of 1,2,3,4
Blades
Supplied in Blue plastic case



Fig. 1



Fig. 2



Fig. 3



Fig. 4



Laryngoscope Battery Handle for Adult C type
2 batteries



With two Spare Bulbs



Laryngoscope Set of conventional Miller
Standard Illumination
Manufactured From Stainless Steel Material

DIAGNOSTIC SETS



Diagnostik-Bestestecke
Trousse à diagnostic

Juegos para diagnóstico
Astucci per diagnostica



**Professional Otoscope & Ophthalmology Set
ENT Medical Diagnostic Set**

F1-044

2.5 V Standard illumination for use with
2 batteries C type.

Including:

Otoscope Head: Luir Lock fitting.
Chrome plated.

Fix lens 4 x in plastic mount can be
removed for introduction of instruments.

Specula sizes: 2.5, 3.5 & 4.5 mm Included,

Ophthalmoscope head: Luir Lock fitting.

Lens selection wheel permits choice of corrective
lenses from 0 to - 20 and 0 to +20 diopters.

Single large circle aperture.

Bent-arm illuminator: pin contact fitting.

Nasal speculum: Chrome plated.

Two laryngeal mirrors: n. 4 and 5.

Battery handle: 28mm. For 2 cell C-batteries.

Chrome plated. For adjustment of all illumination.

Replacement bulb: 2.5 V

Diagnostic set is supplied in our new beautiful
look and quality Blue Case, which protect our quality
Products from moisturizing and damaging.



Handle



Two laryngeal
mirrors: n. 4 and 5



Bent-arm illuminator:
pin contact fitting.



Specula



With 2 spare Bulbs



Otoscope Head



Nasal speculum: Chrome plated.



Ophthalmoscope head



ENT Specula



DIAGNOSTIC SETS

Diagnostik-Bestestecke
Trousse à diagnostic

Juegos para diagnóstico
Astucci per diagnostica



DIAGNOSTIC PENTOSCOPE SET

F1-045

2.5 V Standard illumination for use with 2 batteries type AA.

Consisting:

Universal Handle thread type fit for all Pentoscope Heads like.

- Otoscope Head.
- Ophthalmoscope Head.
- Throat Branch Head.
- Mouth Mirrors Head.

It have two exploring mirrors No. 4 & 5 mm.

Its spare 06 disposable Plastic ear Canulas are with sizes 2 x 2.50 mm, 2 x 3.50 mm & 2 x 4.5 mm.

On special order it can be as 2 x 1.5 mm for new born babies 2 x 2.5 mm for pediatric and 2 x 4 mm for adults, so it means total 06 canula also available in a plastic tube packing.

Sturdy adjustment mount bracket

2 spare 2.5 V bulb.

Pentoscope set battery handle is operating with two AA size batteries.

This Pentoscope set Packed in our new beautiful Blue Colour plastic case in same blue inner packing material.

Spare parts also available of any item.



With 2 spare Bulbs

Mouth Mirrors Head

Standard illumination



Otoscope Head



Sturdy Adjustment Mount Bracket



Plastic ear Canulas

DISSECTING KITS



Diagnostik-bestecke
Estuches de diagnostico

Diagnostic Setts
Combinazioni per diagnostica

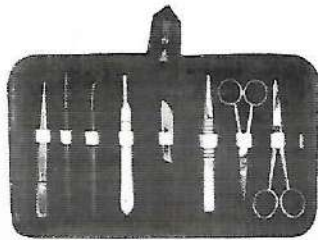

F1-046

Dissecting Set of 9 Pcs.

- Dissecting Forceps 11.5cm Sharp Point.
- Teasing needle Sharp STR.
- Teasing Needle Sharp Angular.
- B.P Handle No.4.
- Blade No. 22.
- Thumb Forcep T.O.E 13cm.
- Dissecting Scissor STR 11.5cm.
- Dissecting Scissor STR 13cm.
- Zipper Case Inside Red Velvet.

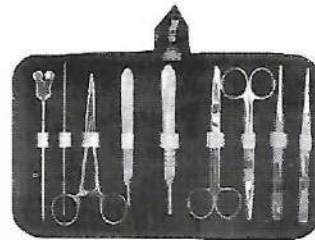

F1-047

Dissecting Set of 10 Pcs.

- Grooved Director with Tongue Tie 14cm.
- Probe Double 14cm.
- Mayo Hegar Needle Holder 14cm.
- B.P Handle No.3
- B.P Handle No.4
- Dressing Scissor 14cm S/B STR.
- Dressing Scissor 14cm S/B CVD.
- Dressing Forcep 1x2 teeth 14cm.
- Dressing Forcep Serrated 14cm.
- Zipper Case Inside Red Velvet.

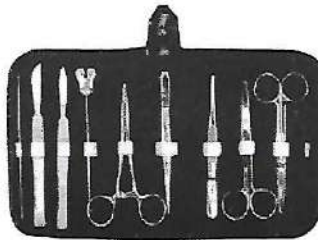

F1-048

Dissecting Set of 10 Pcs.

- Probe Double 13cm.
- 2PCS. Scalpel S.S.
- Grooved Director With Tongue Tie 14cm
- Mayo Hegar Needle Holder 14cm.
- Dissecting Forceps 14cm 1x2 Teeth.
- Dressing Forceps 14cm Serrated.
- Dressing Scissor 14cm S/B STR.
- Dressing Scissor 14cm S/B CVD.
- Zipper Case Inside Red Velvet.

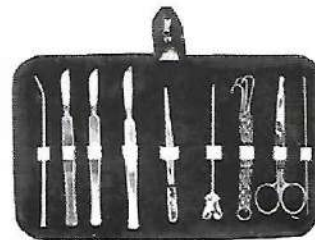

F1-049

Dissecting Set of 10 Pcs.

- Blow Pipe.
- 3PCS Scalpel.
- Dissecting Forceps 14cm.
- Grooved Director With Tongue Tie 14cm
- Triple Chain Hook.
- Dressing Scissor Probe Pointed 14cm.
- Probe Double 14 cm.
- Zipper Case Inside Red Velvet.

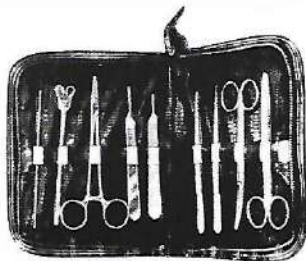

Dissecting Set

F1-050 Containing 9 Instruments

- slice Needle
- Probe Butterfly
- Needle Holder
- Scalpel Handle 3
- Scalpel Handle 4
- Dressing Forceps
- Tissue Forceps
- Tonsil Scissors
- Dressing Scissors

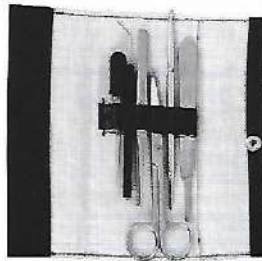

F1-051

Dissecting Set of 6 pcs.

- Dropper Oil
- Probe Plastic Handle
- Dressing Forceps
- Dressing Scissors S/s
- Hook
- Scalpel Handle 4

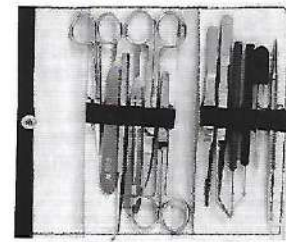

F1-052

Dissecting Set of 12 pcs.

- Iris Scissors
- Scalpel Knives 4
- Probe Single Ended
- Scalpel Handle 3
- Dressing Scissors S/s
- Dressing Scissors S/b
- Dressing Forceps
- College Tweezer
- Probe Straight Plastic Handle
- Probe Angular Plastic Handle
- Dropper Owl
- Hook



DISSECTING KITS

Diagnostik-bestecke

Diagnostic Setts

Estuches de diagnostico

Combinazioni per diagnostica

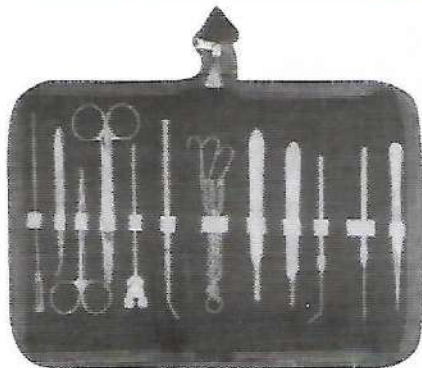

F1-053

- 1- Probe with eye
- 2- Dissecting Forcep CVD Fine 12 cm.
- 3- Iris Scissor
- 4- Operating Scissor S/B STR 14 cm
- 5- Grooved Director and Tongue tie
- 6- Huber Probe
- 7- Triple Chain Hook
- 8- B.P. Handle No. 4
- 9- B.P. Handle No. 3
- 10- Teasing Needle with Chuck CVD.
- 11- Teasing Needle with Chuck STR.
- 12- Dissecting Forceps Fine 14 cm.

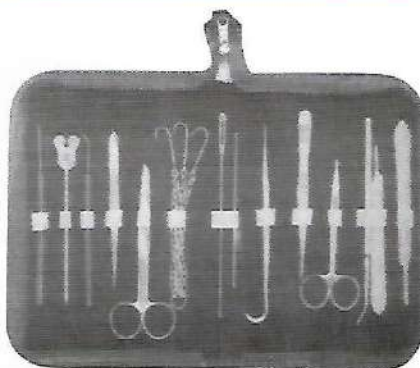

F1-054

- 1- Teasing Needle STR.
- 2- Grooved Director and Tongue Tie.
- 3- Teasing Needle CVD.
- 4- Dissecting Forcep with Pin 12 cm Fine
- 5- Operating Scissor S/B STR 14 cm
- 6- Triple Chain Hook
- 7- Probe with eye
- 8- Probe Double end
- 9- Probe and Hook
- 10- Dissecting Forcep Fine 14 cm
- 11- Iris Scissor
- 12- Huber Probe
- 13- B.P. Handle No.3
- 14- B.P. Handle No.4

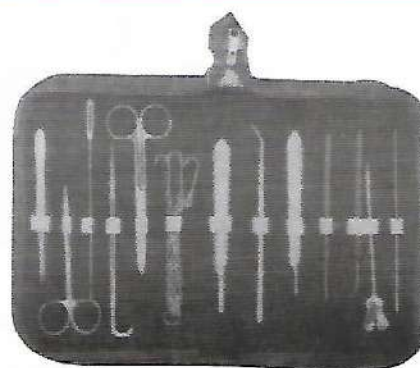

F1-055

- 1- Dissecting Forcep Fine STR with pin 12cm.
- 2- Iris Scissor STR.
- 3- Probe with eye.
- 4- Probe and Hook.
- 5- Operating Scissor S/B STR 14cm
- 6- Triple Chain Hook.
- 7- B.P. Handle No.4
- 8- Humber Probe.
- 9- B.P. Handle No.3
- 10- Teasing Needle STR Plasic Handle.
- 11- Teasing Needle CVD Plasic Handle.
- 12- Grooved Director and Tounge Tie.
- 13- Probe Double end.

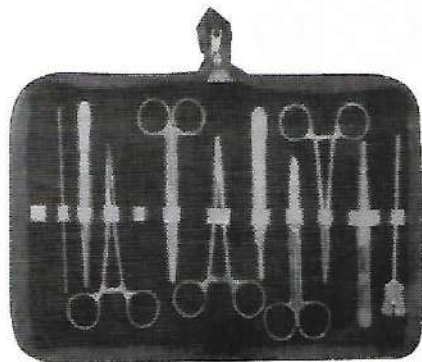

F1-056

- 1- Dissecting Forceps Thumb 14 cm.
- 2- Dissecting Forcep 1x2 Teeth 14 cm.
- 3- B.P. Handle No. 3
- 4- Grooved Director and Tongue tie
- 5- Mayo Hegar Needle Holder 14 cm
- 6- Operating Scissor S/B STR 14 cm
- 7- Probe Double end
- 8- Kelly Forcep STR 14 cm.

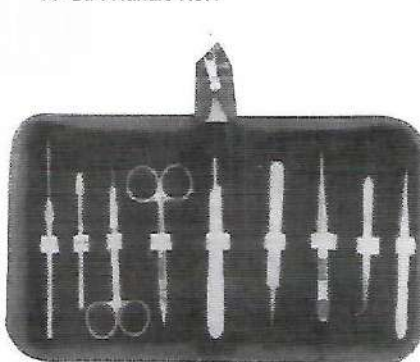

F1-057

- 1- Dissecting Forcep Fine 14cm.
- 2- Dissecting Forcep Fine CVD 12cm
- 3- Dissecting Forcep with Pin 14cm.
- 4- Watchmaker Fine point
- 5- Iris Scissor STR
- 6- Iris Scissor CVD.
- 7- Teasing Needle Holder
- 8- Teasing Needle STR.
- 9- B.P. Handle no. 3

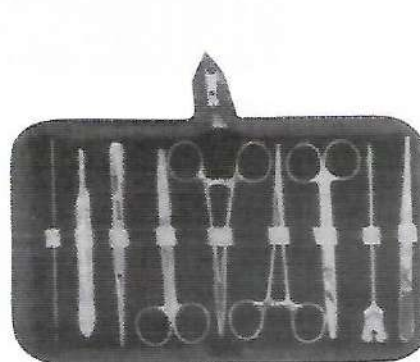

F1-058

- 1- Probe Double end
- 2- B.P. Handle No. 4
- 3- Dissecting Forcep 1x2 Teeth 14 cm.
- 4- Operating Scissor S/B STR 14 cm
- 5- Mayo Hegar Needle Holder 14 cm
- 6- Kelly Forcep STR 14 cm.
- 7- Operating Scissor S/B CVD 14 cm
- 8- Grooved Director and Tongue tie
- 9- Dissecting Forceps Thumb 14 cm.

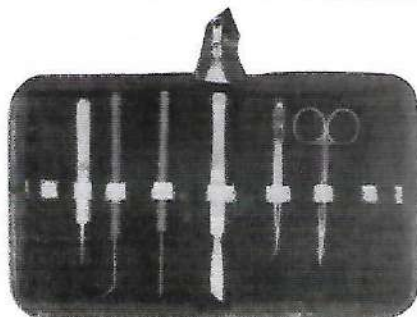

F1-059

- 1- Iris Scissor STR
- 2- Dissecting Forceps CVD 12 cm.
- 3- Scapel
- 4- Teasing Needle STR wooden Handle.
- 5- Teasing Needle CVD wooden Handle.
- 6- Watchmaker fine point.

DISSECTING KITS



Diagnostik-bestecke
Estuches de diagnostico

Diagnostic Setts
Combinazioni per diagnostica

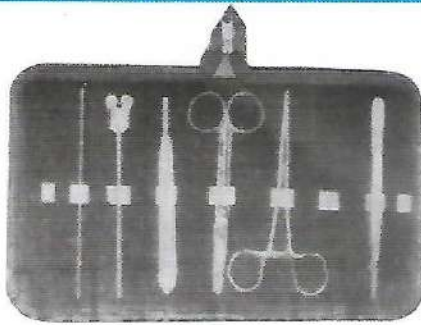

F1-060

- 1- Probe Double end.
- 2- Grooved Director and Tounge tie
- 3- B.P. Handle No. 4
- 4- Operating Scissor STR S/B 14 cm.
- 5- Kelly Forceps STR 14 cm.
- 6- Dissecting Forceps Thumb 13 cm.

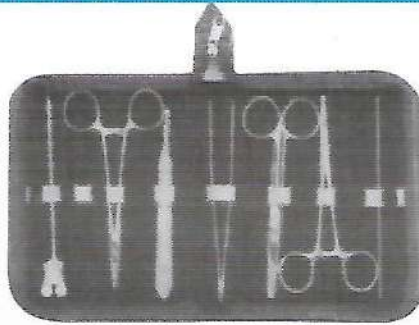

F1-061

- 1- Grooved Director and Tongue tie
- 2- Mayo Hegar Needle Holder 14 cm
- 3- B.P. Handle No. 4
- 4- Dissecting Forceps Thump 14 cm.
- 5- Operating Scissor S/B STR 14 cm
- 6- Kelly Forcep STR 14 cm.
- 7- Probe Double end

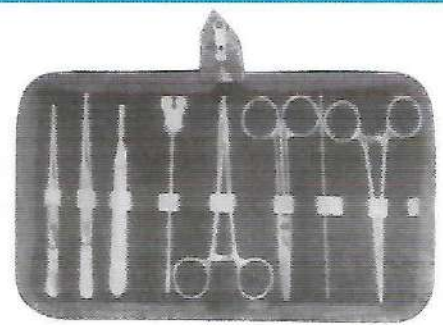

F1-062

- 1- Dissecting Forceps Thumb 14 cm
- 2- Dissecting Forcep 1x2 Teeth 14 cm.
- 3- B.P. Handle No. 3
- 4- Grooved Director and Tongue tie
- 5- Mayo Hegar Needle Holder 14 cm
- 6- Operating Scissor S/B STR 14 cm
- 7- Probe Double end
- 8- Kelly Forcep STR 14 cm.

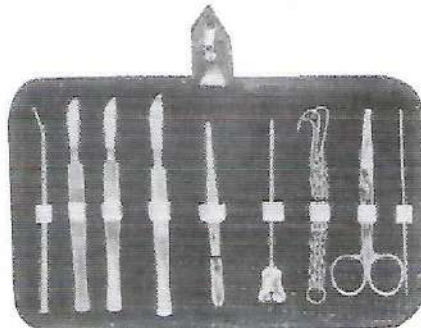

F1-063

- 1- Blow pipe.
- 2- 3 PCS Scalpel.
- 3- Dissecting Forcep 13 cm.
- 4- Grooved Director with Tounge tie 13 cm.
- 5- Triple Chain Hook.
- 6- Dressing Scissors probe pointed 13 cm.
- 7- Probe Double 13 cm.
- 8- Zipper Case inside red velvet.

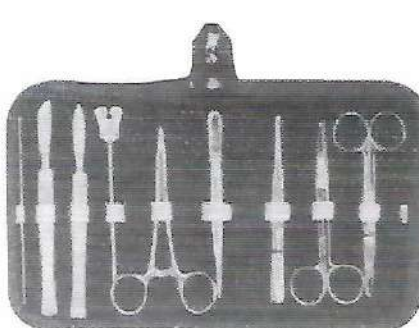

F1-064

- 1- Probe Double 13 cm
- 2- 2 PCS. Scalpel S.S
- 3- Grooved Director with Tongue Tie 13 cm
- 4- Mayo Hegar Needle Holder 13 cm
- 5- Dissecting Forcep 13 cm 1x2 Teeth
- 6- Dressing Forcep 13 CMS Serrated.
- 7- Dressing Scissor 13 cm S/B STR.
- 8- Dressing Scissor 13 cm S/B CVD.
- 9- Zipper Case Inside Red Velvet.

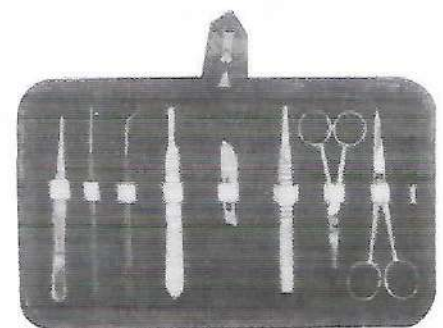

F1-065

- 1- Dissecting Forcep 11.5 cm Sharp Point.
- 2- Iris Scissor
- 3- B.P. Handle No. 4
- 4- Teasing Needle Sharp angular.
- 5- Blade No. 22
- 6- Thumb Forceps T.O.E 13 cm
- 7- Dissecting Scissor STR 11.5 cm
- 8- Dissecting Scissor STR 13 cm
- 9- Zipper case Inside Red Velvet

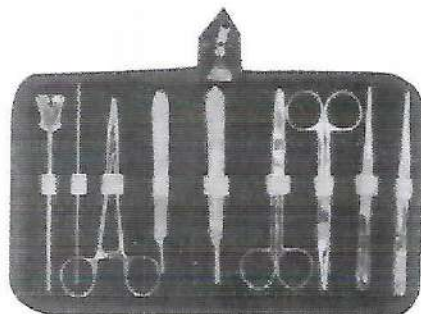

F1-066

- 1- Grooved Director with Tongue Tie 14 cm
- 2- Probe Double 14 cm
- 3- Mayo Hegar Needle Holder 14 cm
- 4- B.P. Handle No. 3
- 5- B.P. Handle No. 4
- 6- Dressing Scissor 14 cm S/B STR
- 7- Dressing Scissor 14 cm S/B CVD.
- 8- Dressing Forcep 1x2 Teeth 14 cm
- 9- Dressing Forcep Serrated 14 cm

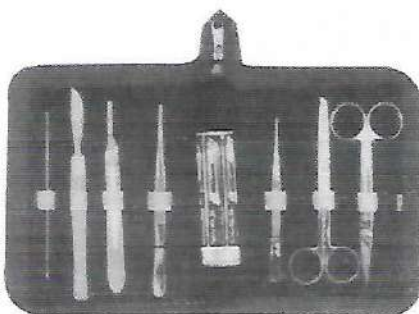

F1-067

- 1- Probe Double 12.5 cm
- 2- Scalpel
- 3- B.P. Handle No. 4
- 4- 6 PCS Blade 2 Each No. 21, 22, 23
- 5- Dissecting Forcep 12.5 cm
- 6- Dissecting Forcep 11.5 cm Sharp Point
- 7- Dissecting Scissor S/B STR 13 cm
- 8- Dissecting Scissor S/S STR 13 cm

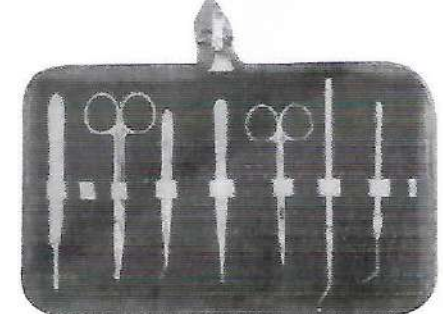

F1-068

- 1- Teasing Needle with Chuck CVD.
- 2- Huber Probe
- 3- Iris Scissor
- 4- Dissecting Forcep Fine 14 cm.
- 5- Dissecting Forcep Fine CVD. 12 cm
- 6- Operating Scissor with Probe 14 cm.
- 7- B.P. Handle No. 4



MEASURING INSTRUMENTS

Messinstrumente
Instruments pour mesurer

Instrumentos para medidas
Strumenti per misurare



F1-069
15 cm, 6"
cm & mm
markings

**GRADUATED
METAL RULER**



**JAMESON
CALIPER**
F1-070
8 cm, 3"



**TOWNLEY
CALIPER**
F1-071
10 cm, 4"

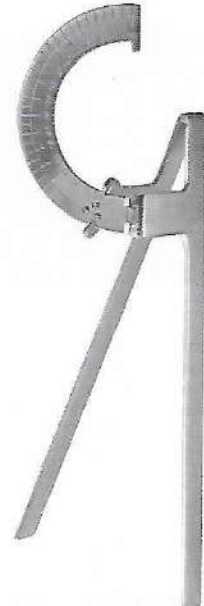

**MÖELTGEN
CALIPER**
F1-072



**CAROLL
POCKET GONIOMETER**
F1-073
14.5 cm, 5 3/4"

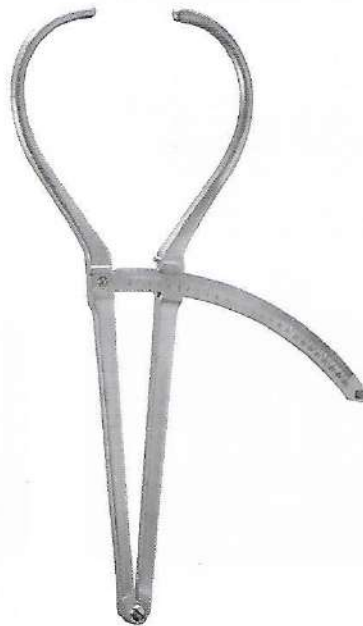

**BERTILLON
MEASURING DEVICE**
F1-074
32cm 12 1/2"

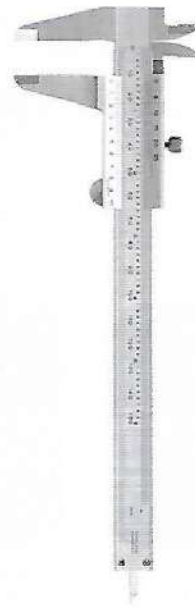

VERNIER CALIPER
F1-075
15 cm, 6"



VERNIER CALIPER
F1-076
15 cm, 6"
Fine Point

MEASURING INSTRUMENTS

Messinstrumente
Instruments pour mesurer

Instrumentos para medidas
Strumenti per misurare

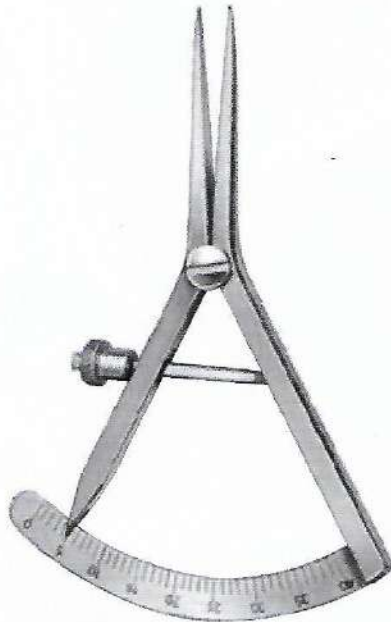

CASTROVIEJO-EPKER
Caliper
F1-077 9 cm, 3 1/2", Str.
Measuring range, 40 mm
F1-078 9 cm, 3 1/2", Cvd.
Measuring range, 40 mm

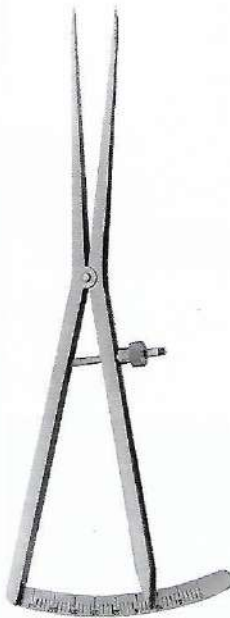

CASTROVIEJO-EPKER
Caliper
F1-079
18 cm, 7"
Measuring range
40 mm, straight

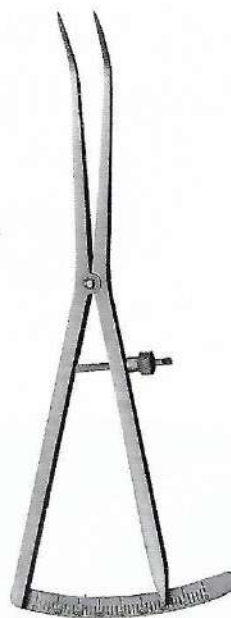

CASTROVIEJO-EPKER
Caliper
F1-080
18 cm, 7" Angled
Measuring range
40 mm



CASTROVIEJO
F1-081
Bone Caliper 7"
Straight



CASTROVIEJO
F1-082
Bone Caliper 7"
Curved

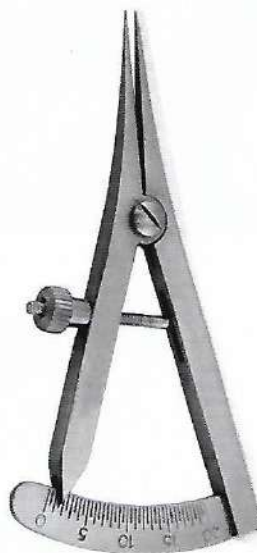

CASTROVIEJO, Left
F1-083 8 cm, 3", Str.
Eye View Caliper
Measuring range, 20 mm
F1-084 8 cm, 3", Cvd.
Measuring range, 20 mm

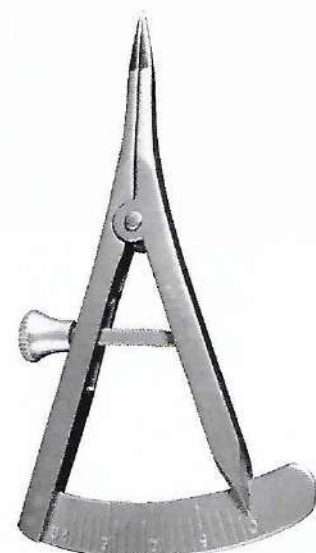

CASTROVIEJO, Right
F1-085
8 cm, 3"
Eye View Caliper
Measuring range
20 mm



TROCARS, SUCTION TUBES & CANNULAS



TROCARS



Trokare | Trócares
Trocarts | Trequarts

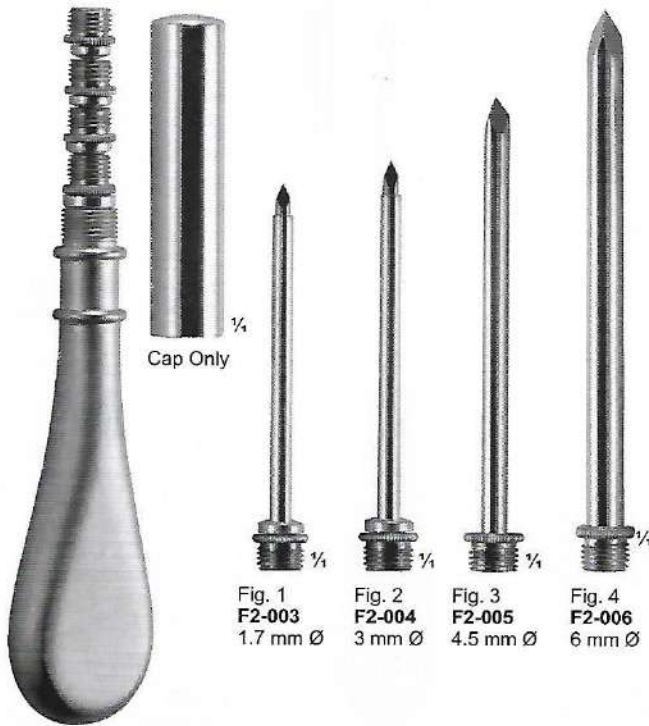

UNIVERSAL Abdominal Trocar Set
F2-001
(Handle with 4 needles) 14 cm, 5 1/2"
Fig. 1.7 mm Ø to 6 mm Ø
F2-002
Only Handle

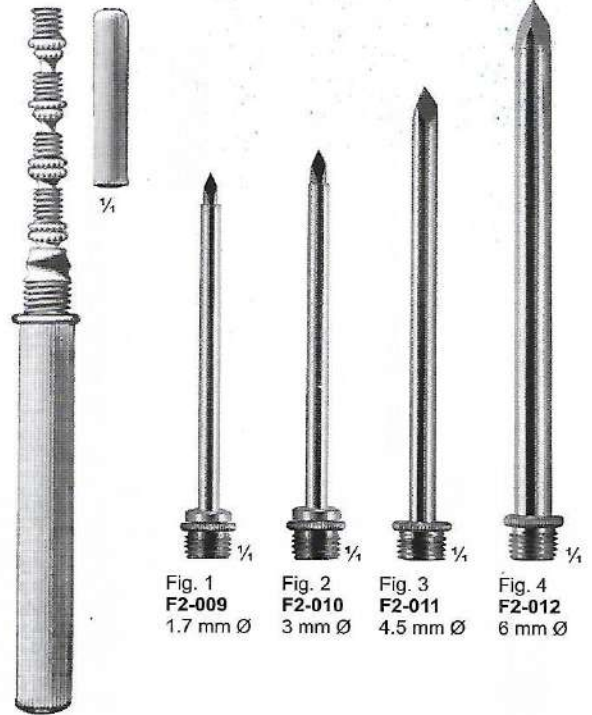

UNIVERSAL Abdominal Trocar Set
F2-007
(Handle with 4 needles) 14 cm, 5 1/2"
Fig. 1.7 mm Ø to 6 mm Ø
F2-008
Only Handle



LUER, Trocar
F2-013
Luer Lock Adapter



UCKERMANN, Trocar
F2-014
13.0 cm 5"

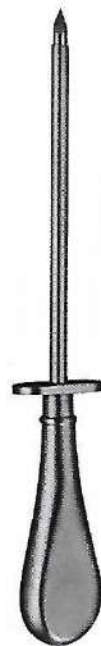

SINUSCOPY, Trocar
17.0 cm 6 3/4"



3.5 mm Ø
F2-015



5.0 mm Ø
F2-016



5.0 mm Ø
F2-017



TROCARS

Trokare | Trocares
Trocaris | Trequarti



LICHTWITZ
Antrum Trocar
19 cm, 7 1/2"



Complete
F2-018 1.8 mm Ø
F2-019 2.0 mm Ø



OCHSNER
Trocar Thorax
10.0 cm 4"

- F2-020 3 1/3 mm Ø
- F2-021 4 mm Ø
- F2-022 4 2/3 mm Ø
- F2-023 5 1/3 mm Ø
- F2-024 6 mm Ø
- F2-025 6 2/3 mm Ø
- F2-026 7 1/3 mm Ø
- F2-027 8 mm Ø
- F2-028 8 2/3 mm Ø
- F2-029 9 1/3 mm Ø



NELSON
Trocar Thorax
21.0 cm 8 1/4"



F2-030
6.0 mm Ø

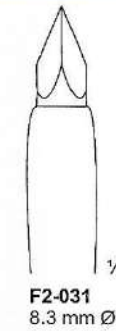

F2-031
8.3 mm Ø



F2-032
9.5 mm Ø

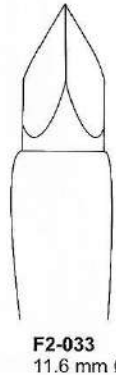

F2-033
11.6 mm Ø



LANDAU, Trocar
F2-034 2.0 mm Ø
16 cm 6 1/4"



PIERCE
Antrum Trocar
17.0 cm 6 3/4"

- F2-035 3.0 mm Ø
- F2-036 4.0 mm Ø
- F2-037 5.0 mm Ø



KRAUSE, Trocar
F2-038 15.0 cm 6"
5.5 mm Ø



COAKLEY, Trocar
F2-039 16.0 cm 6 1/4"
2.25 mm Ø

SUCTION TUBES



Saugrohre

Tubos de aspiracion

Canules d'aspiration

Tubi per aspirazione



ADSON
Suction Tubes
F2-040
4 mm Ø
15 cm, 6"



ADSON
Suction Tubes
21.0 cm 8 1/4"
F2-041 4 mm Ø 12 Charr./Fr
F2-042 5 mm Ø 15 Charr./Fr



PLESTER
Suction Tubes
17.0 cm 6 3/4"

- F2-043** 2 mm Ø 6 Charr./Fr.
- F2-044** 2 1/3 mm Ø 7 Charr./Fr.
- F2-045** 2 2/3 mm Ø 8 Charr./Fr.
- F2-046** 3 mm Ø 9 Charr./Fr.
- F2-047** 3 1/3 mm Ø 10 Charr./Fr.
- F2-048** 3 2/3 mm Ø 11 Charr./Fr.
- F2-049** 4 mm Ø 12 Charr./Fr.
- F2-050** 5 mm Ø 15 Charr./Fr.



FERGUSSON
Suction Tubes
17.0 cm 6 3/4"

- F2-051** 2 mm Ø 6 Charr./Fr.
- F2-052** 2 1/3 mm Ø 7 Charr./Fr.
- F2-053** 2 2/3 mm Ø 8 Charr./Fr.
- F2-054** 3 mm Ø 9 Charr./Fr.
- F2-055** 3 1/3 mm Ø 10 Charr./Fr.
- F2-056** 3 2/3 mm Ø 11 Charr./Fr.
- F2-057** 4 mm Ø 12 Charr./Fr.
- F2-058** 5 mm Ø 15 Charr./Fr.



Yankauer
suction tube
F2-059
27.0 cm, 10 3/4"



FRAZIER
Suction Tubes
F2-060 6 Fr.
F2-061 7 Fr.
F2-062 9 Fr.
F2-063 11 Fr.
19 cm, 7 1/2"



FRAZIER 30°
Suction Tubes
F2-064 6 Fr.
F2-065 7 Fr.
F2-066 8 Fr.
F2-067 9 Fr.
F2-068 10 Fr.
F2-069 11 Fr.
F2-070 12 Fr.
F2-071 15 Fr.
18 cm, 7"

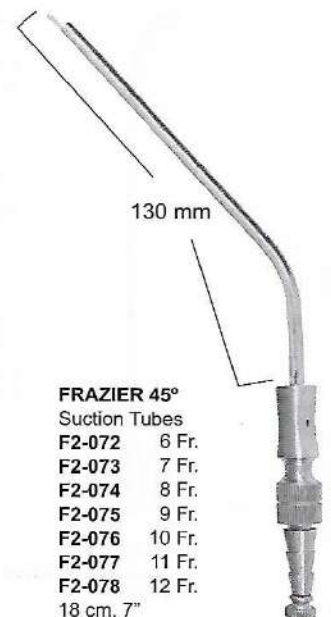

FRAZIER 45°
Suction Tubes
F2-072 6 Fr.
F2-073 7 Fr.
F2-074 8 Fr.
F2-075 9 Fr.
F2-076 10 Fr.
F2-077 11 Fr.
F2-078 12 Fr.
18 cm, 7"



EUSTACHIAN CATHETERS

Ohrkatheter

Sondas auriculares

Sondes auriculaires

Sonde auricolari



HARTMANN,
Eustachian Catheters
Fig. 1
F2-079 2.0 mm Ø
F2-080 2.5 mm Ø
F2-081 3.0 mm Ø



HARTMANN
Eustachian Catheters
Fig. 2
F2-082 2.0 mm Ø
F2-083 2.5 mm Ø
F2-084 3.0 mm Ø



KILLIAN, Eustachian Catheters
F2-085 16.0 cm 6" 2.5 mm Ø
F2-086 16.0 cm 6" 3.0 mm Ø
oval opening



HARTMANN
Eustachian Catheters
15.0 cm 6"



Fig. 0
F2-087



Fig. 2
F2-089



Fig. 4
F2-091



Fig. 1
F2-088



Fig. 3
F2-090



Fig. 5
F2-092



TRÖLTSCHE
Eustachian Catheters
15.0 cm 6"



F2-093
Tube end piece
for eustachian
catheter

1/4



Fig. 2
F2-095



Fig. 4
F2-097



Fig. 1
F2-094



Fig. 3
F2-096



Fig. 5
F2-098

SUCTION TUBES, GUIDE NEEDLE



Saugrohre, Redon Führungsnadeln

Tubos para aspiración, Agujas de guía

Tubes d'aspiration, Aiguilles d'introduction

Cannule d'aspirazione, Aghi guida

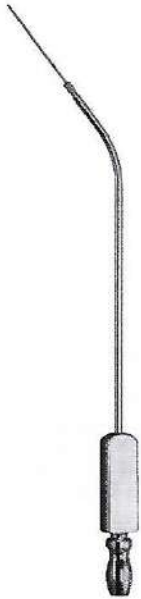

ZÖLLNER, Suction Tube
F2-099 0.7 mm Ø
 complete with 1 slip-on
 cannula, 0.7 mm Ø



IOWA, Suction Tube
F2-100 0.7 mm Ø
 16.0 cm 6 1/4"



MAGILL, Suction Tube
 24.5 cm 9 3/4"
F2-101 3.0 mm Ø
F2-102 3.5 mm Ø
F2-103 4.0 mm Ø



ROSEN, Suction Tube
 X=80 mm
F2-104 0.7 mm Ø
F2-105 0.9 mm Ø
F2-106 1.2 mm Ø



ROSEN, Suction Tube
 X=65 mm
F2-107 0.7 mm Ø
F2-108 0.9 mm Ø
F2-109 1.2 mm Ø

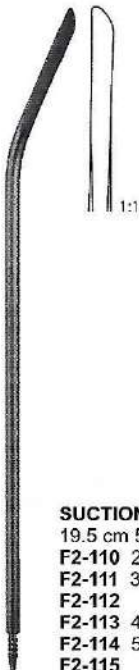

SUCTION TUBE, Guide Needle
 19.5 cm 5 3/4"
F2-110 2.2/3 mm Ø 8 Charr./Fr.
F2-111 3.1/3 mm Ø 10 Charr./Fr.
F2-112 4 mm Ø 12 Charr./Fr.
F2-113 4 2/3 mm Ø 14 Charr./Fr.
F2-114 5 1/3 mm Ø 16 Charr./Fr.
F2-115 6 mm Ø 18 Charr./Fr.

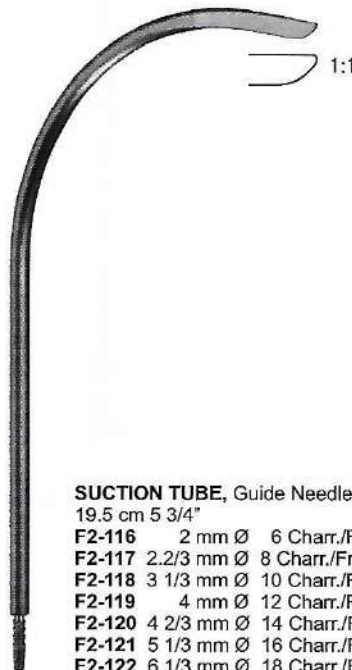

SUCTION TUBE, Guide Needle
 19.5 cm 5 3/4"
F2-116 2 mm Ø 6 Charr./Fr.
F2-117 2.2/3 mm Ø 8 Charr./Fr.
F2-118 3 1/3 mm Ø 10 Charr./Fr.
F2-119 4 mm Ø 12 Charr./Fr.
F2-120 4 2/3 mm Ø 14 Charr./Fr.
F2-121 5 1/3 mm Ø 16 Charr./Fr.
F2-122 6 1/3 mm Ø 18 Charr./Fr.



SUCTION TUBE, Guide Needle
Lancet Tip 19.5 cm 5 3/4"
F2-123 2.2/3 mm Ø 8 Charr./Fr.
F2-124 3.1/3 mm Ø 10 Charr./Fr.
F2-125 4 mm Ø 12 Charr./Fr.
F2-126 4 2/3 mm Ø 14 Charr./Fr.
F2-127 5 1/3 mm Ø 16 Charr./Fr.
F2-128 6 mm Ø 18 Charr./Fr.



PROBES AND DIRECTORS

Sonden	Sondas y estiletes
Sondes et stylets	Specilli e sonde



PROBE, Double Ended
2.0 mm Ø

F2-129	11.5 cm 4 1/2"
F2-130	13.0 cm 5"
F2-131	14.5 cm 5 3/4"
F2-132	16.0 cm 6 1/4"
F2-133	18.0 cm 7"
F2-134	20.0 cm 8"
F2-135	25.0 cm 9 3/4"

PROBE, Double Ended
1.5 mm Ø

F2-136	11.5 cm 4 1/2"
F2-137	13.0 cm 5"
F2-138	14.5 cm 5 3/4"
F2-139	16.0 cm 6 1/4"
F2-140	18.0 cm 7"
F2-141	20.0 cm 8"
F2-142	25.0 cm 9 3/4"

PROBE, Double Ended
1.0 mm Ø

F2-143	11.5 cm 4 1/2"
F2-144	13.0 cm 5"
F2-145	14.5 cm 5 3/4"
F2-146	16.0 cm 6 1/4"
F2-147	18.0 cm 7"
F2-148	20.0 cm 8"
F2-149	25.0 cm 9 3/4"



PROBE With Eye
2.0 mm Ø

F2-150	11.5 cm 4 1/2"
F2-151	13.0 cm 5"
F2-152	14.5 cm 5 3/4"
F2-153	16.0 cm 6 1/4"
F2-154	18.0 cm 7"
F2-155	20.0 cm 8"
F2-156	25.0 cm 9 3/4"

with eyelet



PROBE
2.0 mm Ø

F2-157	11.5 cm 4 1/2"
F2-158	13.0 cm 5"
F2-159	14.5 cm 5 3/4"
F2-160	16.0 cm 6 1/4"

myrtle-shaped



BUTTERFLY GROOVED
Director With Tongue Tie
Plain End

F2-161	11.5 cm 4 1/2"
F2-162	13.0 cm 5"
F2-163	14.5 cm 5 3/4"
F2-164	16.0 cm 6 1/4"
F2-165	18.0 cm 7"
F2-166	20.0 cm 8"



BUTTERFLY GROOVED
Director With Tongue Tie
Plain End

F2-167	11.5 cm 4 1/2"
F2-168	13.0 cm 5"
F2-169	14.5 cm 5 3/4"
F2-170	16.0 cm 6 1/4"
F2-171	18.0 cm 7"
F2-172	20.0 cm 8"



DOYEN
Probes & Directors
F2-173
14.0 cm 5 1/2"



NÉLATON
Probes & Directors
F2-174
16.0 cm 6 1/2"

COTTON APPLICATORS



Watteträger | Porta- algodones
 Porte-cotons | Portacotoni



JOPSON-HORNE
 cotton applicator
F2-175
 18.0 cm 7"



FEIN
 cotton applicator
F2-176
 28.0 cm 11"



PELTESON
 cotton applicator
F2-177
 23.0 cm 9"



BARR Fistula Probe
F2-178
 with 8" (20.3 cm) sterling shaft,
 eye at tip, 11-1/2" (29.2 cm) overall



BARR Crypt Hook,
F2-179
 10" (25.4 cm), short and
 long hook ends



BUIE Suction Tube,
F2-180
 18" (45 cm), with finger
 valve, 15 Fr. (5 mm)



Biolvar
F2-181 15cm
F2-182 18cm
F2-183 20cm



Desjardim
F2-184 18cm
 (Set 3 Pieces)



SCALPEL HANDLE, SCALPEL BLADES, DISSECTING KNIVES & SAWS



SCALPEL HANDLES



Skalpelligriffe
Mangos de bisturias

Manches pour bistouris
Manici per bisturi

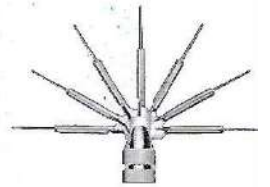

Locks At 90°, 60°, 30°,
Straight, 120°, 150°, 180°,
Angles



SCALPEL HANDLE #3
F3-001
12.75 cm, 5"
Blade Size 10, 11,
12, 13, 15, 17



**#3 SCALPEL HANDLE/
GRADUATED**
F3-002
12.75 cm, 5"
Blade Size 10, 11,
12, 13, 15, 17



**SCALPEL HANDLE
#4 GRADUATED**
F3-003
with scale



SCALPEL HANDLE #4
F3-004
12.75 cm, 5" Blade
Size 18, 20, 21, 22,
23, 24, 25, 60,70



SCALPEL HANDLE 4LA
F3-005
21 cm, 8 1/4" Blade
Size 18, 20, 21, 22,
23, 24, 25, 60,70



**SIEGEL ROUND
SCALPEL HANDLE
#3**
F3-006
With Adjustable
Tip 16 cm, 6 1/4"
Blade Size 10,
11, 12, 13, 15,
17



SCALPEL HANDLES

Skalpelli-griffe
Mangos de bisturios

Manches pour bistouris
Manici per bisturi



**SCALPEL HANDLE #3, #4
F3-007**
Double Ended
16 cm, 6"

**SCALPEL HANDLE
3L LONG
F3-008** 21 cm 8 1/4"
Blade Size
10, 11, 12, 15, 17

**SCALPEL HANDLE #7
F3-009**
16.5 cm, 6 1/4"
Blade 10, 11,
12, 13, 15, 17

**SCALPEL HANDLE
4L LONG
F3-010** 21 cm, 8 1/2"
Blade
Size 18, 20, 21,
22, 23, 24, 25,
60,70

**SCALPEL HANDLE
/ LONG ANGLED #3LA
F3-011**
20.25 cm, 8 1/4"
Blade Size
10, 11, 12, 15, 17

**KNIFE HANDLE
F3-012**
(Smooth) for
Blades Nos.
60 and 70

**ROUND KNURLED
SCALPEL HANDLE
F3-013**
12.7 cm, 5"
Blade Size
50, 60 & 70

SCALPEL HANDLES



Skalpelli-griffe
Mangos de bisturís

Manches pour bistouris
Manici per bisturi



**ROUND KNURLED
SCALPEL HANDLE**
F3-014
12 cm, 4 3/4"



**KAYE ROUND
SCALPEL HANDLE**
#3RK
F3-015
15 cm, 5 3/4", Blade
Size 10, 11,
12, 13, 15, 17



**CORWIN ROUND
SCALPEL HANDLE**
#3R
F3-016
14.5 cm, 5 1/2"
Blade Size 10,
11, 12, 15, 17



SCALPEL HANDLE
#3RC
F3-017
14 cm, 5 1/2"
Blade Size 10,
11, 12, 13, 15,
17



**CORWIN ROUND
SCALPEL HANDLE,**
#4R
F3-018
14.5 cm, 5 1/2",
Blade Size 18, 20,
21, 22, 23, 24,
25, 60, 70



SCALPEL HANDLE
#3P
F3-019
15.5 cm,
6", Blade Size
10, 11, 12, 13,
15, 17



SCALPEL BLADES

Skalpelli klingen,
Lames de bistouris, Mangos

Hojas de bisturi, Manches
Lame per bisturi, Manici



F3-020
Sterile Scalpel
Blade Size # 6
Stainless Steel



F3-021
Sterile Scalpel
Blade Size # 10
Stainless Steel



F3-022
Sterile Scalpel
Blade Size # 10A
Stainless Steel



F3-023
Sterile Scalpel
Blade Size # 11
Stainless Steel



F3-024
Sterile Scalpel
Blade Size # 11P
Stainless Steel



F3-025
Sterile Scalpel
Blade Size # E11
Stainless Steel



F3-026
Sterile Scalpel
Blade Size # 12
Stainless Steel



F3-027
Sterile Scalpel
Blade Size # 13
Stainless Steel



F3-028
Sterile Scalpel
Blade Size # 15
Stainless Steel



F3-029
Sterile Scalpel
Blade Size # 15A
Stainless Steel



F3-030
Sterile Scalpel
Blade Size # 17
Stainless Steel



F3-031
Sterile Scalpel
Blade Size # 18
Stainless Steel



F3-032
Sterile Scalpel
Blade Size # 20
Stainless Steel



F3-033
Sterile Scalpel
Blade Size # 21
Stainless Steel



F3-034
Sterile Scalpel
Blade Size # 22
Stainless Steel

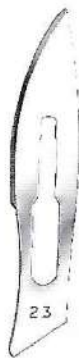

F3-035
Sterile Scalpel
Blade Size # 23
Stainless Steel



F3-036
Sterile Scalpel
Blade Size # 24
Stainless Steel



F3-037
Sterile Scalpel
Blade Size # 25
Stainless Steel



F3-038
Sterile Scalpel
Blade Size # 36
Stainless Steel



F3-039
Sterile Scalpel
Blade Size # 40
Stainless Steel



F3-040
Sterile Scalpel
Blade Size # 60
Stainless Steel



F3-041
Sterile Scalpel
Blade Size # 70
Stainless Steel

SCALPEL HANDLES



Skalpgriffe
Mangos de bisturios

Manches pour bistouris
Manici per bisturi



DIEFFENBACH
16 cm, 6 1/4"



F3-042
Fig. 1
16 cm, 6 1/4"



F3-043
Fig. 2
16 cm, 6 1/4"



F3-044
Fig. 3
16 cm, 6 1/4"



F3-045
Fig. 4
16 cm, 6 1/4"



F3-046
Fig. 5
16 cm, 6 1/4"



F3-047
Fig. 6
16 cm, 6 1/4"



F3-048
Fig. 7
16 cm, 6 1/4"



F3-049
Fig. 8
16 cm, 6 1/4"



F3-050
Fig. 9
16 cm, 6 1/4"



F3-051
Fig. 10
16 cm, 6 1/4"



F3-052
Fig. 15
16 cm, 6 1/4"



F3-053
Fig. 16
16 cm, 6 1/4"



DISSECTING KNIVES

Anatomische skalpelle
Bisturías para disección

Bistouris à dissection
Bisturi para dissezione



COLLIN DISSECTING KNIVES Blade Size
F3-054 13 cm, 5"
F3-055 16 cm, 6 1/4"
F3-056 19 cm, 7 1/2"
F3-057 22 cm, 8 1/2"
F3-058 28 cm, 11 1/4"



CATLIN DISSECTING KNIVES Blade Size
F3-059 16 cm, 6 1/4"
F3-060 19 cm, 7 1/2"
F3-061 22 cm, 8 1/2"



LISTON DISSECTING KNIVES Blade Size
F3-062 16 cm, 6 1/4"
F3-063 19 cm, 7 1/2"
F3-064 22 cm, 8 1/2"

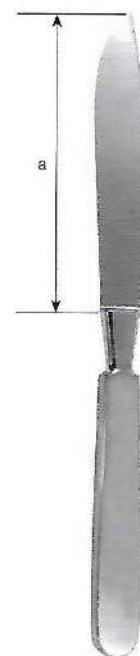

LANGENBECK DISSECTING KNIVES BLADE
F3-065
 12 cm, 4 3/4"



DIEFFENBACH DISSECTING KNIVES
F3-066
 13 cm, 5"



DIEFFENBACH DISSECTING KNIVES
F3-067
 13 cm, 5"



SIMON DISSECTING KNIVES
 23.5 cm, 9 1/2"



F3-068
 Fig.1



F3-069
 Fig. 2



F3-070
 Fig. 3



F3-071
 Fig. 4

AMPUTATION KNIVES & RESECTION SAWS



Amputationsmesser, Cuchillos para amputación
Couteaux à amputation, coltelli per amputazione

Resektionsmesser, Cuchillos para resección
Couteaux à résection, Coltelli per resezione



AMPUTATION KNIFE
F3-072
29 cm, 11 1/2"



AMPUTATION KNIFE
F3-073
32.5 cm, 13"



CATLIN AMPUTATION
F3-074
29 cm, 11 1/2"



RESECTION KNIFE
F3-075
18 cm, 7"



LANGENBECK AMPUTATION
F3-076
18 cm, 7"



LANGENBECK AMPUTATION
F3-077
18 cm, 7"



RAZOR HOLLOW
Blades On Both Sides
Blade Flat / Hollow
F3-078

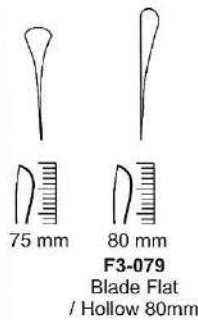

F3-079
Blade Flat / Hollow 80mm



CHARRIERE AMPUTATION & RESECTION
F3-080 27 cm, 11"
F3-081 30 cm, 12"



CHARRIERE AMPUTATION & RESECTION
F3-082
35 cm, 13 3/4"



SATTERLEE AMPUTATION & RESECTION
F3-083
31 cm, 12 1/4"



DERMATOMES

Dermatome
Dermatomes

Dermatomo
Dermatomi



F3-085
spare blade

HUMBY DERMATOMES
F3-084 31cm 12 1/4"
Complete with 1 Blade



WATSON DERMATOMES
F3-086 30cm 12"
Complete with 1 Blade,
fixed bar



SILVER DERMATOMES
F3-087 19cm 7 1/2"



GENERAL OPERATING SCISSORS

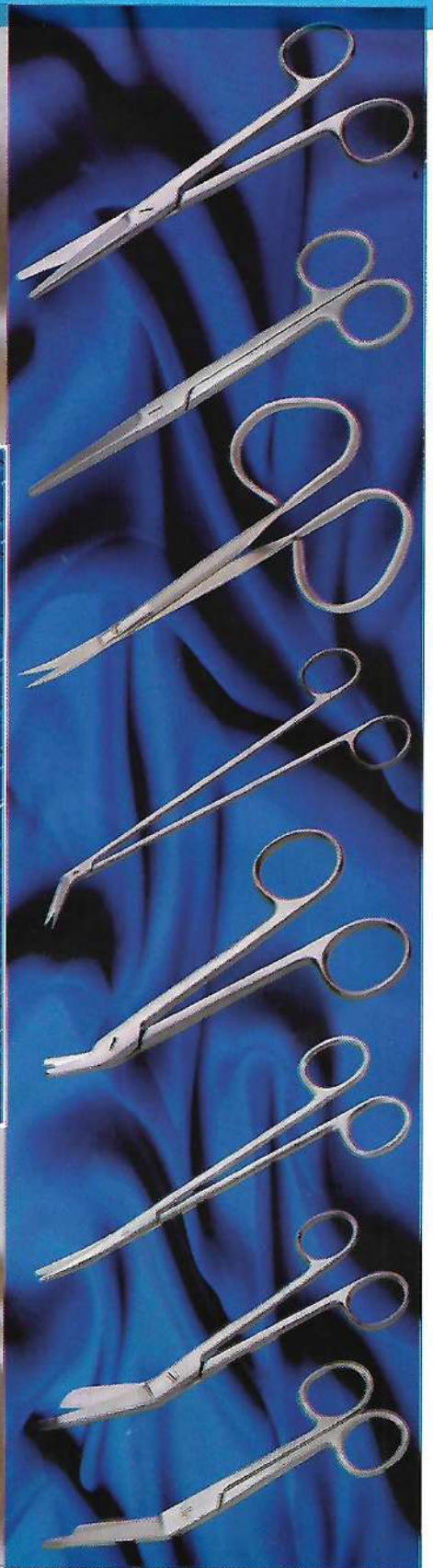
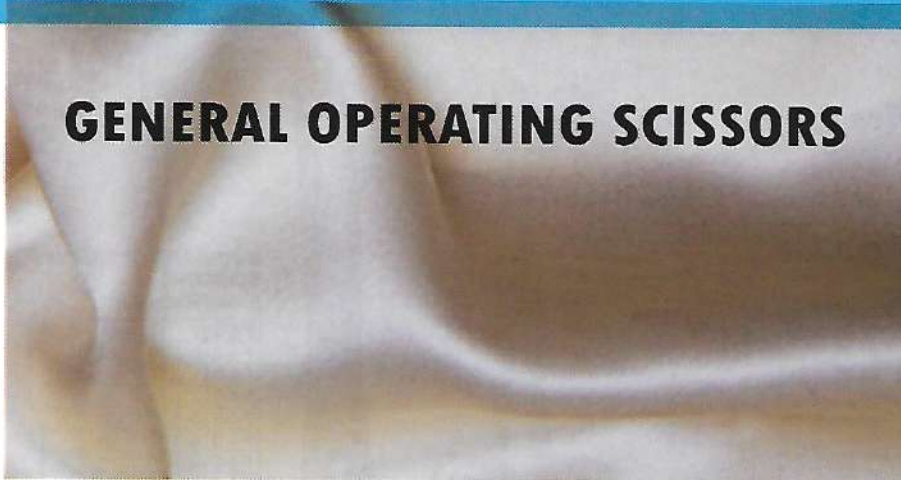



OPERATING SCISSORS

Chirurgische scheren
Tijeras Para Cirugia

Ciseaux à chirurgie
Forbici per chirurgia



1/1 original
4 1/2"

STANDARD OPERATING SCISSORS

Sharp/Sharp Straight

F4-001	11.5 cm, 4 1/2"
F4-002	13.0 cm, 5"
F4-003	14.0 cm, 5 1/2"
F4-004	15.0 cm, 6"
F4-005	16.0 cm, 6 1/4"
F4-006	17.5 cm, 7"
F4-007	18.5 cm, 7 1/4"
F4-008	20.0 cm, 8"



1/1 original
4 1/2"

STANDARD OPERATING SCISSORS

Sharp/Sharp Curved

F4-009	11.5 cm, 4 1/2"
F4-010	13.0 cm, 5"
F4-011	14.0 cm, 5 1/2"
F4-012	15.0 cm, 6"
F4-013	16.0 cm, 6 1/4"
F4-014	17.5 cm, 7"
F4-015	18.5 cm, 7 1/4"
F4-016	20.0 cm, 8"



1/1 original
4 1/2"

STANDARD OPERATING SCISSORS

Blunt/Blunt Straight

F4-017	11.5 cm, 4 1/2"
F4-018	13.0 cm, 5"
F4-019	14.0 cm, 5 1/2"
F4-020	15.0 cm, 6"
F4-021	16.0 cm, 6 1/4"
F4-022	17.5 cm, 7"
F4-023	18.5 cm, 7 1/4"
F4-024	20.0 cm, 8"



1/1 original
4 1/2"

STANDARD OPERATING SCISSORS

Blunt/Blunt Curved

F4-025	11.5 cm, 4 1/2"
F4-026	13.0 cm, 5"
F4-027	14.0 cm, 5 1/2"
F4-028	15.0 cm, 6"
F4-029	16.0 cm, 6 1/4"
F4-030	17.5 cm, 7"
F4-031	18.5 cm, 7 1/4"
F4-032	20.0 cm, 8"

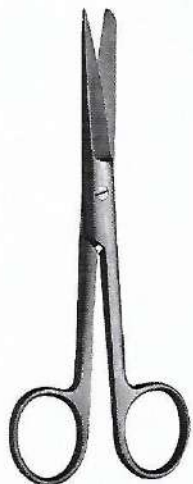

1/1 original
4 1/2"

STANDARD OPERATING SCISSORS

Sharp/Blunt Straight

F4-033	11.5 cm, 4 1/2"
F4-034	13.0 cm, 5"
F4-035	14.0 cm, 5 1/2"
F4-036	15.0 cm, 6"
F4-037	16.0 cm, 6 1/4"
F4-038	17.5 cm, 7"
F4-039	18.5 cm, 7 1/4"
F4-040	20.0 cm, 8"

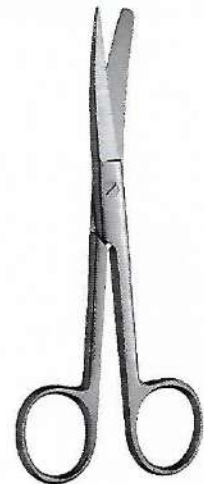

1/1 original
4 1/2"

STANDARD OPERATING SCISSORS

Sharp/Blunt Curved

F4-041	11.5 cm, 4 1/2"
F4-042	13.0 cm, 5"
F4-043	14.0 cm, 5 1/2"
F4-044	15.0 cm, 6"
F4-045	16.0 cm, 6 1/4"
F4-046	17.5 cm, 7"
F4-047	18.5 cm, 7 1/4"
F4-048	20.0 cm, 8"

OPERATING & DISSECTING SCISSORS



Bedienen & Präparierscheren
Funcionamiento y disección Tijeras

D'exploitation & Ciseaux de dissection
Forbici di funzionamento e di dissezione



**LANDOLT OPERATING
SCISSORS**

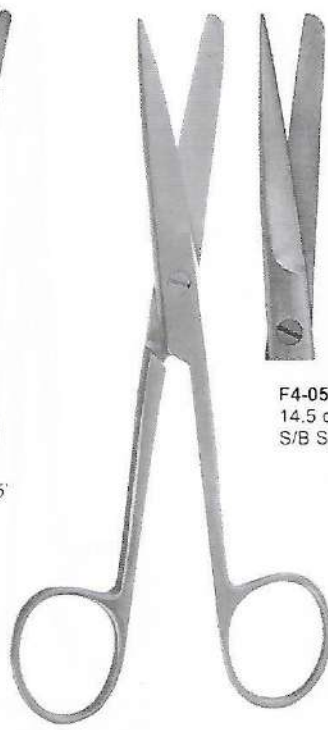

**DEAVER OPERATING,
DISSECTING SCISSORS**



**LONGE OPERATING,
DISSECTING SCISSORS**

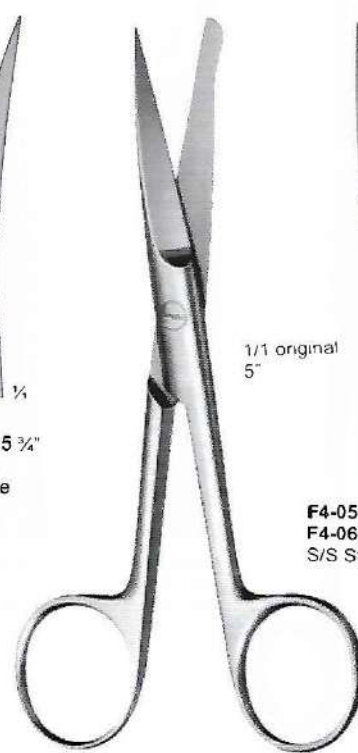

INCISION OPERATING SCISSORS

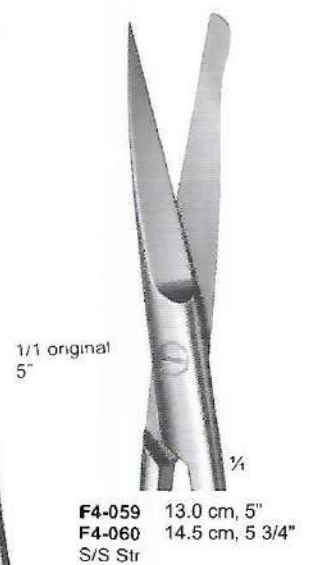



DISSECTING & GYNECOLOGICAL SCISSORS

Präparierscheren & Gynäkologische Scheren
Dissección y tijeras ginecológicas

Dissection et Ciseaux gynécologiques
Dissezione & Forbici Ginecologiche



MAYO DISSECTING & GYNECOLOGICAL SCISSORS



1/1 original
5 3/4"

- F4-061**
14.5 cm 5 3/4"
- F4-062**
15.0 cm 6"
- F4-063**
17.0 cm 6 3/4"
- F4-064**
19.5 cm 7 3/4"
- F4-065**
21.0 cm 8 1/4"
- F4-066**
23.0 cm 9"



- F4-067**
14.5 cm 5 3/4"
- F4-068**
15.0 cm 6"
- F4-069**
17.0 cm 6 3/4"
- F4-070**
19.5 cm 7 3/4"
- F4-071**
21.0 cm 8 1/4"
- F4-072**
23.0 cm 9"



MAYO-STILLE DISSECTING & GYNECOLOGICAL SCISSORS



1/1 original
6"

- F4-073**
15.0 cm 6"
- F4-074**
17.0 cm 6 3/4"
- F4-075**
19.5 cm 7 3/4"
- F4-076**
21.0 cm 8 3/4"

1/4



- F4-077**
15.0 cm 6"
- F4-078**
17.0 cm 6 3/4"
- F4-079**
19.5 cm 7 3/4"
- F4-080**
21.0 cm 8 3/4"

1/4



MAYO-HARRINGTON DISSECTING & GYNECOLOGICAL SCISSORS



- F4-081**
22.5 cm 9"



- F4-082**
22.5 cm 9"



MAYO-NOBLE DISSECTING & GYNECOLOGICAL SCISSORS



- F4-083**
17.0 cm, 6 3/4"



- F4-084**
17.0 cm, 6 3/4"

OPERATING & DISSECTING SCISSORS



Bedienen & Präparierscheren

D'exploitation & Ciseaux de dissection

Funcionamiento y disección Tijeras

Forbici di funzionamento e di dissezione

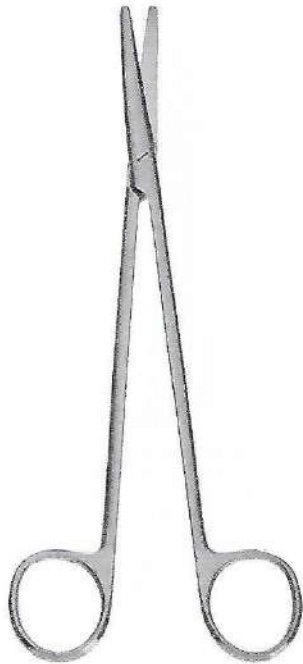

**METZENBAUM OPERATING,
DISSECTING SCISSORS
BLUNT/BLUNT STR.**



F4-085
14.5 cm 5 3/4"
B/B Str.



F4-086
18 cm 7"
B/B Str.



F4-087
20 cm 8"
B/B Str.



F4-088
23 cm 9"
B/B Str.



F4-089
25 cm 10"
B/B Str.



F4-090
28 cm 11"
B/B Str.



**METZENBAUM OPERATING,
DISSECTING SCISSORS
BLUNT/BLUNT CVD.**



F4-091
14.5 cm 5 3/4"
B/B Cvd.



F4-092
18 cm 7"
B/B Cvd.



F4-093
20 cm 8"
B/B Cvd.



F4-094
23 cm 9"
B/B Cvd.



F4-095
25 cm 10"
B/B Cvd.



F4-096
28 cm 11"
B/B Cvd.



OPERATING & DISSECTING SCISSORS

Bedienen & Präparierscheren

D'exploitation & Ciseaux de dissection

Funcionamiento y disección Tijeras

Forbici di funzionamento e di dissezione

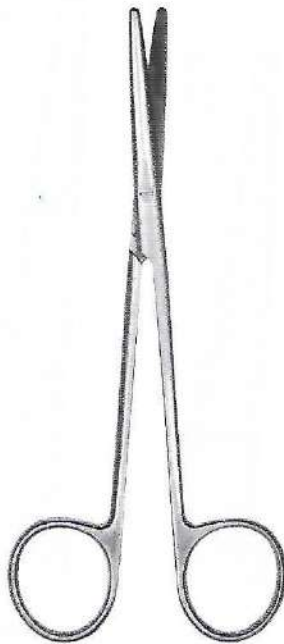

**METZENBAUM-NELSON
SCISSORS**



1/1 original
7"

- F4-097 18.0 cm 7"
- F4-098 20.0 cm 8"
- F4-099 23.0 cm 9"
- F4-100 25.0 cm 9 3/4"
- F4-101 28.0 cm 11"
- F4-102 30.0 cm 12"
B/B Str.



1/1 original
7"

- F4-103 18.0 cm 7"
- F4-104 20.0 cm 8"
- F4-105 23.0 cm 9"
- F4-106 25.0 cm 9 3/4"
- F4-107 28.0 cm 11"
- F4-108 30.0 cm 12"
S/B Str.



- F4-109 18.0 cm 7"
- F4-110 20.0 cm 8"
- F4-111 23.0 cm 9"
- F4-112 25.0 cm 9 3/4"
- F4-113 28.0 cm 11"
- F4-114 30.0 cm 12"
S/S Str.



**METZENBAUM-NELSON
SCISSORS**



1/1 original
7"

- F4-115 18.0 cm 7"
- F4-116 20.0 cm 8"
- F4-117 23.0 cm 9"
- F4-118 25.0 cm 9 3/4"
- F4-119 28.0 cm 11"
- F4-120 30.0 cm 12"
B/B Cvd.



1/1 original
7"

- F4-121 18.0 cm 7"
- F4-122 20.0 cm 8"
- F4-123 23.0 cm 9"
- F4-124 25.0 cm 9 3/4"
- F4-125 28.0 cm 11"
- F4-126 30.0 cm 12"
S/B Cvd.



- F4-127 18.0 cm 7"
- F4-128 20.0 cm 8"
- F4-129 23.0 cm 9"
- F4-130 25.0 cm 9 3/4"
- F4-131 28.0 cm 11"
- F4-132 30.0 cm 12"
S/S Cvd.

OPERATING & DISSECTING SCISSORS



Bedienen & Präparierscheren

D'exploitation & Ciseaux de dissection

Funcionamiento y disección Tijeras

Forbici di funzionamento e di dissezione



**METZENBAUM-FINO
SCISSORS**



F4-133
14.5 cm 5 3/4"
B/B Str.



F4-134
14.5 cm 5 3/4"
S/S Str.



F4-135
14.5 cm 5 3/4"
B/B Cvd.



F4-136
14.5 cm 5 3/4"
S/S Cvd.



**METZENBAUM-FINO
SCISSORS**



F4-137
18 cm 7"
F4-138
220 cm 8"
F4-139
230 cm 9"
B/B Str.

1/1 original
7"



F4-140
18 cm 7"
F4-141
220 cm 8"
F4-142
230 cm 9"
B/B Cvd.

1/1 original
7"



F4-143
18 cm 7"
F4-144
220 cm 8"
F4-145
230 cm 9"
B/B Slightly
Cvd.



OPERATING & DISSECTING SCISSORS

Bedienen & Präparierscheren

D'exploitation & Ciseaux de dissection

Funcionamiento y disección Tijeras

Forbici di funzionamento e di dissezione

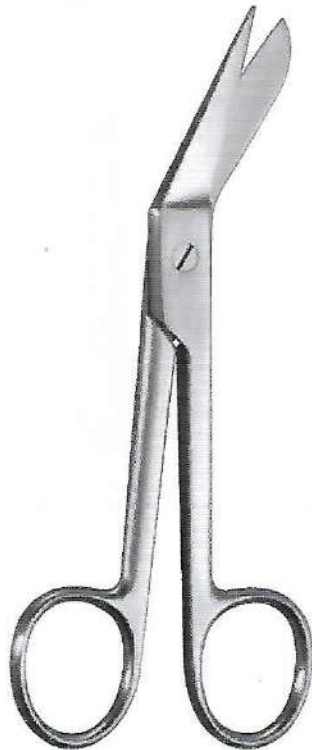

**RICHTER OPERATING,
DISSECTING SCISSORS**
F4-146 14.5 cm, 5 3/4"
Angled

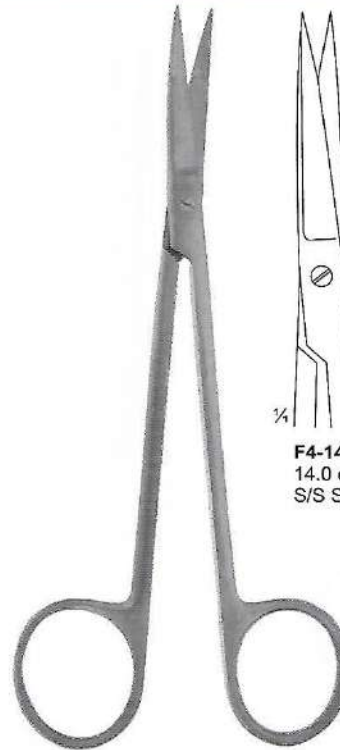

**JOSEPH OPERATING,
DISSECTING SCISSORS**



F4-147
14.0 cm, 5 1/2"
S/S Str.

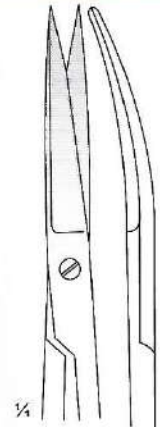

F4-148
14.0 cm, 5 1/2"
S/S Cvd

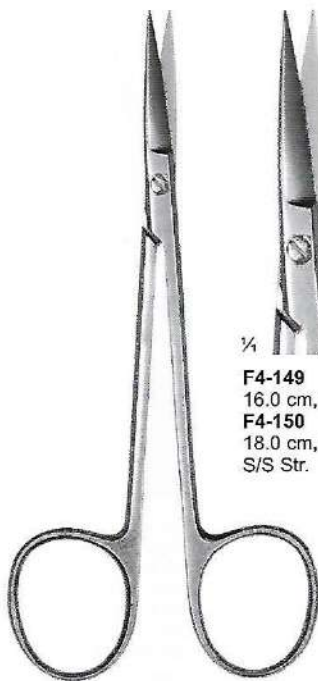

**KELLY OPERATING,
DISSECTING SCISSORS**



F4-149
16.0 cm, 6 1/4"
F4-150
18.0 cm, 7"
S/S Str.



F4-151
16.0 cm, 6 1/4"
F4-152
18.0 cm, 7"
S/S Cvd.



**DOYEN OPERATING,
DISSECTING SCISSORS**
F4-153 17.5 cm, 7"
B/B, Str.



**DOYEN OPERATING,
DISSECTING SCISSORS**
F4-154 17.5 cm, 7"
B/B, Cvd.

DISSECTING & GYNECOLOGICAL SCISSORS



Präparierscheren & Gynäkologische Scheren
Dissección y tijeras ginecológicas

Dissection et Ciseaux gynécologiques
Dissezione & Forbici Ginecologiche



SIMS DISSECTING & GYNECOLOGICAL SCISSORS

F4-155 20.0 cm, 8"
F4-156 23.0 cm, 9"
Str, B/B

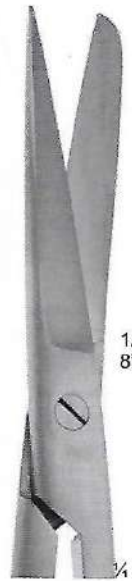

1/1 original
8"

F4-157 20.0 cm, 8"
F4-158 23.0 cm, 9"
Str, S/B



1/1 original
8"

F4-159 20.0 cm, 8"
F4-160 23.0 cm, 9"
Str, S/S



1/1 original
8"

F4-161 20.0 cm, 8"
F4-162 23.0 cm, 9"
Cvd, B/B



1/1 original
8"

F4-163 20.0 cm, 8"
F4-164 23.0 cm, 9"
Cvd, S/B



1/1 original
8"

F4-165 20.0 cm, 8"
F4-166 23.0 cm, 9"
Cvd, S/S

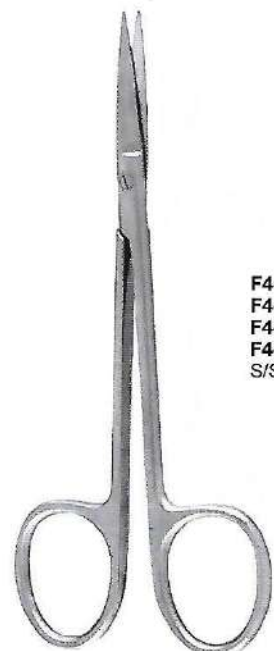

Iris Scissors



1/1 original
3 1/2"

F4-167 09 cm, 3 1/2"
F4-168 10.5 cm, 4 1/4"
F4-169 11.5 cm, 4 1/2"
F4-170 12.0 cm, 4 3/4"
S/S Str.



F4-171 09 cm, 3 1/2"
F4-172 10.5 cm, 4 1/4"
F4-173 11.5 cm, 4 1/2"
F4-174 12.0 cm, 4 3/4"
S/S Cvd.



F4-175
11.5 cm, 4 1/2"
Angular Left



F4-176
11.5 cm, 4 1/2"
Laterally Cvd.



F4-177
11.5 cm, 4 1/2"
Angular Right



OPERATING SCISSORS

Chirurgische scheren
Tijeras Para Cirugia

Ciseaux à chirurgie
Forbici per chirurgia

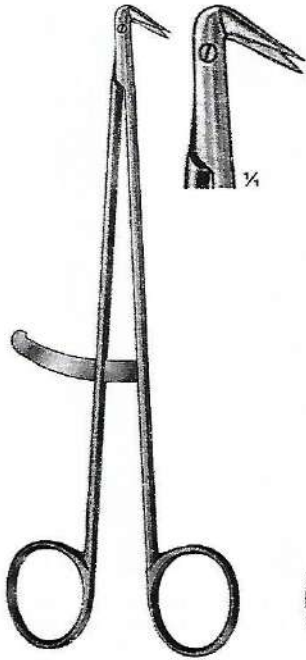

VASCULAR SCISSORS
F4-178 19.0 cm, 7 1/2"
S/S Angled 125°

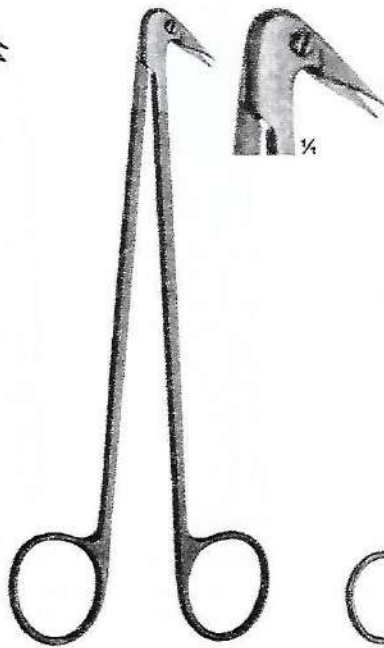

COOLEY REVERSE CUT SCISSORS
F4-179 17.1 cm, 6 3/4"
S/S angled 125°



POTTS-SMITH VASCULAR SCISSORS
S/S Angled

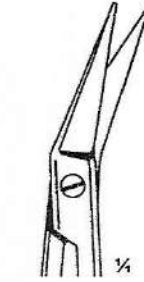

F4-180
19.0 cm, 7 1/2"
25°

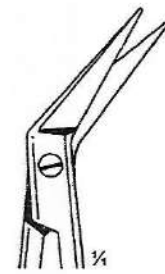

F4-181
19.0 cm, 7 1/2"
45°

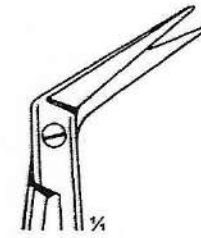

F4-182
19.0 cm, 7 1/2"
60°

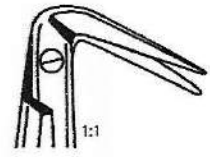

F4-183
19.0 cm, 7 1/2"
125°



HEGEMANN-DIETRICH VASCULAR SCISSORS
S/S Angled

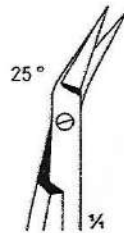

F4-184 16.0 cm, 6 1/4"
F4-185 19.0 cm, 7 1/2"

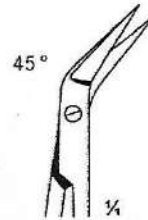

F4-186 16.0 cm, 6 1/4"
F4-187 19.0 cm, 7 1/2"

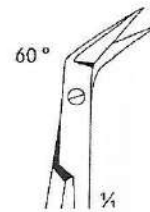

F4-188 16.0 cm, 6 1/4"
F4-189 19.0 cm, 7 1/2"

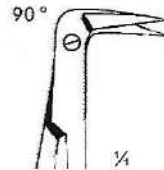

F4-190 16.0 cm, 6 1/4"
F4-191 19.0 cm, 7 1/2"

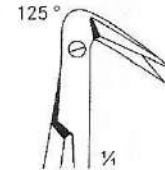

F4-192 16.0 cm, 6 1/4"
F4-193 19.0 cm, 7 1/2"

VASCULAR SCISSORS



Gefäßschere
Tijeras vasculares

Ciseaux vasculaires
Forbici vascolari



DE BAKEY VASCULAR SCISSORS
S/S Angled

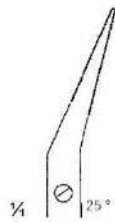

25°
F4-194 16.0 cm, 6 1/4"
F4-195 19.0 cm, 7 1/2"
F4-196 23.0 cm, 9"
F4-197 28.0 cm, 11"

1/1 original
6 1/4"

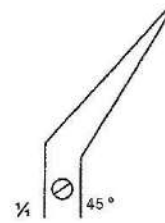

45°
F4-198 16.0 cm, 6 1/4"
F4-199 19.0 cm, 7 1/2"
F4-200 23.0 cm, 9"
F4-201 28.0 cm, 11"

1/1 original
6 1/4"

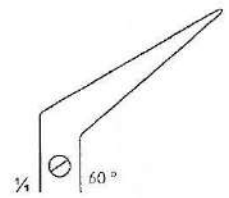

60°
F4-202 16.0 cm, 6 1/4"
F4-203 19.0 cm, 7 1/2"
F4-204 23.0 cm, 9"
F4-205 28.0 cm, 11"

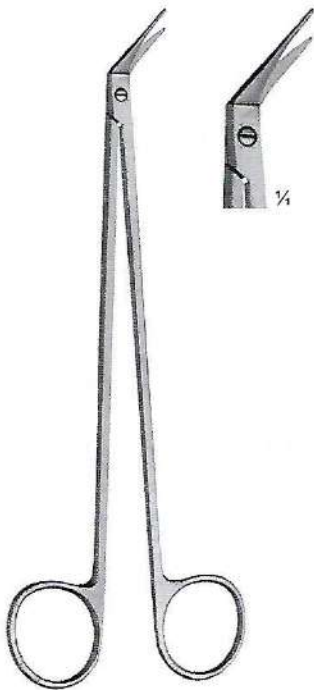

COOLEY VASCULAR SCISSORS
F4-206 18.4 cm, 7 1/2" 1 mm
F4-207 18.4 cm, 7 1/2" 1.5 mm
probe point on tip.
S/S Angled 45°

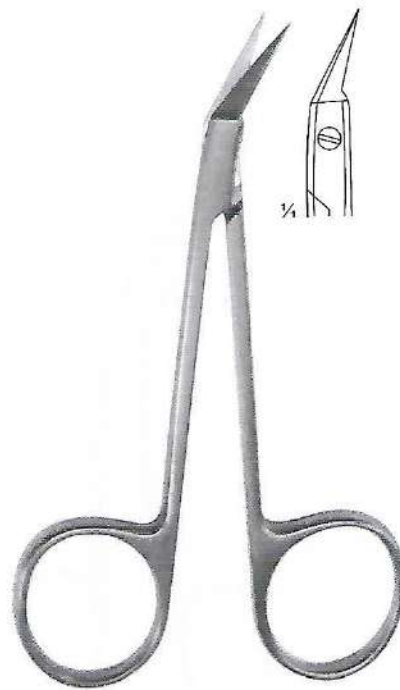

O'BRIEN VASCULAR SCISSORS
F4-208 9.0 cm, 3 1/2"
S/S Angled

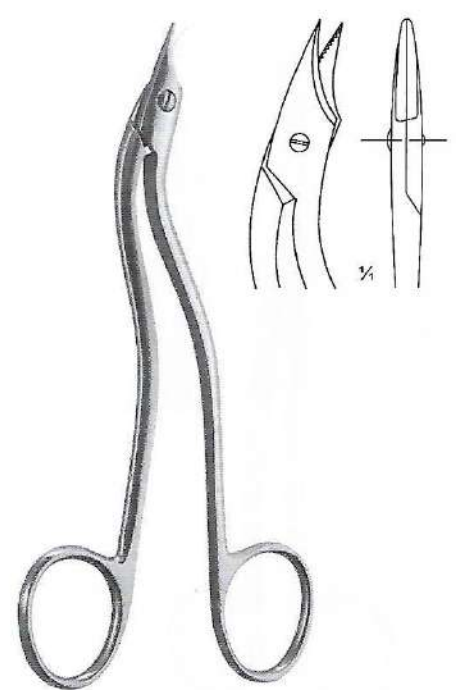

HEATH VASCULAR SCISSORS
F4-209 15.0 cm, 6"
S/S Double Cvd.



DISSECTING & NASAL SCISSORS

Präparierscheren Nasenschere
Tijeras de disección Tijeras Nasal

Ciseaux à dissection Ciseaux Nasal
Dissezione Forbici nasale Forbici

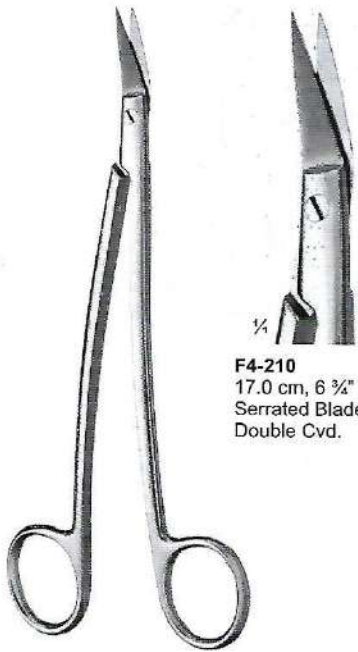

F4-210
17.0 cm, 6 3/4"
Serrated Blade S/S
Double Cvd.

**DEAN-DELICATE
DISSECTING SCISSORS**

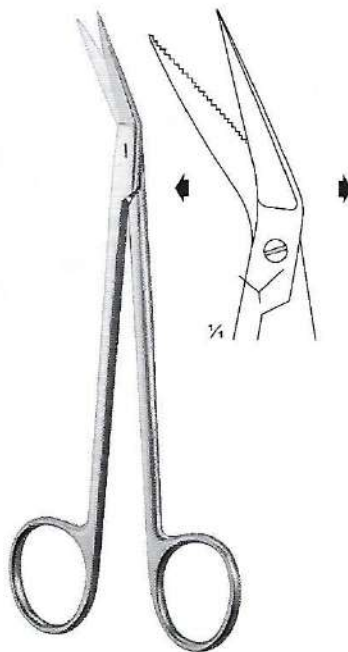

Locklin Dissecting Scissors
F4-211 16.5 cm, 6 1/2"
S/S

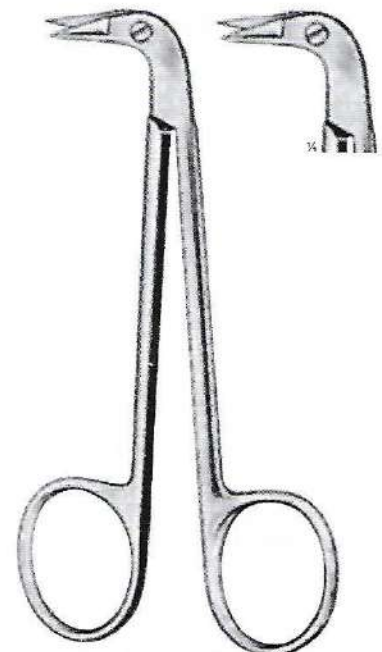

FAVALORO CORONARY
F4-212 10.5 cm, 4"
S/S Angled 90°

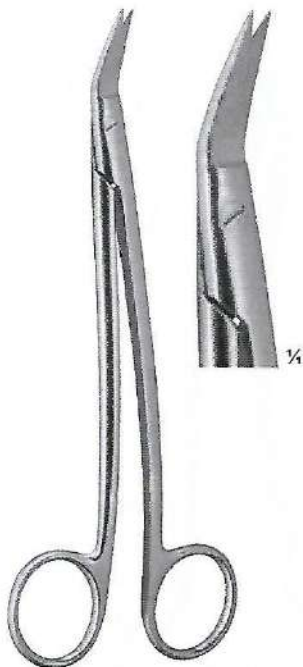

ENT-DEAN SCISSORS
F4-213 17 cm, 6 3/4"
S/S Double Cvd.
Serrated

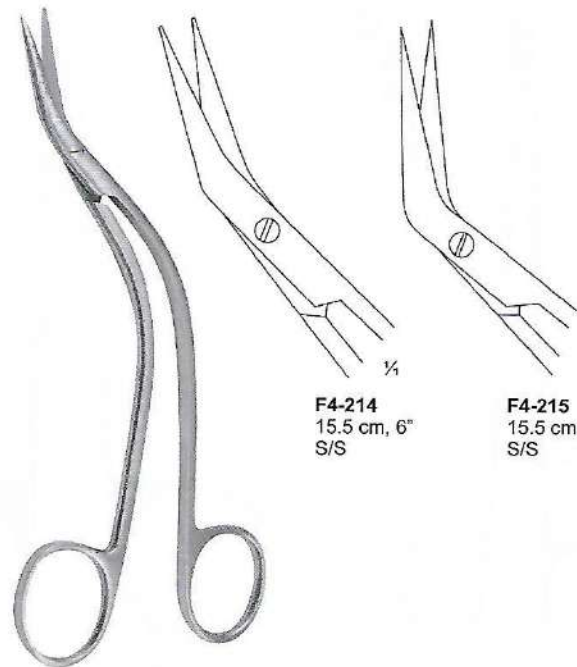

F4-214
15.5 cm, 6"
S/S

F4-215
15.5 cm, 6"
S/S

**DE BAKY VASCULAR
SCISSORS**

VASCULAR SCISSORS



Gefäßschere

Ciseaux vasculaires

Tijeras vasculares

Forbici vascolari

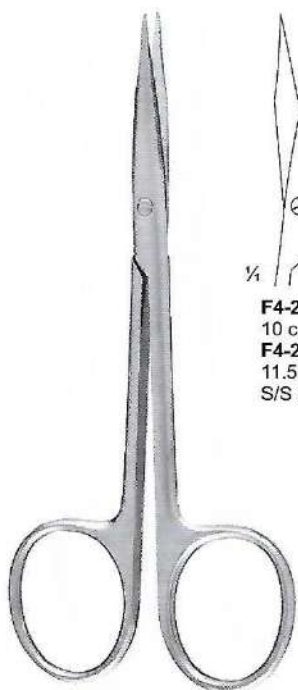

F4-216
10 cm 4"
F4-217
11.5 cm 4 1/2"
S/S Str.

STEVENS SCISSORS



F4-218
10 cm 4"
F4-219
11.5 cm 4 1/2"
S/S Cvd.

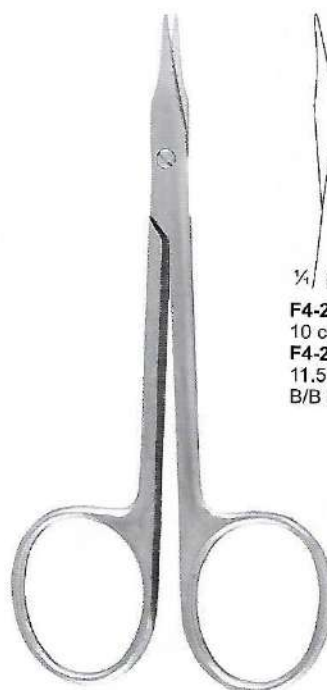

F4-220
10 cm 4"
F4-221
11.5 cm 4 1/2"
B/B Str.

STEVENS SCISSORS



F4-222
10 cm 4"
F4-223
11.5 cm 4 1/2"
B/B Cvd.



NAIL SCISSORS
F4-224 9 cm, 3 1/2"
S/S, Cvd.

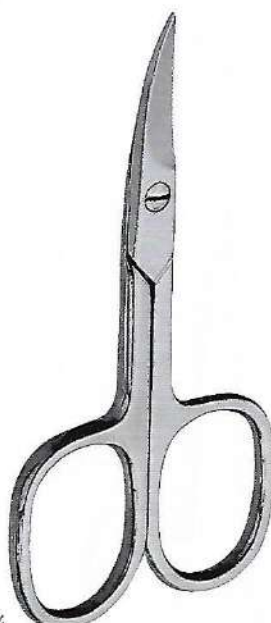

NAIL SCISSORS
F4-225 9 cm, 3 1/2"
S/S, Cvd.

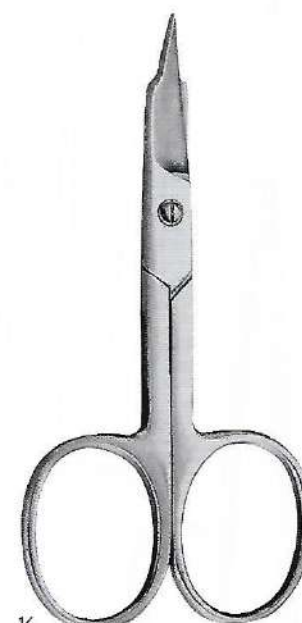

NAIL SCISSORS
F4-226 9 cm, 3 1/2"
Arrow Point Curved



STITCH SCISSORS

stitch Schere | point de ciseaux
Coser Tijeras | Stitch Forbici



1/4
Saw Edge

STITCHES SCISSORS
F4-227 12.0 cm, 4 3/4"
Str.

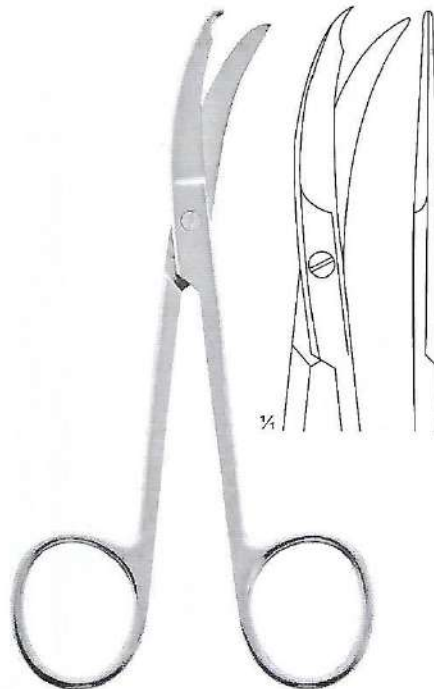

1/4

NORTHBENT STITCHES SCISSORS
F4-228 12.5 cm, 5"
Cvd.

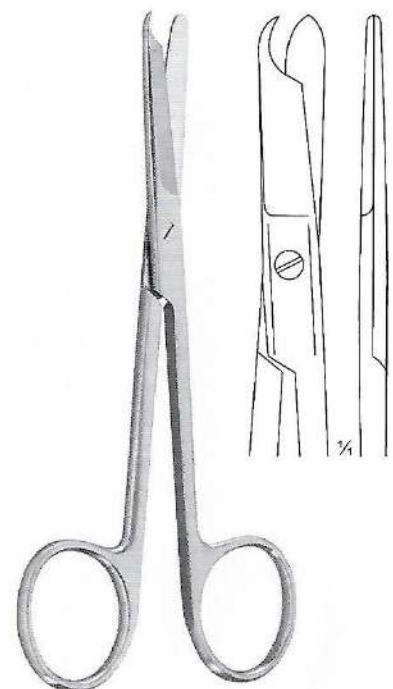

1/4

LITTAUER STITCH SCISSORS
F4-229 14 cm, 5 1/2"
Str.

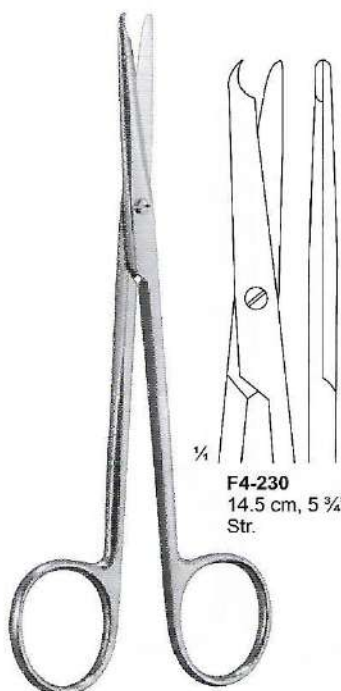

1/4
F4-230
14.5 cm, 5 3/4"
Str.

BUCK STITCH SCISSORS

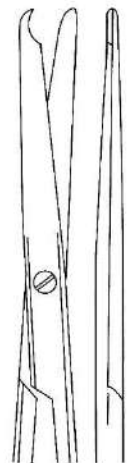

F4-231
18.0 cm, 7"
Str.

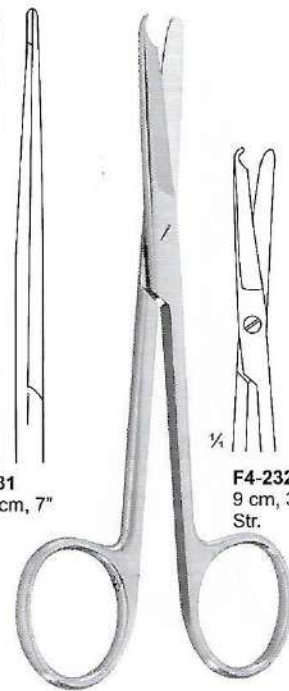

1/4
F4-232
9 cm, 3 1/2"
Str.

SPENCER STITCH SCISSORS

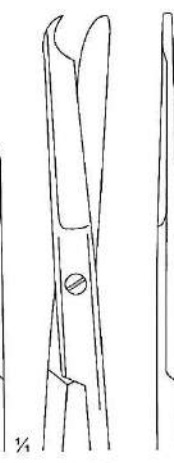

F4-233
11.5 cm, 4 1/2"
Str.



1/4

SHORTBENT STITCH SCISSORS
F4-234 9 cm, 3 1/2"
Cvd.

TONSIL, NASAL SCISSORS



Tonsillensteine Schere, Nasenschere
Tijeras de amígdalas, tijeras nasales

Ciseaux d'amygdale, Ciseaux nasaux
Tonsille forbici, forbici nasali

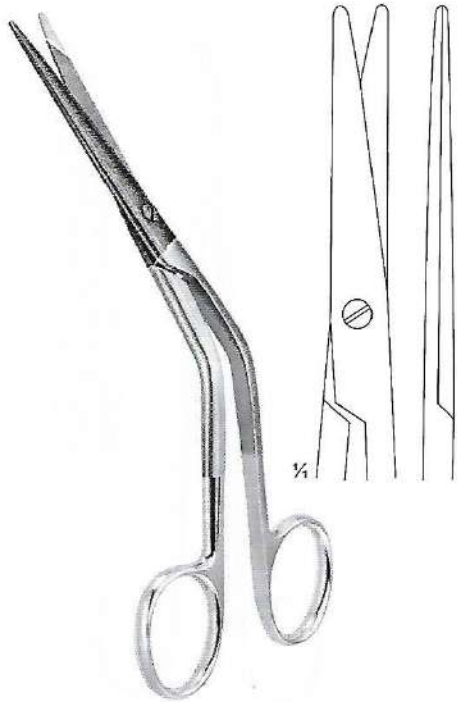

COTTLE SCISSORS
F4-235 16 cm 6 1/4"
B/B, Angled

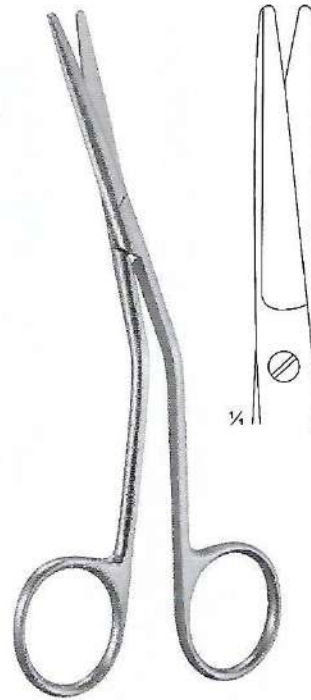

FOMON SCISSORS
F4-236 14.5 cm 5 1/2"
B/B, Angled



SAILER SCISSORS
F4-237 17.0 cm 6 3/4"
B/B, Angled

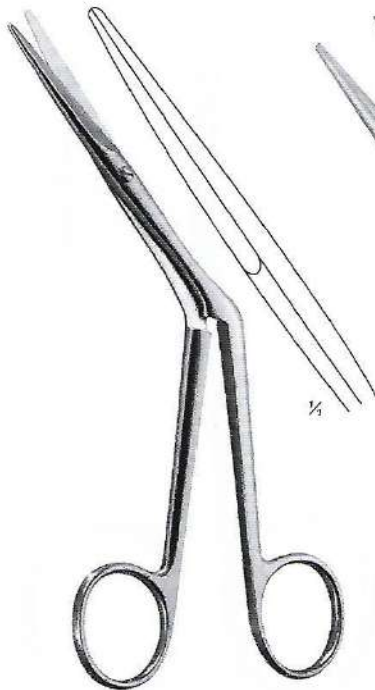

HEYMANN SCISSORS
F4-238 18 cm, 7"
F4-239 19.5 cm, 7 3/4"
B/B, Angled

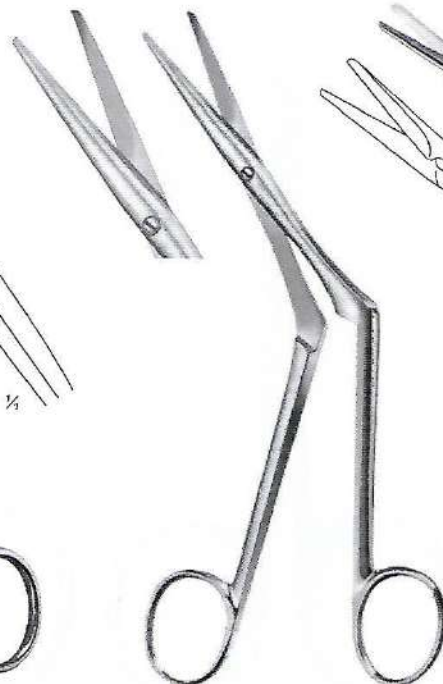

HEYMANN SCISSORS
F4-240 18.0 cm, 7"
B/B, Angled



OLIVECRONA VASCULAR SCISSORS
F4-241 23.0 cm, 9"
B/B



GUM & OPERATING SCISSORS

Chirurgische scheren, Gum Scheren
Goma Tijeras y tijeras de funcionamiento

Gum Ciseaux et Ciseaux d'exploitation
Gum Forbici & Forbici Operativi

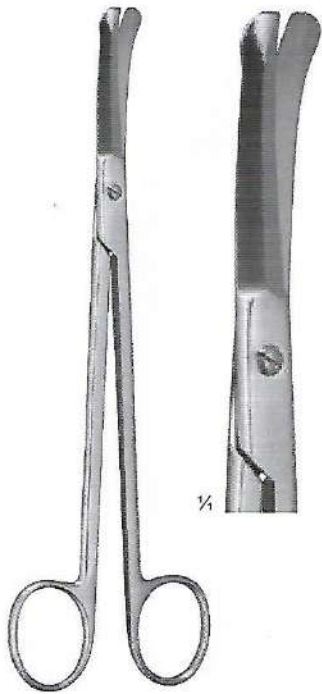

GOOD SCISSORS
F4-242 19.0 cm, 7 1/2"
Probe End, Cvd.



PRINCE SCISSORS
F4-243 17.5 cm, 7"
B/B, Cvd.



HALLE SCISSORS
F4-244 19.0 cm, 7 1/2"
B/B, Cvd.



SULLIVAN SCISSORS
One Teeth Is Serrated As Per

F4-245
14.5 cm, 5 3/4"
Pointed Tip
S/S, Str.



F4-246
14.5 cm, 5 3/4"
Pointed Tip
S/S, Cvd.

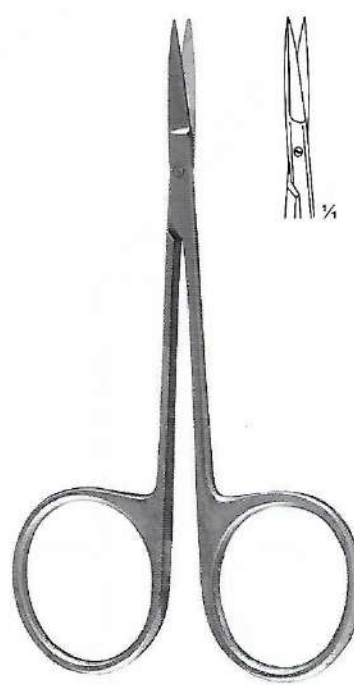

MOD. BONN SCISSORS
F4-247 8.0 cm, 3"
S/S, Str.

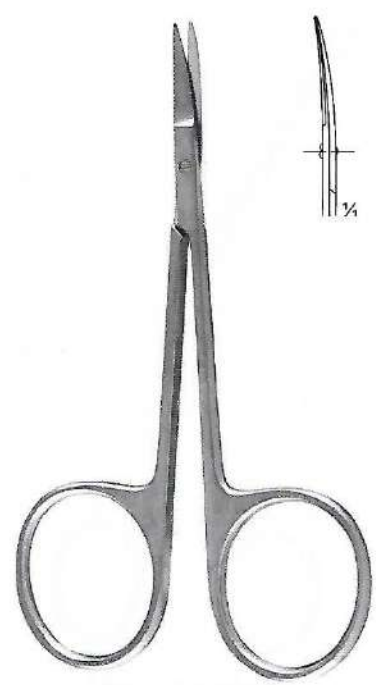

MOD. BONN SCISSORS
F4-248 8.0 cm, 3"
S/S, Cvd.

WIRE CUTTING SCISSORS



Draht-Ausschnitt-Scheren
Tijeras de corte de alambre

Ciseaux de coupe de câbles
Filo da taglio Forbici

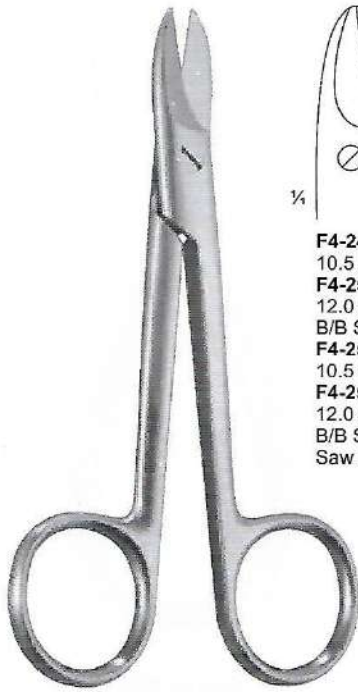

BEEBEE WIRE CUTTING SCISSORS



F4-249
10.5 cm 4 1/4"
F4-250
12.0 cm 4 3/4"
B/B Str.
F4-251
10.5 cm 4 1/4"
F4-252
12.0 cm 4 3/4"
B/B Str.
Saw Edge



F4-253
10.5 cm 4 1/4"
F4-254
12.0 cm 4 3/4"
S/S Str.
F4-255
10.5 cm 4 1/4"
F4-256
12.0 cm 4 3/4"
S/S Str.
Saw Edge

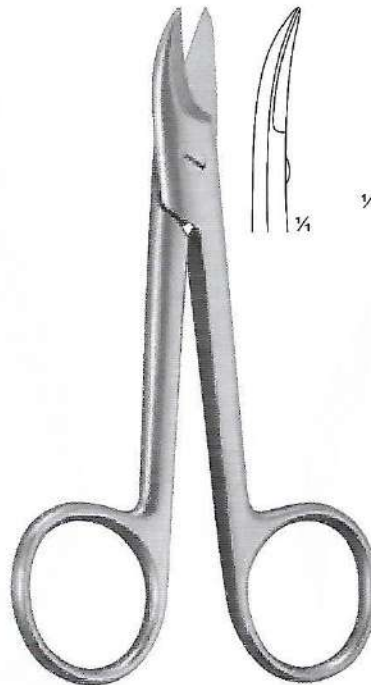

BEEBEE WIRE CUTTING SCISSORS



F4-257
10.0 cm 4"
F4-258
12.0 cm 4 3/4"
B/B Cvd.
F4-259
10.0 cm 4"
F4-260
12.0 cm 4 3/4"
B/B Cvd.
Saw Edge

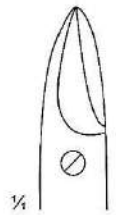

F4-261
10.0 cm 4"
F4-262
12.0 cm 4 3/4"
S/S Cvd.
F4-263
10.0 cm 4"
F4-264
12.0 cm 4 3/4"
S/S Cvd.
Saw Edge



SYSTRUNK SCISSORS



SYSTRUNK
F4-265
13.0 cm 5"
S/S, Str.



SYSTRUNK
F4-266
13.0 cm 5"
S/S, Cvd.

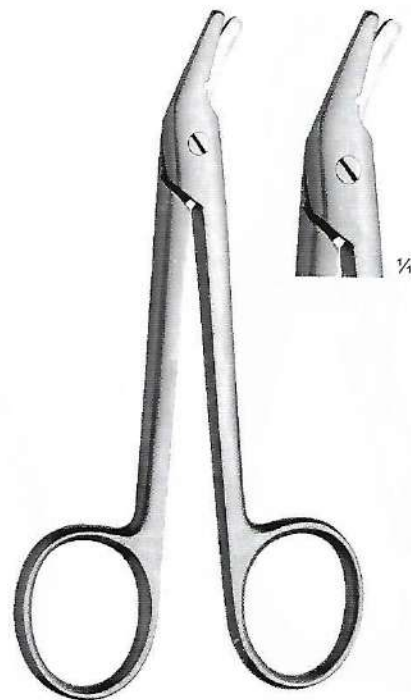

UNIVERSAL WIRE CUTTING SCISSORS
F4-267 12 cm, 4 3/4"



NAIL NIPPERS

Nagelzangen | pincès à ongles
Nail Nippers | Nail Tronchesi



NAIL NIPPERS
F4-268 11 cm 4 1/4"
F4-269 13 cm 5"
F4-270 15 cm 6"



NAIL NIPPERS
F4-271 14 cm 5 1/2"



NAIL NIPPERS
F4-272 14 cm 5 1/2"



TURNBULL NIPPERS
F4-273 11.5 cm 4 1/2"
F4-274 13 cm 5"



NAIL NIPPERS
F4-275 10.5 cm 4 1/4"

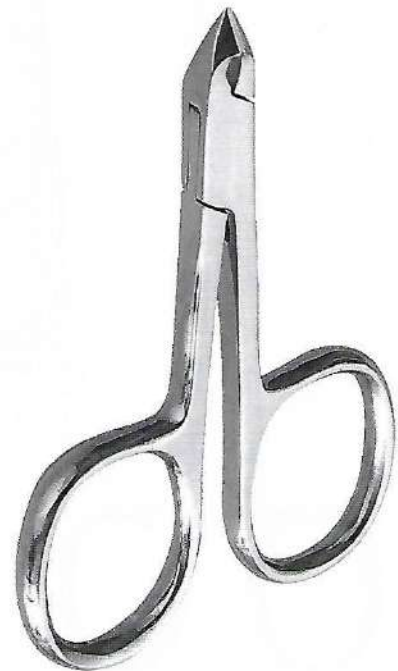

COHEN NIPPERS
F4-276 10.5 cm 4 1/4"

MICRO SCISSORS



Mikroscheren | *micro Ciseaux*
 Micro Tijeras | *Micro Forbici*

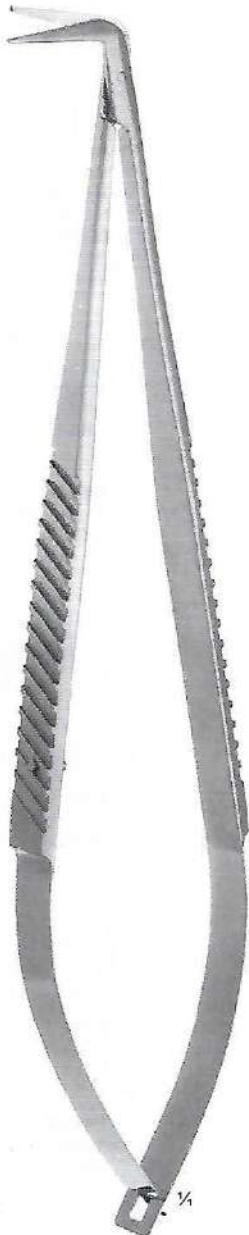

ARTERY SCISSORS
 Probe end Angled

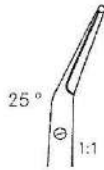

F4-277
 18.0 cm, 7"
 25°

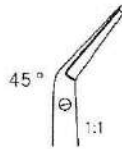

F4-278
 18.0 cm, 7"
 45°

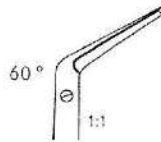

F4-279
 18.0 cm, 7"
 60°

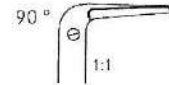

F4-280
 18.0 cm, 7"
 90°

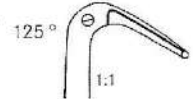

F4-281
 18.0 cm, 7"
 125°

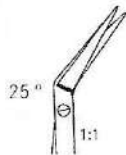

F4-282
 18.0 cm, 7"
 25°

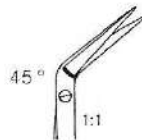

F4-283
 18.0 cm, 7"
 45°

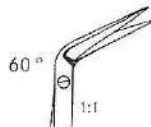

F4-284
 18.0 cm, 7"
 60°



F4-285
 18.0 cm, 7"
 90°

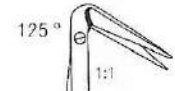

F4-286
 18.0 cm, 7"
 125°



MICRO SCISSORS

Mikroscheren | *micro Ciseaux*
 Micro Tijeras | *Micro Forbici*



F4-287
 9.0 cm, 3 1/2"
 S/B Str.



F4-288
 9.0 cm, 3 1/2"
 S/B Cvd.



F4-289
 9.0 cm, 3 1/2"
 S/S Str.



F4-290
 9.0 cm, 3 1/2"
 S/S Cvd.



F4-291
 11.4 cm, 4 1/2"
 B/B Str.

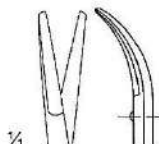

F4-292
 11.4 cm, 4 1/2"
 B/B Cvd.



F4-293
 11.4 cm, 4 1/2"
 S/B Str.

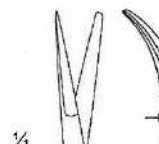

F4-294
 11.4 cm, 4 1/2"
 S/B Cvd.



F4-295
 11.4 cm, 4 1/2"
 S/S Str.

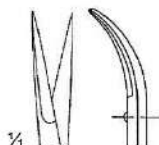

F4-296
 11.4 cm, 4 1/2"
 S/S Cvd.



F4-297
 14 cm, 5 1/2"
 B/B Str.

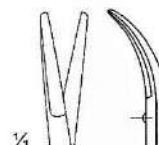

F4-298
 14 cm, 5 1/2"
 B/B Cvd.



F4-299
 14 cm, 5 1/2"
 S/B Str.

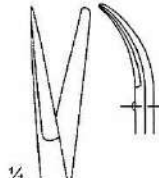

F4-300
 14 cm, 5 1/2"
 S/B Cvd.



F4-301
 14 cm, 5 1/2"
 S/S Str.

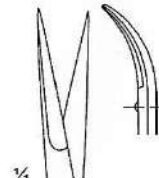

F4-302
 14 cm, 5 1/2"
 S/S Cvd.



CASTROVIEJO SCISSORS
 Spring Type

MICRO SCISSORS



Mikroscheren | micro Ciseaux
 Micro Tijeras | Micro Forbici



F4-303
 12 cm, 4 3/4"
 S/S



F4-304
 12 cm, 4 3/4"
 S/B

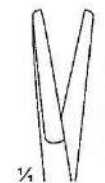

F4-305
 12 cm, 4 3/4"
 B/B



NOYES SCISSORS
 Spring Handle
F4-306 12 cm, 4 3/4"
 Angled,



WECKER SCISSORS
 Angled



F4-307
 11.0 cm, 4 1/4"
 S/B



F4-308
 11.0 cm, 4 1/4"
 B/B



F4-309
 11.0 cm, 4 1/4"
 S/S

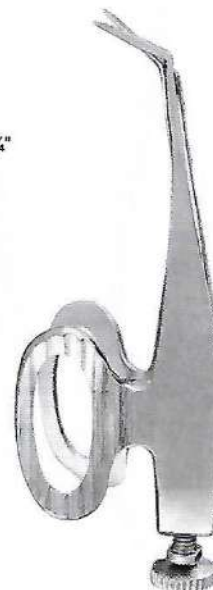

BARRAQUER SCISSORS
F4-310 Sharp Points
F4-311 Blunt Points
 5.5 cm, 2 1/4"



CASTROVIEJO CORNEAL MICRO SCISSORS
F4-312 11 cm, 4 1/3"
 Left Angled,
 Spring Handle



CASTROVIEJO CORNEAL MICRO SCISSORS
F4-313 11 cm, 4 1/3"
 Right Angled,
 Spring Handle



TROUTMAN MICRO SCISSORS
F4-314 10.0 cm, 4"
 Left Angled,
 Spring Handle



TROUTMAN MICRO SCISSORS
F4-315 10.0 cm, 4"
 Right Angled,
 Spring Handle



WESTCOTT MICRO SCISSORS



F4-316
 11.0 cm, 4 1/4"
 S/S Str.



F4-318
 11.0 cm, 4 1/4"
 S/S Cvd.

F4-319
 13.3 cm, 5 1/4"
 S/S Str.



MICRO SCISSORS

Mikroscheren | micro Ciseaux
 Micro Tijeras | Micro Forbici



MICRO SCISSORS
 F4-320 12.0 cm, 4 3/4"
 S/S, Cvd.

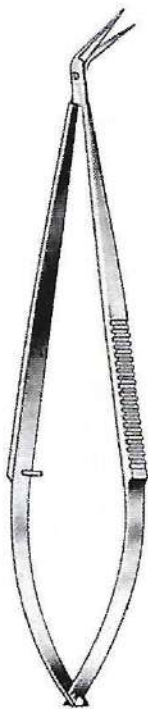

MICRO SCISSORS
 S/S, Angled



F4-321
 18.0 cm, 7"
 25°



F4-322
 18.0 cm, 7"
 45°



F4-323
 18.0 cm, 7"
 60°



F4-324
 18.0 cm, 7"
 90°

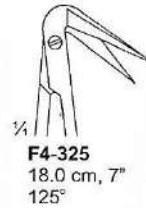

F4-325
 18.0 cm, 7"
 125°

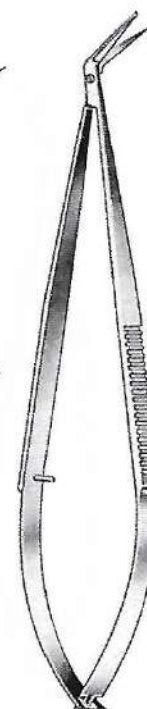

MICRO SCISSORS
 S/S, Angled pointed probe

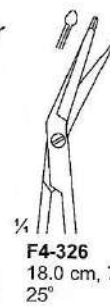

F4-326
 18.0 cm, 7"
 25°



F4-327
 18.0 cm, 7"
 45°

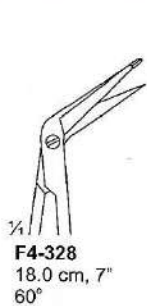

F4-328
 18.0 cm, 7"
 60°

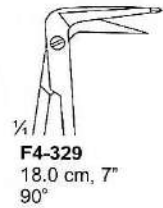

F4-329
 18.0 cm, 7"
 90°

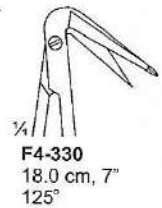

F4-330
 18.0 cm, 7"
 125°



YASARGILL SCISSORS



F4-331 16 cm, 6 1/4"
F4-332 20 cm, 8"
F4-333 22.5 cm, 9"
 S/S, Str.



F4-334 16 cm, 6 1/4"
F4-335 20 cm, 8"
F4-336 22 cm, 8 3/4"
 S/S, Cvd.



F4-337 16 cm, 6 1/4"
F4-338 20 cm, 8"
F4-339 22 cm, 8 3/4"
 B/B, Str.



F4-340 16 cm, 6 1/4"
F4-341 20 cm, 8"
F4-342 22 cm, 8 3/4"
 S/S, Str.



F4-343 16 cm, 6 1/4"
F4-344 20 cm, 8"
F4-345 22 cm, 8 3/4"
 S/S, Cvd.



F4-346 16 cm, 6 1/4"
F4-347 20 cm, 8"
F4-348 22 cm, 8 3/4"
 B/B, Cvd.



NOYES MICRO SCISSORS
 F4-349 15.0 cm, 6"
 S/S



NOYES MICRO SCISSORS
 F4-350 14.5 cm, 5 3/4"
 S/S

UNIVERSAL SCISSORS

Universal-Schere
Tijeras universales

Ciseaux universelles
Forbici universali



UNIVERSAL PARAMEDIC SHEAR

- F4-351 14 cm 5 3/4" (BLACK)
- F4-352 14 cm 5 3/4" (BLUE)
- F4-353 14 cm 5 3/4" (ROYAL BLUE)
- F4-354 14 cm 5 3/4" (BURGANDY)
- F4-355 14 cm 5 3/4" (GREEN)
- F4-356 14 cm 5 3/4" (MAGENTA)
- F4-357 14 cm 5 3/4" (ORANGE)
- F4-358 14 cm 5 3/4" (PINK)
- F4-359 14 cm 5 3/4" (PURPLE)
- F4-360 14 cm 5 3/4" (RED)
- F4-361 14 cm 5 3/4" (TEAL)
- F4-362 14 cm 5 3/4" (WHITE)
- F4-363 14 cm 5 3/4" (YELLOW)

- F4-364 16 cm 6 1/4" (BLACK)
- F4-365 16 cm 6 1/4" (BLUE)
- F4-366 14 cm 5.5" (ROYAL BLUE)
- F4-367 14 cm 5.5" (BURGANDY)
- F4-368 16 cm 6 1/4" (GREEN)
- F4-369 16 cm 6 1/4" (MAGENTA)
- F4-370 16 cm 6 1/4" (ORANGE)
- F4-371 16 cm 6 1/4" (PINK)
- F4-372 16 cm 6 1/4" (PURPLE)
- F4-373 16 cm 6 1/4" (RED)
- F4-374 16 cm 6 1/4" (TEAL)
- F4-375 16 cm 6 1/4" (WHITE)
- F4-376 16 cm 6 1/4" (YELLOW)
- 143 C/290 F Autoclavable



UNIVERSAL SCISSORS

Universal-Schere
Tijeras universales

Ciseaux universelles
Forbici universali

**UNIVERSAL
PARAMEDIC SHEAR
F4-377**
14 cm 5.5"
(GREEN)



**UNIVERSAL
PARAMEDIC SHEAR
F4-382**
14 cm 5.5"
(PINK)



**UNIVERSAL
PARAMEDIC SHEAR
F4-378**
14 cm 5.5"
(ROYAL BLUE)



**UNIVERSAL
PARAMEDIC SHEAR
F4-381**
14 cm 5.5"
(BURGANDY)



**UNIVERSAL
PARAMEDIC SHEAR
F4-379**
14 cm 5.5"
(RED)



**UNIVERSAL
PARAMEDIC SHEAR
F4-380**
14 cm 5.5"
(BLACK)

UNIVERSAL SCISSORS



Universal-Schere
Tijeras universales

Ciseaux universelles
Forbici universali

UNIVERSAL PARAMEDIC
SHEAR PROB END
F4-383
14 cm 5.5"
(YELLOW)



UNIVERSAL PARAMEDIC
SHEAR PROB END
F4-390
14 cm 5.5"
(ROYAL BLUE)



UNIVERSAL PARAMEDIC
SHEAR PROB END
F4-384
14 cm 5.5"
(Chartreuse)



UNIVERSAL PARAMEDIC
SHEAR PROB END
F4-389
14 cm 5.5"
(WHITE)



UNIVERSAL PARAMEDIC
SHEAR PROB END
F4-385
14 cm 5.5"
(RED)



UNIVERSAL PARAMEDIC
SHEAR PROB END
F4-386
14 cm 5.5"
(BLACK)



UNIVERSAL PARAMEDIC
SHEAR PROB END
F4-388
14 cm 5.5"
(GREEN)



UNIVERSAL PARAMEDIC
SHEAR PROB END
F4-387
14 cm 5.5"
(BURGUNDY)





UNIVERSAL SCISSORS

Universal-Schere
Tijeras universales

Ciseaux universelles
Forbici universali

**UNIVERSAL
PARAMEDIC SHEAR
F4-391**
14 cm 5.5"
(BLACK)



**UNIVERSAL
PARAMEDIC SHEAR
F4-395**
14 cm 5.5"
(BLUE)



**UNIVERSAL
PARAMEDIC SHEAR
F4-392**
14 cm 5.5"
(ORANGE)



**UNIVERSAL
PARAMEDIC SHEAR
F4-396**
14 cm 5.5"
(YELLOW)



**UNIVERSAL
PARAMEDIC SHEAR
F4-393**
14 cm 5.5"
(WHITE)



**UNIVERSAL
PARAMEDIC SHEAR
F4-397**
14 cm 5.5"
(BURGUNDY)



**UNIVERSAL
PARAMEDIC SHEAR
F4-394**
14 cm 5.5"
(ORANGE)



**UNIVERSAL
PARAMEDIC SHEAR
F4-398**
14 cm 5.5"
(DEEP YELLOW)

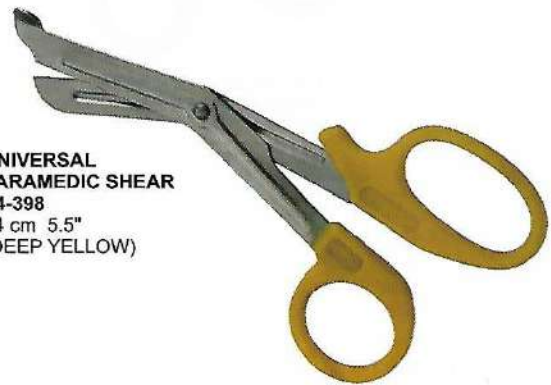

PLASTER SCISSORS



Gips Schere
Tijeras Yeso

plâtre Ciseaux
intonaco Forbici



ESMARCH KNIFE
F4-399 18 cm, 7"

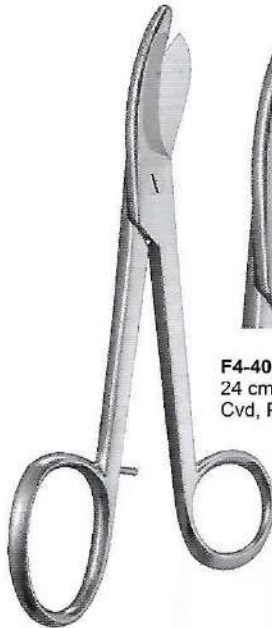

BRUNS SCISSORS



F4-400
24 cm, 9 1/2"
Cvd, Probe End



F4-401
24 cm, 9 1/2"
Cvd, Serrated
Probe End



**LISTER-EXCENTRIC
PLASTER SCISSORS**
F4-402 16 cm, 6 1/4"
F4-403 19 cm, 7 1/2"
Angled, Probe End



Edge Upper
h is Serrated

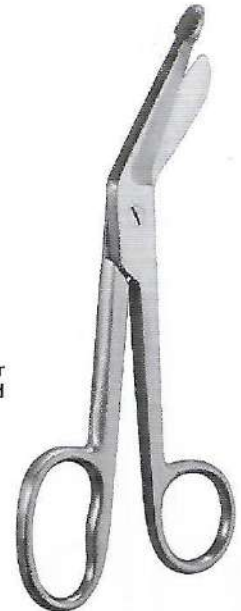

**LISTER BANDAGE PLASTER
SCISSORS**, one large ring
F4-404 9 cm, 3 1/2"
F4-405 11 cm, 4 1/3"
F4-406 14 cm, 5 1/2"
F4-407 15 cm, 6"
F4-408 18 cm, 7"
F4-409 20 cm, 8"
Angled, Probe End



BERGMANN SCISSORS
F4-410 23 cm, 9"
Angled, Probe End



ESMARCH SCISSORS
F4-411 20 cm, 8"
F4-412 23 cm, 9"
Angled, Probe End



**LISTER BANDAGE
PLASTER SCISSORS**
F4-413 9 cm, 3 1/2"
F4-414 11 cm, 4 1/3"
F4-415 14 cm, 5 1/2"
F4-416 15 cm, 6"
F4-417 18 cm, 7"
F4-418 20 cm, 8"
Angled, Probe End



PLASTER SCISSORS
F4-419 17 cm, 6 3/4"
Angled

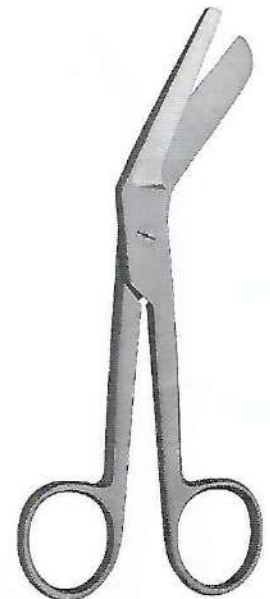

**BURNHAM BANDAGE
PLASTER SCISSORS**
F4-420 14 cm, 5 1/2"
Angled



PLASTER SCISSORS

Gips Schere
Tijeras Yeso

plâtre Ciseaux
intonaco Forbici



BANDAGE SCISSORS
F4-421
16.0 cm 6 1/4"

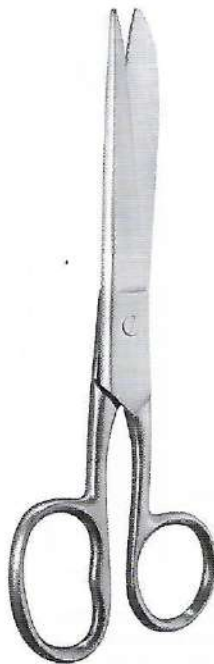

**SMITH (Mod. Usa)
PLASTER SCISSORS**
F4-422 16 cm, 6 1/4"
F4-423 18 cm, 7"
F4-424 20 cm, 8"
F4-425 23 cm, 9"

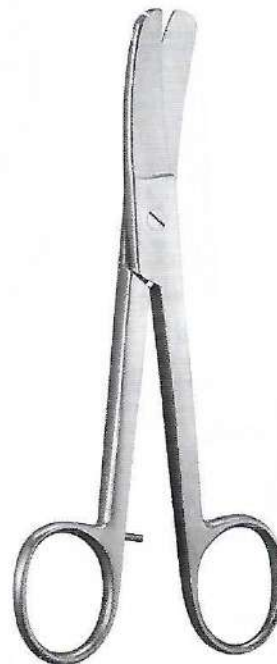

**LORENZ PLASTER
SCISSORS**
F4-426 23 cm, 9"
B/B, Cvd



**LANGE BANDAGE
SCISSORS**
F4-427 18.0 cm 7"
B/B



**BRAUN-STADLER
PLASTER SCISSORS**
F4-428 14 cm, 5 1/2"
F4-429 22 cm, 8 3/4"
B/B, Angled



**BUSCH PLASTER
SCISSORS**
F4-430 13 cm, 5"
F4-431 16 cm, 6 1/4"
B/B, Cvd.



**KNOWLES PLASTER
SCISSORS**
F4-432 14 cm, 5 1/2"
Str. Probe End

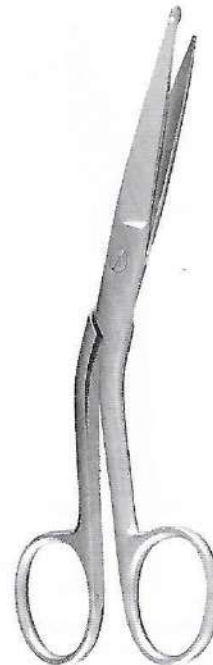

**KNOWLES PLASTER
SCISSORS**
F4-433 14 cm, 5 1/2"
Angled, Probe End



**WALDMANN PLASTER
SCISSORS**
F4-434 18 cm, 7"
Probe End

PLASTER SCISSORS



Gips Schere
Tijeras Yeso

plâtre Ciseaux
intonaco Forbici

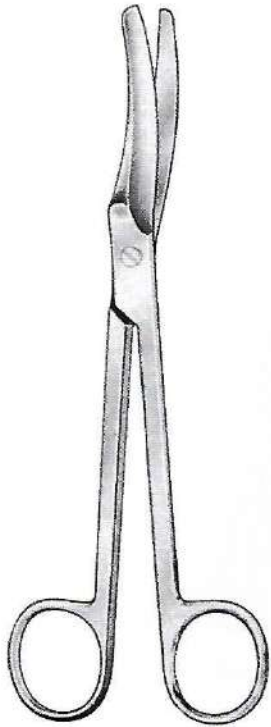

WALDMANN SCISSORS
F4-435 18 cm, 7"



SCHUMACHER PLASTER SCISSORS
F4-436 16 cm, 6 1/4"



MODIFIED-USA PLASTER SCISSORS
F4-437 10.5 cm, 4 1/4"



MARBACH PLASTER SCISSORS
F4-438 15.5 cm, 6"
Probe End, Serrated blade



SEUTIN PLASTER SCISSORS
F4-439 20.0 cm 8"
Probe End



SEUTIN PLASTER SCISSORS
F4-440 23.0 cm 9"
Probe End



PLASTER SHEARS

GipsScheren
Tijeras Yeso

plâtres Ciseaux
Cesoie in gesso



STILLE PLASTER SHEARS
F4-441 23 cm, 9"
F4-442 Spare Blade



STILLE PLASTER SHEARS
F4-443 26 cm, 10 1/2"
F4-444 Spare Blade



STILLE PLASTER SHEARS
F4-445 37 cm, 14 1/2"
F4-446 Spare Blade

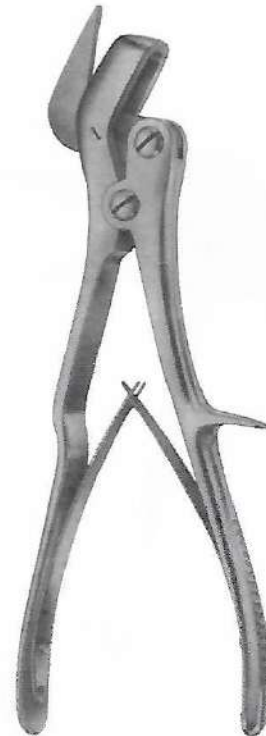

STILLE PLASTER SHEARS
F4-447 24 cm, 9 1/2"
F4-448 Spare Blade

PLASTER SHEARS

GipsScheren
Tijeras Yeso

plâtres Ciseaux
Cesoie in gesso



HENNIG PLASTER CAST SPREADER
F4-449 28 cm, 11"

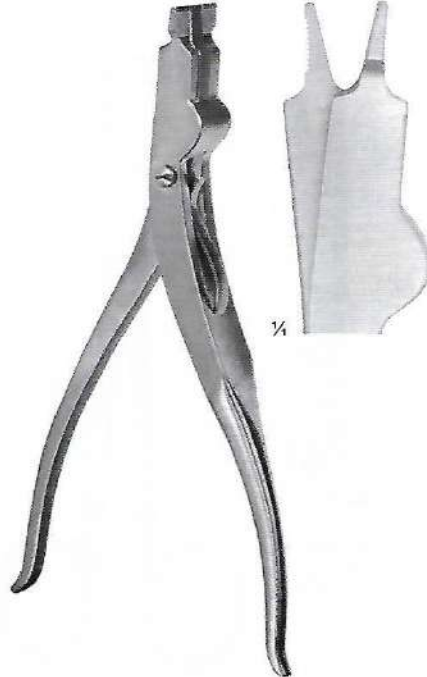

MODEL USA CAST SPREADER PLASTER
F4-450 23 cm, 9" 3 Prong

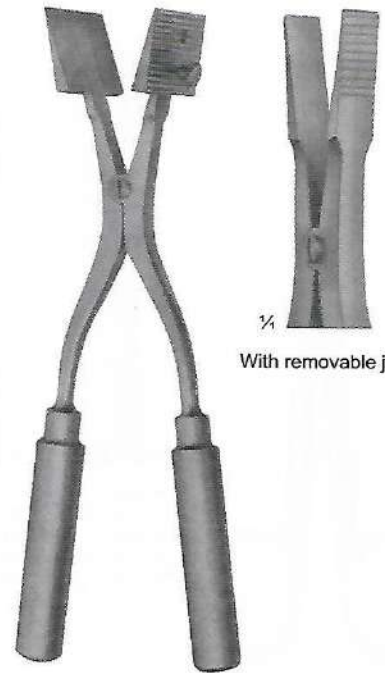

SPREADER PLASTER
F4-451 29 cm, 11 1/2"
With removable jaws



WOLFF SPREADER PLASTER
F4-452 18 cm, 7"
F4-453 24 cm, 9 1/2"



ENGEL PLASTER SAW
F4-454 14 cm, 5 1/2"

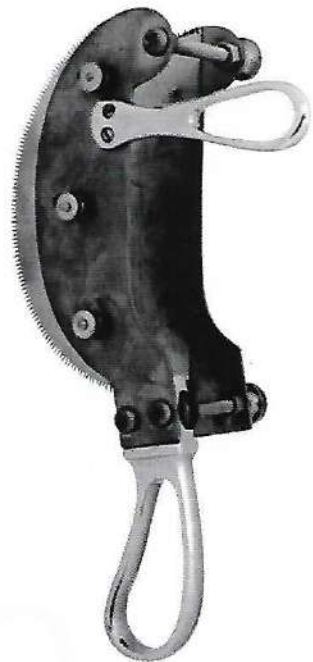

CHARRIERE PLASTER SAW
F4-455 25 cm, 10"
F4-456 27 cm, 10 3/4"
Double saw



SUPER CUT SCISSORS

Super Cut Schere
Súper Cut Tijeras

Ciseaux SuperCut
Forbici SuperCut

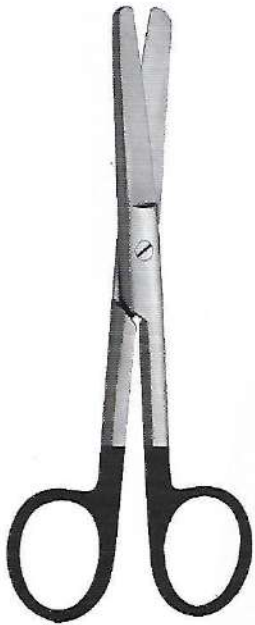

STANDARD OPERATING
SUPER CUT SCISSORS



F4-457
14.5 cm 5 3/4"
F4-458
16.5 cm 6 1/2"
Str. B/B



F4-459
14.5 cm 5 3/4"
F4-460
16.5 cm 6 1/2"
Str. S/B



F4-461
14.5 cm 5 3/4"
F4-462
16.5 cm 6 1/2"
Str. S/S

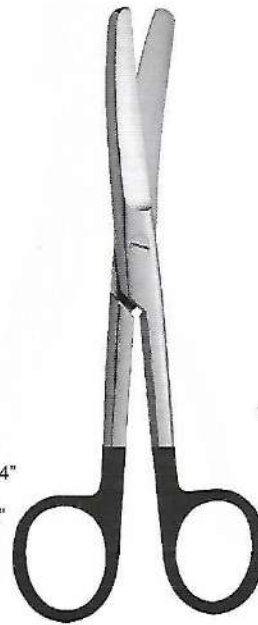

STANDARD OPERATING
SUPER CUT SCISSORS



F4-463
14.5 cm 5 3/4"
F4-464
16.5 cm 6 1/2"
Cvd. B/B



F4-465
14.5 cm 5 3/4"
F4-466
16.5 cm 6 1/2"
Cvd. S/B



F4-467
14.5 cm 5 3/4"
F4-468
16.5 cm 6 1/2"
Cvd. S/S



LAXER OPERATING SUPER
CUT SCISSORS



F4-469 16 cm 6 1/4"
F4-470 21 cm 8 1/4"
B/B, Str.



F4-471 16.5 cm 5 1/2"
F4-472 21 cm 8 1/4"
B/B, Cvd.

SUPER CUT SCISSORS



Super Cut Schere
Super Cut Tijeras

Ciseaux SuperCut
Forbici SuperCut



SAFETY SUPER CUT SCISSORS
F4-473 Str.
F4-474 Cvd.
9.0 cm, 3 1/2", Probe Ends

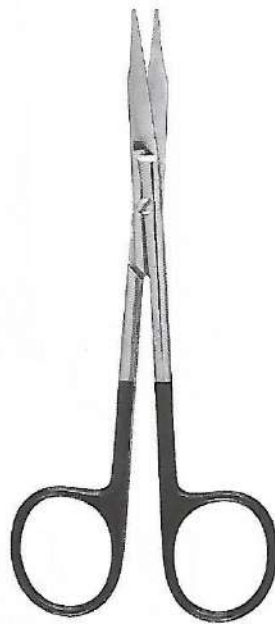

**GOLDMAN-FOX
SUPER CUT SCISSORS**
F4-475 Str.
F4-476 Cvd.
9.0 cm, 3 1/2", S/S
13 cm 5"

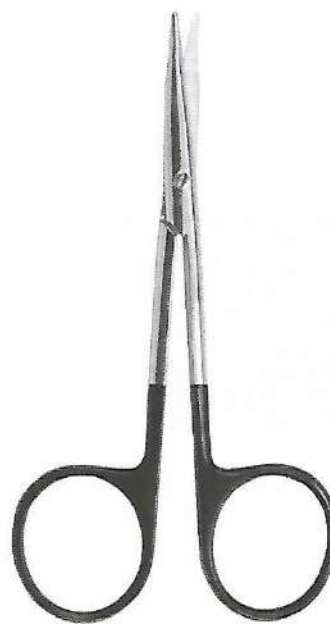

**STEVENS TENOTOMY
SUPER CUT SCISSORS**
F4-477 Str.
F4-478 Cvd.
9.0 cm, 3 1/2", B/B

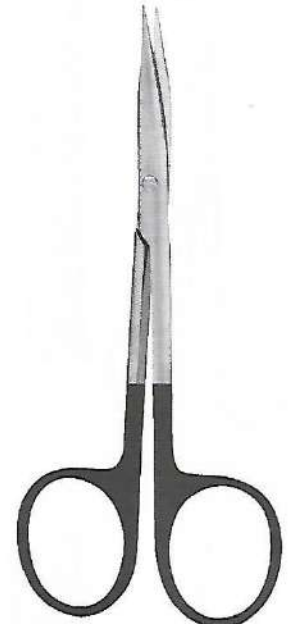

**STEVENS TENOTOMY
SUPER CUT SCISSORS**
F4-479 Str.
F4-480 Cvd.
11.5 cm, 4 1/2", S/S



**BABY METZENBAUM
SUPER CUT SCISSORS**
F4-481 11.5 cm, 4 1/2"
B/B, Str.



**BABY METZENBAUM
SUPER CUT SCISSORS**
F4-482 11.5 cm, 4 1/2"
B/B, Cvd.



IRIS SUPER CUT SCISSORS
F4-483 9.0 cm, 3 1/2"
F4-484 11.5 cm, 4 1/2"
S/S, Str.



IRIS SUPER CUT SCISSORS
F4-485 9.0 cm, 3 1/2"
F4-486 11.5 cm, 4 1/2"
S/S, Cvd.



OPERATING SCISSORS T.C.

Chirurgische scheren
Tijeras quirúrgicas

Ciseaux chirurgicaux
Forbici per chirurgia

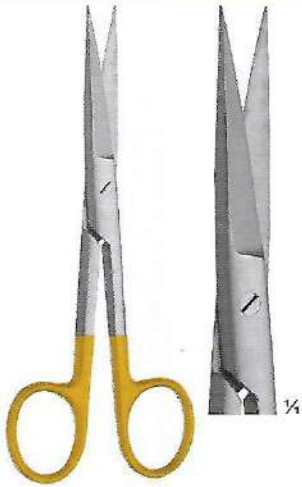

Operating Scissors, S/S Str.
T/C Insert

TCF4-487	11.5 cm, 4 1/2"
TCF4-488	13.0 cm, 5"
TCF4-489	14.0 cm, 5 1/2"
TCF4-490	15.0 cm, 6"
TCF4-491	16.0 cm, 6 1/4"
TCF4-492	17.5 cm, 7"
TCF4-493	18.5 cm, 7 1/4"
TCF4-494	20.0 cm, 8"



Operating Scissors, S/S Cvd.
T/C Insert

TCF4-495	11.5 cm, 4 1/2"
TCF4-496	13.0 cm, 5"
TCF4-497	14.0 cm, 5 1/2"
TCF4-498	15.0 cm, 6"
TCF4-499	16.0 cm, 6 1/4"
TCF4-500	17.5 cm, 7"
TCF4-501	18.5 cm, 7 1/4"
TCF4-502	20.0 cm, 8"



Operating Scissors, B/B Str.
T/C Insert

TCF4-503	11.5 cm, 4 1/2"
TCF4-504	13.0 cm, 5"
TCF4-505	14.0 cm, 5 1/2"
TCF4-506	15.0 cm, 6"
TCF4-507	16.0 cm, 6 1/4"
TCF4-508	17.5 cm, 7"
TCF4-509	18.5 cm, 7 1/4"
TCF4-510	20.0 cm, 8"

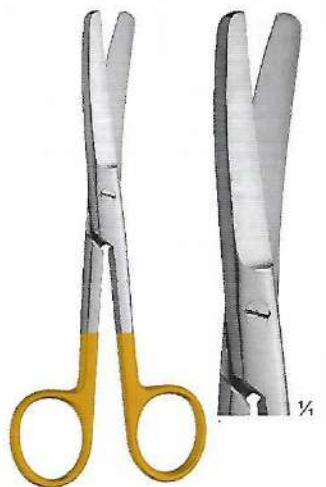

Operating Scissors, B/B Cvd.
T/C Insert

TCF4-511	11.5 cm, 4 1/2"
TCF4-512	13.0 cm, 5"
TCF4-513	14.0 cm, 5 1/2"
TCF4-514	15.0 cm, 6"
TCF4-515	16.0 cm, 6 1/4"
TCF4-516	17.5 cm, 7"
TCF4-517	18.5 cm, 7 1/4"
TCF4-518	20.0 cm, 8"



Operating Scissors, S/B
Standard Str. T/C Insert

TCF4-519	11.5 cm, 4 1/2"
TCF4-520	13.0 cm, 5"
TCF4-521	14.0 cm, 5 1/2"
TCF4-522	15.0 cm, 6"
TCF4-523	16.0 cm, 6 1/4"
TCF4-524	17.5 cm, 7"
TCF4-525	18.5 cm, 7 1/4"
TCF4-526	20.0 cm, 8"

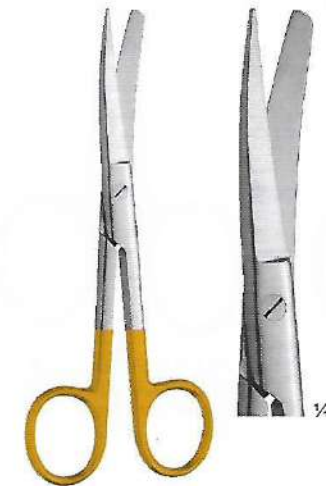

Operating Scissors, S/B
Standard Cvd. T/C Insert

TCF4-527	11.5 cm, 4 1/2"
TCF4-528	13.0 cm, 5"
TCF4-529	14.0 cm, 5 1/2"
TCF4-530	15.0 cm, 6"
TCF4-531	16.0 cm, 6 1/4"
TCF4-532	17.5 cm, 7"
TCF4-533	18.5 cm, 7 1/4"
TCF4-534	20.0 cm, 8"

OPERATING SCISSORS T.C.



Chirurgische scheren
Tijeras quirúrgicas

Ciseaux chirurgicaux
Forbici per chirurgia



Metzenbaum Operating Scissors T/C Insert



TCF4-535
11.5 cm 4 1/2"
TCF4-536
14.5 cm 5 3/4"
B/B Str.



TCF4-537
11.5 cm 4 1/2"
TCF4-538
14.5 cm 5 3/4"
S/B Str.



TCF4-539
11.5 cm 4 1/2"
TCF4-540
14.5 cm 5 3/4"
S/S Str.



Metzenbaum Operating Scissors T/C Insert



TCF4-541
11.5 cm 4 1/2"
TCF4-542
14.5 cm 5 3/4"
B/B Cvd.



TCF4-543
11.5 cm 4 1/2"
TCF4-544
14.5 cm 5 3/4"
S/B Cvd.



TCF4-545
11.5 cm 4 1/2"
TCF4-546
14.5 cm 5 3/4"
S/S Cvd.

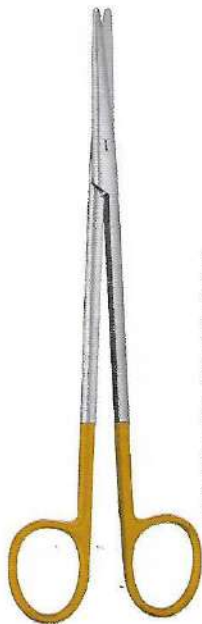

Metzenbaum-Nelson Operating Scissors T/C Insert



TCF4-547
18 cm 7"
TCF4-548
20 cm 8"
TCF4-549
23 cm 9"
TCF4-550
25 cm 10"
TCF4-551
28 cm 11"
TCF4-552
30 cm 12"
B/B Str.



TCF4-553
18 cm 7"
TCF4-554
20 cm 8"
TCF4-555
23 cm 9"
TCF4-556
25 cm 10"
TCF4-557
28 cm 11"
TCF4-558
30 cm 12"
S/B Str.



TCF4-559
18 cm 7"
TCF4-560
20 cm 8"
TCF4-561
23 cm 9"
TCF4-562
25 cm 10"
TCF4-563
28 cm 11"
TCF4-564
30 cm 12"
S/S Str.

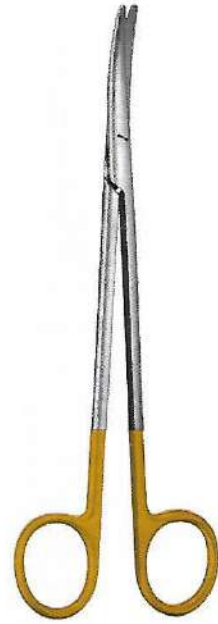

Metzenbaum-Nelson Operating Scissors T/C Insert



TCF4-565
18 cm 7"
TCF4-566
20 cm 8"
TCF4-567
23 cm 9"
TCF4-568
25 cm 10"
TCF4-569
28 cm 11"
TCF4-570
30 cm 12"
B/B Cvd.



TCF4-571
18 cm 7"
TCF4-572
20 cm 8"
TCF4-573
23 cm 9"
TCF4-574
25 cm 10"
TCF4-575
28 cm 11"
TCF4-576
30 cm 12"
S/B Cvd.



TCF4-577
18 cm 7"
TCF4-578
20 cm 8"
TCF4-579
23 cm 9"
TCF4-580
25 cm 10"
TCF4-581
28 cm 11"
TCF4-582
30 cm 12"
S/S Cvd.



OPERATING & GYNECOLOGICAL SCISSORS T.C

Betriebs- und Gynäkologische Scheren
Operación y tijeras ginecológicas

Exploitation & ciseaux gynécologiques
Forbici ginecologiche Operativo e



¼

TCF4-583 14.5 cm 5 3/4"
TCF4-584 18 cm 7"
TCF4-585 20 cm 8"
TCF4-586 23 cm 9"
B/B Str.

¼

TCF4-587 14.5 cm 5 3/4"
TCF4-588 18 cm 7"
TCF4-589 20 cm 8"
TCF4-590 23 cm 9"
B/B Cvd.

¼

TCF4-591 14.5 cm 5 3/4"
TCF4-592 18 cm 7"
TCF4-593 20 cm 8"
TCF4-594 23 cm 9"
S/S Str.

¼

TCF4-595 14.5 cm 5 3/4"
TCF4-596 18 cm 7"
TCF4-597 20 cm 8"
TCF4-598 23 cm 9"
S/S Cvd.

Metzenbaum-Fino
Operating Scissors
T/C Insert



Metzenbaum-Fino
Operating Scissors
T/C Insert



¼

TCF4-599 14.5 cm 5 3/4"
TCF4-600 15.0 cm 6"
TCF4-601 17.0 cm 6 3/4"
TCF4-602 23.0 cm 9"
B/B, Str.

¼

TCF4-603 14.5 cm 5 3/4"
TCF4-604 15.0 cm 6"
TCF4-605 17.0 cm 6 3/4"
TCF4-606 23.0 cm 9"
B/B, Cvd.

¼

TCF4-607 15.0 cm 6"
TCF4-608 17.0 cm 6 3/4"
TCF4-609 19.5 cm 7 3/4"
TCF4-610 21.0 cm 8 3/4"
B/B, Str.

¼

TCF4-611 15.0 cm 6"
TCF4-612 17.0 cm 6 3/4"
TCF4-613 19.5 cm 7 3/4"
TCF4-614 21.0 cm 8 3/4"
B/B, Cvd.

Mayo Dissecting &
Gynecological Scissors
T/C Insert



Mayo-stille Dissecting &
Gynecological Scissors
T/C Insert

OPERATING SCISSORS T.C.



Chirurgische scheren
Tijeras quirúrgicas

Ciseaux chirurgicaux
Forbici per chirurgia



ENT-DEAN SCISSORS
TCF4-615 17 cm, 6 3/4"
S/S Double Cvd.
Serrated



**KELLY OPERATING,
DISSECTING SCISSORS**

TCF4-616
16.0 cm, 6 1/4"
TCF4-617
18.0 cm, 7"
S/S Str.

TCF4-618
16.0 cm, 6 1/4"
TCF4-619
18.0 cm, 7"
S/S Cvd.



**Goldmann-Fox
Operating Scissors**
T/C Insert

TCF4-620
13 cm 5"
S/S Str.

TCF4-621
13 cm 5"
S/S Cvd.

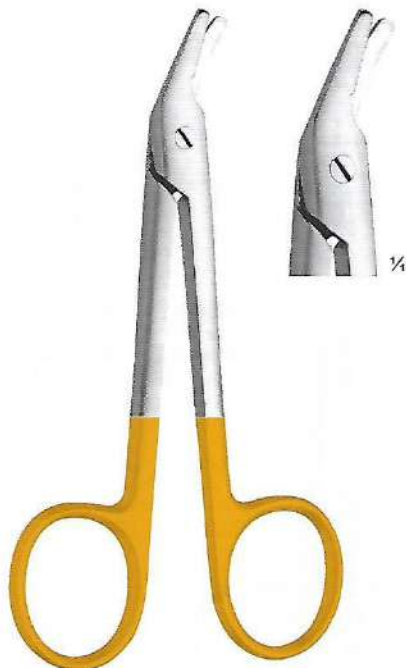

WIRE CUTTING SCISSORS
TCF4-622 12 cm, 4 3/4"



**Lister Bandage Plaster
Scissors T/C Insert, one large ring**
TCF4-623 8.9cm, 3 1/2"
TCF4-624 11.43 cm, 4.5"
TCF4-625 14 cm, 5 1/2"
TCF4-626 16 cm, 6 1/4"
TCF4-627 18 cm, 7"
TCF4-628 20 cm, 8"

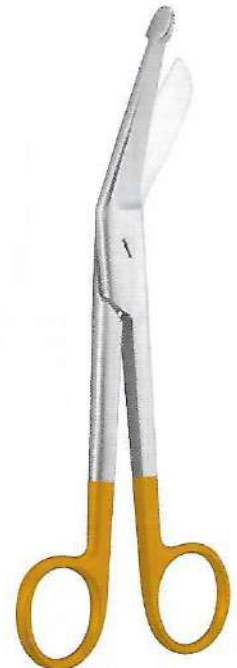

**Lister Bandage Plaster
Scissors, T/C Insert**
TCF4-629 8.9cm, 3 1/2"
TCF4-630 11.43 cm, 4.5"
TCF4-631 14 cm, 5 1/2"
TCF4-632 16 cm, 6 1/4"
TCF4-633 18 cm, 7"
TCF4-634 20 cm, 8"



OPERATING SCISSORS T.C.

Chirurgische scheren
Tijeras quirúrgicas

Ciseaux chirurgicaux
Forbici per chirurgia

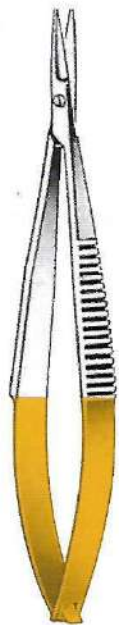

**Castroviejo Scissors
T/C Insert**



TCF4-635
14 cm, 5 1/2"
B/B Str.

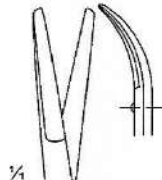

TCF4-636
14 cm, 5 1/2"
B/B Cvd.



TCF4-637
14 cm, 5 1/2"
S/B Str.

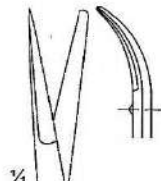

TCF4-638
14 cm, 5 1/2"
S/B Cvd.



TCF4-639
14 cm, 5 1/2"
S/S Str.

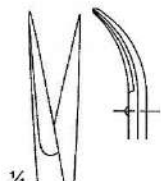

TCF4-640
14 cm, 5 1/2"
S/S Cvd.



**Joseph Operating
Scissors T/C Insert**



TCF4-641
14 cm 5 1/4"
S/S Str.



TCF4-642
14 cm 5 1/4"
S/S Cvd.



**Reynolds Operating
Scissors T/C Insert**



TCF4-643
16 cm 6 1/4"
TCF4-644
18 cm 7"
S/S Str.



TCF4-645
16 cm 6 1/4"
TCF4-646
18 cm 7"
S/S Cvd.



**Foman Operating
Scissors T/C Insert
TCF4-647**
13 cm 5" Full Bent



TCF4-648
10 cm 4"
TCF4-649
11 cm 4 1/4"
Str.



TCF4-650
10 cm 4"
TCF4-651
11 cm 4 1/4"
Cvd.



**Stevens Operating
Scissors T/C Insert**



DRESSING & TISSUE FORCEPS

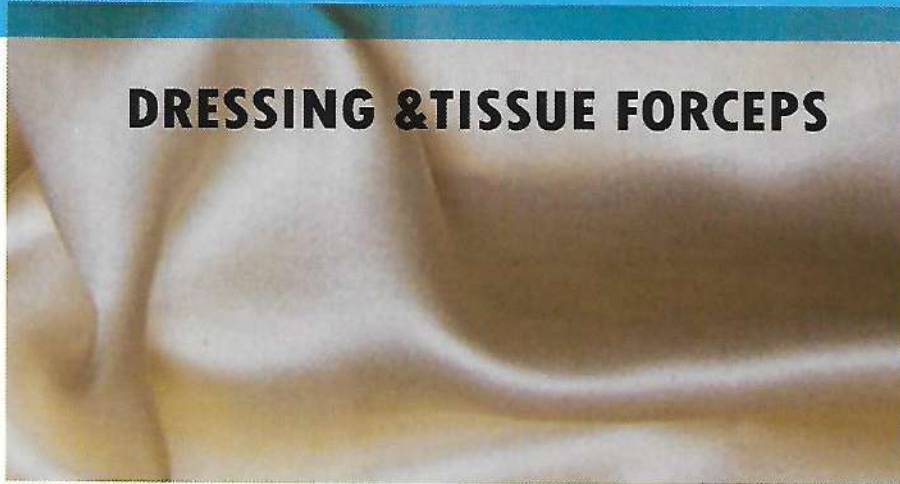



DRESSING FORCEPS, TISSUE FORCEPS

Anatomische pinzetten, chirurgische pinzetten

Pinces à dissection, pinces à griffes

Pinzas de disección, pinzas de disección condientes

Pinze Anatomiche per dissezion, pinze chirurgiche a dentiditopo

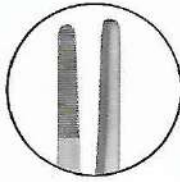

F5-001
10.5 cm, 4 1/4"
serrated



F5-002
11.5 cm, 4 1/2"
serrated



F5-003
13 cm, 5"
serrated



F5-004
14.5 cm, 5 3/4"
serrated



F5-005
16 cm 6 1/4"
serrated



F5-006
18 cm, 7"
serrated



F5-007
20 cm, 8"
serrated



F5-008
25 cm, 10"
serrated



F5-009
30 cm, 12"
serrated

**STANDARD
DRESSING
FORCEPS**



F5-010
10.5 cm, 4 1/4"



F5-011
11.5 cm, 4 1/2"



F5-012
13 cm, 5"



F5-013
14.5 cm, 5 3/4"



F5-014
16 cm 6 1/4"



F5-015
18 cm, 7"

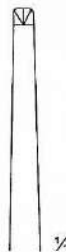

F5-016
20 cm, 8"



F5-017
25 cm, 10"



F5-018
30 cm, 12"

**STANDARD TISSUE
FORCEPS 1x2 teeth**

TISSUE & DRESSING FORCEPS



Pinzas para tejidos, Pincas à dissection
Pinze per tessuti, Pinze per dissezione

Pincas a tissu, Anatomische pinzetten
Gewebe, Pinzas de disección

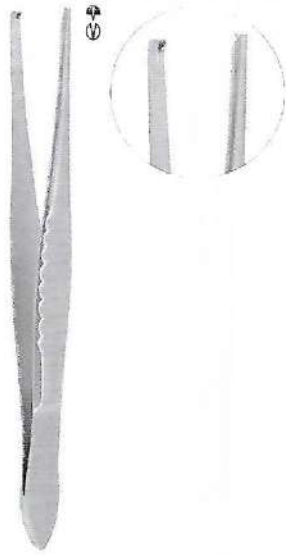

Mod. USA, Tissue Forceps
1x2 teeth

F5-019	10.2 cm, 4"
F5-020	11.4 cm, 4.5"
F5-021	12.7 cm, 5"
F5-022	14.0 cm, 5.5"
F5-023	15.2 cm, 6"
F5-024	17.8 cm, 7"
F5-025	20.3 cm, 8"
F5-026	25.4 cm, 10"
F5-027	30.5 cm, 12"

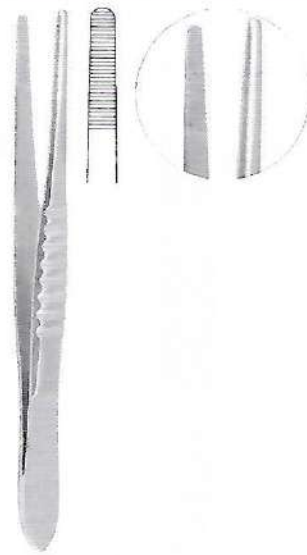

Mod. USA, Dressing Forceps serrated

F5-028	12 cm, 4 3/4"
F5-029	13 cm, 5"
F5-030	14.5 cm, 5 3/4"
F5-031	15.5 cm, 6"
F5-032	18 cm, 7"
F5-033	21 cm, 8 1/4"
F5-034	25 cm, 10"
F5-035	31 cm, 12 1/4"



MOD. MARTIN Dressing Forceps

F5-036	12.7 cm, 5"
F5-037	14.0 cm, 5.5"

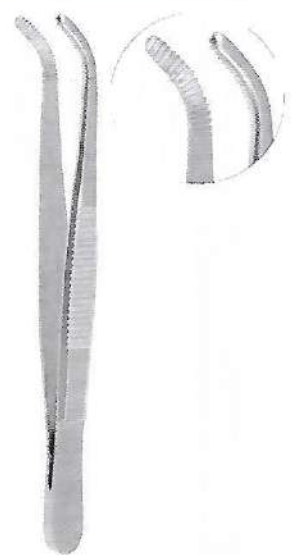

Standard Dressing Forceps

F5-038	11.4 cm, 4.5"
F5-039	12.7 cm, 5"
F5-040	14.0 cm, 5.5"
F5-041	15.2 cm, 6"
F5-042	17.8 cm, 7"
F5-043	20.3 cm, 8"
F5-044	25.4 cm, 10"
F5-045	30.5 cm, 12"

Curved, serrated

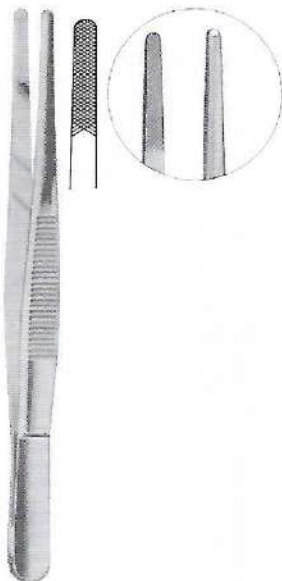

Standard Dressing Forceps wide pattern cross serration

F5-046	11.4 cm, 4.5"
F5-047	12.7 cm, 5"
F5-048	14.0 cm, 5.5"
F5-049	15.2 cm, 6"
F5-050	17.8 cm, 7"
F5-051	20.3 cm, 8"
F5-052	25.4 cm, 10"
F5-053	30.5 cm, 12"



Standard Dressing Forceps Narrow Point

F5-054	12.7 cm, 5" serrated
F5-055	14 cm, 5.5" serrated
F5-056	15.20 cm, 6" serrated
F5-057	17.8 cm, 7" serrated
F5-058	20.3 cm, 8" serrated
F5-059	25.4 cm, 10" serrated
F5-060	30.5 cm, 12" serrated

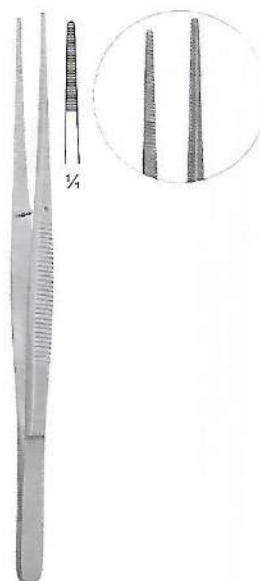

SEMKEN Dressing Forceps straight serrated

F5-061	12.5 cm, 5"
F5-062	15.5 cm, 6"

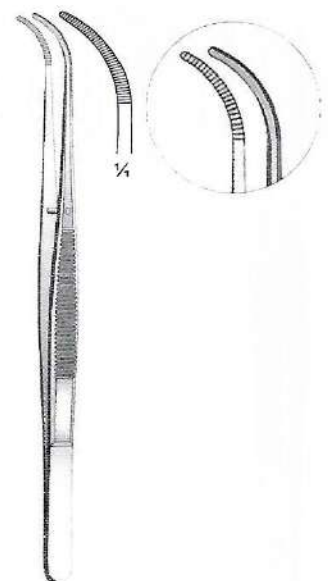

SEMKEN Dressing Forceps curved serrated

F5-063	12.5 cm, 5"
F5-064	15.5 cm, 6"



TISSUE & DRESSING FORCEPS

*Pinces a tissu, Anatomische pinzetten
Gewebe, Pinzas de disección*

*Pinzas para tejidos, Pinces à dissection
Pinze per tessuti, Pinze per dissezione*

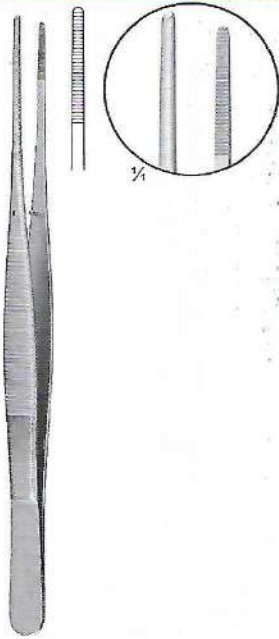

POTTS-SMITH Dressing Forceps
F5-065 17.5 cm, 7"
F5-066 21.0 cm, 8 1/4"
F5-067 25.0 cm, 10"
straight serrated



POTTS-SMITH Dressing Forceps
F5-068 17.5 cm, 7"
F5-069 21.0 cm, 8 1/4"
F5-070 25.0 cm, 10"
curved serrated



POTTS-SMITH Tissue Forceps 1x2 teeth
F5-071 17.5 cm, 7"
F5-072 21.0 cm, 8 1/4"
F5-073 25.0 cm, 10"
straight

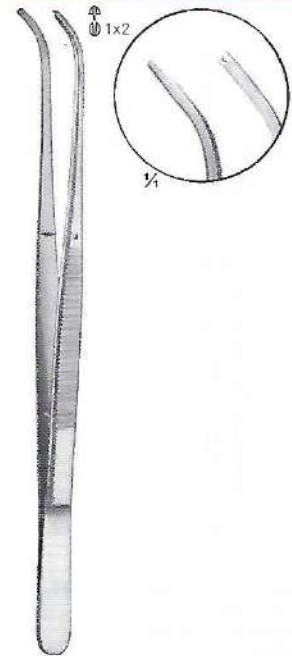

POTTS-SMITH Tissue Forceps 1x2 teeth
F5-074 17.5 cm, 7"
F5-075 21.0 cm, 8 1/4"
F5-076 25.0 cm, 10"
curved



Brophy Dressing Forceps
F5-077 20.0 cm, 8"
straight serrated

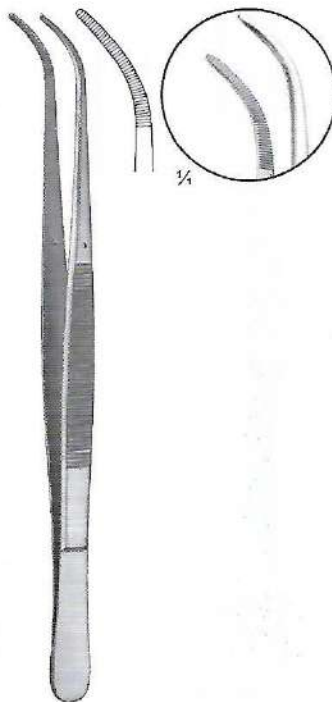

Brophy Dressing Forceps
F5-078 20.0 cm, 8"
curved serrated



Brophy Tissue Forceps 1x2 teeth
F5-079 20.0 cm, 8"
straight serrated

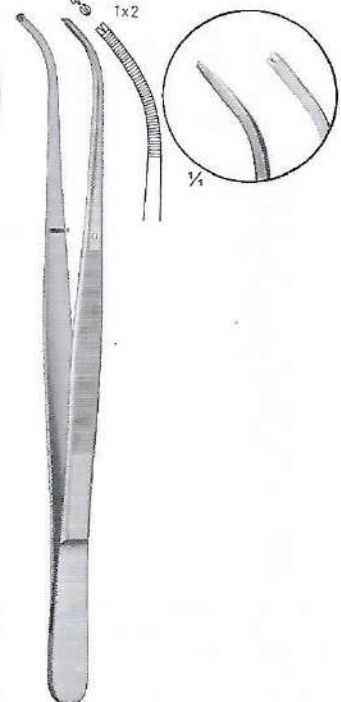

Brophy Tissue Forceps 1x2 teeth
F5-080 20.0 cm, 8"
curved serrated

TISSUE & DRESSING FORCEPS



Pinzas para tejidos, Pincas à dissection
Pinze per tessuti, Pinze per dissezione

Pincas a tissu, Anatomische pinzetten
Gewebe, Pinzas de disecion



WANGENSTEEN
Dressing Forceps
F5-081 23 cm, 9"



Bulldog Straight
F5-081A 4cm
F5-081B 5cm
F5-081C 6cm

Bulldog Curved
F5-081D 4cm
F5-081E 5cm
F5-081F 6cm



Bishop Forceps
F5-081G 8cm



Stone Tissue Forceps
4X5 Teeth
F5-082 15.2 cm, 6"



Lerche Tissue Forceps
5X6 Teeth
F5-083 15 cm, 6"



Adlerkreutz Tissue
Forceps 2X3 Teeth
F5-084 15 cm, 6"
F5-085 20 cm, 8"



Adlerkreutz Tissue
Forceps 4X5 Teeth
F5-086 15 cm, 6"
F5-087 20 cm, 8"



Gillies Tissue Forceps
1X2 Teeth
F5-088 15 cm, 6"
straight serrated



Gillies Tissue Forceps
1X2 Teeth
F5-089 15 cm, 6"
curved serrated



TISSUE & DRESSING FORCEPS

Pinzas para tejidos, Pinces à dissection
Pinze per tessuti, Pinze per dissezione

Pinces a tissu, Anatomische pinzetten
Gewebe, Pinzas de disección

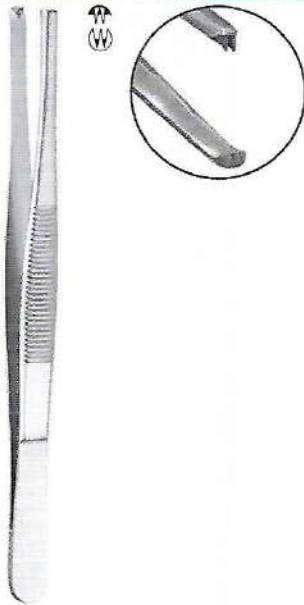

Tissue Forceps 2x3 Teeth
F5-090 11.4 cm 4 1/2"
F5-091 13.0 cm 5"
F5-092 14.5 cm 5 3/4"
F5-093 16.0 cm 6 1/4"
F5-094 17.5 cm 7"
F5-095 20.0 cm 8"
F5-096 25.0 cm 10"
F5-097 30.0 cm 12"

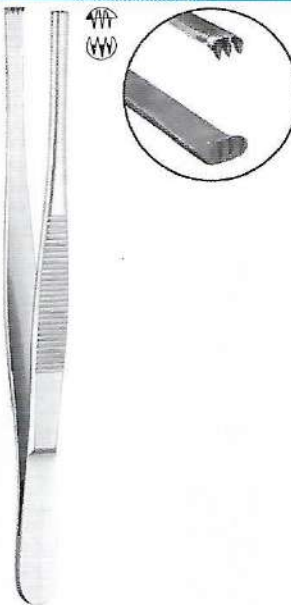

Tissue Forceps 3x4 Teeth
F5-098 11.4 cm 4 1/2"
F5-099 12.7 cm 5"
F5-100 14 cm 5 1/2"
F5-101 15.9 cm 6 1/4"
F5-102 17.8 cm 7"
F5-103 20.3 cm 8"
F5-104 25.4 cm 10"
F5-105 30.5 cm 12"

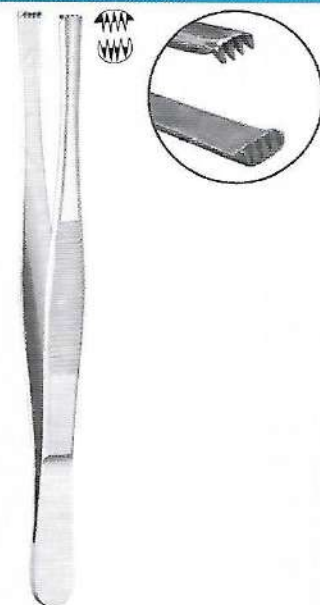

Tissue Forceps 4x5 Teeth
F5-106 11.4 cm 4 1/2"
F5-107 12.7 cm 5"
F5-108 14 cm 5 1/2"
F5-109 15.9 cm 6 1/4"
F5-110 17.8 cm 7"
F5-111 20.3 cm 8"
F5-112 25.4 cm 10"
F5-113 30.5 cm 12"



Iris Tissue Forceps
F5-114 10.2 cm, 4"
1x2 Teeth, Straight



Iris Tissue Forceps
F5-115 10.2 cm, 4"
1x2 Teeth, Half Curved



Iris Tissue Forceps
F5-116 10.2 cm, 4"
1x2 Teeth, Full Curved

TISSUE & DRESSING FORCEPS



Pinzas para tejidos, Pincas à dissection
Pinze per tessuti, Pinze per dissezione

Pincas a tissu, Anatomische pinzetten
Gewebe, Pinzas de disección



Waugh Dressing Forceps
F5-117 15.0 cm, 6"
F5-118 18.0 cm, 7"
slightly heavier
non-toothed,
serrated jaws.



Waugh Tissue Forceps
1x2 Teeth
F5-119 15.0 cm, 6"
F5-120 18.0 cm, 7"
as above but one two
tooth on serrated jaws.
Known as Scott.



Leedham Tissue Forceps
1x2 Teeth
F5-121 14.5 cm, 5.75"
F5-122 18.0 cm, 7"
Green Dissecting
Forceps two three
teeth, smooth jaws.

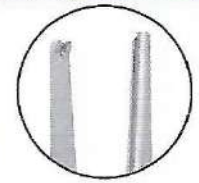

Treves Tissue Forceps
1x2 Teeth
F5-123 12.5 cm, 5"
F5-124 15.0 cm, 6"
F5-125 18.0 cm, 7"
Dissecting Forceps
teeth, on smooth jaws.



Charnley Tissue Forceps
1x2 Teeth
F5-126 14.5 cm, 5 3/4"
F5-127 18.0 cm, 7"
Dissecting Forceps
one into two teeth,
block on jaws.



Ramsay Dissecting Forceps
F5-128 18.0 cm, 7"
serrated jaws.



Ramsay Tissue Forceps
1x2 Teeth
F5-129 18.0 cm, 7"
Dissecting Forceps
one into teeth on
serrated jaws.



**Dissecting Dressing
Forceps**
F5-130 12.5 cm, 5"
F5-131 15.0 cm, 6"
F5-132 18.0 cm, 7"
turn over end,
serrated jaws.



**Dissecting Dressing
Forceps**
F5-133 12.5 cm, 5"
F5-134 15.0 cm, 6"
F5-135 18.0 cm, 7"
F5-136 20.0 cm, 8"
block end, serrated
jaws.



TISSUE & DRESSING FORCEPS

*Pinces a tissu, Anatomische pinzetten
Gewebe, Pinzas de disección*

*Pinzas para tejidos, Pinces à dissection
Pinze per tessuti, Pinze per dissezione*



Ferris-Smith Tissue Forceps 1x2 Teeth
F5-137
18 cm, 7"

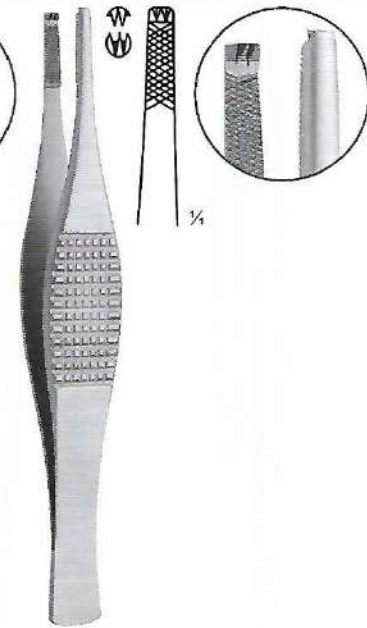

Ferris-Smith Tissue Forceps 2x3 Teeth
F5-138
18 cm, 7"

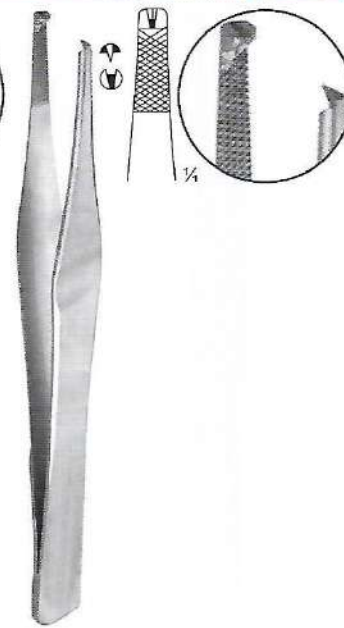

Lane Tissue Forceps 1x2 Teeth
F5-139 12.5cm, 5 1/2"
F5-140 15 cm, 6"
F5-141 17 cm, 6 3/4"
F5-142 18 cm, 7"
F5-143 20 cm, 8"



Lane Tissue Forceps 2x3 Teeth
F5-144 12.5cm, 5 1/2"
F5-145 15 cm, 6"
F5-146 17 cm, 6 3/4"
F5-147 18 cm, 7"
F5-148 20 cm, 8"

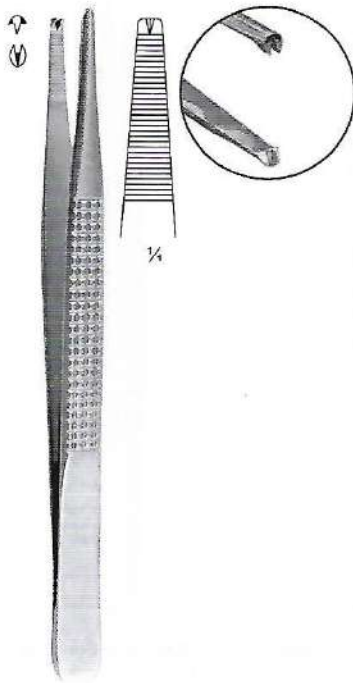

Bonney Tissue Forceps 1x2 Teeth
F5-149
18 cm, 7"

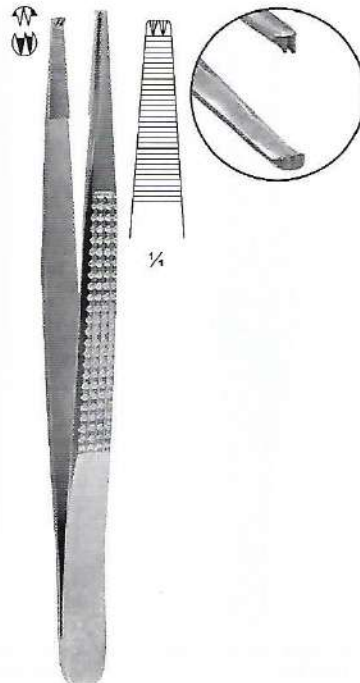

Bonney Tissue Forceps 2x3 Teeth
F5-150
18 cm, 7"



Durante Tissue Grasping Forceps
F5-151 14.5cm, 5 3/4"
F5-152 16 cm, 6 1/4"
F5-153 20 cm, 8"

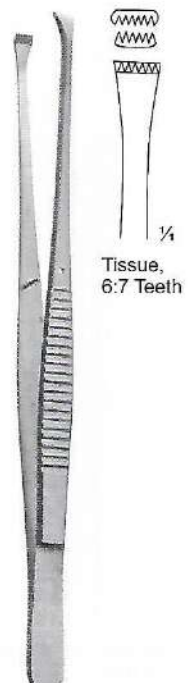

Nelson Tissue Forceps
F5-154 23 cm, 9"
6x7 Teeth

TISSUE & DRESSING FORCEPS



Pinzas para tejidos, Pincas à dissection
Pinze per tessuti, Pinze per dissezione

Pincas a tissu, Anatomische pinzetten
Gewebe, Pinzas de disección

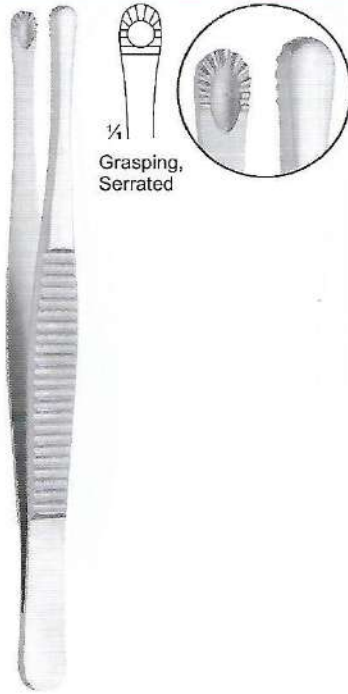

Grasping,
Serrated

**Russian-Modell
Tissue Forceps**
F5-155 15 cm, 6"
F5-156 20 cm, 8"
F5-157 25 cm, 10"



**Singley-Tuttle
Forceps**
F5-158
23 cm, 9"



**Collin-Duval
Forceps**

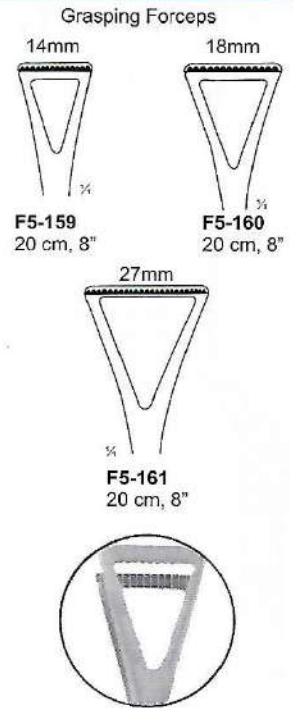

Grasping Forceps

14mm
F5-159
20 cm, 8"

18mm
F5-160
20 cm, 8"

27mm
F5-161
20 cm, 8"



**Stille-Barraya Tissue
Forceps 3x4 Teeth**
F5-162 18 cm, 7"
F5-163 20 cm, 8"
F5-164 25 cm, 10"



**Duehrssen Dressing
Forceps**
F5-165 20 cm, 8"
Serrated



**Duehrssen Tissue
Forceps 1x2 Teeth**
F5-166
20 cm, 8"



**Duehrssen Tissue
Forceps 2x3 Teeth**
F5-167
20 cm, 8"



TISSUE & DRESSING FORCEPS

Pinzas para tejidos, Pinces à dissection
Pinze per tessuti, Pinze per dissezione

Pinces a tissu, Anatomische pinzetten
Gewebe, Pinzas de disección

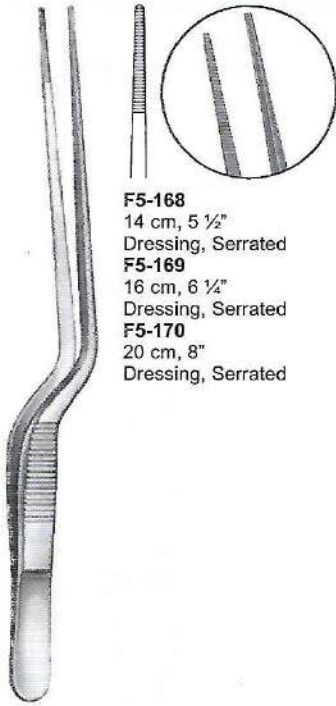

F5-168
 14 cm, 5 1/2"
 Dressing, Serrated
F5-169
 16 cm, 6 1/4"
 Dressing, Serrated
F5-170
 20 cm, 8"
 Dressing, Serrated

LUCAE / ENT
 Dressing Forceps



Paper Dressing
Forceps
F5-171 15 cm, 6"



Paper Dressing
Forceps
F5-172 15 cm, 6"



Paper Dressing
Forceps
F5-173 15 cm, 6"
 Curved

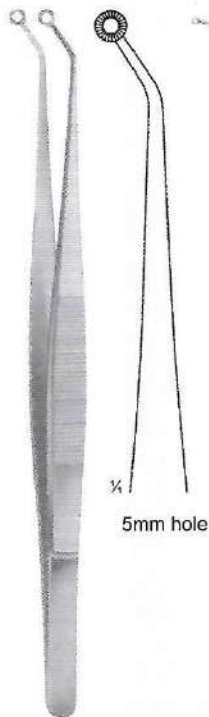

Hunt Tumor and
Vessel Forceps
F5-174
 20 cm, 8"



Samii Forceps
 Spoon-Shaped Jaws Left
F5-175
 24 cm, 9 1/2"
 3mm hole

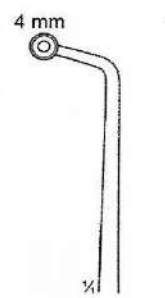

F5-176
 24 cm, 9 1/2"
 4mm hole

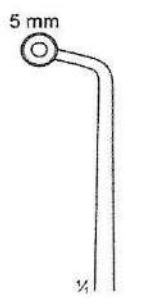

F5-177
 24 cm, 9 1/2"
 5mm hole



Samii Forceps
 Spoon-Shaped Jaws Right
F5-178
 24 cm, 9 1/2"
 3mm hole

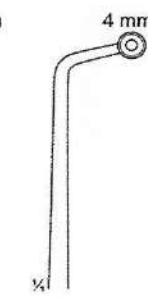

F5-179
 24 cm, 9 1/2"
 4mm hole

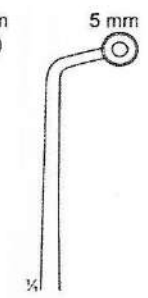

F5-180
 24 cm, 9 1/2"
 5mm hole

TISSUE & DRESSING FORCEPS



Pinces a tissu, Anatomische pinzetten
Gewebe, Pinzas de disección

Pinzas para tejidos, Pinces à dissection
Pinze per tessuti, Pinze per dissezione



F5-181 regular point straight
F5-182 fine point straight
F5-183 micro point straight
12 cm, 4 3/4" 1x2 Teeth



F5-187 regular point curved
F5-188 fine point curved
F5-189 micro point curved
12 cm, 4 3/4" 1x2 Teeth



F5-184 regular point with platform straight
F5-185 fine point with platform straight
F5-186 micro point with platform straight
12 cm, 4 3/4" 1x2 Teeth



F5-190 regular point straight
F5-191 fine point straight
F5-192 micro point straight
12 cm, 4 3/4" 1x2 Teeth



F5-193 regular point, straight
F5-194 fine point, straight
Forceps, 12cm 4 3/4"
9x9 teeth

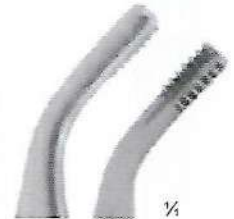

F5-195 regular point, Curved
F5-196 fine point, Curved
Forceps, 12cm 4 3/4"
9x9 teeth

Adson Tissue Forceps
Cuter Print

Adson Brown Tissue



F5-197 regular point straight
F5-198 fine point straight
F5-199 micro point straight
12 cm, 4 3/4" 1x2 Teeth



F5-203 regular point curved
F5-204 fine point curved
F5-205 micro point curved
12 cm, 4 3/4" 1x2 Teeth



F5-200 regular point with platform straight
F5-201 fine point with platform straight
F5-202 micro point with platform straight
12 cm, 4 3/4" 1x2 Teeth



F5-206 regular point curved
F5-207 fine point curved
F5-208 micro point curved
12 cm, 4 3/4" 1x2 Teeth



F5-209 regular point, straight
F5-210 fine point, straight
12cm 4 3/4"
7x7 teeth



F5-211 regular point, Curved
F5-212 fine point, Curved
12cm 4 3/4"
7x7 teeth

Adson Tissue Forceps
with fenestrated handle

Adson Brown Tissue Forceps
Fenestrated Handle



TISSUE & DRESSING FORCEPS

Pinces a tissu, Anatomische pinzetten
Gewebe, Pinzas de disección

Pinzas para tejidos, Pinces à dissection
Pinze per tessuti, Pinze per dissezione

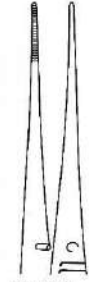

F5-213
7.0 cm, 2 3/4"
F5-214
10.0 cm, 4"
straight
serrated

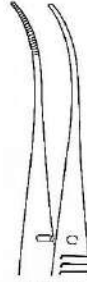

F5-215
7.0 cm, 2 3/4"
F5-216
10.0 cm, 4"
half curved
serrated

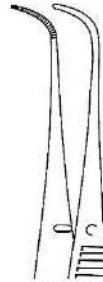

F5-217
7.0 cm, 2 3/4"
F5-218
10.0 cm, 4"
full curved
serrated



F5-225
11.0 cm, 4 1/2"
straight



F5-226
11.0 cm, 4 1/2"
Curved



Graefe Forceps

F5-219 1x2 teeth
7.0 cm, 2 3/4"
F5-220 1x2 teeth
10.0 cm, 4"
straight

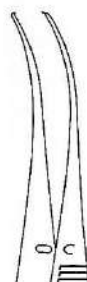

F5-221 1x2 teeth
7.0 cm, 2 3/4"
F5-222 1x2 teeth
10.0 cm, 4"
half curved

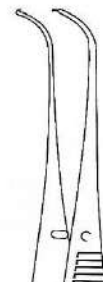

F5-223 1x2 teeth
7.0 cm, 2 3/4"
F5-224 1x2 teeth
10.0 cm, 4"
full curved

Stevens Tissue Forceps
1x2 Teeth

Stevens Tissue Forceps
1x2 Teeth



Graefe Dressing Forceps
F5-227 0.5 mm
F5-228 0.7 mm
F5-229 1.0 mm
7.0 cm, 3"
straight serrated



Graefe Dressing Forceps
F5-230 0.5 mm
F5-231 0.7 mm
F5-232 1.0 mm
7.0 cm, 3"
curved serrated



Graefe Tissue Forceps
1x2 Teeth
F5-233 0.5 mm
F5-234 0.7 mm
F5-235 1.0 mm
7.0 cm, 3"
straight



Graefe Tissue Forceps
1x2 Teeth
F5-236 0.5 mm
F5-237 0.7 mm
F5-238 1.0 mm
7.0 cm, 3"
curved



Graefe Fixation Forceps
F5-239
11.2 cm 4 3/8"
standard jaws 4.5mm wide
with fine teeth

JEWELER TYPE, DISSECTING FORCEPS



Chirurgische pinzetten, Uhrmacher-Pinzetten

Pinces à dissection à grosses, Pinces d'horloger

Pinzas de disección con dientes, Pinzas de relojero

Pinze per dissezione con denti, Pinze de orologiaio



Dumont Forceps
F5-240 11.5 cm, 4 1/2"
curved



1/4
F5-241
10.5 cm, 4"
full curved



F5-242
10.5 cm, 4"
half curved



F5-243
11 cm, 4 1/2"



F5-244
11 cm, 4 1/2"
fine point



1/4
F5-245
11 cm, 4 1/2"
extra fine point



F5-246
12 cm, 5"
fine point



F5-247
12 cm, 5"
extra fine point



F5-248
12 cm, 5"



Dumont Forceps
F5-249
style 1, fine point,
12.1 cm 4 3/4"



Dumont Forceps
F5-250
style 2, strong
fine point,
12.1 cm 4 3/4"



Dumont Forceps
F5-251
style 3, narrow
fine point,
12.1 cm 4 3/4"



Dumont Forceps
F5-252
style 3C, narrow
fine point,
11.2 cm 4 3/8"



JEWELER TYPE, DISSECTING FORCEPS

Chirurgische pinzetten, Uhrmacher-Pinzetten

Pinzas de disección con dientes, Pinzas de relojero

Pinces à dissection à grosses, Pinces d'horloger

Pinze per dissezione con denti, Pinze de orologiaio



**Dumont Forceps
F5-253**
style 4, fine point,
11.2cm 4 3/8"



**Dumont Forceps
F5-254**
style 5, super fine
11.2cm point, 4 3/8"



**Dumont Forceps
F5-255**
style 5, micro fine
11.2cm point, 4 3/8"



**Dumont Forceps
F5-256**
style 6, pick up,
11.4 cm 4 1/2"



**Dumont Forceps
F5-257**
style 7, fine curved,
11.4 cm 4 1/2"



**Dumont Forceps
F5-258**
style 7, micro fine
11.4 cm curved, 4 1/2"

CILIA FORCEPS



Cilienpinzetten
Pinzas depilatorias

Pinces à épiler les cils
Pinze depilatoria



Ziegler Cilia Forceps
F5-259
9 cm, 3 1/2"



Douglas Cilia Forceps
F5-260
9 cm, 3 1/2"



Beer Cilia Forceps
F5-261
9 cm, 3 1/2"



Gradle Cilia Forceps
F5-262
10.5cm, 4"



Kuehne Cilia Forceps
F5-263
10.5cm, 4"



Kuehne Cilia Forceps
F5-264
10.5cm, 4"
angled sideways



Barraquer Cilia Forceps
F5-265
10.5cm, 4"



Littauer Cilia Forceps
F5-266
8.5 cm, 3"



Littauer Cilia Forceps
F5-267
9 cm, 3 1/2"



SPLINTER FORCEPS

Splitterpinzetten
Pinzas Para espinas

Pinces à échardes
Pinze per scheggie



Splinter Forceps
F5-268 8 cm, 3"
F5-269 9 cm, 3 1/2"
F5-270 10.5 cm, 4"
F5-271 11.5 cm, 4 1/2"
F5-272 12.5 cm, 5"
F5-273 14.5 cm, 5 1/2"
Straight Plain



Splinter Forceps
F5-274 8 cm, 3"
F5-275 9 cm, 3 1/2"
F5-276 10.5 cm, 4"
F5-277 11.5 cm, 4 1/2"
F5-278 12.5 cm, 5"
F5-279 14.5 cm, 5 1/2"
Curved Plain



Splinter Forceps
F5-280 8 cm, 3"
F5-281 9 cm, 3 1/2"
F5-282 10.5 cm, 4"
F5-283 11.5 cm, 4 1/2"
F5-284 12.5 cm, 5"
F5-285 14.5 cm, 5 1/2"
Straight serrated

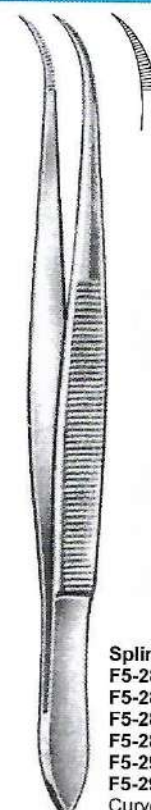

Splinter Forceps
F5-286 8 cm, 3"
F5-287 9 cm, 3 1/2"
F5-288 10.5 cm, 4"
F5-289 11.5 cm, 4 1/2"
F5-290 12.5 cm, 5"
F5-291 14.5 cm, 5 1/2"
Curved serrated



F5-292
7.5 cm, 3"
F5-293
9 cm, 3 1/2"
F5-294
11 cm, 4"
Straight



F5-295
10.5 cm, 4"
Straight



F5-296
10.5 cm, 4"
Curved



F5-297
10.5 cm, 4"
Straight



F5-298
10.5 cm, 4"
Curved

Feilchenfeld Forceps

Hunter Forceps

Hunter Forceps

Carmalt Forceps

Carmalt Forceps

SPLINTER FORCEPS



Splinterpinzetten
Pinzas Para espinas

Pinces à échardes
Pinze per scheggie



Splinter Forceps
F5-299 8.0 cm, 3"
F5-300 9.0 cm, 3 1/2"
F5-301 10.5 cm, 4"
F5-302 11.5 cm, 4 1/2"
F5-303 12.5 cm 5"
F5-304 14.5 cm 5 1/2"
Straight serrated with
guide pin



Splinter Forceps
F5-305 8.0 cm, 3"
F5-306 9.0 cm, 3 1/2"
F5-307 10.5 cm, 4"
F5-308 11.5 cm, 4 1/2"
F5-309 12.5 cm 5"
F5-310 14.5 cm 5 1/2"
Curved serrated with
guide pin



Splinter Forceps
F5-311 8.0 cm, 3"
F5-312 9.0 cm, 3 1/2"
F5-313 10.5 cm, 4"
F5-314 11.5 cm, 4 1/2"
F5-315 12.5 cm 5"
F5-316 14.5 cm 5 1/2"
Straight plain with
guide pin



Splinter Forceps
F5-317 8.0 cm, 3"
F5-318 9.0 cm, 3 1/2"
F5-319 10.5 cm, 4"
F5-320 11.5 cm, 4 1/2"
F5-321 12.5 cm 5"
F5-322 14.5 cm 5 1/2"
Curved plain with
guide pin



**Stieglitz Forceps
with Magnifying
Mirrors**
F5-323
12.5 cm, 5"

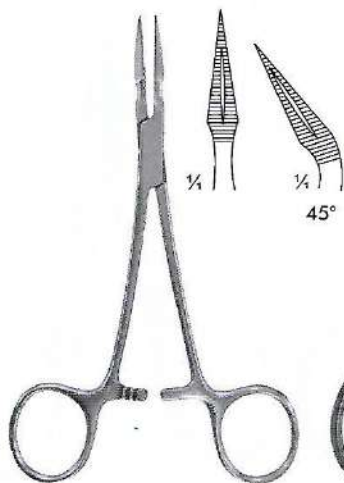

Stieglitz Splinter Forceps
F5-324 14 cm, 5 1/2" Str.
F5-325 14 cm, 5 1/2" 45° Angled



Stieglitz Splinter Forceps
F5-326
14 cm, 5 1/4" 90° Angled



Peet Splinter Forceps
F5-327
11.5 cm, 4 1/2"

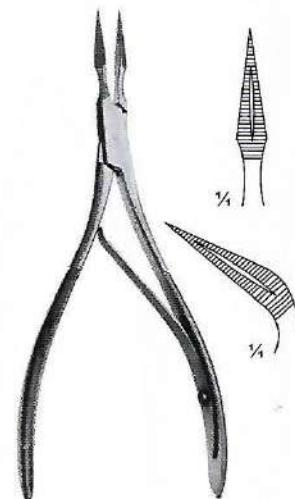

Ralk Splinter Forceps
F5-328 15 cm, 6" Str.
F5-329 15 cm, 6" Cvd.



GENERAL INSTRUMENTS

Allgemeines Instrumentarium
Instrumental general

Instrumentation générale
Strumentario generale



Ochsner Forceps
F5-330
14 cm, 5 1/2"



Lange Tissue Forceps
F5-331
10 cm, 4"

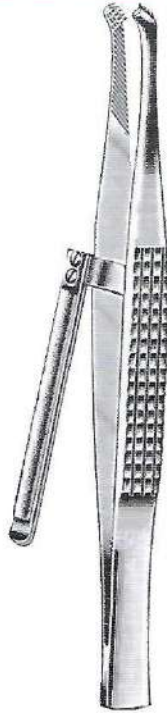

Childe Tissue Forceps
F5-332
18 cm, 7"



Michel Tissue Forceps
F5-333
12 cm, 4 3/4"



Wachenfeldt Tissue Forceps
F5-334
12.5 cm, 5"



HEGENBARTH Tissue Forceps
F5-335
12.5 cm, 5"



Wachenfeldt Tissue Forceps
F5-336
12.5 cm, 5"



Michel Forceps
F5-337
12 cm, 4 3/4"



Michel Clips
F5-338
sizes: 11mm x 3mm
& 18mm x 3mm.



Mod. Michel Forceps
F5-339
12 cm, 4 3/4"

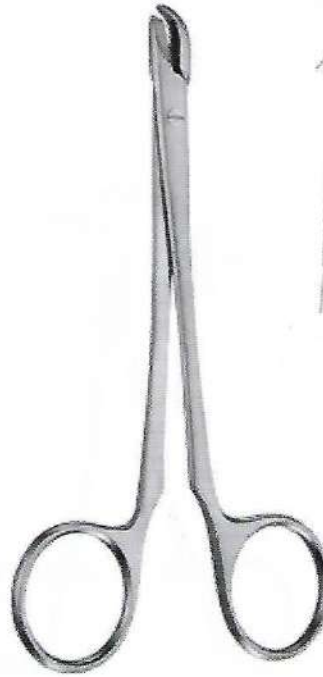

Collin Forceps
F5-340
13 cm, 5"

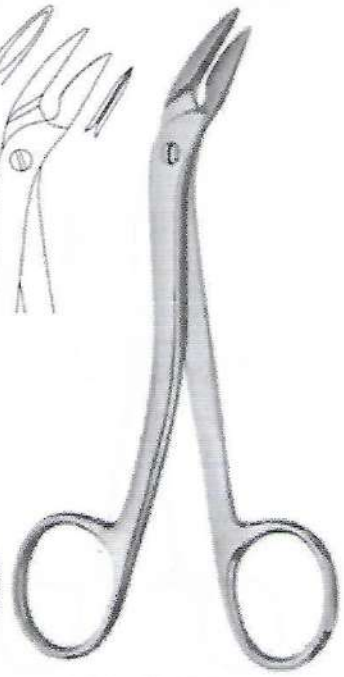

Richter-Heath Forceps
F5-341
14 cm, 5 1/2"

TISSUE & DRESSING FORCEPS T.C



Pinces a tissu, Anatomische pinzetten
Gewebe, Pinzas de disección

Pinzas para tejidos, Pinces à dissection
Pinze per tessuti, Pinze per dissezione

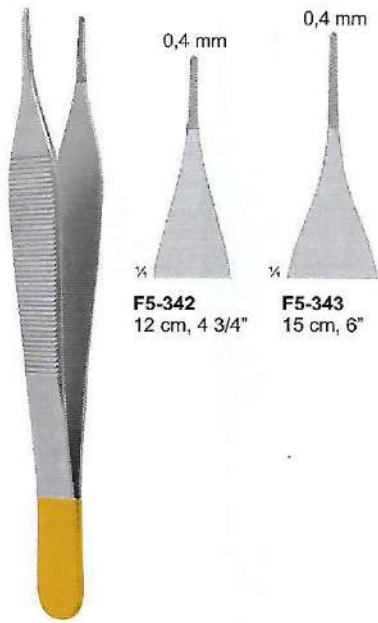

Micro Adson

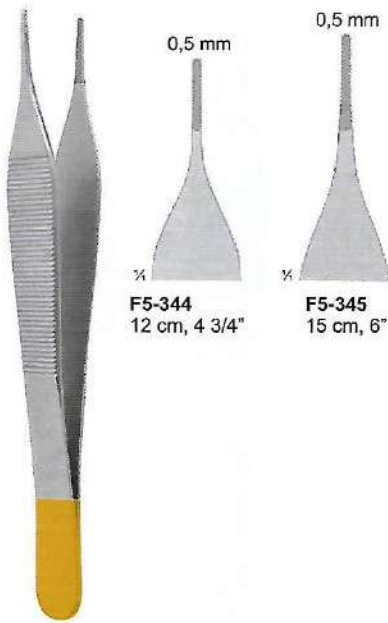

Adson



Adson

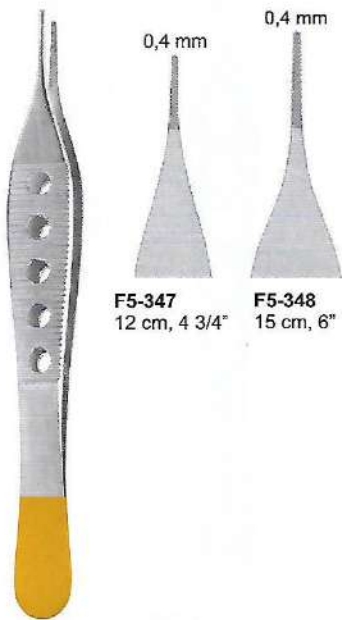

**Micro Adson
Light Weight**

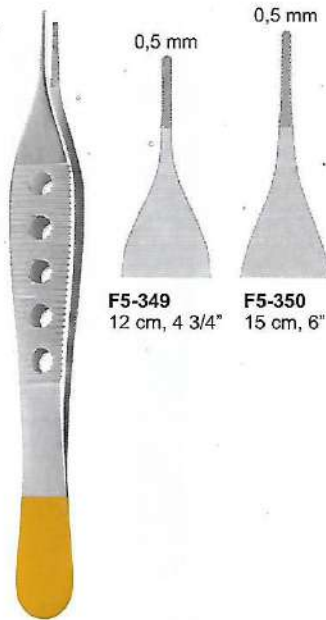

**Adson
Light Weight**



**Adson
Light Weight**



TISSUE & DRESSING FORCEPS T.C

*Pincas a tissu, Anatomische pinzetten
Gewebe, Pinzas de disección*

*Pinzas para tejidos, Pincas à dissection
Pinze per tessuti, Pinze per dissezione*

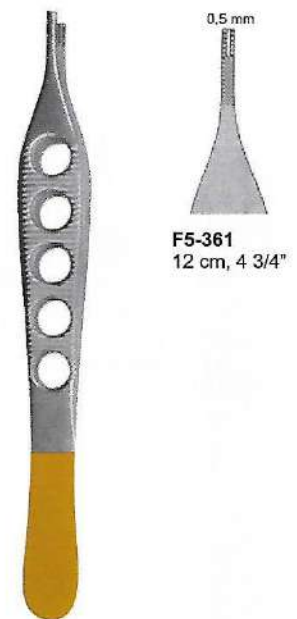
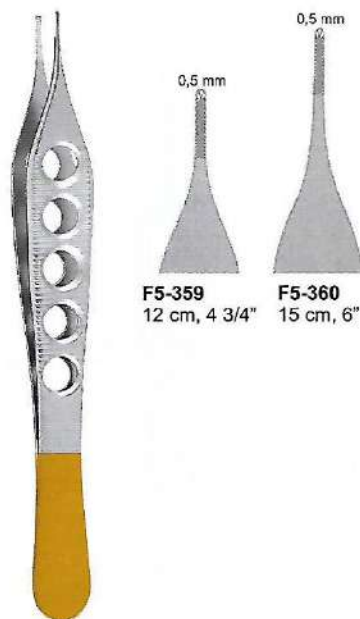
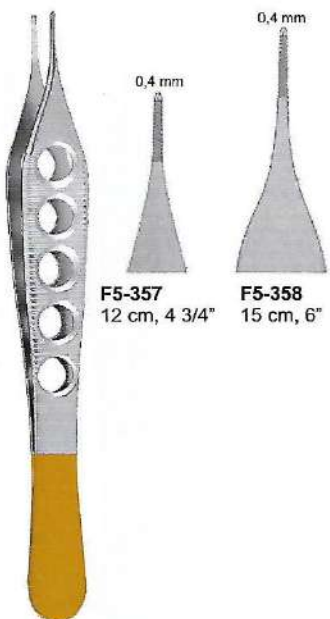
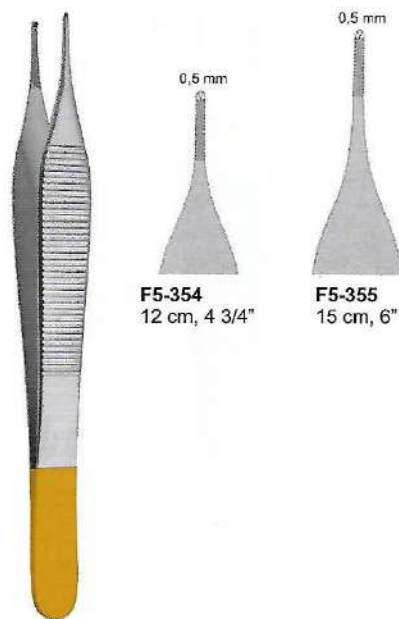
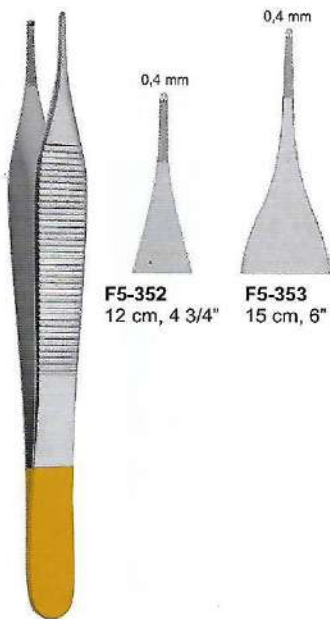

TISSUE & DRESSING FORCEPS T.C



Pinces a tissu, Anatomische pinzetten
Gewebe, Pinzas de disección

Pinzas para tejidos, Pinces à dissection
Pinze per tessuti, Pinze per dissezione

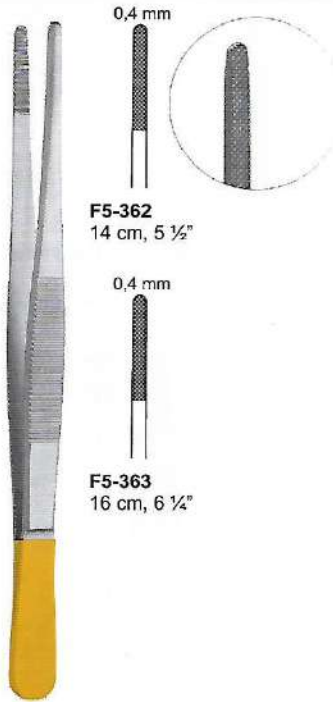

T.C Standard Dressing Forceps



T.C Cushing Tissue Forceps
F5-364 17.8 cm, 7"



T.C Cushing Dressing Forceps
F5-365
18 cm, 7" Cross Serrated



T.C Cushing Dressing Forceps
F5-366 18 cm, 7"



T.C Dissecting Tissue Forceps
F5-367 18 cm, 7"



T.C Resano Dressing Forceps
F5-368
25 cm, 10"

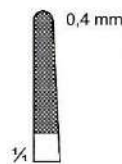

T.C Cushing Dressing Forceps
F5-369
19 cm, 7 1/2"

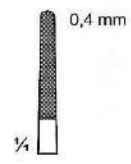



TISSUE & DRESSING FORCEPS T.C

Pincas a tissu, Anatomische pinzetten
Gewebe, Pinzas de disección

Pinzas para tejidos, Pincas à dissection
Pinze per tessuti, Pinze per dissezione

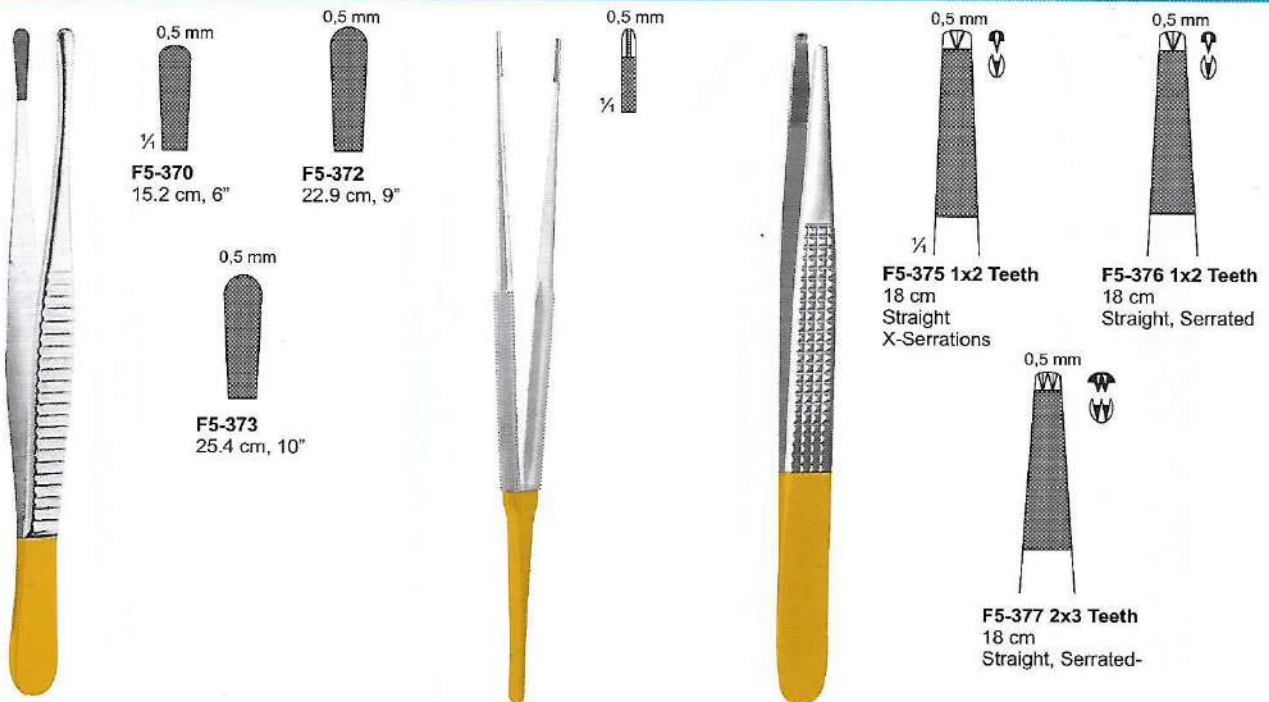

Wangenstein Dressing Forceps T.C.

T.C DeBakey Micro Needle Tissue Forceps F5-374
 18.4 cm, 7"

T.C Bonney Dissecting & Tissue Forceps



T.C POTTS-SMITH Dressing Forceps
 F5-378 15 cm, 6"
 F5-379 18 cm, 7"
 F5-380 20 cm, 8"
 F5-381 23 cm, 9"
 F5-382 25 cm, 10"



T.C POTTS-SMITH Dressing Forceps
 F5-383 16 cm, 6 1/2"
 F5-384 18 cm, 7"
 F5-385 21 cm, 8 1/2"
 F5-386 24 cm, 9 1/2"
 F5-387 26 cm, 10 1/2"



T.C Evans Pelvic Needle Dressing Forceps F5-388
 25.4 cm, 10"



T.C Evans Dressing Forceps F5-389
 25 cm, 10"

DRESSING FORCEPS T.C.



Anatomische pinzetten
Pinzas de disección

Pinces à dissection
Pinze per dissezione



T.C. Mc Indoe Dressing Forceps
F5-390
15.0 cm 6"



T.C. De Bakay Dressing Forceps
F5-391 15.0 cm 6"
F5-392 19.0 cm 7 1/2"
F5-393 24.0 cm 9 1/2"



T.C. Gillies Tissue Forceps
F5-394
15.0 cm 6"



SEMKEN
with dissector end

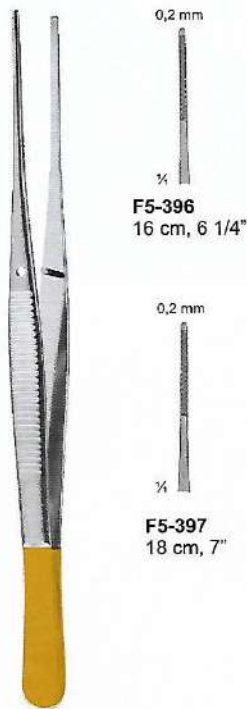

SEMKEN
1x2 teeth



T.C. Oehler Tissue Forceps

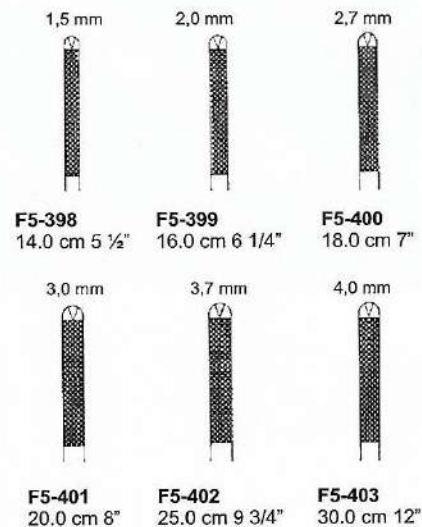



HAEMOSTATIC FORCEPS



HAEMOSTATIC FORCEPS



Arterienklemmen
Pincas Hemostatiques

Pinzas Hemostaticas
Pinze Emostatiche



F6-001
11.3 cm, 4 1/2"
straight, serrated



F6-002
11.3 cm, 4 1/2",
curved, serrated



F6-003
11.3 cm, 4 1/2", straight
Haemostatic tissue
(rat tooth 1x2 teeth)



F6-004
11.3 cm, 4 1/2", curved
Haemostatic tissue
(rat tooth 1x2 teeth)



Mosquito Haemostatic Forceps



F6-005 12.5 cm, 5"
F6-006 20 cm, 8"
straight



F6-007 12.5 cm, 5"
F6-008 20 cm, 8"
curved



F6-009 12.5 cm, 5"
F6-010 20 cm, 8"
straight Left Handed



F6-011 12.5 cm, 5"
F6-012 20 cm, 8"
curved Left Handed

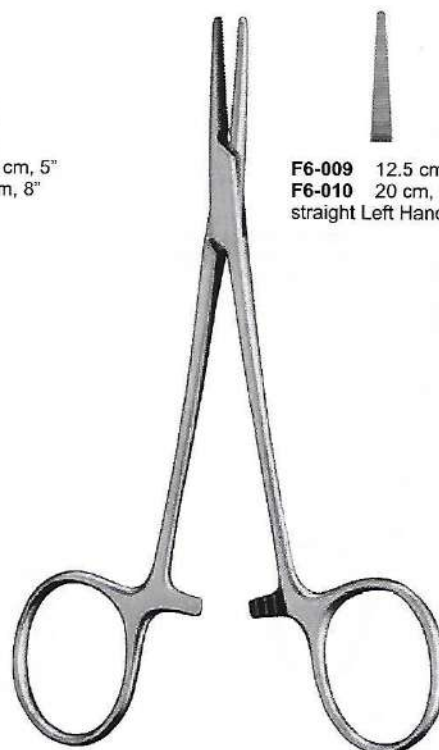

Halsted-Mosquito
Haemostatic Forceps

Halsted-Mosquito
Haemostatic Forceps



HAEMOSTATIC FORCEPS

Arterienklemmen
Pincas Hemostatiques

Pinzas Hemostaticas
Pinze Emostatiche



Kelly Haemostatic Forceps



F6-013
14.0 cm, 5 1/2"
straight



F6-014
14.0 cm, 5 1/2"
curved



F6-015
Kelly Haemostatic Fine
point Forceps 14.0 cm
5 1/2", straight



F6-016
Kelly Haemostatic Fine
point Forceps 14.0 cm
5 1/2", curved



Dandy Haemostatic Forceps
F6-017 14.0 cm, 5 1/2"
Curved sideways

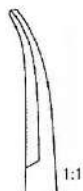

**Dandy Haemostatic
Fine point Forceps**
F6-018 14.0 cm, 5 1/2"
Curved sideways



**Dandy Haemostatic
Tissue Forceps**
F6-019 14.0 cm, 5 1/2"
(rat tooth 1x2 teeth)
Curved sideways



**Dandy Haemostatic Fine
point Tissue Forceps**
F6-020 14.0 cm, 5 1/2"
(rat tooth 1x2 teeth)
Curved sideways

HAEMOSTATIC FORCEPS



Arterienklemmen
Pincas Hemostaticas

Pinzas Hemostaticas
Pinze Emostatiche

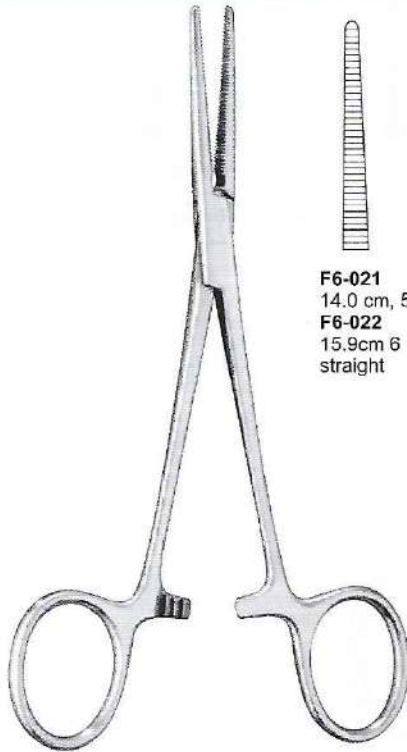

Crile Haemostatic Forceps



F6-021
14.0 cm, 5 1/2"
F6-022
15.9cm 6 1/4"
straight



F6-023
14.0 cm, 5 1/2"
F6-024
15.9cm 6 1/4"
curved

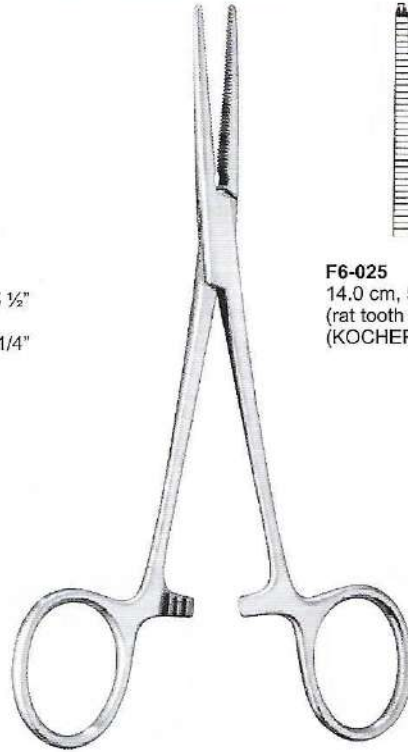

Crile Haemostatic Tissue Forceps



F6-025
14.0 cm, 5 1/2"
(rat tooth 1x2 teeth)
(KOCHER) straight



F6-026
14.0 cm, 5 1/2"
(rat tooth 1x2 teeth)
(KOCHER) curved

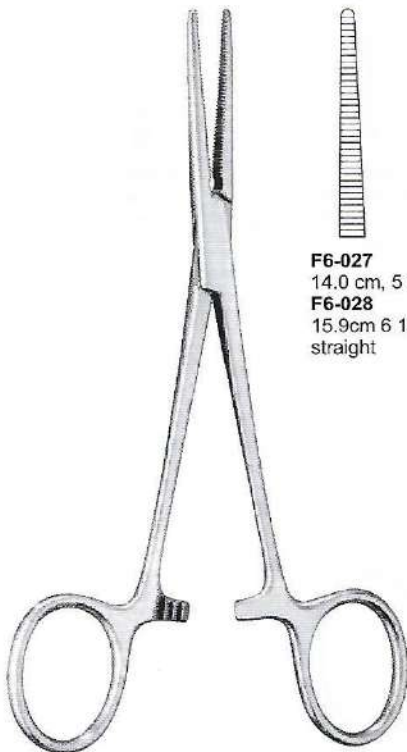

Crile Haemostatic Fine Point Forceps



F6-027
14.0 cm, 5 1/2"
F6-028
15.9cm 6 1/4"
straight

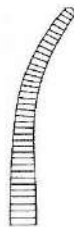

F6-029
14.0 cm, 5 1/2"
F6-030
15.9cm 6 1/4"
curved

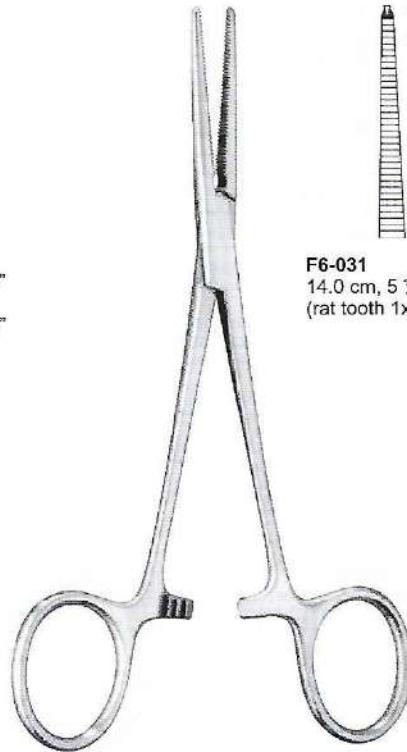

Crile Haemostatic Fine Point Tissue Forceps

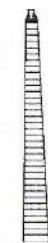

F6-031
14.0 cm, 5 1/2" straight
(rat tooth 1x2 teeth)



F6-032
14.0 cm, 5 1/2" curved
(rat tooth 1x2 teeth)



HAEMOSTATIC FORCEPS

Arterienklemmen
Pinces Hemostatiques

Pinzas Hemostaticas
Pinze Emostatiche



F6-033
18.5 cm, 7.25"
straight

Halsted Haemostatic Forceps



F6-034
18.5 cm, 7.25"
curved

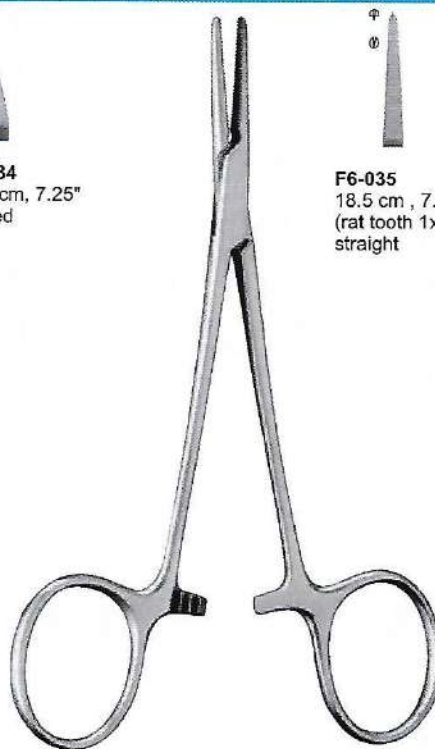

F6-035
18.5 cm, 7.25"
(rat tooth 1x2 teeth)
straight

Halsted Haemostatic
Tissue Forceps



F6-036
18.5 cm, 7.25"
(rat tooth 1x2 teeth)
curved



F6-037
18.5 cm, 7.25"
straight

Halsted Haemostatic
Fine point Forceps



F6-038
18.5 cm, 7.25"
curved



F6-039
18.5 cm, 7.25"
(rat tooth 1x2 teeth)
straight

Halsted Haemostatic Fine
Point Tissue Forceps

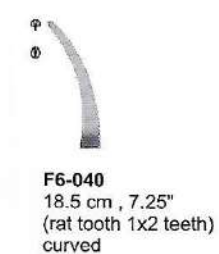

F6-040
18.5 cm, 7.25"
(rat tooth 1x2 teeth)
curved

HAEMOSTATIC FORCEPS



Arterienklemmen
Pinces Hemostatiques

Pinzas Hemostaticas
Pinze Emostatiche



Packer Mosquito Forceps
F6-041 5", 12.7cm
curved, flat jaws

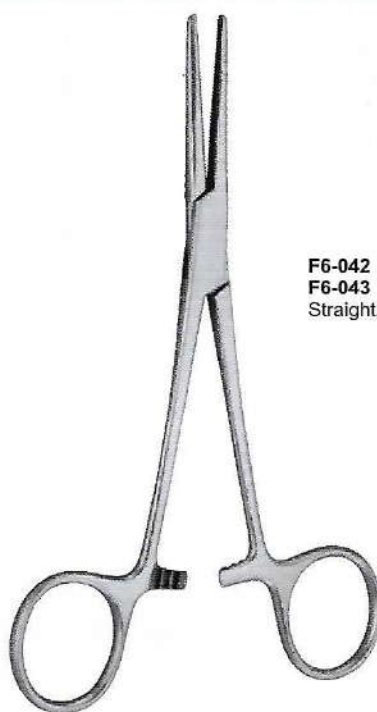

Coller Haemostatic Forceps



F6-042 14 cm, 5 1/2"
F6-043 16 cm, 6 1/4"
Straight, serrated



F6-044 14 cm, 5 1/2"
F6-045 16 cm, 6 1/4"
Curved, serrated



Christophe Haemostatic Forceps



F6-046 13.0 cm, 5"
F6-047 15.0 cm, 6"
Curved, Serrated



Saroot Haemostatic Forceps



F6-048 24 cm, 9 1/2"
Straight, Serrated



F6-049 24 cm, 9 1/2"
Curved Serrated



HAEMOSTATIC FORCEPS

Arterienklemmen
Pinces Hemostatiques

Pinzas Hemostaticas
Pinze Emostatiche

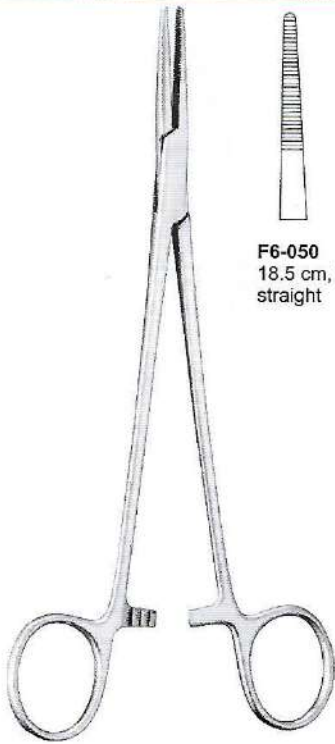

Adson Haemostatic Fine point Forceps

F6-050
18.5 cm, 7 1/4"
straight



F6-051
18.5 cm, 7 1/4"
curved



Adson Haemostatic Tissue Forceps

F6-052
18.5 cm, 7 1/4" straight
(rat tooth 1x2 teeth)



F6-053
18.5 cm, 7 1/4" Curved
(rat tooth 1x2 teeth)



O'Shaughnessy Haemostatic Forceps

F6-054 15 cm, 6"
F6-055 20 cm, 8"
Curved

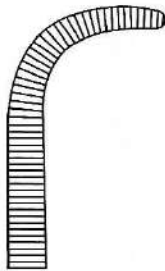

F6-056 15 cm, 6"
F6-057 20 cm, 8"
Curved Fine Point

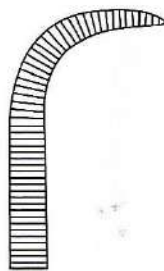

Cairns Haemostatic Forceps

F6-058
14.5 cm, 5 3/4" Straight,
box joint, as above but
curved on flat.



HAEMOSTATIC FORCEPS



Arterienklemmen
Pincas Hemostaticas

Pinzas Hemostaticas
Pinze Emostatiche

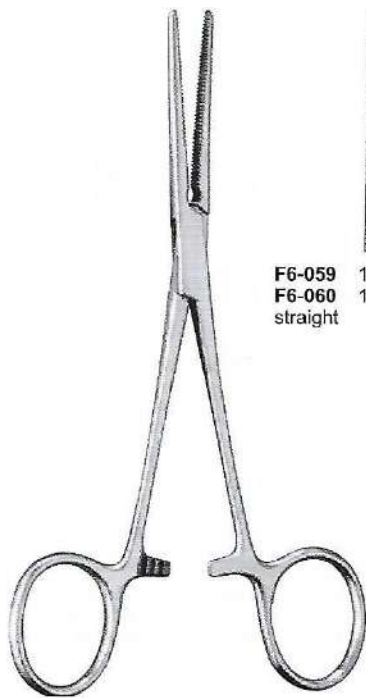

**Pean Haemostatic Forceps
Slender Type**

F6-059 13.0 cm, 5"
F6-060 14.0 cm, 5 1/2"
straight

F6-061 13.0 cm, 5"
F6-062 14.0 cm, 5 1/2"
curved

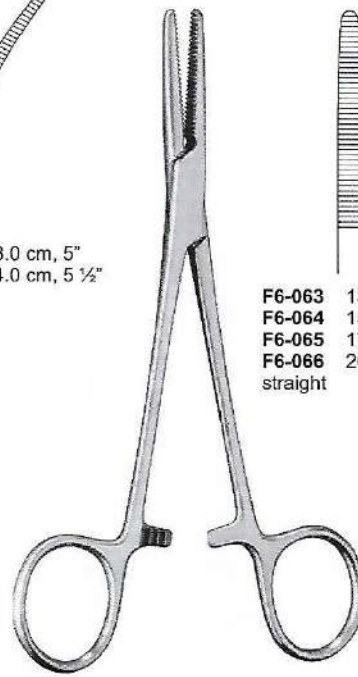

**Spencer-Wells Haemostatic Forceps
Slender Type**

F6-063 13.0 cm, 5"
F6-064 15.0 cm, 6"
F6-065 17.5 cm, 7"
F6-066 20 cm, 8"
straight

F6-067 13.0 cm, 5"
F6-068 15.0 cm, 6"
F6-069 17.5 cm, 7"
F6-070 20 cm, 8"
curved



**Kocher Haemostatic
Forceps Strong Pattern**

F6-071
14.5cm, 5 3/4"
Straight

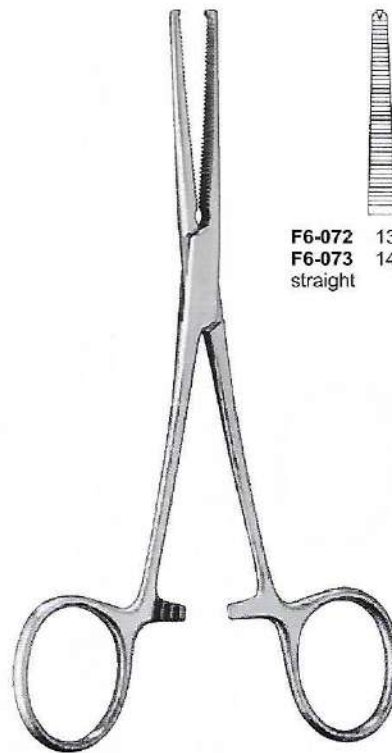

**Kocher Haemostatic Forceps
1x2 teeth**

F6-072 13cm, 5"
F6-073 14cm, 5 1/2"
straight

F6-074 13cm, 5"
F6-075 14cm, 5 1/2"
curved









HAEMOSTATIC FORCEPS

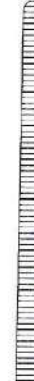

Arterienklemmen
Pinces Hemostatiques

Pinzas Hemostaticas
Pinze Emostatiche

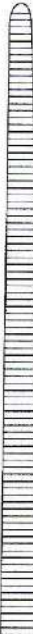
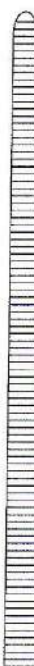
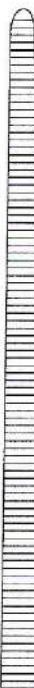

Rochester-Pean
Haemostatic Forceps
Straight

- 
F6-076
14 cm, 5.5"
straight
- 
F6-077
16cm, 6 ¼"
straight
- 
F6-078
18.5cm, 7 ½"
straight
- 
F6-079
20cm, 8"
straight
- 
F6-080
22.5cm, 9"
straight
- 
F6-081
24cm, 9 ¾"
straight
- 
F6-082
25.4 cm, 10"
straight
- 
F6-083
27.9 cm, 11"
straight

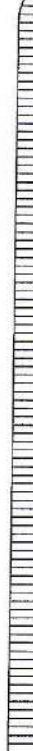
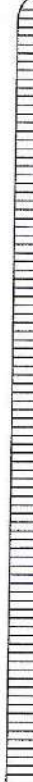
- 
F6-084
30.5 cm,
12"
straight
- 
F6-085
35.6 cm,
14"
straight
- 
F6-086
40.64 cm,
16"
straight
- 
F6-087
45.72 cm,
18"
straight
- 
F6-088
50.8 cm,
20"
straight
- 
F6-089
55.88 cm,
22"
straight
- 
F6-090
60.96 cm,
24"
straight

HAEMOSTATIC FORCEPS



Arterienklemmen
Pinces Hemostatiques

Pinzas Hemostaticas
Pinze Emostatiche



F6-091
14 cm, 5.5"
Curved

F6-092
16cm, 6 ¼"
Curved

F6-093
18.5cm, 7 ¼"
Curved

F6-094
20cm, 8"
Curved

F6-095
22.5cm, 9"
Curved

F6-096
24cm, 9 ¾"
Curved

F6-097
25.4 cm, 10"
Curved

F6-098
27.9 cm, 11"
Curved

Rochester-Pean
Haemostatic Forceps
Curved

F6-099
30.5 cm,
12"
Curved

F6-100
35.6 cm,
14"
curved

F6-101
40.64 cm,
16"
curved

F6-102
45.72 cm,
18"
curved

F6-103
50.8 cm,
20"
curved

F6-104
55.88 cm,
22"
curved

F6-105
60.96 cm,
24"
curved



HAEMOSTATIC FORCEPS

Arterienklemmen
Pinces Hemostatiques

Pinzas Hemostaticas
Pinze Emostatiche

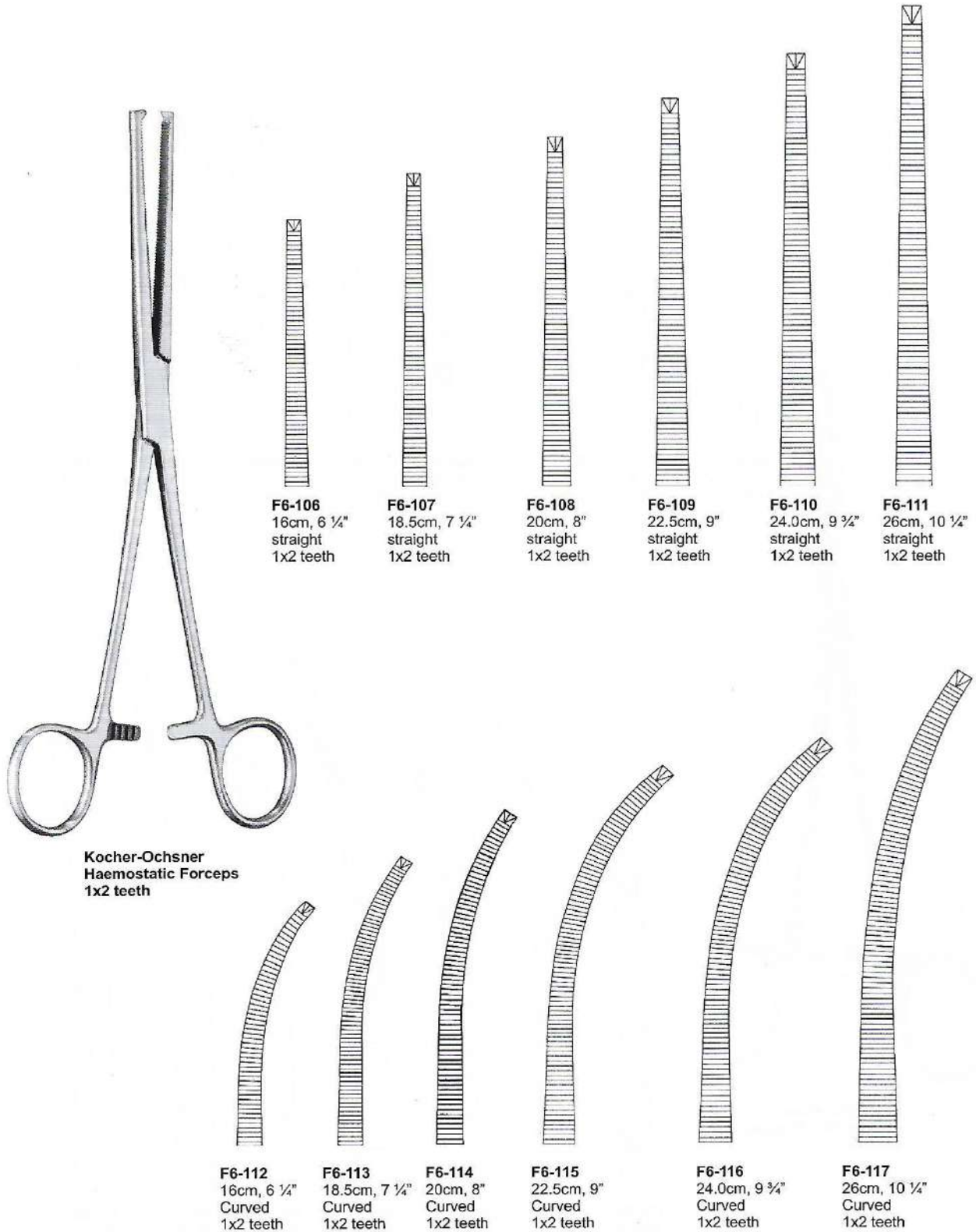

**Kocher-Ochsner
Haemostatic Forceps**
1x2 teeth

F6-106
16cm, 6 1/4"
straight
1x2 teeth

F6-107
18.5cm, 7 1/4"
straight
1x2 teeth

F6-108
20cm, 8"
straight
1x2 teeth

F6-109
22.5cm, 9"
straight
1x2 teeth

F6-110
24.0cm, 9 3/4"
straight
1x2 teeth

F6-111
26cm, 10 1/4"
straight
1x2 teeth

F6-112
16cm, 6 1/4"
Curved
1x2 teeth

F6-113
18.5cm, 7 1/4"
Curved
1x2 teeth

F6-114
20cm, 8"
Curved
1x2 teeth

F6-115
22.5cm, 9"
Curved
1x2 teeth

F6-116
24.0cm, 9 3/4"
Curved
1x2 teeth

F6-117
26cm, 10 1/4"
Curved
1x2 teeth

HAEMOSTATIC FORCEPS



Arterienklemmen
Pinces Hemostatiques

Pinzas Hemostaticas
Pinze Emostatiche

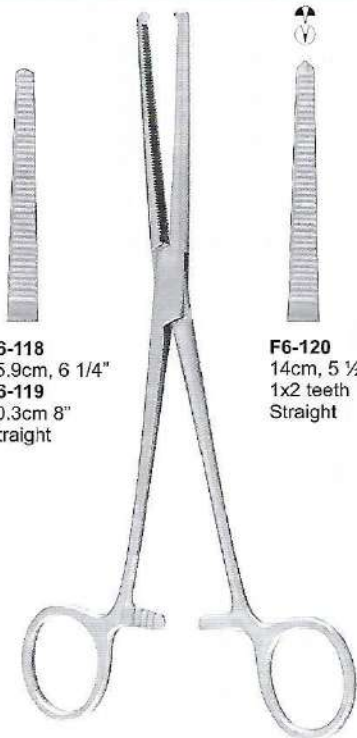

F6-118
15.9cm, 6 1/4"
F6-119
20.3cm 8"
Straight

**Rochester-Ochsner
Haemostatic Forceps**

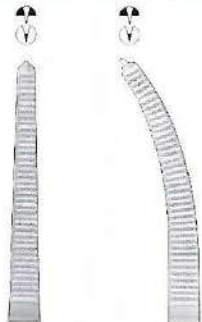

F6-120
14cm, 5 1/2"
1x2 teeth
Straight

F6-121
14cm, 5 1/2"
1x2 teeth
Curved

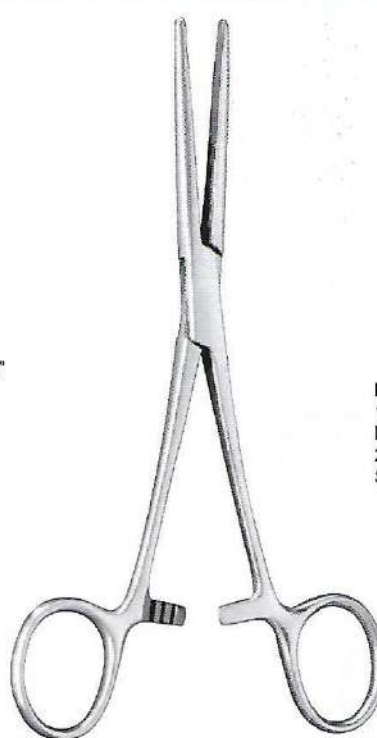

F6-122
16 cm, 6 1/4"
F6-123
20 cm, 8"
Straight

**Rochester-Carmalt
Haemostatic Forceps**



F6-124
16 cm, 6 1/4"
F6-125
20 cm, 8"
Curved

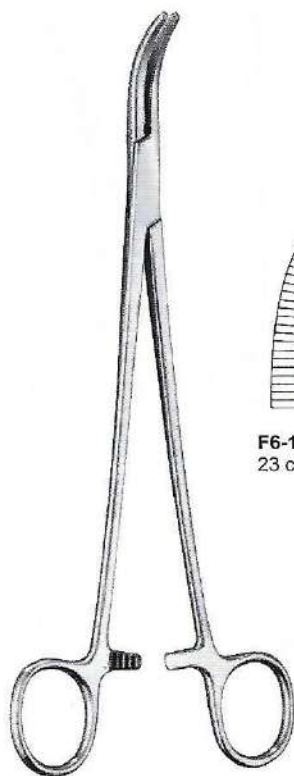

Moynihan Haemostatic Forceps

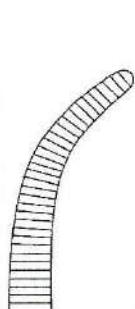

F6-126
23 cm, 9"

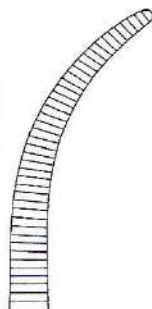

F6-127
24 cm, 9 3/4"



Negus Haemostatic Forceps

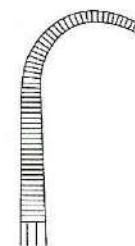

F6-128
19.5 cm, 7 3/4"



F6-129
19.5 cm, 7 3/4"



HAEMOSTATIC FORCEPS

Arterienklemmen
Pinces Hemostatiques

Pinzas Hemostaticas
Pinze Emostatiche

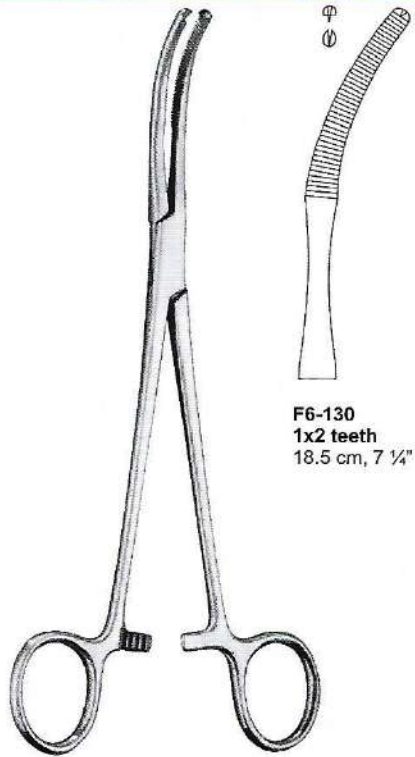

F6-130
1x2 teeth
18.5 cm, 7 1/4"

Mikulicz Haemostatic Tissue Forceps



F6-131
Serrated
21.5 cm, 8 1/2"

F6-132
1x2 teeth
21.5 cm, 8 1/2"

Halsted Haemostatic Forceps

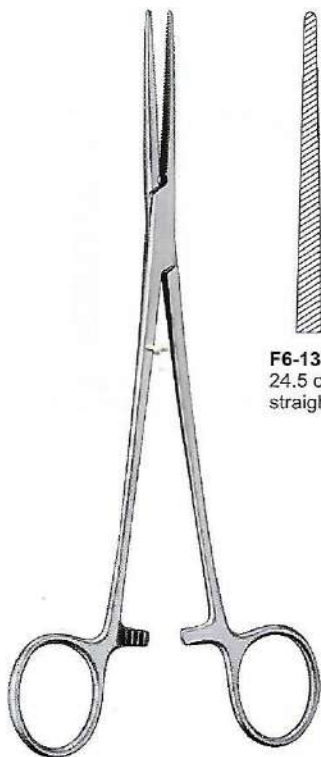

F6-133
24.5 cm, 9 3/4"
straight

Bengolea Haemostatic Forceps



F6-134
24.5 cm, 9 3/4"
Curved

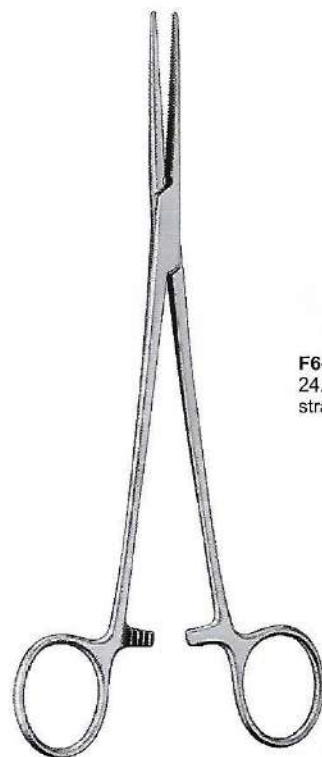

F6-135
24.5 cm, 9 3/4"
straight

Bengolea Haemostatic Tissue Forceps
(rat tooth 1x2 teeth)

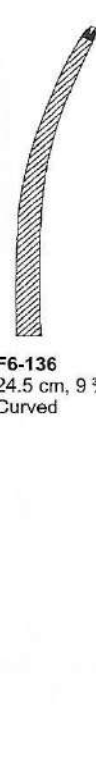

F6-136
24.5 cm, 9 3/4"
Curved

HAEMOSTATIC FORCEPS



Arterienklemmen
Pinces Hemostatiques

Pinzas Hemostaticas
Pinze Emostatiche



- F6-137 14 cm, 5 1/2"
- F6-138 16.5 cm, 6 1/2"
- F6-139 19 cm, 7 1/2"
- F6-140 21.5 cm, 8 1/2"
- F6-141 24 cm, 9 1/2"

Mixer-O'Shaugnessy
Haemostatic Forceps



- F6-142 14 cm, 5 1/2"
- F6-143 16.5 cm, 6 1/2"
- F6-144 19 cm, 7 1/2"
- F6-145 21.5 cm, 8 1/2"
- F6-146 24 cm, 9 1/2"
- Fine Point

Mixer-O'Shaugnessy
Haemostatic Forceps

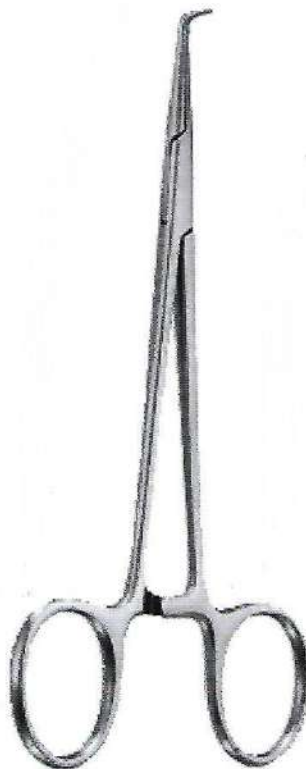

- Mixer-O'Shaugnessy
Haemostatic Forceps
- F6-147 14cm, 5 1/2"
 - F6-148 16.5cm, 6 1/2"
 - F6-149 19cm, 7 1/2"
 - F6-150 21.5cm, 8 1/2"
 - F6-151 24cm, 9 1/2"
 - micro point

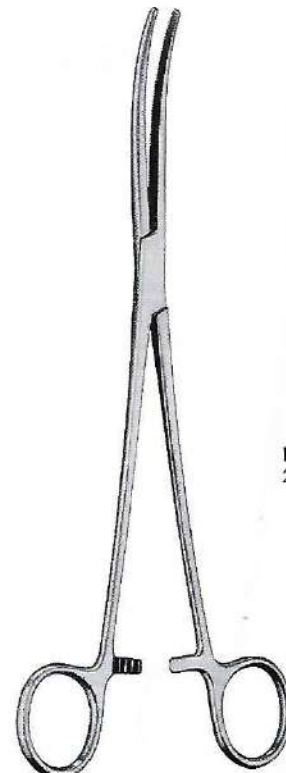

- F6-152
24.5 cm, 9 3/4"

Craford Haemostatic Forceps



HAEMOSTATIC FORCEPS

Arterienklemmen

Pinces Hemostatiques

Pinzas Hemostaticas

Pinze Emostatiche



Herrick Haemostatic Forceps
F6-153 23.0 cm, 9"

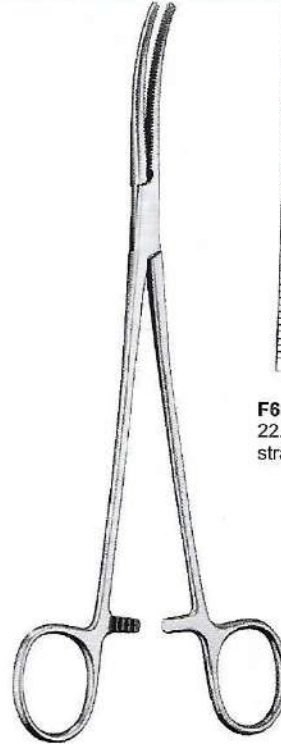
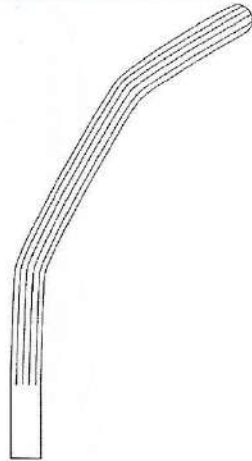

Roberts Haemostatic Forceps



F6-154
22.0 cm, 8 3/4"
straight

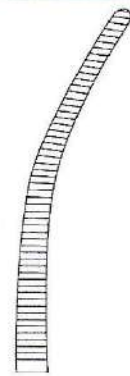

F6-155
22.0 cm, 8 3/4"
Curved



**Craford-Sellors
Haemostatic Forceps**

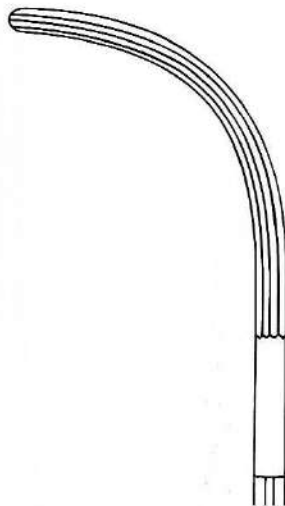

F6-156
22.0 cm, 8 3/4"

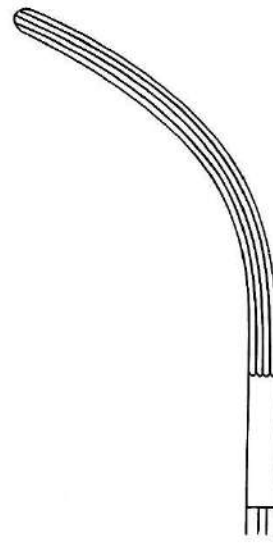

F6-157
23.0 cm, 9"



F6-158
24.0 cm, 9 1/2"

HAEMOSTATIC FORCEPS



Arterienklemmen
Pincas Hemostatiques

Pinzas Hemostaticas
Pinze Emostatiche



F6-159
20 cm, 8"
Straight,
Serrated



F6-160
20 cm, 8"
Slight Curve,
Serrated

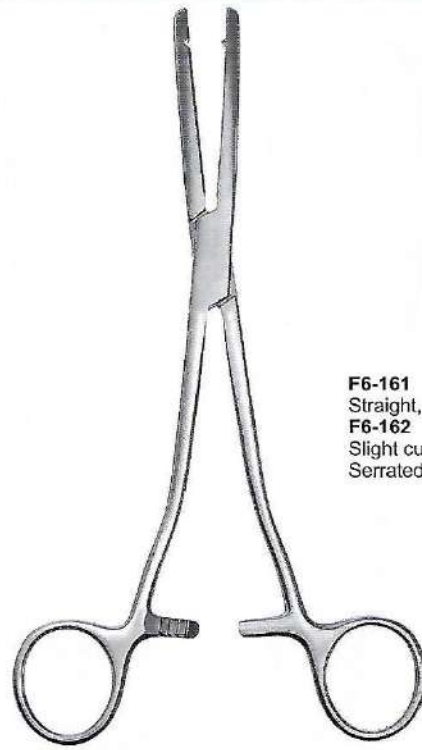

F6-161 21 cm, 8 1/4"
Straight, Cross Serrated
F6-162 21 cm, 8 1/4"
Slight curved, Cross
Serrated



**Heaney / Ballantine
Haemostatic Forceps**

**Heaney / Rezak
Haemostatic Forceps**

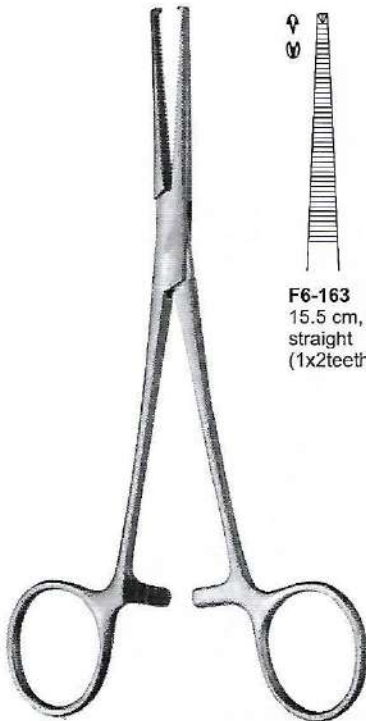

F6-163
15.5 cm, 6"
straight
(1x2teeth)

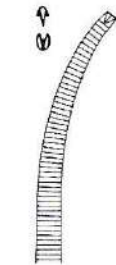

F6-164
15.5 cm, 6"
Curved
(1x2teeth)

**Dixon-Lovelace
Haemostatic Tissue Forceps**

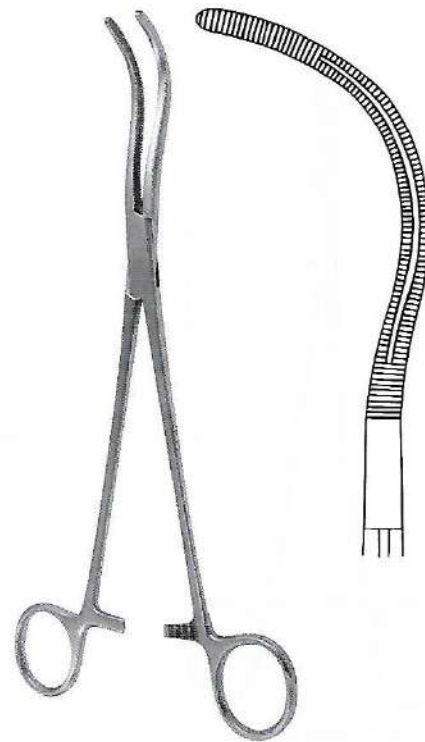

**Stille Haemostatic Forceps
F6-165 23 cm, 9"**



HAEMOSTATIC FORCEPS

Arterienklemmen
Pincas Hemostatiques

Pinzas Hemostaticas
Pinze Emostatiche

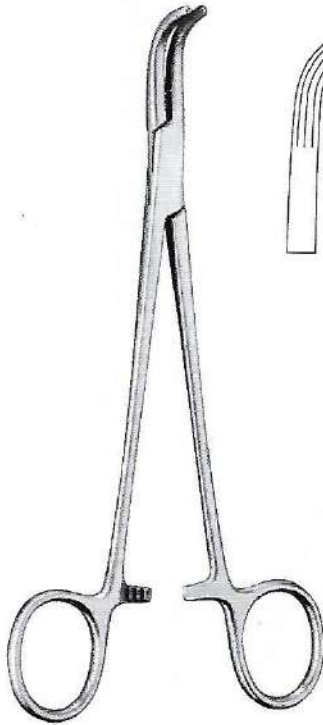

Lower Haemostatic Forceps
F6-166 18cm, 7"

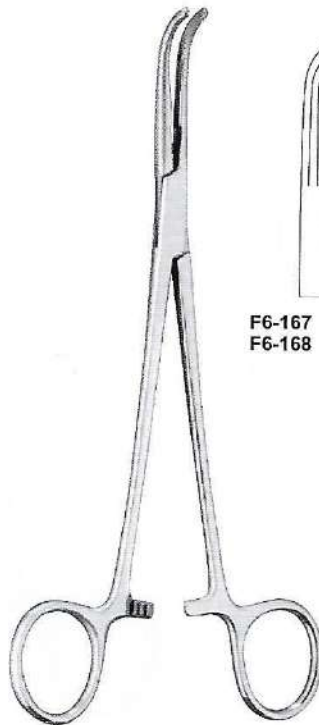

**Lahey (Sweet)
Haemostatic Forceps**

F6-167 19cm, 1/2"
F6-168 22cm, 8 3/4"



**Desjardins Haemostatic
Forceps**
F6-169 22cm, 8 3/4"

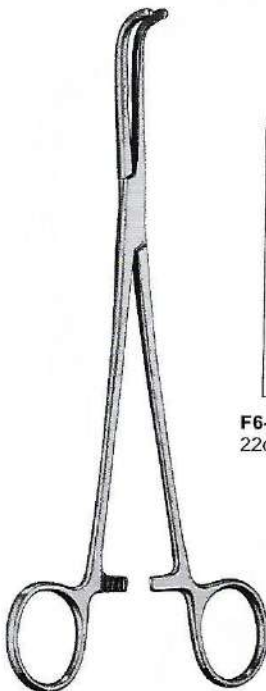

**Mixer Haemostatic
Gall Duct Forceps**

F6-170
22cm, 8 3/4"

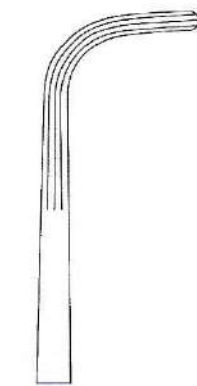

Mixer Forceps, Lee Modif
F6-172 13.3 cm , 5.25"
Curved jaws and angled
shanks, delicate

F6-171
25cm, 10"

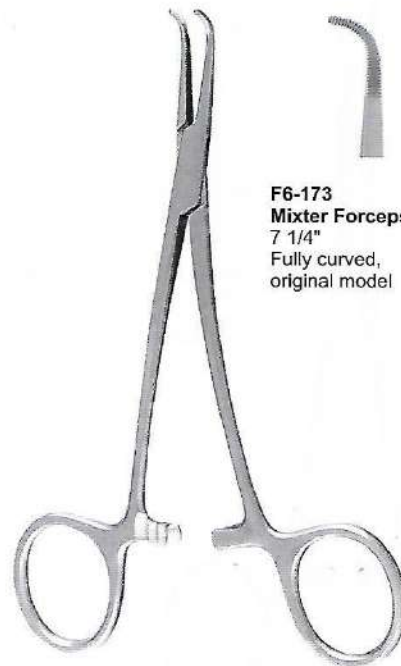

F6-173
Mixer Forceps, 18.4 cm
7 1/4"
Fully curved,
original model

HAEMOSTATIC FORCEPS



Arterienklemmen
Pincas Hemostatiques

Pinzas Hemostaticas
Pinze Emostatiche

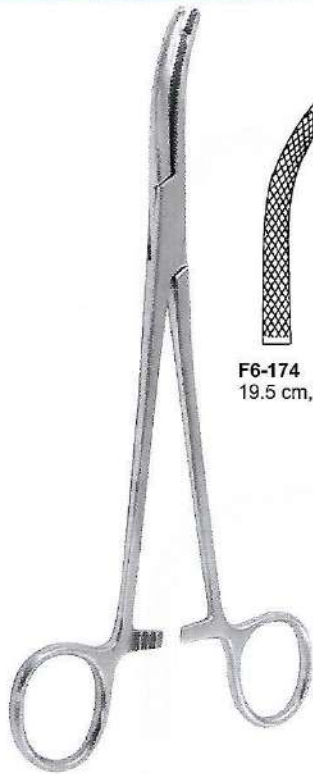

Heaney Haemostatic Forceps

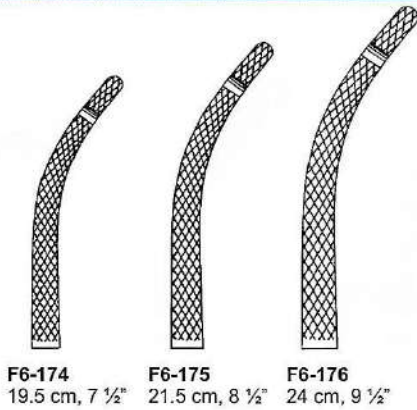

F6-174 19.5 cm, 7 1/2"
F6-175 21.5 cm, 8 1/2"
F6-176 24 cm, 9 1/2"

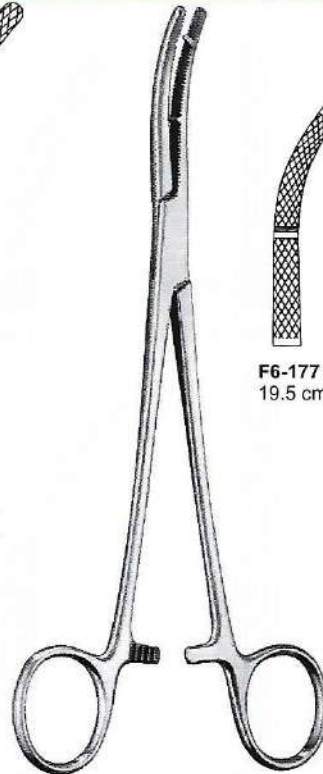

Heaney Modif. Haemostatic Forceps

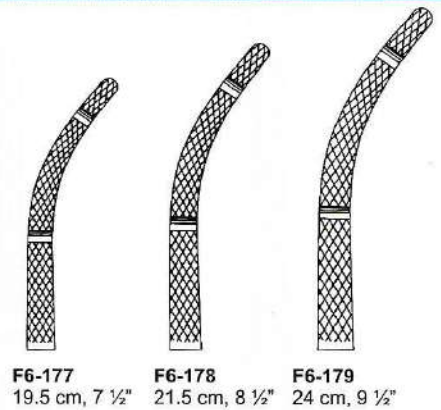

F6-177 19.5 cm, 7 1/2"
F6-178 21.5 cm, 8 1/2"
F6-179 24 cm, 9 1/2"

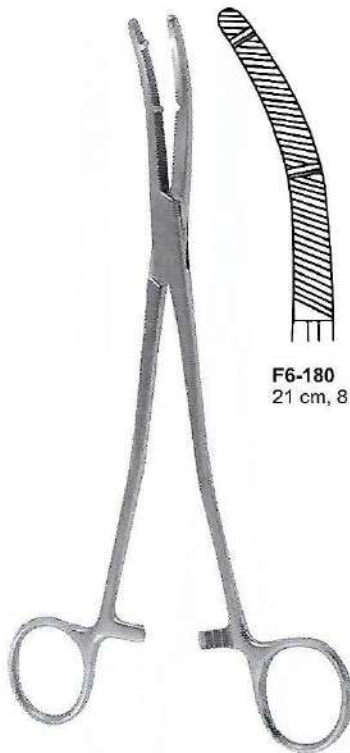

Heaney-Kanter Haemostatic Forceps

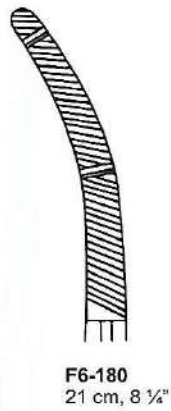

F6-180 21 cm, 8 1/4"

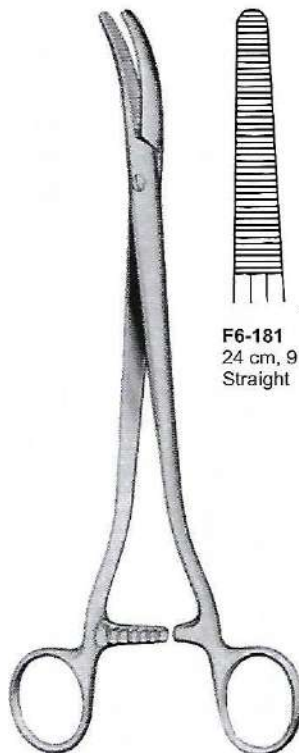

Segond-Landau Haemostatic Forceps

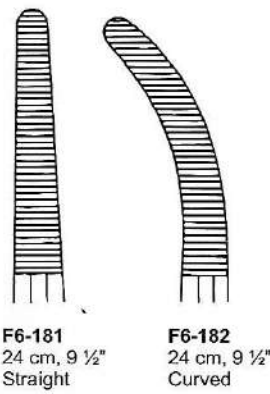

F6-181 24 cm, 9 1/2" Straight
F6-182 24 cm, 9 1/2" Curved

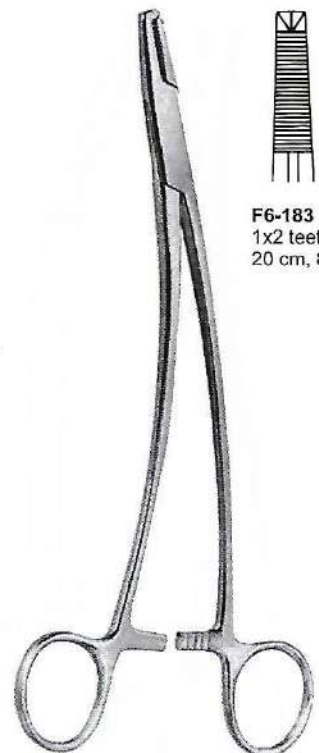

Schindler Haemostatic Tissue Forceps



F6-183 1x2 teeth 20 cm, 8"



HAEMOSTATIC FORCEPS

Arterienklemmen
Pinces Hemostatiques

Pinzas Hemostaticas
Pinze Emostatiche

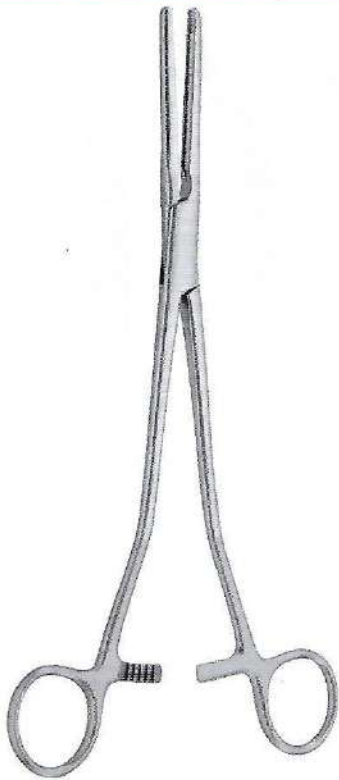

Parametrium Haemostatic Forceps

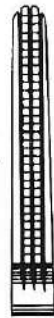

F6-184
21 cm, 8 1/4"
Straight

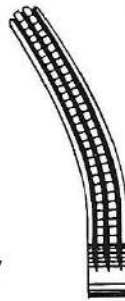

F6-185
21 cm, 8 1/4"
25° Angled



F6-186
21 cm, 8 1/4"
45° Angled

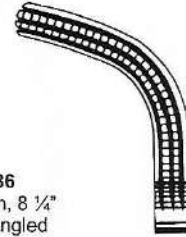

F6-187
21 cm, 8 1/4"
90° Angled

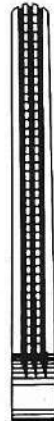

F6-188
24 cm, 9 1/2"
Straight

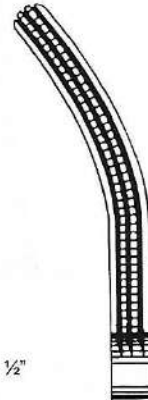

F6-189
24 cm, 9 1/2"
25° Angled

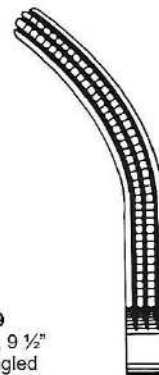

F6-190
24 cm, 9 1/2"
45° Angled

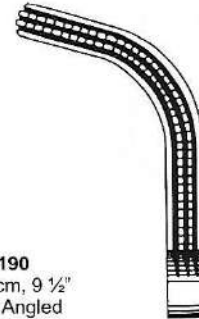

F6-191
24 cm, 9 1/2"
90° Angled

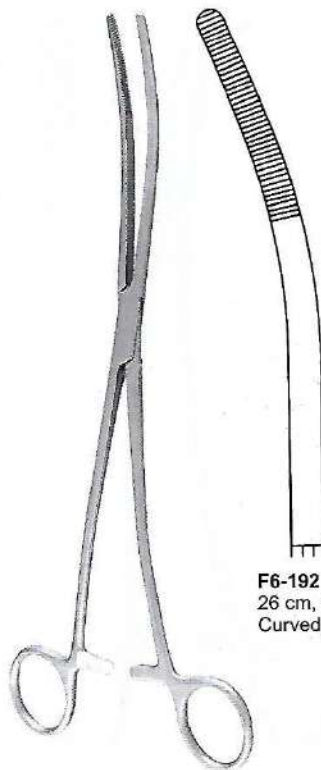

F6-192
26 cm, 10 1/4"
Curved, Serrated

Bozemann Haemostatic Forceps

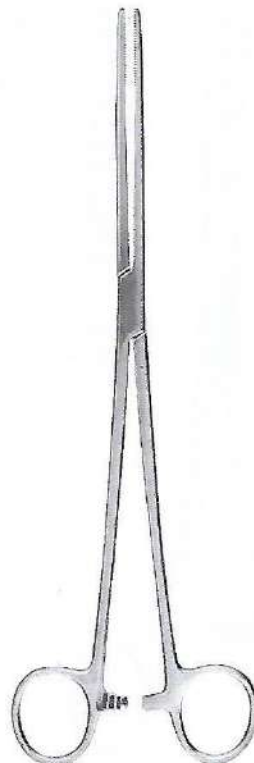

F6-193
26 cm, 10 1/4"
Straight

Bozemann Haemostatic Forceps

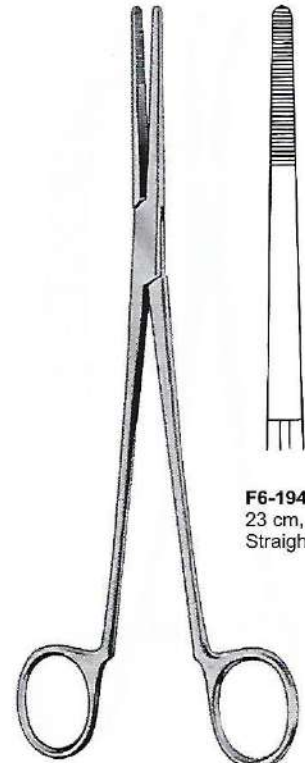

F6-194
23 cm, 9"
Straight

Westermark Haemostatic Forceps

HAEMOSTATIC FORCEPS



Arterienklemmen

Pinzas Hemostaticas

Pinces Hemostatiques

Pinze Emostatiche

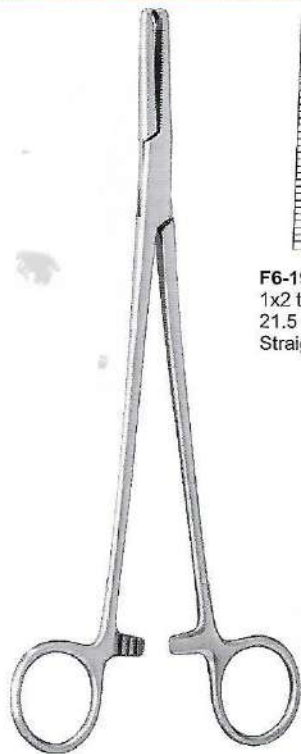

F6-195
1x2 teeth
21.5 cm, 8 1/2"
Straight

Phaneuf Haemostatic Tissue Forceps

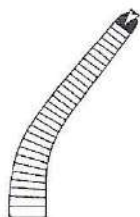

F6-196
1x2 teeth
21.5 cm, 8 1/2"
Hard Curved



F6-197
1x2 teeth
19.0 cm, 7 1/2"
Curved

Long Haemostatic Tissue Forceps



F6-198
1x2 teeth
19.0 cm, 7 1/2"
Straight



F6-199
1x2 teeth
14 cm, 5 1/2"

Baby-Mikulicz Haemostatic Tissue Forceps



F6-200
1x2 teeth
18.5cm, 7 1/4"

Mikulicz Haemostatic Tissue Forceps



HAEMOSTATIC FORCEPS

Arterienklemmen
Pincas Hemostatiques

Pinzas Hemostaticas
Pinze Emostatiche



Mikulicz Haemostatic Tissue Forceps

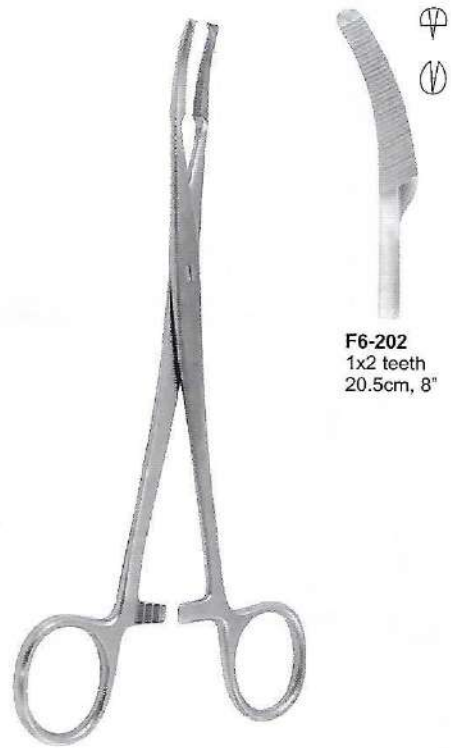

Mikulicz Haemostatic Tissue Forceps



Mikulicz Haemostatic Tissue Forceps

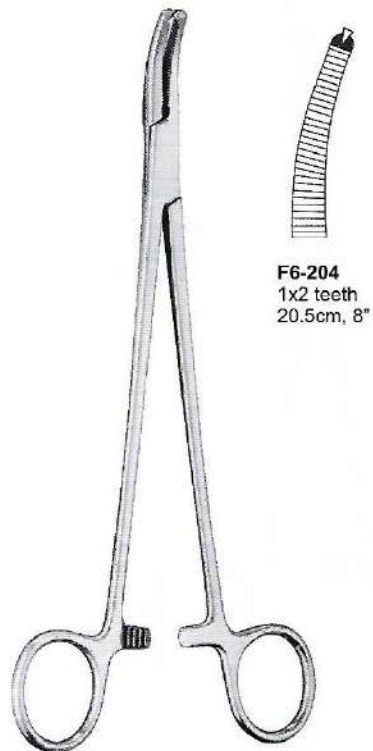

Faure Haemostatic Tissue Forceps

HAEMOSTATIC FORCEPS



Arterienklemmen
Pincas Hemostatiques

Pinzas Hemostaticas
Pinze Emostatiche

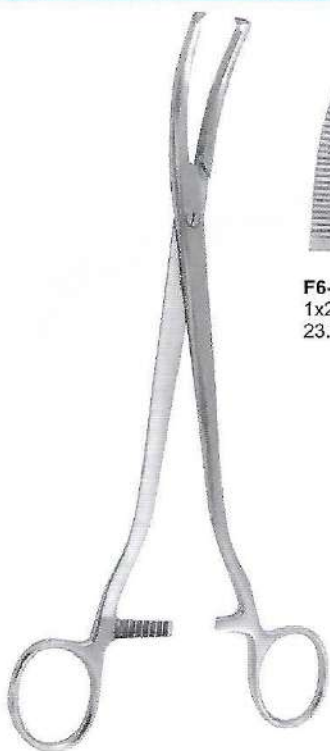

F6-205
1x2 teeth
23.5cm, 9 1/4"

Wertheim Haemostatic
Tissue Forceps

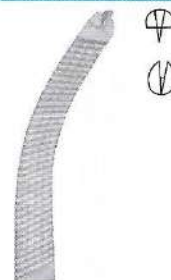

F6-206
1x2 teeth
24.5cm, 9 3/4"

Wertheim Haemostatic
Tissue Forceps



F6-207
22.5cm, 9"
Straight



F6-208
22.5cm, 9"
25° Angled



F6-209
21.5cm, 8 1/2"
45° Angled



F6-210
20.5cm, 8"
90° Angled

Heaney Atraumata
Hysterectomy Forceps



HAEMOSTATIC FORCEPS

Arterienklemmen
Pinces Hemostatiques

Pinzas Hemostaticas
Pinze Emostatiche



Wertheim Parametrium Clamps



F6-211
25cm, 10"
Straight



F6-212
24.5cm, 9 3/4"
25° Angled



F6-213
24cm, 9 1/2"
45° Angled



F6-214
22cm, 8 3/4"
90° Angled



Wertheim Hysterectomy Forceps



F6-215
25.5cm, 10"



Wertheim Parametrium Clamp



F6-216
26cm, 10 1/4"



Gemini Mixer Hemostatic Forceps

F6-217 5 1/2"
F6-218 7"
full curve, delicate

HAEMOSTATIC FORCEPS



Arterienklemmen
Pinces Hemostatiques

Pinzas Hemostaticas
Pinze Emostatiche



Dick Haemostatic Forceps



F6-219
25.5cm, 10"

F6-220
26.5cm, 10 1/2"

F6-221
27.5cm, 10 3/4"



F6-222
21.5cm, 8 1/2"



Wertheim-Cullen
Haemostatic Forceps



Wertheim-Cullen Haemostatic
Forceps
23cm, 9"

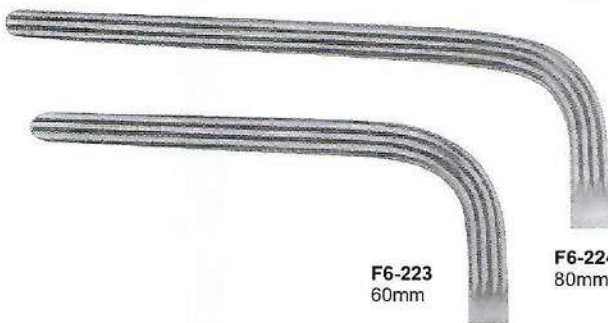

F6-223
60mm

F6-224
80mm



F6-225
25cm, 10"

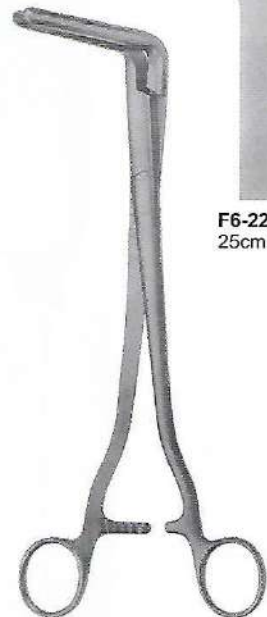

Wertheim Haemostatic Forceps



TOWEL FORCEPS

Tuchklemmen | Pincès à champs
Pinzas de campo | Pinze fissatele



**Jones / Perforating
Towel Forceps**
F6-226 9 cm, 3 1/2"
Slight Curve



**Engl. Modell
Towel Forceps**
F6-227
9 cm, 3 1/2"



**Schaedel Towel
Forceps**
F6-228
9 cm, 3 1/2"



**Thomson-Walker's
Penile Clamps**
F6-229 9 cm, 3 1/2"
Cross-Action model.



Doyen Towel Forceps
F6-230 18 cm, 7"

TOWEL FORCEPS



Tuchklemmen | Pincès à champs
Pinzas de campo | Pinze fissatele

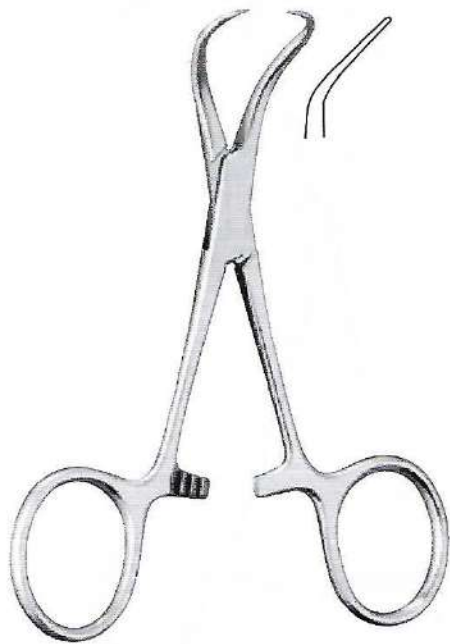

Backhaus Towel Forceps
F6-231 8 cm, 3"
F6-232 11 cm, 4 1/2"
F6-233 13 cm, 5"
F6-234 15 cm, 5 3/4"
Curved



Backhaus Clip Towel Forceps
F6-235 11 cm, 4 1/2"
with clip for tubing or cable



Roeder Towel Forceps
F6-236 13 cm, 5"
F6-237 15 cm, 6"
Curved, Serrated



Lorna Towel Forceps
F6-238 9.0 cm, 3 1/2"
F6-239 11.4 cm, 4 1/2"
F6-240 13.5 cm, 5 1/4"

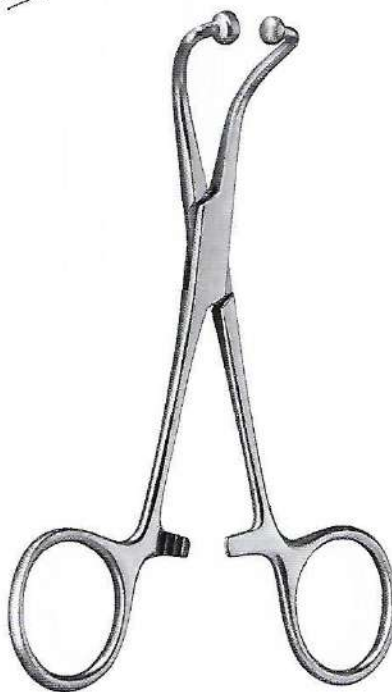

Ball & Socket Towel Forceps
F6-241 13 cm, 5"
Non-perforating



Tohoku Towel Forceps
F6-242 10cm, 4"
F6-243 13cm, 5"
Non-Perforating



HAEMOSTATIC FORCEPS

Arterienklemmen
Pinces Hemostatiques

Pinzas Hemostaticas
Pinze Emostatiche



Non-Perforating Towel Forceps
F6-244 11 cm, 4 1/2"
F6-245 13 cm, 5"



Peers-Bertman Towel Forceps
F6-246 14.5 cm, 5 1/2"
Serrated



Bernhard Towel Forceps
F6-247
16.5 cm, 6 1/2"

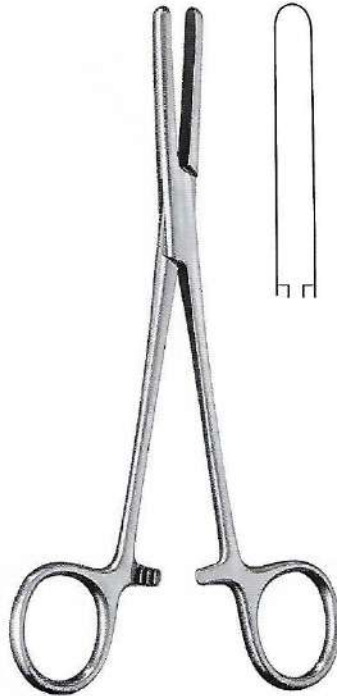

Presbyterian Tubing Clamp
F6-248 16.5 cm, 6 1/2"
F6-249 18 cm, 7"
Straight, Smooth



Tubing Clamp
F6-250 18 cm, 7"
F6-251 20 cm, 8"
Cross Serrated

HAEMOSTATIC FORCEPS



Arterienklemmen

Pinzas Hemostaticas

Pinces Hemostatiques

Pinze Emostatiche

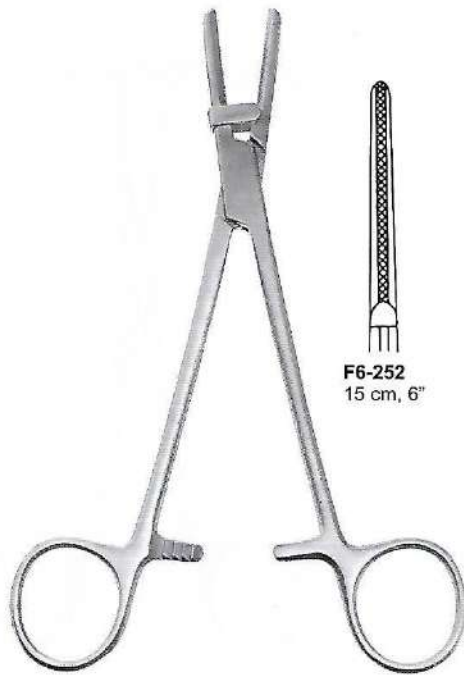

**Tubing Clamp with Protector,
Cross Serrated**

F6-252
15 cm, 6"

F6-253
18 cm, 7"

F6-254
20 cm, 8"



Klinikum Berlin Tubing Clamp

F6-255 14.5 cm, 5 3/4"
with long ratchet



Fergusson Tubing Clamp

F6-256
16 cm, 6 1/4"

F6-257
20 cm, 8"



F6-258
16 cm, 6 1/4"

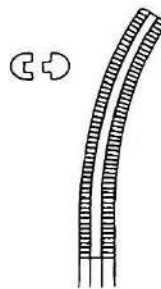

F6-259
20 cm, 8"

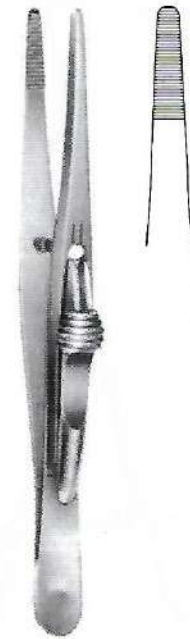

Fricke Artery Forceps
F6-260 13cm, 5 1/4"



HAEMOSTATIC FORCEPS

Arterienklemmen
Pinces Hemostatiques

Pinzas Hemostaticas
Pinze Emostatiche

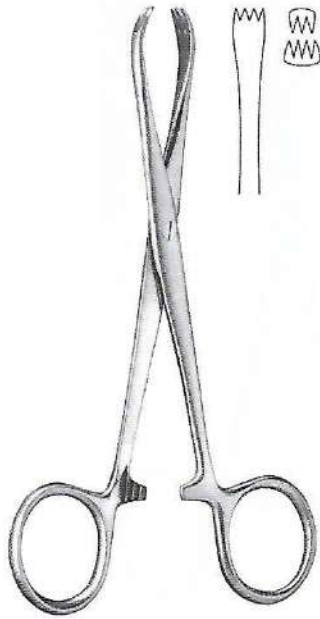

Tuffier Haemostatic Forceps
F6-261 13.0 cm, 5"

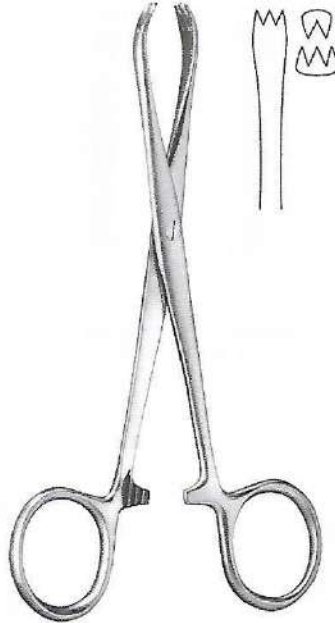

Chaput Haemostatic Forceps
F6-262 13.0 cm, 5"



Martel Haemostatic Forceps
F6-263 14.0 cm, 5 1/2"

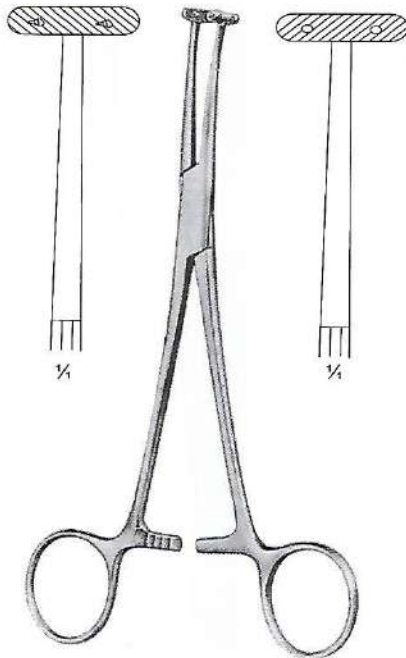

Willet-Martel Haemostatic Forceps
F6-264 19.0 cm, 7 1/2"



Pratt Haemostatic Forceps
F6-265 15 cm, 4 3/4"

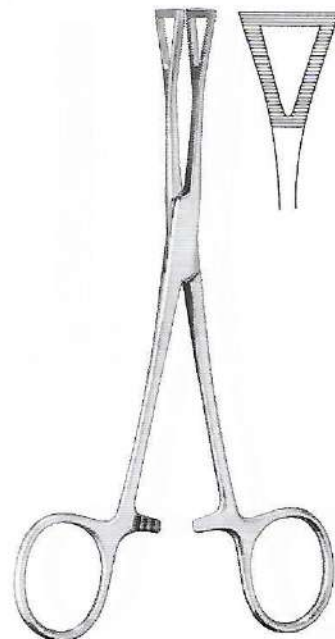

Pennington / Siesing Haemostatic Forceps
F6-266 15.5 cm, 6"
F6-267 20 cm, 8"
Straight

HAEMOSTATIC FORCEPS



Arterienklemmen
Pincas Hemostaticas

Pinzas Hemostaticas
Pinze Emostatiche

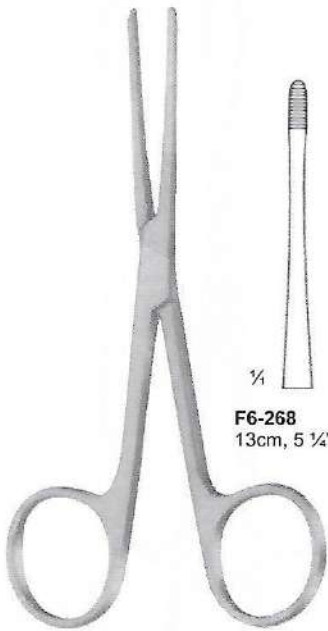

F6-268
13cm, 5 1/4"

Lister Sinus Forceps

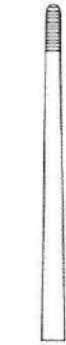

F6-269
15.5cm, 6"



F6-270
17.5cm, 7"



F6-271
12.5cm,
4 3/4"

**Collin Dressing
Haemostatic Forceps**



F6-272
14cm, 5 1/2"

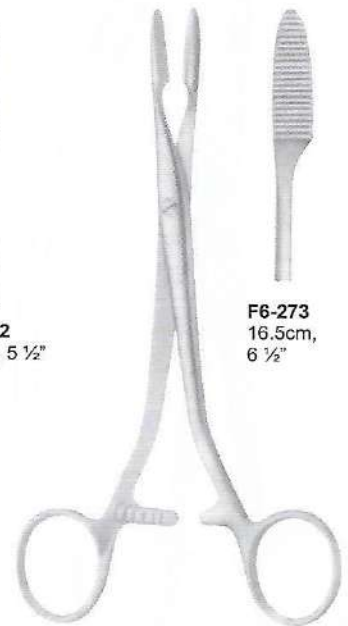

F6-273
16.5cm,
6 1/2"

**Colling Dressing
Haemostatic Forceps**



F6-274
18.5cm,
7 1/4"

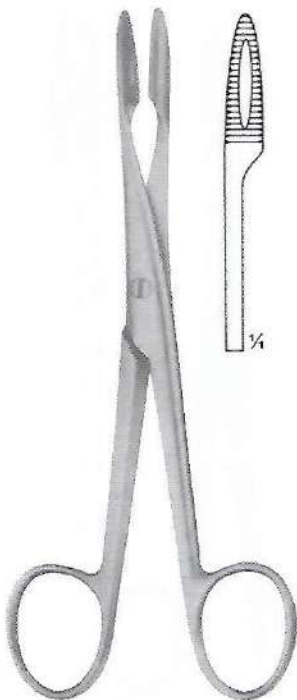

Gross Maier Dressing Forceps
F6-275 14.5cm, 5 3/4" straight
Without Ratchet

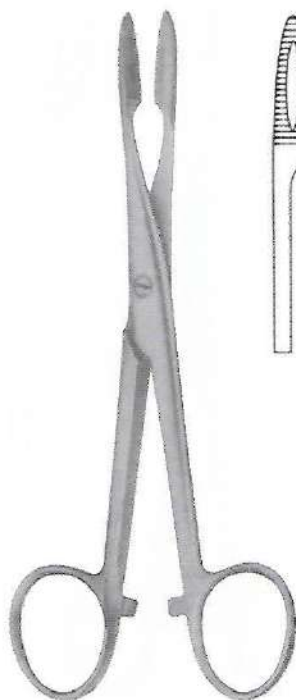

Gross Maier Dressing Forceps
F6-276 14.5cm, 5 3/4" straight
With Ratchet

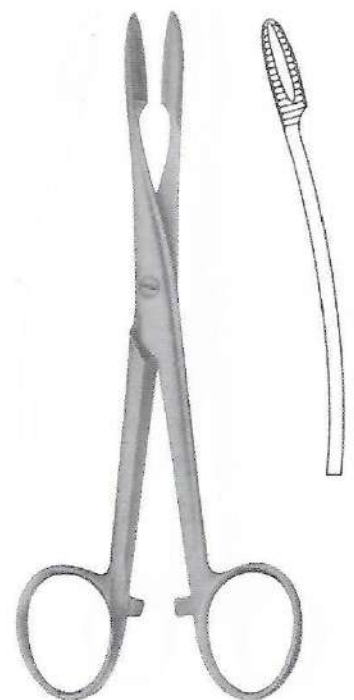

Gross Maier Dressing Forceps
F6-277 14.5cm, 5 3/4" curved
With Ratchet



HAEMOSTATIC FORCEPS

Arterienklemmen
Pinces Hemostatiques

Pinzas Hemostaticas
Pinze Emostatiche

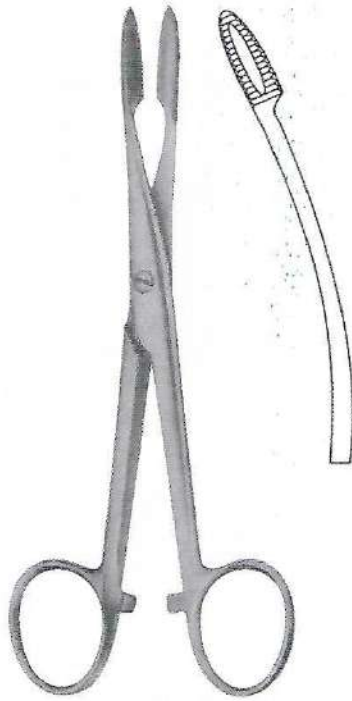

Gross Maier Dressing Forceps
F6-278 14.5cm, 5 3/4" curved
With Ratchet

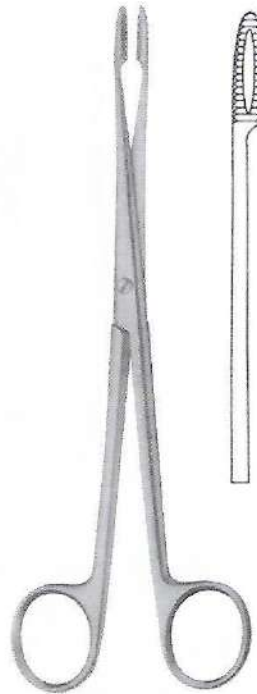

**Gross Maier Dressing
Sponge & Dressing Forceps**
F6-279 20.5 cm, 8" straight
Without Ratchet

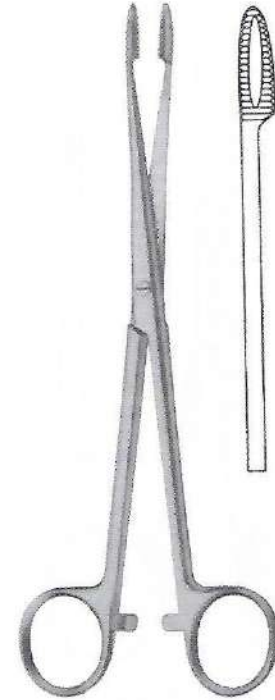

**Gross Maier Dressing
Sponge & Dressing Forceps**
F6-280 17.8 cm, 7" straight
With Ratchet

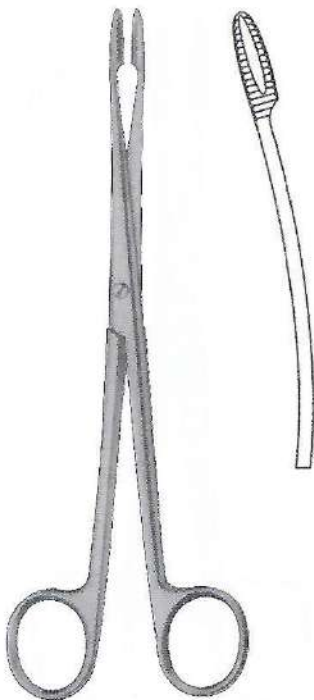

**Gross Maier Dressing
Sponge & Dressing Forceps**
F6-281 20.5 cm, 8" curved
Without Ratchet
(bullet holding forceps)

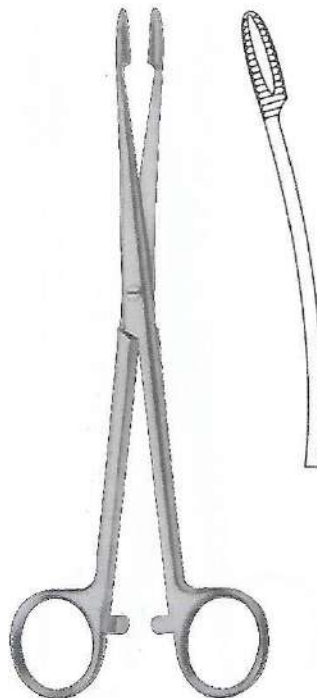

**Gross Maier Dressing
Sponge & Dressing Forceps**
F6-282 17.8 cm, 7" curved
With Ratchet

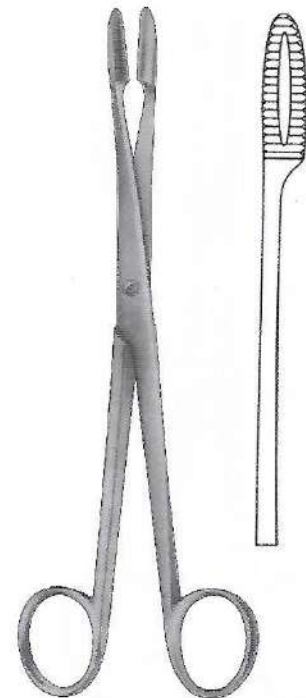

Gross Maier Dressing Forceps
F6-283 26.5cm, 10 1/2" straight
Without Ratchet
(bullet holding forceps)

HAEMOSTATIC FORCEPS



Arterienklemmen
Pinces Hemostatiques

Pinzas Hemostaticas
Pinze Emostatiche

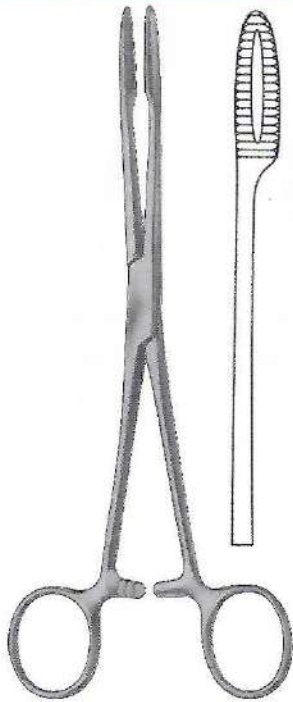

Gross Maier Dressing Forceps
F6-284 26.5cm, 10 1/2" straight
With Ratchet
(bullet holding forceps)

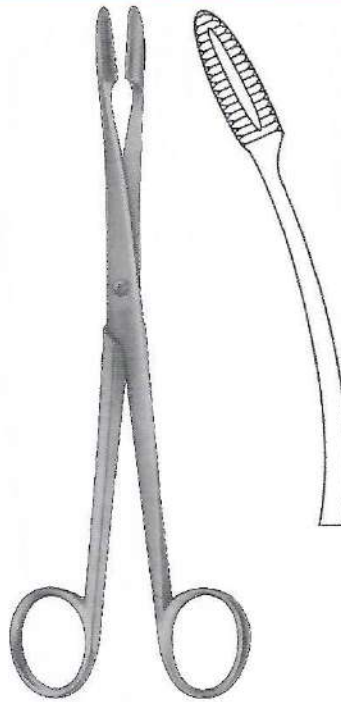

Gross Maier Dressing Forceps
F6-285 26.5cm, 10 1/2" curved
Without Ratchet
(bullet holding forceps)

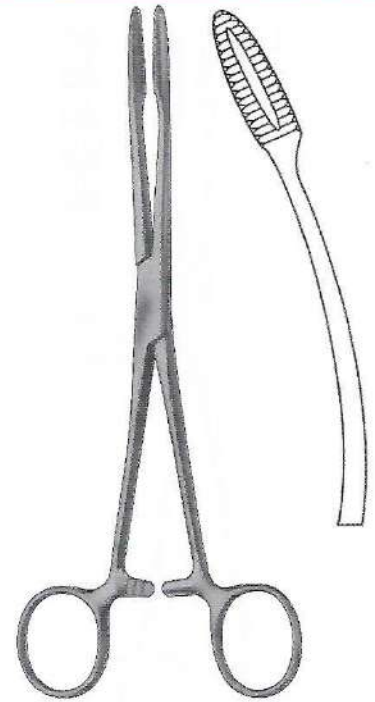

Gross Maier Dressing Forceps
F6-286 26.5cm, 10 1/2" curved
With Ratchet
(bullet holding forceps)

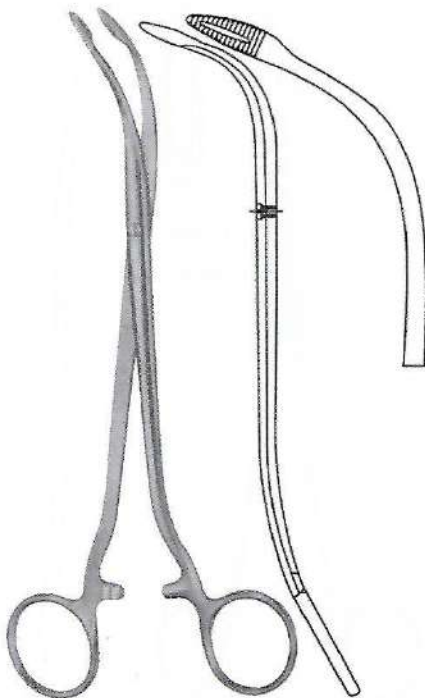

Duplay Sponge & Dressing Forceps
F6-287 19cm, 7 1/2"
Slight Curve

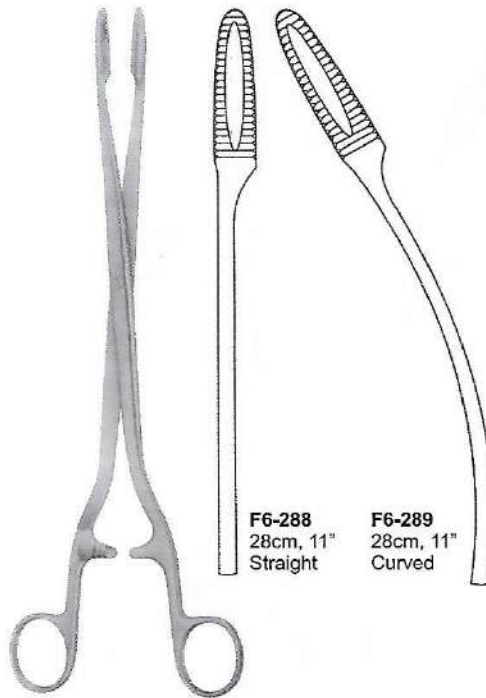

F6-288
28cm, 11"
Straight

F6-289
28cm, 11"
Curved

Sims-Maier Sponge & Dressing Forceps



F6-290
24cm, 9 1/2"

Collin Sponge & Dressing Forceps



HAEMOSTATIC FORCEPS

Arterienklemmen
Pinces Hemostatiques

Pinzas Hemostaticas
Pinze Emostatiche

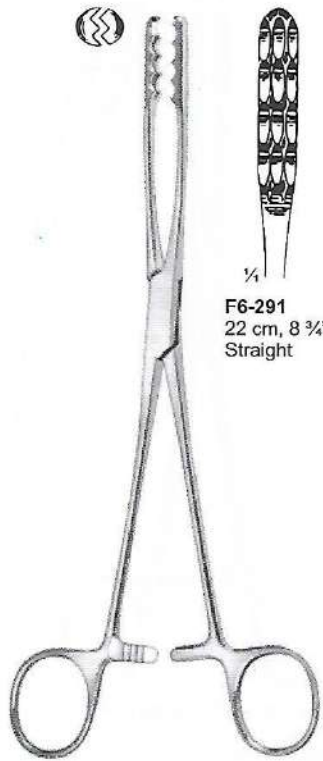

F6-291
22 cm, 8 3/4"
Straight

Ulrich Sponge Forceps



F6-292
25 cm, 10"
F6-293
27 cm, 11"
Straight

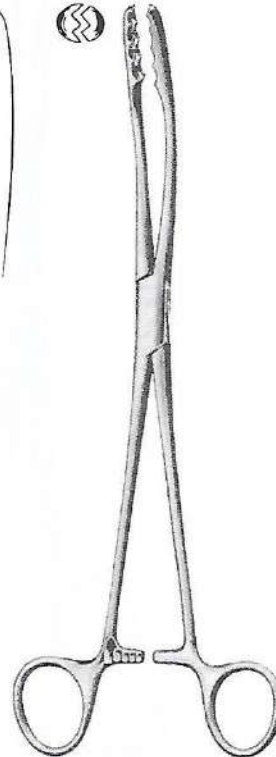
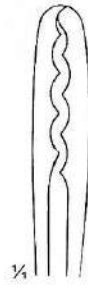

F6-294
22 cm, 8 3/4"
Curved

Ulrich Sponge Forceps



F6-295
25 cm, 10"
F6-296
27 cm, 11"
Curved



F6-297
22cm, 9 3/4"
Straight

Aesculap Sponge &
Dressing Forceps



F6-298
22cm, 9 3/4"
Curved

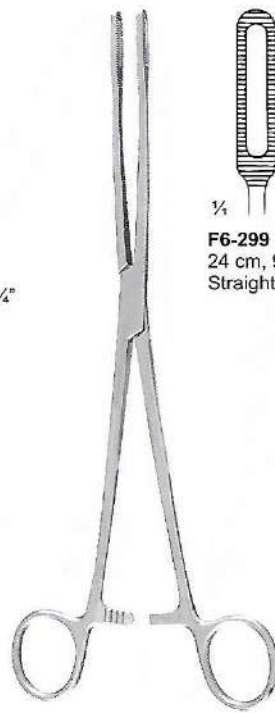

F6-299
24 cm, 9 1/2"
Straight

Fletcher Sponge Forceps

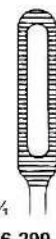

F6-300
24 cm, 9 1/2"
Slight Curve

Fletcher Sponge Forceps

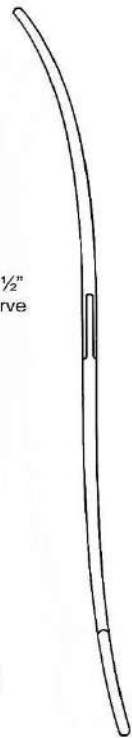

HAEMOSTATIC FORCEPS



Arterienklemmen
Pinces Hemostatiques

Pinzas Hemostaticas
Pinze Emostatiche

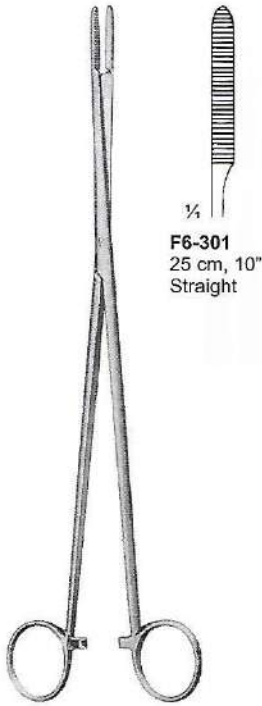

F6-301
25 cm, 10"
Straight

Pelkmann Sponge Forceps

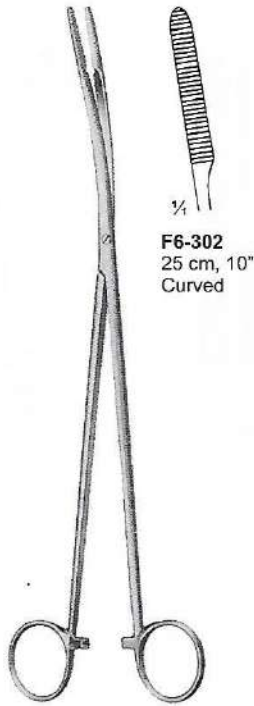

F6-302
25 cm, 10"
Curved

Pelkmann Sponge Forceps

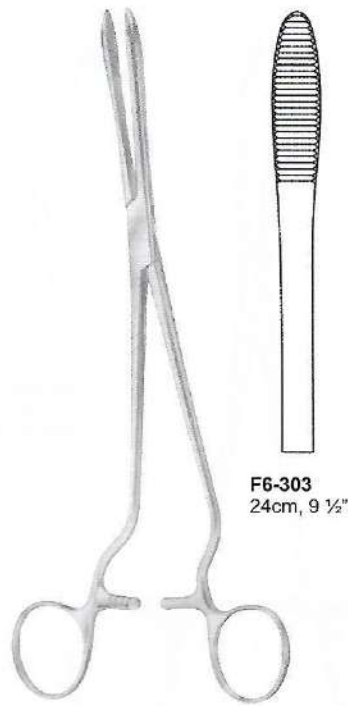

F6-303
24cm, 9 1/2"

Cheron Forceps
Handles Laterally
Angled

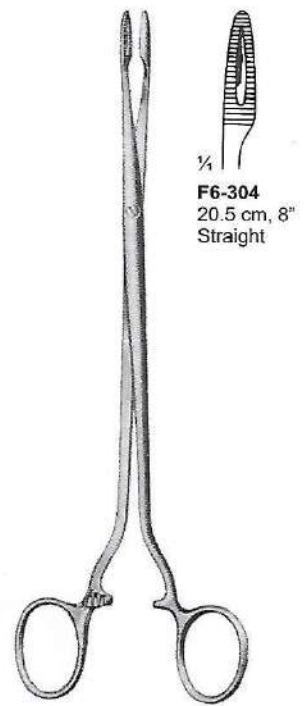

F6-304
20.5 cm, 8"
Straight

Duplay Sponge Forceps

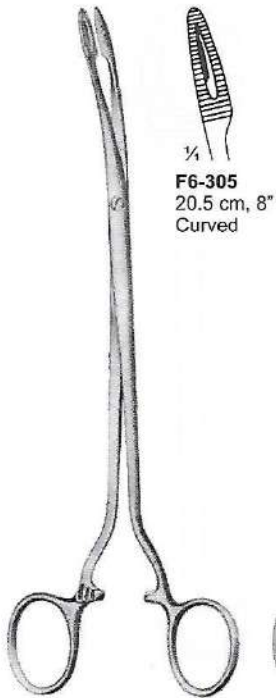

F6-305
20.5 cm, 8"
Curved

Duplay Sponge Forceps



**Heywood Smith
Sponge Forceps**
F6-306 25 cm, 10"

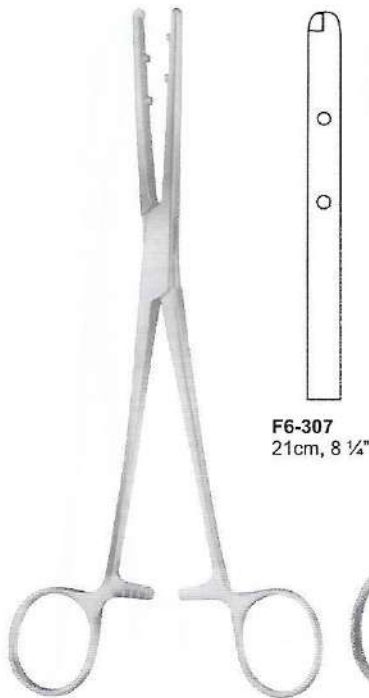

F6-307
21cm, 8 1/4"

Emmet Sponge &
Dressing Forceps

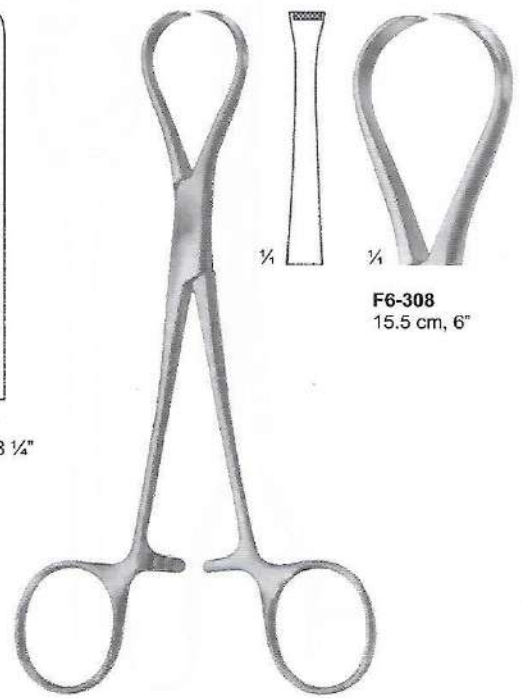

F6-308
15.5 cm, 6"

Tendon Seizing Forceps



HAEMOSTATIC FORCEPS

Arterienklemmen
Pinces Hemostatiques

Pinzas Hemostáticas
Pinze Emostatiche



Herz Tendon Seizing Forceps

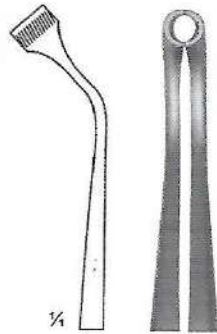

F6-309
15.5 cm, 6"
coarse serration



F6-310
15.5 cm, 6"
fine serrations

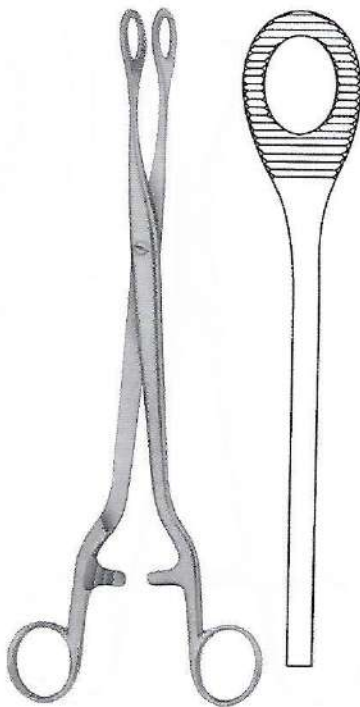

Noto Sponge &
Dressing Forceps
F6-311 28cm, 11"



Kelly Sponge &
Dressing Forceps

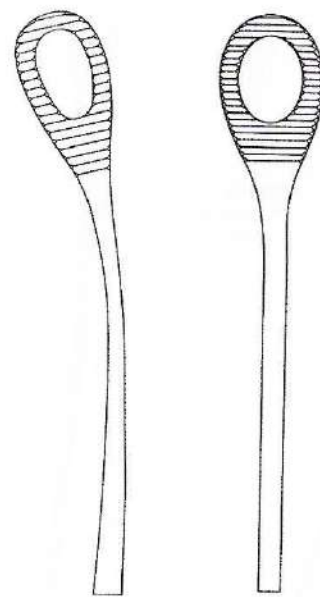

F6-312
32cm, 12 1/2"
Curved

F6-313
32cm, 12 1/2"
Straight

HAEMOSTATIC FORCEPS



Arterienklemmen
Pincas Hemostatiques

Pinzas Hemostaticas
Pinze Emostatiche

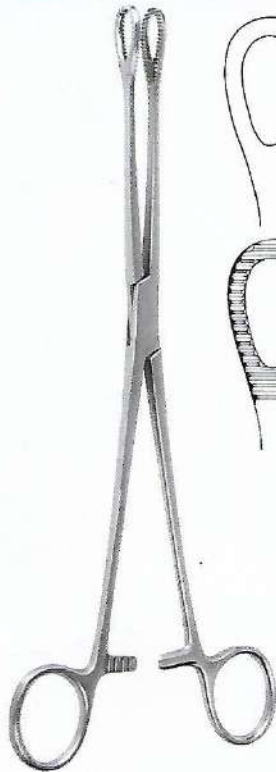

Foerster-Ballenger Sponge Forceps
& (bullet holding forceps)

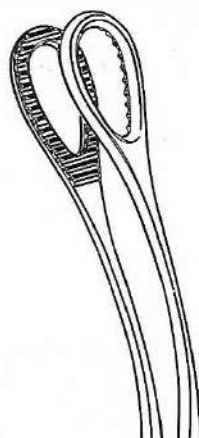
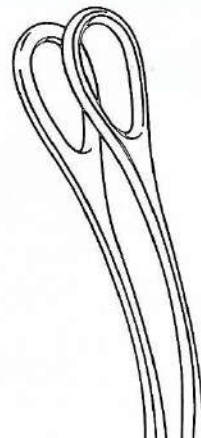
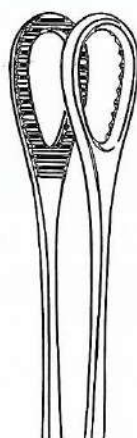
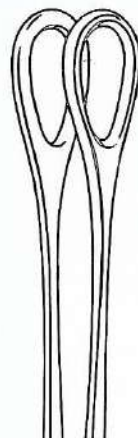

F6-314 18cm, 7"
F6-315 20.3cm, 8"
F6-316 24.1cm, 9.5"
Straight Smooth

F6-317 18cm, 7"
F6-318 20.3cm, 8"
F6-319 24.1cm, 9.5"
Straight Serrated

F6-320 18cm, 7"
F6-321 20.3cm, 8"
F6-322 24.4cm, 9.5"
Curved Smooth

F6-323 18cm, 7"
F6-324 20.3cm, 8"
F6-325 24.1cm, 9.5"
Curved Serrated

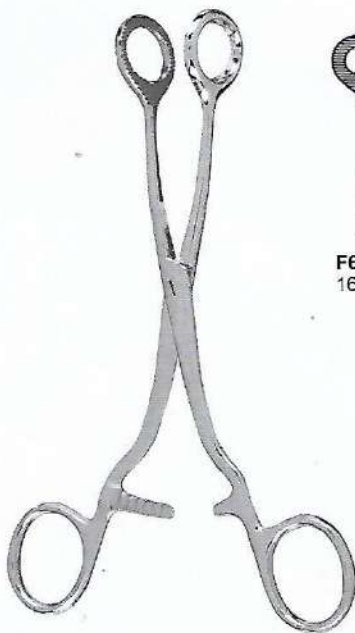

Collin Sponge & Dressing Forceps



F6-326
16cm, 6 1/4"



F6-327
16cm, 6 1/4"



F6-328
17cm, 6 3/4"

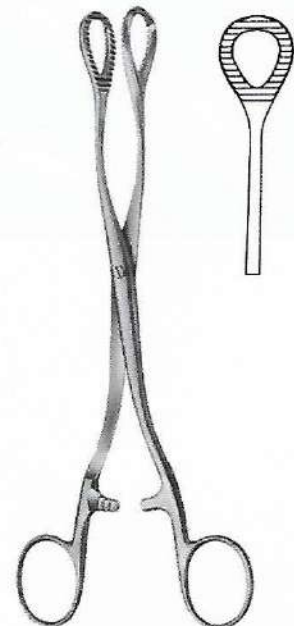

Heywood-Smith Sponge & Dressing Forceps
F6-329 20cm, 8"



NEEDLE HOLDERS

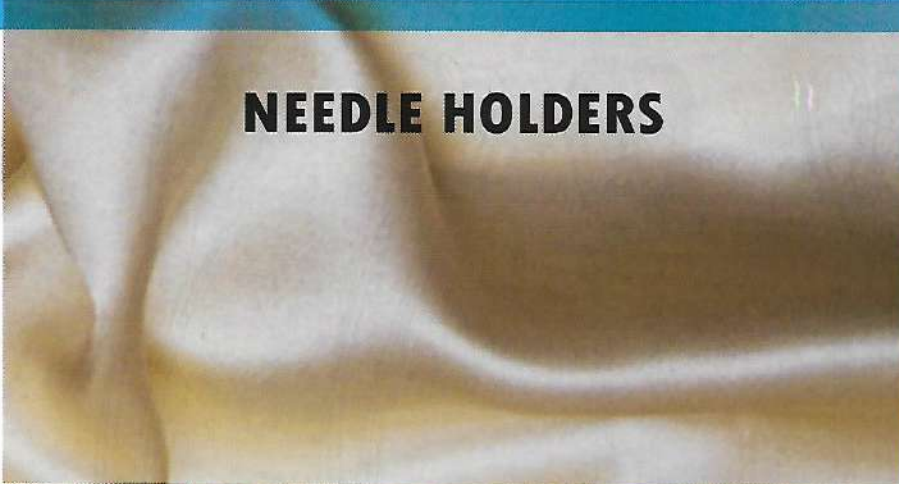

NEEDLE HOLDERS



Nadelhalter | Porta-agujas
 Prote-aiguilles | Porta aghi

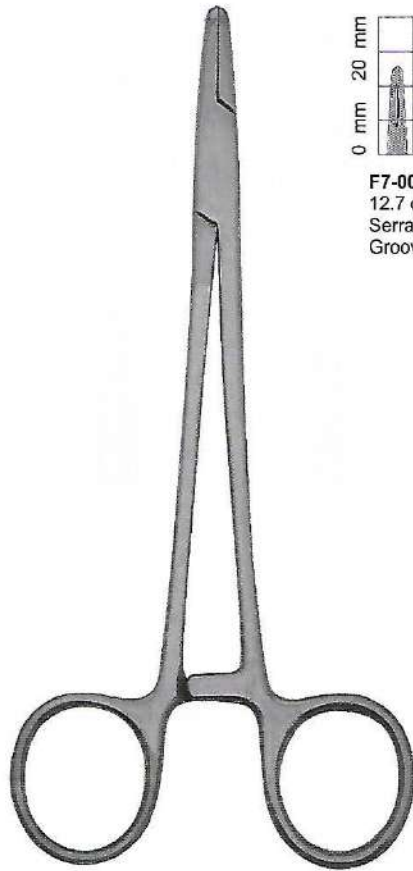

Mayo-Hegar
 Needle Holders

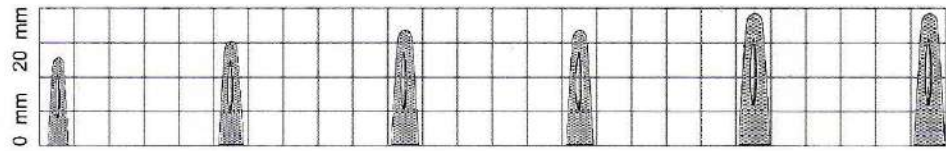

- F7-001**
12.7 cm, 5"
Serrated-Grooved
- F7-002**
14 cm, 5 1/2"
Serrated-Grooved
- F7-003**
15.2 cm, 6"
Serrated-Grooved
- F7-004**
15.2 cm, 6"
Serrated-Grooved
left handed
- F7-005**
17.8 cm, 6 1/4"
Serrated-Grooved
- F7-006**
17.8 cm, 6 1/4"
Serrated-Grooved
left handed

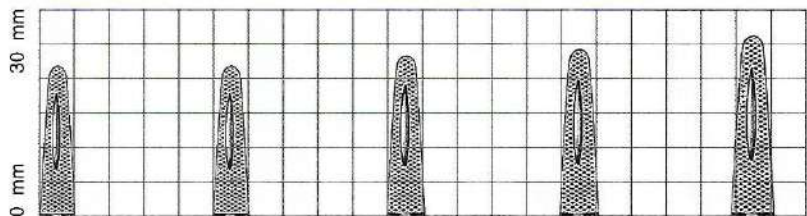

- F7-007**
20.3 cm, 8"
Serrated-Grooved
- F7-008**
20.3 cm, 8"
Serrated-Grooved
left handed
- F7-009**
24.8 cm, 9 3/4"
Serrated-Grooved
- F7-010**
26 cm, 10 1/4"
Serrated-Grooved
- F7-011**
30.5 cm, 12"
Serrated-Grooved

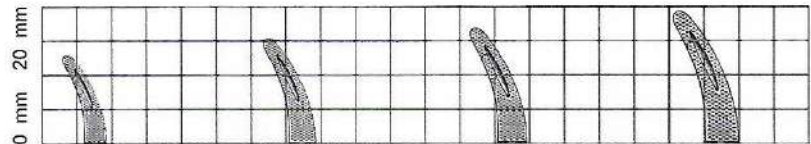

- F7-012**
12.7 cm, 5"
Serrated-Grooved
Curved
- F7-013**
14 cm, 5 1/2"
Serrated-Grooved
Curved
- F7-014**
15.2 cm, 6 1/4"
Serrated-Grooved
Curved
- F7-015**
17.8 cm, 7"
Serrated-Grooved
Curved

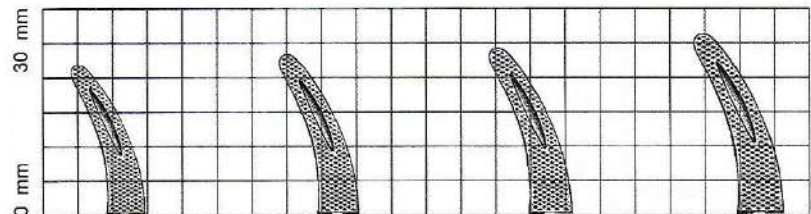

- F7-016**
20.3 cm, 8"
Serrated-Grooved
Curved
- F7-017**
24.8 cm, 9 3/4"
Serrated-Grooved
Curved
- F7-018**
26 cm, 10 1/4"
Serrated-Grooved
Curved
- F7-019**
30.5 cm, 12"
Serrated-Grooved
Curved



NEEDLE HOLDERS

Nadelhalter | Porta-agujas

Prote-aiguilles | Porta aghi



BAUMGARTNER
Needle Holder

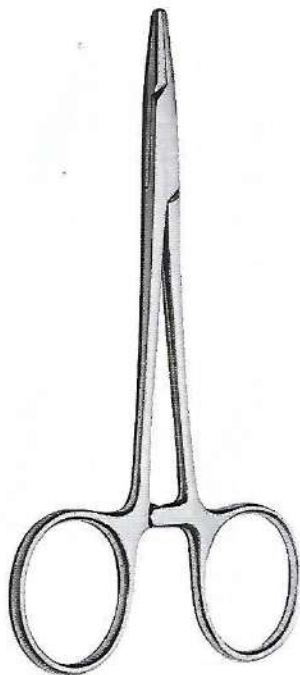
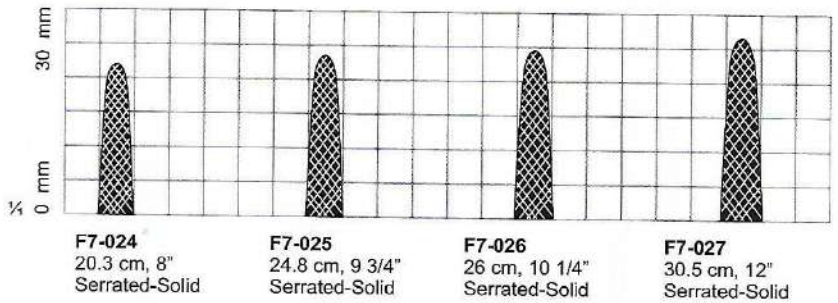
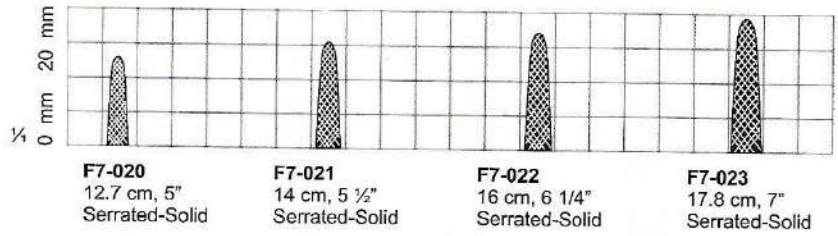

WEBSTER
Needle Holder

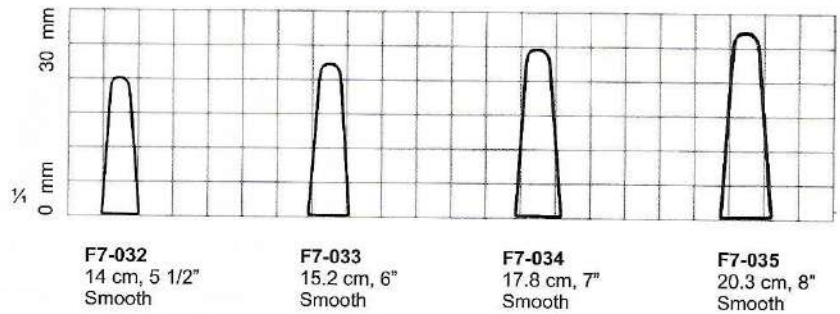
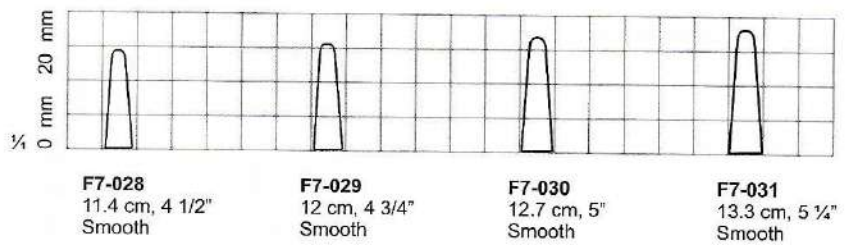

NEEDLE HOLDERS

Nadelhalter | Porta-agujas
 Prote-aiguilles | Porta aghi



BROWN
Needle Holder

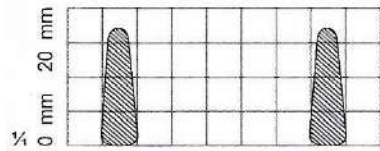

F7-036
13.3 cm, 5 1/4"
Serrated-Solid

F7-037
19.1 cm, 7 1/2"
Serrated-Solid



BABY CRILE-WOOD
Needle Holder

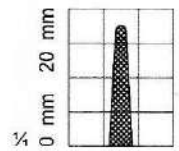

F7-038
15 cm, 6"



CRILE-WOOD
Needle Holder

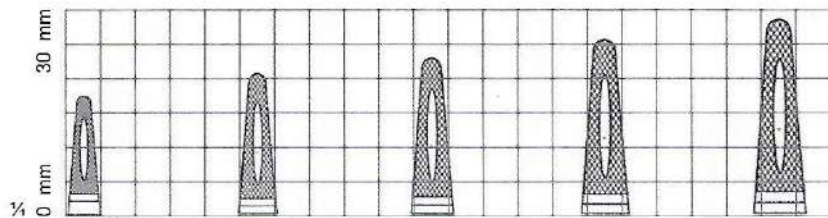

F7-039
15.2 cm, 6"
grooved serrated

F7-040
17.8 cm, 7"
grooved serrated

F7-041
20.3 cm, 8"
grooved serrate

F7-042
22.3 cm, 8 3/4"
grooved serrated

F7-043
25.4 cm, 10"
grooved serrated

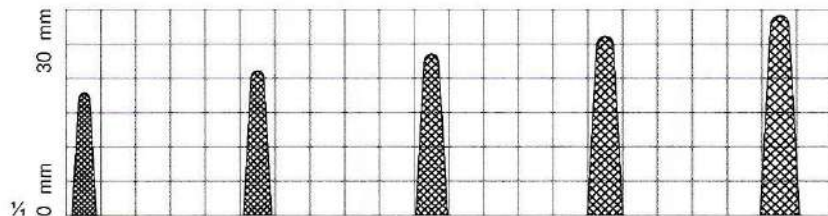

F7-044
15.2 cm, 6"
solid serrated

F7-045
17.8 cm, 7"
solid serrated

F7-046
20.3 cm, 8"
solid serrated

F7-047
22.3 cm, 8 3/4"
solid serrated

F7-048
25.4 cm, 10"
solid serrated



NEEDLE HOLDERS

Nadelhalter | Porta-agujas
Prote-aiguilles | Porta aghi

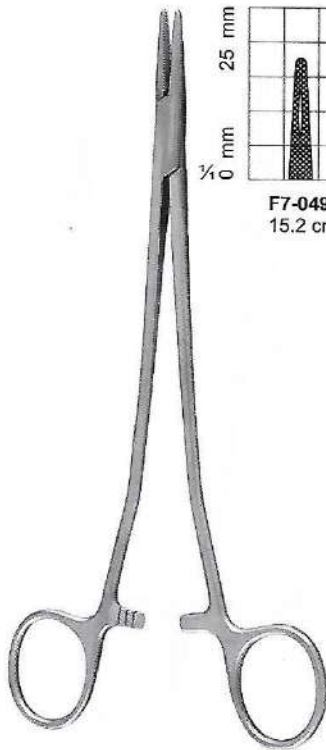

Sarot Needle Holders

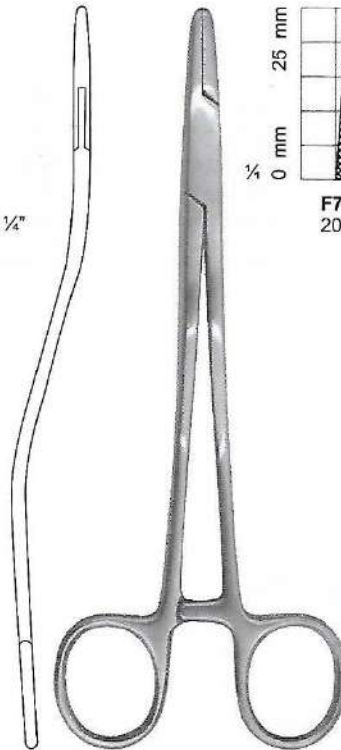
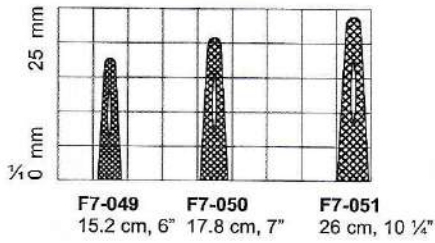

Bozemann Needle Holders

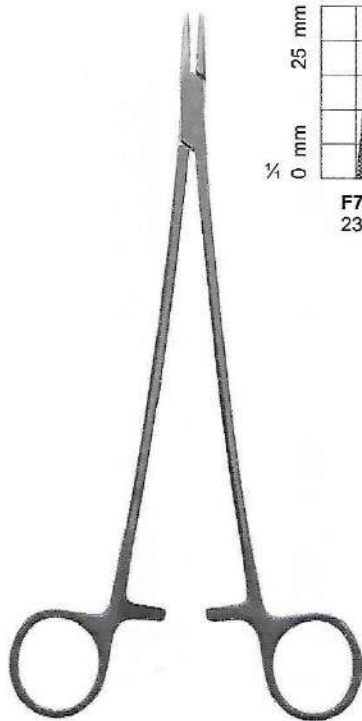
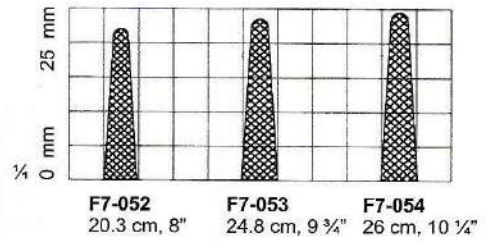

Jameson Needle Holders

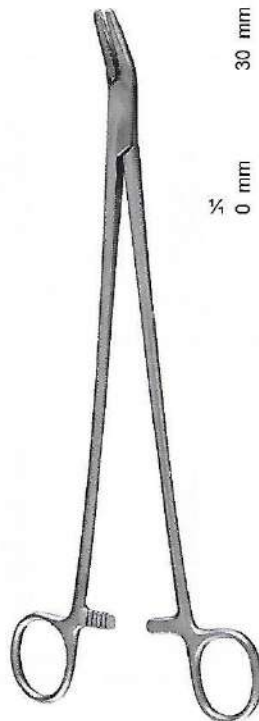
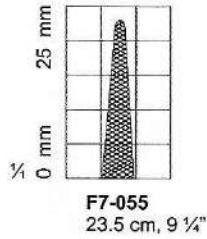

Finocchietto Needle Holders

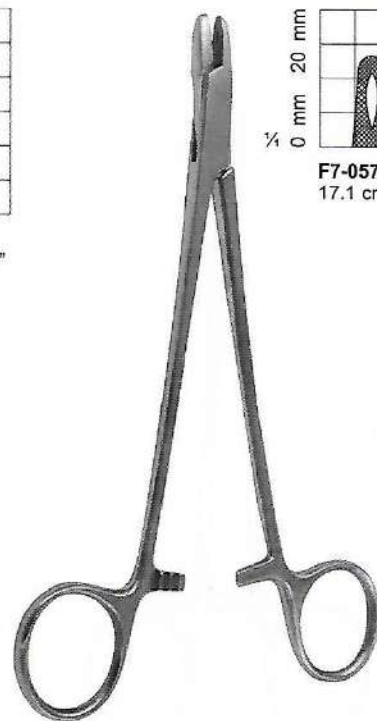
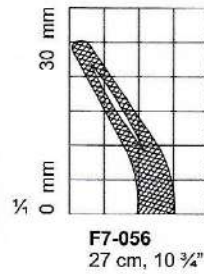

Mass. General Hospital
Needle Holders

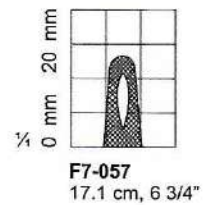

NEEDLE HOLDERS

Nadelhalter | Porta-agujas
 Prote-aiguilles | Porta aghi



F7-058
 17.8 cm, 7"

Adson Needle Holders

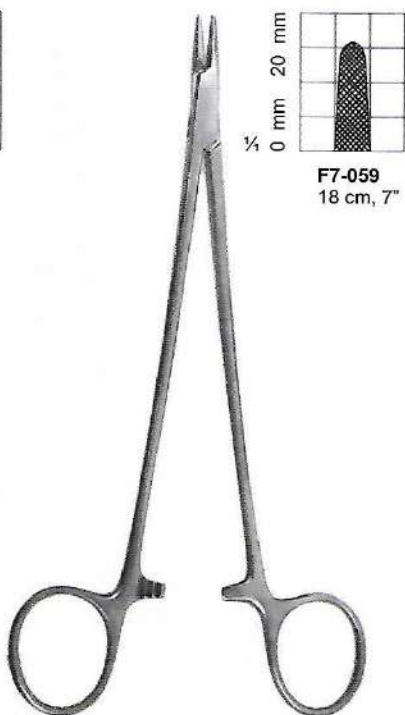

F7-059
 18 cm, 7"

New Orleans Needle Holders

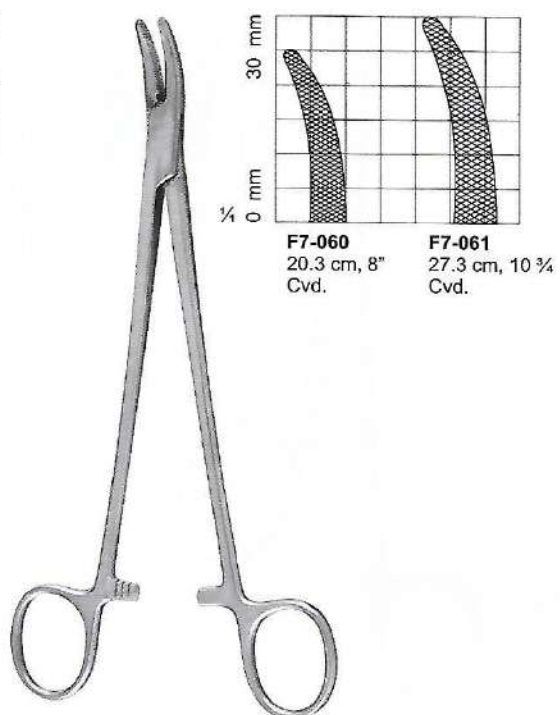

F7-060
 20.3 cm, 8"
 Cvd.

F7-061
 27.3 cm, 10 1/4"
 Cvd.

Heaney Needle Holders
 07-165

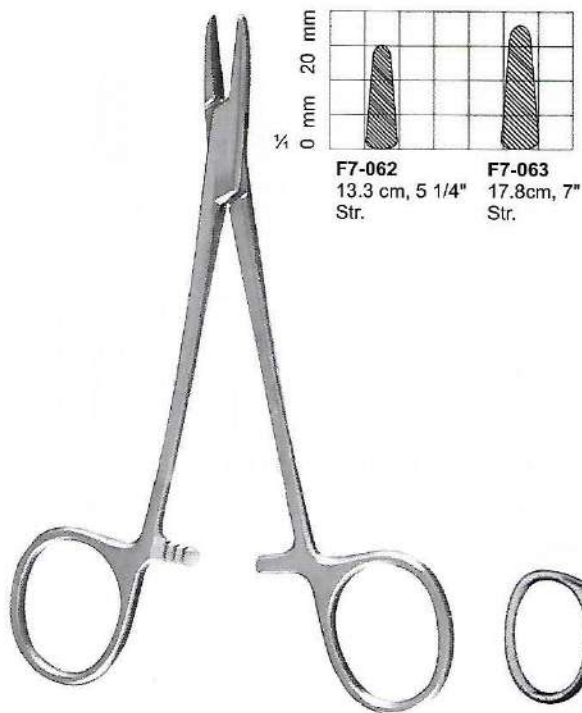

F7-062
 13.3 cm, 5 1/4"
 Str.

F7-063
 17.8cm, 7"
 Str.

Brown Needle Holders

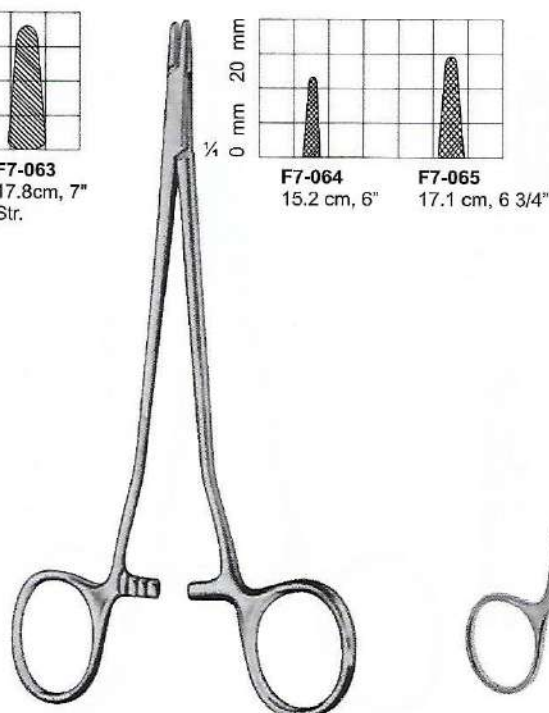

F7-064
 15.2 cm, 6"

F7-065
 17.1 cm, 6 3/4"

Senning Needle Holders
 (Schwed. Model)

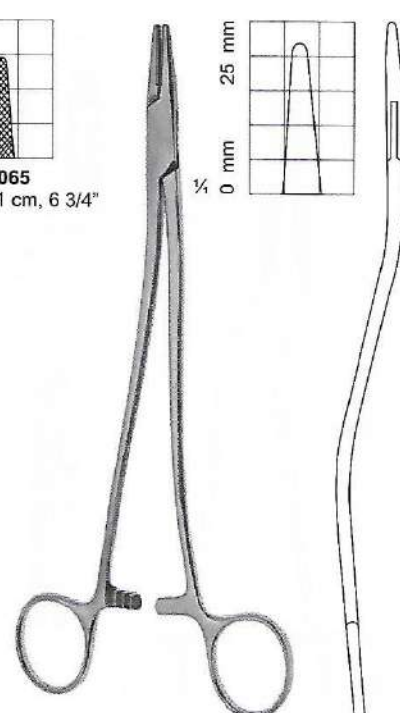

Wertheim Needle Holders
F7-066 20 cm, 8"
F7-067 24 cm, 9 1/2"



NEEDLE HOLDERS

Nadelhalter | Porta-agujas
 Prote-aiguilles | Porta aghi

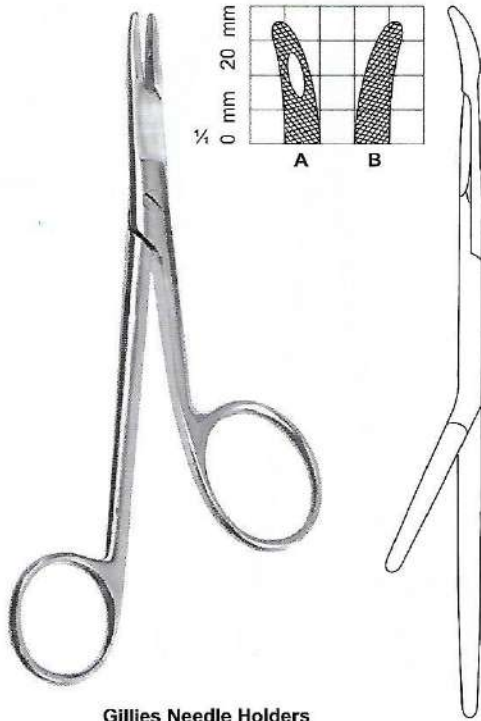

Gillies Needle Holders
F7-068
 16 cm, 6 1/4"

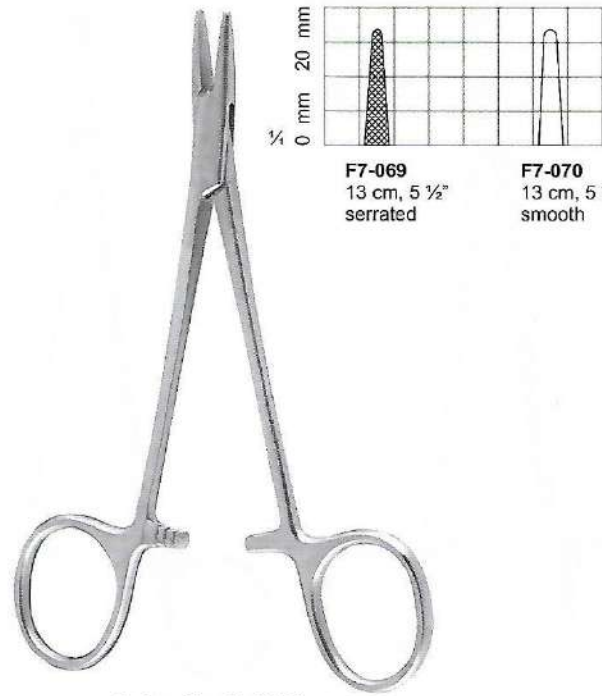

Halsey Needle Holders

F7-069
 13 cm, 5 1/2"
 serrated

F7-070
 13 cm, 5 1/2"
 smooth

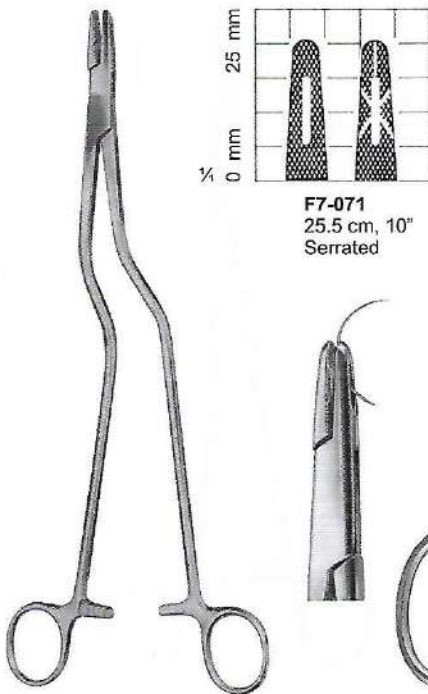

Masson-Luethy
Needle Holders

F7-071
 25.5 cm, 10"
 Serrated

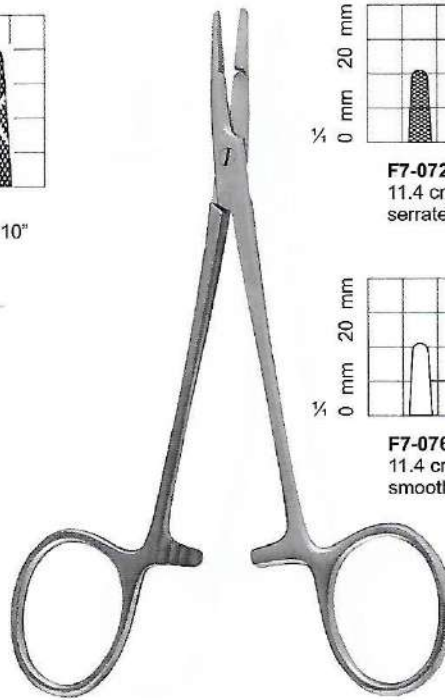

Olsen-Hegar Needle Holders

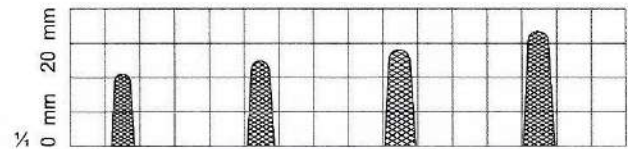

F7-072
 11.4 cm, 4 1/2"
 serrated

F7-073
 14 cm, 5 1/2"
 serrated

F7-074
 17 cm, 6 3/4"
 serrated

F7-075
 19 cm, 7 1/2"
 serrated

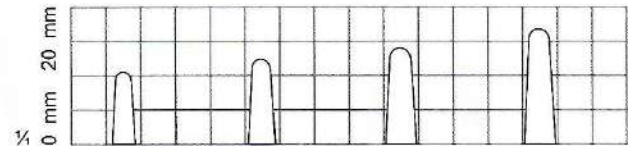

F7-076
 11.4 cm, 4 1/2"
 smooth

F7-077
 14 cm, 5 1/2"
 smooth

F7-078
 17 cm, 6 3/4"
 smooth

F7-079
 19 cm, 7 1/2"
 smooth

NEEDLE HOLDERS



Nadelhalter | Porta-agujas
 Prote-aiguilles | Porta aghi

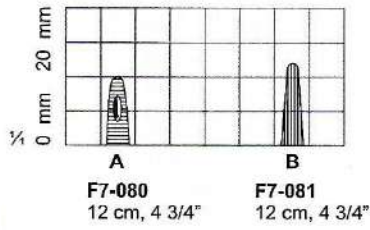
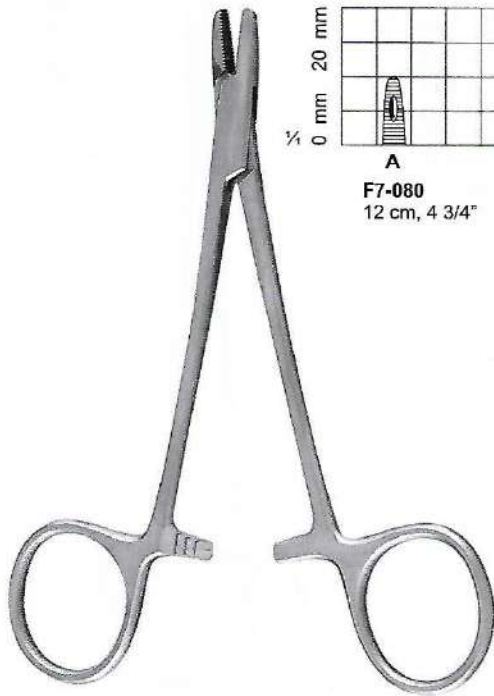

Derf Needle Holders

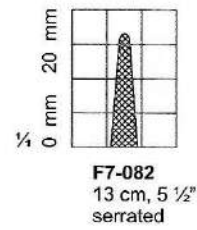

Kilner Needle Holders

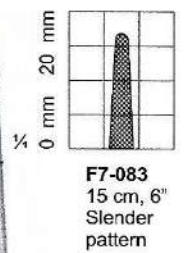
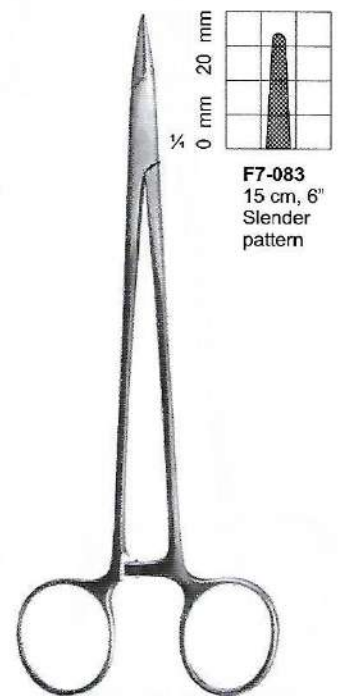

Crile-Murray
 Needle Holders

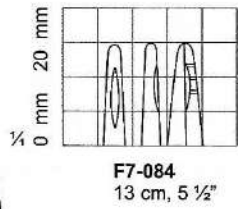

Neivert Needle Holders

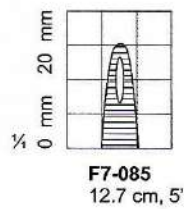
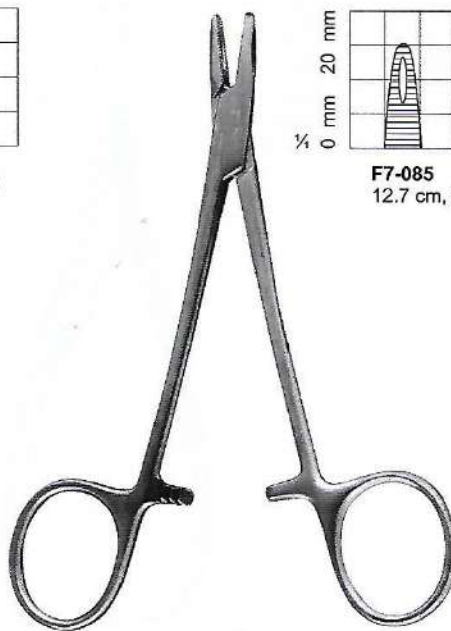

Collier Needle Holders

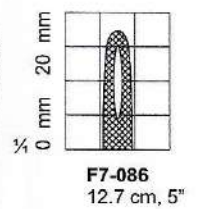
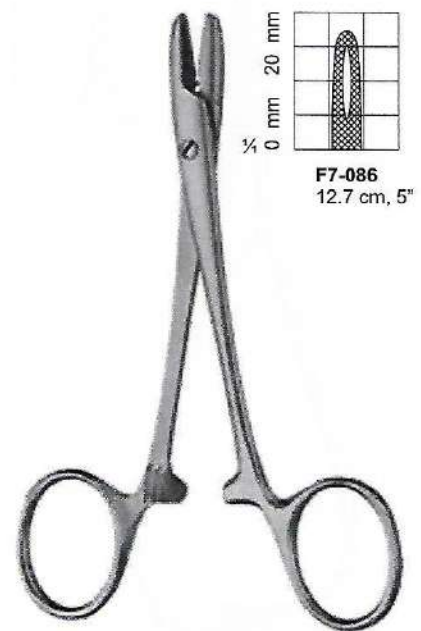

Doyen Needle Holders



NEEDLE HOLDERS

Nadelhalter | Porta-agujas
Prote-aiguilles | Porta aghi

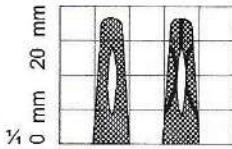
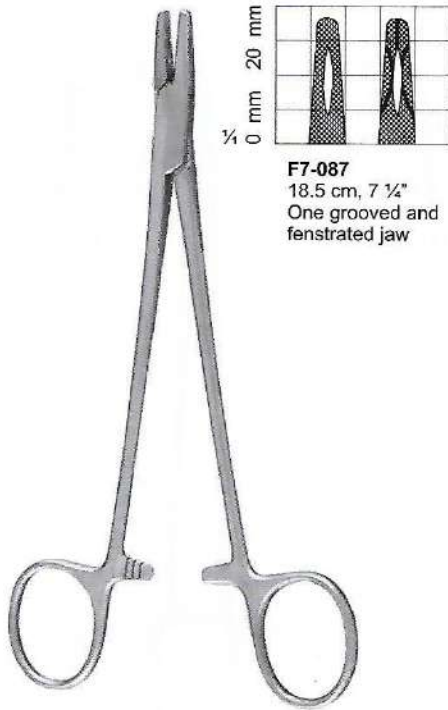

F7-087
18.5 cm, 7 1/4"
One grooved and fenestrated jaw

Metzenbaum Needle Holders

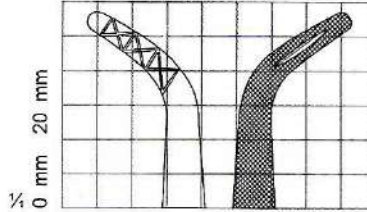
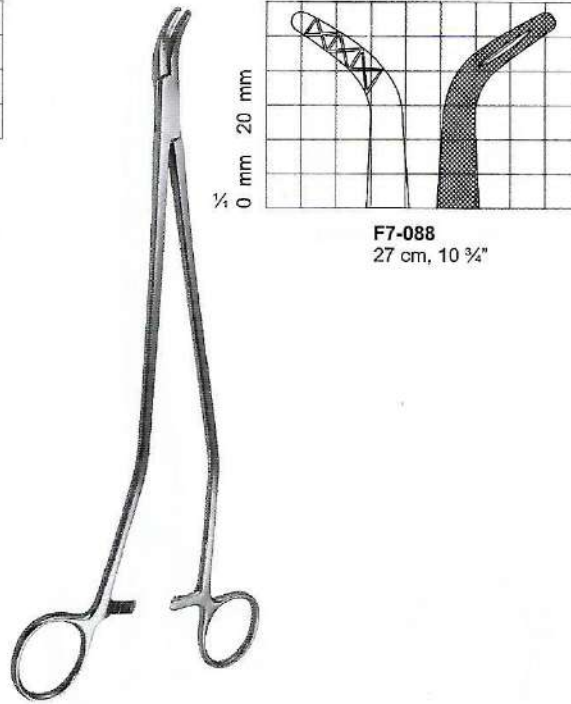

F7-088
27 cm, 10 3/4"

Johnson Needle Holders

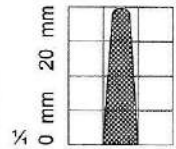

F7-089
26.5 cm, 10 1/2"
Serrated-Solid

Wangensteen Needle Holders

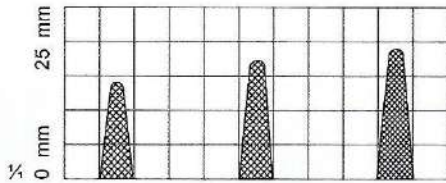
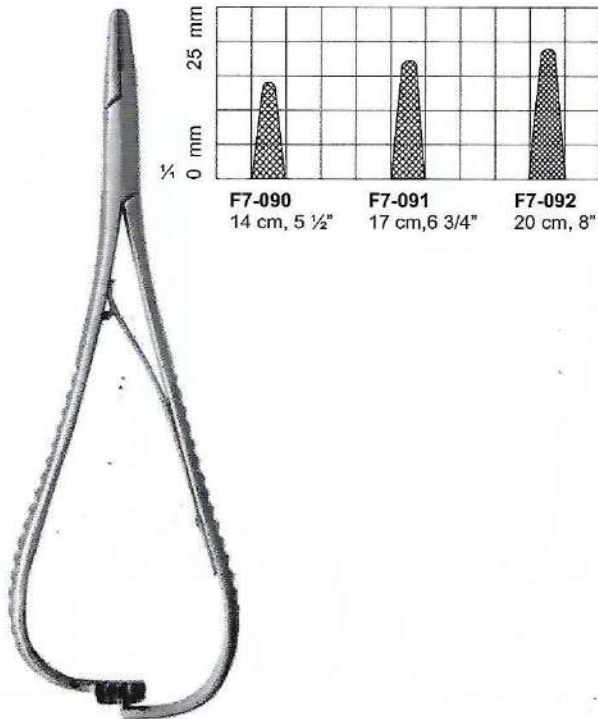

F7-090 14 cm, 5 1/2"
F7-091 17 cm, 6 3/4"
F7-092 20 cm, 8"

Mathieu Needle Holders

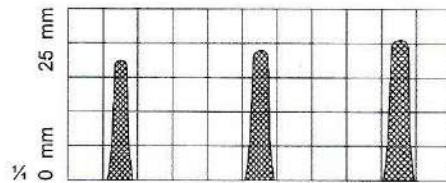
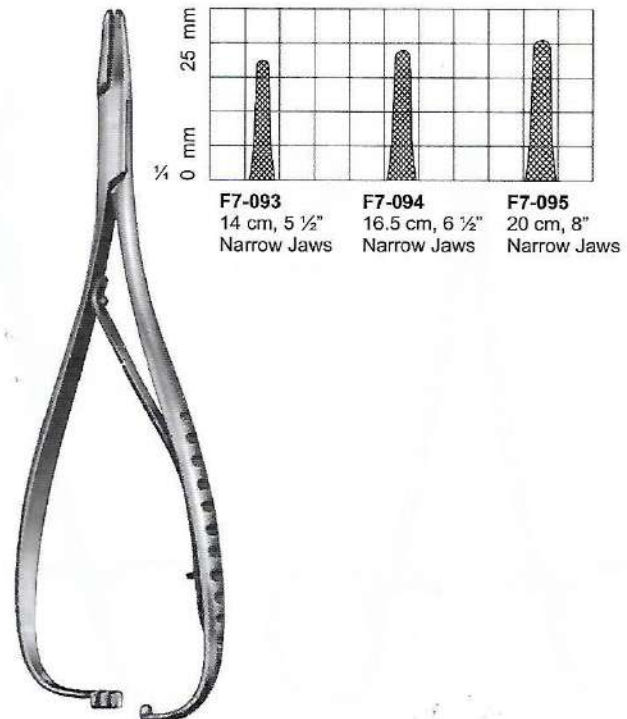

F7-093 14 cm, 5 1/2"
Narrow Jaws
F7-094 16.5 cm, 6 1/2"
Narrow Jaws
F7-095 20 cm, 8"
Narrow Jaws

Mathieu Needle Holders

NEEDLE HOLDERS



Nadelhalter | Porta-agujas
 Prote-aguilles | Porta aghi

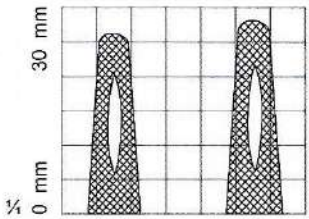
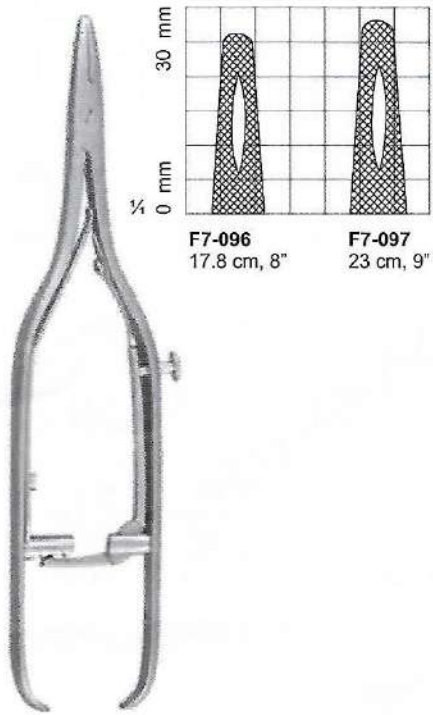

F7-096
17.8 cm, 8"
F7-097
23 cm, 9"

Mayo Rochester Needle Holders
 button release, screw joint.

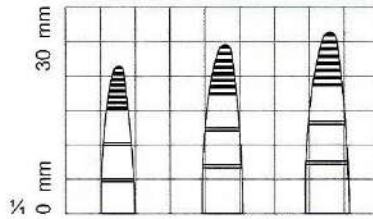
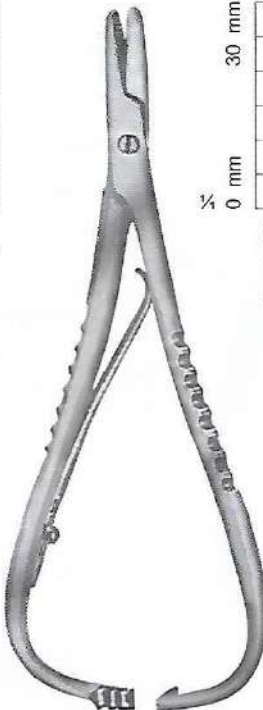

F7-098
15 cm, 6"
lined with copper.
F7-099
17.8 cm, 7"
lined with copper.
F7-100
20 cm, 8"
lined with copper.

Macphail Needle Holders

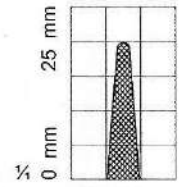
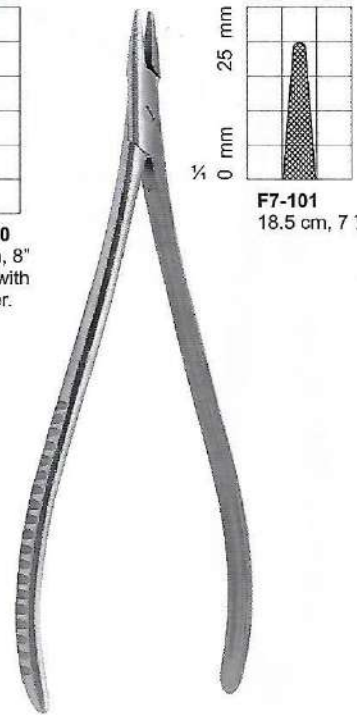

F7-101
18.5 cm, 7 1/4"

Tennis Needle Holders

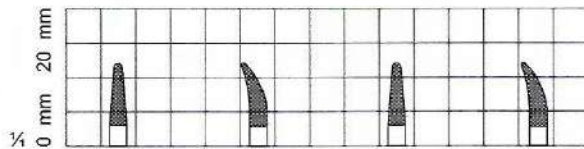

F7-102
12.7 cm, 5"
with lock
straight
F7-103
12.7 cm, 5"
with lock
curved
F7-104
12.7 cm, 5"
without lock
straight
F7-105
12.7 cm, 5"
without lock
curved

Castroviejo Needle Holders

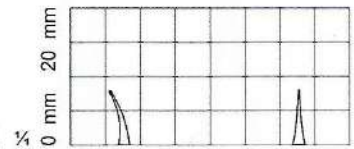

F7-106
14 cm, 5 1/2"
Curved, Smooth
with lock curved
F7-107
14 cm, 5 1/2"
Straight, Smooth
with lock curved

Barraquer Needle Holders



NEEDLE HOLDERS

Nadelhalter | Porta-agujas
 Prote-aiguilles | Porta aghi

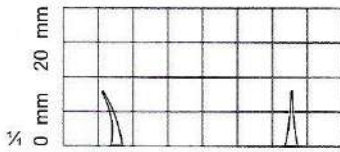

F7-108
 14 cm, 5 1/2"
 Curved, Smooth
 without lock
 curved

F7-109
 14 cm, 5 1/2"
 Straight, Smooth
 without lock
 curved

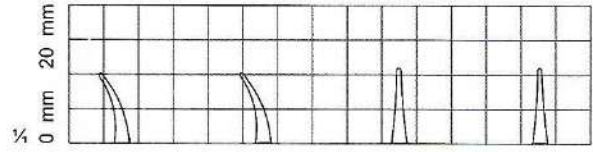

F7-110
 14 cm, 5 1/2"
 Curved
 Smooth
 with lock

F7-111
 14 cm, 5 1/2"
 Curved
 Smooth
 without lock

F7-112
 14 cm, 5 1/2"
 Straight
 Smooth
 with lock

F7-113
 14 cm, 5 1/2"
 Straight
 Smooth
 without lock

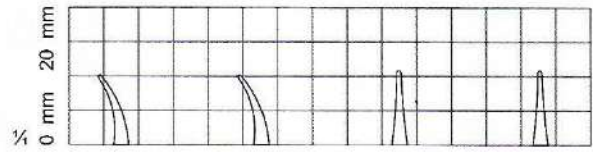

F7-114
 17.8 cm, 7"
 Curved
 Smooth
 with lock

F7-115
 17.8 cm, 7"
 Curved
 Smooth
 without lock

F7-116
 17.8 cm, 7"
 Straight
 Smooth
 with lock

F7-117
 17.8 cm, 7"
 Straight
 Smooth
 without lock

Barraquer Needle Holders

Castroviejo Needle Holders

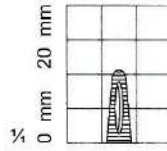

F7-120
 12 cm, 5"

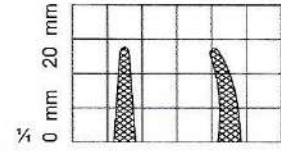

F7-121
 16 cm,
 6 1/4" Str.

F7-122
 16 cm,
 6 1/4" Cvd.

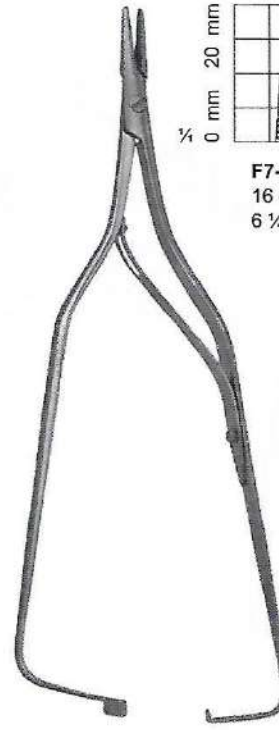
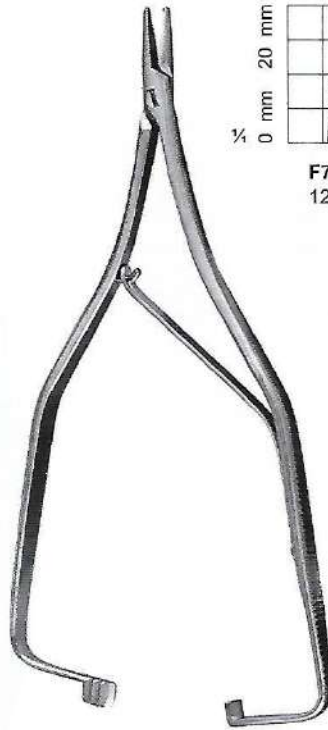

**Castroviejo Olsen Heager /
 Needle Holders / Scissors**
F7-118 14.5 cm, 5 3/4"
F7-119 15.0 cm, 6"

Boynton Needle Holders

Arruga Needle Holders

NEEDLE HOLDERS

Nadelhalter | Porta-agujas
 Prote-aguilles | Porta aghi

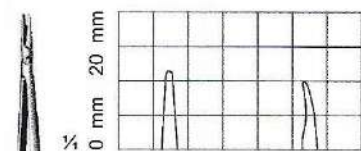

F7-123
 19.5 cm, 7 3/4"
 Smooth Str.

F7-124
 23 cm, 9"
 Smooth Cvd.



Micro Needle Holders

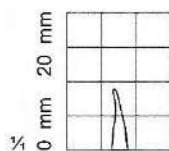

F7-125
 16 cm, 6 1/4"
 Smooth Cvd.



Micro Needle Holders

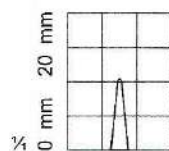

F7-126
 12 cm, 5"
 Smooth Str
 with lock



Castroviejo Needle Holders

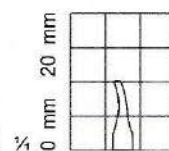

F7-127
 12 cm, 5"
 Smooth Cvd
 with lock



Castroviejo Needle Holders

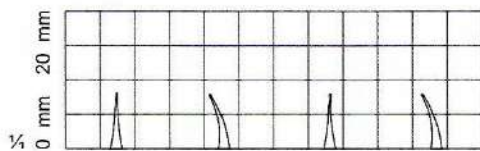

F7-128
 10.5 cm, 4"
 Smooth Str.

F7-129
 10.5 cm, 4"
 Smooth Cvd.

F7-130
 11.5 cm, 4 3/4"
 Smooth Str.

F7-131
 11.5 cm, 4 3/4"
 Smooth Cvd.



Barraquer-Trotman Needle Holders

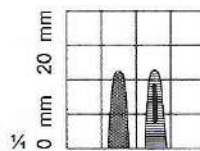

F7-132
 13.5 cm, 5 1/4"
 Serrated



Kalt Needle Holders

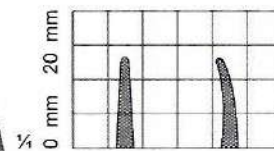

F7-133
 13.5 cm, 5 1/4"
 Serrated Str.

F7-134
 13.5 cm, 5 1/4"
 Serrated Cvd.



Arruga Needle Holders

NEEDLE HOLDERS T.C



Nadelhalter | Porta-agujas
 Prote-aiguilles | Porta aghi

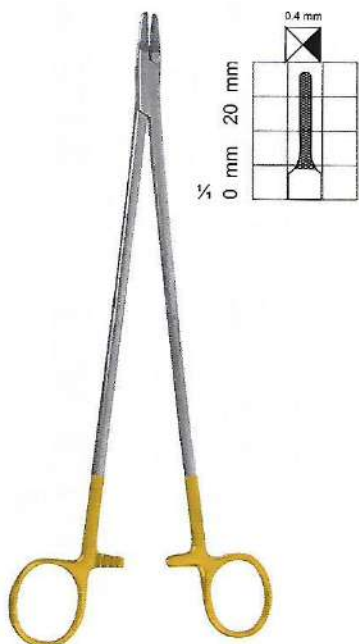

Intracardiac Needle Holders T.C.
 T.C F7-150 18 cm, 7"
 T.C F7-151 20 cm, 8"
 T.C F7-152 22 cm, 8 3/4"
 T.C F7-153 25 cm, 10"

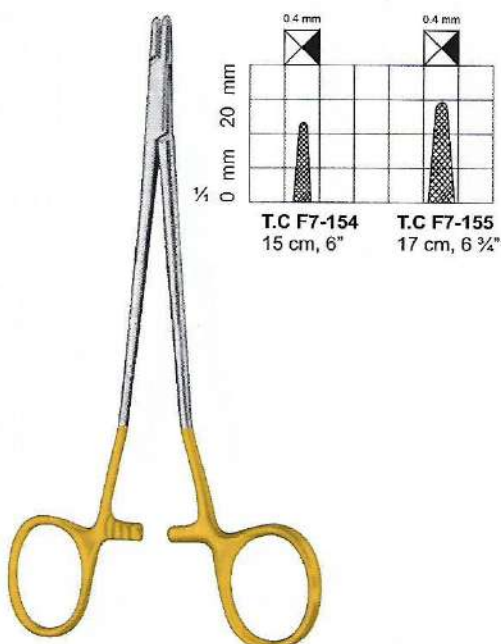

Senning Needle Holders T.C
 (Schwed. Model)

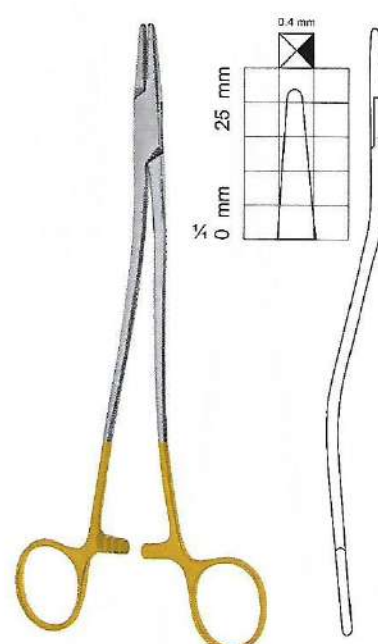

Wertheim Needle Holders T.C
 T.C F7-156 20 cm, 8"
 T.C F7-157 24 cm, 9 1/2"

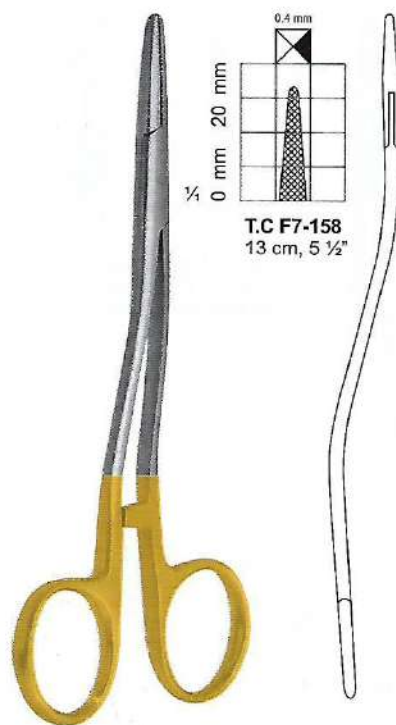

Kilner Needle Holders T.C

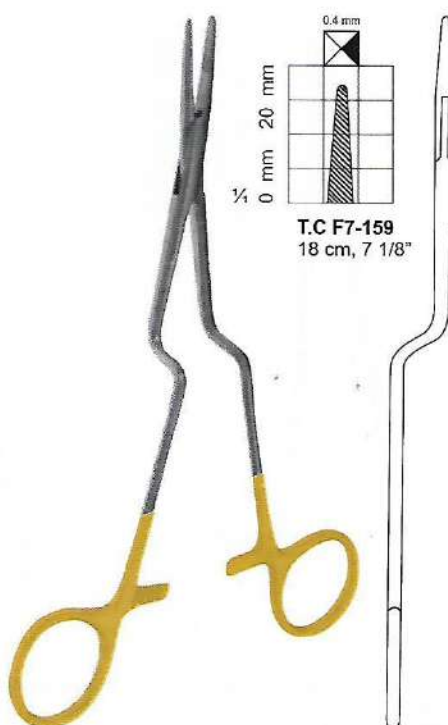

Jacobson Needle Holders T.C

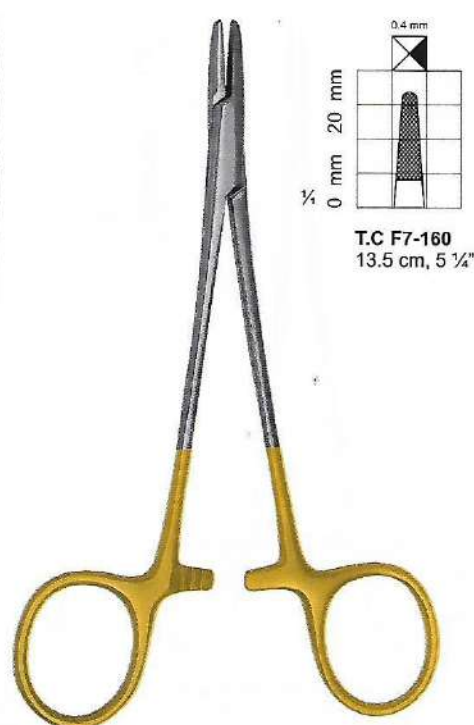

Baumgartner Needle Holders T.C



NEEDLE HOLDERS T.C

Nadelhalter Porta-agujas
 Prote-aiguilles Porta aghi

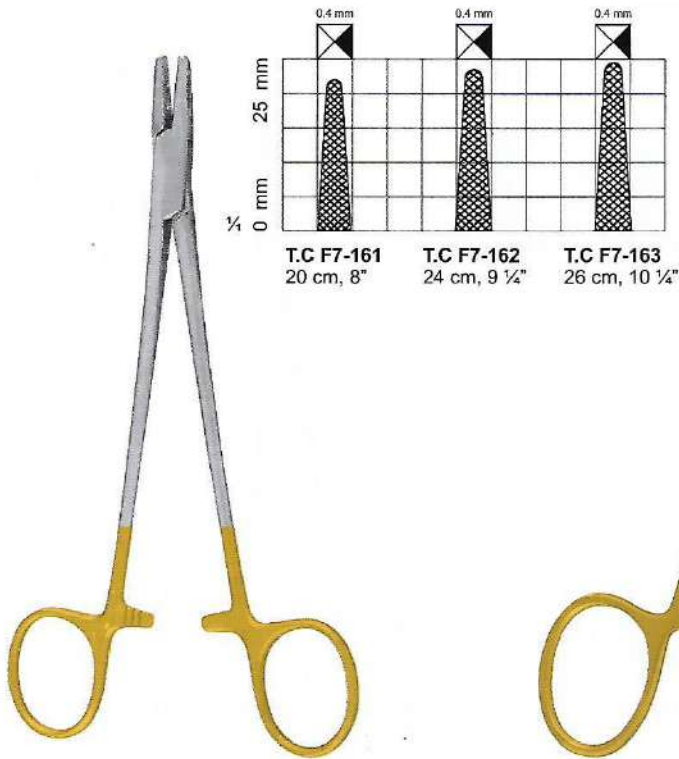

Bozemann Needle Holders T.C

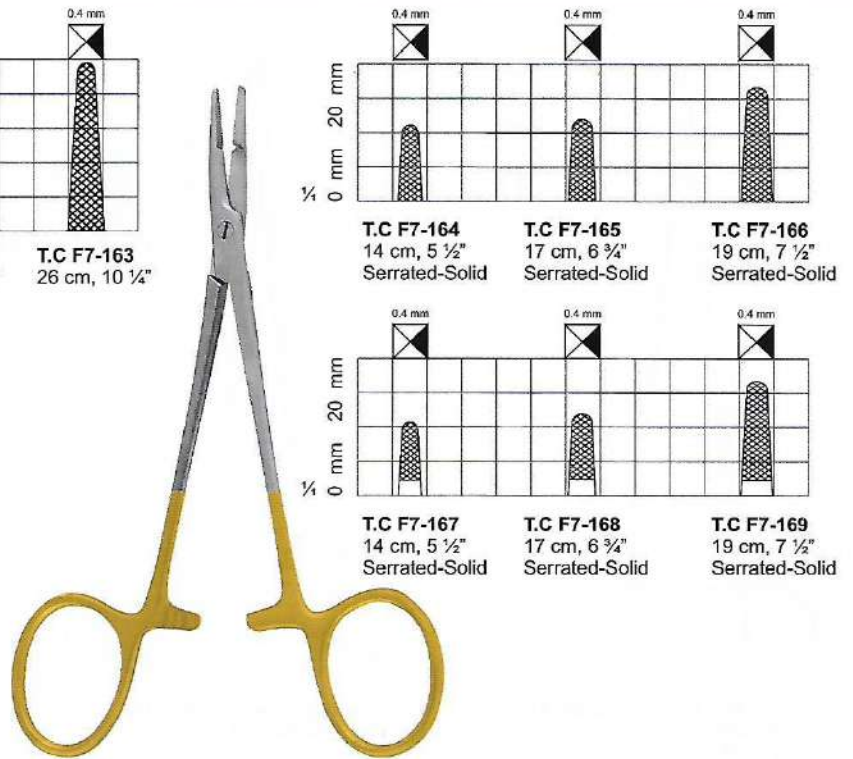

Olsen-Hegar Needle Holders T.C

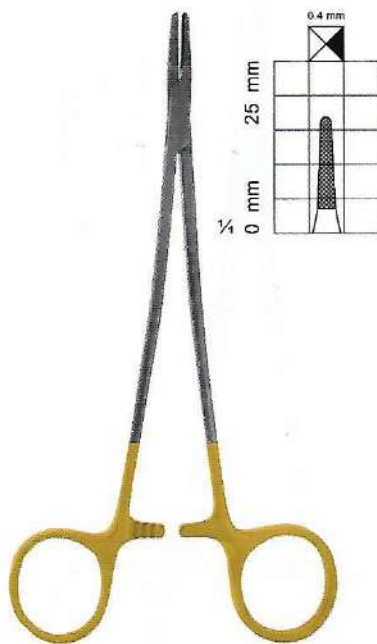

French-Eye Needle Holders T.C

T.C F7-170 16 cm, 6 1/4"
 T.C F7-171 17.8 cm, 7"
 T.C F7-172 20 cm, 8"
 T.C F7-173 22 cm, 8 3/4"
 T.C F7-174 25 cm, 10"

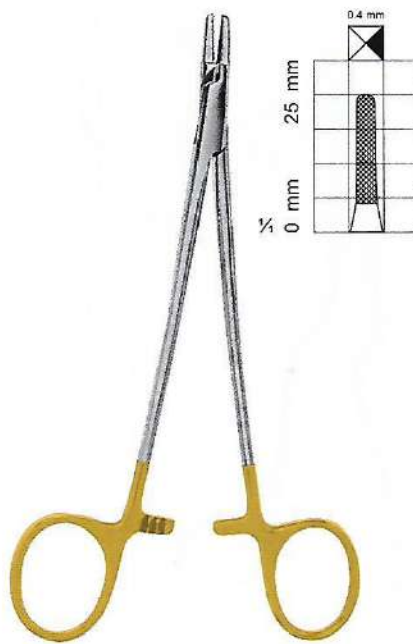

French-Eye Needle Holders T.C

T.C F7-175 15.2 cm, 6"
 T.C F7-176 17.8 cm, 7"
 T.C F7-177 20.3 cm, 8"
 T.C F7-178 25.4 cm, 10"

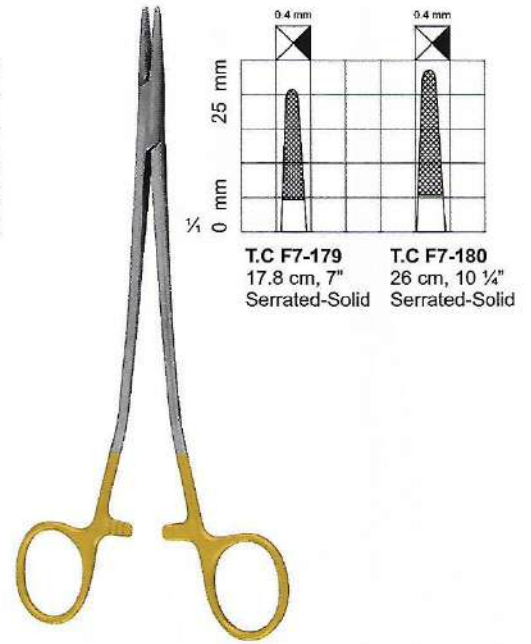

Sarot Needle Holders T.C

T.C F7-179 17.8 cm, 7"
 Serrated-Solid
 T.C F7-180 26 cm, 10 1/4"
 Serrated-Solid

NEEDLE HOLDERS T.C



Nadelhalter | Porta-agujas
 Prote-aiguilles | Porta aghi

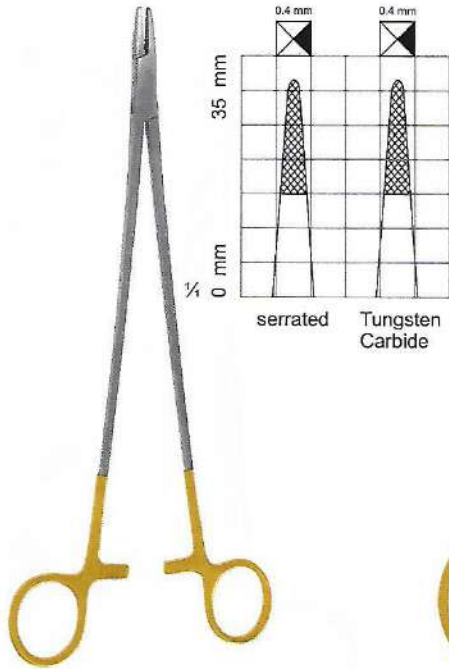

Wangensteen Needle Holders T.C
T.C F7-181
 27.3 cm, 10 3/4"

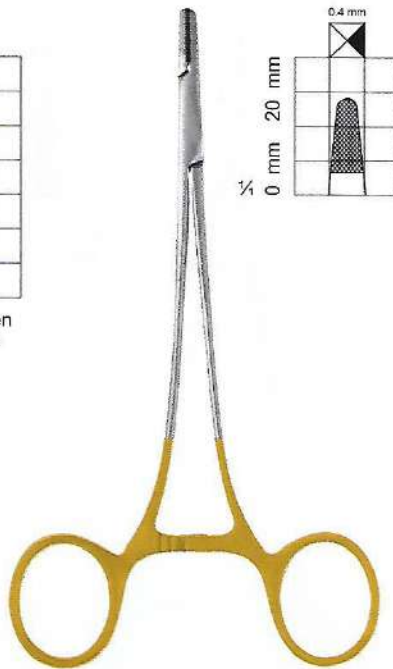

Finocchio Needle Holders T.C
T.C F7-182 13 cm, 5 1/4"
T.C F7-183 16 cm, 6 1/4"
T.C F7-184 19 cm, 7 1/2"
T.C F7-185 21 cm, 8 1/4"

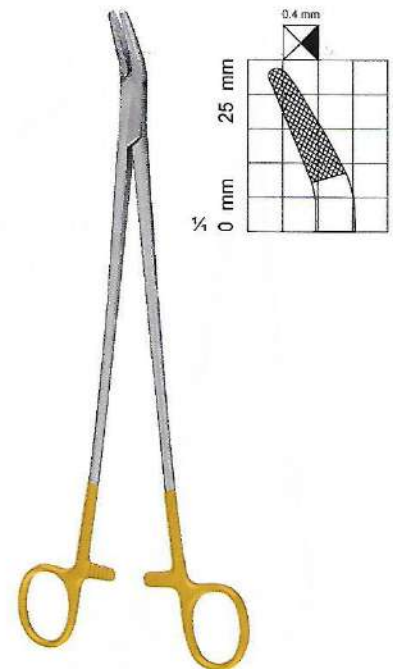

Finocchio Needle Holders T.C
T.C F7-186 13 cm, 5 1/4"
T.C F7-187 16 cm, 6 1/4"
T.C F7-188 19 cm, 7 1/2"

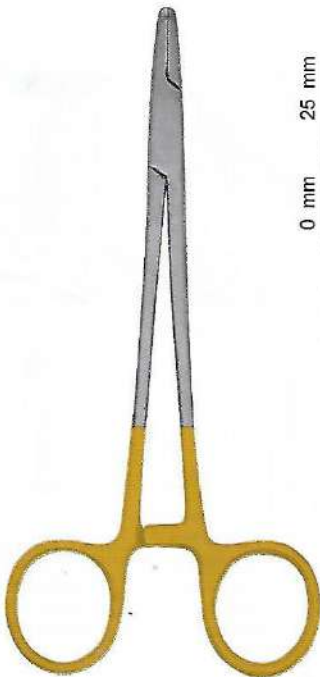

Mayo-Hegar Needle Holders T.C
 Also Available Right Handle

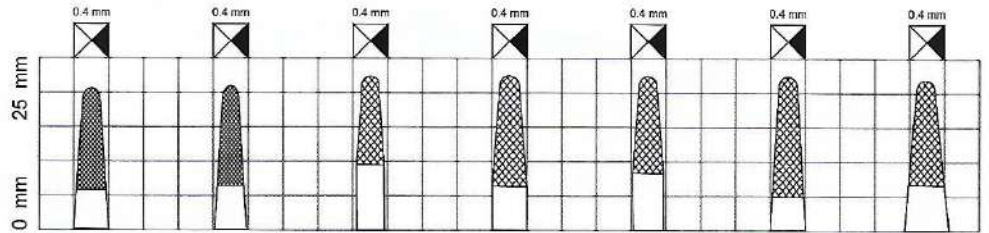

T.C F7-189 16 cm, 6 1/4"	T.C F7-191 20 cm, 8"	T.C F7-193 15.2 cm, 6"	T.C F7-195 17.8 cm, 7"	T.C F7-197 20.3 cm, 8"	T.C F7-199 23 cm, 9"	T.C F7-201 25 cm, 10"
T.C F7-190 17.8 cm, 7" Left handed.	T.C F7-192 20 cm, 8" Left handed.	T.C F7-194 15.2 cm, 6" Left handed.	T.C F7-196 17.8 cm, 7" Left handed.	T.C F7-198 20.3 cm, 8" Left handed.	T.C F7-200 23 cm, 9" Left handed.	T.C F7-202 25 cm, 10" Left handed.

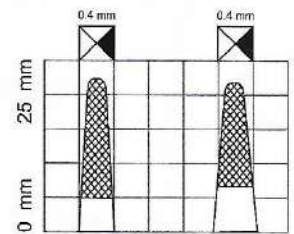

T.C F7-203 27.94 cm, 11"	T.C F7-205 29.8 cm, 12"
T.C F7-204 27.94 cm, 11" Left handed.	T.C F7-206 29.8 cm, 12" Left handed.



NEEDLE HOLDERS T.C

Nadelhalter | Porta-agujas
Prote-aiguilles | Porta aghi

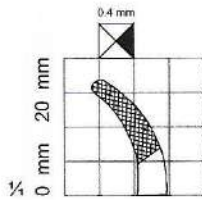
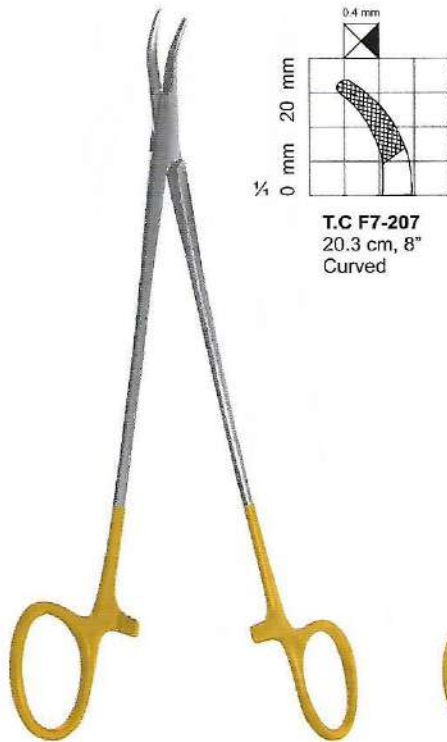

T.C F7-207
20.3 cm, 8"
Curved

Finochietto Needle Holders T.C

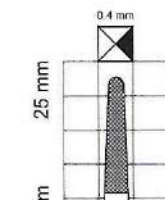

T.C F7-208
17.8 cm, 7"

Rochester Needle Holders T.C

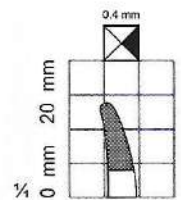

T.C F7-209
16 cm, 6 1/4"

Gillies Needle Holders T.C

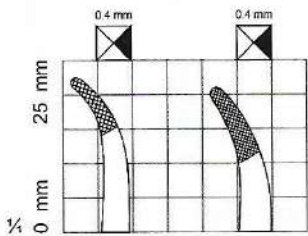
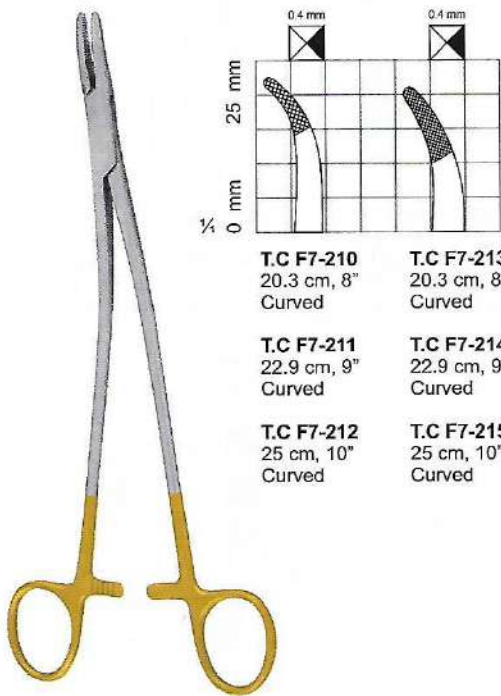

T.C F7-210
20.3 cm, 8"
Curved

T.C F7-213
20.3 cm, 8"
Curved

T.C F7-211
22.9 cm, 9"
Curved

T.C F7-214
22.9 cm, 9"
Curved

T.C F7-212
25 cm, 10"
Curved

T.C F7-215
25 cm, 10"
Curved

Stratte Needle Holders T.C

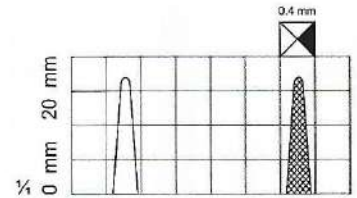
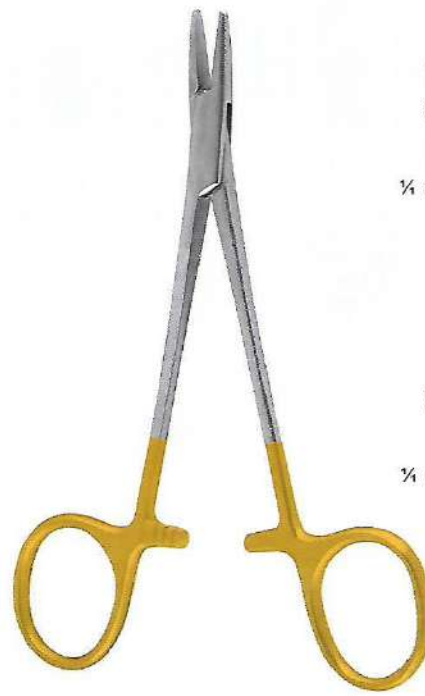

T.C F7-216
12.5 cm, 5 1/4"
Smooth

T.C F7-217
12.5 cm, 5 1/4"
Serrated-Solid

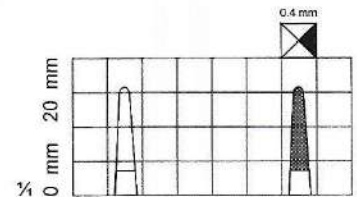

T.C F7-218
12.5 cm, 5 1/4"
Tungsten Carbide
Smooth

T.C F7-219
12.5 cm, 5 1/4"
Tungsten Carbide
Serrated-Solid

Halsey Needle Holders T.C

NEEDLE HOLDERS T.C



Nadelhalter | Porta-agujas
 Prote-aguilles | Porta aghi



Ryder Needle Holders T.C
 Narrow jaws.

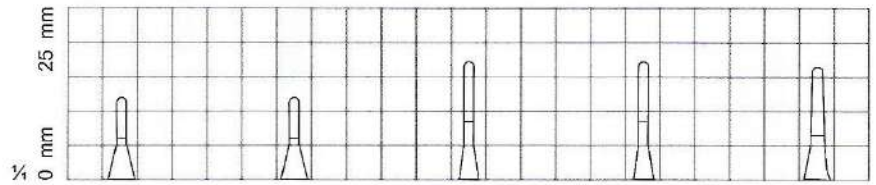

T.C F7-220 Smooth inserts. 12.7 cm, 5 1/2"	T.C F7-221 Smooth inserts. 15.2 cm, 6"	T.C F7-222 Smooth inserts. 17.8 cm, 7"	T.C F7-223 Smooth inserts. 20.3 cm, 8"	T.C F7-224 Smooth inserts. 22.9 cm, 9"
---	---	---	---	---

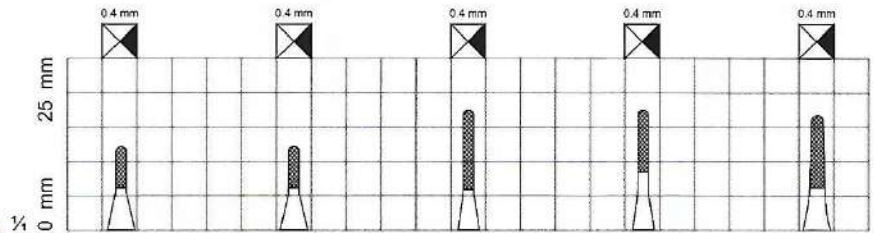

T.C F7-225 12.7 cm, 5 1/2"	T.C F7-226 15.2 cm, 6"	T.C F7-227 17.8 cm, 7"	T.C F7-228 20.3 cm, 8"	T.C F7-229 22.9 cm, 9"
--------------------------------------	----------------------------------	----------------------------------	----------------------------------	----------------------------------

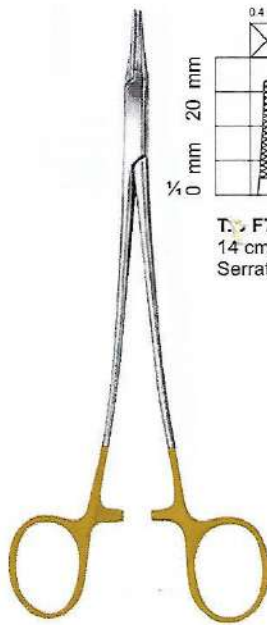

**Eufate Pasque T.C
 Needle Holders**

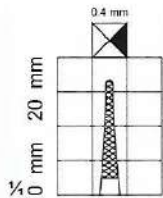

T.C F7-230
 14 cm, 5 1/2"
 Serrated-Delicate



**Cooley Intracardiac Needle
 Holders T.C**
 Narrow Jaw.

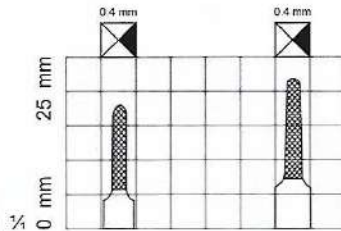

T.C F7-231 17.8 cm, 7"	T.C F7-233 22.9 cm, 9"
T.C F7-232 20.3 cm, 8"	T.C F7-234 26.3 cm, 10 1/2"

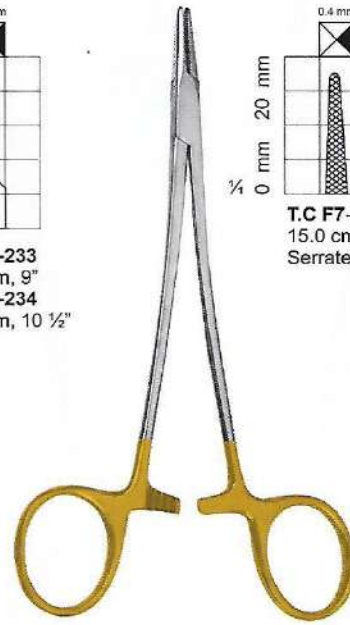

**Baby Crile-Wood Needle
 Holders T.C**

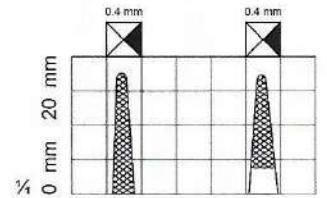

T.C F7-235 15.0 cm, 6"	T.C F7-236 15 cm, 6"
Serrated-Solid	Serrated-Solid



NEEDLE HOLDERS T.C

Nadelhalter | Porta-agujas
Prote-aiguilles | Porta aghi



T.C F7-237
11.5 cm, 4 1/2"
Tungsten Carbide
Serrated-Solid

T.C F7-238
13.5 cm, 5 1/4"

T.C F7-239
13 cm, 5"
Tungsten Carbide
Smooth

T.C F7-240
13 cm, 5"
Tungsten Carbide
Serrated-Solid

Derf Needle Holders T.C

Baumgartner Needle Holders T.C

Halsey Needle Holders T.C

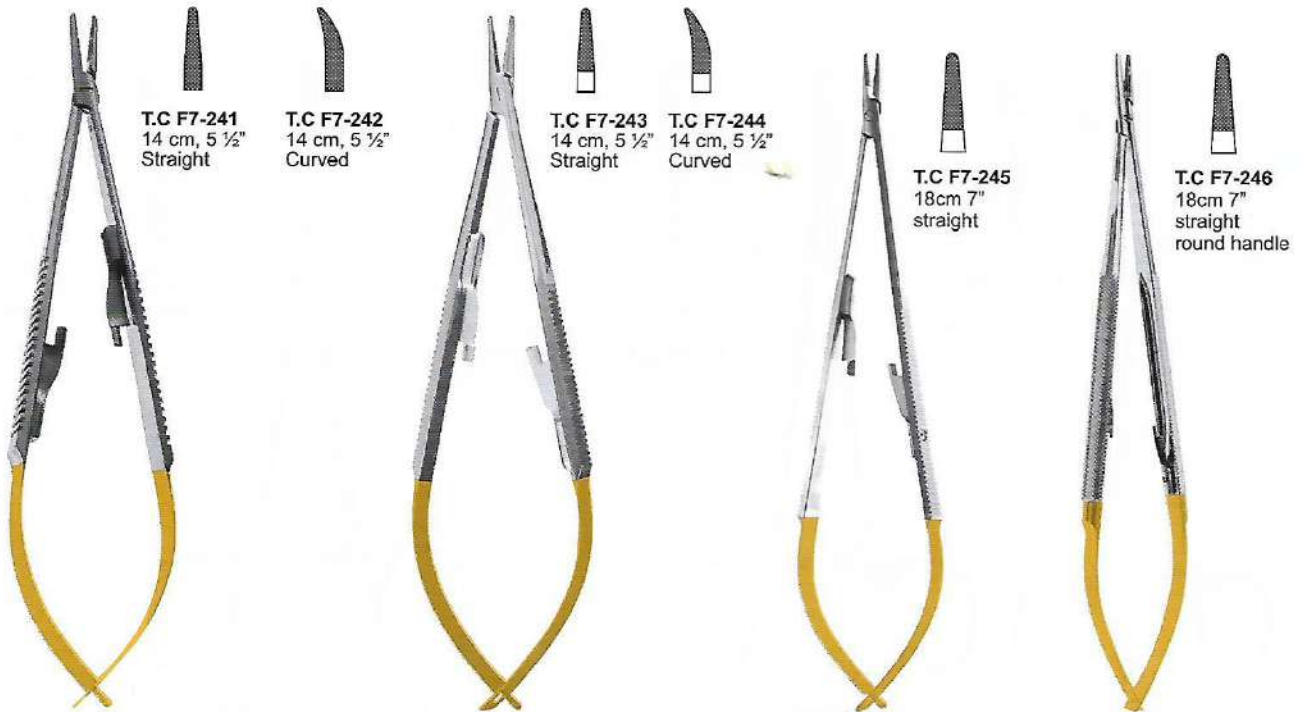

T.C F7-241
14 cm, 5 1/2"
Straight

T.C F7-242
14 cm, 5 1/2"
Curved

T.C F7-243
14 cm, 5 1/2"
Straight

T.C F7-244
14 cm, 5 1/2"
Curved

T.C F7-245
18cm 7"
straight

T.C F7-246
18cm 7"
straight
round handle

Castroviejo Needle Holders T.C

Castroviejo Needle Holders T.C

Castroviejo
Needle Holders
T.C

Castroviejo Needle Holders T.C

NEEDLE HOLDERS T.C



Nadelhalter | Porta-agujas
 Prote-aguilles | Porta aghi

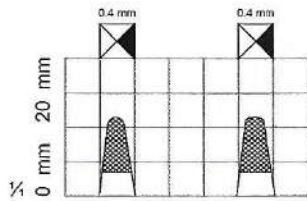

T.C F7-247
 15.2 cm, 6"
 Delicate.

T.C F7-248
 15.2 cm, 6"
T.C F7-249
 17.8 cm, 7"
T.C F7-250
 20 cm, 8"
 Heavy

Wire Twisters Needle Holders T.C

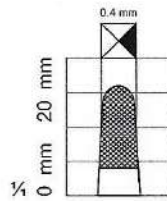

T.C F7-251
 17.8 cm, 7"
 Wire Twister

Sternum Needle Holders T.C

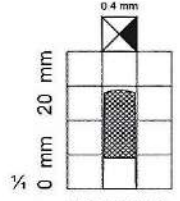
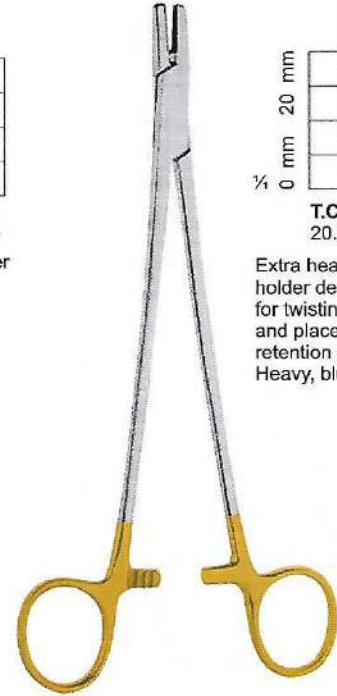

T.C F7-252
 20.3 cm, 8"

Extra heavy needle holder designed for twisting of wire and placement of retention suture. Heavy, blunt jaws.

Cooley-Baumgaften Wire Twister Needle Holders T.C

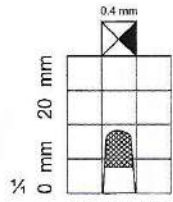
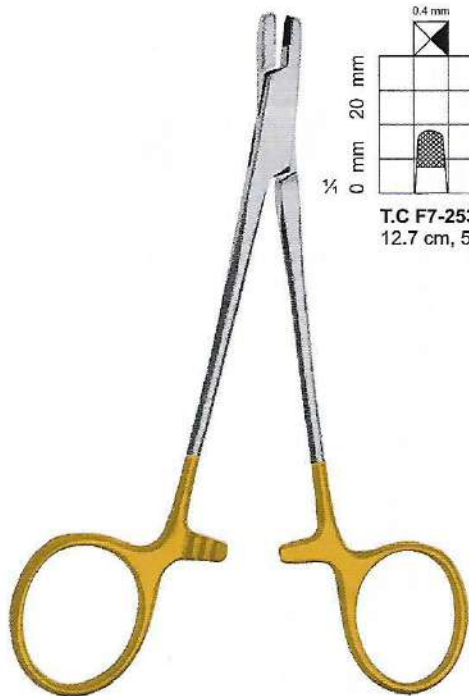

T.C F7-253
 12.7 cm, 5 1/4"

Rubio Wire Twister Needle Holders T.C



Wire Tightening Needle Holders T.C
T.C F7-254 18 cm, 7"

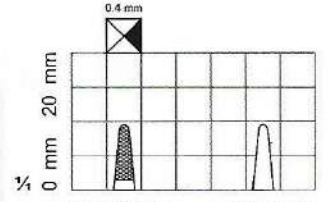
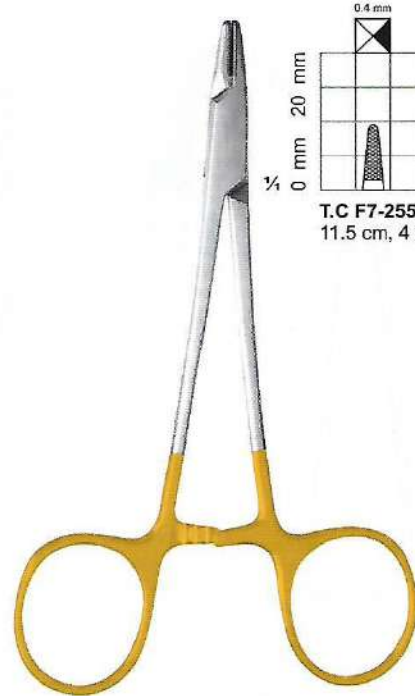

T.C F7-255
 11.5 cm, 4 3/4"

T.C F7-256
 11.5 cm, 4 3/4"
 Smooth

Micro Derf Needle Holders T.C



NEEDLE HOLDERS T.C

Nadelhalter | Porta-agujas
 Prote-aiguilles | Porta aghi

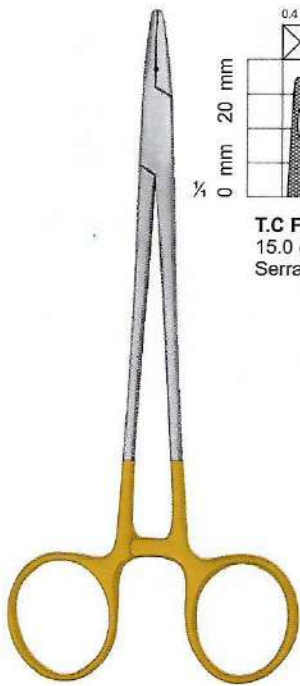

Crile-Wood Needle Holders T.C

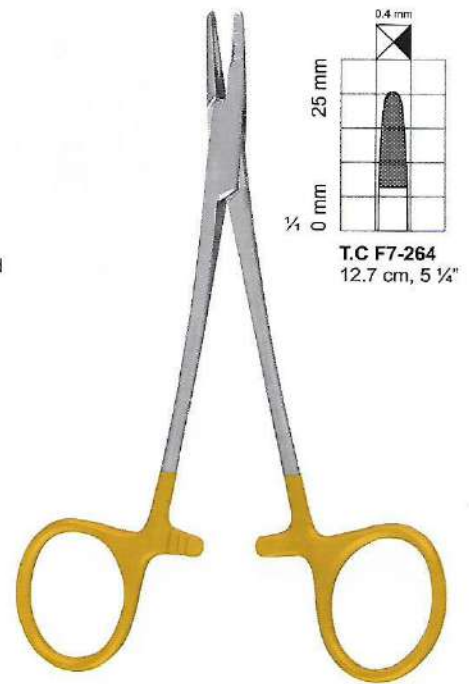
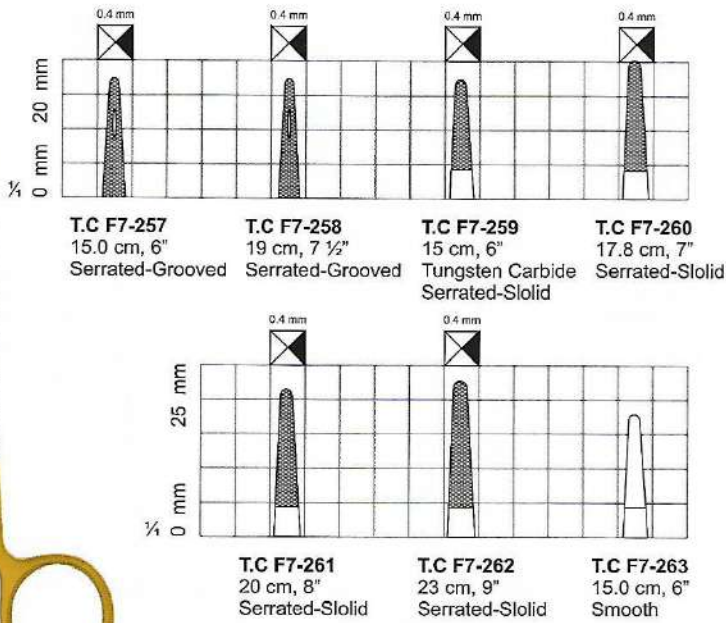

Neivert Needle Holders T.C

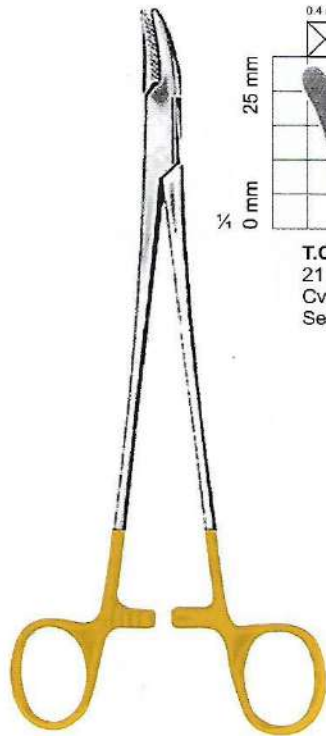
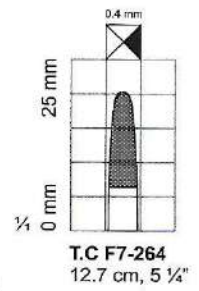

Heaney-Gyne Needle Holders T.C

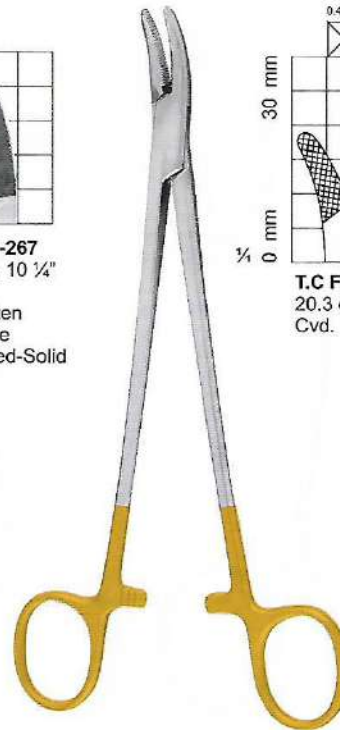
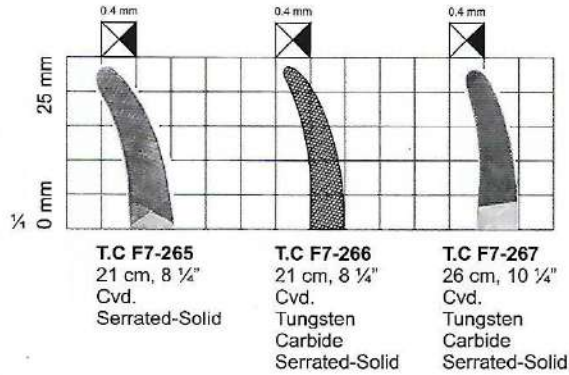

Heaney Needle Holders T.C

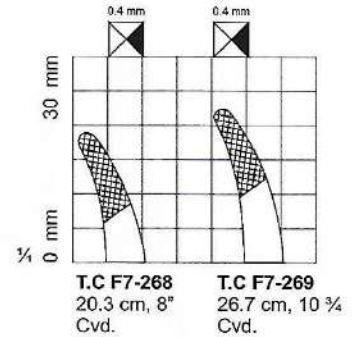

NEEDLE HOLDERS T.C

Nadelhalter | Porta-agujas
 Prote-aiguilles | Porta aghi

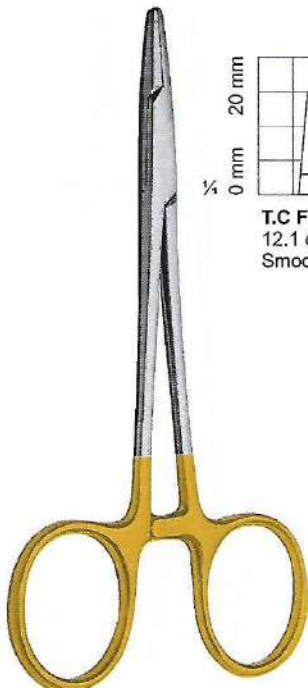

Webster Needle Holders T.C

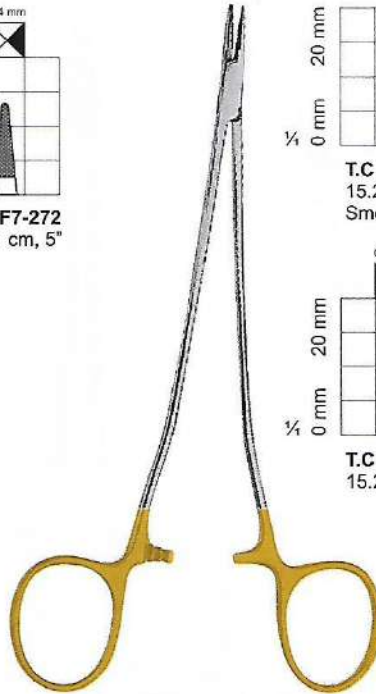
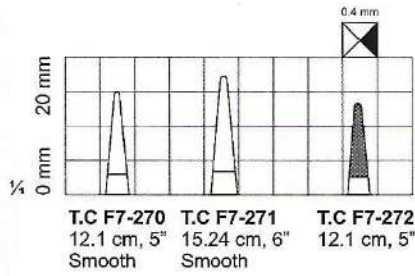

Cooley Microvascular Needle Holders T.C

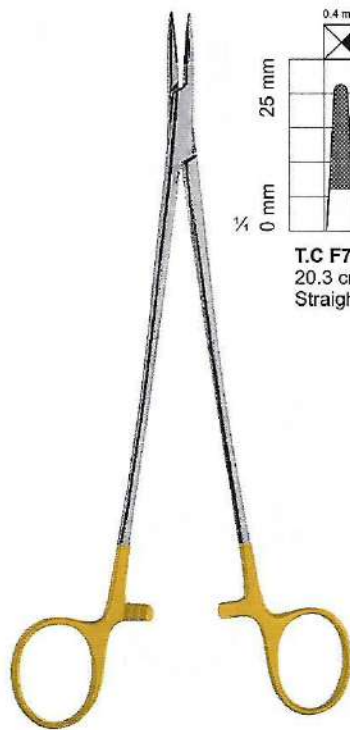
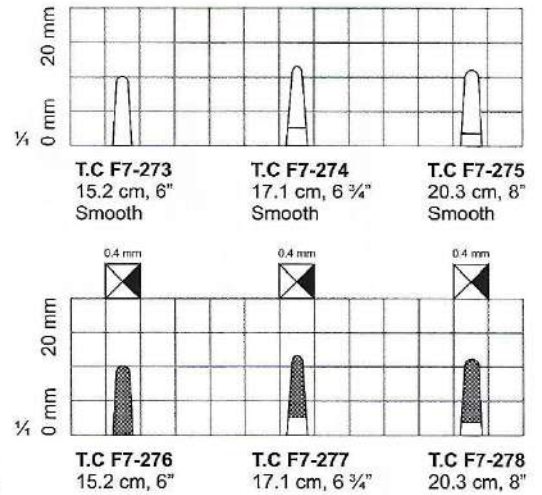

Julian Needle Holders T.C

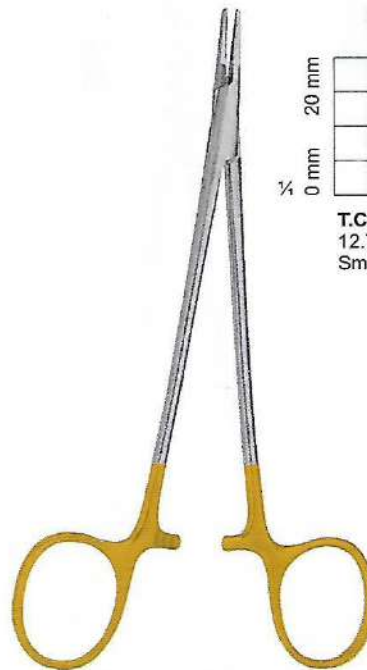
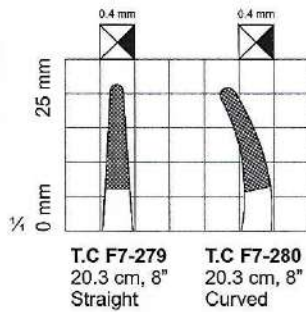

Micro Surgical Needle Holders T.C

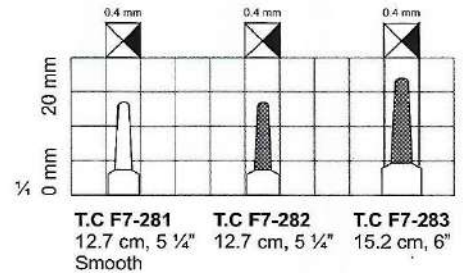



NEEDLE HOLDERS T.C

Nadelhalter | Porta-agujas
Prote-aguilles | Porta aghi



Masson Needle Holders T.C

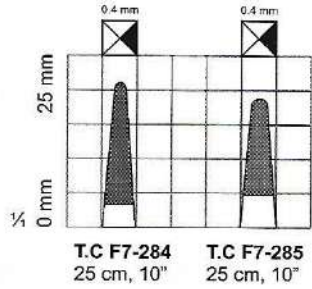

Webster Needle Holders T.C



Crile-Wood Needle Holders T.C.

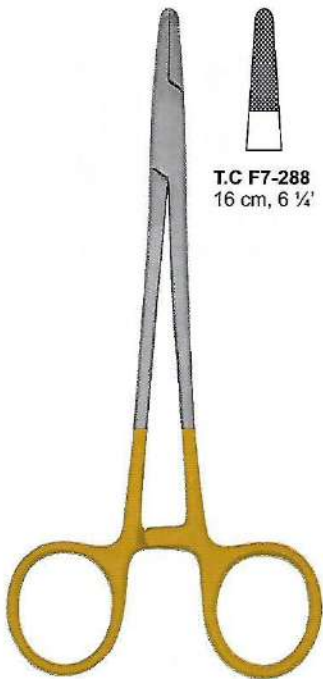

Mayo-Hegar Needle Holders T.C
Also Available Right Handle

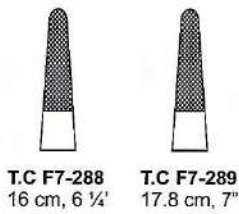

De Bakey Needle Holders T.C
T.C F7-290
17.8 cm, 7"
Delicate



Olsen-Hegar Needle Holders T.C

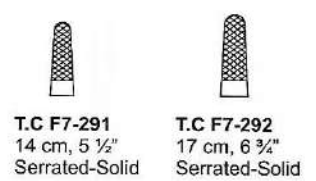

NEEDLE HOLDERS T.C



Nadelhalter | Porta-agujas
 Prote-aiguilles | Porta aghi



Arruga Needle Holders T.C
 T.C F7-293 16 cm, 6 1/4" Str.
 T.C F7-294 16 cm, 6 1/4" Cvd.



Castroviejo Needle Holders T.C

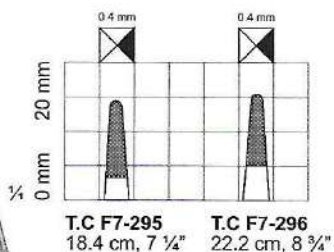

Castroviejo Needle Holders T.C

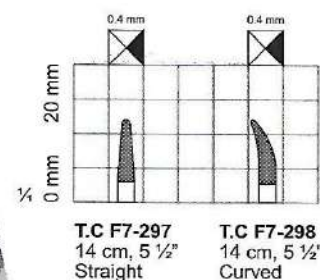

Jacobson Needle Holders T.C

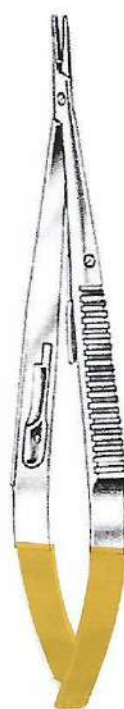
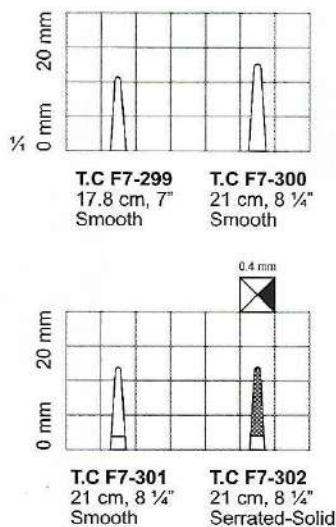

Castroviejo Needle Holders T.C

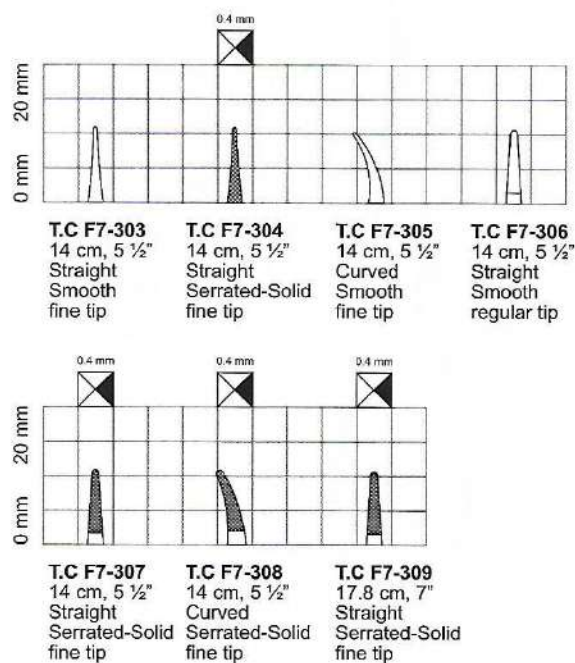



NEEDLE HOLDERS T.C

Nadelhalter | Porta-agujas
Prote-aiguilles | Porta aghi

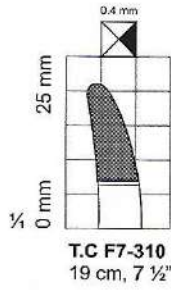

Metzenbaum Needle Holders T.C

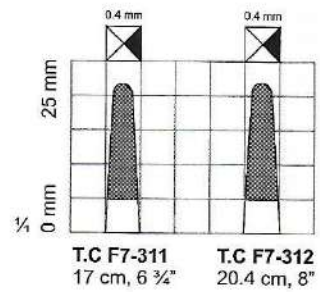

Mathieu-Stille Needle Holders T.C

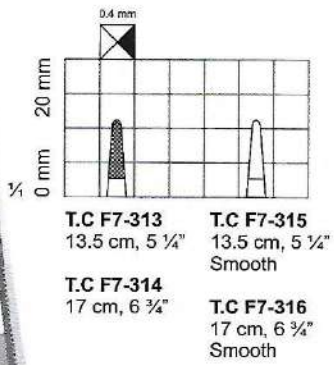

Castroviejo Needle Holders T.C

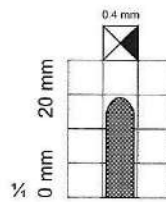

Jacobson Heavy Style
Needle Holders T.C
T.C F7-317 19.0 cm, 7 1/2"
T.C F7-318 22.9 cm, 9"
T.C F7-319 25.4 cm, 10"

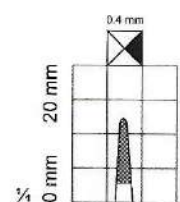

Kalt Needle Holders T.C
T.C F7-320
14 cm, 5 1/2" Str.

NEEDLE HOLDERS T.C



Nadelhalter | Porta-agujas
 Prote-aiguilles | Porta aghi

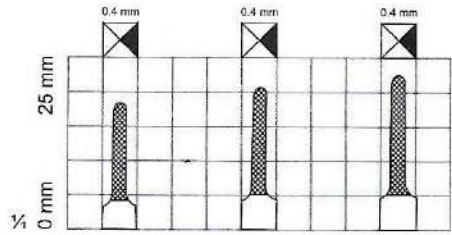
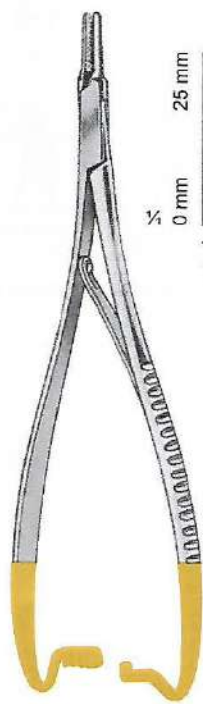

T.C F7-321 17 cm, 6 3/4"
 T.C F7-322 20.4 cm, 8"
 T.C F7-323 24 cm, 9 1/2"

Mathieu-Ryder Needle Holders T.C

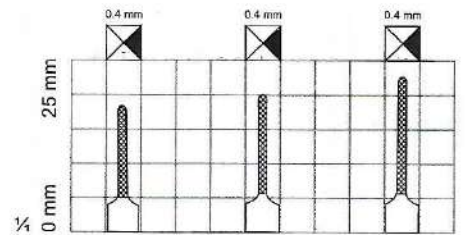
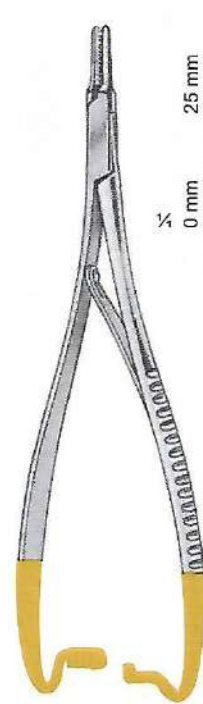

T.C F7-324 17 cm, 6 3/4"
 T.C F7-325 20.4 cm, 8"
 T.C F7-326 24 cm, 9 1/2"

Mathieu-Ryder Vascular Needle Holders T.C

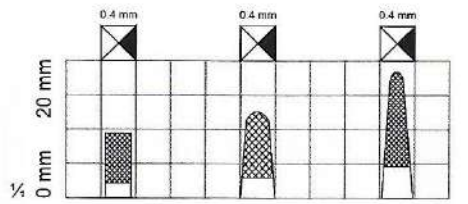
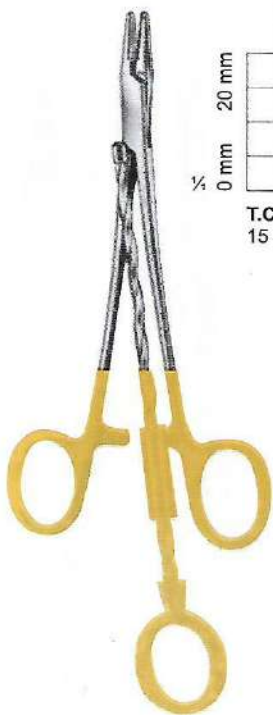

T.C F7-327 15 cm, 6"
 T.C F7-328 15 cm, 6"
 T.C F7-329 16.5 cm, 6 1/2"

Corwin Needle Holders T.C

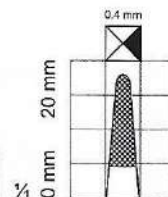

T.C F7-330 20.4 cm, 8"

Lichtenberg Needle Holders T.C



NEEDLE HOLDERS T.C

Nadelhalter | Porta-agujas
 Prote-aiguilles | Porta aghi

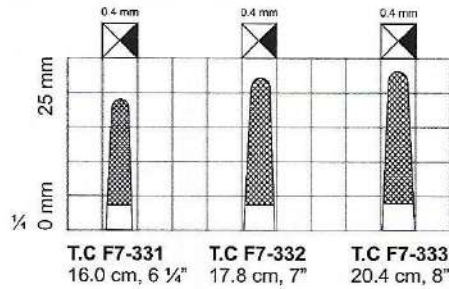

Langenbeck Needle Holders T.C

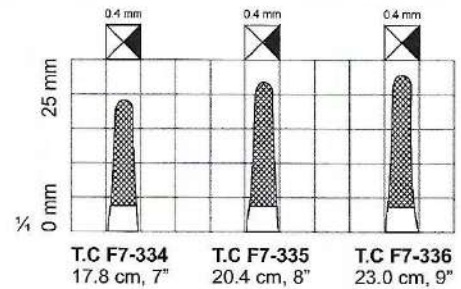

Langenbeck-Delicate Needle Holders T.C

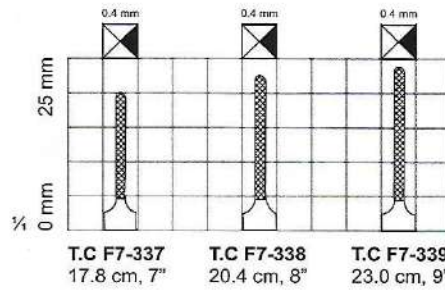

Langenbeck-Ryder Needle Holders T.C

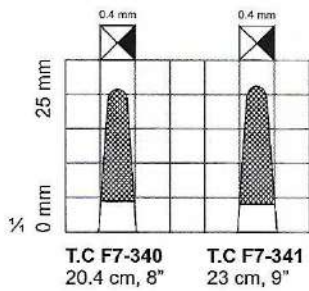

Zweifel Needle Holders T.C

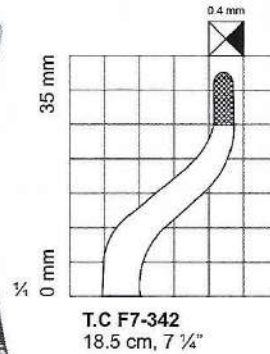
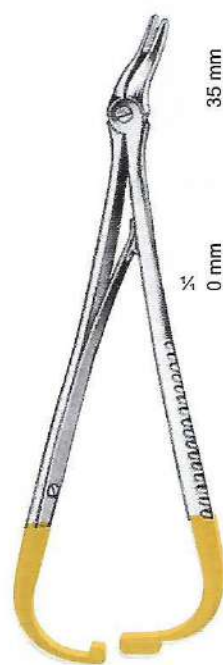

Eiselsberg-Matheiu
 Needle Holders T.C

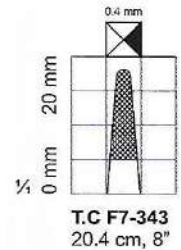
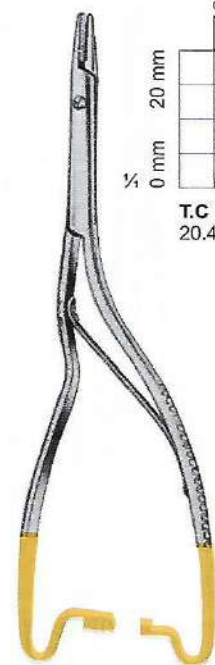

Luethy-Beck
 Needle Holders T.C

TITANIUM NEEDLE HOLDERS



Nadelhalter | Porta-agujas
 Prote-aiguilles | Porta aghi



T F7-344
 TC-Coated jaws
 Straight
 11.5cm 4.5"

Derf Needle Holder
 Ring Handle



T F7-345
 TC-Coated jaws
 Straight
 11.5cm 4.5"

Webster Needle Holder
 Ring Handle



T F7-346
 TC-Coated jaws
 Straight
 13cm 5"

Halsey Needle Holders
 Ring Handle



T F7-347 15cm 6"
T F7-348 17cm 6.75"
T F7-349 19cm 7.5"
 Micro Jaws,
 TC-Coated jaws
 Straight

**Richards Micro
 Needle Holders**
 Ring Handle



T F7-350 15cm 6"
T F7-351 17cm 6.75"
T F7-352 19cm 7.5"
 TC-Coated jaws
 Straight

Ryder Needle Holders
 Ring Handle



T F7-353 17.8cm 7"
T F7-354 20.4cm 8"
T F7-355 22cm 8 3/4"
 Micro Jaws,
 TC-Coated jaws
 Straight

Ultra-Micro Needle Holders
 Ring Handle



TITANIUM NEEDLE HOLDERS

Nadelhalter | Porta-agujas
Prote-aiguilles | Porta aghi



- T F7-356 17.8cm 7"
- T F7-357 20.4cm 8"
- T F7-358 22cm 8 3/4"
- T F7-359 25cm 10"
- TC-Coated jaws
- Straight

Intracardiac Needle Holder
Ring Handle

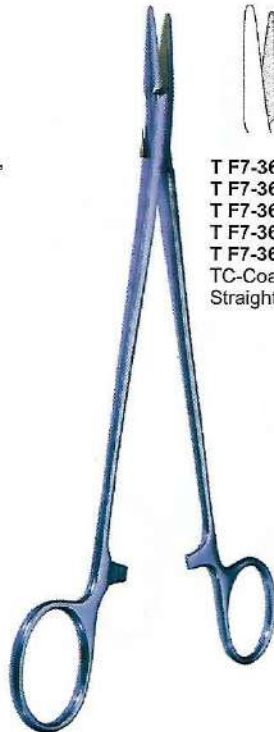

- T F7-360 16cm 6 1/4"
- T F7-361 17.8cm 7"
- T F7-362 20.4cm 8"
- T F7-363 22cm 8 3/4"
- T F7-364 25cm 10"
- TC-Coated jaws
- Straight

DeBakey Needle Holders
Ring Handle



- T F7-365 17.8cm 7"
- T F7-366 20.4cm 8"
- T F7-367 22cm 8 3/4"
- T F7-368 25cm 10"
- Micro, jaws
- TC-Coated jaws
- w/Lock
- Straight

Microvascular Needle Holders
Ring Handle



- T F7-369 16cm 6 1/4"
- T F7-370 17.8cm 7"
- T F7-371 20.4cm 8"
- T F7-372 22cm 8 3/4"
- 2.8mm
- TC-Coated jaws
- Straight

Mayo-Hegar Needle Holders
Ring Handle



- T F7-373 16cm 6 1/4"
- T F7-374 17.8cm 7"
- T F7-375 20.4cm 8"
- T F7-376 22cm 8 3/4"
- 2.8mm
- TC-Inserted jaws
- Straight

Jacobson Heavy Needle Holders
Round Handle, Straight / Curved Jaws



- Heavy, TC-Coated jaws w/Lock
- T F7-377 18.5cm 7.25"
- T F7-378 21cm 8.25"
- T F7-379 23cm 9.25"
- T F7-380 25cm 10"
- T F7-381 30cm 12"



- Heavy, TC-Coated jaws w/Lock
- T F7-382 18.5cm 7.25"
- T F7-383 21cm 8.25"
- T F7-384 23cm 9.25"
- T F7-385 25cm 10"



- Straight, Micro, TC-Coated
- T F7-386 jaws
- T F7-387 jaws w/Lock



- Curved, Micro, TC-Coated
- T F7-388 jaws
- T F7-389 jaws w/Lock

Micro Needle Holders
W/Round Bayonet Handle 23.5cm 9.5"

Round Bayonet Handle,
Straight / Curved Up /
Curved Down Jaws
Round Bayonet Handle,
Straight / Curved Up /
Curved Down Jaws

REVERDIN NEEDLES



Reverdin nadeln | Aguíllas de reverdin
 agujas de reverdin | aghi di reverdin



Reverdin Needle
short



F7-390
14.5cm, 5 3/4"



F7-391
14.5cm, 5 3/4"



F7-392
14.5cm, 5 3/4"



F7-393
14.5cm, 5 3/4"



Reverdin Needle
F7-394-
F7-397
Small



F7-394
19.5cm, 7 3/4"
F7-398
23cm, 9"



F7-395
19.5cm, 7 3/4"
F7-399
23cm, 9"



F7-396
19.5cm, 7 3/4"
F7-400
23cm, 9"

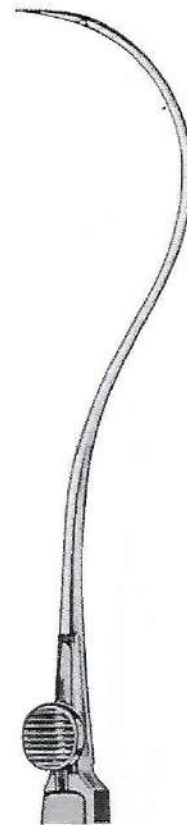

F7-397
19.5cm, 7 3/4"
F7-401
23cm, 9"



Reverdin Needle
F7-398-
F7-401
long



LIGATUER NEEDLES

Unterbindungsnadeln
agujas para ligaduras

Aiguilles à ligatures
aghi di legatura

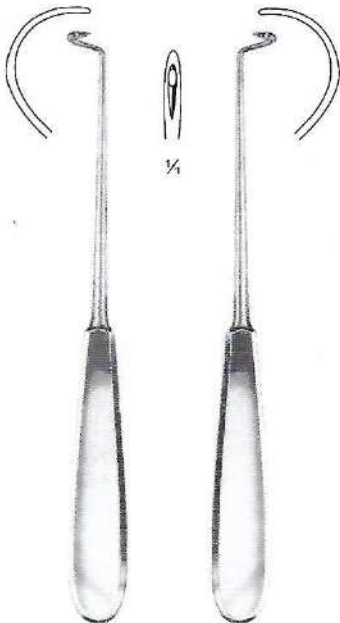

Deschamps Needle
F7-402 20cm, 8"
sharp
for right hand

F7-403 20cm, 8"
sharp
for left hand

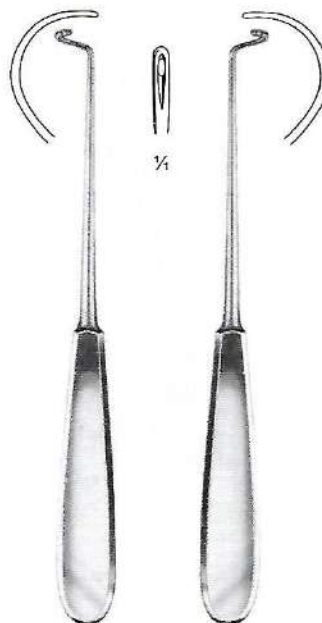

Deschamps Needle
F7-404 20cm, 8"
blunt
for right hand

F7-405 20cm, 8"
blunt
for left hand



Deschamps Needle
F7-406 21cm, 8 1/4"
blunt
for right hand

F7-407 21cm, 8 1/4"
blunt
for left hand

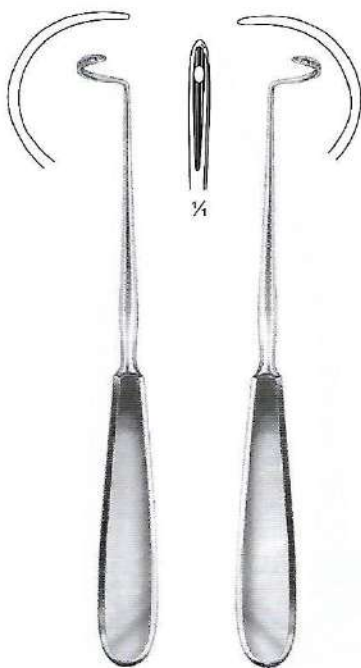

Deschamps Needle
F7-408 20cm
blunt
for right hand

F7-409 20cm
blunt
for left hand

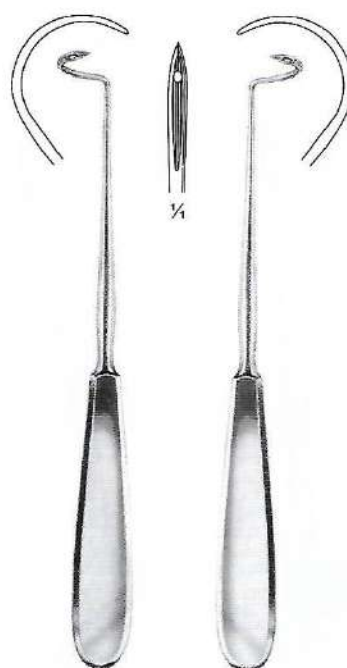

Deschamps Needle
F7-410 20cm
sharp
for right hand

F7-411 20cm
sharp
for left hand

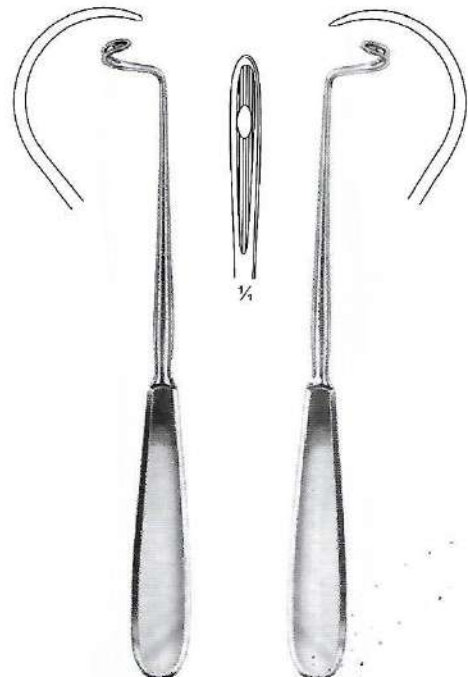

Deschamps Needle
F7-412 20cm
blunt
for right hand

F7-413 20cm
blunt
for left hand

LIGATUER NEEDLES



Unterbindungsnadeln
agujas para ligaduras

Aiguilles à ligatures
aghi di legatura



Deschamps Needle

F7-414	F7-415
20cm, 8"	20cm, 8"
sharp	sharp
for right	for left
hand	hand

Deschamps Needle

F7-416	F7-417
27cm, 10 3/4"	27cm, 10 3/4"
blunt	blunt
for right	for left
hand	hand

Deschamps Needle

F7-418	F7-419
27cm, 10 3/4"	27cm, 10 3/4"
sharp	sharp
for right	for left
hand	hand

Deschamps Needle

F7-420	F7-421
28cm, 11"	28cm, 11"
blunt	blunt
for right	for left
hand	hand



GENERAL INSTRUMENTS

Allgemeines Instrumentarium
Instrumental general

Instrumentation générale
Strumentario generale

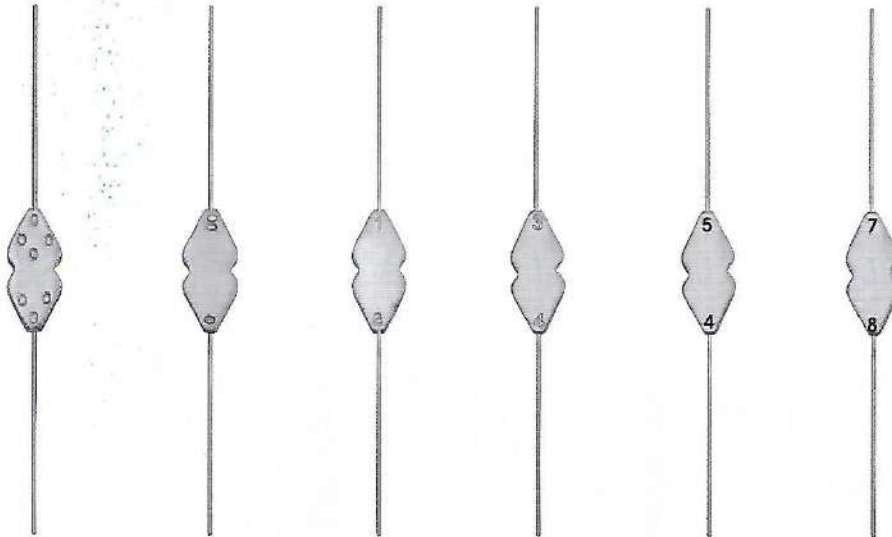

BOWMAN LACRIMAL PROBES

Double Ended, Sterling Silver

F7-422
Bowman Probe,
000-0000

F7-423
Bowman Probe,
00-0

F7-424
Bowman Probe,
1-2

F7-425
Bowman Probe,
3-4

F7-426
Bowman Probe,
5-6

F7-427
Bowman Probe,
7-8

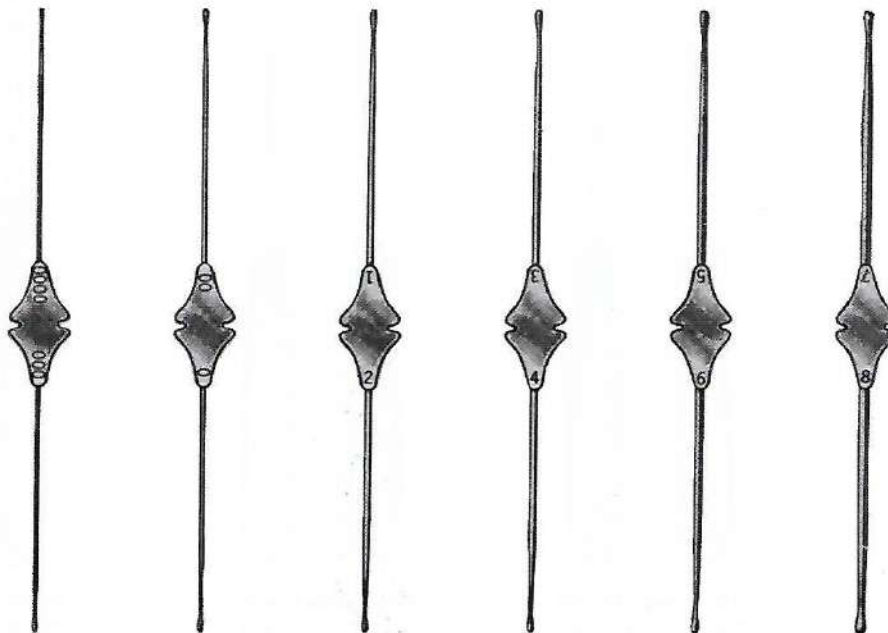

WILLIAM LACRIMAL PROBES

Double Ended, Sterling Silver

F7-428
William Probe,
000-0000

F7-429
William Probe,
00-0

F7-430
William Probe,
1-2

F7-431
William Probe,
3-4

F7-432
William Probe,
5-6

F7-433
William Probe,
7-8

PROBE & DIRECTORS



Allgemeines Instrumentarium
Instrumental general

Instrumentation générale
Strumentario generale



DIRECTORS
F7-434 13 cm, 5"
F7-435 14.5 cm, 5 3/4"
F7-436 16 cm, 6"
LARRY Probe and Grooved Director, 7" 17.8 cm

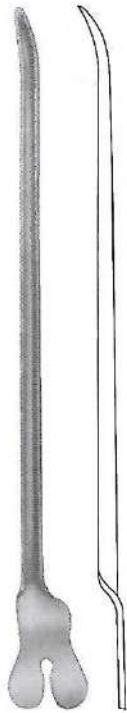

DOYEN
F7-437 14.5 cm, 5 3/4"
F7-438 16 cm, 6"



DIRECTOR
Probe End
F7-439 14 cm, 5 1/2"
Director with tip
Diam. Of tip 3.3 mm



BRODIE
F7-440 20 cm, 8"
Director with tip
Diam. Of tip 3.5 mm

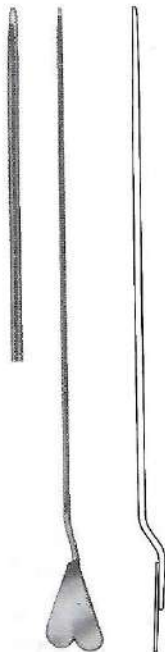

LOCKHART-MUMMERY
F7-441 16.5 cm, 6 1/2"



LOCKHART-MUMMERY
F7-442 16.5 cm, 6 1/2"

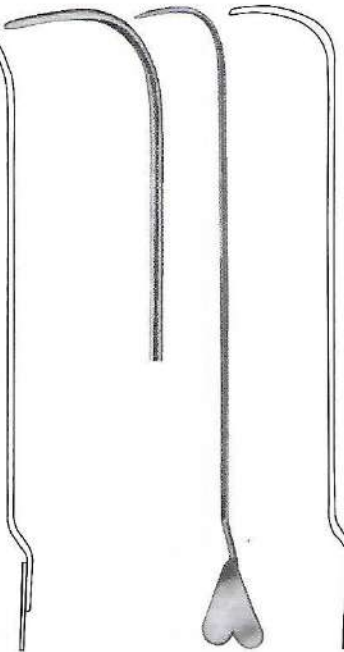

LOCKHART-MUMMERY
F7-443 16.5 cm, 6 1/2"

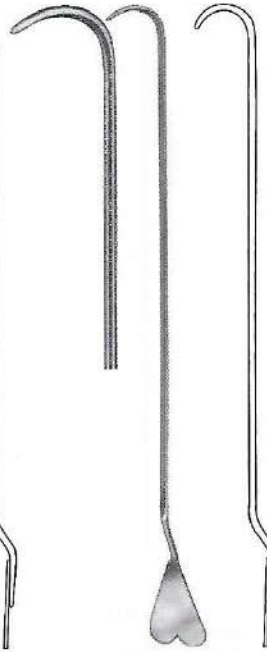

LOCKHART-MUMMERY
F7-444 16.5 cm, 6 1/2"



DIRECTOR
with wire loop, malleable
F7-445 19 cm, 7 1/4"



PROBE & DIRECTORS

Allgemeines Instrumentarium
Instrumental general

Instrumentation générale
Strumentario generale



Probes With Eye
F7-446 14.5 cm, 5 3/4"
F7-447 16.0 cm, 6 1/4"
F7-448 20.0 cm, 8"



Myrtle Leaf Probe
F7-449 14.5 cm, 5 3/4"



Myrtle Leaf Probe
F7-450 13.0 cm, 5"
F7-451 14.5 cm, 5 3/4"
F7-452 16.0 cm, 6 1/4"
F7-453 18.5 cm, 7"
F7-454 20.0 cm, 8"



Probe
F7-455



WILDER Lacrimal Dilator,
F7-456
10.2 cm 4"
medium taper



F7-457
19.0 cm, 8 1/4"
Double ended probe,
malleable, diam, of tips
3 mm with hole



F7-458 25.0 cm, 10"
F7-459 30.0 cm, 12"
Double ended probes,
tin, malleable, diam, of tips
3.5 mm with hole



F7-460
40.0 cm, 15 3/4"
Double ended probes,
tin, malleable, diam, of tips
4 mm with hole



F7-461 1.5 mm
F7-462 2.0 mm
F7-463 2.5 mm
30.0 cm, 12"



CLIPS MAYO
F7-463A 14cm

PROBE & SPATULA



Allgemeines Instrumentarium
Instrumental general

Instrumentation générale
Strumentario generale



STACKE
F7-464
10.0 cm, 4"



KILLIAN
F7-465
16.5 cm, 6 1/2"



F7-466
16.5 cm, 6 1/2"



SEIFFERT
F7-467
18.0 cm, 7"



SPATULA
F7-468
14.5 cm, 5 3/4"



SPATULA
F7-469
14.5 cm, 5 3/4"



MODELL PICCOLO
F7-470
11.0 cm, 4 1/4"
Round Serrated



MODELL PICCOLO
F7-471 11.0 cm, 4 1/4"
Triangular Serrated end



FARRELL
F7-472
11.0 cm, 4 1/4"
Round Serrated end



LATHBURY-FARREL
F7-473
11.0 cm, 4 1/4"
Triangular Serrated end



RETRACTORS

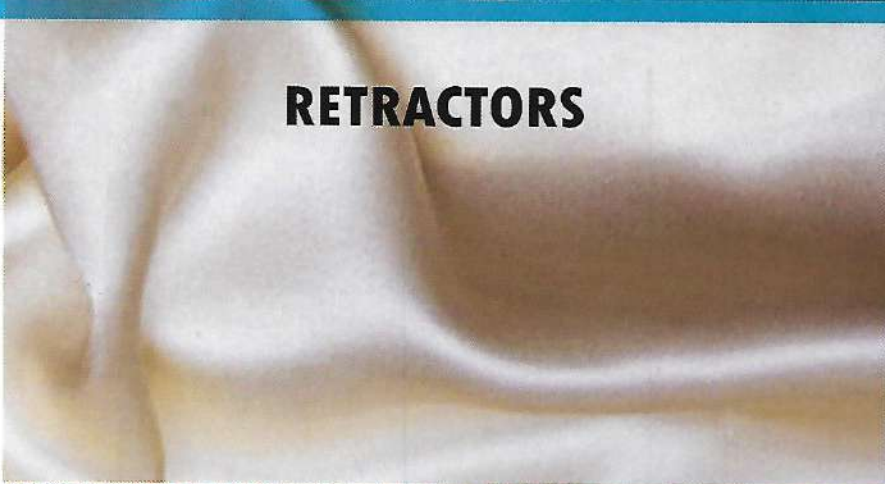

HOOCKET & SKIN HOOKS



Wundhäkchen, Mikrohäkchen
Ganchito, Micro Ganchitos

Crochet, Micro crochetes
Divaricatore, Micro Divaricatori



GUTHRIE HOOKLET

F8-001
16 cm, 6 1/4"
large curve

F8-002
16 cm, 6 1/4"
small curve



GILLIES SKIN HOOK

F8-003
18 cm, 7"
Sharp

F8-004
18 cm, 7"
sharp



KILNER HOOK

F8-005
15 cm, 6"
sharp

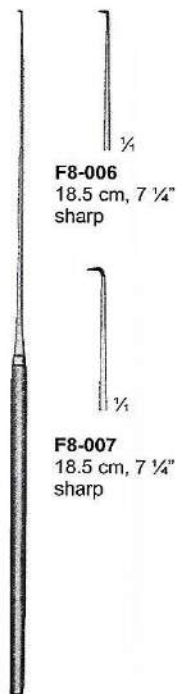

FISCH HOOKLET & Skin Hook

F8-006
18.5 cm, 7 1/4"
sharp

F8-007
18.5 cm, 7 1/4"
sharp



FRAZIER HOOKLET & Skin Hook

F8-008
13 cm, 5"
F8-009
18 cm, 7"
Blunt

F8-010
13 cm, 5"
F8-011
18 cm, 7"
Sharp



DOUBLE PRONG MICRO HOOK & Skin Hook
F8-012
Sharp, 2mm, wide jaws,
14.5 cm, 6 3/4"

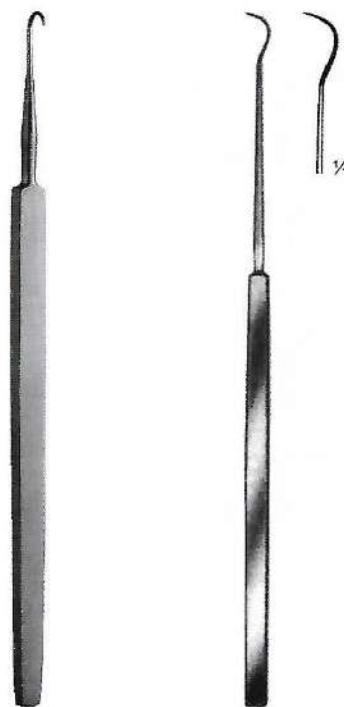

WIENER HOOK & Skin Hook
F8-013
Sharp,
14 cm, 5 1/2"

TOENNIS HOOK & Skin Hook
F8-014
15 cm, 6"
Sharp



ROLLET HOOK

F8-015
2 sharp prong
13 cm, 5"
2.25mm diameter
3mm wide

F8-016
4 sharp prong
13 cm, 5"
2mm diameter
5mm wide

F8-017
4 blunt prong
13 cm, 5"
2mm diameter
5mm wide



FREER SKIN HOOK

F8-018
15 cm, 6", sharp
double prongs
2.5mm wide

F8-019
15 cm, 6", blunt
double prongs
2.5mm wide



HOOKLET & SKIN HOOKS

Wundhäkchen, Mikrohäkchen
Ganchito, Micro Ganchitos

Crochet, Micro crochets
Divaricatore, Micro Divaricatori



**CRILE HOOKLET
& SKIN HOOKS**
F8-020 20.4 cm, 8"



**VON GRAEFE Strabismus
& SKIN HOOKS**
F8-021 13.0 cm, 5" - A
F8-022 14.0 cm, 5 1/2" - B
F8-023 15.0 cm, 6" - C



**WAGENER HOOKLET
& SKIN HOOKS**
F8-024 14 cm, 5 1/2" - A
F8-025 14 cm, 5 1/2" - B
F8-026 14 cm, 5 1/2" - C
F8-027 14 cm, 5 1/2" - D

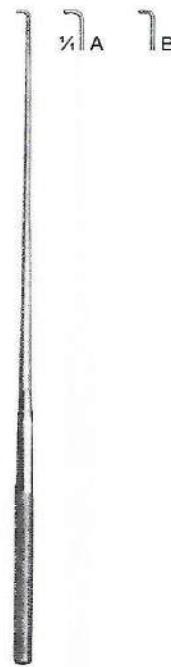

**DAY HOOKLET
& SKIN HOOKS**
F8-028 16 cm, 6 1/4" - A
F8-029 16 cm, 6 1/4" - B



**LUCAS HOOKLET
& SKIN HOOKS**
F8-030 14 cm, 5 1/2" - A
F8-031 14 cm, 5 1/2" - B
F8-032 14 cm, 5 1/2" - C



Converse Hook
F8-033
12 cm, 5"



MANNERFELT-LANGENBECK HOOK
F8-034 15 x 6 mm 15.5 cm, 6" Fig.1
F8-035 20 x 6 mm 15.5 cm, 6" Fig.2
F8-036 25 x 6 mm 15.5 cm, 6" Fig.3
F8-037 30 x 8 mm 15.5 cm, 6" Fig.4

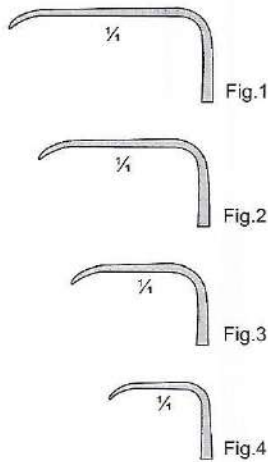

MANNERFELT HOOK
15.5 cm, 6"
large curve, single
hook

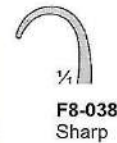

F8-038
Sharp



F8-039
2 prong
Blunt



F8-040
3 prong
Blunt

HOOCKET, RETRACTORS



Wundhäkchen, Wundhaken
Ganchito, Separadores

Crochet, Ecarteurs
Divaricatore, Divaricatori



Sharp



F8-041
2 prong 18 cm, 7"
Sharp



F8-042
3 prong 18 cm, 7"
Sharp



F8-043
4 prong 18 cm, 7"
Sharp

Tracheal Retractor
18 cm, 7"



Blunt



F8-044
2 prong 18 cm, 7"
Blunt



F8-045
3 prong 18 cm, 7"
Blunt



F8-046
4 prong 18 cm, 7"
Blunt

Tracheal Retractor
18 cm, 7"



F8-047
Tracheal Hook
one prong
16.5 cm, 6 1/2" Sharp



F8-048
2 prong 16.5 cm,
6 1/2" Sharp



F8-049
3 prong 16.5 cm,
6 1/2" Sharp



F8-050
4 prong 16.5 cm,
6 1/2" Sharp

Trachea Retractor
16.5 cm, 6 1/2"
Sharp



F8-051
Tracheal Hook
one prong 16.5 cm,
6 1/2" Blunt



F8-052
2 prong 16.5 cm,
6 1/2" Blunt



F8-053
3 prong 16.5 cm,
6 1/2" Blunt



F8-054
4 prong 16.5 cm,
6 1/2" Blunt

Tracheal Retractor
16.5 cm, 6 1/2"
Blunt



WIRE CUTTING INSTRUMENTS

Drahtschneidezangen
Pinces coupantes

Alicates para cortar alambre
Pinze taglia Filo

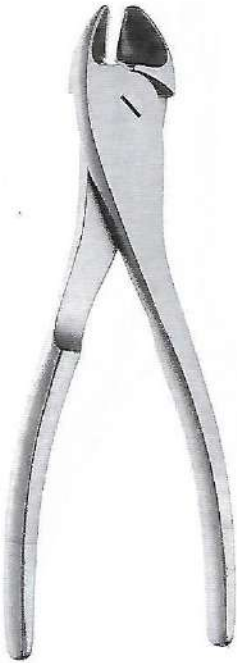

Side Cutter
F9-798 18.5cm 7 1/4"
Welded carbide jaws
max capacity. 1.6mm 062"



Delicate Wire Cutter
F9-799 12.5cm 4 7/8"
Side cutting w/ carbide inserts
max capacity. 0.7mm 028"



Front & Side Wire Cutter
F9-800 17cm 6 3/4"
Front and side cutting w/ carbide inserts,
double action. Max capacity. 1.6mm 062"



Double Action Wire Cutter
Angled, Side cutting w/ carbide inserts
F9-801 17cm 6 5/8"
max cap 1.6mm 062"
F9-802 21.5cm 8 1/2"
max cap. 2.4mm 3/32"



Flush Wire Cutter
F9-803 17cm 6 3/4"
Front and side cutting w/ carbide inserts,
double action. Max capacity. 1.5mm 059"



Wire Forceps
F9-804 17 cm 6 1/2"
Straight, serrated 5.4 mm tip



HOOKLET, RETRACTORS

Wundhäkchen, Wundhaken
Ganchito, Separadores

Crochet, Ecarteurs
Divaricatori, Divaricatori



Rollet Hooklet Retractors
F8-055
12.5 cm, 4 3/4"



Rollet (Blair) Hooklet Retractors
F8-056
13.5 cm, 5"

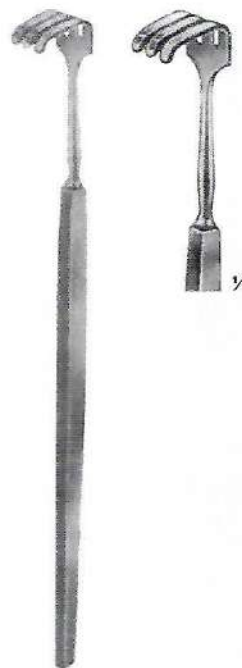

Paul Hooklet Retractors
F8-057
12.5 cm, 4 3/4"



Paul Hooklet Retractors
F8-058
16 cm, 6 1/4"



Miller Retractor
F8-059
13.5 cm, 5 1/4"
Sharp 6 prong

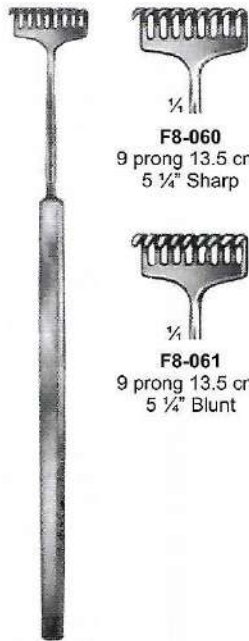

Miller Retractor

F8-060
9 prong 13.5 cm,
5 1/4" Sharp

F8-061
9 prong 13.5 cm,
5 1/4" Blunt



Hooklet Retractors
F8-062
13 cm, 5"



Brom Hooklet Retractors
F8-063
17 cm, 6 3/4"

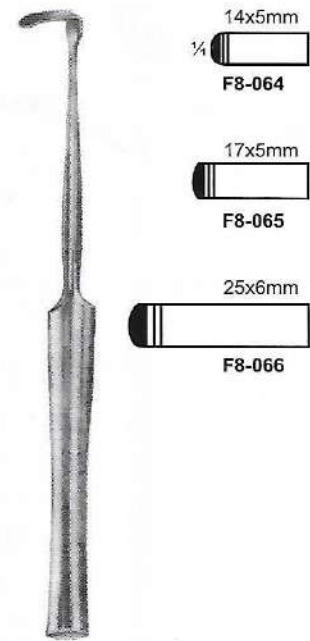

Hooklet Retractors
17 cm, 6 3/4"

14x5mm
F8-064

17x5mm
F8-065

25x6mm
F8-066

HOOCKET, RETRACTORS



Wundhäkchen, Wundhaken
Ganchito, Separadores

Crochet, Ecarteurs
Divaricatore, Divaricatori



Finger Rake, Retractor
16.5 cm, 6 1/2"



Finger Rake, Retractor
16.5 cm, 6 1/2"



Hooklets, Retractors
16 cm, 6 1/4"



Peck Rake Retractor
16.5 cm, 6 1/2"





HOOKLET, RETRACTORS

Wundhäkchen, Wundhaken
Ganchito, Separadores

Crochet, Ecarteurs
Divaricatori, Divaricatori

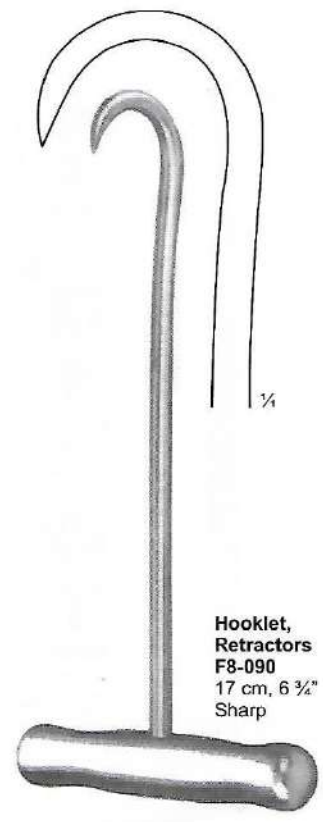
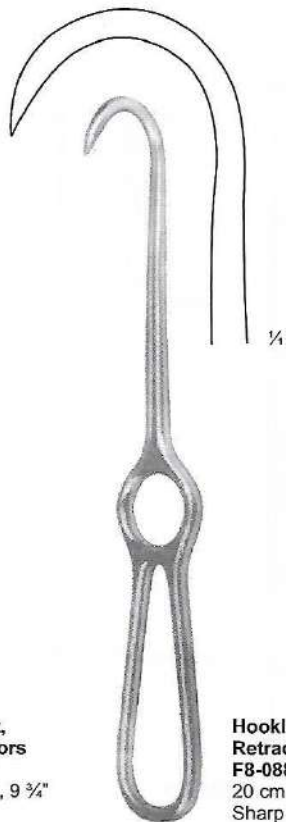
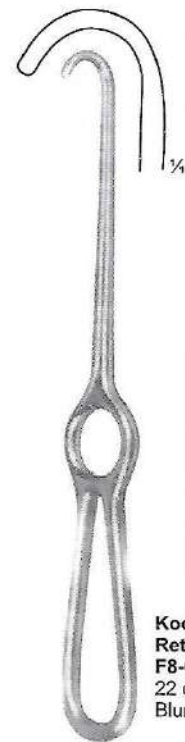

HOOKLET, RETRACTORS



Wundhäkchen, Wundhaken
Ganchito, Separadores

Crochet, Ecarteurs
Divaricatore, Divaricatori



Volkman Retractors
F8-091
23 cm, 9"
Sharp



Volkman Retractors
F8-092
23 cm, 9"
Blunt



Lambotte Retractors
20 cm 18"
F8-093
13 x 235 mm
F8-094
20 x 255 mm
F8-095
27 x 270 mm



Volkman Retractors
11.5 cm, 4 1/2"
Sharp

Sharp



F8-096
2 prong



F8-097
3 prong



F8-098
4 prong



F8-099
6 prong

Blunt



F8-100
2 prong



F8-101
3 prong



F8-102
4 prong

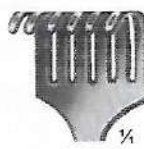

F8-103
6 prong



Murphy Retractors
19.1 cm 7 1/2"
F8-104 3 prongs
F8-105 3 prongs
F8-106 4 prongs
F8-107 4 prongs
Sharp



RETRACTORS

Wundhaken
Separadores

Ecarteurs
Divaricatori



Senn Retractor
F8-108
16 cm 6 1/4"
Blunt



Senn Retractor
F8-109
16 cm 6 1/4"
Sharp



Senn-Mueller Retractor
F8-110
18 x 6 mm
16 cm, 6 1/4"
sharp



Volkman Retractor
F8-111
22 cm 8 3/4"
4 Prongs Sharp



Volkman Retractor
F8-112
22 cm 8 3/4"
4 Prongs Blunt

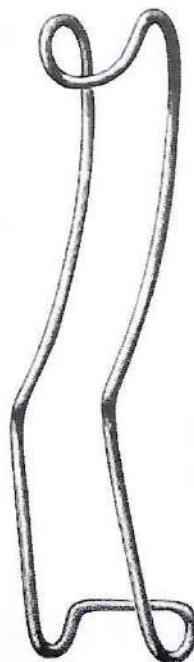

Sternberg Retractor
F8-113 12 cm, 4 3/4"
F8-114 14 cm, 5 1/2"
F8-115 16 cm, 6 1/4"

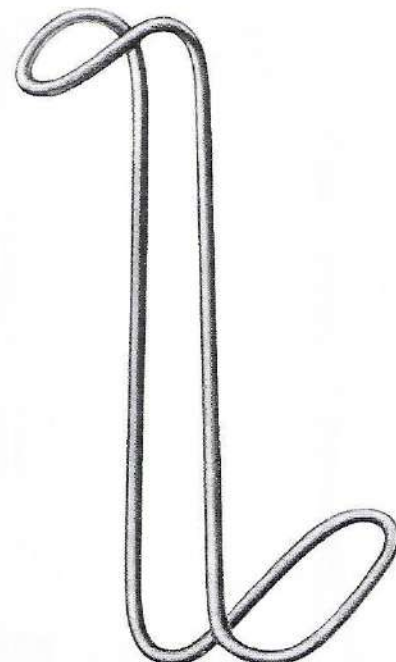

Collin-Hartmann Retractor
F8-116
38 x 28 / 32 x 21 mm 14 cm, 5 1/2"
F8-117
52 x 34 / 36 x 27 mm 16 cm, 6 1/4"

RETRACTORS



Wundhaken
Separadores

Ecarteurs
Divaricatori

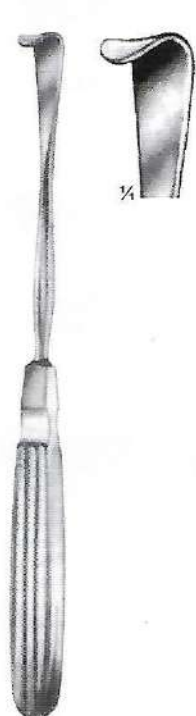

Herzfeld Retractor
F8-118
20 cm, 8"



Strandell-Stille Retractor
F8-119
19 cm, 7 1/2"

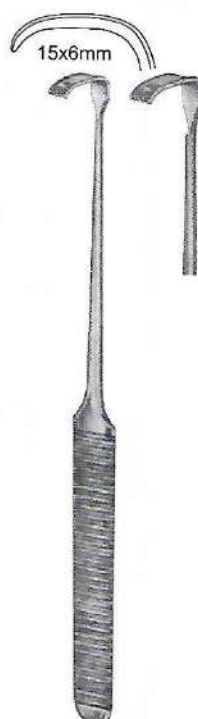

Strandell-Stille Retractor
F8-120
19 cm, 7 1/2"

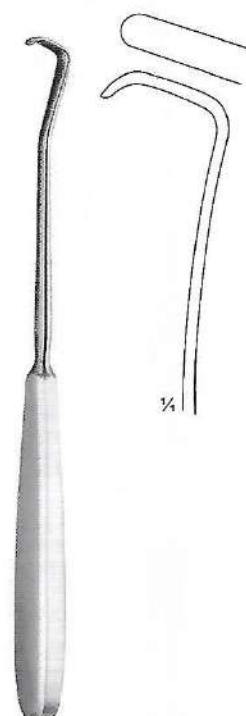

Schoenbore Retractor
F8-121
21 cm, 8 1/4"



König Retractor
17 cm, 6 3/4"



F8-122
13 x 13 mm



F8-123
12 x 16 mm



Senn-Green Retractor
15 cm, 6"



F8-124
10 x 6 mm



F8-125
20 x 6 mm



Cottle Retractor
F8-126
15 cm, 6"
10 x 12 mm



Ragnell-Davis Retractor
F8-127
14 cm, 5 1/2"
F8-127
8 x 4 mm
F8-128
15 x 5.5 mm



HOOKLET

Wundhäkchen | Crochet
Ganchito | Divaricatore



Mannerfelt Hooklet Retractors
15.5 cm, 6"

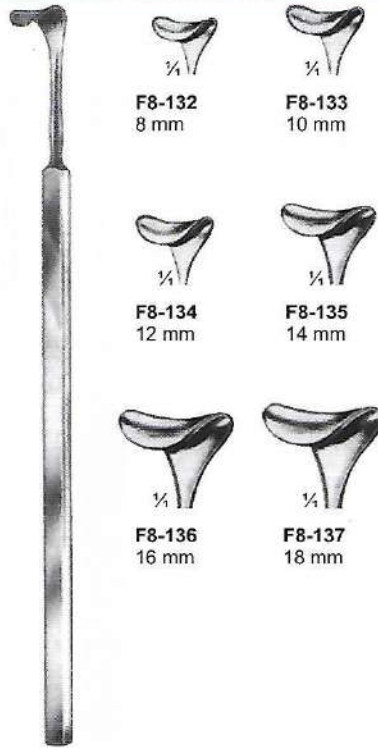

Cushing Hooklet Retractors
20 cm, 8"

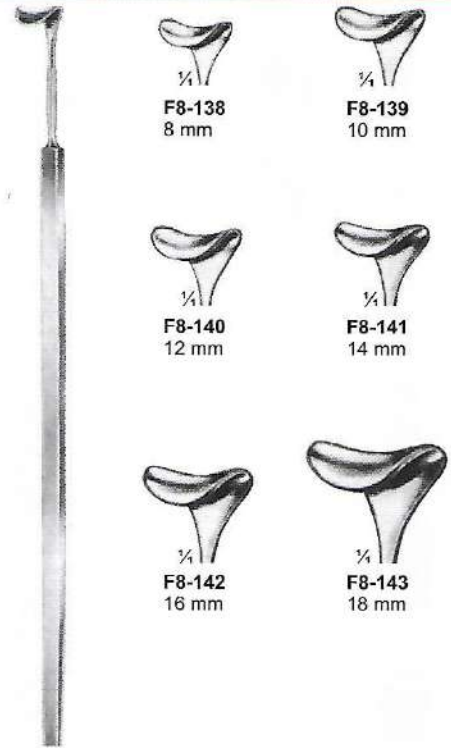

Cushing Hooklet Retractors
24 cm, 9 1/2"

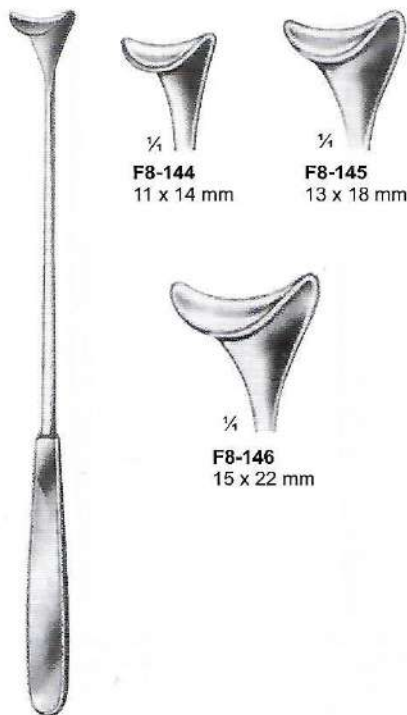

Cushing Hooklet Retractors
24 cm, 9 1/2"



Cushing-Kocher Hooklet Retractors
18 cm, 7"

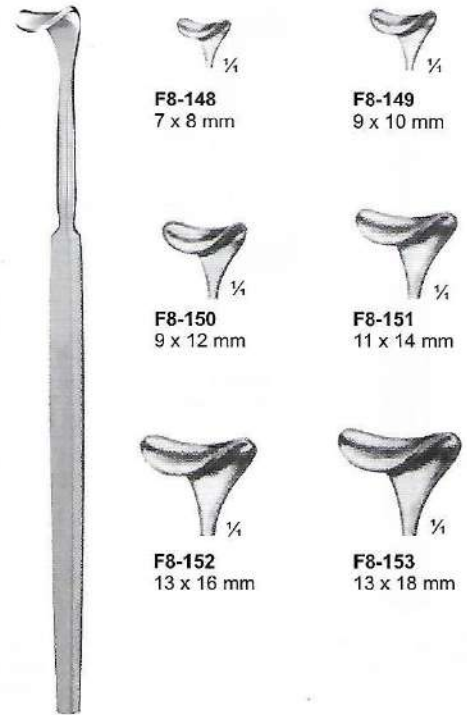

Desmarres Lid Retractors
16 cm, 6 1/4"

RETRACTORS



Wundhaken | Ecarteurs
Separadores | Divaricatori

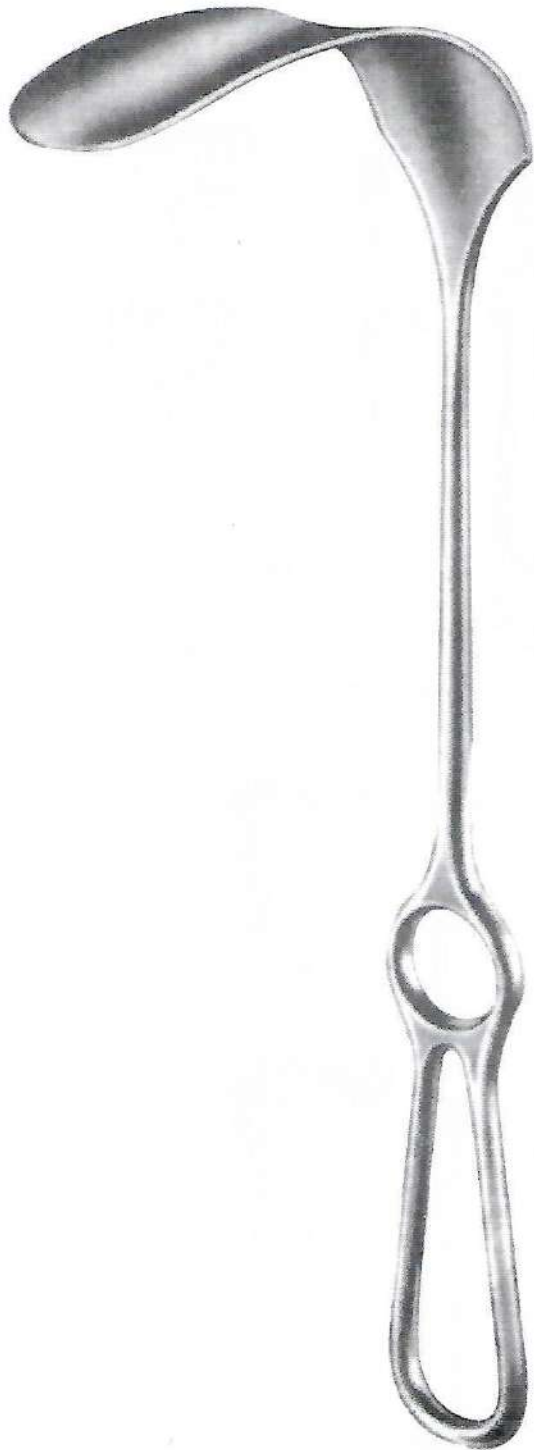

Kocher Retractor
28 cm 11"

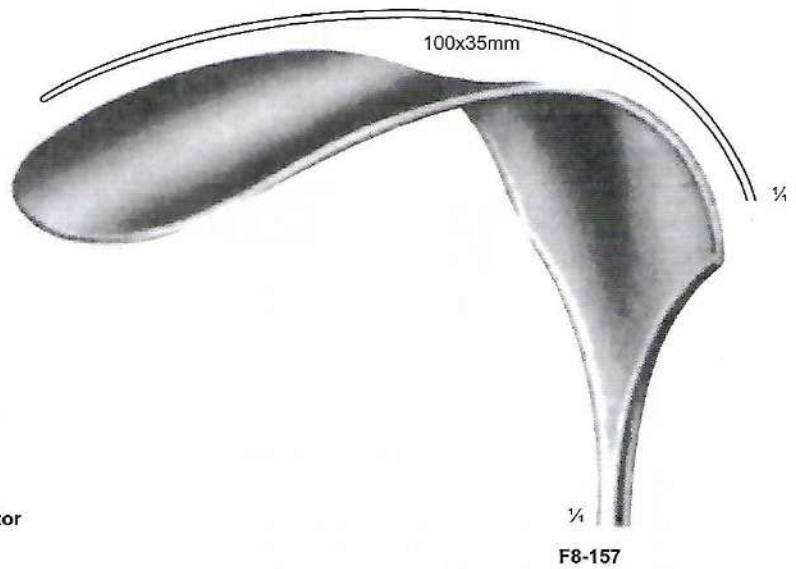
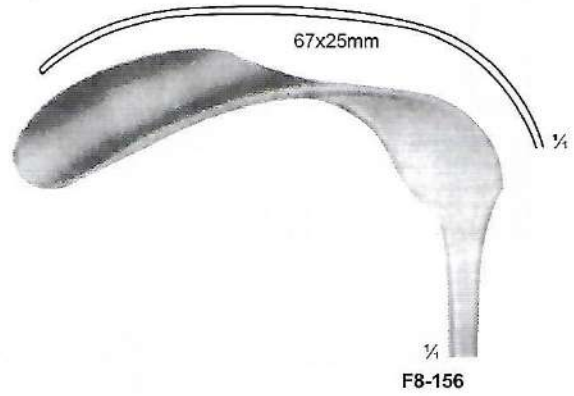
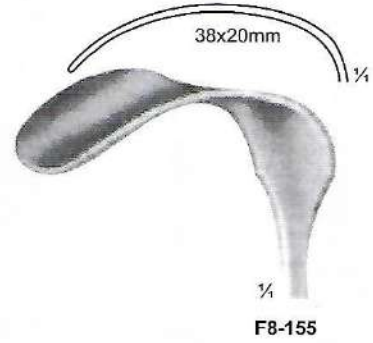
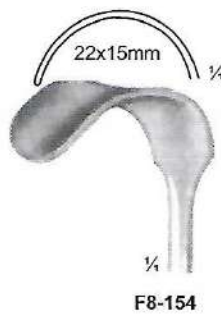



RETRACTORS

Wundhaken
Separadores

Ecarteurs
Divaricatori

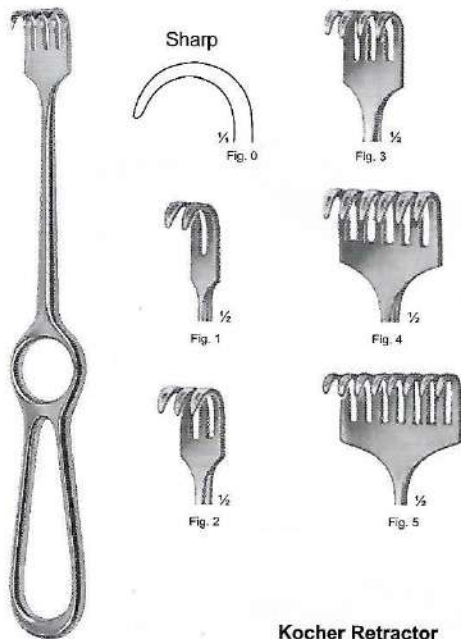

Kocher Retractor

- F8-158 22 cm, 8 3/4" 15 x 10 mm 2 prong Fig. 1
 F8-159 22 cm, 8 3/4" 15 x 15 mm 3 prong Fig. 2
 F8-160 22 cm, 8 3/4" 15 x 20 mm 4 prong Fig. 3
 F8-161 22 cm, 8 3/4" 15 x 30 mm 6 prong Fig. 4
 F8-162 22 cm, 8 3/4" 15 x 40 mm 8 prong Fig. 5

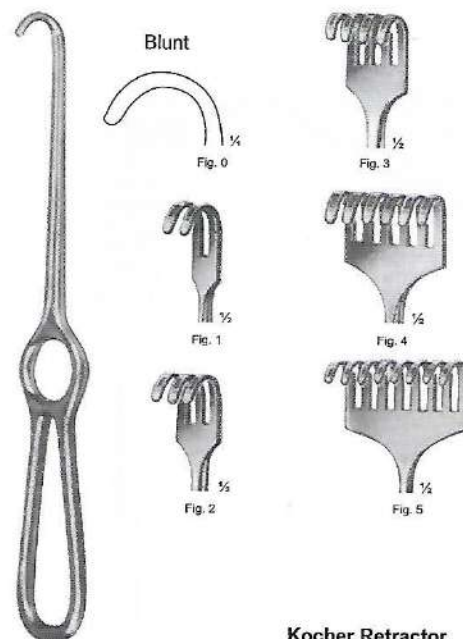

Kocher Retractor

- F8-163 22 cm, 8 3/4" 15 x 10 mm 2 prong Fig. 1
 F8-164 22 cm, 8 3/4" 15 x 15 mm 3 prong Fig. 2
 F8-165 22 cm, 8 3/4" 15 x 20 mm 4 prong Fig. 3
 F8-166 22 cm, 8 3/4" 15 x 30 mm 6 prong Fig. 4
 F8-167 22 cm, 8 3/4" 15 x 40 mm 8 prong Fig. 5

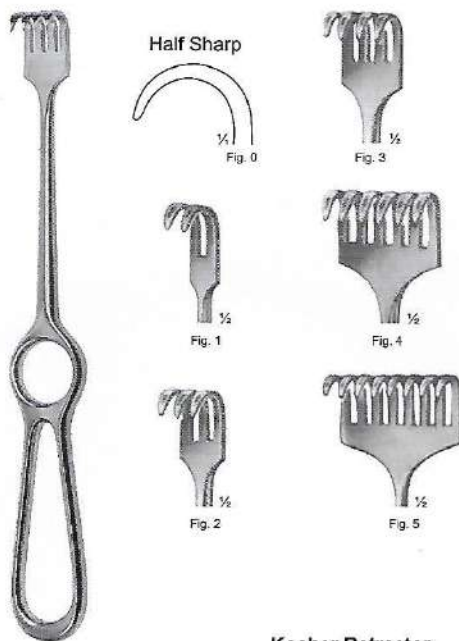

Kocher Retractor

- F8-168 22 cm, 8 3/4" 15 x 10 mm 2 prong Fig. 1
 F8-169 22 cm, 8 3/4" 15 x 15 mm 3 prong Fig. 2
 F8-170 22 cm, 8 3/4" 15 x 20 mm 4 prong Fig. 3
 F8-171 22 cm, 8 3/4" 15 x 30 mm 6 prong Fig. 4
 F8-172 22 cm, 8 3/4" 15 x 40 mm 8 prong Fig. 5

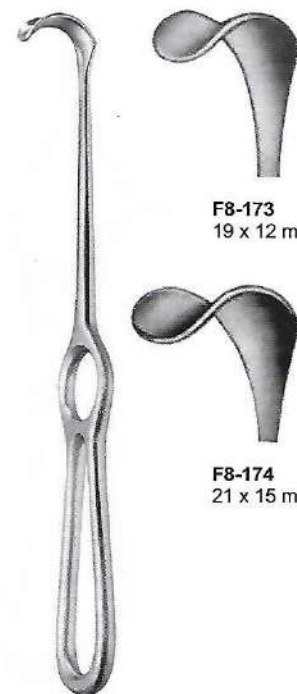

Kocher Retractor

19 cm, 7 1/2"

RETRACTORS



Wundhaken | Ecarteurs
Separadores | Divaricatori



**Kocher-Langenbeck
Retractor**
21.5 cm, 8 1/2"



F8-175
25 x 6 mm



F8-176
35 x 8 mm



F8-177
35 x 11 mm



F8-178
35 x 15 mm



F8-179
40 x 11 mm



F8-180
55 x 11 mm



F8-181
70 x 14 mm



F8-182
80 x 12 mm



F8-183
80 x 16 mm



RETRACTORS

Wundhaken
Separadores

Ecarteurs
Divaricatori

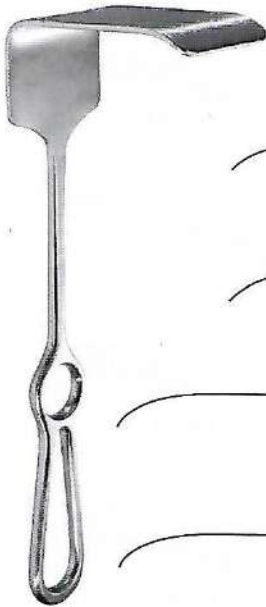

Kocher Retractor
23 cm, 9"

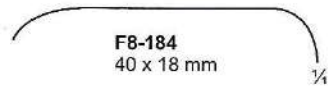

F8-184
40 x 18 mm

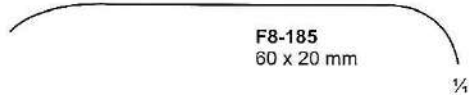

F8-185
60 x 20 mm

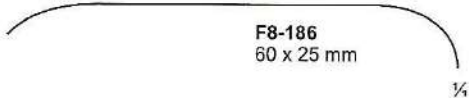

F8-186
60 x 25 mm



F8-187
75 x 30 mm



F8-188
75 x 40 mm



Kocher Retractor
22 cm, 8 1/2"
F8-189 40 x 10 mm
F8-190 40 x 15 mm
F8-191 40 x 20 mm



Kocher Retractor
F8-192
22.5 cm 8 3/4"
70 x 25 mm



Kocher Retractor
F8-193 23 cm, 9" 35 x 18 mm
F8-194 23 cm, 9" 60 x 20 mm
F8-195 23 cm, 9" 60 x 25 mm
F8-196 23 cm, 9" 75 x 30 mm
F8-197 23 cm, 9" 75 x 40 mm

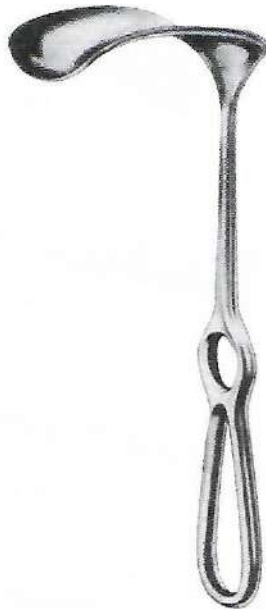

Kocher Retractor
F8-198 25 cm, 9 3/4" 80 x 45 mm
F8-199 25 cm, 9 3/4" 80 x 55 mm
F8-200 25 cm, 9 3/4" 80 x 65 mm

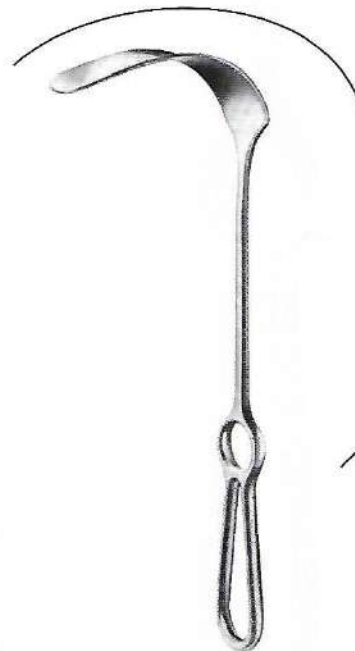

Kocher-Wagner Retractor
28 cm, 11"



F8-201
22 x 15 mm



F8-202
38 x 20 mm



F8-203
67 x 25 mm

RETRACTORS



Wundhaken
Separadores

Ecarteurs
Divaricatori

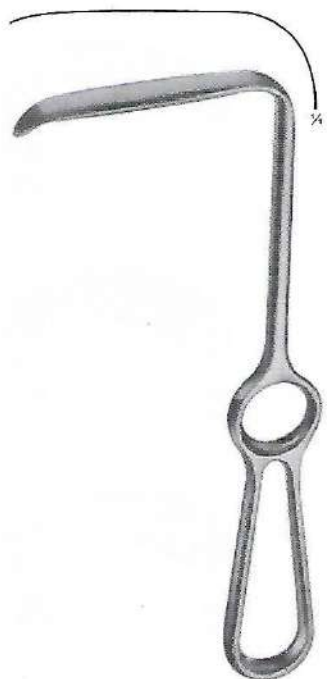

**Langenbeck Retractor
F8-204**
21.5 cm 8 1/2"
Handle vertical
to the blade



**Langenbeck
Retractor
F8-204**
20.4 cm, 8"

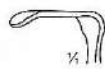

F8-205
20 x 7 mm



F8-206
30 x 7 mm



F8-207
30 x 11 mm



F8-208
30 x 15 mm



F8-209
30 x 20 mm



F8-210
44 x 10 mm



F8-211
44 x 15 mm

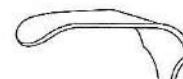

F8-212
45 x 20 mm



F8-213
50 x 20 mm

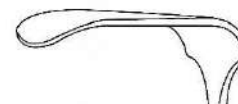

F8-214
60 x 20 mm



**Langenbeck Retractor
F8-215**
21 cm 8 1/4"
38 x 9mm



Langenbeck Retractor
24 cm, 8 1/4"



F8-216
35 x 7mm



F8-217
35 x 11mm



F8-218
35 x 15mm



F8-219
35 x 20mm



RETRACTORS

Wundhaken | *Ecarteurs*
Separadores | *Divaricatori*



**Langenbeck
Retractor**
22 cm, 8 ½"



F8-220
25 x 6 mm



F8-221
35 x 8 mm



F8-222
35 x 11 mm

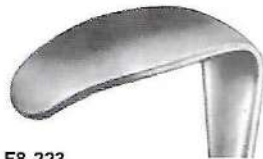

F8-223
35 x 15 mm



F8-224
41 x 11 mm



F8-225
55 x 11 mm



F8-226
70 x 14 mm



**Langenbeck
Retractor**
22 cm, 8 ½"



F8-227
25 x 6 mm



F8-228
35 x 8 mm



F8-229
35 x 11 mm



F8-230
35 x 15 mm



F8-231
41 x 11 mm



F8-232
55 x 11 mm



F8-233
70 x 14 mm

RETRACTORS



Wundhaken
Separadores

Ecarteurs
Divaricatori

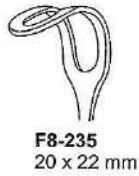

Middeldorpf Retractor
21 cm, 8 1/4"

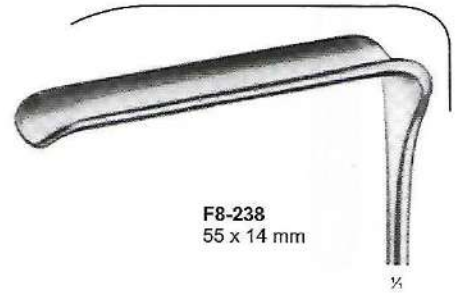
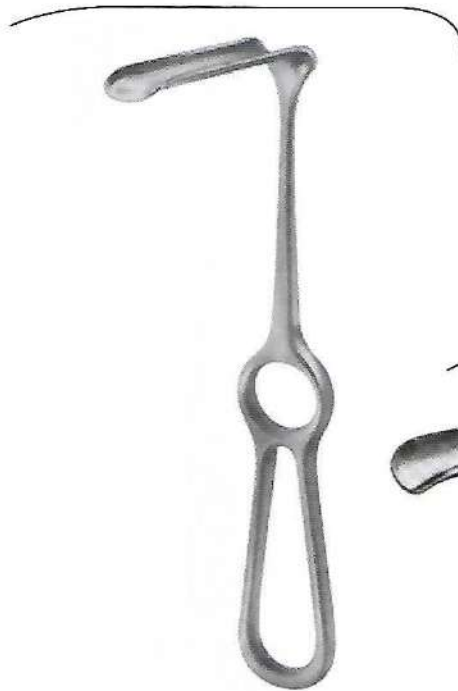

Caspar Retractor
21 cm, 8 1/4"



Ollier Retractor
F8-239
18.5 cm, 7 1/4"



Lahey Goiter Retractor
F8-240 20.4 cm, 8"
Right angle blade, length
1 inch (2.5cm). With lip.



Lahey Retractor
F8-241
19 cm, 7 1/2"



RETRACTORS

Wundhaken | Ecarteurs
Separadores | Divaricatori



Tendon Hooks Retractor
F8-242 12 x 6 mm Fig. 1
F8-243 12 x 11 mm Fig. 2
17.5 cm, 7"



Klapp Retractor
F8-244
17.5 cm, 7"
15 x 11 mm



Little Retractor
F8-245
20 cm, 8"
12x14 mm



Wassmund Retractor
F8-246
20 cm, 8"
33 x 20mm



Meyerdig Finger Retractor
18 cm, 7"



F8-247
long blunt blade,
1/4" x 11/16"
6 x 17 mm Blunt



F8-250
long toothed blade,
3/16" x 5/8"
5 x 16mm



F8-248
short toothed blade
1/8" x 1/4"
3 x 6 mm



F8-251
short blunt blade,
1/8" x 3/8"
3 x 10mm



F8-249
curved blunt blade,
1/8" x 3/8"
3 x 8mm
Saddle Shaped



F8-252
curved three prong
sharp blade,
3/8" x 5/32"
10 x 4mm

RETRACTORS



Wundhaken | Ecarteurs
Separadores | Divaricatori



Blount Knee Retractor
F8-253
17.5 cm, 6 3/4"
42 x 4 mm



Taylor Spinal Retractors
F8-254 16.5 cm, 6 1/2"
75 x 30 mm / 100 x 30 mm



Luer Retractor
F8-255 11 cm, 4 1/4"
10 x 8 mm / 12 x 11 mm



Rose Retractor
F8-256 13 cm, 5"
12 x 12 mm /
12 x 15 mm



20 x 6 mm

12 x 4 mm

Crile Retractor
F8-257 11 cm, 4 1/4"
12 x 4 mm /
20 x 6 mm

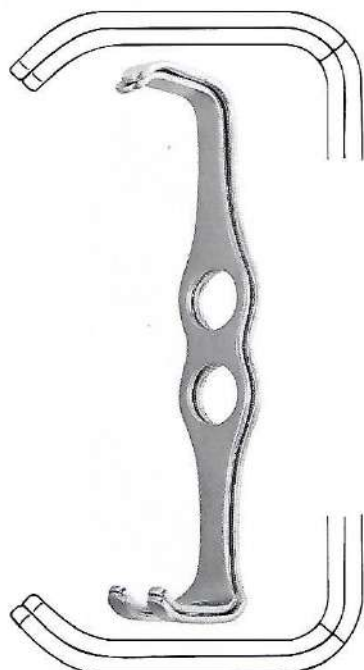

Mathieu Retractor
Set 2 pcs.
F8-258 20 cm, 8"
47 x 13 / 46 x 26 mm
F8-259 20 cm, 8"
42 x 13 / 42 x 26 mm



Us-Army Retractor
Set 2 pcs.
F8-260 21.5 cm, 8 1/2"
28 x 15 / 42 x 15 mm
F8-261 21.5 cm, 8 1/2"
25 x 15 / 38 x 15 mm



Richardson Eastman Retractor
F8-262
26 cm, 10 1/4"
small



Richardson Eastman Retractor
F8-263
28 cm, 11"

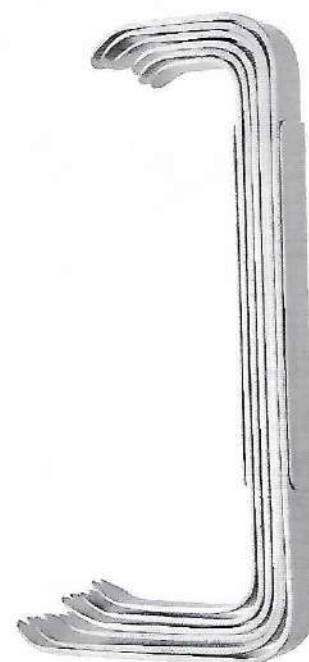

Sofield Retractor
F8-264
set of 6 pec.



RETRACTORS

Wundhaken
Separadores

Ecarteurs
Divaricatori

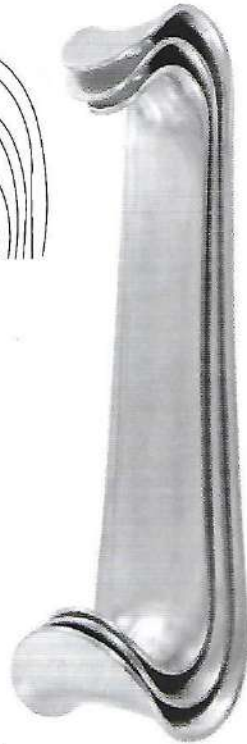
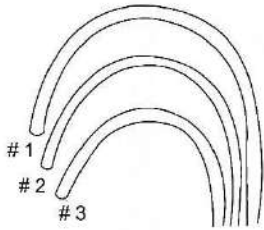

Roux Retractor

Set 3 pcs. consisting of

- # 1 **F8-265** 14 cm, 5 1/2" 24 x 20 / 30 x 28 mm
- # 2 **F8-266** 15 cm, 6" 29 x 26 / 36 x 36 mm
- # 3 **F8-267** 17 cm, 6 3/4" 33 x 29 / 38 x 43 mm



Baby-Roux Retractor

- F8-268** 13 cm, 5" 15 x 15 mm / 18 x 21 mm



Roux Retractor

- F8-269** 16.5 cm, 6 1/2" 28 x 23 mm / 43 x 23 mm



Roux Retractor

- F8-270** 18.5 cm, 7 1/4" 28 x 27 mm / 45 x 27 mm



Mini-Roux Retractor

- F8-271** 14 cm, 5 1/2"



Roux-Magnus Retractor

- F8-272** 15 cm, 6" 20 x 22 mm / 25 x 38 mm

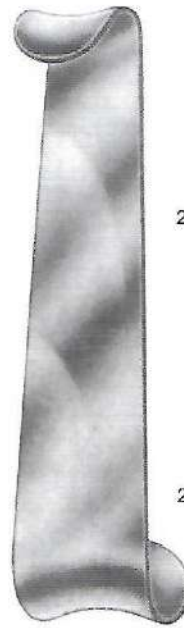

Roux-Magnus Retractor

- F8-273** 16 cm, 6 1/4" 23 x 26 mm / 29 x 38 mm

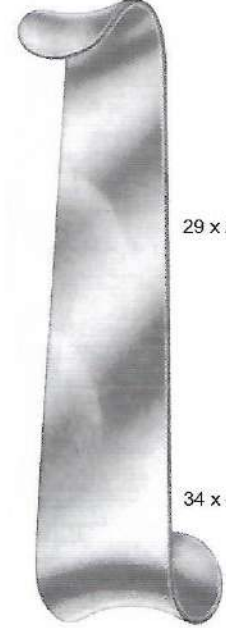

Roux-Magnus Retractor

- F8-274** 17 cm, 6 3/4" 29 x 29 mm / 34 x 44 mm

RETRACTORS



Wundhaken | Ecarteurs
Separadores | Divaricatori



Farabeuf Retractor
Set 2 Pcs.
F8-275 13 cm, 5"
30 x 10 / 34 x 13 mm
F8-276 13 cm, 5"
26 x 10 / 30 x 13 mm



Farabeuf Retractor
Set 2 Pcs.
F8-277 15 cm, 6"
27 x 16 / 30 x 16 mm
F8-278 15 cm, 6"
23 x 16 / 26 x 16 mm



Farabeuf Retractor
F8-278A Baby (7x100mm)
F8-278B infantil (10x120mm)
F8-278C Adult (13x125mm)
F8-278D Adult (15x150mm)
F8-278E Extra Large(20x180mm)



Parker Retractor
Set 2 pcs.
F8-279 13.5 cm, 5 1/4"
22 x 15 mm / 22 x 15 mm
F8-280
18.4 cm 7 1/4"



Parker Retractor
F8-281 13.5 cm, 5 1/4"
18 x 15 mm / 19 x 15 mm

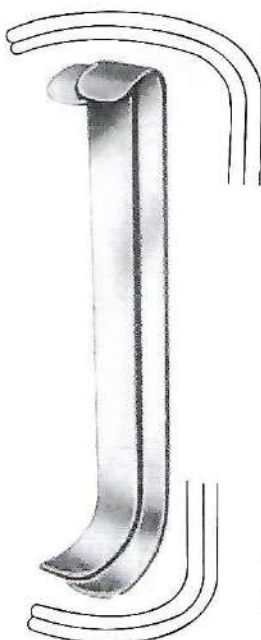

Collin Retractor
Set 2 pcs.
F8-282 16.5 cm, 6 1/2"
25 x 12 / 35 x 16 mm
F8-283 16.5 cm, 6 1/2"
20 x 12 / 30 x 16 mm

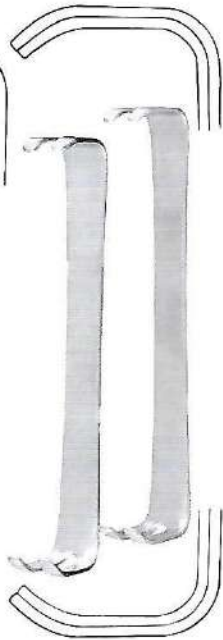

Mayo-Collin Retractor
Set 2 pcs.
F8-284 15 cm, 6"
28 x 18 / 25 x 18 mm

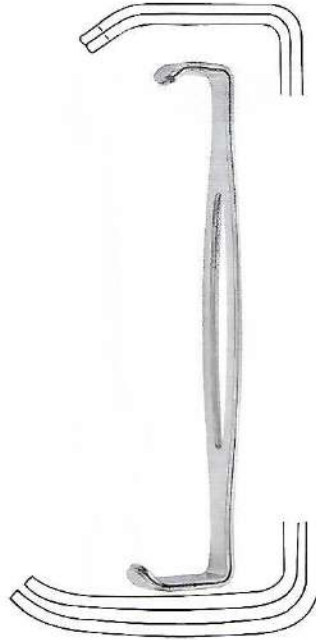

Parker-Langenbeck Retractor
Set of 2 Pcs.
F8-285 21.5 cm, 8 1/2" 25 x 15 mm fig. 2
F8-286 21.5 cm, 8 1/2" 21 x 15 mm fig. 1
F8-287 21.5 cm, 8 1/2" 40 x 15 mm fig. 1
F8-288 21.5 cm, 8 1/2" 46 x 15 mm fig. 2



Parker-Mott Retractor
F8-289
16 cm 6 1/4"
68 x 24 / 74 x 24 mm



RETRACTORS

Wundhaken
Separadores

Ecarteurs
Divaricatori



- F8-290**
Blunt, 2 prongs.
- F8-291**
Blunt, 3 prongs.
- F8-292**
Blunt, 4 prongs.
- F8-293**
Blunt, 5 prongs.
- F8-294**
Blunt, 6 prongs.
- F8-295**
Sharp, 2 prongs.
- F8-296**
Sharp, 3 prongs.
- F8-297**
Sharp, 4 prongs.
- F8-298**
Sharp, 5 prongs.
- F8-299**
Sharp, 6 prongs.

Volkman Retractors
Long Pattern
22.2 cm, 8 1/4"

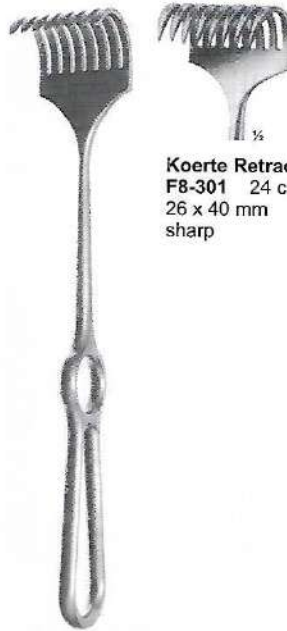

Koerte Retractor
F8-301 24 cm, 9 1/2"
26 x 40 mm
sharp

Koerte Retractor
F8-300 24 cm, 9 1/2"
26 x 40 mm
blunt

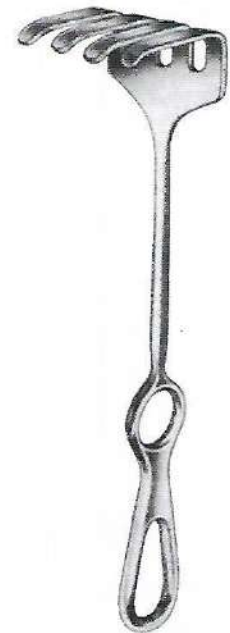

Koerte Retractor
F8-302 23 cm, 9"
46 x 55 mm
blunt



Koerte Retractor
F8-303 28 cm, 11"
25 x 40 mm
semi-sharp



Koerte Retractor
F8-304 23 cm, 9"
Blunt



Korte-Wagner
Retractor
F8-305 28 cm, 11"
Sharp

RETRACTORS



Wundhaken
Separadores

Ecarteurs
Divaricatori

F8-306
115 x 65 mm



F8-307
115 x 38 mm



F8-308
82 x 22 mm



F8-309
130 x 38 mm

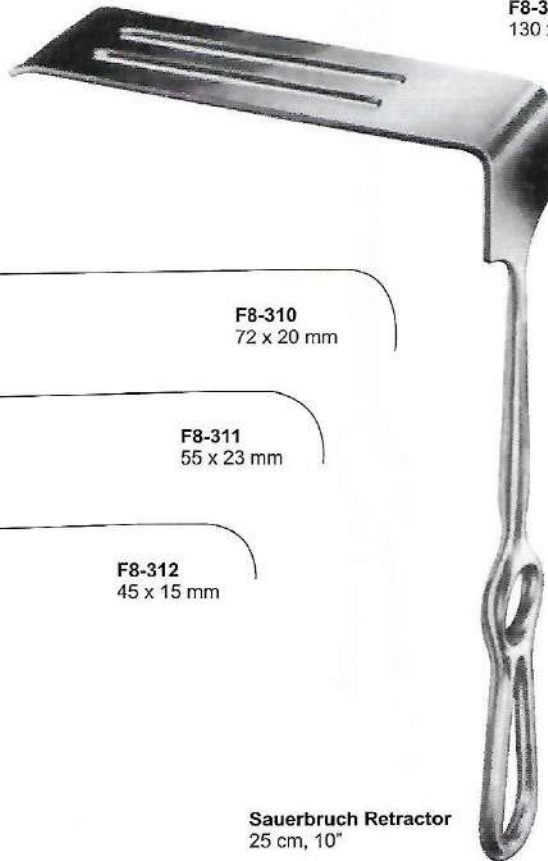

Coryllos Retractor
22.5 cm, 8 3/4"



F8-310
72 x 20 mm

F8-311
55 x 23 mm

F8-312
45 x 15 mm

Sauerbruch Retractor
25 cm, 10"

Davidson Retractor
F8-313 16 cm, 6 1/4" 75 x 50 mm
F8-314 16 cm, 6 1/4" 75 x 90 mm





RETRACTORS

Wundhaken | Ecarteurs
Separadores | Divaricatori

F8-315
180 x 30 mm

F8-316
160 x 30 mm

F8-317
140 x 30 mm

F8-318
130 x 30 mm

F8-319
120 x 25 mm

F8-320
100 x 25 mm

F8-321
80 x 20 mm



¼

Bruner Retractor
25 cm, 10"

RETRACTORS



Wundhaken | Ecarteurs
 Separadores | Divaricatori

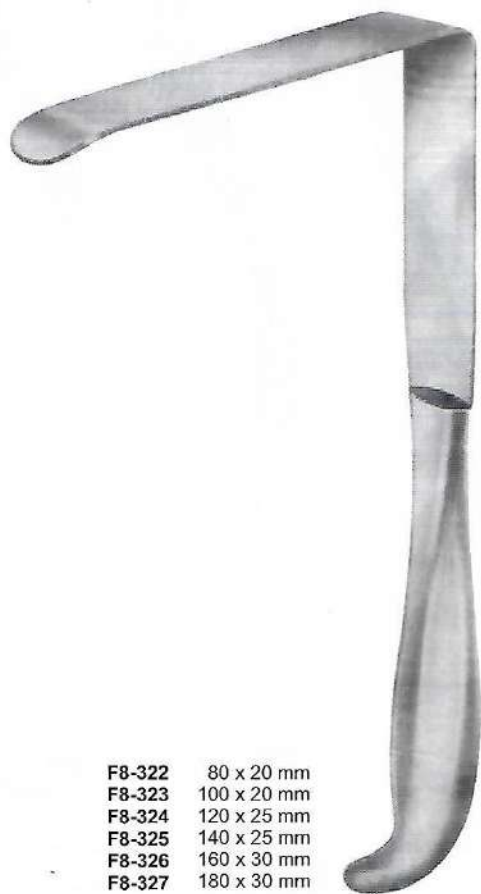
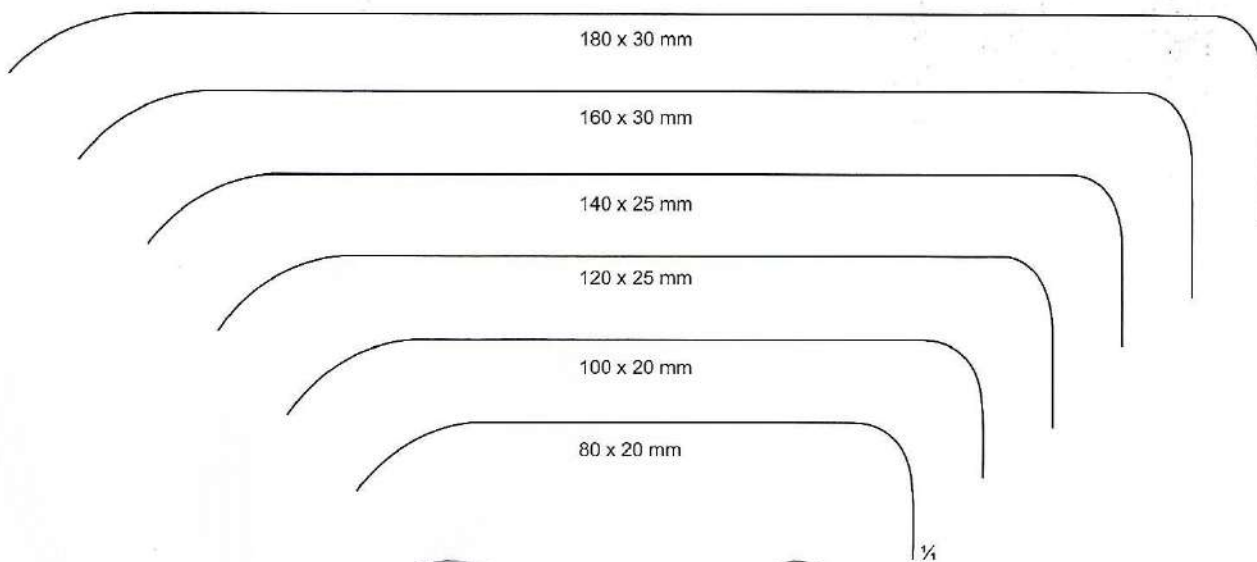

- F8-322 80 x 20 mm
- F8-323 100 x 20 mm
- F8-324 120 x 25 mm
- F8-325 140 x 25 mm
- F8-326 160 x 30 mm
- F8-327 180 x 30 mm

Brunner Retractor
 24 cm, 9 1/2"



- F8-328 80 x 20 mm
- F8-329 100 x 20 mm
- F8-330 120 x 25 mm
- F8-331 140 x 25 mm
- F8-332 160 x 30 mm
- F8-333 180 x 30 mm

Brunner Retractor
 24 cm, 9 1/2"



RETRACTORS

Wundhaken
Separadores

Ecarteurs
Divaricatori



**Deaver Retractor
F8-334**
18 cm, 7"

**Deaver Retractor
F8-335**
21.5 cm, 8 ½"

**Deaver Retractor
F8-336**
23 cm, 9"

**Deaver Retractor
F8-337**
30 cm, 11 ¾"

**Deaver Retractor
F8-338**
33 cm, 13"

**Deaver Retractor
F8-339**
36 cm, 13 ½"

RETRACTORS



Wundhaken
Separadores

Ecarteurs
Divaricatori

38 mm



Deaver Retractor
F8-340
30 cm, 11 3/4"

50 mm



Deaver Retractor
F8-341
30 cm, 11 3/4"

75 mm



Deaver Retractor
F8-342
30 cm, 11 3/4"

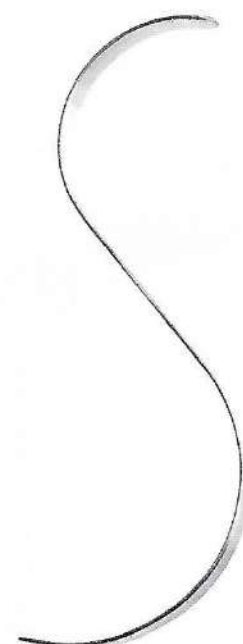

S-Shaped Retractor
F8-343
21 cm, 8 1/4"
12 mm



RETRACTORS

Wundhaken
Separadores

Ecarteurs
Divaricatori

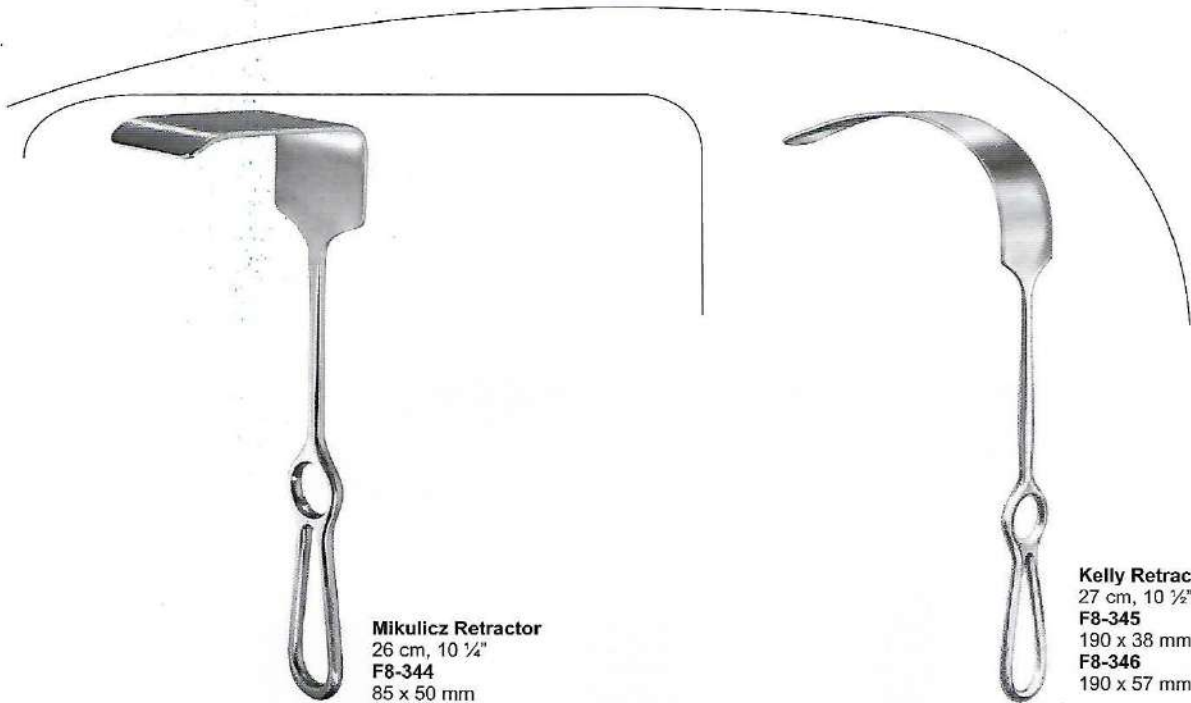

Mikulicz Retractor
26 cm, 10 1/4"
F8-344
85 x 50 mm

Kelly Retractor
27 cm, 10 1/2"
F8-345
190 x 38 mm
F8-346
190 x 57 mm



Mikulicz Retractor
26 cm, 10 1/4"
F8-347
95 x 35 mm

Mikulicz Retractor
26 cm, 10 1/4"
F8-348
120 x 50 mm
F8-349
150 x 50 mm

RETRACTORS



Wundhaken
Separadores

Ecarteurs
Divaricatori



Cheek-And Lip Retractor
19 cm, 7 1/2"
F8-350
Movable



Tuffier Retractor
23 cm, 9"
F8-351 55 x 63 mm



Bennet Retractor
F8-351A
24cm

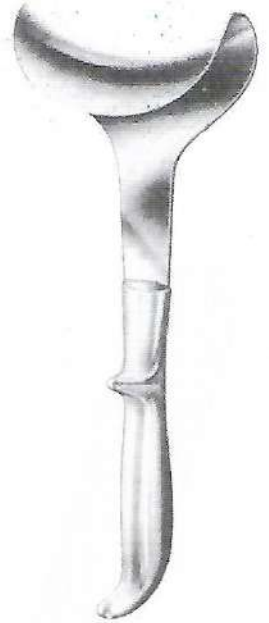

Doyen Retractor
25 cm, 10"
F8-352 50 x 85 mm



Fritch Retractor
F8-353
2.75 x 2 mm



Fritch Retractor
24 cm, 9 1/2"
F8-354 35 x 40 mm



Fritch Retractor
F8-355 24 cm, 9 1/2" 30 x 30 mm
F8-356 24 cm, 9 1/2" 32 x 40 mm
F8-357 24 cm, 9 1/2" 40 x 50 mm
F8-358 24 cm, 9 1/2" 40 x 60 mm
F8-359 24 cm, 9 1/2" 45 x 75 mm
F8-360 24 cm, 9 1/2" 65 x 85 mm



RETRACTORS

Wundhaken
Separadores

Ecarteurs
Divaricatori

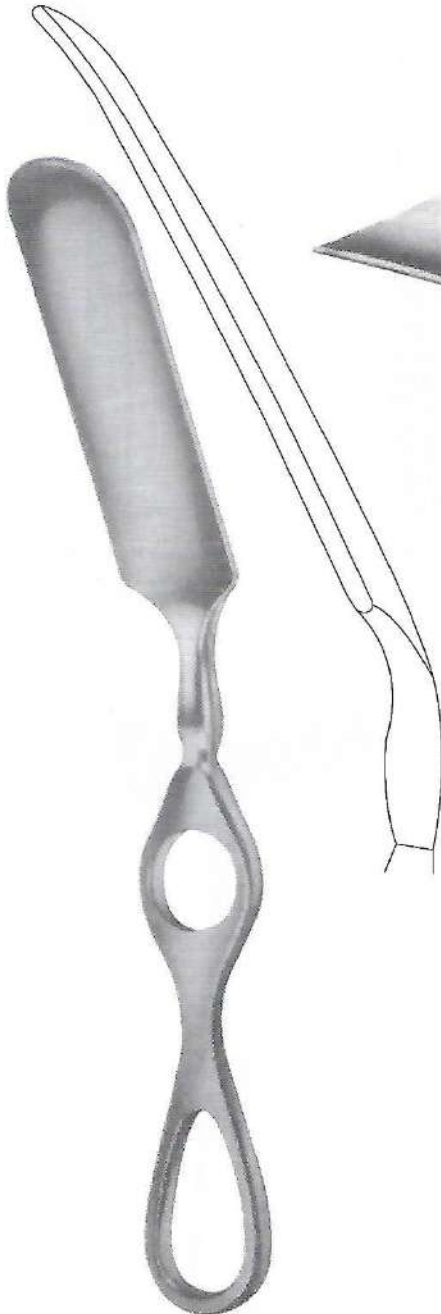

Mikulicz Retractor
F8-361 29 cm 11.5"

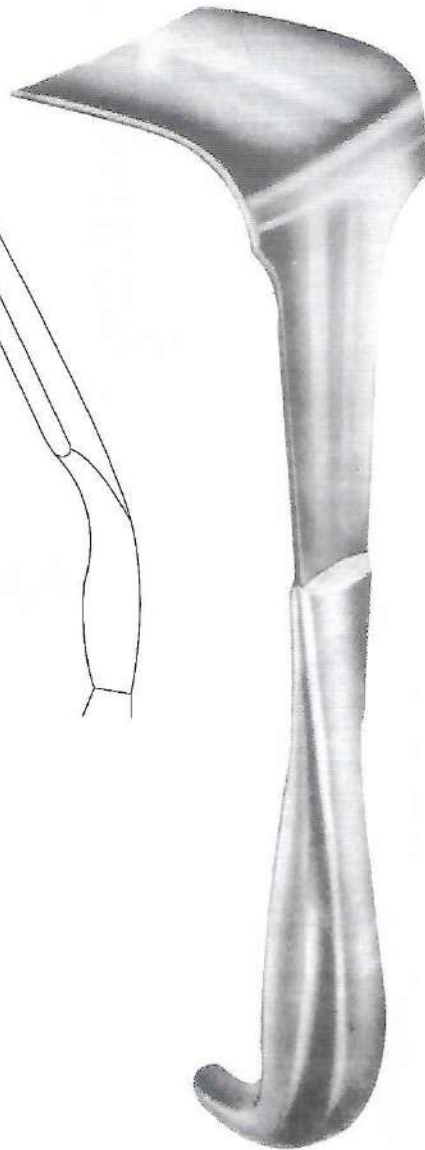

Tuffier Retractor
F8-362 23 cm 9"
64 x 60mm



Harrington Retractor
32 cm, 12 3/4"
F8-363
127 x 40 mm
F8-364
127 x 62 mm

RETRACTORS



Wundhaken | Écarteurs
Separadores | Divaricatori



Harrington Extra Deep Retractor
F8-365 30.0cm 11 3/4"
Hollow handle, 5.7cm 2 1/4"
width x 20.5cm 8" depth blade

Harrington Splanchnic Retractor
F8-366 31.5cm 12 1/2"
Hollow handle, 3.8cm 1 1/2"
width x 12.0cm 4 3/4"
depth blade

Debakey-Coolley Retractor
F8-367 31.0cm 12 1/4"
Hollow handle, 5.7cm 2 1/4"
width x 18.4cm 7 1/4"
depth blade



RETRACTORS, VEIN HOOKS

Wundhaken, Venenhäkchen

Separadores, Ganchitos Para venas

Ecarteurs, Ecarteurs sous

Divaricatori, Divaricatori per veni

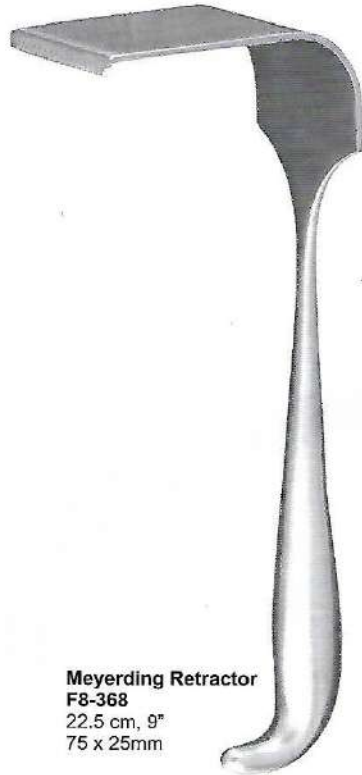

Meyerding Retractor
F8-368
22.5 cm, 9"
75 x 25mm

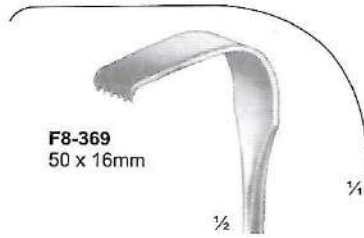

F8-369
50 x 16mm

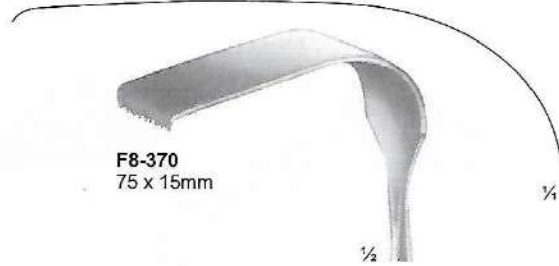

F8-370
75 x 15mm

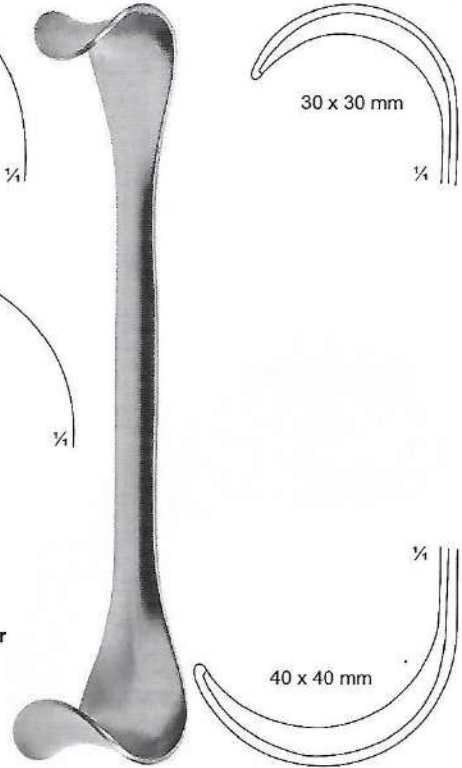

Goelet Retractor
F8-371
19 cm 7 1/2"
Double Ended



Kaye-Millard Retractor
F8-372
8 cm, 3 1/4"



Richardson/Kelly Retractor
24 cm, 9 1/2"



F8-373
5 x 31mm



F8-374
19 x 51mm



F8-375
38 x 51mm



F8-376
64 x 76mm

RETRACTORS



Windhaken | Ecarteurs
 Separadores | Divaricatori



Ross Retractor
 25.5 cm, 10"



F8-377
 Fig.01



F8-378
 Fig.02



F8-379
 Fig.03



F8-380
 Fig.04



F8-381
 Fig.05



¼

F8-382
 Fig.06



Weinberg Vagotomy Retractor (Joe's Hoe)
F8-383
 20 cm, 8"
 Blade 102 x 165 mm wide



Turner-Doyen Retractors
 23.5 cm 9 ½"
F8-384
 Blade 140 x 60 mm wide
F8-385
 Blade 76 x 140 mm wide
F8-386
 Blade 165 x 76 mm wide

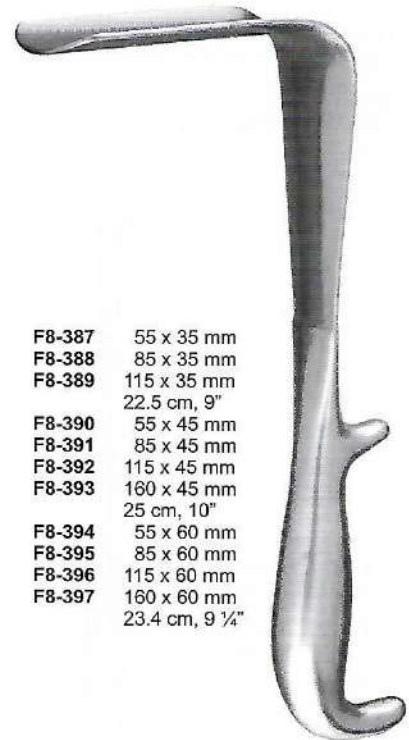

- F8-387** 55 x 35 mm
- F8-388** 85 x 35 mm
- F8-389** 115 x 35 mm
22.5 cm, 9"
- F8-390** 55 x 45 mm
- F8-391** 85 x 45 mm
- F8-392** 115 x 45 mm
- F8-393** 160 x 45 mm
25 cm, 10"
- F8-394** 55 x 60 mm
- F8-395** 85 x 60 mm
- F8-396** 115 x 60 mm
- F8-397** 160 x 60 mm
23.4 cm, 9 ¼"

Doyen Vaginal Retractors



RETRACTORS

Wundhaken
Separadores

Ecarteurs
Divaricatori



Sawyer Retractors

F8-398

Small Blade 70 mm x 19 mm wide
23 cm 9"

F8-399

Medium Blade 82 mm x 29 mm wide
25 cm 10"

F8-400

Large Blade 22 mm X 64 mm
27.9 cm 11"

F8-401

Large Blade 38 mm X 89 mm
27.9 cm 11"



Ferguson-Moon Rectal Retractors

F8-402

Blade 60 mm x 24 mm wide
23 cm 9"

F8-403

Blade 75 mm x 35 mm wide
25 cm 10"



Hill Ferguson Rectal Retractors

F8-404

Blade 64 mm x 24 mm wide
23 cm 9"

F8-405

Blade 76 mm x 32 mm wide
23 cm 9"

F8-406

Blade 76 mm x 35 mm wide
25 cm 10"



Kelly Retractors

F8-407 24 cm 9 1/2"
50 x 40 mm wide

F8-408 24 cm 9 1/2"
65 x 50 mm wide

F8-409 25 cm 10"
75 x 65 mm wide

F8-410 25 cm 10"
90 x 75 mm wide

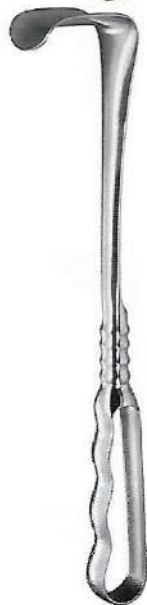

Richardson Retractors



F8-411 24 cm 9 1/2"
Blade 25 x 20 mm wide



F8-412 24 cm 9 1/2"
Blade 36 x 28 mm wide



F8-413 24 cm 9 1/2"
Blade 44 x 28 mm wide

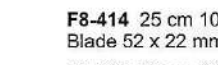

F8-414 25 cm 10"
Blade 52 x 22 mm wide

F8-415 25 cm 10"
Blade 70 x 52 mm wide



Kelly Retractor **F8-416** 25 cm, 10" 55 x 50 mm

RETRACTORS



Wundhaken | Ecarteurs
Separadores | Divaricatori



Richardson-Eastman Retractor
25.0 cm 10", Set of 2 piece



Richardson Retractor
24.0 cm 9.5"



Richardson Retractor
F8-422
24.0 cm 9.5"



RETRACTORS

Wundhaken
Separadores

Ecarteurs
Divaricatori

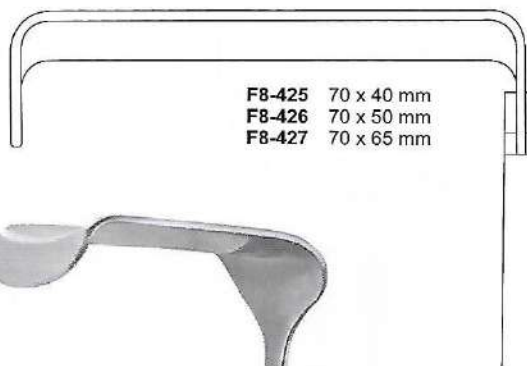
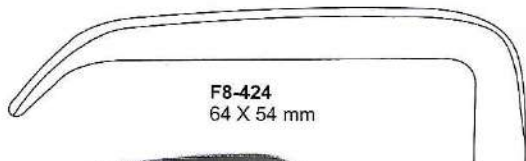
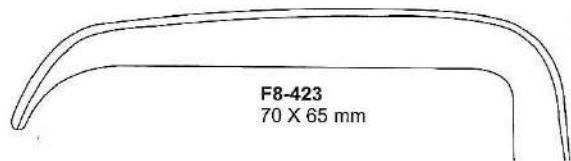

Kelly Retractor
26.0 cm 10 1/4"



Morris Retractor
24.5 cm 9 3/4"

RETRACTORS



Wundhaken | Ecarteurs
Separadores | Divaricatori



Item	Description	Tip
F8-428	20 cm, 8"	12 mm
F8-429	20 cm, 8"	17 mm
F8-430	20 cm, 8"	25 mm
F8-431	33 cm, 13"	25 mm
F8-432	33 cm, 13"	32 mm
F8-433	33 cm, 13"	40 mm
F8-434	33 cm, 13"	50 mm

Malleable Retractor



**Ribbon Retractor
F8-435**
20 cm, 8"
Width 4 cm



**Ribbon Retractor
F8-436**
20 cm, 8"
Width 2.5 cm



Tuffier / Haberer Retractor
F8-437 20 cm, 8" 17 x 25 mm
F8-438 28 cm, 11" 25 x 30 mm
F8-439 30 cm, 11 ¼" 37 x 45 mm
malleable



**Bruening Spatula
F8-439A**
19 cm



Flexival Abdominal Spatula

- F8-439B 300x20mm
- F8-439C 300x25mm
- F8-439D 300x30mm
- F8-439E 300x35mm
- F8-439F 300x40mm
- F8-439G 300x45mm
- F8-439H 300x50mm



**Reverdin Retractor
F8-440** 28 cm, 11"
46 x 60 mm



**Reverdin Retractor
F8-441** 29 cm, 11 ½"

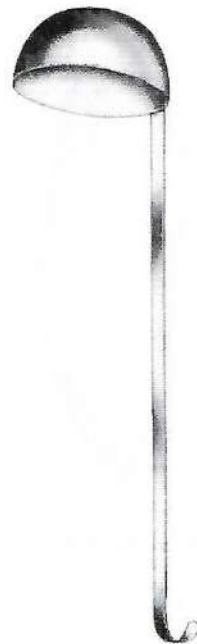

**Blood Scoop
F8-442** 15 cm, 6"



RETRACTORS

Wundhaken
Separadores

Ecarteurs
Divaricatori

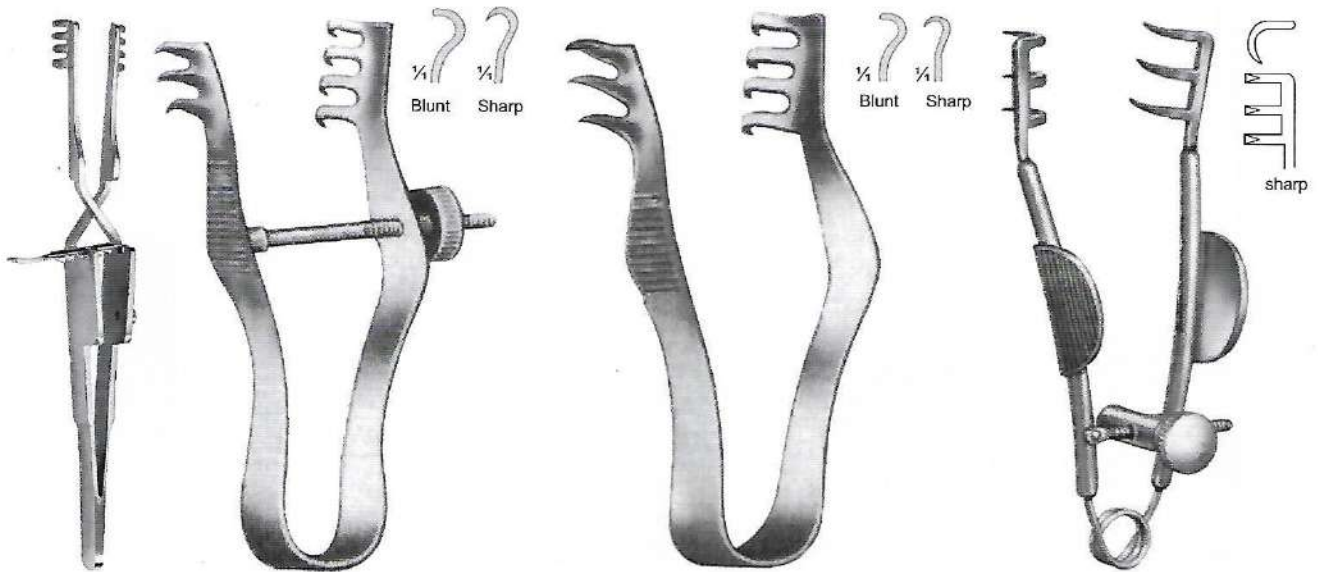

Heiss Retractor
F8-443 10 cm, 4"
Sharp 4:4
F8-444 10 cm, 4"
Blunt 4:4

Finsen Retractor
F8-445 7 cm, 2 3/4"
3 x 4 teeth, sharp
F8-446 7 cm, 2 3/4"
3 x 4 teeth, Blunt

Finsen Retractor
F8-447 5 cm, 2"
2 x 3 teeth sharp/blunt
F8-448 7 cm, 2 1/4"
2 x 3 teeth sharp/blunt

Buckley Retractor
F8-449
6 cm, 2 1/2"



Lancaster Eye Speculum
F8-450
8.3 cm 3 1/4",
blades 15 X 5 mm

Castroviejo Eye Speculum
F8-451
9.5 cm 3 3/4",
medium blades
15 X 5 mm O.D.

Wire Retaining Retractor
F8-452 8.5 cm, 3 1/2" 3 x 3 Prong
F8-453 8.5 cm, 3 1/2" 1 x 1 Prong Sharp

Farr Wire Retractor
F8-454 14 cm 5 1/2"
prongs 1.9 cm 3/4"

ALM Retractor
F8-455 7 cm, 2 3/4"
4 x 4 teeth sharp/blunt
F8-456 10 cm, 4"
4 x 4 teeth sharp/blunt

RETRACTORS

Wundhaken
Separadores

Ecarteurs
Divaricatori



Jansen Retractor
F8-457 10 cm, 4"
Sharp 3x3
F8-458 10 cm, 4"
Blunt 3x3



Houzel Retractor
F8-459 29 cm, 11 1/2"



Mollison Retractor
F8-460 15 cm, 6"
sharp



Markham/Meyerding Retractor
F8-461 18 cm, 7" Blade 55 x 25 mm Left
F8-462 18 cm, 7" Blade 55 x 25 mm Right



Milligan Retractor
F8-463 13 cm, 5"
18.5 mm x 20 mm
Blunt, 3x3



Darling Retractor
F8-464 18 cm, 7"
40 x 76/25 x 54 mm
F8-465 18 cm, 7"
25 x 64/40 x 76 mm
Laminectomy Retractors
1 blade toothed



RETRACTORS

Wundhaken | Ecarteurs
Separadores | Divaricatori



Debaquey Gelpi Retractor
F8-466 13.5cm 5 3/8"
Spread 3 1/8" 8cm, Sharp,

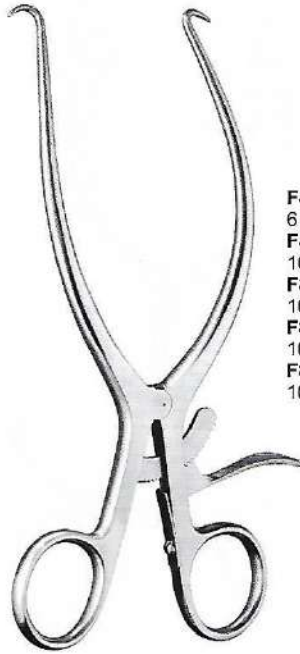

Gelpi-Loktite Retractor

F8-467 9 cm, 3 1/2"
6 mm Sharp
F8-468 11 cm, 4 1/4"
10 mm Sharp
F8-469 14 cm, 5 1/2"
10 mm Sharp
F8-470 16 cm, 6 1/2"
10 mm Sharp
F8-471 19 cm, 7 1/2"
10 mm Sharp



Gelpi-Perineal Retractor
F8-472 17.8 cm, 7"
ball stops on sharp tenaculum prongs,
arm length 4-3/4" 12.1cm



Gelpi-Loktite Retractor
F8-473 9 cm, 3 1/2" 6 mm Sharp CROSS OVER
F8-474 11 cm, 4 1/4" 10 mm Sharp CROSS OVER
F8-475 14 cm, 5 1/2" 10 mm Sharp CROSS OVER
F8-476 16 cm, 6 1/2" 10 mm Sharp CROSS OVER
F8-477 19 cm, 7 1/2" 10 mm Sharp CROSS OVER



Seletz-Gelpi Retractor
F8-478 17.8cm, 7"
modified with long
curve in shanks



Schuhknecht Retractor
F8-479 Sharp
F8-480 Blunt
14 cm, 5 1/2"

RETRACTORS



Wundhaken | Ecarteurs
 Separadores | Divaricatori



Wullstein Retractor
 F8-481 F8-484 10.5 cm, 4"
 F8-482 F8-485 13.0 cm, 5"
 F8-483 F8-486 16.0 cm, 6 1/4"
 Sharp Blunt



Travers Retractor
 F8-487
 21 cm, 8 1/4" Blunt



Rigby Retractor
 F8-488 35 x 20 mm
 F8-489 60 x 20 mm
 F8-490 65 x 15 mm
 18 cm, 7"

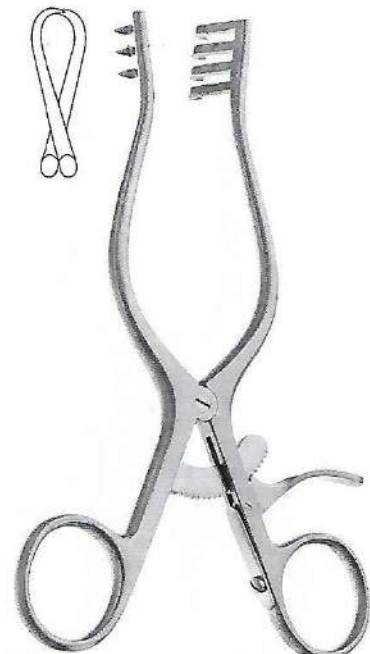

Weitlaner Retractor
 F8-491
 13.0 cm 5.25"
 Sharp

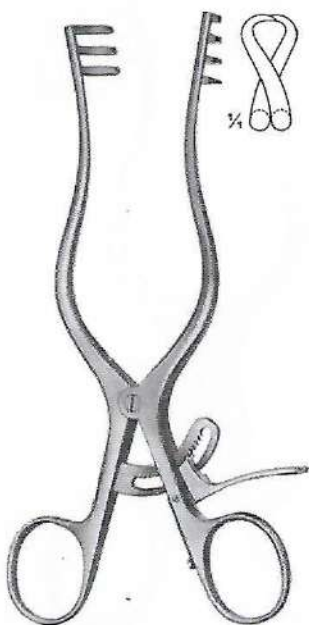

Weitlaner Retractor
 F8-492
 16.5 cm 6.5"
 Sharp



Plester Retractor
 F8-493
 11.0 cm 4.25"
 Blunt

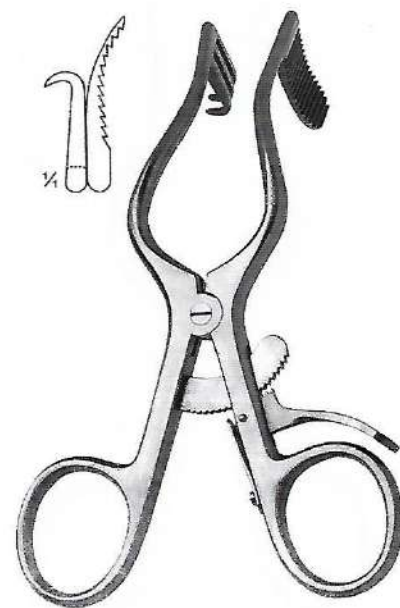

Perkins Retractor
 F8-494
 13.0 cm 5.25"



RETRACTORS

Wundhaken | Ecarteurs
Separadores | Divaricatori

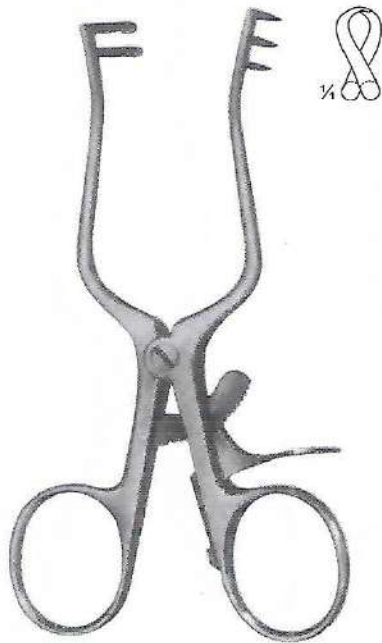

**Weitlaner Retractor
F8-495**
11.0 cm
Sharp

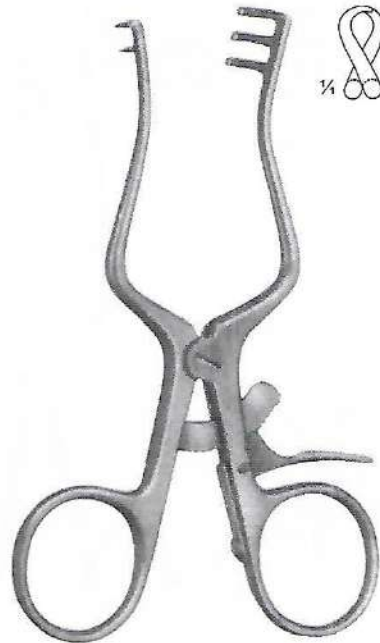

**Weitlaner Retractor
F8-496**
11.0 cm
Semi-Sharp



**Weitlaner Retractor
F8-497**
11.0 cm
Blunt



**Weitlaner Retractor
F8-498**
13.0 cm
Sharp

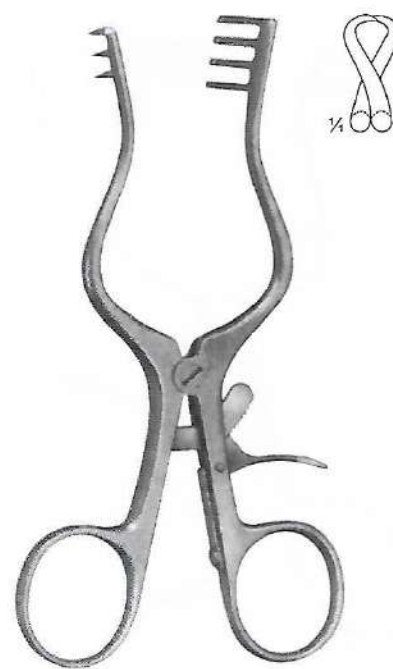

**Weitlaner Retractor
F8-499**
13.0 cm
Semi-Sharp



**Weitlaner Retractor
F8-500**
13.0 cm
Blunt

RETRACTORS



Wundhaken
Separadores

Ecarteurs
Divaricatori



Kolbel Soft Tissue Retractor
F8-501 18.0cm 7"
Angled, 2 x 2 Pronged



Meyerding Retractor
F8-502 16.5cm 6 1/2"
F8-503 24.1cm 9 1/2" Large Blade
8.9 cm 3 1/2" X 5.1 cm 2"
F8-504 24.1 cm 9 1/2" Small Blade
5.1 cm 2" X 1.6 cm 5/8"



D'Errico-Adson Retractor
F8-505 19.0cm 7 3/8"
4 X 4-pronged,
2.0cm 3/4" depth blade
Sharp

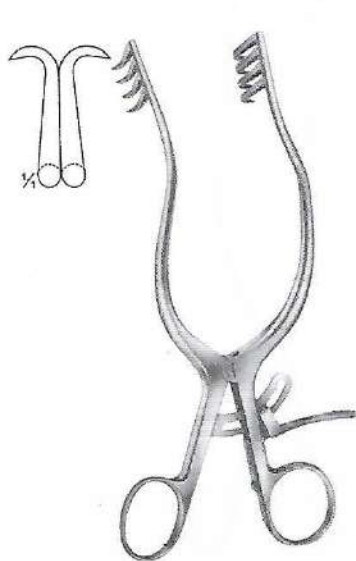

Anderson-Adson Retractor
F8-506 19.0 cm 7 1/2"
Sharp

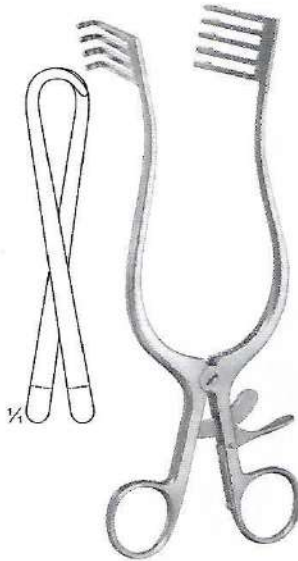

Norfolk & Norwich Retractor
F8-507 22.0 cm 8 3/4"
Blunt



Adson Retractor
F8-508
19.1 cm 7-1/2" sharp,
4 X 4 teeth straight Arms

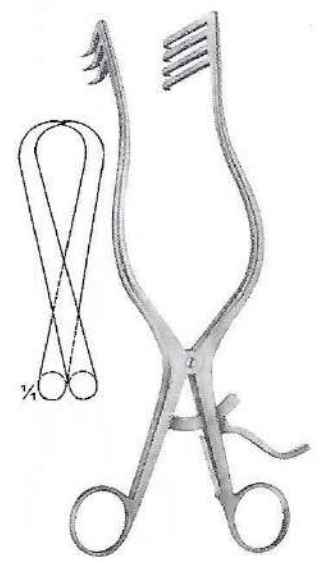

Adson Retractor
F8-509 26.5 cm 10 1/4"
Sharp



RETRACTORS

Wundhaken
Separadores

Ecarteurs
Divaricatori



Beckman-Weitlaner Retractor
F8-510
16.5cm 6 1/2"
3 x 4 Sharp prongs



Beckman-Weitlaner Retractor
F8-511
16.5cm 6 1/2"
3 x 4 Blunt prongs

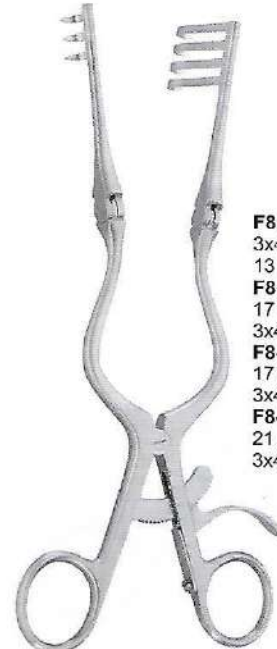

Cone Retractor

F8-512 31 cm, 12"
3x4 Blunt prongs,
13 mm x 14.5 mm
F8-513 16.5 cm, 6 1/2"
17 mm x 19 mm
3x4 Sharp prongs,
F8-514 16.5 cm, 6 1/2"
17 mm x 19 mm
3x4 Blunt prongs,
F8-515 20 cm, 8"
21 mm x 210 mm
3x4 Blunt prongs,



Beckman Retractor
F8-516 31.7cm 12 1/2"
Spread 3.5cm 5 3/8" 4 x 4
Sharp prongs, Arm length
8.5cm 3 3/8"



Beckman Retractor
F8-517 31.1cm 12 1/4"
4 x 4 Sharp prongs 27mm,
Side Blade 1.7cm 5/8" deep,



Beckman Retractor
F8-518 31.1cm 12 1/4"
4 x 4 Blunt prongs 27mm,
Side Blade 1.7cm 5/8" deep,