

Primary Lockers

BISLEY

Contents

03	Introduction	12	Galvanized steel
04	Why choose us?	13	Accessories
05	Everyday lockers	16	Locking technology
	Everyday lockers		
	Lower height lockers		
09	Workwear lockers	17	Finishes
	Combi lockers		
	Police lockers		
	Clean & Dirty lockers	18	Our commitments
	Twin locker		
	Two Person lockers	19	Contact us



Clean & Dirty lockers on locker stands with seats.

Robust, versatile and hard-wearing - lockers crafted for the workplace.

Primary Lockers by Bisley span a wide range of sizes and configurations, allowing you to stow your personal belongings, workwear or equipment as required. With perfect sized compartments to suit every need, whether you're storing uniform and bulky items, to separating your clothes from dirty overalls. Designed for durability, these lockers are aimed at fulfilling tough 'back of house' storage requirements, but the neat and minimalist design means they will look great in changing rooms and customer facing cloakrooms too.

This straightforward locker range is easy to specify. Featuring a smart grey carcass and a selection of door colours, there is also a range of optional upgrades, including benching, feet, sloping tops and a choice of locking options.

Available in single columns or nests of up to four lockers together, Primary Lockers work around your space and capacity.

Primary Lockers: built to last.

Why choose us?



A greener Bisley

View the Bisley Green Guide to learn about our sustainability achievements and commitments.



Over 80 years of award-winning design expertise

Europe's leading manufacturer of steel storage with a state-of-the-art wood plant

15,000 products leave our South Wales factory every week

Manufacturing excellence that's engineered around you.

We're proud to be a full manufacturer that really is Made in Britain. We manufacture all our own steel and wooden furniture in our South Wales factory and export worldwide.

We practice Lean Manufacturing, and have recently invested over £2m in machinery to ensure we are using the latest manufacturing processes and technologies, continually seeking to improve our products and designs.

Our knowledge and expertise is unrivalled and continues to grow. Our team is here to guide you through all the options – from dimensions and finishes, to putting together a precise design specification. Whatever the project requirement, we're on hand to ensure you achieve exactly what you want.

We create furniture that lasts a lifetime for our customers; made from the highest quality materials, using the latest innovative technologies and processes with minimum impact on our environment.

Everyday lockers

Built to last

Uncomplicated and resilient, the Everyday Locker is a workplace essential. Available in a range of heights, widths, depths, and divided into one to six doors, you can choose a configuration that best suits your workforce's personal storage requirements.

Everyday Lockers are available as single columns or in nests of two, three, or four. They feature a light grey carcase as standard and have a choice of door colours, with the option to upgrade to anti-microbial paint. Alternatively, if the lockers are to be placed in areas susceptible to rusting, or you require an extra level of protection, Everyday Lockers can be specified in galvanized steel, with the same paint finishes available.*

Plus, you can choose a specific lock option, moulded feet, or a steel stand to lift lockers off the ground and add benching or sloping tops, if required.



Everyday 2 door lockers.

Features

- Ventilated doors allow air to flow through the lockers.
- Discreet label holders on all doors.
- Strong hinges to withstand rough handling.
- Add optional sloping tops, steel lockers stands, or raised feet with leveling capabilities.
- Choose from a selection of popular industry paints available for door fronts, or specify BioCote paint finishes to inhibit bacteria growth by 99.99%*.
- Lockers can be specified in galvanized steel for added protection against corrosion and damage*.
- Choose from a selection of locks to suit different industry needs.

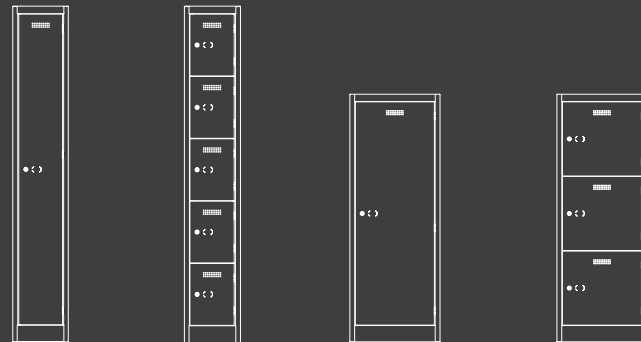

Range overview

Everyday lockers

Available in five depths: 300mm (11.8"), 380mm (15"), 450mm (17.7"), 510mm (20.1") & 600mm (23.6").

*Please note: not all depths are available with every width. Please refer to the [Primary Lockers specification sheet](#) for the full dimension breakdown.

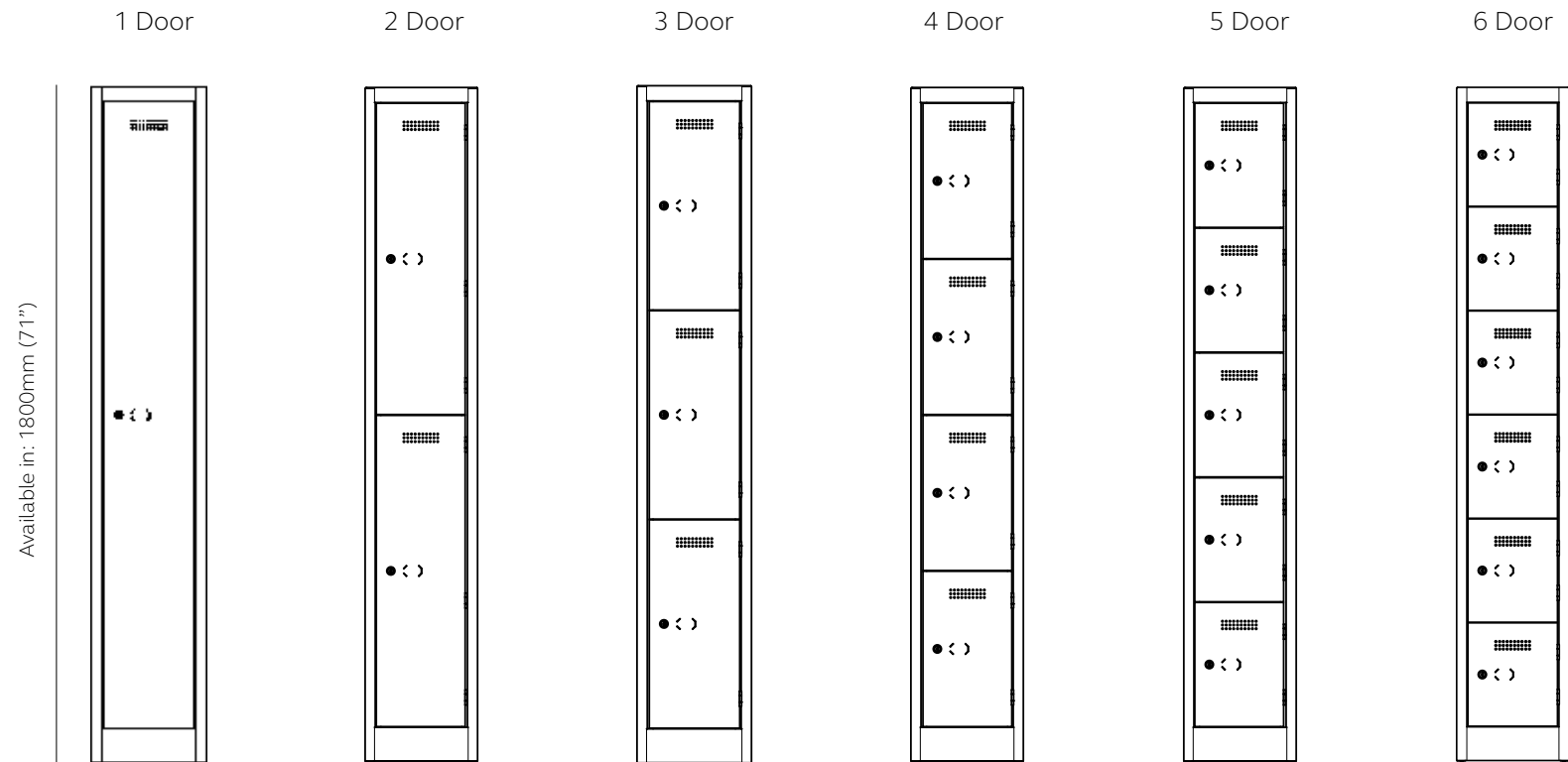

Five widths are available: 225mm (8.9"), 300mm (11.8"), 380mm (15"), 450mm (17.7") & 600mm (23.6").

Lower height lockers

Available in three depths: 300mm (11.8"), 380mm (15") & 450mm (17.7").

*Please note not all depths are available with every width. Please refer to the [Primary Lockers specification sheet](#) for the full dimension breakdown.

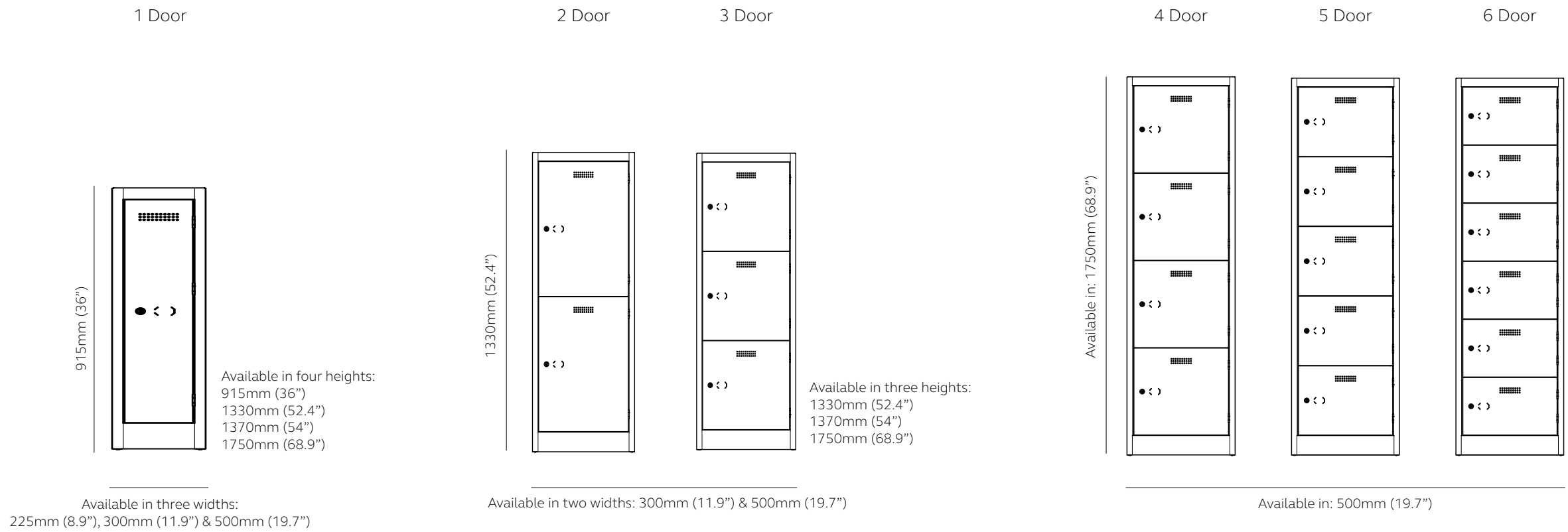



Download images 

Everyday lockers

Workwear lockers

Designed to fit around you.

There are five types of Workwear lockers to choose from. Each has been designed to not only withstand the wear and tear of daily use, but to provide organised, secure storage with specific workwear needs in mind, such as compartments to fit police helmets, internal shelves and dividers, and lockers suited for multiple users.

As with all Primary Lockers, the carcass is light grey as standard, but there are a choice of door colours with the option to upgrade to anti-microbial paint.* Alternatively, if the lockers are to be placed in areas susceptible to rusting, or you require an extra level of protection, Workwear lockers can be specified in galvanized steel, with the same paint finishes available.* You can also specify sloping tops, steel locker stands, raised feet, and add benching, if required.

You can rest assured that our Workwear lockers are a secure option for workwear and personal belongings. They come with a key lock as standard but there are several lock options to choose from to suit your specific needs.



Clean & Dirty lockers.

Range overview

Workwear lockers

Police lockers and Clean & Dirty lockers are 600mm (23.6") deep.
Combi lockers are 450mm (17.7") deep.

Combi locker

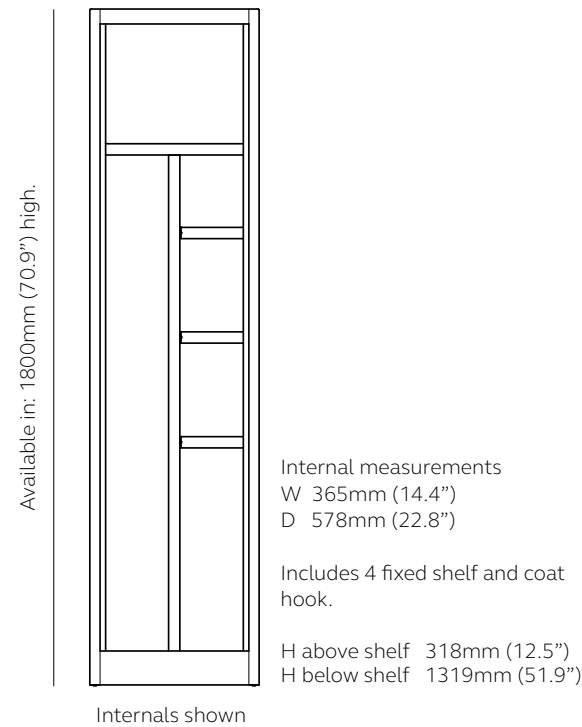

Police locker

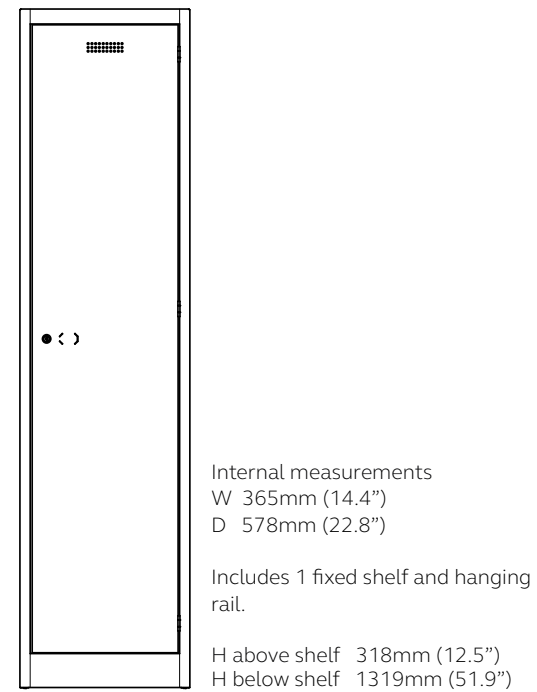

Clean & Dirty locker

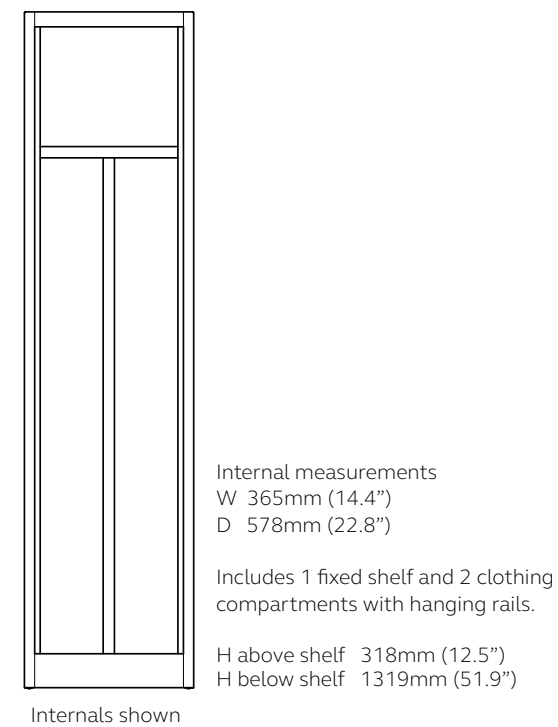

Available in: 450mm (17.7") wide.

Features

- Each of our Workwear lockers have varying internal storage solutions.
- Ventilated doors allow air to flow through the lockers.
- Discreet label holders on all doors.
- Strong hinges to withstand rough handling.
- Add optional sloping tops, steel lockers stands or raised feet with levelling capabilities.
- Choose from a selection of popular industry paints available for door fronts, or specify BioCote paint finishes to inhibit bacteria growth by 99.99%*.
- Lockers can be specified in galvanized steel for added protection against corrosion and damage*.
- Choose from a selection of locks to suit different industry needs.

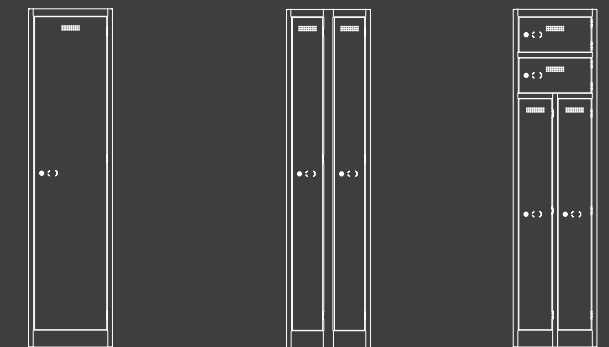



Workwear lockers

Two-person lockers are 600mm (23.6") deep.
Twin lockers are 450mm (17.7") deep.

Twin locker

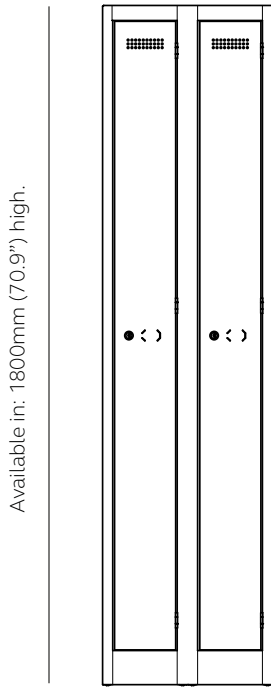

Internal measurements
W 365mm (14.4")
D 578mm (22.8")

2 individual doors, both with a shelf & coat rail.

H above shelf 318mm (12.5")
H below shelf 1319mm (51.9")

Two-person locker

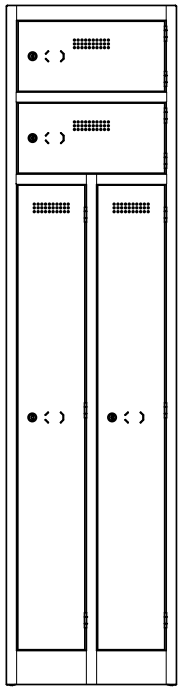

Internal measurements
Lower locker
H 1233mm (48.5")
W 155mm (6.1")
D 428mm (16.9")

Upper locker
H 190mm (7.5")
W 366mm (14.4")
D 428mm (16.9")

2 individual doors with coat rails & 2 sercure lockers.

Available in: 450mm (17.7") wide.

Galvanized steel

Primary Lockers have been designed to be incredibly hard-wearing and able to withstand daily handling in high traffic environments. However, if your workplace requires an extra level of protection, or the lockers are to be placed in areas susceptible to rusting, specifying your lockers in galvanized steel will give you extra peace of mind.

Galvanized steel provides an added thin layer of protection over the entire steel surface, protecting against corrosion and damage.

- The entire locker is manufactured from galvanized steel, giving total protection.
- Superior protection against rust, abrasion, and water.
- Recommended for wet and humid environments, such as swimming pools and gyms.
- Galvanized steel is longer lasting and requires less maintenance, meaning it is a more sustainable option.

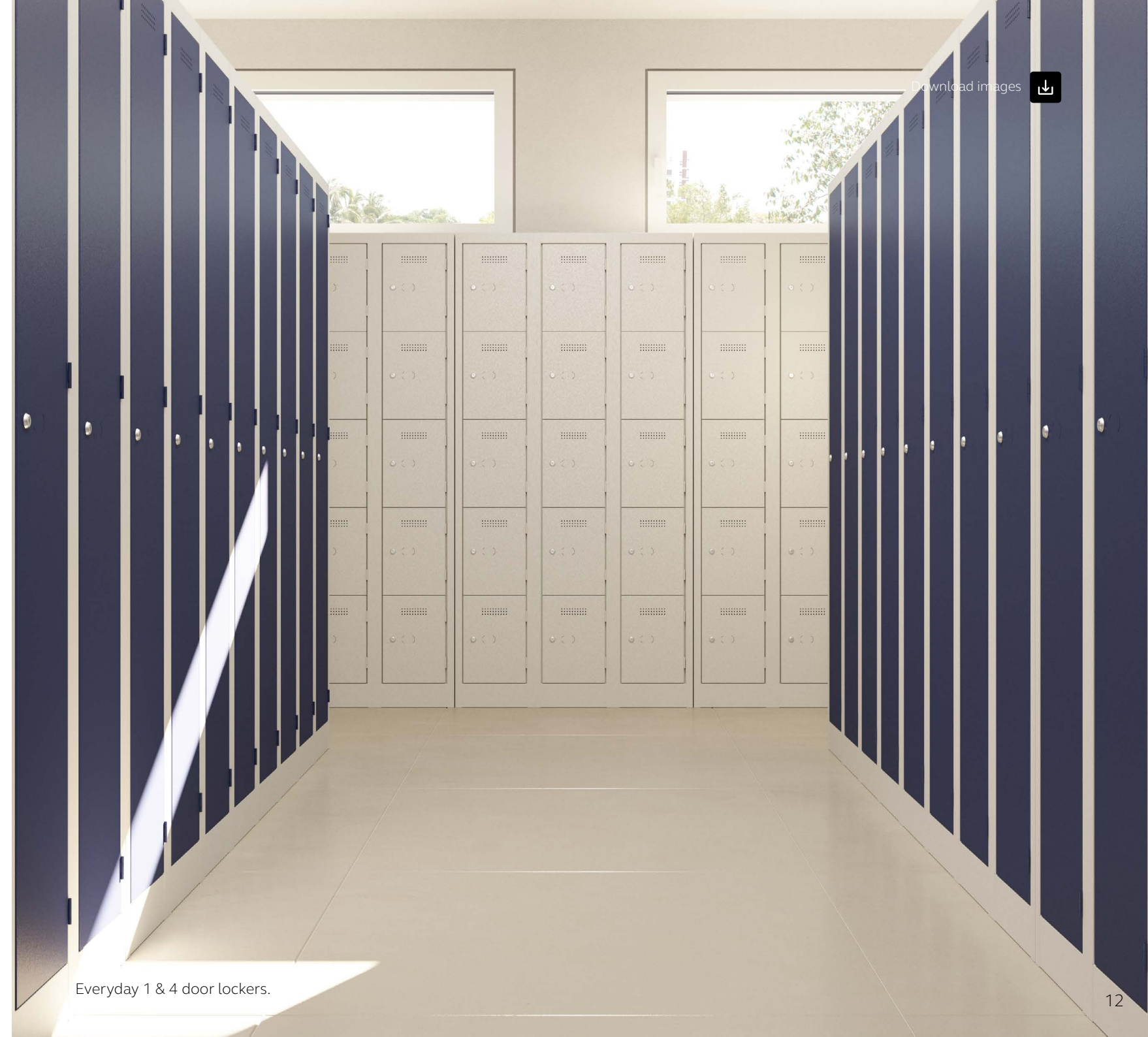

Download images



Everyday 1 & 4 door lockers.

Accessories

Locker stands

All locker stands suit all locker depths and are 150mm (6") high.

Available in 7 widths:
450mm (17.7")
600mm (23.2")
760mm (30")
900mm (35.4")
1000mm (39.3")
1140mm (44.9")
1200mm (47.2")

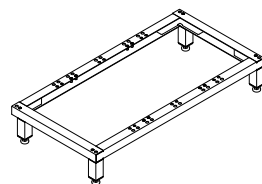

Cloakroom benches

Cloakroom benches are available in options - Standard and Junior. The benches are available in single or double sided.

Standard benches
H 1800mm (70.9")
W 1200mm (47.2") & 1500mm (59")
D 300mm (11.9")*

Seat height 470mm (18.5")

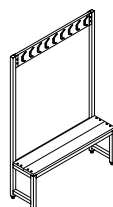

Junior benches
H 1370mm (54")
W 1200mm (47.2") & 1500mm (59")
D 300mm (11.9")*

Seat height 400mm (15.7")

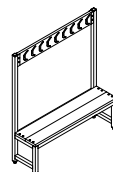

*Depth will be 600mm (23.2") total for double-sided benches.

Locker stand and seats

All locker stands suit all locker depths and are 150mm (6") high.

Available in 7 widths:
450mm (17.7")
600mm (23.2")
760mm (30")
900mm (35.4")
1000mm (39.3")
1140mm (44.9")
1200mm (47.2")

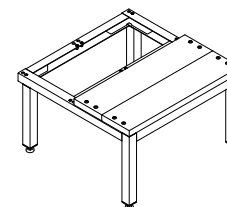

Standalone benches

All benches are 470mm (18.5") high & 300mm (11.8") deep.

Available in 3 widths:
1000mm (39.3")
1200mm (47.2")
1500mm (59.1")

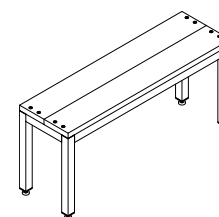

- M6 fixing bolts are provided with locker stands and benches.
- The steel frames match the light grey locker carcasses and are also available in galvanized steel.**
- Bench slats are made from recycled plastic and are available in black, as standard.

**Surcharges apply.

Download images





Sloping tops

All sloping tops suit all locker depths and are 150mm (6") high.

Available in 8 widths:

- 450mm (17.7")
- 600mm (23.2")
- 675mm (26.8")
- 760mm (30")
- 900mm (35.4")
- 1000mm (39.3")
- 1140mm (44.9")
- 1200mm (47.2")

*Please note not all depths are available with every width. Please refer to the [Primary Lockers specification sheet](#) for the full dimension breakdown.

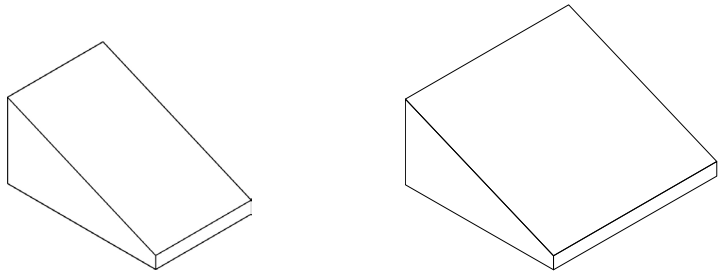

- The sloping tops match the light grey locker carcasses and are also available in galvanized steel.*
- Adhesive strips are provided for fitting the sloping top.

*Other finishes are available with a surcharge.

Clean & Dirty lockers with sloping tops & standalone benches.

Everyday 4 door lockers with cloakroom benches.

Download images 



Locking technology

Key lock

Key locks are a great, cost-effective option if you are looking for a straightforward, secure solution with user keys, ideal for both assigned and shared lockers.

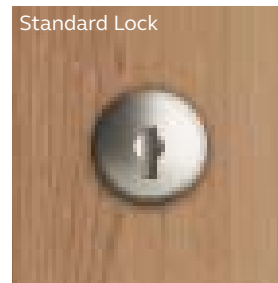

Latch and Coin locks

They are ideal for high traffic and shared locker areas.

They are controlled using a master key, making the lock safe and convenient for both users and management. Choose from coin return or coin retain to suit your needs.

Latch locks are They are a low cost choice, without the worry of master or replacement keys.



Combination locks

Combination locks seamlessly integrate with many of our products while providing enhanced security and protection. With both shared and assigned user options, combination locks are a reliable, cost-effective solution for personal storage.

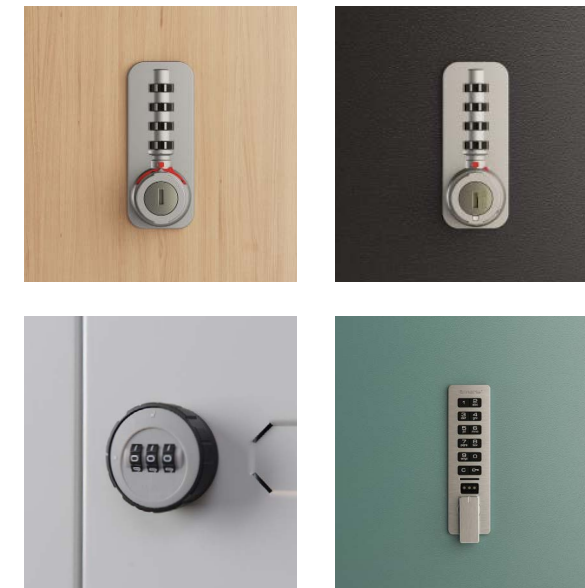

We design and manufacture the highest quality personal storage and workwear lockers, but we also have the knowledge and expertise on hand to advise you on the best lock choice.

Our selection of locking options available for Primary Lockers give all employees – whether permanent, mobile or nomadic – a sense of peace of mind and belonging while in the workplace.

The lockers are fitted with AB locks as standard but you can choose to upgrade to latch, coin return, combination or mechanical combination locks, which are all great solutions for both permanent employees and visitors.

Finishes

Primary Lockers create smart, reliable personal storage for a variety of workplaces, education settings, and leisure requirements.

There is a choice of standard paints or you can choose anti-microbial BioCote finishes which inhibit the growth of bacteria by 99.99%.

Alternatively, Primary Lockers can be specified in galvanized steel for an extra level of protection against damage and corrosion, for peace of mind particularly when the lockers are placed in wet or humid environments.*

All Primary Lockers are available with a light grey carcass.

Palette one

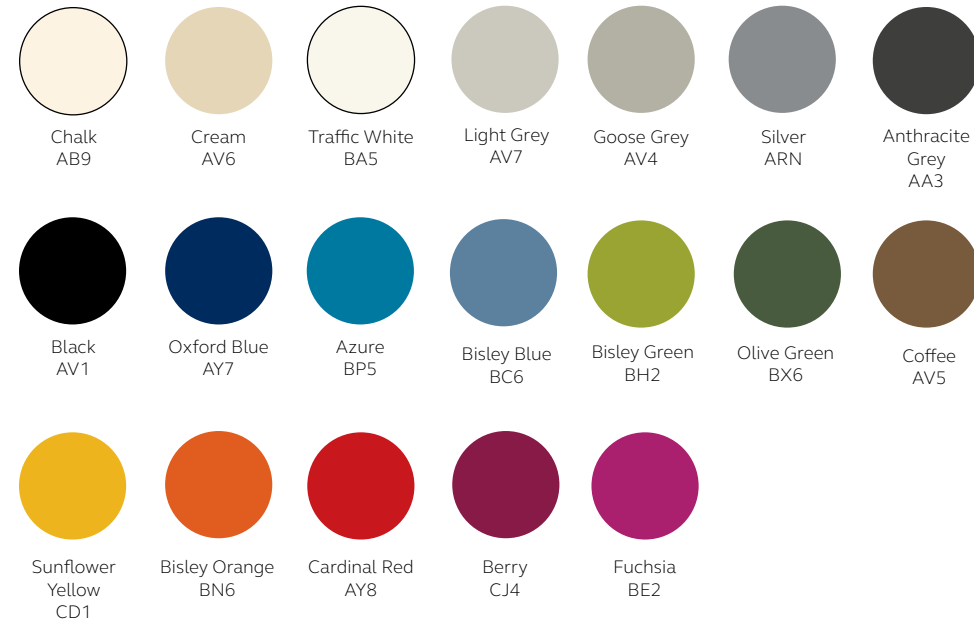

Palette two

*A surcharge may apply, please contact your Bisley representative.

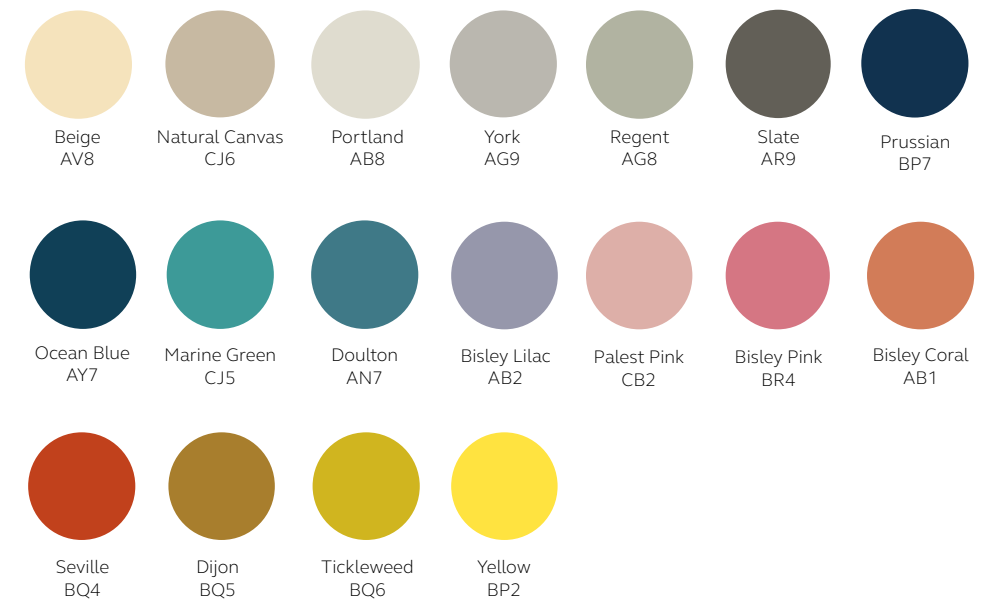

Our commitments



As a proud British manufacturer, we take our responsibilities towards the environment very seriously, ensuring that sustainability runs through everything we do. Our dedicated sustainability team ensures that our facilities are as environmentally friendly as possible, while ensuring our products last and are sustainably sourced.

Bisley products are designed for functionality, durability, and a long service life. They are all tested rigorously to British and European harmonised standards for safety, strength and stability.

We source all of the electricity that powers our manufacturing activities through renewable energy tariff. We also participate in the Energy Savings Opportunity Scheme (ESOS), which has led to substantial investment in procurement and installation of energy efficient machinery and equipment.

Visit the [bisleygroup.com](http://thebisleygroup.com), or contact your Bisley representative to find out more information about Primary Lockers,

Get in touch

www.thebisleygroup.com/get-in-touch

Head Office	London	Manchester	France	North America	Germany
Caswell Way, Reevesland Ind Est, Newport, South Wales NP19 4PW	32 Dallington Street, London, EC1V 0BB	Calico Building, 55 Mosely Street, Manchester, M2 3HQ	Immeuble le Corosa 1-3 rue Eugène et Armand Peugeot 92500 Rueil Malmaison	1140 Broadway Suite 902, New York New York 10001	Hauptsitz und Showroom Wiesenstraße 70 A3 40549 Düsseldorf
+44 (0)1633 637 383	+44 (0)203 952 4000	+44 (0)161 543 0850	+33 (0)1 41 39 97 20	1-212-675-3055	+49 (0)211 87541 600
Bray	Dublin			Dubai	Netherlands
Bisley House IDA Bray Business Park, Southern Cross Road, Bray, Co. Wicklow, Ireland	Bridgewater Business Centre, Bridgewater Quay, Islandbridge, D08 T9NH			Office 4501 U-Bora Tower Marasi Drive Business Bay Dubai United Arab Emirates	Burg. Stekelenburgplein 199 Unit 2.4 5041 SC Tilburg
00353 1 2769100				00971 (4) 450 3747	+31 (0)13 590 10 03

 @wearebisley

 Bisley Storage

BISLEY