

OUTDOOR PRODUCT GUIDE

OAKSTREETMFG.COM

(877) 465-4344



Textured Concrete



Weathered Pewter



Raven Slate



Vintage Oak



Modern Marble



Knotty Oak



Maremma



- COMPCOR outdoor table tops are an HPL product manufactured with high-tech polymers providing extreme durability for both interior & exterior use
- Features a core comprised of thin layers of kraft paper saturated with phenolic resin and pressed under high temperature & pressure
- 12mm thickness with t-slots for easy base mounting (shown below)!
- 2" umbrella hole and grommet are available on some sizes
- All tops boxed; tops over 48" subject to an oversized pallet fee per pallet
- Pairs with Oak Street DURAFINISH outdoor table bases (page 178)

	Weather Resistant		Stain Resistant		Flame Resistant
	Water Resistant		Scratch Resistant		Colorfast
	Heat Resistant		Rot Resistant		Impact Resistant

NEW & IMPROVED base mounting process!

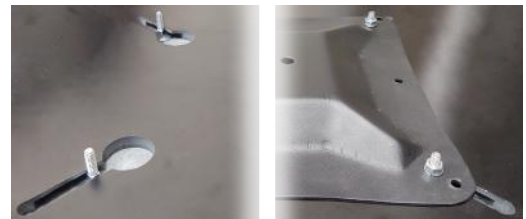

	Knotty Oak	Weathered Pewter	Vintage Oak	Raven Slate	Modern Marble	Textured Concrete	Maremma	Approx. Weight
24" x 30"	CC2430-KO	CC2430-WP	CC2430-VO	CC2430-RS	CC2430-MM	CC2430-TC	CC2430-MA	16 lbs
30" x 30"	CC3030-KO	CC3030-WP	CC3030-VO	CC3030-RS	CC3030-MM	CC3030-TC	CC3030-MA	19 lbs
30" x 48"	CC3048-KO	CC3048-WP	CC3048-VO	CC3048-RS	CC3048-MM	CC3048-TC	CC3048-MA	31 lbs
30" x 72"	CC3072-KO	CC3072-WP	CC3072-VO	CC3072-RS	CC3072-MM	CC3072-TC	CC3072-MA	46 lbs
36" x 36"	CC3636-KO	CC3636-WP	CC3636-VO	CC3636-RS	CC3636-MM	CC3636-TC	CC3636-MA	28 lbs
30" Round	CC30R-KO	CC30R-WP	CC30R-VO	CC30R-RS	CC30R-MM	CC30R-TC	CC30R-MA	15 lbs
36" Round	CC36R-KO	CC36R-WP	CC36R-VO	CC36R-RS	CC36R-MM	CC36R-TC	CC36R-MA	22 lbs
48" Round	CC48R-KO	CC48R-WP	CC48R-VO	CC48R-RS	CC48R-MM	CC48R-TC	CC48R-MA	39 lbs



Shown with: OD-CM-0001-SLV & OD-B30-4-STD

COMPCOR

OUTDOOR TABLE TOPS



Shown with: OD-CM-RN & B30-4-STD



Shown with: OD-CM-234 & OD-B30-4-STD



Shown with: OD-CM-0001-BLK & OD-B30DISC-4-STD



Groove thickness on
Knotty Oak, Vintage Oak & Weathered Pewter tops



Shown with: OD-CM-234 & OD-B30DISC-4-STD

Jubilee Outdoor Table & Bench Frame



Shown with: Jubilee table frame (JUB-3072) +
COMPCOR Weathered Pewter 30" x 72" &
Jubilee bench frame (JUB-1672) +
COMPCOR Weathered Pewter 16" x 72"



Shown with: Jubilee table frame (JUB-3072) +
COMPCOR Vintage Oak 30" x 72" &
Jubilee bench frame (JUB-1672) +
COMPCOR Vintage Oak 16" x 72"



Shown with: Jubilee table frame (JUB-3072) +
COMPCOR Knotty Oak 30" x 72" &
Jubilee bench frame (JUB-1672) +
COMPCOR Knotty Oak 16" x 72"



- 1-1/2" steel square tubing with 14 gauge 1/4" flat steel legs
- Exterior powder coating
- Bench frames are fully assembled
- Table frames ship KD to save on freight! Leg brackets get bolted onto top frame - simple assembly required
- Available in Weathered Pewter, Vintage Oak & Knotty Oak

30" x 72" COMPCOR Table Top on Jubilee Table Frame
JUB-3072 (must specify top selection)
16" x 72" COMPCOR Bench Top on Jubilee Bench Frame
JUB-1672 (must specify top selection)



DuraFinish Outdoor Table Base



Suggested base applications shown on [pg. 40 - 41](#)

- Specially coated (DURAFINISH) to withstand outdoor conditions
- Constructed of stamped steel for unparalleled strength & stability
 - Superior to cast iron table bases in that stamped steel will not fracture under heavier weights
- Easy two-piece assembly (tube/spider to base)
 - Oak Street uses a short bolt to screw into a welded anchor plate - a much improved method than competitors, which use a long rod that will torque & stretch when force is applied - making it permanently loose
- Spider is welded to the tube for added strength
 - Spider includes 1-3/4" opening to accommodate umbrellas | Spider dimensions: 11" x 11" - 15" diagonally
 - Oak Street's spiders are bigger than most competitor's spiders - providing additional strength & durability
- Standard height finishes at 30" with table top attached | Bar height finishes at 42" with table top attached



Description	Part #	Approx. Weight
22" x 22" cross base with 3" standard height labor saver tube	OD-B22-STD	16 lbs
22" x 22" cross base with 3" bar height labor saver tube	OD-B22-BAR	17 lbs
22" x 30" cross base with 3" standard height labor saver tube	OD-B2230-STD	23 lbs
22" x 30" cross base with 3" bar height labor saver tube	OD-B2230-BAR	24 lbs
30" x 30" cross base with 3" standard height labor saver tube	OD-B30-STD	24 lbs
30" x 30" cross base with 3" bar height labor saver tube	OD-B30-BAR	25 lbs
5" x 22" t-base with 3" standard height labor saver tube	OD-B522-STD	16 lbs
5" x 22" t-base with 3" bar height labor saver tube	OD-B522-BAR	17 lbs
18" disc base with 3" standard height labor saver tube	OD-B18DISC-STD	29 lbs
18" disc base with 3" bar height labor saver tube	OD-B18DISC-BAR	30 lbs
22" disc base with 3" standard height labor saver tube	OD-B22DISC-STD	39 lbs
22" disc base with 3" bar height labor saver tube	OD-B22DISC-BAR	40 lbs
22" x 22" cross base with 4" standard height labor saver tube	OD-B22-4-STD	19 lbs
22" x 22" cross base with 4" bar height labor saver tube	OD-B22-4-BAR	21 lbs
22" x 30" cross base with 4" standard height labor saver tube	OD-B2230-4-STD	26 lbs
22" x 30" cross base with 4" bar height labor saver tube	OD-B2230-4-BAR	28 lbs
30" x 30" cross base with 4" standard height labor saver tube	OD-B30-4-STD	27 lbs
30" x 30" cross base with 4" bar height labor saver tube	OD-B30-4-BAR	29 lbs
36" x 36" cross base with 4" standard height labor saver tube	OD-B36-4-STD	28 lbs
36" x 36" cross base with 4" bar height labor saver tube	OD-B36-4-BAR	30 lbs
5" x 22" t-base with 4" standard height labor saver tube	OD-B522-4-STD	18 lbs
5" x 22" t-base with 4" bar height labor saver tube	OD-B522-4-BAR	19 lbs
18" disc base with 4" standard height labor saver tube	OD-B18DISC-4-STD	32 lbs
18" disc base with 4" bar height labor saver tube	OD-B18DISC-4-BAR	34 lbs
22" disc base with 4" standard height labor saver tube	OD-B22DISC-4-STD	42 lbs
22" disc base with 4" bar height labor saver tube	OD-B22DISC-4-BAR	44 lbs
30" disc base with 4" standard height labor saver tube	OD-B30DISC-4-STD	65 lbs
30" disc base with 4" bar height labor saver tube	OD-B30DISC-4-BAR	67 lbs
22" disc umbrella base with 24" H x 1.75" D pipe & set screw	OD-B22DISC-UP	40 lbs
30" disc umbrella base with 24" H x 1.75" D pipe & set screw	OD-B30DISC-UP	60 lbs



Rattan Outdoor Seating

Outdoor

- Sturdy & lightweight 1.8mm aluminum frame
- Wrapped in weather-resistant synthetic rattan (black)
- Barstool features a stainless steel footring
- Chair ships assembled;
- Barstools ship unassembled - leg supports require simple assembly
- Stackable - Chair: Yes Barstool: No
- Non-marring glides

	Part #	Approx. Weight
Rattan chair	OD-CM-RN	16 lbs
Rattan barstool	OD-BM-RN	18 lbs

Rattan Chair

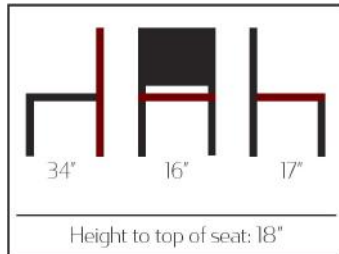

Rattan Barstool

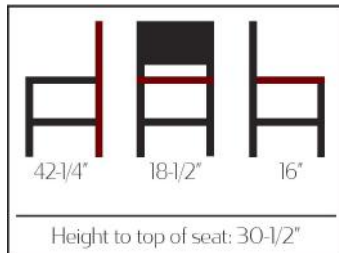

Ladderback Outdoor Seating

- Specially coated frame with additional exterior powder coat to withstand the elements
- Marine-grade black vinyl seat with exterior-grade plywood core and stainless steel staples
- 1.2mm frame; 1-1/4" steel tubing; 100% welded frame
- Seat ships unattached - simple seat attachment required

	Part #	Approx. Weight
Ladderback chair	OD-CM-234	15 lbs
Ladderback barstool	OD-BM-234	20 lbs

Outdoor Ladderback Chair

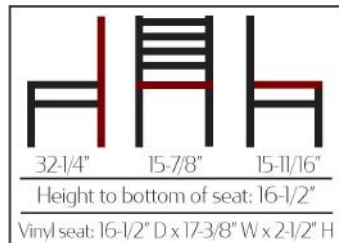

Outdoor Ladderback Barstool

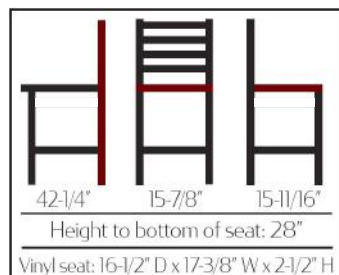

Rattan / Ladderback Outdoor Seating

SMOKESTACK



Distressed White
OD-CM-0001-WHT

Black
OD-CM-0001-BLK

Silver
OD-CM-0001-SLV



Distressed White
OD-BM-0001-WHT

Black
OD-BM-0001-BLK

Silver
OD-BM-0001-SLV



- 1.2mm pressed steel tubular construction
- Available in Distressed White (WHT), Black (BLK) or Silver (SLV) finishes
- Non-marring poly glides
- Stackable: Dining chair: Yes | Barstool: No

- Chairs ship assembled; Barstool's back ships unattached from frame - simple back attachment required
- Freight class: 250
- A great indoor option also!

Smokestack Chair



Smokestack Barstool

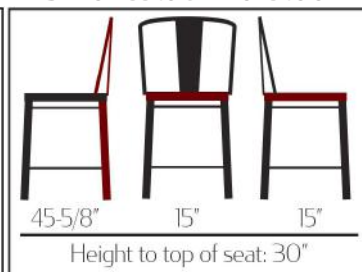

	Metal Seat Part #	Approx. Weight
Chair - Distressed White	OD-CM-0001-WHT	12 lbs
Chair - Silver	OD-CM-0001-SLV	12 lbs
Chair - Black	OD-CM-0001-BLK	12 lbs
Barstool - Distressed White	OD-BM-0001-WHT	15 lbs
Barstool - Silver	OD-BM-0001-SLV	15 lbs
Barstool - Black	OD-BM-0001-BLK	15 lbs

XL Brewhouse Outdoor Seating

Outdoor



Gloss Black
OD-CM-820-GBLK-XL



Matte Black
OD-CM-820-MBLK-XL



Silver
OD-CM-820-PNT-XL

XL Brewhouse
Chair



Matte Black
OD-BB-820-MBLK-XL



Silver
OD-BB-820-PNT-XL

XL Brewhouse
Backless Barstool

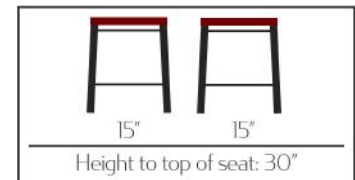

Matte Black
OD-BM-820-MBLK-XL



Silver
OD-BM-820-PNT-XL

XL Brewhouse
Barstool



- 1.2mm pressed steel tubular construction
- Available in Gloss Black (GBLK) *chair only*, Matte Black (MBLK) or Silver (PNT) finishes
- Non-marring poly glides
- Stackable: Dining chair: Yes | Backless Barstool: Yes | Barstool: No
- Chairs & backless barstools ship assembled; Barstool's back (BM series) ships unattached from frame - simple back attachment required
- Weights: Chair - 13 lbs | Backless Barstool - 14 lbs | Barstool - 15 lbs
- Freight class: 250
- A great indoor option also!

XL Brewhouse Outdoor Seating

Olympus Outdoor Seating



Camel Tan
OD-CH-725-CT



Cafe Brown
OD-CH-725-CB



Camel Tan
OD-BS-736-CT



Cafe Brown
OD-BS-736-CB



	Chair Part #	Weight	Barstool Part #	Weight
Camel Tan	OD-CH-725-CT	9 lbs	OD-BS-736-CT	10 lbs
Cafe Brown	OD-CH-725-CB	9 lbs	OD-BS-736-CB	10 lbs

Olympus Chair

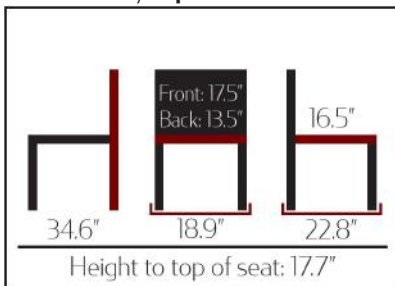

Olympus Barstool

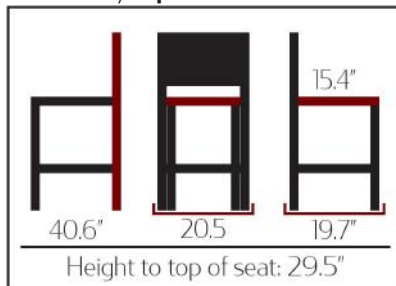

- All-weather (water & UV) resistant polypropylene resin for both indoor & outdoor use
- Classic rattan design, never unravels like traditional wicker
- Anti-slip mats at bottom of legs to ensure stability & prevent floor scratches
- Breathable seat design
- Stackable & space saving
- Easy care - wipe with cloth & water
- 265 lb weight capacity



Greige
OD-CH-727-GG



Cafe Brown
OD-CH-727-CB



All Weather



Stackable for convenient storage



Easy care, wipe with cloth and water



Environment Friendly Materials



EN581 Certified



One Year Warranty

	Part #	Approx. Weight
Greige	OD-CH-727-GG	11 lbs
Cafe Brown	OD-CH-727-CB	11 lbs

- All-weather (water & UV) resistant polypropylene resin for both indoor & outdoor use
- Classic rattan design, never unravels like traditional wicker
- Anti-slip mats at bottom of legs to ensure stability & prevent floor scratches
- Breathable seat design
- Stackable & space saving
- Easy care - wipe with cloth & water
- 265 lb weight capacity

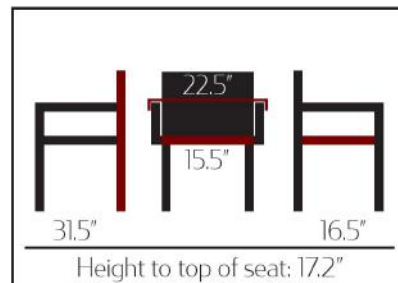

Teton Outdoor Seating



Greige
OD-CH-752-GG



White
OD-CH-752-WHT



Iron Gray
OD-CH-752-IG



Greige
OD-BS-711-GG



White
OD-BS-711-WHT



Iron Gray
OD-BS-711-IG

	Greige Part #	White Part #	Iron Gray Part #	Approx. Weight
Chair	OD-CH-752-GG	OD-CH-752-WHT	OD-CH-752-IG	8 lbs
Barstool	OD-BS-711-GG	OD-BS-711-WHT	OD-BS-711-IG	11 lbs



Teton Chair

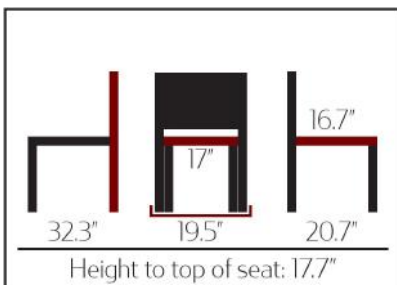

Teton Barstool

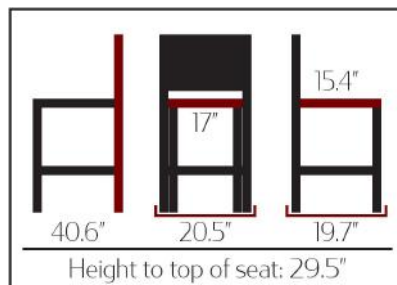

- All-weather (water & UV) resistant polypropylene resin for both indoor & outdoor use
- Modern, elegant design
- Anti-slip mats at bottom of legs to ensure stability & prevent floor scratches
- Curved back offers great support
- Stackable & space saving
- Easy care - wipe with cloth & water
- 250 lb weight capacity



Tan
OD-CM-834-TAN



Black
OD-CM-834-BLK



Tan
OD-BM-834-TAN



Black
OD-BM-834-BLK

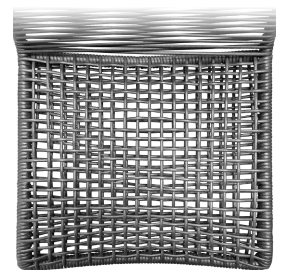

	Black Part #	Tan Part #	Approx. Weight
Chair	OD-CM-834-BLK	OD-CM-834-TAN	9 lbs
Barstool	OD-BM-834-BLK	OD-BM-834-TAN	12 lbs

- 2.0mm galvanized steel frame - black exterior powder coated
- Round PE (polyethylene) rattan seat/back material
 - Better durability, higher bearing capacity & strength
 - 100% waterproof, UV resistant, low maintenance
 - Fishbone weave back; Double open square weave seat
- Stackable: Yes

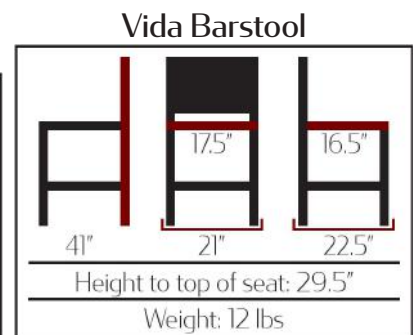
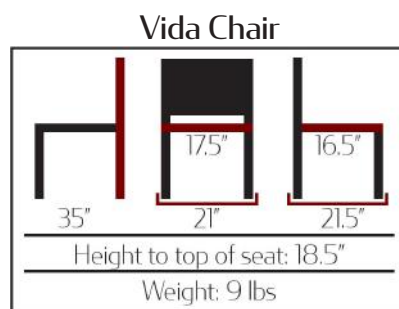

Navy Outdoor Seating



CM-252-ALM



BM-252-ALM

Navy Chair

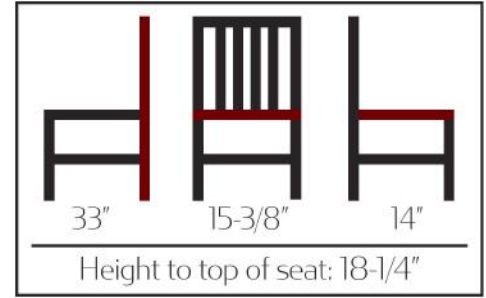

Navy Barstool

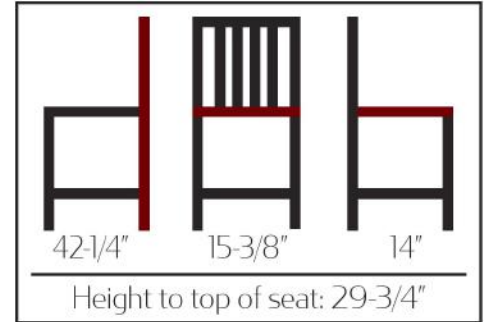

- Lightweight construction with modern line design
- 1.5mm 100% welded aluminum frame
- 1-1/8" tubular construction
- Premium, extended-life, non-marring poly glides
- Ships assembled
- **For indoor and outdoor use!**
- Chair weight: 10 lbs Barstool weight: 18 lbs

	Part #	Approx. Weight
Navy Chair	CM-252-ALM	10 lbs
Navy Barstool	BM-252-ALM	18 lbs



Part #: GL252

Slatback Outdoor Seating



OD-CM-330-BLK

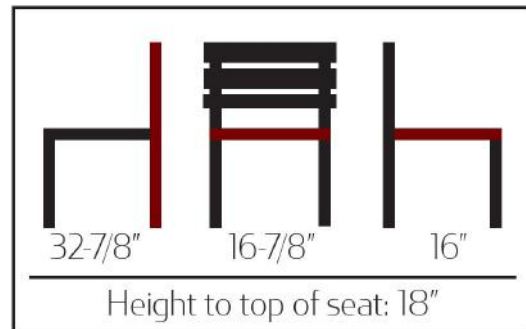

- Available in semi gloss black finish
- Features a lightweight tubular pressed steel construction
- Features wide stance for added stability outdoors
- Stackable: Yes

Description	Part #	Approx. Weight
Slatback Chair	OD-CM-330-BLK	16 lbs



OD-CM-TK

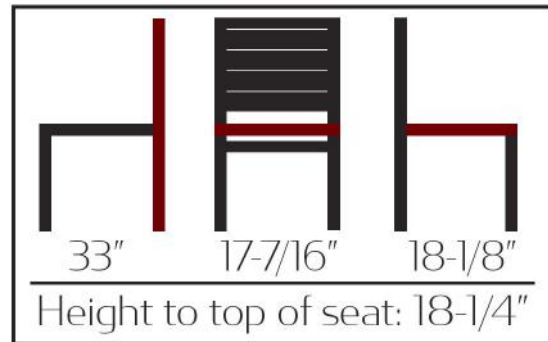

	Gray Part #	Approx. Weight
Teak Chair	OD-CM-TK-G	16 lbs
24" x 30" Standard Height Table	OD-TK2430-G	33 lbs
30" x 30" Standard Height Table	OD-TK3030-G	36 lbs
30" x 48" Standard Height Table	OD-TK3048-G	47 lbs
36" x 36" Standard Height Table	OD-TK3636-G	44 lbs

- Silver e-coated steel frame with exterior powder coating
- 1 piece upper steel frame for rigidity
- Table ships KD
- Chair ships assembled
- Non-marring nylon glides
- Durable, elegant & weather-resistant teak plank top
- Planks are constructed of highly durable, weather-resistant, low-maintenance synthetic teak

Diamondback Outdoor Furniture

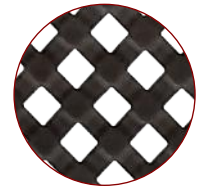
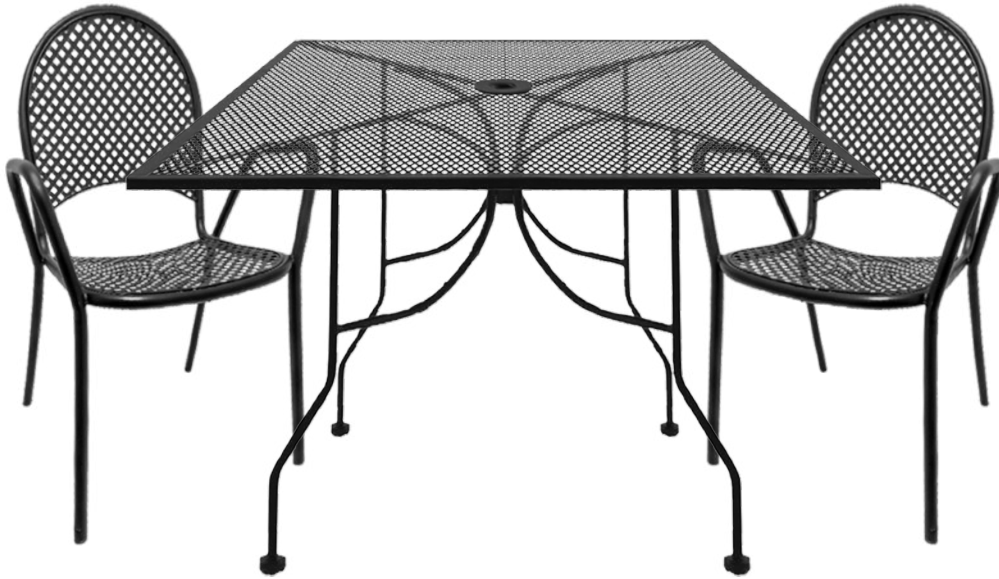

Diamondback Chair

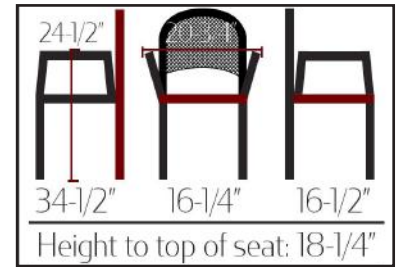

Diamondback Barstool

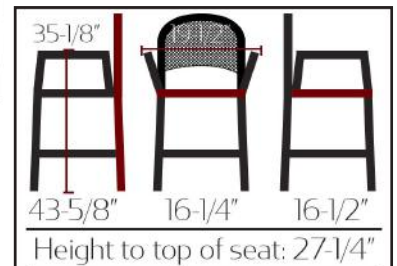

- Exterior powder coat finish to withstand all outdoor weather conditions
- Diamondback pattern on table top, armchair/barstool seat & back
- Reinforced 2" umbrella hole
- Chair/Barstool features pressed steel tubular construction for lightweight durability
- Table base features solid steel construction (not tubular) for added stability in outdoor conditions
- Chair/Barstool ship assembled
- Table top & base ship unassembled - simple assembly required
- Table available in both standard & bar height
- Stackable - Armchair: Yes Barstool: No

Diamondback series glides
Part #: GL-OD105



	Part #	Approx. Weight
Diamondback Armchair	OD105-CHAIR	14 lbs
Diamondback Barstool	OD105-BAR	17 lbs
24" x 30" - Standard Height Table	OD2430-STD	44 lbs
24" x 30" - Bar Height Table	OD2430-BAR	78 lbs
30" x 30" - Standard Height Table	OD3030-STD	45 lbs
30" x 30" - Bar Height Table	OD3030-BAR	81 lbs
30" x 48" - Standard Height Table	OD3048-STD	60 lbs
30" x 48" - Bar Height Table	OD3048-BAR	91 lbs
36" x 36" - Standard Height Table	OD3636-STD	55 lbs
36" x 36" - Bar Height Table	OD3636-BAR	86 lbs
30" Round - Standard Height Table	OD30R-STD	40 lbs
30" Round - Bar Height Table	OD30R-BAR	81 lbs
36" Round - Standard Height Table	OD36R-STD	50 lbs
36" Round - Bar Height Table	OD36R-BAR	86 lbs



Boardwalk Chair

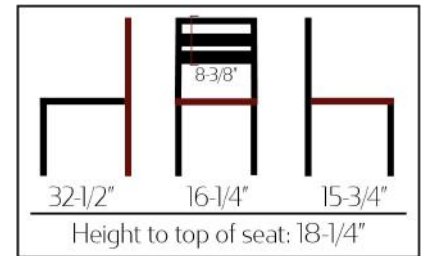

Boardwalk Barstool

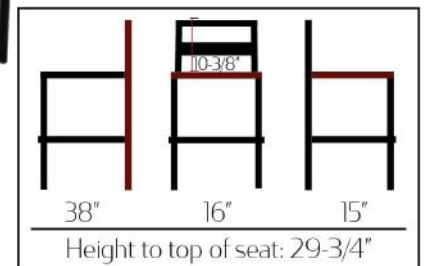

- Roll formed steel top with black finish
- Reinforced 2" umbrella hole
- Chair/Barstool features pressed steel tubular construction for lightweight durability
- Table base features solid steel construction (not tubular) for added stability in outdoor conditions
- Chair/Barstool ship assembled
- Table top & base ship unassembled - simple assembly required
- Table available in both standard & bar height
- Stackable: Yes

	Part #	Approx. Weight
Boardwalk Chair	OD-CM-6079	16 lbs
Boardwalk Barstool	OD-BM-6079	20 lbs
24" x 30" - Standard Height Table	OB2430-STD	54 lbs
24" x 30" - Bar Height Table	OB2430-BAR	88 lbs
30" x 30" - Standard Height Table	OB3030-STD	55 lbs
30" x 30" - Bar Height Table	OB3030-BAR	91 lbs
30" x 48" - Standard Height Table	OB3048-STD	70 lbs
30" x 48" - Bar Height Table	OB3048-BAR	101 lbs
36" x 36" - Standard Height Table	OB3636-STD	65 lbs
36" x 36" - Bar Height Table	OB3636-BAR	96 lbs
30" Round - Standard Height Table	OB30R-STD	50 lbs
30" Round - Bar Height Table	OB30R-BAR	91 lbs
36" Round - Standard Height Table	OB36R-STD	60 lbs
36" Round - Bar Height Table	OB36R-BAR	96 lbs

Pacific Union Station with outdoor components



- Marine-grade vinyl with exterior-grade plywood core & closed-cell foam
- In-house outdoor vinyls include: Ocean Night, Foggy Morning, Silk & Sandy Beach
- Tier 1 pricing includes Futura Caprina Island & Palm Island marine vinyls
- Tier 2 pricing includes Spradling Seabreeze, Beluga & Zander marine vinyls
- Sunbrella outdoor upholstery also available - please contact your Oak Street Account Manager for pricing

Booth Height Vinyl/Upholstery
PAC-4842-SGL-FM
 Length Type

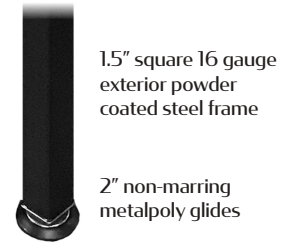

Pacific Booth Dimensions - 42" std. height

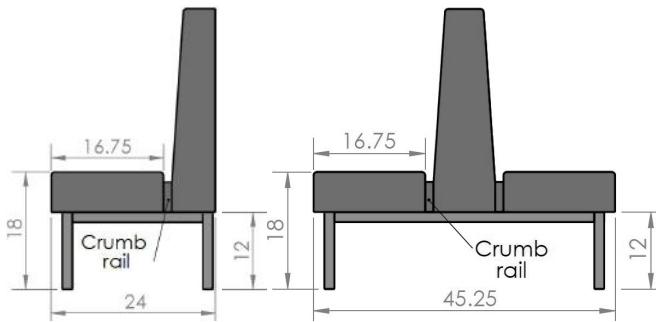

Reef Booth Dimensions - 38" std. height

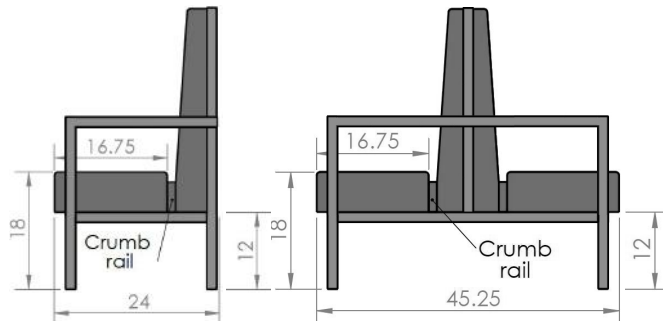

Reef Exterior powder coated steel frame with arm rests, vinyl seat & back



- Marine-grade vinyl with exterior-grade plywood core & closed-cell foam
- In-house outdoor vinyls include: Ocean Night, Foggy Morning, Silk & Sandy Beach
- Tier 1 pricing includes Futura Caprina Island & Palm Island marine vinyls
- Tier 2 pricing includes Spradling Seabreeze, Beluga & Zander marine vinyls
- Sunbrella outdoor upholstery also available - please contact your Oak Street Account Manager for pricing

Booth Height Vinyl/Upholstery
REEF-4838-SGL-FM
 Length Type

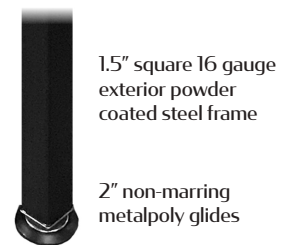

In-House Outdoor Vinyls



Foggy Morning



Silk



Sandy Beach



Ocean Night

Tier 1 outdoor vinyls: bit.ly/outdoor-tier1

Tier 2 outdoor vinyls: bit.ly/outdoor-tier2

Sunbrella upholstery: bit.ly/os-sunbrella

FREIGHT INFORMATION

Please utilize the following freight information as a guideline for the freight process when ordering with Oak Street Manufacturing. Should any issues or concerns arise, please contact your Oak Street Manufacturing Account Manager by email or phone at (877) 465-4344.

Delivery

If a delivery date is not scheduled for your order, you must accept the shipment when the delivery truck arrives. Failure to accept the shipment will result in additional storage, re-consignment, and/or return shipping fees that will be billed back to you.

Liftgate Service

- If liftgate service is needed, you must specify it at time of order.
- If liftgate service is requested, you will be charged for liftgate service regardless if it's utilized or not.

HOW TO PROPERLY ACCEPT FREIGHT SHIPMENTS

Rights & Responsibilities

- It is your right & responsibility to inspect your order at time of delivery.
- It is your right & responsibility to note & describe damage on the BOL (Bill of Lading).
- It is your right & responsibility to also require the driver to sign the BOL that indicates damage.
- It is your right to refuse an entire shipment if damage is discovered (if desired).
- It is your responsibility to take care of all trash items associated with your shipment, e.g. pallets, banding, shrink wrap, etc. It is not the driver's responsibility to take care of the trash items & does not have to take those items with them.
- It is your responsibility to unload your shipment from the end of the driver's truck. It is the driver's responsibility to get your shipment to the end of the truck. It is not the responsibility of the driver to take your shipment off the truck.

Inspecting & Documenting Damage

It is important, in the event of an issue, to carefully follow the instructions below to ensure your shipping claim can be resolved:

All freight companies are required to allow you up to 15-30 minutes to inspect your delivery for damage or missing parts. This means you should make a complete inspection of your shipment to check for dents, cracks or broken parts. We highly recommend opening each box regardless of how it looks to inspect for damage that may not be obvious.

In the event your order is damaged (major or minor), it should be noted by writing the word "DAMAGED" on both the driver copy and your copy of the BOL (Bill of Lading), along with a description of the damage. Items missing from your order need to be written down as "ORDER INCOMPLETE".

It is critical that the driver also sign & initial both copies of the BOL if any damage is present. By noting damage on the driver's copy, this ensures there is written proof that damage was noted at the time of shipping. By having the driver sign your copy, this ensures you have proof that the driver signed in your presence.

Oak Street Manufacturing will assist as best we can in damage claims, but cannot be liable for any shipments that were accepted without a notation of damage on the shipping receipt. Be sure to keep a copy of the receipt, as this will be vital in processing a shipping claim. Photographs of the damage are extremely helpful as well to ensure successful processing of your claim. Any and all information regarding shipping damage should be sent immediately to your Oak Street Manufacturing Account Manager so we may assist you.

Failure to properly report damage will release Oak Street Manufacturing from all liability regarding shipping damage, so please document & inform us as soon as possible by telephone and/or email.

Terms & Conditions

TERMS & CONDITIONS

Orders will not be scheduled or entered into production until an account has been established or made current. Accounts past due are subject to finance charges of 1.5% per month (18% annually) or the maximum rate allowed by law. Credit terms are subject to change without notice. Customers will be liable for any costs incurred if the account is placed for collection. Returned checks are subject to a \$25 returned check charge. As an alternative to opening a credit account, the following payment terms are available:

- Credit card - MasterCard, Visa, American Express or Discover
- Wire transfers
- ACH payments
- Cash in advance - full payment for product & freight before shipping orders
- Proforma - a 50% deposit is required to begin production with the remaining balance due prior to the shipment of the order.

Oak Street Manufacturing operates on a made-to-order basis, therefore all credit requirements must be satisfied before the order can be scheduled into production.

NEW ACCOUNTS

To apply for an open account, complete the Oak Street Manufacturing credit application, found online at www.oakstreetmfg.com. All accounts must provide tax exempt documentation for the resale of restaurant furniture to receive dealer pricing or ship orders.

PRICING

All prices are subject to change without notice. All prices are in US dollars.

ESTIMATES & QUOTES

All estimates & quotes are good for 30 days from quote date unless otherwise noted.

PURCHASE ORDERS

All purchase orders must be submitted in writing via fax, mail or email. Each purchase order must be on company letterhead and bear the buyer's name. To avoid duplication of a faxed order, do not mail a confirming copy. A verification of approval is necessary. Dealers are responsible for providing the acknowledgment, signing & returning before production begins. Please note that the estimated lead time begins after all approvals are received.

DEPOSITS & PREPAYMENTS

For customers with open terms, all custom purchase orders over \$5,000 will require a 50% deposit. For prepay customers, all customer product purchase orders will require prepayment in full. Order will process on receipt of deposit or payment. Any custom orders placed on hold during the production process will result in additional lead time.

BILLING

Invoices will be emailed to customers within 48 hours of shipment unless otherwise requested.

MINIMUM ORDER FEES

All custom laminate table top orders in quantities less than 4 will be charged a small order fee. All solid wood table top orders in quantities less than 5 will be charged a small order fee.

SAMPLES

Samples are available for a 50% discount + freight cost for applicable warehouse locations.

MATCHING ORDERS

When matching a previous shipment, detailed information must be stated on the new purchase order. Please include a customer's original purchase order, Oak Street's original invoice number, sales order number & approximate ship date. Some necessary materials may no longer be available. If matching a previous order is impossible due to unavailable materials, the customer will be notified.

PRODUCT SPECIFICATIONS

Designs & specifications are subject to change without notice. All weights are approximate. Dimension & drawings are nominal. Standard colors & finishes are subject to change without notice.

IMAGE DISCLAIMER

Oak Street Manufacturing does our best to represent all products, including product colors, accurately, but the color calibration of computer monitors, printers, etc., can vary considerably. The images used in this catalog and on our website, social media pages, etc. are a close representation of our actual products & their colors. Due to photographic reproduction limitations, exact color fidelity is difficult to obtain. Actual samples should always be viewed before making a final decision, especially if color accuracy or matching is key to your decision.

ORDER CHANGES

Should circumstances require a change or cancellation of an order during production, a substantial service charge will be levied according to the order status at the time.

CANCELLATIONS

Custom orders cannot be canceled once a purchase order is received & materials have been ordered.

CALIFORNIA PROPOSITION 65

California's Proposition 65 entitles California consumers to special warnings for certain products that contain chemicals above certain threshold levels.

The general Proposition 65 notice is as follows: WARNING: This product contains chemicals known to the State of California to cause cancer and birth defects or other reproductive harm.

Proposition 65 notice for wood products is as follows: WARNING: Drilling, sawing, sanding or machining wood products generates wood dust, a substance known to the State of California to cause cancer. Use a respirator or other safeguards to avoid inhaling wood dust.

STORAGE FEES

Completed orders that require a delay in shipment of 7 business days or more will be subject to a storage fee of up to 10% of the order total per week.

SHORTAGE OF GOODS

The customer must note any shortage of cartons or products on the delivery receipt BEFORE accepting delivery from the freight company. Oak Street Manufacturing affirms all products are inspected & the number of pieces being shipped is noted on the freight Bill of Lading. If the customer does not inspect & note any shortages on the delivery receipt, Oak Street Manufacturing is not responsible for replacing shorted items until a freight claim has been issued & approved by the freight company. If the customer needs items immediately, the items will be replaced at the customer's expense. Oak Street Manufacturing will reimburse those expenses when the freight claim is approved.

RETURNED GOODS

No merchandise can be returned without Oak Street Manufacturing's return authorization. If return authorization is granted, the authorization number must be shown on the outside of the carton. A copy of the related invoice must be included & returned within 30 days of the date of the related invoice. Return authorizations will not be issued after 30 days from the original date of invoice. Merchandise must be shipped prepaid in new & unused condition, not damaged & in the original carton or packaging. All authorized returns are subject to a 25% restocking fee. Customer deductions from the related invoice will not be honored & those amounts will be considered past due. Credit memos will be mailed or faxed & can be deducted from a future invoice. Return authorization numbers expire 30 days after being issued.

Terms & Conditions

BACKORDERS

Oak Street Manufacturing will notify customers of backordered items. Customers will have the option to cancel backordered items if they will delay the shipping of an in-house order. If customers choose to have items ship upon arrival, the items will be shipped at customer's expense.

OUTDOOR USE

All products intended for indoor use only unless specifically labeled as outdoor furniture, granite tops or DuraFinish table bases. Placement of indoor furniture outdoors nullifies all warranties.

TRACKING SHIPMENTS

To track shipments, contact your Oak Street Manufacturing Account Manager for tracking numbers, freight company telephone number & website.

PREFERRED CARRIERS

Oak Street Manufacturing's preferred carriers are: FedEx Ground, Midwest Motor Express, YRC Freight, NM Transfer, R&L Carriers, Estes Express, Old Dominion, Panama Transfer & USF.

FREIGHT CLAIMS

The recipient has the right to inspect all shipments before signing any bill of lading. In the event an order arrives damaged, incomplete or overstated, the customer is required to make the appropriate notations on the delivery receipt BEFORE the bill of lading is signed. Please note all boxes leave Oak Street damaged-free. Products in boxes with damage are re-boxed. Report any product or quantity discrepancies to the carrier and to Oak Street Manufacturing immediately and note issue of bill of lading to allow for inspection and prompt issue resolution. When freight claim issues arise with a customer's designated carriers, the customer is responsible for filing freight claims. In the case of concealed damages, the customer is responsible for contacting either the carrier upon discovery of the damage or shortage of goods. Oak Street Manufacturing will not be held responsible for any concealed damage claims.

FREIGHT

Due to a large volume of outbound freight, Oak Street Manufacturing has been able to negotiate outstanding freight programs with our primary LTL AND FULL TRUCK LOAD freight carriers. Freight will be prepaid and added unless the dealer specifies differently. The customer is responsible for providing detailed and correct destination shipping information. Additional charges due to incorrect or insufficient shipping information will be billed to the customer. Third party billing and drop shipping is available upon request. Please have personnel on hand to receive shipments. Drivers are not obligated to assist in the unloading of product. It is the driver's responsible to get the freight to the rear of the trailer only. Inside or life gate delivery is not included but available upon request FOR AN ADDITIONAL CHARGE. To ensure the best freight rates and shipping safety, some items ship with simple assembly required. Oak Street Manufacturing will schedule pick-ups according to the manufacturing schedule and customer delivery needs, but is not responsible for freight estimated transit times. Guaranteed delivery dates are available for a charge. Freight quotes are estimates only based on fuel surcharges and discounts on the date of the estimate. Oak Street Manufacturing will determine the best freight call to ship all products. Will call pick-ups may be made at ANY Oak Street Manufacturing FACILITY - Please clearly note WILL CALL on the purchase order. The customer will be notified once the shipment is available.

SCHEDULED DELIVERY

Ship date estimates are shown on all sales order acknowledgments. Our best efforts are made to schedule each order based on the customer's requirements. Shipment of an order may be delayed if credit terms have not been satisfied or the account is not current. The scheduled ship date is subject to change due to weather, strikes, accidents, material availability and other factors beyond Oak Street Manufacturing's control. Guaranteed delivery dates available for additional freight charge.

PRINTED MATERIAL

Oak Street Manufacturing is not responsible for typographical or printing errors in our catalog. All such errors are subject to correction. Due to the catalog printing process, colors shown may not be exact.

COLLECTION COSTS

By placing a purchase order with Oak Street Manufacturing, all customers agree to become responsible for any collection costs associated with invoices that go past payment terms.

WARRANTY

All Oak Street Manufacturing products are warranted for indoor use with the exception of outdoor furniture and granite table tops when paired with Oak Street outdoor bases. Oak Street Manufacturing warrants all of its products and their components shall be free of defects in material and workmanship for 12 months from the date of purchase with the exception of swivels and vinyls (see below). If any of these products is found to be defective in material or workmanship during the first 12 months after original purchase date and if the product or component has been properly installed and maintained by purchaser, Oak Street Manufacturing will, at its option, replace or repair the product or component only without charge. Any off-site warranty repair must be pre-approved by Oak Street BEFORE repair work begins in order to receive reimbursement. This warranty policy does not include installation or freight of warranty items. This warranty does not apply to modified products or to those damaged by accident, abuse, neglect or misuse. When customers supplied its own vinyl or fabrics, or chooses unfinished products, there is no Oak Street Manufacturing warranty. The extent of Oak Street Manufacturing's liability is limited to the purchase price of the product sold. In no event will Oak Street Manufacturing be liable for injury, loss or damage, whether direct, consequential or incidental, to persons or property arising out of the purchaser's care or neglect. This warranty does not cover any items which have been in storage, freight damaged, improperly cared for or abused, neglected or misused.

SWIVEL WARRANTY

Oak Street Manufacturing warrants import swivels for 90 days from the date of purchase. Domestic swivels are warranted for one year from date of purchase. If swivels are found to be defective in material or workmanship during their warranted period after original purchase date and if the product or component has been properly installed and maintained by purchaser, Oak Street Manufacturing will, at its option, replace the swivel only without charge. This warranty policy does not include installation or freight of warranty items. This warranty does not apply to modified products or to those damaged by accident, abuse, neglect or misuse.

VINYL & UPHOLSTERY WARRANTY

Oak Street Manufacturing's warranty covers only manufacturer's flaws in vinyl and upholstery. Oak Street Manufacturing's warranty does not cover damage or decreased performance caused by punctures, tears, excessive wear or color loss of any kind. Oak Street Manufacturing disclaims all liability for damage due to fabrication, installation or other labor related costs. When a customer supplies its own vinyl or upholstery, there is no warranty by Oak Street Manufacturing.

SOLID WOOD, E*WOOD & PROWOOD TABLE TOP WARRANTY

Finished products are warranted only to the original customer and only against defects in workmanship for a period of one year from the date of invoice. Oak Street Manufacturing's liability and the customer's sole remedy for any breach of such warranty, breach of contract or negligence regarding a product is limited to the purchase price of the product. We are not responsible for any incidental or consequential damages incurred as a result of defective product such as re-installation costs or breach of contract, nor are we responsible for special or punitive damages. This warranty does not apply to any unfinished products, mineral oil products, or customer's own materials used in manufacturing product. We provide no warranty for such products. Placement of glass sheets or vinyl coverings over the tabletop surface will also void the warranty. Except where noted, our products are not intended for outdoor use and no warranty is made with respect to goods used outdoors which are not intended for use outdoors. Even where our products are designed for outdoor use, our warranty is limited solely to defects in workmanship for a period of one year from the date of invoice. We do not warrant or represent that the products satisfy and fire code, other fire standard, or any other standard. This warranty does not cover any items which has been in storage, freight damaged, improperly cared for or abused, neglected or misused, nor does it cover any item repaired by someone other than one of our employees unless previously authorized by us in writing. We have the option of repairing or replacing any defective item. All claims under the above warranty must be made not later than the earlier of (A) a reasonable period after discovery of any condition that may lead to a claim (not to exceed 30 days) or (B) the date which is one year from the date of our invoice and for the product. It is the customer/user's responsibility to maintain a 30% humidity level to accommodate Solid Wood, E*Wood and ProWood tops.

Oak Street Manufacturing's written warranties above are in lieu of all other expressed or implied warranties and we expressly disclaim any and all implied warranties of merchantability or fitness for a particular purpose. There are no warranties which extend beyond the description of the product list.

Recommended Chair & Table Setup

Operation Type	Space Per Seat (Sq. Ft.)
School Lunchroom / Cafeteria	9 - 12
Banquet Room	10 - 11
Table Service - Minimum	11 - 14
Business or College Cafeteria	12 - 15
Table Service - Maximum (Hotels, Clubs, etc.)	15 - 18
Commercial Cafeteria	16 - 18
Counter Service Restaurant	18 - 20

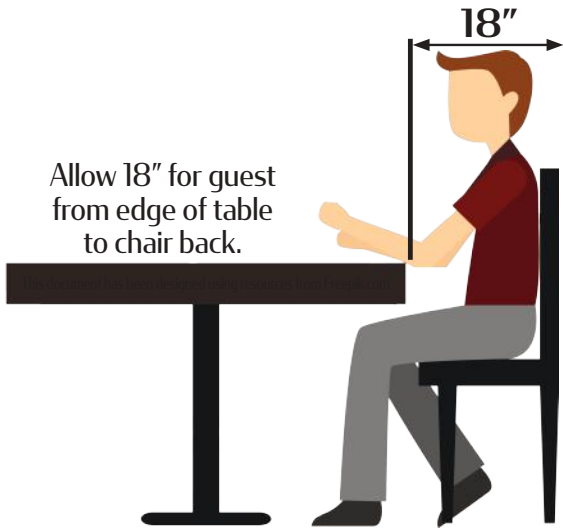

Lateral Seating:

Allow between 24" - 30" between guests.

NOTE: Armchairs & oversized chairs may require additional space between guests.

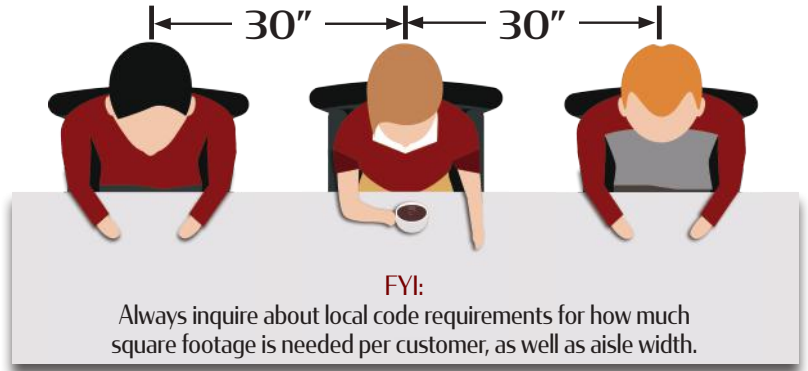

Square Tables (Chairs Back to Back):

Allow 42" between tables.

This provides approximately 6" for guests to push out.

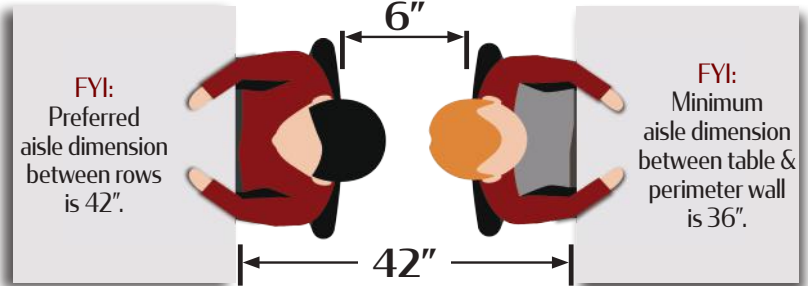

Square Tables (Chairs Back to Back - with Service Aisle):

Allow 62" between tables.

This provides approximately 26" for service aisle.

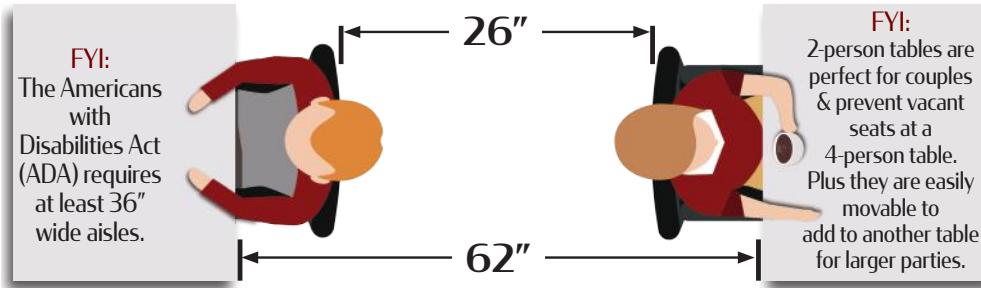

Square Tables (Diagonal Setup):

Allow 24" between table corners for customer access.

Allow 30" between table corners for customer access & narrow service aisle.

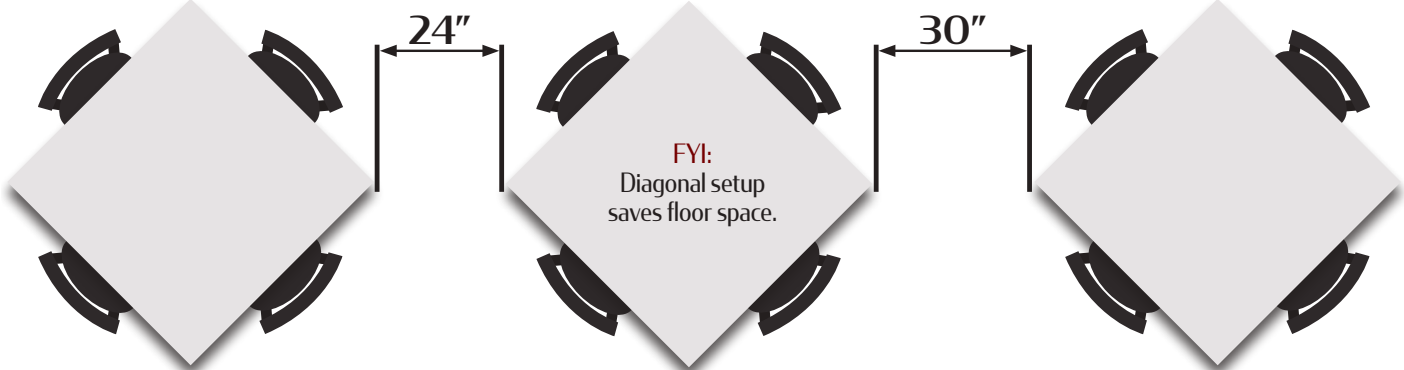

Seating Capacity Per Table Size

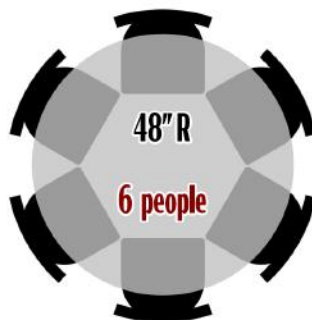
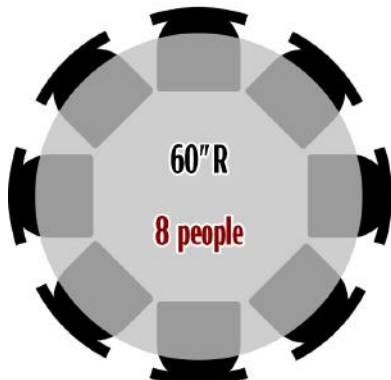
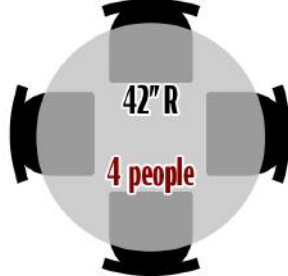
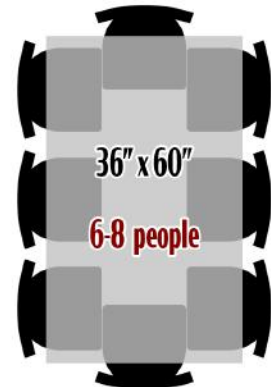
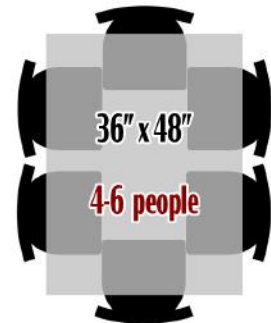
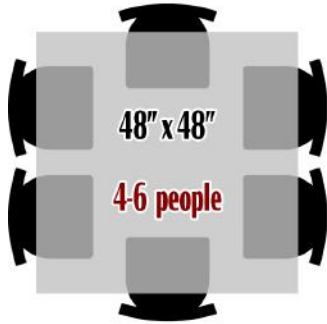
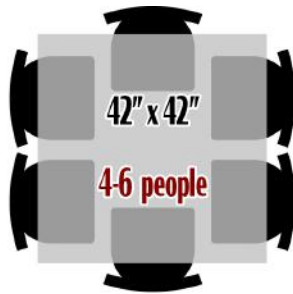

ADA Rules & Guidelines



The Americans with Disabilities Act is a Federal civil rights law that prohibits the exclusion of people with disabilities from everyday activities, such as enjoying a meal at a restaurant.

Establishment Requirements

- 5% of all tables (dining, banquet and bar), or at least 1 (if less than 20 tables), must be wheelchair accessible.
NOTE: If you have a bar or outdoor area in your restaurant, it must be counted separately, in the same way.
- If it is not readily achievable to provide the minimal number of accessible tables in all areas where fixed tables are provided, then services must be provided in another accessible location.
NOTE: Alternative locations must be available for all customers and not just people with disabilities. It is illegal to segregate people with disabilities in one area by designating it as an accessible area to be used only by people with disabilities.

ADA compliant tables must meet the following criteria:

- A surface height of no less than 28" and no more than 34" above the floor.
- A minimum knee clearance of 27" (preferred knee clearance is 29" to accommodate larger electric wheelchairs) between the floor and the underside of the table.
- A clear floor area of 30" x 48" is provided at each accessible seating location.
- Knee clearance extends at least 19" under the table.

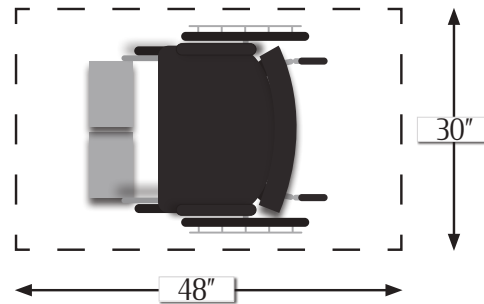
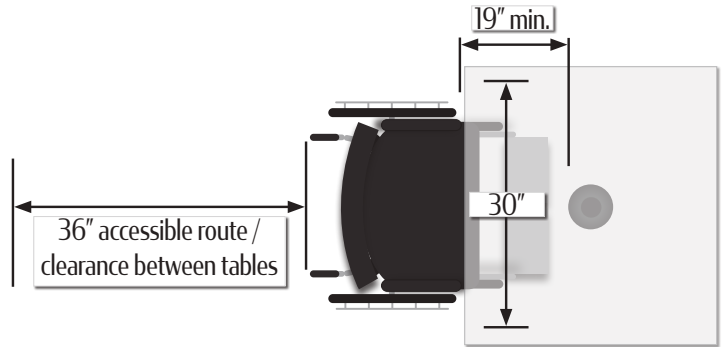
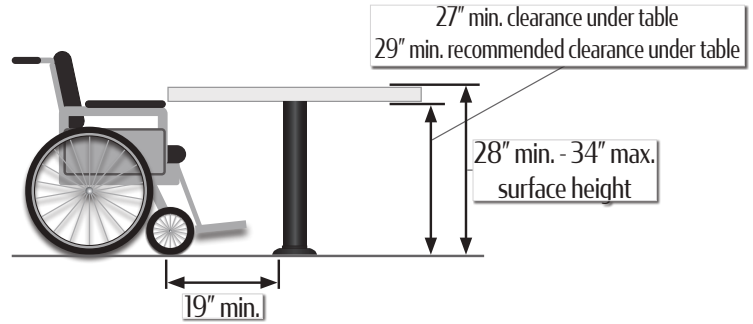

Oak Street Manufacturing has a variety of high-quality table base options to ensure your ADA compliance.

Bolt down table bases, cantilever wall mount table bases and T-bases are the best options.

These table bases offer a small footprint and allow you to meet ADA compliance without using excessively large table tops.

Bolt down table bases work well when you don't want to have a table against a wall and want the flexibility to switch between using chairs or making space for wheelchair accessibility.

Bolt down table bases have a small plate welded to the bottom of the tube, which is anchored to the floor and covered with a small dust cover. Bolt down bases have a footprint of approximately 8" - 11" in diameter.

NOTE: Bolt down bases shouldn't be spaced more than 36" apart.

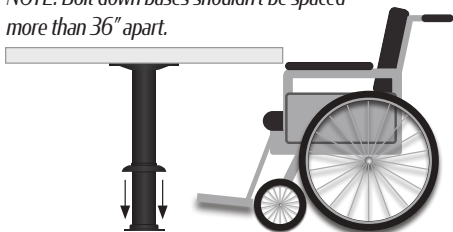

Cantilever wall mount table bases are a great option because they use little to no floor space (depending on the size).

Our **21" Cantilever wall mount table base** (Part No.: CANTILEVER-21) accommodates table sizes up to 30".

Our **27.5" Cantilever wall mount table base*** (Part No.: CANTILEVER-27.5) accommodates table sizes 30" to 48" without the use of a pin leg or 48"+, but requires installing a pin leg (SSB-PIN).

* - Requires special wall construction.

T-Bases use little space and are simple to install. Our T-Bases are constructed of stamped steel for unparalleled strength and stability.

IMPORTANT: Ensure your table size can accommodate a minimum floor space of 30" between the two T-Bases to maintain ADA compliance.

ADA compliant 5" x 22" T-Bases available with 3" ADA standard height tube (Part No.: B522-ADA).

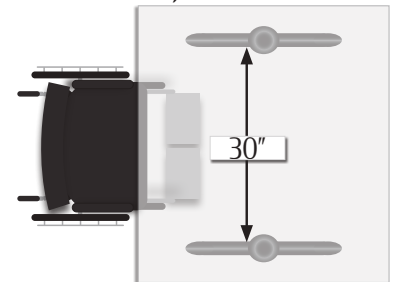

Laminate Care Instructions

CLEANING TIPS

Please see notes of caution below before attempting cleaning

1. To clean the laminate table top surface, use a damp cloth or sponge & a mild soap or detergent. Rinse thoroughly with warm water & wipe dry
2. Difficult stains, such as coffee or tea can be removed using a mild household cleaner/detergent & a soft bristled brush, repeating as necessary.
3. If a stain persists, use a paste of baking soda & water - apply with a soft bristled brush. Light scrubbing for 10 to 20 strokes should remove most stains. Although baking soda is a low abrasive, excessive scrubbing or exerting too much force could damage the decorative surface, especially if it has a gloss finish.
4. Stubborn stains that resist any of the above cleaning methods may require the use of undiluted household bleach or nail polish remover. Apply the bleach or nail polish remover to the stain & let stand no longer than 2 minutes. Rinse thoroughly with warm water & wipe dry. This step may be repeated if the stain appears to be going away & the color of the laminate has not been affected. WARNING: Prolonged exposure of the laminate surface to bleach will cause discoloration.
5. Hot pans & heat-producing appliances (such as electric skillets), when set directly upon countertops, can mar the product's beauty. Always use a heat shield, hot pad or trivet.

RECOMMENDED CLEANERS

- Windex®
- Glass Plus®
- Fantastik®
- Mr. Clean®
- Formula 409®
- Isopropyl Alcohol (Isopropanol)

DAMAGING CLEANERS

Cleaners that can cause damage to the laminate surface include, but are not limited to:

- Hydrochloric Acid
- Muriatic Acid
- Hydrogen Chloride
- Sulfuric Acid
- Oleic Acid
- Oil of Vitriol
- Oleum
- Hydrofluoric Acid
- Rust Remover
- Phosphoric Acid
- Sodium Hydroxide
- Caustic Soda
- Caustic Lye
- Soda Lye
- Pumice (abrasive)

NOTES OF CAUTION

1. Prolonged exposure of the laminate surface to acetone or bleach will cause discoloration. Always rinse laminate surface after cleaning. Failure to rinse after cleaning can cause damage, even if only a small amount of cleaning solution remains on the surface. A dry residue may be invisible, however moisture from cups or drinks can reactivate it and result in permanently etched scars or stains over time.
2. Acidic or abrasive cleaners can damage laminate surfaces – do not use them.
3. Drain cleaners containing lye will permanently damage the laminate surface. If you spill drain cleaner, wipe it up immediately and rinse several times with water.
4. Hair, textile and food dyes can cause permanent stains. If dye is spilled, wipe up immediately with dish washing detergent or an all-purpose cleaner.
5. Never place pots or dishes directly from the oven or burner on an unprotected laminate surface; such extreme heat can cause cracking or blistering.
6. Do not work with oven cleaners on an unprotected laminate top. Wipe spills away promptly and rinse several times with water.
7. Rust removers contain harsh chemicals which will quickly cause permanent damage. If a spill occurs, wipe off all residue immediately, wash thoroughly with soapy water and rinse several times.
8. Steel wool and other abrasive pads will damage the laminate surface. Do not use them for cleaning and do not store steel wool pads on your laminate; the metal can rust and leave stains.
9. Toilet bowl cleaners contain harsh chemicals that can cause permanent damage. If spills occur, wipe up immediately, wash the surface with soapy water and rinse several times.
10. Remember, sharp objects can damage the surface of any laminate: marring its beauty and lowering wear and stain resistance. Although high-pressure laminates are somewhat resistant to scratching, the surface can be damaged even under normal use. Laminate may need occasional dusting depending on where it is used. To keep the surface beautiful, use an oil free furniture spray. Remember to clean the spray off several times a year to prevent build up. Furniture polish may also help hide fine scratching in the surface.

Vinyl/Upholstery Care Instructions

MAINTENANCE / GENERAL RECOMMENDATIONS

Clean and maintain your furniture regularly. Cleaning frequency depends on use. We recommend using a professional furniture cleaning service.

Always test cleaning solutions and methods in an inconspicuous area of the furniture before proceeding. Treat spills and stains promptly. The longer the stain remains, the more difficult it will be to remove. Clean spots or stains from the edge of the stain working toward the center.

For regular cleaning and maintenance, remove excess soil with a damp, non-abrasive cloth. Use a solution of mild liquid soap and water. Rinse with clean water and dry.

STAIN TREATMENT / DISINFECTION

For more difficult stains or to disinfect, use a mixture of no more than 10% bleach and 90% water. **Always** rinse with clean water and dry. **Never** use full strength bleach to clean this material or any other coated fabric.

If stain persists, allow the diluted bleach solution to puddle on the affected area or apply with a clean, soaked cloth for approximately 30 minutes. Rinse with water-dampened cloth to remove any remaining bleach residue.

We do not recommend the use of hard surface cleaners; however, the following cleaners / disinfectants have been tested for use on this material, diluted per manufacturer's instructions: CaviWipes™, Virex® II 256, Virox® 5.

If these cleaners / disinfectants are used, the material **must** be rinsed with clean water and dried with a clean cloth following application. Failure to rinse thoroughly with clean water and to pat dry may lead to cleaner buildup and cause surface deterioration (cracking, blisters, peeling, discoloration, etc.).

Do **not** use cleaners marked "for hard non-porous surfaces only" unless indicated above. Such use may cause surface deterioration (cracking, blisters, peeling, discoloration, etc.).

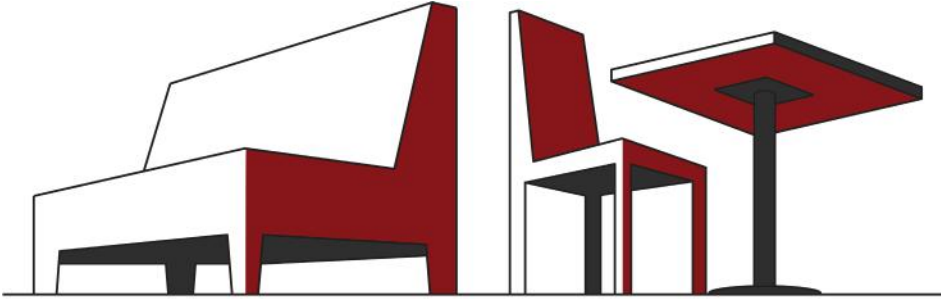

OUTDOOR PRODUCT GUIDE

OAKSTREETMFG.COM

(877) 465-4344



@OAKSTREETMFG



OSM0424