

NAHANCO

2024

EST. 1925

NAHANCO NAHANCO NAHANCO NAHANCO NAHANCO NAHANCO NAHANCO

THE RETAIL SOURCE

# Contents & Page Guides

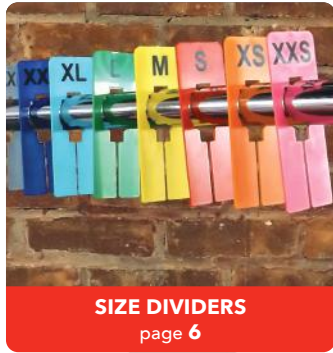

**SIZE DIVIDERS**  
page 6



**HANGING SOLUTIONS**  
page 10



**BACKROOM**  
page 14

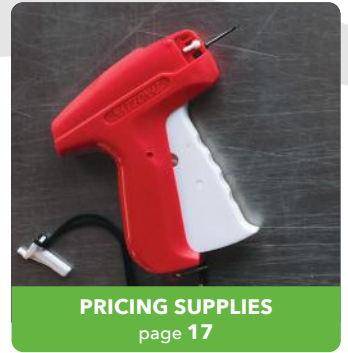

**PRICING SUPPLIES**  
page 17



**GARMENT BAGS**  
page 22



**RACKS & MERCHANDISERS**  
page 24

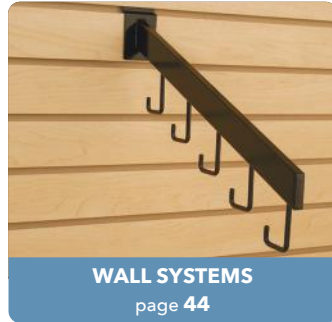

**WALL SYSTEMS**  
page 44



**SIGNAGE**  
page 55



**SECURITY**  
page 63



**DRESSING ROOM SUPPLIES**  
page 66

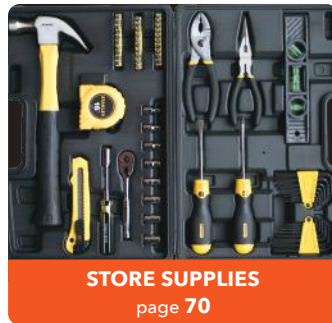

**STORE SUPPLIES**  
page 70

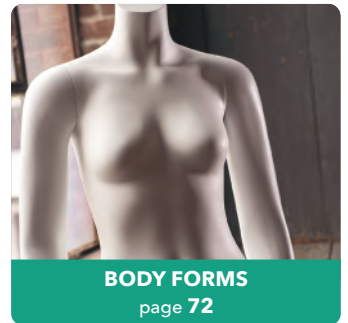

**BODY FORMS**  
page 72

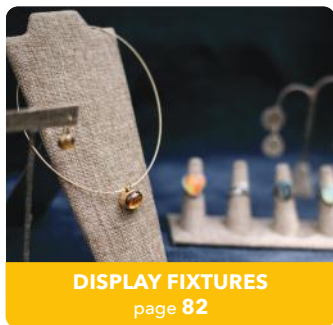

**DISPLAY FIXTURES**  
page 82



**SHOE DISPLAYERS**  
page 85

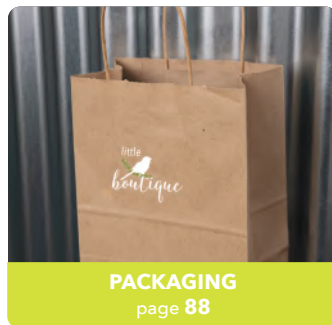

**PACKAGING**  
page 88



**HANGERS**  
page 92

## A GUIDE TO THE SYMBOLS



**Our new items**



**Everyday Value Items**  
Low prices on items you use every day



**Items that can be customized**



**Products made in the USA**



**Assembly video available on our website and YouTube channel**



**Sustainable product**



**Items that ship via truck**



**Our economy items**



**Hangers with concave bodies**



**California Proposition 65 Warning:**  
This product contains chemicals known to the State of California to cause cancer, birth defects or other reproductive harm. For more information: [www.P65Warnings.ca.gov](http://www.P65Warnings.ca.gov).

## A NOTE ON WEIGHTS

Many of our items now list both the **actual** and the **dimensional** or shipping weight as follows:

*actual/dimensional*  
or  
1/3, 3/7, etc.

When multiple cartons are shipped, commas separate the weights as follows:

2, 5 (2 ctns)  
or  
3, 5/8 (2 ctns), etc.

## Sustainability.

Certainly one of the most important and sensitive topics on the planet today – especially as it applies to the business world. **NAHANCO** endeavors to be ever more sustainable with each passing year.

Here's what we've been doing recently:



### Recycling / Waste Management

All of the scrap we use in the manufacturing and shipping process, and during our day-to-day operations – plastics, cardboard/paper, and metal – is collected, processed and/or baled and recycled.

Any additional, non-recyclable waste, is compacted and picked up just 3 times per year.



### A More Sustainability Facility

-  **Cleaner Fuel** – we've converted our entire manufacturing facility from oil to Propane
-  **Better Lighting** – all incandescent lighting has been replaced and florescent fixtures have been fitted with environmentally friendly bulbs
-  **Upgraded Air** – our new compressed air system has resulted in lower operating costs and a reduction in water usage of 100,000 gallons a year

## Sustainability and NAHANCO Hangers

### WOOD

All of our Wood Hangers are made from sustainable materials – Lotus wood and Bamboo – that are grown in China.



### PLASTIC

Plastic Hangers have a useable shelf life of over ten years. And if damaged, the hanger can be recycled. We recycle our own scrap plastic from the manufacturing process. A granulator (and we have a big one!) is used to grind the scrap so we can re-use it. **Zero** plastic goes into the waste stream.



### RECYCLED PLASTICS

Our black hangers are made of up to 80% internal and external recycled plastic material. All other hangers we manufacture use up to 20% of internal recycled plastic.



## BENEFITS OF WORKING WITH US:

99

years in business

Our US-based industry professionals are available to consult with you on your business needs.



We offer **customizable reporting** on your historical usage and spend.



We have unmatched experience in building and executing **custom programs** designed for your individual business needs.

We leverage our buying power to offer highly **competitive prices** on the items you buy – whether a one-off need or a high-volume, ongoing supply program.



## SERVICES WE PROVIDE:



### SOURCING

Custom, branded or generic merchandising supplies; domestic or imported, we have you covered.

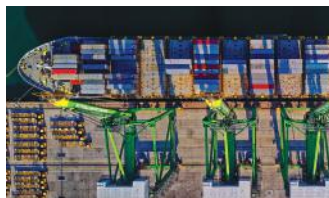

### LOGISTICS & DISTRIBUTION

Services are scaled to fit your needs: to your warehouse, direct roll-outs or consolidated shipments.



### WAREHOUSING & INVENTORY MGMT

We can maintain inventory of the items you buy from us, so they are ready to ship when you need them.



### E-COMMERCE ORDERING PLATFORM

Our web-based ordering platform can be customized to your brand-specific catalog.

# Custom Creations

NAHANCO offers a robust custom program, that includes something for every customer no matter how big or how small. The program divides into 3 categories:

## 1. BUILDABRAND

Considered our "bespoke" option, for customers looking for something completely unique to their brand. We develop custom plans, executed with full involvement of both your creative teams and ours.

### KITH

WE CREATED KITH'S ICONIC BLACK LINE OF HANGERS, WHICH GREW TO INCLUDE A LINE OF KIDS HANGERS.



AN ANNIVERSARY LINE WAS LATER CREATED TO CELEBRATE ALL OF THE COLORS OF KITH



## 2. INSTABRAND — custom items ship in DAYS, not months!

A popular option for customers looking to add branded elements to their store supplies. Hangers are the most common choice, we can print custom designs onto size dividers, bags, and other objects. Select products from our extensive inventory and add your logo.



## 3. CUSTOM CREATOR TOOL

This is our easy-to-use, Do-It-Yourself online customization tool.

A curated selection of our most popular wood hangers are sold in small 24-piece batches, ready for your logo, text, photos... whatever you want to create. Or work with a fun collection of elements available in the tool.

Ideal for smaller boutiques, offices, wedding parties, gifts, and home closets. It can also be employed as a fun way to "test" out logo designs with a small-scale order.



# Our Best Selling Hangers

## WOOD



NAHANCO Slimline Wood /page 95

SLIM & SLEEK



TRIED & TRUE

▲ NAHANCO Line /page 92  
Our most popular wood hanger!



NORTHSHIRE Line /page 99

THE MODERN CLASSIC



THIN-FLAT-NOTCHED

▲ EQUINOX Line /page 97



CONCAVE

EXECUTIVE Line /page 98



NATURAL CURVES

▲ CONTEMPORARY Line /page 101



SIGNATURE Line /page 100

FLOWING LINES



✓ TRADITIONAL Line /page 102

GREAT ALL-AROUND



RETRO

RETRO Line /page 100



✓ SWIMWEAR Hangers /pg 105 Body-shaped, round, tiered and more ✓

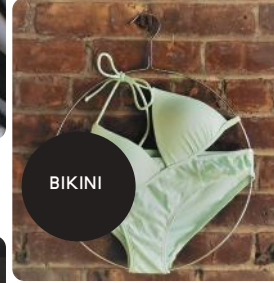

BIKINI

## METAL

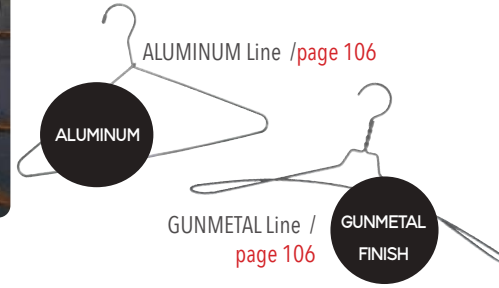

ALUMINUM Line /page 106

GUNMETAL Line /page 106

GUNMETAL FINISH

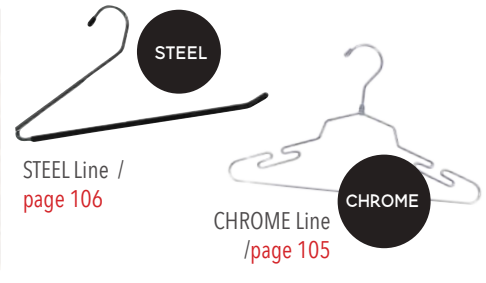

STEEL

STEEL Line /page 106

CHROME Line /page 105

CHROME

## PLASTIC



TRADITIONAL STYLES

TRADITIONAL Plastic /page 113  
Many styles made by us in the USA



INTIMATE STYLES

INTIMATE Lines /page 110



CHILDREN'S

KIDS' Styles /page 118



SLIM & VERSATILE

VELVET Slimline /page 109 ▲



JACKET & SUIT

JACKET Line /page 108



ECONOMY

ECONOMY Lines /page 121 ▲



DISPLAY

DISPLAY Lines /page 112

# SIZE DIVIDERS



We make most of our sizing products in the USA



Scan to explore more sizing details, or visit [nahanco.com](http://nahanco.com)

## ROUND STANDARD

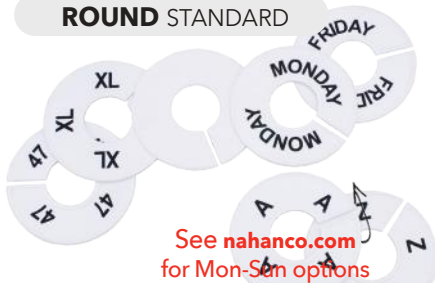

See [nahanco.com](http://nahanco.com) for Mon-Sun options

3 1/2" outside diameter; 1 3/8" inside diameter; 1/2 lbs.

Imprinted: .35 each  
White w/black: "C"  
Black w/gold: "CG"

Imprinted: .35 each  
Black w/silver: CBS  
Black w/white: CBW

Blank: .17 each  
Blank White: CWHT-BLANK  
Blank Black: CBLK-BLANK

## UNIVERSAL



QSD

Fits round, square and rectangular hangrails. Choice of sizes or blank. 2"W x 5"H; 1 3/8" inside diameter; 1/2 lbs.

Imprinted: .35 each  
White w/black: QSD-W  
Black w/gold: QSD-B  
Black w/silver: QSDBS  
Black w/white: QSDBW

Blank: .17 each  
Blank White: QSDWHT-BLANK  
Blank Black: QSDBLK-BLANK



C2WHITE/  
C2BLACK

## ROUND LARGE INTERIOR

3 1/2" outside diameter; 1 5/8" inside diameter; 1/2 lbs.

Imprinted: .35 each  
White w/black: C2WHITE  
Black w/gold: C2BLACK

Blank: .17 each  
Blank White: C2WHITE-BLANK  
Blank Black: C2BLACK-BLANK

## GRAND



GSD

Fits round, square and rectangular hangrails. Choice of sizes or blank. 2 5/8"W x 5 3/4"H; 1 3/8" inside diameter; 1/2 lbs.

.56 each - printed  
White w/black: GSD-W  
Black w/gold: GSD-B

.39 each - blank  
Blank White: GSDWHT-BLANK  
Blank Black: GSDBLK-BLANK

**CUSTOM colors and/or printing available for most styles. Give us a call!**

## REGULAR



RSD

Fits round, square and rectangular hangrails. Choice of sizes or blank. 2 3/4"W x 6 3/4"H; 1 5/16" inside diameter; 1/2 lbs.

.56 each - printed  
White w/black: RSD-W  
Black w/gold: RSD-B

.39 each - blank  
Blank White: RSD-W/BLANK  
Blank Black: RSD-B/BLANK

## EXTRA LARGE



XLRSD

Fits round, square and rectangular hangrails. Choice of sizes or blank. 4"W x 7"H; 1 3/8" inside diameter; 1/2 lbs.

.64 each - printed  
White w/black: XLRSDW  
Black w/gold: XLRSDB

.39 each - blank  
Blank White: XLRSD-W/BLANK  
Blank Black: XLRSD-B/BLANK

## QUEEN



D05

D15

Fits round hangrails. Choice of sizes or blank. 3 3/4"W x 9 5/16"H; 1 1/2" inside diameter; 5/6 lbs. 50 pieces per pack

Blank:  
Blank White: D15 **19.44**  
Blank Clear: D05 **19.44**  
Blank Black: D25 **19.44**

Imprinted\*:  
White w/black: D15l **27.86**  
Clear w/black: D05l **27.86**  
Black w/gold: D25l **27.86**

\* Minimum order of 100 pieces (same size) for imprinting

## DELUXE



D120W

44

D220B

Works with E1 inserts. 3 3/4"W x 10"H; 1 3/4" inside diameter; 8 lbs. 50 pieces per pack/ **36.29**

White: D120W  
Black: D220B

## Extra Inserts (E1)

Fits Deluxe and King size dividers. 3 1/4"W x 2 1.2"H; 1/2 lbs. 100 pieces per pack

White w/black imprint: "E1" **23.33**  
Blank White: E1-BLANK **14.26**



## KING

Slot for inter-changeable sizes. Packed with blank white inserts or specify pre-printed.

3 3/4"W x 10 3/4"H; 1 3/8" inside diameter; 200 pack /21lbs; 100 pack /11lbs.



|        |     |          |              |
|--------|-----|----------|--------------|
| White: | 200 | 175 "E"  | <b>97.90</b> |
|        | 100 | 175E-100 | <b>50.54</b> |
| Clear: | 200 | 75 "E"   | <b>97.90</b> |
|        | 100 | 75E-100  | <b>50.54</b> |
| Black: | 200 | 275 "E"  | <b>97.90</b> |
|        | 100 | 275E-100 | <b>50.54</b> |

PRICE QUOTES ... CUSTOM COLOR ... CUSTOM PRINT ... PRICE QUOTES ... CUSTOM COLOR ... CUSTOM PRINT



## PRINTED KITS

### 5 SIZES / XSMALL - XLARGE

Choose Black, White or Color; Round or Universal  
Sizes include: XS, S, M, L, XL



#### 2 PIECES EACH SIZE

**BLACK or WHITE** 10-Piece Kit; 1 lb; **\$5.05** /kit

Round / White CWBKIT1  
Round /Black CBWKIT1

Universal / White QSDWBKIT1  
Universal /Black QSDBWKIT1

**MIXED COLORS** 10-Piece Kit; 1 lb; **\$10.50** /kit

Round CCKIT1  
Universal QSDCKIT1

#### 5 PIECES EACH SIZE

**BLACK or WHITE** 25-Piece Kit; 1 lb; **\$8.80** /kit

Round / White CWBKIT2  
Round /Black CBWKIT2

Universal / White QSDWBKIT2  
Universal /Black QSDBWKIT2

**MIXED COLORS** 25-Piece Kit; 1 lb; **\$13.35** /kit

Round CCKIT2  
Universal QSDCKIT2

### 10 SIZES / 3 MOS - 4T

Black or White; Round or Universal

Sizes include: 3 Mo, 6 Mo, 9 Mo, 12 Mo, 18 Mo, 24 Mo, 30 Mo, 2T, 3T, 4T



**1**  
PIECE  
EACH SIZE

10-Piece Kit; 1 lb; **\$5.05** /kit

Round / White CWBKIT5  
Round /Black CBWKIT5

Universal / White QSDWBKIT5  
Universal /Black QSDBWKIT5

**5**  
PIECES  
EACH SIZE

50-Piece Kit; 2 lbs; **\$20.87** /kit

Round / White CWBKIT6  
Round /Black CBWKIT6

Universal / White QSDWBKIT6  
Universal /Black QSDBWKIT6

Round and Universal dividers. Choose from black, white, or mixed colors.

### 8 SIZES / XXSMALL - XXLARGE + BLANK

Choose Black, White or Color; Round or Universal  
Sizes include: XXS, XS, S, M, L, XL, XXL, blank



#### 2 PIECES EACH SIZE

**BLACK or WHITE** 16-Piece Kit; 1 lb; **\$8.04** /kit

Round / White CWBKIT3  
Round /Black CBWKIT3

Universal / White QSDWBKIT3  
Universal /Black QSDBWKIT3

**MIXED COLORS** 16-Piece Kit; 1 lb; **\$9.20** /kit

Round CCKIT3  
Universal QSDCKIT3

#### 5 PIECES EACH SIZE

**BLACK or WHITE** 40-Piece Kit; 1 lb; **\$16.72** /kit

Round / White CWBKIT4  
Round /Black CBWKIT4

Universal / White QSDWBKIT4  
Universal /Black QSDBWKIT4

**MIXED COLORS** 40-Piece Kit; 1 lb; **\$19.96** /kit

Round CCKIT4  
Universal QSDCKIT4

# SIZE DIVIDERS Size Divider Kits



## BLANK KITS

Round and Universal dividers. Choose from black, white, or mixed colors. Blank divider kits are available in a range of quantities.

### BLACK & WHITE



**SET OF 20** Black or White; Round or Universal; 1 lb; **\$4.67 /kit**

Round / White CWHTBLANK20  
Round / Black CBLKBLANK20  
Universal / White QSDWBLANK20  
Universal / Black QSDBBLANK20



**SET OF 50** Black or White; Round or Universal; 2 lbs; **\$9.98 /kit**

Round / White CWHTBLANK50  
Round / Black CBLKBLANK50  
Universal / White QSDWBLANK50  
Universal / Black QSDBBLANK50



**SET OF 100** Black or White; Round or Universal; 3 lbs; **\$16.72 /kit**

Round / White CWHTBLANK100  
Round / Black CBLKBLANK100  
Universal / White QSDWBLANK100  
Universal / Black QSDBBLANK100

## MIXED COLOR KITS



**SET OF 5 COLORS**  
**KITS OF 10**  
/2 each color; Round or Universal; 1 lb; **\$4.15 /kit**

Round CCKIT5  
Universal QSDCKIT5



**SET OF 8 COLORS**  
**KITS OF 16**  
/2 each color; Round or Universal; 1 lb; **\$6.74 /kit**

Round CCKIT7  
Universal QSDCKIT7



**KITS OF 25**  
/5 each color; Round or Universal; 1 lb; **\$9.98 /kit**

Round CCKIT6  
Universal QSDCKIT6



**KITS OF 40**  
/5 each color; Round or Universal; 2 lb; **\$16.72 /kit**

Round CCKIT8  
Universal QSDCKIT8

## SALE & CLEARANCE KITS



**SALE** Red & white; Round or Universal; 1 lb; **\$10.50 /kit**

Round CWRSALE25  
Universal QSDWRSALE25



**CLEARANCE** Red & white; Round or Universal; 1 lb; **\$10.50 /kit**

Round CRWCLEARANCE25  
Universal QSDRWCLEARANCE25

## BACK ROOM RAIL DIVIDERS

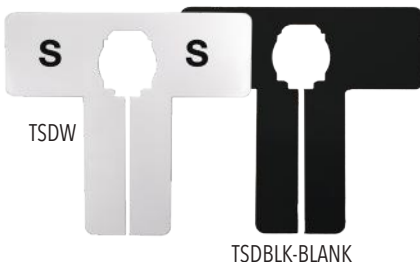

**T-SHAPE STOCKROOM DIVIDER**  
6" high x 6 1/2" wide; 1 1/2" inside dia.; 1/3 lbs.

**BLANK \$0.31 /each**  
TSDBLK-BLANK black  
TSDWHT-BLANK white

**PRINTED \$0.75 /each**  
TSDB black  
TSDW white



**EXTRA-LONG STOCKROOM DIVIDER**  
Black; 21 1/2" long; 4/7 lbs.  
BRDAB **\$20.00 /25 pieces**



**Packs OF 25**  
Choose Black or Yellow; Straight or Curvy body; 19" long; 4/5 lb.

Black Straight Body BRDSB **\$17.82**  
Black Curvy Body BRDCB **\$23.65**  
Yellow Straight Body BRDSY **\$17.82**  
Yellow Curvy Body BRDCY **\$23.65**

**White Blank Inserts**  
each 3.625" x 2.2"; 1 lb.

each BRDSB **\$0.25 each**  
pack of 25 pieces BRDCB **\$9.59**

PRICE **QUOTES** ... CUSTOM **COLOR** ... CUSTOM **PRINT** ... PRICE **QUOTES** ... CUSTOM **COLOR** ... CUSTOM **PRINT**



| style #  | \$             | qty        | description   | size  | wgt        |
|--|----------------|------------|---|---|------------|
| SCXS<br>SCS<br>SCM<br>SCL<br>SCXL<br>SC2XL   | 22.29          | 1000       | White<br>w/ black imprint<br>(works with P12, P13,<br>P14, P16, B14, 2681-10,<br>2681-12, 1681/8W,<br>1681/10W, 1681/12W) | 1/4"L x<br>5/8"H x<br>1/4"W                     | 2          |
| MSM  | 11.15          | 100        | White/Black   | 1/2"  | 1/2        |
| SM25<br>SMSALE   | 4.15<br>13.74  | 25<br>100  | White/Black<br>Red/White  | 3/4"<br>3/4"                                    | 1/2<br>1/2 |
| SM<br>SMB  | 13.74<br>13.74 | 100<br>100 | White/Black<br>Black/White  | 3/4"<br>3/4"                                    | 1/2<br>1/2 |
| VSM  | 20.88          | 500        | Black/White<br>Angular VICS markers   | 3/4"  | 1          |
| <i>Please visit <a href="http://nahanco.com">nahanco.com</a> for a complete list of all of the imprinted sizes available for our SM lines</i>                        |                |            |   |   |            |
| VSMTOOL  | 9.49           | 1          | Metal tool removes size markers from hanger   | 5 5/8"  | 1          |
| SMCOLOR  | 6.87           | 50         | Plain color (Specify)   | 3/4"  | 1/2        |
| <p>COLORS: black, white, violet, brown, green, lt green, dk green, orange, yellow, lt yellow, blue, dk blue, pink, neon-orange red, dk red, grey, beige, magenta</p> |                |            |   |   |            |
| RBKSM  | 13.74          | 100        | Specify size  | 3/4"  | 1/2        |
| <p>SMALL (Red); MEDIUM (Orange); LARGE (Yellow); X-LARGE (Green); XXL (Navy Blue); XXXL (Black)</p>  |                |            |   |   |            |
| TRAY   | 18.01          | 1          | Clear heavy duty tray w/ locking clasps   | Adjusts up to 24 compartments<br>14 x 8 1/2 x 2 | 2/6        |
| DSM  | 5.44           | 250        | Clear with black print on white background  | 1 1/4" w x 5" h                                 | 1/2        |
| DSMBOX   | 8.40           | 1          | Lt. grey cardboard  | 8" w x 5" h x 5" d                              | 1/3        |
| LBXS<br>LBS<br>LBM<br>LBL<br>LBXL<br>LBXXL<br>LB1X<br>LB2X<br>LB3X   | 7.00           | 1000       | Clear with black print:<br>XS<br>S<br>M<br>L<br>XL<br>XXL<br>1X<br>2X<br>3X   | 1/2" w  | 1          |



**PLASTIC SIZE MARKERS**



MSM  
Mini Size Markers 1/2"



Black/White Size Markers 3/4"



VICS Size Markers 3/4"



Size Marker Remover Tool



Plain Colored Size Markers 3/4"

Actual colors may vary slightly from image

Colored Size Markers 3/4"



Storage Tray for Size Markers

**SIZING LABELS**



DSMBOX

Hem / Inseam Labels  
Custom available

Clear Acetate Labels



# HANGING SOLUTIONS

## MODERN ACCESSORIES

Introducing our new, high-end line of metal hanging accessories. Available in five fabulous finishes



### Half-Round Accessory Hanger

Metal accessory hangers in 5 finishes with a fixed cut end hook. Dims: 7" (top to bottom), 5.9" Diameter (holder), 4 mm wire.

Packs of 100 (19 lbs) or 10-(3 lbs) pieces:

|                  |                           |                |
|------------------|---------------------------|----------------|
| <b>AHLHMB</b>    | Matte black; 100 /case    | <b>\$62.49</b> |
| <b>AHLHMB10</b>  | Matte black; 10 /case     | <b>\$7.99</b>  |
| <b>AHLHMCB</b>   | Brushed chrome; 100 /case | <b>\$82.49</b> |
| <b>AHLHMCB10</b> | Brushed chrome; 10 /case  | <b>\$10.49</b> |
| <b>AHLHMW</b>    | Matte white; 1000 /case   | <b>\$62.49</b> |
| <b>AHLHMW10</b>  | Matte white; 10 /case     | <b>\$7.99</b>  |
| <b>AHLHMC</b>    | Chrome; 100 /case         | <b>\$62.49</b> |
| <b>AHLHMC10</b>  | Chrome; 10 /case          | <b>\$7.99</b>  |
| <b>AHLHMG</b>    | Shiny gold; 100 /case     | <b>\$60.49</b> |
| <b>AHLHMG10</b>  | Shiny gold; 10 /case      | <b>\$11.49</b> |



### Round Accessory Hanger

Metal accessory hangers in 5 finishes with a 360° swiveling ball end hook. Dims: 9.5" (top to bottom), 5.9" Diameter (holder) 4 mm wire.

Packs of 100 (19 lbs) or 10-(3 lbs) pieces:

|                  |                           |                 |
|------------------|---------------------------|-----------------|
| <b>AHLMFB</b>    | Matte black; 100 /case    | <b>\$96.99</b>  |
| <b>AHLMFB10</b>  | Matte black; 10 /case     | <b>\$12.49</b>  |
| <b>AHLMFCB</b>   | Brushed chrome; 100 /case | <b>\$119.49</b> |
| <b>AHLMFCB10</b> | Brushed chrome; 10 /case  | <b>\$14.99</b>  |
| <b>AHLMFW</b>    | Matte white; 1000 /case   | <b>\$96.99</b>  |
| <b>AHLMFW10</b>  | Matte white; 10 /case     | <b>\$12.49</b>  |
| <b>AHLMFC</b>    | Chrome; 100 /case         | <b>\$96.99</b>  |
| <b>AHLMFC10</b>  | Chrome; 10 /case          | <b>\$12.49</b>  |
| <b>AHLMFG</b>    | Shiny gold; 100 /case     | <b>\$130.99</b> |
| <b>AHLMFG10</b>  | Shiny gold; 10 /case      | <b>\$16.49</b>  |



### Hang-All Clips

Metal accessory clips in 5 finishes with a 360° rubber-tipped swiveling hook. Dims: 6" (top to bottom), 2.5" H Euroclip.

Packs of 100 (19 lbs) or 10-(3 lbs) pieces:

|                   |                           |                |
|-------------------|---------------------------|----------------|
| <b>610LESB</b>    | Matte black; 100 /case    | <b>\$57.99</b> |
| <b>610LESB10</b>  | Matte black; 10 /case     | <b>\$16.49</b> |
| <b>610LESBC</b>   | Brushed chrome; 100 /case | <b>\$57.99</b> |
| <b>610LESBC10</b> | Brushed chrome; 10 /case  | <b>\$16.49</b> |
| <b>610LESW</b>    | Matte white; 1000 /case   | <b>\$57.99</b> |
| <b>610LESW10</b>  | Matte white; 10 /case     | <b>\$16.49</b> |
| <b>610LESC</b>    | Chrome; 100 /case         | <b>\$57.99</b> |
| <b>610LESC10</b>  | Chrome; 10 /case          | <b>\$16.49</b> |
| <b>610LESG</b>    | Shiny gold; 100 /case     | <b>\$57.99</b> |
| <b>610LESG10</b>  | Shiny gold; 10 /case      | <b>\$16.49</b> |



## NON-SLIP ATTACHMENTS

### Adhesive Gripper

Black or white adhesive gripper with a raised dotted surface; 3 1/4" long

|        |                    |          |
|--------|--------------------|----------|
| BNT    | 1000 /case; 5 lbs. | \$112.90 |
| BNT200 | 200 /case; 2 lbs.  | \$33.31  |
| WNT200 | 200 /case; 2 lbs.  | \$33.31  |

### Stretch Foam Covers

White (w) and grey (c); 17" w; in packs of 500 and 100

|       |                             |         |
|-------|-----------------------------|---------|
| 2045W | White; 500 /case; 4/14 lbs. | \$42.12 |
| 2045C | Grey; 500 /case; 4/14 lbs.  | \$42.12 |
| 2041W | White; 100 /case; 2/8 lbs.  | \$9.72  |
| 2041C | Grey; 100 /case; 2/8 lbs.   | \$9.17  |

### Adhesive Foam Non-slip Attachments

Black or White; 3 1/2" long or 2 1/4" long

|           |                             |         |
|-----------|-----------------------------|---------|
| FG1000B   | Black; 1000 /case; 2/3 lbs. | \$31.88 |
| FG1000W   | White; 1000 /case; 2/3 lbs. | \$31.88 |
| FGSL1000B | Black; 1000 /case; 2/3 lbs. | \$55.47 |
| FGSL1000W | White; 1000 /case; 2/3 lbs. | \$55.47 |

### Hanger Grips - Straight w/ Fins

Non-Slip Long Adhesive Grips; these flexible rubber grips are feathered with adhesive backing; 4" long x 3/8" wide

|            |                              |         |
|------------|------------------------------|---------|
| NSLONG     | Natural; 1000 /case; 4 lbs.  | \$70.76 |
| NSLONG100  | Natural; 100 /case; 1/2 lbs. | \$9.72  |
| BNSLONG    | Black; 1000 /case; 4 lbs.    | \$70.76 |
| BNSLONG100 | Black; 100 /case; 1/2 lbs.   | \$9.72  |

### Adhesive Foam Strips

Adhesive backed foam strips; 3/8" w x 4" l; White or Grey; Choose AP and add this cost to the price of any 100-hanger carton to have the non-slip applied

|      |                             |         |
|------|-----------------------------|---------|
| FP2W | White; 200 /case; 1/2 lbs.  | \$9.72  |
| FP7W | White; 1600 /case; 2/8 lbs. | \$41.60 |
| FP2  | Grey; 200 /case; 1/2 lbs.   | \$8.29  |
| FP-7 | Grey; 1600 /case; 2/8 lbs.  | \$27.73 |
| AP   | Specify color; 100 pairs.   | \$27.73 |

### Rubber Non-slip Hanger Attachments

Grippers that fit over notched, plastic hanger arms without adhesives; 4" long; black or natural; available in packs of 1000 and 200

|      |                             |         |
|------|-----------------------------|---------|
| NS   | Natural; 1000 /case; 6 lbs. | \$57.99 |
| NS2  | Natural; 200 /case; 2 lbs.  | \$16.49 |
| BNS  | Black; 1000 /case; 6 lbs.   | \$57.99 |
| BNS2 | Black; 200 /case; 2 lbs.    | \$16.49 |

### Flexible Non-slip Clear Vinyl Attachments

Gripper snaps over notched, plastic hanger arm without adhesives; for light to medium weight garments; 4" l, 1/2" w

|      |                            |                |
|------|----------------------------|----------------|
| NSV2 | Clear; 200 /case; 2/3 lbs. | <b>\$40.18</b> |
|------|----------------------------|----------------|

### Round Rubber Gripper

Available in Natural or Black; gripper stretches over end of most hanger styles and stays put without adhesive; 1" d

|          |                             |                |
|----------|-----------------------------|----------------|
| NSROUND  | Natural; 100 /case; 1/2 lb. | <b>\$15.29</b> |
| BNSROUND | Black; 100 /case; 1/2 lb.   | <b>\$15.29</b> |

# Specialty Items HANGING SOLUTIONS

| style #                           | \$     | qty     | description   | size                     | wgt |
|-----------------------------------|--------|---------|---|--------------------------|-----|
| <b>SMALL PACK</b>                 |        |         |   |                          |     |
| SHKLG                             | 9.72   | 12 pcs. | Zinc  | 7"                       | 2   |
| SHKLGRS                           | 13.87  |         | Gunmetal  |                          |     |
| SHKLGBC                           | 13.87  |         | Satin Chrome  |                          |     |
| SHKLGW                            | 9.72   |         | White   |                          |     |
| SHKLG B                           | 9.72   |         | Black   |                          |     |
| <i>* Also sold individually</i>   |        |         |   |                          |     |
| <b>LARGE PACK</b>                 |        |         |   |                          |     |
| SHKSM                             | 26.44  | 50 pcs. | Zinc  | 4"                       | 3/4 |
| SHKSMRS                           | 31.23  |         | Gunmetal  |                          |     |
| SHKSMBC                           | 31.23  |         | Satin Chrome  |                          |     |
| SHKSMW                            | 26.44  |         | White   |                          |     |
| SHKSM B                           | 26.44  |         | Black   |                          |     |
| <i>* Also sold in packs of 12</i> |        |         |   |                          |     |
| SH1                               | 17.99  | 500     | Black   | 3 1/2"                   | 2   |
| SH1-100                           | 5.99   | 100     |   | 3 1/2"                   | 1/2 |
| SH2                               | 17.44  | 500     | Black   | 3 7/8"                   | 3   |
| SH2-100                           | 5.99   | 100     |   | 3 7/8"                   | 1/2 |
| 25430005                          | 31.88  | 50      | Black w/black hook  | 11 1/2"                  | 5/9 |
| 305078048                         | 23.46  | 100     | Black   | 7"                       | 2/3 |
| DH                                | 13.99  | 1000    | Black   | 1 3/4"                   | 2/3 |
| DH500                             | 9.49   | 500     | Black   |                          | 1/3 |
| DH-WH                             | 14.99  | 1000    | White   |                          | 2/3 |
| DHWH500                           | 9.49   | 500     | White   |                          | 1/3 |
| TC                                | 24.36  | 500     | Black   | 2 7/8"                   | 6   |
| TC100                             | 6.35   | 100     |   |                          | 2/3 |
| 2MINI                             | 49.99  | 100     | Gunmetal with Black coating; hook measures 1 1/4" in dia. | 4 3/4" W x 3 3/4" H      | 6   |
| 7MINI                             | 78.41  | 100     |   | 8" W X 4 1/4" H          | 8   |
| 6C1                               | 24.36  | 500     | Black   | 2 3/4" h, 1" dia. ring   | 3   |
| 6C1-100                           | 9.72   | 100     |   |                          | 1   |
| CIR1M                             | 40.31  | 1000    | Clear   | 1 1/4" inside dia.       | 5/6 |
| CIR                               | 22.94  | 500     |   |                          | 3   |
| CIR100                            | 8.04   | 100     |   |                          | 1/2 |
| CIR3100                           | 19.44  | 100     | Clear   | 2 1/2" inside dia.       | 4   |
| NHMSH25                           | 20.87  | 25      | Flocked Chrome  | 3 3/4"H x 3"W 1/4" thick | 4   |
| DISPLAYRING                       | 49.25  | 100     | Chrome  | 2 1/4" dia.              | 3   |
| 061204-01                         | 16.72  | 100     | Natural   | 6 3/8"H x 4 1/8" dia.    | 3/7 |
| 06120401B                         | 16.72  |         | Black   |                          |     |
| 1227-04                           | 13.87  |         | Black   | 3 1/8"H x 3 5/8"W        | 2/6 |
| 1227-05                           | 11.15  |         | Black   | 3 1/2"H x 1 5/8"W        | 2   |
| 1227-07                           | 8.42   |         | Black   | 2 3/4"H x 1 3/4" dia.    | 1/2 |
| BC                                | 41.60  | 500     | Black   | open                     | 4   |
| BC100                             | 11.02  | 100     |   | 5"                       | 1   |
| MINI6                             | 72.19  | 100     | Natural with chrome hardware                              | 6"                       | 5   |
| MINI8                             | 90.85  |         |   | 8"                       | 10  |
| MINI6RC                           | 113.79 | 100     | Can be imprinted for an additional charge                 | 6"                       | 9   |
| MINI8RC                           | 123.51 |         |   | 8"                       | 14  |

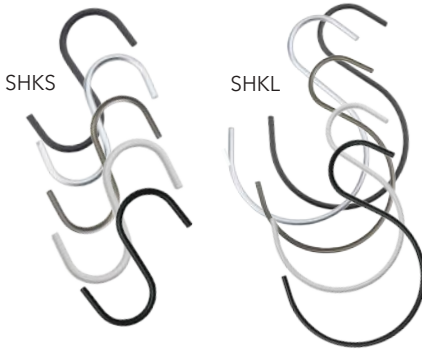

JEAN HOOKS



SOCK HANGERS

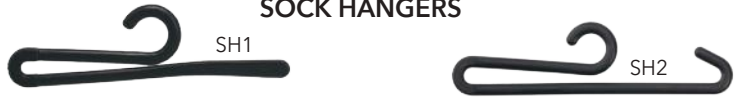

LEGGINGS/SCARF HANGERS



**Display-It Hook**  
You'll find hundreds of uses for this inexpensive display method



Tie / Leggings Hanger

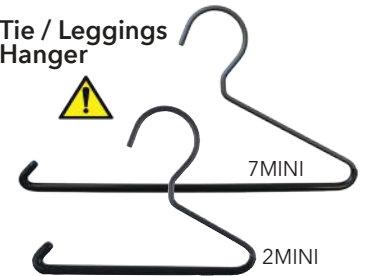

Scarf Hanger



Scarf Rings

CIR

CIR3100



NHMSH25

061204-01 06120401B



BELT HANGER

BC

DISPLAY-RING



1227-04



1227-05



1227-07

MINI WOODEN HANGERS



# HANGING SOLUTIONS Clips

## HANG-ALL CLIPS



| style # | \$    | qty | description        | size   | wgt |
|---------|-------|-----|--------------------|--------|-----|
| 610ECS  | 83.20 |     | Brushed Chrome     |        | 6/7 |
| 610EC   | 54.17 |     | Brushed chrome     |        | 6/7 |
| 610     | 32.90 | 100 | Chrome             | 4 1/2" | 6/7 |
| 610B    | 32.90 |     | Black              |        | 6/7 |
| 610W    | 32.90 |     | White              |        | 6/7 |
| 610BBH  | 37.45 |     | Black w/black hook |        | 6/7 |
| 610PB   | 24.36 | 100 | Black              | 3 1/4" | 2/6 |
| HC101   | 28.51 | 100 | Black              | 2"     | 3   |
| HC100   | 28.51 | 100 | White              | 2"     | 3   |

## CLOTHING CLIPS



**Hercules Clip**

HC101/  
HC100



**Fitting Clips**

FITTING CLIP



FITTING CLIP BC



GIANT FITTING CLIP

|                    |       |     |                |        |   |
|--------------------|-------|-----|----------------|--------|---|
| FITTING CLIPS      | 28.51 | 100 | White          | 2"     | 3 |
| FITTING CLIPS 12   | 8.29  | 12  | White          | 2"     | 1 |
| FITTING CLIP BC    | 71.41 | 100 | Brushed chrome | 2 3/8" | 4 |
| FITTING CLIP BC-12 | 10.50 | 12  | Brushed chrome | 2 3/8" | 1 |
| GIANT FITTING CLIP | 34.73 | 50  | White          | 4"     | 3 |

### Clever Clips



CC2W



CC2B



CC2C

### Ring Clips



RCB

|        |       |     |       |    |     |
|--------|-------|-----|-------|----|-----|
| CC2W   | 17.90 | 100 | White | 2" | 1/3 |
| CC2B   | 17.90 | 100 | Black | 2" | 1/3 |
| CC2C   | 21.51 | 100 | Clear | 2" | 1/3 |
| RCW    | 59.62 | 500 | White |    | 4/6 |
| RCW100 | 21.51 | 100 | White | 2" | 1/2 |
| RCB    | 34.73 | 500 | Black |    | 4/7 |
| RCB100 | 8.42  | 100 | Black |    | 1/3 |

## PANTS CLIPS



PC



PCB /  
PCB100



PCW /  
PCW100

|        |       |     |                            |              |     |
|--------|-------|-----|----------------------------|--------------|-----|
| PC     | 41.47 | 500 | Natural                    | 1 1/2"       | 3   |
| PC100  | 13.74 | 100 | Natural                    | 1 1/2"       | 1/3 |
| PCB    | 38.75 | 500 | Black -<br>Pant Strut Clip | 13/8"Lx3/8"W | 2/2 |
| PCB100 | 12.44 | 100 |                            |              | 2/2 |
| PCW    | 22.29 | 500 | White -<br>Pant Strut Clip | 13/8"Lx3/8"W | 2/2 |
| PCW100 | 7.00  | 100 |                            |              | 2/2 |

## SHIRT CLIPS



**Tie Back Clip**

TIE BK

### Long Clips



LONG

LONGWHITE

|              |      |     |       |                          |     |
|--------------|------|-----|-------|--------------------------|-----|
| TIE BK       | 7.00 | 100 | White | 1 1/2"/<br>2 1/4" elast. | 1   |
| LONG         | 5.57 | 500 | Clear | 1 1/2"                   | 1/3 |
| LONGWHITE    | 8.42 | 500 | White | 1 7/16"                  | 2/2 |
| LONGWHITE100 | 4.15 | 100 | White | 1 7/16"                  | 2/2 |
| LJC200       | 4.15 | 200 | Clear | 2"                       | 1/1 |

### Alligator Shirt Clip



LJC200

### Triangle Shirt Clip



SHCLIP /  
SHCLIP100

|           |       |     |   |                               |     |
|-----------|-------|-----|---|-------------------------------|-----|
| SHCLIP    | 13.22 | 500 | White -<br>Triangle Shape<br>Shirt Clip | 1 1/4"L x<br>5/8"W x<br>1/4"H | 2/2 |
| SHCLIP100 | 4.92  | 100 |   |                               | 2/2 |



CLIP100

### Tubular Hanger Clip

2 1/4" thick, clip snaps on to any of our tubular hangers; white; 100 pcs/carton:

**CLIP100** 3 lbs.; \$24.36

For tubular hangers, see p. 121



### Space Saving Back Room Hooks

Heavy duty black, plastic hook with attached nylon loop strap for hanger management; black;

100 pcs/carton:

**GHB100** 7"L; 8 lbs.; \$59.62

**GHB200** 5 1/2"L; 7 lbs.; \$59.62

12 pcs/carton:

**GHB10012** 7"L; 1 lb.; \$11.65



**BACK ROOM HOOK**

GHB100

GHB200

## PRESSURE SENSITIVE PACKAGE HANGERS



PS1



PS2



NHH3



NHH1C



NHH4C

### Hang Tabs - Hook Style

1 5/8"H x 1"W pre-cut hang tabs with adhesive strip; clear:

**PS1** 500 pcs; 1 lb; \$34.73

**PS1100** 100 pcs; 1 lb; \$13.87

### Hang Tabs - Wide, Delta Hole Style

The delta hole fits almost any style hook; plastic material with a clear adhesive backing; .015" thick; tab measures 1 5/8"W x 1 1/4"H; clear:

**PS2** 500 pcs; 1 lb; \$26.44

**PS2100** 100 pcs; 1 lb; \$9.59

### Economy Hang Tabs - Round Style

13/16" x 1 1/2" economy round hole hang tab with adhesive strip; clear:

**NHH3** 500 pcs; 1 lb;

\$15.29

### Economy Hang Tabs - Hook Style

1 1/2" x 1 11/16" economy hook hang tab with adhesive strip; clear:

**NHH1C** 500 pcs; 1 lb; \$24.36

### Economy Hang Tabs - Delta Hole Style

1 7/16"H x 1 5/8"W delta hole hang tab, wide with adhesive strip; clear:

**NHH4C** 500 pcs; 1 lb; \$22.29



SNB

### Snap Hanger

Measures 2 1/2"W x 2 1/2"H (when snapped shut); black:

**SNB** 500 pcs; 5/8 lbs.; \$61.82

**SNB-100** 100 pcs; 2/3 lb.; \$15.29

## HANGER CONNECTORS



PB / BPB



### Piggy Back Connectors

Plastic connector strips; natural & black: 10" (4 slots) & 2 1/2" (1 slot) lengths; 100 & 500 piece quantities;

Natural; 2 1/2":

**PB** 500 pcs; 2 lbs.; \$34.73

**PB100** 100 pcs; 1 lb.; \$9.72

Natural; 10":

**PB10** 500 pcs; 5/8 lbs; \$99.79

**PB10-100** 100 pcs; 2 lbs; \$27.35

Black; 10":

**BPB-10** 500 pcs; 5/8 lbs; \$99.79

**BPB10-100** 100 pcs; 2 lbs; \$27.35

PB10 / BPB-10

PB8 BPB8



BPB1606

PB16 BPB16



### Coordinate Strips

Displayer hanger strips; 50 pieces;

With 5 slots; 7 1/4"L x 1"W:

**PB8** Clear; 1 lb.; \$12.57

**BPB8** Black; 1 lb; \$12.57

With 11 slots; 15 3/4"L x 1"W:

**PB16** Clear; 2 lbs.; \$27.09

**BPB16** Black; 2 lbs; \$19.90

**BPB1606** Black heavy weight; 2 lbs.; \$22.29



NHHIPB

Clear, flexible connectors; 2 5/8" L x 1 5/8" W; 1000 pieces; 3 lbs; **NHHIPB** \$61.04



NHHIPB



HC001



HC001B

Plastic connectors; 1 3/4"; 1000 pieces; 3/4 lbs; **HC001** Natural \$41.60 **HC001B** Black \$34.73

# BACKROOM Reachers, Boxes & Bins

## REACHING HOOKS

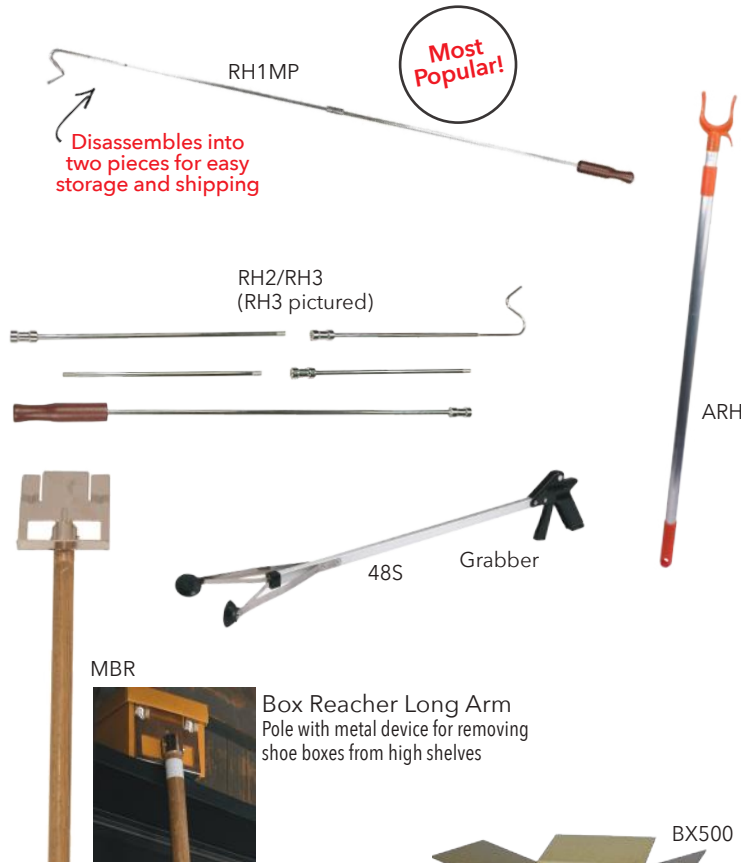

| style #     | \$     | qty | description  | size  | wgt   |
|-------------|--------|-----|--|---|-------|
| RH1MP       | 11.90  | 1   | Chrome w/ wood handle<br>2 pieces, easy assembly     | 54" L   | 2/4   |
| RH2         | 15.49  | 1   | Chrome w/ wood handle<br>4 pieces, assembly required | 70" L   | 2/3   |
| RH3         | 18.49  | 1   | Chrome w/ wood handle<br>5 pieces, assembly required | 84" L   | 2/3   |
| ARH         | 13.87  | 1   | Aluminum w/ plastic tip<br>-adjustable-              | 24" - 60" L   | 1/4   |
| 48S         | 38.75  | 1   | Chrome   | 47 1/2" L   | 2/16  |
| MBR         | 37.45  | 1   | Wood w/ metal end                                    | 60" L   | 3/7   |
| BX500       | 40.31  | 25  | Cardboard  | 14x14x17  | 39/49 |
| CHH-2       | 39.90  | 12  | Cardboard holds 17" dress hangers                    | 17 1/2 x 5 1/2 x 23                                       | 18/21 |
| CHH-3       | 39.90  | 12  | Cardboard holds 14" skirt/slack hangers              | 14 1/2 x 3 x 23   | 14/16 |
| CHH-2 WHITE | 68.30  | 12  | White cardboard holds 17" dress hangers              | 17 1/2 x 5 1/2 x 23                                       | 18/21 |
| CHH-3 WHITE | 68.30  | 12  | White cardboard holds 14" skirt/slack hangers        | 14 1/2 x 3 x 23   | 14/16 |
| H H         | 83.20  | 1   | Black break resistant plastic                        | 17 1/2 x 6 1/2 x 23                                       | 8/22  |
| BB100       | 59.90  | 1   | Black corrugated plastic w/ removable divider        | Assembled: 22 x 21 1/2 x 13<br>Collapsed: 22 x 21 1/2 x 3 | 7/23  |
| NHMB01      | 115.08 | 1   | Large Black Hanger Bin with casters                  | 22" w x 21" d x 23" h (front) / 29" h (back)              | 13/76 |
| NHMB02      | 115.08 | 1   | Small Black Hanger Bin with casters                  | 25 1/2" w x 23" d x 12 1/2" h (front) / 19 1/2" h (back)  | 9/79  |

## STORAGE BOXES & BINS



# Hanger Racks & Stackers BACKROOM

style # \$ qty description size wgt

## MOBILE COLLECTION RACK 24" SYSTEM

(takes IHB2400 bars - see below)

|             |        | 8 bar capacity |  |                          |       |
|-------------|--------|----------------|--|--------------------------|-------|
| CFR6024M4   | 287.06 | 1              | bars sold separately includes 8 (24") bars | 20d x 26 3/8w x 66 3/8 h | 27/48 |
| CFR6024M4WB | 429.88 |                |  |                          | 34/48 |
|             |        | 6 bar capacity |  |                          |       |
| CFR5024M4   | 241.32 | 1              | bars sold separately includes 6 (24") bars | 18d x 26 1/2w x 55 h     | 20/42 |
| CFR5024M4WB | 352.25 |                |  |                          | 25/42 |

## IN STORE TRANSFER RACKS - 21", 24" & 30" SIZES

(bars not included)

|         |        |   |                        |                   |    |
|---------|--------|---|------------------------|-------------------|----|
| ISTR21Z | 432.30 | 1 | 21" rack /uses IHB2100 | 20w x 22 3/8 x77h | 27 |
| ISTR24Z | 447.30 | 1 | 24" rack /uses IHB2400 | 20w x 26 x77h     | 33 |
| ISTR30Z | 475.60 | 1 | 30" rack /uses IHB3000 | 20w x 31 1/4 x77h | 37 |

(Each rack holds 18 hang bars - bars sold separately)

## COORDINATING HANGER BARS WITH CLAMPS - 3 SIZES

|         |       |   |   |          |     |
|---------|-------|---|---|----------|-----|
| IHB2100 | 22.29 | 1 | use with ISTR21Z                          | 21" long | 4   |
| IHB2400 | 22.94 | 1 | use with ISTR24Z & CFR mobile rack system | 24" long | 1/3 |
| IHB3000 | 25.01 | 1 | use with ISTR30Z                          | 30" long | 6   |

(24" long hang bar holds approximately 55 hangers)

|  |        |   |   |   |       |
|--|--------|---|---|---|-------|
| NH6CR                                    | 158.99 | 1 | Metal 6 Bar Rack w/ casters; rack is not adjustable         | 22 1/2" w x 18" d x 51 1/4" h<br>Bars evenly spaced at 8" apart | 19    |
| 101                                      | 14.90  | 1 | Chrome  | 33" H; base - 19 1/4" x 7 1/2"                                  | 5     |
| 101N-WD<br>101W-WD<br>101B-WD<br>101M-WD | 34.08  | 1 | Natural<br>White<br>Black<br>Mahogany                       | 33 1/2" high,<br>19 1/4" x<br>7 1/8" base                       | 5     |
| S21                                      | 77.76  | 1 | Chrome  | 21" H skirt   | 5/18  |
| S29                                      | 79.06  | 1 | Chrome  | 29" H skirt   | 5/23  |
| D21                                      | 77.76  | 1 | Chrome  | 21" H dress   | 5/18  |
| D29                                      | 81.91  | 1 | Chrome  | 29" H dress   | 5/23  |
| HCUCRS                                   | 122.08 | 1 | Chrome Hanger Caddy Under Cabinet Sliding Rack (frame only) | Fits into 26"H x 20"W x 26" D space                             | 11    |
| HCSR                                     | 143.60 | 1 | Black   | Adjusts to hold 21" or 29" hanger caddies                       | 13/25 |

Use with S21 & D21 Caddies (sold separately)

Use with S21 & D21 Caddies (sold separately)

## HANGER COLLECTION RACKS

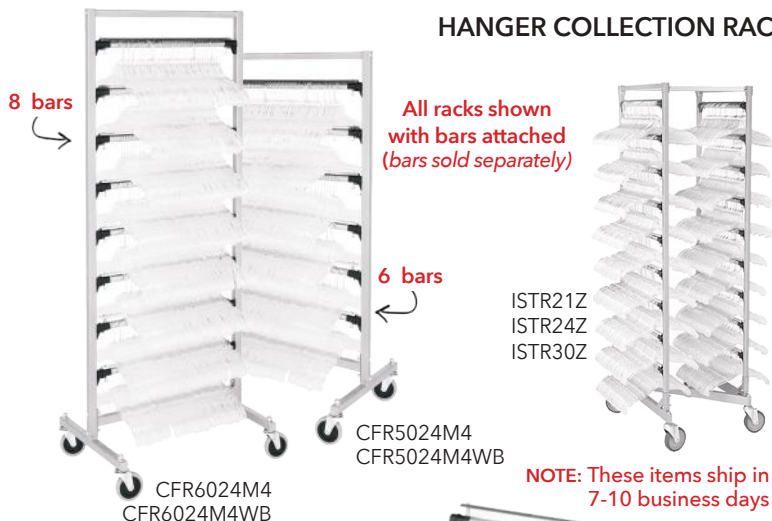

ISTR21Z  
ISTR24Z  
ISTR30Z

CFR5024M4  
CFR5024M4WB

NOTE: These items ship in 7-10 business days

IHB2100 / IHB2400 / IHB3000

|  |        |   |   |   |       |
|--|--------|---|---|---|-------|
| NH6CR                                    | 158.99 | 1 | Metal 6 Bar Rack w/ casters; rack is not adjustable         | 22 1/2" w x 18" d x 51 1/4" h<br>Bars evenly spaced at 8" apart | 19    |
| 101                                      | 14.90  | 1 | Chrome  | 33" H; base - 19 1/4" x 7 1/2"                                  | 5     |
| 101N-WD<br>101W-WD<br>101B-WD<br>101M-WD | 34.08  | 1 | Natural<br>White<br>Black<br>Mahogany                       | 33 1/2" high,<br>19 1/4" x<br>7 1/8" base                       | 5     |
| S21                                      | 77.76  | 1 | Chrome  | 21" H skirt   | 5/18  |
| S29                                      | 79.06  | 1 | Chrome  | 29" H skirt   | 5/23  |
| D21                                      | 77.76  | 1 | Chrome  | 21" H dress   | 5/18  |
| D29                                      | 81.91  | 1 | Chrome  | 29" H dress   | 5/23  |
| HCUCRS                                   | 122.08 | 1 | Chrome Hanger Caddy Under Cabinet Sliding Rack (frame only) | Fits into 26"H x 20"W x 26" D space                             | 11    |
| HCSR                                     | 143.60 | 1 | Black   | Adjusts to hold 21" or 29" hanger caddies                       | 13/25 |

Use with S21 & D21 Caddies (sold separately)

Use with S21 & D21 Caddies (sold separately)



NH6CR



101W-WD 101B-WD 101M-WD 101N-WD

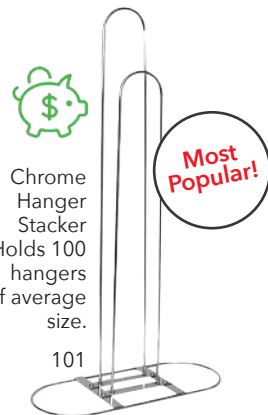

Chrom  
Hanger  
Stacker  
Holds 100  
hangers  
of average  
size.  
101

## HANGER STACKERS

Deluxe Wood Hanger Stacker Accommodates most of our wood styles.



## HANGER CADDIES

- sort /organize hangers by style
- eliminates tangling /breakage
- available in two sizes
- 21" holds approx. 40 hangers
- 29" holds approx. 55 hangers

HCUCRS

## Under Cabinet Sliding Rack (frame only)



Hanger Caddy Spinner

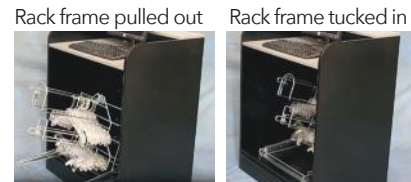

Rack frame pulled out

Rack frame tucked in

# BACKROOM Workstations & Folding

## MOBILE WORKSTATIONS



| style #   | \$     | qty | description  | size   | wgt   |
|-----------|--------|-----|--|--|-------|
| NH701KD   | 137.99 | 1   | Small Workstation w/ adjustable 2-3 bin configuration & bottom storage shelf                                     | 20" w x 15" d x 36-39" h   | 52/82 |
| NH702KD   | 335.99 | 1   | Medium Workstation w/ adjustable 2-3 bin configuration; bottom storage shelf; 2 drop leaves                      | 22" w x 20" d x 39" h; 4 casters (2 locking); expands to 35" x 20" & 48" x 20" | 70    |
| NH703KD   | 426.99 | 1   | Large Workstation w/ adjustable 4-3-2 bin configuration; bottom storage shelf; 2 drop leaves                     | 32" w x 20" d x 39" h; 4 casters (2 locking); expands to 45" x 20" & 58" x 20" | 94    |
|           |        |     | <i>All units: 4" casters w/ locking brakes</i>   |  |       |
| VTL2046   | 290.56 | 1   | Steel tube folding table w/grey powdercoat finish and laminated work surface. With folding leaves and 2 shelves. | 20" w x 18" d x 34 3/4" h without leaves<br><br>Leaves are 20" x 14" each      | 7/23  |
|           |        |     | <i>*Note that this item ships in 7-10 business days</i>  |  |       |
| RUB452500 | 295.99 | 1   | Grey with 5" non-marking casters   | 26" W x 40" L x 33" H  | 49/75 |

Flat top shelf and lower tray with 3"H sides. Ergonomically designed push handle allows for easy steering. Cart rolls on 2 swivel and 2 rigid casters. Assembles easily.

## MOBILE FOLD SYSTEM



|                |        |   |                                |   |    |
|----------------|--------|---|--------------------------------|---|----|
| NHMOBILEFOLD   | 374.99 | 1 | Mobile Fold Station w/ casters | 31"L x 12-33"W x 36" h base; center panel adjusts 7-13"; base 21" w | 50 |
| NHTTMOBILEFOLD | 179.99 | 1 | Table Top Mobile Fold          | Portable folding device adjusts to fold 7-13" widths                | 11 |

## SHIRT FOLDING BOARDS

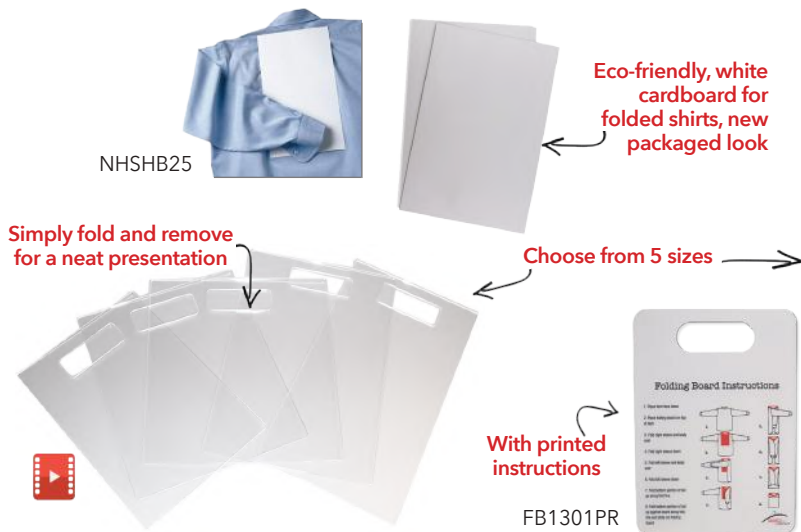

|          |       |                                     |   |              |     |
|----------|-------|-------------------------------------|---|--------------|-----|
| NHSHB25  | 36.16 | 1<br>25LB<br>pack/<br>375<br>pieces | 24-point shirt boards; bio-degradable cardboard | 8" x 12"     | 25  |
| FB1301   | 8.04  |                                     | 1/8" Clear Acrylic                              | 8 1/2" x 12" | 1/2 |
| 1301SF   | 9.72  |                                     |   | 8 1/2" x 15" |     |
| FB1302   | 9.72  | 1                                   |   | 10" x 12"    |     |
| FB1303   | 10.50 |                                     |   | 11" x 12"    |     |
| FB1304   | 10.50 |                                     |   | 9 1/2" x 14" |     |
| FB1301PR | 11.02 | 1                                   | Acrylic Board with printed folding instructions | 8 1/2" x 12" | 2   |



# Tagging Accessories PRICING SUPPLIES

style # \$ qty description size wgt

## National Standard

J11SKIT 19.99 1 J11S tool, needles & fasteners KIT 2/6

J11S 7.90 1 National Standard RED Tagging Tool Standard 1/3

### Standard Replacement Needles

300R 8.29 4 pack Plastic w/steel needles Standard 1

### Standard Fasteners - Natural

|      |      |         |      |     |
|------|------|---------|------|-----|
| F1/2 | 5000 | Natural | 1/2" | 1/3 |
| F1   | 5000 | Natural | 1"   | 1/3 |
| F2   | 5000 | Natural | 2"   | 1/3 |
| F3   | 5000 | Natural | 3"   | 1/3 |
| F5   | 5000 | Natural | 5"   | 1/3 |

### Standard Fasteners - Colors

|           |       |      |         |      |     |
|-----------|-------|------|---------|------|-----|
| F1-COLORS | 11.02 | 5000 | Specify | 1"   | 1/3 |
| F3-COLORS | 11.02 | 5000 | Specify | 3"   | 1/3 |
| 954718    | 11.02 | 5000 | Black   | 1/2" | 1/3 |

### C-Hook (Tacking Hook)

TH 15.29 5000 Natural 1 7/8" 2/7

## National Fine

J11F 13.87 1 National Fine RED Tagging Tool Fine 1/3

### Fine Fabric Replacement Needles

400F 10.90 4 pack Plastic w/steel needles Fine 1

### Fine Fabric Fasteners - Natural

|     |      |      |         |    |     |
|-----|------|------|---------|----|-----|
| FF1 | 5.57 | 5000 | Natural | 1" | 1/3 |
| FF2 | 5.57 | 5000 | Natural | 2" | 1/3 |

## Dennison Standard

MTGS 27.90 1 TEAL Tagging Tool Standard 1/3

STGS 33.90 1 BEIGE Tagging Tool Standard 1/3

|           |      |   |                        |          |     |
|-----------|------|---|------------------------|----------|-----|
| 760111801 | 3.87 | 1 | Needle Locks: For MTGS | Standard | 1/3 |
| 760034907 | 3.87 | 1 | For STGS               | Standard | 1/3 |

08941 16.90 4 pack Replacement needles Standard 1

|       |      |      |         |    |     |
|-------|------|------|---------|----|-----|
| 06214 | 9.90 | 5000 | Natural | 1" | 2/7 |
| 06215 | 9.90 | 5000 | Natural | 3" | 2/7 |

## National Standard Tagging Tool



Tagging Tool Kit Nahanco J11S tagging tool, one pack needles & one pack each of 1" and 3" natural standard fasteners (5000 pieces each)

Standard Replacement Needles

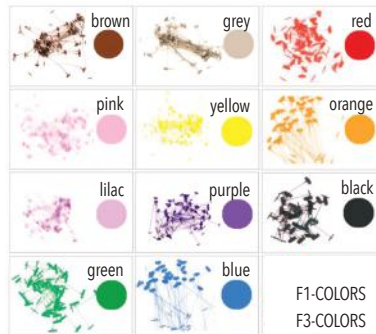

National Standard Tagging Fasteners F1/F3 - Colors

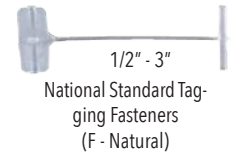

### C-Hook Fasteners

Pair and tag with one hook. For use in standard guns



## National Fine Tagging Tool



National Fine Tagging Fasteners FF1 (1")/FF2 (2")



## Dennison Standard Tagging Tool



Dennison Mark III® Standard Tagging Tool

Dennison Standard Replacement Needles



Dennison Scissor Grip Standard Tagging Tool



Dennison Standard Tagging Fasteners

06214 (1")/06215 (3")

# PRICING SUPPLIES Tagging Accessories

## Dennison Mark III® Fine Tagging Tool



MTGF



STGF

**Dennison Scissor Grip Fine Tagging Gun**

760111801 / 760034907



Dennison Needle Locks



08944

**Dennison Fine Replacement Needles**



**Dennison Fine Tagging Fasteners 08938/08939**

| style #              | \$    | qty    | description            | size | wgt |
|----------------------|-------|--------|------------------------|------|-----|
| <b>Dennison Fine</b> |       |        |                        |      |     |
| MTGF                 | 31.90 | 1      | ORANGE Tagging Tool    | Fine | 1/3 |
| STGF                 | 35.90 | 1      | BLUE Tagging Tool      | Fine | 1/3 |
| 760111801            | 3.87  | 1      | Needle Locks: For MTGF | Fine | 1/3 |
| 760034907            | 3.87  | 1      |                        | Fine | 1/3 |
| 08944                | 16.72 | 4 pack | Replacement needles    | Fine | 1   |
| 08938                | 14.90 | 5000   | Natural                | 3/4" | 1/3 |
| 08939                | 14.90 | 5000   | Natural                | 2"   | 1/3 |

## Dennison System 1000 Tagging Tool



SYS1000

**Dennison SYS1000 Needle Locks**



760796901



08941

**Dennison Standard Replacement Needles**



**System 1000 Fasteners (08284/5)**

| <b>Dennison System 1000</b> |       |        |                           |          |      |
|-----------------------------|-------|--------|---------------------------|----------|------|
| SYS1000                     | 49.90 | 1      | PURPLE Tagging Tool       | Standard | 2/7  |
| 760796901                   | 2.58  | 1      | Needle Locks: For SYS1000 | Standard | 1/3  |
| 08941                       | 18.10 | 4 pack | Replacement needles       | Standard | 1    |
| 08284                       | 17.90 | 5000   | Natural                   | 1"       | 1/2  |
| 08285                       | 17.90 | 5000   | Natural                   | 2 1/2"   | 2/10 |
| DH                          | 13.99 | 1000   | Black                     | 1 3/4"   | 2/3  |
| DH500                       | 9.49  | 500    | Black                     |          | 1/3  |
| DH-WH                       | 14.99 | 1000   | White                     |          | 2/3  |
| DHWH500                     | 9.49  | 500    | White                     |          | 1/3  |
| SC3                         | 15.90 | 5000   | Natural                   | 3"       | 1/3  |
| SC5                         | 15.90 | 5000   | Natural                   | 5"       | 1/3  |
| SC9                         | 17.90 | 5000   | Natural                   | 9"       | 1/3  |

**NAHANCO fasteners - Best Value!**



SC

**NAHANCO Super Circles Fasteners - 3", 5", 9" (SC)**

**Display-It Hook (DH)**

You'll find hundreds of uses for this inexpensive display method



**Dennison Secure-a-Tach - 5" (08300/2)**



**Dennison Secure-a-Tie - 5" (08350)  
Economy Secure-a-Tie - 5" (08350M)**

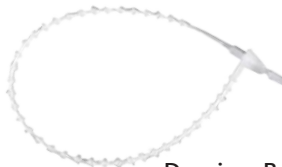

**Dennison Barlock Ladder Ties (08470, 08471)**

08401



|        |       |      |                       |     |     |
|--------|-------|------|-----------------------|-----|-----|
| 08302  | 34.90 | 5000 | Natural               | 3"  | 1/3 |
| 08300  | 29.90 | 5000 | Natural               | 5"  | 1/3 |
| 08350  | 69.21 | 5000 | Natural               | 5"  | 2/3 |
| 08350M | 41.47 | 5000 | Natural               | 5"  | 2/3 |
| 08470  | 39.90 | 1000 | Natural               | 7"  | 2/7 |
| 08471  | 44.90 | 1000 | Natural               | 11" | 2/7 |
| 08401  | 55.90 | 1000 | Black (solid barlock) | 8"  | 2/7 |

style #   \$   qty   description   size   wgt

## Monarch Marking Tools

|         |        |     |  |          |     |
|---------|--------|-----|--|----------|-----|
| 1110-2  | 91.63  | 1   | Pricing Tool<br>Single Line                  |          | 2/7 |
| REB111  | 22.29  | 17M | Labels:<br>White                             | 3/8x3/4" |     |
| REB135  | 24.90  | 17M | Red/Yellow                                   | 3/8x3/4" | 2/3 |
| REB112  | 17.90  | 17M | Red  | 3/8x3/4" |     |
| 3003    | 6.99   | 1   | Ink roller replacement                       |          | 2/3 |
| 1130    | 74.26  | 1   | Pricing Tool,<br>Compact Size<br>Single line |          | 1/3 |
| F0122   | 27.73  | 25M | Labels:<br>White                             | .62x.44" |     |
| F0132   | 34.73  | 25M | Red  | .62x.44" | 2/3 |
| F0151   | 48.60  | 25M | Green  | .62x.44" |     |
| 1130-IR | 8.42   | 1   | Ink roller replacement                       |          | 1   |
| 3002    | 12.57  | 1   | SILICONE                                     | 1/2 oz.  | 1   |
| 3104-1  | 2.85   | 1   | PLASTIC                                      | 5"       | 1   |
| 1115-4  | 139.90 | 1   | Pricing Tool<br>Double Line                  |          | 2/7 |
| FM312   | 26.44  | 15M | Labels:<br>White                             | 5/8x3/4" | 2/3 |
| 3004    | 6.99   | 1   | Ink roller<br>replacement                    |          | 1   |

## Monarch Marking Tools



**Monarch 1110-2**  
Prints 1 line, 6 characters



**1130 Tools**  
Prints 1 line, 6 characters

**Ink Roller 3003**



REB111

REB135

REB112



**Ink Roller 1130-IR**



**Silicone Lubricant 3002**



**Plastic Label Peeler 3104-1**

### Labels



white - F0122

red - F0132

green - F0151



**Monarch 1115-4**  
Prints 2 lines, 8 characters

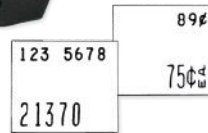

FM312



**Ink Roller 3004**

## Dennison Marking Tools

|        |       |        |                             |          |     |
|--------|-------|--------|-----------------------------|----------|-----|
| 09225  | 49.90 | 1      | Pricing Tool<br>Single line |          | 2/7 |
| 09140  | 66.99 | 15M    | Labels:<br>White            | 1/2x7/8" |     |
| 09141  | 66.99 | 15M    | Red                         | 1/2x7/8" | 1/3 |
| H89891 | 13.87 | 5 Pack | Ink rolls - black           |          | 1/2 |
| 06220  | 89.90 | 1      | Pricing Tool<br>Double line |          | 2/7 |
| 06298  | 66.99 | 12.5M  | Labels:<br>White            | 5/8x7/8" |     |
| 06302  | 66.99 | 12.5M  | Red                         | 5/8x7/8" | 2/3 |
| H89892 | 13.87 | 5 Pack | Ink rolls - black           |          | 1/2 |

## Dennison Marking Tools



**Dennison 09225 The Mighty One™**  
Prints 1 line, 8 characters



**Ink Roller H89891**

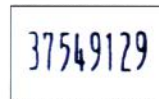

09140



09141



**Dennison 06220 Model 210 Hand Labeler**  
Prints 2 lines, 10 characters

**Ink Roller H89892**

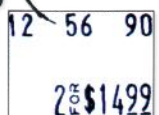

06298



06302



# PRICING SUPPLIES Tags & Labels

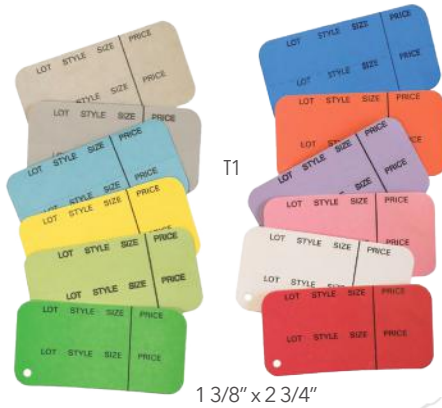

T1  
1 3/8" x 2 3/4"

## Coupon Tags Horizontal

- T1 /T2 /T3 available in:
- (1) white
  - (3) grey
  - (4) dark blue
  - (5) pink
  - (9) yellow
  - (10) red
  - (12) lavender
  - (13) buff
  - (14) orange
  - (15) light green
  - (16) dark green
  - (19) light blue

## Coupon Tags Vertical



T4 / T5



T2 / T3

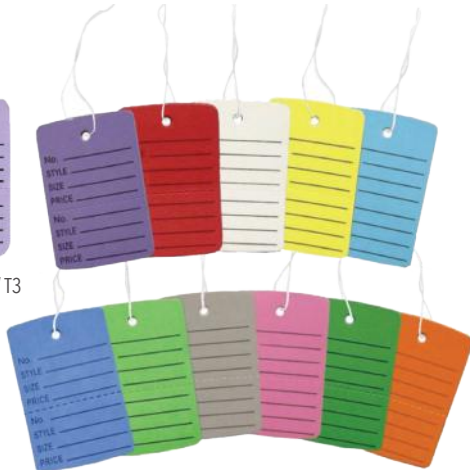

## Clearance Tags



641

510



328C



316C

## Sale Tags

## Special Tags



200

380

320



348



346

## Discount Tags

| style #                | \$    | qty  | description | size         | wgt |
|------------------------|-------|------|-------------|--------------|-----|
| Unstrung T1            | 11.49 | 1000 | Specify     | 1 3/8x2 3/4" | 2   |
| T1-12,13,19            | 11.49 |      |             |              |     |
| Strung T1S             | 24.36 | 1000 | Specify     | 1 3/8x2 3/4" | 2   |
| Unstrung T2-1          | 11.49 | 1000 |             |              |     |
| T2-3,4,5,9,10,12,14-16 | 11.49 |      | Specify     | 1 3/4x2 7/8" | 2   |
| T2-13                  | 11.49 | 1000 |             |              |     |
| T2-19                  | 11.49 |      |             |              |     |
| T3-3                   | 8.99  | 1000 |             |              |     |
| T3-1,4,5,9,12,13-15    | 8.99  |      | Specify     | 1 1/4x1 7/8" | 2   |
| T3-16                  | 8.99  | 1000 |             |              |     |
| T3-10,19               | 8.99  |      |             |              |     |
| Strung T2S-5,9         | 24.49 | 1000 | Specify     | 1 3/4x2 7/8" | 2   |
| T2S-1,3,4,10,12-16,19  |       |      |             |              |     |
| T3S-5                  | 21.51 | 1000 | Specify     | 1 1/4x1 7/8" | 2   |
| T3S-1,19               |       |      |             |              |     |
| T3S-3,4,9,10,12-16     |       |      |             |              |     |
| Unstrung T4            | 11.49 |      | White       | 1 3/4x2 7/8" | 2   |
| T5                     | 8.99  | 1000 |             | 1 1/4x1 7/8" | 2   |
| Strung T4S             | 16.72 | 1000 | White       | 1 3/4x2 7/8" | 2   |
| T5S                    | 18.79 |      |             | 1 1/4x1 7/8" | 2   |
| Unstrung 641           | 26.44 | 1000 | Red/white   | 1 7/8x3 1/2" | 3   |
| 510                    | 18.01 |      |             | 1 3/4x2 7/8" | 2   |
| Strung 641S            | 36.16 | 1000 | Red/white   | 1 7/8x3 1/2" | 3   |
| 510S                   | 24.36 |      |             | 1 3/4x2 7/8" | 3   |
| Unstrung 328           | 17.90 |      | Red/white   | 1 3/4x2 7/8" | 2/3 |
| 328C                   | 17.90 | 1000 | Red/yellow  | 1 3/4x2 7/8" | 2/3 |
| 316                    | 12.57 |      | Red/white   | 1 1/4x1 7/8" | 1/3 |
| 316C                   | 12.57 |      | Red/yellow  | 1 1/4x1 7/8" | 1/3 |
| Strung 328S            | 18.90 |      | Red/white   | 1 3/4x2 7/8" | 3   |
| 328CS                  | 18.90 | 1000 | Red/yellow  | 1 3/4x2 7/8" | 2   |
| 316S                   | 18.90 |      | Red/white   | 1 1/4x1 7/8" | 2   |
| 316CS                  | 18.90 |      | Red/yellow  | 1 1/4x1 7/8" | 2   |
| Unstrung 200           | 18.01 | 1000 | Red/white   | 1 3/4x2 7/8" | 2   |
| 380                    |       |      | Red/yellow  | 1 3/4x2 7/8" |     |
| 320                    |       |      | Red/white   | 1 3/4x2 7/8" |     |
| Strung 200S            | 24.36 | 1000 | Red/white   | 1 3/4x2 7/8" | 2   |
| 380S                   |       |      | Red/yellow  | 1 3/4x2 7/8" |     |
| 320S                   |       |      | Red/white   | 1 3/4x2 7/8" |     |
| Unstrung 348           | 18.01 | 1000 | Red/white   | 1 3/4x2 7/8" | 2/3 |
| 346                    | 13.87 |      |             | 1 1/4x1 7/8" |     |
| Strung 348S            | 24.36 | 1000 | Red/white   | 1 3/4x2 7/8" | 2   |
| 346S                   | 21.51 |      |             | 1 1/4x1 7/8" | 1   |

# Tags & Labels PRICING SUPPLIES

| style #  | \$    | qty  | description                              | size            | wgt |
|----------|-------|------|--|-----------------|-----|
| HOLD     | 16.90 |      | Blue/white                               | 2 3/8x4 3/4"    |     |
| SOLD     | 16.90 | 1000 | Red/white                                | 2 5/8x4 1/4"    | 5   |
| SALE     | 27.90 |      | Red/yellow                               | 2 3/8x4 3/4"    |     |
| 85L      | 39.90 |      | 2 sided, manila<br>Strung                | 3 1/2x8 1/2"    | 6   |
| 85A      | 22.94 | 500  | Unstrung,<br>Button hole                 | 3 1/2x6 1/4"    |     |
| TL       |       |      | 1 sided, strung<br>manila                | 3 1/8x6 1/4"    | 4   |
| TA       | 35.38 | 500  |  |                 |     |
| TR       |       |      |  |                 |     |
| 975      |       |      |  | 1"              |     |
| 970      | 8.42  | 500  | Red/white                                | 1"              | 1   |
| 962      |       |      |  | 1x1 1/4"        |     |
| 965      |       |      |  | 1x1 1/4"        |     |
| 4473TAG  | 5.44  | 250  | White                                    | 1 3/4x2 7/8"    | 1   |
| Strung   |       |      |  |                 |     |
| 4S       | 18.01 |      |  | 1 x 1 1/2"      | 1/2 |
| 5S       | 17.37 | 1000 | White                                    | 1 1/8x1 13/16"  | 1/2 |
| 6S       | 18.01 |      |  | 1 5/16x1 15/16" | 2/3 |
| 7S       | 22.29 |      |  | 1 1/2x2 1/4"    | 2/3 |
| 8S       | 23.59 |      |  | 1 3/4x2 11/16"  | 2/3 |
| Unstrung |       |      |  |                 |     |
| 4NS      | 7.00  |      |  | 1 x 1 1/2"      | 1   |
| 5NS      | 8.42  | 1000 | White                                    | 1 1/8x1 13/16"  | 1   |
| 6NS      | 8.42  |      |  | 1 5/16x1 15/16" | 2/3 |
| 7NS      | 9.07  |      |  | 1 1/2x2 1/4"    | 2/3 |
| 8NS      | 12.57 |      |  | 1 3/4x2 11/16"  | 2/3 |
| APT5NKFT | 4.92  | 50   | Kraft Shipping Tags, Unstrung:<br>Large  | 2.375" x 4.75"  | 1/1 |
| APT2NKFT | 4.14  | 50   | Small                                    | 1.625" x 3.25"  | 1/1 |
| 8SKFT    | 5.57  | 50   | Kraft Merchandise Tags, Strung:<br>Large | 1.75" x 2.875"  | 1/1 |
| 6SKFT    | 4.92  | 50   | Small                                    | 1.25" x 1.875"  | 1/1 |
| Strung   |       |      |  |                 |     |
| APT1     | 28.50 | 1000 |  | 2 3/4x1 3/8"    | 2   |
| APT2     | 29.80 | 1000 |  | 3 1/4x1 5/8"    | 2   |
| APT3     | 31.09 | 1000 |  | 3 3/4x1 7/8"    | 3   |
| APT4     | 37.57 | 1000 | Manila                                   | 4 1/2x2 1/8"    | 3   |
| APT5     | 40.16 | 1000 |  | 4 3/4x2 3/8"    | 4   |
| APT6     | 42.76 | 1000 |  | 5 1/4x2 5/8"    | 5/6 |
| APT7     | 24.61 | 500  |  | 5 3/4x2 7/8"    | 3   |
| APT8     | 27.20 | 500  |  | 6 1/4x3 1/8"    | 3   |
| Unstrung |       |      |  |                 |     |
| APT1N    | 15.54 | 1000 |  | 2 3/4x1 3/8"    | 2   |
| APT2N    | 19.43 | 1000 |  | 3 1/4x1 5/8"    | 3   |
| APT3N    | 20.72 | 1000 | Manila                                   | 3 3/4x1 7/8"    | 3/4 |
| APT4N    | 22.02 | 1000 |  | 4 1/2x2 1/8"    | 4   |
| APT5N    | 27.20 | 1000 |  | 4 3/4x2 3/8"    | 4/6 |
| APT6N    | 29.80 | 1000 |  | 5 1/4x2 5/8"    | 6   |
| APT8N    | 23.32 | 500  |  | 6 1/4x3 1/8"    | 3   |



**Slit Tags**  
Slip over existing tag



**Alteration, Layaway and Repair Tags**



**Deluxe Layaway Alteration**



**Pressure Sensitive Labels**



**Merchandise Tags (4S - 8NS)**  
Available strung or unstrung.



**Kraft Tags**  
Shipping & Merchandise tags



**Manila All-Purpose Tags (APT)**  
Available strung or unstrung.

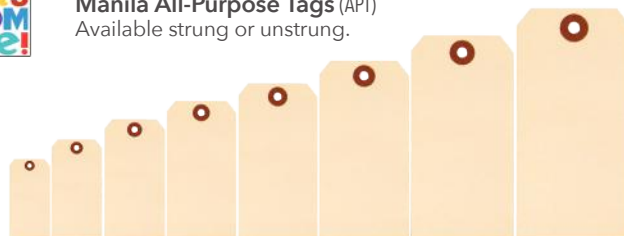

# GARMENT BAGS

## POLYBAG STANDS



### Garment Bag Dispenser /Single Roll Polybags

Base made of 1" square tubing w/ball bearing mounted platform for ease of turning



K31



### 3-Roll Bag Dispenser

Base made of 1" square tubing

K30



### Bagging Jack

For polybags; with heavy weight base

K32



## POLYBAGS



### Garment Bags (Polybags) on a Roll

- 1/2 mil Medium Weight Clear Poly Bags (NTP, X)
- 1 mil Super Weight Clear Poly Bags (U)
- 1 mil Super Weight Poly Bags in White (W) or Black (B)



## GARMENT BAGS

### Transportation Garment Bags

Water-repellent cotton duck w/ full length heavy-duty zippers and 15" hanging bar (with accessory pocket)

**Holds up to 25 garments**



HL38L  
HL48L  
HL57L



### 40" Suit Cover

Polyethylene (taffeta finish), 3 gauge



UV340BB



UV340N



UV340H

| style # | \$     | qty | description                    | size           | wgt |
|---------|--------|-----|--------------------------------|----------------|-----|
| K30     | 116.49 | 1   | Chrome Bagjack adjusts 39-68"H | 18x31x74H      | 29  |
| K31     | 83.49  | 1   | Chrome Bagjack adjusts 39-68"H | 13" x 18"      | 14  |
| K32     | 83.46  | 1   | Chrome Bagjack adjusts 39-68"H | Base: 12" dia. | 14  |

### Large Run Custom Poly Bags

Minimum 50 rolls (can mix sizes same color bag and print).

*Customer must supply camera-ready artwork.*

Black or white bags - stock ink colors include: red, blue, black, white, orange, yellow, green. One time plate charge of \$75.00

**Call us for a low, low price quote!**

|         |        |     |                            |          |       |
|---------|--------|-----|----------------------------|----------|-------|
| NTP330  |        | 840 | Clear                      | 21x4x30" |       |
| NTP338  |        | 663 | 1/2 mil                    | 21x4x38" |       |
| NTP340  | 55.47  | 562 | opening at top of each bag | 21x7x40" | 25    |
| NTP354  |        | 466 |                            | 21x4x54" |       |
| NTP372  |        | 350 |                            | 21x4x72" |       |
| X336    | 75.69  | 999 | Clear                      | 21x3x36" |       |
| X354    | 75.69  | 666 | 1/2 mil                    | 21x3x54" | 33    |
| X372    | 75.69  | 500 |                            | 21x3x72" |       |
| U336    | 75.69  | 519 | Clear                      | 21x3x36" |       |
| U354    | 75.69  | 333 | 1 mil                      | 21x3x54" | 33    |
| U372    | 75.69  | 249 |                            | 21x3x72" |       |
| W336    | 85.28  | 500 | White                      | 21x3x36" |       |
| W354    | 85.28  | 333 | 1 mil                      | 21x3x54" | 33    |
| W372    | 85.28  | 249 |                            | 21x3x72" |       |
| B336    |        | 500 | Black                      | 21x3x36" |       |
| B354    | 84.63  | 333 | 1 mil                      | 21x3x54" | 33    |
| B372    |        | 249 |                            | 21x3x72" |       |
| HL38L   | 78.90  |     | Dark Blue                  | 38"      |       |
| HL48L   | 78.90  | 1   | Dark Blue                  | 48"      | 3/33  |
| HL57L   | 78.90  |     | Dark Blue                  | 57"      |       |
| UV340BB |        |     | Black poly                 |          |       |
| UV340N  | 229.00 | 100 | Brown poly                 | 24 x 40" | 29/33 |
| UV340H  |        |     | Green poly                 |          |       |



| style #   | \$     | qty | description                   | size     | wgt |
|-----------|--------|-----|-------------------------------|----------|-----|
| ETB       | 368.19 | 50  | Black vinyl luggage           | 24 x 40" | 40  |
| NW40BB    | 239.89 | 100 | Black w/ID pocket             | 24 x 40" | 22  |
| NW48BBTUX | 88.49  | 50  |                               | 24 x 48" | 24  |
| NW54BB    | 156.69 | 50  |                               | 24 x 54" | 27  |
| NW455B    | 231.60 | 50  | Black w/handles and 4" gusset | 24 x 45" | 32  |

Customize "NW" styles with a a minimum order of 100 PIECES

|     |        |     |                  |          |    |
|-----|--------|-----|------------------|----------|----|
| S40 | 253.11 | 100 | Clear            | 24 x 40" | 34 |
|     | 246.24 |     | Color - specify  |          |    |
| S54 | 321.02 | 100 | Clear            | 24 x 54" | 36 |
|     | 303.00 |     | Color - specify  |          |    |
|     | 261.40 |     | Brown, Dark Blue |          |    |

**COLORS:** black, red, brown, beige, silver, dark blue, white, grey, clear and burgundy (note: no red or grey for 54" bag)

|         |        |     |  |  |      |
|---------|--------|-----|--|--|------|
| N8X21   | 57.54  | 100 | Clear /2 gauge                           | 8 x 21"                                  | 6/10 |
| BB72    | 79.83  | 12  | 10" Gusset<br>Imprint available<br>CLEAR | 24 x 72"                                 | 12   |
| BB66    | 75.69  |     | CLEAR                                    | 24 x 66"                                 | 11   |
| BB60    | 70.11  |     | CLEAR                                    | 24 x 60"                                 | 10   |
| BB54    | 65.97  |     | CLEAR                                    | 24 x 54"                                 | 10   |
| BLK72   | 61.82  | 12  | Black Vinyl                              | 24" wide at top; 36" at bottom; 72" long | 9/10 |
| W72     | 61.82  |     | White Vinyl                              |  |      |
| PNK72   | 64.54  |     | Pink Vinyl                               |  |      |
| NW7210  | 255.18 | 50  | Non-woven white cloth 10" gusset         | 24 x 72"                                 | 35   |
| NW72206 | 162.26 | 25  | Large 7"-20" full side gusset            | 24 x 68"                                 | 25   |

Customize "NW" styles with a a minimum order of 100 PIECES

|       |       |    |                                |          |       |
|-------|-------|----|--------------------------------|----------|-------|
| WGS72 | 75.69 | 12 | Full 10" Gusset<br>White Vinyl | 24 x 72" | 11/12 |
| C36   | 22.94 |    | Clear Vinyl                    | 24 x 36" | 4/7   |
| C54   | 28.51 | 12 | Clear Vinyl                    | 24 x 54" | 6/8   |
| C72   | 39.53 |    | Clear Vinyl                    | 24 x 72" | 7/8   |

## Luggage Weight Travel Bag

Taffeta finish with window/ card pocket. 6.8 gauge



ETB



## Non-Woven Suit Covers

Cloth-type covers

NW40BB /  
NW48BBTUX



NW455B

## Non-Woven Fur Covers

Cloth-type covers



## Zippered Suit Covers

3 gauge, taffeta finish

S40 / S54

## Sewn Shoulder Covers



N9X24

N8X21

## Crystal Clear Gusseted Vinyl Bridal Gown and Formal Covers

Reinforced hanger opening and full-length zipper. 4 gauge



Gusset detail



BB54  
BB60  
BB66  
BB72



BLK72

W72

PNK72

## Heavy-Duty Embossed Vinyl Bridal Gown Covers

Features a clear vinyl pouch. 3 gauge

## Heavy-Duty Full Length Gown Covers

Clear vinyl pouch and reinforced hanger opening. 3 gauge

## White Non-Woven Bridal Cover

Cloth-type material

NW7210/206



C36

C54



WGS72

## Overlap Clear Covers

Heavy binding, reinforced hanger opening and extra-wide overlap. 2 gauge

C36 / C54 / C72  
Can not be imprinted

# RACKS & MERCHANDISERS Collapsible Racks

## COLLAPSIBLE ROLLING RACKS

Fold flat for easy transportation and storage



Both racks have:



12" extending sides



Clip for storage



Adjustable heights

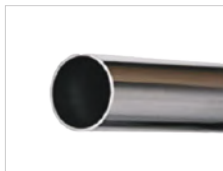

Heavy duty steel frame

### RCS-1/RCS2 ACCESSORIES

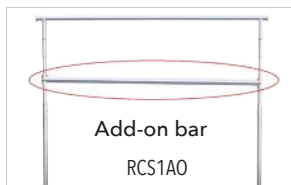

Add-on bar  
RCS1AO

Shelf/Display Screen



RCA5

Garment Rack Cover  
RCA100



Carrying Bag BRSWF

| style # | \$    | qty | description  | wgt   |
|---------|-------|-----|--|-------|
| RCS2    | 41.90 | 1   | Heavy Gauge Chrome: Lightweight, foldable rolling rack with a weight capacity of 250 lbs. Features include: adjustable height risers - 66" - 71"; Center bar that extends 8" on either side; 4 casters | 17    |
| RCS-1   | 59.90 | 1   | Chrome - 1" round tubing w/4"casters - 22 1/2" wide Adjustable height: 55" - 60" - 65"; 48" hangrail tubing w/12" pullouts; weight capacity of 200 lbs.  | 16/24 |



### RCS-1 vs RCS2

Collapsible, Rolling Clothing Racks:  
A side by side comparison

| RCS-1                        |                     | RCS2                          |
|------------------------------|---------------------|-------------------------------|
| \$69.99                      | <b>cost</b>         | \$63.90                       |
| Actual 16lbs /shipping 24lbs | <b>weights</b>      | Actual 17lbs/shipping 17lbs   |
| Holds up to 400 lbs          | <b>capacity</b>     | Holds up to 300 lbs           |
| 55" - 65"H<br>48"L x 22.5"W  | <b>measurements</b> | 65.5" - 70"H<br>48"L x 22.5"W |
| NO locking wheels            | <b>wheels</b>       | TWO locking wheels            |
| 4.45"H collapsed             | <b>compact</b>      | 3"H collapsed                 |



|        |       |   |   |       |
|--------|-------|---|---|-------|
| RCS1AO | 13.90 | 1 | Add on hang bar to create a lower level for hanging (works with both RCS-1 & RCS2)  | 4/5   |
| RCA5   | 54.04 | 1 | Chrome: Opened, 45" x 38" /Folded, 45" x 19" Screen only, rack not included (for RCS-1 rack) Includes two connecting brackets, one stabilizing hook, and 3" wheels with 3/8" stems. Fold in half to serve as merchandise shelf. | 13/19 |
| BRSWF  | 63.89 | 1 | Black heavy canvas carrying bag for collapsible rolling rack RCS1 (see RCS-1 pg 24)   | 4/12  |
| RCA100 | 98.50 | 1 | 60"L x 50"H x 24"W Deluxe zipper garment rack cover. Navy blue nylon  | 3/10  |



# Utility Racks **RACKS & MERCHANDISERS**

| style # | \$     | qty | description   | wgt   |
|---------|--------|-----|---|-------|
| RCS3    | 82.80  | 1   | Chrome, 22" wide<br>1" round chrome tubing<br>Double 48" hangrails with four 12"<br>pull-out rods<br>Height adjustable<br>from 55 to 60 to 65"<br>4" ball bearing casters               | 40/45 |
| EL8000  | 79.90  | 1   | Classic Utility Rack w/ 5 shelves<br>38" L x 14"W x 60" H<br>(61.5"H w/casters)<br>Zinc-plated industrial-strength steel<br><b>SHIPS TRUCK</b>  | 29/29 |
| EL8162  | 199.90 | 1   | Chrome Utility Rack<br>6 Shelves<br>48"W x 18"D x 72"H<br>2 3/4" dia. casters   | 98    |
| EL9000  | 209.90 | 1   | Utility Rack with four casters; holds<br>up to 2500 lbs (250 lbs per shelf);<br>36"Wx18"Dx72"H;<br>Includes leveling feet and<br>3" rubber wheels;<br>easy assemble - no tools required | 49    |
| K43     | 90.20  | 1   | 60" L, 1 1/4" hangrail<br>Adjusts in height from 54 - 74";<br>20" W; 3" casters   | 27    |
| R504    | 98.90  | 1   | 70"H x 66"L<br>1 1/4" chrome tubing<br>4" ball bearing casters<br><b>Ships Oversize UPS</b>   | 34    |
| R504AO  | 24.36  | 1   | Add on hangbar for R504 to<br>create a lower level for hanging  | 8/8   |

*The original garment center workhorse.  
Base is all-welded construction with heavy steel angle iron.  
Large 4" ball casters for easy mobility under heavy loads.*



**Heavy Duty  
Collapsible Rack**



EL8162

**Heavy Duty  
Utility Rack**



EL8000



**Classic  
Utility  
Rack w/5  
Wire  
Shelves**

EL9000

**Heavy Duty  
Mobile  
Shelving Unit  
/Utility Rack**



K43

**Stockroom  
Rolling Rack**



R504

**Add-on  
hangbar**  
R504AO



**Heavy Duty Industrial  
Rolling Rack**

## STANDARD Z RACKS

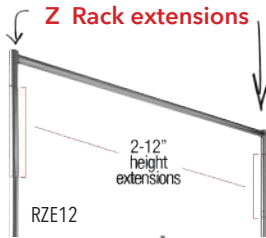

## NESTING "Z" RACKS



Industrial "Z" Rack Racks nest together to save space



## HEAVY DUTY Z RACKS

Universal Rack Cover



"Z" Rack Cover



| style #   | \$    | qty        | description   | wgt   |
|-----------|-------|------------|---|-------|
| Z101      | 74.90 | 1          | <b>Chrome finish stockroom rolling "Z" clothes rack</b> <ul style="list-style-type: none"> <li>• 73" overall height, 60"L x 69"H x 21"W</li> <li>• Ideal for use in showrooms and warehouses</li> <li>• Will nest together for easy storage when not in use</li> <li>• Heavy Z base is one piece construction</li> <li>• The hangrail is made of 1-1/4" round tubing</li> <li>• Includes 4" industrial rubber casters</li> </ul>  | 33/70 |
| RZE12     | 10.50 | set of 2   | 2 - 12" height extensions for Z101  | 33/20 |
| RZH60     | 28.51 | 1          | 60" add on hangrail for Z101  | 2     |
| Z201      | 94.99 | 1          | <b>Chrome finish industrial rolling "Z" clothes rack</b> <ul style="list-style-type: none"> <li>• 63"L x 66"H x 22"W with a blue base</li> <li>• Heavy duty Z base is one piece construction</li> <li>• Will nest together for easy storage when not in use</li> <li>• Features 4" industrial casters</li> <li>• Hangrail made of 1 1/4" square tubing and is 58 1/2" in length</li> <li>• Ideal for showrooms and warehouses</li> <li>• Ships Oversized UPS</li> </ul> | 34/39 |
| Z2464     | 78.41 | 1 set      | Clear Z-rack cover and 2 support bars set for Z101 & Z201; 63.5"W x 69.5"H x 22.5"D   | 4/4   |
| NHRCPB100 | 82.99 | 100 pc/ctn | Rack cover: large, flat polly bag; 58"W x 100"L; 1 mil. thick   | 43    |
| NHRCPB25  | 33.99 | 25 pc/ctn  | Rack cover: large, flat polly bag; 58"W x 100"L; 1 mil. thick   | 10    |

# Floor Racks RACKS & MERCHANDISERS

| style # | \$    | qty | description  | wgt |
|---------|-------|-----|--|-----|
| K40     | 83.16 | 1   | Chrome:<br>1" Square tubing<br>1 1/4" round hangrails<br>60"L x 22" W<br>Height adjustable every 3" from<br>48-66" | 38  |
| K41     | 99.90 | 1   | Same as K40 but with<br>center V reinforcing   | 40  |

Both K40 and K41 pair with casters  
**WHEL** (see details on page 31)

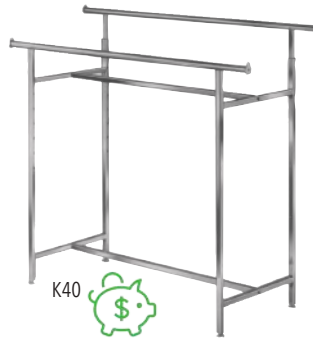

## DOUBLE BAR RACKS



## Rack Accessories (for racks K40 /K41)

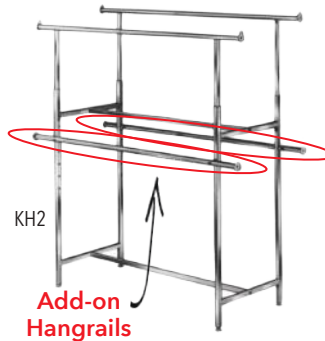

Double-Bar Grid  
Clothing Rack  
Topper  
1000034

|     |       |   |  |   |
|-----|-------|---|--|---|
| KH1 | 29.16 | 2 | Chrome:<br>60" add-on hangrail for K40 or K41<br>racks allows you to create 15'<br>of continuous hangrails using<br>only 2 racks | 8 |
| KH2 | 35.38 | 2 | 60" add-on hangrail for K40 or K41<br>racks allows you to create upper<br>and lower hanging                                      | 8 |

|         |       |   |   |       |
|---------|-------|---|---|-------|
| 1000034 | 81.99 | 1 | Chrome grid topper<br>23"x54"x3"<br><i>Ships oversize UPS</i> | 14/32 |
|---------|-------|---|---|-------|

Add-on  
Hangrails

## FOLDING LINGERIE DISPLAYERS



|     |        |   |  |    |
|-----|--------|---|--|----|
| K35 | 129.90 | 1 | Chrome:<br>1" Square tubing<br>16-twist on 12" tubular arms<br>61" H       | 34 |
| K36 | 129.90 |   | 1" Square tubing<br>16-twist on 1/2"x7/8"x12"<br>rectangular arms<br>61" H | 35 |

|     |        |   |   |    |
|-----|--------|---|---|----|
| K16 | 129.90 | 1 | Chrome:<br>1" Square tubing<br>8- 18" slant arms<br>Total of 40 hooks | 33 |
|-----|--------|---|---|----|

K16 pairs with a variety of casters -  
**CTM65, CTM75, TW12 & TW12LK** (details on page 31)

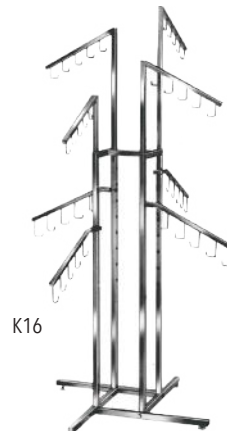

## HANDBAG DISPLAYER

# RACKS & MERCHANDISERS 4-Way Racks

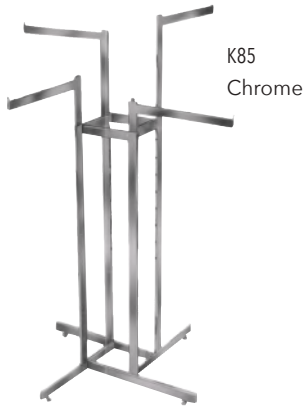

## 4-WAY GARMENT RACKS with Rectangular Tubing

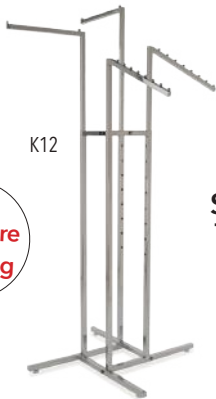
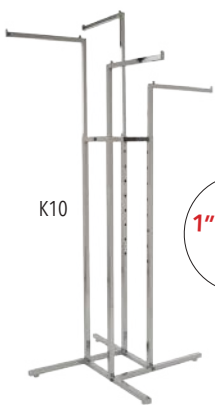
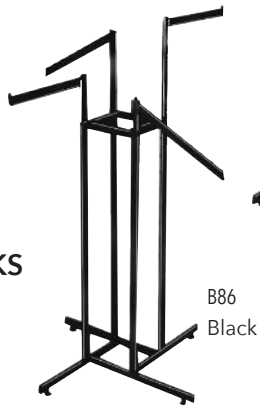

1" Square tubing

## 4-ARM SQUARE TUBING RACKS

## HIGH CAPACITY FLOOR RACKS

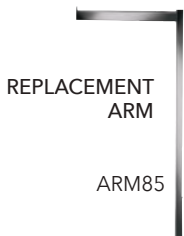

### ADD-ON DISPLAY BARS

Twist on  
Displays  
for Vertical  
1/2" x 1 1/2"  
Rectangular  
Tubing



| style # | \$     | qty | description  | wgt   |
|---------|--------|-----|--|-------|
| K85     | 118.32 | 1   | Chrome<br>4- 16" Straight arms<br>Rectangular Tubing | 33/35 |
| B85     | 118.32 | 1   | Black<br>4- 16" Straight Arms<br>Rectangular Tubing  | 36    |

Racks K85 & B85 pair with caster style  
**CTM60** (details on page 31)



|     |        |   |  |    |
|-----|--------|---|--|----|
| B86 | 118.32 | 1 | Black, 2- 16" Straight arms<br>2- 18" Slant arms<br>Rectangular Tubing | 38 |
|-----|--------|---|--|----|

Rack B86 pairs with caster style  
**CTM60** (details on page 31)



|     |       |   |  |    |
|-----|-------|---|--|----|
| K10 | 79.90 | 1 | 1" square tubing<br>16" straight arm<br>18" slant arm<br>Arms adjust every 3" from<br>48-72" H | 30 |
| K12 | 79.90 |   |  |    |
| K15 | 79.90 |   |  |    |

K10, K12 & K15 pair with casters from kit  
**TW10KIT516** (see details on page 31)



|       |        |   |   |    |
|-------|--------|---|---|----|
| K80   | 145.02 | 1 | Chrome, 4- 22" Straight arms<br>Rectangular tubing        | 34 |
| B80   | 121.05 |   | Black 4- 22" Straight arms<br>Rectangular tubing          | 36 |
| K80SC | 172.63 |   | Satin Chrome<br>4-22" Straight arms<br>Rectangular tubing | 38 |

The above 3 racks pair with caster style  
**CTM60** (details on page 31)



All of the above racks listed on this page  
adjust in height every 3" from 48" to 72" high

|       |       |   |  |     |
|-------|-------|---|--|-----|
| ARM85 | 18.01 | 1 | 16" Chrome Straight arm for<br>rectangular tubing racks                                      | 6   |
| RV16  | 6.99  | 1 | For Rectangular tubing racks:<br>16" Chrome Rectangular tubing<br>For vertical 1/2" x 1 1/2" | 2/6 |
| RV22  | 6.99  |   | 22" Chrome Rectangular tubing<br>For vertical 1/2" x 1 1/2"                                  |     |

# Floor Racks **RACKS & MERCHANDISERS**

| style # | \$     | qty | description  | wgt                  |
|---------|--------|-----|--|----------------------|
| K23     | 72.90  | 1   | Chrome Rectangular tubing<br>2-16" straight arms<br>Adjust every 3" from 48-72" H  | 32                   |
| K24     | 72.90  |     | Chrome Rectangular Tubing<br>2-18" slant arms adjust every 3"<br>from 48-72" H   | 34                   |
| K21X    | 106.27 | 1   | Chrome / 2-16" straight arms with<br>X style base and 4 casters; arms<br>adjust every 3" from 48-72" H                                 | 27                   |
| B90     | 79.06  | 1   | 1/2" W x 1 1/2" H<br>rectangular tubing arms:<br><br>Straight arm is 16"   | 7/10                 |
| B91     |        |     | Slant arm is 18"<br><br>Both racks are independently<br>adjustable every 3",<br>from 52" to 73" H                                      | 7                    |
| K20     | 59.90  | 1   | 1" square tubing<br>16" straight arm   | 18,6,5/8<br>(3 ctns) |
| K22     | 59.90  |     | 18" slant arm<br>Arms adjust every 3" from<br>48-72" H   | 23/33                |
| K25     | 59.90  | 1   | Chrome - 45" H x 19 1/2" W<br>Square tubing upright w/2 round<br>tubing arms with disc ends  | 18,6,6/8<br>(3 ctns) |
| K39     | 49.90  |     |  | 10/13                |
| ARM13   | 7.39   | 1   | 16" Chrome straight arm<br>for square tubing racks   | 6/8                  |
| TV17    | 7.00   |     | For Square tubing racks:<br>17" Chrome Rectangular tubing - for<br>vertical 1" tubing /add-on twist-on arms<br>for square tubing racks |                      |
| TV12    | 5.57   | 1   | 12" Chrome Square tubing<br>For vertical 1" tubing   | 1/6                  |
| TV16    | 6.35   |     | 16" Chrome Square tubing<br>For vertical 1" tubing   |                      |



**CHROME 2-ARM  
RECTANGULAR  
TUBING RACKS**



**MATTE BLACK  
ADJUSTABLE  
2-ARM RACKS**

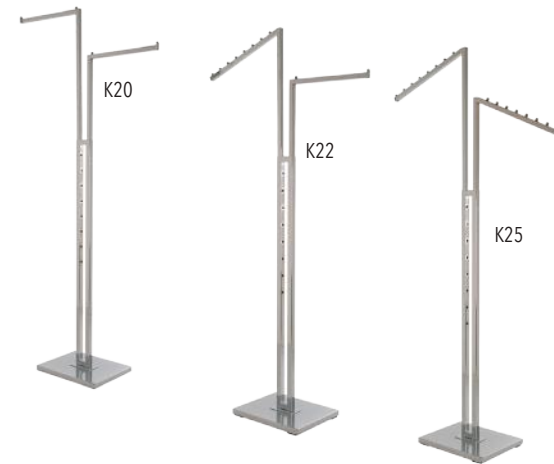

**CHROME  
2-ARM SQUARE  
TUBING RACKS**



**Chrome Bag Rack**



**Replacement Arm**

ARM13

Twist on  
Displays  
for 1"  
Square  
Tubing



**ADD-ON DISPLAY BARS**

# RACKS & MERCHANDISERS Round Racks



## ROUND GARMENT RACKS



K53  
Cannot be used with casters

## ROUND RACK ACCESSORIES



Chrome Grid (1000394)  
attached to a K50 rack



## GLASS OR MELAMINE ROUND TOPPERS



## ROUND RACKS

Welded Construction  
Can be used with casters

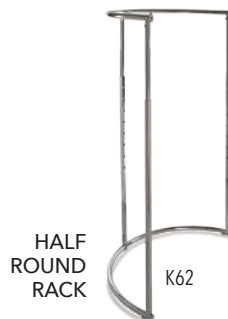

HALF ROUND RACK

| style #   | \$     | qty    | description  | wgt                    |
|---|--------|--------|--|------------------------|
| K50   | 99.90  | 1      | 36" round chrome rack<br><b>Ships oversized UPS</b>  | 8/17<br>26<br>(2 ctns) |
| Works with casters from kit<br><b>TW10KIT516</b> (see page 31 for details)  |        |        |  |                        |
| Racks adjust every 3" from 48" to 66"; uprights are 1" square tubing;<br>round 1 1/4" hangrail; includes shelf supports.  |        |        |  |                        |
| K53   | 114.49 | 1      | 36" Chrome round revolving rack;<br>Adjusts in height from 48-63"                                  | 34/90                  |
| KH5   | 43.68  | 1      | 36" add on hangrail for K50/K52WD<br><b>Ships oversized UPS</b>                                    | 8/17<br>26<br>(2 ctns) |
| KH7   | 27.09  | 4      | Clamps to add a ring   | 4                      |
| 1000394   | 75.49  | 1      | 30" Chrome grid topper   | 9/31                   |
| G30   | 99.90  | 2      | <b>2 pieces per carton</b><br>30" glass topper, 3/16" thick<br>for use with 36" round racks        | 52                     |
| G36   | 50.49  | 1      | <b>1 piece per carton</b><br>36" glass topper, 1/4" thick<br>for use with 42" round racks          | 30                     |
| <b>G30/G36 ships UPS oversized - charges will apply</b>   |        |        |  |                        |
| RTW30<br>RTB  | 45.23  | 1      | 30" round white topper<br>30" round black topper<br>for use with 36" round racks                   | 14                     |
| SHP1  | 1.49   | 1/each | Topper support<br><b>*4 needed for each rack</b>   | 1                      |
| <b>Racks with Welded Construction</b><br>(allows for heavy loads)   |        |        |  |                        |
| K52WD   | 149.90 | 1      | 36" round chrome rack<br><b>Ships truck</b>  | TRUCK<br>35/90         |
| Works with <b>CTM60</b> caster style - (details on page 31)   |        |        |  |                        |
| K71WDSC   | 149.90 | 1      | 36" Satin chrome;<br>adjusts from 48"-66" H<br><b>Ships truck</b>                                  | TRUCK<br>39/90         |
| K73WD   | 142.99 | 1      | 42" round chrome rack<br><b>Ships truck</b>  | TRUCK<br>38/90         |
| Works with <b>TW10KIT</b> casters - (details on page 31)  |        |        |  |                        |
| K73WDSC   | 179.90 | 1      | 42" round satin chrome rack<br><b>Ships truck</b>  | TRUCK<br>38/90         |
| Works with <b>CTM75</b> casters - (details on page 31)  |        |        |  |                        |
| KR57MAB   | 181.90 | 1      | 42" Black - same as K73<br><b>Ships truck</b>  | TRUCK<br>48/90         |
| Works with <b>CTM75</b> casters - (details on page 31)  |        |        |  |                        |
| Racks adjust from 48" to 70" H; uprights are 1" square tubing;<br>square tubing legs taper at bottom to allow casters to fit snugly;<br>hangrail is made of 1" x 1 1/2" rectangular tubing; includes shelf supports |        |        |  |                        |
| K62   | 126.96 | 1      | 43" half round rack; Adjusts in<br>height every 3" from 49-73" /<br>1" sq. tubing / round hangrail | 25/34                  |

# Accessories RACKS & MERCHANDISERS

| style #  | \$    | qty   | description  | wgt               |
|----------|-------|-------|--|-------------------|
| CTM60    | 9.72  |       | 2" ball caster, 1" stem  |                   |
| CTM65    | 9.07  |       | 2" ball caster, 5/8" stem  |                   |
| CTM75    | 10.50 | 1     | 2 1/2" ball caster, 5/8" stem  | 1/3               |
| TW12     | 5.44  |       | 2" twin wheel caster, 5/8" stem  |                   |
| TW12LK   | 4.15  |       | 2" twin wheel caster, 5/8" stem w/ locking brake   |                   |
| TW10KIT  | 8.81  | 1 set | set of (4) 2" wheels, 3/8" stem; (2) w/locking brakes; (2) w/out (works w/ racks K73WD, K87, B87)        | 2/2               |
| WHRCS    | 36.81 | 4     | Replacement casters - 4" for RCS-1, RCS2, RCS3   | 6                 |
| WHEL     | 37.32 | 4     | Heavy duty replacement casters - 2 locking and 2 non-locking; 2 3/4" dia. K40 / K41                      | 5                 |
| BBR2T    | 92.39 |       | 76" H x 5' L   | 26                |
| BBR48    | 52.10 | 1     | 48" H x 5' L   | 14                |
| BBR54    | 53.49 |       | 54" H x 5' L   | 16                |
|          |       |       | Black with chrome hangrails  |                   |
| K56      | 99.90 | 1     | 60" H Chrome Upper ring 19" diameter w/ 20 - 3" hooks Lower ring 27" D w/ 28- 3" hooks 18" diameter base | 11,17,15 (3 ctns) |
| K58      | 97.90 |       | 52" H Chrome 19" diameter ring w/ 20- 3" hooks 18" diameter base   | 23, 4/90 (2 ctns) |
| K29      | 73.49 | 1     | Chrome Spiral Costumer Spiral w/ 29 balls - 65" H round tubing, 18 1/2" base                             | 26                |
| VM504BR  | 79.90 | 2     | Notched Costumer Satin Chrome Adjusts every 3" from 49 - 78" high  | 11, 15 (2 ctns)   |
| VM504MTW | 79.90 | 2     | Notched Costumer Matte White Adjusts every 3" from 49 - 78" high   | 11, 14 (2 ctns)   |
| VM504MAB | 79.90 | 2     | Notched Costumer Matte Black Adjusts every 3" from 49 - 78" high   | 11, 15 (2 ctns)   |

## REPLACEMENT WHEELS



## BLACK BEAUTY RACKS

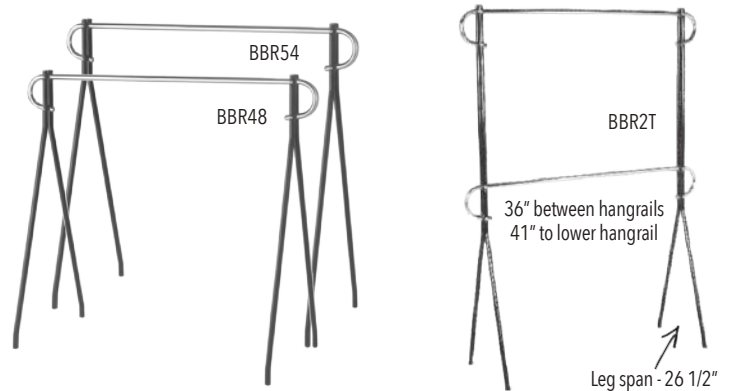

## TIE & BELT DISPLAYERS



## MANNEQUIN FORM NOTCHED COSTUMERS



Inspired by the Bauhaus arts and design movement, this contemporary collection of store fixtures evoke a sense of clean, sleek lines softened with round tubing arms. Use them as a group to delineate a specialty shop environment within your store.

## bauhaus curve series hangrails

*Satin Chrome. Uprights and bases constructed of 1" x 3" tubing. Height adjusts from 48" to 72" in 3" increments, Base: 30" x 24"*



**2-Way Merchandiser**  
Hangrail measures 48" wide; 1 1/4" diameter; 1 piece/case; 22 lbs

**BA48CRVSC \$154.90**



**Single S-Bar Merchandiser**  
Hangrail measures 48" wide; 1 1/4" diameter; 1 piece/case; 30 lbs

**BA45CURVSC \$182.90**



**Single C-Bar Merchandiser**  
Hangrail measures 48" wide; 1 1/4" diameter; 1 piece/case; 30 lbs

**BA45HFRSC \$199.90**



**Adjustable 4-Way Merchandiser**  
Hangrail measures 20" wide; 1" diameter; 1 piece/case; 46 lbs

**BA47CRVSC \$259.90**

## bauhaus collection in satin chrome



**Adjustable 2-Way Rack**  
Adjusts 46" to 75" H; Arms are 16" L x 1" Dia. with puck ends; Upright is 1" x 3" tubing; Base is 12" x 18". Levelers included; 1 piece; 22 lbs

**BA48SC \$129.90**



**Single Bar Merchandiser**  
Adjusts 48" to 72" H; Uprights are 1" x 3" tubing; Hangrail is 1 1/4" Dia. x 48" L with puck ends; Base is 24" x 24". Levelers included; 1 piece; 37 lbs

**BA45SC \$169.90**



**Adjustable 4-Way Rack**  
Adjusts 46" to 75" H; Arms are 16" L x 1" Dia. with puck ends; Uprights are 1" x 3" tubing; Base is 24" x 24". Levelers included; 1 piece; 45 lbs

**BA47SC \$219.90**



**Adjustable Costumer**  
74" H; Upright is 1" x 3" tubing with holes at 72", 60", 48" and 36" from floor. Includes two 6" x 1" diameter; faceouts with puck ends and levelers; 1 piece; 26 lbs

**BA46SC \$169.90**



**Folding Easel**  
Frame holds 22" x 28" sign. Easel is 1/2" x 1 1/2" tubing. Overall height is 60"; Legs are each 18" wide. 1 piece/case; 31 lbs

**BH80SC \$159.90**



**PIPELINE GARMENT RACKS**

Racks have an anthracite grey or a gloss white finish, where noted. Each garment rack includes 3" casters, 2-locking & 2 non-locking.



**Non-adjustable Ballet Bar Rack**  
64" high; Base: 51"W x 23-3/8"D; 1 piece; 31 lbs.

Anthracite Grey - NHPSBB  
Gloss White - NHPSBBWTE

**\$141.13**



**Adjustable Ballet Bar Rack**

Height adjusts from 48" to 72" high.  
Base: 51"W x 23-3/8"D; 1 piece; 35 lbs.

Anthracite Grey - NHPSBBADJ **\$203.86**  
Gloss White - NHPSBBADJWTE **\$180.14**



**Add-On Hangbar**

Only fits the adjustable ballet bar racks  
NHPSBBADJ, NHPSBBCB1ADJ &  
NHPSBBCB2ADJ; 1 piece; 6 lbs.

Anthracite Grey - NHPSAOH **\$56.76**  
Gloss White - NHPSAOHWH **\$51.99**



**60" Wide Ballet Bar Rack**

64" high; Base: 60"W x 23-3/8"D; 1 piece; 31 lbs.

Anthracite Grey - NHPSBB60

**\$160.19**



**60" Wide Adjustable Ballet Bar Rack**

Height adjusts from 48" to 72" high.  
Base: 60"W x 23-3/8"D; 1 piece; 38/46 lbs.

Anthracite Grey - NHPSBB60ADJ  
Gloss White - NHPSBB60ADJWH

**\$203.86**

**Double Tier Ballet Bar Rack**

Top Bar height adjusts from 63" - 78" high.  
Lower Bar Height adjusts from 45" - 60" high.  
Tier step difference measures 18".  
Base: 49 5/8"W x 23 1/4"D; 1 piece; 34/40 lbs.

Anthracite Grey - NHPSBBDTADJ

**\$172.99**



**Adjustable Double Ballet Bar Rack**

Each 50" Long hangbar adjusts from 50" to 78" high.  
Base: 50"W x 29"D; 1 piece; 61 lbs.

Anthracite Grey - NHPSBLLADJ **\$295.62**  
Gloss White - NHPSBLLADJWH **\$258.99**

**Double Ballet Bar Rack with Top**

**Frame Only - NHPSBB2TS**  
48"W x 24"D x 52"H;  
1 piece; 31 lbs.

**\$288.99**

NHPSBB2TS - MDF  
Optional Top in Darkwood measures 28" x 60" x 1.5";  
1 piece; 51 lbs.

**\$144.99**



**More PIPELINE** →

## Pipeline Garment Racks



**Adjustable 4-Way Rack**  
16" long arms adjust from 48" to 72" h;  
base measures 30"; 1 piece; 44 lbs.

Anthracite Grey - NHPSA4; \$204.64  
Gloss White - NHPSA4WH; \$177.99



**Double Bar Rack**  
48"L x 22"W; 60" Long Hangbars adjust from  
53-1/2" to 80" high; 2 pieces; 2ctns. 52, 10 lbs.

Anthracite Grey - NHPSDBR; \$247.92  
Gloss White - NHPSDBRWH; \$225.99



**Adjustable 36" Round Rack**  
Adjusts from 45" to 67" h;  
four (4) rubber tipped shelf supports  
(takes 30" round toppers - see pg 30);  
1 piece; 49/52 lbs.

Anthracite Grey - NHPSR36; \$198.99  
Gloss White - NHPSR36WH; \$198.99



**Adjustable Ballet Bar Rack**  
w/one crossbar  
41"W x 22"D; 44-72" high;  
13" faceouts;  
1 piece; 36 lbs.

Anthracite Grey -  
NHPS2CBADJ  
\$168.99



**Adjustable Ballet Bar Rack w/one crossbar**  
41"W x 22"D; 44-72" high; 13" faceouts; 1 piece; 37 lbs.

Anthracite Grey - NHPSBBCB1ADJ; \$184.99  
Gloss White - NHPSBBCB1ADJWH; \$184.99

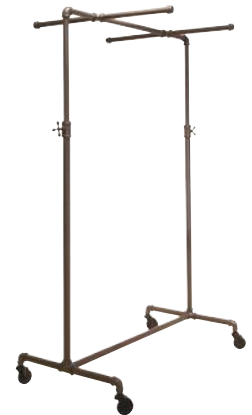

**Adjustable Ballet Bar Rack**  
w/two crossbars

41"W x 22"D; 44-72" high;  
13" faceouts; 1 piece; 50 lbs.

Anthracite Grey - NHPSBBCB2ADJ  
\$202.99



**Adjustable 2-Way Rack**

21"W x 21"D; 44-72" high; 13" faceouts;  
2 pieces; 4,8 lbs. / 4,17 lbs. (2ctns)

Anthracite Grey - NHPS2WADJ; \$112.99  
Gloss White - NHPS2WADJWH; \$112.99



**4-Leg Costumer**

60"H x 21"W x 21"D w/ 6" faceout;  
1 piece; 15 lbs.

Anthracite Grey - NHPSC2; \$95.99  
Gloss White - NHPSC2WH; \$95.99



**Replacement 2" Casters**  
Fits pipeline racks & costumers

|                    |                 |
|--------------------|-----------------|
| <b>NON-LOCKING</b> | <b>LOCKING</b>  |
| 1 piece; 2/6 lbs   | 1 piece; 18 lbs |
| NHCASPS            | NHCASPSLK       |
| \$6.99             | \$6.99          |

## Pipeline Outrigger and Wall Units

Units and accessories have an antracite grey or a gloss white finish, where noted.



### Outrigger Wall Unit

Set of two 96"H slotted uprights (1/2" slots on 1" centers). Can be spaced 24" or 48" on Centers; 1 piece; 30 lbs.

Anthracite Grey - NHPSOR; **\$156.43** Gloss White - NHPSORWH; **\$151.89**



### Freestanding Merchandiser

94" high x 20" deep x 48" wide. Slots (1/2" slots on 1" centers) are on each upright; 1 piece; 38, 28, 12 / 90, 90, 12 - 3 ctns.

Anthracite Grey - NHPFSF96; **\$374.41**  
Gloss White - NHPFSF96WH; **\$375.99**

## Accessories for Outrigger and Wall Units



### Extension Kits for Freestanding Merchandiser

Connect & stabilize two units together.

- Guarantees easy alignment for the 24" or 48" accessories between 2 units.
- Kits include 2 spacers. Can be used on top & bottom or along back.

Anthracite Grey - NHPFSFKT24 - 24"w 7 lbs; **\$34.99**

Gloss White - NHPFSFKT24WH - 24"w

Anthracite Grey - NHPFSFKT48 - 48"w 10 lbs; **\$47.95**

Gloss White - NHPFSFKT48WH - 48"w 10 lbs; **\$43.99**



### Hangrails

Mounts on rear facing slots of uprights.

2 pieces/carton.

48" wide; 14lbs.

Anthracite Grey - NHPSORHB48 **\$100.57**

Gloss White - NHPSORHB48WH **\$82.99**

24" wide; 10 lbs:

Anthracite Grey - NHPSORHB24 **\$76.98**

Gloss White - NHPSORHB24WH **\$76.49**



### Hangrail with 1 Faceout

Works on forward facing slots of uprights of Freestanding Merchandiser only.

24" wide w/12 3/4" faceout;  
2 pieces/carton; 11/17 lbs.

Anthracite Grey - NHPSORFO24N **\$95.49**

Gloss White - NHPSORFO24NWH



### Hangrail with 2 Faceouts

Works on forward facing slots of uprights of Freestanding Merchandiser only.

48" wide w/12 3/4" faceouts;  
2 pieces/carton; 21/31lbs.

Anthracite Grey - NHPSORFO48N **\$162.26**

Gloss White - NHPSORFO48N WH **\$152.99**



### Hangrail with 1 Faceout

Mounts on rear facing slots of uprights.

24"W with one 12" long faceout;

2 pieces/carton; 18/20 lbs.

Anthracite Grey - NHPSORFO24 **\$123.99**

Gloss White - NHPSORFO24WH



### Hangrail with 2 Faceouts

Mounts on rear facing slots of uprights.

48"W with two 12 3/4" long faceouts;

2 pieces/carton; 29/37 lbs.

Anthracite Grey - NHPSORFO48 **\$161.87**

Gloss White - NHPSORFO48WH **\$152.99**



### Add On Arms

**3" Long**

1 piece; 1 lb

Anthracite Grey - NHPSCLP03 **\$14.99**

Gloss White - NHPSCLP03WH

**16" Long**

2 pieces; 2 lbs

Anthracite Grey - NHPSF013 **\$52.75**

Gloss White - NHPSF013WH



### Large Display Shelves

Bottom of shelf includes a slot for brackets to lock in to and metal support bar to handle heavy loads; 46 3/8"W x 15 3/4"D; 2 pcs/carton; 46 lbs.

Black Melamine - NHPSORSLF48-ML **\$147.74**

White Melamine - NHPSORSLF48MLWH **\$133.23**

### Small Display Shelves

Bottom of shelf includes a slot for brackets to lock in to. 22 3/8"W x 15 3/4"D; 2 pcs/carton; 20 lbs.

Black Melamine - NHPSORSLF24-ML

White Melamine - NHPSORSLF24MLWH **\$60.99**



### Shelf Brackets

Left & right (set) for use w/ shelves 2 set (4 pcs); 4 lbs.

Anthracite Grey - NHPSORKB **\$27.09**

Gloss White - NHPSORKBWH

# CLOTHING RACKS Pipeline Collection

## Pipeline Accessories

### Acrylic Sign Holders

Sign holder with swedge stem and C style clamp.  
Fits pipeline racks & costumers.



**5"H x 7"W**  
includes clamp; 1 piece; 1 lb.  
Anthracite Grey - NHPSPJ57P24;  
**\$17.37**  
Gloss White - NHPSPJ57P24WH;  
**\$12.57**

**7"H x 11"W**  
includes clamp; 1 piece; 1lb.  
Anthracite Grey - NHPSPJ711P24;  
**\$19.44**  
Gloss White - NHPSPJ711P24WH  
**\$14.99**

### Wall Mount Faceouts



**4 1/2" Long**  
1 piece; 1 lb  
Anthracite Grey - NHPSSW04 **\$9.70**  
Gloss White - NHPSSW04WH  
**\$13.40**



**10" Long**  
1 piece; 1 lb  
Anthracite Grey - NHPSSL10  
**\$14.70**  
Gloss White - NHPSSL10WH  
**\$13.50**

### Slatwall Faceouts



**4 1/2" Long**  
1 piece; 1 lb  
Anthracite Grey - NHPSSW04 **\$9.12**  
Gloss White - NHPSSW04WH  
**\$8.52**



**10" Long**  
1 piece; 1 lb  
Anthracite Grey - NHPSSW10  
**\$11.16**  
Gloss White - NHPSSW10WH  
**\$10.56**

## Pipeline Tables & Floor Displayers



Large Nesting Table

Small Nesting Table



Table Topper



Display Table



Tower Table

### Large Nesting Table

Frame w/top 62"w x 34"d x 32"h;  
1 pc; 18, 42 lbs (2 ctns);  
Anthracite Grey - NHPNTLSET;  
**\$325.49**  
Gloss White - NHPNTLWHSET;  
**\$325.49**

### Small Nesting Table

Frame w/top 48"w x 24"d x 24"h;  
1 pc; 39, 41 lbs (2 ctns);  
Anthracite Grey - NHPNTSSET;  
**\$218.99**  
Gloss White - NHPNTSWHSET;  
**\$218.99**

### Table Topper

Frame w/top 54"w x 14"d x 13 1/2"h;  
Dark Brown Melamine table top;  
1 pc; 6, 29 lbs (2 ctns);  
Anthracite Grey - NHPNTTOPSET  
**\$109.99**

Frame w/top  
28"w x 16"d x 18"h;  
Dark Brown Melamine table top;  
1 pc; 39, 17 lbs (2 ctns);  
NHPSDTSET **\$144.99**

Frame w/top  
14"w x 14"d x 40"h;  
Dark Brown Melamine table  
top;  
1 pc; 36, 81 lbs (2 ctns);  
NHPSTTSET **\$162.99**

Frame only 58"w x 30"d x 30 1/2"h;  
1 pc; 22 lbs;

Anthracite Grey - NHPNTL  
**\$151.99**  
Gloss White - NHPNTLWH  
**\$151.99**

Frame only 44"w x 20"d x 22 1/2"h;  
1 pc; 18 lbs;

Anthracite Grey - NHPNTS  
**\$122.99**  
Gloss White - NHPNTSWH  
**\$122.99**

Frame only 50"w x 12"d x 12"h;  
1 pc; 6 lbs;

Anthracite Grey - NHPNTTOP  
**\$51.99**

Frame only  
27"w x 15"d x 17"h;  
1 pc; 39 lbs;  
NHPSDT **\$122.04**

Frame only  
13"w x 13"d x 39"h;  
1 pc; 39 lbs;  
NHPSTT **\$118.99**

## Countertop Displays

Pipeline Displayers feature anthracite grey piping and 3/4" thick bases with a stained cherry finish.

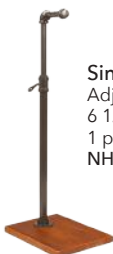

**Single Accessory Displayer**  
Adjusts 16-26"h; 4 1/4" faceout;  
6 1/2"w x 8 1/2" d;  
1 piece; 4 lbs.  
NHPST1 **\$58.99**



**Countertop Mirror**  
10" h x 7 7/8"w; 13 9/16"h;  
8" sq. base; 1 piece; 7 lbs.  
NHPST1078 **\$66.48**



**Triple Accessory Displayer**  
Adjusts 15 1/2-27"h; 8"w  
crossbar; 20"w x 8"d base;  
1 piece; 10 lbs.  
NHPST3X **\$123.99**



### Tiered Accessory Displayers

Small - 8 1/2"h w/ 6 1/2" sq. base; 1 piece; 3 lbs.  
NHPSTAMMS **\$74.26**

Medium - 11 1/2"h w/ 6 1/2" w x 8 1/2" d base; 1 piece; 3 lbs.  
NHPSTAMMM **\$60.99**

Large - 17 1/2"h w/ 6 1/2" w x 8 1/2" d base; 1 piece; 4 lbs.  
NHPSTAMML **\$77.99**

## Black Economy Pipe Racks A matte-black pipe rack collection for less



- 1 Ballet Bar Rack - black**  
48" w x 23.5" d; 48-72" h adjustable; 1 piece; 34/37 lbs; **NHPLKBB \$132.32**  
*\* Casters available*
- 2 Round rack - black**  
Round rail-36" dia; base-42" d; 46" h (not adjustable); includes casters; 1 piece;  
20/44, 15 lbs (2 ctns); **NHPLRR \$303.00**
- 3 Half-round rack - black**  
35" w / height adjustable from 54"; 1 piece; 20, 8/21 bs (2 ctns);  
**NHPLHR \$129.60**
- 4 4-way pipe rack - black**  
30" base; 16" arms; 48-72" h; 1 piece; 40, 19 lbs (2 ctns); **NHPLK4 \$206.97**  
*\* Casters available*
- 5 2-way pipe rack - black**  
24.5" w x 18.5" d base; 16" arms; 48-72" h; 1 piece; 18, 4 lbs (2 ctns); **NHPLK2 \$96.81**  
*\* Casters available*
- 6 H rack - black**  
48" w x 30" d base; height 48-72"; (*Grid topper sold separately*); 1 piece; 50,  
17/21, 7 lbs (3 ctns); **NHPLKH \$209.43**  
*\* Casters available*
- 7 Outrigger pipe rack - black**  
90" h; 1/2" slots on 1" center; stands 3.5" from wall; 2 pieces; 19 lbs;  
**NHPLKF5 \$131.80**
- 8 Display rack with 3 wood trays - black**  
24"L x 24"W x 52"H; (3) adjustable wood trays measure 17"L x 10"W x 3"h, are  
finished in cinnamon melamine & rotate to a 45° or 90° angle; 1 piece; 39/70 lbs;  
**DTB242452BP \$347.72**

## Black Economy Pipe Rack Accessories matte black finish



**C Hangrail for Outrigger rack - black**  
24" w; 12" deep; 1 piece; 20/21 lbs;  
**NHPL12CH \$18.53**

**3" Casters - black**  
3" casters, two with brakes and two  
without; 4 pieces; 5 lbs;  
**NHPLCASTER \$46.66**



**NHPLCASTER**



**12" Hangrail bracket for  
Outrigger rack - black**  
1 piece; 22 lbs; **NHPLCR12  
\$7.26**



**3" Hangrail bracket for  
Outrigger rack - black**  
1 piece; 14 lbs;  
**NHPLCR3 \$5.18**



**12" Faceout w/ball end for  
Outrigger rack - black**  
1 piece; 19 lbs;  
**NHPLRDW12 \$5.18**

## BLACK LADDER SYSTEM

The extremely versatile Ladder System allows you to vary your merchandising techniques to suit any retail environment.

The black finish tower ladders measure 73"H and can be accessorized with specialized hangrails, shelves, face-outs and waterfalls (sold separately).

Ships truck.  
Some assembly required.



1 A305B



2 A304B

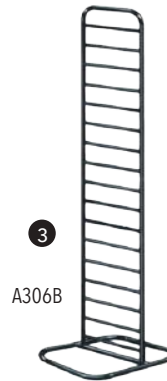

3 A306B



4 A301B



5 AT66B



6 AT77B



7 ARL48B



8 AF12B



9 NHACT4



10 AF7B

- 1 **Double Two-Tier Wall Unit - black**  
16"W x 96"L x 88"H; 1 piece; 92 lbs; **must ship truck**; A305B \$286.04
- 2 **Single Two-Tier Wall Unit - black**  
16"W x 48"L x 88"H; 1 piece; 58/90 lbs; **must ship truck**; A304B \$185.85
- 3 **Tower Ladder - black**  
14"W x 73"H; 18" x 22" base; 1 piece; 23 lbs; A306B \$126.23
- 4 **Double Center Floor Rack - black**  
28"W x 48"L x 58"H; 1 piece; 57 lbs; **must ship truck**; A301B \$169.25
- 5 **Top Shelf - black** Fits A301B  
Epoxy coated perforated steel; 25" x 48"; 1 piece; 18/26 lbs; AT66B \$101.99

- 6 **Interior Shelf - black** Fits all ladders  
Epoxy coated perforated steel; 14" x 45"; 1 piece; 11/15 lbs; AT77B \$50.67
- 7 **Straight Hangrail - black**  
With attached 1/4" chrome wire protector; 48"; 1 piece; 4/5 lbs; ARL48B \$15.29
- 8 **12" Faceout - black**  
Rectangular tubing; 1 piece; 2 lbs; AF12B \$6.99
- 9 **Caster - black**  
4" caster w/ 1"L & 5/16" dia. stem; 150 lb. capacity; 1 piece; 2/2 lbs; NHACT4 \$9.07
- 10 **7-Cube waterfall - black**  
16" L; 1/2" x 1 1/2" thick; 1 piece; AF7B \$10.49

## DESIGNER 400 SERIES

style #   \$   qty   description   wgt

|      |       |   |   |     |
|------|-------|---|---|-----|
| RV24 | 13.74 | 1 | Chrome<br><br>Attaches to rectangular or square tubing<br>1/2" on 1" center | 5/9 |
|------|-------|---|---|-----|

RV24 - A bracket made of rectangular tubing that supports DA224 (13" x 24") Duron shelves. The bracket has a clamp that attaches to an upright of a rectangular or square tubing rack. Tightening screws included.

|        |        |   |                |                        |
|--------|--------|---|----------------|------------------------|
| K410B  | 181.18 | 1 | Black shelves  | 9/11, 26 lbs<br>2 ctns |
| K410AL | 171.99 |   | Almond shelves |                        |
| K410GY | 171.99 |   | Grey shelves   |                        |
| K410W  | 164.72 |   | White shelves  |                        |

57" H, 1" matte black square tubing frame; (8) 12" shelf brackets; (4) 13" x24" shelves; includes casters and one T-stand

|        |        |   |                |                              |
|--------|--------|---|----------------|------------------------------|
| K411B  | 279.99 | 1 | Black shelves  | 9/11, 9/11, 41 lbs<br>3 ctns |
| K411AL | 285.99 |   | Almond shelves |                              |
| K411GY | 285.99 |   | Grey shelves   |                              |
| K411W  | 276.99 |   | White shelves  |                              |

54" H, 1" matte black square tubing frame; (16) 12" shelf brackets; (8) 13" x24" shelves; (2) 36" x 1 1/4" round hangrails

|        |        |   |                |                        |
|--------|--------|---|----------------|------------------------|
| K400B  | 187.50 | 1 | Black shelves  | 9/11, 32 lbs<br>2 ctns |
| K400AL | 184.99 |   | Almond shelves |                        |
| K400GY | 184.99 |   | Grey shelves   |                        |
| K400W  | 180.99 |   | White shelves  |                        |

57" H, 1" x 2" matte black rectangular tubing frame; (8) 12" shelf brackets; (4) 13" x24" shelves; includes casters; two 16" arms adjust to 70" H

**Twist on Shelf Support**  
Converts any 4 arm rack to display folded and hanging apparel



## ECONOMY IMPORT SHOWCASES



### FULL VISION SHOWCASES



Assembly required



SC



| style #                      | \$     | qty | description   | size                  | wgt   |
|------------------------------|--------|-----|---|-----------------------|---|
| SC4B<br>SC4W<br>SC4M<br>SC6C | 224.08 | 1   | Includes 2 glass shelves and shelf brackets:<br><br>Black<br>White<br>Maple<br>Cherry | 38"H x 18"D<br>x 48"L | 80/90,<br>30,<br>10,<br>10 lbs;<br>(4 ctns) |
| SC6B<br>SC6W<br>SC6M<br>SC6C | 317.91 | 1   | Black<br>White<br>Maple<br>Cherry   | 38"H x 18"D<br>x 72"L | 100,<br>30,<br>30,<br>20 lbs;<br>(4 ctns)   |

#### Standard LPL Finishes



### CORNER FILL-IN

Fill-in counters enable you to create various counter configurations and display merchandise.



Barnwood



Rustic Grey



Black



White



Maple

CFC20

|       |        |   |   |                       |       |
|-------|--------|---|---|-----------------------|-------|
| CFC20 | 134.14 | 1 | Corner fill-in - includes 2 glass shelves | 38"H x 18"D<br>x 18"L | 36/75 |
|-------|--------|---|---|-----------------------|-------|

Specify Barnwood, Rustic Grey, Black, White or Maple for CFC20 above and SCPC18 below

### PENTAGONAL FILL-IN

SCPC18



|        |        |   |   |                       |                            |
|--------|--------|---|---|-----------------------|----------------------------|
| SCPC18 | 138.67 | 1 | Pentagonal fill-in - includes 2 glass shelves | 38"H x 18"D<br>x 18"L | 30,<br>18 lbs;<br>(2 ctns) |
|--------|--------|---|---|-----------------------|----------------------------|

### REGISTER STAND

Perfect as a stand alone or with a wrap counter and corner fill-in unit.

RS24



|        |        |   |   |                       |    |
|--------|--------|---|---|-----------------------|----|
| RS24BW |        |   | Includes 1 (4"H) drawer & 1 wood shelf<br>Well Top (w/6" well):<br><br>Barnwood |                       |    |
| RS24RG |        |   | Rustic Grey   |                       |    |
| RS24B  | 134.52 | 1 | Black   | 38"H x 18"D<br>x 24"L | 81 |
| RS24W  |        |   | White   |                       |    |
| RS24M  |        |   | Maple   |                       |    |



# Shelves RACKS & MERCHANDISERS

| style #   | \$     | qty | description          | wgt |
|---|--------|-----|----------------------|-----|
| W1224   | 88.99  | 8   | White / 12"x24"      | 45  |
| B1224   |        |     | Black / 12"x24"      |     |
| M1224   |        |     | Maple / 12"x24"      |     |
| W1248   | 99.99  | 4   | White / 12"x48"      | 45  |
| B1248   |        |     | Black / 12"x48"      |     |
| M1248   |        |     | Maple / 12"x48"      |     |
| W1448   | 110.99 | 4   | White / 14"x48"      | 50  |
| B1448   |        |     | Black / 14"x48"      |     |
| M1448   |        |     | Maple / 14"x48"      |     |
| <b>Metal shelf signs</b>  |        |     |                      |     |
| Ledge piece is 6" front to back; sign holder piece is 6 1/2" across |        |     |                      |     |
| NHSTCH  | 9.72   | 1   | Metal                | 1   |
| NHSTV   | 7.00   |     | High polished chrome |     |
| Accepts 6 1/2"W x 1 1/2"H paper inserts, (not included)             |        |     |                      |     |
| SHGL1048  | 98.49  | 5   | 10" x 48"            | 43  |
| SHGL1224  | 49.25  |     | 12" x 24"            | 28  |
| SHGL1248  | 88.20  |     | 12" x 48"            | 53  |
| SHGL1448  | 99.14  |     | 14" x 48"            | 61  |
| Ships truck   |        |     |                      |     |

## MELAMINE SQUARE EDGE SHELVES



## METAL SHELF OVERLAY RETAIL SIGNS w/framed front

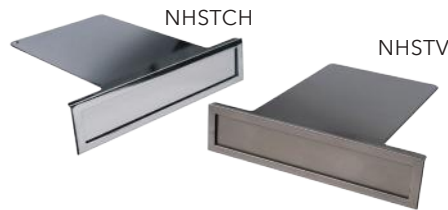

## TEMPERED GLASS SHELVES



3/16" thick



All sizes packed 4 of one size and color per carton:

13" Shelves - to be used with 12" brackets:

| OPEN BOTTOM |        |   |       |      |
|-------------|--------|---|-------|------|
| 13" x 24"   |        |   |       |      |
| DA224B      | 49.99  | 4 | Black | 9/11 |
| DA224G      | 60.49  |   | Grey  |      |
| DA224W      | 49.25  |   | White |      |
| 13" x 48"   |        |   |       |      |
| DA248B      | 90.85  | 4 | Black | 29   |
| DA248W      | 85.99  |   | White |      |
| DA248G      | 123.99 |   | Grey  |      |

15" Shelves - to be used with 14" brackets:

| OPEN BOTTOM                   |        |   |                        |       |
|-------------------------------|--------|---|------------------------|-------|
| 15" x 24" (almond & grey n/a) |        |   |                        |       |
| DA424W                        | 94.35  | 4 |                        | 13/16 |
|                               |        |   |                        |       |
| DA448B                        | 112.99 | 4 | 15" x 48" (black only) | 27/30 |
| DA450B                        | 166.40 |   | 15" x 50" (black only) |       |

follow style # by /B (for black) /W (for white) /G (for grey) /A (for almond)

How to order special finishes:

STYLE NO. FIN #3 /Surface coverage (woodgrain) on top, bullnose and sides. Add \$10.90 for each shelf.

How to order:

- (1) Choose shelf desired;
- (2) Choose style or surface coverage desired (FIN #2 or FIN#3);
- (3) Choose woodgrain color desired;
- (4) **Min. order 12 shelves per finish;**
- (5) Cost of shelf and cost of woodgrain finish equals total cost. Allow approx. 3-4 weeks.

## DURON BULLNOSE SHELVES

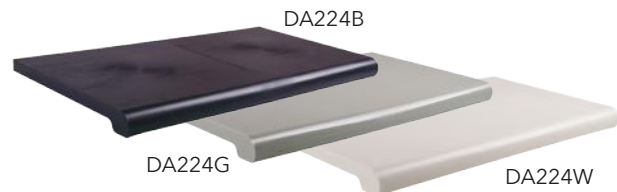

SPECIAL FINISHES

Min. order 12 pieces



Hard Rock Maple



Medium Oak



Walnut

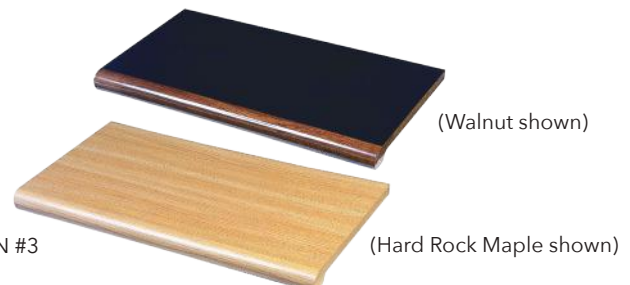

# RACKS & MERCHANDISERS Tables & Bins



**36" Round Folding Table**

WT25



**Lightweight Work Table**

LWT3072



DT48C

chrome

**Folding Dump Table**  
Includes locking casters



white

black



Table folded for storage

**Dump Bin**  
Adjustable base deck.  
Casters optional



white



black



chrome

GTC48C

| style #                            | \$     | qty | description   | size                                   | wgt                    |
|------------------------------------|--------|-----|---|--|------------------------|
| WT25                               | 124.50 | 1   | Table - plywood w/vinyl bullnose edging<br><br>Constructed from high quality 3/4" 12-ply plywood; coated with UV resistant polyurethane; hardwood runners underneath tabletop; legs fold; folded tables are stackable | 36" dia.<br>30"H                       | 80/100                 |
| LWT3072                            | 155.39 | 1   | Lightweight folding work table  | 30"H x 72"L x 30"W                     | 37/90                  |
| <i>ships in 7-10 business days</i> |        |     |   |  |                        |
| DT48C                              | 206.76 |     | CHROME  | 47"L                                   |                        |
| DT48W                              | 186.99 | 1   | WHITE   | 23 1/2"W<br>31"H                       | 35/74                  |
| DT48B                              | 220.90 |     | BLACK   | 4 5/8"D                                |                        |
|                                    |        |     | Includes 2 locking and 2 non-locking casters  |  |                        |
| GTC48B                             | 149.43 |     | BLACK   | All styles measure 38" x 38" x 34 3/4" | 80<br>Ships UPS ground |
| GTC48W                             | 149.43 | 1   | WHITE   |  |                        |
| GTC48C                             | 199.90 |     | CHROME  |  |                        |
| RCS2                               | 63.90  | 1   | Heavy Gauge Chrome: Lightweight, foldable rolling rack with a weight capacity of 250 lbs. Features include: adjustable height risers - 66" - 71"; Center bar that extends 8" on either side; 4 casters                |  | 17                     |
| RCS-1                              | 69.99  | 1   | Chrome - 1" round tubing w/4"casters - 22 1/2" wide Adjustable height: 55" - 60" - 65"; 48" hangrail tubing w/12" pullouts; weight capacity of 200 lbs.   |  | 25/45                  |

## COLLAPSIBLE ROLLING RACKS

Fold flat for easy transportation and storage



RCS2



RCS-1

# Displayers RACKS & MERCHANDISERS

| style #              | \$     | qty | description  | wgt    |
|----------------------|--------|-----|--|--------|
| DDB242143C           | 219.80 | 1   | 4 Stacking Chrome Baskets:<br>24"L x 21"W x 43"H; collapsible;<br>w/4 black casters  | 40/122 |
| BIN2                 | 47.17  | 1   | BLACK<br>30" x18" x1 8"  | 11/14  |
| IMPULSE41P           | 119.49 | 1   | Impulse Tower w/4 Bowls:<br>Clear polycarbonate bowls with<br>metal grey powdercoated base<br>and pole. Acrylic signholder<br>top included; 65 1/2" H;<br>bowls: 12 1/8" dia;<br>6 1/8" depth<br>base: 16" dia.<br>signholder: 7" x 5 1/2" | 22/27  |
| NHSDR                | 84.94  | 1   | Wire Spinner Rack<br>4 adjustable spinning tiers<br>with 16 hooks;<br>Black;<br>Heavy duty plastic base and<br>sign holder for signs 8 1/2 x 11"<br>and 1mm thick;<br>Dims: 24" footprint; 66" high;<br>hook length 5"                     | 14/24  |
| DDB4518B<br>DDB4518W | 85.54  | 1   | 3-Tier Round Impulse Bin:<br>45"H x 18"W; w/ 3 round baskets<br>each measuring 7"H x 18"W<br>Black<br>White  | 23/23  |
| DDB1947B             | 86.70  | 1   | 3-Tier Square Bin:<br>Black; 19"W x 47"H;<br>baskets – 6 1/2"H x 16"W each   | 30/30  |
| DDB1254B             | 107.44 | 1   | 4-Tier Round Display Bin:<br>Black; 54 1/2"H x 12"W; w/ 4 circular<br>baskets measuring 6 1/2"H x 12"W   | 19/19  |
| IMPULSE4W            | 115.99 | 1   | Black floor display rack with<br>4 separate brushed chrome wire<br>rotating baskets.<br>Rack measures 66"H x 22"W;<br>Each individual basket measures<br>21 3/4"W x 7"D  | 10/38  |



DDB242143C

4-Tier  
Stacking  
Chrome  
Baskets  
w/casters



Folding  
Square  
Basket

BIN2

### Impulse Posts

Great for small  
or end of  
season  
clearance  
items near  
register

IMPULSE41P



Holder for  
8.5"x11" signs



Wire Spinner  
Rack



NHSDR

### 3-TIER BINS



DDB4518B



DDB4518W



DDB1947B



DDB1254B



IMPULSE4W

### 4-TIER BINS

# STANDARD SLATWALL PANELS

Laminated, 3/4" medium density fiber board. Optional inserts must be installed at time of manufacturing for an additional charge (see inserts below).

4' high x 8' long panels. Each panel weighs between 80-100 lbs., and must ship via truck. Crate charge on 1-34 sheets is \$45.00. 

## Slatwall Orientation

Horizontal

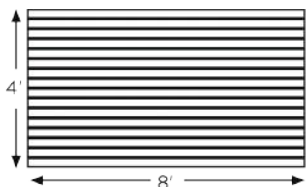

## Optional Inserts

Metal inserts add strength, and enhance the appearance.

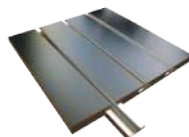

Metal inserts



## SOLIDS / MIRROR



WHITE  
SW48W \$88.99



BLACK  
SW48BK \$93.99



LIGHT GREY  
SW48LG \$90.99



DARK GREY  
SW48G \$90.99



MIRROR  
SW48MIR \$363.99

## WOOD GRAINS



OAK  
SW48O \$91.99



MAHOGANY  
SW48M \$96.99



HARDROCK MAPLE  
SW48HM \$90.99



WEATHERED BARNWOOD  
SW48WB \$97.99



ASH BARNWOOD  
SW48AB \$97.99

## RUSTICS /textured



ASPEN OAK  
SW48AO \$97.99

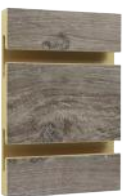

STORMY OAK  
SW48SO \$97.99



TIMBERCREEK OAK  
SW48TCO \$97.99



RECLAIMED BARNWOOD  
SW48RB \$97.99



CAMPFIRE ASH  
SW48CA \$97.99



WHITEWASHED FENCE  
SW48WWF \$97.99

All prices are per panel with No Insert / NI

### INSERT options



Black Aluminum / BAI

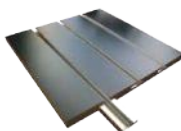

Aluminum / AI

\* Note that actual colors may vary slightly from images.

**Lead time is 2-3 weeks, with and with out inserts.**

CALL or visit online CHAT at [nahanco.com](http://nahanco.com) for more info.  
Our friendly Customer Service reps are based in the USA and ready to assist.

*Panels made in the USA*

# Slatwall Accessories WALL SYSTEMS

| style # | \$    | qty | description | size | wgt |
|---------|-------|-----|-------------|------|-----|
| XT4     | 10.49 |     | Chrome      |      |     |
| XT4B    | 8.99  |     | Black       | 4"   | 2   |
| XT4W    | 8.99  |     | White       |      |     |
| XT6     | 10.49 |     | Chrome      |      |     |
| XT6B    | 8.99  |     | Black       | 6"   | 2   |
| XT6W    | 8.99  |     | White       |      |     |
| XT8     | 10.50 | 12  | Chrome      |      |     |
| XT8B    | 9.07  |     | Black       | 8"   | 3   |
| XT8W    | 9.07  |     | White       |      |     |
| XT10    | 10.50 |     | Chrome      |      |     |
| XT10B   | 9.07  |     | Black       | 10"  | 3   |
| XT10W   | 9.07  |     | White       |      |     |
| XT12    | 11.90 |     | Chrome      |      |     |
| XT12B   | 10.50 |     | Black       | 12"  | 4   |
| XT12W   | 10.50 |     | White       |      |     |

Mounting plate width: 3/4" (for all hook styles listed above)  
 Hook widths: Chrome - 3/16" w; Black/White - 1/4" w

|       |       |     |  |  |     |
|-------|-------|-----|--|--|-----|
| XTB   | 6.35  | 12  | Black  | 1"W x 3                                  | 2   |
| XTW   | 6.35  |     | White  | 1/4"H                                    |     |
| XTH   | 7.91  |     | Chrome   |  |     |
| SWFRC | 1.99  | 1   | Chrome   | 3"                                       | 1/2 |
| SW6   | 6.99  | 1   | Chrome   | 6"                                       | 1/2 |
| SW12  | 6.99  |     | Chrome   | 12"                                      | 1/2 |
| SW12B | 6.99  |     | Black  | 12"                                      | 1/6 |
| SW12W | 6.99  |     | White  | 12"                                      |     |
| HW5H  | 7.00  | 1   | Chrome   | 16"                                      | 2/6 |
| RWA9  | 8.42  | 1   | Chrome<br>Rectangular<br>tubing                | Adjusts from<br>9" to 12" to<br>15" long | 2   |
| RW12  | 5.18  | 1   | Chrome   | 12"                                      | 1/6 |
| EBLR3 | 4.67  |     | Black  | 12"                                      |     |
| EWHR3 | 4.15  |     | White  | 12"                                      |     |
| RW6   | 4.15  | 1   | Chrome   | 6"                                       | 1/2 |
| SW5HB | 7.00  | 1   | Black  | 16"                                      | 2/6 |
| SW5H  | 6.22  |     | Chrome   |  |     |
| SW5HW | 7.00  |     | White  |  |     |
| RW5HB | 5.96  | 1   | Black  | 17 1/4"                                  | 2/6 |
| RW5H  | 7.00  |     | Chrome   |  |     |
| SW6BC | 4.54  | 1   | Chrome   | 16 5/8"                                  | 2/6 |
| SW6BB | 4.15  |     | Black  |  |     |
| SW6BW | 4.15  |     | White  |  |     |
| RW7B  | 15.99 | 1   | Black  | 16 5/8"                                  | 2/6 |
| RW7C  |       |     | Chrome   |  |     |
| SWED6 | 2.07  | 1   | CHROME   | 2 3/4"W x<br>4 1/2"L                     | 1/5 |
| J2387 | 33.17 | 1   | CLEAR<br>Holds 36 - 2" cards<br>(not included) | 12" W x<br>12 1/2" H                     | 2/6 |
| SW122 | 18.79 | 12  | Brushed chrome                                 | 3 7/16"H x<br>2"L                        | 2/5 |
| HG100 | 50.67 | 100 | White  | 2" clip                                  | 3   |
| HG101 | 50.67 | 100 | Black  | 2" clip                                  | 3   |



XT4-12

XTH

SWFRC



SW6/SW12



HW5H

## RECTANGULAR TUBING

RWA9

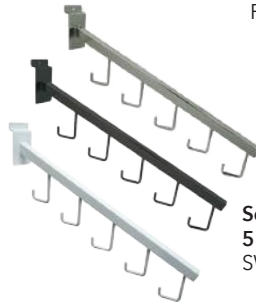

Square Tubing  
5 Hook Waterfall  
SW5H



Rectangular Tubing  
5 Hook Waterfall  
RW5H

RW12/EBL/EWH/RW6



Square Tubing  
6 Ball Waterfall  
SW6C



Rectangular Tubing  
7 Cube Waterfall  
RW7C



Slatwall Earring  
Card Holder  
SWED6

See page 91  
for jewelry  
cards

Slatwall  
Jewelry Card  
Displayer  
J2387



Slatwall  
Clips

SW122



HG100 /  
HG101



SW8-14B

### Shelf Bracket

Chrome, black or white available

- See page 41 for shelving -



SWAJ

### Adjustable Slatwall Bracket

12" - chrome  
14" - chrome



3380-76

### Slatwall Support Arms

3380-76 for 8" & 10" brackets  
3380-77 for 12" & 14" brackets  
3380-78 for 12" rectangular tubing



SWFB

SWR2

### 3" & 12" Rectangular Hangrail Bracket

Chrome, black or white available



SW/RT

### Round Hangrail Bracket

- See page 54 for tubing -



SWR81

### Rectangular Tubing "U" Hangrail



SW681C

### Round Tubing "U" Hangrail



SWT

### Scarecrow Displayer



SWML

### Millinery Displayer

3" diameter

### Tubular Display Form

VM52



Foam Pad  
FPMC

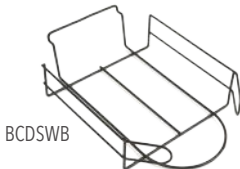

BCDSWB

### Slatwall Cap Merchandiser

Holds 12 hats



SW500

### Revolving Belt / Tie Display



WWS45W

### Slatwall Wire Media Shelf

| style # | \$    | qty | description | size                       | wgt  |
|---------|-------|-----|-------------|----------------------------|------|
| SW8KB   | 2.99  |     | Chrome      |                            |      |
| SW8KBB  | 2.99  |     | Black       | 8"                         | 2/7  |
| SW8KBW  | 2.99  |     | White       |                            |      |
| SW10KB  | 3.29  |     | Chrome      |                            |      |
| SW10KBB | 3.29  |     | Black       | 10"                        | 1/6  |
|         |       | 1   |             |                            |      |
| SW12KB  | 3.49  |     | Chrome      |                            |      |
| SW12KBB | 3.49  |     | Black       | 12"                        | 1/6  |
| SW12KBW | 3.49  |     | White       |                            |      |
| SW14KB  | 3.99  |     | Chrome      |                            |      |
| SW14KBB | 3.99  |     | Black       | 14"                        | 1/6  |
| SW14KBW | 3.99  |     | White       |                            |      |
| SWAJ12  | 4.15  | 1   | CHROME      | 12"                        | 1/6  |
| SWAJ14  | 4.92  |     |             | 14"                        | 1/6  |
| 3380-76 | 6.35  |     |             | 7 3/4"                     |      |
| 3380-77 | 6.35  | 1   | CHROME      | 11 1/2"                    | 1/3  |
| 3380-78 | 6.96  |     |             | 11 1/2"                    |      |
| SWFB    | 5.57  |     | CHROME      | 12"                        | 2/7  |
| SWFBB   | 5.57  |     | BLACK       | 12"                        | 2/7  |
|         |       | 1   |             |                            |      |
| SWR2    | 4.54  |     | CHROME      | 3"                         | 1/3  |
| SW/RT   | 6.74  | 1   | CHROME      | 12"                        | 1/6  |
| SWR81   | 20.22 |     | CHROME      |                            |      |
| EMABR81 | 18.01 | 1   | BLACK       | 22"W x<br>11" D            | 5/21 |
| EMTWR81 | 18.01 |     | WHITE       |                            |      |
| SW681C  | 18.01 |     | CHROME      |                            |      |
| SW681B  | 17.37 | 1   | BLACK       | 23"W x<br>12" D            | 5/21 |
| SW681W  | 17.37 |     | WHITE       |                            |      |
| SWT     | 20.22 |     | CHROME      | Adjusts                    |      |
| EBLT    | 14.49 | 1   | BLACK       | 20 1/2" to                 | 4/21 |
| VM52    | 24.36 | 1   | CHROME      | 16" x 24"                  | 3/21 |
| SWML    |       | 1   | CHROME      |                            |      |
| SWMLB   | 5.44  | 1   | BLACK       | 4 1/2" H x<br>8" D         | 1/3  |
| SWMLW   |       | 1   | WHITE       |                            |      |
| FPMC    | 9.07  | 10  | GREY        | 3"                         | 1    |
| BCDSW   |       |     | CHROME      |                            |      |
| BCDSWB  | 5.44  | 1   | BLACK       | 8 1/2"<br>x 14" x 2"       | 2/6  |
| BCDSWW  |       |     | WHITE       |                            |      |
| SW500   | 27.60 | 1   | CHROME      | 11" x 17"<br>12 - 4" hooks | 1/6  |
| WWS45W  | 22.94 | 1   | WHITE       | 48 x 6 1/2 x 7"            | 5/13 |

# Slatwall Accessories WALL SYSTEMS

## Pipeline Slatwall Fixtures

Coordinates with other pipeline store fixtures (pages 33-37).

### Anthracite Grey & Gloss White Fixtures

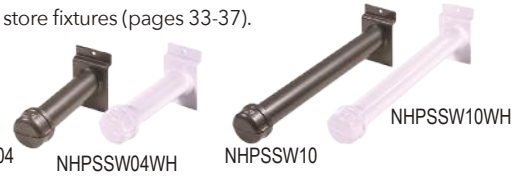

NHPSSW04

NHPSSW04WH

NHPSSW10

NHPSSW10WH

### Matte Black Fixtures



SWP12B

SWP6NB16

SWP5H16

### Acrylic Slatwall Fixtures

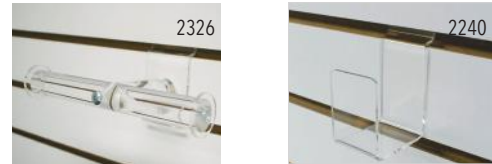

2326

2240

Jewelry Displayer Bar

Display Hook

| style #    | \$    | qty | description                              | size   | wgt  |
|------------|-------|-----|--|--|------|
| NHPSSW04   | 9.07  | 1   | 4 1/2" Faceouts:<br>Anthracite Grey      | 4 1/2" long  | 1    |
| NHPSSW04WH | 8.42  | 1   | Gloss White                              | 4 1/2" long  | 1    |
| NHPSSW10   | 11.15 | 1   | 10" Faceouts:<br>Anthracite Grey         | 10" long   | 1    |
| NHPSSW10WH | 10.50 | 1   | Gloss White                              | 10" long   | 1    |
| SWP12B     | 11.15 | 1   | Matte black faceout                      | 12" long   | 2    |
| SWP6NB16   | 16.85 | 1   | Matte Black Waterfalls:<br>6-ball        | 16 1/2" long                                       | 4    |
| SWP5H16    | 18.27 | 1   | 5-hook                                   | 16 1/2" long                                       | 4    |
| 2326       | 29.90 | 1   | 1/8" ACRYLIC                             | 8" W x 4" D  | 1/3  |
| 2240       | 2.99  | 1   | 1/8" ACRYLIC                             | 2"   | 1/3  |
| 2035       | 8.99  | 1   | 1/8" ACRYLIC                             | 7w x 11"h  | 2/7  |
| 2385       | 15.99 | 1   | 1/8" ACRYLIC                             | 8" W x<br>10 1/4" H                                | 2/7  |
| 850S       | 2.49  | 1   | ACRYLIC                                  | 4" x 10" w/<br>2" tall sign<br>channel at<br>front | 2/3  |
| 2020S      | 4.49  | 1   | ACRYLIC                                  | 4" x 10"   | 2/3  |
| ACR988     | 19.90 | 1   | ACRYLIC                                  | 24"L x<br>2"D x 4"H                                | 3    |
| 2086       | 17.99 | 1   | ACRYLIC                                  | 7" X 10"   | 1/2  |
| 2200S      | 4.49  | 1   | ACRYLIC<br>45° downslant<br>swivels 180° | 2 3/4"W<br>x 9"D                                   | 1/3  |
| 2476       | 18.99 | 1   | ACRYLIC                                  | 17" W x<br>7" H x<br>3 1/2"D                       |      |
| 2486       | 4.99  |     |  | 1PAIR<br>3"L                                       | 2/6  |
| 2487       | 9.99  | 1   | 3/16" ACRYLIC                            | 3 PAIRS<br>11 3/4"L                                | 1/2  |
| 2488       | 18.49 |     |  | 6 PAIRS<br>23 3/4"L                                | 5/11 |
| ACR26SW    | 4.99  | 1   | ACRYLIC                                  | 4 x 9"   | 2/3  |
| ACR28SW    | 8.99  |     |  | 8 1/2 x 11"  | 1/3  |
| ACR102     | 12.99 | 1   | ACRYLIC                                  | 8 x 10"  | 1/7  |
| ACR180     | 15.49 | 1   | 3/16" ACRYLIC                            | 8"D x 12"W   | 2/7  |
| ACR140     | 24.99 | 1   | 3/16" ACRYLIC                            | 12"L x 9"W<br>x 2"D                                | 2/6  |

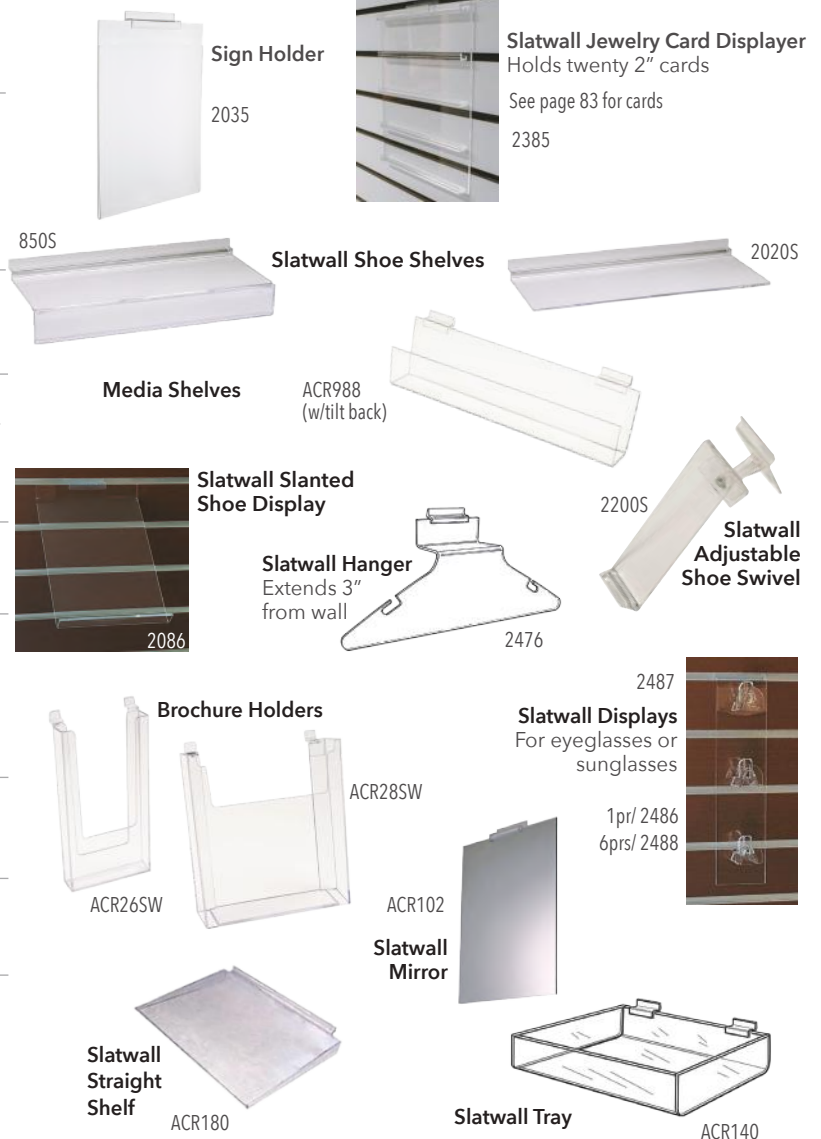

Sign Holder

2035

Slatwall Jewelry Card Displayer

Holds twenty 2" cards

See page 83 for cards

2385



850S

Slatwall Shoe Shelves

2020S

### Media Shelves

ACR988  
(w/tilt back)

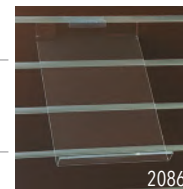

Slatwall Slanted  
Shoe Display

2086

Slatwall Hanger  
Extends 3"  
from wall

2200S

Slatwall  
Adjustable  
Shoe Swivel

2487

Slatwall Displays  
For eyeglasses or  
sunglasses

1pr/ 2486  
6prs/ 2488

### Brochure Holders

ACR28SW

ACR26SW

ACR102

Slatwall  
Mirror

Slatwall  
Straight  
Shelf

ACR180

Slatwall Tray

ACR140

# WALL SYSTEMS Grid Wall & Accessories

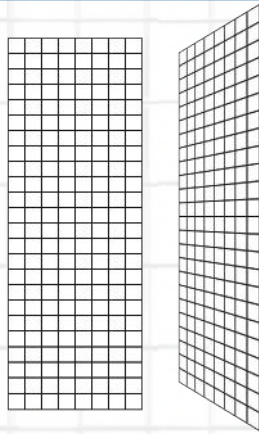

## Grid Wall - 1/4" Wire

Uses either grid wall accessories only

## Slatgrid Panels

Uses either grid wall or slatwall accessories

**3 Panels per Carton**



Slatgrid - Chrome

| style # | \$     | qty    | description | size          | wgt       |
|---------|--------|--------|-------------|---------------|-----------|
| GW26    | 124.16 | 3      | CHROME      |               |           |
| BLK26   | 99.14  | 3      | BLACK       | 2'W x 6'H     | 55        |
| WTE26   | 99.14  | 3      | WHITE       |               |           |
| GW28    | 156.04 | 3      | CHROME      |               | Truck/UPS |
| BLK28   | 131.16 | 3      | BLACK       | 2'W x 8'H     | 66/90     |
| WTE28   | 131.16 | 3      | WHITE       |               |           |
| STGC26  | 133.47 | 3      | CHROME      |               |           |
| STGB26  | 111.44 | 3      | BLACK       | 2'W x 6'H     | 47        |
| STGW26  | 111.44 | 3      | WHITE       |               |           |
| STGC28  | 164.27 | 3      | CHROME      |               | Truck/UPS |
| STGB28  | 145.14 | 3      | BLACK       | 2'W x 8'H     | 52/90     |
| STGW28  | 145.14 | 3      | WHITE       |               |           |
| GW4BA   | 53.52  | 1      | CHROME      |               |           |
| BLK4BA  | 49.90  | 1      | BLACK       | 36 x 36"      | 11        |
| WTE4BA  | 49.90  | 1      | WHITE       |               |           |
| GW3TB   | 44.49  | 1      | CHROME      |               |           |
| BLK3TB  | 40.56  | 1      | BLACK       | 24"           | 10/11     |
| WTE3TB  | 40.56  | 1      | WHITE       |               |           |
| GWG48   | 41.99  | 1      | CHROME      |               |           |
| BLKG48  | 38.99  | 1      | BLACK       | 48 x 24"      | 12        |
| WTEG48  | 38.99  | 1      | WHITE       |               |           |
| GL24C   | 24.90  | 1 pair | CHROME      |               |           |
| GL24B   | 22.94  | 1 pair | BLACK       | 24" H x 24" L | 7         |
| GL24W   | 22.94  | 1 pair | WHITE       |               |           |
| CGW7    | 1.62   | 1      | CHROME      |               |           |
| CBLK7   | 1.62   | 1      | BLACK       | N/A           | 1         |
| CWTE7   | 1.62   | 1      | WHITE       |               |           |
| CGW5    | 3.50   | 1      | CHROME      |               |           |
| CWTE5   | 4.92   | 1      | WHITE       | N/A           | 1         |
| GWWB    | 2.49   | 1      | CHROME      |               |           |
| BLKW5   | 2.49   | 1      | BLACK       | 3"            | 1         |
| WTEWB   | 2.49   | 1      | WHITE       |               |           |

8' length must ship via truck or oversize UPS

## Four Way Base

Requires four panels and 12 grid-to-grid connectors. Includes casters



## Triangle Base

Requires three panels and nine grid-to-grid connectors. Includes casters



## Gondola Base

Requires four panels and nine grid-to-grid connectors



## Legs for Grid

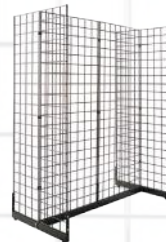

CGW7

## Grid-to-Grid

For 1/4" wire. Connects grid panels at any required angle



## Grid to Square Tubing

Connects 1" square tubing to grid panel



CGW5

## Wall Bracket

For mounting grid wall panels to the wall



WTEWB



# Grid Wall & Accessories WALL SYSTEMS

| style # | \$    | qty   | description | size         | wgt  |
|---------|-------|-------|-------------|--------------|------|
| GWH4C   | 9.07  | 12    | CHROME      | 4"           | 1/3  |
| GWH4B   | 7.65  |       | BLACK       |              |      |
| GWH4W   | 7.65  |       | WHITE       |              |      |
| GWH6C   | 10.50 |       | CHROME      | 6"           | 1/2  |
| GWH6B   | 9.07  |       | BLACK       |              |      |
| GWH6W   | 9.07  |       | WHITE       |              |      |
| GWH8C   | 11.90 |       | CHROME      | 8"           | 1/2  |
| GWH8B   | 10.49 |       | BLACK       |              |      |
| GWH8W   | 10.49 |       | WHITE       |              |      |
| GWH10C  | 11.90 |       | CHROME      | 10"          | 1/2  |
| GWH10B  | 10.50 | BLACK |             |              |      |
| GWH10W  | 10.50 | WHITE |             |              |      |
| GW11    | 4.85  | 1     | CHROME      | 12"          | 3/6  |
| BLK11   | 3.88  |       | BLACK       |              |      |
| WTE11   | 3.88  |       | WHITE       |              |      |
| RG12    | 4.50  | 1     | CHROME      | 12"          | 2/7  |
| BLKR3   | 4.15  |       | BLACK       |              |      |
| WTER3   | 4.15  |       | WHITE       |              |      |
| GW12    | 4.92  | 1     | CHROME      | 12"          | 2/7  |
| BLK12   | 3.50  |       | BLACK       |              |      |
| RG7B    | 7.00  | 1     | CHROME      | 7 cube       | 2/6  |
| RG5H    | 9.07  | 1     | CHROME      | 5 hook       | 2/6  |
| GW5H    | 4.99  | 1     | CHROME      | 5 hook       | 2/6  |
| BLK5H   | 5.31  |       | BLACK       |              |      |
| WTE5H   | 5.31  |       | WHITE       |              |      |
| GW7B    | 6.49  | 1     | CHROME      | 7 ball       | 2/10 |
| BLK7B   | 6.49  |       | BLACK       |              |      |
| WTE7B   | 6.49  |       | WHITE       |              |      |
| GWFRFC  | 5.44  | 1     | CHROME      | 3"           | 1/3  |
| GWFRB   | 5.44  |       | BLACK       |              |      |
| GWML    | 4.02  | 1     | CHROME      | 4 1/2" H     | 2/7  |
| BLKML   | 3.76  | 1     | BLACK       | 8" Deep      |      |
| FPMC    | 9.07  | 10    | GREY        | 3"           | 1    |
| KHG684  | 19.90 | 1     | CHROME      | 52 1/4"      | 3/21 |
| KHG681  | 18.01 | 1     | CHROME      | 19 1/4 x 11" | 3/21 |
| BLHG681 | 17.37 |       | BLACK       |              |      |
| GW12KB  | 3.89  | 1     | CHROME      | 12"          | 2/7  |
| BLK12KB | 3.24  |       | BLACK       |              |      |
| WTE12KB | 3.50  |       | WHITE       |              |      |
| GW14KB  | 4.15  | 1     | CHROME      | 14"          | 2/6  |
| BLK14KB | 3.50  |       | BLACK       |              |      |
| HML4MAB | 5.57  | 1     | BLACK       | 4"           | 1/3  |
| GWRT    | 7.00  | 1     | CHROME      | 12"          | 2/7  |

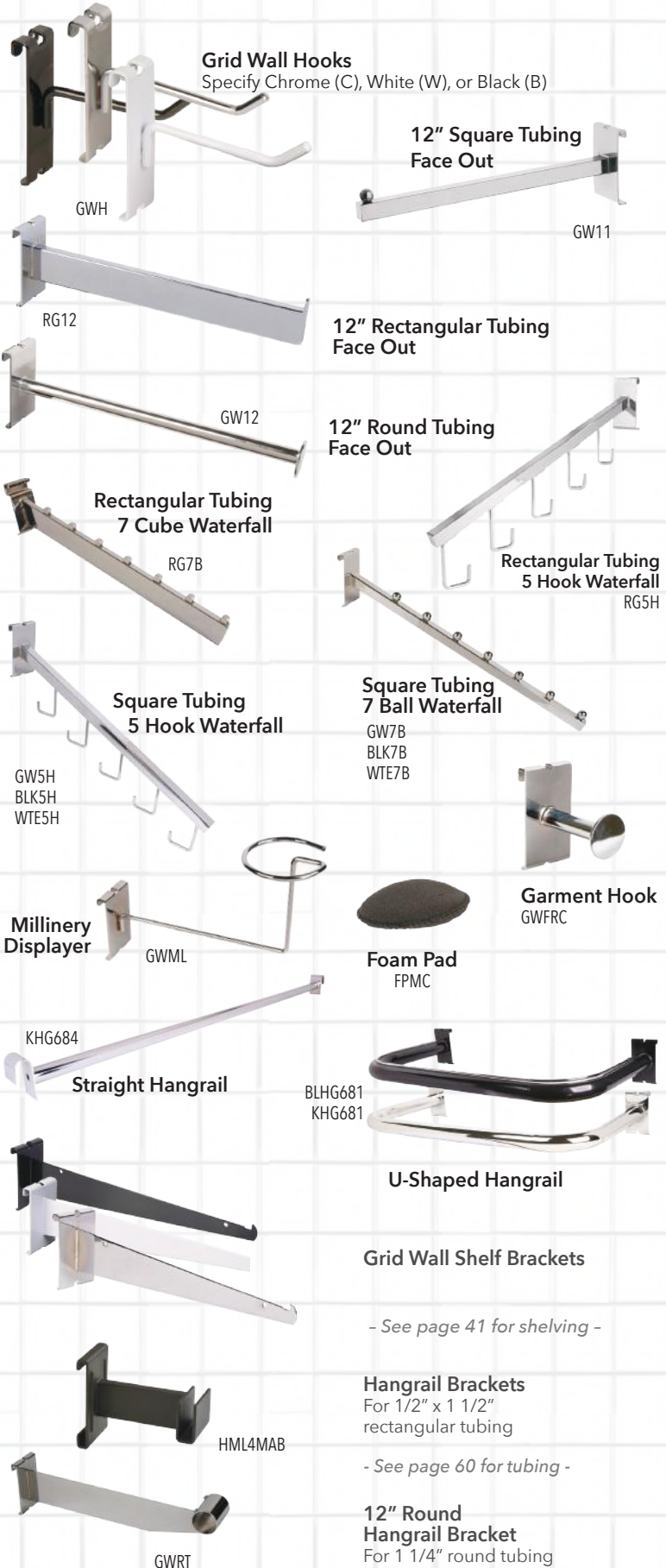

# WALL SYSTEMS Grid Wall Accessories

| style #  | \$    | qty | description                    | size                               | wgt  |
|----------|-------|-----|--------------------------------|------------------------------------|------|
| BCDGWB   |       |     |                                |                                    |      |
| BCDGW    | 6.35  |     | CHROME                         | 8 1/2 x 14                         |      |
| BCDGWB   | 6.35  | 1   | BLACK                          | x 2"                               | 1/7  |
| BCDGWW   | 6.35  |     | WHITE                          |                                    |      |
| GR7      | 21.38 | 1   | CHROME                         | 24"<br>7 - 5" hooks                | 3/12 |
| GW122    | 25.66 | 12  | BRUSHED<br>CHROME              | 3 7/16" H                          | 2/3  |
| HS101    | 34.34 | 100 | BLACK                          | 2"                                 | 8    |
| BLKS90   | 13.22 | 1   | BLACK                          | 24 x 24 x<br>34 1/2"               | 6/21 |
| GWS93    | 24.36 |     | CHROME                         |                                    |      |
| BLKS93   | 21.51 | 1   | BLACK                          | 15 x 24"                           | 6/21 |
| WTES93   | 21.51 |     | WHITE                          |                                    |      |
| GWS91    | 22.29 | 1   | CHROME                         | 15 x 24"                           | 6/21 |
| BLKS91   | 21.51 |     | BLACK                          |                                    |      |
| JGR410ST | 3.88  | 1   | STYRENE                        | 4 x 10"                            | 1/3  |
| HPSG57V  | 6.09  |     |                                | 5 1/2w x 7"h                       |      |
| HPSG811V | 9.59  |     | Vertical                       | 8 1/2w x 11"h                      | 1/2  |
| HPSG114V | 17.36 |     |                                | 11w x 14"h                         |      |
| HPSG57H  | 6.09  | 1   | CLEAR                          | 5 1/2h x 7"w                       |      |
| HPSG711H | 7.78  |     | Horizontal                     | 7h x 11"w                          | 1/2  |
| HPSG811H | 11.99 |     |                                | 8 1/2h x 11"w                      |      |
| ACR26GW  | 4.92  | 1   | ACRYLIC                        | 4 x 9"                             | 1/3  |
| ACR988GW | 25.01 | 1   | ACRYLIC                        | 24"L x 2"D<br>x 4"H                | 2/4  |
| ACR984GW | 17.76 | 1   |                                |                                    |      |
| BSK11B   | 15.99 | 1   | Black<br>Epoxy Chrome<br>White | 24w x 12d<br>x 4"h<br>shallow      | 4/12 |
| BSK11C   | 15.94 |     |                                |                                    |      |
| BSK11W   | 15.99 |     |                                |                                    |      |
| BSK12B   | 18.01 | 1   | Black<br>Epoxy Chrome<br>White | 24w x 10d<br>x 5"h<br>double slope | 4/12 |
| BSK12C   | 19.44 |     |                                |                                    |      |
| BSK12W   | 18.01 |     |                                |                                    |      |
| BSK13B   | 9.72  | 1   | Black<br>Epoxy Chrome<br>White | 12w x 12d<br>x 4"h<br>small basket | 3/10 |
| BSK13C   | 9.72  |     |                                |                                    |      |
| BSK13W   | 9.72  |     |                                |                                    |      |
| BSK14C   | 11.79 | 1   | Epoxy Chrome                   | 12w x 12d<br>x 8"h<br>sloped front | 3/10 |
| BSK15B   | 14.64 | 1   | Black<br>Epoxy Chrome<br>White | 12w x 12d<br>x 8"h<br>deep basket  | 4/14 |
| BSK15C   | 15.94 |     |                                |                                    |      |
| BSK15W   | 14.64 |     |                                |                                    |      |



**Grid Wall Cap Merchandiser**  
Holds approximately 12 hats

BCDGWB

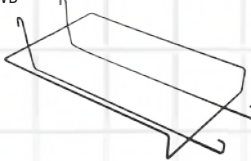

**Grid Wall Belt / Tie Display**

GR7



GW122



HS101

**Triangular Shelf**

BLKS90

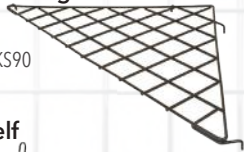

**Slant Shelf**

BLKS91



**Straight Shelf**

GWS93



JGR410ST



**Injection Molded Shoe Shelf**



**Acrylic Sign Holder**

HPSG

**Brochure Holder**



ACR26GW



**Media Shelves**

ACR988GW  
(w/tilt back)

**Standard Baskets**

Fits Slatwall, Grid Wall and Pegboard

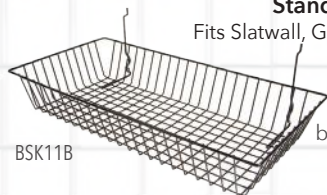

BSK11B

black

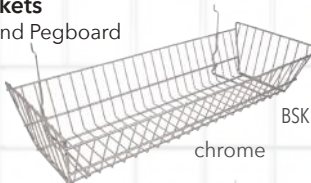

BSK12C

chrome



BSK13B



BSK14B



BSK15W

white

style #   \$   qty   description   size   wgt

Satin Zinc:

**Universal**

|        |       |    |        |     |       |
|--------|-------|----|--------|-----|-------|
| SS1048 | 54.82 | 10 | Single | 48" | 11    |
| SS1060 | 64.54 |    | Single | 60" | 13/19 |
| SS1072 | 75.69 |    | Single | 72" | 1/9   |
| SS1084 | 88.13 |    | Single | 84" | 19    |

**Heavy Duty**

|        |        |    |        |     |      |
|--------|--------|----|--------|-----|------|
| SS1248 | 63.12  | 10 | Single | 48" | 15   |
| SS1260 | 72.84  |    | Single | 60" | 2/8  |
| SS1272 | 89.55  |    | Single | 72" | 3/9  |
| SS1284 | 102.00 |    | Single | 84" | 3/11 |
| SS2248 | 83.98  | 10 | Double | 48" | 21   |
| SS2272 | 132.45 |    | Double | 72" | 4/9  |
| SS2284 | 154.61 |    | Double | 84" | 4/11 |

**Extra Heavy Duty**

|        |        |    |        |     |      |
|--------|--------|----|--------|-----|------|
| SS3048 | 100.57 | 10 | Single | 48" | 29   |
| SS3060 | 126.88 |    | Single | 60" | 36   |
| SS3072 | 149.17 |    | Single | 72" | 43   |
| SS3084 | 158.89 |    | Single | 84" | 5/11 |

**SLOTTED STANDARDS**

Universal, Heavy Duty, Extra Heavy Duty

**Universal Slotted Standards**

Steel thickness: 1/16" (.062")  
 Universal: 1/2" slots on 1" centers  
 Countersunk mounting  
 screw holes 9" apart

**Heavy Duty Slotted Standards**

Steel thickness: 3/32" (.093") /  
 (.062" at the recessed slots)  
 Universal: 1/2" slots on 1" centers  
 Countersunk mounting  
 screw holes 9" apart

**Extra Heavy Duty Slotted Standards**

Steel thickness: 1/8" (.125")  
 1" slots on 2" centers  
 Countersunk mounting  
 screw holes 12" apart

\* Screws not included

**FACEOUT DISPLAYERS**

To use on heavy duty slotted standards with 1/2" slots on 1" centers

|      |      |   |        |     |     |
|------|------|---|--------|-----|-----|
| TS12 | 4.15 | 1 | CHROME | 12" | 2/6 |
| TS5H | 7.65 |   | CHROME | 18" | 2/6 |
| RS12 | 5.96 | 1 | CHROME | 12" | 3/8 |
| RS14 | 5.57 |   | CHROME | 14" | 4/6 |
| TS7B | 6.35 | 1 | CHROME | 18" | 2/6 |

**Straight Arm**  
Square tubing



TS12

**5-Hook**  
Square tubing



TS5H

**Straight Arm**  
Rectangular tubing



RS12/14



TS7B

**7-Ball**  
Square tubing

**FACEOUT DISPLAYERS**

To use on extra heavy duty slotted standards with 1" slots on 2" centers

|      |      |   |        |     |     |
|------|------|---|--------|-----|-----|
| TR7B | 2.46 | 1 | CHROME | 18" | 2/6 |
| RR12 | 7.52 | 1 | CHROME | 12" | 2/6 |
| RR14 | 7.65 |   | CHROME | 14" | 2/6 |
| RR7B | 9.07 |   | CHROME | 18" | 2/6 |



TR7B

**7-Ball**  
Square tubing



RR12/14

**7-Cube**  
Rectangular tubing

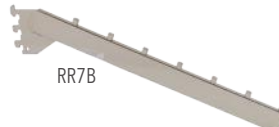

RR7B

**Straight Arm**  
Rectangular tubing

# WALL SYSTEMS Slotted Standard Brackets

## HANGROD BRACKETS - to fit 1 1/4" tubing



**12" or 14" Brackets**  
With nylon stabilizer. For slotted standards with 1/2" slots on 1" centers.



**12" Double Bracket**  
For slotted standards with 1/2" slots on 1" centers.

## RECTANGULAR TUBING BRACKETS

For use on slotted standards with 1/2" slots on 1" centers



**3" Bracket**  
Flat steel.



**8" Bracket**  
Rectangular tubing.



**12" Bracket**  
Rectangular tubing.



**14" Bracket**  
Rectangular tubing.

## RECTANGULAR TUBING BRACKETS

For use on slotted standards with 1" slots on 2" centers



**3" Bracket**  
Flat steel.



**8" Bracket**  
Rectangular tubing.



**12" Bracket**  
Rectangular tubing.

- See page 41 for shelving -



**Tap-In Shelf Bracket**  
Fits universal 1/2" slots on 1" centers. (.080" thick)



**Adjustable Shelf Brackets**  
Fits universal 1/2" slots on 1" centers. Five positive spring loaded settings.



**Extra Heavy Duty Shelf Brackets**  
Fits Extra Heavy Duty Standards. 1" slots on 2" centers. With tightening screw fit "imperial" (.125" thick). Accepts snap-on attachments for use with hangrails.



**Heavy Duty Shelf Brackets with Lip**  
Fits universal extra heavy duty standards, 1" slots on 2" centers with tightening screw.

| style # | \$    | qty | description | size | wgt |
|---------|-------|-----|-------------|------|-----|
| A212    | 7.49  | 1   | CHROME      | 12"  | 2/6 |
| A214    | 7.65  |     | CHROME      | 14"  |     |
| B212    | 14.64 | 1   | CHROME      | 12"  |     |
| CR3     | 4.67  | 1   | CHROME      | 3"   | 1/3 |
| CR3B    | 3.63  |     | BLACK       | 3"   |     |
| CR8     | 7.65  | 1   | CHROME      | 8"   | 2/6 |
| CR12    | 5.05  | 1   | CHROME      | 12"  | 2/6 |
| CR12B   | 4.92  |     | BLACK       | 12"  |     |
| CR14    | 7.12  | 1   | CHROME      | 14"  | 2/6 |
| GR3     | 4.14  | 1   | CHROME      | 3"   | 1/3 |
| GR3MAB  | 4.28  |     | BLACK       | 3"   |     |
| GR8     | 7.20  | 1   | CHROME      | 8"   | 2/6 |
| GR12    | 3.99  | 1   | CHROME      | 12"  | 2/6 |
| GR12MAB | 6.99  |     | BLACK       | 12"  |     |
| GR14    | 7.64  | 1   | CHROME      | 14"  | 2/6 |
| GA8     | 1.81  | 1   | CHROME      | 8"   | 2/6 |
| GA10    | 1.94  |     | CHROME      | 10"  |     |
| GA12    | 2.00  |     | CHROME      | 12"  |     |
| GA14    | 2.20  |     | CHROME      | 14"  |     |
| GC12    | 3.11  | 1   | CHROME      | 12"  | 2/6 |
| G12     | 3.99  | 1   | CHROME      | 12"  | 2/6 |
| G14     | 7.26  | 1   |             | 14"  |     |
| GSBL12  | 7.00  | 1   | CHROME      | 12"  | 3/6 |
| GSBL14  | 6.22  | 1   |             | 14"  |     |

# Pegboard & Wall Mount WALL SYSTEMS

| style #    | \$    | qty | description                 | size                   | wgt |
|------------|-------|-----|-----------------------------|------------------------|-----|
| PHS4       | 7.00  | 12  | STANDARD<br>4" long         | 1/8" D                 | 1/3 |
| PHS6       | 7.65  |     | 6" long                     |                        |     |
| PHS8       | 8.42  |     | 8" long                     |                        |     |
| PHH6       | 9.07  | 12  | HEAVY DUTY<br>6" long       | 3/16" D                | 1/3 |
| PHH8       | 9.72  |     | 8" long                     |                        | 1/3 |
| PHH10      | 11.15 |     | 10" long                    |                        | 2/6 |
| PHH12      | 7.26  |     | 12" long                    |                        | 2/6 |
| PHX6       | 11.79 | 12  | EXTRA HEAVY DUTY<br>6" long | 1/4"D                  | 1/3 |
| PHX8       | 12.57 |     | 8" long                     |                        | 1/3 |
| PHX10      | 13.87 |     | 10" long                    |                        | 2/6 |
| PHX12      | 15.29 |     | 12" long                    |                        | 2/6 |
| PB1C9      | 8.42  | 100 | WHITE                       | ONE SIZE<br>FITS ALL   | 1   |
| SHP6       | 18.01 | 12  | 7 GAUGE                     | 6"                     | 3/7 |
| SHP8       | 20.22 |     |                             | 8" w/2" tab            |     |
| PB6B       | 4.28  | 1   | CHROME                      | 16 5/8"                | 1/6 |
| PB5H       | 4.54  | 1   | CHROME                      | 16"                    | 1/6 |
| PBML       | 8.42  | 1   | CHROME                      | 8 x 4 1/4"             | 1/3 |
| ACR28PB    | 12.83 | 1   | ACRYLIC                     | 8 1/2 x 11"            | 1/7 |
| ACR984PB   | 20.74 | 1   | ACRYLIC                     | 24"L x 2"D x 4"H       | 2/5 |
| TB12       | 4.41  | 1   | CHROME                      | 12"                    | 2/6 |
| RB12       | 6.35  |     | CHROME                      | 12"                    |     |
| TB7B       | 7.78  | 1   | CHROME                      | 16 5/8"<br>7 BALL      | 2/6 |
| TB5H       | 7.00  | 1   | CHROME                      | 16"<br>5 HOOK          | 2/6 |
| FR3        | 7.00  | 1   | CHROME                      | 3"                     | 1/3 |
| ACR28WM    | 7.39  | 1   | ACRYLIC                     | 8 1/2 x 11"            | 1/7 |
| ACR984WM   | 17.76 | 1   | ACRYLIC                     | 24"L x<br>2"D x<br>4"H | 2/5 |
| NHPSWL10WH | 13.49 | 1   | Gloss White                 | 10"<br>long            | 14  |
| NHPSWL10   | 14.64 |     | Anthrocite Grey             |                        |     |

## PEGBOARD ACCESSORIES

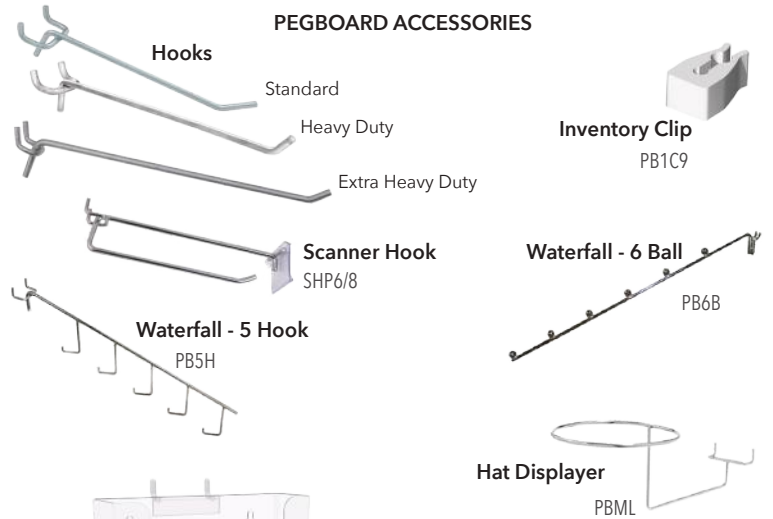

## Brochure Holders



## Media Shelves

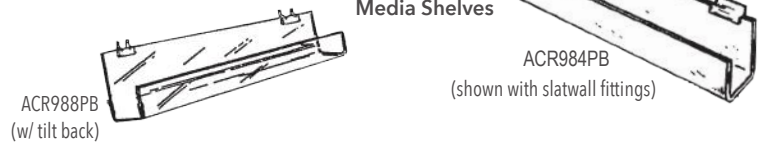

## WALLMOUNT ACCESSORIES

\* Note that screws are NOT included with wall mount accessories

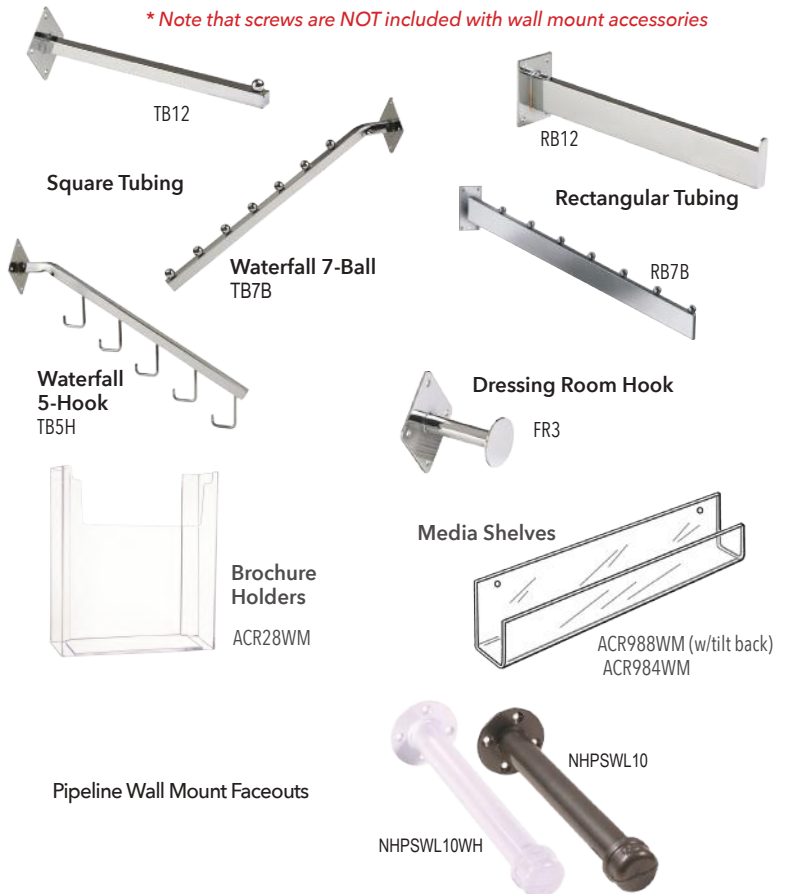

See our selection of coordinating pipeline store fixtures (pages 33-37).

# WALL SYSTEMS Tubing & Accessories

## ROUND TUBING & ACCESSORIES

**Round Tubing**  
1 1/4" diameter, 14 gauge

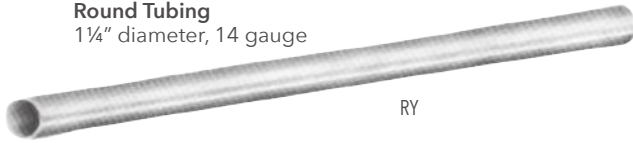

**U Flange**

For 1 1/4" and  
1 5/16" round  
tubing  
UF9



**O Flange**

For 1 1/4" and  
1 5/16" round tubing  
OF7



**Splicer**

For 1 1/4"  
round tubing  
RYSF



**End Cap**

For 1 1/4" and  
1 5/16" tubing  
EC2



## RECTANGULAR TUBING & ACCESSORIES



**Rectangular Tubing**  
1/2" x 1 1/2" x 17 gauge

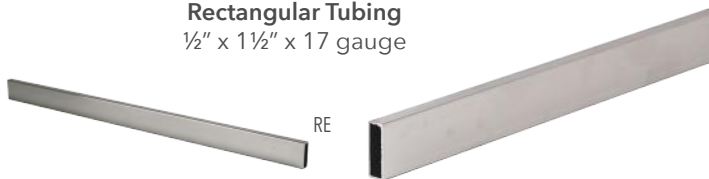

## Rectangular Tubing Accessories

**End Caps**



EC4 chrome plated  
EC4MAB matte black

**Extended  
End Caps**



EC5 chrome plated  
EC5MAB matte black

**Splicer**



RESP splicer for  
rectangular tubing

| style #         | \$           | qty    | description     | size  | wgt             |                         |
|-----------------|--------------|--------|-----------------|---|-----------------|-------------------------|
| RY4             | 13.22        | 1      | CHROME          | 4'  | 4/7             |                         |
| RY5             | 15.94        |        | CHROME          | 5'  | 6               |                         |
| RY6             | 21.51        |        | CHROME          | 6'  | 6/7             |                         |
| RY8             | 23.59        |        | CHROME          | 8'  | 8               |                         |
| RY10            | 34.08        |        | CHROME          | 10'   | 11              |                         |
| RY12            | 40.95        |        | CHROME          | 12'   | 13              |                         |
| UF9             | 3.11         |        | 1               | CHROME  | UFLANGE         | 1                       |
| OF7             | 6.35         | CHROME |                 | OFLANGE   | 1               |                         |
| RYSF            | 2.01         | CHROME |                 | SPLICER   | 1/3             |                         |
| EC2             | .95          | CHROME |                 | END CAP   | 1               |                         |
| RH7B<br>RH7BMAB | 7.39<br>7.00 | 1      |                 | CHROME<br>BLACK   | 14"<br>14"      | 2/6                     |
| RH5H            | 7.65         |        | CHROME          | 17 3/4"   | 2               |                         |
| RH6             | 4.54         |        | CHROME          | 6"  | 1/2             |                         |
| RH2C            | 3.89         |        | CHROME          | 2"  | 1/3             |                         |
| RH12<br>RH12MAB | 6.35<br>4.28 |        | CHROME<br>BLACK | 12"<br>12"  | 2/6             |                         |
| H4              | .78          |        | CHROME          | 4"  | 1/3             |                         |
| H6              | 1.17         |        | CHROME          | 6"  |                 |                         |
| H9              | .91          |        | CHROME          | 9"  |                 |                         |
| H12             | 1.68         |        | CHROME          | 12"   |                 |                         |
| RE2             | 3.99         |        | 1               | All sizes<br>available in<br>chrome except<br>4' which is also<br>available in<br>black and white | 2'              | 2                       |
| RE3             | 8.42         |        |                 |   | 3'              | 3                       |
| RE4             | 11.79        |        |                 |   | 4'              | 4/5                     |
| RE5             | 14.64        | 5'     |                 |   | 5               |                         |
| RE6             | 18.79        | 6'     |                 |   | 6/10            |                         |
| RE8             | 22.29        | 8'     |                 |   | 6/12            |                         |
| RE10            | 34.08        | 10'    |                 |   | 7               |                         |
| RE12            | 41.60        | 12'    |                 |   | 9               |                         |
| REMAB4          | 11.79        | 4'     |                 |   | 4/5             |                         |
| EC4<br>EC4MAB   | .91<br>1.08  | 1      |                 |   | CHROME<br>BLACK | TUBING<br>1/2" x 1 1/2" |
| EC5<br>EC5MAB   | 1.44<br>1.49 |        | CHROME<br>BLACK | TUBING<br>1/2" x 1 1/2"<br>w/1" extension   |                 |                         |
| RESP            | 2.85         |        | CHROME          | 1/2" x 1 1/2"   |                 |                         |



Blue Retro NMSKBLO2

back

front



**Open/Closed Sign Kits**

Sturdy metal constructed, double-sided signs with two pre-drilled holes. Kits include one (1) black metal chain with two (2) black S hooks for hanging, and two (2) suction cups. Printed in the USA.

All signs are 12" w x 8" h; printed with an "open" message on the front and a "closed" message on the back; 5lbs.

**24.36/kit**



front

Blue Wash Tones NMSKBLO



back



front

Spanish NMSKABSE



back



front

Hiring - Black



back



front

Grey w/Dots NMSKGO



back



front

Hiring - Red



back



front

Red NMSKRO



back



front

Black



back



front

Black Awesome NMSKBOWA



back



front

Red Awesome NMSKROWA



back

# SIGNAGE Card Stock Signs

## Card Stock signs, available in 3 sizes and 9 designs.

Double sided. Printed on high quality 10 point card stock. Made in the USA.

*Don't see the message you're looking for? Give us a call and let us know what you need. We can custom make it for you!*



**small**  
5.5" w x 3.5" h  
\$1.93 /each  
\$9.50 /5 pcs  
\$18.90 /10 pcs

**medium**  
7" w x 5.5" h  
\$2.19 /each  
\$10.75 /5 pcs  
\$20.35 /10 pcs

**large**  
11" w x 7" h  
\$2.32 /each  
\$11.20 /5 pcs  
\$21.64 /10 pcs

**ship weights:**  
each - 1 lb  
5-pack - 1 lb  
10-pack - 1 lb

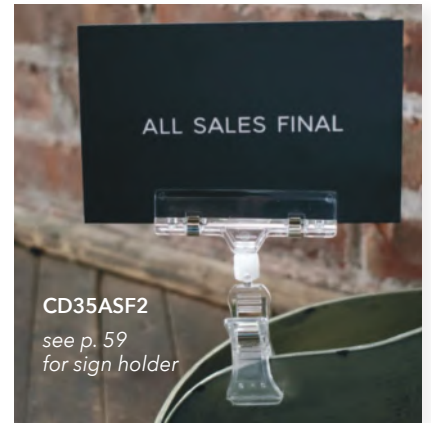

CD35ASF2  
see p. 59  
for sign holder



CD35ASF2 /small  
CD57ASF2 /medium  
CD711ASF2 /large



CD35ASF1 /small  
CD57ASF1 /medium  
CD711ASF1 /large



CD35S1 /small  
CD57S1 /medium  
CD711S1 /large



CD35S2 /small  
CD57S2 /medium  
CD711S2 /large



CD35S3 /small  
CD57S3 /medium  
CD711S3 /large



CD35S4 /small  
CD57S4 /medium  
CD711S4 /large



CD35S5 /small  
CD57S5 /medium  
CD711S5 /large



CD35NA2 /small  
CD57NA2 /medium  
CD711NA2 /large



CD35NA1 /small  
CD57NA1 /medium  
CD711NA1 /large



CD35SS /small  
CD57SS /medium  
CD711SS /large



**SALEBANNER**  
Glossy red sale printed vinyl tags slip over the hook of a hanger. 2" w x 4" h; 5/16" dia. hole is 3/16" from top; 100 pcs; 1/3 lb.

**27.73**



RAH25



RAH007



RAH44

**Plastic Display Cards**  
Red & White plastic card stock, slightly textured on front. Available in 3 styles. 7" w x 11" h; 1 pc; 1 lb. **3.89**



| style #  | \$     | qty   | description   | wgt                              |
|--|--------|-------|---|----------------------------------|
| BH28   | 41.90  | 1     | Chrome, 22x28", 60" H<br><i>(holds graphics up to 3/16" thick, usable sign area 20 3/4" x 26 3/4")</i>                              | 18                               |
| <b>The following signs all hold graphics up to 1/4" thick:</b> |        |       |   |                                  |
| BH28BAW  | 116.51 | 1     | Black, All Weather, 22x28", 60"H indoor/outdoor   | 18                               |
| BH22   | 59.49  | 1     | Chrome, 14x22", 53"H  | 13                               |
| BH28MAB  | 52.99  | 1     | Matte black, 22x28", 60" H  | 23                               |
| BH23   | 75.30  | 1     | Chrome, extra heavy base, 14x22", 53"H  | 13                               |
| BH29   | 105.75 | 1     | Chrome, weighted base, 22x28", 60" H  | 22                               |
| BH24   | 69.21  | 1     | Chrome, rectangular tubing, 14x22", 56"H  | 7                                |
| BH28SP   | 43.03  | 2     | Acrylic Sign Protectors<br>(2) crystal clear panels;<br>each 22"w x 28"h x .04" thick<br><i>(works with BH28 – sold separately)</i> | 4                                |
| BH28SP2  | 97.84  | 1 kit | "Sidewalk Sale" Sign Kit<br>Kit includes (1) BH28 sign,<br>(2) "Sidewalk Sale" poster signs,<br>(2) sign protectors (BH28SP)        | 24                               |
| BH30   | 79.57  | 1     | Rect. tubing, 22x28", 56" H; Chrome<br><i>holds graphics up to 3/16" thick</i>  | 9,8 lbs;<br>(2 ctns)             |
| BH30MAB  | 62.73  | 1     | Rect. tubing, 22x28", 56" H; Matte Black;<br><i>holds graphics up to 1/4" thick</i>   | 9,8 lbs;<br>(2 ctns)             |
| BH55   | 97.99  | 1     | Double 22" x 28" sign holder; 56" H; Chrome;<br><i>holds graphics up to 3/16" thick</i>   | 9,8 lbs;<br>(2 ctns)             |
| BH55MAB  | 86.70  | 1     | Double 22" x 28" sign holder; 56" H; Matte Black;<br><i>holds graphics up to 1/4" thick</i>   | 9,8 lbs;<br>(2 ctns)             |
| BH77   | 208.49 | 1     | Triple 22" x 28" sign holder; 90" H; Chrome;<br><i>holds graphics up to 3/16" thick</i>   | 35/98,<br>10/25 lbs;<br>(2 ctns) |
| BH77MAB  | 169.99 | 1     | Triple 22" x 28" sign holder; 90" H; Matte Black;<br><i>holds graphics up to 1/4" thick</i>   |                                  |
| MCW28V   | 36.81  | 1     | 22x28" frame with wall mount attachment   | 6/21                             |
| NHSTCH   | 9.72   | 1     | <b>Metal shelf signs</b><br>Ledge piece is 6" front to back;<br>sign holder piece is 6 1/2" across                                  | 1                                |
| NHSTV  | 7.00   |       | High Polished Chrome  |                                  |
|  |        |       | Metal   |                                  |
|  |        |       | Accepts 6 1/2"W x 1 1/2"H paper inserts, (not included)   |                                  |

### Bulletin Sign Holders

BH22/BH28  
BH28MAB  
Chrome or Black  
10" x 14"  
flat base

BH23/BH29  
Chrome  
Extra heavy weighted  
10" x 14" base

BH28BAW  
Black  
All Weather  
Sign Holder  
10" x 14"  
flat base

BH24  
Chrome  
Rectangular  
tubing frame

### Acrylic Sign Protectors

BH28SP

"Sidewalk Sale" Sign Kit  
BH28SP2

BH30  
BH30MAB  
Chrome or Black  
22" x 28" sign holder.  
Rectangular tubing  
frame base - 15" x 24"

BH55  
BH55MAB  
Chrome or Black  
22" x 28" double sign  
holder. Rectangular  
tubing frame base -  
15" x 24"

BH77  
BH77MAB  
Chrome or Black  
22" x 28" triple sign  
holder. Rectangular  
tubing frame base -  
24" x 25"

### Wall Mount Square Corner Sign Frame

MCW28V

### Metal Shelf Overlay Retail Signs w/framed front

NHSTCH

NHSTV

# SIGNAGE Sign Holders & Accessories

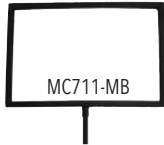

## SQUARE CORNER CARD FRAMES



MVER114

MC57, MC711, MC114

MCP57, MCP711



## CHROME ROUND CORNER FRAMES

## ALLIGATOR CLIP SIGN HOLDERS



WSAC5SN

WSAC6SN

WSAC7SN

## CHROME CLAMPS & STEMS



C5



C6



SC22



SC23



SC8



SC11



M3



M6



NS3



NS6

## MAGNETIC CLAMPS



SC17



SC20



SC21

| style #                            | \$    | qty | description   | wgt   |
|------------------------------------|-------|-----|---|-------|
| MCP711-MB                          | 10.50 | 1   | 7x11" Matte black mitre corner card frame w/double 4" stem 3/2x5" base  | 7/10  |
| MC711-MB                           | 7.49  | 1   | 7x11" Matte black square corner frame w/3" threaded stem atchd.         | 6/10  |
| SC20-MB                            | 8.90  | 1   | Matte black magnetic clamp threaded                                     | 1     |
| SC22-MB                            | 2.48  | 1   | Matte black all purpose clamp threaded                                  | 1     |
| MVER114                            | 89.90 | 6   | 11x14" chrome sign frame with 5 1/2x11" base                            | 3/12  |
| MC57                               | 27.09 | 6   | 5 1/2x7" chrome frame w/ 3/8" fitting                                   | 2     |
| MC711                              | 27.90 | 6   | 7x11" chrome frame w/ 3/8" fitting                                      | 6/10  |
| MC114                              | 42.90 | 6   | 11x14" chrome frame w/ 3/8" fitting                                     | 6/10  |
| MCP57                              | 8.42  | 1   | chrome, 5 1/2x7 card frame mitred Double 4" stem, 4x7" base             | 2/6   |
| MCP711                             | 9.72  | 1   | chrome, 7x11" card frame mitred Double 4" stem, 4x7" base               | 2/6   |
| SB57                               | 10.25 | 1   | 10"H shovel base, 5 1/2x7"  | 2/6   |
| SB711                              | 10.50 | 1   | 10" H shovel base, 7x11"  | 2/6   |
| CF711                              | 8.42  | 6   | 7x11" frame w/ 3/8" fitting * while supplies last                       | 6/7   |
| <b>Alligator Clip Sign Holders</b> |       |     |   |       |
| Satin Nickel / down position clip: |       |     |   |       |
| WSAC1SN                            | 18.01 | 1   | 12" H   | 3/6   |
| WSAC2SN                            | 19.44 | 1   | 24" H   | 3/11  |
| WSAC4SN                            | 20.22 | 1   | 42" H   | 4/21  |
| WSAC5SN                            | 3.95  | 1   | Clear, 1"x1" square base; 4"H   | 0.5/1 |
| WSAC6SN                            | 4.82  | 1   | Black, 1"x1" square base; 4"H   | 0.5/1 |
| WSAC7SN                            | 4.38  | 1   | "S" design; stainless steel; 3 1/2"H                                    | 0.5/1 |
| C5                                 | 20.22 | 6   | 1" Square w/3" stem - 3/8"  | 2/3   |
| C6                                 | 17.37 | 6   | 1/2 x 1 1/2" rect. 2" stem - 3/8"                                       | 2/3   |
| SC22                               | 11.65 | 6   | Universal all purpose clamp; Fits round, square & rect. tubing threaded | 2/3   |
| SC23                               | 17.37 | 6   | All purpose clamp for 3/8" swedge                                       | 2/3   |
| SC8                                | 14.64 | 6   | Spring clamp for 1" sq. tubing w/ threaded 3/8" fitting                 | 2/3   |
| SC11                               | 15.94 | 6   | Spring clamp for rect. tubing w/ threaded 3/8" fitting                  | 2/3   |
| M3                                 | 4.92  | 6   | 3" threaded stem - 3/8"   | 2     |
| M6                                 | 6.74  | 6   | 6" threaded stem - 3/8"   | 2     |
| NS3                                | 4.92  | 6   | 3" swedge stem - 3/8"   | 2     |
| NS6                                | 7.65  | 6   | 6" swedge stem - 3/8"   | 3     |
| SC17                               | 21.51 | 6   | Magnetic clamp for 1/4 & 3/8" threaded stem                             | 2     |
| SC20                               | 31.23 | 6   | Magnetic clamp for 3/8" threaded stem                                   | 2/3   |
| SC21                               | 31.23 | 6   | Magnetic clamp for 3/8" swedge stem                                     | 2/3   |

| style #   | \$    | qty | description  | wgt                                     |
|-----------|-------|-----|--|---|
| POP1      | 18.01 |     | Clear:<br>Double clip sign holder<br>3½" long; clip - 0.75"W x 1.5" H            | 1/3                                     |
| POP2      | 31.23 | 20  | Clip on sign holder w/ spring loaded graphic holder; 4" long; clip - 3.2"W x 1"H | 2/7                                     |
| POP3      | 41.60 |     | Clip on sign holder w/ spring loaded graphic holder; 6¼"L; clip - 3.2"W x 1"H    | 2/7                                     |
| POP4      | 24.36 |     | Clip on sign holder w/ fixed graphic holder; 3 5/8" long; clip - 2.2"W x 0.88"H  | 2/7                                     |
| PK57      | 11.15 |     | 1  | 5½x7" card holder w/ chrome double stem |
| PK711     | 15.03 | 1   | 7x11" card holder w/ chrome double stem  | 3/6                                     |
| JPC57     | 52.10 | 6   | 5½x7½" frame w/ universal stem   | 2/3                                     |
| JPC711    | 76.98 | 6   | 7x11" frame w/ universal stem  | 3/7                                     |
|           |       |     | Horizontal, double-sided, bottom load sign holders:                              |   |
| PG711     | 41.60 | 6   | Straight 7x11" card holder   | 3/7                                     |
| PJ711     | 50.67 | 6   | Card holder, chrome channel 7x11" w/ 3/8" fitting                                | 3                                       |
| PJ57      | 29.81 | 6   | Card holder chrome channel 5½x7" w/ 3/8" fitting                                 | 3/7                                     |
| PH711     | 55.75 | 6   | Slanted 7x11" card holder  | 7/10                                    |
| PH57      | 19.31 | 6   | Slanted 5½x7" card holder  | 3/7                                     |
| HPCT57H   | 4.92  | 1   | TOP LOAD HORIZONTAL<br>5½"H x 7"W  | 2/3                                     |
| HPCT57V   | 6.35  | 1   | TOP LOAD VERTICAL<br>7"H x 5½"W  |   |
| HPCT711V  | 11.92 | 1   | 11"H x 7"W   | 2/3                                     |
| HPCT811V  | 12.57 | 1   | 11"H x 8½"W  |   |
| HPCT114V  | 20.87 | 1   | BOTTOM LOAD VERTICAL<br>14"H x 11"W  | 2/3                                     |
| HPCT57HSB | 4.92  | 1   | SLANT BACK HORIZONTAL<br>5½"H x 7"W  | 2/3                                     |
| HPCT57VSB | 5.44  | 1   | SLANT BACK VERTICAL<br>7"H x 5½"W  | 1/6                                     |
| IMCT49    | 6.35  | 1   | COUNTER BROCHURE HOLDER<br>4" x 9" clear   | 1/3                                     |
| IMCT811   | 9.59  | 1   | 8½" x 11" clear  | 2/6                                     |

## CLIP-ON SIGN HOLDERS



## ACRYLIC CARD HOLDERS



## TOP & BOTTOM LOAD SIGN HOLDERS

Crystal clear sign holders

### Top Load Styles



HPCT57H



HPCT57V  
HPCT711V  
HPCT811V

### Bottom Load Vertical

HPCT114V

### Slant Back Sign Holders



HPCT57HSB



HPCT57VSB

### Brochure Holders



IMCT49



IMCT811

# SIGNAGE Sign Hanging Accessories

## CEILING ANCHORS

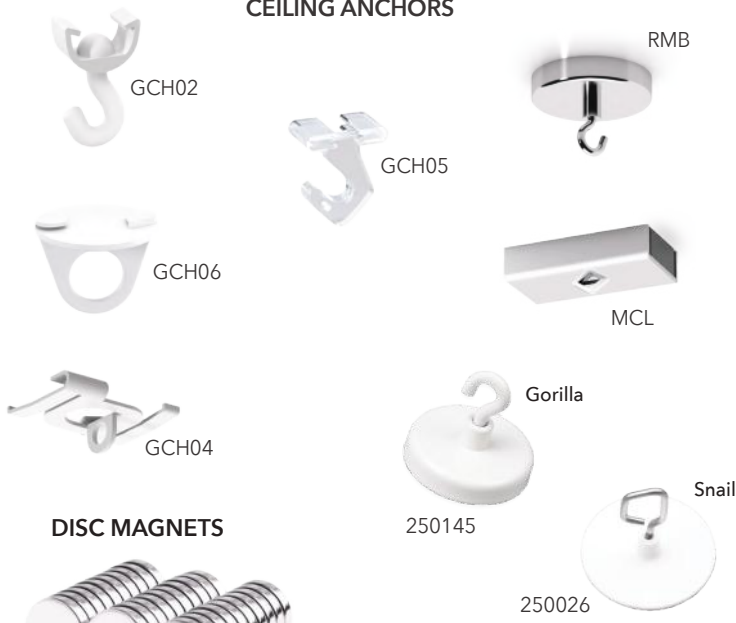

## DISC MAGNETS



## Spider Anchors



## CLEAR LOCKING HOOKS

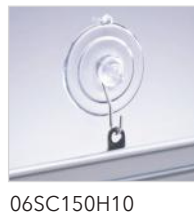
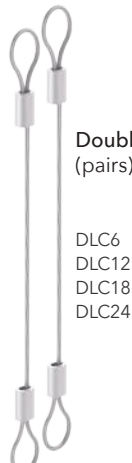
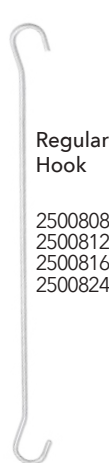

## MIRACLE STICKS® ADHESIVE SIGN TABS

NHMS



| style #    | \$    | qty | description   | wgt  |
|------------|-------|-----|---|------|
| GCH02      | 17.37 | 10  | ¼" swivel hook slot; rotates 360°; snaps on ceiling grids   | 5    |
| GCH05      | 14.64 | 10  | Clear hinged hook ceiling anchor  | 5    |
| GCH06      | 13.87 | 10  | 7/8" loop ceiling anchor w/ 2" base; twist to connect   | 5    |
| GCH04      | 34.08 | 10  | Ceiling anchor w/ steel spring & 15/64" loop  | 5    |
| RMB18      | 8.42  | 1   | Plated steel magnet with hook:<br>1 1/2" dia – holds 18 lbs<br>2" dia – holds 20 lbs<br>2 1/2" dia – holds 38 lbs   | 1    |
| RMB20      | 13.87 |     |   |      |
| RMB38      | 17.37 |     |   |      |
| MCL1       | 1.10  | 1   | Plated steel magnet in 2 sizes:<br>1" – holds 5 lbs<br>2" – holds 14 lbs  | 1    |
| MCL2       | 1.94  |     |   |      |
| 250145     | 12.96 | 1   | White Gorilla magnet: holds up to 20 lbs  | 1    |
| 250026     | 75.69 | 50  | White snail adhesive disk   | 1/3  |
| DISCMAG10  | 13.87 | 10  | 1/2" x 1/8" disc magnet for signage; pull force: 7.36 lb  | 1/3  |
| DISCMAG30  | 27.73 | 30  |   |      |
| RAN1UP     | 7.52  | 10  | ClearOne-Up™ Spider Anchors<br>use w/ hooks to hold signs perpendicular or parallel   | 1/3  |
| RAN1UP2    | 8.29  | 10  |   |      |
| PINCH      | 4.15  | 10  | Galvanized steel  | 1    |
| 2501006    | 32.66 | 50  | Clear, Single locking hooks:<br>6"  | 1/3  |
| 300100     | 28.51 | 100 | Galvanized Steel:<br>Long S Hook - 2 5/8"H  | 2/3  |
| 125309     | 8.42  | 100 | Standard S Hook - 1"H<br>Large S Hook - 1 5/8"H   | 1    |
| 300795     | 11.15 | 50  |   |      |
| 2500808    | 13.87 | 50  | Regular Hook 8"<br>Regular Hook 12"<br>Regular Hook 16"<br>Regular Hook 24"   | 2/3  |
| 25008012   | 15.29 | 50  |   | 2    |
| 25008016   | 20.87 | 50  |   | 2/9  |
| 25008024   | 27.73 | 50  |   | 3/27 |
| DLC6       | 9.72  | 2   | Double loop cable - sold in pairs;<br>1/32" uncoated stainless steel<br>w/ ½" long loops; holds up to 50 lbs<br>6" Cable length<br>12" Cable length<br>18" Cable length<br>24" Cable length | 1/2  |
| DLC12      | 11.15 | 2   |   |      |
| DLC18      | 12.57 | 2   |   |      |
| DLC24      | 13.87 | 2   |   |      |
| 06SC150H10 | 10.50 | 10  | Suction cup - Clear with plated steel hook 1 3/4"   | 1/3  |
| NHMS       | 22.29 | 500 | Adhesive on both sides. Apply to back of signs to avoid messy taping.<br>3/8" x 1 5/8"  | 1    |



**Sign hanging systems & hanging hardware for graphic displays.**

Featuring plastic gripper bar sets with snap closures, hanging dowel kits, sign clips that can be used for hanging signs - or simply turn them over to use as countertop displays. We have updated our ceiling anchors too, including magnets, hooks and cables. Easy to assemble and versatile for every season.

**Plastic Gripper Bar Sets**

Set includes a top and bottom bar, and feature snap grips that close easily. Strong with a rigid torque. Fits signs up to .070" thick. Each set includes two snap grips, two universal hanging clips and is available in three sizes.



GSHR - straight

**Straight Sets**

Available in 3 sizes and 3 colors (clear / black / silver):

|                  |          |              |
|------------------|----------|--------------|
| GSH24R - (C/B/S) | 24" long | <b>11.79</b> |
| GSH36R - (C/B/S) | 36" long | <b>15.29</b> |
| GSH48R - (C/B/S) | 48" long | <b>19.44</b> |



GSHO - oval

**Oval Sets**

Available in 3 sizes and 2 colors (clear / silver):

|                |          |              |
|----------------|----------|--------------|
| GSH24O - (C/S) | 24" long | <b>20.87</b> |
| GSH36O - (C/S) | 36" long | <b>24.36</b> |
| GSH48O - (C/S) | 48" long | <b>31.88</b> |



Can be used 2 ways

RMB

Round magnetic base w/hook available on page 60



**Hanging Dowel Kits**

Made for banners with a hem, top and bottom. Each kit includes (2) aluminum 1/2" diameter dowels, end caps and (1) diamond braided cord. Available in 3 sizes.

|        |          |              |
|--------|----------|--------------|
| GDSH24 | 24" long | <b>11.79</b> |
| GDSH36 | 36" long | <b>13.87</b> |
| GDSH48 | 48" long | <b>15.29</b> |

GDSH



Mini size 1 1/4" w x 2" h

GSHC

2" w x 3" h

**Sign Hanging & Countertop Clip Sets**

Solid aluminum alloy sign clips coated in a satin finish. Clips feature rubber grips, a binder spring and the ability to grip signs up to 1/2" in thickness.

Satin silver or black. Sold in sets of two, same size/color.

|        |                        |              |
|--------|------------------------|--------------|
| GSHCL  | 2" W x 3" H            | <b>39.53</b> |
| GSHCLB |                        |              |
| GSHCS  | 1 1/4" W x 2" H (mini) | <b>27.73</b> |
| GSHCSB |                        |              |



**FEATHER BANNER SWOOPER FLAG SIGN KITS**



**15ft Feather Banner Swooper Flag Sign KIT**  
Includes 1 flag (12' x 2.5'), 1 4-piece pole kit & 1 stake; stands 15' high when assembled;  
1 kit/carton; 7 lbs. **\$97.07 /kit**

- SALEFB** Sale Sign kit
- CLEARANCEFB** Clearance Sign kit
- OPENFB** Open (blue/red) Sign kit
- OPENSSFB** Open (stars & stripes) Sign kit

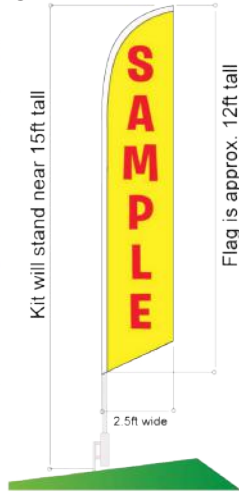

**FLAGS**



PFL00100



PFL00200

**SALE & OPEN Flags**  
Large 3' x 5' flags. Lightweight and durable outdoor polyester material, double stitched on flying edges for extra durability, and two metal grommets for easy display.  
1 /carton; 1 lb.

- SALE PFL00100 \$13.87 each**
- OPEN PFL00200 \$19.43 each**

**PENNANTS**



PNR100-OMC



PNR100-OPT

**Triangle Pennants - (48) 12" x 18"** pennants on 100' of nylon rope. Please specify color: Red/White/Blue(OPT) or Multi-Colored(OMC).

- 1 /carton; 2/10 lbs.
- PNR100-OPT \$26.49**
- PNR100-OMC \$24.99**



OPENHRB2

**LED "OPEN" Sign**  
LED red and blue open sign with black base for indoor use. Measures 13"H x 21 1/2"W x 1"D. Weight 3lbs. Lifetime of 10,000 hours. Low power consumption. No Flashing. Power supply and chain included; 18 5/8" w x 9 5/8" h.  
1 /carton; 3/12 lbs. **\$55.34**



NHMBB03G

**A-Frame Sidewalk Chalkboard**

Features a mahogany finish and can be used with chalk and liquid chalk markers (sold separately). It is double-sided and sits on rubber stoppers to prevent scratched floors and added stability. Can be used indoors and/or outdoors.

Closed Dimensions: 20 1/2" (w) x 39 1/2" (h) x 2" (d)  
Open Dimensions: 20 1/2" (w) x 37 1/2" (h) x 27" (d)  
Writable Area: 17 3/4" x 28 3/4"

1 /carton; 18/24 lbs. **\$116.51**



NHMBB03B

**A-Frame Sidewalk Marker Board**

Features a mahogany finish and black marker board perfect for dry-erase or liquid chalk markers (sold separately). It is double-sided and sits on rubber stoppers to prevent scratched floors and added stability. Indoor use only.

Closed Dimensions: 20 1/2"(w) x 39 1/2" (h) x 2" (d)  
Open Dimensions: 20 1/2" (w) x 37 1/2"(h) x 27" (d)  
Writing Area: 17 3/4" x 58 3/4"

1 /carton; 18/24 lbs. **\$116.51**



NHMBB10C

**Framed Square Chalkboard**

Features a mahogany finish and can be used with chalk and liquid chalk markers (sold separately). It can be hung in portrait and landscape with the (2) hooks provided. Indoor use only.

Overall Size: 24" x 30" x 1"  
Writable Area: 22 1/2" x 28 1/2"

1 /carton; 9/10 lbs. **\$68.04**



PFL00200KT

**OPEN Flag with Pole KIT**  
Kit consists of one 3' x 5' OPEN flag and a 6' flag pole. The flag pole is white, painted steel and includes a mounting bracket and screws, rotating flag clips, and a gold plastic eagle mounted on the top.

1 kit /carton; 2/5 lbs. **\$42.76**

**Fluorescent Liquid Chalk Markers**

Fluorescent liquid chalk markers. Wipe away easily with a wet cloth. A set includes 8 markers: Blue, Green, Pink, Purple, Orange, Red, White, and Yellow.

**with 1/8" Small Bullet Tip (8)**

8 /carton; 1 lb. **\$25.66**



NHGBE06



**with 5/8" Large Flat Tip (8)**

8 /carton; 1/2 lbs.

**\$50.67**

NHGBE05

| style #   | \$    | qty | description  | size  | wgt |
|-----------|-------|-----|--|---|-----|
| NHFT      | 56.99 | 1   | Counterfeit Detector   | 2 3/4" x 4 1/2"   | 1   |
| NHFTRBADD | 16.99 | 1   | Rechargeable Battery   | 2 3/4" x 4 1/2"   | 1   |
| NHFTRB    | 72.99 | 1   | Detector/Battery kit   | both pieces<br>2 3/4" x 4 1/2"  | 1   |
| K20020    | 5.57  | 1   | BLACK  | PEN   | 1   |
| K20020S   | 16.59 | 1   | Pen set  | 3 Pens  | 1   |
| SC3000    | 25.01 | 1   | Indoor/outdoor simulated cameras w/LEDs<br>Black   | 7x3 1/2x5 1/2"  | 2/3 |
| SC2010    | 25.01 | 1   | White  | 5 1/2x3x2 1/2"  |     |
| SCODW     | 32.01 | 1   | 30 LEDs; realistic design; sticker included; uses 2-AA batteries (not included)<br>White wall/ceiling mounted camera dome w/blinking light; uses 2-AA batteries (not included) | 9 1/4x5 1/2x4 1/2"  | 2/7 |
| DOME3051  | 27.48 | 1   | Simulated camera w/ blinking red light; uses 2-AA batteries (not included)   | 4 1/2" dia.;<br>3" h  | 1/3 |
| CA2       | 62.47 | 1   | Compact, self-contained indoor alarm. Easy installation. Motion detection activates a chime or alarm sound. Uses 9V battery (not included).                                    | 3x3x2 1/4"<br>Detects motion at a range of up to 32 feet  | 1   |
| NH3360    | 52.99 | 1   | Wireless Entry Alert @<br>Chime alert w/ Receiver; 10 selectable chimes  | All kits feature:<br>up to 500 ft. range;<br>64-88 dB at 1';<br>UL/cUL listed, FCC and IC Compliant | 1   |
| NH3350    | 55.99 | 1   | Musical doorbell chime w/ Receiver; 10 selectable sounds   |   | 1   |
| NH3300    | 55.99 | 1   | Doorbell extender w/ Receiver; 2 selectable sounds   |   | 1   |
| NH3610    | 54.49 | 1   | Motion-activated chime w/ Receiver; 10 selectable chimes; weather sealed   |   | 1   |
| MG24      | 77.63 | 1   | CHROME   | 24 slot arm   | 2/3 |
| ADAPTERS  |       |     |  |   |     |
| SD75      | 31.88 | 1   | CHROME   | 3/4" tube   | 2   |
| SD100     | 13.74 | 1   | CHROME   | 1" sq. tube   | 1   |
| CABLES    |       |     |  |   |     |
| SD724     | 5.96  | 1   | CHROME   | 8'L   | 1   |
| 606       | 6.87  | 1   | Security chain kit   | Standard lock;<br>46" chain;<br>8" ring   | 1/3 |
| LOCKS     | 3.11  | 5   | Standard Replacement Locks   | Standard  | 1   |



# SECURITY Traffic Control



## POST & ROPE

Posts available in matte black, polished stainless steel or brass. Red or black velvet ropes in a selection of lengths available (sold separately)

**2-post sets for one low price!**



## POST & TENSION BELTS

Economical posts and belts with slow-retracting brake available in a variety of options



**Belt Color Options**

|            |                  |
|------------|------------------|
|            |                  |
| Black (BK) | Yellow (YW)      |
|            |                  |
| Red (RD)   | Maroon (MN)      |
|            |                  |
| Blue (BL)  | Black/White (BW) |

**CAUTION - DO NOT ENTER**  
Caution (CAU)



## POST-MOUNTED FRAME KITS & 2-SIDED SIGNS



Frame kit includes 1 frame, 1 black metal adapter and 2 acrylic protectors



\* Note that custom signs are also available

| style #     | \$     | qty        | description   | size                                 | wgt   |
|-------------|--------|------------|---|--------------------------------------|-------|
| MLFTMB      | 109.64 | 2-post set | Matte black/ flat top                                       | set = 2 x 40" H / base 14"           | 19/25 |
| MLUTPS      | 130.38 |            | Polished stainless steel/ urn top                           | 40" H / base 14"                     |       |
| MLBTPB      | 137.38 |            | Polished brass/ ball top                                    | 40" H / base 14"                     |       |
| MLRBK48SEPS | 88.78  | 1          | Black velvet with stainless steel snap ends and cotton core | 4 ft                                 | 7/10  |
| MLRBK72SEPS | 80.48  |            |   | 6 ft                                 |       |
| MLRBK96SEPS | 88.78  |            |   | 8 ft                                 |       |
| MLRRD48SEPS | 88.78  | 1          | Red velvet with stainless steel snap ends and cotton core   | 4 ft                                 | 7/10  |
| MLRRD72SEPS | 80.48  |            |   | 6 ft                                 |       |
| MLRRD96SEPS | 88.78  |            |   | 8 ft                                 |       |
| MLRRD48SEPB | 88.78  | 1          | Red velvet with brass snap ends and cotton core             | 4 ft                                 | 7/10  |
| MLRRD72SEPB | 80.48  |            |   | 6 ft                                 |       |
| MLRRD96SEPB | 88.78  |            |   | 8 ft                                 |       |
| TL700MBBK   | 114.99 | 2-post set | Matte black Post/Belt                                       | set = 2 x 40" post 14" base 10" belt | 24/27 |
| TL700MB     | 166.41 |            | Black Post/Specify Belt                                     |                                      |       |
| TL700PSBK   | 183.12 |            | Polished SS Post/Specify Belt                               |                                      |       |
| TL700SSBK   | 216.43 |            | Satin SS Post/Specify Belt                                  |                                      |       |
| TL700YWBK   | 221.88 |            | Yellow Post -Black Belt                                     |                                      |       |
| TL700YW     | 221.88 |            | Yellow Post/Specify Belt                                    |                                      |       |
| TLRE        | 13.74  | 1          | Wall Mount Receiving End                                    |                                      | 1     |
| TLWM700MB   | 83.20  | 1          | Matte Black head/plate - specify belt                       | 10' belt                             | 6     |
| TLWM700PS   | 91.63  | 1          | Polished SS head/plate - specify belt                       | 10' belt                             | 6     |
| TLRC700MB   | 60.91  | 1          | Tension line replacement cassettes - specify belt:          | 10' belt                             | 4     |
| TLRC700PS   | 60.91  |            | Matte black finish  |                                      |       |
| TLRC700SS   | 60.91  |            | Polished SS finish  |                                      |       |
| TLRC700YW   | 60.91  |            | Satin SS finish   |                                      |       |
| TLRC700YW   | 60.91  |            | Yellow finish   |                                      |       |
| TLSK1811MB  | 36.44  | 1          | Matte Black Frame   | 8 1/2" x 11" frame kit               | 3     |
| TLSK1811PC  | 83.20  |            | Polished Chrome Frame                                       |                                      |       |
| TLS811BK03  | 36.49  | 1          | Exit  | 8" x 11" 2-sided signs 1/16" thick   | 1     |
| TLS811BK05  | 36.49  |            | Please Enter Here   |                                      |       |



| style #                      | \$               | qty   | description   | size                                   | wgt   |          |    |
|------------------------------|------------------|---|---|--|-------|----------|----|
| 3181S                        | 148.26           | 1   | POSTS:<br>Satin chrome  | 34" ht. / base<br>11.5"                | 22/59 |          |    |
| 3182SA                       | 163.56           |   | Satin brass   | 34" ht. / base<br>11.5"                |       |          |    |
| 3101S                        | 173.28           | 1   | Satin chrome  | 39" ht. / base<br>11.5"                | 22/59 |          |    |
| 3102S                        | 207.88           |   | Satin brass   | 39" ht. / base<br>11.5"                |       |          |    |
| 550541336B<br>550541336C     | 168.09<br>151.50 | 1   | ROPE:<br>Black/ Brass<br>Black/ Chrome                                  | 1 1/2" diameter<br>6 ft                | 3/6   |          |    |
| 550541333BB<br>550541333BC   | 125.71<br>109.12 |   | Black/ Brass<br>Black/ Chrome   | 3 ft                                   |       |          |    |
| 550541246B<br>550541246C     | 168.09<br>151.50 |   | Royal blue/ Brass<br>Royal blue/ Chrome                                 | 6 ft                                   |       |          |    |
| 550541333RBB<br>550541333RBC | 125.71<br>109.12 |   | Royal blue/ Brass<br>Royal blue/ Chrome                                 | 3 ft                                   |       |          |    |
| 550541226B<br>550541226C     | 168.09<br>151.50 |   | Bright Red/ Brass<br>Bright Red/ Chrome                                 | 6 ft                                   |       |          |    |
| 550541223B<br>550541223C     | 125.71<br>109.12 |   | Bright Red/ Brass<br>Bright Red/ Chrome                                 | 3 ft                                   |       |          |    |
|                              |                  |   | <i>See list of available colors pictured right</i>                      |  |       |          |    |
| 890333333                    | 221.75           |   | 1   | Black Post<br>black tape               |       | 40"Hx7"L | 22 |
| 89033333332                  | 235.61           |   |   | Black Post<br>black tape/ white stripe |       | 40"Hx7"L |    |
| 8901P1P23                    | 221.75           |   |   | Polished chrome post<br>Blue tape      |       | 40"Hx7"L |    |
| 8901P333332                  | 221.75           | Polished chrome post<br>Black tape/ white stripe    |   | 40"Hx7"L                               |       |          |    |
| 8902S2S29                    | 249.48           | Satin brass clear<br>coated post<br>dark green tape |   | 40"Hx7"L                               |       |          |    |
| 66                           | 9.59             | 1   | Rubber floor<br>protector set   | 13" base                               | 2     |          |    |
| 8961P23                      | 138.54           |   | Polished chrome<br>head, blue tape                                      | Wall mount                             |       |          |    |
| 8962P28                      | 166.28           |   | Polished brass head,<br>green tape                                      | Wall mount                             |       |          |    |
| 896333332                    | 138.54           |   | Black head/black<br>tape/White stripe                                   | Wall mount                             |       |          |    |
| 698                          | 20.87            |   | Wall receptacle   | N/A                                    |       |          |    |
| 170133899HD                  | 83.07            | 1   | SuperHold sign<br>adapter - black                                       | 3"                                     | 3     |          |    |
| S17P32V                      |                  |   | Single faced signs:<br>line forms here                                  |  |       |          |    |
| S21P32V                      | 78.93            |   | please wait here<br>please wait here<br>for next available<br>associate | 7" w x 11" H<br>1/8" thick             |       |          |    |
| S15P33V                      |                  |   | this section closed   |  |       |          |    |
| S09P32V                      |                  |   |   |  |       |          |    |

## Contemporary Portable Post 318

Clean functional design, lighter weight, lower cost. Available in satin chrome or satin brass.

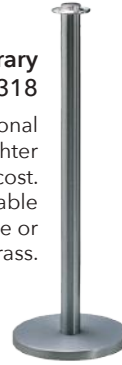

## Standard Portable Post 310

Our most popular post for guiding traffic. A proven design. Built for years of dependable service. Available in satin chrome or satin brass.



### Velour Rope Colors:



- 54 Antique Gold
- 42 Rust
- 46 Brown
- 22 Bright Red
- 43 Maroon
- 24 Royal Blue
- 71 Ice Blue
- 44 Purple
- 29 Hunter Green
- 48 Beige
- 33 Black

### Velour Ropes for the 318 & 310 series

Many other colors and styles of post and ropes available - call Customer Service for more info.

## Tensabarrier 890 Series:

Retractable tape system for pedestrian traffic guidance.

- slow retracting tape cassette
- 4-way connecting system
- superhold sign adapter
  - 2 year warranty
  - locking tape end
  - easy installation



Rubber Floor Mat 66



8961P23  
8962P28  
Wall Mount Tape



Wall Mount Tape 896333332



Wall Receptacle 698



Sign Adapter 170133899HD

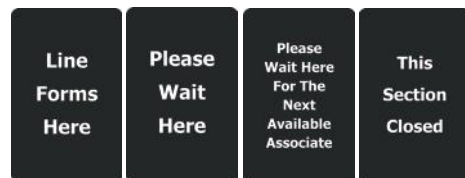

Acrylic Signs

# DRESSING ROOM SUPPLIES



NHBLB

**Brass Wire Lint Brush**



**Horse Hair Coat Brush**

NHCB



**Fabric Comb**  
NHFC

**Lint & Nap Brush**

NHNB

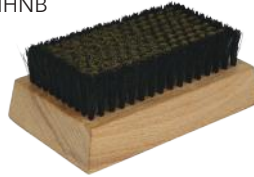

**Sweater Comb**  
NHSC

**Janie® Dry Spot Commercial Stick Remover**

NHCSR



**Grandma's Secret Spot Remover**

NHSR

**Try-On Panty**  
Excellent for bathing suits. Each packed individually.



TSJ

**Hygienic Liner**



TCP1



1030A



1061

**Ever Blum® Cosmetic Stain Remover**

**Powder Spot Remover**  
For fine garments.

**Lint Roller & Replacement Rolls**

LL30



LLR



**Albatross® Electric Spot Cleaning Gun**

SG2000



1005

**Ever Blum® Spray-A-Spot Cleaning Fluid**  
Removes a wide variety of stains.

| style # | \$     | qty  | description  | size                          | wgt |
|---------|--------|------|--|-------------------------------|-----|
| NHBLB   | 24.36  | 1    | Brass wire lint brush  | 9 1/4" long                   | 2/3 |
| NHCB    | 20.87  | 1    | Horse hair coat brush, deluxe  | 14 1/4" long                  | 2/3 |
| NHNB    | 25.66  | 1    | Lint & Nap brush - Brass wire center with outside row of horse hair bristles - excellent for suedes & sweaters | 4 1/2"L x 2 1/2"W             | 2/3 |
| NHFC    | 34.73  | 1    | Fabric comb w/steel blade to remove pills from wool garments   | 6" wide; 7 1/4" long          | 2/3 |
| NHSC    | 25.66  | 1    | Sweater comb   | 6" long, 4 5/8" x 2 1/4" head | 2/3 |
| NHCSR   | 9.72   | 1    | Janie® Dry Spot Commercial Stick Remover   | .40 ounces                    | 2/3 |
| NHSR    | 6.49   | 1    | Grandma's Secret Spot Remover  | 2 ounces                      | 2/3 |
| TS      | 54.17  | 100  | White  | Misses                        | 2/3 |
| TSJ     | 44.45  |      | White thong  | Junior                        | 2/3 |
| TCP1    | 77.99  | 1000 | Natural  | 1 1/2x5"                      | 3   |
| LL30    | 3.50   | 1    | 8" Lint Roller w/ handle   | 30' roll                      | 1/2 |
| LLR     | 2.06   |      | 4" Refill  |                               |     |
| 1030A   | 41.47  | 1    | One can Non-aerosol  | 8 oz                          | 2   |
| 1061    | 25.66  | 1    | One can Aerosol  | 12 oz                         | 2   |
| SG2000  | 180.14 | 1    | Electric spot cleaning gun   | Standard                      | 5/6 |
| 1005    | 81.13  | 1    | Spray-A-Spot cleaning fluid  | Gallon                        | 10  |

# DRESSING ROOM SUPPLIES

| style #                             | \$    | qty      | description                           | size     | wgt |
|-------------------------------------|-------|----------|---------------------------------------|----------|-----|
| <i>25 pieces per color per kit:</i> |       |          |                                       |          |     |
| 608                                 | 41.47 | 100/ kit | Green, red, yellow, blue              | 4x4 1/2" | 3   |
| 608X                                | 54.17 | 150/ kit | Green, red, yellow blue, white, black | 4x4 1/2" | 4   |
| <i>10 pieces per size per kit:</i>  |       |          |                                       |          |     |
| M319                                | 17.37 | 30/ kit  | White: 4,5,6                          | 2x5"     | 1/2 |
| <i>25 pieces per size per kit:</i>  |       |          |                                       |          |     |
| M320                                | 44.45 | 100/ kit | 1,2,3, Guest                          | 2x5"     | 3   |
| <i>25 pieces per size per kit:</i>  |       |          |                                       |          |     |
| 608-6B                              | 50.03 | 150      | Black w/white print                   | 4x4 1/2" | 4   |
| 608-6W                              | 50.03 | 150      | White w/black print                   | 4x4 1/2" | 4   |



## FITTING ROOM CHECKS

Color coded and notched to indicate number of items. 608 /608X

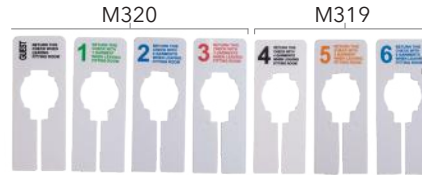

Numbers 1-6 plus 'guest'.



608-6B / 608-6W Numbers 1-6, printed both sides.



Let us create Custom Kits for you today!

|     |        |   |        |  |                         |
|-----|--------|---|--------|--|-------------------------|
| 3WM | 483.99 | 1 | CHROME | center: 20"x60"<br>sides: 18"x60"<br>height: 67 1/4"<br>depth: 30"       | 80,40<br>(2 ctns)       |
| TSM | 204.99 | 1 | CHROME | 20" x 60"<br>panel; legs -<br>22 1/3"H<br>depth: 30"<br>includes casters | 27<br>10/12<br>(2 ctns) |

Note: the above items ship in two boxes - one for the mirror panels and one for the legs

Allow 5-10 business days to ship

|     |        |    |               |   |       |
|-----|--------|----|---------------|---|-------|
| JSB | 101.22 | 12 | SPECIFY color | 19 1/8 x 13 1/4 x 10"<br>(8 gallons/ 28 liters) | 26/43 |
| LSB | 83.07  | 12 | SPECIFY color | 17 x 11 3/4 x 9"<br>(6 gallons/ 22 liters)      | 20/29 |

Colors: Blue (BL), yellow (Y), red (R), black (BLK), grey (GY) and green (G). Note that other colors are available with a 60-90 day lead time.

|     |       |   |             |       |      |
|-----|-------|---|-------------|-------|------|
| BSJ | 36.16 | 1 | BLACK METAL | JUMBO | 5/16 |
| BSL | 33.31 | 1 | BLACK METAL | LARGE | 3/14 |

## MIRRORS

3WM ships truck



TSM ships truck



## PLASTIC SHOPPING BASKETS

Choose from two sizes: JSB (Jumbo) and LSB (Large).

Hot stamp printing is available for this item. Ask for details.

All baskets are drop ship only.

Basket stands sold separately (below).



LSB



BSJ

## Basket Stand

Black wire metal stand available in two sizes that correspond to shopping baskets above.

## PULL & GO BASKETS

- Easy grip pick-up handle and ergonomic, antibacterial, lockable telescopic pull handle
- Smooth panel on the top rim can be used for logo branding
- Washable and 100% recyclable



PGB-BLK

# DRESSING ROOM SUPPLIES Tailor Supplies



## Measuring Tapes



## Tailor's Chalk



## Seam Ripper



## Zipper Ease



## Thread Clip

NT301C



## Multipurpose Scissors

NT2025



## Lightweight Scissors

Fine quality, sharp steel blades  
with lightweight plastic handle  
NT690



NTTPIN24



## Pin Disposal Bank

PDB



| style #          | \$             | qty     | description   | size               | wgt |
|------------------|----------------|---------|---|--------------------|-----|
| NTEZ             | 9.59           | 1       | EZ-Off Iron Cleaner   | 5.25 oz. tube      | 1/3 |
| ZD100            | 27.60          | 1       | 1- 1 oz. tube of soleplate cleaner<br>1- application cloth<br>1- polish/finish cloth<br>1- set of instructions  |                    | 1/3 |
| NTHI450F         | 26.31          | 1       | Replacement Resin Filter - for use w/gravity feed irons   |                    | 1   |
| NTTIS-NTP5N      | 41.60          | 1       | Ironing shoe (for use with NTP5N iron)  |                    | 1   |
| 834              | 6.87           | 5       | White, 60"  | 60"                | 1   |
| NTTMC            | 3.63           | 1       | Crotch tape measure   | 60"                | 1/3 |
| NTPCT            | 2.85           | 1       | Pin cushion tomato  | Red/Green          | 1/3 |
| NTSR6            | 2.72           | 1       | Large seam ripper   |                    | 1   |
| NTSR5            | 1.68           | 1       | Small seam ripper   |                    | 1   |
| NT4              | 3.50           | 3       | For all needle types  | Gold               | 1   |
| NTTCA/<br>NTTCAR | 15.16<br>15.16 | 48      | Tailor's chalk  | White<br>Red       | 1/3 |
| NTZE             | 6.87           | 1       | Zipper ease   |                    | 1   |
| NHBSK            | 18.79          | 1 kit   | Singer® Beginner's Sewing Kit: scissors, needles, pins, thread, measuring tape, thimble, marking pencils, pin cushion, sew/knit gauge, seam ripper included |                    | 2/3 |
| NHBT             | 7.65           | 1       | Basting Tape  | 1/4" x 11 1/3" yds | 2/3 |
| NT301C           | 12.99          | 1       | Thread clip   | 4 1/2"             | 1   |
| NT2025           | 19.43          | 1       | Scissors  | 5"                 | 1/3 |
| NT601            | 13.74          | 1       | Lightweight threadclip  | 4 3/4"             | 1/2 |
| NT690            | 22.16          | 1       | Lightweight dressmaker  | 9"                 | 1/2 |
| NTTPIN24         | 15.16          | 1/2 lb. | T-pin   | 1 1/2"             | 1/3 |
| NTX24SD          | 22.16          | 1 lb.   | Dressmaker pin  | 1 1/2"             | 1/7 |
| 285              | 20.74          | 1 lb.   | Straight pin  | 1"                 | 1/3 |
| NTX3SC           | 40.31          | 1440    | Safety pin  | 2" #3              | 2/3 |
| SBSP             | 10.63          | 100     | black safety  | 1 1/2"             | 1   |
| 00               | 36.03          | 1440    | brass safety  | 3/4"               | 1/2 |
| PDB              | 18.01          | 1       | Pin disposal bank<br>1000 pin capacity; can be wall mounted   |                    | 1   |

# Steamers & Irons DRESSING ROOM SUPPLIES

| style #  | \$     | qty    | description   | size   | wgt   |
|----------|--------|--------|---|--|-------|
| J-2      | 219.90 | 1      | Standard 65" L Hose, 1 gal. water reservoir                                   | 1300 watts                                       | 18/21 |
| J4       | 328.67 | 1      | J4000 / Heavy Duty, 65" L Hose 1 gal. water reservoir                         | 1500 watts                                       | 25    |
| J1       | 166.28 | 1      | Hat Steamer 1 gal. water reservoir  | 1300 watts                                       | 14/21 |
| #3       | 19.31  | 1      | Replacement bottle for J-2  | 1 gallon   | 1/6   |
| 2A       | 88.65  | 1      | Hose/Head replacement for J-2 & J4  | 65" L Hose                                       | 3/4   |
| 2C       | 41.47  | 1      | Replacement head/handle for J1 /J-2/ J4                                       |  | 1/1   |
| 1030     | 41.60  | 1      | Rod & nut set for J1 /J-2/ J4   |  | 3/3   |
| J6       | 152.41 | 1      | Plug In 8 oz. water reservoir   | 600 watts  | 3/7   |
| 0669     | 36.42  | 1      | Water tank replacement for J6   |  | 1/1   |
| 0661     | 2.27   | 1      | Inside O-ring replacement for J6  |  | 1/1   |
| 0662     | 2.27   | 1      | Outside O-ring replacement for J6   |  | 1/1   |
| 0665     | 22.55  | 1      | Right case half - J6  |  | 1/1   |
| 0666     | 22.55  | 1      | Left case half - J6   |  | 1/1   |
| 0663     | 32.01  | 1      | Steam cap w/face plate for J6   |  | 1     |
| ST500    | 136.99 | 1      | Grey Steam Butler 1 gallon water reservoir, snap on brush                     | 1350 watts                                       | 19    |
| JC100    | 12.57  | 1      | Liquid Cleaner  | 10 oz  | 2/3   |
| NTIRON   | 64.54  | 1      | Iron has extra power & steam output; auto off; lifetime sole plate            | 8 ft. cord                                       | 4/10  |
| NH2601   | 34.08  | 1 pair | Black Heat Gloves: steam /heat resistant; latex free; machine washable        | size Large                                       | 1/3   |
| NTP5N    | 211.51 | 1      | Gravity Feed Iron Comes complete w/ water bottle, hoses, iron rest and filter | 120 volt 5 lb.                                   | 10/13 |
| VR8324U1 | 298.07 | 1      | Steam Pro Iron  | 6.5 bar pump pressure w/ 350g/minute steam boost | 10    |

## STEAMERS

### Jiffy Clothes Steamers & Accessories

**Jiffy Handheld Steamer**  
J6

**Steam Butler Steamer**  
ST500

## IRONS

**Steam Iron**  
NTIRON

**Gravity Feed Iron**  
NTP5N

*Self-contained gravity feed iron system. The water tank gets installed above the iron (about 3 feet) and the gravity forces the water into the iron once the steam button is pushed.*

**Heat Gloves**  
NH2601

**Steam Pro Iron**  
VR8324U1

# STORE SUPPLIES Back Room Supplies

style # \$ qty description size wgt



**Folding Platform Truck with Solid Steel Deck**

NHFPT



|       |       |   |  |   |       |
|-------|-------|---|--|---|-------|
| NHFPT | 76.33 | 1 | Folding Platform Truck<br>Lightweight, quiet rolling and maneuvers easily on 4" diameter non-marring rubber wheels; folding comfort-grip foam handle; solid steel deck with a non-skid vinyl surface | 28"L x 18"W x 33"H (to top of handle)<br><br>holds up to 400lbs | 25/35 |
|-------|-------|---|--|---|-------|



**Commercial Bagless Sanitaire upright with HEPA filter**

SCBL

Sanitaire upright with HEPA filter



**Sanitaire Upright**

With HEPA filter; uses paper bags

SCPDB

|       |        |   |  |   |       |
|-------|--------|---|--|---|-------|
| SCBL  | 396.70 | 1 | Sanitaire bagless: 7-position height adjustment; HEPA filter; w/ furniture guard, dusting brush and crevice tool | 13" cleaning path; 10 amps; 3.5 qt; 40 ft. cord; H/ 44", W/ 12-3/4", L/ 13-1/2"   | 24/43 |
| SCPDB | 390.36 | 1 | Sanitaire bagless: 7-position height adjustment; HEPA filter; includes attachments                               | 13" cleaning path; 10 amps; 1 gallon; 40 ft. cord; H/ 44", W/ 12-3/4", L/ 13-1/2" | 17/43 |

*2-year warranty on our Sanitaire vacuums above.*

**Bona® Hardwood Floor Cleaner and Care Kit**

BSB



BMK

|     |       |   |  |   |   |
|-----|-------|---|--|---|---|
| BSB | 13.74 | 1 | Bona® Hardwood Floor Cleaner – Greenguard certified  | 32 oz.  | 1 |
| BMK | 73.48 | 1 | Bona® Professional Hardwood Floor Care Kit<br>Includes pole & base; Bona hardwood cleaner; 18" microfiber cleaning pad; 18" microfiber dusting pad | 72" pole (telescoping); 32 oz. cleaner; (2) 18" cleaning/dusting pads | 1 |

**Bucket & Wringer**

WHT202Y



**Replacement Mop Head**



UNSO2238

**Mop Handle**



UNSO2342

|          |       |   |                               |                |       |
|----------|-------|---|-------------------------------|----------------|-------|
| WHT202Y  | 62.47 | 1 | Bucket/wringer combo (yellow) | 36 qt.         | 18/29 |
| UNSO2238 | 7.00  | 1 | Replacement head              | 16 oz. 5" band | 5     |
| UNSO2342 | 11.79 | 1 | Continental Mop Handle        | 60"            | 7     |

**Wet Floor Signs**

WHT13W



407WFS27

|          |       |   |                             |       |      |
|----------|-------|---|-----------------------------|-------|------|
| WHT13W   | 9.72  | 1 | 2-sided Yellow Caution Sign | 26" H | 3/15 |
| 407WFS27 | 22.29 | 1 | Cone-Shaped Sign            | 27" H | 4/26 |

**Clear Garbage Bags**

CTL15931 / 221459



|           |       |      |         |           |    |
|-----------|-------|------|---------|-----------|----|
| CTL15931  | 40.31 | 1000 | 10 gal. | 15x9x31"  | 25 |
| CTL221459 | 60.39 | 100  | 60 gal. | 22x14x59" | 28 |



**1 Hand Stretch Wrap for Shipping**

Clear, pallet wrap; (65 GA), 1500'L x 18" W;  
4 /case; 33 lbs.  
WRAP \$68.04

**2 Hand Stapler**

Stanley light duty hand stapler; 7" wide; 1 /case; 1 lb.  
P3 \$29.81

**3 Staples**

Staples for item P3; 5000 /pack; 1 lb.  
P3CH \$8.68

**4 Case Cutter**

4" case cutter; 12 /case; 1 lb.  
HC900 \$8.42

**5 Single Edge Blades**

Cutting blades for HC900; .009 thick; 100 /pack; 1 lb.  
RB900 \$7.65

**6 Stanley Tackler**

8" light duty stapler; 1 /case; 2 lbs.  
T11 \$15.29

**7 Staples**

Staples for item T11; 1000 /pack; 1 lb.  
T11S \$3.56

**8 Stanley Tool Kit w/case**

Tool kit in a hard-sided case; 10 lbs.  
92680 \$62.47

**9 Tape Dispenser**

Standard packing tape dispenser; 1 /case;  
2/3 lbs.  
TD \$17.37

**10 Packing Tape**

2" wide; choose Clear (TAPE6) or Brown (TAPE6T); 6  
rolls /pack; 4/6 lbs.  
TAPE6 \$20.22

# BODY FORMS Jersey Covered Forms

## Premium Jersey Display - Dressmaker Forms & Accessories

High-quality professional grade jersey covered forms for dimensional display. Professional, pinnable and long-lasting. Use for display, dressmaking, and tailoring. Create yours for a customized look.

Available in  
2 classic colors  
cream /CR &  
black /BC

### 1 Select a Jersey Torso Form



#### Ladies Dress Torso

P26CR / P26BC

Size 8

**91.99**

7/8" Flange

10/47 lbs

#### Ladies Blouse Torso

P34CR / P34BC

Size 8

**84.99**

7/8" Flange

8/47 lbs

Prices reflect torso only.  
Complete forms shown for effect.



#### Mens Suit/Shirt Torso

P97CR / P97BC

Size 38

**84.99**

7/8" Flange

9/47 lbs

#### Mens Coat/Shirt Torso

P85CR / P85BC

Size 38

**91.99**

7/8" Flange

12/47 lbs

Prices reflect torso only.  
Complete forms shown for effect.



Complete the Set: pair one of the Body Form torsos above with a neck block and a base (see p73)



Pair Components: body form torso (p72) + neck block + base

**2 Add a Neck Block**



**WOOD styles**



**Wood Finial Neck Blocks 11.99**

Women's styles:

NB301N / NB301S / NB301M

Men's styles:

NB302N / NB302S / NB302M

(N=Natural / S=Walnut / M=Mahogany)

**Neck Block Caps 11.99**

Women's styles:

NDISKF / WDISKF / MDISKF

Men's styles:

NDISKM / WDISKM / MDISKM

(N=Natural / W=Walnut / M=Mahogany)

**METAL styles**

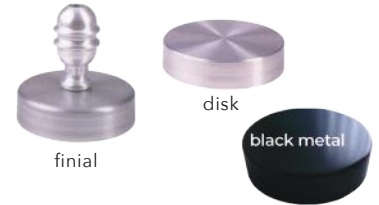

**Unisex Neck Block**

**Brushed Chrome:**

Finial style:

FSFSCFIN **45.99**

Disk style:

FSFSC **11.99**

**Black Metal:**

BKDISCM **11.99**

disk /brushed chrome



**3 Add a Base / Floor Standing**

**WOOD styles**

**Round or Tripod:**

42" Total Height

(24" - Base / 18" - Chrome Pole)

7/8" Flange compatible

10/35lbs - 7/21lbs



**Wood Bases - All Versions 50.99**

Round Base: WB172N7/8; WB172S7/8; WB172M7/8

Tripod Base: WB212N7/8; WB212S7/8; WB212M7/8

(N, Natural / S, Walnut / M, Mahogany)

**METAL styles**

**Dressmaker Base:**

36" Upright Height

7/8" Flange compatible

36 lbs

Includes casters



**DMB1**  
Chrome  
**116.99**

**DMB2**  
Natural Metal  
**116.99**

**DMU48C**  
Replacement  
Upright  
48" height  
7/8" flange  
5 lbs.  
**11.79**

**DMU48C**  
*\*Upright only. For extra height, remove existing upright and insert the DMU48C. Dressmaker base (DMB1) must also be purchased. Available in chrome only.*

# BODY FORMS Jersey Form Sets

## Boutique Dressmaker Forms / Complete Sets

Includes: Cream pinnable form, acorn finial neck block and traditional style base with castors and decorative pedal in black or polished chrome.



### Female Dress Sets

NHZMMFBK / **232.99**  
Cream with Black

NHZMMFCH / **245.99**  
Cream with Polished Chrome

Chest 36.5"  
Waist 25.5"  
Hip 36.5"  
Height 30"  
Adj. Height 63"-82"  
Weight 22/50

### Male Coat Sets

NHZMMMBK / **232.99**  
Cream with Black

NHZMMMCH / **245.99**  
Cream with Polished Chrome

Chest 40"  
Waist 28"  
Hip 39"  
Height 29"  
Adj. Height 60"-79"  
Weight 22/50



## Jersey Form Sets

Complete Sets - Budget Friendly - Professional Grade



### Female Dress Sets 92.99

Satin Chrome Stand and neck cap

Black Jersey NHBFFBM  
Cream Jersey NHBFFOW

Wood Stand and wood neck cap

Black Jersey w/black wood NHBFFBW  
Cream Jersey w/natural wood NHBFFCW

Size 8  
Shoulder 15"  
Chest 36"  
Waist 25"  
Hip 36"  
Height 29"  
Adj. Height 48" base pole  
Weight 15

### Male Suit Sets 108.99

Satin Chrome Stand and neck cap

Black Jersey NHBFMBM  
Cream Jersey NHBFMCM

Wood Stand and wood neck cap

Black Jersey w/black wood NHBFMBW  
Cream Jersey w/natural wood NHBFMCW

Size 38  
Shoulder 19"  
Chest 38"  
Waist 33"  
Hip 39"  
Height 33"  
Adj. Height 48" base pole  
Weight 20



## Pin-On Flexible Arms

Male / Female  
**43.99**

Pinnable flexible arms can be pinned to improved upper torso display. (Fills arms of garments)



FXA001R Female 23 1/4" long 2/12  
FXA002R Male 26" long 3/12

**Ladies 3/4 Torso**

123.99

P27CR / P27BC  
Cream / Black

Size 6  
30" High  
7/8" Flange  
10/45

**Mens 3/4 Torso**

123.99

P86CR / P86BC  
Cream / Black

Size 38  
33" High  
7/8" Flange  
10/45

Price of form includes neck block of your choice:



Each preferred form comes complete with neck block. Specify: **N** (Natural); **W** (Walnut); **M** (Mahogany); **BC** (Brushed Chrome); or **BK** (Black metal).

**Ladies & Mens 3/4 Length Forms**

High Quality Jersey-Covered Forms. Versatile - leg mount or hang. Easy to dress.



**Best Sellers!**



Hanging Loop  
6.99

*Bases are sold separately - see leg mount bases (pictured) below left*

**Leg Mount Bases**

Leg only bases for use with 3/4 length forms - 7/8" flange compatible

61.99 /each

**TFB/58**  
Matte Black / Center PoleBase/12x12"; 32" High

**TFC/58**  
Brushed Chrome / Offset Pole Base/12x16"; 32" High

Ships in 2 cartons 4/6 actual, 10/13 billable



**Floor standing notched costumers with adjustable height**

Pairs with hanging jersey forms, full and half round body forms and display hangers. Hanging loop included - can be easily removed.

see **page 31** for more details

Notched costumers are also ideal for hanging display hangers



visit **nahanco.com** for more details



VM504BR

*Mannequin form not included*

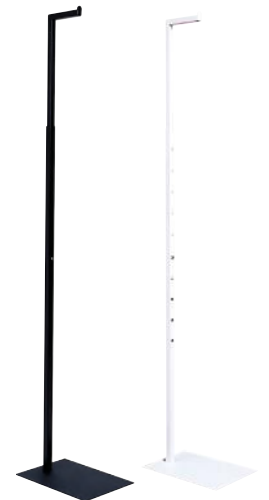

VM504MAB VM504MTW



VM504MAB



Forms shown hanging from notched costumers (forms not included)

**Sold in Sets of 2**

VM504BR - Satin Chrome

105.99

VM504MAB - Matte Black

69.99

VM504MTW - Matte White

72.99

Adjusts every 3" from 79-78"

# BODY FORMS Mannequins

## Premium Fitness Forms in matte white

Body forms in action, stretching or in yoga poses, are an effective way to bring dimensionality to clothing displays.



### Yoga Form

456.99  
NHFCP4FEM  
34" High  
35" Chest  
25" Waist  
35" Hips  
43 /79 lbs

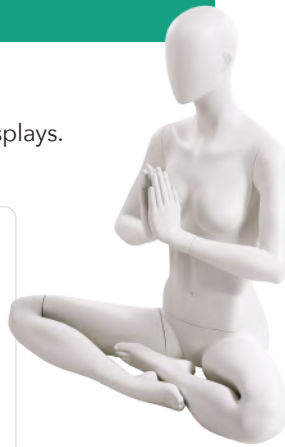

### Male Stretch

498.99  
NHFCP3MALE  
74" High  
41" Chest  
32" Waist  
39" Hips  
43 /87lbs

Removable parts for easy dressing

Standing /Running forms include a heavy, brushed stainless steel base (23.5" x 15.75")



### Male Runner

552.99  
NHFCP4MALE  
72" High  
41" Chest  
32" Waist  
41" Hips  
62 /96 lbs

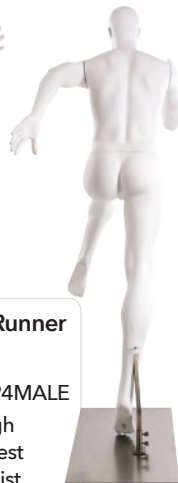

see [nahanco.com](http://nahanco.com) for more info & additional forms



### Female Runner

528.99  
NHFCP1FEM  
71" High  
34" Chest  
25" Waist  
38" Hips  
62 /92 lbs

## Premium Kids Forms

matte white fiberglass  
Right sized, relaxed poses for kids apparel display (most include glass base)



head detail



4 year old  
w/excited hands  
296.99  
NHKP1

43" High  
22" Chest  
19.75" Waist  
24.25" Hips  
10.5" Neck  
23 /40 lbs

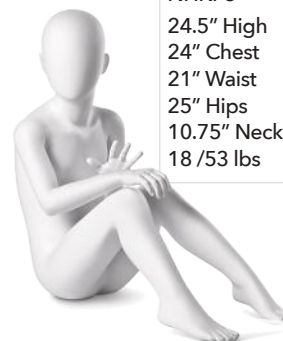

6 year old  
seated

328.99

NHKP3

24.5" High  
24" Chest  
21" Waist  
25" Hips  
10.75" Neck  
18 /53 lbs

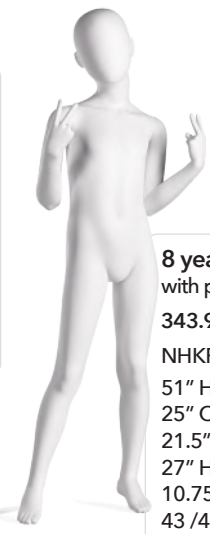

8 year old  
with peace sign  
343.99  
NHKP4

51" High  
25" Chest  
21.5" Waist  
27" Hips  
10.75" Neck  
43 /47 lbs

## WHITE MATTE MANNEQUIN FORMS - Stands included

Fiberglass mannequins provide a sculptured and realistic look for clothing display. Removeable parts for easy dressing. Headless forms keep the focus on the clothing.



### ERICA Series

Height - 5'2" (ERICA5 - 3'2") / 28/57 lbs. **\$245.49** /each



ERICA1

Shoulder - 15 3/4"  
Chest - 32 1/2"  
Waist - 23 1/2"  
Hip - 34 1/4"



ERICA2

ERICA3

Shoulder- 17 3/4"  
Chest- 32 1/2"  
Waist- 24"  
Hip- 34"



ERICA4

Shoulder - 16"  
Chest - 33"  
Waist - 25 1/4"  
Hip - 36 1/4"



ERICA5

Shoulder - 16"  
Chest - 33"  
Waist - 25 1/4"  
Hip - 36 1/4"  
(white seat included)



### ERIC Series

Shoulder - 20 7/8"  
Waist - 31"  
Hip - 37 3/4"  
31/57 lbs  
**\$251.99** /each



ERIC1  
Height - 5'8"



ERIC2  
Height - 5'8"



ERIC3  
Height - 5'4"  
Waist - 30 3/4"

### JANET Series

Plus size  
female  
mannequins



JANET1W  
Shoulder- 21 1/4"  
Chest- 32 1/4"  
Waist- 34"  
Hip- 40 7/8"  
Height- 5' 1/4"  
30/94 lbs.  
**\$287.49** /each



JANET2W  
Shoulder- 21 1/4"  
Chest- 43"  
Waist- 34"  
Hip- 36"  
Height- 6'  
30/61 lbs.  
**\$309.49** /each

*Due to their delicate nature and the fragility of mannequins and their components, all mannequin purchases are final. No returns are accepted, except if carton is unopened. Once a carton is opened and product removed, it cannot be re-sold.*

# BODY FORMS Mannequins

Gloss  
Fiberglass  
Mannequins

**Fiberglass mannequins** provide a sculptured and realistic look for clothing display. Removeable parts for easy dressing. Egghead styles focus the eye on the apparel.

## Michelle 1-3

Gloss Fiberglass  
shoulder - 15¾"  
chest - 32½"  
waist - 23½"  
hips - 34¼"  
height - 5'9"  
28/61 lbs.  
**\$293.99** /each



MICHELLE1W



MICHELLE1B



MICHELLE2B



MICHELLE2W



MICHELLE3W



MICHELLE3B

## Mike 1-3

Gloss Fiberglass  
shoulder - 20 7/8"  
chest - 37"  
waist - 31"  
hips - 37¾"  
height - 6'2"  
31/84 lbs.  
**\$299.99** /each



MIKE1B



MIKE1W



MIKE2W



MIKE2B



MIKE3W



MIKE3B

# Polyethylene Forms **BODY FORMS**

## Milky White - Budget Unbreakable - Polyethylene Forms

Affordable and durable display. Color-infused polyethylene, difficult to break or chip, for long lasting display that doesn't need maintaining or replacing. Armless for easy dressing. Realistic display, full round.

### FEMALE

Measurements: bust 34" / waist 24" / hip 35"  
Order a form only OR a complete set for displaying

| NHLP4WH                                 | NHLPH4M  | NHLPF4M  | NHLPB4WH                                | NHLPHB4M   | NHLPFB4M  |
|---|--|--|---|--|---|
| Female <b>Torso Form</b><br>(form only) | Floor Standing Set<br><b>Hanging</b> base                        | Floor Standing Set<br><b>Leg Mount</b> base        | Female <b>Shirt Form</b><br>(form only) | Floor Standing Set<br><b>Hanging</b> base                        | Female Torso Set<br><b>Mount</b> base/counter display |
| Height 35"                              | Form Height 35"<br>Upright: adjustable 43-74"<br>Base: 14" x 14" | Form Height 35"<br>Upright: 42"<br>Base: 12" x 16" | Height 24"                              | Form Height 24"<br>Upright: adjustable 43-74"<br>Base: 14" x 14" | Form Height 24"<br>Upright: 26"<br>Base: 10" x 10"    |
| 8/46 lbs                                | 23/60 lbs  | 24/66 lbs  | 6/36 lbs                                | 15/60 lbs  | 12/47 lbs   |
| <b>56.99</b>                            | <b>148.99</b>  | <b>153.99</b>                                      | <b>84.99</b>                            | <b>142.99</b>  | <b>130.99</b>   |

### MALE

Measurements: Chest 39" / waist 32" / hip 37"  
Order a form only OR a complete set for displaying

| NHMPB5WH                              | NHMPH5M  | NHMHB5M   | NHMP5WH                               | NHMPH5M  | NHMPF5M  |
|---------------------------------------|--|---|---------------------------------------|--|--|
| Male <b>Shirt Form</b><br>(form only) | Floor Standing Set<br><b>Hanging</b> base                        | Male Torso Set<br><b>Mount</b> base/counter display | Male <b>Torso Form</b><br>(form only) | Floor Standing Set<br><b>Hanging</b> base                        | Floor Standing Set<br><b>Leg Mount</b> base        |
| Height 24"                            | Form Height 24"<br>Upright: adjustable 43-74"<br>Base: 14" x 14" | Form Height 24"<br>Upright: 26"<br>Base: 10" x 12"  | Height 40"                            | Form Height 40"<br>Upright: adjustable 43-74"<br>Base: 14" x 14" | Form Height 40"<br>Upright: 42"<br>Base: 12" x 16" |
| 8/36 lbs                              | 20/60 lbs  | 15/47 lbs   | 10/66 lbs                             | 27/60 lbs  | 24/66 lbs  |
| <b>84.99</b>                          | <b>142.99</b>  | <b>135.60</b>                                       | <b>84.99</b>                          | <b>148.99</b>  | <b>152.49</b>                                      |

# BODY FORMS Display Forms

**INJECTED MODED HALF-ROUND FORMS - STYRENE**  
 Heavy duty hook included. High quality, long lasting and reusable.

**Best Seller!**



**LADIES TORSO**

LHR15



**INJECTION MOLDED FORMS**  
 Half-round forms feature high-quality, lightweight construction. The injection molding process ensures that these forms contain much thicker plastic (1/8" thick) than comparable vacuum formed forms.



**LADIES UPPER TORSO**

LHR35



| style #  | \$                      | qty | description  | wgt  |
|--|-------------------------|-----|--|------|
| LHR15B<br>LHR15W   | 19.44                   | 1   | Ladies<br>waist - 15" across; bust - 19"; hip - 18";<br>shoulder to shoulder - 16"; height - 31"<br>w/out hook & 36" w/hook;<br>back of from is hollow; matte finish<br><br>Matte black<br>Matte white | 6/71 |
| LHR35B<br>LHR35W   | 12.99                   | 1   | Ladies Upper Torso<br>19 x 17 x 6"<br>Matte black<br>Matte white   | 4/22 |
| MHR26B<br>MHR26W   | 26.31<br>22.29          | 1   | Mens<br>35 x 20 x 6"<br>Matte black<br>Matte white   | 6/71 |
| <b>Value Torso Forms</b><br><i>* While Supplies Last</i> |                         |     |  |      |
| FF15B<br>FF15W<br>FF15C                                  | 22.95<br>13.87<br>11.15 | 1   | Girls Sizes 7-14<br>23 x 13 x 1"<br>Black<br>White<br>Clear  | 2/21 |
| FF37B  | 13.74                   | 1   | Maternity<br>30 1/2 x 17 1/2 x 8 1/2"<br>(*Black - while supplies last)  | 5/63 |
| FF27B  | 13.74                   | 1   | Ladies Shirt<br>21 x 19 1/2 x 4 3/4"<br>(*Black only)  | 2/21 |
| FF21B  | 20.22                   | 1   | Mens Shirt<br>Sm. & Up, 14x15x1"<br>(*Black - while supplies last)   | 2/21 |

**HALF-ROUND VALUE TORSO FORMS**



FF37



FF15W



FF15C



FF27B



FF21B



| style #  | \$    | qty | description   | wgt  |
|----------|-------|-----|---|------|
| PEFHIPMW | 63.24 | 1   | Female hip torso<br>milky white<br>Hips are 36", waist measures 26"<br>and the form stands at 14" H | 6/20 |
| PEMHIPMW | 63.76 | 1   | Male hip torso<br>milky white<br>Hips are 38", waist measures 33"<br>and the form stands at 16"H    | 6/20 |

**Female Hip Torso**



PEFHIPMW

**Male Hip Torso**



PEMHIPMW

**Made from Polyethylene - affordable and durable**

|     |       |   |                      |      |
|-----|-------|---|----------------------|------|
| 77  | 9.07  | 1 | 11 1/2" tall / White | 1/10 |
| 804 | 19.31 | 1 | 20" tall / White     | 1/12 |

### 3-D STYRO MANNEQUIN HEAD FORMS



77



804



2775

Mannequin heads above have a hole for mounting on wall

|      |       |   |                                |     |
|------|-------|---|--------------------------------|-----|
| 2775 | 14.64 | 1 | Slatwall/ Pegboard head holder | 1/2 |
|------|-------|---|--------------------------------|-----|

*Universal Wall Mount - one bracket fits all*

|        |       |   |                                       |      |
|--------|-------|---|---------------------------------------|------|
| HW0410 | 36.03 | 1 | Beige:<br>Calf high leg, 15 1/4" high | 3/10 |
| HW0400 | 34.60 | 1 | Anklet, 10 5/8" high                  | 2/3  |

### Women's Weighted, Self-Standing Hosiery Forms



HW0410 HW0400

|        |       |   |  |       |
|--------|-------|---|--|-------|
| HM0340 | 44.32 | 1 | Men's sock display;<br>magnetic/weighted for stability;<br>Beige:<br>Knee high leg, 17 3/4" high<br>Calf high leg, 11 3/4" high<br>Low calf high leg, 10" high | 3/10  |
| HM0320 | 33.18 |   |  | 2/7   |
| HM0310 | 30.46 |   |  | 2/7   |
| MSDW   | 27.99 | 1 | White<br>Beige<br>fits sizes 10-13   | 1/2.1 |
| MSDFT  | 27.99 |   |  |       |

### Men's Weighted, Self-Stand Sock Display Forms



HM0340 HM0320 HM0310



MSDW MSDFT

|         |       |   |   |      |
|---------|-------|---|---|------|
| HC0230  | 34.60 | 1 | Beige:<br>Knee high leg, 15 1/2" high<br>Calf high leg, 12 5/8" high<br>Crew leg, 8" high | 2/16 |
| HC0220  | 34.60 |   |   |      |
| HC0210  | 33.18 |   |   |      |
| HC0200  | 33.18 | 1 | Anklet leg, 6 1/8" high   | 2    |
| HC021FL | 36.03 |   |   |      |

### Children and Infant Weighted, Self-Stand Sock Display Forms



HC021FL



HC0200



HC0210



HC0220



HC0230

# DISPLAY FIXTURES Jewelry

## BURLAP JEWELRY DISPLAYS

Tightly wrapped burlap for durable, eco-chic displays with a beautiful natural woven linen look



**Narrow Necklace Easel Back Stand**

Thin easel stand; 4 1/4"W x 8 7/8"H; 1 piece; 1 lb. **\$5.99**

**Wide Necklace Easel Back Stand**

Displays 1 double-strand or 2 necklaces; 8 1/4"W x 12 1/2"H; 1 piece; 1 lb. **\$5.99**

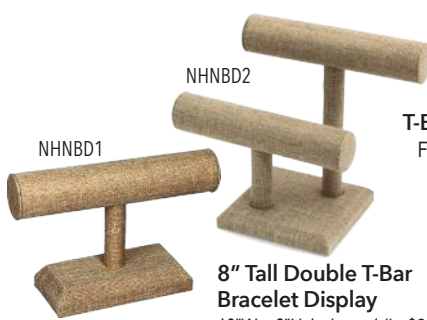

**T-Bar Bracelet Display**

Holds several bracelets; low profile bar is 1 5/8"D x 7 1/4"W x 5"H; 1 piece; 1 lb. **\$12.99**

**8" Tall Double T-Bar Bracelet Display**

10"W x 8"H; 1 piece; 1 lb. **\$25.99**

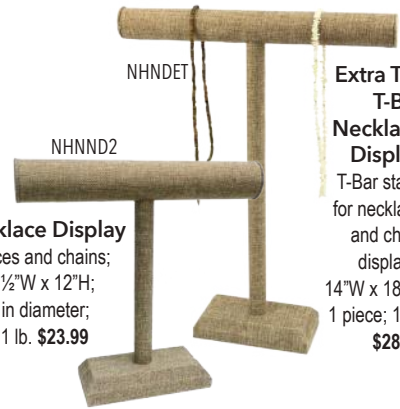

**T-Bar Necklace Display**

For necklaces and chains; 12"L x 3 1/2"W x 12"H; bar is 2" in diameter; 1 piece; 1 lb. **\$23.99**

**Extra Tall T-Bar Necklace Display**

T-Bar stand for necklace and chain displays; 14"W x 18"H; 1 piece; 1 lb. **\$28.99**



Displays 1 pair of earrings

**T-Bar Earring Displays**

T-stand for earring displays; 1 piece; 1 lb; available in 3 sizes:

- Small**  
NHNEDS2 4 3/4"H; **\$4.99**
- Medium**  
NHNEDTS 5 3/4"H; **\$6.49**
- Tall**  
NHNEDS3 6 3/4"H; **\$6.99**



**Fixed Finger Ring Displays**

Fixed fingers fit and display any ring; 1 piece; 1 lb.

**Single Finger**

NHNRD5 2 1/8"L x 2 1/8"W x 2 3/8"H; **\$3.99**

**Three Finger**

NHNRD3 4 7/8"L x 2 1/4"W x 2"H; **\$6.99**

**Five Finger**

NHNRD5 8"L x 2"W x 2 1/4"H; **\$11.99**



**Pillow Jewelry Display**

Small burlap pillow for displaying bracelets, small pendants and pins; 3"L x 3"W; 1 piece; 1 lb. **\$3.99**



**Earring & Pendant Display Stand**

For 1 pair of earrings or a pendant; 2"W x 3"H; 1 piece; 1 lb. **\$3.99**

## ECONOMY BLACK VELVET JEWELRY DISPLAYS

A range of displayers finished in a flocked, faux velvet. Attractive & affordable.



**Finger Displays**

Fixed fingers ring displays; 1 piece; 1 lb.

**Single Finger**

NHBFRD1 2 1/4"L x 2 1/4"W x 2 1/4"H; **\$3.99**

**Five Finger**

NHBFRD5 8"L x 2"W x 2 1/2"H; **\$11.99**



NHBFNE1

**Easel Necklace Stand**

Single necklace or chain display; 3 3/4"L x 5 1/4"H; 1 piece; 1 lb. **\$4.15**



**Pillow Displays**

Versatile displayers for bracelets, watches and pins; 1 piece; 1 lb.

**Small** about 3"L x 3"W **\$2.99**

**Earring & Pendant Display**

2"W x 3"H; 1 piece; 1 lb. **\$2.99**



**Earring Display Tree**

Accommodates 12 pairs of earrings on 3 display bars; 10 1/4"W x 8 1/2"H; 1 piece; 1 lb. **\$23.99**



**Earring & Necklace Display Stand**

4"W x 5 3/4"H; 1 piece; 1 lb. **\$4.99**



**Padded Necklace Display with Easel Stand**

6 1/2" x 7 7/8"H; 1 piece; 1 lb. **\$5.59**



**Padded Necklace/Earring Combo Display with Easel Stand**

Black velvet; 9 3/8"W x 9 1/2"H; 1 piece; 1 lb. **\$10.99**



**Single Bracelet / Watch Display Hump**

1 3/8"W x 5"L x 2 1/2"H; 1 piece; 1 lb. **\$7.99**

| style #  | \$    | qty               | description  | size                       | wgt   |
|----------|-------|-------------------|--|----------------------------|-------|
| NHAND2   | 10.50 | 1                 | Clear acrylic double T                             | 4 1/4" / 8 3/4"            | 1/3   |
| NHAND1   | 9.07  | 1                 | Clear acrylic single T                             | 18 1/2" H                  | 2/6   |
| NHAED32  | 16.72 | 1                 | 4-sided rotating display<br>Holds 32 cards - 2"    | 5 x 5 x 12"                | 3/19  |
| NHAED144 | 29.16 | 1                 | Holds 144 cards - 2"                               | 10 1/2 x 10 1/2 x 19 1/2"  | 18/23 |
| 856      | 20.87 | 1                 | 3-sided rotating display<br>Clear acrylic w/ black | 19 1/2" H                  | 5/10  |
| JCW100   | 11.79 | 100               | White card   | 2" x 2"                    | 1/2   |
| JCB100   |       |                   | Black card   |                            |       |
| JT1      | 18.79 | 1000              | White w/<br>red silk string                        | 1/2 x 7/8"                 | 1/3   |
| JT2      | 18.01 |                   |  | 3/8 x 3/4"                 |       |
| JT3      | 13.61 |                   | White Adhesive                                     | 7/16 x 1 1/2"              |       |
| JT4      | 13.74 |                   |  | 9/16 x 1 5/8"              |       |
| JPC1     | 8.68  | 1                 | Yellow   | 7 1/2" L x<br>5" W         | 1     |
| A845     | 8.42  | 1 Set<br>of three | CLEAR  | 3x3x3"<br>4x4x4"<br>5x5x5" | 2/6   |
| J1394    | 8.68  | 1                 | Clear CounterStand                                 | 13/4 x 23/4 x 3"           | 1     |
| J2394    | 9.72  | 1                 | Clear Slatwall                                     | 2 1/8"                     |       |

## JEWELRY DISPLAYERS

### Acrylic T-Bar Jewelry Displayers



Rotating Jewelry Displayer

### Counter Top Revolving Jewelry Display

Holds 108 two-inch cards.

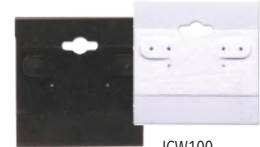
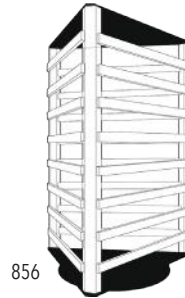

JCB100

JCW100

### Jewelry Cards

Cards can also be used on displayers and peg hooks.

### Jewelry Tags



JT1

JT2

JT3

JT4

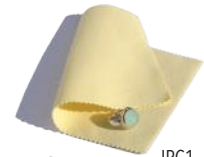

Jewelry Polishing Cloth

JPC1

### Jewelry Risers



A845

J1394

### Watch Displayer

For slatwall or counter



# DISPLAY FIXTURES Counter Displays

## Double Face Mirrors



## Reversible Counter Step Display



## Sunglass Racks



## Countertop or Hanging Cap Display

CAP3

## Tower Cap Displayers



CAP8

CAP16

## Deluxe Cap/Hat Trees

Revolving or stationary - 20 arms with foam caps



K26

## Countertop Handbag Stand

NHCSRHB



## Blouse Displayer

Complete w/ base and waist cincher Q61814



## Hook Stand Displayer

Q61810



## Scarf Stand

Includes 100 white clips

Q83010



| style #    | \$     | qty | description   | size                              | wgt                           |
|------------|--------|-----|---|-----------------------------------|-------------------------------|
| Q61014     | 63.12  | 1   | CHROME oval mirror  | 10x14x22"<br>6" base              | 8/13                          |
| NHQ61016   | 67.26  | 1   | CHROME rectangular mirror   | 10 x 12" H<br>3" base             | 8/13                          |
| A859       | 70.11  | 1   | CLEAR ACRYLIC 2" or 3" D shelves  | 7"D x 15"W x 10"H                 | 2/10                          |
| SUNGLASS36 | 114.49 | 1   | Sunglass rack w/ 5" mirror - holds 36 pairs                               | 28" H x 14" Dia                   | 8/30                          |
| SUNGLASS44 | 105.99 | 1   | Sunglass rack w/5" mirror - holds 44 pairs                                | 32" H x 14" Dia                   | 9/30                          |
| CAP3       | 51.32  | 1   | BLACK METAL Holds 24 to 30 caps   | 24H x 9W x 13"D                   | 6/12                          |
| CAP8       | 138.67 | 1   | POWDER COATED wire tubing Silvervein: Holds 64 to 80 caps: 8 pocket tower | 65H x 14W x 14"D                  | 16/17                         |
| CAP16      | 202.56 | 1   | Holds 128 to 160 caps 16 pocket, 2 sided                                  | 65H x 14W x 24"D                  | 16/17<br>10/13<br>(2 ctns)    |
| KREV26     | 163.04 | 1   | CHROME Revolving  | 18x61 3/8" 14" sq. base           | 14 5 14<br>(4 ctns)<br>34 lbs |
| K26        | 144.99 | 1   | CHROME Stationary   | 18x61 3/8" 14" sq. base           | 14 5 14<br>(3 ctns)<br>33 lbs |
| NHCSRHB    | 37.45  | 1   | CHROME  | 17" - 31" H; 8" base              | 6/18                          |
| Q61814     | 42.38  | 1   | CHROME  | 5/8 x 18"-36"H 6" base 16" hanger | 7/19                          |
| Q61810     | 32.66  | 1   | CHROME  | 5/8 x 18"-36"H 6" base            | 6/19                          |
| Q83010     | 65.97  | 1   | CHROME  | 5/8 x 18"-36"H 8" base 14" dia.   | 8/13                          |

# SHOE DISPLAYERS

| style #  | \$    | qty    | description  | wgt   |
|--|-------|--------|--|-------|
| MF0040   | 4.67  | 1      | Clear Plastic Espadrille Form, size 6-7  | 1/7   |
| MF0013   | 4.15  | 1      | Clear Plastic Gladiator Form, size 6-7, 13" tall   | 1/7   |
| 1205   | 31.88 | 1 set  | Acrylic<br>3"W x 5"H<br>3"W x 6 1/2"H<br>3"W x 8"H<br>5mm thick<br>bottom measures 5 1/2" deep<br>Set includes all 3 sizes | 10/17 |
| S1213  | 4.92  | 1      | Acrylic<br>1"W x 2 1/2"H x 2 1/2"D<br>3/32" thick  | 1     |
| S1214  | 6.35  |        | 1 3/8"W x 4 1/4"H x 3"D  |       |
| 1229A  | 8.42  | 1      | Acrylic<br>3/16" thick   | 3     |
| 1229B  | 9.72  | 1      | 9 1/4"L x 4"W x 5"H  | 3     |
| 1229C  | 11.15 | 1      | 9 1/4"L x 4"W x 7"H  | 3/6   |
| 1230   | 22.29 | 1 set  | 9 1/4"L x 4"W x 9"H<br>Set includes all 3 sizes  | 3/6   |
| 1413   | 8.29  | 1      | Acrylic<br>1/8" thick<br>Single Shoe Rest<br>4 3/4"H x 3"W x 3 3/4"D   | 1/2   |
| <i>See page 81 and 86-87 for our selection of foot &amp; hosiery forms</i> |       |        |  |       |
| 1210   | 40.18 | 1 set  | Acrylic<br>4 mm thick, 7 1/2" D<br>3"W x 4 1/2"H<br>3"W x 6 1/2"H<br>3"W x 9 1/2"H<br>Set includes all 3 sizes             | 3/10  |
| ZDB109OF1  | 31.88 | 12     | Natural color in four sizes:   |       |
| ZDB113OF1  | 34.73 |        | 9" high  | 1/2   |
| ZDB121OF1  | 52.75 |        | 13" high   | 2/6   |
| ZDB126OF1  | 58.32 |        | 21" high   | 4     |
| ZDB1240  | 7.65  | 1      | 7" low top   | 1/2   |
| ZDB1230  | 8.42  |        | 9" medium height   | 1/2   |
| ZDB1020  | 9.72  |        | 14" high top tall  | 2/6   |
| MAR6121PR  | 8.42  | 1 pair | 14" Black plastic boot form  | 1/2   |
| MAR6121  | 69.21 | 16 prs |  | 11    |
| ZSHOT060   | 3.50  | 1      | Boot weight  | 1     |

Specify **M** for male and **F** for female  
Note that male boot shapers are 1" wider than female shapers



**Espadrille & Gladiator Forms**  
Profile of foot, with notched ridges for straps

**Heel Rest Shoe Risers** **Beveled Edge Slant Shoe Risers**

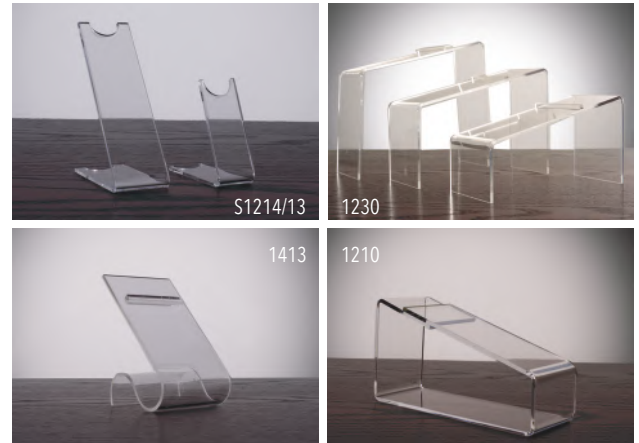

**Shoe Rests** **G-Bend Shoe Risers**

## Roll Up Boot Shapers

Inexpensive boot shapers are made out of a smooth natural plastic finish, easy to insert and remove, and they automatically adjust to fill the boot; in four sizes - 9", 13", 21" and 26"



## Boot Shapers

Smooth plastic finish.  
Easy to insert and remove.  
Specify (M) Male or (F) Female

## Boot Weights

Drop into boots for a more stable display



# SHOE DISPLAYERS

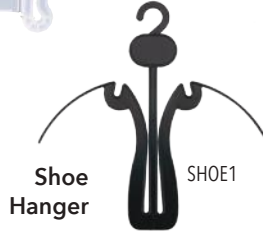
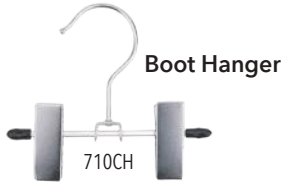

Full-round sandal forms specifically designed for open or closed sandals. Also fits thong styles.

**Shoe Forms**  
Fits right or left shoe. Made from lightweight, natural plastic.



**Flexi-Form**  
Made from lightweight, unbreakable plastic.



All forms fit right or left shoe

**Black Shoe Forms - womens/mens**



**8-Shelf Shoe Merchandiser**  
Includes 12" adjustable, tilt shelves.  
Ships via truck only



| style #    | \$     | qty | description                              | wgt                              |
|------------|--------|-----|--|----------------------------------|
| 710CH      | 94.35  | 100 | Chrome w/ black rubber tips; 5" wide     | 10                               |
| JLP156     | 42.38  | 500 | 3 7/8" W x 3 7/8" H                      | 9/12                             |
| JLP156100  | 16.49  | 100 | Natural                                  | 3/6                              |
| JLP256     | 42.38  | 500 | Black                                    | 9/12                             |
| JLP256100  | 15.49  | 100 |  | 3/6                              |
| SH1        | 17.99  | 500 | Black; 3 1/2" wide                       | 2                                |
| SH1-100    | 5.99   | 100 |  | 1/2                              |
| SHOE1      | 82.56  | 500 | Black; 7 1/4" W x 7 1/4" H               | 19/21                            |
| SHOE1100   | 18.01  | 100 |  | 4/6                              |
| KLGYMR     |        |     | Men's Gray Sprinkle Right - size 8-9     |                                  |
| KLGYML     |        |     | Men's Gray Sprinkle Left - size 8-9      |                                  |
| KLGYWR     | 15.29  | 1   | Women's Gray Sprinkle Right - size 6-7   | 1/2                              |
| KLGYWL     |        |     | Women's Gray Sprinkle Left - size 6-7    |                                  |
| KLGYR13    |        |     | Children's Gray Sprinkle Right - size 13 |                                  |
| KLGYL13    |        |     | Children's Gray Sprinkle Left - size 13  |                                  |
| SHOEFORM10 | .36    |     | 3 3/8" long, 3" wide                     |                                  |
| SHOEFORM13 | .71    | 1   | 4 1/4" long, 3 1/2" wide                 | 1/2                              |
| SHOEFORMMM | .47    |     | 4 7/8" long, 3" wide                     |                                  |
| SHOEFORMMW | .52    |     | 5 7/8" long, 3" wide                     |                                  |
| FM7400B    |        |     | Charcoal Men's, sizes 8-10               |                                  |
| FW7500B    | 4.15   | 1   | Women's, sizes 4-10                      | 1/2                              |
| FC7600B    |        |     | Children's, sizes 10-13                  |                                  |
| FRMDISWB   | 6.87   |     | Women's Low-cut black Fits sizes 6-9     |                                  |
| FRMDISMB   | 6.87   | 1   | Men's Low-cut black Fits sizes 8-11      | 1/2                              |
| FRMDISMHB  | 8.29   |     | Men's High-top Black Fits sizes 8-11     |                                  |
| FRMDISWHB  | 8.29   |     | Women's High-top Black Fits sizes 6-9    |                                  |
| SSUE       | 328.49 | 1   | Chrome 56"H x 46"W x 25"D<br>Ships Truck | 25<br>20/25<br>20/25<br>(3 ctns) |

# SHOE DISPLAYERS

| style #   | \$                              | qty                   | description   | size  | wgt                      |
|---|---------------------------------|-----------------------|---|---|--------------------------|
| SDM<br>SDW<br>SDC<br>SDA<br>SD  | 88.78                           | 1                     | CHROME  | Men's<br>Women's<br>Children's<br>Athletic<br>Adult combo | 2/6                      |
| * Styles SDA & SD measure both men and women  |                                 |                       |   |   |                          |
| SDJ   | 90.07                           | 1                     | STURDY PLASTIC  | Junior  | 2/6                      |
| 24625   | 20.87                           | 1                     | Wood; measures men, women and children  | 17 x 1 1/2"   | 1/2                      |
| T14915  | 138.54                          | 50                    | GREY  | 9"  | 2/3                      |
| T14915-10   | 31.88                           | 10                    |   |   | 1/2                      |
| 06UPC02   | 14.64                           | 144                   | BRONZE  | 1 1/8"  | 1/2                      |
| TOS1<br>SO1G<br>AS1<br>05010  | 8.29<br>16.72<br>23.59<br>13.87 | 144<br>24<br>50<br>48 | Disposable, Polyester/<br>Nylon Blend<br><br>BEIGE<br>BLACK<br>WHITE<br>BEIGE KNEE-HI                       | ONE<br>SIZE FITS<br>MOST                                  | 1/3<br>1/3<br>2/7<br>1/3 |
| NHSDR   | 110.15                          | 1                     | Black Metal Rack;<br>4 spinning tiers w/16<br>hooks & sign holder;<br>66"H, 24" footprint,<br>5" long hooks | 66"H,<br>24" footprint,<br>5" long hooks                  | 14/24                    |
| 09059   | 107.17                          | 144                   | NICKEL PLATED   | 3"  | 7                        |
| 09059/12  | 11.15                           | 12                    |   | 3"  | 1                        |
| SHOEBLA   | 31.88                           | 144                   | BLACK   | 3 1/2"  | 7                        |
| SHOEBLAI  | 62.34                           | 144                   | BLACK printed   | 3 1/2"  | 7                        |
| Shoe horns can be printed: Printing area is 2" x 1/2". \$75 plate charge, and a 3 gross minimum (342 pieces) for imprinting. Shoe horns also available in COLORS: 3 gross minimum (342 pieces). Green, Red, Yellow, Blue or White |                                 |                       |   |   |                          |
| MBR   | 37.45                           | 1                     | Wood box reacher w/ metal end   | 60" L;<br>4" square metal plate, L-shaped                 | 4/7                      |

## FOOT MEASURING DEVICES

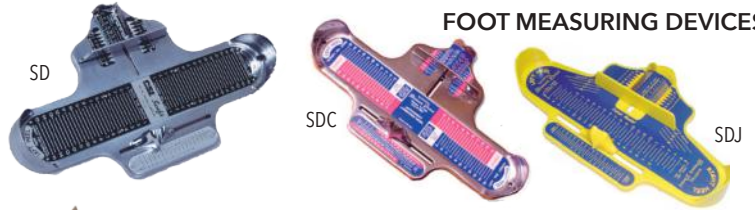

### Try On Socks



**Bronze Sign Holder Clip**  
Clips small signs to the back of footwear.



### Spinning Sock Displayer



### Box Reacher



# PACKAGING Kraft Shopping Bags

## KRAFT SHOPPING BAGS

Available in 3 colors - White, Kraft, and Matte Black. These bags are imprintable and a great way to advertise your store. See the following page (89) for more details.



SBCN1



SBCN1E

SBCN2E



SBCN7E



SBVN1E

SBVN1



SBVN2E



SBQN1

**CUSTOM PRINTING:** Custom printing applies to all style numbers below - see following page 89 for details



SBQN2E



KSB4E

KSB5E



KSB6E

KSB7E



KSB81

KSB82E



KSB91

KSB92E

|    | style # | \$     | qty | color       | size          | imprint area | wgt   |
|----|---------|--------|-----|-------------|---------------|--------------|-------|
| 1  | SBCN1   | 51.99  | 250 | White       | 8x4.75x10.5"  | 6x5"         | 24/30 |
| 2  | SBCN1E  | 71.99  | 250 | White Eco   | 8x4.75x10.5"  | 6x5"         | 24/30 |
|    | SBCN2E  | 59.99  | 250 | Kraft Eco   | 8x4.75x10.5"  | 6x5"         | 24/30 |
| 3  | SBCN7E  | 73.99  | 250 | Kraft Eco   | 10X5X13"      | 7X8"         | 24/30 |
| 4  | SBVN1   | 86.99  | 250 | White       | 16x6x12.5"    | 10x7"        | 38/52 |
| 5  | SBVN1E  | 68.99  | 250 | White Eco   | 16x6x12.5"    | 10x7"        | 38/52 |
|    | SBVN2E  | 107.99 | 250 | Kraft Eco   | 16x6x12.5"    | 10x7"        | 38/52 |
| 6  | SBQN1   | 88.99  | 200 | White       | 16x6x19"      | 10x11"       | 43    |
| 7  | SBQN2E  | 89.99  | 200 | Kraft Eco   | 16x6x19"      | 10x11"       | 42    |
| 8  | KSB4E   | 60.99  | 250 | White Eco   | 6x3.25x8.375" | 3x4"         | 15    |
|    | KSB5E   | 73.99  | 250 | Natural Eco | 6x3.25x8.375" | 3x4"         | 15    |
| 9  | KSB6E   | 110.94 | 250 | White Eco   | 10x7x13.5"    | 7x8"         | 43    |
|    | KSB7E   | 95.00  | 250 | Natural Eco | 10x7x13.5"    | 7x8"         | 43    |
| 10 | KSB81   | 80.99  | 250 | White       | 13x7x13.5"    | 9x8"         | 29    |
|    | KSB82E  | 63.99  | 250 | Natural Eco | 13x7x13.5"    | 9x8"         | 29    |
| 11 | KSB91   | 92.99  | 250 | White       | 13x7x17"      | 9x9"         | 44    |
|    | KSB92E  | 121.99 | 250 | Natural Eco | 13x7x17"      | 9x9"         | 44    |

### A note about imprint areas and set-up fees:

2 different bag sizes will need 2 different set ups.

- check the imprint area specs on for more info

*different size imprint areas  
will need different set ups*

KSB82E





## CUSTOM BAG OPTIONS

for our Natural, White or Black Kraft bags

Create walking billboards for your store



### STEP 1

#### Choose a bag

Choose from any of our Natural, White or Black Kraft bags featured on [page 88](#)



### STEP 2

#### Design it

(Choose from 2 print options below)

#### A. INK PRINT

A flexible plate is dipped in liquid ink and stamped onto the bag.

**ADVANTAGES:** Can print small details.

**DISADVANTAGES:** Ink color appearances may vary.

**COST:** \$0.24 per side, per bag /\$.48 for both sides



#### B. HOT STAMP

Foils are pressed and transferred through heat onto the bag.

**ADVANTAGES:** Produces a true, even color.

**DISADVANTAGES:** Doesn't allow for small details.

**COST:** \$0.45 per side, per bag /\$.90 for both sides



### STEP 3

#### Set it up & Place your order

#### ARTWORK

Vector files are preferred - Illustrator (.ai) files are best. (.docx files will not be accepted)

If artwork quality is not acceptable, art fees may apply.

Please call us (1-800-426-4377) for assistance

#### SET-UP FEES

Ink Printing and Hot Stamp

Set up fees are per bag size, per order

Please call for set-up fees

#### ORDERING

Call it in:

1.800.426.4377 and speak with one of our Customer Reps

You can also connect with us via email ([mail@nahanco.com](mailto:mail@nahanco.com))

# PACKAGING Shopping Bags

## ECO KRAFT EURO SHOPPERS/BAGS



| style #  | \$     | qty | description                          | size                | wgt   |
|----------|--------|-----|--------------------------------------|---------------------|-------|
|          |        |     | Eco Natural Kraft Euro Shoppers/Bags |                     |       |
| NHK19616 | 171.99 | 100 | XX-Large Shopper                     | 19 x 6 x 16"        | 48/49 |
| NHK1010  | 145.99 | 200 | X-Large Shopper                      | 10 1/4 x 10 x 10"   | 30/31 |
| NHK1048  | 94.99  | 200 | Large Shopper                        | 10 x 4 x 8"         | 23/24 |
| NHSN513  | 46.99  | 250 | Tall Wine/Gift Bag w/Serrated Edge   | 5 1/4 x 3 1/2 x 13" | 19/21 |

*Eco friendly, reusable, recyclable and compostable, these bags are made of 80% recycled fibers and 80% post-consumer content*

## CARNIVAL GROOVE EUROTOTES (KE)



| style # | \$     | qty | description   | size       | wgt |
|---------|--------|-----|---|------------|-----|
|         |        |     | CARNIVAL GROOVE EUROTOTES                                   |            |     |
| KE9NH   | 96.49  | 200 | Kraft w/ natural cotton handles; top & bottom board inserts | 9x3 1/2x7" | 20  |
| KE13    | 145.99 | 200 |   | 13x5x10"   | 33  |
| KE16NH  | 94.99  | 100 |   | 16x5x13"   | 23  |

## LUXE GLOSS EUROTOTES (GE)

Gloss laminated bags w/gromets, knotted macrame handle, top and bottom boards

| style # | \$     | qty | description          | size     | wgt |
|---------|--------|-----|----------------------|----------|-----|
|         |        |     | LUXE GLOSS EUROTOTES |          |     |
| GE6B    | 49.99  | 100 | BLACK                | 6x3x8"   | 9   |
| GE6W    | 49.99  |     | WHITE                |          |     |
| GE8B    | 70.76  | 100 | BLACK                | 8x4x10"  | 14  |
| GE8W    | 70.76  |     | WHITE                |          |     |
| GE16B   | 114.49 | 100 | BLACK                | 16x6x12" | 29  |
| GE16W   | 114.49 |     | WHITE                |          |     |

## REINFORCED DIE CUT THANK YOU BAGS



| style #   | \$     | qty | description            | size     | wgt |
|-----------|--------|-----|------------------------|----------|-----|
|           |        |     | THANK YOU DIE CUT BAGS |          |     |
| NHFO15THA | 95.40  | 500 | Medium                 | 15x18x4" | 24  |
| NHFO20THA | 126.99 | 500 | Large                  | 20x20x5" | 35  |

## SUPER GLOSS MERCHANDISING BAGS

In 2 sizes and 2 colors



| style #   | \$    | qty  | description      | size     | wgt |
|-----------|-------|------|------------------|----------|-----|
|           |       |      | SUPER GLOSS BAGS |          |     |
| NHSG9WH   | 55.49 | 1000 | White - small    | 9 x 12"  | 11  |
| NHSG9CLE  |       |      | Clear - small    |          |     |
| NHSG12WH  | 76.49 | 1000 | White - medium   | 12 x 15" | 16  |
| NHSG12CLE |       |      | Clear - medium   |          |     |

## PLASTIC MERCHANDISE BAGS

Economy, high density plastic



|         |       |      |   |                                 |    |
|---------|-------|------|---|---------------------------------|----|
| TSB3-30 | 27.09 | 1000 | Thank You<br><i>Type style &amp; color may vary</i> | 11 1/2 x 6 1/2 x 21"<br>.75 mil | 13 |
| BGA2-1  | 51.99 | 1000 | White   | 12x15"                          | 10 |

# Tissue & Boxes PACKAGING



WHITE TISSUE



BLACK TISSUE



KRAFT TISSUE

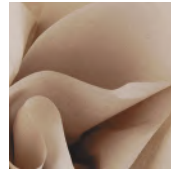

NEWSPAPER PRINT TISSUE

WHITE APPAREL BOXES  
with light gray interior



NATURAL APPAREL BOXES  
with kraft interior



## CORRUGATED BOXES

CORRUGATED E-COMMERCE BOXES  
available in four sizes



NH1293BLA



NH994WHI



NH883NAT

| style #   | \$     | qty    | description                                  | size             | wgt   |
|-----------|--------|--------|--|------------------|-------|
| TP1       | 36.99  | 1000   | WHITE  | 18 x 24"         | 10/14 |
| TP2       | 49.99  | sheets | Tissue Paper                                 | 20 x 30"         | 15/22 |
| TP3       | 58.32  | 500    | WHITE Tissue Paper                           | 24 x 36"         | ?     |
| TP25      | 47.28  | 480    | BLACK Tissue Paper                           | 20 x30"          | 7     |
| NH11018   | 24.49  | sheets | Solid Recycled KRAFT Tissue Paper            |                  | 9     |
| TIKNP     | 50.99  | 2400   | NEWSPRINT Heavy Tissue Paper for bulky items | 20 x30"          | 50    |
| AB2       | 82.49  | 100    | WHITE: Shirts                                | 15x9½x2"         | 29    |
| AB3       | 63.49  | 50     | Sweaters                                     | 17x11x2½"        | 20/21 |
| AB4       | 68.99  | 25     | Coats  | 24x14x4"         | 21/28 |
| KAB2      | 78.99  | 100    | KRAFT: Shirts                                | 15x9½x2"         | 27/29 |
| KAB4      | 61.99  | 25     | Coats  | 24x14x4"         | 23    |
| NH1293BLA | 96.49  |        | Black  |                  |       |
| NH1293NAT | 67.99  | 24     | Natural                                      | 3"h x 12"l x 9"w | 16    |
| NH1293WHI | 96.99  |        | White  |                  |       |
| NH883BLA  | 125.99 |        | Black  |                  |       |
| NH883NAT  | 103.99 | 48     | Natural                                      | 3"h x 8"l x 8"w  | 22    |
| NH883WHI  | 125.99 |        | White  |                  |       |
| NH994BLA  | 178.49 |        | Black  |                  |       |
| NH994NAT  | 119.49 | 48     | Natural                                      | 4"h x 9"l x 9"w  | 30    |
| NH994WHI  | 178.49 |        | White  |                  |       |
| JB1       | 26.99  | 100    | Earring                                      | 2½x1½x 7/8"      | 4/6   |
| JB2       | 36.49  | 100    | Bracelet                                     | 3½x3½x1"         | 12/14 |
| JB3       | 46.99  | 100    | Necklace                                     | 8x2x 7/8"        | 10/15 |
| JB4       | 40.99  | 100    | Large pin                                    | 5½x3¾x 7/8"      | 10/19 |
| JB1N      | 22.49  | 100    | Earring                                      | 2½x1½x 7/8"      | 4/6   |
| JB2N      | 31.49  | 100    | Bracelet                                     | 3½x3½x1"         | 12/14 |
| JB3N      | 48.99  | 100    | Necklace                                     | 8x2x 7/8"        | 10/15 |

COTTON FILLED JEWELRY BOXES



# HANGERS NAHANCO Line Wood



## NAHANCO LINE FLAT SHIRT /DRESS HANGERS

Our most popular wood hanger style - and the style most often chosen for customization. Most styles have inset grippers. Hardware is brushed chrome, bright chrome, gunmetal, black or gold, depending on the finish.

17" wide - 1/2" thick body; 100 pcs /case. SHIRT: 28 lbs. / Dimensional wgt. 34 lbs

19" width - 1/2" thick body; 100 pcs /case.

14" width - 1/2" thick body; 100 pcs /case.

12" width - 1/2" thick body; 100 pcs /case.

10" width - 1/2" thick body; 100 pcs /case.

SHIRT: 31/42 lbs;

SHIRT: 25/25 lbs;

SHIRT: 18/23 lbs

SHIRT: 15/16 lbs



**INSET GRIPPERS**  
Featured on all styles  
except black rubber

### SHIRT HANGERS

|  |         |          |     |
|--|---------|----------|-----|
| Low gloss natural w/brushed chrome         | 20019   | \$166.41 | 19" |
|  | 20017   | \$129.59 | 17" |
|  | 20014   | \$128.29 | 14" |
|  | 20012   | \$125.70 | 12" |
|  | 20010   | \$125.70 | 10" |
| Low gloss white w/brushed chrome           | 20119   | \$166.41 | 19" |
|  | 20117   | \$129.59 | 17" |
|  | 20114   | \$128.29 | 14" |
|  | 20112   | \$125.70 | 12" |
|  | 20110   | \$125.70 | 10" |
| Low gloss black w/brushed chrome           | 20219   | \$166.41 | 19" |
|  | 20217   | \$129.59 | 17" |
|  | 20214   | \$128.29 | 14" |
|  | 20212   | \$125.70 | 12" |
|  | 20210   | \$125.70 | 10" |
| Low gloss mahogany w/brushed chrome        | 20319   | \$166.41 | 19" |
|  | 20317   | \$129.59 | 17" |
|  | 20314   | \$128.29 | 14" |
|  | 20312   | \$125.70 | 12" |
|  | 20310   | \$125.70 | 10" |
| High gloss black w/bright chrome           | 20417   | \$127.00 | 17" |
| High gloss white w/bright chrome           | 20517   | \$127.00 | 17" |
| Low gloss beech w/brushed chrome           | 20617   | \$151.99 | 17" |
| Low gloss espresso w/gunmetal              | 20717   | \$127.00 | 17" |
| Black rubber w/brushed chrome /no grippers | 20817   | \$139.99 | 17" |
| Low gloss whitewash w/brushed chrome       | 20917   | \$151.99 | 17" |
| Raw finish w/gunmetal                      | 21517   | \$127.00 | 17" |
| Low gloss greywash w/brushed chrome        | 29917   | \$151.99 | 17" |
| Low gloss black w/black                    | 20217BH | \$124.40 | 17" |
|  | 20219BH | \$158.10 | 19" |
| High gloss black w/gold                    | 20417GH | \$124.40 | 17" |
| High gloss white w/gold                    | 20517GH | \$124.40 | 17" |



### 14" & 12" KIDS' SHIRT HANGERS



















### 10" INFANT SHIRT HANGERS

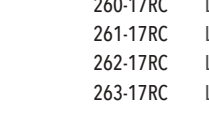

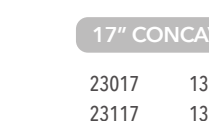
# NAHANCO Line Wood **HANGERS**

## SUIT HANGERS

|  |   |     |           |  |
|--|---|-----|-----------|--|
|     | Low gloss natural w/brushed chrome        | 19" | 20019WB   | \$167.17   |
|    | Low gloss white w/brushed chrome          | 17" | 20017WB   | \$141.25   |
|    | Low gloss black w/brushed chrome          | 14" | 20014WB   | \$141.25   |
|    | Low gloss mahogany w/brushed chrome       | 19" | 20219WB   | \$167.17   |
|    | Low gloss white w/brushed chrome          | 17" | 20217WB   | \$141.25   |
|    | Low gloss black w/brushed chrome          | 14" | 20214WB   | \$141.25   |
|    | High gloss black w/bright chrome          | 19" | 20319WB   | \$167.17   |
|   | High gloss white w/bright chrome          | 17" | 20317WB   | \$141.25   |
|  | Low gloss beech w/brushed chrome          | 14" | 20314WB   | \$156.69   |
|  | Low gloss espresso w/gunmetal             | 17" | 20417WB   | \$141.25   |
|  | Black rubber w/brushed chrome/no grippers | 17" | 20517WB   | \$141.25   |
|  | Low gloss whitewash w/brushed chrome      | 17" | 20617WB   | \$165.88   |
|  | Raw finish w/gunmetal                     | 17" | 20717WB   | \$143.84   |
|  | Low gloss greywash w/brushed chrome       | 17" | 20817WB   | \$158.99  |
|  | Low gloss black w/black                   | 17" | 20917WB   | \$194.39   |
|  | High gloss black w/gold                   | 17" | 21517WB   | \$147.73   |
|  | High gloss white w/gold                   | 17" | 21517WB   | \$147.73   |
|  | Low gloss black w/black                   | 17" | 20217WBBH | \$141.25   |
|  | Low gloss white w/brushed chrome          | 19" | 20219WBBH | \$174.95   |
|  | High gloss black w/gold                   | 17" | 20417WBGH | \$141.25   |
|  | High gloss white w/gold                   | 17" | 20517WBGH | \$141.25   |

## NAHANCO LINE FLAT SUIT HANGERS with BAR

Our most popular wood style in a suit hanger. Most styles have inset grippers. Hardware is brushed chrome, bright chrome, gunmetal, black or gold, depending on the finish.

17" width - 1/2" thick body; 100 pcs /case. SUIT: 30 lbs. / Dim.wgt. 36 lbs  
 19" width - 1/2" thick body; 100 pcs /case. SUIT: 33/35 lbs  
 14" width - 1/2" thick body; 100 pcs /case. SUIT: 22/22 lbs

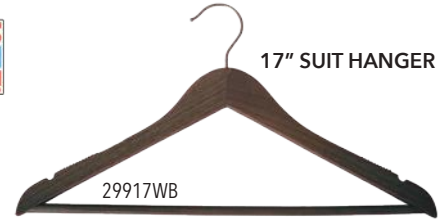

INSET GRIPPERS  
Featured on all styles except black rubber

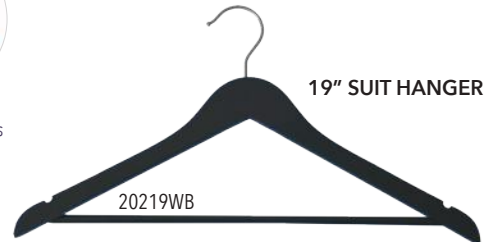

### 14" KIDS' SUIT HANGERS



### FLAT 17" SUIT HANGER w/ CLIPS

|          |                    |
|----------|--------------------|
| 260-17RC | Low gloss natural  |
| 261-17RC | Low gloss white    |
| 262-17RC | Low gloss black    |
| 263-17RC | Low gloss mahogany |



INSET GRIPPERS

1/2" thick; brushed chrome hardware and inset grippers; 1 1/2" drop with brushed chrome clips; 100 /case; 37 lbs; available in four finishes \$158.49



### 17" CONCAVE JACKET HANGER

|       |        |   |
|-------|--------|---|
| 23017 | 131.80 | Low gloss natural /brushed chrome hook  |
| 23117 | 131.80 | Low gloss white /brushed chrome hook  |
| 23217 | 131.80 | Low gloss black /brushed chrome hook  |
| 23317 | 131.80 | Low gloss mahogany /brushed chrome hook   |
| 23417 | 131.80 | High gloss black /bright chrome hook  |
| 23517 | 131.80 | High gloss white /bright chrome hook  |
| 23617 | 156.69 | Low gloss beech /brushed chrome hook  |
| 23717 | 131.80 | Low gloss espresso /gunmetal hook   |
| 23817 | 75.84  | Black rubber /brushed chrome hook  |
| 23917 | 166.41 | Low gloss whitewash /brushed chrome hook  |



17" wide and 3/4" thick; features a 1 1/2" notched flare end; brushed chrome, bright chrome or gunmetal hook depending on the finish; 24 /case; 16/19 lbs; available in ten finishes.

# HANGERS NAHANCO Line Wood

## NAHANCO LINE FLAT PANT HANGERS

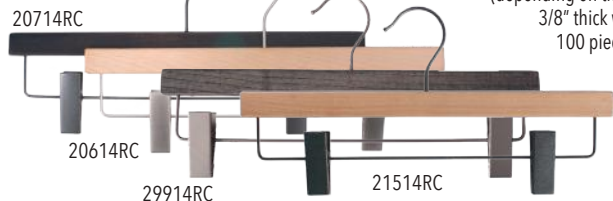

Brushed chrome, bright chrome, black, gold, and gunmetal hardware (depending on the hanger style); 3/8" thick with a 7/8" face; 100 pieces /case; 38 lbs

For a visual reference to all of the NAHANCO Line finishes, see page 92



3/8" thick with a low gloss finish; brushed chrome hardware and locking wooden bar; 100 /case; 27 lbs; available in four finishes \$169.26

### FLAT 14" & 12" SKIRT/PANT HANGERS

|           |        |     |                                   |
|-----------|--------|-----|-----------------------------------|
| 21014RC   | 159.99 | 14" | Low gloss natural                 |
| 21012RC   | 159.99 | 12" |                                   |
| 21114RC   | 159.99 | 14" | Low gloss white                   |
| 21112RC   | 159.99 | 12" |                                   |
| 21216BRC  | 199.90 | 16" | Low gloss black                   |
| 21214RC   | 155.51 | 14" |                                   |
| 21212RC   | 155.51 | 12" |                                   |
| 21314RC   | 155.51 | 14" | Low gloss mahogany                |
| 21312RC   | 155.51 | 12" |                                   |
| 20414RC   | 155.51 | 14" | High gloss black w/ bright chrome |
| 20514RC   | 194.39 | 14" | High gloss white w/ bright chrome |
| 20614RC   | 174.90 | 14" | Low gloss beech                   |
| 20714RC   | 165.88 | 14" | Low gloss espresso w/ gunmetal    |
| 20814RC   | 139.99 | 14" | Black rubber                      |
| 20914RC   | 165.88 | 14" | Low gloss whitewash               |
| 21514RC   | 174.90 | 14" | Raw finish w/ gunmetal            |
| 29914RC   | 165.88 | 14" | Low gloss greywash                |
| 21214BRC  | 209.99 | 14" | Low gloss black w/ black          |
| 21214BRC  | 218.83 | 16" | Low gloss black w/ black          |
| 20414RCGH | 159.99 | 14" | High gloss black w/ gold          |
| 20514RCGH | 159.99 | 14" | High gloss white w/ gold          |

### FLAT 14" PANT HANGERS w/ LOCKING BAR

|         |                    |
|---------|--------------------|
| 21014PB | Low gloss natural  |
| 21114PB | Low gloss white    |
| 21214PB | Low gloss black    |
| 21314PB | Low gloss mahogany |

### 17" CONCAVE DISPLAY HANGER

|       |                    |
|-------|--------------------|
| 24017 | Low gloss natural  |
| 24117 | Low gloss white    |
| 24217 | Low gloss black    |
| 24317 | Low gloss mahogany |

17" wide and 3/4" thick with a 14" drop; with a 1 1/2" notched flare end and brushed chrome hardware; 12 /case; 14/27 lbs; available in four finishes \$100.57



with 1 1/2" flare end

24017



## introducing NAHANCO LINE Rubberized Wood Hangers



Designed for the performance wear industry. Heavy, wood bodies are enveloped in a smooth, no-slip, no-snag, rubber coating. 100 pieces /case



### FLAT 17" TOP HANGERS

17" wide; 1/2" thick; 33 /34 lbs

|          |        |                                  |
|----------|--------|----------------------------------|
| 20817    | 139.99 | Black rubber, chrome hook        |
| 20817BH  | 139.99 | Black rubber, black hook         |
| 20817G   | 139.99 | Grey rubber, brushed chrome hook |
| 20817WWH | 139.99 | White rubber, white hook         |

### FLAT 14" BOTTOM HANGERS

14" wide; 3/8" thick; 31 /31 lbs

|          |        |                                   |
|----------|--------|-----------------------------------|
| 20817    | 145.99 | Black rubber, chrome hardware     |
| 20817BH  | 145.99 | Black rubber, black hardware      |
| 20817G   | 145.99 | Grey rubber, brushed chr hardware |
| 20817WWH | 145.99 | White rubber, white hardware      |



three rubberized finishes



Fit TWICE the merchandise on your racks without giving up the luxury of a wood hanger

## NAHANCO SLIMLINE WOOD

Behold our slimline wood hanger! Almost as thin as our slimline velvet hangers, and as luxe as our NAHANCO line hangers. Slimline styles enable you to fit twice as many hangers onto your racks, without having to give up the sleek look and feel of wood.

Available in a range of finishes, including natural, black, white, and matte black rubber coated, mahogany, high gloss white, unfinished - all with swivel hooks and various hardware finishes, including brushed chrome, bright chrome, black, and gunmetal hardware.



## SlimLine Jacket Hangers

The SlimLine shape now available in a NEW, heavier jacket style!

Turn the page for details...

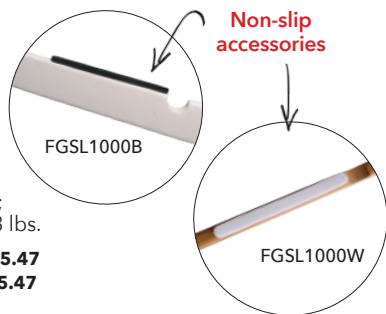

### Adhesive Foam Non-slip Attachments

Available in Black or White; 2 1/4" long; 1000 /case; 2/3 lbs.

FGSL1000B Black \$55.47  
FGSL1000W White \$55.47



The complete SLIMLINE wood collection:  
5 styles, each in 8 finishes

## SHIRT/DRESS



## JACKET



## SKIRT/PANT



## SUIT

w/ bar

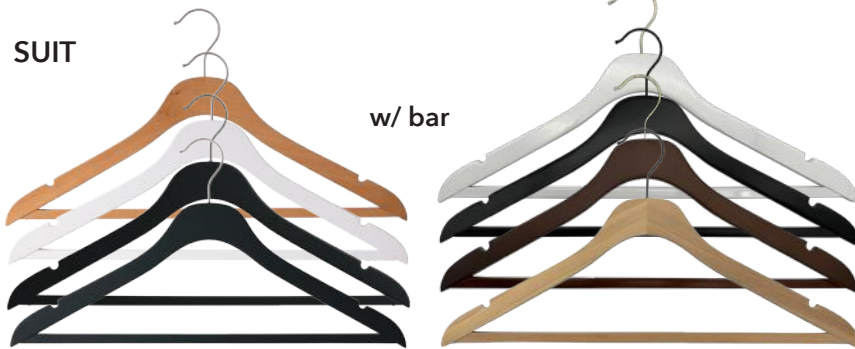

w/ clips

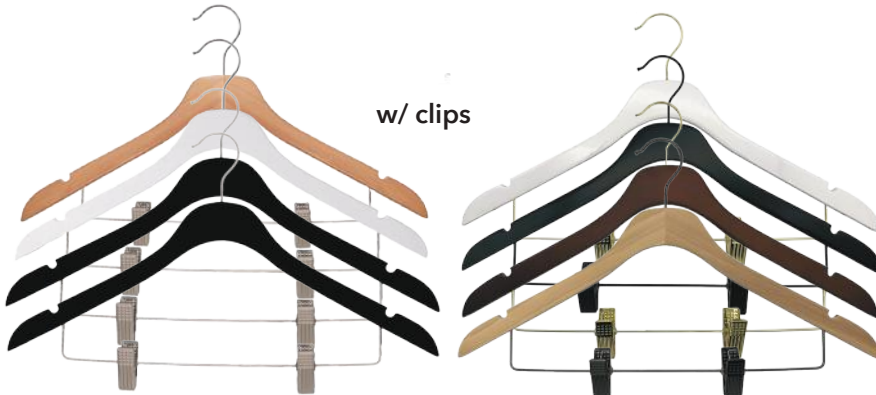

### SHIRT HANGERS 50 /case 17" wide, 1/4" thick; 8/13 lbs.

|             |                              |       |
|-------------|------------------------------|-------|
| SL7001750   | Low gloss Natural            | 65.49 |
| SL7011750   | Low gloss White              | 65.49 |
| SL7021750   | Low gloss Black              | 65.49 |
| SL7081750   | Matte Black Rubber coated    | 71.99 |
| SL7051750GH | High gloss White w/Gold hook | 65.49 |
| SL7021750BH | Low gloss Black w/Black hook | 65.49 |
| SL7031750GH | Mahogany w/Gold hook         | 65.49 |
| SL7151750GM | Raw finish w/Gunmetal hook   | 65.49 |

### JACKET HANGERS 25 /case 17" wide, 1/2" thick; 27 lbs.

|           |                              |       |
|-----------|------------------------------|-------|
| SL23017   | Low gloss Natural            | 71.49 |
| SL23117   | Low gloss White              | 71.49 |
| SL23217   | Low gloss Black              | 71.49 |
| SL23817CH | Matte Black Rubber coated    | 76.49 |
| SL23517GH | High Gloss White /gold hook  | 71.49 |
| SL23217BH | Low gloss Black w/black hook | 71.99 |
| SL23317GH | Mahogany w/gold hook         | 71.99 |
| SL23517GM | Raw finish w/gunmetal hook   | 71.49 |

### SKIRT/PANT HANGERS

50 /case 14" wide, 1/4" thick; 12/12 lbs.

|               |                              |       |
|---------------|------------------------------|-------|
| SL70014RC50   | Low gloss Natural            | 79.99 |
| SL70114RC50   | Low gloss White              | 79.99 |
| SL70214RC50   | Low gloss Black              | 79.99 |
| SL70814RC50   | Matte Black Rubber coated    | 85.89 |
| SL70514RC50GH | High gloss White w/Gold hook | 79.99 |
| SL70214RC50BH | Low gloss Black w/Black hook | 79.99 |
| SL70314RC50GH | Mahogany w/Gold hook         | 79.99 |
| SL71514RC50GM | Raw finish w/Gunmetal hook   | 79.99 |

### SUIT HANGERS

50 /case 17" wide, 1/4" thick; 10/14 lbs.

with bar:

|               |                              |       |
|---------------|------------------------------|-------|
| SL70017WB50   | Low gloss Natural            | 79.99 |
| SL70117WB50   | Low gloss White              | 79.99 |
| SL70217WB50   | Low gloss Black              | 79.99 |
| SL70817WB50   | Matte Black Rubber coated    | 89.99 |
| SL70517WB50GH | High gloss White w/Gold hook | 79.99 |
| SL7021750BH   | Low gloss Black w/Black hook | 79.99 |
| SL70317WB50GH | Mahogany w/Gold hook         | 79.99 |
| SL71517WB50GM | Raw finish w/Gunmetal hook   | 79.99 |

50 /case 17" wide, 1/4" thick; 12/19 lbs.

with clips:

|               |                              |       |
|---------------|------------------------------|-------|
| SL70017RC50   | Low gloss Natural            | 97.99 |
| SL70117RC50   | Low gloss White              | 97.99 |
| SL70217RC50   | Low gloss Black              | 97.99 |
| SL70817RC50   | Matte Black Rubber coated    | 99.99 |
| SL70517RC50GH | High gloss White w/Gold hook | 97.99 |
| SL70217RC50BH | Low gloss Black w/Black hook | 97.99 |
| SL70317RC50GH | Mahogany w/Gold hook         | 97.99 |
| SL71517RC50GM | Raw finish w/Gunmetal hook   | 97.99 |





**EQUINOX LINE SHIRT & PANT/SKIRT HANGERS**

Thin, flat and sleek with deep, sculpted notches. Perfect for customizing. Everything you could want from a modern hanger.

**EQUINOX ACRYLIC HANGERS**



High Gloss Black, White & Clear

**Shirt hangers:**

17"; 5/16" thick; 50 /case; 14 lbs.

w/ brushed chrome hardware:

9201750 Black **\$159.54**

9101750 White **\$159.54**

9001750 Clear **\$159.54**

w/ gold hardware:

92017GH50 Black **\$159.54**

91017GH50 White **\$159.54**

90017GH50 Clear **\$159.54**

w/ black hardware:

92017BH50 Black **\$159.54**

w/ shiny chrome hardware:

92017CH50 Black **\$159.54**

91017CH50 White **\$159.54**

90017CH50 Clear **\$159.54**

**Pant/skirt hangers:**

14"; 5/16" thick; 50 /case; 17 lbs.

w/ brushed chrome hardware:

92014RC50 Black **\$179.90**

91014RC50 White **\$179.90**

90014RC50 Clear **\$179.90**

w/ gold hardware:

92014RCG50 Black **\$179.90**

91014RCG50 White **\$179.90**

90014RCG50 Clear **\$179.90**

w/ black hardware:

92014BRC50BH Black **\$179.90**

w/ shiny chrome hardware:

92014RCCH50 Black **\$179.90**

91014RCCH50 White **\$179.90**

90014RCCH50 Clear **\$179.90**

**EQUINOX WOOD HANGERS**



High Gloss Black & White and Low Gloss Natural w/ brushed chrome hardware; Low Gloss Espresso w/gunmetal hardware

**Shirt hangers:**

17"; 5/16" thick; 50 /case; 13/15 lbs.

29201750 Black **\$124.80**

29101750 White **\$124.80**

29701750 Espresso **\$124.80**

29001750 Natural **\$124.80**



**Pant/skirt hangers:**

14"; 5/16" thick; 50 /case; 16 lbs.

292014RC50 Black **\$137.38**

291014RC50 White **\$137.38**

297014RC50 Espresso **\$137.38**

290014RC50 Natural **\$137.38**



With its thin, flat face, the Equinox is perfect for customizing

# HANGERS Executive Line Wood



## EXECUTIVE HANGER LINE

Concave with chrome hardware and a gloss finish



| style #                                      | \$     | qty | description                         | size                  | wgt   |
|--|--------|-----|-------------------------------------|-----------------------|-------|
| 2007-14N<br>2007-14W<br>2007-14B<br>2007-14C | 62.20  | 50  | Natural<br>White<br>Black<br>Cherry | 17 1/2"<br>1/2" thick | 21/22 |
| 2007-15N<br>2007-15W<br>2007-15B<br>2007-15C | 68.68  | 50  | Natural<br>White<br>Black<br>Cherry | 17 1/2"<br>1/2" thick | 16/21 |
| 2007-16N<br>2007-16W<br>2007-16B<br>2007-16C | 101.08 | 50  | Natural<br>White<br>Black<br>Cherry | 17 1/2"<br>1/2" thick | 20/21 |
| 2007-17N<br>2007-17W<br>2007-17B<br>2007-17C | 62.20  | 25  | Natural<br>White<br>Black<br>Cherry | 18"<br>1/2" thick     | 13/19 |
| 2007-18N<br>2007-18W<br>2007-18B<br>2007-18C | 64.79  | 25  | Natural<br>White<br>Black<br>Cherry | 18"<br>1/2" thick     | 16/22 |
| 2007-19N<br>2007-19W<br>2007-19B<br>2007-19C | 90.71  | 25  | Natural<br>White<br>Black<br>Cherry | 18"<br>1/2" thick     | 17/19 |
| 200713N<br>200713W<br>200713B<br>200713C     | 55.47  | 25  | Natural<br>White<br>Black<br>Cherry | 14"<br>1/2" thick     | 7/9   |

## EXECUTIVE FLARE HANGER LINE

Concave with chrome hardware and a gloss finish

1 7/8" Flare

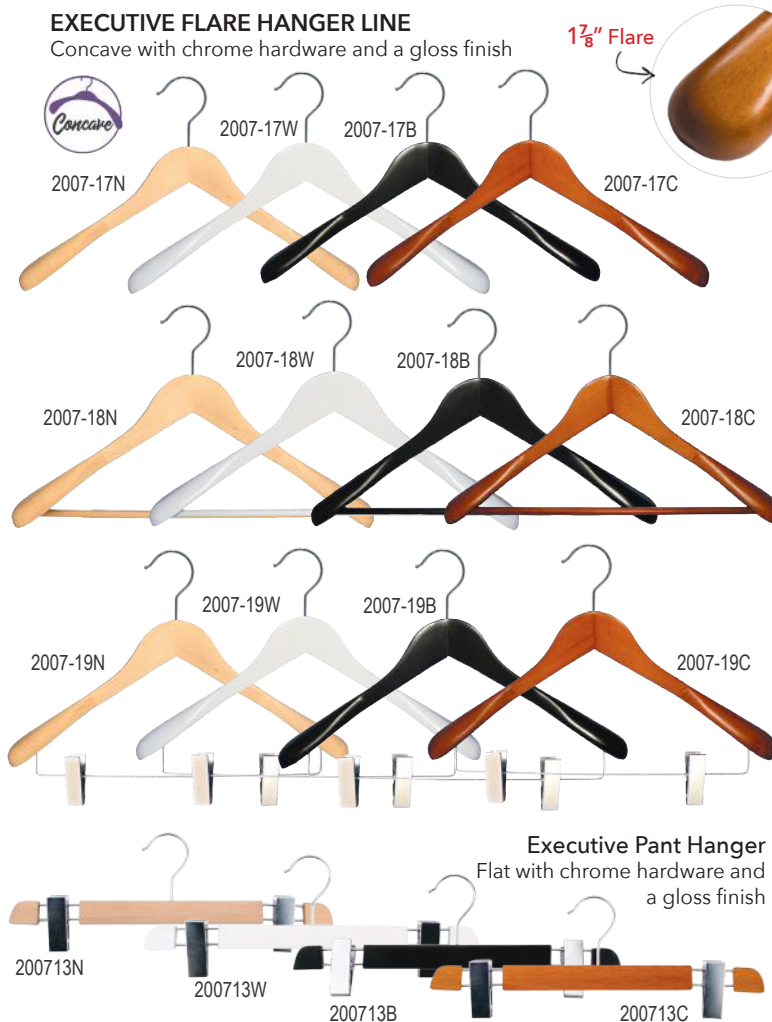

Executive Pant Hanger  
Flat with chrome hardware and a gloss finish

Pairs with our NAHANCO Line

**NORTHSHIRE LINE JACKET HANGERS**

A classic jacket hanger with a 3/8" shoulder, a 1 1/8" flare and a ball end hook. 17" wide; 24 pieces per carton; 9/15 lbs.



Northshire hangers feature notched, flared ends



|  |  |                                 |   |   |   |
|--|--|---------------------------------|---|---|---|
| 25217                                      | 25117                                      | 25517                           | 25717                                   | 29517   | 25317   |
| Low Gloss Black w/ brushed chrome hardware | Low Gloss White w/ brushed chrome hardware | Raw Finish w/ gunmetal hardware | Low Gloss Espresso w/ gunmetal hardware | Low Gloss Greywash w/ brushed chrome hardware | Low Gloss Mahogany w/ brushed chrome hardware |
| 24 pieces/ \$87.35                         | 24 pieces/ \$87.35                         | 24 pieces/ \$87.35              | 24 pieces/ \$87.35                      | 24 pieces/ \$113.79                           | 24 pieces/ \$87.35                            |

**SPECIALTY WOOD HANGERS**

**BAMBOO HANGERS**

Flat with chrome hardware

**SLIMLINE BAMBOO**

Low gloss finish; 1/2" thick; 50 pieces/case.

Shirt hanger; 17" wide; 13 lbs; **SL21417CH \$ 77.99**

Pant/Skirt hanger; 14" wide w/ 7/8" face; 19 lbs; **SL21414RCCH \$ 106.49**

Suit hanger w/drop bar & clear sleeve; 17" wide; 13 lbs; **SL21417DBSCH \$ 110.99**

Suit hanger w/drop bar and clips; 17" wide; 13 lbs; **SL21417RCCH \$ 124.49**

**STANDARD BAMBOO**

Low gloss finish; 1/2" thick; 50 pieces/case.

Shirt hanger; 17" wide; 13 lbs; **21417 \$105.49**

Pant/Skirt hanger; 14" wide w/ 7/8" face; 19 lbs; **21414RC \$119.36**

**BENTWOOD HANGERS**

Flat with chrome hardware

Low gloss natural finish; 1/2" thick; 100 pieces/case.

Shirt hanger; 17" wide; 17 lbs; **664 \$148.39**

Pant/Skirt hanger; 15" wide; 22 lbs; **652 \$206.71**

**DARK WOOD HANGERS**

Flat with gunmetal hardware

Low gloss dark wood; 1/2" thick; 100 pieces/case.

Shirt hanger; 17" wide; 28/32 lbs; **LVS17TOPDKRS \$138.67**

Pant/Skirt hanger; 14" wide w/ 1 1/8" face; 38 lbs; **LVSPANTDKRS \$187.27**

Display hanger; 12 pieces/case.

17" wide w/ 16" drop; 17/27 lbs; **LVS23317DKRS16 \$165.11**

**WALNUT GOLD SERIES HANGERS**

Walnut finish with gold hardware

Gloss walnut finish; 1/2" thick; 100 pieces/case.

Flat Shirt hanger; 17" wide; 1/2" thick; 100 pieces/case; 26/29 lbs;

**8317GH (no notches) \$117.94**

Pant/Skirt hanger; 14" wide; 1/2" thick w/ 7/8" face; flat w/metal clips;

100 pieces/case; 30 lbs; **CLIPGH \$176.13**

Concave Shirt hanger; 17" wide; 1" thick; 40 pieces/case;

24/28 lbs; **2017GH \$138.54**

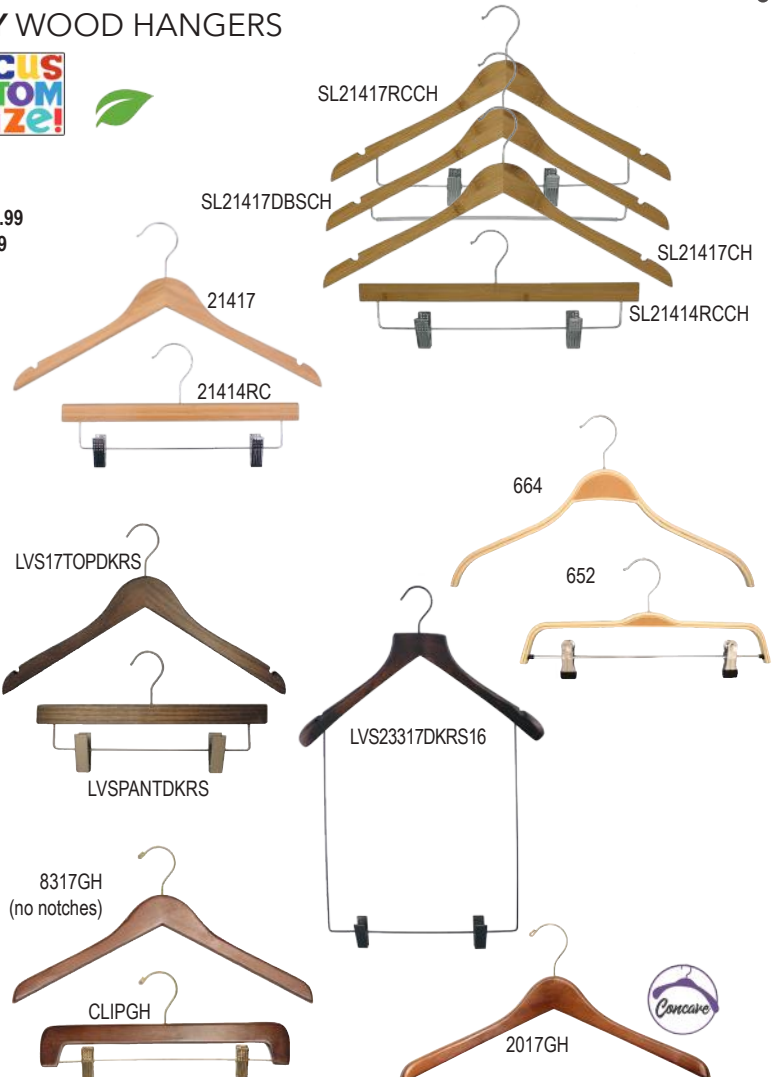

# HANGERS Signature, Retro & Flat Wood

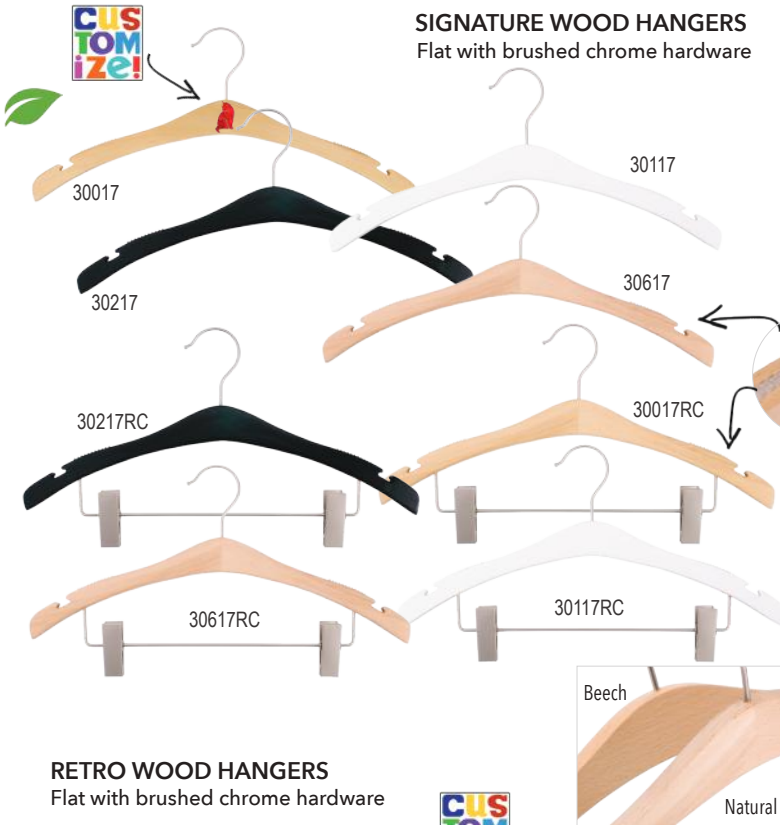

## SIGNATURE WOOD HANGERS Flat with brushed chrome hardware

## RETRO WOOD HANGERS Flat with brushed chrome hardware

### FLAT SHIRT HANGER Chrome hook

### FLAT SUIT HANGER Chrome hardware

### FLAT SKIRT/PANT HANGER Chrome hardware

| style #        | \$     | qty | description       | size                           | wgt   |
|----------------|--------|-----|-------------------|--------------------------------|-------|
| 30017          | 215.01 | 100 | Low gloss natural | 16 3/4"<br>1/2" thick          | 28    |
| 30117          | 215.01 |     | Low gloss white   |                                |       |
| 30217          | 215.01 |     | Low gloss black   |                                |       |
| 30617          | 220.58 |     | Low gloss beech   |                                |       |
| INSET GRIPPERS |        |     |                   |                                |       |
| 30017RC        | 169.99 | 100 | Low gloss natural | 16 3/4"<br>1/2" thick          | 37/42 |
| 30117RC        | 262.18 |     | Low gloss white   |                                |       |
| 30217RC        | 262.18 |     | Low gloss black   |                                |       |
| 30617RC        | 214.00 |     | Low gloss beech   |                                |       |
| INSET GRIPPERS |        |     |                   |                                |       |
| 40017          | 203.86 | 100 | Low gloss natural | 16"<br>1/2" thick              | 22/28 |
| 40117          | 203.86 |     | Low gloss white   |                                |       |
| 40217          | 203.86 |     | Low gloss black   |                                |       |
| 40617          | 206.71 |     | Low gloss beech   |                                |       |
| INSET GRIPPERS |        |     |                   |                                |       |
| 40017RC        | 225.37 | 100 | Low gloss natural | 16"<br>1/2" thick              | 37    |
| 40117RC        | 232.37 |     | Low gloss white   |                                |       |
| 40217RC        | 232.37 |     | Low gloss black   |                                |       |
| 40617RC        | 252.46 |     | Low gloss beech   |                                |       |
| 3117CH         | 151.24 | 100 | Natural gloss     | 16 1/2"<br>3/8" thick          | 24/25 |
| 3117RC         | 170.68 | 100 | Natural gloss     | 16 1/2"<br>3/8" thick          | 35    |
| 32-17          | 166.41 | 100 | Natural gloss     | 14"<br>3/8" thick<br>7/8" face | 27    |

The beauty of our wooden hangers comes in part from the individual craftsmanship required to produce them. Each hanger is unique, so expect slight variations in the lighter wood colors, wood grains and the landscape of each hanger face (resulting in minute differences in logo placement).



**CONTEMPORARY HANGER LINE:** Flat body with a softer slope, chrome hardware, ball end hook and a gloss finish

## CONTEMPORARY SHIRT HANGERS

w/Notches

17" wide; 3/8" thick; 100 /case; 27/29 lbs.

**\$143.99**

|          |         |
|----------|---------|
| 200720NN | Natural |
| 200720WN | White   |
| 200720BN | Black   |



## CONTEMPORARY PANT/SKIRT HANGERS

w/Standard Clips

14" wide; 3/8" thick; 100 /case; 30 lbs.

**\$127.49**

|         |         |
|---------|---------|
| 200723N | Natural |
| 200723W | White   |
| 200723B | Black   |

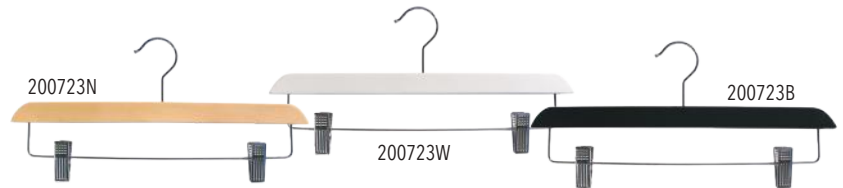

## CONTEMPORARY SHIRT HANGERS

No Notches

17" wide; 3/8" thick; 100 /case; 34/35 lbs.

**\$143.99**

|          |         |
|----------|---------|
| 2007-20N | Natural |
| 2007-20W | White   |
| 2007-20B | Black   |
| 2007-20C | Cherry  |



## CONTEMPORARY SUIT HANGERS

w/Pant Bar

17" wide; 3/8" thick; 100 /case; 37 lbs.

**\$152.99**

|          |         |
|----------|---------|
| 2007-21N | Natural |
| 2007-21W | White   |
| 2007-21B | Black   |
| 2007-21C | Cherry  |

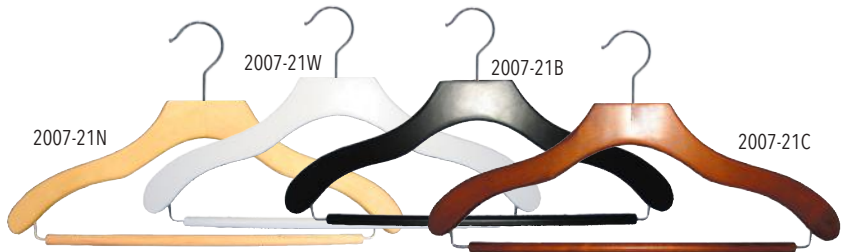

## CONTEMPORARY COORDINATE HANGERS

w/Euro Clips

17" wide; 3/8" thick; 100 /case; 47 lbs.

**\$159.99**

|          |         |
|----------|---------|
| 2007-22N | Natural |
| 2007-22W | White   |
| 2007-22B | Black   |
| 2007-22C | Cherry  |

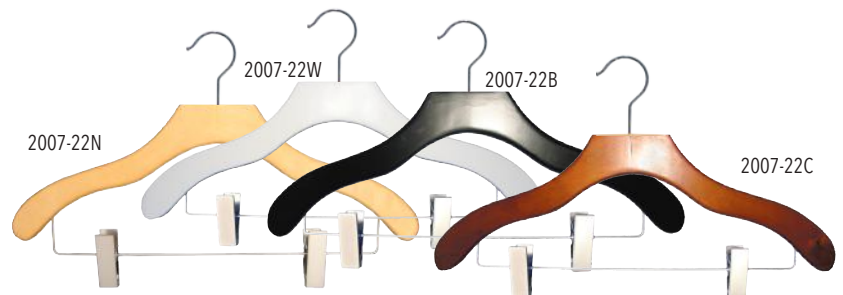

# HANGERS Traditional & Concave Wood



**FLAT SHIRT HANGER**  
with Shoulder Notches  
Chrome hook



81-17CH  
8217CHNOBAR  
8117WCHNOTCH



**FLAT SHIRT HANGER**  
without Shoulder Notches  
Chrome hook

\* Premium hanger, economy price

8117CHNONOTCH  
8117WCH



**FLAT SUIT HANGER**  
Stationary pant bar  
Chrome hook

80-17  
8017W  
8217CH

**FLAT SUIT HANGER**  
2" chrome drop  
Chrome hook



8017CHRC

**SKIRT/PANT HANGERS**  
Flat with chrome or gold hardware

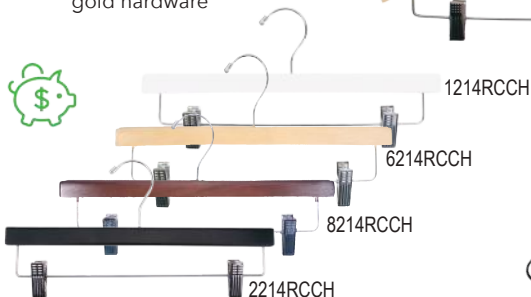

gold hardware

**EXTRA-THICK CONCAVE JACKET HANGER**  
Chrome hook



2317CH  
2017CH  
2117CH  
2217CH

**EXTRA-THICK CONCAVE SUIT HANGER**  
Chrome hardware and locking trouser bar



2117CHPB  
2017CHPB  
2217CHPB  
2317CHPB

| style # | \$ | qty | description | size | wgt |
|---------|----|-----|-------------|------|-----|
|---------|----|-----|-------------|------|-----|

**SHIRT HANGERS - WITH NOTCHES:**

|              |       |     |                          |                   |       |
|--------------|-------|-----|--------------------------|-------------------|-------|
| 81-17CH      | 79.90 |     | Natural gloss w/ notches |                   |       |
| 8217CHNOBAR  | 79.90 | 100 | Black gloss w/ notches   | 17"<br>1/2" thick | 28/29 |
| 8117WCHNOTCH | 79.90 |     | White gloss w/ notches   |                   |       |

**SHIRT HANGERS - NO NOTCHES:**

|               |       |     |                           |                   |       |
|---------------|-------|-----|---------------------------|-------------------|-------|
| 8117CHNONOTCH | 79.90 |     | Natural gloss, no notches | 17"               | 28/29 |
| 8117WCH       | 79.90 | 100 | White gloss, no notches   | 17"<br>1/2" thick | 28/29 |

**SUIT HANGERS - WITH PANT/SKIRT BAR:**

|        |       |     |                                     |                   |       |
|--------|-------|-----|-------------------------------------|-------------------|-------|
| 80-17  | 79.90 |     | Chrome hook:<br>Natural gloss w/bar |                   |       |
| 8017W  | 79.90 | 100 | White w/bar                         | 17"               | 30/31 |
| 8217CH | 79.90 |     | Black gloss w/bar                   | 17"<br>1/2" thick | 30/31 |

**SUIT HANGERS - WITH 2" CHROME DROP:**

|          |        |     |                          |                   |       |
|----------|--------|-----|--------------------------|-------------------|-------|
| 8017CHRC | 109.90 | 100 | Natural w/2" chrome drop | 17"<br>1/2" thick | 30/31 |
|----------|--------|-----|--------------------------|-------------------|-------|

|          |       |     |                           |                   |    |
|----------|-------|-----|---------------------------|-------------------|----|
| 1214RCCH | 94.90 | 100 | White:<br>Chrome hardware | 14"<br>1/2" thick | 31 |
|----------|-------|-----|---------------------------|-------------------|----|

|          |        |     |                             |                   |    |
|----------|--------|-----|-----------------------------|-------------------|----|
| 6214RCCH | 94.90  |     | Natural:<br>Chrome hardware | 14"               |    |
| 6214RCGH | 173.40 | 100 | Gold hardware               | 14"<br>1/2" thick | 31 |

|          |        |     |                            |                   |    |
|----------|--------|-----|----------------------------|-------------------|----|
| 8214RCCH | 129.47 |     | Walnut:<br>Chrome hardware | 14"               |    |
| 8214RCGH | 95.77  | 100 | Gold hardware              | 14"<br>1/2" thick | 31 |

|          |        |     |                           |                   |    |
|----------|--------|-----|---------------------------|-------------------|----|
| 2214RCCH | 94.90  |     | Black:<br>Chrome hardware | 14"               |    |
| 2214RCGH | 184.42 | 100 | Gold hardware             | 14"<br>1/2" thick | 31 |

**1" THICK JACKET HANGERS :**

|        |        |    |                        |                 |       |
|--------|--------|----|------------------------|-----------------|-------|
| 2017CH |        |    | Walnut gloss           |                 |       |
| 2117CH | 129.99 | 40 | Natural gloss          | 17"<br>1" thick | 22/32 |
| 2217CH |        |    | Black gloss            |                 |       |
| 2317CH |        |    | Natural w/waxed finish |                 |       |

**1" THICK SUIT HANGERS :**

|          |        |    |                        |          |       |
|----------|--------|----|------------------------|----------|-------|
| 2017CHPB |        |    | Walnut gloss           |          |       |
| 2117CHPB | 182.35 | 40 | Natural gloss          | 17"      | 29/39 |
| 2217CHPB |        |    | Black gloss            | 1" thick |       |
| 2317CHPB |        |    | Natural w/waxed finish |          |       |

# Traditional Wood HANGERS

style # \$ qty description wgt

## SUIT HANGERS - 1/2" THICK:

|         |        |     |                                     |       |
|---------|--------|-----|-------------------------------------|-------|
| 50-14   | 203.86 |     | 14" Natural w/waxed finish, sq hook | 27/35 |
| 50-17   | 198.29 |     | 17" Natural w/waxed finish, sq hook | 39/40 |
| 50-19   | 203.86 |     | 19" Natural w/waxed finish, sq hook | 42/48 |
| 7017CH  | 162.26 |     | 17" Walnut, chrome hook             | 38/49 |
| 70-19GH | 203.86 | 100 | 19" Walnut, gold hook               | 38/44 |
| 7117CH  | 162.26 |     | 17" Natural, chrome hook            | 38/45 |
| 71-19GH | 203.86 |     | 19" Natural, gold hook              | 41/48 |
| 72-17CH | 165.11 |     | 17" Black, chrome hook              | 33/48 |
| 72-17   | 165.11 |     | 17" Black, gold hook                | 33/48 |

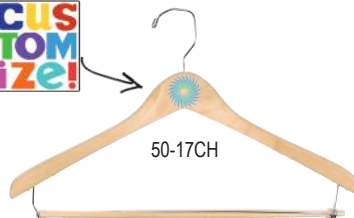

\* Waxed hanger has a square hook

**Hook finishes**  
**CH = Chrome Hook**  
**GH = Gold Hook**

**CONCAVE SUIT HANGER**  
 Chrome or gold hardware  
 with locking trouser bar



## SUIT HANGERS - 1/2" THICK w/ 2" DROP:

|          |        |     |                              |       |
|----------|--------|-----|------------------------------|-------|
| 70-17RC  | 171.98 | 100 | 17" Walnut, gold hardware    | 39/45 |
| 7117RCCH | 171.98 |     | 17" Natural, chrome hardware |       |
| 7217RCCH | 171.98 | 100 | 17" Black, chrome hardware   | 39/48 |
| 72-17RC  | 191.42 |     | 17" Black, gold hardware     |       |

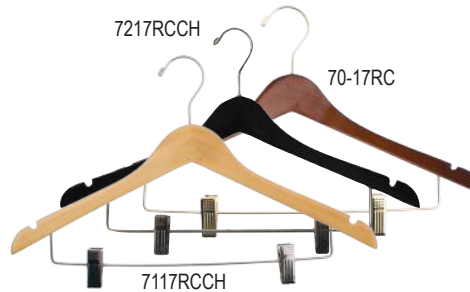

**NOTCHED CONCAVE SUIT HANGER**  
 Chrome or gold hardware

## DISPLAY HANGERS - 1/2" THICK w/ 10" DROP:

|          |       |    |                              |      |
|----------|-------|----|------------------------------|------|
| 100-17RC | 51.32 | 12 | 17" Walnut, chrome hardware  | 7/34 |
| 101-17RC |       |    | 17" Natural, chrome hardware |      |

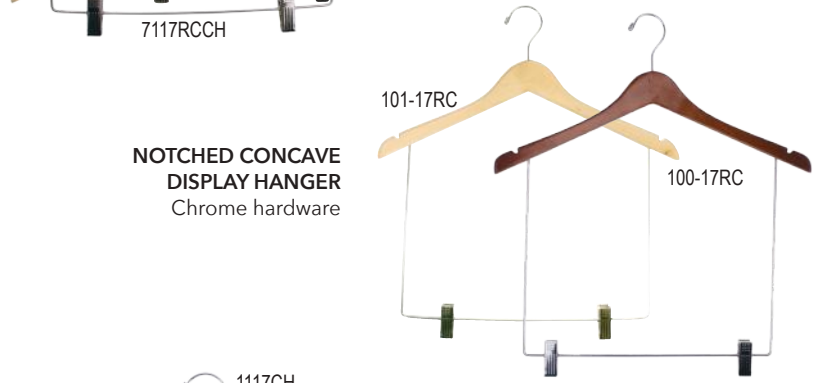

**NOTCHED CONCAVE DISPLAY HANGER**  
 Chrome hardware

## JACKET HANGERS - 1/2" THICK:

|         |        |     |                                    |       |
|---------|--------|-----|------------------------------------|-------|
| 1217CH  | 127.99 |     | 17" Black, chrome hardware         | 29/31 |
| 12-17   | 127.99 |     | 17" Black, gold hardware           | 29/31 |
| 14-17   | 127.99 | 100 | 17" Natural w/waxed finish, chrome | 29/31 |
| 1017CH  | 127.99 |     | 17" Walnut, chrome hardware        | 29/33 |
| 1017GH  | 127.99 |     | 17" Walnut, gold hardware          | 29/33 |
| 10-19GH | 129.99 |     | 19" Walnut, gold hardware          | 33/36 |
| 11155CH | 127.99 |     | 15 1/2" Natural, chrome hardware   | 22/30 |
| 1117CH  | 127.99 |     | 17" Natural, chrome hardware       | 29/33 |
| 11-17GH | 127.99 |     | 17" Natural, gold hardware         | 29/33 |



**CONCAVE JACKET HANGER**  
 Chrome or gold hook

## SUIT HANGERS - 1" THICK w/ BLACK FLOCKED BAR:

|          |        |    |                                     |       |
|----------|--------|----|-------------------------------------|-------|
| 2017CHFB |        |    | 17" Walnut gloss w/chrome hardware  |       |
| 2117CHFB | 153.99 |    | 17" Natural gloss w/chrome hardware |       |
| 2217CHFB |        | 40 | 17" Black gloss w/chrome hardware   | 29/39 |
| 2017GHFB |        |    | 17" Walnut gloss w/gold hardware    |       |
| 2117GHFB | 156.49 |    | 17" Natural gloss w/gold hardware   |       |
| 2217GHFB |        |    | 17" Black gloss w/gold hardware     |       |

## SUIT HANGERS - 1/2" THICK w/ BLACK FLOCKED BAR:

|          |        |    |                                     |       |
|----------|--------|----|-------------------------------------|-------|
| 7017CHFB |        |    | 17" Walnut gloss w/chrome hardware  |       |
| 7117CHFB | 137.99 |    | 17" Natural gloss w/chrome hardware |       |
| 7217CHFB |        | 40 | 17" Black gloss w/chrome hardware   | 29/39 |
| 7017GHFB |        |    | 17" Walnut gloss w/gold hardware    |       |
| 7117GHFB | 142.49 |    | 17" Natural gloss w/gold hardware   |       |
| 7217GHFB |        |    | 17" Black gloss w/gold hardware     |       |

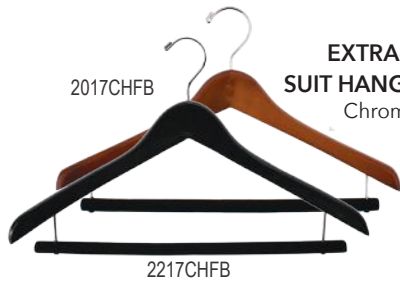

**EXTRA-THICK CONCAVE SUIT HANGER w/Flocked Bar**  
 Chrome or Gold hardware



**8 New styles added!**

see [nahanco.com](http://nahanco.com) for more details



## NAHANCO HOTEL FLAT WOODEN & CHROME HANGERS

Our Hotel Collection features flat suit ball top wooden hangers, a closed hook chrome hanger and the A-style and B-style security rings used with the ball top hangers. Flat wooden hangers feature a low gloss finish, notched ends, pant bars or clips, and are great for imprinting your company's logo.

### FLAT SUIT Ball Top Wood Hanger

w/Metal Sliding Clips

17 1/2" wooden suit hanger features a dropped bar and sliding chrome clips. Notched ends accommodate garments with straps. 100 pieces/case. 33/35 lbs. **\$166.41**



Black  
60217BECRC

Mahogany  
60317BECRC

Natural  
60017BECRC



### FLAT SUIT Ball Top Wood Hanger

w/Pant Bar

17 1/2" wooden flat suit hanger features a stationary pant bar. Notched ends accommodate garments with straps. 100 pieces/case. 29/30 lbs. **\$127.66**



Black  
60217BEC

Mahogany  
60317BEC

Natural  
60017BEC

Most of our wooden hangers can be fitted with a ball post for hotel use. Please call Customer Service for details.



### A-RING for Ball Top Hangers

Chrome plated steel hotel-style ring stays put when installed on any standard closet bar; easily detach from the circular hook. 100 pcs/bag. 9 lbs; **HHSRA100 \$30.59**



### B-RING for Ball Top Hangers

Chrome finished steel clamping hanger. The B-Style Ring clamps down over the bar. 100 pcs/bag. 5/8 lbs; **HHSRB100 \$34.73**

### 17" CLOSED HOOK CHROME HANGER

Made with heavy duty 4mm chrome plated wire, this hanger is durable and long lasting. The opening diameter of the hook measures 1 1/2". 100 pieces/case. 25 lbs; **89017 \$130.38**

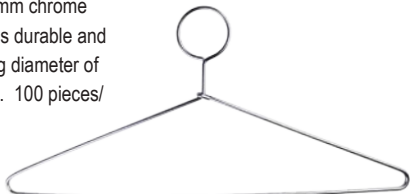

### 17" MINI HOOK HANGERS

17" wooden suit hangers with a natural gloss finish and a flat 1/2" thick profile, feature notched ends for straps and a mini chrome hook to fit a 5/8" diameter hang bar. 100 pieces/case; w/ 2" drop bar and pinch clips: **8017RCMH \$165.76**  
w/ round wood pant bar: **8017NOTCHMH \$126.88**



### More HOTEL hanger options include:

- **NAHANCO** LINE - see p 92
- **Executive** LINE - see p 98
- **Contemporary** LINE - see p 101
- **Northshire** LINE - see p 99
- **Equinox** LINE - see p 97
- **Retro** LINE - see p 100
- **Signature** LINE - see p 100
- **Bamboo** styles - see p 99





# Chrome-Plated Metal HANGERS

| style #                  | \$     | qty | description              | size   | wgt   |
|--------------------------|--------|-----|--------------------------|--|-------|
| Chrome/3.5mm wire gauge: |        |     |                          |  |       |
| SLD12                    | 68.99  |     | standard hook            | 12"  | 18    |
| SLD-12LH                 | 113.99 |     | loop hook                | 12"  | 18    |
| SLD14                    | 78.99  |     | standard hook            | 14"  | 20    |
| SLD-14LH                 | 107.99 |     | loop hook                | 14"  | 20    |
| SLD16                    | 88.78  | 100 | standard hook            | 16"  | 22    |
| SLD-16LH                 | 85.99  |     | loop hook                | 16"  | 22    |
| SLD18                    | 95.99  |     | standard hook            | 18"  | 22    |
| SLD-18LH                 | 99.99  |     | loop hook                | 18"  | 22    |
| SLD19                    | 99.99  |     | standard hook            | 19"  | 24    |
| SLD-19LH                 | 127.49 |     | loop hook                | 19"  | 24    |
| SLD-PANT                 | 133.23 |     |                          | 14"  | 22    |
| DSA9                     | 160.96 | 100 | CHROME                   | 9" drop  | 24    |
| DSA16                    | 167.83 |     | 3.5mm wire gauge         | 16" drop   | 29    |
| SKT-12                   | 117.94 |     | standard hook            | 12"  | 20    |
| SKT12LH                  |        |     | loop hook                |  |       |
| Chrome/3.5mm wire gauge: |        |     |                          |  |       |
| LIN14                    | 119.36 | 100 | standard hook            | 14"  | 22    |
| LIN16                    | 105.49 |     | standard hook            | 16"  | 24    |
| LIN16LH                  | 151.89 |     | loop hook                | 16"  | 24    |
| LIN18                    | 112.36 |     | standard hook            | 18"  | 24    |
| DP1410                   | 22.94  | 10  | Chrome diaper pin rod    | 14"  | 4     |
| SLC-16                   | 156.69 | 100 | Chrome / 3.5mm wire      | 16"  | 24    |
| SLC16LH                  |        |     | With Loop Hook           |  |       |
| BSH12-50                 | 120.66 | 50  | Chrome/3.5mm wire        | 12"  | 34/35 |
| BFWC12                   | 60.99  | 12  | Chrome /4.5mm wire       | All 3 styles -<br>38" body height<br>15" shoulders<br>11" waist/16" hips | 10/11 |
| BFWB12                   | 56.49  |     | Black /4.5mm wire        |  |       |
| BFWBR12                  | 68.99  |     | Black rubber /4.5mm wire |  |       |
| BFWW12                   | 61.49  |     | White /4.5mm wire        |  |       |
| BCH14                    | 27.73  | 12  | Chrome /4mm wire         | 14"  | 5     |
| BBH14                    | 27.73  |     | Black /4mm wire gauge    |  |       |
| BBH14BR                  | 38.23  |     | Black Rubber             |  |       |
| SLGLOVE                  | 125.58 | 100 | CHROME                   | 10" wide at bottom,<br>11 1/2" high                                      | 27    |
| SLGLOVE12                | 33.18  | 12  | 3.5mm wire gauge         |  | 7     |
| SLHAT                    | 137.38 | 100 | CHROME                   | 9" wide at bottom,<br>11 1/2" high                                       | 27    |
| SLHAT12                  | 33.18  | 12  | 3.4mm wire gauge         |  | 7     |
| SBD22                    | 66.64  | 12  | CHROME                   | 22"  | 9     |
| 201                      | 41.60  |     | CHROME                   | 19"  | 9     |
| 201NOTAIL19              | 47.17  | 12  | CHROME                   | 19"  | 12    |
|                          |        |     | 8mm wire gauge           |  |       |

## CHROME-PLATED HANGERS

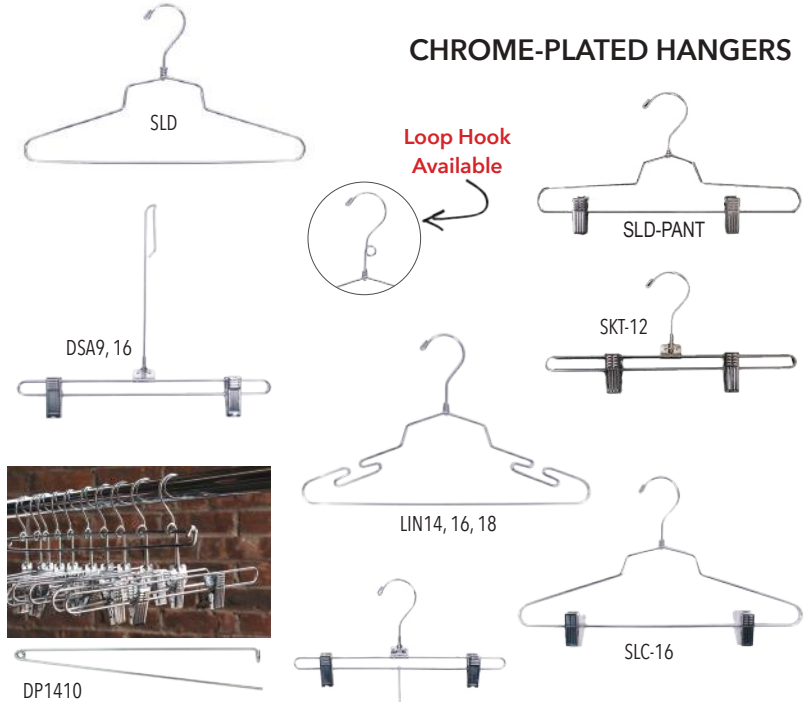

## BIKINI & SWIMSUIT HANGERS

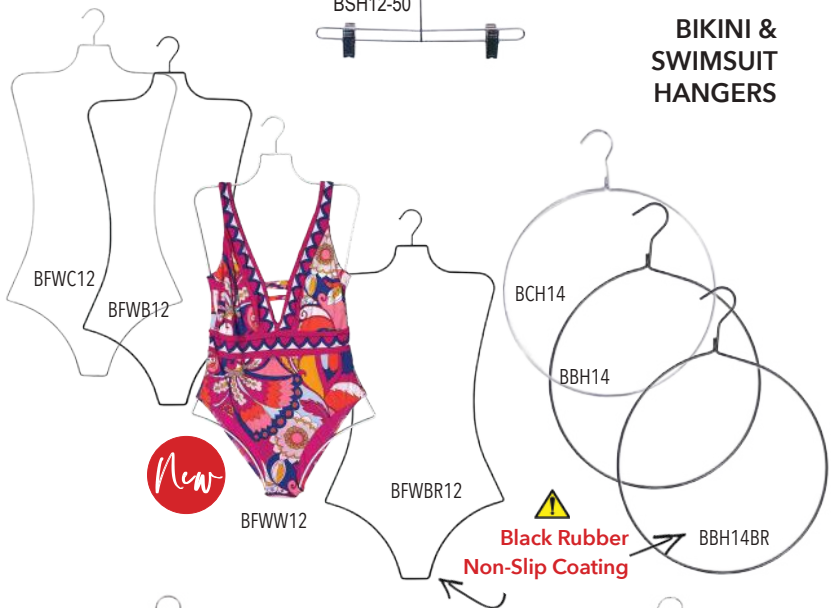

## GLOVES & HAT HANGERS

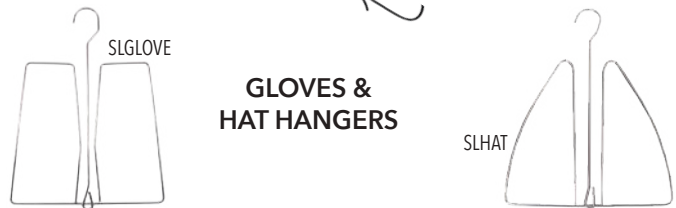

## BEDSPREAD, DRAPERY & SLEEPING BAG HANGERS

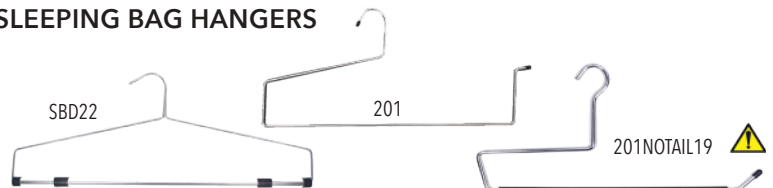

# HANGERS Aluminum, Gunmetal & Steel

## BRUSHED ALUMINUM

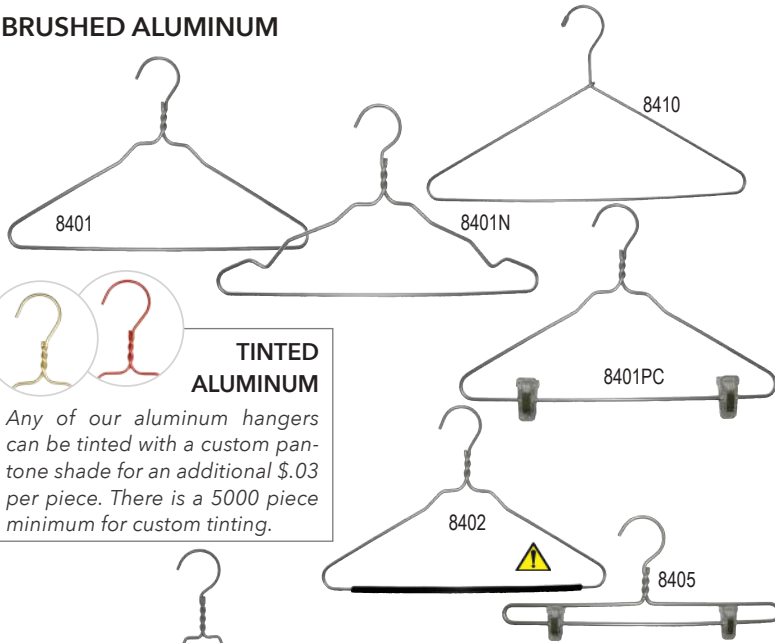

**TINTED ALUMINUM**  
 Any of our aluminum hangers can be tinted with a custom pantone shade for an additional \$.03 per piece. There is a 5000 piece minimum for custom tinting.

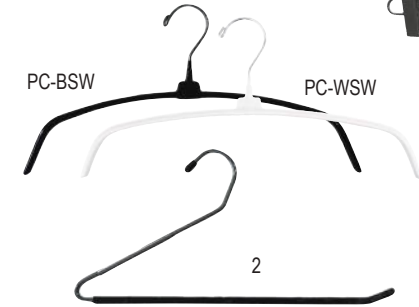
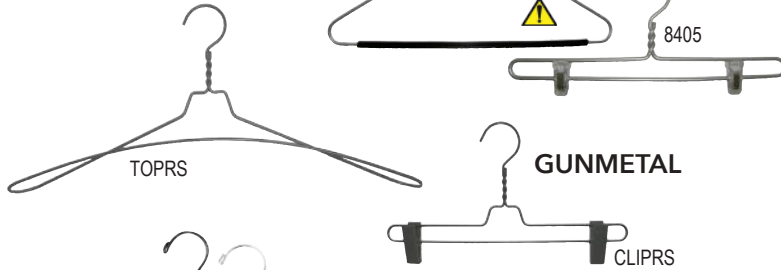

**NON-SLIP STEEL HANGER**  
 A slim, tempered steel shirt hanger coated with a non-slip rubber. Chrome hook does not swivel.

**CHROME-PLATED STEEL Skirt/Pant Hanger**  
 Vinyl-covered, non-slip bar.

**S-Shape Multilayer Metal Hanger**  
 Lightweight and durable stainless steel

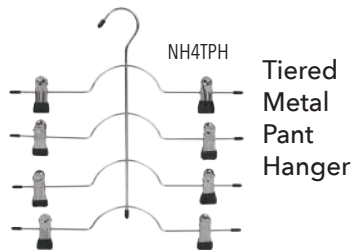
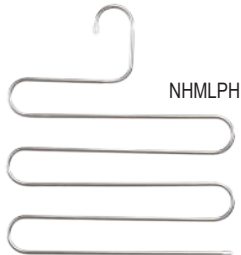

**Tiered Metal Pant Hanger**



**Black Clamp Pant Hanger**  
 Chrome with rubberized coating

## BEDSPREAD, DRAPERY & SLEEPING BAG HANGERS





NHTHSFR1

NHTHSFR2

NHTSHM1

| style #   | \$     | qty | description   | size              | wgt   |
|---|--------|-----|---|-------------------|-------|
| 8410  | 112.49 | 100 | Brushed aluminum standard shirt hanger; 4mm wire gauge                                | 16 1/4"           | 9/15  |
| <b>BRUSHED ALUMINUM w/twisted neck – 4mm wire gauge:</b>  |        |     |   |                   |       |
| 8401  | 149.82 |     | Shirt hanger  |                   | 11/16 |
| 8401N   | 130.99 | 100 | Notched Shirt hanger  | 16 1/2"           | 11/13 |
| 8401PC  | 140.49 |     | Suit hanger w/ clear plastic clips  |                   | 14/30 |
| 8402  | 116.99 | 100 | Brushed aluminum shirt hanger w/ black rubber sleeve and twisted neck; 4mm wire gauge | 16 1/2"           | 13/18 |
| 8405  | 150.99 | 100 | Brushed aluminum pant hanger w/ clear plastic clips & twisted neck; 4mm wire gauge    | 15"               | 11/16 |
| <b>GUNMETAL Finish w/twisted neck – 3.5mm wire gauge:</b> |        |     |   |                   |       |
| TOPRS   | 166.41 |     | Shirt hanger  | 18", 1 7/8" flare | 23    |
| CLIPRS  | 180.27 | 100 | Pant hanger w/metal clips   | 14"               | 27    |
| <b>3.5mm wire gauge hook w/flat steel body</b>            |        |     |   |                   |       |
| PC-BSW  | 71.49  | 100 | Black   | 16"               | 22/24 |
| PC-WSW  |        |     | White   |                   |       |
| 2   | 119.36 |     | Chrome with black bar;  | 12 1/2"           | 31    |
| 2-16  | 127.66 | 100 | 5.4mm wire gauge  | 16"               | 38    |
| NH4TPH  | 16.72  | 3   | CHROME 4-tier pant hanger with clips  | 13" x 15"         | 3/6   |
| NHMLPH  | 11.79  | 3   | Stainless steel w/clear cap ends  | 12" W x 15 1/2" H | 3/6   |
| CP200   | 80.48  | 50  | Black   | 10"               | 37    |
| <b>Heavy Duty Black Metal Hangers:</b>                    |        |     |   |                   |       |
| NHTHSFR1  | 20.87  |     | Sleeping Bag/ Bedspread hanger  | 25" wide          | 4     |
| NHTHSFR2  | 21.51  | 1   | Sleeping Bag/ Bedspread hanger  | 31" wide          | 8     |
| NHTSHM1   | 22.29  |     | Hooded mummy sleeping bag hanger  | 23" wide          | 5     |

# Plastic Jacket & Suit HANGERS

| style #  | \$     | qty | description                    | size                   | wgt   |
|--|--------|-----|--------------------------------|------------------------|-------|
| H70  | 69.34  | 50  | Black                          | 15/8" shoulder:        | 17/45 |
| H90  | 72.19  |     |                                | 17"                    | 20/48 |
| H110   | 68.04  |     |                                | 19"                    | 23/56 |
| <div style="display: flex; justify-content: space-around; align-items: center;"> <div style="text-align: center;">  <p>RH = Round Hook</p> </div> <div style="text-align: center;">  <p>SQ = Square Hook</p> </div> </div> |        |     |                                |                        |       |
| H17SQ  | 62.47  | 100 | Black                          | 17"                    | 21/44 |
| H17RH  | 62.47  |     |                                | 19"                    | 22/44 |
| H19RH  | 83.20  |     |                                |                        |       |
| 2593   | 98.50  | 50  | Black                          | 19"<br>1 1/2" shoulder | 21/46 |
| 2563   | 87.35  |     |                                | 18"<br>1 3/8" shoulder | 20/43 |
| 2515   | 97.07  | 100 | Black                          | 15"                    | 26/31 |
| 2393   | 98.50  | 50  | Black<br>w/clear support strap | 19"                    | 16/39 |
| 2363   | 87.35  |     |                                | 16 1/2"                | 18/43 |
| 8517RH   | 126.23 | 100 | Tan                            | 17"                    | 29/34 |
| 2517RH   | 103.67 |     | Black                          | 17"                    |       |
| 2518   | 91.49  | 100 | Black                          | 18"                    | 37/48 |
| 8518RH   |        |     | Tan                            | 18"                    | 36/48 |
| 2700PB   | 59.99  | 100 | Black                          | 17"                    | 22/34 |
| 1700PB   |        |     | White                          |                        |       |
| 700 PB   |        |     | Clear                          |                        |       |
| 2015PC   | 96.42  | 100 | Black                          | 15 1/4"                | 15/24 |
| 2690EC   | 90.85  | 100 | Black                          | 14"                    | 22    |

## CONCAVE EXTRA WIDE-SHOULDERED PLASTIC SUIT HANGER

Textured finish with smooth area for label. Chrome hook



## CONCAVE PLASTIC SUIT HANGER

Textured finish with smooth area for label. Chrome hook



## CONCAVE WIDE-SHOULDERED SUIT HANGER

Textured finish with smooth area for label & locking trouser bar. Chrome hardware



## CONCAVE PLASTIC SUIT HANGER

Textured finish with smooth area for label & locking trouser bar. Chrome hardware



## CONCAVE WIDE-SHOULDERED SUIT HANGER

Textured finish with smooth area for label. Chrome hook and clear support strap



## CONCAVE STURDY PLASTIC SUIT HANGER

Matte finish with locking trouser bar. Chrome hardware



## FLAT PLASTIC SUIT HANGER

Non-slip plastic bar. Chrome hook



## PANT HANGER W/ CUSHION GRIP CLIPS

Chrome hook



## SUPER STRONG PANT HANGER

For outerwear and jeans



# HANGERS Plastic Jacket & Outerwear



**CONCAVE STURDY PLASTIC JACKET HANGER**  
Textured finish with smooth area for label. Chrome hook



**CONCAVE JACKET HANGER**  
With non-slip pads and black hook



**FLAT PLASTIC ACTIVE SPORTS HANGER**  
Smooth finish with area for label application. Chrome hook



**CONCAVE WIDE-SHOULDERED PLASTIC JACKET HANGER**  
Textured finish with smooth area for label. Chrome hook



**CONCAVE WIDE-SHOULDERED PLASTIC JACKET HANGER**  
Textured finish with smooth area for label. Chrome hook



**PLASTIC CONCAVE JACKET HANGER**  
Textured finish with smooth area for label. Chrome hook



**PLASTIC CONTOUR JACKET HANGER**  
Textured finish with smooth area for label. Black hook



**FLAT ELEGANT SHIRT HANGER**  
Chrome hook



**FLAT ELEGANT COORDINATE SUIT HANGER**  
With notches and chrome hardware



**FLAT ELEGANT SHIRT/SWEATER HANGER**  
Chrome hook



**FLAT SPORTSMEN'S OUTERWEAR HANGER**  
With molded grippers

| style # | \$    | qty | description | size | wgt   |
|---------|-------|-----|-------------|------|-------|
| 2417RH  | 64.79 |     | Black       | 17"  | 20/34 |
| 8417RH  | 76.33 | 100 | Tan         | 17"  | 18/28 |
| 2418    | 81.91 |     | Black       | 18"  | 22/46 |
| 8418RH  | 81.91 |     | Tan         | 18"  | 22/46 |
| 8417SQ  | 81.91 |     | Tan         | 18"  | 22/46 |

|                 |  |   |   |                  |  |
|-----------------|--|---|---|------------------|--|
| RH = Round Hook |  |  |  | SQ = Square Hook |  |
|-----------------|--|---|---|------------------|--|

|          |        |     |                     |                             |       |
|----------|--------|-----|---------------------|-----------------------------|-------|
| 24010550 | 54.17  | 50  | Black w/ black hook | 15"                         | 9/22  |
| H1800RH  | 77.99  | 100 | Black               | 18"                         | 20/30 |
| 2293     | 69.34  |     | Black               | 19"                         | 16/39 |
| 2263     | 66.61  | 50  | Black               | 16 1/2"                     | 16/38 |
| 2493     | 65.97  |     | Black               | 19" wide<br>1 1/2" shoulder | 14/39 |
| 2463     | 56.25  | 50  | Black               | 18" wide<br>1 3/8" shoulder | 14/35 |
| 2415     | 67.91  | 100 | Black               | 15"                         | 14/26 |
| NHC18    | 78.93  |     | Black               | 18"                         | 21/40 |
| NHC17    | 64.67  | 100 | w/ black hook       | 17"                         | 20/39 |
| NHC15    | 63.37  |     | Black               | 15"                         | 18/28 |
| NH250    | 60.39  | 100 | Ivory               | 17"                         | 13/21 |
| BH250    |        |     | Black               |                             |       |
| NH252    | 138.54 |     | Ivory               | 17"                         | 29/38 |
| BH252    | 152.41 | 100 | Black               |                             |       |
| NH229    | 83.98  | 100 | Ivory               | 18 1/2"                     | 18/31 |
| BH229    |        |     | Black               |                             |       |
| BH350BHM | 79.06  | 100 | Black w/ black hook | 18 3/4"                     | 21/32 |

# Flocked Velvet HANGERS

style #    \$    qty    description    size    wgt

|                                  |                |     |                            |                        |       |
|----------------------------------|----------------|-----|----------------------------|------------------------|-------|
| HSL17NB                          | 52.99          | 100 | Black                      | 17 3/8"                | 12/18 |
| HSL17NG<br>HSL17NP               | 36.81          | 50  | Moss Grey<br>Pink          | 17 3/8"                | 6     |
| HSL17SB                          | 49.99          | 100 | Black (no notches)         | 17 3/8"                | 12/18 |
| HSL17PB<br>HSL12B                | 49.99<br>37.99 | 100 | Black                      | 17 3/8"                | 17/19 |
| HSL17PG<br>HSL17PP               | 43.68          | 50  | Moss Grey<br>Pink          | 17 3/8"                | 12/13 |
| HSLCLIPB<br>HSLCLIPG<br>HSLCLIPP | 34.08          | 100 | Black<br>Moss Grey<br>Pink | 2 3/4" h x<br>1 1/2" w | 4     |

## SLIMLINE HANGERS

A thin velvet flocked hanger with chrome hook, often referred to as "huggables"

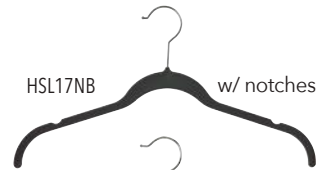

**Top Sellers!**

## SLIMLINE CLIPS



|        |       |    |       |                 |     |
|--------|-------|----|-------|-----------------|-----|
| FNHDH4 | 44.45 | 12 | Black | 17"<br>1" thick | 5/9 |
|--------|-------|----|-------|-----------------|-----|

|         |       |     |                                      |     |       |
|---------|-------|-----|--------------------------------------|-----|-------|
| FLK2508 | 91.63 | 100 | Black<br><i>*while supplies last</i> | 17" | 14/22 |
|---------|-------|-----|--------------------------------------|-----|-------|

|        |       |    |       |     |       |
|--------|-------|----|-------|-----|-------|
| FNH250 | 26.44 | 12 | Black | 17" | 12/21 |
|--------|-------|----|-------|-----|-------|

|        |       |    |       |         |       |
|--------|-------|----|-------|---------|-------|
| FNH229 | 29.81 | 12 | Black | 18 1/2" | 18/31 |
|--------|-------|----|-------|---------|-------|

|                        |                |    |       |            |      |
|------------------------|----------------|----|-------|------------|------|
| F24022222<br>F24044444 | 58.32<br>66.61 | 25 | Black | 16"<br>14" | 9/10 |
|------------------------|----------------|----|-------|------------|------|

## FLOCKED VELVET



**FLOCKED THINLINE DISPLAY HANGER**  
Chrome hook

**FLAT FLOCKED SHIRT HANGER**  
T-shirt weight plastic shirt hanger with velvet finish and chrome hook

**FLAT FLOCKED ELEGANT SHIRT HANGER**  
Chrome hook

**FLAT FLOCKED ELEGANT SHIRT/SWEATER HANGER**  
Chrome hook

**FLAT FLOCKED WOOD SHIRT & SKIRT/PANT HANGER**  
Wood base with chrome hardware



## SHIRT/SUIT HANGERS W/ STATIONARY HOOK & EXTENDED DROP

Perfect for Conveyor Systems

|                |                 |     |  |   |                |
|----------------|-----------------|-----|--|---|----------------|
| NH450<br>NH452 | 51.49<br>101.49 | 100 | Polystyrene Black<br>Shirt/dress<br>Suit w/clips | 18 1/4" w;<br>.3" thick;<br>stationary<br>hook w/ 4.75"<br>drop | 12/21<br>23/29 |
|----------------|-----------------|-----|--|---|----------------|



# HANGERS Intimate Apparel

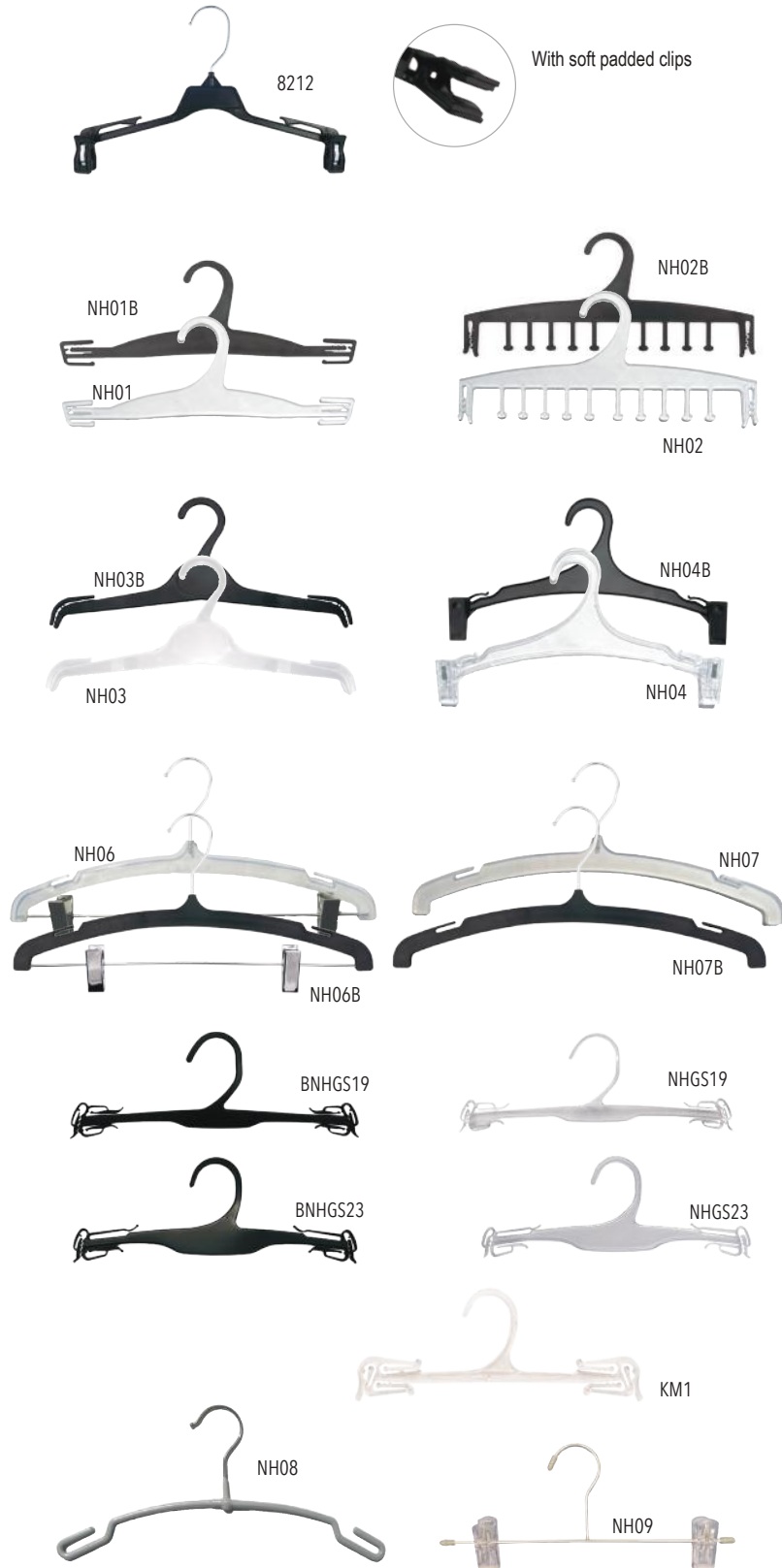

| style #  | \$     | qty  | description  | size       | wgt   |
|--|--------|------|--|------------|-------|
| 8212   | 72.84  | 200  | Black plastic with soft padded clips & chrome ball end hook        | 12"        | 19/31 |
| NH01   | 92.92  | 500  | Opaque polystyrene   | 10"        | 17    |
| NH01B  | 79.83  |      | Black  | 1/8" thick |       |
| NH02   | 101.35 | 500  | with prongs: Opaque polystyrene                                    | 10"        | 24    |
| NH02B  | 82.94  |      | Black  | 1/8" thick |       |
| NH03   | 109.64 | 500  | Polystyrene  |            | 22/33 |
| NH03B  | 102.64 |      | Clear  | 12 1/4"    |       |
| NH03B  | 102.64 |      | Black  |            |       |
| NH04   | 109.64 | 250  | Polystyrene with plastic clips                                     |            | 17/22 |
| NH04B  | 102.64 |      | Clear  | 10 1/2"    |       |
| NH04B  | 102.64 |      | Black  |            |       |
| <i>Opaque polystyrene with brushed chrome hardware or black with chrome hardware (non-slip applied to shoulders of top hanger)</i> |        |      |  |            |       |
| NH06   | 166.28 | 100  | Skirt/Pant hanger  | 15"        | 25    |
| NH06B  | 121.31 |      |  | 1/4" thick |       |
| NH07   | 87.35  | 100  | Top hanger   |            | 15    |
| NH07B  | 63.89  |      |  |            |       |
| <i>Clear - choose from 3 pack sizes:</i>   |        |      |  |            |       |
| NHGS19100  | 13.74  | 100  |  | 10"        | 3/6   |
| NHGS19250  | 40.31  | 250  | Clear  |            | 6/10  |
| NHGS19   | 115.86 | 1000 |  |            | 21/30 |
| NHGS23100  | 15.16  | 100  | Clear  | 10"        | 7/11  |
| NHGS23250  | 45.75  | 250  | w/ logo area   |            | 10/15 |
| NHGS23   | 146.32 | 1000 |  |            | 25/35 |
| <i>Black - 2 pack sizes:</i>   |        |      |  |            |       |
| BNHGS19100   | 13.74  | 100  | Black  | 10"        | 3/6   |
| BNHGS19  | 115.86 | 1000 |  |            | 21/30 |
| BNHGS23100   | 15.16  | 100  | Black  | 10"        | 7/11  |
| BNHGS23  | 146.32 | 1000 | w/ logo area   |            | 25/35 |
| KM1  | 118.99 | 1000 | Clear  | 10"        | 27/37 |
| NH08   | 83.07  | 100  | Grey dip coated metal hanger w/ chrome hook                        | 12"        | 12/21 |
| NH09   | 87.35  | 100  | Chrome bottom hanger with clear plastic clips and grey coated tips | 11"        | 13    |

style # \$ qty description size wgt

**Black flat satin padded hangers with & without a drop. Chrome hardware**

|         |        |     |                                 |               |       |
|---------|--------|-----|---------------------------------|---------------|-------|
| 40840   | 131.49 | 100 | without drop                    | 15¾"          | 25    |
| 40841   | 159.54 |     | with drop                       | 15¾", 2" drop | 36    |
| 4720425 | 138.67 | 100 | Chrome Hardware:<br>Ivory Satin | 15½"          | 25    |
| 4720441 | 149.82 |     | Ivory Satin                     | 15½", 2" drop | 27/35 |
| 3395343 | 153.96 | 100 | Pink Satin                      | 15½", 2" drop | 27/37 |



**Satin hangers with coordinating hook and bow detail**

|        |       |   |                         |     |      |
|--------|-------|---|-------------------------|-----|------|
| 806-1  | 13.87 | 6 | White                   | 15" | 3/15 |
| 806-2  | 14.64 |   | Ivory                   |     |      |
| 806-5  | 11.79 |   | Pink                    |     |      |
| 806-25 | 13.87 |   | Black                   |     |      |
| 806-99 | 16.72 |   | Plush Tiger w/gold hook |     |      |



**Satin hangers w/drop clips & brushed chrome hardware**

|        |        |     |        |         |    |
|--------|--------|-----|--------|---------|----|
| NH10-S |        | 100 | Silver | 10 1/2" | 15 |
| NH10-W | 134.40 |     | White  |         |    |
| NH10-I |        |     | Ivory  |         |    |



**Wooden hanger w/chrome hardware and fine, rubber-tipped strap holders**

|                    |        |     |                                      |         |       |
|--------------------|--------|-----|--------------------------------------|---------|-------|
| <i>with drop -</i> |        |     |                                      |         |       |
| NH11               | 173.40 | 100 | Unfinished beech                     | 11 7/8" | 16/24 |
| NH11B              | 173.40 |     | Low gloss black                      |         |       |
| NH11BR             | 187.27 |     | Black rubber coated w/brushed chrome |         |       |
| <i>no drop -</i>   |        |     |                                      |         |       |
| NH12               | 138.54 | 100 | Unfinished beech                     | 11 7/8" | 16    |
| NH12B              | 109.12 |     | Low gloss black                      |         |       |
| NH12BR             | 149.30 |     | Black rubber coated w/brushed chrome |         |       |
| <i>with drop -</i> |        |     |                                      |         |       |
| NH13               | 191.42 | 100 | Unfinished beech                     | 14"     | 27    |
| NH13B              | 162.26 |     | Low gloss black                      |         |       |
| NH13BR             | 215.01 |     | Black rubber coated w/brushed chrome |         |       |
| <i>no drop -</i>   |        |     |                                      |         |       |
| NH14               | 151.11 | 100 | Unfinished beech                     | 14"     | 18    |
| NH14B              | 122.99 |     | Low gloss black                      |         |       |
| NH14BR             | 161.74 |     | Black rubber coated w/brushed chrome |         |       |

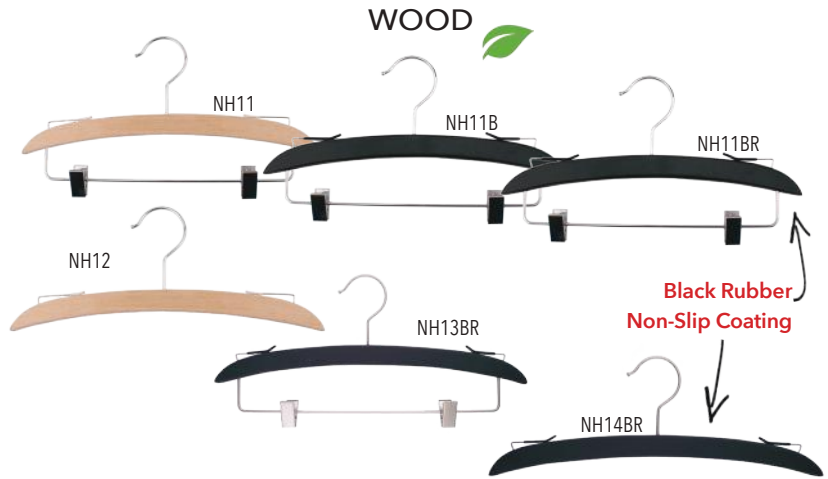

**GOLD & SILVER**

|                                   |        |     |                  |     |       |
|-----------------------------------|--------|-----|------------------|-----|-------|
| <b>Jumbo weight shirt hanger:</b> |        |     |                  |     |       |
| 3405 G                            | 179.63 | 100 | Gold w/gold hook | 17" | 15/22 |
| 4405                              | 167.18 |     | Silver           |     |       |



|  |        |     |   |     |       |
|--|--------|-----|---|-----|-------|
| <b>Heavy weight Suit Hanger w/metal clips:</b> |        |     |   |     |       |
| 3500RC G                                       | 235.74 | 100 | Gold w/gold hardware                      | 17" | 24/29 |
| 4500RC   | 192.84 |     | Silver                                    |     |       |
| 3700 G   | 173.40 | 100 | Heavy weight Gold Coat Hanger w/gold hook | 17" | 20/23 |

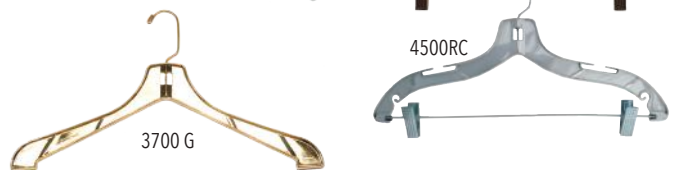

|  |        |     |                      |     |    |
|--|--------|-----|----------------------|-----|----|
| <b>Heavy weight skirt/pant Hanger w/metal clips:</b> |        |     |                      |     |    |
| 3600RC G   | 235.74 | 100 | Gold w/gold hardware | 14" | 19 |
| 4600RCLH   | 235.74 |     | Silver               |     |    |



# HANGERS Plastic Display

## DISPLAY HANGERS



**DISPLAY HANGERS**  
Black w/black hook  
White w/white hook



**DISPLAY HANGERS**  
Black & White  
with chrome hooks



**DISPLAY HANGERS w/ DROP**  
White with 8 or 10" chrome drop  
Black with 8 or 12" chrome drop  
Pewter with 12" chrome drop

**THINLINE  
DISPLAY HANGER**  
Chrome hook



**DISPLAY HANGER**  
Chrome hardware



## FROSTED DISPLAY HANGERS

Frosted with brushed chrome hardware and black with chrome hardware



| style #    | \$     | qty | description                      | size                           | wgt   |
|------------|--------|-----|----------------------------------|--------------------------------|-------|
| DHWS124W   | 24.36  | 12  | 1 1/2" thick:<br>White w/white   | 4" hook:<br>12"                | 4/8   |
| DHBS124B   | 24.36  |     | Black w/black                    | 12"                            |       |
| DHWS15WH12 | 27.73  | 12  | White w/white                    | 15 1/2"                        | 5/12  |
| DHBS15BH12 | 29.03  |     | Black w/black                    | 15 1/2"                        | 5/18  |
| DHBS17/4B  | 31.23  | 12  | Black                            | 17 1/4"                        | 6/15  |
| DHWS15CH12 | 27.73  | 12  | White w/chrome                   | 15 1/2"                        | 4/8   |
| DHBS15CH12 | 29.03  |     | Black w/chrome                   |                                |       |
| WSK8124W   | 41.47  | 12  | 1 1/2" thick:<br>White           | 12"-8" drop                    | 6/15  |
| BSK8124B   | 48.60  |     | Black                            | 12"-8" drop                    |       |
| WSK10144W  | 45.75  | 12  | White                            | 15 1/2"-10" drop               | 8/25  |
| BSK12164B  |        |     | Black                            | 15 1/2"-12" drop               | 8/26  |
| BSK12174B  | 48.60  | 12  | Black<br>Pewter                  | 17 1/4"-12" drop               | 8/30  |
| PSK10174C  |        |     |                                  | 17 1/4"-12" drop               |       |
| DH4        | 20.49  | 12  | Black                            | 17"<br>1" thick                | 5/9   |
| DH3        | 20.49  |     | Black                            | 17"<br>1 1/2" thick<br>2" drop | 7/19  |
| W004       | 78.07  | 100 | <b>Flat:</b><br>Clear Frosted    | 15 1/2"                        | 17/21 |
| W004B      | 60.04  |     | Black                            |                                |       |
| W005       | 279.04 | 100 | Clear Frosted                    | 14"                            | 37    |
| W005B      | 219.78 |     | Black                            |                                |       |
| W006       | 78.07  | 100 | Clear Frosted                    | 17"                            | 18/25 |
| W006B      | 72.93  |     | Black                            |                                |       |
| W006RC     | 284.19 | 100 | Clear Frosted                    | 17"                            | 33/40 |
| W006BRC    | 194.01 |     | Black                            |                                |       |
| W007       | 37.88  | 24  | <b>Concave:</b><br>Clear Frosted | 17"                            | 10/22 |
| W007B      | 30.46  |     | Black                            |                                |       |
| W007RC     | 81.17  | 24  | Clear Frosted                    | 17"                            | 13/28 |
| W007BRC    | 61.38  |     | Black                            |                                |       |



Frosted hangers are available in a range of custom colors, minimum order of 3000 pieces (same color). Call our sales department for more information.



*Department Store style*



## Heavy Weight Shirt Hangers

17" wide; 100 /case; 15/22 lbs.

|          |  |         |
|----------|--|---------|
| 500      | Clear w/chrome hardware                | \$34.99 |
| 1500     | White hi-impact w/chrome hardware      | \$34.99 |
| 2500     | Black w/ chrome hardware               | \$34.99 |
| 2500BH   | Black w/ black hardware                | \$28.09 |
| 9500     | Clear Break Resistant w/chrome         | \$66.49 |
| 1500APWW | White hi-impact w/washer & foam strips | \$58.49 |

weight is 15/26 lbs:

|        |                                 |         |
|--------|---------------------------------|---------|
| 8500   | High Gloss Black w/ chrome hook | \$35.99 |
| 8500BH | High Gloss Black w/ black hook  | \$35.99 |

*Value Hangers*



## Middle Weight Shirt Hangers

17" wide; 100 /case; 13/26 lbs.

|        |                                   |         |
|--------|-----------------------------------|---------|
| 507    | Clear w/chrome hardware           | \$30.99 |
| 1507   | White hi-impact w/chrome hardware | \$30.99 |
| 2507   | Black w/ chrome hardware          | \$30.99 |
| 2507BH | Black w/ chrome hardware          | \$30.99 |

*T-Shirt Hangers*



## T-Shirt Weight Shirt Hangers

17" wide; 100 /case; 12/18 lbs.

|        |                                |         |
|--------|--------------------------------|---------|
| 1508   | Opaque white w/chrome hardware | \$29.99 |
| 2508   | Black w/ chrome hardware       | \$29.99 |
| 2508BH | Black w/ black hardware        | \$29.99 |

## Heavy Weight Shirt Hanger

With molded grippers  
17" wide; 100 /case; 13/26 lbs

|           |                                    |         |
|-----------|------------------------------------|---------|
| 95500     | Clear break resistant w/chrome     | \$61.49 |
| 15500     | White w/chrome hardware            | \$30.99 |
| 25500     | Black w/ chrome hardware           | \$30.99 |
| 25500BH   | Black w/ black hardware            | \$30.99 |
| 25500BHMG | Black w/ black hardware & grippers | \$48.49 |

*With co-ordinate hole*

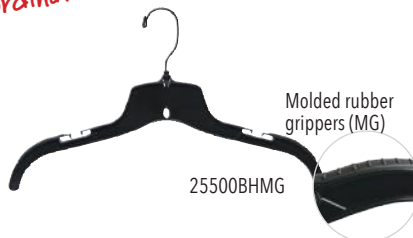

*Chain Store favorites*



## Medium Heavy Weight Shirt Hangers

17" wide; 100 /case; 15/22 lbs.

|        |                                   |         |
|--------|-----------------------------------|---------|
| 505    | Clear w/chrome hardware           | \$31.99 |
| 1505   | White hi-impact w/chrome hardware | \$31.99 |
| 2505   | Black w/ chrome hardware          | \$31.99 |
| 2505BH | Black w/ black hardware           | \$31.09 |



*Black plastics*

## Medium Heavy Weight Shirt Hangers w/molded ridges

17" wide; 100 /case

weight is 14/24 lbs:

|       |                                   |         |
|-------|-----------------------------------|---------|
| 505R  | Clear w/chrome hardware           | \$35.90 |
| 1505R | White hi-impact w/chrome hardware | \$35.90 |
| 2505R | Black w/ chrome hardware          | \$35.90 |

weight is 15/22 lbs:

|         |                         |         |
|---------|-------------------------|---------|
| 2505RBH | Black w/ black hardware | \$35.90 |
|---------|-------------------------|---------|



Molded, ridges on shoulders (R)



*With molded rubber grippers*

Molded, rubber grippers on shoulders (MG)

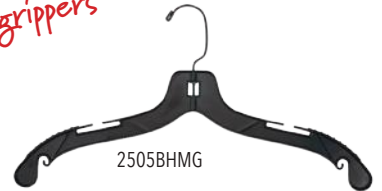

## Medium Heavy Weight Shirt Hangers w/molded rubber grippers

17" wide; 100 /case

|          |                          |         |       |
|----------|--------------------------|---------|-------|
| 505MG    | Clear w/chrome hardware  | \$48.48 | 13/13 |
| 2505MG   | Black w/ chrome hardware | \$48.48 | 14/22 |
| 2505BHMG | Black w/ black hardware  | \$48.48 | 15/24 |

*With molded ridges & co-ordinate loop*

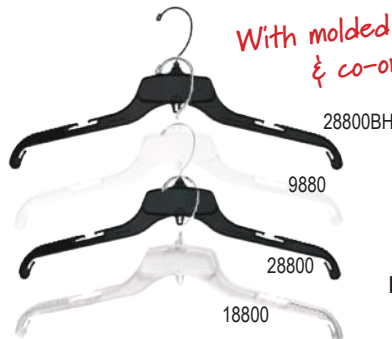

## Heavy Weight Shirt Hangers w/ridges & loop

17" wide; 100 /case; 12/26 lbs.

|         |                                |         |
|---------|--------------------------------|---------|
| 98800   | Clear w/chrome hardware        | \$53.49 |
| 18800   | Clear break resistant w/chrome | \$34.99 |
| 28800   | Black w/ chrome hardware       | \$34.99 |
| 28800BH | Black w/ black hardware        | \$34.99 |

*See more sizes on page 120*

# HANGERS Traditional Gown & Bridal

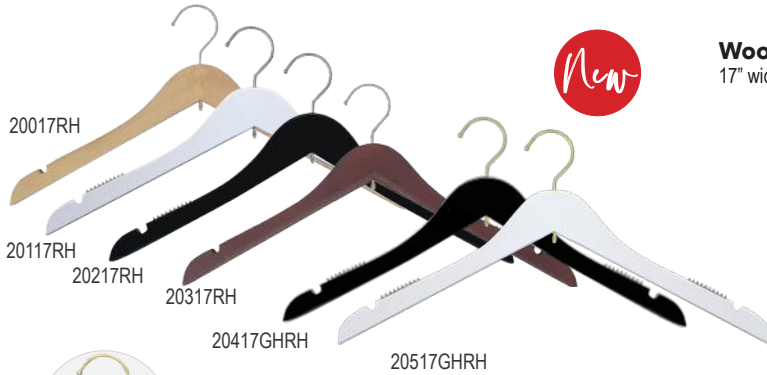

## Wood Bridal Hangers

17" wide; 100 /case; 28/29 lbs.

|           |  |                 |
|-----------|--|-----------------|
| 20017RH   | Low gloss Natural w/ brushed chrome hardware | <b>\$115.49</b> |
| 20117RH   | Low gloss White w/ brushed chrome hardware   | <b>\$115.49</b> |
| 20217RH   | Low gloss Black w/ brushed chrome hardware   | <b>\$115.49</b> |
| 20317RH   | Low gloss Mahogany w/brushed chrome hardware | <b>\$115.49</b> |
| 20417GHRH | Low gloss Black w/ gold hardware             | <b>\$119.49</b> |
| 20517GHRH | Low gloss White w/ gold hardware             | <b>\$119.49</b> |

Reinforced, heavy-duty hooks support all weights of gowns

*Bridal & Formal /Gown*



## Extra Reinforced Bridal and Gown Hangers

Chrome hook reinforced with a washer

17" wide; 100 /case

|          |  |                |       |
|----------|--|----------------|-------|
| 405WW    | Clear w/washer                         | <b>\$58.19</b> | 16/22 |
| 1405WW   | White hi-impact w/washer               | <b>\$58.19</b> | 18/22 |
| 1405APWW | White hi-impact w/washer & foam strips | <b>\$74.49</b> | 18/24 |



## Bridal and Formal Hangers

17" wide; 100 /case; 17/22 lbs.

|        |                                   |                |
|--------|-----------------------------------|----------------|
| 405    | Clear w/chrome hardware           | <b>\$44.49</b> |
| 2405   | Black w/ chrome hardware          | <b>\$44.49</b> |
| 1405   | White hi-impact w/chrome hardware | <b>\$44.49</b> |
| 2405BH | Black w/ black hardware           | <b>\$44.49</b> |

weight is 17/24 lbs:

|         |  |                |
|---------|--|----------------|
| 1405APW | White hi-impact w/chrome & foam strips applied | <b>\$67.49</b> |
|---------|--|----------------|

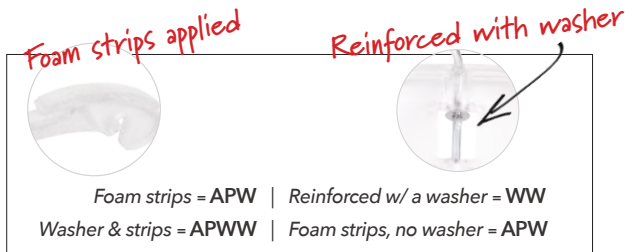

Foam strips = APW | Reinforced w/ a washer = WW  
Washer & strips = APWW | Foam strips, no washer = APW

*Department Store*

*Black plastics*



## Heavy Weight Hangers

Chrome hook reinforced with a washer

17" wide; 100 /case

|        |                          |                |       |
|--------|--------------------------|----------------|-------|
| 500WW  | Clear w/washer           | <b>\$55.34</b> | 18/24 |
| 1500WW | White hi-impact w/washer | <b>\$55.34</b> | 15/24 |



## XXX Heavy Weight Hangers

Chrome hook reinforced with a washer

17" wide; 100 /case

|        |                          |                |       |
|--------|--------------------------|----------------|-------|
| 300WW  | Clear w/washer           | <b>\$60.91</b> | 20/24 |
| 1300WW | White hi-impact w/washer | <b>\$60.91</b> | 20/24 |
| 2300WW | Black w/washer           | <b>\$60.91</b> | 19/22 |

*No notches - great for sweaters & outerwear*



## 19" Heavy Weight Shirt Hangers

19" wide; 100 /case

|      |                                   |                |       |
|------|-----------------------------------|----------------|-------|
| 900  | Clear w/chrome hardware           | <b>\$59.99</b> | 18/31 |
| 1900 | White hi-impact w/chrome hardware | <b>\$59.99</b> | 18/33 |
| 2900 | Black w/ chrome hardware          | <b>\$59.99</b> | 18/33 |

## NO-SNAG © Hangers

17" wide; 100 /case; 19/22 lbs.

|      |                                   |                |
|------|-----------------------------------|----------------|
| 905  | Clear w/chrome hardware           | <b>\$41.99</b> |
| 1905 | White hi-impact w/chrome hardware | <b>\$41.99</b> |
| 2905 | Black w/ chrome hardware          | <b>\$41.99</b> |

# Traditional Plastic Skirt/Pant HANGERS

 Black plastics

| style #  | \$    | qty | description                          | size | wgt |
|----------|-------|-----|--------------------------------------|------|-----|
| 600RC    | 49.90 | 100 | Clear                                | 14"  | 19  |
| 1600RC   | 49.90 |     | White hi-impact                      |      |     |
| 2600RC   | 49.90 |     | Black                                |      |     |
| 600PC    | 49.90 | 100 | Clear                                | 14"  | 19  |
| 1600PC   | 49.90 |     | White hi-impact                      |      |     |
| 2600PC   | 49.90 |     | Black                                |      |     |
| 8600RC   | 52.90 | 100 | Black Hi-gloss (metal clips)         | 14"  | 19  |
| 8600RCBH | 52.90 |     | Black w/Black Hook                   |      |     |
| 8600PC   | 52.90 |     | Black Hi-gloss (plastic clips)       |      |     |
| 8600PCBH | 52.90 |     | Black w/Black Hook                   |      |     |
| 600RCLH  | 49.90 | 100 | Clear                                | 14"  | 19  |
| 1600RCLH | 49.90 |     | White hi-impact                      |      |     |
| 2600RCLH | 49.90 |     | Black                                |      |     |
| 2600RCBH | 50.28 |     | Black w/ Black Hook                  |      |     |
| 600PCLH  | 49.90 | 100 | Clear                                | 14"  | 19  |
| 1600PCLH | 49.90 |     | White hi-impact                      |      |     |
| 2600PCLH | 49.90 |     | Black                                |      |     |
| 2600PCBH | 50.28 |     | Black w/ Black Hook                  |      |     |
| 602RC    | 58.68 | 100 | Clear                                | 14"  | 20  |
| 1602RC   |       |     | White hi-impact                      |      |     |
| 2602RC   |       |     | Black                                |      |     |
| 602PC    | 58.68 | 100 | Clear                                | 14"  | 20  |
| 1602PC   |       |     | White hi-impact                      |      |     |
| 2602PC   |       |     | Black                                |      |     |
| 602RCLH  | 58.68 | 100 | Clear                                | 14"  | 20  |
| 1602RCLH |       |     | White hi-impact                      |      |     |
| 2602RCLH |       |     | Black                                |      |     |
| 602PCLH  | 58.68 | 100 | Clear                                | 14"  | 20  |
| 1602PCLH |       |     | White hi-impact                      |      |     |
| 2602PCLH |       |     | Black                                |      |     |
| 2602RCBH | 50.28 | 100 | <b>Jumbo weight</b>   Black<br>Black | 14"  | 20  |
| 9602RC   | 70.99 | 100 | Clear                                | 14"  | 19  |
| 616RC    | 58.19 | 100 | Clear                                | 16"  | 21  |
| 1616RC   |       |     | White hi-impact                      |      |     |
| 2616RC   |       |     | Black                                |      |     |
| 614RC    | 59.90 | 100 | Clear                                | 14"  | 19  |
| 1614RC   | 59.90 |     | White hi-impact                      |      |     |
| 2614RC   | 59.90 |     | Black                                |      |     |
| 614PC    | 59.90 |     | Clear                                |      |     |
| 1614PC   | 59.90 |     | White hi-impact                      |      |     |
| 2614PC   | 59.90 |     | Black                                |      |     |

## 14" Heavy Weight Skirt/Pant

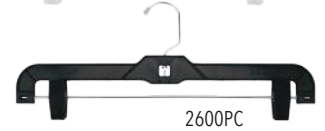
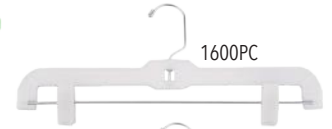
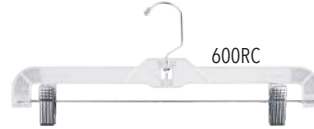

## 14" Heavy Weight Skirt/Pant w/Long Hook

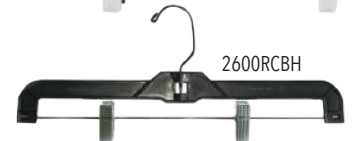
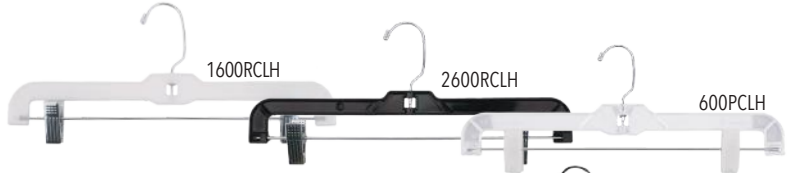

## 14" Jumbo Weight Skirt/Pant



## 14" Jumbo Weight Skirt/Pant w/Long Hook



**JUMBO WEIGHT SKIRT/PANT HANGER**



## 16" Heavy Weight Skirt/Pant



## Coordinate Attachment for Skirts and Pants

4 1/2" drop



# HANGERS Traditional Plastic Suit

## HEAVY WEIGHT SUIT HANGER

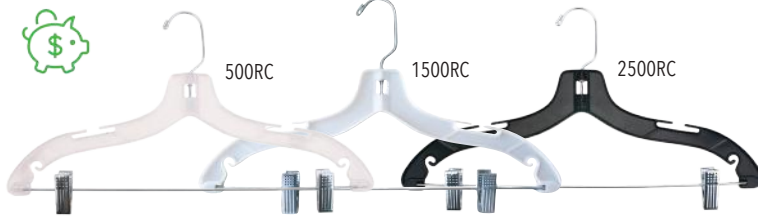

Break Resistant



Glossy Black



| style #  | \$    | qty | description                    | size | wgt   |
|----------|-------|-----|--------------------------------|------|-------|
| 500RC    |       |     | Clear                          |      | 26/27 |
| 1500RC   |       |     | White hi-impact                |      | 26/34 |
| 2500RC   |       |     | Black                          |      | 26/34 |
| 2500RCBH | 73.48 | 100 | Black w/ black hook            | 17"  | 27/34 |
| 500PC    |       |     | Clear                          |      | 27/34 |
| 1500PC   |       |     | White hi-impact                |      | 27/34 |
| 2500PC   |       |     | Black                          |      | 27/34 |
| 2500PCBH |       |     | Black w/ black hook            |      | 26/27 |
| 9500RC   | 94.99 | 100 | Clear - Break Resistant        | 17"  | 27/34 |
| 8500RC   | 74.49 |     | Black Hi-gloss (metal clips)   |      | 26/28 |
| 8500RCBH | 79.19 | 100 | Black w/Black Hook             | 17"  | 26/34 |
| 8500PC   | 79.49 |     | Black Hi-gloss (plastic clips) |      | 26/28 |
| 8500PCBH | 79.19 |     | Black w/Black Hook             |      | 26/34 |

## HEAVY WEIGHT COAT HANGERS

Black plastics

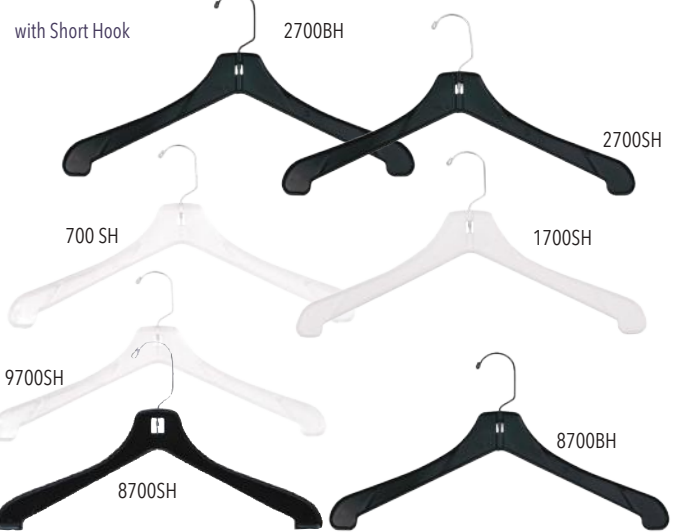
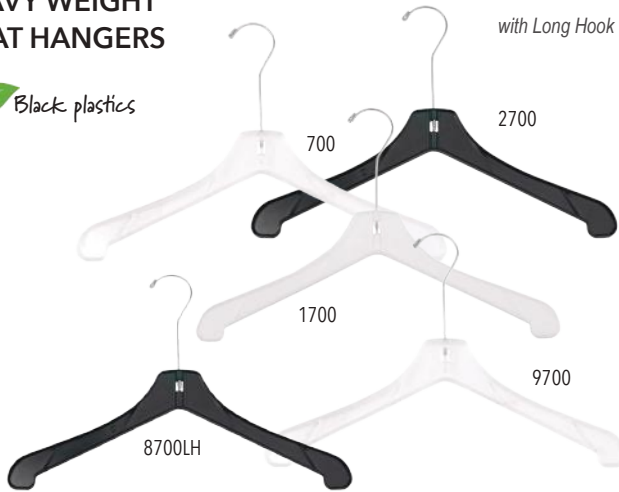

### Coat Hangers /Long Hook:

17" wide; 100 /case; 19/26 lbs.

- 700 Clear w/chrome hardware \$43.49
- 2700 Black w/ chrome hardware \$44.49
- 1700 White hi-impact w/chrome hardware \$44.49
- 9700 Clear Break Resistant w/chrome hardware \$85.99
- 8700LH Black High Gloss w/ chrome hardware \$44.49

### Coat Hangers /Short Hook:

17" wide; 100 /case; 18/26 lbs.

- 2700BH Black w/ black hardware \$43.49
- 2700SH Black w/chrome hardware \$43.49
- 700SH Clear w/chrome hardware \$43.49
- 1700SH White hi-impact w/chrome hardware \$43.49
- 9700SH Clear Break Resistant w/chrome hardware \$84.99
- 8700SH Black High Gloss w/ chrome hardware \$44.99
- 8700BH Black Hi-gloss w/ black hardware \$44.99

## IMPRINT SERIES

Great for Imprinting!



| style # | \$    | qty | description           | size | wgt   |
|---------|-------|-----|-----------------------|------|-------|
| RBK1605 | 95.77 |     | Solid White           | 14"  | 21    |
| RBK2605 | 94.35 |     | Black                 |      |       |
| RBK1400 | 66.99 | 100 | Solid White           | 17"  | 19/21 |
| RBK2400 | 66.99 |     | Black                 |      |       |
| 9705    | 73.48 | 100 | Break-resistant CLEAR | 17"  | 23    |
| 2705BH  | 67.26 |     | BLACK w/black hook    |      | 17/33 |
| 2705CH  | 67.26 |     | BLACK                 |      | 17/33 |

# Plastic Skirt/Pant HANGERS

| style #  | \$  | qty  | description   | size  | wgt  |       |
|--|---|------|---|---|--|-------|
| 1686-8   | 65.19   | 200  | White   | 8"  | 15   |       |
| 1686-10  | 66.61   |      | White   | 10"   | 17   |       |
| 1686/12  | 74.91   |      | White   | 12"   | 18/19  |       |
| 2686-8   | 65.19   | 200  | Black   | 8"  | 15   |       |
| 2686-10  | 66.61   |      | Black   | 10"   | 17   |       |
| 268610BH   | 66.61   |      | Black w/black hook  | 10"   | 17   |       |
| 2686-12  | 74.91   |      | Black   | 12"   | 18/19  |       |
| 2681-8   | 65.19   | 200  | Black   | 8"  | 15   |       |
| 2681-10  | 68.04   |      | Black   | 10"   | 14/19  |       |
| 2681-12  | 72.19   |      | Black   | 12"   | 18/19  |       |
| 1681/8W  | 68.04   |      | White   | 8"  | 11/19  |       |
| 1681/10W   | 72.19   |      | White   | 10"   | 13/18  |       |
| 1681/12W   | 77.76   |      | White   | 12"   | 15/23  |       |
| SCXS<br>SCS<br>SCM<br>SCL<br>SCXL<br>SC2XL               | 22.29   | 1000 | White<br>w/ black imprint<br><small>(works with P12, P13, P14, P16, B14, 2681-10, 2681-12, 1681/8W, 1681/10W, 1681/12W)</small> | 1/4"L x<br>5/8"H x<br>1/4"W                 | 2  |       |
| H29B<br>H29W<br>H211B<br>H211W                           | 50.99   | 100  | Black<br>White<br>Black<br>White  | 9 1/2"<br>11 1/2"                           | 10/15<br>10/15<br>11/19<br>11/19                         |       |
| H39B<br>H39W<br>H311B<br>H311W                           | 53.99   | 100  | Black<br>White<br>Black<br>White  | 9 1/2"<br>11 1/2"                           | 10/15<br>10/15<br>11/18<br>11/18                         |       |
| 6008<br>6010<br>6012<br>6008B<br>6010B<br>6012B<br>6014B | 72.19<br>74.91<br>77.76<br>63.49<br>58.32<br>54.90<br>70.99 | 200  | CLEAR<br>CLEAR<br>CLEAR<br>BLACK<br>BLACK<br>BLACK<br>BLACK   | 8"<br>10"<br>12"<br>8"<br>10"<br>12"<br>14" | 18/20<br>20/22<br>23/32<br>20<br>16/22<br>17/26<br>21/32 |       |
| w/ Soft Pad:<br>6210B<br>6212B<br>6214B                  | 70.76<br>71.99<br>72.99                                     |      | BLACK<br>BLACK<br>BLACK   | 10"<br>12"<br>14"                           | 16/22<br>17/26<br>21/32                                  |       |
| 2650PCBH50   | 55.47   |      | 50  | Black<br>w/black hook                       | 14"  | 10    |
| 7500   | 106.49  |      | 200   | BLACK                                       | 14"  | 25/34 |

## Snap Grip Swivel Hook Skirt/Pant Hanger



## Snap Grip Plastic Hook Skirt/Pant Hanger



## Side Size Clips



## Pinch Clip Plastic Hook Skirt/Pant Hanger



## Pinch Clip Swivel Hook Skirt/Pant Hanger



## Pinch Grip Skirt/Pant Hanger



## Skirt/Pant Hanger With Black Hook and Clips

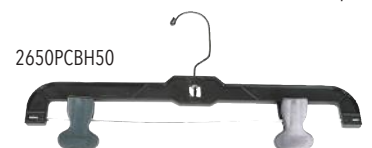

## 14" Black Plastic Skirt/Pant Hanger With detachable strap and foam bar



# HANGERS Junior Plastic Hangers

 Black plastics



## Super Heavy Weight Shirt Hanger



| style # | \$    | qty | description        | size | wgt   |
|---------|-------|-----|--------------------|------|-------|
| 414     |       |     | Clear              |      |       |
| 1414    | 28.99 | 100 | White hi-impact    | 14"  | 11/15 |
| 2414    |       |     | Black              |      |       |
| 2414BH  |       |     | Black w/Black hook |      |       |

## Super Heavy Weight Suit Hanger



|          |       |  Metal clip (RC)<br>w/ vinyl insert |                    |  Plastic clip (PC)<br>available in<br>white or black |       |
|----------|-------|--|--------------------|---|-------|
| 414RC    |       |  | Clear              |   | 20/22 |
| 1414RC   | 59.90 | 100  | White hi-impact    | 14"   | 20    |
| 2414RC   |       |  | Black              |   | 18    |
| 2414RCBH | 59.90 |  | Black w/Black hook |   | 18/24 |

## Super Heavy Weight Coat Hanger



|        |       |     |                    |     |       |
|--------|-------|-----|--------------------|-----|-------|
| 714    |       |     | Clear              |     |       |
| 1714   | 44.49 | 100 | White hi-impact    | 14" | 18/22 |
| 2714   |       |     | Black              |     |       |
| 2714BH |       |     | Black w/Black hook |     |       |

## Super Heavy Weight Skirt/Pant Hanger

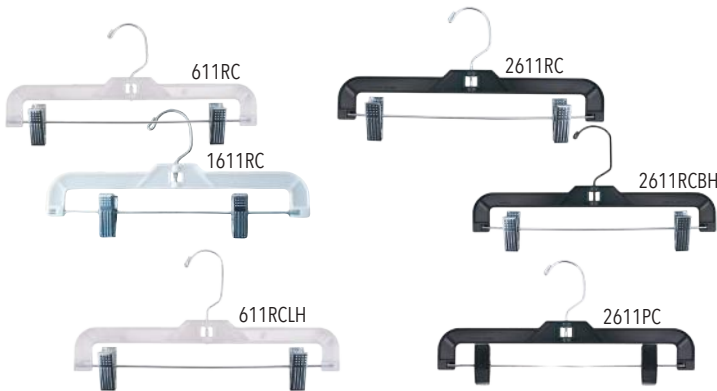

|          |       |     |                               |     |    |
|----------|-------|-----|-------------------------------|-----|----|
| 611RC    |       |     | with metal clips:             |     |    |
| 1611RC   | 59.90 | 100 | Clear                         | 12" | 18 |
| 2611RC   |       |     | White hi-impact               |     |    |
| 2611RCBH |       |     | Black                         |     |    |
|          |       |     | Black w/Black hook            |     |    |
| 611RCLH  |       |     | with long hook & metal clips: |     |    |
| 1611RCLH | 59.90 | 100 | Clear                         | 12" | 18 |
| 2611RCLH |       |     | White hi-impact               |     |    |
|          |       |     | Black                         |     |    |
| 611PC    | 59.90 |     | with plastic clips:           |     |    |
| 2611PC   | 59.90 | 100 | Clear                         | 12" | 18 |
| 1611PC   | 59.90 |     | White hi-impact               |     |    |
| 2611PCBH | 59.90 |     | Black                         |     |    |
|          |       |     | Black w/Black hook            |     |    |

## Coordinate Attachment Skirt/Pant Hanger



|        |       |     |                     |     |    |
|--------|-------|-----|---------------------|-----|----|
| 612RC  | 59.90 |     | Clear               |     |    |
| 1612RC | 59.90 | 100 | White hi-impact     | 12" | 19 |
| 2612RC | 59.90 |     | Black               |     |    |
| 2612PC | 59.90 | 100 | with plastic clips: | 12" | 19 |
|        |       |     | Black               |     |    |

# Children's Plastic HANGERS

 Black plastics

| style #  | \$   | qty                      | description  | size | wgt                              |
|--|--|--------------------------|--|------|----------------------------------|
| 412<br>1412<br>2412<br>2412BH                                      | 26.99  | 100                      | Clear<br>White hi-impact<br>Black<br>Black w/Black hook                | 12"  | 10                               |
| 412LH<br>1412LH  | 27.49<br>26.99                                     | 100                      | Clear<br>White hi-impact   | 12"  | 10/12                            |
| 410<br>1410<br>2410<br>2410BH                                      | 44.99<br>44.99<br>44.99<br>44.99                   | 200<br>200<br>200<br>200 | Clear<br>White hi-impact<br>Black<br>Black w/Black hook                | 10"  | 13                               |
| CP410  | 23.99  | 100                      | Clear  | 10"  | 7                                |
| 412RC<br>1412RC<br>2412RC<br>2412RCBH                              | 59.90<br>59.90<br>59.90<br>59.90                   | 100                      | Clear<br>White hi-impact<br>Black<br>Black w/Black hook                | 12"  | 19/22                            |
| 412RCLH<br>1412RCLH  | 59.90<br>59.90                                     | 100                      | Clear w/Long hook<br>White w/Long hook                                 | 12"  | 19/22                            |
| 712<br>1712<br>2712<br>2712BH                                      | 37.99<br>37.99<br>37.99<br>37.90                   | 100                      | Clear<br>White hi-impact<br>Black<br>Black w/Black hook                | 12"  | 14/22<br>14/22<br>14/28<br>14/28 |
| 610RCLH<br>610PCLH<br>1610RCLH<br>1610PCLH<br>2610RCLH<br>2610PCLH | 59.90<br>59.90<br>59.90<br>59.90<br>59.90<br>59.90 | 100                      | Clear<br>Clear<br>White hi-impact<br>White hi-impact<br>Black<br>Black | 9"   | 16/23                            |



## Super Heavy Weight Shirt Hanger



long hook (LH)



## Super Heavy Weight Infant Shirt Hanger



## Super Heavy Weight Suit Hanger



long hook (LH)



## Super Heavy Weight Coat Hanger



## Super Heavy Weight Infant Skirt/Pant Hanger

Metal or Plastic Clips. Long hook only



# HANGERS Vics /Floor-Ready Hangers



NAHANCO works directly with YOUR garment factories. We can supply any of our hanger styles, giving you control over the hangers that you receive.

For more information and images, please visit [nahanco.com](http://nahanco.com)



484B

### Economy Shirt Hanger

With molded non-slip shoulder



28800

### Heavy Weight Shirt Hanger

With molded non-slip shoulder



25500

### Super Heavy Weight Shirt Hanger



99900

### Shirt Hanger

With molded non-slip shoulder



24400

### Shirt Hanger

With molded non-slip shoulder



22200

### Shirt Hanger

With molded non-slip shoulder



NHPJ41

### Shirt Hanger



2358

### Shirt Hanger



2705CH

### Heavy Weight Coat Hanger



2686-12

### Snap Grip Skirt/Pant Hanger



6012B

### Pinch Grip Skirt/Pant Hanger

style # \$ qty description size wgt

#### Size Markers

Angular VICS size markers. Black with white print.  
3/4" wide. Sold in packs of 500 pieces /1 lb.  
Style # VSM \$20.87

Call or see our website for a complete list of VSM size marker options

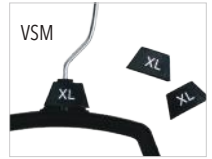

#### Size Marker Remover Tool

5 5/8" metal tool removes size markers from hanger.  
Sold as a single piece /1 lb.  
Style # VSMT00L \$9.49



|              |        |     |                       |         |       |
|--------------|--------|-----|-----------------------|---------|-------|
| 485B         | 52.75  |     | BLACK                 | 15"     | 18/24 |
| 484B         | 49.90  | 200 | BLACK                 | 17"     | 15/29 |
| 479B         | 61.49  |     | BLACK                 | 19"     | 16/36 |
| 98800        | 53.49  |     | Break-resistant CLEAR |         |       |
| 28800        | 34.99  | 100 | BLACK                 | 17"     | 13/22 |
| 28800BH      | 34.99  |     | BLACK w/Black hook    |         |       |
| 18800        | 34.99  |     | WHITE                 |         |       |
| 95500        | 61.49  |     | Break-resistant CLEAR |         |       |
| 25500        | 30.99  | 100 | BLACK                 | 17"     | 14/22 |
| 25500BH      | 30.99  |     | BLACK w/Black hook    |         |       |
| 15500        | 30.99  |     | WHITE                 |         |       |
| 99900        | 69.34  | 100 | Break-resistant CLEAR | 19"     | 13/27 |
| 94400        | 48.99  |     | Break-resistant CLEAR |         |       |
| 24400        | 34.20  | 100 | BLACK                 | 15"     | 11/15 |
| 24400BH      | 34.99  |     | BLACK w/Black hook    |         |       |
| 14400        | 34.99  |     | WHITE                 |         |       |
| 92200        | 47.99  |     | Break-resistant CLEAR |         |       |
| 22200        | 40.49  | 100 | BLACK                 | 12"     | 8/15  |
| 22200BH      | 40.49  |     | BLACK w/Black hook    |         |       |
| 12200        | 40.49  |     | WHITE                 |         |       |
| NHPJ41       | 73.48  | 200 | Black                 | 16"     | 15/36 |
| NHPJ46       | 92.92  |     | w/black hook          | 18"     | 23/38 |
| 2358         | 81.91  | 200 | Black                 | 18 1/2" | 25/36 |
| 9705         | 73.48  |     | Break-resistant CLEAR |         | 23    |
| 2705BH       | 67.26  | 100 | BLACK w/black hook    | 17"     | 17/33 |
| 2705CH       | 67.26  |     | BLACK                 |         | 17/33 |
| 9686-8       | 97.07  |     | Break-resistant CLEAR | 8"      | 15    |
| 2686-8       | 83.20  |     | BLACK                 | 8"      | 15    |
| 9686-10      | 59.49  | 200 | Break-resistant CLEAR | 10"     | 17    |
| 2686-10      | 92.92  |     | BLACK                 | 10"     | 17    |
| 9686-12      | 105.49 |     | Break-resistant CLEAR | 12"     | 18/22 |
| 2686-12      | 97.07  |     | BLACK                 | 12"     | 18/22 |
| 9686-13      | 120.66 |     | Break-resistant CLEAR | 12 1/2" | 18/22 |
| 6008         | 72.19  |     | CLEAR                 | 8"      | 18/20 |
| 6010         | 74.91  |     | CLEAR                 | 10"     | 20/22 |
| 6012         | 77.76  |     | CLEAR                 | 12"     | 23/32 |
| 6008B        | 63.49  |     | BLACK                 | 8"      | 20    |
| 6010B        | 58.32  | 200 | BLACK                 | 10"     | 16/22 |
| 6012B        | 54.90  |     | BLACK                 | 12"     | 17/26 |
| 6014B        | 70.99  |     | BLACK                 | 14"     | 21/32 |
| w/ Soft Pad: |        |     |                       |         |       |
| 6210B        | 70.76  |     | BLACK                 | 10"     | 16/22 |
| 6212B        | 73.48  |     | BLACK                 | 12"     | 17/26 |
| 6214B        | 72.99  |     | BLACK                 | 14"     | 21/32 |



# Plastic Budget HANGERS

| style #                                    | \$              | qty  | description   | size                        | wgt                     |
|--|-----------------|------|---|-----------------------------|-------------------------|
| 1150                                       | 83.20           | 500  | White   | 10"                         | 15/21                   |
| P12  | 87.35           | 500  | White   | 12"                         | 16/20                   |
| P13  | 50.67           | 200  | White   | 13 3/4"                     | 11/20                   |
| P14  | 100.57          | 500  | White   | 14"                         | 20/31                   |
| B14  | 97.07           | 500  | Black   | 14"                         | 20/31                   |
| SCXS<br>SCS<br>SCM<br>SCL<br>SCXL<br>SC2XL | 22.29           | 1000 | White<br>w/ black imprint<br>(works with P12, P13,<br>P14, P16, B14, 2681-10,<br>2681-12, 1681/8W,<br>1681/10W, 1681/12W) | 1/4"L x<br>5/8"H x<br>1/4"W | 2                       |
| 1158                                       | 97.07           | 500  | White   | 18"                         | 29/46                   |
| 2158                                       |                 |      | Black   |                             | 30/42                   |
| P18  | 62.47           | 200  | White   | 18"                         | 17/37                   |
| B18  | 47.17           |      | Black   |                             |                         |
| R16WB<br>P16WB250                          | 124.29<br>43.50 | 500  | White   | 16"                         | 38/51<br>19/26          |
| SK8  | 122.86          | 500  | White   | 8"                          | 23/27                   |
| SK11                                       | 122.86          |      |   | 11"                         | 34/70                   |
| SP8  | 122.86          | 500  | White   | 8"                          | 28                      |
| SP11                                       | 122.86          |      |   | 11"                         | 34/70                   |
| FR10                                       | 189.00          | 500  | White   | 9 1/2"                      | 34/70                   |
| FR11                                       | 92.90           | 200  |   | 11 1/2"                     | 18/37                   |
| TBB<br>TBR<br>TBW<br>TBI                   | 44.90           | 144  | Black<br>Red<br>White<br>Ivory  | 16 3/8"                     | 15/22                   |
| CLIP100                                    | 24.36           | 100  | White   | 2 1/4"                      | 3                       |
| TBB2<br>TBR2<br>TBW2                       | 44.90           | 144  | Black<br>Red<br>White   | 17"                         | 16/41<br>16/41<br>16/44 |
| NT140                                      | 74.99           | 500  | 14 Gauge<br>White wire  | 18"                         | 28                      |
| NT1305                                     | 63.89           | 500  | 13 Gauge<br>Goldtone Wire   | 16"                         | 34                      |
| NT145RS                                    | 81.91           | 500  | NT145RS w/round,<br>white cardboard   |                             | 38                      |

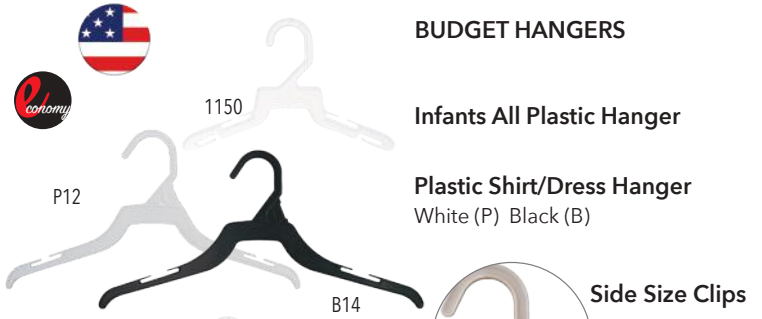

## BUDGET HANGERS

Infants All Plastic Hanger

Plastic Shirt/Dress Hanger  
White (P) Black (B)



High-Impact Plastic  
Shirt Hanger



Economy  
Shirt Hanger

One Piece  
Suit Hanger

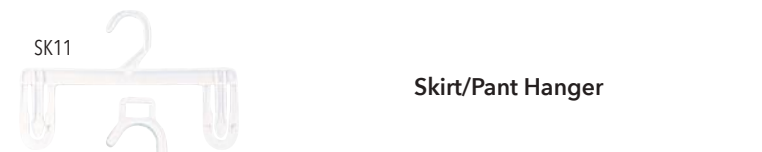

Skirt/Pant Hanger

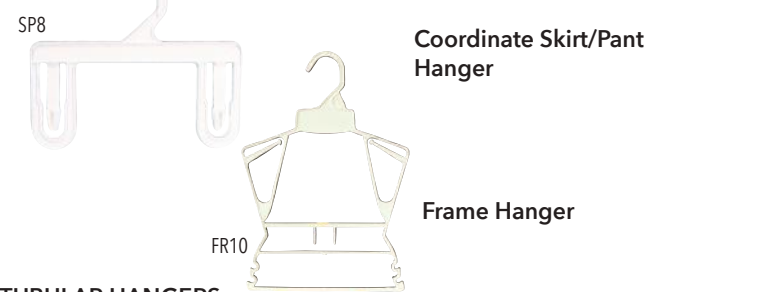

Coordinate Skirt/Pant  
Hanger

Frame Hanger

## TUBULAR HANGERS

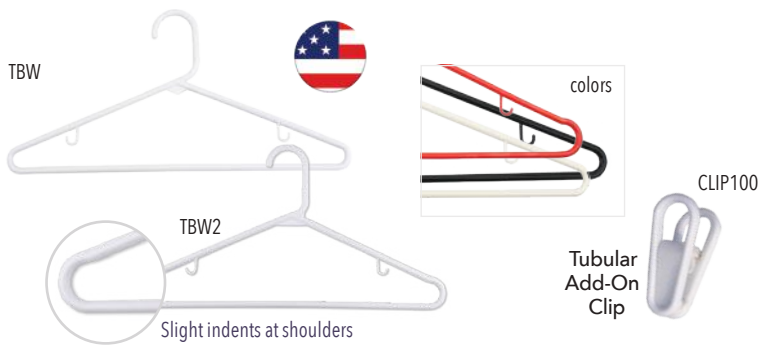

TBW

TBW2

colors

CLIP100

Tubular  
Add-On  
Clip

Slight indents at shoulders

## DRY CLEANING HANGERS



NT140

NT1305

NT145RS

# Introducing THE LUXE EDIT

from NAHANCO

on demand. crafted. experienced. luxe.

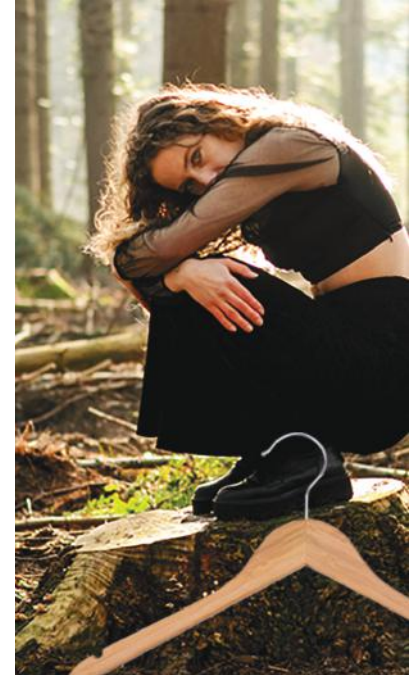

A collection of products meant to inspire, inform and emphasize the best our brand has to offer via a lens of creativity and freshness. These products are both diverse and appropriate for many categories of retail.

A blend of legacy and newly developed products can be used in whatever way excites or moves you. The collections are inventoried and are brandable for an effortless execution of your vision.

Luxury can often be difficult to define. We'd love to be part of how you express and define your own brand of luxury.



SCAN  
to link directly to  
the LUXE catalog



# index

|  |                                      |                                       |                                       |
|--|--------------------------------------|---------------------------------------|---------------------------------------|
| Acrylic sign holders .....36, 50, 59       | Foot/Leg forms .....81, 87           | Metal Hangers .....105-106            | Showcases .....40                     |
| Alteration tags .....21                    | Foot measuring device .....87        | Millinery display .....46, 49, 53, 84 | Sidewalk signs .....62                |
| Bagging Jack .....22                       | Garbage bags .....70                 | Mirrors (counter) .....36, 84         | Sign kits .....55, 61, 62, 64         |
| Bags .....88-90                            | Garment bags .....22                 | Mirrors (floor) .....67               | Sign holders .....57-59, 61           |
| Baskets .....43, 50, 67                    | Glass toppers (round racks) .....30  | Mopping supplies .....70              | Sign hanging systems .....60-61       |
| Bedsread hangers .....106                  | Glove forms .....80                  | Needles (replacement) .....17, 18     | Signs .....56, 64, 65                 |
| Belt hanger .....11                        | Glove hangers .....105               | Non slip attachments .....10          | Size dividers & markers .....6-9      |
| Belt racks .....31, 47                     | Grabber .....14                      | Package hangers .....13               | Slatwall & accessories .....36, 44-47 |
| Bikini hangers .....105                    | Grid wall & accessories .....48-50   | Packaging .....88-91                  | Slatwall panels .....44               |
| Body forms .....72-81                      | Handbag racks.....27, 29, 31, 84     | Pegboard accessories .....53          | Sleeping bag hangers .....106         |
| Boot hanger .....86                        | Hand truck .....70                   | Pennants .....62                      | Sock hangers .....11                  |
| Boot shapers & weights .....85             | Hang all clips .....12               | Pipeline Series .....33-38, 53        | Stain Remover .....66                 |
| Boxes (gift, apparel, jewelry) .....91     | Hanger accessories .....10, 95       | Pins .....68                          | Standards & accessories .....51-52    |
| Boxes (storage) .....14                    | Hanger collection racks .....15      | Pin tickets .....21                   | Staplers .....71                      |
| Box reacher .....14, 87                    | Hangers (garment) .....92-121        | Plastic hangers .....107-121          | Steamers .....69                      |
| Bridal bags .....23                        | Hanger stackers .....15              | Polybag rolls & dispensers .....22    | Storage tray .....7                   |
| Bulletin sign holders .....57              | Hanger storage .....14               | Pricing Supplies .....17-21           | Stretch wrap .....71                  |
| Cap Racks .....84                          | Hanger strips, connectors .....13    | Rack cover .....25, 26                | Suction cups .....60                  |
| Card frames .....57, 58                    | Hat hangers .....105                 | Racks (garment) .....24-39            | Suit covers .....23                   |
| Cards /stock signs .....56                 | Head forms .....81                   | Reaching hook .....14                 | Sunglass racks .....84                |
| Casters (racks) .....24-29, 31, 34, 37, 38 | Hosiery forms .....81                | Register Stands .....40               | Swimsuit hangers .....105             |
| Chalkboards .....62                        | Hotel hangers .....104               | Repair tags .....21                   | Tables .....36, 42                    |
| Circle fasteners .....18                   | Intimate apparel hangers .....110-11 | Rolling racks .....24-26              | Tacking hooks .....17                 |
| Clamps (sign holders) .....36, 58          | Irons & Accessories.....68-69        | S Hooks .....11, 60                   | Tagging tools .....17-18              |
| Cleaning gun & solvent .....66             | Jean hooks .....11                   | Safety pins .....68                   | Tags .....20, 21                      |
| Clips .....12, 13, 61, 109, 121            | Jersey Forms.....72-74               | Sandal forms .....85-86               | Tailor supplies .....68               |
| Clothing racks .....24-39                  | Jewelry displays .....36, 82-83      | Sandal hangers .....86                | Tape .....68, 71                      |
| Coordinate strips .....10                  | Jewelry tags & cards .....83         | Satin hangers .....111                | Tie hanger .....11                    |
| Counterfeit detector pen .....63           | Kraft bags .....88-89                | Scarf racks .....84                   | Tie racks .....31                     |
| Counterfeit cash detector kit .....63      | Kraft tags .....21                   | Scarf rings, scarf hangers .....11    | Tissue paper .....91                  |
| Display bins .....43                       | Kraft tissue .....91                 | Scissors .....68                      | Tool kit .....71                      |
| Display hangers .....99, 103-105, 112      | Labels (pricing) .....19-21          | Seam ripper .....68                   | Traffic control .....64-65            |
| Door alarms .....63                        | Labels (sizing) .....7               | Secure lock system .....63            | Try-on protectors .....66, 87         |
| Dressing room supplies .....66-69          | Ladder systems .....38               | Security devices .....63-65           | Tubing & accessories .....54          |
| Dry cleaning hangers .....118              | Layaway tags .....21                 | Shelves .....41                       | Tubular hangers .....121              |
| Dump tables & bins .....42                 | LED sign .....62                     | Shipping supplies .....71             | Twist on arms (racks) .....28, 29     |
| Easels .....32                             | Leggings hangers .....11             | Shoe accessories .....85-87           | Utility Racks/Storage .....16, 25     |
| Fasteners .....17, 18                      | Lint rollers .....66                 | Shoe forms .....85-86                 | Vacuums .....70                       |
| Fitting room checks .....67                | Literature holders .....47, 50, 53   | Shoe horns .....87                    | VICS hangers .....120                 |
| Fitting clips .....12                      | Mannequin forms .....76-79           | Shoe merchandisers .....47, 85-87     | Wall mount accessories .....36, 53    |
| Flags .....62                              | Markers .....62                      | Shoe risers .....85                   | Wooden hangers .....92-104, 111       |
| Flocked hangers .....109                   | Marking tools .....19                | Shopping baskets .....67              | Workstations .....16                  |
| Foam hanger covers .....10                 | Measuring tape .....68               | Shopping bags .....88-90              | Z-racks .....26                       |
| Folding boards .....16                     | Message boards .....62               | Shoulder covers .....23               |                                       |

## More Ways to Pay

Terms: Net 30 days credit. Sorry, no CODs.

### Credit Cards:



**Prepayment:** prepay by ACH or wire payment in advance.

### Pricing

Prices are subject to change without notice.

## Shipping Information

Shipments are made F.O.B. our warehouse or point of origin. Small orders ship via UPS. Some packages bill as oversized by UPS. When orders exceed UPS limits, we ship via common carrier.

## Returns

If you're not satisfied with your purchase, please contact us, explain the problem and we'll take the necessary steps to resolve the problem to your satisfaction. At times there may be a 25% restocking charge for items returned plus freight costs. Customer service will advise you of these charges should they apply to you. Sorry...**No Returns after 30 days.**

## Carrier Damage

Our products are inspected prior to shipment and any customer claims for visible or concealed damage must be made with the delivering carrier. Our responsibility ceases when the merchandise is turned over to the carrier.

## Backorders

Unfortunately, on occasion we may have to backorder an item. As soon as the item is available, we will ship it - unless otherwise requested not to. If an item is out of stock for more than 30 days, we will notify you.

*Please note that we are not responsible for typographical errors.*



NATIONAL HANGER COMPANY  
 P.O. Box 818, 276 Water St  
 North Bennington, VT 05257

2024



a USA manufacturer!

## usa-based team

Unmatched experience  
 Manufacturing to Customer Service  
 Shipping to Sales  
 Management to Maintenance  
 We're here for YOU

## manufacturer

Many of our hangers and our size dividers are made at our USA headquarters in Vermont

Our knowledge of sourcing and importing is #1 in the industry

## sourcing

## custom

We have the most extensive Custom Programs in the retail supply industry

- BUILDABRAND
- INSTABRAND
- CUSTOM CREATOR TOOL

We can customize (almost) anything  
 See page 4 for details

NAHANCO NAHANCO NAHANCO NAHANCO NAHANCO NAHANCO NAHANCO

## direct importer & distributor

- ALL retail supplies
- Custom Racks, Fixtures, Hangers
- Direct Container shipments
- Leveraged buying power
- Full on-site inventory

## logistics

Looking for help with logistics, reporting or warehousing? We're your people



Order online at [nahanco.com](http://nahanco.com)  
 Call toll-free **800.426.4377** (800-hangers)

EMAIL sign up for our emails at [nahanco.com](http://nahanco.com)  
 ACCOUNT set up an account at [nahanco.com](http://nahanco.com)