



DynaFlex[®]

ORTHODONTIC PRODUCT CATALOG

VOL. 12

Featuring The Exclusive

Norris **20/26**[®]
BRACKET SYSTEM





Online Account Management

Our cutting-edge website seamlessly integrates with our accounting system, ensuring real-time updates for accurate account information. Managing your account and ordering orthodontic products has never been easier. Our secure system is available 24/7 for your convenience. Visit www.dynaflex.com.



Top Notch Customer Service

At DynaFlex®, our talented team is dedicated to providing exceptional care. Our Territory Managers and Customer Care Specialists work daily with clinicians and their staff to build strong, lasting partnerships. We pride ourselves on these relationships. Our team is available to assist you by phone at 866-346-5665 or via online chat at www.dynaflex.com.



Worldwide Distribution

We are proud to announce that our products are recognized and utilized by doctors worldwide, thanks to our high-quality standards and excellence in manufacturing.



Advanced Technology

Leading the way is a statement we truly embody. We consistently adopt the latest technology and advanced manufacturing techniques to deliver the highest level of quality and service in the industry.

PRODUCT PRICING

DynaFlex® is a leading provider of orthodontic products, integrating cutting-edge technology with the finest materials available. Our Product Division, staffed by seasoned experts, brings extensive experience and a deep understanding of orthodontic products. As an industry leader, we are committed to manufacturing high-quality orthodontic products at the best value. Driven by our desire to make orthodontics easier and more efficient, we continuously innovate to stay ahead of the market.

Important Information

ORDERING INFORMATION:

Online ordering is secure and available 24/7. To create or access an account, visit www.dynaflex.com/login and view the left-hand menu for options. For assistance or to place an order by phone, call our Customer Care Team at 866-346-5665. They are available from 7:30am-5:00pm CT, Monday through Friday. After hours, you may leave a message and our team will return your call the next business day.

SHIPMENTS:

Orders placed before 2pm CT are shipped the same day. All orders are shipped via UPS Ground Service. We also offer 2nd Day, 3rd Day, and Next Day Air Service upon request for an additional fee. International orders are shipped based on the customer's preferred service or the most economical option if not specified.

PRODUCT RETURNS:

In accordance with FDA and ISO Regulations, **all product returns require a Return Merchandise Authorization Number (RMA)**, obtainable from our Customer Service Department. Products can be returned for credit within 30 days of the invoice date, subject to quality inspection standards. Items returned must be **unused** and in their **original condition, original packaging, not sterilized** and **no missing parts**.

Custom imprint orders, hot stamped orders, and pre-welded band assemblies are not eligible for return/credit. No returns or credits will be issued for products over 60 days from the invoice date.

PRICING:

DynaFlex® strives to maintain consistent pricing; however, prices in this catalog, on our website, and in sales flyers are subject to change. By purchasing products or services from DynaFlex®, you agree to our terms and conditions. Visit www.dynaflex.com/dynaflex-orthodontic-products-terms-conditions-of-sale.

Physical Address: **8050 Hawk Ridge Trail | Lake St. Louis, MO 63367**

P.O. Box Address: **P.O. Box 390 Wentzville, MO 63385**

Toll Free: **866-346-5665** | Local: **314-426-4020** | International: **001-314-426-4020**

www.dynaflex.com | info@dynaflex.com



TABLE OF CONTENTS

The Norris System	Pages 4-9
Infinity Wire	Page 10
Laser Aligner Cutter (LAC)	Page 11
Glacier® Thermoform Materials Series	Pages 12-13
Precision Aligner Buttons®	Pages 14-15
CS® System	Pages 16-19
Brackets	Pages 20-53
Bands & Attachments	Pages 54-61
Buccal Tubes	Pages 62-71
Archwire & Auxiliaries	Pages 72-95
Elastomerics, Facemasks, Organizers	Pages 96-103
Bonding Supplies, Retractors, & Mirrors	Pages 104-121
Instruments	Pages 122-139
Interproximal Reduction	Pages 140-144
Patient Aids	Pages 146-155
Impression Supplies	Pages 156-157
Laboratory Supplies	Pages 158-167



THE Norris SYSTEM

The Norris 20/26® System is a new dimension in treatment efficiency and by far the most advanced progression in passive self-ligation and arch form technology to date.

Conceived by Dr. Robert "Tito" Norris, it is the culmination of his years of experience in treating with leading passive self-ligating systems, along with his background in mechanical engineering. Together, he was able to identify both the physical attributes and clinical shortcomings of competitive appliances and determine which design elements would most benefit today's practicing orthodontist.

The result is a true twin, passive/active self-ligating appliance system with a reduced slot dimension of .020" x .026", combined with a series of extra broad arch form wires.

○ **Control Without Compromise:**

.020 x .026" slot delivers an unmatched combination of free-sliding passive performance during early stages of treatment and fine-tuned active engagement during finishing.

○ **Improved Workflow:**

Reduces inventory, streamlines scheduling, and finishes easier due to active 3D engagement.

○ **Clinical Efficiency:**

Enhances control and predictability, improving clinical efficiency like no other system on the market.

○ **Facial Aesthetics:**

Maintains optimal three-dimensional control of teeth which offers unparalleled mastery of the finer points of aesthetics.



*Actual Patient Photos



Scan To Request Full Informational Brochure or visit www.dynaflex.com/norris2026

Learn More

www.dynaflex.com/norris2026

Dr. Tito Norris

Orthodontist and Creator of The Norris System

In conjunction with DynaFlex®, Dr. Robert "Tito" Norris has developed the Norris 20/26® Bracket System. His unique background in mechanical engineering provides him with a distinct advantage in mastering the forces, vectors, and movements inherent in performing orthodontic treatment.



Norris 20/26[®]

BRACKET SYSTEM

Nickel-Free SL Bracket With Truly Precise .020 x.026 Slot

Reduced slot dimension delivers unparalleled control. Clinically shown to be 26% more efficient than the leading PSL bracket system. Allows for three common wire sizes.



Center Scribe Line

Aligns the long axis for accurate placement

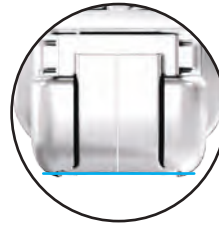

Straight Occlusal Edge

The occlusal edge of the new gingivally offset premolar bracket base is straight so that it can more easily be used as a paralleling guide to the marginal ridges of a premolar.



Rounded Leading Edge Of Door

Leading Edge of door is rounded which aids in the seating of archwire.



Universal Bicuspid Hooks

Reduces inventory with multiple interchangeable brackets. One bracket serves all upper bicuspids.



Deep Tie Wing Undercuts

Optimal tie wing depth for elastic chain, ties or steel ligatures.



Unparalleled Bond Strength

Engineered to conform to each tooth and create unmatched bond strength.

Flawless, Self-Gliding Door Mechanism

The Norris 20/26[®] Brackets Offers A Flawless Door Mechanism

Unfailing door with reciprocal mechanism and audible opening and closing "click", proven to last throughout treatment. Opening the bracket door has never been easier. Insert the Norris Exclusive "Triple Tool" horizontally into the door slot and rotate 90 degrees. The unique mechanism inside the door of the bracket allows the door to actually "glide open" and "glide closed" once the door travels 50% in either direction. This "assisted" opening and closing is the first and only one of its kind, and is another leap forward in PSL technology.



More About Norris Brackets On Pages 26-27

Bracket Color Coding

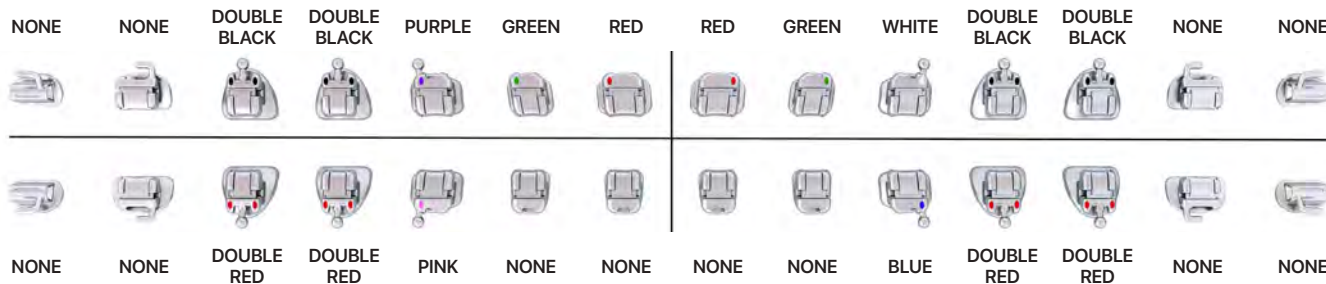

Bracket Placement Guide

The bracket placement guide was developed by Dr. Norris with the projection of the smile in mind. It optimizes the smile arc via the fluid gradient of increasing tooth display.



	Univ HKS			Distal HKS				Univ HKS			Distal HKS			
	UR7	UR6	UR5	UR4	UR3	UR2	UR1	UL1	UL2	UL3	UL4	UL5	UL6	UL7
UPPER														
Torque	-20	-15	-5	-5	0	8	12	12	8	0	-5	-5	-15	-20
Tip	0	0	0	0	5	9	5	5	9	5	0	0	0	0
Rotation	0	12	0	0	0	0	0	0	0	0	0	0	12	0
In/Out			0.69	0.69	0.69	0.89	0.89	0.89	0.89	0.69	0.69	0.69		
LOWER														
	LR7	LR6	LR5	LR4	LR3	LR2	LR1	LL1	LL2	LL3	LL4	LL5	LL6	LL7
Torque	-20	-20	-12	-12	0	-5	-5	-5	-5	0	-12	-12	-20	-20
Tip	0	0	0	0	5	0	0	0	0	5	0	0	0	0
Rotation	0	0	0	0	0	0	0	0	0	0	0	0	0	0
In/Out			0.69	0.69	0.69	1.0	1.0	1.0	1.0	0.69	0.69	0.69		



"I have been practicing orthodontics for 26 years and started using passive self-ligation when they first came out in the late 1990's. Finishing was always a struggle until I started using the Norris 20/26® Bracket. Wow what a difference! With a slot dimension of .020 x .026", the control in all dimensions is truly amazing and I don't have to make all those annoying adjustments in the wire all the time..."

Dr. Hilton Goldreich | Plano, Texas

Repositioning vs. Final Debonding

The bond strength of the Norris 20/26® Bracket is notably higher. The bracket will come off a little easier by using our Debond Plier and grabbing occlusal-gingivally. However, this can distort the wings and archwire. Therefore, a different approach is needed when debonding to reposition the same bracket. In this case, grab the bracket diagonally, at a 45 degree angle. This will preserve the wings and archwire slot. In either case, it's important to have the patient squeeze hard on a cotton roll to stabilize the tooth.

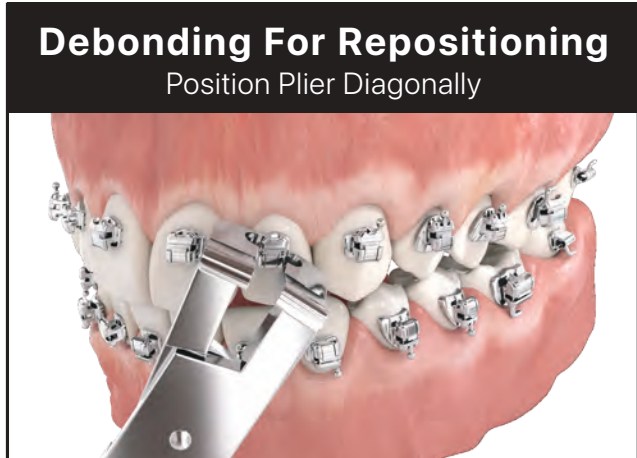

Debonding For Repositioning
Position Plier Diagonally



Final Debond
Position Plier Occlusal-Gingival

The Norris System Tools



TRIPLE TOOL

Three tools in one; door opener, positioner, ruler. **Item #216-5005**



HIP TOOL

Aids in effortlessly seating the wire in the archwire slot and makes placing torque in rectangular wire easy. **Item #216-5000**



BRACKET OPENING TOOL

A single-ended opening instrument that works seamlessly with both Norris Metal and Norris Clear Self-ligating Doors. **Item #216-5015**



DOUBLE TAKE MIRROR

Double-sided intraoral mirror allows the doctor to simultaneously retract and visualize groups of teeth. **Item #216-5010**

BRACKET HEIGHT GAUGE

Crafted from high-quality steel, the Norris gauge features increased height dimensions, ranging from 5.5 mm to 7.0 mm, to accommodate higher bracket placements. The Norris gauge is compatible with both .018 and .020 slots. **Item #216-5020**



THE Norris System Kits



All Norris System Kits and individual components come with simple and straight forward pricing. Talk to your Local Territory Sales Manager for details and specific pricing information.



Scan The QR Code To Learn More About The Norris System Kits.

INTRO KIT: 5-5

Std Bi's: #217-01C5-INT | Offset Bi's: #216-01C5-INT

SKU	QTY	ITEM
#216-01C5	10	5-5 BRACKET SETS
#09-216-200	2	.014 EXTRA BROAD NiTi
#09-226-550	2	.018 x .018 EXTRA BROAD NiTi
#09-426-700	2	.019 x .025 ROUNDED RECT. EXTRA BROAD NiTi
#09-326-700	2	.019 x .025 EXTRA BROAD ROUNDED RECT. BETA
#216-5005	1	TRIPLE TOOL - DOOR OPENER
#216-5000	1	HIP TOOL - ARCHWIRE SEATER
#216-5015	1	BRACKET OPENING TOOL

INTRO KIT: 6-6

Std Bi's - Std Tube Base 217S-01C6-INT | Std Bi's: #217-01C6-INT | Offset Bi's: #216-01C6-INT

SKU	QTY	ITEM
#216-01C6	10	6-6 BRACKET SETS
#09-216-200	2	.014 EXTRA BROAD NiTi
#09-226-550	2	.018 x .018 EXTRA BROAD NiTi
#09-426-700	2	.019 x .025 ROUNDED RECT. EXTRA BROAD NiTi
#09-326-700	2	.019 x .025 EXTRA BROAD ROUNDED RECT. BETA
#216-5005	1	TRIPLE TOOL - DOOR OPENER
#216-5000	1	HIP TOOL - ARCHWIRE SEATER
#216-5015	1	BRACKET OPENING TOOL

INTRO KIT: 7-7

Std Bi's - Std Tube Base 217S-01C7-INT | Std Bi's: #217-01C7-INT

SKU	QTY	ITEM
#217-01C7	10	7-7 BRACKET SETS
#09-216-200	2	.014 EXTRA BROAD NiTi
#09-226-550	2	.018 x .018 EXTRA BROAD NiTi
#09-426-700	2	.019 x .025 ROUNDED RECT. EXTRA BROAD NiTi
#09-326-700	2	.019 x .025 EXTRA BROAD ROUNDED RECT. BETA
#216-5005	1	TRIPLE TOOL - DOOR OPENER
#216-5000	1	HIP TOOL - ARCHWIRE SEATER
#216-5015	1	BRACKET OPENING TOOL

PRO KIT: 5-5

Std Bi's: #217-01C5-PRO | Offset Bi's: #216-01C5-PRO

SKU	QTY	ITEM
#216-01C5	66	(60) 5-5 BRACKET SETS, (6) FREE 5-5 BRACKET SETS
#216-5005	1	TRIPLE TOOL - DOOR OPENER
#216-5000	3	HIP TOOL - ARCHWIRE SEATER
#216-5015	3	BRACKET OPENING TOOL
#3824-NORRIS	1	NORRIS SYSTEM TYPODONT (5-5)

PRO KIT: 6-6Std Bi's - Std Tube Base: **217S-01C6-PRO** | Std Bi's: **#217-01C6-PRO** | Offset Bi's: **#216-01C6-PRO**

SKU	QTY	ITEM
#216-01C6	66	(60) 6-6 BRACKET SETS, (6) FREE 6-6 BRACKET SETS
#216-5005	1	TRIPLE TOOL - DOOR OPENER
#216-5000	3	HIP TOOL - ARCHWIRE SEATER
#216-5015	3	BRACKET OPENING TOOL
#3824-NORRIS1	1	NORRIS SYSTEM TYPODONT (6-6)

PRO KIT: 7-7Std Bi's - Std Tube Base: **217S-01C7-PRO** | Std Bi's: **#217-01C7-PRO**

SKU	QTY	ITEM
#217-01C7	66	(60) 7-7 BRACKET SETS, (6) FREE 7-7 BRACKET SETS
#216-5005	1	TRIPLE TOOL - DOOR OPENER
#216-5000	3	HIP TOOL - ARCHWIRE SEATER
#216-5015	3	BRACKET OPENING TOOL
#3824-NORRIS2	1	NORRIS SYSTEM TYPODONT (7-7)

PRO WIRE KIT: 5-5Std Bi's: **#217-01C5-PRO+** | Offset Bi's: **#216-01C5-PRO+**

SKU	QTY	ITEM
#216-01C5	60	5-5 BRACKET SETS
#09-216-200	5	.014 EXTRA BROAD NiTi
#09-226-550	5	.018 X .018 EXTRA BROAD NiTi
#09-426-700	5	.019 x .025 EXTRA BROAD ROUNDED RECT. NiTi
#09-326-700	5	.019 x .025 EXTRA BROAD ROUNDED RECT. BETA
#216-5005	1	TRIPLE TOOL - DOOR OPENER
#216-5000	5	HIP TOOL - ARCHWIRE SEATER
#216-5015	5	BRACKET OPENING TOOL
#3824-NORRIS	1	NORRIS SYSTEM TYPODONT (5-5)

PRO WIRE KIT: 6-6Std Bi's - Std Tube Base: **217S-01C6-PRO+** | Std Bi's: **#217-01C6-PRO+** | Offset Bi's: **#216-01C6-PRO+**

SKU	QTY	ITEM
#216-01C6	60	6-6 BRACKET SETS
#09-216-200	5	.014 EXTRA BROAD NiTi
#09-226-550	5	.018 X .018 EXTRA BROAD NiTi
#09-426-700	5	.019 x .025 EXTRA BROAD ROUNDED RECT. NiTi
#09-326-700	5	.019 x .025 EXTRA BROAD ROUNDED RECT. BETA
#216-5005	1	TRIPLE TOOL - DOOR OPENER
#216-5000	5	HIP TOOL - ARCHWIRE SEATER
#216-5015	5	BRACKET OPENING TOOL
#3824-NORRIS1	1	NORRIS SYSTEM TYPODONT (6-6)

PRO WIRE KIT: 7-7Std Bi's - Std Tube Base: **217S-01C7-PRO+** | Std Bi's: **#217-01C7-PRO+**

SKU	QTY	ITEM
#217-01C7	60	7-7 BRACKET SETS
#09-216-200	5	.014 EXTRA BROAD NiTi
#09-226-550	5	.018 X .018 EXTRA BROAD NiTi
#09-426-700	5	.019 x .025 EXTRA BROAD ROUNDED RECT. NiTi
#09-326-700	5	.019 x .025 EXTRA BROAD ROUNDED RECT. BETA
#216-5005	1	TRIPLE TOOL - DOOR OPENER
#216-5000	5	HIP TOOL - ARCHWIRE SEATER
#216-5015	5	BRACKET OPENING TOOL
#3824-NORRIS2	1	NORRIS SYSTEM TYPODONT (7-7)

Finally, an aesthetic archwire that looks beautiful from start to finish.

infinity

Chip-Free Aesthetic Wire

Discover a revolutionary solution in the orthodontic market with our Infinity Aesthetic wire! Unlike traditional coated aesthetic wires, our Infinity Wire is not coated; instead, it undergoes a unique etching process that eliminates the common drawbacks found with traditional coatings. This etching process ensures the natural color finish is incredibly durable, will not wear off, and the original wire size is retained and not increased or altered by a coating thickness. Moreover, our etching technique will not increase friction, ensuring optimal performance. The result is a wire that beautifully blends with all enamel, providing a discreet and aesthetic orthodontic experience. Available in packs of 10 wires.



Infinity Wires Paired With Clear Brackets Are Virtually Invisible

Universal Extra Broad Round - 10 Pack	
NiTi .014 Extra Broad Arch	#10-216-200DW
NiTi .018 Extra Broad Arch	#10-216-400DW

Universal Extra Broad Rectangular - 10 Pack	
NiTi .014 x .025 Extra Broad Arch	#10-226-100DW
NiTi .017 x .025 Extra Broad Arch	#10-226-500DW
NiTi .018 x .018 Extra Broad Arch	#10-226-550DW
NiTi .019 x .025 Extra Broad Arch	#10-426-700DW
SS .019 x .025 Extra Broad Arch	#10-500-100DW



INFINITY WIRE

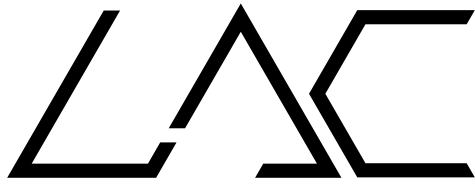

LASER ALIGNER CUTTER

The Future In Aligner Manufacturing

Quickly produce clear aligners that do not require any additional post-processing after cutting.



-  Fully automatic cutting of thermoformed clear aligners
-  Excellent cutting and edge quality
-  No post-processing such as polishing necessary
-  Works with any model
-  Engraving function
-  Developed and manufactured in Salzburg, Austria



Scan To See Video

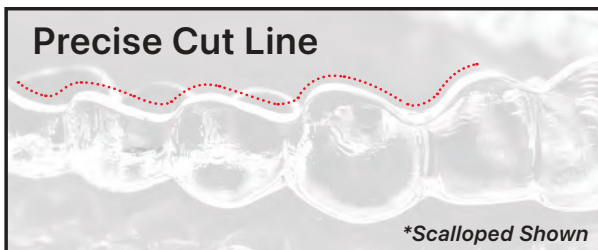

Precise Cut Line

**Scalloped Shown*

(Straight and Modified Scallop Also Available)

LAC Bundle Pack

Includes: LAC Unit, LAC Suction Unit, LAC Separator, Packaging, Transport, Installation, Technical Support & Software-Updates for 12 mo.

LASER ALIGNER CUTTER SEPARATOR

Easily separate clear aligners from the aligner foil model in less than 20 seconds.

- Separated in less than 20 seconds
- Operates with a simple lever without electricity or compressed air
- Works with any model
- Compatible with all major thermoforming systems
- Developed and manufactured in Salzburg, Austria



LASER ALIGNER CUTTER

GLACIER[®] LTR

LONG-TERM RETENTION



Indestructible Material Trusted for Long-Term Smile Preservation.

Glacier[®] LTR (Long-Term Retention) is crafted with precision and expertise, offering practitioners and patients alike an unparalleled orthodontic experience for long-term retention. With its **remarkable durability** and resistance to cracking, Glacier[®] LTR is built to last and **ensures longevity** and **reliability**, providing peace of mind throughout its entire lifespan of use. Glacier[®] LTR is a premium material engineered with the **newest formulation technology** and the latest manufacturing techniques.



Features & Benefits

- Comfortable
- Resistance To Cracking
- Unrivaled Clarity
- Built For Long-Term Use
- Enhanced Durability
- Grab-Force Technology

RETAINERS

Available In Round & Square

Boxes Of 50 Sheets & 100 Sheets

ROUND (125 mm)		
BOX	THICKNESS	ITEM #
50 Sheets	.89 mm (.035)	#0761-035R-50
50 Sheets	1 mm (.040)	#0762-040R-50
100 Sheets	.89 mm (.035)	#0761-035R-100
100 Sheets	1 mm (.040)	#0762-040R-100

SQUARE (127 mm x 127 mm)		
BOX	THICKNESS	ITEM #
50 Sheets	.89 mm (.035)	#0761-035S-50
50 Sheets	1 mm (.040)	#0762-040S-50
100 Sheets	.89 mm (.035)	#0761-035S-100
100 Sheets	1 mm (.040)	#0762-040S-100



SCAN TO REQUEST A **FREE SAMPLE PACK**

GLACIER[®]

Ultra Premium Thermoform Material



An Affordable High-Quality Thermoform Material.

Glacier[®] Ultra Premium Thermoform Aligner Material focuses on **patient comfort** while providing the ultimate in strength, durability and clarity. Glacier[®] Thermoform Material is extremely ductile utilizing our “grab-force” technology which aids in precise tooth movement and **predictable results**. Our exclusive film protected Glacier[®] Material allows for less blockout, superior clarity and provides outstanding patient comfort.



Features & Benefits

- Comfortable
- Durable
- Superior Clarity
- Excellent Ductility
- Grab-Force Technology
- Value Pricing

ALIGNERS & RETAINERS

Available In Round & Square

Box Of 100 Sheets

ROUND (125 mm)		SQUARE (127 mm x 127 mm)	
THICKNESS	ITEM #	THICKNESS	ITEM #
.76 mm (.030)	#0764-030	.76 mm (.030)	#0765-030
.89 mm (.035)	#0764-035	.89 mm (.035)	#0765-035
1 mm (.040)	#0764-040	1 mm (.040)	#0765-040

.76 mm for in-house aligners | .89 mm & 1 mm for in-house retainers



SCAN TO REQUEST A **FREE SAMPLE PACK**

GLACIER THERMOFORM MATERIAL

PRECISION Aligner Buttons®



G2 Metal

Item #10-PAB10210

Base: 5.70mm wide x 4.17mm tall
*25 buttons per pack



Metal Mini

Item #10-PABMINI

Base: 4.97mm wide x 3.81mm tall
*25 buttons per pack



G2 Clear

Item #10-PABCLR2

Base: 4.90mm wide x 3.80mm tall
*10 buttons per pack



G2 Clear Mini

ITEM #10-PABCLR2MINI

Base: 4.16mm wide x 3.23mm tall
*10 buttons per pack

The Only Bondable Buttons Designed Specifically For Clear Aligners.

Metal Features & Benefits

- New base pad is slightly reduced to help fit all 1st molars and perfectly tailored to fit the shape of the aligner cutout windows.
- Base pad is contoured to fit the tooth at the gumline.
- Maximum surface area for a reliable bond strength.
- Enhanced button head is now slightly thicker and more rounded to make it easier to attach elastics of different sizes and not irritate the cheek.

Clear Features & Benefits

- Thickness of the stem has been slightly increased to reinforce the strength of the stem, leading to less breakage.
- Button head is now smoother and more comfortable for the patient.
- G2 Clear Mini with a 15% reduced base for smaller cut-outs and tooth anatomy.



"My team and my patients love the Precision Aligner Buttons®. The large bonding pad, ease of use, and the shape make it a perfect match for my aligner patients and a perfect match for my practice. They truly are rockstar buttons!"

Dr. Dovi Prero | Beverly Hills, CA



"The Precision Buttons® have allowed me to use what I want - orthodontic buttons - without the headaches of frequent breakage and it has really changed the way I practice. The low profile and smooth corners provide spectacular comfort"

Dr. Bryan Lockhart | Charlotte, NC

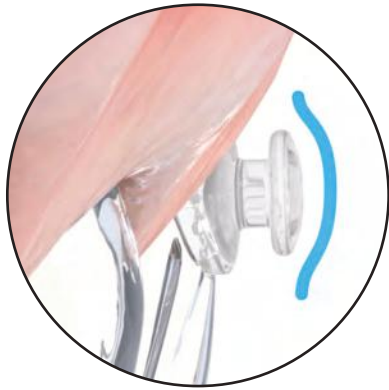

Engineered Button Head

Our enhanced button head makes it easy to attach elastics of different sizes, improving patient compliance and comfort.



Developed for Gumline Placement

Instead of the center of the crown, our anatomically-contoured base pad matches the shape of the tooth at the gingival third



Precise Fit

The shape of the base pad is perfectly tailored to fit the aligner cutout windows.

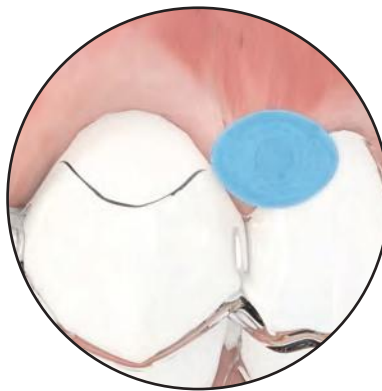

Reliable Bond Strength

The maximized surface area of the base pad prevents detachment.

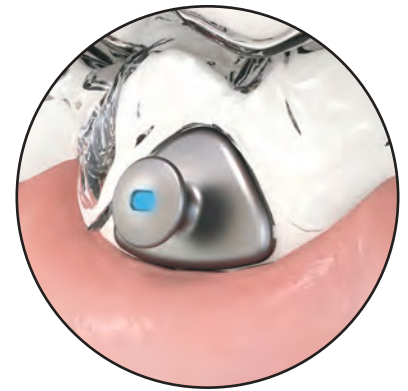

Perfect Placement

The dimple on the button face is intended for precise positioning using an explorer or scaler.

Exclusively Designed For Precision Aligner Buttons®

The Precision Punch Plier®

We are delighted to announce our strategic collaboration with HuFriedy, a distinguished leader in precision instrument manufacturing. Fabricated from premium stainless steel and engineered to accommodate second-generation metal precision aligner buttons with unparalleled precision. This innovative tool guarantees a seamless cutout, ensuring a flawless, snug fit for the Precision Aligner Buttons. With their expertise complementing our commitment to excellence, our partnership has yielded a groundbreaking product, redefining industry standards in precision button alignment. **Item #10-678812**



HuFriedyGroup
The Best In Practice
a STERIS company

*DynaFlex has partnered with
The HuFriedy Group To Create
This Top Quality Plier*



THE ULTIMATE CLASS II & CLASS III CORRECTOR

A Complete System Of Options For Any Type Of Case!

CS SYSTEM



Attached To Archwires



Bondable To Use With Aligners



Attached To Fixed Appliances

The DynaFlex® exclusive CS®5 System represents a breakthrough in non-compliance orthodontic treatment, offering a comprehensive solution for your most challenging Class II & Class III cases. This system is designed for simplicity, effectiveness, and lasting results. With its innovative pivot/spring and screw combination options, installation becomes a breeze for any type of treatment, ensuring a smooth and efficient process from start to finish.

What sets the CS® System apart is its ability to deliver consistent force levels throughout treatment, resulting in a smoother, more constant force that outperforms alternatives on the market. Its proven track record as one of the most successful Class II and Class III chairside appliances globally

speaks to its simplicity, effectiveness, and exceptional value, making it a go-to choice for doctors.

The original system, designed to be attached to archwires or fixed appliances also features cutting-edge hybrid screws, with a blue Nylok™ coating for easy identification and a secure fit. This screw effectively resists loosening within the pivot, ensuring dependable performance.

The CS®5 Bondable low-profile pivot adds versatility to the system and providing a solution for patients in clear aligners. The Bondable Pivot is paired with the CS®5 low force spring and low profile screw offering precision and patient comfort.

Join the thousands of orthodontists worldwide who trust the DynaFlex® CS® System for its exceptional results and lasting benefits. Elevate your orthodontic practice with a system that simplifies treatment, delivers consistent outcomes, and redefines excellence in orthodontics. DynaFlex® CS®5 System is the solution you've been waiting for.

"DynaFlex® CS® is my appliance of choice for Class III correction. It's easy to place and compatible with all bracket systems. It's also easy on the patient. You get excellent, proven results in a short period of time. I am always amazed at how much Class III correction you can achieve in just a couple of visits."

Dr. Katherine Friedman | Litchfield County Orthodontics



LOW FORCE SPRING DELIVERS
150 GRAMS OF FORCE

ENGINEERED FOR ALIGNERS

CS⁵ Bondable represents a ground breaking advancement in orthodontic technology. CS⁵ Bondable Pivot directly bonds to the tooth, offering a seamless integration that enhances the effectiveness of orthodontic treatments when used alongside aligners. Featuring the innovative Bondable pivot, meticulously crafted for patient comfort with its low-profile design, this device ensures a smooth and comfortable orthodontic experience. The accompanying low-profile screw effortlessly attaches the spring to the pivot, simplifying the application process for orthodontists. The CS⁵ Bondable spring is engineered to exert a gentle yet effective force of only 150 grams, facilitating the correction of Class II or III cases with remarkable precision and minimal discomfort. With Bondable CS⁵, orthodontists can elevate their treatment outcomes, providing patients with the confidence of a beautifully aligned smile.

CS⁵ BONDABLE:

Great For Aligners: Specifically for use in conjunction with aligners, CS⁵ Bondable seamlessly integrates into various orthodontic treatment plans for enhanced efficiency.

Gentle, Effective Correction: The low force spring which generates 150 grams of force, accompanied with low-profile bondable pivot ensures predictable results.

CS SYSTEM

Actual Case Submitted By Dr. Michael Williams



Dr. Michael Williams, DDS, PA
Gulf Coast Center For Advanced Cosmetic Orthodontic
Gulfport, MS

Dr. Williams is a member of the American Dental Association and the American Association of Orthodontists, and is a fellow of the World Federation of Orthodontists. He has served as a past president of the Fifth District Dental Association and the Greater Gulfport Dental Society. Dr. Williams was elected to serve as the Delegate for the State of Mississippi to the House of Delegates for the American Association of Orthodontists.

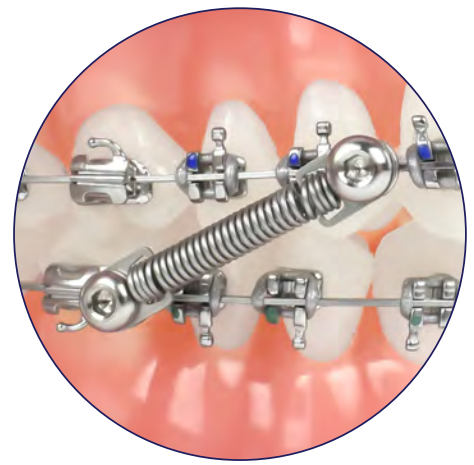

INSTANT LOADING AND MORE CONSISTENT FORCE LEVELS

THE ULTIMATE CLASS II & CLASS III CORRECTOR

Simple, Effective, Proven

The CS⁵ System, exclusively from DynaFlex[®], is a revolutionary advancement in orthodontic technology designed to tackle the toughest Class II and Class III cases with unparalleled precision and effectiveness.

The cornerstone of the CS⁵ System lies in its cutting-edge spring technology, utilized across all three variations for attachment to archwires or fixed appliances. Engineered for precision and reliability, the spring has been rigorously tested and is proven to be dependable throughout treatment (*See Chart Below*). The CS⁵ spring delivers instant loading with consistent force levels of up to 350 grams, ensuring optimal treatment outcomes with minimal discomfort for patients.

Complementing this advanced spring technology are the three pivot options available within the CS⁵ System. The CS⁵ with Traditional Pivot, the original variant, offers a time-tested solution for orthodontic treatment, providing versatile attachment options for various clinical scenarios. Building upon this foundation, the CS⁵ with Self-Ligating Pivot introduces a streamlined design, simplifying the installation process and enhancing performance with its innovative self-ligating mechanism. Meanwhile, the CS⁵ with Twist-Lock Pivot offers unmatched ease of installation, featuring a seamless, one-piece component engineered for reliability and efficiency.

The CS⁵ System incorporates hybrid screws coated with a blue Nylok[™] coating, compatible with all pivot options. These screws ensure a secure fit and resistance to loosening within the pivot, guaranteeing dependable performance throughout the treatment process. With its comprehensive approach to orthodontic treatment, the CS⁵ System empowers orthodontists with the tools they need to achieve superior clinical outcomes and patient satisfaction.

RESULTS MATTER

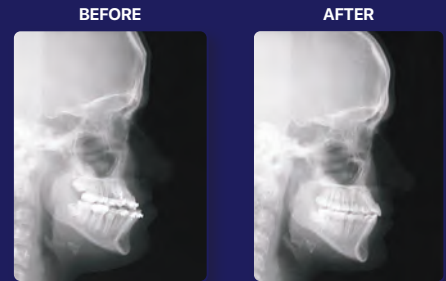

Class III X-Rays: Case photos compliments of Dr. Andy Hayes of St. Louis, MO

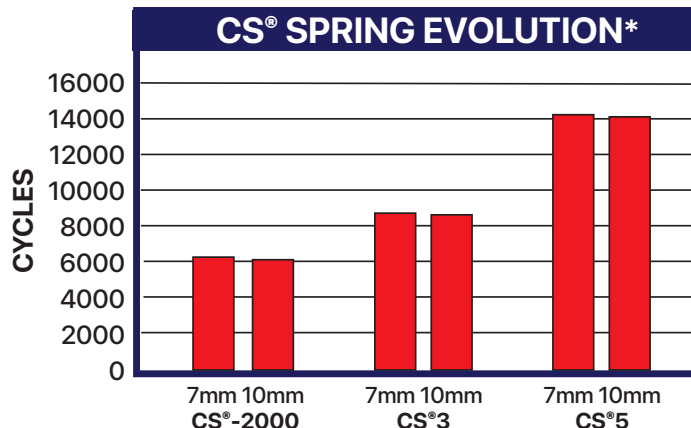

"As a Class III corrector, nothing compares. I had a patient with a 10mm underbite and severe mandibular crowding. Surgery wasn't an option due to cost, so we opted to align his lower incisors. After extracting lower first premolars, we started orthodontic treatment with brackets on both upper and lower teeth. Using the CS⁵ system in a class III direction, we achieved impressive results."

Dr. Ted Bennion
Bennion Orthodontics | Medford, Oregon

PURCHASE OPTIONS

We offer flexibility to cater to your specific orthodontic needs with our versatile kit options. Whether you prefer a smaller kit for targeted cases or the convenience of a master kit for a broader scope, we have you covered with the ideal selection to optimize your orthodontic treatments.



5 Patient:

- 10 CS®5 NiTi Springs (350g)
- 20 Pivots (Your Choice)
- 20 Hybrid Screws
- 1 Magnetic Allen Pencil
- 1 Magnet Charger

Master Kit:

- 20 10mm CS®5 NiTi Springs (350g)
- 20 7mm CS®5 NiTi Springs
- 20 Twist-Lock Pivots
- 20 Traditional Pivots
- 20 Hybrid Screws
- 40 Hybrid Screws
- 1 Magnetic Allen Pencil
- 1 Magnet Charger

5 Patient Bondable Kit:

- 10 CS®5 Low-Force Springs (150g)
- 20 Bondable Pivots
- 20 Low-Profile Screws
- 1 Magnetic Allen Pencil
- 1 Magnet Charger

5 Patient Kits	Item #
TRADITIONAL PIVOT	
.018 10mm Spring	#39-1810-5M
.018 7mm Spring	#39-1807-5M
.022 10mm Spring	#39-2210-5M
.022 7mm Spring	#39-2207-5M
TWIST-LOCK PIVOT	
10mm Spring	#39-T10-5M
7mm Spring	#39-T07-5M
SELF-LIGATING PIVOT	
10mm Spring	#39-SL10-5M
7mm Spring	#39-SL07-5M
BONDABLE LOW PROFILE PIVOT	
10mm Spring	#40-LF10
7mm Spring	#40-LF07

Components	Item #
SPRINGS	
A. CS®5 NiTi Spring 10mm	#38094
A. CS®5 NiTi Spring 7mm	#38114
A. Bondable CS Niti Low Force Spring 7mm	#40-1007
A. Bondable CS Niti Low Force Spring 10mm	#40-1010
PIVOTS	
B. Traditional Pivot .022 x .027	#3810-E
B. Traditional Pivot .018 x .027	#3830-E
C. SL Pivot	#3810-SL
D. Twist-Lock Pivot	#3810-T
E. Bondable CS Low Profile Pivot	#40-2000
SCREWS	
F. Magnetic Hybrid Screw With Nylok™	#3815-5MC
G. Bondable CS Low Profile Screw	#40-5000
ACCESSORIES	
H. Magnetic Allen Pencil	#3823-EM
I. Magnetic Charger	#3823-500
J. SL Tool	#3823-SL

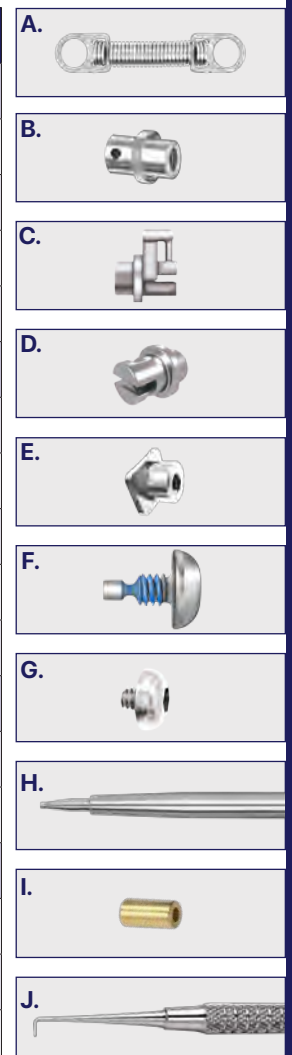

Master Kits	Item #
.018 Pivot	#39T-018M
.022 Pivot	#39T-022M

BRACKETS

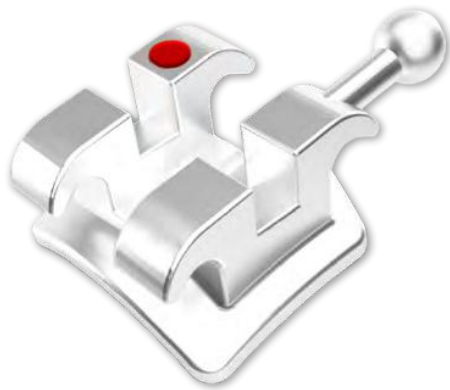

Metal Bracket Lines

DynaFlex® is your total solution for high quality precision direct bonding brackets. Using state of the art materials during the manufacturing process provides controlled tolerance of the slot, low profile materials, and tie wings that are rounded for smooth patient comfort. DynaFlex® uses the best materials and the highest quality systems available, you know the products you are using will exceed your expectations.



Norris 20/26® Brackets, the flagship Self-ligating System by DynaFlex®. Renowned for its unique .020 x .026 slot dimension, this metal bracket system ensures unprecedented control and precision in treatment planning. Among its best-in-class features are four true tie-wings with undercuts, facilitating the use of ligature ties and elastic chain; a Cobalt-Chromium composition that provides a nickel-free alternative for allergy-sensitive patients; a flawless door mechanism offering 'glided' opening and closing; universal bicuspid hooks to minimize inventory needs; and a mechanical base designed for trouble-free bonding.

See pages 26-27.



Atlas Mini is our most popular twin metal bracket system. Depending on the system of choice, the Atlas bracket line provides specific torque, angulation and rotation; with precise tooth movement and outstanding treatment results.

See pages 28-31.



Atlas Standard has the same great features as our Atlas Mini Bracket but 30% larger. Wider tie wing positioning allows for excellent rotational control and the larger base enhances bond strength.

See pages 34-35.



MTX™ Brackets create the perfect smile with unlimited features such as one-piece MIM construction, rounded slot entry, perfectly contoured for great fit, and ultra-smooth slot. Previously known as Artista (Ortho-Direct) & Futura (MAO).

See pages 36-37.



Gemini™ Stainless Steel Bracket offer ultimate full rotational control with their state-of-the-art base design that incorporates torque. Every bracket's compound-contoured base is anatomically designed for an accurate fit. Simplified bracket placement and improved bond strength help make your job easier.

See pages 40-41.



Endurance® Self-Ligating Bracket is a fully interactive self-ligating bracket with a Nickel Titanium spring clip. Clip allows for an exceptional memory characteristic, delivering continuous and consistent forces without deformation.

See pages 42-43.

Aesthetic Bracket Lines

With any of our bracket systems you have the ability to choose a wide range of treatment options that best suits the needs of your practice and treatment protocols. Whether your preference is a stainless steel or aesthetically pleasing brackets, DynaFlex® offers a wide selection for your product needs.

Light Gold

Bright Gold



Atlas Mini Light & Bright Gold have all the same great features of our Atlas Mini bracket along with the aesthetic appeal of Gold, your options have no limits with DynaFlex® bracket systems. The Gold brackets retains all the strength and durability of the Atlas Mini as well as the ultra-smooth slot that improves sliding mechanics and enhances patient treatment time.

See pages 32-33.



Gold'n Braces: Midas Brackets™ (MTX) are mini sized with a luxurious finish. Our 24-karat gold multi-layered alloy presents an aesthetically superior bracket. Only available in Roth .018 and .022. Sold individually.

See pages 38.



ClearViz+™ Mini is a highly aesthetic bracket made of revolutionary Monocrystalline Sapphire material. With superior strength and durability, the possibilities are endless for those patients looking for cosmetic options.

See pages 44-45.



ClearViz+™ is the same as our ClearViz+™ Mini with a slightly larger mesial distal direction. A clear bracket your patients will love. Previously known as ClearTek (Ortho-Direct).

See pages 46-47.



ClearTek™ Mini Brackets are the ultimate aesthetic bracket. Brackets are crystal clear monocrystalline sapphire, stain resistant, have high bond strength, easy debonding and have a low bracket profile.

See pages 48-49.



The Krystal™ SL is precisely manufactured using a combination of copolymers and ceramics to create a translucent, glass-like appearance for superior cosmetics. This innovative bracket has a super smooth surface that will not stain, break or flex during treatment. Superior aesthetics in a completely clear self-ligating bracket makes this the ideal choice for superior treatment!

See pages 50-51.



Krystal™ Brackets are the choice for a true ceramic bracket! Manufactured from 99.9% pure alumina oxide, these polycrystalline brackets are non-staining and do not discolor. Krystal Brackets are a true twin design offering outstanding bond, high strength, precise tip and torque and are very easy to ligate. Your patients will be pleased with the comfort and aesthetic look! Previously known as Natralyke (Ortho-Direct) and Spectra (MAO).

See pages 52-53

MAXILLARY

Complete Bracket Reference Chart

BRACKET LINES

	CENTRAL		LATERAL		CUSPID			1ST BICUSPID			2ND BICUSPID		
	TRQ	ANG	TRQ	ANG	TRQ	ANG	ROT	TRQ	ANG	ROT	TRQ	ANG	ROT
Norris 20/26® - Metal	+12	+5	+8	+9	0	+5	0	-5	0	0	-5	0	0
Atlas Mini - Roth*	+12	+5	+8	+9	-2	+11	0	-7	0	0	-7	0	0
Atlas Mini - MBT*	+17	+4	+10	+8	-7	+8	0	-7	0	0	-7	0	0
Atlas Light & Bright Gold- Roth	+12	+5	+8	+9	-2	+11	0	-7	0	0	-7	0	0
Atlas Light & Bright Gold - MBT	+17	+4	+10	+8	-7	+8	0	-7	0	0	-7	0	0
Atlas Standard - Roth*	+12	+5	+8	+9	-2	+11	0	-7	0	0	-7	0	0
Atlas Standard - MBT*	+17	+4	+10	+8	-7	+8	0	-7	0	0	-7	0	0
MTX™ - Roth*	+12	+5	+8	+9	-2	+13	+4	-7	0	0	-7	0	0
MTX™ - MBT*	+17	+4	+8	+9	-7	+9	0	-7	0	0	-7	0	0
Gemini™ - Roth*	+12	+5	+8	+9	-2	+11	0	-7	0	0	-7	0	0
Gemini™ - MBT*	+17	+4	+10	+8	-7	0	0	-7	0	0	-7	0	0
Endurance® SL - Roth*	+12	+5	+8	+9	-2	+11	0	-7	0	0	-7	0	0
Endurance® SL - MBT*	+17	+4	+10	+8	-7	+8	0	-7	0	0	-7	0	0
Kystal™ SL - Roth*	+12	+5	+8	+9	-2	+8	0	-7	0	0	-7	0	0
Krystal™ SL - MBT*	+17	+5	+10	+8	0	+8	0	-7	0	0	0	0	0
Gold'n Braces: Midas - Roth* (MTX)	+12	+5	+8	+9	-2	+13	+4	-7	0	0	-7	0	0
Krystal™ - Roth*	+12	+5	+8	+9	0	+11	0	-7	0	0	-7	0	0
Krystal™ - MBT*	+17	+4	+10	+8	0	+8	0	-7	0	0	-7	0	0
ClearViz+™ Mini - Roth*	+12	+5	+8	+9	-2	+11	0	-7	0	0	-7	0	0
ClearViz+™ Mini - MBT*	+17	+4	+10	+8	-7	+8	0	-7	0	0	-7	0	0
ClearViz+™ - Roth*	+12	+5	+8	+9	0	+11	0	-7	0	0	-7	0	0
ClearViz+™ - MBT*	+17	+4	+10	+8	-7	+8	0	-7	0	0	-7	0	0
ClearTek™ - Roth*	+12	+5	+8	+9	0	+11	0	-7	0	0	-7	0	0
ClearTek™ - MBT*	+17	+4	+10	+8	-7	+8	0	-7	0	0	-7	0	0

MANDIBULAR

Complete Bracket Reference Chart

BRACKET LINES

	LOWER ANTERIORS		CUSPID			1ST BICUSPID			2ND BICUSPID		
	TRQ	ANG	TRQ	ANG	ROT	TRQ	ANG	ROT	TRQ	ANG	ROT
Norris 20/26® - Metal	-5	0	0	+5	0	-12	0	0	-12	0	0
Atlas Mini - Roth*	0	0	-11	+5	0	-17	0	0	-22	0	0
Atlas Mini - MBT*	-6	0	-6	+3	0	-12	+2	0	-17	+2	0
Atlas Light & Bright Gold - Roth	0	0	-11	+5	0	-17	0	0	-22	0	0
Atlas Light & Bright Gold - MBT	-6	0	-6	+3	0	-12	+2	0	-17	+2	0
Atlas Standard - Roth*	-1	+2	-11	+5	0	-17	0	0	-22	0	0
Atlas Standard - MBT*	-6	0	-6	+3	0	-12	+2	0	-17	+2	0
MTX™ - Roth*	0	0	-7	+2	0	-17	0	0	-22	0	0
MTX™ - MBT*	-6	0	-6	+3	0	-12	+2	0	-17	0	0
Gemini™ - Roth*	-1	0	-11	0	0	-17	0	0	-22	0	0
Gemini™ - MBT*	-6	0	-6	+3	0	-12	0	0	-17	0	0
Endurance® SL - Roth*	0	0	-11	+7	0	-17	0	0	-22	0	0
Endurance® SL - MBT*	-6	0	-6	+3	0	-12	+2	0	-17	+2	0
Krystal™ SL - Roth*	0	0	-11	+5	2	-17	0	0	-22	0	0
Krystal™ SL - MBT*	-6	0	0	+3	2	-12	+2	0	-17	+2	0
Gold'n Braces: Midas - Roth* (MTX)	0	0	-7	+2	0	0	0	0	-22	0	0
Krystal™ - Roth*	0	0	-11	+5	0	-17	0	0	-22	0	0
Krystal™ - MBT*	-6	0	0	3	0	-12	+2	0	-17	+2	0
ClearViz+™ Mini - Roth*	-1	0	-11	+7	0	-17	0	0	-22	0	0
ClearViz+™ Mini - MBT*	-6	0	0	+3	0	-12	+2	0	-17	+2	0
ClearViz+™ - Roth*	0	0	-11	+5	0	-17	0	0	-22	0	0
ClearViz+™ - MBT*	-6	0	-6	+3	0	-12	+2	0	-17	+2	0
ClearTek™ - Roth*	0	0	-11	+5	0	-17	0	0	-17	0	0
ClearTek™ - MBT*	-6	0	-6	+3	0	-12	+2	0	-17	+2	0

Norris 20/26 METAL

FEATURES *and* BENEFITS

Nickel-Free Cobalt-Chromium Alloy:

Cobalt-chromium not only boasts superior frictional characteristics but is also completely nickel-free.

Integrated Hooks:

Strong integrated hooks accommodate all directions of elastic wear.

Universal Bicuspid Hooks:

Reduces inventory with multiple interchangeable brackets. One bracket serves all upper Bicuspid.

Deep Tie Wing Undercuts:

Optimal tie wing depth for elastic chain, ties or steel ligatures.

.020" x .026" Slot:

Reduced slot dimension delivers unparalleled control. Clinically shown to be 26% more efficient than the leading PSL bracket system.

Rounded Leading Edge Of Door:

Leading edge of door which aids in arch wire seating.



Scan To Learn More

Center Scribe Line:

Center scribe line aligns the long axis for accurate placement.

Unparalleled Bond Strength:

Engineered to conform to each tooth and create unmatched bond strength.

Straight Occlusal Edge:

The occlusal edge of the new gingivally offset premolar bracket base is straight so that it can more easily be used as a paralleling guide to the marginal ridges of a premolar.

Mesial Distal Span Of Door:

Width of reciprocal door provides additional rotational control.

Self-Ligating Molar Tube

Full 6-6 Self-Ligating System



Flawless, Self-Gliding Door Mechanism

Unfailing door with reciprocal mechanism and audible opening and closing "click", proven to last throughout treatment. Opening the bracket door has never been easier. Insert the Norris Exclusive "Triple Tool" horizontally into the door slot and rotate 90 degrees. The unique mechanism inside the door of the bracket allows the door to actually "glide open" and "glide closed" once the door travels 50% in either direction. This "assisted" opening and closing is the first and only one of its kind, and is another leap forward in PSL technology.

Rounded Leading Edge

Audible Click When Opened or Closed

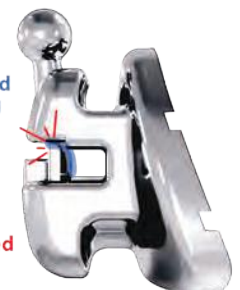



Norris 20/26® Brackets Full Sets	ITEM #
U / L 5 - 5, Offset Bi's	#216-01C5
U / L 6 - 6, Offset Bi's	#216-01C6
U / L 6 - 6, Offset Bi's - Stnd Tube Base	#216S-01C6
U / L 5 - 5, Stnd Bi's	#217-01C5
U / L 6 - 6, Stnd Bi's	#217-01C6
U / L 6 - 6, Stnd Bi's - Stnd Tube Base	#217S-01C6
U / L 7 - 7, Stnd Bi's	#217-01C7
U / L 7 - 7, Stnd Bi's - Stnd Tube Base	#217S-01C7

Norris 20/26® Maxillary Brackets - 10 Packs	ITEM #
Maxillary Right, Central	#216-1011
Maxillary Right, Lateral	#216-1012
Maxillary Right, Cuspid W/ Hk	#216-1013
Maxillary Universal, Bicuspid W/ Hk, Offset Bi's	#216-1014
Maxillary Universal, Bicuspid W/ Hk, Stnd Bi's	#216-1014N
Maxillary Left, Central	#216-2021
Maxillary Left, Lateral	#216-2022
Maxillary Left, Cuspid W/ Hk	#216-2023

Norris 20/26® Mandibular Brackets - 10 Packs	ITEM #
Mandibular, Lower Anteriors	#216-3031
Mandibular Right, Cuspid W/ Hk	#216-3033
Mandibular Universal, Bicuspid W/ Hk, Offset Bi's	#216-3034
Mandibular Universal, Bicuspid W/ Hk, Stnd Bi's	#216-3034N
Mandibular Left, Cuspid W/ Hk	#216-4043

Premolar With Gingival Offset

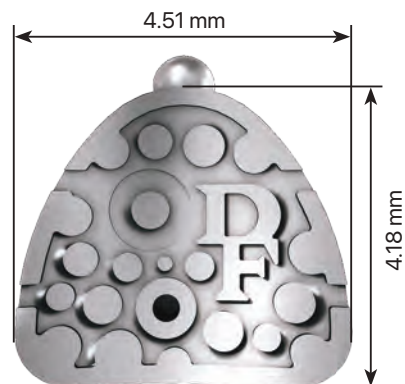

Premolar With No Gingival Offset

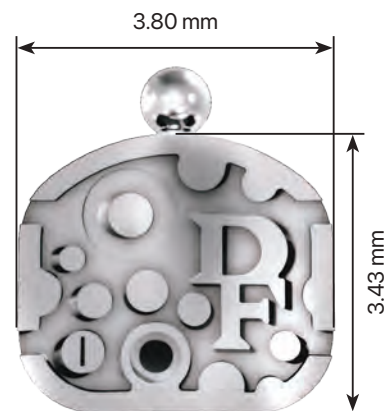

Bracket Prescription Reference Chart														
UPPER	UR7	UR6	UR5*	UR4*	UR3**	UR2	UR1	UL1	UL2	UL3**	UL4*	UL5*	UL6	UL7
Torque	-20	-15	-5	-5	0	8	12	12	8	0	-5	-5	-15	-20
Tip	0	0	0	0	5	9	5	5	9	5	0	0	0	0
Rotation	0	10	0	0	0	0	0	0	0	0	0	0	10	0
In/out	-	-	0.69	0.69	0.69	0.89	0.89	0.89	0.89	0.69	0.69	0.69	-	-
LOWER	LR7	LR6	LR5*	LR4*	LR3**	LR2	LR1	LL1	LL2	LL3**	LL4*	LL5*	LL6	LL7
Torque	-20	-20	-12	-12	0	-5	-5	-5	-5	0	-12	-12	-20	-20
Tip	0	0	0	0	5	0	0	0	0	5	0	0	0	0
Rotation	0	0	0	0	0	0	0	0	0	0	0	0	0	0
In/out	-	-	0.69	0.69	0.69	1.0	1.0	1.0	1.0	0.69	0.69	0.69	-	-

* = Universal Hooks ** = Distal Hooks





















Atlas Mini Bracket System

An exceptionally remarkable bracket engineered for strength and unwavering durability. Its extraordinary strength takes center stage, fortified by the meticulous fusion of highly robust stainless steel and the finesse of precise tooth movement. This fusion incorporates an 80-gauge foil mesh pad, ensuring unparalleled bond strength. Other noteworthy attributes of the Atlas encompass: 17-4 stainless steel construction, flawlessly smooth slots, and a sleek low-profile design. These features collectively instill the confidence needed to address even the most challenging malocclusions—achieving feats previously deemed unattainable with other brackets.

Available In Roth, MBT, Offset Base, and Oval Pad - .018 And .022

BRACKETS

Atlas Mini Bracket System, Roth Rx - 10 Pack

MAXILLARY	REF	HK	TRQ	ANG	M/D	IN/OUT	.018 RIGHT	.018 LEFT	.022 RIGHT	.022 LEFT
Central	UR  UL 	-	12	5	3.4mm	0.61mm	#201-R8-11	#201-R8-21	#201-R2-11	#201-R2-21
Lateral	UR  UL 	-	8	9	2.8mm	0.80mm	#201-R8-12	#201-R8-22	#201-R2-12	#201-R2-22
Lateral w/ Hk	UR  UL 	D	8	9	2.8mm	0.80mm	#201-R8-12D	#201-R8-22D	#201-R2-12D	#201-R2-22D
Cuspid	UR  UL 	-	-2	11	3.0mm	0.58mm	#201-R8-13	#201-R8-23	#201-R2-13	#201-R2-23
Cuspid w/ Hk	UR  UL 	D	-2	11	3.0mm	0.58mm	#201-R8-131	#201-R8-231	#201-R2-131	#201-R2-231
1st Bicuspid	UR  UL 	-	-7	0	2.8mm	0.59mm	#201-R8-14	#201-R8-24	#201-R2-14	#201-R2-24
1st Bicuspid w/ Hk	UR  UL 	M	-7	0	2.8mm	0.59mm	#201-R8-141	#201-R8-241	#201-R2-141	#201-R2-241
1st Bicuspid w/ DG Hk	UR  UL 	D	-7	0	2.8mm	0.59mm	#201-R8-141D	#201-R8-241D	#201-R2-141D	#201-R2-241D
2nd Bicuspid	UR  UL 	-	-7	0	2.8mm	0.59mm	#201-R8-15	#201-R8-25	#201-R2-15	#201-R2-25
2nd Bicuspid w/ Hk	UR  UL 	M	-7	0	2.8mm	0.59mm	#201-R8-151	#201-R8-251	#201-R2-151	#201-R2-251
2nd Bicuspid w/ DG Hk	UR  UL 	D	-7	0	2.8mm	0.59mm	#201-R8-151D	#201-R8-251D	#201-R2-151D	#201-R2-251D
MANDIBULAR	REF	HK	TRQ	ANG	M/D	IN/OUT	.018 RIGHT	.018 LEFT	.022 RIGHT	.022 LEFT
Lower Anteriors	LR  LL 	-	0	0	2.3mm	0.78mm	#201-R8-31	Universal	#201-R2-31	Universal
Lower Anteriors Wide	LR  LL 	-	0	0	2.9mm	0.78mm	#201-R8-31S	Universal	#201-R2-31S	Universal
Lateral w/ Hk	LR  LL 	D	0	0	2.3mm	0.78mm	#201-R8-32D	#201-R8-42D	#201-R2-32D	#201-R2-42D
Cuspid	LR  LL 	-	-11	5	2.8mm	0.61mm	#201-R8-33	#201-R8-43	#201-R2-33	#201-R2-43
Cuspid w/ Hk	LR  LL 	D	-11	5	2.8mm	0.61mm	#201-R8-331	#201-R8-431	#201-R2-331	#201-R2-431
1st Bicuspid	LR  LL 	-	-17	0	2.8mm	0.64mm	#201-R8-34	#201-R8-44	#201-R2-34	#201-R2-44
1st Bicuspid w/ Hk	LR  LL 	M	-17	0	2.8mm	0.64mm	#201-R8-341	#201-R8-441	#201-R2-341	#201-R2-441
1st Bicuspid w/ DG Hk	LR  LL 	D	-17	0	2.8mm	0.64mm	#201-R8-341D	#201-R8-441D	#201-R2-341D	#201-R2-441D
2nd Bicuspid	LR  LL 	-	-22	0	2.8mm	0.69mm	#201-R8-35	#201-R8-45	#201-R2-35	#201-R2-45
2nd Bicuspid w/ Hk	LR  LL 	M	-22	0	2.8mm	0.69mm	#201-R8-351	#201-R8-451	#201-R2-351	#201-R2-451
2nd Bicuspid w/ DG Hk	LR  LL 	D	-22	0	2.8mm	0.69mm	#201-R8-351D	#201-R8-451D	#201-R2-351D	#201-R2-451D

Atlas Mini Bracket System, Roth Rx - 5x5 Set

FULL SETS	.018 SLOT	.022 SLOT
Upper/Lower 5x5 No Hks	#201-R8-NHK	#201-R2-NHK
Upper/Lower 5x5 Hks on 3's	#201-R8-3	#201-R2-3
Upper/Lower 5x5 Hks on 3,4,5's	#201-R8-345	#201-R2-345
Upper/Lower 5x5 Hks on 3,4,5's Distal Gingival Bicuspid	#201-R8-345DG	#201-R2-345DG

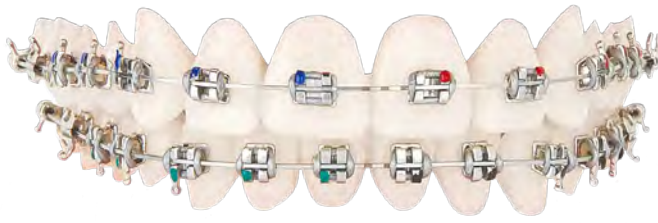

Atlas Mini Bracket System , MBT™ Rx - 10 Pack

MAXILLARY	REF	HK	TRQ	ANG	M/D	IN/OUT	.018 RIGHT	.018 LEFT	.022 RIGHT	.022 LEFT
Central	UR ● UL ●	-	17	4	3.1mm	0.40mm	#201-M8-11	#201-M8-21	#201-M2-11	#201-M2-21
Lateral	UR ● UL ●	-	10	8	2.8mm	0.78mm	#201-M8-12	#201-M8-22	#201-M2-12	#201-M2-22
Lateral w/ Hk	UR ● UL ●	D	10	8	2.8mm	0.78mm	#201-M8-12D	#201-M8-22D	#201-M2-12D	#201-M2-22D
Cuspid	UR ● UL ●	-	-7	8	2.8mm	0.40mm	#201-M8-13	#201-M8-23	#201-M2-13	#201-M2-23
Cuspid	UR ● UL ●	-	0	8	2.8mm	0.40mm	#201-M8-13C	#201-M8-23C	#201-M2-13C	#201-M2-23C
Cuspid w/ Hk	UR ● UL ●	D	-7	8	2.8mm	0.40mm	#201-M8-131	#201-M8-231	#201-M2-131	#201-M2-231
Cuspid w/ Hk	UR ● UL ●	D	0	8	2.8mm	0.40mm	#201-M8-131C	#201-M8-231C	#201-M2-131C	#201-M2-231C
1st Bicuspid	UR ● UL ●	-	-7	0	2.8mm	0.40mm	#201-M8-14	#201-M8-24	#201-M2-14	#201-M2-24
1st Bicuspid w/ Hk	UR ● UL ●	M	-7	0	2.8mm	0.40mm	#201-M8-141	#201-M8-241	#201-M2-141	#201-M2-241
1st Bicuspid DG Hk	UR ● UL ●	D	-7	0	2.8mm	0.40mm	#201-M8-141D	#201-M8-241D	#201-M2-141D	#201-M2-241D
2nd Bicuspid	UR ● UL ●	-	-7	0	2.8mm	0.40mm	#201-M8-15	#201-M8-25	#201-M2-15	#201-M2-25
2nd Bicuspid w/ Hk	UR ● UL ●	M	-7	0	2.8mm	0.40mm	#201-M8-151	#201-M8-251	#201-M2-151	#201-M2-251
2nd Bicuspid DG Hk	UR ● UL ●	D	-7	0	2.8mm	0.40mm	#201-M8-151D	#201-M8-251D	#201-M2-151D	#201-M2-251D
MANDIBULAR	REF	HK	TRQ	ANG	M/D	IN/OUT	.018 RIGHT	.018 LEFT	.022 RIGHT	.022 LEFT
Lower Anteriors	LR ● LL ●	-	-6	0	2.2mm	0.76mm	#201-M8-31	Universal	#201-M2-31	Universal
Lower Anteriors Wide	LR ● LL ●	-	-6	0	2.9mm	0.78mm	#201-M8-31S	Universal	#201-M2-31S	Universal
Lateral w/ Hk	LR ● LL ●	D	-6	0	2.2mm	0.76mm	#201-M8-32D	#201-M8-42D	#201-M2-32D	#201-M2-42D
Cuspid	LR ● LL ●	-	-6	3	2.8mm	0.40mm	#201-M8-33	#201-M8-43	#201-M2-33	#201-M2-43
Cuspid w/ Hook	LR ● LL ●	D	-6	3	2.8mm	0.40mm	#201-M8-331	#201-M8-431	#201-M2-331	#201-M2-431
1st Bicuspid	LR ● LL ●	-	-12	2	2.8mm	0.40mm	#201-M8-34	#201-M8-44	#201-M2-34	#201-M2-44
1st Bicuspid w/ Hk	LR ● LL ●	M	-12	2	2.8mm	0.40mm	#201-M8-341	#201-M8-441	#201-M2-341	#201-M2-441
1st Bicuspid DG Hk	LR ● LL ●	D	-12	2	2.8mm	0.40mm	#201-M8-341D	#201-M8-441D	#201-M2-341D	#201-M2-441D
2nd Bicuspid	LR ● LL ●	-	-17	2	2.8mm	0.40mm	#201-M8-35	#201-M8-45	#201-M2-35	#201-M2-45
2nd Bicuspid w/ Hk	LR ● LL ●	M	-17	2	2.8mm	0.40mm	#201-M8-351	#201-M8-451	#201-M2-351	#201-M2-451
2nd Bicuspid DG Hk	LR ● LL ●	D	-17	2	2.8mm	0.40mm	#201-M8-351D	#201-M8-451D	#201-M2-351D	#201-M2-451D

Atlas Mini Bracket System , MBT™ Rx - 5x5 Set

FULL SETS	.018 SLOT	.022 SLOT
Upper/Lower 5x5 No Hks	#201-M8-NHK	#201-M2-NHK
Upper/Lower 5x5 Hks on 3's	#201-M8-3	#201-M2-3
Upper/Lower 5x5 Hks on 3,4,5's	#201-M8-345	#201-M2-345
Upper/Lower 5x5 Hks on 3,4,5's Distal Gingival Bicuspid	#201-M8-345DG	#201-M2-345DG

*DynaFlex® does not imply any endorsements from Drs. McLaughlin, Bennett and Trevisi and does not claim to be an exact duplicate of the MBT™ system. MBT™ is a registered trademark of 3M/Unitek Corporation.

ENGINEERED FOR STRENGTH AND UNWAVERING DURABILITY

With a focus on clinical precision, these brackets not only enhance treatment efficiency but also prioritize patient comfort. The smooth slot, low-profile design, and meticulously crafted features make every step of the orthodontic journey seamless and comfortable for both you and your patients. Elevate your practice with the reliability and performance that these brackets bring to your orthodontic toolkit.

Medical Grade Steel

Uncompromising Quality Crafted from 17-4 medical grade stainless steel, ensuring exceptional durability and performance.

Rounded Tie Wings

uniquely designed round ties wings, ensuring unmatched comfort during treatment.

Low Profile

Experience a sleek and low-profile design that enhances both aesthetics and functionality.

Parallel Slot & Base

Maintain precise positioning as the slot and base align seamlessly with the tooth's incisal edge.

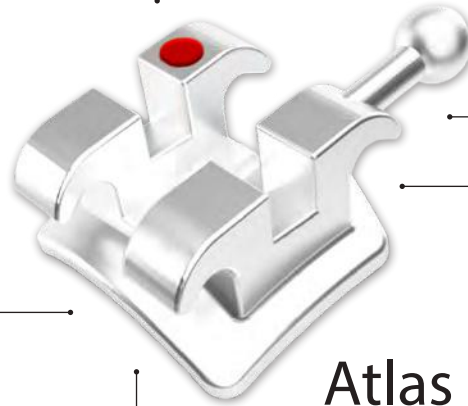

Deep Tie Wings

The deep tie wing design enables the simultaneous use of ties and chains, providing you with versatile treatment possibilities for optimal patient care.

Zero Slot Deformation

Save Time and Money with repositioning, Ensuring consistent performance.

Atlas Mini OFFSET BASE

The offset base provides outstanding coverage in both the mesial and distal direction for rounded bicuspid teeth.



Atlas Mini - Offset Base

Atlas Mini Bracket System With Offset Base, Roth Rx - 10 Pack

MAXILLARY	REF	HK	TRQ	ANG	M/D	IN/OUT	.018 RIGHT	.018 LEFT	.022 RIGHT	.022 LEFT
1st Bicuspid	UR ● UL ●	-	-7	0	2.8mm	0.59mm	#201-R8-140-2	#201-R8-240-2	#201-R2-140-2	#201-R2-240-2
1st Bicuspid w/ Hk	UR ● UL ●	D	-7	0	2.8mm	0.59mm	#201-R8-1410-2	#201-R8-2410-2	#201-R2-1410-2	#201-R2-2410-2
2nd Bicuspid	UR ● UL ●	-	-7	0	2.8mm	0.59mm	#201-R8-150-2	#201-R8-250-2	#201-R2-150-2	#201-R2-250-2
2nd Bicuspid w/ Hk	UR ● UL ●	D	-7	0	2.8mm	0.59mm	#201-R8-1510-2	#201-R8-2510-2	#201-R2-1510-2	#201-R2-2510-2
MANDIBULAR	REF	HK	TRQ	ANG	M/D	IN/OUT	.018 RIGHT	.018 LEFT	.022 RIGHT	.022 LEFT
1st Bicuspid	LR ● LL ●	-	-17	0	2.8mm	0.64mm	#201-R8-340-2	#201-R8-440-2	#201-R2-340-2	#201-R2-440-2
1st Bicuspid w/ Hk	LR ● LL ●	D	-17	0	2.8mm	0.64mm	#201-R8-3410-2	#201-R8-4410-2	#201-R2-3410-2	#201-R2-4410-2
2nd Bicuspid	LR ● LL ●	-	-22	0	2.8mm	0.69mm	#201-R8-350-2	#201-R8-450-2	#201-R2-350-2	#201-R2-450-2
2nd Bicuspid w/ Hk	LR ● LL ●	D	-22	0	2.8mm	0.69mm	#201-R8-3510-2	#201-R8-4510-2	#201-R2-3510-2	#201-R2-4510-2

Atlas Mini Bracket System With Offset Base, MBT™ Rx - 10 Pack

MAXILLARY	REF	HK	TRQ	ANG	M/D	IN/OUT	.018 RIGHT	.018 LEFT	.022 RIGHT	.022 LEFT
1st Bicuspid	UR ● UL ●	-	-7	0	2.8mm	0.40mm	#201-M8-140-2	#201-M8-240-2	#201-M2-140-2	#201-M2-240-2
1st Bicuspid w/ Hk	UR ● UL ●	D	-7	0	2.8mm	0.40mm	#201-M8-1410-2	#201-M8-2410-2	#201-M2-1410-2	#201-M2-2410-2
2nd Bicuspid	UR ● UL ●	-	-7	0	2.8mm	0.40mm	#201-M8-150-2	#201-M8-250-2	#201-M2-150-2	#201-M2-250-2
2nd Bicuspid w/ Hk	UR ● UL ●	D	-7	0	2.8mm	0.40mm	#201-M8-1510-2	#201-M8-2510-2	#201-M2-1510-2	#201-M2-2510-2
MANDIBULAR	REF	HK	TRQ	ANG	M/D	IN/OUT	.018 RIGHT	.018 LEFT	.022 RIGHT	.022 LEFT
1st Bicuspid	LR ● LL ●	-	-12	+2	2.8mm	0.40mm	#201-M8-340-2	#201-M8-440-2	#201-M2-340-2	#201-M2-440-2
1st Bicuspid w/ Hk	LR ● LL ●	D	-12	+2	2.8mm	0.40mm	#201-M8-3410-2	#201-M8-4410-2	#201-M2-3410-2	#201-M2-4410-2
2nd Bicuspid	LR ● LL ●	-	-17	+2	2.8mm	0.40mm	#201-M8-350-2	#201-M8-450-2	#201-M2-350-2	#201-M2-450-2
2nd Bicuspid w/ Hk	LR ● LL ●	D	-17	+2	2.8mm	0.40mm	#201-M8-3510-2	#201-M8-4510-2	#201-M2-3510-2	#201-M2-4510-2

PROVEN STRENGTH

Independent testing has shown the strength and durability of the Atlas Mini Bracket outperforms leading industry twin brackets. Other bracket lines collapsed earlier on under pressure when compared to Atlas Mini Bracket during the most rigorous crush test. The result is unparalleled performance and reliability that set a new standard in orthodontic excellence.

Verified Slot Strength

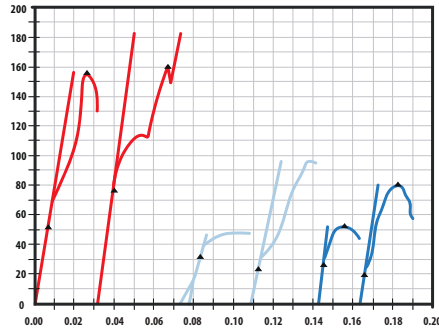

Brackets Tested:

- Atlas Mini
- Competitor 1
- Competitor 2



80 Gauge Foil Mesh Pad
Achieve Superior Bond strength and uncompromising reliability.



Base Palmer Notation
Effortless Identification using The Palmer Notation on the bracket base simplifying tooth identification.

Compound Contour Base
A compound contour base ensures a secure fit and optimal adaptation to various tooth contours.

Atlas Mini OVAL BASE

Our Atlas Mini - Oval Base is slightly smaller than our Atlas Mini bicuspid bracket, yet longer on the mesial and distal for added strength.



Atlas Mini - Oval Pad

Atlas Mini Bracket System With Oval Base, Roth™ Rx - 10 Pack

MAXILLARY	REF	HK	TRQ	ANG	M/D	IN/OUT	.018 RIGHT	.018 LEFT	.022 RIGHT	.022 LEFT
1st Bicuspid	UR ● UL ●	-	-7	0	2.8mm	0.59mm	#201-R8OV-14	#201-R8OV-24	#201-R2OV-14	#201-R2OV-24
1st Bicuspid w/ Hook	UR ● UL ●	D	-7	0	2.8mm	0.59mm	#201-R8OV-141	#201-R8OV-241	#201-R2OV-141	#201-R2OV-241
2nd Bicuspid	UR ● UL ●	-	-7	0	2.8mm	0.59mm	#201-R8OV-15	#201-R8OV-25	#201-R2OV-15	#201-R2OV-25
2nd Bicuspid w/ Hook	UR ● UL ●	D	-7	0	2.8mm	0.59mm	#201-R8OV-151	#201-R8OV-251	#201-R2OV-151	#201-R2OV-251
MANDIBULAR	REF	HK	TRQ	ANG	M/D	IN/OUT	.018 RIGHT	.018 LEFT	.022 RIGHT	.022 LEFT
1st Bicuspid	LR ● LL ●	-	-17	0	2.8mm	0.64mm	#201-R8OV-34	#201-R8OV-44	#201-R2OV-34	#201-R2OV-44
1st Bicuspid w/ Hook	LR ● LL ●	D	-17	0	2.8mm	0.64mm	#201-R8OV-341	#201-R8OV-441	#201-R2OV-341	#201-R2OV-441
2nd Bicuspid	LR ● LL ●	-	-22	0	2.8mm	0.69mm	#201-R8OV35	#201-R8OV-45	#201-R2OV-35	#201-R2OV-45
2nd Bicuspid w/ Hook	LR ● LL ●	D	-22	0	2.8mm	0.69mm	#201-R8OV351	#201-R8OV-451	#201-R2OV-351	#201-R2OV-451

Atlas Mini Bracket System With Oval Base, MBT™ Rx - 10 Pack

MAXILLARY	REF	HK	TRQ	ANG	M/D	IN/OUT	.018 RIGHT	.018 LEFT	.022 RIGHT	.022 LEFT
1st Bicuspid	UR ● UL ●	-	-7	0	2.8mm	0.40mm	#201-M8OV-14	#201-M8OV-24	#201-M2OV-14	#201-M2OV-24
1st Bicuspid w/ Hook	UR ● UL ●	D	-7	0	2.8mm	0.40mm	#201-M8OV-141	#201-M8OV-241	#201-M2OV-141	#201-M2OV-241
2nd Bicuspid	UR ● UL ●	-	-7	0	2.8mm	0.40mm	#201-M8OV-15	#201-M8OV-25	#201-M2OV-15	#201-M2OV-25
2nd Bicuspid w/ Hook	UR ● UL ●	D	-7	0	2.8mm	0.40mm	#201-M8OV-151	#201-M8OV-251	#201-M2OV-151	#201-M2OV-251
MANDIBULAR	REF	HK	TRQ	ANG	M/D	IN/OUT	.018 RIGHT	.018 LEFT	.022 RIGHT	.022 LEFT
1st Bicuspid	LR ● LL ●	-	-12	0	2.8mm	0.40mm	#201-M8OV-34	#201-M8OV-44	#201-M2OV-34	#201-M2OV-44
1st Bicuspid w/ Hook	LR ● LL ●	D	-12	0	2.8mm	0.40mm	#201-M8OV-341	#201-M8OV-441	#201-M2OV-341	#201-M2OV-441
2nd Bicuspid	LR ● LL ●	-	-17	0	2.8mm	0.40mm	#201-M8OV-35	#201-M8OV-45	#201-M2OV-35	#201-M2OV-45
2nd Bicuspid w/ Hook	LR ● LL ●	D	-17	0	2.8mm	0.40mm	#201-M8OV-351	#201-M8OV-451	#201-M2OV-351	#201-M2OV-451

Atlas Mini *Light Gold* Bracket System

Our Atlas Mini Light Gold brackets are refreshingly beautiful as well as extremely functional. With all the same great features of our Atlas Mini bracket along with the aesthetic appeal of Light Gold, your options have no limits with DynaFlex® bracket systems. The Light Gold bracket retains all the strength and durability of the Atlas Mini as well as the ultra-smooth slot that improves sliding mechanics and enhances patient treatment time. Our exclusive ionizing process leaves a brilliant, smooth finish without the risk of abrasion or peeling off.

Available in .018 and .022 – Roth or MBT.



BRACKETS

Atlas Mini Light Gold Bracket System, Roth Rx - 10 Pack

MAXILLARY	HK	TRQ	ANG	M/D	IN/OUT	.018 RIGHT	.018 LEFT	.022 RIGHT	.022 LEFT
Central	-	+12	+5	3.4mm	0.61mm	#200-1811	#200-1821	#204-2211	#204-2221
Lateral	-	+8	+9	2.8mm	0.80mm	#200-1812	#200-1822	#204-2212	#204-2222
Cuspid w/ Hk	D	-2	+11	3.0mm	0.58mm	#200-18131	#200-18231	#204-22131	#204-22231
1st/2nd Bi w/ DG Hk	D	-7	0	2.8mm	0.59mm	#200-18141D	#200-18241D	#204-22141D	#204-22241D
MANDIBULAR	HK	TRQ	ANG	M/D	IN/OUT	.018 RIGHT	.018 LEFT	.022 RIGHT	.022 LEFT
Lower Anteriors	-	0	0	2.3mm	0.78mm	#200-1831	Universal	#204-2231	Universal
Cuspid w/ Hk	D	-11	+5	2.8mm	0.61mm	#200-18331	#200-18431	#204-22331	#204-22431
1st/2nd Bi w/ DG Hk	D	-17	0	2.8mm	0.64mm	#200-18341D	#200-18441D	#204-22341D	#204-22441D

Atlas Mini Light Gold Bracket System, Roth Rx - 5x5 Set

FULL SETS	.018 SLOT	.022 SLOT
Upper/Lower 5x5 Hks on 3,4,5's	#200-R8-345	#204-R2-345

Atlas Mini Light Gold Bracket System, MBT™ Rx - 10 Pack

MAXILLARY	HK	TRQ	ANG	M/D	IN/OUT	.018 RIGHT	.018 LEFT	.022 RIGHT	.022 LEFT
Central	-	+17	+4	3.1mm	0.40mm	#210-1811	#210-1821	#214-2211	#214-2221
Lateral	-	+10	+8	2.8mm	0.78mm	#210-1812	#210-1822	#214-2212	#214-2222
Cuspid w/ Hook	D	-7	+8	2.8mm	0.40mm	#210-18131	#210-18231	#214-22131	#214-22231
1st/2nd Bi w/ DG Hk	D	-7	0	2.8mm	0.40mm	#210-18141D	#210-18241D	#214-22141D	#214-22241D
MANDIBULAR	HK	TRQ	ANG	M/D	IN/OUT	.018 RIGHT	.018 LEFT	.022 RIGHT	.022 LEFT
Lower Anteriors	-	-6	0	2.2mm	0.76mm	#210-1831	Universal	#214-2231	Universal
Cuspid w/ Hk	D	-6	+3	2.8mm	0.40mm	#210-18331	#210-18431	#214-22331	#214-22431
1st/2nd Bi w/ DG Hk	D	-12	+2	2.8mm	0.40mm	#210-18341D	#210-18441D	#214-22341D	#214-22441D

Atlas Mini Light Gold Bracket System, MBT™ Rx - 5x5 Set

FULL SETS	.018 SLOT	.022 SLOT
Upper/Lower 5x5 Hks on 3,4,5's	#210-M8-345	#214-M2-345

*DynaFlex® does not imply any endorsements from Drs. McLaughlin, Bennett and Trevisi and does not claim to be an exact duplicate of the MBT™ system. MBT™ is a registered trademark of 3M/Unitek Corporation.

Atlas Mini *Bright Gold* Bracket System

For a bolder look, try our Atlas Mini Bright Gold Brackets! With all the same great features of our Atlas Mini bracket along with the aesthetic and bold appeal of Bright Gold, your options have no limits with DynaFlex® bracket systems. The Bright Gold bracket retains all the strength and durability of the Atlas Mini as well as the ultra-smooth slot that improves sliding mechanics and enhances patient treatment time. Our exclusive coating process leaves a brilliant, smooth finish without the risk of abrasion or peeling off. Patients love these!

Available in .018 and .022 – Roth or MBT.



BRACKETS

Atlas Mini Bright Gold Bracket System, Roth Rx - 10 Pack

MAXILLARY	HK	TRQ	ANG	M/D	IN/OUT	.018 RIGHT	.018 LEFT	.022 RIGHT	.022 LEFT
Central	-	+12	+5	3.4mm	0.61mm	#2194G-11	#2194G-21	#2195G-11	#2195G-21
Lateral	-	+8	+9	2.8mm	0.80mm	#2194G-12	#2194G-22	#2195G-12	#2195G-22
Cuspid w/ Hk	D	-2	+11	3.0mm	0.58mm	#2194G-131	#2194G-231	#2195G-131	#2195G-231
1st/2nd Bi w/ DG Hk	D	-7	0	2.8mm	0.59mm	#2194G-141D	#2194G-241D	#2195G-141	#2195G-241
MANDIBULAR	HK	TRQ	ANG	M/D	IN/OUT	.018 RIGHT	.018 LEFT	.022 RIGHT	.022 LEFT
Lower Anteriors	-	0	0	2.3mm	0.78mm	#2194G-31	Universal	#2195G-31	Universal
Cuspid w/ Hook	D	-11	+5	2.8mm	0.61mm	#2194G-331	#2194G-431	#2195G-331	#2195G-431
1st/2nd Bi w/ DG Hk	D	-17	0	2.8mm	0.64mm	#2194G-341D	#2194G-441D	#2195G-341	#2195G-441

Atlas Mini Bright Gold Bracket System, Roth Rx - 5x5 Sets

FULL SETS	.018 SLOT	.022 SLOT
Upper/Lower 5x5 Hks on 3,4,5's	#2194G-345	#2195G-345

Atlas Mini Bright Gold Bracket System, MBT™ Rx - 10 Pack

MAXILLARY	HK	TRQ	ANG	M/D	IN/OUT	.018 RIGHT	.018 LEFT	.022 RIGHT	.022 LEFT
Central	-	+17	+4	3.1mm	0.40mm	#2197G-11	#2197G-21	#2198G-11	#2198G-21
Lateral	-	+17	+4	3.1mm	0.78mm	#2197G-12	#2197G-22	#2198G-12	#2198G-22
Cuspid w/ Hook	D	-7	+8	2.8mm	0.40mm	#2197G-131	#2197G-231	#2198G-131	#2198G-231
1st/2nd Bi w/ DG Hk	D	-7	0	2.8mm	0.40mm	#2197G-141D	#2197G-241D	#2198G-141	#2198G-241
MANDIBULAR	HK	TRQ	ANG	M/D	IN/OUT	.018 RIGHT	.018 LEFT	.022 RIGHT	.022 LEFT
Lower Anteriors	-	-6	0	2.2mm	0.76mm	#2197G-31	Universal	#2198G-31	Universal
Cuspid w/ Hook	D	-6	+3	2.8mm	0.40mm	#2197G-331	#2197G-431	#2198G-331	#2198G-431
1st/2nd Bi w/ DG Hk	D	-12	+2	2.8mm	0.40mm	#2197G-341D	#2197G-441D	#2198G-341	#2198G-441

Atlas Mini Bright Gold Bracket System, MBT™ Rx - 5x5 Set

FULL SETS	.018 SLOT	.022 SLOT
Upper/Lower 5x5 Hks on 3,4,5's	#2197G-345	#2198G-345

Atlas Standard Bracket System

The Atlas Standard Profile bracket system offers the same features and benefits that our Atlas Mini provides. These standard profile brackets provide excellent bond strength and outstanding control and function. By offering a slightly larger base and with the mesial distal being similar to other larger brackets in the market, we can guarantee greater rotational control.

Available in .018 and .022 – Roth or MBT.

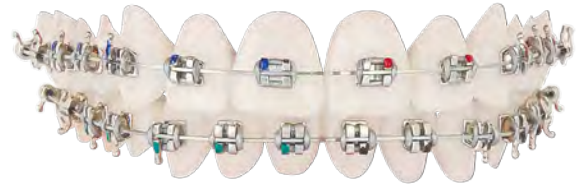

Atlas Standard Bracket System, Roth Rx - 10 Pack

MAXILLARY	REF	HK	TRQ	ANG	M/D	IN/OUT	.018 RIGHT	.018 LEFT	.022 RIGHT	.022 LEFT
Central	UR UL	-	+12	+5	3.4mm	0.70mm	#202-R8-11	#202-R8-21	#202-R2-11	#202-R2-21
Lateral	UR UL	-	+8	+9	2.9mm	1.08mm	#202-R8-12	#202-R8-22	#202-R2-12	#202-R2-22
Cuspid	UR UL	-	-2	+11	3.0mm	0.70mm	#202-R8-13	#202-R8-23	#202-R2-13	#202-R2-23
Cuspid w/ Hk	UR UL	D	-2	+11	3.0mm	0.70mm	#202-R8-131	#202-R8-231	#202-R2-131	#202-R2-231
1st Bicuspid	UR UL	-	-7	0	2.9mm	0.70mm	#202-R8-14	#202-R8-24	#202-R2-14	#202-R2-24
1st Bicuspid w/ Hk	UR UL	M	-7	0	2.9mm	0.70mm	#202-R8-141	#202-R8-241	#202-R2-141	#202-R2-241
2nd Bicuspid	UR UL	-	-7	0	2.9mm	0.70mm	#202-R8-15	#202-R8-25	#202-R2-15	#202-R2-25
2nd Bicuspid w/ Hk	UR UL	M	-7	0	2.9mm	0.70mm	#202-R8-151	#202-R8-251	#202-R2-151	#202-R2-251
MANDIBULAR	REF	HK	TRQ	ANG	M/D	IN/OUT	.018 RIGHT	.018 LEFT	.022 RIGHT	.022 LEFT
Lower Anterior	LR LL	-	-1	+2	2.5mm	1.08mm	#202-R8-31	Universal	#202-R2-31	Universal
Cuspid	LR LL	-	-11	+5	2.9mm	0.70mm	#202-R8-33	#202-R8-43	#202-R2-33	#202-R2-43
Cuspid w/ Hk	LR LL	D	-11	+5	2.9mm	0.70mm	#202-R8-331	#202-R8-431	#202-R2-331	#202-R2-431
1st Bicuspid	LR LL	-	-17	0	2.9mm	0.70mm	#202-R8-34	#202-R8-44	#202-R2-34	#202-R2-44
1st Bicuspid w/ Hk	LR LL	M	-17	0	2.9mm	0.70mm	#202-R8-341	#202-R8-441	#202-R2-341	#202-R2-441
2nd Bicuspid	LR LL	-	-22	0	2.9mm	0.70mm	#202-R8-35	#202-R8-45	#202-R2-35	#202-R2-45
2nd Bicuspid w/ Hk	LR LL	M	-22	0	2.9mm	0.70mm	#202-R8-351	#202-R8-451	#202-R2-351	#202-R2-451

Atlas Standard Bracket System, Roth Rx - 5x5 Set

FULL SETS	.018 SLOT	.022 RIGHT
Upper/Lower 5x5 Hks on 3,4,5's	#202-R8-345	#202-R2-345

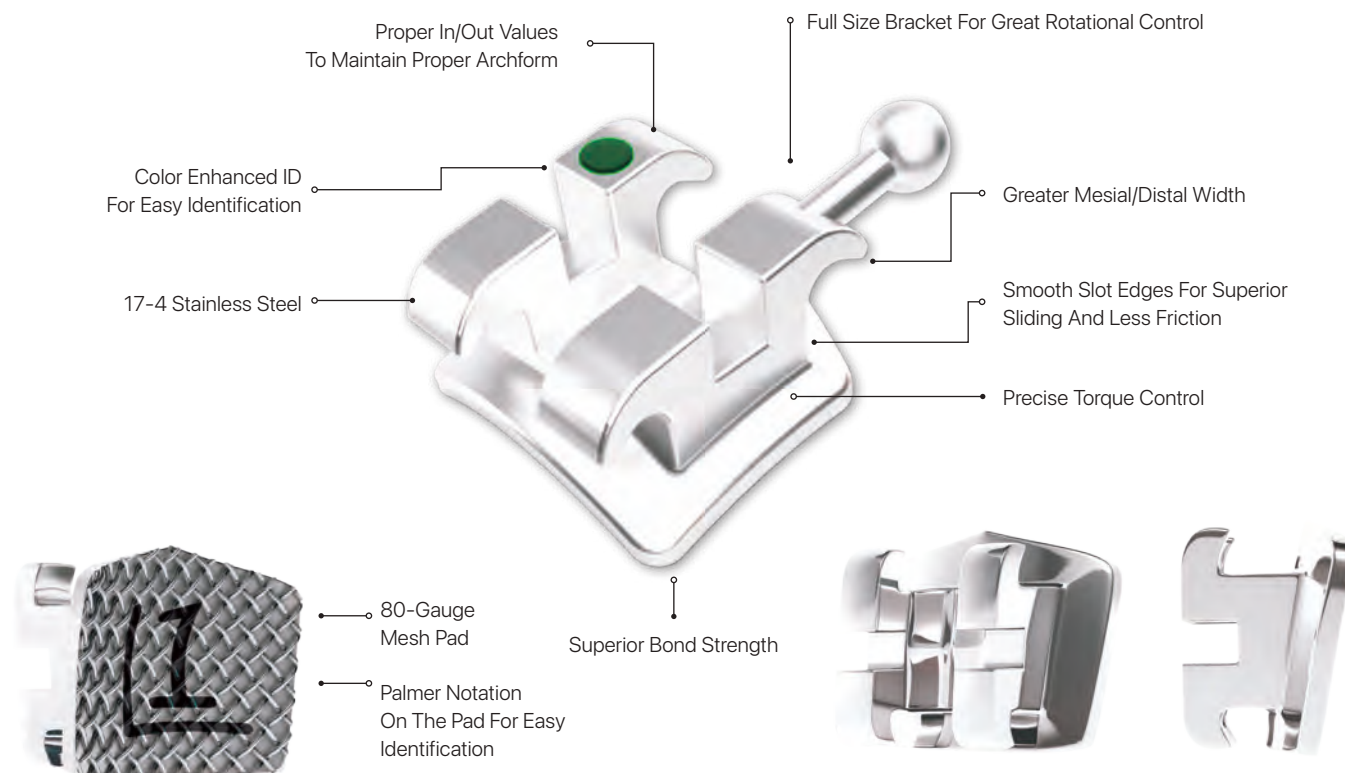

Atlas Standard Bracket System, MBT™ Rx - 10 Pack

MAXILLARY	REF	HK	TRQ	ANG	M/D	IN/OUT	.018 RIGHT	.018 LEFT	.022 RIGHT	.022 LEFT
Central	UR ● UL ●	-	+17	+4	3.6mm	0.40mm	#202-M8-11	#202-M8-21	#202-M2-11	#202-M2-21
Lateral	UR ● UL ●	-	+10	+8	2.8mm	0.78mm	#202-M8-12	#202-M8-22	#202-M2-12	#202-M2-22
Cuspid	UR ● UL ●	-	-7	+8	3.0mm	0.40mm	#202-M8-13	#202-M8-23	#202-M2-13	#202-M2-23
Cuspid w/ Hk	UR ● UL ●	D	-7	+8	3.0mm	0.40mm	#202-M8-131	#202-M8-231	#202-M2-131	#202-M2-231
1st Bicuspid	UR ● UL ●	-	-7	0	3.0mm	0.40mm	#202-M8-14	#202-M8-24	#202-M2-14	#202-M2-24
1st Bicuspid w/ Hk	UR ● UL ●	M	-7	0	3.0mm	0.40mm	#202-M8-141	#202-M8-241	#202-M2-141	#202-M2-241
2nd Bicuspid	UR ● UL ●	-	-7	0	3.0mm	0.60mm	#202-M8-15	#202-M8-25	#202-M2-15	#202-M2-25
2nd Bicuspid w/ Hk	UR ● UL ●	M	-7	0	3.0mm	0.60mm	#202-M8-151	#202-M8-251	#202-M2-151	#202-M2-251
MANDIBULAR	REF	HK	TRQ	ANG	M/D	IN/OUT	.018 RIGHT	.018 LEFT	.022 RIGHT	.022 LEFT
Central	LR ● LL ●	-	-6	0	2.7mm	0.78mm	#202-M8-31	#202-M8-41	#202-M2-31	Universal
Lateral	LR ● LL ●	-	-6	0	2.7mm	0.78mm	#202-M8-32	#202-M8-42	Universal	Universal
Cuspid	LR ● LL ●	-	-6	+3	3.0mm	0.40mm	#202-M8-33	#202-M8-43	#202-M2-33	#202-M2-43
Cuspid w/ Hk	LR ● LL ●	D	-6	+3	3.0mm	0.40mm	#202-M8-331	#202-M8-431	#202-M2-331	#202-M2-431
1st Bicuspid	LR ● LL ●	-	-12	+2	3.0mm	0.40mm	#202-M8-34	#202-M8-44	#202-M2-34	#202-M2-44
1st Bicuspid w/ Hk	LR ● LL ●	M	-12	+2	3.0mm	0.40mm	#202-M8-341	#202-M8-441	#202-M2-341	#202-M2-441
2nd Bicuspid	LR ● LL ●	-	-17	+2	3.0mm	0.40mm	#202-M8-35	#202-M8-45	#202-M2-35	#202-M2-45
2nd Bicuspid w/ Hk	LR ● LL ●	M	-17	+2	3.0mm	0.40mm	#202-M8-351	#202-M8-451	#202-M2-351	#202-M2-451

Atlas Standard Bracket System, MBT™ Rx - 5x5 Set

FULL SETS	.018 SLOT	.022 SLOT
Upper/Lower 5x5 Hks on 3,4,5's	#202-M8-345	#202-M2-345

*DynaFlex® does not imply any endorsements from Drs. McLaughlin, Bennett and Trevisi and does not claim to be an exact duplicate of the MBT™ system. MBT™ is a registered trademark of 3M/Unitek Corporation.

MTX™

MINI-TWIN EXTREME



Bracket System

To ensure absolute control, we've intricately integrated torque into the base of each bracket, meticulously designed to conform to the unique contours of teeth, encompassing both their mesial-distal and occlusal-gingival dimensions. These brackets have been ingeniously engineered with precise angulation, aligning the long axis of the root with the distal part of the crown, thus ensuring a parallel alignment of all roots. The anatomically contoured design not only enhances the precision of bracket placement but also guarantees that all slots align perfectly at the conclusion of treatment. In the case of upper central and lateral teeth, they exhibit an intentional "plus" torque, promoting optimal contact point alignment and bolstering occlusion stability. With these brackets, you can expect unrivaled control, ensuring that teeth remain rotation-free throughout the treatment process.

Available in .018 and .022 – Roth or MBT.



Occlusal View

Torque Built Into Base

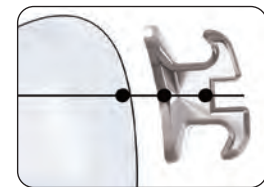
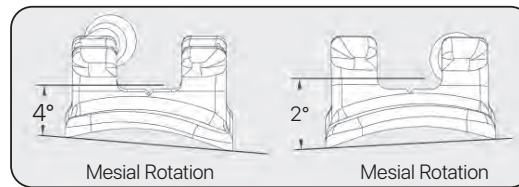

for efficient tooth movement.

MTX™ Bracket System, Roth Rx - 10 Pack

MAXILLARY	REF	HK	TRQ	ANG	M/D	.018 RIGHT	.018 LEFT	.022 RIGHT	.022 LEFT
Central	UR ● UL ●	-	+12	+5	3.7mm	#2501-11	#2501-21	#2500-11	#2500-21
Lateral	UR ● UL ●	-	+8	+9	2.9mm	#2501-12	#2501-22	#2500-12	#2500-22
Cuspid w/ Hook	UR ● UL ●	D	-2	+13	3.0mm	#2501-131	#2501-231	#2500-131	#2500-231
1st/2nd Bicuspid	UR ● UL ●	-	-7	0	3.0mm	#2501-14	Universal	#2500-14	Universal
1st/2nd Bicuspid w/ Hook	UR ● UL ●	M	-7	0	3.0mm	#2501-141	#2501-241	#2500-141	#2500-241
MANDIBULAR	REF	HK	TRQ	ANG	M/D	.018 RIGHT	.018 LEFT	.022 RIGHT	.022 LEFT
Anteriors	LR ○ LL ○	-	0	0	2.6mm	#2501-31	Universal	#2500-31	Universal
Cuspid w/ Hook	LR ● LL ●	D	-7	+2	3.0mm	#2501-331	#2501-431	#2500-331	#2500-431
1st Bicuspid	LR ○ LL ○	-	-17	0	3.0mm	#2501-34	Universal	#2500-34	Universal
1st Bicuspid w/ Hook	LR ○ LL ○	D	-17	0	3.0mm	#2501-341	#2501-441	#2500-341	#2500-441
2nd Bicuspid	LR ● LL ●	-	-22	0	3.0mm	#2501-35	Universal	#2500-35	Universal
2nd Bicuspid w/ Hook	LR ● LL ●	D	-22	0	3.0mm	#2501-351	#2501-451	#2500-351	#2500-451

MTX™ Bracket System, Roth Rx - 5x5 Set

FULL SETS	.018 SLOT	.022 SLOT
Upper/Lower 5x5 Hks on 3's	#2501-3HK	#2500-3HK
Upper/Lower 5x5 Hks on 3,4,5's	#2501-345HK	#2500-345HK

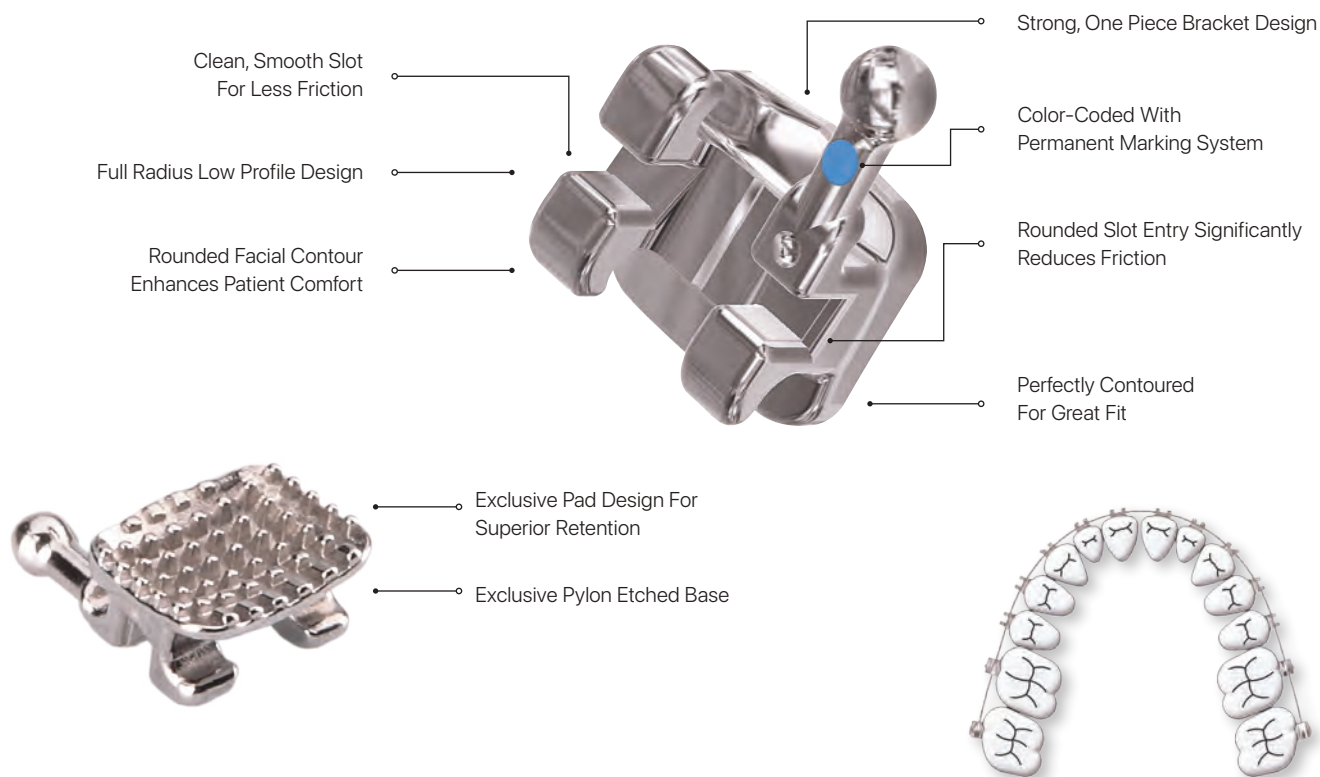

Combined Effort

Individual bracket thicknesses are built into each bracket and buccal tube (labial-lingual), reducing the need for first order in-out wire bends. The combination of these features easily allows for a flat curve of spee.

MTX™ Bracket System, MBT™ Rx - 10 Pack

MAXILLARY	REF	HK	TRQ	ANG	M/D	.018 RIGHT	.018 LEFT	.022 RIGHT	.022 LEFT
Central	UR ● UL ●	-	+17	+4	3.5mm	#2401-11	#2401-21	#2400-11	#2400-21
Lateral	UR ● UL ●	-	+8	+9	2.9mm	#2401-12	#2401-22	#2400-12	#2400-22
Cuspid w/ Hook	UR ● UL ●	D	-7	+9	3.0mm	#2401-131	#2401-231	#2400-131	#2400-231
1st/2nd Bicuspid	UR ● UL ●	-	-7	0	3.0mm	#2401-14	Universal	#2400-14	Universal
1st/2nd Bicuspid w/ Hook	UR ● UL ●	M	-7	0	3.0mm	#2401-141	#2401-241	#2400-141	#2400-241
MANDIBULAR	REF	HK	TRQ	ANG	M/D	.018 RIGHT	.018 LEFT	.022 RIGHT	.022 LEFT
Anteriors	LR ○ LL ○	-	-6	0	2.6mm	#2401-31	Universal	#2400-31	Universal
Cuspid w/ Hook	LR ● LL ●	D	-6	+3	3.2mm	#2401-331	#2401-431	#2400-331	#2400-431
1st Bicuspid	LR ● LL ●	-	-12	+2	2.9mm	#2401-34	Universal	#2400-34	Universal
1st Bicuspid w/ Hook	LR ● LL ●	D	-12	+2	2.9mm	#2401-341	#2401-441	#2400-341	#2400-441
2nd Bicuspid	LR ○ LL ○	-	-17	0	2.9mm	#2401-35	Universal	#2400-35	Universal
2nd Bicuspid w/ Hook	LR ○ LL ○	D	-17	0	2.9mm	#2401-351	#2401-451	#2400-351	#2400-451

MTX™ Bracket System, MBT™ Rx - 5x5 Set

FULL SETS	.018 SLOT	.022 SLOT
Upper/Lower 5x5 Hks on 3's	#2401-3HK	#2400-3HK
Upper/Lower 5x5 Hks on 3,4,5's	#2401-345HK	#2400-345HK

Gold'nBRACES

A DynaFlex® Company

Utilizing a proprietary 24-karat gold plating process, we ensure our orthodontic products are not only aesthetically pleasing but also safe and durable, with a guarantee against chipping and a non-toxic, low-reactivity finish. Unlike traditional metal alternatives, our gold braces are nickel-free, preventing mouth irritations, and offer an anti-inflammatory experience for patients. Additionally, 24-karat gold's non-corrosive and bacteria-resistant properties make it easy for patients to maintain oral hygiene during their treatment period, while its smooth finish enhances overall comfort, ensuring a luxurious and health-conscious orthodontic solution.



- ✓ **Non-Toxic**
- ✓ **Anti-Inflammatory**
- ✓ **Resistant To Bacteria**
- ✓ **Superior Patient Comfort**



Midas® Brackets

Brackets are mini sized with a luxurious finish. Our 24-karat gold multi-layered alloy presents an aesthetically superior bracket.

Only available in Roth .018 and .022. Sold individually.

Midas® Bracket System, Roth Rx - 10 Pack

MAXILLARY	HK	TRQ	ANG	M/D	.018 RIGHT	.018 LEFT	.022 RIGHT	.022 LEFT
Central	-	+12	+5	3.7mm	#2501G-11	#2501G-21	#2500G-11	#2500G-21
Lateral	-	+8	+9	2.9mm	#2501G-12	#2501G-22	#2500G-12	#2500G-22
Cuspid w/ Hook	D	-2	+13	3.0mm	#2501G-131	#2501G-231	#2500G-131	#2500G-231
1st/2nd Bicuspid	-	-7	0	3.0mm	#2501G-14	#2501G-24	#2500G-14	#2500G-24
1st/2nd Bicuspid w/ Hook	M	-7	0	3.0mm	#2501G-141	#2501G-241	#2500G-141	#2500G-241
MANDIBULAR	HK	TRQ	ANG	M/D	.018 RIGHT	.018 LEFT	.022 RIGHT	.022 LEFT
Anteriors	-	0	0	2.6mm	#2501G-31	Universal	#2500G-31	Universal
Cuspid w/ Hook	D	-7	+2	3.0mm	#2501G-331	#2501G-431	#2500G-331	#2500G-431
1st Bicuspid	-	-17	0	3.0mm	#2501G-34	#2501G-44	#2500G-34	#2500G-44
1st Bicuspid w/ Hook	D	-17	0	3.0mm	#2501G-341	#2501G-441	#2500G-341	#2500G-441
2nd Bicuspid	-	-22	0	3.0mm	#2501G-35	#2501G-45	#2500G-35	#2500G-45
2nd Bicuspid w/ Hook	D	-22	0	3.0mm	#2501G-351	#2501G-451	#2500G-351	#2500G-451

Midas® Bracket System, Roth Rx - 5x5 Set

FULL SETS	.018 SLOT	.022 SLOT
Upper/Lower 5x5 Hks on 3's	#2501G-3	#2500G-3
Upper/Lower 5x5 Hks on 3,4,5's	#2501G-345	#2500G-345

Bracket Packaging Options

Our bracket packaging solutions provide secure storage and easy access, designed to meet the needs of any orthodontic practice. Whether storing single sets or bulk quantities, each tray ensures brackets stay organized and visible for efficient workflow. From compact trays to larger storage options, our packaging enhances organization and speeds up daily operations.



Single Set Bracket Tray

Our Single Set Bracket Tray is a sticky pad to hold brackets into place. Up to one 7x7 set per tray with mixing wells. Plastic with clear plastic snap on lid. **Item #3020**



Bulk Bracket Tray

The DynaFlex® Bulk Bracket Tray is designed to hold up to 10 6x6 bracket sets per tray. Hard plastic with clear lid. **Item #3030**



Master Bracket Tray

Specifically designed for bracket storage of up to 50 7x7 sets of brackets. Excellent to have on hand in each office. Hard plastic with clear lid. **Item #3050**

Bracket Typodonts

Did you know that we've expanded our offerings to include typodonts featuring various bracket lines? Each model is meticulously designed to provide an authentic educational and hands-on experience, reflecting the nuances of each bracket system. Whether you're an emerging dental student or a seasoned orthodontist, these typodonts present an accurate representation of human dentition, paving the way for in-depth practice and demonstrations of a range of orthodontic techniques. Beyond their educational value, our typodonts serve as a crucial patient communication tool, enabling clear explanations and demonstrations of orthodontic procedures. Explore our diverse range and enhance your proficiency across all our bracket systems.



Norris **20/26 METAL**

Item #3824-NORRIS



CS5

Item #3824



**CS5
BONDABLE**

Item #3824-BOND

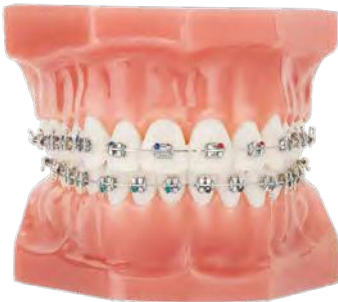

Atlas Mini

Item #3824-ATLAS



Atlas Mini Light Gold

Item #3824-GOLD



Atlas Mini Bright Gold

Item #3824-BRIGHT

Ask About Other Typodonts Available!

GEMINI™ Bracket System

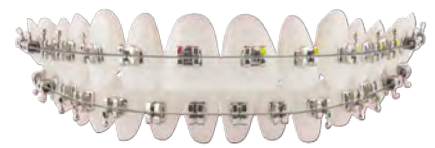

BRACKETS

Gemini™ Bracket System, Roth Standard Rx - 10 Pack

MAXILLARY	REF	HK	TRQ	ANG	M/D	IN/OUT	.018 RIGHT	.018 LEFT	.022 RIGHT	.022 LEFT
Central	UR ●	-	+12	+5	3.7mm	0.9mm	#M-G8001	#M-G8002	#M-G2001	#M-G2002
	UL ●									
Lateral	UR ●	-	+8	+9	3.0mm	1.1mm	#M-G8003	#M-G8004	#M-G2003	#M-G2004
	UL ●									
Cuspid w/ Hk	UR ●	D	-2	+11	3.4mm	0.9mm	#M-G8007	#M-G8008	#M-G2007	#M-G2008
	UL ●									
Upper Bi's	UR ●	-	-7	0	3.2mm	0.9mm	#M-G8010	#M-G8011	#M-G2010	#M-G2011
	UL ●									
Upper Bicuspid w/ Hook	UR ●	M	-7	0	3.2mm	0.9mm	#M-G8013	#M-G8014	#M-G2013	#M-G2014
	UL ●									
MANDIBULAR	REF	HK	TRQ	ANG	M/D	IN/OUT	.018 RIGHT	.018 LEFT	.022 RIGHT	.022 LEFT
Lower Anteriors	LR ○	-	-1	0	2.4mm	1.3mm	#M-G8020	Universal	#M-G2020	Universal
	LL ○									
Cuspid w/ Hook	LR ●	D	-11	0	3.4mm	0.9mm	#M-G8023	#M-G8024	#M-G2023	#M-G2024
	LL ●									
1st Bicuspid	LR ●	-	-17	0	3.2mm	1.0mm	#M-G8026	#M-G8027	#M-G2026	#M-G2027
	LL ●									
1st Bicuspid w/ Hook	LR ●	M	-17	0	3.2mm	1.0mm	#M-G8028	#M-G8029	#M-G2028	#M-G2029
	LL ●									
2nd Bicuspid	LR ●	-	-22	0	3.2mm	1.1mm	#M-G8031	#M-G8032	#M-G2031	#M-G2032
	LL ●									
2nd Bicuspid w/ Hook	LR ●	M	-22	0	3.2mm	1.1mm	#M-G8033	#M-G8034	#M-G2033	#M-G2034
	LL ●									

Gemini™ Bracket System, Roth Standard Rx - 5x5 Sets

FULL SETS	.018 SLOT	.022 SLOT
Gemini Roth .022 5x5 Set Hooks on 3's	-	#M-G20C2
Gemini Roth .022 5x5 Set Hooks on 3,4,5's	#M-G80C4	#M-G20C4

Gemini™ Bracket System, MBT™ Standard - 10 Pack

MAXILLARY	REF	HK	TRQ	ANG	M/D	IN/OUT	.018 RIGHT	.018 LEFT	.022 RIGHT	.022 LEFT
Central	UR ●	-	+17	4	3.7mm	0.8mm	#M-G8101	#M-G8102	#M-G2101	#M-G2102
	UL ●									
Lateral	UR ●	-	+10	+8	3.0mm	1.2mm	#M-G8103	#M-G8104	#M-G2103	#M-G2104
	UL ●									
Cuspid w/ Hk	UR ●	D	-7	0	3.4mm	0.7mm	#M-G8107	#M-G8108	#M-G2107	#M-G2108
	UL ●									
Upper Bi's	UR ●	-	-7	0	3.2mm	0.8mm	#M-G8110	#M-G8111	#M-G2110	#M-G2111
	UL ●									
Upper Bicuspid w/ Hook	UR ●	M	-7	0	3.2mm	0.8mm	#M-G8113	#M-G8114	#M-G2113	#M-G2114
	UL ●									
MANDIBULAR	REF	HK	TRQ	ANG	M/D	IN/OUT	.018 RIGHT	.018 LEFT	.022 RIGHT	.022 LEFT
Lower Anteriors	LR ○	-	-6	0	2.4mm	1.2mm	#M-G8120	Universal	#M-G2120	Universal
	LL ○									
Cuspid w/ Hook	LR ●	D	-6	3	3.4mm	0.7mm	#M-G8123	#M-G8124	#M-G2123	#M-G2124
	LL ●									
1st Bicuspid	LR ●	-	-12	0	3.2mm	0.8mm	#M-G8126	#M-G8127	#M-G2126	#M-G2127
	LL ●									
1st Bicuspid w/ Hook	LR ●	M	-12	0	3.2mm	0.8mm	#M-G8128	#M-G8129	#M-G2128	#M-G2129
	LL ●									
2nd Bicuspid	LR ●	-	-17	0	3.2mm	0.8mm	#M-G8131	#M-G8132	#M-G2131	#M-G2132
	LL ●									
2nd Bicuspid w/ Hook	LR ●	M	-17	+2	3.2mm	0.8mm	#M-G8133	#M-G8134	#M-G2133	#M-G2134
	LL ●									

Gemini™ Bracket System, MBT™ Standard - 5x5 Sets

FULL SETS	.018 SLOT	.022 SLOT
Gemini MBT .022 5x5 Set Hooks on 3's	-	#M-G21C2
Gemini MBT .022 5x5 Set Hooks on 3,4,5's	#M-G81C4	#M-G21C4

Gemini™ brackets, crafted from durable 17-4 grade stainless steel, provide exceptional durability and sustained treatment efficacy in orthodontic care. These brackets feature a unique compound contour base and a center scribe line, ensuring precise alignment and an anatomically accurate fit to teeth. The rounded tie wings and increased tie wing area enhance both patient comfort and secure ligature ties, while the 80-gauge mesh pad ensures optimal adhesive bonding. Also featuring a color id dot for easy identification, the brackets are available in alternative materials like palladium alloy bronze and are offered in both standard and mini sizes to cater to various orthodontic needs.

Gemini™ Bracket System, Roth Mini Rx - 10 Pack

MAXILLARY	REF	HK	TRQ	ANG	M/D	IN/OUT	.018 RIGHT	.018 LEFT	.022 RIGHT	.022 LEFT
Central	UR ● UL ●	-	+12	+5	3.2mm	0.9mm	#M-G8M001	#M-G8M002	#M-G2M001	#M-G2M002
Lateral	UR ● UL ●	-	+8	+9	2.8mm	1.1mm	#M-G8M003	#M-G8M004	#M-G2M003	#M-G2M004
Cuspid w/ Hk	UR ● UL ●	D	0	+11	2.8mm	0.7mm	#M-G8M007	#M-G8M008	#M-G2M007	#M-G2M008
Upper Bi's	UR ● UL ●	-	-7	0	2.8mm	0.8mm	#M-G8M010	#M-G8M011	#M-G2M010	#M-G2M011
Upper Bicuspid w/ Hook	UR ● UL ●	M	-7	0	2.8mm	0.8mm	#M-G8M013	#M-G8M014	#M-G2M013	#M-G2M014
MANDIBULAR	REF	HK	TRQ	ANG	M/D	IN/OUT	.018 RIGHT	.018 LEFT	.022 RIGHT	.022 LEFT
Lower Anteriors	LR ○ LL ○	-	-1	0	2.3mm	1.0mm	#M-G8M020	Universal	#M-G2M020	Universal
Cuspid w/ Hook	LR ● LL ●	D	-5	0	2.8mm	0.7mm	#M-G8M023	#M-G8M024	#M-G2M023	#M-G2M024
1st Bicuspid	LR ● LL ●	-	-17	0	2.8mm	0.7mm	#M-G8M026	#M-G8M027	#M-G2M026	#M-G2M027
1st Bicuspid w/ Hook	LR ● LL ●	M	-17	0	2.8mm	0.7mm	#M-G8M028	#M-G8M029	#M-G2M028	#M-G2M029
2nd Bicuspid	LR ● LL ●	-	-22	0	2.8mm	0.7mm	#M-G8M031	#M-G8M032	#M-G2M031	#M-G2M032
2nd Bicuspid w/ Hook	LR ● LL ●	M	-22	0	2.8mm	0.7mm	#M-G8M033	#M-G8M034	#M-G2M033	#M-G2M034

Gemini™ Bracket System, Roth Mini Rx - 5x5 Sets

FULL SETS	.018 SLOT	.022 SLOT
Gemini Mini Roth .022 Hooks on 3's	#M-G8M0C2	#M-G2M0C2
Gemini Mini Roth .022 Hooks on 3,4,5's	#M-G8M0C4	#M-G2M0C4

Gemini™ Bracket System, MBT™ Mini Rx - 10 Packs

MAXILLARY	REF	HK	TRQ	ANG	M/D	IN/OUT	.018 RIGHT	.018 LEFT	.022 RIGHT	.022 LEFT
Central	UR ● UL ●	-	+17	4	3.2mm	0.9mm	#M-G8M101	#M-G8M102	#M-G2M101	#M-G2M102
Lateral	UR ● UL ●	-	+10	+8	2.8mm	1.2mm	#M-G8M103	#M-G8M104	#M-G2M103	#M-G2M104
Cuspid w/ Hk	UR ● UL ●	D	0	+8	2.8mm	0.9mm	#M-G8M107	#M-G8M108	#M-G2M107	#M-G2M108
Upper Bi's	UR ● UL ●	-	-7	0	2.8mm	0.8mm	#M-G8M110	#M-G8M111	#M-G2M110	#M-G2M111
Upper Bicuspid w/ Hook	UR ● UL ●	M	-7	0	2.8mm	0.8mm	#M-G8M113	#M-G8M114	#M-G2M113	#M-G2M114
MANDIBULAR	REF	HK	TRQ	ANG	M/D	IN/OUT	.018 RIGHT	.018 LEFT	.022 RIGHT	.022 LEFT
Lower Anteriors	LR ○ LL ○	-	-6	0	2.3mm	1.2mm	#M-G8M120	Universal	#M-G2M120	Universal
Cuspid w/ Hook	LR ● LL ●	D	-6	+3	2.8mm	0.8mm	#M-G8M123	#M-G8M124	#M-G2M123	#M-G2M124
1st Bicuspid	LR ● LL ●	-	-12	0	2.8mm	0.8mm	#M-G8M126	#M-G8M127	#M-G2M126	#M-G2M127
1st Bicuspid w/ Hook	LR ● LL ●	M	-12	0	2.8mm	0.8mm	#M-G8M128	#M-G8M129	#M-G2M128	#M-G2M129
2nd Bicuspid	LR ● LL ●	-	-17	0	2.8mm	0.8mm	#M-G8M131	#M-G8M132	#M-G2M131	#M-G2M132
2nd Bicuspid w/ Hook	LR ● LL ●	M	-17	0	2.8mm	0.8mm	#M-G8M133	#M-G8M134	#M-G2M133	#M-G2M134

Gemini™ Bracket System, MBT™ Mini Rx - 5x5 Sets

FULL SETS	.018 SLOT	.022 SLOT
Gemini Mini MBT .022 Hooks on 3's	#M-G8M1C2	#M-G2M1C2
Gemini Mini MBT .022 Hooks on 3,4,5's	#M-G8M1C4	#M-G2M1C4

Endurance®

SELF-LIGATING BRACKET SYSTEM

The all new Endurance® Self-Ligating Bracket System provides similar features to our traditional twin brackets with an integrated Nickel Titanium clip. The exceptional memory characteristic of NiTi ensures reliable operation without the risk of deformation throughout the entire length of treatment. The flexible clip will provide greater leveling and alignment during the early stages of treatment. Once the archwire is increased the bracket becomes active providing greater rotational control. With greater rotational and full archwire engagement, the friction or active part of the bracket will provide greater individual tooth control. The Endurance® Self-Ligating Bracket System delivers all the performance and control you would expect in a self-ligating appliance.

Available in Roth .018 and .022, or MBT .022.



Self-Ligating Instrument

Item #1444

We recommend our Self-Ligating Instrument for easy opening and closing of the bracket door.

Endurance® Bracket System, Roth Rx - 10 Pack

MAXILLARY	REF	HK	TRQ	ANG	M/D	.018 RIGHT	.018 LEFT	.022 RIGHT	.022 LEFT
Central	UR ●	-	12	5	4.0mm	#605-1811	#605-1821	#610-2211	#610-2221
	UL ●								
Lateral	UR ●	-	8	9	4.0mm	#605-1812	#605-1822	#610-2212	#610-2222
	UL ●								
Cuspid w/ Hk	UR ●	D	-2	11	3.5mm	#605-18131	#605-18231	#610-22131	#610-22231
	UL ●								
1st Bicuspid	UR ●	-	-7	0	4.0mm	#605-1814	Universal	#610-2214	Universal
	UL ●								
1st Bicuspid w/ Hk	UR ●	D	-7	0	4.0mm	#605-18141	#605-18241	#610-22141	#610-22241
	UL ●								
2nd Bicuspid	UR ●	-	-7	0	4.0mm	#605-1815	Universal	#610-2215	Universal
	UL ●								
2nd Bicuspid w/ Hk	UR ●	D	-7	0	4.0mm	#605-18151	#605-18251	#610-22151	#610-22251
	UL ●								
MANDIBULAR	REF	HK	TRQ	ANG	M/D	.018 RIGHT	.018 LEFT	.022 RIGHT	.022 LEFT
Lower Anteriors	LR ⊙	-	0	0	3.2mm	#605-1831	Universal	#610-2231	Universal
	LL ⊙								
Cuspid w/ Hk	LR ●	D	-11	7	4.0mm	#605-18331	#605-18431	#610-22331	#610-22431
	LL ●								
1st Bicuspid	LR ●	-	-17	0	4.0mm	#605-1834	Universal	#610-2234	Universal
	LL ●								
1st Bicuspid w/ Hk	LR ●	D	-17	0	4.0mm	#605-18341	#605-18441	#610-22341	#610-22441
	LL ●								
2nd Bicuspid	LR ●	-	-22	0	4.0mm	#605-1835	Universal	#610-2235	Universal
	LL ●								
2nd Bicuspid w/ Hk	LR ●	D	-22	0	4.0mm	#605-18351	#605-18451	#610-22351	#610-22451
	LL ●								

Endurance® Bracket System, Roth Rx - 5x5 Sets

FULL SETS	.018 SLOT	.022 SLOT
Upper/Lower 5x5 Hks on 3,4,5's	#605-R8-345	#605-R2-345

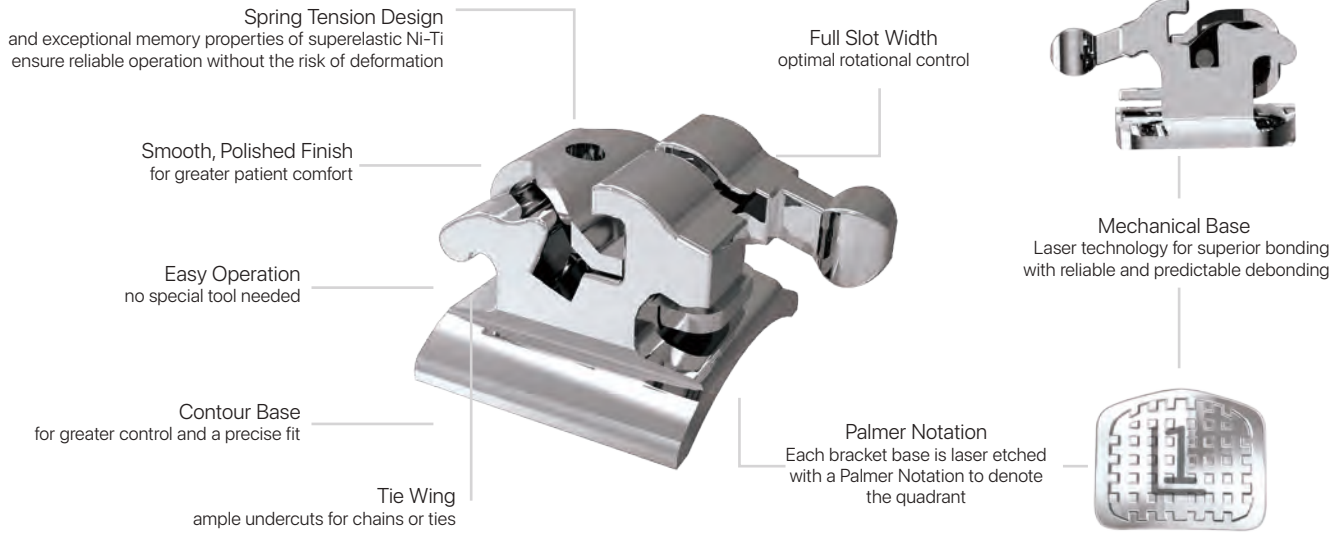

Interactive Control

The dynamic interaction between the ligating mechanism and the archwire enables the precise degree of control needed for each phase of treatment.

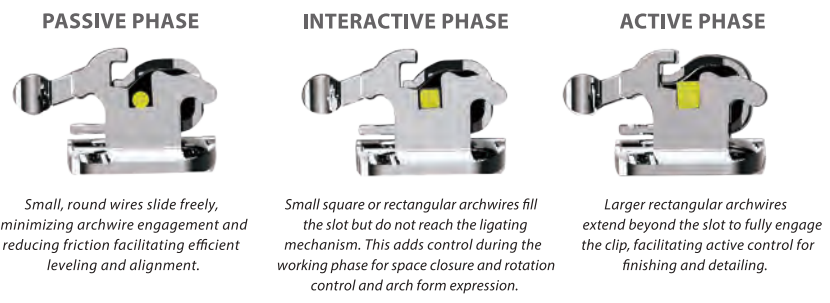

Endurance® Bracket System, MBT™ Rx - 10 Pack

MAXILLARY	REF	HK	TRQ	ANG	M/D	.022 RIGHT	.022 LEFT
Central	UR ● UL ●	-	17	4	4.0mm	#700-2211	#700-2221
Lateral	UR ● UL ●	-	10	8	4.0mm	#700-2212	#700-2222
Cuspid w/ Hook	UR ● UL ●	D	-7	8	3.5mm	#700-22131	#700-22231
1st Bicuspid	UR ● UL ●	-	-7	0	4.0mm	#700-2214	Universal
1st Bicuspid w/ Hook	UR ● UL ●	D	-7	0	4.0mm	#700-22141	#700-22241
2nd Bicuspid	UR ● UL ●	-	-7	0	4.0mm	#700-2215	#700-2225
2nd Bicuspid w/ Hook	UR ● UL ●	D	-7	0	4.0mm	#700-22151	#700-22251
MANDIBULAR	REF	HK	TRQ	ANG	M/D	.022 RIGHT	.022 LEFT
Lower Anteriors	LR ⊙ LL ⊙	-	-6	0	3.2mm	#700-2231	Universal
Cuspid w/ Hook	LR ● LL ●	D	-6	3	4.0mm	#700-22331	#700-22431
1st Bicuspid	LR ● LL ●	-	-12	2	4.0mm	#700-2234	Universal
1st Bicuspid w/ Hook	LR ● LL ●	D	-12	2	4.0mm	#700-22341	#700-22441
2nd Bicuspid	LR ● LL ●	-	-17	2	4.0mm	#700-2235	Universal
2nd Bicuspid w/ Hook	LR ● LL ●	D	-17	2	4.0mm	#700-22351	#700-22451

Endurance® Bracket System, MBT™ Rx - 5x5 Sets

FULL SETS	.022 SLOT
Upper/Lower 5x5 Hooks on 3,4,5's	#700-M2-345

ClearViz+™ Mini Bracket System

BRACKETS

This Monocrystalline Sapphire bracket that is poised to redefine your perception of clear brackets forever. The ClearViz+™ Mini offers a remarkable advantage – it allows you to embrace the crystal-clear beauty of a bracket without compromising on treatment quality. Its extensive array of features includes the unmatched strength and clarity of Monocrystalline Sapphire, a Plasma silica coating that enhances sliding mechanics and slot durability, a 30% reduction in size with impeccably rounded edges for unparalleled patient comfort, consistent bond strength throughout treatment, and minimal fracture risk during debonding. Clearly, when it comes to aesthetic orthodontic treatment, the ClearViz+™ Mini stands in a league of its own.



Available in .018 and .022 – Roth or MBT.

Silicone Placement Guides Simplify Bracket Placement!

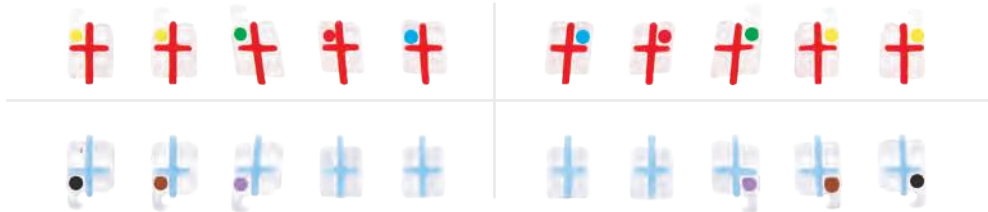

ClearViz+™ Mini Bracket System, Roth Rx - 5 Pack

MAXILLARY	REF	HK	TRQ	ANG	M/D	.018 RIGHT	.018 LEFT	.022 RIGHT	.022 LEFT
Central	UR ● UL ●	-	+12	+5	3.1mm	#300-R8-11	#300-R8-21	#300-R2-11	#300-R2-21
Lateral	UR ● UL ●	-	+8	+9	2.85mm	#300-R8-12	#300-R8-22	#300-R2-12	#300-R2-22
Cuspid w/ Hook	UR ● UL ●	D	-2	+11	3.4mm	#300-R8-131	#300-R8-231	#300-R2-131	#300-R2-231
1st Bicuspid	UR ● UL ●	-	-7	0	3.1mm	#300-R8-14	#300-R8-24	#300-R2-14	#300-R2-24
1st Bicuspid w/ Hook	UR ● UL ●	D	-7	0	3.1mm	#300-R8-141	#300-R8-241	#300-R2-141	#300-R2-241
2nd Bicuspid	UR ● UL ●	-	-7	0	3.1mm	#300-R8-15	#300-R8-25	#300-R2-15	#300-R2-25
2nd Bicuspid w/ Hook	UR ● UL ●	D	-7	0	3.1mm	#300-R8-151	#300-R8-251	#300-R2-151	#300-R2-251
MANDIBULAR	REF	HK	TRQ	ANG	M/D	.018 RIGHT	.018 LEFT	.022 RIGHT	.022 LEFT
Lower Anteriors	LR ○ LL ○	-	-1	0	2.85mm	#300-R8-31	Universal	#300-R2-31	Universal
Cuspid w/ Hook	LR ● LL ●	-	-11	+7	3.4mm	#300-R8-331	#300-R8-431	#300-R2-331	#300-R2-431
1st Bicuspid	LR ● LL ●	-	-17	0	3.2mm	#300-R8-34	#300-R8-44	#300-R2-34	#300-R2-44
1st Bicuspid w/ Hook	LR ● LL ●	D	-17	0	3.2mm	#300-R8-341	#300-R8-441	#300-R2-341	#300-R2-441
2nd Bicuspid	LR ● LL ●	-	-22	0	3.2mm	#300-R8-35	#300-R8-45	#300-R2-35	#300-R2-45
2nd Bicuspid w/ Hook	LR ● LL ●	D	-22	0	3.2mm	#300-R8-351	#300-R8-451	#300-R2-351	#300-R2-451

ClearViz+™ Mini Bracket System, Roth Rx - 5x5 Sets

FULL SETS	.018 SLOT	.022 SLOT
Upper/Lower 5x5 Hks on 3's	#300-R8-3	#300-R2-3
Upper/Lower 5x5 Hks on 3,4,5's	#300-R8-345	#300-R2-345

30% Smaller Than The Original Clearviz+™

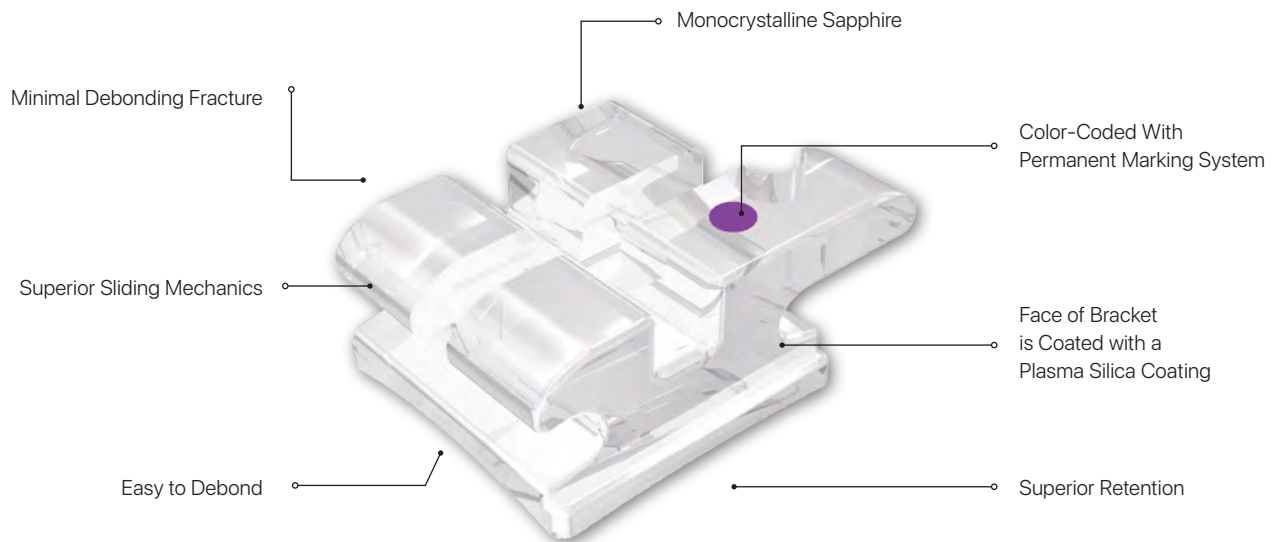

Debonding Tip:

Using a dull Pin & Ligature Cutter or Straight Bracket Removing plier.
 Grip bracket as close to the bracket pad as possible.
 Then gently rock back and forth to break adhesive bond.

ClearViz+™ Mini Bracket System, MBT™ - 5 Pack									
MAXILLARY	REF	HK	TRQ	ANG	M/D	.018 RIGHT	.018 LEFT	.022 RIGHT	.022 LEFT
Central	UR ● UL ●	-	+17	+4	3.1mm	#300-M8-11	#300-M8-21	#300-M2-11	#300-M2-21
Lateral	UR ● UL ●	-	+10	+8	2.85mm	#300-M8-12	#300-M8-22	#300-M2-12	#300-M2-22
Cuspid w/ Hk	UR ● UL ●	D	-7	+8	3.4mm	#300-M8-131	#300-M8-231	#300-M2-131	#300-M2-231
1st Bicuspid	UR ● UL ●	-	-7	0	3.1mm	#300-M8-14	#300-M8-24	#300-M2-14	#300-M2-24
1st Bicuspid w/ Hk	UR ● UL ●	D	-7	0	3.1mm	#300-M8-141	#300-M8-241	#300-M2-141	#300-M2-241
2nd Bicuspid	UR ● UL ●	-	-7	0	3.1mm	#300-M8-15	#300-M8-25	#300-M2-15	#300-M2-25
2nd Bicuspid w/ Hk	UR ● UL ●	D	-7	0	3.1mm	#300-M8-151	#300-M8-251	#300-M2-151	#300-M2-251
MANDIBULAR	REF	HK	TRQ	ANG	M/D	.018 RIGHT	.018 LEFT	.022 RIGHT	.022 LEFT
Lower Anteriors	LR ● LL ●	-	-6	0	2.85mm	#300-M8-31	Universal	#300-M2-31	Universal
Cuspid w/ Hk	LR ● LL ●	-	0	+3	3.4mm	#300-M8-331	#300-M8-431	#300-M2-331	#300-M2-431
1st Bicuspid	LR ● LL ●	-	-12	+2	3.2mm	#300-M8-34	#300-M8-44	#300-M2-34	#300-M2-44
1st Bicuspid w/ Hk	LR ● LL ●	D	-12	+2	3.2mm	#300-M8-341	#300-M8-441	#300-M2-341	#300-M2-441
2nd Bicuspid	LR ● LL ●	-	-17	+2	3.2mm	#300-M8-35	#300-M8-45	#300-M2-35	#300-M2-45
2nd Bicuspid w/ Hk	LR ● LL ●	D	-17	+2	3.2mm	#300-M8-351	#300-M8-451	#300-M2-351	#300-M2-451

ClearViz+™ Mini Bracket System, MBT™ - 5x5 Sets

FULL SETS	.018 SLOT	.022 SLOT
Upper/Lower 5x5 Hks on 3's	#300-M8-3	#300-M2-3
Upper/Lower 5x5 Hks on 3,4,5's	#300-M8-345	#300-M2-345

ClearViz+™

Bracket System

Crafted from Monocrystalline Sapphire, our ClearViz+™ brackets embody the epitome of clarity. These low-profile brackets not only offer exceptional bond strength but also exhibit impressive stain resistance.

Available in .018 and .022 – Roth or MBT.

Debonding Tip:

Using a dull Pin & Ligature Cutter or Straight Bracket Removing plier. Grip bracket as close to the bracket pad as possible. Then gently rock back and forth to break adhesive bond.



ClearViz+™ Bracket System, Roth Rx - 5 Pack

MAXILLARY	REF	HK	TRQ	ANG	M/D	.018 RIGHT	.018 LEFT	.022 RIGHT	.022 LEFT
Central	UR ●	-	+12	+5	3.2mm	#2188-11	#2188-21	#2189-11	#2189-21
	UL ●								
Lateral	UR ●	-	+8	+9	3.0mm	#2188-12	#2188-22	#2189-12	#2189-22
	UL ●								
Cuspid	UR ●	-	0	+11	3.3mm	#2188-13	#2188-23	#2189-13	#2189-23
	UL ●								
Cuspid w/ Hk	UR ●	D	0	+11	3.5mm	#2188-131	#2188-231	#2189-131	#2189-231
	UL ●								
1st Bicuspid	UR ●	-	-7	0	3.2mm	#2188-14	Universal	#2189-14	Universal
	UL ●								
1st Bicuspid w/ Hk	UR ●	D	-7	0	3.5mm	#2188-141	#2188-241	#2189-141	#2189-241
	UL ●								
2nd Bicuspid	UR ●	-	-7	0	3.2mm	#2188-15	Universal	#2189-15	Universal
	UL ●								
2nd Bicuspid w/ Hk	UR ●	D	-7	0	3.5mm	#2188-151	#2188-251	#2189-151	#2189-251
	UL ●								
MANDIBULAR	REF	HK	TRQ	ANG	M/D	.018 RIGHT	.018 LEFT	.022 RIGHT	.022 LEFT
Lower Anteriors	LR ●	-	0	0	2.7mm	#2188-31	Universal	#2189-31	Universal
	LL ●								
Cuspid	LR ●	-	-11	+5	3.3mm	#2188-33	#2188-43	#2189-33	#2189-43
	LL ●								
Cuspid w/ Hk	LR ●	D	-11	+5	3.5mm	#2188-331	#2188-431	#2189-331	#2189-431
	LL ●								
1st Bicuspid	LR ●	-	-17	0	3.2mm	#2188-34	Universal	#2189-34	Universal
	LL ●								
1st Bicuspid w/ Hk	LR ●	D	-17	0	3.5mm	#2188-341	#2188-441	#2189-341	#2189-441
	LL ●								
2nd Bicuspid	LR ●	-	-22	0	3.2mm	#2188-35	Universal	#2189-35	Universal
	LL ●								
1st Bicuspid w/ Hk	LR ●	D	-22	0	3.5mm	#2188-351	#2188-451	#2189-351	#2189-451
	LL ●								

ClearViz+™ Bracket System, Roth Rx - 5x5 Sets

FULL SETS	.018 SLOT	.022 SLOT
Upper/Lower 5x5 No Hks	#2188-NHK	#2189-NHK
Upper/Lower 5x5 Hks on 3's	#2188-3HK	#2189-3HK
Upper/Lower 5x5 Hks on 3,4,5's	#2188-345HK	#2189-345HK

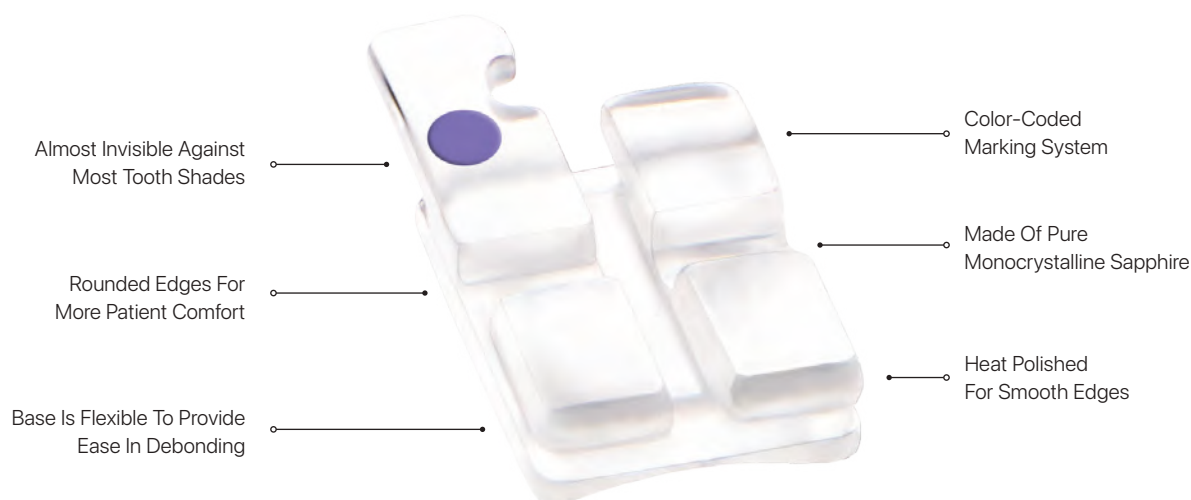

Crystal Clear... **Stain Resistant!**

ClearViz+™ Bracket System, MBT™ Rx - 5 Pack

MAXILLARY	REF	HK	TRQ	ANG	M/D	.018 RIGHT	.018 LEFT	.022 RIGHT	.022 LEFT
Central	UR ●	-	+17	+4	3.2mm	#2190-11	#2190-21	#2191-11	#2191-21
	UL ●								
Lateral	UR ●	-	+10	+8	3.0mm	#2190-12	#2190-22	#2191-12	#2191-22
	UL ●								
Cuspid	UR ●	-	-7	+8	3.3mm	#2190-13	#2190-23	#2191-13	#2191-23
	UL ●								
Cuspid w/ Hook	UR ●	D	-7	+8	3.5mm	#2190-131	#2190-231	#2191-131	#2191-231
	UL ●								
1st Bicuspid	UR ●	-	-7	0	3.2mm	#2190-14	Universal	#2191-14	Universal
	UL ●								
1st Bicuspid w/ Hook	UR ●	D	-7	0	3.5mm	#2190-141	#2190-241	#2191-141	#2191-241
	UL ●								
2nd Bicuspid	UR ●	-	-7	0	3.2mm	#2190-15	Universal	#2191-15	Universal
	UL ●								
2nd Bicuspid w/ Hook	UR ●	D	-7	0	3.5mm	#2190-151	#2190-251	#2191-151	#2191-251
	UL ●								
MANDIBULAR	REF	HK	TRQ	ANG	M/D	.018 RIGHT	.018 LEFT	.022 RIGHT	.022 LEFT
Lower Anteriors	LR ●	-	-6	0	2.7mm	#2190-31	#Universal	#2191-31	Universal
	LL ●								
Cuspid	LR ●	-	-6	+3	3.3mm	#2190-33	#2190-43	#2191-33	#2191-43
	LL ●								
Cuspid w/ Hook	LR ●	D	-6	+3	3.5mm	#2190-331	#2190-431	#2191-331	#2191-431
	LL ●								
1st Bicuspid	LR ●	-	-12	+2	3.2mm	#2190-34	Universal	#2191-34	Universal
	LL ●								
1st Bicuspid w/ Hook	LR ●	D	-12	+2	3.5mm	#2190-341	#2190-441	#2191-341	#2191-441
	LL ●								
2nd Bicuspid	LR ●	-	-17	+2	3.2mm	#2190-35	Universal	#2191-35	Universal
	LL ●								
2nd Bicuspid w/ Hook	LR ●	D	-17	+2	3.5mm	#2190-351	#2190-451	#2191-351	#2191-451
	LL ●								

ClearViz+™ Bracket System, MBT™ Rx - 5x5 Sets

FULL SETS	.018 SLOT	.022 SLOT
Upper/Lower 5x5 No Hks	#2190-NHK	#2191-NHK
Upper/Lower 5x5 Hks on 3's	#2190-3HK	#2191-3HK
Upper/Lower 5x5 Hks on 3,4,5's	#2190-345HK	#2191-345HK

ClearTek™ Mini Bracket System

Crafted from premium Monocrystalline sapphire, ClearTek™ Mini Brackets not only excel in bonding but also ease the bracket removal process post-treatment. The slot's innovative design minimizes friction, even when accommodating larger wires. Their low-profile build, complete with rounded edges, ensures exceptional patient comfort while aligning with the exacting standards that doctors aim for. With outstanding clarity, ClearTek™ Mini Brackets seamlessly blend with any tooth shade, delivering a natural and aesthetically pleasing result.



Available in .018 and .022 – Roth or MBT.

- Crystal Clear Monocrystalline Sapphire
- Stain Resistant
- High Bond Strength
- Easy Debonding
- Low Bracket Profile

ClearTek™ Mini Bracket System, Roth Rx - 5 Pack

MAXILLARY	REF	HK	TRQ	ANG	M/D	.018 RIGHT	.018 LEFT	.022 RIGHT	.022 LEFT
Central	UR UL	-	+12	+5	3.2mm	#O-624-2000	#O-624-2002	#O-624-2100	#O-624-2102
Lateral	UR UL	-	+8	+9	3.0mm	#O-624-2004	#O-624-2006	#O-624-2104	#O-624-2106
Cuspid	UR UL	-	0	+11	3.3mm	#O-624-2008	#O-624-2012	#O-624-2108	#O-624-2112
Cuspid w/ Hk	UR UL	D	0	+11	3.3mm	#O-624-2010	#O-624-2014	#O-624-2110	#O-624-2114
1st Bicuspid	UR UL	-	-7	0	3.0mm	#O-624-2016	#O-624-2020	#O-624-2116	#O-624-2120
1st Bicuspid w/ Hk	UR UL	D	-7	0	3.5mm	#O-624-2018	#O-624-2022	#O-624-2118	#O-624-2122
2nd Bicuspid	UR UL	-	-7	0	3.0mm	#O-624-2024	#O-624-2028	#O-624-2124	#O-624-2128
2nd Bicuspid w/ Hk	UR UL	D	-7	0	3.5mm	#O-624-2026	#O-624-2029	#O-624-2126	#O-624-2129
MANDIBULAR	REF	HK	TRQ	ANG	M/D	.018 RIGHT	.018 LEFT	.022 RIGHT	.022 LEFT
Lower Anteriors	LR LL	-	0	0	2.7mm	#O-624-1030	Universal	#O-624-1130	Universal
Cuspid	LR LL	-	-11	+5	3.0mm	#O-624-1032	#O-624-1036	#O-624-1132	#O-624-1136
Cuspid w/ Hk	LR LL	D	-11	+5	3.3mm	#O-624-1034	#O-624-1038	#O-624-1134	#O-624-1138
1st Bicuspid	LR LL	-	-17	0	3.0mm	#O-624-1040	#O-624-1044	#O-624-1140	#O-624-1144
1st Bicuspid w/ Hk	LR LL	D	-17	0	3.3mm	#O-624-1042	#O-624-1046	#O-624-1142	#O-624-1146
2nd Bicuspid	LR LL	-	-17	0	3.0mm	#O-624-1048	#O-624-1052	#O-624-1148	#O-624-1152
2nd Bicuspid w/ Hk	LR LL	D	-17	0	3.3mm	#O-624-1050	#O-624-1054	#O-624-1150	#O-624-1154

ClearTek™ Mini Bracket System, Roth Rx - 5x5 Sets

FULL SETS	.018 SLOT	.022 SLOT
5 x 5 U/L No Hks	#O-624-2030	#O-624-2130
5 x 5 U/L Hks on 3 only	#O-624-2032	#O-624-2132
5 x 5 U/L Hks on 3, 4, and 5	#O-624-2034	#O-624-2134

































Debonding Tip:

Using a dull Pin & Ligature Cutter or Straight Bracket Removing plier.

Grip bracket as close to the bracket pad as possible.

Then gently rock back and forth to break adhesive bond.

ClearTek™ Mini Bracket System, MBT™ Rx - 5 Pack

MAXILLARY	REF	HK	TRQ	ANG	M/D	.018 RIGHT	.018 LEFT	.022 RIGHT	.022 LEFT
Central	UR  UL 	-	+17	+4	3.2mm	#O-626-2000	#O-626-2002	#O-626-2100	#O-626-2102
Lateral	UR  UL 	-	+10	+8	2.8mm	#O-626-2004	#O-626-2006	#O-626-2104	#O-626-2106
Cuspid	UR  UL 	-	-7	+8	3.0mm	#O-626-2008	#O-626-2012	#O-626-2108	#O-626-2112
Cuspid w/ Hk	UR  UL 	D	-7	+8	3.3mm	#O-626-2010	#O-626-2014	#O-626-2110	#O-626-2114
1st Bicuspid	UR  UL 	-	-7	0	3.0mm	#O-626-2016	#O-626-2020	#O-626-2116	#O-626-2120
1st Bicuspid w/ Hk	UR  UL 	D	-7	0	3.3mm	#O-626-2018	#O-626-2022	#O-626-2118	#O-626-2122
2nd Bicuspid	UR  UL 	-	-7	0	3.0mm	#O-626-2024	#O-626-2028	#O-626-2124	#O-626-2128
2nd Bicuspid	UR  UL 	-	-7	0	3.3mm	#O-626-2026	#O-626-2029	#O-626-2126	#O-626-2129
MANDIBULAR	REF	HK	TRQ	ANG	M/D	.018 RIGHT	.018 LEFT	.022 RIGHT	.022 LEFT
Lower Anteriors	LR  LL 	-	-6	0	2.7mm	#O-626-1030	Universal	#O-626-1130	Universal
Cuspid	LR  LL 	-	-6	+3	3.0mm	#O-626-1032	#O-626-1036	#O-626-1132	#O-626-1136
Cuspid w/ Hk	LR  LL 	-	-6	+3	3.3mm	#O-626-1034	#O-626-1038	#O-626-1134	#O-626-1138
1st Bicuspid	LR  LL 	-	-12	+2	3.0mm	#O-626-1040	#O-626-1044	#O-626-1140	#O-626-1144
1st Bicuspid w/ Hk	LR  LL 	D	-12	+2	3.3mm	#O-626-1042	#O-626-1046	#O-626-1142	#O-626-1146
2nd Bicuspid	LR  LL 	-	-17	+2	3.0mm	#O-626-1048	#O-626-1052	#O-626-1148	#O-626-1152
2nd Bicuspid w/ Hk	LR  LL 	D	-17	+2	3.3mm	#O-626-1050	#O-626-1054	#O-626-1150	#O-626-1154

ClearTek™ Mini Bracket System, MBT™ Rx - 5x5 Sets

FULL SETS	.018 SLOT	.022 SLOT
5 x 5 U/L No Hks	#O-626-2030	#O-626-2130
5 x 5 U/L Hks on 3 only	#O-626-2032	#O-626-2132
5 x 5 U/L Hks on 3, 4, and 5	#O-626-2034	#O-626-2134

Krystal™ SL

Self-Ligating Bracket System

Introducing the new Krystal™ SL Bracket System! The Krystal™ SL is manufactured using a combination of copolymers and ceramics which create a translucent glass-like material for superior cosmetics and smooth finish for comfort. With torque in the base for excellent control, the clear clip provides enhanced aesthetics. Mechanical locking base with grooves allows for adhesive to be distributed easily along the bracket base. Bracket base is formulated to minimize breakage during debonding. This new innovative bracket has a super smooth surface which will not stain, break or flex during treatment. Easy to open and close for treatment, dependable, clear and comfortable, making the Krystal™ SL the perfect choice for both practices and patients!

Available in .018 and .022 – Roth or MBT.

Debonding Tip:

Using a dull Pin & Ligature Cutter or Straight Bracket Removing plier. Grip bracket as close to the bracket pad as possible. Then gently rock back and forth to break adhesive bond.



We recommend our Self-Ligating Instrument for easy opening and closing of the bracket door.



Self-Ligating Instrument

#1444

Krystal™ SL Bracket System, Roth Rx - 5 Pack

MAXILLARY	REF	HK	TRQ	ANG	M/D	ROT	.018 RIGHT	.018 LEFT	.022 LEFT	.022 RIGHT
Central	UR UL	-	12	5	3.8mm	0	#400-8011	#400-8021	#400-2011	#400-2021
Lateral	UR UL	-	8	9	3.7mm	0	#400-8012	#400-8022	#400-2012	#400-2022
Cuspid	UR UL	-	-2	8	3.7mm	4	#400-8013	#400-8023	#400-2013	#400-2023
Cuspid w/ Hk	UR UL	D	-2	8	3.7mm	4	#400-80131	#400-80231	#400-20131	#400-20231
Bicuspid	UR UL	-	-7	0	3.7mm	0	#400-8014	Universal	#400-2014	Universal
Bicuspid w/ Hk	UR UL	D	-7	0	3.7mm	0	#400-80141	#400-80241	#400-20141	#400-20241
MAXILLARY	REF	HK	TRQ	ANG	M/D	ROT	.018 RIGHT	.018 LEFT	.022 LEFT	.022 RIGHT
Lower Anteriors	LR LL	-	0	0	3.7mm	0	#400-1831	Universal	#400-2031	Universal
Cuspid	LR LL	-	-11	5	3.7mm	2	#400-1833	#400-1843	#400-2033	#400-2043
Cuspid w/ Hk	LR LL	D	-11	5	3.7mm	2	#400-18331	#400-18431	#400-20331	#400-20431
1st Bicuspid	LR LL	-	-17	0	3.7mm	0	#400-1834	#400-1844	#400-2034	#400-2044
1st Bicuspid w/ Hk	LR LL	D	-17	0	3.7mm	0	#400-18341	#400-18441	#400-20341	#400-20441
2nd Bicuspid	LR LL	-	-22	0	3.7mm	0	#400-1835	#400-1845	#400-2035	#400-2045
2nd Bicuspid w/ Hk	LR LL	D	-22	0	3.7mm	0	#400-18351	#400-18451	#400-20351	#400-20451

Krystal™ SL Bracket System, Roth Rx - 5x5 Sets

FULL SETS	.018 SLOT	.022 SLOT
Upper/Lower 5x5 Hks on 3's	#400-R8-3HK	#400-R2-3HK
Upper/Lower 5x5 Hks on 3,4,5's	#400-R8-345HK	#400-R2-345HK

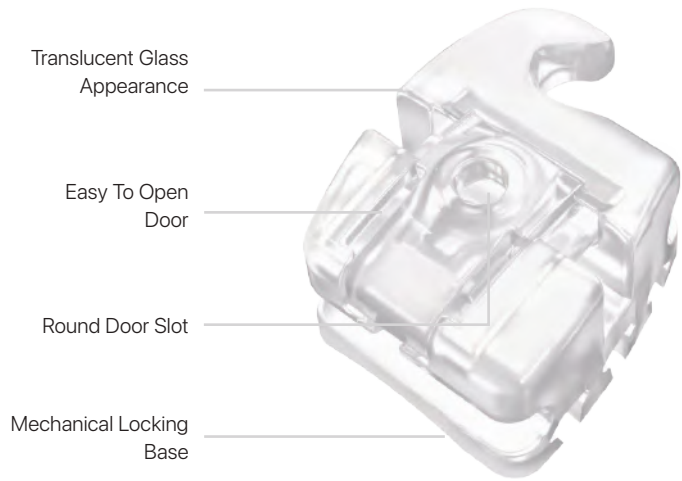

Easy to use!

Place a tweezer or explorer onto the bracket, making sure the tool fits exactly in the door slot, pull the tool smoothly from the gingival to the occlusal and the door will open. Close the door using tweezers, tool or your fingers. Door is completely closed when you hear a "click".



Krystal™ SL Bracket System, MBT™ Rx - 5 Pack

MAXILLARY	REF	HK	TRQ	ANG	M/D	ROT	.018 RIGHT	.018 LEFT	.022 RIGHT	.022 LEFT
Central	UR	-	17	5	3.8mm	0	#500-1811	#500-1821	#500-2211	#500-2221
	UL									
Lateral	UR	-	10	8	3.7mm	0	#500-1812	#500-1822	#500-2212	#500-2222
	UL									
Cuspid	UR	-	0	8	3.7mm	4	#500-1813	#500-1823	#500-2213	#500-2223
	UL									
Cuspid w/ Hk	UR	D	0	8	3.7mm	4	#500-18131	#500-18231	#500-22131	#500-22231
	UL									
Bicuspid	UR	-	-7	0	3.7mm	0	#500-1814	Universal	#500-2214	Universal
	UL									
Bicuspid w/ Hk	UR	D	-7	0	3.7mm	0	#500-18141	#500-18241	#500-22141	#500-22241
	UL									
MAXILLARY	REF	HK	TRQ	ANG	M/D	ROT	.018 RIGHT	.018 LEFT	.022 LEFT	.022 RIGHT
Lower Anteriors	LR	-	-6	0	3.7mm	0	#500-1831	Universal	#500-2231	Universal
	LL									
Cuspid	LR	-	0	3	3.7mm	2	#500-1833	#500-1843	#500-2233	#500-2243
	LL									
Cuspid w/ Hk	LR	D	0	3	3.7mm	2	#500-18331	#500-18431	#500-22331	#500-22431
	LL									
1st Bicuspid	LR	-	-12	2	3.7mm	0	#500-1834	#500-1844	#500-2234	#500-2244
	LL									
1st Bicuspid w/ Hk	LR	D	-12	2	3.7mm	0	#500-18341	#500-18441	#500-22341	#500-22441
	LL									
2nd Bicuspid	LR	-	-17	2	3.7mm	0	#500-1835	#500-1845	#500-2235	#500-2245
	LL									
2nd Bicuspid w/ Hk	LR	D	-17	2	3.7mm	0	#500-18351	#500-18451	#500-22351	#500-22451
	LL									

Krystal™ SL Bracket System, MBT™ Rx - 5x5 Sets

FULL SETS	.018 SLOT	.022 SLOT
Upper/Lower 5x5 Hks on 3's	#500-M8-3HK	#500-M2-3HK
Upper/Lower 5x5 Hks on 3,4,5's	#500-M8-345HK	#500-M2-345HK

Krystal™

Bracket System

Krystal™ Brackets represent the pinnacle of ceramic bracket technology. These brackets are meticulously crafted from 99.9% pure alumina oxide, ensuring they remain stain-free and resistant to discoloration. Their true twin design embodies excellence, offering outstanding bonding strength, exceptional durability, precise control over tip and torque, and effortless ligation. Patients can expect not only the utmost comfort but also an orthodontic experience that is visually pleasing. Krystal™ Brackets provide a superior solution for those seeking both aesthetics and performance in their orthodontic treatment.

Available in .018 and .022 – Roth or MBT.



Debonding Tip:

Using a dull Pin & Ligature Cutter or Straight Bracket Removing plier.

Grip bracket as close to the bracket pad as possible.

Then gently rock back and forth to break adhesive bond.

Krystal™ Bracket System, Roth Rx - 5 Pack

MAXILLARY	REF	HK	TRQ	ANG	M/D	.018 RIGHT	.018 LEFT	.022 RIGHT	.022 LEFT
Central	UR UL	-	+12	+5	3.1mm	#2180-11	#2180-21	#2181-11	#2181-21
Lateral	UR UL	-	+8	+9	2.7mm	#2180-12	#2180-22	#2181-12	#2181-22
Cuspid	UR UL	-	0	+11	2.8mm	#2180-13	#2180-23	#2181-13	#2181-23
Cuspid w/ Hk	UR UL	D	0	+11	2.8mm	#2180-131	#2180-231	#2181-131	#2181-231
1st/2nd Bicuspid	UR UL	-	-7	0	2.8mm	#2180-14	Universal	#2181-14	Universal
1st/2nd Bicuspid w/ Hk	UR UL	Univ.	-7	0	2.8mm	#2180-141	Universal	#2181-141	Universal
MANDIBULAR	REF	HK	TRQ	ANG	M/D	.018 RIGHT	.018 LEFT	.022 RIGHT	.022 LEFT
Lower Anteriors	LR LL	-	0	0	2.8mm	#2180-31	Universal	#2181-31	Universal
Cuspid	LR LL	-	-11	+5	3.4mm	#2180-33	#2180-43	#2181-33	#2181-43
Cuspid w/ Hk	LR LL	D	-11	+5	3.4mm	#2180-331	#2180-431	#2181-331	#2181-431
1st Bicuspid	LR LL	-	-17	0	3.4mm	#2180-34	Universal	#2181-34	Universal
1st Bicuspid w/ Hk	LR LL	Univ.	-17	0	3.4mm	#2180-341	Universal	#2181-341	Universal
2nd Bicuspid	LR LL	-	-22	0	3.4mm	#2180-35	Universal	#2181-35	Universal
2nd Bicuspid w/ Hk	LR LL	Univ.	-22	0	3.4mm	#2180-351	Universal	#2181-351	Universal

Krystal™ Bracket System, Roth Rx - 5x5 Sets

FULL SETS	.018 SLOT	.022 SLOT
Upper/Lower 5x5 No Hks	#2180-NHK	#2181-NHK
Upper/Lower 5x5 Hks on 3's	#2180-3HK	#2181-3HK
Upper/Lower 5x5 Hks on 3,4,5's	#2180-345HK	#2181-345HK

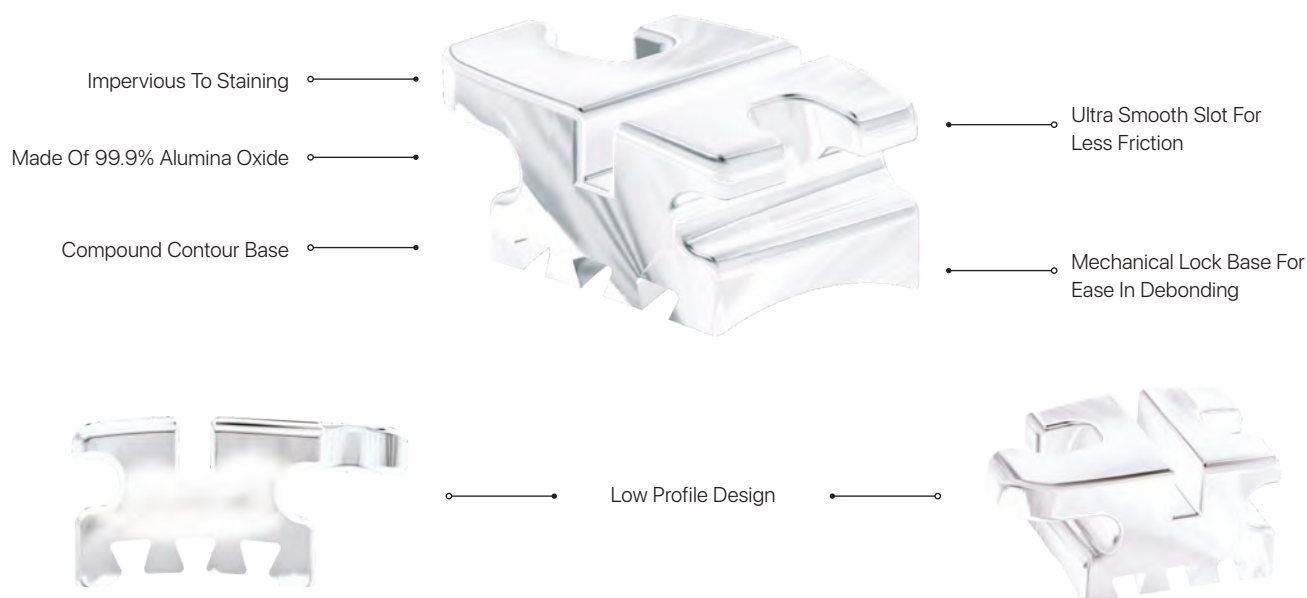

Krystal™ Bracket System, MBT™ Rx - 5 Pack

MAXILLARY	REF	HK	TRQ	ANG	M/D	.018 RIGHT	.018 LEFT	.022 RIGHT	.022 LEFT
Central	UR UL	-	+17	+4	3.1mm	#2084-11	#2084-21	#2086-11	#2086-21
Lateral	UR UL	-	+10	+8	2.7mm	#2084-12	#2084-22	#2086-12	#2086-22
Cuspid	UR UL	-	0	+8	2.8mm	#2084-13	#2084-23	#2086-13	#2086-23
Cuspid w/ Hk	UR UL	D	0	+8	2.8mm	#2084-131	#2084-231	#2086-131	#2086-231
1st/2nd Bicuspid	UR UL	-	-7	0	2.8mm	#2084-14	Universal	#2086-14	Universal
1st/2nd Bicuspid w/ Hk	UR UL	Univ.	-7	0	2.8mm	#2084-141	Universal	#2086-141	Universal
MANDIBULAR	REF	HK	TRQ	ANG	M/D	.018 RIGHT	.018 LEFT	.022 RIGHT	.022 LEFT
Lower Anteriors	LR LL	-	-6	0	2.8mm	#2084-31	#Universal	#2086-31	Universal
Cuspid	LR LL	-	0	+3	3.4mm	#2084-33	#2084-43	#2086-33	#2086-43
Cuspid w/ Hk	LR LL	D	0	+3	3.4mm	#2084-331	#2084-431	#2086-331	#2086-431
1st Bicuspid	LR LL	-	-12	+2	3.4mm	#2084-34	Universal	#2086-34	Universal
1st Bicuspid w/ Hk	LR LL	Univ.	-12	+3	3.4mm	#2084-341	Universal	#2086-341	Universal
2nd Bicuspid	LR LL	-	-17	+2	3.4mm	#2084-35	Universal	#2086-35	Universal
2nd Bicuspid w/ Hk	LR LL	Univ.	-17	+2	3.4mm	#2084-351	Universal	#2086-351	Universal

Krystal™ Bracket System, MBT™ Rx - 5x5 Sets

FULL SETS	.018 SLOT	.022 SLOT
Upper/Lower 5x5 No Hks	#2084-NHK	#2086-NHK
Upper/Lower 5x5 Hks on 3's	#2084-3HK	#2086-3HK
Upper/Lower 5x5 Hks on 3,4,5's	#2084-345HK	#2086-345HK

BANDS & ATTACHMENTS



Atlas 1st Molar Bands

The innovative Atlas Molar Bands are meticulously crafted to offer unparalleled retention and an exceptional fit. These bands feature reduced interproximal dimensions to minimize tissue impingement, ensuring an optimal contour that prevents washout both occlusally and gingivally. Moreover, the occlusal edge of the band has been thoughtfully enhanced for heightened strength during the seating procedure, and the interior is finely micro-etched to enhance retention. Plus, we now offer half sizes to ensure precise fit and optimal functionality.



* Band In Photo Shown With Tube As Example Only.
Bands Are Sold Individually and without attachments. **Tubes Sold Separately.**

SIZE	UR	UL	LR	LL	INTRO KIT	PRO KIT	MASTER KIT
29	#280-1290	#280-2290	#280-3290	#280-4290	2	4	8
29.5	#280-1295	#280-2295	#280-3295	#280-4295	2	4	8
30	#280-1300	#280-2300	#280-3300	#280-4300	2	4	8
30.5	#280-1305	#280-2305	#280-3305	#280-4305	2	4	8
31	#280-1310	#280-2310	#280-3310	#280-4310	2	4	8
31.5	#280-1315	#280-2315	#280-3315	#280-4315	2	4	8
32	#280-1320	#280-2320	#280-3320	#280-4320	4	8	16
32.5	#280-1325	#280-2325	#280-3325	#280-4325	4	8	16
33	#280-1330	#280-2330	#280-3330	#280-4330	6	12	24
33.5	#280-1335	#280-2335	#280-3335	#280-4335	8	16	32
34	#280-1340	#280-2340	#280-3340	#280-4340	8	16	32
34.5	#280-1345	#280-2345	#280-3345	#280-4345	10	20	40
35	#280-1350	#280-2350	#280-3350	#280-4350	10	20	40
35.5	#280-1355	#280-2355	#280-3355	#280-4355	10	20	40
36	#280-1360	#280-2360	#280-3360	#280-4360	12	24	48
36.5	#280-1365	#280-2365	#280-3365	#280-4365	10	20	40
37	#280-1370	#280-2370	#280-3370	#280-4370	10	20	40
37.5	#280-1375	#280-2375	#280-3375	#280-4375	8	16	32
38	#280-1380	#280-2380	#280-3380	#280-4380	6	12	24
38.5	#280-1385	#280-2385	#280-3385	#280-4385	4	8	16
39	#280-1390	#280-2390	#280-3390	#280-4390	4	8	16
39.5	#280-1395	#280-2395	#280-3395	#280-4395	4	8	16
40	#280-1400	#280-2400	#280-3400	#280-4400	2	4	8
40.5	#280-1405	#280-2405	#280-3405	#280-4405	2	4	8
41	#280-1410	#280-2410	#280-3410	#280-4410	2	4	8
41.5	#280-1415	#280-2415	#280-3415	#280-4415	2	4	8
42	#280-1420	#280-2420	#280-3420	#280-4420	2	4	8
42.5	#280-1425	#280-2425	#280-3425	#280-4425	2	4	8
43	#280-1430	#280-2430	#280-3430	#280-4430	2	4	8
43.5	#280-1435	#280-2435	#280-3435	#280-4435	2	4	8
44	#280-1440	#280-2440	#280-3440	#280-4440	2	4	8
44.5	#280-1445	#280-2445	#240-3445	#280-4445	2	4	8
					150 BANDS	300 BANDS	600 BANDS
					75 RIGHTS 75 LEFTS	150 RIGHTS 150 LEFTS	300 RIGHTS 300 LEFTS

Ultra-Fit™ 1st Molar Bands

Ultra Fit™ Molar bands have been crafted with a keen focus on the intricacies of molar anatomy and form. The Ultra-Fit™ molar band is a testament to our unwavering commitment to maintaining the utmost levels of consistency and quality in manufacturing. Notably, the inclusion of rolled gingival edges serves to significantly diminish the likelihood of band washout. Furthermore, our emphasis on a reduced interproximal area guarantees a precise fit and exceptional retention during the cementation process.

* Band In Photo Shown With Tube As Example Only.
Bands Are Sold Individually and without attachments. **Tubes Sold Separately.**

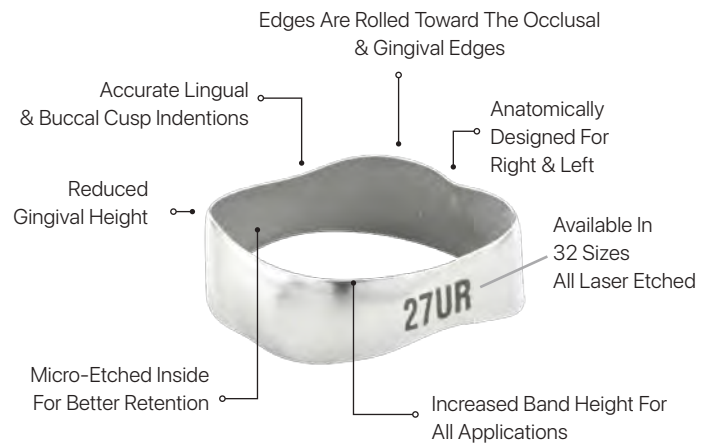

SIZE/ITEM #	UR	UL	LR	LL	INTRO KIT	PRO KIT	MASTER KIT
1	#301-0001	#302-0001	#303-0001	#304-0001	2	4	8
2	#301-0002	#302-0002	#303-0002	#304-0002	2	4	8
3	#301-0003	#302-0003	#303-0003	#304-0003	2	4	8
4	#301-0004	#302-0004	#303-0004	#304-0004	2	4	8
5	#301-0005	#302-0005	#303-0005	#304-0005	2	4	8
6	#301-0006	#302-0006	#303-0006	#304-0006	2	4	8
7	#301-0007	#302-0007	#303-0007	#304-0007	4	8	16
8	#301-0008	#302-0008	#303-0008	#304-0008	4	8	16
9	#301-0009	#302-0009	#303-0009	#304-0009	6	12	24
10	#301-0010	#302-0010	#303-0010	#304-0010	8	16	32
11	#301-0011	#302-0011	#303-0011	#304-0011	8	16	32
12	#301-0012	#302-0012	#303-0012	#304-0012	10	20	40
13	#301-0013	#302-0013	#303-0013	#304-0013	10	20	40
14	#301-0014	#302-0014	#303-0014	#304-0014	10	20	40
15	#301-0015	#302-0015	#303-0015	#304-0015	12	24	48
16	#301-0016	#302-0016	#303-0016	#304-0016	10	20	40
17	#301-0017	#302-0017	#303-0017	#304-0017	10	20	40
18	#301-0018	#302-0018	#303-0018	#304-0018	8	16	32
19	#301-0019	#302-0019	#303-0019	#304-0019	6	12	24
20	#301-0020	#302-0020	#303-0020	#304-0020	4	8	16
21	#301-0021	#302-0021	#303-0021	#304-0021	4	8	16
22	#301-0022	#302-0022	#303-0022	#304-0022	4	8	16
23	#301-0023	#302-0023	#303-0023	#304-0023	2	4	8
24	#301-0024	#302-0024	#303-0024	#304-0024	2	4	8
25	#301-0025	#302-0025	#303-0025	#304-0025	2	4	8
26	#301-0026	#302-0026	#303-0026	#304-0026	2	4	8
27	#301-0027	#302-0027	#303-0027	#304-0027	2	4	8
28	#301-0028	#302-0028	#303-0028	#304-0028	2	4	8
29	#301-0029	#302-0029	#303-0029	#304-0029	2	4	8
30	#301-0030	#302-0030	#303-0030	#304-0030	2	4	8
31	#301-0031	#302-0031	#303-0031	#304-0031	2	4	8
32	#301-0032	#302-0032	#303-0032	#304-0032	2	4	8
					150 Bands	300 Bands	600 Bands
					75 RIGHTS 75 LEFTS	150 RIGHTS 150 LEFTS	300 RIGHTS 300 LEFTS

Ultra-Fit™ 2nd Molar Bands

The Ultra-Fit™ 2nd Molar Bands are precisely engineered to ensure precise adaptation to tooth anatomy. They feature buccal and lingual grooves that deliver exceptional retention during trial fitting. With a range encompassing 34 different sizes, you'll find the perfect fit for every patient.

* Band In Photo Shown With Tube As Example Only.
Bands Are Sold Individually and without attachments.
Tubes Sold Separately.



BANDS & ATTACHMENTS

SIZE	UR7	UL7	LR7	LL7	INTRO KIT	PRO KIT	MASTER KIT
3	#401-0003	#402-0003	#403-0003	#404-0003	2	2	4
4	#401-0004	#402-0004	#403-0004	#404-0004	2	2	4
5	#401-0005	#402-0005	#403-0005	#404-0005	2	2	4
6	#401-0006	#402-0006	#403-0006	#404-0006	2	2	4
7	#401-0007	#402-0007	#403-0007	#404-0007	2	2	4
8	#401-0008	#402-0008	#403-0008	#404-0008	2	2	6
9	#401-0009	#402-0009	#403-0009	#404-0009	2	4	6
10	#401-0010	#402-0010	#403-0010	#404-0010	2	4	8
11	#401-0011	#402-0011	#403-0011	#404-0011	2	4	8
12	#401-0012	#402-0012	#403-0012	#404-0012	4	6	8
13	#401-0013	#402-0013	#403-0013	#404-0013	4	6	14
14	#401-0014	#402-0014	#403-0014	#404-0014	4	6	14
15	#401-0015	#402-0015	#403-0015	#404-0015	4	6	14
16	#401-0016	#402-0016	#403-0016	#404-0016	4	6	14
17	#401-0017	#402-0017	#403-0017	#404-0017	4	8	14
18	#401-0018	#402-0018	#403-0018	#404-0018	4	8	14
19	#401-0019	#402-0019	#403-0019	#404-0019	4	8	14
20	#401-0020	#402-0020	#403-0020	#404-0020	4	8	14
21	#401-0021	#402-0021	#403-0021	#404-0021	4	8	14
22	#401-0022	#402-0022	#403-0022	#404-0022	4	6	14
23	#401-0023	#402-0023	#403-0023	#404-0023	4	6	14
24	#401-0024	#402-0024	#403-0024	#404-0024	4	6	14
25	#401-0025	#402-0025	#403-0025	#404-0025	4	6	14
26	#401-0026	#402-0026	#403-0026	#404-0026	4	6	8
27	#401-0027	#402-0027	#403-0027	#404-0027	4	4	8
28	#401-0028	#402-0028	#403-0028	#404-0028	2	4	8
29	#401-0029	#402-0029	#403-0029	#404-0029	2	4	6
30	#401-0030	#402-0030	#403-0030	#404-0030	2	2	6
31	#401-0031	#402-0031	#403-0031	#404-0031	2	2	6
32	#401-0032	#402-0032	#403-0032	#404-0032	2	2	4
33	#401-0033	#402-0033	#403-0033	#404-0033	2	2	4
34	#401-0034	#402-0034	#403-0034	#404-0034	2	2	4
35	#401-0035	#402-0035	#403-0035	#404-0035	2	2	4
36	#401-0036	#402-0036	#403-0036	#404-0036	2	2	4
					150 BANDS	300 BANDS	600 BANDS
					75 R 75 L	150 R 150 L	300 R 300 L

DynaFlex® Weldable Lingual Attachments



Lug 3.8m

#2000

Lingual Cleat

#2001 5.3mm : #2001-05 8.1mm

Lingual Button

#2002

Wilson 3D

#2003

Sheath

#2004

Placement

Buccal Tube to Upper Molar

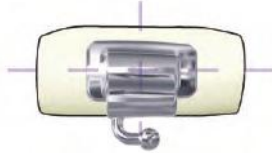

Upper Molar: Entrance to buccal tube will bisect the mesial/buccal cusp.

Buccal Tube to Lower Molar

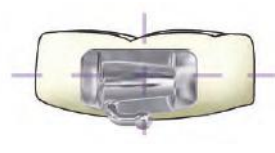

Lower Molar: Entrance to buccal tube will bisect the mesial/buccal cusp.

Please specify if you prefer a different position.

Lingual Attachments

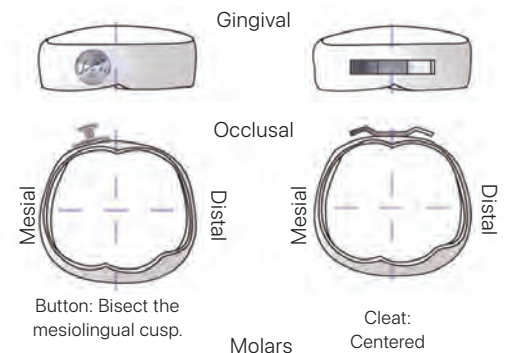

Button: Bisect the mesiolingual cusp.

Cleat: Centered

DynaFlex® Autoclavable Bite Stick

Brighten your office with these colorful bite sticks! Bite sticks are autoclavable up to 260 degrees or cold sterilizable.

Item #1426-05



DynaFlex® Heavy Duty Band Pusher

Easy to hold handle allows for increased control in pushing and seating bands. Item #1420



Stackable Band Drawers

The Stackable Molar Band Drawer System is a highly adaptable and convenient solution designed to cater to the unique needs of dental offices. This modular system allows you to select as few or as many drawers as necessary, ensuring that it perfectly aligns with the specific requirements of your practice. Each drawer within this system comes equipped with a size-divided tray, making it remarkably easy for dental professionals to access and select the appropriate band sizes. This thoughtful design not only enhances the efficiency of band selection but also contributes to a streamlined workflow in the dental office, ultimately improving the overall patient experience and treatment process. Item #3070



Each Tray

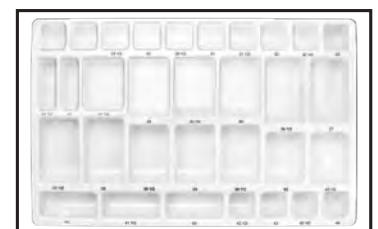

Ultra-Fit™ Upper & Lower Bicuspid Bands

The Ultra-Fit™ Bicuspid Bands for are designed to keep true molar anatomy in focus. Ultra-Fit™ molar bands are crafted to premium standards for unmatched consistency and quality. Their gingival rolled edges minimize band wash-out, while the optimized interproximal area guarantees a tight fit and superior retention during cementation. With an anatomical contour, these bands assure a perfect fit and enhanced adaptability during the cementing process. Each band size is permanently laser-etched, making identification simple even post-sterilization. You can purchase them either individually or as part of pre-packaged kits, with options for plain or pre-welded versions.

- The Ultra-Fit™ bicuspid band is sturdy, ensuring it won't collapse when positioned.
- DynaFlex® specializes in in-house custom welding for both bicuspid and molar bands, accommodating both buccal and lingual attachments.
- We employ high-speed, industry-standard welders and expert technicians to guarantee perfect placement for all custom welding projects.
- Our bands are universally shaped for an authentic fit and function. Their unique shapes and sizes are laser-marked and span a comprehensive size range for optimal retention.
- Allow 14 business days for our welding services. Please note that custom-welded orders are final and cannot be returned.



**Upper Right
1st & 2nd Bicuspid**

Item #501-00xx



**Lower Right
1st Bicuspid**

Item #503-00xx



**Lower Left
1st Bicuspid**

Item #504-00xx



DynaFlex® Weldable Bicuspid Brackets - Roth Rx

Crafted to precise tolerances and meticulously finished to perfection, our weldable design ensures exceptional performance.

MAXILLARY	WITH HOOK	MANDIBULAR 1ST BI	WITH HOOK	MANDIBULAR 2ND BI	WITH HOOK
Torque	-7	Torque	-17	Torque	-22
Angulation	0	Angulation	0	Angulation	0
Rotation	2	Rotation	4	Rotation	4
.018 Right	#741-0503	.018 Right	#741-1503	.018 Right	#741-1603
.018 Left	#740-0503	.018 Left	#740-1503	.018 Left	#740-1603
.022 Right	#741-0501	.022 Right	#741-1501	.022 Right	#741-1601
.022 Left	#740-0501	.022 Left	#740-1501	.022 Left	#740-1601

Ultra-Fit™ Bicuspid Bands

The Ultra-Fit™ Bicuspid Bands from DynaFlex® epitomize precision and high-quality orthodontic care, ensuring optimal fit and retention through an anatomically accurate design. The bands facilitate an efficient cementing process while their laser-etched sizing remains visible even post-sterilization. Available individually or in pre-packaged kits, they also offer customization options to meet diverse orthodontic needs.



Laser Etched



Contoured Edges

SIZE	UPPER RIGHT 1ST & 2ND BI	UPPER LEFT 1ST & 2ND BI	LOWER RIGHT 1ST BI	LOWER LEFT 1ST BI	LOWER RIGHT 2ND BI	LOWER LEFT 2ND BI	INTRO KIT	PRO KIT	MASTER KIT
1	#501-0001	#502-0001	#503-0001	#504-0001	#505-0001	#506-0001	2	4	8
2	#501-0002	#502-0002	#503-0002	#504-0002	#505-0002	#506-0002	2	4	8
3	#501-0003	#502-0003	#503-0003	#504-0003	#505-0003	#506-0003	4	8	16
4	#501-0004	#502-0004	#503-0004	#504-0004	#505-0004	#506-0004	4	8	16
5	#501-0005	#502-0005	#503-0005	#504-0005	#505-0005	#506-0005	4	8	16
6	#501-0006	#502-0006	#503-0006	#504-0006	#505-0006	#506-0006	6	12	24
7	#501-0007	#502-0007	#503-0007	#504-0007	#505-0007	#506-0007	6	12	24
8	#501-0008	#502-0008	#503-0008	#504-0008	#505-0008	#506-0008	8	16	32
9	#501-0009	#502-0009	#503-0009	#504-0009	#505-0009	#506-0009	10	20	40
10	#501-0010	#502-0010	#503-0010	#504-0010	#505-0010	#506-0010	10	20	40
11	#501-0011	#502-0011	#503-0011	#504-0011	#505-0011	#506-0011	12	24	48
12	#501-0012	#502-0012	#503-0012	#504-0012	#505-0012	#506-0012	12	24	48
13	#501-0013	#502-0013	#503-0013	#504-0013	#505-0013	#506-0013	12	24	48
14	#501-0014	#502-0014	#503-0014	#504-0014	#505-0014	#506-0014	10	20	40
15	#501-0015	#502-0015	#503-0015	#504-0015	#505-0015	#506-0015	10	20	40
16	#501-0016	#502-0016	#503-0016	#504-0016	#505-0016	#506-0016	8	16	32
17	#501-0017	#502-0017	#503-0017	#504-0017	#505-0017	#506-0017	6	12	24
18	#501-0018	#502-0018	#503-0018	#504-0018	#505-0018	#506-0018	6	12	24
19	#501-0019	#502-0019	#503-0019	#504-0019	#505-0019	#506-0019	4	8	16
20	#501-0020	#502-0020	#503-0020	#504-0020	#505-0020	#506-0020	4	8	16
21	#501-0021	#502-0021	#503-0021	#504-0021	#505-0021	#506-0021	4	8	16
22	#501-0022	#502-0022	#503-0022	#504-0022	#505-0022	#506-0022	2	4	8
23	#501-0023	#502-0023	#503-0023	#504-0023	#505-0023	#506-0023	2	4	8
24	#501-0024	#502-0024	#503-0024	#504-0024	#505-0024	#506-0024	2	4	8
							150 Bands	300 Bands	600 Bands
							75 R 75 L	150 R 150 L	300 R 300 L

BUCCAL TUBES

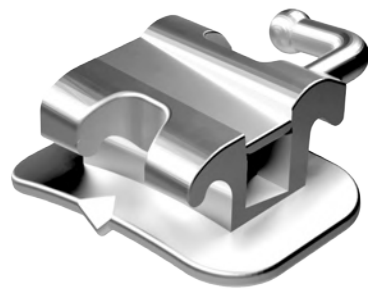

Atlas Buccal Tubes: Convertible, Bondable

The new Atlas Convertible Tubes are available in lengths of 3.5mm and 4.2mm. These tubes feature 80-gauge mesh pads, buccal indents, and integrated hooks. Made from 17-4 stainless steel, they also have deep undercut wings for securing ties and power chains. The built-in torque in the base ensures better control and precise tooth movement. Buccal indents and a compound-contoured pad provide excellent bond strength. The mesial side of the tube is flared for easy archwire insertion, and the convertible cap allows access to partially impacted second molars. Each tube includes a color code on the distal-gingival tie wing, and both tubes feature palmer notation on the pad for easy identification.

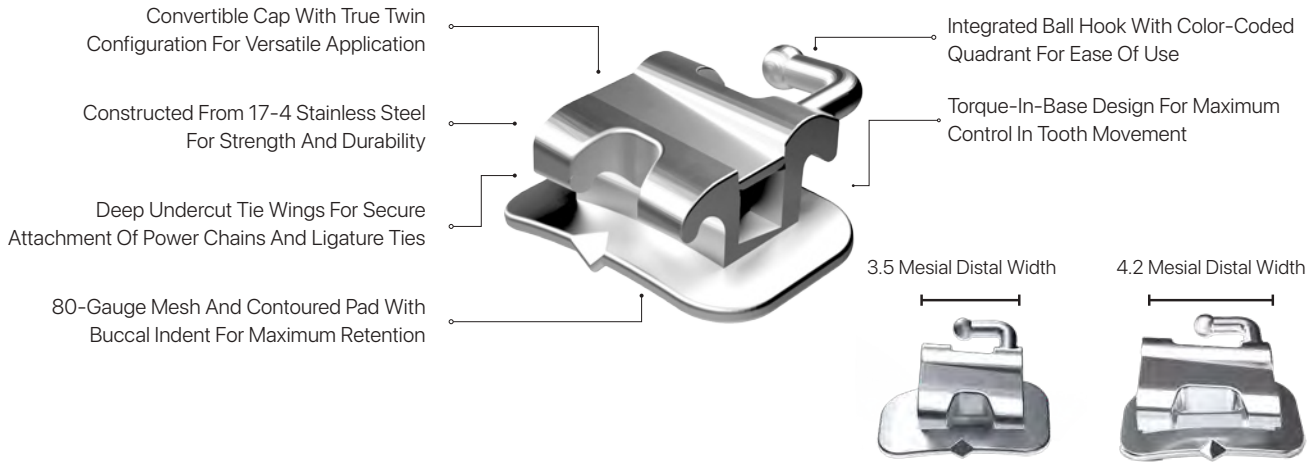

Maxillary: 10 Pack

M/D WIDTH	TORQUE	ROTATION	RIGHT/LEFT	.018	.022
3.5mm	-10	0	UR6	#901-8002	#901-2002
3.5mm	-10	0	UL6	#902-8002	#902-2002
3.5mm	-10	8	UR6	#901-8003	#901-2003
3.5mm	-10	8	UL6	#902-8003	#902-2003
3.5mm	-14	10	UR6	#901-8001	#901-2001
3.5mm	-14	10	UL6	#902-8001	#902-2001
4.2mm	-10	0	UR6	#911-8002	#911-2002
4.2mm	-10	0	UL6	#912-8002	#912-2002
4.2mm	-10	8	UR6	#911-8003	#911-2003
4.2mm	-10	8	UL6	#912-8003	#912-2003
4.2mm	-14	10	UR6	#911-8001	#911-2001
4.2mm	-14	10	UL6	#912-8001	#912-2001

Mandibular: 10 Pack

M/D WIDTH	TORQUE	ROTATION	RIGHT/LEFT	.018	.022
3.5mm	-20	0	LR6	#903-8002	#903-2002
3.5mm	-20	0	LL6	#904-8002	#904-2002
3.5mm	-25	5	LR6	#903-8001	#903-2001
3.5mm	-25	5	LL6	#904-8001	#904-2001
4.2mm	-20	0	LR6	#923-8002	#923-2002
4.2mm	-20	0	LL6	#924-8002	#924-2002
4.2mm	-25	5	LR6	#923-8001	#923-2001
4.2mm	-25	5	LL6	#924-8001	#924-2001

BUCCAL TUBES

Atlas Buccal Tubes: Convertible, Weldable

The new Atlas Convertible Tubes are available in lengths of 3.5mm and 4.2mm. These tubes feature 80-gauge mesh pads, buccal indents, and integrated hooks. Made from 17-4 stainless steel, they also have deep undercut wings for securing ties and power chains. The built-in torque in the base ensures better control and precise tooth movement. Buccal indents and a compound-contoured pad provide excellent bond strength. The mesial side of the tube is flared for easy archwire insertion, and the convertible cap allows access to partially impacted second molars. Each tube includes a color code on the distal-gingival tie wing, and both tubes feature palmer notation on the pad for easy identification.

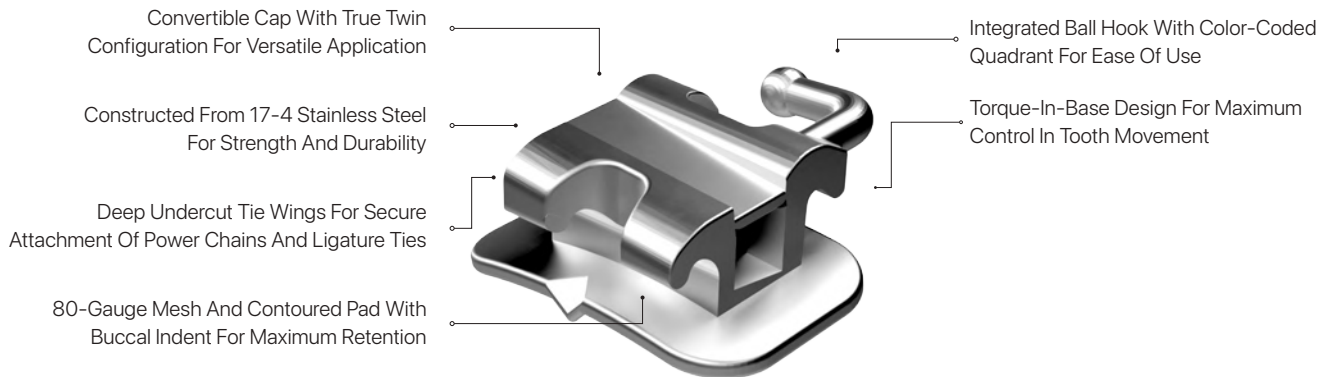

Maxillary: 10 Pack

M/D WIDTH	TORQUE	ROTATION	RIGHT/LEFT	.018	.022
3.5mm	-10	0	UR6	#890-103	#895-103
3.5mm	-10	0	UL6	#890-104	#895-104
3.5mm	-10	8	UR6	#890-105	#895-105
3.5mm	-10	8	UL6	#890-106	#895-106
3.5mm	-14	10	UR6	#890-101	#895-101
3.5mm	-14	10	UL6	#890-102	#895-102
4.2mm	-10	0	UR6	#890-203	#895-203
4.2mm	-10	0	UL6	#890-204	#895-204
4.2mm	-10	8	UR6	#890-205	#895-205
4.2mm	-10	8	UL6	#890-206	#895-206
4.2mm	-14	10	UR6	#890-201	#895-201
4.2mm	-14	10	UL6	#890-202	#895-202

Mandibular: 10 Pack

M/D WIDTH	TORQUE	ROTATION	RIGHT/LEFT	.018	.022
3.5mm	-20	0	LR6	#890-109	#895-109
3.5mm	-20	0	LL6	#890-110	#895-110
3.5mm	-25	5	LR6	#890-107	#895-107
3.5mm	-25	5	LL6	#890-108	#895-108
4.2mm	-20	0	LR6	#890-209	#895-209
4.2mm	-20	0	LL6	#890-210	#895-210
4.2mm	-25	5	LR6	#890-207	#895-207
4.2mm	-25	5	LL6	#890-208	#895-208

Atlas Buccal Tubes: Non-Convertible, Bondable, 4.5mm

The Atlas Buccal Tubes are manufactured using advanced design and production techniques, with a contoured base featuring buccal indents and a groove for bracket tweezers, the Atlas Buccal Tubes are easy to place on the tooth. The mesial side of the tube has a flared opening for easy archwire insertion, and the notch on top of the tube aids in the bonding process. The hook is angled away from the gingiva to support elastic retention and minimize tissue impingement. Additionally, there is a small extension on the distal side of the tube. The low-profile design helps reduce occlusal interference. Both the 3.2mm and 4.5mm tubes are color-coded, and palmer notation is added to the back of the pad for easy identification.

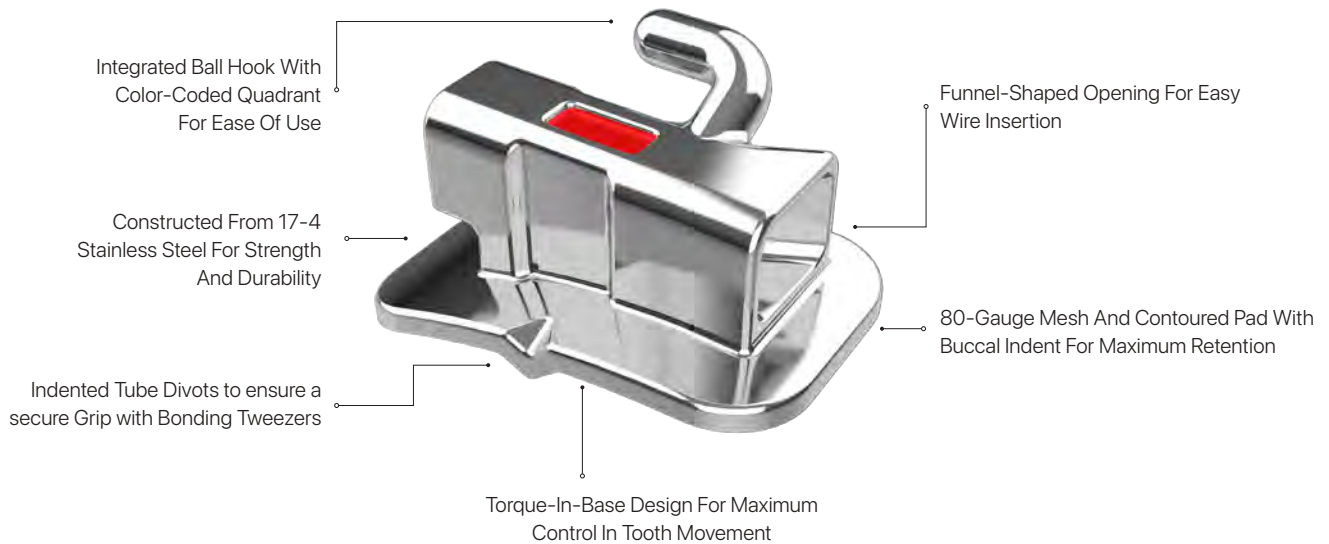

BUCCAL TUBES

Maxillary: 10 Pack

M/D WIDTH	TORQUE	ROTATION	RIGHT/LEFT	.018	.022
4.5mm	0	0	UR6	#908-101	#902-101
4.5mm	0	0	UL6	#908-102	#902-102
4.5mm	-10	8	UR6	#908-105	#902-105
4.5mm	-10	8	UL6	#908-106	#902-106
4.5mm	-14	10	UR6	#908-103	#902-103
4.5mm	-14	10	UL6	#908-104	#902-104

Mandibular: 10 Pack

M/D WIDTH	TORQUE	ROTATION	RIGHT/LEFT	.018	.022
4.5mm	0	0	LR6	#908-201	#902-201
4.5mm	0	0	LL6	#908-202	#902-202
4.5mm	-10	0	LR6	#908-205	#902-205
4.5mm	-10	0	LL6	#908-206	#902-206
4.5mm	-20	0	LR6	#908-203	#902-203
4.5mm	-20	0	LL6	#908-204	#902-204
4.5mm	-25	5	LR6	#908-207	#902-207
4.5mm	-25	5	LL6	#908-208	#902-208

Atlas Buccal Tubes: Non-Convertible, Bondable, 3.2mm

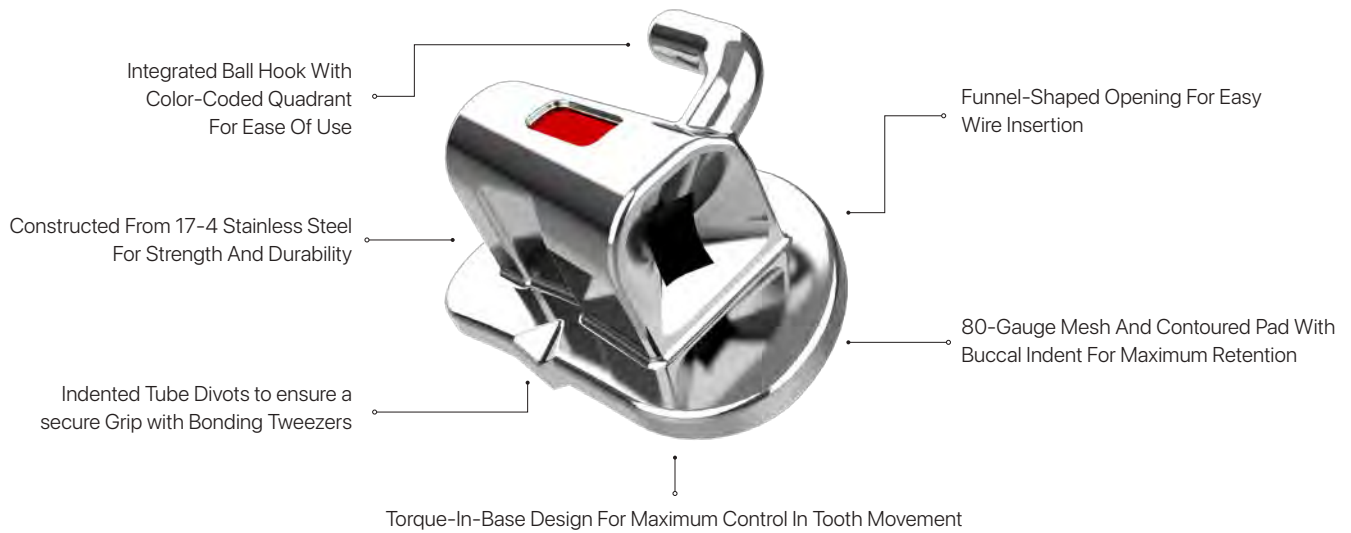

Maxillary: 10 Pack					
M/D WIDTH	TORQUE	ROTATION	RIGHT/LEFT	.018	.022
3.2mm	0	0	UR7	#908-307	#902-307
3.2mm	0	0	UL7	#908-308	#902-308
3.2mm	-10	0	UR7	#908-303	#902-303
3.2mm	-10	0	UL7	#908-304	#902-304
3.2mm	-10	8	UR7	#908-305	#902-305
3.2mm	-10	8	UR7	#908-306	#902-306
3.2mm	-14	10	UR7	#908-301	#902-301
3.2mm	-14	10	UL7	#908-302	#902-302
Mandibular: 10 Pack					
M/D WIDTH	TORQUE	ROTATION	RIGHT/LEFT	.018	.022
3.2mm	0	0	LR7	#908-407	#902-407
3.2mm	0	0	LL7	#908-408	#902-408
3.2mm	-12	0	LR7	#908-405	#902-405
3.2mm	-12	0	LL7	#908-406	#902-406
3.2mm	-20	0	LR7	#908-409	#902-409
3.2mm	-20	0	LL7	#908-410	#902-410
3.2mm	-25	0	LR7	#908-403	#902-403
3.2mm	-25	0	LL7	#908-404	#902-404
3.2mm	-25	5	LR7	#908-401	#902-401
3.2mm	-25	5	LL7	#908-402	#902-402

The Norris System Self-Ligating Tubes: Bondable

The Norris Bondable Tubes are designed to work seamlessly with the Norris 20/26 Self-Ligating Bracket System. Each features the trusted self-ligating door, ensuring easy access to second molars.

Norris System Self-Ligating Tubes: Standard Base



Maxillary: 10 Pack				
M/D WIDTH	TORQUE	ROTATION	RIGHT/LEFT	.020 X .026
4.3mm	-17	6	UR6	#216-6210
4.3mm	-17	6	UL6	#216-6220
Mandibular: 10 Pack				
4.3mm	-20	2	LR6	#216-6230
4.3mm	-20	2	LL6	#216-6240

Norris System Self-Ligating Tubes: Expanded Base



Maxillary: 10 Pack				
M/D WIDTH	TORQUE	ROTATION	RIGHT/LEFT	.020 X .026
4.3mm	-15	12	UR6	#216-6000
4.3mm	-15	12	UL6	#216-6002
Mandibular: 10 Pack				
4.3mm	-20	0	LR6	#216-6500
4.3mm	-20	0	LL6	#216-6501

Self-Ligating Tubes: Standard Base



Maxillary: 10 Pack				
M/D WIDTH	TORQUE	ROTATION	RIGHT/LEFT	.022 X .028
4.3mm	-17	6	UR6	#216-2016HCO
4.3mm	-17	6	UL6	#216-2026HCO
Mandibular: 10 Pack				
4.3mm	-20	2	LR6	#216-2036HGO
4.3mm	-20	2	LL6	#216-2046HGO

The Norris System 2nd Molar Tubes: Bondable

Second molar tubes are a low-profile non-convertible tube with an anatomically correct base for optimal fit. All first and second molar tubes are made from nickel-free cobalt-chromium and are available in packs of 10.



Maxillary: 10 Pack				
M/D WIDTH	TORQUE	ROTATION	RIGHT/LEFT	.020 X .026
3.0mm	-15	12	UR7	#216-7100
3.0mm	-15	12	UL7	#216-7120
Mandibular: 10 Pack				
3.0mm	-20	0	LR7	#216-7130
3.0mm	-20	0	LL7	#216-7140

Stability™ Buccal Tubes: Weldable

Stability™ Buccal Tubes represent our unwavering commitment to excellence and meticulous craftsmanship. Both Maxillary and Mandibular pieces are forged with uncompromising quality, guaranteeing the pinnacle of product offerings in the market. Stability™ symbolizes unmatched quality and offers various variations to seamlessly integrate into clinical scenarios. Our team is ready to assist you in identifying the precise prescription that aligns with your office's needs. Discover how Stability™ Buccal Tubes - Weldable can elevate orthodontic care in your practice with impeccable quality and practical application.



Maxillary: 10 Pack							
	RX	TRQ	ROT	M/D	R/L	.018	.022
GINGIVAL .045 HG CONV. BUCCAL TUBE	MBT	-10	8	3.5mm	UR6	#600-001	#600-101
	MBT	-10	8	3.5mm	UL6	#600-002	#600-102
OCCLUSAL .045 HG CONV. BUCCAL TUBE	Roth	-10	8	3.5mm	UR6	#600-003	#600-103
	Roth	-10	8	3.5mm	UL6	#600-004	#600-104
1ST/2ND MOLAR NON-CONVERTIBLE BUCCAL TUBE	Roth	-10	8	3.5mm	UR6/7	#600-013	#600-113
	Roth	-10	8	3.5mm	UL6/7	#600-014	#600-114
	Standard	0	0	3.5mm	UR6/7	#700-013	#700-113
	Standard	0	0	3.5mm	UL6/7	#700-014	#700-114
	MBT	-14	10	3.5mm	UR6/7	#800-013	#800-113
	MBT	-14	10	3.5mm	UL6/7	#800-014	#800-114
Mandibular: 10 Pack							
	RX	TRQ	ROT	M/D	R/L	.018	.022
.018 UTILITY ARCH SLOT CONVERTIBLE BUCCAL TUBE	Roth	-25	5	3.5mm	LR6	#600-023	#600-123
	Roth	-25	5	3.5mm	LL6	#600-024	#600-124
GINGIVAL HEADGEAR/LIP BUMPER CONVERTIBLE BUCCAL TUBE	Roth	-25	5	3.5mm	LR6	#600-028	#600-128
	Roth	-25	5	3.5mm	LL6	#600-029	#600-129
1ST/2ND MOLAR NON- CONVERTIBLE BUCCAL TUBE	Roth	-25	5	3.5mm	LR6/7	#600-031	#600-131
	Roth	-25	5	3.5mm	LL6/7	#600-032	#600-132
	-	-10	0	3.5mm	LR6/7	#700-031	#700-131
	-	-10	0	3.5mm	LL6/7	#700-032	#700-132
	Standard	0	0	3.5mm	LR6/7	#800-031	#800-131
	Standard	0	0	3.5mm	LL6/7	#800-032	#800-132

NOTE: Weld your own buccal tubes in your office or allow us to weld for you, welding service is no extra charge.
Allow 14 business days for welding services. Pre-welded band assemblies are custom & are non-returnable.

GEMINI™ Low Profile Buccal Tubes: Bondable

Gemini Stainless Steel Buccal Tube features a low profile, comfortable hooks, and an anatomical design maximizing patient comfort. Additional features include a larger wire opening, torque in base, color coding for each quadrant, buccal indent for ideal fit and 80-gauge mesh base for unsurpassed retention.



Gemini™ Mini Non-Convertible - 10 Pack

MAXILLARY	TRQ	ROT	M/D	R/L	.018	.022
MBT	-14	+10	3.8mm	UL	#M-GMT816UL	#M-GMT216UL
MBT	-14	+10	3.8mm	UR	#M-GMT816UR	#M-GMT216UR
Roth	-9	+7	3.8mm	UL	#M-GMT806UL	#M-GMT206UL
Roth	-9	+7	3.8mm	UR	#M-GMT806UR	#M-GMT206UR
Standard	0	+6	3.8mm	UL6/LR6	#M-GMT8SUL6/LR6	#M-GMT2SUL6/LR6
Standard	0	+6	3.8mm	UR6/LL6	#M-GMT8SUR6/LL6	#M-GMT2SUR6/LL6
MANDIBULAR	TRQ	ROT	M/D	R/L	.018	.022
MBT	-20	0	3.8mm	LL	#M-GMT816LL	#M-GMT216LL
MBT	-20	0	3.8mm	LR	#M-GMT816LR	#M-GMT216LR
Roth	-30	+7	3.8mm	LL	#M-GMT806LL	#M-GMT206LL
Roth	-30	+7	3.8mm	LR	#M-GMT806LR	#M-GMT206LR

Gemini™ Micro Non-Convertible - 10 Pack

MAXILLARY	TRQ	ROT	M/D	R/L	.018	.022
MBT	-14	+10	3.5mm	UL	#M-GMT817UL	#M-GMT217UL
MBT	-14	+10	3.5mm	UR	#M-GMT817UR	#M-GMT217UR
Roth	-9	+6	3.5mm	UL	#M-GMT807UL	#M-GMT207UL
Roth	-9	+6	3.5mm	UR	#M-GMT807UR	#M-GMT207UR
Standard	0	+6	3.5mm	UL7/LR7	#M-GMT8SUL7/LR7	#M-GMT2SUL7/LR7
Standard	0	+6	3.5mm	UR7/LL7	#M-GMT8SUR7/LL7	#M-GMT2SUR7/LL7
MANDIBULAR	TRQ	ROT	M/D	R/L	.018	.022
MBT	-10	0	3.5mm	LL	#M-GMT817LL	#M-GMT217LL
MBT	-10	0	3.5mm	LR	#M-GMT817LR	#M-GMT217LR
Roth	-30	+6	3.5mm	LL	#M-GMT807LL	#M-GMT207LL
Roth	-30	+6	3.5mm	LR	#M-GMT807LR	#M-GMT207LR

DynaFlex® Buccal Tube Instrument

This product offers exceptional convenience, making the placement of molar brackets significantly easier with its slender tip that effortlessly inserts into the slot on the molar bracket, while the reverse-action tweezers ensures precise and effortless bracket placement. **Item #1400-676**



GEMINI™ Low Profile Buccal Tubes: Bondable

Gemini Stainless Steel Buccal Tube feature a low profile, comfortable hooks, and an anatomical design maximizing patient comfort. Additional features include a larger wire opening, torque in base, color coding for each quadrant, buccal indent for ideal fit and 80-gauge mesh base for unsurpassed retention.



Gemini™ Mini Double-Convertible - 10 Pack

MAXILLARY	TRQ	ROT	M/D	R/L	.022
Roth	-9	+7	3.8mm	UL	#M-GMT203DUL
Roth	-9	+7	3.8mm	UR	#M-GMT203DUR
MANDIBULAR	TRQ	ROT	M/D	R/L	.022
Roth	-28	+7	3.8mm	LL	#M-GMT203DLL
Roth	-28	+7	3.8mm	LR	#M-GMT203DLR

Gemini™ Mini Convertible - 10 Pack

MAXILLARY	TRQ	ROT	M/D	R/L	.018	.022
MBT	-14	+10	3.8mm	UL	#M-GMT813UL	#M-GMT213UL
MBT	-14	+10	3.8mm	UR	#M-GMT813UR	#M-GMT213UR
Roth	-9	+7	3.8mm	UL	#M-GMT803UL	#M-GMT203UL
Roth	-9	+7	3.8mm	UR	#M-GMT803UR	#M-GMT203UR
MANDIBULAR	TRQ	ROT	M/D	R/L	.018	.022
MBT	-20	0	3.8mm	LL	#M-GMT813LL	#M-GMT213LL
MBT	-20	0	3.8mm	LR	#M-GMT813LR	#M-GMT213LR
Roth	-30	+7	3.8mm	LL	#M-GMT803LL	#M-GMT203LL
Roth	-30	+7	3.8mm	LR	#M-GMT803LR	#M-GMT203LR

BUCCAL TUBES



Mini Single Buccal Tubes: Bondable

Featuring a comfort hook designed for optimal patient comfort, a trumpeted torque in the base, a metal injection-molded archwire slot for easy insertion, a non-convertible cap to eliminate cap failure, rounded edges for enhanced patient comfort, a superior base for stronger bonds.

Mini Single Buccal Tubes, Bondable - 10 Pack

DESCRIPTION	TRQ	ROT	M/D	IN/OUT	.018	.022
UR/LL	0	0	2.41mm	.023mm	#O-600-1500	#O-600-1550
UL/LR	0	0	2.41mm	.023mm	#O-600-1502	#O-600-1552
UR	-10	0	2.41mm	.023mm	#O-600-1504	#O-600-1554
UL	-10	0	2.41mm	.023mm	#O-600-1506	#O-600-1556
UR/LL	-12	0	2.41mm	.023mm	#O-600-1510	#O-600-1558
UL/LR	-12	0	2.41mm	.023mm	#O-600-1512	#O-600-1560
LR	-25	0	2.41mm	.023mm	#O-600-1514	#O-600-1562
LL	-25	0	2.41mm	.023mm	#O-600-1516	#O-600-1564

ARCHWIRES & AUXILIARIES



Archwire Comparisons

Shown to full scale

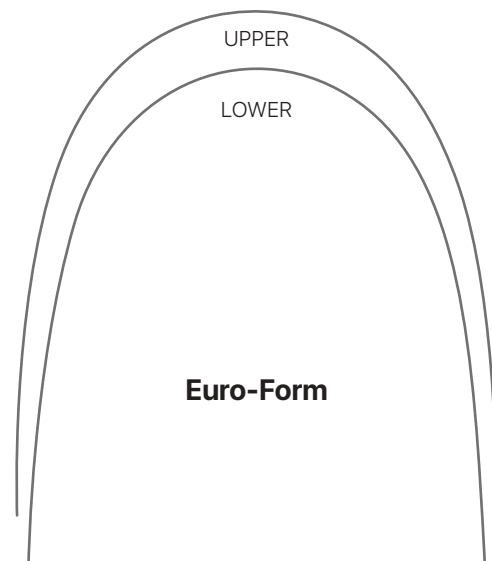
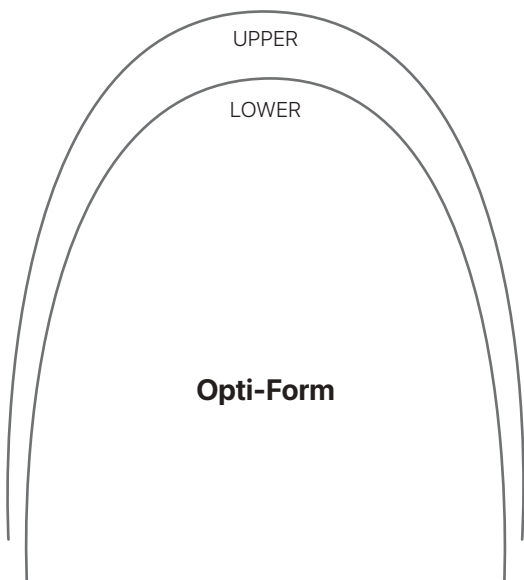
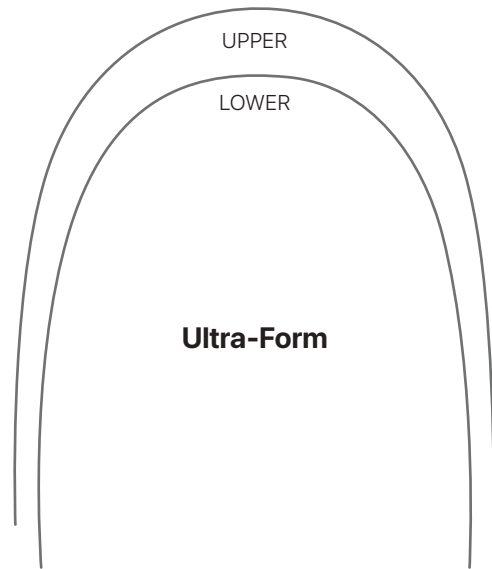
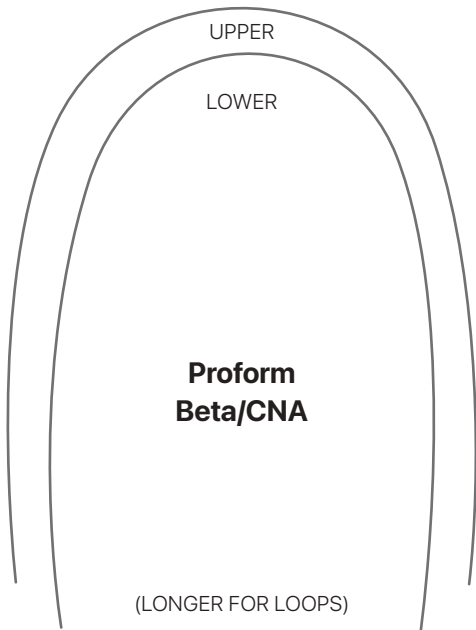
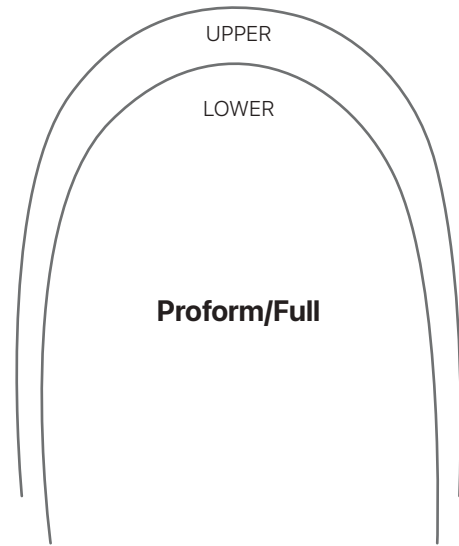
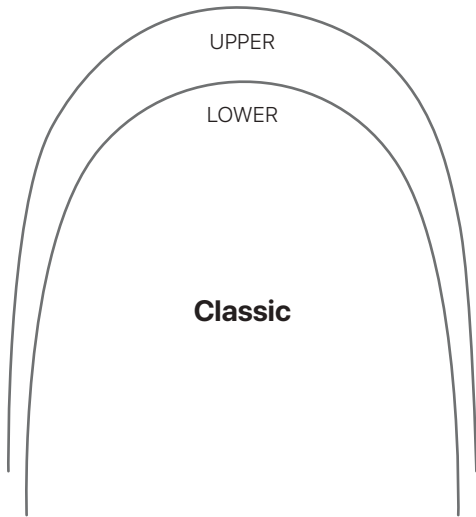

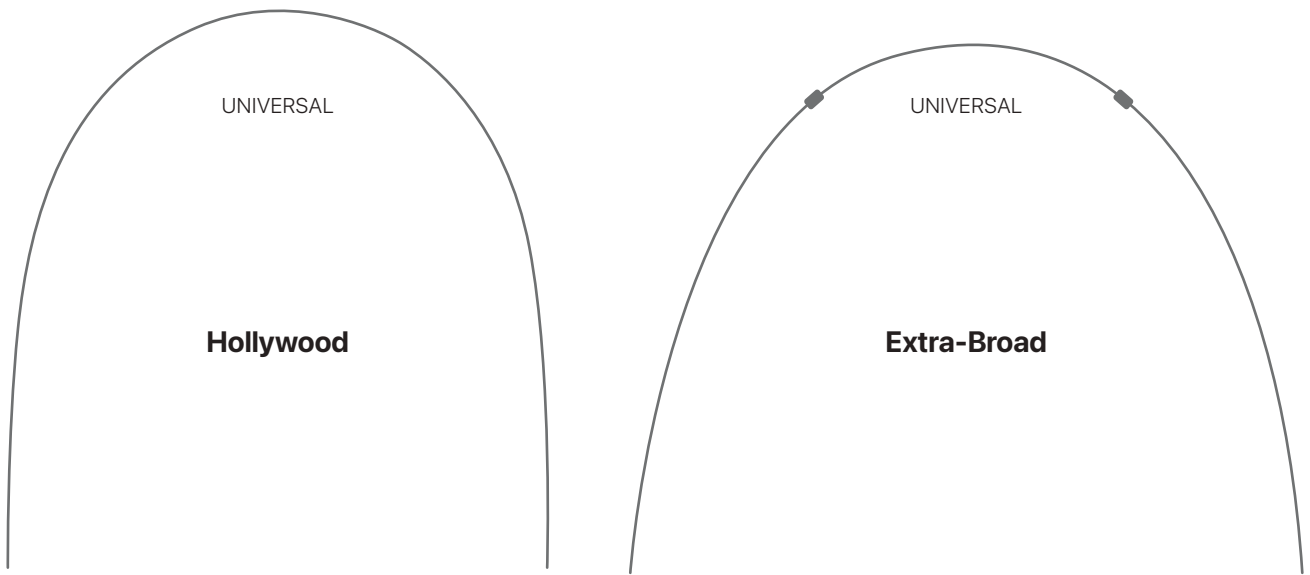

Archwire Force Load Chart

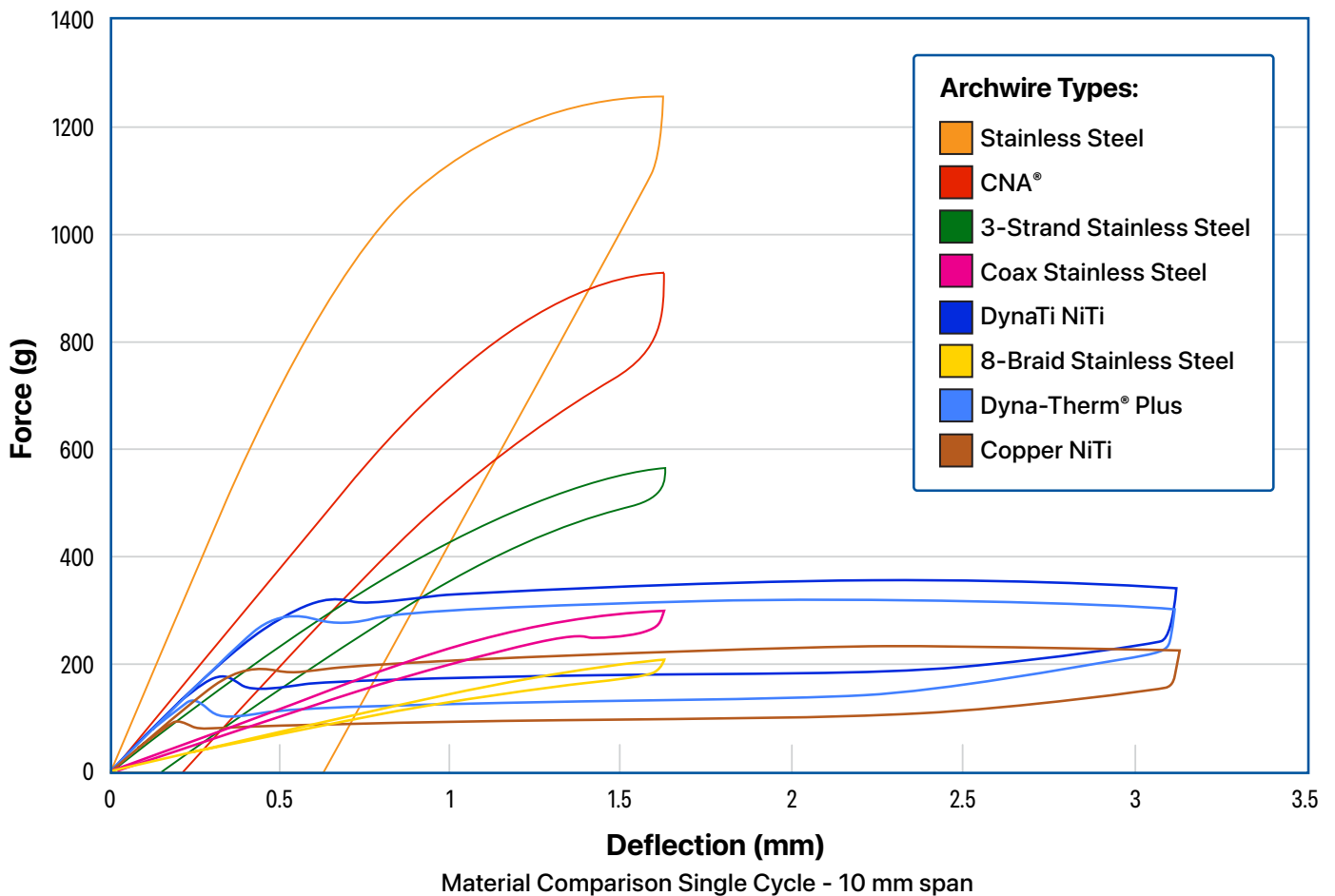

Norris **EXTRA BROAD** ARCHWIRE



As with the Norris 20/26® Brackets, the Norris Extra Broad wires are a break from convention and take what we know about expanded arches and aesthetic expression to a whole new level. Once again, Dr. Robert "Tito" Norris learned from observation and trial and error, then synthesized what he experienced from the use of existing broad arch forms into the extra broad arch form we have now developed. A non-coordinated arch makes it possible to treat both the maxilla and mandible with the same form. Thirty percent broader than the broadest arch on the market, this extra broad arch achieves a number of key efficiencies and effects: it affords maximum space as it expresses each tooth to its full outer- most potential; it gains maximum leveling and alignment as the teeth are afforded a greater range of motion; it influences the musculature of the surrounding soft tissue earlier in preparation for subsequent desired reprogramming; and it introduces a collaborative dynamic sooner between the bracket and the wire.

Throughout the later working and finishing stages of treatment, a "Rounded" Rectangular (19x25) arch wire is introduced (yet another DynaFlex® exclusive) that makes insertion, clip closure, and seating smoother than ever. Norris Extra Broad Wires are the perfect complement in how they fully express the torque and tip of the bracket over existing passive systems, yet without the binding of other higher frictional systems. Most importantly, however, is how they both fit to produce broader, more expressive smiles than anything else available today.

The Norris Extra Broad Archwires are 30% broader than the broadest arch on the market. This extra broad arch achieves a number of key efficiencies and effects.

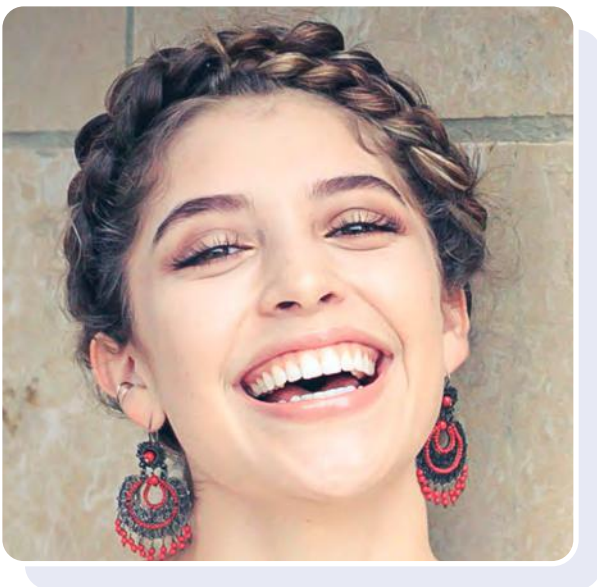
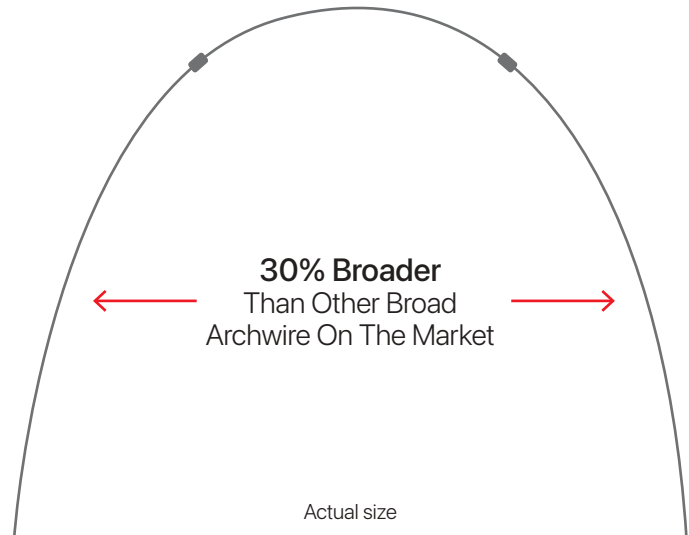

Maximum Leveling & Alignment

Teeth are afforded a greater range of motion.

Treating Posterior Cross Bite

The broad shaped archwire can often be effective at correcting crossbites.

Produces A Beautiful Broad Smile

Reduces The Dark Posterior Buccal Corridors and expresses each tooth to its full outer- most potential.

Pre-Stopped

This helps control wire shifting archwire and can be tightened at any position along the arch in accordance with the doctor's preference.

19x25 "Rounded Rectangular"

This "Rounded-Rectangular" NiTi, Beta and Stainless Steel archwire shape makes insertion, clip closure, and seating smoother than ever. Only the sharp corners are rounded so torque control is not compromised.



Rounded Rectangular

Control Without Compromise

Makes insertion, clip closure, and seating smoother than ever.
Only the corners are rounded so torque control is not compromised.

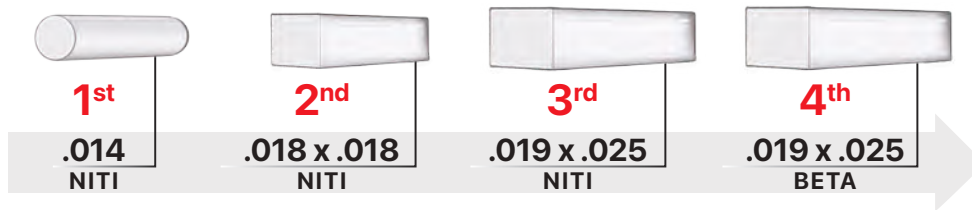

Archwire Sequencing Guide

PHASE	INITIAL ALIGNMENT	WORKING ALIGNMENT	WORKING FINISHING I	WORKING FINISHING II
WIRE	.014 NiTi	.018 x .018" NiTi	.019 x .025" Rounded NiTi	.019 x .025" Rounded Beta
DURATION	10 Weeks	10 Weeks	10 Weeks	8 Weeks Or Until Finished

TYPE	MATERIAL	NORRIS EXTRA BROAD ARCHWIRE 10 PACK	ITEM #
Round	NiTi	Norris Extra Broad Archwire, .014	#09-216-200
Round	NiTi	Norris Extra Broad Archwire, .016	#09-216-300
Round	NiTi	Norris Extra Broad Archwire, .018	#09-216-400
Rectangular	NiTi	Norris Extra Broad Archwire, .014 X .025	#09-226-100
Square	NiTi	Norris Extra Broad Archwire, .016 X .016	#09-226-200
Rectangular	NiTi	Norris Extra Broad Archwire, .016 X .022	#09-226-300
Rectangular	NiTi	Norris Extra Broad Archwire, .016 X .025	#09-226-350
Rectangular	NiTi	Norris Extra Broad Archwire, .017 X .025	#09-226-500
Square	NiTi	Norris Extra Broad Archwire, .018 X .018	#09-226-550
Rectangular	NiTi	Norris Extra Broad Archwire, .018 X .025	#09-226-600
Square	NiTi	Norris Extra Broad Archwire, .020 X .020	#09-226-800
Rectangular	Beta	Norris Extra Broad Archwire, .017 X .025	#09-326-500
Rounded Rectangular	Beta	Norris Extra Broad Archwire, .019 X .025	#09-326-700
Rounded Rectangular	NiTi	Norris Extra Broad Archwire, .019 X .025	#09-426-700
Rounded Rectangular	Stainless Steel	Norris Extra Broad Archwire, .019 X .025	#09-500-100
Round	NiTi	Norris Universal Archwire, .014	#09-5014-100
Rectangular	NiTi	Norris Universal Archwire, .014 X .025	#09-51425-100
Square	NiTi	Norris Universal Archwire, .018 X .018	#09-51818-100
Rounded Rectangular	NiTi	Norris Universal Archwire, .019 X .025	#09-51925-100
Rounded Rectangular	Beta	Norris Universal Archwire, .019 X .025	#09-61925-500

Dyna Ti Nickel Titanium Archwires Super Elastic Nickel Titanium

Only the highest-grade raw materials meet our manufacturing standards. We firmly believe in the philosophy of "Start with the best, finish with the best!" Our Super Elastic Nickel Titanium surpasses all others while also being easy on your budget. With an exceptionally broad working range and an impeccably smooth finish, it consistently delivers guaranteed results.



100 PACK	PROFORM		CLASSIC FULL	
	UPPER	LOWER	UPPER	LOWER
.012	N/A	N/A	#M-NCFC012U	#M-NCFC012L
.013	#095-006U	#095-006L	#M-NCFC013U	#M-NCFC013L
.014	#095-002U	#095-002L	#M-NCFC014U	#M-NCFC014L
.016	#095-003U	#095-003L	#M-NCFC016U	#M-NCFC016L
.018	#095-004U	#095-004L	#M-NCFC018U	#M-NCFC018L
.020	#095-005U	#095-005L	#M-NCFC020U	#M-NCFC020L
.014x.025	#097-007U	#097-007L	#M-NCFC1425U	#M-NCFC1425L
.016x.016	#097-001U	#097-001L	#M-NCFC1616U	#M-NCFC1616L
.016x.022	#097-002U	#097-002L	#M-NCFC1622U	#M-NCFC1622L
.016x.025	N/A	N/A	#M-NCFC1625U	#M-NCFC1625L
.017x.025	#097-003U	#097-003L	#M-NCFC1725U	#M-NCFC1725L
.018x.018	#097-008U	#097-008L	#M-NCFC1818U	#M-NCFC1818L
.018x.025	#097-004U	#097-004L	#M-NCFC1825U	#M-NCFC1825L
.019x.025	#097-005U	#097-005L	#M-NCFC1925U	#M-NCFC1925L
.020x.020	#097-009U	#097-009L	#M-NCFC2020U	#M-NCFC2020L
.021x.025	#097-006U	#097-006L	#M-NCFC2125U	#M-NCFC2125L

10 PACK	PROFORM		OPTIFORM	EUROFORM		ULTRAFORM	
	UPPER	LOWER	UNIV U/L	UPPER	LOWER	UPPER	LOWER
.013	#0910-FU	#0910-FL	#0980-BU	#0940-FU	#0940-FL	N/A	N/A
.014	#0910-BU	#0910-BL	#0980-CU	#0940-BU	#0940-BL	#0927-BU	#0927-BL
.016	#0910-CU	#0910-CL	#0980-DU	#0940-CU	#0940-CL	#0927-CU	#0927-CL
.018	#0910-DU	#0910-DL	#0980-EU	#0940-DU	#0940-DL	#0927-DU	#0927-DL
.020	#0910-EU	#0910-EL	#0980-FU	#0940-EU	#0940-EL	#0927-EU	#0927-EL
.014 x .025	#0911-HU	#0911-HL	#0981-AU	#0941-GU	#0941-GL	N/A	N/A
.016 x .016	#0911-AU	#0911-AL	#0981-BU	#0941-AU	#0911-AL	#0928-AU	#0928-AL
.016 x .022	#0911-BU	#0911-BL	#0981-FU	#0941-BU	#0941-BL	#0928-BU	#0928-BL
.016 x .025	N/A	N/A	#0981-IU	#0941-IU	#0941-IL	N/A	N/A
.017 x .025	#0911-CU	#0911-CL	#0981-CU	#0941-CU	#0941-CL	#0928-CU	#0928-CL
.018 x .018	#0911-DU	#0911-DL	#0981-GU	#0941-HU	#0941-HL	N/A	N/A
.018 x .025	#0911-EU	#0911-EL	#0981-DU	#0941-DU	#0941-DL	#0928-DU	#0928-DL
.019 x .025	#0911-FU	#0911-FL	#0981-EU	#0941-EU	#0941-EL	#0928-EU	#0928-EL
.020 x .020	#0911-IU	#0911-IL	#0981-HU	#0941-JU	#0941-JL	#0928-FU	#0928-FL
.021 x .025	#0911-GU	#0911-GL	N/A	#0941-FU	#0941-FL	N/A	N/A

DynaTherm Plus™ - Heat Activated Alloy Technology

DynaTherm Plus™ boasts exceptional resilience, engineered to excel in even the most challenging clinical scenarios involving severely misaligned teeth. This cutting-edge archwire is truly thermal in nature, exhibiting a pliable softness at room temperature while becoming dynamically active at 90°Fahrenheit.

- Low Forces For Greater Patient Comfort
- Lighter Forces For Easier Ligation In Difficult Cases
- Improved Resiliency To Permanent Deformation
- Ideal For Patients With Significant Crowding
- Ability To Place Heavier Wires In Earlier
- Compare To Copper NiTi™ 35°C And GAC Sentalloy
- Dynatherm Plus Wire Delivers 200gm Of Force



Tinius Olsen Load Chart

Based on .250 in lb. Load and ¼" span (@100°F)

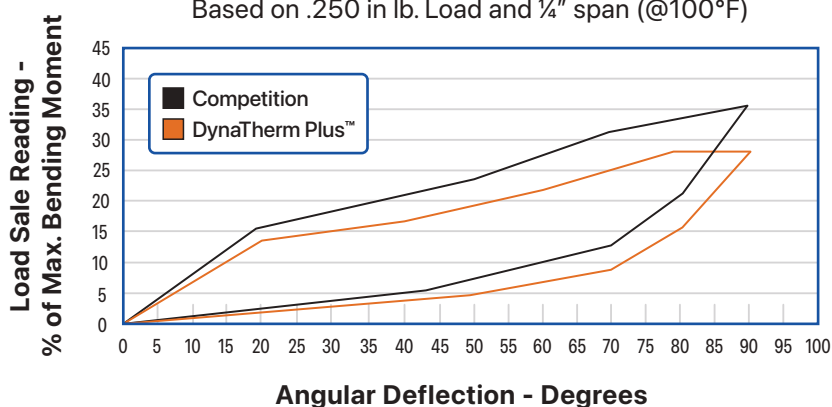

10 PACK	PROFORM		OPTIFORM	EUROFORM		ULTRAFORM	
	UPPER	LOWER	UNIV U/L	UPPER	LOWER	UPPER	LOWER
.013	#0944-FU	#0944-FL	#0949-AU	#0942-AU	#0942-AL	N/A	N/A
.014	#0944-AU	#0944-AL	#0949-BU	#0942-BU	#0942-BL	#0947-AU	#0947-AL
.016	#0944-BU	#0944-BL	#0949-CU	#0942-CU	#0942-CL	#0947-BU	#0947-BL
.018	#0944-CU	#0944-CL	#0949-DU	#0942-DU	#0942-DL	#0947-CU	#0947-CL
.020	#0944-DU	#0944-DL	N/A	#0942-EU	#0942-EL	#0947-DU	#0947-DL
.014 x .025	#0945-IU	#0945-IL	#0950-AU	#0943-GU	#0943-GL	N/A	N/A
.016 x .016	#0945-AU	#0945-AL	#0950-BU	#0943-AU	#0943-AL	#0948-AU	#0948-AL
.016 x .022	#0945-BU	#0945-BL	#0950-IU	#0943-BU	#0943-BL	#0948-BU	#0948-BL
.016 x .025	#0945-JU	#0945-JL	#0950-CU	#0943-IU	#0943-IL	N/A	N/A
.017 x .025	#0945-CU	#0945-CL	#0950-DU	#0943-CU	#0943-CL	#0948-CU	#0948-CL
.018 x .018	#0945-HU	#0945-HL	#0950-GU	#0943-HU	#0943-HL	N/A	N/A
.018 x .025	#0945-DU	#0945-DL	#0950-EU	#0943-DU	#0943-DL	#0948-DU	#0948-DL
.019 x .025	#0945-EU	#0945-EL	#0950-FU	#0943-EU	#0943-EL	#0948-EU	#0948-EL
.020 x .020	#0945-GU	#0945-GL	#0950-HU	#0943-JU	#0943-JL	N/A	N/A
.021 x .025	#0945-FU	#0945-FL	#0950-JU	#0943-FU	#0943-FL	N/A	N/A

CNA™ Archwire - Beta Titanium Alloy - The Alternative To TMA™

We've taken a leap beyond TMA™ with CNA™. This exceptional alloy enhances bending characteristics and features a remarkably smooth surface, enhancing the overall sliding mechanics. CNA™ is the ultimate nickel-free alloy, designed to effortlessly accommodate intricate bends and exhibit roughly half the stiffness of stainless steel. Deflects 100% more than stainless steel without deformation. You can find it in the proform shape with extended ends, ideal for precision detailing.

- Nickel - Free
- Weldable
- Low modules of elasticity.
- Constant forces over longer period of time.
- Compare to TMA™



Round Force Chart

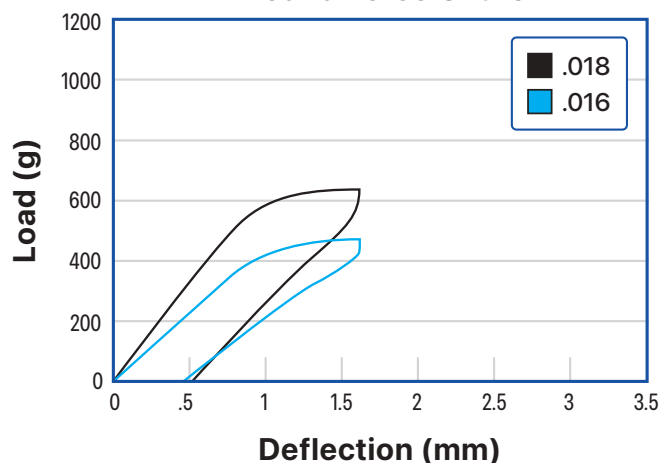

Testing done in accordance with ISO 15841:2008(E)

Rectangular Force Chart

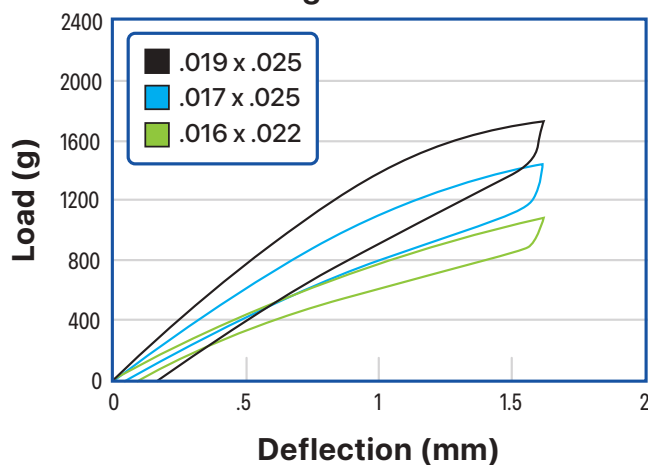

Testing done in accordance with ISO 15841:2008(E)

10 PACK	PROFORM		OPTIFORM	EUROFORM		ULTRAFORM	
	UPPER	LOWER	UNIV U/L	UPPER	LOWER	UPPER	LOWER
.016	#0963-BU	#0963-BL	N/A	#0962-AU	#0962-AL	#0926-AU	#0926-AL
.018	#0963-CU	#0963-CL	N/A	#0962-BU	#0962-BL	#0926-BU	#0926-BL
.016 x .016	#0961-FU	#0961-FL	N/A	#0962-GU	#0962-GL	N/A	N/A
.016 x .022	#0961-AU	#0961-AL	#0964-AU	#0962-CU	#0962-CL	#0926-CU	#0926-CL
.016 x .025	#0961-EU	#0961-EL	#0964-BU	#0962-IU	#0962-IL	N/A	N/A
.017 x .025	#0961-BU	#0961-BL	#0964-CU	#0962-DU	#0962-DL	#0926-DU	#0926-DL
.018 x .018	#0961-GU	#0961-GL	N/A	#0962-HU	#0962-HL	N/A	N/A
.018 x .025	#0961-HU	#0961-HL	#0964-DU	#0962-EU	#0962-EL	#0926-EU	#0926-EL
.019 x .025	#0961-CU	#0961-CL	#0964-EU	#0962-FU	#0962-FL	#0926-FU	#0926-FL
.021 x .025	#0961-DU	#0961-DL	N/A	N/A	N/A	N/A	N/A

Copper NiTi - Ensures True Activation

Introducing our Copper NiTi wire, a revolutionary advancement that not only surpasses clinical expectations but also outperforms other copper archwires. Our Copper NiTi boasts exceptional control over tooth movement loads and maintains a superior balance of force levels. With its impeccably smooth finish and the ability to provide gentle loading for early engagement, this wire is poised to surpass all your expectations.

- Revolutionary Orthodontic Advancement
- Exceeds Clinical Expectations
- Outperforms Comparable Archwires
- Unparalleled Control Over Movement
- Optimal Force Balance
- Impeccably Smooth Finish
- Ensures Gentle Early Engagement



27 DEGREE 10 PACK	PROFORM		OPTIFORM	EUROFORM	
	UPPER	LOWER	UNIV U/L	UPPER	LOWER
.013	#10-C27013U	#10-C27013L	#09-C27013	#15-C27013U	#15-C27013L
.014	#10-C27014U	#10-C27014L	#09-C27014	#15-C27014U	#15-C27014L
.016	#10-C27016U	#10-C27016L	#09-C27016	#15-C27016U	#15-C27016L
.018	#10-C27018U	#10-C27018L	#09-C27018	#15-C27018U	#15-C27018L
.014 x .025	#10-C27014025U	#10-C27014025L	#09-C27014025	#15-C27014025U	#15-C27014025L
.016 x .022	#10-C27016022U	#10-C27016022L	#09-C27016022	#15-C27016022U	#15-C27016022L
.016 x .025	#10-C27016025U	#10-C27016025L	#09-C27016025	#15-C27016025U	#15-C27016025L
.017 x .025	#10-C27017025U	#10-C27017025L	#09-C27017025	#15-C27017025U	#15-C27017025L
.018 x .025	#10-C27018025U	#10-C27018025L	#09-C27018025	#15-C27018025U	#15-C27018025L
.019 x .025	#10-C27019025U	#10-C27019025L	#09-C27019025	#15-C27019025U	#15-C27019025L

35 DEGREE 10 PACK	PROFORM		OPTIFORM	EUROFORM	
	UPPER	LOWER	UNIV U/L	UPPER	LOWER
.016	#10-C35016U	#10-C35016L	#09-C35016	#15-C35016U	#15-C35016L
.018	#10-C35018U	#10-C35018L	#09-C35018	#15-C35018U	#15-C35018L
.016 x .022	#10-C35016022U	#10-C35016022L	#09-C35016022	#15-C35016022U	#15-C35016022L
.017 x .025	#10-C35017025U	#10-C35017025L	#09-C35017025	#15-C35017025U	#15-C35017025L
.018 x .025	#10-C35018025U	#10-C35018025L	#09-C35018025	#15-C35018025U	#15-C35018025L
.019 x .025	#10-C35019025U	#10-C35019025L	#09-C35019025	#15-C35019025U	#15-C35019025L
.020 x .020	#10-C35020020U	#10-C35020020L	#09-C35020020	#15-C35020020U	#15-C35020020L
.021 x .025	#10-C35021025U	#10-C35021025L	#09-C35021025	#15-C35021025U	#15-C35021025L

Copper NiTi With Stops

DynaFlex's Pre-Stopped Copper NiTi alloy offers low hysteresis and gentle loading forces for easy wire engagement, enhancing efficiency and patient comfort. The precise temperature transformation occurs at 35 degrees. Copper addition improves thermal reactive properties and force consistency. Precise manufacturing and thermal treatment ensure proven clinical efficiency and desired forces. Each wire includes two adjustable pre-assembled stops. Available in packages of 10.

10 PACK	EXTRA BROAD	UNIVERSAL
	UNIV U/L	UNIV U/L
.014	#13-C35014-S	#11-C35014-S
.018	#13-C35018-S	#11-C35018-S
.014 x .025	#13-C351425-S	#11-C351425-S
.016 x .025	#13-C351625-S	#11-C351625-S
.018 x .018	#13-C351818-S	#11-C351818-S
.018 x .025	#13-C351825-S	#11-C351825-S

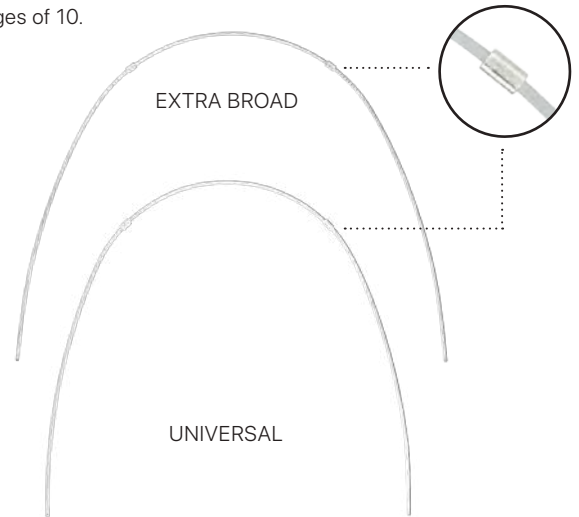

Bioflex3® Heat Activated, Multi-Force Nickel Titanium

Experience the innovation of a heat-activated, multi-force Nickel Titanium wire, offering three distinct force regions within a single archwire. Benefit from the perfect alignment with biological forces for highly efficient tooth movement, resulting in reduced wire changes and enhanced cost-effectiveness. Compare to GAC BioForce®.

10 PACK	PROFORM	
	UPPER	LOWER
.016	#0931-GU	#0931-GL
.018	#0931-HU	#0931-HL
.016 x .016	#0931-AU	#0931-AL
.016 x .022	#0931-BU	#0931-BL
.017 x .025	#0931-JU	#0931-JL
.018 x .018	#0931-CU	#0931-CL
.018 x .025	#0931-DU	#0931-DL
.019 x .025	#0931-EU	#0931-EL
.020 x .020	#0931-FU	#0931-FL

Nickel-Titanium Wire Force Chart
Tooth-Moving Forces At 1.5 MM Deflection

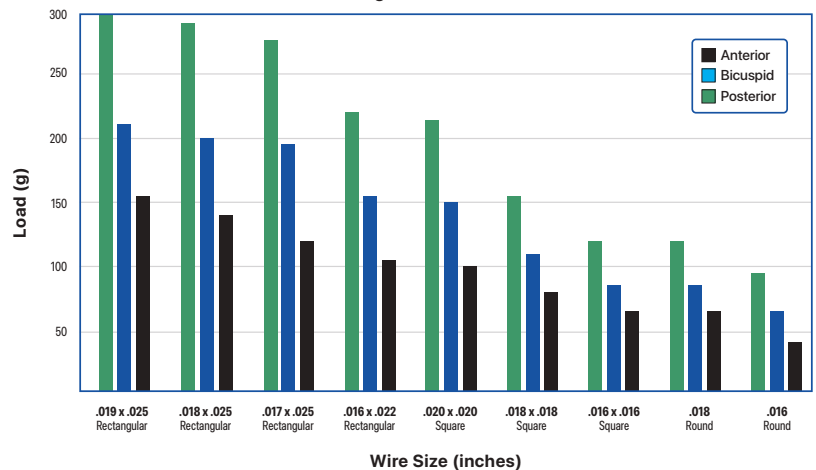

3-Point Bend Test performed on a 10 mm wire span.
Wire tested in the Buccal-Lingual plane to allow for curvature of the archwire.



DynaFlex® Dynalce Spray

Instantly softens NiTi! Make your work with Niti memory wire and expanders a breeze with Chill Spray Chilling down to an impressive -62°F, this nonflammable aerosol spray offers unparalleled convenience. A quick, effortless spray is all it takes to transform your Niti materials. Available in a convenient 10 oz can. **Item #0913**

DynaTorque™ Archwires - Multi-Force Nickel Titanium

DynaTorque™ is a full-sized NiTi archwire with the anterior section pre-torqued to 20°. This specialized, preformed wire allows for the addition of torque into the anterior region while maintaining non-torque in the posterior region. DynaTorque™ Archwires are ideal for passive, self-ligating bracket systems, offering a 20° anterior torque bend without the need for additional bending. This design allows for early introduction of torque in upper centrals and laterals, as well as providing uprighting torque in the lower anterior segment. You can achieve labial or lingual torque forces by simply reversing the wire orientation. Available in packs of 10 for your convenience.



20° Anterior Torque Bend

10 PACK	PROFORM		
	34MM UPPER	38MM UPPER	28MM LOWER
.016 x .022	#0971-AU	#0972-AU	#0970-AL
.017 x .025	#0971-BU	#0972-BU	#0970-BL
.018 x .025	#0971-CU	#0972-CU	#0970-CL
.019 x .025	#0971-DU	#0972-DU	#0970-DL
.021 x .025	#0971-EU	#0972-EU	#0970-EL

HOLLYWOOD Archwire

Developed By: Dr. Michael Williams, DDS

Hollywood Arches have been meticulously designed to enhance the bicuspid area and deliver bicuspid prominence, resulting in a stunning Hollywood smile! These archwires possess the widest transverse archform in the bicuspid region, and the benefits are remarkable. They effectively eliminate the unsightly triangular dark spaces in your patients' smiles. Originally conceived for compatibility with the Series 2000 appliances, they're also a valuable choice for practitioners seeking enhanced expression from self-ligating bracket systems. When used following the Series 2000 appliances, these archwires not only maintain the dimensional gains achieved but also elevate dental and facial aesthetics to unprecedented heights. Recent enhancements have extended the archwire length, simplifying the creation of helical and other closed-loop configurations. This extra length also enables the wire to reach the second molar bracket, facilitating cinch-back activation. Elevate your orthodontic practice to the next level with Hollywood Arches.

Stainless Steel, Universal Archwire For Perfecting Your Patient's Smile!

Hollywood - 10 Pack	
SIZE	UNIVERSAL
.016 x .016	#0919U-1616
.016 x .022	#0919U-1622
.018 x .018	#0919U-1818
.018 x .025	#0919U-1825

BEFORE



AFTER

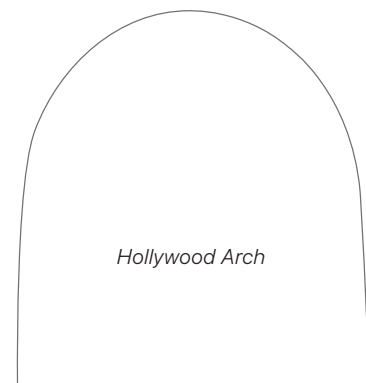

Hollywood Arch

Stainless Steel Archwires

As a constant commitment, we meticulously polish all our archwires to attain a brilliant shine, accompanied by a remarkably smooth finish that effectively minimizes friction. These archwires are not only of superior quality but also represent a preferred and cost-effective choice for your practice.



100 PACK	PROFORM		CLASSIC FULL	
	UPPER	LOWER	UPPER	LOWER
.012	N/A	N/A	#M-SSFC012U	#M-SSFC012L
.013	N/A	N/A	N/A	N/A
.014	#100-002U	#100-002L	#M-SSFC014U	#M-SSFC014L
.016	#100-003U	#100-003L	#M-SSFC016U	#M-SSFC016L
.018	#100-004U	#100-004L	#M-SSFC018U	#M-SSFC018L
.020	#100-005U	#100-005L	#M-SSFC020U	#M-SSFC020L

50 PACK	PROFORM		CLASSIC FULL	
	UPPER	LOWER	UPPER	LOWER
.016 x .016	#102-001U	#102-001L	#M-SSFC1616U	#M-SSFC1616L
.016 x .022	#102-002U	#102-002L	#M-SSFC1622U	#M-SSFC1622L
.016 x .025	#102-007U	#102-007L	#M-SSFC1625U	#M-SSFC1625L
.017 x .025	#102-003U	#102-003L	#M-SSFC1725U	#M-SSFC1725L
.018 x .018	#102-008U	#102-008L	#M-SSFC1818U	#M-SSFC1818L
.018 x .025	#102-004U	#102-004L	#M-SSFC1825U	#M-SSFC1825L
.019 x .025	#102-005U	#102-005L	#M-SSFC1925U	#M-SSFC1925L
.020 x .020	#102-009U	#102-009L	#M-SSFC2020U	#M-SSFC2020L
.021 x .025	#102-006U	#102-006L	#M-SSFC2125U	#M-SSFC2125L

10 PACK	PROFORM		OPTIFORM	EUROFORM		ULTRAFORM	
	UPPER	LOWER	UNIV U/L	UPPER	LOWER	UPPER	LOWER
.014	#0900-BU	#0900-BL	#0976-BU	#0908-BU	#0908-BL	#0924-BU	#0924-BL
.016	#0900-CU	#0900-CL	#0976-CU	#0908-CU	#0908-CL	#0924-CU	#0924-CL
.018	#0900-DU	#0900-DL	#0976-DU	#0908-DU	#0908-DL	#0924-DU	#0924-DL
.020	#0900-EU	#0900-EL	N/A	#0908-EU	#0908-EL	#0924-EU	#0924-EL
.016 x .016	#0902-AU	#0902-AL	#0977-FU	#0909-AU	#0909-AL	#0925-AU	#0925-AL
.016 x .022	#0902-BU	#0902-BL	#0977-AU	#0909-BU	#0909-BL	#0925-BU	#0925-BL
.016 x .025	#0902-IU	#0902-IL	#0977-BU	#0909-GU	#0909-GL	N/A	N/A
.017 x .025	#0902-CU	#0902-CL	#0977-CU	#0909-CU	#0909-CL	#0925-CU	#0925-CL
.018 x .018	#0902-GU	#0902-GL	N/A	#0909-HU	#0909-HL	N/A	N/A
.018 x .025	#0902-DU	#0902-DL	#0977-DU	#0909-DU	#0909-DL	#0925-DU	#0925-DL
.019 x .025	#0902-EU	#0902-EL	#0977-EU	#0909-EU	#0909-EL	#0925-EU	#0925-EL
.020 x .020	#0902-HU	#0902-HL	#0977-GU	N/A	N/A	#0925-FU	#0925-FL
.021 x .025	#0902-FU	#0902-FL	#0977-HU	#0909-FU	#0909-FL	N/A	N/A

Finally, an aesthetic archwire that looks beautiful from start to finish.

Infinity

Chip-Free Aesthetic Wire

Discover a revolutionary solution in the orthodontic market with our Infinity Aesthetic wire! Unlike traditional coated aesthetic wires, our Infinity Wire is not coated; instead, it undergoes a unique etching process that eliminates the common drawbacks found with traditional coatings. This etching process ensures the natural color finish is incredibly durable, will not wear off, and the original wire size is retained and not increased or altered by a coating thickness. Moreover, our etching technique will not increase friction, ensuring optimal performance. The result is a wire that beautifully blends with all enamel, providing a discreet and aesthetic orthodontic experience.



Infinity Wires Paired With Clear Brackets Are Virtually Invisible



Universal Extra Broad Round - 10 Pack	
NiTi .014 Extra Broad Arch	#10-216-200DW
NiTi .018 Extra Broad Arch	#10-216-400DW

Universal Extra Broad Rectangular - 10 Pack	
NiTi .014 x .025 Extra Broad Arch	#10-226-100DW
NiTi .017 x .025 Extra Broad Arch	#10-226-500DW
NiTi .018 x .018 Extra Broad Arch	#10-226-550DW
NiTi .019 x .025 Extra Broad Arch	#10-426-700DW
SS .019 x .025 Extra Broad Arch	#10-500-100DW

DynaFlex® Archwire Dispensers

Maintain a tidy and well-organized office environment with our range of covered archwire dispensers! Choose from two distinct styles tailored to meet the specific needs of your practice.

HOLDS 12 DIFFERENT WIRES - **Item #1493-01**

HOLDS 10 DIFFERENT WIRES - **Item #1493**



DynaFlex® U Marc™ Markers

A beloved choice among our customers! Our Markers excel at labeling archwires, retainers, headgear, and facebows. The octagon-shaped blue plastic handle ensures effortless handling, even while wearing gloves. Take your pick from either vibrant orange or classic white options.

U Marc™ Markers - 100 Pack	
ITEM #	DESCRIPTION
#1373	Orange Markers
#1374	White Markers



ARCHWIRES & AUXILIARIES

DynaFlex® 3-Strand Twist Archwire

Designed to provide a gentle yet effective force with exceptional flexibility and reliable spring back. The DynaFlex® 3-strand wire is not prone to unraveling when cut, making it an excellent choice for initial treatments.



Proform - Round - 10 Pack		
SIZE	UPPER	LOWER
.0155	#0920-AU	#0920-AL
.0175	#0920-BU	#0920-BL
.0195	#0920-CU	#0920-CL
.0215	#0920-DU	#0920-DL

DynaFlex® 8-Braid Archwire

This wire offers outstanding flexibility for precise torque control during leveling and exceptional durability without fraying when cut. Its resilience makes it ideal for both initial and finishing orthodontic stages. Available in packs of 10.

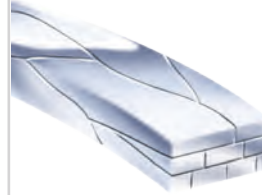

Proform Shape - 10 Pack		
SIZE	UPPER	LOWER
.016 x .016	#0959-001	#0959-011
.016 x .022	#0959-002	#0959-012
.017 x .025	#0959-003	#0959-013
.018 x .025	#0959-005	#0959-015
.019 x .025	#0959-006	#0959-016

DynaFlex® 6-Strand Coaxial Archwire

Ideal for the initial leveling and alignment phase, especially in cases of severe misalignment. Its exceptional flexibility and ultra-smooth, silky finish translate to reduced resistance and minimal friction when engaged in the bracket slot.



30" Spools- Spool	
SIZE	ITEM
.0155	#O-952-7100
.0175	#O-952-7102
.0195	#O-952-7104
.0215	#O-952-7106

14" Lengths - 10 Pack	
SIZE	ITEM
.0155	#O-952-7200
.0175	#O-952-7202
.0195	#O-952-7204
.0215	#O-952-7206

Proform Shape - 10 Pack		
SIZE	UPPER	LOWER
.0155	#0958-001	#0958-011
.0175	#0958-002	#0958-012
.0195	#0958-003	#0958-013
.0215	#0958-004	#0958-014

DynaFlex® Dyna Ti Reverse Curve II Nickel Titanium Archwires

the Reverse Curve II – Nickel Titanium wire. Designed with a subtle curve and minimal toe-in action at the molars, it's the wire you've been anticipating. Available in packs of 10.

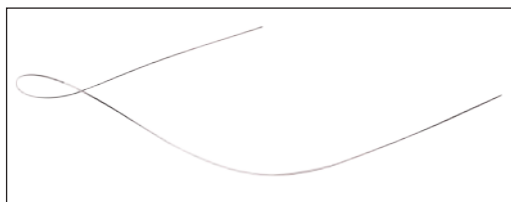

Round - 10 Pack		
SIZE	UPPER	LOWER
.014	#0932-BU	#0932-BL
.016	#0932-CU	#0932-CL
.018	#0932-DU	#0932-DL
.020	#0932-EU	#0932-EL

Rectangular - 10 Pack		
SIZE	UPPER	LOWER
.016 x .016	#0933-AU	#0933-AL
.016 x .022	#0933-BU	#0933-BL
.017 x .025	#0933-CU	#0933-CL
.018 x .025	#0933-DU	#0933-DL
.019 x .025	#0933-EU	#0933-EL
.021 x .025	#0933-FU	#0933-FL

DynaFlex® Dimple Nickel Titanium

The strategically placed dimple in the archwire serves as a lasting mid-line marker, effectively preventing midline shifting and reducing patient discomfort.

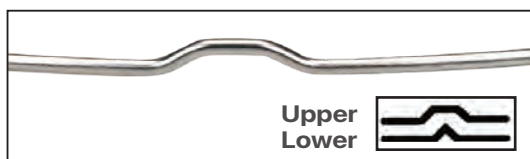

Round - 10 Pack		
SIZE	UPPER	LOWER
.014	#0934-AU	#0934-AL
.016	#0934-BU	#0934-BL
.018	#0934-CU	#0934-CL
.020	#0934-DU	#0934-DL

Rectangular - 10 Pack		
SIZE	UPPER	LOWER
.016 x .016	#0935-AU	#0935-AL
.016 x .022	#0935-BU	#0935-BL
.017 x .025	#0935-CU	#0935-CL
.018 x .025	#0935-EU	#0935-EL
.019 x .025	#0935-FU	#0935-FL
.021 x .025	#0935-GU	#0935-GL

Gold'nBRACES Gold Plated Archwire

Achieve a radiant golden smile with our Gold-Plated Stainless Steel and NiTi Archwire. We've enhanced our superior Proform Archwire with a durable gold plating that never flakes or discolors. Each pack contains 5 premium archwires, blending aesthetics with top-notch performance.



Proform Stainless Steel - Gold - 10 Pack		
SIZE	UPPER	LOWER
.014	#0900G-BU	#0900G-BL
.016	#0900G-CU	#0900G-CL
.018	#0900G-DU	#0900G-DL
.016x.016	#0902G-AU	#0902G-AL
.016x.022	#0902G-BU	#0902G-BL
.017x.025	#0902G-CU	#0902G-CL
.018x.025	#0902G-DU	#0902G-DL
.019x.025	#0902G-EU	#0902G-EL
.021x.025	#0902G-FU	#0902G-FL

Proform Nickel Titanium - Gold - 10 Pack		
SIZE	UPPER	LOWER
.012	#0910G-AU	#0910G-AL
.014	#0910G-BU	#0910G-BL
.016	#0910G-CU	#0910G-CL
.018	#0910G-DU	#0910G-DL
.016x.016	#0911G-AU	#0911G-AL
.016x.022	#0911G-BU	#0911G-BL
.017x.025	#0911G-CU	#0911G-CL
.018x.025	#0911G-DU	#0911G-DL
.021x.025	#0911G-FU	#0911G-FL

DynaFlex® Copper Niti With Stops

Experience the benefits of our exceptional wire: exceptional springback provides fast and efficient tooth movement, easy engagement in the slot due to smaller loading forces than standard Nickel Titanium, even at small deflections still provides continuous force, resistant to permanent deformation, precise temperature range means predictable results, very easy to engage, making it a versatile choice for orthodontic procedures. Pack of 10.

Round - 10 Pack	
SIZE	ITEM NUMBER
.014	#O-950-1140
.016	#O-950-1142
.018	#O-950-1144

Rectangular - 10 Pack	
SIZE	ITEM NUMBER
.014 x .025	#O-950-1160
.016 x .025	#O-950-1162
.018 x .018	#O-950-1164
.018 x .025	#O-950-1166
.019 x .025	#O-950-1168



DynaFlex® Pre-Stopped Nickel Titanium Archwire

Two crimpable tube stops are pre-loaded and lightly Our archwires come pre-loaded with two crimpable tube stops, offering clinicians effortless positioning along the arch. A gentle crimp is all that's needed to securely hold the tube stops in place, streamlining the orthodontic process for you.

- Tube stops help to control wire movement along the arch.
- Convenient alternate to cinching
- Two bright, fully annealed 304SS 2mm long stops pre-crimped per archwire
- Small tubes (ID of .019") are pre-installed on round wires.
- Large tubes (ID of .031") are pre-installed on square and rectangle wires

Round - 10 Pack	
SIZES	ITEM #
.012	#O-950-4042
.014	#O-950-4044
.016	#O-950-4046
.018	#O-950-4048

Rectangular - 10 Pack			
SIZES	ITEM #	SIZES	ITEM #
.014 x .025	#O-950-4052	.018 x .018	#O-950-4062
.016 x .016	#O-950-4054	.018 x .025	#O-950-4064
.016 x .022	#O-950-4056	.019 x .025	#O-950-4066
.016 x .025	#O-950-4058	.020 x .020	#O-950-4068
.017 x .025	#O-950-4060		



DynaFlex® Nickel-Free Beta III CNA: Mushroom Looped Archwire

Benefit from our orthodontic innovation: biomechanically-designed loops for optimal performance, ensures a consistent application of force, allows for larger activations, enhancing treatment efficacy.

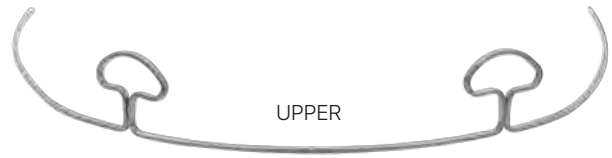

Mushroom Looped - 10 Pack			
UPPER SIZE	.016 x .022	.017 x .025	.019 x .025
32 mm	#O-950-9030	#O-950-9031	#O-950-9032
34 mm	#O-950-9033	#O-950-9034	#O-950-9035
36 mm	#O-950-9036	#O-950-9037	#O-950-9038
38 mm	#O-950-9039	#O-950-9040	#O-950-9041
40 mm	#O-950-9042	#O-950-9043	#O-950-9044
42 mm	#O-950-9045	#O-950-9046	#O-950-9047
46 mm	#O-950-9048	#O-950-9049	#O-950-9050

Mushroom Looped - 10 Pack			
LOWER SIZE	.016 x .022	.017 x .025	.019 x .025
24 mm	#O-950-9060	#O-950-9061	#O-950-9062
26 mm	#O-950-9063	#O-950-9064	#O-950-9065
28 mm	#O-950-9066	#O-950-9067	#O-950-9068
30 mm	#O-950-9069	#O-950-9070	#O-950-9071

DynaFlex® Stainless Steel: Keyhole Looped Archwire

Available in 2 and 4 loop options, these archwires will ensure accurate placement every time. Made from medical grade 304V stainless steel these wires feature bright, smooth, flat surfaces. The consistent shape will ensure your patients of great results every time. Used in sliding mechanics for extraction space closure and also in non-extraction Class II cases. Commonly used in combination with elastics or closed coil springs. Biocompatible, able to place and hold intricate bends, consistent force, and superior tensile strength.

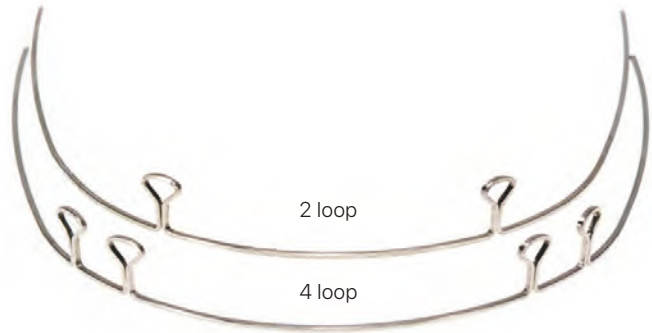

2 Loop - 10 Pack			
UPPER	.016 X .022	.017 X .025	.019 X .025
34 mm	#O-951-8001	#O-951-8002	#O-951-8003
36 mm	#O-951-8005	#O-951-8006	#O-951-8007
38 mm	#O-951-8009	#O-951-8010	#O-951-8011
40 mm	#O-951-8013	#O-951-8014	#O-951-8015
42 mm	#O-951-8017	#O-951-8018	#O-951-8019
44 mm	#O-951-8021	#O-951-8022	#O-951-8023
LOWER	.016 X .022	.017 X .025	.019 X .025
22 mm	#O-951-8025	#O-951-8026	#O-951-8027
24 mm	#O-951-8029	#O-951-8030	#O-951-8031
26 mm	#O-951-8033	#O-951-8034	#O-951-8035
28 mm	#O-951-8037	#O-951-8038	#O-951-8039
30 mm	#O-951-8041	#O-951-8042	#O-951-8043
32 mm	#O-951-8045	#O-951-8046	#O-951-8047

4 Loop - 10 Pack				
UPPER	.016 X .022	.017 X .025	.019 X .025	.021 X .025
34 mm	#O-951-8049	#O-951-8050	#O-951-8051	#O-951-8052
36 mm	#O-951-8053	#O-951-8054	#O-951-8055	#O-951-8056
38 mm	#O-951-8057	#O-951-8058	#O-951-8059	#O-951-8060
40 mm	#O-951-8061	#O-951-8062	#O-951-8063	#O-951-8064
42 mm	#O-951-8065	#O-951-8066	#O-951-8067	#O-951-8068
44 mm	#O-951-8069	#O-951-8070	#O-951-8071	#O-951-8072
LOWER	.016 X .022	.017 X .025	.019 X .025	.021 X .025
22 mm	#O-951-8073	#O-951-8074	#O-951-8075	#O-951-8076
24 mm	#O-951-8077	#O-951-8078	#O-951-8079	#O-951-8080
26 mm	#O-951-8081	#O-951-8082	#O-951-8083	#O-951-8084
28 mm	#O-951-8085	#O-951-8086	#O-951-8087	#O-951-8088
30 mm	#O-951-8089	#O-951-8090	#O-951-8091	#O-951-8092
32 mm	#O-951-8093	#O-951-8094	#O-951-8095	#O-951-8096

DynaFlex® Niti Open Coil Spring on Spool

Our .012 x .045 Nickel Titanium open coil spring is now conveniently available on a 15" spool. **Item #1018**

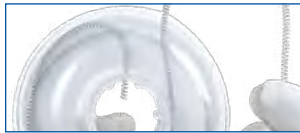

DynaFlex® Nickel Titanium Open Coil Spring

Offers a gentle and continuous force, making space opening a breeze. Each pack contains three 7" pieces.



NiTi Open Coil Spring	
SIZE	ITEM #
.010 x .030	#1011-1
.012 x .030	#1011-2
.014 x .036	#1011-3
.010 x .045	#1011-4
.012 x .045	#1011-5



DynaFlex® Coated NiTi Open Coil & NiTi Closed Coil Spring

Discover the versatility of Coated Niti Open Coil, facilitating controlled force, tooth movement, and aesthetic appeal. Additionally, don't miss out on our new Coated Closed Coil.

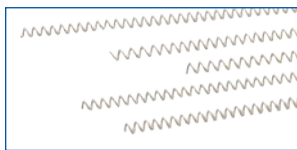

010X030 COATED OPEN COIL
(3-7" PIECES/PACK) - **Item #1006-01**

010X030 COATED CLOSED COIL
(32" SPOOL) - **Item #1006-05**

DynaFlex® Nickel Titanium Closing Spring

Discover our preformed springs featuring eye-looped ends, ideal for bracket hooks or ligation applications. Pack of 10.

NiTi Closing Spring		
FORCE	LENGTH	ITEM #
200 GMS	9mm	#1010-H
150 GMS	9mm	#1010-M
100 GMS	9mm	#1010-L
100 GMS	12mm	#1012-L



DynaFlex® Stainless Steel Open Coil Spring

Crafted from high-quality double-tempered stainless steel, neatly packed on convenient spools. 40" Spools

.010 X .030 - **Item #1008-102**

.010 X .036 - **Item #1008-103**

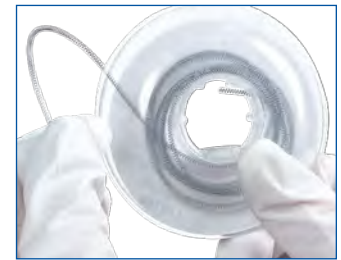

DynaFlex® Stainless Steel Closed Coil Spring

Effortlessly utilize our high-quality stainless steel spring, neatly spooled for your convenience. Experience outstanding rebound, whether for precise retraction mechanics or dependable space maintenance. 40" Spool. **Item #1007**



DynaFlex® Distalizing Coil Springs, NiTi

Versatility at its best: Accommodates any archwire size. Offers optimal superelastic force levels. Designed for easy 'cut and fit' customization to any desired length.

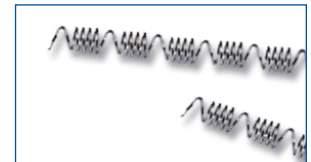

15" SPOOL .010X.045 - **Item #O-950-5105**

3 X 7" LENGTHS - **Item #0972**

DynaFlex® Variable Force Coil Springs Nickel Titanium

Embrace the benefits of our single-spring design, streamlining inventory and eliminating the need for frequent spring changes. Enjoy the reliability of consistent and predictable forces, optimizing tooth movement efficiency.

Compression: 15" Spool	
SIZES	ITEM #
.010 x .030	#O-950-5220
.012 x .030	#O-950-5222
.010 x .040	#O-950-5223
.012 x .045	#O-950-5224
.011 x .030	#O-950-5228



Extension - 10 Pack	
SIZES	ITEM #
.010 x .030 x 9mm	#O-950-5210
.010 x .030 x 12mm	#O-950-5212
.011 x .030 x 9mm	#O-950-5216



DynaFlex® Crimpable Stops: Non-Slip Design

Get ready to redefine your expectations of crimpable archwire stops with our revolutionary patent-pending non-slip design. Once crimped, our Non-Slip Stops stay securely in place, thanks to their innovative treated surface. These crimpable split archwire stops are meticulously crafted to seamlessly accommodate wires of any type or size, ranging from nickel titanium to stainless steel, .012" to .021" x .025". Bid farewell to the hassle of managing an inventory of various stop sizes or wasting precious chair time deliberating which size to use. Our non-slip stops are the ultimate solution for every situation that demands a crimpable stop.

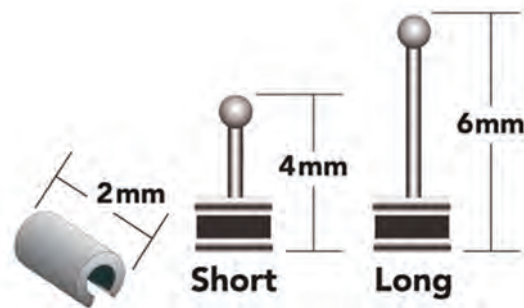

ETCHED CRIMPABLE STOPS, PACK OF 100 - **Item #O-160-1065**

ETCHED CRIMPABLE HOOKS LONG, PACK OF 20 - **Item #O-160-1066**

ETCHED CRIMPABLE HOOKS SHORT, PACK OF 20 - **Item #O-160-1067**



DynaFlex® Crimpable Stops

Ensure consistent wire positioning and control over tooth movement with ease. Compatible with both round and rectangular archwires, ranging from .018 to .021 x .025 in size. Pack of 10.



Item #O-160-1046

DynaFlex® Sure Grip Stops

Experience the confidence of a secure grip with our meticulously sandblasted Sure Grip Stops. These versatile stops can be strategically placed anywhere along the archwire to effectively control and limit tooth movement.



Item #M-SGSTOP 100 PK

DynaFlex® Crimpable Mini Stops

Ensure precise positioning of archwires with our innovative Crimpable Mini Stops. These versatile stops can be effortlessly placed anywhere along the archwire. Their small size ensures optimal patient comfort, and their low-profile design adds an aesthetically pleasing touch. Choose from two available sizes to suit your specific needs. Pack of 25.



SMALL .019 - **Item #2019**

LARGE .030 - **Item #2021**

DynaFlex® Crimpable Stops

User-friendly and straightforward, this accessory is as simple as it gets. Just position it on the archwire to control tooth movement and maintain the desired alignment. It's compatible with both round and rectangular wires, accommodating sizes up to .021x.025. Pack of 10. **Item #2020**



DynaFlex® Direct Bond Eyelet

Our nickel-free direct bond eyelet offers easy bonding to either the buccal or lingual surface of any tooth. Its specially designed base ensures superior bond strength, providing a reliable solution for your orthodontic needs. Pack of 10.



Item #2016



DynaFlex® Stop Locks & Wrench

Stop Locks remain a reliable and secure method for archwire locking. Featuring a .022 slot base that effortlessly slides over the archwire, it is firmly secured in place by the nut. This ingenious tool serves multiple purposes, helping prevent the archwire from slipping out of the buccal tube and facilitating compression spring treatment with ease. Pack of 5.



STOP LOCKS - **Item #2022**

STOP LOCK WRENCH (STERILIZABLE) - **Item #2022-W**



Kaplin Hook

Bondable Kaplin Hooks aid in accepting maxillary and mandibular appliances and seating and positioning of bands. Pack of 10.

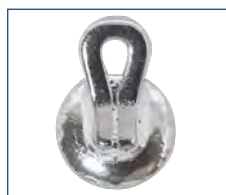

Item #2023

DynaFlex® Crimpable Ball Hooks

Our Crimpable Ball Hooks provide a secure attachment to archwires, both inside and outside the mouth. With a stable, non-sliding lock and a bendable hook design, they adapt to various treatment needs. They're compatible with wires up to size .018 x .025, offering flexibility in orthodontic procedures. 5mm tall. Available in packs of 20. **Use with plier #17-3026, see page 133.**

Item #2018



DynaFlex® Crimpable Ball Hooks

Offering a non-sliding, robust lock with the archwire, this product features a versatile ball hook, adaptable for left or right bending. Suitable for round or rectangular archwires up to .018 x .025 and available in a pack of 10, it ensures reliable and flexible orthodontic applications. 4.5mm tall. **Use with plier #17-3026, see page 133.**

Item #O-160-1044



DynaFlex® Shark Tooth Crimpable Ball Hook

The textured interior surface guarantees a secure and slip-free lock, ensuring your peace of mind. This versatile design is compatible with all types of wires and incorporates a meticulously crafted hook for optimal patient comfort. Pack of 100.



HOOK - **Item #M-1020335204**

STOP - **Item #M-1020335205**

Bondable Lingual Cleats

Bondable Lingual Cleats are manufactured from Stainless Steel and feature a mesh pad, low profile design for minimum tissue irritation. 10 per pack.

#2015-05



DynaFlex® Crimpable Ball Hooks - Curved

An excellent alternative to posted archwires, this accessory fits wire sizes up to .021x.025. Its .022 slotted base allows easy placement on wires, both inside and outside the mouth. Curved hooks further facilitate the use of elastics and extension springs, adding versatility to orthodontic treatments. Pack of 10.

RIGHT CURVED HOOK - **Item #2018-R**

LEFT CURVED HOOK - **Item #2018-L**



DynaFlex® Crimpable Hooks, Stainless Steel

.012 x .025. Pack of 20.

RIGHT

Item #O-160-1056

LEFT

Item #O-160-1057



Bondable Lingual Rings

Bondable lingual rings manufactured with high grade stainless steel with a slightly curved mesh base. The mesh base allows for excellent bonding strength. Round or rectangular base with flat or circle ring. 10 per pack.

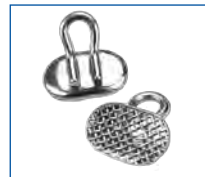

#2037

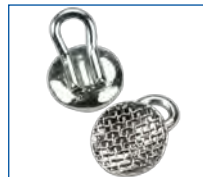

#2040

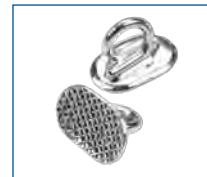

#2037-05

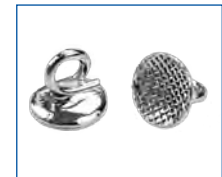

#2040-05

RECTANGULAR BASE WITH FLAT RING - **Item #2037**

RECTANGULAR BASE WITH CIRCLE RING - **Item #2037-05**

ROUND BASE WITH FLAT RING - **Item #2040**

ROUND BASE WITH CIRCLE RING - **Item #2040-05**

DynaFlex® Habit Control Device

The DynaFlex® Habit Control Device adeptly eliminates detrimental forces and discourages over-active muscle activity, ensuring optimal orthodontic outcomes. Suitable for bonding to either upper or lower arches and constructed with a robust 80-gauge foil mesh bonding base and high-quality 17-4 stainless steel, it guarantees durability and stability. Its curved base is precisely designed for perfect lingual placement, offering both comfort and efficacy. Available in a pack of 10, it provides a reliable, high-quality solution for varied orthodontic needs. **Item #O-152-1070**



PRECISION Aligner Buttons®

The Only Bondable Buttons Designed Specifically For Clear Aligners.



DynaFlex® Bondable Buttons

Distinguished by its durability and resistance to stains, this product features a secure dovetail base design that not only enhances functionality but also offers an aesthetically pleasing appearance. Pack of 10.

COMPOSITE - **Item #O-600-1113**

CERAMIC - **Item #O-600-1114**

Composite



Ceramic



DynaFlex® Polycarbonate Buttons

These compact, low-profile buttons are perfectly sized for seamless bonding in challenging, hard-to-reach areas.

Pack of 10. **Item #O-600-1115**



DynaFlex® Multi Lingual Button

Exceptional clarity, unmatched bond strength. Patented base: central groove, multiple holes for maximum bonding strength. Neck hole fits .012 To .018 Wires, smooth dome head for effortless bonding and secure elastic attachment. Pack of 20.

ROUND - **Item #2008**

RECTANGULAR - **Item #2008-05**



DynaFlex® De-Impactor Springs

An adjustable separating spring that uprights and erupts impacted molars and bicuspid in 4-6 weeks! Step-by-step illustrated instructions included. Pack of 12.

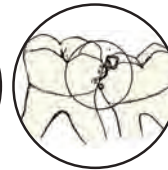

REGULAR SIZE - **Item #1050**

DynaFlex® Micro Direct Bond Round Lingual Button

Compact, Low-Profile Micro Buttons: Maximize Comfort with Ample Space for Elastics. Contoured Mesh Base for Easy Bonding, Streamlined Experience. Pack of 10. **Item #2017**

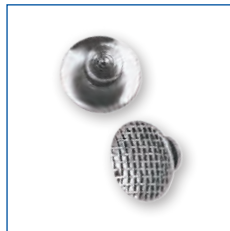

DynaFlex® Spooled Ligature Wire

Experience Excellence: High-Quality Stainless Steel Ligature Wire, Exceptionally Smooth Surface for Easy Tying. Available in .009 and .010 Diameters, One-Pound Spool.

.008 - **Item #0979-008**

.009 - **Item #0979-009**

.010 - **Item #0979-010**

.012 - **Item #0979-012**



DynaFlex® Lingual Buttons: Bondable

Weldable Buttons: Single-Unit Cast, Minimal Discomfort. New Bondable Buttons: Sleek Metal Injection Molding (MIM), Enhanced Strength, Comfortable Rounded Edges. Pack of 10.

CURVED - **Item #2010**



DynaFlex® Gold Eruption Chain

24k Gold Eyelet with Traction Chain with 80-gauge mesh pad. Round curved base 3x3.75mm. Rectangular base is 3.5mm diameter flat. Package of 5.

(A) ROUND - **Item #O-160-1048**

(B) RECTANGULAR - **Item #O-160-1050**



DynaFlex® Eruption Chain

Erupting impacted teeth has never been simpler with our innovative chain system! This user-friendly solution comes with 10 buttons, each equipped with chains for effortless application. Crafted from durable stainless steel, please note it contains a small percentage of nickel. **Item #2007**



DynaFlex® Stainless Steel Ligature Ties

Elevate your tying experience with our top-tier, preformed stainless steel ties, designed for effortless use.

Long Ties – 1,000 Pack	
ITEM #	SIZE
#0974	.008
#0974-05	.009
#0975	.010
#0976	.012

Short Ties – 500 pack	
ITEM #	SIZE
#0975-001	.010

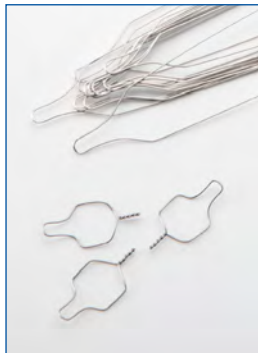

DynaFlex® Stainless Steel Kobayashi Ties

Premium stainless steel preformed ties, designed for effortless and secure fastening.

Long Ties - 100 Pack	
ITEM #	SIZE
#1000-010	.010
#1000-012	.012
#1000-014	.014

Short Ties - 100 Pack	
ITEM #	SIZE
#1001-012	.012
#1001-014	.014



DynaFlex® Flat Lingual Retainer Wire

Discover the Flat Lingual Retainer Wire, an excellent option for maxillary and mandibular bonded lingual retainers. This wire maintains its integrity without fraying when cut and can be securely bonded in place using any type of adhesive. Available in the dimensions of .010x.028.

10 6" PIECES PER PACK - **Item #1009**

60" SPOOL - **Item #1009-10**

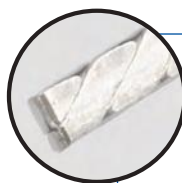

DynaFlex® Coated Ligature Ties

Stainless steel .012 ligature ties (coated .014), available in short or long. Pack of 100.



100 Pack	Short	Long
Almond	#0975-50	#0975-56
White	#0975-55	#0975-61

DynaFlex® Multi-Strand Round Dead Soft Stainless Steel

Length 7" (Pack of 10).

.0175 - **Item #O-952-8300**

.0195 - **Item #O-952-8302**



DynaFlex® 8 Braid Flat Dead Soft Stainless Steel

Length 6": .021 x .028 (Pack of 10).

#O-952-8250



DynaFlex® Titanium Tri-Flex

Nickel-Free: Safe for

Nickel-Sensitive Patients.

Three strands for strength,

preventing snapping and enhancing surface area. 6" length.

.010 x .028. Pack of 10. **Item #O-952-8315**



DynaFlex® Habit Control Device

The DynaFlex® Habit Control Device adeptly eliminates detrimental forces and discourages over-active muscle activity, ensuring optimal orthodontic outcomes. Suitable for bonding to either upper or lower arches and constructed with a robust 80-gauge foil mesh bonding base and high-quality 17-4 stainless steel, it guarantees durability and stability. Its curved base is precisely designed for perfect lingual placement, offering both comfort and efficacy. Available in a pack of 10, it provides a reliable, high-quality solution for varied orthodontic needs. **Item #O-152-1070**





DynaFlex® Mini Molds Starter Kit

Unlock Crafting Ease: Mini Mold Starter Kit for Resin Attachments. Comprehensive Selection, 3 of Each Type: Wire Bonders (Large/Small), Button Bonders, Bite Ramps (3mm/5mm), Cuspid Bite Ramps, Molar Pad Bonder, Habit Control Spikes, Bracket Bonders, Tube Bonders, 2 Handles.

MINI MOLD KIT - **Item #2045**

HANDLES - **Item #1786**



DynaFlex® Universal Bite Opening Kit

Versatile Universal Bite Opening Kit: Craft Bite Openings in Seconds. Kit includes: 4 Child and Adult Cuspid Bite Ramp Mini Molds, 3mm Bite Ramp Mini Molds, 5mm Bite Ramp Mini Molds, Molar Pad Mini Molds, 2 Bonder Handles. Customized Solutions Made Easy. **Item #2046**

DynaFlex® Mini-Mold Adhesive Paste

Engineered for Quick Curing, Superior Bonding Strength. Smooth, Tacky Viscosity for Easy Application, Compatible with Light Cure Sealants. Two Aesthetic Options: Blue or Tooth-Tone.

BLUE - **#2045-10**

TOOTH-TONE - **#2045-20**



DynaFlex® Wire Bonder

Crafts a meticulously shaped resin mound around the archwire, offered in both large and small sizes. 10 pack + handle. **Item #2045-045**



DynaFlex® Bite-Ramp Bonder

Creates a specialized bite-opening ramp on the lingual side of upper incisors. 8 pack + handle.

3MM - **Item #2045-03**

5MM - **Item #2045-08**



DynaFlex® Button Bonder

Facilitates the placement of erupting molars with ease through the creation of a temporary tube. 10 pack + handle.

Item #2045-07



DynaFlex® Molar Pad

Crafts an exact spherical mound on the posterior cusps, complementing the anterior bite-ramp for effective bite opening from the rear teeth.

10 pack + handle. **Item #2045-05**



DynaFlex® Cuspid Bite Ramp

Perfect for prompt bite opening, especially when dealing with an overjet exceeding 5mm. Offered in both adult and pedo sizes. 8 pack + handle.

CUSPID BITE RAMP - **Item #2045-25**

PEDO BITE RAMP - **Item #2045-25P**



Mini Molds are ideal for aesthetic attachments. A great solution for sensitive patients. Simply choose from the 6 mold types, fill the mold with light cure resin, and place the mold on the desired tooth and light cure. Fluoride releasing. Available in a kit of 24 (3 of each style) or individual style packages of 10. Bite-Ramp Bonder packaged 8 per pack

PRECISION Aligner Buttons®

The Only Bondable Buttons Designed Specifically For Clear Aligners



G2 METAL

ITEM #10-PAB10210

Nickel-Free Alloy
25/pk.

More Comfortable
Button Head

Maximized Base Precisely
Matches Molar Curvature

Lower Profile Stem For
Patient Comfort



METAL MINI

ITEM #10-PABMINI

Nickel-Free Alloy
25/pk.

Ideal For 7's or Partially
Erupted 1st Molars

15% Smaller Base Pad

Same Precise Base Shape
For Superb Retention



G2 CLEAR

ITEM #10-PABCLR2

Composite Ceramic
10/pk.

More Retentive Base Pad

Sturdier Button Stem With
Less Breakage

Lower Profile Stem For
Patient Comfort



G2 CLEAR MINI

ITEM #10-PABCLR2MINI

Composite Ceramic
10/pk.

15% Smaller Pad Design

Fits Snuggly In Smaller
Aligner Cut-Outs

Suited For Patients With
Smaller Tooth Anatomy



"My team and my patients love the Precision Aligner Buttons®. The large bonding pad, ease of use, and the shape make it a perfect match for my aligner patients and a perfect match for my practice. They truly are rockstar buttons!"

Dr. Dovi Prero | Beverly Hills, CA



"The Precision Buttons® have allowed me to use what I want - orthodontic buttons - without the headaches of frequent breakage and it has really changed the way I practice. The low profile and smooth corners provide spectacular comfort"

Dr. Bryan Lockhart | Charlotte, NC

See Pages 14-15 For More Info

Clear: Design Patent (USD910,191) Metal: Design Patent (USD859,663) Utility Patent (US11,564,778)

Shop Online! www.dynaflex.com

ELASTOMERICS, FACEMASKS & ORGANIZERS



All DynaFlex Elastomerics Proudly Made In The USA

DynaFlex® Single Stick Ligature Ties

Our ligature ties have great strength and vibrant colors. Guaranteed Brilliance, No Fading or Discoloration. 10 Ties per Stick, 100 Sticks per Pack, Total of 1000 Ties!
#1218 SERIES

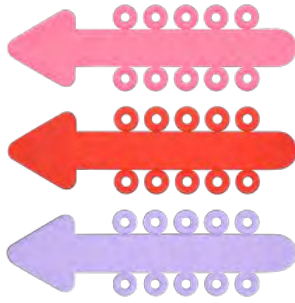

Latex & BPA FREE

DynaFlex® D20 Ties

Our D20 ligature ties have great strength and vibrant colors. Guaranteed Brilliance, No Fading or Discoloration. 20 Ties per Stick, 50 Sticks per Pack, Total of 1000 Ties!
#1219 SERIES

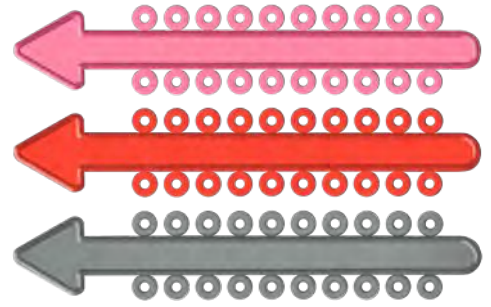

Latex & BPA FREE

DynaFlex® Power Chain

Experience Unmatched Strength with DynaFlex Power Chain! Remarkable Rebound for Extended Durations, Precise Force. Highest Quality Chain, Complements Tie Colors. 15 Feet per Spool for Reliability and Performance.
#1233, #1234, #1235, #1236 SERIES



Latex & BPA FREE

Continuous #1233 SERIES



Ultra-Short #1236 SERIES



Short #1235 SERIES



Long #1234 SERIES



DynaFlex® Power Chain Dispenser

Transparent acrylic design for easy chain dispensing: holds up to 12 spools. 6.5" x 3" x 3.25"

Item #1494-01



Tie & Chain Organizer w/ Cover

Showcase vibrant colors in Twelve Tubes for Dyna Sticks and Twelve Power Chains. The Ultimate Tool for Neat and Accessible Supplies. **Item #1491**



DynaFlex® Power Chain Organizer w/ Guide Holes

Accommodates an impressive array of up to 18 spools. 9.75" x 4" x 4"

Item #1494-20











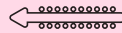

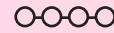
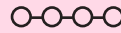
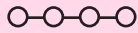

























DynaFlex® Power Chain Organizer w/ Cover

Robust and durable design with hinged cover: Ideal storage for 18 Power Chain spools. **Item #1494**



Elastomeric Color Chart: Single Stick, D20 & Power Chain

COLOR	COLOR NAME	LIGATURE TIES				POWER CHAIN	
		SINGLE STICK 	D20 TIES 	CONTINUOUS 	ULTRA SHORT 	SHORT 	LONG 
	Aquamarine	#1218-AM	#1219-AM	#1233-AM	#1236-AM	#1235-AM	#1234-AM
	Black	#1218-BK	#1219-BK	#1233-BK	#1236-BK	#1235-BK	#1234-BK
	Bright Red	#1218-BR	#1219-BR	#1233-BR	#1236-BR	#1235-BR	#1234-BR
	Clear	#1218-C	#1219-C	#1233-C	#1236-C	#1235-C	#1234-C
	Cobalt Blue	#1218-CB	#1219-CB	#1233-CB	#1236-CB	#1235-CB	#1234-CB
	Dark Grey	#1218-GY	#1219-GY	#1233-GY	#1236-GY	#1235-GY	#1234-GY
	Fuchsia	#1218-F	#1219-F	#1233-F	#1236-F	#1235-F	#1234-F
	Glow	#1218-GL	#1219-GL	#1233-GL	#1236-GL	#1235-GL	#1234-GL
	Gold	#1218-GD	#1219-GD	#1233-GD	#1236-GD	#1235-GD	#1234-GD
	Hot Pink	#1218-HPK	#1219-HPK	#1233-HPK	#1236-HPK	#1235-HPK	#1234-HPK
	Kelly Green	#1218-KG	#1219-KG	#1233-KG	#1236-KG	#1235-KG	#1234-KG
	Lavender	#1218-L	#1219-L	#1233-L	#1236-L	#1235-L	#1234-L
	Light Blue	#1218-LB	#1219-LB	#1233-LB	#1236-LB	#1235-LB	#1234-LB
	Light Green	#1218-LG	#1219-LG	#1233-LG	#1236-LG	#1235-LG	#1234-LG
	Light Pink	#1218-LP	#1219-LP	#1233-LP	#1236-LP	#1235-LP	#1234-LP
	Lilac	#1218-LL	#1219-LL	#1233-LL	#1236-LL	#1235-LL	#1234-LL
	Maroon	#1218-M	#1219-M	#1233-M	#1236-M	#1235-M	#1234-M
	Metallic Blue	#1218-MB	#1219-MB	#1233-MB	#1236-MB	#1235-MB	#1234-MB
	Metallic Silver	#1218-SI	#1219-SI	#1233-SI	#1236-SI	#1235-SI	#1234-SI
	Navy Blue	#1218-NB	#1219-NB	#1233-NB	#1236-NB	#1235-NB	#1234-NB
	Neon Green	#1218-NG	#1219-NG	#1233-NG	#1236-NG	#1235-NG	#1234-NG
	Orange	#1218-O	#1219-O	#1233-O	#1236-O	#1235-O	#1234-O
	Pearl	#1218-PRL	#1219-PRL	#1233-PRL	#1236-PRL	#1235-PRL	#1234-PRL
	Pearl Blue	#1218-PB	#1219-PB	#1233-PB	#1236-PB	#1235-PB	#1234-PB
	Pearl Watermelon	#1218-PRW	#1219-PRW	#1233-PRW	#1236-PRW	#1235-PRW	#1234-PRW
	Pink	#1218-PK	#1219-PK	#1233-PK	#1236-PK	#1235-PK	#1234-PK
	Purple	#1218-P	#1219-P	#1233-P	#1236-P	#1235-P	#1234-P
	Red	#1218-R	#1219-R	#1233-R	#1236-R	#1235-R	#1234-R
	Royal Blue	#1218-RB	#1219-RB	#1233-RB	#1236-RB	#1235-RB	#1234-RB
	Sky Blue	#1218-SB	#1219-SB	#1233-SB	#1236-SB	#1235-SB	#1234-SB
	Teal	#1218-T	#1219-T	#1233-T	#1236-T	#1235-T	#1234-T
	Turquoise	#1218-TQ	#1219-TQ	#1233-TQ	#1236-TQ	#1235-TQ	#1234-TQ
	Violet	#1218-V	#1219-V	#1233-V	#1236-V	#1235-V	#1234-V
	Watermelon	#1218-WAT	#1219-WAT	#1233-WAT	#1236-WAT	#1235-WAT	#1234-WAT
	White	#1218-W	#1219-W	#1233-W	#1236-W	#1235-W	#1234-W
	Yellow	#1218-Y	#1219-Y	#1233-Y	#1236-Y	#1235-Y	#1234-Y

Rainforest™ Elastics

Our commitment to quality: Rainforest Elastics made from premium medical-grade materials. Precise cutting for consistent force and optimal treatment. Non-Latex Option for Latex allergy concerns. Impervious to water and saliva. Each box: 50 Patient Bags, 100 Elastics per Bag, Total of 5,000 Elastics.

- Non-Latex Performs Like Latex Elastics
- Eliminates The Use Of Heavy Talc
- Offers Consistent Force Levels



Available in Latex and Latex Free



	1/8" (3.2MM)	3/16" (4.8MM)	1/4" (6.4 MM)	5/16" (7.9MM)	3/8" (9.5MM)
LIGHT FORCE (2.5 OZ.)	Ant	Coffee Beans	Caterpillar	Orchid	Fern
Clear (Amber)	#1200-AL	#1200-BL	#1200-CL	#1200-DL	#1200-EL
Clear Non-Latex	#1207-AL	#1207-BL	#1207-CL	#1207-DL	#1207-EL
Neon Non-Latex	-	#1208-BL	#1208-CL	-	-
MEDIUM FORCE (4.5 OZ.)	Toucan	Anteater	Butterfly	Water Lily	Frog
Clear (Amber)	#1200-AM	#1200-BM	#1200-CM	#1200-DM	#1200-EM
Clear Non-Latex	#1207-AM	#1207-BM	#1207-CM	#1207-DM	#1207-EM
Neon Non-Latex	-	#1208-BM	#1208-CM	-	-
HEAVY FORCE (6.5 OZ.)	Lemur	Chimpanzee	Parrot	Lizard	Bamboo
Clear (Amber)	#1200-AH	#1200-BH	#1200-CH	#1200-DH	#1200-EH
Clear Non-Latex	#1207-AH	#1207-BH	#1207-CH	#1207-DH	#1207-EH
Neon Non-Latex	-	#1208-BH	#1208-CH	-	-

Extra-Oral Latex Elastics

Unwavering uniformity: Achieve consistent force by stretching our elastics to three times their initial size. Extra-Oral Elastics in 8, 14, and 16 Ounce Options. Each package contains 1,000 elastics, bulk-packed for your convenience.

SIZE	ITEM #
1/4"	#1200-CE
5/16"	#1200-DE
3/8"	#1200-EE
1/2"	#1200-FE



DynaFlex® Safe-T Separators

Small knobs ensure secure sub-gingival position. Available in slim and standard sizes. star-shaped dispenser with 960 separators per package. Non-radiopaque.

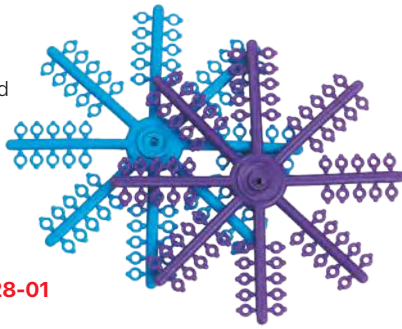

SLIM (BLUE) - #1228

STANDARD (PURPLE) - #1228-01

DynaFlex® Star Seps

These separators offer convenience for your office and easy module removal, with smooth, round edges for patient comfort. Each package includes twelve modules, totaling 960 radiopaque separators. **Item #1230**

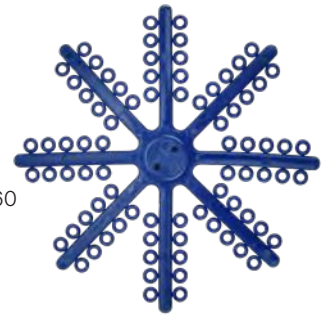

DynaFlex® Elastic Tooth Separators

Effortless tooth separation for a wide range of orthodontic procedures. Each package includes 1000 radiopaque separators. **Item #1222**



DynaFlex® Niti Tooth Separating Spring

The most effective method for precision contact separation, offering a quicker and more convenient alternative to elastic separators. Ensuring patient comfort throughout the process. With a diameter of 0.018 inches, each pack contains 25 separators.

LARGE - **Item #1014**

SMALL - **Item #1015**



DynaFlex® Force Module Separating Plier

Crafted with exceptional quality, this stainless steel instrument features specially angled beaks that securely hold separators in position, preventing any unwanted sliding. **#1400-018A**



Get In Touch!

SUBSCRIBE



Scan The QR Code For the latest news, info and promotional offers from DynaFlex®.

We are committed to keeping your e-mail address confidential. We do not sell, rent, or lease our contact data or lists to third parties, and we will not provide your personal information to any third party individual, government agency, or company at any time unless compelled to do so by law.

DynaFlex® Rotation Wedges on Canes

A genuine "wedge" shape optimizes tooth movement efficiency and prevents wire shifts. Choose from gray or clear options. Each package contains 100 rotation wedges, 10 per cane for your convenience.

GRAY - **Item #1003-GY**

CLEAR - **Item #1003-C**

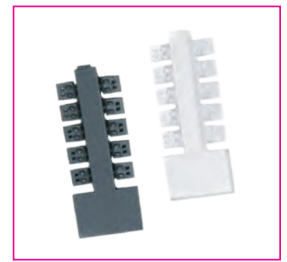
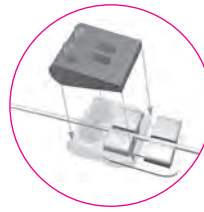

DynaFlex® Rotation Wedges

The wedge section facilitates optimal force interaction between wire and bracket for smooth rotation. Simply slide it over tie wings on the bracket. Each pack contains 25 rotation-enabling wedges.

GRAY - **Item #1004-GY**

CLEAR - **Item #1004-C**

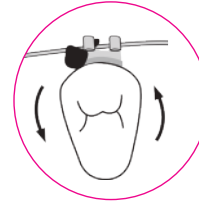

DynaFlex® Elastic Sleeve

Protect archwires with this tissue-friendly covering in gray or clear. Available in .018 and .027 inside diameters, each spool is 10 feet long and latex-free.

SIZE	COLOR	ITEM #
.018	Gray	#1105-018
.027	Gray	#1105-027
.018	Clear	#1106-018
.027	Clear	#1106-027

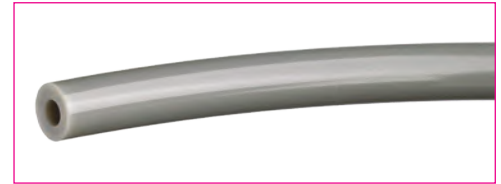

DynaFlex® Elastic Thread

Exceptionally durable solid thread with break resistance for reliability. Choose gray or clear and sizes .025 or .030. Each spool has 25 feet of latex-free thread for your convenience.

SIZE	COLOR	ITEM #
.025	Gray	#1101
.030	Gray	#1101-030
.025	Clear	#1100
.030	Clear	#1100-030

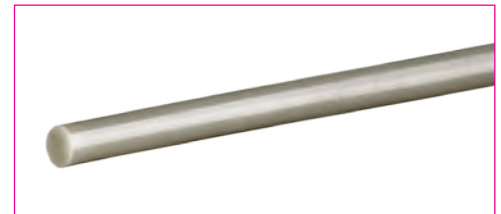

DynaFlex® Ultra-Tuff Thread

Solid thread with a textured surface for secure knots, it resists stains and offers consistent force over time. Choose .025 or .030 clear or gray options, with each spool offering 25 feet of this remarkable thread.

SIZE	COLOR	ITEM #
.025	Clear	#1108-025
.030	Clear	#1108-030
.025	Gray	#1109-025
.030	Gray	#1109-030



DynaFlex® Lip Bumper Tubing, Gray

Opt for the .050 size tubing, exclusively available in the sophisticated gray hue. Each spool contains a generous 10-foot length of tubing. **Item #1102-GY**



Champion™ Comfort Fit Facemask

Crafted from stainless steel and shatterproof plastic for strength and patient comfort. Single vertical spindle design for easy fit adjustment. Includes adjustment wrench and comfortable pads. A comprehensive orthodontic solution.

COLOR	ITEM #
Blue	#0811
Pearl White	#0811-02
Red	#0811-03
Teal	#0811-04
American Flag	#0811-09

REPLACEMENT PADS - #0811-RNEW



FREE
CARRYING CASE



#0811
BLUE

#0811-02
PEARL WHITE

#0811-03
RED

#0811-04
TEAL

#0811-09
AMERICAN FLAG

MultiJust II™: Adjustable Face Masks

Each mask comes with...

- Extra Set of Pads
- Additional Screw
- Adjusting Wrench
- Free Carrying Bag

COLOR	ITEM NUMBER
Red	#O-165-1002
Blue	#O-165-1004
Pearl	#O-165-1006
Green	#O-165-1008
Clear	#O-165-1010

REPLACEMENT PAD SET - #O-165-1001



Ultra Suede Chin & Forehead
Pads with Velcro On/Off
Comfortable and
Machine Washable



FREE
CARRYING CASE



FACEMASKS

BONDING SUPPLIES



Reliance®

Bonding Products

Consistent Quality You Can Count On

Light Bond™ Adhesive

We recommend a fluoride-releasing light-cure bonding system suitable for all bracket types, including metal, plastic, or ceramic, with a notably tacky paste to prevent bracket "flotation."



DESCRIPTION	ITEM #
Light Bond Adhesive Kit	#18-LBEPF
5gm Light Bond Paste w/ Fluoride, Toothtone, 5gm	#18-LBPPF
5gm Light Bond Paste w/ Fluoride, Blue, 5gm	#18-LBBPPF
5gm Light Bond Paste w/ Fluoride, Medium Viscosity, Toothtone, 5gm	#18-LBMPPF
Light Bond Paste in Tips w/ Fluoride, Blue, 11pk	#18-LBBPTF
Light Bond Paste in Tips w/ Fluoride, Medium Viscosity, Toothtone, 11pk	#18-LBMPTF
Light Bond Paste in Tips w/ Fluoride, Toothtone, 11pk	#18-LBPTF
Light Bond Paste in Long Nose Tips w/ Fluoride, Toothtone, 11pk	#18-LBPTFLN
Light Bond Sealant w/ Fluoride, 3cc	#18-LBS3F
Light Bond Sealant w/ Fluoride, 7cc	#18-LBS7F
Liquid Etch, 9gm	#18-EL9
C.R. Syringe Mark II	#18-CRII

Rely-A-Bond® Adhesive

Fluoride-releasing, no-mix bonding for metal, plastic, or ceramic brackets. Ideal for direct and indirect bonding, achieving max strength in 5 mins.



DESCRIPTION	ITEM #
Rely-A-Bond Adhesive Kit	#18-RPF
Rely-A-Bond Paste, in Push Syringe	#18-1RPP
Rely-A-Bond Paste, in Tips, 33pk	#18-RPT
Rely-A-Bond Paste, in Jar, 14gm	#18-RPJ
Rely-A-Bond Primer w/ Fluoride, 16gm	#18-RPRF

Reliance® Ultra Band Lok® & Luer Lok Ultra Band Lok Adhesive

Superior band adhesive, single syringe for no-mix ease and less waste. Exclusively for light curing. Versatile fluoride-releasing cement for brackets, lingual retainers, and acrylic appliances. Enamel surface etching needed for appliance bonding.



DESCRIPTION	ITEM #
Ultra Band-Lok Paste, Toothtone, in Push Syringe, 5gm	#18-UBLPP
Ultra Band-Lok Paste, Blue, in Push Syringe, 5gm	#18-UBLBPP
Luer Lok Ultra Band-Lok, Toothtone, in Push Syringe, 5gm	#18-LLUBLP
Luer Lok Ultra Band-Lok, Blue, in Push Syringe, 5gm	#18-LLUBLBP
Luer Lok Tips, 60pk	#18-LLTIPS

Band-Lok® Glass Ionomer Dual Cure Cement

Band-Lok® is a versatile dual-cure cement with fluoride release, consisting of two pastes. It works with or without a dental curing light. After band placement and flash removal, a quick 20-second light activation ensures moisture protection. Without light, it sets in 10 minutes with a four-minute working time at room temperature. No need for a frozen slab. Band-Lok eliminates messy Powder-Liquid Systems, providing ideal mix viscosity every time. Unlike Glass Monomer cements, it has no lingering aftertaste or unpleasant odor.

DESCRIPTION	ITEM #
Part A Band-Lok Paste, Screw Syringe, 6gm	#18-BLSA
Part A Band-Lok Paste, Blue Screw Syringe, 6gm	#18-BLSAB
Part B Band-Lok Paste, Screw Syringe, 6gm	#18-BLSB



Reliance® Pad Lock Light Cure Adhesive

Fluorescing Light Cure Adhesive for delicate mesh pad bracket bases! Pad Lock forms a strong chemical bond with metal and fluoresces under black light. Easily spot missed flash and adhesive remnants during removal.



DESCRIPTION	ITEM #
PadLock LC Push Syringe 4.5 gram	#18-PLP
PadLock LC Push Syringe w/ Fluoride 4.5 gram	#18-PLPF
PadLock LC Paste in Tips 4.5 gram - 10 pk	#18-PLT
PadLock LC Paste in Tips w/Fluoride 4.5 gm - 10 pk	#18-PLTF
C.R. Syringe Mark II	#18-CRII
Assure Sealant - 6cc	#18-AS

TKO, Composite Bite Turbo Gel Pink

TKO is a quick light cure acrylic for repairs and occlusal build ups. The needle tip dispenser allows for accurate placement. Pink shade contrasts tooth light. 3.4g syringe with 5 tips.

Item #18-TKO



A Perfect Substitute For Triad Gel

GoTo Light Cure Bracket Adhesive

Crafted with a substantial filler content, GoTo paste ensures that brackets remain securely in place upon tooth placement and during flash removal. This robust filler composition facilitates the seamless removal of flash in a single, unbroken piece.



SYRINGE, 4 GRAM - Item #18-GTP

SYRINGE TIPS, (10) 4 GRAM TIPS - Item #18-GTT

FlowTain™

A light-cured composite that excels in various applications like lingual retainers, splinting materials, and indirect bracket bonding, thanks to its low modulus of elasticity. Its outstanding polishability improves aesthetics and reduces wear. Each purchase includes individual FlowTain™ with 10 tips for your convenience.

SYRINGE W/TIPS, TOOTH TONE - Item #1888



Reliance®

Bonding Products Consistent Quality You Can Count On

Excel Regular Herbst Screw Syringe Kit with Fluoride

Experience strong bonds with a thin, long-lasting formula. Patented fluoride-releasing monomer maintains bond strength. Kit includes 2 Excel Part A 6gm Syringes, 2 Excel Part B 6gm Syringes, 7g Bonding Agent (Part A and B), 10cc Plastic Conditioner, and 9g Liquid Etch for all your bonding needs. **Item #18-EHSF**



Self Mix Crown Lok Blue

Introducing metal crown luting cement, bonds chemically to stainless steel. Two-minute working time, dual-syringe format for easy mixing. Includes fluoride, blue hue, one 5gm syringe, and 15 self-mixing tips for streamlined application. **Item #18-SMCLB**



Retainium

Original TM Alloy Retainer Wire, designed for lingual retention. Interproximal flexibility, nickel-free, low profile. .027" x .011" in ribbon arch design. Each package has 10 six-inch wires for retention needs. **Item #1800-RET**



Retainium XL

Optimum Strength Bet Titanium Retainer Wire for lingual retention, diastema maintenance, and more. flat .027" x .016" ribbon arch design, low profile, nickel-free. each package has 10 six-inch wires for precise retention and maintenance. **Item #1800-RETXL**

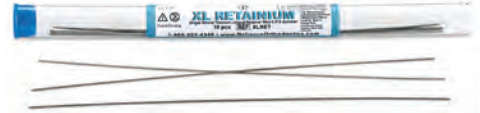

Bond-A-Braid Lingual Retainer Wire

Our dead-soft wire is highly adaptable and ideal for semi-permanent orthodontic splinting, diastema maintenance, and more. .027" x .011" ribbon arch wire with 8-strand braided design retains dead-soft properties for easy adaptation. each tube includes 10 six-inch wires for effective use. **Item #18-BAB2**



Ortho Stainless Steel Flextech®

30% more tensile strength and 300% greater torsional strength than Gold OrthoFlex-Tech, our product excels. Each spool has a generous 30-inch length for effective use.



Item #18-SSOFT

Ortho Flextech®

Ortho Flextech® revolutionizes lingual retention in orthodontics. Stabilizes corrections, prevents rotational relapses, enhances patient comfort, reduces chair time, and offers lasting aesthetics with 14-karat gold. Exclusively in 30-inch spools.



Item #18-OFT2

Bond Aligner

Introducing Light Cure Aligner Adhesive for secure, aesthetic bonds with clear aligner materials. no primers or conditioners needed, simplifying bonding. bonds ceramic, metal, or plastic attachments with high modulus of elasticity. each package has a 1.4gm syringe and 5 tips for precision.



BOND ALIGNER SYRINGE (1.4GM) - **Item #18-BA**

Economy Etchant by Reliance®

Reliance etchant in the economical package saves you money!

DESCRIPTION	ITEM #
Green Etch Syringe, 6.5gm	#18-EGSS
Liquid Etch, 9gm	#18-EL9
Liquid Etch, 23gm	#18-EL24
Liquid Etch, Cherry, 23gm	#18-EL24C



37% phosphoric acid

Reliance® S.E.P

In today's task-efficient era, simplifying bonding by combining etching, rinsing, and sealing into one step is natural. it saves time and costs. our S.E.P (Self-Etching Primer) Kit achieves this with an acid etch and monomer primer. blend, rub on tooth for 5 seconds, air bursts, then place the bracket. requires light-cured adhesive paste system. *Compared with Transbond for reference.



DESCRIPTION	ITEM #
SEP Dispenser	#18-SEPD
SEP Refill Cartridge, 4ml	#18-SEPR
SEP Mixing Well - 1 per pack	#18-1SEPW

* Transbond is a registered trademark of 3M Unitek.

L.C.R. - Light Cure Retainer

Light Cure Retainer Kit with a smooth viscosity. Micro+ nano fill for flowable consistency with durability of highly filled composite. Kit contains 4 5g Light Cure Retainer Push Syringes, 2 3CC Light Bond Regular with fluoride, 1 23g liquid etchant.



DESCRIPTION	ITEM #
Light Cure Retainer Kit	#18-LCREP
LCR Push Syringe, 5gm	#18-LCR
LCR Preloaded Tips, 11pk	#18-LCRT5

Plastic Conditioner

Readies plastic brackets, acrylic appliances, and more for bonding. also conditions composite restorations and rebonds brackets with adhesive impregnation. each package has 10cc of this essential product. **Item #18-PL**



Porcelain Conditioner

Porcelain conditioner prepares glazed porcelain for bonding adhesives. each package includes 8cc of this essential product.



Item #18-PO

Reliance® L.E.D. Pro Seal

An advanced light-cured sealant with fluoride and a unique catalyst to ensure complete polymerization, eliminating oxygen-inhibited layers and porosity. It creates a protective, resilient shield around enamel at the bracket base, resisting oral fluids and abrasive foods. Each bottle has 6ml of this exceptional product. *Comparable to Ortho Solo for reference. **Item #18-LEDPRO**

Can be used with any LED light



Porc-Etch

Our Porcelain Etch, coupled with a 7cc Barrier Gel, facilitates the preparation of glazed porcelain crowns, ensuring their compatibility with bonding adhesives. **Item #18-POE**



Pro Seal

A sealant, whether chemical or light-cured, with a complete set and no oxygen-inhibited layer. It ensures a smooth, durable surface, prevents leakage, protects enamel, and simplifies paste cleanup. Each package contains 6ml of this innovative product. **Item #18-PRO**



Assure® Plus

The versatile all-surface bonding resin that simplifies your bonding process. No need for multiple conditioners for different surfaces. it bonds directly to various surfaces, including enamel, wet or dry conditions, dentin, and various materials. pairs with both light and chemical cure pastes for a comprehensive bonding solution. **Item #18-PLUS**



Ultra S.E.P. Self Etch Primer

Efficient and effective tooth prep. Reduces chair time with simplified process: scrub onto enamel for 5 seconds, allow to air dry, apply Assure Plus (#18-PLUS), allow to air dry, apply light cure paste to bracket, place bracket and cure. No mixing. A great alternative for initial bonding and emergency repair appointments. 2ml or 6ml bottle.



- 6ML - **#18-USEP**
- 2ML - **#18-USEP2ML**

Metal Primer

Ensures optimal bonding compatibility with adhesive agents. Each bottle contains 8ml of this essential product. **Item #18-ME**



Reliance®

Bonding Products

Consistent Quality You Can Count On



1st & Final Prophy Pumice

Optimum Strength Bet Titanium Retainer Wire for lingual retention, diastema maintenance, and more. flat .027" x .016" ribbon arch design, low profile, nickel-free. each package has 10 six-inch wires for precise retention and maintenance. **Item #18-FF**

Sponge Pellets by Reliance®

Item #18-SP

Each pack contains 500 pellets.



Reliawax

ReliaWax is a reliable and revolutionary wax-like protection in a syringe that provides enduring comfort for your patients. The standard orthodontic patient wax may last a couple of hours or at most a couple of days, but ReliaWax is different. Apply ReliaWax in office, light cure, and it will stay in place between appointments! **Item 18-RWX**

- Outperforms Traditional Patient Wax
- Light Cure Gel In A Syringe
- Semi-Permanent - Remains In Place From One Appointment To The Next
- Withstands Routine Brushing And Eating
- Crystal Clear And Durable
- Fluoresces Under Black Light
- Contains One 1.5g 1rx Syringe With 10 Tips



Glass Lok Economy Kit-Natural Shade

Dual-core Glass Ionomer band cement, robust adhesion wet or dry, fluoride for enamel protection. Bonds chemically to metal, choose dual-core or light-cure. Kit includes 3 25gm Glass Lok syringes and 1 100g Glas Lok Powder for precise banding needs. **Item #18-GLE**



A. **Item #18-RSPFG**



B. **Item #18-RSPHP**

Renew Finishing Points

Renew Finishing System Points #383 gently remove adhesive remnants and polish enamel harmlessly. Rubberized tapered shape aids in gingival adhesive removal. Second step in the Renew Finishing System Points, 12 points per pack for your finishing needs.

Renew System Burs #218

A specialized design with 18 flutes, tapered for precise adhesive removal in intricate spaces. self-cleaning wide flutes ensure efficiency. These burs are the first step in the Renew Finishing System. Available for individual purchase to meet your needs. **Item #18-RSB2**



Renew System Bur

- 118L - **Item #18-RSBL**
- 118S - **Item #18-RSB**

Extended shank for excellent adhesive removal. Non-tapered friction grip for swift, efficient cutting with wide self-cleaning flute. Available for individual purchase for tailored solutions.



Finishing Bur

Debond with our premium Carbide Finishing Burs, known for superior quality, precise cement removal without enamel damage, exceptional trimming precision, and smoothness. Reduces pressure sensitivity and efficiently removes bulk while leaving a smooth finish. Each pack has five burs. **Item #1804**



Renew Finishing Bur Straight Handpiece

#815 lingual composite bur, perfect for removing lingual composite, with friction grip, custom length, and precision-engineered cutting head. first step in the Renew Finishing System, available for individual purchase to meet your needs. **Item #1800-RSB815**



DynaFlex® Mixing Pads

Poly-Coated, 100 sheets per pad,
Non-Skid Foam Base, Set of 4 pads.

3" X 3" PADS

Item #O-115-1090

3" X 6" PADS

Item #O-115-1092



Champion™ Pre-Mixed Prophy Pumice

Our pre-mixed pumice won't affect bond strength and is fluoride, oil, and flavoring-free for a mess-free experience. Each box has 200 pre-mixed cups and a convenient finger holder. **Item #4401-05**



Economy Etchant by Reliance®

Reliance etchant in the economical package saves you money!

DESCRIPTION	ITEM #
Green Etch Syringe, 6.5gm	#18-EGSS
Liquid Etch, 9gm	#18-EL9
Liquid Etch, 23gm	#18-EL24
Liquid Etch, Cherry, 23gm	#18-EL24C



37% phosphoric acid

Green Etch: Viscous Etch-Green

The green color provides excellent tissue contrast. Our viscous etch boasts a honey-like consistency, falling between a gel and water in thickness. With a robust 37% phosphoric acid content, it delivers exceptional performance.

Viscous Etch in Bottle

8 OZ. BOTTLE - **Item #O-115-1032**

12 OZ. BOTTLE - **Item #O-115-1034**

Gel Etch Syringes

60G SYRINGE - **Item #O-115-1038**

(WITH FIVE 5G REFILLABLE SYRINGES & 20 TIPS)



Blue Etch: Silica-Free Enamel Etch

Silica-Free easy rinse formula. Viscous etch in bottles is slightly thinner than a gel but thicker than water. 37% phosphoric acid.

Viscous Etch in Bottle

2 OZ. BOTTLE

Item #O-115-1040

Gel Etch Syringes

12G SYRINGE (W/ 25 DISPOSABLE TIPS)

Item #O-115-1046



Ketac-Cem®

Ketac-Cem® offers a simplified technique by adhering seamlessly to both tooth structure and metal oxides without the need for conditioning, making it a user-friendly alternative to hybrid cements.

- Radiopaque
- Low Coefficient Of Thermal Expansion
- High Fluoride Release
- Ideal Setting Characteristics
- Stability
- Exceptional Adhesion

KETAC TRIPLE KIT 3-33G POWDER & 3- 12ML LIQUID
Item #O-120-1010

KETAC CEMENT POWDER ONLY 33G
Item #O-120-1011

KETAC CEMENT LIQUID ONLY 12ML
Item #O-120-1012





Fuji LC Automix

A dual-cured, resin-reinforced glass ionomer cement in an easy-to-use automix paste pack. It offers long-term fluoride release to prevent white spot lesions. Accompanied by GC Fuji Ortho Gel Conditioner, a gentle enamel conditioning solution with 20% concentration, available in a syringe delivery system with brush tips for easy and precise application.

- LC AUTOMIX REFILL CONTAINS: 2 PASTE PACK CARTRIDGES (13.5 GMS EACH) - **Item #9-003103**
- LC PASTE PACK AUTOMIX SET CONTAINS: 1 PASTE PACK CARTRIDGE (13.5 GMS), 2 ORTHO GEL CONDITIONER SYRINGES (1.4 GMS EACH), 20 MIXING TIPS AND 15 BRUSH TIPS - **Item #9-003102**
- GEL CONDITIONER - **Item #9-003104**
- MIXING TIPS FOR LC REFILL (20 MIXING TIPS) **Item #9-423008**

GC Fuji Ortho Band LC Automix

GC Fuji Ortho LC and GC Fuji Ortho Band LC, both dual-cured, resin-reinforced glass ionomer cements in convenient automix paste packs. They offer sustained fluoride release to prevent white spot lesions. Accompanying them is GC Fuji Ortho Gel Conditioner, a gentle polyacrylic acid gel with 20% concentration, for enamel conditioning. It's applied easily through a syringe delivery system with brush tips for effortless precision.



- STARTER KIT: 2 PASTE PK CARTRIDGES (13.3 GRAMS EACH), 1 PASTE PK DISPENSER, 20 MIXING TIPS, 1 MIXING PAD - **Item #9-439466**
- REFILL CONTAINS: 2 PASTE PK CARTRIDGES (13.3 GRAMS EACH) AND 1 MIXING PAD - **Item #9-003105**
- GC MIXING TIPS FOR LC REFILL (20 MIXING TIPS) - **Item #9-423008**

GC Fuji® Ortho™ Band Paste Pack Self-Cure

A blue resin-modified glass ionomer band cement. This user-friendly dispenser system includes a metering slide for precise and consistent mixes. Adjust the slide, dispense the needed amount, and streamline the process. Mix for 20 seconds, get a 3-1/2 minute working window, and achieve a final set in 3 minutes. The blue color makes cleanup and removal easier, improving orthodontic procedures.



- PASTE PACK STARTER PACKAGE - **Item #9-439460**
- BAND PASTE PACK REFILL (2-13.3GM PASTE PACK CARTRIDGES) - **Item #9-001888**
- PASTE PACK DISPENSER - **Item #9-001573**



MI Paste® and MI Paste Plus™

Both MI Paste and MI Paste Plus contain RECALDENT™, a unique milk-derived protein that replenishes lost tooth minerals. This strengthens teeth and protects against decay and erosion. Ideal for at-home use, these dental products are one-of-a-kind.

- MI PASTE® (10 TUBES) - **Item #9-002265**
- MI PASTE PLUS (10 TUBES, STRAWBERRY ONLY) - **Item #9-002886**
- MI PASTE PLUS™ (10 TUBES, MINT ONLY) - **Item #9-002621**
- MI PASTE PLUS™ (10 TUBES, ASSORTED FLAVORS) - **Item #9-002614**



MI Paste®:

- Before and after tooth whitening
- For pregnant women
- For children under 6
- During and/or after orthodontics
- For desensitizing
- To provide extra protection for teeth

MI Paste Plus™:

- Extra protection for the teeth
- After tooth whitening
- For desensitizing
- During and/or after orthodontics
- For medically compromised patients
- For Salivary deficiency; dry mouth

- For patients with acidic oral environments
- For erosion and gastric reflux
- For patients with poor plaque control
- For high-carries risk patients

GC Fuji ORTHO™ LC

Fuji ORTHO LC is a versatile light-cured resin-modified glass ionomer for secure bonding of brackets, attachments, and appliances to enamel, porcelain, and metal restorations. It's moisture-resistant and comes in powder-liquid and capsule forms.

- INTRO KIT (15GM POWDER, 6.8ML LIQUID) - **Item #9-439401**
- STANDARD KIT (40GM POWDER, 2-6.8ML LIQUID) - **Item #9-439403**
- POWDER REFILL (40GMS) - **Item #9-000029**
- LIQUID REFILL (6.8ML) - **Item #9-000030**
- CONDITIONER (25GMS, LIQUID) - **Item #9-001820**

*Bonds In A Wet Field
Without Etching!*



GC Fuji ORTHO™ LC Capsule

Introducing Fuji ORTHO LC, an advanced light-cured resin-modified glass ionomer for strong bonds on enamel, porcelain, and metal restorations. It's highly moisture-resistant and comes in 50 convenient capsules for easy bonding.

- CAPSULES (50 CAPSULES) - **Item #9-439450**
- CAPSULE APPLIER - **Item #9-437555**
- CMII CAP MIXER - **Item #9-003680**

*Low Sensitivity To
Moisture*



GC Fuji Ortho™ Self-Cured Bonding Adhesive

Much like Fuji ORTHO LC, Fuji ORTHO SC delivers outstanding bonding outcomes while minimizing the risk of enamel damage and decalcification during debonding.

- FUJI ORTHO SC STANDARD PK (40GM POWDER, 2-6.8ML LIQUID) - **Item #9-439503**
- FUJI ORTHO SC LIQUID REFILL (6.8ML) - **Item #9-000210**
- FUJI ORTHO SC POWDER REFILL (40GMS) - **Item #9-000209**



DynaFlex® Turbo Curing Light

The DynaFlex® Turbo Curing Light emerges as a pinnacle of technological advancement in the dental equipment sector, incorporating a multitude of features meticulously engineered to optimize performance and user convenience. This device is endowed with a built-in radiometer, ensuring precise measurement and control of light intensity, which can reach up to a potent 2,400 mW of power. Operating within a light wavelength spectrum of 440 to 480 nm, it meticulously adheres to the optimal range for polymerization of dental materials. Furthermore, the DynaFlex® is cordless and lightweight, offering unparalleled ease of use and mobility, supported by a long-lasting rechargeable battery that ensures sustained operation during procedures. It astutely integrates an auto sleep mode to judiciously conserve battery life when not in active use. With 6 powerful extensive modes and a rapid 3-second turbo mode, it provides versatile utility to accommodate various curing requirements. Notably, the advanced cooling system is meticulously designed to safeguard against overheating, guaranteeing a safe, flawless performance that stands the test of time, and maintaining the integrity of both the device and the dental work being undertaken. **Item #WL090**

- Built in radiometer
- Intensity up to 2,400 mW of power.
- Light wavelength between 440 and 480 nm.
- Cordless, lightweight
- Long-lasting rechargeable battery.
- Auto sleep mode to save battery life.
- 6 powerful extensive modes
- 3 sec. turbo mode.
- Advanced cooling system to protect from overheating and guarantees safe and flawless performance.

8mm Rod Replacement Tip

M-WL092

The 8mm Replacement Rod for M-WL090 and M-WL090+ Lights. Made from high-quality black fiber optic glass, the smaller 8mm rod is designed for easier access to posterior teeth and tighter intra-oral curing.



DynaFlex® Turbo Curing Light PLUS

DynaFlex® Turbo Curing Light PLUS sets a new benchmark in dental curing technology, offering an innovative, high-performance tool that promises exceptional curing capabilities and multifaceted functionality. Notably, it has the capability to cure composites of over 2mm thickness in a mere 2 seconds when deployed in the turbo mode, thereby exemplifying efficient operability. The inclusion of high-power 10W broadband LEDs, with a staggering average lifespan of 100,000 hours, ensures not only longevity but also a potent radiant intensity of up to 2400mW/cm². The device features an 8mm light rod and comes with both 8mm and 5mm tips, enhancing its versatility and applicability across different dental procedures. The easy-to-change cartridge battery not only ensures sustained performance but also augments convenience, minimizing downtime during critical procedures. The multifunctional light offers a range of operational modes, with the 2-second cure in "turbo" mode standing out as the highest mode, adeptly balancing speed and efficacy. Remarkably, the DynaFlex® Turbo Curing Light PLUS is not just a curing light but is also equipped to serve as a Plaque and Caries Detector, thereby consolidating two pivotal functions into one sophisticated device, and enhancing its utility in the dental practice. **Item #WL090+**

- Cures composites over 2mm in 2 sec. in turbo mode.
- High power 10W broadband LEDs
- Average lifespan of 100,000 hours
- Radiant intensity Up to 2400mW/cm₂
- 8mm light rod
- Easy to change cartridge battery
- Multifunctional light allowing 2-second cure in "turbo" mode as the highest mode
- Considered to have two main functions: Light Curing and Plaque/Caries Detector
- 8mm and 5mm tip included



DynaFlex® Nola Dry Field System

Keep A Dry Field With The Help Of This System

Enables unrestricted access to the entire dental arch while ensuring patient comfort. This system eliminates saliva-related issues and fully exposes both dental arches, making it ideal for bonding procedures. Easy to assemble and use by a single operator, it comes in two sizes for both child and adult needs and can be autoclaved up to 260° for sterilization.

CHILD (RED) - **Item #1363**

ADULT (WHITE) - **Item #1364**



full arch access while still being comfortable for the patient

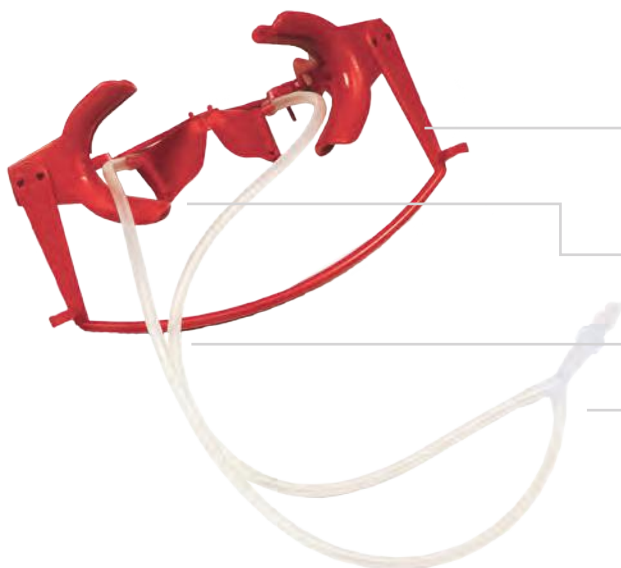

Adjustable Cheek Retractors

Keeps the cheeks back and fully exposes both dental arches.

Tongue Guard

Holds the tongue in place and allows the patient to continue swallowing.

Low or High-Volume Bilateral Silicone Tubing

Part of the unique central suction system that precisely directs saliva flow and ensures unrestricted evacuation for a totally dry environment.

Central Suction

"Y" connector with low-volume adapter.

DynaFlex® Adjustable Cheek Retractor

ADULT WHITE RETRACTOR ONLY (5.50" X 2.00") - **Item #1365-A**

CHILD RED RETRACTOR ONLY (5.25" X 1.75") - **Item #1365-C**



DynaFlex® Nola Center Connector Arm, White

Individual Sale: Center Connector for Nola Retractor. **Item #1365-405**

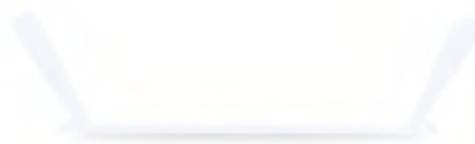

DynaFlex® Silicone Tubing

10 per pack. **Item #1364-T**



DynaFlex® Low Volume Adapters w/ "Y" Connectors

4 Adapters. **Item #1365-409**



DynaFlex® High Volume Adapters w/ "Y" Connectors

4 Adapters. **Item #1365-411**



DynaFlex® Tongue Guard

2 per pack

- LARGE WHITE - **Item #1365-403**
- SMALL RED - **Item #1365-413**



DynaFlex® Y Connector

4 per pack. **Item #1364-Y**





DynaFlex® Stainless Steel Cheek Retractor, 4.00" L x 1.50" H

Crafted from top-grade stainless steel with a brushed finish. It's double-ended, with a large retractor on one end and a small retractor on the other. It can be sterilized using any method and comes one per package containing this superior instrument. **Item #1345**



DynaFlex® Double Ended Expander

Designed exclusively for photography needs. It comes in two size options: pedo/small and med/large, with each pack containing two expanders. Please note that it can only be cold-sterilized for optimal performance.

PEDO/SMALL (1.25"/1.50" H X 5.50" L) - **Item #1350-05**

MEDIUM/LARGE (1.50"/2.00" H X 6.25" L) - **Item #1350-06**



DynaFlex® Retract-EEZ™ Cheek Retractor, (6.25" L x 2.50" H)

Ideal for occlusal photographs. Its angled bend provides comfortable lip retraction, improving your photography experience. It's compatible with both cold and heat sterilization, with the added advantage of being heat sterilizable up to 290°F. **Item #1349**



DynaFlex® Mirahold® Cheek Retractor

Provides precise force control, ideal for photography, and can be autoclaved for hygiene. Each pack includes one set in Adult or Child sizes. Ensure not to exceed 93°C for cleaning or disinfection, and for sterilization, use vapor sterilization at 121°C for 15 minutes to ensure thorough sterilization.

ADULT (4.50" L X 2.00" H) - **Item #1352**

CHILD (4.25" L X 1.50" H) - **Item #1353**

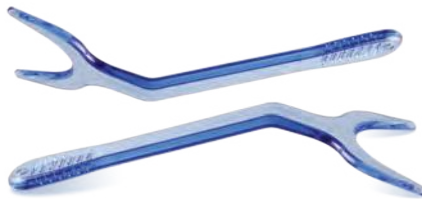

DynaFlex® EZ-Retractor

Allows Unrestricted Access

Excel in capturing occlusal photos and aiding quick direct bond repairs. Their angle head aids in comfortable lip retraction. They are autoclavable and can withstand temperatures of up to 275°, ensuring optimal hygiene. **Item #O-110-1055**



DynaFlex® Double Ended Retractors

This premium-quality retractor, available in a set of two sizes (small and medium), is autoclavable up to 275° F, ensuring safe sterilization for medical use. Featuring smooth, rounded ends, it prioritizes patient comfort during procedures. Its durable construction and ability to be safely sterilized offer reliable performance in clinical settings. **Item #O-110-1028**



DynaFlex® X-Spando Retractors:

High quality & extremely durable. The ultimate choice for bonding procedures. Capable of withstanding autoclavable temperatures up to 275°F.

SMALL - **Item #O-110-1086**

MEDIUM - **Item #O-110-1087**

LARGE - **Item #O-110-1088**



Reliance® Wire Cheek Retractors

These retractors offer easy tension control. They can be sterilized through autoclaving, dry heat, or chemical methods and can handle heat sterilization at up to 375 degrees. Available in Adult and Child sizes, each pack includes one retractor.

ADULT (5.75" L X 2.00" H) - **Item #1333**

CHILD (4.75" L X 1.50" H) - **Item #1334**



DynaFlex® Cheek Retractor

Ensure an unobstructed view for direct bonding and photography, making them versatile. They are self-retaining for ease of use and come in packs of two, with options for adult, child, and teen sizes. Please note they are cold sterile, and avoiding metal contact during sterilization is important.

ADULT (5.00" L X 1.75" H) - **Item #1350**

TEEN (4.75" L X 1.50" H) - **Item #1350-11**

CHILD (3.50" L X 1.25" H) - **Item #1351**



DynaFlex® Spandex Cheek Retractors: Autoclavable Up To 275° F

Can be autoclaved at temperatures up to 275°F. These retractors are offered in three sizes to accommodate patients of all ages: Adult, Child, and Teen, providing flexibility and comfort in your practice.

TEEN SET OF 2 RETRACTORS - **Item #O-110-1011**

ADULT SET OF 2 RETRACTORS - **Item #O-110-1012**



DynaFlex® Soft-Dex Retractors Autoclavable

These soft, flexible retractors prioritize patient comfort and are easy to place. They provide a comprehensive view of both anterior and posterior regions. Available in Adult and Child sizes, these retractors can withstand autoclaving at temperatures up to 255° F. Each package includes two retractors.

CHILD (4.50" L X 1.50" H) - **Item #O-110-1004**

ADULT (5.25" L X 1.75" H) - **Item #O-110-1005**



DynaFlex® Disposable Spandeez Retractor

A disposable retractor with a design reminiscent of the renowned Expando model! Choose from Medium (blue) and Large (red) options, each conveniently color-coded for effortless size recognition. Sold in packs of 10.

MEDIUM (BLUE) - **Item #1358-M**

LARGE (RED) - **Item #1358-L**



4.75" L x 1.25" H



5.25" L x 2.00" H

DynaFlex® Microbrush® Disposable Applicators, Multi-Colored Box

Microbrush® Applicators have a patented design with a flexible neck for easy placement in challenging areas. Their non-absorbent, lint-free fibers can hold small solutions without dripping. Each package has four tubes of 100 applicators, available in assorted packs. **Item #1590-05**



DynaFlex® 2" Bendable Bonding Brushes

Handle And Brush In One

Come with a flexible neck for easy access to tight spots. Ideal for applying etchants, bonding agents, sealants, adhesives, and resins, they offer outstanding performance. Box of 400. **Item #O-125-1015**



DynaFlex® 2 1/4 Bonding Brushes

Handle and Brush In One

High-quality bristles with excellent carrying capacity and spreading action make these brushes ideal for applying etchants, bonding agents, sealants, adhesives, and resins. Box of 400. **Item #O-125-1016**



DynaFlex® Plastic Spatulas

White plastic spatulas are the ideal choice for effortlessly blending cement. These spatulas come in a convenient 4 1/2-inch size and are available in packs of 100. **Item #1886**



DynaFlex® Prophylaxis Polishing Cups

Choose between regular or refreshing mint flavor for our 37% phosphoric acid etching agent. Apply it for 30 seconds to achieve optimal results. Available in a 2-ounce bottle or 12-gram syringe to suit your preferences.

SNAP-ON - **Item #O-108-1012**

SCREW-ON - **Item #O-108-1013**



DynaFlex® Prophy Cup Holder

Our prophy cup holders come in two options for your convenience. The autoclavable version can be sterilized and reused, while the disposable package includes 25 cups and handles for one-time use, providing both convenience and versatility. **Item #1402-05**



DynaFlex® Tongue Blocks

Use our Tongue Blocks to help patients relax their jaws during direct bonding procedures. Made from high-quality, low-density polyethylene plastic, these blocks have breathing holes for patient comfort. They come unscented in Small or Medium sizes, with each pack containing 50 Tongue Blocks.

REGULAR - **Item #13-500**

SMALL - **Item #13-501**

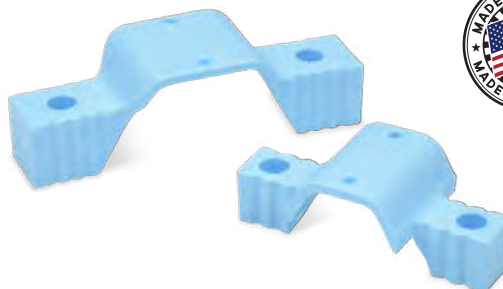



Single Set Bracket Tray

Our Single Set Bracket Tray is a sticky pad to hold brackets into place. Up to one 7x7 set per tray with mixing wells. Plastic with clear plastic snap on lid.

Item #3020

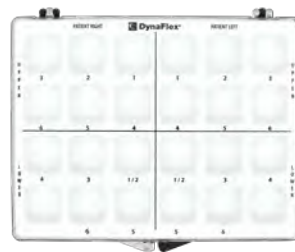

Bulk Bracket Tray

The DynaFlex Bulk Bracket Tray is designed to hold up to 10 6x6 bracket sets per tray. Hard plastic with clear lid.

Item #3030



Master Bracket Tray

Specifically designed for bracket storage of up to 50 7x7 sets of brackets. Excellent to have on hand in each office. Hard plastic with clear lid.

Item #3050

DynaFlex® Bonding Trays - Disposable

Each variant securely accommodates a complete set-up of brackets for direct bonding. Choose from vibrant blue or soothing teal with convenient mixing wells. Each pack includes 25 of these essential tools.

- BLUE - **Item #1888-11** WHITE - **Item #1888-31**
- TEAL - **Item #1888-21** GREEN - **Item #1888-41**

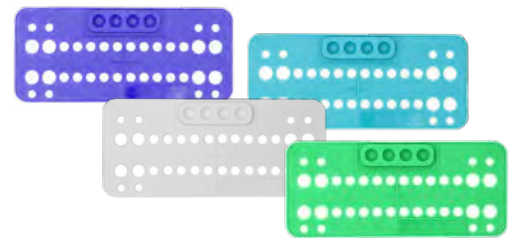

DynaFlex® Bonding Tray Holder

Prepare for your day with ease and organization using our Bonding Tray Holder. It keeps all your essential items within reach in designated slots. Made from UV-conditioned plastic, it's suitable for doctors using LC adhesives and can store up to 10 bonding trays, streamlining your workflow. Bonding trays sold separately.

- CLEAR - **Item #1890**
- SMOKE - **item #1891**



DynaFlex® Stainless Steel Bracket Height Gauge

Attain precise bracket placement every time with ease. Just measure from the incisal edge for accurate results.



SIZE	ITEM #
.018	#1433-05
.022	#1433

DynaFlex® Boone Bracket Gauge

To simplify the precise positioning of brackets, place this durable solid stainless steel gauge on the incisal/occlusal surface of the tooth. It offers measurements of 3.5mm, 4.0mm, 4.5mm, and 5.0mm to ensure lasting accuracy. **Item #1324**



DynaFlex® Boone Combo Gauge & Marker

This convenient combo features both a gauge and marker in one package, and it even includes replaceable graphite for added value and versatility.

Item #O-600-1022



DynaFlex® Fog Free Intraoral Photo Mirror System

Item #176-4150

- Includes: Base, #3 Mirror, Charger and Barrier Sleeves
- Micro fan in the base prevents fogging
- 3 L.E.D. lights provides direct lighting
- Interchangeable highly polished stainless steel mirrors with a special coating process
- Cordless – charger included
- 4" x 2.5" x 1" base serves as a handle during photography
- Battery Included
- 220 volt available upon request



Item #O-176-4157 BATTERY ONLY

Item #O-176-4156 FF BASE W/ MICRO FAN (BATTERY NOT INCLUDED)

Item #O-176-4158 VINYL COVERS FOR FF SYSTEM. 20 SHEETS

DynaFlex® Individual Stainless Steel Fog Free Mirrors

Designed to prevent fogging during dental procedures, ensuring uninterrupted visibility.

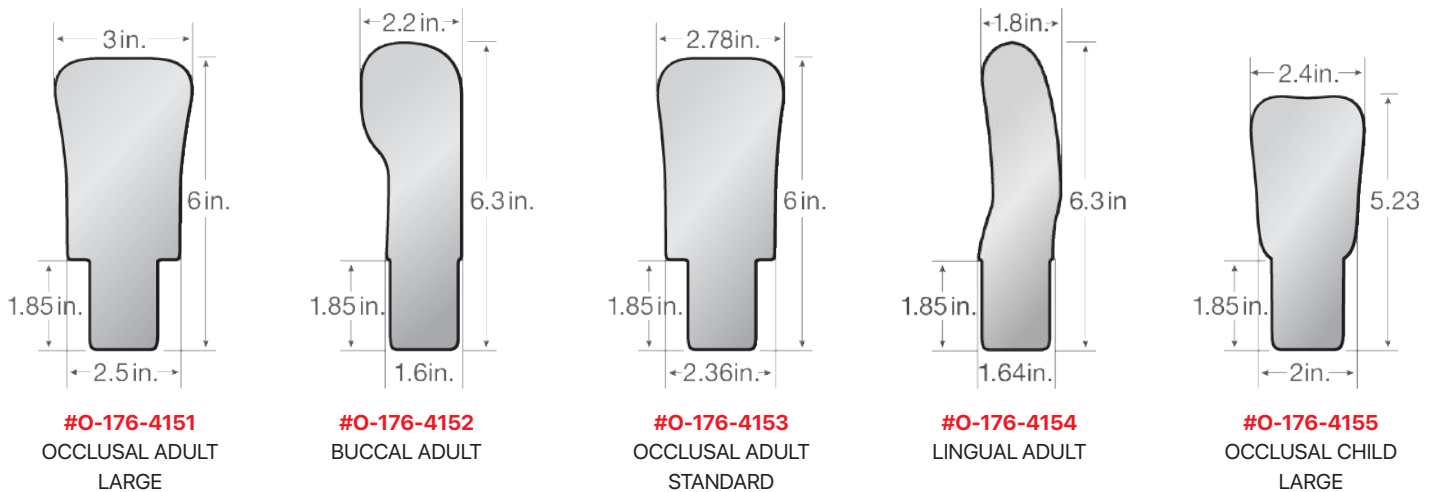

Convert Your Fog Free Mirror System To Use Glass Mirrors!

DynaFlex® Individual Glass Fog Free Mirrors & Accessories

Convert your Fog Free System to use Glass Mirrors! It's simply, remove the original adapter piece from the Fog Free Handle, replace with the Glass Mirror Adapter Piece. Glass Mirrors are available in 3 different shapes. All the benefits of the Fog Free Mirror System but now compatible with Glass Mirrors.

Item #O-176-5000 Fog Free System Glass Mirror Adapter Piece

Item #O-176-5002 Fog Free System, Glass Mirror, Small Occlusal

Item #O-176-5001 Fog Free System, Glass Mirror, Buccal

Item #O-176-5003 Fog Free System, Glass Mirror, Large Occlusal

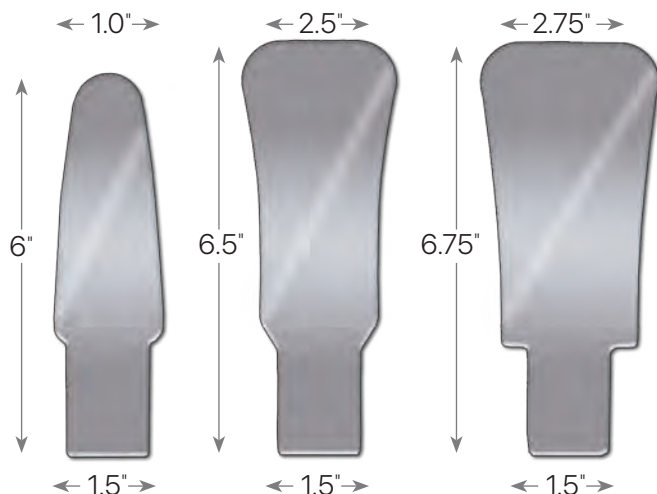

**Easily Go
From This...**



To This!



Glass Adapter Piece Firmly
Holds Mirror In Place.

DynaFlex® Photographic Mirrors - Plated

Made from laser-cut stainless steel, these mirrors offer precise and durable performance without the risk of breakage. They are expertly polished and coated for the highest resolution. These double-ended mirrors are angled for easy use, and we offer a satisfaction guarantee on their quality. Heat sterilization is recommended for optimal results, as cold sterilization is not advisable for these mirrors.

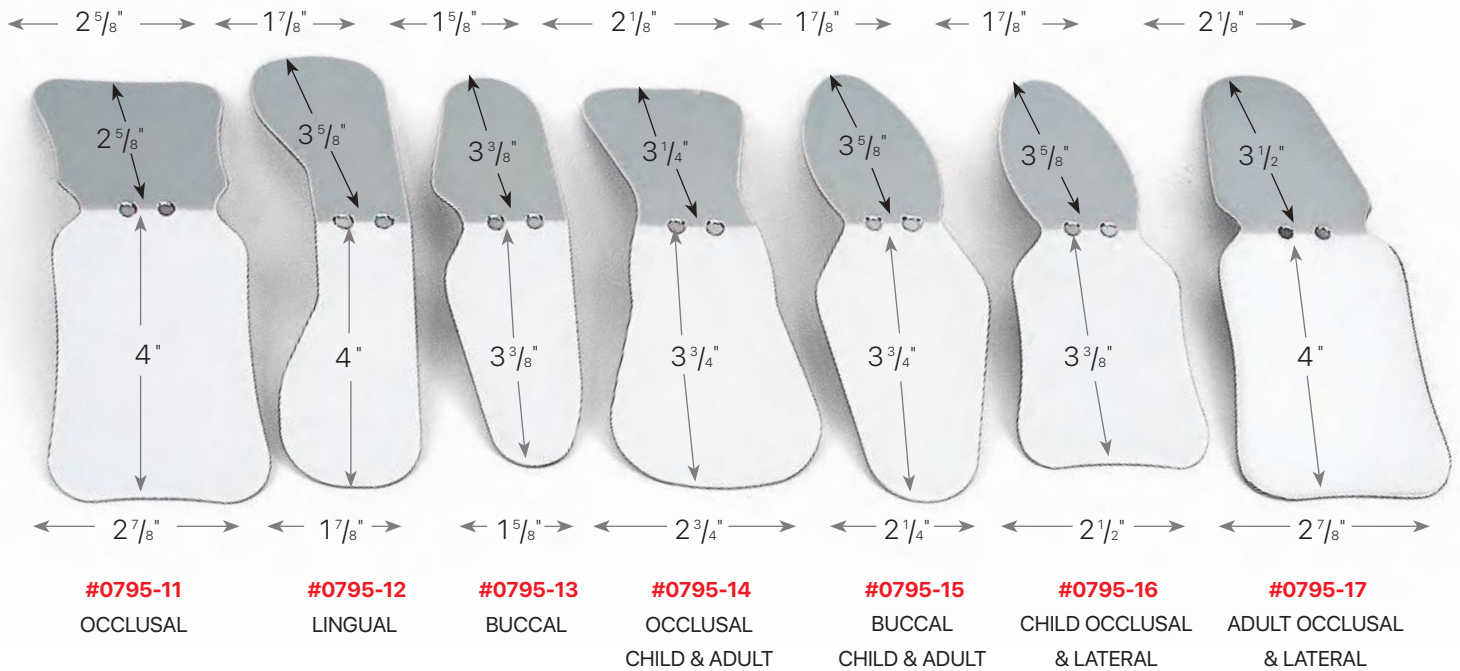

DynaFlex® Photo Mirrors

Feature a highly reflective coating for excellent visibility during procedures. They have rounded edges for patient comfort and are chip-resistant, ensuring durability in a clinical setting. These mirrors can withstand sterilization temperatures of up to 350 degrees, ensuring hygiene and readiness for use. Do not cold sterilize.

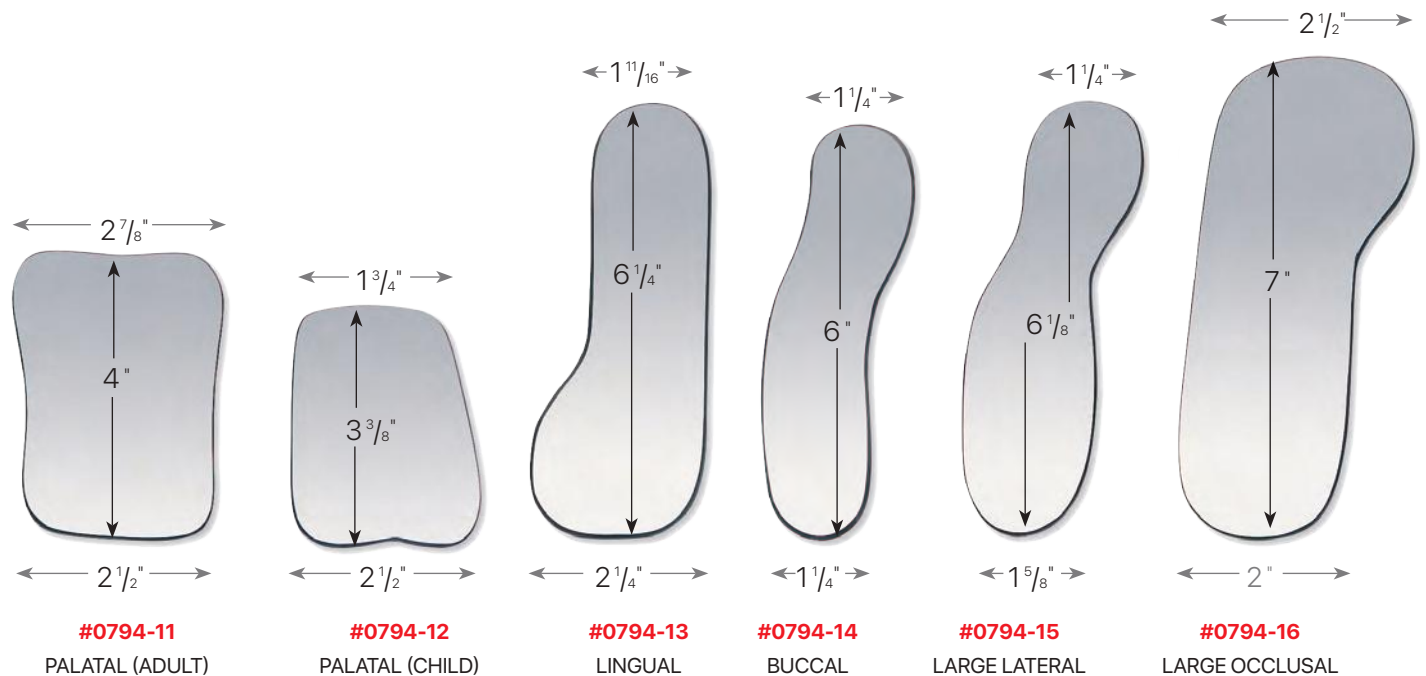

INSTRUMENTS



OLYMPUS

— INSTRUMENTS —

The Ultimate Orthodontic Instrument

DynaFlex® Olympus Pliers, meticulously handcrafted from the finest German Stainless-Steel bar stock, boast a flawless, corrosion-resistant finish, precision design featuring a sliding lock for tip alignment, and an exclusive Flush Screw Joint for seamless operation from the start, offering a high-quality, enduring instrument that remains sharp and durable, further enhanced by super hard T-12 stainless steel inserts for effortless, long-lasting precision cuts.

DynaFlex® provides a 2-year warranty, covering damage to instruments resulting from normal everyday use for the first year from the date of purchase, with the option of Renu Plier Repair Service, including applicable fees, beyond the initial 1-year period as detailed on page 137.

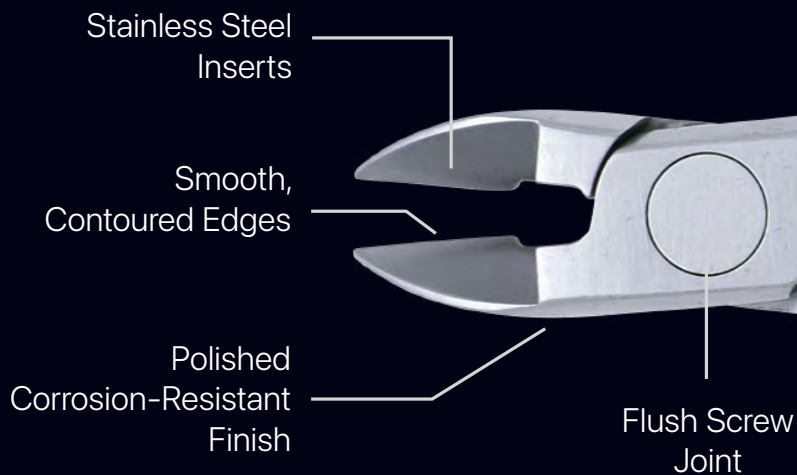

Olympus Orthodontic Instrument Sterilization Instructions

Instrument Sterilization:

It is essential to inspect, clean, and sterilize before each use, utilizing steam sterilization at a minimum of 4 minutes at 270°F/132°C or 30 minutes at 250°F/121°C, while avoiding high-pressure steam sterilization with alcohol-based medications, and strictly adhering to recommended chemicals. Hinged instruments should undergo cleaning and sterilization in the open position, and thorough cleaning, rinsing, and drying should precede sterilization; instruments should be promptly removed upon cycle completion to prevent potential corrosion or discoloration.

Ultrasonic Cleaning:

Ultrasonic cleaning is not recommended for cutting pliers, as it can dull or damage the cutters. If you choose to use ultrasonic cleaning, follow the manufacturer's recommended immersion schedule, rinse with a large volume of water, and ensure thorough air and towel drying before sterilization.

Lubrication:

To enhance the lifespan of instruments, it is advisable to perform regular lubrication.

Always lubricate after sterilization.

Always apply lubrication to instruments. A single drop or a light spray is sufficient, and excess lubricant should be wiped off. Insufficient lubrication can lead to sticky instrument joints.

Sharpening:

Frequent sharpening of orthodontic cutting pliers is recommended to prolong their lifespan and maintain efficient cutting performance. The frequency of sharpening should be determined by factors such as how often the pliers are used and the types and diameters of wires they are used on. It's essential to regularly inspect the cutters to assess whether sharpening is necessary.

Corrosion or Discoloration:

Orthodontic instruments, crafted from the highest quality surgical-grade stainless steel, are naturally resistant to rust, but their longevity and protection from corrosion or oxidation depend on proper care following the manufacturer's recommendations. Discoloration, manifested as brown or yellow stains, primarily occurs when instruments are inadequately dried after sterilization, not thoroughly cleaned, or stored in a humid environment. Discoloration may not necessarily indicate corrosion and can often be remedied by gently scrubbing with a light wool saturate. It is advisable to store instruments in a protective and dry case when not in use. If an instrument is corroded, it is best to replace or dispose of it. Mixing a corroded instrument with new ones can potentially spread oxidation to the new instruments.

Olympus Hole Punch - Item #17-0010

Hole punch aligner plier, 5mm with standard handle.

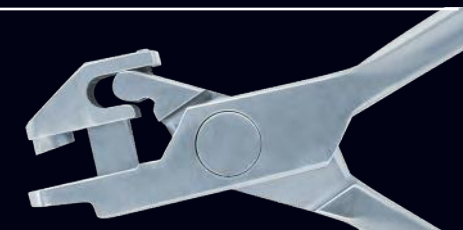

Olympus Tear Drop - Item #17-0011

Teardrop punch with standard handle.

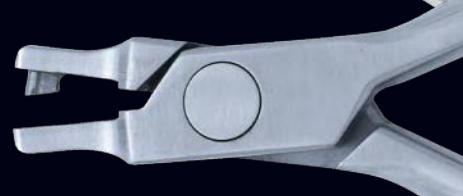

Olympus Horizontal - Item #17-0012

Horizontal punch with standard handle.



Olympus Vertical - Item #17-0013

Vertical punch with standard handle.

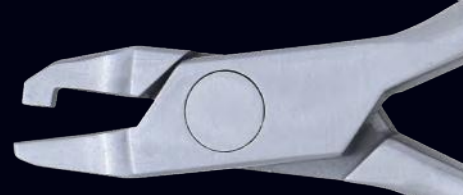

OLYMPUS

— INSTRUMENTS —



INSTRUMENTS



Olympus Pin & Ligature Cutter - Item #17-0014

Used to cut ligature wires up to .015". Standard handle.

Olympus Distal End Cutter - Item #17-0015

Distal End Cutter, standard handle. Cuts wires from .014" to .022 x .025".

Olympus Flush Distal End Cutter - Item #17-0016

Flush Distal End Cutter, flush cut with hold, standard handle. Cuts wires from .014" to .022 x .025".

Olympus Hard Wire Cutter - Item #17-0018

Cuts NiTi, Australian and Stainless Steel wire up to .030". Standard handle.

Olympus Bracket Removing Plier - Item #17-0019

Straight tip, standard handle.

Olympus Posterior Bracket Removing Plier - Item #17-0020

Posterior band remover, standard beak, standard handle. Stainless steel tip.

Olympus Adhesive Removing Plier - Item #17-0021

Remove adhesive from teeth easily with this plier, standard handle.



OLYMPUS

— INSTRUMENTS —

Olympus Weingart Plier - Item #17-0022

Weingart utility Plier, standard handle. Bends wires up to .030".

Olympus How Plier - Item #17-0023

How Utility Plier used for grasping auxilliary attachments.

Olympus Three Prong Plier - Item #17-0024

Standard handle Three Prong Plier will bend wires up to .030".

Olympus Light Wire Plier - Item #17-0025

Used for bending wires of all types, up to .020", standard handle.

Olympus V Stop Plier - Item #17-0026

Used to make "V" bends in wires up to .030", standard handle.

Olympus Posterior Band Remover Short Jaw - Item #17-0027

Designed to effortlessly remove posterior bands without stress on the tooth or patient discomfort. The short jaw makes for easier band removal with optimal control.

Olympus Posterior Band Remover Long Jaw - Item #17-0028

This standard size band removing plier has a slightly longer mouth that allows for an extended access to posterior bands.

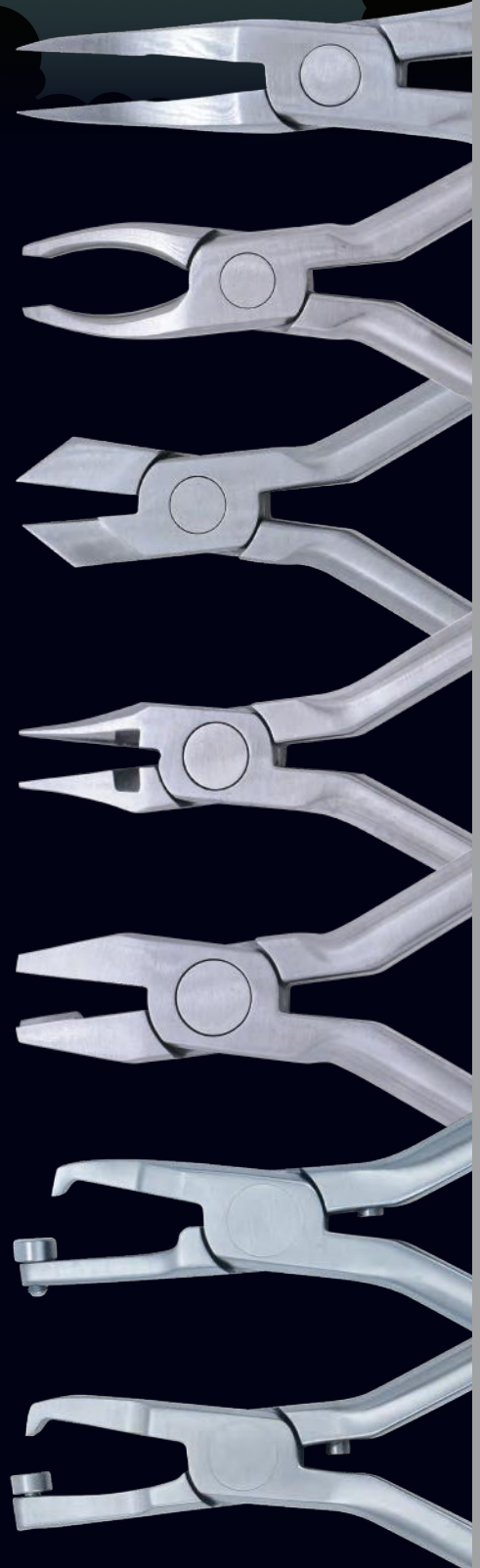

OLYMPUS

— INSTRUMENTS —



INSTRUMENTS

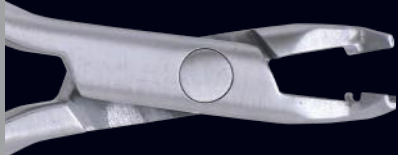

Olympus NiTi Cinch Back Premium - Item #M-O610

Long handle for easy gripping capability to bend distal end of NiTi wires.



Olympus NiTi Cinch Back Long Handle - Item #M-O610L

Standard handle NiTi cinching plier. Securely bends NiTi behind the buccal tube without rolling wire.



Olympus Distal End Flush Standard Handle - Item #M-O606

Flush cut standard size handle with standard size head. Cuts and holds round and rectangular archwires FLUSH to the tube. Wire cutting range .012" .022" Round up to .022" x .028" rectangle. Safety hold.

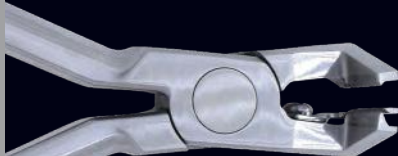

Olympus Distal End Flush Long Handle - Item #M-O606L

Flush cut standard size handle with standard size head. Cuts and holds round and rectangular archwires FLUSH to the tube. Wire cutting range .012" .022" Round up to .022" x .028" rectangle. Safety hold.



Olympus Distal Mini Flush Long Handle - Item #M-O606LM

Flush cut standard size handle with mini size head. Cuts and holds round and rectangular archwires FLUSH to the tube. Wire cutting range .012" .022" Round up to .019" x .025" rectangle. Safety hold.



Olympus Distal End Cutter w/Hold Flush Cut - Item #1443

Enables doctor to cut excess wire flush to the molar tube, leaving no protrusion of wire from behind the buccal tube. Safety hold feature holds cut wire and prevents wire from falling.



OLYMPUS

— INSTRUMENTS —

Olympus Niti Distal Cinch Back - Item #O-224-3090

The simple one-step cinch back of nickel titanium archwires. The slim line design allows quick and easy bending of distal ends inside the mouth. No heat treating of wires is required. This provides maximum comfort for the patient as well as ease of use for the clinician.

- This universal plier can be used in any quadrant
- Features a cylindrical beak opposite concave-double sided
- Accepts all methods of sterilization

Olympus Hook Crimp Plier - #M-O449S

Designed to easily crimp hooks and stops on the archwire. The plier has a slotted design that fits over the stop or hook base to hold in place while crimping.

Olympus Weingart Plier, Extra Slim - #M-O453ES

Versatile utility pliers for archwire placement or removal, slightly smaller tip has serrations for ease of use.

Olympus Convertible Cap Remover - #M-O702

Stainless Steel pliers use a reciprocal action to shear off the temporary cap of a convertible first molar tube.

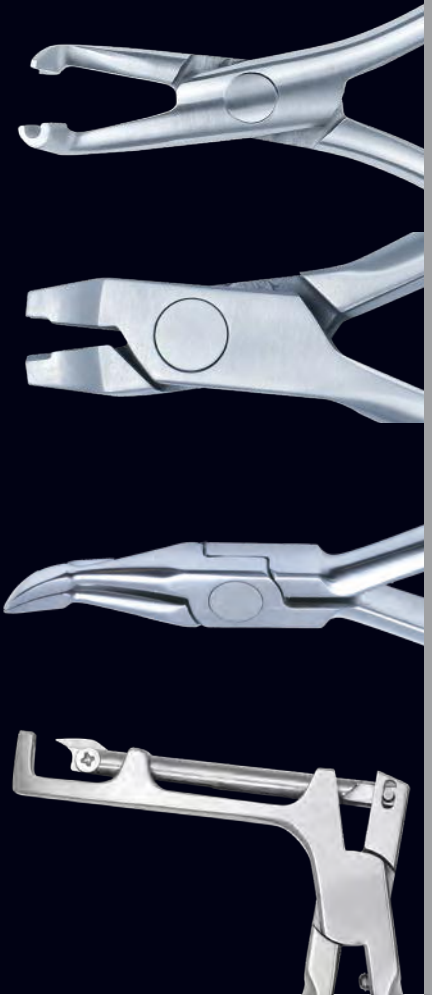

DynaFlex® Plier Brite Ultrasonic Solution

Plier Brite is a powerful ultrasonic cleaning solution designed to clean, polish, and revitalize pliers. It contains anti-corrosion enzymes to prevent rust. It can restore older pliers and protect new ones from corrosion.

Item #M-PLIERBRITEQT



DynaFlex® Multi-Purpose Ultrasonic Solution

Designed to be Gentle on Orthodontic Pliers

Engineered for the delicate care of orthodontic pliers, this solution combines a corrosion inhibitor for safety, a built-in lubricant for optimal maintenance, and an impressive 40:1 concentration that yields 40 gallons from just one gallon, all in a no-rinse formula designed for easy transition between ultrasonic cleaning and sterilization, conveniently packaged in a 1-gallon container. Item #O-155-5005





**Quality you can feel,
value you can depend on!**

DynaFlex® Legend™ Pliers are meticulously crafted dental and orthodontic tools with a superior stain and corrosion-resistant finish, a precision design featuring a sliding lock for tip alignment, ergonomic handles for a secure grip, and high-quality super hard T-12 stainless steel inserts for precise wire cuts, making them essential for dental professionals seeking durable and reliable instruments.

DynaFlex® offers a 1-year warranty covering damage to instruments due to normal everyday use from the date of purchase, and after this initial period, they provide the option of Renu Plier Repair Service.

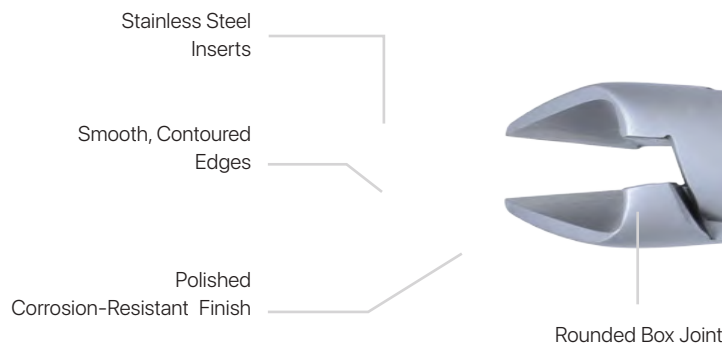

Orthodontic Instrument Sterilization Instructions

Instrument Sterilization:

Inspect, clean, and sterilize instruments before each use, utilizing steam sterilization for a minimum of 4 minutes at 270°F/132°C or 30 minutes at 250°F/121°C, avoiding high-pressure steam sterilization with alcohol-containing substances, using recommended chemicals, cleaning and sterilizing hinged instruments in the open position, thoroughly cleaning, rinsing, and drying instruments before sterilization, and promptly removing them after the cycle to prevent corrosion or discoloration.

Ultrasonic Cleaning:

Avoid ultrasonic cleaning for cutting pliers, as it may dull or damage the cutters; if used, follow the equipment manufacturer's recommended immersion schedule, rinse instruments with high-volume water before sterilization, and ensure instruments are air and towel dried before sterilizing.

Lubrication:

For prolonged instrument life, lubricate after sterilization with one drop or a light spray, ensuring excess lubricant is wiped off, as insufficient lubrication commonly causes sticky joints.

Sharpening:

Regular sharpening of orthodontic cutting pliers increases their life and cutting efficiency, with the sharpening frequency dependent on usage and the wire types and diameters; assess the need for sharpening through regular cutter inspection.

Corrosion or Discoloration:

Orthodontic instruments, crafted from high-quality surgical-grade stainless steel to prevent rust, require diligent care for longevity and rust protection, following all manufacturer recommendations, as discoloration (brown or yellow stains) typically results from inadequate drying after sterilization, poor cleaning, or improper storage and can often be removed with gentle scrubbing using a saturated light wool pad; store instruments in a protective, dry case when not in use and consider replacing or discarding corroded instruments to prevent potential oxidation transfer to new ones.



LEGEND II

ORTHODONTIC INSTRUMENTS

*Quality you can feel,
value you can depend on!*

Legend II Aligner - Hole Punch - Item #17-3010

Hole punch, .5mm with standard handle.



Legend II Aligner - Tear Drop - Item#17-3011

Teardrop punch with standard handle.



Legend II Aligner - Horizontal - Item #17-3012

Horizontal punch with standard handle.



Legend II Aligner - Vertical - Item #17-3013

Vertical punch with standard handle.

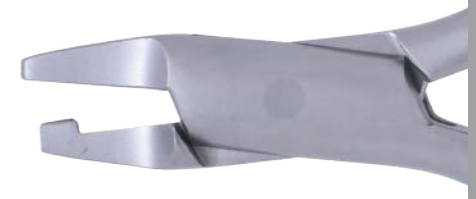
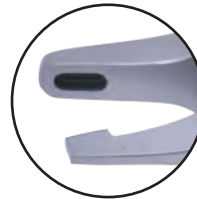

Legend II Micro Pin & Lig Cutter 15° Angle - Item #17-3015

Micro small head Pin and Ligature Cutter with 15 degree angle. Standard handle.
Cuts wires up to .015"



Legend II Pin & Ligature Cutter - Item #17-3016

Straight Pin and Ligature Cutter, standard handle. Cuts wires up to .015".





Legend II Hard Wire Cutter - Item #17-3017

Straight jaw hard wire cutter, standard handle. Cuts wires up to .022 x .025".



Legend II Flush Cut Distal End Cutter w/ Safety Hold - Item #17-3018

Flush cut Distal End Cutter with hold, standard handle. Cuts wires from .014" to .021 x .025".



Legend II Long Handle Distal End Cutter w/ Safety Hold - Item #17-3019

Long handle distal end cutter with hold. Long handle. Cuts wires from .014" to .021 x .025".



Legend II Weingart Plier - Item #17-3020

Weingart utility plier, standard handle. Bends wires up to .030".



Legend II Posterior Band Remover Pliers - Item #17-3021

Posterior Band Remover, standard beak, standard handle. Diameter of pad 6.35mm. Replacement pads are heat sterilizable. Replacement tip is heat sterilizable up to 130°F.



Legend II Bracket Removing Pliers - Item #17-3022

Bracket and adhesive removing pliers, standard handle. Diameter of pad 6.35mm. Replacement pads are heat sterilizable. Replacement tip is heat sterilizable up to 130°F.



*Quality you can feel,
value you can depend on!*

Legend II Adhesive Removing Pliers - Item #17-3023

Adhesive Removing Pliers with standard handle. Diameter of pad 6.35mm.
Replacement pads are heat sterilizable.

Legend II Bird Beak Pliers - Item #17-3024

Bird Beak Pliers with standard handle. Bends wires up to .030". Beak size measures .035".

Legend II Step Plier 1mm - Item #17-3025

1mm Step Plier with standard handle. Bends wires up to .020".

Legend II Crimpable Ball Hook - Item #17-3026

Ball Hook Crimping Pliers with standard handle. Hooks insert into plier tip and are then easily crimped on the archwire.

Legend II Torquing Plier Set (Male/Female) - Item #17-3027

Male and Female Torquing Plier Set, standard handle. Torques wires up to size .021" x .025".

Legend II Optical Plier - Item #17-3028

Optical Pliers with standard handle. Bends wires up to .030".

Legend II Three Prong Plier - Item #17-3029

Three Prong Pliers with standard handle. Bends wires up to .030".



INSTRUMENTS

Herbst Appliance Removing Plier #D444

Universally accepted as the #1 orthodontic instrument for removing Herbst crowns. Manufactured of Stainless Steel.

Item# M-D444



DynaFlex® Mathieu Forcep Stainless Steel, Narrow Satin Finish

Our Mathieu forceps are made from the highest grade stainless steel available for instrument manufacturing. Exceptionally smooth operating and extremely precise tips makes our Mathieu forceps the premier instrument available today. You won't find a better value than our Mathieu forceps and most orthodontic companies charge three times our price for a lesser quality instrument. Guaranteed to outperform all others. Item #1400-025SS



DynaFlex® Mathieu Forcep Stainless Steel, Narrow #D503

Ideal for placing elastomerics and tying ligatures. All Stainless Steel construction with serrated jaws. Perfect for smaller hands for less fatigue. Item #M-MATHIEU D503



DynaFlex® Mathieu Forcep Stainless Steel, Narrow with Tungsten Carbide Inserts #D515

Perfect for elastomeric placement or tying ligatures. Manufactured of Stainless Steel with serrated jaws with Tungsten Carbide inserts. Item #M-MATHIEU D515



DynaFlex® Mathieu Forcep Stainless Steel, Narrow Single Spring Design #O526

Manufactured from Stainless Steel with tapered, serrated tip excellent for ligating. Manufactured with a precision tip providing a firm, non-slip grip on elastics. Item #M-MATHIEU O526



The Norris System Tools



Triple Tool
Three tools in one; door opener, positioner, ruler. **Item #216-5005**



Hip Tool
Aids in effortlessly seating the wire in the archwire slot and makes placing torque in rectangular wire easy. **Item #216-5000**



Bracket Opening Tool
A single-ended opening instrument that works seamlessly with both Norris Metal and Norris Clear Self-ligating Doors. **Item #216-5015**



Double Take Mirror
Double-sided intraoral mirror allows the doctor to simultaneously retract and visualize groups of teeth. **Item #216-5010**

Bracket Height Gauge

Crafted from high-quality steel, the Norris gauge features increased height dimensions, ranging from 5.5 mm to 7.0 mm, to accommodate higher bracket placements. The Norris gauge is compatible with both .018 and .020 slots. **Item #216-5020**



Debond Plier

The DynaFlex Ceramic Debonding Instrument features two uniquely designed claw tips and a carefully crafted wedge. The claw tips securely grip bracket bases occlusal-gingivally, while the wedge applies optimal pressure for a comfortable, efficient debonding process. Perfect for ceramic brackets, this versatile tool also works exceptionally well with metal brackets. **Item #216-5025**

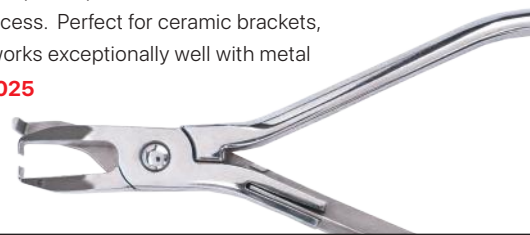

DynaFlex® Distal Bender

Features a long handle with an angle tube. Simply slip the tube over the archwire and bend distal to the buccal tube to create a cinch back bend. Fits wire up to .019 x .025. **Item #1407**

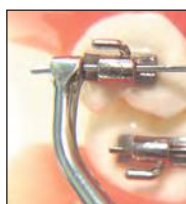

DynaFlex® Aligner Scissors

This tool is designed for precise trimming of Essix® appliances, particularly useful for trimming the lingual aspects of Glacier® and Essix® appliances. **Item #O-220-1016**

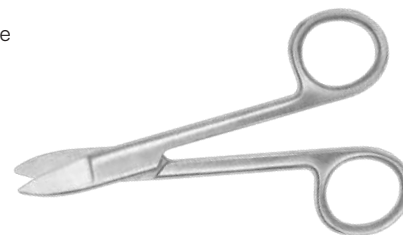

DynaFlex® Hemostat Stainless Steel, Without Hook Tip

Made from high-grade stainless steel. Easy to use and reliable. 3 tip designs to choose from. **Item #1400-014**



DynaFlex® Spee Scissor

Ideal for all your bleaching, invisible retainers, and fluoride tray needs. The curve cutting blade makes it easy to contour the anterior lingual area. **Item #O-220-1018**



DynaFlex® Buccal Tube Instrument

This product offers exceptional convenience, making the placement of molar brackets significantly easier with its slender tip that effortlessly inserts into the slot on the molar bracket, while the reverse-action tweezer ensures precise and effortless bracket placement. **Item #1400-676**



DynaFlex® Stainless Steel Hand Instruments

These hand instruments are manufactured with high grade stainless steel and feature accuracy in each tip. Guaranteed not to rust or corrode. Sold individually.



DOUBLE ENDED LIG DIRECTOR - **Item #1429**



SMALL LIGATURE DIRECTOR/SCALER - **Item #1400-833**



SCALER/BAND PUSHER - **Item #1400-030**

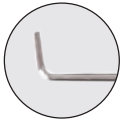

SELF-LIGATING INSTRUMENT - **Item #1444**

DynaFlex® Zeffiro™ Stainless Steel Hand Instruments

Super high quality hand instruments have a patented handle system that reduces bacterial residue that usually hides on grid type instruments. Extremely lightweight with a slightly larger handle makes these instruments feel more comfortable to your hand with better tactile control. **Item #1400-50**



DynaFlex® Premium Scalers

Made by a leading US instrument company, these hand instruments will provide you with the quality you expect and the comfort you deserve. A great value for your purchasing dollars!



SCALER LT H6H7 - **Item #1400-4839**



SCALER LT U15/33 - **Item #1400-4843**

DynaFlex® Round Plier Rack with Holding Tube

The round rack measures 4 inches in diameter by 4-1/4 inches in height, with an outer ring for holding pliers and an inner tube for hand instruments or straight wire, and a center holding tube diameter of 1-1/4 inches. **Item #1486**



DOES YOUR OFFICE HAVE PLIERS THAT NEED TO BE
REPAIRED, SHARPENED OR RE-TIPPED?

Renu™ Instrument Repair Service



BEFORE

AFTER

DynaFlex® is proud to offer Renu™, a quality instrument repair service that is both economical and reliable. Most repairs will be returned back to you complete in about 10-14 business days. However, pliers or instruments that need extra attention may take 2-3 weeks. Make sure to include the doctor's name, address and phone number. We recommend using a carrier with tracking capabilities.

Mail Your Instruments To:

DynaFlex®
ATTN: Renu™
8050 Hawk Ridge Trail
Lake St. Louis, MO 63367

Service
Sharpen Cutters
Sharpen Band & Bracket Remover
Retip Bird Beak
Retip Cutter
Retip Band & Bracket Remover
Retip Scalars, Hand Instruments, Explorers
Mathieu Spring Replacement
Sharpen Scalars
Repair Hemostat, Serrated Needle
Miscellaneous Repair
Repair Scissors
Repair Mathieu Forceps
Repair Utility Pliers
Replace Screw
Replace Hand Instrument Handle
Replace Rests
Repair Bird Beak Pliers
Retip 3 Prong Plier
Re-Tip Utility Pliers
Handpiece



DynaFlex® Bracket Tweezer - Stainless Steel

This tool, made of high-grade stainless steel, provides a secure grip on brackets with its reverse action and serrated tips. **Item #1418**



DynaFlex® Posterior Bracket Tweezer Long Handled

Similar to our regular posterior bracket tweezer, with a small tip, but it has an extended handle for easier access to the posterior region, making it 5-1/4 inches in total length. **Item #1416**



DynaFlex® Posterior Bracket Tweezer, Small

Similar to our standard bracket tweezer but has smaller, angled beaks for better visibility during bracket placement. It offers reverse action for easy loading and a secure grip, with a total length of 4 1/2 inches. **Item #1417**



DynaFlex® Bracket Placement Instrument

Combines the functions of two instruments in one: Features a reverse action bracket tweezer at one end and a bracket positioning tool at the other end, eliminating the need for separate instruments. **Item #1417-15**

DynaFlex® Multi-Task™ Tweezer

The DynaFlex® Multi-Task™ Tweezer is your go-to tool for placing, positioning, and cleaning brackets with ease. Its serrated end securely grips the bracket for precise placement, while the specialized tip fits into the slot for accurate positioning. This versatile instrument also removes residual composite around the bracket, streamlining your workflow with one compact tool. **Item #O-600-1003**



Place Bracket



Serrated End Fits in Slot to Position Bracket



Clean Residual Composite Around Bracket

DynaFlex® Boone Bracket Gauge

To simplify the precise positioning of brackets, place this durable solid stainless steel gauge on the incisal/occlusal surface of the tooth. It offers measurements of 3.5mm, 4.0mm, 4.5mm, and 5.0mm to ensure lasting accuracy. **Item #1324**



DynaFlex® Boone Combo Gauge & Marker

This convenient combo features both a gauge and marker in one package. **Item #O-600-1022**



DynaFlex® College Pliers Stainless Steel

Non-locking stainless steel pliers with serrated tips. **Item #1415**

Exclusively Designed For Precision Aligner Buttons®

The Precision Punch Plier®

We are delighted to announce our strategic collaboration with HuFriedy, a distinguished leader in precision instrument manufacturing. Fabricated from premium stainless steel and engineered to accommodate second-generation metal precision aligner buttons with unparalleled precision. This innovative tool guarantees a seamless cutout, ensuring a flawless, snug fit for the Precision Aligner Buttons. With their expertise complementing our commitment to excellence, our partnership has yielded a groundbreaking product, redefining industry standards in precision button alignment. **Item #10-678812**

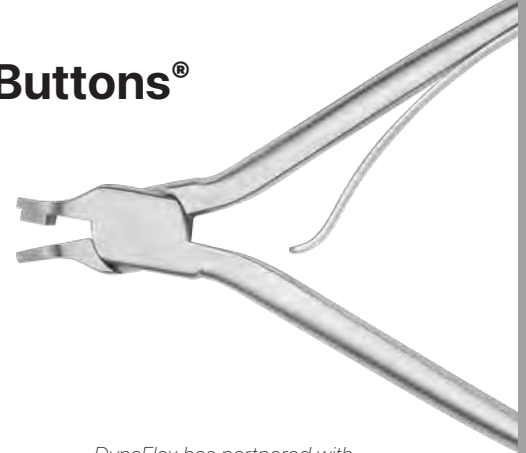
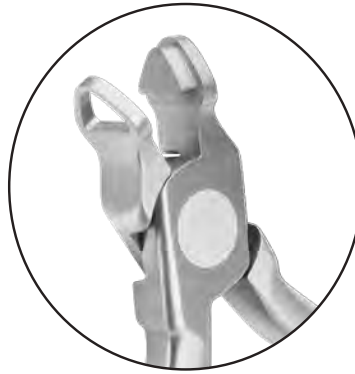

*DynaFlex has partnered with
The HuFriedy Group To Create
This Top Quality Plier*

HuFriedyGroup
The Best in Practice
a STERIS company

INSTRUMENTS

Norris Double Take Mirror

The Norris Double Take Mirror is a double-sided intraoral mirror designed to streamline dental procedures. It allows for simultaneous retraction and visualization of multiple tooth groups, providing enhanced efficiency and precision. With its dual-sided design, it offers clear views from multiple angles, making it an essential tool for comprehensive intraoral assessments and improved patient care. **Item #216-5010**



DynaFlex® Disposable Mouth Mirror

Our highly reflective mirror provides exceptional intraoral views, and each mirror comes with a peel-away seal for a consistently clean and clear perspective. 24 mirrors per pack. **Item #4905**



DynaFlex® Stainless Steel Mouth Mirrors

An affordable high-quality mouth mirror is now available! Crafted from high-grade stainless steel, these mirrors and handles will not rust or corrode. Sterilizable by any method. Mirrors are available in size 4 or 5.

SIZE 4 MIRROR - **Item #1479-10**

SIZE 5 MIRROR - **Item #1479-20**



DynaFlex® Replacement Mirrors

Designed to perfectly fit our DynaFlex® Stainless Steel Mouth Mirrors. Each pack includes 5 replacement mirrors.

SIZE 4 MIRROR - **Item #1479-4**

SIZE 5 MIRROR - **Item 1479-5**



Interproximal Reduction



DynaFlex® Diamond Disc



SINGLE-SIDED:
7/8" DIA. 0.10 MM THICK

Item #O-109-1300

DOUBLE-SIDED:

7/8" DIA. 0.15 MM THICK **Item #O-109-1302**

DynaFlex® Interproximal Disc

Expertly designed for precision in shaping enamel, composite, acrylic, and ceramic restorations on various dental surfaces. These discs undergo a durable electroplating process and come pre-attached to a mandrel for immediate use. Featuring a unique honeycomb swirl design, they ensure maximum tooth contact. These discs have a thickness of 0.18mm and can be sterilized for hygiene compliance: 30 minutes at 121°C or 4 minutes at 134°C.



HONEYCOMB 22MM - **Item #0778**

HONEYCOMB 18MM - **Item #0778-01**

HONEYCOMB 14MM - **Item #0778-02**

HONEYCOMB SWIRL 22MM - **Item #0779**

HONEYCOMB SWIRL 18MM - **Item #0779-01**

DynaFlex® See Thru Diamond Disc

Smooth Interproximal Stripping



DOUBLE SIDED:
7/8" DIA. 0.18 MM THICK.

#O-109-1303

DynaFlex® Ortho Stripping Disc

Our double-sided interproximal stripping disc is designed for easy and flexible use with low-speed handpieces. These discs are ultra-thin at just 0.14mm and come in two diameter options: 22mm and 16mm, providing versatility for your needs.



22MM DIAMETER - **Item #0760**

16MM DIAMETER - **Item #0760-01**

STERILIZATION RECOMMENDATION:
Rinse with water and dry, then steam sterilize at 121° C for 20 min or 134° C for 5 min.

DynaFlex® ContacEz® Thickness Gauge Set

Incremental stainless steel thickness gauges include six guides, each representing a different size: 0.10mm, 0.20mm, 0.25mm, 0.30mm, 0.40mm, and 0.50mm.



Item #O-109-1525

DynaFlex® Disc Guard Set

Enhance patient safety with this innovative shield, designed to protect against stripping discs. This kit includes a shaft and guards in three sizes (22mm, 16mm, and 8mm) to accommodate 7/8" discs effectively.



Item #0761



DynaFlex® ContacEZ® IPR System

A groundbreaking method for interproximal enamel reduction (IPR) that enhances the safety and precision of the procedure while ensuring minimal enamel removal.

- Will not cut lips or gums and eliminates gagging
- Flexible strip does not create corners or subgingival ledges
- Single-handed design offers optimal tactile control
- Effective for anterior teeth, easy to access to posterior areas, and case refinement.

Starter Kit (4 EACH: YELLOW, RED, GREEN, DARK BLUE) - **Item #O-109-1500**

Full Kit (8 EACH: YELLOW, RED, GREEN, DARK BLUE) - **Item #O-109-1501**

Individual Refill Strips

STERILIZATION RECOMMENDATION:
Do not heat sterilize.
Steam sterilization only, up to 270° F at 30 psi max.



COLOR	SIZE	FUNCTION	DOUBLE /SINGLE SIDED	GRIT	ITEM #
Yellow	.06mm	Starter	Single Sided	Extra Fine	#O-109-1502
Clear	.10mm	Single Sided Opener	Single Sided	Medium Fine	#O-109-1506
Red	.012mm	Opener	Double Sided	Medium	#O-109-1503
Dark Blue	.015mm	Widener	Double Sided	Coarse	#O-109-1505
Green	.020mm	Extra Widener	Double Sided	Coarse	#O-109-1504

DynaFlex® Dome® Manual Stripping Handle

This instrument is essential for expanding tight interdental spaces and performing precise contouring. It has a lightweight stainless steel handle available for individual purchase, with separate tips offered in various options. **Item #0716**



DynaFlex® Replacement Heads for Dome® Manual Stripping Handle

Suitable for cold sterilization exclusively. Each pack contains four units.

SINGLE/DOUBLE SIDED	GRIT	ITEM #
Double Sided	Coarse	#0714-011
Double Sided	Med.	#0714-012
Single Sided - Left	Med.	#0714-014L
Single Sided - Right	Med.	#0714-014R
Single Sided - Left	Coarse	#0714-013L
Single Sided - Right	Coarse	#0714-013R



DynaFlex® Interproximal Stripping Strips

Meshed strip designed for versatile interproximal reduction, contouring, and meticulous finishing on a variety of surfaces. These strips are offered in widths of 2.5mm or 3.75mm and come in three grit options: medium, fine, and extra fine. Single-sided can be purchased individually or in convenient bulk packs of 10.

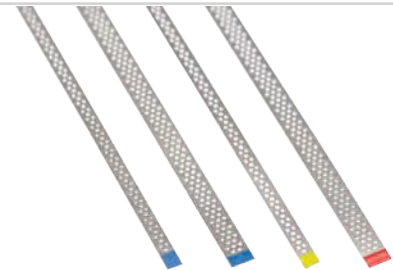

STERILIZATION RECOMMENDATION:
Autoclave 30 min at 121° C
or 4 minutes at 134° C

GRIT	COLOR CODE	SIZE	SINGLE PACK	10 PACK
Extra Fine	Yellow	2.5	#1013	#1013-B
Extra Fine	Yellow	3.75	#1013-15	#1013-15B
Fine	Red	2.5	#1013-11	#1013-11B
Fine	Red	3.75	#1013-14	#1013-14B
Medium	Blue	2.5	#1013-12	#1013-12B
Medium	Blue	3.75	#1013-13	#1013-13B



DynaFlex® Lightning Strips

Crafted for interproximal reduction, contouring, and finishing of enamel, metallic, and composite surfaces. Made from high-quality 304 Stainless Steel, these strips are 0.003 inches thick. Choose from single or double-sided surfaces and widths of 6mm or 8mm. Each strip is 6 inches long, and each pack contains 10 strips.

Single Sided Lightning Strips

FINE (6MM) - **Item #1012-01**
MEDIUM (6MM) - **Item #1012-02**
COARSE (6MM) - **Item #1012-04**
MEDIUM (8MM) - **Item #1013-02**
COARSE (8MM) - **Item #1013-04**

Double Sided Lightning Strips

MEDIUM (6MM) - **Item #1012-03**
MEDIUM (8MM) - **Item #1013-03**



STERILIZATION RECOMMENDATION:
Steam autoclave with the following parameters:
134 degrees C, 2.5 minutes, 10 minute drying time.

DynaFlex® Reciprocating Contra Angle

- Fits 'E' type handpieces
- 1.4 mm stroke
- Autoclavable sterilization
- Optimal torque

Item #O-109-1600



*Heads Sold Separately

DynaFlex® Reciprocating IPR System

Experience a safe, precise, and dependable approach to achieve meticulous interproximal stripping, surpassing the control and safety levels offered by diamond discs. This method delivers unparalleled flexibility, surpassing the capabilities of both diamond and carbide burs. Notably, it ensures a faster and more comfortable experience for patients compared to manual hand stripping. With a maximum speed of 20,000 oscillations per minute, it guarantees exceptional results while prioritizing both the dentist's and patient's well-being.



Double Sided Available in 5 different grits

- 90 micron - for use as a saw for opening contacts
- 60 micron - for reduction
- 40 micron - for contouring
- 25 micron - for finishing
- 15 micron - for pre polishing

W/ HOLES	#O-109-1605H	#O-109-1606H	#O-109-1607H	#O-109-1608H	#O-109-1609H
GRIT	15 micron/Extra Fine	25 micron/Fine	40 micron/Medium	60 micron/Coarse	90 micron/Extra Coarse

DynaFlex® Single Sided

Available In 5 Different Grits / Right And Left

- 90 micron - for precision cutting to open contacts
- 60 micron - for reduction
- 40 micron - for both reduction and contouring
- 25 micron - for finishing
- 15 micron - for pre polishing

LEFT W/ HOLES	#O-109-1620H	#O-109-1622H	#O-109-1624H	#O-109-1626H	#O-109-1627H
GRIT	15 micron Extra Fine	25 micron Fine	40 micron Medium	60 micron Coarse	90 micron Extra Coarse



RIGHT W/ HOLES	#O-109-1628H	#O-109-1630H	#O-109-1632H	#O-109-1634H	#O-109-1635H
GRIT	15 micron Extra Fine	25 micron Fine	40 micron Medium	60 micron Coarse	90 micron Extra Coarse

Your All-in-One Solution for Account Management



www.dynaflex.com

Simplified Account Management at Your Fingertips

Real-Time Dashboard

Monitor all pending and shipped supply and lab orders. Easily view overall account activity from one clean, intuitive interface - giving you a complete view of your practice's supply and laboratory activity in one place.

Seamless Multi-Account Access

Manage all your orders effortlessly with a single email and password. Switch between accounts quickly to submit supply orders, ortho cases, aligner cases, sleep cases with ease.

Streamlined Order Entry

OnCommand simplifies ordering with a user-friendly grid of your most-ordered items. Easily search by product name, number, or line, and quickly add multiple items to your cart for a fast checkout. Saves time with this effortless ordering experience.

Live Support When You Need It

Have a question about a product? Connect instantly with our live chat support for expert guidance on products or technical assistance.



DynaFlex Online offers this all-in-one platform, specifically designed to be tailored to your workflow. With industry-leading tools and real-time support, managing your account with DynaFlex has never been easier.

Visit www.dynaflex.com/instant-access to begin.

PATIENT AIDS



DynaFlex® Retainer Cases - 20 Pack

Elevate your patients' experience with our vibrant, scented, and visually captivating retainer cases. Whether they prefer a splash of color, a touch of sparkle, or a classic design, our cases are designed to impress. Each pack includes 20 cases, complete with name tags, and we offer generous discounts for bulk orders.

CUSTOM IMPRINTING AVAILABLE!

A great and inexpensive marketing tool!

See Page 150 For Details

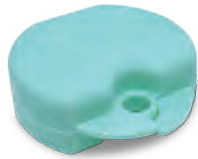

Aqua
Item #0854-AQ



Blueberry
Item #0854-BB



Bubble Gum
Item #0854-BG



Black
Item #0854-BL



Cherry
Item #0854-C



Fuchsia
Item #0854-F



Grape
Item #0854-G



Grey
Item #0854-GY



Light Blue
Item #0854-LB



Mint
Item #0854-M



Maroon
Item #0854-MR



Orange
Item #0854-O



Sparkle Tropical Blue
Item #0854-TB



White
Item #0854-W



Banana
Item #0854-Y



Under The Sea Splash
Item #0854-21

DynaFlex® Retainer Brite

Preserve the freshness and appearance of your retainers with our cleaning tablets, featuring a refreshing minty taste. Rest assured, these tablets won't compromise the shine or durability of your appliance. Choose from convenient packages of 36 or 92 tablets.

36 COUNT - Item #0858

92 COUNT - Item #0859

RETAINER BRITE TRIAL (100PK POUCHES) - Item #M-RETBRT100

Great For Clear Aligners



DynaFlex® Mini Retainer Cases - 20 Pack

Vibrantly colored and built to withstand daily wear, our new small retainer cases, measuring 2.75" W x 2.5" L x 3/4" deep, come in a range of delightful colors and scents. Your patients are sure to love them!"



Aqua

Item #0859-AQ



Black

Item #0859-BL



Fuchsia

Item #0859-F



Grape

Item #0859-G



Grey

Item #0859-GY



Light Blue

Item #0859-LB



Mint

Item #0859-M



Maroon

Item #0859-MR



Orange

Item #0859-O



White

Item #0859-W



Banana

Item #0859-Y

DynaFlex® Wax Boxes

Enhance patient comfort while providing them with options that cater to their preferences. Whether it's plain, tropical, splash, or scented wax, our variety is sure to delight your patients! Each box includes 50 compacts filled with clear bracket wax.



Aqua

Item #1309-AQ



Blueberry

Item #1309-BB



Bubble Gum

Item #1309-BG



Cherry

Item #1309-C



Grape

Item #1309-G



Light Blue

Item #1309-LB



Mint

Item #1309-M



Maroon

Item #1309-MR



Tropical Blue

Item #1309-TB



Tropical Green

Item #1309-TG



Tropical Pink

Item #1309-TP

DynaFlex® Pontic Wax: Tooth Colored

Simulate the appearance of teeth within aligners, even in areas with missing teeth or tooth gaps. Simple to apply and remove as needed, and if the pontic wax diminishes during treatment, patients can easily replace it between appointments. Each package includes 25 cases.

Item #O-101-1062



DynaFlex® Bracket Wax

Wax Packs Relieves Irritation From Sharp Wires

Your Solution for Sharp Wire Irritation - Choose from pre-filled wax packs or empty compacts. Save on emergency visits with quick and effective relief. Wax blends seamlessly with teeth for minimal visibility. Each crystal clear box contains 5 unflavored wax strips. Adheres easily to orthodontic appliances, providing much-needed relief to irritated tissues. Each box contains 100 packs. **Item #O-100-1066**



Custom Imprinting Services

Personalized Retainer Cases & Wax Boxes - Ink Stamped

High quality retainer cases and wax boxes fully customized with your logo.

Simply place your order online, with your local rep, or by calling 866-346-5665.

- Choose your imprint/ink color, retainer case/wax box colors, then select a quantity.
- E-mail your logo file to imprints@dynaflex.com, you'll then receive a proof for approval.
- Once approval is received, production on your personalized retainer cases or wax boxes will begin!

One time setup fee varies, \$100 for plate ready artwork (vector file; pdf, eps) , \$125 for all other artwork (raster file; jpg, png).



Learn More

A great and *inexpensive* marketing tool!



Personalized Retainer Case With Black Ink

DynaFlex® Personalized Retainer Cases

Available on the 0854 and 0859 series. See **PAGE 149** for color options. Price includes retainer case with imprint. **100 unit minimum order.**



Personalized Wax Box With White Ink

DynaFlex® Personalized Wax Boxes

See **PAGE 148** for color options. Price includes wax box with imprint and wax. **100 unit minimum order.**



DynaFlex® Personalized Bracket Wax Packs: Hot Foil Stamped

FREE One-Time Artwork
FREE One-Time Setup
FREE One-Time Impression Plate

Elevate your branding with our premium wax packs, which can be fully customized with your practice name, phone number, and a personalized message. These wax packs serve as a cost-effective yet highly effective marketing tool. Our crystal clear boxes are meticulously hot-stamped with a stunning foil that mirrors the quality and care your office provides. Patient wax packs are conveniently available in boxes of 100, with each pack containing 5 wax strips, all personalized with your practice details. Make your mark with a box of 100.

GOLD FOIL PRINT - **#O-100-1063**
RED FOIL PRINT - **#O-100-1064**
BLUE FOIL PRINT - **#O-100-1065**

Patient Home Care & Travel Kit

The Right Stuff™ Kit consists of an impact resistant, translucent blue case containing the most commonly used ortho patient care items.

An easy and convenient way for your patients to maintain dental hygiene as well as their new appliances between visits. The Travel Case keeps the contents clean and intact so they're always ready whenever and wherever your patients need them.



*Personalized Shown

Each Right Stuff™ Kit Includes

- Ortho Wax Pack
- Dental Mouth Mirror
- Proxi Brush With Cover
- Ortho Appliance Care Instructions
- Floss Threaders
- Johnson & Johnson 5 Yard Waxed Floss
- Home Use V Trim Toothbrush
- Travel V Trim Toothbrush

The Right Stuff™ Kits

NO MINIMUM

NON-PERSONALIZED - **Item #O-100-1002**

100 KIT MINIMUM

PERSONALIZED GOLD PRINT - **Item #O-100-1004**

PERSONALIZED BLUE PRINT - **Item #O-100-1006**

PERSONALIZED RED PRINT - **Item #O-100-1008**

Get your personalization form online or by phone.



Ortho Care™ Orthodontic Home Hygiene Kit

The Ortho Care Home Hygiene Kit gives the orthodontic patient all the tools to properly maintain their appliances. The handy, durable, pouch keeps everything in one place for the patient on the go. **Item #O-100-1009**

Each Ortho Care™ Kit Includes

- 12 yards Dental Floss
- 10 Floss Threaders
- Patient Emergency Wax Pack
- V Trim Orthodontic Toothbrush
- V Trim Travel Orthodontic Toothbrush
- Proxi Brush
- Mouth Mirror
- 2 Minute Timer

Place Your Business Card Here



DynaFlex® Bracket Wax

Clear bracket relief wax. Easy to use compacts. 50 per box. **Item #1300**



DynaFlex® Brace Gard™ Silicone Brace Wax Squares

Each package includes a handy mirror for easy application, and you can choose from five vibrant box colors. Each package contains 80 squares. **Item #1319**



DynaFlex® Lip Protectors

Perfect For Patients Who Play Musical Instruments



Small, bur-free fingers securely grips the archwire between brackets, meeting the unique needs of musical instrument-playing patients. These cover the entire 5 to 5 prescription, including buccal tubes, and come in pairs for upper and lower arches. **Item #O-100-1090**

DynaFlex® Magic Touch Antiseptic Gel Only

Highly effective Antiseptic/Anesthetic Gel. It's designed to promote healing and strengthen previously treated tissue, aiding newly bonded patients. This gel utilizes natural Myrrh's astringent properties to facilitate the healing process for sore soft tissues caused by braces and mouth ulcers. Each tube contains 1/8 ounce.



MAGIC TOUCH ORTHODONTIC GEL (BULK PACK-72) - **Item #1320-10**
MAGIC TOUCH DISPENSER SERIES (144/PK.) - **Item #1320-500**

DynaFlex® Comfort Covers™ For Orthodontic Braces

Protects patients' lips and cheeks, providing relief from the discomfort commonly associated with orthodontic treatment and reducing the risk of oral lacerations during various activities. **Item #O-100-1088**



DynaFlex® Patient Relief Wax In Bulk Boxes

Effortlessly craft a total of 540 Wax Packs! These packs feature the identical top-tier high-grade wax found in our standard wax packs. Inside, you'll find a generous quantity of 450 strips, each measuring an impressive 12 inches in length and 3/16 inches in width, ensuring you have an abundance of high-quality material at your disposal.

Item #O-100-1068



L' il Palates™





Discover the simplicity of our device designed for removing trapped food between the expander and the palate. This tool features a retractable, pocketknife-style plastic hook for practicality. Each purchase includes a pack of 12 for your convenience.

BLUE - **Item #8010**
PURPLE - **Item #8020**



Champion™ Comfort Covers

Crafted for easy installation, these protective shields provide cushioning and safeguarding for lips and cheeks against discomfort. Made from soft, flexible medical-grade PVC, they feature a user-friendly C-shaped design that securely clamps over braces. Each pack includes five one-foot lengths.

-  CLEAR - **Item #1160-1**
-  FLUORESCENT BLUE - **Item #1161-FB**
-  FLUORESCENT GREEN - **Item #1161-FG**
-  FLUORESCENT RED - **Item #1161-FR**



The DynaFlex® Super-Guard™ - With Strap

These items prioritize your comfort and safety with their tapered design for a snug fit. They feature three breathing vents for airflow, a curved design for added comfort, and a tongue guard for protection. Each pack includes a helmet strap, and you'll receive 10 items in one pack.

W/ OUT STRAP	COLOR	WITH STRAP
#1335-B	Blue	#1336-B
#1335-C	Clear	#1336-C
#1335-G	Green	#1336-G
#1335-SI	Silver	#1336-SI
#1335-Y	Yellow	#1336-Y

Latex Free



The DynaFlex® Super-Guard™ - Without Strap

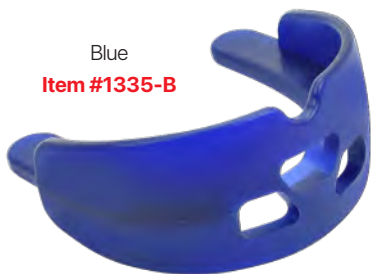

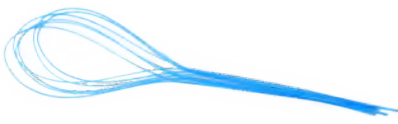

DynaFlex® Eez-thru® Floss Threader

Discover the versatile nylon loop, an essential tool for precision flossing. It's designed to assist patients in threading dental floss under bridges, splints, or orthodontic appliances with ease. Each envelope contains 5 of these essential tools. Box of 100. **Item #O-100-1126**



The DynaFlex® Platypus Orthodontic Flosser

The Platypus Flosser has transformed the way people approach oral hygiene with braces. Its remarkable ease of use allows you to floss effortlessly at school, in the car, or wherever you may be!

PACK OF 30 - **Item #0800-150**

BULK PACK - 75 BAGS OF 3 - **Item #0800-151**



Reach® Floss - Easy Slide®

Experience the Convenience of Patient Trial Size Floss: Each box contains 144 trial-sized portions of our ultra shed-resistant floss, with each portion measuring 5 yards (4.6m) for your patients' convenience. **Item #O-100-1128**

DynaFlex® Toothbrushes With Paste

Our toothbrushes are designed with soft plastic bristles that come impregnated with toothpaste powder, making them a perfect choice for patients to use just before their appointments. Each pack contains 100 individually wrapped toothbrushes. **Item #O-100-1116**

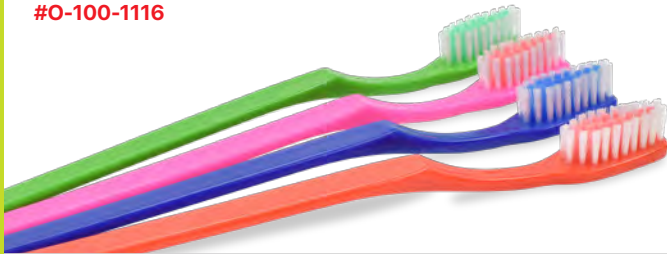

DynaFlex® Toothbrushes

Our toothbrushes feature premium nylon bristles that ensure top-notch oral care. They strike the perfect balance between affordability and durability, designed to be disposable while being robust enough for multiple uses. Available in assorted packs of 100 individually wrapped toothbrushes.

Item #O-100-1114



DynaFlex® Orthodontic Toothbrush - 'V' Trim Design

Our orthodontic toothbrushes are meticulously designed with bristle tips that are smooth and evenly rounded, thanks to our patented process. These rounded tip bristles are gentle on gums, minimizing any potential trauma during brushing. The innovative 'V' Trim Design ensures that the brush can deliver a thorough cleaning without interfering with orthodontic appliances. Each package includes a box of 72 toothbrushes in assorted colors, and to maintain hygiene, each toothbrush is individually bagged.

Item #O-100-1110

DynaFlex® Travel Toothbrush 'V' Trim Design

Our toothbrushes feature handles that double as protective covers, ensuring both convenience and hygiene. The innovative 'V' Trim Design allows for thorough cleaning without any interference with orthodontic appliances. Each toothbrush is thoughtfully individually bagged for your convenience. Our package includes a box of 100 toothbrushes in assorted colors. **Item #O-100-1112**



DynaFlex® Two Minute Sand Timers

Ideal for keeping kids on track during their teeth-cleaning routine. Each box contains 100 timers in a variety of vibrant colors. **Item #O-100-1136**



DynaFlex® Aligner Seaters™

These specially crafted Seaters are designed to ensure even pressure on specific areas of your mouth when necessary. Say goodbye to messy cotton rolls because Aligner Seaters™ offer a cleaner alternative. Each pack contains 20 Seaters, neatly organized into 10 sealed patient packs of 2 for your convenience.



COLOR/SCENT	ITEM #
WHITE/UNSCENTED	#0853-W
PURPLE/GRAPE	#0853-G
PINK/BUBBLEGUM	#0853-BG
GREEN/MINT	#0853-M
YELLOW/PINEAPPLE	#0853-P

DynaFlex® Tapered Proxi Brush: With Cover

Experience fast and efficient plaque and food particle removal from braces and dental appliances with the specially designed Proxi Brush. Its bristles effortlessly reach and clean the spaces between teeth and braces, complementing your daily brushing routine. It even includes a convenient cover for on-the-go use. Pack of 144. **Item #O-100-1122**



DynaFlex® Proxi-Clean Interproximal Brushes

Experience enhanced comfort and convenience with our newly designed travel brushes. They feature larger ergonomic handles for a secure grip and come with plastic covers that can be used as extensions. Available in various colors, each package contains 144 brushes, offering both quality and convenience in one. **Item #1541**



DynaFlex® Therapy Wafers

Alleviate orthodontic discomfort by promoting increased blood flow to the gum tissues. Patients can effortlessly ease their discomfort by simply chewing on one of these wafers after a wire change appointment. Each pack includes 25 wafers and comes in four delightful scents: Bubble Gum, Cherry, Grape, or Mint.



SCENT	ITEM #
BUBBLE GUM	#1270-BG
CHERRY	#1270-C
GRAPE	#1270-G
MINT	#1270-M

DynaFlex® Appliance Remover Tool

Simplify the appliance removal process for patients with our appliance remover tool. It enables effortless removal of aligners and various appliances from both the cheek-side and tongue-side of the mouth. Plus, it's as easy to clean as the aligner itself. Each pack includes 10 of these handy tools.



COLOR	ITEM #
BLUE	#0870
GREEN	#0870-GN
ORANGE	#0870-O
PINK	#0870-PK
WHITE	#0870-W

DynaFlex® Elastic Attachers

Effortlessly position elastics using our Elastic Attachers, thoughtfully crafted with a hook on one end and a pusher on the other. Simplify the process of placing and removing intraoral elastics for your patients, and kids will adore the glow-in-the-dark attachers with a secure, slip-resistant handle. Each pack includes a generous supply of 250 attachers. **Item #1225-05**



DynaFlex® Kromopan® Alginate

It maintains its form for an impressive 100 hours, demonstrating excellence in quality, precision, and compression resistance. It changes color for precise guidance: Purple for Spatulate, Pink for Load Tray, and White for Insert Tray. Each pouch yields around 50 impressive impressions.

1LB. POUCH - **Item #1552**

RESEALABLE 1 LB. CANISTER - **Item #1551**



DynaFlex® DeBubblizer by DeLar Corporation

Try our surface tension reducer to banish bubbles and enhance impression crispness. Simply spray it about 15cm from the impression and vibrate your stone mix for stunning results. Available in 32-ounce bottle. Elevate your detailing game effortlessly!

Item #1525-01



DynaFlex® Disposa-Bowl™

Tailor-made for blending alginate, plaster, or stone materials with ease. These bowls are designed for single-use convenience and are crafted from thin, recyclable plastic with side grips for easy handling. Each package includes 50 bowls.

Item #1550-05



TreClean

GC TreClean is a tray cleaner that effectively removes alginate impression material from impression trays. 1.2kg canister.

Item #9-10000144



A Real Orthodontic Products Online Shopping Experience

- Simplified Shopping Experience
- View Your Order History, Easily Reorder
- Bulk Ordering Made Easy
- You Choose Your Shipping Methods Based On Cost
- Quick Search & Find Feature



DynaFlex® Disposable Impression Trays

Our DynaFlex plastic impression trays are color-coded for easy size identification. Crafted from sterilizable plastic, they offer exceptional cost-effectiveness. Choose from six sizes: pedo, x-small, small, medium, large, and x-large. Each pack includes 50 trays, ensuring you're well-equipped for your needs.

Disposable Impression Trays 50 Pack

Pedo Upper (#1 - Red)	#1192-U
Pedo Lower (#1 - Red)	#1192-L
X-Sml Upper (#2 - Orange)	#1193-U

X-Sml Lower (#2 - Orange)	#1193-L
Sml Upper (#3 - Blue)	#1194-U
Sml Lower (#3 - Blue)	#1194-L
Med Upper (#4 - Green)	#1195-U
Med Lower (#4 - Green)	#1195-L

Lg Upper (#5 - Yellow)	#1196-U
Lg Lower (#5 - Yellow)	#1196-L
X-Lg Upper (#6 - Purple)	#1197-U
X-Lg Lower (#6 - Purple)	#1197-L
Assorted Pack of 60 Trays	#1191



DynaFlex® Secure Lock™ Disposable Impression Trays

Our new disposable impression trays will quickly become your new office favorite. We named them Secure Lock™ because of the exclusive design that will let the alginate flow easily into the tray and "lock" into place without pulling away, even when you double pour your impressions. High gingival margins. Side view of exclusive locking system. Color coded by size and available in five different sizes. Pack of 50.

Disposable Impression Trays 50 Pack

#1199-1L	X-Large Lower (Yellow)
#1199-1U	X-Large Upper (Yellow)

#1199-2L	Large Lower (Green)
#1199-2U	Large Upper (Green)
#1199-3L	Medium Lower (Blue)
#1199-3U	Medium Upper (Blue)

#1199-4L	Small Lower (Orange)
#1199-4U	Small Upper (Orange)
#1199-5L	X-Small Lower (Red)
#1199-5U	X-Small Upper (Red)

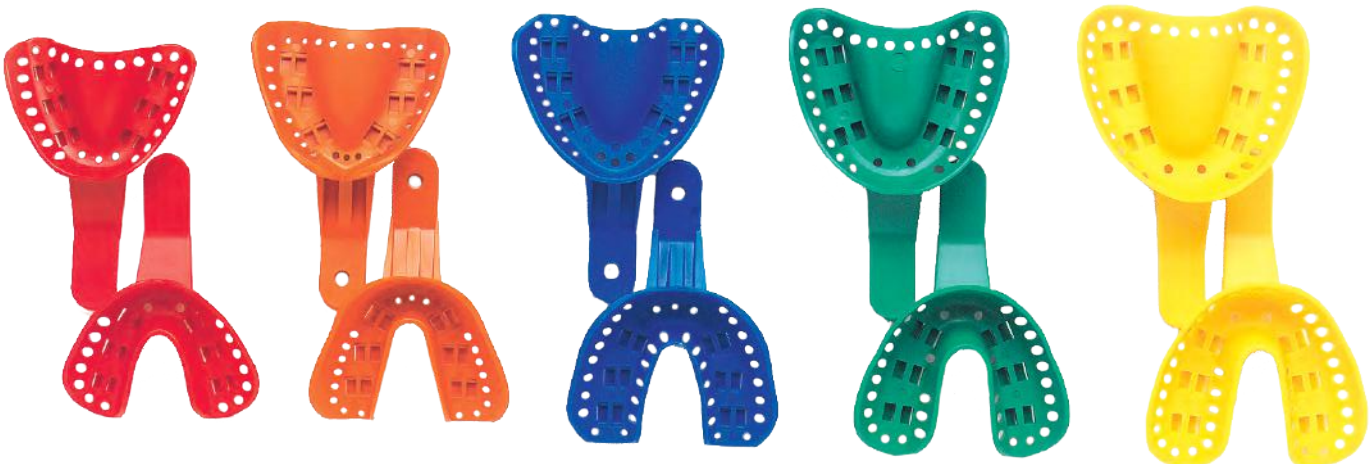

LABORATORY SUPPLIES



from dentalcreations
wonderfill™

A water-soluble tongue void filler designed to streamline your modeling process! With Wonderfill, there's no need for the hassle of mixing alginate filler or painstakingly removing plaster or stone from lower impressions. Just effortlessly fill the tongue area with Wonderfill and proceed to pour your model. When the model has set, Wonderfill can be effortlessly removed without any annoying sticking. Wonderfill is conveniently water-soluble and requires zero setup time or any special cleanup effort. Available in a generous 51-ounce tub. **Item #1549**

Trims the time. Polishes the model. Pampers your hands. No mixing, no mess, no wasted time grinding, ending in exceptional model appearance.



Remove a palmful of Wonderfill from tub.

Form a domed bridge in the tongue area.

After plaster/stone fully sets, easily pop out Wonderfill.

With Wonderfill in the tongue area, pour plaster/stone.

DynaFlex® Model Storage Boxes

These easily assembled boxes save valuable space and offer remarkable sturdiness once put together. Each box is designed with dedicated compartments for secure model storage and includes a tray, compartment insert, and protective sleeve for added convenience.



4 COMPARTMENT BOX - **Item #0850-4**

Case of 50 boxes: 11" x 3.375" x 1.875"

8 Compartment

8 COMPARTMENT BOX - **Item #0850-8**

Case of 50 boxes: 11" x 6.875" x 1.875"

4 Compartment

DynaFlex® Vibrator General Purpose

Compact, Robust Motor.

Item #O-190-1432



DynaFlex® Trimming Wheel

One-piece instrument to achieve precise trimming of Essix® appliances. **Item #O-109-1055**

Head Size: 10 mm

Thickness: 0.5 mm

Maximum Speed: 10,000 rpm



DynaFlex® Polishing Brushes

This product is tailor-made for use with cordless Dremel tools, with a maximum speed of 13,000 RPM. The brush head come pre-mounted on a mandrel and are crafted from Scotch-Brite material. They are available for individual purchase and offer a choice of three different textures. Please note that these brushes are autoclavable only.



FINE
#0750-F

MEDIUM
#0750-M

COARSE
#0750-C

DynaFlex® Lc Blockout Resin



DynaFlex® Lc Blockout Resin, provided in two 2g syringes, boasts low viscosity and a distinctive blue pigment, ensuring easy application and visibility. It's an indispensable utility resin for creating bleaching trays and conducting various laboratory procedures, allowing for precise application with its Black Mini® tip. Though it is light-cured, it is specifically formulated for external laboratory use, not for intraoral applications, guaranteeing adherence to safe use practices. **Item #O-115-1140**

DynaFlex® Specialty Burs

Burs meticulously crafted for the precise requirements of various laboratory materials

H251EF, FOR ACRYLICS & METALLIC ALLOYS - **Item #O-109-1240**

H251E, FOR ACRYLICS, METALLIC ALLOYS & PLASTER - **Item - #O-109-1242**

H79GSQ, FOR SOFT ACRYLICS - **Item #O-109-1244**

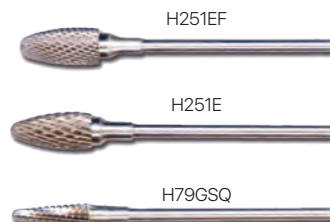

Expansion Screws

Midline Upper & Lower:
EXPANSION 7MM, LENGTH 11MM, WIDTH 7MM

Item #3100-2000

Midline Upper:
EXPANSION 7MM, LENGTH 11MM, WIDTH 10MM

Item #3150-2000

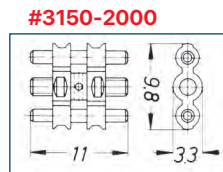
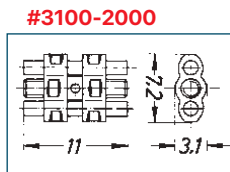

Super Screw Telescopic Maxillary Expander

The cutting-edge telescopic construction of this device eliminates the need for reverse turning and allows for activation from the front of the mouth. It also features an expansion limit indicator and a graduated scale for precise adjustment, making it a convenient and advanced tool.

16 MM - **Item #O-160-1027**

12 MM - **Item #O-160-1035**



DYNAFLEX® LOCKING NUT - **Item #O-160-1036**

DYNAFLEX® SUPER SCREW WRENCH - **Item #O-160-1037**

Palatal Expanders, 12mm, Pre-Bent

Discover our best-selling palatal expanders, offering versatility to suit your needs. You can choose from options with pre-bent arms, straight arms, or no arms, ensuring the perfect fit for your requirements.

Item #3602-812

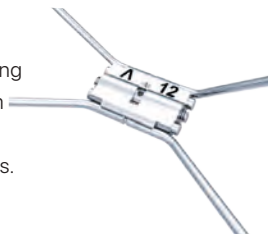

Variety RPE, 12mm

Originally designed for mandibular use, these RPEs (Rapid Palatal Expanders) are now suitable for effective palatal expansion in the maxilla as well. They feature a compact design for patient comfort and robust laser-welded arms capable of withstanding high mechanical loads. With just two arms, these appliances offer versatile applications to address various clinical needs.

Item #3602-806

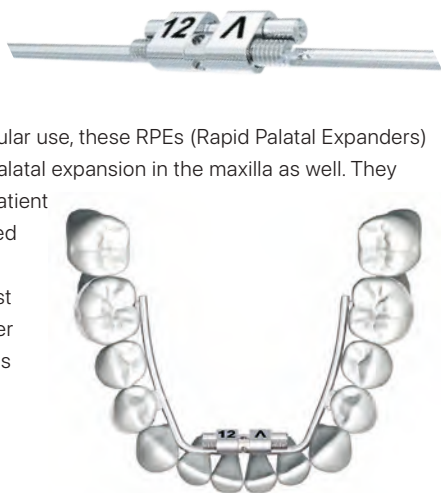

Snap Lock Expanders

The Snap Lock Expander offers a secure locking mechanism that prevents unintentional reversals. When the spindle is activated with a 1/4 turn, a flat spring locks it firmly in place. Both the patient and doctor can feel the screw "locking" into position. The spindle is always ready for reactivation or turning, and if accidentally overactivated, it can be easily reversed when necessary.

10MM SNAP LOCK EXPANDER - **Item #3-A167-1439**

12MM SNAP LOCK EXPANDER - **Item #3-A167-1639**



Palex® RPE Click Expanders, 12mm

The Palex® RPE "Click" Expander has a patented "Click" feature to prevent unwanted reversing for rapid palatal expansion in the fixed appliance. When the Palex® RPE "Click" Expander is properly activated by 1/4 turn, both the patient and doctor will be able to feel the screw "lock". The hole in the spindle is always in the correct position for reactivation/turning. By chance if the palex® RPE "Click" Expander is overactivated, it can be turned back.

Item #3602-834



RES Screw – Ratchet Expansion Screw

This expansion device emits an audible "click" for every 1/4 mm turn of the screw, providing a clear signal to parents and patients that the correct adjustment has been made, thus avoiding any reversals. It also includes a built-in safety mechanism to prevent the screw from separating inside the mouth. The screw can be extended up to 11mm in precise 1/4mm increments and comes with a Safety Key for added security.

11MM - 2-ARM - **Item #3120**

11MM - 4-ARM - **Item #3125**



"Audible Click"

DynaFlex® Q.C.M. Labial Bow

These labial bows are not only aesthetically pleasing but also easy to shape, requiring no special tools. They are available in three sizes: 42mm, 48mm, and 54mm, and can be purchased individually to suit your specific needs.

SIZE	ITEM #
42MM	#2013-42
48MM	#2013-48
54MM	#2013-54



DynaFlex® Ball Clasp

These ball clasps are meticulously crafted, ensuring they are the shiniest available in the market. They are the very same clasps trusted and used daily in our laboratory. Each pack includes 100 of these top-quality clasps, providing you with reliability and value.

SIZE	ITEM #
.024	#1124-1
.028	#1128
.032	#1132
.036	#1136-1
.040	#1140

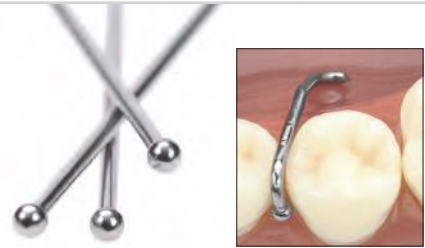

DynaFlex® 14" Straight Lengths - Stainless Steel

This economical wire is an excellent choice for laboratory use or spring formation. It is available in both round and rectangular shapes. Round sold in pack of 25. Rectangular sold in pack of 10.

Round - 20 Pack				Rect. - 10 Pack	
SIZE	ITEM #	SIZE	ITEM #	SIZE	ITEM #
.014	#0952-014	.032	#0952-032	.016 x .016	#0951-016
.016	#0952-016	.036	#0952-036	.016 x .022	#0951-022
.018	#0952-018	.040	#0952-040	.017 x .025	#0951-017
.020	#0952-020	.045	#0952-045	.018 x .025	#0951-018
.028	#0952-028	.048	#0952-048	.019 x .025	#0951-019
.030	#0952-030	.056	#0952-056	.021 x .025	#0951-021



DynaFlex® Smart-Key

The Smart-Key offers precise activation detection for RPE screws. Simply align the key tip with the front stop, insert it into the RPE expander screw, and push the handle toward the back of the throat. As you activate the RPE, the key head and tip will rotate. Keep pushing until it reaches the 180-degree activation stop, which may produce a subtle "bump" or "click." Available in packs of 10. **Item #3017**



DynaFlex® Safety Key

This extended-handle key offers effortless screw turning while ensuring the patient's safety by preventing key ingestion. The button is crafted from ultra-safe Hi Impact Polystyrene, securely fixed and non-removable. Both key styles are compatible with and effective for all screw mechanisms. Sold in packs of 10.

NEW & IMPROVED - **Item #3010-K**

THE ORIGINAL - **Item #3011**

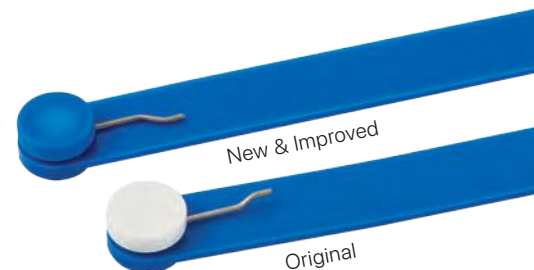

DynaFlex® Hot Air Sterilizer - RH-PRO11

Introducing the RH-PRO11, your ideal High-Velocity Hot Air (HVHA) Sterilizer for office environments. This cutting-edge sterilizer offers waterless sterilization without chemicals and is highly energy-efficient, consuming 85% less energy than traditional steam sterilizers. It accommodates both Small and Large Cassettes, along with 4 Large Instrument Trays per cycle, providing versatility. Cycle documentation simplifies record-keeping, and the Self-Locking door ensures cycle completion. The RH-PRO11 is priced at \$8100 and backed by a robust 3-year parts and labor warranty. **Item #0789-PRO11**

Cycle 1: 6 min. for unwrapped instruments.

Cycle 2: 8 min. for handpieces and medical drills.

Cycle 3: 12 min. for pouched, wrapped instruments, trays and cassettes

Overall Dimensions	Chamber Dimensions	Instrument Tray
Width: 22.5"	Width: 11"	Width: 9"
Depth: 22.5"	Depth: 17.75"	Depth: 15"
Height: 19.5"	Height: 11.75"	Height: 1"

Electrical

110-120V, 60Hz, 1400 Watts warm up, 300 Watts operating
220-240V, 50Hz, 1400 Watts warm up, 300 Watts operating

Sterilization Temperature: 375° Fahrenheit (190° Celsius)

Weight: 75 lbs.



Includes: Instruction/Care Card, User Manual, 4 Instrument Trays, 1 pair of Removal Safety Gloves and a KN95 FM Sterilizer.

DynaFlex® SteriDent Dry Heat Sterilizer

This economical dry heat sterilizer is perfect for your practice. Available in two models: #200 equipped with two trays, #300 equipped with three trays. One year full warranty. Five year warranty on heating element.

Item #0798 MODEL #200 - W/ 2 TRAYS - 15-1/2" X 10-1/2" X 9-1/2"

Item #0799 MODEL #300 - W/ 3 TRAYS - 19-1/2" X 14-1/2" X 11"

Item #0798-01 DRY HEAT BAGS - 250



DynaFlex® Torque Master



A lightweight, balanced design for prophy procedures, compatible with all contra angles and straight burs. Adjustable speed range from 0 to 20,000 rpm. Also available in a 4-hole model for convenience. **Item #O-190-8014**

DynaFlex® High Speed Air Handpiece

Push-button grip-lock cartridge features extreme gripping & locking power, yet easy to change burs.



Streamlined, lightweight design for reliable, whisper-quiet performance. Balanced for comfortable grip. Available in a 4-hole model for maximum comfort and functionality in dental procedures. **Item #O-190-8020**

DynaFlex® Microlab Digital Micromotor

High-quality heavy-duty micromotor with state-of-the-art Microprocessor Control. 35,000 RPM, hand or foot control, forward or reverse, has a twist-type chuck release. Easy to change chucks. Improved dust seal protection. Heavy-duty front bearings with safety overload. **Item #O-190-8000C**

- 0-35,000 RPM
- LED functions and display
- Hand or foot control
- Forward and reverse rotation
- High torque
- Touch panel buttons for durability
- Safety overload protection



DynaFlex® Heavy Wire Cutter

This versatile cutter is designed to handle orthodontic wires of all sizes. The cutter is equipped with a spring-action handle for effortless operation and measures 5 1/2 inches in length. **Item #1461**



DynaFlex® Butane Refills

Each canister contains 270ml of premium grade butane gas. Box of 12. NOTE: A UPS Hazmat surcharge will be applied to each box ordered.

Item #O-189-3000



DynaFlex® Micro-Etcher II Intra-Oral Micro Sandblaster

An autoclavable tip recommended by dental experts nationwide, delivering enhanced bond strength for various treatments. Quick disconnect kits available for added convenience. Trust in our recommended tip for excellence.

MICRO-ETCHER II - **Item #0735**

MICRO-ETCHER IIA - **Item #0735-5**

QUICK DISCONNECT KIT - **Item #0736**

4-HOLE HANDPIECE ADAPTER - **Item #0737**

MICRO-ETCHER TIP-60° - **Item #0735-4**

MICRO-CAB PLUS (6-1/2" X 6-1/2" X 12") - **Item #0741**

MACRO-CAB PLUS (9.8" X 12" X 7") - **Item #0741-2**

MICRO-CAB PLUS REPLACEMENT GLASS - **Item #0742**

MICRO-CAB PLUS HANDGUARD KIT - **Item #0743**

MACRO-CAB PLUS HANDGUARD KIT - **Item #0743-2**

MICRO-CAB PLUS REPLACEMENT SHIELDS (10) - **Item #0744**

MACRO-CAB PLUS REPLACEMENT SHIELDS (10) - **Item #0744-2**



Item #0735-5
Micro-Etcher IIA



DynaFlex® Aluminum Oxide For Microetcher

Aluminum Oxide is compatible with all sandblasting machines, offering versatility in your abrasive choices. It comes in two variations: the 50-micron option, boasting a white hue and 240 grit, and the 90-micron choice, characterized by a gray shade and 150 grit. Each variation is conveniently packaged in a 1 lb. bottle, making it readily available for your sandblasting needs.

50 MICRON - **Item #0740**

90 MICRON - **Item #0740-2**



Did You Know?

DynaFlex Has Developed and Engineered Exclusive Materials Designed Specifically For Aligners and Retainers.

GLACIER®

Thermoform Material Series

See Pages 12-13 For More Info

VALUE ALIGNERS & RETAINERS



Learn More

RETAINERS



Learn More

Essix® Plastic Sheet: "ACE":

Best for Aligners and Retainers. Clear, rigid and accepts bonding agents. Ideal for retention, minor tooth movement and temporary bridges using Essix pontics.

5" SQUARE .030MM (100) 1A350 - **Item #O-205-1022**

5" SQUARE .035MM (100) 1AH50 - **Item#O-205-1023**

5" SQUARE .040MM(100) 1A450 - **Item #O-205-1024**

Essix® Plastic Sheet: Type "A+":

Excellent when the patient wears the appliance full time. Crystal clear. Rugged, inexpensive, excellent flex memory, and a snap-in fit is insured. Light reflection properties makes the teeth look brilliant. .040" Type "A" used exclusively for moving teeth with Windows and Divots™. Acrylic will bond to Essix® Type 'A'. (Patent Pending)

Type "A+" For Essix® Retainers:

- BIOSTAR® 125MM SQUARE .020"(.5MM) 100 SHEETS 10020 - **Item #0769-01**
- VACUUM 5" SQUARE .020"(.5MM) 100 SHEETS 10025 - **Item #0769-02**
- VACUUM 5" SQUARE .030"(.75MM) 100 SHEETS 10035 - **Item #0769-03**
- BIOSTAR® 125MM SQUARE .030"(.75MM) 100 SHEETS 10030 - **Item #0769-04**
- BIOSTAR®/MINISTAR® 125MM CIR. .030" (.75MM) 100 SHEETS 11030 - **Item #0769-05**
- ERKOPRESS 120MM CIR. .030" (.75MM) 100 SHEETS 10031 - **Item #0769-06**
- VACUUM 5" SQUARE .060"(1.5MM) 50 SHEETS 10065 - **Item #0769-07**
- BIOSTAR® 125MM SQUARE .080"(2MM) 50 SHEETS 10080 - **Item #0769-09**
- VACUUM 5" SQUARE .080"(2MM) 50 SHEETS 10085 - **Item #0769-10**
- BIOSTAR® /MINISTAR® 125MM CIR. .080" (2MM) 50 SHEETS 11080 - **Item #0769-11**
- ERKOPRESS 120MM CIR. .080" (2MM) 25 SHEETS 10081 - **Item #0769-12**
- BIOSTAR® /MINISTAR® 125MM CIR. .120" (3MM) 25 SHEETS 13125 - **Item #0769-13**
- VACUUM 5" SQUARE .120"(3MM) 25 SHEETS 13500 - **Item #0769-14**

Essix® Plastic Sheet: Type "C+":

For night wear and/or when the patient bruxes or grinds. No plastic on the market combines the features of clarity, esthetics, resistance to wear and formability that is inherent in Essix® Type 'C' plastic. This plastic will not crack or bubble, has outstanding wear resistance. We guarantee to replace any appliance that cracks within 12 months with two pieces of Essix® Type 'C' plastic at no charge! Acrylic will not bond to Essix® Type 'C'. (Patent Pending)

- BIOSTAR®/MINISTAR® 125MM CIR. .040" (1MM) 100 SHEETS 1C125 - **Item #0768-125**
- BIOSTAR® 125MM SQUARE .040" (1MM) 100 SHEETS 1C478 - **Item #0768-478**
- VACUUM 5" SQUARE .040"(1MM) 100 SHEETS 1C500 - **Item #0768-500**



Type "A+" For Tooth Movement with Divots & Windows™:

- VACUUM 5" SQUARE .040" (1MM) 100 SHEETS 10045 - **Item #0769-15**
- BIOSTAR® 125MM SQUARE .040" (1MM) 100 SHEETS 10040 - **Item #0769-16**
- BIOSTAR®/MINISTAR® 125MM CIR. .040" (1MM) 100 SHEETS 11040 - **Item #0769-17**
- ERKOPRESS 120MM CIR. .040" (3MM) 100 SHEETS 11041 - **Item #0769-18**

Euro-Cryl™ Orthodontic Acrylic

Experience exceptional strength and density, reducing the risk of breakage and providing ample working time without slumping. Achieve a stunning luster upon polishing for exceptional results. Choose from convenient kits or cost-effective bulk packaging to suit your needs.



Polymer and Monomer Kits			
DESCRIPTION		ITEM	
Clinic Combo - 1 lb. Polymer & 8 oz. Monomer		#1561-PL	
Lab Combo - 5 lbs. Polymer & 1 quart Monomer		#1562-PL	
Monomer Only		Polymer Only	
DESCRIPTION	ITEM	DESCRIPTION	ITEM
8 ounces	#1561-L	1 pound	#1561-P
1 quart	#1562-L	5 pounds	#1562-P

DynaFlex® Silver Solder

Lab technicians value our user-friendly solder for its smooth flow. It works with gold, silver, or stainless steel, is cadmium-free, and melts at 756°F. The larger gauge means less usage and cost savings. Each spool holds 5 DWT of solder, extending up to 4 feet.



.045 - **Item #0718-5** .025 - **Item #0718**

DynaFlex® Flux

Smooth quick flowing flux makes your soldering easy and consistent in color.

7 ounce jar. **Item #0719-05**



DynaFlex® Notched Electrodes

Our notched silver solder electrodes are designed for tasks involving elastic hooks, headgear hooks, stops, and tiebacks. Each package contains 100 electrodes. **Item #0720-N**



DynaFlex® Ball Electrodes

Elevate your dental work with our silver solder ball electrodes, ideal for a wide range of applications such as reinforcing wires to models, attaching auxiliaries, and strengthening the lingual surface of anterior bands. These electrodes are also compatible with lingual arches. Crafted from sturdy .032 brass wire, each package contains 100 electrodes, providing you with a reliable and ample supply for your dental needs.



SMALL - **Item #0720-A**

MEDIUM - **Item #0720-B**

LARGE - **Item #0720-C**

DynaFlex® Sterilization Pouches

Trust our triple-sealed sterilization pouches for top-tier protection. Made from medical-grade paper and plastic, they provide maximum safety. Indicator arrows verify sterilization. Available in two sizes, each box contains 200 pouches.

3.5" X 9" - **Item #O-120-2056**

5.75" X 10" - **Item #O-120-2058**



DynaFlex® Patient Bibs

Case of 500

BLUE - **Item #O-120-3180**

WHITE - **Item #O-120-3182**



DynaFlex® Tray Covers

Box of 1000

RITTER - 8.5" X 12.25" WHITE

Item #O-120-2000

WEBER - 11" X 17.5" WHITE

Item #O-120-2028



DynaFlex® 5 oz. Plastic Cups

Case of 1000

BLUE - **Item #O-120-3112**

WHITE - **Item #O-120-3114**



CaviCide1™

Introducing CaviCide1, the next-generation surface disinfectant designed for hard, non-porous surfaces. In just 1 minute, it eliminates 99.9% of bacteria, viruses, and fungi, including TB, Norovirus, A. baumannii, HIV-1, HBV, HCV, and more. This fragrance-free solution cleans and disinfects effectively, reducing the risk of cross-contamination.



1 GALLON - **Item #4060-5000**

24 FLUID OUNCE SPRAY BOTTLE - **Item #4060-5024**

CaviCide1™ Wipes

Experience ultimate convenience with our pre-saturated disposable towelettes infused with potent CaviCide Surface Disinfectant Cleaner. These durable, non-woven, and non-abrasive towelettes are recommended for nonporous surfaces, proven to eliminate TB in 5 minutes and HBV in 3 minutes. Each canister contains 160 towelettes for ample cleaning and disinfecting power.



REGULAR SIZE 6" X 6.75" 160/CANISTER - **Item #4060-5100**

XL SIZE 9" X 12.65" 65/CANISTER - **Item #4060-5150**



MetriCide™ 28: High-Level Disinfectant

2.5% buffered glutaraldehyde. Made by Kerr/Metrex. FDA-registered. Time-tested tried-and-true formula with 20+ year history. Contains surfactant: increase penetration of sterility into instruments & equipment. Extra Long life: use & reuse up to 28 days. Ideal cold sterilization product. 1 gallon bottle. **Item #4006-10**

- MetriCide bullet points
- High Level Disinfectant/Sterilant
- 2.5% Glutaraldehyde
- Manufactured by Kerr/Metrex
- Use and reuse up to 28 days



DynaFlex® Disposable Air & Water Pre-Punched Syringe Sleeves with Ties, Clear

Compatible with handpieces, saliva ejectors, Cavitrons, and HVE valves, these sleeves offer versatility in your dental practice. They come pre-punched for easy application, including the 3-way syringe. Using these sleeves helps reduce the risk of cross-contamination. Each dispenser box includes 500 sleeves and ties. **Item #O-121-1020**

DynaFlex® Lock Top Tray Sleeves: Disposable

Our Lock Top design offers complete tray coverage, reducing cross-contamination risk and eliminating the need for frequent tray cleaning. This innovative solution replaces traditional paper tray covers, saving staff time on maintenance. Available in two sizes, each dispenser box contains 500 clear sleeves.

10.5" X 14" - **Item #O-121-1014** 11.625" X 16" - **Item #O-121-1016**

DynaFlex® Chair & Stool Covers: Disposable

Tapered Top for Customized Fit. Our chair covers are designed to protect the top half of your operatory chair, including the headrest and controls, from the potentially damaging effects of surface disinfectants like cracking and fading. Each dispenser box contains 200 clear covers. **Item #O-121-1008**



DynaFlex® Headrest Covers: Disposable

Protect your operatory chair's headrest from disinfectant damage with these covers, preventing issues like cracking and fading. They enhance equipment longevity and reduce wear and tear. Choose from two sizes to fit your needs, with each dispenser box containing 250 clear covers for ongoing protection.

10" X 11.25" (REGULAR)- **Item #O-121-1010**

10" X 14.5" (LARGE)- **Item #O-121-1012**

A

Acrylic	166
Adhesives	106-108, 111-113
Aesthetic Wire	10, 85
Alginate	156
Aligner Seaters	155
Aluminum Oxide	164
Appliance Remover Tool	155
Archwire Markers	85
Archwire Forms	74-75
Archwire Stops	90-91
Atlas Brackets	28-35

B

Ball Clasps	162
Bands	56-61
Band Pusher	59
Band Storage Solutions	59
Barrier Products	166-167
Bibs	166
Bicuspid Bands	61
BioFlex Archwire	82
Bite Sticks	59
Block Out Resin	160
Bondable Molar Brackets	64, 66-67, 70-71
Bonding Brushes	118
Bonding Trays	119
Bonding Tray Organizer	119
Brace Gard/Magic Touch Antiseptic Gel	152
Bracket Placement Instruments	70, 119, 135, 139
Bracket Storage Solutions	39
Bracket Wax	149, 152
Braided Archwire	86
Brushes	118
Brushing Timers	154

Burs	110, 160
Butane Refills	164

C

Cavicide1	167
Cavicide1 Caviwipes	167
Cheek Retractors	115-117
Chill Spray	82
Clear Brackets	44-53
ClearTec Mini Brackets	48-49
ClearViz+ Brackets	46-47
ClearViz+ Mini Brackets	44-45
Coated Springs, Ligs & Koby Ties	93
Coax Archwire	86
Coil Spring	89
Comfort Covers	152
Comfort Fit Facemask	103
ContactEZ IPR System & Gauges	142
Convertible Cap Remover Instrument	129
Copper Niti Archwire	81-82, 87
C.N.A. Nickel Free Archwire	80
Crimpable Stops/Ball Hooks	90-91
Cups	166
Curing Lights	114
CS System	16-19

D

Dead Soft Wire	93
Debubblizer	156
De-Impactor Springs	92
Dimple Archwire	86
Diamond Discs	142
Direct Bond Lingual Cleat	91
Disc Guard Set	142
Disposa-Bowl	156
Disposable Impression Trays	157

Disposable Mouth Mirror	139
Distalizing Spring	89
Dome Stripping Handle/Tips	143

E

Elastic Attachers	155
Elastic Sleeve/Thread/Tubing	102
Elastomeric Ties and Chain	98-99
Electrodes	166
Endurance SL Brackets	42-43
Eruption Chains	92
Essix Material	165
Etch	108, 111
Expansion Screws	61
Extra-Oral Elastics	100

F

Finishing Burs	110
Flat Retainer Wire	93
Floss	154
Floss Threaders	154
FlowTain	107
Flux	166
Fog Free Photo Mirror System	120

G

GC Fuji/Fuji Ortho	112-113
Gemini Brackets	40-41
Gemini Bondable Molar Brackets	70-71
Glacier	12-13
Gold Archwire	87
Gold Brackets	32-33, 38-39
Gold N Braces	38, 87

H

Habit Control Device	92
Hand Instruments	136

Handpieces	163
Hemostats	135
Hollywood Archwire	83

I

Impression Tray Cleaner	156
Impression Trays	157
Imprinting Services	150-151
Infinity Wire	10, 85
Intraoral Elastics	100
Interproximal Stripping	142-144

K

Ketac Cement	111
Koby Ties	93
Kromopan	156
Krystal Brackets	52-53
Krystal SL Brackets	50-51

L

LAC-Laser Aligner Cutter	11
L'il Palates	152
Ligature Wire	93
Lightning Strips	143
Lingual Buttons	92
Lingual Retainer Wire	93
Lip Bumper Tubing	102
Lip Protector	152
Looped Wire	88

M

Mathieu Forcep	134
Metricide	167
MI Paste and MI Paste Plus	113
MicroBrush	118
MicroEtcher/Accessories	164
MicroMotor	163

Mini Molds	94
Mirrors, Photography	120-121
Mixing Pads	111
Model Storage Boxes	160
Molar Bands	56-58
Mouthguards	153
Mouth Mirrors	139
MTX Brackets	36-37
Multi-Force Archwire	82
Multi-Just Facemask	103
Mushroom Looped Archwire	88

N

Nickel Titanium Archwire	78
Niti Springs	89
NOLA Dry Field System/Accessories	115
Norris Archwire	76-77
Norris Bondable Tubes	68
Norris System Tools	7
Norris System	4-9, 26-27

O

Organizers	85, 98, 136
Ortho Care Kit	151

P

Personalized Products	150-151
Photographic Mirrors	120-121
Plastic Spatulas	118
Platypus Flosser	154
Plier Brite Ultrasonic Solution	129
Pliers	7, 124-135
Polishing Brushes	160
Pontic Wax	149
Power Chain	98-99
Precision Aligner Buttons	14-15, 95

Precision Punch Plier	15, 139
Pre-Stopped Wire	76-77, 82, 87
Pre-Torqued Archwire	83
Prophy Pumice	110-111
Prophy Cup Holder/Instrument	118
Prophy Cups	118
Proxi Brushes	155

Q

QCM Retainer/Labial Bow	162
-----------------------------------	------------

R

Raintree Essix Material	165
Reliance Products	106-110
RENU Instrument Repair Service	137
Retainer Brite	148
Retainer Cases	148-149
Reverse Curve Archwire	86
Right Stuff Kits	151
Rotation Wedges	102

S

Safety Key	162
Scalers	136
Scissors	135
Self Ligating Brackets	4-9, 26-27, 42-43, 50-51, 50-51
Separator Plier	101
Separators	101
Silver Solder	166
Sponge Pellets	110
Spoiled Ligature Wire	93
Stability Weldable Tubes	69
Stainless Steel Archwire	84
Stainless Steel Coil Spring	89
Stainless Steel Ligatures	92-93

Stainless Steel Lab Lengths	162
Sterilizers	163
Sterilization Pouches	166
Stop Locks & Wrench	90

T

Therapy Wafers.....	155
Thermal Archwire.....	79
Thickness Gauge Set	142
Tongue Blocks.....	118
Toothbrushes	154
Tray Covers	166
Twist Wire.....	86
Typodont Demonstration Models	39

U

Ultrasonic Solution.....	129
--------------------------	-----

V

Vibrator.....	160
---------------	-----

W

Wax	149-150, 152
Weldable Lingual Attachments	59
Weldable Bicuspids Brackets.....	60
Weldable Molar Brackets	65
Wonderfill.....	16

ORDERING OPTIONS:

Visit Us Online:
www.dynaflex.com

**Contact Your
 Local Territory Manager**

Call Us Toll Free:
 866-346-5665

Your All-in-One Solution for Account Management

www.dynaflex.com

- Real-Time Dashboard
- Seamless Multi-Account Access
- Streamlined Order Entry
- Live Support When You Need It

Simplified Account Management at Your Fingertips

DynaFlex Online offers this all-in-one platform, specifically designed to be tailored to your workflow. With industry-leading tools and real-time support, managing your account with DynaFlex has never been easier.



Scan To Access Instantly



Local: 314-426-4020
8050 Hawk Ridge Trail
Lake St. Louis, MO 63367
info@dynaflex.com • www.dynaflex.com

Products: **866.346.5665**

Laboratory: **800.489.4020**