

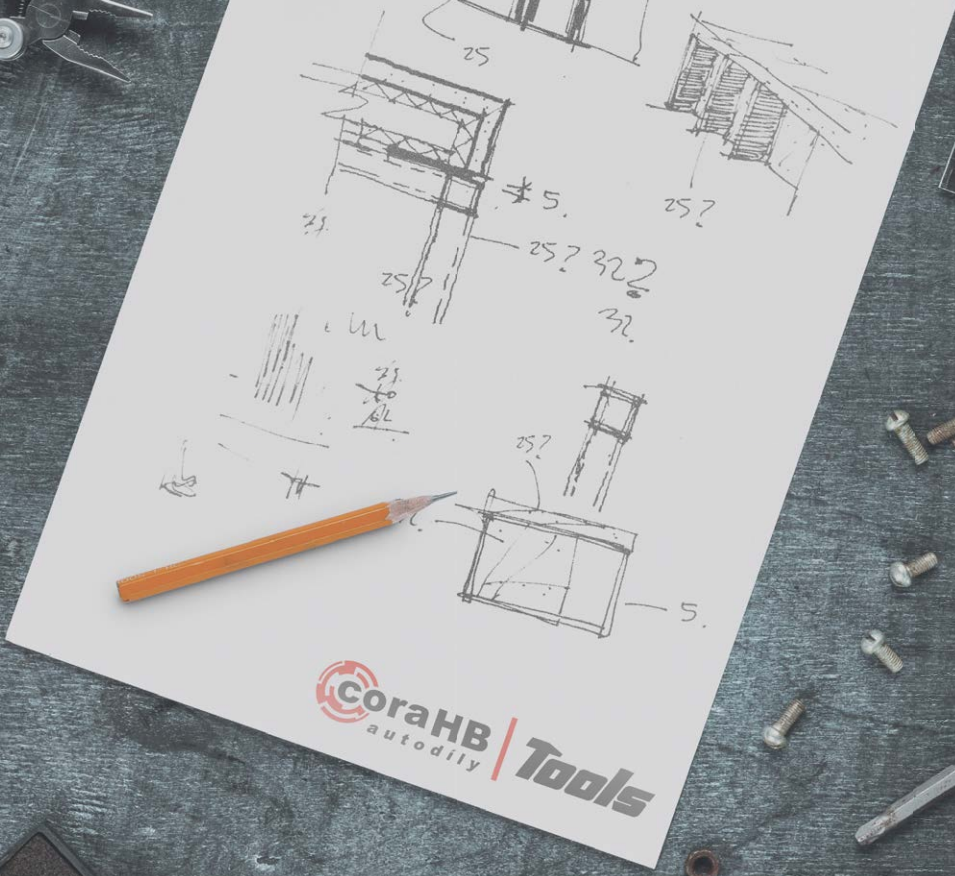

Tools

KATALOG

DÍLNA / STAVBA / ZAHRADA

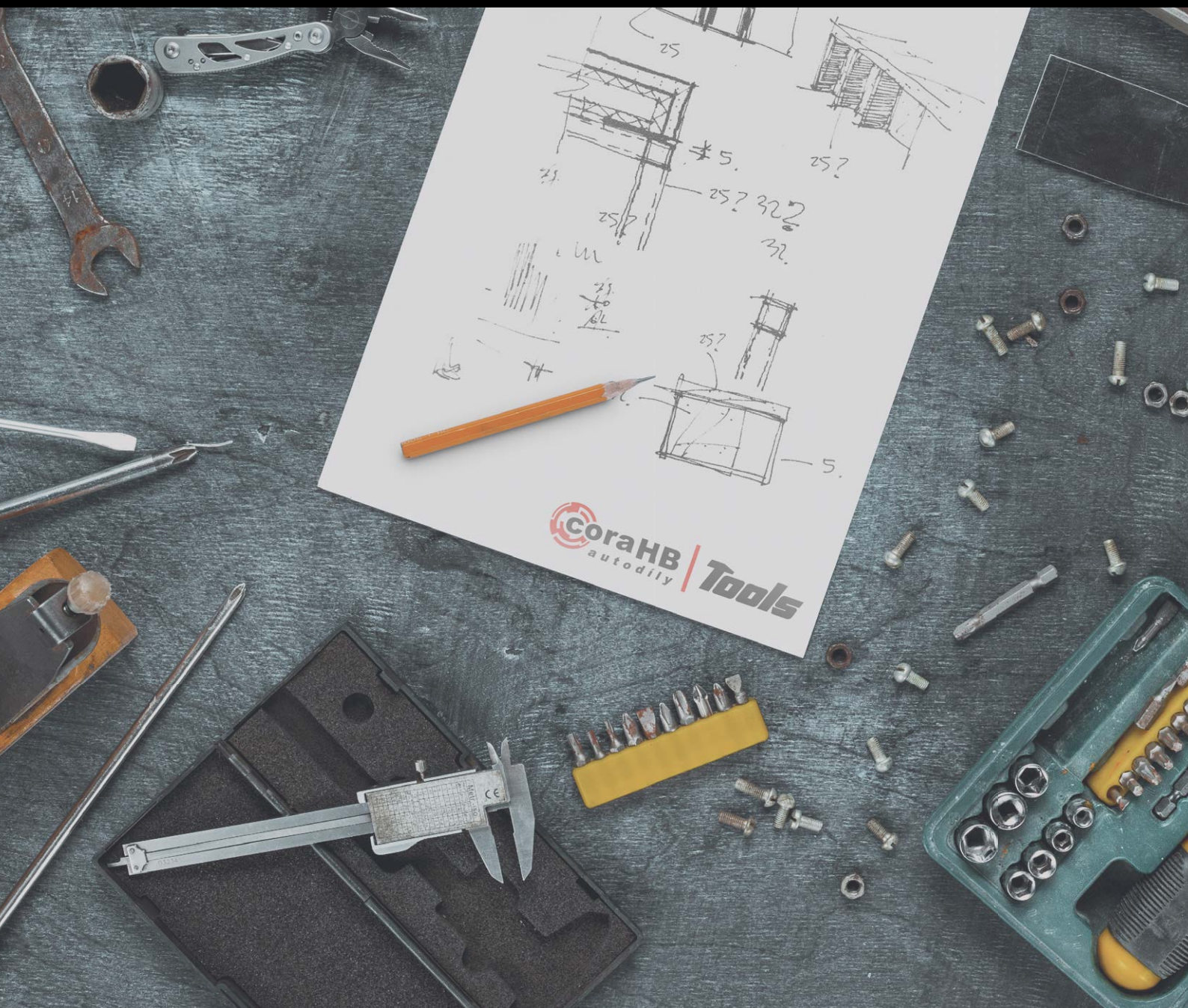

FESTA[®]

Značka kvalitního ručního nářadí pro stavbu dílnu i zahradu

HORIZONT^{EXACTA}

Značka profesionálních vodováh

HORIZONT

Značka profesionálních vodováh a kvalitních latí

FESTA
POWER X TOOLS

Ucelená řada AKU produktů s využitím kvalitních komponentů, nejnovějších technologií a současných trendů v AKU nářadí.

FESTA[®]
AQUATIC

Profesionální zavlažovací sortiment s moderním designem, kompatibilní s řadou produktů Rosa

ROSA

Kvalitního zavlažovací systémy a zahradní nářadí

KDS[®]

Japonské nože s dlouholetou tradicí

KOMELON[®]

Profesionální měřidla



Profesionální řezačky obkladů



Výrobce kvalitních zahradních nůžek

Lescha

Profesionální stavební míchačky

Stahlberg

Profesionální šroubovací nástavce



Značka profesionálních pil

AKU NÁŘADÍ

2 - 23



4 10 11 12 13 13 14 15 15 18

MĚŘIDLA, ZNAČKOVAČE

24 - 57



26 28 31 32 34 35 38 43 44 46 50 56

DÍLENSKÉ NÁŘADÍ

58 - 159



60 70 73 87 101 115 122 129 131 136 140 144 149 155

ŘEZNÉ A BRUSNÉ NÁSTROJE

160 - 241



162 173 178 181 184 194 198 209 210 214 219 222 228 234

STAVEBNÍ NÁŘADÍ

242 - 329

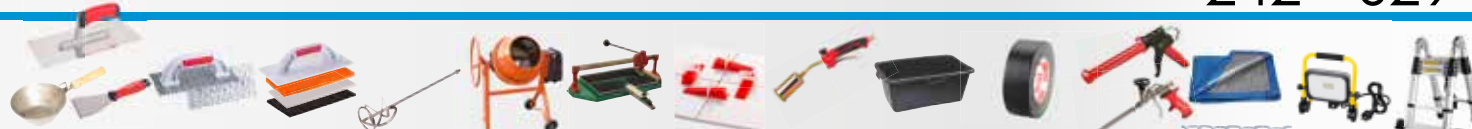

244 256 261 266 272 280 287 300 304 306 310 322 327 328

ZAHRADNÍ NÁŘADÍ

330 - 397



332 343 345 346 348 364 365 367 372 381 387 389 394 395

ŽELEZÁŘSKÉ ZBOŽÍ

398 - 431



400 404 406 409 411 412 413 415 417 418 420 426

AUTODOPLŇKY

432 - 443



434 435 436 438 439 440 440 441 441 442 443

REJSTRÍK

444 - 456

FESTA

POWER X TOOLS

SHARE
20V

Li-ion
technology



AKU NÁŘADÍ

2 - 23



BRUSHLESS **SHARE** **20V** *Li-ion technology*

otáčky
0-550 min⁻¹
0-2000 min⁻¹

hmotnost
s baterií 2,0 Ah **1,8 kg**
s baterií 4,0 Ah **2,1 kg**

kroučící moment
80 Nm

sklíčidlo
2 – 13 mm



- Sada obsahuje:
- vrtačku
 - baterii 2,0 Ah
 - baterii 4,0 Ah
 - nabíječku 2,4 A
 - přídatnou rukojeť
 - kufr



FESTA
POWER X TOOLS

VRTAČKA AKU PŘÍKLEPOVÁ

max 80 Nm		I.0-8800 bpm II.0-32000 bpm	I.0-550min ⁻¹ II.0-2000min ⁻¹		 2-13 mm			 1,4 kg	 2x	
--------------	--	--------------------------------	--	--	-------------	--	--	------------	--------	--



BRUSHLESS SHARE 20V *Li-ion technology*



volba režimu
volba síly kroučícího momentu

otáčky
0-550 min⁻¹
0-2000 min⁻¹

hmotnost
s baterií 2,0 Ah **1,8 kg**
s baterií 4,0 Ah **2,1 kg**

kroučící moment
80 Nm

sklíčidlo
2 – 13 mm

Sada obsahuje:
- vrtačku
- baterii 2,0 Ah
- nabíječku 2,4 A
- přídatnou rukojeť
- kufr



přídatná rukojeť

přepínač rychlosti

rychloupínací
sklíčidlová
hlava

přepínač
směru otáčení

ergonomická pogumovaná
rukojeť pro pohodlný
a bezpečný úchop

háček pro
zavěšení

LED osvětlení

aretače baterie



FESTA
POWER X TOOLS

VRTAČKA AKU PŘÍKLEPOVÁ



Č.p.
28001

specifikace

2

BRUSHLESS SHARE 20V



volba režimu
volba síly kroučícího momentu

otáčky
0-550 min⁻¹
0-2000 min⁻¹

hmotnost
bez baterie
1,4 kg

kroučící moment
80 Nm

sklíčidlo
2 – 13 mm

Doporučujeme příslušenství

28080 Baterie 2,0 Ah

28081 Baterie 4,0 Ah

28085 Nabíječka 2,4 A

28086 Nabíječka 4,0 A



přídatná rukojeť

přepínač rychlosti

rychloupínací
sklíčidlová
hlava

přepínač
směru otáčení

ergonomická pogumovaná
rukojeť pro pohodlný
a bezpečný úchop

háček pro zavěšení

LED osvětlení



FESTA
POWER X TOOLS

VRTAČKA AKU PŘÍKLEPOVÁ



*baterie není součástí balení

Č.p.
28002

specifikace

5

SHARE
20VLi-ion
technology

otáčky
0-500 min⁻¹
0-1800 min⁻¹

hmotnost
s baterií 2,0 Ah
1,7 kg

kroučící moment
45 Nm

sklíčidlo
2 - 13 mm

Sada obsahuje:

- vrtačku
- 2x baterii 2,0 Ah
- nabíječku 2,4 A
- kufr
- unášec a bity:
- ⊖ S5, S6 x 25 mm
- ⊕ PH1, PH2 x 25 mm
- ✦ PZ1, PZ2 x 25 mm
- vrtáky HSS
2-2,5-3-4-5-6 mm

volba režimu
volba síly kroučícího momenturychloupínací
sklíčidlová
hlava

přepínač rychlosti

přepínač
směru otáčeníergonomická pogumovaná
rukojeť pro pohodlný
a bezpečný úchop

LED osvětlení

aretace baterie

háček
pro zavěšeníFESTA
POWER X TOOLS

VRTAČKA AKU PŘÍKLEPOVÁ



Č.p. specifikace

28003

3

SHARE
20V

otáčky
0-550 min⁻¹
0-2000 min⁻¹

hmotnost
bez baterie
1,4 kg

kroučící moment
80 Nm

sklíčidlo
2 - 13 mm

Doporučujeme příslušenství

28080 Baterie 2,0 Ah
28081 Baterie 4,0 Ah28085 Nabíječka 2,4 A
28086 Nabíječka 4,0 Avolba režimu
volba síly kroučícího momenturychloupínací
sklíčidlová
hlava

přepínač rychlosti

ergonomická pogumovaná
rukojeť pro pohodlný
a bezpečný úchop

LED osvětlení

háček
pro zavěšeníFESTA
POWER X TOOLS

VRTAČKA AKU PŘÍKLEPOVÁ



*baterie není součástí balení

Č.p. specifikace

28004

5

SHARE
20V *Li-ion*
technology

otáčky
0-350 min⁻¹
0-1300 min⁻¹

hmotnost
s baterií 2,0 Ah
1,3 kg

kroučící moment
28 Nm

sklíčidlo
1 – 10 mm

Sada obsahuje:
- vrtačku
- 2x baterii 2,0 Ah
- nabíječku 2,4 A
- kufr
- unášec a bity:
⊖ S5, S6 x 25 mm
⊕ PH1, PH2 x 25 mm
✳ PZ1, PZ2 x 25 mm
- vrtáky HSS
1,5-2,5-3-4-5-6 mm



volba režimu
nastavení kroučícího momentu

rychloupínací
sklíčidlová hlava

přepínač rychlosti

přepínač
směru otáčení

ergonomická pogumovaná
rukojeť pro pohodlný
a bezpečný úchop

LED osvětlení

aretace baterie

háček
pro zavěšení



FESTA
POWER X TOOLS

VRTAČKA AKU



Č.p. specifikace

28005

3

SHARE
20V

otáčky
0-350 min⁻¹
0-1300 min⁻¹

hmotnost
bez baterie
0,9 kg

kroučící moment
28 Nm

sklíčidlo
1 – 10 mm

Doporučujeme příslušenství

28080 Baterie 2,0 Ah

28081 Baterie 4,0 Ah

28085 Nabíječka 2,4 A

28086 Nabíječka 4,0 A



volba režimu
nastavení kroučícího momentu

rychloupínací
sklíčidlová hlava

přepínač rychlosti

přepínač
směru otáčení

ergonomická pogumovaná
rukojeť pro pohodlný
a bezpečný úchop

LED osvětlení

háček
pro zavěšení



FESTA
POWER X TOOLS

VRTAČKA AKU



*baterie není součástí balení

Č.p. specifikace

28006



5

Li-ion
technology

otáčky
0-350 min⁻¹
0-1300 min⁻¹

hmotnost
s baterií 1,5 Ah
1 kg

kroučící moment
20 Nm

skličidlo
1 – 10 mm

Sada obsahuje:

- vrtačku
- 2x baterii 12 V I 1,5 Ah
- nabíječku 12 V I 2,4 A
- kufr
- unášec a bity:
 - ⊖ S5, S6 x 25 mm
 - ⊕ PH1, PH2 x 25 mm
 - ⊕ PZ1, PZ2 x 25 mm
- vrtáky HSS
1,5-2,5-3-4-5-6 mm

volba režimu
nastavení kroučícího momenturychloupínací
skličidlová hlava

přepínač rychlosti

LED osvětlení

indikátor nabití baterie

ergonomická pogumovaná
rukojeť pro pohodlný
a bezpečný úchoppřepínač
směru otáčení

baterie

**FESTA**
POWER X TOOLS**VRTAČKA AKU**

Č.p. specifikace

28007

5

Li-ion
technology

otáčky
bez zatížení
200 min⁻¹

hmotnost
s baterií 1,5 Ah
0,4 kg

maximální kroučící
moment
3 Nm

unášec
nástroje
1/4" šestihran

Sada obsahuje:

- šroubovák
- nabíječku 5 V I 0,5 A
- unášec a bity:
 - ⊖ S5 x 50 mm
 - ⊕ PH1 x 50 mm
 - ⊕ PH2 x 50 mm
 - ⊕ H5 x 50 mm
 - ⊕ T20 x 50 mm

rychloupínací hlava
1/4" s pojistkounastavení
kroučícího momentu

indikátor nabití baterie

aretace nastavení
polohy rukojeti

LED osvětlení

přepínač směru
otáčeníergonomická pogumovaná
rukojeť pro pohodlný
a bezpečný úchop

LED svítlna

FESTA
POWER X TOOLS**ŠROUBOVÁK AKU**

Č.p. specifikace

28008

10

SHARE
20V



otáčky bez zatížení
0-2000 min⁻¹

hmotnost bez baterie
1,2 kg

kroučící moment
150 Nm

počet rázů
0-3000 bpm

rychloupínací hlava
1/4" s pojistkou



volitelný směr otáčení

ergonomická pogumovaná rukojeť pro pohodlný a bezpečný úchop

LED osvětlení

háček pro zavěšení

Doporučujeme příslušenství

28080 Baterie 2,0 Ah

28081 Baterie 4,0 Ah



28085 Nabíječka 2,4 A

28086 Nabíječka 4,0 A



UTAHOVÁK AKU RÁZOVÝ



*baterie není součástí balení

Č.p.
28021

specifikace



5

SHARE
20V



otáčky bez zatížení
I.0-300 min⁻¹
II.0-1000 min⁻¹

hmotnost bez baterie
1,7 kg

počet přiklepů
0-5000 bpm

úchyt
SDS+

přepínání režimu vrtání
(s/bez přiklepu)

hloubkový doraz

přepínač rychlosti

přepínač směru otáčení



SDS upínací hlava nástroje

Doporučujeme příslušenství

28080 Baterie 2,0 Ah

28081 Baterie 4,0 Ah



28085 Nabíječka 2,4 A

28086 Nabíječka 4,0 A



KLADIVO VRTACÍ AKU



*baterie není součástí balení

Č.p.
28025

specifikace



2

SHARE 20V

frekvence
nastřelování
60-100 min⁻¹

max. délka
hřebíků/spon
30 mm
tvrdé materiály

max. délka
hřebíků/spon
50 mm
měkké materiály

hmotnost
bez baterie
2,7 kg



Doporučujeme příslušenství

28080 Baterie 2,0 Ah

28081 Baterie 4,0 Ah



28085 Nabíječka 2,4 A

28086 Nabíječka 4,0 A



Hřebíky

23930 Hřebík nastřelovací 30 mm, 2000 ks

23931 Hřebík nastřelovací 40 mm, 2000 ks

23932 Hřebík nastřelovací 50 mm, 2000 ks

Spony

23935 Spona nastřelovací 30 mm, 2000 ks

23936 Spona nastřelovací 40 mm, 2000 ks

Vhodné typy hřebíků a spon:

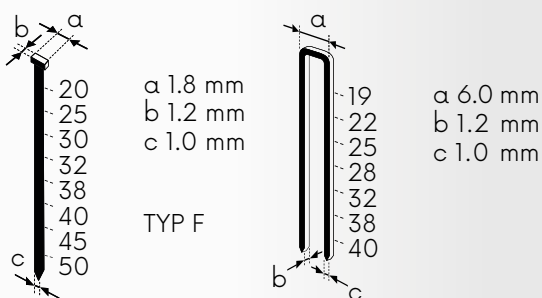

FESTA
POWER X TOOLS

HŘEBÍKOVAČKA – SPONKOVAČKA AKU



*baterie není součástí balení



Č.p. 28070

specifikace

SHARE
20V

barevná teplota
6000 K

světelný tok
1800 lm (100%)
1000 lm (60%)
500 lm (30%)

hmotnost bez baterie
1,6 kg

výkon LED
30W



nastavení otočné hlavy 360°

příruba pro montáž

nastavení intenzity svícení
30%, 60%, 100%



Doporučujeme příslušenství

28080 Baterie 2,0 Ah

28081 Baterie 4,0 Ah

28085 Nabíječka 2,4 A

28086 Nabíječka 4,0 A



LED SVĚTLO AKU STAVEBNÍ



*baterie není součástí balení

Č.p. specifikace

28065



**BRUSHLESS SHARE
20V**

otáčky
bez zatížení
8500 min⁻¹

hmotnost
bez baterie
1,6 kg

maximální tloušťka
řezaného materiálu
15 mm

maximální
průměr kotouče
125 mm

větrací otvory motoru

ergonomická pogumovaná
rukojeť pro pohodlný
a bezpečný úchop

aretace otáčení

pojistka
provozního spínače**Doporučujeme příslušenství**

28080 Baterie 2,0 Ah

28081 Baterie 4,0 Ah

28085 Nabíjačka 2,4 A

28086 Nabíjačka 4,0 A

rychloupínací
mechanismus
ochranného krytu

upínací matice kotouče

FESTA
POWER X TOOLS**BRUSKA AKU**

*baterie a kotouč není součástí balení

Č.p. specifikace

28030



4

**SHARE
20V**

otáčky
bez zatížení
8000 min⁻¹

hmotnost
bez baterie
1,6 kg

maximální tloušťka
řezaného materiálu
15 mm

maximální
průměr kotouče
115 mm

ergonomická pogumovaná
rukojeť pro pohodlný
a bezpečný úchop

aretace otáčení

pojistka
provozního spínače**Doporučujeme příslušenství**

28080 Baterie 2,0 Ah

28081 Baterie 4,0 Ah

28085 Nabíječka 2,4 A

28086 Nabíječka 4,0 A

rychloupínací
mechanismus
ochranného krytu

upínací matice kotouče

FESTA
POWER X TOOLS**BRUSKA AKU**

*baterie a kotouč není součástí balení

Č.p. specifikace

28032



4

SHARE
20V



otáčky
bez zatížení
10000 min⁻¹

hmotnost
bez baterie
1 kg

excentricita
kotouče
5 mm

průměr
kotouče
125 mm

Doporučujeme příslušenství

28080 Baterie 2,0 Ah

28081 Baterie 4,0 Ah

28085 Nabíječka 2,4 A

28086 Nabíječka 4,0 A



FESTA
POWER X TOOLS

BRUSKA AKU EXCENTRICKÁ



*baterie není součástí balení

Č.p. specifikace

28040



SHARE
20V

počet kmitů
bez zatížení
5000-15000 min⁻¹

hmotnost
bez baterie
1 kg

regulace otáček



Doporučujeme příslušenství

28080 Baterie 2,0 Ah

28081 Baterie 4,0 Ah

28085 Nabíječka 2,4 A

28086 Nabíječka 4,0 A



FESTA
POWER X TOOLS

BRUSKA AKU MULTIFUNKČNÍ



*baterie není součástí balení

Č.p. specifikace

28045



SHARE
20Vergonomická pogumovaná rukojeť
pro pohodlný a bezpečný úchop

pojistka provozního spínače

kryt kotouče

připojení
externího
odsávánínastavení úhlu
sklonu řezu
45-90 stupňů

základna

hřídel 16 mm

stupnice
hloubky řezuotáčky
bez zatížení
3650 min⁻¹nastavitelný
úhel sklonu řezu
45-90 stupňůmax. průměr
kotouče
165 mm
(ø16 mm)max. prořez
50 mm* při úhlu 90 stupňů
s kotoučem ø165 mm

aretace otáčení

nastavení hloubky řezu

Doporučujeme příslušenství

28080 Baterie 2,0 Ah

28081 Baterie 4,0 Ah



28085 Nabíječka 2,4 A

28086 Nabíječka 4,0 A

FESTA
POWER X TOOLS

PILA AKU KOTOUČOVÁ

3650min⁻¹

ø165x16mm

L R

2,7
KG

*baterie není součástí balení

Č.p. specifikace
28035 součástí balení pilový kotouč ø165x16 mm 24T

vodící lišta



SHARE
20V



ergonomická pogumovaná rukojeť pro pohodlný a bezpečný úchop

počet zdvihů plátku
0-2400 min⁻¹

hmotnost bez baterie
1,8 kg

max. úhel zkosení řezu
45 stupňů

max. řezaný profil
ocel: 6 mm
dřevo: 80 mm

pojistka provozního spínače

nastavení předkmitu

osvětlení

páčka aretace sklonu

Doporučujeme příslušenství

28080 Baterie 2,0 Ah

28081 Baterie 4,0 Ah

28085 Nabíječka 2,4 A

28086 Nabíječka 4,0 A



aretace lišty

základna

vodící lišta



zkosení řezu

0°
45° 45°



PILA AKU PŘÍMOČARÁ



*baterie není součástí balení

Č.p. specifikace

28050



4

SHARE
20V



pojistka provozního spínače

počet kmitů bez zatížení
0-3000 min⁻¹

hmotnost bez baterie
1,7 kg

max. řezná tloušťka
dřevo: 100 mm
ocel: 5 mm
hliník/měď: 20 mm



ergonomická pogumovaná rukojeť pro pohodlný a bezpečný úchop

Doporučujeme příslušenství

28080 Baterie 2,0 Ah

28081 Baterie 4,0 Ah

28085 Nabíječka 2,4 A

28086 Nabíječka 4,0 A



rychloupínání pilového plátku



PILA AKU OCASKA



*baterie není součástí balení

Č.p. specifikace

28055



4

SHARE
20VLi-ion
technology28004
str. 628032
str. 1228055
str. 1528035
str. 14

37330

28040
str. 13ZVÝHODNĚNÁ
CENA
+ TAŠKA ZDARMAFESTA
POWER X TOOLS

AKU SET S TAŠKOU SADA 5+3

- 28004 - Vrtačka AKU s příklepem FESTA SHARE20V
 28032 - Bruska úhlová AKU FESTA SHARE20V 115 mm
 28035 - Pila kotoučová AKU FESTA SHARE20V 165 mm/d 16 mm
 28040 - Bruska excentrická AKU FESTA SHARE20V 125 mm 8 otv.
 28055 - Pila ocaska AKU FESTA SHARE20V
 28080 - Baterie do AKU nářadí FESTA SHARE20V 2,0 Ah
 28081 - Baterie do AKU nářadí FESTA SHARE20V 4,0 Ah
 28086 - Nabíječka FESTA SHARE20V 4,0 A

28080
str. 1828081
str. 1828086
str. 18

Č.p. specifikace

28101



1

SHARE
20VLi-ion
technology

BRUSHLESS

28002
str. 528030
str. 1228040
str. 13

BRUSHLESS

37330

28055
str. 1528035
str. 14ZVÝHODNĚNÁ
CENA
+ TAŠKA ZDARMAFESTA
POWER X TOOLS

AKU SET S TAŠKOU SADA 5+3

- 28002 - Vrtačka AKU s příklepem FESTA SHARE20V
 28030 - Bruska úhlová AKU FESTA "BRUSHLESS" SHARE20V 125 mm
 28035 - Pila kotoučová AKU FESTA SHARE20V 165 mm/d 16 mm
 28040 - Bruska excentrická AKU FESTA SHARE20V 125 mm 8 otv.
 28055 - Pila ocaska AKU FESTA SHARE20V
 28080 - Baterie do AKU nářadí FESTA SHARE20V 2,0 Ah
 28081 - Baterie do AKU nářadí FESTA SHARE20V 4,0 Ah
 28086 - Nabíječka FESTA SHARE20V 4,0 A

28080
str. 1828081
str. 1828086
str. 18

Č.p. specifikace

28104



1

SHARE
20V *Li-ion*
technology

ZVÝHODNĚNÁ
CENA
+ TAŠKA ZDARMA

28004
str. 6



28030
str. 12



BRUSHLESS

28025
str. 9



37330



FESTA
POWER X TOOLS

AKU SET S TAŠKOU SADA 3+3

- 28004 - Vrtačka AKU s příklepem FESTA SHARE20V
- 28025 - Kladivo vrtací AKU FESTA SDS+ SHARE20V
- 28030 - Bruska úhlová AKU FESTA "BRUSHLESS" SHARE20V 125 mm
- 28080 - Baterie do AKU nářadí FESTA SHARE20V 2,0 Ah
- 28081 - Baterie do AKU nářadí FESTA SHARE20V 4,0 Ah
- 28086 - Nabíječka FESTA SHARE20V 4,0 A

28080
str. 18



28081
str. 18



28086
str. 18



Č.p. specifikace

28102



1

BRUSHLESS **SHARE**
20V *Li-ion*
technology

ZVÝHODNĚNÁ
CENA
+ TAŠKA ZDARMA

28030
str. 12



37330



28002
str. 5



FESTA
POWER X TOOLS

AKU SET S TAŠKOU SADA 2+3

- 28002 - Vrtačka AKU s příklepem FESTA SHARE20V
- 28030 - Bruska úhlová AKU FESTA "BRUSHLESS" SHARE20V 125 mm
- 28080 - Baterie do AKU nářadí FESTA SHARE20V 2,0 Ah
- 28081 - Baterie do AKU nářadí FESTA SHARE20V 4,0 Ah
- 28086 - Nabíječka FESTA SHARE20V 4,0 A

28080
str. 18



28081
str. 18



28086
str. 18



Č.p. specifikace

28103



1

SHARE 20V



2,0 Ah



4,0 Ah



FESTA
POWER X TOOLS

NABÍJEČKA 20 V I 24 A

Č.p.	specifikace
28085	220 – 240 V, 50 – 60 Hz, 70 W



20

SHARE 20V



2,0 Ah



4,0 Ah



FESTA
POWER X TOOLS

NABÍJEČKA 20 V I 4,0 A

Č.p.	specifikace
28086	*220 – 240 V, 50 – 60 Hz, 105 W



20

SHARE 20V *Li-ion* technology



indikátor nabití baterie



FESTA
POWER X TOOLS

BATERIE 20 V I 2,0 Ah

20V	2,0 Ah	Li-ion	0,4
-----	-----------	--------	-----

Č.p.	specifikace
28080	



20

SHARE 20V *Li-ion* technology



indikátor nabití baterie



FESTA
POWER X TOOLS

BATERIE 20 V I 4,0 Ah

20V	4,0 Ah	Li-ion	0,7
-----	-----------	--------	-----

Č.p.	specifikace
28081	



20

BRUSHLESS

nářadí je poháněno
bezkartáčovým
stejnsměrným motorem

krouťící moment	
otáčky	
volitelný směr otáčení	
sklíčidlo	
vrtání, vrtání s příklepem, šroubování	
počet úderů za minutu	
vrtání, šroubování	
hmotnost s/bez baterie	
způsob uchycení	
způsob uchycení	
způsob uchycení	
excentricita kotouče	
ovládání přístroje pro pravou i levou ruku	
splňuje uvedenou normu	
světelný tok	
směrový úhel světla	>120° icon" data-bbox="393 856 438 889"/>
maximální frekvence nastřelování	

SHARE 20V

nářadí je kompatibilní
s oběma bateriemi

	vhodné typy hřebíků
	vhodné typy spon
	brusný kotouč s otvory
	maximální průměr kotouče
	průměr kotouče
	maximální řezná tloušťka materiál: dřevo
	maximální řezná tloušťka materiál: ocel
	rychloupínání pilky
	uchycení pilky
	počet zdvihů pilky
	nastavení předkmitu
	rychloupínání pilové pilky
	počet kmitů pily
	LED osvětlení
	kapacita baterie
	baterie
	doba nabíjení baterie

TECHNICKÁ SPECIFIKACE



KATALOGOVÉ ČÍSLO PRODUKTU	28000	28001	28002	28003	28004
Název	Vrtačka AKU s příklepem	Vrtačka AKU s příklepem	Vrtačka AKU s příklepem	Vrtačka AKU s příklepem	Vrtačka AKU s příklepem
Otáčky bez zatížení	I.0-550 min ⁻¹ II.0-2000 min ⁻¹	I.0-550 min ⁻¹ II.0-2000 min ⁻¹	I.0-550 min ⁻¹ II.0-2000 min ⁻¹	I.0-500 min ⁻¹ II.0-1800 min ⁻¹	I.0-500 min ⁻¹ II.0-1800 min ⁻¹
Počet příklepů	I.0-8800min ⁻¹ II.0-32000min ⁻¹	I.0-8800min ⁻¹ II.0-32000min ⁻¹	I.0-8800min ⁻¹ II.0-32000min ⁻¹	0-19200 min ⁻¹	0-19200 min ⁻¹
Počet rázů					
Kroutící moment	80 Nm	80 Nm	80 Nm	45 Nm	45 Nm
Max. napětí akumulátoru	20V	20V	20V	20V	20V
Počet stupňů kroutícího momentu	20+1+1	20+1+1	20+1+1	19+1+1	19+1+1
Upínací hlava	2-13 mm	2-13 mm	2-13 mm	2-13 mm	2-13 mm
Hmotnost bez baterie	1,4kg	1,4kg	1,4kg	1,3kg	1,3kg
Krytí	IPX0	IPX0	IPX0	IPX0	IPX0
Hladina akustického tlaku nejistota K	LpA=97,04dB(A) K=5dB(A)	LpA=97,04dB(A) K=5dB(A)	LpA=97,04dB(A) K=5dB(A)	LpA=79dB(A) K=5dB(A)	LpA=79dB(A) K=5dB(A)
Hladina akustického výkonu nejistota K	LwA=86,04dB(A) K=5dB(A)	LwA=86,04dB(A) K=5dB(A)	LwA=86,04dB(A) K=5dB(A)	LwA=90dB(A) K=5dB(A)	LwA=90dB(A) K=5dB(A)
Vibrace bez příklepu do kovu	$a_{h,D}=3,9m/s^2$ K=1,5m/s ²	$a_{h,D}=3,9m/s^2$ K=1,5m/s ²	$a_{h,D}=3,9m/s^2$ K=1,5m/s ²	$a_{h,D}=2,4m/s^2$ K=1,5m/s ²	$a_{h,D}=2,4m/s^2$ K=1,5m/s ²
Vibrace bez příklepu do betonu	$a_{h,D}=11,4m/s^2$ K=1,5m/s ²	$a_{h,D}=11,4m/s^2$ K=1,5m/s ²	$a_{h,D}=11,4m/s^2$ K=1,5m/s ²	$a_{h,D}=7,5m/s^2$ K=1,5m/s ²	$a_{h,D}=7,5m/s^2$ K=1,5m/s ²
Maximální vibrace, nejistota K					
Síla úderu					
Průměr vrtání					
Vibrace do betonu-hlavní rukojeť					
Vibrace do betonu-přídavná rukojeť					
Obsah balení	vrtačka, nabíječka 2,4 A, baterie 2,0 Ah, baterie 4,0 Ah, přídavná rukojeť, kufr	vrtačka, nabíječka 2,4 A, baterie 2,0 Ah, přídavná rukojeť, kufr	vrtačka	vrtačka, nabíječka 2,4 A, 2x baterie 2,0 Ah, 6x bit, unášec, 6x vrták, kufr	vrtačka



28005	28006	28007	28008	28021	28025
Vrtačka AKU	Vrtačka AKU	Vrtačka AKU	Šroubovák AKU	Utahovák AKU rázový	Kladivo vrtací AKU
I.0-350 min ⁻¹ II.0-1300 min ⁻¹	I.0-350 min ⁻¹ II.0-1300 min ⁻¹	I.0-350 min ⁻¹ II.0-1300 min ⁻¹	200 min ⁻¹	0-2000 min ⁻¹	I.0-300 min ⁻¹ II.0-1000 min ⁻¹
					0-5000bpm
					0-3000bpm
28 Nm	28 Nm	20 Nm	3 Nm	150 Nm	
20V	20V	12V	3.6V	20V	20V
19+1	19+1	19+1	6+1		
1-10mm	1-10mm	1-10mm	1/4" šestihran	1/4" šestihran	SDS+
0,9kg	0,9kg	*1kg	*0,4kg	1,2kg	1,7kg
IPX0	IPX0	IPX0	IPX0	IPX0	IPX0
LpA=69dB(A) K=5dB(A)	LpA=69dB(A) K=5dB(A)	LpA=78dB(A) K=5dB(A)	LpA=58dB(A) K=3dB(A)	LpA=92dB(A) K=3dB(A)	LpA=82,98dB(A) K=3dB(A)
LwA=80dB(A) K=5dB(A)	LwA=80dB(A) K=5dB(A)	LwA=67dB(A) K=5dB(A)	LwA=69dB(A) K=3dB(A)	LwA=103dB(A) K=3dB(A)	LwA=93,98dB(A) K=3dB(A)
$\alpha_{h,D} < 1,9m/s^2$ K=1,5m/s ²	$\alpha_{h,D} < 1,9m/s^2$ K=1,5m/s ²	$\alpha_{h,D} = 2,1m/s^2$ K=1,5m/s ²			
$\alpha_{h,D} = 10,1m/s^2$ K=1,5m/s ²	$\alpha_{h,D} = 10,1m/s^2$ K=1,5m/s ²	$\alpha_{h,D} = 7,5m/s^2$ K=1,5m/s ²			
			$\alpha_h < 2,5m/s^2$ K=1,5m/s ²	$\alpha_{h,D} = 15,9m/s^2$ K=1,5m/s ²	
					1,2J
					ocel:10mm beton: 20mm dřevo: 20mm
					$\alpha_{h,(HD)} = 5,582m/s^2$ K=1,5m/s ²
					$\alpha_{h,(HD)} = 5,523m/s^2$ K=1,5m/s ²
vrtačka, nabíječka 2,4 A, 2x baterie 2,0 Ah, 6x bit, unášec, 6x vrták, kufr	vrtačka	vrtačka, nabíječka 2,4 A, 2x baterie 1,5 Ah, 6x bity, unášec, 6x vrták, kufr	šroubovák, nabíječka 0,5 A, baterie 1,5 Ah, 5x bit	utahovák	vrtací kladivo, přídavná rukojeť, hloubkový doraz

*hmotnost je uvedena včetně baterie

TECHNICKÁ SPECIFIKACE



KATALOGOVÉ ČÍSLO PRODUKTU	28030	28032	28035	28040
Název	Bruska AKU	Bruska AKU	Pila AKU kotoučová	Bruska AKU excentrická
Otáčky bez zatížení	8500 min ⁻¹	8000 min ⁻¹	3650 min ⁻¹	10.000 min ⁻¹
Počet kmitů bez zatížení				
Předkmit				
Počet stupňů předkmitu				
Počet zdvihů pilového plátku				
Maximální řezaný profil				
Maximální průměr kotouče	125 mm	115 mm		
Nosný kotouč				125 mm
8 odsávacích otvorů na kružnici				65 mm
Excentricita kotouče				5 mm
Velikost závitu vřetena	M14	M14		
Maximální tloušťka řezaného materiálu	15 mm	15 mm		
Max. napětí akumulátoru	20V	20V	20V	20V
Nastavitelný úhel sklonu řezu			0-45°	
Prořez při úhlu 45°			35 mm	
Prořez při úhlu 90°			50 mm	
Úhel oscilace				
Rozměr delta brusné základny				
Regulace rychlosti kmitání				
Uchycení pilového plátku				
Zdvih pilového plátku				
Rozměr základové desky			28 cm x 13,3 cm	
Hmotnost bez baterie	1,6kg	1,6kg	2,7kg	1kg
Průměr kotouče			165 mm	
Tloušťka těla kotouče			1,4 mm ± 5% mm	
Tloušťka SK plátku kotouče			2,0 ± 5% mm	
Šířka řezu			2,3 ± 5% mm	
Průměr otvoru kotouče po upnutí			16 mm	
Počet zubů kotouče			24	
Krytí	IPX0	IPX0	IPX0	IPX0
Hřebíky-typ, výška x šířka x tloušťka				
Spony-rozpětí x výška x šířka x tloušťka				
Max. délka hřebíků/spon do měkkých mat.				
Max. délka hřebíků/spon do tvrdých mat.				
Průměrná/max. frekvence nastřelování				
Doba provozu (baterie 4 AH, plně nabitá)				
Kapacita zásobníku hřebíků/spon				
Hladina akustického tlaku nejistota K	LpA=87,1dB(A) K=3dB(A)	LpA=76,67dB(A) K=3dB(A)	LpA=84dB(A) K=3dB(A)	LpA=76dB(A) K=3dB(A)
Hladina akustického výkonu nejistota K	LwA=98,1dB(A) K=3dB(A)	LwA=87,67dB(A) K=3dB(A)	LwA=95dB(A) K=3dB(A)	LwA=87dB(A) K=3dB(A)
Vibrace při broušení povrchu	a _{h,AG} =8,363m/s ² K=1,5m/s ²	a _{h,AG} =5,324m/s ² K=1,5m/s ²		
Vibrace pro řezání desky				
Vibrace pro řezání plechu				
Vibrace pro řezání dřevěných rámu				
Maximální vibrace, nejistota K			a _h <2,5m/s ² K=1,5m/s ²	a _h =9,5m/s ² K=1,5m/s ²
Obsah balení	bruska, kryt kotouče, přídatná rukojeť, klíč	bruska, kryt kotouče, přídatná rukojeť, klíč	pila, hloubkový doraz, pilový kotouč	bruska, sběrný vak na prach



28045	28050	28055	28070
Bruska AKU multifunkční	Pila AKU přímočará	Pila AKU ocaska	Hřebíkovačka/sponkovačka AKU
5000-15000 min ⁻¹		0-3000 min ⁻¹	
	3+0	1°	
	0-2400 min ⁻¹		
	ocel: 6mm, dřevo: 80mm	dřevo: 100 mm, ocel: 5 mm, hliník/měď: 20 mm	
20V		20V	20V
	zkosení řezu max. 45°		
3°			
90 mm			
ANO			
univerzální		univerzální	
		20 mm	
1kg	1,8kg	1,7kg	2,7kg
IPX0	IPX0	IPX0	IPX0
			F, 20-50mm x 1,2mm x 1,0 mm
			6,0mm x 19-40mm x 1,2mm x 1,0mm
			50 mm
			30 mm
			60/100 min ⁻¹
			1 hodina
			100 kusů
LpA=78dB(A) K=3dB(A)	LpA=88,1dB(A) K=5dB(A)	LpA=87,33dB(A) K=5dB(A)	LpA=79,9dB(A) K=3dB(A)
LwA=89dB(A) K=3dB(A)	LwA=99,1dB(A) K=5dB(A)	LwA=98,33dB(A) K=5dB(A)	LwA=90,9dB(A) K=3dB(A)
	$a_{h,B}=3,3m/s^2$ $K=1,5m/s^2$ $a_{h,M}=4m/s^2$ $K=1,5m/s^2$	$a_{h,B}=21,10m/s^2$ $K=1,5m/s^2$	
		$a_{h,WB}=21,98m/s^2$ $K=1,5m/s^2$	
$a_h=2,8m/s^2$ $K=1,5m/s^2$			$a_h=1,39m/s^2$ $K=1,5m/s^2$
bruska, nástavce (pilka, škrabka, unašeč), 3x brusný papír P80	pilka, vodící lišta, nástavec pro odsávání, 2x pilový list	pila, 2x pilový plátek	hřebíkovačka/ sponkovačka, 200x hřebíky, 200x spony



MĚŘIDLA A
ZNAČKOVAČE

24 - 57



26

SVINOVACÍ METRY A
PÁSMA KOMELON

28

SVINOVACÍ METRY FESTA



31

PÁSMA



32

SKLÁDACÍ METRY



34

POSUVNÁ MĚŘIDLA



35

PRAVÍTKA A ÚHELNÍKY



38

VODOVÁHY A LATĚ
HORIZONT

43

VODOVÁHY NIVELA



45

DIGITÁLNÍ VODOVÁHY
A ÚHLOMĚRY

46

LASEROVÁ MĚŘIDLA



50

TUŽKY A ZNAČKOVAČE



56

SPREJE



· VYSOCE PŘESNÁ A KVALITNÍ MĚŘIDLA

KOMELON®

- II. třída přesnosti dle ČSN 251104, EEC 755345
- nylonový povrch pásku DURA NY Coat™ zaručuje desetinásobně vyšší odolnost proti otěru stupnice

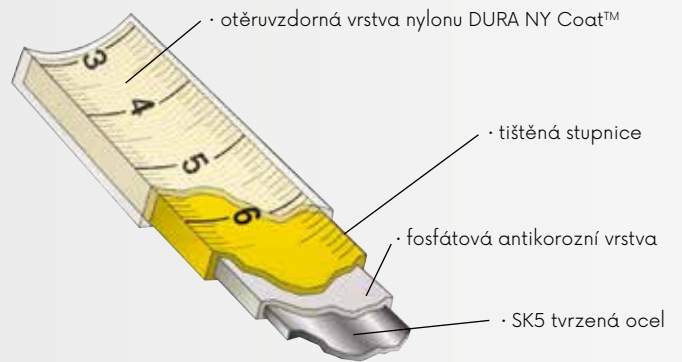

KOMELON® METR SVINOVACÍ

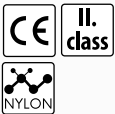

· Otěruvzdorná vrstva nylonu DURA NY Coat™



Č.p.	specifikace	
10002	2 m · 16 mm	10
10003	3 m · 16 mm	10
10005	5 m · 19 mm	10
10008	8 m · 25 mm	10

KOMELON® METR SVINOVACÍ

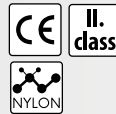

· Otěruvzdorná vrstva nylonu DURA NY Coat™



Č.p.	specifikace	
10025	5 m · 25 mm	10

KOMELON® METR SVINOVACÍ

- automatická brzda
- protiskluzové pogumování

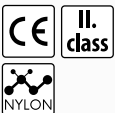

· Otěruvzdorná vrstva nylonu DURA NY Coat™



Č.p.	specifikace	
10033	3 m · 16 mm	6
10035	5 m · 19 mm	6

KOMELON® METR SVINOVACÍ



Č.p.	specifikace	
10043	3 m · 16 mm	30
10045	5 m · 19 mm	30
10048	8 m · 25 mm	12

KOMELON®
PÁSMO
OCELOVÉ



Č.p.	specifikace	
10110	10 m · 10 mm	6
10120	20 m · 10 mm	6
10130	30 m · 10 mm	6

KOMELON®
PÁSMO
SKLOLAMINÁTOVÉ



Č.p.	specifikace	
10330	10 m · 13 mm	6
10332	20 m · 13 mm	6
10334	30 m · 13 mm	6
10336	50 m · 13 mm	6



KOMELON®
PÁSMO
SKLOLAMINÁTOVÉ



Č.p.	specifikace	
10430	30 m · 13 mm	1
10450	50 m · 13 mm	1
10490	100 m · 13 mm	1

KOMELON®
STOJAN NA METRY

· osazení stojanu 10996

- 10003 · 5 ks
- 10005 · 4 ks
- 10008 · 1 ks
- 10033 · 2 ks
- 10035 · 3 ks
- 10045 · 2 ks
- 10025 · 3 ks
- 10110 · 1 ks
- 10120 · 1 ks
- 10130 · 1 ks
- 10430 · 1 ks
- 10330 · 1 ks
- 10332 · 1 ks
- 10334 · 1 ks
- 10336 · 1 ks



· ilustrační foto

Č.p.	specifikace	
10999	stojan na metry	1
10996	stojan na metry osazený	1



· Informace o pásce metru



- A** 15m · délka metru
- B** II · třída přesnosti
- C** CE · prohlášení o shodě - CE
- D** M17 · rok výroby
- E** 00071 · číslo akreditované zkušebny vydávající certifikát
- F** 9 · výrobce
- G** 12 · speciální úprava pásky
- H** 29°C · teplota, při které byla zkouška prováděna



· ilustrační foto

STOJAN NA METRY

Č.p.	specifikace	
10998		1

**FESTA®****METR SVINOVACÍ**

- stupnice s velkými číslicemi
- protiskuzové pogumování
- nylonová vrstva



Č.p.	specifikace	
11353	3 m · 19 mm	12
11355	5 m · 19 mm	12
11356	5 m · 25 mm	12
11358	8 m · 25 mm	6
11360	10 m · 25 mm	6

**FESTA®****METR SVINOVACÍ**

Č.p.	specifikace	
11343	3 m · 16 mm	6
11345	5 m · 19 mm	6
11347	7,5 m · 25 mm	6

**FESTA®****METR SVINOVACÍ - MAGNET**

- 3 x brzda
- magnetický háček
- přibrzdování
- protiskuzové pogumování



Č.p.	specifikace	
11323	3 m · 16 mm	10
11325	5 m · 19 mm	10
11327	7,5 m · 25 mm	6

FESTA®**METR SVINOVACÍ COMPACT**

- malý rozměr metru
- nylonová vrstva



Č.p.	specifikace	
11220	3 m · 16 mm	12
11221	5 m · 19 mm	12

**FESTA®****METR SVINOVACÍ**

- stupnice s velkými číslicemi



Č.p.	specifikace	
11226	2 m · 16 mm	10
11239	3 m · 19 mm	10
11259	5 m · 19 mm	10
11260	7,5 m · 25 mm	10



FESTA**METR SVINOVACÍ
MAGNETIC**

- magnetický háček
- protiskuzové pogumování
- fluorescenční páska
- stupnice s velkými číslicemi



Č.p.	specifikace	
11102	2 m · 16 mm	10
11103	3 m · 16 mm	10
11105	5 m · 19 mm	12
11106	5 m · 25 mm	12
11107	7,5 m · 25 mm	10
11110	10 m · 25 mm	6

**FESTA****METR SVINOVACÍ**

- automatická brzda
- protiskuzové pogumování



Č.p.	specifikace	
11333	3 m · 16 mm	12
11335	5 m · 19 mm	12
11337	7,5 m · 25 mm	12
11338	10 m · 25 mm	12

**Johnney®****METR SVINOVACÍ**

- matná úprava pásky



Č.p.	specifikace	
11002	2 m · 13 mm	12
11003	3 m · 13 mm	12
11005	5 m · 13 mm	12
11006	5 m · 19 mm	12
11007	7,5 m · 19 mm	12
11008	10 m · 25 mm	12

**METR SVINOVACÍ - ERGO**

- přibrždění
- protiskuzové pogumování

Č.p.	specifikace	
11082	2 m · 16 mm	12
11083	3 m · 16 mm	12
11085	5 m · 19 mm	12

**METR SVINOVACÍ**

- metrická a palcová stupnice
- protiskuzové pogumování

Č.p.	specifikace	
11416	5 m · 19 mm	10

METR SVINOVACÍ

- přibrždění

Č.p.	specifikace	
11200	2 m · 13 mm	24
11201	2 m · 16 mm	24
11202	2 m · 19 mm	24
11204	3 m · 13 mm	24
11205	3 m · 16 mm	24
11206	3 m · 19 mm	24
11207	5 m · 19 mm	12
11208	5 m · 25 mm	12
11209	7,5 m · 25 mm	12
11210	10 m · 25 mm	12





PÁSKA KOVOVÁ, MĚŘICÍ PLOCHĀ, SAMOLEPICÍ

II. class



Č.p.	specifikace	
11311	1 m · 12,5 mm	30
11312	2 m · 12,5 mm	30
11313	3 m · 16 mm	30
11314	5 m · 19 mm	30



METR SVINOVACÍ SE JMÉNEM 3M · 16 MM



II. class



Č.p.	jméno na metru	Č.p.	jméno na metru	Č.p.	jméno na metru
13500	JIRÍ	13512	MICHAL	13524	ROMAN
13501	PETR	13513	MILAN	13525	ŠIKULA
13502	JOSEF	13514	KAREL	13526	RADEK
13503	TOMÁŠ	13515	VLADIMÍR	13527	MISTR
13504	JAN	13516	DĚDEČEK	13528	ONDŘEJ
13505	MARTIN	13517	MŮJ METR	13529	MAREK
13506	JAROSLAV	13518	VÁCLAV	13530	STANISLAV
13507	FRANTIŠEK	13519	JAKUB	13531	BOREC
13508	PAVEL	13520	LUKÁŠ	13532	TATÍNEK
13509	MIROSLAV	13521	2X MĚŘ	13533	ANTONÍN
13510	BIG BOSS	13522	LADISLAV	13534	ALEŠ
13511	ZDENĚK	13523	DAVID		



FESTA

METR SVINOVACÍ - PŘÍVĚSEK

- stupnice s velkými číslicemi
- vlastnosti plnohodnotného metru

II. class

MOQ 12

Č.p.	specifikace	
11410	2 m · 16 mm 6 barev	12



METR SVINOVACÍ - PŘÍVĚSEK

Č.p.	specifikace	
11420	1 m · 6 mm oranžový	24



MĚTR SVINOVACÍ PŘÍVĚSEK

Č.p.	specifikace	
11444	1 m · 6 mm bílý	20



MĚTR SVINOVACÍ PŘÍVĚSEK

Č.p.	specifikace	
11425	1 m · 6 mm	25



LIBELA - PŘÍVĚSEK

Č.p.	specifikace	
11445		100

**FESTA****PÁSMO
OCELOVÉ**

· očko



Č.p.	specifikace	
12010	10 m · 10 mm	1
12020	20 m · 10 mm	1
12030	30 m · 10 mm	1
12050	50 m · 10 mm	6

**FESTA****PÁSMO
SKLOLAMINÁTOVÉ**

· očko



Č.p.	specifikace	
12110	10 m · 13 mm	6
12120	20 m · 13 mm	1
12130	30 m · 13 mm	1
12150	50 m · 13 mm	1

**FESTA****PÁSMO
OCELOVÉ**

· očko + háček



Č.p.	specifikace	
12210	10 m · 10 mm	6
12220	20 m · 10 mm	6
12230	30 m · 10 mm	6
12250	50 m · 10 mm	6

**FESTA****PÁSMO OCELOVÉ**

· očko



Č.p.	specifikace	
12433	30 m · 12,5 mm	20
12435	50 m · 12,5 mm	10

**FESTA****TYČ MĚŘICÍ
TELEKOPIČKÁ**

· včetně pouzdra

Č.p.	specifikace	
15983	0,7 - 3 m	10
15985	1,1 - 5 m	10
15988	1,6 - 8 m	5

KOLEČKO MĚŘICÍ

- odolné, lehké a kompaktní
- počítadlo přičítá při pohybu vpřed a odečítá při pohybu vzad
- vestavěné osvětlení pro noční práci, 2 baterie AAA v rukojeti
- včetně pouzdra



Č.p.	specifikace	
15989	max. 10 km	2

METR SKLÁDACÍ



Č.p.	specifikace	
13010	1 m · bílý	20
13020	2 m · bílý	10
13021	1 m · žlutý	20
13022	2 m · žlutý	10
13023	2 m · bílo - žlutý	10



METR SKLÁDACÍ



Č.p.	specifikace	
13111	1 m · žlutý	10
13120	2 m · žlutý	5

METR SKLÁDACÍ



Č.p.	specifikace	
13210	1 m · mini	10
13211	1 m	1
13220	2 m	1



METR SKLÁDACÍ SE JMÉNEM



Č.p.	jméno na metru	Č.p.	jméno na metru	Č.p.	jméno na metru
13401	JIŘÍ	13426	DANIEL	13451	JANA
13402	JAN	13427	ANTONÍN	13452	EVA
13403	PETR	13428	VOJTĚCH	13453	PETRA
13404	JOSEF	13429	FILIP	13454	MAJKA
13405	PAVEL	13430	ADAM	13455	HANA
13406	MARTIN	13431	MILOSLAV	13456	ANNA
13407	JAROSLAV	13432	MATĚJ	13457	LENKA
13408	TOMÁŠ	13433	ALEŠ	13458	KATKA
13409	MIROSLAV	13434	JAROMÍR	13459	LUCIE
13410	ZDENĚK	13435	LIBOR	13460	ALENA
13411	FRANTIŠEK	13436	DOMINIK	13461	VERONIKA
13412	VÁCLAV	13437	PATRIK	13462	MARTINA
13413	MICHAL	13438	VLASTIMIL	13463	JITKA
13414	MILAN	13439	JINDŘICH	13464	BIG BOSS
13415	KAREL	13440	MILOŠ	13465	2 x MĚŘ
13416	JAKUB	13441	JÁN	13466	TATÍNEK
13417	DAVID	13442	PETER	13467	DĚDEČEK
13418	LUKÁŠ	13443	ONDREJ	13468	ŠIKULA
13419	VLADIMÍR	13444	JOZEF	13469	MISTR
13420	LADISLAV	13445	PAVOL	13470	MACHR
13421	ONDŘEJ	13446	L'UBOMÍR	13471	BOREC
13422	ROMAN	13447	KAROL	13472	UŽ JE MŮJ
13423	STANISLAV	13448	RADOSLAV	13473	MŮJ METR
13424	MAREK	13449	VOJTĚCH		
13425	RADEK	13450	ZDENKO		

**STOJAN
NA SKLÁDACÍ METRY**

· osazení stojanu 13399

- 13401 · 15 ks
- 13402 · 15 ks
- 13403 · 15 ks
- 13404 · 15 ks
- 13405 · 15 ks
- 13406 · 15 ks
- 13412 · 15 ks
- 13413 · 15 ks
- 13414 · 15 ks
- 13415 · 15 ks
- 13416 · 15 ks
- 13417 · 15 ks
- 13418 · 15 ks
- 13419 · 15 ks
- 13420 · 15 ks
- 13421 · 10 ks
- 13422 · 10 ks
- 13423 · 10 ks
- 13424 · 10 ks
- 13425 · 10 ks
- 13426 · 10 ks
- 13427 · 10 ks
- 13428 · 10 ks
- 13429 · 10 ks
- 13430 · 10 ks
- 13431 · 10 ks
- 13432 · 10 ks
- 13433 · 10 ks
- 13434 · 10 ks
- 13435 · 10 ks
- 13436 · 10 ks
- 13437 · 10 ks
- 13438 · 10 ks
- 13439 · 10 ks
- 13440 · 10 ks



Č.p.	specifikace	
13399	Stojan osazený	1
13400	Stojan bez metrů	1

FESTA
MĚŘÍTKO S RUKOJETÍ

ALU

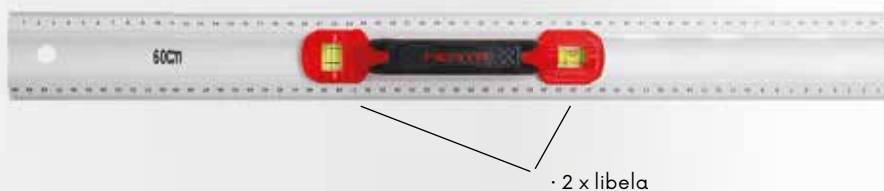

Č.p.	specifikace	
14030	600 mm	6

FESTA
MĚŘÍTKO HLINÍKOVÉ

ALU



Č.p.	specifikace	
14015	400 mm	48
14017	600 mm	50
14019	1000 mm	40

FESTA
MĚŘÍTKO OCELOVÉ

INOX



Č.p.	specifikace	
14010	300 mm	10
14011	600 mm	20
14012	1000 mm	20

**FESTA**

MĚŘIDLO POSUVNÉ DIGITÁLNÍ

INOX

Č.p.	specifikace	
14007	150 0,01 mm	10
14008	200 0,01 mm	10
14009	300 0,01 mm	10



MĚŘIDLO POSUVNÉ DIGITÁLNÍ FIBERGLASS

· přesnost 0,2 mm, rozlišení 0,1 mm

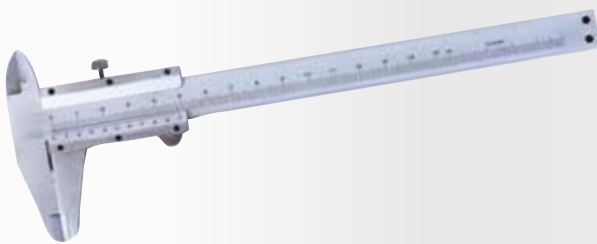

Č.p.	specifikace	
14013	150 0,2 mm	10

**FESTA**

MĚŘIDLO POSUVNÉ

INOX

Č.p.	specifikace	
14001	150 0,02 mm	10
14002	200 0,02 mm	10
14003	300 0,02 mm	10

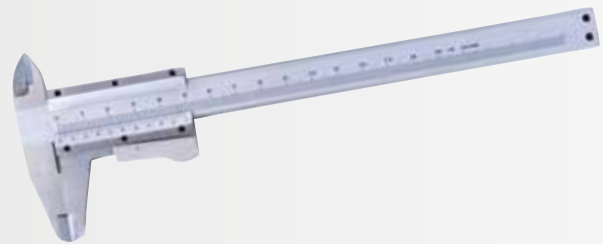
**FESTA**

MĚŘIDLO POSUVNÉ

INOX

Č.p.	specifikace	
14004	150 0,02 mm	10

**FESTA**

MIKROMETR



Č.p.	specifikace	
14040	0 - 0,25 0,01 mm	10
14045	25 - 50 0,01 mm	10



MĚŘIDLO POSUVNÉ

HOBBY

Č.p.	specifikace	
14006	150 mm	50

**FESTA**

ÚCHYLKOMĚŘ

INOX

Č.p.	specifikace	
14035	0 - 10mm 0,01 mm	10



MĚŘKY SPÁROVÉ

· 20 listů



Č.p.	specifikace	
14080	0,05 - 1 mm	10



FESTA

ÚHLOMĚŘ S OTOČNÝM RAMENEM

· včetně pouzdra

INOX

Č.p.	specifikace	
14060	0° - 180° · 150 x 200 mm	5
14070	0° - 180° · 300 x 500 mm	7



ÚHLOMĚŘ

HOBBY

Č.p.	specifikace	
14075	0° - 180° · 230 x 500 mm	30

NEW



PRAVÍTKO VÍCEÚČELOVÉ SKLÁDACÍ



Č.p.	specifikace	
14077		1



MĚŘÍTKO VÍCEÚČELOVÉ

PLASTIC

Č.p.	specifikace	
14480	250 x 120 mm	1



ŠABLONA NA KOPÍROVÁNÍ TVARŮ

PLASTIC

Č.p.	specifikace	
14090	125 x 30 mm	1
14091	250 x 30 mm	1



FESTA

ÚHELNÍK TRUHLÁŘSKÝ
MULTIFUNKČNÍ

ALU

Č.p.	specifikace	
14420	180 mm	10
14421	300 mm	10

NEW

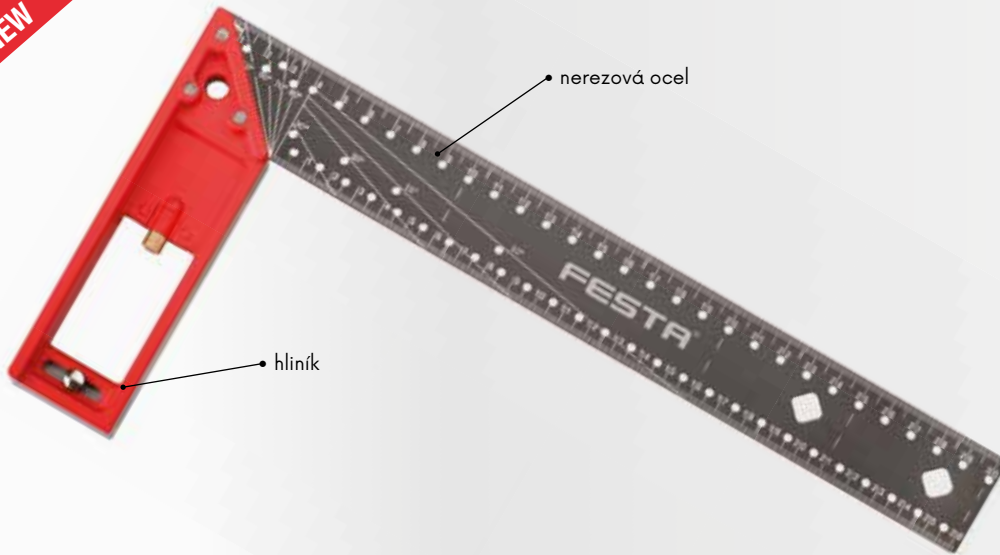

FESTA

ÚHELNÍK TRUHLÁŘSKÝ VÍCEÚČELOVÝ

INOX ALU

Č.p.	specifikace	
14415	300 mm	6
14417	400 mm	6

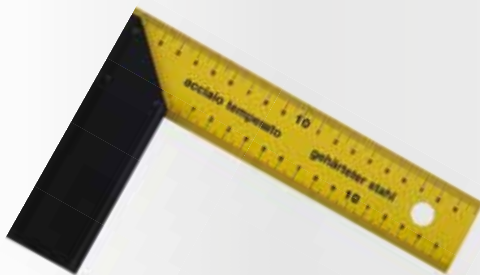

FESTA

ÚHELNÍK TRUHLÁŘSKÝ



Č.p.	specifikace	
14220	200 x 125 mm	10
14225	250 x 135 mm	10
14230	300 x 135 mm	10



FESTA

ÚHELNÍK TESAŘSKÝ



Č.p.	specifikace	
14350	500 x 235 mm	10
14360	600 x 300 mm	10
14370	700 x 300 mm	10

Č.p.	specifikace	
14380	800 x 320 mm	10
14399	1000 x 360 mm	10



FESTA

ÚHELNÍK

ALU



Č.p.	specifikace	
14450	190 x 355 mm	6
14451	200 x 405 mm	6

NEW



FESTA

ÚHELNÍK SKLÁDACÍ

ALU

Č.p.	specifikace	
14445	600 x 600 mm	1
14446	1200 x 1200 mm	1

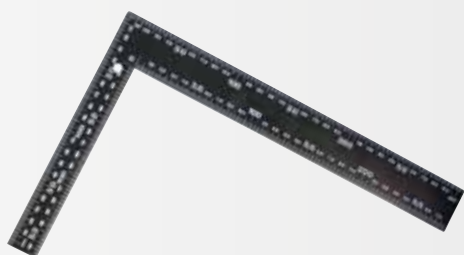

ÚHELNÍK

Č.p.	specifikace	
14410	300 x 200 mm	50
14411	600 x 400 mm	36



ÚHELNÍK ZEDNICKÝ

Č.p.	specifikace	
14455	300 x 200 mm	50
14456	500 x 250 mm	50
14457	700 x 300 mm	40
14458	1000 x 450 mm	30



ÚHELNÍK PLOCHÝ

Zn

Č.p.	specifikace	
14471	150 x 100 mm	25
14472	250 x 125 mm	25
14473	400 x 200 mm	30
14474	600 x 300 mm	25



ÚHELNÍK PŘÍLOŽNÝ

Zn

Č.p.	specifikace	
14490	100 x 50 mm	10
14491	150 x 75 mm	10
14492	250 x 125 mm	10
14493	400 x 200 mm	10
14494	600 x 300 mm	10



ÚHELNÍK TRUHLÁŘSKÝ

ALU

HOBBY

Č.p.	specifikace	
14425	250 x 130 mm	12
14430	300 x 130 mm	12
14435	350 x 156 mm	12
14440	400 x 156 mm	12



POKOSNÍK DŘEVĚNÝ

MADE IN EU



Č.p.	specifikace	
14025	255 x 285 mm	1

HORIZONT[®] EXACTA

Vodováhy s nejvyšší přesností

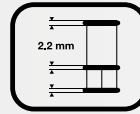
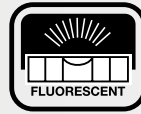
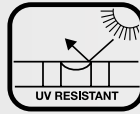
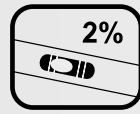
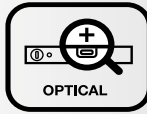
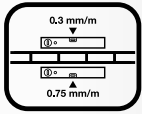

Každý kus je elektronicky testován a má své evidenční číslo, výrobce je držitelem certifikátu ISO 9001



HORIZONT[®]

VODOVÁHA EXACTA, 2 LIBELY

ALU

Č.p.	specifikace	
15033	60 cm	10



HORIZONT[®]

VODOVÁHA EXACTA, 3 LIBELY

ALU

Č.p.	specifikace	
15034	80 cm	10
15035	100 cm	10



HORIZONT[®]

VODOVÁHA EXACTA, 3 LIBELY, S MADLY

ALU

Č.p.	specifikace	
15036	120 cm	10
15037	150 cm	10
15039	200 cm	10

HORIZONT®

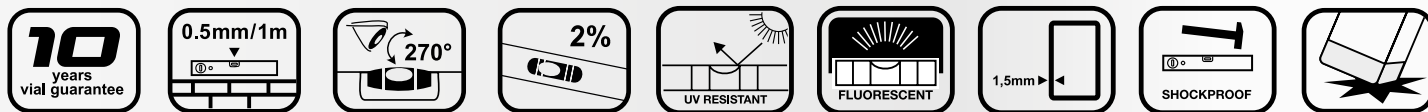

Každý kus je elektronicky testován a má své evidenční číslo, výrobce je držitelem certifikátu ISO 9001



HORIZONT® VODOVÁHA, 2 LIBELY



Č.p.	specifikace	
15003	30 cm	30
15004	40 cm	30
15005	50 cm	30
15006	60 cm	30
15008	80 cm	30
15010	100 cm	30
15012	120 cm	10
15015	150 cm	10
15018	180 cm	10
15020	200 cm	10



HORIZONT® VODOVÁHA, 3 LIBELY



Č.p.	specifikace	
15103	30 cm	30
15104	40 cm	30
15105	50 cm	30
15106	60 cm	30
15108	80 cm	30
15110	100 cm	30
15112	120 cm	10
15115	150 cm	10
15118	180 cm	10
15120	200 cm	10

**HORIZONT.**

VODOVÁHA, 2 LIBELY + MAGNET

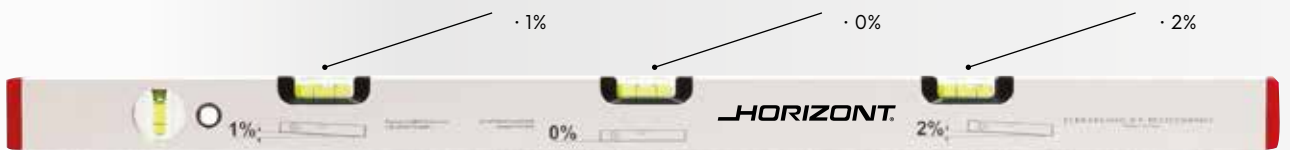

Č.p.	specifikace	
15204	40 cm	30
15205	50 cm	30
15206	60 cm	30
15208	80 cm	30
15210	100 cm	30
15212	120 cm	10
15215	150 cm	10
15218	180 cm	10
15220	200 cm	10

**HORIZONT.**

VODOVÁHA SKLONOVÁ, 4 LIBELY



Č.p.	specifikace	
15230	80 cm	10

**HORIZONT.**

VODOVÁHA SKLONOVÁ, 1 LIBELA



Č.p.	specifikace	
15235	60 cm	1

**HORIZONT.**

LAŤ STAHOVACÍ - BEZ LIBEL



Č.p.	specifikace	
15310	100 cm	10
15315	150 cm	10
15318	180 cm	10
15320	200 cm	10
15325	250 cm	10
15330	300 cm	10
15335	350 cm	10
15340	400 cm	10



HORIZONT®

HORIZONT®

LAŤ STAHOVACÍ - 1 LIBELA

ALU

Č.p.	specifikace	
15415	150 cm	10
15418	180 cm	10
15420	200 cm	10
15425	250 cm	10
15430	300 cm	10



HORIZONT®

HORIZONT®

LAŤ STAHOVACÍ - 2 LIBELY

ALU

Č.p.	specifikace	
15510	100 cm	10
15515	150 cm	10
15518	180 cm	10
15520	200 cm	10
15525	250 cm	10
15530	300 cm	10
15535	350 cm	10
15540	400 cm	5



HORIZONT®

HORIZONT®

LAŤ STAHOVACÍ - 2 MADLA, BEZ LIBEL

ALU

Č.p.	specifikace	
15615	150 cm	10
15620	200 cm	10
15625	250 cm	10
15630	300 cm	10



HORIZONT®

HORIZONT®

LAŤ STAHOVACÍ - 2 MADLA, 2 LIBELY

ALU

Č.p.	specifikace	
15710	100 cm	10
15715	150 cm	10
15720	200 cm	10
15725	250 cm	10
15730	300 cm	10
15735	350 cm	10
15740	400 cm	5

NEW

HORIZONT. ÚHELNÍK STAVEBNÍ

ALU



Č.p.	specifikace	
14485	800 x 1200 mm	1
14486	1000 x 1500 mm	1



HORIZONT. LAŤ STAHOVACÍ - TRAPÉZOVÝ PROFIL

PROFIL TRAPÉZOVÝ

- trapézový profil slouží k jemnějším úpravám povrchu
- vhodné pro štukatéry a fasádníky
- vhodný pro tenkovrstvé omítky

ALU



Č.p.	specifikace	
15810	100 cm	10
15812	120 cm	10
15815	150 cm	10
15818	180 cm	10
15820	200 cm	10
15825	250 cm	10
15830	300 cm	10



HORIZONT. LAŤ STAHOVACÍ - H PROFIL

PROFIL "h"

- "h" profil slouží k jemnějším úpravám povrchu
- vhodné pro štukatéry a fasádníky
- vhodná ke štukování stropních omítek

ALU



Č.p.	specifikace	
15850	100 cm	10
15853	150 cm	10
15855	180 cm	10
15860	200 cm	10
15870	250 cm	10
15880	300 cm	10

HORIZONT. STOJAN NA VODOVÁHY

· osazení stojanu 15998

15003	· 5 ks
15004	· 5 ks
15005	· 5 ks
15006	· 5 ks
15008	· 5 ks
15010	· 5 ks
15012	· 5 ks
15015	· 3 ks
15018	· 3 ks
15020	· 3 ks
15108	· 3 ks
15206	· 3 ks
15210	· 3 ks



Č.p.	specifikace	
15999	85 x 210 x 50 cm	1
15998	85 x 210 x 50 cm osazený	1

HORIZONT. STOJAN NA VODOVÁHY A LAŤ

· osazení stojanu 15996

15004	· 5 ks
15005	· 5 ks
15006	· 5 ks
15008	· 5 ks
15010	· 5 ks
15012	· 5 ks
15015	· 5 ks
15018	· 5 ks
15020	· 5 ks
15315	· 2 ks
15320	· 2 ks
15325	· 3 ks
15515	· 2 ks
15520	· 2 ks
15525	· 3 ks



Č.p.	specifikace	
15997	55 x 75 x 40 cm	1
15996	55 x 75 x 40 cm osazený	1

- Přesnost 0,5 mm | 1 m (v základní poloze)
- UV stabilní kapalina libely
- Nárazuvzdorne gumové koncovky
- Tloušťka profilu základny 2,4 mm



NIVELA

VODOVÁHA NIVELA - 2 LIBELY

· gumové koncovky



č.p.	specifikace	
15904	40 cm	30
15906	60 cm	30
15908	80 cm	30
15910	100 cm	30
15912	120 cm	20
15915	150 cm	10
15920	200 cm	20



VODOVÁHA - 3 LIBELY

ALU **HOBBY**

č.p.	specifikace	
15954	40 cm	60
15956	60 cm	60
15958	80 cm	60
15960	100 cm	30
15962	120 cm	30
15965	150 cm	30
15970	200 cm	30



VODOVÁHA DIGITÁLNÍ

- přesnost 0,5 mm | m
- rozlišení 0,1°
- funkce HOLD pro uchování naměřené hodnoty
- tloušťka profilu 1,8 mm



č.p.	specifikace	
26215	600 mm	1



VODOVÁHA NA PROVÁZEK



č.p.	specifikace	
15981		1



č.p.	specifikace	
15980	230 mm	1



VODOVÁHA SLOUPKOVÁ

- 3 libely, magnety, fixační pásek



č.p.	specifikace	
26028		12



VODOVÁHA HADICOVÁ



č.p.	specifikace	
15992	skleněné trubice - hadice 10 m	1
15993	skleněné trubice - hadice 15 m	1
15990	skleněné trubice	50
15991	plastové trubice	50

FESTA**SKLONOMĚŘ DIGITÁLNÍ**

- 0° - 360°
- přesnost $\pm 0,1^\circ$
- rozlišení $0,1^\circ$
- funkce automatického vypnutí
- funkce HOLD pro uchování naměřené hodnoty
- podsvícený display
- specifikace 60x60x25 mm
- baterie 1xAAA



· pouzdro

· magnetická spodní strana

Č.p. specifikace

26218

1

FESTA**ÚHLOMĚŘ DIGITÁLNÍ**

- LCD display
- rozsah měření 0° - 360°
- rozlišení 0,1°
- přesnost $\pm 0,3$



Č.p. specifikace

26217 200 mm

1

FESTA**VODOVÁHA S DIGITÁLNÍM ÚHLOMĚŘEM**

- LCD display
- rozsah měření 0° - 225°
- rozlišení 0,1°
- přesnost $\pm 0,3$



Č.p. specifikace

26216 300 mm

1

NEW



FESTA

LASER ALL LINE ZELENÝ 3 X 360 °

- 1x horizontální rovina + 2x vertikální rovina (zelený paprsek)
- samonivelační rozsah $\pm 4^\circ$
- přesnost: 0,2 mm/m
- ve vnitřních prostorech 30 m, s laserovým přijímačem až 50 m
- pulzní režim – doporučené příslušenství přijímač 26209
- dodáváno s: přepravní kufr, 4 x AA alkalické baterie, laserový terč, brýle, Li-ion baterie 2600 mAh, profesionální držák, nabíječka, držák Li-ion baterie



Č.p. Specifikace

26204



1

NEW



FESTA

LASER ZELENÝ KŘÍŽOVÝ

- 1x horizontální rovina + 1x vertikální rovina (zelený paprsek) | samonivelační rozsah $\pm 3^\circ$
- přesnost: 0,2 mm/m
- ve vnitřních prostorech 20 m, s laserovým přijímačem až 50 m
- pulzní režim – doporučené příslušenství přijímač 26209
- dodáváno s: přepravní pouzdro, 2 x AA alkalické baterie, držák



Č.p. Specifikace

26201



1

NEW

**FESTA****LASEROVÝ PŘIJÍMAČ**

- pro lasery s pulsním režimem k prodloužení dosahu až 50 m
- dodáváno s: 9 V baterie, držák
- pro 26201, 26204



Č.p.

Specifikace

26209 dosah: 50 m



1

NEW

Laser

**FESTA****DÁLKOMĚR**

- rozsah měření 0,05 - 50 m
- přesnost měření ± 2 mm, jednotka měření mm/in/ft
- kontinuální měření, měření plochy, měření objemu, výpočet délky třetí strany dle pythagorovi věty, LCD FSTN, sčítání/odčítání, max./min. měření
- maximální úložisko na 100 hodnot, čtyřřádkový displej LCD FSTNS s podsvícením,
- vlnová délka laseru 630 - 670 nm, pracovní teplota 0 - 40°C
- rozměry 112 x 50 x 25 mm, hmotnost 90 g
- dodáváno s: přepravní pouzdro, 2xAAA alkalické baterie



Č.p.

Specifikace

26211



1

Laserliner®**LUXTEST-MASTER****Profesionální měřicí přístroj intenzity osvětlení**

- měření intenzity osvětlení na pracovištích, kancelářích, veřejných budovách a v průmyslu
- citlivé fotodiody s kosinovou korekcí pro širokouhlé měření světla
- relativní funkce měření pro referenční měření a porovnávání
- špičková funkce pro registraci rychlé změny v úrovni osvětlení.
- funkce automatického zapamatování hodnoty.
- automatické a manuální přepínání rozsahu
- funkce nulování
- měření proměnné: lux (lm /m²), nožní svíčky (lm /ft²)
- min. | max. displej
- 1/4" závít pro umístění na stativ



Č.p. specifikace

	Rozsah měření:	20 Lux ... 200000 Lux
26520	Přesnost:	± 3% (referenční hodnota 2854 K)
	Kosínus úhlová odchylka:	± 2% (30°), ± 6% (60°)

**Laserliner®****AIRFLOWTEST-MASTER****Profesionální anemometr pro měření průtoku vzduchu, objemového průtoku a rychlosti větru**

- integrovaný senzor pro měření okolní teploty, relativní vlhkosti a rosného bodu
- usb rozhraní pro ukládání naměřených dat
- pc software
- velké oběžné kolo: 65 mm.
- min. | max. displej.
- 1/4" závít pro připojení na stativ při dlouhodobém měření
- osvětlený, přehledný displej s trvale viditelnými hodnotami okolní teploty a relativní vlhkosti



Č.p. specifikace

	Průtok:	0.80...30 m s ± 2%
	Teplota okolního prostředí:	-10...60°C ± 1.5°C
26521	Relativní vlhkost vzduchu:	20%...80% ± 3%
	Proud vzduchu:	0...99990 CMM



NAHRÁVÁNÍ DAT NA PC

specifikace

Dodáno s: PC software, USB kabel, baterie, přepravní kufr



1

specifikace

Dodáno s: baterie, přepravní kufr



1

Laserliner®**CONDENSESPOT PLUS****Infračervený teploměr tepelných mostů a kondenzace**

- 8-bodový laserový kruh měřící přesně potřebnou oblast
- lokalizace kondenzace v režimu tepelného mostu a rosného bodu
- rozsah měření -40°C...365°C
- emisní poměr 0,01-1,0
- funkce barevného upozornění pomocí barev na displeji
- rychlý výběr 5 výchozích hodnot emisí
- sloupcový graf jako ukazatel pro kondenzaci vody
- čočka 12:1, přehledný podsvícený displej.

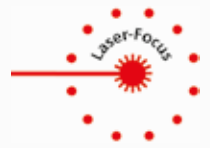

1

Č.p.	specifikace
	Rozsah měření infračerveným paprskem: -40°C ... 365°C
	Přesnost: ± -40°C ... 0°C (± 1°C + 0,1°C 1°C) 0°C ... 30°C (± 1°C or ± 1%, záleží na vyšší hodnotě) >30°C (± 2°C or ± 2%, záleží na vyšší hodnotě)
26528	Teplota okolí: -20°C...65°C Přesnost: ± 1°C (0°C...50°C) ± 2,5°C (<0°C and >50°C)
	Vlhkost vzduchu (relativní): 1%...99% Přesnost: ± 3% (20%...80%) ± 5% (<20% and >80%)
	Dodáváno s: baterie

**Laserliner®****COMPACTCROSS - LASER PLUS****Automatický křížový laser k vyrovnávání dlaždic, hrázdného zdiva, oken, dveří atd.**

- doplňkový režim sklonu umožňuje osazovat také plochy se spádem
- rx-ready: integrovaný režim ručního přijímače
- rozhraní bluetooth® pro dálkové ovládání přístroje
- rozsah samočinné nivelace 4°, přesnost 0,35 mm |m



1

Č.p.	specifikace
26037	Dodáno s: baterie



FESTA

ZNAČKOVAČ HLOUBKOVÝ HB



Č.p.	specifikace	
13262	150 mm	20



FESTA

TUŽKA S VÝMĚNITELNOU TUHOU HB



Č.p.	specifikace	
13279	tužka + náhradní tuha HB	24
13284	náhradní tuhy 5 ks	20

NEW



FESTA

BAREVNÉ TUHY DO HLOUBKOVÉHO ZNAČKOVAČE pro 13262



Č.p.	Specifikace	
13267	2x žlutá 2x červená 2x modrá	1



FESTA

ČERNÉ TUHY HB DO HLOUBKOVÉHO ZNAČKOVAČE pro 13262

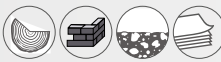

Č.p.	Specifikace	
13263	6x černá	20



FESTA

TUŽKA TESAŘSKÁ HB



Č.p.	specifikace	MOQ
13270	HB · 180 mm	12
13271	HB · 180 mm · sada 3 ks	96
13265	HB · 250 mm	32
		96



FESTA

TUŽKA TESAŘSKÁ HB



Č.p.	specifikace	MOQ
13269	HB · 180 mm	50
13266	HB · 250 mm	50



FESTA

TUŽKA TESAŘSKÁ HB



MOQ
12

Č.p.	specifikace	MOQ
13272	HB · 250 mm	96
13264	HB · 250 mm · bez potisku	96



FESTA

TUŽKA TESAŘSKÁ HB



MOQ
50

Č.p.	specifikace	MOQ
13268	250 mm	50



FESTA

TUŽKA TROJHRANNÁ HB

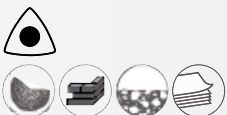

MOQ
12

Č.p.	specifikace	MOQ
13278	250 mm	96



TUŽKA TESAŘSKÁ HB



MOQ
12

Č.p.	specifikace	MOQ
13280	180 mm	96



FESTA

TUŽKA 6H



MOQ
12

Č.p.	specifikace	MOQ
13275	6H · 250 mm	96



FESTA

TUŽKA NA SKLO A KERAMIKU



MOQ
12

Č.p.	specifikace	MOQ
13273	175 mm červená tuha - sklo, keramika	144

**FESTA**

TUŽKA S BAREVNOU TUHOU

MOQ
12

Č.p.	specifikace
13274	175 mm, červeno - modrá



96



TUŽKA S ČERVENOU TUHOU

MOQ
12

Č.p.	specifikace
13276	175 mm



144



smirek

OŘEZÁVÁTKO NA TUŽKY

Č.p.
13261



12



ZNAČKOVAČ PERMANENTNÍ

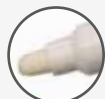

- extra silný hrot
- pro značení i na mastných a vlhkých površích

MOQ
12

Č.p.	specifikace	
13216	červený	12
13217	černý	12
13218	modrý	12
13219	zelený	12



ZNAČKOVAČ PERMANENTNÍ



- 2 typy hrotu značkovace
- pro značení i na mastných a vlhkých površích

MOQ
12

Č.p.	specifikace		
13227	bílý	ALU pouzdro	40
13222	bílý	PVC pouzdro	12
13228	červený	ALU pouzdro	40
13229	černý	ALU pouzdro	40
13230	modrý	ALU pouzdro	12
13231	zelený	ALU pouzdro	12



ZNAČKOVAČ PERMANENTNÍ

MOQ
12

Č.p.	specifikace	
13214	bílý	12
13225	červený	12
13226	černý	12
13223	modrý	12
13224	zelený	12

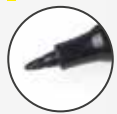

ZNAČKOVAČ PERMANENTNÍ

MOQ
12

Č.p.	specifikace	
13235	červený	12
13236	černý	12
13237	modrý	12
13238	zelený	12



NEW



NEW



ZNAČKOVAČ PERMANENTNÍ, OBOUSTRANNÝ

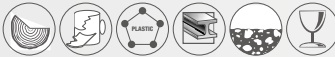

MOQ
12



Č.p.	Specifikace	
13206	○ bílý	12

FESTA

ZNAČKOVAČ HLOUBKOVÝ, PERMANENTNÍ

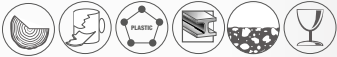

Č.p.	Specifikace	
13246	● černý	10

NEW

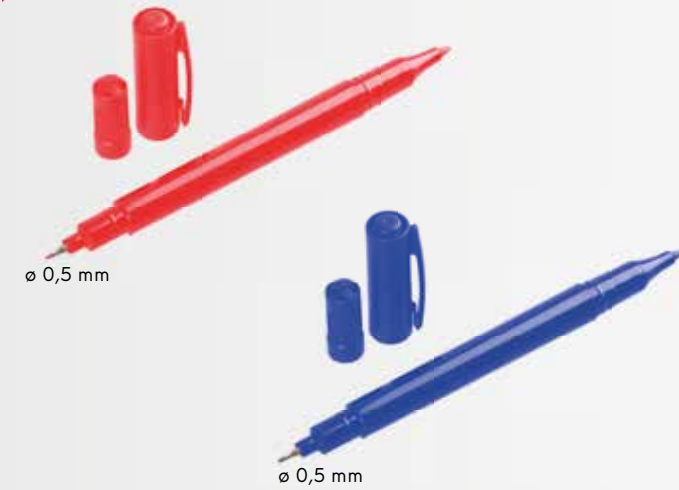

ZNAČKOVAČ PERMANENTNÍ, OBOUSTRANNÝ



MOQ
12



Č.p.	Specifikace Specification	
13207	● červený	12
13208	● modrý	12

ZNAČKOVAČ PERMANENTNÍ MINI



· délka fixu 9 cm



MOQ
72



Č.p.	specifikace	
13205	● ● ● ● ● ●	72

ZNAČKOVAČ PERMANENTNÍ, OBOUSTRANNÝ

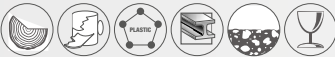

MOQ
12



Č.p.	specifikace	
13212	černý	12

**FESTA**

JEHLA RÝSOVACÍ



Č.p.	specifikace
13281	150 mm

50



KRUŽÍTKO RÝSOVACÍ



Č.p.	specifikace
13285	200 mm

10

**FESTA**

JEHLA RÝSOVACÍ



Č.p.	specifikace
13282	200 mm

50



KŘÍDA BÍLÁ

12x



Č.p.	specifikace
13260	12 x 12 x 80 mm

46

**FESTA**ZNAČKOVAČ
UNIVERZÁLNÍ SADA 5 KS

· Ø 13 × 110 mm

5x



Č.p.	specifikace	
13240	5 barev	20
13241	červená	20
13242	černá	20

Č.p.	specifikace	
13243	žlutá	20
13244	zelená	20
13245	obílá	20



TUŽKY VOSKOVÉ SADA 6 KS

6x



Č.p.	specifikace
13277	● ● ○ ● ● ●

88

SPREJ FLUORESCENČNÍ TRACKMARKER 500ML

- vysoká viditelnost - fluorescenční pigment
- bezpečnostní víčko
- rychleschnoucí 10 min.
- trvanlivost 3 měsíce
- použití - beton, asfalt, tráva, štěrk, písek, kámen, dřevo

MADE IN EU



Č.p.	specifikace	
13250	● žlutý	12
13251	● červený	12
13252	● oranžový	12
13253	● zelený	12
13254	● růžový	12
13249	● modrý	12



SPREJ FLUORESCENČNÍ MARK 6M FLUO 500 ML

- vysoká viditelnost - fluorescenční pigment
- bezpečnostní víčko
- rychleschnoucí 10 min.
- trvanlivost 6 měsíců
- použití - beton, asfalt, tráva, štěrk, písek, kámen, dřevo, sklo

MADE IN EU



Č.p.	specifikace	
13360	● žlutý	12
13361	● červený	12
13362	● oranžový	12
13363	● zelený	12
13364	● růžový	12
13365	○ bílý	12



SPREJ FLUORESCENČNÍ FLUO 500 ML

- vysoká viditelnost - fluorescenční pigment
- bezpečnostní víčko
- rychleschnoucí 10 min.
- trvanlivost 12 měsíců
- použití - beton, asfalt, tráva, štěrk, písek, kámen, dřevo, sklo

MADE IN EU



Č.p.	specifikace	
13350	● žlutý	12
13351	● červený	12
13352	● oranžový	12
13353	● zelený	12
13354	● růžový	12
13355	○ bílý	12



SPREJ FLUORESCENČNÍ IDEAL 500 ML

- vysoká viditelnost - fluorescenční pigment
- bezpečnostní víčko
- rychleschnoucí 10 min.
- trvanlivost 12 měsíců
- použití - beton, asfalt, tráva, štěrk, písek, kámen, dřevo

MADE IN
EU



Č.p.	specifikace	
13255	● žlutý	12
13256	● červený	12
13257	● oranžový	12
13258	● zelený	12
13259	● růžový	12



DRŽÁK POJÍZDNÝ NA SPREJ SOPPEC

- pro spreje Trackmarker a Fluó

MADE IN
EU

Č.p.	specifikace	
13296		1

DRŽÁK PISTOLOVÝ NA SPREJ SOPPEC

- pro spreje Trackmarker a Fluó

MADE IN
EU

Č.p.	specifikace	
13295		1



60

KLEŠTĚ



66

SIKO KLEŠTĚ, HASÁKY



68

KLEŠTĚ PÁKOVÉ



70

NŮŽKY NA PLECH, NŮŽKY
TECHNICKÉ

73

GOLA SADY A RÁČNY



82

HLAVICE, NÁSTAVCE,
ADAPTÉRY

87

KLÍČE



93

ŠROUBOVÁKY



101

BITY



110

INBUSY, SADY



115

KLADIVA, PALICE



120

GUMOVÉ PALICE



122

SEKERY



125

PÁČIDLA



126

SEKÁČE, DLÁTA

DÍLENSKÉ NÁŘADÍ

58 - 159



129

SPONKOVAČKY



131

SVĚRKY A SVĚRÁKY



134

PRACOVNÍ STOLY



136

KLEŠTĚ NÝTOVACÍ



140

SVÁŘENÍ



143

ZÁVITOVÉ TYČE,
PODLOŽKY, MATICE

144

KOMPRESORY, STRÍKACÍ A
OFUKOVACÍ PISTOLE

149

OCHRANNÉ POMŮCKY



155

NÁŘAĐOVÉ PÁSY, BRAŠNY A
POUZDRA

FESTA®



ERGONOMIC handle



STANDARD

+30%

FESTA



FESTA

KLEŠTĚ KOMBINOVANÉ



Č.p.	specifikace	
17101	160 mm	6
17102	180 mm	6
17103	200 mm	6



FESTA

KLEŠTĚ BOČNÍ ŠTÍPACÍ



Č.p.	specifikace	
17148	180 mm	6

FESTA

KLEŠTĚ BOČNÍ ŠTÍPACÍ



Č.p.	specifikace	
17104	160 mm	6
17105	180 mm	6



FESTA

KLEŠTĚ RADIOVÉ



Č.p.	specifikace	
17140	160 mm	6
17142	200 mm	6

FESTA

KLEŠTĚ RADIOVÉ ZAHNUTÉ



Č.p.	specifikace	
17145	160 mm	6
17146	200 mm	6



FESTA

KLEŠTĚ KOMBINOVANÉ

DIN 5746					
Č.p.	specifikace				
17001	160 mm				6
17002	180 mm				6
17003	200 mm				6



FESTA

KLEŠTĚ BOČNÍ ŠTÍPACÍ

DIN 5749					
Č.p.	specifikace				
17004	160 mm				6
17005	180 mm				6



FESTA

KLEŠTĚ BOČNÍ ŠTÍPACÍ

DIN 5749					
Č.p.	specifikace				
17108	180 mm				6



FESTA

KLEŠTĚ ŠTÍPACÍ ČELNÍ

DIN 5749					
Č.p.	specifikace				
17110	160 mm				6



FESTA

KLEŠTĚ RADIOVÉ

DIN 5745					
Č.p.	specifikace				
17006	160 mm				6
17011	200 mm				6



FESTA

KLEŠTĚ RADIOVÉ ZAHNUTÉ

DIN 5745					
Č.p.	specifikace				
17007	160 mm				6
17008	200 mm				6



FESTA

KLEŠTĚ PLOCHÉ

DIN 5746					
Č.p.	specifikace				
17009	160 mm				6



FESTA

KLEŠTĚ OČKOVÉ

DIN 5745					
Č.p.	specifikace				
17010	160 mm				6



FESTA

KLEŠTĚ ODIZOLOVÁVACÍ

DIN 5744					
Č.p.	specifikace				
17024	160 mm				6



KLEŠTĚ KOMBINOVANÉ

DIN 5746			
Č.p.	specifikace		
17094	160 mm		6
17095	180 mm		6
17096	200 mm		6



KLEŠTĚ BOČNÍ ŠTÍPACÍ

DIN 5749			
Č.p.	specifikace		
17097	160 mm		6
17098	180 mm		6



KLEŠTĚ RADIOVÉ

DIN 5745			
Č.p.	specifikace		
17099	160 mm		6
17100	200 mm		6



FESTA

VDE KLEŠTĚ KOMBINOVANÉ

⚡ 1000 V ⚡
IEC/EN60900:2004

DIN 5746

CrV

HRC 58-62



Č.p.	specifikace	
17125	160 mm	6
17126	180 mm	6
17127	200 mm	6



FESTA

VDE KLEŠTĚ BOČNÍ ŠTÍPACÍ

⚡ 1000 V ⚡
IEC/EN60900:2004

DIN 5749

CrV

HRC 58-62



Č.p.	specifikace	
17128	160 mm	6



FESTA

VDE KLEŠTĚ KABELOVÉ ŠTÍPACÍ

⚡ 1000 V ⚡
IEC/EN60900:2004

CrV

HRC 58-62



Č.p.	specifikace	
17130	160 mm	6



FESTA

VDE KLEŠTĚ RADIOVÉ

⚡ 1000 V ⚡
IEC/EN60900:2004

DIN 5745

CrV

HRC 58-62



Č.p.	specifikace	
17133	160 mm	6



FESTA

VDE KLEŠTĚ RADIOVÉ ZAHNUTÉ

⚡ 1000 V ⚡
IEC/EN60900:2004

DIN 5745

CrV

HRC 58-62



Č.p.	specifikace	
17135	160 mm	6



FESTA

VDE KLEŠTĚ OČKOVÉ

⚡ 1000 V ⚡
IEC/EN60900:2004

DIN 5745

CrV

HRC 58-62



Č.p.	specifikace	
17137	160 mm	6



FESTA

VDE KLEŠTĚ ODIZOLOVÁVACÍ

⚡ 1000 V ⚡
IEC/EN60900:2004

CrV

DIN 5744



Č.p.	specifikace	
17138	160 mm	6



KLEŠTĚ ODIZOLOVÁVACÍ

Č.p.	specifikace	
17180	Ø 0,75 - 2,5 mm	12



KLEŠTĚ ODIZOLOVÁVACÍ

Č.p.	specifikace	
17181	Ø 0,60 - 2,6 mm	10

NEW

FESTA

ODIZOLOVÁVAČ KABELŮ

AWG	mm ²
10	6,0
12	4,0
14	2,5
16	1,5
18	1,0
20	0,5

- koaxiální kabel RG6/59
- nízkonapěťový kabel Ø 8 - 13 mm

Č.p.	specifikace
16202	125 mm



10

NEW



FESTA

KLEŠTĚ ŠTÍPACÍ NA JEMNÉ KABELY

max Ø 0,2 - 2,1 mm

CrV

Č.p. No.	Specifikace Specification
17047	140 mm



10

FESTA

KLEŠTĚ KOMBINOVANÉ MINI

Č.p.	specifikace
17041	110 mm



12



FESTA

KLEŠTĚ BOČNÍ ŠTÍPACÍ MINI

Č.p.	specifikace
17042	110 mm



12

FESTA

KLEŠTĚ ČELNÍ ŠTÍPACÍ MINI

Č.p.	specifikace
17043	100 mm



12

FESTA

KLEŠTĚ RADIOVÉ MINI

Č.p.	specifikace
17044	120 mm



12



FESTA

KLEŠTĚ OČKOVÉ MINI

Č.p.	specifikace
17045	120 mm



12

FESTA

KLEŠTĚ MINI SADA

4x

Č.p.	specifikace
17040	



6



FESTA

KLEŠTĚ NA SEGEROVY KROUŽKY

Č.p.	specifikace
17190	180 mm vnitřní
17191	180 mm vnější



6

FESTA

KLEŠTĚ NA SEGEROVY KROUŽKY

Č.p.	specifikace
17192	180 mm vnitřní
17193	180 mm vnější



15

FESTA

KLEŠTĚ NA SEGEROVY KROUŽKY

Č.p.	specifikace
17025	sada



10



FESTA

**KLEŠTĚ
MULTIFUNKČNÍ**

- 9 funkcí
- pouzdro

CrV

Č.p. specifikace

16232



12



FESTA

**KLEŠTĚ
MULTIFUNKČNÍ**

- pro montáž oplacení

CrV

Č.p. specifikace

17109 270 mm



4



KLEŠTĚ RYCHLOUPÍNACÍ

Č.p. specifikace

17034 220 mm



5



KLEŠTĚ RYCHLOUPÍNACÍ

Č.p. specifikace

17036 260 mm



5



KLEŠTĚ RYCHLOUPÍNACÍ

Č.p. specifikace

17035 220 mm



10



KLEŠTĚ RYCHLOUPÍNACÍ

Č.p. specifikace

17033 220 mm



6

**FESTA**KLEŠTĚ SIKO
S TLAČÍTKEM

CrV

Č.p.	specifikace	rozsah čelistí	
17059	180 mm	0 - 30 mm	6
17061	250 mm	0 - 30 mm	6
17062	300 mm	0 - 40 mm	6
17080	400 mm	0 - 84 mm	4

**FESTA**KLEŠTĚ SIKO
S TLAČÍTKEM

CrV

Č.p.	specifikace	rozsah čelistí	
17084	250 mm	0 - 30 mm	6

**FESTA**

KLEŠTĚ SIKO

CrV

· velký rozsah čelistí

Č.p.	specifikace	rozsah čelistí	
17086	250 mm	0 - 50 mm	6

**FESTA**

KLEŠTĚ SIKO

CrV

Č.p.	specifikace	rozsah čelistí	
17081	180 mm	0 - 30 mm	6
17014	250 mm	0 - 30 mm	6
17082	300 mm	0 - 50 mm	6

**FESTA**KLEŠTĚ SIKO
AUTOMATICKY STAVITELNÉ

CrV

Č.p.	specifikace	rozsah čelistí	
17079	250 mm	0 - 50 mm	6

**FESTA**

KLEŠTĚ SIKO

CrV

Č.p.	specifikace	rozsah čelistí	
17012	250 mm	0 - 40 mm	6
17060	300 mm	0 - 50 mm	10



KLEŠTĚ SIKO

Č.p.	specifikace	rozsah čelistí	
17013	250 mm	0 - 30 mm	6
17033	300 mm	0 - 50 mm	6

ČELISTI PĚŠTOVÉ
PRO KLEŠTĚ SIKO

· vhodné pro 17061, 17079, 17086

Č.p.	specifikace	
17085	1 pár	1



FESTA

HASÁK 45°, S

CrV



Č.p.	specifikace	
17067	1" 330 mm	1
17068	1,5" 420 mm	1
17069	2" 540 mm	1



FESTA

HASÁK 90°

CrV



Č.p.	specifikace	
17075	1" 330 mm	1
17076	1,5" 420 mm	1
17077	2" 540 mm	1



FESTA

HASÁK 90°

CrV



Č.p.	specifikace	
17070	2,5" 355 mm	12
17071	3" 455 mm	8
17072	3,5" 610 mm	10



FESTA

HASÁK SE STAVĚCÍM ŠROUBEM

CrV

Č.p.	specifikace	
17063	230 mm	6
17064	300 mm	6



HASÁK S VODÍCÍ MATICÍ

Č.p.	specifikace	
17065	260 mm	36
17066	300 mm	36

FESTA

KLEŠTĚ NA LANA

- ocelové dráty
- ACSR kabely
- letecké kabely

CrV

max. Ø
12 mm

Č.p.	specifikace
17039	24' 610 mm



FESTA

KLEŠTĚ NA LANKA

- ocelové dráty
- ACSR kabely
- letecké kabely

CrV

max. Ø
6 mm

Č.p.	specifikace
17029	200 mm



FESTA

KLEŠTĚ PÁKOVÉ PROFESIONÁLNÍ

- čelisti na kabely a lanka

Cr-Mo

HRC 58-62

Č.p.	specifikace	max. Ø drátu	max. Ø lanka	max. Ø kabelu	
17055	14' 360 mm	max. 5 mm < 45 HRC	max. 3,5 mm	max. 8 mm	1
17056	18' 460 mm	max. 6 mm < 45 HRC	max. 5 mm	max. 10 mm	1
17057	24' 610 mm	max. 8 mm < 45 HRC	max. 7 mm	max. 12 mm	1
17058	30' 760 mm	max. 10 mm < 45 HRC	max. 9 mm	max. 14 mm	1
17046	35' 900 mm	max. 12 mm < 45 HRC	max. 10 mm	max. 16 mm	1



FESTA

KLEŠTĚ PÁKOVÉ PROFESIONÁLNÍ

Cr-Mo

HRC 58-62

Č.p.	specifikace	max. Ø drátu	
17051	14' 360 mm	max. 5 mm < 45 HRC	1
17052	18' 450 mm	max. 6 mm < 45 HRC	1
17053	24' 610 mm	max. 8 mm < 45 HRC	1
17054	30' 760 mm	max. 10 mm < 45 HRC	1
17048	36' 910 mm	max. 12 mm < 45 HRC	1



KLEŠTĚ PÁKOVÉ

Č.p.	specifikace	max. Ø drátu	
17028	14' 350 mm	max. 5 mm < 30 HRC	30
17020	18' 450 mm	max. 6 mm < 30 HRC	6
17021	24' 610 mm	max. 8 mm < 30 HRC	10
17022	30' 760 mm	max. 10 mm < 30 HRC	5



NEW



FESTA

KLEŠTĚ ŠTÍPACÍ

- měkký drát: Ø 6 mm
- středně tvrdý drát: Ø 5 mm
- tvrdý drát: Ø 4 mm

CrV

Č.p.	specifikace	
17078	200 mm	12

KLEŠTĚ PÁKOVÉ

max. Ø
5 mm

Č.p.	specifikace	
17038	8' 210 mm	10



FESTA

KLEŠTĚ ŠTÍPACÍ ČELNÍ

CrV

Č.p.	specifikace	
17300	160 mm	1
17301	180 mm	10
17302	200 mm	6
17303 NEW	250 mm	1

FESTA

KLEŠTĚ RABITOVÉ

CrV

Č.p.	specifikace	
17305	220 mm	5
17306 NEW	250 mm	1
17304	275 mm	6



KLEŠTĚ ŠTÍPACÍ ČELNÍ

Č.p.	specifikace	
17015	160 mm	6
17016	180 mm	6
17017	200 mm	6

KLEŠTĚ RABITOVÉ

Č.p.	specifikace	
17019	220 mm	6
17083	275 mm	6



FESTA

KLEŠTĚ KLEMPÍŘSKÉ ROVNÉ

Č.p.	specifikace
17089	150 x 215 mm



2



FESTA

KLEŠTĚ KLEMPÍŘSKÉ ROVNÉ

Č.p.	specifikace
17093	95 x 270 mm



6



FESTA

KLEŠTĚ KLEMPÍŘSKÉ ROVNÉ

Č.p.	specifikace
17090	60 x 280 mm



10



FESTA

KLEŠTĚ KLEMPÍŘSKÉ VYHNUTÉ 45°

Č.p.	specifikace
17091	60 x 280 mm



10



FESTA

KLEŠTĚ KLEMPÍŘSKÉ VYHNUTÉ 90°

Č.p.	specifikace
17092	60 x 260 mm



10



FESTA

NŮŽKY NA PLECH

Cr-Mo **HRC 58-62**



Č.p.	specifikace
17112	rovné 40 260 mm
17117	pravé 40 260 mm
17122	levé 40 260 mm



FESTA

NŮŽKY NA PLECH

Cr-Mo **HRC 58-62**



Č.p.	specifikace
17111	rovné 40 250 mm
17116	pravé 40 250 mm
17121	levé 40 250 mm



FESTA

NŮŽKY NA PLECH

CrV



Č.p.	specifikace	
17170	50 250 mm	6



FESTA

NŮŽKY NA PLECH

CrV



Č.p.	specifikace	
17156	60 245 mm	6



FESTA

NŮŽKY NA PLECH

CrV



Č.p.	specifikace	
17155	70 260 mm	6



NŮŽKY NA PLECH

CrV

Č.p.	specifikace	
17167	70 300 mm	5



NŮŽKY NA PLECH

CrV

Č.p.	specifikace	
17165	60 250 mm	5



NŮŽKY NA PLECH

CrV

Č.p.	specifikace	
17169	35 250 mm	5



NŮŽKY PROSTŘIHOVACÍ NA PLECH

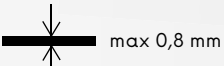

Č.p.	specifikace	
17186	265 mm	6



NÁSTAVEC NA STRÍHÁNÍ PLECHU

Max. tloušťka plechu

- 1,8 mm - ocel
- 1,2 mm - nerez
- 2 mm - plasty, hliník, měď

Č.p.	specifikace	
20363		5



NŮŽKY PÁKOVÉ

	17175	17177
	max. 4mm	5mm
	max. ø10mm	ø12mm
	max. 8x8mm	10x10mm

Č.p.	specifikace	
17175	150 mm	1
17177	250 mm	1



FESTA

KLEŠTĚ DĚROVACÍ



Č.p.	specifikace	
17185	Ø 2; 2,5; 3; 3,5; 4; 4,5 mm	12

FESTA

NŮŽKY NA PVC LIŠTY A TRUBKY

· Použití pro: lišty, trubky, profily



Č.p.	specifikace	
17050	60 220 mm ø 17 mm, ø 20 mm, ø 27 mm	8



NŮŽKY TECHNICKÉ

INOX



Č.p.	specifikace	
16420	60 200 mm	12



NŮŽKY

INOX



Č.p.	specifikace	
17159	65 220 mm	12



NŮŽKY TECHNICKÉ

INOX



Č.p.	specifikace	
17158	50 150 mm	10



NŮŽKY - SADA

INOX

3x



Č.p.	specifikace	
16401	3 ks	48



NŮŽKY

INOX



Č.p.	specifikace	
17160	70 210 mm	12



NŮŽKY

INOX

Č.p.	specifikace	
16405	14 cm	24
16406	17 cm	24
16407	19 cm	24
16408	21,5 cm	12

FESTA®

10 years
guarantee

GOLA SADY

- použití v průmyslu a servisech
- kvalitní Chrom vanadiová ocel
- ráčna se 72 vybroušenými zuby pro tu nejpřesnější práci
- všechny komponenty dle DIN normy
- vroubkované hlavice pro zlepšení úchopu
- odolné plechové nebo plastové kufry



made by

HONITON

FESTA made by **HONITON**

GOLA SADA

- 1/2" · 72 T
- 1/2" · 125 mm
- 1/2" · 8-9-10-11-12-13-14-15-17-19-22 mm

CrV **1/2"** **13x**

Č.p. specifikace

17210



10 years
guarantee



1

FESTA made by **HONITON**

GOLA SADA

- 1/4" · 72 T
- 1/4" · 50 mm, 100 mm
- 1/4"
- 1/4" · 4-4,5-5-5,5-6-7-8-9-10-11-12-13 mm

CrV **1/4"** **17x**

Č.p. specifikace

17211







10 years
guarantee

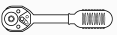
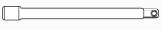

1

FESTA made by **HUNTON**

GOLA SADA

-  1/2"
-  1/2" · 125 mm, 250 mm
-  1/2"
-  16 mm, 21 mm
-  1/2"
-  1/2" · 10-11-12-13-14-15-16-17-18-19-20-21-22-23-24-27-30-32 mm

CrV **1/2"** **25x**









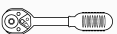

Č.p. specifikace
17212

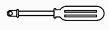

4

FESTA made by **HUNTON**

GOLA SADA

-  1/2", 1/4" · 72 T
-  1/2", 1/4"
-  1/4" · 150 mm
-  1/4" · 100 mm
-  1/2", 1/4"
-  1/2" · 125 mm, 250 mm
-  1/4" · 4-4,5-5-5,5-6-7-8-9-10-11-12-13 mm
-  1/2" · 10-11-12-13-14-15-17-19-21-22-24-27-30-32 mm
-  16 mm, 21 mm
-  18x

Inbus 3x

CrV **1/2"** **1/4"** **59x**







Č.p. specifikace
17214

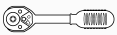

4

FESTA made by **HUNTON**

GOLA SADA

-  1/2" · 72 T
-  1/2" · 125 mm, 250 mm
-  1/2"
-  16 mm, 21 mm
-  1/2"
-  1/2"
-  1/2" · 8-9-10-11-12-13-14-15-16-17-18-19-20-21-22-23-24-27-30-32 mm

CrV **1/2"** **28x**



Č.p. specifikace
17213



4

FESTA made by **HUNTON**

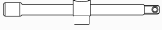
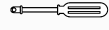
GOLA SADA

-  1/4" · 72 T
-  1/4" · 50 mm
-  1/4"
-  1/4"
-  1/4" · 4-4,5-5-5,5-6-7-8-9-10-11-12-13 mm

CrV **1/4"** **16x**

Č.p. specifikace
17215



1



FESTA made by **HUNTON**

GOLA SADA

- 1/2" · 72 T
- 1/2" · 125 mm, 250 mm
- 1/2"
- 16 mm, 21 mm
- 1/2"
- 1/2" · 10-11-12-13-14-15-16-17-18-19-20-21-22-23-24-27-30-32 mm

CrV **1/2"** **25x**

Č.p. specifikace

17216



10 years guarantee



10

FESTA made by **HUNTON**

GOLA SADA

- 1/4" · 72 T
- 1/4" · 50 mm
- 1/4"
- 1/4"
- 1/4"
- 1/4" · 4-4,5-5-5,5-6-7-8-9-10-11-12-13 mm
- 12x

Inbus 3x

CrV **1/4"** **32x**

Č.p. specifikace

17217



10 years guarantee



1

FESTA made by **HUNTON**

GOLA SADA

- 1/2", 1/4" · 72 T
- 1/2", 1/4"
- 1/4" 150 mm
- 1/4" 100 mm
- 1/2", 1/4"
- 1/2" · 125 mm, 250 mm
- 1/4" · 4-4,5-5-5,5-6-7-8-9-10-11-12-13 mm
- 1/2" · 10-11-12-13-14-15-17-19-21-22-24-27-30-32 mm
- 16 mm, 21 mm
- 16x

Inbus 3x

CrV **1/4"** **1/2"** **56x**

Č.p. specifikace

17218



10 years guarantee



4

FESTA made by **HUNTON**

GOLA SADA

- 1/2", 1/4" · 72 T
- 1/2", 1/4"
- 1/4"
- 1/4" · 50 mm, 100 mm
- 1/2", 1/4"
- 1/2", 1/4"
- 1/2" 125 mm, 250 mm
- 1/4" · 4-4,5-5-5,5-6-7-8-9-10-11-12-13-14 mm
- 1/2" · 10-11-12-13-14-15-17-19-21-22-24-27-30-32 mm
- 1/4" · 6-7-8-9-10-11-12-13 mm
- 1/2" · 14-15-17-19-22 mm
- 16 mm, 21 mm
- 34x

Inbus 3x

CrV **1/4"** **1/2"** **94x**

Č.p. specifikace

17219









10 years guarantee

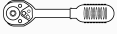

3

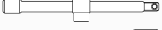
FESTA made by **HUNTON**

GOLA SADA

-  1/2" · 72 T
-  1/2" · 125 mm, 250 mm
-  1/2"
-  16 mm, 21 mm
-  1/2"
-  1/2" · 8-9-10-11-12-13-14-15-16-17-18-19-20-21-22-23-24-27-30-32 mm

CrV **1/2"** **27x**





Č.p. specifikace
17225



4

FESTA made by **HUNTON**

GOLA SADA

-  3/4" · 72 T
-  3/4" · 100 mm, 200 mm
-  3/4" · 460 mm
-  3/4" · 22-24-27-30-32-36-38-41-46-50 mm

CrV **3/4"** **14x**





Č.p. specifikace
17226

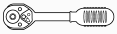

1

FESTA made by **HUNTON**

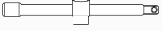
GOLA SADA

-  3/4" · 72 T
-  3/4" · 100 mm, 200 mm, 400 mm
-  3/4" · 460 mm
-  3/4" · 19-21-22-23-24-26-27-29-30-32-35-36-38-41-46-50 mm

CrV **3/4"** **21x**

Č.p. specifikace
17227



1



FESTA made by **HUNTON**

SADA HLAVIC INBUS

-  1/2" HEX · 4-5-6-7-8-10-12-14-17 mm

CrV **1/2"** **9x**

Č.p. specifikace
17345



1



FESTA made by **HUNTON**

SADA HLAVIC TORX

-  T20-T25-T27-T30-T40-T45-T50-T55-T60 mm

CrV **1/2"** **9x**

Č.p. specifikace
17346



1



FESTA made by **HUNTON**

HLAVICE NA KOLA

Cr-Mo 1/2" 3x

Č.p.	specifikace	
17336	17 mm	5
17337	19 mm	5
17338	21 mm	5



FESTA made by **HUNTON**

HLAVICE NA KOLA

1/2" · 17-19-21 mm

Cr-Mo 1/2" 3x

Č.p.	specifikace	
17335		1



FESTA made by **HUNTON**

RÁČNA

CrV

Č.p.	specifikace	
17220	1/4" 36 zubů	20
17222	3/8" 36 zubů	10
17224	1/2" 36 zubů	6
17208	1/2" 72 zubů	6



SADA NÁSTRČNÝCH HLAVIC DRIVELOCK

4-5-5,5-6-7-8-9-10-11-12-13 mm

CrV 1/4" 12x

Č.p.	specifikace	
17250		10



SADA NÁSTRČNÝCH HLAVIC TORX

1/4" · 5-6-7-8-10

1/2" · 12-14-16-18

CrV 1/2" 1/4" 9x

Č.p.	specifikace	
17255		4



FESTA®

10 years
guarantee



Cr-Mo

GOLA SADY

- použití v průmyslu a servisech
- vysoce kvalitní Chrom vanadiová ocel
- ráčna se 72 vybroušenými zuby pro tu nejpřesnější práci
- všechny komponenty dle DIN normy
- vroubkované hlavice pro zlepšení úchopu
- odolný kufr s kovovými zámky a kovovými panty



FESTA

SADA NÁŘADÍ

- | | |
|--|--|
| 1/2" · 1/4" | 1/4" · S 4 · 5.5 · 6.5 |
| 1/4" · 4-5-6-7-8-9mm | 1/4" · PH 1 · 2 · 3 |
| 1/2" · 10-12-13-14-17-19mm | 1/4" · PZ 2 · 3 |
| 1/4" · 4-4.5-5-5.5-6-7-8-9-10-11-12-13-14mm | 1/4" · H 3 · 4 · 5 · 6 |
| 1/2" · 12-13-14-15-16-17-18-19-20-21-22-24mm | 1/4" · T 8 · 10 · 15 · 20 · 25 |
| 1/2" · 1/4" | 1/4" · TTa · 10 · 15 · 20 · 25 · 40 |
| 1/4" · 1/4" → A4+ | 2 · 2.5 · 3 · 4 · 5 · 6 · 7 · 8 · 10mm |
| 1/4" · 150mm | 8-9-10-11-12-13-14-15-16-17-18-19mm |
| 1/2" · 254mm | S 4x100 · 6.5x150 |
| 1/2" · 1/4" | PH 2x100 · 3x150 |
| 1/2" · 16-21mm | 180mm |
| 1/4" · 150mm | 160mm |
| 1/2" · E10-E12-E14-E16-E18-E20-E22-E24 | 160mm |
| 1/4" · S 3 · 4 · 5 · 6 | 250mm |
| 1/4" · PH 0 · 1 · 2 | 300g |
| 1/4" · PZ 0 · 1 · 2 | |



CrV S2 1/4" 1/2" 72T 122x ERGO HANDLE

č.p. 17238 specifikace 122 ks



1

FESTA

GOLA SADA

- 1/2" · 72T
- 1/2" · 125 mm
- 1/2" · 10-11-12-13-14-15-17-19-22-24 mm

CrV 1/2" 72T 12x ERGO HANDLE

č.p. 17245 specifikace 15

10 years
guarantee



15

FESTA

GOLA SADA

- 1/2" · 72T
- 1/2" · 125 mm
- 1/2" · 10-11-12-13-14-15-17-19-22-24 mm

CrV 1/2" 72T 12x ERGO HANDLE

č.p. 17229 specifikace 8

10 years
guarantee



8

FESTA

GOLA SADA

- 1/2" · 72 T
- 1/2" · 75, 125 mm
- 1/2"
- 1/2" · 10-11-12-13-14-15-16-17-18-19-22-24 mm
- 1/2" · 17mm, 19mm
- 3-cestný adaptér
- 16mm, 21mm



Č.p. specifikace

17230



4

FESTA

GOLA SADA

- 1/4" · 72 T
- 1/4" · 50, 100 mm
- 1/4"
- 1/4" · 4-5-5,5-6-7-8-10-11-12-13 mm
- 1/4" · 6-7-8-10-12-13 mm
- 3-cestný adaptér
- 4 x
- 11x
- 1x



Č.p. specifikace

17231



10

FESTA

GOLA SADA

- 1/4"
- 1/4"
- 1/4" · 4-4,5-5-5,5-6-7-8-9-10-11-12-13-14 mm
- 1/4" · 50 mm, 100 mm
- 1/4"
- 1/4"
- 21 x
- 1/4"
- L 1/4"



Č.p. specifikace

17233



10

FESTA

GOLA SADA

- 1/2", 1/4" · 72T
- 1/4"
- 16 mm, 21 mm
- 1/4" · 10-11-12-13-14-15-16-17-18-19-20-21-22-23-24-27 mm
- 1/4" · 100 mm
- 1/2" · 125 mm, 250 mm
- 1/2"
- 1x
- 1/4" · 4-5-5,5-6-7-8-10-11-12-13 mm
- 33 x

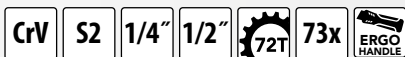

Č.p. specifikace

17234



4

**FESTA**

GOLA SADA

- 1/2", 1/4" · 72T
- 1/4"
- 16 mm, 21 mm
- 1/4" · 4 -4,5-5-5,5-6-7-8-9-10-11-12-13-14 mm
- 1/2" · 10-11-12-13-14-15-16-17-18-19-20-21-22-23-24-27-30-32 mm
- 1/4" · 6-7-8-9-10-11-12-13 mm
- 1/2" · 14-15-17-19 mm
- 1/4" · 50 mm, 100 mm
- 1/2" · 125 mm, 250 mm
- 1/4"
- 5/16" nástavec na bity
- 17x
- 15x
- 3-cestný adaptér
- 3 x
- 1/4"
- L 1/4"
- 1/2", 1/4"

CrV S2 1/4" 1/2" 72T 94x ERGO HANDLE

Č.p. specifikace

17235



10 years guarantee



4

FESTA

GOLA SADA

- 1/2", 1/4" · 72T
- 150 mm
- 16 mm, 21 mm
- 1/4" · 4 -4,5-5-5,5-6-7-8-9-10-11-12-13-14 mm
- 1/2" · 10-11-12-13-14-15-16-17-18-19-20-21-22-24-27-30-32 mm
- 1/4" · 6-7-8-9-10-11-12-13 mm
- 1/2" · 14-15-17-19-22 mm
- 1/4" · 50 mm, 100 mm
- 1/2" · 125 mm, 250 mm
- E · 4-5-6-7-8-10-11-12-14-16-18-20-24-27-30-32 mm
- 1/2", 1/4"
- 5/16" nástavec na bity
- 18 x
- 17 x
- 3-cestný adaptér
- 4 x
- 1/4"
- L 1/4"

CrV S2 1/4" 1/2" 72T 110x ERGO HANDLE

Č.p. specifikace

17236



10 years guarantee



4

FESTA

GOLA SADA

- 1/2", 1/4", 3/8"
- 1/4" · 4-5-6-7-8-9-10mm
- 3/8" · 10-11-12-13-14-15mm
- 1/2" · 16-17-18-19-22mm
- 1/4" · 4-4,5-5-5,5-6-7-8-9-10-11-12-13-14mm
- 3/8" · 10-11-12-13-14-15-16-17-18-19mm
- 1/2" · 10-11-12-13-14-15-16-17-18-19-20-21-22-24-27-30-32mm
- 1/4" · E4-E5-E6-E7-E8
- 3/8" · E10-E11-E12-E14-E16-E18
- 1/2" · E20-E24
- 1/2" · 24x
- 1/4" · 20x
- 1/4" · 30x
- 1/4" · 50 mm, 100 mm
- 1/2" · 125 mm, 250 mm
- 3/8" · 150 mm
- 1/2" · 16-21mm
- 3/8" · 18mm
- 1/2", 1/4", 3/8" bit holder
- 1/2", 1/4", 3/8"
- 1/4" · 150mm
- 1/4" · 115mm
- Inbus 7X

CrV S2 1/4" 1/2" 3/8" 72T 171x ERGO HANDLE

Č.p. specifikace

17237



10 years guarantee



2



RÁČNY FESTA

- ráčna je vyrobená z nejkvalitnější Chrom vanadiové oceli
- ráčna se 72 vybroušenými zuby pro tu nejpřesnější práci
- kvalitní, ergonomická, dvoukomponentní rukojeť z měkké TPE gumy
- SYSTÉM QUICK RELEASE pro snadnou a rychlou výměnu hlavice



RÁČNA



Č.p.	specifikace	délka	
17297	1/4"	155 mm	6
17298	3/8"	210 mm	5
17299	1/2"	255 mm	4



RÁČNA



Č.p.	specifikace	délka	
17240	1/4"	155 mm	10
17241	3/8"	200 mm	10
17242	1/2"	250 mm	5



RÁČNA



Č.p.	specifikace	délka	
17294	1/4"	155 mm	6
17295	3/8"	205 mm	10
17296	1/2"	255 mm	4



RÁČNA OTOČNÁ 1/4"



Č.p.	specifikace	
17292	1/4"	1



RÁČNA



Č.p.	specifikace	
17243	1/4"	25
17244	1/2"	25



ŠROUBOVÁK NA HLAVICE

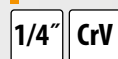

Č.p.	specifikace	
18603	1/4" 150 mm	10

NEW



HLAVICE UNIVERZÁLNÍ



Č.p.	specifikace	
17812	10 - 19 mm	1



HLAVICE UNIVERZÁLNÍ

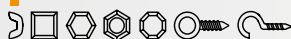

Č.p.	specifikace	
17810	pro šrouby 7 - 19mm • 52mm x ø26mm	1



HLAVICE UNIVERZÁLNÍ

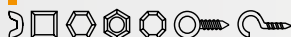

Č.p.	specifikace	
17811	pro šrouby 11 - 32mm • 83mm x ø43mm	5

FESTA

HLAVICE PRODLOUŽENÁ 1/4"



Č.p.	specifikace		Č.p.	specifikace	
17860	4 mm • 50 mm	10	17866	10 mm • 50 mm	10
17861	5 mm • 50 mm	10	17867	11 mm • 50 mm	10
17862	6 mm • 50 mm	10	17868	12 mm • 50 mm	10
17863	7 mm • 50 mm	10	17869	13 mm • 50 mm	10
17864	8 mm • 50 mm	10	17870	14 mm • 50 mm	10
17865	9 mm • 50 mm	10			



FESTA

HLAVICE 1/4"



Č.p.	specifikace		Č.p.	specifikace	
17820	4 mm • 25 mm	10	17827	9 mm • 25 mm	10
17821	4,5 mm • 25 mm	10	17828	10 mm • 25 mm	10
17822	5 mm • 25 mm	10	17829	11 mm • 25 mm	10
17823	5,5 mm • 25 mm	10	17830	12 mm • 25 mm	10
17824	6 mm • 25 mm	10	17831	13 mm • 25 mm	10
17825	7 mm • 25 mm	10	17832	14 mm • 25 mm	10
17826	8 mm • 25 mm	10			



FESTA

HLAVICE PRODLOUŽENÁ 1/2"



Č.p.	specifikace		Č.p.	specifikace	
17871	10 mm • 70 mm	10	17882	21 mm • 70 mm	10
17872	11 mm • 70 mm	10	17883	22 mm • 70 mm	10
17873	12 mm • 70 mm	10	17884	23 mm • 70 mm	10
17874	13 mm • 70 mm	10	17885	24 mm • 70 mm	10
17875	14 mm • 70 mm	10	17886	25 mm • 70 mm	10
17876	15 mm • 70 mm	10	17887	26 mm • 70 mm	10
17877	16 mm • 70 mm	10	17888	27 mm • 70 mm	10
17878	17 mm • 70 mm	10	17889	28 mm • 70 mm	10
17879	18 mm • 70 mm	10	17890	30 mm • 70 mm	10
17880	19 mm • 70 mm	10	17891	32 mm • 70 mm	10
17881	20 mm • 70 mm	10	17892	34 mm • 70 mm	10

FESTA

HLAVICE 1/2"



Č.p.	specifikace		Č.p.	specifikace	
17308	8 mm • 38 mm	10	17319	19 mm • 38 mm	10
17309	9 mm • 38 mm	10	17320	20 mm • 38 mm	10
17310	10 mm • 38 mm	10	17321	21 mm • 38 mm	10
17311	11 mm • 38 mm	10	17322	22 mm • 38 mm	10
17312	12 mm • 38 mm	10	17323	24 mm • 38 mm	10
17313	13 mm • 38 mm	10	17327	27 mm • 42 mm	20
17314	14 mm • 38 mm	10	17330	30 mm • 42 mm	25
17315	15 mm • 38 mm	10	17332	32 mm • 42 mm	20
17316	16 mm • 38 mm	10	17333	34 mm • 42 mm	20
17317	17 mm • 38 mm	10	17334	36 mm • 42 mm	20
17318	18 mm • 38 mm	10			





FESTA

HLAVICE 3/4"



Č.p.	specifikace	
17835	17 mm · 48 mm	10
17836	18 mm · 48 mm	10
17837	19 mm · 48 mm	10
17838	21 mm · 48 mm	10
17839	22 mm · 48 mm	10
17840	24 mm · 48 mm	10
17841	26 mm · 48 mm	10
17842	27 mm · 52 mm	10
17843	28 mm · 52 mm	10
17844	30 mm · 52 mm	10
17845	32 mm · 52 mm	10

Č.p.	specifikace	
17846	33 mm · 55 mm	10
17847	36 mm · 60 mm	10
17848	38 mm · 60 mm	10
17849	41 mm · 65 mm	10
17850	46 mm · 65 mm	10
17851	50 mm · 70 mm	10
17852	55 mm · 75 mm	10
17853	60 mm · 78 mm	10
17854	65 mm · 82 mm	10
17855	70 mm · 82 mm	10
17856	75 mm · 88 mm	10



FESTA

HLAVICE MULTILOCK 1/4"



Č.p.	specifikace	
17895	4 mm · 25 mm	10
17896	4,5 mm · 25 mm	10
17897	5 mm · 25 mm	10
17898	5,5 mm · 25 mm	10

Č.p.	specifikace	
17902	9 mm · 25 mm	10
17904	11 mm · 25 mm	10
17905	12 mm · 25 mm	10
17907	14 mm · 25 mm	10



FESTA

HLAVICE MULTILOCK 1/2"



Č.p.	specifikace	
17910	8 mm · 38 mm	10
17912	10 mm · 38 mm	10
17913	11 mm · 38 mm	10
17914	12 mm · 38 mm	10
17916	14 mm · 38 mm	10

Č.p.	specifikace	
17922	21 mm · 38 mm	10
17924	24 mm · 38 mm	10
17925	27 mm · 38 mm	10
17926	30 mm · 38 mm	10
17927	32 mm · 38 mm	10



FESTA

HLAVICE TORX 1/4"



Č.p.	specifikace	
17930	E4	10
17931	E5	10
17932	E6	10

Č.p.	specifikace	
17933	E7	10
17934	E8	10
17935	E10	10



FESTA

HLAVICE TORX 1/2"



Č.p.	specifikace	
17943	E22	10
17944	E24	10



FESTA

NÁSTAVEC ŠROUBOVACÍ 1/4"

CrV S2  1/4"



Č.p.	specifikace	
18920	S 4 mm	10
18921	S 5,5 mm	10
18922	S 7 mm	10



FESTA

NÁSTAVEC ŠROUBOVACÍ 1/4"

CrV S2  1/4"



Č.p.	specifikace	
18925	PH 1	10
18926	PH 2	10
18927	PH 3	10



FESTA

NÁSTAVEC ŠROUBOVACÍ 1/4"

CrV S2  1/4"



Č.p.	specifikace	
18928	PZ 0	10
18929	PZ 1	10
18930	PZ 2	10
18931	PZ 3	10



FESTA

NÁSTAVEC ŠROUBOVACÍ 1/2"

CrV S2  1/2"



Č.p.	specifikace	
18971	M 16	10



FESTA

NÁSTAVEC ŠROUBOVACÍ 1/4"

CrV S2  1/4"



Č.p.	specifikace	
18934	3 mm	10
18937	6 mm	10
18939	8 mm	10



FESTA

NÁSTAVEC ŠROUBOVACÍ 1/2"

CrV S2  1/2"



Č.p.	specifikace	
18944	12 mm	10
18945	14 mm	10



FESTA

NÁSTAVEC ŠROUBOVACÍ 1/4"

CrV S2  1/4"



Č.p.	specifikace	
18948	T 5	10
18950	T 8	10
18951	T 10	10



FESTA

NÁSTAVEC ŠROUBOVACÍ 1/2"

CrV S2  1/2"



Č.p.	specifikace		Č.p.	specifikace	
18954	T 10	10	18960	T 40	10
18955	T 15	10	18961	T 45	10
18956	T 20	10	18963	T 55	10
18957	T 25	10			



FESTA
ADAPTÉR

CrV



Č.p.	specifikace		
17410	A - 1/4"	B - 3/8"	10
17411	A - 3/8"	B - 1/4"	10
17412	A - 3/8"	B - 1/2"	10
17413	A - 1/2"	B - 3/8"	10

Č.p.	specifikace		
17414	A - 1/2"	B - 3/4"	10
17415	A - 3/4"	B - 1/2"	10
17416	A - 1/4"	B - 1/2"	10



FESTA
KARDAN

CrV



Č.p.	specifikace	
17405	1/4" · 39 mm	10
17406	1/2" · 71 mm	10
17407	3/4" · 105 mm	10



FESTA
JEZDEC NA „T“ VRATIDLO

CrV



Č.p.	specifikace	
17420	1/4"	1
17421	1/2"	1
17422	3/4"	1



FESTA
„T“ VRATIDLO

CrV



Č.p.	specifikace	
17382	1/4" · 115 mm	1
17383	3/8" · 190 mm	1
17384	1/2" · 250 mm	1
17385	3/4" · 460 mm	1
17386	1" · 640 mm	1



FESTA
„T“ NÁSTAVEC PRODLOUŽENÝ S KLOUBEM

CrV



Č.p.	specifikace	
17401	1/4" · 250 mm	1
17402	1/2" · 400 mm	1



FESTA
VRATIDLO KLOUBOVÉ - TRHÁK

CrV



Č.p.	specifikace	
17380	1/2" · 350 mm	1
17381	3/4" · 500 mm	1



FESTA
RUKOJEŘ OHNUTÁ

CrV 1/2"



Č.p.	specifikace	
17427	1/2" · 60 x 320 mm	1

FESTA

NÁSTAVEC PRODLUŽOVACÍ

CrV

Č.p.	specifikace	
17390	1/4" · 50 mm	1
17391	1/4" · 100 mm	1
17392	1/4" · 150 mm	1
17393	1/2" · 75 mm	1
17394	1/2" · 125 mm	1

Č.p.	specifikace	
17395	1/2" · 250 mm	1
17396	3/4" · 100 mm	1
17397	3/4" · 200 mm	1
17398	3/4" · 400 mm	1



FESTA

NÁSTAVEC FLEXIBILNÍ

CrV 1/4"

Č.p.	specifikace	
17400	1/4" · 150 mm	1



Stahlberg

ADAPTÉR RÁČNA 1/4" - BIT

CrV

1/4" ↔ 1/4"

Č.p.	specifikace	
18619		5



SADA ADAPTÉRŮ DO VRTAČKY

CrV 1/4" 3x

Č.p.	specifikace	
18604	1/4", 3/8", 1/2"	10



NEW



KLÍČ ODVZDUŠŇOVACÍ PRO TOPNÁ TĚLESA SE ZÁSOBNÍKEM



Č.p.	specifikace	
17459	50 ml	1

FESTA

KLÍČ NA RADIÁTOROVÉ ŠROUBENÍ

CrV 1/2"

Č.p.	specifikace	
17455	pro ráčnu 1/2"	10

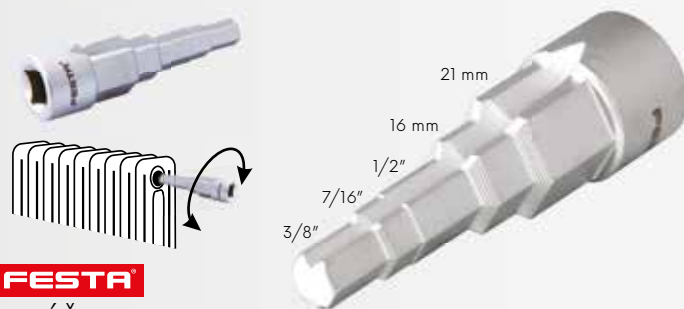

NEW

FESTA

KLÍČ K ROZVODNÝM SKŘÍNÍM

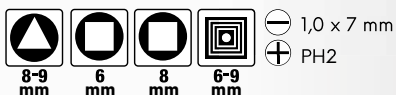

Č.p. / No.	specifikace	
17458		1

FESTA

KLÍČ UNIVERZÁLNÍ K ROZVODNÝM SKŘÍNÍM

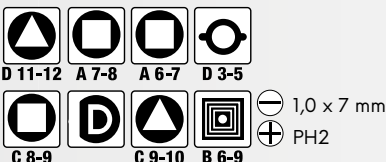

Č.p.	specifikace	
17456		50



FESTA[®]

KLÍČE FESTA

- kované klíče z kvalitní CrV oceli
- vyrobeno dle DIN normy
- chromová povrchová úprava



FESTA

KLÍČ OBOUSTRANNÝ OTEVŘENÝ

CrV **DIN 3110**



Č.p.	specifikace	
17550	6 x 7 mm	10
17551	8 x 9 mm	10
17552	8 x 10 mm	10
17553	10 x 11 mm	10
17590	10 x 13 mm	10
17554	12 x 13 mm	10
17555	14 x 15 mm	10
17556	13 x 16 mm	10
17557	13 x 17 mm	10
17591	14 x 17 mm	10
17558	16 x 17 mm	10
17559	17 x 19 mm	10
17560	18 x 19 mm	10

Č.p.	specifikace	
17592	19 x 22 mm	10
17593	19 x 24 mm	10
17561	20 x 22 mm	10
17569	21 x 23 mm	10
17548	22 x 24 mm	10
17562	24 x 27 mm	10
17549	24 x 30 mm	10
17563	30 x 32 mm	10
17564	30 x 34 mm	10
17565	32 x 36 mm	10
17566	36 x 41 mm	10
17567	46 x 50 mm	10
17568	50 x 55 mm	3

FESTA

KLÍČ OČKOPLOCHÝ

CrV **DIN 3113**



Č.p.	specifikace	
17487	6 mm	10
17570	7 mm	10
17571	8 mm	10
17572	9 mm	10
17573	10 mm	10
17574	11 mm	10
17575	12 mm	10
17576	13 mm	10
17577	14 mm	10
17578	15 mm	10
17579	16 mm	10
17580	17 mm	10
17581	18 mm	10
17582	19 mm	10
17488	20 mm	10

Č.p.	specifikace	
17489	21 mm	10
17583	22 mm	10
17490	23 mm	10
17584	24 mm	10
17491	25 mm	10
17492	26 mm	10
17585	27 mm	10
17493	28 mm	10
17494	29 mm	10
17586	30 mm	10
17587	32 mm	10
17495	33 mm	10
17496	34 mm	10
17589	36 mm	10



FESTA

KLÍČ RÁČNOVÝ KLOUBOVÝ

CrV **72T**



Č.p.	specifikace	
17628	8 mm	10
17622	10 mm	10
17623	13 mm	10
17624	14 mm	10
17629	15 mm	10
17630	16 mm	5

Č.p.	specifikace	
17625	17 mm	10
17631	18 mm	10
17626	19 mm	10
17632	21 mm	5
17633	22 mm	5

FESTA

KLÍČ RÁČNOVÝ

CrV **72T**



Č.p.	specifikace	
17660	6 mm	10
17676	7 mm	10
17661	8 mm	10
17662	9 mm	10
17663	10 mm	10
17664	11 mm	10
17665	12 mm	10
17666	13 mm	10
17667	14 mm	10
17668	15 mm	10

Č.p.	specifikace	
17669	16 mm	10
17670	17 mm	10
17671	18 mm	10
17672	19 mm	10
17674	21 mm	5
17675	22 mm	5
17677	24 mm	5
17678	27 mm	5
17679	30 mm	5
17683	32 mm	5

**FESTA**

KLÍČ OČKOVÝ VYHNUTÝ

CrV **DIN 838**

Č.p.	specifikace	
17605	6 x 7 mm	10
17606	8 x 9 mm	10
17607	8 x 10 mm	10
17608	10 x 11 mm	10
17609	12 x 13 mm	10
17611	13 x 16 mm	10
17612	13 x 17 mm	10

Č.p.	specifikace	
17610	14 x 15 mm	10
17613	16 x 17 mm	10
17614	18 x 19 mm	10
17615	20 x 22 mm	10
17616	24 x 27 mm	10
17617	30 x 32 mm	10

**FESTA**

KLÍČ OBOUSTRANNÝ OTEVŘENÝ DIN 895

DIN 895

Č.p.	specifikace	
17460	6 x 7 mm	10
17461	8 x 9 mm	10
17462	8 x 10 mm	10
17463	10 x 11 mm	10
17481	10 x 13 mm	10
17464	12 x 13 mm	10
17465	14 x 15 mm	10
17466	13 x 16 mm	10
17467	13 x 17 mm	10
17482	14 x 17 mm	10
17468	16 x 17 mm	10

Č.p.	specifikace	
17469	17 x 19 mm	10
17470	18 x 19 mm	10
17483	19 x 22 mm	10
17484	19 x 24 mm	10
17471	20 x 22 mm	10
17472	24 x 27 mm	10
17486	21 x 23 mm	10
17480	28 x 30 mm	10
17473	30 x 32 mm	10
17485	36 x 41 mm	10

**FESTA**

KLÍČ OBOUSTRANNÝ OTEVŘENÝ

CrV **DIN 3110**

Č.p.	specifikace	
17761	14 x 15 mm	10
17769	20 x 22 mm	10

**FESTA**

KLÍČ OČKOPLOCHÝ

CrV **DIN 3113**

Č.p.	specifikace	
17788	14 mm	10
17789	15 mm	10

Č.p.	specifikace	
17795	21 mm	10
17806	33 mm	10



12-13-14-15 mm

16-17-18-19 mm

KLÍČ UNIVERZÁLNÍ

Cr-Mo

Č.p.	specifikace	
17685	12-13-14-15-16-17-18-19 mm	1

**FESTA**

KLÍČ STAVITELNÝ

CrV

Č.p.	rozsah	délka	
17197	0 - 29 mm	200 mm	1
17198	0 - 33 mm	250 mm	1
17199	0 - 38 mm	300 mm	1



KLÍČ STAVITELNÝ

Č.p.	rozsah	délka	
17200	0 - 24 mm	200 mm	6
17201	0 - 30 mm	250 mm	6
17202	0 - 34 mm	300 mm	6



FESTA

KLÍČ OBOUSTRANNÝ OTEVŘENÝ - SADA

CrV

DIN 3110



Č.p.	specifikace	
17506	6 ks · 6 x 7, 8 x 9, 10 x 11, 12 x 13, 14 x 15, 16 x 17	1
17508	8 ks · 6 x 7, 8 x 9, 10 x 11, 12 x 13, 14 x 15, 16 x 17, 18 x 19, 20 x 22	1



FESTA

KLÍČ OČKOPLOCHÝ - SADA

CrV

DIN 3113



Č.p.	specifikace	
17526	6 ks · 10 x 10, 11 x 11, 13 x 13, 14 x 14, 16 x 16, 17 x 17	1
17528	8 ks · 8 x 8, 10 x 10, 11 x 11, 13 x 13, 14 x 14, 16 x 16, 17 x 17, 19 x 19	1



FESTA

KLÍČ OČKOVÝ VYHNUTÝ - SADA

CrV

DIN 838

8x



Č.p.	specifikace	
17539	6 x 7, 8 x 9, 10 x 11, 12 x 13, 14 x 15, 16 x 17, 18 x 19, 20 x 22	1



FESTA

KLÍČ OBOUSTRANNÝ OTEVŘENÝ - SADA

CrV

DIN 3110

12x



Č.p.	specifikace	
17512	6 x 7, 8 x 9, 10 x 11, 12 x 13, 14 x 15, 16 x 17, 18 x 19, 20 x 22, 21 x 23, 24 x 27, 25 x 28, 30 x 32	1



FESTA

KLÍČ OČKOPLOCHÝ - SADA

CrV

DIN 3113



Č.p.	specifikace	
17532	12 ks · 8 x 8, 9 x 9, 10 x 10, 11 x 11, 13 x 13, 14 x 14, 16 x 16, 17 x 17, 18 x 18, 19 x 19, 21 x 21, 22 x 22	10
17533	18 ks · 6 x 6, 7 x 7, 8 x 8, 9 x 9, 10 x 10, 11 x 11, 12 x 12, 13 x 13, 14 x 14, 15 x 15, 16 x 16, 17 x 17, 18 x 18, 19 x 19, 20 x 20, 21 x 21, 22 x 22, 24 x 24	1
17534	25 ks · 6 x 6, 7 x 7, 8 x 8, 9 x 9, 10 x 10, 11 x 11, 12 x 12, 13 x 13, 14 x 14, 15 x 15, 16 x 16, 17 x 17, 18 x 18, 19 x 19, 20 x 20, 21 x 21, 22 x 22, 23 x 23, 24 x 24, 25 x 25, 26 x 26, 27 x 27, 28 x 28, 30 x 30, 32 x 32	4



FESTA

KLÍČ OTEVŘENÝ - SADA DIN 895

DIN 895



Č.p.	specifikace	
17475	8 ks · 6 x 7, 8 x 9, 10 x 11, 12 x 13, 14 x 15, 16 x 17, 18 x 19, 20 x 22	5
17476	12 ks · 6 x 7, 8 x 9, 10 x 11, 12 x 13, 14 x 15, 16 x 17, 18 x 19, 20 x 22, 21 x 23, 24 x 27, 28 x 30, 30 x 32	3



FESTA

KLÍČ RÁČNOVÝ - SADA

CrV 72T 7x

Č.p.	specifikace	
17620	8, 10, 12, 13, 14, 17, 19	5



FESTA

KLÍČ RÁČNOVÝ, KLOUBOVÝ - SADA

CrV 72T 7x

Č.p.	specifikace	
17621	10, 12, 13, 14, 15, 17, 19	5



FESTA

KLÍČ TRUBKOVÝ - SADA

CrV 7x



Č.p.	specifikace	
17501	6 x 7, 8 x 9, 10 x 11, 12 x 13, 14 x 15, 16 x 17, 18 x 19	20
17640	páka na trubkové klíče · 135 mm	50



FESTA

KLÍČ HÁKOVÝ

CrV



Č.p.	specifikace	
17680	19 - 51 mm 165 mm	5
17681	32 - 76 mm 216 mm	5
17682	51 - 121 mm 267 mm	5

FESTA

KLÍČ TRUBKOVÝ

CrV



Č.p.	specifikace		Č.p.	specifikace	
17650	6 x 7 mm	10	17655	16 x 17 mm	10
17651	8 x 9 mm	10	17645	16 x 18 mm	10
17642	8 x 10 mm	10	17653	16 x 21 mm	10
17652	10 x 11 mm	10	17656	18 x 19 mm	10
17643	12 x 13 mm	10	17657	19 x 22 mm	10
17654	14 x 15 mm	10	17659	22 x 24 mm	10
17644	14 x 17 mm	10	17658	24 x 27 mm	10



KLÍČ PRO ÚHLOVÉ BRUSKY, STAVITELNÝ



Č.p.	specifikace	
20967	200 mm	15

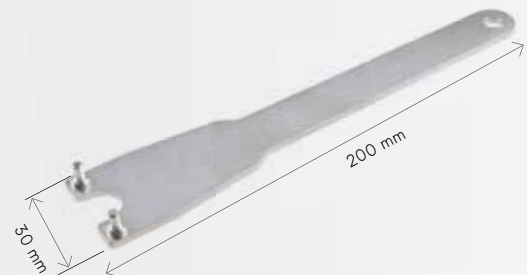

KLÍČ NA ÚHLOVÉ BRUSKY



Č.p.	specifikace	
20968	200 mm	1



FESTA

KLÍČ MOMENTOVÝ

Č.p.	specifikace	
17203	1/4" 5 - 25 Nm	1
17204	1/2" 19 - 110 Nm	1
17205	1/2" 42 - 210 Nm	1
17206	3/4" 140 - 700 Nm	1



FESTA

RÁČNA LEŠENÁŘSKÁ

Č.p.	specifikace	
17451	18 mm	10
17450	19 mm	10



KLÍČ NA KOLA



Č.p.	specifikace	
17600	17, 19, 22 mm, 13/16"	16

KLÍČ NA KOLA



Č.p.	specifikace	
17601	17, 19, 21 mm	20



KLÍČ TELESKOPICKÝ NA KOLA



Č.p.	specifikace	
17603	17 x 19 mm, 21 x 23 mm	20



KLÍČ NÁSTRČNÝ KLOUBOVÝ



Č.p.	specifikace	
17261	16 mm	1
17262	21 mm	1



FESTA

DRŽÁK MAGNETICKÝ



Č.p. specifikace

70098



12



FESTA

TELESKOP MAGNETICKÝ S LED OSVĚTLENÍM



Č.p. specifikace

13294



6

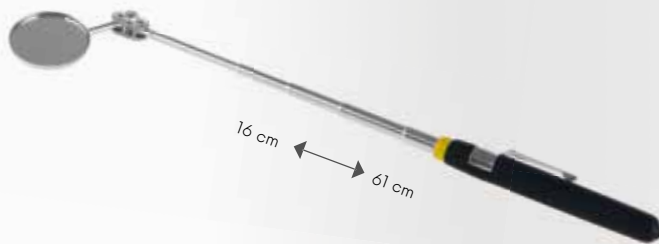

ZRCÁTKO INSPEKČNÍ TELESKOPIKÉ



Č.p. specifikace

13290



20

Č.p. specifikace

13293



20

TELESKOP MAGNETICKÝ

FESTA[®]

ŠROUBOVÁKY FESTA

- dřík z kvalitní S2 oceli
- magnetické koncovky
- ergonomická dvoukomponentní rukojeť s měkčenou TPE gumou



FESTA[®]

ŠROUBOVÁK PLOCHÝ



Č.p.	specifikace	
18113	3 x 75 mm	12
18114	4 x 100 mm	12
18115	5,5 x 125 mm	12
18116	6,5 x 150 mm	12
18118	8 x 175 mm	6
18120	10 x 200 mm	6



FESTA[®]

ŠROUBOVÁK PLOCHÝ KRÁTKÝ

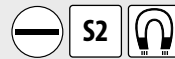

Č.p.	specifikace	
18124	5,5 x 38 mm	12
18125	6,5 x 38 mm	12



FESTA[®]

ŠROUBOVÁK PHILIPS



Č.p.	specifikace	
18210	0 x 75 mm	12
18211	1 x 75 mm	12
18212	2 x 100 mm	12



FESTA[®]

ŠROUBOVÁK PHILIPS KRÁTKÝ

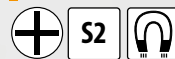

Č.p.	specifikace	
18215	1 x 38 mm	12
18216	2 x 38 mm	12



FESTA[®]

ŠROUBOVÁK POZIDRIVE



Č.p.	specifikace	
18310	0 x 75 mm	12
18311	1 x 100 mm	12
18312	2 x 100 mm	12
18313	3 x 150 mm	6



FESTA[®]

ŠROUBOVÁK POZIDRIVE KRÁTKÝ

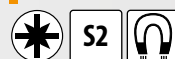

Č.p.	specifikace	
18321	1 x 38 mm	12
18322	2 x 38 mm	12

**FESTA**

ŠROUBOVÁK TORX



Č.p.	specifikace	
18350	T6	12
18351	T7	12
18352	T8	12
18353	T9	12
18354	T10	12
18355	T15	12

Č.p.	specifikace	
18356	T20	12
18357	T25	12
18358	T27	12
18359	T30	12
18360	T40	6

**FESTA**

NÁSTRČNÝ ŠROUBOVÁK



Č.p.	specifikace	
18455	6 mm	12
18456	7 mm	12
18460	13 mm	12

**FESTA**

ŠROUBOVÁK ÚDEROVÝ PLOCHÝ



Č.p.	specifikace	
18062	5,5 x 100 mm	12
18063	7 x 125 mm	6
18064	8 x 150 mm	8

Č.p.	specifikace	
18065	10 x 175 mm	6
18066	10 x 200 mm	6
18067	10 x 250 mm	6

**FESTA**

VDE ŠROUBOVÁK ELEKTRO PLOCHÝ



Č.p.	specifikace	
18088	3 x 75 mm S2	12
18089	4 x 100 mm CrV	12
18090	5,5 x 125 mm CrV	12
18091	6,5 x 150 mm CrV	12
18092	8 x 175 mm CrV	12

**FESTA**

ŠROUBOVÁK ÚDEROVÝ PHILIPS



Č.p.	specifikace	
18070	PH 1 x 80 mm	8
18071	PH 2 x 100 mm	12
18072	PH 3 x 150 mm	6

FESTA

VDE ŠROUBOVÁK ELEKTRO PHILIPS



Č.p.	specifikace	
18080	PH 0 x 60 mm S2	12
18081	PH 1 x 80 mm CrV	12
18082	PH 2 x 100 mm CrV	12
18083	PH 3 x 150 mm CrV	12

**FESTA**

ŠROUBOVÁK ÚDEROVÝ POZIDRIVE



Č.p.	specifikace	
18075	PZ 1 x 80 mm	12
18076	PZ 2 x 100 mm	12
18077	PZ 3 x 150 mm	6

FESTA

VDE ŠROUBOVÁK ELEKTRO POZIDRIVE



Č.p.	specifikace	
18084	PZ 0 x 60 mm S2	12
18085	PZ 1 x 80 mm CrV	12
18086	PZ 2 x 100 mm CrV	12
18087	PZ 3 x 150 mm CrV	12



FESTA

SADA ŠROUBOVÁKŮ

⊖ S 3x75 · 5x100 · 6x175 mm

⊕ PH 0 · 1 · 2 · 3



Č.p. specifikace
18402

6



FESTA

SADA ŠROUBOVÁKŮ A BITŮ

⊖ S 3 x 75 · 4x100 · 5,5x125 · 6,5 x 150 mm

⊕ PH 1 x 100 · 2 x 100 mm

○ adapter 1/4"

bity: ⊖ S 4 · 5 · 6 · 7

⊕ PH 1 · 2 · 3

⊗ PZ 1 · 2 · 3

⊛ T 10 · 15 · 20 · 25 · 30

● H 2 · 3 · 4 · 5 · 6



Č.p. specifikace
18422 27 ks

6



FESTA

SADA ŠROUBOVÁKŮ

⊖ S 3x75 · 5x100 · 6x150 mm

⊕ PH 0 · 1 · 2



Č.p. specifikace
18403

6



FESTA

SADA ŠROUBOVÁKŮ

⊖ S 3x60 · 6x100 · 6x125 mm

⊗ PZ 0 · 1 · 2



Č.p. specifikace
18404

6



FESTA

SADA ŠROUBOVÁKŮ TORX

⊛ T 10 · 15 · 20 · 25 · 30



Č.p. specifikace
18340

6

FESTA

SADA ŠROUBOVÁKŮ

⊖ S 6x38 · 5x75 · 6x100 · 8x150 mm
2,5x50 · S 3x50 mm

⊕ PH 2x38 · 1x75 · 2x100 · 3x150 mm
0x50 · 00x50 mm

⊗ T 5x50 · 6x50 · 7x50 · 8x50 · 9x50 · 10x50 mm



Č.p. specifikace
18424

6

**FESTA**

SADA ÚDEROVÝCH ŠROUBOVÁKŮ

⊖ S 5 · 6 · 8 mm

⊕ PH 1 · 2 · 3

CrV **6x**Č.p. specifikace
18423

10

**FESTA**

SADA ELEKTRO ŠROUBOVÁKŮ

⊖ S 4x100 · 5,5x125 mm · elektro zkoušečka 0 - 250 V

⊕ PH 0x60 · 1x80 · 2x100 mm

⊖ ⊕ **6x** 1000 V
IEC/EN60900

Č.p. specifikace

18413



6

**FESTA**

ŠROUBOVÁK ÚDEROVÝ

⊖ S 7 x 35 · 8 x 35 · 8 x 70 mm

⊕ PH 2 x 35 · 3 x 35 · 3 x 70 mm

CrV **6x**Č.p. specifikace
18411

1

**FESTA**

SADA ELEKTRO ŠROUBOVÁKŮ

⊖ S 4x100 · 5,5x125 · 6,5x150 mm · elektro zkoušečka 0 - 250 V

⊕ PH 0x75 · 1x100 · 2x100 mm

⊖ ⊕ **7x** 1000 V
IEC/EN60900:2004

Č.p. specifikace

18410



40

**FESTA**

OTVÍRÁK

Č.p. specifikace
18437

5



ELEKTRO ZKOUŠEČKA

DIN VDE 0680
73/23 EEC

⊖

Č.p. specifikace
18426 0 - 250 V

1



ŠROUBOVÁK PLOCHÝ



Č.p.	specifikace	
18101	4 x 75 mm	10
18102	4 x 100 mm	10
18103	5,5 x 100 mm	10
18104	5,5 x 125 mm	10
18105	6,5 x 100 mm	10
18106	6,5 x 125 mm	10
18107	8 x 160 mm	10
18108	10 x 160 mm	10



SADA ŠROUBOVÁKŮ A BITŮ

- ⊖ S 3x75 · 4x75 · 6x100 · 8x150 mm
 - ⊕ PH 1x75 · 2x100 mm
 - ⊙ adapter 1/4"
- bity:
- ⊖ S 4 · 5 · 6 · 7 mm
 - ⊕ PH 1 · 2 · 3
 - ⊗ PZ 1 · 2 · 3
 - ⊛ T 10 · 15 · 20
 - ⊙ ↔ ⊠ adapter



Č.p.	specifikace	
18418		10



ŠROUBOVÁK PHILIPS



Č.p.	specifikace	
18201	0 x 75 mm	10
18202	1 x 75 mm	10
18203	2 x 100 mm	10
18204	3 x 150 mm	10



SADA ŠROUBOVÁKŮ

- ⊖ S 3x60 · 4x75 · 6x100 · 6x125 mm
- ⊕ PH 0x60 · 1x75 · 2x100 mm



Č.p.	specifikace	
18400		10



ŠROUBOVÁK POZIDRIVE



Č.p.	specifikace	
18301	0 x 75 mm	10
18302	1 x 75 mm	10
18303	2 x 100 mm	10
18304	3 x 150 mm	10



SADA ŠROUBOVÁKŮ

- ⊖ S 3x60 · 6x100 · 6x125 mm
- ⊕ PH 1x75 · 2x100 mm



Č.p.	specifikace	
18401		1



FESTA

T ŠROUBOVÁK NA BITY S RÁČNOU

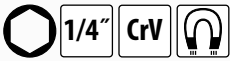

Č.p. specifikace

18608

6



FESTA

ŠROUBOVÁK NA BITY S RÁČNOU

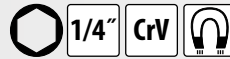

Č.p. specifikace

18433

6



FESTA

ŠROUBOVÁK NA BITY



Č.p. specifikace

18110

12



FESTA

FLEXI ŠROUBOVÁK NA BITY



Č.p. specifikace

18451

12



FESTA

ŠROUBOVÁK NA BITY + 7 BITŮ

⊖ S 5 · 6 mm

⊕ PH 1 · 2 · 3

★ T 15 · 20

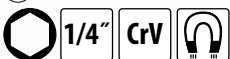

Č.p. specifikace

18425

10

FESTA

FLEXI ŠROUBOVÁK
NA HADICOVÉ SPONY



Č.p. specifikace

18450

7 mm

6





FESTA

ŠROUBOVÁK RÁČNOVÝ S BITY

1/4" → 1/4"

- ⊖ S 3 · 4 · 5 · 6 · 7 · 5 L
- ⊕ PH 1 · 2 · 3 · 1 L · 2 L
- ⊛ PZ 1 · 2 · 3 · 1 L · 2 L
- H 2 · 2.5 · 3 · 4 · 5 · 6
- ⊛ T 10 · 15 · 20 · 25 · 27 · 30
- ⊞ SQ 0 · 1 · 2 · 3
- 1/4" 5 · 6 · 7 · 8 · 9 · 10 · 11 · 12 · 13 mm

1/4" CrV 45x



Č.p. specifikace
18419

6



FESTA

SADA MINI ŠROUBOVÁKŮ

- ⊖ S 1,5x50 · 2x50 · 2,5x50 mm
- ⊕ PH 000x50 · 00x50 · 0x50 mm

CrV 6x



Č.p. specifikace
18416

6



FESTA

SADA MINI ELEKTRO ŠROUBOVÁKŮ

- ⊖ S 2,4 · 3,0 mm
- ⊕ PH 0 · 1
- ⊛ T 6 · 8

6x



Č.p. specifikace
18415

10



FESTA

T ŠROUBOVÁK + 20 NÁSTAVCŮ

- ⊖ S 3 · 4 · 5 · 6 · 8 mm
- ⊕ PH 0 · 1 · 2 · 3
- adapter + 5 · 6 · 7 · 8 · 9 · 10 · 11 · 12 · 13 mm

1/4" 20x



Č.p. specifikace
18420

5



FESTA

SADA MINI ŠROUBOVÁKŮ TORX

- ⊛ T 4 · 5 · 6 · 7 · 8 · 9 · 10x50 mm

CrV 7x



Č.p. specifikace
18417

6



FESTA

ŠROUBOVÁK S MINI BITY

- ⊖ S 1,5 · 2 · 2,5 · 3 · 3,5 mm
- ⊕ PH 000 · 00 · 0 · 1
- ⊛ PZ 0 · 1
- ⊛ T 5 · 6 · 7 · 8 · 9 · 10 · 15 · 20
- H 0,9 · 1,3 · 2,0 · 2,5 · 3,0 · 4,0

CrV 50x



Č.p. specifikace
18431

6



ŠROUBOVÁKY HODINÁŘSKÉ

⊖ S 1,4 · 2,0 · 2,4 · 3,0 mm

⊕ PH 0 · 1

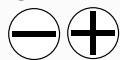

6x HOBBY



10

ŠROUBOVÁKY HODINÁŘSKÉ

⊖ S 1,0 · 1,2 · 1,4 · 1,8 · 2,4 · 3,0 mm

⊕ PH 00 · 0 · 1



11x HOBBY



48



ÚHLOVÝ NÁSTAVEC NA BITY 90°

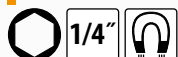

18910



25

RÁČNA NA BITY

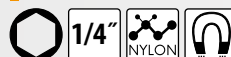

18435 93 mm



1



 **Stahlberg**





bity - profesionální šroubovací nástavce z vysoce legované oceli S2

Výrobce STAHLBERG

Značka světového výrobce šroubovacích nástavců s mnohaletými zkušenostmi v oboru a se zákazníky po celém světě. Při výrobě používá nejnovější technologie, nejlepší dosud vyvinuté materiály a povrchové úpravy.

Technologie výroby

křížové a ploché šroubovací nástavce jsou vyráběny speciální technikou přesného kování. Ta umožňuje dosažení vysoké přesnosti tvaru a současně zvýšení pevnosti oproti obráběným bitům až o 20 %. Po kování jsou bity kaleny pro získání optimální tvrdosti a houževnatosti.



TiN vrstva

vrstva nitridu titanu nanášená na povrch šroubovacího hrotu maximálně zvyšuje tvrdost povrchu, oteřuvzdornost a třecí vlastnosti zabraňující vysmeknutí ze záběru.



Diamantová zrna

na povrchu hrotu se doslova „zakousnou“ do hlavy vrutu či šroubu a udrží bit v záběru pro přenos maximálního utahovacího momentu. Jsou nejlepší zárukou setrvání v záběru. Nejčastěji se šroubovací bit totiž poškodí při vysmeknutí ze záběru. Kroučící moment se v tu chvíli přenáší na minimální plochu, která se deformuje.



Protismykové drážky

na pracovních plochách šroubovacích hrotů vyrobených kováním jsou další velmi účinnou obranou proti vysmeknutí hrotu ze záběru.



Stahlberg

BIT PH



S2

2x



Č.p.	specifikace	
18632A	PH2 x 25 mm	1
18633A	PH3 x 25 mm	1



Stahlberg

BIT PZ



S2

2x



Č.p.	specifikace	
18636A	PZ1 x 25 mm	1
18637A	PZ2 x 25 mm	1
18638A	PZ3 x 25 mm	1



Stahlberg

BIT T



S2

2x



Č.p.	specifikace	
18827A	T20 x 25 mm	1
18828A	T25 x 25 mm	1
18830A	T30 x 25 mm	1
18831A	T40 x 25 mm	1

Stahlberg

BIT PH DIAMANT



DIN 3128



MOQ 5



Č.p.	specifikace	
18770	PH1 x 25 mm	5
18771	PH2 x 25 mm	5
18772	PH3 x 25 mm	5

Stahlberg

BIT PZ DIAMANT



DIN 3128



MOQ 5



Č.p.	specifikace	
18775	PZ1 x 25 mm	5
18776	PZ2 x 25 mm	5
18777	PZ3 x 25 mm	5

Stahlberg

BIT S



S2



MOQ 5



Č.p.	specifikace	
18620	S 3 x 25 mm	5
18621	S 4 x 25 mm	5
18623	S 5 x 25 mm	5
18625	S 6 x 25 mm	5
18627	S 7 x 25 mm	5
18628	S 8 x 25 mm	5

Stahlberg

BIT PH



S2



MOQ 5



Č.p.	specifikace	
18630	PH0 x 25 mm	5
18631	PH1 x 25 mm	5
18632	PH2 x 25 mm	5
18633	PH3 x 25 mm	5
18634	PH4 x 25 mm	5

Stahlberg

BIT PZ



S2



MOQ 5



Č.p.	specifikace	
18635	PZ0 x 25 mm	5
18636	PZ1 x 25 mm	5
18637	PZ2 x 25 mm	5
18638	PZ3 x 25 mm	5
18639	PZ4 x 25 mm	5

Stahlberg

BIT PH



S2



MOQ 25



Č.p.	specifikace	
18685	PH2 x 25 mm	25

Stahlberg

BIT PZ



S2



MOQ 25



Č.p.	specifikace	
18680	PZ2 x 25 mm	25

Stahlberg

BIT PH



S2



MOQ 10



Č.p.	specifikace	
18640	PH1 x 70 mm	10
18641	PH2 x 70 mm	10

Stahlberg

BIT PZ



S2



MOQ 10



Č.p.	specifikace	
18645	PZ1 x 70 mm	10
18646	PZ2 x 70 mm	10

Stahlberg

BIT PH



S2 TiN



MOQ 5



Č.p.	specifikace	
18760	PH0 x 25 mm	5
18761	PH1 x 25 mm	5
18762	PH2 x 25 mm	5
18763	PH3 x 25 mm	5
18764	PH4 x 25 mm	1 5

Stahlberg

BIT PZ



S2 TiN



MOQ 5



Č.p.	specifikace	
18765	PZ0 x 25 mm	5
18766	PZ1 x 25 mm	5
18767	PZ2 x 25 mm	5
18768	PZ3 x 25 mm	5
18769	PZ4 x 25 mm	5

Stahlberg

BIT S



S2 TiN



MOQ 5



Č.p.	specifikace	
18750	S 3 x 25 mm	5
18751	S 4 x 25 mm	5
18753	S 5 x 25 mm	5
18755	S 6 x 25 mm	5

Stahlberg

BIT H



S2



MOQ 5



Č.p.	specifikace	
18800	H 1,5 x 25 mm	5
18801	H 2,0 x 25 mm	5
18802	H 2,5 x 25 mm	5
18803	H 3,0 x 25 mm	5
18804	H 4,0 x 25 mm	5
18805	H 5,0 x 25 mm	5
18806	H 5,5 x 25 mm	5
18807	H 6,0 x 25 mm	5

Stahlberg

BIT TTA



S2



MOQ 5



Č.p.	specifikace	
18835	TTa 5 x 25 mm	10
18836	TTa 6 x 25 mm	5
18837	TTa 7 x 25 mm	5
18838	TTa 8 x 25 mm	5
18839	TTa 9 x 25 mm	5
18840	TTa 10 x 25 mm	5
18841	TTa 15 x 25 mm	5
18842	TTa 20 x 25 mm	5
18843	TTa 25 x 25 mm	5
18844	TTa 27 x 25 mm	5
18845	TTa 30 x 25 mm	5
18846	TTa 40 x 25 mm	5
18847	TTa 45 x 25 mm	5

Stahlberg

BIT T



S2



MOQ 5



Č.p.	specifikace	
18820	T5 x 25 mm	5
18821	T6 x 25 mm	5
18822	T7 x 25 mm	5
18823	T8 x 25 mm	5
18824	T9 x 25 mm	5
18825	T10 x 25 mm	5
18826	T15 x 25 mm	5
18827	T20 x 25 mm	5
18828	T25 x 25 mm	5
18829	T27 x 25 mm	5
18830	T30 x 25 mm	5
18831	T40 x 25 mm	5
18832	T45 x 25 mm	5

Stahlberg

BIT HTA



S2



MOQ 5



Č.p.	specifikace	
18810	HTa 1,5 x 25 mm	5
18811	HTa 2,0 x 25 mm	5
18812	HTa 2,5 x 25 mm	5
18813	HTa 3,0 x 25 mm	5
18814	HTa 4,0 x 25 mm	5
18815	HTa 5,0 x 25 mm	5
18816	HTa 5,5 x 25 mm	5
18817	HTa 6,0 x 25 mm	5

Stahlberg

BIT T



S2



MOQ 3



Č.p.	specifikace	
17980	T30 x 35 mm	3
17981	T40 x 35 mm	3

Č.p.	specifikace	
17982	T45 x 35 mm	3
17983	T50 x 35 mm	3

Stahlberg

BIT SQ



S2



MOQ 5



Č.p.	specifikace	
18850	SQ 0 x 25 mm	5
18851	SQ 1 x 25 mm	5
18852	SQ 2 x 25 mm	5
18853	SQ 3 x 25 mm	5

Stahlberg

BIT T



S2



MOQ 3



Č.p.	specifikace	
17970	T20 x 75 mm	3
17971	T25 x 75 mm	3
17972	T30 x 75 mm	3
17973	T40 x 75 mm	3

Č.p.	specifikace	
17974	T45 x 75 mm	3
17975	T50 x 75 mm	3
17976	T55 x 75 mm	3

Stahlberg

BIT SD



S2



MOQ 5



Č.p.	specifikace	
18855	SD 6 x 25 mm	5
18856	SD 8 x 25 mm	5

Stahlberg

BIT TS



S2



MOQ 5



Č.p.	specifikace	
18864	TS 4 x 25 mm	5
18865	TS 6 x 25 mm	5

Stahlberg

BIT



S2



MOQ 5



Č.p.	specifikace	
18866	5/32 x 25 mm	5
18867	3/16 x 25 mm	5

Stahlberg

BIT TW



S2



MOQ 5



Č.p.	specifikace	
18860	TW 1 x 25 mm	5
18861	TW 2 x 25 mm	5
18862	TW 3 x 25 mm	5
18863	TW 4 x 25 mm	5



Stahlberg

BIT XZN



Č.p.	specifikace	
18870	M4 x 25 mm	5
18871	M5 x 25 mm	5
18872	M6 x 25 mm	5
18873	M8 x 25 mm	5
18874	M10 x 25 mm	5



Stahlberg

BIT
NA SÁDROKARTON



2x

Č.p.	specifikace	
18795	PH 2 x 25 mm	24



Stahlberg

BIT
NA SÁDROKARTON



2x

Č.p.	specifikace	
18796	PH 2 x 55 mm	24



Stahlberg

BIT



1/4" ↔ 1/4"

Č.p.	specifikace	
18868	25 mm	5



Stahlberg

BIT



1/4" ↔ 1/4"

Č.p.	specifikace	
18869	50 mm	5



Stahlberg

ADAPTER
RÁČNA 1/4' - BIT



1/4" ↔ 1/4"

Č.p.	specifikace	
18619		5



Stahlberg

NÁSTAVEC
NA BITY

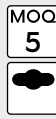

Č.p.	specifikace	
18600	1/4' x 60 mm	5



Stahlberg

NÁSTAVEC
NA BITY



Č.p.	specifikace	
18797	1/4' x 60 mm	1



Stahlberg

NÁSTAVEC
NA BITY
· rychloupínací

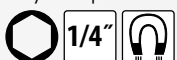

Č.p.	specifikace	
18601	1/4' x 60 mm	5



Stahlberg

NÁSTAVEC
NA BITY
· rychloupínací

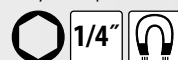

Č.p.	specifikace	
18798	1/4' x 60 mm	1



Stahlberg

NÁSTAVEC NA BITY

· s dorazem

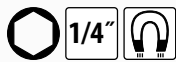

MOQ
5



Č.p.	specifikace	
18602	1/4" x 60 mm	5



Stahlberg

NÁSTAVEC NA BITY

· s dorazem



Č.p.	specifikace	
18799	1/4" x 60 mm	1

NEW



Stahlberg

NÁSTAVEC NA BITY



Č.p.	specifikace	
18605	150 mm	25

NEW



FESTA

ADAPTÉR SDS + NA BIT 1/4"



Č.p.	specifikace	
20743	75 mm	1



NÁSTAVEC NA BITY VODICÍ

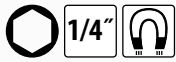

Č.p.	specifikace	
18607	80 mm	25



Stahlberg

ADAPTER

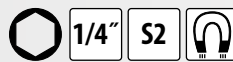

MOQ
5



Č.p.	specifikace		Č.p.	specifikace	
18610	6 mm	5	18613	10 mm	5
18611	7 mm	5	18614	12 mm	5
18612	8 mm	5	18615	13 mm	5

ADAPTER SADA

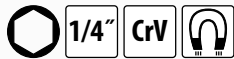

8x

Č.p.	specifikace	
18618	6, 7, 8, 9, 10, 11, 12, 13 mm	



12



Stahlberg

SADA BITŮ A ADAPTÉRŮ

- 10x ⊕ 18630 PH0
- 10x ⊕ 18631 PH1
- 10x ⊕ 18632 PH2
- 10x ⊕ 18633 PH3
- 10x ⊕ 18635 PZ0
- 10x ⊕ 18636 PZ1
- 10x ⊕ 18637 PZ2
- 10x ⊕ 18638 PZ3
- 10x ⊕ 18761 PH1 TiN
- 10x ⊕ 18762 PH2 TiN
- 10x ⊕ 18763 PH3 TiN
- 10x ⊕ 18766 PZ1 TiN
- 10x ⊕ 18767 PZ2 TiN
- 10x ⊕ 18768 PZ3 TiN
- 10x ⊕ 18770 PH1 DIAMANT
- 10x ⊕ 18771 PH2 DIAMANT
- 10x ⊕ 18775 PZ1 DIAMANT
- 10x ⊕ 18776 PZ2 DIAMANT
- 10x ⊙ 18814 4,0HTa
- 10x ⊙ 18815 5,0HTa
- 10x ⊕ 18842 20TTa
- 10x ⊕ 18845 30TTa
- 10x ⊕ 18795 PH2 na sádrokarton
- 5x 18612 adapter 1/4" 8mm
- 5x 18613 adapter 1/4" 10mm
- 5x 18600 nástavec magnetický 1/4" 60mm
- 5x 18601 nástavec magnetický, rychloupínací 1/4" 60mm
- 5x 18602 nástavec magnetický, s dorazem 1/4" 65mm



Č.p. 18993 specifikace

1

Stahlberg

SADA BITŮ

- 10x ⊕ 18631 PH1
- 10x ⊕ 18632 PH2
- 10x ⊕ 18633 PH3
- 10x ⊕ 18636 PZ1
- 10x ⊕ 18637 PZ2
- 10x ⊕ 18638 PZ3
- 10x ⊕ 18761 PH1 TiN
- 10x ⊕ 18762 PH2 TiN
- 10x ⊕ 18763 PH3 TiN
- 10x ⊕ 18766 PZ1 TiN
- 10x ⊕ 18767 PZ2 TiN
- 10x ⊕ 18768 PZ3 TiN
- 10x ⊙ 18804 H 4
- 10x ⊙ 18805 H 5
- 10x ⊕ 18825 T 10
- 10x ⊕ 18826 T 15
- 10x ⊕ 18827 T 20
- 10x ⊕ 18828 T 25
- 10x ⊕ 18830 T 30
- 10x ⊕ 18831 T 40

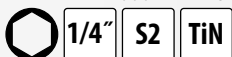

Č.p. 18994 specifikace

1

FESTA

SADA BITŮ



- ⊖ S 3 · 4 · 5 · 6
 - ⊕ PH 1 · 2 · 3
 - ✱ PZ 1 · 2 · 3
 - H 3 · 4 · 5 · 6
 - ★ T 10 · 15 · 20 · 25 · 27 · 30 · 40
 - ⊗ TTa 10 · 15 · 20 · 25 · 27 · 30 · 40
- magnetický rychloupínací
nástavec na bity

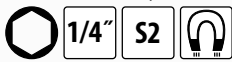

32x



Č.p. specifikace

18905

10

FESTA

SADA BITŮ



- ⊖ S 4 · 5 · 6
 - ⊕ PH 1 · 2 · 3
 - ✱ PZ 1 · 2 · 3
 - H 3 · 4 · 5 · 6
 - ★ T 10 · 15 · 20 · 25 · 27 · 30 · 40
 - ⊗ TTa 10 · 15 · 20 · 25 · 27 · 30 · 40
- magnetický rychloupínací
nástavec na bity

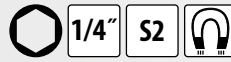

57x



Č.p. specifikace

18906

6

FESTA

SADA BITŮ



- ⊗ HTa 2 · 2.5 · 3 · 4 · 5 · 6
5/32" · 9/64" · 1/8"
7/64" · 3/32" · 5/64"
 - ⊙ SD 4 · 6 · 8 · 10
 - ✱ TS 6 · 8 · 10
 - ✶ TW 1 · 2 · 3 · 4
 - ⊗ TTa 8 · 10 · 15 · 20 · 25 · 27 · 30 · 35 · 40
- magnetický nástavec na bity

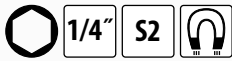

33x



Č.p. specifikace

18900

10

FESTA

SADA BITŮ



- ⊖ S 3 · 4 · 4.5 · 5 · 5.5 · 6 · 6.5 · 7 · 8
 - ⊕ PH 0 · 1 · 2 · 3
 - ✱ PZ 0 · 1 · 2 · 3
 - ⊗ SQ 0 · 1 · 2 · 3
 - ★ T 8 · 10 · 15 · 20 · 25 · 27 · 30 · 40 · 45
 - ⊗ TTa 8 · 10 · 15 · 20 · 25 · 27 · 30 · 35 · 40
 - H 1.5 · 2 · 2.5 · 3 · 4 · 5 · 5.5 · 6 · 8 mm
1/16" · 5/64" · 3/32" · 7/64" · 1/8" · 9/64"
5/32" · 3/16" · 7/32" · 1/4"
 - ⊗ HTa 2 · 2.5 · 3 · 4 · 5 · 6 mm
5/64" · 3/32" · 7/64" · 1/8" · 9/64" · 5/32"
 - ⊙ SD 4 · 6 · 8 · 10
 - ✱ TS 6 · 8 · 10
 - ✶ TW 1 · 2 · 3 · 4
 - Ⓜ 2-wing 1 · 2 · 3
 - XZN 5 · 6 · 8
- magnetický nástavec na bity
nástavec „Y”
1/4" DR nástavec na šroubovák
1/4" bit adapter: 25mm, 50mm

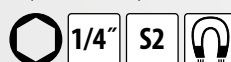

100x



Č.p. specifikace

18909

24

FESTA

SADA BITŮ



- ⊖ S 3 · 4 · 5 · 6 · 7
 - ⊕ PH 0 · 1 · 2 · 3
 - ✱ PZ 1 · 2 · 3
 - H 2 · 2.5 · 3 · 4 · 5 · 6
 - ★ T 10 · 15 · 20 · 25 · 30 · 40
- magnetický nástavec na bity

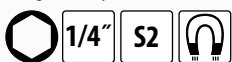

33x



Č.p. specifikace

18901

10



SADA BITŮ

- ⊖ S 4 · 5 · 6 · 7
- ⊕ PH 1 · 2 · 3
- ✱ PZ 1 · 2 · 3
- H 4 · 5 · 6
- ★ T 10 · 15 · 20 · 25
- SQ 1 · 2 · 3

S2

20x



SADA BITŮ

- ⊖ S 4 · 5 · 6 · 7
- ⊕ PH 1 · 2 · 3
- ✱ PZ 1 · 2 · 3

CrV TiN

10x

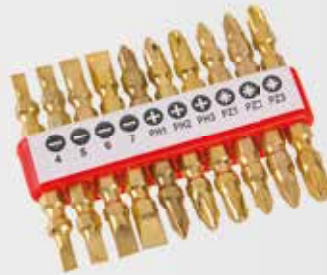

SADA BITŮ

- ⊖ S 3 · 5 · 7
 - ⊕ PH 1 · 2 · 3
- magnetický nástavec na bity

HOBBY

7x



Č.p.	specifikace
18907	10

Č.p.	specifikace
18440	10

Č.p.	specifikace
18430	20



SADA BITŮ A NÁSTAVCŮ

- ⊖ S 3 · 4 · 4,5 · 5 · 5,5 · 6 · 7
- ⊕ PH 1 · 2 · 3
- ✱ PZ 1 · 2 · 3
- H 2 · 3 · 4 · 5
- ★ T 20 · 30
- 1/4" 4 · 4,5 · 5 · 5,5 · 6 · 7 · 8 · 9 · 10
5/32" · 3/16" · 7/32" · 1/4" · 9/32" · 5/16" · 11/32" · 3/8" · 7/16"

magnetický šroubovák
nástavec na bity
2 ks adapter

1/4" CrV

41x



SADA BITŮ A NÁSTAVCŮ

- ⊖ S 3 · 3,5 · 4 · 5,5
- ⊕ PH 0 · 1 · 2 · 3
- ✱ PZ 0 · 1 · 2 · 3
- H 3 · 4
- ★ T 10 · 15 · 20 · 25 · 27 · 30
- 1/4" 4 · 4,5 · 5 · 5,5 · 6 · 7 · 8 · 9 · 10 · 11 · 13

nástavec na šroubovák 1/4"
magnetický nástavec na bity

CrV 1/4"

40x



Č.p.	specifikace
18916	10

Č.p.	specifikace
18915	10

SADA NÁŘADÍ

- ⊖ S 5 · 6 mm
- ⊕ PH 1 · 2
- H 3 · 4 · 5 · 6
- ★ T 15 · 20 · 25 · 30
- 1/4" 4 · 5 · 6 · 7 · 8 · 9 · 10 · 12 · 13 mm

75 mm 1/4" 1/4" 1/4"













1/4" CrV

23x



Č.p.	specifikace
18421	10

SADA NÁŘADÍ

-  120mm
-  125mm
-  115mm
-  150mm max. 19mm
-  9mm
-  1/4" 160mm
-  5 · 6 · 7 · 8 · 9 · 10 · 11 mm
-  1/4"
-  1/4"
-  S 4 · 6 mm
-  PH 1 · 2 · 3
-  PZ 1 · 2
-  H 4 · 5 · 6

35x































č.p. specifikace
17260



10

FESTA

SADA NÁŘADÍ

-  1/2", 1/4"
-  1/4" · 4-5-6-7-8-9mm
-  1/2" · 10-12-13-14-17-19mm
-  1/4" · 4-4.5-5-5.5-6-7-8-9-10-11-12-13-14mm
-  1/2" · 12-13-14-15-16-17-18-19-20-21-22-24mm
-  1/2", 1/4"
-  1/4" → 1/4"
-  1/4" · 150mm
-  1/2" · 254mm
-  1/2", 1/4"
-  1/2" · 16-21mm
-  1/4" · 150mm
-  1/2" · E10-E12-E14-E16-E18-E20-E22-E24
-  1/4" S 3 · 4 · 5 · 6
-  1/4" PH 0 · 1 · 2
-  1/4" PZ 0 · 1 · 2
-  1/4" S 4 · 5,5 · 6,5
-  1/4" PH 1 · 2 · 3
-  1/4" PZ 2 · 3
-  1/4" H 3 · 4 · 5 · 6
-  1/4" T 8 · 10 · 15 · 20 · 25
-  1/4" Tta 10 · 15 · 20 · 25 · 40
-  2 · 2,5 · 3 · 4 · 5 · 6 · 7 · 8 · 10mm
-  8-9-10-11-12-13-14-15-16-17-18-19mm
-  S 4x100 · 6,5x150
-  PH 2x100 · 3x150
-  180mm
-  160mm
-  160mm
-  250mm
-  300g

CrV S2 1/4" 1/2" 72T













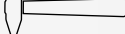
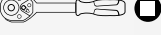



122x

č.p. specifikace
17238 122 ks

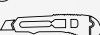
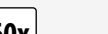

1

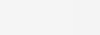
SADA NÁŘADÍ

-  160 mm
-  160 mm
-  300 g
-  1/4" 45T
-  4 · 5 · 6 · 7 · 8 · 9 · 10 · 11 · 12 · 13 mm
-  1/4" 75 mm
-  1,5 · 2 · 2,5 · 3 · 4 · 5 · 6 · 8 · 10 mm
-  S 3 · 4 · 5 · 6 mm
-  PH 0 · 1 · 2 · 3
-  PZ 0 · 1 · 2 · 3
-  T 10 · 15 · 20 · 25
-  H 3 · 4 · 5 · 6
-  S 5x100 mm
- PH 1x100 · 2x100 mm
-  S 2,5x50 mm
- PH 00x50 · 0x50 mm
-  AC 100-250 V
-  200 mm max. 22 mm
-  10x11 · 12x13 · 14x15 · 16x17 mm
-  18 mm
-  2 m 13 mm



60x











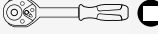
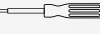

Č.p. specifikace

17259



5

SADA NÁŘADÍ

-  1/4" 5 · 6 · 7 · 8 · 9 · 10 · 11 · 12 mm
-  1/4"
-  1/4"
-  AC 230 V
-  PH 0, SL 3
-  9x 1,5-10 mm
-  160 mm
-  S 3 · 4 · 5 · 6 mm
-  PH 0 · 1 · 2 · 3
-  H 4 · 5
-  PH 2x100, S 6x100
-  18 mm
-  1 m
-  300 g



32x

Č.p. specifikace

17247



10

FESTA

SADA INBUSŮ

- H 1,5 mm
- H 2 mm
- H 2,5 mm
- H 3 mm
- H 4 mm
- H 5 mm
- H 6 mm
- H 8 mm
- H 10 mm



9x



Č.p. specifikace 18496 5

FESTA

SADA INBUSŮ S HLAVIČKOU

- H 1,5 mm
- H 2 mm
- H 2,5 mm
- H 3 mm
- H 4 mm
- H 5 mm
- H 6 mm
- H 8 mm
- H 10 mm



9x



Č.p. specifikace 18500 5

FESTA

SADA INBUSŮ PRODLOUŽENÉ

- H 1,5 mm
- H 2 mm
- H 2,5 mm
- H 3 mm
- H 4 mm
- H 5 mm
- H 6 mm
- H 8 mm
- H 10 mm



9x



Č.p. specifikace 18490 5

FESTA

SADA INBUSŮ S HLAVIČKOU

- H 1,5 mm
- H 2 mm
- H 2,5 mm
- H 3 mm
- H 4 mm
- H 5 mm
- H 6 mm
- H 8 mm
- H 10 mm



9x



Č.p. specifikace 18498 5

FESTA

SADA INBUSŮ S HLAVIČKOU

- 1/16"
- 5/64"
- 3/32"
- 1/8"
- 5/32"
- 3/16"
- 1/4"
- 5/16"
- 3/8"



9x



Č.p. specifikace 18493 6

FESTA

SADA KLÍČŮ TORX

- T 10 mm
- T 15 mm
- T 20 mm
- T 25 mm
- T 27 mm
- T 30 mm
- T 40 mm
- T 45 mm
- T 50 mm



9x



Č.p. specifikace 18497 5

FESTA

SADA INBUSŮ S HLAVIČKOU PRODLOUŽENÉ

- H 1,5 mm
- H 2 mm
- H 2,5 mm
- H 3 mm
- H 4 mm
- H 5 mm
- H 6 mm
- H 8 mm
- H 10 mm



9x



Č.p. specifikace 18492 10

FESTA

SADA KLÍČŮ TORX PRODLOUŽENÉ

- T 10 mm
- T 15 mm
- T 20 mm
- T 25 mm
- T 27 mm
- T 30 mm
- T 40 mm
- T 45 mm
- T 50 mm



9x



Č.p. specifikace 18491 5



FESTA

KLÍČ INBUS - STANDARD



Č.p.	specifikace		
18548	8 mm	36 x 100 mm	1
18559	19 mm	70 x 180 mm	1
18562	22 mm	80 x 200 mm	1
18567	27 mm	100 x 250 mm	1
18572	32 mm	125 x 315 mm	1



FESTA

KLÍČ INBUS S HLAVIČKOU PRODLOUŽENÝ



Č.p.	specifikace		
18575	1,5 mm	15 x 75 mm	1
18576	2 mm	17 x 81 mm	1
18577	2,5 mm	18 x 87 mm	1
18578	3 mm	20 x 96 mm	1
18579	4 mm	24 x 107 mm	1
18580	5 mm	30 x 120 mm	1
18581	6 mm	33 x 136 mm	1
18582	7 mm	34 x 144 mm	1
18583	8 mm	36 x 153 mm	1
18584	9 mm	38 x 155 mm	1
18585	10 mm	40 x 171 mm	1
18586	11 mm	40 x 230 mm	1
18587	12 mm	42 x 250 mm	1
18588	13 mm	45 x 260 mm	1
18589	14 mm	56 x 280 mm	1
18593	17 mm	61 x 290 mm	1



FESTA

KLÍČ INBUS - PRODLOUŽENÝ



Č.p.	specifikace		
18510	1,5 mm	15 x 75 mm	1
18511	2 mm	17 x 81 mm	1
18512	2,5 mm	18 x 87 mm	1
18513	3 mm	20 x 96 mm	1
18514	4 mm	24 x 107 mm	1
18515	5 mm	30 x 120 mm	1
18516	6 mm	33 x 136 mm	1
18518	8 mm	36 x 153 mm	1
18519	9 mm	38 x 155 mm	1
18520	10 mm	40 x 171 mm	1
18521	11 mm	40 x 230 mm	1
18522	12 mm	42 x 250 mm	1
18523	13 mm	45 x 260 mm	1
18524	14 mm	56 x 280 mm	1
18527	17 mm	61 x 290 mm	1



FESTA

KLÍČ TORX



Č.p.	specifikace	
18466	T7	1
18468	T9	1
18476	T45	1
18477	T50	1



FESTA

SADA INBUSŮ



Č.p.	specifikace	
18508	1,5 · 2 · 2,5 · 3 · 4 · 5 · 6 mm	1



FESTA

NÁSTRČNÝ T - KLÍČ INBUS SADA

- 2 mm
- 2,5 mm
- 3 mm
- 4 mm
- 5 mm
- 6 mm
- 7 mm
- 8 mm
- 10 mm



9x

Č.p.	specifikace
18494	



6



FESTA

NÁSTRČNÝ T - KLÍČ TORX SADA

- T 10
- T 15
- T 20
- T 25
- T 27
- T 30
- T 40
- T 45
- T 50



9x

Č.p.	specifikace
18495	



6



SADA INBUSŮ



8x

Č.p.	specifikace
18499	2 · 2,5 · 3 · 4 · 5 · 6 · 8 · 10 mm



1



FESTA

KLÍČ NÁSTRČNÝ T - TORX



Č.p.	specifikace		Č.p.	specifikace	
17350	T 7	10	17357	T 27	10
17351	T 8	10	17359	T 40	10
17352	T 9	10	17360	T 45	10
17353	T 10	10	17361	T 50	10



FESTA®

KLADIVA A PALICE

**FESTA®**

KLADIVO

· jasanová násada

**DIN
1041**

Č.p.	specifikace	
19081	100 g	1
19082	200 g	1
19083	300 g	1
19084	400 g	1
19085	500 g	1
19086	600 g	1
19088	800 g	1
19090	1000 g	1
19092	1500 g	1
19095	2000 g	1

**FESTA®**

KLADIVO

· jasanová násada

**DIN
1041**

Č.p.	specifikace	
19096	3000 g	1
19097	4000 g	1
19098	5000 g	1
19106	6000 g	1
19108	8000 g	1
19109	10000 g	1

NEW**FESTA®**

PALICE

· jasanová násada

**DIN
6475**

Č.p.	specifikace	
19041	1000 g	1
19042	1250 g	1
19043	1500 g	1
19044	2000 g	1

**FESTA®**

PALICE

· jasanová násada

**DIN
6475**

Č.p.	specifikace	
19045 NEW	3000 g	1
19046 NEW	4000 g	1
19074	5000 g	1
19075	6000 g	1
19076	8000 g	1
19077	10000 g	1



FESTA

KLADIVO FIBERGLASS

· násada fiberglass

Č.p.	specifikace		Č.p.	specifikace	
19021	100 g	12	19026	600 g	6
19022	200 g	12	19028	800 g	6
19023	300 g	12	19030	1000 g	6
19024	400 g	12	19031	1500 g	6
19025	500 g	12	19032	2000 g	1



FESTA

PALICE FIBERGLASS

· násada fiberglass

Č.p.	specifikace	
19034	3000 g	4
19036	4000 g	4



FESTA

PALICE FIBERGLASS

· násada fiberglass

DIN 6475

Č.p.	specifikace	
19066	1000 g	4
19067	1250 g	4
19068	1500 g	4
19069	2000 g	2



FESTA

PALICE FIBERGLASS

· násada fiberglass

DIN 6475

Č.p.	specifikace	
19070	3000 g	4
19071	4000 g	4
19058	5000 g	4
19059	6000 g	2



PALICE

· kruhový klín

DIN 6475

Č.p.	specifikace	
19053	1000 g	6
19050	1250 g	6
19054	1500 g	6
19055	2000 g	6



KLADIVO

· kruhový klín

DIN 1041

Č.p.	specifikace	
19001	100 g	12
19002	200 g	12
19003	300 g	6
19004	400 g	6
19005	500 g	6
19006	600 g	6
19008	800 g	6
19010	1000 g	6
19015	1500 g	6
19020	2000 g	6



PALICE

· kruhový klín

DIN 6475

Č.p.	specifikace	
19056	3000 g	6
19057	4000 g	6

**FESTA**

KLADIVO ŠEVCOVSKÉ FIBERGLASS

· násada fiberglass

Č.p.	specifikace	
19064	450 g	6

**FESTA**

KLADIVO POKRÝVAČSKÉ FIBERGLASS

· násada fiberglass



Č.p.	specifikace	
19061	600 g	6

**FESTA**

KLADIVO ZEDNICKÉ FIBERGLASS

· násada fiberglass

Č.p.	specifikace	
19151	600 g	6

**FESTA**

KLADIVO ŠEVCOVSKÉ MONOLIT

Č.p.	specifikace	
19063	450 g	6

**FESTA**

KLADIVO POKRÝVAČSKÉ MONOLIT



Č.p.	specifikace	
19062	600 g	6

**FESTA**

KLADIVO ZEDNICKÉ MONOLIT

Č.p.	specifikace	
19150	600 g	6



KLADIVO POKRÝVAČSKÉ



Č.p.	specifikace	
19100	600 g	6



FESTA

KLADIVO ŠEVCOVSKÉ

Č.p.	specifikace	
19065	600 g	6



FESTA

KLADIVO POKRÝVAČKÉ



Č.p.	specifikace	
19060	600 g	6



FESTA

PALICE

Č.p.	specifikace	
19051	1000 g	6
19052	1500 g	6



FESTA

KLADIVO - SEKERA

Č.p.	specifikace	
19303	600 g	6



FESTA

KLADIVO ZEDNICKÉ

jasanová násada

Č.p.	specifikace	
19149	44 mm	1



FESTA

KLADIVO ZEDNICKÉ

jasanová násada

Č.p.	specifikace	
19124	24 mm	1
19136	36 mm	1
19148	48 mm	1



KLADIVO SVÁŘEČSKÉ



Č.p.	specifikace	
19115	300 g	1



FESTA

JASANOVÁ NÁSADA NA ZEDNICKÉ KLADIVO

Č.p.	specifikace	
61240	násada	1



NÁSADA NA KLADIVO JASANOVÁ



Č.p.	specifikace	pro kladivo	
61320	26 cm	19081	10
61321	28 cm	19082	10
61322	30 cm	19083	10
61323	31 cm	19084	10
61324	32 cm	19085	10



NÁSADA NA PALICI JASANOVÁ



Č.p.	specifikace	pro palice	
61330	80 cm	19074, 19075	10
61331	90 cm	19076, 19077	10



KLÍNEK KRUHOVÝ KÓNICKÝ

Č.p.	specifikace	
19430	6 mm	10
19431	8 mm	10
19432	10 mm	10
19433	12 mm	10
19434	14 mm	10
19435	16 mm	10



KLÍNEK KOVANÝ



Č.p.	specifikace	
19440	úzký	10
19441	střední	10
19442	široký	10
19443	široký S	10



FESTA

KLÍNEK DO TOPORA



Č.p.	specifikace	
19398	20 x 25 x 5 mm	1
19399	30 x 40 x 5 mm	1

3x

**FESTA****PALICE DŘEVĚNÁ**

· bukové dřevo



Č.p.	specifikace		
19202	Ø 60 x 120 mm	350 g	1

**FESTA****PALICE DŘEVĚNÁ**

· bukové dřevo



Č.p.	specifikace		
19200	80 x 60 mm	520 g	1

**FESTA****PALICE GUMOVÁ**

· jasanová násada



Č.p.	specifikace		
19245	Ø 55 mm	400 g	1
19246	Ø 60 mm	800 g	1
19247	Ø 70 mm	1000 g	1
19248	Ø 95 mm	2000 g	1
19249	Ø 115 mm	3000 g	1

**FESTA****PALICE GUMOVÁ**

· násada fiberglass



Č.p.	specifikace		
19270	Ø 55 mm		6
19271	Ø 65 mm		6
19272	Ø 90 mm		6

**FESTA****PALICE GUMOVÁ**

Č.p.	specifikace		
19255	Ø 55 mm		6
19265	Ø 65 mm		6
19290	Ø 90 mm		6

**FESTA****PALICE GUMOVÁ BÍLÁ**

Č.p.	specifikace		
19293	NEW Ø 55 mm		6
19294	Ø 65 mm		6
19295	Ø 90 mm		6

**PALICE GUMOVÁ ČERNO-BÍLÁ**

Č.p.	specifikace		
19254	Ø 65 mm		6



PALICE GUMOVÁ



Č.p.	specifikace	
19251	Ø 55 mm 400 g	12
19252	Ø 65 mm 700 g	6
19253	Ø 90 mm 1300 g	4



PALICE MOSAZNÁ

· násada fiberglass

Č.p.	specifikace	
19211	Ø 30 mm 500 g	1



PALICE SILIKONOVÁ

Č.p.	specifikace	
19297	Ø 35 mm	12



PALICE NYLONOVÁ

· násada fiberglass

Č.p.	specifikace	
19209	Ø 34 mm	6



PALIČKA S VÝMĚNNÝMI KONCI

· PP - 97 Shore A



· TPE - 90 Shore A



· TPU - 92 Shore A



· TPU - 88 Shore A



· TPU - 95 Shore A



· TPE - 90 Shore A



· TPU - 92 Shore A



· TPE - 90 Shore A



Č.p.	specifikace	
19208	Ø 40 mm	1

FESTA®

SEKERY



FESTA®

SEKERA

DIN 5131

DIN 7294

- jasanová násada
- kruhový klín

Č.p.	specifikace		Č.p.	specifikace	
19380	600 g	1	19384	1400 g	1
19381	800 g	1	19385	1600 g	1
19382	1000 g	1	19387	2000 g	1
19383	1250 g	1			



FESTA®

SEKERA TESAŘSKÁ

- jasanová násada

Č.p.	specifikace	
19340	700 g	22



FESTA®

SEKERA ŠTÍPACÍ

- jasanová násada
- kruhový klín

DIN 7294

Č.p.	specifikace	
19391	2000 g	1

FESTA®

KALAČ

- jasanová násada
- kruhový klín

DIN 5129

Č.p.	specifikace	
19389	3000 g	1
19388	4000 g	1



SEKERA

Č.p.	specifikace	
19306	600 g	24
19308	800 g	24
19310	1000 g	24
19312	1250 g	12
19314	1500 g	12



NÁSADA NA SEKERU JASANOVÁ



Č.p.	specifikace	pro sekery	
61340	36 cm	19380	10
61341	40 cm	19381, 19340	10
61342	50 cm	19382	10
61343	70 cm	19383, 19384	10

Č.p.	specifikace	pro sekery	
61344	80 cm	19385, 19391	10
61345	90 cm	19387	10
61346	90 cm	19388, 19389	10



FESTA

SEKERA FIBERGLASS

· násada fiberglass

Č.p.	specifikace	
19326	600 g	6
19328	800 g	24
19330	1000 g	12



FESTA

SEKERA CAMP FIBERGLASS

· násada fiberglass

Č.p.	specifikace	
19301	500 g	6



FESTA

SEKERA ŠTÍPACÍ FIBERGLASS

· násada fiberglass

Č.p.	specifikace	
19392	1000 g	6



FESTA

SEKERA ŠTÍPACÍ FIBERGLASS

· násada fiberglass

Č.p.	specifikace	
19390	2000 g	6



FESTA

KALAČ FIBERGLASS

· násada fiberglass

Č.p.	specifikace	
19370	3000 g	4
19371	4000 g	4



Black Eagle

SEKERA



Č.p.	specifikace	
19356	1200 g	5
19357	1800 g	1



ŠTÍPACÍ TRN SDS+



Č.p.	specifikace	
19393	Ø 32 x 132 mm	10
19374	Ø 42 x 145 mm	10



KLÍN ŠTÍPACÍ TORZNÍ

Č.p.	specifikace	
19397	2000 g 55 x 210 x 45 mm	10
19465	2500 g 65 x 230 x 45 mm	10



KLÍN ŠTÍPACÍ ČTYŘRAMENNÝ

Č.p.	specifikace	
19469	2500 g 165 x 87 mm	10



KLÍN ROZEVÍRACÍ NYLONOVÝ



Č.p.	specifikace	
19462	175 x 65 x 20 mm	1
19463	230 x 70 x 30 mm	1
19464	240 x 75 x 40 mm	1



KLÍN ŠTÍPACÍ

Č.p.	specifikace	
19394	1000 g 35 x 180 x 40 mm	6
19395	2000 g 40 x 255 x 55 mm	6
19396	2500 g 40 x 260 x 55 mm	8



FESTO®



FESTO
PÁČIDLO

14 mm



Č.p.	specifikace	
19424	400 mm	6
19425	600 mm	6
19426	800 mm	6
19427	1000 mm	6

PÁČIDLO

Č.p.	specifikace	
19416	600 mm Ø 16 mm	4
19422	800 mm Ø 16 mm	4
19421	1000 mm Ø 18 mm	4

PÁČIDLO

Č.p.	specifikace	
19423	380 x 35 x 6 mm	1

VYTAHOVÁK PÁČIDLO

Č.p.	specifikace	
19415	300 mm Ø 15 mm	6

**FESTA**

SEKÁČ PLOCHÝ

CrV

Č.p.	specifikace	šířka hrotu	
19406	300 mm	25 mm	5
19407	400 mm	30 mm	5

**FESTA**

SEKÁČ ŠPIČATÝ

CrV

Č.p.	specifikace	
19408	250 mm	5
19409	350 mm	5

**FESTA**

SEKÁČ PLOCHÝ

CrV

Č.p.	specifikace	šířka hrotu	
19460	300 mm	25 mm	5
19470	400 mm	30 mm	5



SEKÁČ ŠPIČATÝ

Č.p.	specifikace	
19400	250 mm	5
19403	350 mm	6



SEKÁČ PLOCHÝ

Č.p.	specifikace	šířka hrotu	
19401	250 mm	19 mm	6
19404	350 mm	22 mm	6



SEKÁČ PLOCHÝ

Č.p.	specifikace	šířka hrotu	
19402	250 mm	50 mm	2
19405	350 mm	50 mm	6

**FESTA**

SEKÁČ PLOCHÝ

CrV

Č.p.	specifikace	šířka hrotu	
19410	200 mm	20 mm	10
19411	250 mm	25 mm	10
19412	300 mm	25 mm	10
19418	400 mm	25 mm	5
19419	500 mm	25 mm	5



SEKÁČ ZÁMEČNICKÝ PLOCHÝ

CrV

Č.p.	specifikace	šířka hrotu	
19436	200 mm	20 mm	15



DLÁTA



FESTA

DLÁTO

CrV



Č.p.	specifikace		Č.p.	specifikace	
19490	6 mm 275 mm	6	19496	18 mm 280 mm	6
19491	8 mm 275 mm	6	19497	20 mm 280 mm	6
19492	10 mm 275 mm	6	19498	22 mm 280 mm	6
19493	12 mm 275 mm	6	19499	25 mm 280 mm	6
19494	14 mm 275 mm	6	19501	32 mm 290 mm	6
19495	16 mm 275 mm	6	19502	38 mm 290 mm	6

SADA DLÁT

- 8 mm
- 12 mm
- 19 mm
- 25 mm

4x



Č.p.	specifikace	
19450		20

FESTA

SADA DLÁT S BROUSKEM

- 6 mm
- 10 mm
- 15 mm
- 20 mm
- 25 mm

CrV 5x



Č.p.	specifikace	
19451		10

FESTA

SADA DLÁT

- 6 mm
- 12 mm
- 19 mm
- 25 mm

CrV 4x



Č.p.	specifikace	
19457		10



FESTA

DLÁTO TRUHLÁŘSKÉ MULTIFUNKČNÍ

INOX



Č.p.	specifikace	
16231	20 80 mm	12

SADA DLÁT

- 8 mm
- 12 mm
- 19 mm
- 25 mm

4x



Č.p.	specifikace	
19455		30



FESTA

SADA SOUSTRUŽNICKÝCH DLÁT

CrV

8x



Č.p.	specifikace	
19458	365 125mm	1



HOBLÍK
KLOPKAŘ



Č.p.	specifikace	
19510	220 x 65 x 130 mm, nůž 48 mm	1



SADA ŘEZBÁŘSKÝCH DLÁT

CrV

12x



Č.p.	specifikace	
19459		5



HOBLÍK
HLADÍK



Č.p.	specifikace	
19515	200 x 55 x 130 mm, nůž 39 mm	1



HOBLÍK
ŘÍMSOVNÍK



Č.p.	specifikace	
19520	225 x 27 x 155 mm, nůž 27 mm	1



SADA
KLEMPÍŘSKÁ

7x

Č.p.	specifikace	
19110		5



Č.p.	specifikace	
19110		5

FESTA®







SPONKOVAČKY



FESTA®

SPONKOVAČKA 5 V 1





-  | 6 - 14 mm
23960 - 23964
23760 - 23764,
23906 - 23914
-  | 10 - 14 mm
23965
-  | 15 mm
23966
-  | 15 mm
23967

Č.p. specifikace
23927



FESTA®

SPONKOVAČKA 4 V 1

-  | 6 - 14 mm
23960 - 23964
-  | 12 mm
23965
-  | 14 mm
23966
-  | 14 mm
23967





Č.p. specifikace
23924



FESTA®

SPONKOVAČKA 3 V 1

-  | 6 - 14 mm
23960 - 23964
-  | 14 mm
23966
-  | 14 mm
23967



Č.p. specifikace
23923



FESTA®

SPONKOVAČKA

-  53 | 4 - 14 mm
23904 - 23914,
23760 - 23765



Č.p. specifikace
23925 4 - 14 mm s aretací



FESTA®

ODSTRAŇOVAČ SPON

Č.p. specifikace
23945



SPONKOVAČKA

 53 | 4 - 14 mm
23760 - 23765,
23904 - 23914



Č.p.	specifikace	
23800		20

SPONKOVAČKA

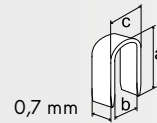

 α=9-11 mm, b=5,5mm, c=6,4mm





Č.p.	specifikace	
23920		4

FESTA

KLADIVO SPONKOVACÍ

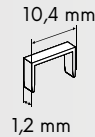
 | 6 - 10 mm
23960 - 23962



Č.p.	specifikace	
23922		10

KLADIVO SPONKOVACÍ

 | 6 - 10 mm
23960 - 23962



Č.p.	specifikace	
23928		6

FESTA

SPONY EXTRA

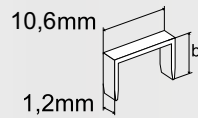

Č.p.	specifikace	
23960	b=6 mm, 1000 ks	50
23961	b=8 mm, 1000 ks	50
23962	b=10 mm, 1000 ks	50
23963	b=12 mm, 1000 ks	50
23964	b=14 mm, 1000 ks	50

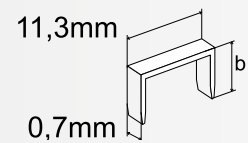

SPONY - TYP 53



Č.p.	specifikace	
23904	b=4 mm 1000 ks	200
23906	b=6 mm 1000 ks	200
23908	b=8 mm 1000 ks	200
23910	b=10 mm 1000 ks	200
23912	b=12 mm 1000 ks	200
23914	b=14 mm 1000 ks	200

FESTA

SPONY

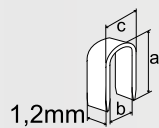

Č.p.	specifikace	
23965	α=12 mm, b=6,5 mm, c=7,5 mm, 1000 TW	50

FESTA

HŘEBÍKY



Č.p.	specifikace	
23966	hřebíky 4 mm 1000 TW	100

FESTA

HŘEBÍKY



Č.p.	specifikace	
23967	hřebíky 14 mm 1000 TW	100

SPONY - TYP 53



Č.p.	specifikace	
23760	b=4 mm 2000 ks	10
23761	b=6 mm 2000 ks	10
23762	b=8 mm 2000 ks	10
23763	b=10 mm 2000 ks	10
23764	b=12 mm 2000 ks	10

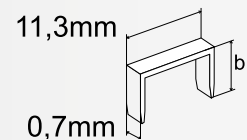



SVĚRKY A SVĚŘÁKY

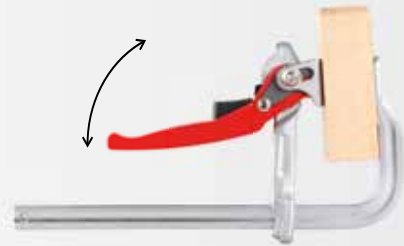

FESTA

SVĚRKA RYCHLOUPÍNACÍ

· kovaná

Č.p.	specifikace	
23560	200 x 80 mm	1
23561	300 x 100 mm	1
23562	400 x 100 mm	1
23563	500 x 120 mm	1



Č.p.	specifikace	
23564	600 x 120 mm	1
23565	800 x 120 mm	1
23566	1000 x 120 mm	1

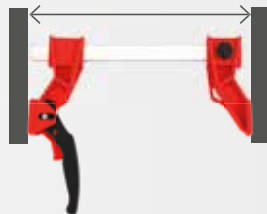

FESTA

SVĚRKA RYCHLOUPÍNACÍ



Č.p.	specifikace	
23570	100 x 80 mm	1
23571	160 x 80 mm	1
23572	200 x 80 mm	1
23573	250 x 80 mm	1
23574	300 x 80 mm	1



FESTA

ZTUŽIDLO TRUHLÁŘSKÉ



Č.p.	specifikace		Č.p.	specifikace		Č.p.	specifikace	
23670	150 x 105 mm	1	23676	500 x 175 mm	1	23682	1500 x 175 mm	1
23671	200 x 105 mm	1	23677	600 x 175 mm	1	23683	1750 x 175 mm	1
23672	250 x 105 mm	1	23678	700 x 175 mm	1	23684	2000 x 175 mm	1
23673	300 x 105 mm	1	23679	800 x 175 mm	1	23685	2200 x 175 mm	1
23674	350 x 105 mm	1	23680	1000 x 175 mm	1			
23675	400 x 175 mm	1	23681	1250 x 175 mm	1			





SVĚRKA

DIN
5117

Č.p.	specifikace	
23506	300 x 120 mm	10
23507	500 x 120 mm	10
23508	800 x 120 mm	6

SVĚRKA

Č.p.	specifikace	
23515	150 x 50 mm	50
23520	200 x 50 mm	50
23525	250 x 50 mm	50
23530	300 x 50 mm	50
23531	300 x 120 mm	20
23551	500 x 120 mm	10



FESTA

SVĚRKA RYCHLOUPÍNACÍ

Č.p.	specifikace	
23625	200 mm	6
23626	300 mm	6
23628	450 mm	6
23630	600 mm	6
23632	760 mm	6

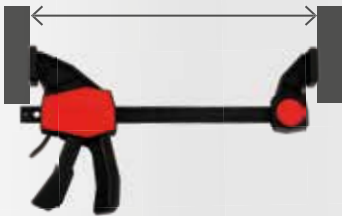

FESTA

SVĚRKA RYCHLOUPÍNACÍ

Č.p.	specifikace	
23585	150 mm	6
23587	300 mm	6
23589	450 mm	6
23591	600 mm	6

SVĚRKA
SE ZUBOVOU POJISTKOU

rozteč 80 mm

Č.p.	specifikace	
23605	9' 230 mm	6

SVĚRKA PLASTOVÁ

Č.p.	specifikace	
23600	4', rozteč 40 mm	20
23601	6', rozteč 50 mm	12
23602	9', rozteč 80 mm	20

'G' SVĚRKY SADA

3x

Č.p.	specifikace	
23620	25 mm, 50 mm, 75 mm	10



FESTA

SVĚRÁK

· tvrzené čelisti

Č.p.	specifikace	
23410	100 mm	1
23411	125 mm	1
23412	150 mm	1



SVĚRÁK OTOČNÝ

· tvrzené čelisti

Č.p.	specifikace	
23415	100 mm	1
23416	125 mm	1
23417	150 mm	1



SVĚRÁK OTOČNÝ

Č.p.	specifikace	
23407	65 mm	10



SVĚRÁK POD VRTAČKU

· tvrzené čelisti

Č.p.	specifikace	
23400	18 80 mm	10
23401	22 100 mm	10
23402	24 125 mm	5



SVĚRKA ROHOVÁ 90°

ALU	specifikace	
rozsah 0 - 65 mm		
23420	65 mm	20



**SVĚRÁK MODELÁŘSKÝ
OTOČNÝ 360° STOLNÍ**

ALU	specifikace	
23406	80 mm	24



NEW



PRACOVNÍ STŮL SKLÁDACÍ

· max. 100 kg

Č.p.	specifikace
23655	100 x 50 x 84 cm



1



STŮL PRACOVNÍ

· ideální do sklepních kójí

Č.p.	specifikace
23660	



1

STŮL PRACOVNÍ MULTIFUNKČNÍ

Č.p.	specifikace
23650	



1

NEW



FESTA

KOZA STAVEBNÍ

· maximální nosnost: 590 kg

Č.p. Specifikace

23657



1

NEW



FESTA

PŘENOSNÝ STOJANOVÝ SVĚRÁK

· rozsah čelistí: 0 - 95 cm
· maximální nosnost: 250 kg

Č.p. Specifikace

37553



1

FESTA®

KLEŠTĚ NÝTOVACÍ



FESTA

KLEŠTĚ
NÝTOVACÍ

Cr-Mo

Ø 2,4 mm
Ø 3,2 mm
Ø 4,0 mm
Ø 4,8 mm



Č.p. specifikace
24007 200 mm



1



FESTA

KLEŠTĚ
NÝTOVACÍ

Cr-Mo

Ø 2,4 mm
Ø 3,2 mm
Ø 4,0 mm
Ø 4,8 mm



Č.p. specifikace
24010 250 mm



12



FESTA

KLEŠTĚ NÝTOVACÍ

Cr-Mo

- Ø 2,4 mm
- Ø 3,2 mm
- Ø 4,0 mm
- Ø 4,8 mm
- Ø 6,4 mm



Č.p. specifikace
24017 280 mm

1



FESTA

KLEŠTĚ NÝTOVACÍ

Cr-Mo

- Ø 2,4 mm
- Ø 3,2 mm
- Ø 4,0 mm
- Ø 4,8 mm
- Ø 6,4 mm



Č.p. specifikace
24015 530 mm

1



FESTA

KLEŠTĚ NÝTOVACÍ

Cr-Mo

- Ø 2,4 mm
- Ø 3,0 mm
- Ø 3,2 mm
- Ø 4,0 mm
- Ø 4,8 mm



Č.p. specifikace
24030 260 mm

24



FESTA

KLEŠTĚ NÝTOVACÍ

· stavitelná hlava kleští
· 2 pozice

Cr-Mo



Č.p. specifikace
24002 260 mm

6

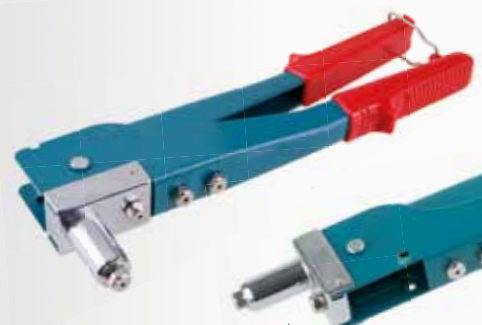

FESTA

KLEŠTĚ NÝTOVACÍ

Cr-Mo

- Ø 2,4 mm
- Ø 3,2 mm
- Ø 4,0 mm
- Ø 4,8 mm



Č.p. specifikace
24006 250 mm

12



KLEŠTĚ NÝTOVACÍ + NÝTY

Cr-Mo

- Ø 2,4 x 6 mm
- Ø 3,2 x 6 mm
- Ø 4,0 x 6 mm
- Ø 4,8 x 6 mm



Č.p. specifikace
24005 260 mm

5



FESTA

KLEŠTĚ NÝTOVACÍ S OTOČNOU HLAVOU

Cr-Mo



Č.p. specifikace
24020 290 mm

8



KLEŠTĚ NÝTOVACÍ PEVNÉ



Č.p. specifikace
24001 260 mm

6



KLEŠTĚ NÝTOVACÍ



Č.p. specifikace
24000 250 mm

24

**FESTA**

KLEŠTĚ NÝTOVACÍ PRO NÝTOVACÍ MATICE

Cr-Mo

M3
M4
M5
M6
M8
M10



Č.p. specifikace
24036 330 mm



1

**FESTA**

KLEŠTĚ NÝTOVACÍ PRO NÝTOVACÍ MATICE

Cr-Mo

M3
M4
M5
M6



Č.p. specifikace
24035 200 mm



1

**FESTA**

HLAVICE DO NÝTOVACÍCH KLEŠTÍ PRO NÝTOVACÍ MATICE

vhodné pro 24035, 24036

Cr-Mo

Č.p.	specifikace	
24038	M3	1
24039	M4	1
24040	M5	1
24041	M6	1
24042	M8	1
24043	M10	1



NÝTY HLINÍKOVÉ TRHACÍ

ALU**50x**

Č.p.	specifikace	
23970	3,2 x 6 mm	25
23971	3,2 x 8 mm	25
23972	3,2 x 10 mm	25
23973	3,2 x 12 mm	25
23974	3,2 x 14 mm	25
23975	4,0 x 6 mm	25
23976	4,0 x 8 mm	25
23977	4,0 x 10 mm	25
23978	4,0 x 12 mm	25
23979	4,0 x 14 mm	25
23985	4,8 x 6 mm	25
23986	4,8 x 8 mm	25
23987	4,8 x 10 mm	25
23988	4,8 x 12 mm	25
23989	4,8 x 14 mm	25

MATICE NÝTOVACÍ, 20 KS

ALU**20x**

Č.p.	specifikace	
23950	M3 x 9 mm	20
23951	M4 x 11 mm	20
23952	M5 x 12 mm	50
23953	M6 x 14 mm	50
23954	M8 x 16,5 mm	25
23955	M10 x 18 mm	20





FESTA

KLEŠTĚ SPOJOVACÍ
NA PROFILY - PERFORAČNÍ



Č.p.	specifikace	
17187	350 mm	6



FESTA

KLEŠTĚ SPOJOVACÍ
NA PROFILY - PERFORAČNÍ



Č.p.	specifikace	
17188	250 mm	12



KLEŠTĚ NA HMOŽDINKY

Č.p.	specifikace	
17189	255 mm	12



STAHOVÁK NA LOŽISKA
DVOURAMENNÝ

Č.p.	max. průměr	hloubka	
23734	Ø 100 mm	50-95 mm	1
23735	Ø 150 mm	100-150 mm	1
23736	Ø 200 mm	110-190 mm	1



STAHOVÁK NA LOŽISKA
TŘÍRAMENNÝ

Č.p.	max. průměr	hloubka	
23730	Ø 100 mm	50-95 mm	2
23731	Ø 150 mm	100-150 mm	2
23732	Ø 200 mm	110-190 mm	2

**FESTA****SVÁŘECÍ INVERTOR
TIG/MMA 160 A**

napětí/frekvence:	230 V / 50 Hz
napětí naprázdno:	55 V
regulační rozsah svářecích proudů	10 - 160 A
průměr elektrody:	1,5 - 4,0 mm
pracovní cyklus:	TIG- 160 A / 60%, MMA - 140 A / 60%
třída ochrany:	IP 21
druh svařování:	TIG/MMA
rozměry:	405 x 165 x 270 mm
technologie:	anti-stick, Arc-force, Hot start, Lift TIG
hmotnost:	6 kg

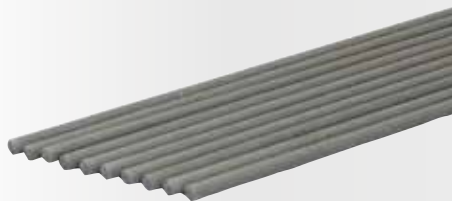

Č. p.	specifikace	
70040	svařovací invertor TIG/MMA 160A	1
70045	svařovací kabely náhradní	1
70046	hořák TIG náhradní	1

**ELEKTRODA RUTILOVÁ ER 117**

· certifikované

Č. p.	specifikace	množství	
70021	Ø 2,0 x 300 mm	10 ks	1
70020	Ø 2,0 x 300 mm	2,5 kg	8
70026	Ø 2,5 x 300 mm	10 ks	1
70025	Ø 2,5 x 300 mm	2,5 kg	8
70033	Ø 3,2 x 350 mm	10 ks	1
70032	Ø 3,2 x 350 mm	5 kg	4

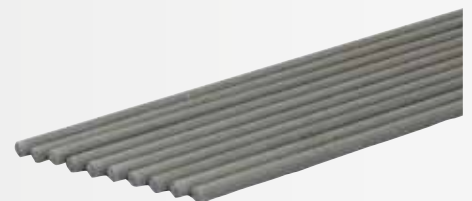
**ELEKTRODA BAZICKÁ**

· certifikované

Č. p.	specifikace	množství	
70030	Ø 2,0 x 300 mm	2,5 kg	1
70031	Ø 2,0 x 300 mm	5 kg	1
70035	Ø 2,5 x 300 mm	2,5 kg	8
70036	Ø 2,5 x 300 mm	10 ks	1
70037	Ø 3,2 x 350 mm	5 kg	5
70038	Ø 3,2 x 350 mm	10 ks	1



FESTA

KUKLA SVÁŘEČSKÁ SAMOSTMÍVACÍ

velikost zorného pole:	98 x 80 mm
rychlost zatmavení filtru:	1/25 000 s
zatmavení filtru:	DIN 5-8 / 9-13
UV/IR ochrana:	DIN 16
optická třída:	1 1 1 2
počet senzorů:	4
napájení:	solární článek + vyměnitelná baterie CR2450
pracovní režim:	sváření, broušení

LCD display



CE EN
379

č.p.	specifikace	
70064	aktivní	1
70066	náhradní krycí plexisklo	1

FESTA

KUKLA SVÁŘEČSKÁ SAMOSTMÍVACÍ - CARBON

2x CR2032 3V
CARBON
7-15 shade



č.p.	specifikace	
70063	aktivní	4

KUKLA SVÁŘEČSKÁ SAMOSTMÍVACÍ

2x AAA
7-15 shade



č.p.	specifikace	
70060	aktivní	4

KUKLA SVÁŘEČSKÁ

UV-IR protection
11 shade



č.p.	specifikace	
70061		4

BRÝLE SVÁŘEČSKÉ

UV-IR protection

č.p.	specifikace	
70062		1



SKLÍČKO NÁHRADNÍ
KRYCÍ DO SVÁŘEČSKÉ KUKLY

2x

Č.p.	specifikace	
70065	113 x 80 mm	20



KLADIVO SVÁŘEČSKÉ



Č.p.	specifikace	
19115	300 g	1



DRŽÁK ELEKTRODY



Č.p.	specifikace	
70070	300 A	1



KLEŠTĚ ZEMNÍCÍ



Č.p.	specifikace	
70075	300 A	1



FESTA

MAGNET ÚHLOVÝ



Č.p.	specifikace	nosnost	
70096	150 x 130 x 30 mm · 45°, 90°, 135°	25 kg	10



MAGNET ÚHLOVÝ



Č.p.	specifikace	nosnost	
70090	85 x 85 mm · 45°, 90°	9 kg	10



MAGNET ÚHLOVÝ



Č.p.	specifikace	nosnost	
70093	95 x 64 mm · 30°, 45°, 60°, 75°, 90°	9 kg	10
70094	120 x 90 mm · 30°, 45°, 60°, 75°, 90°	18 kg	10
70095	137 x 110 mm · 30°, 45°, 60°, 75°, 90°	27 kg	10



MAGNET ÚHLOVÝ



Č.p.	specifikace	nosnost	
70091	95 x 109 x 25 mm · 45°, 90°, 135°	13 kg	10
70092	130 x 150 x 32 mm · 45°, 90°, 135°	22 kg	5



TYČ ZÁVITOVÁ NEREZOVÁ

DIN 976 **INOX**

4.8 · třída pevnosti

Č.p.	specifikace	
55311	M 5 1 m	150
55313	M 8 1 m	50
55314	M 10 1 m	25
55315	M 12 1 m	20
55316	M 14 1 m	15
55317	M 16 1 m	15
55318	M 18 1 m	10
55319	M 20 1 m	10

TYČ ZÁVITOVÁ

DIN 975 **Zn**

4.8 · třída pevnosti

Č.p.	specifikace	
55040	M 4 1 m	200
55050	M 5 1 m	150
55060	M 6 1 m	100
55080	M 8 1 m	50
55100	M 10 1 m	20
55120	M 12 1 m	20
55140	M 14 1 m	15
55160	M 16 1 m	15
55180	M 18 1 m	10
55200	M 20 1 m	10
55220	M 22 1 m	5
55240	M 24 1 m	5
55300	M 30 1 m	5

TYČ ZÁVITOVÁ

DIN 975

4.8 · třída pevnosti

Č.p.	specifikace	
55041	M 4 1 m	200
55051	M 5 1 m	150
55181	M 18 1 m	10
55201	M 20 1 m	10
55221	M 22 1 m	5
55301	M 30 1 m	5

NEW



před po



FESTA

ODJEHLOVAČ

Ø 3 – 19 mm

1/4"



Č.p. Specifikace

16321

5



MATICE

DIN 934 **Zn**

4.8 · třída pevnosti

Č.p.	specifikace	
55350	M 4 100 ks	1
55351	M 5 100 ks	1
55352	M 6 100 ks	1
55353	M 8 100 ks	1
55354	M 10 100 ks	1
55355	M 12 100 ks	1
55356	M 14 100 ks	1
55357	M 16 100 ks	1
55358	M 18 100 ks	1
55359	M 20 10 ks	1
55360	M 22 10 ks	1
55361	M 24 10 ks	1
55362	M 30 10 ks	1



PODLOŽKA

DIN 440R **Zn**



Č.p.	specifikace	
55331	M 5 100 ks	1
55332	M 6 100 ks	1
55333	M 8 100 ks	1
55334	M 10 100 ks	1
55335	M 12 100 ks	1
55336	M 14 100 ks	1
55337	M 16 100 ks	1
55339	M 20 10 ks	1
55340	M 22 10 ks	1
55341	M 24 10 ks	1
55342	M 30 10 ks	1



**FESTA****KOMPRESOR 6 L - BEZOLEJOVÝ**

napětí/frekvence:	230 V / 50Hz
příkon:	1,2 kW (1,5HP)
objem nádrže:	6 l
max. tlak:	8 Bar
otáčky:	3900 min.
sací výkon:	180 l/min.
plnicí výkon:	116 l/min.
hmotnost:	10 kg



č.p.

35360



1

**KOMPRESOR 24 L - BEZOLEJOVÝ**

výkon:	1100 W
napájení:	230 V / 50Hz
běh bez zátěže:	2850 min-1
pracovní tlak:	8 bar
volný přívod vzduchu:	160 l / min
typ:	bezolejový / without oil
kapacita zásobníka:	24 L
hmotnost:	23 kg



č.p.

35361 1,1 kW, 24 l



1

**KOMPRESOR 24 L**

výkon:	1500 W
napájení:	230 V / 50Hz
běh bez zátěže:	2850 min-1
pracovní tlak:	8 bar
volný přívod vzduchu:	200 l / min
typ:	olejový / oleic
kapacita zásobníka:	24 L
hmotnost:	24 kg



č.p.

35362 1,5 kW, 24 l



1



FESTA

KOMPRESOROVÁ SADA

5x

- postřikovací pistole se spodním nádržkou
- foukací pistole s nanometrem
- postřikovací pistole s horní nádržkou
- ofukovací pistole
- hadice s rychlospojkami



Č.p. specifikace
48001

1



FESTA

KOMPRESOROVÁ SADA

3x

- foukací pistole s nanometrem
- ofukovací pistole
- hadice s rychlospojkami



Č.p. specifikace
48002

1



800 ml

FESTA

PISTOLE STRÍKACÍ



Č.p. specifikace
48015

spodní

1



FESTA

PISTOLE NA SPODKY A DUTINY



Č.p. specifikace
48036

spodní



1

500 ml



FESTA

PISTOLE STRÍKACÍ



Č.p.	specifikace	
48020	horní	1

600 ml



FESTA

PISTOLE STRÍKACÍ



Č.p.	specifikace	
48021	horní	1
48047	náhradní tryska Ø 1,7 mm	1

1000 ml



FESTA

PISTOLE STRÍKACÍ



Č.p.	specifikace	
48022	horní	1
48046	náhradní tryska Ø 1,5 mm	1

600 ml



FESTA

PISTOLE STRÍKACÍ

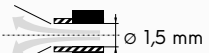

Č.p.	specifikace	
48030	dolní	1

PISTOLE STRÍKACÍ NA BARVY A OMÍTKY

- doporučený tlak 4 - 6 Bar
- objem nádoby 5 l
- průměr trysky 4; 6; 8 mm



Č.p.	specifikace	
48037		1



FESTA

PISTOLE OFUKOVACÍ



Č.p.	specifikace	
48005	krátká	25

← 50 mm →



FESTA

PISTOLE OFUKOVACÍ



Č.p.	specifikace	
48006	střední	25

← 90 mm →



FESTA

PISTOLE OFUKOVACÍ



Č.p.	specifikace	
48007	dlouhá	25



FESTA

PISTOLE FOUKACÍ
S MANOMETREM

Č.p.	specifikace
48010	



1



FESTA

HADICE TLAKOVÁ
S RYCHLOSPOJKAMI

· max. 20 Bar

Č.p.	specifikace		
48031	5 m	ø 9/15 mm	1
48032	10 m	ø 9/15 mm	1
48033	15 m	ø 9/15 mm	1
48034	20 m	ø 9/15 mm	1



FESTA

HADICE
S RYCHLOSPOJKAMI

Č.p.	specifikace	světlost
48043	5 m 8 atm	10 mm



1



FESTA

HADICE
S RYCHLOSPOJKAMI

Č.p.	specifikace	světlost	
48040	5 m 8 atm	8 mm	1
48041	10 m 8 atm	8 mm	1
48042	15 m 8 atm	8 mm	1



FESTA

FILTR

· maximální tlak 10 bar

Č.p.	specifikace
48008	G 1/4"



1



FESTA

REGULÁTOR TLAKU
S MANOMETREM

· pracovní tlak 0 - 10 bar

Č.p.	specifikace
48009	G 1/4"



1



FESTA

TRYSKA NÁHRADNÍ

· vhodné pro 48021

Č.p.	specifikace
48047	tryska Ø 1,7 mm



1



FESTA

TRYSKA NÁHRADNÍ

· vhodné pro 48022

Č.p.	specifikace
48046	tryska Ø 1,5 mm



1

TABULKA ROZMĚRŮ TRUBKOVÝCH ZÁVITŮ WHITWORTH

VELIKOST ZÁVITU G V PALCÍCH	MAXIMÁLNÍ VNĚJŠÍ Ø ZÁVITU V MM
1/8	9,728
1/4	13,157
3/8	16,662
1/2	20,955
3/4	26,441
1	33,249



RYCHLOSPOJKA

Č.p.	specifikace	
48075	1/4' vnější	10
48076	3/8' vnější	10
48077	1/2' vnější	10
48095	1/4' vnitřní	10
48096	3/8' vnitřní	10
48097	1/2' vnitřní	10

REDUKCE

Č.p.	specifikace	
48054	3/8' vnější x 1/4' vnitřní	10
48055	1/2' vnější x 3/8' vnitřní	10
48056	redukce 3/8' vnější x 1/2' vnitřní	10
48057	redukce 1/4' vnější x 3/8' vnitřní	10

ŠROUBENÍ
S VNĚJŠÍMI ZÁVITÝ

Č.p.	specifikace	
48050	spojka 1/4' vnější x 1/4' vnější	10
48051	redukce 1/4' vnější x 3/8' vnější	10

RYCHLOSPOJKA
/ HADICOVÁ VSUVKA

Č.p.	specifikace	
48070	1/4' - 6 mm	10
48071	3/8' - 9 mm	10
48072	1/2' - 13 mm	10

ADAPTÉR RYCHLOSPOJKY
/ HADICOVÁ VSUVKA

Č.p.	specifikace	
48085	1/4' - 6 mm	10
48086	3/8' - 9 mm	10
48087	1/2' - 13 mm	10



ADAPTÉR RYCHLOSPOJKY

Č.p.	specifikace	
48080	1/4' vnější	10
48081	3/8' vnější	10
48090	3/8' vnitřní	10
48091	1/4' vnitřní	10

HADICOVÁ VSUVKA

Č.p.	specifikace	
48060	Ø 6 mm - 1/8' vnější	10
48061	Ø 6 mm - 1/4' vnější	10
48062	Ø 6 mm - 3/8' vnější	10
48063	Ø 9 mm - 1/4' vnější	10
48064	Ø 9 mm - 3/8' vnější	10
48065	Ø 13 mm - 1/4' vnější	10
48066	Ø 13 mm - 3/8' vnější	10
48067	Ø 6 mm - 3/8' vnitřní	10
48068	Ø 9 mm - 3/8' vnitřní	10
48093	Ø 6 mm - 1/4' vnitřní	10
48094	Ø 9 mm - 1/4' vnitřní	10



OCHRANNÉ POMŮCKY



BRÝLE OCHRANNÉ

CE EN
166

Č.p. specifikace
50510

10



BRÝLE OCHRANNÉ

CE EN
166

Č.p. specifikace
50514

10



BRÝLE OCHRANNÉ

nastavitelná délka straniček

CE EN
166

Č.p. specifikace
50511

12



BRÝLE OCHRANNÉ

CE EN
170

Č.p. specifikace
50512 tmavé

12



BRÝLE OCHRANNÉ

CE EN
166

Č.p. specifikace
50513

1



SLUCHÁTKA OCHRANNÁ

CE EN 352 27 dB



Č.p.	specifikace	
50563		1



SLUCHÁTKA OCHRANNÁ

CE EN 352 27 dB



Č.p.	specifikace	
50564		1



ŠTÍT OCHRANNÝ PE

CE EN 166

Č.p.	specifikace	
50556		10



PŘILBA OCHRANNÁ CLIMAX

CE EN 397

MADE IN EU

Č.p.	specifikace	
50550	modrá	30
50551	červená	30
50553	bílá	30
50554	žlutá	30



ŠTÍT OCHRANNÝ S MŘÍŽKOU

CE EN 1731

Č.p.	
50562	10



VESTA REFLEXNÍ

CE EN 20471

Č.p.	specifikace	
50570	oranžová	100
50571	žlutá	100



ZÁTKY DO UŠÍ

Č.p.	specifikace	
50560		100



ZÁTKY DO UŠÍ NA ŠŤURCE

Č.p.	specifikace	
50559		100



RESPIRÁTOR

CE EN
149

Č.p.	specifikace	
50500	FFP2 bez ventilu	30
50501	FFP1 bez ventilu	30

RESPIRÁTOR

CE EN
149

Č.p.	specifikace	
50502	FFP1 s ventilem	20
50503	FFP2 s ventilem	20

ROUŠKA - ÚSTENKA

MOQ
40

50x



Č.p.	specifikace	
50505		40



RUKAVICE KOŽENÉ, ZESÍLENÉ

· s podšívkou v dlani

CE EN
166



Č.p.	specifikace	
50518	velikost 11"	12



RUKAVICE KOŽENÉ, ZESÍLENÉ

· s podšívkou v dlani

CE EN
388



Č.p.	specifikace	
50519	velikost 10,5"	12



RUKAVICE KOŽENÉ

CE EN
388



Č.p.	specifikace	
50520	velikost 10,5"	12



RUKAVICE KOŽENÉ

CE EN
388



Č.p.	specifikace	
50521	velikost 10,5"	12



RUKAVICE KOŽENÉ, S TEPLOU PODŠÍVKOU

CE EN
388



Č.p.	specifikace	
50523	velikost 11"	12



BAVLNĚNÉ RUKAVICE S PVC TERČÍKY

Č.p.	specifikace	
50524	velikost 10"	12



RUKAVICE BAVLNĚNÉ
MÁČENÉ V PVC

CE EN
388

Č.p.	specifikace	
50525	velikost 10" - délka 35 cm	12



RUKAVICE POLYESTER
S PVC TERČÍKY

· s PVC terčíky

Č.p.	specifikace	
50526	velikost 10"	12



RUKAVICE BAVLNĚNÉ
MÁČENÉ V LATEXU

CE EN
388

Č.p.	specifikace	
50522	velikost 10"	12



RUKAVICE NYLONOVÉ
MÁČENÉ V NITRILU

CE EN
388

Č.p.	specifikace	
50533	velikost 10"	12



RUKAVICE NYLON
MÁČENÉ V LATEXOVÉ PĚŇĚ

· s PVC terčíky

CE EN
388

Č.p.	specifikace	
50537	velikost 10"	12



RUKAVICE NYLON
MÁČENÉ V NITRILOVÉ PĚŇĚ

· s PVC terčíky

CE EN
388

Č.p.	specifikace	
50539	velikost 10"	12



RUKAVICE ZIMNÍ AKRYLOVÉ
MÁČENÉ V LATEXU

CE EN
388

Č.p.	specifikace	
50529	velikost 10"	12



RUKAVICE ZAHRADNÍ

Č.p.	specifikace	
50557	velikost 7"	12
50558	velikost 8"	12
50549	velikost 9"	12



RUKAVICE BAVLNĚNÉ

· s PVC terčíky

Č.p.	specifikace	
50531	velikost 9"	12





RUKAVIČE MECHANIK,
KOŽÍ KŮŽE



Č.p.	specifikace	
50541	velikost 9"	12
50542	velikost 10"	12



RUKAVIČE MECHANIK,
NYLON - VEPŘOVICE



Č.p.	specifikace	
50544	velikost 10"	12



RUKAVIČE - NYLON
MÁČENÉ V POLYURETANU



Č.p.	specifikace	
50527	velikost 10"	12



RUKAVIČE SVÁŘEČSKÉ,
KOŽENÉ



Č.p.	specifikace	
50540	velikost 11"	12



RUKAVIČE VINYLOVÉ
JEDNORÁZOVÉ

· čiré, nepudrované



Č.p.	specifikace	
50532	velikost 9"	100



OCHRANNÁ KOMBINÉZA
S KAPUCÍ

Č.p.	specifikace	
50585	velikost M	1
50586	velikost L	1
50587	velikost XL	1
50588	velikost XXL	1



ZÁSTĚRA NA SVAŘOVÁNÍ



Č.p.	specifikace	
50555	kůže	1

**FESTA**

OCHRANA KOLEN



KLEKÁTKO POJÍZDNÉ

Č.p.	specifikace	
37135		1

Č.p.	specifikace	
37145	gel	8

**FESTA**

OCHRANA KOLEN



Č.p.	specifikace	
37140	gel	12

FESTA

OCHRANA KOLEN



Č.p.	specifikace	
37144	gel	12

FESTA

OCHRANA KOLEN



Č.p.	specifikace	
37143		12

**FESTA**

OCHRANA KOLEN

Č.p.	specifikace	
37142	komfort	20

OCHRANA KOLEN



Č.p.	specifikace	
37139	neopren	10

OCHRANA KOLEN

Č.p.	specifikace	
37141		6

· kvalitní kovová rukojeť, polstrovaná

· pohodlný ramenní, odnímatelný popruh

· popruhy se suchým zipem pro upevnění dlouhého nářadí

· 18 kapes
· vyztužená vnitřní konstrukce



FESTO

TAŠKA NA NÁŘADÍ S KOVOVOU RUKOJETÍ

č.p.	výška	délka	hloubka	
37331	280 mm	490 mm	230 mm	2



FESTO

TAŠKA

č.p.	šířka	výška	hloubka	
37332	480 mm	290 mm	250 mm	1



FESTO

TAŠKA

č.p.	šířka	výška	hloubka	
37330	610 mm	400 mm	270 mm	5

**FESTA****POUZDRO NÁŘAĐOVÉ**

· vyztužené kapsy



10

Č.p. specifikace
37325**FESTA****POUZDRO NÁŘAĐOVÉ**

· vyztužené kapsy



12

Č.p. specifikace
37326**FESTA****OPASEK SE SPONOU**Č.p. specifikace
37328 145 cm

20

**FESTA**

**FESTA****OPASEK MONTÁŽNÍ - SADA**

· 14 kapes + oko

č.p.	délka	šířka
37311	120 cm	6 cm



1

**FESTA****POUZDRO NÁŘAĐOVÉ**

· 8 kapes

č.p.	šířka	výška
37320	300 mm	250 mm



1

**FESTA****POUZDRO NÁŘAĐOVÉ**

· 4 kapsy

č.p.	šířka	výška
37321	350 mm	300 mm



1

**FESTA****OPASEK NYLONOVÝ**

č.p.	délka	šířka
37310	120 cm	6 cm



1

**FESTA****VESTA PRACOVNÍ**

č.p.	specifikace
37350	



20

**FESTA**

PÁS NÁŘAĎOVÝ KOŽENÝ



Č.p.	specifikace	
37302	6 kapes	50
37303	11 kapes	25



PÁS NÁŘAĎOVÝ KOŽENÝ

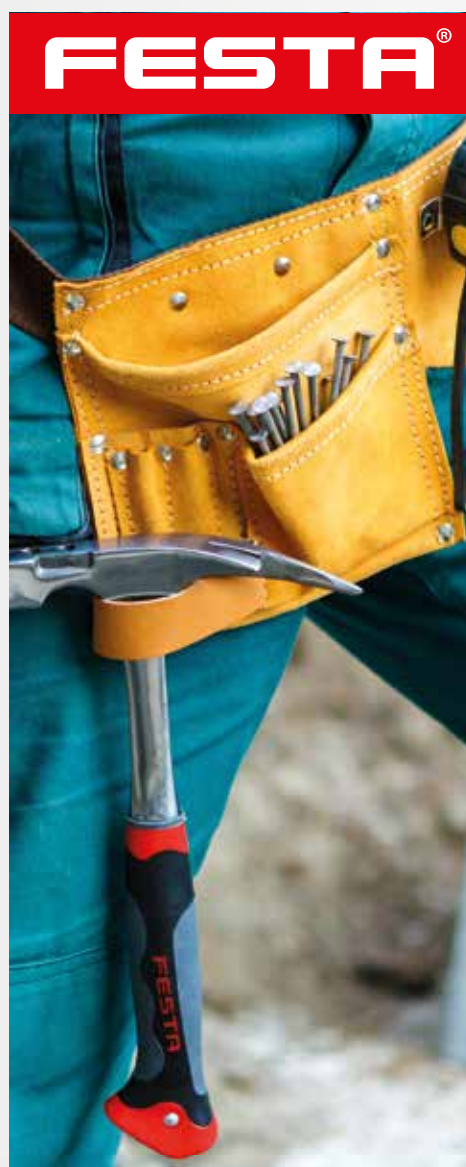

Č.p.	specifikace	
37300	6 kapes	50
37301	11 kapes	25

**FESTA®**BRAŠNA KOŽENÁ
PROFESIONÁLNÍ

Č.p.	výška	délka	hloubka	
37342	270 mm	430 mm	180 mm	1

BRAŠNA ELEKTRIKÁŘSKÁ
KOŽENÁ

Č.p.	výška	délka	hloubka	
37341	260 mm	430 mm	200 mm	1



BRAŠNA KOŽENÁ
S VYZTUŽENÝM DNEM



Č.p.	výška	délka	hloubka	
37340	240 mm	430 mm	150 mm	1



BRAŠNA ŘEMESLNICKÁ
S POPRUHEM

Č.p.	výška	délka	hloubka	
37344	250 mm	300 mm	130 mm	1



BRAŠNA
S VYZTUŽENÝM DNEM

Č.p.	výška	délka	hloubka	
37343	240 mm	430 mm	150 mm	1



BRAŠNA ELEKTRIKÁŘSKÁ

Č.p.	výška	délka	hloubka	
37345	270 mm	430 mm	180 mm	1



SPONA - KŮŽE "O"



Č.p.	specifikace	
37308		20



SPONA - KŮŽE "U"



Č.p.	specifikace	
37309		20

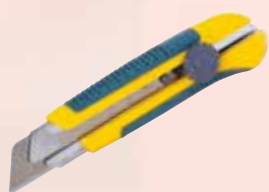

162

ODLAMOVACÍ NOŽE KDS



164

ODLAMOVACÍ NOŽE FESTA



170

ŠKRABKY



171

NÁHRADNÍ ČEPELE

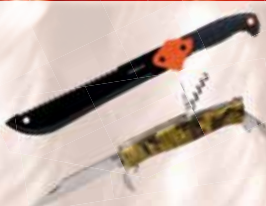

173

NOŽE A MAČETY



178

SVÁŘEČKY, ŘEZAČE,
KLEŠTĚ NA PVC TRUBKY

181

ŘEZAČKY NA POLYSTYREN



184

VRTÁKY DO KOVU



194

VYKRUŽOVÁKY, SEKÁČE,
PRŮBOJNÍKY

198

DIAMANTOVÉ KORUNKY



204

VRTÁKY DO DŘEVA,
VYKRUŽOVACÍ PILY, FRÉZY

208

SKLÍČIDLA

VRTÁKY, ŘEZNÉ
A BRUSNÉ NÁSTROJE 160 - 241



210

ROTAČNÍ BRUSNÉ KARTÁČE



214

BRUSNÉ KOTOUČE A
PAPÍRY



219

RAŠPLE NA SÁDROKARTON



220

PILNÍKY A RAŠPLE



222

PILOVÉ KOTOUČE, PLÁTKY



225

PILOVÉ PLÁTKY



228

PILY NA DŘEVO, KOV A JINÉ



234

DIAMANTOVÉ KOTOUČE



238

ŘEZNÉ A BRUSNÉ
KOTOUČE

KDS®

Nože japonské firmy KDS

- vynikající ergonomie rukojetí
- vysoký výkon a životnost břitů
- nejlepší použité materiály břitů
- nízký rezný odpor umožňující lehký řez

KDS® NŮŽ ODLAMOVACÍ



Č.p.	specifikace		
16002	LC405	18 mm zelený	25
16011	LB10	náhradní čepele	10



KDS® NŮŽ ODLAMOVACÍ



Č.p.	specifikace		
16003	G11	18 mm + 2 čepele	10
16012	GB10	náhradní čepele	10



KDS® NŮŽ ODLAMOVACÍ



Č.p.	specifikace		
16019	LI9	18 mm + 2 čepele	10
16011	LB10	náhradní čepele	10
16012	GB10	náhradní čepele	10





KDS®
NŮŽ ODLAMOVCÍ

Č.p.	specifikace	
16004	H11 25 mm	10
16013	HB10 náhradní čepele	10



KDS®
NŮŽ ODLAMOVCÍ



Č.p.	specifikace	
16005	S14 9 mm + 2 čepele	10
16010	SB10 náhradní čepele	10



KDS®
SKALPEL



Č.p.	specifikace	
16006	D12 + 16 čepele	10



KDS®
ČEPEL NÁHRADNÍ KDS



Č.p.	specifikace	
16010	SB10 9 0,38 mm 13 segmentů	20
16011	LB10 18 0,5 mm 15 segmentů	20
16012	GB10 18 0,6 mm 15 segmentů	20
16013	HB10 25 0,7 mm 7 segmentů	10



KDS®
ČEPEL NÁHRADNÍ KDS

- speciální slitina
- dvojí broušení
- zvýšená životnost
- nízký řezný odpor
- umožňující lehké řezání



Č.p.	specifikace	
16016	LB10B 18 0,5 mm 8 segmentů	20
16017	HB10B 25 0,7 mm 7 segmentů	10

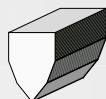

• ilustrační foto

KDS®
STOJAN NA ODLAMOVCÍ NOŽE

- osazení stojanu 16998 : 16001 · 5 ks
- 16003 · 5 ks
- 16004 · 3 ks
- 16005 · 3 ks
- 16006 · 2 ks
- 16008 · 3 ks
- 16010 · 4 ks
- 16012 · 4 ks
- 16013 · 1 ks
- 16016 · 4 ks
- 16018 · 4 ks
- 16019 · 4 ks
- 16020 · 4 ks

Č.p.	specifikace	
16999	reklamní stojan	1
16998	osazený reklamní stojan	1

FESTO
FESTO
NŮŽ ODLAMOVCÍ S KERAMICKOU ČEPELÍ

- 3x ostřejší než čepel ocelová
- 10x delší životnost
- žáruvzdorná, nevodivá, nemagnetická



Č.p.	specifikace	
16131	18 mm	10
16066	náhradní čepel 18 mm, 5 ks	10

FESTO
NŮŽ ODLAMOVCÍ



Č.p.	specifikace	
16110	L11 18 mm + 1 čepel	12

FESTO
NŮŽ ODLAMOVCÍ

Č.p.	specifikace	
16100	L12 18 mm + 1 čepel	12

FESTO
NŮŽ ODLAMOVCÍ

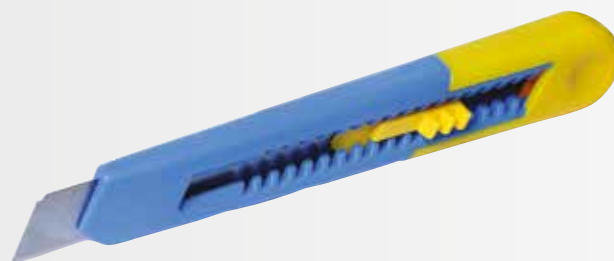
Č.p.	specifikace	
16105	L17 18 mm + 1 čepel	12

FESTO
NŮŽ ODLAMOVCÍ

Č.p.	specifikace	
16125	L4 9 mm	24
16120	L8 18 mm	24

FESTO
NŮŽ ODLAMOVCÍ

Č.p.	specifikace	
16115	L10 9 mm	24

FESTO
NŮŽ ODLAMOVCÍ

Č.p.	specifikace	
16150	18 mm	24
16151	18 mm bez loga FESTO	20



FESTA

NŮŽ ODLAMOVCÍ

ALU



Č.p.	specifikace
16136	18 mm

12



FESTA

NŮŽ ODLAMOVCÍ

ALU



Č.p.	specifikace
16137	25 mm

12



FESTA

NŮŽ ODLAMOVCÍ

• protiskluzové pogumování

+4 ALU



Č.p.	specifikace
16090	18 mm

12



FESTA

NŮŽ ODLAMOVCÍ

• protiskluzové pogumování

+4 ALU



Č.p.	specifikace
16091	25 mm

6



FESTA

NŮŽ ODLAMOVCÍ

• protiskluzové pogumování

ALU



Č.p.	specifikace
16145	L25 18 mm

12



FESTA

NŮŽ ODLAMOVCÍ

• protiskluzové pogumování

ALU



Č.p.	specifikace
16144	L24 18 mm

12



NŮŽ ODLAMOVCÍ

ALU



Č.p.	specifikace
16143	18 mm

12



NŮŽ ODLAMOVCÍ

ALU



Č.p.	specifikace
16142	18 mm

12



NŮŽ ODLAMOVCÍ

ALU



Č.p.	specifikace
16025	18 mm

12



FESTA

NŮŽ ODLAMOVCÍ

ALU



Č.p.	specifikace
16029	18 mm

25



FESTA

NŮŽ ODLAMOVCÍ

· protiskluzové pogumování



Č.p.	specifikace
16146	18 mm

12



FESTA

NŮŽ ODLAMOVCÍ

· protiskluzové pogumování



Č.p.	specifikace
16147	25 mm

12



FESTA

NŮŽ ODLAMOVCÍ

· protiskluzové pogumování



Č.p.	specifikace
16130	L18 18 mm + 5 čepelek

12



FESTA

NŮŽ ODLAMOVCÍ

· protiskluzové pogumování



Č.p.	specifikace
16135	L20 25 mm + 5 čepelek

6



FESTA

NŮŽ ODLAMOVCÍ

· protiskluzové pogumování



Č.p.	specifikace
16140	L22 18 mm

12



FESTA

NŮŽ ODLAMOVCÍ

· protiskluzové pogumování

ALU



Č.p.	specifikace
16034	25 mm

12



FESTA

NŮŽ ODLAMOVCÍ

INOX

Č.p.	specifikace
16085	9 mm



24



FESTA

NŮŽ ODLAMOVCÍ

INOX

Č.p.	specifikace
16086	18 mm



24



NŮŽ BEZPEČNOSTNÍ

· samozatahovací čepel

Č.p.	specifikace
16057	135 mm



12



FESTA

NŮŽ BEZPEČNOSTNÍ

ALU INOX

Č.p.	specifikace
16058	
16074	náhradní čepel 10 ks



6

1



FESTA

NŮŽ TURBO

+5 ALU

Č.p.	specifikace
16037	+ 5 čepel



6



FESTA

NŮŽ ZAVÍRACÍ

+5 ALU

Č.p.	specifikace
16023	nůž zavírací + 5 čepel
16071	náhradní čepel 10 ks



12

10

FESTA

NŮŽ ZAVÍRACÍ, SADA ČEPELÍ

ALU

Č.p.	specifikace
16095	25 čepel



1

**FESTA****NŮŽ S ARETACÍ**

· protiskluzové pogumování



Č.p.	specifikace
16035	+ 2 čepeleky

12

**FESTA****NŮŽ S ARETACÍ**

Č.p.	specifikace
16033	NP 110 + 3 čepeleky

5

**FESTA****NŮŽ S ARETACÍ**

Č.p.	specifikace
16038	+ 5 čepeleky

12

**NŮŽ S ARETACÍ**

Č.p.	specifikace
16032	NP 109

48

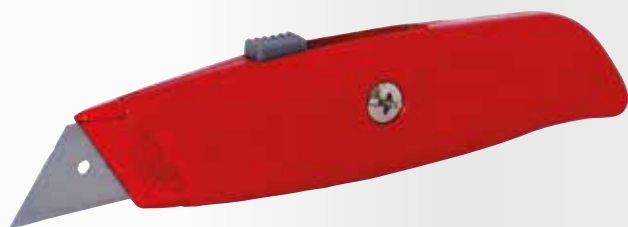
**NŮŽ S ARETACÍ**

Č.p.	specifikace
16031	NS 107 B

24

**NŮŽ**

Č.p.	specifikace
16030	NS 107

24

**NŮŽ NA PODLAHOVINY**

· na koberce a podlahové krytiny

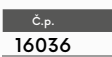

Č.p.	specifikace
16036	45 mm

12

**NŮŽ HÁKOVÝ**

· na koberce a podlahové krytiny

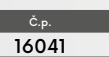

Č.p.	specifikace
16041	

12



NŮŽ ODLAMOVCÍ

ALU



Č.p.	specifikace	
16046	18 mm	12



NŮŽ ODLAMOVCÍ

Č.p.	specifikace	
16028	S 201 18 mm	24



NŮŽ ODLAMOVCÍ

Č.p.	specifikace	
16026	P 205 18 mm	30



NŮŽ ODLAMOVCÍ

HOBBY

Č.p.	specifikace	
16021	P 201 9 mm	60



NŮŽ ODLAMOVCÍ

HOBBY

Č.p.	specifikace	
16024	P 204 18 mm	60



MOQ 24



NŮŽ ODLAMOVCÍ

protiskluzové pogumování

Č.p.	specifikace	
16141	18 mm	24



SADA NOŽŮ

HOBBY 12x

Č.p.	specifikace	
16053	9 mm	12
16055	18 mm	12



SADA NOŽŮ

HOBBY 3x

Č.p.	specifikace	
16043		24



ŠKRABKA

ALU



Č.p.	specifikace	
16059	50 mm	10
16082	břit náhradní	1



ŠKRABKA

· pro použití s 18 mm čepeli k odlamovacím nožům

ALU



Č.p.	specifikace	
16054	100 mm	1



FESTA

ŠKRABKA POGUMOVANÁ

· protiskuzové pogumování



Č.p.	specifikace	
16049		12
16069	náhradní čepel	1



FESTA

ŠKRABKA



Č.p.	specifikace	
16052	48 cm délka	6
16070	čepel	25



ŠKRABKA



Č.p.	specifikace	
16051		24



ŠKRABKA



Č.p.	specifikace	
16050		24



SADA NA APLIKACI A ODSTRANĚNÍ SILIKONU

3x



Č.p.	specifikace	
16042		12

FESTA

ČEPEL NÁHRADNÍ

- 7 segmentů
- 3x delší životnost
- dvojitě broušení
- nízký řezný odpor

SK2 10x

Č.p. specifikace
16064 25 | 0,7 mm



20



ČEPEL NÁHRADNÍ

- 7 segmentů

10x

Č.p. specifikace
16068 25 | 0,6 mm



20

FESTA

ČEPEL NÁHRADNÍ

- 8 segmentů
- 3x delší životnost
- dvojitě broušení
- nízký řezný odpor

SK2 10x

Č.p. specifikace
16062 18 | 0,7 mm



10

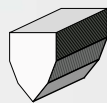

FESTA

ČEPEL NÁHRADNÍ

- 15 segmentů
- 3x delší životnost
- dvojitě broušení
- nízký řezný odpor

SK2 10x

Č.p. specifikace
16063 18 | 0,7 mm



10

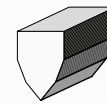

FESTA

ČEPEL NÁHRADNÍ KERAMICKÁ

- 8 segmentů
- 3x ostřejší než čepel ocelová
- 10x delší životnost
- Žáruvzdorná, nevodivá, nemagnetická

5x

Č.p. specifikace
16066 18 | 0,6 mm



10

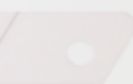

ČEPEL NÁHRADNÍ

- 4 segmenty

10x

Č.p. specifikace
16067 18 | 0,5 mm



10



ČEPEL NÁHRADNÍ

- 8 segmentů

10x

Č.p. specifikace
16065 18 | 0,5 mm



60



ČEPEL NÁHRADNÍ

- 15 segmentů

10x

Č.p. specifikace
16081 18 | 0,5 mm



60



ČEPEL NÁHRADNÍ

- 8 segmentů

- dvojitě broušení

10x

Č.p. specifikace
16078 18 | 0,5 mm



25



ČEPEL NÁHRADNÍ

- 8 segmentů

- dvojitě broušení

10x

Č.p. specifikace
16077 18 | 0,6 mm



25





ČEPEL NÁHRADNÍ 30°

· 7 segmentů

10x

Č.p.	specifikace	
16061	9 0,4 mm	60



60

ČEPEL NÁHRADNÍ

· 13 segmentů

10x

Č.p.	specifikace	
16060	9 0,45 mm	10



FESTA

ČEPEL NÁHRADNÍ

· pro 16058

10x

Č.p.	specifikace	
16074		1

FESTA

ČEPEL NÁHRADNÍ

10x



Č.p.	specifikace	
16072	R 004	10

FESTA

ČEPEL NÁHRADNÍ

10x



Č.p.	specifikace	
16075	R 003	10



ČEPEL NÁHRADNÍ

10x

Č.p.	specifikace	
16071	R 001	60

ČEPEL NÁHRADNÍ

10x

Č.p.	specifikace	
16073	R 002	60

ČEPEL NÁHRADNÍ

5x

Č.p.	specifikace	
16084	18 mm	50

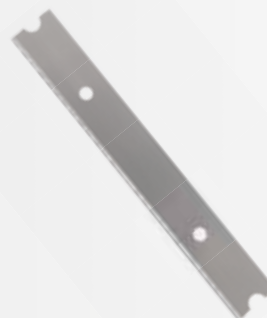
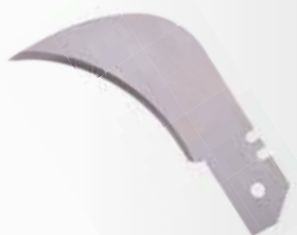

ČEPEL NÁHRADNÍ

5x

Č.p.	specifikace	
16083	18 mm	50

ČEPEL NÁHRADNÍ

· pro 34315

Č.p.	specifikace	
34316		1

ČEPEL NÁHRADNÍ NA ŠKRABKU

· pro 16052

Č.p.	specifikace	
16070	100 mm	25



FESTA

NŮŽ LOVECKÝ

- nylonová rukojeť
- čepel s teflonovým povrchem
- pouzdro s pojistkou a klipem



Č.p.	specifikace	
16234	21 10 cm	10



FESTA

NŮŽ LOVECKÝ



Č.p.	specifikace	
16229	23 10 cm	12



FESTA

DLÁTO TRUHLÁŘSKÉ MULTIFUNKČNÍ

- zesílená čepel



Č.p.	specifikace	
16231	20 8 cm	12



NŮŽ TECHNICKÝ

- zesílená čepel



Č.p.	specifikace	
16230	21 10 cm	12



NŮŽ



Č.p.	specifikace	
16022	16 6,5 cm	100



FESTA

NŮŽ ZAHNUTÝ NA PODLAHOVINY

Č.p.	specifikace	
16225	20 8,5 cm	12



FESTA

NŮŽ ELEKTRIKÁŘSKÝ

- zesílená čepel



Č.p.	specifikace	
16212	15 3,2 cm	12



FESTA

NŮŽ ODIZOLOVÁVACÍ

Č.p.	specifikace	
16201	Ø 8 - 27 mm	10

**FESTA**

NŮŽ ELEKTRIKÁŘSKÝ

INOX



Č.p.	specifikace
16211	20 8,5 cm

10

**FESTA**

NŮŽ ELEKTRIKÁŘSKÝ

INOX



Č.p.	specifikace
16210	20,5 9 cm

10

**FESTA**

NŮŽ OČKOVACÍ

INOX



Č.p.	specifikace
16219	19 11 cm

24

**FESTA**

NŮŽ ROUBOVACÍ

INOX



Č.p.	specifikace
16218	18,5 10,5 cm

24

**FESTA**

NŮŽ ŠTĚPAŘSKÝ

INOX



Č.p.	specifikace
16220	18,5 11 cm

24

**FESTA**

NŮŽ ZAVÍRACÍ

INOX



Č.p.	specifikace
16235	17,5 8,5 cm

24

**FESTA**

NŮŽ ZAVÍRACÍ

INOX



Č.p.	specifikace
16221	21 12 cm

24

**FESTA**

NŮŽ ZAVÍRACÍ

INOX



Č.p.	specifikace
16236	22,5 10 cm

24



FESTA

NŮŽ ZAVÍRACÍ



Č.p.	specifikace
16209	14,5 5,5 cm

1



FESTA

NŮŽ ZAVÍRACÍ

INOX



Č.p.	specifikace
16222	20 12 cm

24



FESTA

NŮŽ ZAVÍRACÍ

INOX ALU



Č.p.	specifikace
16223	18,5 10,5 cm

24



FESTA

NŮŽ ZAVÍRACÍ MULTIFUNKČNÍ

• 10 funkcí

INOX



Č.p.	specifikace
16226	17,5 7 cm

24



FESTA

NŮŽ ZAVÍRACÍ MULTIFUNKČNÍ

• 5 funkcí

INOX



Č.p.	specifikace
16228	27 10,5 cm

24



NŮŽ ZAVÍRACÍ LOVECKÝ

• 3 funkce



Č.p.	specifikace
16227	20,5 10 cm

24



NŮŽ ZAVÍRACÍ MULTIFUNKČNÍ

• 7 funkcí

INOX



Č.p.	specifikace
16224	17,5 7 cm

24

**FESTA****KLEŠTĚ MULTIFUNKČNÍ**

- 9 funkcí
- pouzdro

CrV

Č.p.	specifikace
16232	



12

**FESTA****NŮŽ NA MINERÁLNÍ VATU**

Č.p.	specifikace
16198	44,5 33 cm

12

**FESTA****NŮŽ NA IZOLACE**

- na minerální vatu, polystyren



Č.p.	specifikace
16199	48 35 cm

10

**FESTA****MAČETA****TEFLON**

Č.p.	specifikace
45069	440 mm

6

**FESTA****MAČETA****TEFLON**

Č.p.	specifikace
44950	490 mm

4

**MAČETA NEREZ****INOX**

Č.p.	specifikace
45083	430 mm
45084	600 mm

12

6

**MAČETA**

- rukojeť vyrobená z jasanového dřeva

Č.p.	specifikace
45081	510 mm
45082	710 mm

36

36



SADA SKALPELŮ

23x



24

Č.p. specifikace

16282



SADA SKALPELŮ

13x



10

Č.p. specifikace

16281



BROUSEK OVÁLNÝ

Č.p. specifikace

45370

250 x 33 x 18 mm



20

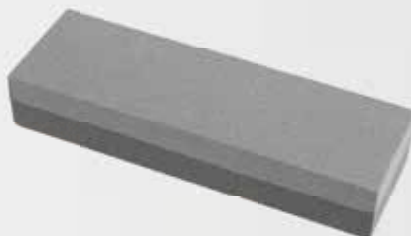

BROUSEK

Č.p. specifikace

45045

150 x 50 x 30 mm



1



BROUSEK NA KOSU

Č.p. specifikace

45046

205 x 15 mm



100



BROUSEK NA NOŽE A NŮŽKY

Č.p. specifikace

16991



20



BROUSEK NA NOŽE A NŮŽKY

Č.p. specifikace

16990

Ø 50 mm



1



BROUSEK NA NOŽE A NŮŽKY

Č.p. specifikace

45048



20



BROUSEK NA NOŽE A NŮŽKY 6 V 1

Č.p. specifikace

45068



10



WINLAND



WINLAND

**FESTA****POLYFÚZNÍ SVÁŘEČKA PLASTOVÝCH TRUBEK**

- napětí / frekvence 230 V / 50 Hz
- příkon 750 / 1500 W
- teplota 0-300 C°
- nástavce Ø 20,25,32,40,50,63 mm
- váha 1,6 kg



· součást balení: metr, vodováha, šroubovák, inbus klíč, nůžky na trubky, 6x svařovací nástavec, stojánek, plechový kufr

Č.p.

17182

**FESTA****HROTOVÁ POLYFÚZNÍ SVÁŘEČKA PLASTOVÝCH TRUBEK**

- napětí / frekvence 230 V / 50 Hz
- příkon 800 / 1000 W
- teplota 0-300 C°
- nástavce Ø 16, 20, 25, 32 mm
- váha 1 kg



· součást balení: inbus, 4x svařovací nástavec, stojánek, plechový kufr

Č.p.

17183





FESTA®

FESTA®

KLEŠTĚ NA PVC TRUBKY

ID max.
42 mm



Č.p.	specifikace	
17027		10
16315	náhradní čepel	1



ČEPEL NÁHRADNÍ PRO KLEŠTĚ

· pro klešče 17027

Č.p.	specifikace	
16315		1

NEW



FESTA®

KLEŠTĚ NA PVC TRUBKY

ID max.
32 mm



Č.p.	specifikace	
17037		12



KLEŠTĚ NA PVC TRUBKY

ID max.
42 mm



Č.p.	specifikace	
17026		6



FESTA®

NUŽKY NA PVC LIŠTY A TRUBKY

· lišty, trubky, profily

Ø 17 mm Ø 20 mm Ø 27 mm

5x

Č.p.	specifikace	
17050		8



**FESTA**

ŘEZAČ TENKOSTĚNNÝCH TRUBEK

ID 3-22
mm

Č.p.	specifikace	
16301		10
16311	náhradní kolečko	1

**FESTA**

ŘEZAČ TENKOSTĚNNÝCH TRUBEK

ID 6-64
mm

Č.p.	specifikace	
16304		6
16312	náhradní kolečko	1



ŘEZAČ TENKOSTĚNNÝCH TRUBEK

ID 3-32
mm

Č.p.	specifikace	
16303		10
16311	náhradní kolečko	1



ŘEZAČ TENKOSTĚNNÝCH TRUBEK

ID 3-32
mm

Č.p.	specifikace	
16300		10
16310	náhradní kolečko	1

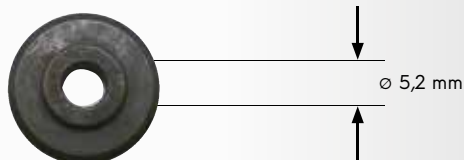
**NEW**

před

po

KOLEČKO NÁHRADNÍ
PRO ŘEZAČE PVC TRUBEK

Č.p.	specifikace	
16310	Ø 17,5 mm x 6 m pro 16300	1
16311	Ø 18,0 mm x 4,5 mm pro 16303, 16301	1
16312	Ø 27,5 mm x 6 mm pro 16304	1

ODJEHLOVAČ

1/4"

Č.p.	specifikace	
16321		5

ODJEHLOVAČ NA TRUBKY

ID 6-32
mm

Č.p.	specifikace	
16320		1



FRÉZA ODJEHLOVACÍ, RUČNÍ HSS

1/4" HSS

4x



Č.p.	specifikace	
20360		10



ODJEHLOVAČ

Č.p.	specifikace	
16361		1



FESTA

ŘEZAČKA POLYSTYRENU AKUMULÁTOROVÁ

- baterie 36 V, 1,5Ah Li-ion
- výkon 180 W
- teplota max 350 C°
- délka čepele 20 cm



· vybavení: 2 ks baterie, nabíječka, čepel, čistící mosazný kartáč, inbus

Č.p.	specifikace
35323	



FESTA

ŘEZAČKA POLYSTYRENU ELEKTRICKÁ

- napětí / frekvence 230 V/50 Hz
- příkon 250 W
- teplota 50-600 C°
- délka čepele 25 cm
- délka přívodního kabelu 3 m



· vybavení: čistící mosazný kartáč, inbus, nůž 25 cm, kufr

Č.p.	specifikace	1
35326	elektrická řezačka polystyrenu	1
35328	náhr. nůž do řezačky polystyrenu 14 cm	1
35329	náhr. nůž do řezačky polystyrenu 25 cm	1



VODÍČÍ LIŠTA PRO ŘEZAČKU POLYSTYRENU

· pro 35323, 35326

Č.p.	specifikace	1
35327	vodící lišta	1
35335	náhradní nůž - 30 cm	1

FESTA

ŘEZAČKA POLYSTYRENU ELEKTRICKÁ



· regulace teploty

Č.p.	specifikace
35325	220 W



NEW



FESTA

ŘEZAČKA POLYSTYRENU STRUNOVÁ

- napětí/frekvence 230 V/50 Hz
 - příkon 160 W
 - délka řezu 137 cm
 - výška řezu 30 cm
 - krytí IP44
 - úhel řezu 0° - 90°
- vybavení: stojan, nožní spínač, držák na lešení, 2x Ni-Cr řezací drát, čistící mosazný kartáč, nářadí a spojovací materiál, plastový box s kolečky



Č.p. Specifikace

35348



1

NEW



1,7 m

FESTA

NOŽNÍ SPÍNAČ
PRO ŘEZAČKU POLYSTYRENU

pro 35330, 35345, 35348

Č.p. Specifikace

35334



1

NEW



FESTA

STOJAN
PRO ŘEZAČKU POLYSTYRENU

pro 35330, 35345, 35348

Č.p. Specifikace

35336



1

NEW



FESTA

NÁHRADNÍ PRUŽINA
PRO ŘEZAČKU POLYSTYRENU

pro 35330, 35345, 35348

Č.p. Specifikace

35332



1

NEW



FESTA

DRŽÁK NA LEŠENÍ
PRO ŘEZAČKU POLYSTYRENU

pro 35330, 35345, 35348

Č.p. Specifikace

35333



1

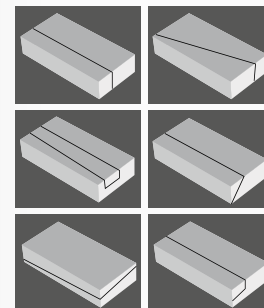
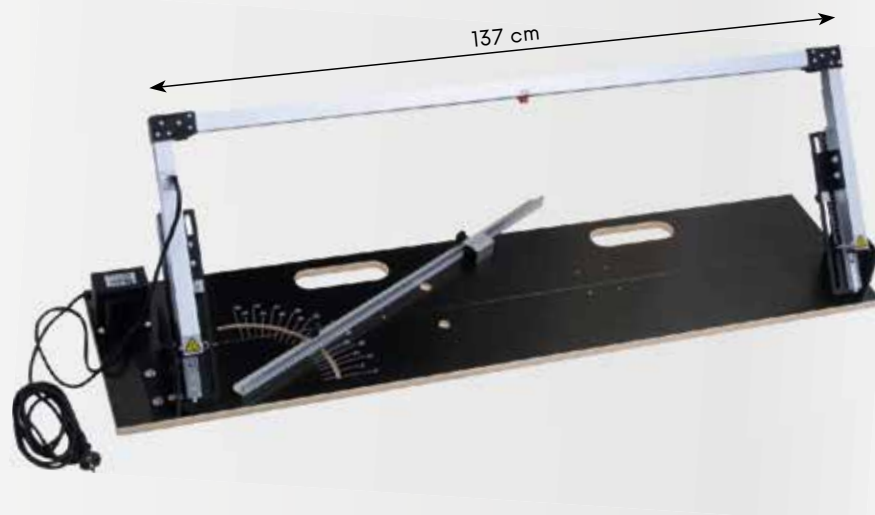

FESTA

ŘEZAČKA POLYSTYRENU STRUNOVÁ

- napětí/frekvence: 230 V / 50 Hz
- příkon: 160 W
- délka řezu: 137 cm
- výška řezu: 30 cm
- krytí: IP44
- úhel řezu: 0° - 90°



· vybavení: Ni-Cr řezací drát, čistící mosazný kartáč, inbus

Č.p.	specifikace	
35345	Řezačka polystyrenu 1500 x 450 mm	1
35346	Náhradní řezná struna Ni-Cr	1
35347	Náhradní zdroj	1

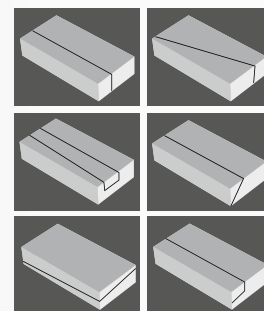
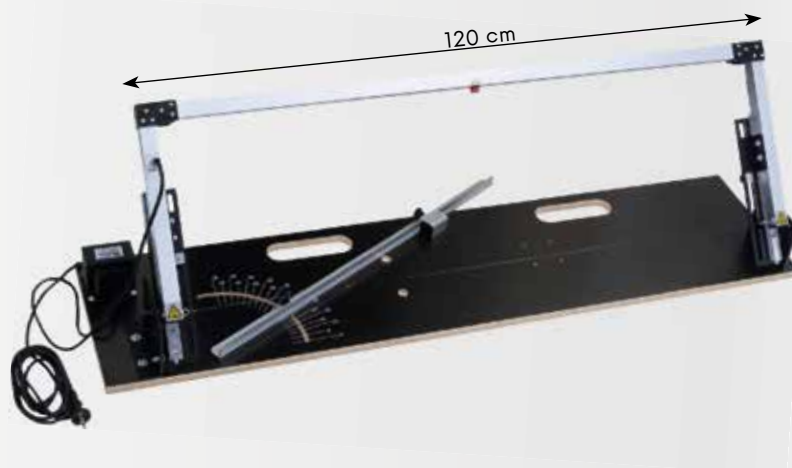

FESTA

ŘEZAČKA POLYSTYRENU STRUNOVÁ

- napětí/frekvence: 230 V / 50 Hz
- příkon: 160 W
- délka řezu: 120 cm
- výška řezu: 30 cm
- krytí: IP44
- úhel řezu: 0° - 90°



· vybavení: Ni-Cr řezací drát, čistící mosazný kartáč, inbus

Č.p.	specifikace	
35330	Řezačka polystyrenu 1350 x 450 mm	1
35331	Náhradní řezná struna Ni-Cr	1
35347	Náhradní zdroj	1

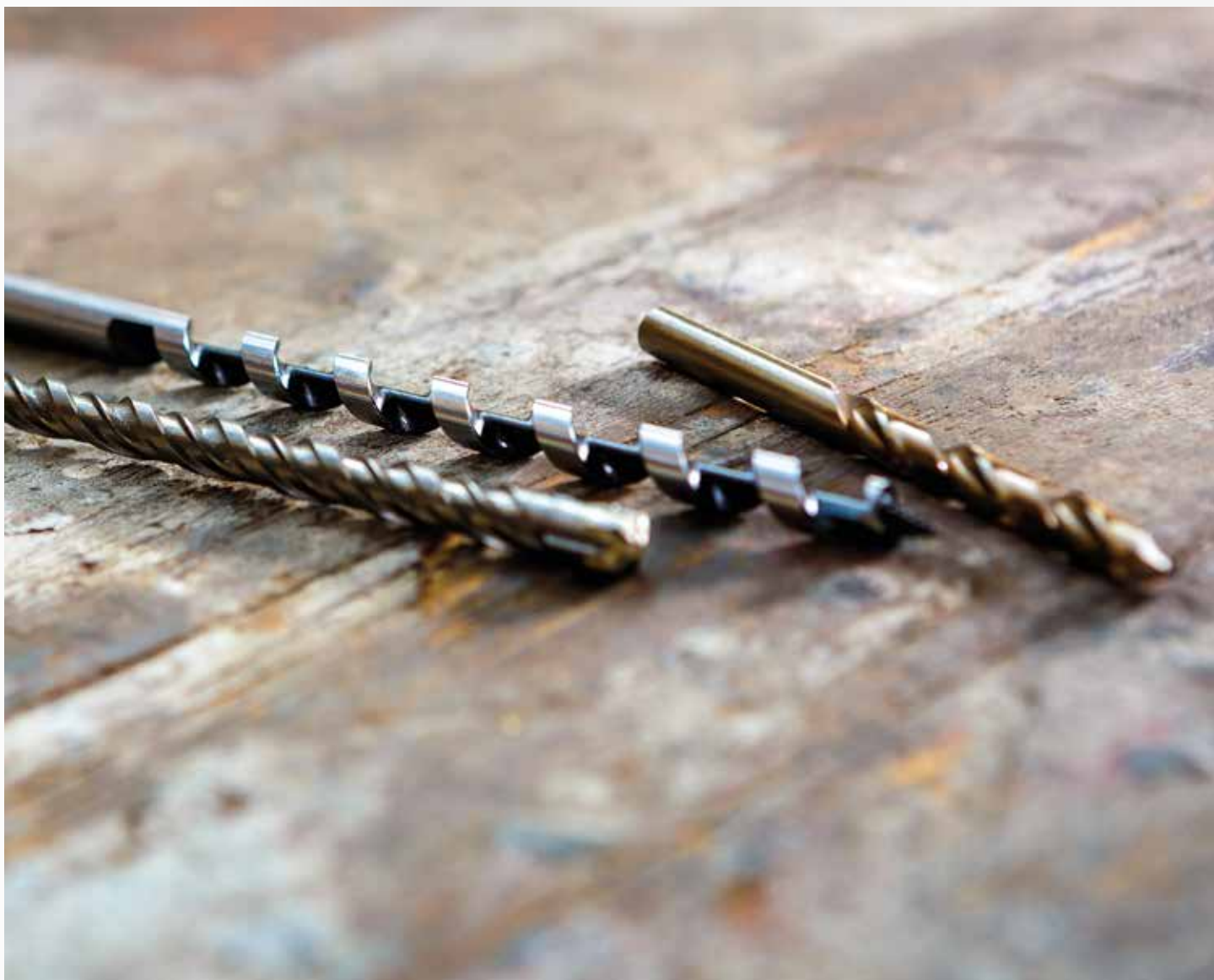
**FESTA**

VRTÁK VYBRUŠOVANÝ DO KOVU HSS-G COBALT 5 %

Co 5%, W 6%	HSS	DIN 338	135°
Mo 5%, Cr 4%, V 4%			

INOX	1400 MPa
------	----------

Č.p.	specifikace		Č.p.	specifikace		Č.p.	specifikace	
22510	Ø 1,00 mm	1	22548	Ø 4,80 mm	1	22590	Ø 9,00 mm	1
22515	Ø 1,50 mm	1	22550	Ø 5,00 mm	1	22595	Ø 9,50 mm	1
22520	Ø 2,00 mm	1	22555	Ø 5,50 mm	1	22600	Ø 10,00 mm	1
22525	Ø 2,50 mm	1	22560	Ø 6,00 mm	1	22602	Ø 10,20 mm	1
22530	Ø 3,00 mm	1	22565	Ø 6,50 mm	1	22605	Ø 10,50 mm	1
22532	Ø 3,20 mm	1	22568	Ø 6,80 mm	1	22610	Ø 11,00 mm	1
22535	Ø 3,50 mm	1	22570	Ø 7,00 mm	1	22615	Ø 11,50 mm	1
22540	Ø 4,00 mm	1	22575	Ø 7,50 mm	1	22620	Ø 12,00 mm	1
22542	Ø 4,20 mm	1	22580	Ø 8,00 mm	1	22625	Ø 12,50 mm	1
22545	Ø 4,50 mm	1	22585	Ø 8,50 mm	1	22630	Ø 13,00 mm	1



FESTA

VRTÁK VYBRUŠOVANÝ DO KOVU HSS-G W 9 %

W 9%, Mo 3%
Cr 4%, V 1%

HSS

DIN 338

INOX



1100 MPa

MOQ



Č.p.	specifikace	
19530	Ø 1,00 mm	10
19532	Ø 1,20 mm	10
19533	Ø 1,30 mm	10
19534	Ø 1,40 mm	10
19535	Ø 1,50 mm	10
19536	Ø 1,60 mm	10
19537	Ø 1,70 mm	10
19538	Ø 1,80 mm	10
19539	Ø 1,90 mm	10
19540	Ø 2,00 mm	10
19541	Ø 2,10 mm	10
19542	Ø 2,20 mm	10
19543	Ø 2,30 mm	10
19544	Ø 2,40 mm	10
19545	Ø 2,50 mm	10
19546	Ø 2,60 mm	10
19547	Ø 2,70 mm	10
19548	Ø 2,80 mm	10
19550	Ø 3,00 mm	10
19552	Ø 3,20 mm	10
19553	Ø 3,30 mm	10
19554	Ø 3,40 mm	10
19555	Ø 3,50 mm	10
19556	Ø 3,60 mm	10

Č.p.	specifikace	
19557	Ø 3,70 mm	10
19558	Ø 3,80 mm	10
19559	Ø 3,90 mm	10
19560	Ø 4,00 mm	10
19561	Ø 4,10 mm	10
19562	Ø 4,20 mm	10
19563	Ø 4,30 mm	10
19564	Ø 4,40 mm	10
19565	Ø 4,50 mm	10
19567	Ø 4,70 mm	10
19568	Ø 4,80 mm	10
19569	Ø 4,90 mm	5
19570	Ø 5,00 mm	5
19573	Ø 5,30 mm	5
19574	Ø 5,40 mm	5
19575	Ø 5,50 mm	5
19576	Ø 5,60 mm	5
19577	Ø 5,70 mm	5
19578	Ø 5,80 mm	5
19579	Ø 5,90 mm	5
19580	Ø 6,00 mm	5
19581	Ø 6,10 mm	5
19583	Ø 6,30 mm	5
19584	Ø 6,40 mm	5

Č.p.	specifikace	
19585	Ø 6,50 mm	5
19586	Ø 6,60 mm	5
19587	Ø 6,70 mm	5
19588	Ø 6,80 mm	5
19589	Ø 6,90 mm	5
19590	Ø 7,00 mm	5
19591	Ø 7,10 mm	5
19593	Ø 7,30 mm	5
19594	Ø 7,40 mm	5
19595	Ø 7,50 mm	5
19596	Ø 7,60 mm	5
19597	Ø 7,70 mm	5
19598	Ø 7,80 mm	5
19599	Ø 7,90 mm	5
19600	Ø 8,00 mm	5
19601	Ø 8,10 mm	5
19603	Ø 8,30 mm	5
19604	Ø 8,40 mm	5
19605	Ø 8,50 mm	5
19606	Ø 8,60 mm	5
19607	Ø 8,70 mm	5
19608	Ø 8,80 mm	5
19609	Ø 8,90 mm	5
19610	Ø 9,00 mm	5
19611	Ø 9,10 mm	5
19612	Ø 9,20 mm	5
19613	Ø 9,30 mm	5
19614	Ø 9,40 mm	5
19615	Ø 9,50 mm	3
19616	Ø 9,60 mm	3
19617	Ø 9,70 mm	3
19618	Ø 9,80 mm	3
19619	Ø 9,90 mm	3
19620	Ø 10,00 mm	3
19621	Ø 10,10 mm	3
19622	Ø 10,20 mm	3
19623	Ø 10,30 mm	3
19624	Ø 10,40 mm	3
19625	Ø 10,50 mm	3
19626	Ø 10,60 mm	3

Č.p.	specifikace	
19627	Ø 10,70 mm	3
19628	Ø 10,80 mm	3
19629	Ø 10,90 mm	3
19630	Ø 11,00 mm	3
19631	Ø 11,10 mm	3
19632	Ø 11,20 mm	3
19633	Ø 11,30 mm	3
19634	Ø 11,40 mm	3
19635	Ø 11,50 mm	3
19636	Ø 11,60 mm	3
19637	Ø 11,70 mm	3
19638	Ø 11,80 mm	3
19639	Ø 11,90 mm	3
19640	Ø 12,00 mm	3
19641	Ø 12,10 mm	3
19642	Ø 12,20 mm	3
19643	Ø 12,30 mm	3
19644	Ø 12,40 mm	3
19645	Ø 12,50 mm	3
19646	Ø 12,60 mm	1
19647	Ø 12,70 mm	1
19648	Ø 12,80 mm	1
19649	Ø 12,90 mm	1
19650	Ø 13,00 mm	1
19651	Ø 13,20 mm R13	1
19652	Ø 13,50 mm R13	1
19653	Ø 14,00 mm R13	1
19654	Ø 14,50 mm R13	1
19655	Ø 15,00 mm R13	1
19656	Ø 15,50 mm R13	1
19657	Ø 16,00 mm R13	1
19658	Ø 16,50 mm R13	1
19659	Ø 17,00 mm R13	1
19660	Ø 17,50 mm R13	1
19661	Ø 18,00 mm R13	1
19662	Ø 18,50 mm R13	1
19663	Ø 19,00 mm R13	1
19664	Ø 19,50 mm R13	1
19665	Ø 20,00 mm R13	1



FESTA

BOX S VYBRUŠOVANÝMI VRTÁKY DO KOVU HSS-G W 9 %

W 9%, Mo 3%
Cr 4%, V 1%

HSS

DIN 338

INOX



1100 MPa

Č.p.	specifikace	
19669		1
90191	bez vrtáků	1

Č.p.	obsah sady
19530	Ø 1,00 mm 20x
19535	Ø 1,50 mm 20x
19540	Ø 2,00 mm 20x
19545	Ø 2,50 mm 20x
19550	Ø 3,00 mm 20x
19552	Ø 3,20 mm 20x
19555	Ø 3,50 mm 20x
19558	Ø 3,80 mm 20x
19560	Ø 4,00 mm 30x
19562	Ø 4,20 mm 20x
19565	Ø 4,50 mm 20x
19568	Ø 4,80 mm 20x
19570	Ø 5,00 mm 15x
19575	Ø 5,50 mm 15x
19580	Ø 6,00 mm 30x

Č.p.	obsah sady
19585	Ø 6,50 mm 15x
19590	Ø 7,00 mm 15x
19595	Ø 7,50 mm 15x
19600	Ø 8,00 mm 15x
19605	Ø 8,50 mm 15x
19610	Ø 9,00 mm 15x
19615	Ø 9,50 mm 15x
19620	Ø 10,00 mm 15x
19625	Ø 10,50 mm 6x
19630	Ø 11,00 mm 6x
19635	Ø 11,50 mm 6x
19640	Ø 12,00 mm 6x
19645	Ø 12,50 mm 6x
19650	Ø 13,00 mm 6x

**FESTA****VRTÁK VYBRUŠOVANÝ DO KOVU**W 4%, Mo 3%
Cr 4%, V 1%**HSS****DIN
338****ALU****900
MPa****MOQ**

Č.p.	specifikace	
19670	Ø 0,6 mm	10
19671	Ø 0,8 mm	10
19672	Ø 0,9 mm	10
19673	Ø 1,0 mm	10
19674	Ø 1,1 mm	10
19675	Ø 1,2 mm	10
19676	Ø 1,3 mm	10
19677	Ø 1,4 mm	10
19678	Ø 1,5 mm	10
19679	Ø 1,6 mm	10
19680	Ø 1,7 mm	10
19681	Ø 1,8 mm	10
19682	Ø 1,9 mm	10
19683	Ø 2,0 mm	10
19684	Ø 2,1 mm	10
19685	Ø 2,2 mm	10
19686	Ø 2,3 mm	10
19687	Ø 2,4 mm	10
19688	Ø 2,5 mm	10
19689	Ø 2,6 mm	10
19690	Ø 2,7 mm	10
19691	Ø 2,8 mm	10
19692	Ø 2,9 mm	10
19693	Ø 3,0 mm	10

Č.p.	specifikace	
19694	Ø 3,1 mm	10
19695	Ø 3,2 mm	10
19696	Ø 3,3 mm	10
19697	Ø 3,4 mm	10
19698	Ø 3,5 mm	10
19699	Ø 3,6 mm	10
19700	Ø 3,7 mm	10
19701	Ø 3,8 mm	10
19702	Ø 3,9 mm	10
19703	Ø 4,0 mm	10
19704	Ø 4,1 mm	10
19705	Ø 4,2 mm	10
19706	Ø 4,3 mm	10
19707	Ø 4,4 mm	10
19708	Ø 4,5 mm	10
19709	Ø 4,6 mm	10
19710	Ø 4,7 mm	10
19711	Ø 4,8 mm	10
19712	Ø 4,9 mm	10
19713	Ø 5,0 mm	10
19714	Ø 5,1 mm	10
19715	Ø 5,2 mm	10
19716	Ø 5,3 mm	10
19717	Ø 5,4 mm	10

Č.p.	specifikace	
19718	Ø 5,5 mm	10
19719	Ø 5,6 mm	10
19720	Ø 5,7 mm	10
19721	Ø 5,8 mm	10
19722	Ø 5,9 mm	10
19723	Ø 6,0 mm	10
19724	Ø 6,1 mm	10
19725	Ø 6,2 mm	10
19726	Ø 6,3 mm	10
19727	Ø 6,4 mm	10
19728	Ø 6,5 mm	10
19729	Ø 6,6 mm	10
19730	Ø 6,7 mm	10
19731	Ø 6,8 mm	10
19732	Ø 6,9 mm	10
19733	Ø 7,0 mm	10
19734	Ø 7,1 mm	10
19735	Ø 7,2 mm	10
19736	Ø 7,3 mm	10
19737	Ø 7,4 mm	10
19738	Ø 7,5 mm	10
19739	Ø 7,6 mm	10
19740	Ø 7,7 mm	10
19741	Ø 7,8 mm	10
19742	Ø 7,9 mm	10
19743	Ø 8,0 mm	10
19744	Ø 8,1 mm	10
19745	Ø 8,2 mm	10
19746	Ø 8,3 mm	10
19747	Ø 8,4 mm	10
19748	Ø 8,5 mm	10
19749	Ø 8,6 mm	5
19750	Ø 8,7 mm	5
19751	Ø 8,8 mm	5
19752	Ø 8,9 mm	5
19753	Ø 9,0 mm	5
19754	Ø 9,1 mm	5
19755	Ø 9,2 mm	5
19756	Ø 9,3 mm	5
19757	Ø 9,4 mm	5
19758	Ø 9,5 mm	5
19759	Ø 9,6 mm	5

Č.p.	specifikace	
19760	Ø 9,7 mm	5
19761	Ø 9,8 mm	5
19762	Ø 9,9 mm	5
19763	Ø 10,0 mm	5
19764	Ø 10,1 mm	5
19765	Ø 10,2 mm	5
19766	Ø 10,3 mm	5
19767	Ø 10,4 mm	5
19768	Ø 10,5 mm	5
19769	Ø 10,6 mm	5
19770	Ø 10,7 mm	5
19771	Ø 10,8 mm	5
19772	Ø 11,0 mm	5
19773	Ø 11,2 mm	5
19774	Ø 11,3 mm	5
19775	Ø 11,4 mm	5
19776	Ø 11,5 mm	5
19777	Ø 11,6 mm	5
19778	Ø 11,7 mm	5
19779	Ø 11,8 mm	5
19780	Ø 11,9 mm	5
19781	Ø 12,0 mm	5
19782	Ø 12,2 mm	5
19783	Ø 12,5 mm	5
19784	Ø 12,8 mm	5
19785	Ø 12,9 mm	5
19786	Ø 13,0 mm	5
19787	Ø 13,2 mm R13	5
19788	Ø 13,5 mm R13	5
19789	Ø 14,0 mm R13	5
19790	Ø 14,5 mm R13	5
19791	Ø 15,0 mm R13	5
19792	Ø 15,5 mm R13	5
19793	Ø 16,0 mm R13	5
19794	Ø 16,5 mm R13	5
19795	Ø 17,0 mm R13	5
19796	Ø 17,5 mm R13	5
19797	Ø 18,0 mm R13	5
19798	Ø 18,5 mm R13	5
19799	Ø 19,0 mm R13	5
19800	Ø 19,5 mm R13	5
19801	Ø 20,0 mm R13	5

**FESTA****BOX S VYBRUŠOVANÝMI VRTÁKY DO KOVU HSS 4341**W 4%, Mo 3%
Cr 4%, V 1%**HSS****DIN
338****ALU****900
MPa**

Č.p.	specifikace	
19802		1
90192	bez vrtáků	1

Č.p.	obsah sady	
19673	Ø 1,00 mm	20x
19678	Ø 1,50 mm	20x
19683	Ø 2,00 mm	20x
19688	Ø 2,50 mm	20x
19693	Ø 3,00 mm	30x
19695	Ø 3,20 mm	30x
19698	Ø 3,50 mm	30x
19701	Ø 3,80 mm	30x
19703	Ø 4,00 mm	30x
19705	Ø 4,20 mm	30x
19708	Ø 4,50 mm	30x
19711	Ø 4,80 mm	30x
19713	Ø 5,00 mm	20x
19718	Ø 5,50 mm	20x
19723	Ø 6,00 mm	20x
19728	Ø 6,50 mm	20x
19733	Ø 7,00 mm	10x
19738	Ø 7,50 mm	10x
19743	Ø 8,00 mm	10x
19748	Ø 8,50 mm	10x
19753	Ø 9,00 mm	10x
19758	Ø 9,50 mm	10x
19763	Ø 10,00 mm	10x
19768	Ø 10,50 mm	10x
19772	Ø 11,00 mm	10x
19776	Ø 11,50 mm	10x
19781	Ø 12,00 mm	10x
19783	Ø 12,50 mm	10x
19786	Ø 13,00 mm	5x

FESTA

VRTÁK DO KOVU PRODLOUŽENÝ

W 4%, Mo 3%
Cr 4%, V 1% **HSS** **DIN 338**



MOQ

Č.p.	specifikace		Č.p.	specifikace	
20220	Ø 2,0 mm x 85 mm	10	20255	Ø 5,5 mm x 139 mm	10
20225	Ø 2,5 mm x 95 mm	10	20260	Ø 6,0 mm x 139 mm	10
20230	Ø 3,0 mm x 100 mm	10	20270	Ø 7,0 mm x 156 mm	10
20235	Ø 3,5 mm x 110 mm	10	20280	Ø 8,0 mm x 165 mm	10
20240	Ø 4,0 mm x 119 mm	10	20290	Ø 9,0 mm x 175 mm	10
20245	Ø 4,5 mm x 126 mm	10	20296	Ø 10,0 mm x 184 mm	10
20250	Ø 5,0 mm x 132 mm	10			

VRTÁK DO KOVU TIN

· titanový povrch pro zvýšení výkonu a životnosti

TiN **HSS** **DIN 338**



Č.p.	specifikace		Č.p.	specifikace		Č.p.	specifikace	
20400	Ø 1,0 mm	1	20411	Ø 4,8 mm	1	20422	Ø 9,5 mm	1
20401	Ø 1,5 mm	1	20412	Ø 5,0 mm	1	20423	Ø 10,0 mm	1
20402	Ø 2,0 mm	1	20413	Ø 5,5 mm	1	20424	Ø 10,2 mm	1
20403	Ø 2,5 mm	1	20414	Ø 6,0 mm	1	20425	Ø 10,5 mm	1
20404	Ø 3,0 mm	1	20415	Ø 6,5 mm	1	20426	Ø 11,0 mm	1
20405	Ø 3,2 mm	1	20416	Ø 6,8 mm	1	20427	Ø 11,5 mm	1
20406	Ø 3,5 mm	1	20417	Ø 7,0 mm	1	20428	Ø 12,0 mm	1
20407	Ø 3,8 mm	1	20418	Ø 7,5 mm	1	20429	Ø 12,5 mm	1
20408	Ø 4,0 mm	1	20419	Ø 8,0 mm	1	20430	Ø 13,0 mm	1
20409	Ø 4,2 mm	1	20420	Ø 8,5 mm	1			
20410	Ø 4,5 mm	1	20421	Ø 9,0 mm	1			

VRTÁK DO KOVU

HSS **DIN 338**



MOQ

Č.p.	specifikace		Č.p.	specifikace	
19841	Ø 4,1 mm 5 ks	10			
19842	Ø 4,2 mm 5 ks	10			
19845	Ø 4,5 mm 5 ks	10			
19885	Ø 8,5 mm 1 ks	10			
19895	Ø 9,5 mm 1 ks	10			

**FESTA**VRTÁKY DO KOVU
VYBRUŠOVANÉW 9%, Mo 3%
Cr 4%, V 1% HSS DIN 338

13x

Č.p. specifikace
20333 Ø 1,5 - 6,5 mm

1

**FESTA**VRTÁKY
DO KOVUW 4%, Mo 3%
Cr 4%, V 1% HSS DIN 338

13x

Č.p. specifikace
20336 Ø 1,5 - 6,5 mm

1

**FESTA**VRTÁKY DO KOVU
VYBRUŠOVANÉW 9%, Mo 3%
Cr 4%, V 1% HSS DIN 338

19x

Č.p. specifikace
20334 Ø 1,0 - 10,0 mm

20

**FESTA**VRTÁKY
DO KOVUW 4%, Mo 3%
Cr 4%, V 1% HSS DIN 338

19x

Č.p. specifikace
20337 Ø 1,0 - 10,0 mm

20

**FESTA**VRTÁKY DO KOVU
VYBRUŠOVANÉW 9%, Mo 3%
Cr 4%, V 1% HSS DIN 338

25x

Č.p. specifikace
20335 Ø 1,0 - 13,0 mm

5

**FESTA**VRTÁKY
DO KOVUW 4%, Mo 3%
Cr 4%, V 1% HSS DIN 338

25x

Č.p. specifikace
20338 Ø 1,0 - 13,0 mm

10



FESTA

SADA VRTÁKŮ

TiN



9x

Č.p. 20317 specifikace Ø 5-6-8 mm



20



FESTA

VRTÁKY S ŠESTIHRANNOU STOPKOU

1/4" HSS



7x

Č.p. 20316 specifikace Ø 1,5-2-3-4-5-5,5-6 mm



20



VRTÁKY DO KOVU

HSS DIN 338



19x

Č.p. 20305 specifikace Ø 1,0 - 13,0 mm

25



VRTÁKY DO KOVU

HSS DIN 338



25x

Č.p. 20311 specifikace Ø 1,0 - 13,0 mm

10



VRTÁKY DO KOVU

HSS DIN 338



13x

Č.p. 20300 specifikace Ø 1,5 - 6,5 mm

50



VRTÁKY DO KOVU

HSS DIN 338



19x

Č.p. 20310 specifikace Ø 1 - 13 mm

10



VRTÁKY DO KOVU

TiN HSS DIN 338

INOX ALU

19x



Č.p.	specifikace	
20320	Ø 1 - 10 x 0,5 mm	30



VRTÁKY DO KOVU

HSS DIN 338

ALU

19x



Č.p.	specifikace	
20321	Ø 1 - 10 x 0,5 mm	5

VRTÁKY DO KOVU

HSS DIN 338



19x



Č.p.	specifikace	
20315	Ø 1 - 10 mm	10



OSTŘIČ VRTÁKŮ

Č.p.	specifikace	
20380	pro Ø 3,5 - 10 mm	20

FESTA

VRTÁK STUPŇOVITÝ TiN

TiN HSS



Č.p.	specifikace	
20489	Ø 4 - 12 mm 8 stupňů	20
20490	Ø 4 - 20 mm 9 stupňů	10
20491	Ø 5 - 35 mm 13 stupňů	10
20492	Ø 7 - 40,5 mm 13 stupňů	5



VRTÁK STUPŇOVITÝ

HSS



Č.p.	specifikace	
20487	Ø 4 - 20 mm 9 stupňů	10
20488	Ø 5 - 35 mm 13 stupňů	10
20494	Ø 4 - 32 mm 15 stupňů	10
20493	Ø 7 - 40,5 mm 13 stupňů	1

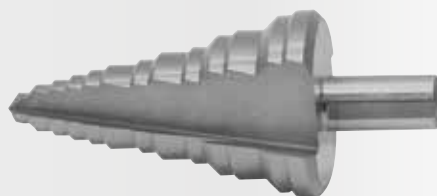

FESTA

SADA STUPŇOVITÝCH VRTÁKŮ TiN

TiN HSS



3x

Č.p.	specifikace	
20495	Ø 4 - 12, 4 - 20, 4 - 32 mm	1



SADA STUPŇOVITÝCH VRTÁKŮ

HSS



3x

Č.p.	specifikace	
20496	Ø 4 - 12, 4 - 20, 4 - 32 mm	1



**FESTA**

VYKRUŽOVACÍ KORUNKA BI-METAL

HSS



Č.p.	specifikace	
24419	Ø 19 mm	1
24420	Ø 20 mm	1
24422	Ø 22 mm	1
24425	Ø 25 mm	1
24429	Ø 29 mm	1
24432	Ø 32 mm	1
24435	Ø 35 mm	1
24437	Ø 37 mm	1
24444	Ø 44 mm	1
24451	Ø 51 mm	1
24457	Ø 57 mm	1
24464	Ø 64 mm	1
24476	Ø 76 mm	1
24483	Ø 83 mm	1

**FESTA**

UNAŠEČ PRO VYKRUŽOVACÍ KORUNKY

Č.p.	specifikace	
24410	pro korunky 14 - 30 mm	1

**FESTA**

UNAŠEČ PRO VYKRUŽOVACÍ KORUNKY

Č.p.	specifikace	
24411	pro korunky 32 - 152 mm	1

NEW

**FESTA**NÁHRADNÍ VRTÁK
PRO UNAŠEČ
NA VYKRUŽOVACÍ KORUNKY
pro 24410, 24411

Č.p.	specifikace	
24412		5

**FESTA**

VYKRUŽOVACÍ KORUNKY BI-METAL - SADA

HSS



9x

Č.p.	specifikace	
24750	Ø 19, 22, 29, 38, 44, 57 mm	10

**FESTA**

VYKRUŽOVACÍ KORUNKY BI-METAL - SADA

HSS



13x

Č.p.	specifikace	
24751	Ø 19, 22, 29, 35, 38, 44, 51, 57, 64 mm	10



FESTA

VYTAHOVÁK ZALOMENÝCH ŠROUBŮ - SADA

- Ø 4 mm Ø 11 mm
- Ø 4,5 mm Ø 15 mm
- Ø 6,5 mm Ø 19 mm
- Ø 7,5 mm Ø 24 mm

8x



Č.p. specifikace

20387

5



FESTA

VYTAHOVÁK ZALOMENÝCH ŠROUBŮ - SADA

- Ø 4 mm
- Ø 4,5 mm
- Ø 6 mm
- Ø 7,5 mm
- Ø 11 mm

5x



10

Č.p. specifikace

20386



VYTAHOVÁK ZALOMENÝCH ŠROUBŮ - SADA

- Ø 4 mm
- Ø 4,5 mm
- Ø 6 mm
- Ø 7,5 mm
- Ø 11 mm

5x



10

Č.p. specifikace

20385



VRTADLO RÁČNOVÉ NA ZÁVITNÍKY

Č.p. specifikace

20397

M3 - M8

10



FESTA

DRŽÁK NA ZÁVITOVÁ OČKA

DIN 225



10

Č.p. specifikace

20396 25 x 9 mm



FESTA

VRTADLO STAVITELNÉ

DIN 1814



10

Č.p. specifikace

20395 1 - 1/2; M3 - M12



FESTA

ZÁVITNÍKY A ZÁVITOVÁ OČKA SADA

32x



1

Č.p. specifikace

20391 M 3, 4, 5, 6, 8, 10, 12 mm



FESTA

ZÁVITNÍKY SADA

21x



1

Č.p. specifikace

20390 M 3, 4, 5, 6, 8, 10, 12 mm

FESTA**VRTÁK PŘÍKLEPOVÝ VIDIOVÝ**

• dvoubřitý vrták

**DIN
8039**

Č.p.	specifikace	A mm	B mm	
20673	Ø 3 mm	60	30	100
20674	Ø 4 mm	75	40	100
20675	Ø 5 mm	85	50	100
20676	Ø 6 mm	100	60	100
20677	Ø 6 mm	200	160	50
20685	Ø 6 mm	300	260	50
20678	Ø 8 mm	120	75	50
20686	Ø 8 mm	200	155	50

Č.p.	specifikace	A mm	B mm	
20687	Ø 8 mm	300	255	25
20688	Ø 8 mm	400	340	25
20680	Ø 10 mm	120	70	50
20690	Ø 10 mm	200	150	50
20691	Ø 10 mm	300	250	25
20692	Ø 10 mm	400	340	25
20682	Ø 12 mm	150	100	50
20694	Ø 12 mm	300	250	25

Č.p.	specifikace	A mm	B mm	
20696	Ø 12 mm	400	340	25
20684	Ø 14 mm	150	90	25
	redukce Ø 10 mm			
20697	Ø 14 mm	300	240	5
	redukce Ø 10 mm			
20698	Ø 14 mm	400	340	15
	redukce Ø 10 mm			

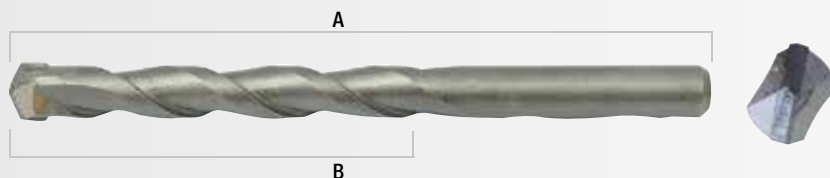
**FESTA****VRTÁK PŘÍKLEPOVÝ VIDIOVÝ SDS+**

• dvoubřitý vrták

SDS+

Č.p.	specifikace	A mm	B mm	
20855	Ø 14 mm	160	75	25

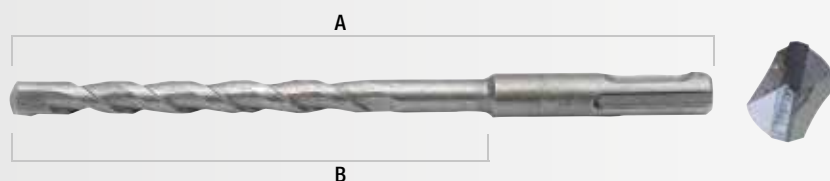
**FESTA****VRTÁK PŘÍKLEPOVÝ VIDIOVÝ SDS+**

• čtyřbřitý vrták se zvýšenou výkonností a trvanlivostí

SDS+

Č.p.	specifikace	A mm	B mm	
20748	Ø 6 mm	110	40	50
20749	Ø 6 mm	160	90	50
20750	Ø 6 mm	210	140	50
20751	Ø 6 mm	260	190	50
20861	Ø 6,5 mm	230	160	50
20862	Ø 6,5 mm	300	230	50
20752	Ø 8 mm	110	40	50
20753	Ø 8 mm	160	90	50
20754	Ø 8 mm	210	140	50
20755	Ø 8 mm	260	190	50
20825	Ø 8 mm	350	280	50
20756	Ø 10 mm	160	90	50
20757	Ø 10 mm	210	140	50
20758	Ø 10 mm	260	190	50
20759	Ø 10 mm	350	280	50
20760	Ø 10 mm	450	380	50
20761	Ø 10 mm	600	530	50
20762	Ø 10 mm	1000	930	50
20764	Ø 12 mm	160	80	50
20765	Ø 12 mm	210	130	50
20766	Ø 12 mm	260	180	50
20767	Ø 12 mm	350	270	50

Č.p.	specifikace	A mm	B mm	
20768	Ø 12 mm	460	380	50
20769	Ø 12 mm	600	520	25
20770	Ø 12 mm	1000	920	25
20771	Ø 14 mm	160	80	25
20772	Ø 14 mm	260	180	25
20773	Ø 14 mm	350	270	25
20774	Ø 14 mm	460	380	25
20775	Ø 14 mm	600	520	25
20776	Ø 14 mm	1000	920	30
20777	Ø 16 mm	160	80	25
20778	Ø 16 mm	210	130	25
20779	Ø 16 mm	260	180	25
20780	Ø 16 mm	350	270	25
20781	Ø 16 mm	460	380	25
20782	Ø 16 mm	600	520	30
20783	Ø 16 mm	1000	920	25
20784	Ø 18 mm	260	180	25
20785	Ø 18 mm	450	370	25
20786	Ø 18 mm	600	520	32
20787	Ø 18 mm	1000	920	20
20788	Ø 20 mm	450	370	20
20789	Ø 20 mm	600	520	20

Č.p.	specifikace	A mm	B mm	
20790	Ø 20 mm	800	720	25
20791	Ø 20 mm	1000	920	10
20792	Ø 22 mm	450	365	20
20793	Ø 22 mm	600	520	20
20794	Ø 22 mm	800	715	20
20795	Ø 22 mm	1000	920	10
20796	Ø 24 mm	450	365	10
20797	Ø 24 mm	600	520	20
20798	Ø 24 mm	800	715	10
20799	Ø 24 mm	1000	920	10
20870	Ø 26 mm	450	370	10
20871	Ø 26 mm	650	570	20
20872	Ø 26 mm	800	720	10
20873	Ø 26 mm	1000	920	10
20874	Ø 28 mm	450	365	10
20875	Ø 28 mm	600	565	20
20876	Ø 28 mm	800	715	10
20877	Ø 28 mm	1000	915	10
20878	Ø 30 mm	450	365	10
20879	Ø 30 mm	600	565	20
20880	Ø 30 mm	800	715	10
20881	Ø 30 mm	1000	915	10

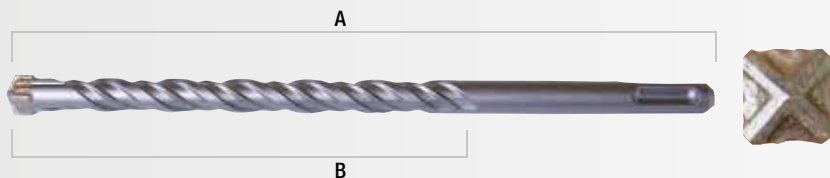

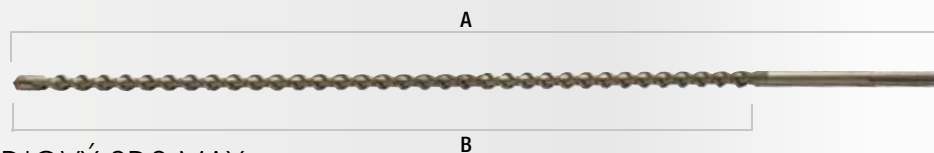

FESTA

VRTÁK PŘÍKLEPOVÝ VIDIOVÝ SDS MAX

• čtyřbřitý vrták se zvýšenou výkonností a trvanlivostí

SDS MAX



Č.p.	specifikace	A mm	B mm	
20508 NEW	Ø 16 mm	550	395	5
20510	Ø 18 mm	550	395	5
20520	Ø 18 mm	800	650	5
20511	Ø 20 mm	550	395	5
20521	Ø 20 mm	800	650	5

Č.p.	specifikace	A mm	B mm	
20512	Ø 22 mm	550	395	5
20522	Ø 22 mm	800	650	5
20513	Ø 24 mm	550	395	5
20523	Ø 24 mm	800	650	5
20514	Ø 28 mm	550	395	5

Č.p.	specifikace	A mm	B mm	
20524	Ø 28 mm	800	650	5
20515	Ø 30 mm	550	395	5
20525	Ø 30 mm	800	650	5
20516	Ø 40 mm	550	395	2
20526	Ø 40 mm	800	650	1



STOJAN PREZENTAČNÍ

Č.p. specifikace

20999

1

SADA VRTÁKŮ DO ZDIVA SDS+

SDS+

5x



Č.p.	specifikace	
20890	Ø 5, 6, 8, 10, 12 mm 160 mm	25

SADA VRTÁKŮ DO ZDIVA SDS+

SDS+

6x



Č.p.	specifikace	
20891	Ø 5, 6, 8 mm 110 mm Ø 8, 10, 12 mm 160 mm	25

SADA VRTÁKŮ DO ZDIVA

DIN 8039

6x



Č.p.	specifikace	
20895	Ø 5, 6, 8, 10, 12 mm	25

SADA VRTÁKŮ DO ZDIVA



Č.p.	specifikace	
20805	5 ks Ø 4 - 10 mm	10
20820	8 ks Ø 3 - 10 mm	10

FESTA**SEKÁČE A VRTÁKY SDS+**

- 2 x špičák
- 3 x sekáč
- 12 x vrták

SDS+



17x

Č.p. specifikace

20952



1

**FESTA****SEKÁČE A VRTÁKY SDS+**

- 1 x špičák 250 mm
- 1 x drážkovač 22 x 250 mm
- 1 x plochý 20 x 250 mm

- Ø 5 x 110 mm
- Ø 6 x 110 mm
- Ø 8 x 160 mm
- Ø 10 x 160 mm
- Ø 12 x 160 mm
- Ø 14 x 210 mm
- Ø 16 x 210 mm
- Ø 18 x 310 mm
- Ø 20 x 450 mm

SDS+



12x

Č.p. specifikace

20950



5

**FESTA****SEKÁČE SADA**

SDS+

4x

Č.p. specifikace

20954 250 mm



1

FESTA**SEKÁČ PLOCHÝ, ZAHNUTÝ 15°**

SDS+

Č.p. specifikace
20936 40 x 250 mm

5

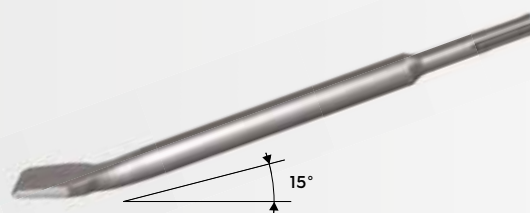



FESTA

SEKÁČ

SDS
MAX



Č.p.	specifikace	
20940	25 x 280 mm	5
20941	40 x 280 mm	5
20942	75 x 280 mm	5
20943	25 x 400 mm	5
20944	40 x 400 mm	5
20945	25 x 600 mm	5
20946	50 x 600 mm	5



FESTA

SEKÁČ

SDS+



Č.p.	specifikace	
20948	20 x 250 mm	25
20990	20 x 400 mm	25
20949	40 x 250 mm	25
20991	40 x 400 mm	25



FESTA

ŠPIČÁK

SDS
MAX



Č.p.	specifikace	
20937	Ø 18 x 280 mm	5
20938	Ø 18 x 400 mm	5
20939	Ø 18 x 600 mm	2



FESTA

ŠPIČÁK

SDS+



Č.p.	specifikace	
20947	250 mm	25
20992	400 mm	25



FESTA

STOPKA UPÍNACÍ
PRO VYKRUŽOVACÍ KORUNKY

SDS
MAX



Č.p.	specifikace	
24730	180 mm	1



FESTA

STOPKA UPÍNACÍ
PRO VYKRUŽOVACÍ KORUNKY

SDS+



Č.p.	specifikace	
24731	300 mm	1
24732		1



FESTA

DRÁŽKOVÁČ

SDS+



Č.p.	specifikace	
20956	22 x 250 mm	25



FESTA

ADAPTÉR SDS+ NA BIT 1/4"



Č.p.	specifikace	
20743	75 mm	1



ADAPTÉR SDS MAX NA SDS+



Č.p.	specifikace	
20744		1

**FESTA****KORUNKA VYKRUŽOVACÍ S SK PLÁTKY**

· korunka je možné použít se stopkami 24730, 24731 a 24732

SDS+



Č.p.	specifikace	
24719	Ø 67 mm	1
24717	Ø 73 mm	1
24723	Ø 80 mm	1
24718	Ø 100 mm	1
24757	Ø 115 mm	1
24758	Ø 125 mm	1
24759	Ø 150 mm	1

**VYKRUŽOVÁK STAVITELNÝ**

Č.p.	specifikace	
24725	Ø 20-95mm	10

**VYKRUŽOVÁK STAVITELNÝ S KRYTEM**

Č.p.	specifikace	
24726	Ø 20-95mm	1

**FESTA****VYKRUŽOVACÍ KORUNKY KARBIDOVÉ - SADA**

8x

Č.p.	specifikace	
24747	Ø 33, 53, 67, 73, 83 mm unašeč, vrták, pilník	1

**FESTA****KORUNKY VYKRUŽOVACÍ KARBIDOVÉ - SADA**

6x

Č.p.	specifikace	
24745	Ø 33, 53, 67, 73 mm + unašeč, vrták	1

FESTA

KORUŇKA VYKRUŽOVACÍ KARBIDOVÁ

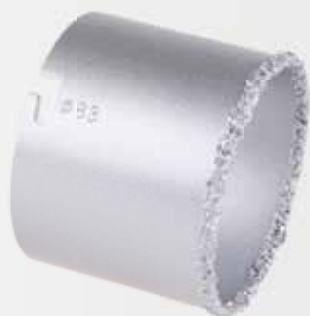

Č.p.	specifikace	
24735	Ø 33 mm	1
24736	Ø 43 mm	1
24737	Ø 53 mm	1
24738	Ø 67 mm	1
24739	Ø 73 mm	1
24740	Ø 83 mm	1
24741	Ø 103 mm	1

FESTA

KORUŇKA VYKRUŽOVACÍ KARBIDOVÁ - SADA

3x



Č.p.	specifikace	
24746	Ø 103 mm + unašeč, vrták	1



FESTA

UNAŠEČ PRO KORUNKY VYKRUŽOVACÍ



Č.p.	specifikace	
24748	Ø 33 - 83 mm	10
24743	Ø 33 - 103 mm	10

FESTA

VRTÁK PRO KORUNKY VYKRUŽOVACÍ



Č.p.	specifikace	
24749		50



PILNÍK NA OBKLADY A DLAŽBU



Č.p.	specifikace	
22200	200 mm	20



PILNÍK PLOCHÝ NA OBKLADY, DLAŽBU A ZDIVO

· pro broušení cihel před vložením stěnové kotvy



Č.p.	specifikace	
22201	200 mm dvojí hrubost	20

FESTA

KORUŇKA VRTACÍ KARBIDOVÁ

· pro vrtání do skla a keramiky
· nutné chlazení



Č.p.	specifikace	
24770	Ø 4 mm	1
24771	Ø 6 mm	1
24772	Ø 8 mm	1
24773	Ø 10 mm	1
24774	Ø 12 mm	1



VODIČ NA VRTÁKY A VRTACÍ KORUNKY

Č.p.	specifikace	
20379	Ø 4, 5, 6, 7, 8, 10, 12 mm	10



NEW



FESTA

KORUNKA VYKRUŽOVACÍ DIAMANTOVÁ

M14

- keramické obklady
- mramor
- žula

- použití bez chlazení vodou



Č.p.	specifikace	úchyt	
24760	Ø 6 mm	M14	1
24761	Ø 8 mm	M14	1
24762	Ø 10 mm	M14	1
24763	Ø 12 mm	M14	1
24764	Ø 14 mm	M14	1
24670	NEW Ø 16 mm	M14	1
24671	NEW Ø 18 mm	M14	1
24790	Ø 20 mm	M14	1
24672	NEW Ø 22 mm	M14	1
24673	NEW Ø 25 mm	M14	1
24765	Ø 28 mm	M14	1
24674	NEW Ø 30 mm	M14	1

Č.p.	specifikace	úchyt	
24675	NEW Ø 32 mm	M14	1
24766	Ø 35 mm	M14	1
24776	NEW Ø 40 mm	M14	1
24767	Ø 45 mm	M14	1
24791	Ø 50 mm	M14	1
24768	Ø 53 mm	M14	1
24792	Ø 60 mm	M14	1
24793	Ø 65 mm	M14	1
24769	Ø 68 mm	M14	1
24794	Ø 75 mm	M14	1
24796	Ø 83 mm	M14	1
24676	NEW Ø 110 mm	M14	1

FESTA

KORUNKA VYKRUŽOVACÍ DIAMANTOVÁ, SADA

- Ø 8 mm
- Ø 10 mm
- Ø 14 mm
- Ø 22 mm
- Ø 32 mm
- Ø 40 mm
- Ø 68 mm

7x M14

- keramické obklady
- mramor
- žula

- použití bez chlazení vodou



Č.p.	Specifikace	
24650		1



FESTA

KORUNKA VYKRUŽOVACÍ DIAMANTOVÁ

- keramické obklady
- mramor
- žula

Č.p.	specifikace	
24700	Ø 6 mm	1
24701	Ø 8 mm	1
24702	Ø 10 mm	1
24703	Ø 12 mm	1
24704	Ø 14 mm	1
24705	Ø 20 mm	1



FESTA

KORUNKA VYKRUŽOVACÍ DIAMANTOVÁ - SADA

6x

- keramické obklady
- mramor
- žula



Č.p.	specifikace	
24798	Ø 6, 8, 10, 12, 14, 20 mm	1

NEW

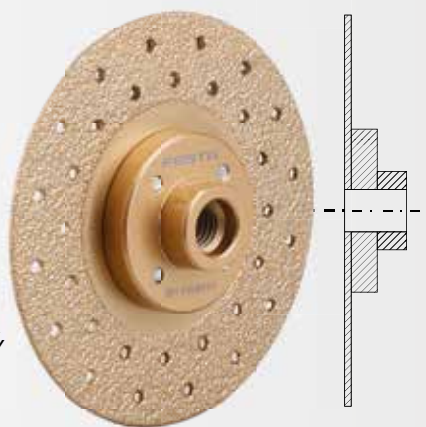

FESTA

**KOTOUČ
ŘEZNÝ A BRUSNÝ
- DIAMANTOVÝ**

M14

- keramické obklady
- mramor
- žula

použití bez chlazení vodou



Č.p.	Specifikace	
24655	Ø 115 mm M14	1

NEW

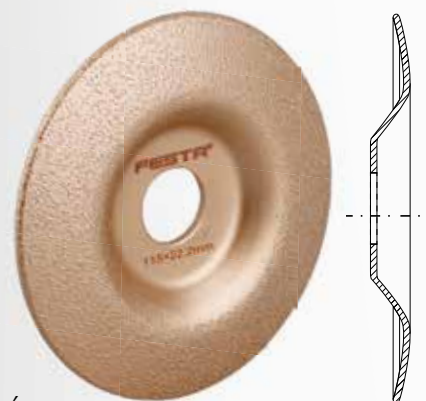

FESTA

**KOTOUČ BRUSNÝ
- DIAMANTOVÝ**

- keramické obklady
- mramor
- žula

použití bez chlazení vodou



Č.p.	Specifikace	
24658	Ø 115 mm Ø 22,2 mm	1

NEW

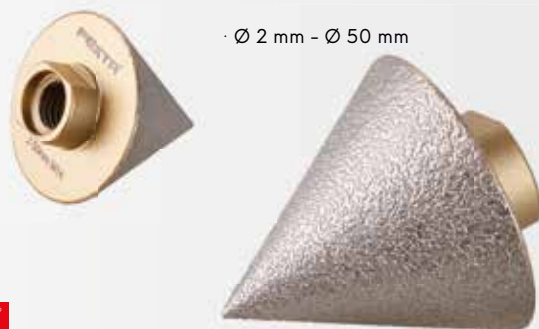

· Ø 2 mm - Ø 50 mm

FESTA

**KORUNKA BRUSNÁ,
DIAMANTOVÁ**

M14

- keramické obklady
- mramor
- žula

použití bez chlazení vodou



Č.p.	Specifikace	
24778	Ø 2 - 50 mm	1

NEW

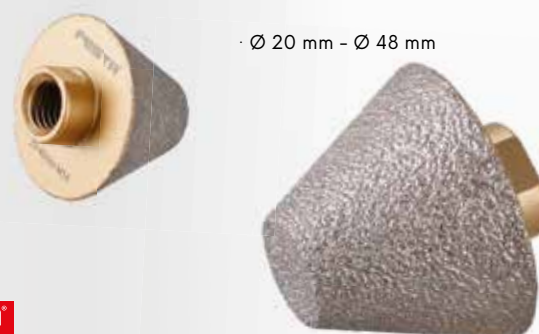

· Ø 20 mm - Ø 48 mm

FESTA

**KORUNKA BRUSNÁ,
DIAMANTOVÁ**

M14

- keramické obklady
- mramor
- žula

použití bez chlazení vodou



Č.p.	Specifikace	
24779	Ø 20 - 48 mm	1



FESTA

**KORUNKA BRUSNÁ
DIAMANTOVÁ**

M14

- keramické obklady
- mramor
- žula

použití bez chlazení vodou



Č.p.	specifikace	
24795	Ø 20 x 50 mm	1

FESTA

**VRTÁK NA SKLO
A KERAMIKU**

TiN

1/4"

- keramické obklady
- žula

Č.p.	specifikace	
24780	Ø 4 mm	40
24781	Ø 5 mm	40
24782	Ø 6 mm	40
24783	Ø 8 mm	40
24784	Ø 10 mm	40
24785	Ø 12 mm	40
24786	Ø 14 mm	1
24787	Ø 16 mm	1
24788	Ø 18 mm	1
24789	Ø 20 mm	1



**FESTA**

SEKÁČE, DŮLČÍKY, PRŮBOJNÍKY - SADA

CrV

12x

2, 6, 8 mm
10, 12, 16 mm
Ø 1,5-3-4-5-6-8 mm



Č.p.	specifikace
19487	

4

**FESTA**

SEKÁČE, DŮLČÍKY A PRŮBOJNÍKY - SADA

CrV

6x

2 x 140, 8 x 115 mm
12 x 152, 10 x 142 mm
Ø 3 x 152, 6 x 152 mm



Č.p.	specifikace
19486	

10

**FESTA**

SEKÁČ ZÁMEČNICKÝ KŘÍŽOVÝ

CrV

Č.p.	specifikace
19429	200 mm



1

**FESTA**

SEKÁČE - SADA

CrV

3x

10, 12, 16 mm



Č.p.	specifikace
19485	

10

**FESTA**

SEKÁČ PLOCHÝ

CrV

Č.p.	specifikace		
19410	200 mm	20 mm	10
19411	250 mm	25 mm	10
19412	300 mm	25 mm	10
19418	400 mm	25 mm	5
19419	500 mm	25 mm	5



SEKÁČ ZÁMEČNICKÝ PLOCHÝ

CrV

Č.p.	specifikace		
19436	200 mm	20 mm	15



FESTA

PRŮBOJNÍKY - SADA

CrV 6x

Č.p.	specifikace	
19483	Ø 3, 4, 5, 6, 7, 8 mm	5



FESTA

PRŮBOJNÍKY - SADA

CrV 6x

Č.p.	specifikace	
19482	Ø 3, 4, 5, 6, 8 mm	5



FESTA

PRŮBOJNÍK

CrV

Č.p.	specifikace	
19472	Ø 4 mm 150 mm	1
19473	Ø 5 mm 150 mm	1
19474	Ø 6 mm 150 mm	1



FESTA

PRŮBOJNÍKY - SADA

CrV 3x

Č.p.	specifikace	
19480	Ø 0,8, 1,5, 2,5 mm	10



FESTA

DŮLČÍK

CrV

Č.p.	specifikace	
19477	Ø 2,5 mm	20



FESTA

DŮLČÍKY - SADA

CrV 3x

Č.p.	specifikace	
19481	Ø 0,8, 1,5, 2,5 mm	10



FESTA

DŮLČÍK AUTOMATICKÝ

CrV

Č.p.	specifikace	
19478	Ø 2,5 mm	12



ŘEZAČ SKLA





Č.p.	specifikace	
20350	130 mm	12

**FESTA**

VRTÁK HADOVITÝ DO DŘEVA



Č.p.	specifikace		Č.p.	specifikace	
20980	Ø 6 x 230 mm	1	20984	Ø 16 x 230 mm	1
20957	Ø 6 x 300 mm	1	20899	Ø 16 x 300 mm	1
20981	Ø 8 x 230 mm	1	20917	Ø 16 x 450 mm	1
20958	Ø 8 x 300 mm	1	20922	Ø 16 x 600 mm	1
20982	Ø 10 x 230 mm	1	20918	Ø 18 x 450 mm	1
20896	Ø 10 x 300 mm	1	20923	Ø 18 x 600 mm	1
20913	Ø 10 x 450 mm	1	20919	Ø 20 x 450 mm	1
20983	Ø 12 x 230 mm	1	20924	Ø 20 x 600 mm	1
20897	Ø 12 x 300 mm	1	20724	Ø 22 x 450 mm	1
20915	Ø 12 x 450 mm	1	20725	Ø 24 x 450 mm	1
20920	Ø 12 x 600 mm	1	20726	Ø 26 x 450 mm	1
20898	Ø 14 x 300 mm	1	20727	Ø 28 x 450 mm	1
20916	Ø 14 x 450 mm	1	20728	Ø 30 x 450 mm	1
20921	Ø 14 x 600 mm	1			

**FESTA**

VRTÁKY HADOVITÉ DO DŘEVA - SADA



5x



10

Č.p.	specifikace
20911	Ø 8, 10, 12, 14, 16 x 460 mm

**FESTA**

VRTÁKY HADOVITÉ DO DŘEVA - SADA



6x



10

Č.p.	specifikace
20912	Ø 6, 8, 10, 12, 16, 20 x 230 mm



VRTÁK DO DŘEVA



Č.p.	specifikace		Č.p.	specifikace		Č.p.	specifikace	
20729	Ø 6 x 400 mm	1	20732	Ø 12 x 400 mm	1	20734	Ø 16 x 400 mm	1
20731	Ø 8 x 400 mm	1	20738	Ø 12 x 600 mm	1	20740	Ø 16 x 600 mm	1
20736	Ø 8 x 600 mm	1	20733	Ø 14 x 400 mm	1	20735	Ø 18 x 400 mm	1
20730	Ø 10 x 400 mm	1	20739	Ø 14 x 600 mm	1	20741	Ø 18 x 600 mm	1
20737	Ø 10 x 600 mm	1						



VRTÁK DO DŘEVA



Č.p.	specifikace	
21440	Ø 4 x 75 mm	1
21441	Ø 5 x 85 mm	1
21442	Ø 6 x 90 mm	1
21443	Ø 7 x 105 mm	1
21444	Ø 8 x 115 mm	1
21445	Ø 9 x 120 mm	1
21446	Ø 10 x 120 mm	1

VRTÁK DO DŘEVA
SADA

Č.p.	specifikace	
20910	8 ks Ø 3, 4, 5, 6, 7, 8, 9, 10 mm	10
20905	5 ks Ø 4, 5, 6, 8, 10 mm	10



VRTÁK FRÉZOVACÍ

HSS TiN



Č.p.	specifikace	
20460	Ø 6 mm	50

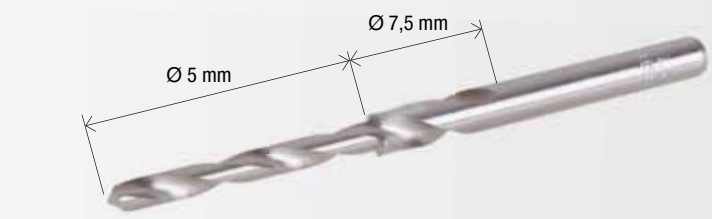

FESTA

VRTÁK NA KONFIRMÁTY - VYBRUŠOVANÝ

HSS



Č.p.	specifikace	
20210	Ø 7,5, 5 mm	1

VRTÁKY FRÉZOVACÍ SADA

HSS TiN



6x

Č.p.	specifikace	
20450	Ø 3, 4, 5, 6, 6.5, 8 mm	20



VRTÁKY KOPINATÉ DO DŘEVA - SADA



6x

Č.p.	specifikace	
20901	Ø 10, 12, 16, 18, 20, 25 mm	20

SUKOVNÍKY - SADA



5x

Č.p.	specifikace	
21530	Ø 15, 20, 25, 30, 35 mm Ø 8 mm	20



TVAROVÉ FRÉZY DO DŘEVA



5x

Č.p.	specifikace	
21450	Ø 8 mm	1



TVAROVÉ FRÉZY DO DŘEVA



12x

Č.p.	specifikace	
21451	Ø 8 mm	1



TVAROVÉ FRÉZY DO DŘEVA



24x

Č.p.	specifikace	
21452	Ø 8 mm	1



TVAROVÉ FRÉZY DO DŘEVA

35x

Č.p. 21453 specifikace Ø 8 mm



1



TVAROVÉ FRÉZY DO DŘEVA

59x

Č.p. 21454 specifikace Ø 8 mm



1



ROTAČNÍ RAŠPLE

6 mm  12 mm

5x

Č.p. 21541 specifikace



25



ROTAČNÍ BRUSKY

5x

Č.p. 21540 specifikace Ø 3 mm, 6 mm



12



NÁSTAVCE NA PŘÍMOU BRUSKOU

100x

Č.p. 24755 specifikace



5



NÁSTAVCE NA PŘÍMOU BRUSKOU

150x

Č.p. 24756 specifikace

10

NEW



· Ø 19 - 127 mm

FESTA

KORUNKA VYKRUŽOVACÍ - NASTAVITELNÁ



Č.p.	Specifikace		
24415	Ø 19 - 127 mm	max. hloubka 29 mm	6

FESTA

PILY VYKRUŽOVACÍ

- Ø 19 mm
- Ø 22 mm
- Ø 25 mm
- Ø 35 mm
- Ø 44 mm
- Ø 51 mm
- Ø 60 mm
- Ø 67 mm
- Ø 76 mm
- Ø 82 mm

inbus

2x hlavička



12x



Č.p.	specifikace		
24712	6 tpi		20

FESTA

PILY VYKRUŽOVACÍ

- Ø 64 mm
- Ø 76 mm
- Ø 89 mm
- Ø 102 mm
- Ø 127 mm

inbus

hlavička



8x



Č.p.	specifikace		
24706	6 tpi		20

**FESTA**

VYKRUŽOVACÍ PILA NA DŘEVO A SÁDROKARTON



Č.p.	specifikace	
24715	1' Ø 67 mm 6 tpi	5
24713	1' Ø 73 mm 6 tpi	5
24714	1' Ø 102 mm 6 tpi	5
24720	1' Ø 152 mm 6 tpi	5



VYKRUŽOVACÍ PILY - SADA



Č.p.	specifikace	
24721	1' Ø 26, 32, 38, 45, 50, 56, 63 mm	10
24722	2' Ø 26, 32, 38, 45, 50, 56, 63 mm	10



VYKRUŽOVÁK STAVITELNÝ



Č.p.	specifikace	
24716	Ø 30 - 120 mm	5



NEBOZEZY - SADA

HOBBY**4x**

Č.p.	specifikace	
20381	Ø 2, 3, 4, 5 mm	20



ADAPTÉR SDS MAX NA SDS +



Č.p.	specifikace	
20744		1

ADAPTÉR SDS +

SDS+

Č.p.	specifikace	
20745		1



FESTA
SKLÍČIDLO

1/2"



Č.p.	specifikace	
20960	1-13 mm + 2 klíče, 1/2 - 20 UNF	3
20966	náhradní klíček	25



FESTA

SKLÍČIDLO RYCHLOUPÍNACÍ

1/2"



Č.p.	specifikace	
20965	1,5 - 13 mm 1/2' - 20 UNF	1



SKLÍČIDLO RYCHLOUPÍNACÍ

1/2"



Č.p.	specifikace	
20961	1,5 - 13 mm 1/2' - 20 UNF	1



NÁSTAVEC NA VRTÁNÍ 90°

Č.p.	specifikace	
20365	Ø 1,00 - 10 mm	10



SKLÍČIDLO RYCHLOUPÍNACÍ DO AKU

1/4"



Č.p.	specifikace	
20963	Ø 1 - 6 mm	10



RAZNICE ČÍSLA

Č.p.	specifikace	
20972	6 mm	5
20973	8 mm	5



VÝSEČNÍKY

13x



Č.p.	specifikace	
24695	Ø 5, 6, 8, 10, 11, 13, 16, 19, 22, 25, 28, 32, 35 mm	5



DĚROVAČE

24690 - Ø 2,5 mm	24691 - Ø 2 mm
Ø 3 mm	Ø 2,5 mm
Ø 4 mm	Ø 3,2 mm
Ø 5 mm	Ø 4 mm
Ø 6 mm	Ø 4,8 mm
Ø 7 mm	Ø 5 mm
Ø 8 mm	Ø 6,4 mm
Ø 9 mm	Ø 8 mm
Ø 10 mm	Ø 9,5 mm
	Ø 11,1 mm
	Ø 12,7 mm
	Ø 14 mm
	Ø 15,8 mm
	Ø 19 mm
	Ø 22 mm

Č.p.	specifikace	
24690	9 ks Ø 2,5 - 10 mm	10
24691	15 ks Ø 2 - 22 mm	5



RAZNICE ABCEDA

Č.p.	specifikace	
20970	6 mm	5
20971	8 mm	5

FESTA®**KARTÁČE**

20mm



10mm

**FESTA®****KARTÁČ MISKOVÝ, VLNITÝ**

· pomosazený

M14

Č.p.	specifikace	drát	
21900	Ø 100 mm M14	s 0,3	60
21902	Ø 125 mm M14	s 0,3	42

FESTA®**KARTÁČ MISKOVÝ, VLNITÝ**

· pomosazený

M14

Č.p.	specifikace	drát	
22001	Ø 100 mm M14	s 0,3	60
21901	Ø 125 mm M14	s 0,3	42

FESTA®**KARTÁČ MISKOVÝ, VLNITÝ**

· mosazný

M14

Č.p.	specifikace	drát	
21920	Ø 100 mm M14	s 0,3	60

**FESTA®****KARTÁČ HRNKOVÝ, VLNITÝ**

· pomosazený

M14

Č.p.	specifikace	drát	
21903	Ø 65 mm M14	s 0,3	60
22002	Ø 75 mm M14	s 0,3	80
21904	Ø 85 mm M14	s 0,3	60
22003	Ø 100 mm M14	s 0,3	36
21905	Ø 125 mm M14	s 0,3	24
21906	Ø 150 mm M14	s 0,3	12

FESTA®**KARTÁČ HRNKOVÝ, VLNITÝ**

· mosazný

M14

Č.p.	specifikace	drát	
21925	Ø 75 mm M14	0,3 mm	80
21926	Ø 100 mm M14	0,3 mm	36

FESTA®**KARTÁČ OKRUŽNÍ, VLNITÝ**· pomosazený
· redukční kroužky

Č.p.	specifikace	drát	
22007	Ø 100 mm Ø 20 mm	s 0,3	60
22008	Ø 125 mm Ø 20 mm	s 0,3	42
22009	Ø 150 mm Ø 32,2 mm	s 0,3	32
22010	Ø 175 mm Ø 32,2 mm	s 0,3	20
22011	Ø 200 mm Ø 32,2 mm	s 0,3	20



FESTA

KARTÁČ HRNKOVÝ, COPY

· patentované

M14



Č.p.	specifikace	drát	
22004	Ø 65 mm M14	s 0,3	60
22005	Ø 75 mm M14	s 0,3	24
22006	Ø 100 mm M14	s 0,3	24
21907	Ø 125 mm M14	s 0,3	24
21908	Ø 150 mm M14	s 0,3	12



FESTA

KARTÁČ HRNKOVÝ, COPY

· patentované

INOX M14



Č.p.	specifikace	drát	
22037	Ø 65 mm M14	s 0,5	60
22038	Ø 80 mm M14	s 0,5	24



FESTA

KARTÁČ RADIÁLNÍ, COPY

· patentované

M14



Č.p.	specifikace	drát	počet copů	
21911	Ø 100 mm M14	s 0,5	30	60
21912	Ø 115 mm M14	s 0,5	32	42
21913	Ø 125 mm M14	s 0,5	36	42
21914	Ø 150 mm M14	s 0,5	40	32



FESTA

KARTÁČ RADIÁLNÍ, COPY

· patentované

M14



Č.p.	specifikace	drát	
22012	Ø 100 mm M14	s 0,5	60
22013	Ø 115 mm M14	s 0,5	42
22014	Ø 125 mm M14	s 0,5	42
22015	Ø 150 mm M14	s 0,5	32
22016	Ø 178 mm M14	s 0,5	20



FESTA

KARTÁČ RADIÁLNÍ, COPY

· patentované

INOX M14



Č.p.	specifikace	drát	
22039	Ø 100 mm M14	s 0,5	60
22040	Ø 125 mm M14	s 0,5	42



FESTA

KARTÁČ MISKOVÝ, COPY

· patentované

M14



Č.p.	specifikace	drát	
22017	Ø 100 mm M14	s 0,5	60
21909	Ø 115 mm M14	s 0,5	42
21910	Ø 125 mm M14	s 0,5	42



Ø 6 mm

FESTA

KARTÁČ OKRUŽNÍ, COPY, STOPKA

· patentované



Č.p.	specifikace	drát	
22023	Ø 75 mm	s 0,5	10



Ø 6 mm

FESTA

KARTÁČ HRNKOVÝ, COPY, STOPKA

· patentované



Č.p.	specifikace	drát	
22024	Ø 75 mm	s 0,5	12



Ø 6 mm

FESTA

KARTÁČ MISKOVÝ, COPY, STOPKA

· patentované



Č.p.	specifikace	drát	
22025	Ø 75 mm	s 0,5	12

Ø 6 mm



Ø 6 mm



Ø 6 mm

**FESTA**KARTÁČ OKRUŽNÍ, VLNITÝ,
POMOSAZENÝ

pomosažený



Č.p.	specifikace	drát	
22026	Ø 50 mm	s 0,3	15
22027	Ø 63 mm	s 0,3	15
22028	Ø 75 mm	s 0,3	10
22029	Ø 100 mm	s 0,3	15

FESTAKARTÁČ HRNKOVÝ,
VLNITÝ, POMOSAZENÝ

pomosažený



Č.p.	specifikace	drát	
22030	Ø 65 mm	s 0,3	12
22031	Ø 75 mm	s 0,3	12

FESTAKARTÁČ KONCOVÝ,
COPÝ, STOPKA

patentované



Č.p.	specifikace	drát	
22021	Ø 19 mm	s 0,5	30
22022	Ø 22 mm	s 0,5	25



Ø 6 mm



Ø 6 mm

**FESTA**KARTÁČ KONCOVÝ, VLNITÝ
STOPKA

Č.p.	specifikace	drát	
22058	Ø 12 mm	s 0,3	25
22059	Ø 25 mm	s 0,3	25

FESTAKARTÁČ KONCOVÝ, VLNITÝ
POMOSAZENÝ

pomosažený



Č.p.	specifikace	drát	
22018	Ø 12 mm	s 0,3	15
22019	Ø 17 mm	s 0,3	15
22020	Ø 25 mm	s 0,3	25

FESTAKARTÁČ OKRUŽNÍ,
NYLONOVÝ

M14 NYLON



Č.p.	specifikace	drát	
21930	Ø 125 mm	M14 1,2 mm	10
21931	Ø 150 mm	M14 1,2 mm	15



Ø 6 mm

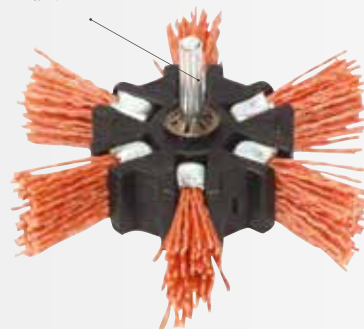

Ø 6 mm

**FESTA**KARTÁČ HRNKOVÝ, VLNITÝ,
NYLONOVÝ

M14 NYLON



Č.p.	specifikace	drát	
21940	Ø 75 mm	M14 1,2 mm	1
21941	Ø 100 mm	M14 1,2 mm	1

FESTAKARTÁČ OKRUŽNÍ,
NYLONOVÝ, STOPKA

NYLON



Č.p.	specifikace	drát	
21935	Ø 50 mm	1,2 mm	15
21936	Ø 75 mm	1,2 mm	10
21937	Ø 100 mm	1,2 mm	15

FESTAKARTÁČ OKRUŽNÍ,
NYLONOVÝ, STOPKA

NYLON



Č.p.	specifikace	drát	
22032	Ø 100 mm	1,2 mm	12



ŠTĚTEC DRÁTĚNÝ

Č.p.	specifikace	drát	
22158	200 mm	ocel	36
22159	200 mm	mosaz	36



KARTÁČ VLNITÝ

Č.p.	specifikace	drát	
22035	270 mm	ocel	24
22036	270 mm	nerez	24



KARTÁČ OCELOVÝ

Č.p.	specifikace	řady	
22033	300 mm	4 řady	12
22034	300 mm	5 řad	12



KARTÁČ POMOSAZENÝ

Č.p.	řady	
22078	3 řady	20



KARTÁČ POMOSAZENÝ

Č.p.	specifikace	řady	
22079	300 mm	4 řady	6



FESTA

KARTÁČ OCELOVÝ

Č.p.	specifikace	řady	
22080	270 mm	5 řad	12



FESTA

KARTÁČ MOSAZNÝ

Č.p.	specifikace	řady	
22082	300 mm	5 řad	12



KARTÁČE OCELOVÉ, POMOSAZENÉ - SADA

3x



Č.p.	řady	
22081	3 řady	12



FESTA

KARTÁČE - SADA

• nylon, nerez, mosaz

3x



Č.p.	specifikace	
22086	180 mm	12

**FESTA**

UNAŠEČ BRUSNÉHO PAPIŘU SE SUCHÝM ZIPEM

- M14 | Ø 8 mm
- EVA10 mm

M14

Č.p.	specifikace	
22062	Ø 115 mm	25
22063	Ø 125 mm	25
22064	Ø 150 mm	10

**FESTA**

KOTOUČ DIAMANTOVÝ LEŠTICÍ Ø 100 MM, SE SUCHÝM ZIPEM

- keramické obklady
- sklo
- mramor
- žula



Č.p.	hrubost	
22701	50	1
22702	100	1
22703	200	1
22704	400	1
22705	800	1
22706	1500	1
22707	3000	1

**FESTA**

UNAŠEČ PRO FIBROVÝ KOTOUČ

NORTON MADE IN EU

M14

Č.p.	specifikace	
22073	Ø 125 mm, M14	1
22074	Ø 150 mm, M14	1

**FESTA**

UNAŠEČ DIAMANTOVÝCH LEŠTICÍCH KOTOUČŮ

- pro úhlovou brusku

M14

Č.p.	specifikace	
22043	Ø 100 mm se suchým zipem	1



UNAŠEČ BRUSNÉHO PAPIŘU

- pro úhlovou brusku

M14

Č.p.	specifikace	
22044	Ø 125 mm M14 se suchým zipem	15
22060	Ø 150 mm M14 se suchým zipem	6



ADAPTÉR

M14

Č.p.	specifikace	
22087		1



UNAŠEČ BRUSNÉHO PAPÍŘU - KLOUBOVÝ

Č.p.	specifikace	stopka shank	
22061	Ø 125 mm se suchým zipem	Ø 8 mm	6



UNAŠEČ BRUSNÉHO PAPIŘU

Č.p.	specifikace	
22041	Ø 125 mm upínání šroubem	11
22042	Ø 125 mm se suchým zipem	11





KOTOUČ LEŠTÍCÍ, BERÁNEK



Č.p.	specifikace	specifikace	
22065	Ø 125 mm	se suchým zipem	20
22066	Ø 150 mm	se suchým zipem	20



KOTOUČ LEŠTÍCÍ, BERÁNEK S LÍMCEM



Č.p.	specifikace	specifikace	
22068	Ø 125 mm		20
22069	Ø 150 mm		20

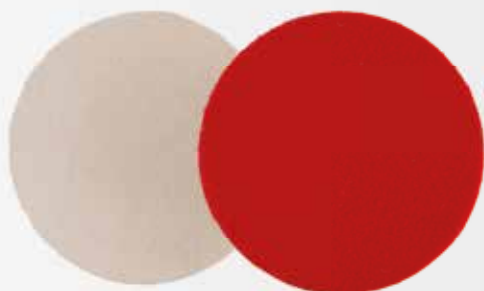

FILC LEŠTÍCÍ SE SUCHÝM ZIPEM



Č.p.	specifikace	specifikace	
22070	Ø 115 mm		20
22071	Ø 125 mm	se suchým zipem	20
22072	Ø 150 mm		20



KOTOUČ NYLONOVÝ, BRUSNÝ



Č.p.	specifikace	specifikace	
22091	Ø 50 mm	P240	1
22092	Ø 75 mm	P240	1
22093	Ø 100 mm	P240	1



KOTOUČ BRUSNÝ UNIVERZÁLNÍ



Č.p.	specifikace	specifikace	
21798	Ø 125 mm Ø 22,2 mm		1



KOTOUČ NYLONOVÝ, STOPKA



Č.p.	specifikace	specifikace	
22088	Ø 65 mm		9
22090	Ø 100 mm		5



KARTÁČ NYLON



Č.p.	specifikace	specifikace	
22083	Ø 115 mm Ø 22,2 mm		10
22084	Ø 125 mm Ø 22,2 mm		10
22085	Ø 150 mm Ø 22,2 mm		10



KOTOUČ NYLONOVÝ



Č.p.	specifikace	specifikace	
22095	Ø 178 mm		1

**FESTA**

KOTOUČ FIBROVÝ - Ø 125 MM

3x



Č.p.	hrubost	
22160	P40	1
22161	P60	1
22162	P80	1
22163	P100	1
22164	P120	1

**FESTA**

KOTOUČ FIBROVÝ - Ø 150 MM

3x



Č.p.	hrubost	
22166	P60	1
22167	P80	1
22168	P100	1

**FESTA**

PAPÍR BRUSNÝ Ø 125 MM, SE SUCHÝM ZIPEM

3x



Č.p.	hrubost	
22045	P40	1
22046	P60	1
22047	P80	1
22048	P100	1
22049	P120	1
22050	P150	1
22051	P180	1
22052	P220	1

**FESTA**

PAPÍR BRUSNÝ Ø 150 MM, SE SUCHÝM ZIPEM

3x



Č.p.	hrubost	
22053	P40	1
22054	P60	1
22055	P80	1
22056	P100	1
22057	P120	1

**FESTA**VIBRAČNÍ VÝSEK
94 X 94 X 94 MM

5x



Č.p.	hrubost	
21831	P60	1
21832	P80	1
21834	P120	1

PAPÍR BRUSNÝ SE SUCHÝM
ZIPEM - 125 MM

3x

Č.p.	hrubost	
22096	P40	20
22097	P60	20
22098	P80	20
22099	P120	20

**FESTA**NEKONEČNÝ BRUSNÝ PÁS
75 X 533 MM

3x



Č.p.	hrubost	
21810	P40	20
21811	P60	20
21812	P80	20
21813	P100	20
21814	P120	20



PAPÍR BRUSNÝ 93 X 230 MM

5x



Č.p.	hrubost	počet otvorů	
21740	P40	8	20
21741	P60	8	20
21742	P80	8	20
21743	P100	8	20
21744	P120	8	20



PAPÍR BRUSNÝ 115 X 280 MM

5x



Č.p.	hrubost	počet otvorů	
21750	P40	10	20
21751	P60	10	20
21752	P80	10	20
21753	P100	10	20
21754	P120	10	20



PLÁTNO BRUSNÉ 230 X 280 MM

10x

Č.p.	hrubost	
21732	P40	1
21734	P60	1
21735	P80	1
21736	P100	1
21737	P120	1

PAPÍR BRUSNÝ VODĚODOLNÝ 230 X 280 MM

10x

Č.p.	hrubost	
21701	P60	1
21702	P80	1
21703	P100	1
21704	P120	1
21705	P150	1
21706	P180	1
21709	P240	1

PAPÍR BRUSNÝ 230 X 280 MM

10x

Č.p.	hrubost	
21715	P40	1
21716	P60	1
21717	P80	1
21718	P100	1
21719	P120	1
21720	P150	1
21721	P180	1
21724	P240	1



FESTA

DRŽÁK BRUSNÉHO PAPÍRU

rychloupínací
buková rukojeť

Č.p.	specifikace	
22067	170 x 70 mm	10



DRŽÁK BRUSNÉHO PAPÍRU



Č.p.	specifikace	
22075	210 x 105 mm	100
22076	160 x 85 mm	100



DRŽÁK BRUSNÉHO PAPÍRU GUMOVÝ

Č.p.	specifikace	
22077	125 x 68 mm	10

**FESTA****HOUBA DIAMANTOVÁ
BRUSNÁ**

- 90 x 55 x 25 mm
- keramické obklady
- sklo
- mramor
- žula



Č.p.	hrubost	
22115	P60	10
22116	P120	10
22117	P200	10

**BRUSNÝ LAMELOVÝ KOTOUČ
NA STOPCE**

Č.p.	hrubost	specifikace	
21850	P40		1
21851	P60		1
21852	P80	20 x 20, Ø 6 mm	1
21853	P100		1
21854	P120		1
21855	P40		1
21856	P60		1
21857	P80	30x30, Ø 6mm	1
21858	P100		1
21859	P120		1
21860	P40		1
21861	P60		1
21862	P80	60x30, Ø 6mm	1
21863	P100		1
21864	P120		1

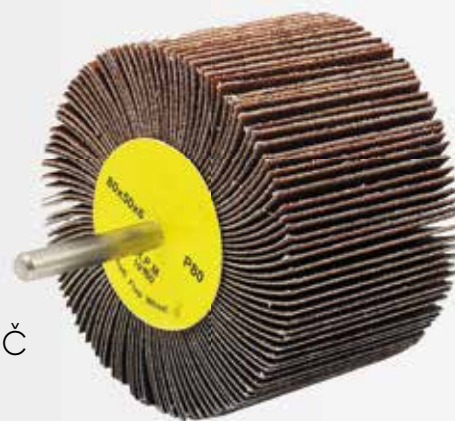
**FESTA****HOUBA BRUSNÁ
100 X 70 X 28 MM - ZKOSENÁ**

Č.p.	hrubost	
22106	P 60	10
22107	P 80	10
22108	P 100	10
22109	P 120	10

**FESTA****HOUBA BRUSNÁ 100 X 70 X 25 MM**

Č.p.	hrubost	
22100	P60	20
22101	P80	20
22102	P100	20
22103	P120	20
22104	P180	20
22105	P220	20

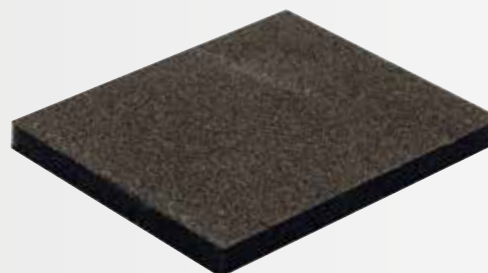
**FESTA****HOUBA BRUSNÁ 120 X 95 X 10 MM**

Č.p.	hrubost	
22110	P80	20
22111	P120	20
22112	P180	20
22113	P220	20



NÁŘADÍ NA SÁDROKARTON



RAŠPLE NA SÁDROKARTON

Č.p.	specifikace	
22120	250 x 40 mm	10



RAŠPLE NA SÁDROKARTON

Č.p.	specifikace	
22121	250 x 40 mm	10
22122	140 x 40 mm	6



RAŠPLE NA SÁDROKARTON

Č.p.	specifikace	
22126	155 x 40 mm	1



RAŠPLE NA SÁDROKARTON

Č.p.	specifikace	
22125	Ø 250 x 40 mm	6



RAŠPLE NA SÁDROKARTON

Č.p.	specifikace	
22124	Ø 250 x 16 mm	10



RAŠPLE NA SÁDROKARTON

Č.p.	specifikace	
22123	60 x 40 mm	6



FESTA

PILKA NA SÁDROKARTON

Č.p.	specifikace	
24159	150 mm	12



HOBLÍK NA SÁDROKARTON

Č.p.	specifikace	
34315	náhradní břit	10
34316	náhradní břit	1



PILKA VRTACÍ NA SÁDROKARTON

Č.p.	specifikace	
24190	270 mm	10

RAŠPLE NÁHRADNÍ

Č.p.	specifikace	
22130	250 x 40 mm	20
22129	155 x 40 mm	20
22132	140 x 40 mm	20
22133	60 x 40 mm	20
22134	Ø 16 x 250 mm	20





RAŠPLE A PILNÍKY



FESTA PILNÍK PLOCHÝ



Č.p.	specifikace	hrubost	
22206	150 mm	2	10
22180	250 mm	2	10



FESTA PILNÍK ČTYŘHRANNÝ



Č.p.	specifikace	hrubost	
22184	250 mm	2	10



FESTA PILNÍK TROJHRANNÝ



Č.p.	specifikace	hrubost	
22183	250 mm	2	10



FESTA PILNÍK PŮLKULATÝ



Č.p.	specifikace	hrubost	
22207	150 mm	2	10
22182	250 mm	2	10



FESTA PILNÍK TROJHRANNÝ NA PILOVÉ ZUBY



Č.p.	specifikace	hrubost	
22178	150 mm	1	10



FESTA PILNÍK KULATÝ



Č.p.	specifikace	hrubost	
22181	250 mm	2	10



FESTA PILNÍKY - SADA



5x



Č.p.	specifikace	hrubost	
22209	150 mm	2	10
22186	250 mm	2	5



FESTA PILNÍKY - SADA



3x



Č.p.	specifikace	hrubost	
22208	150 mm	2	10
22185	250 mm	2	5



FESTA

RAŠPLE PLOCHÁ



Č.p.	specifikace	
22202	150 mm	10
22197	300 mm	10



FESTA

RAŠPLE KULATÁ



Č.p.	specifikace	
22204	150 mm	10
22205	250 mm	10
22198	300 mm	10



FESTA

RAŠPLE PŮLKULATÁ



Č.p.	specifikace	
22203	150 mm	6
22199	300 mm	6

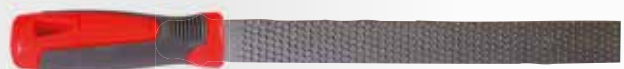

FESTA

RAŠPLE SADA



3x



Č.p.	specifikace	
22195	300 mm	5



FESTA

PILNÍK NA ŘETĚZOVOU PILU



Č.p.	specifikace		Č.p.	specifikace	
22170	200 mm 3,5 mm	10	22173	200 mm 5 mm	10
22171	200 mm 4 mm	10	22174	200 mm 5,5 mm	10
22172	200 mm 4,5 mm	10			



FESTA

PILNÍKY JEHLOVÉ - SADA

10x



Č.p.	specifikace	
22188		20



FESTA

SADA NA BROUŠENÍ ŘETĚŽŮ



Č.p.	specifikace	
22190	300 mm	5



FESTA

PILNÍKY DIAMANTOVÉ - SADA

10x



Č.p.	specifikace	
22189		25

FESTA®

Č.p.	specifikace	počet zubů	
	Ø 115 mm		
22300	Ø 115 x 22 mm	40	1
	Ø 125 mm		
22301	Ø 125 x 22 mm	40	1
	Ø 140 mm		
22302	Ø 140 x 20 mm	24	1
22303	Ø 140 x 20 mm	30	1
	Ø 150 mm		
22305	Ø 150 x 20 mm	24	1
	Ø 160 mm		
22307	Ø 160 x 20 mm	18	1
22309	Ø 160 x 20 mm	24	1
22310	Ø 160 x 20 mm	30	1
22311	Ø 160 x 20 mm	36	1
22312	Ø 160 x 20 mm	48	1
22313	Ø 160 x 20 mm	60	1
	Ø 165 mm		
22314	Ø 165 x 20 mm	24	1
	Ø 180 mm		
22315	Ø 180 x 30 mm	24	1
22317	Ø 180 x 30 mm	50	1
22318	Ø 180 x 20 mm	50	1
	Ø 190 mm		
22319	Ø 190 x 20 mm	40	1
22320	Ø 190 x 30 mm	40	1
	Ø 200 mm		
22322	Ø 200 x 30 mm	24	1
22324	Ø 200 x 30 mm	40	1
22326	Ø 200 x 30 mm	60	1
	Ø 205 mm		
22328	Ø 205 x 30 mm	40	1
22329	Ø 205 x 30 mm	60	1
	Ø 210 mm		
22332	Ø 210 x 30 mm	40	1
22333	Ø 210 x 30 mm	60	1
	Ø 250 mm		
22335	Ø 250 x 30 mm	40	1
22337	Ø 250 x 30 mm	60	1
	Ø 300 mm		
22340	Ø 300 x 30 mm	40	1
22343	Ø 300 x 30 mm	60	1
22345	Ø 300 x 30 mm	96	1
	Ø 350 mm		
22350	Ø 350 x 30 mm	40	1
22351	Ø 350 x 30 mm	54	1
	Ø 400 mm		
22355	Ø 400 x 30 mm	40	1
22357	Ø 400 x 30 mm	60	1
	Ø 500 mm		
22365	Ø 500 x 30 mm	60	1
	Ø 600 mm		
22370	Ø 600 x 30 mm	60	1

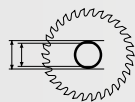
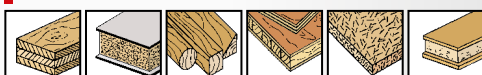
FESTA
KOTOUČ PILOVÝ DO DŘEVA S SK PLÁTKY

REDUKČNÍ KROUŽEK

Č.p.	specifikace	
22399	Ø 20 16 mm	1
22398	Ø 30 25 mm	1

























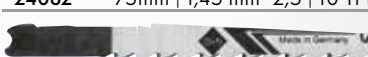



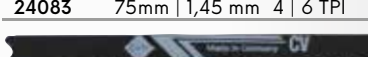



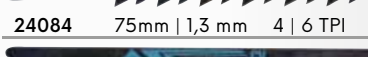

PROFESIONÁLNÍ PŘÍMOČARÉ PILKY
VYROBENO V NĚMECKU TECHNOLOGIÍ VYPALOVÁNÍM LASEREM

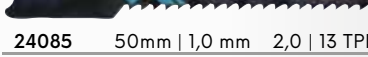

PILKA PŘÍMOČARÁ HSS - UCHYCENÍ AEG, BOSCH, FESTO, MAKITA, METABO

	24060	50mm/1mm	0,7 mm/ 36TPI	31007	5 ks	10	
	24061	50mm/1mm	1,2 mm/ 21TPI	31012	5 ks	10	
	24062	50mm/1mm	2,0 mm/ 13TPI	31020	5 ks	10	
	24063	75mm/1mm	3,0 mm/ 8TPI	31030	5 ks	10	
	24064	100mm/1mm	1,2 mm/ 21TPI	31112	5 ks	10	
	24065	100mm/1,3mm	2,0 mm/ 13TPI	31112	5 ks	10	
	24066	75mm/1,45mm	2,0 mm/ 13TPI	31220	5 ks	10	
	24067	120mm/1,3mm	1,8 - 2,4 mm/ 10 - 14 TPI	31220	5 ks	10	
	24068	75mm/1,45mm	2,5 mm/ 10 TPI	32225	5 ks	10	
	24069	75mm/1,45mm	4 mm/ 6 TPI	32240	5 ks	10	
	24070	75mm/1,3mm	4 mm/ 6 TPI	32340	5 ks	10	
	24071	75mm/1,3mm	4 mm/ 6 TPI	32440	5 ks	10	
	24072	75mm/1,45mm	2,5 mm/ 10 TPI	32625	5 ks	10	
	24073	85mm/1,45mm	3 mm/ 8 TPI	32730	5 ks	10	
	24074	85mm/1,45mm	4 mm/ 6 TPI	32730	5 ks	10	
	24075	75mm/1,45mm	2,5 1,2 mm/10 21 TPI	32825	5 ks	10	
	24076	75mm/1,7mm	4 mm 6 TPI	32940	5 ks	10	
	24077	120mm/1,3mm	4 mm 6 TPI	32040	5 ks	10	
	24078	105mm/1,45mm	4 mm 6 TPI	34040	5 ks	10	
	24055	55mm	karbidová		5 ks	1	

PILKA PŘÍMOČARÁ HSS - UCHYCENÍ BLACK & DECKER, FERM

	24080	50mm 1,0 mm	1,2 21 TPI	11012	5 ks	10	   
	24081	75mm 1,0 mm	3,0 8 TPI	11030	5 ks	10	   
	24082	75mm 1,45 mm	2,5 10 TPI	12225	5 ks	10	   
	24083	75mm 1,45 mm	4 6 TPI	12240	5 ks	10	   
	24084	75mm 1,3 mm	4 6 TPI	12340	5 ks	10	  
	24085	50mm 1,0 mm	2,0 13 TPI	12420	5 ks	10	  
	24086	75mm 1,3 mm	4,0 6 TP	12440	5 ks	10	  
	24087	75mm 1,45 mm	2,5 10 TPI	12625	5 ks	10	  

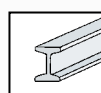
měkká ocel
(s malým obsahem uhlíku)

ocelový plech

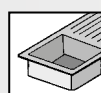

nerezavějící ocel

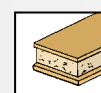

laminovaná prkna

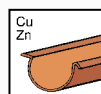

neželezné kovy

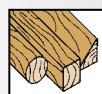

tvrdé a měkké dřevo

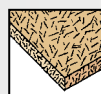

dřevotříska

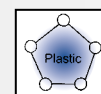

plasty

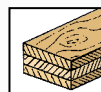

překlížka

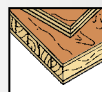

laťová překlížka

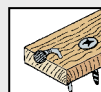

dřevo s hřebíky

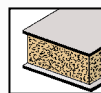

sendvičový materiál



dlažba a obklady

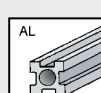

hliník

STOJAN PŘÍMOČARÝCH PILEK

- osazení stojanu 24098 - 24060 · 5 ks
- 24080 · 5 ks
- 24061 · 5 ks
- 24062 · 5 ks
- 24081 · 5 ks
- 24063 · 5 ks
- 24066 · 5 ks
- 24067 · 5 ks
- 24082 · 5 ks
- 24068 · 5 ks
- 24083 · 5 ks
- 24069 · 5 ks
- 24084 · 5 ks
- 24070 · 5 ks
- 24086 · 5 ks
- 24071 · 5 ks
- 24087 · 5 ks
- 24072 · 5 ks
- 24073 · 5 ks
- 24074 · 5 ks
- 24075 · 5 ks
- 24076 · 5 ks



SADA PŘÍMOČARÝCH PILEK



5x



č.p.	specifikace	
24045	sada	50

č.p.	specifikace	
24099	64 x 50 cm - prázdný	1
24098	64 x 50 cm - osazený	1

FESTA

PILOVÝ PLÁTEK

HCS 3x

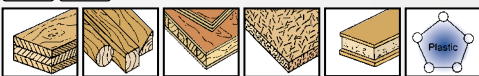

Č.p. specifikace
24301 150 x 19 x 1,3 mm TPI 6

1

FESTA

PILOVÝ PLÁTEK

HCS 3x

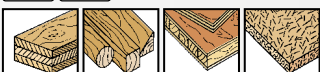

Č.p. specifikace
24302 225 x 19 x 1,3 mm TPI 3

1

FESTA

PILOVÝ PLÁTEK

HCS 3x

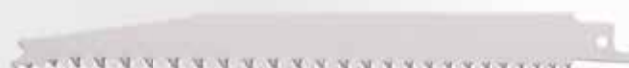
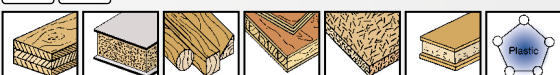

Č.p. specifikace
24303 200 x 19 x 1,3 mm TPI 6 - 10

1

FESTA

PILOVÝ PLÁTEK

HCS 3x



Č.p. specifikace
24304 240 x 19 x 1,5 mm TPI 5

1

FESTA

PILOVÝ PLÁTEK

Bi Metal 3x

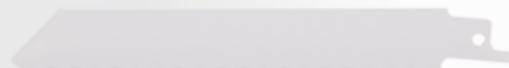
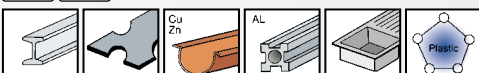

Č.p. specifikace
24305 150 x 19 x 1 mm TPI 24

1

FESTA

PILOVÝ PLÁTEK

Bi Metal 3x

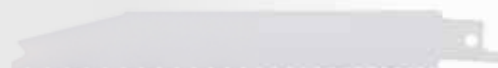
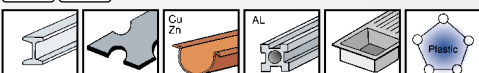

Č.p. specifikace
24306 150 x 19 x 1 mm TPI 9

1

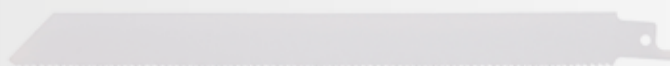
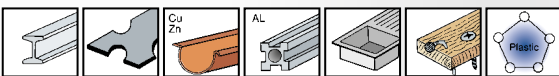
FESTA**PILOVÝ PLÁTEK****Bi Metal 3x**

Č.p. specifikace
24308 225 x 19 x 1 mm TPI 10 - 14

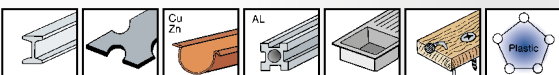
**FESTA****PILOVÝ PLÁTEK****Bi Metal 3x**

Č.p. specifikace
24310 150 x 22 x 1,6 mm TPI 9

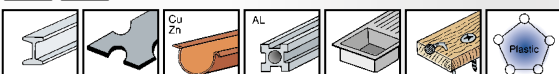
**FESTA****PILOVÝ PLÁTEK****Bi Metal 3x**

Č.p. specifikace
24313 225 x 22 x 1,6 mm TPI 6

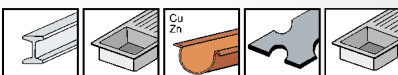
**FESTA****PILA NA KOV HSS****HSS**

Č.p. specifikace
24050 203 x 19 x 1 mm TPI 10 - 14

**FESTA****PILOVÝ PLÁTEK**

· SK zuby, dlouhá životnost

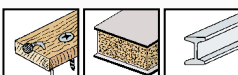
TC 3x

Č.p. specifikace
24312 225 x 19 x 1,3 mm TPI 6 - 9

**FESTA****PILOVÝ PLÁTEK****SK**

Č.p. specifikace
24315 305 x 50 x 1,5 mm
24316 **NEW** 455 x 50 x 1,5 mm



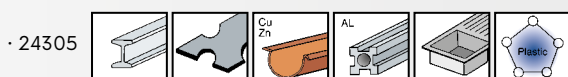

FESTA

SADA PILOVÝCH PLÁTKŮ

Bi Metal HCS 3x

Č.p. specifikace
24314



PILOVÝ PLÁTEK

· kalené zuby



Č.p.	specifikace	
24185	533 mm	1
24186	610 mm	1
24187	760 mm	1
24188	800 mm	1
24189	914 mm	1



FESTA

PILOVÝ PLÁTEK

· kalené zuby



Č.p.	specifikace	
24169	350 mm	10
24167	450 mm	10
24166	533 mm	10
24163	610 mm	10
24164	760 mm	10
24168	800 mm	10
24165	914 mm	10



PILOVÝ PLÁTEK



Č.p.	specifikace	
24195	rozteč 3 mm 300 mm	1
24196	rozteč 4 mm 300 mm šikmý zub	1
24197	rozteč 5 mm 300 mm kalený zub	1
24192	pilový list do řeznické pily 450 mm	1



PILOVÝ PLÁTEK

Č.p.	specifikace	
24160	rozteč 3 mm 300 mm	20
24161	rozteč 4 mm 300 mm	20
24162	rozteč 5 mm 300 mm	50



PILOVÝ PLÁTEK

10x

Č.p.	specifikace	
24108	6 mm 150 mm	1



ŘEZACÍ STRUNA



Č.p.	specifikace	
24120	300 mm	50



**FESTA****PILOVÝ PLÁTEK BI - METAL**

· 8 % COBALT



Č.p.	specifikace
24180	300 mm



125

FESTA**PILOVÝ PLÁTEK**

MOQ

Č.p.	specifikace		
24109	12,5 mm 300 mm	na kov	144
24118	25 mm 300 mm	na kov oboustranný	72
24119	25 mm 300 mm	na kov a dřevo	72

FESTA**PILA NA KOV**

Č.p.	specifikace
24104	300 mm



6

FESTA**PILA NA KOV**

· zesílený rám



Č.p.	specifikace
24102	300 mm



6

PILA NA KOV

Č.p.	specifikace
24153	300 mm

12

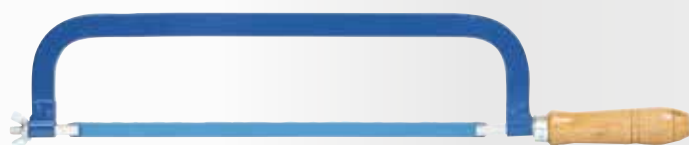
**PILA NA KOV**

Č.p.	specifikace
24100	300 mm

12





PILA NA KOV



Č.p.	specifikace	
24170	300 mm	12



FESTA

PILA NA KOV



2x

MADE IN EU



Č.p.	specifikace	
24126	300 x 25 x 0,65 mm TPI 24 14	10



PILA NA KOV

· plátky 24108



Č.p.	specifikace	
24125	150 mm	6



PILA NA KOV

· plátky 24109



Č.p.	specifikace	
24124	260 mm	12



LUPÉNKOVÁ PILA



Č.p.	specifikace	
24121	pila	12
24110	pilový plátek	30

PILA

· 5x pilový plátek



Č.p.	specifikace	
24122	pila	20
24111	pilový plátek	30

FESTA**PILA OCASKA**

TEFLON



 · 3 x broušené a kalené zuby

Č.p.	specifikace	
24143	300 mm	12
24144	400 mm	12
24145	500 mm	12

**FESTA****PILA ČEPOVKA**

TEFLON



 · 3 x broušené a kalené zuby

Č.p.	specifikace	
24147	300 mm	6

**FESTA****PILA DĚROVKA**

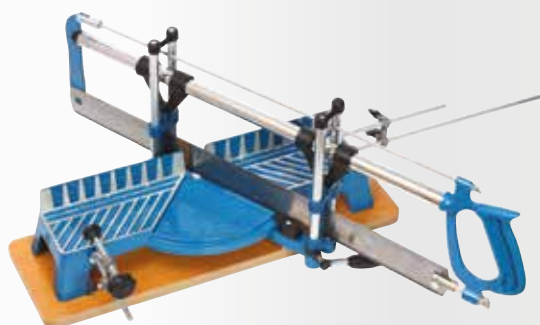
 · 3 x broušené a kalené zuby

Č.p.	specifikace	
24149	300 mm	12

**PILA POKOSOVÁ PROFI**

Č.p.	specifikace	
24130	600 mm	1
24131	600 mm, pilový plátek	1

POKOSNICE PLASTOVÁ

Č.p.	specifikace	
24133	300 x 140 mm	18

**POKOSNICE DŘEVĚNÁ**
 · buk
MADE IN EU

Č.p.	specifikace	
24171	80 x 300 mm	10

KOSOŘEZ + PILA

Č.p.	specifikace	
24148	300 mm	25







FESTA

PILA OBLOUKOVÁ

· kalené zuby

Č.p.	specifikace		Č.p.	specifikace	
24141	450 mm	12	24136	760 mm	12
24140	533 mm	12	24142	800 mm	12
24135	610 mm	12	24137	914 mm	12

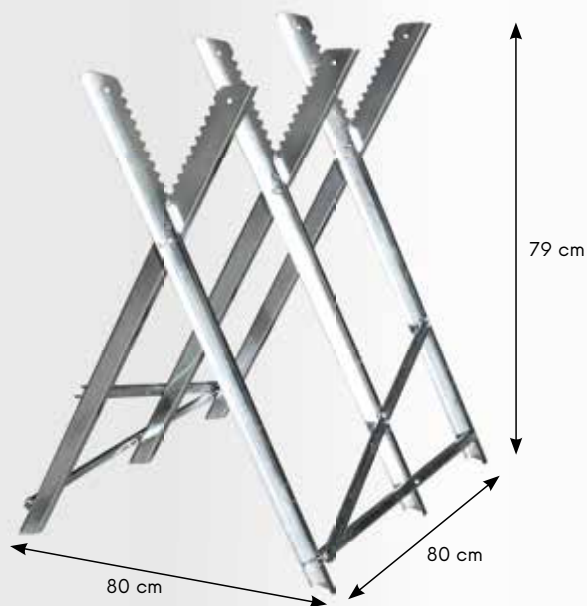

FESTA

PILA OBLOUKOVÁ OTOČNÁ

· kalené zuby

Č.p.	specifikace	
24173	350 mm	24

KOZA NA ŘEZÁNÍ DŘEVA



Č.p.	specifikace	
37570	max. 150 kg	3



PILA ZAHRADNÍ



Č.p.	specifikace	
24151	300 mm	10



PILA ZAHRADNÍ - OTOČNÁ



Č.p.	specifikace	
24150	300 mm	5

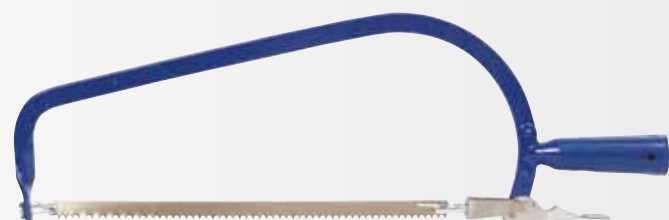

PILA ZAHRADNÍ - TULEJ



Č.p.	specifikace	
24154	300 mm	10



PILA

Č.p.	specifikace	
24128	450 mm plátky 24192	6

**FESTA****PILA ZAVÍRACÍ**

· 3 x broušené a kalené zuby



Č.p.	specifikace
45061	150 mm s krytem rukojeti

12

**FESTA****PILA ZAVÍRACÍ**

· 3 x broušené a kalené zuby



Č.p.	specifikace
45060	180 mm

6

**FESTA****PILA S POUZDREM**

· 3 x broušené a kalené zuby



Č.p.	specifikace
45062	260 mm s pouzdem

24

**FESTA****PILA PROŘEZÁVACÍ**

· 3 x broušené a kalené zuby



Č.p.	specifikace
24152	350 mm 7 tpi

12

**FESTA****PILA TELESKOPICKÁ PROŘEZÁVACÍ**

· 3 x broušené a kalené zuby

Č.p.	specifikace
45033	230 - 490 mm

1

**HOUSENICE S PILOU**

Č.p.	specifikace
45030	pilka 30 cm teleskopická tyč 260 cm
45031	pilka 30 cm

6

6

**HOUSENICE**

Č.p.	specifikace
45032	kovová housenice bez pilky

6

6



FESTA

PILA NA POLYSTYREN

Č.p.	specifikace	
24174	370 mm	1



FESTA

PILA NA SÁDROKARTON



· 3 x broušené a kalené zuby



Č.p.	specifikace	
24159	150 mm	12



PILA VRTACÍ NA SÁDROKARTON



Č.p.	specifikace	
24190	270 mm	10



FESTA

PILA NA DUTÉ CIHLY (PORO-THERM)



Č.p.	specifikace	
24181	550 mm	1



FESTA

PILA NA POROBETON



Č.p.	specifikace	
24158	22 22 SK zubů - 450 mm	5



FESTA

PILA NA POROBETON



Č.p.	specifikace	
24155	34 17 SK zubů - 630 mm	2
24156	34 34 SK zubů - 630 mm	2



FESTA

PILA NA POROBETON

Č.p.	specifikace	
24176	34 17 SK zubů - 750 mm	6
24177	34 34 SK zubů - 750 mm	6



FESTA

PILA NA POROBETON

· kalené zuby



Č.p.	specifikace	
24175	bez SK zubů - 600 mm EU	2
24178	bez SK zubů - 600 mm	6

FESTA®



Použití řezných diamantových kotoučů



materiály	festa industry	plný	turbo	segment
cihla	••	••	••	••
obklady	••	•••	••	-
zdivo, kámen	••	••	••	••
beton	•••	•	•••	•••
železobeton	-	-	•••	-
střešní tašky	••	•	••	••
sklo a keramika	-	•••	-	-
mramor	•	••	•	•
žula	•••	••	•••	••
pískovec	••	-	••	••
asfalt	-	••	-	••
křemen	••	•	••	•



FESTA
INDUSTRY

KOTOUČ DIAMANTOVÝ

Č.p.	specifikace			
21200	Ø 115 mm	1,4 mm	Ø 22,2 mm	1
21201	Ø 125 mm	1,4 mm	Ø 22,2 mm	1
21204	Ø 200 mm	1,8 mm	Ø 25,4 mm	1
21203	Ø 230 mm	1,8 mm	Ø 22,2 mm	1

FESTA

KOTOUČ DIAMANTOVÝ PLNÝ

Č.p.	specifikace		
21210	Ø 110 mm	Ø 22,2 mm	1
21211	Ø 115 mm	Ø 22,2 mm	1
21212	Ø 125 mm	Ø 22,2 mm	1
21215	Ø 150 mm	Ø 22,2 mm	1
21218	Ø 180 mm	Ø 22,2 mm	1
21219	Ø 180 mm	Ø 25,4 mm	1
21220	Ø 200 mm	Ø 25,4 mm	1
21223	Ø 230 mm	Ø 22,2 mm	1
21224	Ø 300 mm	Ø 25,4 mm	1



FESTA

KOTOUČ DIAMANTOVÝ SEGMENTOVÝ



Č.p.	specifikace		
21311	Ø 115 mm	Ø 22,2 mm	1
21312	Ø 125 mm	Ø 22,2 mm	1
21315	Ø 150 mm	Ø 22,2 mm	1
21318	Ø 180 mm	Ø 22,2 mm	1
21323	Ø 230 mm	Ø 22,2 mm	1
21324	Ø 300 mm	Ø 25,4 mm	1
21327	Ø 350 mm	Ø 25,4 mm	1
21326	Ø 400 mm	Ø 25,4 mm	1



FESTA

KOTOUČ DIAMANTOVÝ TURBO



Č.p.	specifikace		
21410	Ø 110 mm	Ø 22,2 mm	1
21411	Ø 115 mm	Ø 22,2 mm	1
21412	Ø 125 mm	Ø 22,2 mm	1
21415	Ø 150 mm	Ø 22,2 mm	1
21418	Ø 180 mm	Ø 22,2 mm	1
21423	Ø 230 mm	Ø 22,2 mm	1
21424	Ø 300 mm	Ø 25,4 mm	1



FESTA

KOTOUČ ŘEZNÝ DIAMANTOVÝ UNIVERZÁLNÍ



Č.p.	specifikace			
21301	Ø 125 mm	Ø 22,2 mm	1,5 mm	1
21303	Ø 230 mm	Ø 22,2 mm	1,8 mm	1



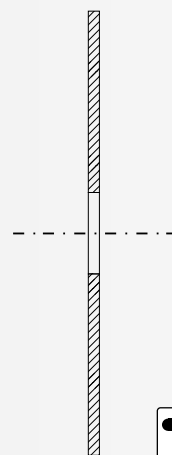

KOTOUČ DIAMANTOVÝ PLNÝ

Č.p.	specifikace		
21010	Ø 110 mm	Ø 22,2 mm	1
21011	Ø 115 mm	Ø 22,2 mm	1
21012	Ø 125 mm	Ø 22,2 mm	1
21015	Ø 150 mm	Ø 22,2 mm	1
21018	Ø 180 mm	Ø 22,2 mm	1
21023	Ø 230 mm	Ø 22,2 mm	1

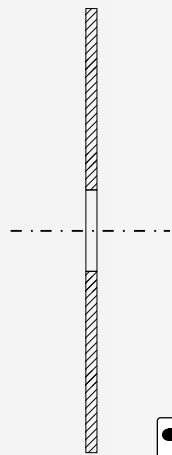

KOTOUČ DIAMANTOVÝ SEGMENTOVÝ

Č.p.	specifikace		
21110	Ø 110 mm	Ø 22,2 mm	1
21111	Ø 115 mm	Ø 22,2 mm	1
21112	Ø 125 mm	Ø 22,2 mm	1
21115	Ø 150 mm	Ø 22,2 mm	1
21118	Ø 180 mm	Ø 22,2 mm	1
21123	Ø 230 mm	Ø 22,2 mm	1

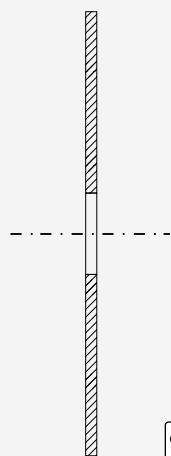

KOTOUČ DIAMANTOVÝ TURBO

Č.p.	specifikace		
21130	Ø 110 mm	Ø 22,2 mm	1
21135	Ø 115 mm	Ø 22,2 mm	1
21140	Ø 125 mm	Ø 22,2 mm	1
21150	Ø 150 mm	Ø 22,2 mm	1
21180	Ø 180 mm	Ø 22,2 mm	1
21190	Ø 230 mm	Ø 22,2 mm	1



FESTA

KOTOUČ DIAMANTOVÝ BRUSNÝ DVOUŘADÝ



Č.p.	specifikace		
21430	Ø 115 mm	Ø 22,2 mm	1
21431	Ø 125 mm	Ø 22,2 mm	1
21432	Ø 150 mm	Ø 22,2 mm	1



FESTA

KOTOUČ DIAMANTOVÝ BRUSNÝ TURBO



Č.p.	specifikace		
21425	Ø 100 mm	Ø 22,2 mm	1
21426	Ø 115 mm	Ø 22,2 mm	1
21427	Ø 125 mm	Ø 22,2 mm	1
21428	Ø 150 mm	Ø 22,2 mm	1



6 mm



FESTA

KOTOUČ DIAMANTOVÝ SEGMENTOVÝ, DVOJITÝ



Č.p.	specifikace		
21195	Ø 125 x 22,2 mm		1

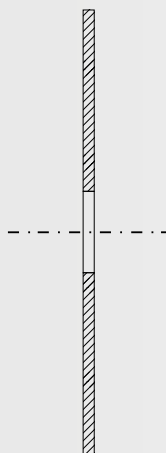

NEW



FESTA

KOTOUČ ŘEZNÝ NA KOV



Č.p.	specifikace			
22211	Ø 115 mm	Ø 22,2 mm x 1 mm	INOX	50
22212	Ø 115 mm	Ø 22,2 mm x 1,2 mm	INOX	50
22225	Ø 125 mm	Ø 22,2 mm x 1 mm	INOX	50
22217	Ø 125 mm	Ø 22,2 mm x 1,2 mm	INOX	50

Č.p.	specifikace			
22251	Ø 115 mm	Ø 22,2 mm x 1,6 mm		50
22215	Ø 115 mm	Ø 22,2 mm x 2 mm		50
22216	Ø 115 mm	Ø 22,2 mm x 2,5 mm		50
22252	Ø 125 mm	Ø 22,2 mm x 1,6 mm		25
22218	Ø 125 mm	Ø 22,2 mm x 2,5 mm		25
22219	Ø 150 mm	Ø 22,2 mm x 1,2 mm		25
22253	Ø 150 mm	Ø 22,2 mm x 1,6 mm		50
22220	Ø 150 mm	Ø 22,2 mm x 2,5 mm		50
22254	Ø 180 mm	Ø 22,2 mm x 1,6 mm		50
22222	Ø 180 mm	Ø 22,2 mm x 2,5 mm		25
22255	Ø 230 mm	Ø 22,2 mm x 1,6 mm		25
22224	Ø 230 mm	Ø 22,2 mm x 2,5 mm		25

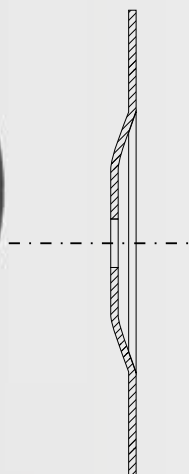

FESTA

KOTOUČ BRUSNÝ NA KOV



Č.p.	specifikace			
22240	Ø 115 mm	Ø 22,2 mm x 6,4 mm		25
22242	Ø 125 mm	Ø 22,2 mm x 6,4 mm		25
22244	Ø 150 mm	Ø 22,2 mm x 6,4 mm		25
22246	Ø 180 mm	Ø 22,2 mm x 6,4 mm		25
22248	Ø 230 mm	Ø 22,2 mm x 6,4 mm		25

FESTA

KOTOUČ ŘEZNÝ NA KOV

10x

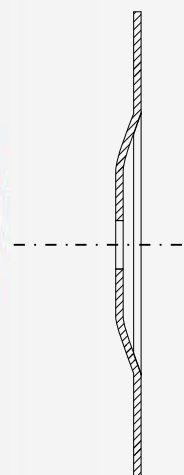

Č.p.	specifikace			
22228	Ø 115 mm	Ø 22,2 mm x 1 mm	INOX	1
22229	Ø 125 mm	Ø 22,2 mm x 1,2 mm	INOX	1

FESTA
INDUSTRY

KOTOUČ ŘEZNÝ NA KOV

MADE IN
EU OSA

Č.p.	specifikace			
22258	NEW	Ø 115 mm	Ø 22,2 mm x 0,8 mm	25
22260		Ø 115 mm	Ø 22,2 mm x 1 mm	25
22263		Ø 115 mm	Ø 22,2 mm x 1,6 mm	25
22264	NEW	Ø 115 mm	Ø 22,2 mm x 2 mm	25
22259		Ø 125 mm	Ø 22,2 mm x 0,8 mm	25
22266		Ø 125 mm	Ø 22,2 mm x 1 mm	25
22269		Ø 125 mm	Ø 22,2 mm x 1,6 mm	25
22270		Ø 125 mm	Ø 22,2 mm x 2 mm	25
22273		Ø 150 mm	Ø 22,2 mm x 1,6 mm	25
22274		Ø 150 mm	Ø 22,2 mm x 2 mm	25
22275		Ø 150 mm	Ø 22,2 mm x 2,5 mm	25
22277		Ø 180 mm	Ø 22,2 mm x 2 mm	25
22280		Ø 230 mm	Ø 22,2 mm x 2 mm	25
22281		Ø 230 mm	Ø 22,2 mm x 2,5 mm	25

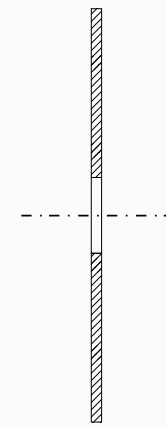
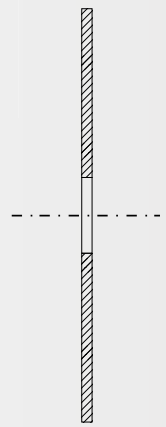

FESTA
INDUSTRY

KOTOUČ ŘEZNÝ NA HLINÍK

ALU



Č.p.	specifikace	
22285	Ø 115 mm Ø 22,2 mm x 1 mm	1
22286	Ø 125 mm Ø 22,2 mm x 1 mm	1

FESTA

KOTOUČ ŘEZNÝ NA KOV - DIAMANTOVÝ

INOX ALU



Č.p.	specifikace	
21306	Ø 125 mm Ø 22,2 mm 1,3 mm	1
21308	Ø 230 mm Ø 22,2 mm 1,8 mm	1

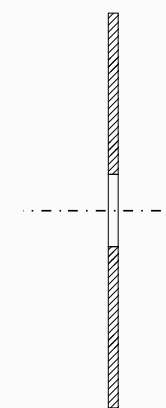

FESTA

KOTOUČ ŘEZNÝ UNIVERZÁLNÍ - KARBIDOVÝ



Č.p.	specifikace	
21192	Ø 125 mm Ø 22,2 mm	1
21194	Ø 230 mm Ø 22,2 mm	1

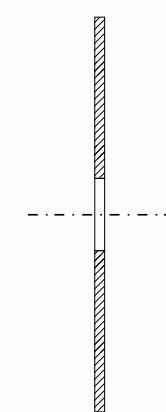
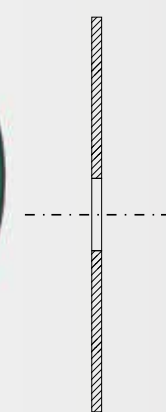

FESTA
INDUSTRY

KOTOUČ ŘEZNÝ NA KÁMEN



Č.p.	specifikace	
22294	Ø 230 mm Ø 22,2 mm x 3 mm	1

FESTA

KOTOUČ ŘEZNÝ NA KÁMEN



Č.p.	specifikace	
22230	Ø 115 mm Ø 22,2 mm x 2,5 mm	50
22232	Ø 125 mm Ø 22,2 mm x 2,5 mm	50
22234	Ø 150 mm Ø 22,2 mm x 2,5 mm	25
22236	Ø 180 mm Ø 22,2 mm x 2,5 mm	25
22238	Ø 230 mm Ø 22,2 mm x 2,5 mm	25

NEW

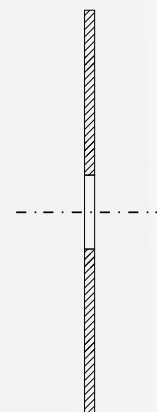

KOTOUČ ŘEZNÝ ŘETĚZOVÝ



Č.p.	Specifikace
21804	Ø 125 mm Ø 22,2 mm 14T

1

NEW



FESTA

KOTOUČ RAŠPLOVÝ - PILOVÝ



Č.p.	Specifikace
21803	Ø 125 mm Ø 22,2 mm

1

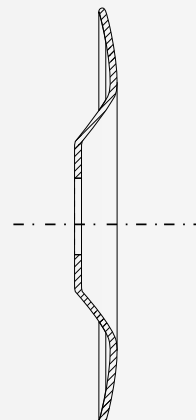

FESTA

KOTOUČ RAŠPLOVÝ - STŘEDNĚ HRUBÝ



Č.p.	specifikace
21802	Ø 125 mm Ø 22,2 mm 3 mm

10



FESTA

KOTOUČ RAŠPLOVÝ - HRUBÝ



Č.p.	specifikace
21801	Ø 125 mm Ø 22,2 mm 3 mm

10

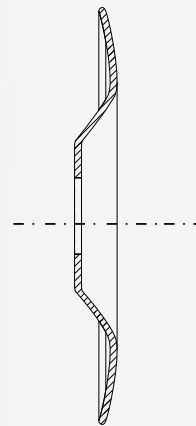

FESTA

KOTOUČ NA DŘEVO S OTVORY

· brusný kotouč vhodný pro broušení dřeva



Č.p.	specifikace
21800	Ø 125 mm Ø 22,2 mm

1

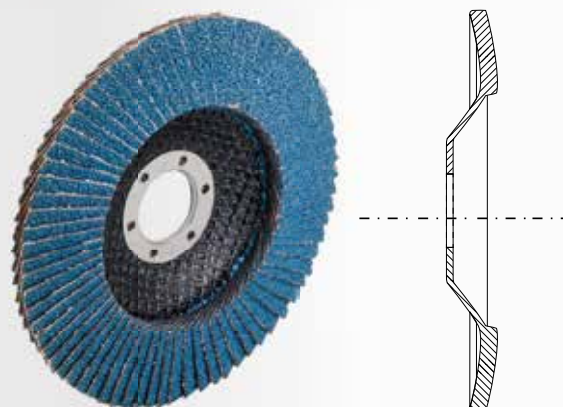
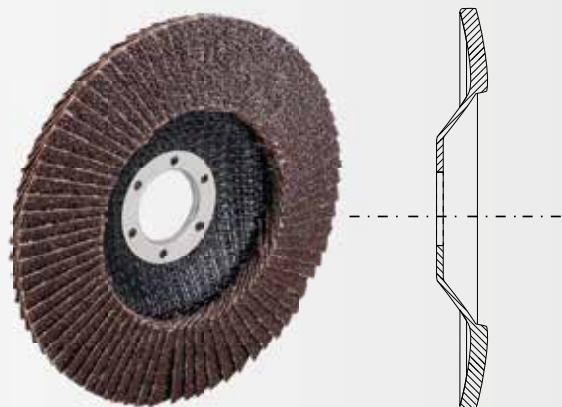

KOTOUČ LAMELOVÝ



Č. p.	specifikace	hrubost	
21780	Ø 115 mm Ø 22,2 mm	P40	10
21781	Ø 115 mm Ø 22,2 mm	P60	10
21782	Ø 115 mm Ø 22,2 m	P80	10
21783	Ø 115 mm Ø 22,2 mm	P100	10
21784	Ø 115 mm Ø 22,2 mm	P120	10
21786	Ø 125 mm Ø 22,2 mm	P40	10
21787	Ø 125 mm Ø 22,2 mm	P60	10
21788	Ø 125 mm Ø 22,2 mm	P80	10
21789	Ø 125 mm Ø 22,2 mm	P100	10
21790	Ø 125 mm Ø 22,2 mm	P120	10
21792	Ø 150 mm Ø 22,2 mm	P40	10
21793	Ø 150 mm Ø 22,2 mm	P60	10
21794	Ø 150 mm Ø 22,2 mm	P80	10
21795	Ø 150 mm Ø 22,2 mm	P100	10
21796	Ø 150 mm Ø 22,2 mm	P120	10

FESTA

KOTOUČ LAMELOVÝ

• brusný kotouč vhodný pro broušení nerez oceli



Č. p.	specifikace	hrubost	
22140	Ø 115 mm Ø 22,2 mm	P40	5
22141	Ø 115 mm Ø 22,2 mm	P60	5
22142	Ø 115 mm Ø 22,2 mm	P80	5
22143	Ø 115 mm Ø 22,2 mm	P100	5
22145	Ø 125 mm Ø 22,2 mm	P40	5
22146	Ø 125 mm Ø 22,2 mm	P60	5
22147	Ø 125 mm Ø 22,2 mm	P80	5
22148	Ø 125 mm Ø 22,2 mm	P100	5
22150	Ø 150 mm Ø 22,2 mm	P40	5
22151	Ø 150 mm Ø 22,2 mm	P60	5
22155	Ø 150 mm Ø 22,2 mm	P80	5
22156	Ø 150 mm Ø 22,2 mm	P100	5



KOTOUČ BRUSNÝ UNIVERZÁLNÍ



Č. p.	specifikace	
21798	Ø 125 mm Ø 22,2 mm	1



ZEDNICKÁ HLADÍTKA,
LŽÍCE, ŠPACHTLE

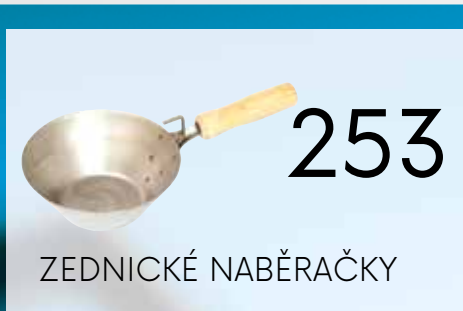

ZEDNICKÉ NABĚRAČKY



ŠKRABÁKY A BRUSNÁ
HLADÍTKA



HLADÍTKA A BRUSNÉ
MŘÍŽKY



HLADÍTKA PRO ÚPRUVU
OMÍTEK



MÍCHADLA



PRODLUŽOVACÍ KABELY



ELEKTRICKÁ A PLYNOVÁ
TOPIDLA



STAVEBNÍ MÍCHAČKY



SHOZ STAVEBNÍ SUTI



STAVEBNÍ KOLEČKA



LÁMAČE DLAŽBY A
NOSIČE OBRUBNÍKŮ



ŘEZAČKY DLAŽBY



POMŮCKY PRO POKLÁDÁNÍ
DLAŽBY



NIVELACE



293

ŘEZAČKY NA POLYSTYREN



298

OMÍTAČKY



300

PB HOŘÁKY A
REGULÁTORY TLAKU

304

ZEDNICKÉ NÁDOBY

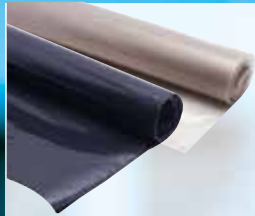

305

PYTLE NA SUŠ A ODPAD



306

LEPÍCÍ A MASKOVACÍ PÁSKY



310

VYTLAČOVACÍ PISTOLE



313

PISTOLE NA PU PĚNU



314

HORKOVZDUŠNÉ A
TAVNÉ PISTOLE

STAVEBNÍ NÁŘADÍ 242 - 329



316

MALÍŘSKÉ POTŘEBY



322

PE PLACHTY



324

KARABINY, ŘETĚZY A
OCELOVÉ LANA

327

STAVEBNÍ SVĚTLA



328

ŽEBŘÍKY



328

DVÍŘKA KOMÍNOVÁ A
BEDNÍCÍ STOJKY

HLADÍTKA, LŽÍCE A ŠPACHTLE

FESTA
HLADÍTKO NEREZ 280 X 130 MM

· gumová rukojeť

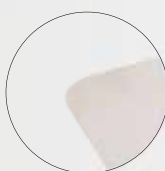

Č.p.	specifikace	
31140	rovné	10

FESTA
HLADÍTKO NEREZ 280 X 130 MM

· gumová rukojeť



Č.p.	specifikace	
31148	rovné s oblými rohy	10

FESTA
HLADÍTKO NEREZ 280 X 130 MM ZUBOVÉ

· gumová rukojeť



Č.p.	specifikace	
31146	Ø 16	10

FESTA
HLADÍTKO NEREZ 280 X 130 MM ZUBOVÉ

· gumová rukojeť



Č.p.	specifikace		Č.p.	specifikace	
31141	e 4	10	31144	e 10	10
31142	e 6	10	31145	e 12	10
31143	e 8	10			

FESTA
HLADÍTKO NEREZ 280 X 130 MM ZUBOVÉ

Č.p.	specifikace		Č.p.	specifikace	
31101	e 4	10	31131	e 10	10
31111	e 6	10	31132	e 12	10
31121	e 8	10			

FESTA
HLADÍTKO NEREZ 280 X 130 MM

Č.p.	specifikace	
31091	rovné	10



FESTA

HLADÍTKO NEREX 280 X 130 MM



Č.p.	specifikace	
31011	rovné	10



FESTA

HLADÍTKO NEREX 280 X 130 MM ZUBOVÉ



Č.p.	specifikace		Č.p.	specifikace	
31021	e 4	10	31051	e 10	10
31031	e 6	10	31053	e 12	10
31041	e 8	10			



HLADÍTKO NEREX 270 X 125 MM



Č.p.	specifikace	
31005	rovné	25



HLADÍTKO NEREX 270 X 125 MM ZUBOVÉ



Č.p.	specifikace		Č.p.	specifikace	
31006	e 4	24	31008	e 8	24
31007	e 6	24	31009	e 10	24



FESTA

HLADÍTKO NEREX 360 X 130 MM



Č.p.	specifikace	
31151	rovné	10



FESTA

HLADÍTKO NEREX 360 X 130 MM



Č.p.	specifikace	
31150	rovné	10



FESTA

HLADÍTKO NEREX 480 X 130 MM



Č.p.	specifikace	
31082	rovné	10



FESTA

HLADÍTKO NEREX 680 X 130 MM



Č.p.	specifikace	
31155	rovné	10

**FESTA**

HLADÍTKO NEREZ 500 X 130 MM

INOX

Č.p.	specifikace	
31081	rovné	10

**FESTA**

HLADÍTKO NEREZ 500 X 130 MM ZUBOVÉ

INOX

Č.p.	specifikace	
31052	e 4	10
31061	e 6	10
31062	e 8	10
31071	e 10	10
31072	e 12	10

**FESTA**

LŽÍCE NEREZ

· gumová rukojeť

INOX

Č.p.	specifikace		Č.p.	rozměry	
31232	120 mm	10	31234	160 mm	10
31233	140 mm	10	31235	180 mm	10

**FESTA**

LŽÍCE NEREZ

INOX

Č.p.	specifikace		Č.p.	specifikace	
31220	120 x 80 mm	10	31222	160 x 115 mm	10
31221	140 x 80 mm	10	31231	180 x 120 mm	10

**FESTA**

LŽÍCE NEREZ OBLÁ

· gumová rukojeť

INOX

Č.p.	specifikace	
31334	160 x 100 mm	10

**FESTA**

LŽÍCE NEREZ OBLÁ

INOX

Č.p.	specifikace	
31343	160 x 100 mm	10

**FESTA**

LŽÍCE NEREZ VYMAZÁVACÍ

· gumová rukojeť

INOX

Č.p.	specifikace		Č.p.	specifikace	
31360	40 mm	10	31400	100 mm	10
31380	60 mm	10	31403	120 mm	10
31390	80 mm	10			

**FESTA**

LŽÍCE NEREZ VYMAZÁVACÍ

INOX

Č.p.	specifikace		Č.p.	specifikace	
31362	40 mm	10	31392	80 mm	10
31382	60 mm	10	31402	100 mm	10
			31404	120 mm	10

**FESTA****LŽÍCE NEREX KOČIČÍ JAZYK**

· gumová rukojeť

INOX

Č.p.	specifikace	
31330	140 x 50 mm	10
31340	160 x 60 mm	10

**FESTA****LŽÍCE NEREX KOČIČÍ JAZYK****INOX**

Č.p.	specifikace	
31332	140 x 50 mm	10
31341	160 x 60 mm	10

**FESTA****LŽÍCE NEREX KOUTOVÁ**

· gumová rukojeť

INOX

Č.p.	specifikace	
31280	80 x 60 x 60 mm	10

**FESTA****LŽÍCE NEREX KOUTOVÁ****INOX**

Č.p.	specifikace	
31281	80 x 60 x 60 mm	10

**FESTA****LŽÍCE NEREX ROHOVÁ**

· gumová rukojeť

INOX

Č.p.	specifikace	
31270	80 x 60 x 60 mm	10

**FESTA****LŽÍCE NEREX ROHOVÁ****INOX**

Č.p.	specifikace	
31271	80 x 60 x 60 mm	10

**FESTA****LŽÍCE NEREX POKRÝVAČSKÁ**

· gumová rukojeť

INOX

Č.p.	specifikace	
31320	140 x 75 mm	10

**FESTA****LŽÍCE NEREX POKRÝVAČSKÁ****INOX**

Č.p.	specifikace	
31322	140 x 75 mm	10

**FESTA****LŽÍCE NEREZ ZUBOVÁ S HRANOU****INOX**

Č.p.	specifikace	
31218	180 mm e 6	12

**FESTA****ŠPACHTLE NEREZ**

· gumová rukojeť

INOX

Č.p.	specifikace		Č.p.	specifikace	
31510	40 mm	10	31513	100 mm	10
31511	60 mm	10	31514	120 mm	10
31512	80 mm	10	31515	140 mm	10

**FESTA****ŠPACHTLE NEREZ****INOX**

Č.p.	specifikace		Č.p.	specifikace	
31461	40 mm	12	31491	100 mm	12
31471	60 mm	12	31467	120 mm	12
31481	80 mm	12	31468	140 mm	12

**FESTA****ŠKRABKA NEREZ**· zesílená čepel
· gumová rukojeť**INOX**

Č.p.	specifikace	
32173	75 mm	10

**FESTA****ŠKRABKA NEREZ S TULEJÍ**· zesílená čepel
· vhodná násada 52010**INOX**

Č.p.	specifikace	
32170	100 mm	12

**FESTA****ŠPACHTLE NEREZ S BITEM**

· gumová rukojeť

INOX

Č.p.	specifikace	
31455	150 mm	12
31456	200 mm	12

**FESTA****STĚRKA NEREZ S VÝZTUŽÍ**

· gumová rukojeť

INOX

Č.p.	specifikace	
31505	200 mm	5
31506	250 mm	5
31507	300 mm	5







FESTA

ŠPACHTLE NEREZ PRO CELOPLOŠNÉ TMELENÍ

INOX

Č.p.	specifikace	
31555	35 cm	1
31556	45 cm	1
31557	60 cm	1

Č.p.	specifikace	
31558	80 cm	1
31559	100 cm	1

NEW



FESTA

DRŽÁK ŠPACHTLE PRO CELOPLOŠNÉ TMELENÍ

· pro 31555 - 31559
· násada 52010, 52011, 52012, 52020, 52030

Č.p.	Specifikace	
31610		1

NEW



· tyč univerzálně použitelná i pro malířské válečky



FESTA

NÁSADA TELESKOPICKÁ

· závit pro 31610, 34203

Č.p.	Specifikace	
52011	88 - 140 cm	1



ŠPACHTLE NEREZ S VÝZTUŽÍ

INOX

MADE IN
EU

Č.p.	specifikace	
31520	400 mm	1
31521	500 mm	
31522	600 mm	



31523

násada 61254



31524

PŘÍSLUŠENSTVÍ KE ŠPACHTLI S VÝZTUŽÍ

MADE IN
EU

Č.p.	specifikace	
31523	držák ALU	1
31524	držák plastic	1



FESTA

STĚRKA NEREZ FASÁDNÍ

INOX

Č.p.	specifikace	
31552	400 mm	10
31553	600 mm	10

STĚRKA NEREZ

INOX

MADE IN
EU

Č.p.	specifikace	
31541	250 mm	1
31551	250 mm úzká	1



FESTA

ŠPACHTLE NEREZ

INOX

Č.p.	specifikace	
31498	150 mm	12
31499	200 mm	12
31500	100 mm	12



ŠPACHTLE NEREZ

INOX

MADE IN
EU

Č.p.	specifikace	
31493	40 mm	20
31494	60 mm	20
31495	80 mm	20
31496	100 mm	20



FESTA

ŠPACHTLE OCEL

Č.p.	specifikace	
32161	30 mm	10
32162	40 mm	10
32163	50 mm	10
32164	60 mm	10
32169	70 mm	10
32165	80 mm	10



FESTA

ŠKRABKA NA STĚNY A PODLAHY

zesílená čepel

INOX

Č.p.	šířka	délka	
32174	100 mm	500 mm	1



ŠPACHTLE OCEL

Č.p.	specifikace	
32176	30 mm	12
32186	40 mm	12
32196	50 mm	12
32206	60 mm	12

Č.p.	specifikace	
32216	80 mm	12
32226	100 mm	12
32234	125 mm	12

SADA ŠPACHTLÍ OCEL

3x

Č.p.	specifikace	
32240	30, 50, 80 mm	10



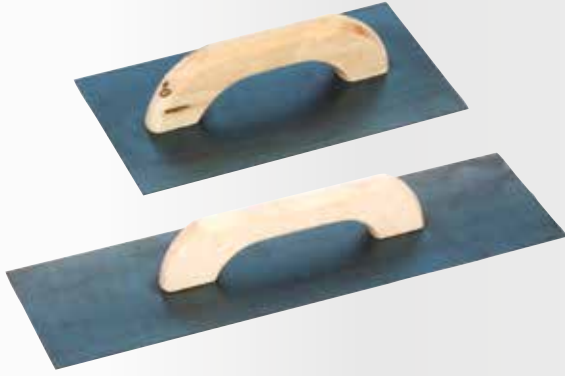

HLADÍTKO OCEL

Č.p.	specifikace	
32062	280 x 160 mm	10
32076	400 x 100 mm	36
32060	500 x 140 mm	5



HLADÍTKO OCEL ŠPIČATÉ

Č.p.	specifikace	
32064	500 x 90 mm	5
32066	550 x 140 mm	5



LŽÍCE OCEL BROUŠENÁ

Č.p.	specifikace	
32015	160 x 130 mm	10
32014	180 x 130 mm	10
32016	200 x 140 mm	10



LŽÍCE OCEL

Č.p.	specifikace	
32001	160 x 110 mm	10
32002	160 x 130 mm	10
32003	180 x 130 mm	10
32013	200 x 140 mm	10



LŽÍCE OCEL OBLÁ

Č.p.	specifikace	
32018	160 x 110 mm	10



LŽÍCE VYMAZÁVACÍ OCEL

Č.p.	specifikace	
32024	140 x 80 mm	12



LŽÍCE KOČIČÍ JAZYK OCEL

Č.p.	specifikace	
32020	140 x 65 mm	12
32021	140 x 40 mm	12



LŽÍCE POKRÝVAČSKÁ OCEL

Č.p.	specifikace	
32026	140 x 85 mm	12



FESTA

NABĚRAČKA ZEDNICKÁ S RUČKOU NEREZ

INOX

Č.p.	specifikace	
32285	Ø 180 mm	1



FESTA

NABĚRAČKA ZEDNICKÁ S RUČKOU POZINK

Zn

Č.p.	specifikace	
32265	Ø 180 mm	10



FESTA

NABĚRAČKA ZEDNICKÁ S RUČKOU

Č.p.	specifikace	
32273	Ø 160 mm	10
32283	Ø 180 mm	10
32293	Ø 215 mm	10



NABĚRAČKA ZEDNICKÁ PLASTOVÁ



Č.p.	specifikace	
32270	Ø 160 mm	1



NABĚRAČKA ZEDNICKÁ OCEL

· vhodná násada 61215

Č.p.	specifikace	
32302	Ø 180 mm	1
32313	Ø 215 mm	1
32301	Ø 235 mm	1



NABĚRAČKA ZEDNICKÁ OCEL S RUČKOU PRO LOPATOVOU NÁSADU

· vhodná násada 61200, 61201

Č.p.	specifikace	
32268	Ø 215 mm	1
32269	Ø 235 mm	1
32296	Ø 215 mm	1



NABĚRAČKA ZEDNICKÁ OCEL S NÁSADOU

MOQ 3

Č.p.	specifikace	
32295	Ø 180 mm délka násady 160 cm	3
32297	Ø 215 mm délka násady 160 cm	3
32298	Ø 235 mm délka násady 160 cm	3



HRÁBLO NA BETON

Č.p.	specifikace	
60100	hráblo na beton 295 x 150 mm	24
61169	hráblo s násadou 160 cm	3
61218	násada 160 cm	5

**FESTA**

ŠPACHTLE NEREZ MALÍŘSKÁ

INOX

Č.p.	specifikace	
31497	63 x 195 mm	12

**FESTA**

NŮŽ NEREZ TAPETÁŘSKÝ

INOX

Č.p.	specifikace	
31503	150 mm	12



ŠKRABÁK MALÍŘSKÝ

MADE IN EU

Č.p.	specifikace	
31501	100 mm	30
31502	náhradní břit	1



ŠPACHTLE PRO SÁDROKARTONÁŘE

PLASTIC

Č.p.	specifikace	
34308	50 mm	20
34307	80 mm	12
34306	100 mm	10
34305	150 mm	12

FESTA

STĚRKA JAPONSKÁ

4x

Č.p.	specifikace	
31452	nerez 50, 80, 100, 120 mm	10
31453	ocel 50, 80, 100, 120 mm	10

**FESTA**

STĚRKA JAPONSKÁ, PLAST

PLASTIC 4x

Č.p.	specifikace	
31454	50, 80, 100, 120 mm	12





STĚRKA OCELOVÁ

Č.p.	specifikace	
31601	180 mm - rovná	1
31602	180mm A1	1
31603	180mm A2	1
31641	180 mm - e4	1



STĚRKA OCELOVÁ

Č.p.	specifikace	
31651	250 mm - rovná	1
31655	250 mm - e4	1



STĚRKA PLASTOVÁ - ZUBOVÁ

Č.p.	specifikace	
37101	150 x 80 mm	100
37111	170 x 115 mm	100



STĚRKA PLASTOVÁ

Č.p.	specifikace	
37051	rovná	1
37031	zub - 4 x 6 mm	1
37041	zub - 6 x 6 mm	1



LŽÍCE MODELOVACÍ OCEL

Č.p.	specifikace	
32022	140 x 80 mm	12
32023	125 x 40 mm	12

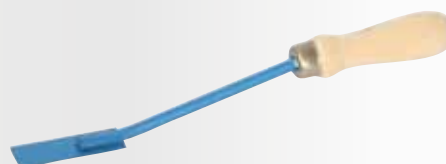

SPÁROVAČKA JEDNOSTRANNÁ

Č.p.	specifikace	
32040	10 mm	20
32041	12 mm	20
32042	15 mm	20
32043	18 mm	20
32044	20 mm	20



SPÁROVAČKA DVOUSTRANNÁ

Č.p.	specifikace	
32050	10 12 mm	50
32051	10 15 mm	50
32052	10 18 mm	50
32053	15 20 mm	50



DRÁŽKOVACĚ NA YTONG

Č.p.	specifikace	
32037	600 mm	1

**FESTA**

ŠKRABÁK NA YTONG

· topol

MOQ
2

Č.p.	specifikace
32317	450 x 95 mm

**FESTA**

ŠKRABÁK NA YTONG - JEMNÝ ZUB

· topol

MOQ
2

Č.p.	specifikace
32312	450 x 95 mm

**FESTA**

ŠKRABÁK NA YTONG

· topol

MOQ
2

Č.p.	specifikace
32337	260 x 95 mm

**FESTA**

ŠKRABÁK NA YTONG - JEMNÝ ZUB

· topol

MOQ
2

Č.p.	specifikace
32338	260 x 95 mm

**FESTA**

ŠKRABÁK NA BŘIZOLIT

· topol

MOQ
2

Č.p.	specifikace
32327	230 x 145 mm

**NEW**

ŠKRABÁK NA YTONG

MOQ
2

Č.p.	Specifikace
32332	450 x 95 mm

**NEW**

ŠKRABÁK NA BŘIZOLIT

MOQ
2

Č.p.	Specifikace
32333	230 x 145 mm





FESTA

ŠKRABÁK NA STARÉ OMÍTKY



Č.p.	specifikace	
32314	400 x 180 mm	2



FESTA

ŠKRABÁK NA STARÉ OMÍTKY



Č.p.	specifikace	
32329	270 x 130 mm	2



FESTA

ŠKRABÁK NA STARÉ OMÍTKY S OTVORY



Č.p.	specifikace	
33168	380 x 160 mm	2

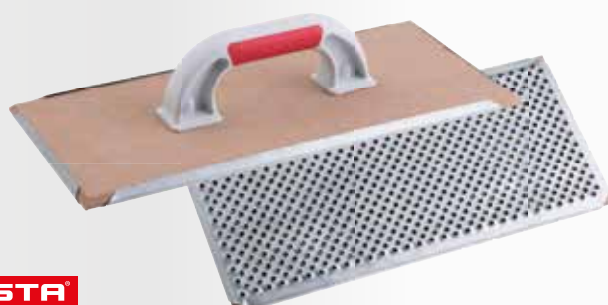

FESTA

ŠKRABÁK NA STARÉ OMÍTKY



Č.p.	specifikace	
32320	400 x 180 mm	2

NEW



ŠKRABÁK NA STARÉ OMÍTKY



Č.p.	specifikace	
32311	400 x 180 mm	2



FESTA

HLADÍTKO BRUSNÉ NA POLYSTYREN



Č.p.	specifikace	
32418	400 x 180 mm hr. 16	2
32421	400 x 180 mm hr. 16 brusný papír	10



FESTA

HLADÍTKO BRUSNÉ NA POLYSTYREN



Č.p.	specifikace	
32318	400 x 180 mm	2
32319	500 x 250 mm	2
32321	400 x 180 mm hr. 16 brusný papír	10
32322	500 x 250 mm hr. 16 brusný papír	10



FESTA

HLADÍTKO BRUSNÉ NA POLYSTYREN PLASTOVÉ



Č.p.	specifikace	
32324	270 x 130 mm hr. 16	2
32323	270 x 130 mm hr. 16 brusný papír	10

**FESTA**

HLADÍTKO S LEPENÝM BRUSIVEM

MADE IN
EUMOQ
2

Č.p.	specifikace	
32330	400 x 180 mm	2
32331	270 x 130 mm	2

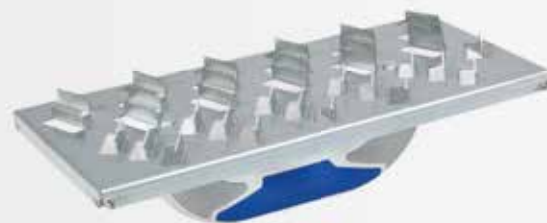

ŠKRABÁK NA KAMENNOU VLNU

Zn

MADE IN
EUMOQ
2

Č.p.	specifikace	
32328	285 x 145 mm	10

**FESTA**

ŠKRABÁK

MADE IN
EUMOQ
2

Č.p.	specifikace	
32325	225 x 105 mm	2

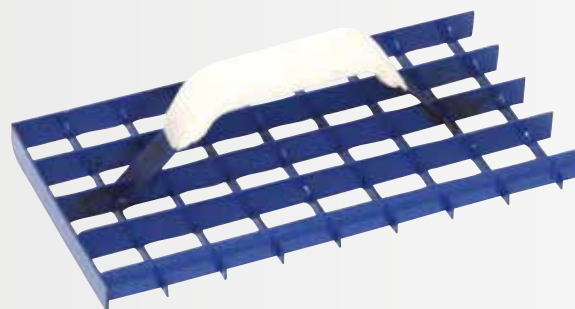

ŠKRABÁK MŘÍŽOVÝ

MOQ
2

Č.p.	specifikace	
32316	280 x 150 mm	20

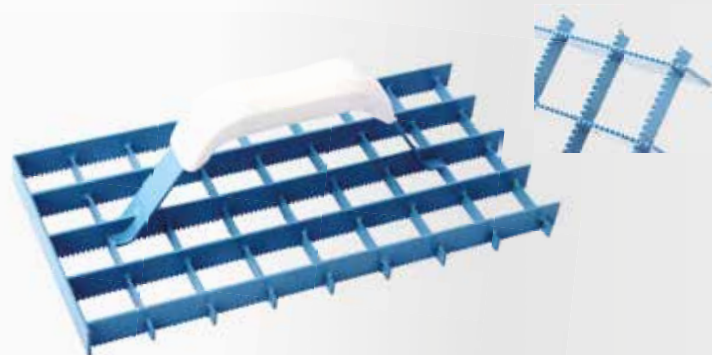

ŠKRABÁK MŘÍŽOVÝ OZUBENÝ

MOQ
2

Č.p.	specifikace	
32335	290 x 145 mm	2



ŠKRABÁK

- 8 břitů

ALU

MOQ
2

Č.p.	specifikace	
32326	450 x 90 mm	20



ŠKRABÁK PLASTOVÝ

- 6 břitů

MOQ
2

Č.p.	specifikace	
32315	270 x 90 mm	30

NEW



HLADÍTKO PLASTOVÉ

MADE IN
EU

Č.p.	specifikace	
34028	400 x 180 mm	20



FESTA
HLADÍTKO PLASTOVÉ



Č.p.	specifikace	
34027	400 x 180 mm	20

FESTA
HLADÍTKO PLAST BEZ POVRCHU



Č.p.	specifikace	
30003	270 x 125 mm	28
30004	235 x 115 mm	35
30005	210 x 115 mm	38
30007	210 x 60 mm	44



FESTA
HLADÍTKO DŘEVĚNÉ

lipové dřevo



Č.p.	specifikace	
34005	400 x 145 mm	40
34007	290 x 145 mm	20

HLADÍTKO DŘEVĚNÉ

topolové dřevo



Č.p.	specifikace	
34006	400 x 145 mm	40



FESTA
HLADÍTKO ABS



Č.p.	specifikace	
34041	280 x 140 - 2 mm	10
34051	280 x 140 - 3 mm	10
34053	280 x 140 - 3 mm zubové - e6	10

HLADÍCÍ DESKA NA BETON



Č.p.	specifikace	
15889	980 x 380 mm násada Ø 32 mm	1



STĚRKA S GUMOU

Č.p.	specifikace	
15886	450 mm násada Ø 23 mm	48
15887	600 mm násada Ø 23 mm	48
15888	750 mm násada Ø 23 mm	32

STAHOVACÍ DESKA



Č.p.	specifikace	
15885	100 x 800 mm násada Ø 32 mm	1

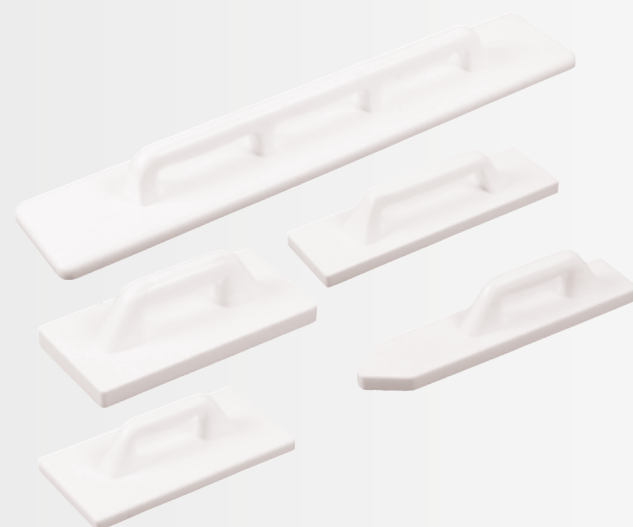

HLADÍTKO POLYURETANOVÉ



Č.p.	specifikace		Č.p.	specifikace	
34122	120 x 240 mm	50	34154	220 x 420 mm	15
34132	140 x 280 mm	40	34155	240 x 480 mm	15
34142	180 x 320 mm	25	34156	280 x 500 mm	10
34152	200 x 360 mm	20	34157	330 x 330 mm	5
34121	80 x 260 mm zkosené	50	34158	120 x 800 mm	5
34153	100 x 400 mm	30	34159	120 x 1000 mm	5
			34160	120 x 1200 mm	5

HLADÍTKO POLYSTYRENOVÉ



Č.p.	specifikace		
34101	80 x 350 mm	zkosené	10
34061	130 x 270 mm		10
34111	170 x 320 mm		10
34071	130 x 450 mm		10
34081	140 x 750 mm		10
34091	140 x 900 mm		5



HLADÍTKO POLYURETANOVÉ PUR



Č.p.	specifikace	
34115	140 x 280 mm	36
34116	180 x 320 mm	36
34117	200 x 360 mm	24
34118	220 x 420 mm	24

HLADÍTKO PRO BRUSNOU MŘÍŽKU

Č.p.	specifikace	
34301	230 x 105 mm	1
34304	235 x 80 mm	1

FESTA

HLADÍTKO PRO BRUSNOU MŘÍŽKU

Č.p.	specifikace	
34200	210 x 115 mm	30
34201	240 x 105 mm	50
34202	240 x 80 mm	50



HLADÍTKO NA NÁSADU PRO BRUSNOU MŘÍŽKU

násada 52030

ALU

Č.p.	specifikace	
34203	230 x 80 mm aluminium	1
52030	teleskopická násada	12

BRUSNÉ MŘÍŽKY SADA

10x

Č.p.	specifikace	
34271	115 x 290 mm zrn. 120	80
34272	115 x 290 mm zrn. 100	80
34273	115 x 290 mm zrn. 80	80
34274	93 x 290 mm zrn. 120	80
34275	93 x 290 mm zrn. 100	80
34276	93 x 290 mm zrn. 80	80

BRUSNÉ MŘÍŽKY SADA

3x

Č.p.	specifikace	
34280	115 x 290 mm zrn. 120	20
34281	115 x 290 mm zrn. 100	20
34282	115 x 290 mm zrn. 80	20
34283	93 x 290 mm zrn. 120	20
34284	93 x 290 mm zrn. 100	20
34285	93 x 290 mm zrn. 80	20

MATERIÁL POVRCH	BETON		OMÍTKA			LEPIDLO A SPÁROVACÍ HMOTY	FASÁDNÍ LEPIDLO	POUŽITÍ
	HRUBÝ	POTĚROVÝ	JÁDROVÁ	JEMNÁ VNITŘNÍ	JEMNÁ YTONG			
ČERNÁ PLSTĚ (HNĚDÁ, ŠEDÁ)				••••		••		srovnání jemné omítky, na větší zrno omítek
BÍLÁ PLSTĚ				••••	••••	••••		srovnání jemné omítky, na jemnější zrno omítek
MOLITAN JEMNÝ				••••	••••	••••		odstranění volného písku, na jemný štuk (keraštuk), na omytí obkladů po spárování
MOLITAN HRUBÝ				••••	••••	••••		odstranění volného písku, na hrubý štuk
MOLITAN RASTROVANÝ				••••	••••	••••		odstranění volného písku, díky rastrování lépe zachytí hrubé části štuky, na omytí po spárování
MOŘSKÁ HOUBA					•••		••••	smytí spárovací hmoty
HYDRO HOUBA HRUBÁ, JEMNÁ					•		••••	smytí spárovací hmoty
HOUBA				••	••••	••	••••	smytí spárovací hmoty, dočištění jemné omítky, vyhlazení štukových omítek
MIKROPYŽ							••••	zatlačení spárovací hmoty do spáry
GUMOVÁ PĚNA							••••	zatlačení spárovací hmoty do spáry
MIRELON		••••	•••					zpracování betonu, zapucování jádra
DUREN				••••	••	••••		srovnání jemné omítky, všeobecně k dokončení štukových omítek
DŘEVO	••••	••••	••••					zpracování betonu, zapucování jádra
OCELOVÝ PLECH	••	••••		••		••••	••	gletování betonu, nedostupná místa
POLYSTYREN	•••	••••	•••	••		••		zpracování betonu, zapucování jádra
POLYURETAN	••••	••••	••••					zpracování betonu, zapucování jádra
ABS		••		••••	••••	••••	••••	škrabaná a točená omítka, nanášení lepidla, omítek a štuků, natahování jemné, špalety
NEREZ HLADKÉ				••••	••••	••••	••••	natahování jemné, nanášení lepidel, omítek a štuků, natahování fasádního lepidla
NEREZ ZUBATÉ							••••	natahování lepidla na obklady a dlažbu
BRUSNÉ HLADÍTKO NA POLYSTYREN, PLASTOVÉ			••				••••	broušení polystyrenu, broušení cementového lepidla
BRUSNÉ HLADÍTKO NA POLYSTYREN, PŘEKLIŽKOVÉ			••				••••	broušení fasádního polystyrenu, broušení cementového lepidla

**FESTA**

HLADÍTKO PLASTOVÉ S BÍLOU PLSTÍ



Č.p.	specifikace		Č.p.	specifikace	
34400	280 x 140 x 8 mm	15	34450	220 x 130 x 8 mm	15
34415	250 x 130 x 8 mm	15	34445	220 x 70 x 8 mm	20

**FESTA**

HLADÍTKO PLASTOVÉ S ČERNOU PLSTÍ



Č.p.	specifikace		Č.p.	specifikace	
34401	280 x 140 x 10 mm	15	34451	220 x 130 x 10 mm	15
34416	250 x 130 x 10 mm	15	34446	220 x 70 x 10 mm	20

**FESTA**

HLADÍTKO PLASTOVÉ S HRUBOU HOUBOU



Č.p.	specifikace	
34441	280 x 140 x 12 mm	15
34440	250 x 130 x 12 mm	15

**FESTA**

HLADÍTKO PLASTOVÉ S JEMNOU HOUBOU



Č.p.	specifikace		Č.p.	specifikace	
34405	280 x 140 x 18 mm	15	34480	280 x 140 x 12 mm	15
34420	250 x 130 x 18 mm	15	34481	250 x 130 x 12 mm	15
34454	220 x 130 x 18 mm	15	34482	220 x 130 x 12 mm	15
34449	220 x 70 x 18 mm	20			

**FESTA**HLADÍTKO PLASTOVÉ S EXTRA
JEMNOU HOUBOU

Č.p.	specifikace	
34443	280 x 140 x 12 mm	15
34442	250 x 130 x 12 mm	15
34439	250 x 130 x 18 mm	15

**FESTA**

HLADÍTKO PLASTOVÉ S JEMNÝM MOLITANEM



Č.p.	specifikace		Č.p.	specifikace	
34404	280 x 140 x 30 mm	10	34419	250 x 130 x 20 mm	10
34485	280 x 130 x 20 mm	10	34453	220 x 130 x 20 mm	10
34486	250 x 130 x 30 mm	10	34447	220 x 70 x 20 mm	10

**FESTA**HLADÍTKO PLASTOVÉ S RASTROVANÝM
MOLITANEM

Č.p.	specifikace	
34409	280 x 140 x 30 mm	10
34425	250 x 130 x 20 mm	10

**FESTA**

HLADÍTKO PLASTOVÉ S HRUBÝM MOLITANEM



Č.p.	specifikace	
34410	280 x 140 x 30 mm	10
34426	250 x 130 x 20 mm	10



FESTA

HLADÍTKO PLASTOVÉ S MOŘSKOU HOUBOU



Č.p.	specifikace	
34406	280 x 140 x 30 mm	10
34421	250 x 130 x 30 mm	10
34455	220 x 130 x 30 mm	10



FESTA

HLADÍTKO PLASTOVÉ S MOŘSKOU HOUBOU, RASTROVANOU



Č.p.	specifikace	
34413	280 x 140 x 30 mm	10
34428	250 x 130 x 30 mm	10



FESTA

HLADÍTKO PLASTOVÉ S HYDRO HOUBOU HRUBOU



Č.p.	specifikace	
34412	280 x 140 x 30 mm	10
34424	250 x 130 x 30 mm	10
34458	220 x 130 x 30 mm	10



FESTA

HLADÍTKO PLASTOVÉ S HYDRO HOUBOU HRUBOU, RASTROVANOU



Č.p.	specifikace	
34490	280 x 140 x 30 mm	10
34491	250 x 130 x 30 mm	10



FESTA

HLADÍTKO PLASTOVÉ S HYDRO HOUBOU JEMNOU



Č.p.	specifikace	
34411	280 x 140 x 30 mm	10
34423	250 x 130 x 30 mm	10
34457	220 x 130 x 30 mm	10



FESTA

HLADÍTKO PLASTOVÉ S GUMOVOU PĚNOU

Č.p.	specifikace	
34402	280 x 140 x 10 mm	15
34417	250 x 130 x 10 mm	15
34452	220 x 130 x 10 mm	15



FESTA

HLADÍTKO PLASTOVÉ S MIKROPYŽÍ

Č.p.	specifikace	
34403	280 x 140 x 8 mm	15
34418	250 x 130 x 8 mm	15
34496	220 x 130 x 8 mm	15



FESTA

HLADÍTKO PLASTOVÉ S DURENEM

Č.p.	specifikace	
34407	280 x 140 x 20 mm	10
34422	250 x 130 x 20 mm	10
34456	220 x 130 x 20 mm	10
34448	220 x 70 x 20 mm	10

FESTA
HLADÍTKO PLASTOVÉ S RUVENEM



Č.p.	specifikace	
34414	280 x 140 x 20 mm	10
34429	250 x 130 x 20 mm	10
34459	220 x 130 x 20 mm	10
34479	220 x 70 x 20 mm	10

FESTA
HLADÍTKO PLAST BEZ POVRCHU

Č.p.	specifikace	
30003	270 x 125 mm	28
30004	235 x 115 mm	35
30005	210 x 115 mm	38
30007	210 x 60 mm	44

FESTA
HLADÍTKO SPÁROVACÍ

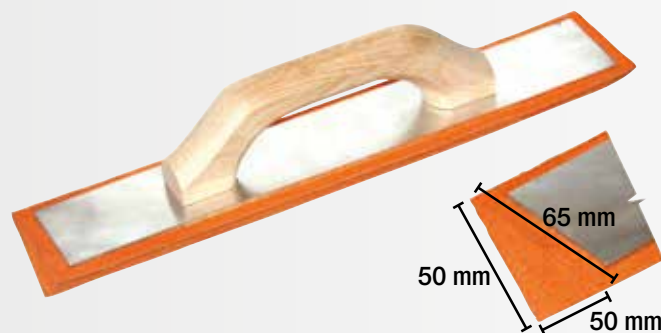
Č.p.	specifikace	
34033	240 x 95 mm	5

HLADÍTKO KOUTOVÉ S HOUBOU 90°

Č.p.	specifikace	
34500	350 mm	6

NÁHRADNÍ POVRCH - BÍLÁ PLŠŤ

Č.p.	specifikace	
34241	280 x 140 x 8 mm	1
34223	250 x 130 x 8 mm	1

NÁHRADNÍ POVRCH - ČERNÁ PLŠŤ



Č.p.	specifikace	
34243	280 x 140 x 10 mm	1
34221	250 x 130 x 10 mm	1

NÁHRADNÍ POVRCH - JEMNÁ HOUBA

Č.p.	specifikace	
34262	280 x 140 x 18 mm	1

NÁHRADNÍ POVRCH - JEMNÝ MOLITAN

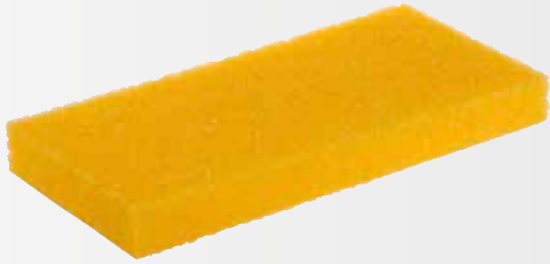
Č.p.	specifikace	
34251	280 x 140 x 30 mm	1



NÁHRADNÍ POVRCH - HRUBÝ MOLITAN



Č.p.	specifikace	
34261	280 x 140 x 30 mm	1



NÁHRADNÍ POVRCH - MOŘSKÁ HOUBA



Č.p.	specifikace	
34265	280 x 140 x 30 mm	1

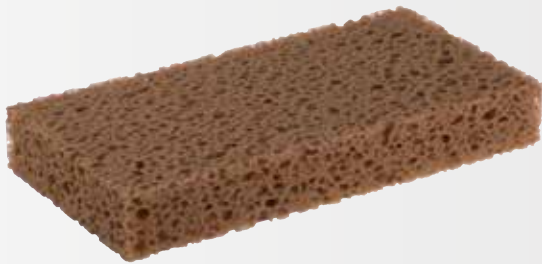

NÁHRADNÍ POVRCH - HYDRO HOUBA HRUBÁ



Č.p.	specifikace	
34238	280 x 140 x 30 mm	1



NÁHRADNÍ POVRCH - HYDRO HOUBA JEMNÁ



Č.p.	specifikace	
34237	280 x 140 x 30 mm	1
34235	250 x 130 x 30 mm	1



NÁHRADNÍ POVRCH - GUMOVÁ PĚNA



Č.p.	specifikace	
34231	280 x 140 x 10 mm	1

FESTA**ELEKTRICKÉ MÍCHADLO STAVEBNÍCH SMĚSÍ DVOUMETLOVÉ**

příkon	1800 W
napětí/frekvence	230 V / 50 Hz
rychlostní stupně	2
1. stupeň (volnoběžné otáčky)	0 - 450 ot./min.
2. stupeň (volnoběžné otáčky)	0 - 790 ot./min.
ochrana proti přetížení	Ano
průměr míchacího koše	100 mm
délka míchací metly	570 mm
hmotnost	5,6 kg



Č.p.	specifikace	
35311	míchadlo	1
35318	náhradní uhlík	1
35319	míchadla náhradní - pár (L+P)	1

FESTA**ELEKTRICKÉ MÍCHADLO STAVEBNÍCH SMĚSÍ 850 W**

příkon	850 W
napětí/frekvence	230 V / 50 Hz
rychlostní stupně	1
1. stupeň (volnoběžné otáčky)	0 - 500 ot./min.
2. stupeň (volnoběžné otáčky)	-
ochrana proti přetížení	Ano
závit míchací metly	M 14
průměr míchacího koše	120 mm
délka míchací metly	600 mm
hmotnost	3,7 kg

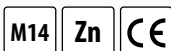

Č.p.	specifikace	
35300		1
35316	náhradní uhlík	1

FESTA**ELEKTRICKÉ MÍCHADLO STAVEBNÍCH SMĚSÍ 1600 W**

příkon	1600 W
napětí/frekvence	230 V / 50 Hz
rychlostní stupně	2
1. stupeň (volnoběžné otáčky)	0 - 480 ot./min.
2. stupeň (volnoběžné otáčky)	0 - 800 ot./min.
ochrana proti přetížení	Ano
závit míchací metly	M 14
průměr míchacího koše	140 mm
délka míchací metly	600 mm
hmotnost	4,7 kg

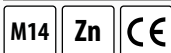

Č.p.	specifikace	
35310		1
35317	náhradní uhlík	1

FESTA**MÍCHADLO S KRUHEM PRAVOTOČIVÉ**

Spirálová metla se třemi rameny a kroužkem pravotočivá – pro těžké materiály s vysokou viskozitou. Malty, betony, cementové a vápenné omítky, spojovací hmoty, mazaniny, epoxidové pryskyřice, živичné vrstvy. Míchací účinek odspodu nahoru – metla se jako šroub vtahuje do materiálu.

Zn M14

Č.p.	specifikace	
35085	M14 Ø 120 x 600 mm	12
35086	M14 Ø 140 x 600 mm	12
35087	M14 Ø 160 x 600 mm	12

**FESTA****MÍCHADLO S KRUHEM LEVOTOČIVÉ**

Spirálová metla se třemi rameny a kroužkem levotočivá – pro řídké tekuté směsi ve velkém množství. Míchaný materiál je tlačěn dolů. Řídký tekutý materiál nestříká z nádoby, usazené pigmenty barev se dostávají vzhůru a ideálně se promíchají.

Zn M14

Č.p.	specifikace	
35091	M14 Ø 120 x 600 mm	12
35092	M14 Ø 140 x 600 mm	12
35093	M14 Ø 160 x 600 mm	12

**FESTA****MÍCHADLO S KRUHEM**

Spirálová metla se dvěma rameny – pro důkladné rozmíchání lepidel na obklady, spárovaných hmot, lepicích malt, hotových omítek, mazaniny, stěrkových hmot, vyrovnávacích hmot.

Zn

Č.p.	specifikace	
35038	Ø 80 x 500 mm	24
35058	Ø 100 x 500 mm	24
35023	Ø 120 x 500 mm	24

**FESTA****MÍCHADLO S KRUHEM**

Spirálová metla se dvěma rameny – pro důkladné rozmíchání lepidel na obklady, spárovaných hmot, lepicích malt, hotových omítek, mazaniny, stěrkových hmot, vyrovnávacích hmot.

SDS+ Zn

Č.p.	specifikace	
35094	Ø 80 x 500 mm	24
35095	Ø 100 x 500 mm	24
35096	Ø 120 x 500 mm	24



FESTA**MÍCHADLO S KRUHEM**

Spirálová metla se dvěma rameny – pro důkladné rozmíchání lepidel na obklady, spárovaných hmot, lepicích malt, hotových omítek, mazaniny, stěrkových hmot, vyrovnávacích hmot.

M14 **Zn**

Č.p.	specifikace
35059	M14 Ø 90 x 550 mm



24

FESTA**MÍCHADLO S KRUHEM, PRODLOUŽENÁ SPIRÁLA**

Spirálová metla se dvěma rameny – pro důkladné rozmíchání lepidel na obklady, spárovaných hmot, lepicích malt, hotových omítek, mazaniny, stěrkových hmot, vyrovnávacích hmot.

 **Zn**

Č.p.	specifikace
35013	Ø 80 x 500 mm
35006	Ø 100 x 500 mm
35007	Ø 120 x 500 mm



24

24

24

FESTA**MÍCHADLO S KRUHEM, PRODLOUŽENÁ SPIRÁLA**

Spirálová metla se dvěma rameny – pro důkladné rozmíchání lepidel na obklady, spárovaných hmot, lepicích malt, hotových omítek, mazaniny, stěrkových hmot, vyrovnávacích hmot.

SDS+ **Zn**

Č.p.	specifikace
35012	Ø 100 x 500 mm



24

FESTA**MÍCHADLO SPIRÁLA DRÁT**

Spirálová metla se dvěma rameny – pro důkladné rozmíchání lepidel na obklady, spárovaných hmot, lepicích malt, hotových omítek, mazaniny, stěrkových hmot, vyrovnávacích hmot.

 **Zn**

Č.p.	specifikace
35069	Ø 60 x 500 mm
35078	Ø 80 x 500 mm
35081	Ø 100 x 500 mm



50

24

24

FESTA**MÍCHADLO SPIRÁLA DRÁT**

Spirálová metla se dvěma rameny – pro důkladné rozmíchání lepidel na obklady, spárovaných hmot, lepicích malt, hotových omítek, mazaniny, stěrkových hmot, vyrovnávacích hmot.

SDS+

Zn



Č.p.	specifikace	
35070	Ø 60 x 500 mm	50
35079	Ø 80 x 500 mm	24
35082	Ø 100 x 500 mm	24

FESTA**MÍCHADLO BEZ KRUHU**

Spirálová metla se dvěma rameny – pro důkladné rozmíchání lepidel na obklady, spárovaných hmot, lepicích malt, hotových omítek, mazaniny, stěrkových hmot, vyrovnávacích hmot.



Zn



Č.p.	specifikace	
35048	Ø 70 x 500 mm	24
35068	Ø 90 x 500 mm	24

FESTA**MÍCHADLO BEZ KRUHU**

Spirálová metla – pro vysoce viskózní a lepidivé materiály, jako jsou stavební lepidla a tmely, omítky, podlahové stěrky a pod. Materiál proudí ode dna k hladině.



Zn



Č.p.	specifikace	
35021	Ø 100 x 500 mm	24

FESTA**MÍCHADLO KALICH**

Klecová metla – pro materiály, kde je zavzdušnění směsi nežádoucí. Pro řídké vyrovnávací hmoty, stěrkové hmoty, těsnicí látky, lepidla.



Zn



Č.p.	specifikace	
35015	Ø 100 x 500 mm	20

FESTA**MÍCHADLO VRTULE**

Vrtulová metla – pro tekuté materiály, barvy, laky, nástěnné a disperzní klišy na lepení tapet, lepidla na dlaždice.



Č.p.	specifikace	
35011	Ø 80 x 500 mm	50

MÍCHADLO S KRUHEM

Oblouková metla s kruhem – pro důkladné rozmíchání nástěnných barev, disperzních barev, klišů, laků.



Č.p.	specifikace	
35125	Ø 60 x 400 mm	40
35126	Ø 80 x 400 mm	40
35127	Ø 100 x 600 mm	20

MÍCHADLO S KRUHEM LAKOVANÉ

Oblouková metla s kruhem – pro důkladné rozmíchání nástěnných barev, disperzních barev, klišů, laků.



Č.p.	specifikace	
35103	Ø 60 x 400 mm	40
35113	Ø 80 x 400 mm	40
35123	Ø 100 x 600 mm	20

**KABEL PRODLUŽOVACÍ S NAVIJÁKEM**

- prodlužovací přívod s navijákem 25 m – IP20
- H05VV - F 3G 1,5mm² - vybavený tepelnou pojistkou
- výkon v navinutém stavu : 1000 W max.
- výkon v rozvinutém stavu : 3000 W max.
- 4 uzemněné zásuvky s dětskou pojistkou



Č.p.	specifikace	
37760	4 zásuvky délka 25 m, IP 20, 1,5 mm ²	2
37761	4 zásuvky délka 50 m, IP 20, 1,5 mm ²	2

**KABEL PRODLUŽOVACÍ**

Č.p.	specifikace	
37730	max. 3680 W délka 10 m, 1,5 mm ²	8
37731	max. 3680 W délka 20 m, 1,5 mm ²	4

TOPIDLO ELEKTRICKÉ

napětí	230V ~50Hz
výkon	3300W
proudové zatížení	14.5A
nastavení výkonu	30/1650/3300W
teplotní rozsah	5-40°C
krytí	IP24
rozměry	27 x 25.5 x 40cm
hmotnost	4.8 kg

- rychlé a efektivní vytápění sklepů, dílen, obchodů, párty stanů, skleníků atd.
- nespotebovává kyslík
- bezpečný provoz, plynulá regulace výkonu, prostorový termostat, ventilátor
- topné těleso z nerezavějící oceli
- možnost letního využití pro ventilaci bez ohřevu
- nízká hladina hluku
- kvalitní zpracování, materiály, robustní ocelová konstrukce, snadná a bezpečná manipulace, dlouhá životnost



Č.p.	specifikace
35833	3,3 kW



1



TOPIDLO PLYNOVÉ

plyn	G30-I3B/P
tlak plynu	0.7bar
jmenovité napětí	230V 50Hz
výkon motoru	25W
maximální spotřeba plynu	1.11 Kg/h
maximální tepelný výkon	15KW
maximální objem horkého vzduchu	300m ³ /h

- rychlé a efektivní vytápění při stavebních pracích, v dílnách atd.
- spotřebovává kyslík!
- přímý ohřev vzduchu s nucenou cirkulací – rychlý nástup tepla
- bezpečný provoz, plynulá regulace výkonu
- termostat a bezpečnostní ventil proti přehřátí a úniku plynu
- včetně příslušenství – regulátor a přívodní plynová hadice
- kvalitní zpracování, materiály, robustní ocelová konstrukce, snadná a bezpečná manipulace, dlouhá životnost



Č.p.	specifikace
35845	15 kW



1



TOPIDLO PLYNOVÉ

plyn	g30-i3b/p
tlak plynu	1.5bar
jmenovité napětí	230v 50hz
výkon motoru	70w
maximální spotřeba plynu	2.2kg/h
maximální tepelný výkon	30kw
maximální objem horkého vzduchu	750m ³ /h

- rychlé a efektivní vytápění při stavebních pracích, v dílnách atd.
- spotřebovává kyslík!
- přímý ohřev vzduchu s nucenou cirkulací – rychlý nástup tepla
- bezpečný provoz, plynulá regulace výkonu
- termostat a bezpečnostní ventil proti přehřátí a úniku plynu
- včetně příslušenství – regulátor a přívodní plynová hadice
- kvalitní zpracování, materiály, robustní ocelová konstrukce, snadná a bezpečná manipulace, dlouhá životnost



Č.p.	specifikace
35850	30 kW



1





Stavební míchačky pro nejnáročnější profesionální použití

Zubový věnec z litiny s patentovaným uchycením

Nastavitelná vůle zubů

Vysoce kvalitní povrchová úprava

Dvojitě uložené ložisek na dně bubnu

Patentovaná ochranná izolace, kvalitativní jistění dle DIN EN ISO 9001

Speciálně vyvinutý tvar bubnu

Ochrana proti střikající vodě IP 45

Dodávané v provedení na 230V i 400V

PROFESIONÁLNÍ STAVEBNÍ MÍCHAČKY

Lescha



Lescha

MÍCHAČKA STAVEBNÍ



Č.p.	specifikace	
35500	Star 150 - 125 l, 230 V nožní brzda	1



Lescha

MÍCHAČKA STAVEBNÍ



Č.p.	specifikace	
35502	EUROMIX 125 l, 230 V	1
35503	EUROMIX 125 l, 400 V	1



Lescha

MÍCHAČKA STAVEBNÍ



Č.p.	specifikace	
35501	BX 135 - 125 l, 230 V	1



Lescha

MÍCHAČKA STAVEBNÍ



Č.p.	specifikace	
35504	ABM 135 l, 230 V nožní brzda	1



Lescha

MÍCHAČKA STAVEBNÍ



Č.p.	specifikace	
35505	SM 145 S - 140 l, 230 V	1
35506	SM 145 S - 140 l, 400 V	1
35507	SM 145 S - 140 l, 230 V nožní brzda	1
35508	SM 145 S - 140 l, 400 V nožní brzda	1



Lescha

MÍCHAČKA STAVEBNÍ



Č.p.	specifikace	
35510	SM 165 S - 160 l, 230 V nožní brzda	1
35511	SM 165 S - 160 l, 400 V nožní brzda	1
35512	SM 165 S - 160 l, G benzínová	1





Lescha
MÍCHAČKA STAVEBNÍ



Č.p.	specifikace	
35514	SM 185 S - 180 l, 230 V nožní brzda	1
35515	SM 185 S - 180 l, 400 V nožní brzda	1



Lescha
MÍCHAČKA STAVEBNÍ



Č.p.	specifikace	
35516	S 180 HR - 180 l, 230 V nožní brzda	1
35517	S 180 HR - 180 l, 400 V nožní brzda	1



Lescha
MÍCHAČKA STAVEBNÍ



Č.p.	specifikace	
35524	LB 354 230 V, 1,5 kW	1
35525	LB 354 400 V, 1,5 kW	1
35527	LB 354 Honda G200	1
35532	LB 404 230 V, 1,5 kW	1
35533	LB 404 400 V, 1,5 kW	1
35539	LB 484 Robin EH17B	1
35540	LB 484 Honda GX160LX	1
35542	AT 480 400 V, 1,2 kW	1



Lescha
MÍCHAČKA STAVEBNÍ



Č.p.	specifikace	
35552	LHB 1000 400 V	1
35553	LHB 1000 HATZ Diesel	1
35555	LHB 1200 400 V	1



Lescha
MÍCHAČKA STAVEBNÍ



Č.p.	specifikace	
35518	S 230 HR - 230 l, 230 V nožní brzda	1
35519	S 230 HR - 230 l, 400 V nožní brzda	1



130 L

specifikace

objem bubnu	130 l
otáčky bubnu	26±Min ⁻¹
příkon	700 W
napětí	230 V / 50 Hz
stupeň krytí	IP44
materiál věnce	litinový
rozměry	délka 1170 mm
	šířka 650 mm
	výška 1280 mm
váha	53 kg

165 L

specifikace

objem bubnu	165 l
otáčky bubnu	23±Min ⁻¹
příkon	900 W
napětí	230 V / 50 Hz
stupeň krytí	IP44
materiál věnce	litinový
rozměry	délka 1295 mm
	šířka 735 mm
	výška 1440 mm
váha	70 kg



MÍCHAČKA STAVEBNÍ



č.p.	specifikace				
37500	MIX 130Zk	230 V	rozložená		1
37501	MIX 130Z	230 V	složená		1
37505	MK 165Bk	230 V	rozložená		1
37506	MK 165B	230 V	složená		1

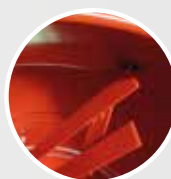

· speciálně vyrobené lopatky, tloušťka 4 mm



· kvalitní patní ložisko s krytem



· vypínač s bezpečnostní krytkou

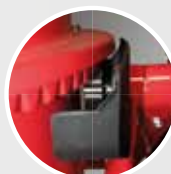

· plastový kryt pohonu, litinový věnec

MÍCHAČKA STAVEBNÍ



125 L

specifikace	
objem bubnu	125 l
otáčky bubnu	26±Min ⁻¹
příkon	550 W
napětí	230 V / 50 Hz
stupeň krytí	IP44
materiál věnce	litinový
rozměry	délka 1102 mm
	šířka 690 mm
	výška 1310 mm
váha	52,5 kg

Č.p.	specifikace		
37509	126 l, 230 V	složená	1
37510	126 l, 230 V	rozložená	1

142 L

specifikace	
objem bubnu	142 l
otáčky bubnu	26±Min ⁻¹
příkon	650 W
napětí	230 V / 50 Hz
stupeň krytí	IP44
materiál věnce	litinový
rozměry	délka 1164 mm
	šířka 690 mm
	výška 1293 mm
váha	54 kg

Č.p.	specifikace		
37511	142 l, 230 V	rozložená	1
37512	142 l, 230 V	složená	1

162 L

specifikace	
objem bubnu	162 l
otáčky bubnu	26±Min ⁻¹
příkon	650 W
napětí	230 V / 50 Hz
stupeň krytí	IP44
materiál věnce	litinový
rozměry	délka 1180 mm
	šířka 710 mm
	výška 1310 mm
váha	56 kg

Č.p.	specifikace		
37515	162 l, 230 V	rozložená	1
37516	162 l, 230 V	složená	1

180 L

specifikace	
objem bubnu	180 l
otáčky bubnu	26±Min ⁻¹
příkon	850 W
napětí	230 V / 50 Hz
stupeň krytí	IP44
materiál věnce	litinový
rozměry	délka 1164 mm
	šířka 690 mm
	výška 1368 mm
váha	58 kg

Č.p.	specifikace		
37517	180 l, 230 V	rozložená	1
37518	180 l, 230 V	složená	1

**Lescha**

SHOZ STAVEBNÍ SUTI



Č.p.	specifikace	
35603	shoz základní průměr 50/40 cm, délka 108 cm PE (HDPE)	1
35604	násepka shozu stavební suti PE (HDPE)	1
35605	nosný rám pro násepku shozu stavební suti	1



KOLEČKO STAVEBNÍ



Č.p.	specifikace	
37530	60 l, Ø 38 cm samonosné kolečko	1
37532	60 l, Ø 40 cm nafukovací	1



KOLEČKO STAVEBNÍ POZINK



Č.p.	specifikace	
37527	80 l, Ø 40 cm nafukovací	1
37533	80 l, Ø 38 cm samonosné kolečko	1



KORBA ČERNÁ



Č.p.	specifikace	
37539	60 l	1



KORBA POZINK



Č.p.	specifikace	
37541	80 l	1



NÁHRADNÍ KOLA



Č.p.	specifikace		
48729	typ AA 400	nafukovací	1
48730	typ AA 380	samonosné	1
48731	typ AA 380	samonosné	1



JAPONKA STAVEBNÍ TŘÍKOLÁ



Č.p.	specifikace		
37564	60 l		1



DRŽÁK DLAŽBY STAVITELNÝ

Č.p.	specifikace		
36310	max. 20kg		5



NOSIČ OBRUBNÍKŮ

specifikace	60116
rozměr čelistí:	750-1000 mm
max. zatížení:	120 kg



Č.p.	specifikace		
60116	PRO 041		1



PALICE PRO SROVNÁNÍ ŘAD

specifikace	60121	60123
výška	200 mm	200 mm
šířka	70 kg	70 kg
délka	870 mm	450 mm
hmotnost	2,5 kg	2,2 kg



Č.p.	specifikace		
60121	870 mm		1
60123	450 mm		1



NOSIČ OBRUBNÍKŮ

specifikace	60115
rozměr čelistí:	80-370 mm
max. zatížení:	50 kg



Č.p.	specifikace		
60115	PRO 040		1



NOSIČ OBRUBNÍKŮ

specifikace	60117	60118
rozměr čelistí:	500-1000 mm	0-500 mm
max. zatížení:	150 kg	150 kg



Č.p.	specifikace		
60117	PRO 042		1
60118	PRO 043		1



PODLOŽKA VYROVNÁVACÍ POD DLAŽBU



Č.p.	specifikace		
37166	D10 základní		25

NEW



FESTA

KOZA STAVEBNÍ

· maximální nosnost: 590 kg

Č.p. Specifikace

23657



1

NEW



FESTA

PŘENOSNÝ STOJANOVÝ SVĚŘÁK

· rozsah čelistí: 0 - 95 cm
· maximální nosnost: 250 kg

Č.p. Specifikace

37553



1



RUDL

Č.p.	specifikace	nosnost	
48719	kolo 260 mm bantam	250 kg	1

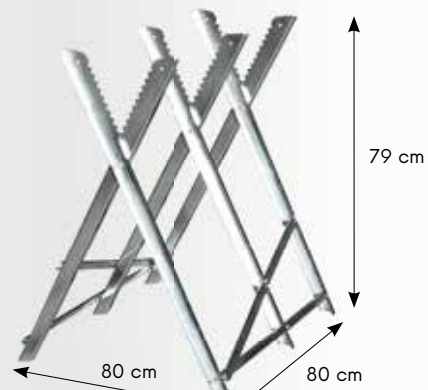

KOZA NA ŘEZÁNÍ DŘEVA

Č.p. / No.	rozměry	
37570	max. 150 kg	1



KOZA SKLÁDACÍ

max. nosnost 125 kg

2x

Č.p.	specifikace	
37549	pár	1



KOZA PLASTOVÁ, SKLÁDACÍ

max. nosnost 150 kg (300 kg v páru)

2x

Č.p.	specifikace	
37560	pár	1



PODPĚRA STAVEBNÍ

Č.p.	specifikace	
36300	68 - 130 cm, max. 125 kg	1



KOZA LEŠENÁŘSKÁ

Č.p.	specifikace	
37545	140 cm, výška 98 - 165 cm	1
37546	120 cm, výška 98 - 165 cm	1

PROFESIONÁLNÍ ŘEZAČKY OBKLADŮ

- řezačky dlažby pro nejnáročnější profesionální použití
- pojezd je řešen 9 zapouzdřenými kuličkovými ložisky skf
- 4 jsou stavitelné a vymezují vůli pojezdu
- odpružené stoly
- lze kompletovat i pro práci levou rukou
- zajištěny veškeré náhradní díly a servis
- řezná kolečka z chrom wolframové oceli

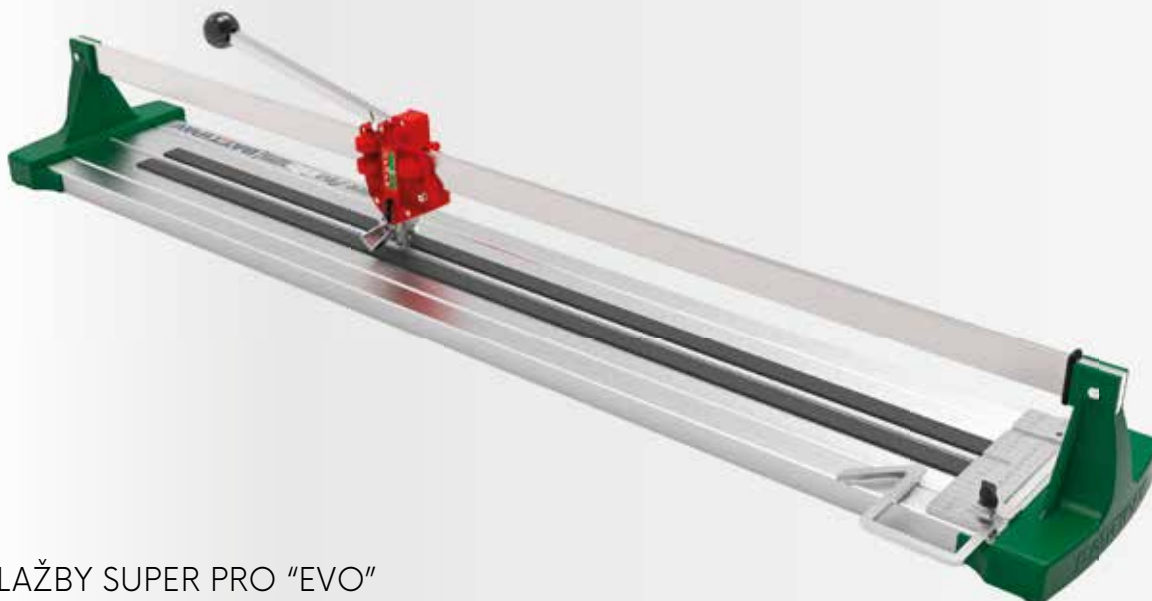

SUPER PRO



ŘEZAČKA DLAŽBY SUPER PRO "EVO"

· 36195 náhr. řezné kolečko - Ø 22 mm



Č.p.	specifikace
36191	1250 mm



1

SUPER PRO



ŘEZAČKA DLAŽBY SUPER PRO

· 36195 náhr. řezné kolečko - Ø 22 mm



Č.p.	specifikace
36145	SUPER PRO 450 mm
36160	SUPER PRO 600 mm
36175	SUPER PRO 750 mm
36190	SUPER PRO 900 mm



1



ŘEZAČKA DLAŽBY BASIC PLUS + KUFR

· 36261 náhr. řezné kolečko - Ø 15 mm



Č.p.	specifikace	
36240	400 mm	1



· ilustrační foto

PRODEJNÍ STOJAN SUPER PRO



Č.p.	specifikace	
36200	prodejní stojan	1
36199	prodejní stojan osazený 36160, 36175, 36190	1



ŘEZAČKA DLAŽBY „X“

· 36138 náhr. řezné kolečko - Ø 22 mm



Č.p.	specifikace	
36085	600 mm	1
36087	900 mm	1
36086	1300 mm	1



ŘEZAČKA DLAŽBY

· 36195 náhr. řezné kolečko - Ø 22 mm



Č.p.	specifikace	
36080	600 mm	1
36081	750 mm	1
36082	900 mm	1

Č.p.	specifikace	
36076	750 mm složená	1
36077	900 mm složená	1

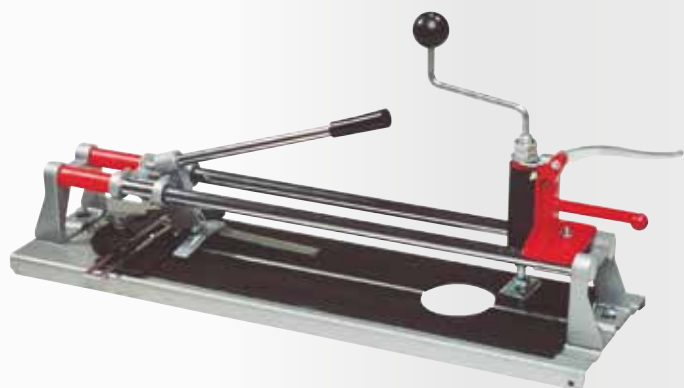

ŘEZAČKA DLAŽBY S VYKRUŽOVÁKEM

· 36128 náhr. řezné kolečko - Ø 16 mm



Č.p.	specifikace
36014	480 mm



4

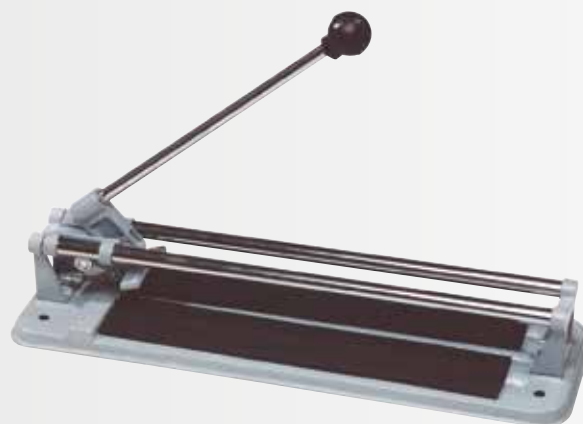

ŘEZAČKA DLAŽBY

· 36126 náhr. řezné kolečko - Ø 15 mm



Č.p.	specifikace	
36024	300 mm	10
36034	400 mm	10
36035	600 mm	4



4



ŘEZAČKA DLAŽBY

· 36136 náhr. řezné kolečko - Ø 22 mm



Č.p.	specifikace
36036	480 mm



1



ŘEZAČKA DLAŽBY RUČNÍ

· 36136 náhr. řezné kolečko - Ø 22,2 mm



Č.p.	specifikace	
36046	22 mm	1



1



NÁHRADNÍ KOLEČKO DO ŘEZAČEK DLAŽBY



Č.p.	specifikace	
36126	a= Ø 15 mm, b= Ø 6 mm, c= 1,5 mm	1
36128	a= Ø 16 mm, b= Ø 6 mm, c= 3 mm	1
36130	a= Ø 20 mm, b= Ø 6 mm, c= 5 mm	1
36136	a= Ø 22 mm, b= Ø 6 mm, c= 2 mm	1



PILKA PŘÍMOČARÁ NA OBKLADY A KERAMIKU

Č.p.	specifikace	
24055	karbid - BOSCH, MAKITA	1



1



FESTA

KLEŠTĚ NA OBKLADY



Č.p.	specifikace
36057	200 mm

6



KLEŠTĚ NA OBKLADY



Č.p.	specifikace
36056	200 mm

10



KLEŠTĚ ŠTÍPACÍ NA KERAMIKU



Č.p.	specifikace
36059	

1



KLEŠTĚ NA OBKLADY "PAPOUŠEK"



Č.p.	specifikace
36058	200 mm

6



37028



37029

HOUBA VYMÝVACÍ 160 X 110 X 60 MM



Č.p.	specifikace
37028	hydro houba
37029	mořská houba

1

1



37025



37026

HOUBA VYMÝVACÍ 200 X 100 X 100 MM



Č.p.	specifikace
37025	jemný molitan
37026	mořská houba

1

1



VANIČKA VYMÝVACÍ



Č.p.	specifikace
37117	sada
90070	nádoba 25 l

1

1



VANIČKA VYMÝVACÍ - PŘÍSLUŠENSTVÍ



Č.p.	specifikace
90072	mřížka
90071	válečky kovové

1

1



ČISTIČ SPÁR

Č.p.	specifikace
37012	



1



ČISTIČ SPÁR

Č.p.	specifikace	
37006	30 mm	20
37007	50 mm	20
37008	náhradní ostří 30 mm	50
37009	náhradní ostří 50 mm	50



SADA NA APLIKACI A ODSTRANĚNÍ SILIKONU

3x

Č.p.	specifikace
16042	



12

FESTA

APLIKÁTOR SILIKONU

Č.p.	specifikace
16056	145 mm



50



SADA STĚREK

4x

Č.p.	specifikace
37053	



48



STĚRKA

Č.p.	specifikace
37054	



1



STĚRKA

na spárování oken

Č.p.	specifikace
37055	na spárování oken



1



STĚRKA DŘEVĚNÁ S GUMOU

Č.p.	specifikace
37011	180 mm
37021	280 mm



12

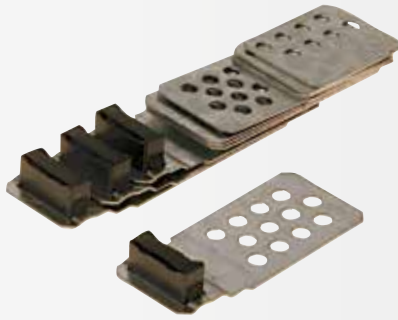

MAGNETY POD OBKLADY



Č.p.
38920

1



MAGNETY STAVITELNÉ
POD OBKLADY



Č.p.
38923



ROŽKY STAVEBNÍ - SADA



Č.p.
38919

50

NEW



FESTA

ŘEZAČKA
VINYLU A LAMINÁTU



Č.p. specifikace
36140 210 mm



4



MONTÁŽNÍ SADA NA
PLOVOUCÍ PODLAHY

24x

Č.p.
52130

1



MONTÁŽNÍ KLÍNKY - PLAST

50x

Č.p.	specifikace	ks
37210	95 x 45 x 15 - 0 mm	50
37211	70 x 30 x 8 - 0 mm	50



POLŠTÁŘEK MONTÁŽNÍ,
ROZPÍNACÍ

· rozměr 15•17 cm
· max. výška 5 cm

Č.p.
37220

1

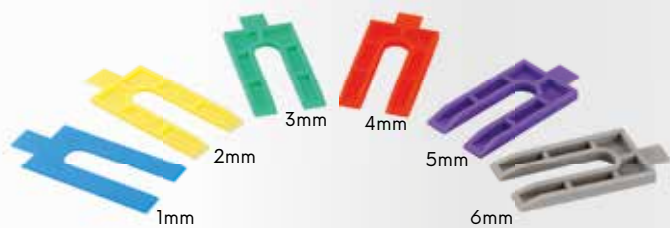

VYMEZOVACÍ PODLOŽKY

30x

Č.p.	specifikace	ks
37212	1 - 6 mm, 5 ks každé velikosti	1



FESTA

MONTÁŽNÍ KLÍNKY - DŘEVO



Č.p.	specifikace	ks
37204	55 x 20 x 0 - 6 mm	20
37203	65 x 18 x 0 - 12 mm	20
37202	80 x 25 x 3 - 10 mm	20
37201	100 x 25 x 1 - 16 mm	14
37200	150 x 25 x 1 - 25 mm	8
37205	55 x 8 x 0 - 10 mm	250



PISTOLE SPÁROVACÍ



Č.p.	specifikace	ks
38026	5x špička	1



PYTEL SPÁROVACÍ



Č.p.	specifikace	ks
38042	3x špička	1



NIVELYS

KŘÍŽKY DISTANČNÍ

· opakovaně použitelné

100x

Č.p.	specifikace	ks
37195	1,0 mm	100
37196	1,5 mm	100
37197	2 mm	100
37198	3 mm	100



FESTA

KŘÍŽKY OBKLADAČSKÉ



Č.p.	specifikace	ks
37148	1,0 mm	200
37149	1,5 mm	200
37150	2 mm	200
37151	2,5 mm	200
37152	3 mm	150
37153	4 mm	100
37154	5 mm	75
37158	10 mm	30

FESTA

KLÍNKY OBKLADAČSKÉ



Č.p.	specifikace	ks
37155	0 - 8 mm	30
37156	0 - 4 mm	100
37157	2,5 - 8 mm	30

250x



Č.p.	specifikace	ks
37205	55 x 8 x 0 - 10 mm	250

FESTA

MONTÁŽNÍ KLÍNKY - DŘEVO

NEW



NIVELAČNÍ KLIP SADA

50x

Č.p.	specifikace
37199	1,5 mm



NIVELYS
DISTANČNÍ KLIP SE ZÁVITEM

50x

Č.p.	specifikace
37131	1 mm
37132	2 mm



NIVELYS
KLOBOUČEK NIVELAČNÍ SE ZÁVITEM

· opakovaně použitelné

50x

Č.p.
37130



NIVELYS
LEVELING SYSTEM **FESTA**



NIVELYS DÍSTANČNÍ SPONY

· nivelační klíny 37175, 37176

50x



Č.p.	specifikace	ks	
37170	1 mm	50	60
37171	2 mm	50	60
37172	3 mm	50	60



NIVELYS DÍSTANČNÍ SPONY

100x



Č.p.	specifikace	ks	
37185	1 mm	100	1
37190	1,5 mm	100	1
37186	2 mm	100	1

Č.p.	specifikace	ks	
37187	3 mm	100	1
37188	4 mm	100	1
37189	5 mm	100	1

NEW

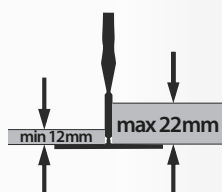

NIVELYS SPONY DÍSTANČNÍ

100x



Č.p.	Specifikace	
37162	1,5 mm	1



NIVELYS
LEVELING SYSTEM **FESTA**

NIVELYS NIVELAČNÍ KLÍNKY

Č.p.	ks	
37175	50	40
37176	400	3



NIVELYS DÍSTANČNÍ SPONY

600x



Č.p.	specifikace	ks	krabice	
37125	1 mm	600	38 x 28 x 19 cm	1
37126	1,5 mm	600	38 x 28 x 19 cm	1
37127	2 mm	600	38 x 28 x 19 cm	1

NIVELYS NIVELAČNÍ SADA

Č.p.	specifikace	
37173	spony 1 mm, 400 ks + klíny 200 ks	1
37174	spony 1,5 mm, 400 ks + klíny 200 ks	1



NIVELYS
KLEŠTĚ NIVELAČNÍ

Č.p.
37177



NIVELYS
KLEŠTĚ NIVELAČNÍ

Č.p.
37178



NEW



FESTA

PŘÍSAVKA NA DLAŽBU
S INDIKÁTOREM TLAKU
· pro hrubé povrchy

Č.p. Specifikace
36325 max. nosnost 220 kg



FESTA

PUDR 180 G

Č.p.	specifikace	
37096	modrý	10
37094	světle modrý	10
37097	červený	10
37095	světle červený	10
37098	černý	10

**FESTA**

SADA NAVÍJEČ 30 M + PUDR 120 G

· 6x rychlejší mechanismus navíjení
· funkce olovnice

Č.p.	
37070	6

**FESTA**

SADA NAVÍJEČ 30 M + PUDR 150 G

· 5x rychlejší mechanismus navíjení

Č.p.	
37065	6



SADA NAVÍJEČ ABS 30 M + PUDR 180 G

Č.p.	
37069	10



NAVÍJEČ ABS 30 M

Č.p.	
37067	25



NAVÍJEČ PLASTOVÝ 30 M

Č.p.	
37066	25



NAVÍJEČ KOVOVÝ 30 M

ALU	Č.p.	
	37068	25



FESTA

PROVÁZEK ČERVENÝ



Č.p.	specifikace	
38895	50 m	24
38896	100 m	24

FESTA

PROVÁZEK ŽLUTÝ



Č.p.	specifikace	
38899	50 m	24
38900	100 m	24



FESTA

PROVÁZEK ZEDNICKÝ POLYETYLEN 50 M



Č.p.	specifikace	
38907	červený 1,0 mm	100
38908	červený 1,7 mm	100
38909	červený 2,0 mm	100

FESTA

PROVÁZEK ZEDNICKÝ POLYETYLEN 50 M



Č.p.	specifikace	
38904	žlutý 1,0 mm	100
38905	žlutý 1,7 mm	100
38906	žlutý 2,0 mm	100



FESTA

PROVÁZEK ZEDNICKÝ POLYETYLEN 50 M



Č.p.	specifikace	
38910	oranžový 1,0 mm	100
38911	oranžový 1,7 mm	100
38912	oranžový 2,0 mm	100

FESTA

PROVÁZEK ZEDNICKÝ POLYETYLEN 50 M



Č.p.	specifikace	
38901	bílý 1,0 mm	100
38902	bílý 1,7 mm	100
38903	bílý 2,0 mm	100

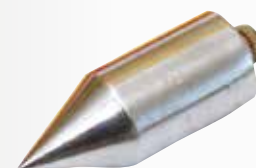

ŠŤŮRA VOSKOVANÁ



Č.p.	délka	Ø	
50920	50 m	1 mm	80

FESTA

OLOVNICE S PROVÁZKEM 15 M



Č.p.	specifikace	
38916	150 g	10
38917	300 g	6
38918	500 g	5

FESTA

OLOVNICE



Č.p.	specifikace	
38913	150 g	10
38914	300 g	10
38915	500 g	10

NEW



FESTA

ŘEZAČKA POLYSTYRENU STRUNOVÁ

- napětí/frekvence 230 V/50 Hz
- příkon 160 W
- délka řezu 137 cm
- výška řezu 30 cm
- krytí IP44
- úhel řezu 0° - 90°

· vybavení: stojan, nožní spínač, držák na lešení, 2x Ni-Cr řezací drát, čistící mosazný kartáč, nářadí a spojovací materiál, plastový box s kolečky



Č.p. Specifikace

35348



1

NEW



1,7 m

FESTA

NOŽNÍ SPÍNAČ
PRO ŘEZAČKU POLYSTYRENU

pro 35330, 35345, 35348

Č.p. Specifikace

35334



1

NEW



FESTA

STOJAN
PRO ŘEZAČKU POLYSTYRENU

pro 35330, 35345, 35348

Č.p. Specifikace

35336



1

NEW



FESTA

NÁHRADNÍ PRUŽINA
PRO ŘEZAČKU POLYSTYRENU

pro 35330, 35345, 35348

Č.p. Specifikace

35332



1

NEW



FESTA

DRŽÁK NA LEŠENÍ
PRO ŘEZAČKU POLYSTYRENU

pro 35330, 35345, 35348

Č.p. Specifikace

35333



1

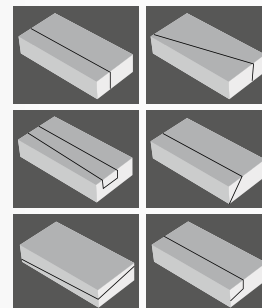
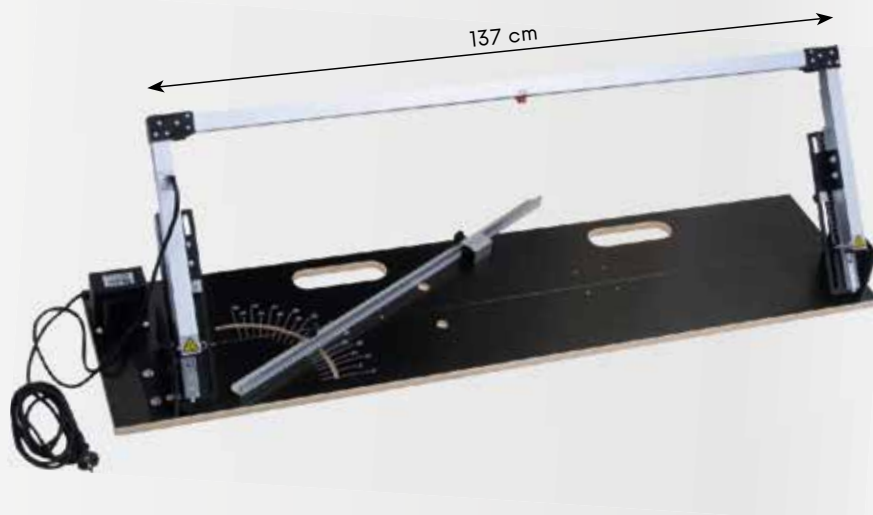

FESTA

ŘEZAČKA POLYSTYRENU STRUNOVÁ

- napětí/frekvence: 230 V / 50 Hz
- příkon: 160 W
- délka řezu: 137 cm
- výška řezu: 30 cm
- krytí: IP44
- úhel řezu: 0° - 90°



· vybavení: Ni-Cr řezací drát, čistící mosazný kartáč, inbus



Č.p.	specifikace	
35345	řezačka polystyrenu 1500 x 450 mm	1
35346	náhradní řezná struna Ni-Cr	1
35347	náhradní zdroj	1

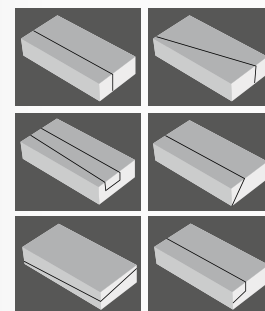
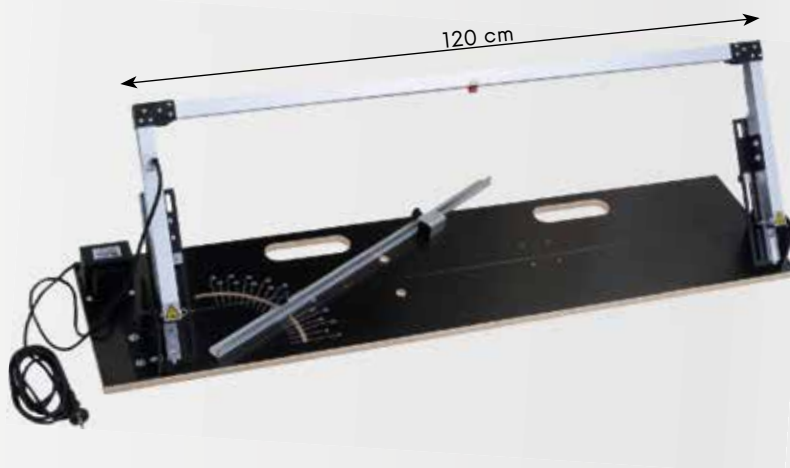

FESTA

ŘEZAČKA POLYSTYRENU STRUNOVÁ

- napětí/frekvence: 230 V / 50 Hz
- příkon: 160 W
- délka řezu: 120 cm
- výška řezu: 30 cm
- krytí: IP44
- úhel řezu: 0° - 90°



· vybavení: Ni-Cr řezací drát, čistící mosazný kartáč, inbus



Č.p.	specifikace	
35330	řezačka polystyrenu 1350 x 450 mm	1
35331	náhradní řezná struna Ni-Cr	1
35347	náhradní zdroj	1

**FESTA****ŘEZAČKA POLYSTYRENU AKUMULÁTOROVÁ**

- baterie 36 V, 1,5Ah Li-ion
- výkon 180 W
- teplota max 350 C°
- délka čepele 20 cm



- vybavení: 2 ks baterie, nabíječka, čepele, čistící mosazný kartáč, inbus

č.p.	specifikace
35323	



1

**FESTA****ŘEZAČKA POLYSTYRENU ELEKTRICKÁ**

- napětí / frekvence 230 V/50 Hz
- příkon 250 W
- teplota 50-600 C°
- délka čepele 25 cm
- délka přívodního kabelu 3 m



- vybavení: čistící mosazný kartáč, inbus, nůž 25 cm, kufr

č.p.	specifikace	
35326	elektrická řezačka polystyrenu	1
35328	náhr. nůž do řezačky polystyrenu 14 cm	1
35329	náhr. nůž do řezačky polystyrenu 25 cm	1

**VODÍČÍ LIŠTA
PRO ŘEZAČKU POLYSTYRENU**

· pro 35323, 35326

č.p.	specifikace	
35327	vodíčí lišta	1
35335	náhradní nůž - 30 cm	1



1

FESTA**ŘEZAČKA POLYSTYRENU ELEKTRICKÁ**

- regulace teploty

č.p.	specifikace
35325	220 W



1



NEW



FESTO

FRÉZA DO POLYSTYRENU A VATY

ALU

Č.p.	specifikace	
24752	Ø 65 mm	1
24753	Ø 70 mm	1

NEW



HMOŽDINKA DO IZOLACE PRO ŠROUBOVACÍ OBJÍMKY SVODU

2x

Č.p.	specifikace	
39240	bílá M10	1
39241	šedá M10	1
39242	antracit M10	1
39243	hnědá M10	1
39244	černá M10	1



FRÉZA DO POLYSTYRENU

Č.p.	specifikace	
24727	Ø 65 mm	1
24729	Ø 68 mm	1
24728	Ø 70 mm	1



HMOŽDINKA FASÁDNÍ

100x

MADE IN EU

Č.p.	specifikace		Č.p.	specifikace	
39210	Ø 10 x 100 mm	1	39218	Ø 10 x 180 mm	1
39212	Ø 10 x 120 mm	1	39217	Ø 10 x 200 mm	1
39214	Ø 10 x 140 mm	1	39219	Ø 10 x 220 mm	1
39216	Ø 10 x 160 mm	1			

NEW



PODLOŽKA ZATEPLOVACÍ

pro šrouby Ø 6 a 8 mm

50x

Č.p.	Specifikace	
39208	Ø 68 mm	1



PODLOŽKA ZATEPLOVACÍ

Č.p.	specifikace	
39206	Ø 40 mm	200
39207	Ø 60 mm	100



ROH PLASTOVÝ



Č.p.	specifikace	
39238	3 m	25



ROH HLINÍKOVÝ



Č.p.	specifikace	
39245	AL 30 m x 5 cm	1



PODLOŽKA RABICOVÁ



Č.p.	specifikace	
42420	Ø 30 mm	1



PLETIVO RABICOVÉ



Č.p.	specifikace	
42312	1 m 50 bm 16 x 16 mm	1



VÁLEČEK NIVELAČNÍ



Č.p.	průměr	výška hrotů	délka	
38950	Ø 69 mm	12 mm	25 cm	10
38951	Ø 69 mm	12 mm	40 cm	8
38952	Ø 122 mm	34 mm	25 mm	10
38953	Ø 122 mm	34 mm	40 cm	8
38954	Ø 122 mm	34 mm	60 mm	4

PODEŠVE S HROTY PÁR



Č.p.	specifikace	
38970	hroty 25 mm	1
38971	hroty 30 mm	1





SADA PRO SÁDROKARTONÁŘE

Č.p.	specifikace	
34300	sada 9 ks	10
34303	vanička	60



ZVEDÁK SÁDROKARTONOVÝCH DESEK

- zdvih 153 - 344 cm
- maximální zatížení 54 kg

Č.p.	specifikace	
26775		1



FESTA

NOSIČ DESEK

2x



Č.p.	specifikace	
36312		12



FESTA

NOSIČ DESEK

Č.p.	specifikace	
36308	36 x 16,5 x 7,5 cm	10

NEW



VÁLEČEK NA NANÁŠENÍ STĚRKY

- ručka 180 mm - 52630
- ručka 250 mm - 52625
- násada 52010, 52011, 52012, 52020, 52030



Č.p.	Specifikace	
52611	250 mm Ø 8 mm Ø 48 mm	50
52612	180 mm Ø 8 mm Ø 48 mm	10





OMÍTAČKA

Zn



1

Č.p.
37114



OMÍTAČKA

Zn



1

Č.p.	specifikace
37115	

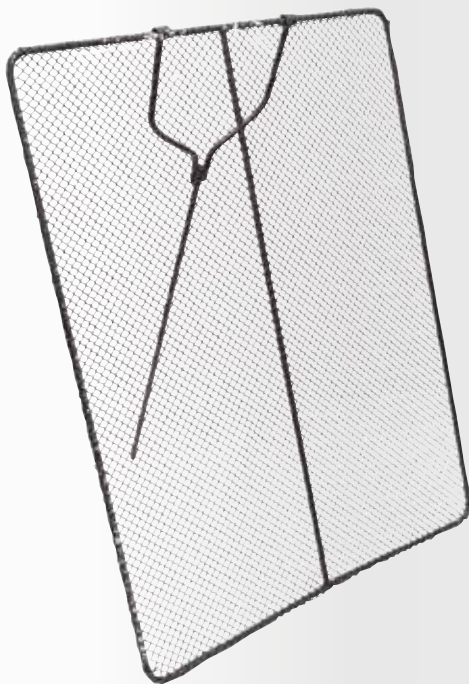

SÍTO PROHAZOVACÍ

Č.p.	šířka	výška	oko síta	
37236	0,8 m	1 m	10 mm	1
37237	0,8 m	1 m	12 mm	1
37238	0,8 m	1 m	16 mm	1
37239	0,8 m	1 m	20 mm	1



SÍTO NA ŠTUK



Č.p.	šířka	výška	oko síta	
37216	50 mm	50 mm	2 mm	1
37217	50 mm	50 mm	3 mm	1
37218	50 mm	50 mm	4 mm	1



DŘEVĚNÝ OMÍTNÍK



Č.p.	délka	tloušťka	šířka
37120	200 mm	1,7 mm	20 mm
37119	250 mm	1,7 mm	20 mm

MOQ
10

10



SÍŤ NA LEŠENÍ

Č.p.	specifikace		
42120	2,5 x 20 m, 80 g/m ²	zelená	5



KRYT OTVORU MAGNETICKÝ



Č.p.	specifikace		
82105	25 x 25 cm zdivo		1



VLÁKNO VÝZTUŽNÉ DO BETONU 0,9KG

- +/- 150 g/ 50 kg cementu
- 600 - 900 g/m² betonu nebo malty



Č.p.	váha		
42115	0,9 kg		9



SKOBA ZEDNICKÁ KOVANÁ



Č.p.	specifikace		
37229	14,5 cm		10



SKOBA ZEDNICKÁ POZINK



Č.p.	specifikace		
37231	14 cm volně		10



SKOBA ZEDNICKÁ KOVANÁ



Č.p.	specifikace		
37232	14,5 cm		5



SKOBA ZEDNICKÁ SADA



Č.p.	specifikace		
37230	16 cm		6



KRAMLE POZINKOVANÁ



Č.p.	specifikace		
37233	320 x 10 mm		100
37234	320 x 12 mm		100



KRAMLE



Č.p.	specifikace		
37235	250 x 12 mm		1



PB HOŘÁKY

FESTA

PB HOŘÁK - SADA

Ø 17, 22, 40 mm



AK 601423580004

Č.p.	specifikace
69918	2 kW, 1,5 m hadice



10

FESTA

PB HOŘÁK - SADA

Ø 25, 35, 50 mm



AK 601423580004

Č.p.	specifikace
69919	19,5 kW, 1,5 m hadice



10

FESTA

PB HOŘÁK - SADA

Ø 55 mm



AK 601423580004

Č.p.	specifikace
69904	60 kW, 850 mm, 5 m hadice



8



FESTA

PÁJECÍ SOUPRAVA 3 KW



AK 601423580004

Č.p.	specifikace
69914	300 mm + 2 m hadice



5



FESTA

PB HOŘÁK



AK 601423580004

Č.p.	specifikace
69900	Ø 35 mm, délka 300 mm, bez hadice
69901	Ø 35 mm, délka 300 mm + 3 m hadice



5



FESTA

PB HOŘÁK



AK 601423580004

Č.p.	specifikace
69902	Ø 55 mm, délka 550 mm, bez hadice



10



FESTA

PB HOŘÁK



AK 601423580004

Č.p.	specifikace
69903	Ø 55 mm, délka 550 mm + 3 m hadice



10



FESTA

PB HOŘÁK



AK 601423580004

Č.p.	specifikace
69905	Ø 55 mm, délka 850 mm, bez hadice



10



FESTA

PB HOŘÁK



AK 601423580004

Č.p.	specifikace
69906	Ø 55 mm, délka 850 mm + 3 m hadice



5

**FESTA****PB HOŘÁK - SADA S REDUKČNÍM VENTILEM**

· redukční ventil pro připojení 10 a 33 kg bomby



Č. p.	specifikace
69917	Ø 60 mm, délka 900 mm + 3 m hadice 3 m



1

FESTA**HADICE PRO PB HOŘÁK**

Č. p.	specifikace	
69910	3 m s koncovkami	20
69911	5 m s koncovkami	12
69912	10 m s koncovkami	8



20

12

8

**FESTA****HOŘÁK PLYNOVÝ NA KARTUŠI SE ZÁVITEM**

· max. teplota:	1200 °C
· výkon:	1,7 kW
· průměr hořáku:	Ø 20 mm



PIEZO START



Č. p.	specifikace	
69930	piezo	20

20

FESTA**HOŘÁK PLYNOVÝ NA PROPICHOVACÍ KARTUŠI**

· max. teplota:	1200 °C
· výkon:	1,7 kW
· průměr hořáku:	Ø 20 mm



PIEZO START



Č. p.	specifikace	
69931	piezo	12

12



REDUKČNÍ VENTIL PROPAN BUTAN



Č.p. specifikace
69923 W 21,8; G 3/8; 4 bar

1



REDUKČNÍ VENTIL PROPAN BUTAN



Č.p. specifikace
69920

25

výstupní tlak	4,0 bar
jmenovitý průtok	16 kg h
připojení - vstup	W 21,8 x 1 14" LH
připojení - výstup	G3 8" LH



REDUKČNÍ VENTIL PROPAN BUTAN



Č.p. specifikace
69907

1



vstupní tlak	25 bar
výstupní tlak	0,5 - 4,0 bar
jmenovitý průtok	16 kg h
připojení - vstup	W 21,8 x 1 14" LH
připojení - výstup	G3 8" LH



JEDNOCESTNÝ UZAVÍRACÍ VENTIL

výstup G 3/8L, pro 2 kg PB láhev



Č.p. specifikace
69928

1



REGULÁTOR TLAKU



Č.p. specifikace
69908 30 mBar, trn
69909 30 mBar, závit G 1/4L

1

69908	30 mBar, trn	1
69909	30 mBar, závit G 1/4L	1



MISKA NA SÁDRU

Č.p.	specifikace	
37121	kónická	1



MISKA NA SÁDRU

Č.p.	specifikace	
37122	nízká	1



MISKA NA SÁDRU



Č.p.	specifikace	
33275	nízká gumová	20



VĚDRO POZINKOVANÉ

Č.p.	specifikace	
Zn		
39000	5 l	40
39001	10 l	30
39002	12 l	20
39003	15 l	20



VĚDRO ZEDNICKÉ



Č.p.	specifikace	
39005	5 l	1
39010	10 l	1
39012	12 l	1
39014	15 l s nálevkou	1
39020	20 l	1
39021	20 l s nálevkou	1



NÁDOBA PLAST - PRUŽNÁ



Č.p.	specifikace	
39192	30 l	20
39193	45 l	20



ZEDNICKÁ NÁDOBA KRUHOVÁ



Č.p.	specifikace	
39045	45 l Ø 54 x 27 cm	1
39065	60 l Ø 60 x 35 cm	1
39090	90 l Ø 66 x 35 cm	1



ZEDNICKÁ NÁDOBA OBDÉLNÍKOVÁ



Č.p.	specifikace	
39145	45 l 71 x 40 x 21 cm	1
39165	65 l 71 x 40 x 30 cm	1
39190	85 l 77 x 48 x 30 cm	1

KLDKA ZEDNICKÁ Z 500



Č.p.	specifikace	
26780	0,5 t A s hákem	1
26781	0,5 t B s okem	1
26782	0,5 t C s hákem a chráničem	1
26783	0,5 t D s okem a chráničem	1



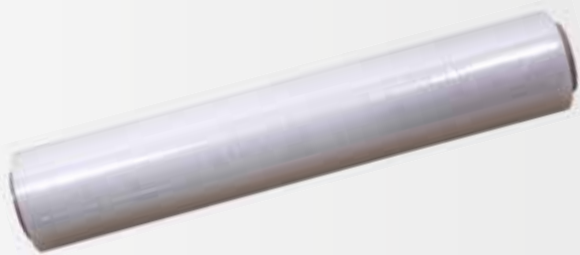

FOLIE SMRŠŤOVACÍ



Č.p.	šířka	délka	tloušťka	objem	ks	
38095	500 mm	600 m	8 µm	čirá	1	
38097	100 mm	150 m	20 µm	čirá	1	
38096	500 mm	200 m	23 µm	černá	1	



PE PYTLE NA SUŠ
TRANSPARENTNÍ



Č.p.	šířka	délka	tloušťka	objem	ks	
39194	500 mm	1100 mm	0,16 mm	100 l	1	10
39196	600 mm	1200 mm	0,16 mm	110 l	1	10
39198	700 mm	1100 mm	0,16 mm	120 l	1	10
39200	500 mm	1100 mm	0,20 mm	100 l	1	10
39202	600 mm	1200 mm	0,20 mm	110 l	1	10
39204	700 mm	1100 mm	0,20 mm	120 l	1	10



PE PYTLE NA SUŠ
ČERNÉ



Č.p.	šířka	délka	tloušťka	objem	ks	
39195	500 mm	1100 mm	0,16 mm	100 l	1	10
39197	600 mm	1200 mm	0,16 mm	110 l	1	10
39199	700 mm	1100 mm	0,16 mm	120 l	1	10
39201	500 mm	1100 mm	0,20 mm	100 l	1	10
39203	600 mm	1200 mm	0,20 mm	110 l	1	10
39205	700 mm	1100 mm	0,20 mm	120 l	1	10



PYTLE NA ODPAD



Č.p.	šířka	délka	tloušťka	objem	ks	
38060	700 mm	1100 mm	0,08 mm		10	1
38063	700 mm	1100 mm	0,10 mm		3	1
38065	700 mm	1100 mm	0,20 mm		3	1



SÁČKY NA ODPAD



Č.p.	šířka	délka	tloušťka	objem	ks	
38050	500 mm	600 mm	0,04 mm		25	1
38052	600 mm	800 mm	0,04 mm		25	1
38054	700 mm	1100 mm	0,04 mm		25	1



PE PYTLE NA ODPAD



Č.p.	šířka	délka	tloušťka	objem	ks	
38055	1200 mm	1000 mm	0,08 mm		5	

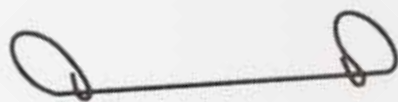

ÚVAZEK PYTLOVÝ



Č.p.	specifikace	ks
42365	1,25 100 mm	1
42366	1,25 125 mm	1
42367	1,25 140 mm	1
42368	1,25 160 mm	1



VAZAČ PYTLŮ

Č.p.	specifikace	ks
50052		12
50050		1



VAZAČ ÚVAZEKŮ - RÁDLOVAČKA

Č.p.	specifikace	ks
50051		2



FOLIE VÝSTRAŽNÁ - EL. VEDENÍ

Č.p.	šířka	délka	
38955	22 cm	20 m	1
38956	22 cm	50 m	1



FOLIE VÝSTRAŽNÁ - VODA

Č.p.	šířka	délka	
38957	22 cm	20 m	1
38958	22 cm	50 m	1



FOLIE VÝSTRAŽNÁ - PLYN

Č.p.	šířka	délka	
38959	22 cm	20 m	1
38960	22 cm	50 m	1



PÁSKA VAROVACÍ

Č.p.	specifikace	délka	
38944	ZÁKAZ VSTUPU, SK	80 mm 250 m	8
38945	VSTUP ZAKÁZÁN, CZ	80 mm 250 m	8



PÁSKA VAROVACÍ

Č.p.	délka	
38948	80 mm 250 m	8

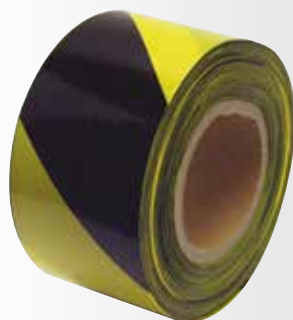

PÁSKA VAROVACÍ

Č.p.	délka	
38946	80 mm 250 m	8



PÁSKA VAROVACÍ - SAMOLEPICÍ

Č.p.	délka	specifikace	
38947	48 mm 33 m	pravá	48
38961	48 mm 33 m	levá	48



PÁSKA TRASOVACÍ

Č.p.	šířka	délka	tloušťka materiálu	
38949	50 mm	50 m	0,15 mm	36

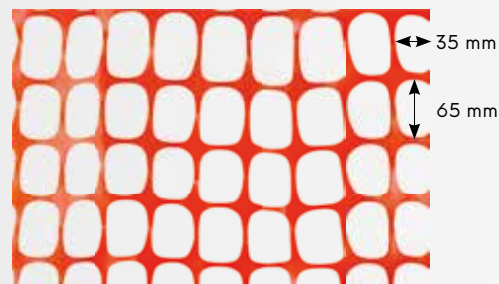

BEZPEČNOSTNÍ SÍŤ

Č.p.	specifikace	
42190	1,2 x 50 m HDPE 140g/m ²	1



PÁSKY PVC

5x

Č.p.	šířka	délka	tloušťka materiálu	
38931	19 mm	5 m	0,13 mm	100



PÁSKA PVC - ČERNÁ

Č.p.	šířka	délka	tloušťka materiálu	
38932	19 mm	10 m	0,13 mm	10



PÁSKA PVC

Č.p.	šířka	délka	tloušťka materiálu	
38925	19 mm	10 m	0,13 mm	10



PÁSKA PVC, ČERNÁ

Č.p.	šířka	délka	tloušťka materiálu	
38968	19 mm	10 m	0,19 mm	10



PÁSKA TEXTIL ČERNÁ

Č.p.	šířka	délka	
38927	19 mm	10 m	10



PÁSKA TEXTILNÍ, KOBERCOVÁ

Č.p.	šířka	délka	
38980	48 mm	10 m	24
38981	48 mm	20 m	24



PÁSKA LEPICÍ OBOUSTRANNÁ S VÝZTUŽÍ

Č.p.	šířka	délka	
38924	50 mm	10 m	1
38964	50 mm	25 m	1



PÁSKA LEPICÍ OBOUSTRANNÁ, POLYPROPYLEN

Č.p.	šířka	délka	
38929	50 mm	10 m	1
38966	50 mm	25 m	1



PÁSKA LEPICÍ OBOUSTRANNÁ MONTÁŽNÍ

Č.p.	šířka	délka	
38990	19 mm	5 m	48
38991	25 mm	5 m	36

PP
Polypropylen

MADE IN
EU



PÁSKA PROFESIONÁLNÍ ZESÍLENÁ, VODĚODOLNÁ



Č.p.	šířka	délka	
38995	48 mm	25 m	24



PÁSKA TEXTILNÍ, VODĚODOLNÁ

Č.p.	šířka	délka	
38965	30 mm	10 m	1
38928	50 mm	10 m	72
38934	50 mm	45 m	24



PÁSKA DUCT TAPE, VODĚODOLNÁ



Č.p.	šířka	délka	
37275	48 mm	50 m	24



PÁSKA FASÁDNÍ NA OMÍTKU



Č.p.	šířka	délka	
37271	38 mm	20 m	24
37270	48 mm	20 m	24
37272	48 mm	50 m	24



PÁSKA PE VENKOVNÍ OCHRANA NA OKNA

po dobu 30 dní



Č.p.	šířka	délka	
37273	48 mm	50 m	24



PÁSKA PROFI PAPIŘOVÁ MASKOVACÍ



Č.p.	šířka	délka	
37263	38 mm	50 m	24
37264	48 mm	50 m	24



PÁSKA PVC MASKOVACÍ



Č.p.	šířka	délka	
37266	30 mm	33 m	60
37267	38 mm	33 m	48
37268	50 mm	33 m	36



PÁSKA PAPIŘOVÁ MASKOVACÍ



Č.p.	šířka	délka	
37255	19 mm	50 m	12
37256	25 mm	50 m	12
37257	30 mm	50 m	7
37258	38 mm	50 m	6
37259	50 mm	50 m	6



PÁSKA BALÍCÍ PVC



Č.p.	šířka	délka	
38942	50 mm	50 m	72



PÁSKA POKOVENÁ



Č.p.	šířka	délka	
38972	50 mm	50 m	1
38973	50 mm	100 m	1



FÓLIE HLINÍKOVÁ SAMOLEPÍCÍ



Č.p.	šířka	délka	
38963	48 mm	10 m	1
38943	48 mm	45 m	24



PÁSKA PROTISKLUZOVÁ

Č.p.	šířka	délka	tloušťka	
37280	25 mm	15 m	0,8 mm	72
37281	50 mm	15m	0,8 mm	36



PÁSKA SAMOVULKANIZAČNÍ

Č.p.	šířka	délka	
38930	19 mm	5 m	100



PÁSKA SÁDROKARTONÁŘSKÁ SAMOLEPÍCÍ



Č.p.	šířka	délka	
38935	50 mm	20 m	60
38937	50 mm	45 m	36
38939	50 mm	90 m	24
38940	50 mm	153 m	24



PÁSKA SKLOVLÁKNOVÁ



Č.p.	šířka	délka	
38941	50 mm	25 m	40



PÁSKA INSTALATÉRSKÁ TEFLONOVÁ



Č.p.	šířka	délka	tloušťka materiálu	
38969	19 mm	15 m	0,2 mm	10



PÁSKA INSTALATÉRSKÁ TEFLONOVÁ



Č.p.	šířka	délka	tloušťka materiálu	
38933	12 mm	10 m	0,075 mm	10



NIT TEFLONOVÁ

· na vodu, a plyn, instalace



Č.p.	šířka	délka	
38926	2 mm	150 m	20



ODVÍJEČ PÁSKY

Č.p.	
38985	1



VÁZACÍ PÁSKA, SUCHÝ ZIP

Č.p.	specifikace	
45471	12 mm x 5 m	1



PÁSKA NA SUCHÝ ZIP 3 KS



Č.p.	šířka	délka	
37295	20 mm	150 mm	1
37296	20 mm	200 mm	1
37297	20 mm	250 mm	1

NEW



- 3 polohy přepínání zpětného odskoku



- otočná hlava o 360°

- nárazuvzdorná rukojeť nylon + sklovlákno



- přepínání dávkování 9:1 / 18:1

**FESTA**

PISTOLE VYTLAČOVACÍ S PŘEPÍNAČEM ZPĚTNÉHO ODSKOKU A DÁVKOVÁNÍ

Č.p. specifikace

38027



1

NEW



- přepínač zpětného odskoku

FESTA

PISTOLE VYTLAČOVACÍ S PŘEPÍNAČEM ZPĚTNÉHO ODSKOKU

Č.p. specifikace

38028



1



FESTA

PISTOLE VYTLAČOVACÍ ZESÍLENÁ

Č.p. specifikace 12



FESTA

PISTOLE VYTLAČOVACÍ

Č.p. specifikace 24



FESTA

PISTOLE VYTLAČOVACÍ

Č.p. specifikace 6



FESTA

PISTOLE VYTLAČOVACÍ

Č.p. specifikace 1



PISTOLE VYTLAČOVACÍ SE ZPĚTNÝM ODSKOKEM

Č.p. specifikace 24
6ti hran



PISTOLE VYTLAČOVACÍ

Č.p. specifikace 24



FESTA

PISTOLE VYTLAČOVACÍ NA CHEMICKÉ KOTVY 380 ML

Č.p. specifikace 12



PISTOLE VYTLAČOVACÍ - KROKOVÁ

Č.p. specifikace 12



PISTOLE VYTLAČOVACÍ

Č.p.	specifikace	
38002	6ti hran	24



PISTOLE VYTLAČOVACÍ - PLASTOVÁ

Č.p.	specifikace	
38003	6ti hran	24



PISTOLE VYTLAČOVACÍ

Č.p.	specifikace	
38007		24



PISTOLE VYTLAČOVACÍ - PLASTOVÁ, POLOUZAVŘENÁ

Č.p.	specifikace	
38008		24



PISTOLE VYTLAČOVACÍ OZUBENÁ

Č.p.	specifikace	
38009		24

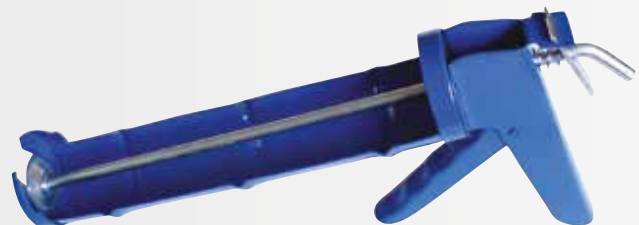

PISTOLE VYTLAČOVACÍ

Č.p.	specifikace	
38000		24



FESTA

PISTOLE VYTLAČOVACÍ

ALU

Č.p.	specifikace	
38005	310 ml	20
38014	špička 3 ks	100



FESTA

PISTOLE VYTLAČOVACÍ

ALU

Č.p.	specifikace	
38004	600 ml	12
38014	špička 3 ks	100



FESTA

PISTOLE NA PU PĚNY S TEFLONOVÝM POVRCHEM

TEFLON

Č.p. specifikace

38018



20



FESTA

PISTOLE NA PU PĚNY S TEFLONOVÝM POVRCHEM

TEFLON

Č.p. specifikace

38017



20



FESTA

PISTOLE NA PU PĚNY

TEFLON

Č.p. specifikace

38016



20



FESTA

PISTOLE NA PU PĚNY

TEFLON

Č.p. specifikace

38015



20



PISTOLE NA PU PĚNY

Č.p. specifikace

38031



20



FESTA

PISTOLE NA PU PĚNY ABS

Č.p. specifikace

38022

ABS



20



PISTOLE NA PU PĚNY

Č.p. specifikace

38021



24



TRYSKA NÁHRADNÍ NA PISTOLE

pro pistole 38015, 38016, 38017, 38018

TEFLON

Č.p. specifikace
38030



5



PISTOLE SPÁROVACÍ

objem 1,5 l



Č.p. specifikace
38026 5x špička



25

PYTEL SPÁROVACÍ



Č.p. specifikace
38042 3x špička



6



FESTA

PISTOLE HORKOVZDUŠNÁ S REGULACÍ TEPLoty A PROUDU VZDUCHU

digitální display

FESTA

PISTOLE HORKOVZDUŠNÁ S REGULACÍ TEPLoty

napětí / frekvence	230V / 50Hz
příkon	2000W
poloha spínače	0 - I (350°C) - II (600°C)
příslušenství	nerezové nástavce - 4 ks

napětí / frekvence	230V / 50Hz
příkon	2000W
poloha spínače	0 - I (50°C) - II (50 - 600°C)
proud vzduchu	250 - 500 l/min.
příslušenství	nerezové nástavce - 4 ks



Č.p. specifikace
35320 2000 W



1



Č.p. specifikace
35322 2000 W



1



TAVNÉ PISTOLE

FESTA

PISTOLE TAVNÁ - BEZDRÁTOVÁ

Ø tavné tyčinky 11,2 mm



Č.p.	specifikace
89975	80 W 230 V



20

PISTOLE TAVNÁ

Ø tavné tyčinky 7,2 mm



Č.p.	specifikace
89970	15 W 230 V



25

PISTOLE TAVNÁ

Ø tavné tyčinky 11,2 mm



Č.p.	specifikace
89973	60 W 230 V



20



TYČINKY DO TAVNÉ PISTOLE

Č.p.	Ø tyčinky	délka	ks	kg
89980	7,2 mm	100 mm	12 ks	100
89988	7,2 mm	100 mm	1 kg	25



TYČINKY DO TAVNÉ PISTOLE

Č.p.	Ø tyčinky	délka	ks	kg
89985	11,2 mm	200 mm	10 ks	50
89987	11,2 mm	200 mm	1 kg	25



TYČINKY DO TAVNÉ PISTOLE

Č.p.	Ø tyčinky	délka	ks	kg
89989	7,2 mm	100 mm	12 ks	100
89990	11,2 mm	200 mm	10 ks	50



ŠTĚTCE A VÁLEČKY



ŠTĚTEC PLOCHÝ NATUR

Č.p.	šířka	tloušťka	délka	
52212	20 mm	15 mm	40 mm	12
52213	30 mm	15 mm	45 mm	12
52214	40 mm	15 mm	45 mm	12
52215	50 mm	15 mm	50 mm	12
52216	60 mm	15 mm	60 mm	12
52217	70 mm	15 mm	65 mm	12
52218	80 mm	15 mm	65 mm	12
52220	100 mm	15 mm	70 mm	12



ŠTĚTEC PLOCHÝ

Č.p.	šířka	tloušťka	délka	
52202	20 mm	12,5 mm	38 mm	12
52203	30 mm	13 mm	38 mm	12
52204	40 mm	14 mm	44 mm	12
52205	50 mm	16 mm	44 mm	12
52206	60 mm	17 mm	52 mm	12
52208	80 mm	17 mm	52 mm	12
52207	100 mm	18 mm	52 mm	12



ŠTĚTEC ZÁROHOVÝ

Č.p.	šířka	tloušťka	délka	
52283	25 mm	10 mm	44 mm	12
52284	38 mm	10 mm	44 mm	12
52285	50 mm	10 mm	44 mm	12
52286	62 mm	10 mm	50 mm	12
52288	76 mm	10 mm	50 mm	12



SADA ŠTĚTCŮ - PLASTOVÁ RUKOJEŽ

Č.p.	specifikace	
52070	20, 30, 50 mm	50

3x



SADA ŠTĚTCŮ - PLASTOVÁ RUKOJEŤ

5x



Č.p.	specifikace
52071	15 mm, 25 mm, 40 mm, 60 mm, 80 mm

50



ŠKRABKA NA BARVY A LAKY

Č.p.
37005

12



MALÍŘSKÁ ŠTĚTKA PROFI



Č.p.	specifikace
52075	Ø 90 mm

10



MALÍŘSKÁ ŠTĚTKA PROFI



Č.p.	šířka	délka
52076	170 mm	80 mm

10



MALÍŘSKÁ ŠTĚTKA

Č.p.	specifikace	délka
52077	Ø 105 mm	70 mm

12



MALÍŘSKÁ ŠTĚTKA

Č.p.	šířka	délka
52078	170 mm	70 mm

12

TABULKA POUŽITÍ MALÍŘSKÝCH VÁLEČKŮ		BARVY A LAKY												
MATERIÁL	VÝŠKA VLASU l mm	DISPERZNÍ	ANTIKOROZNÍ	PRYSKYŘIC.	OLEJOVÉ	VODOU ŘED.	POLYESTEROVÉ	POJIVOVÉ	LAZURY	LATEXOVÉ	EPOXYDOVÉ	2-KOMPONENTNÍ	HUSTÉ	AKRYLOVÉ
PES	20	•						•		•			•	
PES	20	•	•			•		•		•				•
PAC	18	•						•		•				
PAC	12, 13	•								•				
PAD	18, 21	•								•				
PAD	13	•	•							•				
BERÁNEK	23	•								•				
NYLON	13		•	•	•	•	•			•	•	•		
VELOUR	4		•	•			•			•	•		•	
MICROFIBRE	10					•			•	•				
MOLITAN				•		•								•



PENETRAČNÍ SOUPRAVA

č.p.	polster	180 mm	Ø 8 mm	Ø 53 mm	18 mm	1
52600	polster 4	180 mm	Ø 8 mm	Ø 53 mm	18 mm	1

MALÍŘSKÁ SOUPRAVA - VESTAN

č.p.	180 mm	Ø 6 mm	Ø 42 mm	20 mm	25
52610	180 mm	Ø 6 mm	Ø 42 mm	20 mm	25
52605	250 mm	Ø 6 mm	Ø 42 mm	20 mm	20



LAKOVACÍ SADA

- 1x váleček PAD 13mm/ 10 cm
- 1x váleček PAC 12mm/ 10 cm
- 1x váleček PES 11mm/ 10 cm
- držák
- miska

č.p.	52602	10
52602		10



ROHOVÝ VÁLEČEK POLYAKRYL

č.p.	52601	včetně držáku	Ø 6 mm	18 mm	1
52601	včetně držáku		Ø 6 mm	18 mm	1



VÁLEČEK POLYAKRYL

PAC MADE IN EU					
Č.p.					
52331	100 mm	Ø 6 mm	Ø 17 mm	12 mm	50
52334	250 mm	Ø 8 mm	Ø 48 mm	12 mm	10



VÁLEČEK POLYAKRYL

PAC MADE IN EU					
Č.p.					
52391	polster 5 250 mm	Ø 8 mm	Ø 54 mm	18 mm	10



VÁLEČEK POLYAKRYL

PAC MADE IN EU					
Č.p.					
52328	polster 5 250 mm	Ø 8 mm	Ø 54 mm	18 mm	10
52456	polster 7 250 mm	Ø 8 mm	Ø 67 mm	18 mm	10



VÁLEČEK POLYAMID

PAD MADE IN EU					
Č.p.					
52428	polster 7 250 mm	Ø 8 mm	Ø 67 mm	18 mm	10



VÁLEČEK POLYESTER

PES MADE IN EU					
Č.p.					
52315	polster 5 180 mm	Ø 8 mm	Ø 54 mm	20 mm	10



VÁLEČEK LAZUROVACÍ - NYLON

PAD MADE IN EU					
Č.p.					
52421	100 mm	Ø 6 mm	Ø 17 mm	13 mm	50
52424	250 mm	Ø 8 mm	Ø 48 mm	13 mm	10



VÁLEČEK POLYESTER

PES MADE IN EU					
Č.p.					
52305	180 mm	Ø 6 mm	Ø 42 mm	20 mm	10
52306	250 mm	Ø 6 mm	Ø 42 mm	20 mm	10



VÁLEČEK LAKOVACÍ MOLITAN

MADE IN EU				
Č.p.				
52471	rovný 100 mm	Ø 6 mm	Ø 35 mm	50

NEW

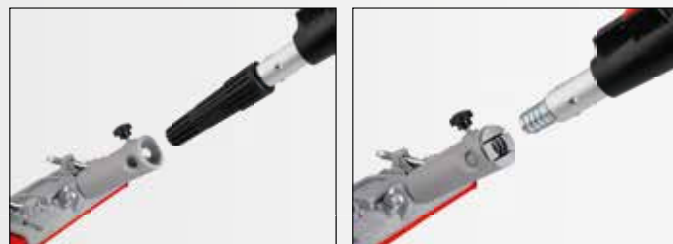

FESTA®

NÁSADA TELESKOPIČKÁ

- závit pro 31610, 34203

Č.p.	Specifikace	
52011	88 - 140 cm	1



TELESKOPIČKÁ TYČ

ALU

Č.p.	délka		
52010	120 cm	ALU	50
52012	240 cm	ALU	25

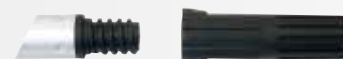

TELESKOPIČKÁ TYČ

Č.p.	délka		
52020	300 cm	ocel	10

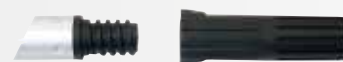

TELESKOPIČKÁ TYČ

Č.p.	délka		
52030	240 cm	fiberglass	6



MISKA

MADE IN EU



Č.p.	specifikace	
52662	150 x 270 mm 100 mm	1
52666	260 x 290 mm 180 mm	1
52671	330 x 340 mm 250 mm	1

KBELÍK NA BARVU

MADE IN EU

Č.p.	objem	
52694	8 l	25
52695	12 l	20



MŘÍŽKA



Č.p.	šířka	výška	
52652	230 mm	250 mm	100
52656	270 mm	290 mm	100



DRŽÁK



Č.p.	specifikace	
52640	5 cm Ø 6 mm	100
52645	8,5 cm Ø 6 mm x 27 mm	100



DRŽÁK



Č.p.	specifikace	
52630	18 cm Ø 6 mm	100
52635	25 cm Ø 6 mm	100
52620	18 cm Ø 8 mm	50
52625	25 cm Ø 8 mm	50



PÁSKA KRYCÍ SAMOLEPÍCÍ S FÓLIÍ

Č.p.	šířka	délka	
37243	55 cm	30 m	60
37244	110 cm	30 m	30
37245	140 cm	30 m	30
37246	180 cm	15 m	30
37290	210 cm	20 m	30
37247	240 cm	15 m	30
37291	270 cm	16 m	30



OCHRANNÁ KOMBINÉZA S KAPUCÍ

Č.p.	specifikace	
50585	velikost M	1
50586	velikost L	1
50587	velikost XL	1
50588	velikost XXL	1



FOLIE DO DVEŘÍ SE ZIPEM

Č.p.	specifikace	
37248	1,2 x 2,2 m páska 100 µm 45 mm x 25 m	25



UNIVERZÁLNÍ KRYCÍ FÓLIE

Č.p.	objem	tloušťka materiálu	
37250	4 x 5 m	0,007 mm	100
37251	4 x 12,5 m	0,007 mm	50
37252	2 x 50 m	0,007 role	20



UNIVERZÁLNÍ KRYCÍ FÓLIE

Č.p.	specifikace	tloušťka materiálu	
37253	4 x 5 m	0,03 mm	100



LEPENKA VLNITÁ



Č.p.	šířka	délka	
54008	1 m	10 m	1



EKONOMIK ** STANDARD *** PROFI ****

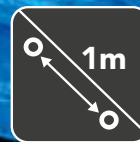

- Zdvojené svažené lemy s polypropylenovou šňůrou
- Stříbrná vrstva pro zvýšený odraz slunečního záření
- ALU oka po 1 m



ZAKRÝVACÍ PLACHTA EKONOMIK

· modrá



Č.p.	specifikace	
25369	2 x 2 m	50
25370	2 x 3 m	20
25371	3 x 4 m	10
25372	3 x 5 m	10
25373	4 x 5 m	10

Č.p.	specifikace	
25374	4 x 6 m	5
25376	5 x 8 m	5
25378	6 x 10 m	2
25379	8 x 12 m	2
25380	10 x 15 m	2

ZAKRÝVACÍ PLACHTA

· modro-stříbrná



Č.p.	specifikace		Č.p.	specifikace	
25155	2 x 2 m	50	25025	5 x 5 m	10
25006	2 x 3 m	50	25030	5 x 6 m	10
25009	3 x 3 m	35	25040	5 x 8 m	5
25012	3 x 4 m	20	25048	6 x 8 m	5
25015	3 x 5 m	10	25060	6 x 10 m	5
25016	4 x 4 m	10	25096	8 x 12 m	2
25020	4 x 5 m	10	25150	10 x 15 m	2
25024	4 x 6 m	10	25153	15 x 20 m	1



ZAKRÝVACÍ PLACHTA

· zelená



70 g/m²

Č.p.	specifikace	
25179	2 x 2 m	50
25180	2 x 3 m	50
25195	2 x 8 m	20
25181	3 x 4 m	20
25182	3 x 5 m	10
25183	4 x 5 m	10

Č.p.	specifikace	
25184	4 x 6 m	10
25186	5 x 8 m	5
25188	6 x 10 m	5
25189	8 x 12 m	2
25190	10 x 15 m	2

PE PLACHTA PROFÍ

· modro-stříbrná



140 g/m²

Č.p.	specifikace	
25206	2 x 3 m	25
25212	3 x 4 m	10
25215	3 x 5 m	8
25220	4 x 5 m	8
25224	4 x 6 m	8
25230	5 x 6 m	8

Č.p.	specifikace	
25240	5 x 8 m	4
25248	6 x 8 m	3
25260	6 x 10 m	3
25296	8 x 12 m	2
25350	10 x 15 m	1



PE PLACHTA PROFI

· zeleno-zelená

200 g/m²

Č.p.	specifikace	
25160	2 x 3 m	15
25171	2 x 8 m	1
25162	3 x 5 m	5
25163	4 x 5 m	4

Č.p.	specifikace	
25164	4 x 6 m	3
25167	6 x 8 m	2
25169	8 x 12 m	1
25170	10 x 15 m	1

PE PLACHTA KULATÁ

· modro-stříbrná

120 g/m²

Č.p.	specifikace	
25003	Ø 3,6 m	15
25004	Ø 4,5 m	5
25005	Ø 5,5 m	4
25002	Ø 6,5 m	3



NAPÍNÁK PLACHET

4x

Č.p.	specifikace	
25400	20 cm	1



APLIKÁTOR OK DO PLACHET

Č.p.	specifikace	
25410	aplikátor ok + 25 ok	1



OKA DO PE PLACHET

10x

Č.p.	specifikace	
25001		1



KARABINY, ŘETĚZY A OCELOVÁ LANA



NAPÍNACÍ ŠROUB

DIN 1480 Zn

Č.p.	specifikace	
50100	5 x 70 mm	10
50101	6 x 90 mm	10
50102	8 x 125 mm	10
50103	10 x 150 mm	10

Č.p.	specifikace	
50104	12 x 200 mm	10
50106	16 x 230 mm	10
50108	20 x 220 mm	10



KARABINA

DIN 5299 C Zn

Č.p.	specifikace	
51204	4 mm	10
51205	5 mm	10
51206	6 mm	10
51207	7 mm	10
51208	8 mm	10

Č.p.	specifikace	
51209	9 mm	10
51210	10 mm	10
51211	11 mm	10
51212	12 mm	10



ČLÁNEK RAPID

Zn

Č.p.	specifikace	
51241	4 mm	10
51242	5 mm	10
51243	6 mm	10
51244	7 mm	10

Č.p.	specifikace	
51245	8 mm	10
51246	10 mm	10
51247	12 mm	10



S HÁK

Zn

Č.p.	specifikace	
51271	3 mm	10
51272	4 mm	10
51273	5 mm	10
51274	6 mm	10

Č.p.	specifikace	
51275	7 mm	10
51276	8 mm	10
51278	10 mm	10



MATICE OČKOVÁ

DIN 5820 Zn

Č.p.	specifikace	
51320	6 mm	10
51321	8 mm	10
51322	10 mm	10
51323	12 mm	10

Č.p.	specifikace	
51324	14 mm	10
51325	16 mm	10
51327	20 mm	10



ŠROUB OČKOVÝ

DIN 5820 Zn

Č.p.	specifikace	
51300	6 mm	10
51301	8 mm	10
51302	10 mm	10
51303	12 mm	10
51304	14 mm	10

Č.p.	specifikace	
51305	16 mm	10
51306	18 mm	10
51307	20 mm	10
51308	22 mm	10



SVĚRKA LANOVÁ

Zn

Č.p.	specifikace	
51280	3 mm	10
51281	5 mm	10
51282	6 mm	10
51283	8 mm	10

Č.p.	specifikace	
51284	10 mm	10
51286	12 mm	10
51287	14 mm	10
51288	16 mm	10



KARABINA OTOČNÁ

Zn

Č.p.	specifikace	
51220	53 mm	10
51221	67 mm	10
51222	76 mm	10



LANOVÁ SVĚRKA OTOČNÁ

Zn

Č.p.	specifikace	
51225	3,8 mm	10
51226	4,5 mm	10
51227	6,0 mm	10



ŘETĚZ KRÁTKÉ OKO

DIN 5685 A Zn

Č.p.	velikost oka	délka	
51402	2 x 10 mm	110 m	1
51403	3 x 16 mm	60 m	1
51404	4 x 21 mm	40 m	1
51405	5 x 23 mm	30 m	1

Č.p.	velikost oka	délka	
51406	6 x 24 mm	18 m	1
51407	7 x 50 mm	16 m	1
51408	8 x 32 mm	10 m	1
51410	10 x 39 mm	10 m	1



ŘETĚZ UZLOVÝ

DIN 5686 Zn

Č.p.	Ø materiálu	délka		Č.p.	Ø materiálu	délka	
51430	1,4 mm	150 m	1	51433	2,0 mm	118 m	1
51431	1,6 mm	150 m	1	51435	2,5 mm	70 m	1
51432	1,8 mm	150 m	1	51436	2,8 mm	50 m	1



ŘETĚZ DLOUHÉ OKO

DIN 5685 C Zn

Č.p.	velikost oka	délka	
51412	2 x 12 mm	80 m	1
51413	3 x 26 mm	60 m	1
51414	4 x 32 mm	38 m	1
51415	5 x 35 mm	32 m	1

Č.p.	velikost oka	délka	
51416	6 x 43 mm	18 m	1
51417	7 x 50 mm	16 m	1
51418	8 x 54 mm	10 m	1
51420	10 x 65 mm	10 m	1



ŘETĚZ PLASTOVÝ



Č.p.	specifikace	
51450	6 mm 25 m červeno-bílý	1



SPOJKA LANOVÁ DVOJITÁ

DIN 5685 C **Zn**

Č.p.	specifikace	
51348	Ø 10 mm	10



SPOJKA LANOVÁ

DIN 5685 C **Zn**

Č.p.	specifikace	
51338	Ø 5 mm	10
51341	Ø 10 mm	10



OČNICE PRO LANA

Zn

Č.p.	specifikace	
51257	Ø 14 mm	10
51258	Ø 16 mm	10
51259	Ø 18 mm	10
51260	Ø 20 mm	10
51261	Ø 22 mm	10
51262	Ø 24 mm	10
51263	Ø 26 mm	10
51264	Ø 28 mm	10
51265	Ø 30 mm	10



NAVIJÁK S LANEM A HÁKEM

Zn

Č.p.	nosnost	délka lana	
26720	300 kg	8 m	1
26705	450 kg	8 m	1
26721	500 kg	8 m	1
26722	800 kg	8 m	1
26706	900 kg	8 m	1
26707	1350 kg	8 m	1

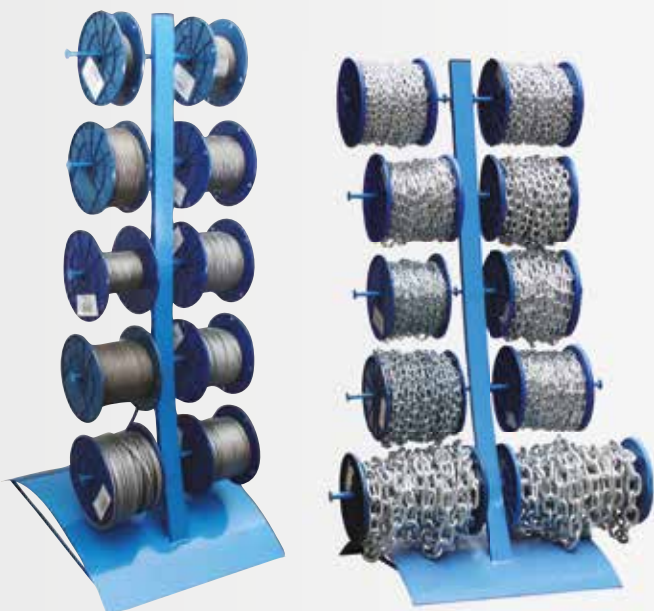

STOJAN PRODEJNÍ NA LANKA A ŘETĚZY

Č.p.	specifikace	
51196	stojan na řetězy osazený	10
51197	stojan na lanka osazený	10
51198	stojan na řetězy	10
51199	stojan na lanka	10



LANKO OCELOVÉ POZINKOVANÉ

Zn

Č.p.	průměr lana	délka	
51100	Ø 1 mm	500 m	1
51101	Ø 1,2 mm	500 m	1
51102	Ø 1,5 mm	500 m	1
51103	Ø 2 mm	200 m	1
51104	Ø 3 mm	200 m	1
51105	Ø 4 mm	100 m	1
51106	Ø 5 mm	75 m	1
51107	Ø 6 mm	75 m	1
51130	Ø 8 mm	75 m	1
51131	Ø 10 mm	50 m	1
51132	Ø 12 mm	50 m	1



LANKO OCELOVÉ POZINKOVANÉ V PVC OBALU

Zn

Č.p.	průměr lana	délka	
51108	Ø 2/3 mm	200 m	1
51109	Ø 3/4 mm	100 m	1
51110	Ø 4/5 mm	75 m	1
51111	Ø 5/6 mm	50 m	1



LANKO OCELOVÉ NEREZOVÉ

INOX

Č.p.	průměr lana	délka	
51120	Ø 1 mm	300 m	1
51121	Ø 1,2 mm	300 m	1
51122	Ø 1,5 mm	300 m	1
51123	Ø 2 mm	200 m	1
51124	Ø 3 mm	200 m	1
51125	Ø 4 mm	100 m	1
51126	Ø 5 mm	75 m	1
51127	Ø 6 mm	75 m	1



FESTA

SVĚTLO STAVEBNÍ LED



Č.p.	specifikace
37611	

1

SVĚTLO STAVEBNÍ HALOGENOVÉ



Č.p.	specifikace	
37600	120 W	1
37601	400 W	1

HALOGENOVÁ ŽÁROVKA

Č.p.	specifikace	
37604	120 W	1
37606	250 W	1
37605	400 W	1



FESTA

SVĚTLO STAVEBNÍ LED

· maximální výška 180 cm



Č.p.	specifikace
37615	20 W
37616	2 x 20 W

1

1

SVĚTLO STAVEBNÍ HALOGENOVÉ

· maximální výška 180 cm



Č.p.	specifikace
37602	400 W
37603	2 x 400 W



2

2



ŽEBŘÍK TELESKOPICKÝ SKLÁDACÍ

· max. nosnost 150 kg



Č.p.	specifikace	
48415	1,9 / 3,8 m	6/12 příček 1



PLOŠINA PRACOVNÍ SKLÁDACÍ

· max. nosnost 150 kg



Č.p.	specifikace	
48420		1

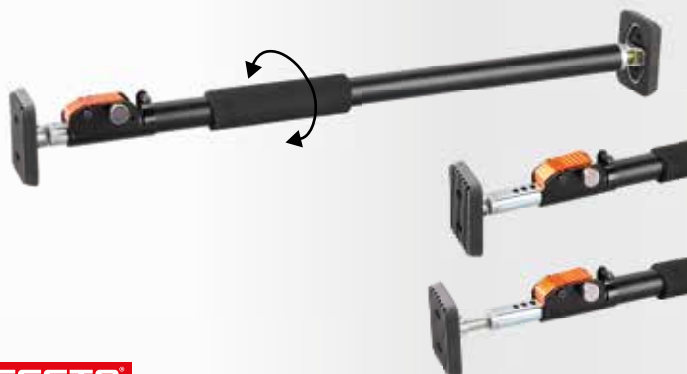

FESTA

TYČ ROZPÍNACÍ, PODPĚRNÁ

· max. nosnost 40 kg

Č.p.	specifikace	
52060	66 - 115 cm	1
52065	160 - 290 cm	1



ŽEBŘÍK TELESKOPICKÝ

· max. nosnost 150 kg



Č.p.	specifikace	
48410	3,2 m	11 příček 1
48411	3,8 m	13 příček 1



STOJKA BEDNÍCÍ

· 48449 klec na bednicí stojky



Č.p.	specifikace	
48452	160 - 290 cm	1
48453	180 - 320 cm	1
48454	200 - 360 cm	1
48455	250 - 440 cm	1
48456	260 - 380 cm	1
48457	220 - 400 cm	1



TYČ ROZPÍNACÍ, PODPĚRNÁ

Č.p.	specifikace	
52050	50 - 115 cm	1
52055	115 - 290 cm	1





VRUTY DO DŘEVA, BOX

ks	obsah balení
60	3,0 x 12 mm
50	3,0 x 16 mm
40	3,0 x 20 mm
50	3,5 x 20 mm
40	3,5 x 30 mm
25	4,0 x 30 mm
20	4,0 x 40 mm
15	5,0 x 50 mm
10	5,0 x 60 mm



VRUTY DO DŘEVA + HMOŽDINKY, BOX

vruty do dřeva	
ks	obsah balení
40	3,5 x 30 mm
25	4,0 x 40 mm
12	5,0 x 50 mm
8	6,0 x 60 mm

hmoždinky	
ks	obsah balení
40	5 x 25 mm
25	6 x 30 mm
12	8 x 40 mm
8	10 x 50 mm

310x



170x



Č.p. specifikace
55642

1

Č.p. specifikace
55645

1

VRUTY DO DŘEVA

ks	obsah balení
350	3,0 x 16 mm
280	3,0 x 20 mm
220	3,0 x 25 mm
250	3,5 x 20 mm
240	3,5 x 25 mm
180	3,5 x 3, mm
280	4,0 x 16 mm
80	4,0 x 30 mm
40	4,0 x 40 mm
30	4,0 x 50 mm
25	5,0 x 50 mm
25	5,0 x 60 mm

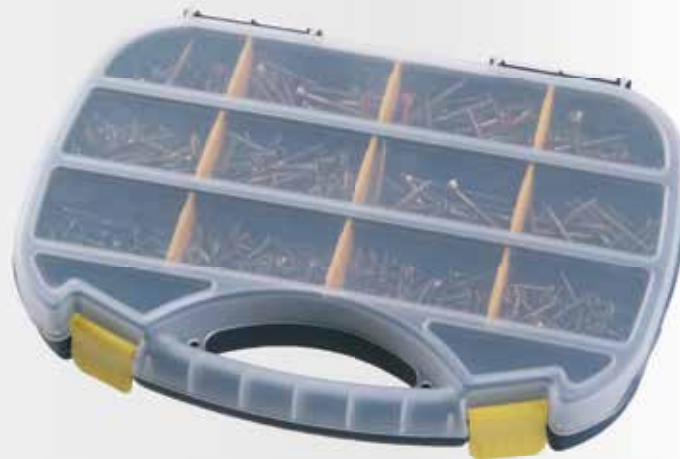

2000x

Č.p. specifikace
55640 2000 ks

1



DVÍŘKA KOMÍNOVÁ PLECHOVÁ



Č.p. specifikace
65062

1



DVÍŘKA KOMÍNOVÁ KOMAX



Č.p. specifikace
65063 šedá
65064 bílá

1



DVÍŘKA KOMÍNOVÁ ZINKOVANÁ



Č.p. specifikace
65065

1



332

WINLAND ZAHRADNICKÉ
NŮŽKY

338

ZAHRADNICKÉ NŮŽKY



339

ZAHRADNÍ PILY



340

MAČETY A ZAHRADNICKÉ
NÁŘADÍ

341

ZAHRADNICKÉ NÁŘADÍ



343

STRUNY DO SEKAČKY



344

BROUSKY



345

RAJČATOVÉ A ZAHRADNÍ
TYČE

346

MULČOVACÍ TEXTILIE



348

ZAVLAŽOVÁNÍ AQUATIC,
ROSA

360

VOZÍKY A DRŽÁKY
NA HADICE

362

HADICOVÉ SPOJKY MOSAZ



364

HADICOVÉ SPOJKY



365

POSTŘIKOVAČE
A KOMPRESORY



367

HRÁBĚ



372

RÝČE, LOPATY A VIDLE



378

MOTYKY A KRUMPÁČE



381

SMETÁKY

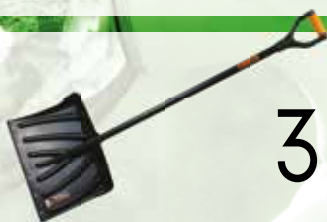

384

SHRNOVAČE SNĚHU



386

NÁSADY DŘEVĚNÉ,
ALU A FIBERGLASS

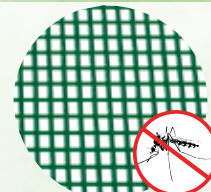

387

SÍŤ PROTI HMYZU

ZAHRADNÍ NÁŘADÍ
A PLETIVA

330 - 397



389

PLETIVA A VÁZACÍ DRÁTY



392

KOTEVNÍ PATKY A ZEMNÍ
VRUTY



394

STÍNÍCÍ TKANINY

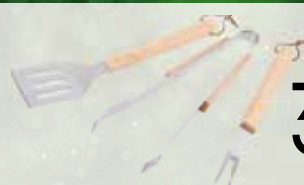

395

GRILOVACÍ NÁŘADÍ



ZAHRADNICKÉ NŮŽKY

- profesionální zahradní nůžky
- vysoká kvalita použitých materiálů
- kvalitní zpracování
- ergonomické rukojeti



ZAHRADNICKÉ NŮŽKY

· čepel HCS SK - 5, japonská ocel

SK5



Č.p.	specifikace	
45020	205 mm	10
44980	náhradní pružina	1



ZAHRADNICKÉ NŮŽKY

· čepel HCS SK - 5, japonská ocel

SK5



Č.p.	specifikace	
45023	205 mm	10
44980	náhradní pružina	1



ZAHRADNICKÉ NŮŽKY

· čepel HCS SK - 5, japonská ocel

SK5



Č.p.	specifikace	
45063	215 mm	10
44981	náhradní pružina	1



ZAHRADNICKÉ NŮŽKY

· čepel HCS SK - 5, japonská ocel

SK5

TEFLON



Č.p.	specifikace	
44972	215 mm	10
44981	náhradní pružina	1



ZAHRADNICKÉ NŮŽKY

SK5

Č.p.	specifikace	
45099	190 mm	10
44983	náhradní pružina	1



ZAHRADNICKÉ NŮŽKY

SK5

Č.p.	specifikace	
45098	220 mm	10
44983	náhradní pružina	1



ZAHRADNICKÉ NŮŽKY

SK5

TEFLON

Č.p.	specifikace	
45095	200 mm	10
44982	náhradní pružina	1



• otočná rukojeť



ZAHRADNICKÉ NŮŽKY

• čepel HCS SK - 5, japonská ocel

SK5

TEFLON

Č.p.	specifikace	
45096	220 mm	6
44982	náhradní pružina	1



ZAHRADNICKÉ NŮŽKY

• čepel HCS SK - 5, japonská ocel

SK5

TEFLON

Č.p.	specifikace	
45097	250 mm	10
44981	náhradní pružina	1



ZAHRADNICKÉ NŮŽKY

INOX

Č.p.	specifikace	
45089	160 mm	10



ZAHRADNICKÉ NŮŽKY

INOX

Č.p.	specifikace	
45088	160 mm	10



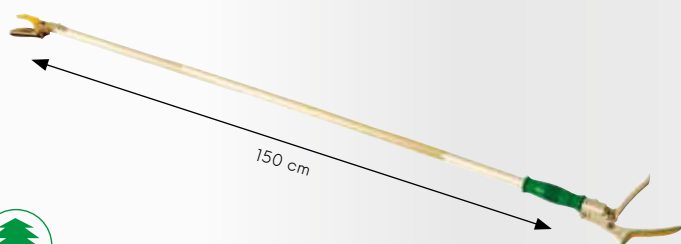

WINLAND®

ZAHRADNICKÉ NŮŽKY PRODLOUŽENÉ



10

Č.p.	specifikace
45017	



WINLAND®

NÁHRADNÍ BŘIT

· pro nůžky 45095, 45027

SK5 TEFLON



20

Č.p.	specifikace
45094	



WINLAND®

NŮŽKY NA VĚTVE

· čepel HCS SK - 5, japonská ocel

	Ø max. 45mm	SK5	TEFLON
--	-------------	-----	--------



12

Č.p.	specifikace
44991	76 cm



WINLAND®

NŮŽKY NA VĚTVE TELESKOPICKÉ

· čepel HCS SK - 5, japonská ocel

	Ø max. 45mm	SK5	TEFLON
--	-------------	-----	--------



10

Č.p.	specifikace
44992	70 - 103 cm



WINLAND®

NÁHRADNÍ PRUŽINA

Č.p.	pro nůžky	
44981	45021, 45025, 45063, 45097	1
44980	45020, 45023	1
44983	45098, 45099	1
44982	45027, 45095, 45096	1
44984	45110, 45014, 45026	1
44985	45018	1
44986	45019, 45029, 44970	1
44987	45021	1
44988	44971	1
44989	45015, 45016	1

NŮŽKY NA VĚTVE



WINLAND®

NŮŽKY

TEFLON

Č.p.	specifikace	
44996	61 cm, vlnité ostří	12



NŮŽKY

TEFLON



Č.p.	specifikace	
44997	61 cm, rovné ostří	12



NŮŽKY NA TRÁVU OTOČNÉ 360°



Č.p.	specifikace	
44998		6



BROUSEK NA NŮŽKY A NOŽE 6 V 1



Č.p.	specifikace	
45068		10



BROUSEK NA NŮŽKY A NOŽE



Č.p.	specifikace	
45048		20

NŮŽKY

INOX



Č.p.	specifikace	
45010	190 mm	12
44984	náhradní pružina	1

NŮŽKY

INOX



Č.p.	specifikace	
45014	190 mm	12
44984	náhradní pružina	1

NŮŽKY

INOX



Č.p.	specifikace	
45026	150 mm	12
44985	náhradní pružina	1

NŮŽKY ZAHRADNICKÉ



Č.p.	specifikace	
45018	210 mm kované	10



NŮŽKY ZAHRADNICKÉ

SK5 TEFLON



Č.p. specifikace
45019 210 mm

10



FESTA

NŮŽKY ZAHRADNICKÉ

nylonová rukojeť

SK5 TEFLON NYLON



Č.p. specifikace
45021 200 mm

6



NŮŽKY ZAHRADNICKÉ

ALU



Č.p. specifikace
45025 200 mm

12



NŮŽKY ZAHRADNICKÉ

INOX



Č.p. specifikace
44970 210 mm

10



NŮŽKY ZAHRADNICKÉ

TEFLON



Č.p. specifikace
45027 200 mm

10



NŮŽKY ZAHRADNICKÉ

INOX ALU



Č.p. specifikace
45029 200 mm

24



NŮŽKY ZAHRADNICKÉ

INOX



Č.p. specifikace
44971 160 mm

10



NŮŽKY ZAHRADNICKÉ



Č.p. specifikace
45016 180 mm

12



NŮŽKY ZAHRADNICKÉ



POUZDRO NA ZAHRADNICKÉ NŮŽKY

Č.p. specifikace
45015 190 mm, rovné

12

Č.p. specifikace
37317

1



NŮŽKY NA TRÁVU



Č.p. specifikace
45011 300 mm

1



NŮŽKY NA TRÁVU OTOČNÉ



Č.p. specifikace
45012 370 mm, otočné 180°

1



NŮŽKY NA VĚTVE

· nylonová rukojeť



Č.p. specifikace
44999 540 mm, oblé

12



FESTA

NŮŽKY NA VĚTVE



Č.p. specifikace
45000 750 mm, oblé

6



FESTA

NŮŽKY NA VĚTVE



Č.p. specifikace
45001 710 mm, oblé

6

**FESTA**

NŮŽKY NA VĚTVE

TEFLON

Č.p.	specifikace	
45002	750 mm, ráčnové	12

**FESTA**

NŮŽKY NA VĚTVE TELESKOPICKÉ

TEFLON

Č.p.	specifikace	
45003	660-900 mm, teleskopické	6



NŮŽKY

TEFLON



Č.p.	specifikace	
44995	440 160 mm	12

**FESTA**

NŮŽKY NA VĚTVE

TEFLON

Č.p.	specifikace	
45005	580 230 mm, vlnité ostří	6



NŮŽKY

Č.p.	specifikace	
45009	500 190 mm, vlnité ostří	6

**FESTA**

NŮŽKY

TEFLON

Č.p.	specifikace	
45006	580 230 mm, rovné ostří	6



NŮŽKY

Č.p.	specifikace	
45008	500 190 mm, rovné ostří	6

**FESTA**

NŮŽKY TELESKOPICKÉ

TEFLON

Č.p.	specifikace	
45007	670-870 230 mm, vlnité ostří	6



FESTA

PILA ZAVÍRACÍ



· 3 x broušené a kalené zuby



Č.p.	specifikace
45061	150 mm

12



FESTA

PILA ZAVÍRACÍ



· 3 x broušené a kalené zuby



Č.p.	specifikace
45060	180 mm

6



FESTA

PILA S POUZDREM



· 3 x broušené a kalené zuby



Č.p.	specifikace
45062	260 mm

24



FESTA

PILA PROŘEZÁVACÍ



· 3 x broušené a kalené zuby



Č.p.	specifikace
24152	300 mm

12



FESTA

PILA TELESKOPICKÁ PROŘEZÁVACÍ



· 3 x broušené a kalené zuby

Č.p.	specifikace
45033	230 - 490 cm 340 mm

1



HOUSENICE S PILKOU

Č.p.	specifikace
45030	pilka 300 mm teleskopická tyč 240 cm
45031	pilka 300 mm

6

6



HOUSENICE

Č.p.	specifikace
45032	kovová housenice bez pilky

10

**FESTA**

MAČETA

TEFLON

Č.p.	specifikace	
45069	440 mm	6

**FESTA**

MAČETA

TEFLON

Č.p.	specifikace	
44950	490 mm	4



MAČETA NEREZ

INOX

Č.p.	specifikace	
45083	430 mm	12
45084	600 mm	6



MAČETA

rukojeť vyrobená z jasanového dřeva

Č.p.	specifikace	
45081	510 mm	36
45082	710 mm	36



LOPATKA ŠIROKÁ NEREZ

INOX

Č.p.	specifikace	
45056	360 mm	12



LOPATKA ÚZKÁ NEREZ

INOX

Č.p.	specifikace	
45057	350 mm	12



MOTYČKA NEREZ

INOX

Č.p.	specifikace	
45058	270 mm	12



VYPICHOVAČ PLEVELE S KOLÉBKOU NEREZ

INOX

Č.p.	specifikace	
45059	370 mm	12



LOPATKA ŠIROKÁ NYLON

NYLON

Č.p.	specifikace	
45065	280 mm	1



LOPATKA ÚZKÁ NYLON

NYLON

Č.p.	specifikace	
45066	310 mm	1



KULTIVÁTOR RUČNÍ NYLON

NYLON

Č.p.	specifikace	
45067	290 mm	1



SADA NÁŘADÍ

HOBBY

4x

Č.p.	specifikace	
45035	240 mm	35



KOLÍK SÁZECÍ "T"

Č.p.	specifikace	
45038	280 mm	60



VYTRHÁVAČ PLEVELE

Č.p.	specifikace	
44955	950 mm	16



NŮŽ NA PLEVEL

Č.p.	specifikace	
45079	200 mm	1



NŮŽ NA PLEVEL

Č.p.	specifikace	
45080	200 mm „L“	1



LOPATKA SKLÁDACÍ 3 V 1

Č.p.	specifikace	
61085	410 mm	6



SAZEČ CIBULOVIN

INOX

Č.p.	specifikace	
45040	230 mm	60



ČESÁČEK NA OVOCE

Č.p.	specifikace	
45041		75



ČESÁČEK NA OVOCE

Č.p.	specifikace	
45039		50
45034	170 - 300 cm, teleskopická násada	5



STRUNA DO SEKAČKY S NYLONOVÝM STŘEDEM



Č.p.	specifikace	
45530	2 mm x 15 m	1
45531	2,4 mm x 15 m	1
45532	3 mm x 15 m	1
45533	3,15 mm x 15 m	1
45534	4 mm x 15 m	1

STRUNA DO SEKAČKY



Č.p.	specifikace	
45500	1,3 mm x 15 m	30
45502	1,3 mm x 15 m	30
45503	1,6 mm x 15 m	20
45505	1,6 mm x 15 m	20
45506	2 mm x 15 m	12
45508	2 mm x 15 m	12
45517	2 mm x 15 m	10
45509	2,4 mm x 15 m	12
45511	2,4 mm x 15 m	12
45512	2,4 mm x 15 m	12
45518	2,4 mm x 15 m	10
45523	2,7 mm x 15 m	10
45524	2,7 mm x 15 m	10
45513	3 mm x 15 m	10
45515	3 mm x 15 m	10
45516	3 mm x 15 m	10
45519	3 mm x 15 m	10



STRUNA DO SEKAČKY

Č.p.	specifikace	
45520	2 mm x 162 m	10
45521	2,4 mm x 112 m	10
45528	2,7 mm x 90 m	10
45522	3 mm x 72 m	10
45525	2 mm x 162 m	10
45526	2,4 mm x 112 m	10
45529	2,7 mm x 90 m	10
45527	3 mm x 72 m	10



BROUSEK NA KOSU

Č.p.	specifikace	
45046	205 x 15 mm	100



BROUSEK OVÁLNÝ

Č.p.	specifikace	
45370	250 x 33 x 18 mm	20



BROUSEK

Č.p.	specifikace	
45045	150 x 50 x 30 mm	10



BROUSEK NA NOŽE A NŮŽKY

Č.p.	specifikace	
45068		10



BROUSEK NA NOŽE A NŮŽKY

Č.p.	specifikace	
45048		20



BROUSEK NA NOŽE A NŮŽKY

Č.p.	specifikace	
16990	Ø 50 mm	50



BROUSEK NA NOŽE A NŮŽKY

Č.p.	specifikace	
16991		20



VÁZACÍ PÁSKY

Č.p.	specifikace	
45472	3 cm x 3 m, 3 ks	36



VÁZACÍ PÁSKA

Č.p.	specifikace	
45473	3 cm x 50 m	60



VÁZACÍ PÁSKA SUCHÝ ZIP

Č.p.	specifikace	
45471	12 mm x 5 m	1



DRÁT VÁZACÍ PVC

Č.p.	specifikace	
45043	30 m	30



DRÁT VÁZACÍ POGUMOVANÝ

Č.p.	specifikace	
23845	3 mm x 8 m	30
23846	4 mm x 6 m	30
23847	5 mm x 4 m	30



TYČ SKLOVLÁKNOVÁ

Č.p.	specifikace	
45036	180 cm Ø 7,9 mm	100



PÁSEK VÁZACÍ ZUBATÝ

50x

Č.p.	specifikace	
23840		20



TYČ SPIRÁLOVÁ K RAJČATŮM

Č.p.	specifikace	
44041	1,2 m, Ø 5,5 mm komaxit - zelená	10
44042	1,5 m, Ø 6 mm komaxit - zelená	10
44043	1,8 m, Ø 6 mm komaxit - zelená	10
45049	1,8 m, Ø 7 mm komaxit - zelená	10
45044	1,8 m, Ø 7 mm komaxit - stříbrná	10
44050	2,2 m, Ø 7 mm komaxit - zelená	10



SPOJKA PLASTOVÁ

Č.p.	specifikace	
45670	8 mm	10
45671	11 mm	10
45672	16 mm	10
45673	20 mm	10

MOQ 10



TYČ ZAHRADNÍ POPLASTOVANÁ

Č.p.	specifikace		Č.p.	specifikace		Č.p.	specifikace	
45650	90 cm Ø 8 mm	25	45655	150 cm Ø 11 mm	25	45659	180 cm Ø 16 mm	25
45651	120 cm Ø 8 mm	25	45656	180 cm Ø 11 mm	25	45660	210 cm Ø 16 mm	25
45652	150 cm Ø 8 mm	25	45661	210 cm Ø 11 mm	25	45662	150 cm Ø 20 mm	10
45653	90 cm Ø 11 mm	25	45657	120 cm Ø 16 mm	25	45663	180 cm Ø 20 mm	10
45654	120 cm Ø 11 mm	25	45658	150 cm Ø 16 mm	25	45664	210 cm Ø 20 mm	10

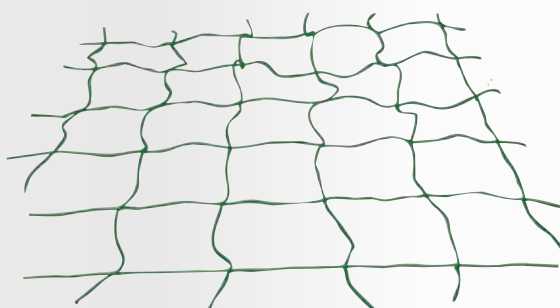

SÍŤ NA OKURKY

Č.p.	specifikace	velikost oka	
45560	2 x 10 m	10 x 10 cm	100

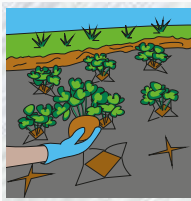

TEXTILIE NETKANÁ S VÝSEKY NA VÝSADBU JAHODNÍKU

uv
STABLE 45 g/m²

Č.p.	specifikace	
45535	1,6 x 5 m	18



TEXTILIE NETKANÁ MULČOVACÍ ČERNÁ

uv
STABLE 50 g/m²

Č.p.	specifikace	
45550	1,6 x 5 m	50
45551	1,6 x 10 m	20
45564	3,2 x 10 m	20
45552	1,6 x 50 m	v roli 1
45553	1,6 x 100 m	v roli 1
45562	3,2 x 50 m	v roli 1
45563	3,2 x 100 m	v roli 1



TEXTILIE NETKANÁ MULČOVACÍ HNĚDÁ

uv
STABLE 50 g/m²

Č.p.	specifikace	
45556	1,6 x 5 m	50
45557	1,6 x 10 m	20
45565	3,2 x 10 m	20
45558	1,6 x 50 m	v roli 1
45559	1,6 x 100 m	v roli 1



TEXTILIE NETKANÁ BÍLÁ

uv
STABLE 17 g/m²

Č.p.	specifikace	
45540	1,6 x 5 m	40
45541	1,6 x 10 m	40
45542	1,6 x 50 m	v roli 1
45543	1,6 x 100 m	v roli 1



KOLÍK KOTVÍCÍ K UPEVNĚNÍ NETKANÉ TEXTILIE

10x

Č.p.	specifikace	
45555	11,5 cm	1



STOLIČKA ZAHRADNÍ SKLÁDACÍ

• oboustranná - klekátko, sedátko

Č.p.	specifikace	
45074	58 x 48 x 28 cm	4



PODLOŽKA KLEKACÍ

Č.p.	specifikace	
45086	40 x 18 x 2 cm	50



KULTIVÁTOR

Č.p.	specifikace	
45042	160 x 132 cm	12



KULTIVÁTOR

Č.p.	specifikace	
44053		12
61251	160 cm násada	1



VOZÍK SYPACÍ

ROZMĚRY	
výška	111 cm
šířka	55 cm
objem zásobníku	12 l

Č.p.	specifikace	
45085	12 l	1



NÁDOBA PLAST - PRUŽNÁ



Č.p.	specifikace	
39192	30 l	20
39193	45 l	20

KOŠ NA LISTÍ, SKLÁDACÍ

Č.p.	specifikace	
45047	55 x 70 cm, 3 držadla	20



KOŠ SKLÁDACÍ

Č.p.	specifikace	
45093	40 x 25 x 23 cm	10

VAK NA LISTÍ

Č.p.	specifikace	
44960	200 l 60 x 60 x 55 cm	50

- PROFESIONÁLNÍ ZAVLAŽOVACÍ SORTIMENT
- KVALITNÍ MATERIÁLY A ZPRACOVÁNÍ
- MODERNÍ DESIGN
- KOMPATIBILNÍ S ŘADOU PRODUKTŮ ROSA

FESTA®
AQUATIC



FESTA®
AQUATIC

PISTOLE

- 7 funkcí
- přední spoušť s pojistkou
- snadná regulace průtoku



Č.p. specifikace

45386



12



FESTA®
AQUATIC

PISTOLE

- plynulá regulace proudu
- přední spoušť s pojistkou
- snadná regulace průtoku



Č.p. specifikace

45388



12



FESTA®
AQUATIC

ROZSTŘIKOVAČ

- plynulá regulace proudu



Č.p. specifikace

45389



24



FESTA®
AQUATIC

SADA S ROZSTŘIKOVAČEM

- plynulá regulace proudu



Č.p. specifikace

45385

4 ks



12



FESTA
AQUATIC
SPOJKA



Č.p. specifikace
45390

24



FESTA
AQUATIC
SPOJKA



Č.p. specifikace
45391

24



FESTA
AQUATIC
RYCHLOSPOJKA



Č.p. specifikace
45392

24



FESTA
AQUATIC
RYCHLOSPOJKA



Č.p. specifikace
45393

24



FESTA
AQUATIC
STOP RYCHLOSPOJKA



Č.p. specifikace
45394

24



FESTA
AQUATIC
STOP RYCHLOSPOJKA



Č.p. specifikace
45395

24



FESTA
AQUATIC
ADAPTÉR



Č.p. specifikace
45396

24



FESTA
AQUATIC
ADAPTÉR



Č.p. specifikace
45397

24

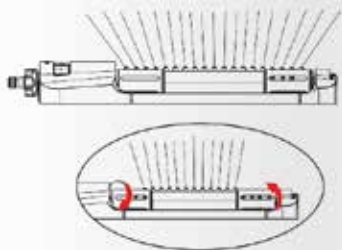

FESTA
AQUATIC

ZAVLAŽOVAČ VÝKYVNÝ

· 19 trysek, z toho 8 vypínatelných



Č.p. specifikace

45398



6

FESTA
AQUATIC

ZAVLAŽOVAČ ROTAČNÍ

· nastavitelná ramena s tryskami



Č.p. specifikace

45399



12



FESTA
AQUATIC

ROZDĚLOVAČ 2 CESTNÝ

· plynulá regulace průtoku



Č.p. specifikace

45400



6



FESTA
AQUATIC

ROZDĚLOVAČ 4 CESTNÝ

· plynulá regulace průtoku



Č.p. specifikace

45401



6



ROSA

Watering system



ROSA PISTOLE

- 10 funkcí
- přední spoušť s pojistkou

0,7 bar min
5,5 bar max



Č.p. specifikace

45124

12



ROSA PISTOLE

- 10 funkcí
- spoušť s pojistkou
- snadná regulace průtoku

0,7 bar min
5,5 bar max



Č.p. specifikace

45125

12



ROSA PISTOLE

- 7 funkcí
- spoušť s pojistkou

0,7 bar min
5,5 bar max



Č.p. specifikace

45126

12



ROSA PISTOLE DELUX

- 7 funkcí
- spoušť s pojistkou
- snadná regulace průtoku

0,7 bar min
5,5 bar max



Č.p. specifikace

45123

kovová

12



ROSA PISTOLE

- 6 funkcí
- spoušť s pojistkou
- snadná regulace průtoku

0,7 bar min
5,5 bar max



Č.p. specifikace

45117

12



ROSA PISTOLE DELUX

- 6 funkcí
- spoušť s pojistkou
- snadná regulace průtoku

0,7 bar min
5,5 bar max



Č.p. specifikace

45118

kovová hlavice

12



ROSA PISTOLE

- 5 funkcí
- spoušť s pojistkou
- snadná regulace průtoku

0,7 bar min
5,5 bar max



Č.p. specifikace

45110

12



ROSA PISTOLE

- pistole růžicová
- snadná regulace průtoku

0,7 bar min
5,5 bar max



Č.p. specifikace

45116

12



ROSA PISTOLE

- kovová hlavice
- spoušť s pojistkou
- snadná regulace průtoku

0,7 bar min
5,5 bar max



Č.p. specifikace

45120

12



ROSA PISTOLE

- spoušť s pojistkou
- snadná regulace průtoku

0,7 bar min
5,5 bar max



Č.p. specifikace

45115

12



ROSA PISTOLE

- kovová
- spoušť s pojistkou
- snadná regulace průtoku

0,7 bar min
5,5 bar max



Č.p. specifikace

45122

kovová

12



ROSA PISTOLE SADA

- spoušť s pojistkou
- snadná regulace průtoku

0,7 bar min
5,5 bar max

1/2"

2x



Č.p. specifikace

45114

1/2 rychlospojka

12



ROSA PISTOLE

- spoušť s pojistkou
- snadná regulace průtoku

0,7 bar min
5,5 bar max



Č.p. specifikace

45111

12



ROSA ROZSTŘIKOVAČ

- plynulá regulace proudu

0,7 bar min
5,5 bar max



Č.p. specifikace

45113

60

ROSA

ROZSTŘIKOVAČ

· proudnicový, klasické připojení



32

Č.p. specifikace

45112

ROSA

PISTOLE SADA

· 6 funkcí
· spoušť s pojistkou
· snadná regulace průtoku



4x



12

Č.p. specifikace

45181

ROSA

SOUPRAVA S ROZSTŘIKOVAČEM

· plynulá regulace proudu



4x



12

Č.p. specifikace

45180

ROSA

ROZDVOJKA "Y"

· s ventilem



12

Č.p. specifikace

45134

ROSA

SPOJKA



60

Č.p. specifikace

45140

ROSA

SPOJKA



MOQ 20



MOQ 20

Č.p. specifikace

45296

ROSA

RYCHLOSPOJKA



60

Č.p. specifikace

45142

ROSA

RYCHLOSPOJKA



MOQ 20



MOQ 20

Č.p. specifikace

45298



ROSA

STOP RYCHLOSPOJKA

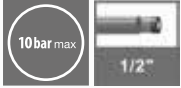

Č.p. specifikace

45138



60



ROSA

STOP RYCHLOSPOJKA



Č.p. specifikace

45294

MOQ
20



MOQ 20



ROSA

SPOJKA



Č.p. specifikace

45141



60



ROSA

SPOJKA



Č.p. specifikace

45297

MOQ
20



MOQ 20



ROSA

RYCHLOSPOJKA



Č.p. specifikace

45143



60



ROSA

RYCHLOSPOJKA



Č.p. specifikace

45299

MOQ
20



MOQ 20



ROSA

STOP RYCHLOSPOJKA



Č.p. specifikace

45139



60



ROSA

STOP RYCHLOSPOJKA



Č.p. specifikace

45295

MOQ
20



MOQ 20



ROSA
ADAPTÉR



Č.p.	specifikace	
45130	1/2" + 3/4"	60
45131	3/4" + 1"	60

ROSA
ADAPTÉR



Č.p.	specifikace	
45289	1/2" + 3/4"	MOQ 20
45290	3/4" + 1"	MOQ 20

MOQ 20



ROSA
RYCHLOSPOJKA SADA



2x



Č.p.	specifikace	
45144		60



ROSA
REDUKCE 1/2" - 3/4"



Č.p.	specifikace	
45213	1/2" - 3/4"	60



ROSA
SPOJOVACÍ VENTIL

* s ventilem



Č.p.	specifikace	
45135		60



ROSA
ADAPTÉR



Č.p.	specifikace	
45145		60



ROSA
ADAPTÉR



Č.p.	specifikace	
45132		60

ROSA
ADAPTÉR

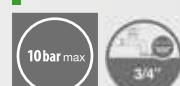

Č.p.	specifikace	
45291		MOQ 20

MOQ 20





ROSA
ADAPTÉR



Č.p. specifikace
45133

60



ROSA
ADAPTÉR



Č.p. specifikace
45292

MOQ
20



MOQ 20



ROSA
ADAPTÉR



Č.p. specifikace
45136

60



ROSA
ADAPTÉR



Č.p. specifikace
45293

MOQ
20



MOQ 20



ROSA
ADAPTÉR



Č.p. specifikace
45137



60

ROSA
ADAPTÉR



Č.p. specifikace
45215



48



ROSA
SPOJKA



Č.p. specifikace
45218



48



ROSA
RYCHLOSPOJKA



Č.p. specifikace
45219



48



ROSA

REDUKCE 3/4" - 1"

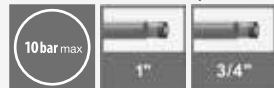

Č.p. specifikace

45216

48



ROSA

ADAPTÉR



Č.p. specifikace

45217

48

ROSA

PRODEJNÍ SADA

· obsah sady

45113 15 ks
45117 10 ks
45120 15 ks
45132 40 ks
45131 40 ks
45133 40 ks
45142 25 ks
45143 20 ks
45140 20 ks

225x



Č.p. specifikace

45146



1



ROSA

POSTŘIKOVACÍ HUBICE

· plynulá regulace proudu



Č.p. specifikace

45214

48

ROSA

ZAVLAŽOVAČ IMPULSNÍ

· impulsní



Č.p. specifikace

45162

24



ROSA

ZAVLAŽOVAČ

· 8 funkcí



Č.p. specifikace

45154

48



ROSA

ZAVLAŽOVAČ

· rotační
· 2 ramena



Č.p. specifikace

45153

24



ROSA

ZAVLAŽOVAČ

· rotační
· 3 ramena



Č.p. specifikace

45152

24





ROSA

ZAVLAŽOVAČ VÝKYVNÝ

· 17 trysek



ALU



Č.p. specifikace
45158

6



ROSA

ZAVLAŽOVAČ

· pyramidový



Č.p. specifikace
45167

12



ROSA

ZAVLAŽOVAČ

· hrotový



Č.p. specifikace
45160

25



ROSA

ZAVLAŽOVAČ

· konvicový s ventilem



Č.p. specifikace
45156

12



ROSA

PODSTAVEC PRO IMPULSNÍ ZAVLAŽOVAČ



Č.p. specifikace
45155

24



ROSA

ZAVLAŽOVAČ IMPULSNÍ

· na trojnožce



Č.p. specifikace
45163 impulsní na trojnožce

20



ROSA

ČASOVAČ

· 0 - 120 min.



Č.p. specifikace
45147

24



ROSA

ZAVLAŽOVAČ IMPULSNÍ

· mosazný

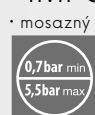

Č.p. specifikace
45150

12



ROSA
ZAVLAŽOVAČ IMPULSNÍ



Č.p.	specifikace	
45151		12

ROSA
ZAVLAŽOVAČ IMPULSNÍ, HROTOVÝ



Č.p.	specifikace	
45168	plastový hrot	12
45169	kovový hrot	12



ROSA
ZAVLAŽOVAČ IMPULSNÍ, HROTOVÝ



Č.p.	specifikace	
45161	plastový hrot	20

ROSA
ZAVLAŽOVAČ ROTAČNÍ, HROTOVÝ

- 3 ramena
- dvoucestný



Č.p.	specifikace	
45164	plastový hrot	12



ROSA
HROTOVÝ PODSTAVEC



Zn



Č.p.	specifikace	
45159		12

ROSA
HROTOVÝ PODSTAVEC



Č.p.	specifikace	
45179		12

ROSA
VODIČ HADICE



Č.p.	specifikace	
45186		48



ROSA
ZAVLAŽOVAČ IMPULSNÍ



Č.p.	specifikace	
45185		20

ROSA
ZAVLAŽOVAČ IMPULSNÍ



Č.p.	specifikace	
45184		20

ROSA**SADA TĚSNĚNÍ**

· pro položky

45110, 45111, 45118,
45120, 45121, 45123,
45125, 45126, 45130,
45131, 45132, 45134,
45135, 45152, 45153,
45154, 45155, 45156,
45162, 45177, 45178,
45180, 45196, 45197,
45198**ROSA****TĚSNĚNÍ NA SPOJKY A KONEKTORY****50x**

Č.p.	specifikace	
45175		1

Č.p.	specifikace	
45187		1

**ROSA****NAVÍJEČ NA HADICI**

· včetně hadice 1/2" 20 m

ROSA**DRŽÁK NA HADICI**

Č.p.	specifikace	
45182	1/2" 40 m	4

Č.p.	specifikace	
45176	0,7 bar min 5,5 bar max 1/2"	1

**ROSA****VOZÍK NA HADICI KOVOVÝ**

Č.p.	specifikace	
45183	1/2" 60 m	5

ROSA**VOZÍK NA HADICI**

Č.p.	specifikace	
45177	1/2" 60 m	5

ROSA**DRŽÁK NA HADICI**

Č.p.	specifikace	
45178	1/2" 60 m	5



ROSA
SPRCHA

0,7 bar min
5,5 bar max

Č.p.	specifikace	
45171	stavitelná	12



ROSA
SPRCHA

0,7 bar min
5,5 bar max

Č.p.	specifikace	
45170	3 nohy	6



ROSA
SPRCHA - RUČNÍ

0,7 bar min
5,5 bar max

Č.p.	specifikace	
45172	s ventilem	12
45173	10 funkcí	12



ROSA
DRŽÁK HADIC

Č.p.	specifikace	
45174		60



HADICE ZAHRADNÍ
PRŮHLEDNÁ



Č.p.	specifikace	
45345	1/2" 25 m	1
45349	3/4" 25 m	1
45353	1" 25 m	1



HADICE ZAHRADNÍ
NEPRŮHLEDNÁ



Č.p.	specifikace	
45360	1/2" 25 m	1
45364	3/4" 25 m	1
45366	1" 25 m	1



ROSA
SPIRÁLOVÁ HADICE
SADA

0,7 bar min
5,5 bar max

Č.p.	specifikace	
45300	7,5 m	6
45301	15 m	8



NOSIČ HADIC

• max. 30 m, 1/2" zahradní hadice

Č.p.	specifikace	
45350	max. nosnost 20 kg	1



ROSA
SPOJKA MOSAZ

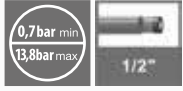

Č.p. specifikace 
45192 48



ROSA
RYCHLOSPOJKA MOSAZ

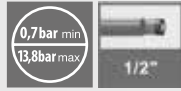

Č.p. specifikace 
45194 48



ROSA
STOP RYCHLOSPOJKA
MOSAZ



Č.p. specifikace 
45190 48



ROSA
SPOJKA MOSAZ



Č.p. specifikace 
45193 48



ROSA
RYCHLOSPOJKA MOSAZ



Č.p. specifikace 
45195 48



ROSA
STOP RYCHLOSPOJKA
MOSAZ



Č.p. specifikace 
45191 48



ROSA
ADAPTÉR MOSAZ



Č.p. specifikace 
45196 s vnitřním závitem 1/2" + 3/4" 48



ROSA
ADAPTÉR MOSAZ



Č.p. specifikace 
45197 s vnitřním závitem 3/4" 48



ROSA
ADAPTÉR MOSAZ



Č.p. specifikace 
45199 s vnitřním závitem 1" 48



ROSA
ADAPTÉR MOSAZ



Č.p. specifikace 
45198 s vnitřním závitem 3/4 + 1" 48



ROSA
ADAPTÉR MOSAZ



Č.p. specifikace 
45200 s vnějším závitem 3/4" 48



ROSA
POSTŘIKOVACÍ HUBICE MOSAZ



Č.p. specifikace 
45206 stavitelná 48



ROSA

ADAPTÉR MOSAZ



Č.p.	specifikace	
45203	mezikus pro 2 rychlospojky	48



ROSA

ADAPTÉR MOSAZ



Č.p.	specifikace	
45204	mezikus pro 3 rychlospojky	48



ADAPTÉR



Č.p.	specifikace	
45211	vnitřní závit 1"	25



HADICOVÁ SPOJKA

Č.p.	specifikace	
45220	1/2" závit 3/4"	10
45221	3/4" závit 1"	10
45222	1" závit 1"	10



HADICOVÁ KONCOVKA

Č.p.	specifikace	
45223	1/2" závit 3/4"	10
45224	3/4" závit 1"	10
45225	1" závit 1"	10



HADICOVÁ REDUKCE

Č.p.	specifikace	
45226	1/2" - 3/4" závit 1"	10
45227	1" - 3/4" závit 1"	10
45228	1" - 1/2" závit 1"	10



ROZPRAŠOVAČ

Č.p.	specifikace	
45229		10



SPONA HADICOVÁ

Zn **MOQ 2**

Č.p.	průměr	
45600	8 - 12 mm	2
45601	10 - 16 mm	2
45602	12 - 20 mm	2

Č.p.	průměr	
45603	16 - 25 mm	2
45604	20 - 32 mm	2
45605	25 - 40 mm	2
45606	30 - 45 mm	2
45607	32 - 50 mm	2
45608	40 - 60 mm	2
45609	50 - 70 mm	2
45610	60 - 80 mm	2
45611	70 - 90 mm	2
45612	80 - 100 mm	2
45613	90 - 110 mm	2
45614	100 - 120 mm	2
45615	110 - 130 mm	2
45616	120 - 140 mm	2
45617	130 - 150 mm	2
45618	140 - 160 mm	2
45619	150 - 170 mm	2



SPONA HADICOVÁ

INOX **MOQ 2**

Č.p.	průměr	šířka	
45620	8 - 12 mm	9 mm	2
45621	10 - 16 mm	9 mm	2
45622	12 - 20 mm	9 mm	2

Č.p.	průměr	šířka	
45623	16 - 25 mm	9 mm	2
45624	20 - 32 mm	9 mm	2
45625	25 - 40 mm	12 mm	2
45626	30 - 45 mm	12 mm	2
45627	32 - 50 mm	12 mm	2
45628	40 - 60 mm	12 mm	2
45629	50 - 70 mm	12 mm	2
45630	60 - 80 mm	12 mm	2
45631	70 - 90 mm	12 mm	2
45632	80 - 100 mm	12 mm	2
45633	90 - 110 mm	12 mm	2
45634	100 - 120 mm	12 mm	2
45635	110 - 130 mm	12 mm	2
45636	120 - 140 mm	12 mm	2
45637	130 - 150 mm	12 mm	2
45638	140 - 160 mm	12 mm	2
45639	150 - 170 mm	12 mm	2



VENTILY A ZAVLAŽOVACÍ KONVE



VENTIL ZAHRADNÍ DVOJITÝ

č.p.	specifikace	
45105		8



VENTIL ZAHRADNÍ

č.p.	specifikace	
45100	1/2"	12
45101	3/4"	10
45102	1"	6



VENTIL KULOVÝ

č.p.	specifikace	
45106	1/2"	12
45107	3/4"	10
45108	1"	8



ROHÁČEK

č.p.	specifikace	
45104	1/2" x 3/8"	10



KONEV PLASTOVÁ



č.p.	specifikace	
45280	2,5 l	10
45283	5 l	10
45285	10 l	10
45286	12 l	10
45287	15 l	10



FESTA

POSTŘIKOVAČ TLAKOVÝ ZAHRADNÍ 12 L

max. tlak	2,5 Bar
objem	12 l
délka hadice	3 m
rozměry	32 x 25 x 59 cm



Č.p.	specifikace	
45249	postřikovač tlakový zahradní 12 l	1
45273	pistole náhradní	1
45274	tlaková hadice náhradní	1

FESTA

ČISTIČ VYSOKOTLAKÝ

napětí/ frekvence	230 V/50 Hz
příkon	1500 W
maximální tlak	120 Bar
pracovní tlak	80 Bar
průtok vody	6 l
délka hadice	5 m
krytí	IPX5
funkce	Auto Stop



Č.p.	specifikace	
45270	čistič vysokotlaký	1
45271	pistole náhradní	1
45272	tlaková hadice náhradní	1



FESTA

POSTŘIKOVAČ TLAKOVÝ ZAHRADNÍ

Č.p.	specifikace	
45247	12 l	1
45248	16 l	1



Č.p.	specifikace	
45263	náhradní hadička k postřikovači	1
45251	náhradní sada těsnění	1
45254	náhradní tryska	1
45257	náhradní rukojeť	1
45260	náhradní tyč - 370 mm	1
45267	náhradní tyč 45 - 250 cm	1
45268	náhradní tyč 65 - 260 cm	1



FESTA

POSTŘIKOVAČ TLAKOVÝ ZAHRADNÍ

Č.p.	specifikace	
45244	3 l	6
45245	5 l	6
45246	8 l	6



Č.p.	specifikace	
45262	náhradní hadička k postřikovači	1
45250	náhradní sada těsnění	1
45253	náhradní tryska	1
45256	náhradní rukojeť	1
45261	náhradní tyč - 370 mm	1

**FESTA****POSTŘIKOVAČ RUČNÍ TLAKOVÝ**

Č.p.	typ	
45242	1,5 l	20
45241	2 l	20

**POSTŘIKOVAČ RUČNÍ**

MADE IN EU

Č.p.	typ	
45239	0,5 l	1
45240	0,7 l	1

**TYČ K POSTŘIKOVAČI TELESKOPIČKÁ**

Č.p.	typ	
45267	45 - 250 cm	inox 1
45268	65 - 260 cm	fiberglass 1

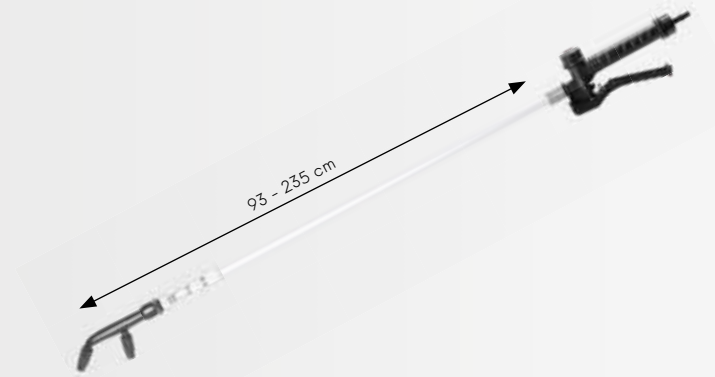
**TYČ K POSTŘIKOVAČI TELESKOPIČKÁ**

Č.p.	specifikace	
45269		1

**NÁHRADNÍ HADIČKA K POSTŘIKOVAČI**

Č.p.	typ	
45263	pro postřikovač 45247, 45248	1
45262	pro postřikovač 45244, 45245, 45246	1

**ZVON HERBICIDNÍ**

• pro postřikovače 45247, 45248, 45249

Č.p.	velikost	délka	šířka	výška	
45265	malý	230 mm	90 mm	130 mm	1
45266	velký	370 mm	140 mm	200 mm	1

FESTA[®]



HRÁBĚ



FESTA

HRÁBĚ PLASTOVÉ

Č.p.	počet lamel	šířka	výška	
45327	13	24 cm	200 cm	12



FESTA

SET HRÁBĚ PLASTOVÉ,
HLINÍKOVÁ NÁSADA

MOQ
3

Č.p.	počet lamel	délka násady	
61136	13	160 cm	3
61147	13	100 cm	3



FESTA

HRÁBĚ PLASTOVÉ

Č.p.	počet lamel	šířka	výška	
45328	23	48 cm	28 cm	12



FESTA

SET HRÁBĚ PLASTOVÉ,
HLINÍKOVÁ NÁSADA

MOQ
3

Č.p.	počet lamel	délka násady	
61137	23	160 cm	3
61148	23	100 cm	3

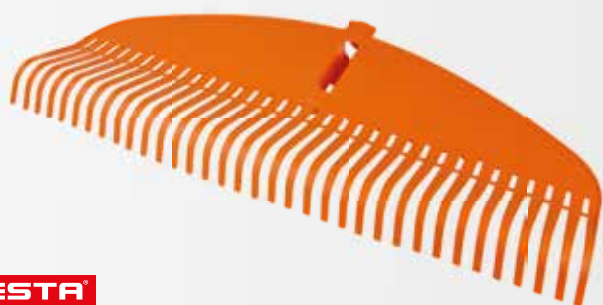

FESTA

HRÁBĚ PLASTOVÉ

Č.p.	počet lamel	šířka	výška	
45329	35	76 cm	31 cm	1



FESTA

SET HRÁBĚ PLASTOVÉ,
HLINÍKOVÁ NÁSADA

MOQ
3

Č.p.	počet lamel	délka násady	
61138	35	160 cm	3

**FESTA**

HRÁBĚ PLASTOVÉ

Č.p.	počet lamel	šířka	
45325	12	41 cm	12

**FESTA**

SET HRÁBĚ PLASTOVÉ, HLINÍKOVÁ NÁSADA

MOQ
3

Č.p.	počet lamel	délka násady	
61139	12	160 cm	3

**FESTA**

HRÁBĚ PLASTOVÉ

Č.p.	počet lamel	šířka	
45326	18	58 cm	12

**FESTA**

SET HRÁBĚ PLASTOVÉ, HLINÍKOVÁ NÁSADA

MOQ
3

Č.p.	počet lamel	délka násady	
61140	18	160 cm	3



SMETÁK

Č.p.	specifikace	
45323	37 cm	16



SET SMETÁK, NÁSADA

MOQ
3

Č.p.	specifikace	délka násady	
61149	37 cm	160 cm (45330)	3

**FESTA**

HRÁBĚ KOVOVÉ STAVITELNÉ, TELESKOPICKÉ

Zn

Č.p.	počet lamel	rozsah	
44965	15	20 - 59 cm	12



HRÁBĚ KOVOVÉ STAVITELNÉ

Zn

Č.p.	počet lamel	váha	rozsah	
45050	15	1200 g	20 - 59 cm	25



FESTA

HRÁBĚ KOVOVÉ LAMELOVÉ

pružinová ocel

Č.p.	počet lamel	šířka	
45071	22	55 cm	1



FESTA

HRÁBĚ KOVOVÉ LAMELOVÉ, S NÁSADOU

MOQ
3

Č.p.	šířka	délka násady	
61150	55 cm	160 cm	3



HRÁBĚ KOVOVÉ LAMELOVÉ

Č.p.	počet lamel	šířka	
45051	22	40 cm	60



HRÁBĚ KOVOVÉ LAMELOVÉ, S NÁSADOU

MOQ
3

Č.p.	šířka	délka násady	
61130	40 cm	160 cm	3



HRÁBĚ KOVOVÉ DRÁTOVÉ

Č.p.	počet lamel	šířka	
45052	22	45 cm	36



HRÁBĚ KOVOVÉ S NÁSADOU

MOQ
3

Č.p.	šířka	délka násady	
61131	45 cm	160 cm	3



HRÁBĚ PLASTOVÉ

MADE IN EU

Č.p.	počet lamel	šířka	
45320	24	60 cm	10



HRÁBĚ PLASTOVÉ S NÁSADOU

MOQ
3

Č.p.	počet lamel	šířka	délka násady	
61132	24	60 cm	160 cm	3



HRÁBĚ PLASTOVÉ

MADE IN EU

Č.p.	počet lamel	šířka	
45055	22	50 cm	10



HRÁBĚ PLASTOVÉ S NÁSADOU

MOQ
3

Č.p.	počet lamel	šířka	délka násady	
61133	22	50 cm	160 cm	3



HRÁBĚ PLASTOVÉ



Č.p.	počet lamel	šířka	
45321	23	40 cm	20



HRÁBĚ PLASTOVÉ S NÁSADOU

MOQ
3

Č.p.	počet lamel	délka násady	
61134	23	160 cm	3



HRÁBĚ PLASTOVÉ



Č.p.	počet lamel	šířka	
45054	23	40 cm	10



HRÁBĚ PLASTOVÉ S NÁSADOU

MOQ
3

Č.p.	počet lamel	šířka	délka násady	
61135	23	40 cm	160 cm	3



HRÁBĚ PLASTOVÉ



Č.p.	počet lamel	šířka	
45053	16	58 cm	35



HRÁBĚ PLASTOVÉ S NÁSADOU

MOQ
3

Č.p.	počet lamel	šířka	délka násady	
61141	16	58 cm	160 cm	3



HRÁBĚ PLASTOVÉ, SE ZAROVNÁVACÍ HRANOU



Č.p.	počet zubů	šířka	
45070	14	41 cm	4



HRÁBĚ PLASTOVÉ, SE ZAROVNÁVACÍ HRANOU, S NÁSADOU

MOQ
3

Č.p.	počet zubů	šířka	délka násady	
61142	14	41 cm	160 cm	3

HRÁBĚ KOVOVÉ

Č.p.	počet zubů	šířka	
61030	10	24 cm	24
61031	12	29 cm	24
61032	14	34 cm	24
61033	16	40 cm	24

HRÁBĚ KOVOVÉ S NÁSADOU

 MOQ
3

Č.p.	počet zubů	šířka	délka násady	
61060	10	24 cm	160 cm	3
61061	12	29 cm	160 cm	3
61062	14	34 cm	160 cm	3
61063	16	40 cm	160 cm	3

HRÁBĚ VERTIKUTAČNÍ KOVOVÉ

· kladivkový lak

Č.p.	počet zubů	šířka	
61045	12	30 cm	25
61046	14	39 cm	25
61047	16	45 cm	25

HRÁBĚ VERTIKUTAČNÍ S NÁSADOU

· kladivkový lak

 MOQ
3

Č.p.	počet zubů	šířka	délka násady	
61143	12	30 cm	160 cm	3
61144	14	39 cm	160 cm	3
61145	16	45 cm	160 cm	3

HRÁBĚ VERTIKUTAČNÍ

Č.p.	počet zubů	šířka	
61048	11 21	35 cm	12

HRÁBĚ VERTIKUTAČNÍ S NÁSADOU

 MOQ
3

Č.p.	počet zubů	šířka	délka násady	
61146	11 21	35 cm	160 cm	3

HRÁBĚ KOVOVÉ S NÁSADOU, FIBERGLASS

 MOQ
3

Č.p.	počet zubů	šířka	délka násady	
61034	14	34 cm	160 cm	3

RÝČE
A LOPATY

FESTA®

FESTA®

RÝČ ŠPIČATÝ MALÝ

· vhodný pro práci ve skleníku

Č.p.	specifikace	délka násady	
61008	19 x 28 cm	85 cm	5

FESTA®

RÝČ OBLÝ

Č.p.	specifikace	délka násady	
61005	20 x 29 cm	120 cm	5

FESTA®

RÝČ ŠPIČATÝ

Č.p.	specifikace	délka násady	
61006	19 x 28 cm	120 cm	5

FESTA®

RÝČ OBLÝ, PRODLOUŽENÝ

· pro postavy vyšší 180 cm

Č.p.	specifikace	délka násady	
61157	20 x 29 cm	130 cm	5

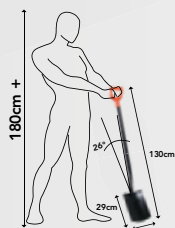

FESTA®

RÝČ ŠPIČATÝ, PRODLOUŽENÝ

· pro postavy vyšší 180 cm

Č.p.	specifikace	délka násady	
61158	19 x 28 cm	130 cm	5

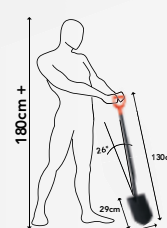

FESTA®

LOPATA STANDARD

Č.p.	specifikace	délka násady	
61155	24 x 29 cm	120 cm	5

FESTA®

VIDLE

Č.p.	specifikace	délka násady	
61156	19 x 28 cm	130 cm	5

FESTA
RYČÍ VIDLE

Č.p.	specifikace	délka násady	
61007	18 x 28 cm	130 cm	5

RYČÍ VIDLE, NÁSADA FIBERGLASS

Č.p.	specifikace	délka násady	
61010	18 x 30 cm	95 cm	12

RYČ ŠPIČATÝ, NÁSADA FIBERGLASS

Č.p.	specifikace	délka násady	
61029	19 x 30 cm	95 cm	12

RYČ OBLÝ, NÁSADA FIBERGLASS

Č.p.	specifikace	délka násady	
61015	19 x 30 cm	95 cm	12

LOPATA HLINÍKOVÁ

Č.p.	specifikace	
61026	26 x 29 cm	10
61025	34 x 30 cm	10

LOPATA HLINÍKOVÁ S NÁSADOU

• buková násada kolínko

 MOQ
3

Č.p.	specifikace	délka násady	
61057	26 x 29 cm	130 cm	3
61056	34 x 30 cm	130 cm	3

LOPATA UHELNÁ

Č.p.	specifikace	
61021	35 x 35 cm	10

LOPATA UHELNÁ S NÁSADOU

 MOQ
3

Č.p.	specifikace	délka násady	
61089	35 x 35 cm	130 cm	3



LOPATA SRDCOVKA S NÁSADOU

- kladivkový lak
- buková násada kolínko

MOQ
3

Č.p.	specifikace	délka násady	
61050	26 x 28 cm	130 cm	3



LOPATA SRDCOVKA

- kladivkový lak

Č.p.	specifikace	
61000	26 x 28 cm	12



LOPATA SRDCOVKA S NÁSADOU

- buková násada kolínko

MOQ
3

Č.p.	specifikace	délka násady	
61088	26 x 28 cm	130 cm	3



LOPATA SRDCOVKA

Č.p.	specifikace	
61020	26 x 28 cm	12



LOPATA STANDARD S NÁSADOU

- kladivkový lak
- buková násada kolínko

MOQ
3

Č.p.	specifikace	délka násady	
61051	24 x 29 cm	130 cm	3



LOPATA STANDARD

- kladivkový lak

Č.p.	specifikace	
61001	24 x 29 cm	12



LOPATA STANDARD S NÁSADOU

- buková násada kolínko

MOQ
3

Č.p.	specifikace	délka násady	
61090	24 x 29 cm	130 cm	3
61053	24 x 29 cm	130 cm "T _n " násada	3



LOPATA STANDARD

Č.p.	specifikace	
61022	24 x 29 cm	12





LOPATA HOLŠTÝNSKÁ

Č.p.	specifikace	
61058	25 x 27 cm	12



LOPATA HOLŠTÝNSKÁ S NÁSADOU

· buková násada kolínko

MOQ
3

Č.p.	specifikace	délka násady	
61059	25 x 27 cm	130 cm	3



LOPATA ÚZKÁ

· kladivkový lak

Č.p.	specifikace	
61002	19 x 27 cm	12



LOPATA ÚZKÁ S NÁSADOU

· kladivkový lak
· buková násada kolínko

MOQ
3

Č.p.	specifikace	délka násady	
61052	19 x 27 cm	130 cm	3



LOPATA ÚZKÁ

Č.p.	specifikace	
61024	19 x 27 cm	12



LOPATA ÚZKÁ S NÁSADOU

· buková násada kolínko

MOQ
3

Č.p.	specifikace	délka násady	
61054	19 x 27 cm	130 cm	3



RÝČ ŠPIČATÝ

· kladivkový lak

Č.p.	specifikace	
61004	22 x 30 cm	12



RÝČ ŠPIČATÝ S "T," NÁSADOU

· kladivkový lak

MOQ
3

Č.p.	specifikace	délka násady	
61161	22 x 30 cm	90 cm	3



RÝČ ŠPIČATÝ S "T,, NÁSADOU

MOQ
3

Č.p.	specifikace	délka násady	
61097	19 x 30 cm	90 cm	3



RÝČ ŠPIČATÝ

Č.p.	specifikace	
61019	22 x 30 cm	12



RÝČ KOVANÝ, ŠPIČATÝ, S "T,, NÁSADOU

Č.p.	specifikace	délka násady	MOQ
61162	22 x 25 cm	90 cm	3
61223	násada	90 cm	1



RÝČ KOVANÝ, ŠPIČATÝ

Č.p.	specifikace	
61013	22 x 25 cm	12



RÝČ OBLÝ S "T,, NÁSADOU

· kladívkový lak

MOQ
3

Č.p.	specifikace	délka násady	
61163	21 x 30 cm	90 cm	3



RÝČ OBLÝ

· kladívkový lak

Č.p.	specifikace	
61003	21 x 30 cm	12



RÝČ OBLÝ S "T,, NÁSADOU

MOQ
3

Č.p.	specifikace	délka násady	
61098	21 x 30 cm	90 cm	3



RÝČ OBLÝ

Č.p.	specifikace	
61018	21 x 30 cm	12



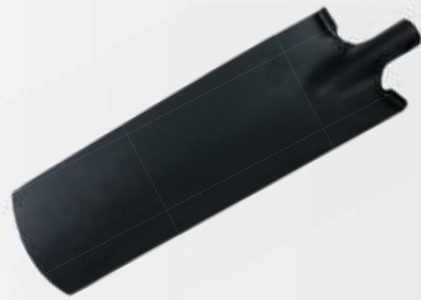

RÝČ ŠTYCHAR

Č.p.	specifikace	
61014	14 x 37 cm	12



RÝČ ŠTYCHAR S "T," NÁSADOU

Č.p.	specifikace	délka násady	
61164	14 x 37 cm	90 cm	MOQ 3
61203	násada	90 cm	1



VIDLE NA SENO

Č.p.	specifikace	
61009	20 x 32 cm	12



VIDLE NA SENO S NÁSADOU

Č.p.	specifikace	délka násady	
61165	20 x 32 cm	90 cm	MOQ 3

• buková násada kolníko



VIDLE RYČÍ KOVANÉ

Č.p.	specifikace	
61012	22 x 30 cm	12



VIDLE RYČÍ KOVANÉ S "T," NÁSADOU

Č.p.	specifikace	délka násady	
61166	22 x 30 cm	90 cm	MOQ 3
61222	násada	90 cm	1



RYČÍ VIDLE

Č.p.	specifikace	
61044	20 x 30 cm	12



RYČÍ VIDLE S "T," NÁSADOU

Č.p.	specifikace	délka násady	
61028	20 x 30 cm	90 cm	MOQ 3
61209	násada	90 cm	1

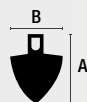

MOTYKA KOVANÁ, ŠPIČATÁ, S NÁSADOU

Č.p.	specifikace	délka násady	MOQ	
61111	0,4 kg	120 cm	3	
61112	0,6 kg	120 cm	3	
61224	násada	120 cm	1	

MOTYKA KOVANÁ, ŠPIČATÁ

Č.p.	specifikace	A	B	MOQ	
61035	0,4 kg	18 cm	12,5 cm	1	
61036	0,6 kg	23 cm	16 cm	30	

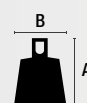

MOTYKA PLOCHÁ, KOVANÁ, S NÁSADOU

Č.p.	specifikace	délka násady	MOQ	
61114	0,6 kg	120 cm	3	
61224	násada	120 cm	1	

MOTYKA KOVANÁ, PLOCHÁ

Č.p.	specifikace	A	B	MOQ	
61038	0,6 kg	16,5 cm	13,5 cm	20	



KRUMPÁČ KOVANÝ S NÁSADOU

MOQ
3

Č.p.	specifikace	délka násady	MOQ	
61121	1,5 kg	95 cm	3	
61042	2,5 kg	95 cm	3	

KRUMPÁČ KOVANÝ

Č.p.	specifikace	MOQ	
61120	1,5 kg	6	
61040	2,5 kg	6	





MOTYKA

Č.p.	specifikace	
61067	75 mm	1
61068	125 mm	1
61069	175 mm	1



MOTYKA S NÁSADOU

MOQ
3

Č.p.	specifikace	délka násady	
61290	75 mm	120 cm	3
61291	125 mm	120 cm	3
61292	175 mm	120 cm	3



MOTYKA SRDCOVÁ

Č.p.	specifikace	
61070	140 mm	40



MOTYKA SRDCOVÁ S NÁSADOU

MOQ
3

Č.p.	specifikace	délka násady	
61293	140 mm	120 cm	3



MOTYKA PLOCHÁ S NÁSADOU

Č.p.	specifikace	délka násady	MOQ	
61294	140 mm	27 cm	3	
61221	násada	27 cm	1	



MOTYKA SRDCOVÁ S NÁSADOU

Č.p.	specifikace	délka násady	MOQ	
61295	140 mm	27 cm	3	
61221	násada	27 cm	1	



MOTYKA PLEČKA S NÁSADOU

Č.p.	specifikace	délka násady	MOQ	
61296	175 mm	27 cm	3	
61221	násada	27 cm	1	



DRÁBEK SE 3 HROTY S NÁSADOU

Č.p.	specifikace	délka násady	MOQ	
61297		27 cm	3	
61221	násada	27 cm	1	



120 cm

80 cm



• ilustrační foto

REKLAMNÍ STOJAN NA LOPATY A RÝČE

Č.p.	specifikace	
61077	stojan osazený	1
61079	stojan s paletou	1



• ilustrační foto

DRŽÁK ZAHRADNÍHO NÁŘADÍ

Č.p.	specifikace	
51185	45 cm	15

• otočné gumové válečky



DRŽÁK ZAHRADNÍHO NÁŘADÍ

5x		
Č.p.	specifikace	
51184		12



SRP

Č.p.	specifikace	
45490	450 mm	1



FESTA
KARTÁČ OCELOVÝ

Č.p.	specifikace	
22135	6 x 19 cm bez násady	8
22137	6 x 19 cm s násadou 140 cm	MOQ 3



FESTA
KARTÁČ NYLONOVÝ

Č.p.	specifikace	
22136	6 x 19 cm bez násady	8
22138	6 x 19 cm s násadou 140 cm	MOQ 3



KARTÁČ OCELOVÝ NA ČIŠTĚNÍ SPÁR S NÁSADOU

Č.p.	délka násady	
52198	140 cm	1



SMETÁČEK
MADE IN EU

Č.p.	specifikace	
52119	29 cm	24



SMETÁČEK S LOPATKOU

MADE IN EU

Č.p.	specifikace	
52168		26



SMETÁČEK S LOPATKOU

MADE IN EU

Č.p.	specifikace	
52173		26



FESTA
LOPATKA PLECHOVÁ - ZESÍLENÁ

Č.p.	specifikace	
52176	22 x 23 cm	24



LOPATKA PLECHOVÁ

Zn

Č.p.	specifikace	
52175	22 x 23 cm	50

SMETÁK S NÁSADOU



Č.p.	specifikace	MOQ
52197	30 cm 120 cm dřevěná	3

Č.p.	specifikace	MOQ
52197	30 cm 120 cm dřevěná	3



SMETÁK



Č.p.	specifikace	MOQ
52108	30 cm hrubý závit	25
61172	násada 120 cm hrubý závit	1

SET SMETÁK, NÁSADA

Č.p.	specifikace	délka násady	MOQ
61149	37 cm	160 cm	3

Č.p.	specifikace	délka násady	MOQ
61149	37 cm	160 cm	3



system click
ON - OFF

SMETÁK

Č.p.	specifikace	MOQ
45323	37 cm	16

Č.p.	specifikace	MOQ
45323	37 cm	16

SMETÁK S NÁSADOU



Č.p.	specifikace	délka násady	MOQ
52190	30 cm	150 cm	3
52191	40 cm	150 cm	3
52192	50 cm	150 cm	3
52193	60 cm	150 cm	3
52194	80 cm	150 cm	3

Č.p.	specifikace	délka násady	MOQ
52190	30 cm	150 cm	3
52191	40 cm	150 cm	3
52192	50 cm	150 cm	3
52193	60 cm	150 cm	3
52194	80 cm	150 cm	3



Ø 22 mm

SMETÁK

Č.p.	specifikace	MOQ
52101	30 cm	10
52102	40 cm	10
52103	50 cm	10
52104	60 cm	10
52105	80 cm	10

Č.p.	specifikace	MOQ
52101	30 cm	10
52102	40 cm	10
52103	50 cm	10
52104	60 cm	10
52105	80 cm	10

SÁLOVÝ SMETÁK S NÁSADOU



Č.p.	specifikace	délka násady	MOQ
52185	40 cm	150 cm	3
52186	50 cm	150 cm	3
52187	60 cm	150 cm	3
52188	70 cm	150 cm	3
52189	80 cm	150 cm	3

Č.p.	specifikace	délka násady	MOQ
52185	40 cm	150 cm	3
52186	50 cm	150 cm	3
52187	60 cm	150 cm	3
52188	70 cm	150 cm	3
52189	80 cm	150 cm	3



Ø 22 mm

SÁLOVÝ SMETÁK

Č.p.	specifikace	MOQ
52160	40 cm	10
52161	50 cm	10
52162	60 cm	10
52163	70 cm	10
52164	80 cm	10

Č.p.	specifikace	MOQ
52160	40 cm	10
52161	50 cm	10
52162	60 cm	10
52163	70 cm	10
52164	80 cm	10



SMETÁK



Č.p.	specifikace		
52114	28 cm	hrubý závit	1



SMETÁK S NÁSADOU



Č.p.	specifikace	délka násady	
52116	28 cm	s násadou 130 cm	3

MOQ
3



SMETÁK



Č.p.	specifikace		
52113	30 cm	hrubý závit	26
52115	30 cm	bez závitů	26



SMETÁK S NÁSADOU



Č.p.	specifikace		
52195	30 cm	150 cm dřevěná	3
52196	30 cm	130 cm ALU	3

MOQ
3



Ø 23 mm

STĚRKA S GUMOU

Č.p.	specifikace		
15886	450 mm	násada Ø 23 mm	48
15887	600 mm	násada Ø 23 mm	48
15888	750 mm	násada Ø 23 mm	32



ULICOVÝ SMETÁK S NÁSADOU



Č.p.	specifikace		
52109	25 cm	120 cm dřevěná	12

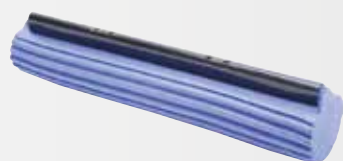

NÁHRADNÍ MOP

Č.p.	specifikace		
52111	30 cm		1



ČISTÍCÍ MOP

Č.p.	specifikace		
52110	30 cm		16



SHRNOVAČE SNĚHU

**FESTA**

SHRNOVAČ SNĚHU

Č.p.	specifikace	
60006	46 x 34 cm	12
60206	46 x 34 cm, složený	1

**FESTA**

SHRNOVAČ SNĚHU

Č.p.	specifikace	
60008	50 x 34 cm	12
60208	50 x 34 cm, složený	1



SHRNOVAČ SNĚHU

Č.p.	specifikace	
60001	48 x 40 cm	10
60201	48 x 40 cm, složený	1



SHRNOVAČ SNĚHU

Č.p.	specifikace	
60012	50 x 38 cm	12
60212	50 x 38 cm, složený	1

ALU



SEKÁČ NA LED

MOQ
3

Č.p.	specifikace	
60022	20 cm	3



SEKÁČ NA LED

Č.p.	specifikace	
60018	15 cm	20
60019	20 cm	24
60020	30 cm	20
61201	násada 130 cm	10



POSYPOVÁ SŮL

Č.p.	specifikace	
43300	10 kg	1
43301	25 kg	1



NÁSADA NA SMETÁK

ALU

Č.p.	specifikace	
52125	130 cm, jemný závit	1
52126	130 cm, hrubý závit	1



FESTA

system click
ON - OFF

NÁSADA HLINÍKOVÁ

ALU

Č.p.	specifikace	
45330	161 cm	24
45331	100 cm	24

NÁSADA NA SMETÁK

MADE IN EU

Č.p.	specifikace	
61172	120 cm dřevěná násada s hrubým závitem	1
61192	150 cm dřevěná násada pro 52195	1
61193	150 cm dřevěná násada pro 52185 - 94	1
61194	140 cm dřevěná násada s hrubým závitem	1

NÁSADA NA SMETÁK

MADE IN EU

Č.p.	specifikace		Č.p.	specifikace	
61171	1,2 m	1	61175	1,6 m	1
61173	1,4 m	1	61176	1,7 m	1
61174	1,5 m	1	61177	1,8 m	1

NÁSADA NA VIDLE A LOPATU - KOLÍNKO



Č.p.	specifikace	
61200	130 cm	10



NÁSADA NA LOPATU



Č.p.	specifikace	
61201	130 cm, rovná	10



NÁSADA NA RÝČ "T,"



Č.p.	specifikace	
61208	90 cm	10



NÁSADA NA LOPATU "T,"



Č.p.	specifikace	
61202	130 cm, rovná	10



NÁSADA NA ZEDNICKOU NABĚRAČKU



Č.p.	specifikace	
61215	160 cm	10



NÁSADA NA RÝČ "Y,"



Č.p.	specifikace	
61207	100 cm	10



NÁSADA NA KRUMPÁČ



Č.p.	specifikace	
61204	95 cm, úzká (pro 61120)	10
61205	95 cm	10



NÁSADA NA MOTYKU



Č.p.	specifikace	
61219	120 cm	10



NÁSADA NA PLASTOVÉ HRÁBĚ



Č.p.	specifikace	
61195	120 cm	10

NÁSADA NA ŽELEZNÉ HRÁBĚ



Č.p.	specifikace	
61183	150 cm	10
61184	160 cm	10
61189	170 cm	10
61190	180 cm	10

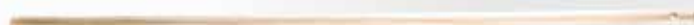

NÁSADA NA HRÁBĚ



Č.p.	specifikace	vhodné pro	
61250	160 cm	45051, 61048	20
61251	160 cm	45052	20
61252	160 cm	45320	20
61253	160 cm	45053	20
61254	160 cm	45054	20
61255	160 cm	45070	20
61256	160 cm	45055	20



PLASTOVÁ RUČKA "Y," NA NÁSADU

Č.p.	specifikace	
61230		10

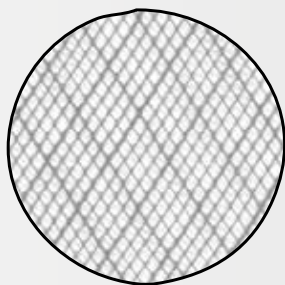

SÍŤ PROTI HMYZU

Č.p.	specifikace	
40100	1 x 25 m - PE bílá	1
40120	1,2 x 25 m - PE bílá	1

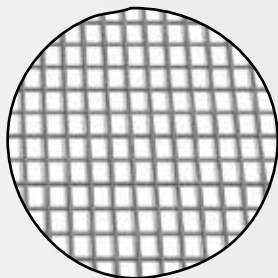

SÍŤ PROTI HMYZU

ALU Zn

Č.p.	specifikace	
42101	1 x 30 m - ALUMINIUM	2
42103	1 x 30 m - galvanizovaný drát	2

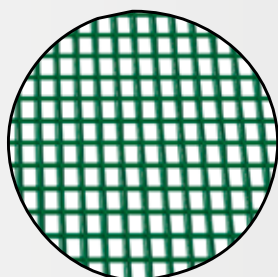

SÍŤ PROTI HMYZU

Č.p.	specifikace	
42102	1 x 30 m - zeleně lakovaný ocelový drát	2

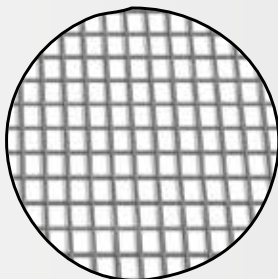
 SÍŤ PROTI HMYZU
SKLOVLÁKNO

Č.p.	specifikace	
41083	0,8 x 30 m bílá	6
41103	1 x 30 m bílá	6
41123	1,2 x 30 m bílá	6
41153	1,5 x 30 m bílá	6

Č.p.	specifikace	
41082	0,8 x 30 m bílá-šedá	6
41102	1 x 30 m bílá-šedá	6
41122	1,2 x 30 m bílá-šedá	6
41152	1,5 x 30 m bílá-šedá	6



SÍŤ PROTI HMYZU

Č.p.	specifikace	
41050	0,5 x 30 m šedá	6
41080	0,8 x 30 m šedá	6
41100	1 x 30 m šedá	6
41120	1,2 x 30 m šedá	6
41150	1,5 x 30 m šedá	6

Č.p.	specifikace	
41081	0,8 x 30 m černá	6
41101	1 x 30 m černá	6
41121	1,2 x 30 m černá	6
41151	1,5 x 30 m černá	6

NEW



DVEŘNÍ ZÁVĚS PROTI HMYZU MAGNETICKÝ, ANTRACIT



Č.p.	specifikace	
40077	100 x 220 cm	1



DVEŘNÍ ZÁVĚS PROTI HMYZU

· variabilní rozměr 60 - 120 cm

Č.p.	specifikace	
40075	4 x 35 x 220 cm bílá	20
40076	4 x 35 x 220 cm černá	20



OKENNÍ SÍŤ SE SUCHÝM ZIPEM - BÍLÁ



Č.p.	specifikace	
40050	150 x 130 cm	5,6 m
40052	150 x 180 cm	6,6 m
40054	150 x 90 cm	4,8 m
40056	220 x 75 cm 2 ks	5,8 m



OKENNÍ SÍŤ SE SUCHÝM ZIPEM - ŠEDÁ



Č.p.	specifikace	
40051	150 x 130 cm	5,6 m
40053	150 x 180 cm	6,6 m
40055	150 x 90 cm	4,8 m



OKENNÍ SÍŤ SE SUCHÝM ZIPEM - ČERNÁ



Č.p.	specifikace	
40057	150 x 130 cm	5,6 m
40058	150 x 180 cm	6,6 m
40059	150 x 90 cm	4,8 m



SUCHÝ ZIP SAMOLEPÍCÍ PRO OKENNÍ SÍŤ

Č.p.	specifikace	
40060	9 mm 7 m	1



PLETIVO HEX

· zinkováno před spletením

Zn

Č.p.	specifikace	
42150	13 0,7 x 1000 mm - 50 m	1
42151	16 0,7 x 1000 mm - 50 m	1
42152	20 0,7 x 1000 mm - 50 m	1
42153	25 0,8 x 1000 mm - 50 m	1

PLETIVO HEX

Zn

Č.p.	specifikace	
42155	13 0,7 x 1000 mm - 50 m	1
42156	16 0,7 x 1000 mm - 50 m	1
42157	20 0,7 x 1000 mm - 50 m	1
42158	25 0,8 x 1000 mm - 50 m	1



PLETIVO HEX POPLASTOVANÉ

Zn

Č.p.	specifikace	
42160	13 1 x 1000 mm - 25 m	1
42161	16 1 x 1000 mm - 25 m	1
42162	20 1 x 1000 mm - 25 m	1
42163	25 1 x 1000 mm - 25 m	1



OKRASNÉ PLETIVO POPLASTOVANÉ

Č.p.	velikost oka	Ø drátu	výška	length	
42175	15 x 9 mm	2 mm	40 cm	25 m	1
42176	15 x 9 mm	2 mm	65 cm	25 m	1
42177	15 x 9 mm	2 mm	90 cm	25 m	1
42178	15 x 9 mm	2 mm	120 cm	25 m	1
42179	15 x 9 mm	2 mm	25 cm	25 m	1

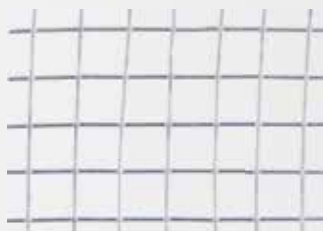

PLETIVO ČTVEREC

Zn

Č.p.	specifikace		Č.p.	specifikace	
42185	6 0,65 x 1000 mm - 25 m	1	42174	25 1,4 x 1000 mm - 25 m	1
42170	10 0,8 x 100 mm - 25 m	1	42186	13 1,05 x 1000 mm - 25 m	1
42171	13 0,8 x 1000 mm - 25 m	1	42187	25 2,0 x 1000 mm - 25 m	1
42172	16 1,2 x 1000 mm - 25 m	1	42188	50 2,0 x 1000 mm - 25 m	1
42173	19 1,4 x 1000 mm - 25 m	1			



PLETIVO ČTVEREC - POPLASTOVANÉ

Č.p.	specifikace	
42180	13 1,2 x 1000 mm - 25 m	1
42181	16 1,2 x 1000 mm - 25 m	1
42182	25 2,3 x 1000 mm - 25 m	1

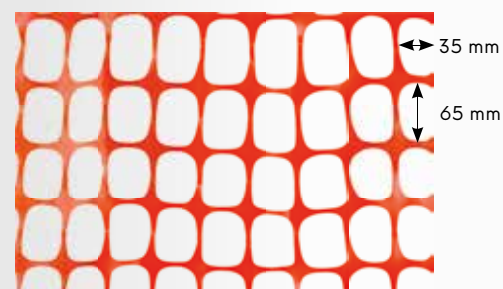

SÍŤ PROTI PTÁKŮM



Č.p.	specifikace	
45570	2 x 5 m 18 x 18 mm	45
45571	2 x 10 m 18 x 18 mm	28
45572	4 x 5 m 18 x 18 mm	24
45573	4 x 10 m 18 x 18 mm	15

BEZPEČNOSTNÍ SÍŤ

Č.p.	specifikace	
42190	1,2 x 50 m HDPE 140g/m ²	1



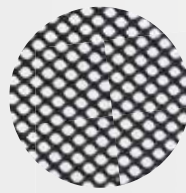

PLETIVO RABICOVÉ



Č.p.	specifikace	
42312	1 m 50 bm, 16 x 16 mm	1

OCHRANA STROMŮ PROTI OKUSU

* samosvorná



Č.p.	specifikace	
45580	Ø 11 x 80 cm	1



VÁZACÍ DRÁT



Č.p.	Ø drátu	délka drátu	
42203	0,6 mm	30 m	50

VÁZACÍ DRÁT



Č.p.	Ø drátu	délka drátu	
42207	0,8 mm	50 m	40
42208	0,8 mm	100 m	20
42209	0,9 mm	100 m	20
42240	1,0 mm	50 m	40
42210	1,0 mm	100 m	20
42211	1,2 mm	50 m	40
42212	1,2 mm	100 m	20
42213	1,4 mm	30 m	40
42214	1,4 mm	50 m	20
42217	1,8 mm	30 m	40
42218	1,8 mm	50 m	20

NAPÍNACÍ DRÁT



Č.p.	Ø drátu	délka drátu	
42219	2,0 mm	26 m	20
42220	2,0 mm	52 m	20
42221	2,0 mm	78 m	20
42228	3,15 mm	26 m	10
42229	3,15 mm	52 m	10
42230	3,15 mm	78 m	10



VÁZACÍ DRÁT

Č.p.	Ø drátu	délka drátu	povrch	
42201	0,6 mm	30 m	PVC	50
42202	0,9 mm	30 m	PVC	50

DRÁT VÁZACÍ

Č.p.	Ø drátu	délka drátu	
42244	1,4 mm	50 m	20
42248	1,8 mm	50 m	20
42249	2,0 mm	50 m	20

DRÁT NAPÍNACÍ

Č.p.	Ø drátu	délka drátu	
42251	2,6 mm	26 m	20
42252	2,6 mm	52 m	20
42253	2,6 mm	78 m	20
42255	3,4 mm	26 m	10
42256	3,4 mm	52 m	10
42257	3,4 mm	78 m	10



OSTNATÝ DRÁT

Zn			
Č.p.	Ø drátu	délka drátu	
42260	1,7 mm	50 m	1
42261	1,7 mm	100 m	1

SVORKA NAPÍNACÍHO DRÁTU

INOX			MOQ 50
Č.p.	specifikace		
50040	nerez hrot, zelená	50	
50041	nerez hrot, černá	50	

SVORKA NAPÍNACÍHO DRÁTU

10x			
Č.p.	specifikace		
50042		10	



PLOTOVÝ NAPÍNÁK MALÝ

Zn			
Č.p.	specifikace		
50030	pozink malý	50	
50032	PVC malý	50	

PLOTOVÝ NAPÍNÁK VELKÝ

Zn			
Č.p.	specifikace		
50031	pozink	50	
50033	PVC	50	



PLOTOVÝ NAPÍNÁK MALÝ LT

Zn			
Č.p.	specifikace		
50037	pozink	50	
50038	PVC	50	

NAPÍNACÍ ZAŘÍZENÍ

Č.p.	specifikace		
50035	2 t	6	
50036	4 t	4	

NEW

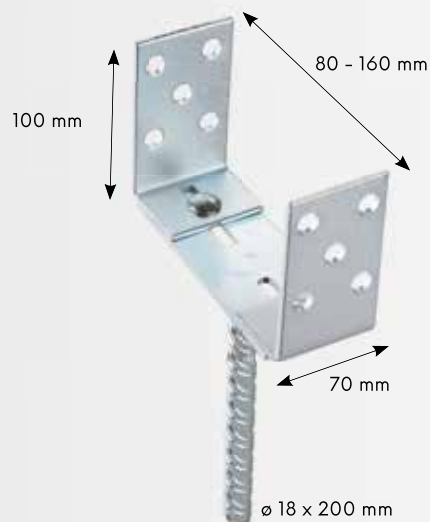

KOTEVNÍ PATKA SLOUPKU STAVITELNÁ

Zn

Č.p.	specifikace	tl.	
55465	80 - 160 x 70 mm	100 mm	4 mm



Ø 18 x 200mm



Ø 18 x 200mm

KOTEVNÍ PATKA SLOUPKU

Zn

Č.p.	specifikace	tl.	
55436	70 x 75 mm	110 mm	4 mm
55437	80 x 90 mm	130 mm	4 mm

KOTEVNÍ PATKA SLOUPKU

Zn

Č.p.	specifikace	tl.	
55429	70 x 60 mm	100 mm	4 mm
55433	81 x 60 mm	100 mm	4 mm
55430	91 x 60 mm	100 mm	4 mm
55431	101 x 60 mm	100 mm	4 mm
55432	121 x 60 mm	100 mm	4 mm



KOTEVNÍ PATKA SLOUPKU

Zn

Č.p.	Ø patky	délka patky	tloušťka materiálu	
55400	71 x 71 mm	750 mm	2 mm	1
55401	91 x 91 mm	750 mm	2 mm	1
55406	81 x 81 mm	750 mm	2 mm	1
55402	91 x 91 mm	900 mm	2 mm	1
55403	101 x 101 mm	900 mm	2 mm	1
55404	121 x 121 mm	900 mm	2 mm	1
55405	151 x 151 mm	900 mm	2 mm	1



KOTEVNÍ PATKA SLOUPKU

Zn

Č.p.	Ø patky	délka patky	tloušťka materiálu	
55420	71 x 71 mm	150 mm	2 mm	1
55425	81 x 81 mm	150 mm	2 mm	1
55421	91 x 91 mm	150 mm	2 mm	1
55422	101 x 101 mm	150 mm	2 mm	1
55423	121 x 121 mm	150 mm	2 mm	1
55424	151 x 151 mm	150 mm	2 mm	1



PŮDNÍ VRTÁK

Č.p.	Ø	A	B	
61299	110 mm	270 mm	1200 mm	1
61300	140 mm	270 mm	1200 mm	1
61301	170 mm	270 mm	1200 mm	1
61302	200 mm	270 mm	1200 mm	1



ZEMNÍ VRUT

· redukce

 Ø 24 mm
 Ø 35 mm
 Ø 40 mm
 Ø 48 mm
 Ø 55 mm

Zn **6x**

Č.p.	Ø patky	délka patky	specifikace	
55450	60 mm	550 mm	1 ks + 5x redukce	8

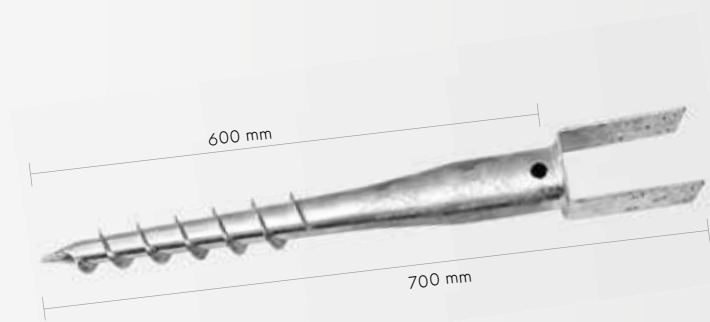

ZEMNÍ VRUT "U"

Zn

Č.p.	Ø patky	délka patky	tloušťka materiálu	
55455	71 x 60 mm	100 mm	4 mm	1
55452	81 x 60 mm	100 mm	4 mm	1
55456	90 x 60 mm	100 mm	4 mm	1
55453	101 x 60 mm	100 mm	4 mm	1
55457	110 x 60 mm	100 mm	4 mm	1
55454	121 x 60 mm	100 mm	4 mm	1



PATKA SLOUPKU S NASTAVITELNÝM ŠROUBEM

Zn

Č.p.	Ø patky	výška patky	závit	
55460	80 x 80 mm	150 mm	M16	10
55461	100 x 100 mm	150 mm	M16	10
55462	150 x 150 mm	150 mm	M24	10

BAMBUSOVÉ ZÁSTĚNY A STÍNÍCÍ TKANINY

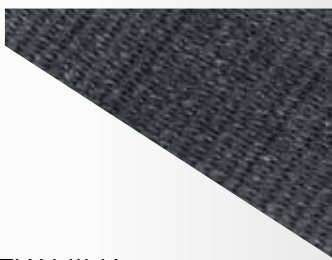
STÍNÍCÍ TKANINA
HDPE 150 g/m² ANTRACIT

· stínění 85%

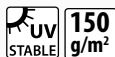

Č.p.	specifikace	
45496	1 x 10 m	1
45497	1,5 x 10 m	1
45498	1,8 x 10 m	1
45499	2 x 10 m	1

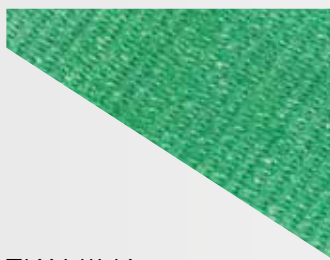
STÍNÍCÍ TKANINA
HDPE 150 g/m²

· stínění 85%

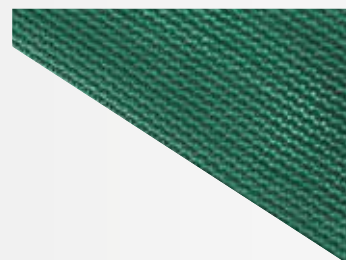

Č.p.	specifikace	
45460	1 x 10 m	1
45461	1,5 x 10 m	1
45463	1,8 x 10 m	1
45462	2 x 10 m	1

STÍNÍCÍ TKANINA
HDPE 220 g/m²

· stínění 95%

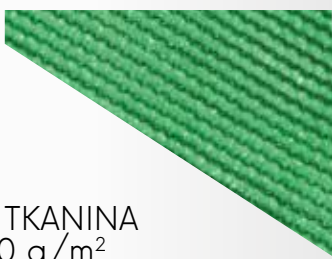
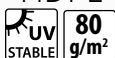

Č.p.	specifikace	
45465	1 x 10 m	1
45466	1,5 x 10 m	1
45467	2 x 10 m	1

STÍNÍCÍ TKANINA
HDPE 80 g/m²

Č.p.	specifikace	
45450	1 x 10 m	1
45451	1,5 x 10 m	1
45453	1,8 x 10 m	1
45452	2 x 10 m	1

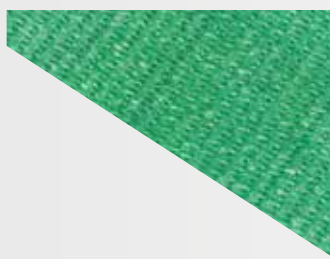
STÍNÍCÍ TKANINA
HDPE 150 g/m²

· stínění 85%

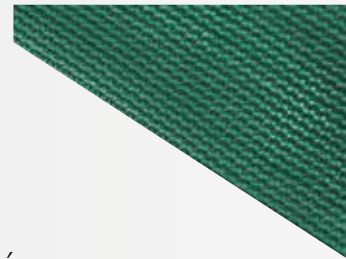

Č.p.	specifikace	
45480	1,5 x 50 m	1

STÍNÍCÍ TKANINA
HDPE 220 g/m²

· stínění 95%



Č.p.	specifikace	
45485	1,5 x 50 m	1

NEW



PÁSKY VÁZACÍ ZELENÉ

· EN 50146

· nylon

50x

Č.p.	specifikace	
23875	120 mm 4,8 mm	1



UPÍNKA STÍNÍCÍ TKANINY

20x

Č.p.	specifikace	
45470		1



GRILOVÁNÍ



SADA GRILOVACÍHO NÁŘADÍ

INOX 18x

Č.p. specifikace
43077



6



SADA GRILOVACÍHO NÁŘADÍ

INOX 3x

Č.p. specifikace
43071 380 mm



16



GRILOVACÍ KLEŠTĚ

INOX

Č.p. specifikace
43072 360 mm



25



GRILOVACÍ TÁCEK

INOX 4x

Č.p. specifikace
43050 300 x 200 mm

50

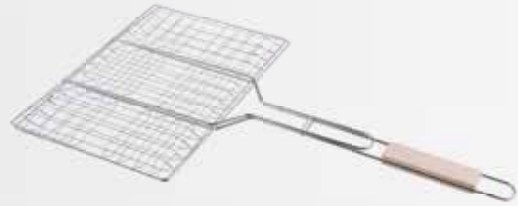
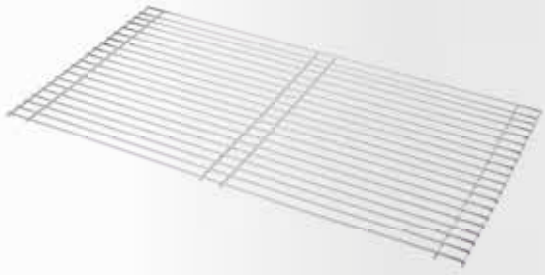

GRILOVACÍ ROŠT

Č.p.	specifikace	
43058	58 x 30 mm	20
43060	60 x 40 mm	20
43068	68 x 40 mm	16

OPÉKACÍ MŘÍŽKA

Č.p.	specifikace	
43084	330 x 290 mm	50

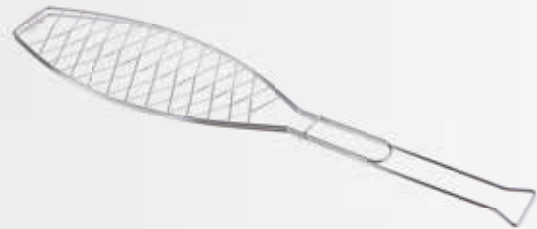
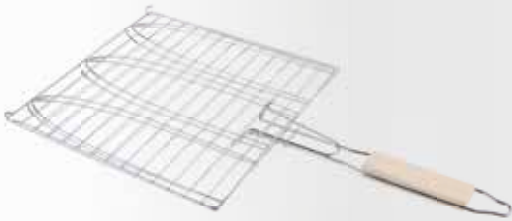

OPÉKAČ RYB

Č.p.	specifikace	
43082	280 x 276 mm	50

OPÉKAČ RYB

Č.p.	specifikace	
43083	360 x 130 mm	12



ŠAŠLIKOVÉ JEHLICE

4x

Č.p.	specifikace	
43086	Ø 3 x 380 mm	80

GRILOVACÍ VIDLICE

· grilovací vidlice s hygienickým atestem

Č.p.	specifikace	
43097	100 cm	100



GRILOVACÍ MOTOR 230V



Č.p. specifikace
43090



24



GRILOVACÍ MOTOREK BATERIOVÝ
· baterie typ D



Č.p. specifikace
43089

48



KARTÁČ NA ČIŠTĚNÍ 2 V 1

Č.p. specifikace
43098 30 cm

10



KARTÁČ 3 V 1

Č.p. specifikace
43099

40



MECHANICKÉ DMYCHADLO

Č.p. specifikace
43087



1



400

ZÁMKY, VISACÍ A
ZÁMKY NA KOLA

404

POKLADNY A POŠTOVNÍ
SCHRÁNKY

406

UPÍNACÍ POPRUHY



409

PROVAZY, MOTOUZY A
VÁZACÍ PÁSKY

411

TAVNÉ PISTOLE



413

DRŽÁKY A NOSIČE



415

ČISTIČE ODPADU



417

DOMÁCÍ POTŘEBY



418

SVÍTILNY



421

PAPÍROVÉ PREZENTAČNÍ
STOJANY



422

REGÁLOVÝ SYSTÉM SU-5



426

ZEDNICKÉ NÁŘADÍ KUBALA

ŽELEZÁŘSKÉ ZBOŽÍ

398 - 431



ZÁMKY

**FESTA**TREZOR
S ELEKTRONICKÝM ZÁMKEM

4x AA

- typ zámku: elektronický, mechanický
- bezpečnostní klíč
- rozměry 350 x 250 x 250 mm
- hmotnost 10 kg



1

Č.p. specifikace
23270

**FESTA**

VLOŽKA ZÁMKU MOSAZNÁ



3x

Č.p. specifikace
23001 65 mm · 175 g



10



VLOŽKA ZÁMKU POMOSAZENÁ



3x

Č.p. specifikace
23000 65 mm · 75 g



15



FESTA

ZÁMEK VISACÍ



Č.p.	specifikace		Č.p.	specifikace	
23261	25 mm	6	23264	45 mm	6
23262	32 mm	12	23265	52 mm	12
23263	38 mm	6	23266	63 mm	6



FESTA

ZÁMEK VISACÍ PRODLOUŽENÝ



Č.p.	specifikace		Č.p.	specifikace	
23211	25 mm	12	23214	45 mm	6
23212	32 mm	12	23215	52 mm	6
23213	38 mm	6			



FESTA

ZÁMEK VISACÍ MOSAZNÝ
POPLASTOVANÝ



Č.p.	specifikace		Č.p.	specifikace	
23310	30 mm	10			
23311	40 mm	10			
23312	50 mm	6			



FESTA

ZÁMEK MOSAZNÝ ZESÍLENÝ



Č.p.	specifikace		Č.p.	specifikace	
23125	25 mm	12	23140	40 mm	12
23130	30 mm	12	23150	50 mm	12
23135	35 mm	12	23160	60 mm	12



FESTA

ZÁMEK VISACÍ



Č.p.	specifikace		Č.p.	specifikace	
23274	60 mm	6			
23275	70 mm	12			



ZÁMEK VISACÍ



Č.p.	specifikace		Č.p.	specifikace	
23220	25 mm	6	23240	40 mm	6
23225	30 mm	6	23250	50 mm	6
23232	32 mm	6	23260	60 mm	6



ZÁMEK POMOSAZENÝ



Č.p.	specifikace		Č.p.	specifikace	
23020	20 mm	12	23040	40 mm	12
23025	25 mm	12	23050	50 mm	12
23030	30 mm	12	23060	60 mm	12
23035	35 mm	12			

ZÁMEK POMOSAZENÝ PRODLOUŽENÝ



Č.p.	specifikace	
23070	40 mm	12



ZÁMEK VISACÍ



Č.p.	specifikace	
23010	50 mm	6

ZÁMEK VISACÍ



Č.p.	specifikace	
23005	40 mm	6
23006	50 mm	6

FESTA

ZÁMEK NA KOLO S ČÍSELNÝM KÓDEM



Č.p.	specifikace	
23288	120 cm x Ø 10 mm	1

FESTA

ZÁMEK NA KOLO S ČÍSELNÝM KÓDEM



Č.p.	specifikace	
23287	65 cm x Ø 10 mm	1



FESTA

ZÁMEK NA KOLO S ÚCHYTEM



Č.p.	specifikace	
23290	120 cm x Ø 8 mm	1
23291	150 cm x Ø 8 mm	20
23292	180 cm x Ø 8 mm	1



ZÁMEK NA KOLO S ÚCHYTEM



Č.p.	specifikace	
23297	180 cm x Ø 8 mm	25



ZÁMEK NA KOLO



Č.p.	specifikace	
23282	55 cm x Ø 8 mm	50
23284	65 cm x Ø 8 mm	50



ZÁMEK VISACÍ S ČÍSELNÝM KÓDEM

Č.p.	
23281	20



FESTA

VISAČKY KE KLÍČŮM

100x

· zesílený kroužek

Č.p.	
23391	50



VISAČKY KE KLÍČŮM

100x

Č.p.	
23390	1



PETLICE

Č.p.	specifikace	
51514	100 mm	25
51515	120 mm	25
51516	140 mm	25
51517	160 mm	25



ZÁSTRČ

Č.p.	specifikace	
51510	100 mm	12
51511	120 mm	12
51512	140 mm	12
51513	160 mm	12



POKLADNY A
POŠTOVNÍ SCHRÁNKY



SCHRÁNKA NA KLÍČE



Č.p.	specifikace	
70140	250 x 180 x 80 mm - pro 48 klíčů	12
70141	300 x 230 x 90 mm - pro 90 klíčů	8



POKLADNA



Č.p.	šířka	hloubka	výška	
70120	125 mm	95 mm	60 mm	1



POKLADNA



Č.p.	šířka	hloubka	výška	
70121	152 mm	118 mm	80 mm	36



POKLADNA



Č.p.	šířka	hloubka	výška	
70122	200 mm	160 mm	90 mm	20



POKLADNA



Č.p.	šířka	hloubka	výška	
70123	250 mm	180 mm	90 mm	16



POKLADNA



Č.p.	šířka	hloubka	výška	
70124	300 mm	240 mm	90 mm	10



POKLADNA



Č.p.	šířka	hloubka	výška	
70125	370 mm	280 mm	90 mm	8



SCHRÁNKA POŠTOVNÍ



Č.p.	barva	šířka	hloubka	výška	
70101	bílá	290 mm	360 mm	105 mm	5
70100	hnědá	290 mm	360 mm	105 mm	5



SCHRÁNKA POŠTOVNÍ



Č.p.	barva	šířka	hloubka	výška	
70102	bílá	310 mm	260 mm	90 mm	10
70103	hnědá	310 mm	260 mm	90 mm	10



SCHRÁNKA POŠTOVNÍ



Č.p.	barva	šířka	výška	hloubka	
70104	bílá	310 mm	360 mm	90 mm	6
70105	hnědá	310 mm	360 mm	90 mm	5



SCHRÁNKA POŠTOVNÍ



Č.p.	barva	šířka	hloubka	výška	
70108	bílá	370 mm	134 mm	364 mm	5



SCHRÁNKA POŠTOVNÍ



Č.p.	materiál	šířka	hloubka	výška	
70107	nerez	360 mm	100 mm	520 mm	6



SCHRÁNKA POŠTOVNÍ



Č.p.	materiál	šířka	hloubka	výška	
70106	nerez	360 mm	100 mm	360 mm	5



SCHRÁNKA POŠTOVNÍ



Č.p.	materiál	šířka	hloubka	výška	
70109	nerez	310 mm	90 mm	260 mm	6



SCHRÁNKA POŠTOVNÍ



Č.p.	materiál	šířka	hloubka	výška	
70110	nerez	310 mm	90 mm	360 mm	6



UPÍNACÍ POPRUHY



FESTA

POPURHY UPÍNACÍ SAMONAVÍJECÍ



2x

Č.p.	šířka	délka	nosnost	ks	
51070	18 mm	2 m	100 kg	2	12



FESTA

POPURH UPÍNACÍ SAMONAVÍJECÍ



Č.p.	šířka	délka	nosnost	ks	
51071	25 mm	3,5 m	300 kg	1	8



FESTA

POPURH UPÍNACÍ SAMONAVÍJECÍ



Č.p.	šířka	délka	nosnost	ks	
51072	35 mm	4 m	500 kg	1	6



FESTA

POPURH UPÍNACÍ



Č.p.	šířka	délka	nosnost	ks	
51040	25 mm	6 m	1000 kg	1	1
51041	35 mm	8 m	2000 kg	1	1
51042	35 mm	8 m	3000 kg	1	1
51043	50 mm	10 m	5000 kg	1	1



FESTA

POPURHY UPÍNACÍ



2x

Č.p.	šířka	délka	nosnost	ks	
51060	25 mm	5 m	750 kg	2	5



FESTA

POPURH UPÍNACÍ



Č.p.	šířka	délka	nosnost	ks	
51065	50 mm	10 m	960 kg	1	6



FESTA

POPURH UPÍNACÍ



Č.p.	šířka	délka	nosnost	ks	
51026	75 mm	5 m	3000 kg	1	4

NEW

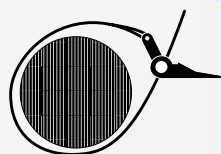

FESTA

POPURH UPÍNACÍ



Č.p.	šířka	délka	nosnost	ks
51032	25 mm	5 m	500 kg	1



FESTA

POPURH UPÍNACÍ



Č.p.	šířka	délka	nosnost	ks
51017	50 mm	6 m	480 kg	2
51018	50 mm	6 m	480 kg	1



POPURH UPÍNACÍ

Č.p.	šířka	délka	specifikace	ks
51022	25 mm	5 m	s háky	40
51023	50 mm	5 m	s háky	12



FESTA

POPURH UPÍNACÍ

PE

• měkká EVA podložka

Č.p.	šířka	délka	ks
51046	38 mm	4 m	1



POPURH UPÍNACÍ

Č.p.	šířka	délka	specifikace	ks
51030	50 mm	6 m	s háky	20
51034	50 mm	8 m	s háky	10



POPURHY UPÍNACÍ

2x

Č.p.	šířka	délka	ks
51020	25 mm	2,5 m	2



POPURH UPÍNACÍ

PE

Č.p.	šířka	délka	ks
51045	25 mm	4 m	1



GUMY UPÍNACÍ NASTAVITELNÉ

2x

Č.p.	délka	Ø	ks
51013	1,2 m	8 mm	2





GUMY UPÍNACÍ

2x

Č.p.	délka	ks	
51008	1 m	2	25



GUMA UPÍNACÍ S KARABINAMI



Č.p.	délka	Ø	ks	
51009	1 m	10 mm	1	25



SADA UPÍNACÍCH POPRUHŮ

8x

- 2 x 0,4 m
- 2 x 0,6 m
- 1 x 0,8 m
- 1 x 1,0 m

Č.p.	délka	Ø	ks	
51011	1 m	8 mm	8	10



GUMY UPÍNACÍ

2x

Č.p.	délka	Ø	ks	
51001	80 cm	10 mm	2	50
51002	100 cm	10 mm	2	50
51003	150 cm	10 mm	2	50
51004	200 cm	10 mm	2	50



GUMY UPÍNACÍ S HÁKY

2x

Č.p.	délka	Ø	ks	
51007	1 m	8 mm	2	25



GUMY UPÍNACÍ - PAVOUK

Č.p.	délka	Ø	specifikace	
51010	80 cm	8 mm	8 ramen	50



PRUŽNÁ UPEVŇOVACÍ SÍŤ S HÁKY

Č.p.	délka	šířka	
51015	80 cm	120 cm	20



LANO ELASTICKÉ



Č.p.	délka	Ø	
51036	20 m	8 mm	10
51037	20 m	10 mm	6



HÁČKY K UPÍNACÍM GUMÁM

20x

Č.p.	délka	
51038	8 mm	30



LANO PRŮMYSLOVÉ



Č.p.	délka	Ø	
50915	5 m	8 mm	1
50916	25 m	8 mm	1
50917	25 m	10 mm	1
50918	25 m	12 mm	1
50919	25 m	14 mm	1



KARABINA

ALU

MOQ
2

Č.p.	Ø	délka	
51187	5 mm	50 mm	2
51200	6 mm	60 mm	2
51202	7 mm	70 mm	2



LANO SILONOVÉ

Č.p.	délka	Ø	
51050	50 m	8 mm	10
51051	50 m	10 mm	4



PROVÁZEK SILONOVÝ

Č.p.	délka	Ø	
51055	80 m	1,5 mm	50
51056	50 m	2 mm	50
51057	20 m	4 mm	50



MOTOUZ POLYPROPYLEN

Č.p.	váha	
50905	80 g	80
50906	100 g	100
50907	200 g	50

MOTOUZ POLYPROPYLEN

Č.p.	váha	
50909	500 g (250 m)	1
50910	1000 g (500 m)	1
50911	5000 g (2500 m)	1



MOTOUZ JUTA

Č.p.	váha	
50900	80 g (61 m)	1
50901	100 g (76 m)	1
50902	200 g (153 m)	1

ŠŇŮRA VOSKOVANÁ



Č.p.	délka	Ø	
50920	50 m	1 mm	80



NEW



PÁSKY VÁZACÍ ZELENÉ

· EN 50146
· nylon

50x

Č.p.	délka	šířka	
23875	120 mm	4,8 mm	1



Ø 15 - 32 mm

PÁSKY VÁZACÍ S ÚCHYTEM

10x

UV
STABLE

Č.p.	délka	šířka	
23865	160 mm	7,5 mm	1



FESTRA

PÁSKA NA SUCHÝ ZIP 3 KS

3x

Č.p.	šířka	délka	
37295	20 mm	150 mm	1
37296	20 mm	200 mm	1
37297	20 mm	250 mm	1



VÁZACÍ PÁSKA, SUCHÝ ZIP

Č.p.	specifikace	
45471	12 mm x 5 m	1



PÁSKY VÁZACÍ BAREVNÉ

100x

· EN 50146
· nylon

Č.p.	délka	šířka	
23880	100 mm	2,5 mm	1
23882	150 mm	2,5 mm	1
23884	200 mm	3,6 mm	1



PÁSKY VÁZACÍ BÍLÉ

50x

· EN 50146
· nylon

Č.p.	délka	šířka	
23850	120 mm	2,5 mm	1
23854	200 mm	3,6 mm	1
23856	250 mm	3,6 mm	1
23858	250 mm	4,8 mm	1
23860	300 mm	4,8 mm	1
23864	400 mm	4,8 mm	1
23866	500 mm	4,8 mm	1
23868	400 mm	7,6 mm	1
23870	500 mm	7,6 mm	1



PÁSKY VÁZACÍ ČERNÉ

50x

· EN 50146
· nylon

Č.p.	délka	šířka	
23810	120 mm	2,5 mm	1
23814	200 mm	3,6 mm	1
23816	250 mm	3,6 mm	1
23818	250 mm	4,8 mm	1
23820	300 mm	4,8 mm	1
23824	400 mm	4,8 mm	1
23826	500 mm	4,8 mm	1
23828	400 mm	7,6 mm	1
23830	500 mm	7,6 mm	1





FESTA

PISTOLE TAVNÁ - BEZDRÁTOVÁ



Č.p.	specifikace		
89975	80 W 230 V	Ø tavné tyčinky 11,2 mm	20



PISTOLE TAVNÁ



Č.p.	specifikace		
89973	60 W 230 V	Ø tavné tyčinky 11,2 mm	20



PISTOLE TAVNÁ



Č.p.	specifikace		
89970	15 W 230 V	Ø tavné tyčinky 7,2 mm	25



TYČINKY DO TAVNÉ PISTOLE - ČIRÉ

Č.p.	Ø tyčinky	délka	počet ks v balení	
89985	11,2 mm	200 mm	10	50
89987	11,2 mm	200 mm	1 kg	25



TYČINKY DO TAVNÉ PISTOLE - ČIRÉ

Č.p.	Ø tyčinky	délka	počet ks v balení	
89980	7,2 mm	100 mm	12	100
89988	7,2 mm	100 mm	1 kg	25



TYČINKY DO TAVNÉ PISTOLE - BAREVNÉ

Č.p.	Ø tyčinky	délka	počet ks v balení	
89990	11,2 mm	200 mm	10	50



TYČINKY DO TAVNÉ PISTOLE - BAREVNÉ

Č.p.	Ø tyčinky	délka	počet ks v balení	
89989	7,2 mm	100 mm	12	100

**FESTA**

PISTOLE HORKOVZDUŠNÁ S REGULACÍ TEPLoty

napětí / frekvence	230V / 50Hz
příkon	2000W
poloha spínače	0 - I (350°C) - II (600°C)
příslušenství	nerezové nástavce - 4 ks



Č.p. specifikace
35320 2000 W

5

FESTA

PISTOLE HORKOVZDUŠNÁ S REGULACÍ TEPLoty A PROUDU VZDUCHU

napětí / frekvence	230V / 50Hz
příkon	2000W
poloha spínače	0 - I (50°C) - II (50 - 600°C)
proud vzduchu	250 - 500 l/min.
příslušenství	nerezové nástavce - 4 ks
	· digitální display



Č.p. specifikace
35322 2000 W

5

NEW**FESTA**

PŘÍSAVKA NA DLAŽBU S INDIKÁTOREM TLAKU

· pro hrubé povrchy

Č.p. Specifikace
36325 max. nosnost 220 kg



1



FESTA

SKLENÁŘSKÝ DRŽÁK

poloha	max. nosnost
horizontální poloha	50 kg
vertikální poloha	50 kg

ALU

Č.p.	specifikace
36314	jednoduchý



20

SKLENÁŘSKÝ DRŽÁK

Č.p.	specifikace
36305	jednoduchý



60



FESTA

SKLENÁŘSKÝ DRŽÁK

poloha	max. nosnost
horizontální poloha	80 kg
vertikální poloha	100 kg

ALU

Č.p.	specifikace
36313	dvojitý



20

SKLENÁŘSKÝ DRŽÁK

Č.p.	specifikace
36306	dvojitý



20



FESTA

SKLENÁŘSKÝ DRŽÁK

poloha	max. nosnost
horizontální poloha	120 kg
vertikální poloha	150 kg

ALU

Č.p.	specifikace
36318	trojitý



10

SKLENÁŘSKÝ DRŽÁK

poloha	max. nosnost
horizontální poloha	80 kg
vertikální poloha	100 kg

Č.p.	specifikace
36319	trojitý



10



MINCÍŘ ANALOGOVÝ

Č.p.	maximální nosnost
24260	50 kg



10

MINCÍŘ

Č.p.	maximální nosnost	
24212	12,5 kg	48
24225	25 kg	6
24250	50 kg	6
24255	100 kg	6
24258	150 kg	6



PINZETA S LED SVĚTLEM



Č.p.	specifikace
50005	95 mm



8



SADA PINZET NEREZ

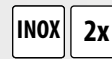

Č.p.	specifikace
50004	



1



PAST NA MYŠI

2x

Č.p.	specifikace
70221	90 x 45 mm dřevěná



1



PAST NA MYŠI

2x

Č.p.	specifikace
70220	97 x 47 mm plastová



48

NEW



KLÍČ ODVZDUŠŇOVACÍ PRO TOPNÁ TĚLESA SE ZÁSObNÍKEM



Č.p.	Specifikace
17459	50 ml



1



Ø 15 mm

ČISTIČ ODPADU

· možnost použití s vrtačkou

Č.p.	délka	Ø
50014	6 m	6 mm



6



Ø 10mm

Ø 20mm

Ø 5mm

ČISTIČ ODPADU

Č.p.	délka	Ø
50010	3 m	10
50011	5 m	5
50012	10 m	3
50013	15 m	4

ČISTIČ ODPADU

Č.p.	délka	Ø
50009	3 m	5 mm



40



PUMPA NA ČIŠTĚNÍ ODPADU

Č.p.	délka	Ø
50015	385 mm	65 mm



30

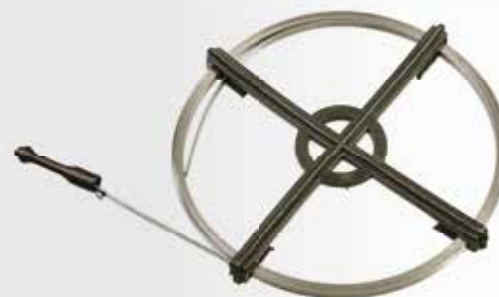

ELEKTRIKÁŘSKÉ PROTAHOVACÍ PERO

Č.p.	délka	Ø
51181	8 m	5 mm
51182	10 m	5 mm



25

25

NEW

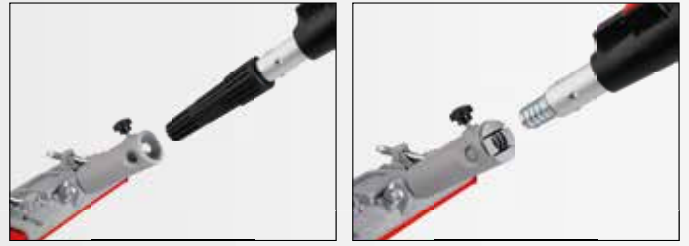

FESTA

NÁSADA TELESKOPIČKÁ

· závit pro 31610, 34203

Č.p.	Specifikace	
52011	88 - 140 cm	1



TELESKOPIČKÁ TYČ

ALU

Č.p.	délka	ALU	
52010	120 cm	ALU	50
52012	240 cm	ALU	25



TELESKOPIČKÁ TYČ

Č.p.	délka	ocel	
52020	300 cm	ocel	10

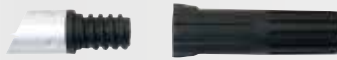

TELESKOPIČKÁ TYČ

Č.p.	délka	fiberglass	
52030	240 cm	fiberglass	6



SBĚRAČ ODPADKŮ

· otočné o 90°

Č.p.	délka	
61235	81 cm	12

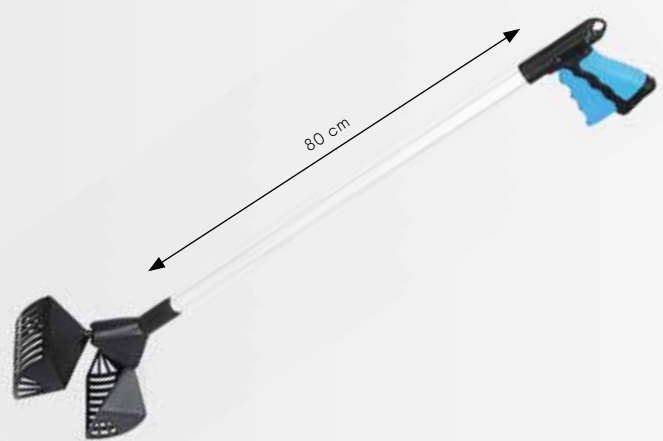

SBĚRAČ ODPADKŮ

· max. 4 kg

Č.p.	
61236	12



OLEJNIČKA

Č.p.	specifikace
50020	300 ml

10

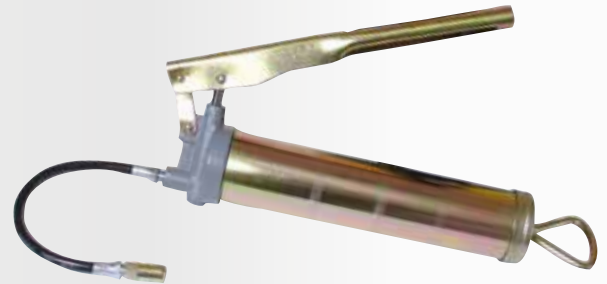

MAZNICE

- přímé plnění
- plnění kartuší
- plnění čerpadlem

Č.p.	specifikace
50022	400 ml



20



BARELOVÁ PUMPA

Č.p.
50017



10



OLEJNIČKA

Č.p.	specifikace
50019	90 ml

1



POVOLOVAČ FILTRŮ

Č.p.	specifikace
50021	60 x 140 mm

6



TRYCHTÝŘ

Č.p.	specifikace
50025	60 x 140 mm

50



HADICE PŘEČERPÁVACÍ SE SAMONASÁVACÍM VENTILEM

Č.p.	délka	Ø
50026	180 cm	15 mm



24

SVÍTILNY



· magnety k připevnění např: na kovová zárubně aj.



· magnetický, otočný, klip

FESTA

LED SVÍTILNA



MOQ
12

Č.p.	specifikace
37645	200 mm 3 x AAA

12

FESTA

LED ČELOVKA

váha	42 g
zdroj světla	1 x 1 W white LED + 2x red LED
baterie	3 x AAA
rozměry	40 x 59 x 32 mm
doba svícení	45 h
tok světla	120 lumen
dosvit	60 m (100% battery)
režimy svícení	4



· 5 pozic vyklopení



Č.p.	specifikace
37641	120 lumen + červené světlo



1



FESTA

LED ČELOVKA



Č.p.	specifikace
37640	120 lumen + červené světlo



6





FESTA

LED SVÍTELNA

LED light 3x AA

Č.p.

37650



12



FESTA

LED SVÍTELNA

ALU LED light 2x AA 80 lumen

Č.p.

specifikace

37630

185 mm

2 x AA



20

LED SVÍTELNA

výkon	0,6 W
barevná teplota	700k
baterie	2xD
váha	138g
délka dosvitu	30 m
světelnost	50 lm



ALU LED light 2x AA 80 lumen

Č.p.

specifikace

37621

185 mm



6



KONZOLA BÍLÁ

 MOQ
2

č.p.	specifikace	
81100	100 x 75 mm	24
81101	125 x 100 mm	24
81102	150 x 125 mm	24
81103	200 x 150 mm	24
81104	250 x 200 mm	24
81105	300 x 250 mm	24
81106	350 x 300 mm	24



REGÁLOVÁ STOJKA JEDNODUCHÁ

č.p.	specifikace	
81053	50 cm	10
81054	80 cm	10
81056	150 cm	10
81057	200 cm	10



REGÁLOVÝ HÁK JEDNODUCHÝ

č.p.	specifikace	
81070	10 cm	10
81071	15 cm	10
81072	20 cm	10
81074	30 cm	10
81075	35 cm	10
81077	50 cm	10



PAPÍROVÝ PREZENTAČNÍ STOJAN FESTA

Č.p.	specifikace
81600	60 x 40 x 175 cm - CZ



PAPÍROVÝ PREZENTAČNÍ STOJAN FESTA POWER TOOLS

Č.p.	specifikace
81603	60 x 40 x 175 cm



PAPÍROVÝ PREZENTAČNÍ STOJAN NA NIVELAČNÍ SYSTÉMY

Č.p.	specifikace
37129	60 x 40 x 175 cm - CZ
37123	60 x 40 x 175 cm - osazený
37124	60 x 40 x 175 cm - osazený



REGÁLOVÝ SYSTÉM SU - 5

RÁDI VÁM SESTAVÍME NABÍDKU NA POŽADOVANOU
REGÁLOVOU SESTAVU

STOJAN FESTA + PŘÍSLUŠENSTVÍ

Č.p.	specifikace		
81011	stojan FESTA 220 x 100 cm	1	
81011A	stojan 81011 + samolepka AQUATIC	1	
81011F	stojan 81011 + samolepka FESTA CZ	1	
81011G	stojan 81011 + samolepka FESTA GB	1	
81011H	stojan 81011 + samolepka FESTA SK	1	
81011R	stojan 81011 + samolepka ROSA	1	
81012	police FESTA 100 x 40 cm	8	
81013	háček 10 cm	10	
81014	háček 16 cm	10	
81015	háček 20 cm	10	
81035	háček s visačkou 20 cm	10	
81016	háček 30 cm	10	
81036	háček s visačkou 30 cm	10	
81022	koš na hladítka - velký, 50 cm	1	
81023	koš na hladítka - malý, 40 cm	1	
81024	příčka ke koši - velká, 50 cm	1	
81025	příčka ke koši - malá, 40 cm	1	



REGÁLOVÝ SYSTÉM SU - 5



RÁDI VÁM SESTAVÍME NABÍDKU NA POŽADOVANOU REGÁLOVOU SESTAVU

Č.p.	specifikace	
81200	Stojina 40/2400 mm kotvená	1
81201	Stojina 80/1108 mm	1
81202	Stojina 80/1208 mm	1
81203	Stojina 80/1408 mm	1
81204	Stojina 80/1608 mm	1
81205	Stojina 80/1808 mm	1
81206	Stojina 80/2000 mm	1
81207	Stojina 80/2108 mm	1
81208	Stojina 80/2208 mm	1
81209	Stojina 80/2308 mm	1
81210	Stojina 80/2408 mm	1
81211	Stojina 80/2600 mm	1
81212	Stojina 60/1000 mm	1
81213	Stojina 60/1208 mm	1
81214	Stojina 60/1408 mm	1
81215	Stojina 60/1608 mm	1
81216	Stojina 60/1808 mm	1
81217	Stojina 60/2108 mm	1
81218	Stojina 60/2208 mm	1
81225	Stojina 30/2108 mm přední	1
81486	Stojina 60/2000 mm	1
81219	Nástavec stojiny 80x30/100mm	1
81220	Nástavec stojiny 80x30/400 mm	1
81221	Nástavec stojiny 80x30/600 mm	1
81222	Nástavec stojiny 60x30/400 mm	1
81223	Stojina rohová 90st. 2100mm	1
81224	Stojina rohová 90st. 2200mm	1
81226	Podpěra 80	1
81227	Podpěra 60	1
81228	Spojka gondoly s regálem 80	1
81229	Kotevní lišta	1
81230	Kotevní hák	1
81231	Kotvení lehké	1
81232	Kotvení vrchní	1
81233	Výplň 400	1
81234	Výplň 500	1
81235	Výplň 600	1
81236	Výplň 700	1
81237	Výplň 800	1
81238	Konzola nízká 200	1
81239	Konzola nízká 300	1
81240	Konzola nízká 400	1
81241	Konzola nízká 500	1
81242	Konzola vysoká 400	1
81243	Konzola vysoká 500	1
81244	Konzola vysoká 600	1
81245	Konzola vysoká 700	1
81246	Konzola nízká 300 dvojitá	1
81247	Konzola nízká 400 dvojitá	1
81248	Konzola nízká 300 dvojitá	1
81251	Konzola RR 80	1
81249	Konzola vysoká dvojitá 500	1
81250	Nosník vys. vitríny 400/2000	1
81252	Dělitko korytově police	1
81253	Dělitko nízké 300	1
81254	Dělitko nízké 400	1
81255	Dělitko nízké 500	1
81256	Dělitko nízké 300 sklo	1
81257	Dělitko nízké 400 sklo	1
81258	Dělitko nízké 500 sklo	1
81259	Dělitko vysoké 300 sklo	1
81262	Dělitko vysoké 300 plexi	1
81263	Dělitko vysoké 400 plexi	1
81264	Dělitko vysoké 500 plexi	1
81260	Dělitko vysoké 400 sklo	1
81261	Dělitko vysoké 500 sklo	1
81265	Bok vys. vitríny 400/2000	1
81266	Bočnice zastřešení RR 80	1
81267	Bočnice zásobníku 500mm	1
81268	Bočnice vitríny 500	1
81269	Nosník horní vitríny 500	1
81271	Bočnice police nízká 300 plast	1
81272	Bočnice police nízká 400 plast	1
81273	Bočnice police nízká 500 plast	1
81274	Bočnice vysoká sklo 300/250	1
81275	Pojistka bočnice	1
81276	Bočnice vysoká sklo 500/250	1
81277	Bočnice police vysoká 400	1
81278	Bočnice police vysoká 500	1
81270	Nosník zastřešení RR 80	1
81279	Nosník zastřešení	1
81280	Bočnice zastřešení levá	1
81281	Bočnice zastřešení pravá	1
81282	Závěsová rameno	1
81284	Rameno dvojitě 400/10	1
81285	Rameno dvojitě 300/8	1
81286	Rameno jednoduché 350	1
81287	Rameno jednoduché 500	1
81288	Rameno jednoduché 250	1
81289	Závěs dvojitý 100	1
81290	Závěs dvojitý 200	1
81291	Závěs dvojitý 300	1
81292	Závěs 130 V	1

Č.p.	specifikace	
81293	Závěs jednoduchý 100	1
81294	Závěs jednoduchý 200	1
81295	Závěs jednoduchý 300	1
81296	Jednoháček s hrazdou 200	1
81297	Jednoháček s hrazdou 300	1
81298	Zámek vitríny	1
81299	Dělitko drátěné 360mm vysoké	1
81300	Dělitko drátěné 460 mm vysoké	1
81301	Dělitko drátěné 560 mm vysoké	1
81302	Dělitko drátěné 560 mm nízké	1
81303	Konzola 300 dvojitá L	1
81304	Konzola 300 dvojitá P	1
81305	Konzola 400 dvojitá L	1
81306	Konzola 400 dvojitá P	1
81307	Konzola 500 dvojitá L	1
81308	Konzola 500 dvojitá P	1
81309	Police půlkruh 300	1
81310	Police půlkruh 400	1
81311	Police půlkruh 500	1
81312	Sokl půlkruhu 500	1
81313	Celo soklu půlkruhu 500	1
81314	Držák cenovky pol. 300 půlkruh	1
81315	Držák cenovky pol. 400 půlkruh	1
81316	Držák cenovky pol. 500 půlkruh	1
81317	Police půlkruh 600	1
81318	Sokl půlkruhu 600	1
81319	Celo soklu půlkruhu 600	1
81320	Cenovka P 7,5x5 cm	1
81321	Cenovka P 2,6x3,2 cm	1
81322	Cenovka P 5,0x4,0 cm	1
81323	Police děrovaná 500/1000	1
81324	Spojnice stojin 80, modul 1	1
81325	Zadní panel 10x100cm	1
81326	Zadní panel 20x100cm	1
81327	Zadní panel 40x100cm	1
81328	Zadní panel dř. 20x100 cm EUR	1
81329	Zadní panel dř. 40x100 cm EUR	1
81330	Kryt gondol 8x100cm	1
81331	Kryt gondol 6x100cm	1
81332	Nosník závěsů 100cm	1
81333	Police skleněná 985/300 vitrína	1
81334	Police skleněná 985/400 vitrína	1
81335	Police dřevěná 47/98,5	1
81336	Police drátěná 1000/500	1
81337	Police korytová 1000x500	1
81338	Police 200/1000	1
81339	Police 300/1000	1
81340	Police 400/1000	1
81341	Police 500/1000	1
81342	Police 400/1000 RAL7015	1
81343	Police 500/1000 RAL7015	1
81347	Rám vysoké vitríny 1000/400	1
81348	Sklo rámu vysoké vitríny 1000/400	1
81349	Zásuvková vložka regalová	1
81350	Podhled kovové police 500/100	1
81352	Čelní opěra vysoká 1000 mm, sklo	1
81353	Čelní opěra vysoká, plexi	1
81354	Čelní opěra nízká 1000 mm, plast	1
81355	Cenovková lišta, 1000mm	1
81356	Hřeben zásuvky regálů	1
81351	Hřeben pro vysoká dělitka, 1000	1
81357	Hřeben, 1000 mm	1
81403	Hřeben pro vysoká dělitka, 1250 mm	1
81420	Hřeben pro vysoká dělitka, 625 mm	1
81358	Dvoudrážky dvířek vitríny	1
81359	Držák cenovky, 1000mm	1
81360	Dveře vys. vitríny 1000/2000	1
81361	Čelo zastřešení, 1000mm	1
81362	Deska zastřešení, 1000mm	1
81363	Dvířka zásobníku	1
81364	Dvířka vitríny posuvná	1
81365	Zrcadlo vitríny	1
81366	Závěsový rám, modul 1	1
81367	Závěsový tyč	1
81370	Koš drátěný šikmý	1
81371	Pult s plnou deskou 1000mm	1
81372	Sokl pultu SU 5 1000mm	1
81373	Pult prosklený 1000mm	1
81374	Pult s nerez deskou 1000mm	1
81375	Pult s plnou deskou 600mm	1
81376	Police do pultu 600mm	1
81377	Pult prosklený 600mm	1
81378	Police do pultu 1000mm	1
81379	Polička pultu dlouhá	1
81380	Segment pultu vysoký 90st.	1
81381	Dvoudrážka pultu 1000mm, pár	1
81382	Dvířka posuvná, pult 1000mm, pár	1
81383	Zásuvka pod desku	1
81384	Police drátěná RDE 1000/360mm	1
81385	Police drátěná RDE 1000/460mm	1
81386	Police drátěná RDE 1000/560mm	1
81387	Cenovková lišta RDE 1000 mm	1
81388	Zadní panel 100/1250mm plný	1

Č.p.	specifikace	
81389	Zadní panel 200/1250mm plný	1
81390	Zadní panel 400/1250mm plný	1
81391	Zadní panel 200/1250mm děrovaný	1
81393	Kryt gondoly 80/1250mm	1
81392	Zadní panel 400/1250mm děrovaný	1
81394	Kryt gondoly 60/1250mm	1
81395	Nosník závěsů 1250mm	1
81396	Police 200/1250mm	1
81439	Nosník závěsů 1000 mm	1
81344	Police 300/1000 zesílená	1
81345	Police 400/1000 zesílená	1
81346	Police 500/1000 zesílená	1
81397	Police 300/1250mm	1
81400	Police 300/1250mm, zesílená	1
81401	Police 400/1250mm, zesílená	1
81402	Police 500/1250mm, zesílená	1
81398	Police 400/1250mm	1
81399	Police 500/1250mm	1
81404	Čelní opěra nízká 1250mm, plast bílý	1
81405	Cenovková lišta, 1250mm	1
81406	Hřeben 1250mm	1
81407	Držák cenovky, 1250mm	1
81408	Celo zastřešení, 1250mm	1
81409	Deska zastřešení, 600x1250mm	1
81410	Zadní panel 100/625 plný	1
81411	Zadní panel 200/625 plný	1
81412	Zadní panel 400/625 plný	1
81413	Zadní panel 400/625 děrovaný	1
81414	Kryt gondol 60/650	1
81415	Kryt gondol 60/650	1
81416	Nosník závěsů, modul 3	1
81432	Nosník závěsů, 1330mm	1
81417	Police 300/625	1
81418	Police 400/625	1
81419	Police 500/625	1
81421	Čelní opěra nízká 625, plast bílý	1
81422	Cenovková lišta 625mm	1
81423	Hřeben 625mm	1
81424	Držák cenovky, 625mm	1
81425	Zadní panel 100/1330 plný	1
81457	Čelní opěra nízká 200 plast	1
81426	Zadní panel 200/1330 plný	1
81427	Zadní panel 400/1330 plný	1
81428	Zadní panel 200/1330 děrovaný S	1
81429	Zadní panel 400/1330 děrovaný S	1
81430	Kryt gondol 80/1330	1
81431	Kryt gondol 60/1330	1
81433	Police 300/1330	1
81434	Police 400/1330	1
81435	Police 500/1330	1
81436	Cenovková lišta, 1330 mm	1
81437	Hřeben 1330 mm	1
81438	Držák cenovky 1330 mm	1
81440	Police drátěná - koš	1
81441	Zadní panel 100 koutový	1
81442	Zadní panel 400 koutový	1
81443	Celo soklu koutové 500/1000mm	1
81444	Celo soklu koutové 600 mm	1
81445	Zadní panel koutový 400mm děrovaný	1
81447	Police 300 koutová	1
81448	Police 400 koutová	1
81449	Police 500 koutová	1
81450	Police 600 koutová	1
81451	Držák cenovky 300 koutový	1
81452	Držák cenovky 400 koutový	1
81453	Držák cenovky 500 koutový	1
81454	Lišta cenovková 300 koutová	1
81455	Lišta cenovková 400 koutová	1
81456	Lišta cenovková 500 koutová	1
81458	Police drátěná koš U 1000/400	1
81459	Police drátěná koš U 1000/500	1
81460	Rohové celo soklu 90st.	1
81461	Panel zadní rohový 100, stojina 60	1
81462	Panel zadní rohový 200, stojina 60	1
81463	Panel zadní rohový 400, stojina 80	1
81466	Panel zadní rohový 100, stojina 80	1
81467	Panel zadní rohový 400, stojina 60	1
81468	Police rohová 90st. 400mm	1
81469	Police rohová 90st. 500mm	1
81470	Držák cenovky rohový 90st. 400mm	1
81471	Držák cenovky rohový 90st. 500mm	1
81472	Cenovková lišta rohová 90st. 400mm	1
81473	Cenovková lišta rohová 90st. 500mm	1

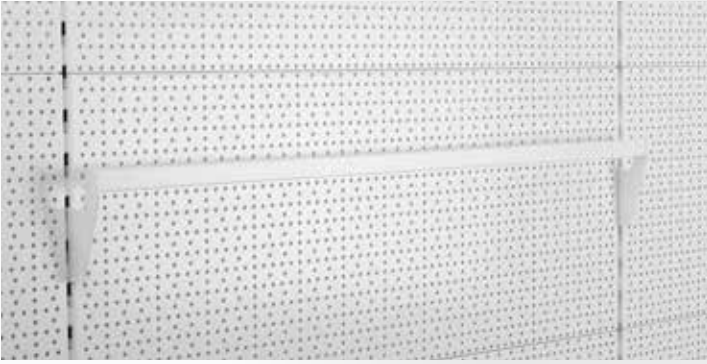

TRADE KONZOLA

kompatibilní se stojanem FESTA

Č.p.	specifikace	
81150	1000 × 50 × 135 mm	1

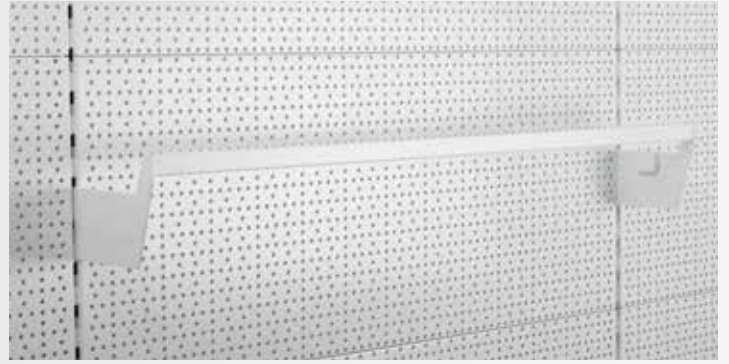

TRADE KONZOLA

kompatibilní se stojanem FESTA

Č.p.	specifikace	
81151	1000 × 150 × 135 mm	1

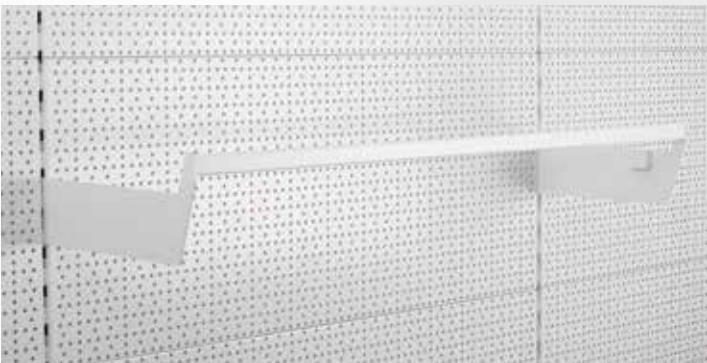

TRADE KONZOLA

kompatibilní se stojanem FESTA

Č.p.	specifikace	
81152	1000 × 350 × 135 mm	1

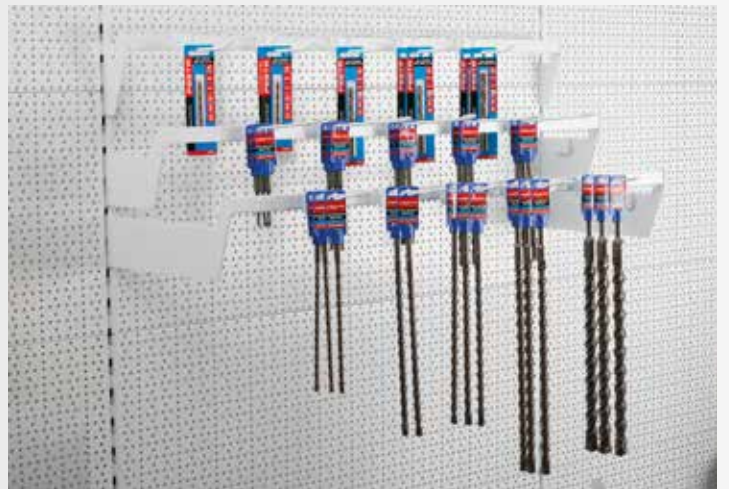

DRŽÁK CENOVKOVÉ LIŠTY

kompatibilní se stojanem FESTA

Č.p.	specifikace	
81155	1000 × 80 × 100 mm	1

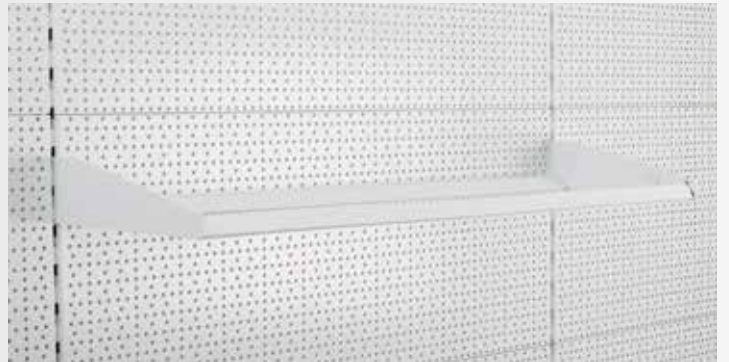

RÁM PRO ŘEZNÉ KOTOUČE

kompatibilní se stojanem FESTA

Č.p.	specifikace	
81170	1000 × 450 × 85 mm	1

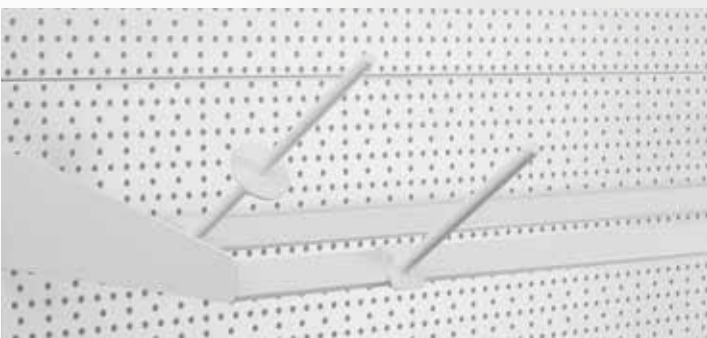

HÁK PRO ŘEZNÉ KOTOUČE

kompatibilní se stojanem FESTA

Č.p.	specifikace	
81186	150 mm	1
81185	250 mm	1



HÁK PRO AKU NÁŘADÍ

kompatibilní se stojanem FESTA

Č.p.	
81189	1

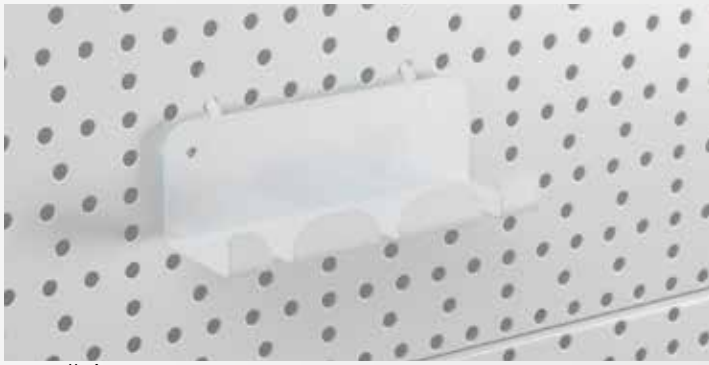

DRŽÁK NA PILY

kompatibilní se stojanem FESTA

Č.p. 81190 specifikace



1



POLICE PRO KOTOUČE

kompatibilní se stojanem FESTA

Č.p. 81191 specifikace 220 x 220 x 200 mm



1

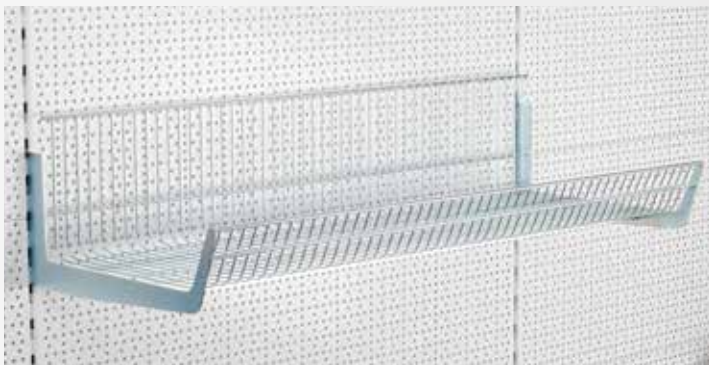

KOŠ ZÁVĚSNÝ

kompatibilní se stojanem FESTA

Č.p. 81160 specifikace 1000 x 470 x 180 mm



1



DĚLÍTKO

kompatibilní se stojanem FESTA

Č.p. 81165 specifikace 470 x 180 mm



1

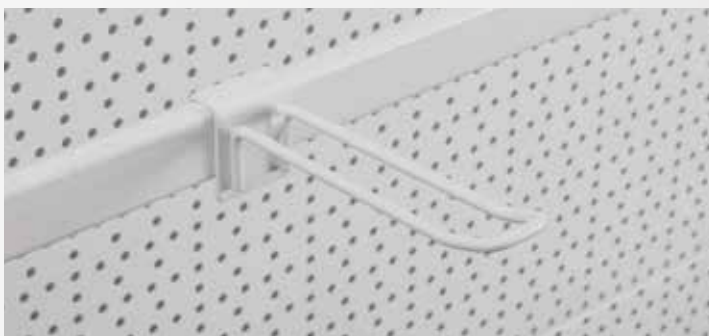

HÁK DVOJITÝ NA HRAZDU

kompatibilní se stojanem FESTA

Č.p. 81175 specifikace 120 mm
81178 specifikace 180 mm



1

1



HÁK JEDNODUCHÝ NA HRAZDU

kompatibilní se stojanem FESTA

Č.p. 81180 specifikace 120 mm



1



Kubala
HLADÍTKO NEREZ

INOX

Č.p.	specifikace		
33100	130 x 270 mm	hladké, 2 zaoblené rohy	10



Kubala
HLADÍTKO NEREZ

INOX

Č.p.	specifikace		
33102	130 x 270 mm	hladké, G-1 ručka	10



Kubala
HLADÍTKO NEREZ

INOX

Č.p.	specifikace		
33105	130 x 350 mm	hladké, G-8 ručka	6



Kubala
HLADÍTKO NEREZ

INOX

Č.p.	specifikace		
33107	110 x 270 mm	rohové	10



Kubala
HLADÍTKO NEREZ

INOX

Č.p.	specifikace		
33110	130 x 270 mm	hladké, G-11 ručka	10



Kubala
HLADÍTKO NEREZ

INOX

Č.p.	specifikace		
33112	130 x 270 mm	zub 6 x 6, G-11 ručka	10
33113	130 x 270 mm	zub 8 x 8, G-11 ručka	10
33114	130 x 270 mm	zub 10 x 10, G-11 ručka	10



Kubala
HLADÍTKO NEREZ

INOX

Č.p.	specifikace		
33120	130 x 480 mm	hladké, G-12 ručka	10



Kubala
HLADÍTKO NEREZ

INOX

Č.p.	specifikace		
33123	130 x 480 mm	zub 8 x 8, G-12 ručka	10
33124	130 x 480 mm	zub 10 x 10, G-12 ručka	10



Kubala

HLADÍTKO NEREZ OBLÉ ROHY

INOX

Č.p.	specifikace	
33127	130 x 480 mm 2 zaoblené rohy	10



Kubala

HLADÍTKO NEREZ " BENÁTSKÉ "

INOX

Č.p.	specifikace	
33131	80 x 200 mm G-1 ručka	10
33132	75 x 95 x 240 mm trapézové G-1 ručka	10



Kubala

HLADÍTKO NEREZ

INOX

Č.p.	specifikace	
33135	130 x 270 mm šikmé zuby 8 mm, G-1 ručka	10



Kubala

HLADÍTKO NEREZ

INOX

Č.p.	specifikace	
33137	130 x 270 mm zub půlkulatý, G-1 ručka	10



Kubala

LŽÍCE ŠTUKATÉRSKÁ

INOX

Č.p.	specifikace	
33140	50 mm	20
33141	60 mm	20
33142	80 mm	20
33143	100 mm	20



Kubala

HLADÍTKO PLASTOVÉ ABS

Č.p.	specifikace	
33150	130 x 240 mm	12

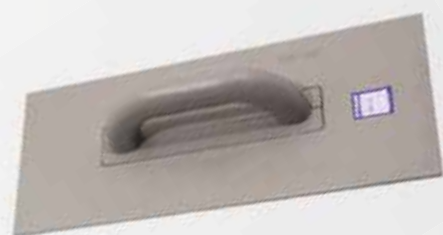

Kubala

HLADÍTKO PLASTOVÉ

Č.p.	specifikace	
33151	180 x 400 mm	1
33152	130 x 600 mm	1



Kubala

HLADÍTKO PLASTOVÉ

Č.p.	specifikace	
33154	130 x 270 mm G-17 ručka	12



Kubala

ŠKRABÁK
NA KAMENNOU VLNU

Zn

Č.p.	specifikace	MOQ
32328	285 x 145 mm	2 10



Kubala

HLADÍTKO PRO BRUSNOU MŘÍŽKU

Č.p.	specifikace	MOQ
33160	105 x 210 mm s podkladovou gumou	2 20



Kubala

HLADÍTKO BRUSNÉ

INOX

Č.p.	specifikace	MOQ
33162	130 x 270 mm	2 20
33163	180 x 400 mm	10
33164	160 x 380 mm	10



Kubala

HLADÍTKO BRUSNÉ PLASTOVÉ

Č.p.	specifikace	MOQ
33165	165 x 365 mm	2 10



Kubala

HLADÍTKO BRUSNÉ S OTVORY

Č.p.	specifikace	MOQ
33169	160 x 380 mm děrované, G-16 ručka	2 10



Kubala

HLADÍTKO BRUSNÉ S OTVORY

Č.p.	specifikace	MOQ
33167	130 x 270 mm G-17 ručka	2 20
33168	160 x 380 mm G-17 ručka	10
33170	180 x 400 mm G-17 ručka	10



Kubala
STĚRKA NEREZOVÁ

INOX

Č.p.	specifikace	
33200	40 mm	20
33201	60 mm	20
33202	80 mm	20
33203	100 mm	20



Kubala
STĚRKA NEREZOVÁ

INOX

Č.p.	specifikace	
33205	130 x 90 mm	20



Kubala
STĚRKA NEREZOVÁ

INOX

Č.p.	specifikace	
33206	130 x 37 mm	20



Kubala
STĚRKA NEREZOVÁ

INOX

Č.p.	specifikace	
33207	150 mm s bitem PH2	30



Kubala
STĚRKA NEREZOVÁ

INOX

Č.p.	specifikace	
33208	350 x 90 mm	10



Kubala
STĚRKA NEREZOVÁ

INOX

Č.p.	specifikace	
33209	335 x 37 mm	20



Kubala
STĚRKA NEREZOVÁ

INOX

Č.p.	specifikace	
33210	150 mm G-15 ručka	10
33211	250 mm G-15 ručka	10
33212	350 mm G-15 ručka	10



Kubala
STĚRKA NEREZOVÁ FASÁDNÍ

INOX

Č.p.	specifikace	
33215	600 mm AL uchycení, G-14 ručka	10



Kubala
STĚRKA PLASTOVÁ

Č.p.	specifikace	
33220	145 mm s gumou	10



Kubala
STĚRKA PLASTOVÁ

Č.p.	specifikace	
33221	245 mm s gumou	10



Kubala
HLADÍTKO PLASTOVÉ, GUMA POD ÚHLEM

Č.p.	specifikace	
33155	95 x 240 mm s podkladovou gumou	5



Kubala
SOUPRAVA PRO OBKLADAČE

Č.p.	specifikace	
33250		1



Kubala
KBELÍK OBDÉLNÍKOVÝ

Č.p.	specifikace	
33254	16 l mřížka, kolečka	1
33255	20 l mřížka, kolečka	1



Kubala
SOUPRAVA PRO OBKLADAČE MINI

Č.p.	specifikace	
33252		1



Kubala
DÍLY PRO VYMÝVACÍ SADY

Č.p.	specifikace	
33257	trojté válečky do kbelíku	1



Kubala
DÍLY PRO VYMÝVACÍ SADY

Č.p.	specifikace	
33256	válečky do kbelíku	1
33258	válečky do kbelíku	1



Kubala

DISTANČNÍ SPONY SMART LEVEL

· nivelační klínky 33246, 33246

100x

Č.p.	specifikace	
33247	1 mm	15
33248	2 mm	15
33249	3 mm	15

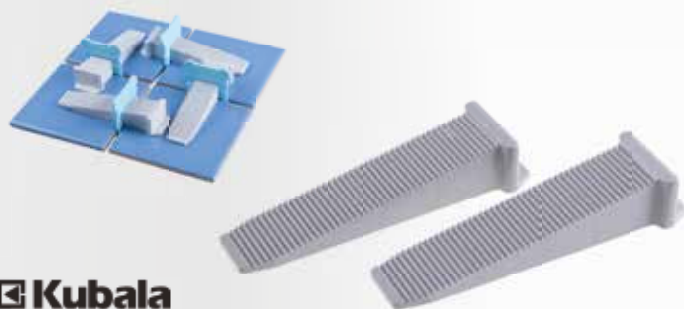

Kubala

NIVELAČNÍ KLÍNKY

50x

Č.p.	specifikace	
33246	Smart Level	15



Kubala

NABĚRAČKA PLASTOVÁ

Č.p.	specifikace	
33270	175 mm	20



Kubala

MISKA NA SÁDRU GUMOVÁ

Č.p.	specifikace	
33275	0,5 l	20



Kubala

STĚRKA GUMOVÁ

Č.p.	specifikace	
33280	200 mm	10
37010	135 mm	20



Kubala

NIVELAČNÍ VÁLEČEK

Č.p.	specifikace	
33289	85 x 230 mm	15



Kubala

ŠKRABÁK NA BARVY CIDLINKA

Č.p.	specifikace	
33285	60 mm	1
33286	náhradní ostří 60 mm	1



Kubala

VRTÁK DO POROBETONU

Č.p.	specifikace	
33291	60 mm	1
33292	80 mm	1
33293	120 mm	1



Kubala

POKOSNICE PLASTOVÁ

Č.p.	specifikace	
33298	250 x 80 x 50 mm	1
33299	300 x 115 x 65 mm	1



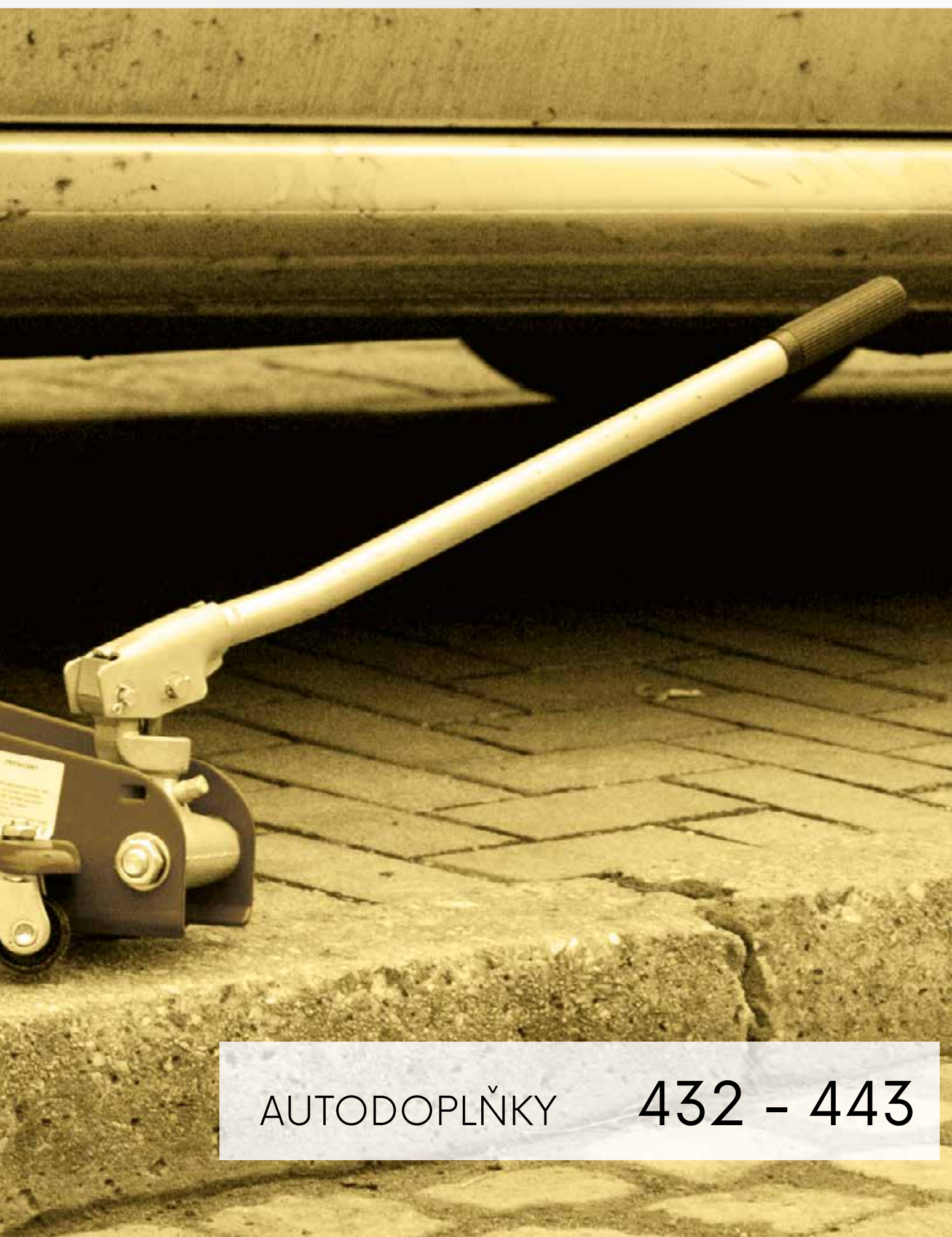

AUTODOPLŇKY 432 - 443





HYDRAULICKÝ ZVEDÁK, JEDNOPÍSTOVÝ

- stavitelný šroub umožňuje jemné nastavení výšky a maximální zdvih
- dvojitý bezpečnostní přepouštěcí ventil
- velká vroubkovaná dosedací plocha pro bezpečné podepření
- široká základna zajišťuje stabilitu a odolnost
- všechny silně namáhané body jsou zesílené pro zvýšení odolnosti a životnosti



Č.p.	specifikace	nosnost	min. výška	zdvih	jemné nastavení výšky	rozměry základny	váha	
26800	hydraulický zvedák	2 000 kg	181mm	116 mm	48 mm	88 x 92 mm	2,6 kg	1
26801	hydraulický zvedák	3 000 kg	194 mm	118 mm	60 mm	92 x 100 mm	3,3 kg	1
26802	hydraulický zvedák	5 000 kg	216 mm	127 mm	70 mm	96 x 112 mm	4,5 kg	1
26803	hydraulický zvedák	8 000 kg	230 mm	147 mm	80 mm	103 x 118 mm	5,7 kg	1
26804	hydraulický zvedák	10 000 kg	230 mm	150 mm	80 mm	110 x 123 mm	6,8 kg	1
26805	hydraulický zvedák	12 000 kg	230 mm	155 mm	80 mm	116 x 134 mm	7,3 kg	1
26806	hydraulický zvedák	15 000 kg	230 mm	150 mm	80 mm	133 x 136 mm	8,4 kg	1
26807	hydraulický zvedák	20 000 kg	242 mm	150 mm	60 mm	144 x 152 mm	11 kg	1

HYDRAULICKÝ ZVEDÁK, DVOUPÍSTOVÝ

- stavitelný šroub umožňuje jemné nastavení výšky a maximální zdvih.
- dvojitý bezpečnostní přepouštěcí ventil.
- velká vroubkovaná dosedací plocha pro bezpečné podepření.
- široká základna zajišťuje stabilitu a odolnost.
- všechny silně namáhané body jsou zesílené pro zvýšení odolnosti a životnosti.



Č.p.	specifikace	nosnost	min. výška	zdvih	jemné nastavení výšky	váha	
26815	hydraulický zvedák teleskopický	2 000 kg	150 mm	160 mm	60 mm	4,7 kg	1
26816	hydraulický zvedák teleskopický	4 000 kg	160 mm	170 mm	60 mm	6,4 kg	1
26817	hydraulický zvedák teleskopický	6 000 kg	215 mm	270 mm	-	8,9 kg	1
26819	hydraulický zvedák teleskopický	10 000 kg	228 mm	284 mm	89 mm	10,2 kg	1



NŮŽKOVÝ ZVEDÁK



Č.p.	specifikace	nosnost	min výška	max výška	váha	
26844	nůžkový zvedák	1 000 kg	88 mm	380 mm	2,5 kg	1
26845	nůžkový zvedák	2 000 kg	120 mm	395 mm	3,5 kg	1



26820



26826



26824



26825

HYDRAULICKÝ POJÍZDNÝ ZVEDÁK



Č.p.	specifikace	nosnost	min výška	max výška	váha	
26820	hydraul. zvedák pojízdný, přenosný	2 000 kg	130 mm	345 mm	9,6 kg	1
26826	hydraul. zvedák pojízdný, nízký profil, 360° otoč. madlo	2 000 kg	89 mm	359 mm	14,2 kg	1
26824	hydraul. zvedák pojízdný, dílenský, nožní pedál	3 000 kg	145 mm	500 mm	37,2 kg	1
26825	hydraul. zvedák pojízdný, dílenský, nízký profil, profi	2 500 kg	85 mm	455 mm	34,8 kg	1



HYDRAULICKÝ POJÍZDNÝ ZVEDÁK + PODPĚRY

· ovládací tyč otočná o 360°



Č.p.	specifikace	nosnost	min výška	max výška	váha	
26829	hydraulický zvedák pojízdný	2 000 kg	130 mm	350 mm	10,5 kg	1
	2ks stavitelné podpěry	2 000 kg	275 mm	420 mm	5 kg (pair)	



STAVITELNÁ PODPĚRA

- 1ks = 1pár
- hřeben pro přesné nastavení výšky s dvojitým zajištěním
- masivní ocelová rukojeť
- velká dosedací plocha, silná konstrukce rámu
- litinová podpěrná část



Č.p.	specifikace	nosnost	min výška	max výška	váha	
26857	stavitelná podpěra - pár; s pojistkou	2 000 kg	275 mm	420 mm	4,8 kg	1
26858	stavitelná podpěra - pár; s pojistkou	3 000 kg	285 mm	425 mm	6,3 kg	1
26859	stavitelná podpěra - pár; s pojistkou	6 000 kg	393 mm	593 mm	13 kg	1
26853	stavitelná podpěra - pár	12 000 kg	465 mm	715 mm	28 kg	1



HYDRAULICKÝ JEŘÁBOVÝ ZVEDÁK, SKLÁDACÍ

- pro zvedání a ukládání agregátů při jejich montáži a demontáži
- nosné rameno má několik poloh vysunutí a podle toho se také řídí nosnost jeřábu
- konstrukce ve sklopném provedení umožňuje, aby jeřáb zabíral mimo provoz malý prostor



Č.p.	specifikace	nosnost	min výška	max výška	váha	
26862	hydraulický jeřábový zvedák, skládací	2 000 kg	0	2360 mm	88 kg	1



OPĚRNÝ DRŽÁK MOTORU

- kyvadlové zavěšení ramene držáku v závislosti na sklonu kapoty,
- zajišťuje vždy vyvážené a stabilní upevnění motoru



Č.p.	specifikace	nosnost	délka	rozsah	váha	
26871	opěrný držák motoru	500 kg	1500 mm	150 mm	20,3 kg	1



HYDRAULICKÝ ZVEDÁK PŘEVODOVKY

- snadná montáž a demontáž agregátů (motorů, převodovek, náprav apod.)



Č.p.	specifikace	nosnost	délka	rozsah	váha	
26880	hydraulický zvedák převodovky	500 kg	1100 mm	1900 mm	30,0 kg	1
26881	nástavec pro automatické převodovky	500 kg	1100 mm	1900 mm	15,0 kg	1



ROZPÍNACÍ SOUPRAVA

- hydraulické zařízení pro opravování karoserií vozidel
- skládá se z hydraulického rozpínacího válce a 14ti dílů příslušenství
- široký rozsah využití při opravách karoserií osobních, dodávkových a nákladních vozidel především v místech, kde není možnost napojení na zdroj energie
- zařízení lze využít pro rozpínání, stlačování, zvedání a natahování ve vertikálních i horizontálních směrech
- jednoduché přenášení v plastovém kufru



Č.p.	specifikace	nosnost	hydraulický zdvih	váha	
26886	rozpínací souprava	4 000 kg	125 mm	17,0 kg	1
26888	rozpínací souprava	10 000 kg	135 mm	32,0 kg	1



26920



26921



26922

STOJAN NA MOTOR

- pojízdný stojan pro upevnění a práci na demontovaných motorech
- univerzální upínací jednotka umožňuje jak upnutí motoru, tak jeho otáčení



Č.p.	specifikace	nosnost	váha	
26920	stojan na motor polohovatelný, pojízdný	450 kg	20 kg	1
26921	stojan na motor polohovatelný, pojízdný	560 kg	27 kg	1
26922	stojan na motor polohovatelný, pojízdný, skládací	675 kg	35 kg	1

RUČNÍ LANOVÝ NAVIJÁK

Zn

- kvalitní pozinkovaný naviják s odolným ocelovým lanem



Č.p.	specifikace	Ø průměr lana	max.zátěž	délka lana	
26705	ruční lanový naviják	4,0mm	450 kg	10 m	1
26706	ruční lanový naviják	5,0mm	900 kg	10 m	1
26707	ruční lanový naviják	6,0mm	1350 kg	10 m	1
26720	ruční lanový naviják	4,0mm	300 kg	10 m	1
26721	ruční lanový naviják	4,0mm	500 kg	10 m	1
26722	ruční lanový naviják	5,0mm	800 kg	10 m	1

ŘETĚZOVÝ ZVEDÁK



Č.p.	specifikace	zátěž	min.výška	zdvih	počet kladek	síla řetězu	váha	
26700	řetězový zvedák	500 kg	280 mm	3 m	1	6 mm	7,5 kg	1
26701	řetězový zvedák	1 000 kg	300 mm	3 m	1	6 mm	9 kg	1
26702	řetězový zvedák	2 000 kg	380 mm	3 m	2	6 mm	12 kg	1



STLAČOVAČ PRUŽIN

· 26897 - pro demontáž pružin typu mcpherson přímo na vozidle.

· 26943 - pro demontáž pružin typu mcpherson mimo vozidlo masivní ocelové profily pro větší stabilitu.



Č.p.	specifikace	zátěž	Ø stlač. pružiny	rozpětí stlačení	váha	
26897	stlačovač pružin přenosný	1 000 kg	100-200 mm	150 mm	24,5 kg	1
26943	stlačovač pružin	1 000 kg	400 mm	210-570 mm	35 kg	1



HYDRAULICKÝ LIS



Č.p.	specifikace	rozsah	max.zátěž	váha	
26940	hydraulický lis	0 - 610 mm	12 000 kg	43 kg	1
26941	hydraulický lis	0 - 880 mm	20 000 kg	75 kg	1

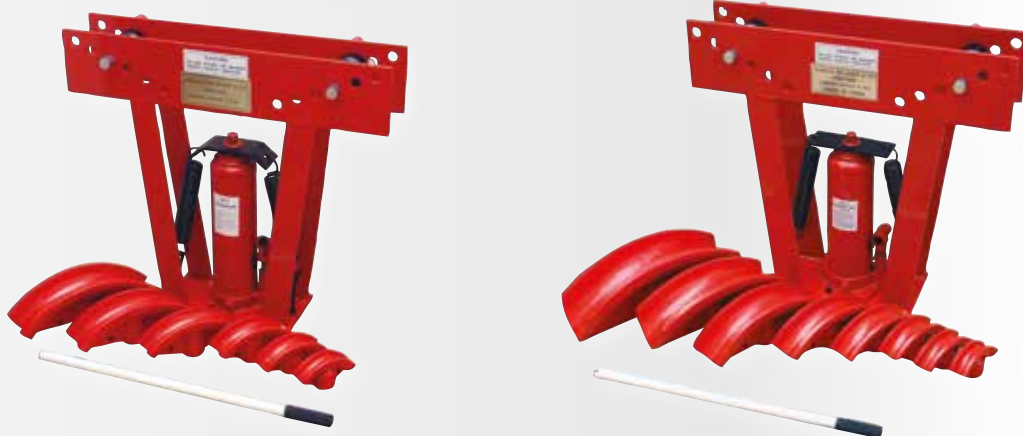

HYDRAULICKÁ OHÝBAČKA TRUBEK



Č.p.	specifikace	zátěž	zdvih	ohýbací kolena	váha	
26895		12 000 kg	232 mm	1½", 3¼", 1", 1-1¼", 1-1½", 2"	36 kg	1
26896		16 000 kg	238 mm	1½", 3¼", 1", 1-1¼", 1-1½", 2", 2-1½", 3"	65 kg	1



HYDRAULICKÝ VÁLEC



Č.p.	specifikace	zátěž	min.délka (mm)	max.délka (mm)	váha	
26911	hydraulický válec, jednoduchá pumpa	5 000 kg	620	1100	12 kg	2
26912	hydraulický válec, jednoduchá pumpa	8 000 kg	620	1100	13 kg	2
26914	hydraulický válec, dvojitá pumpa	5 000 kg	620	1100	12 kg	2
26915	hydraulický válec, dvojitá pumpa	8 000 kg	620	1100	14 kg	2



MYČKA SOUČÁSTEK

· pro běžné mytí předmětů (součástky, díly strojů apod.)



Č.p.	specifikace	objem vany	objem čisticí kapaliny	Průtok	Max. teplota čisticí kapaliny	váha	
26961	myčka součástek	90 l	45 l	10-12 l/min.	50°C	25 kg	1
26963	myčka součástek	180l	150 l	20 l/min	50°C	42 kg	1



ODSÁVAČKA VYJETÉHO OLEJE

- olej se z motoru vypouští do vypouštěcí vaničky, odkud stéká do zásobníku
- nádoba je navíc vybavena pneumatickou odsávačkou
- vyprazdňování zásobníku se provádí pneumaticky jeho připojením na stlačený vzduch



Č.p.	objem	max.tlak	váha	
26954	90 l	0,5 MPa	28 kg	1



STAHOVÁK NA LOŽISKA - DVOURAMENNÝ



STAHOVÁK NA LOŽISKA - TŘÍRAMENNÝ



Č.p.	max. průměr	hloubka	
23734	Ø 100 mm	50-95 mm	1
23735	Ø 150 mm	100-150 mm	1
23736	Ø 200 mm	110-190 mm	1

Č.p.	max. průměr	hloubka	
23730	Ø 100 mm	50-95 mm	12
23731	Ø 150 mm	100-150 mm	2
23732	Ø 200 mm	110-190 mm	2

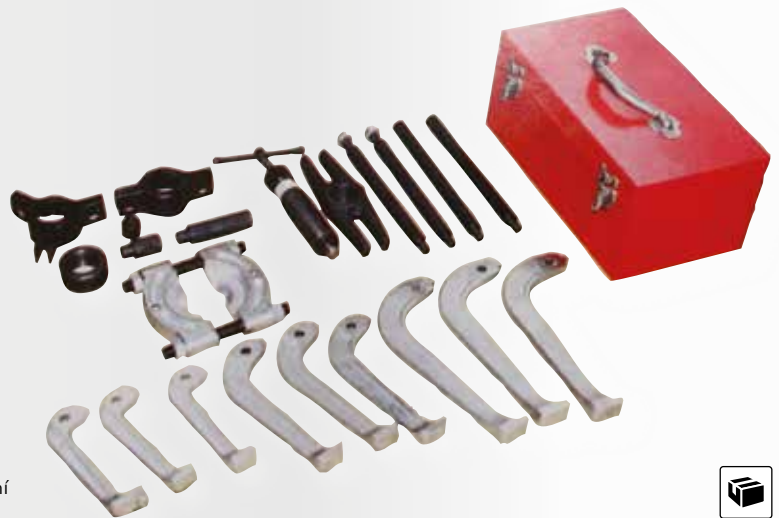

HYDRAULICKÝ STAHOVÁK

- sada s hydraulickým stahovákem na ložiska, náboje kol, ozubená kola
- obsahuje hydraulický šroub, třmen, separátor, tažné šrouby + prodloužení
- v kovovém kufru



Č.p.	specifikace	zátěž	váha	
26891	univerzální sada hydraulických stahováků	12 000 kg	18 kg	1



NÁHRADNÍ DÍLY K PÍSKOVACÍ KABINĚ

Č.p.	rozměry	
26973	rukavice	1
26974	trysky	1
26975	fólie 53,5 x 26 cm	1
26976	plexisklo 60 x 30 cm	1
26977	sklo 60 x 30 cm	1

PÍSKOVACÍ KABINA 220 L



Č.p.	spotřeba vzduchu	vnější rozměry	vnitřní rozměry	max.tlak	váha	
26972	420-710 l/min.	1500 x 830 x 630 mm	600 x 840 x 630 mm	8 bar	38 kg	1

**FESTA****VOZÍK NA NÁŘADÍ**

Č.p.	Pojezdy zásuvek	Zásuvky	Celkové rozměry (mm)	
26986	kluzné	7	680 x 460 x 1020 mm	1

**VOZÍK NA NÁŘADÍ**

· horní skříňku lze uložit do spodního vozíku

Č.p.	specifikace	Pojezdy zásuvek	Zásuvky	Vnitřní rozměry zásuvek ŠxHxV	Celkové rozměry	Celková váha (kg)	
26985	horní skříňka	kluzné	3	151,5 x 225 x 40 mm	600 x 260 x 340 mm	11,5 kg	1
			2	511 x 225 x 40 mm			
26985	spodní skříňka	kluzné	1	511 x 225 x 85 mm	616 x 330 x 742 mm	16,4 kg	1
			2	511 x 308 x 85 mm			



MAGNETICKÁ MISKA



Č.p.	Specifikace	
26996	200 x 20 mm	1



NAPÍNACÍ ZAŘÍZENÍ



Č.p.	Specifikace	
50035	2 t	6
50036	4 t	4



POJÍZDNÉ KLEKÁTKO



Č.p.	
37135	1



MONTÁŽNÍ SEDÁTKO

čalouněné pojízdné sedátko s plastovou odkládací přihrádkou

Č.p.	Specifikace	
26988	360 x 365 x 365 mm	1



HYDRAULICKÝ MINI JEŘÁB - MODEL

Č.p.	
26998	1

číslo položky	str.	číslo položky	str.	číslo položky	str.	číslo položky	str.	číslo položky	str.	číslo položky	str.
10002	26	12020	31	13275	51	13452	32	14077	35	15230	40
10003	26	12030	31	13276	52	13453	32	14080	34	15235	40
10005	26	12050	31	13277	55	13454	32	14090	35	15310	40
10008	26	12110	31	13278	51	13455	32	14091	35	15315	40
10025	26	12120	31	13279	50	13456	32	14220	36	15318	40
10033	26	12130	31	13280	51	13457	32	14225	36	15320	40
10035	26	12150	31	13281	55	13458	32	14230	36	15325	40
10043	26	12210	31	13282	55	13459	32	14235	36	15330	40
10045	26	12220	31	13284	50	13460	32	14240	36	15335	40
10048	26	12230	31	13285	55	13461	32	14250	36	15340	40
10110	27	12250	31	13290	92	13462	32	14350	36	15415	41
10120	27	12433	31	13293	92	13463	32	14360	36	15418	41
10130	27	12435	31	13294	92	13464	32	14370	36	15420	41
10330	27	13010	32	13295	57	13465	32	14380	36	15425	41
10332	27	13020	32	13296	57	13466	32	14399	36	15430	41
10334	27	13021	32	13350	56	13467	32	14410	37	15510	41
10336	27	13022	32	13351	56	13468	32	14411	37	15515	41
10430	27	13023	32	13352	56	13469	32	14415	36	15518	41
10450	27	13111	32	13353	56	13470	32	14417	36	15520	41
10490	27	13120	32	13354	56	13471	32	14420	36	15525	41
10996	27	13205	54	13355	56	13472	32	14421	36	15530	41
10998	27	13206	54	13360	56	13473	32	14425	37	15535	41
10999	27	13207	54	13361	56	13500	30	14430	37	15540	41
11002	29	13208	54	13362	56	13501	30	14435	37	15615	41
11003	29	13210	32	13363	56	13502	30	14440	37	15620	41
11005	29	13211	32	13364	56	13503	30	14450	37	15625	41
11006	29	13212	54	13365	56	13504	30	14451	37	15630	41
11007	29	13214	53	13399	33	13505	30	14455	37	15710	41
11008	29	13216	53	13400	33	13506	30	14456	37	15715	41
11082	29	13217	53	13401	32	13507	30	14457	37	15720	41
11083	29	13218	53	13402	32	13508	30	14458	37	15725	41
11085	29	13219	53	13403	32	13509	30	14471	37	15730	41
11102	29	13220	32	13404	32	13510	30	14472	37	15735	41
11103	29	13222	53	13405	32	13511	30	14473	37	15740	41
11105	29	13223	53	13406	32	13512	30	14474	37	15810	42
11106	29	13224	53	13407	32	13513	30	14480	35	15812	42
11107	29	13225	53	13408	32	13514	30	14485	37	15815	42
11110	29	13226	53	13409	32	13515	30	14485	42	15818	42
11200	29	13227	53	13410	32	13516	30	14486	37	15820	42
11201	29	13228	53	13411	32	13517	30	14486	42	15825	42
11202	29	13229	53	13412	32	13518	30	14490	37	15830	42
11204	29	13230	53	13413	32	13519	30	14491	37	15850	42
11205	29	13231	53	13414	32	13520	30	14492	37	15853	42
11206	29	13235	53	13415	32	13521	30	14493	37	15855	42
11207	29	13236	53	13416	32	13522	30	14494	37	15860	42
11208	29	13237	53	13417	32	13523	30	15003	39	15870	42
11209	29	13238	53	13418	32	13524	30	15004	39	15880	42
11210	29	13240	55	13419	32	13525	30	15005	39	15885	259
11220	28	13241	55	13420	32	13526	30	15006	39	15886	259
11221	28	13242	55	13421	32	13527	30	15008	39	15886	383
11226	28	13243	55	13422	32	13528	30	15010	39	15887	259
11239	28	13244	55	13423	32	13529	30	15012	39	15887	383
11259	28	13245	55	13424	32	13530	30	15015	39	15888	259
11260	28	13246	54	13425	32	13531	30	15018	39	15888	383
11311	30	13249	56	13426	32	13532	30	15020	39	15889	259
11312	30	13250	56	13427	32	13533	30	15033	38	15904	43
11313	30	13251	56	13428	32	13534	30	15034	38	15906	43
11314	30	13252	56	13429	32	14001	34	15035	38	15908	43
11323	28	13253	56	13430	32	14002	34	15036	38	15910	43
11325	28	13254	56	13431	32	14003	34	15037	38	15912	43
11327	28	13255	57	13432	32	14004	34	15039	38	15915	43
11333	29	13256	57	13433	32	14006	34	15103	39	15920	43
11335	29	13257	57	13434	32	14007	34	15104	39	15954	43
11337	29	13258	57	13435	32	14008	34	15105	39	15956	43
11338	29	13259	57	13436	32	14009	34	15106	39	15958	43
11343	28	13260	55	13437	32	14010	33	15108	39	15960	43
11345	28	13261	52	13438	32	14011	33	15110	39	15962	43
11347	28	13262	50	13439	32	14012	33	15112	39	15965	43
11353	28	13263	50	13440	32	14013	34	15115	39	15970	43
11355	28	13264	51	13441	32	14015	33	15118	39	15980	44
11356	28	13265	50	13442	32	14017	33	15120	39	15981	44
11358	28	13266	50	13443	32	14019	33	15204	40	15983	31
11360	28	13267	50	13444	32	14025	37	15205	40	15985	31
11410	30	13268	51	13445	32	14030	33	15206	40	15988	31
11416	29	13269	50	13446	32	14035	34	15208	40	15989	31
11420	30	13270	50	13447	32	14040	34	15210	40	15990	44
11425	30	13271	50	13448	32	14045	34	15212	40	15991	44
11444	30	13272	51	13449	32	14060	35	15215	40	15992	44
11445	30	13273	51	13450	32	14070	35	15218	40	15993	44
12010	31	13274	52	13451	32	14075	35	15220	40	15996	42

REJSTRÍK POLOŽEK



číslo položky	str.	číslo položky	str.	číslo položky	str.	číslo položky	str.	číslo položky	str.	číslo položky	str.
15997	42	16085	167	16991	177	17083	69	17211	73	17351	114
15998	42	16086	167	16991	344	17084	66	17212	74	17352	114
15999	42	16090	165	16998	163	17085	66	17213	74	17353	114
16002	162	16091	165	16999	163	17086	66	17214	74	17357	114
16003	162	16095	167	17001	62	17089	70	17215	74	17359	114
16004	163	16100	164	17002	62	17090	70	17216	75	17360	114
16005	163	16105	164	17003	62	17091	70	17217	75	17361	114
16006	163	16110	164	17004	62	17092	70	17218	75	17380	85
16010	163	16115	164	17005	62	17093	70	17219	75	17381	85
16010	163	16120	164	17006	62	17094	62	17220	77	17382	85
16011	162	16125	164	17007	62	17095	62	17222	77	17383	85
16011	162	16130	166	17008	62	17096	62	17224	77	17384	85
16011	163	16131	164	17009	62	17097	62	17225	76	17385	85
16012	162	16135	166	17010	62	17098	62	17226	76	17386	85
16012	162	16136	165	17011	62	17099	62	17227	76	17390	86
16012	163	16137	165	17012	66	17100	62	17229	78	17391	86
16013	163	16140	166	17013	66	17101	61	17230	79	17392	86
16013	163	16141	169	17014	66	17102	61	17231	79	17393	86
16016	163	16142	165	17015	69	17103	61	17233	79	17394	86
16017	163	16143	165	17016	69	17104	61	17234	79	17395	86
16019	162	16144	165	17017	69	17105	61	17235	80	17396	86
16021	169	16145	165	17019	69	17108	62	17236	80	17397	86
16022	173	16146	166	17020	68	17109	65	17237	80	17398	86
16023	167	16147	166	17021	68	17110	62	17238	110	17400	86
16024	169	16150	164	17022	68	17111	70	17238	78	17401	85
16025	166	16151	164	17023	65	17112	70	17240	81	17402	85
16026	169	16198	176	17024	62	17116	70	17241	81	17405	85
16028	169	16199	176	17025	64	17117	70	17242	81	17406	85
16029	166	16201	173	17026	179	17121	70	17243	81	17407	85
16030	168	16202	63	17027	179	17122	70	17244	81	17410	85
16031	168	16209	175	17028	68	17125	63	17245	78	17411	85
16032	168	16210	174	17029	68	17126	63	17247	111	17412	85
16033	168	16211	174	17033	66	17127	63	17250	77	17413	85
16034	166	16212	173	17034	65	17128	63	17255	77	17414	85
16035	168	16218	174	17035	65	17130	63	17259	111	17415	85
16036	168	16219	174	17036	65	17133	63	17260	110	17416	85
16037	167	16220	174	17037	179	17135	63	17261	91	17420	85
16038	168	16221	174	17038	69	17137	63	17262	91	17421	85
16041	168	16222	175	17039	68	17138	63	17292	81	17422	85
16042	170	16223	175	17040	64	17140	61	17294	81	17427	85
16042	284	16224	175	17041	64	17142	61	17295	81	17450	91
16043	169	16225	173	17042	64	17145	61	17296	81	17451	91
16046	169	16226	175	17043	64	17146	61	17297	81	17455	86
16049	170	16227	175	17044	64	17148	61	17298	81	17456	86
16050	170	16228	175	17045	64	17155	71	17299	81	17458	86
16051	170	16229	173	17046	68	17156	71	17300	69	17459	86
16052	170	16230	173	17047	64	17158	72	17301	69	17460	88
16053	169	16231	127	17048	68	17159	72	17302	69	17461	88
16054	170	16231	173	17050	72	17160	72	17303	69	17462	88
16055	169	16232	65	17050	179	17165	71	17304	69	17463	88
16056	284	16232	176	17051	68	17167	71	17305	69	17464	88
16057	167	16234	173	17052	68	17169	71	17306	69	17465	88
16058	167	16235	174	17053	68	17170	71	17308	82	17466	88
16059	170	16236	174	17054	68	17175	71	17309	82	17467	88
16060	172	16281	177	17055	68	17177	71	17310	82	17468	88
16061	172	16282	177	17056	68	17180	63	17311	82	17469	88
16062	171	16300	180	17057	68	17181	63	17312	82	17470	88
16063	171	16301	180	17058	68	17182	178	17313	82	17471	88
16064	171	16303	180	17059	66	17183	178	17314	82	17472	88
16065	171	16304	180	17060	66	17185	72	17315	82	17473	88
16066	164	16310	180	17061	66	17186	71	17316	82	17475	89
16066	171	16310	180	17062	66	17187	139	17317	82	17476	89
16067	171	16311	180	17063	67	17188	139	17318	82	17480	88
16068	171	16311	180	17064	67	17189	139	17319	82	17481	88
16069	170	16311	180	17065	67	17190	64	17320	82	17482	88
16070	170	16312	180	17066	67	17191	64	17321	82	17483	88
16070	172	16312	180	17067	67	17192	64	17322	82	17484	88
16071	167	16315	179	17068	67	17193	64	17324	82	17485	88
16071	172	16315	179	17069	67	17197	88	17327	82	17486	88
16072	172	16320	180	17070	67	17198	88	17330	82	17487	87
16073	172	16321	143	17071	67	17199	88	17332	82	17488	87
16074	167	16321	180	17072	67	17200	88	17333	82	17489	87
16074	172	16401	72	17075	67	17201	88	17334	82	17490	87
16075	172	16405	72	17076	67	17202	88	17335	77	17491	87
16077	171	16406	72	17077	67	17203	91	17336	77	17492	87
16078	171	16407	72	17078	69	17204	91	17337	77	17493	87
16081	171	16408	72	17079	66	17205	91	17338	77	17494	87
16082	170	16420	72	17080	66	17206	91	17345	76	17495	87
16083	172	16990	177	17081	66	17208	77	17346	76	17496	87
16084	172	16990	344	17082	66	17210	73	17350	114	17501	90

číslo položky	str.	číslo položky	str.	číslo položky	str.	číslo položky	str.	číslo položky	str.	číslo položky	str.
17506	89	17631	87	17851	83	18066	94	18416	99	18607	106
17508	89	17632	87	17852	83	18067	94	18417	99	18608	98
17512	89	17633	87	17853	83	18070	94	18418	97	18610	106
17526	89	17640	90	17854	83	18071	94	18419	99	18611	106
17528	89	17642	90	17855	83	18072	94	18420	99	18612	106
17532	89	17643	90	17856	83	18075	94	18421	109	18613	106
17533	89	17644	90	17860	82	18076	94	18422	95	18614	106
17534	89	17645	90	17861	82	18077	94	18423	96	18615	106
17539	89	17650	90	17862	82	18080	94	18424	95	18618	106
17548	87	17651	90	17863	82	18081	94	18425	98	18619	105
17549	87	17652	90	17864	82	18082	94	18426	96	18619	86
17550	87	17653	90	17865	82	18083	94	18430	109	18620	103
17551	87	17654	90	17866	82	18084	94	18431	99	18621	103
17552	87	17655	90	17867	82	18085	94	18433	98	18623	103
17553	87	17656	90	17868	82	18086	94	18435	100	18625	103
17554	87	17657	90	17869	82	18087	94	18437	96	18627	103
17555	87	17658	90	17870	82	18088	94	18440	109	18628	103
17556	87	17659	90	17871	82	18089	94	18450	98	18630	103
17557	87	17660	87	17872	82	18090	94	18451	98	18631	103
17558	87	17661	87	17873	82	18091	94	18455	94	18632	103
17559	87	17662	87	17874	82	18092	94	18456	94	18632A	102
17560	87	17663	87	17875	82	18101	97	18460	94	18633	103
17561	87	17664	87	17876	82	18102	97	18466	113	18633A	102
17562	87	17665	87	17877	82	18103	97	18468	113	18634	103
17563	87	17666	87	17878	82	18104	97	18476	113	18635	103
17564	87	17667	87	17879	82	18105	97	18477	113	18636	103
17565	87	17668	87	17880	82	18106	97	18490	112	18636A	102
17566	87	17669	87	17881	82	18107	97	18491	112	18637	103
17567	87	17670	87	17882	82	18108	97	18492	112	18637A	102
17568	87	17671	87	17883	82	18110	98	18493	112	18638	103
17569	87	17672	87	17884	82	18113	93	18494	114	18638A	102
17570	87	17674	87	17885	82	18114	93	18495	114	18639	103
17571	87	17675	87	17886	82	18115	93	18496	112	18640	103
17572	87	17676	87	17887	82	18116	93	18497	112	18641	103
17573	87	17677	87	17888	82	18118	93	18498	112	18645	103
17574	87	17678	87	17889	82	18120	93	18499	114	18646	103
17575	87	17679	87	17890	82	18124	93	18500	112	18680	103
17576	87	17680	90	17891	82	18125	93	18508	113	18685	103
17577	87	17681	90	17892	82	18201	97	18510	113	18750	103
17578	87	17682	90	17895	83	18202	97	18511	113	18751	103
17579	87	17683	87	17896	83	18203	97	18512	113	18753	103
17580	87	17685	88	17897	83	18204	97	18513	113	18755	103
17581	87	17761	88	17898	83	18210	93	18514	113	18760	103
17582	87	17769	88	17902	83	18211	93	18515	113	18761	103
17583	87	17788	88	17904	83	18212	93	18516	113	18762	103
17584	87	17789	88	17905	83	18215	93	18518	113	18763	103
17585	87	17795	88	17907	83	18216	93	18519	113	18764	103
17586	87	17806	88	17910	83	18301	97	18520	113	18765	103
17587	87	17810	82	17912	83	18302	97	18521	113	18766	103
17589	87	17811	82	17913	83	18303	97	18522	113	18767	103
17590	87	17812	82	17914	83	18304	97	18523	113	18768	103
17591	87	17820	82	17916	83	18310	93	18524	113	18769	103
17592	87	17821	82	17922	83	18311	93	18527	113	18770	103
17593	87	17822	82	17924	83	18312	93	18548	113	18771	103
17600	91	17823	82	17925	83	18313	93	18559	113	18772	103
17601	91	17824	82	17926	83	18321	93	18562	113	18775	103
17603	91	17825	82	17927	83	18322	93	18567	113	18776	103
17605	88	17826	82	17930	83	18340	95	18572	113	18777	103
17606	88	17827	82	17931	83	18350	94	18575	113	18795	105
17607	88	17828	82	17932	83	18351	94	18576	113	18796	105
17608	88	17829	82	17933	83	18352	94	18577	113	18797	105
17609	88	17830	82	17934	83	18353	94	18578	113	18798	105
17610	88	17831	82	17935	83	18354	94	18579	113	18799	106
17611	88	17832	82	17943	83	18355	94	18580	113	18800	104
17612	88	17835	83	17944	83	18356	94	18581	113	18801	104
17613	88	17836	83	17970	104	18357	94	18582	113	18802	104
17614	88	17837	83	17971	104	18358	94	18583	113	18803	104
17615	88	17838	83	17972	104	18359	94	18584	113	18804	104
17616	88	17839	83	17973	104	18360	94	18585	113	18805	104
17617	88	17840	83	17974	104	18400	97	18586	113	18806	104
17620	90	17841	83	17975	104	18401	97	18587	113	18807	104
17621	90	17842	83	17976	104	18402	95	18588	113	18810	104
17622	87	17843	83	17980	104	18403	95	18589	113	18811	104
17623	87	17844	83	17981	104	18404	95	18593	113	18812	104
17624	87	17845	83	17982	104	18408	100	18600	105	18813	104
17625	87	17846	83	17983	104	18409	100	18601	105	18814	104
17626	87	17847	83	18062	94	18410	96	18602	106	18815	104
17628	87	17848	83	18063	94	18411	96	18603	81	18816	104
17629	87	17849	83	18064	94	18413	96	18604	86	18817	104
17630	87	17850	83	18065	94	18415	99	18605	106	18820	104

REJSTRÍK POLOŽEK



číslo položky	str.	číslo položky	str.	číslo položky	str.	číslo položky	str.	číslo položky	str.	číslo položky	str.
18821	104	18957	84	19115	142	19410	126	19537	185	19607	185
18822	104	18960	84	19124	118	19410	202	19538	185	19608	185
18823	104	18961	84	19136	118	19411	126	19539	185	19609	185
18824	104	18963	84	19148	118	19411	202	19540	185	19610	185
18825	104	18971	84	19149	118	19412	126	19540	185	19610	185
18826	104	18993	107	19150	117	19412	202	19541	185	19611	185
18827	104	18994	107	19151	117	19415	125	19542	185	19612	185
18827A	102	19001	116	19200	120	19416	125	19543	185	19613	185
18828	104	19002	116	19202	120	19418	126	19544	185	19614	185
18828A	102	19003	116	19208	121	19418	202	19545	185	19615	185
18829	104	19004	116	19209	121	19419	126	19545	185	19615	185
18830	104	19005	116	19211	121	19419	202	19546	185	19616	185
18830A	102	19006	116	19245	120	19421	125	19547	185	19617	185
18831	104	19008	116	19246	120	19422	125	19548	185	19618	185
18831A	102	19010	116	19247	120	19423	125	19550	185	19619	185
18832	104	19015	116	19248	120	19424	125	19550	185	19620	185
18835	104	19020	116	19249	120	19425	125	19552	185	19620	185
18836	104	19021	116	19251	121	19426	125	19552	185	19621	185
18837	104	19022	116	19252	121	19427	125	19553	185	19622	185
18838	104	19023	116	19253	121	19429	202	19554	185	19623	185
18839	104	19024	116	19254	120	19430	119	19555	185	19624	185
18840	104	19025	116	19255	120	19431	119	19555	185	19625	185
18841	104	19026	116	19265	120	19432	119	19556	185	19625	185
18842	104	19028	116	19270	120	19433	119	19557	185	19626	185
18843	104	19030	116	19271	120	19434	119	19558	185	19627	185
18844	104	19031	116	19272	120	19435	119	19558	185	19628	185
18845	104	19032	116	19290	120	19436	126	19559	185	19629	185
18846	104	19034	116	19293	120	19436	202	19560	185	19630	185
18847	104	19036	116	19294	120	19440	119	19560	185	19630	185
18850	104	19041	115	19295	120	19441	119	19561	185	19631	185
18851	104	19042	115	19297	121	19442	119	19562	185	19632	185
18852	104	19043	115	19301	123	19443	119	19562	185	19633	185
18853	104	19044	115	19303	118	19450	127	19563	185	19634	185
18855	104	19045	115	19306	123	19451	127	19564	185	19635	185
18856	104	19046	115	19308	123	19455	127	19565	185	19635	185
18860	104	19050	116	19310	123	19457	127	19565	185	19636	185
18861	104	19051	118	19312	123	19458	128	19567	185	19637	185
18862	104	19052	118	19314	123	19459	128	19568	185	19638	185
18863	104	19053	116	19326	123	19460	126	19568	185	19639	185
18864	104	19054	116	19328	123	19462	124	19569	185	19640	185
18865	104	19055	116	19330	123	19463	124	19570	185	19640	185
18866	104	19056	116	19332	123	19464	124	19570	185	19641	185
18867	104	19057	116	19333	123	19465	124	19573	185	19642	185
18868	105	19058	116	19335	123	19469	124	19574	185	19643	185
18869	105	19059	116	19337	123	19470	126	19575	185	19644	185
18870	105	19060	118	19340	122	19472	203	19575	185	19645	185
18871	105	19061	117	19356	124	19473	203	19576	185	19645	185
18872	105	19062	117	19357	124	19474	203	19577	185	19646	185
18873	105	19063	117	19370	123	19477	203	19578	185	19647	185
18874	105	19064	117	19371	123	19478	203	19579	185	19648	185
18900	108	19065	118	19374	124	19480	203	19580	185	19649	185
18901	108	19066	116	19380	122	19481	203	19580	185	19650	185
18905	108	19067	116	19381	122	19482	203	19581	185	19650	185
18906	108	19068	116	19382	122	19483	203	19583	185	19651	185
18907	109	19069	116	19383	122	19485	202	19584	185	19652	185
18909	108	19070	116	19384	122	19486	202	19585	185	19653	185
18910	100	19071	116	19385	122	19487	202	19585	185	19654	185
18915	109	19074	115	19387	122	19490	127	19586	185	19655	185
18916	109	19075	115	19388	122	19491	127	19587	185	19656	185
18920	84	19076	115	19389	122	19492	127	19588	185	19657	185
18921	84	19077	115	19390	123	19493	127	19589	185	19658	185
18922	84	19081	115	19391	122	19494	127	19590	185	19659	185
18925	84	19082	115	19392	123	19495	127	19590	185	19660	185
18926	84	19083	115	19393	124	19496	127	19591	185	19661	185
18927	84	19084	115	19394	124	19497	127	19593	185	19662	185
18928	84	19085	115	19395	124	19498	127	19594	185	19663	185
18929	84	19086	115	19396	124	19499	127	19595	185	19664	185
18930	84	19088	115	19397	124	19501	127	19595	185	19665	185
18931	84	19090	115	19398	119	19502	127	19596	185	19669	185
18934	84	19092	115	19399	119	19510	128	19597	185	19670	186
18937	84	19095	115	19400	126	19515	128	19598	185	19671	186
18939	84	19096	115	19401	126	19520	128	19599	185	19672	186
18944	84	19097	115	19402	126	19530	185	19600	185	19673	186
18945	84	19098	115	19403	126	19530	185	19600	185	19673	186
18948	84	19100	117	19404	126	19532	185	19601	185	19674	186
18950	84	19106	115	19405	126	19533	185	19603	185	19675	186
18951	84	19108	115	19406	126	19534	185	19604	185	19676	186
18954	84	19109	115	19407	126	19535	185	19605	185	19677	186
18955	84	19110	128	19408	126	19535	185	19605	185	19678	186
18956	84	19115	118	19409	126	19536	185	19606	185	19678	186

číslo položky	str.	číslo položky	str.	číslo položky	str.	číslo položky	str.	číslo položky	str.	číslo položky	str.
19679	186	19743	186	20235	187	20493	191	20767	194	20942	197
19680	186	19743	186	20240	187	20494	191	20768	194	20943	197
19681	186	19744	186	20245	187	20495	191	20769	194	20944	197
19682	186	19745	186	20250	187	20496	191	20770	194	20945	197
19683	186	19746	186	20255	187	20508	195	20771	194	20946	197
19683	186	19747	186	20260	187	20510	195	20772	194	20947	197
19684	186	19748	186	20270	187	20511	195	20773	194	20948	197
19685	186	19748	186	20280	187	20512	195	20774	194	20949	197
19686	186	19749	186	20290	187	20513	195	20775	194	20950	196
19687	186	19750	186	20296	187	20514	195	20776	194	20952	196
19688	186	19751	186	20300	189	20515	195	20777	194	20954	196
19688	186	19752	186	20305	189	20516	195	20778	194	20956	197
19689	186	19753	186	20310	189	20520	195	20779	194	20957	204
19690	186	19753	186	20311	189	20521	195	20780	194	20958	204
19691	186	19754	186	20315	190	20522	195	20781	194	20960	209
19692	186	19755	186	20316	189	20523	195	20782	194	20961	209
19693	186	19756	186	20317	189	20524	195	20783	194	20963	209
19693	186	19757	186	20320	190	20525	195	20784	194	20965	209
19694	186	19758	186	20321	190	20526	195	20785	194	20966	209
19695	186	19758	186	20333	188	20673	194	20786	194	20967	90
19695	186	19759	186	20334	188	20674	194	20787	194	20968	90
19696	186	19760	186	20335	188	20675	194	20788	194	20969	90
19697	186	19761	186	20336	188	20676	194	20789	194	20970	209
19698	186	19762	186	20337	188	20677	194	20790	194	20971	209
19698	186	19763	186	20338	188	20678	194	20791	194	20972	209
19699	186	19763	186	20350	203	20680	194	20792	194	20973	209
19700	186	19764	186	20360	180	20682	194	20793	194	20980	204
19701	186	19765	186	20361	180	20684	194	20794	194	20981	204
19701	186	19766	186	20363	71	20685	194	20795	194	20982	204
19702	186	19767	186	20365	209	20686	194	20796	194	20983	204
19703	186	19768	186	20379	199	20687	194	20797	194	20984	204
19703	186	19768	186	20380	190	20688	194	20798	194	20990	197
19704	186	19769	186	20381	208	20690	194	20799	194	20991	197
19705	186	19770	186	20385	193	20691	194	20805	195	20992	197
19705	186	19771	186	20386	193	20692	194	20820	195	20999	195
19706	186	19772	186	20387	193	20694	194	20825	194	21010	236
19707	186	19772	186	20390	193	20696	194	20855	194	21011	236
19708	186	19773	186	20391	193	20697	194	20861	194	21012	236
19708	186	19774	186	20395	193	20698	194	20862	194	21015	236
19709	186	19775	186	20396	193	20724	204	20870	194	21018	236
19710	186	19776	186	20397	193	20725	204	20871	194	21023	236
19711	186	19776	186	20400	187	20726	204	20872	194	21110	236
19711	186	19777	186	20401	187	20727	204	20873	194	21111	236
19712	186	19778	186	20402	187	20728	204	20874	194	21112	236
19713	186	19779	186	20403	187	20729	204	20875	194	21115	236
19713	186	19780	186	20404	187	20730	204	20876	194	21118	236
19714	186	19781	186	20405	187	20731	204	20877	194	21123	236
19715	186	19781	186	20406	187	20732	204	20878	194	21130	236
19716	186	19782	186	20407	187	20733	204	20879	194	21135	236
19717	186	19783	186	20408	187	20734	204	20880	194	21140	236
19718	186	19783	186	20409	187	20735	204	20881	194	21150	236
19718	186	19784	186	20410	187	20736	204	20890	195	21180	236
19719	186	19785	186	20411	187	20737	204	20891	195	21190	236
19720	186	19786	186	20412	187	20738	204	20895	195	21192	239
19721	186	19786	186	20413	187	20739	204	20896	204	21194	239
19722	186	19787	186	20414	187	20740	204	20897	204	21195	237
19723	186	19788	186	20415	187	20741	204	20898	204	21200	234
19723	186	19789	186	20416	187	20743	106	20899	204	21201	234
19724	186	19790	186	20417	187	20743	197	20901	205	21203	234
19725	186	19791	186	20418	187	20744	197	20905	204	21204	234
19726	186	19792	186	20419	187	20744	208	20910	204	21210	234
19727	186	19793	186	20420	187	20745	208	20911	204	21211	234
19728	186	19794	186	20421	187	20748	194	20912	204	21212	234
19728	186	19795	186	20422	187	20749	194	20913	204	21215	234
19729	186	19796	186	20423	187	20750	194	20915	204	21218	234
19730	186	19797	186	20424	187	20751	194	20916	204	21219	234
19731	186	19798	186	20425	187	20752	194	20917	204	21220	234
19732	186	19799	186	20426	187	20753	194	20918	204	21223	234
19733	186	19800	186	20427	187	20754	194	20919	204	21224	234
19733	186	19801	186	20428	187	20755	194	20920	204	21301	235
19734	186	19802	186	20429	187	20756	194	20921	204	21303	235
19735	186	19841	187	20430	187	20757	194	20922	204	21306	239
19736	186	19842	187	20450	205	20758	194	20923	204	21308	239
19737	186	19845	187	20460	205	20759	194	20924	204	21311	235
19738	186	19885	187	20487	191	20760	194	20936	196	21312	235
19738	186	19895	187	20488	191	20761	194	20937	197	21315	235
19739	186	20210	205	20489	191	20762	194	20938	197	21318	235
19740	186	20220	187	20490	191	20764	194	20939	197	21323	235
19741	186	20225	187	20491	191	20765	194	20940	197	21324	235
19742	186	20230	187	20492	191	20766	194	20941	197	21326	235

REJSTRÍK POLOŽEK



číslo položky	str.	číslo položky	str.	číslo položky	str.	číslo položky	str.	číslo položky	str.	číslo položky	str.
21327	235	21803	240	22031	212	22113	218	22222	238	22535	184
21410	235	21804	240	22032	212	22115	218	22224	238	22540	184
21411	235	21810	216	22033	213	22116	218	22225	238	22542	184
21412	235	21811	216	22034	213	22117	218	22228	238	22545	184
21415	235	21812	216	22035	213	22120	219	22229	238	22548	184
21418	235	21813	216	22036	213	22121	219	22230	239	22550	184
21423	235	21814	216	22037	211	22122	219	22232	239	22555	184
21424	235	21831	216	22038	211	22123	219	22234	239	22560	184
21425	237	21832	216	22039	211	22124	219	22236	239	22565	184
21426	237	21834	216	22040	211	22125	219	22238	239	22568	184
21427	237	21850	218	22041	214	22126	219	22240	238	22570	184
21428	237	21851	218	22042	214	22129	219	22242	238	22575	184
21430	237	21852	218	22043	214	22130	219	22244	238	22580	184
21431	237	21853	218	22044	214	22132	219	22246	238	22585	184
21432	237	21854	218	22045	216	22133	219	22248	238	22590	184
21440	204	21855	218	22046	216	22134	219	22251	238	22595	184
21441	204	21856	218	22047	216	22135	381	22252	238	22600	184
21442	204	21857	218	22048	216	22136	381	22253	238	22602	184
21443	204	21858	218	22049	216	22137	381	22254	238	22605	184
21444	204	21859	218	22050	216	22138	381	22255	238	22610	184
21445	204	21860	218	22051	216	22140	241	22258	238	22615	184
21446	204	21861	218	22052	216	22141	241	22259	238	22620	184
21450	205	21862	218	22053	216	22142	241	22260	238	22625	184
21451	205	21863	218	22054	216	22143	241	22263	238	22630	184
21452	205	21864	218	22055	216	22145	241	22264	238	22701	214
21453	206	21900	210	22056	216	22146	241	22266	238	22702	214
21454	206	21901	210	22057	216	22147	241	22269	238	22703	214
21530	205	21902	210	22058	212	22148	241	22270	238	22704	214
21540	206	21903	210	22059	212	22150	241	22273	238	22705	214
21541	206	21904	210	22060	214	22151	241	22274	238	22706	214
21701	217	21905	210	22061	214	22155	241	22275	238	22707	214
21702	217	21906	210	22062	214	22156	241	22277	238	23000	400
21703	217	21907	211	22063	214	22158	213	22280	238	23001	400
21704	217	21908	211	22064	214	22159	213	22281	238	23005	402
21705	217	21909	211	22065	215	22160	216	22285	239	23006	402
21706	217	21910	211	22066	215	22161	216	22286	239	23010	402
21709	217	21911	211	22067	217	22162	216	22294	239	23020	402
21715	217	21912	211	22068	215	22163	216	22300	222	23025	402
21716	217	21913	211	22069	215	22164	216	22301	222	23030	402
21717	217	21914	211	22070	215	22166	216	22302	222	23035	402
21718	217	21920	210	22071	215	22167	216	22303	222	23040	402
21719	217	21925	210	22072	215	22168	216	22305	222	23050	402
21720	217	21926	210	22073	214	22170	221	22307	222	23060	402
21721	217	21930	212	22074	214	22171	221	22309	222	23070	402
21724	217	21931	212	22075	217	22172	221	22310	222	23125	401
21732	217	21935	212	22076	217	22173	221	22311	222	23130	401
21734	217	21936	212	22077	217	22174	221	22312	222	23135	401
21735	217	21937	212	22078	213	22178	220	22313	222	23140	401
21736	217	21940	212	22079	213	22180	220	22314	222	23150	401
21737	217	21941	212	22080	213	22181	220	22315	222	23160	401
21740	217	22001	210	22081	213	22182	220	22317	222	23211	401
21741	217	22002	210	22082	213	22183	220	22318	222	23212	401
21742	217	22003	210	22083	215	22184	220	22319	222	23213	401
21743	217	22004	211	22084	215	22185	220	22320	222	23214	401
21744	217	22005	211	22085	215	22186	220	22322	222	23215	401
21750	217	22006	211	22086	213	22188	221	22324	222	23220	401
21751	217	22007	210	22087	214	22189	221	22326	222	23225	401
21752	217	22008	210	22088	215	22190	221	22328	222	23232	401
21753	217	22009	210	22090	215	22195	221	22329	222	23240	401
21754	217	22010	210	22091	215	22197	221	22332	222	23250	401
21780	241	22011	210	22092	215	22198	221	22333	222	23260	401
21781	241	22012	211	22093	215	22199	221	22335	222	23261	401
21782	241	22013	211	22095	215	22200	199	22337	222	23262	401
21783	241	22014	211	22096	216	22201	199	22340	222	23263	401
21784	241	22015	211	22097	216	22202	221	22343	222	23264	401
21786	241	22016	211	22098	216	22203	221	22345	222	23265	401
21787	241	22017	211	22099	216	22204	221	22350	222	23266	401
21788	241	22018	212	22100	218	22205	221	22351	222	23274	401
21789	241	22019	212	22101	218	22206	220	22355	222	23275	401
21790	241	22020	212	22102	218	22207	220	22357	222	23281	403
21792	241	22021	212	22103	218	22208	220	22365	222	23282	403
21793	241	22022	212	22104	218	22209	220	22370	222	23284	403
21794	241	22023	211	22105	218	22211	238	22398	222	23287	402
21795	241	22024	211	22106	218	22212	238	22399	222	23288	402
21796	241	22025	211	22107	218	22215	238	22510	184	23290	403
21798	215	22026	212	22108	218	22216	238	22515	184	23291	403
21798	241	22027	212	22109	218	22217	238	22520	184	23292	403
21800	240	22028	212	22110	218	22218	238	22525	184	23297	403
21801	240	22029	212	22111	218	22219	238	22530	184	23310	401
21802	240	22030	212	22112	218	22220	238	22532	184	23311	401

číslo položky	str.	číslo položky	str.	číslo položky	str.	číslo položky	str.	číslo položky	str.	číslo položky	str.
23312	401	23735	139	24001	137	24148	230	24483	192	24779	201
23390	403	23736	441	24002	137	24149	230	24650	200	24780	201
23391	403	23736	139	24005	137	24150	231	24655	201	24781	201
23400	133	23760	130	24006	137	24151	231	24658	201	24782	201
23401	133	23761	130	24007	136	24152	232	24670	200	24783	201
23402	133	23762	130	24010	136	24152	339	24671	200	24784	201
23406	133	23763	130	24015	137	24153	228	24672	200	24785	201
23407	133	23764	130	24017	137	24154	231	24673	200	24786	201
23410	133	23800	130	24020	137	24155	233	24674	200	24787	201
23411	133	23810	410	24030	137	24156	233	24675	200	24788	201
23412	133	23814	410	24035	138	24158	233	24676	200	24789	201
23415	133	23816	410	24036	138	24159	219	24690	209	24790	200
23416	133	23818	410	24038	138	24159	233	24691	209	24791	200
23417	133	23820	410	24039	138	24160	227	24695	209	24792	200
23420	133	23824	410	24040	138	24161	227	24700	200	24793	200
23506	132	23826	410	24041	138	24162	227	24701	200	24794	200
23507	132	23828	410	24042	138	24163	227	24702	200	24795	201
23508	132	23830	410	24043	138	24164	227	24703	200	24796	200
23515	132	23840	345	24045	224	24165	227	24704	200	24798	200
23520	132	23845	344	24050	226	24166	227	24705	200	25001	323
23525	132	23846	344	24055	223	24167	227	24706	207	25002	323
23530	132	23847	344	24055	282	24168	227	24712	207	25003	323
23531	132	23850	410	24060	223	24169	227	24713	208	25004	323
23551	132	23854	410	24061	223	24170	229	24714	208	25005	323
23560	131	23856	410	24062	223	24171	230	24715	208	25006	322
23561	131	23858	410	24063	223	24173	231	24716	208	25009	322
23562	131	23860	410	24064	223	24174	233	24717	198	25012	322
23563	131	23864	410	24065	223	24175	233	24718	198	25015	322
23564	131	23865	410	24066	223	24176	233	24719	198	25016	322
23565	131	23866	410	24067	223	24177	233	24720	208	25020	322
23566	131	23868	410	24068	223	24178	233	24721	208	25024	322
23570	131	23870	410	24069	223	24180	228	24722	208	25025	322
23571	131	23875	394	24070	223	24181	233	24723	198	25030	322
23572	131	23880	410	24071	223	24185	227	24725	198	25040	322
23573	131	23882	410	24072	223	24186	227	24726	198	25048	322
23574	131	23884	410	24073	223	24187	227	24727	295	25060	322
23585	132	23904	130	24074	223	24188	227	24728	295	25096	322
23587	132	23906	130	24075	223	24189	227	24729	295	25150	322
23589	132	23908	130	24076	223	24190	219	24730	197	25153	322
23591	132	23910	130	24077	223	24190	233	24731	197	25155	322
23600	132	23912	130	24078	223	24192	227	24732	197	25160	323
23601	132	23914	130	24080	224	24195	227	24735	199	25162	323
23602	132	23920	130	24081	224	24196	227	24736	199	25163	323
23605	132	23922	130	24082	224	24197	227	24737	199	25164	323
23620	132	23923	129	24083	224	24212	414	24738	199	25167	323
23625	132	23924	129	24084	224	24225	414	24739	199	25169	323
23626	132	23925	129	24085	224	24250	414	24740	199	25170	323
23628	132	23927	129	24086	224	24255	414	24741	199	25171	323
23630	132	23928	130	24087	224	24258	414	24743	199	25179	322
23632	132	23945	129	24098	224	24260	414	24745	198	25180	322
23650	134	23950	138	24099	224	24301	225	24746	199	25181	322
23655	134	23951	138	24100	228	24302	225	24747	198	25182	322
23657	135	23952	138	24102	228	24303	225	24748	199	25183	322
23657	278	23953	138	24104	228	24304	225	24749	199	25184	322
23660	134	23954	138	24108	227	24305	225	24750	192	25186	322
23670	131	23955	138	24109	228	24306	225	24751	192	25188	322
23671	131	23960	130	24110	229	24308	226	24752	295	25189	322
23672	131	23961	130	24111	229	24310	226	24753	295	25190	322
23673	131	23962	130	24118	228	24312	226	24755	206	25195	322
23674	131	23963	130	24119	228	24313	226	24756	206	25206	322
23675	131	23964	130	24120	227	24314	227	24757	198	25212	322
23676	131	23965	130	24121	229	24315	226	24758	198	25215	322
23677	131	23966	130	24122	229	24316	226	24759	198	25220	322
23678	131	23967	130	24124	229	24410	192	24760	200	25224	322
23679	131	23970	138	24125	229	24411	192	24761	200	25230	322
23680	131	23971	138	24126	229	24412	192	24762	200	25240	322
23681	131	23972	138	24128	231	24415	207	24763	200	25248	322
23682	131	23973	138	24130	230	24419	192	24764	200	25260	322
23683	131	23974	138	24131	230	24420	192	24765	200	25296	322
23684	131	23975	138	24133	230	24422	192	24766	200	25350	322
23685	131	23976	138	24135	231	24425	192	24767	200	25369	322
23730	441	23977	138	24136	231	24429	192	24768	200	25370	322
23730	139	23978	138	24137	231	24432	192	24769	200	25371	322
23731	441	23979	138	24140	231	24435	192	24770	199	25372	322
23731	139	23985	138	24141	231	24437	192	24771	199	25373	322
23732	441	23986	138	24142	231	24444	192	24772	199	25374	322
23732	139	23987	138	24143	230	24451	192	24773	199	25376	322
23734	441	23988	138	24144	230	24457	192	24774	199	25378	322
23734	139	23989	138	24145	230	24464	192	24776	200	25379	322
23735	441	24000	137	24147	230	24476	192	24778	201	25380	322

REJSTRÍK POLOŽEK



číslo položky	str.	číslo položky	str.	číslo položky	str.	číslo položky	str.	číslo položky	str.	číslo položky	str.
25400	323	26963	440	31146	244	31559	249	32318	257	33257	430
25410	323	26972	441	31148	244	31601	255	32319	257	33258	430
26028	44	26973	441	31150	245	31602	255	32320	257	33270	431
26037	49	26974	441	31151	245	31603	255	32321	257	33275	431
26201	46	26975	441	31155	245	31610	249	32322	257	33275	431
26204	46	26976	441	31218	248	31641	255	32323	257	33280	431
26209	47	26977	441	31220	246	31651	255	32324	257	33285	431
26211	47	26979	443	31221	246	31655	255	32325	258	33286	431
26215	44	26985	442	31222	246	32001	252	32326	258	33289	431
26216	45	26986	442	31231	246	32002	252	32327	256	33291	431
26217	45	26988	443	31232	246	32003	252	32328	258	33292	431
26218	45	26996	443	31233	246	32013	252	32329	257	33293	431
26520	48	26997	443	31234	246	32014	252	32330	258	33298	431
26521	48	26998	443	31235	246	32015	252	32331	258	33299	431
26528	49	28000	4	31270	247	32016	252	32332	256	34005	259
26700	438	28001	5	31271	247	32018	252	32333	256	34006	259
26701	438	28002	5	31280	247	32020	252	32335	258	34007	259
26702	438	28003	6	31281	247	32021	252	32337	256	34027	259
26705	438	28004	6	31320	247	32022	255	32338	256	34028	258
26705	326	28005	7	31322	247	32023	255	32418	257	34033	264
26706	438	28006	7	31330	247	32024	252	32421	257	34041	259
26706	326	28007	8	31332	247	32026	252	33100	426	34051	259
26707	438	28008	8	31334	246	32037	255	33102	426	34053	259
26707	326	28021	9	31340	247	32040	255	33105	426	34061	260
26720	438	28025	9	31341	247	32041	255	33107	426	34071	260
26720	326	28030	12	31343	246	32042	255	33110	426	34081	260
26721	438	28032	12	31360	246	32043	255	33112	426	34091	260
26721	326	28035	14	31362	246	32044	255	33113	426	34101	260
26722	438	28040	13	31380	246	32050	255	33114	426	34111	260
26722	326	28045	13	31382	246	32051	255	33120	426	34115	260
26775	297	28050	15	31390	246	32052	255	33123	426	34116	260
26780	304	28055	15	31392	246	32053	255	33124	426	34117	260
26781	304	28065	11	31400	246	32060	252	33127	427	34118	260
26782	304	28070	10	31402	246	32062	252	33131	427	34121	260
26783	304	28080	18	31403	246	32064	252	33132	427	34122	260
26800	434	28081	18	31404	246	32066	252	33135	427	34132	260
26801	434	28085	18	31452	254	32076	252	33137	427	34142	260
26802	434	28086	18	31453	254	32161	251	33140	427	34152	260
26803	434	28101	16	31454	254	32162	251	33141	427	34153	260
26804	434	28102	17	31455	248	32163	251	33142	427	34154	260
26805	434	28103	17	31456	248	32164	251	33143	427	34155	260
26806	434	28104	16	31461	248	32165	251	33150	427	34156	260
26807	434	30003	259	31467	248	32166	251	33151	427	34157	260
26815	434	30003	264	31468	248	32167	251	33152	427	34158	260
26816	434	30004	259	31471	248	32168	251	33154	427	34159	260
26817	434	30004	264	31481	248	32169	251	33155	430	34160	260
26819	434	30005	259	31491	248	32170	248	33160	428	34200	260
26820	435	30005	264	31493	250	32171	251	33162	428	34201	260
26824	435	30007	259	31494	250	32172	251	33163	428	34202	260
26825	435	30007	264	31495	250	32173	248	33164	428	34203	260
26826	435	31005	245	31496	250	32174	251	33165	428	34221	264
26829	436	31006	245	31497	254	32176	251	33167	428	34223	264
26844	435	31007	245	31498	250	32186	251	33168	428	34231	265
26845	435	31008	245	31499	250	32196	251	33168	257	34235	265
26853	436	31009	245	31500	250	32206	251	33169	428	34237	265
26857	436	31011	245	31501	254	32216	251	33170	428	34238	265
26858	436	31021	245	31502	254	32226	251	33200	429	34241	264
26859	436	31031	245	31503	254	32234	251	33201	429	34243	264
26862	436	31041	245	31505	248	32240	251	33202	429	34251	264
26871	437	31051	245	31506	248	32265	253	33203	429	34261	265
26880	437	31052	246	31507	248	32268	253	33205	429	34262	264
26881	437	31053	245	31510	248	32269	253	33206	429	34265	265
26886	437	31061	246	31511	248	32270	253	33207	429	34271	260
26888	437	31062	246	31512	248	32273	253	33208	429	34272	260
26891	441	31071	246	31513	248	32283	253	33209	429	34273	260
26895	439	31072	246	31514	248	32285	253	33210	429	34274	260
26896	439	31081	246	31515	248	32293	253	33211	429	34275	260
26897	439	31082	245	31520	250	32295	253	33212	429	34276	260
26911	440	31091	244	31521	250	32296	253	33215	429	34280	260
26912	440	31101	244	31522	250	32297	253	33220	430	34281	260
26914	440	31111	244	31523	250	32298	253	33221	430	34282	260
26915	440	31121	244	31524	250	32301	253	33246	431	34283	260
26920	438	31131	244	31541	250	32302	253	33247	431	34284	260
26921	438	31132	244	31551	250	32311	257	33248	431	34285	260
26922	438	31140	244	31552	250	32312	256	33249	431	34300	297
26940	439	31141	244	31553	250	32313	253	33250	430	34301	260
26941	439	31142	244	31555	249	32314	257	33252	430	34303	297
26943	439	31143	244	31556	249	32315	258	33254	430	34304	260
26954	440	31144	244	31557	249	32316	258	33255	430	34305	254
26961	440	31145	244	31558	249	32317	256	33256	430	34306	254

číslo položky	str.	číslo položky	str.	číslo položky	str.	číslo položky	str.	číslo položky	str.	číslo položky	str.
34307	254	35081	268	35517	273	37041	255	37204	286	37500	274
34308	254	35082	269	35518	273	37051	255	37205	286	37501	274
34315	219	35085	267	35519	273	37053	284	37205	286	37505	274
34316	172	35086	267	35524	273	37054	284	37210	285	37506	274
34316	219	35087	267	35525	273	37055	284	37211	285	37509	275
34400	262	35091	267	35527	273	37065	290	37212	286	37510	275
34401	262	35092	267	35532	273	37066	290	37216	298	37511	275
34402	263	35093	267	35533	273	37067	290	37217	298	37512	275
34403	263	35094	267	35539	273	37068	290	37218	298	37515	275
34404	262	35095	267	35540	273	37069	290	37220	285	37516	275
34405	262	35096	267	35542	273	37070	290	37229	299	37517	275
34406	263	35103	270	35552	273	37094	290	37230	299	37518	275
34407	263	35113	270	35553	273	37095	290	37231	299	37527	276
34409	262	35123	270	35555	273	37096	290	37232	299	37530	276
34410	262	35125	270	35603	276	37097	290	37233	299	37532	276
34411	263	35126	270	35604	276	37098	290	37234	299	37533	276
34412	263	35127	270	35605	276	37101	255	37235	299	37539	276
34413	263	35300	266	35833	271	37111	255	37236	298	37541	276
34414	264	35310	266	35845	271	37114	298	37237	298	37545	279
34415	262	35311	266	35850	271	37115	298	37238	298	37546	279
34416	262	35316	266	36014	282	37117	283	37239	298	37549	279
34417	263	35317	266	36024	282	37119	298	37243	321	37553	135
34418	263	35318	266	36034	282	37120	298	37244	321	37553	278
34419	262	35319	266	36035	282	37121	304	37245	321	37560	279
34420	262	35320	314	36036	282	37122	304	37246	321	37564	277
34421	263	35322	314	36046	282	37123	421	37247	321	37570	231
34422	263	35323	181	36056	283	37124	421	37248	321	37570	279
34423	263	35323	294	36057	283	37125	288	37250	321	37600	327
34424	263	35325	181	36058	283	37126	288	37251	321	37601	327
34425	262	35325	294	36059	283	37127	288	37252	321	37602	327
34426	262	35326	181	36076	281	37129	421	37253	321	37603	327
34428	263	35326	294	36077	281	37130	287	37255	308	37604	327
34429	264	35327	181	36080	281	37131	287	37256	308	37605	327
34439	262	35327	294	36081	281	37132	287	37257	308	37606	327
34440	262	35328	181	36082	281	37135	443	37258	308	37611	327
34441	262	35328	294	36085	281	37135	154	37259	308	37615	327
34442	262	35329	181	36086	281	37139	154	37263	308	37616	327
34443	262	35329	294	36087	281	37140	154	37264	308	37621	419
34445	262	35330	183	36126	282	37141	154	37266	308	37630	419
34446	262	35330	293	36128	282	37142	154	37267	308	37640	418
34447	262	35331	183	36130	282	37143	154	37268	308	37641	418
34448	263	35331	293	36136	282	37144	154	37270	308	37645	418
34449	262	35332	182	36140	285	37145	154	37271	308	37650	419
34450	262	35332	292	36145	280	37148	286	37272	308	37730	270
34451	262	35333	182	36160	280	37149	286	37273	308	37731	270
34452	263	35333	292	36175	280	37150	286	37275	308	37760	270
34453	262	35334	182	36190	280	37151	286	37280	309	37761	270
34454	262	35334	292	36191	280	37152	286	37281	309	38000	312
34455	263	35335	181	36199	281	37153	286	37290	321	38001	311
34456	263	35335	294	36200	281	37154	286	37291	321	38002	312
34457	263	35336	182	36240	281	37155	286	37295	410	38003	312
34458	263	35336	292	36300	279	37156	286	37295	309	38004	312
34459	264	35345	183	36305	413	37157	286	37296	410	38005	312
34479	264	35345	293	36306	413	37158	286	37296	309	38006	311
34480	262	35346	183	36308	297	37162	288	37297	410	38007	312
34481	262	35346	293	36310	277	37166	277	37297	309	38008	312
34482	262	35347	183	36312	297	37170	288	37300	158	38009	312
34485	262	35347	183	36313	413	37171	288	37301	158	38010	311
34486	262	35347	293	36314	413	37172	288	37302	158	38012	311
34490	263	35347	293	36325	289	37173	288	37303	158	38013	311
34491	263	35348	182	37005	317	37174	288	37308	159	38014	312
34496	263	35348	292	37006	284	37175	288	37309	159	38014	312
34500	264	35360	144	37006	284	37176	288	37310	157	38015	313
35006	268	35361	144	37007	284	37177	289	37311	157	38016	313
35007	268	35362	144	37007	284	37178	289	37317	337	38017	313
35011	270	35500	272	37008	284	37185	288	37320	157	38018	313
35012	268	35501	272	37009	284	37186	288	37321	157	38020	311
35013	268	35502	272	37010	431	37187	288	37325	156	38021	313
35015	269	35503	272	37011	284	37188	288	37326	156	38022	313
35021	269	35504	272	37012	284	37189	288	37328	156	38024	311
35023	267	35505	272	37021	284	37190	288	37330	155	38025	311
35038	267	35506	272	37025	283	37195	286	37331	155	38026	286
35048	269	35507	272	37025	283	37196	286	37332	155	38026	314
35058	267	35508	272	37026	283	37197	286	37340	159	38027	310
35059	268	35510	272	37026	283	37198	286	37341	158	38028	310
35068	269	35511	272	37028	283	37199	287	37342	158	38030	314
35069	268	35512	272	37028	283	37200	286	37343	159	38031	313
35070	269	35514	273	37029	283	37201	286	37344	159	38042	286
35078	268	35515	273	37029	283	37202	286	37345	159	38042	314
35079	269	35516	273	37031	255	37203	286	37350	157	38050	305

číslo položky	str.	číslo položky	str.	číslo položky	str.	číslo položky	str.	číslo položky	str.	číslo položky	str.
38052	305	38980	307	41120	387	42368	305	45019	336	45096	333
38054	305	38981	307	41121	387	42420	296	45020	332	45097	333
38055	305	38985	309	41122	387	43050	395	45021	336	45098	333
38060	305	38990	307	41123	387	43058	396	45023	332	45099	333
38063	305	38991	307	41150	387	43060	396	45025	336	45100	364
38065	305	38995	308	41151	387	43068	396	45026	335	45101	364
38095	305	39000	304	41152	387	43071	395	45027	336	45102	364
38096	305	39001	304	41153	387	43072	395	45029	336	45104	364
38097	305	39002	304	42101	387	43077	395	45030	232	45105	364
38895	291	39003	304	42102	387	43082	396	45030	339	45106	364
38896	291	39005	304	42103	387	43083	396	45031	232	45107	364
38899	291	39010	304	42115	299	43084	396	45031	339	45108	364
38900	291	39012	304	42120	299	43086	396	45032	232	45110	352
38901	291	39014	304	42150	389	43087	397	45032	339	45111	352
38902	291	39020	304	42151	389	43089	397	45033	232	45112	353
38903	291	39021	304	42152	389	43090	397	45033	339	45113	352
38904	291	39045	304	42153	389	43097	396	45034	342	45114	352
38905	291	39065	304	42155	389	43098	397	45035	341	45115	352
38906	291	39090	304	42156	389	43099	397	45036	345	45116	352
38907	291	39145	304	42157	389	43300	385	45038	342	45117	351
38908	291	39165	304	42158	389	43301	385	45039	342	45118	351
38909	291	39190	304	42160	389	44041	345	45040	342	45120	352
38910	291	39192	304	42161	389	44042	345	45041	342	45122	352
38911	291	39192	347	42162	389	44043	345	45042	347	45123	351
38912	291	39193	304	42163	389	44050	345	45043	344	45124	351
38913	291	39193	347	42170	389	44053	347	45044	345	45125	351
38914	291	39194	305	42171	389	44950	176	45045	177	45126	351
38915	291	39195	305	42172	389	44950	340	45045	344	45130	355
38916	291	39196	305	42173	389	44955	342	45046	177	45131	355
38917	291	39197	305	42174	389	44960	347	45046	344	45132	355
38918	291	39198	305	42175	389	44965	368	45047	347	45133	356
38919	285	39199	305	42176	389	44970	336	45048	177	45134	353
38920	285	39200	305	42177	389	44971	336	45048	335	45135	355
38923	285	39201	305	42178	389	44972	332	45048	344	45136	356
38924	307	39202	305	42179	389	44980	332	45049	345	45137	356
38925	307	39203	305	42180	389	44980	332	45050	368	45138	354
38926	309	39204	305	42181	389	44980	334	45051	369	45139	354
38927	307	39205	305	42182	389	44981	332	45052	369	45140	353
38928	308	39206	295	42185	389	44981	332	45053	370	45141	354
38929	307	39207	295	42186	389	44981	333	45054	370	45142	353
38930	309	39208	295	42187	389	44981	334	45055	369	45143	354
38931	307	39210	295	42188	389	44982	333	45056	341	45144	355
38932	307	39212	295	42190	306	44982	333	45057	341	45145	355
38933	309	39214	295	42190	389	44982	334	45058	341	45146	357
38934	308	39216	295	42201	390	44983	333	45059	341	45147	358
38935	309	39217	295	42202	390	44983	333	45060	232	45150	358
38937	309	39218	295	42203	390	44983	334	45060	339	45151	359
38939	309	39219	295	42207	390	44984	334	45061	232	45152	357
38940	309	39238	296	42208	390	44984	335	45061	339	45153	357
38941	309	39240	295	42209	390	44984	335	45062	232	45154	357
38942	308	39241	295	42210	390	44985	334	45062	339	45155	358
38943	309	39242	295	42211	390	44985	335	45063	332	45156	358
38944	306	39243	295	42212	390	44986	334	45065	341	45158	358
38945	306	39244	295	42213	390	44987	334	45066	341	45159	359
38946	306	39245	296	42214	390	44988	334	45067	341	45160	358
38947	306	40050	388	42217	390	44989	334	45068	177	45161	359
38948	306	40051	388	42218	390	44991	334	45068	335	45162	357
38949	306	40052	388	42219	390	44992	334	45068	344	45163	358
38950	296	40053	388	42220	390	44995	338	45069	176	45164	359
38951	296	40054	388	42221	390	44996	334	45069	340	45167	358
38952	296	40055	388	42228	390	44997	335	45070	370	45168	359
38953	296	40056	388	42229	390	44998	335	45071	369	45169	359
38954	296	40057	388	42230	390	44999	337	45074	346	45170	361
38955	306	40058	388	42240	390	45000	337	45079	342	45171	361
38956	306	40059	388	42244	390	45001	337	45080	342	45172	361
38957	306	40060	388	42248	390	45002	338	45081	176	45172	361
38958	306	40075	388	42249	390	45003	338	45081	340	45173	361
38959	306	40076	388	42251	390	45005	338	45082	176	45173	361
38960	306	40077	388	42252	390	45006	338	45082	340	45174	361
38961	306	40100	387	42253	390	45007	338	45083	176	45175	360
38963	309	40120	387	42255	390	45008	338	45083	340	45176	360
38964	307	41050	387	42256	390	45009	338	45084	176	45177	360
38965	308	41080	387	42257	390	45010	335	45084	340	45178	360
38966	307	41081	387	42260	391	45011	337	45085	347	45179	359
38968	307	41082	387	42261	391	45012	337	45086	346	45180	353
38969	309	41083	387	42312	296	45014	335	45088	333	45181	353
38970	296	41100	387	42312	390	45015	337	45089	333	45182	360
38971	296	41101	387	42365	305	45016	336	45093	347	45183	360
38972	309	41102	387	42366	305	45017	334	45094	334	45184	359
38973	309	41103	387	42367	305	45018	335	45095	333	45185	359

číslo položky	str.	číslo položky	str.	číslo položky	str.	číslo položky	str.	číslo položky	str.	číslo položky	str.
45186	359	45296	353	45520	343	45651	345	48415	328	50541	153
45187	360	45297	354	45521	343	45652	345	48420	328	50542	153
45190	362	45298	353	45522	343	45653	345	48452	328	50544	153
45191	362	45299	354	45523	343	45654	345	48453	328	50549	152
45192	362	45300	361	45524	343	45655	345	48454	328	50550	150
45193	362	45301	361	45525	343	45656	345	48455	328	50551	150
45194	362	45320	369	45526	343	45657	345	48456	328	50553	150
45195	362	45321	370	45527	343	45658	345	48457	328	50554	150
45196	362	45323	368	45528	343	45659	345	48719	279	50555	153
45197	362	45323	382	45529	343	45660	345	48729	277	50556	150
45198	362	45325	368	45530	343	45661	345	48730	277	50557	152
45199	362	45326	368	45531	343	45662	345	48731	277	50558	152
45200	362	45327	367	45532	343	45663	345	50004	414	50559	150
45203	363	45328	367	45533	343	45664	345	50005	414	50560	150
45204	363	45329	367	45534	343	45670	345	50009	415	50562	150
45206	362	45330	385	45535	346	45671	345	50010	415	50563	150
45211	363	45331	385	45540	346	45672	345	50011	415	50564	150
45213	355	45345	361	45541	346	45673	345	50012	415	50570	150
45214	357	45349	361	45542	346	48001	145	50013	415	50571	150
45215	356	45350	361	45543	346	48002	145	50014	415	50585	153
45216	357	45353	361	45550	346	48005	146	50015	415	50585	321
45217	357	45360	361	45551	346	48006	146	50017	417	50586	153
45218	356	45364	361	45552	346	48007	146	50019	417	50586	321
45219	356	45366	361	45553	346	48008	147	50020	417	50587	153
45220	363	45370	177	45555	346	48009	147	50021	417	50587	321
45221	363	45370	344	45556	346	48010	147	50022	417	50588	153
45222	363	45385	348	45557	346	48015	145	50025	417	50588	321
45223	363	45386	348	45558	346	48020	146	50026	417	50900	409
45224	363	45388	348	45559	346	48021	146	50030	391	50901	409
45225	363	45389	348	45560	345	48022	146	50031	391	50902	409
45226	363	45390	349	45562	346	48030	146	50032	391	50905	409
45227	363	45391	349	45563	346	48031	147	50033	391	50906	409
45228	363	45392	349	45564	346	48032	147	50035	443	50907	409
45229	363	45393	349	45565	346	48033	147	50035	391	50909	409
45239	366	45394	349	45570	389	48034	147	50036	443	50910	409
45240	366	45395	349	45571	389	48036	145	50036	391	50911	409
45241	366	45396	349	45572	389	48037	146	50037	391	50915	409
45242	366	45397	349	45573	389	48040	147	50038	391	50916	409
45244	365	45398	350	45580	390	48041	147	50040	391	50917	409
45245	365	45399	350	45600	363	48042	147	50041	391	50918	409
45246	365	45400	350	45601	363	48043	147	50042	391	50919	409
45247	365	45401	350	45602	363	48046	146	50050	305	50920	409
45248	365	45450	394	45603	363	48046	147	50050	305	51001	408
45249	365	45451	394	45604	363	48047	146	50051	305	51002	408
45250	365	45452	394	45605	363	48047	147	50052	305	51003	408
45251	365	45453	394	45606	363	48050	148	50052	305	51004	408
45253	365	45460	394	45607	363	48051	148	50100	324	51007	408
45254	365	45461	394	45608	363	48054	148	50101	324	51008	408
45256	365	45462	394	45609	363	48055	148	50102	324	51009	408
45257	365	45463	394	45610	363	48056	148	50103	324	51010	408
45260	365	45465	394	45611	363	48057	148	50104	324	51011	408
45261	365	45466	394	45612	363	48060	148	50106	324	51013	407
45262	365	45467	394	45613	363	48061	148	50108	324	51015	408
45262	366	45470	394	45614	363	48062	148	50500	151	51017	407
45263	365	45471	309	45615	363	48063	148	50501	151	51018	407
45263	366	45471	344	45616	363	48064	148	50502	151	51020	407
45265	366	45472	344	45617	363	48065	148	50503	151	51022	407
45266	366	45473	344	45618	363	48066	148	50505	151	51023	407
45267	365	45480	394	45619	363	48067	148	50510	149	51026	406
45267	366	45485	394	45620	363	48068	148	50511	149	51030	407
45268	365	45490	380	45621	363	48070	148	50512	149	51032	407
45268	366	45496	394	45622	363	48071	148	50513	149	51034	407
45269	366	45497	394	45623	363	48072	148	50514	149	51036	408
45270	365	45498	394	45624	363	48075	148	50518	151	51037	408
45271	365	45499	394	45625	363	48076	148	50519	151	51038	409
45272	365	45500	343	45626	363	48077	148	50520	151	51040	406
45273	365	45502	343	45627	363	48080	148	50521	151	51041	406
45274	365	45503	343	45628	363	48081	148	50522	152	51042	406
45280	364	45505	343	45629	363	48085	148	50523	151	51043	406
45283	364	45506	343	45630	363	48086	148	50524	151	51045	407
45285	364	45508	343	45631	363	48087	148	50525	152	51046	407
45286	364	45509	343	45632	363	48090	148	50526	152	51050	409
45287	364	45511	343	45633	363	48091	148	50527	153	51051	409
45289	355	45512	343	45634	363	48093	148	50529	152	51055	409
45290	355	45513	343	45635	363	48094	148	50531	152	51056	409
45291	355	45515	343	45636	363	48095	148	50532	153	51057	409
45292	356	45516	343	45637	363	48096	148	50533	152	51060	406
45293	356	45517	343	45638	363	48097	148	50537	152	51065	406
45294	354	45518	343	45639	363	48410	328	50539	152	51070	406
45295	354	45519	343	45650	345	48411	328	50540	153	51071	406

REJSTRÍK POLOŽEK



číslo položky	str.	číslo položky	str.	číslo položky	str.	číslo položky	str.	číslo položky	str.	číslo položky	str.
51072	406	51288	325	52125	385	55041	143	55465	392	61077	380
51100	326	51300	324	52126	385	55050	143	55640	329	61079	380
51101	326	51301	324	52130	285	55051	143	55642	329	61085	342
51102	326	51302	324	52160	382	55060	143	55645	329	61088	374
51103	326	51303	324	52161	382	55080	143	60001	384	61089	373
51104	326	51304	324	52162	382	55100	143	60006	384	61090	374
51105	326	51305	324	52163	382	55120	143	60008	384	61097	376
51106	326	51306	324	52164	382	55140	143	60012	384	61098	376
51107	326	51307	324	52168	381	55160	143	60018	385	61111	378
51108	326	51308	324	52173	381	55180	143	60019	385	61112	378
51109	326	51320	324	52175	381	55181	143	60020	385	61114	378
51110	326	51321	324	52176	381	55200	143	60022	385	61120	378
51111	326	51322	324	52185	382	55201	143	60100	253	61121	378
51120	326	51323	324	52186	382	55220	143	60115	277	61130	369
51121	326	51324	324	52187	382	55221	143	60116	277	61131	369
51122	326	51325	324	52188	382	55240	143	60117	277	61132	369
51123	326	51327	324	52189	382	55300	143	60118	277	61133	369
51124	326	51338	326	52190	382	55301	143	60121	277	61134	370
51125	326	51341	326	52191	382	55311	143	60123	277	61135	370
51126	326	51348	326	52192	382	55313	143	60201	384	61136	367
51127	326	51402	325	52193	382	55314	143	60206	384	61137	367
51130	326	51403	325	52194	382	55315	143	60208	384	61138	367
51131	326	51404	325	52195	383	55316	143	60212	384	61139	368
51132	326	51405	325	52196	383	55317	143	61000	374	61140	368
51181	415	51406	325	52197	382	55318	143	61001	374	61141	370
51182	415	51407	325	52198	381	55319	143	61002	375	61142	370
51187	409	51408	325	52202	316	55331	143	61003	376	61143	371
51196	326	51410	325	52203	316	55332	143	61004	375	61144	371
51197	326	51412	325	52204	316	55333	143	61005	372	61145	371
51198	326	51413	325	52205	316	55334	143	61006	372	61146	371
51199	326	51414	325	52206	316	55335	143	61007	373	61147	367
51200	409	51415	325	52207	316	55336	143	61008	372	61148	367
51201	409	51416	325	52208	316	55337	143	61009	377	61149	368
51202	409	51417	325	52212	316	55339	143	61010	373	61149	382
51203	409	51418	325	52213	316	55340	143	61012	377	61150	369
51204	324	51420	325	52214	316	55341	143	61013	376	61155	372
51205	324	51430	325	52215	316	55342	143	61014	377	61156	372
51206	324	51431	325	52216	316	55350	143	61015	373	61157	372
51207	324	51432	325	52217	316	55351	143	61018	376	61158	372
51208	324	51433	325	52218	316	55352	143	61019	376	61161	375
51209	324	51435	325	52220	316	55353	143	61020	374	61162	376
51210	324	51436	325	52283	316	55354	143	61021	373	61163	376
51211	324	51450	325	52284	316	55355	143	61022	374	61164	377
51212	324	51510	403	52285	316	55356	143	61024	375	61165	377
51220	325	51511	403	52286	316	55357	143	61025	373	61166	377
51221	325	51512	403	52288	316	55358	143	61026	373	61169	253
51222	325	51513	403	52305	319	55359	143	61028	377	61171	385
51225	325	51514	403	52306	319	55360	143	61029	373	61172	382
51226	325	51515	403	52315	319	55361	143	61030	371	61172	385
51227	325	51516	403	52328	319	55362	143	61031	371	61173	385
51241	324	51517	403	52331	319	55400	392	61032	371	61174	385
51242	324	52010	416	52334	319	55401	392	61033	371	61175	385
51243	324	52011	249	52391	319	55402	392	61034	371	61176	385
51244	324	52011	320	52421	319	55403	392	61035	378	61177	385
51245	324	52012	416	52424	319	55404	392	61036	378	61183	386
51246	324	52020	416	52428	319	55405	392	61038	378	61184	386
51247	324	52030	416	52456	319	55406	392	61040	378	61189	386
51257	326	52030	260	52471	319	55420	392	61042	378	61190	386
51258	326	52050	328	52600	318	55421	392	61044	377	61192	385
51259	326	52055	328	52601	318	55422	392	61045	371	61193	385
51260	326	52060	328	52602	318	55423	392	61046	371	61194	385
51261	326	52065	328	52605	318	55424	392	61047	371	61195	386
51262	326	52070	316	52610	318	55425	392	61048	371	61200	385
51263	326	52071	317	52611	297	55429	392	61050	374	61201	385
51264	326	52075	317	52612	297	55430	392	61051	374	61201	385
51265	326	52076	317	52620	321	55431	392	61052	375	61202	386
51271	324	52077	317	52625	321	55432	392	61053	374	61203	377
51272	324	52078	317	52630	321	55433	392	61054	375	61204	386
51273	324	52101	382	52635	321	55436	392	61056	373	61205	386
51274	324	52102	382	52640	321	55437	392	61057	373	61207	386
51275	324	52103	382	52645	321	55450	393	61058	375	61208	386
51276	324	52104	382	52652	321	55452	393	61059	375	61209	377
51278	324	52105	382	52656	321	55453	393	61060	371	61215	386
51280	325	52108	382	52662	320	55454	393	61061	371	61218	253
51281	325	52109	383	52666	320	55455	393	61062	371	61219	386
51282	325	52113	383	52671	320	55456	393	61063	371	61221	379
51283	325	52114	383	52694	320	55457	393	61067	379	61221	379
51284	325	52115	383	52695	320	55460	393	61068	379	61221	379
51286	325	52116	383	54008	321	55461	393	61069	379	61221	379
51287	325	52119	381	55040	143	55462	393	61070	379	61222	377

číslo položky	str.	číslo položky	str.	číslo položky	str.	číslo položky	str.	číslo položky	str.	číslo položky	str.
61223	376	70036	140	81152	424	81267	423	81348	423	81430	423
61224	378	70037	140	81155	424	81268	423	81349	423	81431	423
61224	378	70038	140	81160	425	81269	423	81350	423	81432	423
61230	386	70040	140	81165	425	81270	423	81351	423	81433	423
61235	416	70045	140	81170	424	81271	423	81352	423	81434	423
61240	118	70046	140	81175	425	81272	423	81353	423	81435	423
61250	386	70060	141	81178	425	81273	423	81354	423	81436	423
61251	347	70061	141	81180	425	81274	423	81355	423	81437	423
61251	386	70062	141	81185	424	81275	423	81356	423	81438	423
61252	386	70063	141	81186	424	81276	423	81357	423	81439	423
61253	386	70064	141	81189	424	81277	423	81358	423	81440	423
61254	386	70065	142	81190	425	81278	423	81359	423	81441	423
61255	386	70066	141	81191	425	81279	423	81360	423	81442	423
61256	386	70070	142	81200	423	81280	423	81361	423	81443	423
61290	379	70075	142	81201	423	81281	423	81362	423	81444	423
61291	379	70090	142	81202	423	81282	423	81363	423	81445	423
61292	379	70091	142	81203	423	81284	423	81364	423	81447	423
61293	379	70092	142	81204	423	81285	423	81365	423	81448	423
61294	379	70093	142	81205	423	81286	423	81366	423	81449	423
61295	379	70094	142	81206	423	81287	423	81367	423	81450	423
61296	379	70095	142	81207	423	81288	423	81370	423	81451	423
61297	379	70096	142	81208	423	81289	423	81371	423	81452	423
61299	393	70098	92	81209	423	81290	423	81372	423	81453	423
61300	393	70100	405	81210	423	81291	423	81373	423	81454	423
61301	393	70101	405	81211	423	81292	423	81374	423	81455	423
61302	393	70102	405	81212	423	81293	423	81375	423	81456	423
61320	119	70103	405	81213	423	81294	423	81376	423	81457	423
61321	119	70104	405	81214	423	81295	423	81377	423	81458	423
61322	119	70105	405	81215	423	81296	423	81378	423	81459	423
61323	119	70106	405	81216	423	81297	423	81379	423	81460	423
61324	119	70107	405	81217	423	81298	423	81380	423	81461	423
61325	119	70108	405	81218	423	81299	423	81381	423	81462	423
61326	119	70109	405	81219	423	81300	423	81382	423	81463	423
61327	119	70110	405	81220	423	81301	423	81383	423	81466	423
61328	119	70120	404	81221	423	81302	423	81384	423	81467	423
61329	119	70121	404	81222	423	81303	423	81385	423	81468	423
61330	119	70122	404	81223	423	81304	423	81386	423	81469	423
61331	119	70123	404	81224	423	81305	423	81387	423	81470	423
61340	123	70124	404	81225	423	81306	423	81388	423	81471	423
61341	123	70125	404	81226	423	81307	423	81389	423	81472	423
61342	123	70140	404	81227	423	81308	423	81390	423	81473	423
61343	123	70141	404	81228	423	81309	423	81391	423	81486	423
61344	123	70220	414	81229	423	81310	423	81392	423	81600	421
61345	123	70221	414	81230	423	81311	423	81393	423	81603	421
61346	123	81011	422	81231	423	81312	423	81394	423	82105	299
65062	329	81011A	422	81232	423	81313	423	81395	423	89970	411
65063	329	81011F	422	81233	423	81314	423	81396	423	89970	315
65064	329	81011G	422	81234	423	81315	423	81397	423	89973	411
65065	329	81011H	422	81235	423	81316	423	81398	423	89973	315
69900	301	81011R	422	81236	423	81317	423	81399	423	89975	411
69901	301	81012	422	81237	423	81318	423	81400	423	89975	315
69902	301	81013	422	81238	423	81319	423	81401	423	89980	411
69903	301	81014	422	81239	423	81320	423	81402	423	89980	315
69904	300	81015	422	81240	423	81321	423	81403	423	89985	411
69905	301	81016	422	81241	423	81322	423	81404	423	89985	315
69906	301	81022	422	81242	423	81323	423	81405	423	89987	411
69907	303	81023	422	81243	423	81324	423	81406	423	89987	315
69908	303	81024	422	81244	423	81325	423	81407	423	89988	411
69909	303	81025	422	81245	423	81326	423	81408	423	89988	315
69910	302	81035	422	81246	423	81327	423	81409	423	89989	411
69911	302	81036	422	81247	423	81328	423	81410	423	89989	315
69912	302	81053	420	81248	423	81329	423	81411	423	89990	411
69914	301	81054	420	81249	423	81330	423	81412	423	89990	315
69917	302	81056	420	81250	423	81331	423	81413	423	90070	283
69918	300	81057	420	81251	423	81332	423	81414	423	90071	283
69919	300	81070	420	81252	423	81333	423	81415	423	90072	283
69920	303	81071	420	81253	423	81334	423	81416	423	90191	185
69923	303	81072	420	81254	423	81335	423	81417	423	90192	186
69928	303	81074	420	81255	423	81336	423	81418	423		
69930	302	81075	420	81256	423	81337	423	81419	423		
69931	302	81077	420	81257	423	81338	423	81420	423		
70020	140	81100	420	81258	423	81339	423	81421	423		
70021	140	81101	420	81259	423	81340	423	81422	423		
70025	140	81102	420	81260	423	81341	423	81423	423		
70026	140	81103	420	81261	423	81342	423	81424	423		
70030	140	81104	420	81262	423	81343	423	81425	423		
70031	140	81105	420	81263	423	81344	423	81426	423		
70032	140	81106	420	81264	423	81345	423	81427	423		
70033	140	81150	424	81265	423	81346	423	81428	423		
70035	140	81151	424	81266	423	81347	423	81429	423		

GRAFICKÉ SYMBOLY POUŽITÉ V KATALOGU

PIKTOGRAMY SPECIFIKACE PRODUKTŮ



SPECIFIKACE POUŽITÍ

- dřevo
- keramika
- plasty
- hliník
- měď
- kámen
- sklo
- zdivo
- papír
- ocel
- kompozit
- obklady
- nerezová ocel
- omítka
- dřevo se šrouby, hřebíky
- sádrokarton
- pro vrtání do materiálů s pevností v tahu do ...

- S2** · funkční části z vysoce legované nástrojové oceli S2
- HSS** · funkční části vyrobeny z rychlořezné oceli
- Cr-Mo** · funkční části z chrom-molybdenové oceli
- CrV** · funkční části z chrom-vanadové oceli
- INOX** · funkční části z nerezavějící oceli
- NYLON** · nylonová rukojeť
- TEFLON** · teflonový povrch
- Zn** · zinkováno
- TiN** · povrch potažen nitridem titanu
- HRC 58-61** · tvrdost materiálu funkčních částí podle Rockwella
- 40% PES** · složení materiálu - obsahuje 40% polyesteru
- PES** · složení materiálu - vyrobeno z polyesteru
- DIAMANT** · diamantová zrna na povrchu funkčních částí
- MAGNETICKÉ** · magnetické

- SDS+** · způsob uchycení
- SDS MAX** · způsob uchycení
- M14** · způsob uchycení
- 72T** · počet zubů ráčny
- 36T** · počet zubů ráčny
- 1/2"** · velikost uchycení
- 3/4"** · velikost uchycení
- 1/4"** · velikost uchycení
- 27 dB** · údaj o výši ochrany sluchu
- DIN 3113** · splňuje uvedenou normu
- IP 54** · splňuje uvedenou normu
- 32x** · počet produktů v sadě
- II. class** · splňuje uvedenou třídu přesnosti
- III. class** · splňuje uvedenou třídu přesnosti
- WINTER** · vhodné do chladného počasí
- ERGO HANDLE** · ergonomická rukojeť
- HOBBY** · pro hobby použití
- 2x AAA** · počet a typ baterií
- UV STABLE** · odolné proti UV záření
- RUBBER ENDS** · nárazuvzdorné gumové koncovky



SPECIFIKACE BALENÍ

- KRABICE** · baleno v krabici
- ZÁVĚSEM** · balení se závěsem
- MOQ 12** · minimální objednatelné množství
- 5** · počet kusů v balení

SPECIFIKACE PRODUKTŮ VODNÍHO PROGRAMU

volitelný tvar proudu vody



minimální a maximální tlak



maximální průtok vody



zavlažovaná plocha



velikost závitů pro připojení adaptéru



průměr hadice pro připojení do rychlospojky





eshop.corahb.cz