



Larkin

ENGINEERING
STREET PRODUCTS

Engineer | Pioneer | Innovate

Contact Us

 +353 9324504

 info@larkin-eng.com

 www.larkin-eng.com

Table of Content

05	MATERIAL OPTIONS
06	PROJECT HIGHLIGHTS IN A NUTSHELL
11	LITTER BINS
16	BOLLARDS
18	ASHTRAYS
20	BIKE STANDS
23	BIKE RACKS
29	SHELTERS
34	SEATINGS
39	BENCHES
44	PICNIC SETS
47	RAILINGS & BARRIERS
53	PLANTERS
58	LOCKERS
62	PUBLIC UTILITY STATIONS
67	INFORMATION BOARDS & SIGNAGES
70	BANDSTANDS, CANOPIES & PODS
75	SPORTS FACILITY EQUIPMENTS
78	DOG FOUL BINS
81	TREE GRILLES
83	TRAFFIC MANAGEMENT SYSTEM

ABOUT US

With a legacy spanning over three decades, Larkin Engineering stands as a one of the industry leader in the field of Street Furniture and Steel Fabrication solutions in Ireland. Our reputation for excellence is built upon a purpose-built 20,000 square ft. facility located in Tuam, Co. Galway, where our dedicated team of highly skilled craftsmen precisely craft a diverse range of street furniture.

At Larkin Engineering, we take pride in our commitment to solving the challenges our esteemed clients encounter. Our investment in cutting-edge machinery empowers us to provide comprehensive solutions that cater to a wide range of needs. An impressive portfolio of robust and precisely designed street furniture, showcasing our expertise in working with materials such as mild steel, stainless steel, aluminum, galvanized steel & Corten Steel and as well as Iroko Wood, Oak ,Timber & Recycled Plastic.

Our accolades, including the prestigious Irish Exporters Association's First Flight Exporter of the Year award in 2008, underscore our unwavering dedication to innovation and quality. We are honored to have collaborated on successful street furniture projects with distinguished organizations like Bus Eireann, Belfast City Council, Iarnrod Eireann, and the National Transport Authority.

Larkin Engineering epitomizes a synergy of durability, customization, and sustainability in street furniture solutions. Our offerings transform urban landscapes into vibrant, inviting spaces. With a customer-centric approach at our core, we have been a preferred partner for architects, construction professionals, and end-users alike. Our bespoke products, precisely designed, flawlessly and sustainably manufactured, and expertly installed, blend seamlessly into urban environments, enriching lives and enhancing surroundings.

In choosing Larkin Engineering, you choose more than street furniture – you choose a commitment to quality that resonates with architects, contractors, and all stakeholders who share a vision for excellence and sustainable urban development. Join hands with us to create sustainable, inspiring, and dynamic urban spaces that stand as testaments to our collective aspirations.



Over three decades of Expertise

- We specialize in custom design and manufacturing.
- We have a strong in-house design team and a robust manufacturing facility.
- We are dedicated to serving urban planners and developers.
- We have a wealth of knowledge and experience working with the region's unique environmental challenges.



Design, Development and Manufacturing



Limitless Potential

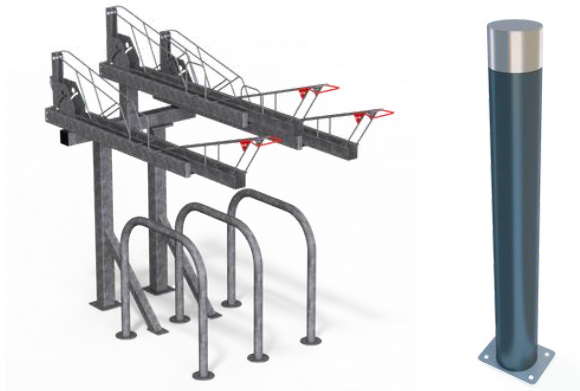



Turning your project into a reality

- We help you bring your project to life by offering design consultation, concepts & estimation, production & manufacturing, and installation & maintenance services.
- We are known for our expertise in bringing projects to life, and we offer a range of services to help you every step of the way.
- We understand that every project is unique, and we tailor our services to meet your specific needs.
- We are committed to providing you with the highest quality service, and we guarantee your satisfaction.



①

DESIGN CONSULTATION



②

ESTIMATION



③

PRODUCTION & MANUFACTURING



④

INSTALLATION



our CLIENTS



Local Authorities (Ireland)



Local Authorities (UK)



Contractors



Material Options



METALS

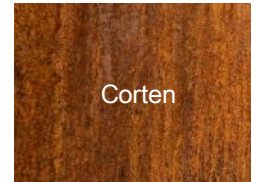
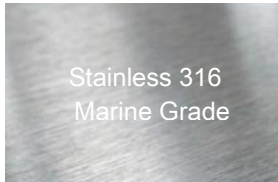

WOODS

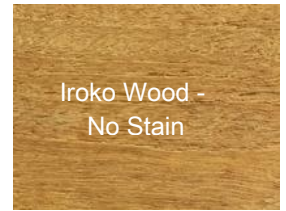
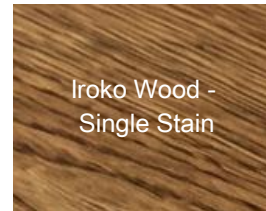
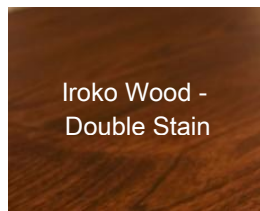

RECYCLED PLASTIC

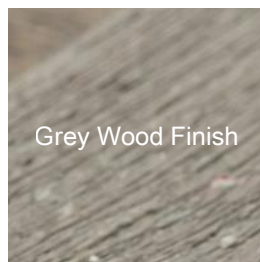
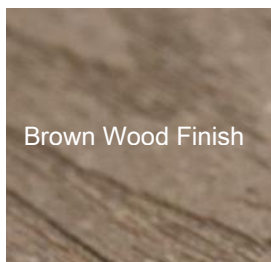
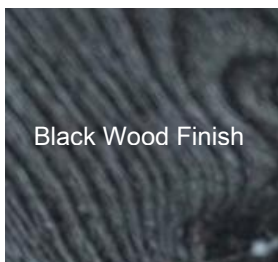

GLASS

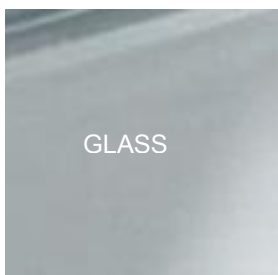

Project Highlights in a Nutshell:



A Glimpse into Our Work



 Exo Building, Dublin

Products Supplied



Bespoke Bench & Eire Bin



Two Tier Bike Racks



Bespoke Bus/Taxi Shelter



Flat Top Bollards



Bespoke Bike Stairs Canopy

Project Highlights in a Nutshell:



A Glimpse into Our Work



 76 SIR JOHN ROGERSON QUAY, Dublin

Products Supplied



Modular Planters



Trellis



Two Tier Bike Racks



Pargola

Project Highlights in a Nutshell:



A Glimpse into Our Work



 City Quay (Grant Thornton), Dublin

Products Supplied



Corner Protectors



Flat Top Bollards



Modular Planters

Project Highlights in a Nutshell:



A Glimpse into Our Work

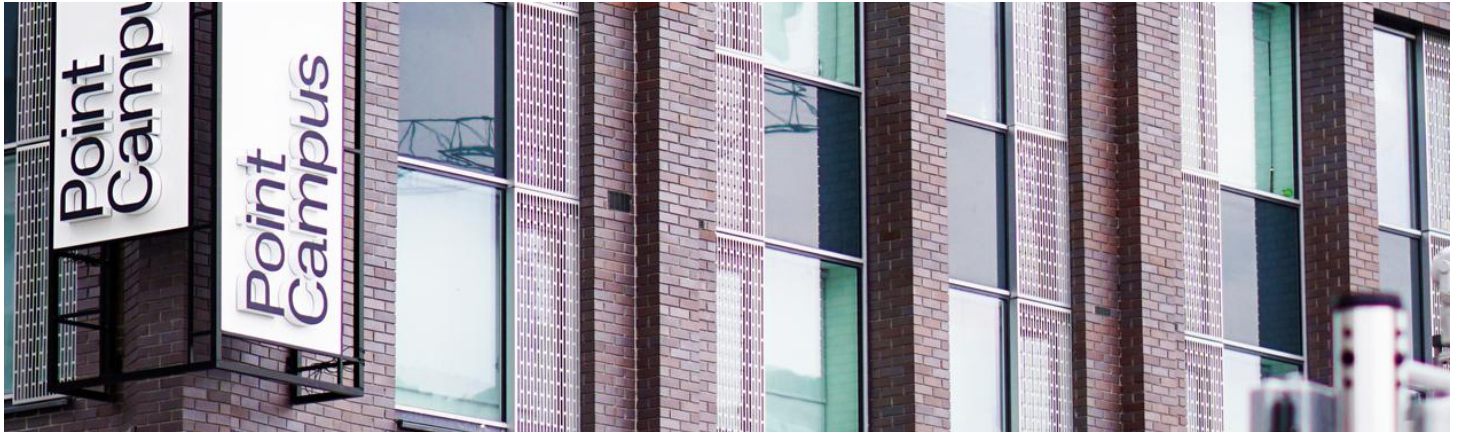

 Point Campus , Dublin

Products Supplied



Bespoke Shelter & Seatings



Flat Top Bollards



Modular Planters

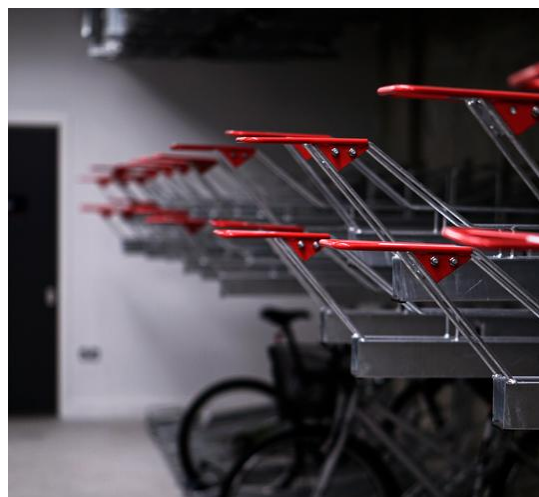

Two Tier Bike Racks

Project Highlights in a Nutshell:



A Glimpse into Our Work



 Galway Shopping Centre, Galway, Co. Galway , Ireland

Products Supplied



MK 5 Bin & Square Planter



Sheffield Bike Stand



Corrib Bench



Flat Top Bollard

our PRODUCTS



LITTER BINS





LITTER BINS



Airport Bin - Double

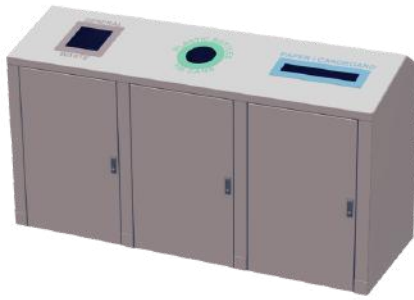

Airport Bin - Triple



Battery Bin



Box Bin - Single



Box Bin - Double



Box Bin - Triple



Eco Bin - Single



Eco Bin - Double



Eco Bin - Triple



Eire Bin



Euro Bin



Euro Bin - Double



LITTER BINS



Forest Bin



Grange Bin



Grange Bin - Double



Grange Bin - Triple



Half Jumbo Bin



Heritage Bin



Internal Bin - Double



Internal Bin - Triple



Eco Bin - Triple



Jumbo Bin



Jumbo Peforated Bin



MK1 Bin - Single

our PRODUCTS



LITTER BINS



MK1 Bin - Double



MK1 Bin - Triple



MK2 Bin



MK2 Bin - Double



MK3 Bin



MK3 Bin - Double

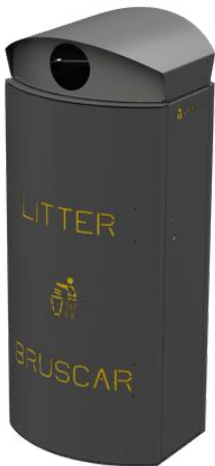

MK4 Bin



MK5 Bin



Phoenix Bin



Jumbo Bin



Tilt Bin



Truckstop Bin

our PRODUCTS



LITTER BINS



MK1 Bin - Double



Vendetta Bin



Wheelie Bin Storage Unit



our PRODUCTS



BOLLARDS



our PRODUCTS



BOLLARDS



Angled Top Bollard



B1 Bollard



Cast Iron Bollard



Castle Bollard



Corrib Bollard



Domed Top Bollard



Fall Bollard



Flat Top Bollard



Flexible Bollard



ForgeLine Bollard



Hollow Bollard



Pencil Bollard



Rhombus Bollard



Signage Bollard



Signal Bollard



Timber Bollard

our PRODUCTS



ASHTRAYS



Freestanding Ashtray



Metro Ashtray



Stainless Steel Outdoor Cigarette Disposal Ashtray



Wall Mounted Ashtray



Stumped Cig Ashtray



Ashtray Bollard



Diamond Ashtray Bollard



our PRODUCTS



BIKE STANDS

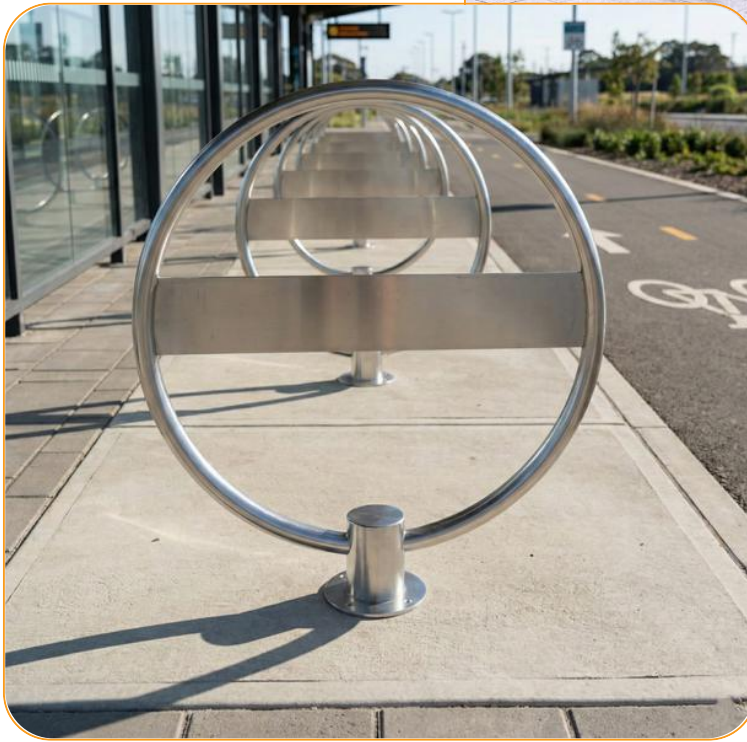

our PRODUCTS



BIKE STANDS



Andor Bike Stand



Armadillo Bike Stand



Bike Shaped Bike Stand



Box Type Bike Stand



Cargo Bike Stand



Corrib Bike Stand



Edge Bike Stand



Heritage Bike Stand



Limerick Bike Stand



O - Ring Bike Stand



Reform Bike Stand



Sheffield Bike Stand

our PRODUCTS



BIKE STANDS

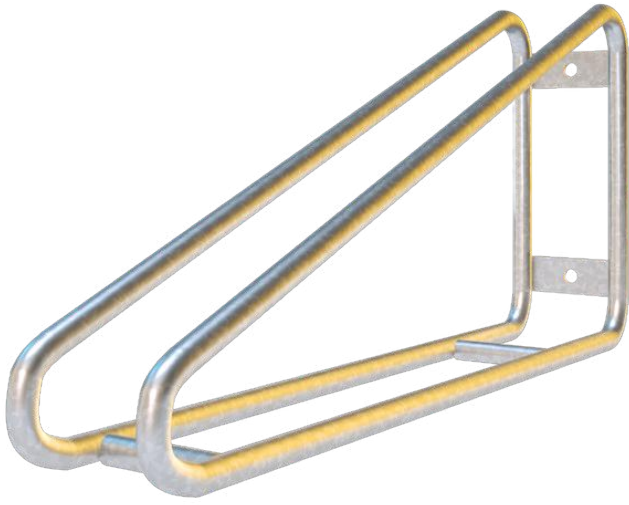

Andor Bike Stand



Slanted Sheffield Bike Stand



U Type Bike Stand



X Bike Stand

our PRODUCTS



BIKE RACKS

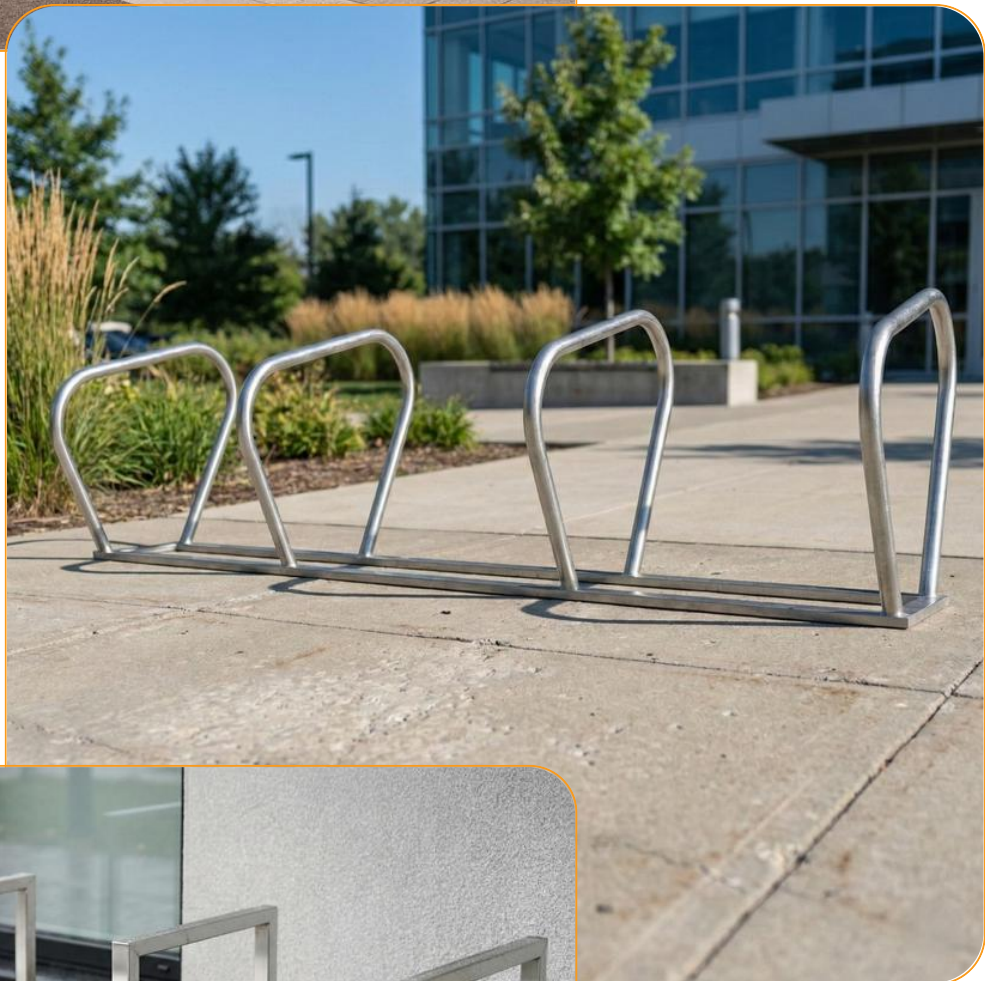
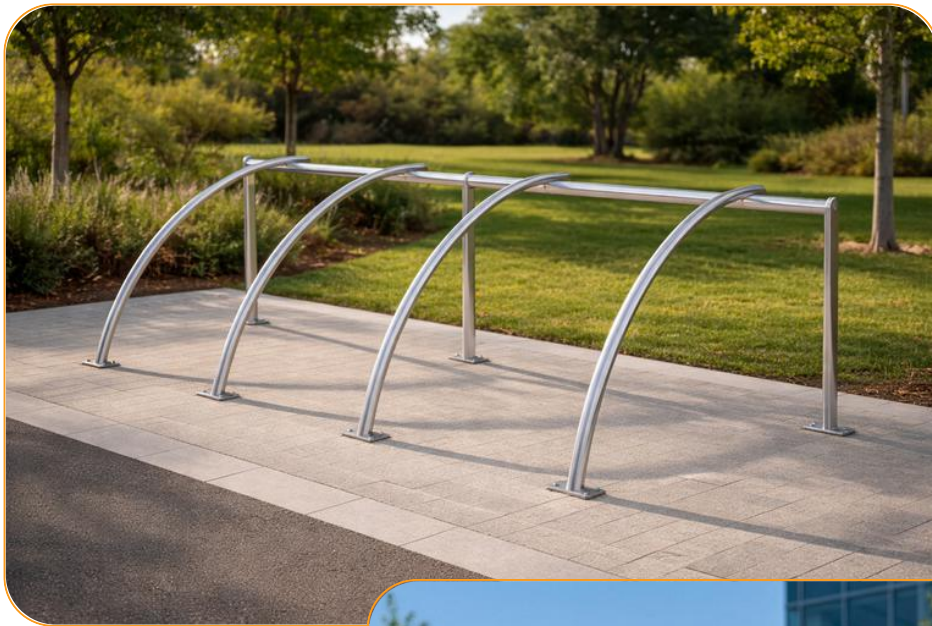

our PRODUCTS



BIKE RACKS



Two Tier Bike Rack



Two Tier Bike Rack with lower sheffield stand

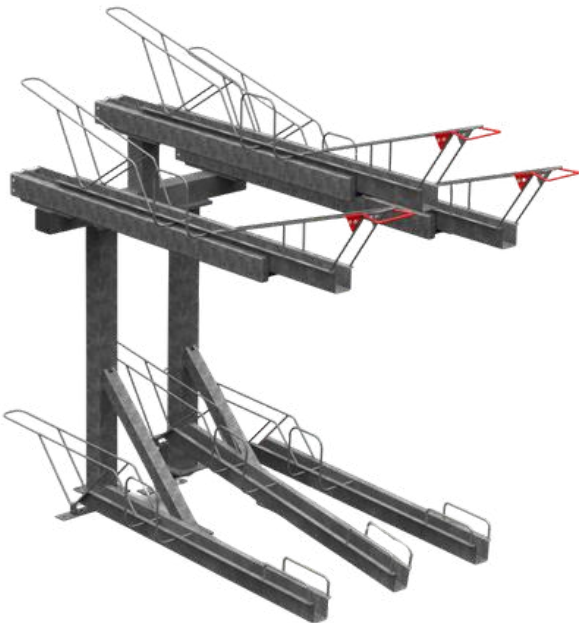

Two Tier Bike Rack (Non Gas Assist)

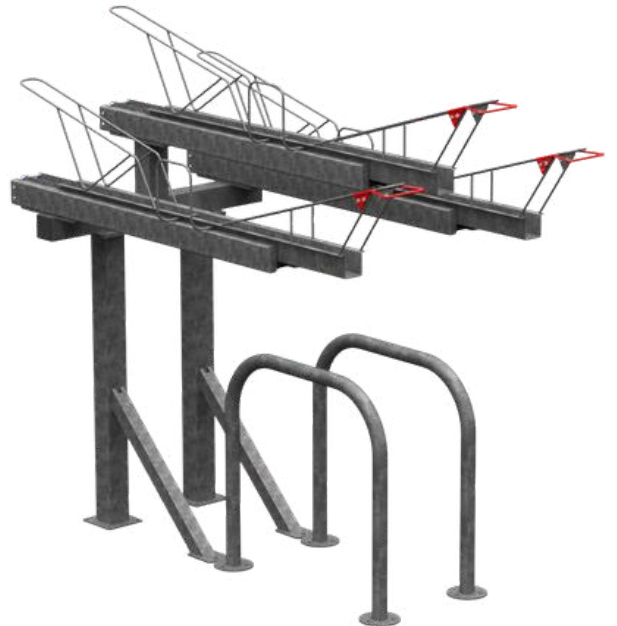

Two Tier Bike Rack (Non Gas Assist) with lower sheffield stand



BIKE RACKS



Armadillo Bike Rack

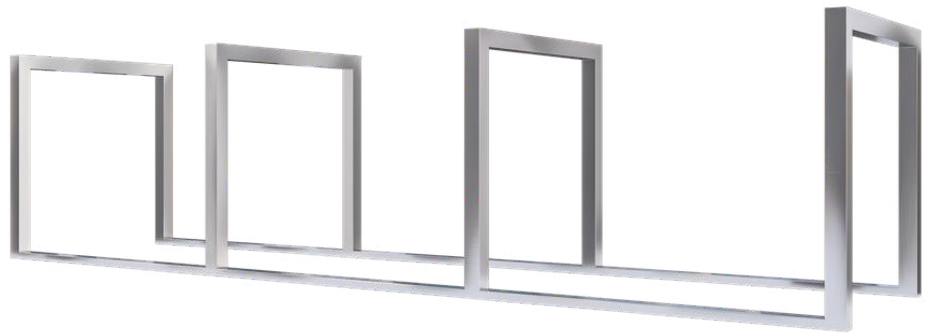

Box Type Bike Rack

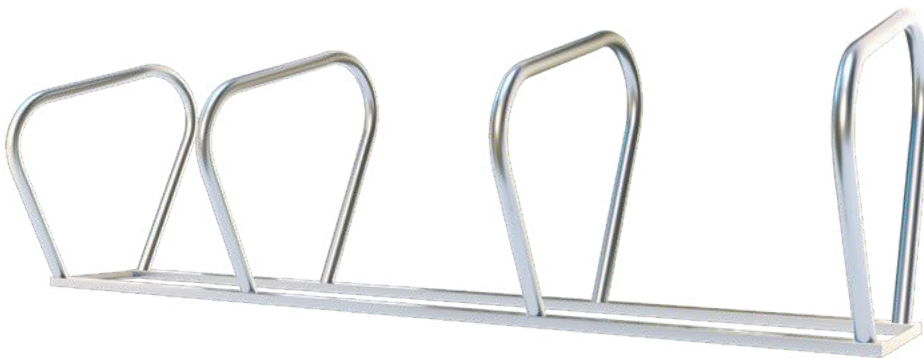

Corrib Bike Rack



BIKE RACKS

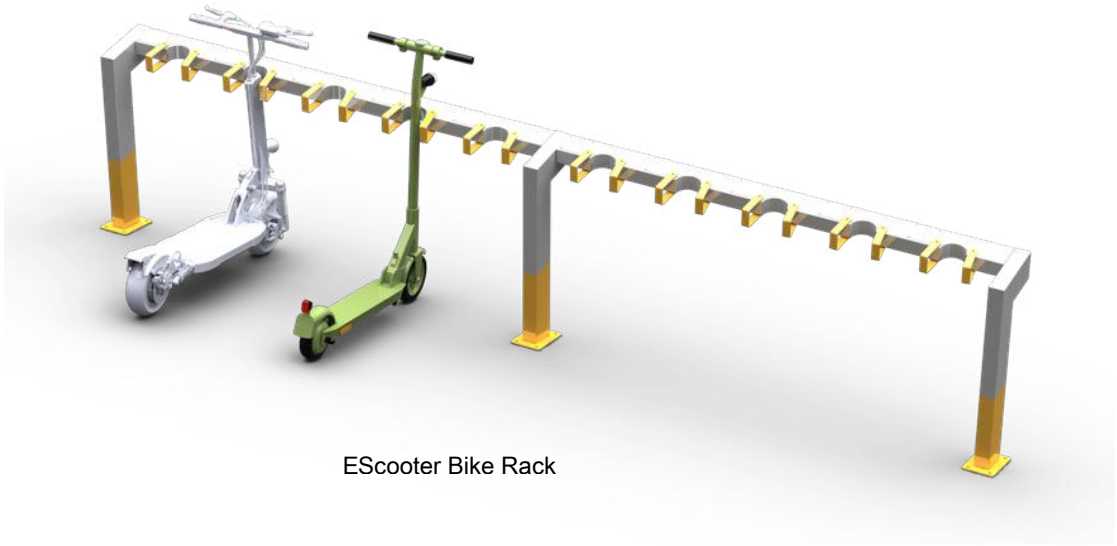

EScooter Bike Rack

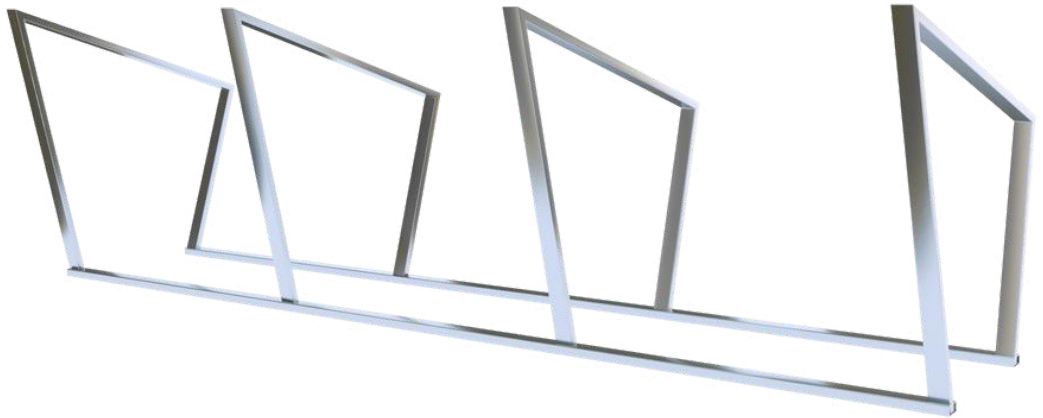

Edge Bike Rack



Scooter Bike Rack



BIKE RACKS



Semi Vertical Bike Rack

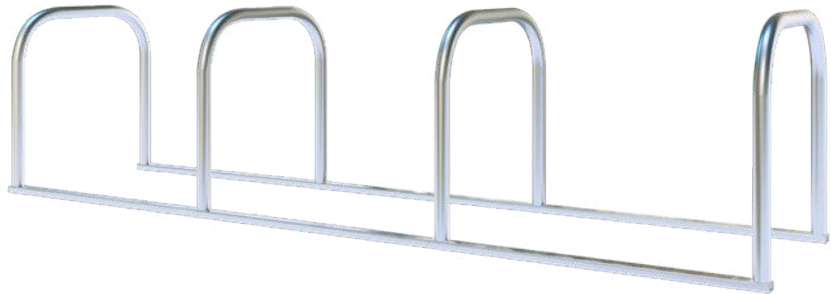

Sheffield Bike Rack



Triangle Bike Rack



BIKE RACKS



Up & Down Bike Rack

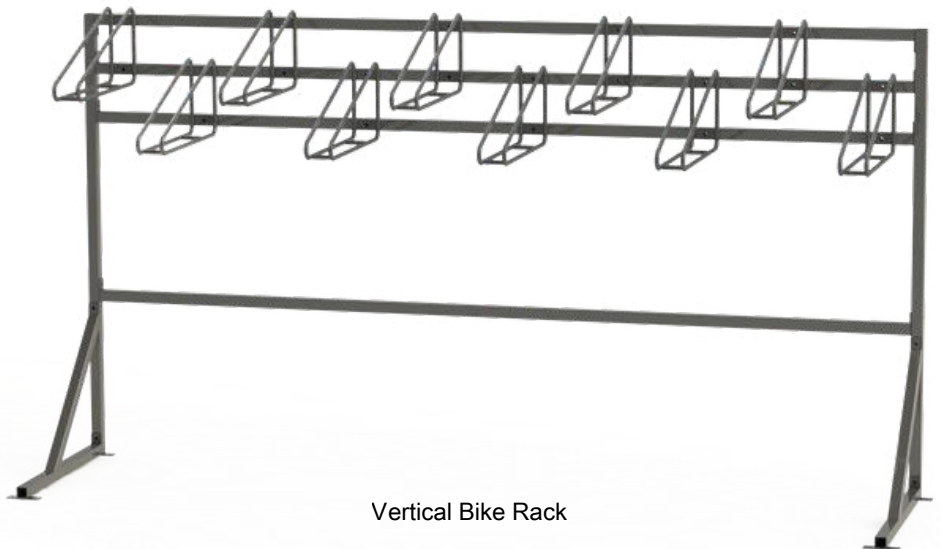

Vertical Bike Rack



U Type Bike Rack

our PRODUCTS



SHELTERS





SHELTERS



Barna Bus Shelter



City Bus Shelter



Classic Bus Shelter

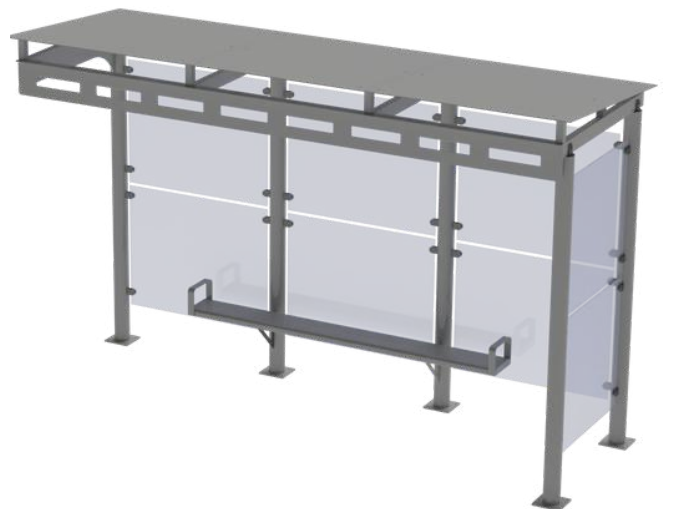

Delta Bus Shelter

our PRODUCTS



SHELTERS

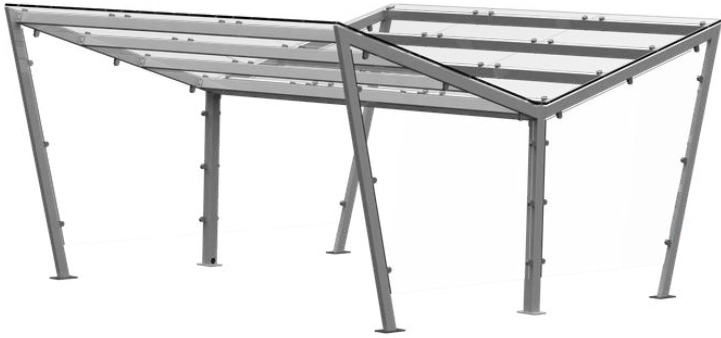

Double Edge Shelter



Edge Shelter



Recycled Plastic Shelter



Flo Shelter

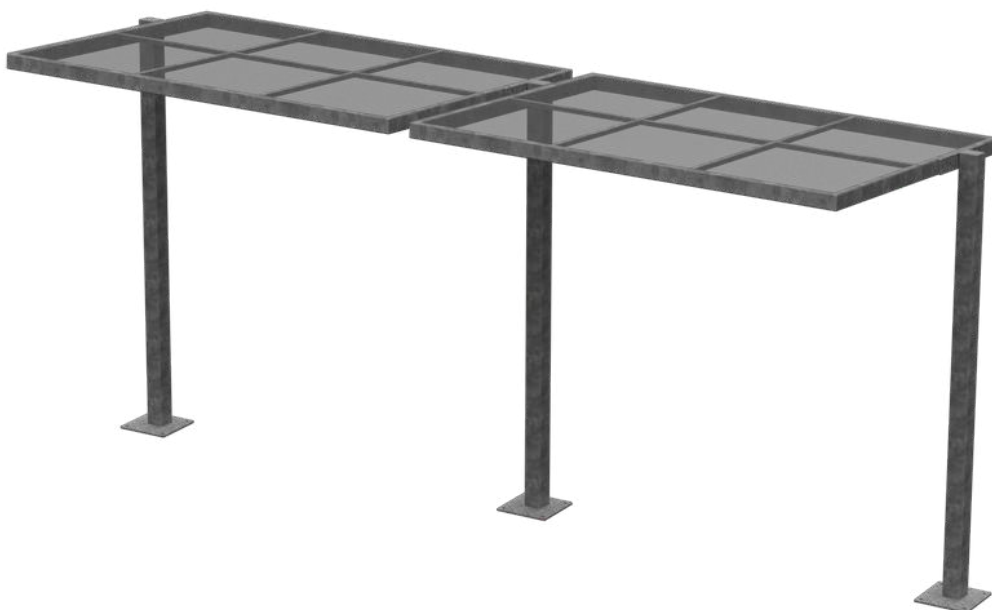

L Shelter



SHELTERS



Half Platform Shelter



Platform Shelter



Skellig Shelter



Vendetta Bus Shelter



Heritage Shelter



Picnic Shelter

our PRODUCTS



SEATINGS

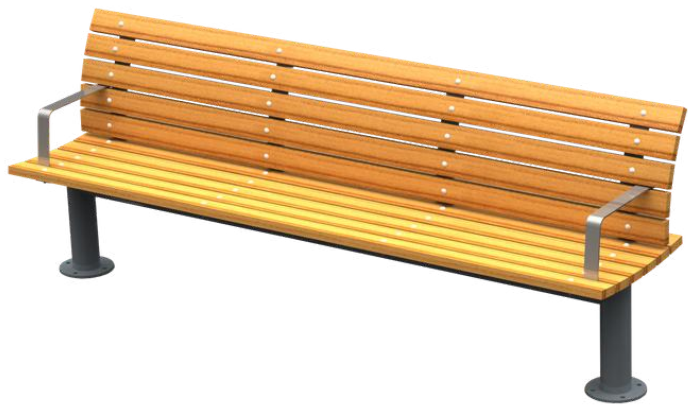

Abbey Concave Seat



Aero Seat



Ashford Seat



Cast Iron Seat



Castle Seat



Chesham Seat



SEATINGS



Corrib (A) Seat



Corrib (B) Seat

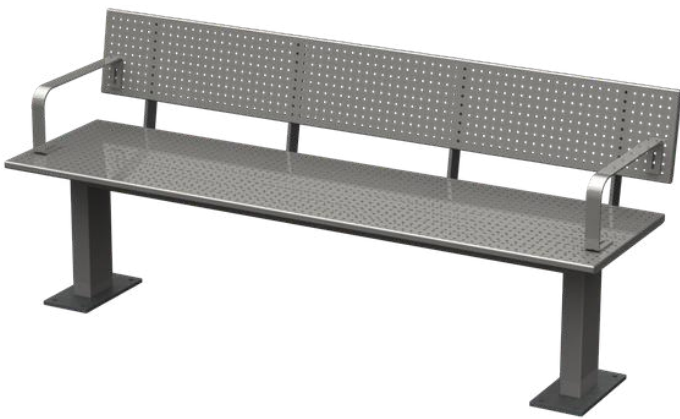

Corrib (C) Seat



Foyle Seat



Haven Seat



Highback Seat

our PRODUCTS



BENCHES

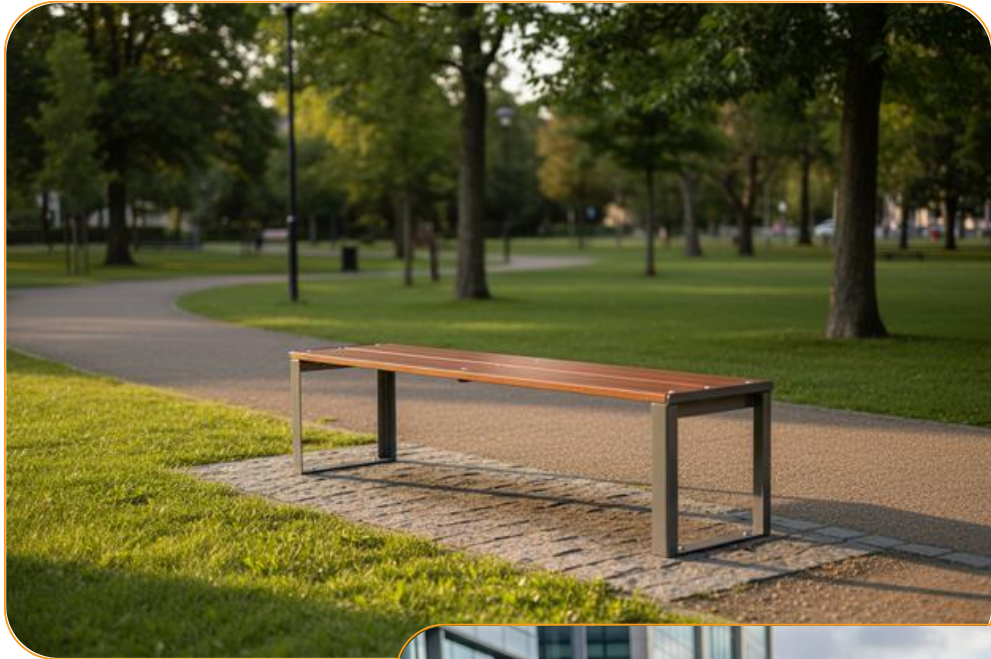

our PRODUCTS



BENCHES



Abbey Concave Bench



Aero Bench



Ashford Bench



Cast Iron Bench



Castle Bench

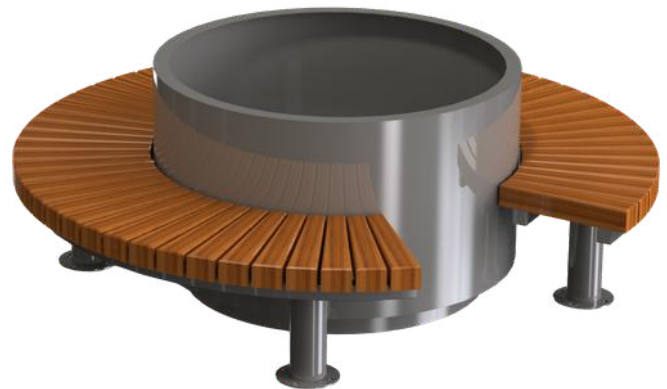

Circular Bench

our PRODUCTS



BENCHES



Corrib (A) Bench



Corrib (B) Bench



Corrib (C) Bench

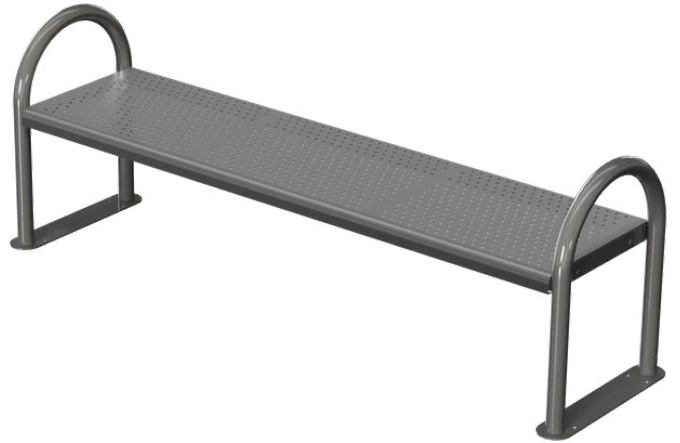

Form Type A Bench

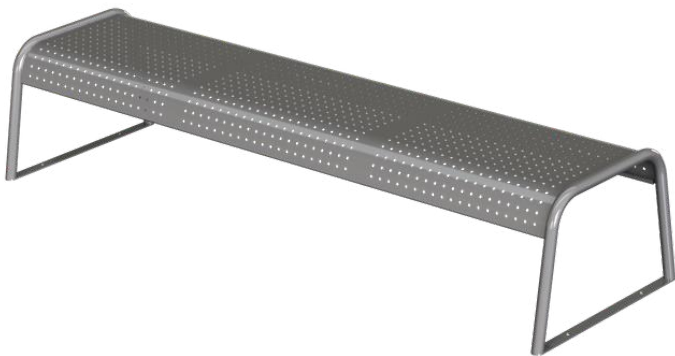

Form Type B Bench

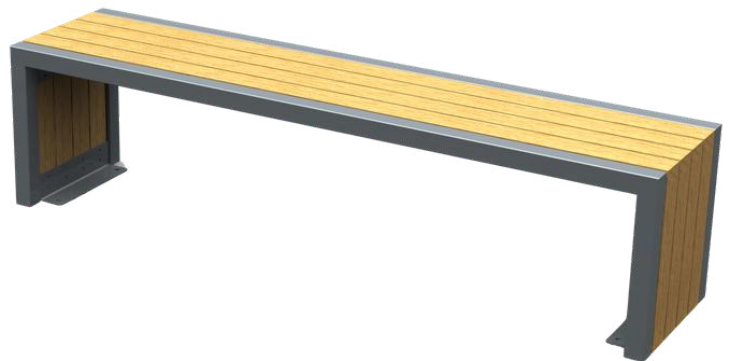

Fort Bench

our PRODUCTS



BENCHES

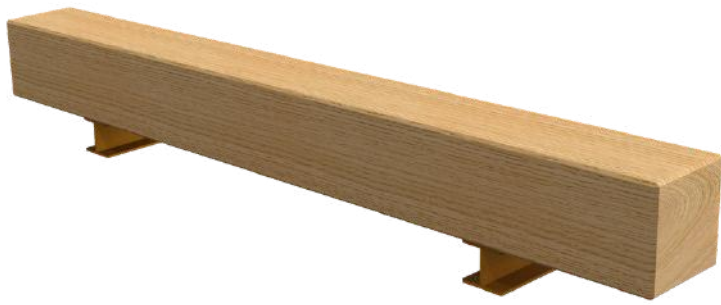

Rustic Bench



Square Bench

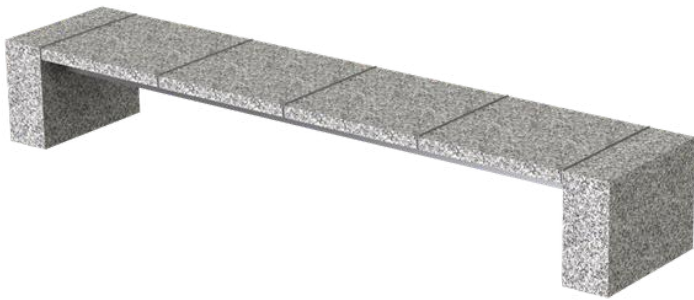

Stone & Stainless Bench



UCD Bench



Vendetta Bench



Weir Bench

our PRODUCTS



PICNIC SETS



our PRODUCTS



PICNIC SETS



Abbey Picnic Set



Ashford Picnic Set



Castle Picnic Set



Corrib (A) Picnic Set



Corrib (B) Picnic Set



Fort Picnic Set

our PRODUCTS



PICNIC SETS



Kylemore Picnic Set



Recycled Plastic Picnic Set



Rustic Picnic Set



School Picnic Set



Triad Picnic Set



Weir Picnic Set



Railing & Barrier

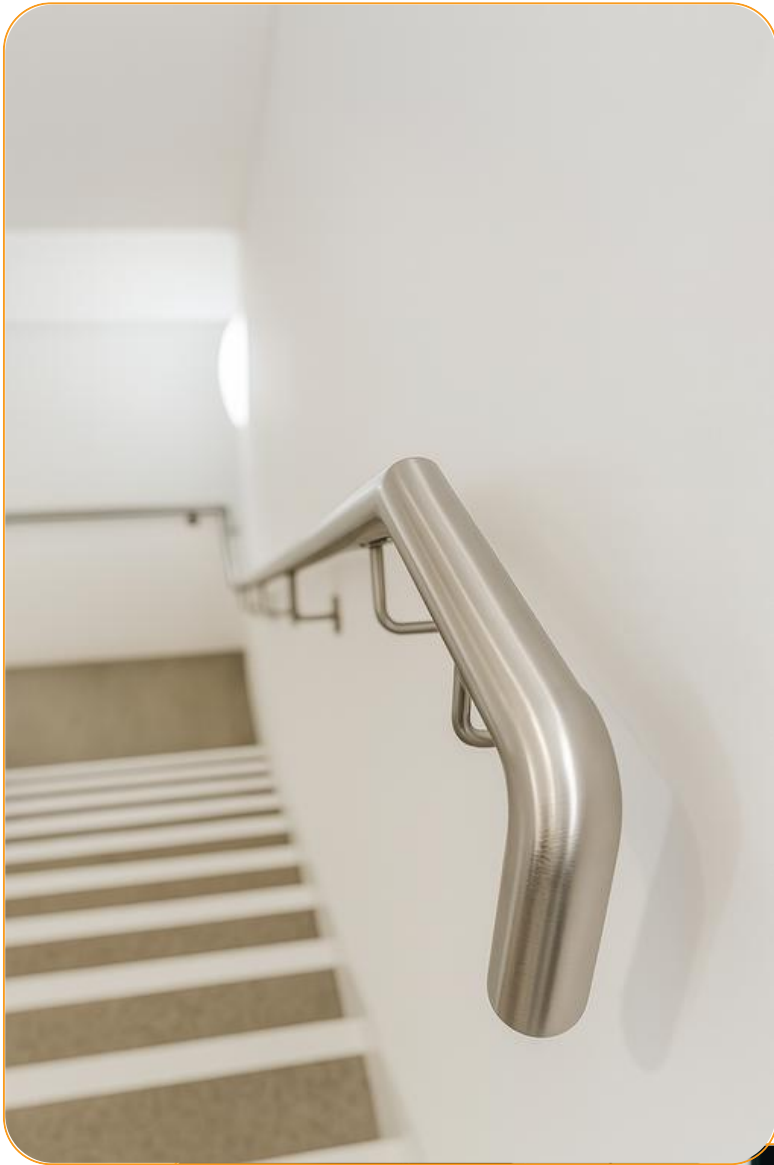



Railing & Barrier

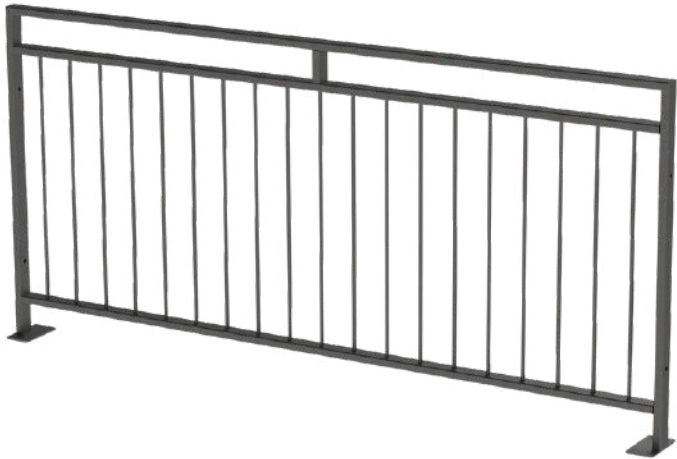

Pedestrian Guard Railing



Key Clamp Railings

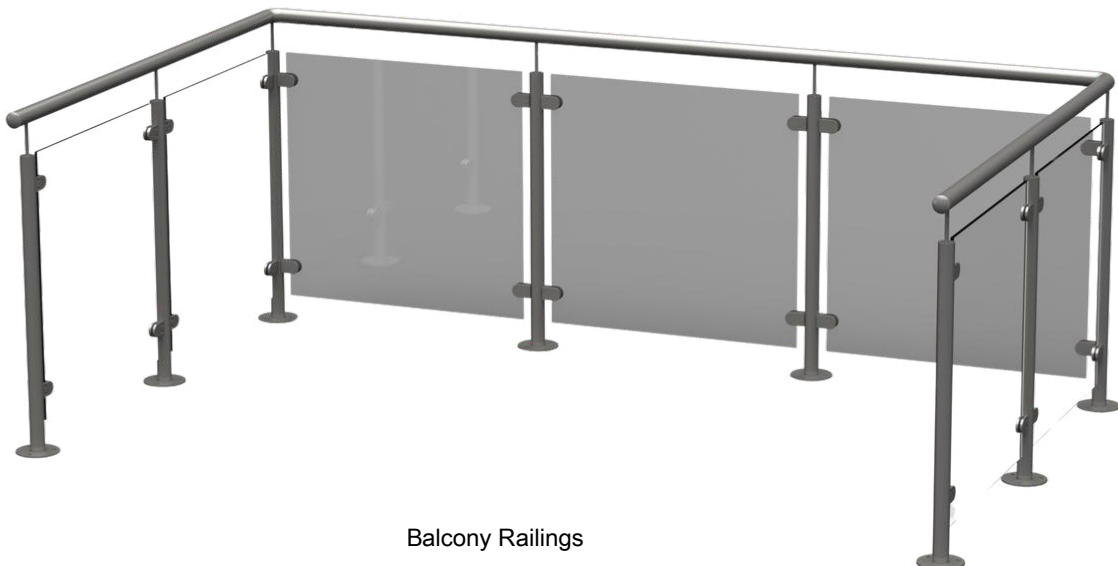

Balcony Railings



Railing & Barrier

Barriers



Height Restriction Barrier - Fixed

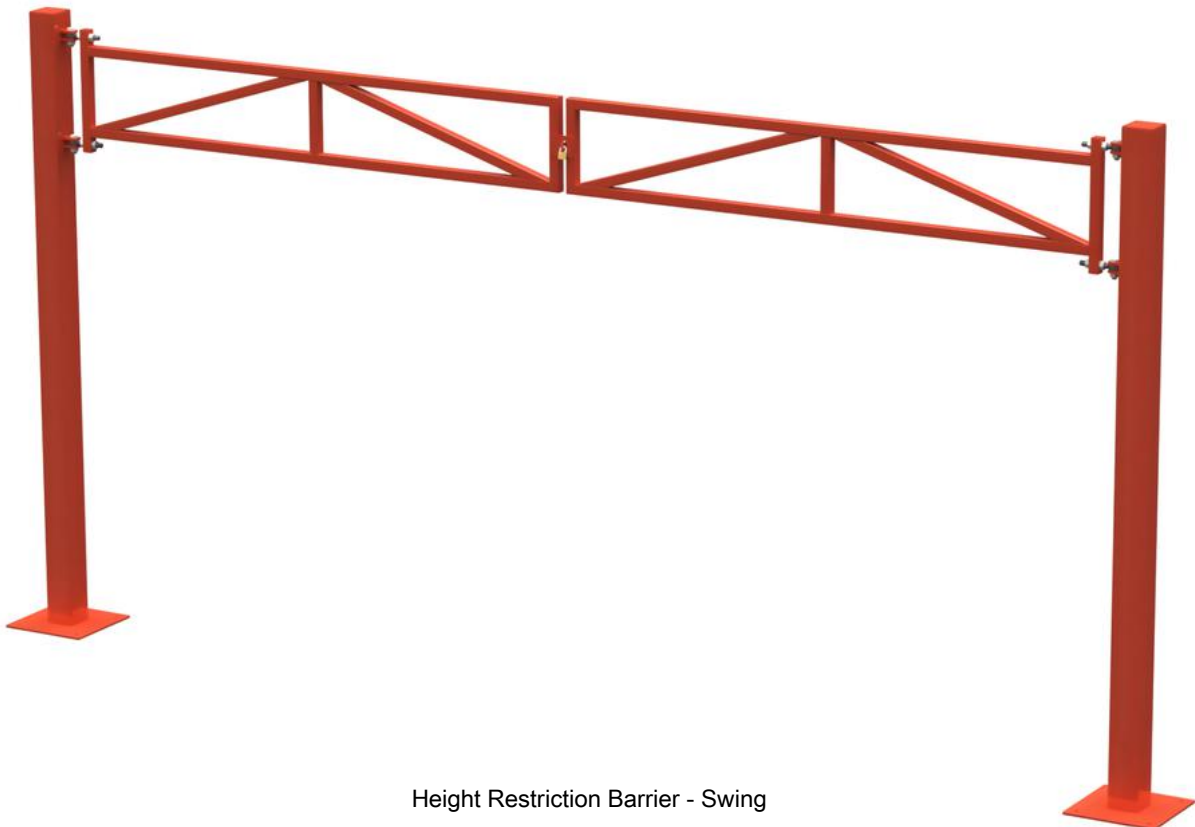

Height Restriction Barrier - Swing



Railing & Barrier



Box Type Door Protection Barrier - Glass Infill

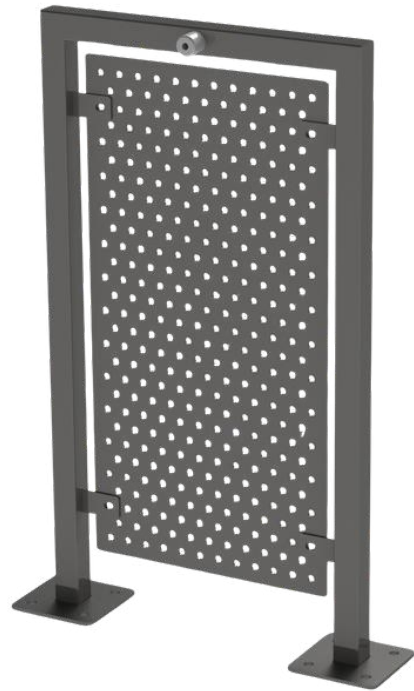

Box Type Door Protection Barrier - Perforated Infill

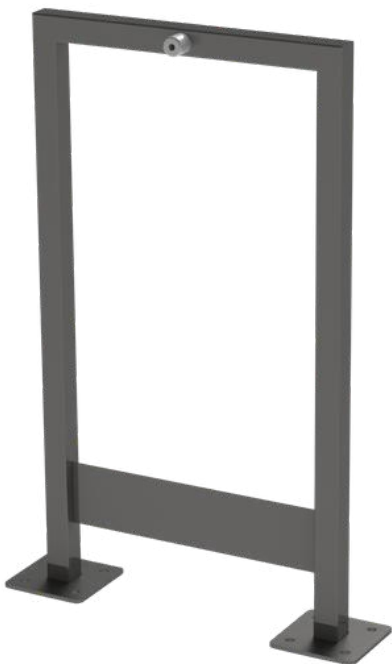

Box Type Door Protection Barrier - Tapping Rail



Railing & Barrier



Door Protection Barrier - Glass Infill

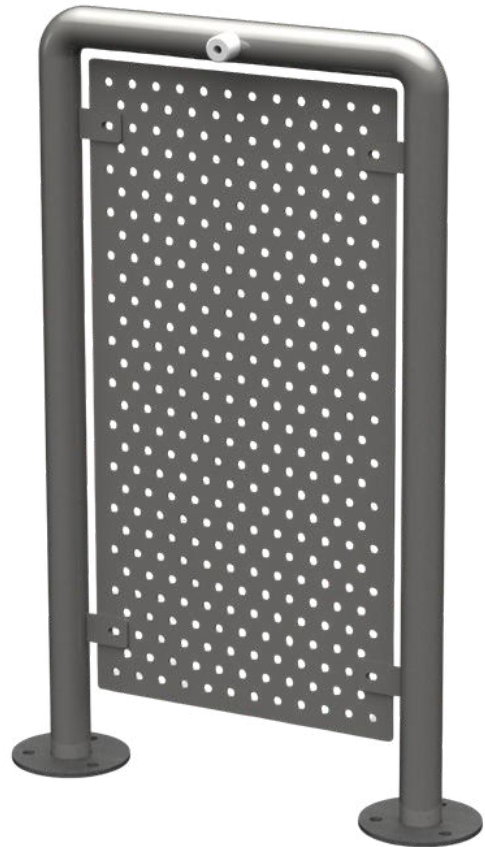

Door Protection Barrier - Perforated Infill

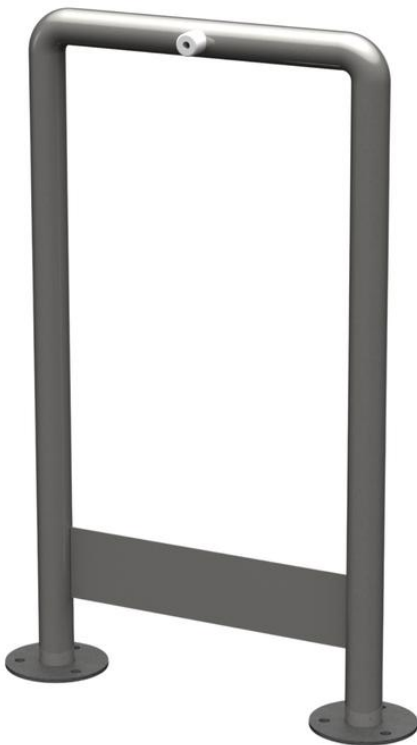

Door Protection Barrier - Tapping Rail



Railing & Barrier



Road Barrier - Single Leaf



Road Barrier - Double Leaf

our PRODUCTS



PLANTERS

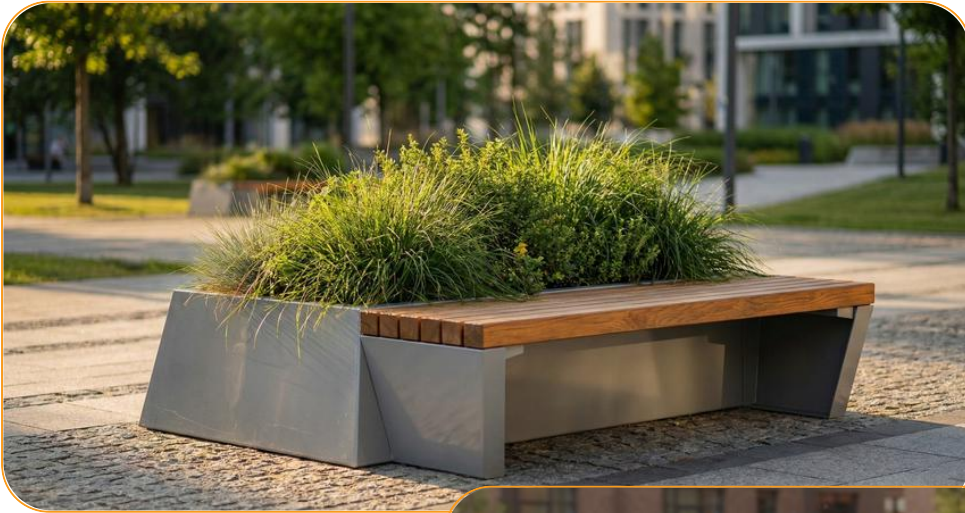



PLANTERS



Circular Planter



Corrib Planter



Edge Planter



Floating Planter

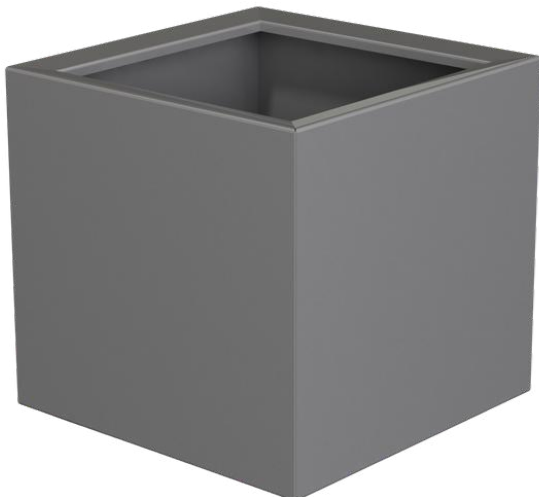

Galway Planter



Heritage Planter



PLANTERS



Hexagon Planter

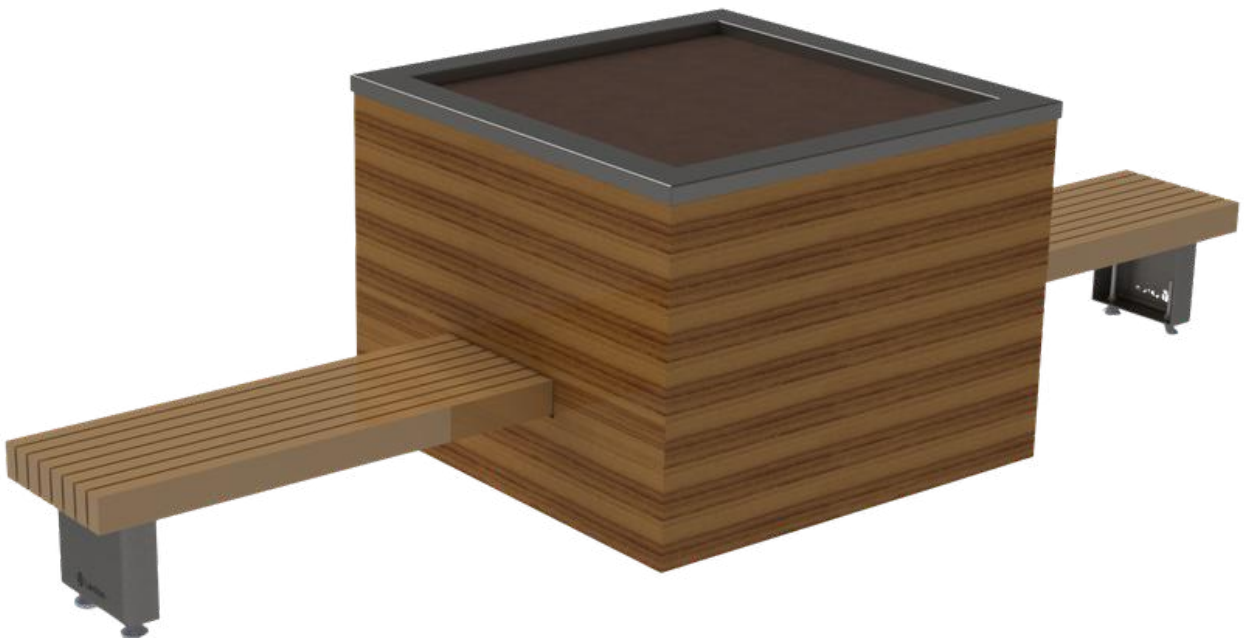

Limerick Planter



PLANTERS



Modern Planter

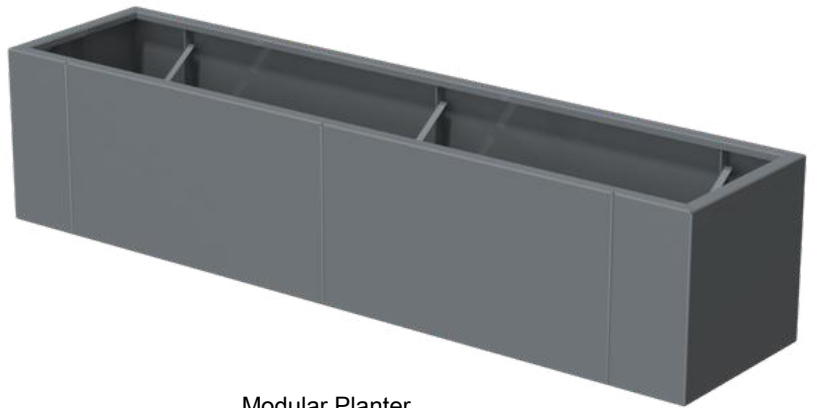

Modular Planter



Phoenix Planter

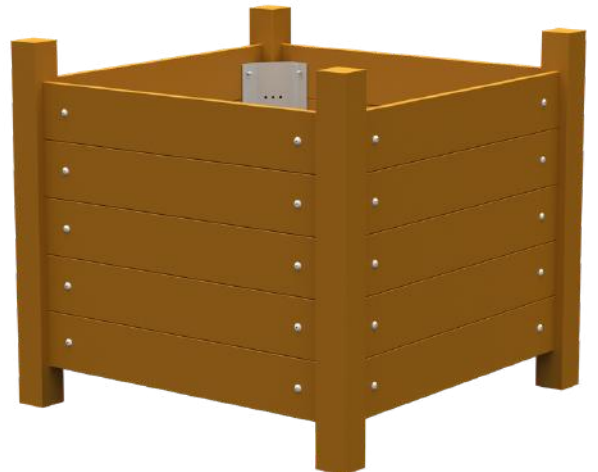

Recycled Plastic Planter



PLANTERS



Square Planter



Three Tier Planter



Tapered Planter

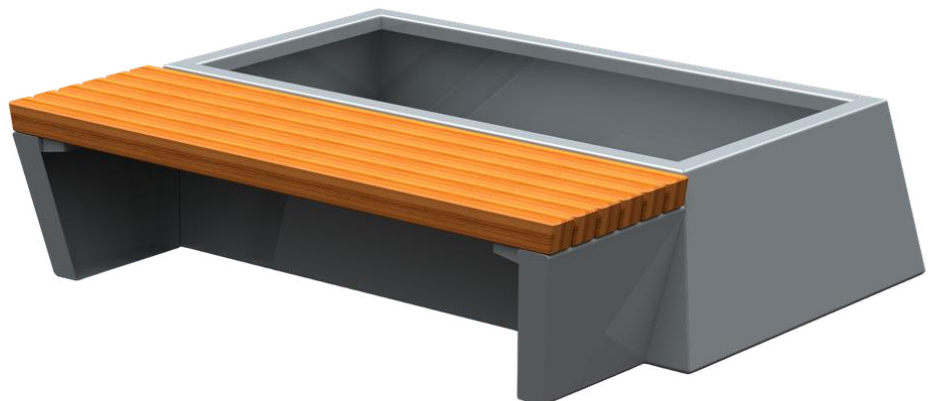

Vista Planter

our PRODUCTS



STORAGE
LOCKERS





STORAGE
LOCKERS



2- Bank Scooter Storage Locker



4- Bank Scooter Storage Locker



STORAGE
LOCKERS



2- Bank Scooter Storage Locker



E - Bike Storage Locker



STORAGE
LOCKERS



Semi - Vertical Bike Storage Locker



Perforated Locker



Sports Locker

our PRODUCTS



PUBLIC UTILITY STATIONS

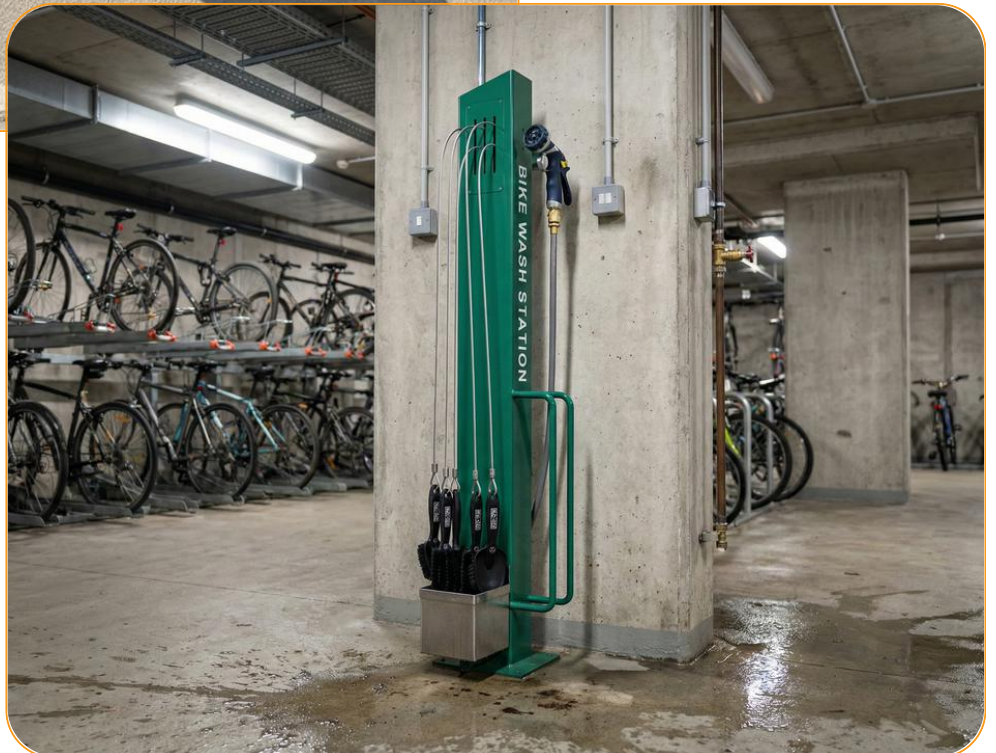

our PRODUCTS



PUBLIC UTILITY STATIONS



Bike Repair Station



Bike Wash Station



PUBLIC UTILITY STATIONS



E- Bike Charging Station



EV Charging Station



PUBLIC UTILITY STATIONS



Water Filling Station

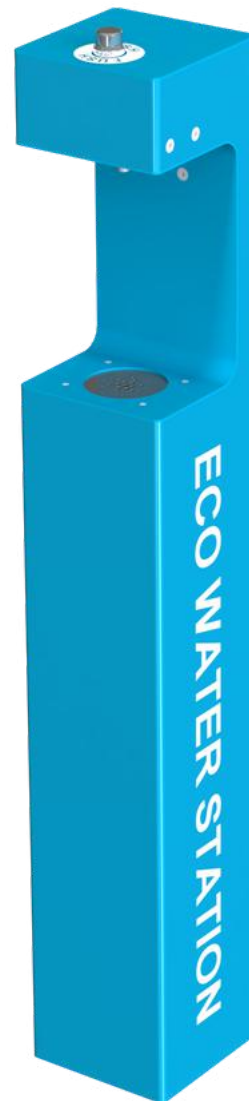

Eco Water Station

our PRODUCTS



PUBLIC UTILITY STATIONS



Wall Mounted Bike Repair Station

our PRODUCTS



INFORMATION BOARD & SIGNAGES



Advertising Panel - 6 Sheet



Advertising Panel - A0 Size



Forest Info Board



Forest Info Stand



Heritage Single Information Stand



Heritage Double Information Stand



Information Stand

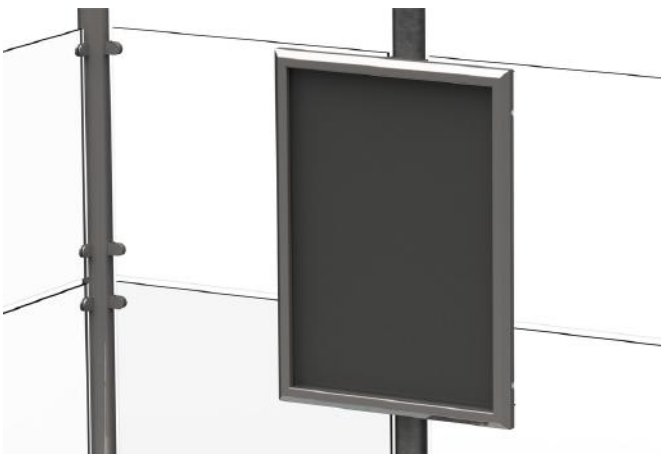

Timetable Display



Recycled Plastic Notice Panel

our PRODUCTS



BANDSTANDS , CANOPIES &
PODS





BANDSTANDS , CANOPIES &
PODS



Bandstand



BANDSTANDS , CANOPIES &
PODS

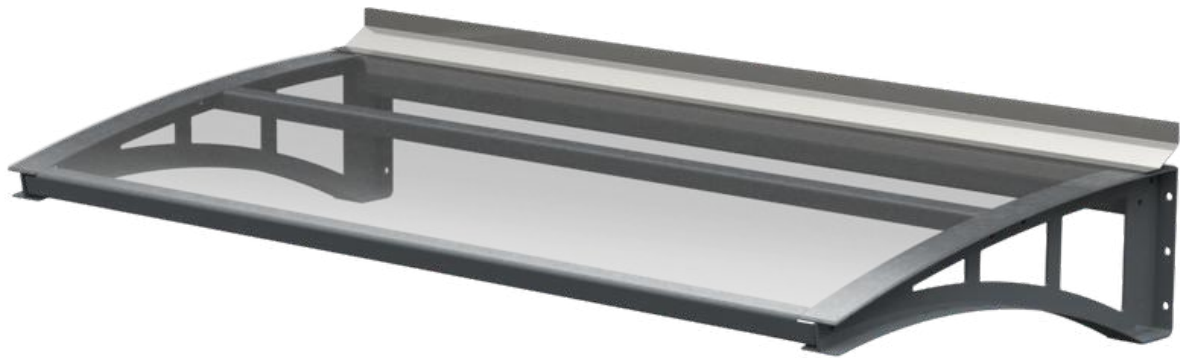

Door Canopy (Wall Fixed)



BANDSTANDS , CANOPIES &
PODS



Door Canopy (Floor Fixed)

our PRODUCTS



SPORTS FACILITY
EQUIPMENTS





SPORTS FACILITY
EQUIPMENTS



Sports Dugout

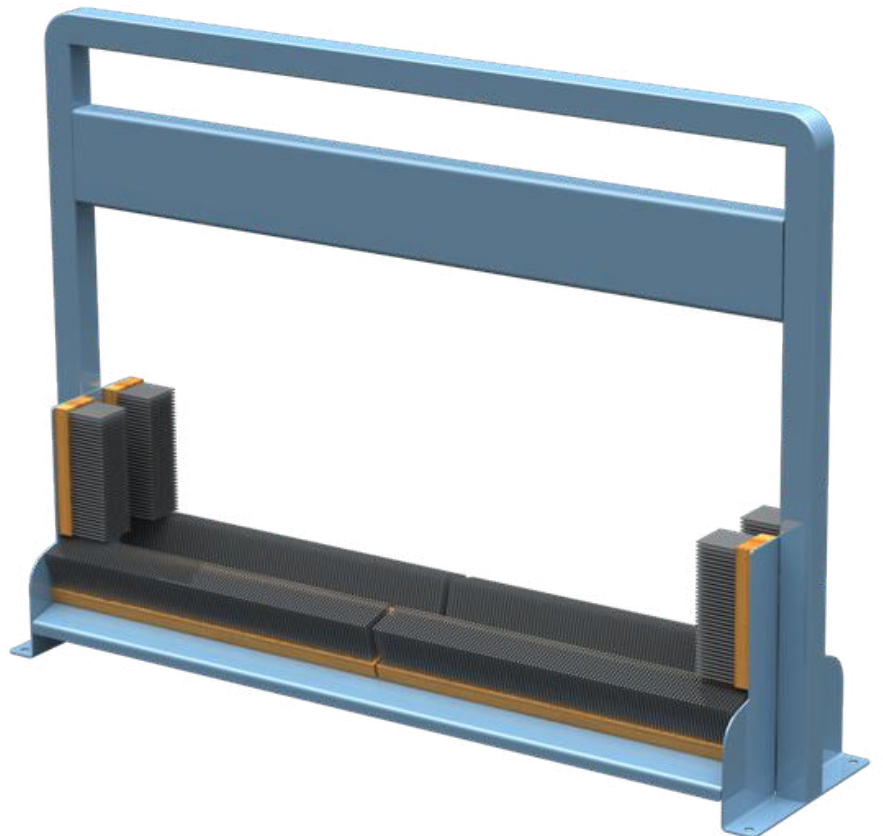

Boot Cleaner



SPORTS FACILITY
EQUIPMENTS



Locker Room Bench

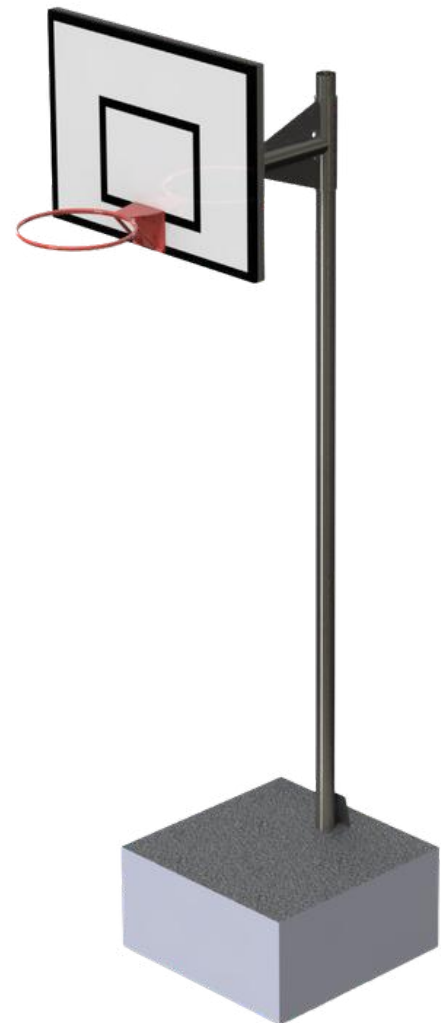

Basketball Post & Hoop



DOG FOUL BINS





DOG FOUL BINS



Dog Foul Bin



DOG FOUL BINS



Dog Foul Bollard



Dog Foul Station Bin



Tree Grilles & Protectors





Tree Grilles & Protectors

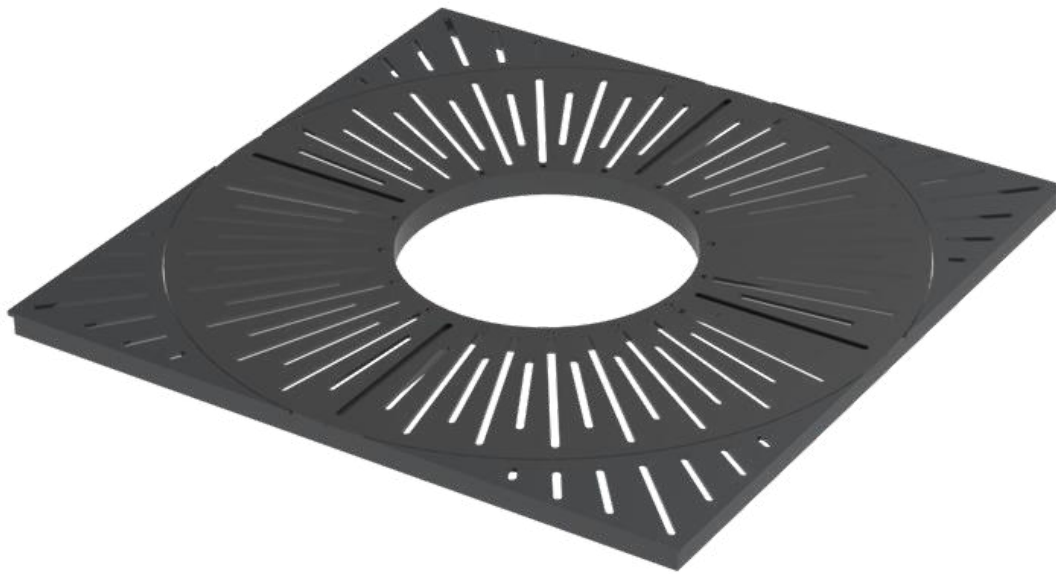

Sun Beam Tree Grille



Traffic Management System





Traffic Management System



Bullnose Corner Protector



Square Corner Protector



Speed Bump

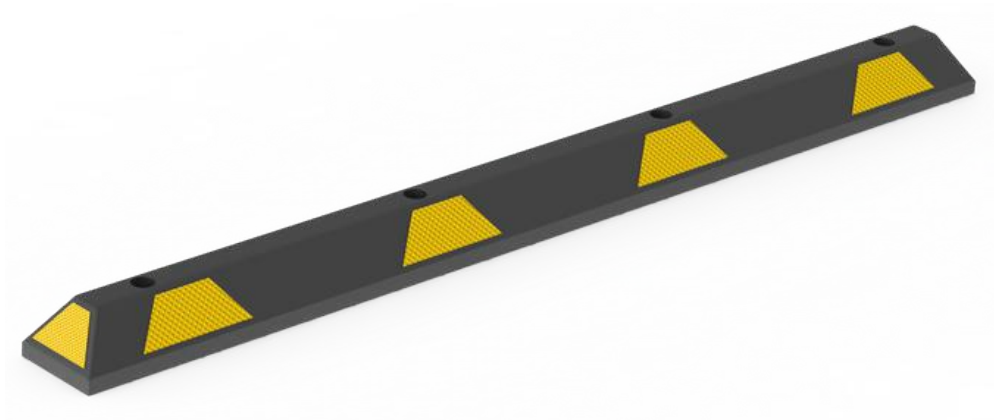

Wheel Stop



Ready to enhance urban infrastructure ?

We specialize in manufacturing street furniture, customizing solutions to perfectly meet your street furniture infrastructure needs.

Contact us today to discuss how our innovative products can transform your spaces.

Website: www.larkin-eng.com

Email: info@larkin-eng.com

Phone: +353 (0)93 24629

Social Media:

Facebook: facebook.com/LarkinEngineering

LinkedIn: linkedin.com/company/larkin-engineering

Instagram: instagram.com/larkinengineeringsf