

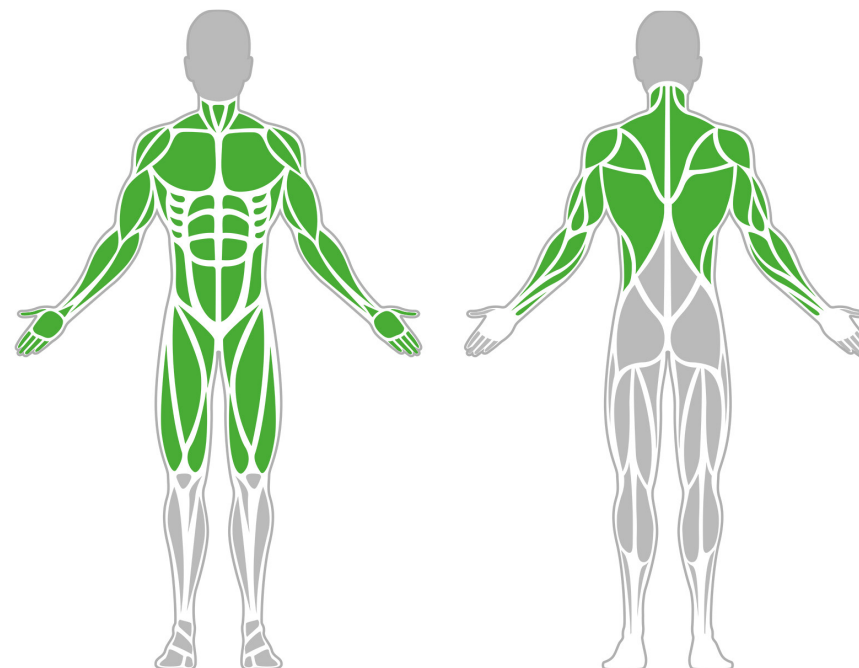

Muscle Groups Focus



Three Element Parallel Bar 1500 - Lite

The parallel bar is a classic piece of exercise equipment that can be used to develop a wide range of muscles, as it can be used for a variety of bodyweight exercises. The parallel bars are excellent for developing strength, endurance, coordination and balance.

Attributes

Product code	1-1-701
Certificate	EN 16630
Age group	14 + years
Capacity	2 people
Max. weight load	99 kg
Type	Calisthenics
Difficulty level	Medium

Side View

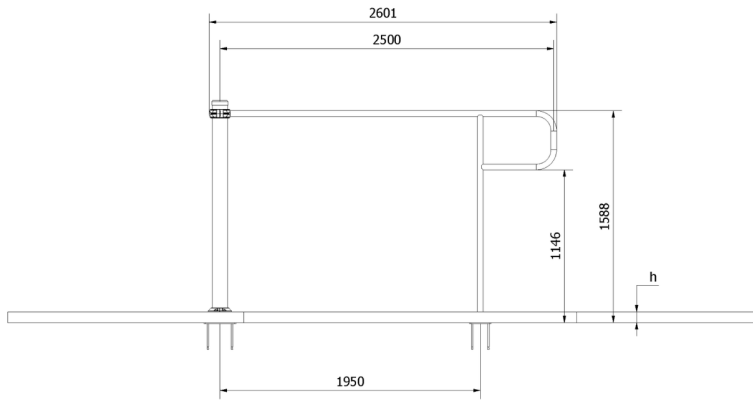

Plan View

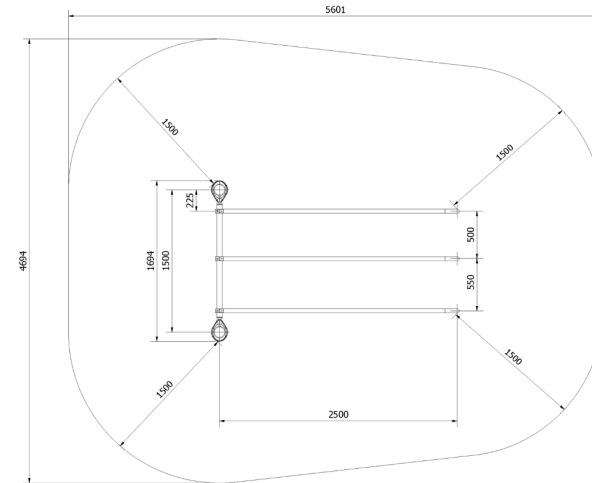

Installation information

Number of installers (concrete)	At least 2 people
Total installation time (concrete)	60-120 min.
Number of installers (equipment)	At least 3 people
Total installation time (equipment)	30-45 min.
Excavation volume	0.65 m ³
Concrete volume	0.65 m ³
Size of the base structure	2pc 0,5 x 0,5 x 0,8 m + 0,5 x 1,5 x 0,35 m
Anchoring options	In-ground or surface
In combined structures, the volume of concrete required varies.	

Technical specification

Safety surface area	Around 1,5 m radius
Net weight	109 kg
Material	S235
Critic fall height	1500 mm
Color options	

For more color options, discuss with your sales representative.

Warranty

Structure	25-15 years
Steel	5-10 years
Paint	2 years
Plastic	5-10 years
Rubber	1-3 years
Moving parts	2 years
Detailed information in the warranty document	

Material specification

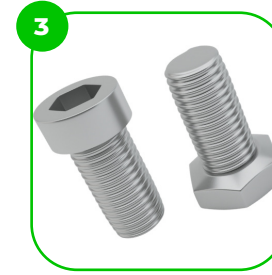
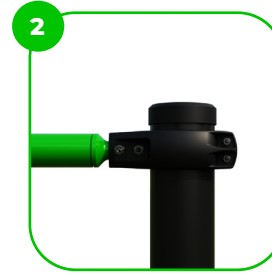
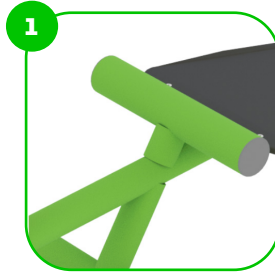

The element is made of high quality S235 steel, which has been cleaned via sandblasting. A corrosion resistant powder coating finish is then applied. Also available with galvanized surface for even greater protection and longevity!

The plastic clamp system allows for easy assembly and extreme stability.

The connecting elements are fastened with vandal-proof stainless steel screws and nuts.

The ends of the bars and posts are sealed with injection-moulded plastic caps.

BESTSTRONG

 [beststrongworld](#)  [beststrongworld](#)  [global.beststrong.com](#)  [info@beststrong.com](#)

