

Muscle Groups Focus

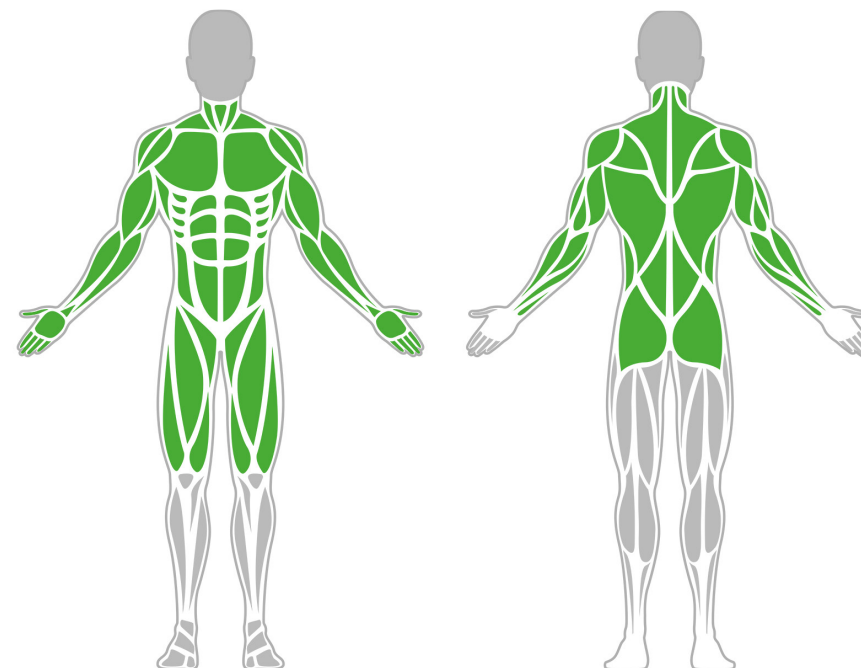

Double Multifunctional Trainer - Lite

The double multifunctional trainer is an extremely versatile training tool that allows two people to work out at the same time. It can be used for push-ups, leg lifts and knee lifts, and the tabs at the foot of the machine can be used for both easy and difficult push-ups, and can be used by two people at the same time. It's this versatility that makes the double multifunctional trainer the perfect choice for those looking for a complex outdoor workout tool for the home.

Attributes

Product code	1-1-712
Certificate	EN 16630
Age group	14 + years
Capacity	2 people
Max. weight load	99 kg
Type	Fitness
Difficulty level	Medium

Side View

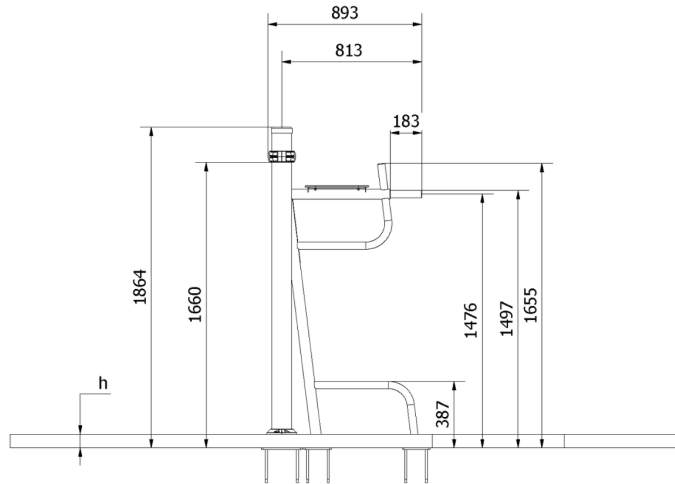

Plan View

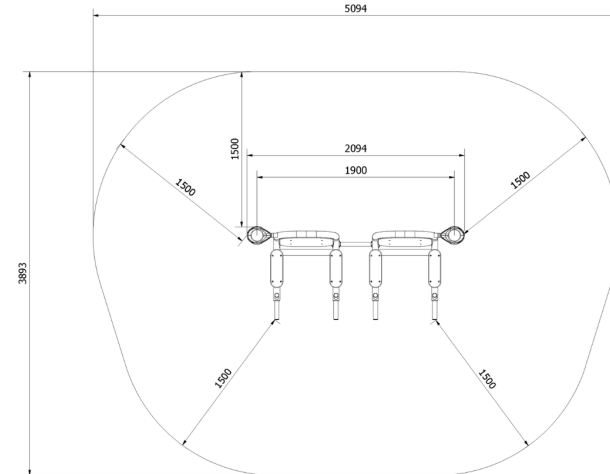

Installation information

Number of installers (concrete)	At least 2 people
Total installation time (concrete)	75-130 min.
Number of installers (equipment)	At least 2 people
Total installation time (equipment)	30-60 min.
Excavation volume	1.3 m ³
Concrete volume	1.3 m ³
Size of the base structure	1,5 x 2,5 x 0,35 m
Anchoring options	In-ground or surface
In combined structures, the volume of concrete required varies.	

Technical specification

Safety surface area	Around 1,5 m radius
Net weight	124 kg
Material	S235
Critic fall height	1370 mm
Color options	
For more color options, discuss with your sales representative.	

Warranty

Structure	25-15 years
Steel	5-10 years
Paint	2 years
Plastic	5-10 years
Rubber	1-3 years
Moving parts	2 years
Detailed information in the warranty document	

Material specification

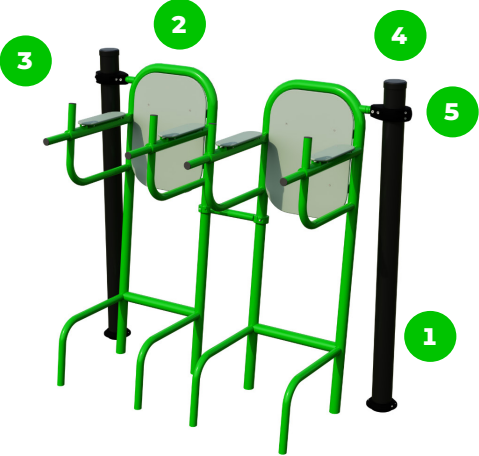

The element is made of high quality S235 steel, which has been cleaned via sandblasting. A corrosion resistant powder coating finish is then applied. Also available with galvanized surface for even greater protection and longevity!

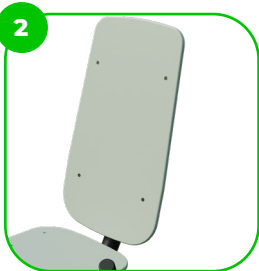

The seats and backrests are made of strong HDPE material. Which is fully heat, moisture and UV resistant.



The connecting elements are fastened with vandal-proof stainless steel screws and nuts.



The ends of the bars and posts are sealed with injection-moulded plastic caps.



The plastic clamp system allows for easy assembly and extreme stability.

