

VAL-PAK PRODUCTS

PRODUCT CATALOG



1-800-798-5123 | www.val-pakproducts.com

WHISPERFLO REPLACEMENT LIQUID END COMPLETE LESS MOTOR



Val-Pak Part No.

Description

V20-410-LE	1/2 HP Liquid End Complete Less Motor
V20-411-LE	3/4 HP Liquid End Complete Less Motor
V20-412-LE	1.0 HP Liquid End Complete Less Motor
V20-413-LE	1.5 HP Liquid End Complete Less Motor
V20-414-LE	2.0 HP Liquid End Complete Less Motor
V20-415-LE	3.0 HP Liquid End Complete Less Motor

TABLE OF CONTENTS

New Products.....	2-3
The Story Of Val-Pak Products	4
Terms And Conditions Of Sale.....	5
Ultra Flow Pump Parts.....	6-7
American Products Pump Parts	8
American Products Skimmer Parts.....	8
American Products Return Fittings	9
Pentair/American Products Filter Parts	10-13
Anthony Pump Parts.....	14
Anthony Selector Valve.....	15
Anthony Apollo Filter Exploded View	16-17
Anthony Filter Parts	18
Anthony Light Parts	18
Aqua-Flo A Series 1/3-3 Horsepower Brass Pump	19
Aqua-Flo A Series Brass Pump Exploded View	20
Aqua-Flo AC Series 3 & 5 Horsepower Brass Pump	21
Aqua-Flo AC Series Brass Pump Exploded View	22
Dominator Pump	23
Dominator Pump Exploded View	24
Hayward Replacement Baskets.....	25
Hayward Replacement Parts	26
Jandy Pump Parts.....	27
Jandy Filter Parts.....	28-29
Martin 100 Series 1/3-3 Horsepower Brass Pump	30
Martin 100 Series Brass Pump Exploded View	31
Martin 500 Series 3-10 Horsepower Brass Pump	32
Martin 500 Series Brass Pump Exploded View	33
Martin 600 Series 5-20 Horsepower Brass Pump.....	34
Martin 600 Series Brass Pump Exploded View.....	35
Martin 600 Series Motors and Impellers.....	36-37
Landon & Marlin Deck Filter Parts	38
Pac-Fab Pump Parts	39
Pac-Fab Filter Parts	39-41
Pac-Fab Skimmer Part	41
Pool Sweep Parts	42
Premier Pump Parts	43-44
Premier 658 Pump Parts.....	45
658 Series Motors.....	46
Premier Filter Parts	47
Purex Pump Parts	47
Pentair/Purex Pump Parts.....	48-49
Pentair/C-Series Brass Pump Exploded View	50
Pentair/C-Series Motors and Impellers	51
Pentair/Purex Ortega Valve Parts	52-54
Pentair/Purex Return Fittings	55
Purex Filter Parts	56-58
Pentair/Purex Center Rods.....	59-60
Sta-Rite/Dura Glas Exploded View.....	61
Pentair/Sta-Rite Pump Parts.....	62-63
Pentair/Sta-Rite Filter Parts	64
Swimquip Filter/Skimmer Parts.....	65-66
Swimrite Equipment Parts	66
Wet Industries Pump Parts.....	67
Miscellaneous Parts & Products	68-71
Pump & Skimmer Baskets	72-74

NEW PRODUCTS!

MINIMUM ORDER IS \$100

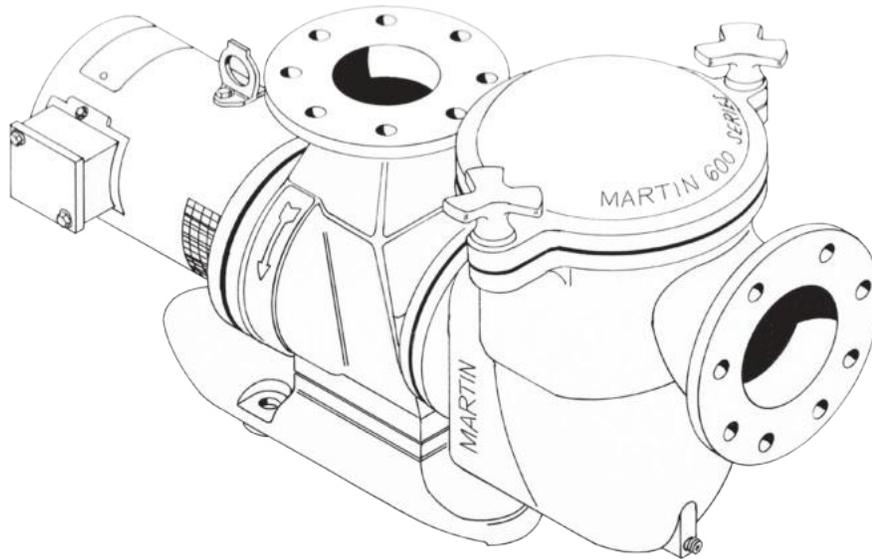

Martin 600/C-Series Pump
Page 34/50



**JANDY STEALTH TAIL
PIECE/UNION NUT**
Page 27



**JANDY SMALL
DRAIN PLUG**
Page 28



**JANDY LARGE
DRAIN PLUG**
Page 28



**JANDY SLIP CONNECTOR/
UNION NUT**
Page 28



**HYDROSTATIC
RELIEF VALVE
(1.5", 2") (BRASS)**
Page 71



**ORTEGA CHECK
VALVE CAP
(2", 1.5")**
Page 54

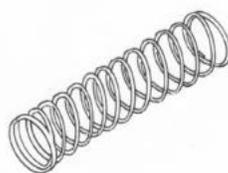

**ORTEGA SPRING
(1 LB)**
Page 54



**ORTEGA CHECK
VALVE SEAT
ASSEMBLY**
Page 54



**LID BUSHING
ASSEMBLY**
Page 56



CLAMP KNOB
Page 56

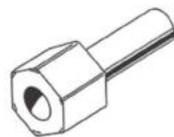

**FNS PLUS TANK
CLAMP NUT**
Page 13

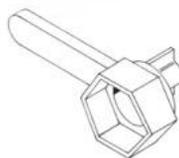

**EYEBALL/POLARIS WALL
FITTING REMOVAL WRENCH**
Page 70



**LID REMOVAL WRENCH
FOR DURA-GLAS/MAX-E GLAS**
Page 62

NEW PRODUCTS!

MINIMUM ORDER IS \$100

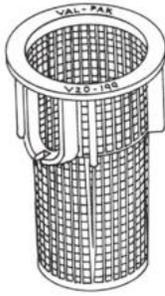

**SUPERFLO/SUPERMAX
PUMP BASKET**
Page 49



**WHISPERFLO
IMPELLERS**
1/2-2 HP
Page 48



**WHISPERFLO
DIFFUSER**
1/3-3 HP
Page 48

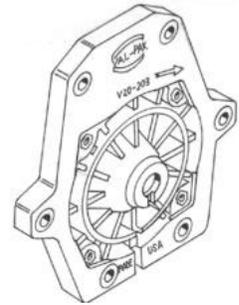

**WHISPERFLO
SEAL PLATE**
Page 48

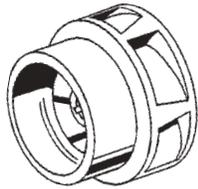

**ALL C-SERIES PARTS
NOW AVAILABLE**
Pages 34-36



**JANDY
VALVE & GAUGE
ASSEMBLY**
Page 29



**PENTAIR
VALVE & GAUGE
ASSEMBLY**
Page 13



**STA-RITE S3
VALVE & GAUGE
ASSEMBLY**
Page 64



**TR100/TR140 BRASS
AIR RELIEF
ASSEMBLY**
Page 13

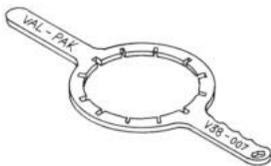

**LID REMOVAL
WRENCH
FOR TR100/140C**
Page 11

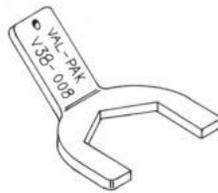

**BULK HEAD
NUT REMOVAL
WRENCH**
Page 11

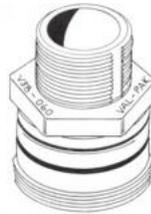

**2" BRASS
BULK HEAD
ASSEMBLY**
Page 11



ALGAE GUN
Page 68



**NORYL ROTOR
WITH SEAL**
Page 56

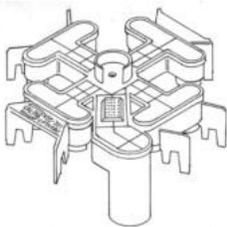

JANDY DE MANIFOLD
Page 29

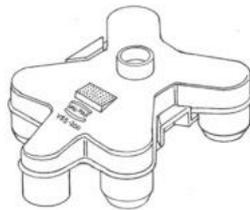

**JANDY CARTRIDGE
MANIFOLD**
Page 28



**ORTEGA 3 WAY VALVE
CAP (2", 1.5")**
Page 53

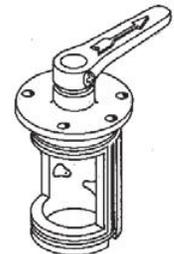

**ORTEGA DIVERTER
CAP & HANDLE (2", 1.5")**
Page 53

THE STORY OF VAL-PAK

Established in 1979, Val-Pak Products was founded by a pool service professional who became frustrated when a large pump manufacturer stopped making a widely used repair part. Unable to obtain the copper liner he needed to perform pump repairs, Ben Solakian decided to manufacture the part himself. In his garage workshop in Van Nuys, Calif., he started to turn out the liners and sell them through a local wholesale distributor. A cast-iron adapter for the same line of pumps was added shortly thereafter as the original manufacturer stopped making them. The initial demand for Val-Pak's repair parts was overwhelming. As equipment makers discontinued various parts, Val-Pak began producing them. Starting with a single part, the Val-Pak line has grown to include more than 750 repair and replacement products.

In 1984, joined by his son, Mike, Ben Solakian opened a 2,500-square-foot building in Saugus, Calif. Val-Pak continued to expand its parts line and also began packaging private-label chemical products, adding silk-screen bottle-decorating and filling to its list of services. The company soon outgrew its Saugus plant, and in 1986 relocated to a 6,800-square-foot facility in Valencia, Calif. Just one year later, it expanded to a 10,800-square-foot building in nearby Canyon Country, Calif., where it remained until 2002.

To gain greater control over the quality of its manufacturing operation, Val-Pak in 1990 purchased a state-of-the-art machining center. A pair of computerized lathes and an additional machining center were added as the business expanded throughout the 1990s.

Also in 1990, Val-Pak began to manufacture D.E. filter grids, purchasing the molded grid frames from an outside supplier and sewing on the fabric to produce the finished product. An 1,100-square-foot building was opened specifically for this operation. And in 1993, an additional 1,800-square-foot building was opened to accommodate Val-Pak's silk-screen operation. To further increase its ability to control every step of the manufacturing process, Val-Pak in 1998 purchased an injection molding company in Chatsworth, Calif., enabling it to mold all of its plastic parts in-house. One year later, it began to build a mold-making shop so it could actually produce the molds from which its plastic parts are made. Currently, Val-Pak has three full-time tool and die makers to run its mold-making operation.

Val-Pak has never stopped growing. In 2002, it moved to its present location — a new 34,000-square-foot facility in Santa Clarita, Calif. — and consolidated all of its operations there. With 20 employees, all of the company's manufacturing, mold making, injection molding and machining is performed in-house, with no outsourcing. This permits the company to react quickly to customer demands and to maintain absolute control over the quality of its products.

In April 2006, Val-Pak purchased the assets of Martin Pump Co., which made 1/3- to 3-horsepower residential brass pumps and 3-, 5-, 7½- and 10-horsepower commercial brass pumps. And on June 1, 2007, Val-Pak acquired the assets of Aqua-Flo, another maker of residential and commercial brass pumps. The acquisitions allow Val-Pak to meet demands of other industries worldwide. With the vast in-field experience of its owners, Val-Pak is able to keep a watchful eye on market demands and over the quality & durability of its products, which always exceed the specifications of the original manufacturer.

All Val-Pak parts are produced to the highest standards and sold through distribution. The quality and reliability of its products have made Val-Pak the brand that professional pool and spa service and repair technicians ask for by name.

TERMS AND CONDITIONS OF SALE

• • • PRICES:

All products and prices are subject to change without notice.

• • • PAYMENT TERMS:

All invoices are due and payable as per the terms on the invoice. No further discounts will be allowed. All invoices are due within 30 days. Any invoices that are not paid will be subject to a late fee of 1.5% per month.

• • • ORDERING:

Prepacked items must be ordered per case or quantities shown, no exceptions. To insure prompt and proper shipment, please order by Val-Pak number and description.

• • • SHIPPING:

No Vender Direct Shipping

• • • FREIGHT DAMAGE:

Val-Pak is not responsible for merchandise lost, damaged or destroyed after picked up by carrier and consigned to purchaser. If a claim is necessary, Val-Pak will furnish proof of shipment to purchaser, but claims must be filed with carrier.

• • • RETURNED CHECKS:

All returned checks are subject to a \$20.00 service charge.

• • • RETURNED MERCHANDISE:

All merchandise returned for credit is subject to a 20% restocking charge. Special-ordered, non-stocked merchandise is not returnable. All returns must be in the original, resaleable cartons. All returns must be submitted within 30 days.

• • • OUR PRODUCTS:

Val-Pak products are produced to the highest standards that meet or exceed OEM specifications. Val-Pak Products does not represent that Val-Pak's parts are either manufactured or endorsed by the original equipment manufacturer. Any mention of the OEM's product name or part number is for reference purposes only.

• • • COPYRIGHT:

No part of this publication may be reproduced, photocopied, stored in a retrieval system, or transmitted in any form or by any means, without prior written permission of Val-Pak Products.

• • • CA PROP 65 WARNING:

"Some items contain lead and are not allowed by Federal Law to be installed for potable water use in the U.S.A. and its territories. WARNING: Furthermore, these products contain a chemical known to the State of California to cause cancer, birth defects or other reproductive harm."

ULTRA FLOW PUMP WITH MOTOR

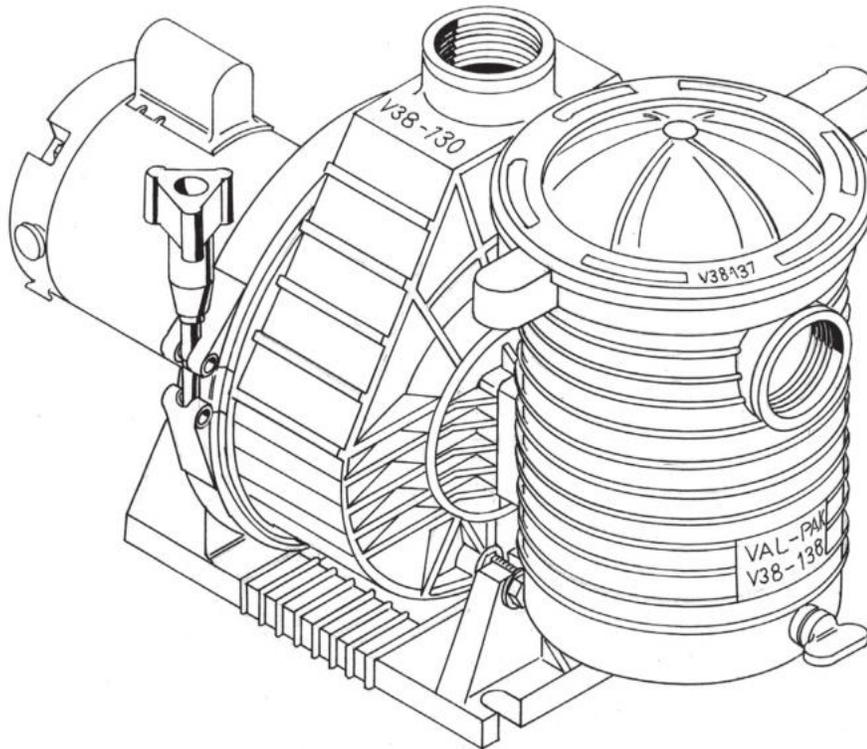

Val-Pak Part No.	Description	List Price
V38-300	1/2 HP 115/230 2" Suction 6" Trap	\$900.67
V38-301	3/4 HP 115/230 2" Suction 6" Trap	\$963.00
V38-302	1.0 HP 115/230 2" Suction 6" Trap	\$1,025.33
V38-303	1.5 HP 230 Volt 2" Suction 6" Trap	\$1,087.66
V38-304	2.0 HP 230 Volt 2" Suction 6" Trap	\$1,181.16
V38-305	3.0 HP 230 Volt 2" Suction 6" Trap	\$1,265.28

THREE PHASE VERSION AVAILABLE UPON REQUEST

LIQUID END ONLY

Val-Pak Part No.	Description	List Price
V38-306	1/2 HP Liquid End 2" In & Out 6" Trap	\$521.44
V38-307	3/4 HP Liquid End 2" In & Out 6" Trap	\$521.44
V38-308	1.0 HP Liquid End 2" In & Out 6" Trap	\$521.44
V38-309	1½ HP Liquid End 2" In & Out 6" Trap	\$521.44
V38-310	2.0 HP Liquid End 2" In & Out 6" Trap	\$521.44
V38-311	3.0 HP Liquid End 2" In & Out 6" Trap	\$521.44

ULTRA FLOW PUMP EXPLODED VIEW

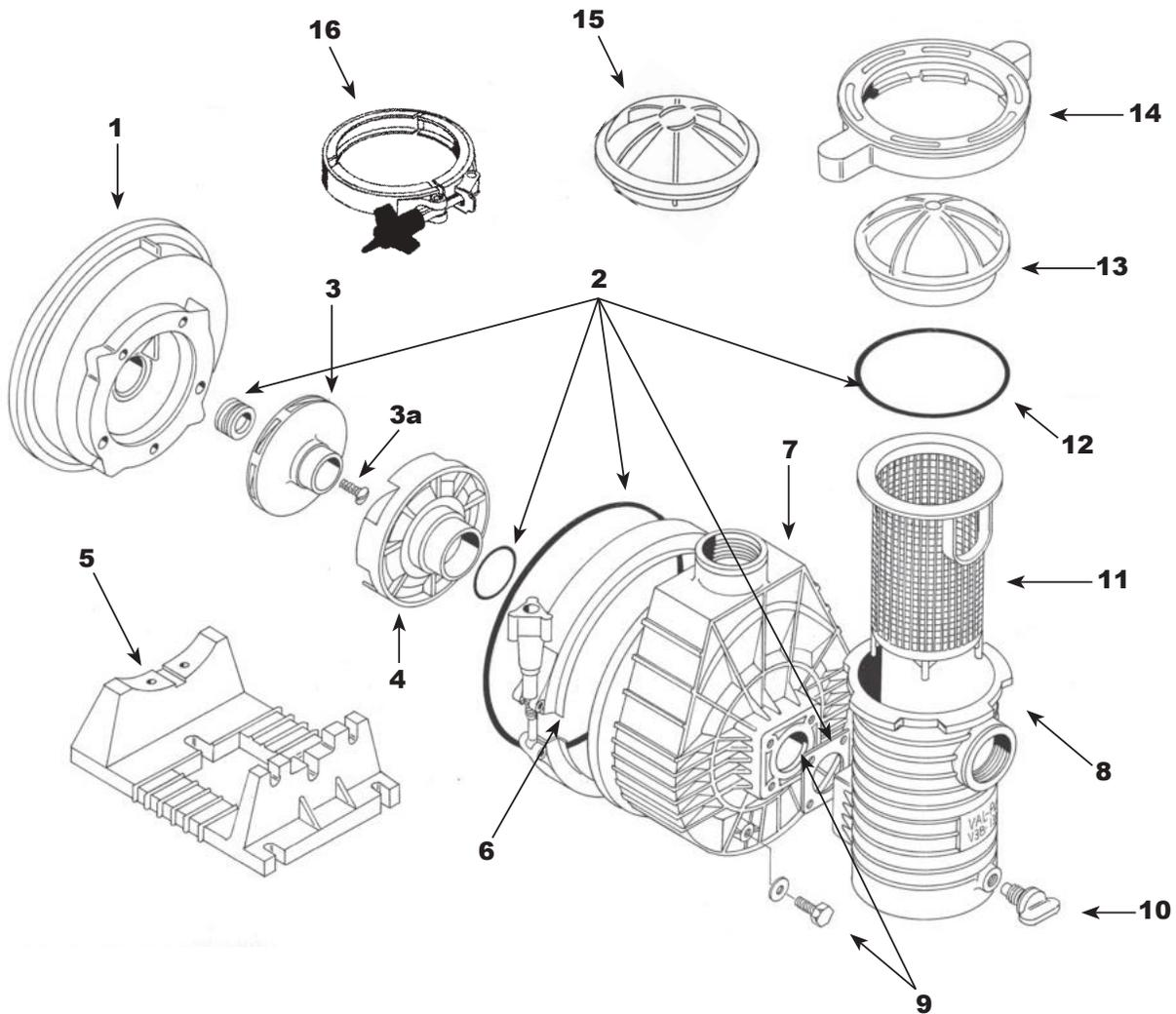

Key No.	Description	Val-Pak Part No.	List Price	Key No.	Description	Val-Pak Part No.	List Price
1	Seal Plate	V38-131	\$121.96	6	Volute Clamp	V38-163	\$97.09
2	Seal Kit	V38-144	\$103.85	7	Volute	V38-130	\$148.47
3	1/2 HP Impeller	V38-122	\$93.17	8	Trap	V38-138	\$152.02
	3/4 HP Impeller	V38-123	\$93.17	8a	Trap Assembly	V38-138-1	\$330.44
	1 HP Impeller	V38-124	\$93.17	9	Bolt Kit	V38-189	\$5.72
	1 1/2 HP Impeller	V38-126	\$93.17	10	Drain Plug	V40-907	\$3.21
	2 HP Impeller	V38-127	\$93.17	11	Basket	V38-185	\$34.39
	3 HP Impeller	V38-128	\$93.17	12	Lid O-Ring (94-Present)	V38-164	\$4.41
3a	Screw	V26-352	\$5.35	12a	Lid O-Ring (Pre-94)	V38-161	\$4.41
4	1-1/2 HP Diffuser	V38-132	\$34.68	13	Pump Lid (94-Present)	V38-162	\$51.41
	2 & 3 HP Diffuser	V38-133	\$34.68	14	Locking Ring	V38-137	\$47.05
4a	Wear Ring	V38-134	\$14.95	15	Pump Lid (O/S Pre-94)	V38-160	\$53.95
5	Pump Base	V38-139	\$56.80	16	Pump Lid Clamp (O/S)	V38-166	\$92.90

AMERICAN PRODUCTS PUMP PARTS

MARINE PUMP LID, CLAMP, KNOB, T-BOLT

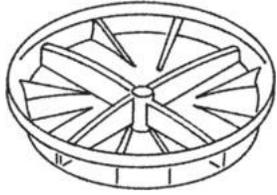

Val-Pak Part No.	Description	OEM Part No.	List Price
V38-112	Marine Pump Clear Lid - 6-3/4" dia.	393002	\$79.41
V38-113	Marine Pump Clamp - 6-3/4"	393005	\$94.00
V38-118	Marine Pump Clamp Knob	39302700	\$12.47
V38-119	Pump Clamp T-Bolt 1/4 x 20"		\$12.97
V38-120	Pump Clamp T-Bolt 1/4 x 28"		\$12.97

AMERICANA PUMP IMPELLER



Val-Pak Part No.	Description	OEM Part No.	List Price
V38-179	1/2 Horsepower Impeller	39500600	\$102.44
V38-180	3/4 Horsepower Impeller	39500700	\$102.44
V38-181	1 Horsepower Impeller	39500800	\$102.44
V38-182	1½ Horsepower Impeller	39500900	\$102.44
V38-183	2 Horsepower Impeller	39501000	\$102.44

AMERICAN PRODUCTS SKIMMER PARTS

AMERICAN BASKET, FLOATING WEIR

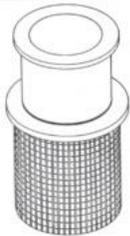

Val-Pak Part No.	Description	OEM Part No.	List Price
V38-135	Basket (24/box)	R38013A	\$26.24
V38-136	Floating Weir	R38013B	\$17.95

AMERICAN TAPERED SKIMMER BASKET



Val-Pak Part No.	Description	OEM Part No.	List Price
V38-125	Tapered Skimmer Basket (20/Box)	85014500	\$27.17

BRASS DIVERTER, THREAD LOCK DIVERTER

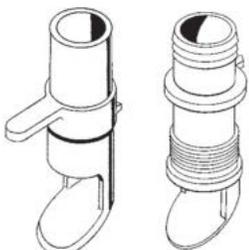

Val-Pak Part No.	Description	OEM Part No.	List Price
V38-099	Brass Diverter (Vari-Flo)	850025	\$155.58
V38-100	Thread Lock Diverter		\$28.19

AMERICAN PRODUCTS SKIMMER PARTS (CONT.)

COMMERCIAL DIVERTER



Val-Pak Part No.	Description	List Price
V38-101	Commercial Diverter	\$40.27

AMERICAN SKIMMER LID

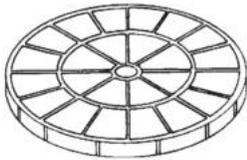

Val-Pak Part No.	Description	OEM Part No.	List Price
V50-115W	American Skimmer Lid (White) 9-1/8" dia.	85007400	\$11.56
V50-115G	American Skimmer Lid (Gray) 9-1/8" dia.	85007413	\$11.56
V50-115T	American Skimmer Lid (Tan) 9-1/8" dia.	85007430	\$11.56
V50-115R	American Skimmer Lid (Red) 9-1/8" dia.		\$11.56
V50-115GN	American Skimmer Lid (Green) 9-1/8" dia.		\$11.56

THROTTLING PLUG WITH O-RING

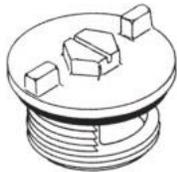

Val-Pak Part No.	Description	List Price
V50-350	1 1/2" Throttling Plug with O-Ring	\$12.87
V50-350-1	Throttling Plug O-Ring	\$1.86

AMERICAN PRODUCTS RETURN FITTINGS

RETURN FITTING

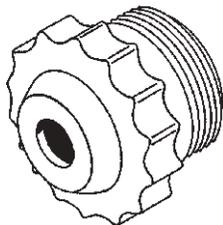

Val-Pak Part No.	Description	OEM Part No.	List Price
V20-386	Return Fitting - White 1/2"	540014	\$3.96
V20-387	Return Fitting - White 3/4"	540021	\$3.96
V20-388	Return Fitting - White 1"	540028	\$3.96
V20-406	Return Fitting - Black 1/2"	540015	\$3.96
V20-391	Return Fitting - Black 3/4"	540022	\$3.96
V20-392	Return Fitting - Black 1"	540029	\$3.96
V20-394	Return Fitting - Light Gray 1/2"		\$3.96
V20-395	Return Fitting - Light Gray 3/4"		\$3.96
V20-396	Return Fitting - Light Gray 1"		\$3.96
V20-398	Return Fitting - Dark Gray 1/2"	540016	\$3.96
V20-399	Return Fitting - Dark Gray 3/4"	540023	\$3.96
V20-400	Return Fitting - Dark Gray 1"	540030	\$3.96

AMERICAN PRODUCTS RETURN FITTINGS (CONT.)

BLANK RETURN FITTING

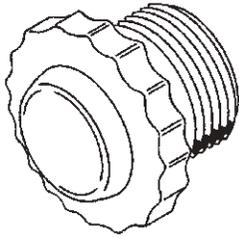

Val-Pak Part No.	Description	List Price
V20-377	Blank Return Fitting - White	\$4.66
V20-378	Blank Return Fitting - Black	\$4.66
V20-379	Blank Return Fitting - Dark Gray	\$4.66
V20-380	Blank Return Fitting - Light Gray	\$4.66

WALL FITTING WRENCH

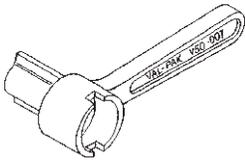

Val-Pak Part No.	Description	List Price
V50-007	Flush Mount and Threaded Eyeball Fitting Removal Wrench (Aluminum)	\$94.47

PENTAIR/AMERICAN PRODUCTS FILTER PARTS

FNS PLUS FILTER ASSEMBLY

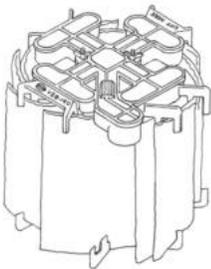

Val-Pak Part No.	Description	OEM Part No.	List Price
V20-824	24 sq. ft. Filter Assembly	59023800	\$360.27
V20-836	36 sq. ft. Filter Assembly	59023500	\$318.70
V20-848	48 sq. ft. Filter Assembly	59023400	\$362.52
V20-860	60 sq. ft. Filter Assembly	9023300	\$389.07
V20-872	72 sq. ft. Filter Assembly	195060	\$743.53

FILTER GRID, FULL & PARTIAL

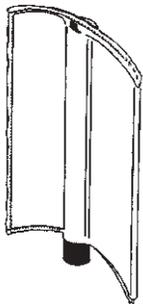

Val-Pak Part No.	Description	List Price
V38-190-7	24 sq. ft. Filter Grid 7 Full/1Partial	\$201.33
V38-191-7	36 sq. ft. Filter Grid 7 Full/1Partial	\$255.80
V38-192-7	48 sq. ft. Filter Grid 7 Full/1Partial	\$313.55
V38-193-7	60 sq. ft. Filter Grid 7 Full/1Partial	\$379.80
V38-194-7	72 sq. ft. Filter Grid 7 Full/1Partial	\$438.12

UNIVERSAL FILTER TEMPLATE



Val-Pak Part No.	Description	OEM Part No.	List Price
V38-141	Universal Filter Template (15/box)	98725800	\$14.35

PENTAIR/AMERICAN PRODUCTS FILTER PARTS (CONT.)

FNS PLUS TOP MANIFOLD

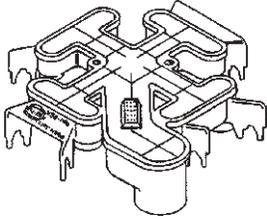

Val-Pak Part No.	Description	OEM Part No.	List Price
V38-140	FNS Plus/American Top Manifold with Air-Relief Screen (12/Box)	59023700 59000400	\$76.08

FNS PLUS SPREADER

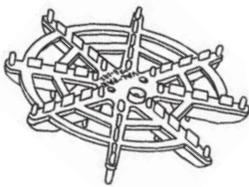

Val-Pak Part No.	Description	OEM Part No.	List Price
V38-142	FNS Plus/American Bottom Spreader (6/Box)	59000500	\$53.83

LID REMOVAL WRENCH

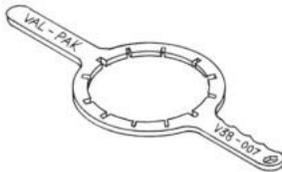

Val-Pak Part No.	Description	OEM Part No.	List Price
V38-007	Lid Removal Wrench for Pentair TR100C/140 C/Triton C-3 Filters (Aluminum)	154527	\$107.38

BULK HEAD NUT REMOVAL WRENCH

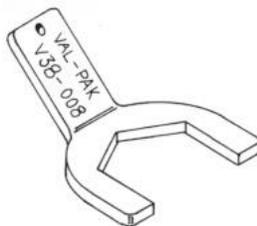

Val-Pak Part No.	Description	OEM Part No.	List Price
V38-008	Bulk Head Nut Removal Wrench for Pentair TR100C/140 C (Aluminum)	151600 151604	\$34.88

BRASS BULK HEAD ASSEMBLY

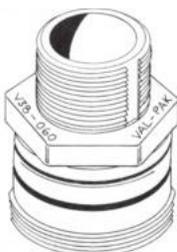

Val-Pak Part No.	Description	OEM Part No.	List Price
V38-060	2" Brass Bulk Head Assembly for TR100C/140C American Filters	154714	\$221.72

PENTAIR/AMERICAN PRODUCTS FILTER PARTS (CONT.)

COMMANDER FILTER KNOB, O-RING



Val-Pak Part No.	Description	OEM Part No.	List Price
V38-152	Commander Filter Knob	57006900	\$36.98
V38-153	Knob O-Ring (12/Bag)	57006700	\$3.93

COMMANDER FILTER LID, O-RING

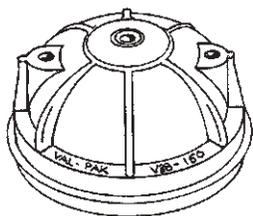

Val-Pak Part No.	Description	OEM Part No.	List Price
V38-150	Commander Filter Lid	57005600	\$122.07
V38-151	Filter Lid O-Ring	57007300	\$4.66

QUANTUM MANIFOLD, GASKET & SUPPORT RING

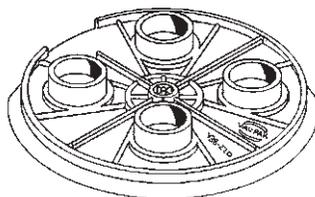

Val-Pak Part No.	Description	OEM Part No.	List Price
V38-220	Manifold — CM, RPM & S.S.	56626800	\$101.88
V38-221	Gasket — CM, RPM & S.S.	57000300	\$104.96
V38-222	Quantum Manifold Support Ring	59004000	\$32.23

ECLIPSE FILTER LID

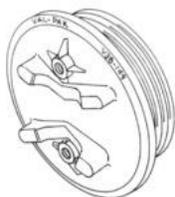

Val-Pak Part No.	Description	OEM Part No.	List Price
V38-149	Eclipse Filter Lid	55022000	\$58.80

AMERICAN PISTON CAP & HANDLE, O-RING SET



Val-Pak Part No.	Description	OEM Part No.	List Price
V38-145	Piston Cap & Handle 2" (Brass)	51013811	\$164.67
V38-102	Piston O-Ring Set 1½" (25/Bag)		\$4.08
V38-103	Piston O-Ring Set 2" Brass Old Stlye (25/Bag)		\$4.08
V38-121	Piston O-Ring Set 2" Plastic New Style (25/Bag)		\$4.08

PENTAIR/AMERICAN PRODUCTS FILTER PARTS (CONT.)

AIR RELIEF/GAUGE ASSEMBLY



Val-Pak Part No.	Description	OEM Part No.	List Price
V20-225	FNS Plus/4000 Series Clean & Clear	98209800	\$57.25

AIR RELIEF VALVE, O-RING

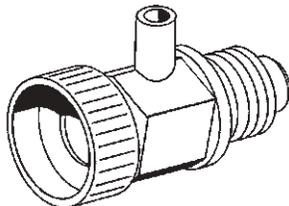

Val-Pak Part No.	Description	OEM Part No.	List Price
V38-115	Celcon Air Relief Valve 1/4" (50/Bag)	982058	\$12.29
V38-156	Repl. Valve Stem O-Ring (100/Bag)		\$0.52

TIE ROD



Val-Pak Part No.	Description	OEM Part No.	List Price
V38-106	Tie Rod 15½" 24 Sq. Ft.	590008	\$27.85
V38-107	Tie Rod 21½" 36 Sq. Ft.	590015	\$30.94
V38-108	Tie Rod 27½" 48 Sq. Ft.	590021	\$34.84
V38-109	Tie Rod 33½" 60 Sq. Ft.	590027	\$34.84
V38-110	Tie Rod 39½" 72 Sq. Ft.	590033	\$38.93

BRASS AIR RELIEF/GAUGE ASSEMBLY COMMERCIAL



Val-Pak Part No.	Description	OEM Part No.	List Price
V20-230	Brass Air Relief, Gauge Assembly TR100 & TR140	273564	\$120.08

FNS PLUS FILTER NUT

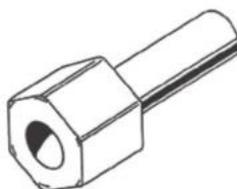

Val-Pak Part No.	Description	List Price
V38-146	FNS Filter Nut, Qty. 10	\$15.56

ANTHONY PUMP PARTS

BRASS IMPELLER



Val-Pak Part No.	Description	OEM Part No.	List Price
V40-453	1/2 Horsepower Impeller	04381	\$117.06
V40-454	3/4 Horsepower Impeller	06323	\$117.06
V40-455	1 Horsepower Impeller	06324	\$117.06
V40-456	1½ Horsepower Impeller	06325	\$117.06
V40-457	2 Horsepower Impeller	06326	\$117.06

ADAPTER BRACKET

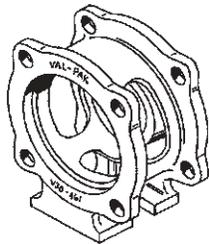

Val-Pak Part No.	Description	OEM Part No.	List Price
V30-461	1/2-2 Horsepower Bracket (w/Foot)	004378	\$298.10

PUMP SHAFT, GASKET, SET SCREW

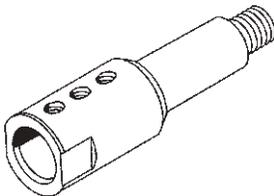

Val-Pak Part No.	Description	OEM Part No.	List Price
V40-116	Pump Shaft (10/Bag)	004377	\$26.56
V40-115	H & F Gasket (12/Bag)	G44	\$4.74
V40-401	1/4 x 20 Set Screw S.S. (100/Bag)		\$1.33

AR PUMP IMPELLER, O-RING

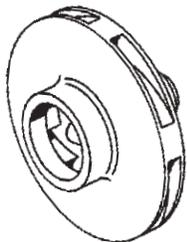

Val-Pak Part No.	Description	List Price
V34-001	3/4 Horsepower Impeller	\$100.70
V34-002	1 Horsepower Impeller	\$100.70
V34-003	1½ Horsepower Impeller	\$121.11
V34-004	2 Horsepower Impeller	\$121.11
V34-005	2½ Horsepower Impeller	\$121.11
V34-012	Seal Plate O-Ring — AR Pump	\$12.96

DIFFUSER, O-RING

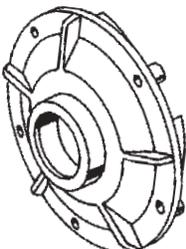

Val-Pak Part No.	Description	List Price
V34-011	Diffuser 1-2½ Horsepower - AR Pump	\$33.94
V34-013	Diffuser Seal O-Ring - AR Pump	\$20.98

ANTHONY 1½" & 2" SELECTOR VALVE EXPLODED VIEW

1½" VALVE

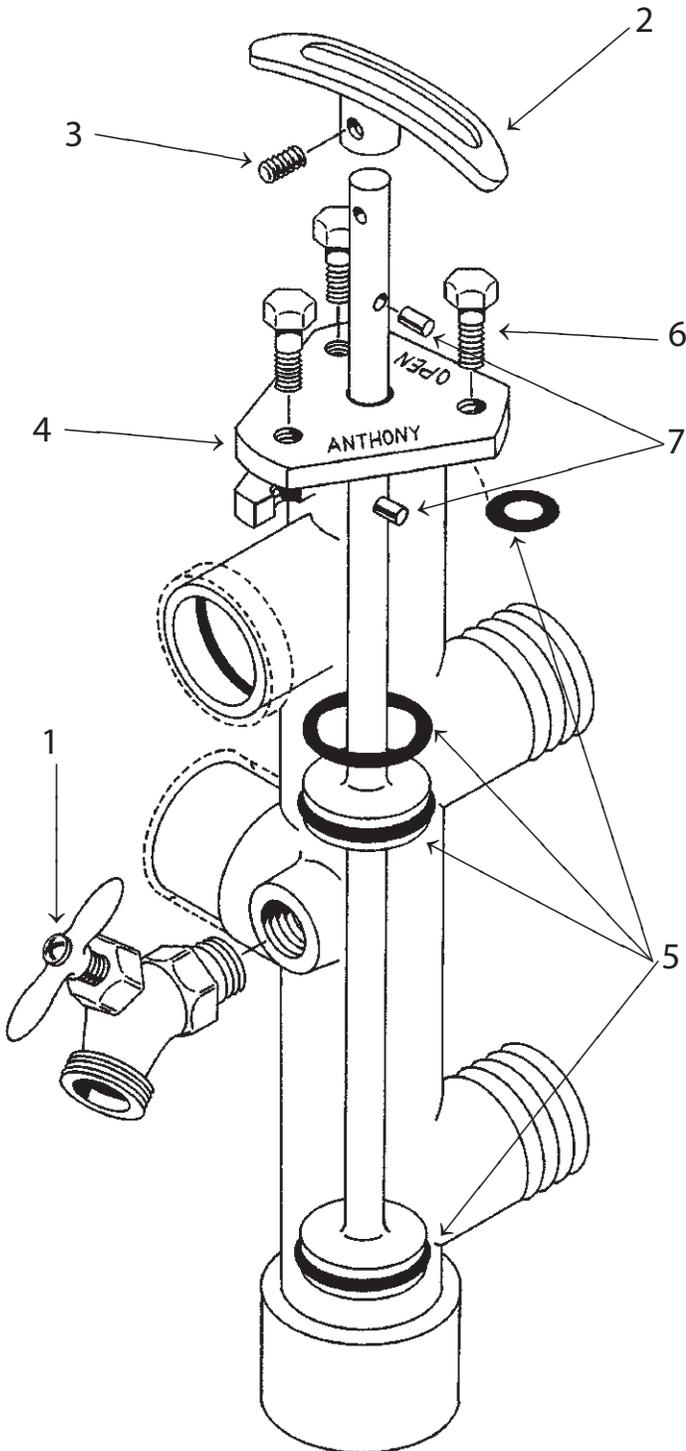

Key No.	Part Description	Part No.	List Price
1.	Hose Bib.....	V34-169	\$26.11
2.	Handle w/Screw.....	V34-127	\$30.80
3.	Set Screw	V34-135	\$2.02
4.	Cap.....	V34-152	\$94.16
5.	O-Ring Kit, Qty. 25.....	V34-115	\$4.33
6.	Screw	V34-170	\$0.55
7.	Spring Pin, Qty. 25.....	V34-021	\$2.09
8.	Hose Coupling.....	V34-172	\$53.90
	(Rubber, w/S.S. Clamp)		
	Piston & Shaft	V34-015	\$207.73
	(Includes Spring Pins & O-Rings)		
	Piston, Cap & Handle	V34-016	\$332.05
	(Includes Set Screw, Spring Pins & O-Rings)		

2" VALVE

Key No.	Part Description	Part No.	List Price
1.	Hose Bib.....	V34-169	\$26.11
2.	Handle w/Screw.....	V34-127	\$30.80
3.	Set Screw	V34-135	\$2.02
4.	Cap.....	V34-153	\$99.36
5.	O-Ring Kit, Qty. 25.....	V34-120	\$4.33
6.	Screw	V34-170	\$0.55
7.	Spring Pin, Qty. 25.....	V34-021	\$2.09
8.	Hose Coupling.....	V34-171	\$57.27
	(Rubber, w/S.S. Clamp, See Pg. 16)		
	Piston & Shaft	V34-020	\$223.29
	(Includes Spring Pins & O-Rings)		
	Piston, Cap & Handle	V34-022	\$358.83
	(Includes Set Screw, Spring Pins & O-Rings)		
	2" Brass Selector.....	V34-168	\$840.54
	Valve (Threaded)		

ANTHONY APOLLO FILTER EXPLODED VIEW

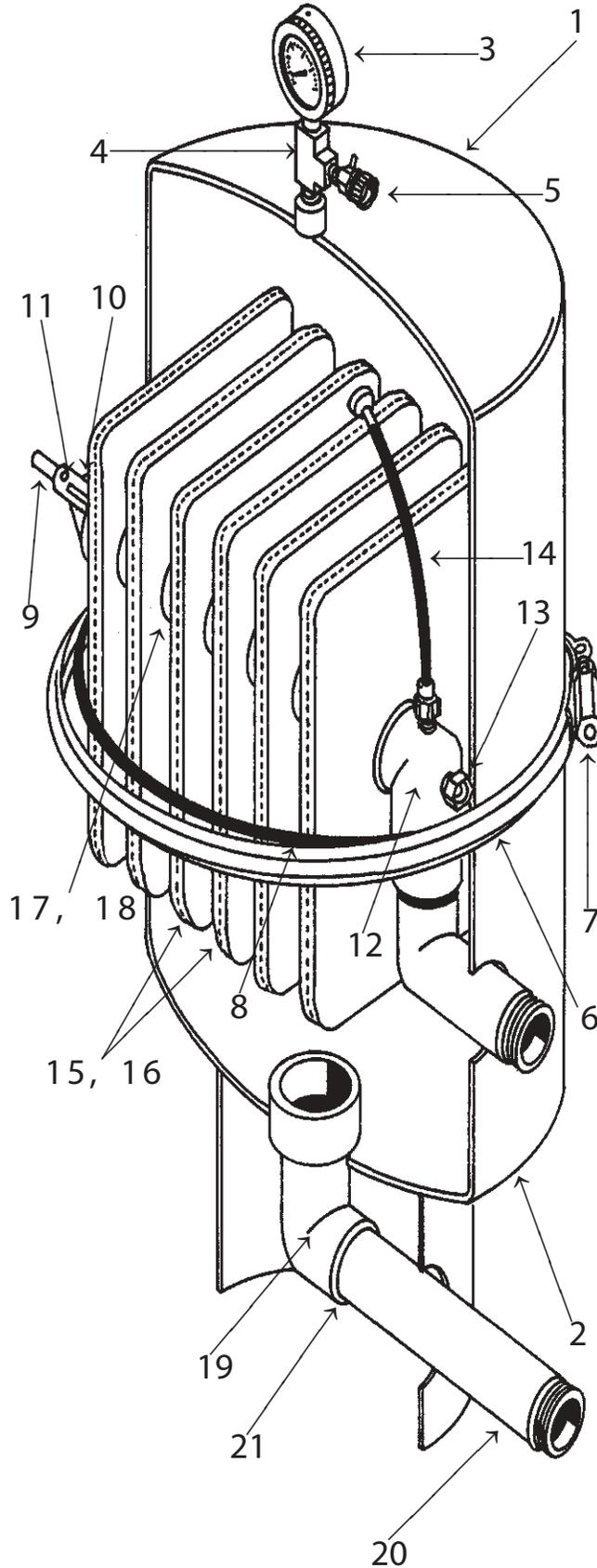

ANTHONY APOLLO FILTER EXPLODED VIEW (CONT.)

PART DESCRIPTION	PART NUMBER (by filter size)					LIST PRICE
	VA-26	VA-32	VA-38	VA-52	VA-52-2"	
1. TOP SHELL ASSY.	V34-157	V34-157	V34-157	V34-158	V34-158	V34-157
2. BOTTOM SHELL ASSY.	V34-159	V34-159	V34-159	V34-160	V34-160	V34-157
3. PRESSURE GAUGE	V34-161	V34-161	V34-161	V34-161	V34-161	V34-157
4. BRASS TEE	V34-162	V34-162	V34-162	V34-162	V34-162	V34-157
5. AIR RELIEF VALVE	V38-115	V38-115	V38-115	V38-115	V38-115	V34-157
6. TANK CLAMP W/NUT	V34-132	V34-132	V34-132	V34-133	V34-133	V34-157
7. BRASS NUT 5/16 X 24	V34-151	V34-151	V34-151	V34-151	V34-151	V34-157
8. O-RING	V34-154	V34-154	V34-154	V34-139	V34-139	V34-157
9. SHAFT	V34-125	V34-125	V34-125	V34-126	V34-126	V34-157
10. REAR END BELL w/Screw	V34-122	V34-122	V34-122	V34-122	V34-122	V34-157
11. SET SCREW	V34-123	V34-123	V34-123	V34-123	V34-123	V34-157
12. COLLECTION ELBOW	V34-130	V34-130	V34-130	V34-130	V34-131	V34-157
13. INSERT NUT (Brass)	V34-121	V34-121	V34-121	V34-121	V34-121	V34-157
14. AIR BLEED ASSY.	V34-136	V34-136	V34-136	V34-136	V34-136	V34-157
15. GRIDS (13½" X 24")	V34-128	V34-128	V34-128	V34-128	V34-128	V34-157
16. GRIDS (17½" X 24")	NONE	V34-129	V34-129	V34-129	V34-129	V34-157
17. SPACERS (1" wide)	NONE	V34-149	V34-149	V34-149	V34-149	V34-157
18. SPACERS (1½" wide)	V34-150	V34-150	NONE	NONE	NONE	V34-157
19. INLET ELBOW	V34-163	V34-163	V34-163	V34-163	V34-163	V34-157
20. INLET PIPE	V34-166	V34-166	V34-166	V34-166	V34-164	V34-157
21. BUSHING	V34-167	V34-167	V34-167	NONE	NONE	V34-157
GRID ASSEMBLY (Complete) Includes Items 9 thru 18)	V34-147	V34-146	V34-145	V34-144	V34-143	V34-157

GRID LINEUP CHART

MODEL NO.	GRIDS (LEFT TO RIGHT)									
	1	2	3	4	5	6	7	8	9	10
VA-26	13½"	13½"	13½"	13½"	13½"	13½"				
VA-32	13½"	13½"	13½"	17½"	13½"	13½"	13½"			
VA-38	13½"	13½"	13½"	17½"	17½"	13½"	13½"	13½"		
VA-52	13½"	13½"	17½"	17½"	17½"	17½"	17½"	17½"	13½"	13½"
VA-52-2"	13½"	13½"	17½"	17½"	17½"	17½"	17½"	17½"	13½"	13½"

SPACER LINEUP CHART

MODEL NO.	SPACERS (LEFT TO RIGHT)							
	1	2	3	4	5	6	7	8
VA-26	1½"	1½"	1½"	1½"	1½"			
VA-32	1½"	1"	1"	1"	1"	1½"		
VA-38	1"	1"	1"	1"	1"	1"	1"	
VA-52	1"	1"	1"	1"	1"	1"	1"	1"
VA-52-2"	1"	1"	1"	1"	1"	1"	1"	1"

ANTHONY SKIMMER PARTS

DIVERTER VALVE

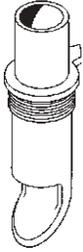

Val-Pak Part No.	Description	OEM Part No.	List Price
V34-124	Diverter Valve O/S	5227	\$56.14

LONG DIVERTER



Val-Pak Part No.	Description	OEM Part No.	List Price
V34-134	Long Diverter for U-3 Skimmer	6683	\$74.59

SKIMMER BASKET

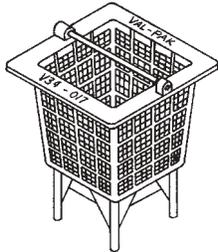

Val-Pak Part No.	Description	OEM Part No.	List Price
V34-017	Anthony 7"X 7" Skimmer Basket (18/Box)	002908	\$23.06

SKIMMER LID

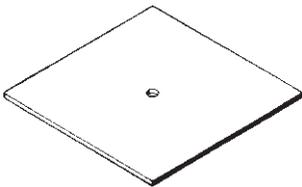

Val-Pak Part No.	Description	List Price
V34-018	Skimmer Lid, 9"X 9" for Anthony Precast Skimmer	\$77.28

ANTHONY LIGHT PARTS

FACE RING LIGHT SCREW WITH RETAINER

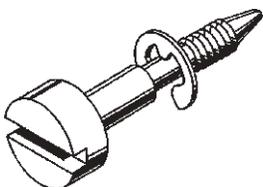

Val-Pak Part No.	Description	OEM Part No.	List Price
V34-138	Face Ring Light Screw with Retainer (10/Bag)	014434	\$12.67

AQUA-FLO A SERIES 1/3-3 HP BRASS PUMP

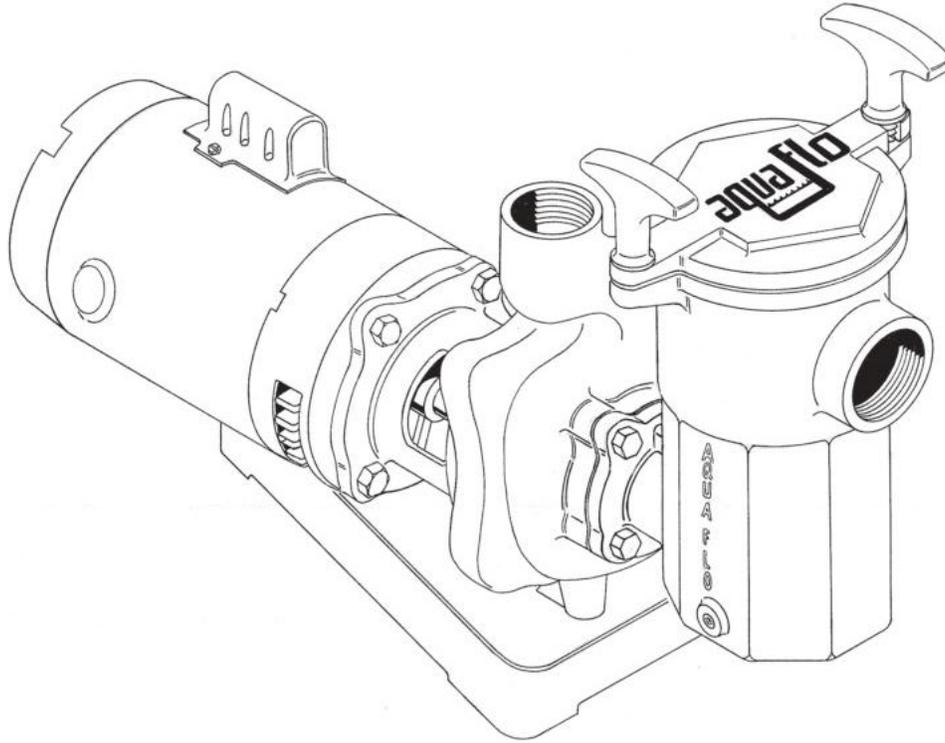

Val-Pak Part No.	Description	List Price
11003000	1/3 HP 115/230 1½" Suction 5" Trap	\$1,648.78
11005000	1/2 HP 115/230 1½" Suction 5" Trap	\$1,648.78
11007000	3/4 HP 115/230 1½" Suction 5" Trap	\$1,679.31
11010000	1.0 HP 115/230 2" Suction 5" Trap	\$1,705.46
11015000	1.5 HP 115/230 2" Suction 5" Trap	\$1,840.66
11020000	2.0 HP 230 Volt 2" Suction 5" Trap	\$1,997.67
11030000	3.0 HP 230 Volt 2" Suction 6" Trap	\$2,573.44

**Aqua-Flo A Series pumps are available with 5" clear lid, Viton seal,
3PH, TEFC and 50Hz at additional cost.**

Val-Pak ultra-silent "Balance Flo" pumps also available.

LIQUID END ONLY

Val-Pak Part No.	Description	List Price
11903000	1/3 HP Liquid End 1½" Suction 5" Trap	\$1,132.50
11905000	1/2 HP Liquid End 1½" Suction 5" Trap	\$1,132.50
11907000	3/4 HP Liquid End 1½" Suction 5" Trap	\$1,132.50
11910000	1.0 HP Liquid End 2" Suction 5" Trap	\$1,132.50
11915000	1½ HP Liquid End 2" Suction 5" Trap	\$1,132.50
11920000	2.0 HP Liquid End 2" Suction 5" Trap	\$1,132.50
11930000	3.0 HP Liquid End 2" Suction 6" Trap	\$1,536.87

AQUA-FLO A SERIES 1/3-3 HP BRASS PUMP EXPLODED VIEW

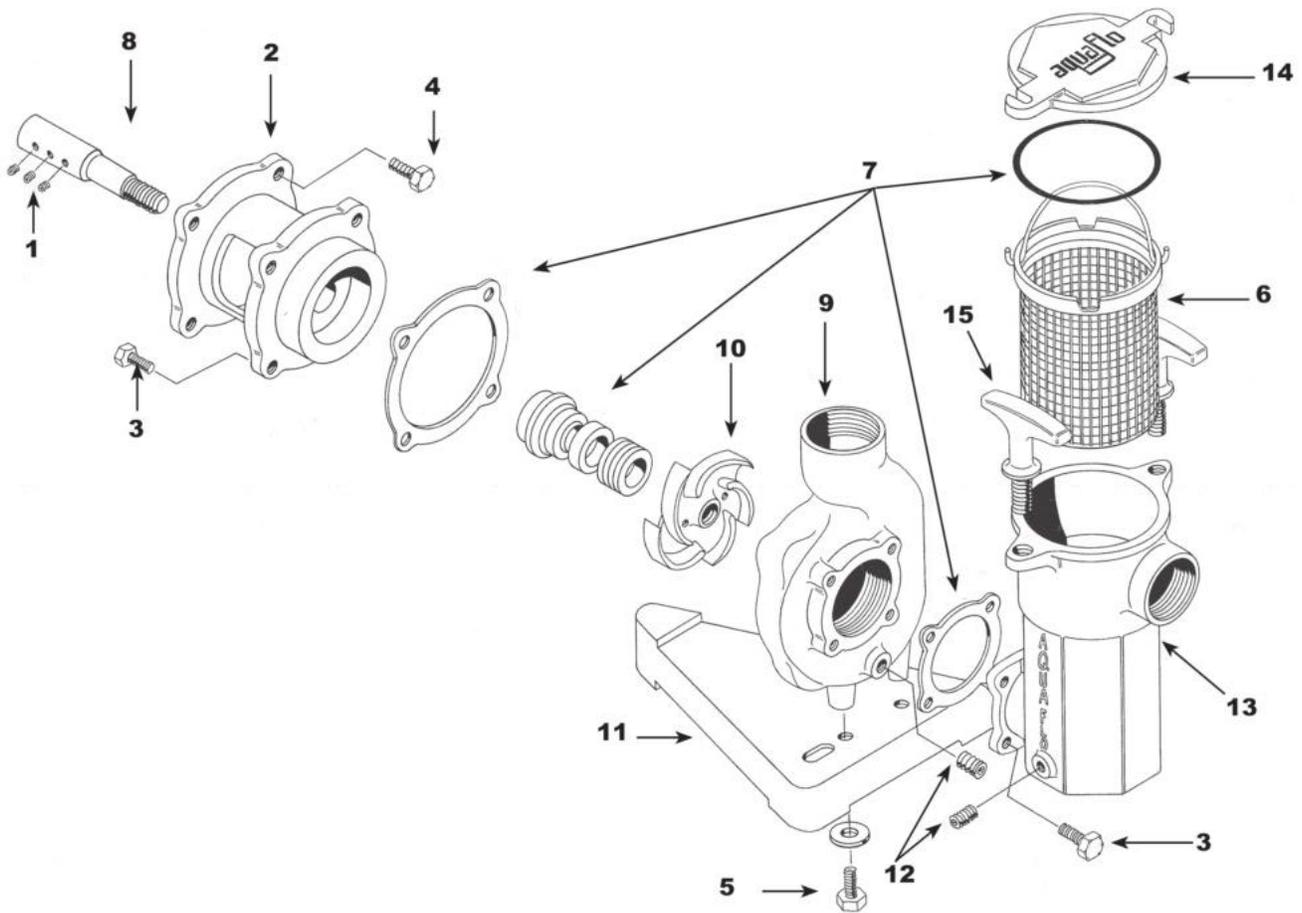

Key No.	Description	Val-Pak Part No.	List Price	Key No.	Description	Val-Pak Part No.	List Price
1	Set Screw 1/4"-20x5/16" S.S. (100/bag)	99730000	\$1.32	10	Impeller .33 HP	91691000	\$130.02
2	Bracket .33-2.0 HP	91140050	\$290.39	10	Impeller .50 HP	91691051	\$117.06
2	Bracket 3.0 HP	91140150	\$564.02	10	Impeller .75 HP	91691101	\$117.06
3	Bolt, 5/16"-18x5/8" S.S. (25/bag)	99050030	\$1.67	10	Impeller 1.0 HP	91691151	\$117.06
4	Bolt, 3/8"-16x5/8" S.S. (25/bag)	99050050	\$1.67	10	Impeller 1.5 HP	91691201	\$117.06
5	Bolt, 5/16"-18x3/4" S.S. (25/bag)	99050100	\$1.67	10	Impeller 2.0 HP	91691251	\$117.06
6	Basket Strainer 5" (16/box)	91110000	\$21.86	10	Impeller 3.0 HP	91691300	\$202.15
6	Basket Strainer 6"	91110010	\$33.04	11	Plastic Base	91100100	\$63.52
7	A Series Seal Kit .33-2.0 HP	93500200	\$105.87	12	1/4 Plug Brass (12/bag)	92290000	\$5.75
7	A Series Seal Kit 3.0 HP	93500200-2	\$108.45	13	5" Trap 1-1/2" Suction	92620000	\$466.45
	Trap Assembly 5" x 1-1/2"	91040010	\$620.09	13	5" Trap 2" Suction	92620050	\$466.45
	Trap Assembly 5" x 2"	91040020	\$620.09	13	6" Trap 2" Suction	92620100	\$584.96
	Trap Assembly 6" x 2"	91040030	\$764.55	14	Trap Cover 5"	91230000	\$102.34
8	Shaft Extension (10/bag)	92520002	\$54.30	14	Trap Cover 6"	91230050	\$118.74
9	Volute .33-2.0 HP	92770050	\$309.73	15	Lock Handle	91920001	\$29.27
9	Volute 3.0 HP	92770150	\$436.44				

AQUA-FLO AC SERIES 3 & 5 HP BRASS PUMP

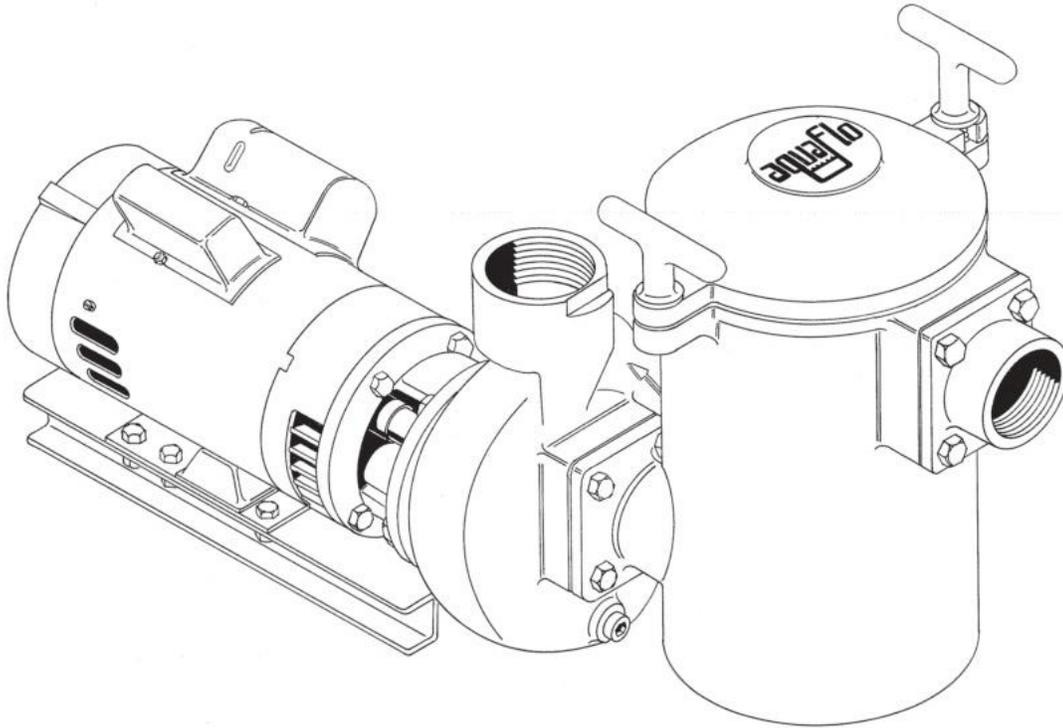

Val-Pak Part No.	Description	List Price
10030010	3.0 HP High Head 230 Volt 1 Phase 3" Suction 8" Trap	\$4,979.20
10130000	3.0 HP High Head 208-230/460 Volt 3 Phase 3" Suction 8" Trap	\$4,720.49
10031010	3.0 HP Med. Head 230 Volt 1 Phase 3" Suction 8" Trap	\$4,979.20
10131010	3.0 HP Med. Head 208-230/460 Volt 3 Phase 3" Suction 8" Trap	\$4,731.59
10050010	5.0 HP High Head 230 Volt 1 Phase 3" Suction 8" Trap	\$5,281.33
10150010	5.0 HP High Head 208-230/460 Volt 3 Phase 3" Suction 8" Trap	\$4,837.40

**All Aqua-Flo AC Series pumps are equipped with 3" flanged inlet,
2" FIP outlet and come with a Stainless Steel basket.**

Viton Pump Seal and 3" flanged outlet are available on request at additional cost.

Val-Pak ultra-silent "Balance Flo" pumps also available.

AQUA-FLO AC SERIES MOTORS

Val-Pak Part No.	Description	List Price
93497000	Motor 3" HP Single Phase	\$1,930.97
93497010	Motor 3" HP Three Phase	\$1,849.91
93498000	Motor 5" HP Single Phase	\$2,111.79
93498010	Motor 5" HP Three Phase	\$1,896.24

AQUA-FLO AC SERIES 3 & 5 HP BRASS PUMP EXPLODED VIEW

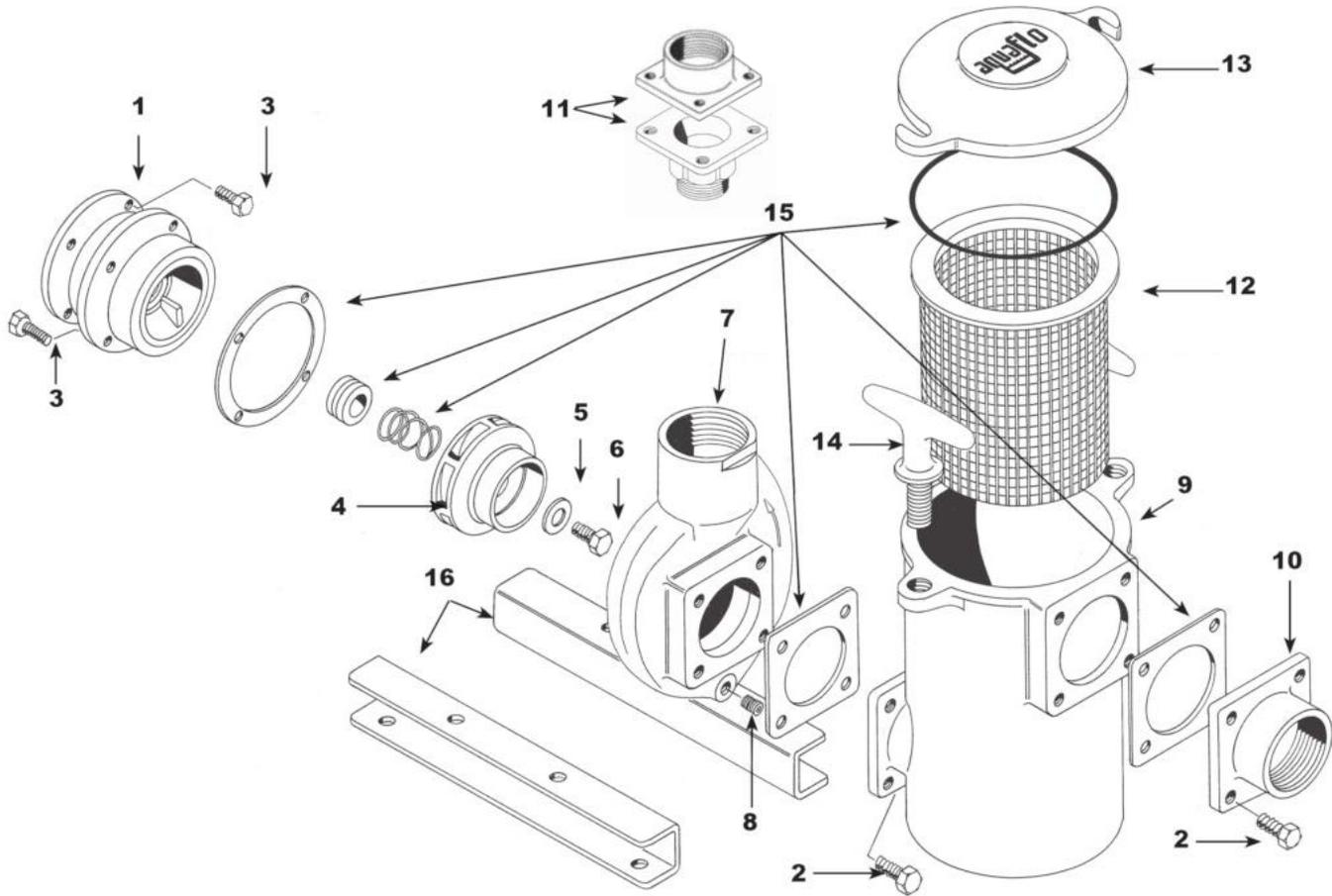

Key No.	Description	Val-Pak Part No.	List Price	Key No.	Description	Val-Pak Part No.	List Price
1	Bracket 3 & 5 HP	91140000	\$689.35	10	3" Flange	91450010	\$182.60
2	Bolt 3/8"-16x5/8 S.S. (25bag)	99050050	\$1.67	11	2" MIP x 3" FIP Flange	91450010-1	\$163.34
3	Bolt 3/8"-16x3/4" S.S. (25bag)	99050000	\$1.96	12	Basket Strainer 6"	91110010	\$33.03
4	3.0 HP Hi. Head Impeller (O.D. 5-1/8")	91690002	\$564.32	12	Basket Strainer 8" S.S.	91110050	\$223.50
4	3.0 HP Med. Head Impeller (O.D. 4-7/8")	91690051	\$564.32	13	Trap Cover 6"	91230050	\$115.91
4	5.0 HP Hi. Head Impeller (O.D. 5-1/4")	91690102	\$610.25	13	Trap Cover 8"	91230100	\$258.98
5	Flat Washer 5/16" x .096 S.S.	99890160	\$3.97	14	Lock Handle	91920001	\$29.26
6	Bolt 5/16" - 18 x 5/8" S.S.	99050030	\$1.67	15	Seal Kit	93500200-1	\$167.89
7	Volute 3 & 5 HP	92770000	\$1,420.49	16	AC Series Pump Base	91100000	\$53.45
8	Pipe Plug Brass (12/bag)	92290000	\$5.75		Trap Assembly 6" x 2"	91040030	\$802.78
9	Trap 6" x 2"	92620100	\$584.96		Trap Assembly 8" x 3"	91040050	\$2,251.91
9	Trap 8" x 3"	92620150	\$1,754.70				

DOMINATOR PUMP

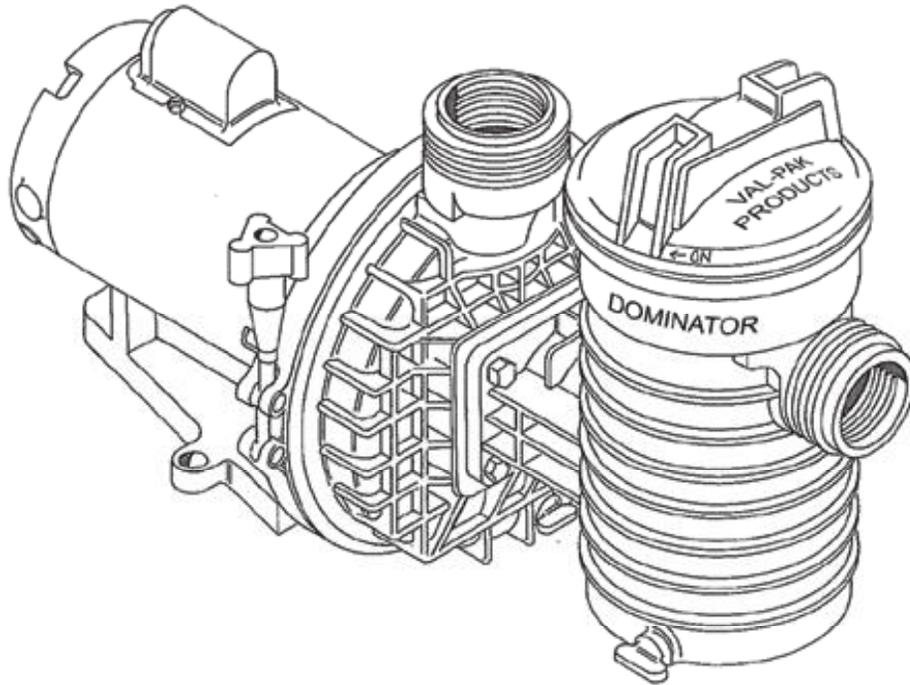

Val-Pak Part No.	Description	List Price
159050H-1	1/2 HP High Head 115/230 1PH Pump	\$900.67
159050M-1	1/2 HP Medium Head 115/230 1PH Pump	\$900.67
159070H-1	3/4 HP High Head 115/230 1PH Pump	\$963.00
159070M-1	3/4 HP Medium Head 115/230 1PH Pump	\$963.00
159100H-1	1.0 HP High Head 115/230 1PH Pump	\$1,025.33
159100M-1	1.0 HP Medium Head 115/230 1PH Pump	\$1,025.33
159150H-1	1½ HP High Head 115/230 1PH Pump	\$1,087.66
159150M-1	1½ HP Medium Head 115/230 1PH Pump	\$1,087.66
159200H-1	2.0 HP High Head 115/230 1PH Pump	\$1,181.16
159200M-1	2.0 HP Medium Head 115/230 1PH Pump	\$1,181.16

LIQUID END ONLY

Val-Pak Part No.	Description	List Price
159050H	1/2 HP High Head 2" Suction	\$521.44
159050M	1/2 HP Medium 2" Suction	\$521.44
159070H	3/4 HP High Head 2" Suction	\$521.44
159070M	3/4 HP Medium 2" Suction	\$521.44
159100H	1.0 HP High Head 2" Suction	\$521.44
159100M	1 HP Medium 2" Suction	\$521.44
159150H	1½ HP High Head 2" Suction	\$521.44
159150M	1½ HP Medium 2" Suction	\$521.44
159200H	2.0 HP High Head 2" Suction	\$521.44
159200M	2.0 HP Medium 2" Suction	\$521.44

DOMINATOR PUMP EXPLODED VIEW

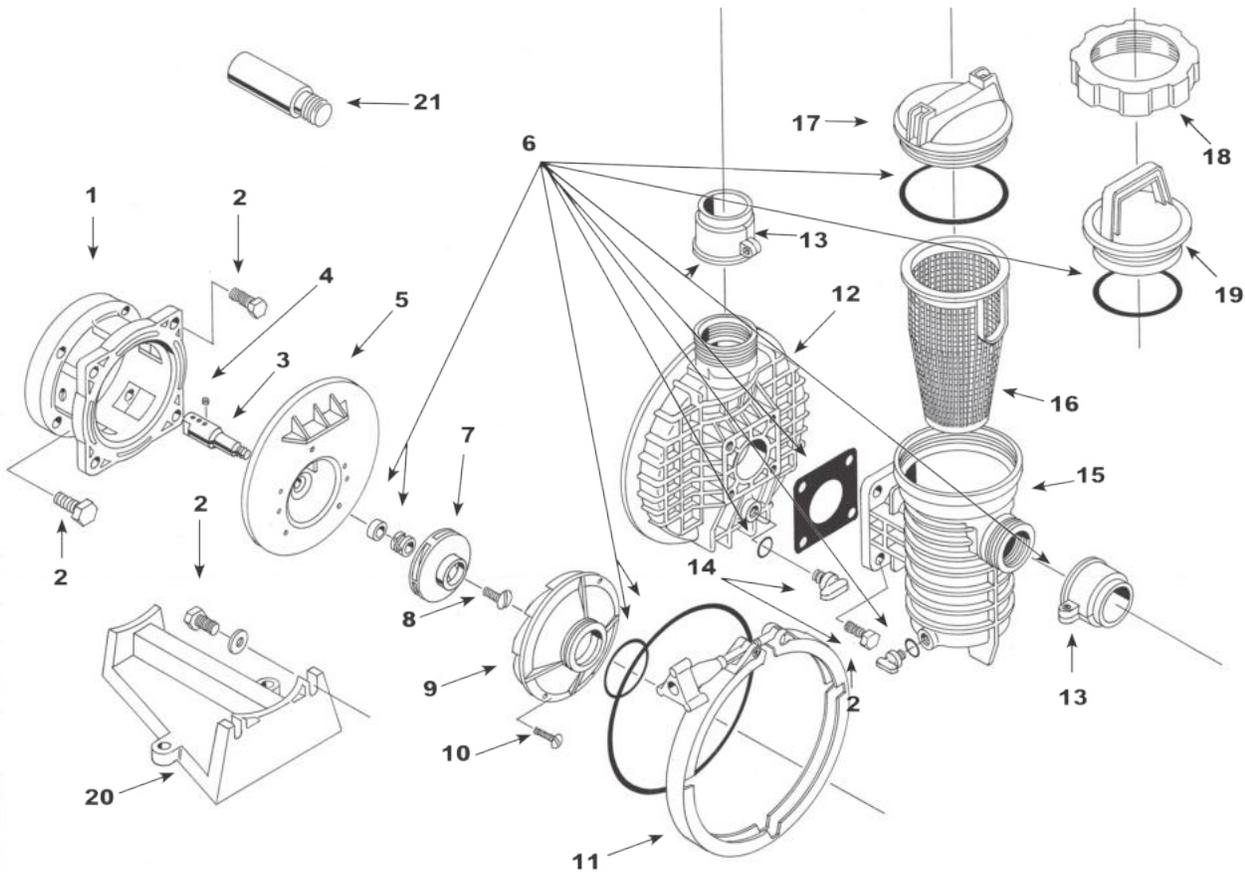

Key No.	Description	Val-Pak Part No.	List Price	Key No.	Description	Val-Pak Part No.	List Price
1	Bracket	V40-902	\$100.55	8	High Head Impeller Lock Screw (10/bag)	V40-428	\$6.29
2	Bolt Kit	V40-908	\$22.03	9	Med. Head Diffuser	V40-410	\$46.20
3	Pump Shaft	V40-116-1	\$50.38	9	High Head Diffuser	V40-415	\$47.14
4	Set Screws 1/4"-20 X 5/16" (100/bag)	V40-401	\$1.32	10	Med. Head Diffuser Screw (25/bag)	V40-425	\$0.44
5	Seal Plate	V40-901	\$152.63	10	High Head Diffuser Screw (25/bag)	V40-426	\$0.44
6	Seal Parts Kit - Medium Head*	V40-911	\$103.85	11	Volute Clamp W/Knob	V40-906	\$92.84
6	Seal Parts Kit - High Head*	V40-911-1	\$103.85	12	Volute Casing	V40-900	\$152.63
	*Pump Seal Prior to 1995	V40-300	\$14.09	13	Compression Fitting 2"	V40-432	\$16.21
7	3/4 HP Med. Head IMP	V40-411	\$94.25	14	1/4" Drain Plug W/O-ring (10/bag)	V40-907	\$3.21
7	1 HP Med. Head IMP	V40-412	\$94.25	15	Trap	V40-903	\$152.00
7	1 - 1/2 HP Med. Head IMP	V40-413	\$94.25	16	Pump Basket (12/box)	V40-409	\$21.87
7	2 HP Med. Head IMP	V40-414	\$94.25	17	Pump Lid N/S 2010 to Present	V26-361	\$37.52
7	3/4 HP High Head IMP	V40-416	\$94.25	18	Lock Ring Prior to 2009	V40-905	\$43.11
7	1 HP High Head IMP	V40-417	\$94.25	19	Pump Lid Prior to 2009	V40-430	\$50.35
7	1 - 1/2 HP High Head IMP	V40-418	\$94.25	20	Base	V40-904	\$60.30
7	2 HP High Head IMP	V40-419	\$94.25	21	Extension Shaft, Shorty	V40-910	\$16.52
8	Med. Head Impeller Lock Screw (10/bag)	V40-427	\$6.29				

HAYWARD REPLACEMENT BASKETS

HAYWARD SUPER II PUMP BASKET

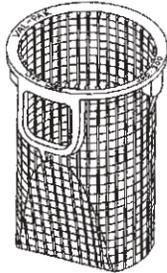

Val-Pak Part No.	Description	OEM Part No.	List Price
V60-300	Hayward Super II Pump Basket (12/Box)	SPX3000M	\$14.90

HAYWARD LEAF CANISTER BASKETS

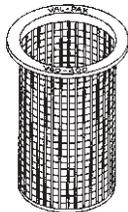

V60-400



V50-600

Val-Pak Part No.	Description	OEM Part No.	List Price
V60-400	Std. Leaf Canister Basket (16/Box)	AXW431A	\$14.27
V50-600	Large Leaf Canister Basket (9/Box)		\$47.38

HAYWARD SKIM-MASTER BASKET

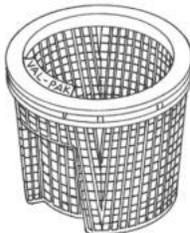

Val-Pak Part No.	Description	OEM Part No.	List Price
V22-110	Skim-Master Basket (28/Box)	SPX1070E	\$26.65

HAYWARD SUPER PUMP BASKET

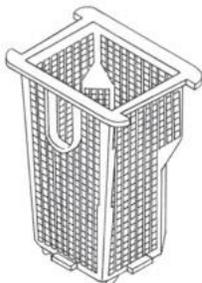

Val-Pak Part No.	Description	OEM Part No.	List Price
V60-500	Hayward Super Pump Basket (12/Box)	SPX1600M	\$16.68

HAYWARD 1082 SKIMMER BASKET

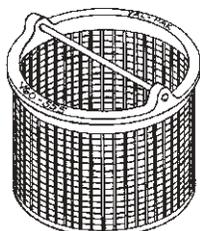

Val-Pak Part No.	Description	OEM Part No.	List Price
V60-555	SP1082 & SP1084 (12/Box)	SPX1082CA	\$26.13

HAYWARD REPLACEMENT PARTS

HAYWARD PISTON COMPLETE, O-RING SET

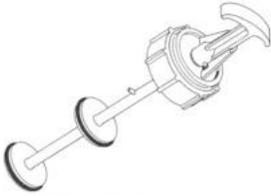

Val-Pak Part No.	Description	List Price
V60-200	Hayward Piston, Cap & Handle - Brass	\$160.31
V60-100	Hayward Backwash Piston O-Ring Set (25/Bag)	\$4.15

HAYWARD O-RINGS

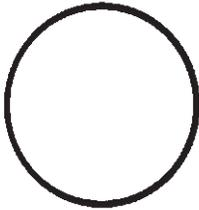

Val-Pak Part No.	Description	OEM Part No.	List Price
V60-566	Micro Clear/Pro Grid Old Style Tank O-Ring (12/Bag)	DEX2400K	\$27.55
V60-101	CL200 & CL220 Viton Lid O-Ring (12/Bag)	CLX200K	\$18.02
V60-301	Super II Pump Lid O-Ring (12/Bag)	SPX300S	\$3.13
V60-567	Micro/Pro Outlet Elbow O-Ring (12/Bag)	DEX2400Z5	\$1.55

HAYWARD CARTRIDGE MANIFOLD

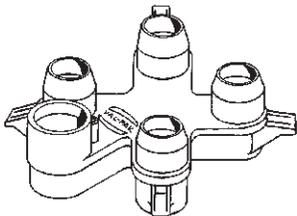

Val-Pak Part No.	Description	OEM Part No.	List Price
V60-550	Hayward Manifold (11/Box) (FOR PLASTIC TANK BODY ONLY)	CX3000C	\$56.65

HAYWARD DE TOP MANIFOLD

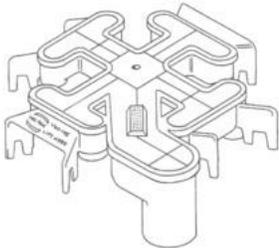

Val-Pak Part No.	Description	OEM Part No.	List Price
V60-105	Hayward Micro Clear & Pro Grid Top Manifold (11/Box)	DEX2400C	\$50.38

BRASS SLEEVE NUT

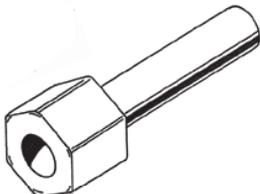

Val-Pak Part No.	Description	OEM Part No.	List Price
V60-110	Brass Sleeve Nut (10/Bag)	DEX2400JN	\$15.18

JANDY PUMP PARTS

STEALTH TAIL PIECE/UNION NUT, O-RING

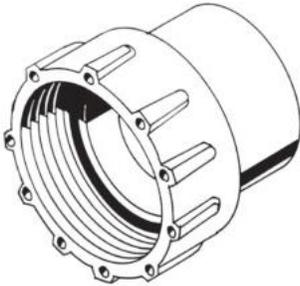

Val-Pak Part No.	Description	List Price
V55-209	Tail Piece with O-Ring, 2" Inside 2-½" Outside Dia. & Union Nut	\$22.93

STEALTH UNION NUT



Val-Pak Part No.	Description	List Price
V55-210	Union Nut, Qty. 1	\$28.06

MAX TAIL PIECE/UNION NUT, O-RING

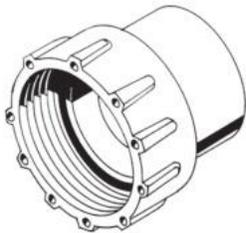

Val-Pak Part No.	Description	List Price
V55-211	Tail Piece with O-Ring, 2" Inside 2-½" Outside Dia. Qty. 1 & Union Nut	\$22.93

MAX UNION NUT



Val-Pak Part No.	Description	List Price
V55-212	Union Nut, Qty. 1	\$20.37

**FOR THE MOST UPDATED INFORMATION
VISIT US ONLINE:**

WWW.VALPAKPRODUCTS.COM

JANDY FILTER PARTS

SMALL DRAIN PLUG

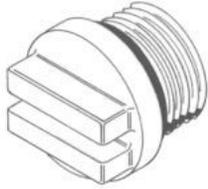

Val-Pak Part No.	Description	OEM Part No.	List Price
V55-205	Drain Plug with O-Ring, CL & DEL Series	R0358800	\$22.93

LARGE DRAIN PLUG



Val-Pak Part No.	Description	OEM Part No.	List Price
V55-206	Drain Plug with O-Ring, CV & DEV Series	R0523000	\$28.06

SLIP CONNECTOR/UNION NUT & O-RING

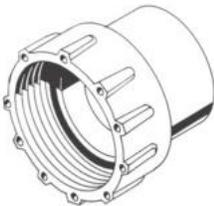

Val-Pak Part No.	Description	List Price
V55-207	Slip Connector, Nut & O-Ring 2" Inside, 2-1/2" Outside Dia. (CL, CV, DEL, & DEV. Series)	\$22.93

UNION NUT



Val-Pak Part No.	Description	List Price
V55-208	Union Nut (CL, CV, DEL & DEV Series)	\$20.37

TANK LID O-RING



Val-Pak Part No.	Description	OEM Part No.	List Price
V55-100	Tank Lid O-Ring CL & DEL Series (12/Bag)	R0357800	\$37.61

JANDY CARTRIDGE MANIFOLD

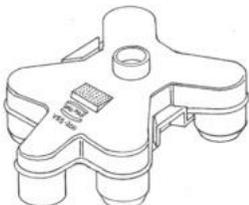

Val-Pak Part No.	Description	OEM Part No.	List Price
V55-200	Jandy Cartridge Manifold	R0357600	\$70.74

JANDY FILTER PARTS (CONT.)

JANDY DE MANIFOLD

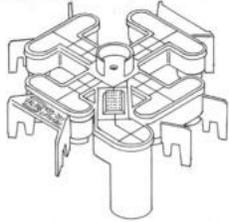

Val-Pak Part No.	Description	OEM Part No.	List Price
V55-201	Jandy De Manifold	R0359000	\$51.90

JANDY AIR RELIEF ASSEMBLY



Val-Pak Part No.	Description	OEM Part No.	List Price
V55-110	Jandy Air Relief Assembly	R0357200	\$57.25

JANDY FILTER CLAMP RING KNOB ASSEMBLY

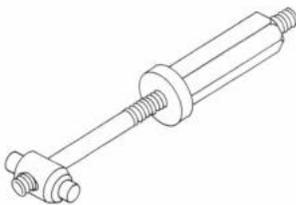

Val-Pak Part No.	Description	OEM Part No.	List Price
V55-101	Jandy Filter Clamp Ring Knob Assembly	R0357500	\$63.63

JANDY BACKWASH VALVE O-RING KIT

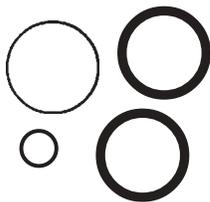

Val-Pak Part No.	Description	List Price
V55-120	Jandy Backwash Valve O-Ring Kit (25/Bag)	\$4.83

JANDY MISC. PARTS

JANDY O-RING 3-WAY VALVE

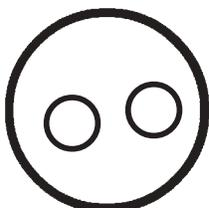

Val-Pak Part No.	Description	List Price
V55-105	Jandy 3 Way Valve O-Ring Kit	\$4.01

MARTIN 100 SERIES 1/3-3 HORSEPOWER BRASS PUMP

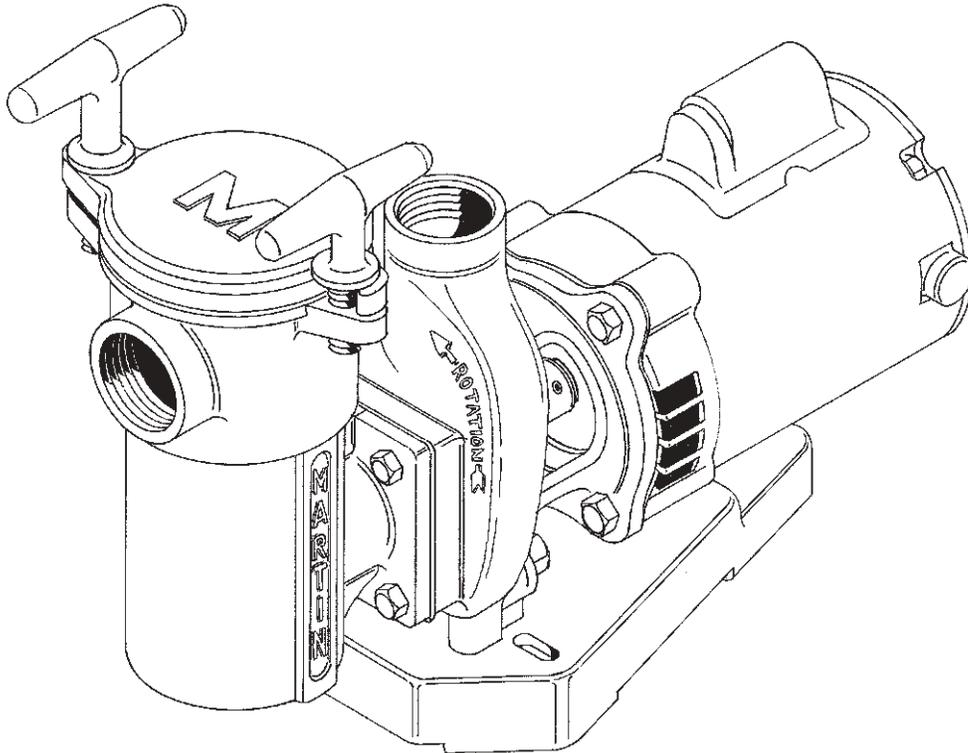

Val-Pak Part No.	Description	List Price
V40-504	1/3 HP 115/230 2" Suction 5" Trap	\$1,648.78
V40-505	1/2 HP 115/230 2" Suction 5" Trap	\$1,648.78
V40-506	3/4 HP 115/230 2" Suction 5" Trap	\$1,679.31
V40-507	1 HP 115/230 2" Suction 5" Trap	\$1,705.48
V40-508	1½ HP 115/230 2" Suction 5" Trap	\$1,840.67
V40-509	2 HP 115/230 2" Suction 5" Trap	\$1,997.68
V40-510	3 HP 115/230 2" Suction 5" Trap	\$2,183.91

Martin 100 Series pumps are available with 6" brass trap, 5" clear lid, Viton seal, 3PH, TEFC, 50Hz and aluminum pump base at additional cost.

Val-Pak ultra-silent "Balance Flo" pumps also available.

LIQUID END ONLY

Val-Pak Part No.	Description	List Price
V40-516	1/3 HP 2" Suction 5" Trap	\$1,132.50
V40-517	1/2 HP 2" Suction 5" Trap	\$1,132.50
V40-518	3/4 HP 2" Suction 5" Trap	\$1,132.50
V40-519	1 HP 2" Suction 5" Trap	\$1,132.50
V40-520	1½ HP 2" Suction 5" Trap	\$1,132.50
V40-521	2 HP 2" Suction 5" Trap	\$1,132.50
V40-522	3 HP 2" Suction 5" Trap	\$1,132.50

MARTIN 100 SERIES 1/3-3 HP BRASS PUMP EXPLODED VIEW

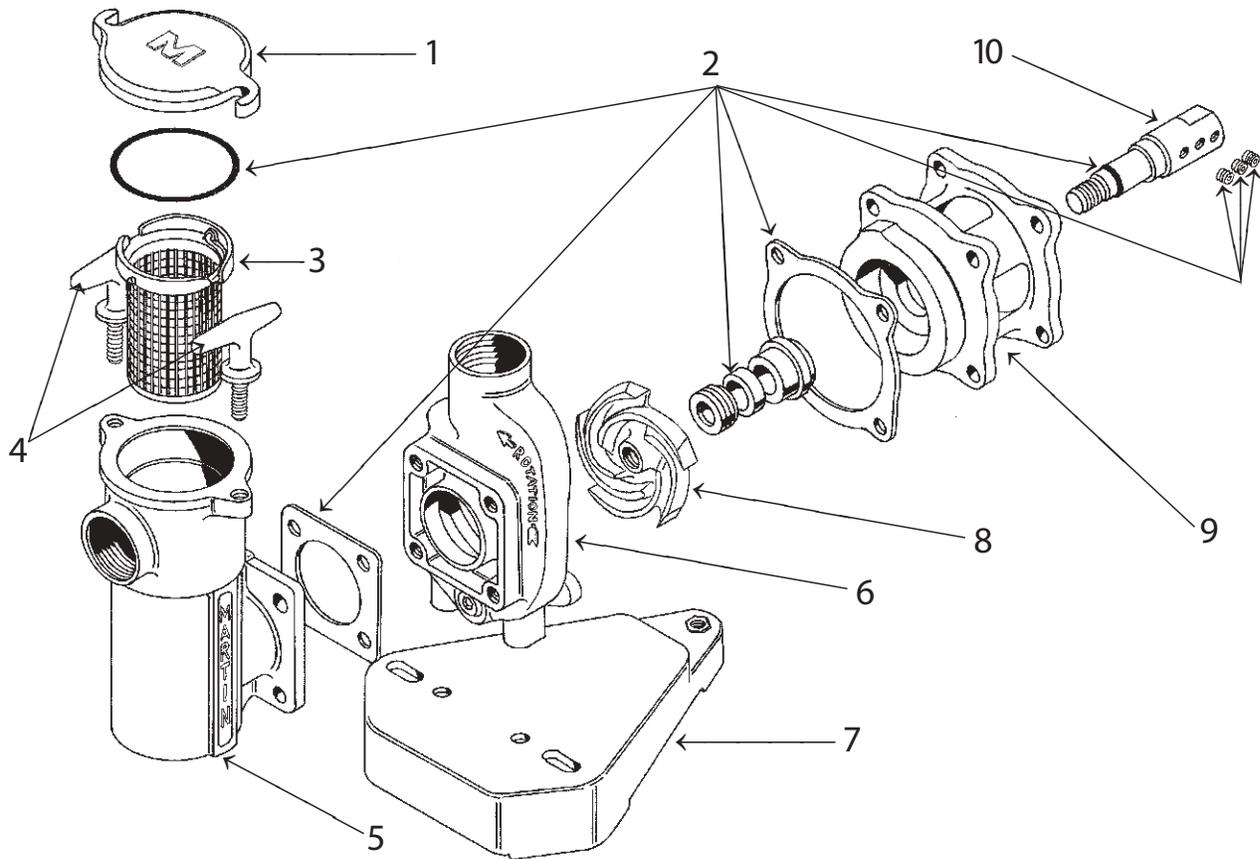

Key No.	Description	Val-Pak Part No.	List Price
1	5" Brass Pump Lid	V40-463	\$102.34
2	Parts Kit (incl. Seal, Gaskets, O-Rings & Set Screws)	V40-481	\$111.55
3	5" Pump Basket Lg. Holes (16/Box)	91110000	\$21.86
4	Tee Handle, Bronze w/S.S. Stud	V40-468	\$29.98
5	5" Brass Trap w/2" NPT	V40-464	\$477.83
6	Brass Volute	V31-458	\$326.18
7	Pump Base (ABS Plastic)	V40-467	\$63.52
7	Pump Base (Aluminum)	V40-485	\$122.89
8	1/3 Horsepower Impeller	V40-452	\$130.02
8	1/2 Horsepower Impeller	V40-453	\$117.06
8	3/4 Horsepower Impeller	V40-454	\$117.06
8	1 Horsepower Impeller	V40-455	\$117.06
8	1 1/2 Horsepower Impeller	V40-456	\$117.06
8	2 Horsepower Impeller	V40-457	\$117.06
8	3 Horsepower Impeller	V40-458	\$130.02
9	1/3-3 Horsepower Brass Adapter	V40-460	\$300.31
10	Brass Pump Shaft w/O-Ring Groove	V30-449	\$55.40
Not Shown	Bolt & Drain Plug Kit	V40-482	\$53.47

MARTIN 500 SERIES 3-10 HORSEPOWER BRASS PUMP

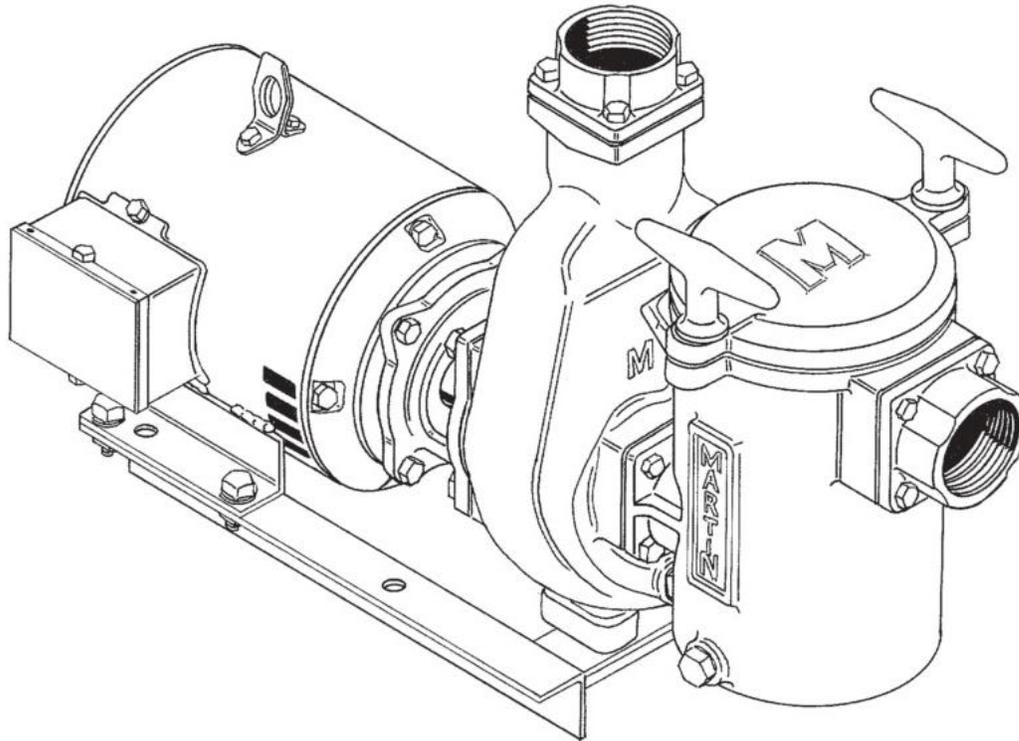

Val-Pak Part No.	Description	List Price
V40-535	3 HP & Motor, 60Hz, 1-PH 8" Trap	\$5,473.67
V40-536	3 HP Pump & Motor, 60Hz, 3-PH 8" Trap	\$5,038.75
V40-537	5 HP Pump & Motor, 60Hz, 1-PH 8" Trap	\$5,601.95
V40-538	5 HP Pump & Motor, 50/60Hz, 3-PH 8" Trap	\$5,195.34
V40-539	7½ HP Pump & Motor, 50/60Hz, 3-PH 8" Trap	\$5,773.00
V40-540	10 HP Pump & Motor, 50/60Hz, 3-PH 8" Trap	\$7,248.35

All 500 Series pumps are equipped with 3" flanged inlet & outlet ports and come with a Stainless Steel basket.

Viton Pump Seal available on request at additional cost. Val-Pak ultra-silent "Balance Flo" pumps also available.

MARTIN 500 SERIES MOTORS

Val-Pak Part No.	Description	List Price
V40-545	3 HP Motor 60 Cycle 1 Phase	\$2,162.35
V40-546	3 HP Motor 60 Cycle 3 Phase	\$1,725.24
V40-547	5 HP Motor 60 Cycle 1 Phase	\$2,950.71
V40-548	5 HP Motor 60 Cycle 3 Phase	\$1,918.44
V40-549	7 1/2 HP Motor 60 Cycle 3 Phase	\$2,156.39
V40-550	10 HP Motor 60 Cycle 3 Phase	\$2,819.59

MARTIN 500 SERIES 3-10 HP BRASS PUMP EXPLODED VIEW

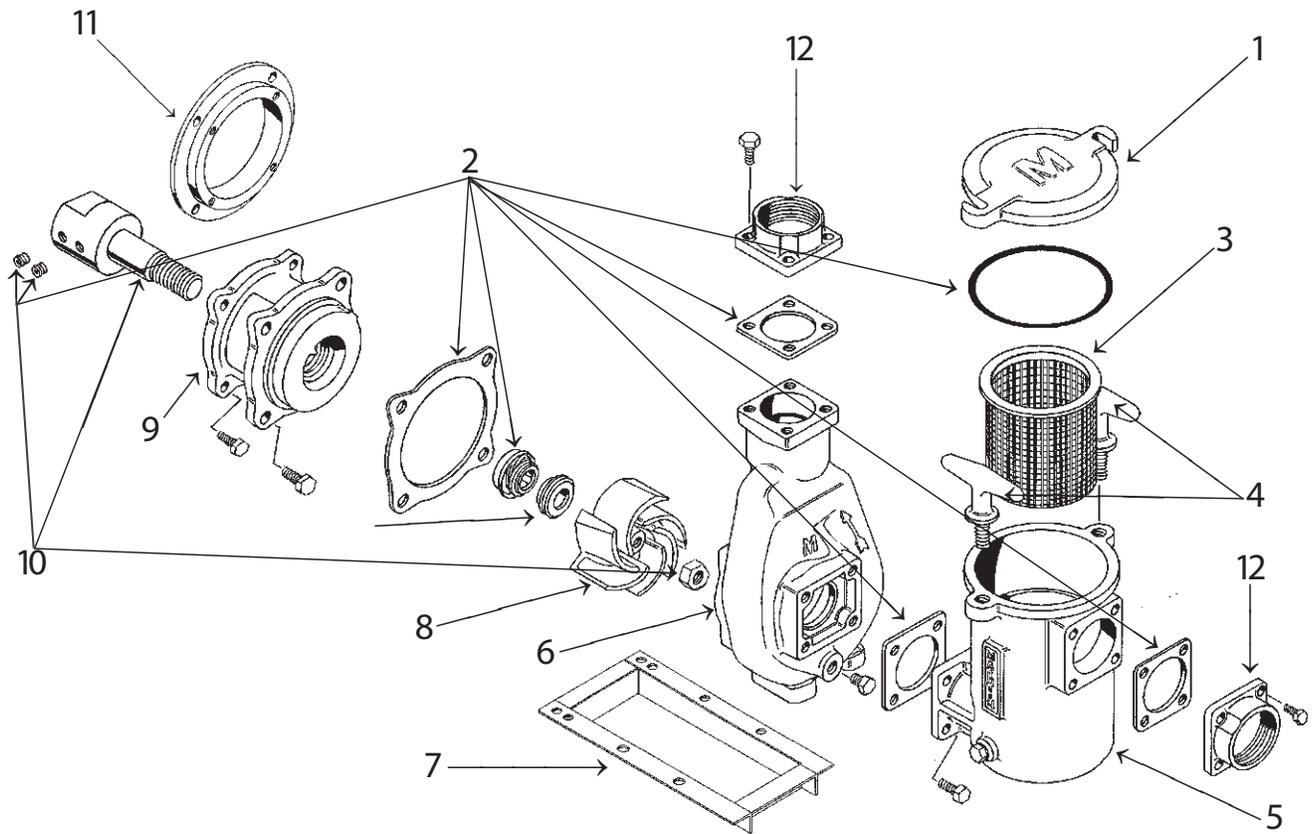

Key No.	Description	Val-Pak Part No.	List Price
1	8" Brass Pump Lid	V40-573	\$272.91
2	Parts Kit (incl. Seal, Gaskets, O-Rings & Set Screws)	V40-576	\$165.44
3	8" Pump Basket	V40-574	\$230.26
4	Tee Handle, Bronze w/S.S. Stud	V40-575	\$29.98
5	8" Brass Trap	V40-572	\$1,838.27
6	Brass Volute	V40-570	\$1,546.98
7	Angle Iron Base 3, 5 & 7 1/2 HP Pump	V40-556	\$129.04
7	Angle Iron Base for 10 HP Pump	V40-557	\$150.14
8	3 Horsepower Impeller	V40-562	\$498.76
8	5 Horsepower Impeller	V40-563	\$583.28
8	7 1/2 Horsepower Impeller	V40-564	\$648.05
8	10 Horsepower Impeller	V40-565	\$907.31
9	3-10 Horsepower Brass Adapter	V40-561	\$569.40
10	Brass Pump Shaft w/Nut & Setscrews	V40-559	\$337.41
11	Motor Adapter Ring (10 HP only)	V40-558	\$501.89
12	Brass Flange 3" NPT	V40-571	\$193.37
	Bolt & Drain Plug Kit (inc. 20 Bolts + 2 Brass Plugs)	V40-555	\$62.70
	3/8-16 5/8 Stainless Steel Bolts	V40-555-1	\$3.05

MARTIN 600 SERIES 5-20 HORSEPOWER BRASS PUMP

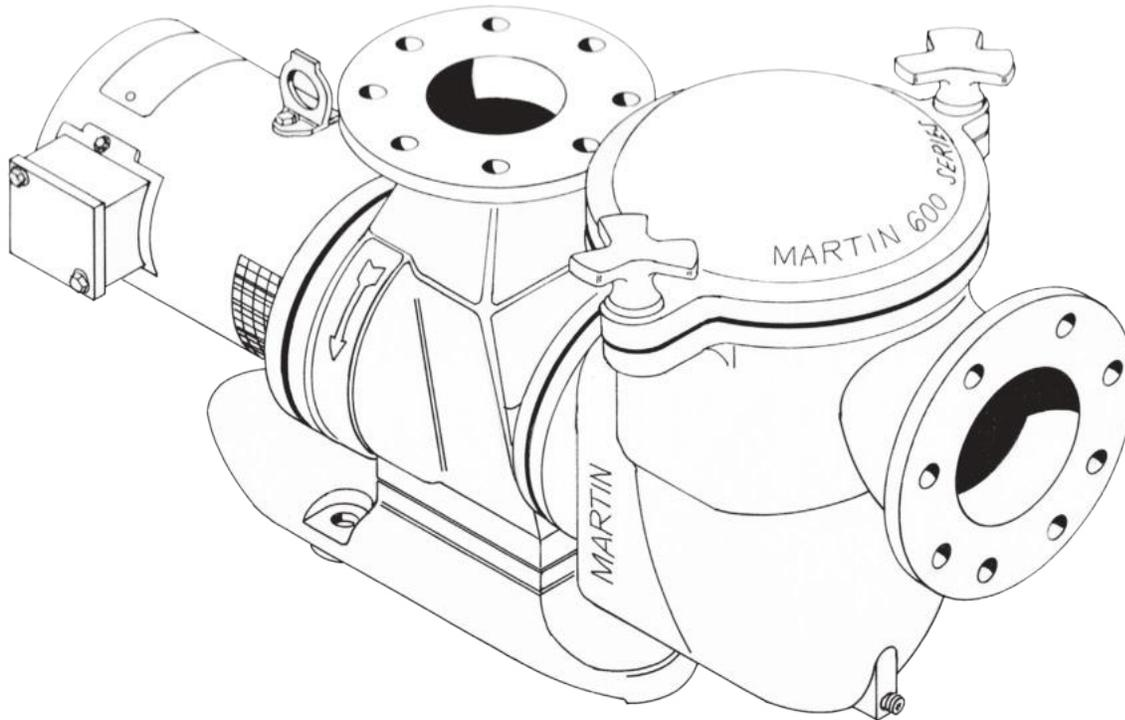

Val-Pak Part No.	Description	List Price
V40-600	Martin 600 5HP H/H 1-PH 230V	\$9,902.06
V40-601	Martin 600 5HP M/H 1-PH 230V	\$9,902.06
V40-610	Martin 600 5HP H/H 3-PH 220-440V	\$9,425.97
V40-610-2	Martin 600 5HP H/H 3-PH 200V	\$9,425.97
V40-611	Martin 600 5HP M/H 3-PH 220/440V	\$9,425.97
V40-611-2	Martin 600 5HP M/H 3-PH 200V	\$9,425.97
V40-804	Martin 600 7.5HP H/H 1-PH 230V	\$10,210.10
V40-805	Martin 600 7.5HP M/H 1-PH 230V	\$10,210.10
V40-612	Martin 600 7.5HP H/H 3-PH 220/440V	\$9,648.67
V40-612-2	Martin 600 7.5HP H/H 3-PH 200V	\$9,648.67
V40-613	Martin 600 7.5HP M/H 3-PH 220/440V	\$9,648.67
V40-613-2	Martin 600 7.5HP M/H 3-PH 200V	\$9,648.67
V40-614	Martin 600 10HP H/H 3-PH 220/440V	\$10,797.79
V40-614-1	Martin 600 10HP H/H 1-PH 230V	\$10,839.95
V40-615	Martin 600 10HP M/H 3-PH 220/440V	\$10,797.79
V40-615-1	Martin 600 10HP M/H 1-PH 230V	\$10,839.95
V40-616	Martin 600 15HP H/H 3-PH 220/440V	\$11,458.11
V40-617	Martin 600 15HP M/H 3-PH 220/440V	\$11,458.11
V40-618	Martin 600 20HP H/H 3-PH 220-440V	\$13,854.51

MARTIN 600 SERIES 5-20 HP BRASS PUMP EXPLODED VIEW

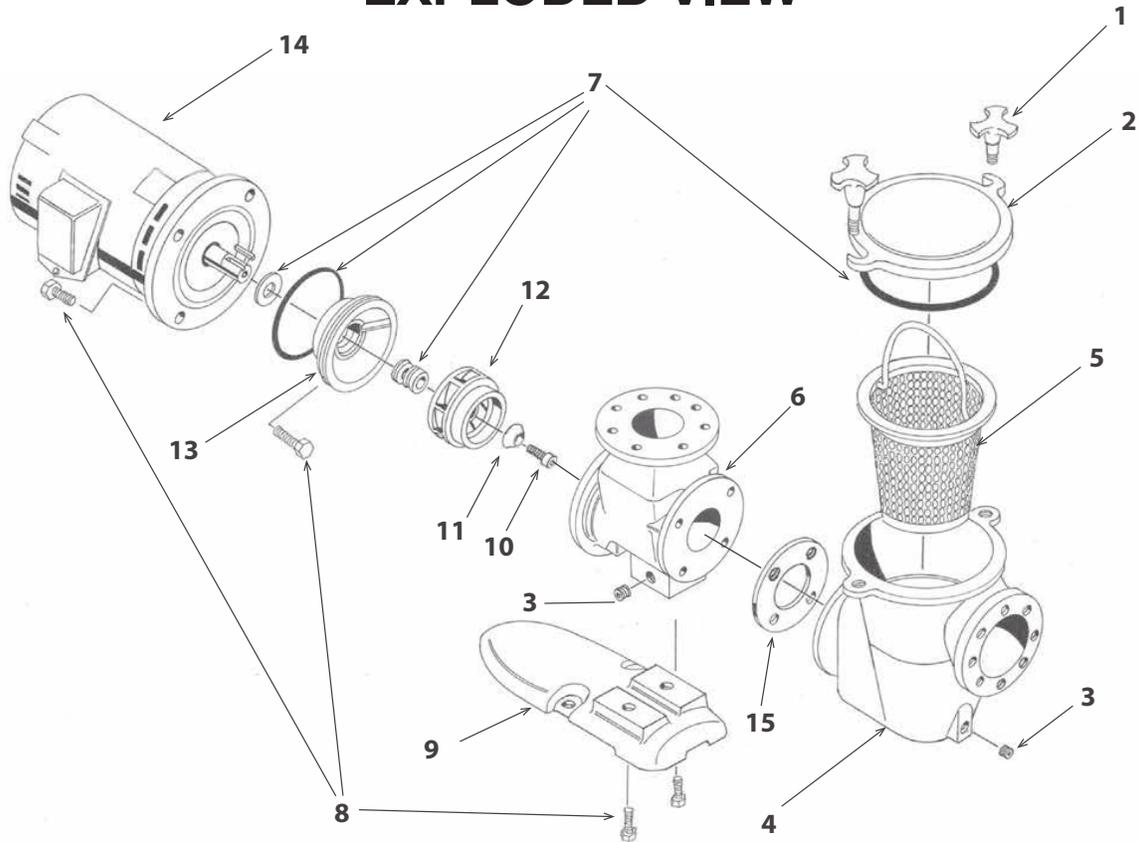

Key No.	Description	Val-Pak Part No.	List Price
1	Hand Nut Assembly (Tee Handle)	V20-287	\$107.94
2	Pump Lid	V20-292	\$897.39
3	Brass Plug (1/4")	92290000	\$5.75
4	Brass Trap	V20-291	\$5,735.36
5	Pump Basket	V20-312	\$433.78
6	Brass Volute	V20-290	\$5,638.65
7	Seal Kit	V20-275	\$165.45
8	Bolt Kit 5 & 7 HP	V20-314	\$135.13
8	Bolt Kit 10,15 & 20 HP	V20-314-1	\$137.16
9	Cast Iron Foot/Base	V20-293	\$108.21
10	C-35 Impeller Lock Screw	V20-313	\$5.14
11	Brass Impeller Washer	V20-311	\$11.94
12	Multiple Horsepower Impellers (See Page 36)	V20-300-V20-307 V20-520	
13	Brass Flange	V20-286	\$730.31
14	Multiple Motors (See Page 36)	V20-280-V20-285	
15	Gasket	V20-276	\$23.69

MARTIN 600 SERIES MOTORS

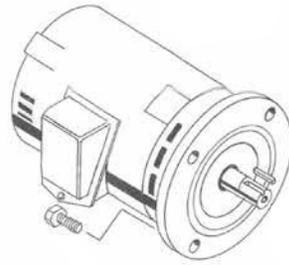

Val-Pak Part No.	Description	List Price
V20-280	5.0 HP 1-PH 230 V Motor	\$1,979.13
V20-281	5.0 HP 3-PH 220/440 V Motor	\$2,074.95
V20-281-2	5.0 HP 3-PH 200 V Motor	\$2,124.85
V20-282	7.5 HP 3-PH 220/440 V Motor	\$2,290.85
V20-282-1	7.5 HP 1-PH 230 V Motor	\$3,299.25
V20-282-2	7.5 HP 3-PH 200 V Motor	\$2,602.43
V20-283	10 HP 3-PH 220/440 V Motor	\$2,891.30
V20-283-1	10 HP 1-PH 230 V Motor	\$3,369.70
V20-284	15 HP 3-PH 220/440 V Motor	\$3,671.78
V20-285	20 HP 3-PH 220/440 V Motor	\$7,237.50

MARTIN 600 SERIES IMPELLERS

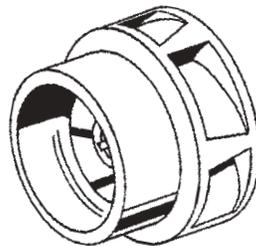

Val-Pak Part No.	Description	List Price
V20-300	5.0 HP CHK Impeller with S.S. Key	\$1,288.97
V20-301	7.5 HP CHK Impeller with S.S. Key	\$1,288.97
V20-302	5.0 HP CMK Impeller with S.S. Key	\$1,288.97
V20-303	7.5 HP CMK Impeller with S.S. Key	\$1,288.97
V20-304	10 HP CHK Impeller with S.S. Key	\$1,288.97
V20-305	10 HP CMK Impeller with S.S. Key	\$1,288.97
V20-306	15 HP CHK Impeller with S.S. Key	\$1,288.97
V20-307	15 HP CMK Impeller with S.S. Key	\$1,288.97
V20-520	20 HP CHK Impeller with S.S. Key	\$1,288.97

MARTIN 600 SERIES 5-20 HORSEPOWER MOTOR SUB ASSEMBLIES

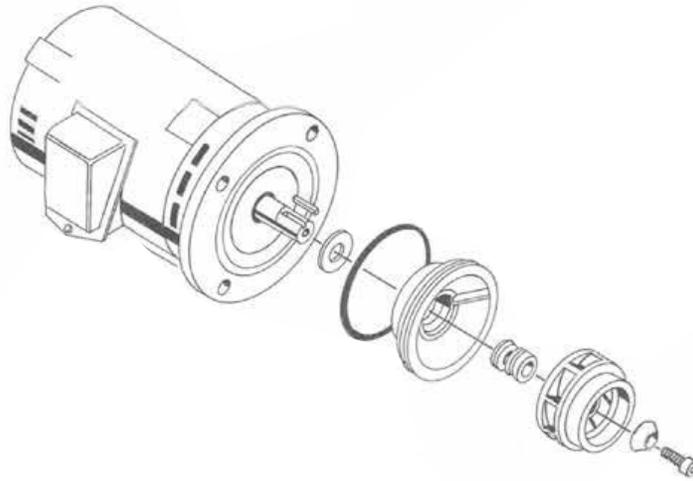

MOTOR SUB ASSEMBLY INCLUDES ALL PARTS ASSEMBLED

Val-Pak Part No.	Description	OEM Part No.	List Price
V20-500	Martin 600 5.0 HP CM-50 230V 1 PH	73260	\$4,556.06
V20-501	Martin 600 5.0 HP CH-50 230V 1 PH	73264	\$5,525.23
V20-502	Martin 600 5.0 HP CMK-50 220/440V 3 PH	73262	\$5,161.32
V20-502-2	Martin 600 5.0 HP CMK-50 200V 3 PH		\$5,481.80
V20-503	Martin 600 5.0 HP CHK-50 220/440V 3 PH	73265	\$5,302.83
V20-503-2	Martin 600 5.0 HP CHK -50 200V 3 PH		\$5,481.80
V20-504	Martin 600 7.5 HP CMK-75 220/440V 3 PH	73263	\$5,308.17
V20-504-1	Martin 600 7.5 HP CMK-75 230V 1 PH		\$5,975.26
V20-504-2	Martin 600 7.5 HP CMK-75 200V 3 PH		\$5,666.92
V20-505	Martin 600 7.5 HP CHK-75 220/440V 3 PH	73266	\$5,453.64
V20-505-1	Martin 600 7.5 HP CHK-75 230V 1 PH	357910	\$5,975.26
V20-505-2	Martin 600 7.5 HP CHK-75 200V 3 PH		\$5,666.92
V20-506	Martin 600 10 HP CMK-100 220/440V 3 PH	73680	\$5,689.59
V20-506-1	Martin 600 10 HP CMK-100 230V 1PH	357251	\$6,882.31
V20-507	Martin 600 10 HP CHK-100 220/440V 3 PH	73267	\$5,808.75
V20-507-1	Martin 600 10 HP CHK-100 230V 1PH	357250	\$6,882.31
V20-508	Martin 600 15 HP CMK-150 220/440V 3 PH	73261	\$7,533.25
V20-509	Martin 600 15 HP CHK-150 220/440V 3 PH	73268	\$7,657.17
V20-510	Martin 600 20 HP CHK-200 220/440V 3 PH	73269	\$11,081.67

LANDON & MARLIN DECK FILTER PARTS

FILTER ELEMENT

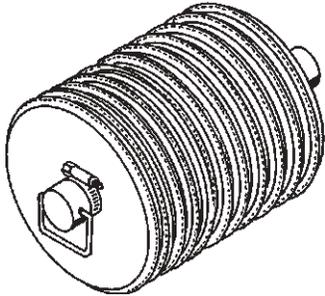

Val-Pak Part No.	Description	List Price
V28-011	11 Plate Element (14½" in length)	\$593.47
V28-015	15 Plate Element (19¼" in length)	\$686.97
V28-018	18 Plate Element (22½" in length)	\$732.76
V28-022	22 Plate Element (27¼" in length)	\$801.46

SKIM FILTER BASKET

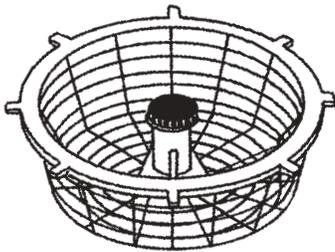

Val-Pak Part No.	Description	List Price
V28-600	Landon Skim Filter Basket	\$33.08
V28-601	Marlin Skim Filter Basket	\$33.08

VAC LID

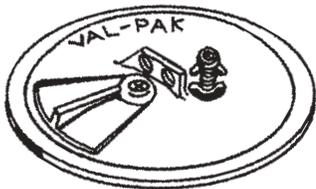

Val-Pak Part No.	Description	List Price
V28-602	Landon Vac Lid 12-7/8" in Diameter	\$108.76
V28-604	Marlin Vac Lid 12-½" in Diameter	\$108.76

KING SLEEVE



Val-Pak Part No.	Description	List Price
V28-605	King Sleeve, 6"	\$23.00
V28-606	King Sleeve, 10"	\$32.63
V28-607	King Sleeve, 18"	\$51.39

PAC-FAB PUMP PARTS

CHALLENGER PUMP LID, O-RING

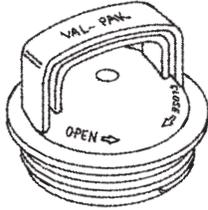

Val-Pak Part No.	Description	OEM Part No.	List Price
V36-190	Challenger Pump Lid	355301	\$44.04
V36-191	Challenger Lid O-ring (12/Bag)	350013	\$2.69

CHALLENGER PUMP BASKET

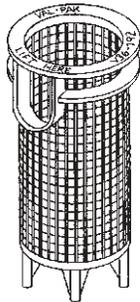

Val-Pak Part No.	Description	OEM Part No.	List Price
V36-192	Challenger Pump Basket (12/Box)	355318	\$22.29

PUMP SHAFT, SET SCREW

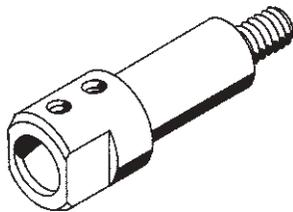

Val-Pak Part No.	Description	OEM Part No.	List Price
V36-115	Pump Shaft (5/Bag)	35-3750	\$38.21
V40-401	1/4 X 20 Set Screw S.S. (100/Bag)		\$1.33

PAC-FAB FILTER PARTS

PISTON, CAP & HANDLE

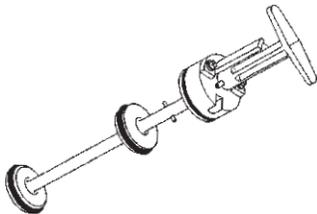

Val-Pak Part No.	Description	OEM Part No.	List Price
V36-177	Piston, Cap & Handle, 2" (Brass)	27-3240 27-3241	\$178.57

PISTON & SHAFT - O/S

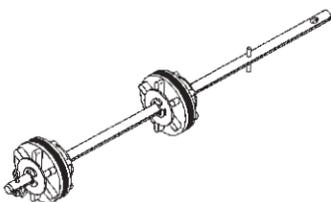

Val-Pak Part No.	Description	List Price
V36-100	Piston & Shaft, 2" - 16½", O/S for Brass Body	\$187.09

PAC-FAB FILTER PARTS (CONT.)

PISTON HALF REPLACEMENT KIT

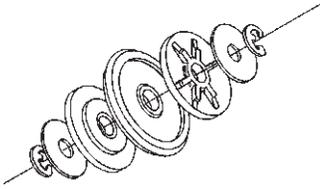

Val-Pak Part No.	Description	OEM Part No.	List Price
V36-178	Piston Half Replacement Kit, 2"	27-3028	\$35.48

TEE HANDLE

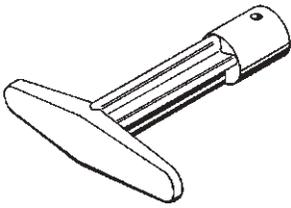

Val-Pak Part No.	Description	OEM Part No.	List Price
V36-179	Tee Handle, 3/8" Shaft	27-3065	\$24.52
V36-180	Tee Handle, 1/2" Shaft		\$24.52
V36-181	Tee Handle, 5/8" Shaft	27-3089	\$24.52

POSITION BRACKET

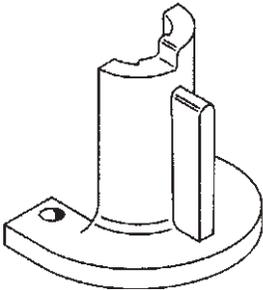

Val-Pak Part No.	Description	OEM Part No.	List Price
V36-184	Position Bracket	27-3064	\$27.40

PISTON O-RING SET

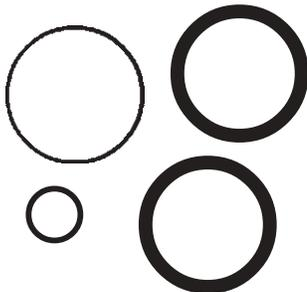

Val-Pak Part No.	Description	List Price
V36-185	Piston O-Ring Set 2", Brass New Style (25/Bag)	\$4.15
V36-186	Piston O-Ring Set 2", Plastic New Style (25/Bag)	\$4.15

PISTON CAP

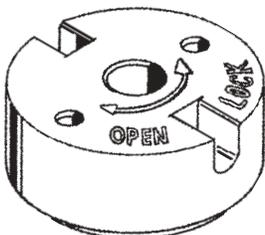

Val-Pak Part No.	Description	OEM Part No.	List Price
V36-182	PVC Piston Cap 2", Old Style (3/8" Shaft)	27-3050	\$34.65
V36-183	PVC Piston Cap 2" (1/2" Brass Shaft)		\$34.65

PAC-FAB FILTER PARTS (CONT.)

PISTON SEAL

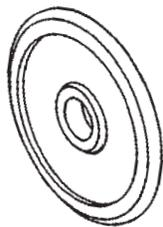

Val-Pak Part No.	Description	OEM Part No.	List Price
V36-110	Piston Seal, 2" (5/Bag)	27-3059	\$3.87

E-CLIP



Val-Pak Part No.	Description	OEM Part No.	List Price
V36-120	E-Clip, Stainless Steel (25/Bag)	27-3057	\$1.67

AIR RELIEF VALVE

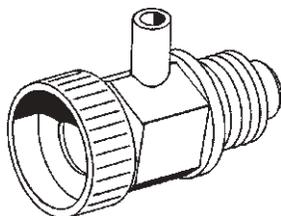

Val-Pak Part No.	Description	OEM Part No.	List Price
V38-115	Celcon Air Relief Valve 1/4" (50/Bag)	07-5207	\$12.29
V38-156	Repl. Valve Stem O-Ring (100/Bag)		\$0.52

NAUTILUS CENTER ROD



Val-Pak Part No.	Description	OEM Part No.	List Price
V36-124	Rod, 15½" Manifold Retainer NS 24	19-2182	\$41.59
V36-136	Rod, 21½" Manifold Retainer NS 36	19-2183	\$49.73
V36-148	Rod, 27½" Manifold Retainer NS 48	19-2184	\$59.79
V36-160	Rod, 33½" Manifold Retainer NS 60	19-2185	\$72.16
V36-172	Rod, 39½" Manifold Retainer NS 72	19-5002	\$78.42

PAC-FAB SKIMMER PARTS

BERMUDA SKIMMER BASKET

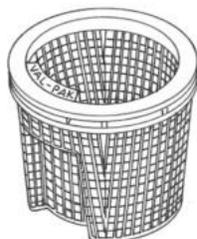

Val-Pak Part No.	Description	OEM Part No.	List Price
V22-110	Bermuda Skimmer Basket (28/Box)	516112	\$26.65

POOL SWEEP PARTS

A-40 GASKET

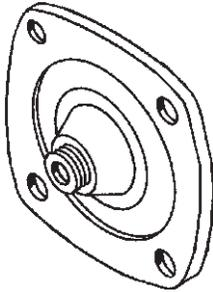

Val-Pak Part No.	Description	OEM Part No.	List Price
V32-604	A-40 Gasket	AXA40	\$34.68

IMPELLER

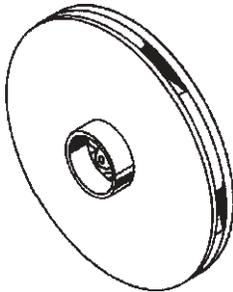

Val-Pak Part No.	Description	OEM Part No.	List Price
V32-612	A-02L Impeller 5-7/8"	AXA02L	\$34.68

B-5 HOSE, HOSE WASHER



Val-Pak Part No.	Description	OEM Part No.	List Price
V32-606	B-5 Hose w/ Washer (50/Box)	AXB05	\$26.95
V32-607	D-10 Hose Washer (50/Bag)	AXD10P	\$0.93

SADDLE TEE

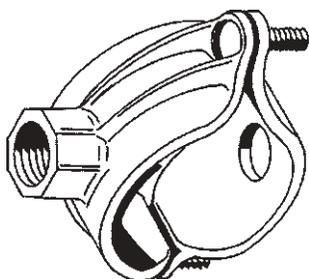

Val-Pak Part No.	Description	List Price
V32-613	K-17 — 1" X 3/4 for 1 1/4" O/D Copper	\$52.29
V32-614	K-18 — 1 1/4" X 3/4 for 1 1/2" O/D Copper	\$52.29
V32-615	K-20 — 1 1/2" X 3/4 for 2" O/D Copper	\$54.12
V32-616	K-31 — 1 1/2" X 3/4 for 1 1/2" O/D PVC	\$55.24
V32-617	K-32 — 2" X 3/4 for 2" O/D PVC	\$57.27

PREMIER PUMP PARTS

BRASS IMPELLER

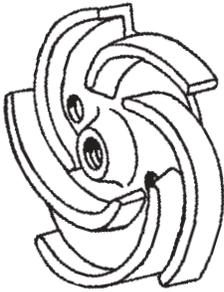

Val-Pak Part No.	Description	OEM Part No.	List Price
V40-452	1/3 Horsepower Impeller		\$130.02
V40-453	1/2 Horsepower Impeller	31-380	\$117.06
V40-454	3/4 Horsepower Impeller	31-381	\$117.06
V40-455	1 Horsepower Impeller	31-382	\$117.06
V40-456	1½ Horsepower Impeller	31-383	\$117.06
V40-457	2 Horsepower Impeller	31-384	\$117.06
V40-458	3 Horsepower Impeller	31-385	\$130.02

IMPELLER WRENCH

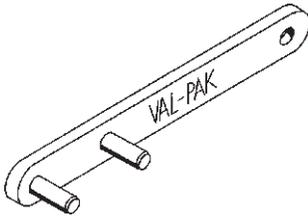

Val-Pak Part No.	Description	List Price
V40-469	Impeller Wrench	\$62.56

BRASS BRACKET

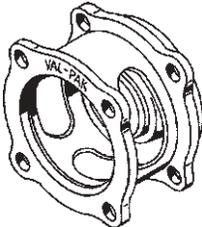

Val-Pak Part No.	Description	OEM Part No.	List Price
V40-460	1/3-2 Horsepower Bracket (w/out Foot)	31-096	\$300.31

H & F GASKET, PUMP LID O-RING

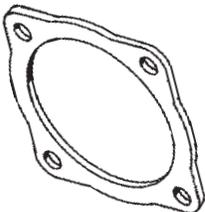

Val-Pak Part No.	Description	OEM Part No.	List Price
V40-115	H & F Gasket (12/Bag)	G44	\$4.74
V40-117	Pump Lid O-Ring, 5" (12/Bag)	080	\$4.44

LOCK HANDLE

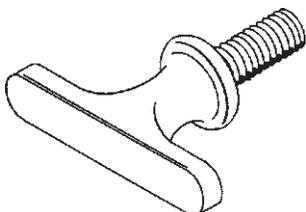

Val-Pak Part No.	Description	OEM Part No.	List Price
V40-468	Lock Handle, S.S. Stud	31-622	\$29.97

PREMIER PUMP PARTS (CONT.)

5" CLEAR LID, O-RING

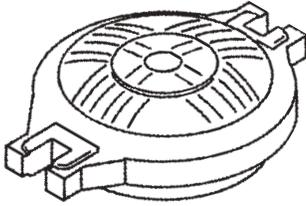

Val-Pak Part No.	Description	OEM Part No.	List Price
V31-452	Clear Lid, 5"	31-484	\$71.52
V40-117	Pump Lid O-Ring, 5" (12/Bag)	080	\$4.44

5" BRASS LID

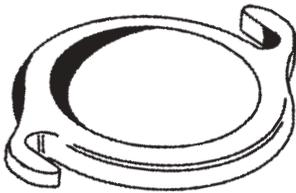

Val-Pak Part No.	Description	OEM Part No.	List Price
V40-463	Brass Lid, 5"	31-482	\$102.34

6" CLEAR LID

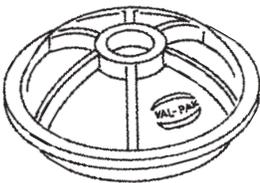

Val-Pak Part No.	Description	OEM Part No.	List Price
V31-451	Clear Lid, 6"	33-488	\$76.82

455 PUMP SHAFT, SET SCREW

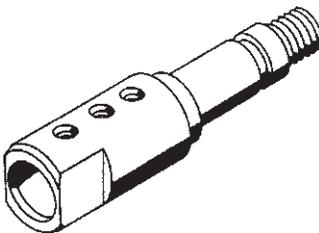

Val-Pak Part No.	Description	OEM Part No.	List Price
V30-449	Pump Shaft (w/O-Ring Groove (5/Bag)	31-814	\$55.40
V40-401	1/4 X 20 Set Screw S.S. (100/Bag)	31-812	\$1.33

455 BRASS VOLUTE, TRAP GASKET

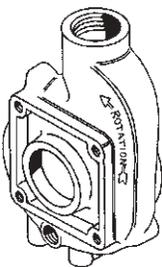

Val-Pak Part No.	Description	OEM Part No.	List Price
V31-458	Brass Volute, 455 Series	33-819	\$326.18
V31-459	Trap Gasket (12/Bag)	G99	\$8.10

PREMIER PUMP PARTS (CONT.)

556 BRASS VOLUTE

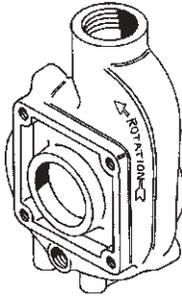

Val-Pak Part No.	Description	OEM Part No.	List Price
V31-456	Brass Volute, 556 Series	35-843	\$528.23
V31-460	556 Parts Kit		\$107.31

556 BRASS IMPELLER



Val-Pak Part No.	Description	OEM Part No.	List Price
V31-457	3-Horsepower Brass Impeller (Outside Diameter 5½)	31-330	\$202.16

556 BRASS ADAPTER

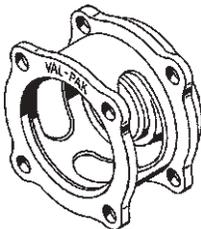

Val-Pak Part No.	Description	OEM Part No.	List Price
V40-561P	Brass Adapter, 556 Series	35-109	\$594.29

PREMIER 658 PUMP PARTS

658 PUMP SHAFT

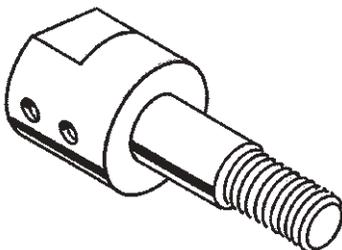

Val-Pak Part No.	Description	OEM Part No.	List Price
V40-560	Premier Pump Shaft w/Nut (5, 7½ & 10 Horsepower)	39-862	\$362.22
V40-580P	Premier Pump Shaft w/Nut (3 Horsepower)	39-861	\$362.22

PREMIER 658 PUMP PARTS (CONT.)

658 BRASS IMPELLER, PARTS KIT

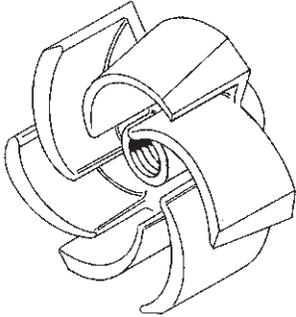

Val-Pak Part No.	Description	OEM Part No.	List Price
V40-566	3-Horsepower Brass Impeller	39-879	\$562.76
V40-567	5-Horsepower Brass Impeller	39-880	\$637.80
V40-568	7½-Horsepower Brass Impeller	39-881	\$712.83
V40-569	10-Horsepower Brass Impeller	39-882	\$870.40
V40-577	658 Parts Kit		\$172.17

658 BRASS ADAPTER

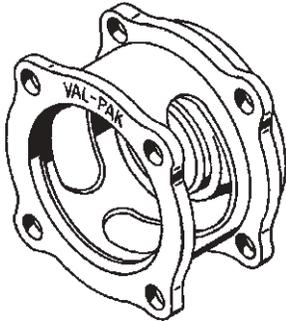

Val-Pak Part No.	Description	OEM Part No.	List Price
V40-561P	Brass Adapter, 658 Series	35-109	\$594.29

658 PUMP BASKET

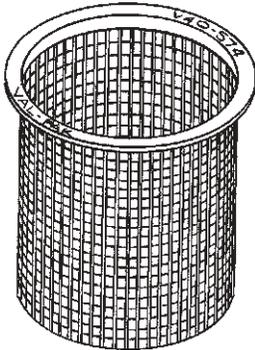

Val-Pak Part No.	Description	OEM Part No.	List Price
V40-574	8" Stainless Steel Pump Basket	39-225	\$230.26

658 SERIES MOTORS

Val-Pak Part No.	Description	List Price
V40-545	3.0 HP Motor 60 Cycle 1 Phase	\$2,162.35
V40-546	3.0 HP Motor 60 Cycle 3 Phase	\$1,725.24
V40-547	5.0 HP Motor 60 Cycle 1 Phase	\$2,950.71
V40-548	5.0 HP Motor 60 Cycle 3 Phase	\$1,918.44
V40-549	7½ HP Motor 60 Cycle 3 Phase	\$2,156.39
V40-550	10 HP Motor 60 Cycle 3 Phase	\$2,819.59

PREMIER FILTER PARTS

TOP HOLDING WHEEL

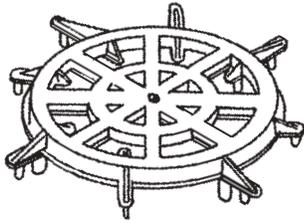

Val-Pak Part No.	Description	OEM Part No.	List Price
V20-318	Top Holding Wheel	23-780	\$25.77
V20-666	Wing Nut, S.S. 1/4 x 20" (25/Bag)	90-340	\$1.29
V20-667	Washer, S.S. 1/4" (25/Bag)	90-250	\$0.80

PREMIER DE MANIFOLD

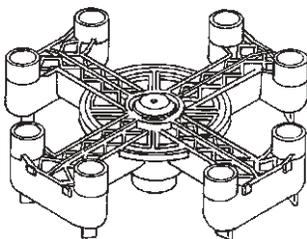

Val-Pak Part No.	Description	OEM Part No.	List Price
V30-126	Manifold, 1½"	23-791	\$125.02
V30-127	Manifold, 2"	23-792	\$125.02

CENTER ROD

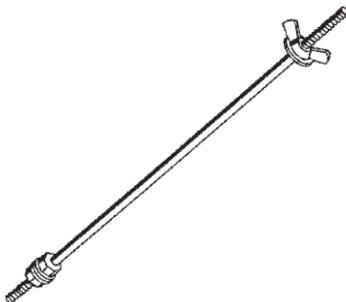

Val-Pak Part No.	Description	OEM Part No.	List Price
V30-444	PA Brass Center Rod, 24 sq. ft.	23-876	\$35.63
V30-445	PA Brass Center Rod, 36 sq. ft.	23-877	\$35.63
V30-446	PA Brass Center Rod, 48 sq. ft.	23-878	\$35.63
V30-447	PA Brass Center Rod, 60 sq. ft.	23-879	\$44.93
V30-448	PA Brass Center Rod, 72 sq. ft.	23-880	\$44.91

PUREX PUMP PARTS

AQ & AU SERIES IMPELLER

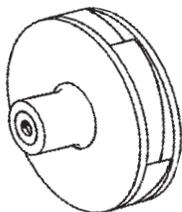

Val-Pak Part No.	Description	List Price
V20-210	1 Horsepower Impeller AQ & AU, O/S	\$116.10
V20-215	1½ Horsepower Impeller AQ & AU, O/S	\$116.10
V20-220	2 Horsepower Impeller AQ & AU, O/S	\$116.10

PENTAIR/PUREX PUMP PARTS

WHISPERFLO SEAL PLATE

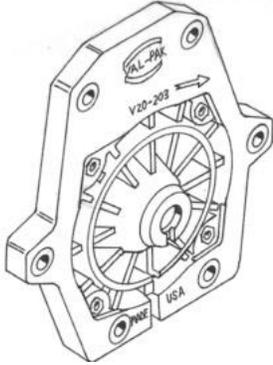

Val-Pak Part No.	Description	OEM Part No.	List Price
V20-208	Whisperflo Seal Plate	74564	\$85.60

WHISPERFLO DIFFUSER

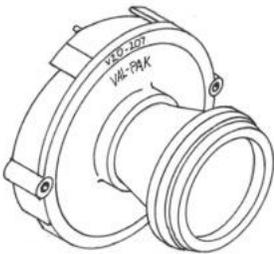

Val-Pak Part No.	Description	OEM Part No.	List Price
V20-207	Whisperflo 1/2-2 HP Diffuser	072927	\$54.25
V20-207-1	Whisperflo 3 HP Diffuser	072928	\$66.38
V20-368	Whisperflo Diffuser O-ring (12/Bag)	071444	\$2.27

WHISPERFLO IMPELLER



Val-Pak Part No.	Description	OEM Part No.	List Price
V20-201	1/2 Horsepower Impeller	073126	\$75.39
V20-202	3/4 Horsepower Impeller	073127	\$75.39
V20-203	1 Horsepower Impeller	073128	\$75.39
V20-204	1 1/2 Horsepower Impeller	073129	\$75.39
V20-205	2 Horsepower Impeller	073130	\$75.39
V20-206	3 Horsepower Impeller	073131	\$75.39

WHISPERFLO BASKET

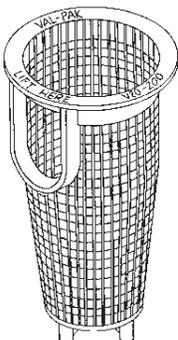

Val-Pak Part No.	Description	OEM Part No.	List Price
V20-200	Whisperflo Basket (24/Box)	070387	\$19.12

PENTAIR/PUREX PUMP PARTS (CONT.)

WHISPERFLO PUMP LID, O-RING (PRE-98)

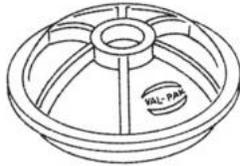

Val-Pak Part No.	Description	OEM Part No.	List Price
V20-371	Whisperflo Pump Lid (pre-98)	070795	\$36.80
V20-370	Whisperflo O-Ring (pre-98) (12/Bag)	071422	\$2.17

WHISPERFLO PUMP LID, O-RING (N/S)

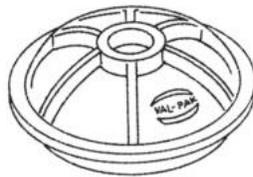

Val-Pak Part No.	Description	OEM Part No.	List Price
V20-390	Whisperflo Pump Lid N/S	357151	\$25.05
V20-389	Whisperflo O-Ring N/S (12/Bag)	350013	\$2.68

WHISPERFLO PUMP LID CLAMP

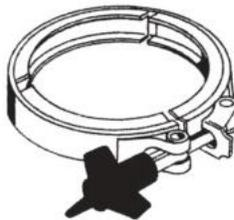

Val-Pak Part No.	Description	OEM Part No.	List Price
V20-373	Pump Lid Clamp AQ, AU & Whisperflo (pre-98)	070711	\$68.29

WHISPERFLO LOCKING RING

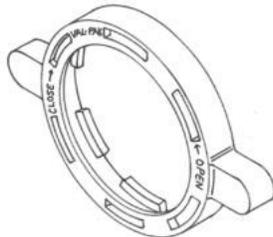

Val-Pak Part No.	Description	OEM Part No.	List Price
V20-407	Whisperflo Locking Ring, Almond	357199	

SUPER FLO/SUPER MAX PUMP BASKET

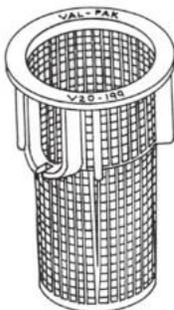

Val-Pak Part No.	Description	OEM Part No.	List Price
V20-199	Super Flo/Super Max Pump Basket (8/Box)	355667	\$17.83

PENTAIR/C-SERIES BRASS PUMP EXPLODED VIEW

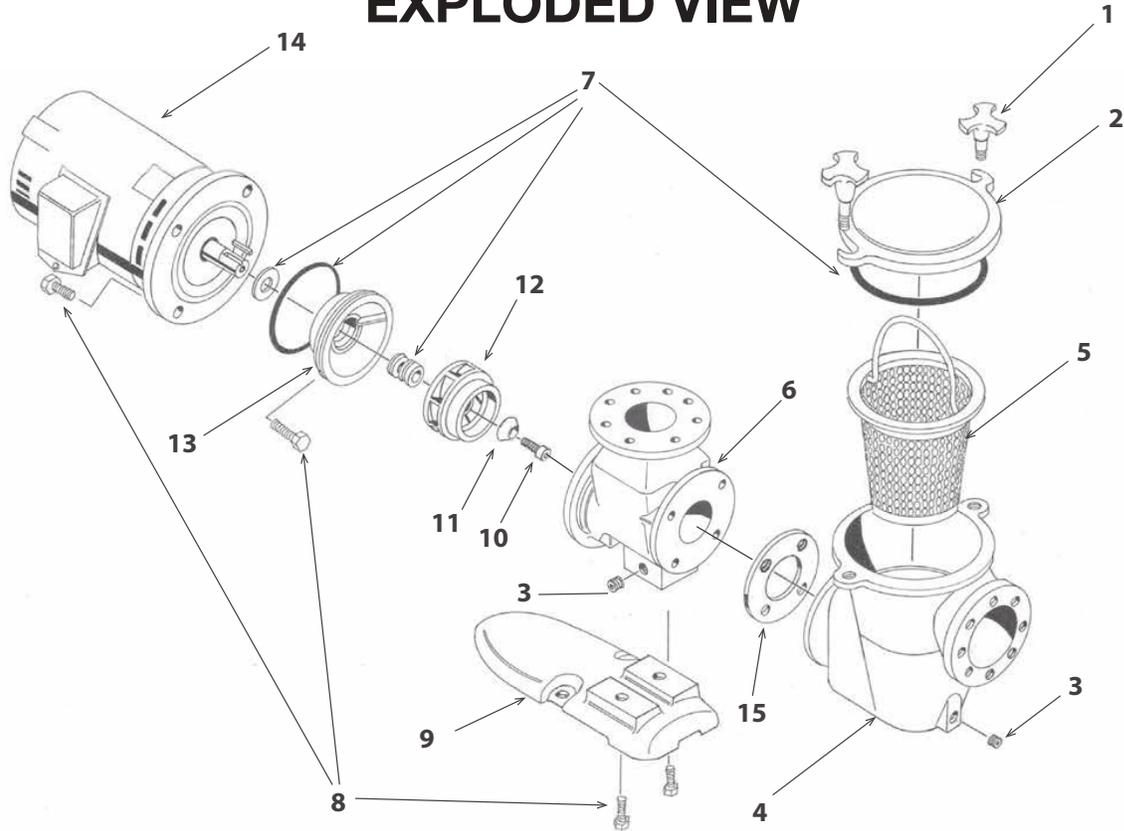

Key No.	Description	Val-Pak Part No.	OEM Part No.	List Price
1	Hand Nut Assembly (Tee Handle)	V20-287	75280	\$107.94
2	Pump Lid	V20-292	75275	\$897.39
3	Brass Plug (1/4")	92290000		\$5.75
4	Brass Trap	V20-291	075271Z	\$5,735.36
5	Pump Basket	V20-312	72795	\$433.78
6	Brass Volute	V20-290	75273	\$5,638.65
7	Seal Kit	V20-275		\$165.45
8	Bolt Kit	V20-314		\$135.13
8	Bolt Kit	V20-314-1		\$137.16
9	Cast Iron Foot/Base	V20-293	75287	\$108.21
10	C-35 Impeller Lock Screw	V20-313	71037	\$5.14
11	Brass Impeller Washer	V20-311	71048	\$11.94
12	Multiple Horsepower Impellers (See Page 51)	V20-300-V20-307 V20-520		\$1,288.97 \$1,288.97
13	Brass Flange	V20-286	70906	\$730.31
14	Multiple Motors (See Page 51)	V20-280-V20-285		
15	Gasket	V20-276		\$23.69

FOR COMPLETE PUMP REPLACEMENTS, PLEASE REFER TO PAGE 34

PENTAIR/C-SERIES MOTORS

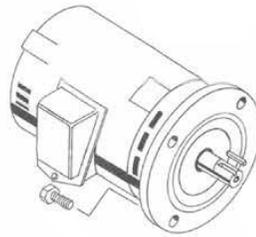

Val-Pak Part No.	Description	OEM Part No.	List Price
V20-280	5.0 HP 1-PH 230 Motor	71366	\$1,979.13
V20-281	5.0 HP 3-PH 220/440 Motor	71364	\$2,074.95
V20-281-2	5.0 HP 3-PH 200 Motor	357206S	\$2,124.85
V20-282	7.5 HP 3-PH 220/440 Motor	71365	\$2,290.85
V20-282-1	7.5 HP 1-PH 230 Motor	357204	\$3,299.25
V20-282-2	7.5 HP 3-PH 200 Motor	357208	\$2,602.43
V20-283	10 HP 3-PH 220/440 Motor	71363	\$2,891.30
V20-283-1	10 HP 1-PH 230 Motor	357249S	\$3,369.70
V20-284	15 HP 3-PH 220/440 Motor	71361	\$3,671.78
V20-285	20 HP 3-PH 220/440 Motor	71362	\$7,237.50

PENTAIR/C-SERIES IMPELLERS

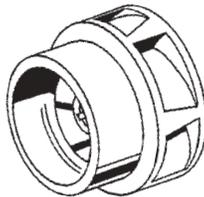

Val-Pak Part No.	Description	OEM Part No.	List Price
V20-300	5.0 HP CHK Impeller with S.S. Key	73828	\$1,288.97
V20-301	7.5 HP CHK Impeller with S.S. Key	73829	\$1,288.97
V20-302	5.0 HP CMK Impeller with S.S. Key	70228	\$1,288.97
V20-303	7.5 HP CMK Impeller with S.S. Key	70227	\$1,288.97
V20-304	10 HP CHK Impeller with S.S. Key	73830	\$1,288.97
V20-305	10 HP CMK Impeller with S.S. Key	70226	\$1,288.97
V20-306	15 HP CHK Impeller with S.S. Key	73831	\$1,288.97
V20-307	15 HP CMK Impeller with S.S. Key	70225	\$1,288.97
V20-520	20 HP CHK Impeller with S.S. Key	73832	\$1,288.97

**FOR COMPLETE PUMP REPLACEMENTS,
PLEASE REFER TO PAGE 34**

PENTAIR/PUREX ORTEGA VALVE PARTS

BRASS ORTEGA VALVE COMPLETE



Val-Pak Part No.	Description	List Price
V20-090	Ortega Valve Complete 1½" Brass	\$524.56
V20-089	Ortega Valve Complete 2" Brass	\$553.69

BRASS DIVERTER, CAP & HANDLE

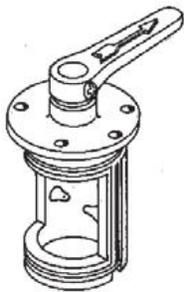

Val-Pak Part No.	Description	OEM Part No.	List Price
V20-092	Brass Diverter Cap & Handle 1½"	072432	\$193.17
V20-091	Brass Diverter Cap & Handle 2"	072431	\$214.33

ORTEGA SHAFT

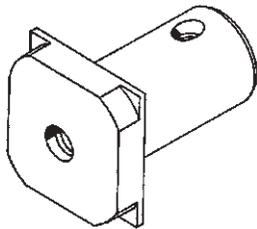

Val-Pak Part No.	Description	OEM Part No.	List Price
V20-335	Ortega Shaft for Noryl Diverter	072427	\$13.97

ORTEGA HANDLE, SCREW

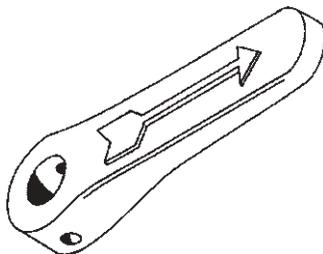

Val-Pak Part No.	Description	OEM Part No.	List Price
V20-330	Ortega Handle (Metal)	072392	\$23.68
V20-338	Handle Screw 8-32 x 3/8" S.S. (50/Bag)	072540	\$0.38

PENTAIR/PUREX ORTEGA VALVE PARTS (CONT.)

ORTEGA O-RING SET

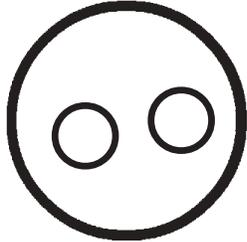

Val-Pak Part No.	Description	List Price
V20-331	Ortega Valve O-Ring Set 1½" (25/Bag)	\$3.26
V20-332	Ortega Valve O-Ring Set 2" (25/Bag)	\$3.26

NORYL DIVERTER, CAP & HANDLE

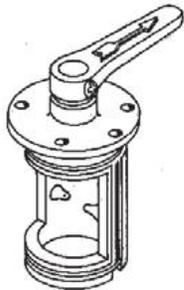

Val-Pak Part No.	Description	List Price
V20-061	Ortega 1½" Diverter Cap & Handle (Noryl)	\$102.30
V20-060	Ortega 2" Diverter Cap & Handle (Noryl)	\$94.42

NORYL VALVE CAP



Val-Pak Part No.	Description	OEM Part No.	List Price
V20-065	Ortega 3 Way Valve Cap 1½"	72420	\$20.88
V20-064	Ortega 3 Way Valve Cap 2"	72414	\$16.28

NORYL DIVERTER & SEAL

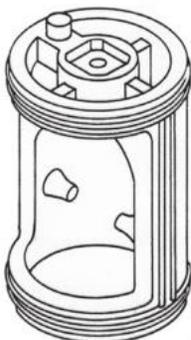

Val-Pak Part No.	Description	OEM Part No.	List Price
V20-063	Ortega 1½" Noryl Diverter with Seal	263032	\$59.10
V20-062	Ortega 2" Noryl Diverter with Seal	73484	\$45.96

PENTAIR/PUREX ORTEGA VALVE PARTS (CONT.)

ORTEGA CHECK VALVE SEAT



Val-Pak Part No.	Description	OEM Part No.	List Price
V20-069	Ortega 1½" Check Valve Seat Assembly	73503	\$57.38
V20-068	Ortega 2" Check Valve Seat Assembly	73502	\$57.38

ORTEGA CHECK VALVE CAP

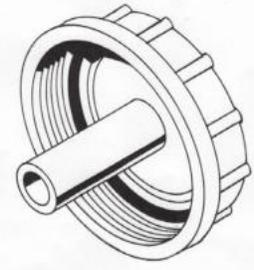

Val-Pak Part No.	Description	OEM Part No.	List Price
V20-071	Ortega 1½" Check Valve Cap with O-Ring	72477	\$33.88
V20-070	Ortega 2" Check Valve Cap with O-Ring	357152	\$24.95

ORTEGA SPRING

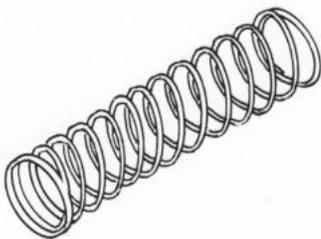

Val-Pak Part No.	Description	OEM Part No.	List Price
V20-072	Ortega 2" 1 lb. Spring	10652	\$13.79
V20-073	Ortega 1.5" 1 lb. Spring		\$13.79

**FOR THE MOST UPDATED INFORMATION
VISIT US ONLINE:**

WWW.VALPAKPRODUCTS.COM

PENTAIR/PUREX RETURN FITTINGS

SPA CHECK VALVE

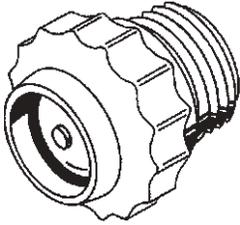

Val-Pak Part No.	Description	OEM Part No.	List Price
V20-339	Spa Check Valve 1½" MIP (White)	010646	\$29.04
V20-340	Spa Check Valve 1½" MIP (Black)		\$29.04
V20-341	Spa Check Valve 1½" MIP (Dark Gray)		\$29.04
V20-342	Spa Check Valve 1½" MIP (Light Gray)		\$29.04
V20-343	Spa Check Valve Slip (White)		\$33.14
V20-344	Spa Check Valve Slip (Black)		\$33.14
V20-345	Spa Check Valve Slip (Dark Gray)		\$33.14
V20-346	Spa Check Valve Slip (Light Gray)		\$33.14

1" SPA CHECK VALVE

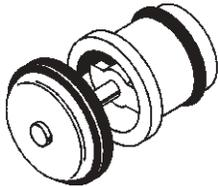

Val-Pak Part No.	Description	OEM Part No.	List Price
V20-350	Spa Check Valve, 1" Slip	10647	\$33.75

RETURN FITTING

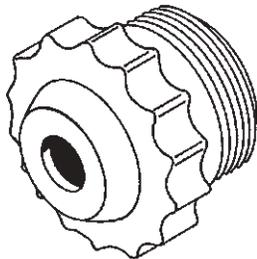

Val-Pak Part No.	Description	OEM Part No.	List Price
V20-386	Return Fitting - White 1/2"	540014	\$3.96
V20-387	Return Fitting - White 3/4"	540021	\$3.96
V20-388	Return Fitting - White 1"	540028	\$3.96
V20-406	Return Fitting - Black 1/2"	540015	\$3.96
V20-391	Return Fitting - Black 3/4"	540022	\$3.96
V20-392	Return Fitting - Black 1"	540029	\$3.96
V20-394	Return Fitting - Light Gray 1/2"		\$3.96
V20-395	Return Fitting - Light Gray 3/4"		\$3.96
V20-396	Return Fitting - Light Gray 1"		\$3.96
V20-398	Return Fitting - Dark Gray 1/2"	540016	\$3.96
V20-399	Return Fitting - Dark Gray 3/4"	540023	\$3.96
V20-400	Return Fitting - Dark Gray 1"	540030	\$3.96

BLANK RETURN FITTING

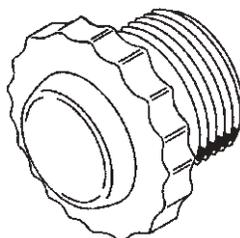

Val-Pak Part No.	Description	List Price
V20-377	Blank Return Fitting - White	\$4.66
V20-378	Blank Return Fitting - Black	\$4.66
V20-379	Blank Return Fitting - Dark Gray	\$4.66
V20-380	Blank Return Fitting - Light Gray	\$4.66

PUREX FILTER PARTS

LID BUSHING ASSEMBLY



Val-Pak Part No.	Description	OEM Part No.	List Price
V20-102	Purex 2000 Series Lid Bushing Assembly	70548 071407 07095	\$32.16

CLAMP KNOB

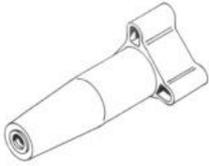

Val-Pak Part No.	Description	OEM Part No.	List Price
V20-221-1	Purex 2000 Series Clamp Knob	76033	\$10.89

COMPRESSION RING



Val-Pak Part No.	Description	OEM Part No.	List Price
V20-322	Compression Ring (5/Package)	070731	\$83.06

BRASS/NORYL O-RING KIT

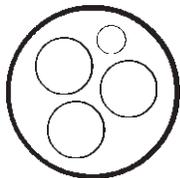

Val-Pak Part No.	Description	List Price
V20-319	Brass Rotor O-Ring Kit (25/Bag)	\$11.70
V20-353	Noryl Rotor O-Ring Kit (25/Bag)	\$6.02

NORYL ROTOR AND SEAL, BRASS ROTOR



Val-Pak Part No.	Description	OEM Part No.	List Price
V20-227	Noryl Rotor with Seal	73370	\$112.81
V20-320	Brass Rotor	72110	\$463.51

PORT SEAL



Val-Pak Part No.	Description	OEM Part No.	List Price
V20-321	Port Seal	072875	\$63.45

PUREX FILTER PARTS (CONT.)

COMPRESSION RING BOLT

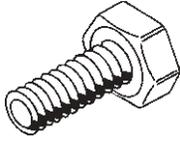

Val-Pak Part No.	Description	OEM Part No.	List Price
V20-323	Compression Ring Bolt S.S. (100/bag)	74927	\$0.54

ROTOR VALVE HANDLE AND HANDLE EXTENSION



Val-Pak Part No.	Description	OEM Part No.	List Price
V20-326	Brass/Noryl Rotor Valve Handle	190026	\$54.34
V20-334	Brass/Noryl Rotor Valve Handle Ext.	70971	\$106.67

2000 SERIES LID, FILTER CLAMP

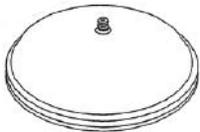

Val-Pak Part No.	Description	OEM Part No.	List Price
V20-222	2000 Series S.S. Lid	188603	\$341.29
V20-221	2000 Series S.S. Clamp w/Knob	072898	\$93.00

TOP HOLDING WHEEL

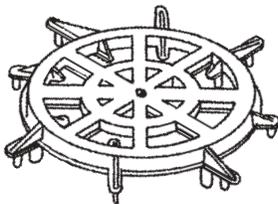

Val-Pak Part No.	Description	OEM Part No.	List Price
V20-318	Top Holding Wheel	071019	\$25.77
V20-666	Wing Nut, S.S. 1/4 x 20" (25/Bag)	071404	\$1.29
V20-667	Washer, S.S. 1/4" (25/Bag)	072173	\$0.80

PUREX FILTER GRID

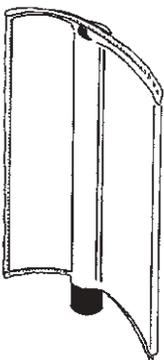

Val-Pak Part No.	Description	OEM Part No.	List Price
V20-624	2024 Commercial Filter Grid (25/Box)	74922	\$27.59
V20-636	2036 Commercial Filter Grid (25/Box)	70923	\$35.51
V20-648	2048 Commercial Filter Grid (25/Box)	70924	\$43.70
V20-660	2060 Commercial Filter Grid (25/Box)	70925	\$53.26
V20-672	2072 Commercial Filter Grid (25/Box)	70926	\$57.36

PUREX FILTER PARTS (CONT.)

MANIFOLD 2000 SERIES

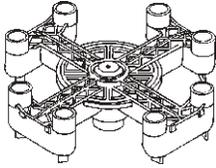

Val-Pak Part No.	Description	OEM Part No.	List Price
V20-369	Manifold 2000 Series 8-hole (12/Box)	073270	\$40.96

RED LINE TANK O-RINGS

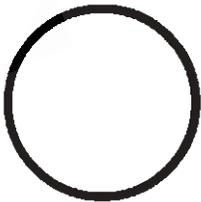

Val-Pak Part No.	Description	OEM Part No.	List Price
V20-365	2000 Series Red Line Tank O-Ring (25/Bag)	071442	\$24.16
V20-364	4000 Series Red Line Tank O-Ring (12/Bag)	071439	\$46.87

AIR RELIEF ASSEMBLY

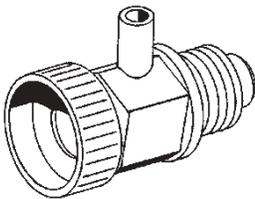

Val-Pak Part No.	Description	OEM Part No.	List Price
V38-115	Celcon Air Relief Valve 1/4" (50/Bag)	075207	\$12.29
V38-156	Repl. Valve Stem O-Ring (100/Bag)		\$0.52

PRESSURE GAUGE

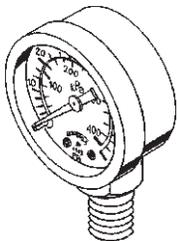

Val-Pak Part No.	Description	List Price
V34-161	1/4" Pressure Gauge 0-60 PSI	\$11.68

BRASS TEE



Val-Pak Part No.	Description	List Price
V34-162	1/4" Brass Tee	\$14.47

PENTAIR/PUREX CENTER RODS

2000 SERIES SM RED

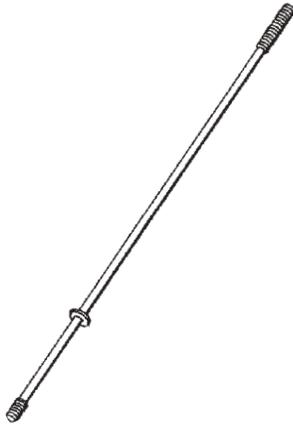

Val-Pak Part No.	Description	OEM Part No.	List Price
V20-224	SM-2024 21" Red	072885	\$32.08
V20-236	SM-2036 27" Red	072871	\$32.08
V20-248	SM-2048 33" Red	072872	\$32.08
V20-260	SM-2060 39" Red	072873	\$35.13
V20-272	SM-2072 45" Red	072874	\$37.70

2000 SERIES SMBW BLUE

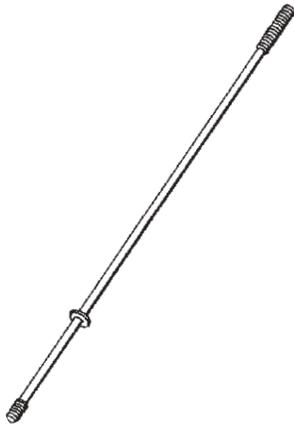

Val-Pak Part No.	Description	OEM Part No.	List Price
V20-324	SMBW-2024-21" Brass Rotor Blue	073663	\$31.47
V20-336	SMBW-2036-27" Brass Rotor Blue	073662	\$32.08
V20-348	SMBW-2048-33" Brass Rotor Blue	073661	\$32.08
V20-360	SMBW-2060-39" Brass Rotor Blue	073660	\$35.13
V20-372	SMBW-2072-45" Brass Rotor Blue	073659	\$37.70

2000, 4000 SERIES SMBW WHITE

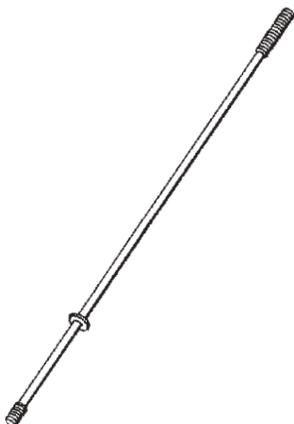

Val-Pak Part No.	Description	OEM Part No.	List Price
V20-424	SMBW-2024/4024-21" Noryl Rotor White	072870	\$32.08
V20-436	SMBW-2036/4036-27" Noryl Rotor White	072869	\$32.08
V20-448	SMBW-2048/4048-33" Noryl Rotor White	072868	\$32.08
V20-460	SMBW-2060-39" Noryl Rotor White	072867	\$35.13
V20-472	SMBW-2072-45" Noryl Rotor White	072866	\$37.70

Rods must be ordered in quantities of 5 or more.

PENTAIR/PUREX CENTER RODS (CONT.)

4000 SERIES SM RED

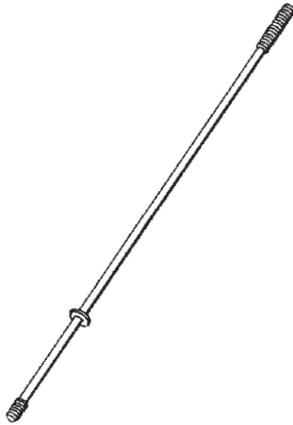

Val-Pak Part No.	Description	OEM Part No.	List Price
V20-524	SM-4024-21" Red	072875	\$32.08
V20-536	SM-4036-27"Red	072876	\$32.08
V20-548	SM-4048-33"Red	072877	\$32.08

CFM & CFW SERIES

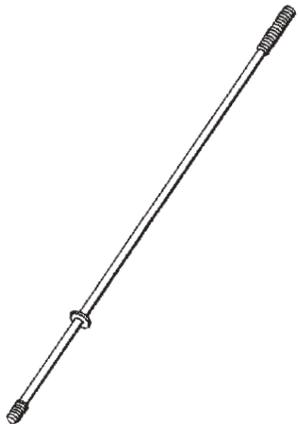

Val-Pak Part No.	Description	OEM Part No.	List Price
CFM SERIES			
V20-544	CFM-120 (18 7/8")	070666	\$30.16
V20-546	CFM-180/240 (27¼")	075147	\$30.16
V20-547	CFM-315 (33½")	070241	\$35.29
CFW SERIES			
V20-327	CFW-100 (17")	070668	\$35.29
V20-545	CFW-120 (13")	070664	\$35.29
V20-328	CFW-150 (22¾")	070665	\$35.29

Rods must be ordered in quantities of 5 or more.

2" PISTON SHAFT

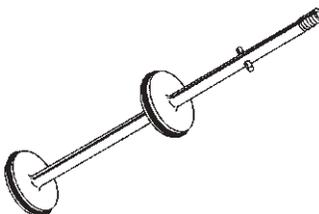

Val-Pak Part No.	Description	List Price
V20-337	Piston Shaft, 2" (CHD)	\$279.51

STA-RITE/DURA-GLAS EXPLODED VIEW

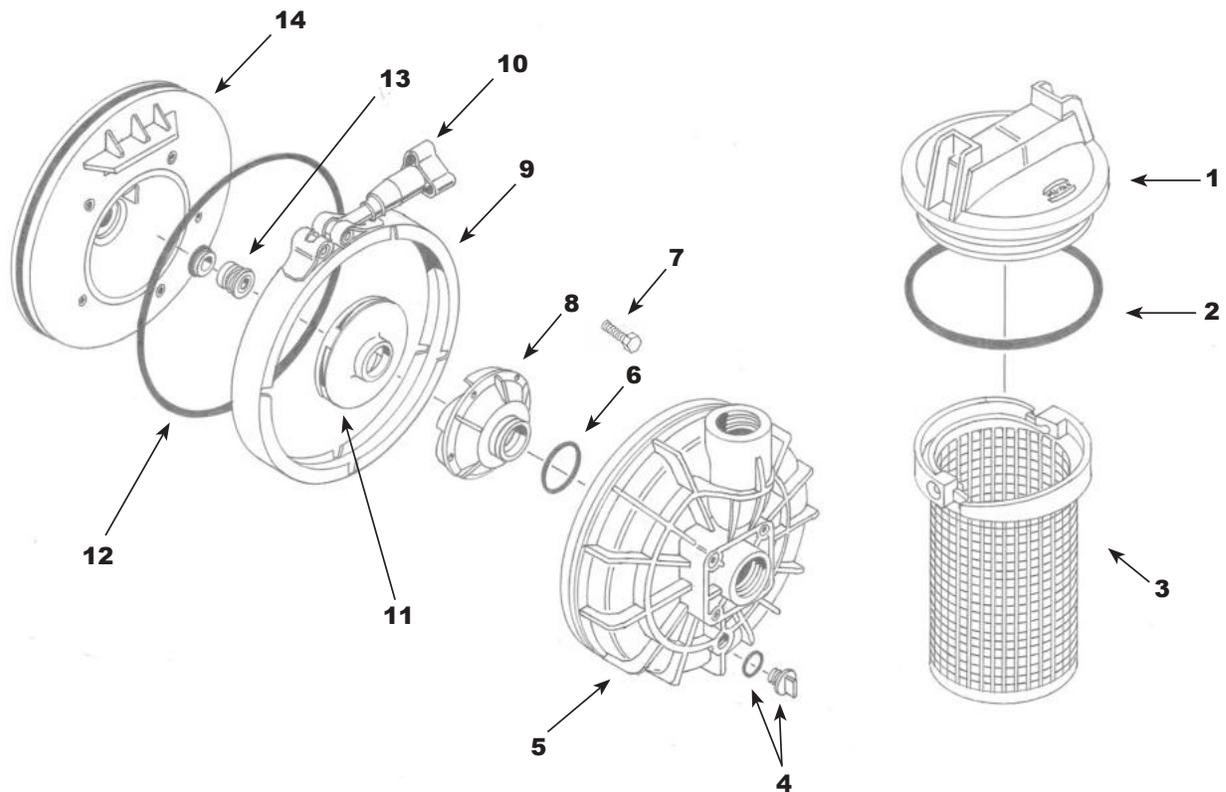

Key No.	Description	Val-Pak Part No.	List Price
1	Trap Cover	V26-361	\$37.52
2	Trap Cover O-Ring 5" (12/Bag)	V20-360	\$3.20
3	5" Strainer Basket Small Holes (16/Box)	V40-465	\$19.84
4	1/4" Drain Plug w/ O-Ring	V40-907	\$3.21
5	Tank Body (Volute)	V26-381	\$96.90
6	Diffuser O-Ring (12/Bag)	V26-368	\$1.17
7	Impeller Locking Screw	V26-352	\$5.35
8	Diffuser 3/4-2 HP (Full Rated)	V26-367	\$20.09
9	Clamp	V26-351	\$79.44
10	Clamp Knob	V26-358	\$10.86
11	1/2" Horsepower Impeller	V26-375	\$50.41
11	3/4" Horsepower Impeller	V26-376	\$50.41
11	1" Horsepower Impeller	V26-377	\$53.46
11	1 1/2" Horsepower Impeller	V26-378	\$62.63
11	2" Horsepower Impeller	V26-379	\$62.63
12	Seal Plate O-Ring (12/Bag)	V26-354	\$5.06
13	P.S. 200 S.S. Pump Seal	V40-200	\$11.00
14	Seal Plate	V26-380	\$114.75

PENTAIR/STA-RITE PUMP PARTS

6" TRAP COVER, O-RING

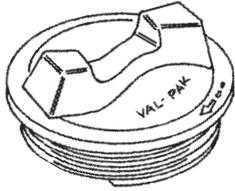

Val-Pak Part No.	Description	OEM Part No.	List Price
V26-363	Trap Cover	16920-0011	\$53.69
V26-366	Trap Cover O-Ring (12/Bag)	16920-0012	\$3.13

MAX-E-PRO / MAX-E-GLAS II TRAP COVER, O-RING



Val-Pak Part No.	Description	OEM Part No.	List Price
V26-362	Trap Cover	C3-185P	\$38.39
V26-365	Trap Cover O-Ring (12/Bag)	U9-375	\$3.35

MAX-E-PRO/ DURA-GLAS II PUMP BASKET

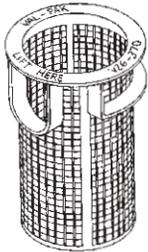

Val-Pak Part No.	Description	OEM Part No.	List Price
V26-370	Pump Basket (16/Box)	C8-58P	\$15.82

STARITE 6" PUMP BASKET

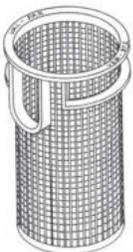

Val-Pak Part No.	Description	OEM Part No.	List Price
V26-372	Pump Basket, 6" (12/Box)	16920-0017	\$22.28

LID REMOVAL WRENCH



Val-Pak Part No.	Description	OEM Part No.	List Price
V26-007	Lid Removal Wrench for Dura-Glas/ Max-E-Glas II Pumps/Hayward Super II Pumps	SP3100T	\$24.88

PENTAIR/STA-RITE PUMP PARTS (CONT.)

STA-RITE CF-6 BRASS IMPELLERS

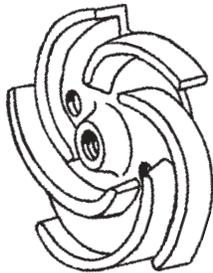

Val-Pak Part No.	Description	OEM Part No.	List Price
V40-452	1/3 Horsepower Impeller		\$130.02
V40-453	1/2 Horsepower Impeller	CS-164D	\$117.06
V40-454	3/4 Horsepower Impeller	CS-166D	\$117.06
V40-455	1.0 Horsepower Impeller	CS-183D	\$117.06
V40-456	1½ Horsepower Impeller	CS-181D	\$117.06
V40-457	2.0 Horsepower Impeller	CS-182D	\$117.06
V40-458	3.0 Horsepower Impeller		\$130.02

BRASS BRACKET

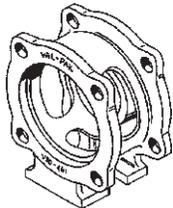

Val-Pak Part No.	Description	OEM Part No.	List Price
V30-461	1/3-3 Horsepower Bracket (w/Foot)	C2-57D	\$298.10

TRAP HANDLE

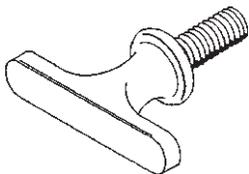

Val-Pak Part No.	Description	OEM Part No.	List Price
V40-468	Trap Handle	C154-18D	\$29.97

COPPER LINER/CAST IRON ADAPTER



Val-Pak Part No.	Description	OEM Part No.	List Price
V26-333	C3-66D Copper Liner F Series		\$83.21
V26-334	C3-67 Cast Iron Adapter	C3-67	\$90.45

**FOR THE MOST UPDATED INFORMATION
VISIT US ONLINE:**

WWW.VAL-PAKPRODUCTS.COM

PENTAIR/STA-RITE FILTER PARTS

STA-RITE SYSTEM 3 AIR RELIEF & GAUGE ASSEMBLY



Val-Pak Part No.	Description	OEM Part No.	List Price
V26-100	Sta-Rite System 3 Air Relief & Gauge Assembly	24850-0105	\$57.25

AIR RELIEF VALVE

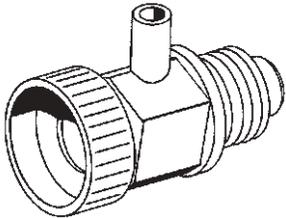

Val-Pak Part No.	Description	OEM Part No.	List Price
V38-115	Celcon Air Relief Valve 1/4" (50/Bag)	982058	\$12.29
V38-156	Replacement Valve Stem O-Ring (100/Bag)		\$0.52

THROUGH ROD



Val-Pak Part No.	Description	OEM Part No.	List Price
V26-335	247/8" S.S. 1/4" Through Rod	WC30-39	\$35.83
V26-350	36" S.S. 1/4" X 20 All Thread Rod		\$37.80

DUETTA PISTON SHAFT, O-RING KIT

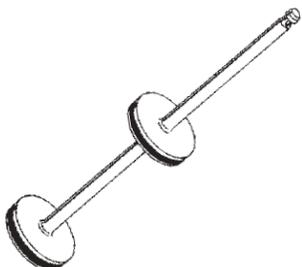

Val-Pak Part No.	Description	List Price
V26-500	Piston Shaft 2" - 15 3/4" in Length Brass	\$166.83
V22-121	Piston O-Ring Set 2" Plastic (25/Bag)	\$5.07

SWIMQUIP FILTER/SKIMMER PARTS

FILTER CLAMP

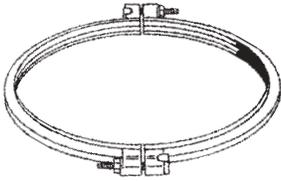

Val-Pak Part No.	Description	OEM Part No.	List Price
V22-123	DES-36 Filter Clamp	24700-0594	\$267.50

PISTON & SHAFT, O-RING SET

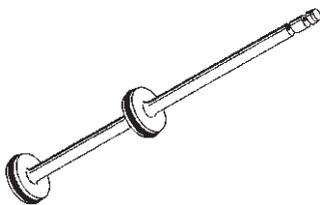

Val-Pak Part No.	Description	OEM Part No.	List Price
V22-113	Piston & Shaft 1½"-15¼" in Length	14819-11	\$173.09
V22-114	Piston & Shaft 2"-15¼" in Length	14823-11	\$173.09
V22-115	Piston O-Ring Set (1½" (25/Bag)		\$4.25
V22-116	Piston O-Ring Set 2" (25/Bag)		\$4.25

SPRING PIN

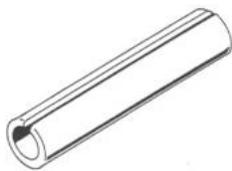

Val-Pak Part No.	Description	List Price
V22-118	Spring Pin 1/8 x 9/16" S.S. (50/Bag)	\$2.96
V22-119	Spring Pin 1/8 x 7/8" S.S. (50/Bag)	\$2.96

U-3 SKIMMER BASKET

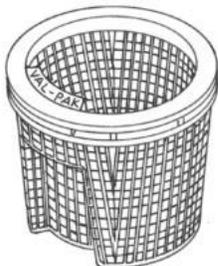

Val-Pak Part No.	Description	OEM Part No.	List Price
V22-110	U-3 Skimmer Basket (28/Box)	08650-0007	\$26.65

U-3 BRASS SKIMMER RING & LID

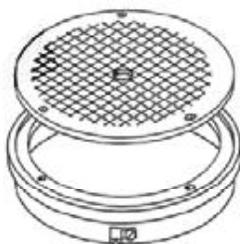

Val-Pak Part No.	Description	List Price
V22-100	U-3 Brass Skimmer Ring & Lid	\$595.80
V22-100-2	U-3 Brass Skimmer Lid with Screws	\$310.05

SWIMQUIP FILTER/SKIMMER PARTS (CONT.)

U-3 PLASTIC SKIMMER LID

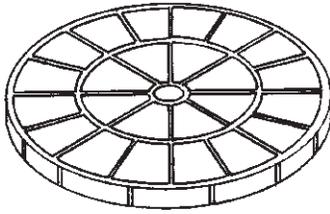

Val-Pak Part No.	Description	OEM Part No.	List Price
V22-109W	U-3 Skimmer Lid (White)	06850-0058	\$13.07
V22-109G	U-3 Skimmer Lid (Gray)	06850-0058C	\$13.07
V22-109T	U-3 Skimmer Lid (Tan)	06850-0158	\$13.07
V22-109R	U-3 Skimmer Lid (Red)		\$13.07
V22-109GN	U-3 Skimmer Lid (Green)		\$13.07

4D ELEMENT RETAINING ROD



Val-Pak Part No.	Description	OEM Part No.	List Price
V22-111	4D Element Retaining Rod S.S.	23900-0039	\$27.06

SWIMRITE EQUIPMENT PARTS

7" CLEAR LID FOR S.S. POT

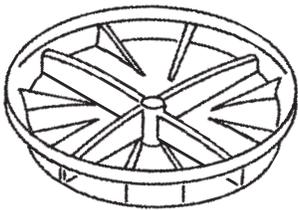

Val-Pak Part No.	Description	OEM Part No.	List Price
V30-442	Clear Lid for S.S. Pot - 7" Dia.	397048	\$90.87
V30-443	Clamp for S.S. Pot, 7"		\$94.51

SATELLITE UNDERDRAIN

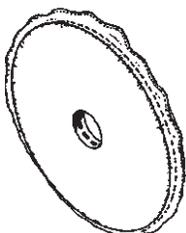

Val-Pak Part No.	Description	OEM Part No.	List Price
V30-431	Satellite Underdrain, 1½"	28-828-748	\$174.85
V30-432	Satellite Underdrain, 2"	28-828-754	\$174.85

WET INDUSTRIES PUMP PARTS

WET INDUSTRIES 6" PUMP CLAMP

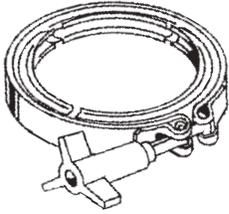

Val-Pak Part No.	Description	OEM Part No.	List Price
V65-102	Wet Industries 6" Pump	34-050-301	\$97.69

WET INDUSTRIES 6" PUMP BASKET

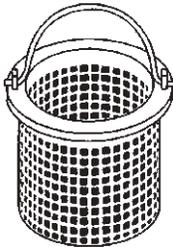

Val-Pak Part No.	Description	OEM Part No.	List Price
V65-101	Wet Industries 6" Pump Basket	34-050-304	\$33.69

WET INDUSTRIES 6" CLEAR LID, O-RING

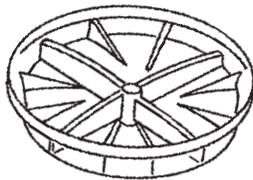

Val-Pak Part No.	Description	OEM Part No.	List Price
V65-100	Wet Industries 6" Clear Lid - 6½" Diameter	34-050-302	\$68.56
V65-103	6" Pump Lid O-Ring (12/Bag)		\$3.53

WET INDUSTRIES BRACKET

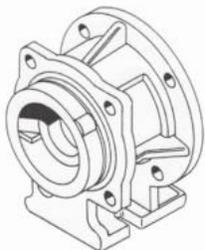

Val-Pak Part No.	Description	OEM Part No.	List Price
V65-112	Wet Industries Noryl Bracket	34-050-313	\$137.63

WET INDUSTRIES TRAP

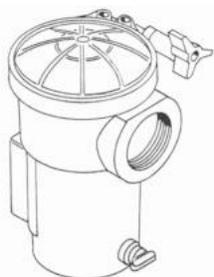

Val-Pak Part No.	Description	OEM Part No.	List Price
V65-107	Wet Industries Trap (Only)	34-050-306	\$185.59
V65-109	Wet Industries Trap Assembly (O-Ring, Lid, Clamp, Drain Plug & Trap Gasket)	34-050-322	\$370.54

MISCELLANEOUS PARTS & PRODUCTS

TOOL CADDY

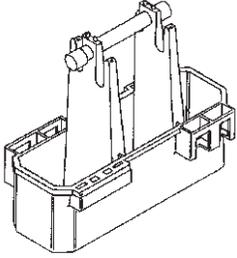

Val-Pak Part No.	Description	List Price
V50-200	Tool Caddy (Min. Order is 24)	\$79.54
V50-204	Tool Caddy (Under 24, 4/Box)*	\$84.84

*Under 24, Must Order in Multiples of 4/Box

ALGAE GUN

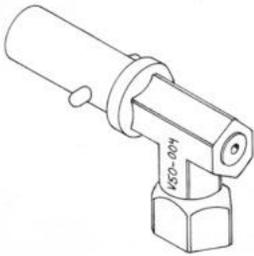

Val-Pak Part No.	Description	List Price
V50-004	Algae Gun, Water Pressure Cleaning Tool (Green and Yellow Algae)	\$37.38
V50-005	Algae Gun, Water Pressure Cleaning Tool (Black Algae)	\$37.38

BRASS DECK DRAIN GRATE



Val-Pak Part No.	Description	List Price
V65-110	3" Brass Deck Drain Cover	\$50.11
V65-111	4" Brass Deck Drain Cover	\$60.13

SOLDER



Val-Pak Part No.	Description	List Price
V42-102	1 Lb. 50/50 Solder	\$43.17
V42-103	1 Lb. 50/50 Solder (Min. Order is 50/Box)	\$39.90

EZ CLOR WINTERIZING PLUG



Val-Pak Part No.	Description	List Price
V40-400	EZ Clor Winterizing Plugs (100/Bag)	\$1.42

MISCELLANEOUS PARTS & PRODUCTS (CONT.)

ZINC BALL



Val-Pak Part No.	Description	List Price
V50-202	Zinc Ball (25/Box)	\$20.95

DECK ANCHOR WITH WEDGE

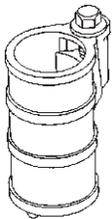

Val-Pak Part No.	Description	List Price
V40-998	Deck Anchor w/Wedge	\$73.72
V40-999	Anchor Wedge (10/Bag)	\$43.95

PLASTIC DECK DRAIN GRATE

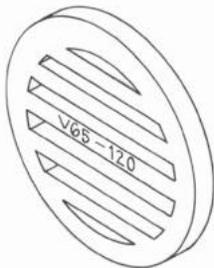

Val-Pak Part No.	Description	List Price
V65-120	3" White Deck Drain Grate	\$3.84
V65-120-G	3" Gray Deck Drain Grate	\$4.52
V65-120-R	3" Red Deck Drain Grate	\$4.52
V65-120-T	3" Tan Deck Drain Grate	\$4.52
V65-120-GR	3" Green Deck Drain Grate	\$4.52
V65-120-B	3" Brass Deck Drain Grate	\$50.55

JACUZZI, L SERIES & SWIMQUIP PUMP SHAFT

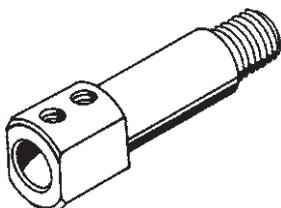

Val-Pak Part No.	Description	OEM Part No.	List Price
V45-100	Jacuzzi Pump shaft	07361009	\$43.43
V20-329	L-6 Brass Extension Shaft	071748	\$56.56
V20-374	LK-6 Brass Ext. Shaft 3-Phase	071749	\$43.43
V22-112	Pump Shaft (5/Bag)	16800-29	\$37.30
V40-401	1/4 X 20 Set Screw S.S. (100/Bag)		\$1.33

MISCELLANEOUS PARTS & PRODUCTS (CONT.)

V-CLIP

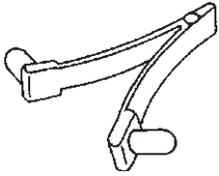

Val-Pak Part No.	Description	List Price
V50-110	Quick Change V-Clip, Black (100/Bag)	\$0.57
V50-111	Quick Change V-Clip, White (100/Bag)	\$0.57

EYEBALL/POLARIS WALL FITTING REMOVAL WRENCH

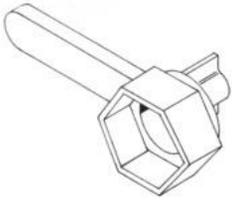

Val-Pak Part No.	Description	List Price
V50-008	Eyeball/Polaris Wall Fitting Removal Wrench (Aluminum)	\$94.60

BAKER HYDRO SKIMMER BASKET

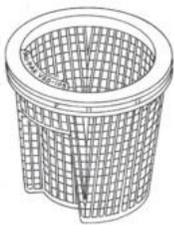

Val-Pak Part No.	Description	OEM Part No.	List Price
V50-105	Baker Hydro Skimmer Basket (12/Box)	51B1026	\$28.54

RAINBOW - HAYWARD CANISTER BASKET

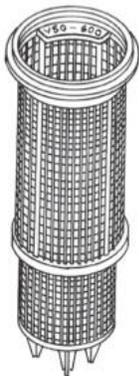

Val-Pak Part No.	Description	List Price
V50-600	Large Canister Basket (9/box)	\$47.38

WATERWAY SKIMMER BASKET

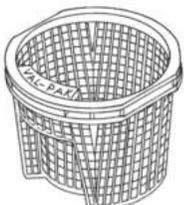

Val-Pak Part No.	Description	OEM Part No.	List Price
V50-300	Renegade Skimmer Basket with Handle (28/Box)	1593240	\$26.92

MISCELLANEOUS PARTS & PRODUCTS (CONT.)

SKIMMER COVER



Val-Pak Part No.	Description	List Price
V50-113	10" x 15" Molded Skimmer Cover (10/Box)	\$59.65

INVERTED STRAINER BASKET

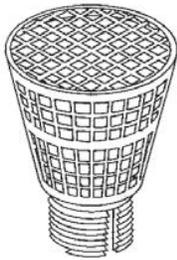

Val-Pak Part No.	Description	List Price
V50-120	Inverted Strainer Basket (28/Box)	\$27.14

HANDLE GRIP

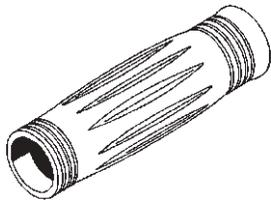

Val-Pak Part No.	Description	List Price
V50-114	Handle Grip - Red (12/Bag)	\$5.57

POLARIS IMPELLER, O-RING

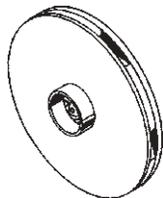

Val-Pak Part No.	Description	OEM Part No.	List Price
V50-116	PB-4 Booster Pump Impeller	P-15	\$28.66
V50-117	Volute O-Ring (12/Bag)		\$2.15

HYDROSTATIC RELIEF VALVE (BRASS)

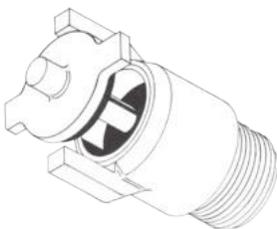

Val-Pak Part No.	Description	List Price
V50-125	Hydrostatic Relief Valve (Brass) 1.5"	\$131.71
V50-126	Hydrostatic Relief Valve (Brass) 2"	\$131.71

PUMP & SKIMMER BASKETS

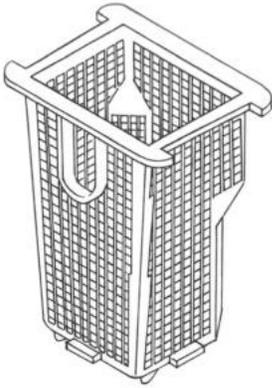

V60-500 (12/Box)
Hayward Super
Pump Basket
SPX1600M

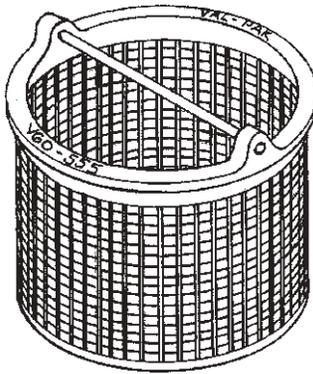

V60-555 (12/Box)
Hayward 1082
Skimmer Basket
SPX1082CA

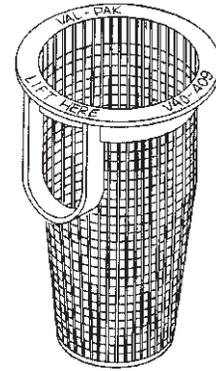

V40-409 (12/Box)
Dominator
Pump Basket

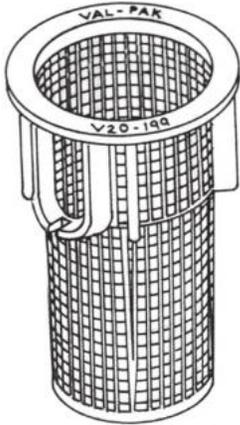

V20-199 (12/Box)
Super-Flo/Super Max
Pump Basket
355667

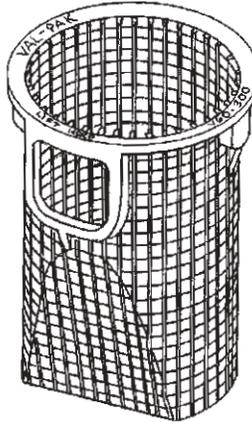

V60-300 (12/Box)
Hayward Super II
Pump Basket
SPX3000M

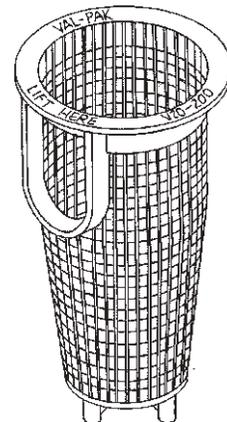

V20-200 (24/Box)
Whisper-Flo
Pump Basket
70387

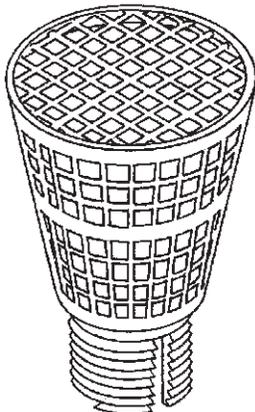

V50-120 (28/Box)
Val-Pak Inverted
Strainer Basket
B-99

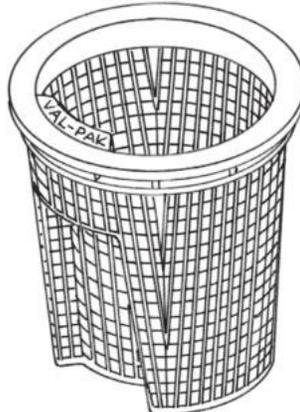

V38-125 (20/Box)
American Products
Tapered Skimmer Basket
85014500

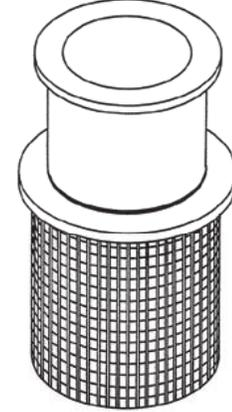

V38-135 (24/Box)
American Products
Skimmer Basket: R38013A
V38-136 Floating Weir

PUMP & SKIMMER BASKETS (CONT.)

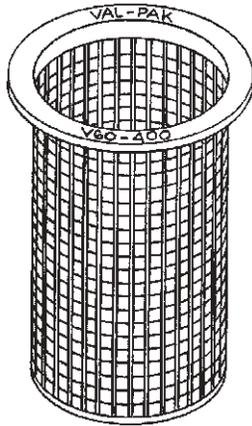

V60-400 (16/Box)
Hayward Standard
Canister Basket
AXW431A

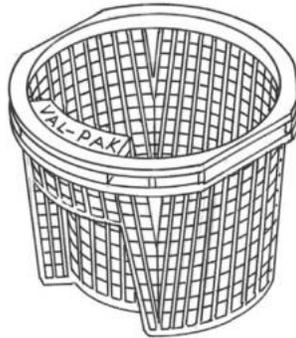

V50-300 (28/Box)
Waterway
Skimmer Basket
1593240

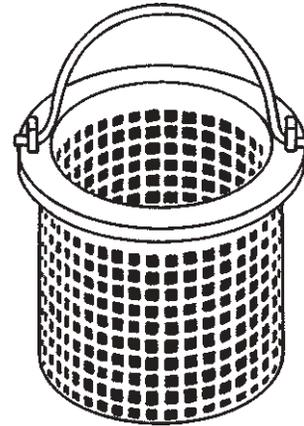

V65-101
Wet Industries
6" Pump Basket
34-050-304

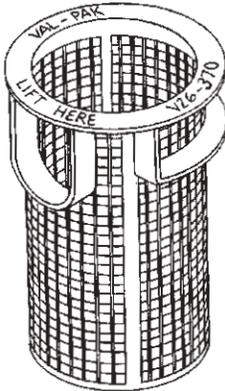

V26-370 (16/Box)
Max-E-Glas II & Max-E-Pro
Pump Basket
C8-58P

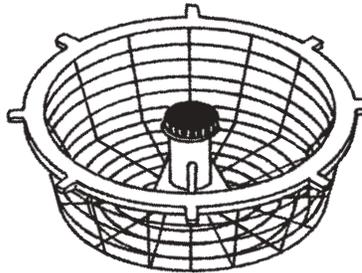

V28-600
Landon/Marlin
Skim Filter Basket
B-40

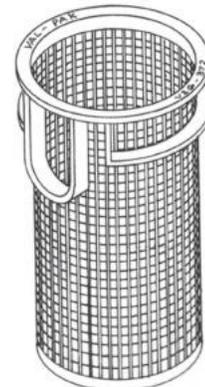

V26-372
Sta-Rite 6"
Pump Basket
16920-0017

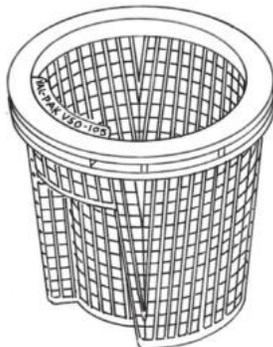

V50-105 (12/Box)
Baker Hydro
Skimmer Basket
51B1026

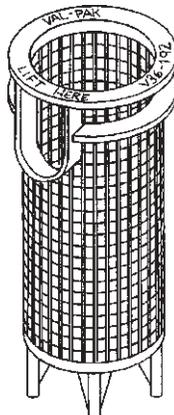

V36-192 (12/Box)
Challenger
Pump Basket
355318

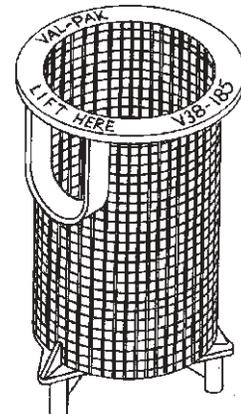

V38-185 (12/Box)
Ultra-Flow
Pump Basket
39303500

PUMP & SKIMMER BASKETS (CONT.)

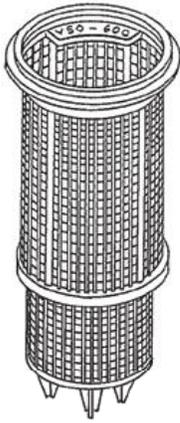

V50-600 (9/Box)
Rainbow-Hayward
Lg. Canister Basket
R211526

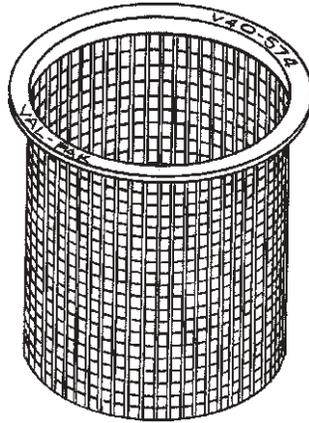

V40-574
Martin/Aqua-Flo/Premier
8" S.S. Pump Basket

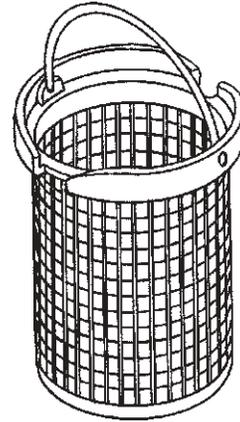

91110000 (16/Box)
Aqua-Flo/Martin/Premier
5" Strainer Basket Lg. Holes

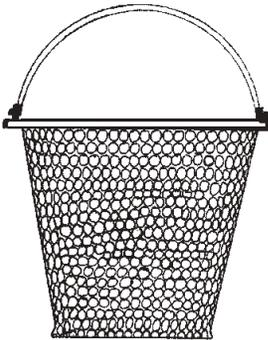

V20-312
C-Series S.S.
Pump Basket
72795

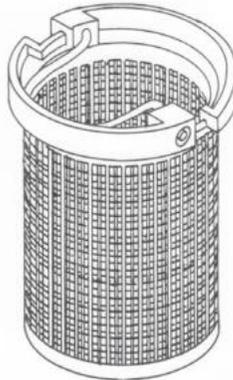

V40-465 (16/Box)
Dura Glas
5" Strainer Basket Sm. Hole
C108-33P

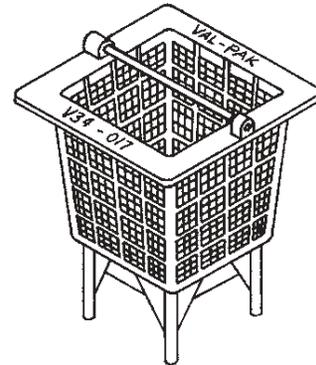

V34-017 (18/Box)
Anthony
Skimmer Basket
2908

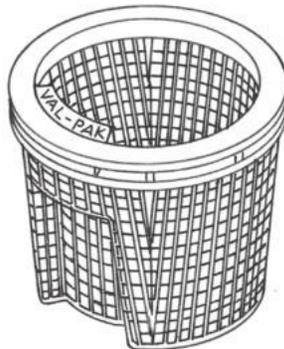

V22-110 (28/Box)
Aladdin: B-9
Hayward: SPX1070E
Bermuda: 516112
Pentair/U-3: 08650-0007
(Swimquip/Sta-Rite)

\$6.95



ALL PRODUCTS MANUFACTURED IN SANTA CLARITA, CA



20731 CENTRE POINTE PKWY.
SANTA CLARITA, CA 91350

1-800-798-5123 | Fax: 661-252-0117

www.val-pakproducts.com | info@val-pakproducts.com