



Andy Mannhart

be professionally
equipped

E-Catalogue | updated July 2018

"Happiness is a great kitchen"

Paul Bocuse

TABLE OF CONTENTS





Buffet Display & Chafing Dishes **4**



Storage & Cleaning **5**



Bakery & Pastry **6**



Trolleys & Dispensers **7**



Kitchen Machines **8**



Bar **9**

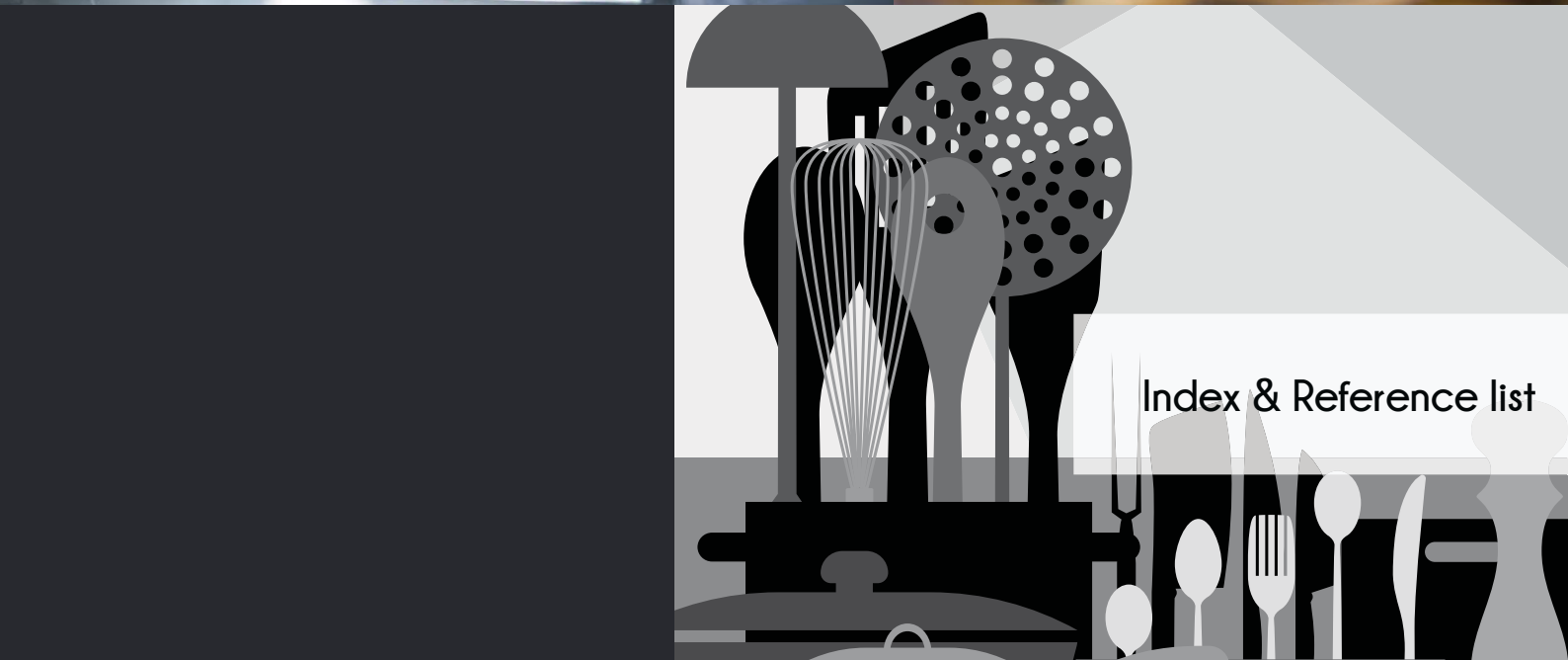

Index & Reference list

Welcome to Andy Mannhart AG



Head Office in Küssnacht, Switzerland



E-Catalogue



Video

News in this edition:

Smart Presentation....

Chapter Front of House: Full range of Copper pots / pans
Chapter 2: Salt / Pepper / Spices Mills
Chapter 4: Fondues and more

Latest in Technology....

Chapter 8: Dry Ager / Josper Charcoal Oven

Front of House...

Chapter Front of House: Venta Buffet Concept / livecookintable / InductWarm by Gastros

Team in Küssnacht

Daniel Sutter
CEO
daniel.sutter@andymannhart.com



Michaela Muff
Head of Finance & Accounting
cfo@andymannhart.com

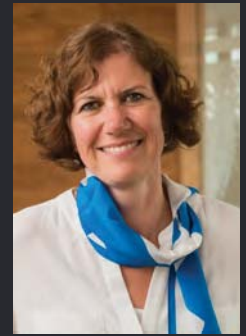

Regula Schiegg
Marketing Manager
regula.schiegg@andymannhart.com



Sascha Sutter
Business Development Manager
sascha.sutter@andymannhart.com

Markus Gubler
Head of Customer Service & Logistics
info@andymannhart.com



Tommaso De Pascali
Customer Service
info@andymannhart.com



Sabine Glaser
Customer Service
info@andymannhart.com



Sabrina Zbinden
Customer Service
info@andymannhart.com



Martina Furrer
Customer Service
info@andymannhart.com



Beat Truttmann
Logistics Manager
info@andymannhart.com



Judith Herger
Logistics
info@andymannhart.com



Team in Bangkok and Kuala Lumpur



Pilaiporn Chucherd
Branch Manager
info@andymannhart.com



Chutima Srichart (Orm)
Customer Service
info@andymannhart.com

Poonsak Chucherd (Pan)
Customer Service
info@andymannhart.com

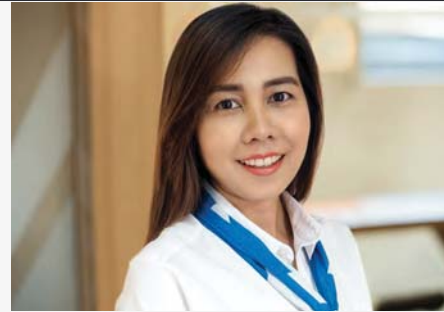

Monthira Kongyim (Fon)
Customer Service
info@andymannhart.com



Maneerat Choosiphath (Sa)
Customer Service
info@andymannhart.com



Zulfadzli Ahmad (Zul)
Corporate Graphic Designer (Group)

Andy Mannhart key legend and green initiatives



- BPA stands for Bisphenol A. BPA is an industrial chemical that has been used to make certain plastics and resins since the 1960s.



- Andy Mannhart's latest innovations



- Made of at least 50% recycled material or 50% less energy consumption

induction

- Suitable for induction



Matterhorn . Zermatt, Switzerland . Photo by: Zulfadzli Ahmad



Eco friendly disclaimer : This catalogue has been printed using an eco friendly material

Online E-Catalogue Andy Mannhart

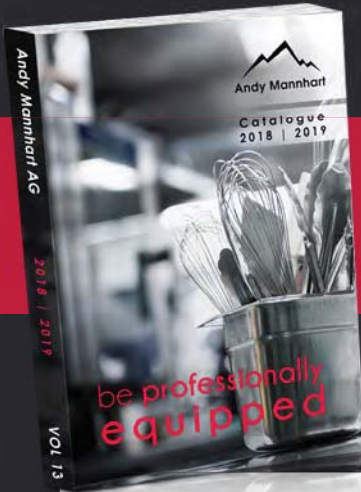

The Andy Mannhart Catalogue Vol13 2018/2019 is available as E-Catalogue on our homepage <https://www.andymannhart.com/en/E-Catalogue>



The E-Catalogue offers fully interactive features from selecting, searching, offers, etc.

- 1 Zoom in / out the page
- 2 Search for particular product
- 3 Activate the thumbnail page preview
- 4 Activate table of contents
- 5 Save desired single page
- 6 View your selected item in shopping cart
- 7 Recommend page to clients / partners
- 8 Flip to your desired page or chapter



7

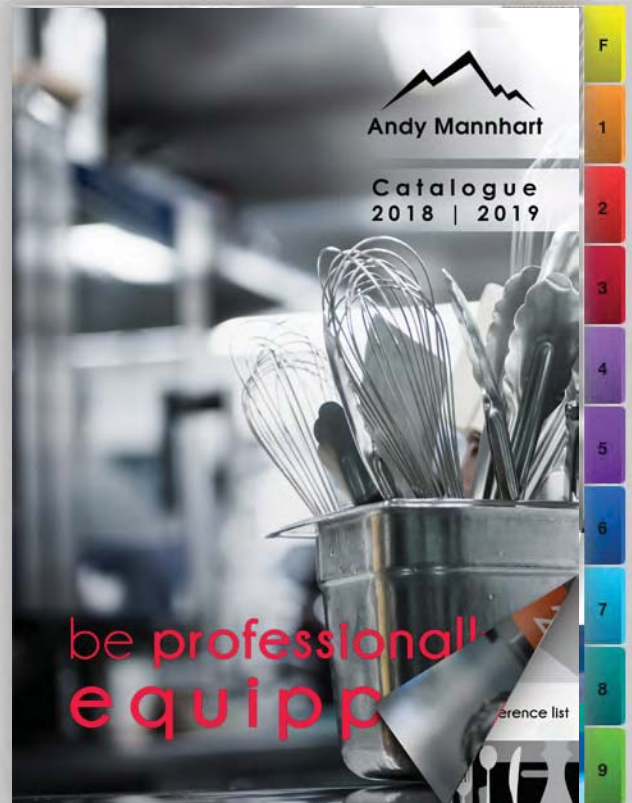

You also may request an offer :

		D cm	H in cm	Cap. lit	Infection
1	317310	Paella pan with 2 handles	20.0	0.0	1.9
	317311	Paella pan with 2 handles	24.0	0.0	2.7
	317312	Paella pan with 2 handles	28.0	0.0	3.7
	317313	Paella pan with 2 handles	32.0	0.0	4.3
	317314	Paella pan with 2 handles	33.0	0.0	4.7
	317315	Paella pan with 2 handles	35.0	7.0	6.7
	317316	Paella pan with 2 handles	40.0	0.0	10.0
	317317	Paella pan with 2 handles	45.0	0.0	12.0
	317318	Paella pan with 2 handles	50.0	0.0	17.5
	317319	Paella pan with 2 handles	60.0	10.0	28.0

		D cm	H in cm	Cap. lit	Infection
	317315	Stock pot with tag, lid and grate	29.0	29.0	16.5
	317316	Stock pot with tag, lid and grate	32.0	32.0	24.0
	317317	Stock pot with tag, lid and grate	35.0	35.0	25.5
	317318	Stock pot with tag, lid and grate	40.0	40.0	50.0
	317319	Stock pot with tag, lid and grate	45.0	45.0	73.0

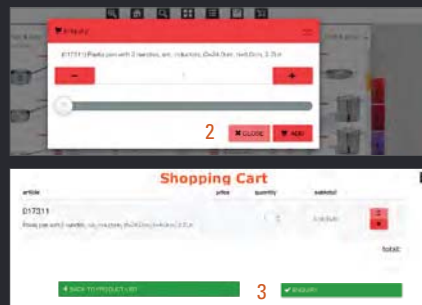

- Step 1: Choose a product by clicking into the red field which covers the article number
- Step 2: An enquiry window will appear – select your quantity and click ADD
- Step 3: Check your shopping cart for confirmation and click on ENQUIRY
- Step 4: Fill in your contact details
- Step 5: Select the way of transmission by choosing the "Print" or "via Mail" button



Andy Mannhart

FRONT OF HOUSE

Latest Trends in Food Display & Live Cooking



THE BAUKASTEN

There are many modular systems, but a Baukasten is much more than just modular. Like Lego, for example. Children are already able to create an unlimited number of creative worlds from Lego bricks. They do not have to be particularly gifted or skilled to do this. The standardised bricks can always be stacked precisely. For nothing is accidental with a Baukasten. Everything follows a system, like our livecookintable® Baukasten. The creative power of a Baukasten is still underestimated. Modular systems like our livecookintable® Baukasten are based on standardised processes and on standards. This makes them the real driving force of progress, diversity and creativity.

DESIGN + ENGINEERING

Norbert Fischbach comes from cooking to design. He is no stranger when it comes to dealing with food professionally. In his early career he continued the family tradition as a Pastry Chef in Michelin Stars awarded kitchens. Simone Heckmann who comes from Architecture to cooking, brings in her well founded training and her experience as an Architect and Designer. Product Design, Engineering and Room Planning are her core competences. The Team of MEC2 is livecookintable® - together with our distributor Andy Mannhart - and we all love what we do!

MEC2



CATALOG



Video



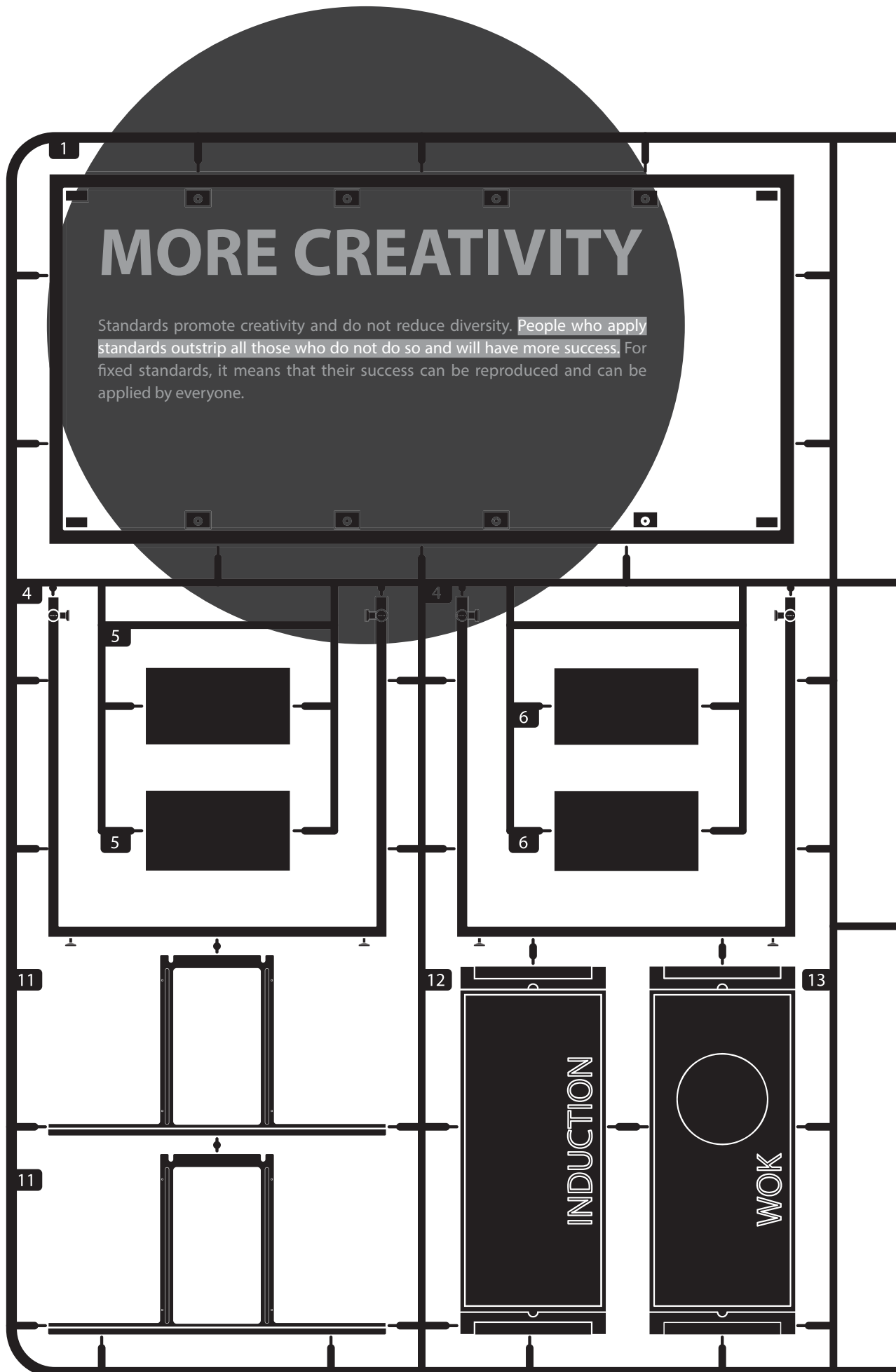

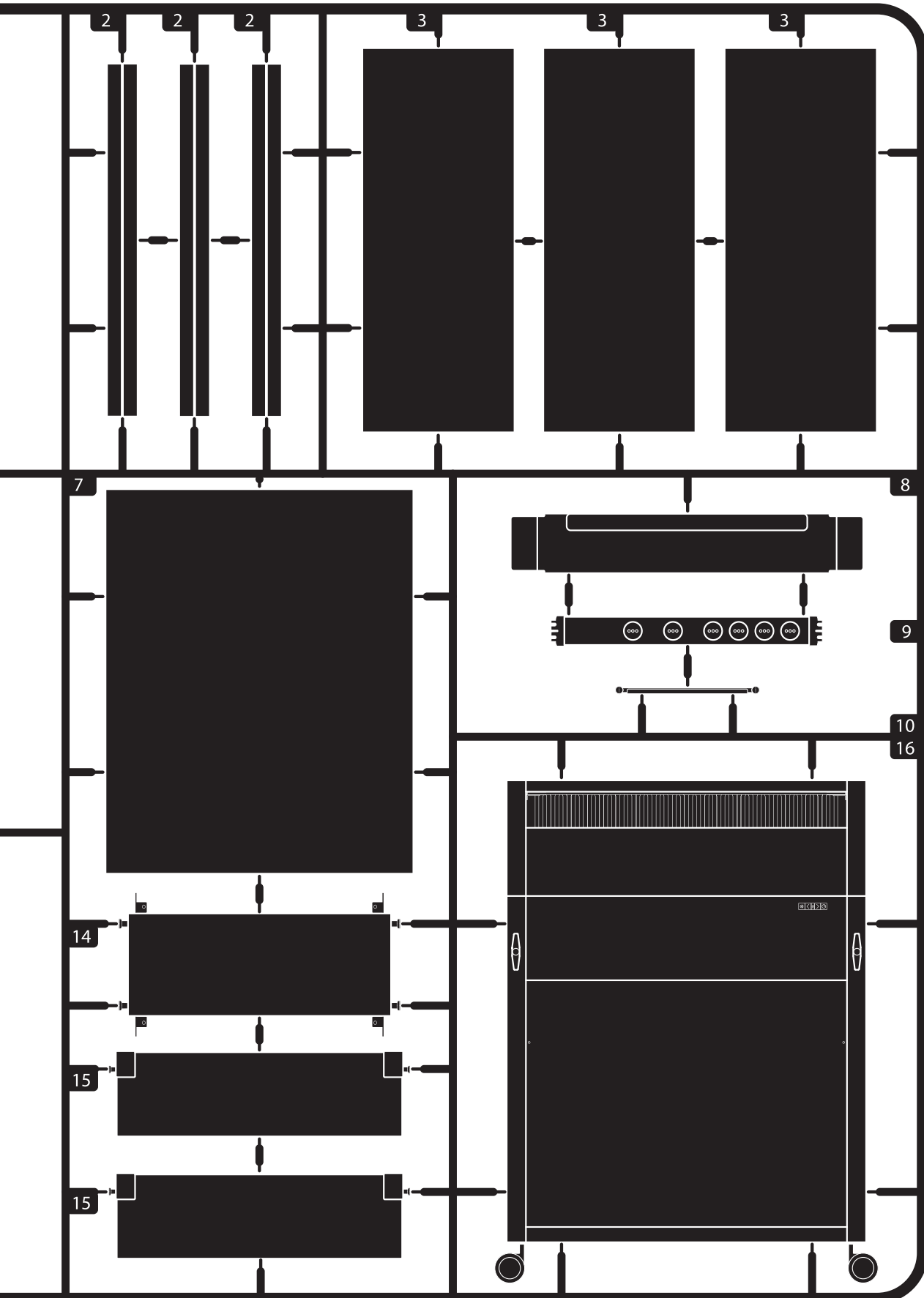

RESTAURANT

ASIAN
FUSION

WESTERN
GRILL

PASTA
PASTA

BU

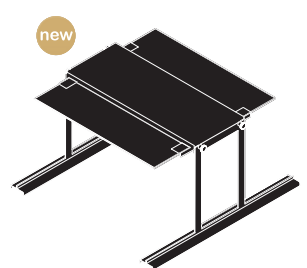
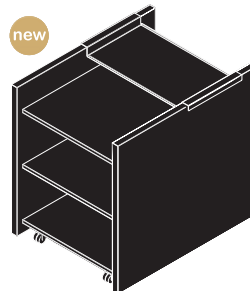
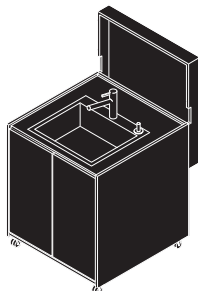
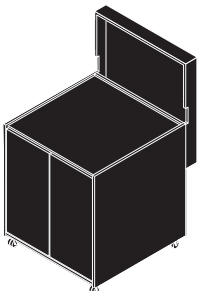
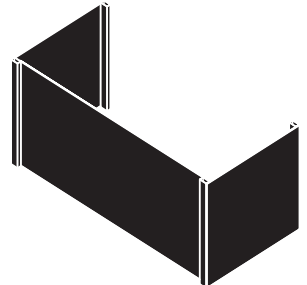
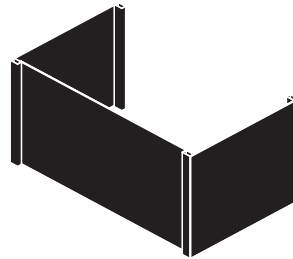
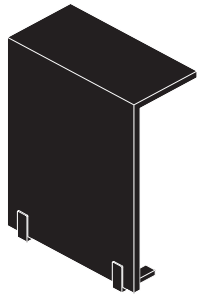
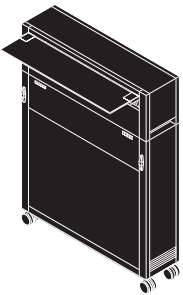
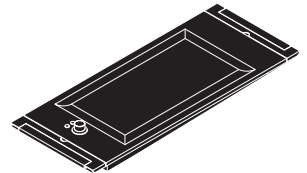
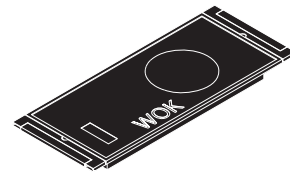
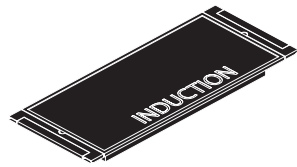
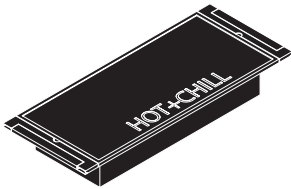
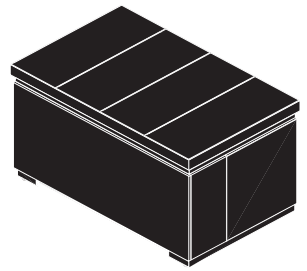
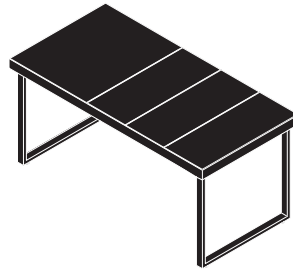
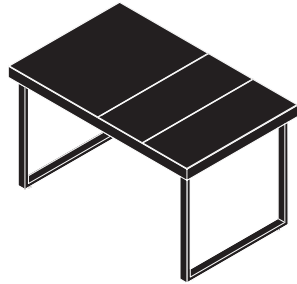
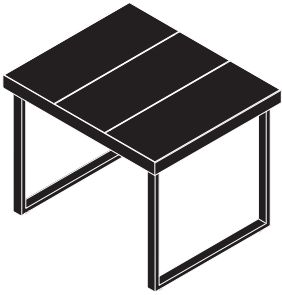

FFET

SUSHI
YAKI

CHINA
DIM-SUM

BAR

RECEPTION DESK

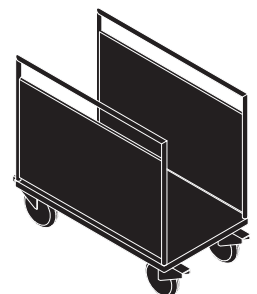
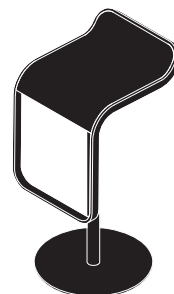
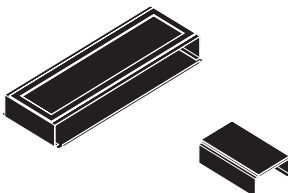
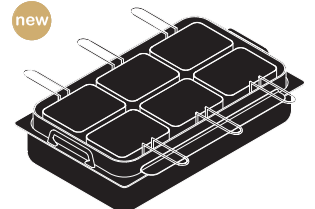
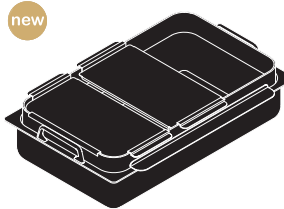
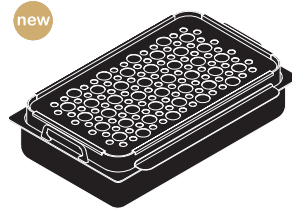
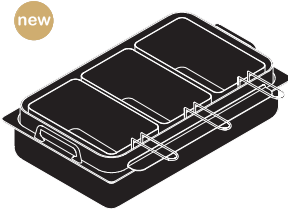
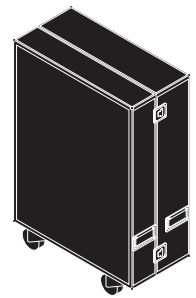
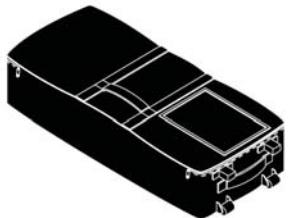
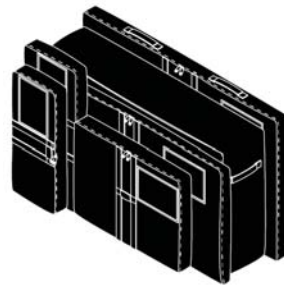
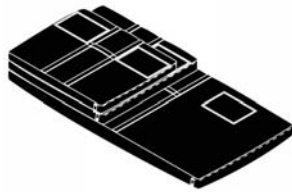
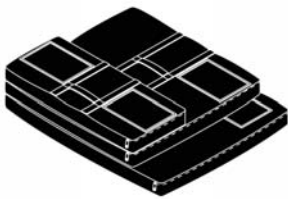



OUR BRAND VALUES

- 01 livecookintable features **experience, interaction and communication.**
- 02 The timeless product design: **Form follows function, Form follows emotion.**
- 03 The high brand awareness. **livecookintable is distinctive.**
- 04 **livecookintable is indisputable the leading international brand in design and engineering. MEC2 won numerous design awards for its contemporary design language.**
- 05 The brand reputation. livecookintable has a credible product biography. **The only brand following no „copy and paste“ strategy from the beginning. Genuine product range, characterized by what we call the distinctive livecookintable DNA.**

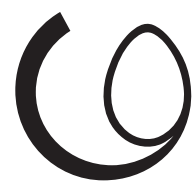
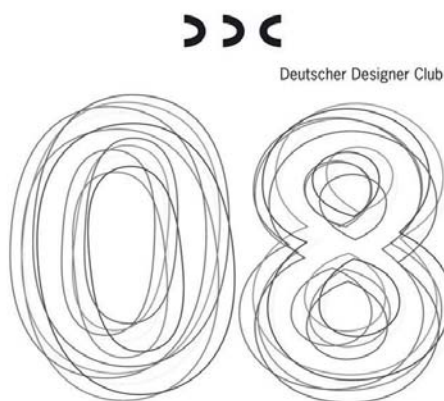

DESIGNPREIS
2009

NOMINEE



Unique selling points: 18 good reasons

- 01 Highest value for money! 50% less livecookintable units needed as against the competitors while ensuring the same pax capacity.
- 02 The table design provides the widest possible variety of uses.
- 03 The unique Baukasten enables you to create all F&B concepts out of one single system.
- 04 livecookintable designs the room! A contract furniture with cooking function, not just a buffet or a cooking station.
- 05 Levelling the heights: Perfect work and presentation level.
- 06 We are technical buffet furniture designers with its own device engineering.
- 07 Specially designed equipment, designed exclusively for livecookintable and extremely flat built.
- 08 The 2 in 1 principle: two functions in one device to reduce the number of devices.
- 09 Free positioning in the system without restrictions, always oriented to the daily needs.
- 10 Our 360° food logistic concept significantly increases the pax capacity per hour per table.
- 11 All devices and table segments are Gastronom-sized. Only one system for back-of-house and front-of-house.
- 12 Maximum storage space for mise-en-place under the tables. Plenty of space for hot and cold cars and shelves.
- 13 Intuitive user interface, no installation service needed, no tools required.
- 14 Smallest possible packaging, unique storage and transport logistics through bags and wheeled cases.
- 15 Easy change of all decors for all surfaces, can be updated at any time at very reasonable prices.
- 16 Most efficient, autonomous air cleaning in the market. 5 years maintenance free. In-house filter change not requiring professional service.
- 17 No expensive services: Easy in-house care, maintenance and cleaning.
- 18 The average number of warranty cases is between 1% and 1‰ only.





013540



016522

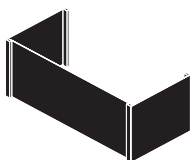

005772

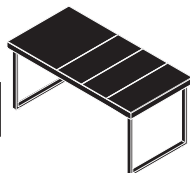

026126

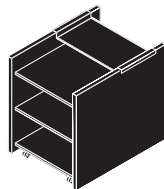

032170
032171



032166



005707

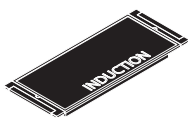

026902

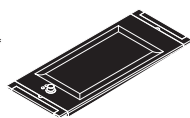

003425



004752

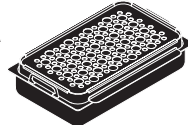

031061
031066

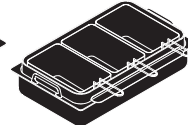

031061
031065

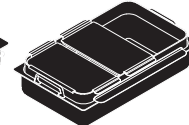

031061
031063

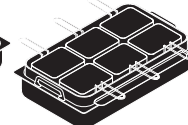

031061
031064

Pop-up Restaurant

Capacity paxe/h: 75

Efficiency paxe/day: 300

Amortization cost/pax
by 60% average occupancy: 0,16 EUR







026126

016522

005772

030867

026902

020942

026125

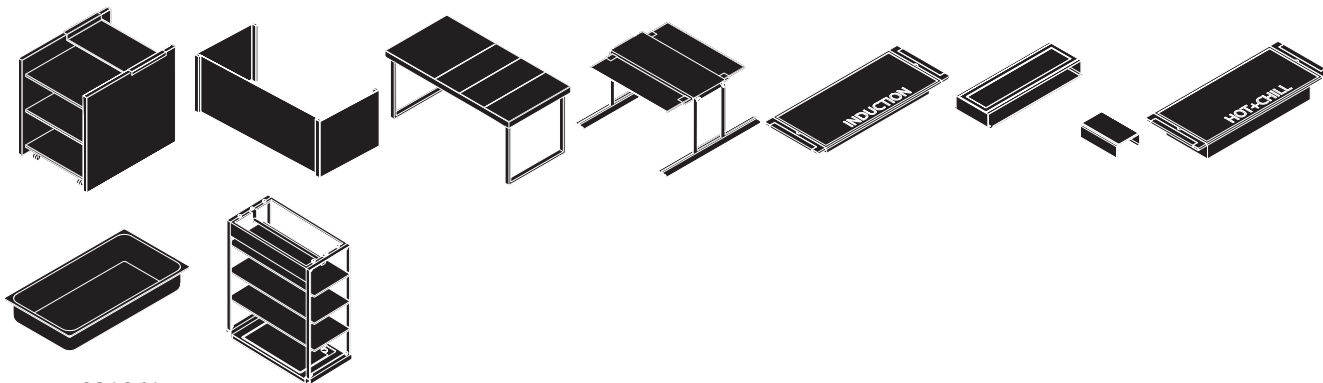

031061

Buffet Restaurant

Capacity paxe/h: 250

Efficiency paxe/day: 750

Amortization cost/pax
by 60% average occupancy: 0,08 EUR







003444

016522

005772

026126

032170
032171

030867

020942

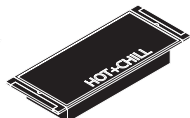
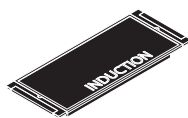
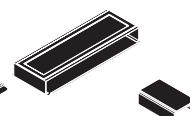
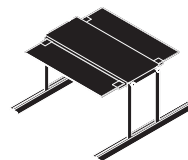
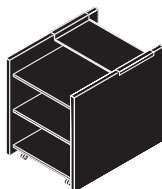
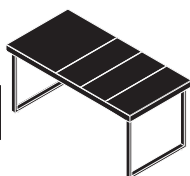
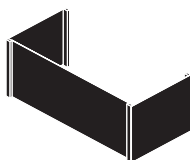
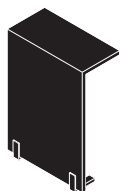

026902

026125

Terrace, Patio and Garden

Capacity paxe/h: 150

Efficiency paxe/day: 450

Amortization cost/pax
by 60% average occupancy: 0,09 EUR



MULTISTATION new

026126



- 037704 Rack new
- 037703 3 Shelves new
- 040074 Decor panel new
- 038402 Tray s/s new



- 037666 Duck hanger new
- 037667 Cutting board new
- 038402 Tray s/s new
- 038675 Container GN 1/1 new

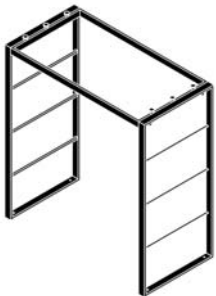

037704

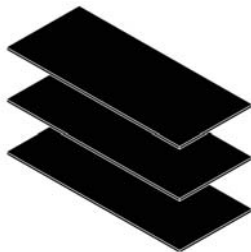

037703



040074



038402



037667



037666

Top element for multistation

Carving station with cutting board and GN-container
 Expandable by Beijing Duck - Duck hanger
 Expandable by 3 shelves
 Expandable by heatbridge
 Expandable by LED lighting

Application examples:
 01 Porcelain shelf
 02 Coffee and Tea station
 03 Bread and Butter station
 04 Condiment, herbs display
 05 Cooling display



BUFFETGUARD

030867

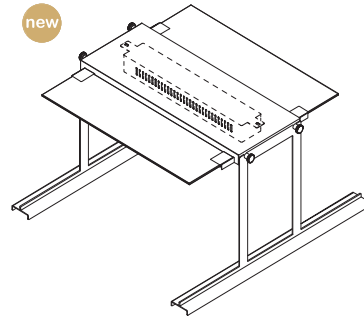
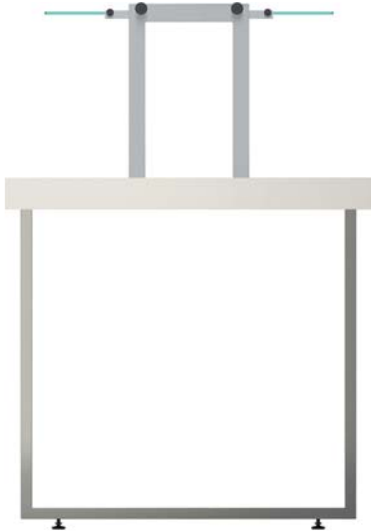

030867 Buffet Guard +
030868 Heatbridge



↓ PDF en

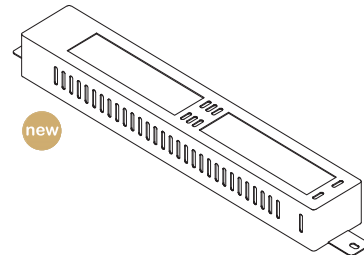

030868 Heatbridge



↓ PDF en

Art 030867 Buffet Guard for 2 table segments. Freely positionable, maintaining full functionality. Can be supplemented by Art 030869 LED lighting, alternatively by Art 030868 Heat Bridge.

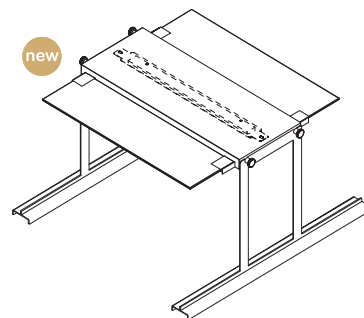

030867 Buffet Guard +
030869 LED Lighting

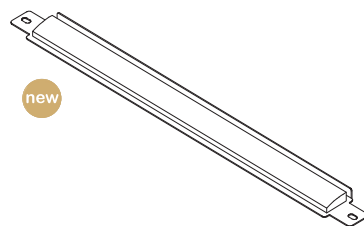
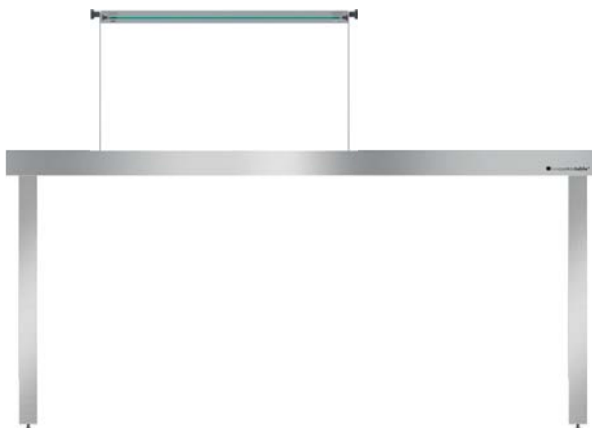

030869 LED Lighting



↓ PDF en

MULTI POT 1/1 new

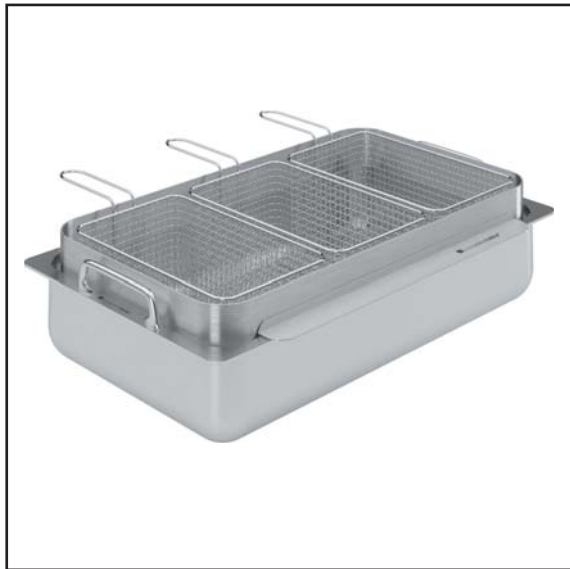
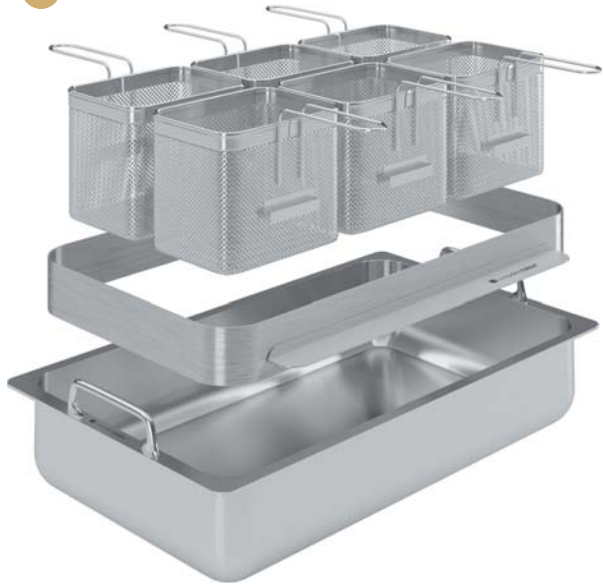
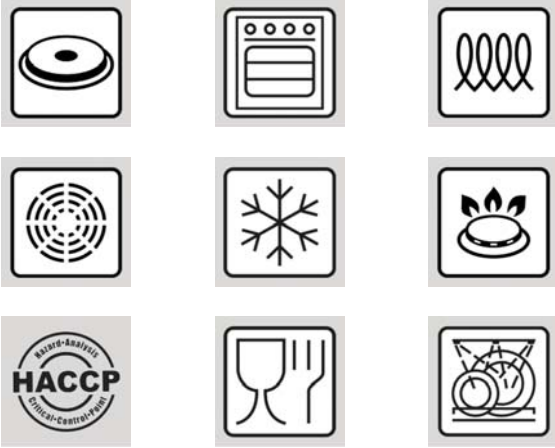

induction

new

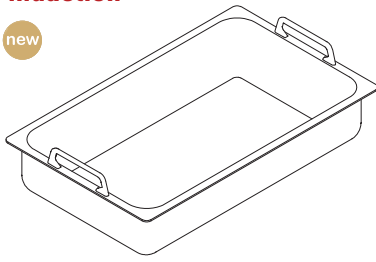

031061 Multi Pot Base (1/1 GN SwissPly Cooking Pot plus top element)

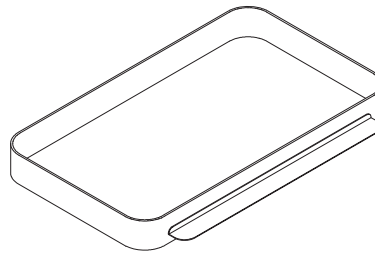

031063 Multi Pot Lid

new

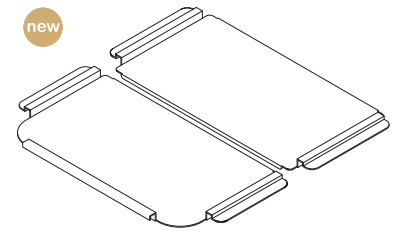

new

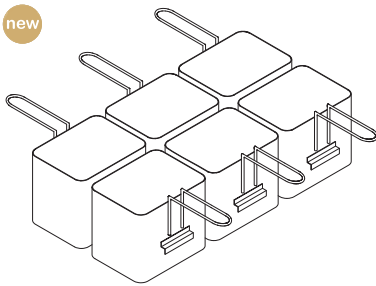

031064 Multi Pot Pasta Baskets

new

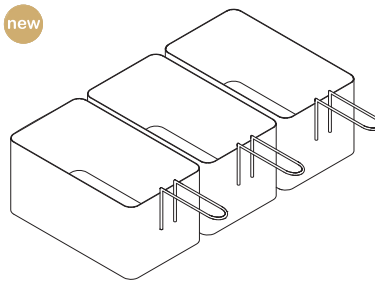

031065 Multi Pot Frying Baskets

new

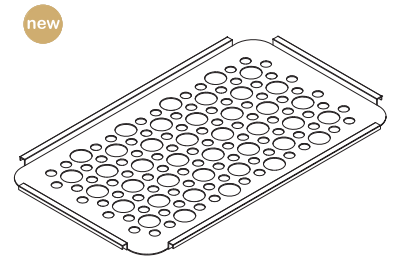

031066 Multi Pot Dimsum Plate

induction

new

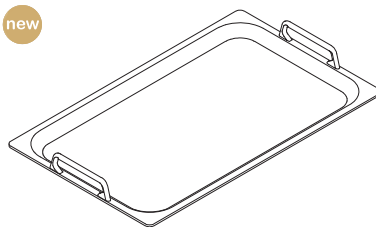

032166 Teppan Griddle Plate

031061 Multi Pot

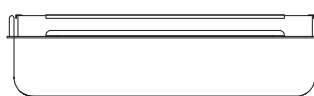

530 mm
1/1 GN

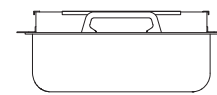

353 mm
1/1 GN

135-145 mm

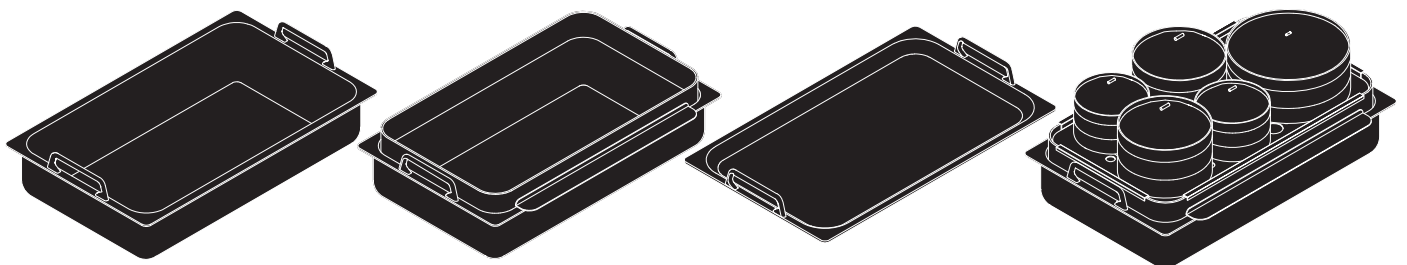

to cook, to hold hot, to braise

to cook, to blanch, to fry

to grill, to pan-fry

to steam



005772 Set Professional 5

Frame 5
 Buffet Legs
 Cable Tray
 Tabletops for one table



2 Years Warranty

1.4301

Platinum Satin Brush



60 kg net/ 80 Kg



3 x 16A, 230V



Easy to clean



1946 mm



970 mm

925 mm



↓ Video

005771 Set Professional 3

Frame 3
 Buffet Legs
 Table tops for one table



Easy to clean



2 Years Warranty

1.4301

Platinum Satin Brush



38 kg net/ 47 Kg



1176 mm



970 mm

925 mm





006954 Set Professional 4

Frame 4
Buffet Legs
Cable Tray
Tabletops for one table



2 Years Warranty

1.4301

Platinum Satin Brush



53 kg net/ 69 Kg



3 x 16A, 230V



Easy to clean

1558 mm



970 mm

925 mm

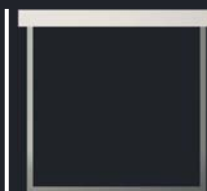

↓ PDF en



026126 Multistation

new



1 Year Warranty



Easy to clean

1.4301

Platinum Satin Brush



Made in EU (D)

750 mm



970 mm

925 mm

Multifunction shelf with double rollers for high load, (plates and buffet ware), 30 kg per shelf, heavy duty plywood, both sides 1mm laminate.



019922 Set Moove 4

Chassis Moove 4
 Frame 4
 Segment Bar
 Electro Fix
 Tabletops for one table



2 Years Warranty

1.4301

Platinum Satin Brush



106 kg net/ 136 Kg



3 x 16A, 230V



Easy to clean



Caster wheels



↓ Video



↓ PDF en

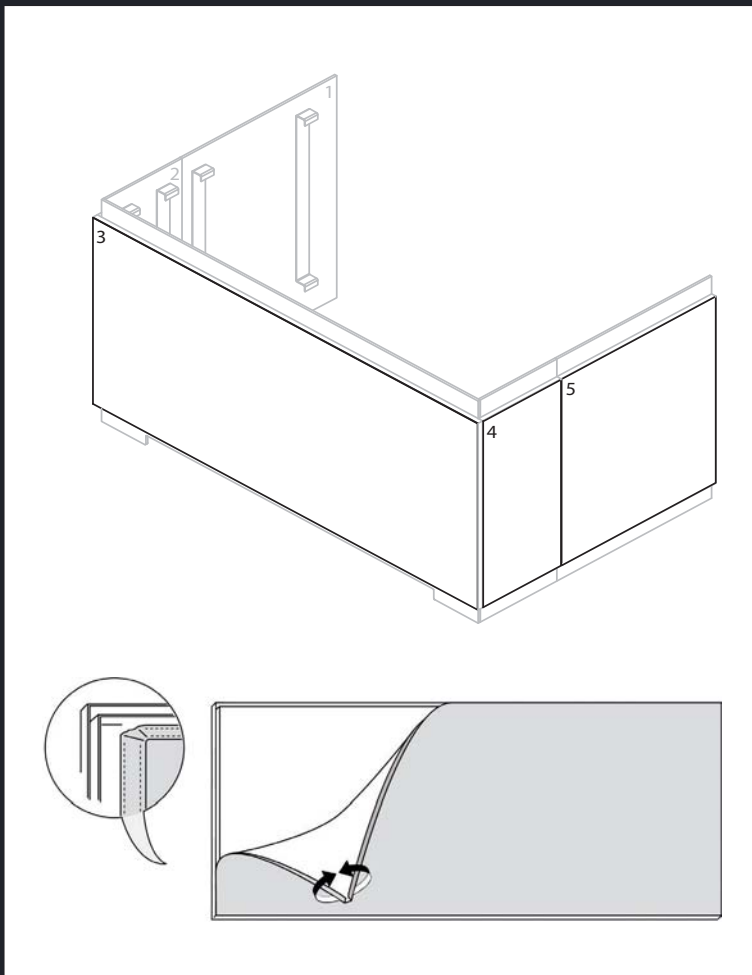

CDF side panels, laminated with mounted clip-in frame with a deco high-performance material (Designs). Changes can be done on the fly, no knowledge necessary.

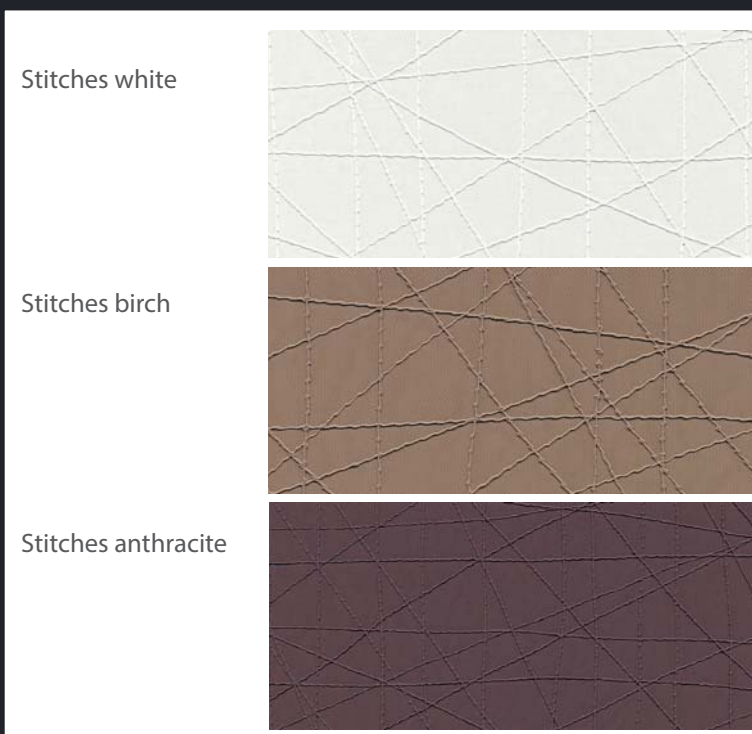

019923 Panel Standard Design

new

for 019922 Moove 4



Easy to clean



No machine wash



Non iron



Washable by hand



1 Year warranty



Technical properties:
long-lasting, tear-resistant,
abrasion-resistant, lightfast,
flame-retardant BS5852 0+1

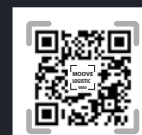

↓ Video

F6494095 sharkgrey

Outdoor: High-quality upholstery material with a classic cowhide grain. The material is especially used in sophisticated outdoor and contract applications. It is particularly well-suited for boats and yachts.
Palette spans 11 trendy colours.

**F6495017 black**

Outdoor: It reduces the heat build-up of the surface when exposed to direct sunlight. The nano coating makes the material extremely weather, UV, and dirt resistant.
Palette spans 12 trendy colours.

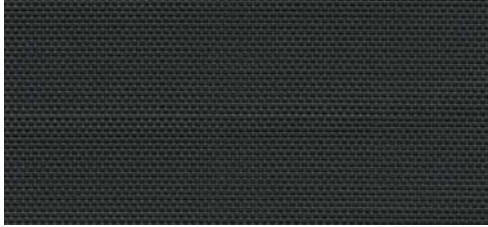
**F6411214 black**

Indoor: high-quality upholstery material with a textile look. The material is notable due to its compliance with the rigorous B1-flame resistance standard. 15 trendy colours, pleasant feel, extremely detailed embossing make it a genuine premium product.

**F6411228 gold**

Indoor: high-quality upholstery material with a delicate textile structure. The material looks elegant and classy in trendy metallic shades. It meets the rigorous B1-flame resistance standard.
Palette spans 16 trendy colours.

**F5076036 pearl**

Indoor: Pearl fascinates with its unique manta ray look. Its special allure results from its interesting colour contrast and a fine play of matt and shiny areas due to grain valleys and lacquered peaks.
Palette spans 13 trendy colours.

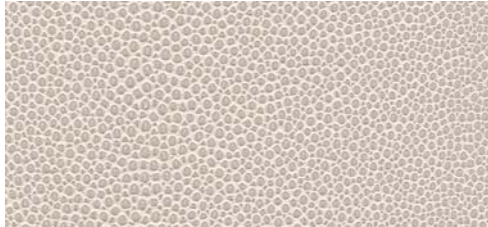
**F6800041 birch**

Indoor: High-quality first generation nature base material. It has a surface that feels very pleasant with a characteristic leather grain. As is the case with its natural prototype, the depth of the grain valleys varies, underscoring the natural impression. Palette spans 17 trendy colours.

**F5076088 ivory**

Indoor: a high-quality upholstery material with an attractive seam look, which gives the impression of being handmade. It has crisscrossing virtual quilted seams that form classical rhombi, which give the material a special elegance and sophistication. The feel is particularly pleasant.
Palette spans 8 trendy colours.

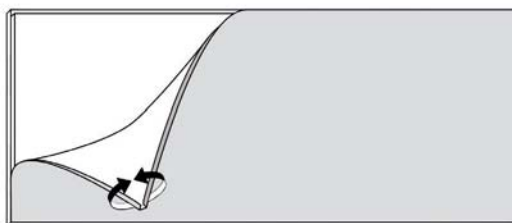
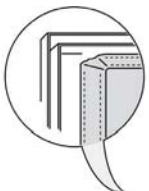
**020251 Panel Individual Design** new

for 019922 Moove 4



Easy to clean



No machine wash



Non iron



Washable by hand



1 Year warranty



Technical properties:
Dessins available with different properties, eg. tear-resistant, long-lasting, lightfast, flame-retardant BS5852 0+1, fulfills REACH requirements, easy-to-clean, partly resistant to disinfectants, normal to highly resistant to abrasion, lightfast, waterproof, resistant to chlorine, resistant to saltwater, UV-stable

Random Selection
More Designs
upon request

INDIVIDUAL

INDIVIDUAL

Monocrete 3563-TS
Traceless

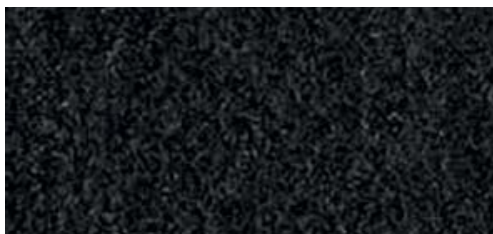

Marmo Bianco
3570-RM



Linen 3115-AJ



Colourado 3527-RM



Marmo Nero 3577-RM



032161 Tabletop Individual

new



Tabletop in HPL. Individual decor upon request. Front- and backside the same. Outdoor and Indoor. Minimum acceptance.

Technical properties:
resistant to steam, light, heat, scratch, abrasion, impact, staining. Spread-of-flame-retardant French standard NFF 16101, F2

for
019922 Moove 4
005771 Set Professional 3
006954 Set Professional 4
005772 Set Professional 5

Random Selection
More Decors
upon request

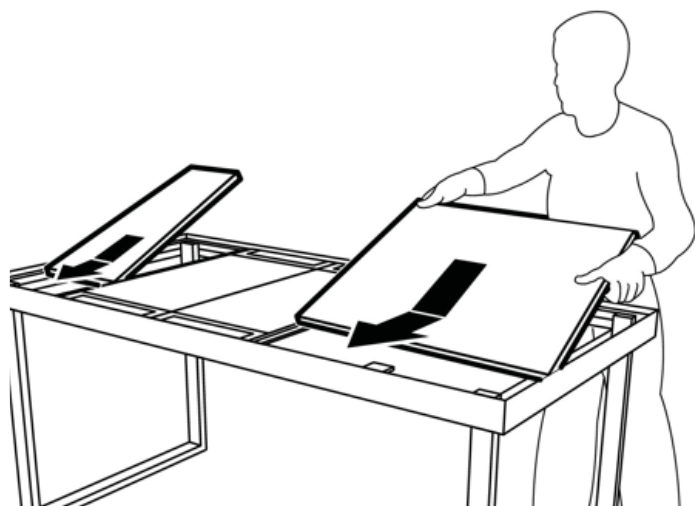

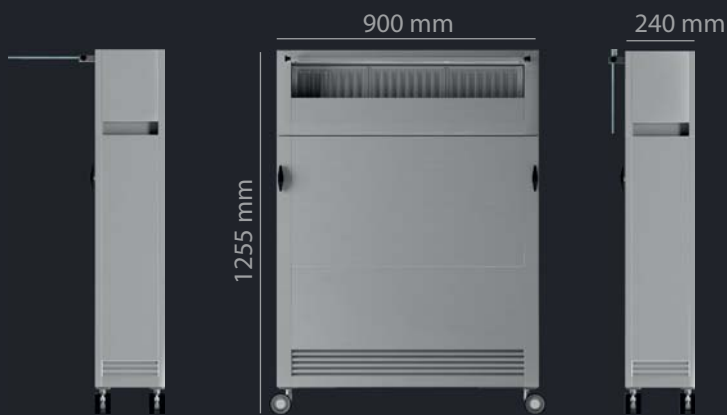

013540 Airwall 15



Run-on function



- 1) 195 W/ 460 m³/h
- 2) 233 W/ 640 m³/h
- 3) 286 W/ 855 m³/h
- 4) 330 W/ 1.060 m³/h



1 Year Warranty



337 W (Schuko 16A/1 phs 230V)

1.4301

Platinum Satin Brush



Made in EU (D)



40 kg net/ 50 Kg



7 W LED

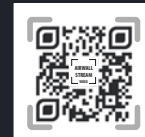

↓ Video



Proven effectiveness

(Tests by Fraunhofer Institut)

The plasma filter cleans the air sustainably. No ozone emission. The reference gas for odor removal is reliably eliminated. The operation of the Airwall significantly reduced the microbial load in the air.

- Energy efficient operation
- Silent operation mode
- Finished in stainless steel
- Special Platinum surface
- Non mirroring surface
- Hygienic according HACCP

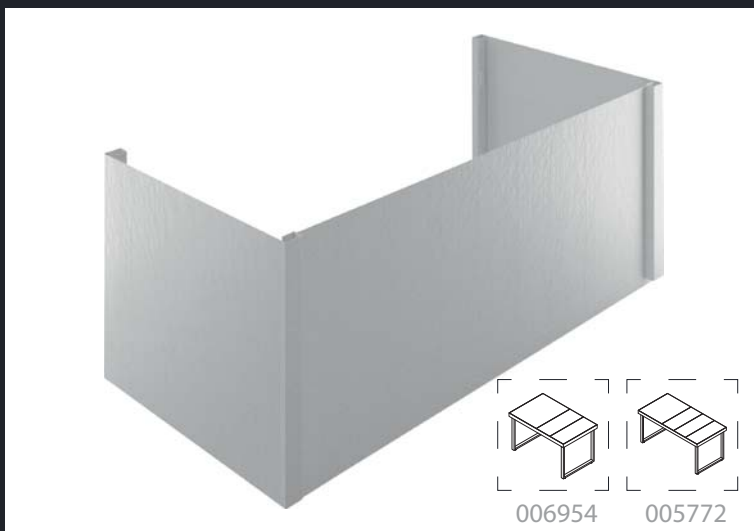

025771 Buffet Blind 4

016522 Buffet Blind 5

Front- and Side panels



Easy to clean



No machine wash



Non iron



1 Year warranty



Washable by hand

[↓ PDF en](#)

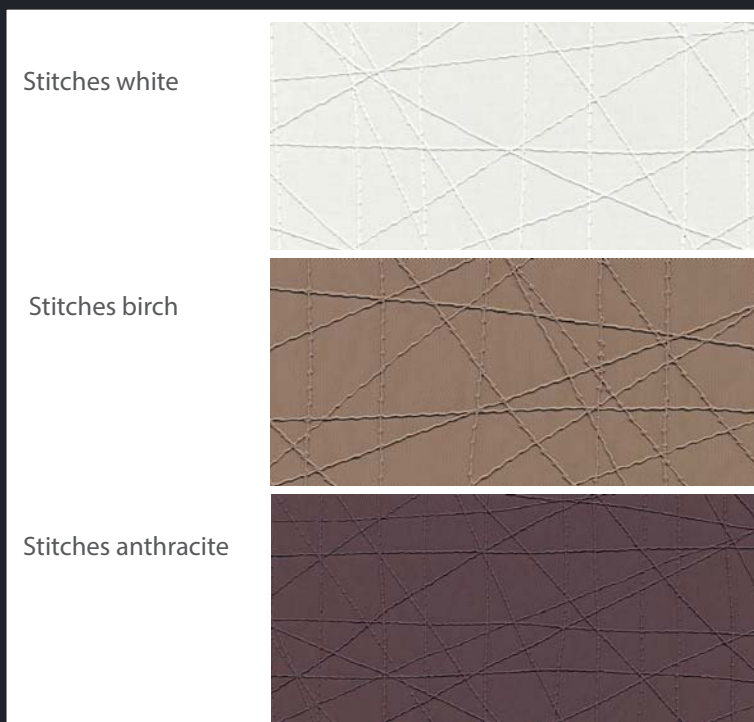
[↓ Video](#)

Technical properties:
 long-lasting, tear-resistant,
 abrasion-resistant, lightfast,
 flame-retardant BS5852 0+1



962 mm

383 mm



383 mm

90 mm

026902 Induction Plus 16

2 Cooking zones 1/2 GN to 1/1 GN



Hot Plate to 94°C up to 1/1 GN



max. 3,7 kW



max. 2,1 kW



1 Year Warranty



3,7 kW (Schuko 16A/1 phs 230V)



1.4301 Platinum Satin Brush



Made in EU (AT)



15 kg net/ 17 Kg

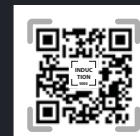

Video



962 mm

383 mm

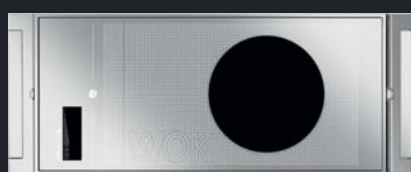

383 mm

90 mm

004752 Wok Smart

max. 3,0 kW



3,0 kW



2,4 kW



1 Year Warranty



3,0 kW (Schuko 16A/1 phs 230V)



1.4301 Platinum Satin Brush



Made in EU (AT)



15 kg net/ 17 Kg



Video



962 mm



383 mm

145 mm

383 mm

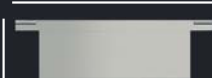
**026125 Hot + Chill Plus 16**

110°C on the surface



0°C- 3°C at 21°C room temperature



1 Year Warranty



850 W (Schuko 16A/1 phs 2300V)

1.4301

Platinum Satin Brush



Made in EU (AT)



26 kg net/ 28 Kg

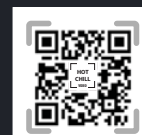

↓ Video



962 mm



383 mm

90 mm

383 mm

**003425 Grill Smart**

max. 250°C



1 Year Warranty)



3,2 kW (Schuko 16A/1 phs 230V)

1.4301

Platinum Satin Brush



Made in EU (D)



25 kg net/ 28 Kg

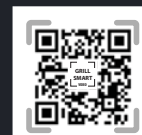

↓ Video



020942 Set Zieher Buffet Display

Food Bridge and Raiser incl.
Zieher Tablet Modul and GN
table top. Developed for the
Zieher product series Solid,
Modul and Melamine Trays.
Zieher catalog
pages 108-111,121-139
www.zieher.com

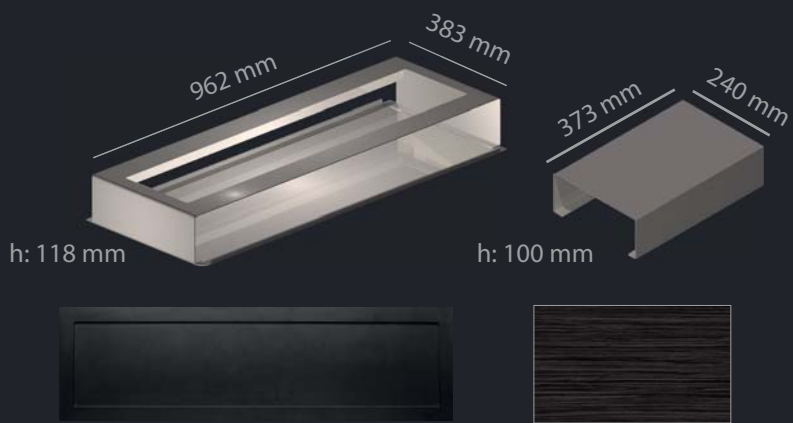

↓ Video



↓ PDF en





h: 660 - 790 mm

019807 Lem

Bar stool, adjustable height
black/ white, Stainless/ Leather



Waterproof



easy
to clean



1 Year Warranty

1.4301

Platinum Satin Brush



Made in EU (IT)

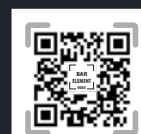

↓ Video



800 mm x 400 mm x h 1155 mm

003444 Bar Element

Counter Furniture HPL white



Waterproof



easy
to clean



1 Year Warranty

1.4301

Platinum Satin Brush



Made in EU (Germany)

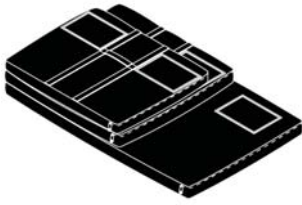

019946 Carry Bag Set 3



033379 Rain Cover 3

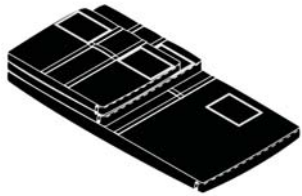

019808 Carry Bag Set 4



030426 Rain Cover 4

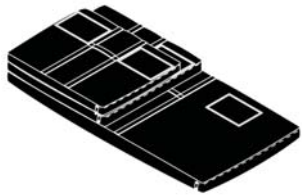

019587 Carry Bag Set 5



030427 Rain Cover 5

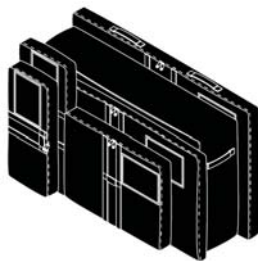

032164 Carry Bag Set Moove
(6 bags)



030426 Rain Cover 4

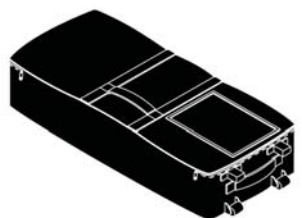

004755 Trolley

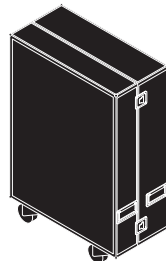

015425 Airwall Case 15

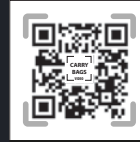

↓ Video

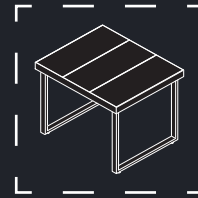

for 005771 Professional 3

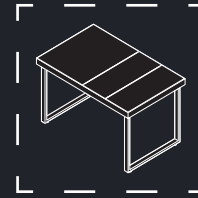

for 006954 Professional 4

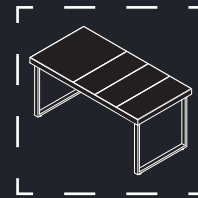

for 005772 Professional 5

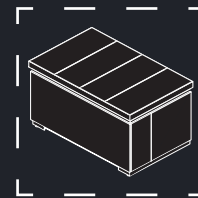

for 019922 Moove 4



↓ Video

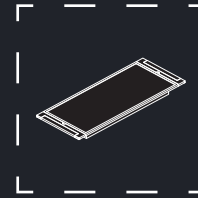

for all Electrical
Devices

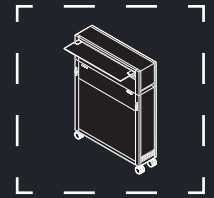

for 013540
Airwall 15



↓ Video



new

028397 Cover Multistation



016319 Cover Bar Element



004785 Carry Bag Lem

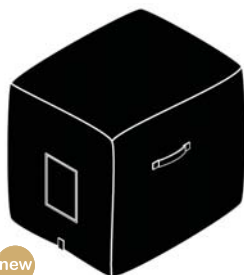

new

030425 Cover Cube

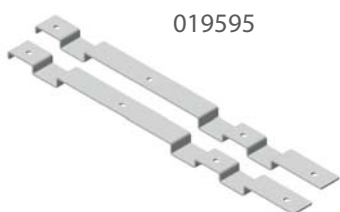

019595

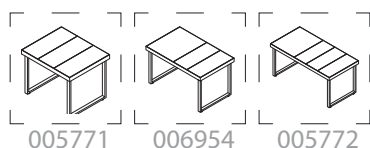

600 mm x 50 mm x h: 20 mm



032122



004777



004776



020368



015909



032171



032170



Video

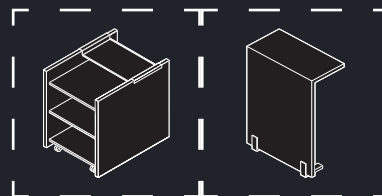

for 026126 Multistation new

for 003444 Bar Element

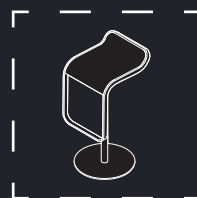

for 019807 Lem

019595
Adapter for cable tray positioning within one table segment
Professional 3-5
004777 Cable tray
032122 Adapter GB (3-Pin)
004776 CEE 6-fold socket strip

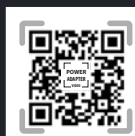

Video

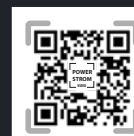

Video

livecookintable recommends
360° Food Logistik

020368 L-Transport Cart
015909 U-Transport Cart
032170 Thermoport 1400U
032171 Thermoport 1000 K-Unit new

Perfect logistics require a well-founded system. Functionality and material perfectly matched. Mise-en-place in GN, food transport in suitable carts, storage under the livecookintable, GN-compatible devices and table segments. That's livecookintable 360° food logistics. Our recommendation: Rieber Thermoplate, Revol and others, developed a dry system that only works with the natural moisture of the food. Disadvantages of chafing dishes can be avoided.

Architecture and Design

Planning on a scale.
How is the buffet connected to the kitchen?

Where is the service running?
How does the guest move?

The plans of our designers and architects are not colorful pictures, but solutions that are no question leave open.



3D Planning Studio:

We define the best solution
in price and performance.

We propose individual designs,
suitable for every environment.

We visualize with our 3D studio.

Do Design Yourself!

Augmented Reality Application for the free configuration of livecookintable buffets and live cooking stations in the real customer environment of the respective guest room. And this in original size.

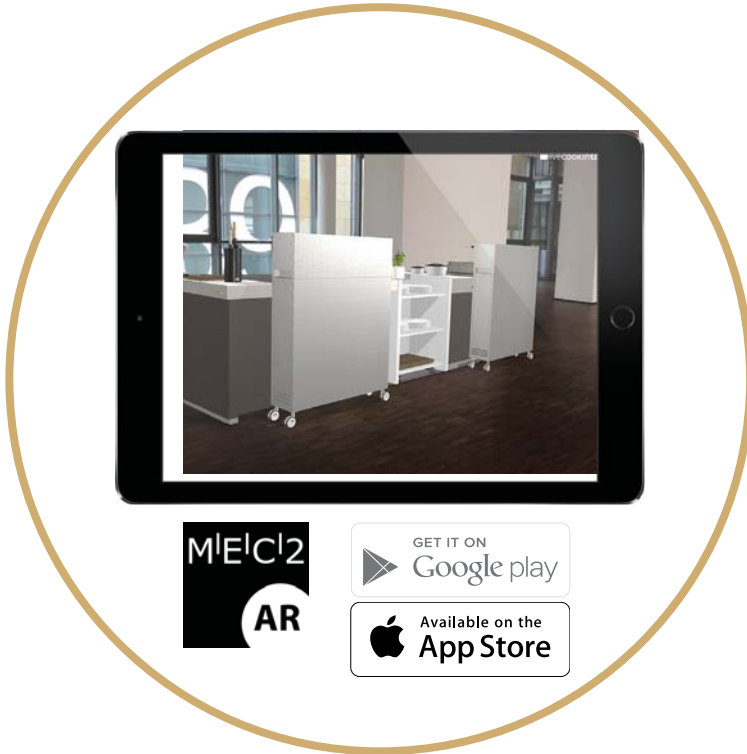

livecookintable® Augmented Reality.

The App is available for Android and IOS Devices. Download the App from your App-Store. Allow the application to use the camera. From the app menu, you can print out the needed tracker. Place it in your room on the floor. If you now capture the tracker with the app, you can see livecookintable rendered in your room. You can now configure your buffet station and your live cooking station according your needs.



Please print out the tracker in the original size of 1950 mm x 700 mm to see the rendered livecookintable in original sizes.

livecookintable Website

Available content: Many design examples in the lookbook, planner documents for download, explaining video tutorials and all user information, eg manuals and data sheets.

www.livecookintable.com





Brennwagen

phenomenal **Flexibility**
Innovation
Technology
 efficient accurate
 Gourmet **Passion**
Design



Video

Brennwagen

- Forging a Legend

Formula 1™ racing meets BBQ innovation – and a passion for culinary excellence gets a new name: Brennwagen. Brennwagen lives up to exacting standards and the highest expectations for mobile outdoor catering. In design. In technology. In sheer power. Enough to fire up the real passion of any BBQ connoisseur.

An idea born on the race track. Where a Formula 1™ engineer lived his Professional passion for motorsports. A passion for barbecues took him from petrol fumes to smoking charcoal. To Brennwagen. The end result: Record performance. In every BBQ challenge. The Brennwagen GT series gets BBQ fans and design aficionados fired up. Every time.

STANDARD DEVICES



**BBQ charcoal grill
GT 800**

Item No. 005505
L 105 x W 97 x H 120 cm



**BBQ gas grill
GT 800i**

Item No. 005506
2 x long and 1 infrared burner
Item No. 034563
2 x short and 2 x infrared burner
L 105 x W 97 x H 120 cm



**BBQ charcoal grill
GT 1200**

Item No. 005507
L 123 x W 97 x H 126 cm



**BBQ gas grill
GT 1200i**

Item No. 005508
L 123 x W 97 x H 126 cm

COOLING SYSTEM



GT Foodstation*

Item No. 012608
L 125 x W 97 x H 125 cm
* Glass lid is optional



GT Saladbar

Item No. 025051
L 125 x W 97 x H 95 cm



GT Juicebar

Item No. 015868
L 125 x W 97 x H 95 cm

SPECIAL BBQ



GTX3000

Item No. 025540
L 140 x W 100 x H 180 cm



GTX1500 Smoker

Item No. 005509
L 165 x W 115 x H 176 cm



GT Rotisserie BBQ

Item No. 015866
L 132 x W 95 x H 122 cm



GT Wokgrill

Item No. 025048
L 105 x W 97 x H 98 cm

BUILT-IN



BBQ charcoal grill GT 800 built-in

Item No. 025541
L 95 x W 52 x H 63 cm



BBQ gas grill GT 800i built-in

Item No. 025542
2 x long and 1 infrared burner
Item No. 034565
2 x short and 2 x infrared burner
L 95 x W 52 x H 63 cm



BBQ charcoal grill GT 1200 built-in

Item No. 025543
L 112 x W 52 x H 63 cm



BBQ gas grill GT 1200i built-in

Item No. 025544
L 112 x W 52 x H 63 cm

STAND ALONE



Stand Alone Charcoal Grill

Item No. 025545
L 40 x W 56 x H 35 cm



Stand Alone Gas Grill

Item No. Infrared burners - 025546
L 40 x W 56 x H 21 cm



Stand Alone Induction

Item No. 034567
L 41 x W 55.5 x H 35 cm



Stand Alone Wok Grill

Item No. 025548
L 41 x W 57 x H 28 cm
(+ 5 cm cast grillage)



Stand Alone Tray

Item No. with Synthetic Board - 025549
with Wooden Board - 025550
L 56 x W 40 x H 21 cm

A winner in the making - Brennwagen gets your setup in pole position

Creative innovations, surprising ideas: You are fascinated by Brennwagen and our passion for barbecuing. We are fascinated by your creativity. By your vision of a unique Brennwagen.

The Brennwagen formula is: Whatever you can dream of, we can build it. Brennwagen is the only tuning specialist where you get to design your very own grill. A grill to match your personality. Unique – and unmistakable. Tell us what you want ... and Brennwagen will fire up the engines.



CUSTOM-MADE





Внешний вид

DESIGN YOUR MOBILE KITCHEN

A stainless steel masterpiece
- for outdoor cooking around the globe



Workspace



Description

1	Worktop
2	Worktop low
3	Saladbar
4	Induction
5	Gas Grill
6	Charcoal Grill
7	Wok Grill
8	Fryer
9	Sink
10	Doublesink
11	Wash hand basin



Gas grill, sinks, juice bar, or salad buffet – A versatile layout to fulfill your catering ambitions.

Storage



Description

12	Frozen Compartment *
13	Storage Compartment with Double Door
14	Storage Compartment with Single Door
15	Compressor Unit
16	Apothecary Cabinet
17	Double Drawer



* Compressor Unit required

A space for cutlery, accessories and all utensils or a cooling system for beverages – A clever use of space to fit your needs.

Design



Description

18	Marble
19	Carbon Edition
20	Walnut
21	Alabaster
22	Red Kingdom
23	Blue Kingdom
24	Yellow
25	White
26	Dark Blue
27	Black
28	Red

Individual lighting, bespoke colours, special designs and exclusive extras - Be it retractable appliances, custom sizes or additional modules: A unique design to match your vision.



Buffet-Tables to keep food warm or cold

nesting function | height adjustable | all tables on wheels

mobile buffet solutions



Video

VENTA by Büchin Design developed an elegant buffet furniture range for the high demands of the hotel industry and for exclusive events. It is equipped with a range of technical features to keep dishes hot or cold.

We offer exclusive buffet tables with integrated devices, which are installed below the table-top and are almost invisible. The need for a clean and clear table surface is not affected by this functionality.



Buffet-Tables to keep food warm or cold

modular system | trolleys for storage | variations of colour

The modular buffet table system STAGE_80 can be assembled and disassembled in just a few easy steps, without the need for any tools.

Item No.: 012674
L: 1960 x 800 x 920 mm
M: 1800 x 800 x 840 mm
2 x XS: 800 x 800 x 760 mm
total weight: 187 kg

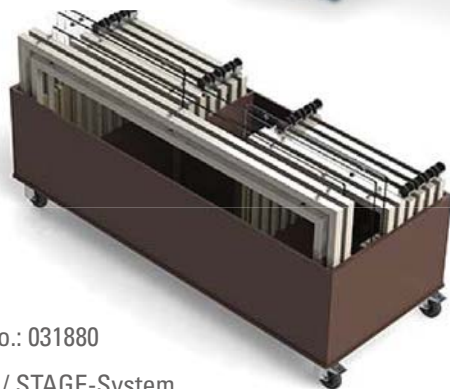
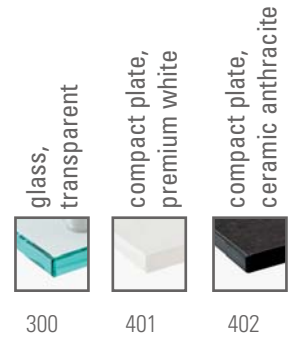

Item No.: 031880
Trolley / STAGE-System

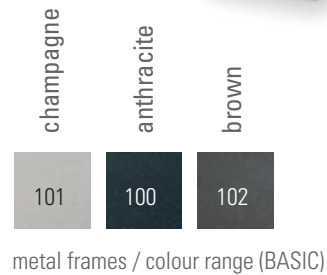

Buffet-Tables to keep food warm or cold

The new highlight of our furniture range is the STAGE_80_M_INDUCTION_2G buffet table with integrated surface induction. You can place three to four pots on the four induction hobs and set the temperature for each hob individually.



new

STAGE_80_M_INDUCTION_2G

Item No.: 030649
 [LxWxH]: 1800 x 800 x 840 mm
 weight: 88.5 kg

Perfect system to keep the food warm, no cooking!

*technical details see item no. 031119
 on page 0.44

The buffet table STAGE_80_XS_COOL+HOT glass surface, which houses a cold-hot plate. This cold-hot plate enables you to keep dishes cool at temperatures as low as -3°C or to switch on the heating function (max. 120°C).



STAGE_80_XS_COOL+HOT

Item No.: 014193
 LxWxH]: 800 x 800 x 760 mm
 weight: 60 kg

The HOT-mode keeps the food warm, no cooking!

*technical details see item no. 005037
 on page 0.44

Our exclusive STAGE_80_XS_COOL_2G table with integrated cold plates works without the need for any power cables.



STAGE_80_XS_COOL_2G

Item No.: 020968
 [LxWxH]: 800 x 800 x 760 mm
 weight: 43 kg

**5h cooling / 5° - 10°C
 on the table surface
 without electricity.**

*technical details see item no. 005038
 on page 0.44

Buffet-Tables to keep food warm or cold

four fields to place chafing dishes and/or pots
four fields with different temperature options

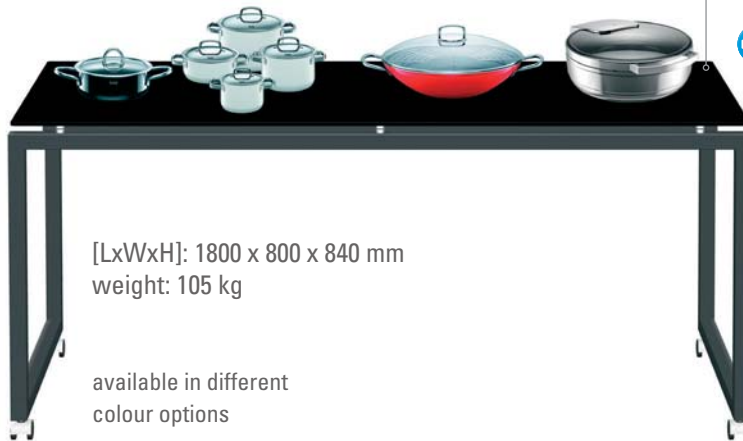

[LxWxH]: 1800 x 800 x 840 mm
weight: 105 kg

available in different
colour options

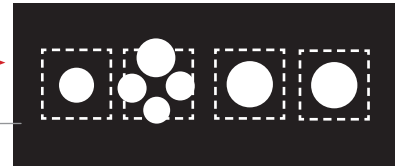

new

top-view/example: positioning of the pots
STAGE_80_M_INDUCTION_2G

Item No.: 031119
frame colour: anthracite
table-top: glass, black coloured

technical details:
induction system: InductWarm
manufacturer: Gastros AG Switzerland
model: InductWarm 130
measures: (L x W x H) 35 x 35 x 11 cm / weight: 5,3 kg
voltage range: 220-240V AC
maximum power input: 750 W
electrical fuse protection: 10 A / frequency: 50Hz

[LxWxH]: 800 x 800 x 760 mm
weight: 60 kg



available in different
colour options



SIZE: 2/1 GN
660 x 530 mm

STAGE_80_XS_COOL+HOT

Item No.: 005037
frame colour: anthracite
table-top: compact plate, ceramic anthracite
2/1 GN area: glass, underside black coloured

technical details:
CCP built-in system, 2/1 GN, size:
660 x 530 mm, height: 190 mm,
power supply: 230V, heat output:
1400W, coolant: R600a, cooling
output: 140W



1. Lift the glass-top.
2. Insert the Cool-plate.

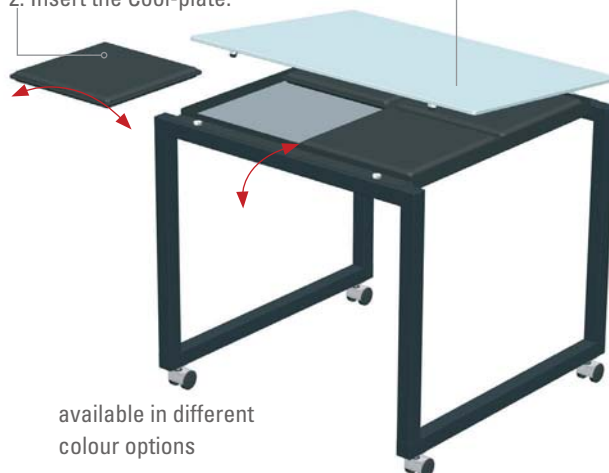

available in different
colour options

freeze-field:
700 x 700 mm

STAGE_80_XS_COOL_2G

Item No.: 005038
frame colour: anthracite
table-top: glass, underside
white coloured

[LxWxH]: 800 x 800 x 760 mm
weight: 43 kg

Item No.: 018731
trolley to storage
the COOL-PLATES
(max. 8 pieces)



Mobile bar | lighted tables

Variations of the STAGE buffet system:



Stool / Item No.: 020984

The established STAGE buffet system from the VENTA Interior range can be converted into a Mobile Bar.

In place of the glass panels already part of all versions, we have added an additional table-top option to our portfolio.

The compact panel is a heavy-duty plastic surface.

Item No.: 020969

 T_1 [LxWxH]: 1960 x 500 x 1000 mm,
 weight: 40 kg

 T_2 [LxWxH]: 1800 x 800 x 920 mm,
 weight: 76 kg

STAGE_50_L

 Buffet Table with table-top material
 „compact panel“ (decorative surface)

Table system with a dept of 50 cm. Designed for coffee break areas or using as a meeting table with our stools.

Item No.: 030447

 [LxWxH]: 1960 x 500 x 920 mm
 height adjustable: 1000, 1080, 1160 mm
 weight: 38 kg

Cocktail-Tables

For prefunctional area we recommend our cocktail tables and stools.



SET_70_LED

Cocktail Table
with additional LED frame
(including rechargeable battery)

Item No.: 020977
[LxWxH]: 700 x 700 x 1050 mm
weight: 20 kg



Second Generation of INDUCTION tables

new material compact panel





STAGE_80_M_INDUCTION_2G

Item No.: 030448
 [LxWxH]: 1800 x 800 x 840 mm
 height adjustable: 920, 1000, 1080 mm
 weight: 75 kg
 features: 4x field induction (4x 750 W, 230V, 50Hz)

table-top,
compact panel
(BASIC)

- 401  premium white
- 402  ceramic anthracite

metal frames,
colour range
(BASIC)

- 100  anthracite
- 101  champagne
- 102  brown

The new generation of keeping food warm on a buffet table. A wonderful and decorative surface to place the pots and pans directly on the table-top. Only a thin silicone mat has to be placed between the table surface and the pot. This mat avoid scratches and the movement of the pot. Additionally the mat helps to keep the surface protected in case of overheating the pot.

*silicone mat included



Silicone mat No.: 030497
 *extra mat can be
 ordered separately

this outline define
the induction area

50_XS Item No.: 030460



80_XS Item No.: 030461



50_M Item No.: 030462



80_M Item No.: 030448



Buffet Module System

table-top unit
STAGE_80_XS_BAIN-MARIE_COOL+HOT
Item No.: 035212
[LxWxH]: 790 x 790 x 260 mm
Colour: ceramic anthracite

new

SNEEZEGUARD
STAGE_80_XS_LED
Item No.: 030464
[LxWxH]: 800 x 800 x 400 mm

table-top unit
STAGE_80_XS_INDUCTION_2G
Item No.: 035215
[LxWxH]: 790 x 790 x 120 mm
Colour: ceramic anthracite

new

create your own Buffet Table



table-top unit
STAGE_80_XS_COOL+HOT
Item No.: 029428
[LxWxH]: 790 x 790 x 120 mm
Colour: white glass top

FRONTBLIND
STAGE_S_BAMBOO_COV.
Item No.: 030466
[LxWxH]: 1600 x 822 x 17 mm

SIDEBLIND
STAGE_80_BAMBOO_COV.
Item No.: 030467
[LxWxH]: 800 x 822 x 17 mm

Base frame STAGE 80_S (only base)
prepared for two XS modules
Item no.: 028037
Colour: champagne



Table-top unit
STAGE_80_COOL
Item No. 030468
Colour: black glass top



Table-top unit
STAGE_80_XS_COOL+HOT
Item No.: 032045
Colour: black glass top

new



Table-top unit
STAGE_80_XS_INDUCTION_2G
Item No.: 035215
Colour: ceramic anthracite

new



Table-top
STAGE_80_XS_Glass
Item No. 030469



Table-top
STAGE_80_XS_Compact panel
Item No. 029931
Colour: ceramic anthracite



Table-top
STAGE_80_XS_BAIN-MARIE_COOL+HOT
Item No. 035212
Colour: ceramic anthracite

new



Cocktail Table + Trolley

base frame colour: anthracite (100) / table-top: glass, transparent (300)

Cocktail table SET 70 new

Item No.: 010159

[LxWxH]: 700 x 700 x 1050 mm



trolley for storage the tables new

(max. 10 pieces)

Item No.: 020379

[LxWxH]: 1070 x 55 x 920 mm



10 x table

easy to dismantle



without tool



space: 0,5 m²

options in material + colour

base frame colour: anthracite (100)



Item No.: 035234

new

table-top: glass, white
coloured (303)



Item No.: 033650

new

table-top: glass, black
coloured (307)



Item No.: 035235

new

table-top: compact panel,
ceramic anthracite (402)

base frame colour: champagne (101)



Item No.: 014174

new

table-top: glass, white
coloured (303)



Item No.: 035236

new

table-top: glass, black
coloured (307)



Item No.: 035237

new

table-top: compact panel,
ceramic anthracite (402)

The Cocktail-Table is available in:

BASIC: 100, 101, 102, 300, 401, 402

OPTION: 103, 104, 105, 109, 303, 305, 307, 308, 309, 310, 311, 319, 407, 409, 411, 414, 415, 416, 417, 418, 419

CUSTOMIZED: 312, 317, 318, any available colour or decor

VENTA - Code

Büchin Design offers a wide range of materials and colours in three categories BASIC, OPTION and CUSTOMIZED.

Most of the VENTA products contains of more than one material.
If you choose one part of a model in the higher category, all the other materials and colours can also be taken in the higher category.

example:

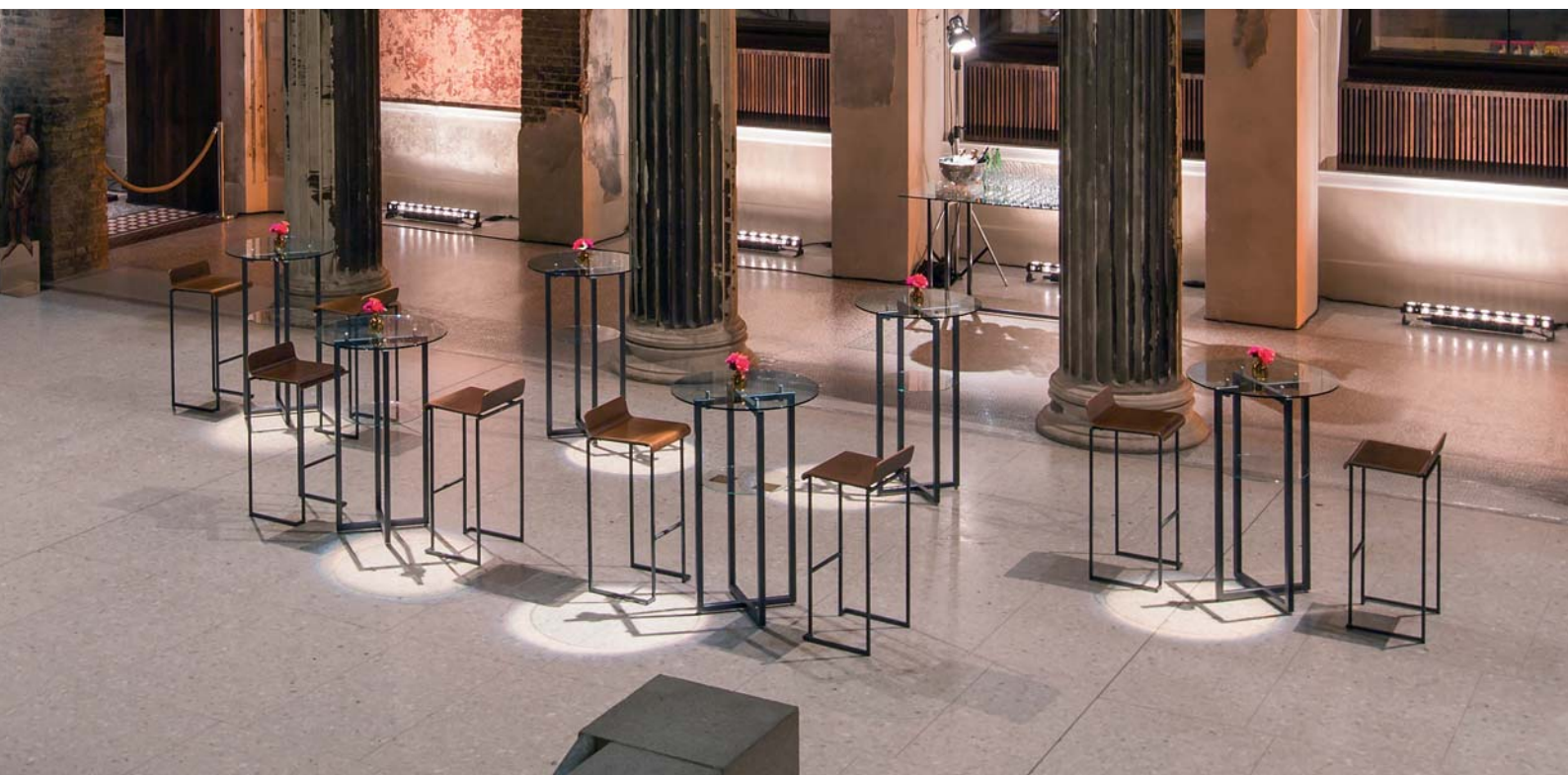
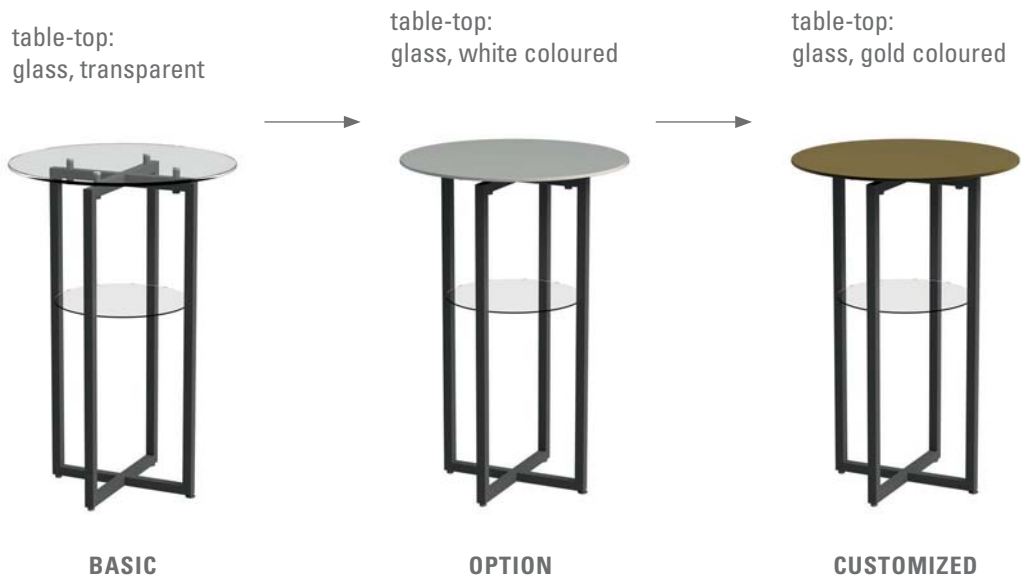

base frame | metal | colour

BASIC | base frame



100
anthracite



101
champagne



102
brown

OPTION | base frame



103
golden yellow



104
black

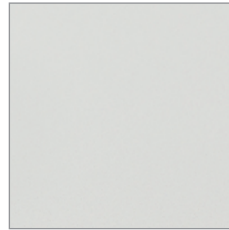

105
white



109
platinum grey

CUSTOMIZED | base frame



any color

RAL range, but transferred to IGP-range [same brightness and pigment as our other colors]

table-top | glass | colour

BASIC | table-top

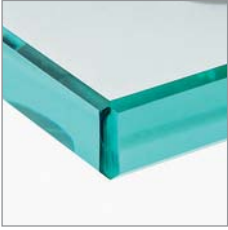
300
 transparent

OPTION | table-top

303
 white

305
 parsol grey

307
 black

319
 platinum

308
 red

309
 yellow

310
 green

311
 purple

CUSTOMIZED | table-top

312
 pearlmousegrey

317
 silver

318
 gold

any color
 RAL-range
 [printed on the backside of the glass]

table-top | compact panel | colour

BASIC | table-top



401
premium white



402
ceramic anthracite

OPTION | table-top



407
Natural Bardolino
Oak



409
Beige Linen



411
Natural Corbridge Oak



414
Light Grey
Chicago Concrete



415
Dark Grey
Chicago Concrete



416
Ferro Bronze



417
Whitewood



418
Grey Arizona Oak



419
Lava Grey
Fleetwood

CUSTOMIZED | table-top



any color
EGGER-range
[available on compact panel]

LECTERN_3G

Item No.: 016192

model: LECTERN_3G

version: poster under a transparent acrylic front, small desktop (600 x 495 mm), no additional connections on desktop

measures: 550 x 600 x 1200 mm / weight: 37.7 kg

material: acrylic glass, body anthracite, desktop white satined, front panel transparent

- ① exchangeable front cover (poster in anthracite)
- ② reading lamp (LED)
- ③ XLR-microphone socket on the desktop
- ④ rollerskate for inhouse transport
- ⑤ softcover for storage
- ⑥ cable inlet under the base
- ⑦ small desktop (600 mm)

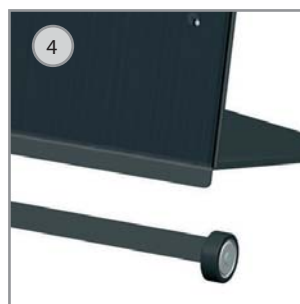
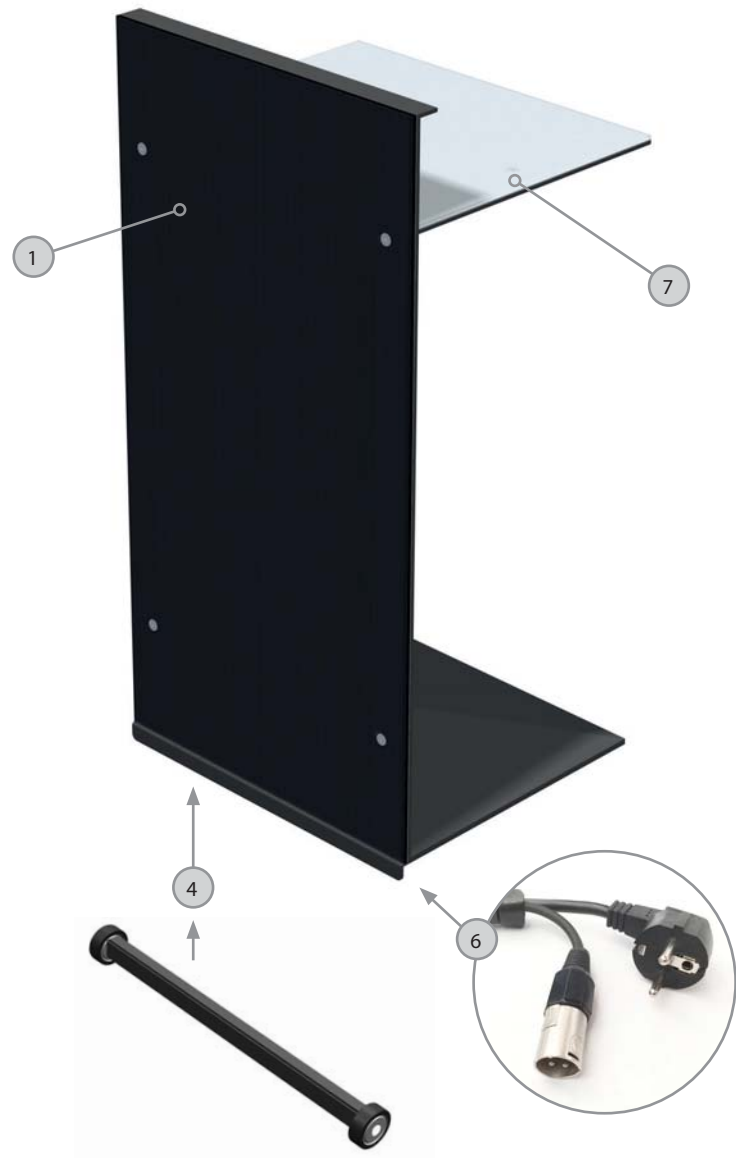
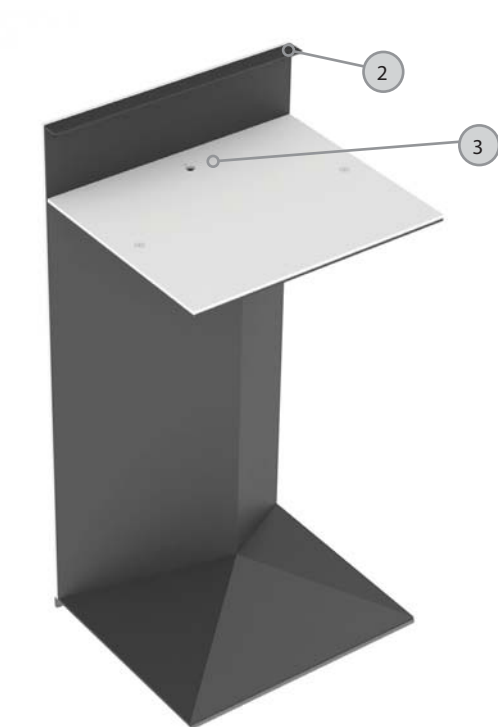

LECTERN_3Gs_MONITOR

Item No.: 028708

new

model: LECTERN_3GS_MONITOR

version: poster under a transparent acrylic front, wide desktop (860 x 495 mm), additional connections on desktop: power supply, VGA cable, sound cable (covered in a separate case with lit)

measures: 550 x 860 x 1200 mm / weight: 53.7 kg

material: acrylic glass, body anthracite, desktop white satined, front panel transparent

- 1 front monitor to present your Logo
- 2 reading lamp (LED)
- 3 XLR-microphone socket on the desktop
- 4 rollerskate for inhouse transport
- 5 softcover for storage
- 6 cable inlet under the base
- 7 wide desktop (860 mm)
- 8 additional connections on desktop

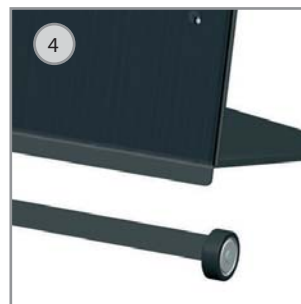

BAIN-MARIE

STAGE_80_XS_BAIN-MARIE_COOL+HOT 

Item No.: 035238

[LxWxH]: 800 x 800 x 760 mm

height adjustable: 840, 920, 1000 mm

weight: 80 kg

features: multifunctional well Hot-Cold with lit (two pieces), material: compact panel, 10 mm (Bain-Marie: adjustable from 30°C up to 110°C / static cooling: up to -5°C, max. ambient temperature 25°C), base: steel, powder-coated, profile: 40 x 40 mm, table-top: compact plate, 10 mm, table height adjustable: 840, 920, 1000 mm, CW unit: GN 2/1, 230V, heat output: 1800 Watt, coolant: R600a, cooling output: 140 Watt

BAIN-MARIE



VENTA presents a unique, mobile furniture to keep food cool or hot. 

The BAIN-MARIE has two modes: cooling up to minus 5°C or heating to a maximum of 110°C. The size of 2 GN allows to place two 1/1 GN inserts in the well.

















The BAIN-MARIE has two lids manufactured in material „compact panel“ to close the well and allows the usage as a standard table.

COLD & HOT

-5°C AT YOUR FINGERTIP +140°C

THE COMFORT COMBI PLATE (CCP) IS MADE OF A MULTILAYER MATERIAL WITH AN INTEGRATED CHANNEL FOR COOLING AND A PANEL HEATING FOR KEEPING WARM

- Adjustable temperature range from -5°C to +140°C
- Plate made of a multilayer material with s/s surface
- Temperature fluctuations are compensated by a heat-controller
- Uniform and constant temperature across the entire plate
- Universal buffet landscape – no conversion needed
- Cooling fluid R600
- Stainless steel body
- Plug-in system
- Plate available in all the following RAL colours

	1007		1023		3000
	6015		6033		7000
	7021		7031		7035
	5001		5005		6005
	7009		7011		7016
	9004		9010		

BUILT-IN MODELS



		Ø cm	H in cm
004932	Cold/hot plate round, 230V/50-60Hz, 0.7kW	48.0	18.0



		L in cm	W in cm	H in cm
023374	Cold/hot plate GN 1/1, 230V/50-60Hz, 0.7kW	53.0	33.0	18.0
023376	Cold/hot plate GN 2/1, 230V/50-60Hz, 0.14kW	66.0	53.0	18.0
023378	Cold/hot plate GN 3/1, 230V/50-60Hz, 0.21kW	99.0	53.0	18.0

FREESTANDING MODELS



		L in cm	W in cm	H in cm
016493	Cold/hot plate GN 1/1, 230V/50-60Hz, 0.7kW, black	53.0	33.0	18.0
016494	Cold/hot plate GN 2/1, 230V/50-60Hz, 1.4kW, black	66.0	53.0	18.0



		L in cm	W in cm	H in cm
016711	Cold/hot plate GN 1/1, 230V/50-60Hz, 0.7kW, white	53.0	33.0	18.0
016712	Cold/hot plate GN 2/1, 230V/50-60Hz, 1.4kW, white	66.0	53.0	18.0

BUILT-IN MODEL

new

Ice/cold unit to create your very own brand of ice, adjustable to -30°C



		L in cm	W in cm	H in cm
035183	Ice/cold Teppan plate 1, 230V/50-60Hz, 1.2 kW	46.0	46.0	30.0



Induction Undercounter Solutions

InductWarm® - The elegant buffet solution.
Simple to use, in premium design.



glass



wood



Ease of use



Premium design



Energy efficiency



Safety



Food quality



Temperature control

Customized Built-in and Undercounter Induction Technology

Your advantages

- Freedom of surface selection: **stone, wood** or **glass**
- **Seamless high technology**
- **Multifunctional**: use it as banquet, conference or serving table
- Easy-to-clean counter due to **flush mount integration**
- **Compatible** with any induction compatible tableware
- **Safety**: Heats only the metal coated dishes and not the counter tops
- **Easy operation** with front mounted control panel



Video

InductWarm® 130 Built-in and Undercounter

- Highest level of **individualization**: buffet tops from wood, stone, glass can be used, available in different colours and sizes
- **Multifunctionality**: almost invisible the InductWarm®130 can be mounted under different tops (10 - 13 mm) and therefore it can be used for various occasions: as a conference table, as serving table etc.
- **Design**: if the dishes are removed from the induction surface, you get an elegant, smooth top; with wood even jointless top
- Highest **energy efficiency** due to its ability to run up to three devices with only one single 230V/10A or 16A plug
- Especially **intuitive and immediate operation** with the integrated touch panel or external control unit
- **All-round safety**: the InductWarm® technology heats the metal-coated dish and not the counter surface (only reflection heat is possible)
- **Best ventilation** due to an integral cooling fan on the device bottom

Model	Number of warming zones	Dimensions in cm	Weight in kg
InductWarm® Built-in/Undercounter 130 GN 2/3 with EU-plug : 036126 / with UK-plug : 036127	1	35.0x35.0x10.0	6



stone

Technical details

Maximum pot size: GN 2/3

Warming zones: 1 individually adjustable

Temp. levels: 4 (ca. 40°C - 90°C)

Construction: modular, built-in

Colour: black

Power supply: ~230V/50Hz

Max. input: 0.75kW

Operation: integrated manual control panel,
optional external control unit

Guarantee: 2 years



Optional accessories

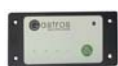

External control unit
029363



Connecting cable for control unit
100.0cm - 029366
200.0cm - 029367
300.0cm - 029369



Connecting cable to combine 2 to 3 devices
029373



the Mounting set
029372

InductWarm® 200 Built-in

- **Field induction** : Six induction coils with three individually adjustable warming zones which allow highest level of flexibility regarding the sizes of the used dishes
- **Modern design** with the combination of high-grade steel and black glass-ceramic top, usable with matching porcelain
- 1 device only; **easy plug & play**, no putting together from single components needed
- Highest **energy efficiency** thanks to induction technology offering 4 different temperature levels, using just 1.0kW
- **Intelligent temperature control**; the device measures the temperature within the pot (not directly at the induction field) and adapts constantly the energy given in. A constant temperature level is guaranteed, according to the selected temperature level
- Especially **intuitive and immediate operation** with the integrated touch panel with locking function and remote control alternatively
- **Maximum usability** at all areas - from installation to cleaning and to transport

Model	Number of warming zones	Dimensions in cm	Weight in kg	Power usage at 110-230 volts
InductWarm® Built-in 200 GN 1/1 029352 : country specific plugs are provided	3	58.8x33.1x6.4	9.9	max. 1.0 kW



Technical details

- Maximum pot size:** GN 1/1
- Warming zones:** 3 à GN 1/3
- Temp. levels:** 4 (ca. 40°C - 90°C)
- Construction:** compact, built-in
- Surface:** glass ceramic (black)
- Housing:** brushing stainless steel
- Power supply:** 110-230V/50-60Hz
- Max. input:** 1.0kW
- Operation:** external remote control and integrated touch panel
- Guarantee:** 2 years



Accessories

InductWarm® Porcelain



029558
 Bowl GN 1/1 Emotion
 Height: 6.5cm
 Capacity: 7.0ltr



029559
 Bowl GN 1/2 Emotion
 Height: 6.5cm
 Capacity: 3.15ltr



029560
 Bowl GN 1/3 Emotion
 Height: 6.5cm
 Capacity: 1.75ltr



029561
 Bowl L
 Diameter: 33.0cm
 Capacity: 4.3ltr



029562
 Bowl M
 Diameter: 29.0cm
 Capacity: 2.75ltr



029563
 Pot for sauces
 Diameter: 12.1cm
 Capacity: 0.9ltr

InductWarm® Buffet covers



029564
 Buffet cover GN 1/1 Emotion
 Brushed high-grade steel
 Dimension: 54.0x34.5x8.0cm



029565
 Buffet cover GN 1/2 Emotion
 Brushed high-grade steel
 Dimension: 36.0x27.5x8.0cm



029566
 Buffet cover GN 1/3 Emotion
 Brushed high-grade steel
 Dimension: 36.0x12.0x8.0cm

ANDY MANNHART INDUCTION BUFFET

0.64

EXACT FOOD TEMPERATURE CONTROL WITH RTCSmp TECHNOLOGY

INNOVATION
LEADER

R·T·C·S[®] mp
realtime temperature control system

- Available in freestanding & built-in version
- Control unit to regulate exact food temperature from 50°C to 100°C
- Option to design your individual theme buffets
- Flexibility of using buffet servers in different shapes and materials simultaneously
- Up to 50% energy saving compared to conventional induction units
- Large surface area of 80.0x40.0cm with 2 separate heating zones which can be regulated independently
- 230V/50-60Hz, 1Ph, 1.5kW, 8A



INNOVATION LEADER
R·T·C·S[®]_{mp}
 realtime temperature control system



BUILT-IN MODEL

FREESTANDING MODEL



PRODUCT FACTS :

- Size : Width : 80.0cm Depth : 40.0cm Height : 11.4cm (incl. foot)
- Power supply : 230V/50-60Hz, 1Ph, 1.5kW, 8A
- Operation : - For built-in version, 2 temperature rotary knobs mounted on a built-in control plate, 50°C to 100°C
 - For freestanding version, 2 temperature rotary knobs (position under surface) 50°C to 100°C
- Temp. control : Dial 1-10 with LCD display on the right hand side of the glass top



 **eco**

		Dim in cm
023070	RTCSmp Hold-Line 1500 induction warmer, freestanding model , 2 temperature rotary knobs 50°C to 100°C, 230V/50-60Hz, 1 Ph, 1.5kW, 8A	80.0x40.0x11.4



 **eco**

		Dim in cm
023071	RTCSmp Install Hold-Line 1500 induction warmer, built-in model , 2 temperature rotary knobs mounted on a built-in control plate, 50°C to 100°C, 230V/50-60Hz, 1 Ph, 1.5kW, 8A	80.0x40.0x11.4











 **eco**

		Dim in cm
095123	Induction trolley with induction warmer Install Hold-Line RTCSmp 1500, 2 heating zones with independent temperature control 50°C to 100°C, heating surface 80.0x40.0cm, racing red colour, suitable for all induction compatible pans and dishes, 230V/50-60Hz, 1.5kW, 8A	116.5x53.0x81.5

Remarks: available in each RAL colour



		Dim in cm	
010452	RTCSmp Hold-Line 1500 induction warmer, freestanding model , black, 2 warming zones with independent temperature control via rotary knobs 50°C to 100°C, 230V/50-60Hz, 1.5kW, 8A	80.0x40.0x11.4	
		Dim in cm	
010461	RTCSmp Hold-Line 1500 induction warmer, freestanding model , white, 2 warming zones with independent temperature control via rotary knobs 50°C to 100°C, 230V/50-60Hz, 1.5kW, 8A	80.0x40.0x11.4	
		Dim in cm	
015946	RTCSmp Hold-Line induction warmer GN, freestanding model , 2 GN 1/1 warming zones with independent temperature control via rotary knobs, 50°C to 100°C, 230V/50-60Hz, 1.6kW, 8A	71.0x57.0x12.4	
		Dim in cm	
015950	RTCSmp Install Hold-Line induction warmer GN, built-in model , 2 GN 1/1 warming zones with independent temperature control via rotary knobs mounted on a built-in control plate, 50°C to 100°C, 230V/50-60Hz, 1.6kW, 8A	71.0x57.0x12.4	

RTCSMP 1800 INSTALL HOLD-LINE INDUCTION GENERATOR:



- Continuous temperature control from 50°C to 100°C
- Electronic limitation of power consumption
- 230V/50-60Hz, 0.45kW
- Real time temperature monitoring
- Generator housing 29.7x29.5x13.5cm



		Plate in cm
023121	Version with 1 heat retention plate	32.2x32.2
023122	Version with 2 heat retention plates, 2 separate temperature controllers	32.2x32.2
<p>Remark for the versions with 3 and 4 heat retention plates: The plates controlled by the same temperature controller must be equipped with the same cooking material.</p>		
		Plate in cm
023123	Version with 3 heat retention plates, 2 separate temperature controllers	32.2x32.2
023124	Version with 4 heat retention plates, 2 separate temperature controllers	32.2x32.2



RTCSMP 3200 INSTALL HOLD-LINE INDUCTION GENERATOR:



- Continuous temperature control from 50°C to 100°C
- Electronic limitation of power consumption
- 230V/50-60Hz, 0.45kW

- Real time temperature monitoring
- Generator housing 29.6x29.4x13.cm
- Recommended to be used with the alu-cast containers from page 0.42



		Plate in cm
023074	Version with 1 heat retention plate	52.0x32.0
023075	Version with 2 heat retention plates, 2 separate temperature controllers	52.0x32.0

Remark for the versions with **3** and **4** heat retention plates: The plates controlled by the same temperature controller must be equipped with the same cooking material.

		Plate in cm
023076	Version with 3 heat retention plates, 2 separate temperature controllers	52.0x32.0
023077	Version with 4 heat retention plates, 2 separate temperature controllers	52.0x32.0



INDUCTION HEATER



		Dim in cm
005033	Built-in induction unit with ceran panel, touch screen and keep-warm function, 230V/50-60Hz, 1.0kW, 10.9A	36.0x36.0x8.5









		Ø cm
020428	Induction warmer with ceran panel for CBS, 230V/50-60Hz, 1.0kW	24.0





		Dim in cm
036074	Buffet induction warmer, black glass top, touch control, 4 power settings, connect up to 3 units together with inter-connect cords, 230V/50-60Hz, 0.3kW, 1.3A	40.6x40.6x9.8



Alu-cast

023213	GN container 1/1 with handles	Dim in cm	53.0x32.5x6.5	induction	
023214	GN container 1/1 with handles	Dim in cm	53.0x32.5x2.0	induction	
023215	GN container 1/1	Dim in cm	53.0x32.5x6.5	induction	
023216	GN container 1/1	Dim in cm	53.0x32.5x2.0	induction	
023209	GN container 1/2 with handles	Dim in cm	32.5x26.5x6.5	induction	
023210	GN container 1/2 with handles	Dim in cm	32.5x26.5x2.0	induction	
023211	GN container 1/2	Dim in cm	32.5x26.5x6.5	induction	
023212	GN container 1/2	Dim in cm	32.5x26.5x2.0	induction	
023217	GN container 2/3 with handles	Dim in cm	35.4x32.5x6.5	induction	
023218	GN container 2/3	Dim in cm	35.4x32.5x6.5	induction	

Porcelain

007258	GN container 2/3, 35.0x32.5x6.5	Colour	white	induction	
007259	GN container 2/3, 35.0x32.5x6.5	Colour	yellow		
007260	GN container 2/3, 35.0x32.5x6.5	Colour	blue		
007261	GN container 2/3, 35.0x32.5x6.5	Colour	orange		
007266	GN container 1/1, 53.0x32.5x6.5	Colour	white	induction	
007267	GN container 1/1, 53.0x32.5x6.5	Colour	yellow		
007268	GN container 1/1, 53.0x32.5x6.5	Colour	blue		
007269	GN container 1/1, 53.0x32.5x6.5	Colour	orange		

Multimetal

ANDY MANNHART RAINBOW COLLECTION PANS

- Attractive multifunctional coloured pans available in the rainbow colours: orange, blue, green, yellow and white
- Made of 3-ply stainless steel material, suitable for electric, gas, ceran and induction
- Perfect heat transmission
- Cook and present your food in the same pan
- Lid specially modified, it can be stored on top or on the side of the pan, equipped with a steam-release
- Special paint, heat-resistant (Whitford Technology), please handle with care
- Do not clean with hard sponge, use soft detergent

RAINBOW
collection

STEW PAN, ROUND
**induction**

		Ø cm	H in cm	Cap. ltr	P/U
001262	Stew pan incl. glass lid, white, 3-ply, s/s	16.0	8.0	1.6	8
001264	Stew pan incl. glass lid, white, 3-ply, s/s	20.0	10.0	3.1	6
001263	Stew pan incl. glass lid, white, 3-ply, s/s	24.0	12.0	5.4	4

**induction**

		Ø cm	H in cm	Cap. ltr	P/U
001259	Stew pan incl. glass lid, yellow, 3-ply, s/s	16.0	8.0	1.6	8
001261	Stew pan incl. glass lid, yellow, 3-ply, s/s	20.0	10.0	3.1	6
001260	Stew pan incl. glass lid, yellow, 3-ply, s/s	24.0	12.0	5.4	4

**induction**

		Ø cm	H in cm	Cap. ltr	P/U
001256	Stew pan incl. glass lid, green, 3-ply, s/s	16.0	8.0	1.6	8
001258	Stew pan incl. glass lid, green, 3-ply, s/s	20.0	10.0	3.1	6
001257	Stew pan incl. glass lid, green, 3-ply, s/s	24.0	12.0	5.4	4

**induction**

		Ø cm	H in cm	Cap. ltr	P/U
001253	Stew pan incl. glass lid, blue, 3-ply, s/s	16.0	8.0	1.6	8
001255	Stew pan incl. glass lid, blue, 3-ply, s/s	20.0	10.0	3.1	6
001254	Stew pan incl. glass lid, blue, 3-ply, s/s	24.0	12.0	5.4	4

**induction**

		Ø cm	H in cm	Cap. ltr	P/U
001250	Stew pan incl. glass lid, orange, 3-ply, s/s	16.0	8.0	1.6	8
001252	Stew pan incl. glass lid, orange, 3-ply, s/s	20.0	10.0	3.1	6
001251	Stew pan incl. glass lid, orange, 3-ply, s/s	24.0	12.0	5.4	4



		Ø cm	H in cm	Cap. ltr
031053	Insert 16cm, white, porcelain	17.6	6.6	0.6
031054	Insert 20cm, white, porcelain	21.0	7.9	1.5
031055	Insert 24cm, white, porcelain	25.7	8.9	2.3

Multimetal



RAINBOW
collection

ROASTING PAN, SQUARE

		Dim in cm	Cap. ltr	P/U	induction
007634	Roasting pan, incl. glass lid, white, 3-ply, s/s	27.35x27.35x7.0	4.0	4	



		Dim in cm	Cap. ltr	P/U	induction
007635	Roasting pan, incl. glass lid, yellow, 3-ply, s/s	27.35x27.35x7.0	4.0	4	



		Dim in cm	Cap. ltr	P/U	induction
007636	Roasting pan, incl. glass lid, green, 3-ply, s/s	27.35x27.35x7.0	4.0	4	



		Dim in cm	Cap. ltr	P/U	induction
007637	Roasting pan, incl. glass lid, blue, 3-ply, s/s	27.35x27.35x7.0	4.0	4	



		Dim in cm	Cap. ltr	P/U	induction
007638	Roasting pan, incl. glass lid, orange, 3-ply, s/s	27.35x27.35x7.0	4.0	4	



		Dim in cm	Cap. ltr
031056	Insert, white, porcelain	28.10x28.10x6.0	1.8



Stainless steel

ANDY MANNHART RAINBOW COLLECTION SERVING BOWLS

Slightly inclined Rainbow Collection serving bowls made of stainless steel, insulated double wall system to keep food passively cold. Available in the following colours: white, yellow, green, blue, orange or stainless steel.



		P/U	Ø cm	H in cm
025665	Serving bowl slightly inclined, insulated double wall, white	8	18.0	14.0
025662	Serving bowl slightly inclined, insulated double wall, white	8	24.0	19.0



		P/U	Ø cm	H in cm
025651	Serving bowl slightly inclined, insulated double wall, yellow	8	18.0	14.0
025648	Serving bowl slightly inclined, insulated double wall, yellow	8	24.0	19.0



		P/U	Ø cm	H in cm
025657	Serving bowl slightly inclined, insulated double wall, green	8	18.0	14.0
025654	Serving bowl slightly inclined, insulated double wall, green	8	24.0	19.0



		P/U	Ø cm	H in cm
025659	Serving bowl slightly inclined, insulated double wall, blue	8	18.0	14.0
025658	Serving bowl slightly inclined, insulated double wall, blue	8	24.0	19.0



		P/U	Ø cm	H in cm
025661	Serving bowl slightly inclined, insulated double wall, orange	8	18.0	14.0
025660	Serving bowl slightly inclined, insulated double wall, orange	8	24.0	19.0



		P/U	Ø cm	H in cm
025667	Serving bowl slightly inclined, insulated double wall, s/s	8	18.0	14.0
025666	Serving bowl slightly inclined, insulated double wall, s/s	8	24.0	19.0

Ceramic

Suitable for selected induction units

		Ø cm	H in cm	Cap. ltr
033755	Cocotte round with s/s handle, satin white	22.0	14.0	2.4
033756	Cocotte round with s/s handle, satin white	26.0	14.5	3.4

induction



		Ø cm	H in cm	Cap. ltr
032444	Cocotte round with s/s handle, satin black	22.0	14.0	2.4
033326	Cocotte round with s/s handle, satin black	26.0	14.5	3.4

induction



		Ø cm	H in cm	Cap. ltr
030687	Cocotte round with s/s handle, pepper red	22.0	14.0	2.4
033758	Cocotte round with s/s handle, pepper red	26.0	14.5	3.4

induction



		Ø cm	H in cm	Cap. ltr
033760	Cocotte round with s/s handle, touareg blue	22.0	14.0	2.4
033761	Cocotte round with s/s handle, touareg blue	26.0	14.5	3.4

induction



		Ø cm	H in cm	Cap. ltr
033762	Cocotte round with s/s handle, seychelles yellow	22.0	14.0	2.4
033763	Cocotte round with s/s handle, seychelles yellow	26.0	14.5	3.4

induction



		Ø cm	H in cm	Cap. ltr
030680	Cocotte round with s/s handle, taupe	22.0	14.0	2.4
033772	Cocotte round with s/s handle, taupe	26.0	14.5	3.44

induction



		Ø cm	H in cm	Cap. ltr
032442	Cocotte round with s/s handle, glass lid	22.0	14.0	2.4
033764	Cocotte round with s/s handle, glass lid	25.5	14.0	3.4

induction



		Ø cm	H in cm	Cap. ltr
030672	Cocotte round, without lid	22.0	9.5	2.4
033775	Cocotte round, without lid	25.5	9.5	3.4

induction



Ceramic

Suitable for selected induction units

**induction**

		Dim in cm	Cap. ltr
032450	Cocotte oval with s/s handle, satin white	32.5x26.5x16.0	3.5

**induction**

		Dim in cm	Cap. ltr
030728	Cocotte oval with s/s handle, satin black	32.5x26.5x16.0	3.5

**induction**

		Dim in cm	Cap. ltr
030710	Cocotte oval with s/s handle, pepper red	32.5x26.5x16.0	3.5

**induction**

		Dim in cm	Cap. ltr
030713	Cocotte oval with s/s handle, touareg blue	32.5x26.5x16.0	3.5

**induction**

		Dim in cm	Cap. ltr
033771	Cocotte oval with s/s handle, seychelles yellow	32.5x26.5x16.0	3.5

**induction**

		Dim in cm	Cap. ltr
033773	Cocotte oval with s/s handle, taupe	32.5x26.5x16.0	3.5

**induction**

		Dim in cm	Cap. ltr
033738	Cocotte oval with s/s handle, glass lid	30.5x25.5x14.0	3.5

**induction**

		Dim in cm	Cap. ltr
030704	Cocotte oval, without lid	30.5x25.5x9.5	3.5

Enamelled cast iron

		Ø cm	Cap. ltr	induction
015067	Mini slow cooker round, black	10.0	0.25	



		Ø cm	Cap. ltr	induction
015068	Mini slow cooker round, dark blue	10.0	0.25	



		Ø cm	Cap. ltr	induction
015069	Mini slow cooker round, red	10.0	0.25	



		Ø cm	Cap. ltr	induction
021929	Slow cooker round, grey	20.0	2.2	
016733	Slow cooker round, grey	24.0	3.8	
021491	Slow cooker round, grey	26.0	5.2	
021492	Slow cooker round, grey	28.0	6.7	
021930	Slow cooker round, grey	30.0	8.35	



		Ø cm	Cap. ltr	induction
011215	Slow cooker round, green	24.0	3.8	
001954	Slow cooker round, green	26.0	5.2	
002352	Slow cooker round, green	28.0	6.7	



		Ø cm	Cap. ltr	induction
001691	Slow cooker round, black	20.0	2.2	
002910	Slow cooker round, black	24.0	3.8	
023005	Slow cooker round, black	26.0	5.2	
023006	Slow cooker round, black	28.0	6.7	
023007	Slow cooker round, black	30.0	8.35	



		Ø cm	Cap. ltr	induction
016940	Slow cooker round, dark blue	24.0	3.8	
002648	Slow cooker round, dark blue	26.0	5.2	
002649	Slow cooker round, dark blue	28.0	6.7	
010714	Slow cooker round, dark blue	30.0	8.35	



		Ø cm	Cap. ltr	induction
005017	Slow cooker round, red	20.0	2.2	
013296	Slow cooker round, red	24.0	3.8	
005024	Slow cooker round, red	26.0	5.2	
002650	Slow cooker round, red	28.0	6.7	
009507	Slow cooker round, red	30.0	8.35	



Enamelled cast iron

**induction**

		Ø cm	Cap. ltr
006753	Slow cooker oval, grey	29.0	4.2
016431	Slow cooker oval, grey	31.0	5.5
013596	Slow cooker oval, grey	33.0	6.7

**induction**

		Ø cm	Cap. ltr
002041	Slow cooker oval, green	29.0	4.2
021493	Slow cooker oval, green	33.0	6.7

**induction**

		Ø cm	Cap. ltr
023013	Slow cooker oval, black	27.0	3.2
023014	Slow cooker oval, black	29.0	4.2
023015	Slow cooker oval, black	31.0	5.5
023016	Slow cooker oval, black	33.0	6.7

**induction**

		Ø cm	Cap. ltr
002551	Slow cooker oval, dark blue	29.0	4.2
010715	Slow cooker oval, dark blue	31.0	5.5
002647	Slow cooker oval, dark blue	33.0	6.7

**induction**

		Ø cm	Cap. ltr
015818	Slow cooker oval, red	27.0	3.2
003903	Slow cooker oval, red	29.0	4.2
009685	Slow cooker oval, red	31.0	5.5
003905	Slow cooker oval, red	33.0	6.7
002646	Slow cooker oval, red	37.0	8.0

Cast iron

		Ø cm	H in cm	Cap. ltr	induction new
034875	Roaster oval, black	31.0	13.0	5.8	



		Ø cm	H in cm	Cap. ltr	induction new
034876	Casserole round, black	20.0	10.5	2.8	



		Ø cm	H in cm	Cap. ltr	induction new
034877	Casserole round, black	24.0	12.0	4.7	



		Ø cm	H in cm	Cap. ltr	induction new
034878	Roaster oval, red	31.0	13.0	5.8	



		Ø cm	H in cm	Cap. ltr	induction new
034879	Casserole round, red	20.0	10.5	2.8	



		Ø cm	H in cm	Cap. ltr	induction new
034880	Casserole round, red	24.0	12.0	4.7	



		Dim in cm	new
037828	Lid holder, s/s	22.0x28.0x47.0	



Cast iron

induction

		Ø cm	Cap. ltr
023025	Oval stacking dish, black	28.0	1.6
023026	Oval stacking dish, black	32.0	2.2

induction

		Ø cm	H in cm	Cap. ltr
003299	Wok with glass lid, red, enamelled	37.0	10.2	5.7
005113	Wok with glass lid, black	37.0	10.2	5.7

induction

new



		Ø cm	H in cm	Cap. ltr
009978	Wok with glass lid, round, mat, flat-bottom shiny enamelled, exterior and interior mat enamelled, with accessories, 4-piece set	35.0	9.5	2.0

induction

new



		Ø cm	H in cm	Cap. ltr
035026	Wok with lid, round, mat, flat-bottom shiny enamelled, exterior and interior mat enamelled, with accessories, 6-piece set, lid handle and side grips in wood	35.0	10.0	4.0

Stainless steel

induction

new



		Ø cm	H in cm	Cap. ltr
035027	Gourmet Wok with glass lid and side grips, round	30.0	9.0	5.0



		Ø cm
035117	Gas rechaud, infinitely adjustable, refillable	18.00

Enamelled cast iron

induction

		Ø cm
001689	Tajine, cream	28.0

induction

		Ø cm
006799	Tajine, red	28.0

Copper-Stainless steel

		Ø cm	H in cm		
037824	Frying pan with s/s handle	20.0	3.4		induction new 
027789	Frying pan with s/s handle	24.0	4.9		
020366	Frying pan with s/s handle	28.0	5.2		
020388	Sauce pan with s/s lid and handle	16.0	7.5	Cap. ltr	induction new 
037826	Sauce pan with s/s lid and handle	20.0	9.0	2.7	
020389	Sauce pan with s/s lid and additional side handle	20.0	12.0	Cap. ltr	induction new 
				3.7	
037825	Casserole with s/s lid and 2 handles	20.0	9.0	Cap. ltr	induction new 
				2.7	
020391	Casserole with s/s lid and 2 handles	20.0	12.0	Cap. ltr	induction new 
020413	Casserole with s/s lid and 2 handles	24.0	14.0	3.7	
				6.5	
027790	Saute pan with s/s lid and 2 handles	28.0	7.0	Cap. ltr	induction new 
				4.0	
037827	Sauteuse with s/s handle	18.0	6.5	Cap. ltr	induction new 
020415	Sauteuse with s/s handle	20.0	7.0	1.5	
				2.0	
032776	Mini casserole with s/s lid and 2 handles	9.0	4.8	Cap. ltr	induction new 
				0.35	
032778	Mini sauce pan with s/s handle	9.0	4.8	Cap. ltr	induction new 
				0.35	
032783	Mini frying pan with s/s handle	12.0	3.0		induction new 
032732	Copper cleaner, 0.25 kg				induction new 
037192	Copper cleaner, 0.75 kg				induction new 
037839	Copper cleaner, 5.0 kg				induction new 

Tinned copper



		Ø cm	H in cm	Cap. ltr
022095	Sauce pan	12.0	7.0	0.8
022096	Sauce pan	14.0	8.0	1.2
022097	Sauce pan	16.0	9.0	1.8
022098	Sauce pan	18.0	10.0	2.5
022099	Sauce pan	20.0	10.5	3.3
022976	Sauteuse conical	16.0	6.0	0.9
022977	Sauteuse conical	20.0	8.0	1.7
022978	Sauteuse conical	24.0	9.0	2.9

Copper-Stainless steel

induction

		Ø cm	H in cm	Cap. ltr
022074	Sauce pan	14.0	7.8	1.2
022075	Sauce pan	16.0	8.9	1.8
022076	Sauce pan	18.0	10.0	2.5
022077	Sauce pan	20.0	10.7	3.3
022078	Sauce pan	24.0	13.0	6.0

induction

		Ø cm	H in cm	Cap. ltr
022085	Saute pan straight	16.0	5.8	1.0
022086	Saute pan straight	20.0	6.5	1.8
022087	Saute pan straight	24.0	7.5	3.0

induction

		Ø cm	H in cm	Cap. ltr
022088	Sauteuse conical	20.0	7.2	1.7
010035	Sauteuse conical	24.0	8.2	3.1

induction

		Ø cm	H in cm	
010033	Frying pan	20.0	4.0	
022089	Frying pan	24.0	4.0	
022090	Frying pan	28.0	4.0	
010034	Frying pan	32.0	4.0	

induction

		Ø cm	H in cm	Cap. ltr
000578	Saute pan conical	28.0	10.0	3.5

induction

		Ø cm	H in cm	Cap. ltr
022091	Saute pan with s/s lid	24.0	7.5	3.1

induction

		Ø cm	H in cm	Cap. ltr
010036	Casserole with s/s lid	16.0	12.0	1.8
022092	Casserole with s/s lid	20.0	10.7	3.3
022093	Casserole with s/s lid	24.0	13.0	5.4
022094	Casserole with s/s lid	28.0	13.8	8.0

Ø cm



		Ø cm		
020808	Lid s/s	14.0		
020809	Lid s/s	16.0		
020810	Lid s/s	18.0		
020811	Lid s/s	20.0		
020813	Lid s/s	24.0		
020812	Lid s/s	28.0		

Stainless steel

AFFINITY

		Ø cm	H in cm	Cap. ltr	induction
005734	Sauce pan	14.0	7.5	1.2	
005735	Sauce pan	16.0	9.0	1.8	
005736	Sauce pan	18.0	10.0	2.5	
005737	Sauce pan	20.0	11.0	3.4	



		Ø cm	H in cm	Cap. ltr	induction
005738	Saute pan straight	20.0	6.0	1.8	
005739	Saute pan straight	24.0	7.5	3.0	



		Ø cm	H in cm	Cap. ltr	induction
005740	Sauteuse conical	20.0	7.0	1.7	
005741	Sauteuse conical	24.0	8.0	3.0	



		Ø cm	H in cm		induction
005742	Frying pan	20.0	4.0		
005743	Frying pan	24.0	4.0		
005744	Frying pan	28.0	4.5		
005745	Frying pan	32.0	5.0		



		Ø cm	H in cm		induction
010037	Saute pan with lid	24.0	7.5		



		Ø cm	H in cm	Cap. ltr	induction
038610	Saute pan round with lid	28.0	10.0	4.9	



		Ø cm	H in cm	Cap. ltr	induction
010039	Stew pan with lid	14.0	8.0	1.0	
010042	Stew pan with lid	16.0	12.0	2.4	
010043	Stew pan with lid	20.0	11.0	3.4	
010044	Stew pan with lid	24.0	13.0	5.4	
010045	Stew pan with lid	28.0	15.0	8.6	



Aluminium

CHOC INDUCTION EXTRÊME



induction

		Ø cm
010046	Frying pan non-stick	20.0
010047	Frying pan non-stick	24.0
010048	Frying pan non-stick	28.0
010049	Frying pan non-stick	32.0



induction

		Ø cm
010050	Saute pan non-stick	24.0
010051	Saute pan non-stick	28.0



induction

		Ø cm
016251	Saute pan with 2 handles non-stick	20.0

Sandblasted steel

Made of thick, sand-blasted steel with protective coating.



induction

		Ø cm	H in cm
028325	Frying pan	20.0	5.0
028326	Frying pan	24.0	6.0
028327	Frying pan	28.0	6.5
028328	Frying pan	32.0	7.0



Andy Mannhart



POTS & PANS
GN Containers, Bain-Maries

1

Top quality cooking ranges from Andy Mannhart

All our series are suitable for:



GAS

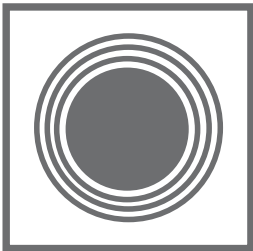

ELECTRIC



CERAMIC GLASS

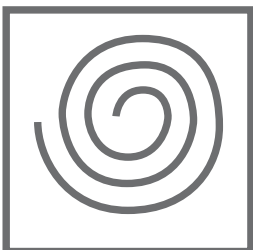

HALOGEN

Some are also suitable for induction and are marked with the induction sign:

induction

Stainless steel

ANDY MANNHART STANDARD

This line is made of 18/10 stainless steel and specially designed to achieve the best performance in professional cooking. Excellent resistance to corrosion. The special impact welding system of the sandwich base offers maximum robustness. The inside radius allows easy and fast cleaning, achieving NSF certification. The majority of the Andy Mannhart Standard Line are certified class induction, guaranteeing the best performance on induction.

		Ø cm	H in cm	Cap. ltr	induction
017001	Stock pot	16.0	16.0	3.0	
017002	Stock pot	18.0	18.0	4.5	
017003	Stock pot	20.0	20.0	6.2	
017004	Stock pot	24.0	24.0	10.0	
017005	Stock pot	28.0	28.0	16.5	
017006	Stock pot	30.0	30.0	21.2	
017007	Stock pot	32.0	32.0	24.0	
017008	Stock pot	35.0	35.0	33.6	
017009	Stock pot	40.0	40.0	50.0	
017010	Stock pot	45.0	45.0	72.0	
017011	Stock pot	50.0	50.0	98.0	
017012	Stock pot	60.0	55.0	155.0	



		Ø cm	H in cm	Cap. ltr	induction
017020	Casserole	16.0	11.0	2.1	
017021	Casserole	18.0	12.0	3.0	
017022	Casserole	20.0	13.0	4.0	
017023	Casserole	24.0	14.0	6.3	
017024	Casserole	28.0	17.5	10.2	
017025	Casserole	30.0	18.0	12.7	
017026	Casserole	32.0	19.0	15.2	
017027	Casserole	35.0	21.0	20.2	
017028	Casserole	40.0	25.0	31.4	
017029	Casserole	45.0	28.0	44.5	
017030	Casserole	50.0	30.0	59.0	
017031	Casserole	60.0	35.0	99.0	



		Ø cm	H in cm	Cap. ltr	induction
017032	Stew pan	16.0	7.5	1.5	
017033	Stew pan	18.0	8.0	2.0	
017034	Stew pan	20.0	8.0	2.5	
017035	Stew pan	24.0	9.5	4.3	
017036	Stew pan	28.0	11.0	6.7	
017037	Stew pan	30.0	12.0	8.4	
017038	Stew pan	32.0	12.5	10.0	
017039	Stew pan	35.0	14.0	13.6	
017040	Stew pan	40.0	15.5	19.5	
017041	Stew pan	45.0	17.0	27.0	
017042	Stew pan	50.0	20.0	39.0	
017043	Stew pan	60.0	23.0	65.0	



		Ø cm	H in cm	Cap. ltr	induction
017074	Sauce pan	16.0	11.0	2.1	
017075	Sauce pan	18.0	12.0	3.0	
017076	Sauce pan	20.0	13.0	4.0	
017077	Sauce pan	24.0	14.0	6.3	
017078	Sauce pan	28.0	17.5	10.2	
017079	Sauce pan	32.0	19.0	15.2	



Stainless steel

ANDY MANNHART STANDARD

induction



		Ø cm	H in cm	Cap. ltr
017065	Sauce pan	12.0	7.0	0.7
017066	Sauce pan	14.0	7.0	1.0
017067	Sauce pan	16.0	7.5	1.5
017068	Sauce pan	18.0	9.0	2.3
017069	Sauce pan	20.0	10.0	3.1
017070	Sauce pan	22.0	11.0	4.2
017071	Sauce pan	24.0	12.0	5.4
017073	Sauce pan	28.0	14.0	8.6

induction



		Ø cm	H in cm	Cap. ltr
017059	Sauce pan	16.0	7.5	1.5
017060	Sauce pan	18.0	8.0	2.0
017061	Sauce pan	20.0	8.0	2.5
017062	Sauce pan	24.0	9.5	4.3
017063	Sauce pan	28.0	11.0	6.7
017064	Sauce pan	32.0	12.5	10.0

induction



		Ø cm	H in cm
017300	Frying pan	18.0	3.5
017301	Frying pan	20.0	3.8
017302	Frying pan	22.0	4.2
017303	Frying pan	24.0	4.6
017304	Frying pan	26.0	5.0
017305	Frying pan	28.0	5.5
017306	Frying pan	32.0	6.0
017307	Frying pan	36.0	6.0
017308	Frying pan	40.0	6.5

induction



		Ø cm	H in cm	Cap. ltr
017080	Sauteuse conical	16.0	6.0	1.0
017081	Sauteuse conical	18.0	6.0	1.2
017082	Sauteuse conical	20.0	6.5	1.6
017083	Sauteuse conical	22.0	7.0	2.1
017084	Sauteuse conical	24.0	7.5	2.7

induction



		Ø cm	H in cm	Cap. ltr
015402	Sauteuse round	20.0	7.5	1.8
015403	Sauteuse round	24.0	8.5	3.0

induction



		Ø cm	H in cm	Cap. ltr
017274	Saute pan	20	6.0	1.9
017275	Saute pan	24	6.0	2.7
017276	Saute pan	28	6.0	3.7
017277	Saute pan	30	6.0	4.3
017278	Saute pan	32	6.0	4.7
017279	Saute pan	35	7.0	6.7
017280	Saute pan	40	8.0	10.0

Suitable for all round Andy Mannhart pans



		Ø cm
017044	Lid	14.0
017045	Lid	16.0
017046	Lid	18.0
017047	Lid	20.0
017048	Lid	22.0
017049	Lid	24.0
017051	Lid	28.0

		Ø cm
017052	Lid	30.0
017053	Lid	32.0
017054	Lid	35.0
017055	Lid	40.0
017056	Lid	45.0
017057	Lid	50.0
017058	Lid	60.0

Stainless steel

		Ø cm	H in cm	Cap. ltr	induction
017310	Paella pan with 2 handles	20.0	6.0	1.9	
017311	Paella pan with 2 handles	24.0	6.0	2.7	
017312	Paella pan with 2 handles	28.0	6.0	3.7	
017313	Paella pan with 2 handles	30.0	6.0	4.3	
017314	Paella pan with 2 handles	32.0	6.0	4.7	
017315	Paella pan with 2 handles	35.0	7.0	6.7	
017316	Paella pan with 2 handles	40.0	8.0	10.0	
017317	Paella pan with 2 handles	45.0	8.5	12.0	
017318	Paella pan with 2 handles	50.0	9.0	17.5	
017319	Paella pan with 2 handles	60.0	10.0	28.0	



		Ø cm	H in cm	Cap. ltr	induction
017015	Stock pot with tap, lid and grate	28.0	28.0	16.5	
017016	Stock pot with tap, lid and grate	32.0	32.0	24.0	
017017	Stock pot with tap, lid and grate	35.0	35.0	33.6	
017018	Stock pot with tap, lid and grate	40.0	40.0	50.0	
017019	Stock pot with tap, lid and grate	45.0	45.0	72.0	



		Ø cm	H in cm	Cap. ltr	induction
017605	Stock pot with tap and lid	28.0	28.0	16.5	
017606	Stock pot with tap and lid	32.0	32.0	24.0	
017607	Stock pot with tap and lid	35.0	35.0	33.6	
017608	Stock pot with tap and lid	40.0	40.0	50.0	
017609	Stock pot with tap and lid	45.0	45.0	72.0	



		H in cm
017085	Pasta cooker insert (1/4 segment) fits pan Ø 35.0cm	23.0
017086	Pasta cooker insert (1/4 segment) fits pan Ø 40.0cm	26.0

induction



		Ø cm	H in cm	Cap. ltr	induction
017013	Pasta cooker with 4 inserts	35.0	21.0	20.2	
017014	Pasta cooker with 4 inserts	40.0	25.0	31.4	

induction



		Ø cm	H in cm
017320	Frying pan non-stick	18.0	3.5
017321	Frying pan non-stick	20.0	3.8
017322	Frying pan non-stick	22.0	4.2
017323	Frying pan non-stick	24.0	4.6
017324	Frying pan non-stick	26.0	5.0
017325	Frying pan non-stick	28.0	5.5
017326	Frying pan non-stick	32.0	6.0
017327	Frying pan non-stick	36.0	6.0
017328	Frying pan non-stick	40.0	6.5

induction



		Dim in cm
017632	Roasting pan with 2 drop handles, rectangular	43.0x33.0x6.5
017633	Roasting pan with 2 drop handles, rectangular	54.0x39.0x7.0
017634	Roasting pan with 2 drop handles, rectangular	64.0x44.0x9.0
017635	Roasting pan with 2 drop handles, rectangular	74.0x49.0x10.0



Stainless steel

ANDY MANNHART AM COLLECTION

- Ideal for professional and intensive use in restaurants and for front cooking
- Special stainless steel with impact bonded capsuled bottom for uniform heating which results in energy saving
- Food cooks faster and stays longer hot after cooking
- Handles welded with special technique. So does not heat up during cooking
- Suitable for induction as well as for all other heating modes

induction



		Cap. ltr	Dim in cm
058194	Stock pot	3.0	16.0x15.0
058100	Stock pot	5.6	20.0x18.0
058195	Stock pot	9.0	24.0x20.0
058101	Stock pot	10.0	24.0x24.0
058196	Stock pot	14.5	28.0x24.0
058102	Stock pot	16.5	28.0x28.0
058197	Stock pot	22.1	32.0x27.5
058103	Stock pot	24.0	32.0x32.0
058198	Stock pot	31.0	36.0x31.0
058104	Stock pot	36.0	36.0x36.0
058199	Stock pot	43.0	40.0x34.0
058105	Stock pot	50.0	40.0x40.0
058106	Stock pot	70.0	45.0x45.0
058200	Stock pot	98.0	50.0x50.0
058201	Stock pot	155.0	60.0x55.0

induction



		H in cm
058310	Pasta cooker insert (1/4 segment) fits pan Ø 36.0cm	23.0
058311	Pasta cooker insert (1/4 segment) fits pan Ø 40.0cm	26.0

induction



		Cap. ltr	Dim in cm
058202	Casserole	2.4	16.0x12.0
058115	Casserole	3.3	18.0x13.0
058116	Casserole	4.4	20.0x14.0
058117	Casserole	7.2	24.0x16.0
058118	Casserole	11.1	28.0x18.0
058203	Casserole	14.5	32.0x18.0
058119	Casserole	16.1	32.0x20.0
058120	Casserole	22.0	36.0x21.5
058204	Casserole	23.0	36.0x23.0
058121	Casserole	30.8	40.0x24.5
058205	Casserole	33.0	40.0x26.0
058122	Casserole	44.0	45.0x27.5
058206	Casserole	47.5	45.0x30.0
058207	Casserole	63.0	50.0x32.0
058208	Casserole	107.0	60.0x38.0

induction



		Cap. ltr	Dim in cm
058130	Stew pan	1.5	16.0x8.0
058209	Stew pan	1.9	16.0x9.5
058131	Stew pan	2.0	18.0x8.0
058132	Stew pan	2.5	20.0x8.0
058210	Stew pan	3.3	20.0x10.5
058133	Stew pan	4.3	24.0x9.5
058211	Stew pan	5.0	24.0x11.0
058134	Stew pan	6.7	28.0x11.0
058212	Stew pan	8.0	28.0x13.0
058213	Stew pan	12.9	32.0x16.0
058135	Stew pan	18.0	36.0x18.0
058136	Stew pan	25.0	40.0x20.0
058214	Stew pan	36.0	45.0x23.0
058215	Stew pan	40.0	50.0x23.0
058216	Stew pan	84.0	60.0x30.0

		Cap. ltr	Dim in cm	induction
058145	Sauce pan	0.7	12.0x7.0	
058146	Sauce pan	1.0	14.0x8.0	
058217	Sauce pan	2.4	16.0x12.0	
058147	Sauce pan	3.3	18.0x13.0	
058218	Sauce pan	4.4	20.0x14.0	
058148	Sauce pan	7.2	24.0x16.0	
058149	Sauce pan	11.1	28.0x18.0	

		Cap. ltr	Dim in cm	induction
058155	Sauce pan	1.4	16.0x7.0	
058219	Sauce pan	1.9	16.0x9.5	
058156	Sauce pan	2.0	18.0x8.0	
058157	Sauce pan	3.3	20.0x10.5	
058158	Sauce pan	5.0	24.0x11.0	
058159	Sauce pan	8.0	28.0x13.0	

		Dim in cm	induction
058161	Frying pan	20.0x4.5	
058162	Frying pan	24.0x4.5	
058163	Frying pan	28.0x5.0	
058164	Frying pan	32.0x5.5	
058165	Frying pan	36.0x6.0	
058220	Frying pan	40.0x6.5	
058221	Frying pan	45.0x7.0	

		Dim in cm	induction
058222	Omlette pan	20.0x4.5	
058223	Omlette pan	24.0x4.5	
058170	Omlette pan	28.0x5.0	
058224	Omlette pan	32.0x5.5	
058171	Omlette pan	36.0x6.0	
058225	Omlette pan	40.0x6.5	

		Dim in cm	induction
058176	Frying pan non-stick	20.0x4.0	
058177	Frying pan non-stick	24.0x5.5	
058178	Frying pan non-stick	28.0x5.5	
058179	Frying pan non-stick	32.0x5.5	
058179	Frying pan non-stick	32.0x5.5	
058309	Frying pan non-stick	36.0x6.0	

		Cap. ltr	Dim in cm	induction
058180	Sauteuse	1.0	16.0x6.0	
058226	Sauteuse	1.25	18.0x6.0	
058181	Sauteuse	1.6	20.0x6.5	
058182	Sauteuse	2.0	22.0x7.0	
058183	Sauteuse	2.8	24.0x7.5	

		Cap. ltr	Dim in cm	induction
058302	Saute pan	1.7	20.0x6.0cm	
058303	Saute pan	2.4	24.0x6.0cm	
058304	Saute pan	3.3	28.0x6.0cm	
058305	Saute pan	3.8	30.0x6.0cm	
058306	Saute pan	4.3	32.0x6.0cm	
058307	Saute pan	6.4	36.0x7.0cm	
058308	Saute pan	9.0	40.0x8.0cm	

		Ø cm		Ø cm		Ø cm		
058185	Lid	16.0	058189	Lid	28.0	058193	Lid	45.0
058186	Lid	18.0	058190	Lid	32.0	058227	Lid	50.0
058187	Lid	20.0	058191	Lid	36.0	058228	Lid	60.0
058188	Lid	24.0	058192	Lid	40.0			



HEAT TRANSMISSION

The homogenous heat transmission on the entire body makes the MULTIMETAL cookware 5 PLY highly recommended for the elaboration of sauces, chocolate, creams, etc. Extremely efficient (20% less time and energy). Highest performance on all kind of stoves. Either GAS, VITROCERAMIC, ELECTRIC and above all INDUCTION



Heat transmission on stainless steel cookware



Heat transmission on MULTIMETAL cookware

Multimetal

ANDY MANNHART MULTIPLY

It gets all the advantages of aluminium and stainless steel. Excellent resistance to corrosion along with a perfect heat diffusion due to its special sandwich alloy this range is the most appropriate for induction stoves.

		Ø cm	H in cm	Cap. ltr
017600	Saute pan, 5-ply	16.0	6.5	1.2
017601	Saute pan, 5-ply	18.0	7.0	1.7
017602	Saute pan, 5-ply	20.0	7.5	2.2
017603	Saute pan, 5-ply	24.0	8.5	3.5
017604	Saute pan, 5-ply	28.0	10.0	5.5

induction



		Ø cm	H in cm	Cap. ltr
017369	Saute pan non-stick, 5-ply	24.0	6.0	2.5
017370	Saute pan non-stick, 5-ply	28.0	6.0	3.5
017371	Saute pan non-stick, 5-ply	32.0	6.0	4.5

induction



		Ø cm
017373	Lid for 5-ply cookware	20.0



		Ø cm	H in cm
017179	Frying pan Excalibur non-stick, 5-ply	20.0	4.0
017180	Frying pan Excalibur non-stick, 5-ply	24.0	4.5
017181	Frying pan Excalibur non-stick, 5-ply	28.0	5.0
017182	Frying pan Excalibur non-stick, 5-ply	32.0	5.5

induction





Multimetal

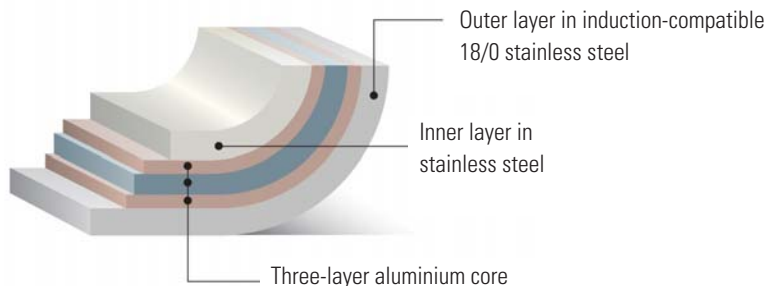
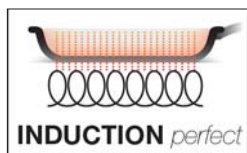

ANDY MANNHART GOURMET LINE

Vulcano frying pans are made of highly conductive multi-ply material with a non-stick coating that can be renewed after protracted use. Their ergonomic handle ensures safe, professional handling.



	induction		Ø cm	H in cm
	035146	Frying pan Vulcano Ceramic non-stick, 5-ply	20.0	3.4
	025280	Frying pan Vulcano Ceramic non-stick, 5-ply	24.0	4.2
	025279	Frying pan Vulcano Ceramic non-stick, 5-ply	28.0	4.5
	002528	Frying pan Vulcano Ceramic non-stick, 5-ply	32.0	5.0

	induction		Ø cm	H in cm
	004975	Frying pan Vulcano Ceramic XL non-stick, 5-ply	24.0	6.0
	004976	Frying pan Vulcano Ceramic XL non-stick, 5-ply	28.0	7.0

	induction		Ø cm	H in cm
	025282	Gratin pan Vulcano Ceramic non-stick, 5-ply	28.0	7.0

	induction		Dim in cm	H in cm
	025283	Grill pan Vulcano Ceramic non-stick, 5-ply	28.0x28.0	2.5cm

	induction new		Ø cm	H in cm
	037835	Sauteuse Vulcano Classic non-stick, 5-ply	20.0	7.0

	induction		Ø cm	H in cm
	033083	Wok pan Vulcano Classic non-stick, 5-ply	28.0	8.5

	induction		Ø cm
	004977	Crêpe pan Vulcano non-stick, 5-ply	28.0cm

Multimetal

VULCANO CUT RESIST CLASSIC

The pan with the shield: Sharp-edged spatula, tongs gripping meat, robust sponges - a non-stick frying pan must put away a lot. The Vulcano Cut Resist Classic is particularly tough. This is due to the clever construction: A network slightly elevated stainless steel webs lies like a protective shield over the non-stick coating. So the pan spared drastic experiences, it is also after years of use resistant to scratching and abrasion.



		Ø cm	H in cm	induction
027859	Frying pan Vulcano Cut Resist Classic non-stick, 5-ply	20.0	3.4	
025357	Frying pan Vulcano Cut Resist Classic non-stick, 5-ply	24.0	4.2	
025278	Frying pan Vulcano Cut Resist Classic non-stick, 5-ply	28.0	4.5	
025358	Frying pan Vulcano Cut Resist Classic non-stick, 5-ply	32.0	4.9	



		Ø cm	H in cm	induction
027862	Frying pan Vulcano Cut Resist Classic XL non-stick, 5-ply	28.0	7.0	



Multimetal

new



induction

037836 Sauteuse Vulcano Cut Resist non-stick, 5-ply

Ø cm H in cm

20.0 7.0



induction

033084 Wok pan Vulcano Cut Resist Classic non-stick, 5-ply

Ø cm H in cm

28.0 8.5



induction

033086 Baking pan Vulcano Cut Resist Classic XL non-stick, 5-ply

Ø cm H in cm

28.0 7.0



033088 Glass lid Vulcano

Ø cm

20



033089 Glass lid Vulcano

Ø cm

32

Multimetal

ANDY MANNHART RAINBOW COLLECTION PANS

- Attractive multifunctional coloured pans available in the rainbow colours: orange, blue, green, yellow and white
- Made of 3-ply stainless steel material, suitable for electric, gas, ceran and induction
- Perfect heat transmission
- Cook and present your food in the same pan
- Lid specially modified, it can be stored on top or on the side of the pan, equipped with a steam-release
- Special paint, heat-resistant (Whitford Technology), please handle with care
- Do not clean with hard sponge, use soft detergent



STEW PAN, ROUND

		Ø cm	H in cm	Cap. ltr	P/U	induction
001262	Stew pan incl. glass lid, white, 3-ply, s/s	16.0	8.0	1.6	8	
001264	Stew pan incl. glass lid, white, 3-ply, s/s	20.0	10.0	3.1	6	
001263	Stew pan incl. glass lid, white, 3-ply, s/s	24.0	12.0	5.4	4	



		Ø cm	H in cm	Cap. ltr	P/U	induction
001259	Stew pan incl. glass lid, yellow, 3-ply, s/s	16.0	8.0	1.6	8	
001261	Stew pan incl. glass lid, yellow, 3-ply, s/s	20.0	10.0	3.1	6	
001260	Stew pan incl. glass lid, yellow, 3-ply, s/s	24.0	12.0	5.4	4	



		Ø cm	H in cm	Cap. ltr	P/U	induction
001256	Stew pan incl. glass lid, green, 3-ply, s/s	16.0	8.0	1.6	8	
001258	Stew pan incl. glass lid, green, 3-ply, s/s	20.0	10.0	3.1	6	
001257	Stew pan incl. glass lid, green, 3-ply, s/s	24.0	12.0	5.4	4	



		Ø cm	H in cm	Cap. ltr	P/U	induction
001253	Stew pan incl. glass lid, blue, 3-ply, s/s	16.0	8.0	1.6	8	
001255	Stew pan incl. glass lid, blue, 3-ply, s/s	20.0	10.0	3.1	6	
001254	Stew pan incl. glass lid, blue, 3-ply, s/s	24.0	12.0	5.4	4	



		Ø cm	H in cm	Cap. ltr	P/U	induction
001250	Stew pan incl. glass lid, orange, 3-ply, s/s	16.0	8.0	1.6	8	
001252	Stew pan incl. glass lid, orange, 3-ply, s/s	20.0	10.0	3.1	6	
001251	Stew pan incl. glass lid, orange, 3-ply, s/s	24.0	12.0	5.4	4	



		Ø cm	H in cm	Cap. ltr
031053	Insert 16cm, white, porcelain	17.6	6.6	0.6
031054	Insert 20cm, white, porcelain	21.0	7.9	1.5
031055	Insert 24cm, white, porcelain	25.7	8.9	2.3



Multimetal

ANDY MANNHART RAINBOW COLLECTION PANS

 RAINBOW
collection

ROASTING PAN, SQUARE

**induction**

		Dim in cm	Cap. ltr	P/U
007634	Roasting pan, incl. glass lid, white, 3-ply, s/s	27.35x27.35x7.0	4.0	4

**induction**

		Dim in cm	Cap. ltr	P/U
007635	Roasting pan, incl. glass lid, yellow, 3-ply, s/s	27.35x27.35x7.0	4.0	4

**induction**

		Dim in cm	Cap. ltr	P/U
007636	Roasting pan, incl. glass lid, green, 3-ply, s/s	27.35x27.35x7.0	4.0	4

**induction**

		Dim in cm	Cap. ltr	P/U
007637	Roasting pan, incl. glass lid, blue, 3-ply, s/s	27.35x27.35x7.0	4.0	4

**induction**

		Dim in cm	Cap. ltr	P/U
007638	Roasting pan, incl. glass lid, orange, 3-ply, s/s	27.35x27.35x7.0	4.0	4



		Dim in cm	Cap. ltr
031056	Insert, white, porcelain	28.10x28.10x6.0	1.8

Aluminium

ANDY MANNHART ALUMINIUM

Manufactured from the very best quality aluminium which allows fast and homogenous heat distribution. Suitable for gas, vitroceramic and electricity. Easy to clean. This range is presented in non-stick coating, multilayer.

		Ø cm	H in cm
002664	Frying pan non-stick, cast aluminium	20.0	5.0
002665	Frying pan non-stick, cast aluminium	24.0	5.0
002666	Frying pan non-stick, cast aluminium	28.0	5.0
002667	Frying pan non-stick, cast aluminium	30.0	5.0

induction



		Ø cm	H in cm
017718	Frying pan non-stick	18.0	4.0
017719	Frying pan non-stick	20.0	4.0
017720	Frying pan non-stick	22.0	4.5
017721	Frying pan non-stick	24.0	4.5
017722	Frying pan non-stick	26.0	5.0
017723	Frying pan non-stick	28.0	5.0
017724	Frying pan non-stick	32.0	5.5
017725	Frying pan non-stick	36.0	6.0
017726	Frying pan non-stick	40.0	6.5



		Ø cm	H in cm
022065	Saute pan non-stick	24.0	7.0
022066	Saute pan non-stick	28.0	7.5



		Ø cm	H in cm
020955	Blinis pan non-stick	12.0	2.0



		Ø cm	H in cm
020960	Egg pan with iron handle non-stick	14.0	2.0



		Dim in cm
020950	Fish pan rectangular non-stick	38.0x26.0x5.0



		Dim in cm
029038	Roasting pan with 2 standing handles non-stick	40.0x30.0x6.5
032036	Roasting pan with 2 standing handles non-stick	45.0x32.0x6.5





induction

Superthermic sandwich base, flavour valve, fully automatic lid-locking system. Products that are very easy to service and care for, made in Switzerland.

		Ø cm	H in cm	Cap. ltr
026503	Pressure cooker with side handles and lid	28.0	14.0	8.0
026505	Pressure cooker with side handles and lid	28.0	20.6	12.0

Multilayer material, polished stainless steel. The ideal wok for show-cooking on the wok-base induction cooker.



induction

		Ø cm	H in cm	Cap. ltr
017184	Wok round	36.0	10.0	6.0



induction

		Ø cm	H in cm	Cap. ltr
017187	Wok round non-stick	36.0	10.0	6.0



		Ø cm		
035392	Wok ring for easy handling	32.0		



induction

		Ø cm	H in cm	Cap. ltr
017186	Wok flat	36.0	9.0	5.5



induction

		Ø cm	H in cm	Cap. ltr
017309	Wok flat non-stick	36.0	9.0	5.5



		Dim in cm	Cap. ltr
028731	Roasting pan with 2 drop handles, non-stick, aluminium	49.0x32.0x8.0	10.0
028730	Roasting pan with 2 drop handles, non-stick, aluminium	54.0x32.0x8.5	12.0
028109	Roasting pan with 2 drop handles, non-stick, aluminium	64.0x37.5x9.5	20.0



028733	Lid for roasting pan 028731, aluminium		
028734	Lid for roasting pan 028730, aluminium		
028735	Lid for roasting pan 028109, aluminium		



		Dim in cm	Cap. ltr
030479	Roasting pan with 2 drop handles, s/s	37.5x27.5x7.5	6.0
030481	Roasting pan with 2 drop handles, s/s	42.0x28.5x9.0	9.0
034125	Roasting pan with 2 drop handles, s/s	47.0x32.5x9.0	10.0
033085	Roasting pan with 2 drop handles, s/s	52.5x32.5x9.0	12.0
028107	Roasting pan with 2 drop handles, s/s	62.5x37.5x9.0	24.0
034127	Roasting pan with 2 drop handles, s/s	63.5x45.5x9.0	35.0



030480	Lid for roasting pan 030481, s/s		
034129	Lid for roasting pan 034125, s/s		
033087	Lid for roasting pan 033085, s/s		
028108	Lid for roasting pan 028107, s/s		
034130	Lid for roasting pan 034127, s/s		



		Dim in cm	Cap. ltr
028736	Roasting pan with lid, s/s	57.5x32.0x19.5	20.0
028202	Roasting pan with lid, s/s	67.5x37.5x19.5	30.0
028737	Roasting pan with lid, s/s	68.5x46.0x19.5	40.0



		Dim in cm		
028738	Fish kettle complete with strainer and lid	50.5x15.5x11.5		



		Dim in cm		
020986	Fish kettle with lid and grid	60.0x16.5x11.5		

Aluminium

		Ø cm	H in cm
022132	Frying pan non-stick, yellow handle	20.0	3.0
022133	Frying pan non-stick, yellow handle	24.0	3.5
022134	Frying pan non-stick, yellow handle	28.0	4.0
022135	Frying pan non-stick, yellow handle	32.0	4.5



		Ø cm	H in cm
022136	Frying pan non-stick, red handle	20.0	3.0
022137	Frying pan non-stick, red handle	24.0	3.5
022138	Frying pan non-stick, red handle	28.0	4.0
022139	Frying pan non-stick, red handle	32.0	4.5



		Ø cm	H in cm
022140	Frying pan non-stick, green handle	20.0	3.0
022141	Frying pan non-stick, green handle	24.0	3.5
022142	Frying pan non-stick, green handle	28.0	4.0
022143	Frying pan non-stick, green handle	32.0	4.5



		Ø cm	H in cm
022144	Frying pan non-stick, blue handle	20.0	3.0
022145	Frying pan non-stick, blue handle	24.0	3.5
022146	Frying pan non-stick, blue handle	28.0	4.0
022147	Frying pan non-stick, blue handle	32.0	4.5



Iron

		Ø cm	H in cm
026271	Paella pan with 2 handles	24.0	3.9
026272	Paella pan with 2 handles	28.0	4.0
026273	Paella pan with 2 handles	32.0	4.2
019020	Paella pan with 2 handles	34.0	5.0
019021	Paella pan with 2 handles	37.0	5.2
019022	Paella pan with 2 handles	42.0	5.8
019023	Paella pan with 2 handles	47.0	6.5
019024	Paella pan with 2 handles	60.0	6.7
019025	Paella pan with 2 handles	80.0	9.0

induction



Iron

		Ø cm	H in cm	Cap. ltr
022060	Frying pan with deep frying basket	28.0	8.5	4.0
022061	Frying pan with deep frying basket	32.0	9.8	6.0
022062	Frying pan with deep frying basket	36.0	11.0	8.8
022063	Frying pan with deep frying basket	40.0	15.0	12.2
022064	Frying pan with deep frying basket	50.0	17.6	23.5



induction

Iron

**induction**

		Ø cm	H in cm
019483	Frying pan	20.0	3.3
019484	Frying pan	26.0	4.0
019485	Frying pan	32.0	4.2

**induction**

		Ø cm	H in cm
019486	Grill pan ribbed	26.0	4.0
019487	Grill pan ribbed	32.0	4.2

**induction**

		Ø cm	H in cm
019488	Country frying pan	24.0	7.5
019489	Country frying pan	32.0	9.0

**induction**

		Ø cm	H in cm
019001	Frying pan "lyonnaise"	20.0	3.3
019002	Frying pan "lyonnaise"	22.0	3.4
019003	Frying pan "lyonnaise"	24.0	3.9
019004	Frying pan "lyonnaise"	26.0	4.0
019005	Frying pan "lyonnaise"	28.0	4.0
019006	Frying pan "lyonnaise"	32.0	4.2
019007	Frying pan "lyonnaise"	36.0	5.1
019008	Frying pan "lyonnaise"	40.0	5.3
019010	Frying pan "lyonnaise"	50.0	5.7



019026

induction

		Dim in cm
019026	Fish frying pan oval	32.0x23.5x4.6
019027	Fish frying pan oval	36.0x26.5x4.8
019028	Fish frying pan oval	40.0x29.0x5.0
022073	Fish frying pan rectangular	38.0x26.0x4.5

022073

**induction**

		Ø cm	H in cm
019030	Crêpe pan	20.0	1.3
019031	Crêpe pan	24.0	1.5

induction

		Ø cm	H in cm
017149	Blinis pan	12.0	2.0

Cast iron

**induction**

		Ø cm	H in cm
007380	Frying pan round	20.0	4.5
007381	Frying pan round	24.0	4.5
007382	Frying pan round	28.0	5.5
007383	Frying pan round	30.0	5.5

**induction**

		Ø cm	H in cm	Cap. ltr
007384	Wok pan round with glass lid	32.0	8.0	4.4

**induction**

		Ø cm	H in cm	Cap. ltr
007385	Casserole round with glass lid	26.0	10.0	3.4
007386	Casserole round with glass lid	28.0	11.0	3.75
007387	Casserole round with glass lid	30.0	12.0	4.2
007388	Casserole round with glass lid	32.0	13.0	6.0

Cast iron

		Ø cm	H in cm	Cap. ltr
007389	Shallow casserole round with glass lid	24.0	6.0	2.0
007390	Shallow casserole round with glass lid	28.0	7.0	3.0
007391	Shallow casserole round with glass lid	30.0	8.0	3.8

induction

		Dim in cm
006670	Grill pan rectangular, grooved	38.0x26.0x2.5

induction

		Ø cm
018005	Grill pan round, grooved	33.0

induction

Black steel

		Ø cm	H in cm
017485	Paella pan with 2 handles	26.0	3.5
017486	Paella pan with 2 handles	30.0	4.0
017487	Paella pan with 2 handles	34.0	4.5
017488	Paella pan with 2 handles	38.0	4.5
017489	Paella pan with 2 handles	42.0	4.5
017490	Paella pan with 2 handles	55.0	5.6
017491	Paella pan with 2 handles	65.0	6.0
017492	Paella pan with 2 handles	80.0	6.5
017493	Paella pan with 2 handles	90.0	7.5

induction

Enamelled steel

		Ø cm	H in cm
017510	Paella pan with 2 handles	10.0	1.7
017511	Paella pan with 2 handles	15.0	2.5
017512	Paella pan with 2 handles	26.0	3.5
017513	Paella pan with 2 handles	30.0	4.0
017514	Paella pan with 2 handles	34.0	4.5
017515	Paella pan with 2 handles	38.0	4.5
017516	Paella pan with 2 handles	42.0	4.5
017517	Paella pan with 2 handles	50.0	5.6
017518	Paella pan with 2 handles	60.0	6.0



		Ø cm	Cap. ltr
017524	Frying pan with 2 handles	14.0	0.4
017525	Frying pan with 2 handles	16.0	0.5
017526	Frying pan with 2 handles	28.0	3.9
017527	Frying pan with 2 handles	32.0	5.3
017528	Frying pan with 2 handles	36.0	7.8
017529	Frying pan with 2 handles	40.0	9.4



		Ø cm
017530	Gas burner	35.0
017531	Gas burner	50.0
017532	Gas burner	70.0



017533	Base for Burner
--------	-----------------

017533

Sandblasted steel

Made of thick, sand-blasted steel with protective coating.

induction

		Ø cm	H in cm
028325	Frying pan	20.0	5.0
028326	Frying pan	24.0	6.0
028327	Frying pan	28.0	6.5
028328	Frying pan	32.0	7.0

Tinned copper



		Ø cm	H in cm	Cap. ltr
022095	Sauce pan	12.0	7.0	0.8
022096	Sauce pan	14.0	8.0	1.2
022097	Sauce pan	16.0	9.0	1.8
022098	Sauce pan	18.0	10.0	2.5
022099	Sauce pan	20.0	10.5	3.3
022976	Sauteuse conical	16.0	6.0	0.9
022977	Sauteuse conical	20.0	8.0	1.7
022978	Sauteuse conical	24.0	9.0	2.9

Copper-Stainless steel

induction

		Ø cm	H in cm	Cap. ltr
022074	Sauce pan	14.0	7.8	1.2
022075	Sauce pan	16.0	8.9	1.8
022076	Sauce pan	18.0	10.0	2.5
022077	Sauce pan	20.0	10.7	3.3
022078	Sauce pan	24.0	13.0	6.0

induction

022085	Saute pan straight	16.0	5.8	1.0
022086	Saute pan straight	20.0	6.5	1.8
022087	Saute pan straight	24.0	7.5	3.0

induction

		Ø cm	H in cm	Cap. ltr
022088	Sauteuse conical	20.0	7.2	1.7
010035	Sauteuse conical	24.0	8.2	3.1

induction

		Ø cm	H in cm
010033	Frying pan	20.0	4.0
022089	Frying pan	24.0	4.0
022090	Frying pan	28.0	4.0
010034	Frying pan	32.0	4.0

induction

		Ø cm	H in cm	Cap. ltr
000578	Saute pan conical	28.0	10.0	3.5

induction

		Ø cm	H in cm	Cap. ltr
022091	Saute pan with s/s lid	24.0	7.5	3.1

induction

		Ø cm	H in cm	Cap. ltr
010036	Casserole with s/s lid	16.0	12.0	1.8
022092	Casserole with s/s lid	20.0	10.7	3.3
022093	Casserole with s/s lid	24.0	13.0	5.4
022094	Casserole with s/s lid	28.0	13.8	8.0

Ø cm

020808	Lid s/s	14.0
020809	Lid s/s	16.0
020810	Lid s/s	18.0
020811	Lid s/s	20.0
020813	Lid s/s	24.0
020812	Lid s/s	28.0

Stainless steel

AFFINITY

		Ø cm	H in cm	Cap. ltr	induction
005734	Sauce pan	14.0	7.5	1.2	
005735	Sauce pan	16.0	9.0	1.8	
005736	Sauce pan	18.0	10.0	2.5	
005737	Sauce pan	20.0	11.0	3.4	



		Ø cm	H in cm	Cap. ltr	induction
005738	Saute pan straight	20.0	6.0	1.8	
005739	Saute pan straight	24.0	7.5	3.0	



		Ø cm	H in cm	Cap. ltr	induction
005740	Sauteuse conical	20.0	7.0	1.7	
005741	Sauteuse conical	24.0	8.0	3.0	



		Ø cm	H in cm		induction
005742	Frying pan	20.0	4.0		
005743	Frying pan	24.0	4.0		
005744	Frying pan	28.0	4.5		
005745	Frying pan	32.0	5.0		



		Ø cm	H in cm		induction
010037	Saute pan with lid	24.0	7.5		



		Ø cm	H in cm	Cap. ltr	induction
036810	Saute pan round with lid	28.0	10.0	4.9	



		Ø cm	H in cm	Cap. ltr	induction
010039	Stew pan with lid	14.0	8.0	1.0	
010042	Stew pan with lid	16.0	12.0	2.4	
010043	Stew pan with lid	20.0	11.0	3.4	
010044	Stew pan with lid	24.0	13.0	5.4	
010045	Stew pan with lid	28.0	15.0	8.6	



Aluminium

CHOC INDUCTION EXTRÊME

induction



		Ø cm
010046	Frying pan non-stick	20.0
010047	Frying pan non-stick	24.0
010048	Frying pan non-stick	28.0
010049	Frying pan non-stick	32.0

induction



		Ø cm
010050	Saute pan non-stick	24.0
010051	Saute pan non-stick	28.0

induction



		Ø cm
016251	Saute pan with 2 handles non-stick	20.0

Ceramic



		Ø cm	H in cm
011365	Frying pan non-stick	20.0	3.8
010761	Frying pan non-stick	24.0	4.6
010762	Frying pan non-stick	28.0	5.5
011366	Frying pan non-stick	32.0	6.0
011367	Frying pan non-stick	36.0	6.0
011368	Frying pan non-stick	40.0	6.5

GN SIZE IN CM

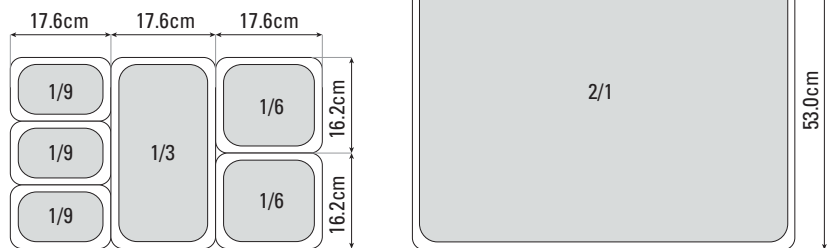
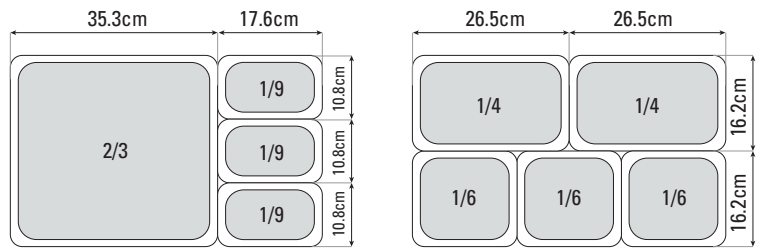
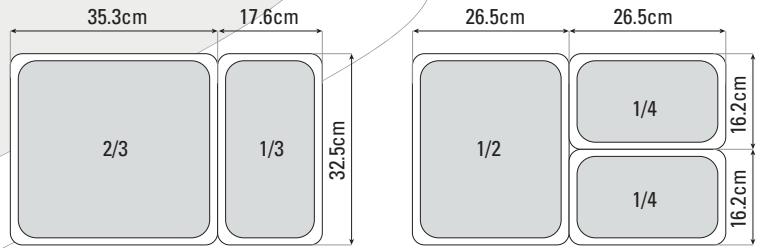
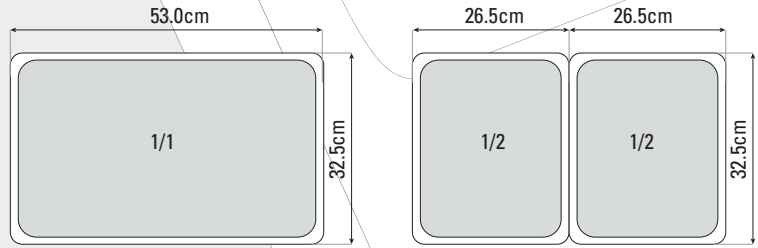

GN depth	
2 cm	
4 cm	
5.5 cm	
6.5 cm	
10.0 cm	
15.0 cm	
20.0 cm	

Special plates for cooking and refrigeration - from storage to preparation to production to serving without transferring food.

Thermoplates are made of SWISS-PLY multi-layer material, for energy efficient cooking, grilling and cooling with an extremely high thermal conductivity and an optimum energy transfer to food. Thermoplates are hygienic, dishwasher-safe, rustproof and suitable for all energy sources temperature range from -20°C to +250°C.

All of them are also available with drop handles.

Coated thermoplates should not be used for open-flame cooking.



Thermoplates with a material thickness of 4.0mm for grilling, frying, braising, preparing sauces, fast frying as well as keeping cool.



Without handles	With handles		Depth in cm
056439	056448	GN tray 1/1, 53.0x32.5cm	2.0
056440	056449	GN tray 2/3, 35.3x32.5cm	2.0
056441	056450	GN tray 1/2, 32.5x26.5cm	2.0



Without handles	With handles		Depth in cm
056442	056451	GN tray 1/1, 53.0x32.5cm, coated	2.0
056443	056452	GN tray 2/3, 35.3x32.5cm, coated	2.0
056444	056453	GN tray 1/2, 32.5x26.5cm, coated	2.0

Thermoplates with a material thickness of 2.3mm for cooking with liquids, boiling, simmering, steaming, (max. 230°C on bottom, approx. 140°C on the sides) as well as keeping food cool.

Without handles	With handles		Depth in cm	Cap. ltr
056402	056420	GN container 1/1, 53.0x32.5cm	4.0	3.4
056401	056419	GN container 1/1, 53.0x32.5cm	6.0	6.0
056400	056418	GN container 1/1, 53.0x32.5cm	10.0	11.7

			Depth in cm	Cap. ltr
056405	056423	GN container 2/3, 35.3x32.5cm	4.0	2.4
056404	056422	GN container 2/3, 35.3x32.5cm	6.0	4.0
056403	056421	GN container 2/3, 35.3x32.5cm	10.0	7.4

			Depth in cm	Cap. ltr
056408	056426	GN container 1/2, 32.5x26.5cm	4.0	1.7
056407	056425	GN container 1/2, 32.5x26.5cm	6.0	3.0
056406	056424	GN container 1/2, 32.5x26.5cm	10.0	5.3



Without handles	With handles		Depth in cm	Cap. ltr
056411	056429	GN container 1/1, 53.0x32.5cm, coated	4.0	3.4
056410	056428	GN container 1/1, 53.0x32.5cm, coated	6.0	6.0
056409	056427	GN container 1/1, 53.0x32.5cm, coated	10.0	11.7

			Depth in cm	Cap. ltr
056414	056432	GN container 2/3, 35.3x32.5cm, coated	4.0	2.4
056413	056431	GN container 2/3, 35.3x32.5cm, coated	6.0	4.0
056412	056430	GN container 2/3, 35.3x32.5cm, coated	10.0	7.4

			Depth in cm	Cap. ltr
056417	056435	GN container 1/2, 32.5x26.5cm, coated	4.0	1.7
056416	056434	GN container 1/2, 32.5x26.5cm, coated	6.0	3.0
056415	056433	GN container 1/2, 32.5x26.5cm, coated	10.0	5.3



Stainless steel sandwich bottom

		Depth in cm	Cap. ltr	induction
017780	GN container 1/1, 53.0x32.5cm	4.0	3.4	
017781	GN container 1/1, 53.0x32.5cm	6.5	7.0	
017782	GN container 1/1, 53.0x32.5cm	10.0	11.7	
017783	GN container 1/1, 53.0x32.5cm	15.0	18.4	

017784	GN container 1/2, 32.5x26.5cm	4.0	1.7	induction
017785	GN container 1/2, 32.5x26.5cm	6.5	3.3	
017786	GN container 1/2, 32.5x26.5cm	10.0	5.3	
017787	GN container 1/2, 32.5x26.5cm	15.0	8.4	



Aluminium non-stick

		Depth in cm	Cap. ltr
017790	GN tray 1/1, 53.0x32.5cm	6.5	7.0



MULTI POT 1/1 new

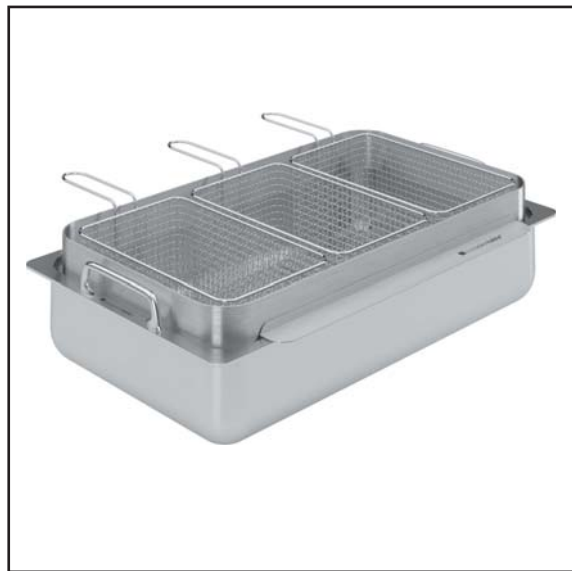
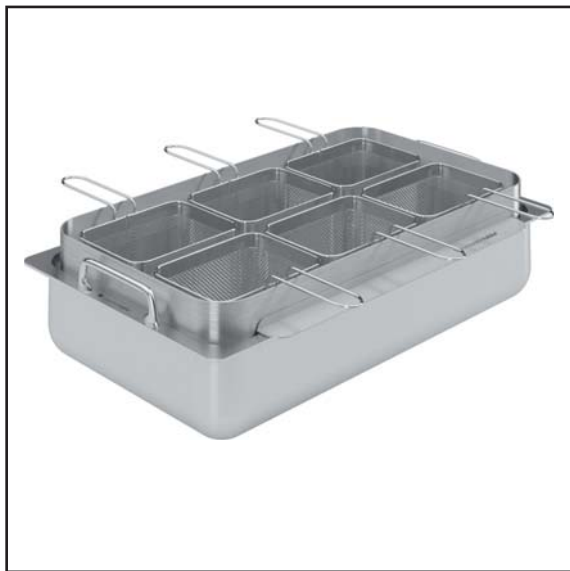
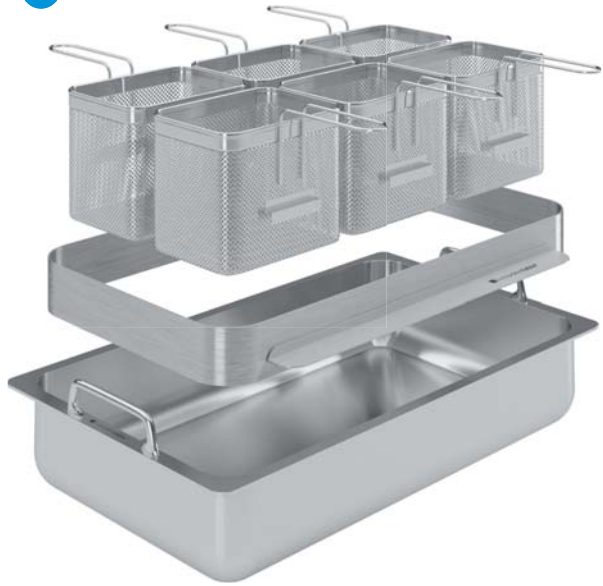
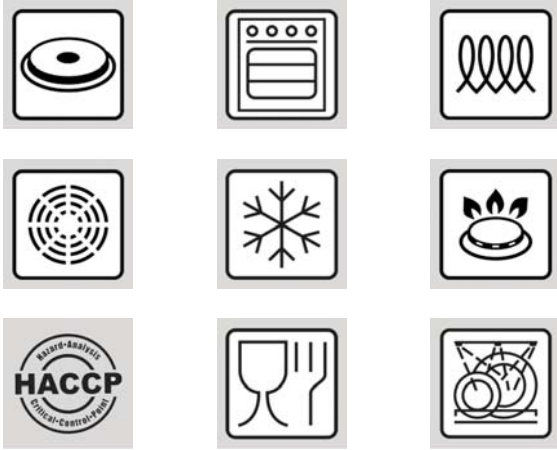

induction

new

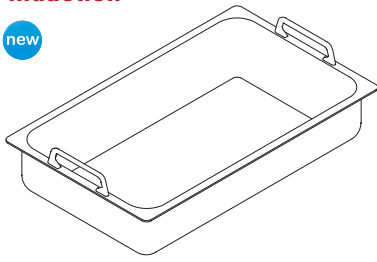

035062 Multi Pot Base (1/1 GN SwissPly Cooking Pot plus top element)

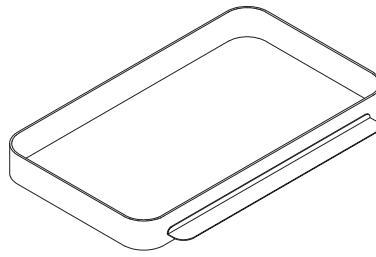

new

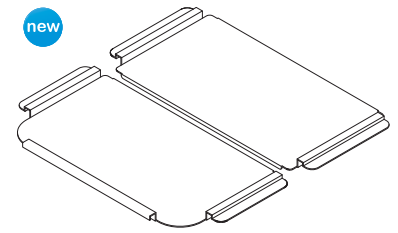

035087 Multi Pot Lid

new

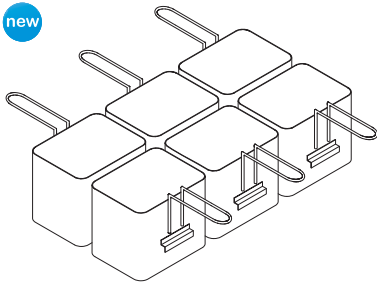

035088 Multi Pot Pasta Baskets

new

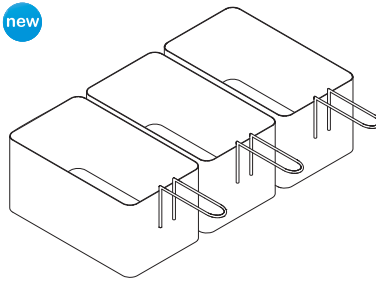

035089 Multi Pot Frying Baskets

new

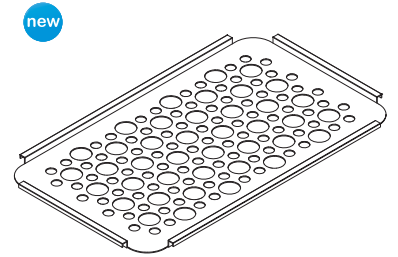

035090 Multi Pot Dimsum Plate

induction

new



035091 Teppan Griddle Plate

035062 Multi Pot

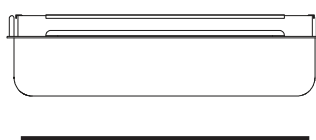

530 mm
1/1 GN

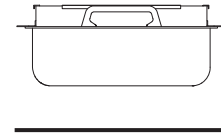

353 mm
1/1 GN

135-145 mm

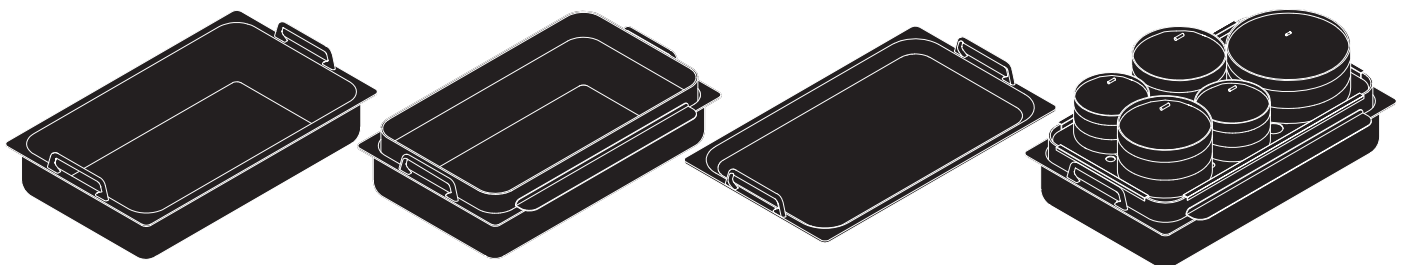

to cook, to hold hot, to braise

to cook, to blanch, to fry,

to grill, to pan-fry

to steam

ACCESSORIES FOR THERMOPLATES



056324	Lid flat polycarbonate for GN 1/1
056325	Lid flat polycarbonate for GN 1/1



010433	Hermetic lid with silicone joint for GN 1/1, s/s
016680	Hermetic lid with silicone joint for GN 1/2, s/s



056456	GN press-in lid 1/1, with handle cut-out, stackable, s/s
056457	GN press-in lid 2/3, with handle cut-out, stackable, s/s
056458	GN press-in lid 1/2, with handle cut-out, stackable, s/s

Stainless steel

GN pans are one of the most used equipment in the hotel kitchens. Therefore it is of utmost importance that the containers are of high quality matching the EN-standards. Andy Mannhart GN pans are made of 18/10 stainless steel, 0.8mm material thickness.



		Depth in cm	Cap. ltr
073400	GN container 2/1, 65.0x53.0cm	2.0	6.2
073401	GN container 2/1, 65.0x53.0cm	4.0	11.5
073402	GN container 2/1, 65.0x53.0cm	6.5	18.8
073403	GN container 2/1, 65.0x53.0cm	10.0	28.9
073404	GN container 2/1, 65.0x53.0cm	15.0	43.1
073405	GN container 2/1, 65.0x53.0cm	20.0	52.0



		Depth in cm	Cap. ltr
073411	GN container 1/1, 53.0x32.5cm	2.0	2.8
073412	GN container 1/1, 53.0x32.5cm	4.0	5.1
073413	GN container 1/1, 53.0x32.5cm	6.5	8.3
073414	GN container 1/1, 53.0x32.5cm	10.0	14.2
073415	GN container 1/1, 53.0x32.5cm	15.0	20.2
073416	GN container 1/1, 53.0x32.5cm	20.0	26.0



		Depth in cm	Cap. ltr
073422	GN container 2/3, 35.3x32.5cm	4.0	3.1
073423	GN container 2/3, 35.3x32.5cm	6.5	5.6
073424	GN container 2/3, 35.3x32.5cm	10.0	8.8
073425	GN container 2/3, 35.3x32.5cm	15.0	13.2
073426	GN container 2/3, 35.3x32.5cm	20.0	18.3

Stainless steel

		Depth in cm	Cap. ltr
017638	GN container 1/2, 32.5x26.5cm	2.0	1.2
073432	GN container 1/2, 32.5x26.5cm	4.0	2.2
073433	GN container 1/2, 32.5x26.5cm	6.5	4.1
073434	GN container 1/2, 32.5x26.5cm	10.0	6.1
073435	GN container 1/2, 32.5x26.5cm	15.0	9.1
073436	GN container 1/2, 32.5x26.5cm	20.0	12.0



		Depth in cm	Cap. ltr
017640	GN container 1/3, 32.5x17.6cm	2.0	0.8
017639	GN container 1/3, 32.5x17.6cm	4.0	1.5
073443	GN container 1/3, 32.5x17.6cm	6.5	2.5
073444	GN container 1/3, 32.5x17.6cm	10.0	3.8
073445	GN container 1/3, 32.5x17.6cm	15.0	5.6
073446	GN container 1/3, 32.5x17.6cm	20.0	7.3



		Depth in cm	Cap. ltr
017641	GN container 1/4, 26.5x16.2cm	2.0	0.5
073452	GN container 1/4, 26.5x16.2cm	6.5	1.7
073453	GN container 1/4, 26.5x16.2cm	10.0	2.8
073454	GN container 1/4, 26.5x16.2cm	15.0	4.1
073455	GN container 1/4, 26.5x16.2cm	20.0	5.0



		Depth in cm	Cap. ltr
056060	GN container 2/4, 53.0x16.2cm	2.0	0.9
056059	GN container 2/4, 53.0x16.2cm	4.0	1.7
029624	GN container 2/4, 53.0x16.2cm	6.5	4.0
007941	GN container 2/4, 53.0x16.2cm	10.0	6.0
007943	GN container 2/4, 53.0x16.2cm	15.0	10.0
056064	GN container 2/4, 53.0x16.2cm, internal handles	4.0	1.7
056063	GN container 2/4, 53.0x16.2cm, internal handles	6.5	3.3
056062	GN container 2/4, 53.0x16.2cm, internal handles	10.0	5.3
056061	GN container 2/4, 53.0x16.2cm, internal handles	15.0	8.4



		Depth in cm	Cap. ltr
073474	GN container 1/6, 17.6x16.2cm	6.5	1.0
073475	GN container 1/6, 17.6x16.2cm	10.0	1.6
073476	GN container 1/6, 17.6x16.2cm	15.0	2.2
073477	GN container 1/6, 17.6x16.2cm	20.0	2.9



Stainless steel



		Depth in cm	Cap. ltr
073483	GN container 1/9, 17.6x10.8cm	10.0	0.8
073482	GN container 1/9, 17.6x10.8cm	6.5	0.6
056082	GN container 1/9, 17.6x10.8cm, internal handles	10.0	0.7
056083	GN container 1/9, 17.6x10.8cm, internal handles	6.5	0.5



		Size GN
017505	Strainer plate with finger hole	2/1
073853	Strainer plate with finger hole	1/1
073854	Strainer plate with finger hole	1/2
073855	Strainer plate with finger hole	1/3
010768	Strainer plate with finger hole	1/4
010769	Strainer plate with finger hole	2/3



		Size GN
073859	Dividing bar	1/1
073860	Dividing bar	1/2



		Size GN
073890	Plain lid with handle	2/1
073484	Plain lid with handle	1/1
073486	Plain lid with handle	2/3
073488	Plain lid with handle	1/2
073490	Plain lid with handle	1/3
073492	Plain lid with handle	1/4
073498	Plain lid with handle	1/6
073800	Plain lid with handle	1/9



		Size GN
073485	Plain lid with handle, notched for spoon	1/1
073489	Plain lid with handle, notched for spoon	1/2
073491	Plain lid with handle, notched for spoon	1/3
073493	Plain lid with handle, notched for spoon	1/4
073499	Plain lid with handle, notched for spoon	1/6



		Size GN
010433	Hermetic lid with silicone joint	1/1
016680	Hermetic lid with silicone joint	1/2
018358	Hermetic lid with silicone joint	1/3
018359	Hermetic lid with silicone joint	1/4
018360	Hermetic lid with silicone joint	1/6

Polycarbonate

Transparent, stackable, withstands temperatures from -40°C to +99°C

		Depth in cm	Cap. ltr
020392	GN container 2/1, 65.0x53.0cm	15.0	38.0
020393	GN container 2/1, 65.0x53.0cm	20.0	50.0

		Depth in cm	Cap. ltr
019724	GN container 1/1, 53.0x32.5cm	6.5	8.7
019725	GN container 1/1, 53.0x32.5cm	10.0	13.3
019726	GN container 1/1, 53.0x32.5cm	15.0	19.6
019727	GN container 1/1, 53.0x32.5cm	20.0	25.5

		Depth in cm	Cap. ltr
019728	GN container 1/2, 32.5x26.5cm	6.5	4.0
019729	GN container 1/2, 32.5x26.5cm	10.0	6.0
019730	GN container 1/2, 32.5x26.5cm	15.0	8.7
019731	GN container 1/2, 32.5x26.5cm	20.0	11.2

		Depth in cm	Cap. ltr
019732	GN container 1/3, 32.5x17.5cm	6.5	2.4
019733	GN container 1/3, 32.5x17.5cm	10.0	3.5
019734	GN container 1/3, 32.5x17.5cm	15.0	5.0
019754	GN container 1/3, 32.5x17.5cm	20.0	6.4

		Depth in cm	Cap. ltr
019755	GN container 1/4, 26.5x16.2cm	6.5	1.7
019735	GN container 1/4, 26.5x16.2cm	10.0	2.5
019736	GN container 1/4, 26.5x16.2cm	15.0	3.5
019756	GN container 1/4, 26.5x16.2cm	20.0	5.0

		Depth in cm	Cap. ltr
742211	GN container 2/4, 53.0x16.2cm	6.5	3.3
742201	GN container 2/4, 53.0x16.2cm	10.0	5.3
056335	GN container 2/4, 53.0x16.2cm	15.0	8.4

		Depth in cm	Cap. ltr
019737	GN container 1/6, 17.6x16.2cm	6.5	1.0
019738	GN container 1/6, 17.6x16.2cm	10.0	1.4
019739	GN container 1/6, 17.6x16.2cm	15.0	2.0
019757	GN container 1/6, 17.6x16.2cm	20.0	2.8

019740	GN container 1/9, 17.6x10.8cm	6.5	0.5
019741	GN container 1/9, 17.6x10.8cm	10.0	0.7

		Size GN
019748	Strainer plate with finger hole	1/1
019749	Strainer plate with finger hole	1/2
019750	Strainer plate with finger hole	1/3
019751	Strainer plate with finger hole	1/4
019752	Strainer plate with finger hole	1/6

		Size GN
020394	Plain lid	2/1
019742	Plain lid with handle	1/1
019743	Plain lid with handle	1/2
019744	Plain lid with handle	1/3
019745	Plain lid with handle	1/4
019746	Plain lid with handle	1/6
019747	Plain lid with handle	1/9

GN 1/1



GN 1/2



GN 1/3



GN 1/4



GN 1/6



GN 1/9



Polypropylene

White transparent, dish-washer safe, unbreakable, stackable with lids, temperature from -30°C to +100°C



		Depth in cm	Cap. ltr
019034	GN container 1/1, 53.0x32.5cm	10.0	13.3
019033	GN container 1/1, 53.0x32.5cm	15.0	19.6
019032	GN container 1/1, 53.0x32.5cm	20.0	25.5



		Depth in cm	Cap. ltr
019039	GN container 1/2, 32.5x26.5cm	6.5	4.0
019038	GN container 1/2, 32.5x26.5cm	10.0	6.0
019037	GN container 1/2, 32.5x26.5cm	15.0	8.7
019036	GN container 1/2, 32.5x26.5cm	20.0	11.2



		Depth in cm	Cap. ltr
019043	GN container 1/3, 32.5x17.6cm	6.5	2.4
019042	GN container 1/3, 32.5x17.6cm	10.0	3.5
019041	GN container 1/3, 32.5x17.6cm	15.0	5.0
019040	GN container 1/3, 32.5x17.6cm	20.0	6.4



		Depth in cm	Cap. ltr
019046	GN container 1/4, 26.5x16.2cm	6.5	1.65
019045	GN container 1/4, 26.5x16.2cm	10.0	2.4
019044	GN container 1/4, 26.5x16.2cm	15.0	3.4



		Depth in cm	Cap. ltr
019049	GN container 1/6, 17.6x16.2cm	6.5	1.0
019048	GN container 1/6, 17.6x16.2cm	10.0	1.4
019047	GN container 1/6, 17.6x16.2cm	15.0	2.0



		Depth in cm	Cap. ltr
019051	GN container 1/9, 17.6x10.8cm	6.5	0.5
019050	GN container 1/9, 17.6x10.8cm	10.0	0.8



		Size GN
019052	Strainer plate with finger hole	1/1
019053	Strainer plate with finger hole	1/2
019054	Strainer plate with finger hole	1/3
019055	Strainer plate with finger hole	1/4
019056	Strainer plate with finger hole	1/6



Red	Blue	Yellow	Green	White		Size GN
019057	019063	019069	019075	019575	Plain lid	1/1
019058	019064	019070	019076	019576	Plain lid	1/2
019059	019065	019071	019077	019577	Plain lid	1/3
019060	019066	019072	019078	019578	Plain lid	1/4
019061	019067	019073	019079	019579	Plain lid	1/6
019062	019068	019074	019080	019580	Plain lid	1/9

Stainless steel

		Depth in cm	Cap. ltr
073799*	Perforated GN container 2/1, 65.0x53.0cm	2.0	5.4
073798*	Perforated GN container 2/1, 65.0x53.0cm	4.0	10.8
073797*	Perforated GN container 2/1, 65.0x53.0cm	6.5	17.0
073796	Perforated GN container 2/1, 65.0x53.0cm	10.0	27.0
073795	Perforated GN container 2/1, 65.0x53.0cm	15.0	41.0
073794	Perforated GN container 2/1, 65.0x53.0cm	20.0	55.0



		Depth in cm	Cap. ltr
073806*	Perforated GN container 1/1, 53.0x32.5cm	2.0	1.7
073807*	Perforated GN container 1/1, 53.0x32.5cm	4.0	3.4
073808*	Perforated GN container 1/1, 53.0x32.5cm	6.5	7.0
073809	Perforated GN container 1/1, 53.0x32.5cm	10.0	11.7
073810	Perforated GN container 1/1, 53.0x32.5cm	15.0	18.4
073811	Perforated GN container 1/1, 53.0x32.5cm	20.0	26.0



		Depth in cm	Cap. ltr
017648*	Perforated GN container 2/3, 35.3x32.5cm	2.0	1.2
017647*	Perforated GN container 2/3, 35.3x32.5cm	4.0	2.4
017646*	Perforated GN container 2/3, 35.3x32.5cm	6.5	4.3
017645	Perforated GN container 2/3, 35.3x32.5cm	10.0	7.4
017644	Perforated GN container 2/3, 35.3x32.5cm	15.0	11.8
017643	Perforated GN container 2/3, 35.3x32.5cm	20.0	15.3



		Depth in cm	Cap. ltr
073828	Perforated GN container 1/2, 32.5x26.5cm	6.5	3.3
073829	Perforated GN container 1/2, 32.5x26.5cm	10.0	5.3
073830	Perforated GN container 1/2, 32.5x26.5cm	15.0	8.4
073831	Perforated GN container 1/2, 32.5x26.5cm	20.0	10.9



		Depth in cm	Cap. ltr
017654*	Perforated GN container 1/3, 32.5x17.6cm	2.0	0.5
017653*	Perforated GN container 1/3, 32.5x17.6cm	4.0	1.0
017652*	Perforated GN container 1/3, 32.5x17.6cm	6.5	2.0
017651	Perforated GN container 1/3, 32.5x17.6cm	10.0	3.3
017650	Perforated GN container 1/3, 32.5x17.6cm	15.0	4.9
017649	Perforated GN container 1/3, 32.5x17.6cm	20.0	6.6



All article marked with * are only bottom perforated.

Stainless steel 18/10 manufactured from best quality, according to EN-Norm 631
 Peraluman a special aluminium alloy, stronger than aluminium
 Peraluman anodized a special aluminium alloy, with a silky finish
 Enamelled classy-looking tray with non-stick effect, scratch-proof

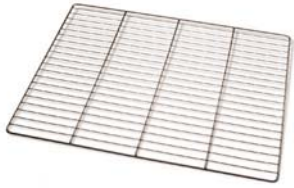

		Size GN	Dim in cm
056130	Grid s/s	2/1	65.0x53.0
056131	Grid s/s	1/1	53.0x32.5
056136	Grid s/s		60.0x40.0



		Size GN	Dim in cm
073400	Tray s/s	2/1	65.0x53.0x2.0
073868	Tray s/s	1/1	53.0x32.5x2.0
018128	Tray s/s	2/3	35.3x32.5x2.0
017638	Tray s/s	1/2	32.5x26.5x2.0
056060	Tray s/s	2/4	53.0x16.2x2.0

073401	Tray s/s	2/1	65.0x53.0x4.0
073412	Tray s/s	1/1	53.0x32.5x4.0
073422	Tray s/s	2/3	35.3x32.5x4.0
073432	Tray s/s	1/2	32.5x26.5x4.0
056059	Tray s/s	2/4	53.0x16.2x4.0



		Size GN	Dim in cm
022857	Tray s/s 18/10, oblique edges	2/1	65.0x53.0x1.0
022858	Tray s/s 18/10, oblique edges	1/1	53.0x32.5x1.0
022853	Tray s/s 18/10, oblique edges		60.0x40.0x1.0
022854	Tray s/s 18/10, oblique edges		40.0x30.0x1.0



		Size GN	Dim in cm
016079	Display tray s/s 18/10, polished finish	GN 2/1	65.0x53.0x1.2
016080	Display tray s/s 18/10, polished finish	GN 1/1	53.0x32.5x1.2
016081	Display tray s/s 18/10, polished finish	GN 2/3	35.3x32.5x1.2
016082	Display tray s/s 18/10, polished finish	GN 1/2	32.5x26.5x1.2



		Size GN	Dim in cm
056210	Tray enamelled	GN 2/1	65.0x53.0x2.0
056213	Tray enamelled	GN 1/1	53.0x32.5x2.0
056216	Tray enamelled	GN 2/3	35.3x32.5x2.0
056214	Tray enamelled	GN 1/1	53.0x32.5x4.0
056217	Tray enamelled	GN 2/3	35.2x32.5x4.0
056215	Tray enamelled	GN 1/1	53.0x32.5x6.5



		Size GN	Dim in cm
023702	All purpose tray plain aluminium	GN 1/1	53.0x32.5x1.0
016083	All purpose tray plain peraluman	GN 2/1	65.0x53.0x2.7
016087	All purpose tray plain peraluman	GN 1/1	53.0x32.5x2.7
016084	All purpose tray plain anodized	GN 2/1	65.0x53.0x2.7
016088	All purpose tray plain anodized	GN 1/1	53.0x32.5x2.7



		Size GN	Dim in cm
016091	All purpose tray perforated, peraluman	GN 2/1	65.0x53.0x2.7
016094	All purpose tray perforated, peraluman	GN 1/1	53.0x32.5x2.7

Porcelain

Designed for professional use. Can be used in traditional and microwave ovens, bain marie or for buffet and counter service.

		Depth in cm	Cap. ltr	Colour
007270	GN container 1/1, 53.0x32.5cm	6.5	7.0	white 
007271	GN container 1/1, 53.0x32.5cm	6.5	7.0	yellow 
007272	GN container 1/1, 53.0x32.5cm	6.5	7.0	blue 



		Depth in cm	Cap. ltr	Colour
007273	GN container 2/3, 35.4x32.5cm	6.5	4.3	white 





		Depth in cm	Cap. ltr	Colour
007274	GN container 1/2, 32.5x26.5cm	6.5	3.3	white 

		Depth in cm	Cap. ltr	Colour
007275	GN container 1/3, 32.5x17.6cm	6.5	2.0	white 





		Depth in cm	Cap. ltr	Colour
007276	GN container 1/4, 26.5x16.2cm	6.5	1.5	white 
007277	GN container 1/4, 26.5x16.2cm	6.5	1.5	yellow 
007278	GN container 1/4, 26.5x16.2cm	6.5	1.5	blue 







		Depth in cm	Cap. ltr	Colour
007279	GN container 1/6, 16.2x17.6cm	6.5	0.9	white 
007280	GN container 1/6, 16.2x17.6cm	6.5	0.9	yellow 
007281	GN container 1/6, 16.2x17.6cm	6.5	0.9	blue 

		Depth in cm	Cap. ltr	Colour	induction
007253	GN container 1/3, 32.5x17.6cm	6.5	2.0	white 	
007255	GN container 1/3, 32.5x17.6cm	6.5	2.0	yellow 	
007256	GN container 1/3, 32.5x17.6cm	6.5	2.0	blue 	
007257	GN container 1/3, 32.5x17.6cm	6.5	2.0	orange 	







		Depth in cm	Cap. ltr	Colour	induction
007258	GN container 2/3, 35.0x32.0cm	6.5	4.3	white 	
007259	GN container 2/3, 35.0x32.0cm	6.5	4.3	yellow 	
007260	GN container 2/3, 35.0x32.0cm	6.5	4.3	blue 	
007261	GN container 2/3, 35.0x32.0cm	6.5	4.3	orange 	



		Depth in cm	Cap. ltr	Colour	induction
007262	GN container 2/4, 53.0x16.2cm	6.5	3.3	white 	
007263	GN container 2/4, 53.0x16.2cm	6.5	3.3	yellow 	
007264	GN container 2/4, 53.0x16.2cm	6.5	3.3	blue 	
007265	GN container 2/4, 53.0x16.2cm	6.5	3.3	orange 	



		Depth in cm	Cap. ltr	Colour	induction
007266	GN container 1/1, 53.0x32.5cm	6.5	7.0	white 	
007267	GN container 1/1, 53.0x32.5cm	6.5	7.0	yellow 	
007268	GN container 1/1, 53.0x32.5cm	6.5	7.0	blue 	
007269	GN container 1/1, 53.0x32.5cm	6.5	7.0	orange 	



Melamine



		Depth in cm	Dim in cm
006420	GN Pan 1/1, white	2.0	52.0x32.5
006421	GN Pan 1/1, white	4.0	52.0x32.5
006422	GN Pan 1/1, white	6.5	52.0x32.5



		Depth in cm	Dim in cm
006424	GN Pan 2/3, white	6.5	35.3x32.5



		Depth in cm	Dim in cm
006425	GN Pan 1/2, white	2.0	32.5x26.5
006426	GN Pan 1/2, white	4.0	32.5x26.5
006427	GN Pan 1/2, white	6.5	32.5x26.5
006428	GN Pan 1/2, white	10.0	32.5x26.5



		Depth in cm	Dim in cm
006429	GN Pan 2/4, white	2.0	53.0x16.2



		Depth in cm	Dim in cm
006481	GN Pan 1/3, white	6.5	32.5x17.5
006482	GN Pan 1/3, white	10.0	32.5x17.5



		Depth in cm	Dim in cm
006483	GN Pan 1/4, white	6.5	26.5x16.2



		Depth in cm	Dim in cm
006484	GN Pan 1/6, white	6.5	17.6x16.2
006485	GN Pan 1/6, white	10.0	17.6x16.2

Stainless steel

		Cap. ltr	Dim in cm
026403	A Bain marie pan without lid	4.0	24.0x24.0x7.5
026402	A Bain marie pan without lid	9.0	24.0x24.0x16.0
026401	A Bain marie pan without lid	13.0	24.0x24.0x23.5

		Cap. ltr	Dim in cm
026407	B Bain marie pan without lid	1.5	15.5x15.5x7.5
026406	B Bain marie pan without lid	3.5	15.5x15.5x16.0
026405	B Bain marie pan without lid	5.0	15.5x15.5x23.5

		Cap. ltr	Dim in cm
026411	C Bain marie pan without lid	0.5	15.5x10.5x5.5
026410	C Bain marie pan without lid	1.0	15.5x10.5x7.5
026409	C Bain marie pan without lid	2.5	15.5x10.5x16.0

		Dim in cm
026404	Lid to bain marie pan A	24.0x24.0
026408	Lid to bain marie pan B	15.5x15.5
026412	Lid to bain marie pan C	15.5x10.5



Stainless steel

		Ø cm	H in cm	Cap. ltr
014130	Bain marie pot with drop handle	14.0	16.0	2.0
014131	Bain marie pot with drop handle	16.0	18.0	3.0
014132	Bain marie pot with drop handle	18.0	20.0	5.0



		Ø cm	H in cm	Cap. ltr
017733	Bain marie pot with long handle	16.0	16.0	3.0
017734	Bain marie pot with long handle	18.0	18.0	4.5
017735	Bain marie pot with long handle	20.0	20.0	6.2

induction



		Ø cm	H in cm	Cap. ltr
017729	Bain marie pot with long handle, sandwich bottom	16.0	16.0	3.0
017730	Bain marie pot with long handle, sandwich bottom	18.0	18.0	4.5
017731	Bain marie pot with long handle, sandwich bottom	20.0	20.0	6.2
017732	Bain marie pot with long handle, sandwich bottom	24.0	24.0	10.0

induction



		Ø cm	H in cm	Cap. ltr
019015	Bain marie pot with 2 handles	16.0	16.0	3.0
019016	Bain marie pot with 2 handles	18.0	18.0	4.5
019017	Bain marie pot with 2 handles	20.0	20.0	6.2



		Ø cm
003507	Lid	16.0
003508	Lid	18.0
003509	Lid	20.0
003510	Lid	24.0
003511	Lid	28.0



		Ø cm	H in cm	Cap. ltr
013115	Food storage container round	14.0	12.0	1.7
012627	Food storage container round	16.0	13.0	2.5
012628	Food storage container round	20.0	16.5	5.0
012688	Food storage container round	24.0	20.0	8.0
012629	Food storage container round	28.0	23.0	14.0





Andy Mannhart



SMALL KITCHEN UTENSILS

Sieves, Strainers, Mixing Bowls

| 2

Plastic

		Ø cm	H in cm	Cap. ltr
019581	Mixing bowl	19.0	7.9	1.0
019582	Mixing bowl	24.0	11.5	2.5
019583	Mixing bowl	28.0	13.5	4.5
019584	Mixing bowl	32.5	14.7	6.0
019585	Mixing bowl	36.0	16.5	9.0
019586	Mixing bowl	40.0	18.5	13.0



Stainless steel

		Ø cm	H in cm	Cap. ltr
042120	Kitchen bowl conical	12.0	7.0	0.50
042121	Kitchen bowl conical	16.0	5.5	0.65
042122	Kitchen bowl conical	15.0	8.0	1.00
010192	Kitchen bowl conical	18.0	9.5	1.50
001176	Kitchen bowl conical	19.5	11.5	2.00
000934	Kitchen bowl conical	22.0	12.5	3.00
002940	Kitchen bowl conical	24.5	13.5	4.00
042125	Kitchen bowl conical	26.5	13.0	5.00
004112	Kitchen bowl conical	28.5	14.5	6.00
000936	Kitchen bowl conical	31.0	16.5	8.00
037649	Kitchen bowl conical	31.0	18.0	9.00
004113	Kitchen bowl conical	35.5	18.0	11.00
042129	Kitchen bowl conical	37.0	20.0	14.00



		Ø cm	H in cm	Cap. ltr
037179	Kitchen bowl round	16.0	6.8	0.5
037180	Kitchen bowl round	18.0	7.2	0.9
037181	Kitchen bowl round	20.0	7.8	1.2
037182	Kitchen bowl round	22.5	8.2	1.6
037183	Kitchen bowl round	23.5	8.5	2.0
037184	Kitchen bowl round	28.0	9.7	3.0
002089	Kitchen bowl round	32.0	10.5	5.0
037185	Kitchen bowl round	36.0	12.3	7.0
037186	Kitchen bowl round	39.5	13.0	8.2



		Ø cm	H in cm	Cap. ltr
037321	Kitchen bowl round with 2 handles	35.0	14.5	8.5
001456	Kitchen bowl round with 2 handles	40.0	16.5	13.0
001458	Kitchen bowl round with 2 handles	45.0	17.5	20.0



		Ø cm	H in cm	Cap. ltr
026050	Mixing bowl, semi spheric with bordered rim	20.0	10.0	2.1
026052	Mixing bowl, semi spheric with bordered rim	24.0	12.5	3.0
026048	Mixing bowl, semi spheric with bordered rim	30.0	15.0	7.0
026049	Mixing bowl, semi spheric with bordered rim	35.0	17.5	11.2
026047	Mixing bowl, semi spheric with bordered rim	40.0	20.0	16.0



		Ø cm	H in cm	Cap. ltr
005234	Bowl round with one handle	18.0	10.0	1.8



		Ø cm	H in cm	Cap. ltr
028031	Mixing bowl round with 2 handles	22.0	10.5	2.5
028024	Mixing bowl round with 2 handles	25.0	14.0	5.0
028032	Mixing bowl round with 2 handles	32.0	20.0	10.0
028033	Mixing bowl round with 2 handles	36.0	22.0	14.0
028034	Mixing bowl round with 2 handles	40.0	24.0	22.0



Stainless steel



		Ø cm	H in cm	Cap. ltr
017656	Kitchen bowl conical with 2 handles	25.0	13.0	3.8
017657	Kitchen bowl conical with 2 handles	30.0	16.0	6.5
012004	Kitchen bowl conical with 2 handles	40.0	16.5	13.0
012006	Kitchen bowl conical with 2 handles	50.0	19.0	25.0



		Ø cm	H in cm	Cap. ltr
029021	Planetary mixing bowl	26.5	20.0	10.0
029118	Planetary mixing bowl	30.0	25.0	16.0
029119	Planetary mixing bowl	31.5	30.0	20.0
029120	Planetary mixing bowl	35.5	28.5	25.0
029121	Planetary mixing bowl	35.5	35.5	32.0
029122	Planetary mixing bowl	40.0	35.5	40.0



		Ø cm	H in cm	Cap. ltr
012023	Conical vegetable strainer	30.0	14.5	6.0
012024	Conical vegetable strainer	35.0	16.5	8.5
012025	Conical vegetable strainer	40.0	17.5	13.0
012022	Conical vegetable strainer	45.0	20.0	20.0
012026	Conical vegetable strainer	50.0	22.5	25.0



		Ø cm	H in cm	Cap. ltr
038707	Colander shallow	21.0	9.5	1.7
038752	Colander shallow	25.0	12.0	3.5
038753	Colander shallow	30.0	13.5	5.5
034295	Colander shallow	34.0	15.5	9.0



		Ø cm	H in cm	Cap. ltr
028160	Colander deep	21.0	14.0	3.0
008972	Colander deep	25.0	16.0	4.0
032228	Colander deep	36.0	22.0	15.0



		Ø cm	H in cm	Cap. ltr
026055	Salad sieve with side handles	24.0	12.0	9.0



		Ø cm	H in cm	Cap. ltr
017659	Strainer with handle	20.0	10.0	2.5
019205	Strainer with handle	22.0	11.5	3.7
017660	Strainer with handle	24.0	12.0	4.5
019206	Strainer with handle	26.0	13.0	5.0



		Ø cm		
038020	Strainer small, fine mesh	7.0		
038021	Strainer small, fine mesh	10.0		



		Ø cm		
017668	Soup strainer with s/s rim	8.0		
035542	Soup strainer with s/s rim	10.0		
035543	Soup strainer with s/s rim	12.0		
019303	Soup strainer with s/s rim	15.0		
019305	Soup strainer with s/s rim	18.0		
017669	Soup strainer with s/s rim	20.0		

Stainless steel

		Ø cm
038023	Bouillon sieve, medium mesh	14.0
038024	Bouillon sieve, medium mesh	16.0
038025	Bouillon sieve, medium mesh	18.0
038026	Bouillon sieve, medium mesh	20.0
038010	Bouillon sieve, medium mesh	26.0



		Ø cm
038033	Bouillon sieve with interchangeable sieve	30.0
038034	Bouillon sieve with interchangeable sieve	34.0



		Ø cm
038037	Interchangeable sieve, mesh fine	30.0
038041	Interchangeable sieve, mesh coarse	30.0
038038	Interchangeable sieve, mesh fine	34.0
038042	Interchangeable sieve, medium mesh	34.0



		Ø cm
017661	Sauce sieve chinois	16.0
019291	Sauce sieve chinois	18.0
019292	Sauce sieve chinois	20.0
017662	Sauce sieve chinois	22.0
019293	Sauce sieve chinois	24.0
017663	Sauce sieve chinois	26.0
012244	Sauce sieve chinois	27.0



		Ø cm
026244	Cloth/sieve, cone shape with wire gauze	20.0
026245	Cloth/sieve, cone shape with wire gauze	24.0



		Ø cm
017664	Bouillon sieve, cone shape, fine mesh	8.0
017665	Bouillon sieve, cone shape, fine mesh	10.0
017666	Bouillon sieve, cone shape, fine mesh	12.0
017667	Bouillon sieve, cone shape, fine mesh	15.0
038015	Bouillon sieve, cone shape, fine mesh	18.0



Linen



		Dim in cm
090301	Strainer towel 100% linen	80.0x80.0

Polyethylene



		Ø cm	Cap. ltr
022501	Manual salad spin dryer, plastic, green	33.0	10.0
022502	Manual salad spin dryer, plastic, green	43.0	20.0

Polyethylene



		Ø cm
026299	Funnel	5.5
000907	Funnel	7.0
000908	Funnel	9.5
029207	Funnel	11.0
029208	Funnel	13.0
000909	Funnel	15.0

Stainless steel



		Ø cm
026083	Funnel with handle	9.0
029904	Funnel with handle	11.0
028707	Funnel with handle	14.0
026087	Funnel with handle	20.0



		Ø cm	H in cm	Cap. ltr
019226	Bucket with base and scale	30.0	26.5	10.0
001203	Bucket with base and scale	31.0	29.0	12.0
019228	Bucket with base and scale	32.5	32.5	15.0



		Cap. ltr
018043	Grad kitchen measure	0.5
018044	Grad kitchen measure	1.0
018045	Grad kitchen measure	2.0

Stainless steel

		Cap. ltr
000939	Measure cup set (4 parts)	0.06, 0.08, 0.125 and 0.25
008020	Measure spoon set (4 parts) including	
	1 Tablespoon	
	1 Teaspoon	
	1/2 Teaspoon	
	1/4 Teaspoon	



Polypropylene

		Cap. ltr
005334	Kitchen measure with scale and handle	0.25
000905	Kitchen measure with scale and handle	1.00
000941	Kitchen measure with scale and handle	2.00
068634	Kitchen measure with scale and handle	5.00



Stainless steel

		L in cm
019294	Scoop	10.0
019295	Scoop	15.0
019296	Scoop	19.0
019297	Scoop	24.0



Aluminium

		L in cm	Cap. ltr
018909	Scoop with inside handle	32.0	2.6



		L in cm	Cap. ltr
026160	Scoop	18.5	0.11
026161	Scoop	21.0	0.13
026162	Scoop	25.0	0.25
026163	Scoop	31.0	0.45
026164	Scoop	35.0	0.80
026165	Scoop	40.0	1.50



Polypropylene

		Dim in cm	Cap. ltr
001446	Scoop	17.0x12.0	0.6
007248	Scoop	24.0x15.0	2.7



Stainless steel



		Ø cm	L in cm	Cap. ltr
004608	Sauce ladle, one piece	6.0	32.0	0.1



		Ø cm	L in cm	Cap. ltr
019251	Kitchen ladle, one piece	6.5	31.0	0.07
019252	Kitchen ladle, one piece	8.0	32.0	0.12
019253	Kitchen ladle, one piece	9.0	33.0	0.2
019254	Kitchen ladle, one piece	10.0	37.0	0.25
019255	Kitchen ladle, one piece	12.0	42.0	0.5
019256	Kitchen ladle, one piece	14.0	43.0	0.75
019257	Kitchen ladle, one piece	16.0	45.0	1.0
017672	Kitchen ladle, one piece	18.0	48.0	1.5



		Ø cm	L in cm	Cap. ltr
004198	Kitchen ladle, one piece	20.0	63.5	2.0



		Ø cm	L in cm	Cap. ltr
029601	Kitchen ladle, one piece	20.0	74.0	2.0
029602	Kitchen ladle, one piece	24.0	94.0	4.0



		Ø cm	L in cm	Cap. ltr
019288	Ladle for sauce with lip	6.0	32.0	0.1



		L in cm		
000568	Ladle crosswire, one piece	38.0		



		Ø cm	L in cm	Cap. ltr
028858	Portioning ladle perforated, one piece	7.0	29.0	0.08
028859	Portioning ladle perforated, one piece	8.0	32.0	0.125
019242	Portioning ladle perforated, one piece	9.0	33.0	0.2
019243	Portioning ladle perforated, one piece	10.0	37.0	0.25
019244	Portioning ladle perforated, one piece	12.0	42.0	0.5
028863	Portioning ladle perforated, one piece	14.0	41.0	0.75
028864	Portioning ladle perforated, one piece	16.0	45.0	1.0



		L in cm		
078021	Ladle holder	79.0		

Copolyester

		L in cm
032056	Serving spoon	34.0

		L in cm
030855	Serving spoon perforated	34.0



Stainless steel

		L in cm
005716	Sauce spoon/ladle	22.0

		L in cm
005259	All purpose spoon	24.0

		L in cm
005260	All purpose spoon perforated	24.0

		L in cm
019283	Basting spoon/ladle perforated	37.0

		L in cm
019281	Basting spoon/ladle	37.0

		Ø cm	H in cm
038050	Potato baking spoon	10.0	8.0
038051	Potato baking spoon	12.0	10.0



Exoglass

		L in cm
022016	Spoon	30.0
022017	Spoon	38.0
022018	Spoon	45.0



Wood

		L in cm
015719	Spoon	25.0
015720	Spoon	30.0
015721	Spoon	40.0
015722	Spoon	50.0

		L in cm
015724	Spoon with hole	25.0
015725	Spoon with hole	35.0



Stainless steel

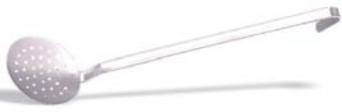

		Ø cm	L in cm
019260	Skimmer, one piece	8.0	29.0
019261	Skimmer, one piece	10.0	32.0
019262	Skimmer, one piece	12.0	35.0
019263	Skimmer, one piece	14.0	37.0
019264	Skimmer, one piece	16.0	44.0
019265	Skimmer, one piece	18.0	44.0
019266	Skimmer, one piece	20.0	47.0



		Ø cm	L in cm
029603	Skimmer, two piece	25.0	92.0



		Ø cm	L in cm
078013	Deep frying skimmer	15.0	50.0
078014	Deep frying skimmer	17.0	54.0
078015	Deep frying skimmer	20.0	61.5



		Ø cm	L in cm
078018	Deep frying skimmer, fine mesh	17.0	54.0



		L in cm
038085	Potato masher	30.0



		Ø cm	L in cm
011822	Skimmer	13.0	47.5
021236	Skimmer	15.0	49.5
011823	Skimmer	18.0	52.5
012667	Skimmer	20.0	54.5
038076	Skimmer	22.0	67.0
007076	Skimmer	24.0	69.0
028888	Skimmer	28.0	69.0



		L in cm
017679	Kitchen fork	30.0
017680	Kitchen fork	37.0
019271	Kitchen fork	47.0

Stainless steel

		Ø cm	L in cm
019267	Lifter, one piece	10.0	36.0
019268	Lifter, one piece	12.0	39.0
		Ø cm	L in cm
019269	Lifter, one piece, perforated	10.0	36.0
019270	Lifter, one piece, perforated	12.0	39.0
		Dim in cm	L in cm
019258	Lifter, one piece, perforated	8.0x9.5	24.0
		Dim in cm	L in cm
028605	Perforated spatula	13.0x13.0	35.5
029176	Perforated spatula	13.0x13.0	85.0
		Dim in cm	L in cm
026152	Fish server, one piece	11.0x11.0	36.0
		Dim in cm	L in cm
026154	Fish spatula	16.0x12.0	42.0
		Dim in cm	L in cm
026156	Pizza shovel	20.0x20.5	150.0
		Dim in cm	L in cm
026153	Fast food and fish turner, perforated	7.3x25.0	38.0
		Dim in cm	L in cm
026155	Fast food and fish turner, flexible	7.3x25.0	38.0
		Width of blade cm	L in cm
018355	Triangular spatula safety handle	8.0	24.5
018356	Triangular spatula safety handle	10.0	25.0
		Dim in cm	L in cm
017737	Spatula ABS handle	7.0x16.0	29.0

Nylon

		Total length cm
015696	Spatula bent and slotted for non-stick pans	29.0



Wood



		L in cm
042141	Spatula lobe form	30.0
042142	Spatula lobe form	35.0
042143	Spatula lobe form	40.0
042144	Spatula lobe form	45.0
042145	Spatula lobe form	50.0
042146	Spatula lobe form	60.0
042147	Spatula lobe form	80.0
042148	Spatula lobe form	120.0



		L in cm
015770	Spatula/scraper, flat	30.0

Plastic



		L in cm
027907	Spatula with reinforced fiber glass handle	25.0
027939	Spatula with reinforced fiber glass handle	30.0
027932	Spatula with reinforced fiber glass handle	35.0
027884	Spatula with reinforced fiber glass handle	40.0
027885	Spatula with reinforced fiber glass handle	45.0
027886	Spatula with reinforced fiber glass handle	50.0



		L in cm
055011	Hygenia reduit spatula	80.0
008147	Hygenia reduit spatula	100.0
010748	Hygenia reduit spatula	120.0
036810	Hygenia reduit spatula	160.0

Stainless steel



		Wire thickness mm	L in cm
017681	Whisk/beater, 12 wires	1.3	25.0
017682	Whisk/beater, 12 wires	1.3	30.0
017683	Whisk/beater, 12 wires	1.3	35.0
017684	Whisk/beater, 12 wires	1.3	40.0
017685	Whisk/beater, 12 wires	1.3	45.0
017686	Whisk/beater, 12 wires	1.3	50.0

Stainless steel

		Wire thickness mm	L in cm
017705	Whisk/beater 10 wires	1.8	25.0
017706	Whisk/beater 10 wires	1.8	30.0
017707	Whisk/beater 10 wires	1.8	35.0
017708	Whisk/beater 10 wires	1.8	40.0
017709	Whisk/beater 10 wires	1.8	45.0
017710	Whisk/beater 10 wires	1.8	50.0



		Wire thickness mm	L in cm
017711	Whisk/beater 8 wires	2.4	25.0
017712	Whisk/beater 8 wires	2.4	30.0
017713	Whisk/beater 8 wires	2.4	35.0
017714	Whisk/beater 8 wires	2.4	40.0
017715	Whisk/beater 8 wires	2.4	45.0
017716	Whisk/beater 8 wires	2.4	50.0



		Wire thickness mm	L in cm
017690	Whisk/beater with anti-slip handle, 8 wires	2.0	25.0
017691	Whisk/beater with anti-slip handle, 8 wires	2.0	30.0
017692	Whisk/beater with anti-slip handle, 8 wires	2.0	35.0
017693	Whisk/beater with anti-slip handle, 8 wires	2.0	40.0
017694	Whisk/beater with anti-slip handle, 8 wires	2.0	45.0
017695	Whisk/beater with anti-slip handle, 8 wires	2.0	50.0



		Wire thickness mm	L in cm
005100	Whip strong type	1.4	30.0
005101	Whip strong type	2.2	36.0
005102	Whip strong type	2.2	40.0
005103	Whip strong type	2.2	50.0



		L in cm
031921	Balloon whisk with nylon handle	35.0
031922	Balloon whisk with nylon handle	45.0



		Wire thickness mm	L in cm
017687	Big whisk	3.0	80.0
017688	Big whisk	3.0	100.0
017689	Big whisk	3.0	125.0
038061	Big whisk	3.0	135.0



Stainless steel



		L in cm
019287	Spaghetti tong	19.0



		L in cm
017704	Pasta tong	24.0



		L in cm
005010	Serving tong	24.0



		L in cm
005624	Utility tong	24.0
017701	Utility tong	29.5
005625	Utility tong	40.0



	L in cm : 24.0	L in cm : 30.0	L in cm : 40.0
● Utility tong black	017700	004984	017702
● Utility tong blue	005045	004986	005051
● Utility tong green	005044	004985	005050
● Utility tong red	005046	004987	005052
● Utility tong tan	005049	004990	005055
○ Utility tong white	005048	004989	005054
● Utility tong yellow	005047	004988	005053



		L in cm
017696	Salad tong	26.5



		L in cm
038053	Barbeque tong	40.0



		L in cm
017697	Burger tong	24.0



		L in cm
078025	Salad tong	16.0

Stainless steel

		L in cm
001029	Cake tong with plain handle	17.
005287	Pastry tong with flat tips	19.5
008652	Fine tong	30.0
005286	Sugar tong with rectangular tips	10.5
017699	Bread tong	25.0



Aluminium

		Dim in cm
018901	Kitchen tong	27.5x7.3x1.3



Polycarbonate

		L in cm
019495	All purpose tong	23.0



Polyamide

		L in cm
008704	Fine tong, heat resistant up to +240°C	29.5



Stainless steel

		Dim in cm
017175	Grater large shaver, with handle	31.5x7.3
017176	Grater ribbon, with handle	31.5x7.3
017177	Grater extra coarse, with handle	31.5x7.3
017178	Grater fine, with handle	31.5x7.3



Stainless steel



		L in cm
017703	Box grater, 4 different sides	23.0



		L in cm
029197	Grater	25.0



		Dim in cm	L in cm
002916	Lemon grater	11.0x6.0	23.5



		Dim in cm
026213	Roesti/potato grater	29.0x11.0



		Dim in cm
005262	Cheese grater with basin	20.0x10.5x15.0



		Dim in cm	L in cm
026215	Bircher fruit grater	11.5x6.0	24.0



		Dim in cm
026080	Dumpling grater with plastic sled	32.0x11.0

Aluminium



		Ø cm
016061	Knoepfli sieve with long handle	24.0
016062	Knoepfli sieve with long handle	32.0

Stainless steel



		Ø cm	H in cm with handle
069903	Egg ring with handle	8.5	11.0

		Ø cm	H in cm
038226	Egg ring with handle, flower shape	11.0	2.0
038227	Egg ring with handle, circle shape	11.0	2.0
038228	Egg ring with handle, heart shape	11.0	2.0



		Ø cm
026091	Rice ring mould, polished	12.0
026092	Rice ring mould, polished	14.0
026093	Rice ring mould, polished	17.0
026094	Rice ring mould, polished	20.0
026095	Rice ring mould, polished	22.0



		Dim in cm
012092	Mini guitar, slice thickness 0.5cm	45.5x23.3x15.0

005298	Truffle slicer s/s	L in cm 16.0
033014	Vegetable slicer V-shaped blade, adjustment of thickness up to 0.5cm	Dim in cm 36.8x80.0x12.1
038633	Japanese mandolin 3 julienne blades 1, 2.5 and 6.0mm, safety guard, cutting width 6.5cm	Dim in cm 32.5x9.2x2.9
038632	Japanese mandolin 3 julienne blades 1, 2.5 and 6.0mm, safety guard, cutting width 9.5cm	Dim in cm 34.5x13.0x2.5
018412	Strip slicer cuts wide and thin strips, s/s, 4 suction cups, cutting unit 1.5mm	Dim in cm 20.0x20.0x20.0
018413	Japanese strip slicer 2 blades strips and spaghetti, plastic frame, blade s/s	Dim in cm 28.0x25.0x16.5
018414	Japanese strip slicer 4 blades strip, spaghetti and 2 nets, plastic frame, blade s/s	Dim in cm 28.0x25.0x16.5
022155	Mandolin vegetable slicer with safety handguard, complete with 4 exchangeable razor shape blades (0.2, 0.4, 0.7 and 1.0cm), adjustable cutting thickness from 0 to 1.0cm	Dim in cm 13.5x40.0x5.5
022157	Mandolin vegetable slicer two horizontal blades (straight/serrated), 3 julienne blades 0.2, 0.4 and 1.0cm, able to produce cubes	Dim in cm 50.0x18.5x18.0
018155	Mandolin vegetable slicer with 38 blades (3+10mm), various cutting possibilities, with safety handguard	Dim in cm 13.5x40.0x5.5
018156	Mandolin vegetable slicer with 60 blades (2+4.5mm), various cutting possibilities, with safety handguard	



Stainless steel



		Dim in cm
040229	Tomato slicer, slices 0.64cm, aluminium and plastic	39.0x21.5x20.0



		Dim in cm
018157	Vegetable carver complete with 2 grids (0.2 and 0.3cm) and clamp for table	37.0x14.0x25.0



		Dim in cm
018423	Terrine slicer with wires, slices 1cm, to cut terrine in regular slices, at a temperature of 3 to 4° C, all s/s, dishwasher safe	30.6x14.0x4.0
018424	Terrine slicer with wires, slices 0.7cm, to cut terrine in regular slices, at a temperature of 3 to 4° C, all s/s, dishwasher safe	

Aluminium



		Parts	Dim in cm
018902	Egg divider with s/s wires	6	18.0x6.5x3.0



		Wires	Dim in cm
017738	Egg slicer with s/s wires	10	10.3x8.5x2.7



		Parts	Ø cm
018903	Apple cutter	8	8.5



		Dim in cm
018910	Multipurpose slicer with 7 s/s blades	20.0x7.0x3.0



		L in cm
001537	Lobster cracker	14.0



		Dim in cm
018170	Nut cracker Herkules	15.0x3.0x1.5



		L in cm
038233	Lobster cracker	21.0



		L in cm
038232	Lobster fork, set of 4pcs	20.5

Stainless steel

		L in cm
006025	Juice press	22.0



		Ø cm	H in cm	Cap. ltr
042150	Lemon juice squeezer, 2 parts	11.5	10.0	0.4



		H in cm
033353	Lemon squeezer with pouring edge	6.4



038230	Lemon squeezer with spiral in a funnel
--------	--



Aluminium

		Dim in cm
006692	Garlic press	15.5



		Dim in cm
018908	Olive stoner	17.5x5.0x1.0



Tinned

		L in cm
026355	Potato puree press	28.0



Stainless steel

		Dim in cm
019505	Potato press with 3 sieves, Ø of holes 2.0, 5.0 and 7.0mm	32.0x12.5x9.0



Aluminium

		L in cm
018920	Vermicelle/spaetzle/potato puree press with extra long handle, Ø of holes 0.3cm	40.0



Stainless steel



		Ø cm
042010	Food mill	31.0
	incl. 3 perforated discs 1.5, 2.5 and 4.0mm, flowrate 1.0 to 1.5kg of purée per minute, sieve Ø 14.0cm	



		Ø cm
042011	Food mill professional	37.0
	incl. disc 3.0mm, flowrate 5.0kg of purée per minute, sieve Ø 18.0cm	



		Ø cm
042012	Additional sieve 1.0mm to 042011	18.0
042013	Additional sieve 1.5mm to 042011	18.0
042014	Additional sieve 2.0mm to 042011	18.0
042015	Additional sieve 3.0mm to 042011	18.0
005979	Additional sieve 4.0mm to 042011	18.0

Wood



80 cm



Pepper mill mechanism, steel

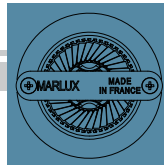

Salt mill mechanism, s/s



Spices Ceramic mechanism, setting with the mill knob

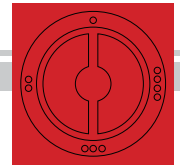

Spices Ceramic mechanism, setting with the mill base



Pepper mill Java, mechanism, steel

natural	brown	white	black	H in cm
033830	033829	033828	033822	14.0
033836	033835	033834	033823	21.0
033853	033854	033856	033824	25.0
033862	033864	033865	033866	30.0
033879	033881	033882	033884	40.0
033888	033889	033890	033891	80.0

Salt mill Java, mechanism, s/s

natural	brown	white	black	H in cm
033833	033832	033831	033825	14.0
033837	033843	033844	033826	21.0
033857	033858	033860	033827	25.0
033867	033868	033869	033870	30.0
033885	033886			40.0



Wood



Spices mill Java, ceramic mechanism, setting with the mill knob

natural	brown	white	black	H in cm
034073	034074	034075	034076	14.0
034077	034078	034079	034080	21.0
034081	034082	034083	034084	25.0

Stainless steel - Wood



		Colour	H in cm
033997	Pepper mill Springar	natural	13.5
033994	Salt mill Springar	natural	13.5
033996	Pepper mill Springar	ebony	13.5
033995	Salt mill Springar	ebony	13.5

Stainless steel



		Colour	H in cm
033952	Pepper mill Madison	transparent	14.0
033954	Salt mill Madison	transparent	14.0



		Colour	H in cm
033992	Pepper mill Salsa	transparent	13.0
033993	Salt mill Salsa	transparent	13.0

Acryl



		Colour	H in cm
033945	Pepper mill Vira	transparent	10.0
033946	Salt mill Vira	transparent	10.0

Acryl

		Colour	H in cm
033937	Pepper mill Tango	transparent	11.0
033941	Salt mill Tango	transparent	11.0
033939	Pepper mill Tango	transparent	14.0
033942	Salt mill Tango	transparent	14.0
033940	Pepper mill Tango	transparent	25.0
033943	Salt mill Tango	transparent	25.0



Ceramic mechanism, setting with the mill base

		Colour	H in cm
034085	Pepper mill Tango	transparent	11.0
034086	Salt mill Tango	transparent	11.0
034087	Pepper mill Tango	transparent	14.0
034088	Salt mill Tango	transparent	14.0
034089	Pepper mill Tango	transparent	25.0
034090	Salt mill Tango	transparent	25.0



Acryl - Stainless steel

		Colour	H in cm
033950	Nutmeg mill Twist	transparent	10.0



Stainless steel

		Colour	H in cm
033991	Pepper mill and salt shaker Two-Step	transparent	12.5



		P/U	Colour	H in cm
014630	Salt or pepper mill, battery operated	6	transparent	21.0



		P/U	Colour	H in cm
014631	Salt or pepper mill	6	transparent	21.0



Wood - Acryl

Pepper mill Hip Hop,
mechanism, steel,
H in cm 11.0



Article	Colour
033893	white
033899	red
033909	black
033911	taupe
033913	green
033914	curry
033916	grey
033917	orange
033919	blue



Salt mill Hip Hop,
mechanism, s/s,
H in cm 11.0

Article	Colour
033921	white
033924	red
033925	black
033927	taupe
033928	green
033929	curry
033931	grey
033932	orange
033933	blue



Pepper mill Hip Hop, ceramic
mechanism, setting with the
mill base, H in cm 11.0

Article	Colour
034091	white
034092	red
034093	black
034094	taupe
034095	green
034096	curry
034097	grey
034098	orange
034099	blue



Salt mill Hip Hop, ceramic
mechanism, setting with the
mill base, H in cm 11.0

Article	Colour
034100	white
034101	red
034102	black
034103	taupe
034104	green
034105	curry
034106	grey
034107	orange
034108	blue



Beech wood

Ceramic mechanism, 6 different adjustments from fine grind (1) to rough (6)

		Ø cm	H in cm
038116	Pepper mill Frankfurt, beech, wenge stained	5.8	14.0
038114	Salt mill Frankfurt, beech, wenge stained	5.8	14.0
038117	Pepper mill Frankfurt, beech, wenge stained	5.8	18.0
038115	Salt mill Frankfurt, beech, wenge stained	5.8	18.0
036341	Pepper mill Frankfurt, beech, wenge stained	6.0	24.0
036342	Salt mill Frankfurt, beech, wenge stained	6.0	24.0
036343	Pepper mill Frankfurt, beech, wenge stained	6.4	30.0
036344	Salt mill Frankfurt, beech, wenge stained	6.4	30.0

new



		Ø cm	H in cm
038103	Pepper mill Frankfurt, beech, natural	5.8	14.0
038107	Salt mill Frankfurt, beech, natural	5.8	14.0
038106	Pepper mill Frankfurt, beech, natural	5.8	18.0
038108	Salt mill Frankfurt, beech, natural	5.8	18.0
038109	Pepper mill Frankfurt, beech, natural	6.0	24.0
038112	Salt mill Frankfurt, beech, natural	6.0	24.0
038111	Pepper mill Frankfurt, beech, natural	6.4	30.0
038113	Salt mill Frankfurt, beech, natural	6.4	30.0

new



		Ø cm	H in cm
038118	Pepper mill Hamburg, beech, natural	5.8	18.0
038120	Salt mill Hamburg, beech, natural	5.8	18.0

new



		Ø cm	H in cm
038126	Pepper mill Hamburg, beech, black	5.8	18.0
038127	Salt mill Hamburg, beech, black	5.8	18.0

new



		Ø cm	H in cm
038128	Pepper mill Hamburg, beech, white	5.8	18.0
038129	Salt mill Hamburg, beech, white	5.8	18.0

new



Stainless steel - Wood



Ceramic mechanism, 6 different adjustments from fine grind (1) to rough (6)

new

		Ø cm	H in cm
038130	Pepper mill Augsburg, beech, satin black and s/s	5.5	14.0
038132	Salt mill Augsburg, beech, satin black and s/s	5.5	14.0



new

		Ø cm	H in cm
038131	Pepper mill Augsburg, beech, satin black and s/s	5.5	18.0
038133	Salt mill Augsburg, beech, satin black and s/s	5.5	18.0



new

		Ø cm	H in cm
038145	Pepper mill Augsburg, olive wood and s/s	5.5	14.0
038147	Salt mill Augsburg, olive wood and s/s	5.5	14.0



new

		Ø cm	H in cm
038148	Pepper mill Augsburg, olive wood and s/s	5.5	18.0
038149	Salt mill Augsburg, olive wood and s/s	5.5	18.0



new

		Ø cm	H in cm
038160	Pepper mill Dresden, electric, chrome	6.5	24.0
038161	Salt mill Dresden, electric, chrome	6.5	24.0

Plastic

		Cap. ltr	Dim in cm
042005	Spice compartment with transparent lid, 4 compartments	4x0.7	47.0x13.0x7.5



		Cap. ltr	Dim in cm
042007	Spice compartment with transparent lid, 6 compartments	6x0.5	50.0x15.5x9.0



022500	First aid kit, 1 insulating survival coat 2.20x1.40cm, 1 leather finger-stall, 1 pressure pad 10.0x10.0cm, 1 s/s splinter forceps, 1 elastic ankle band 5.0x300.0cm, 1 elastic ankle band 7.0x300.0cm, 4 sanitizing and bactericidal wipes, 4 dry wipes, 4 soothing wipes, 1 pair of s/s scissors, 1 fabric plaster 2.5x500.0cm, 1 pair of gloves, 18 Urgo pads in 3 sizes, 10 sterilized compresses, First aid notice		
--------	--	--	--





Andy Mannhart



KNIVES & BOARDS

Cutting & Carving Tools, Butchery Equipment

3

Andy Mannhart

Stainless steel

HACCP (Hazard Analysis Critical Control Points) is a preventive system - a risk management that provides safety for food and consumers. Through its coloured handles, the scope of application for each knife will be visible. The international colour coding concept for the risk management looks as follows:

Red	raw meat	Yellow	poultry / cooked meat	Green	vegetable and fruits
Brown	cooked meat	Blue	fish	White	pastry / bakery

ANDY MANNHART KNIVES WITH COLOURED HANDLE

The slip resistant nylon handles can be sterilised at temperatures of up to max. 150° Celsius.

Butcher knife wide shape blade

black	blue	yellow	green	red	white	Blade in cm
038065	038080	038083	038087	038090	038093	18.0
025685	025642	025569	025760	025566	025645	20.0
025686	025643	025570	025761	025567	025646	24.0
025687	025644	025571	025758	025568	025759	26.0
038066	038081	038084	038088	038091	038094	30.0
038067	038082	038086	038089	038092	038095	36.0

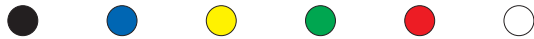

Steak knife

black	blue	yellow	green	red	white	Blade in cm
025677	025647	025653	025756	025572	025757	20.0
025678	025649	025655	025754	025573	025755	25.0
025679	025650	025656	025752	025574	025753	30.0



Slicing knife

black	blue	brown	yellow	green	red	white	Blade in cm
028165	037752	037990	037991	037989	037992	036774	25.0
028121	028115	028117	028118	028116	028114	028119	30.0



Slicing knife wavy blade

black	blue	brown	yellow	green	red	white	Blade in cm
025692	025610	025616	025618	025614	025608	025663	25.0
025693	025611	025617	025619	025613	025609	025664	30.0



Chef's knife narrow blade

black	blue	brown	yellow	green	red	white	Blade in cm
025673	025582	025720	025718	025604	025576	025719	17.0
025671	025583	025717	025715	025605	025578	025716	20.0
025674	025584	025714	025712	025606	025579	025713	26.0
025675	025585	025711	025709	025607	025580	025710	30.0



Stainless steel

Chef's knife wide blade



black	blue	brown	yellow	green	red	white	Blade in cm
025721	025723	025727	025725	025724	025722	025726	17.0
025731	025729	025735	025732	025730	025728	025734	20.0
025739	025737	025742	025740	025738	025736	025741	26.0
025746	025744	025748	025747	025745	025743	025749	30.0
●	●	●	●	●	●	○	

Chef's knife wavy edge blade



black	blue	brown	yellow	green	red	white	Blade in cm
038096	038097	038098	038099	036775	038100	038101	25.0
●	●	●	●	●	●	○	

Skinning knife



black	blue	brown	yellow	green	red	white	Blade in cm
036763	037875	037876	037743	037874	037873	037872	16.0
036764	036813	037881	037744	037879	037878	037877	18.0
●	●	●	●	●	●	○	

Fish filleting knife



black	blue	Blade in cm
028125	028124	18.0
037737	037733	20.0
037738	037735	22.0
●	●	

Salmon knife scalloped blade, Proflex handle



black	blue	Blade in cm
032266	032265	30.0
●	●	

Ham slicing knife



black	blue	brown	yellow	green	red	white	Blade in cm
036769	036765	037885	037882	037884	037883	037745	24.0
036771	037746	037889	037886	037888	037887	037747	30.0
●	●	●	●	●	●	○	

Bread knife



black	white	Blade in cm
028122	028123	25.0
●	●	



Blade in cm
036767 Cheese/Pizza knife, black nylon handle 38.0



Stainless steel

Cheese knife

black	blue	green	Blade in cm
037896	037969	037929	12.0
			









Cheese knife with 2 handles

black	yellow	Blade in cm
037893	037895	26.0
036772	037751	30.0
037890	037892	30.0
036770	037749	36.0
		









Cleaver chinese style

black	blue	brown	yellow	green	red	white	Blade in cm
025670	025622	025624	025625	025623	025620	025750	20.0
							









Shaping knife curved blade

black	blue	brown	yellow	green	red	white	Blade in cm
025691	028147	028149	028151	028148	028146	028152	6.0
							









Boning knife narrow blade

black	blue	yellow	green	red	white	Blade in cm
025683	025558	025556	025762	025554	025763	13.0
025684	025559	025557	025764	025555	025765	15.0
						









Boning knife curved blade

black	blue	yellow	green	red	white	Blade in cm
025680	025564	025562	025766	025560	025767	13.0
025681	025565	025563	025768	025561	025769	15.0
						



Sticking knife

black	blue	brown	yellow	green	red	white	Blade in cm
036731	037868	037869	036734	036768	036811	036814	17.0
036732	037870	037871	037739	037741	037740	036815	22.0
038164	038165	038166	036812	038162	036733	038163	25.0
							











































Stainless steel

HACCP (Hazard Analysis Critical Control Points) is a preventive system - a risk management that provides safety for food and consumers. Through to its coloured handles, the scope of application for each knife will be visible. The international colour coding concept for the risk management looks as follows:

Red	raw meat	Yellow	poultry / cooked meat	Green	vegetable and fruits
Brown	cooked meat	Blue	fish	White	pastry / bakery

KNIVES WITH COLOURED HANDLE

The slip resistant nylon handles can be sterilised at temperatures of up to max. 150° Celsius.

		Blade in cm	Colour	
009986	Butcher knife wide shape blade	18.0	black	
020090	Butcher knife wide shape blade	18.0	blue	
020185	Butcher knife wide shape blade	18.0	yellow	
020142	Butcher knife wide shape blade	18.0	red	
				
		Blade in cm	Colour	
004688	Butcher knife wide shape blade	21.0	black	
020095	Butcher knife wide shape blade	21.0	blue	
020186	Butcher knife wide shape blade	21.0	yellow	
020644	Butcher knife wide shape blade	21.0	red	
020241	Butcher knife wide shape blade	21.0	white	
				
		Blade in cm	Colour	
000710	Butcher knife wide shape blade	24.0	black	
020096	Butcher knife wide shape blade	24.0	blue	
020187	Butcher knife wide shape blade	24.0	yellow	
020143	Butcher knife wide shape blade	24.0	red	
				
		Blade in cm	Colour	
001806	Butcher knife wide shape blade	27.0	black	
020097	Butcher knife wide shape blade	27.0	blue	
020188	Butcher knife wide shape blade	27.0	yellow	
020649	Butcher knife wide shape blade	27.0	red	
				
		Blade in cm	Colour	
000689	Butcher knife wide shape blade	30.0	black	
020098	Butcher knife wide shape blade	30.0	blue	
025126	Butcher knife wide shape blade	30.0	yellow	
				
		Blade in cm	Colour	
014618	Steak knife	21.0	black	
020101	Steak knife	21.0	blue	
020213	Steak knife	21.0	brown	
020191	Steak knife	21.0	yellow	
019702	Steak knife	21.0	green	
020147	Steak knife	21.0	red	
				
		Blade in cm	Colour	
006775	Steak knife	24.0	black	
020102	Steak knife	24.0	blue	
020192	Steak knife	24.0	yellow	
006776	Steak knife	24.0	green	
020148	Steak knife	24.0	red	
				
		Blade in cm	Colour	
020651	Steak knife	27.0	black	
020103	Steak knife	27.0	blue	
020193	Steak knife	27.0	yellow	
022767	Steak knife	27.0	green	
020149	Steak knife	27.0	red	
025145	Steak knife	27.0	white	
				

Stainless steel



			Blade in cm	Colour
●	004687	Steak knife	30.0	black
●	020743	Steak knife	30.0	blue
●	020194	Steak knife	30.0	yellow
●	006788	Steak knife	30.0	green
●	020738	Steak knife	30.0	red
○	006791	Steak knife	30.0	white



			Blade in cm	Colour
●	000716	Slicing knife	25.0	black
●	020075	Slicing knife	25.0	blue
●	020729	Slicing knife	25.0	brown
●	020159	Slicing knife	25.0	yellow
●	020047	Slicing knife	25.0	green
●	020726	Slicing knife	25.0	red
○	020222	Slicing knife	25.0	white



			Blade in cm	Colour
●	002052	Slicing knife	28.0	black
●	020076	Slicing knife	28.0	blue
●	020162	Slicing knife	28.0	yellow
●	020048	Slicing knife	28.0	green
●	020127	Slicing knife	28.0	red
○	020223	Slicing knife	28.0	white



			Blade in cm	Colour
●	001177	Slicing knife	31.0	black
●	020077	Slicing knife	31.0	blue
●	020208	Slicing knife	31.0	brown
●	020163	Slicing knife	31.0	yellow
●	020049	Slicing knife	31.0	green
●	020128	Slicing knife	31.0	red
○	020224	Slicing knife	31.0	white



			Blade in cm	Colour
●	003561	Slicing knife wavy blade	25.0	black
●	020078	Slicing knife wavy blade	25.0	blue
●	020730	Slicing knife wavy blade	25.0	brown
●	020164	Slicing knife wavy blade	25.0	yellow
●	020747	Slicing knife wavy blade	25.0	green
●	020129	Slicing knife wavy blade	25.0	red
○	007540	Slicing knife wavy blade	25.0	white



			Blade in cm	Colour
●	000891	Slicing knife wavy blade	28.0	black
●	020079	Slicing knife wavy blade	28.0	blue
●	020209	Slicing knife wavy blade	28.0	brown
●	020165	Slicing knife wavy blade	28.0	yellow
●	020050	Slicing knife wavy blade	28.0	green
●	020131	Slicing knife wavy blade	28.0	red
○	020226	Slicing knife wavy blade	28.0	white







			Blade in cm	Colour
●	001950	Slicing knife wavy blade	31.0	black
●	020080	Slicing knife wavy blade	31.0	blue
●	020212	Slicing knife wavy blade	31.0	brown
●	020166	Slicing knife wavy blade	31.0	yellow
●	020055	Slicing knife wavy blade	31.0	green
●	020132	Slicing knife wavy blade	31.0	red
○	020227	Slicing knife wavy blade	31.0	white

Stainless steel

		Blade in cm	Colour	
000715	Universal knife	25.0	black	
025165	Universal knife	25.0	blue	
025167	Universal knife	25.0	yellow	
025168	Universal knife	25.0	green	
025169	Universal knife	25.0	red	
020731	Universal knife	25.0	white	







		Blade in cm	Colour	
008053	Cook's knife	15.0	black	
005530	Cook's knife	15.0	blue	
011680	Cook's knife	15.0	yellow	
003078	Cook's knife	15.0	green	
005528	Cook's knife	15.0	red	



		Blade in cm	Colour	
008055	Cook's knife	20.0	black	
005532	Cook's knife	20.0	blue	
008083	Cook's knife	20.0	yellow	
001833	Cook's knife	20.0	green	
005529	Cook's knife	20.0	red	









		Blade in cm	Colour	
012496	Cook's knife	23.0	black	
005531	Cook's knife	23.0	blue	
011681	Cook's knife	23.0	yellow	
025170	Cook's knife	23.0	green	
004452	Cook's knife	23.0	red	



		Blade in cm	Colour	
020654	Cook's knife	25.0	black	
020655	Cook's knife	25.0	blue	
020658	Cook's knife	25.0	yellow	
020656	Cook's knife	25.0	green	
020657	Cook's knife	25.0	red	



		Blade in cm	Colour	
001668	Chef's knife	16.0	black	
025172	Chef's knife	16.0	blue	
020714	Chef's knife	16.0	brown	
025173	Chef's knife	16.0	yellow	
020713	Chef's knife	16.0	green	
025174	Chef's knife	16.0	red	
020707	Chef's knife	16.0	white	



		Blade in cm	Colour	
000686	Chef's knife	20.0	black	
002510	Chef's knife	20.0	blue	
020204	Chef's knife	20.0	brown	
020157	Chef's knife	20.0	yellow	
000924	Chef's knife	20.0	green	
002509	Chef's knife	20.0	red	
025175	Chef's knife	20.0	white	



		Blade in cm	Colour	
000711	Chef's knife	23.0	black	
000930	Chef's knife	23.0	blue	
001938	Chef's knife	23.0	brown	
000933	Chef's knife	23.0	yellow	
000785	Chef's knife	23.0	green	
000922	Chef's knife	23.0	red	
001937	Chef's knife	23.0	white	



Stainless steel



			Blade in cm	Colour
●	020662	Chef's knife	26.0	black
●	002512	Chef's knife	26.0	blue
●	020723	Chef's knife	26.0	brown
●	020158	Chef's knife	26.0	yellow
●	002511	Chef's knife	26.0	green
●	002513	Chef's knife	26.0	red
○	004710	Chef's knife	26.0	white



			Blade in cm	Colour
●	001115	Chef's knife	29.0	black
●	025176	Chef's knife	29.0	blue
●	025177	Chef's knife	29.0	brown
●	025178	Chef's knife	29.0	yellow
●	025179	Chef's knife	29.0	green
●	025180	Chef's knife	29.0	red
○	025181	Chef's knife	29.0	white



			Blade in cm	Colour
●	020669	Chef's knife	31.0	black
●	025182	Chef's knife	31.0	blue
●	020205	Chef's knife	31.0	brown
●	025183	Chef's knife	31.0	yellow
●	002514	Chef's knife	31.0	green
●	002515	Chef's knife	31.0	red
○	020672	Chef's knife	31.0	white



			Blade in cm	Colour
●	003930	Chef's knife wavy blade	31.0	black
●	020087	Chef's knife wavy blade	31.0	blue
●	020676	Chef's knife wavy blade	31.0	yellow
●	020674	Chef's knife wavy blade	31.0	green
●	020675	Chef's knife wavy blade	31.0	red
○	012540	Chef's knife wavy blade	31.0	white



			Blade in cm	Colour
●	012499	Skinning knife	18.0	black
●	020089	Skinning knife	18.0	blue
●	020183	Skinning knife	18.0	yellow
●	025098	Skinning knife	18.0	green
●	020138	Skinning knife	18.0	red
○	020228	Skinning knife	18.0	white



			Blade in cm	Colour
●	016111	Skinning knife	21.0	black
●	020184	Skinning knife	21.0	yellow
●	020139	Skinning knife	21.0	red



			Blade in cm	Colour
●	008407	Fish filleting knife	18.0	black
●	020088	Fish filleting knife	18.0	blue





















































			Blade in cm	Colour
●	020652	Fish filleting knife	21.0	black
●	020653	Fish filleting knife	21.0	blue



			Blade in cm	Colour
●	000741	Salmon knife scalloped blade	31.0	black
●	015871	Salmon knife scalloped blade	31.0	blue



















































Stainless steel

		Blade in cm	Colour		
001625	Bread knife wavy blade	24.0	black		
015662	Bread knife wavy blade	24.0	white		
		Blade in cm	Colour		
001643	Cheese knife with fork-tip	15.0	black		
025220	Cheese knife with fork-tip	15.0	blue		
025221	Cheese knife with fork-tip	15.0	red		
020705	Cheese knife with fork-tip	15.0	white		
		Blade in cm	Colour		
013974	Cleaver Chinese style	17.0	black		
020117	Cleaver Chinese style	17.0	blue		
020214	Cleaver Chinese style	17.0	brown		
020196	Cleaver Chinese style	17.0	yellow		
020065	Cleaver Chinese style	17.0	green		
020151	Cleaver Chinese style	17.0	red		
		Blade in cm	Colour		
004136	Cleaver Chinese style	19.0	black		
020118	Cleaver Chinese style	19.0	blue		
020215	Cleaver Chinese style	19.0	brown		
020197	Cleaver Chinese style	19.0	yellow		
020066	Cleaver Chinese style	19.0	green		
020152	Cleaver Chinese style	19.0	red		
		Blade in cm	Colour		
016304	Cleaver Chinese style	21.0	black		
020119	Cleaver Chinese style	21.0	blue		
020216	Cleaver Chinese style	21.0	brown		
020198	Cleaver Chinese style	21.0	yellow		
020067	Cleaver Chinese style	21.0	green		
020153	Cleaver Chinese style	21.0	red		
		Blade in cm	Colour		
000717	Shaping knife curved blade	6.0	black		
020700	Shaping knife curved blade	6.0	blue		
007094	Shaping knife curved blade	6.0	yellow		
004894	Shaping knife curved blade	6.0	green		
007446	Shaping knife curved blade	6.0	red		
020217	Shaping knife curved blade	6.0	white		
		Blade in cm	Colour		
019942	Boning knife curved blade	13.0	black		
020105	Boning knife curved blade	13.0	blue		
020167	Boning knife curved blade	13.0	yellow		
025229	Boning knife curved blade	13.0	green		
020733	Boning knife curved blade	13.0	red		
004512	Boning knife curved blade	13.0	white		
		Blade in cm	Colour		
000687	Boning knife curved blade	15.0	black		
020106	Boning knife curved blade	15.0	blue		
020168	Boning knife curved blade	15.0	yellow		
006719	Boning knife curved blade	15.0	green		
020123	Boning knife curved blade	15.0	red		
006827	Boning knife curved blade	15.0	white		

Stainless steel

		007870	Boning knife straight blade	Blade in cm	13.0	Colour	black
		020111	Boning knife straight blade		13.0		blue
		020176	Boning knife straight blade		13.0		yellow
		020133	Boning knife straight blade		13.0		red
		013972	Boning knife straight blade	Blade in cm	16.0	Colour	black
		020112	Boning knife straight blade		16.0		blue
		020177	Boning knife straight blade		16.0		yellow
		020058	Boning knife straight blade		16.0		green
		020134	Boning knife straight blade		16.0		red
		020233	Boning knife straight blade		16.0		white
		004686	Boning knife straight blade	Blade in cm	18.0	Colour	black
		020113	Boning knife straight blade		18.0		blue
		020178	Boning knife straight blade		18.0		yellow
		020059	Boning knife straight blade		18.0		green
		020135	Boning knife straight blade		18.0		red
		020236	Boning knife straight blade		18.0		white
		001540	Boning knife straight blade	Blade in cm	21.0	Colour	black
		020114	Boning knife straight blade		21.0		blue
		020179	Boning knife straight blade		21.0		yellow
		025230	Boning knife straight blade		21.0		green
		020136	Boning knife straight blade		21.0		red
		020237	Boning knife straight blade		21.0		white
		012678	Boning knife straight blade	Blade in cm	24.0	Colour	black
		020115	Boning knife straight blade		24.0		blue
		020181	Boning knife straight blade		24.0		yellow
		020137	Boning knife straight blade		24.0		red
		025231	Boning knife narrow blade	Blade in cm	10.0	Colour	black
		025232	Boning knife narrow blade		10.0		yellow
		001951	Boning knife narrow blade	Blade in cm	13.0	Colour	black
		020107	Boning knife narrow blade		13.0		blue
		020169	Boning knife narrow blade		13.0		yellow
		024544	Boning knife narrow blade		13.0		green
		020124	Boning knife narrow blade		13.0		red
		024545	Boning knife narrow blade		13.0		white
		003524	Boning knife narrow blade	Blade in cm	16.0	Colour	black
		020108	Boning knife narrow blade		16.0		blue
		020174	Boning knife narrow blade		16.0		yellow
		006720	Boning knife narrow blade		16.0		green
		020125	Boning knife narrow blade		16.0		red
		018862	Boning knife narrow blade		16.0		white

Stainless steel

		Blade in cm	Colour	
000714	All purpose knife	8.0	black	
020068	All purpose knife	8.0	blue	
020199	All purpose knife	8.0	brown	
020154	All purpose knife	8.0	yellow	
020039	All purpose knife	8.0	green	
020122	All purpose knife	8.0	red	
020218	All purpose knife	8.0	white	
				
		Blade in cm	Colour	
000886	All purpose knife	10.0	black	
020069	All purpose knife	10.0	blue	
020155	All purpose knife	10.0	yellow	
001934	All purpose knife	10.0	green	
003037	All purpose knife	10.0	red	
001935	All purpose knife	10.0	white	
				
		Blade in cm	Colour	
000888	Vegetable knife serrated blade	10.0	black	
020706	Vegetable knife serrated blade	10.0	green	
007080	Vegetable knife serrated blade	10.0	red	
				
		Blade in cm	Colour	
001072	All purpose knife wavy blade	11.0	black	
020070	All purpose knife wavy blade	11.0	blue	
020156	All purpose knife wavy blade	11.0	yellow	
020040	All purpose knife wavy blade	11.0	green	
000927	All purpose knife wavy blade	11.0	red	
				
		Blade in cm	Colour	
010822	Paring knife	10.0	black	
011721	Paring knife	10.0	blue	
011679	Paring knife	10.0	yellow	
001830	Paring knife	10.0	green	
025235	Paring knife	10.0	red	
				
		Blade in cm	Colour	
006282	Claw fork straight tines	18.0	black	
007487	Claw fork straight tines	18.0	blue	
007486	Claw fork straight tines	18.0	brown	
007573	Claw fork straight tines	18.0	yellow	
007571	Claw fork straight tines	18.0	green	
006285	Claw fork straight tines	18.0	red	
003349	Claw fork straight tines	18.0	white	
				
		Blade in cm	Colour	
004901	Carving fork	13.0	black	
020104	Carving fork	13.0	blue	
020206	Carving fork	13.0	brown	
020182	Carving fork	13.0	yellow	
020060	Carving fork	13.0	green	
020145	Carving fork	13.0	red	
020243	Carving fork	13.0	white	
				
		Blade in cm	Colour	
020030	Carving fork	19.0	black	
025236	Carving fork	19.0	yellow	
				

Stainless steel



			Blade in cm	Colour
●	015693	Spatula angled	21.0	black
○	020752	Spatula angled	21.0	white



			Blade in cm	Colour
●	020827	Spatula straight	16.0	black
●	020833	Spatula straight	16.0	brown
●	020828	Spatula straight	16.0	yellow
●	020829	Spatula straight	16.0	green
●	020831	Spatula straight	16.0	red
○	020832	Spatula straight	16.0	white



			Blade in cm	Colour
●	020834	Spatula straight	21.0	black
●	020838	Spatula straight	21.0	red
○	020750	Spatula straight	21.0	white



			Blade in cm	Colour
●	020841	Spatula straight	26.0	black
●	020847	Spatula straight	26.0	brown
●	020842	Spatula straight	26.0	yellow
●	020843	Spatula straight	26.0	green
○	020751	Spatula straight	26.0	white



			Blade in cm	Colour
●	020848	Spatula straight	31.0	black
●	020854	Spatula straight	31.0	brown
●	020849	Spatula straight	31.0	yellow
●	020850	Spatula straight	31.0	green
●	020852	Spatula straight	31.0	red
○	020853	Spatula straight	31.0	white



			Blade in cm	Colour
●	003018	Sharpening steel round	25.0	black
●	020116	Sharpening steel round	25.0	blue
●	020207	Sharpening steel round	25.0	brown
●	020195	Sharpening steel round	25.0	yellow
●	020064	Sharpening steel round	25.0	green
●	020144	Sharpening steel round	25.0	red
○	020244	Sharpening steel round	25.0	white



			Blade in cm	Colour
●	002056	Sharpening steel round	31.0	black
●	020761	Sharpening steel round	31.0	blue
●	020767	Sharpening steel round	31.0	brown
●	020760	Sharpening steel round	31.0	yellow
●	020762	Sharpening steel round	31.0	green
●	020765	Sharpening steel round	31.0	red
○	020764	Sharpening steel round	31.0	white

Where food is being prepared, particular attention needs to be paid to safety and hygiene. The HACCP range was extended by adding a knife with special light violet handles for preparing vegan, allergen free and halal dishes, thereby responding to current developments in the food industry.

- High-quality nylon handle without any additives that could be derived from tallow/lard
- The colour supports and complements your hygiene concept
- Ideal for vegan, allergen free and halal gastronomy

Stainless steel

		Blade in cm
027707	Chef's knife	20.0
027715	Chef's knife	26.0



		Blade in cm
027716	Chef's knife narrow blade	16.0



		Blade in cm
027717	Slicing knife wavy blade	31.0



		Blade in cm
027719	Boning knife straight blade	15.0



		Blade in cm
027866	Boning knife curved blade	15.0



		Blade in cm
027726	Steak knife	16.0
027720	Steak knife	24.0
027722	Steak knife	26.0



		Blade in cm
027728	Butcher knife	21.0
027730	Butcher knife	24.0



Stainless steel



		Blade in cm
027718	All purpose knife	10.0



		Blade in cm
028167	Bread knife wavy blade	21.0



		L in cm
028168	Tongs, polyamide, heat resistant up to 250°C	24.0



		L in cm
028169	Spatula, polyamide, heat resistant up to 250°C	30.0



		L in cm
028170	Spoon, polyamide, heat resistant up to 250°C	30.0



		L in cm
028171	Dough scraper, polyamide/steel, heat resistant up to 250°C	25.0



		Dim in cm
028173	Cutting board, polyamide	50.0x30.0x1.5

Stainless steel

KNIVES WITH NYLON HANDLE

The slip resistant nylon handles can be sterilised at temperatures of up to max. 150° Celsius.

		P/U	Blade in cm
024318	Butcher knife wide tip	6	18.0
024327	Butcher knife wide tip	6	20.0
024328	Butcher knife wide tip	6	25.0
024329	Butcher knife wide tip	6	31.0
024325	Butcher knife wide tip	6	36.0



		P/U	Blade in cm
024182	Butcher knife	6	16.0
024183	Butcher knife	6	18.0
024191	Butcher knife	6	20.0
024192	Butcher knife	6	23.0
024193	Butcher knife	6	26.0
024194	Butcher knife	6	28.0
024195	Butcher knife	6	31.0
024190	Butcher knife	6	36.0



		P/U	Blade in cm
024034	Cook's knife broad blade	6	12.0
024055	Cook's knife broad blade	6	15.0
024071	Cook's knife broad blade	6	19.0
024057	Cook's knife broad blade	6	22.0
024056	Cook's knife broad blade	6	25.0
024074	Cook's knife broad blade	6	28.0
024075	Cook's knife broad blade	6	31.0



		P/U	Blade in cm
024227	Sticking knife straight blade	6	18.0
024228	Sticking knife straight blade	6	20.0
024229	Sticking knife straight blade	6	25.0



		P/U	Blade in cm
024230	Sticking knife pointed tip	6	12.0
024231	Sticking knife pointed tip	6	14.0
024232	Sticking knife pointed tip	6	16.0
024233	Sticking knife pointed tip	6	18.0
024234	Sticking knife pointed tip	6	20.0



		P/U	Blade in cm
024076	Filleting knife flexible blade	6	16.0
024077	Filleting knife flexible blade	6	18.0
024078	Filleting knife flexible blade	6	20.0



		P/U	Blade in cm
024135	Slicing knife round tip	6	25.0
024136	Slicing knife round tip	6	30.0
024137	Slicing knife round tip	6	36.0



Stainless steel



		P/U	Blade in cm
024145	Slicing knife wavy blade, round tip	6	25.0
024146	Slicing knife wavy blade, round tip	6	30.0
024147	Slicing knife wavy blade, round tip	6	36.0



		P/U	Blade in cm
024156	Slicing knife pointed tip	6	25.0



		P/U	Blade in cm
024163	Slicing knife wavy blade, pointed tip	6	25.0



		P/U	Blade in cm
024264	Boning knife straight blade	6	12.0
024266	Boning knife straight blade	6	15.0



		P/U	Blade in cm
024273	Boning knife narrow blade	6	12.0
024274	Boning knife narrow blade	6	15.0
024275	Boning knife narrow blade	6	18.0



		P/U	Blade in cm
024215	Boning knife curved blade	6	15.0



		P/U	Blade in cm
024019	Carving knife narrow blade	6	12.0
024022	Carving knife narrow blade	6	15.0
024023	Carving knife narrow blade	6	18.0



		P/U	Blade in cm
035550	Carving knife wide blade	10	19.0



		P/U	Blade in cm
024066	Carving knife wavy blade	6	19.0
024059	Carving knife wavy blade	6	22.0
024067	Carving knife wavy blade	6	25.0

Stainless steel

		P/U	Blade in cm
024012	Bread knife wavy blade	6	18.0
024013	Bread knife wavy blade	6	21.0



		P/U	Blade in cm
024175	Cimeter steak knife curved blade	6	25.0
024177	Cimeter steak knife curved blade	6	36.0



		P/U	Blade in cm
024305	Steak knife	6	30.0



		P/U	Blade in cm
024072	Ham slicer pointed blade	6	25.0
024073	Ham slicer pointed blade	6	30.0



		P/U	Blade in cm
024128	Dux knife wavy blade adjustable from 1 to 15mm	6	21.0



		P/U	Blade in cm
024091	Fish filleting knife narrow blade	6	16.0



		L in cm
038235	Fish bone remover tweezers	12.0



		L in cm
022028	Fish bone tweezers	17.0



		P/U	Blade in cm
024122	Salmon knife fluted edge	6	30.0



		P/U	L in cm
024361	Carving fork	6	15.0



		P/U	L in cm
024368	Kitchen fork forged	6	18.0



Andy Mannhart

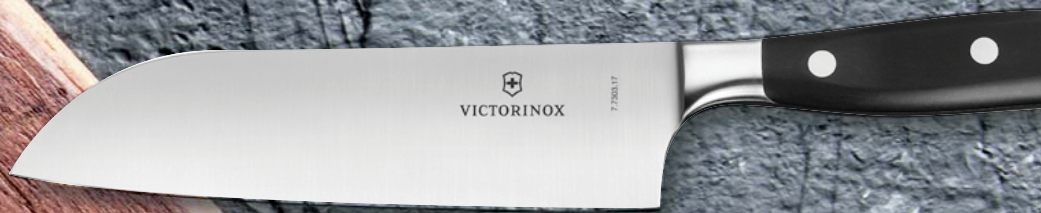

VICTORINOX
HOUSEHOLD AND PROFESSIONAL KNIVES

Stainless steel

		P/U	Blade in cm	
024088	Bread knife forged, wavy blade	6	23.0	
024048	Slicing knife forged, scalloped edge	6	26.0	
024054	Santoku knife forged	6	17.0	
024058	Santoku knife forged, scalloped edge	6	17.0	
024049	Chef's fork forged	6	15.0	
248501	Sharpening steel round		L in cm 18.0	
248511	Sharpening steel round		20.0	
248541	Sharpening steel round		L in cm 27.0	
248551	Sharpening steel oval		27.0	
248581	Sharpening steel round		L in cm 30.0	
248591	Sharpening steel oval		30.0	



		Blade in cm
001627	Mincing knife single blade, nylon handle	22.0
001628	Mincing knife single blade, nylon handle	36.0



		Blade in cm
024754	Mincing knife double blade, nylon handle	22.0



		Blade in cm
020110	Frozen food knife with 2 serrated blades, nylon handle	23.0



		Blade in cm
000501	Butcher saw with ABS handle, stainless steel mirrorpolished finish	45.0



		Blade in cm
003673	Spare blade, s/s for 000501	45.0



		Blade in cm
016447	Butcher saw with snap handle, s/s frame, nylon handle	50.0
016448	Spare saw blade for 016447	



		Dim in cm
010305	Electric knife with double saw, nylon handle including special blade for frozen goods delivered with wall holder 230V/50Hz, 0.12kW	23.5x6.5x11.0



		L in cm
020240	Kettle fork forged, plastic handle	60.0

AM FORGED JAPANESE KNIVES

Blades are made of high quality Chromium-Molybdenum-Vanadium-steel (X50CrMoV15). Handles are made of stainless steel AISI 304 that have an excellent resistance against corrosion, impact and aging.

031278	Paring knife	Blade in cm 10.0	
031279	All purposed knife	Blade in cm 15.0	
031280	Filleting knife	Blade in cm 15.0	
031281	Chef's knife	Blade in cm 20.0	
031282	Chef's knife	Blade in cm 25.0	
031284	Santoku knife, serrated	Blade in cm 18.0	
031287	Bread knife wavy blade	Blade in cm 20.0	
031288	Carving knife	Blade in cm 20.0	
031289	Carving knife	Blade in cm 25.0	
031290	Carving fork	Blade in cm 16.0	
031291	Ham slicing knife	Blade in cm 24.0	
031292	Ham slicing knife	Blade in cm 30.0	
031293	Sharpening steel	Blade in cm 23.0	

AM TOKYO SERIES

Blades are made of high quality Chromium-Molybdenum-Vanadium-steel (X50CrMoV15) - single bevel edge for easy and precise cuts. Lifoflex handles with high grip. Lifoflex is a soft-touch material with resistance against high temperatures and aggressive elements.

YANAGIBA KNIFE

Knife with narrow pointed blade, suitable for cutting and slicing fish and preparing sushi and sashimi.



		Blade in cm
031267	Yanagiba knife	15.0



		Blade in cm
031270	Yanagiba knife	18.0



		Blade in cm
031271	Yanagiba knife	21.0



		Blade in cm
031272	Yanagiba knife	24.0



		Blade in cm
031273	Yanagiba knife	27.0



		Blade in cm
031274	Yanagiba knife	30.0

DEBA KNIFE

Sashimi knife with a wide blade, suitable for cutting, boning meat and fish and for chopping vegetables. Can be used as a light cleaver.



		Blade in cm
031275	Deba knife	15.0



		Blade in cm
031711	Deba knife	18.0



		Blade in cm
031277	Deba knife	21.0

USUBA KNIFE

The most versatile of traditional Japanese knives with a strong wide blade, suitable for cutting paper-thin slices of vegetables.



		Blade in cm
031276	Usuba knife	18.0

GLOBAL KNIVES

A combination of good design and the know-how of Japanese art of creating knives. Extremely sharp, easy in weight and perfect in balance. The blades are made of Molybdenum-Vanadium-steel.

G SERIES: Knives with a longer blade with a weighted hollow handle, ensuring perfect balance in the hand.

		Blade in cm	
022162	Slicing knife round tip	18.0	
007063	Slicing knife round tip	21.0	
		Blade in cm	
022172	Slicing knife	18.0	
		Blade in cm	
007064	Kitchen knife sharp tip	20.0	
		Blade in cm	
007073	Cook's knife	24.0	
022037	Cook's knife	27.0	
		Blade in cm	
022175	Kitchen knife serrated blade	16.0	
022176	Kitchen knife serrated blade	20.0	
		Blade in cm	
007065	Meat knife sharp tip	21.0	
		Blade in cm	
007066	Universal knife wide blade	18.0	
		Blade in cm	
007068	Meat knife	18.0	
		Blade in cm	
022033	Bread knife wavy edge blade	22.0	
		Blade in cm	
007071	Fish knife Yanagi Sashimi	25.0	
022167	Fish knife Yanagi Sashimi	30.0	
		Blade in cm	
022039	Carving fork	31.0	
		Blade in cm	
022168	Fish knife Tako Sashimi	30.0	
		Blade in cm	
022171	Fish slicing knife flexible blade	21.0	
022170	Fish slicing knife flexible blade	24.0	
022034	Fish slicing knife flexible blade	27.0	
		Blade in cm	
007070	Salmon and ham knife flexible	31.0	
		Blade in cm	
022038	Fluted ham slicing knife	30.0	
		Blade in cm	
007069	Roastbeef and ham knife	22.0	



		Blade in cm
022035	Swedish filet knife very thin and flexible blade	21.0



		Blade in cm
022173	Santoku knife serrated blade	18.0



		Blade in cm
022174	Vegetable cleaver serrated blade	18.0



		Blade in cm
022036	Boning knife thin flexible blade	16.0



		Blade in cm
007072	Kitchen cleaver	16.0



		Blade in cm
007067	Vegetable hatcher	18.0

GF SERIES: Drop-forged bladed knives with an optimum resistance. Weighted hollow handle, ensuring perfect balance in the hand.



		Blade in cm
022043	Boning knife thin blade	16.0



		Blade in cm
022044	Butcher's knife	16.5



		Blade in cm
022046	Meat fork	31.0



		Blade in cm
022177	Peeling knife	21.0



		Blade in cm
022178	Peeling knife	27.0



		Blade in cm
022179	Peeling knife	30.0



		Blade in cm
022180	Vegetable cleaver	20.0

GS SERIES: Smaller bladed knives with a weighted hollow handle.



		Blade in cm
022047	Kitchen knife	11.0
022049	Kitchen knife	13.0



		Blade in cm
022048	Cook's knife	13.0



		Blade in cm
022059	Vegetal knife Oriental DEBA	12.0



		Blade in cm
022072	Paring knife straight cut	10.0
022100	Paring knife sharp blade	10.0



		Blade in cm
022182	Tomato knife	8.0

		Blade in cm
022183	Cheese knife	14.0
022184	Utility knife serrated	15.0
022116	Utility knife flexible blade	15.0
022185	Santoku knife serrated blade	13.0
022181	Vegetable cleaver	14.0
022186	Vegetable cleaver serrated blade	14.0



GSF SERIES: Short-bladed knives with a solid handle.

		Blade in cm
022187	Paring knife	8.0
022190	Paring knife	11.0
022129	Peeling knife large handle	8.0
022148	Universal knife	15.0
022188	Paring knife	6.0
022189	Peeler knife	6.0



ACCESSORIES

		Blade in cm
022114	Fish bone tweezers	1.9
022115	Fish bone tweezers ergonomic	1.9
022117	Plain turner/spatula	Dim in cm 15.0x5.0
022118	Slotted turner	Blade in cm 27.0
022119	Chef's serving tong	Blade in cm 30.0
022149	Magnetic knife bar	Dim in cm 51.0x4.5
022150	Knife block for 8 knives for up to 28.0cm	Dim in cm 25.5x30.0x13.5





		Dim in cm
022151	Knife case for 11 knives	52.0x11.5x6.5



		Dim in cm
022152	Knife case for 16 knives	52.0x16.0x7.0



		Dim in cm
022153	Knife roll case for 9 knives	52.0x15.5



		Blade in cm
022160	Ceramic sharpening steel	24.0
022161	Diamond sharpening steel	26.0
022163	Diamond sharpening steel	30.0



		L in cm
005304	Meat tenderizer forged, s/s, pressed handle, 1.1kg	31.0



019299	Meat tenderizer, s/s, weight 1.1kg
--------	------------------------------------



005299	Steak hammer, aluminium, 0.8kg
--------	--------------------------------



		L in cm
020000	Meat hammer, polypropylene	29.0



		P/U
024099	Kitchen cleaver, nylon handle, 0.32kg	6
024098	Kitchen cleaver, nylon handle, 0.6kg	6



		Blade in cm
020190	Swiss type cleaver, 1.5kg	16.0



		Blade in cm
020171	Kitchen chopper, light plastic handle, 0.4kg	15.0



		Blade in cm
020201	Beef splitter, nylon handle, 2.5kg	35.0



	025672	Paring knife, black nylon handle	Blade in cm 8.0
	025552	Paring knife, red nylon handle	8.0
	025682	All purpose knife, black nylon handle	Blade in cm 10.0
	025690	All purpose knife, green nylon handle	10.0
	025691	Shaping knife, curved blade, nylon handle	Blade in cm 6.0
	001682	Tomato knife with prongs, black nylon handle	Blade in cm 11.0
	026393	Cucumber slicer, 8 hardened blades, each 0.9cm	Blade in cm 1.7
	024434	Potato peeler, double sided, nylon handle	
	024570	Potato peeler REX, movable blade	
	024571	Replacement blade to peeler REX	P/U 10
	005598	Fruit and vegetable peeler s/s, to peel fruits and vegetables for easy carving	
	018159	Asparagus peeler movable blade	
	020462	Asparagus peeler, black nylon handle	

020370	Orange peeler, nylon handle		
			L in cm
054153	Lemon zester, nylon fibreglass handle		15.0
			L in cm
054165	Lemon decorater, nylon fibreglass handle		15.0
024904	Double lemon decorater, nylon handle		
			L in cm
054168	Butter curler, nylon handle		19.0
			L in cm
054169	Apple corer, nylon fibreglass handle	Ø cm	L in cm
		1.6	18.5
			L in cm
004978	Melon knife, green double handles		35.0
			L in cm
022082	Universal corer, orange, anti-slip handle	Ø cm	L in cm
		1.2	9.0
			L in cm
022083	Universal corer, green, anti-slip handle	Ø cm	L in cm
		2.0	11.2
			L in cm
022084	Universal corer, red, anti-slip handle	Ø cm	L in cm
		3.0	11.2
			L in cm
024902	Corer heart shaped, nylon handle	Ø cm	
		2.0	
024901	Corer heart shaped, nylon handle	Ø cm	
		2.7	
			L in cm
038465	Fruit decorator knife		23v.0
			Ø cm
000811	Potato baller, nylon handle	1.5	
024632	Potato baller, nylon handle	1.8	





		Ø cm
024633	Potato baller, nylon handle	2.2
054138	Potato baller, nylon handle	2.5
054139	Potato baller, nylon handle	3.0



		Ø cm
024641	Potato baller, 2 scoops, nylon handle	2.2 / 2.5



		Dim in cm
020464	Potato baller, oval, wavy, nylon handle	3.2x1.8



		L in cm	Blade in cm
054173	Decorating knife with serrated sharpened blade, nylon/fibreglass handle	19.0	8.5



		Ø cm
042402	Pineapple corer s/s	2.8



		L in cm
028957	Radish spiral cutter, s/s	15.0



		L in cm
007878	Oyster knife with handguard, nylon handle	15.0



		L in cm
018170	Nut cracker	17.0



		L in cm
018160	Fish scaler	24.5



		L in cm
038234	Fish scaler s/s	23.5



		L in cm
022029	Fish scaler aluminium	22.0



		L in cm
022032	Fish scale Scalex, long special blade made of s/s, dishwasher proof	22.0

Stainless steel

		Blade in cm
012624	Cheese knife scalloped edge, nylon handle	20.0
015666	Cheese knife scalloped edge, nylon handle	26.0
029985	Cheese knife scalloped edge, nylon handle	29.0



		Blade in cm
029987	Cheese knife scalloped edge, 2 nylon handles	26.0
029986	Cheese knife scalloped edge, 2 nylon handles	30.0



		Blade in cm
024341	Cheese knife, nylon handle	15.0x9.0
024343	Cheese knife, nylon handle	20.0x20.0



005303	Cheese cutting wire with 2 plastic handles, s/s
--------	---



		Dim in cm
006897	Raclette knife with wooden handle	27.0x5.0x2.0



024610	Cheese slicer, nylon handle
--------	-----------------------------



		Blade in cm
028043	Parmesan cheese knife, nylon handle	10.0



		P/U	Blade in cm
024421	Pastry knife wavy blade, nylon handle	6	26.0



		Blade in cm
068502	Knife for cake sheet wavy blade, bent, plastic handle	18.0



		P/U
024470	Chestnut knife, wooden handle	6



Stainless steel



			Blade in cm
020250	Cake lifter, nylon handle one side plain, one side serrated		16.0



		P/U	Blade in cm
024370	Flexible spatula, nylon handle	6	10.0
024394	Flexible spatula, nylon handle	6	12.0
024395	Flexible spatula, nylon handle	6	15.0
024397	Flexible spatula, nylon handle	6	20.0
024398	Flexible spatula, nylon handle	6	23.0
024399	Flexible spatula, nylon handle	6	25.0
024401	Flexible spatula, nylon handle	6	31.0



			Blade in cm
020028	Mini spatula		10.0



			Blade in cm
020753	Angle-shaped spatula, nylon handle		26.0



			Blade in cm
020029	Mini spatula angle-shaped		9.0



		P/U	Blade in cm
024415	Spatula conical blade, nylon handle	6	16.0



		Width of blade in cm	Length of blade in cm
017737	Angle-shaped spatula with ABS-handle	7.0	16.0



		Width of blade in cm	Length of blade in cm
003594	Slotted turner, heat-resistant, nylon handle	8.5	30.0

Plastic

		Dim in cm
007393	Knife-Hygiene-Box for 4 knives and 1 steel incl. holder for sharp easy, blue	55.0x17.0x7.0



		Dim in cm
007394	Knife-Hygiene-Box for 4 knives and 1 steel incl. holder for sharp easy, yellow	55.0x17.0x7.0



		Dim in cm
007395	Knife-Hygiene-Box for 4 knives and 1 steel incl. holder for sharp easy, green	55.0x17.0x7.0



		Dim in cm
007396	Knife-Hygiene-Box for 4 knives and 1 steel incl. holder for sharp easy, red	55.0x17.0x7.0



		Dim in cm
007397	Knife-Hygiene-Box for 4 knives and 1 steel incl. holder for sharp easy, black	55.0x17.0x7.0





		Cap.
034586	Knife sterilizer for 20 knives s/s housing, methacrylate door, anti UV dispersion with magnetic closure, safety switch for automatic shutdown of the lamp when the door is opened, timer 0 - 60 minutes, 51.0x13.0x67.0cm, 230V/50Hz, 0.016kW	20 knives



		Cap.
015919	Knives sterilisation cabinet, with transparent door and lock, with wire frame, 230V/50-60Hz, 0.034kW	40 knives



065991	Natural, abrasive sharpening stone	
--------	------------------------------------	--



		Blade in cm
027453	Sharpening rod professional „QUINTUM“, 5-stage, s/s	25.0



		Dim in cm
020026	Sharpening machine, 1 grinding and 1 polishing station, diamond-coated grinding wheels, easy to use, fast cleaning, 230V/50-60Hz, 0.12kW, 1500rpm	20.2x55.9x19.7



		Dim in cm
020027	Sharpening machine, 2 grinding and 2 polishing stations, diamond-coated grinding wheels, easy to use, fast cleaning, 230V/50Hz, 0.18kW, 2500rpm	20.2x55.9x19.7

Stainless steel

		L in cm
020425	Skewer with spring ring	25.0
020426	Skewer with spring ring	30.0



		P/U	L in cm (without head)
030222	Schaschlik skewer with brass head (lily)	3	28.0



		L in cm
029586	Skewer sabre, s/s with brass handle	29.5
029587	Skewer rapier, s/s with brass handle	29.5
029588	Skewer fleur-de-Lis, s/s with brass handle	30.5
009428	Skewer sword, s/s with brass handle	29.5



		L in cm
020004	Skewer wild pig	33.0



		L in cm
020005	Skewer rooster	34.5



		L in cm
020006	Skewer ram	33.5



		L in cm
020007	Skewer chicken	34.5



		L in cm
020008	Skewer fish	34.0



		L in cm
020009	Skewer cow	33.5



		L in cm
024791	Magnetic knife bar with 3 holes for wall mounting	35.0



		L in cm
020035	Magnetic knife bar extra long and broad	60.0



		L in cm
006846	Poultry shears, black POM handles	25.0













		L in cm
038236	Poultry shears	25.0



		L in cm
022736	Shelling scissors for shrimps, s/s, curved blades with harpoon	17.0



Stainless steel

	024710	Masticator curved blade, chromed	
	001681	All purpose kitchen scissors, with nylon handle	L in cm 20.0
	020459	Kitchen shears with bone breaker, black	L in cm 21.0
	001544	Fish scissors one plain and one serrated blade	L in cm 18.5
	022197	Herb scissors with 5 s/s blades	L in cm 20.0x7.5
	020402	Dressing needle curved	L in cm 20.0
	020406	Dressing needle straight	L in cm 18.0
	005300	Larding needle with flap	L in cm 19.5
	020455	Larding needle curved	L in cm 18.0
	005755	Larding needle set in plastic box, consisting of: 3 larding needles curved 2 dressing needles straight 1 larding needle straight with flap	L in cm 16.0-24.0
	002715	Larding tube with plastic handle	L in cm 25.0

		Dim in cm	Range
025355	Folding food thermometer, waterproof	26.5x4.8x1.9	-50°C to +250°C



		Dim in cm	Range
025349	Dual purpose IR and penetration thermometer, waterproof, precise 2-point laser with 10:1 optics	28.1x4.8x2.1	-50°C to +250°C



		Range
017763	Infrared thermometer with laser pointer and LCD display	-50°C to +550°C



		Dim in cm	Range
022164	Digital thermometer, waterproof, adjustable in °C or °F	8.2x4.2	-67°C to +1400°C



		Dim in cm	Range
022165	Digital thermometer with removable standard needle	8.0x4.2	-67°C to +1400°C



022166	Oven needle s/s cable 1.0m, heat-resistant up to 300°C suits Art. 022164/022165		
--------	---	--	--



Vacuum packing needle to article 022164/022165, tefloncoated, heat-resistant up to 250°C, cable 1.0m.

022193	L=6.0cm		
--------	---------	--	--

022196	L=12.0cm		
--------	----------	--	--





		Dim in cm	Range
029848	Digital pocket test thermometer with storing of momentary display, automatic switch off, protective casing and clip	2.2x5.5	-50°C to +200°C



		Dim in cm	Range
029830	Digital thermometer with s/s probe, splash-proof, probe attached to side panel, illuminated display 4.2x2.2cm	13.5x9.2x2.7	-20°C to +200°C



		Range
029849	Pocket test thermometer	-10°C to +100°C



		Range
029832	Oven thermometer	0°C to 300°C



		Range
029831	Refrigerator thermometer	-40°C to +40°C



		Ø cm	L in cm	Range
029843	Fat thermometer with wire casing	3.0	30.0	90°C to 220°C



		Range
029845	Kettle thermometer with casing	0°C to 100°C



		Range
029833	Meat thermometer	10°C to 110°C



		Ø cm
015800	Kitchen clock white, chrome, coverage pure glass, white dial	29.5



023634	Digital timer, magnetic, incl. battery
--------	--

		H in cm
018194	Can opener table model	60.0
018195	Spare blade to can opener 018194	
018197	Spare wheel to can opener 018194	
		L in cm
034400	Can opener with black nylon handle	20.8
		L in cm
001405	Corkscrew, zinc alloy chrome plated, wooden lever	53.0
		L in cm
018178	Lever corkscrew with bottle opener and knife	13.0
		L in cm
018179	Lever corkscrew with wings, s/s	17.5
		L in cm
018177	Bottle opener with hanging loop, handle and opener, s/s	18.5
		L in cm
018196	Can opener with hanging loop, blade and handle, s/s	18.0



Stainless steel

		P/U	L in cm
005306	Meat hook s-shape	10	10.0
005307	Meat hook s-shape	10	12.0
005308	Meat hook s-shape	10	14.0
005309	Meat hook s-shape	10	16.0
005310	Meat hook s-shape	10	18.0
086055	Meat hook s-shape	1	20.0





		Blade in cm
033121	Carving set in box complete with carving knife, and carving fork, black nylon handle	19.0
		15.0



		Dim in cm
024862	Chef's case (14 utensils) complete with cooks knife, carving knife, pastry knife wavy blade, spatula, carving knife, kitchen knife, boning knife, filleting knife, carving fork, sharpening steel, decorator and zester, shaping knife, potato peeler and double melon baller, all knives with black nylon handle	49.0x31.0



		Dim in cm
024863	Chef's case large (23 utensils) with spatula, cooks knife, salmon and pastry knife wavy, butcher knife, carving knife, boning knife, filleting knife, shaping knife, decorating and kitchen knife, 5 larding and sewing needles, potato baller and peeler, oyster knife, fish scissors, decorator and zester, meat fork, 2 set funnels and decorators, apple corer and sharpening steel, all knives with black nylon handle	51.0x38.0



		Dim in cm
020790	Decorating bag (7 utensils) vegetable peeler, apple corer, lemon zester and decorater, butter curler, orange peeler, potato scoop	20.0x7.0x4.5



020015	Starter set, (8 utensils) chef's knife 21.0cm, filleting knife 21.0cm, boning knife 15.0cm, kitchen knife 7.0cm, peeling knife 5.0cm, utility knife with serrated blade 26.0cm, utility tong 25.0cm, sharpening steel round 30.0cm	
--------	--	--



		Dim in cm
020245	Schoolset with knife bag with shoulder strap black, kitchen knife 13.0cm, kitchen knife 15.0cm, vegetable cutter tulip, vegetable cutter maple leaf, vegetable cutter maple leaf big, spatula 26.0cm, ham knife 28.0cm, dough scraper set	51.0x9.0x9.0



		Dim in cm
new 031712	Schoolset Andy Mannhart with 4 knives in a rollbag, peeling knife 6.0cm, paring knife 10.0cm, all purpose knife 15.0cm, chef's knife 20.0cm, all knives with black Proflex handle	43.0x16.0x4.5

020001	Carving knife set, 25 utensils for vegetables, plastic case, knives made of s/s, ergonomic plastic handles, ceramic sharpening steel included
--------	---



025507	Decoration case, 22 tools
--------	---------------------------



020414	Electric ice-carving Power Mac CSE1835, oil tank 0.24ltr, electronic controlled capacity, blade 35.6cm, 230V/50Hz	Dim in cm 52.0x25.5x26.5
--------	---	------------------------------------



065020	Ice crusher/marker with 6 teeth, wooden handle	Dim in cm 23.5x6.3
--------	--	------------------------------



001075	Ice sculpting saw, special steel, wooden handle	L in cm 43.0
--------	---	------------------------



065085	Ice carving chisel set of 6 pcs with short wooden handle, consisting of 1 V-chisel 2.0 cm, 1 round chisel 3.0 cm, 2 flat chisels 3.0 cm and 6.0cm, 1 ice pick and ice crusher, 1 cloth for drying chisels
--------	---



HACCP COLOUR CODED CUTTING BOARDS

Carving/cutting boards with groove, plastic

brown	white	green	red	blue	yellow	GN size	Dim in cm
055540	055556	055589	055566	055577	055593	1/2	32.5x26.5x2.0
055541	055557	055551	055567	055578	055572	1/1	53.0x32.5x2.0
055543	055559	055552	055568	055579	055573	2/1	65.0x53.0x2.0
055588	055591	055590	055592	055595	055594		60.0x40.0x2.0

Carving/cutting boards plain, plastic

brown	white	green	red	blue	yellow	GN size	Dim in cm
023283	023189	023287	023285	023284	023286	1/2	32.5x26.5x2.0
023288	023194	023292	023290	023289	023291	1/1	53.0x32.5x2.0
055548	055564	055555	055571	055582	055576	2/1	65.0x53.0x2.0
023450	023449	023453	023452	023451	023454		60.0x40.0x2.0

		Dim in cm
028062	Cutting board with feet, white, polyethylene	45.0x30.0x1.2

		Dim in cm
028063	Cutting board with feet, yellow, polyethylene	45.0x30.0x1.2

		Dim in cm
028064	Cutting board with feet, blue, polyethylene	45.0x30.0x1.2

		Dim in cm
028070	Cutting board with feet, brown, polyethylene	45.0x30.0x1.2

		Dim in cm
028071	Cutting board with feet, green, polyethylene	45.0x30.0x1.2

		Dim in cm
028072	Cutting board with feet, red, polyethylene	45.0x30.0x1.2

		Dim in cm
005195	Cutting board, light blue, antibacterial	53.0x32.5x1.0

		Dim in cm
028329	Cutting board, white, polyethylene	25.0x15.0x1.0

		Dim in cm
013643	Cutting board, white, polyethylene	30.0x22.0x1.0



		Dim in cm
029680	Cutting board rack with 6 slots, polypropylene	31.6x23.0x17.0



		Dim in cm
022040	Scraper for cutting boards	20.2x7.0
022041	Interchangeable blade to 022040	



		L in cm	Dim in cm
026033	Fish/salmon platter, s/s mirror polished	94.0	50.0x26.5



Epicurean cutting boards, made of environmental friendly wooden fiber material, robust, perfect for knives, dishwasherproof

		Dim in cm
015072	Cutting board plain, black	38.0x28.0
015073	Cutting board plain, black	46.0x33.0
015074	Cutting board plain, black	55.0x25.5



		Dim in cm
015075	Cutting board with groove, black	38.0x28.0
015076	Cutting board with groove, black	46.0x33.0
015077	Cutting board with groove, black	51.0x38.0



Rubber tree wood from sustainable forestry

		Dim in cm
015080	Cutting board with groove	37.0x29.0x2.7
015081	Cutting board with groove	42.0x34.0x2.7



		Dim in cm
015855	Bread cutting board with insert	45.0x26.0x2.0



		Dim in cm
015083	Cutting board round	25.0x1.8



		Dim in cm
015085	Cutting board round with groove	25.0x1.8
015086	Cutting board round with groove	33.0x1.2



3.43 Meat pans

Stainless steel



		Cap. ltr	Dim in cm
026250	Meat pan	4.0	35.0x25.0x5.0
026251	Meat pan	6.0	45.0x30.0x5.0
026252	Meat pan	8.0	55.0x35.0x5.0
026253	Meat pan	10.0	65.0x40.0x5.0



		Dim in cm
013563	Meat pan with strainer plate	50.0x35.0x7.2

		Cap. kg	Dim in cm
051610	Ham mould rectangular, aluminium	1.75	20.0x8.5x10.5
051611	Ham mould rectangular, aluminium	2.25	24.0x9.5x10.5
051612	Ham mould rectangular, aluminium	2.00	18.0x11.0x12.0
051613	Ham mould rectangular, aluminium	2.50	21.0x11.0x12.0
051614	Ham mould rectangular, aluminium	2.5-3.5	23.0x13.5x14.0
051618	Ham mould rectangular, aluminium	2.50	26.0x10.0x11.0
051615	Ham mould rectangular, aluminium	4.0-5.0	32.0x12.0x14.0
051616	Ham mould rectangular, aluminium	7.5-10.0	33.0x20.0x16.0



		Cap. kg	Dim in cm
051617	Ham mould pear shaped, aluminium	3.0-4.0	27.0x17.0x13.0



		Cap. kg	Dim in cm
051619	Ham mould for cutlet in aspic, aluminium	4.0-5.0	44.5x12.7x8.5



		Cap. kg	Dim in cm
051620	Mould for rolled ham with ridges, aluminium	4.0-6.0	45.0x11.0



		Cap. kg	Dim in cm
051621	Mould for rolled ham, inside plain, aluminium	3.0-4.0	33.0x11.5



		Dim in cm
009090	Terrine mould conical, s/s	30.0x6.5x4.5



		Dim in cm
009091	Terrine mould half-round, s/s	30.0x5.2x5.0
009094	Terrine mould half-round, s/s	50.0x8.0x6.5



		Dim in cm
009092	Terrine mould triangular, s/s	30.0x7.0x6.5



Stainless steel



		Dim in cm
010571	Poekelboy IDEAL, s/s, integrated pressure control, suction device with pre-filter-system, quick change of needles, pressure 3.5bar, 230V/50Hz, 0.12kW	39.0x18.0x24.0



		Dim in cm
010570	Poekelboy EUROPA, s/s, integrated pressure control, suction device with pre-filter-system, quick change of needles, and motor overload protector, pressure 3bar, 3x380V/50Hz, 0.25kW	39.0x18.0x24.0



		L in cm
020600	Brine tester 0°C to 25°C	19.0

020601	Brine pump complete	
--------	---------------------	--



		Dim in cm
022079	Smoker oven, 2 shelves, s/s, incl. thermometer and sawdust, self installation	21.9x31.3x31.3



010572	Ham stuffer incl. 1 bag of 500 clips	
--------	--------------------------------------	--

010573	Ham grip tool for gripping the boiled pickle items in casings	
--------	---	--



		Dim in cm
018420	Sausage pusher, 2 speed steel gears	85.0x28.0x28.0



		Cap. ltr	H in cm
020615	Sausage filler sturdy construction, easy to operate, solid frame (plastic coated) cylinder 1 base plate made of s/s, nylon piston with air exhaust valve, supplied with 4 filling tubes (12, 18, 22 and 30mm)	6.0	44.0

Every stuffer will come with 4 filling tubes 1.2/1.8/2.2/3.0cm, the hygienic and tightly sealing plastic piston is equipped with an air exhaust valve which sucks the filling tube empty during the return stroke



		Cap. ltr	H in cm
020611	Sausage stuffer	9.0	63.5
020612	Sausage stuffer	12.0	72.0
020613	Sausage stuffer	15.0	82.0

Aluminium

		Ø cm
086710	Hamburger press round	8.5
086711	Hamburger press round	10.5



		Dim in cm
086712	Hamburger press square	9.0x9.5



		Ø cm	Dim in cm
080716	Hamburger press, anodized aluminium alloy, rubber feet	10.0	27.0x25.5x26.0
080717	Hamburger press, anodized aluminium alloy, rubber feet	13.0	31.0x26.0x27.5
080718	Hamburger press, manual, aluminium alloy, rubber feet	15.0	33.0x26.0x27.5



Wood

		Dim in cm
008582	Wooden ham holder, s/s parts	48.0x23.0x13.0



028672	Universal mesh safety glove, s/s, for right and left-handed use, onesize
--------	--



		Size
020607	Safety chainmail glove orange, s/s	XL
020606	Safety chainmail glove blue, s/s	L
020605	Safety chainmail glove red, s/s	M
020604	Safety chainmail glove white, s/s	S
020603	Safety chainmail glove green, s/s	XS
020602	Safety chainmail glove brown, s/s	XXS



		Dim in cm
028750	Butcher safety apron, s/s	80.0x55.0





		Dim in cm
026036	Chopping block beech wood with s/s stand	30.0x30.0x65.0
026037	Chopping block beech wood with s/s stand	40.0x40.0x60.0
026038	Chopping block beech wood with s/s stand	50.0x40.0x60.0
026039	Chopping block beech wood with s/s stand	50.0x50.0x60.0



		Dim in cm
026041	Chopping block polyethylene with s/s stand	40.0x40.0x77.0
026042	Chopping block polyethylene with s/s stand	50.0x40.0x77.0
026043	Chopping block polyethylene with s/s stand	50.0x50.0x77.0



		L in cm
020451	Block brush, steel bristles	20.0



020449	Bacon ripper
--------	--------------



020453	Rip puller
--------	------------



020454	Spare loop to rib puller
--------	--------------------------

		Weight range
064200	Spice scale with aluminium bowl	0-250gr



		Weight range	Reading
019089	Mechanical scale s/s	0-5.0kg	20.0gr



		Weight range	Reading
019087	Mechanical scale, removable pan s/s	0-15.0kg	50.0gr



		Weight range	Reading
038677	Kitchen scale digital, s/s platform, 24.2x19.cm, waterproof, LED-display, 230V/50-60Hz	0-6.0kg	1.0gr



		Weight range	Reading
038678	Kitchen scale digital, s/s platform, 24.2x19.cm, waterproof, LED-display, 230V/50-60Hz	0-30.0kg	5.0gr

		Weight range	Reading
017760	Electronic scale, 23.7x15.0cm	0-10.0kg	2.0gr



		Weight range	Reading
015109	Digital scale, platform 30.0x23.0cm, mains operation or also with accu, uncalibrated, 230V/50-60Hz	0-15.0kg	1.0gr

		Weight range	Reading
015110	Digital scale, platform 30.0x23.0cm, mains operation or also with accu, uncalibrated, 230V/50-60Hz	0-30.0kg	2.0gr





		Weight range	Reading
064420	Digital scale, platform size 30.0x40.0x12.0cm, robust built s/s construction, adjustable feet in height, adjustable display mounting, including LCD display. With functions for setting to zero, to tare, gross and net weight. Battery operation or power cable, 230V/50-60Hz	0-30.0kg	5.0gr



		Weight range	Reading
064421	Table/floor digital scale, platform size 42.0x52.0x12.0cm robust built s/s construction, adjustable feet in height, adjustable display mounting, including LCD display. With functions for setting to zero, to tare, gross and net weight. Battery operation or power cable, 230V/50-60Hz	0-150.0kg	10.0gr



		Weight range	Reading
064422	Digital scale, platform size 42.0x52.0cm, robust built s/s construction, adjustable feet in height, including battery and charger. Perfect for use in the kitchen because of the splash-proof display, 230V/50-60Hz	0-30.0kg	2.0gr



		Weight range	Reading
064423	Digital scale, platform size 25.0x30.0cm, including splash-proof display, adjustable feet in height, incl. battery and charger, 230V/50-60Hz	0-6.0kg	0.5gr



		Weight range	Reading
064413	Hand lift scale, integrated rechargeable battery 36hrs, with LCD display, with buttons for zero, tare, gross and net weight, 115.5x56.0x121.0cm	0-2200.0kg	1.0kg



Andy Mannhart



BUFFET DISPLAY & CHAFING DISHES
Hollowware, Cookware

4

Stainless steel

CBS CLASSIC

		Cap. ltr	Dim in cm	induction
035381	Window chafing dish GN 2/3, s/s mirror polished, induction, with s/s insert GN 2/3, incl. lid with glass window and lid brake	8.0	41.0x44.0x23.0	



		Cap. ltr	Dim in cm	induction
003417	Window chafing dish GN 1/1, s/s mirror polished, induction, with s/s insert GN 1/1, incl. lid with glass window and lid brake	9.5/14.0	59.0x42.5x22.0	



		Cap. ltr	Dim in cm	induction
035382	Window chafing dish, round, s/s mirror polished, induction, with s/s insert Ø 38.0cm, incl. lid with glass window and lid brake	5.5	46.0x50.0x23.0	



		Cap. ltr	Dim in cm	induction
035383	Chafing dish, s/s mirror polished, induction, with insert GN 2/3, incl. lid and lid brake	8.0	41.0x44.0x23.0	



		Cap. ltr	Dim in cm	induction
035384	Chafing dish round, s/s mirror polished, induction, with s/s insert Ø 38.0cm, incl. lid and lid brake	5.5	46.0x50.0x23.0	



Stainless steel

**induction**

		Cap. ltr	Dim in cm
035385	Window chafing dish station GN 2/3, s/s mirror polished, induction, with s/s insert GN 2/3, incl. lid with glass window, lid brake and incl. frame	8.0	41.0x44.0x33.0

**induction**

		Cap. ltr	Dim in cm
003418	Window chafing dish station GN 1/1, s/s mirror polished, induction, with s/s insert GN 1/1, incl. lid with glass window, lid brake and frame	9.5/14.0	59.0x42.5x34.0

**induction**

		Cap. ltr	Dim in cm
035386	Window chafing dish station, round, s/s mirror polished, induction, with round s/s insert Ø 38.0cm, incl. lid with glass window, lid brake and frame	5.5	46.0x50.0x33.0

**induction**

		Cap. ltr	Dim in cm
035387	Chafing dish station, s/s mirror polished, induction, with s/s insert GN 2/3, incl. lid, lid brake and frame	8.0	41.0x44.0x33.0

**induction**

		Cap. ltr	Dim in cm
035388	Chafing dish station, round, s/s mirror polished, induction, with s/s insert Ø 38.0cm, incl. lid, lid brake and frame	5.5	46.0x50.0x23.0

**induction**

		Ø cm	Cap. ltr
003419	Window soup tureen, s/s mirror polished, induction, without insert, incl. lid with glass window and lid brake	37.0	11.0

**induction**

		Ø cm	Cap. ltr	H in cm
003432	Window soup tureen station, s/s mirror polished, induction, incl. s/s insert, s/s frame and window soup tureen with glass window and lid brake	37.0	11.0	42.0/44.0



020432 Frame GN 2/3, s/s



020431 Frame GN 1/1, s/s



020433 Frame round 38.0 cm, s/s

Stainless steel

CBS ADVANTAGE

		Dim in cm	induction
020434	Window chafing dish GN 2/3, s/s mirror polished, induction	40.0x48.0x16.0	
020444	Window chafing dish GN 1/1, s/s mirror polished, induction	57.5x47.5x16.0	
020437	Window chafing dish round, Ø 30.0cm, s/s mirror polished, induction	48.5x38.5x16.0	
020435	Window chafing dish station GN 2/3, s/s mirror polished, induction	47.0x47.5x37.5	
020445	Window chafing dish station GN 1/1, s/s mirror polished, induction	65.0x47.5x37.5	
020438	Window chafing dish station round, Ø 30.0cm, s/s mirror polished, induction	48.5x38.5x37.5	
033090	Window soup tureen, Ø 30.0cm, s/s mirror polished, induction, incl. insert	48.5x38.5x23.0	
033091	Window soup tureen station incl. frame and insert, Ø 30.0 cm, s/s mirror polished, induction	48.5x38.5x43.0	
020436	Frame GN 2/3, s/s mirror polished	47.0x28.0x24.5	
020446	Frame GN 1/1, s/s mirror polished	65.0x28.0x24.5	
020439	Frame round 30.0 cm, s/s mirror polished	34.5x34.5x24.5	



Stainless steel

**RONDO RENNAISSANCE**

		Cap. ltr	Dim in cm
035195	Chafing dish GN 1/1 with rolltop lid, with insert, supporting frame, burner holder and lid brake	9.5/14.0	66.0x49.0x40.0



		Ø cm	Cap. ltr	H in cm
035270	Chafing dish with rolltop lid, for inserts of 30.0cm, with insert and burner holder, lid brake	46.0	4.6	39.0



		Ø cm	Cap. ltr	H in cm
035271	Chafing dish with rolltop lid, for inserts of 40.0cm, with insert and burner, lid brake	56.0	8.0	50.0

**RONDO ADVANTAGE**

		Cap. ltr	Dim in cm
035620	Chafing dish GN 1/1 with rolltop lid, with insert and burner holder, lid brake, non-slip feet, stackable	9.5/14.0	66.0x45.0x42.0



		Ø cm	Cap. ltr	H in cm
035675	Chafing dish with rolltop lid, for 30.0cm inserts, with insert, burner holder, lid brake, non-slip feet, stackable,	44.0	4.6	39.0



		Ø cm	Cap. ltr	H in cm
035676	Chafing dish with roll-top lid, for 40.0cm inserts, with insert, burner holder, lid brake, non-slip feet, stackable	54.0	8.0	50.0



		Dim in cm
010255	Spoon rest attachable, for RONDO RENNAISSANCE, CLASSIC and ADVANTAGE	26.0x13.0x18.0

035675 / 035676
stackable035620 / 020448
stackable

Stainless steel

ECO CATERING

		Cap. ltr	Dim in cm
035197	Chafing dish GN 1/1 with lift-off lid, without insert, stackable	9.5/14.0	64.0x35.0x34.0

		Cap. ltr	Dim in cm
035198	Chafing dish GN 1/1 rolltop, without insert, tip-up function for easy swapping of inserts	9.5	64.0x38.0x39.0

		Dim in cm
035199	Soup station GN 1/1 incl. 2 soup tureens each 4.5ltr, can be used as built-in soup station	64.0x35.0x34.0

		Ø cm	Cap. ltr	H in cm
035325	Round soup station, incl. soup tureen, with wind break	37.0	10.0	39.0

		Ø cm	Cap. ltr	H in cm
035321	Soup tureen with lid, to use with adaptor lid for soup tureens only	24.0	4.5	18.0

		Ø cm	Cap. ltr	H in cm
035328	Soup tureen with lid, to use with adapter lid for soup tureens only	30.0	10.0	21.5

035028	Lid holder soup tureen 10 ltr Eco Catering, to part 035321
010695	Lid holder soup tureen 10 ltr Eco Catering, to part 035328

		Ø cm	Cap. ltr	H in cm
035187	Chafing dish ECO round, with insert and wind break, can be used as built-in unit	30.0	5.0	33.0

		Ø cm	Cap. ltr	H in cm
035178	Chafing dish round OUZY/KINGSIZE, with insert, wind brake and burner	87.0	36.0	56.0

INDUCTION HEATER

		Dim in cm
005033	Built-in induction unit with ceran panel, touch screen and keep-warm function, 230V/50-60Hz, 1.0kW, 10.9A	36.0x36.0x8.5

		Ø cm
020428	Induction warmer with ceran panel for CBS, 230V/50-60Hz, 1.0kW	24.0

		Dim in cm
036074	Buffet induction warmer, black glass top, touch control, 4 power settings, connect up to 3 units together with inter-connect cords, 230V/50-60Hz, 0.3kW, 1.3A	40.6x40.6x9.8



Porcelain



		Ø cm	Cap. ltr	H in cm
035268	Round porcelain insert, white	30.0	2.2	4.5
	* for Rondo/Eco: 035270/035675/035187			



		Ø cm	Cap. ltr	H in cm
004659	Round insert to Rondo, Porcelain,	40.0	6.0	5.5
	* for Rondo: 035271/035676			



		Ø cm	Cap. ltr	H in cm
001807	Round porcelain insert, white	38.0	5.5	6.0
	* for CBS: 035382/035386			

		Ø cm	Cap. ltr	H in cm
035267	Round porcelain insert, divided into two equal sections	30.0	2.0	4.5
	* for Rondo: 035270/035675			



		Ø cm	Cap. ltr	H in cm
035269	Round porcelain insert, divided into two equal sections	40.0	6.0	5.5
	* for Rondo: 035271/035676			



		Cap. ltr	Dim in cm
035776	White porcelain insert GN 1/1, ovenproof, stackable * for all GN 1/1 chafers	8.0	53.0x32.5x6.0



		Cap. ltr	Dim in cm
035777	White porcelain insert GN 1/2, ovenproof, stackable * for all GN 1/2 chafers	3.2	32.0x26.5x6.0



		Cap. ltr	Dim in cm
035779	White porcelain insert GN 2/3, ovenproof, stackable * for all GN 2/3 chafers	5.0	32.5x32.5x6.0



		Cap. ltr	Dim in cm
035778	Insert GN 1/3 * for all GN 1/3 chafers	2.5	32.5x17.5x6.0



035787	Adapting bar (strut) fits all GN 1/1 and GN 2/3 chafers to be used with porcelain inserts
--------	---

Stainless steel

		Dim in cm
003517	Spoon rest * for Eco: 035197/035198/035187/035178	26.5x11.5x2.5

		Dim in cm
035786	Supporting frame, for inserts with a depth of 10.0cm * for Rondo: 035195/035620	54.0x34.0x6.5

020460	Supporting frame GN 2/3, for inserts with a depth of 10.0cm * for Rondo: 020447/020448
--------	--

		Ø cm	Cap. ltr	H in cm
035260	Round insert * for Rondo: 035270/035675	30.0	4.6	7.5
035261	Round insert * for Rondo: 035271/035676	40.0	8.0	7.5

		Ø cm	Cap. ltr
006097	Insert round * for CBS: 035382/035386	38.0	5.5

		Cap. ltr	Dim in cm
035783	Insert GN 1/1 * for all GN 1/1 chafers	9.5	53.0x32.5x6.5
035780	Insert GN 1/1 * for all GN 1/1 chafers	14.0	53.0x32.5x10.0

		Cap. ltr	Dim in cm
035784	Insert GN 1/2 * for all GN 1/2 chafers	4.0	32.5x26.5x6.5
035781	Insert GN 1/2 * for all GN 1/2 chafers	6.5	32.5x26.5x10.0

		Cap. ltr	Dim in cm
014570	Insert GN 2/3 * for all GN 2/3 chafers	5.0	32.5x35.2x6.5
035264	Insert GN 2/3 * for all GN 2/3 chafers	8.0	32.5x32.5x10.0

		Cap. ltr	Dim in cm
035785	Insert GN 1/3 * for all GN 1/3 chafers	2.5	32.5x17.6x6.5
035782	Insert GN 1/3 * for all GN 1/3 chafers	4.0	32.5x17.6x10.0

		Ø cm	Cap. ltr	H in cm
003446	Insert for window soup tureen, induction * for CBS: 003419/003432	29.0	11.0	29.0

		Ø cm	Cap. ltr	H in cm
035266	Round insert with handles, for round chafing dish KINGSIZE 035178	70.0	36.0	10.0

		Ø cm	Cap. ltr	H in cm
035263	Round insert for round ECO chafing dish 035187	30.0	5.0	8.5

		Ø cm	Cap. ltr	H in cm
033092	Insert for window soup tureen, induction * for CBS Advantage: 033090/033091	30.0	13.0	23.0





		Dim in cm
004623	Water pan GN 1/1 * for Rondo: 035195/035620	60.0x37.0x10.0



		Ø cm
020475	Water pan for, round * for Rondo: 035270/035675	30.0
004624	Water pan for, round * for Rondo: 035271/035676	40.0



		Dim in cm
035323	Adapting lid to chafing dishes RONDO GN 1/1 for two 4-5ltr soup tureens * for Rondo: 035195/035620	53.0x33.0x3.5



		Dim in cm
035210	Electric heating unit with infinitely variable heat control, cable length 2.5m, 230V/50-60Hz, 0.8kW * for all chafing dishes GN 1/1, 2/3 and round with Ø 40.0-70.0cm	30.0x20.0x1.5



		Dim in cm
035789	Electric heating unit without heat control, 2.5m cable, 230V/50-60Hz, 0.6kW * for all chafing dishes GN 1/1, 2/3 and round with Ø 40.0-70.0cm	30.0x20.0x1.5



		Dim in cm
035209	Electric heating unit with infinitely adjustable heat control, cable length 2.5m, 230V/50-60Hz, 0.5kW * for all chafing dishes GN 1/1 and round with Ø 30.0cm	20.0x20.0x1.5



		Dim in cm
035790	Electric heating unit without heat control, cable length 2.5m, 230V/50-60Hz, 0.5kW * for all chafing dishes GN 1/1 and round with Ø 30.0cm	20.0x20.0x1.5



		Ø cm	Cap. ltr
035211	Gel burner s/s, with fine flame adjustment, long handle, for fuel gel * for Eco: 035187	10.0	5.0



035213	Gel burner s/s, to KINGSIZE chafing dish 35178, not adjustable * for Eco: 035178
--------	---



035216	Burner holder and regulator, for all GN 1/1, 2/3 and all round chafing dishes
--------	---

		Ø cm	H in cm	induction
025202	Chafing dish round, fitting inserts up to depth 10.0cm, electrical and sterno heating possible, glass lid with brake, bow handle	39.0	19.0	



		Ø cm	H in cm
025085	Insert round, s/s	33.5	8.0
025086	Insert round, s/s	33.5	10.0



		Ø cm	H in cm
025208	Insert round, porcelain	33.5	7.0



		Ø cm	H in cm
025209	Insert round divided, porcelain	33.5	7.0



		Dim in cm	induction
025203	Chafing dish GN 2/3, fitting inserts up to depth 10.0cm, electrical and sterno heating possible, glass lid with brake, bow handle	37.0x45.0x19.0	



		Dim in cm
025084	GN insert 2/3, s/s	32.5x35.2x10.0



		Cap. ltr	Dim in cm
012170	Chafing dish Oyster round, s/s	3.5	45.5x40.0x13.5
012171	Chafing dish Oyster round, silverplated	3.5	45.5x40.0x13.5
012172	Chafing dish Oyster round, Venetian gold cover	3.5	45.5x40.0x13.5
012173	Chafing dish Oyster round, black cover	3.5	45.5x40.0x13.5



		Cap. ltr	Dim in cm
012176	Insert full size for chafing dish Oyster, porcelain	3.5	36.0x6.7



		Cap. ltr	Dim in cm
012177	Insert divided for chafing dish Oyster, porcelain	3.5	36.0x6.7





		Cap. ltr	H in cm
016673	Coffee urn including burner	10.5	54.5

		Cap. ltr	H in cm
000550	Coffee urn including burner	12.0	64.0



		Dim in cm
024356	Chafing Dish "Cool + Hot" GN 1/1, case steel panel coated, lower frame s/s, Insert GN 1/1 stainless steel, 6.5cm deep, 1 removable rolltop cover acrylic glass, coolant R134a, -5°C to +75°C, 230V/50Hz, 0.7kW	61.0x36.0x45.0



		Dim in cm
024357	Cooling Top Sushi Bar, 5x GN 1/2, plastic body, silver, storage space CNS 18/10, electrical control, coolant: R600a, automatic defrost function, individually switchable, energy-saving LED lightning, incl. 1 intermediate bar 32.5x3.0cm, 2°C to 7°C, 230V/50Hz, 0.18kW	180.0x42.5x29.5









		Dim in cm
025273	Warming tray, s/s, 35°C to 95°C, 230V/50-60Hz, 0.45kW	90.0x45.0x6.4



		Dim in cm
025274	Warming tray, s/s, 35°C to 95°C, 230V/50-60Hz, 0.60kW	100.0x50.0x6.4



		Dim in cm
422501	Warming tray, s/s, 35°C to 95°C, 230V/50-60Hz, 0.25kW	50.0x37.5x6.4

035143	Fondue pot set, red, aluminium, inside non-stick coating, outside enamelled, handle in brushed s/s, fondue rechaud PEAK s/s, incl. paste burner and 6 forks	Ø cm 23.0	Cap. ltr 2.0	induction new	
035142	Fondue pot set, white, aluminium, inside non-stick coating, outside enamelled, handle in brushed s/s, fondue rechaud PEAK s/s, incl. paste burner and 6 forks	Ø cm 23.0	Cap. ltr 2.0	induction new	
032076	Fondue pot set, black, aluminium, inside non-stick coating, outside enamelled, handle in brushed s/s, fondue rechaud PEAK s/s, incl. paste burner and 6 forks	Ø cm 23.0	Cap. ltr 2.0	induction new	
033102	Fondue rechaud PEAK, s/s, plate high mirror polished, incl. paste burner	Ø cm 16.0		new	
035121	Cheese Fondue set MONTANA, black/gold, ceramic, rechaud base in black lacquered metal, incl. burner, aluminium disc and 6 forks	Ø cm 22.0	Cap. ltr 2.0	new	
035122	Cheese Fondue set MONTANA, white/black, ceramic, rechaud base in black lacquered metal, incl. burner, aluminium disc and 6 forks	Ø cm 22.0	Cap. ltr 2.0	new	
035144	Fondue rechaud TRADITION, s/s, base in black lacquered metal, incl. burner and aluminium discs	Ø cm 20.0		new	

**induction**

new

035119 Fondue set ANDERMATT with splash guard, black, s/s, fondue rechaud s/s, incl. gas burner and 6 forks

Ø cm

18.0

Cap. ltr

2.0

**induction**

new

035120 Fondue set INTERLAKEN with splash guard, enamelled, black, s/s, fondue rechaud s/s, incl. paste burner and 6 forks

Ø cm

16.0

Cap. ltr

1.5

**induction**

new

035130 Fondue set SAAS FEE with splash guard, black, cast iron, rechaud made of enamelled cast iron, incl. paste burner and 8 forks

Ø cm

20.0

Cap. ltr

2.0

**induction**

new

035131 Fondue set SAAS FEE with splash guard, red, cast iron, rechaud made of enamelled cast iron, incl. paste burner and 8 forks

Ø cm

20.0

Cap. ltr

2.0

**induction**

new

035125 Fondue set GSTAAD CULINOX with splash guard, copper, rechaud s/s high mirror polished, incl. paste burner and 6 forks

Ø cm

18.0

Cap. ltr

1.5

**induction**

new

010438 Fondue set BASIC with splash guard, s/s, rechaud chrome, base in black wood, incl. paste burner and 6 forks

Ø cm

18.0

Cap. ltr

2.0



new

035117 Gas rechaud, s/s, infinitely adjustable, refillable

Ø cm

18.00

		Dim in cm
018016	Raclette oven for 1 half loaf cheese capacity up to 15 persons, 230V/50-60Hz, 1.0kW	51.0x30.0x34.0



		Dim in cm
018017	Raclette oven for 2 half loaves cheese capacity up to 25 persons, 230V/50-60Hz, 1.0kW	52.0x28.0x33.0



		Dim in cm
006897	Raclette knife with wooden handle	27.0x5.0x2.0



		Dim in cm
010321	Hot stone grill, grill platter of natural stone, temperature control, 8 pans and 8 spatulas included	50.5x25.0x11.0



		Dim in cm
004972	Pizza-Raclette-6 grill, aluminium, non-stick coating, white, 230V/50-60Hz	46.0x16.0x21.5



		Dim in cm
004973	Pizza-Raclette-6 grill, aluminium, non-stick coating, black, 230V/50-60Hz	46.0x16.0x21.5



		Dim in cm
004974	Pizza-Raclette-6 grill, aluminium, non-stick coating, red, 230V/50-60Hz	46.0x16.0x21.5



035654	Raclette grill red for 2 persons, grill plate made of cast aluminium with non-stick coating, dish holder and base made of s/s, incl. 2 dishes, 2 spatulas, 2.0m power cord	
--------	--	--



ACCESSORIES TO RACLETTE GRILL PLATE MODULE 035654

		Dim in cm
029116	Raclette dish with non-stick coating, set of 2	21.0x10.0x3.0



		Dim in cm
029115	Spatula, set of 2	13.0x5.0x2.0



		Ø cm
007991	Portable countertop hot plate, s/s, to cook meals at the table	70.0





		Ø cm
054426	Elegance freshness plate, white marble plastic board, cover hood with holding device, s/s base incl. cooling packs	41.0



		Ø cm
054873	Elegance freshness plate, white marble plastic board, gold, cover hood with holding device, gilded base incl. cooling packs	45.0



		Ø cm
054430	White marble plastic carving board to 054426/054873	40.0



		Ø cm
054874	Stainless steel plate to 054426/054873	40.0



		Dim in cm
032980	Cooling plate set GN 1/1, s/s and beechwood, waterproof, woodbox with plastic insert, incl. 1 GN tray 1/1 and 2 cooling cushions, cover with chrome handles	60.0x41.0x24.0



		Ø cm
032981	Cooling plate set round, s/s and beechwood, waterproof, woodbox with plastic insert, incl. tray 38.0cm and 1 cooling cushions, cover with chrome handles	48.0



		Ø cm
005661	Cheese / Choco curler, wooden base incl. cover	22.0



		Dim in cm
052020	Cheese plane (hobel), beech wood	30.0x10.0x8.0
052030	Cheese plane (hobel), beech wood	35.0x15.5x12.5

Fireproof porcelain

		P/U	Cap. ltr	Dim in cm
075022	Ramekin	12	0.09	7.5x3.6
075023	Ramekin	12	0.15	8.0x4.5



		P/U	Cap. ltr	Dim in cm
075015	Souffle dish	4	0.37	11.8x5.4
075018	Souffle dish	2	1.65	20.0x8.4



		P/U	Cap. ltr	Dim in cm
075024	Rectangular baking dish, stackable	6	0.50	13.0x19.0
075025	Rectangular baking dish, stackable	2	1.50	27.0x21.0
075026	Rectangular baking dish, stackable	2	2.50	34.0x24.0



		P/U	Cap. ltr	Dim in cm
075028	Oval eared baking dish	4	0.40	23.0x13.0
075029	Oval eared baking dish	4	0.70	29.0x17.0



		P/U	Cap. ltr	Dim in cm
075071	Pate mould rectangular	2	1.10	26.5x10.0x9.3
075072	Pate mould rectangular	2	2.10	31.0x12.0x10.5



		P/U	H in cm	Ø cm
075051	Shell dish	6	4.0	13.0



		P/U	H in cm	Ø cm
075065	Mustard pot with spatula	6	9.0	7.0



		P/U	Cap. ltr	Ø cm
075035	Flan or tart mould	6	0.20	12.5



		P/U	Cap. ltr	Ø cm
075040	Egg platter with handles	6	0.13	12.8
075041	Egg platter with handles	6	0.20	15.0
075042	Egg platter with handles	6	0.35	18.0



		P/U	Cap. ltr	Ø cm
075055	Soup tureen	6	0.35	11.5
075057	Soup tureen	2	0.65	13.7
075058	Soup tureen	2	0.9	15.6
075059	Soup tureen	2	1.5	18.5



Fireproof porcelain



		P/U	Ø cm	H in cm
075701	Miniature lion head terrine	6	5.5	4.5



		P/U	Ø cm	H in cm
075702	Miniature dariole mould	6	5.0	4.5



		P/U	Ø cm	H in cm
075705	Miniature sauce pan with handle	6	7.0	2.5



		P/U	Ø cm	H in cm
075707	Miniature egg pan with handles plain	6	7.0	3.0



		P/U	Ø cm	H in cm
008274	Miniature souffle mould	6	6.0	2.5



		P/U	Ø cm	H in cm
075927	Miniature round eared casserole	6	6.3	3.0



		P/U	Ø cm	H in cm
075929	Miniature lyonnais salad bowl	6	6.3	2.6

Fireproof porcelain

		P/U	Dim in cm
075715	Miniature rectangular mould	6	7.0x5.0x2.0
075922	Miniature rectangular	6	9.7x6.0x2.0
075923	Miniature scallop-shell	6	7.5x7.0x2.0
075924	Miniature creme brulee dish	12	7.5x7.0x2.0
075925	Miniature square dish shallow	12	7.0x7.0x3.0
075926	Miniature square dish	6	6.0x6.0x2.5
075932	Miniature mussel	6	8.0x4.5x2.0
075933	Miniature calisson dish	6	9.5x4.0x2.0
075936	Miniature cube bowl	8	6.5x6.5x4.7





		P/U	Cap. ltr	Dim in cm
022528	Creme brulee dish, red, enameled porcelain	6	0.25	14.5x13.0x3.0



		P/U	Cap. ltr	Dim in cm
022529	Creme brulee dish, black, enameled porcelain	6	0.25	14.5x13.0x3.0



		P/U	Cap. ltr	Dim in cm
022576	Miniature stew pot, red, enameled porcelain	6	0.05	5.8x6.0



		P/U	Cap. ltr	Dim in cm
022577	Miniature stew pot, black, enameled porcelain	6	0.05	5.8x6.0



		P/U	Cap. ltr	Dim in cm
022601	Roasting dish rectangular, black porcelain, in cast iron style	4	0.45	16.0x11.0x4.5



		P/U	Cap. ltr	Dim in cm
022602	Roasting dish rectangular, black porcelain, in cast iron style	3	0.7	19.0x12.5x5.0



		P/U	Cap. ltr	Dim in cm
022603	Roasting dish rectangular, black porcelain, in cast iron style	2	1.7	26.0x18.5x6.0



		P/U	Cap. ltr	Dim in cm
022604	Roasting dish rectangular, black porcelain, in cast iron style	1	2.5	30.0x21.5x6.5



		P/U	Cap. ltr	Dim in cm
022605	Roasting dish rectangular, black porcelain, in cast iron style	1	3.5	34.0x25.0x6.5

NACRYL®, INNOVATION ON THE BUFFET

Nacryl® is an exclusive TECHNOPLAK high-end material recognized for its aesthetics and ease of use.

Completely food safe, it seduces with its bright colours, its subtly translucent and silky touch. It is very appreciated by professionals for its resistance to the stresses of everyday use.

Nacryl® is offered in all shapes, thicknesses, colours and dimensions ... according to your desires.



Video



Made for professionals



Food safe



Dishwasher safe



Thermal shock resistant (-100°C to +80°C)

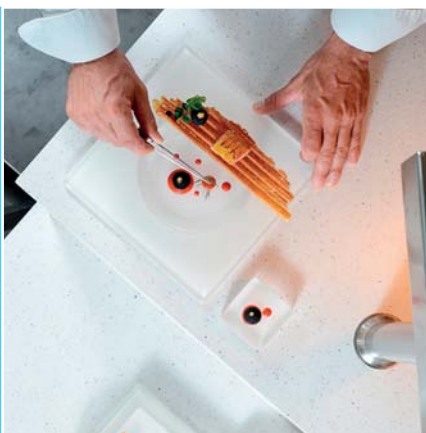

Shockproof



10 years warranty against UV



Silky touch



Colourful

COLLAPSIBLE RAISERS



white	anthracite	cherry	lemon	raspberry	lagoon	mandarin	greige	P/U	Dim in cm
031643	031608	036663	031644	031645	031646	031647	036665	4	15.0x15.0x10.0
031582	031580	036666	031583	031584	031593	031574	036670	2	20.0x20.0x19.5
031594	031576	036675	031595	031596	031597	031598	036676	2	30.0x30.0x19.5





ROUND TRAYS



white	anthracite	cherry	lemon	raspberry	lagoon	mandarin	greige	P/U	Dim in cm
031602	031578	036679	031603	031604	031605	031606	036680	8	19.5x1.0
031650	031656	036681	031651	031652	031653	031654	036682	4	24.5x1.0
031675	031673	036683	031676	031677	031678	031679	036684	4	30.0x1.0









FOOTED TRAYS RECTANGULAR



						
	white	anthracite	lemon	raspberry	P/U	Dim in cm
	031586	031585	031587	031588	8	24.5x10.0x1.5
	031590	031589	031591	031592	4	33.0x15.0x1.5

TASTING TRAYS RECTANGULAR



											
	white	anthracite	cherry	lemon	raspberry	lagoon	mandarin	greige	Holes	P/U	Dim in cm
	031659	031657	036685	031660	031661	031662	031663	036686	4	8	24.5x10.0x1.0
	031667	031665	036687	031668	031669	031670	031671	036688	8	8	30.0x10.0x1.0
	036780	036781	036782	036785	036784	036786	036788	036783	20	4	49.5x15.0x1.0

STACKABLE BUFFET new

white
036755



cherry
039516



lemon
039517



lagoon
039518

P/U

1

Dim in cm

49.5x19.5x12.0 / 44.5x19.5x8.5 / 39.5x19.5x5.0

CAKE STAND new

white
036664
034124
034123



anthracite
036667
036672
034463



lemon
036669
036674
036753



raspberry
036668
036673
036752

P/U

1
2
2

H in cm

40.0
21.0
11.0

Dim in cm

28.0/39.5/28.0
28.0/15.0
28.0/15.0

GOURMET ROUND AND KUBE new



white	P/U	Dim in cm
036659	2	15.0x4.0
036660	2	15.0x15.0x4.0

MENU HOLDER KUBE new



white	P/U	Dim in cm
036661	8	4.0x4.0x2.0
034122	8	4.0x4.0x4.0



NACRYL

innovation on the buffet



Stainless steel

ANDY MANNHART RAINBOW COLLECTION SERVING BOWLS

Slightly inclined Rainbow Collection serving bowls made of stainless steel, insulated double wall system to keep food passively cold. Available in the following colours: white, yellow, green, blue, orange or stainless steel.



		P/U	Ø cm	H in cm
025665	Serving bowl slightly inclined, insulated double wall, white	8	18.0	14.0
025662	Serving bowl slightly inclined, insulated double wall, white	8	24.0	19.0



		P/U	Ø cm	H in cm
025651	Serving bowl slightly inclined, insulated double wall, yellow	8	18.0	14.0
025648	Serving bowl slightly inclined, insulated double wall, yellow	8	24.0	19.0



		P/U	Ø cm	H in cm
025657	Serving bowl slightly inclined, insulated double wall, green	8	18.0	14.0
025654	Serving bowl slightly inclined, insulated double wall, green	8	24.0	19.0



		P/U	Ø cm	H in cm
025659	Serving bowl slightly inclined, insulated double wall, blue	8	18.0	14.0
025658	Serving bowl slightly inclined, insulated double wall, blue	8	24.0	19.0



		P/U	Ø cm	H in cm
025661	Serving bowl slightly inclined, insulated double wall, orange	8	18.0	14.0
025660	Serving bowl slightly inclined, insulated double wall, orange	8	24.0	19.0



		P/U	Ø cm	H in cm
025667	Serving bowl slightly inclined, insulated double wall, s/s	8	18.0	14.0
025666	Serving bowl slightly inclined, insulated double wall, s/s	8	24.0	19.0

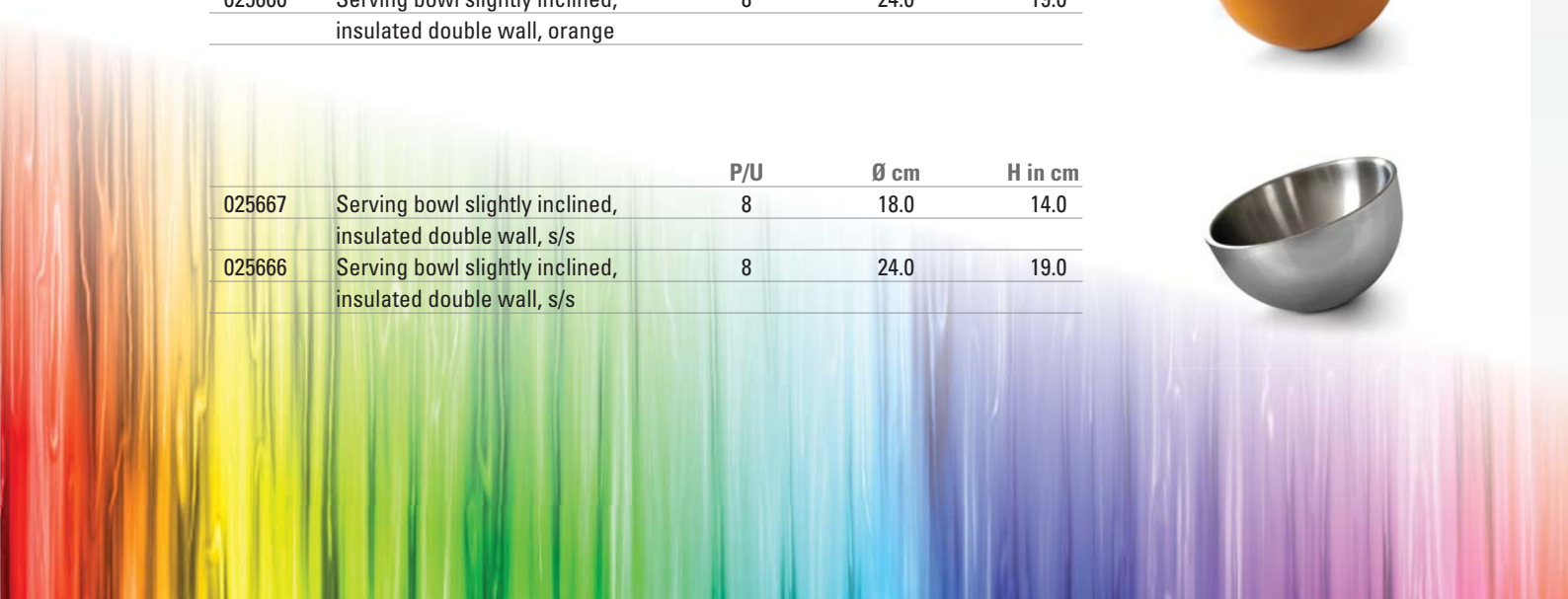

Waterproof wood



Video



		Dim in cm
018130	Presentation kit "Cubic" for 4 square bowls, set includes: 2x cubes with lid, 1x crossbar 50.0cm, 1x displayer for 4 bowls, 4x melamine bowls	91.0x49.0x17.0



		Dim in cm
018131	Presentation kit "Cubic" for 6 square bowls, set includes: 2x cubes with lid, 1x crossbar 100.0cm, 1x displayer for 6 bowls, 6x melamine bowls	141.0x49.0x17.0



		Dim in cm
018132	2 levels presentation kit "Cubic" for 6 square bowls, set includes: 4x cubes with lid, 1x crossbar 100.0cm, 1x displayer for 6 bowls, 6x melamine bowls, 1x narrow shelf 100.0cm	141.0x49.0x31.5

Waterproof wood

018133	Presentation kit "Cubic" for 8 square bowls, set includes: 2x cubes with lid, 1x crossbar 80.0cm, 2x displayer for 4 bowls, 8x melamine bowls	Dim in cm 121.0x49.0x17.0	
018134	2 Levels presentation kit "Cubic" for 8 square bowls, set includes: 4x cubes with lid, 1x crossbar 80.0cm, 2x displayer for 4 bowls, 8x melamine bowls, 1x narrow shelf 80.0cm	Dim in cm 121.0x49.0x31.5	
018135	Basic 2 levels presentation kit "Cubic", set includes: 4x cubes with lid, 1x wide shelf 100.0cm, 1x narrow shelf 100.0cm	Dim in cm 141.5x35.0x31.5	
018136	"L"-shape 2 levels presentation kit "Cubic", set includes: 6x cubes lid, 1x wide shelf 100.0cm, 1x narrow shelf 100.0cm, 1x wide shelf 80.0cm, 1x narrow shelf 80.0cm	Dim in cm 141.5x121.5x31.5	
018137	2 trays 40.0x40.0cm presentation kit "Cubic", set includes: 4x cubes with lid, 1x crossbar 100.0cm, 2x serving trays 40.0x40.0cm	Dim in cm 141.0x39.0x31.5	
018138	2 levels presentation kit "Cubic" for 40.0x40.0cm trays, set includes: 6x cubes with lid, 1x crossbar 100.0cm, 2x serving trays 40.0x40.0cm, 1x narrow shelf 100.0cm	Dim in cm 141.0x39.0x46.0	
018139	2 trays 60.0x40.0cm presentation kit "Cubic", set includes: 2x cubes with lid, 1x crossbar 100.0cm, 2x serving trays 60.0x40.0cm	Dim in cm 141.0x60.0x17.0	
018142	2 levels presentation kit "Cubic" for 60.0x40.0cm trays, set includes: 6x cubes with lid, 1x crossbar 100.0cm, 2x serving trays 60.0x40.0cm, 1x narrow shelf 100.0cm	Dim in cm 141.0x60.0x46.0	

Waterproof wood



		Dim in cm
018145	2 levels presentation kit L "Cubic" 100.0cm, set includes: 2x cubes with lid, 1x crossbar 80.0cm, 1x serving tray 60.0x40.0cm, 1x complete kit juice dispenser 6ltr	121.0x39.0x48.0

		Dim in cm
018143	3 levels 2/3 GN stand "Cubic", set includes: 3 Containers 2/3 GN	65.1.0x38.0x59.1

MATCHING ACCESSORIES

		Dim in cm
009834	"Cubic" cube with lid, black	23.0x23.0x16.5

		Dim in cm
009835	"Cubic" cube with lid, white	23.0x23.0x16.5

018115	Displayer for 4 melamine bowls "Cubic", black	
--------	---	--

018122	Displayer for 6 melamine bowls "Cubic", black	
--------	---	--

		L in cm
018120	Crossbar for buffet trays 500mm "Cubic", black	50.0

		L in cm
018123	Crossbar for buffet trays 800mm "Cubic", black	80.0

		L in cm
018121	Crossbar for buffet trays 1000mm "Cubic", black	100.0

		Dim in cm
018124	Serving tray 40.0x40.0cm "Cubic", black	40.0x40.0

		Dim in cm
018126	Serving tray 60.0x40.0cm "Cubic", black	60.0x40.0

		Dim in cm
018129	Juice dispenser 6.0 ltr kit "Cubic", black	23.0x39.0x49.1

		Dim in cm
009836	Narrow shelf "Cubic", black	50.0x18.0x1.5
009837	Narrow shelf "Cubic", black	80.0x18.0x1.5
009838	Narrow shelf "Cubic", black	100.0x18.0x1.5
009839	Narrow shelf "Cubic", white	50.0x18.0x1.5
009840	Narrow shelf "Cubic", white	80.0x18.0x1.5
009841	Narrow shelf "Cubic", white	100.0x18.0x1.5

		Dim in cm
009842	Wide shelf "Cubic", black	50.0x35.0x1.5
009843	Wide shelf "Cubic", black	80.0x35.0x1.5
009844	Wide shelf "Cubic", black	100.0x35.0x1.5
009845	Wide shelf "Cubic", white	50.0x35.0x1.5
009846	Wide shelf "Cubic", white	80.0x35.0x1.5
009847	Wide shelf "Cubic", white	100.0x35.0x1.5

		Dim in cm
009849	Perforated buffet displayer "Cubic", black	57.0x37.0x31.0
009850	Perforated buffet displayer "Cubic", white	57.0x37.0x31.0



		Dim in cm
009851	Standard buffet displayer "Cubic", black	57.0x37.0x31.0
009852	Standard buffet displayer "Cubic", white	57.0x37.0x31.0



		Dim in cm
009853	Triple buffet displayer "Cubic", black	57.0x37.0x31.0
009854	Triple buffet displayer "Cubic", white	57.0x37.0x31.0



		Dim in cm
009855	Buckets buffet displayer "Cubic", black	57.0x37.0x25.5
009856	Buckets buffet displayer "Cubic", white	57.0x37.0x25.5



		Dim in cm
009857	Cheese buffet displayer "Cubic", black	57.0x37.0x31.0
009858	Cheese buffet displayer "Cubic", white	57.0x37.0x31.0



		Dim in cm
009859	Bread buffet displayer "Cubic", black	57.0x37.0x14.5
009860	Bread buffet displayer "Cubic", white	57.0x37.0x14.5



		Dim in cm
009861	Melamine slate buffet displayer "Cubic", black	57.0x37.0x14.5
009862	Melamine slate buffet displayer "Cubic", white	57.0x37.0x14.5





		Dim in cm
009848	Buffet trolley "Cubic", black, waterproof wood	143.0x75.0x85.4



		Dim in cm
027865	Gueridon trolley "Cubic", oak melamine	69.0x50.0x85.5



		Dim in cm
027961	Trolley with two shelves "Cubic", black, wood/aluminium, anodised aluminium legs, soundproof and revolving castors 10.0cm, two with brakes, tabletop wood with waterproof treatment	105.0x55.0x85.0



		Dim in cm
027962	Trolley with two shelves "Cubic", white, wood/aluminium, anodised aluminium legs, soundproof and revolving castors 10.0cm, two with brakes, tabletop wood with waterproof treatment	105.0x55.0x85.0



		Dim in cm
027963	Gueridon trolley "Cubic", black, wood, anodised aluminium legs, soundproof and revolving castors 10.0cm, two with brakes	70.0x50.0x80.0











FRILICH THE ORIGINAL
o

Frilich offers a versatile selection of presentation and dispensing systems for buffets in the hotel business and gastronomy.

Different designs provide the buffet with an impressively and incomparable appearance without renouncing the high claim for quality and functionality.

FRILICH Juice and Fruit Station



①		<p>032275 Beverage-Set, Barrel Classic Vintage White 5.0ltr on raiser, with decor steel frame, s/s, glass barrel with universal adapter and stainless steel faucet incl. cooling cushion and drip tray, wooden stand in white varnish</p>	<p>Dim in cm 47.0x31.5x23.0</p>
②		<p>032277 Beverage-Set, Barrel Classic Vintage White 8.0ltr on raiser, with decor steel frame, s/s, glass barrel with universal adapter and stainless steel faucet incl. cooling cushion and drip tray, wooden stand in white varnish</p>	<p>Dim in cm 52.5x33.0x23.0</p>
③		<p>032278 Raiser M, Timber Vintage White, made of wood with white varnish</p>	<p>Dim in cm 22.8x22.8x10.5</p>
④		<p>032279 Beverage-Set Glasses, s/s 9 portion glasses each 0.2ltr, incl. 2 cooling fins</p>	<p>Dim in cm 20.6x20.6x15.5</p>
⑤		<p>032280 Raiser L, Timber Vintage White, made of wood with white varnish</p>	<p>Dim in cm 32.7x32.7x17.0</p>
⑥		<p>032281 Beverage-Set Bottles, s/s 20 swing top bottles each 0.2ltr, incl. 3 cooling fins</p>	<p>Dim in cm 30.6x30.6x19.5</p>
⑦		<p>032283 Fruit station, Timber Vintage White on raiser white varnish, hinged fruit crate</p>	<p>Dim in cm 75.0x33.0x33.0</p>
⑧		<p>032284 Bread and fruit basket, beige, plastic</p>	<p>Dim in cm 30.5x30.5x12.0</p>

FRILICH Bread Station



		Dim in cm
032286	Bread station, Nature on raiser hinged bread chute with divider to create divisions	74.0x33.0x33.0

		Dim in cm
032284	Bread and fruit basket, beige, plastic	30.5x30.5x12.0

		Dim in cm
032288	Raiser Display system, Cube Nature	25.0x25.0x23.0

		Dim in cm
002738	Bread tray, wood with s/s reservoir for bread crumbs	58.0x37.5x35.0

		Dim in cm
032296	Raiser Display system, Oblong Nature	48.0x28.0x16.5
032298	China plate 1/3 GN, cyan	32.5x17.5x1.6
032299	China plate 1/3 GN, grey	32.5x17.5x1.6
032300	China plate 1/3 GN, caramel	32.5x17.5x1.6

		Dim in cm
032302	Raiser M, Timber Nature	22.8x22.8x10.5

	Ø cm	Dim in cm
032308	China plate round, caramel	20.0 23.0x23.0x2.7
032306	Decoration steel frame, anthrazit, with plastic insert	20.6x20.6x3.6
001884	Cooling cushion	16.0x16.0x2.5
054779	Unison cool 230, Elegance cover hood, s/s	

		Dim in cm
032303	Raiser L, Timber Vintage Red made of wooden in red varnish	22.8x22.8x17.0
032304	Raiser M, Timber Vintage Red made of wood in red varnish	22.8x22.8x10.5

	Ø cm	Dim in cm
032305	China plate round, blue	20.0 23.0x23.0x2.7
032306	Decoration steel frame, anthrazit, with plastic insert	20.6x20.6x3.6
001884	Cooling cushion	16.0x16.0x2.5
054779	Unison cool 230, Elegance cover hood, s/s	

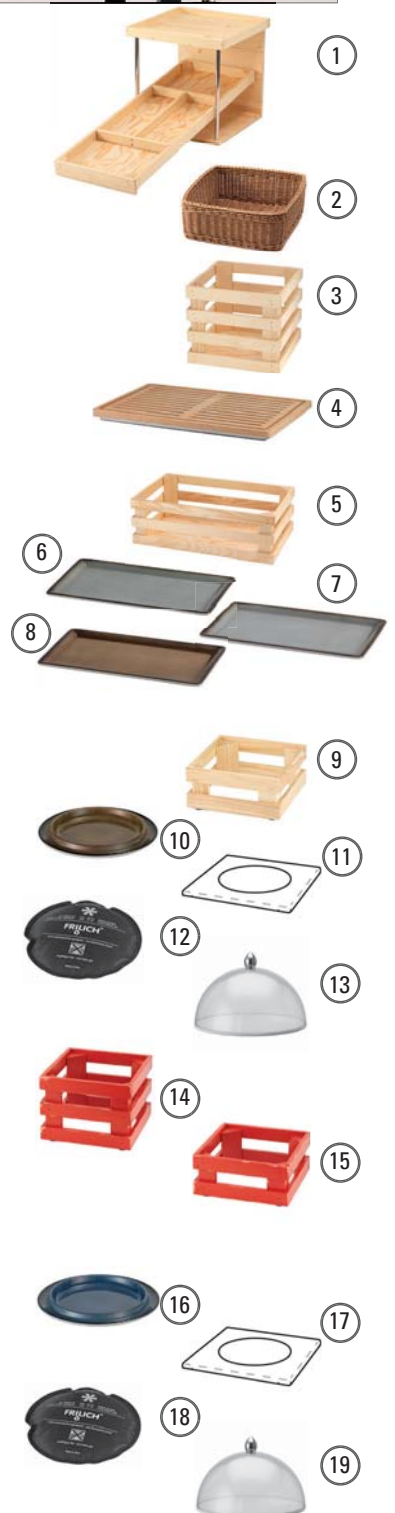



Earth china plate incl. cooling cushion system. Can be combined with cover hood



		Ø cm	H in cm
021674	Soapstone with round plate, s/s finish	41.0	7.0



		Ø cm	H in cm
021731	Cover hood with knob, plastic, incl. hinged hood device, for 021674	43.0	31.0



		Ø cm	H in cm
021675	Soapstone with round plate, s/s finish	31.0	14.2



		Ø cm	H in cm
021732	Cover hood with knob, plastic, incl. hinged hood device, for 021675	33.0	33.5



Picnic china plate/dish incl. cooling cushion system. Can be combined with cover hood

		Ø cm	H in cm
021754	Wicker basket, plastic, black with round plate	41.0	7.0

		Ø cm	H in cm
021755	Wicker basket, plastic, beige with round plate	41.0	7.0

		Ø cm	H in cm
021731	Cover hood with knob, plastic, incl. hinged hood device, for 021754 and 021755	43.0	31.0

		Ø cm	H in cm
021756	Wicker basket, plastic, black with round dish	31.0	14.5

		Ø cm	H in cm
021757	Wicker basket, plastic, beige with round dish	31.0	14.5

		Ø cm	H in cm
021732	Cover hood with knob, plastic, incl. hinged hood device, for 021756 and 021757	33.0	33.5





		Dim in cm
054537	Connect hopper, 2.5ltr, with base model s/s, rotary dispenser with acrylic container	17.0x19.0x68.5

		Dim in cm
054538	Connect hopper, 3.5ltr, with base model s/s, rotary dispenser with acrylic container	17.0x19.0x87.5

		Dim in cm
006668	Connect hopper, 4.5ltr, with base model s/s, rotary dispenser with acrylic container	96.5x17.0x19.0

		Dim in cm
054529	Connect goblet (china slide) 2.0ltr, with base model s/s	17.0x22.0x30.5

		Dim in cm
054528	Connect muesli flute, 1.5ltr, with base model s/s	17.0x15.4x29.0

		Dim in cm
004933	Connect china carafine 1.2ltr, s/s lid, with base model s/s	17.0x15.4x30.0

		Dim in cm
054519	Connect jam pot, 0.6ltr, translucent, with base model s/s, incl. s/s lid	17.0x15.4x17.5

		Dim in cm
003603	Connect jam pot 0.6ltr, china, with base model s/s, incl. s/s lid	17.0x15.4x17.5



		Dim in cm
029933	Connect juice dispenser, acrylic glass, 4.0 ltr, s/s, cooling pack inside base	19.0x17.0x82.5

		Dim in cm
029932	Connect juice dispenser, acrylic glass, 3.0 ltr, s/s, cooling pack inside base	19.0x17.0x68.5

		Dim in cm
054527	Connect glass carafine, 1.2ltr, s/s lid, base s/s	17.0x15.4x30.0
016676	Connect plastic carafine, 1.2ltr, s/s lid, base s/s	17.0x15.4x30.0





Pure nature raiser system with different presentation inserts, satin finished stainless steel base in different levels



		Dim in cm
054276	China plate on raiser L	31.0x31.0x18.0
054277	China plate on raiser M	31.0x31.0x13.0
054278	China plate on raiser S	31.0x31.0x8.0
054791	Cooling set for china plates	



		Dim in cm
054282	China plate basalt on raiser L	31.0x31.0x17.0
054283	China plate basalt on raiser M	31.0x31.0x12.0
054284	China plate basalt on raiser S	31.0x31.0x7.0
054791	Cooling set for china plates	



		Dim in cm
054285	Serving bowl 3.0ltr on raiser L	31.0x31.0x22.0
054286	Serving bowl 3.0ltr on raiser M	31.0x31.0x17.0
054287	Serving bowl 3.0ltr on raiser S	31.0x31.0x12.0
054795	Cooling set for serving bowls	



		Dim in cm
054322	Serving bowl 1.2ltr on raiser L	21.0x21.0x21.5
054323	Serving bowl 1.2ltr on raiser M	21.0x21.0x16.5
006235	Serving bowl 1.2ltr on raiser S	21.0x21.0x11.5
054817	Cooling set for plates	

Stainless steel tray incl. cooling fins to be filled with crushed ice or to be frozen with water



		Dim in cm
016706	Beverage tray on raiser L, 20 swing top bottles, 0.2ltr each	33.5x33.5x35.0
016704	Beverage tray on raiser M, 20 swing top bottles, 0.2ltr each	33.5x33.5x30.0
008724	Beverage tray on raiser S, 20 swing top bottles, 0.2ltr each	33.5x33.5x25.0

		Dim in cm
021759	Beverage tray on raiser L, 9 swing top bottles, 0.2ltr each	23.5x23.5x32.5
021760	Beverage tray on raiser M, 9 swing top bottles, 0.2ltr each	23.5x23.5x27.5
021761	Beverage tray on raiser S, 9 swing top bottles, 0.2ltr each	23.5x23.5x22.5

Pure nature raiser system with different presentation inserts, satin finished stainless steel base in different levels

		Dim in cm
054344	Circular china platter and cover hood on raiser L	21.0x21.0x28.5
054348	Circular china platter and cover hood on raiser M	21.0x21.0x23.5
006664	Circular china platter and cover hood on raiser S	21.0x21.0x18.5
001884	Cooling cushion	



		Dim in cm
021762	Buffet bowl on raiser L, 0.5ltr	18.0x18.0x30.5
021155	Buffet bowl on raiser M, 0.5ltr	18.0x18.0x25.5
021154	Buffet bowl on raiser S, 0.5ltr	18.0x18.0x20.5



		Dim in cm
021153	Buffet bowl on raiser L, 1.5ltr	21.0x21.0x33.0
009005	Buffet bowl on raiser M, 1.5ltr	21.0x21.0x28.0
009004	Buffet bowl on raiser S, 1.5ltr	21.0x21.0x23.0



		Dim in cm
009009	Buffet bowl on raiser L, 3.5ltr	21.0x21.0x38.5
009022	Buffet bowl on raiser M, 3.5ltr	21.0x21.0x33.5
009023	Buffet bowl on raiser S, 3.5ltr	21.0x21.0x28.5



		Dim in cm
054324	Buffet bowl Ø 28.0cm on raiser L	21.0x21.0x25.5
054331	Buffet bowl Ø 28.0cm on raiser M	21.0x21.0x20.5
006661	Buffet bowl Ø 28.0cm on raiser S	21.0x21.0x15.5
054332	Buffet bowl Ø 30.0cm on raiser L	21.0x21.0x29.5
054343	Buffet bowl Ø 30.0cm on raiser M	21.0x21.0x24.5
006663	Buffet bowl Ø 30.0cm on raiser S	21.0x21.0x18.5
001884	Cooling cushion	



		Dim in cm
054288	Fruit basket on raiser L	31.0x31.0x30.5
054289	Fruit basket on raiser M	31.0x31.0x25.5
054290	Fruit basket on raiser S	31.0x31.0x20.5





		Dim in cm
016269	Yogurt display on raiser L, incl. cooling cushion	31.0x31.0x20.8
016270	Yogurt display on raiser M, incl. cooling cushion	31.0x31.0x15.8
006985	Yogurt display on raiser S, incl. cooling cushion	31.0x31.0x10.8



		Dim in cm
006948	Bread basket on raiser L	31.0x31.0x39.0
006949	Bread basket on raiser M	31.0x31.0x34.0
006950	Bread basket on raiser S	31.0x31.0x29.0



		Dim in cm
006986	Bread basket on raiser L, grey	31.0x31.0x39.5
006987	Bread basket on raiser M, grey	31.0x31.0x34.5
009026	Bread basket on raiser S, grey	31.0x31.0x29.5



		Dim in cm
006951	Bread basket on raiser L	21.0x21.0x37.0
006952	Bread basket on raiser M	21.0x21.0x32.0
006953	Bread basket on raiser S	21.0x21.0x29.0



		Dim in cm
021764	Bread basket on raiser L, grey	23.5x23.5x39.5
021765	Bread basket on raiser M, grey	23.5x23.5x34.5
021766	Bread basket on raiser S, grey	23.5x23.5x29.5



Elegance carafine with glass carafes, insulated base and cooling system

		Ø cm	H in cm
054268	Carafine beverage set "Polished Quintet", double wall s/s bowl with s/s crushed ice tube in center, incl. 5 carafes, 1.2ltr each with s/s lid	35.0	32.0
033274	Carafine beverage set "Hammered Quintet", double wall s/s bowl with crushed ice tube in center, incl. 5 carafes, 1.2ltr each with s/s lid	35.0	32.0
054367	Carafine beverage set "Polished Triplet", double wall s/s bowl with s/s crushed ice tube in center, incl. 3 carafes, 1.2ltr each with s/s lid	32.0	33.0
034273	Carafine beverage set "Hammered Triplet", double wall s/s bowl with s/s crushed ice tube in center, incl. 3 carafes, 1.2ltr each with s/s lid	32.0	33.0
021879	Carafine plastic carafe, dishwasher proof, s/s drip tray	Dim in cm	
		22.0x22.0x29.5	
054269	Carafine glass carafe with s/s lid, 1.2ltr, insulated base incl. 3 cooling packs and s/s shell	Dim in cm	
		16.5x16.5x31.0	
013410	Septet Nature, wooden bucket, 7 flip top bottles, 1.0ltr each, plastic insert	Dim in cm	
		40.0x40.0x36.3	
021880	Septet Vintage, wooden bucket, 7 flip top bottles, 1.0ltr each, plastic insert	Dim in cm	
		40.0x40.0x36.3	





		Dim in cm
021881	Trio Vintage Wooden Crate, white, 3 glass bottles with milk motive, 1.0ltr each, 3 plastic inserts and cooling packs	41.0x17.0x44.5

		Dim in cm
021882	Trio Nature Wooden Crate, nature, 3 glass bottles with milk motive, 1.0ltr each, 3 plastic inserts and cooling packs	41.0x17.0x44.5



		Dim in cm
021883	China plate, Timber Vintage on raiser L, white	33.5x33.5x18.0
021884	China plate, Timber Vintage on raiser M, white	33.5x33.5x13.0
021885	China plate, Timber Nature on raiser L, nature	33.5x33.5x18.0
021886	China plate, Timber Nature on raiser M, nature	33.5x33.5x13.0



		Dim in cm
021887	China plate Basalt, Timber Vintage on raiser L, white	33.5x33.5x22.0
021888	China plate Basalt, Timber Vintage on raiser M, white	33.5x33.5x17.0
021889	China plate Basalt, Timber Nature on raiser L, nature	33.5x33.5x22.0
021890	China plate Basalt, Timber Nature on raiser M, nature	33.5x33.5x17.0



		Dim in cm
021891	Bread basket, Timber Vintage plastic on raiser L, white	33.5x33.5x39.5
021892	Bread basket, Timber Vintage plastic on raiser M, white	33.5x33.5x34.5
021893	Bread basket, Timber Nature plastic on raiser L, nature	33.5x33.5x39.5
021894	Bread basket, Timber Nature plastic on raiser M, white	33.5x33.5x34.5



		Dim in cm
021895	Freshness dish, Timber Vintage on raiser L, white	33.5x33.5x22.0
021896	Freshness dish, Timber Vintage on raiser M, white	33.5x33.5x17.0
021897	Freshness dish, Timber Nature on raiser L, nature	33.5x33.5x22.0
021898	Freshness dish, Timber Nature on raiser M, nature	33.5x33.5x17.0



		Dim in cm
021899	Condiment Display, Timber Vintage on raiser L, white	33.5x33.5x22.00
021900	Condiment Display, Timber Vintage on raiser M, white	33.5x33.5x17.00
021901	Condiment Display, Timber Nature on raiser L, nature	33.5x33.5x22.00
021902	Condiment Display, Timber Nature on raiser M, nature	33.5x33.5x17.00



		Dim in cm
021903	Timber Vintage L, 20 swing top bottles, s/s dish, 3 cooling fins	33.5x33.5x31.0
021904	Timber Vintage M, 20 swing top bottles, s/s dish, 3 cooling fins	33.5x33.5x26.0
021905	Timber Nature L, 20 swing top bottles, s/s dish, 3 cooling fins	33.5x33.5x31.0
021906	Timber Nature M, 20 swing top bottles, s/s dish, 3 cooling fins	33.5x33.5x26.0



Pure nature milk can with wooden base, stainless steel faucet, crushed ice cube, cooling pack in base and drip tray

		Dim in cm
054849	Milk can 3.0ltr, beech decor "Cherry"	22.5x22.0x38.3
054465	Milk can 5.0ltr, beech decor "Cherry"	22.5x22.0x41.5

		Dim in cm
054259	Milk can 3.0ltr, natural beech	22.5x22.0x38.3
054463	Milk can 5.0ltr, natural beech	22.0x22.0x41.5

Pure nature bowl bar, wooden tray (multiplex) with china bowl, lid and lid holder, different levels

		Dim in cm
054490	Bowl bar L, natural beech, with 3 china bowls each 3.5ltr	75.0x25.0x39.3
054857	Bowl bar L, decor "Cherry", with 3 china bowls each 3.5ltr	74.0x25.0x39.3

		Dim in cm
054489	Bowl bar M, natural beech, with 3 china bowls each 1.5ltr	60.0x19.0x28.0
054856	Bowl bar M, decor "Cherry", with 3 china bowls each 1.5ltr	60.9x19.0x28.0

		Dim in cm
054488	Bowl bar S, natural beech, with 3 china bowls each 0.5ltr	45.0x12.5x20.5
054855	Bowl bar S, decor "Cherry", with 3 china bowls each 0.5ltr	45.0x12.5x20.5

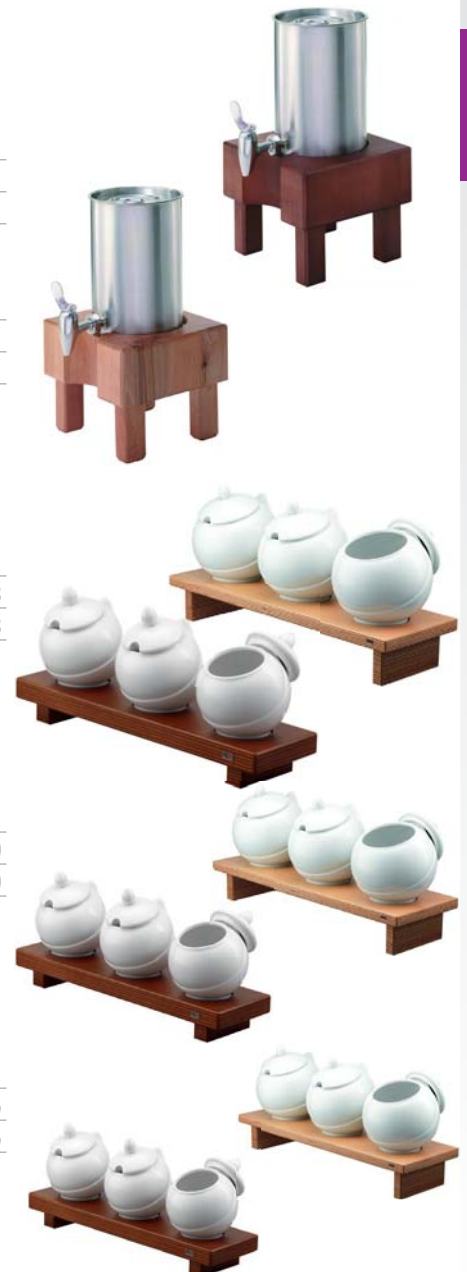



Elegance juice dispenser with stainless steel faucet, crushed ice tube and cooling pack in base



		Dim in cm
054314	Juice dispenser 2.5ltr, s/s version, transparent container	20.5x33.6x44.0
054368	Juice dispenser 2.5ltr, s/s version, translucent container	20.5x33.6x44.0
054014	Juice dispenser 5.0ltr, s/s version, transparent container	23.0x36.0x47.6
054376	Juice dispenser 5.0ltr, s/s version, translucent container	23.0x36.0x47.6
054839	Juice dispenser 9.0ltr, s/s version, transparent container	28.5x36.2x55.0



Elegance juice dispenser Aktiv, lid with electrical cooling unit, base stainless steel

		Dim in cm
021907	Juice dispenser Aktiv 5.0ltr, transparent container	23.0x36.0x47.0
021908	Juice dispenser Aktiv 5.0ltr, translucent container	23.0x36.0x47.0



Elegance milk can top quality with stainless steel faucet, crushed ice tube and cooling pack in base

		Dim in cm
021909	Milk can Aktiv 5.0ltr, base with electrical cooling system, s/s, lid with electrical stirring	23.5x37.0x49.5



		Dim in cm
054301	Milk can 3.0ltr, s/s finish	33.6x20.5x40.0
054847	Milk can 5.0ltr, s/s finish	36.0x23.0x44.0



Elegance Unison china tray GN incl. cooling cushion system. Can be combined with hygienic cover or cover hood

		Dim in cm
054197	Tray with china plate GN 1/1, s/s finish	55.0x34.5x6.0
054198	Tray with china plates 2x GN 1/2, s/s finish	55.0x34.5x6.0
054196	Tray with china plates GN 1/3 and GN 2/3, s/s finish	55.0x34.5x6.0
054199	Tray with china plates 3x GN 1/3, s/s finish	55.0x34.5x6.0

		L in cm	H in cm
054273	Hygienic cover	65.0	39.0

		Dim in cm
054671	Rolltop hood, rectangular, s/s knob	55.0x34.5



Elegance Unison china tray with round china plate incl. cooling cushion system. Can be combined with hygienic cover or cover hood

		Ø cm	H in cm
054219	Tray with round china plate, s/s finish	41.2	4.6

		Ø cm
054677	Rolltop with s/s knob for 054219	40.0

		Ø cm	H in cm
054218	Tray with round china plate, s/s finish	30.5	4.6

		Ø cm
054232	Cover hood with knob, incl. hinged hood device, s/s finish, for 054218	30.0



Elegance Unison china tray with round china plate incl. cooling cushion system with cover hood

		Ø cm
014543	Elegance freshness plate, cover hood with holding device, s/s base incl. cooling packs	31.0





Pure nature cheese stands, different levels and sizes for a wooden buffet landscape



		Dim in cm
054470	Cheese stand natural beech	22.0x22.0x12.0
054471	Cheese stand natural beech	22.0x22.0x16.5
054472	Cheese stand natural beech	22.0x22.0x21.0



		Dim in cm
054473	Cheese stand natural beech, oblong size	32.5x22.0x12.0
054474	Cheese stand natural beech, oblong size	32.5x22.0x16.5
054475	Cheese stand natural beech, oblong size	32.5x22.0x21.0



		Dim in cm
054476	Cheese stand beech decor "Cherry"	22.0x22.0x12.0
054477	Cheese stand beech decor "Cherry"	22.0x22.0x16.5
054478	Cheese stand beech decor "Cherry"	22.0x22.0x21.0



		Dim in cm
054479	Cheese stand beech decor "Cherry", oblong size	32.5x22.0x12.0
054480	Cheese stand beech, decor "Cherry", oblong size	32.5x22.0x16.5
054481	Cheese stand beech, decor "Cherry", oblong size	32.5x22.0x21.0

		Dim in cm
054482	Cheese stand beech decor "Enigma"	22.0x22.0x12.0
054483	Cheese stand beech decor "Enigma"	22.0x22.0x16.5
054484	Cheese stand beech decor "Enigma"	22.0x22.0x21.0



		Dim in cm
054485	Cheese stand beech decor "Enigma" oblong size	32.5x22.0x12.0
054486	Cheese stand beech decor "Enigma" oblong size	32.5x22.0x16.5
054487	Cheese stand beech decor "Enigma" oblong size	32.5x22.0x21.0



		Dim in cm
021955	Cheese stand natural beech	32.5x32.5x12.0
021957	Cheese stand natural beech	32.5x32.5x16.5
021956	Cheese stand natural beech	32.5x32.5x21.0



		Dim in cm
021958	Cheese stand beech décor "Cherry"	22.0x22.0x12.0
021959	Cheese stand beech décor "Cherry"	22.0x22.0x16.5
021960	Cheese stand beech décor "Cherry"	22.0x22.0x21.0



		Dim in cm
021961	Cheese stand beech décor "Enigma"	22.0x22.0x12.0
021962	Cheese stand beech décor "Enigma"	22.0x22.0x16.5
021963	Cheese stand beech décor "Enigma"	22.0x22.0x21.0





Elegance honey dispenser stainless steel body, easy cleaning dispensing valve for non-dripping portioning

054350	Honey dispenser for 1.0kg, s/s finish	Dim in cm 20.8x23.2x35.0
--------	---------------------------------------	------------------------------------



Elegance bowl dispenser, preparation for a bulk of portion glass bowls, gives an easy buffet handling

054852	Bowl dispenser, incl. 30 glass bowls, 6.0cm, s/s finish	Dim in cm 16.0x16.0x21.0
--------	---	------------------------------------



054854	Bowl dispenser, incl. 60 glass bowls, 7.0cm, s/s finish	Dim in cm 20.5x20.5x26.2
--------	---	------------------------------------

Elegance jam bar, dishwasher proof plastic pots in frosted look, each 0.6ltr, with stainless steel lids, incl. lid holder and good night lid, base made of high grade stainless steel

054869	Jam bar with 2 pots, s/s version	Dim in cm 34.0x14.0x18.0
--------	----------------------------------	------------------------------------



054868	Jam bar with 3 pots, s/s version	Dim in cm 47.0x14.0x18.0
--------	----------------------------------	------------------------------------



054867	Jam bar with 4 pots, s/s version	Dim in cm 60.0x14.0x18.0
--------	----------------------------------	------------------------------------



054866	Jam bar with 5 pots, s/s version	Dim in cm 72.5x14.0x18.0
--------	----------------------------------	------------------------------------



Elegance muesli flutes set, dishwasher proof plastic flutes, each 1.5ltr, with stainless steel lids, incl. good night lid, base made of high grade stainless steel

054334	Muesli flutes set with 2 flutes, s/s finish	Dim in cm 34.0x14.0x29.0
--------	---	------------------------------------



054336	Muesli flutes set with 3 flutes, s/s finish	Dim in cm 47.0x14.0x29.0
--------	---	------------------------------------



054871	Muesli flutes set with 4 flutes, s/s finish	Dim in cm 60.0x14.0x29.0
--------	---	------------------------------------



054338	Muesli flutes set with 5 flutes, s/s finish	Dim in cm 72.5x14.0x29.0
--------	---	------------------------------------





		H in cm	Dim in cm
095101	Display s/s, with 45 party spoons	60.0	47.0x26.0



		Dim in cm
095128	Cereal dispenser, 3.5ltr, black wood, s/s base, BPA free	17.0x17.0x69.0



		Dim in cm
095129	Cereal dispenser, 2x3.5ltr, black wood, s/s base, BPA free	33.0x17.0x69.0



		Dim in cm
095130	Juice dispenser, 6.0ltr, s/s base, ice tube incl., BPA free	33.0x18.0x49.0



		Dim in cm
095131	Juice dispenser, 6.0ltr, black wood base, ice tube incl., BPA free	33.0x18.0x52.0



		Dim in cm
095132	Milk dispenser, 6.0ltr, s/s base, ice tube incl., BPA free	33.0x18.0x49.0



		Dim in cm
095133	Milk dispenser, 6.0ltr, black wood base, ice tube incl., BPA free	33.0x18.0x52.0

		Ø cm	H in cm
003663	Cereal dispenser Rotation with 3 cylinders, 3x4.5ltr, polycarbonate containers, s/s base	38.0	54.0



		Dim in cm
017087	Cereal dispenser, 8ltr, polycarbonate containers, s/s base	26.5x35.0x68.0



		Dim in cm
004941	Cereal dispenser, 2x1.5ltr plexiglas frosted	26.0x17.0x28.5



		Dim in cm
003795	Cereal dispenser, 3x1.5ltr plexiglas frosted	38.0x17.0x29.0



		Ø cm	H in cm
001495	Fruit stand for approx. 25 oranges/apples, s/s, wire chrome plated	32.0	53.0



Porcelain



		Dim in cm
010176	Buffet tray white	40.0x35.0
010202	Buffet tray black	40.0x35.0
010203	Buffet tray white	45.0x40.0
010204	Buffet tray black	45.0x40.0
010206	Buffet tray white	55.0x40.0
010207	Buffet tray black	55.0x40.0
010208	Buffet tray white	65.0x40.0
010210	Buffet tray black	65.0x40.0

Stainless steel



		Dim in cm
005263	Oval display tray with flat edge	15.0x17.5
005264	Oval display tray with flat edge	30.0x20.2
005265	Oval display tray with flat edge	35.0x23.3
005266	Oval display tray with flat edge	40.0x26.7
005267	Oval display tray with flat edge	45.0x29.2
005268	Oval display tray with flat edge	50.0x31.2



		Ø cm
005269	Round display tray	28.0
005270	Round display tray	36.0
005271	Round display tray	42.0
013446	Round display tray	80.0



		Ø cm
012359	Round display tray	35.0
005270	Round display tray	36.0
005271	Round display tray	42.0



		Dim in cm
012365	Long oval fish tray	70.0x31.5
012366	Long oval fish tray	80.0x40.5



		Dim in cm
005273	Rectangular display tray	24.0x18.0
005274	Rectangular display tray	30.5x23.0
005275	Rectangular display tray	33.0x25.0
005276	Rectangular display tray	42.0x28.0
005277	Rectangular display tray	47.0x36.0
005278	Rectangular display tray	60.0x47.0



		Dim in cm
019803	Rectangular heavy tray with handles	40.0x26.0
019804	Rectangular heavy tray with handles	50.0x38.0
019805	Rectangular heavy tray with handles	65.0x50.0

Stainless steel

		Cap. ltr
017500	Tea pot with lid and filter	0.13
017501	Tea pot with lid and filter	0.25
019810	Tea pot with lid and filter	0.35
019811	Tea pot with lid and filter	0.60



		Cap. ltr
019815	Coffee pot with lid	0.35
019816	Coffee pot with lid	0.60
019817	Coffee pot with lid	0.90
019818	Coffee pot with lid	1.50
019819	Coffee pot with lid	2.00



		Cap. ltr
019820	Creamer/milk jug	0.15
017502	Creamer/milk jug	0.25
019821	Creamer/milk jug	0.35
019822	Creamer/milk jug	0.60
019823	Creamer/milk jug	0.80
019824	Creamer/milk jug	1.30
019825	Creamer/milk jug	2.00



		Cap. ltr
019831	Insulated thermos jug	0.3
019832	Insulated thermos jug	0.6
019833	Insulated thermos jug	0.9
019834	Insulated thermos jug	1.5
017503	Insulated thermos jug	2.0



Polycarbonate

		P/U	Ø cm	Cap ltr	H in cm
010157	Jug	12	22.0	2.0	26.1



Stainless steel



019840	Condiment set, consisting of pepper/salt shaker, tooth stick, glass with s/s cover
--------	--



019843	Condiment set, consisting of oil/vinegar glass bottle, pepper/salt shaker, s/s
--------	--



		Ø cm	H in cm
019845	Cheese bowl with frame and lid frame, s/s	10.0	7.0



		Cap. ltr
019846	Gravy boat with foot and handle	0.15
017504	Gravy boat with foot and handle	0.20
019847	Gravy boat with foot and handle	0.30



		Ø cm	Cap. ltr
000900	Soup tureen with foot and lid	15.5	1.0
007246	Soup tureen with foot and lid	19.0	1.5
000901	Soup tureen with foot and lid	22.5	2.5
000902	Soup tureen with foot and lid	25.0	4.5



		Ø cm	H in cm
001018	Snail pan with 6 holes	13.5	1.5



019861	Snail fork and tong set
--------	-------------------------



		Dim in cm
008804	Bread basket oval, poly rattan	23.0x16.5x9.0



		Dim in cm
005594	Bread basket round, stackable, poly rattan	20.0x7.0



		Dim in cm
018525	Bread basket rectangular, poly rattan	31.5x22.0x8.5



		Dim in cm
018510	Bread basket with 2 handles, poly rattan	40.0x7.5

		Dim in cm
018526	Bread basket rectangular, poly rattan	43.0x40.0x17.0/25.0
018500	Parisian bread basket, poly rattan	Ø cm H in cm 35.0 42.0
018501	Buffet basket on 2 levels, with 2 baskets, nature, dimension of the baskets: 32.5x25.5x8.0cm, poly rattan	Dim in cm 29.0x27.0x35.0
035538	Bread basket oval, silver wire	Dim in cm 20.0x16.5x6.0
054209	Buffet basket round, wire frame, stackable, poly rattan	Dim in cm 40.0x20.0
054214	Cover for round buffet basket, with chrome handles	Dim in cm 38.0x20.0



Walnut wood

004140	Tray stand slant	Dim in cm 72.5x51.0x5.0/22.0
004133	Serving tray Solid with 2 recessed grips	Dim in cm 53.0x37.0x4.0
007882	Cutting board for bread incl. crumb grid	Dim in cm 48.0x32.5x4.3
007883	Cutting board	Dim in cm 48.0x32.5x4.8
007884	Wooden bridge	Dim in cm 54.0x17.0x16.0
007885	Wooden bridge with 3 holes	Dim in cm 54.0x17.0x12.0





Andy Mannhart



STORAGE & CLEANING

Boxes, Dish Washing, Brushes, Clogs

5

Polyethylene

FOOD CONTAINERS

yellow	green	white	red	blue	grey	P/U	Cap. ltr	Dim in cm
		074104			074113	6	37.9	39.7x43.5
074108	006495	074105		006496	074114	6	75.7	49.5x58.1
006497	006498	074106	074111	006499	006500	6	121.1	55.9x69.2
					006505	3	208.2	67.3x83.8

LIDS

yellow	green	white	red	grey	P/U	Cap. ltr	Ø cm
		074118		074127	6	37.9	40.6
074122	006506	074119		006508	6	75.7	50.5
006509	006511	074120	074125	006512	6	121.1	56.5
		074121		006525	4	166.5	62.2
				006526	3	208.2	67.9



		P/U	Dim in cm
074138	Dolly for 75.7, 121.1, 166.5 and 208.2ltr round container	2	46.4x16.8



Plastic



		P/U	Cap. ltr	Dim in cm
074132	Food container, red	6	106.0	54.6x54.6x57.2
074134	Food container, white	6	106.0	54.6x54.6x57.2
074136	Food container, grey	6	106.0	54.6x54.6x57.2
074149	Food container, yellow	6	106.0	54.6x54.6x57.2

		P/U	Cap. ltr
074133	Lid for square container, red	6	106.0
074135	Lid for square container, white	6	106.0
074137	Lid for square container, grey	6	106.0

Polyethylene



		Cap. ltr	Dim in cm
013019	Food bucket round with lid, white	0.22	9.7x4.0
013020	Food bucket round with lid, white	0.25	7.8x9.0
013021	Food bucket round with lid, white	0.40	11.5x5.4
013022	Food bucket round with lid, white	0.70	11.5x8.8
013023	Food bucket round with lid, white	1.00	13.5x11.0
013024	Food bucket round with lid, white	2.00	16.8x14.3



		Cap. ltr	Dim in cm
013040	Food box rectangular with snap-lid, white	0.5	10.0x10.0x6.5
013041	Food box rectangular with snap-lid, white	1.0	10.0x10.0x13.0
013042	Food box rectangular with snap-lid, white	1.0	10.0x20.0x6.5
013043	Food box rectangular with snap-lid, white	1.5	10.0x20.0x9.5
013045	Food box rectangular with snap-lid, white	2.0	20.0x20.0x6.5
013046	Food box rectangular with snap-lid, white	3.3	20.0x20.0x9.5

Polypropylene



		Cap. ltr	Dim in cm
013090	Food bucket round with lid, white	1.0	13.0x13.0
013091	Food bucket round with lid, white	2.0	18.0x16.3
013092	Food bucket round with lid, white	3.0	22.5x14.8
013093	Food bucket round with lid, white	5.0	22.5x20.3
013094	Food bucket round with lid, white	10.0	29.0x23.5
013095	Food bucket round with lid, white	12.0	29.0x28.0
013096	Food bucket round with lid, white	20.0	33.0x33.5
013097	Food bucket round with lid, white	30.0	38.5x39.0

Stainless steel



		Ø cm	Cap. ltr	H in cm
019226	Bucket conical with base, scale and handle	30.0	10.0	26.5
001203	Bucket conical with base, scale and handle	31.0	12.0	29.0
019228	Bucket conical with base, scale and handle	32.5	15.0	32.5

		Ø cm
008302	Lid to bucket 019226	30.0
019230	Lid to bucket 001203	31.0
019231	Lid to bucket 019228	32.5

Plastic

		Cap. ltr	Depth in cm
028001	GN container 1/1, 53.0x32.5, white	27.2	20.0
028002	GN container 1/1, 53.0x32.5, white	20.5	15.0
028003	GN container 1/1, 53.0x32.5, white	13.5	10.0
028007	GN container 1/2, 32.5x26.5, white	12.3	20.0
028008	GN container 1/2, 32.5x26.5, white	9.3	15.0
028009	GN container 1/2, 32.5x26.5, white	6.0	10.0
028011	GN container 1/3, 32.5x17.6, white	5.5	15.0
028012	GN container 1/3, 32.5x17.6, white	3.8	10.0
028016	GN container 1/6, 16.2x17.6, white	2.3	15.0
028017	GN container 1/6, 16.2x17.6, white	1.6	10.0
028018	GN container 1/9, 17.6x10.8, white	0.9	10.0

		GN Size	Dim in cm
028020	Lid, white	1/1	53.0x32.5
028022	Lid, white	1/2	32.5x26.5
028023	Lid, white	1/3	32.5x17.6
028025	Lid, white	1/6	16.2x17.6
028026	Lid, white	1/9	17.6x10.8



Polypropylene

		Dim in cm
013054	Mis en place tray, white	31.0x25.0x6.5
013055	Mis en place tray, white	37.0x31.0x7.5
013056	Mis en place tray, white	52.0x42.0x12.0
013057	Mis en place tray, white	63.4x53.4x14.0
013058	Mis en place tray, white	84.8x64.8x16.0



Polyethylene

		Cap. ltr	Colour
022050	Squeeze dispenser	0.24	clear
022051	Squeeze dispenser	0.24	yellow
022052	Squeeze dispenser	0.24	red
022053	Squeeze dispenser	0.36	clear
022054	Squeeze dispenser	0.36	yellow
022055	Squeeze dispenser	0.36	red
022056	Squeeze dispenser	0.72	clear
022057	Squeeze dispenser	0.72	yellow
022058	Squeeze dispenser	0.72	red



		Cap. ltr	Colour
017199	Twin squeeze dispenser	0.2	clear
017200	Tri squeeze dispenser	0.5	clear



		Ø cm	Cap. ltr	H in cm
013171	Spraying bottle	2.5	1.0	25.5



Polyethylene



		Cap. ltr	Dim in cm
742281	Ingredient bin movable, with sliding lid	81.0	33.0x74.9x71.1



		Cap. ltr	Dim in cm
744501	Ingredient bin movable, with sliding lid	102.0	42.0x75.0x71.0



		Cap. ltr	Dim in cm
744521	Ingredient bin movable, with sliding lid	140.0	55.0x75.0x71.0



		Cap. ltr	Dim in cm
742291	Ingredient bin movable, with flat lid	129.0	38.7x74.9x73.6



		Cap. ltr	Dim in cm
744511	Ingredient bin movable, with flat lid	121.0	56.0x61.0x58.5



		Cap. ltr	Dim in cm
744531	Ingredient bin movable, with flat lid	161.0	47.0x75.0x74.0



		Cap. ltr	Dim in cm
744541	Vegetable crisper movable, with threaded faucet drain and polycarbonate drain shelf, clear polycarbonate sliding lid	121.0	55.8x60.9x58.4

Polypropylene

THE STACKABLE BOX SYSTEM

The standard dimensions are 80.0x60.0cm, 60.0x40.0cm, 40.0x30.0cm, 30.0x20.0cm and 20.0x10.0cm
Corresponding with most of the international pallet sizes in use. Shock and scratch resistant.

Stackable box 80.0x60.0cm

	grey	Cap. ltr	H in cm
	028320	45.0	12.0
	028360	90.0	22.0
	028370	134.0	32.5
	028380	175.0	42.5



Lid plain 80.0x60.0cm

	dark grey
	028425



Stackable box 60.0x40.0cm

red	blue	yellow	green	grey	Cap. ltr	H in cm
				034500	8.0	5.0
				034510	12.5	7.3
				034511	15.0	8.0
039564	039565	039566	039567	034512	20.0	12.0



Stackable box with hand-holes 60.0x40.0cm

red	blue	yellow	green	grey	Cap. ltr	H in cm
				034513	27.0	15.0
039572	039573	039574	039575	034514	33.0	17.0
				034515	40.0	20.0
039576	039577	039578	039579	034516	42.0	22.0
				034517	47.0	24.0
				034518	52.0	27.0
				034519	55.0	29.0
039584	039585	039586	039587	034520	60.0	32.0
				034509	76.0	40.0



Lid plain 60.0x40.0cm

red	blue	yellow	green	grey
039863	039864	039865	039866	034521



Stackable box with hand-holes, side perforated 60.0x40.0cm

	grey	Cap. ltr	H in cm
	034522	23.0	12.0
	034523	29.0	15.0
	034524	33.0	17.0
	034525	43.0	22.0
	034526	63.0	32.0
	034527	69.0	35.0
	034528	83.0	42.0



Polypropylene



Lid plain for perforated box 60.0x40.0cm

grey
034529



Stackable box 40.0x30.0cm

red	blue	yellow	green	grey	Cap. Ltr	H in cm
				034483	6.0	7.0
039560	039561	039562	039563	034484	10.0	12.0



Stackable box with hand-holes 40.0x30.0cm

red	blue	yellow	green	grey	Cap. Ltr	H in cm
039568	039569	039570	039571	034485	15.0	17.0
039580	039581	039582	039583	034486	20.0	22.0
				034488	22.0	24.0
				034489	25.0	27.0
039867	039868	039869	039870	034490	30.0	32.5
				034494	35.0	36.0



Lid plain 40.0x30.0cm

red	blue	yellow	green	grey
039556	039557	039558	039559	034495



Stackable box 30.0x20.0cm

grey	Cap. Ltr	H in cm
034481	5.0	12.0



Lid plain 30.0x20.0cm

grey
034482

Polypropylene

Stackable box 60.0x40.0cm

red	blue	yellow	green	grey	Cap. Ltr	H in cm
034131	034132	034133	034134	034135	9.5	5.0
034136	034137	034138	034139	034140	14.7	7.5
034141	034142	034143	034144	034145	22.0	12.0
034146	034147	034148	034149	034150	26.0	14.5
034151	034152	034153	034154	034155	33.0	17.5



Stackable box with hand-holes 60.0x40.0cm

red	blue	yellow	green	grey	Cap. Ltr	H in cm
034156	034157	034158	034159	034160	40.0	21.0
034161	034162	034163	034164	034165	51.0	27.0
034166	034167	034168	034169	034170	61.0	32.0



Stackable box, side perforated 60.0x40.0cm

red	blue	yellow	green	grey	Cap. Ltr	H in cm
034305	034304	034303	034306	034307	9.5	5.0
034308	034309	034310	034311	034312	14.7	7.5
034313	034314	034315	034316	034317	22.0	12.0
034318	034320	034321	034322	034323	26.0	14.5
034324	034328	034325	034326	034327	33.0	17.5



Stackable box with hand-holes, side perforated 60.0x40.0cm

red	blue	yellow	green	grey	Cap. Ltr	H in cm
034329	034330	034331	034332	034333	40.0	21.0
034339	034340	034341	034342	034343	51.0	27.0
034344	034345	034346	034347	034348	61.0	32.0



Lid plain 60.0x40.0cm

red	blue	yellow	green	grey	black
034171	034172	034173	034174	034175	034176



Stackable box, side perforated 40.0x30.0cm

red	blue	yellow	green	grey	Cap. Ltr	H in cm
034202	034203	034204	034205	034206	4.6	5.0
034207	034208	034209	034211	034212	7.0	7.5
034213	034214	034215	034216	034217	10.0	12.0
034218	034224	034226	034228	034230	13.0	14.5
034232	034234	034235	034238	034239	15.0	17.5



Polypropylene

Stackable box with hand-holes, side perforated 40.0x30.0cm



red	blue	yellow	green	grey	Cap. Ltr	H in cm
034243	034244	034246	034247	034248	19.0	21.0
034249	034257	034260	034261	034264	24.0	27.0
034265	034266	034267	034268	034269	29.0	29.0

Lid plain 40.0 x 30.0cm



red	blue	yellow	green	grey	black
034270	034298	034299	034300	034301	034302

Stackable box, side perforated 30.0x20.0cm



red	blue	yellow	green	grey	Cap. Ltr	H in cm
034183	034184	034185	034186	034187	5.5	14.5

Lid plain 30.0x20.0cm



red	blue	yellow	green	grey	black
034196	034197	034198	034199	034200	034201

Stackable box, side perforated 20.0x10.0cm



red	blue	yellow	green	grey	Cap. Ltr	H in cm
034177	034179	034180	034181	034182	1.0	12.0

Lid plain 20.0x10.0cm



red	blue	yellow	green	grey	black
034188	034190	034191	034192	034193	034194

Tinned



		Cap. kg
028460	Dolly expandable, tinned, galvanized with 4 swivel casters	80.0



		Cap. kg	Dim in cm
028435	Dolly, plastic	500.0	80.0x60.0x20.0



		Cap. kg	Dim in cm
039214	Dolly, plastic	150.0	61.0x41.0x16.0



		Cap. kg	Dim in cm
028450	Dolly, plastic	100.0	38.0x28.0x13.5



		Cap. kg	Dim in cm
028670	2-storey trolley galvanized, suitable for all containers 60.0x40.0cm and 40.0x30.0cm	150.0	61.0x41.0x50.0

Plastic



		Cap. ltr	Dim in cm
028600	Food storage box, on wheels	20.0	40.0x30.0x23.5
028620	Food storage box, on wheels	60.0	60.0x40.0x34.0
028630	Food storage box, on wheels	90.0	60.0x40.0x44.0



		Cap. ltr	Outside Dim in cm
034996	Cool box insulated, blue, with white lid inside dim=48.0x27.0x30.5cm	35.0	55.5x33.3x41.5

		Cap. ltr	Dim in cm
056750	Material trolley, complete in s/s, deep-drawn, with hinged lid, 4 casters	90.0	59.5x42.0x60.5



		Cap. ltr	Dim in cm
056746	Material trolley, complete in plastic, seamless, molded-in pushing handle, with hinged lid, drainage cock, 4 casters	90.0	70.0x46.0x67.0



Made of polyethylene with thick foam insulation, keeps ice frozen for days! With non-drip, recessed faucet for convenience draining, available in 4 different colours (grey, green, red, sand)

		Cap. ltr	Dim in cm
744561	Ice caddy insulated, with non-drip recessed faucet, sliding lid, molded-in handles, recesses handle on front end, 2 easy wheels, 1 swivel caster and 1 caster with brake	80.0	86.5x58.5x95.5

		Cap. ltr	Dim in cm
744571	Ice caddy insulated, with non-drip recessed faucet, sliding lid, molded-in handles, recesses handle on front end, 2 easy wheels, 1 swivel caster and 1 caster with brake	57.0	80.0x58.5x74.5

		Cap. ltr	Dim in cm
744581	Ice caddy insulated, with non-drip recessed faucet, sliding lid, molded-in handles, recesses handle on front end, 2 easy wheels, 1 swivel caster and 1 caster with brake	57.0	80.0x58.5x88.0

		Cap. ltr	Dim in cm
744591	Ice caddy insulated, with non-drip recessed faucet, sliding lid, molded-in handles, recesses handle on front end, 2 easy wheels, 1 swivel caster and 1 caster with brake	80.0	97.8x62.2x76.8



Plastic



		Cap. ltr	Dim in cm
028700	Garbage container with lid	180.0	85.0x60.0x50.0



		Cap. ltr	Dim in cm
028710	Garbage container with lid, on casters	180.0	85.0x60.0x50.0



		P/U	Cap. ltr	Dim in cm
074141	Garbage container with green lid, wheels	4	100.0	50.5x52.5x80.0
074142	Garbage container with blue lid, wheels	4	100.0	50.5x52.5x80.0
074143	Garbage container with yellow lid, wheels	4	100.0	50.5x52.5x80.0
074144	Garbage container with beige lid, wheels	4	100.0	50.5x52.5x80.0
074151	Garbage container with black lid, wheels	4	100.0	50.5x52.5x80.0
074153	Garbage container with red lid, wheels	4	100.0	50.5x52.5x80.0



		Ø cm	Cap. ltr	H in cm
013160	Garbage container, black	44.0	50.0	46.0



		Ø cm		
013162	Lid to garbage container 013160	44.0		

Polyethylene

GARBAGE CONTAINER FOOT OPERATED



beige	white	red	yellow	grey	black	blue	green	Cap. Ltr	Dim in cm
031546	031861	031840	031841	031846	031849	031852	031859	30	42.5x27.1x53.6
031547	031860	031839	031842	031845	031848	031851	031858	50	45.6x29.2x71.9
031548	031556	031557	031843	031844	031847	031850	031857	68	50.0x31.1x80.3
031549*	031555*	031554*	031551*	031837*	031838*	031550*	031552*	90	57.0x35.3x82.6

*with built in wheels

Plastic



		Cap. kg	Dim in cm
028560	Hygienic pallet, redbrown	1500.0	120.0x80.0x16.0
028561	Hygienic pallet reinforced, brown	1500.0	120.0x80.0x16.0



Compatible with the stackable boxes on page 5.04

Polypropylene

The one and only: Andy Mannhart glass and plate baskets usable opened for cleaning or closed for transporting and storing. Stackable with other market baskets.

Washing: Higher cleaning

Transport: Higher security

Storing: Higher hygiene

Glass basket for 9 glasses, 50.0x50.0cm, glass max. Ø 15.1cm

		H in cm	Max. glass height cm
016226	Glass basket	10.0	8.0
009445	Glass basket with 1 extender	14.0	12.0
009446	Glass basket with 2 extenders	18.0	16.0
009447	Glass basket with 3 extenders	22.0	20.0
009448	Glass basket with 4 extenders	26.0	24.0
009450	Glass basket with 5 extenders	30.0	28.0



Glass basket for 16 glasses, 50.0x50.0cm, glass max. Ø 11.3cm

		H in cm	Max. glass height cm
012378	Glass basket	10.0	8.0
009451	Glass basket with 1 extender	14.0	12.0
009452	Glass basket with 2 extenders	18.0	16.0
009453	Glass basket with 3 extenders	22.0	20.0
009454	Glass basket with 4 extenders	26.0	24.0
009455	Glass basket with 5 extenders	30.0	28.0



Glass basket for 25 glasses, 50.0x50.0cm, glass max. Ø 8.9cm

		H in cm	Max. glass height cm
012389	Glass basket	10.0	8.0
009456	Glass basket with 1 extender	14.0	12.0
009457	Glass basket with 2 extenders	18.0	16.0
009458	Glass basket with 3 extenders	22.0	20.0
009459	Glass basket with 4 extenders	26.0	24.0
009460	Glass basket with 5 extenders	30.0	28.0



Glass basket for 36 glasses, 50.0x50.0cm, glass max. Ø 7.3cm

		H in cm	Max. glass height cm
014521	Glass basket	10.0	8.0
009461	Glass basket with 1 extender	14.0	12.0
009462	Glass basket with 2 extenders	18.0	16.0
009463	Glass basket with 3 extenders	22.0	20.0
009464	Glass basket with 4 extenders	26.0	24.0
009465	Glass basket with 5 extenders	30.0	28.0



Glass basket for 49 glasses, 50.0x50.0cm, glass max. Ø 6.3cm

		H in cm	Max. glass height cm
012392	Glass basket	10.0	8.0
009466	Glass basket with 1 extender	14.0	12.0
009467	Glass basket with 2 extenders	18.0	16.0
009468	Glass basket with 3 extenders	22.0	20.0
009469	Glass basket with 4 extenders	26.0	24.0
009470	Glass basket with 5 extenders	30.0	28.0



		Dim in cm
073641	Trolley for glass and plate baskets with pushing handle, s/s	98.0x54.0x54.0



		Dim in cm
073640	Trolley for glass and plate baskets without handle	54.0x54.0x23.0



Polypropylene



PLATE BASKET 50.0x50.0cm

		Max. plate Ø in cm	Max. plate H in cm
009758	Plate basket for 14 plates	27.0-31.0	3.5



		Max. plate Ø in cm	Max. plate H in cm
009760	Plate basket for 15 plates	23.0-28.0	3.5



		Max. plate Ø in cm	Max. plate H in cm
009776	Plate basket for 19 plates	28.0-30.5	2.5



		Max. plate Ø in cm	Max. plate H in cm
009777	Plate basket for 20 plates	25.0-28.0	2.5



		Max. plate Ø in cm	Max. plate H in cm
009778	Plate basket for 21 plates	23.0-25.0	2.5



		Max. plate Ø in cm	Max. plate H in cm
009781	Plate basket for 30 plates	20.0-22.0	2.5

Polypropylene

		Max. plate Ø in cm	Max. plate H in cm
009784	Plate basket for 32 plates	12.0-19.0	2.5



		Max. plate Ø in cm	Max. plate H in cm
009785	Plate basket for 44 plates	15.0-18.0	2.5



		Max. plate Ø in cm	Max. plate H in cm
009787	Plate basket for 63 plates	10.0-13.0	2.5



		Dim in cm
026100	Plate and tray basket	50.0x50.0x10.0



		Dim in cm
026096	Universal open basket	50.0x50.0x10.0



		Dim in cm
026098	Flatware basket	50.0x50.0x10.0



Plastic



		Dim in cm
025985	Flatware rack with wire handles, 8 compartments	42.5x22.0x14.5

		Dim in cm
025983	Flatware rack without handles, 8 compartments	42.5x22.0x14.5



		Dim in cm
025984	Flatware basket	10.0x10.0x14.0



		Dim in cm
007393	Knife-Hygiene-Box for 4 knives and 1 steel incl. holder for sharp easy, blue	55.0x17.0x7.0



		Dim in cm
007394	Knife-Hygiene-Box for 4 knives and 1 steel incl. holder for sharp easy, yellow	55.0x17.0x7.0



		Dim in cm
007395	Knife-Hygiene-Box for 4 knives and 1 steel incl. holder for sharp easy, green	55.0x17.0x7.0



		Dim in cm
007396	Knife-Hygiene-Box for 4 knives and 1 steel incl. holder for sharp easy, red	55.0x17.0x7.0



		Dim in cm
007397	Knife-Hygiene-Box for 4 knives and 1 steel incl. holder for sharp easy, black	55.0x17.0x7.0

		Dim in cm	
071401	Broom with coco bristles, wood	50.0x5.6x6.7	
071402	Broom with coco bristles, wood	80.0x5.6x6.7	
		L in cm	
071403	Broomstick with holder straight, wood	150.0	
		Dim in cm	
071405	Counter brush with coco bristles, wooden handle	36.0x6.7	
		Dim in cm	
071406	Scrub brush "S-shape", wood	19.4x6.2x3.0	
		Dim in cm	
071408	Casserole brush soft, wooden handle	32.0x5.5x3.5	
		L in cm	
071422	Oven broom, wood	50.0	
		L in cm	
071423	Broomstick, wood	150.0	
		L in cm	
026021	Flour brush red, polypropylene	29.0	
		L in cm	
002252	Bread brush, polypropylene	39.5	
		Dim in cm	
026018	Scrub brush and broom, bristle height 5.0cm, soft, polypropylene	40.0x6.0x12.0	
		Dim in cm	
026019	Floor cleaner (squeegee), bristle height 2.5cm, polypropylene	62.0x3.5x10.5	
		L in cm	
026020	Broomstick, alu anodised, handle and lock made of polypropylene	145.0	
		Dim in cm	
071410	Bottle/glasse brush, nylon handle	32.0x6.0	
		Dim in cm	
071411	Utility brush, nylon handle	23.5x7.5	
		Ø cm	L in cm
024496	Pastry brush, round, plastic handle	1.5	21.0





		L in cm	Dim in cm
012163	Pastry brush, synthetic bristles, polypropylene handle	24.0	4.0
018954	Pastry brush, synthetic bristles, polypropylene handle	24.0	5.0
012241	Pastry brush, synthetic bristles, polypropylene handle	24.0	6.0
012240	Pastry brush, synthetic bristles, polypropylene handle	24.5	7.5



			Dim in cm
071425	Grill brush with 2 rows		29.0x2.5x3.0
071426	Grill brush with 4 rows		29.0x3.5x3.0



			Dim in cm
071427	Grease brush with 2 rows		29.0x2.5x2.7
071428	Grease brush with 4 rows		29.0x3.5x2.7



			Dim in cm
071429	Grill brush with scraper with 4 rows		29.0x3.5x3.0



		L in cm	
020451	Block brush, steel bristles	20.0	



			Dim in cm
090301	Strainer towel 100% linen		80.0x80.0



			Dim in cm
090305	Glass towel, 58% cotton, 42% linen, white with blue, red or green stripes		50.0x90.0



			Dim in cm
090306	Service towel, thread-half-linen		47.0x60.0



			Dim in cm
090306	Service towel, thread-half-linen		47.0x60.0



			Dim in cm
090306	Service towel, thread-half-linen		47.0x60.0



			Dim in cm
090308	Chef-torchon, 100% cotton		45.0x80.0



			Dim in cm
090312	Cleaning towel, 100% cotton		40.0x80.0

		L in cm	
013100	Box with 100 disposable gloves, transparent	30.0	
			Size
013110	Latex gloves, yellow		S
013111	Latex gloves, yellow		M
013112	Latex gloves, yellow		L
		L in cm	Size
071310	Cold protection gloves, cotton looped fabric	30.0	S
		L in cm	Size
071311	Cold protection gloves, cotton looped fabric	30.0	M
071314	Mitten oven gloves, cotton looped fabric, one size		
			Dim in cm
009681	Baking mittens long cuffs, natural colour, special cotton fabric, reinforced palm and thumb, heat resistant up to +200°C, machine-washable up to 40°C		40.0x15.0
		L in cm	
022000	Heat insulation gloves, made of leather, double fabric, inner layer, usable up to 300°C	10.0	
022007	Heat insulation gloves, made of leather, double fabric, inner layer, usable up to 300°C	20.0	
		L in cm	
022014	Heat insulation gloves, made of leather with woollen inner layer, usable up to 300°C	10.0	
022015	Heat insulation gloves, made of leather with woollen inner layer, usable up to 300°C	20.0	
		L in cm	
071319	Oven mitt, flame retardant silicone coating, cotton	33.0	
071322	Oven mitt, flame retardant silicone coating, cotton	38.0	
071323	Oven mitt, flame retardant silicone coating, cotton	43.0	
			Size
071320	Finger gloves, cotton terry		M
071321	Finger gloves, cotton terry		L
			Size
020607	Safety chainmail glove orange		XL
020606	Safety chainmail glove blue		L
020605	Safety chainmail glove red		M
020604	Safety chainmail glove white		S
020603	Safety chainmail glove green		XS
020602	Safety chainmail glove brown		XXS





		Dim in cm
010944	Apron with adjustable neck tie, white, vinyl	100.0x75.0
003607	Apron with adjustable neck tie, white, vinyl	115.0x90.0
011327	Apron with adjustable neck tie, white, vinyl	130.0x90.0



		Dim in cm
090310	Apron without front flap, 100% cotton	90.0x100.0



		Size in cm
028750	Butcher safety apron, s/s	80.0x55.0



024833	Freezer jacket model X33 "high-visibility", rotproof thread, twin seam, very durable Cordura texture, warming hand pockets, reach easy sleeves, washable at 40°C, suitable for freezers up to -51°C, available in sizes XS, S, M, L, XL, 2XL, 3XL, 4XL
--------	--

SAFETY CLOGS WITH STEEL TOE CAP, NON SLIP SOLE, IN PAIRS



black	white		Size
014736	014712	Safety clogs with steel toe cap	35
014739	014716	Safety clogs with steel toe cap	36
014740	014720	Safety clogs with steel toe cap	37
014742	014721	Safety clogs with steel toe cap	38
014744	014722	Safety clogs with steel toe cap	39
014745	014723	Safety clogs with steel toe cap	40
014746	014725	Safety clogs with steel toe cap	41
014747	014726	Safety clogs with steel toe cap	42
014749	014728	Safety clogs with steel toe cap	43
014750	014730	Safety clogs with steel toe cap	44
014752	014731	Safety clogs with steel toe cap	45
014754	014732	Safety clogs with steel toe cap	46
014755	014734	Safety clogs with steel toe cap	47
014760	014735	Safety clogs with steel toe cap	48

KITCHEN CLOGS WITH HEEL STRAP, LEATHER SURFACE, NON-SLIP, IN PAIRS

black	white		Size
055936	055836	Kitchen clogs with heel strap	36
055937	055837	Kitchen clogs with heel strap	37
055938	055838	Kitchen clogs with heel strap	38
055939	055839	Kitchen clogs with heel strap	39
055940	055840	Kitchen clogs with heel strap	40
055941	055841	Kitchen clogs with heel strap	41
055942	055842	Kitchen clogs with heel strap	42
055943	055843	Kitchen clogs with heel strap	43
055944	055844	Kitchen clogs with heel strap	44
055945	055845	Kitchen clogs with heel strap	45
055946	055846	Kitchen clogs with heel strap	46



		Size
022328	Rubber boots	36
022329	Rubber boots	37
022330	Rubber boots	38
022331	Rubber boots	39
022332	Rubber boots	40
022333	Rubber boots	41
022334	Rubber boots	42
022335	Rubber boots	43
022336	Rubber boots	44
022337	Rubber boots	45
022338	Rubber boots	46



072010	Set of 10 chef's hats, high toque paper
--------	---



072011	Set of 100 chef's hats, ship size
--------	-----------------------------------



Plastic



		Dim in cm
028065	Cutlery box stackable	17.0x10.2x7.7
028066	Cutlery box stackable	23.0x14.7x13.2
028067	Cutlery box stackable	35.0x21.0x14.5
028068	Cutlery box stackable	50.0x31.0x14.5
028069	Cutlery box stackable	50.0x31.0x20.0



		Dim in cm
072000	Cutlery box	29.0x12.7x10.5



		Dim in cm
072001	Cutlery box stand with 4 boxes	27.0x22.0x23.5
072002	Cutlery box stand with 6 boxes	38.5x22.0x23.5
072003	Cutlery box stand with 8 boxes	51.5x22.0x23.5



		Dim in cm
042100	Cutlery box with 4 compartments GN-size	53.0x32.5x10.0

Plastic coated steel



		Ø cm	H in cm
021127	Plate holder cassette	13.0	30.0
021128	Plate holder cassette	15.0	30.0
021129	Plate holder cassette	17.0	30.0
021130	Plate holder cassette	20.0	30.0
021131	Plate holder cassette	22.0	30.0
021132	Plate holder cassette	25.5	30.0
021133	Plate holder cassette	28.0	30.0
021134	Plate holder cassette	32.0	30.0

Stainless steel



		Dim in cm
026031	Clingfilm tear-off-dispenser double, made of s/s with saw for endless rolls Ø 8.0cm, width of foil 45.0cm	50.0x24.5x9.0

Satinated aluminium



		L in cm
070701	Tab grabber	60.0
070704	Tab grabber	90.0



070603	Revolving desk recipe holder with 40 metal frames (80 pages) for size A4
--------	--



027387	Recipe holder, A4 wall fastening with 10 metal frames (20 pages) 10 files with black coloured frame
--------	--



		P/U
070606	Files A4 for recipe holder, black frame, to 027387	5

Polyester fibreglass reinforced, dishwasher proof, temperature resistant from -50°C to +140°C, resistant to food, acids and alcohol, virtually unbreakable

		Dim in cm
026026	Tray rectangular, light grey	46.0x36.0x2.5
026027	Tray rectangular, granite grey	46.0x36.0x2.5



		Dim in cm
026029	Tray oval, granite grey	29.0x21.0x1.8



Griptite non-slip trays, colour black, heavy duty construction with metal reinforced rods which prevent warping. Rubber lines permanently bonded to the tray, cover, side wall and tray top to provide extra grip. Dishwasher safe

		P/U	Dim in cm
749011	Tray rectangular, non-slip	6	65.0x45.0
749021	Tray rectangular, non-slip	12	56.0x40.5
749031	Tray rectangular, non-slip	12	53.0x32.5
749041	Tray rectangular, non-slip	12	51.5x38.0
749051	Tray rectangular, non-slip	12	46.0x36.0
749061	Tray rectangular, non-slip	12	41.5x30.5
749091	Tray rectangular, non-slip	12	35.0x27.0



		P/U	Dim in cm
749101	Tray oval, non-slip	6	73.5x60.0
749111	Tray oval, non-slip	6	59.0x49.0
749121	Tray oval, non-slip	6	68.5x56.0



		P/U	Ø cm
749151	Tray round, non-slip	12	40.5
749161	Tray round, non-slip	12	35.5
749171	Tray round, non-slip	12	28.0



		Dim in cm
006908	Tray stand, folding, chrome plated	49.0x48.0x74.0





		Dim in cm
006638	Cleaning cart complete, consisting of frame with holder for garbage bag, lid to rubbish bag, mop trolley complete on casters with 2 buckets 18.0ltr, 1 mop press and 1 mop holder to attach to trolley	116.8x55.2x97.5



		Dim in cm
032326	Triple capacity cart, 12 bags, 4 yellow, 4 green and 4 red, each 128.0ltr, non-rusting, aluminium, 2 swivel casters and 2 wheels	131.4x55.9x111.8



		Dim in cm
074052	Mop trolley, down press wringer, separate dirty water bucket 33.0ltr, can be easily removed, accessory bucket, quiet caster dolly, moulded-in wavebrake system, yellow	73.4x46.2x98.0



		Dim in cm
074009	Mop trolley DUO complete, consisting of - 1 trolley with pushing handle - 2 buckets of 18.0ltr capacity each - 1 mop press for mops up to 480gr	59.0x41.0x49.0



		Colour
074010	Mop bucket on wheels with mop press 25.0ltr	green
074011	Mop bucket on wheels with mop press 25.0ltr	blue
074012	Mop bucket on wheels with mop press 25.0ltr	yellow
074013	Mop bucket on wheels with mop press 25.0ltr	red

		Colour	Dim in cm
074015	Mop press for all mops up to 500gr	blue	8.5x10.0x4.0

		P/U	Colour
074017	Anti-microbial mop 300gr, mixed texture	6	blue
074018	Anti-microbial mop 300gr, mixed texture	6	white



With anti-microbial protection, large plastic head, fibreglass handle

		P/U	Colour	L in cm
074021	Mop holder, fibreglass handle	12	blue	152.4
074022	Mop holder, fibreglass handle	12	grey	152.4



		P/U	Dim in cm
074060	Flexi frame with patented shape	6	28.0x11.0



		P/U
074066	Extension pole 50.8-101.6cm for flexi frames 074060	6



		P/U	Dim in cm
074061	Flexi frame damp cover for 074060	12	29.0x12.0



		P/U	Dim in cm
074062	Flexi frame high performance dust cover for 074060	12	29.0x12.0



		P/U	Dim in cm
074063	Flexi frame glass cover for 074060	12	29.0x12.0



		P/U	Dim in cm
074064	Flexi frame scrubber cover for 074060	12	29.0x12.0



		P/U	Dim in cm
074056	Microfibre cloth, withstands up to 90°C, zig-zag scrubbing stripes, yellow	12	40.0x40.0x0.2

074057	Microfibre cloth, withstands up to 90°C, zig-zag scrubbing stripes, red	12	40.0x40.0x0.2
--------	---	----	---------------

074058	Microfibre cloth, withstands up to 90°C, zig-zag scrubbing stripes, blue	12	40.0x40.0x0.2
--------	--	----	---------------

074059	Microfibre cloth, withstands up to 90°C, zig-zag scrubbing stripes, green	12	40.0x40.0x0.2
--------	---	----	---------------



		P/U	Dim in cm
074067	Flexible duster kit, for dry or damp use durable	6	72.5x5.7x1.0





		Dim in cm	
074025	Housekeeping cart complete consist of: -Plastic frame with molded in handles for stress-free pushing - Top shelf for soap, shampoo, conditioner, pen, note pads and other accessories - Vinyl bag for dirty laundry - 2 storage shelves	152.4x55.9x127.0	



		Cap. kg	Dim in cm
074027	Transport trolley with 3 shelves, black	90.7	85.4x47.3x95.9



		P/U	Cap. ltr	Dim in cm
074026	All purpose tub to 074027	2	15.1	31.5x18.0x17.0



		Cap. kg	Dim in cm
074028	Transport trolley with 2 shelves	226.0	99.0x45.0x85.0



		P/U	Dim in cm
074045	Sign "CAUTION" in 3 languages, foldable	6	96.5x30.5



		P/U	Dim in cm
074069	Pop-up cone "Caution" multilingual, incl storage tube, can be wall mounted	12	53.3x53.3x50.8



		Dim in cm
074068	Portable mobile barrier, up to 4.0m long, 16 panels, 2 wheels, 4 locking straps	60.0x35.0x100.0



		Cap. ltr	Dim in cm
074031	Ashtray with integrated dust bin	7.6	31.8x49.5



		Cap. ltr	Dim in cm
074036	Ashtray with integrated dust bin, snap lid, fireproof	94.6	45.7x107.3



		Cap. ltr	Dim in cm
074038	Dust bin snap lid, fireproof	56.8	39.1x92.7
074040	Dust bin snap lid, fireproof	94.6	45.0x106.7

		Dim in cm
011401	Glass washer for separate cleaning and rinsing in one sink, suitable for all normal glass sizes	31.0x19.0x34.0
010400	<p>Conveyorised metal burnisher Goliath 2000 type B</p> <p>A large number of small balls made of hardened and highly polished steel continuously roll in a container filled with cold soapwater. The products to be polished are inserted into the steel balls mass for a few minutes. The balls smoothen and roll the scratched surface, condense and harden the metal surface by the combined pressure of the balls. This method permits the original sparkling shine to be maintained or regained by a mechanical mean. The harder and "closed" surface is more resistant to wear and oxidation.</p> <p>The insertion and removal of the products is done non-stop.</p> <p>Approx. 150 pcs of cutlery can be polished per filling in approx. 3 minutes, or a number of other products, such as sauce boats, bowls, casseroles, wine coolers and platters, 1x230V/50-60Hz, 330W</p> <p>Following material can be polished: solid silver, silver-/gold-plated, copper, brass, stainless steel, aluminium, high gloss pewter and bronze.</p> <p>Complete with:</p> <ul style="list-style-type: none"> - 70kg carbon steel balls - 1 compartment device - 5 knife polishing device 	



		Dim in cm
023687	Knee operated hand wash basin, TS2000N, s/s, knee push button at the front, with back splash, bowl dim 35.0x27.5x8.0cm, wall fixation, with paper bin underneath basin and nail brush	44.0x40.0x75.5





		Dim in cm
011141	High pressure cold water cleaner Poseidon 2-22 XT, pressure 130bar, water flow 520.0ltr/hour, high pressure hose 15.0m, detergent tank, 230V/50Hz, 2.3KW	30.0x35.0x90.0



		Cap. ltr	Dim in cm
010801	Vacuum cleaner wet and dry Attix 751-11, air flow 3600.0ltr/hour, 230V/50Hz	70.0	60.5x58.0x97.0



		Cap. ltr	Dim in cm
011143	Wet and dry cleaner Attix 30-21 PC, air flow 3700.0ltr/hour, with push & clean filter system, compact, suitable for fine dust, 230V/50Hz, 1.5kW	30.0	45.0x38.0x59.5



011121	Rotary brush, driven by the pressure of water
--------	---



011125	Extension hose 7.0m
--------	---------------------

ALUMINIUM AND POLYETHYLENE MODULAR SHELVING

Anticorrosive – Rust-resistant shelving. Manufactured with special anodised aluminium frame providing cold and heat resistance from -30°C to +75°C.

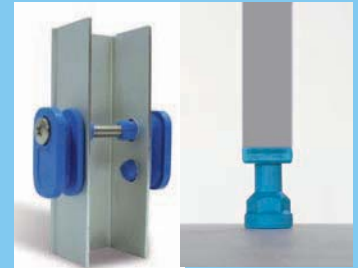

Support for grossbars

Levelling feet with hidden thread, for gradient floor



Possibility to adapt wheels Ø=12.5cm

POLYETHYLENE RACK/SHELVES, SUITABLE FOR FOODSTUFF USE.

EASY AND QUICK ASSEMBLY – Very easy and quick assembly. No tools required.

ROBUSTNESS AND RESISTANCE – Very strong and resistant with a load capacity per shelf of 120.0kg and 300.0kg total shelving. Rack/shelves with a special design providing robustness to itself and providing also a very strong and resistant support on the frame.

GASTRONORM COMPATIBILITY – Adapted to GN sizes 1/1 and 2/3. It is possible to put the rack/shelves or directly the 1/1 and 2/3 GN containers, stainless steel or polycarbonate (compatible with most of gastronorm pans in the market).



GN 1/1 (55.5cm)

GN 2/3 (38.5cm)

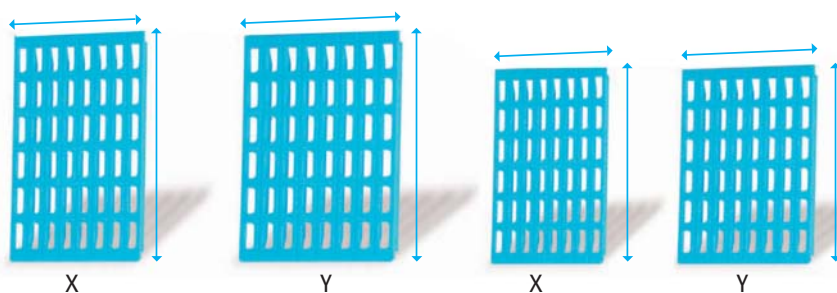

Combining rack shelves among the same group (X/Y) allows to personalize the length of each shelf

Angled shelves: depth 38.5cm adaptable to GN containers 2/3

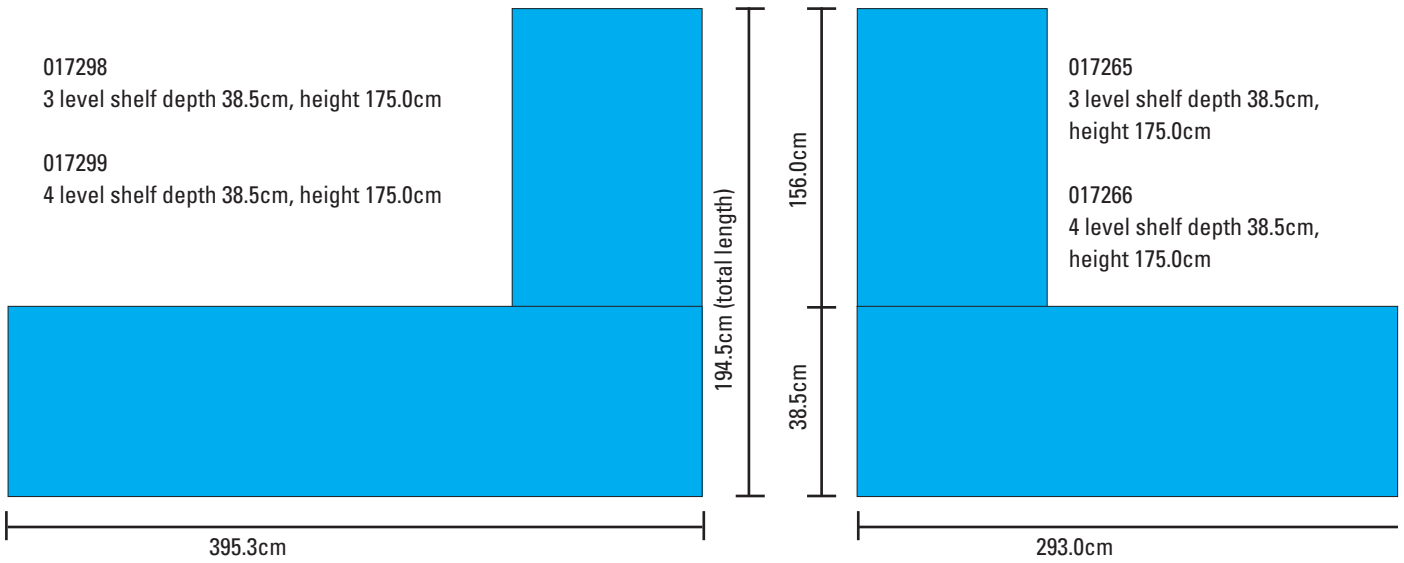

Angle can be attached on each side of the shelf:



Straight shelves:

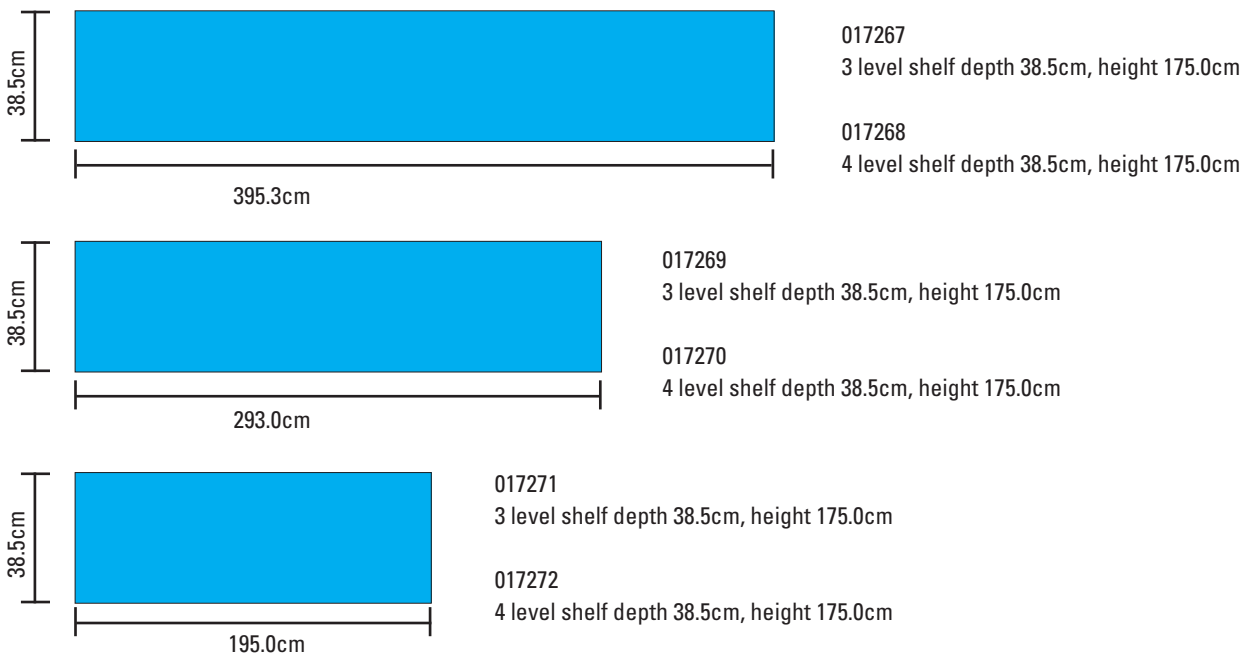

Also available in GN 1/1. Please contact us to help you to set up your personalized shelving.

Kids Booster



easy to fix



easy to clean



children love it

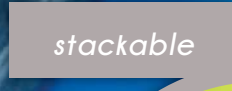

stackable

Toddler Booster, age: 12 months up to 6 years +, including 3-point safety harness, plug-and-sit construction, easy to clean and fix, stackable, certification "safety tested" TÜV Thüringen (Germany), UV-protection, increases the seat area by 8.4cm, Dim in cm: 37.2x37.7x25.2

lime green : 039602



fuchsia : 039640



ocean blue : 039641



grey : 039642



Extra chair strap for Toddler Booster, lime green



	L in cm
039646	75.0
039647	95.0
039648	110.0
039649	130.0
039650	170.0

Junior Booster, age: 3 years up to 6 years +, plug-and-sit construction, easy to clean and fix, stackable, certification "safety tested" TÜV Thüringen (Germany), UV-protection, increases the seat area by 8.4cm, Dim in cm: 37.2x37.7x25.2

lime green : 039304



fuchsia : 039643



ocean blue : 039644



grey : 039645



Safety tested
DIN EN 16120:2017-03

- mechanical safety
- thermal safety
- chemical safety
- product information

ID 5231/16/3510 Z





Andy Mannhart





BAKERY & PASTRY

| 6

Stainless steel

		Ø cm	H in cm
067821	Tart ring, expandable	16.5 - 32.0	6.0



		Ø cm	H in cm
028853	Flower tart ring	20.0	4.0
028785	Flower tart ring	24.0	4.0
028854	Flower tart ring	28.0	4.0
028855	Flower tart ring	30.0	4.0



		Ø cm	H in cm
028856	Flower cake ring	24.0	5.0
028857	Flower cake ring	28.0	5.0



		Ø cm	H in cm
022901	Tart ring, rolled edge	8.0	2.0
022902	Tart ring, rolled edge	10.0	2.0
022903	Tart ring, rolled edge	12.0	2.0
022904	Tart ring, rolled edge	14.0	2.0
022905	Tart ring, rolled edge	16.0	2.0
022906	Tart ring, rolled edge	18.0	2.0
022907	Tart ring, rolled edge	20.0	2.0
022908	Tart ring, rolled edge	22.0	2.0
022909	Tart ring, rolled edge	24.0	2.0
022910	Tart ring, rolled edge	26.0	2.0
022911	Tart ring, rolled edge	28.0	2.0
022912	Tart ring, rolled edge	30.0	2.0
022913	Tart ring, rolled edge	32.0	2.0



		Ø cm	H in cm
022540	Mousse/cake ring	8.0	4.5
022539	Mousse/cake ring	12.0	4.5
022541	Mousse/cake ring	16.0	4.5
022542	Mousse/cake ring	18.0	4.5
022543	Mousse/cake ring	20.0	4.5
022544	Mousse/cake ring	22.0	4.5
022545	Mousse/cake ring	24.0	4.5



		Ø cm	H in cm
022550	Ice cake ring	12.0	6.0
022551	Ice cake ring	16.0	6.0
022552	Ice cake ring	20.0	6.0
022553	Ice cake ring	24.0	6.0
022554	Ice cake ring	28.0	6.0
022555	Ice cake ring	30.0	6.0



Stainless steel

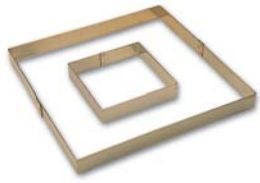

		Dim in cm
022560	Square frame	12.0x12.0x3.5
022561	Square frame	17.0x17.0x3.5
022562	Square frame	22.5x22.5x3.5
022563	Square frame	27.5x27.5x3.5
022564	Square frame	33.0x33.0x3.5
022565	Square frame	38.0x38.0x3.5



		Dim in cm
022568	Rectangular frame	57.0x9.0x4.0

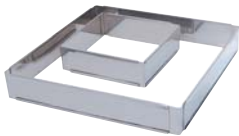

		Dim in cm min.
000958	Expandable baking frame, length and width adjustable, max. 57.0x57.0cm	30.0x30.0x5.0

Polystyrene



		Dim in cm
068516	Cream cake frame, usable on both sides	44.0x22.0x5.0

Stainless steel



		Ø cm	H in cm
071850	Heart shaped ring	18.0	4.5
071851	Heart shaped ring	20.0	4.5
071852	Heart shaped ring	22.0	4.5
071853	Heart shaped ring	24.0	4.0



		Ø cm	H in cm
024690	Hexagon shaped ring	16.0	4.0
024692	Hexagon shaped ring	18.0	4.0
071859	Hexagon shaped ring	20.0	4.5
008350	Hexagon shaped ring	24.0	4.5



		Ø cm	H in cm
071856	Octagon shaped ring	16.0	5.0



		Dim in cm
071863	Oval shaped ring	25.0x11.2x4.5

Stainless steel

		W in cm	L in cm	H in cm
071870	Drop shaped ring	12.0	20.0	4.0
071871	Drop shaped ring	14.5	23.0	4.0
071872	Drop shaped ring	16.0	26.0	4.0



		L in cm	H in cm
001680	Triangular shaped ring	18.0	5.0
006855	Triangular shaped ring	23.0	4.5
006857	Triangular shaped ring	27.5	4.5



		Ø cm	H in cm
022740	Nonette mould hexagonal	7.0	4.5



		Ø cm	H in cm
022741	Nonette mould round	6.0	3.0



		Dim in cm
022742	Nonette mould diamond	9.0x6.0x3.0



		Dim in cm
022743	Nonette mould oval	7.5x4.5



		Dim in cm
022744	Nonette mould rectangular	6.1x5.1x3.0



		Ø cm	H in cm
022745	Nonette mould heart	7.0	4.5



Stainless steel

new



		Ø cm	H in cm
037208	Tart ring round, perforated with straight edge	10.5	2.0
037209	Tart ring round, perforated with straight edge	12.5	2.0
026850	Tart ring round, perforated with straight edge	15.5	2.0
026851	Tart ring round, perforated with straight edge	18.5	2.0
033719	Tart ring round, perforated with straight edge	20.5	2.0
035839	Tart ring round, perforated with straight edge	24.5	2.0
032006	Tart ring round, perforated with straight edge	28.5	2.0

new



		Ø cm	H in cm
033498	Tart ring round, mini, perforated with straight edge	5.5	2.0
033717	Tart ring round, mini, perforated with straight edge	6.5	2.0
027602	Tart ring round, mini, perforated with straight edge	7.5	2.0
033718	Tart ring round, mini, perforated with straight edge	8.5	2.0

new



		Dim in cm
026852	Tart ring square, perforated with straight edge	7.0x7.0x2.0
037222	Tart ring square, perforated with straight edge	8.0x8.0x2.0
027605	Tart ring square, perforated with straight edge	15.0x15.0x2.0
037225	Tart ring square, perforated with straight edge	17.5x17.5x2.0
037224	Tart ring square, perforated with straight edge	20.0x20.0x2.0

new



		Dim in cm
033720	Tart ring rectangular, perforated with straight edge	12.0x4.0x2.0
037212	Tart ring rectangular, perforated with straight edge	28.0x8.0x2.0
037213	Tart ring rectangular, perforated with straight edge	28.0x11.0x2.0

Stainless steel

		Dim in cm	new
036954	Tart ring oblong, perforated with straight edge	14.5x3.5x2.0	
037210	Tart ring oblong, perforated with straight edge	27.0x8.0x2.0	
037211	Tart ring oblong, perforated with straight edge	30.0x11.0x2.0	



		Ø cm	H in cm	new
037214	Tart ring heart, perforated with straight edge	8.0	2.0	
037215	Tart ring heart, perforated with straight edge	12.0	2.0	
037216	Tart ring heart, perforated with straight edge	18.0	2.0	
037217	Tart ring heart, perforated with straight edge	22.0	2.0	



		Dim in cm	new
037218	Tart ring straight, perforated with straight edge	12.0x5.5x2.0	
037219	Tart ring straight, perforated with straight edge	18.0x7.8x2.0	
037220	Tart ring straight, perforated with straight edge	25.5x11.0x2.0	



037221	Tart ring Renou collection, expert perforated with straight edge, 4 portion		new
--------	---	--	-----



037223	Tart ring Renou collection, expert perforated with straight edge, 6 portion		new
--------	---	--	-----



037226	Tart ring Renou collection, standard perforated with straight edge, 4 portion		new
--------	---	--	-----



037227	Tart ring Renou collection, standard perforated with straight edge, 6 portion		new
--------	---	--	-----



Stainless steel



		Cap. ltr	Dim in cm
071834	Pyramid mould	0.16	9.0x9.0x6.0
071835	Pyramid mould	0.39	12.0x12.0x8.0
071836	Pyramid mould	0.77	15.0x15.0x10.0
071837	Pyramid mould	1.15	17.0x17.0x12.0



		Ø cm	H in cm
071840	Hemispherical ball mould	10.0	6.0
071841	Hemispherical ball mould	12.0	8.0
071842	Hemispherical ball mould	16.0	8.0
071843	Hemispherical ball mould	18.0	8.7

Plastic



		Ø cm
071845	Set of 3 hemispherical ball moulds	14.0,16.0,18.0

Stainless steel



		Ø cm	H in cm
026395	Dariole mould, conical	4.5	4.0
026396	Dariole mould, conical	5.5	5.0
005767	Dariole mould, conical	6.5	6.0

Aluminium



		Dim in cm
038537	Dariole mould oval	7.5x5.5x3.7

		Cap. ltr	Ø cm	H in cm
005825	Cream caramel mould	0.75	5.0	5.0

Aluminium non-stick



		Ø cm	H in cm
038538	Dariole/baba mould	6.0	6.0

Aluminium



		Ø cm	H in cm
012832	Jelly/small pudding mould	7.0	5.0



		H in cm	Dim in cm
012834	Jelly/small pudding mould	3.5	10.0x7.0



		Ø cm	H in cm
012836	Small gugelhopf/pudding mould	10.0	4.5



		Ø cm	H in cm
012840	Pudding mould with decorated bottom	16.0	9.0



		Ø cm	H in cm
012838	Flan mould with decorated ring bottom	20.0	5.0

Aluminium

		Ø cm
029701	Cake sheet flat, without rim	20.0
029702	Cake sheet flat, without rim	24.0
066010	Cake sheet flat, without rim	26.0
005828	Cake sheet flat, without rim	28.0
005203	Cake sheet flat, without rim	30.0
005829	Cake sheet flat, without rim	32.0



		Ø cm	H in cm
022861	Cake sheet perforated	24.0	1.5
022862	Cake sheet perforated	28.0	1.5
022863	Cake sheet perforated	32.0	1.5



Non-stick

		Ø cm	H in cm
038536	Pie mould, non-stick	12.0	2.1
022365	Pie mould, non-stick	24.0	1.3
010751	Pie mould, non-stick	28.0	2.5
010752	Pie mould, non-stick	32.0	2.5



Non-stick



		Ø cm	H in cm
026963	Pie mould	24.0	3.5
026964	Pie mould	26.0	3.5
026965	Pie mould	28.0	3.5
026966	Pie mould	30.0	3.5
026967	Pie mould	32.0	3.5
026968	Pie mould	34.0	3.5
026969	Pie mould	36.0	3.5



		Ø cm	H in cm
026970	Pizza mould	24.0	2.3
026971	Pizza mould	28.0	2.3



		Ø cm	H in cm
026951	Cheese flan pan	28.0	4.0



		Ø cm	H in cm
026950	Fruit flan pan	28.0	3.2



		Ø cm	H in cm
026740	Springform with 1 plain and 1 rosace bottom with chimney	26.0	6.5



		Ø cm	H in cm
026939	Spring cake mould conical	28.0	6.0
026940	Spring cake mould conical	32.0	6.0



		Ø cm	H in cm
026941	Spring cake mould	24.0	7.0
026942	Spring cake mould	26.0	7.0
026943	Spring cake mould	28.0	7.0

Non-stick

		Ø cm	H in cm
026932	Rodon mould	14.0	7.2
026933	Rodon mould	16.0	8.5
026934	Rodon mould	18.0	9.5
026935	Rodon mould	20.0	10.5
026936	Rodon mould	22.0	11.5
026937	Rodon mould	24.0	12.5
026938	Rodon mould	26.0	13.5



		Ø cm	H in cm
026923	Frankfurter mould	20.0	6.5
026924	Frankfurter mould	22.0	7.0
026925	Frankfurter mould	24.0	7.7
026926	Frankfurter mould	26.0	8.2
026927	Frankfurter mould	28.0	8.9



		Dim in cm
005452	Bread/cake mould	26.0x11.0x7.0



		Dim in cm
026952	Loaf cake mould	15.0x7.0x5.5
026953	Loaf cake mould	21.0x9.0x7.0
026954	Loaf cake mould	24.0x9.0x7.5
038535	Loaf cake mould	30.0x10.0x8.0
026956	Loaf cake mould	36.0x10.5x8.0



Alusteel

		Dim in cm
066060	Cake/bread mould, rectangular	15.0x7.5x6.5
066061	Cake/bread mould, rectangular	20.0x8.0x7.0
066062	Cake/bread mould, rectangular	25.0x8.5x7.5
066063	Cake/bread mould, rectangular	30.0x9.0x8.0
066065	Cake/bread mould, rectangular	38.0x9.0x8.0



Stainless-steel

		Dim in cm
001906	Yule log mould	35.0x6.0x4.5
032212	Yule log mould	50.0x6.0x4.5
030730	Yule log mould	50.0x7.0x5.0
030731	Yule log mould	50.0x8.0x6.2



Non-stick



		Dim in cm
026948	Ridged baking mould	28.0x11.0x6.0
026949	Ridged baking mould	33.0x11.0x6.0



		Dim in cm
026748	Muffin sheet with 12 holes	36.0x27.0x2.0
	Remark: top Ø=8.0cm, bottom Ø=5.5cm	



		Dim in cm
066017	Baking tray with 24 gugelhopf moulds, 8.3x4.5cm, non-stick	58.0x40.0



		Dim in cm
066018	Baking tray with 24 halfball moulds, 8.3x4.0cm, non-stick	58.5x40.0



		Dim in cm
066019	Baking tray with 25 small madeleine moulds, 10.0x6.0x3.8, non-stick	58.0x40.0



		Dim in cm
022700	Sheet of 12 madeleine moulds, each 8.0cm	39.5x20.0



		Dim in cm
022701	Sheet of 20 madeleine moulds, each 4.2cm	39.5x12.5



		Ø cm	H in cm
026976	Brioche mould	12.0	4.5



		Ø cm	H in cm
026972	Hedgehog mould	8.0	3.0
026973	Hedgehog mould	10.0	4.0
026974	Hedgehog mould	15.0	5.1
026975	Hedgehog mould	20.0	6.7

Aluminium



		L in cm	H in cm
012830	Cake mould fish shape	27.0	4.0
012831	Cake mould fish shape	12.0	2.0

non-stick	tin-plated		Ø cm	H in cm
022320	022620	Round fluted tart mould	6.0	1.0
022321		Round fluted tart mould	6.5	1.0
022322	022622	Round fluted tart mould	7.0	1.0
022323		Round fluted tart mould	7.5	1.0
022324	038527	Round fluted tart mould	8.0	1.2
022325	022625	Round fluted tart mould	10.0	1.8
022326	022626	Round fluted tart mould	12.0	2.0
038530	038532	Round fluted tart mould	14.0	2.5



non-stick	tin-plated		Ø cm	H in cm
022340	005439	Quiche/tart mould, fluted	20.0	2.5
022341	005440	Quiche/tart mould, fluted	24.0	2.5
022342	005441	Quiche/tart mould, fluted	28.0	2.5
022343	005442	Quiche/tart mould, fluted	32.0	2.5



non-stick	tin-plated		Ø cm	H in cm
038531	038534	Quiche/tart mould fluted with removable bottom	14.0	2.5
022345	005443	Quiche/tart mould fluted with removable bottom	20.0	2.5
022346	005444	Quiche/tart mould fluted with removable bottom	24.0	2.5
022347	005445	Quiche/tart mould fluted with removable bottom	28.0	2.5
022348	005432	Quiche/tart mould fluted with removable bottom	32.0	2.5



	tin-plated		Ø cm	H in cm
	022630	Manqué mould with fluted rim	10.0	3.0
	022631	Manqué mould with fluted rim	15.0	4.0
	022632	Manqué mould with fluted rim	20.0	4.5
	038533	Manqué mould with fluted rim	25.0	5.0



non-stick	tin-plated		Ø cm	H in cm
038523	038528	Manqué mould fluted with removable bottom	10.0	3.0
038524	022636	Manqué mould fluted with removable bottom	15.0	4.0
038525	022637	Manqué mould fluted with removable bottom	20.0	4.5
038326	038529	Manqué mould fluted with removable bottom	25.0	5.0



non-stick	tin-plated		Ø cm	H in cm
022750	022649	Square cake mould	22.0	5.0
022751	022639	Square cake mould	24.0	5.0



non-stick			Ø cm	H in cm
022390		High tartlet mould	4.5	1.2
022391		High tartlet mould	5.0	1.2
022392		High tartlet mould	5.5	1.3
022393		High tartlet mould	6.0	1.5
022394		High tartlet mould	6.5	1.6
022395		High tartlet mould	7.0	1.7
022396		High tartlet mould	7.5	1.9
022397		High tartlet mould	8.0	2.0





non-stick	tin-plated		Ø cm	H in cm
022310	022610	Low tartlet mould	6.0	1.0
022312	022612	Low tartlet mould	7.0	1.0
022314	022614	Low tartlet mould	8.0	1.2



non-stick	tin-plated		Ø cm	H in cm
022350	022650	Cheese tartlet mould	6.0	1.7
022352		Cheese tartlet mould	7.0	1.7
038517	022654	Cheese tartlet mould	8.0	1.8
022356	022656	Cheese tartlet mould	9.0	1.9
022358	038519	Cheese tartlet mould	10.0	2.1



non-stick	tin-plated		Ø cm	H in cm
005447	022770	Cake mould round	14.0	3.5
034319	022771	Cake mould round	16.0	4.0
022372	022772	Cake mould round	18.0	4.5
022373	022773	Cake mould round	20.0	4.5
005448	022774	Cake mould round	22.0	5.0
022375	022775	Cake mould round	24.0	5.0
005449	022776	Cake mould round	26.0	5.0
038520	022777	Cake mould round	28.0	5.0
038521	022778	Cake mould round	30.0	5.3
022379	022779	Cake mould round	32.0	5.5



non-stick	tin-plated		Ø cm	H in cm
038518	032214	Savarin mould closed	7.0	1.7
022471	022671	Savarin mould	8.0	2.0
022472	022672	Savarin mould	12.0	2.5
022474	005451	Savarin mould	22.0	4.5
022475	022675	Savarin mould	24.0	5.0



non-stick	tin-plated		Dim in cm	
022488	022688	Plain boat mould	8.0x3.3x1.0	
022485	022685	Plain boat mould	10.0x4.3x1.2	
022486	022686	Plain boat mould	11.0x4.6x1.3	
022487	022687	Plain boat mould	12.0x5.0x1.3	



non-stick	tin-plated		Dim in cm	
038515	022689	Fluted boat mould	8.0x4.0x1.0	
038516	022690	Fluted boat mould	10.0x4.3x1.3	
022491	022691	Fluted boat mould	11.0x4.6x1.3	
022492	038522	Fluted boat mould	12.0x5.0x1.3	



non-stick	tin-plated		Ø cm	H in cm
022482	022752	Leaf tart mould	12.0	2.0



non-stick	tin-plated		Ø cm	H in cm
022380	022580	Brioche mould	6.0	2.5
005450	022581	Brioche mould	7.0	3.0
022382	022582	Brioche mould	8.0	3.2
022383	022583	Brioche mould	9.0	3.5
022384	022584	Brioche mould	11.0	3.8
022385	022585	Brioche mould	14.0	4.8
	022586	Brioche mould	16.0	5.5
022387	022587	Brioche mould	18.0	5.6
022388	005438	Brioche mould	20.0	7.2
022389	022589	Brioche mould	22.0	7.2



non-stick			Dim in cm	
022753		Friand mould	9.8x5.1x1.4	

Exoglass

		Dim in cm
002544	Bread pan with lid	18.0x8.5x7.5
011475	Bread pan with lid	25.0x9.0x7.5
012198	Bread pan with lid	27.0x10.0x90
002124	Bread pan with lid	29.0x11.0x10.0
031245	Bread pan with lid	40.0x10.0x10.0
022817	Bread pan with lid	40.0x12.0x12.0
005057	Bread pan with lid	40.0x14.0x14.0

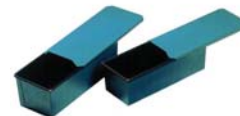

Non-stick

		Ø cm	Dim in cm
012229	Muffin pan with 12 holes, non-stick	6.2	37.0x24.2



Aluminium

		Dim in cm
022818	Sheet waffled for 6 baguettes	65.0x43.0
022819	Sheet waffled for 6 baguettes	75.0x43.0
022820	Sheet waffled for 6 baguettes	85.0x43.0



		Dim in cm
066020	Baking tray for 5 baguettes, non-stick	60.0x40.0
066021	Baking tray for 6 baguettes, non-stick	78.0x58.0



Stainless steel

		Dim in cm
013128	Tuiles sheet fluted	35.0x30.0x2.5



Tin-plated

		Dim in cm
022835	Cake roll pan	30.0x20.0x3.5
022836	Cake roll pan	35.0x25.0x3.5
022837	Cake roll pan	40.0x30.0x3.5
022838	Cake roll pan	51.0x36.0x5.0
022839	Cake roll pan	61.0x41.0x5.0





		Dim in cm
022126	Pate mould rectangular, mini with hinges and loose bottom, non-stick	50.0x4.0x6.0
022127	Pate mould rectangular, mini with hinges and loose bottom, non-stick	30.0x4.0x6.0



		Dim in cm
022122	Pate mould oval fluted	18.0x11.0x7.5
022123	Pate mould oval fluted	21.0x14.0x9.0
022124	Pate mould oval fluted	24.0x14.0x9.5



		Dim in cm
022103	Pate mould rectangular with hinges and loose bottom, non-stick	30.0x7.0x8.0
022104	Pate mould rectangular with hinges and loose bottom, non-stick	35.0x7.0x8.0
038514	Pate mould rectangular with hinges and loose bottom, non-stick	40.0x7.5x8.5
022106	Pate mould rectangular with hinges and loose bottom, non-stick	50.0x7.0x8.5



		Dim in cm
022109	Pate mould rectangular with ridges, exopan	30.0x7.0x8.5
022111	Pate mould rectangular with ridges, exopan	40.0x7.5x8.5
022112	Pate mould rectangular with ridges, exopan	50.0x8.5x8.5

Tinplated



		Dim in cm
022003	Pate mould rectangular with hinges and loose bottom	30.0x7.0x8.0
022004	Pate mould rectangular with hinges and loose bottom	35.0x7.5x8.5
022005	Pate mould rectangular with hinges and loose bottom	40.0x7.5x8.5
022006	Pate mould rectangular with hinges and loose bottom	50.0x8.5x8.5

Stainless steel



new

		Dim in cm
036820	Pate mould rectangular, GEO form folding, perforated	24.0x5.0x6.0
036821	Pate mould rectangular, GEO form folding, perforated	35.0x7.0x7.5
036822	Pate mould rectangular, GEO form folding, perforated	48.0x9.0x8.5



new

		Dim in cm
036823	Pate mould rectangular, GEO form folding	24.0x5.0x6.0
036824	Pate mould rectangular, GEO form folding	35.0x7.0x7.5
036825	Pate mould rectangular, GEO form folding	48.0x8.0x8.5

Stainless steel

		Dim in cm
009090	Terrine-mould conical	30.0x6.5x4.5



		Dim in cm
009091	Terrine-mould half-round	30.0x5.2x5.0



		Dim in cm
009092	Terrine-mould triangular	30.0x7.0x6.5



		Dim in cm
009094	Terrine-mould half-round with removable ends	50.0x8.0x6.5



non-stick

tin-plated



		L in cm
006055	Boat, non-stick	6.0
022710	Boat, tin-plated	6.0



		L in cm
022411	Boat, non-stick	7.0
005433	Boat, tin-plated	7.0



		Ø cm	H in cm
022412	Brioche small fluted, non-stick	3.5	2.9



		Ø cm	H in cm
022413	Brioche large fluted, non-stick	4.5	3.6



		Ø cm	H in cm
022414	Cake bouchon, non-stick	2.5	3.0



		Dim in cm
022415	Square, non-stick	3.5x3.5x4.5



		Dim in cm
022416	Square fluted, non-stick	3.5x3.5
005176	Square fluted, tin-plated	3.5x3.5



		Dim in cm
022417	Square ridged, non-stick	4.0x4.0x4.0



		Ø cm
022418	Lozenge, non-stick	6.0
005177	Lozenge, tin-plated	6.0



		Ø cm
038512	Oval fluted, non-stick	3.5
038513	Oval fluted, tin-plated	4.5



		Ø cm
038510	Oval large ribbed, non-stick	4.5
038511	Oval large ribbed, tin-plated	4.5



		Ø cm	H in cm
022421	Oval long, non-stick	5.1	2.3

			non-stick	tin-plated	
022422	Oval ridged, non-stick	Ø cm 5.0	H in cm 3.1		
022423	Rectangular, non-stick	Ø cm 5.0			
022723	Rectangular, tin-plated	Ø cm 5.0			
005446	Round fluted, non-stick	Ø cm 3.5			
022724	Round fluted, tin-plated	Ø cm 4.5			
032344	Round deep, non-stick	Ø cm 3.5			
022725	Round deep, tin-plated	Ø cm 3.5			
038508	Round flower, non-stick	Ø cm 4.5			
038509	Round flower, tin-plated	Ø cm 4.5			
022427	Round curved sides, non-stick	Ø cm 3.0	H in cm 2.1		
022428	Round curved sides, non-stick	Ø cm 3.5	H in cm 2.1		
030768	Round plain, non-stick	Ø cm 3.5			
005435	Round plain, tin-plated	Ø cm 3.5			
022430	Round plain, non-stick	Ø cm 4.0			
032213	Round plain, tin-plated	Ø cm 4.0			
022431	Savarin, non-stick	Ø cm 3.5	H in cm 2.1		
022432	Savarin, non-stick	Ø cm 4.0	H in cm 2.6		
022433	Savarin, non-stick	Ø cm 4.5	H in cm 3.1		
023264	Savarin, non-stick	Ø cm 5.0	H in cm 1.2		
022434	Triangle, non-stick	Ø cm 4.5			
022435	Box of 60 petit fours moulds, non-stick				
005437	Box of 60 petit fours moulds, tin-plated				
Remark: 5pcs each of 12 different moulds					



		Moulds	Ø cm	H in cm
023948	Charlotte moulds 60.0x40.0cm	24	6.2	3.5
023949	Charlotte moulds 40.0x30.0cm	12	6.2	3.5

		Moulds	Ø cm	H in cm
023942	Charlotte moulds 60.0x40.0cm	18	7.8	4.0
023943	Charlotte moulds 40.0x30.0cm	8	7.8	4.0

		Moulds	Ø cm	H in cm
023946	Mini charlotte moulds 60.0x40.0cm	60	3.5	1.5
023947	Mini charlotte moulds 40.0x30.0cm	30	3.5	1.5

		Moulds	Ø cm	H in cm
023954	Daisy moulds 60.0x40.0cm	24	7.0	2.7
023955	Daisy moulds 40.0x30.0cm	12	7.0	2.7

		Moulds	Ø cm	H in cm
023937	Flower moulds 60.0x40.0cm	24	7.8	2.0
023938	Flower moulds 40.0x30.0cm	12	7.8	2.0

		Moulds	Dim in cm
023950	Madeleine moulds 60.0x40.0cm	40	7.8x4.7x1.9
023951	Madeleine moulds 40.0x30.0cm	20	7.8x4.7x1.9

		Moulds	Dim in cm
023570	Mini madeleine moulds 60.0x40.0cm	56	5.2x3.3x1.5
023571	Mini madeleine moulds 40.0x30.0cm	28	5.2x3.3x1.5

		Moulds	Ø cm	H in cm
023572	Rosace moulds 60.0x40.0cm	18	7.8	3.5
023573	Rosace moulds 40.0x30.0cm	8	7.8	3.5

		Moulds	Dim in cm
023944	Shell moulds 60.0x40.0cm	24	8.0x7.5x2.0
023945	Shell moulds 40.0x30.0cm	12	8.0x7.5x2.0

		Moulds	Dim in cm
023952	Teddy bear moulds 60.0x40.0cm	12	11.5x11.3x3.1
023953	Teddy bear moulds 40.0x30.0cm	6	11.5x11.3x3.1

		Moulds	Dim in cm
023940	Teddy bear moulds 60.0x40.0cm	18	9.0x5.5x2.0
023941	Teddy bear moulds 40.0x30.0cm	9	9.0x5.5x2.0

		Moulds	Dim in cm
023654	Little man moulds 60.0x40.0cm	24	7.0x6.5x1.2
023655	Little man moulds 40.0x30.0cm	12	7.0x6.5x1.2

		Moulds	Ø cm	H in cm
003294	Mini volcano moulds 60.0x40.0cm	54	4.0	2.2

		Moulds	Dim in cm
023574	Mini sapphire moulds 60.0x40.0cm	54	4.0x4.0x2.4
023575	Mini sapphire moulds 40.0x30.0cm	24	4.0x4.0x2.4



		Moulds	Dim in cm
023576	Mini sapphire moulds 60.0x40.0cm	24	7.0x7.0x3.5
023577	Mini sapphire moulds 40.0x30.0cm	12	7.0x7.0x3.5



		Moulds	Ø cm	H in cm
023964	Flan bases moulds 60.0x40.0cm	24	8.0	2.0
023965	Flan bases moulds 40.0x30.0cm	12	8.0	2.0



		Moulds	Dim in cm
023578	Oval savarin moulds 60.0x40.0cm	30	7.0x5.0x2.2
023579	Oval savarin moulds 40.0x30.0cm	15	7.0x5.0x2.2



		Moulds	Ø cm	H in cm
023968	Mini savarin moulds 60.0x40.0cm	60	4.1	1.2
023969	Mini savarin moulds 40.0x30.0cm	30	4.1	1.2
023970	Mini savarin moulds 32.5x26.5cm	24	4.1	1.2



		Moulds	Dim in cm
023961	Oval savarin moulds 60.0x40.0cm	24	8.0x6.0x2.5
023962	Oval savarin moulds 40.0x30.0cm	12	8.0x6.0x2.5
023963	Oval savarin moulds 32.5x26.5cm	6	8.0x6.0x2.5



		Moulds	Ø cm	H in cm
023967	Savarin moulds 60.0x40.0cm	24	7.0	2.3
023614	Savarin moulds 40.0x30.0cm	12	7.0	2.3
023966	Savarin moulds 60.0x40.0cm	35	6.6	2.0



		Moulds	H in cm
023580	Savarin moulds 40.0x30.0cm, 6 squares 5.6x5.6cm, 6 ovals 7.0x5.0cm	12	2.2



		Moulds	Dim in cm
023582	Spoon moulds 60.0x40.0cm	36	9.0x2.8x1.2
023583	Spoon moulds 40.0x30.0cm	18	9.0x2.8x1.2



		Moulds	Dim in cm
023589	Mini square savarin moulds 60.0x40.0cm	60	3.7x3.7x1.7
023590	Mini square savarin moulds 40.0x30.0cm	30	3.7x3.7x1.7



		Moulds	Dim in cm
023588	Square savarin moulds 60.0x40.0cm	35	5.6x5.6x2.4
023587	Square savarin moulds 40.0x30.0cm	15	5.6x5.6x2.4

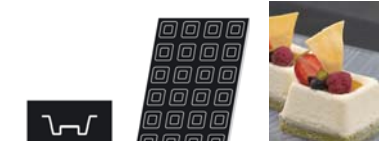

		Moulds	Dim in cm
023993	Square savarin moulds 60.0x40.0cm	24	7.0x7.0x3.0
023994	Square savarin moulds 40.0x30.0cm	12	7.0x7.0x3.0





		Moulds	Dim in cm
023591	Square financier moulds 60.0x40.0cm	60	4.5x4.5x1.2
023592	Square financier moulds 40.0x30.0cm	30	4.5x4.5x1.2

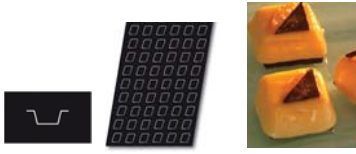

		Moulds	Dim in cm
023584	Square moulds 60.0x40.0cm	60	3.7x3.7x1.7
023585	Square moulds 40.0x30.0cm	30	3.7x3.7x1.7



		Moulds	Dim in cm
023586	Square moulds 60.0x40.0cm	35	5.6x5.6x2.4
023587	Square moulds 40.0x30.0cm	15	5.6x5.6x2.4



		Moulds	Dim in cm
023593	Square moulds 60.0x40.0cm	40	6.0x6.0x1.5
023581	Square moulds 40.0x30.0cm	20	6.0x6.0x1.5



		Moulds	Ø cm	H in cm
023837	Cylinder moulds 60.0x40.0cm	24	6.3	3.5
023618	Cylinder moulds 40.0x30.0cm	12	6.3	3.5
023838	Cylinder moulds 32.5x26.5cm	9	6.3	3.5
023839	Cylinder moulds 60.0x40.0cm	24	6.3	2.5
024003	Cylinder moulds 40.0x30.0cm	12	6.3	2.5



		Moulds	Ø cm	H in cm
023841	Dariole moulds 60.0x40.0cm	15	6.5	5.5

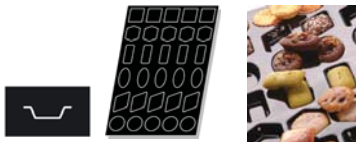

		Moulds	H in cm
023988	Assorted moulds 40.0x30.0cm	30	1.2

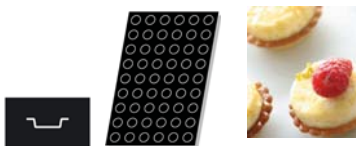

		Moulds	Ø cm	H in cm
023992	Mini cylinder moulds 60.0x40.0cm	54	3.8	1.0

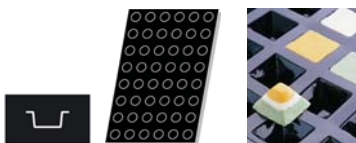

		Moulds	Ø cm	H in cm
023989	Cylinder moulds 60.0x40.0cm	48	4.0	2.0
023990	Cylinder moulds 40.0x30.0cm	24	4.0	2.0
023991	Cylinder moulds 32.5x26.5cm	20	4.0	2.0



		Moulds	Dim in cm
023971	Hexagonal moulds 60.0x40.0cm	60	4.5x4.0x1.2
023972	Hexagonal moulds 40.0x30.0cm	30	4.5x4.0x1.2

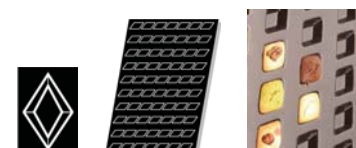

		Moulds	Dim in cm
023984	Lozenge moulds 60.0x40.0cm	70	6.0x3.5x1.0
023985	Lozenge moulds 40.0x30.0cm	35	6.0x3.5x1.0

		Moulds	Ø cm	H in cm
023979	Medaillon moulds 60.0x40.0cm	96	2.8	0.8
023980	Medaillon moulds 40.0x30.0cm	48	2.8	0.8



		Moulds	Dim in cm
023975	Mini briochette moulds 60.0x40.0cm	40	4.6x3.8x1.5
023976	Mini briochette moulds 40.0x30.0cm	20	4.6x3.8x1.5

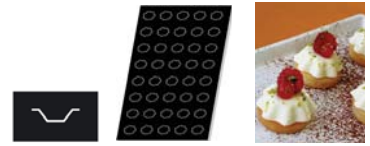

		Moulds	Ø cm	H in cm
023977	Mini cone moulds 60.0x40.0cm	96	3.0	2.0
023978	Mini cone moulds 40.0x30.0cm	48	3.0	2.0

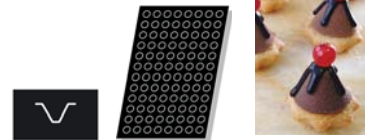

		Moulds	Dim in cm
023973	Mini oval savarin moulds 60.0x40.0cm	60	40.0x30.0x1.2
023974	Mini oval savarin moulds 40.0x30.0cm	30	40.0x30.0x1.2

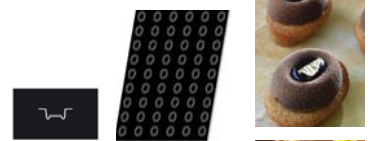

		Moulds	Dim in cm
023983	Octagon moulds 60.0x40.0cm	40	43.0x40.0x2.6
023602	Octagon moulds 40.0x30.0cm	20	43.0x40.0x2.6

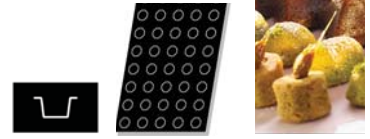

		Moulds	Ø cm	H in cm
023605	Mini cylinder moulds 60.0x40.0cm	54	40.0	2.0

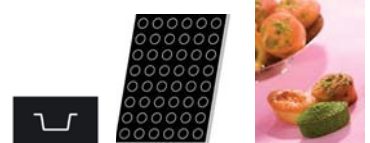

		Moulds	Ø cm	H in cm
023981	Pomponette moulds 60.0x40.0cm	96	36.0	1.7
023606	Pomponette moulds 40.0x30.0cm	48	36.0	1.7
023982	Pomponette moulds 32.5x26.5cm	30	36.0	1.7

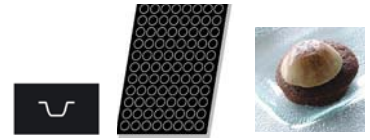

		Moulds	Dim in cm
023986	Triangular moulds 60.0x40.0cm	80	48.0x41.0x1.0
023987	Triangular moulds 40.0x30.0cm	40	48.0x41.0x1.0



		Moulds	Ø cm	H in cm
023824	Fluted brioche moulds 60.0x40.0cm	24	8.1	3.7
023612	Fluted brioche moulds 40.0x30.0cm	12	8.1	3.7
023826	Fluted brioche moulds 60.0x40.0cm	24	6.2x4.9	2.6
023827	Fluted brioche moulds 40.0x30.0cm	12	6.2x4.9	2.6
023828	Fluted brioche moulds 60.0x40.0cm	24	6.8	2.5
023829	Fluted brioche moulds 40.0x30.0cm	12	6.8	2.5
023820	Fluted brioche moulds 60.0x40.0cm	24	7.8	3.0
023821	Fluted brioche moulds 40.0x30.0cm	12	7.8	3.0

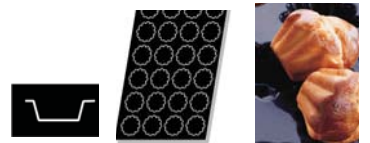

		Moulds	Dim in cm
023830	Long brioche moulds 60.0x40.0cm	24	13.0x4.8x1.8
023831	Long brioche moulds 40.0x30.0cm	12	13.0x4.8x1.8



		Moulds	Dim in cm
023822	Mini brioche moulds 60.0x40.0cm	48	7.0x3.0x1.0
023823	Mini brioche moulds 40.0x30.0cm	24	7.0x3.0x1.0

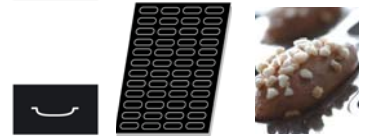

		Moulds	Dim in cm
023832	Round brioche moulds 60.0x40.0cm	24	7.9x1.5
023833	Round brioche moulds 40.0x30.0cm	12	7.9x1.5





		Moulds	Ø cm	H in cm
023834	Cone moulds 60.0x40.0cm	20	7.0	6.0

		Moulds	Ø cm	H in cm
023835	Insert for cone moulds 60.0x40.0cm	40	5.0	4.0
023836	Insert for cone moulds 40.0x30.0cm	20	5.0	4.0

		Moulds	Ø cm	H in cm
023846	Cookie moulds 60.0x40.0cm	24	7.8	1.0
023847	Cookie moulds 40.0x30.0cm	12	7.8	1.0
023845	Cookie moulds 60.0x40.0cm	15	9.1	0.8

		Moulds	Ø cm	H in cm
023842	Florentine moulds 60.0x40.0cm	15	10.2	2.0
023843	Florentine moulds 32.5x26.5cm	5	10.2	2.0

		Moulds	Ø cm	H in cm
023844	Mini florentine moulds 60.0x40.0cm	40	5.9	1.3
023620	Mini florentine moulds 40.0x30.0cm	20	5.9	1.3

		Moulds	Ø cm	H in cm
023849	Half sphere moulds 60.0x40.0cm	24	7.0	4.0
023615	Half sphere moulds 40.0x30.0cm	12	7.0	4.0
023850	Half sphere moulds 32.5x26.5cm	9	7.0	4.0

		Moulds	Ø cm	H in cm
023851	Half sphere moulds 60.0x40.0cm	48	4.2	2.1
023852	Half sphere moulds 40.0x30.0cm	24	4.2	2.1
023853	Half sphere moulds 32.5x26.5cm	20	4.2	2.1

		Moulds	Ø cm	H in cm
023857	Half sphere moulds 60.0x40.0cm	28	5.8	3.1
023858	Half sphere moulds 32.5x26.5cm	12	5.8	3.1

		Moulds	Ø cm	H in cm
023855	Half sphere moulds 60.0x40.0cm	24	8.0	4.0
023856	Half sphere moulds 40.0x30.0cm	12	8.0	4.0

		Moulds	Ø cm	H in cm
023854	Mini half sphere moulds (flat bottom) 40.0x30.0cm	48	3.0	1.3

		Moulds	Ø cm	H in cm
023861	Mini half sphere moulds (upside down) 60.0x40.0cm	45	2.6	1.6

		Moulds	Ø cm	H in cm
023848	Mini half sphere moulds 40.0x30.0cm	63	2.3	1.1

		Moulds	Ø cm	H in cm
023859	Mini half sphere moulds 60.0x40.0cm	96	2.6	1.6
023860	Mini half sphere moulds 40.0x30.0cm	48	2.6	1.6

		Moulds	Ø cm	H in cm
023862	Mini half sphere moulds 60.0x40.0cm	70	2.9	1.8
023863	Mini half sphere moulds 40.0x30.0cm	35	2.9	1.8
023864	Mini half sphere moulds 32.5x26.5cm	35	2.9	1.8

		Moulds	Dim in cm
023869	Chestnut moulds 60.0x40.0cm	24	6.4x6.4x2.6
023870	Chestnut moulds 40.0x30.0cm	12	6.4x6.4x2.6

		Moulds	Dim in cm
023867	Interlacing heart moulds 60.0x40.0cm	8	12.0x11.3x3.5
023868	Interlacing heart moulds 40.0x30.0cm	4	12.0x11.3x3.5

		Moulds	Dim in cm
023872	Heart moulds 40.0x30.0cm	30	5.2x4.9x1.0

		Moulds	Dim in cm
023873	Heart moulds 60.0x40.0cm	20	6.6x6.2x2.5
023611	Heart moulds 40.0x30.0cm	20	6.6x6.2x3.5

		Moulds	Dim in cm
023865	Heart moulds 60.0x40.0cm	20	7.5x6.5x3.5
023866	Heart moulds 40.0x30.0cm	12	7.5x6.5x3.5

		Moulds	Dim in cm
023601	Mini pyramid moulds 60.0x40.0cm	54	3.5x3.5x2.3
023899	Mini pyramid moulds 40.0x30.0cm	24	3.5x3.5x2.3
023900	Mini pyramid moulds 32.5x26.5cm	30	3.5x3.5x2.3

		Moulds	Dim in cm
023903	Pyramid moulds 60.0x40.0cm	35	5.0x5.0x3.5
023904	Pyramid moulds 32.5x26.5cm	12	5.0x5.0x3.5
Remark: Cut up top			

		Moulds	Dim in cm
023901	Pyramid moulds 60.0x40.0cm	24	7.1x7.1x4.1
023607	Pyramid moulds 40.0x30.0cm	12	7.1x7.1x4.1
023902	Pyramid moulds 32.5x26.5cm	9	7.1x7.1x4.1

		Moulds	Dim in cm
023657	Annapurna moulds with s/s frame 60.0x40.0cm, 370ml	54	9.5x4.0x3.3

		Moulds	Ø cm	H in cm
023874	Mini muffin moulds 60.0x40.0cm	40	5.1	2.9
023621	Mini muffin moulds 40.0x30.0cm	20	5.1	2.9

		Moulds	Ø cm	H in cm
023879	Muffin moulds 60.0x40.0cm	24	7.9	3.6
023617	Muffin moulds 40.0x30.0cm	12	7.9	3.6
023877	Muffin moulds 60.0x40.0cm	24	7.3	4.0
023878	Muffin moulds 40.0x30.0cm	12	7.3	4.0
023876	Muffin moulds 60.0x40.0cm	15	8.2	5.0
023875	Muffin moulds 60.0x40.0cm	15	9.1	3.5

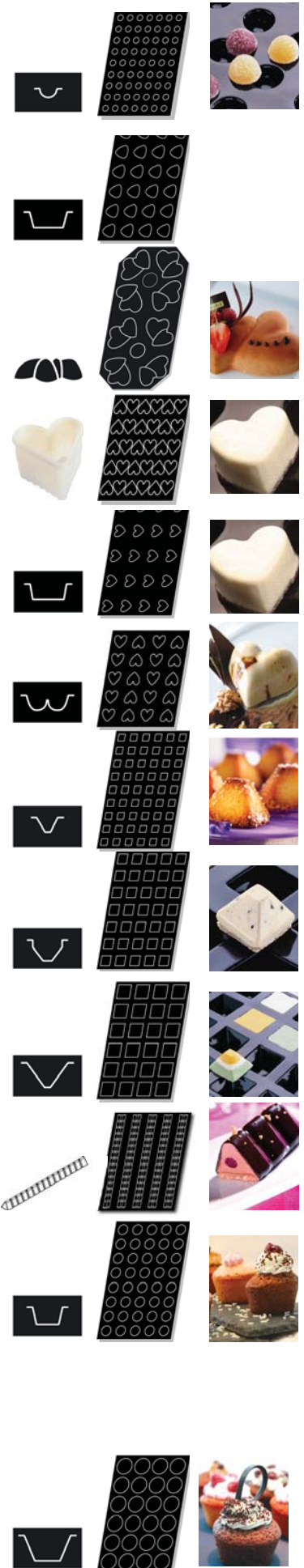

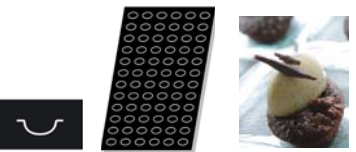
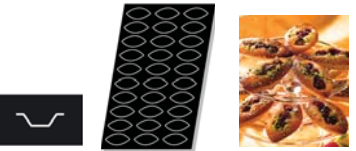
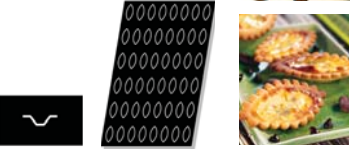
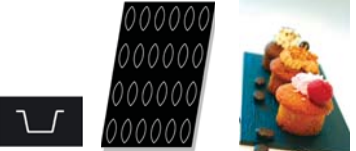
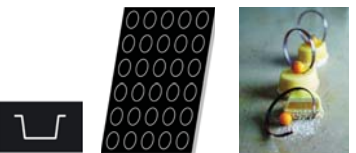
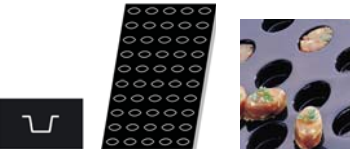
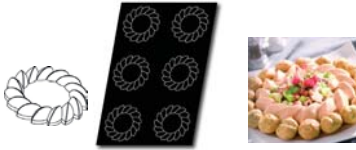
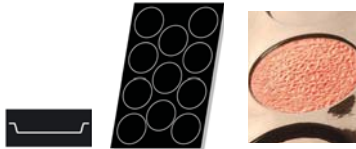

		Moulds	Ø cm	H in cm
023956	Round moulds 60.0x40.0cm	11	12.5	1.6
023957	Round moulds 60.0x40.0cm	6	16.6	1.2
023958	Round moulds 60.0x40.0cm	6	14.7	1.2
023959	Round moulds 60.0x40.0cm	6	18.6	1.2
023960	Round moulds 60.0x40.0cm	6	15.0	1.5

		Moulds	Ø cm	H in cm
023656	St. Honoré moulds 60.0x40.0cm	6	15.0	2.6

		Moulds	Ø cm	H in cm
003293	Mini-St. Honoré crown moulds 60.0x40.0cm	35	5.4	1.5

		Moulds	Dim in cm
023887	Mini oval moulds 60.0x40.0cm	64	5.7x3.5x1.2
023888	Mini oval moulds 40.0x30.0cm	32	5.7x3.5x1.2
Remark: Flat bottom			

		Moulds	Dim in cm
023895	Oval moulds 60.0x40.0cm	50	5.1x3.1x2.0
023603	Oval moulds 40.0x30.0cm	25	5.1x3.1x2.0
023896	Oval moulds 32.5x26.5cm	20	5.1x3.1x2.0

		Moulds	Dim in cm
023889	Oval moulds 60.0x40.0cm	30	7.0x5.0x3.0
023619	Oval moulds 40.0x30.0cm	15	7.0x5.0x3.0
023897	Oval moulds 60.0x40.0cm	30	7.0x5.0x2.5
023898	Oval moulds 40.0x30.0cm	15	7.0x5.0x2.5

		Moulds	Dim in cm
023890	Oval moulds 60.0x40.0cm	20	8.5x6.0x3.0
023891	Oval moulds 40.0x30.0cm	12	8.5x6.0x3.0



























		Moulds	Dim in cm
023894	Oval moulds 60.0x40.0cm	24	9.6x4.5x2.8
023610	Oval moulds 40.0x30.0cm	12	9.6x4.5x2.8

		Moulds	Dim in cm
023892	Mini oval tartlet moulds 60.0x40.0cm	48	6.6x2.7x1.1
023893	Mini oval tartlet moulds 40.0x30.0cm	24	6.6x2.7x1.1

		Moulds	Dim in cm
023880	Oval tartlet moulds 60.0x40.0cm	30	10.6x4.5x1.5
023881	Oval tartlet moulds 40.0x30.0cm	15	10.6x4.5x1.5

		Moulds	Dim in cm
023885	Mini quenelle moulds 60.0x40.0cm	72	4.2x2.6x2.0
023886	Mini quenelle moulds 40.0x30.0cm	36	4.2x2.6x2.0

		Moulds	Dim in cm
023882	Quenelle moulds 60.0x40.0cm	42	6.0x4.0x2.5
023883	Quenelle moulds 40.0x30.0cm	18	6.0x4.0x2.5
023884	Quenelle moulds 32.5x26.5cm	15	6.0x4.0x2.5

		Moulds		Dim in cm			
023995	Star moulds 60.0x40.0cm	24		8.0x6.5x1.5			
023996	Star moulds 40.0x30.0cm	12		8.0x6.5x1.5			
		Moulds	Ø cm	H in cm			
023905	Mince pie moulds 60.0x40.0cm	40	5.8	2.0			
023906	Mince pie moulds 40.0x30.0cm	20	5.8	2.0			
		Moulds	Ø cm	H in cm			
023907	Mini tartlets moulds 60.0x40.0cm	60	4.2	1.0			
023604	Mini tartlets moulds 40.0x30.0cm	30	4.2	1.0			
023908	Mini tartlets moulds 32.5x26.5cm	24	4.2	1.0			
		Moulds	Ø cm	H in cm			
023909	Mini quiche moulds 60.0x40.0cm	48	4.8	1.5			
023910	Mini quiche moulds 40.0x30.0cm	24	4.8	1.5			
023911	Mini quiche moulds 32.5x26.5cm	20	4.8	1.5			
		Moulds	Ø cm	H in cm			
023912	Pie moulds 60.0x40.0cm	15	9.6	2.5			
		Moulds	Ø cm	H in cm			
023916	Quiche moulds 60.0x40.0cm	6	14.0	2.5			
023915	Quiche moulds 60.0x40.0cm	6	15.0	2.4			
		Moulds	Ø cm	H in cm			
023913	Tartlet moulds 60.0x40.0cm	24	7.7	2.0			
023914	Tartlet moulds 40.0x30.0cm	12	7.7	2.0			
		Moulds	Ø cm	H in cm			
023997	Tart moulds 60.0x40.0cm	15	8.2	3.0			
		Moulds	Ø cm	H in cm			
023998	Tart moulds 60.0x40.0cm	12	10.0	3.5			
023999	Tart moulds 40.0x30.0cm	6	10.0	3.5			
024000	Tart moulds 60.0x40.0cm	12	10.5	4.0			
024001	Tart moulds 40.0x30.0cm	6	10.5	4.0			



		Moulds	Dim in cm
023924	Champagne biscuit moulds 60.0x40.0cm	45	10.9x2.4x1.0

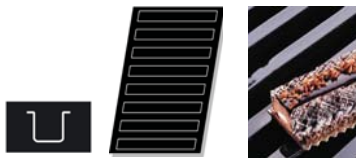

		Moulds	Dim in cm
023929	Christmas log moulds 60.0x40.0cm	8	33.9x4.0x3.9



		Moulds	Dim in cm
023930	Insert for christmas log moulds 60.0x40.0cm	5	59.5x4.0x3.9



		Moulds	Dim in cm
023920	Fluted cake moulds 60.0x40.0cm	16	11.0x6.0x2.5
023921	Fluted cake moulds 40.0x30.0cm	8	11.0x6.0x2.5

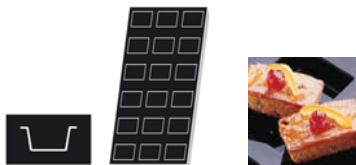

		Moulds	Dim in cm
023933	Cake moulds 60.0x40.0cm	18	10.2x5.8x3.0
023934	Cake moulds 40.0x30.0cm	9	10.2x5.8x3.0

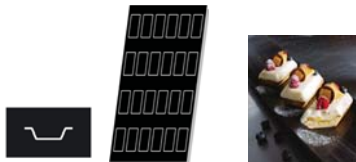

		Moulds	Dim in cm
023925	Financier moulds 60.0x40.0cm	24	8.6x4.6x1.4
023926	Financier moulds 40.0x30.0cm	12	8.6x4.6x1.4

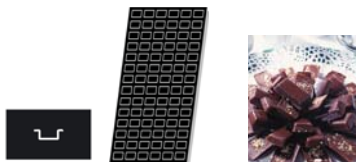

		Moulds	Dim in cm
023922	Mini financier moulds 60.0x40.0cm	84	5.0x2.6x1.1
023923	Mini financier moulds 40.0x30.0cm	42	5.0x2.6x1.1
024002	Mini financier moulds 32.5x26.5cm	35	5.0x2.6x1.1

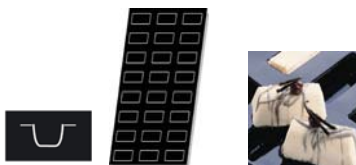

		Moulds	Dim in cm
023927	Mini log moulds 60.0x40.0cm	24	12.2x4.2x3.2
023928	Mini log moulds 40.0x30.0cm	12	12.2x4.2x3.2
023917	Mini log moulds 60.0x40.0cm	24	9.5x4.0x3.0
023918	Mini log moulds 40.0x30.0cm	12	9.5x4.0x3.0
023919	Mini log moulds 32.5x26.5cm	8	9.5x4.0x3.0

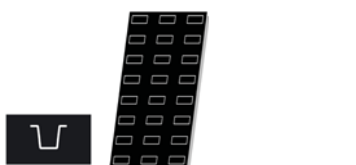

		Moulds	Dim in cm
023931	Rectangular cake moulds 60.0x40.0cm	24	8.0x3.0x3.0
023932	Rectangular cake moulds 40.0x30.0cm	12	8.0x3.0x3.0

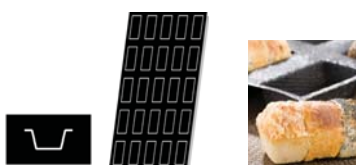

		Moulds	Dim in cm
023935	Rectangular cake moulds 60.0x40.0cm	25	8.9x4.6x2.5
023936	Rectangular cake moulds 40.0x30.0cm	12	8.9x4.6x2.5

		Dim in cm
022300	Baking paper siliconized, non-stick, double side, 500pcs	60.0x40.0
022301	Baking paper siliconized, non-stick, double side, 500pcs	53.0x32.5



Silform

BREAD BAKING SHEETS

Silform, a combination of knitted glass fabric and food grade silicone. Aerated mat. Formed to specific shapes of bread.

Uses: Proofing and baking various small breads on baking sheets

Advantage: Even shape of the baked product

		Dim in cm
023650	Silform 60.0x40.0cm, 18 hot dogs - éclairs	15.5x4.1x2.5
023651	Silform 60.0x40.0cm, 8 sandwich moulds	25.9x6.4x3.0



		Ø cm	H in cm
023652	Silform 60.0x40.0cm, 11 hamburger buns	12.5	1.6
023653	Silform 60.0x40.0cm, 6 pizzas	16.6	1.2



Silpat

PASTRY MAT

A combination of woven fibre glass and food grade silicone. Non-perforated material with a smooth side on which the products to bake or freeze will be placed, and a less smooth reversed side which will prevent the Silpat to slip from the tray.

Uses: Replaces silicone paper to bake or freeze fluid or soft pastry doughs on baking sheets (meringue, cookies, chou paste, croissants, sugarcraft)

Advantages: Lasting, non-stick, hygienic

		GN size	Dim in cm
023660	Pastry sheet/baking mat SILPAT		60.0x40.0
023661	Pastry sheet/baking mat SILPAT	2/1	64.0x52.0
023662	Pastry sheet/baking mat SILPAT	1/1	53.0x32.5



Silpain

BREAD BAKING MAT

A combination of woven fibre glass and food grade silicones. Open mesh.

Uses: Proving and baking bread of all shapes and sizes, especially effective for baking frozen dough

Advantages: Can replace the recoating of a flat metallic tray

		GN size	Dim in cm
023671	Bread baking mat SILPAIN	2/1	64.0x52.0
023670	Bread baking mat SILPAIN		58.5x38.5



- Alusteel:** Is a special strong steel plate with an aluminium coating on both sides. The sheet surface is non-rusting.
- Peraluman:** Special aluminium alloy. Absolutely non-rusting, therefore suitable for storing goods in refrigerator. Very high quality sheet
- Aluminium:** Baking sheet with good baking results and non-stick performance. Non-rusting - but tend to oxidise
- Non-stick:** Baking sheet with good baking results and non-stick performance. Non-rusting
- Blue steel:** The sheets need to be greased before baking. Tend to rust easily - must be kept dry and oiled
- Black steel:** Advised in combination with non-stick mats. Tend to rust very easily - must be kept dry and oiled

Aluminium



		GN size	Dim in cm
023702	Baking sheet, 45° rims	1/1	53.0x32.5x1.0
023703	Baking sheet, 45° rims	2/1	65.0x53.0x2.5
023701	Baking sheet, 45° rims		60.0x40.0x2.0



003556	Baking sheet, 45° rims, perforated	1/1	53.0x32.5x1.0
020971	Baking sheet, 45° rims, perforated	2/1	65.0x53.0x2.5
020973	Baking sheet, 45° rims, perforated		60.0x40.0x1.0



022205	Baking sheet, 90° rims	1/1	32.5x53.0x2.0
037858	Baking sheet, 90° rims		60.0x40.0x1.5
022207	Baking sheet, 90° rims		80.0x40.0x2.5
022208	Baking sheet, 90° rims		80.0x60.0x2.5
023706	Baking sheet, 90° rims, perforated	2/1	65.0x53.0x2.5
023707	Baking sheet, 90° rims, perforated		78.0x58.0x2.5
066031	Baking sheet with 3 rims		58.0x58.0x2.5
066037	Baking sheet with 3 rims		78.0x58.0x2.5

Aluminium non-stick

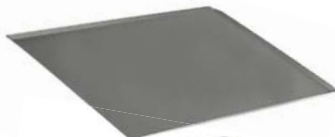

		GN size	Dim in cm
020966	Baking sheet, oblique rims	1/1	53.0x32.5x1.0
020967	Baking sheet, oblique rims	2/1	65.0x53.0x1.0
020965	Baking sheet, oblique rims		60.0x40.0x1.0



023721	Baking sheet, 45° rims, perforated	1/1	53.0x32.5x2.0
023722	Baking sheet, 45° rims, perforated	2/1	65.0x53.0x2.5
023720	Baking sheet, 45° rims, perforated		60.0x40.0x1.0



023726	Baking sheet, 90° rims, perforated	2/1	65.0x53.0x2.5
023727	Baking sheet, 90° rims, perforated		78.0x58.0x2.5
023724	Baking sheet, 90° rims, perforated		60.0x40.0x2.0

Peraluman

		GN size	Dim in cm
016087	Baking sheet	1/1	53.0x32.5x2.7
016083	Baking sheet	2/1	65.0x53.0x2.7



Black steel

		GN size	Dim in cm
022851	Baking sheet	1/1	53.0x32.5x1.0
022852	Baking sheet	2/1	65.0x53.0x1.0
022847	Baking sheet		60.0x40.0x1.0



Blue steel

		Dim in cm
066026	Baking sheet with 3 rims	58.0x58.0x2.5
066027	Baking sheet with 3 rims	78.0x58.0x2.5



Polypropylene

		Dim in cm
005206	Bread proofing rectangular 0.5kg, light green	27.0x12.0
004443	Bread proofing rectangular 1.0kg, orange	35.0x13.0
005207	Bread proofing rectangular 1.5kg, blue	42.0x14.0

		Ø cm
004662	Bread proofing round 0.5kg, light green	19.0
004444	Bread proofing round 1.0kg, orange	22.0
005208	Bread proofing round 1.5kg, blue	25.0
Remark: Very hygienic, dishwasher proof, easy cleaning due to closed surface, durable, stackable, do not use in oven		



Aluminium

		Height of rim in cm	Dim in cm
066070	Oven blade with 3 rims perforated (Ø of hole 1.0cm)	3.0	58.0x47.0



Wood

		L in cm	Blade in cm
029816	Baking peel	400.0	60.0x40.0
029817	Peel for pizza	300.0	35.0
029818	Peel for baking sheets	300.0	60.0x22.0



Stainless steel

		L in cm	Dim in cm
026156	Pizza shovel	150.0	20.0x20.5



Plastic



		Dim in cm
068572	Dough scraper conical, with handy reinforced rim	21.0x13.0



		Dim in cm
009555	Dough scraper half round	12.0x8.8



		Dim in cm
068574	Dough and cream scraper half round	19.8x14.9

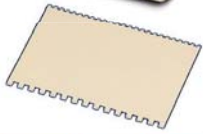

		Dim in cm
068575	Comb and spatula, giving 2 different designs	11.0x7.5



		Dim in cm
068576	Comb profile set 4 pcs	7.5x7.0



		Dim in cm
004903	Dough ruler flexible	64.0x5.0

Stainless steel



		Dim in cm
017824	Dough scraper with plastic handle	15.0x7.5



		Width of blade cm	Length of blade cm
018355	Triangular spatula safety handle	8.0	24.5
018356	Triangular spatula safety handle	10.0	25.0



		Ø cm	H in cm
067934	Cake knife rinsing & scraping box, plastic execution	10.0	22.0



		Blade in cm
024800	Jack knife for bakers, red handle	12.0



		Ø cm	L in cm
024496	Pastry brush, round, plastic handle	1.5	21.0



		L in cm	Dim in cm
012163	Pastry brush, synthetic bristles, polypropylene handle	24.0	4.0
018954	Pastry brush, synthetic bristles, polypropylene handle	24.0	5.0
012241	Pastry brush, synthetic bristles, polypropylene handle	24.0	6.0
012240	Pastry brush, synthetic bristles, polypropylene handle	24.5	7.5



		L in cm
009553	Flour brush black bristles, wood grip	30.0

Stainless steel

		Dim in cm
002091	Croissant cutting device with 3 sections	18.0x14.0
001240	Triangular croissant cutter with nylon handles	18.0x20.0



Plastic

		W in cm
068557	Roller with spikes, distance between teeth 1.5cm	11.5
068558	Roller with spikes, distance between teeth 1.5 cm, with metal bow and plastic handle	27.0
005107	Cutting roller	6.5
068559	Lattice roller/cutter, distance between blade 0.7cm	12.0
068560	Lattice cutter round, consisting of 2 parts	Ø cm 30.0



Stainless steel

		Ø cm	L in cm
026370	Pastry wheel plain	5.7	18.5
026371	Pastry wheel serrated	5.7	18.5
021122	Pizza wheel plain	6.7	19.0
018890	Dough divider expandable 5 wheels plain	Ø cm 5.5	
018891	Dough divider expandable 7 wheels plain	5.5	
018892	Dough divider expandable 5 wheels plain and 5 wheels serrated	Ø cm 5.5	
018894	Dough divider expandable 7 wheels plain and 7 wheels serrated	5.5	



Hard plastic



		Ø cm	L of roll cm
042001	Plastic rolling pin with handles	8.0	30.0
042003	Plastic rolling pin with handles	8.0	40.0



		Ø cm	L in cm
002103	Plastic rolling pin with handles	5.8	60.0

Wood



		Ø cm	L of roll cm	Total L in cm
015840	Rolling pin with handles, small	25.0	44.0	6.0



		Ø cm	L of roll cm	Total L in cm
018880	Rolling pin with ball bearing	8.0	30.0	58.0
018881	Rolling pin with ball bearing	8.0	35.0	63.0
018882	Rolling pin with ball bearing	8.0	40.0	68.0



		Ø cm	L in cm
042160	Rolling pin without handles	5.0	50.0

Polystyrene



		Ø cm	L in cm
068551	Basketweave rolling pin without handles	5.1	25.5



		Ø cm	L in cm
022799	Basketweave rolling pin with handles s/s	3.8	38.0

Anodized aluminium



		Ø cm	L in cm
068552	Ribbed rolling pin without handles	5.1	24.0

Plastic



022800	Rolling pin with 11 sets of spacer washers each set is suitable for a different dough thickness: thickness in cm: 2.0, 2.5, 3.0, 3.5, 4.0, 5.0, 6.0, 7.0, 8.0, 9.0, 10.0		
--------	--	--	--

Polystyrene

		Ø cm	H in cm
068581	Stirring bowl with base	25.0	14.5



		Dim in cm
068582	Fruit strainer	34.0x11.0x8.0



Plastic

		Ø cm	H in cm
002622	Flour sieve, white, dishwasher proof, with refined steel mesh, width of mesh 2.8mm	30.5	11.5
001106	Flour sieve, white, dishwasher proof, with refined steel mesh, width of mesh 1.8mm	30.5	11.5
002623	Flour sieve, white, dishwasher proof, with refined steel mesh, width of mesh 1.2mm	30.5	11.5
001551	Flour sieve, white, dishwasher proof, with refined steel mesh, width of mesh 0.85mm	30.5	11.5



Stainless steel

		Ø cm
017396	Flour sieve, width of mesh 1.15x1.15mm	30.0
017397	Flour sieve, width of mesh 8.0x8.0mm	30.0
017398	Flour sieve, width of mesh 5.0x5.0mm	30.0

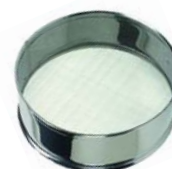

		Ø cm
018849	Flour sieve with handle and spring-lever	10.0



		Cap. ltr	L in cm
019294	Scoop	0.1	10.0
019295	Scoop	0.4	15.0
019296	Scoop	1.0	19.0
019297	Scoop	1.7	24.0



Aluminium

		Cap. ltr	L in cm
018909	Scoop with inside handle	2.6	30.0



		Cap. ltr	L in cm
026160	Scoop	0.11	18.5
026161	Scoop	0.13	21.0
026162	Scoop	0.25	25.0
026163	Scoop	0.45	31.0
026164	Scoop	0.80	35.0
026165	Scoop	1.50	40.0



Polypropylene

		Cap. ltr	Dim in cm
001446	Scoop	0.6	17.0x12.0
007248	Scoop	2.7	24.0x15.0



Stainless steel

STENCILS FOR DECORATION 60.0x40.0cm



071991 Squares



071995 Oblong ovals



071992 Lattices



071996 Oval zigzags



071993 Rhombs



071997 Rhombs with dots



071994 Small dots



071998 Circles and squares

Plastic

STENCILS FOR DECORATION 60.0x40.0cm



071801 Bells



071819 Squares

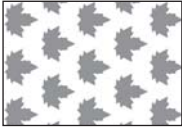

071802 Maple leaves

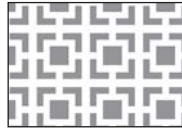

071828 Fancy squares



071815 Dots

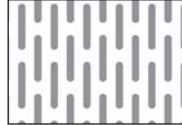

071829 Oblong ovals

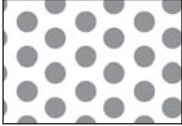

071816 Round holes



071838 Hearts



071817 Small fancy flowers



071839 Hexagons



071818 Fancy flowers

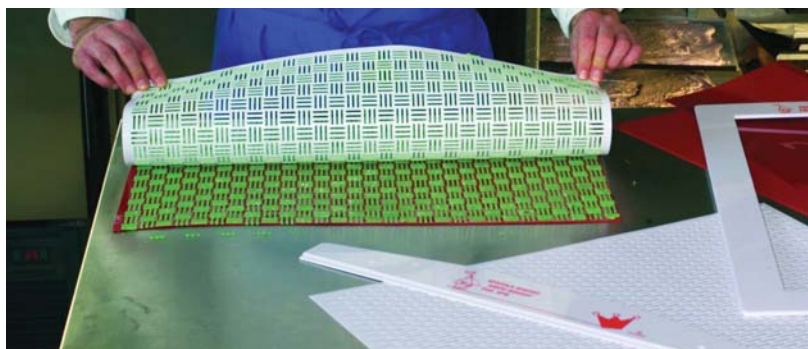

Silicone

RELIEF PASTRY MATS

Create designs for your cakes and desserts.

The mats are bakeable and freezable, 60.0x40.0cm

023680 Decor greek big



068639 Decor greek square



068635 Decor stripe



068638 Decor frieze



068637 Decor round

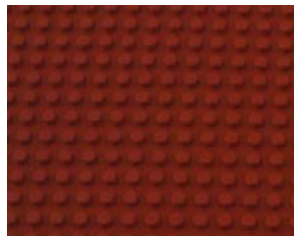

068640 Decor mayolica



Plastic



		Ø cm
013066	Decor primrose, set of 5 pcs	6.0-19.0

		Ø cm
023479	Decor star, set of 5 pcs	6.0-19.0

		Ø cm
071743	Decor leaf, set of 5 pcs	6.0-19.0

		Ø cm
071744	Decor poppy, set of 5 pcs	6.0-19.0



		Ø cm
071928	Stencil for cake decoration, decor sunshine	26.0

Silicone

PASTRY STENCIL MATS 57.0x37.3cm

Pastry stencils made of silicone. Stencils to be placed directly on the pastry sheets. Dough filled in the stencils and baked in it. This results in even cookies.



		Pcs	Ø cm	H in cm
071750	Decor square	96	3.5	3.5

		Pcs	Ø cm	H in cm
071751	Decor round	96	3.4	3.5

		Pcs	Ø cm	H in cm
071752	Decor heart	96	3.8	3.5

		Pcs	Ø cm	H in cm
071753	Decor oval	96	3.0	4.1

Plastic

STENCIL MATS WHITE, FOOD RESISTANT 58.0x39.0cm

		Pcs	Ø cm
068650	Round fluted	20	9.0
068651	Round fluted	72	4.5
016135	Round fluted	90	3.5
068653	Round plain	53	5.3
068654	Round plain	95	3.5
068655	Star	63	4.5
068656	Star	95	3.5
007750	Clover leaf	63	5.0
068658	Clover leaf	105	3.5
011471	Heart	95	4.5
068660	Heart	116	3.5
007753	Moon	78	4.8
068662	Moon	128	3.5

		Pcs	L in cm
011764	Three leaves	68	4.8

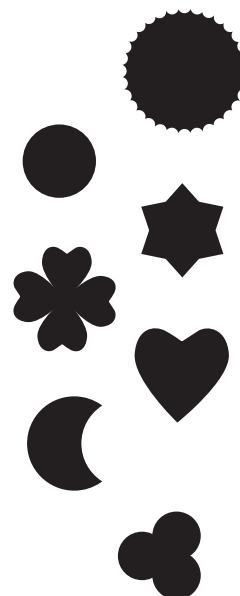

Polycarbonate

		Pcs	Dim in cm
025285	Mould for decorations	18	6.3x2.1
025286	Mould for decorations	18	6.6x2.0
025287	Mould for decorations	16	6.4x2.6
025288	Mould for decorations	18	6.3x2.3
025289	Mould for decorations	18	7.2x2.4
025290	Mould for decorations	18	7.2x1.9
025291	Mould for decorations	18	6.6x2.1
025292	Mould for decorations	18	6.5x2.2
025293	Mould for decorations	18	7.0x1.9



		Pcs	Dim in cm
025294	Mould for decorations	14	5.0x3.8
025295	Mould for decorations	16	6.2x3.1
025296	Mould for decorations	12	5.0x4.9
025297	Mould for decorations	15	4.7x3.9

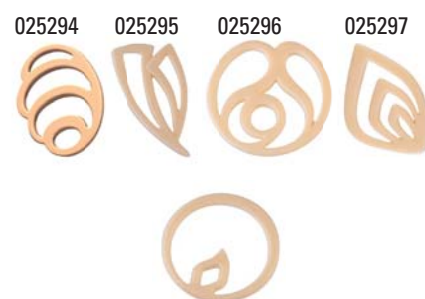

		Pcs	Ø cm
025298	Mould for decorations	11	5.0

		Pcs	Dim in cm
025299	Mould for decorations	12	12.9x1.7
025300	Mould for decorations	22	11.0x0.7

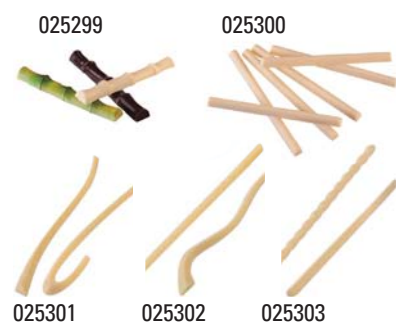

		Pcs	Dim in cm
025301	Mould for decorations	8 + 8	10.8x1.7 / 10.1x1.8
025302	Mould for decorations	10 + 10	12.5x0.4 / 10.2x1.7
025303	Mould for decorations	13 + 13	12.3x0.4 / 10.9x0.5

Plastic

PASTRY SHEET MONOPORTION

35 moulds each 75gr sheet with 7 bars plus 1 bar ejector dimension: 60.0x40.0cm

071970	Round shape	071971	Oval shape	071972	Hexagonal shape
071973	Heart shape	071978	Square shape	071979	Triangle shape
071980	Drop shape	071981	Rhomb shape	071964	Comma shape

PASTRY CUTTER FOR ABOVE PASTRY SHEETS

071940	Round shape	071941	Oval shape	071942	Hexagonal shape
071943	Heart shape	071944	Square shape	071945	Triangle shape
071946	Drop shape	071947	Rhomb shape	071967	Comma shape

PASTRY SHEET MIGNON

96 moulds each 20gr sheet with 6 bars, plus 1 bar ejector dimension: 60.0x40.0cm

071974	Round shape	071975	Oval shape	071976	Hexagonal shape
071982	Heart shape	071983	Square shape	071984	Triangle shape
071985	Drop shape	071986	Rhomb shape	071968	Comma shape

PASTRY CUTTER FOR ABOVE PASTRY SHEETS

071820	Round shape	071821	Oval shape	071822	Hexagonal shape
071823	Heart shape	071824	Square shape	071825	Triangle shape
071826	Drop shape	071827	Rhomb shape	071969	Comma shape

Plastic

Dim in cm

071987	Pastry sheet pyramid	60.0x40.0
35 moulds each 75gr sheet with 7 bars		

071988	Pastry set halfsphere 20 moulds each 75gr
--------	---

W in cm

071955	Comb, design trunk	10.0
071956	Comb, design trunk	15.0

Stainless steel

Dim in cm

071954	Comb for biscuit, two sides, with frame, one side zigzag pattern, one side striped	75.0x11.0
--------	---	-----------

Dim in cm

028703	Universal comb stainless steel with 5 different rubber blades. Blades can be easily exchanged, each blade has 2 different sides giving 2 designs, good-graded and rubber strip	71.0x15.0x5.5
--------	--	---------------

		Ø cm
067894	Set of 25 letter cutters in box, tin	5.0



		L in cm	H in cm
003655	Set of 26 letter cutters in box, tin	2.5	2.0



		L in cm	H in cm
003656	Set of 9 number cutters in box, tin	3.5	2.0



		H in cm
012850	Set of 10 different animal cutters in box, tin	2.0



		H in cm
067868	Set of 5 Easter cutters, tin	2.5



		Ø cm	H in cm
067858	Set of 10 Christmas cutters, tin	5.0	2.0
067859	Set of 10 Christmas cutters, tin	6.0	2.0



		Ø cm	H in cm
067504	Set of 8 Christmas cutters, tin	5.0	2.5



		Ø cm	H in cm
029585	Set of 12 fruit cutters, tin	12.0	2.0





		Ø cm	H in cm
067840	Set of 5 round fluted cutters, s/s	2.2-6.5	3.0
067841	Set of 8 round fluted cutters, s/s	2.2-11.0	3.0
067842	Set of 10 round fluted cutters, s/s	2.2-14.0	3.0



		Ø cm	H in cm
068506	Set of 9 round fluted cutters, polyglass	2.0-10.0	3.5
001729	Set of 9 round plain cutters, polyglass	2.0-10.0	3.5



		Ø cm	H in cm
068508	Set of 7 oval fluted cutter, polyglass	4.0-13.0	3.5



		Ø cm	H in cm
067843	Set of 10 round plain cutters, tin	1.2-7.3	3.0
067844	Set of 16 round plain cutters, tin	1.2-11.3	3.0
067845	Set of 20 round plain cutters, tin	1.2-14.0	3.0



		Ø cm	H in cm
000569	Set of 14 round plain cutters, tin	12.5	3.0



		Ø cm	H in cm
067501	Set of 9 oval plain cutters, tin	2.3x2.8 - 12.5x14.4	3.0



		Ø cm	H in cm
067502	Set of 6 oval serrated cutters, tin	4.0x5.5 - 8.5x11.5	3.5



		Ø cm	H in cm
001595	Set of 14 round fluted cutters, tin	3.0	2.0-10.5



		Ø cm	H in cm
067863	Set of 75 extra fine worked cutters, tin	0.6-4.0	1.8



		Ø cm	H in cm
067864	Set of 25 extra fine worked cutters, tin	2.0-3.5	1.8



		Ø cm	H in cm
067854	Set of 42 extra fine worked cutters "Mosaik", tin	0.6-2.2	1.8



		Ø cm	H in cm
067855	Set of 12 different shaped cutters, tin	1.4	1.8



		Ø cm	H in cm
067856	Set of 15 different shaped cutters, tin	1.5	1.8
067857	Set of 15 different shaped cutters, tin	2.0	1.8

		Ø cm	H in cm
012849	Set of 12 different small cutters, tin	2.0-3.0	2.0
		Ø cm	
067865	Set with 3 flower cutters with ejector complete with box, aluminium	0.6, 0.9, 1.3	
		Ø cm	
067866	Set with 3 heart cutters with ejector complete with box, aluminium	0.5, 1.0, 1.5	
		Ø cm	H in cm
002363	Set of 9 plain star cutters, s/s	3.7-14.9	3.0
		Ø cm	H in cm
067848	Set of 8 heart cutters, s/s	4.5-13.5	3.0
		Ø cm	H in cm
002522	Set of 6 heart cutters, tin	10.0	3.0
		Ø cm	H in cm
067849	Set of 7 heart cutters plain and scalloped, s/s	3.0-14.0	3.0
		Ø cm	H in cm
029599	Set of 6 plain drop cutters, tin	10.0	3.0
		L in cm	H in cm
001031	Set of 6 plain square cutters, tin	3.0-7.0	3.0
		Ø cm	H in cm
016662	Set of 6 plain hexagon shaped cutters, polyamide	1.5-9.0	5.0
		Ø cm	H in cm
001552	Set of 9 plain oval cutters, tin	10.0	3.0
		Ø cm	H in cm
001166	Set of 6 flower shaped cutters, tin	10.0	3.0
		Ø cm	H in cm
029600	Set of 6 half moon cutters, tin	10.0	3.0
		L in cm	
067850	Set of 3 different rose leaf cutters with ejectors, plastic	2.5/3.0/4.0	
		L in cm	
067851	Set of 3 different ivy leaf cutters with ejectors, plastic	1.5/2.2/2.8	





		Ø cm
003361	Set of 4 petal flower cutters, plastic	0.6/0.9/1.4/2.4



		Ø cm
003362	Set of 2 Gerbera cutters, plastic	7.0/9.0



		Ø cm	H in cm
003363	Alveolar tray, to model big Gerbera flowers, plastic	5.0	2.5



		Ø cm	H in cm
003366	Alveolar tray, to model small Gerbera flowers, plastic	4.0	2.0



		Dim in cm	
003364	Set of 3 orchid cutters, plastic	10.5x8.5/4.8x4.8/6.0x3.0	



003365	Set of 4 orchid flower formers, plastic		
--------	---	--	--



026168	Doughnut cutter, outer dim 6.0cm, inner dim 2.5cm, depth 2.0cm, s/s		
026169	Doughnut cutter, outer dim 6.7cm, inner dim 3.0cm, depth 1.7cm, s/s		
026170	Doughnut cutter, outer dim 8.0cm, inner dim 4.0cm, depth 2.0cm, s/s		



		L in cm	H in cm
067510	Horse-shoes cutter, tin	10.0	2.5



		L in cm	H in cm
067511	Christmas tree cutter, tin	11.5	3.0
024488	Christmas tree cutter, tin	20.0	3.0



		L in cm	H in cm
067513	Santa Claus cutter, tin	23.0	3.0

		Ø cm	H in cm
067870	Star cutter, tin	5.0	6.0
068524	Cinnamon star cutter, polystyrene	5.0	2.0
067869	Vol au vent cutter and holder, polystyrene	3.8	5.0
068601	Round vol au vent cutter with rubber punch and ejector	8.0/5.6	1.7
068602	Round, double vol au vent cutter with rubber punch and ejector	4.0/2.4	1.7
068603	Round, fluted vol au vent cutter with rubber punch and ejector	6.3/4.0	1.7
068604	Hexagonal vol au vent cutter with rubber punch and ejector	8.2/5.4	1.7
029852	Aluminium stencil for "Japonais", round with handle	20.0	0.2
029853	Aluminium stencil for "Japonais", round with handle	26.0	0.2
029854	Aluminium stencil for "Japonais", round with handle	14.0	0.3
029855	Aluminium stencil for "Japonais", round with handle	20.0	0.3
029856	Aluminium stencil for "Japonais", round with handle	24.0	0.3
029857	Aluminium stencil for "Japonais", round with handle	20.0	0.5
029858	Aluminium stencil for "Japonais", round with handle	26.0	0.5
067937	Sugar dredger with mesh cover, s/s	7.0	9.6
003025	Sugar dredger with perforated cover, s/s	7.0	9.6
004341	Tart divider, 8/12 pieces, plastic	26.5	
004342	Tart divider, 12/16 pieces, plastic	26.5	
004343	Tart divider, 14/16 pieces, plastic	26.5	
004725	Tart divider, 12/18 pieces, plastic	26.5	
Remark: Useable on both sides, with 2 handles			
029823	Cake saw with 3 adjustable blades steel tube frame, ideal for rational and regular slicing of sandwich and cakes in every required thickness		L in cm 46.0
029824	Spare blade to cake saw 029823		L in cm 45.0



Tin



		Ø cm	H in cm
067871	Set of 14 plain nozzles	0.4-1.5	5.0



		Ø cm	H in cm
067872	Set of 14 star nozzles	0.4-1.5	5.0



		Ø cm	H in cm
067873	Set of 5 rose nozzles	0.8-1.6	5.0



		Ø cm	H in cm
067875	Star ribbon nozzles 6 points	1.7	5.0

067876	Star ribbon nozzles 8 points	2.1	5.0
--------	------------------------------	-----	-----



		H in cm
067874	Set of 7 different decorating nozzles	5.0



		Ø cm	L in cm
067884	Cream cornet mould	3.5	14.0

034584	Cream cornet mould	4.0	13.4
--------	--------------------	-----	------



		Ø cm	L in cm
067886	Cream roll mould cylindrical	2.0	14.0

067887	Cream roll mould conical	2.3/1.9	15.0
--------	--------------------------	---------	------



		Ø cm	H in cm
000953	Fritter tube, s/s	4.0	9.5



068619	Set of 55 assorted fine decorating tubes, complete with connection ring, light execution, packed in a plastic box		
--------	---	--	--

German silver



067878	Set of 12 decorating tubes, very fine worked tubes in German Silver, strong and heavy execution, packed in metal box		
--------	--	--	--



067881	Set of 24 assorted decorating tubes with connection ring, packed in a plastic box, strong tubes for extra fine decoration		
--------	---	--	--

Polycarbonate

068618	Set of 6 assorted decorating tubes transparent 3 plain tubes, 3 star tubes		
011615	Piping tube box assorted with 12 tubes, polycarbonate		
023266	Piping tube box assorted with 24 tubes, polycarbonate		
003151	Set of 6 plain tubes	Ø cm 0.5-1.5	L in cm 6.0
068523	Set of 6 star tubes with a reinforced point for fine writing	Ø cm 0.3-1.3	L in cm 6.0



Polystyrene

068527	Piping tube set, 20 different tubes and 2 adapters, plastic
068528	Piping tube box assorted with 12 tubes



Plastic

068709	Wall rack for piping tubes, for 24 tubes	Dim in cm 27.0x25.0
--------	--	------------------------



Polypropylene

068500	Connection piece 2 parts, bayonet joint for easy change of tubes from outside, suitable for all nozzles from 0.4 to 1.5cm
--------	---





		Dim in cm
068530	Wall rack for tubes and bags	50.0x50.0

		H in cm
068532	Support for pastry bags	23.5

PASTRY BAGS

Pastry bags weldless, with double outward-folded seam, with hanger boilable, impermeable, suitable for all mixtures. Flexible even after long usage



		L in cm
068534	Export pastry bag	28.0
068535	Export pastry bag	34.0
068536	Export pastry bag	40.0
068537	Export pastry bag	46.0
068538	Export pastry bag	50.0
068548	Export pastry bag	55.0
068549	Export pastry bag	60.0



		L in cm
068546	Double dressing bag with separation	34.0
Remark: Because of separating insert, substances of 2 different colours and 2 different tastes can be sprayed at the same time		



		H in cm
068614	Pastry bag dispenser	58.0
It contains up to 50 pastry bags of 50.0cm		



		H in cm
068615	Set of 50 pastry bags "oneday"	50.0
strong polyethylene bag with special welding closed tip to be used with or without nozzle		
Remark: Suitable for pastry bag dispenser 068614		



		L in cm
068611	Disposable pastry bags strong polyethylene bag with special wide band, seal with closed tip to be used with or without nozzle, 100 pcs per roll, perforated	55.0

		L in cm
068613	Disposable pastry bags strong polyethylene bag with special wide band, seal with closed tip to be used with or without nozzle, 100 pcs per roll, perforated	40.0



		L in cm
015042	Decor pencil, to be filled with liquid to decorate, dishwasher safe, silicone	13.5



		L in cm
015043	Decor pencil, to be filled with liquid to decorate, dishwasher safe, silicone	19.5

Stainless steel

		Ø cm	Cap. ltr	H in cm
067940	Sauce dispenser/liqueur and fondant funnel 2 openings 4/8 mm	18.0	1.9	25.0



067950	Stand for fondant funnel, s/s			
--------	-------------------------------	--	--	--



		Ø cm	Cap. ltr	H in cm
017741	Confectionery funnel, without stand	17.5	1.5	16.5



022789	Stand for fondant funnel, chrome-wire			
--------	---------------------------------------	--	--	--



		Ø cm	Cap. ltr	Dim in cm	
004934	Mini piston funnel, black handle	15.0	0.8	18.5x15.0x15.5	●
004935	Mini piston funnel, green handle	15.0	0.8	18.5x15.0x15.5	●
004936	Mini piston funnel, orange handle	15.0	0.8	18.5x15.0x15.5	●
004937	Mini piston funnel, red handle	15.0	0.8	18.5x15.0x15.5	●
004938	Mini piston funnel, fuchsia handle	15.0	0.8	18.5x15.0x15.5	●



Polycarbonate

		Ø cm	Cap. ltr	H in cm
022788	Polycarbonate liqueur funnel, complete with 4 different nozzles, 2.5/4.0/5.5/8.0mm, polycarbonate resistant up to 100°C, incl. wire stand	20.8	1.5	30.8



		L in cm	Blade in cm
018841	Dough scraper	31.5	10.5x7.0



		L in cm	Blade in cm
005654	High heat spatula	25.0	9.0x6.0

005253	High heat spatula	35.0	11.0x7.0
--------	-------------------	------	----------

034066	High heat spatula	40.0	11.0x7.0
--------	-------------------	------	----------



		L in cm
001029	Cake tong, s/s	17.5



		L in cm
005287	Pastry tong with flat tips, s/s	19.5



Stainless steel



		L in cm
006920	Cake server, rectangular	24.0



		P/U	Blade in cm
024370	Flexible spatula, nylon handle	6	10.0
024394	Flexible spatula, nylon handle	6	12.0
024395	Flexible spatula, nylon handle	6	15.0
024397	Flexible spatula, nylon handle	6	20.0
024398	Flexible spatula, nylon handle	6	23.0
024399	Flexible spatula, nylon handle	6	25.0
024401	Flexible spatula, nylon handle	6	31.0



		Colour	Blade in cm	
●	020827	Spatula straight, nylon handle	black	16.0
●	020828	Spatula straight, nylon handle	yellow	16.0
●	020829	Spatula straight, nylon handle	green	16.0
●	020831	Spatula straight, nylon handle	red	16.0
○	020832	Spatula straight, nylon handle	white	16.0
●	020833	Spatula straight, nylon handle	brown	16.0



		Colour	Blade in cm	
●	020834	Spatula straight, nylon handle	black	21.0
●	020838	Spatula straight, nylon handle	red	21.0
○	020750	Spatula straight, nylon handle	white	21.0



		Colour	Blade in cm	
●	020841	Spatula straight, nylon handle	black	26.0
●	020842	Spatula straight, nylon handle	yellow	26.0
●	020843	Spatula straight, nylon handle	green	26.0
○	020751	Spatula straight, nylon handle	white	26.0
●	020847	Spatula straight, nylon handle	brown	26.0



		Colour	Blade in cm	
●	020848	Spatula straight, nylon handle	black	31.0
●	020849	Spatula straight, nylon handle	yellow	31.0
●	020850	Spatula straight, nylon handle	green	31.0
●	020852	Spatula straight, nylon handle	red	31.0
○	020853	Spatula straight, nylon handle	white	31.0
●	020854	Spatula straight, nylon handle	brown	31.0



		Width of blade in cm	Length of blade in cm
017737	Angle-shaped spatula with ABS-handle	7.0	16.0



		P/U	Blade in cm
024415	Angled conical shaped spatula, nylon handle	6	16.0



		Blade in cm
068502	Knife for cake sheet, wavy, bent plastic handle	18.0

029840	Sugar thermometer with wire casing	Range 80°C to 180°C
004597	Syrup scale	Range 0-50 Baumé
025401	Digital thermometer	Range -50°C to +300°C
022801	Inspection jug for syrup scale	
004743	Dough thermometer	Range -20°C to +50°C
029844	Dough thermometer with plastic cage	Range 0°C to 50°C
029845	Kettle thermometer with cage	Range 0°C to 100°C
029848	Digital pocket test thermometer with storing of momentary display, automatic switch off, protective casing and clip	Range -50°C to +200°C
029849	Pocket test thermometer	Range -10°C to +100°C
029831	Freezer/refrigerator thermometer	Range -40°C to +40°C
029832	Oven thermometer	Range 0°C to 300°C
029835	Digital timer 20 hours, magnetic back clip & easel stand	Dim in cm 5.0x6.0



Stainless steel



		Ø cm	H in cm
011042	Cassata mould with lid	9.5	8.5
029584	Cassata mould with lid	12.5	10.0



		Ø cm	Cap. ltr	H in cm
026390	Pudding mould with lid	14.0	1.2	13.5
026391	Pudding mould with lid	16.0	1.5	14.0
026392	Pudding mould with lid	18.0	2.4	15.5



		Cap. ltr	Dim in cm
026386	Brick shape ice mould	1.0	28.5x9.0x4.5
026387	Brick shape ice mould	1.5	33.5x11.5x4.5
026388	Brick shape ice mould	2.0	34.0x14.0x4.5



		Ø cm	Cap. ltr	H in cm
026380	Ice cream bomb with lid, stackable	10.0	0.3	7.0
026381	Ice cream bomb with lid, stackable	12.0	0.5	8.0
026382	Ice cream bomb with lid, stackable	14.0	0.8	9.0
026383	Ice cream bomb with lid, stackable	16.0	1.0	9.5
026384	Ice cream bomb with lid, stackable	18.0	1.5	11.0
026385	Ice cream bomb with lid, stackable	20.0	2.0	12.0

Tinned



		Ø cm	Cap. ltr	H in cm
026364	Charlotte mould	20.0	3.0	11.0

Stainless steel



		Ø cm
022069	Lid for charlotte mould	16.0
022209	Lid for charlotte mould	20.0

Plastic



		Ø cm	Cap. ltr
068590	Ice cream mould with lid	14.0	1.0



		Dim in cm
068591	Ice cream mould (cassata)	28.0x8.5x6.5

Aluminium

Ice cream scoops with special liquid filling makes portioning easy. Very strong execution

		Ø cm	Cap. ltr
004728	Ice cream scoop	4.9	1/30
024507	Ice cream scoop	5.1	1/24
000954	Ice cream scoop	5.6	1/20
024506	Ice cream scoop	5.9	1/16

		Cap. ltr
001116	Ice cream scoop, non-stick	1/24
008585	Ice cream scoop, non-stick	1/20
026394	Ice cream scoop, non-stick	1/16
014404	Ice cream scoop, non-stick	1/12



Stainless steel

		Ø cm	Cap. ltr
015846	Universal scoop round	3.3	1/70
015844	Universal scoop round	3.5	1/60
015847	Universal scoop round	3.8	1/50
015848	Universal scoop round	4.3	1/40
015849	Universal scoop round	4.7	1/30
015850	Universal scoop round	4.9	1/24
015851	Universal scoop round	5.2	1/20
015852	Universal scoop round	5.5	1/16
015853	Universal scoop round	6.3	1/12
015845	Universal scoop round	7.0	1/8



		Cap. ltr	Dim in cm
042227	Universal scoop oval	1/40	5.7x3.8
042226	Universal scoop oval	1/30	6.2x4.3
042225	Universal scoop oval	1/20	7.0x5.2



		Ø cm	Cap. ltr
042220	Univeral scoop square	3.7	1/20



		Ø cm	Cap. ltr
042222	Universal scoop heart	3.7	1/20



Stainless steel



		Dim in cm
067920	Ice cream scoop washer for 3-4 scoops for water connection on the right side	20.2x12.4
067921	Ice cream scoop washer for 3-4 scoops for water connection on the left side Remark: Full height with hood 13.0cm	20.2x12.4



		Dim in cm
067941	Rinsing box for 3-4 ice cream scoops with lid Remark: Full height with hood 13.0cm	20.2x12.4



		Dim in cm
026200	Ice cream cone holder with 3 holes, Ø=26.0cm, with non-slip feet	20.0x9.5x8.5
026201	Ice cream cone holder with 4 holes, Ø=26.0cm, with non-slip feet	27.0x9.5x8.5



		H in cm
068160	Pyramid display, 4 triangular plastic plates, 65.0x57.0cm, 42.0x48.0cm, 34.0x39.0cm, 25.0x29.0cm	72.0

Aluminium



		Ø of tiers in cm	Tiers
005285	Round cake stand, removable	20, 26, 32	3
005292	Round cake stand, removable	20, 26, 32, 40, 45	5
005293	Round cake stand, removable	16, 20, 26, 32, 40, 45, 50	7

Stainless steel



		Ø cm	H in cm
005294	Cake stand round with foot	8.0	30.0



		Ø cm	H in cm
000998	Cake stand revolving	32.0	7.5

Plastic

		Ø cm	H in cm
004605	Cake stand turnable, white	32.0	10.0



		Ø cm	H in cm
068592	Cake plate with low stand, white	32.0	2.5



		Ø cm	H in cm
068594	Protection cover transparent	32.0	9.0



		Ø cm
060810	Cake cooling tray, chrome-plated s/s	25.0

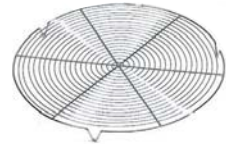

Stainless steel

		Dim in cm
038146	Truffle grid, fine mesh, with feet Remark: Grid fits into powderbox art. 038143	59.0x39.0x2.0



		Dim in cm
060816	Grid GN 1/2	32.5x26.5
056131	Grid GN 1/1	53.0x32.5
056130	Grid GN 2/1	65.0x53.0
056136	Grid	60.0x40.0

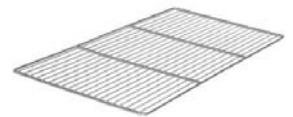

		Dim in cm
006921	Icing grid with feet	47.0x31.0
002640	Icing grid with feet, fits GN 2/1 sheets	59.0x39.0



Plastic

		Dim in cm
034524	Stackable box with hand-holes, side perforated	60.0x40.0x17.0
034526	Stackable box with hand-holes, side perforated	60.0x40.0x32.0



		Dim in cm
034511	Stackable box	60.0x40.0x8.0



Stainless steel

PASTRY FILLERS



		Ø cm
002374	Pastry filling machine with 1 filling piston s/s, guarantees maximum speed and precision of filling, capacity funnel 2.0ltr, filling quantity up to 1-30 gr	25.0



		Ø cm
002375	Pastry filling machine with 1 filling piston s/s, guarantees maximum speed and precision of filling, capacity funnel 5.2ltr, filling quantity up to 1-60 gr	37.0



		Ø cm
067926	Pastry filling machine with 1 filling piston s/s, bowl, guarantees even amount of filling, capacity of bowl 5.0ltr, filling quantity up to 1-14 gr, adjustable injection depth, very robust design for placing on tables without fastener	28.0



		Ø cm
067927	Pastry filling machine with 2 filling pistons s/s, bowl, guarantees even amount of filling, capacity of bowl 5.0ltr, filling quantity up to 1-10 gr, adjustable injection depth, very robust design for placing on tables without fastener	28.0



		L in cm	Ø cm
029885	Pastry syringe manual	22.0	6.9



		Cap. ltr	Dim in cm
022288	Pressure pastry syringe for dosing of pastes, creams and mousses, knob for selecting pressure, incl. 1 plain and 1 star nozzle	0.75	38.4x10.5



		Cap. ltr	Dim in cm
022289	Spare container with hermetically-sealing lid	0.75	19.6x8.54



070210	Vermicelle press KISAG with 2 inserts adjustable height, 8-10 portions per filling	
--------	--	--

		Dim in cm
042820	Apple peeling machine KALI, clamp fixation for peeling, coring and slicing	31.5x12.5x21.0

Polycarbonate

The high quality of polycarbonate assures a long life period and repeated usage without any quality losses. The high class material allows the best production of bright and elegant shapes. Everything the heart of a pastry chef desires.

		Moulds	H in cm
036894	Small reindeer	4	10.0
033840	Reindeer	4	12.0
038614	Christmas tree and candle	4	7.1/7.6
038615	Santa Claus and snowman	4	7.9/7.2



Polyethylene

The polyethylene moulds are easy to use. Put them on the working top, spread chocolate over them, then shake lightly to remove any air bubbles. The handling of polyethylene is simple and allows an efficient and time saving performance. The perfect combination of price and performance make these products unbeatable.

		Moulds	H in cm
038639	Christmas tree moulds	4	12.0
038638	Christmas tree moulds	4	18.0



		Moulds	H in cm
038781	Sphere mould kit	2	6.0
038782	Sphere mould kit	2	6.0
038783	Sphere mould kit	2	6.0
038784	Sphere mould kit	2	6.0



038639



038638



038781



038782



038783



038784



Polyethylene



		Moulds	H in cm
038640	Christmas sledging moulds	2	7.0



		Moulds	H in cm
038668	Sweet home	2	11.8



		Moulds	H in cm
038669	Chocolate gift	2	6.9



		Moulds	H in cm
038671	Santa Claus with reindeer	3	12.2



		Moulds	H in cm
038672	Santa Claus with fawn	1	18.0



		Moulds	H in cm
001609	Santa Claus with teddy bear	1	16.8



		Moulds	H in cm
011775	Santa Claus with gifts	1	17.0



		Moulds	H in cm
033810	Santa Claus in the chimney	1	18.5



		Moulds	H in cm
071618	Santa Claus	2	7.5



		Moulds	H in cm
038673	Santa Claus teddy	1	18.0



		Moulds	H in cm
038779	Teddy bear with surprise	1	10.1



		Moulds	H in cm
038780	Teddy bear	1	10.5

Polyethylene

		Moulds	H in cm
032348	Penguin with scarf	1	23.0
032353	Happy snowman	2	10.0
037605	Small bell	1	11.0
033812	Big bell	1	14.0
035181	Snowman	3	11.4
037594	Angel with candle	1	17.5
038670	Angel with candle	2	12.5
071617	Christmas subject moulds with 9 different shapes	9	
071619	Boot	2	4.5
071625	Bells	11	1.2
071616	Mary, Joseph and baby Jesus	9	6.0x/6.5/3.0



Polycarbonate

The high quality of polycarbonate assures a long life period and repeated usage without any quality losses. The high class material allows the best production of bright and elegant shapes. Everything the heart of a pastry chef desires.

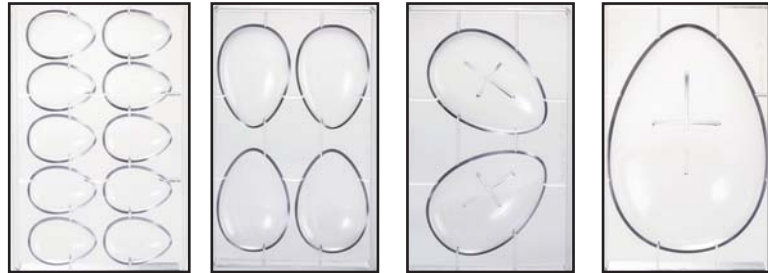

		Moulds	H in cm
038812	Egg moulds sheet at 7g	32	3.2
038813	Egg moulds sheet at 25g	10	4.4
038814	Egg moulds sheet at 70g	4	7.2
038815	Egg moulds sheet at 150g	2	9.0
038816	Egg moulds sheet at 230g	2	10.4
038817	Egg moulds sheet at 260g	1	12.1
038818	Egg moulds sheet at 380g	1	14.1
038819	Egg moulds sheet at 430g	1	15.7
033880	Egg moulds sheet at 500 g	1	17.5
033883	Egg moulds sheet at 850 g	1	21.0



		Moulds	H in cm
013828	Sectioned egg moulds sheet at 250gr	2	11.0
038820	Sectioned egg moulds sheet at 250gr	2	18.0

013828



038820



Polyethylene

The polyethylene moulds are easy to use. Put them on the working top, spread chocolate over them, then shake lightly to remove any air bubbles. The handling of polyethylene is simple and allows an efficient and time saving performance. The perfect combination of price and performance make these products unbeatable.



038786



038787



038788



038789

		Moulds	H in cm
038786	Easter egg	2	18.5
038787	Easter egg	2	18.5
038788	Easter egg	2	18.5
038789	Easter egg	2	18.5

038790

038785



		Moulds	H in cm
038790	Easter egg	2	15.5
038785	Easter egg	2	22.0

Polyethylene



		Moulds	H in cm
038799	Mr Bunny	1	15.2
038800	Ms Cocodé	1	12.0



		Moulds	H in cm
038791	Origami easter pack	3	13.2/10.0/14.2















		Moulds	H in cm
038795	Duck with bow	1	12.0
038798	Bunny on ice cream	1	12.0
038796	Astonished chicken	1	13.0
038797	Bunny in basket	1	12.0

Polyethylene

		Moulds	H in cm
038794	Bunny	1	22.0
038792	Chicken in basket	1	21.0
038793	Sheep with bell	1	19.0
038802	Bunny with stroller	1	14.0
038805	Three friends	1	22.0
034950	Bunny and chicken with shell	2	17.0
038409	Baby bunny	1	18.0
038801	Bunny in love	1	23.5
001606	Bunnies in a basket	1	17.0
034949	Bunny and giant egg	1	15.0
038808	Small chicken	1	11.0
038809	Big chicken	1	16.0



Polyethylene

		Moulds	H in cm
033849	Small chicken	2	16.0
		Moulds	H in cm
038806	Big chicken	1	20.5
		Moulds	H in cm
007219	Baby chicken	3	11.0
		Moulds	H in cm
038811	Baby Goose	1	14.5
		Moulds	H in cm
035830	Mrs Goose	2	12.5
		Moulds	H in cm
038810	Mr Goose	2	12.5
		Moulds	H in cm
009596	Easter duck	2	9.7
		Moulds	H in cm
071610	Sitting duck	6	2.6
		Moulds	H in cm
071613	Sitting bunny	6	1.5
		Moulds	H in cm
071661	Baby chicken	8	1.4
		Moulds	H in cm
071651	Egg	4	2.5
071652	Egg	2	4.0
001618	Egg	2	5.0
071654	Egg	1	8.5
		Moulds	H in cm
071650	Cracked egg	14	1.3
071655	Cracked egg	4	2.4
034948	Cracked egg	6	2.6
071656	Cracked egg	2	4.0
071657	Cracked egg	1	4.9

Silicone

		Moulds	Dim in cm
038822	Bride and groom with heart	1	21.0
038821	Bride and groom with heart	1	26.0

		Moulds	Dim in cm
038823	Doves and hearts	1	25.0

		Moulds	Dim in cm
038826	Married couple	1	12.0

		Moulds	Dim in cm
038828	Happy couple in the car	1	12.0

		Moulds	Dim in cm
038831	Married couple plate	1	2.0

		Moulds	Dim in cm
071624	Love bird	4	0.8

		Moulds	Dim in cm
071659	Heart	12	1.0
071660	Heart	8	1.2

		Moulds	Dim in cm
071669	Rose	4	1.6



Polyethylene

The polyethylene moulds are easy to use. Put them on the working top, spread chocolate over them, then shake lightly to remove any air bubbles. The handling of polyethylene is simple and allows an efficient and time saving performance. The perfect combination of price and performance make these products unbeatable.



		Moulds	H in cm
038612	Medium squirrel	4	8.0



		Moulds	H in cm
071620	Big bass	1	2.2

		Moulds	H in cm
071621	Sea creatures with 7 different shapes	14	0.8



		Moulds	H in cm
071622	Music instruments with 7 different shapes	11	0.6



		Moulds	H in cm
071623	Various fish moulds with 3 different shapes	11	1.0



		Moulds	H in cm
071626	Vehicle with 4 different shapes	8	1.0



		Moulds	H in cm
071653	Football	2	4.4

		Moulds	H in cm
071663	Music notes in 6 different shapes	11	0.6



		Moulds	H in cm
071664	Swans in 2 different shapes	4	2.8



		Moulds	H in cm
071667	7 working tools in 7 different shapes	7	0.8



		Moulds	H in cm
071662	Mould with numbers 0-9	1	0.5



		Moulds	H in cm
071672	Mould with numbers 0-9 inclusive stick	1	0.3

		Moulds	H in cm
071674	Number „50“ with stick	11	0.3

Polyethylene

The polyethylene moulds are easy to use. Put them on the working top, spread chocolate over them, then shake lightly to remove any air bubbles. The handling of polyethylene is simple and allows an efficient and time saving performance. The perfect combination of price and performance make these products unbeatable.

		Moulds	Dim in cm
038833	Egg Lollipop	8	7.7

		Moulds	Dim in cm
038834	Bar Lollipop	8	7.5

		Moulds	Dim in cm
038835	Heart Lollipop	8	6.5

		Moulds	Dim in cm
034792	Round Lollipop	8	7.5

		Moulds	Dim in cm
038836	Christmas tree and star Lollipop	4	7.6/7.4

		Moulds	Dim in cm
038837	Pumpkin and skull Lollipop	4	7.0/7.0



Polycarbonate



		Moulds	Grammes	Dim in cm
004344	Praline moulds round with swirl	24	10.0	2.9x1.8

		Moulds	Grammes	Dim in cm
007708	Praline moulds round with stripes	24	11.0	2.9x1.7

		Moulds	Grammes	Dim in cm
007709	Praline moulds hexagon with swirl	24	10.0	3.0x1.6

		Moulds	Grammes	Dim in cm
006973	Praline moulds triangle with line	24	11.0	3.3x2.2x1.8

		Moulds	Grammes	Dim in cm
007710	Praline moulds rectangle with stripes	24	9.0	3.8x2.0x1.1

		Moulds	Grammes	Dim in cm
007711	Praline moulds oval with stripes	24	11.0	3.5x2.4x1.6

		Moulds	Grammes	Dim in cm
007712	Praline moulds oval with one stripe	24	9.0	3.5x2.3x1.6

		Moulds	Grammes	Dim in cm
007713	Praline moulds with two hearts	24	11.0	3.0x2.0

		Moulds	Grammes	Dim in cm
007715	Praline moulds with fancy design	24	11.0	2.5x2.0

		Moulds	Grammes	Dim in cm
007716	Praline moulds oval with net design	24	14.0	3.3x2.5x2.1

		Moulds	Grammes	Dim in cm
007717	Praline moulds rectangle with stripes	24	11.0	2.7x2.2x1.5

		Moulds	Grammes	Dim in cm
007718	Praline moulds rectangle with diagonal stripe	24	10.0	3.3x2.0x1.5

		Moulds	Grammes	Dim in cm
007719	Praline moulds oval with leaf	24	11.0	3.8x2.2x1.5

		Moulds	Grammes	Dim in cm
007720	Praline moulds round with flower design	24	10.0	2.8x1.5

		Moulds	Grammes	Dim in cm
038320	Praline moulds square with flower design	24	10.0	2.6x2.6x1.3

		Moulds	Grammes	Dim in cm
026179	Praline moulds "Mon Cherie"	24	13.0	2.9x2.5x1.9



Polycarbonate

		Moulds	Grammes	Dim in cm
026181	Praline moulds bell	21	12.0	31.0x2.7



		Moulds	Grammes	Dim in cm
080799	Praline moulds 3-nuts	32	14.0	5.2x1.8x 1.5



		Moulds	Grammes	Dim in cm
080798	Praline moulds flower	21	20.0	3.5x2.3



		Moulds	Grammes	Dim in cm
026178	Praline moulds octagon	35	6.0	2.5x2.5x1.1



		Moulds	Grammes	Dim in cm
081420	Praline moulds "florentine", comb design	8	12.0	5.9x0.4



		Moulds	
017426	Mixed praline moulds, 27.5x17.5cm	24	

006436	Mixed praline moulds, 27.5x17.5cm	36	
--------	-----------------------------------	----	--



		Moulds	Dim in cm
005330	Praline moulds hexagon long snowdrop, 27.5x20.5cm	36	3.0x2.2x1.5



Plexiglass

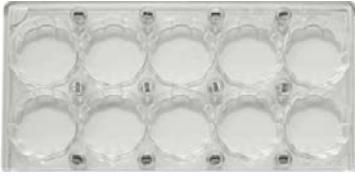

		Moulds	Grammes	Dim in cm
080000	Sheet of rosette moulds	10	30.0	5.0x1.4
080012	Plastic sheets 1 colour (own logo), 2000 prints, attention food colour			
080020	Cost for film and litho 1 colour			
080013	Plastic sheets 2 colours (own logo), 2000 prints, attention food colour			
080022	Cost for film and litho 2 colours			



		Moulds	Grammes	Dim in cm
080001	Sheet of bar moulds	10	22.0	2.8x4.8x1.4
080012	Plastic sheets 1 colour (own logo), 2000 prints, attention food colour			
080020	Cost for film and litho 1 colour			
080013	Plastic sheets 2 colours (own logo), 2000 prints, attention food colour			
080022	Cost for film and litho 2 colours			



		Moulds	Grammes	Dim in cm
080002	Sheet of square praline moulds	16	13.0	3.0x3.0x1.4
080003	Sheet of heart praline moulds	16	10.0	3.3x3.6x1.4
080014	Plastic sheets 1 colour (own logo), 3200 prints, attention food colour			
080020	Cost for film and litho 1 colour			
080015	Plastic sheets 2 colours (own logo), 3200 prints, attention food colour			
080022	Cost for film and litho 2 colours			



		Moulds	Grammes	Dim in cm
080004	Sheet of round praline moulds	15	13.0	3.2x1.4
080005	Sheet of rectangle praline moulds	15	13.0	2.8x3.5x1.4
080016	Plastic sheets 1 colour (own logo), 3000 prints, attention food colour			
080020	Cost for film and litho 1 colour			
080017	Plastic sheets 2 colours (own logo), 3000 prints, attention food colour			
080022	Cost for film and litho 2 colours			

		Dim in cm
005567	Praline slicing machine, s/s, incl 3 frames, distance between wires 1.0, 2.0 and 3.0cm, and fixture	60.0x34.0x12.8



		Dim in cm
010500	Electric chocolate grater 220V/50-60Hz incl. grater knives with 4 cutting edges, adjustable guide strips for different block sizes	36.0x34.0x40.0



		Dim in cm
010501	Chocolate grater, hand model incl. grater knives with 4 cutting edges adjustable guide strips for different block sizes	40.0x40.0x33.0



		Dim in cm
067890	Dipping fork set 10 pcs, s/s, handle made of plastic, set consisting of 1 fork each: round (1.4, 1.6, 1.8, 2.0cm), triangle, spiral, drop, 2-, 3-, 4- points, l=9.9cm, incl. case made of plastic	24.0x19.5x4.5



Stainless steel



CHOCOLATE DIPPING MACHINES WITH LID

		Dim in cm
059810	EFFECTOR model F1, capacity of inset basin 20.0ltr, 230V/50-60Hz, 0.295kW	62.0x37.5x26.5



		Dim in cm
059811	EFFECTOR model F2, capacity of inset basin 2.0x9.0ltr, 230V/50-60Hz, 0.295kW	62.0x37.5x26.5



		Dim in cm
059812	EFFECTOR model F3, capacity of inset basin 5.4 and 12.6ltr, 230V/50-60Hz, 0.295kW	62.0x37.5x26.5



		Dim in cm
059815	EFFECTOR model F4, capacity of inset basin 3.0x5.4ltr, 230V/50-60Hz, 0.295kW	62.0x37.5x26.5

Additional inset basins to EFFECTOR models F		Cap. ltr
059816	Basin to 059810	20.0
059817	Basin to 059812	12.6
059818	Basin to 059811	9.0
059819	Basin to 059812 and 059815	5.4



		Ø cm	Size cm
059813	EFFECTOR model 32, capacity of inset basin 6.0ltr, 230V/50-60Hz, 0.215kW Remark: Supplied with an additional inset basin 6.0ltr	36.0	26.0



059820	Additional inset basin 6.0ltr for 059813
--------	--



		Dim in cm
027656	Chocolate melter dry heat, plastic, removable lid and s/s basin, manual thermostat to control the temperature, 230V/50-60Hz, 0.08kW	40.0x24.0x13.5



		Dim in cm
022261	Chocolate tempering machine 230V/50Hz, water heated, s/s bowl 12.0ltr	51.0x40.0x26.5

		Ø cm	H in cm
007400	Chocolate fountain, 0.7kg capacity, 230V/50-60Hz	21.0	38.0



		Ø cm	H in cm
007401	Chocolate fountain, 1.2kg capacity, 230V/50-60Hz	23.0	45.0



		Ø cm	H in cm
012406	Chocolate fountain, 2.5kg capacity, 230V/50Hz	33.0	40.8





		L in cm
019895	Pie iron with plastic handle	52.5



		Dim in cm
028673	Caramelizer model 230V/50-60Hz, 0.4kW, insulated handle, Ø of iron 8.0cm	25.0x8.0x5.2



022865	Caramelizing iron in stainless steel complete with blow-lamp pistol, fit standard camping gas bottles (not included)
--------	--



071900	Kopykake projector, for easy decoration of cakes by projecting on the cake customized drawings or selected from 70 coloured models incl. in the package, 230V/50-60Hz, 0.275kW
--------	--



		Dim in cm
036105	Airbrush set make-up pistol with compressor, ensures regulated air-flow, 230V/50-60Hz, 4 bar	50.0x25.0x10.0



071899	Additional airbrush attachment with table-clamp
--------	---



036455	Electric grease spray gun multiSPRAY+, 60W, 230V/50Hz, with round jet nozzle R6, flat jet nozzle F7S and nozzle extension for convenient spraying in all directions, container 0.7ltr, 2.5m cable and additional container with lid, 2 spare nozzles R6/R8
--------	--



032159	Electric food spray gun volumeSPRAY 90W, 230V/50Hz, 2.5 meter cable, round jet nozzle R8, flat jet nozzle F7 and nozzle extension, cap. 0.7ltr
--------	--

ACCESSORIES TO GREASE SPRAY GUNS 071210 + 071213



071211	Optional suction tube
--------	-----------------------



071212	Bent nozzle extension
--------	-----------------------

		Size
068704	Sugar gloves, pair	7-7 1/2
068705	Sugar gloves, pair	8-8 1/2
068706	Sugar gloves, pair	9-9 1/2



Food colours in powder, suitable to the colouring of fat masses or to mix with water or alcohol

		Grammes
071915	Yellow	25.0
071916	Green	25.0
071919	Orange	25.0
071921	Pink	20.0
071922	White	25.0
071923	Blue	25.0
071924	Black	15.0



		Cap. ltr
071100	Food-varnish (for marzipan, nougat, sugar)	1.0



		Dim in cm
071904	Moistening bottle for aliments	7.0x7.0x23.0





		Dim in cm
022990	Sugar heating lamp with non-stick surface, lamp 40.0x30.0cm, s/s, 230V/50-60Hz, 0.5kW	46.0x33.0x58.0



079509	Sugar dryer, 230V/50Hz, 1.8kW, cable 1.5m
--------	---



068701	Sugar pump
--------	------------



		Dim in cm
015041	Torch, running time 120min, filling capacity 28.0ml, working with butane gas (not included)	13.0x7.0x16.0



		Dim in cm
068702	Mini torch for sugar blowing, running time 90min, filling capacity 20.0ml, working with butane gas (not included)	8.0x7.2x16.0

Bronze

013589 Set of 17 decorating tools Magyfleur



Aluminium

029800 Marzipan leaf stamp



Plastic

034379 Marzipan modelling rods, 12 pieces



006992 Marzipan modelling rods, 6 pieces



025072 Marzipan set including:
- 1 marzipan knife
- 2 special scrapers
- 12 tools



Stainless steel

067891 Set of 4 marzipan nippers
brass polished, deep fluted, sizes 1-4

Dim in cm
10.0x2.0



067892 Set of 7 marzipan nippers
breadth 0.4, 0.6, 0.8, 1.0, 1.5, 2.0, 2.5cm

L in cm
5.5



Chrome

022802 Pie crimper

L in cm
10.0





Andy Mannhart



TROLLEYS & DISPENSERS

Carts, Plate Warmers

7

Stainless steel

		Dim in cm
003649	Tray transport cart disassembled	45.5x63.5x171.0
17 pairs of support rails, 2 swivel casters, 2 swivel casters with brake, suitable for GN 1/1, 1/3, 2/3, 1/2 and 2/8, clearance between rails 7.5cm		



		Dim in cm
003648	Double tray transport cart	81.0x63.5x171.0
2x17 pairs of support rails, 2 swivel casters, 2 swivel casters with brake, suitable for GN 1/1, 1/3, 2/3 and 2/8, clearance between rails 7.5cm		



		Dim in cm
006772	Double tray transport cart with working top, 2x7 pairs of support rails, 2 swivel casters, 2 swivel casters with brake, suitable for GN 1/1, 2/3, 1/3 and 2/8, clearance between rails 7.5cm	81.0x63.5x90.0



		Dim in cm
003950	Tray transport cart disassembled	75.5x66.0x171.0
17 pairs of support rails, 2 swivel casters, 2 swivel casters with brake, suitable for GN 2/1, 1/1 and 2/4, clearance between rails 7.5cm		



Stainless steel



		Dim in cm
004880	Tray transport with working top, 7 pairs of support rails, 2 swivel casters, 2 swivel casters with brake, suitable for GN 2/1, 1/1, 2/4, clearance between rails 7.5cm	66.0x75.0x90.0



		Dim in cm
017844	Stackable trolley for GN container 2/1, 17 pairs of support rails, distance between rails 7.5cm	66.0x75.0x171.0

		Dim in cm
017845	Stackable trolley for GN container 1/1, 17 pairs of support rails, distance between rails 7.5cm	45.5x63.0x171.0



		Dim in cm
017840	Swinging beam trolley for GN container 1/1, 17 pairs of support rails, distance between rails 7.5cm	52.5x70.0x179.0



		Dim in cm
017841	Defrost trolley for GN container 2/1, 9 pairs of support rails, distance between rails 15.0cm	66.5x75.5x172.0

		Dim in cm
017839	Defrost trolley for GN container 1/1, 9 pairs of support rails, distance between rails 15.0cm	45.5x63.5x172.0

Stainless steel

		Dim in cm
017842	GN container 2/1, with draining hole, for defrost trolley 017841	65.0x53.0
017838	GN container 1/1, with draining hole, for defrost trolley 017839	53.0x32.5
017505	Perforated bottom for GN container 2/1, article 017842	
073853	Perforated bottom for GN container 1/1, article 017838	



		Dim in cm
007497	Tray transport cart with working top for 60.0x40.0cm trays, 7 levels	52.5x70.0x90.0



		Dim in cm
010690	Bakery trolley for 60.0x40.0cm trays, 15 levels	70.0x52.5x171.0



		Dim in cm
005202	Tray transport cart for 60.0x40.0cm trays, 20 levels	54.0x70.0x170.0



		Dim in cm
028588	Tray trolley for GN 1/1 trays, with acrylic glass doors, anodized special light metal, tray capacity: 20 trays, distance between trays 12.5cm, 4 corrosion protected castors with distance holding bumpers, 2 of them lockable, melamine resin laminated side walls	83.0x64.0x165.0

		Dim in cm
028589	Tray trolley for 46.0x34.4cm trays, with acrylic glass doors, anodized special light metal, tray capacity: 20 trays, distance between trays 12.5cm, 4 corrosion protected castors with distance holding bumpers, 2 of them lockable, melamine resin laminated side walls	87.0x57.0x165.0



Polyethylene



		Dim in cm
074100	Tray transport cart, suitable for GN 1/1, 1/2 and 1/3 with 18 pairs of rails, stain-resistant and easy to clean	60.3x47.3x172.4

		Dim in cm
074101	Tray transport cart with working top, suitable for GN 1/1, 1/2, and 1/3, 8 pairs of rails, stain-resistant and easy to clean	60.3x47.3x91.8

Aluminium



		Dim in cm
017172	Light serving trolley, anodised aluminium with polyethylene racks, flat pack, shelf size 55.5x87.0cm, maximum load 150.0kg and per level 75.0kg, racks adjustable to GN containers 1/1 and dishwashing racks 50.0x50.0cm	97.0x59.0x101.5

Stainless steel

SERVING TROLLEYS

With round tubular pushing handles, deep-drawn shelves with raised edges, sound-proof, screwed construction, impact corners on every shelf, deflection casters, 4 swivel casters, 2 with brakes.



		Dim in cm
Shelf size 80.0x50.0cm		
006850	Serving trolley with 2 shelves	88.0x58.0x101.5
000760	Serving trolley with 3 shelves	88.0x58.0x101.5
006851	Serving trolley with 4 shelves	88.0x58.0x130.0



		Dim in cm
Shelf size 90.0x50.0cm		
006852	Serving trolley with 2 shelves	98.0x58.0x101.5
006853	Serving trolley with 3 shelves	98.0x58.0x101.5
006854	Serving trolley with 4 shelves	98.0x58.0x130.0



		Dim in cm
Shelf size 100.0x60.0cm		
006858	Serving trolley with 2 shelves	108.0x68.0x101.5
006859	Serving trolley with 3 shelves	108.0x68.0x101.5
006860	Serving trolley with 4 shelves	108.0x68.0x130.0



Delivered flatpacked, very strong and resistant once assembled. Approximate time of assembly is about 10 minutes.

		Dim in cm
Shelf size 80.0x50.0cm		
003650	Serving trolley with 2 shelves, disassembled	81.0x54.5x104.0
003652	Serving trolley with 3 shelves, disassembled	81.0x54.5x104.0



		Dim in cm
Shelf size 90.0x50.0cm		
003651	Serving trolley with 2 shelves, disassembled	91.0x54.5x104.0
003653	Serving trolley with 3 shelves, disassembled	91.0x54.5x104.0

Brass plated

		Dim in cm
035618	Luggage cart, brass with red carpet	110.0x63.0x100.0



		Dim in cm
035619	Luggage crown cart, coloured carpet, brass	120.0x63.0x182.0



Stainless steel

		Dim in cm
056901	Delivery cart for 2x GN containers 1/1 20.0cm deep, deep-drawn heated well, draining tap, stepless thermostat controller 30°C to 110°C, 2 swivel casters	85.8x67.5x90.0



		Dim in cm
056902	Delivery cart for 3x GN containers 1/1 20.0cm deep, deep-drawn heated well, draining tap, stepless thermostat controller 30°C to 110°C, 2 swivel casters	122.7x67.5x90.0

		Dim in cm
056651	Spice compartment trolley with 12 spice compartments with transparent lids on top shelf, 8 removable separations on bottom shelf	76.5x63.5x90.0



		Dim in cm
056752	Potato and vegetable washing trolley 90.0ltr with lever operated drainage valve with 2 strainers	80.7x61.5x60.5



		Dim in cm
056800	Heavy duty cart with heavy load shelf and extra strong drive shaft, 2 fix and 2 swivel casters, 1 with brake, max. load 350.0kg	106.5x66.5x95.6



		Dim in cm
003724	Platform cart in s/s, with swivel casters, 1 with brake, max. load 350.0kg	57.0x90.0x107.0



Polyethylene



		Dim in cm
074103	Heavy duty triple trolley cap. 181.0kg with 4 big castors	82.6x52.1

Stainless steel



		Dim in cm
056823	Clearing trolley, strong execution with 2 clearing containers 21.0ltr, space for 4 dishwashing baskets 50.0x50.0cm and 2 garbage containers , 4 swivel casters, 2 with brakes	132.0x72.0x132.5



		Dim in cm
064413	Hand lift scale, integrated rechargeable battery 56h, with LCD display, buttons for zero, tare, gross and net weight, weight range 0-2200.0kg, reading 1.0kg	115.5x56.0x121.0

Stainless steel

		Dim in cm
009394	Plate transport trolley for 400 plates with 2 removable wire dividers, 4 rubber casters, 2 with brakes, giving 3 columns	111.2x62.7x78.5



Polyethylene

		Dim in cm
742731	Dish trolley (caddy) holds 5 columns of 45-60 round plates up to 24.1cm or 4-5 columns of square plates up to 20.5cm, 227.0kg loading capacity, molded-in handles, swivel casters with brake, vinyl cover included	69.0x78.0x81.0



		Dim in cm
742911	Adjustable dish trolley, 6 removable dividers, plates per column approx. 45-60, for plates and bowls from 11.7-33.0cm, 227.0kg loading capacity, swivel casters with brake, vinyl cover included	73.0x96.0x81.0



		Dim in cm
742921	Dish trolley (caddy) holds 4 columns of 45-60 round plates up to 28.6cm or square plates up to 24.1cm, 227.0kg loading capacity, molded-in handles, swivel casters with brake, vinyl cover included	69.0x78.0x81.0



		Dim in cm
742931	Tray and silver transport cart, tray size max. 36.0x46.0cm, including 4x GN container 1/3 and 4x GN container 1/6, 227.0kg loading capacity, swivel casters with brake, vinyl cover included	83.0x54.0x116.0



		Dim in cm
051731	Dish trolley (caddy) adjustable, polyethylene, holds 180-480 plates or 45-60 plates per column. For round, square and oval plates with a diameter of 11.0-73.6cm, 227.0kg loading capacity, molded-in handles, swivel casters with brakes	97.1x82.2x73.9





		Dim in cm
025433	Room service cleaning trolley, equipped with yellow containers and high-capacity vinyl bags	130.1x57.5x112.9



		Dim in cm
025434	Housekeeping cart with 3 shelves, 2 linen bags and full wrap around rubber bumper	140.0x46.0x110.0



		Dim in cm
035625	Room service trolley, hot food warmer not included, steel coated foldable legs, tip-up and stackable structure	102.0x75.0



		Dim in cm
035626	Hot food warmer, thermostatic control up to 70°C, exterior s/s, interior aluminium, 230V/50-60Hz	39.0x37.0x49.5

THERMOPORT BANQUET TROLLEY 2x6000K MOBILE, UNHEATED

For GN 2/1, 1/1, double-walled insulated, cap. 208.0ltr, 2x12 deep-drawn support rails, application range -20°C to +100°C, s/s insulated pushing handles, 4 swivel casters, 2 with double brake

		Dim in cm
056803	Banquet trolley, orange	76.6x77.9x128.0
056548	Banquet trolley, black	76.6x77.9x128.0

THERMOPORT BANQUET TROLLEY 1x6000K UNHEATED + 1x6000KB MOBILE HEATED

For GN 2/1, 1/1, double-walled insulated, cap. 208.0ltr, 2x12 deep-drawn support rails, application range -20°C to +100°C, s/s insulated pushing handles, 230V/50Hz, 0.38kW

		Dim in cm
056663	Banquet trolley, orange	76.6x79.0x128.0
056510	Banquet trolley, black	76.6x79.0x128.0

Banquet trolley made of s/s, housing and doors are double-walled and insulated, cupboard compartment with seamless deep-drawn support rails for s/s grills or GN containers, rail clearance 11.5cm, 4 corner bumpers, 2 fixed and 2 swivel casters with brake

HEATED VERSION:

Thermostat controller from 30°C to 110°C, temperature display storage protected, controller for damp air enrichment, compartment allocation GN compliant, for plates up to 31.0cm

		Dim in cm
056760	Banquet trolley BKW 1 x GN 2/1, single door, heated, clearance between rails 11.5cm, for max. 11 grids or containers GN 2/1, cap. 64 stacked plates or 44 unstacked plates Ø 26.0cm, resp. 22 unstacked plates Ø 31.0cm incl. 3 wire shelves size GN 2/1, 230V/50-60Hz, 2.0kW	77.7x83.7x171.2

		Dim in cm
056511	Banquet trolley BKW 1 x GN 2/1, single door, heated, clearance between rails 7.0cm, for max. 18 grids or GN containers 2/1, cap. 64 stacked plates or 72 unstacked plates Ø 26.0cm, resp. 36 unstacked plates Ø 31.0cm, incl. 3 wire shelves size GN 2/1, 230V/50-60Hz, 2.0kW	77.7x83.7x171.2

		Dim in cm
056762	Banquet trolley BKW 2 x GN 2/1, double door, heated, clearance between rails 11.5cm, for max. 22 grids or GN containers GN 2/1, cap. 160 stacked plates or 110 unstacked plates Ø 26.0cm resp. 88 unstacked plates Ø 31.0cm, incl. 6 wire shelves size GN 2/1, 230V/50-60Hz, 2.7kW	149.0x83.7x171.2

		Dim in cm
056512	Banquet trolley BKW 2 x GN 2/1, double door, heated, clearance between rails 7.0cm, for max. 36 grids or GN containers GN 2/1, cap. 160 stacked plates or 180 unstacked plates Ø 26.0cm resp. 144 unstacked plates Ø 31.0cm incl. 6 wire shelves size GN 2/1, 230V/50-60Hz, 2.7kW	149.0x83.7x171.2



**REFRIGERATED VERSION**

		Dim in cm
023685	Banquet trolley, Roll fresh, GN 1/1, s/s, with door s/s, for refrigerated link, 15 levels 7.1cm spaced, 4 swivel polyamide wheels with Ø 12.5cm, 2 with brakes, 0°C to 10°C, 230V/50Hz, 0.2kW	82.1x52.8x175.0
		Dim in cm
023686	Banquet trolley, Roll fresh, GN 2/1, s/s, with door s/s, for refrigerated link, 15 levels 7.1cm spaced, 4 swivel wheels with Ø 16.0cm s/s cover, 2 with brakes, 0°C to 10°C, 230V/50Hz, 0.3kW	94.1x73.3x178.6

Polypropylene



		Ø cm	H in cm
042240	Plate cover, yellow	25.0	6.0
042241	Plate cover, yellow	26.5	6.0
042242	Plate cover, yellow	27.0	6.0
042243	Plate cover, yellow	28.3	6.0

Polycarbonate



		P/U	Ø cm	H in cm
742601	Plate cover, transparent	12	23.2	7.0
742611	Plate cover, transparent	12	24.8	7.0
742621	Plate cover, transparent	12	25.4	7.0
742631	Plate cover, transparent	12	25.9	6.8
742641	Plate cover, transparent	12	26.8	7.2
742651	Plate cover, transparent	12	27.0	7.0
742661	Plate cover, transparent	12	27.5	6.8
742671	Plate cover, transparent	12	27.9	6.8
742681	Plate cover, transparent	12	30.8	7.0

Stainless steel



		Ø cm	H in cm
019588	Plate cover	21.0	5.0
019589	Plate cover	24.1	5.0
019590	Plate cover	25.0	5.0
019591	Plate cover	26.2	5.5
019592	Plate cover	27.2	5.5
019593	Plate cover	28.3	5.0



		Cap. ltr	Dim in cm
056137	Hybrid Kitchen 140 mobile version regenerating, cooking, core temperature simmering, steaming, keeping hot and chilling at the same time, functional door can be removed, incl. core temperature sensor, -20°C to +140°C, 230V/50-60Hz, 3.2kW	78.0	59.2x76.9x99.2



		Cap. ltr	Dim in cm
056138	Hybrid Kitchen 200 mobile version regenerating, cooking, baking, core temperature simmering, steaming, keeping hot and chilling at the same time, functional door can be removed, incl. core temperature sensor, -20°C to +200°C, 230V/50-60Hz, 3.2kW	78.0	64.2x82.8x98.1

MOBILE THERMOPORTS

Completely made of rustproof s/s, highly suitable for transporting hot or cold food or for use as rolling storage stations in the kitchen and serving area. The interior is absolutely tightly welded and corresponds to the hygiene version H3 (except 1600 DU: H2), with rounded corners (water-jet resistant). Suitable for GN containers and wire shelves GN 1/1

HEATED VERSION (=U)

Air circulation heating, IP X5 protection, max. achievable temperature 95°C, rated voltage: 230V/50-60Hz, connected load 0.432kW

REFRIGERATED VERSION (=K)

Protection glass IP X3, cooling range 5°C to 8°C (when door is closed), refrigeration output 180W at evap. temperature -10°C, rated voltage: 230V/50-60Hz, connected load 0.170kW

		Cap. ltr	Dim in cm
056812	Thermoport 1600DU heated front loader, 16 pairs of deep-drawn support rails	78.0	49.2x76.9x96.3

		Cap. ltr	Dim in cm
056836	Thermoport 1600K refrigerated front loader, 16 pairs of deep-drawn support rails	70.4	49.2x76.9x96.3

		Cap. ltr	Dim in cm
056814	Thermoport 2000U heated front loader, 20 pairs of seamless deep-drawn support rails	89.7	49.2x76.9x107.8

		Cap. ltr	Dim in cm
056837	Thermoport 2000K refrigerated front loader, 20 pairs of seamless deep-drawn support rails	89.7	49.2x76.9x113.0

		Cap. ltr	Dim in cm
056816	Thermoport 3000U heated front loader, 30 pairs of seamless deep-drawn support rails	130.0	49.2x76.9x144.8

		Cap. ltr	Dim in cm
056838	Thermoport 3000K refrigerated front loader, 30 pairs of seamless deep-drawn support rails	130.0	49.2x76.9x164.8

		Dim in cm
021979	Thermoport trolley 3000 hybrid hot/cold passive, divided into two completely isolated sections, top section with active heating, cap. 70.0ltr, lower section as neutral compartment, can be cooled passively by using cooling packs, cap. 44.0ltr, 16 support rails (warm) and 8 support rails (cold), 2°C to 100°C, 230V/50-60Hz, 0.763kW	59.2x76.9x164.8

		Dim in cm
025276	Thermoport trolley 3000 hybrid hot/cold active, divided into two completely isolated sections, top section with active heating, cap. 70.0ltr, lower section with active cooling system with refrigerant 134A, cap. 44.0ltr, 16 support rails (warm) and 8 support rails (cold), 2°C to 100°C, 230V/50-60Hz, 0.95kW	59.2x76.9x164.8

056812 / 056836



056814 / 056837



056816 / 056838



021979



025276



Thermoports, pore-free plastic surface, top loaders with lid or front loaders, double-walled, tightly welded, for 1 GN container 1/1 20.0cm deep or 2 GN containers 1/1 20.0cm deep



		Cap. ltr	Dim in cm
056821	Thermoport 100K unheated, orange	26.0	37.0x64.5x30.8



		Cap. ltr	Dim in cm
056516	Thermoport 100K unheated, black	26.0	37.0x64.5x30.8



		Cap. ltr	Dim in cm
056519	Thermoport 100K unheated, lid with integrated cooling plate GN 1/1 (removable, fastened with push buttons), orange	26.0	37.0x64.5x30.8



		Cap. ltr	Dim in cm
056520	Thermoport 100K unheated, lid with integrated cooling plate GN 1/1 (removable, fastened with push buttons), black	26.0	37.0x64.5x30.8



		Cap. ltr	Dim in cm
056846	Thermoport 100KB heated, -20°C to +100°C, 230V/50Hz, orange	26.0	37.0x64.5x30.8



		Cap. ltr	Dim in cm
056521	Thermoport 100KB heated, -20°C to +100°C, 230V/50Hz, black	26.0	37.0x64.5x30.8



		Cap. ltr	Dim in cm
056798	Thermoport 1000K orange, front loader for GN containers up to max. 2x1/1 20.0cm deep, 12 pairs of support rails, unheated	52.0	43.5x61.0x56.1



		Cap. ltr	Dim in cm
056524	Thermoport 1000K black, front loader for GN containers up to max. 2x1/1 20.0cm deep, 12 pairs of support rails, unheated	52.0	43.5x61.0x56.1

		Cap. ltr	Dim in cm
021982	Thermoport 100 K hybrid, plastic, orange, hot/cold separation in the thermoport, CHECK sensor, for GN 1/1, 1/2, 2/3, 1/3, operating range -20°C to +100°C, dishwasher-safe up to + 90°C	26.0	69.0x42.5x36.35



		Cap. ltr	Dim in cm
021977	Thermoport drink dispenser, plastic, for the transport and serving of hot or chilled drinks, level indicator on the inside, discharge tap with a push-type, 2 robust snap catches, 2 handles, operation range -20°C to +100°C	40.0	41.0x39.7x61.1



056799	Insulated divider for thermoport 056798, 056524, 056803, 056548, 056663, 056510 size GN 1/1, for transportation of hot and cold food at the same time, orange
--------	---



056526	Insulated divider for thermoport 056798, 056524, 056803, 056548, 056663, 056510 size GN 1/1, for transportation of hot and cold food at the same time, black
--------	--

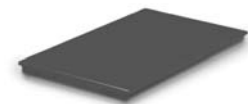

056848	Cooling plate GN 1/1 plastic to slide in thermoport models 056798, 056524, 056803, 056548, 056663, 056510 or to put in the lid of a thermoport, to be hold for the transportation of cold food, orange
--------	--



056527	Cooling plate GN 1/1 plastic to slide in thermoport models 056798, 056524, 056803, 056548, 056663, 056510 or to put in the lid of a thermoport, to be hold for the transportation of cold food, black
--------	---



056850	Interlock stacking kit for thermoport 1000K/1000B, fast and secure locking of 2 thermoports to holding cabinet
--------	--



		Dim in cm
056822	Rolliport transport trolley for all portable thermoports, s/s, load capacity 100.0kg	85.0x47.0x89.0



		Dim in cm
026420	Isobox GN 1/1, 46.0ltr, inside dim. 53.8x33.7x25.7cm, usable from -40°C to +120°C, polypropylene	60.0x40.0x32.0



		Dim in cm
026421	Isobox front loader for 10 baking sheets size 40.0x60.0cm, inside dim. 41.0x61.0x51.0cm, 128.0ltr, polypropylene	70.0x49.0x64.0





		Dim in cm
007582	Plate warmer for 5 hotplates with dim 28.0x16.5cm, aluminium, 230V/50-60Hz	38.0x25.0x32.0



		Dim in cm
007584	Plate warmer for 5 hotplates with dim 28.0x16.5cm, aluminium, 230V/50-60Hz	38.0x25.0x44.7



		Ø cm	H in cm
001688	Plate warmer standing unit, s/s casing with glass swivel door, for 30-40 plates Ø 32.0cm, temperature adjustable, fixed inserted board, interior size Ø 33.0cm, 230V/50Hz, 0.6kW	46.0	57.5

		Ø cm	H in cm
000684	Plate warmer standing unit, s/s casing with acrylic glass door, for 45-60 plates Ø 32.0cm, temperature adjustable, self closing swivel door, interior size Ø 33.0cm, 230V/50Hz, 0.6kW	45.0	80.0



		Ø cm	H in cm
011047	Dish warmer set for 29 plates incl. base and hood, suitable for plates max. Ø 29.0cm, insulated, robust and foldable hood with transparent plastic slot for customized logo, fiberglass special plastic, fireproof, heat resistant, warm-up time about 45min., base Ø 35.0x8.5cm, cable length 1.5m, 40°C to 50°C, 230V/50-60Hz, 0.85kW	37.0	42.5



		Ø cm	H in cm
011049	Dish warmer set for 40 plates incl. base and hood, suitable for plates max. Ø 29.0cm, insulated, robust and foldable hood with transparent plastic slot for customized logo, fiberglass special plastic, fireproof, heat resistant, warm-up time about 45min., base Ø 35.0x8.5cm, cable length 1.5m, 40°C to 50°C, 230V/50-60Hz, 0.85kW	37.0	58.5



		Dim in cm
030512	Dish warmer set for 80 plates incl. base and hood, suitable for plates max. Ø 33.0cm, insulated, robust and foldable hood with transparent plastic slot for customized logo, fiberglass special plastic, fireproof, heat resistant, warm-up time about 60min., base Ø 35.0x8.5cm, cable length 1.5m, 40°C to 50°C, 230V/50-60Hz, 0.85kW	71.0x36.0x49.0

		Dim in cm
030562	Dish warmer set for 120 plates incl. base and hood, suitable for plates max. Ø 32.0cm, insulated, robust and foldable hood with transparent plastic slot for customized logo, fiberglass special plastic, fireproof, heat resistant, warm-up time about 75min., base Ø 35.0x8.5cm, cable length 1.5m, 40°C to 50°C, 230V/50-60Hz, 0.85kW	60.0x60.0x50.0



030563	Embroidery with customized logo	
--------	---------------------------------	--



030628	Creation matrix for embroidery (only 1 x)	
--------	---	--

Matrix

		Ø cm	H in cm
030564	Hood for 29 plates with transparent plastic slot for customized logo	34.0	39.0



		Ø cm	H in cm
030565	Hood for 40 plates with transparent plastic slot for customized logo	34.0	55.0



		Dim in cm
030566	Hood for 80 plates with transparent plastic slot for customized logo	71.0x36.0x49.0



		Dim in cm
030567	Hood for 120 plates with transparent plastic slot for customized logo	60.0x60.0x50.0



		Dim in cm
030569	Transport bag for max. 2 dish warmers and 2 hoods (29 or 40 plates)	55.0x51.0x5.0



PLATE TROLLEYS

Dispensers for plates, covers and underplates, heatable. To be used for heating, storing and distributing. Trolley complete in s/s, double-walled and insulated with thermostat control 30°C to 110°C, 4 swivel casters, 2 with brake, max. loading cap. 75.0kg, protection class IP X5



		Dim in cm
056808	Dispenser-trolley with 1 tube adjustable for plates Ø 19.0-32.0cm, cap. 60 plates, with polycarbonate lid, 30°C to 90°C, 230V/50-60Hz, 0.86kW	62.0x48.0x90.0

		Dim in cm
056826	Dispenser-trolley with 2 tubes adjustable for plates Ø 19.0-32.0cm, cap. 120 plates, with polycarbonate lid, 30°C to 90°C, 230V/50-60Hz, 1.4kW	95.5x48.0x90.0

		Dim in cm
002217	Plate dispenser for approx. 80 plates round Ø 18.0-33.0cm, square 28.0x28.0cm, 30°C to 110°C, 230V/50-60Hz, 0.9kW	68.0x52.0x103.0

		Dim in cm
002218	Double plate dispenser for approx. 160 plates round Ø 18.0-33.0cm, square 28.0x28.0cm, 30°C to 110°C, 230V/50-60Hz, 0.9kW	107.6x52.0x103.0

		Dim in cm
042300	Mobile plate cart JS104 for 104 plates, adjustable to any plate size requested, welded steel plate supports, 4 casters, 2 with brakes	60.0x60.0x179.0



042301	Plastic protection cover for JS104 Remark: protects prepared food longer and keeps food fresher in cold storage
--------	---



042305	Thermo cover for JS104 preserves in transit 104 plates with warm or cold food in a transportable cabin, keeps food fresh longer
--------	---



		Dim in cm
042302	Plate carrier JS052C for 52 plates, table top model, revolving	48.0x48.0x89.0



		Dim in cm
042304	Plate carrier JS012HW for 12 plates, wall model, adjustable to any plate size requested welded steel plate supports	24.0x70.0

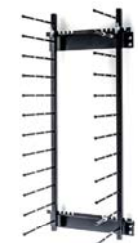

		Dim in cm
056000	Mobile plate carrier Servistar Gastro 80 Flatpack, for 80 plates max Ø 30.0cm, with galvanized castors, 2 with brakes	65.3x66.3x185.6
056200	Mobile plate carrier Servistar Gastro 120 Flatpack, for 120 plates max Ø 30.0cm, with galvanized castors, 2 with brakes	65.3x99.3x185.6



Premium service trolley line with special surface treatment which gives an unique soft and rubber-like touch to the wood, self-cleaning effect, excellent resistance to fire, high temperatures, abrasion and scratches

095123

Induction trolley with induction warmer Install Hold-Line RTCSmp 1500, 2 heating zones with independent temperature control 50°C to 100°C, heating surface 80.0x40.0cm, racing red colour, suitable for all induction compatible pans and dishes, swivel casters with brakes, 230V/50-60Hz, 1.5kW, 8A

Dim in cm

116.5x53.0x81.5



 eco



004807

Trolley with CCP cooling-warming plate, Dual Use Trolley, temperature -5°C to +140°C, plate size GN 2/1, 230V/50-60Hz

Dim in cm

103.0x66.0x82.0

010092

Cheese and cake trolley, 1 roll top, 2 plate holders, swivel casters with brakes, 2 big s/s trolley handles, 4 roll top handles (2 on each side), incl. 1 professional ice pack for cooling.

Remarks: When the roll top is open, the lower level automatically comes towards the operator. This mechanism works on both sides. The 2 plate holders are foldable.

Dim in cm

115.0x52.0x125.0



		Dim in cm
095116	Flambé trolley incl. 1 gas burner 1.5kW, 1 drawer, 1 bottle holder, swivel casters with brakes	99.5x53.0x85.0



		Dim in cm
095117	Flambé trolley incl. electric induction hob, 1 drawer, 1 bottle holder, swivel casters with brakes, 230V/50-60Hz, 3.6kW	99.5x53.0x85.0



		Dim in cm
095118	Wine trolley incl. 3 s/s wine coolers, glass holders, 2 bottle holder for 6 bottles, 2 drawers, swivel casters with brakes	99.5x53.0x104.0



		Dim in cm
095119	Gueridon trolley, 2 levels, swivel casters with brakes	93.0x53.0x80.0



		Dim in cm
095102	Gueridon trolley, 3 levels, anti-scratch material, flat pack, 4 swivel casters, 2 with brakes	90.0x52.0x80.0





		Dim in cm
095120	Gueridon trolley, 2 lateral drawers with 3 compartments each, swivel casters with brakes	99.0x53.0x80.0



		Dim in cm
095112	Basic service trolley, 2 drawers, 1 removable shelf, 1 handle, swivel casters with brakes	99.5x53.0x80.0



		Dim in cm
095113	Top bar for 095112	93.0x53.0x7.0



		Dim in cm
095114	Top dessert & hors d'oeuvres top chilled for 095112, ice pack included	93.0x53.0x29.0



		Dim in cm
095115	Roll top hood for 095112	93.0x53.0x29.0



		Dim in cm
095121	Bottle holder, 3 holes Ø 10.5cm	38.0x14.0x10.0



		Dim in cm
095122	Glacette holder, 3 s/s glacettes, Ø 19.5cm, h=12.0cm	47.0x17.0x22.0

All products on p. 7.16 and 7.17 are also available in white colour

Wood

		Dim in cm
010091	Nature basic service trolley, 2 drawers, 1 removable shelf, walnut wood	99.5x53.0x80.0



		Dim in cm
017591	Nature champagne service trolley, incl. champagne bowl, glass holder rack, big glass holder rack on the bottom, 2 bottle holder on the lower level for 6 bottles, 2 drawers, 1 removable shelf, walnut wood	93.0x53.0x114.0



		Dim in cm
025396	Nature wine and liquor trolley, incl. rack with 3 insulated s/s wine cooler, 1 big glass holder rack, 2 bottle holder on the lower level for 6 bottles, 2 drawers, 2 removable shelf, walnut wood	99.5x53.0x104.0



		Dim in cm
025400	Nature gueridon service trolley with 2 levels, walnut wood	93.0x53.0x80.0



		Dim in cm
033122	Nature cheese trolley, special roll top system, serpentin stone cutting board 38.0x75.0cm, chilled by include ice pack, 1 drawer for cutlery, 1 aluminium handle, 1 foldable working tray 23.0x53.0cm, 4 professional mid-soft swivel castors with breaks	111.0x110.0x53.0



Wood



		Dim in cm
024523	Base service trolley 2 levels, wenge wood, 1 extractable build in service tray in PE, 2 handles, 4 professional swivel castors d=100 mm, 2 with brakes	106.0x52.0x80.0



		Dim in cm
024524	Top bar, wenge wood, for item 024523	92.0x52.0x15.0



		Dim in cm
024525	Top dessert and hors d'oeuvres, 2 levels, chilled, lower level chilled with included ice pack, top level with 2 removable trays, two doors, for item 024523	92.0x52.0x64.0



		Dim in cm
024526	Top dessert and hors d'oeuvres, chilled, tray s/s chilled with included ice pack and roll top, for item 024523	92.0x52.0x28.0



		Dim in cm
024527	Cheese roll top, not chilled, wood, PE cutting board with handles included, for item 024523	92.0x52.0x28.0



		Ø in cm	H in cm
004826	Champagne, Martini and Liquor trolley, incl. champagne bowl for 4-5 bottles (which can be removed to store liquor bottles), glass holder with 24 positions for flutes, cocktail or wine glasses	65.0	108.0



Andy Mannhart



KITCHEN MACHINES

Bakery & Butchery, Induction Cooking

ROBOT COUPE MOD. R201XL ULTRA

1 speed: 1500rpm, pulse function, industrial induction motor, delivered with s/s cutter bowl 2.9ltr with brushed finish and ergonomic handle, vegetable slicer inside ejection, 1 XL hopper for improved productivity, 1 cylindrical hopper for fragile vegetables, incl. 1 slicing disc (2.0mm), 1 grating disc (2.0mm), 1 smooth blade

		Dim in cm
009260	Version 230V/50Hz, 0.55kW	22.0x28.0x49.5
083811	Version 230V/60Hz, 0.55kW	22.0x28.0x49.5

Accessories to R201XL Ultra

083812	Coarse serrated blade for kneading and grinding
083813	Fine serrated blade for chopping herbs and spices
083720	Smooth blade



ROBOT COUPE MOD. R301 ULTRA

2 machines in 1: a cutter bowl and a vegetable preparation attachment on the same motor base, industrial induction motor, 1 speed, 1500rpm, pulse function, delivered with s/s bowl 3.7ltr with brushed finish and ergonomic handle, vegetable slicer with ejection equipped with 1 half-moon hopper and 1 cylindrical hopper, incl. 2 slicing discs (2.0mm, 4.0mm), 1 grating disc (2.0mm)

		Dim in cm
083622	Version 230V/50Hz, 0.65kW	32.5x30.0x55.0
083619	Version 230V/60Hz, 0.65kW	32.5x30.0x55.0

Accessories to R301 Ultra

083626	Coarse serrated blade for kneading and grinding
083627	Fine serrated blade for chopping herbs and spices
083721	Smooth blade



ROBOT COUPE MOD. R402

2 machines in 1: a cutter bowl and a vegetable preparation attachment on the same metal motor base, 2 speeds : 750/1500rpm, industrial induction motor, pulse function, delivered with s/s bowl with finish and ergonomic handle and smooth blade, s/s vegetable preparation bowl with lid and equipped with 1 half-moon hopper and 1 cylindrical hopper

		Dim in cm
006212	Version 230V/50Hz, 0.75kW	32.0x30.4x59.0
083800	Version 3x380V/50Hz, 0.75kW	32.0x30.4x59.0
838001	Version 3x230V/60Hz, 0.75kW	32.0x30.4x59.0

Accessories to R402

083724	Coarse serrated blade for kneading and grinding
083725	Fine serrated blade for chopping herbs and spices
083726	Smooth blade
083723	Citrus press attachment: delivered with 1 basket and 1 cone





Discs for R301 Ultra and R402

083610	Slicer 1.0mm
083611	Slicer 2.0mm
083730	Slicer 3.0mm
083612	Slicer 4.0mm
083731	Slicer 5.0mm
083613	Slicer 6.0mm



083614	Ripple cut slicer 2.0mm
--------	-------------------------



083603	Grater 1.5mm
083604	Grater 2.0mm
083605	Grater 3.0mm
083606	Grater 6.0mm
083607	Grater 9.0mm
083602	Grater Parmesan
083732	Grater Roesti potatoes
083608	Grater 0.7mm for horseradish paste
083609	Grater 1.0mm for horseradish paste



083615	Julienne 2.0x2.0mm
083623	Julienne 2.0x4.0mm
083624	Julienne 2.0x6.0mm
083616	Julienne 4.0x4.0mm
083617	Julienne 6.0x6.0mm
083618	Julienne 8.0x8.0mm



Discs only for R402

083737	Dicing equipment (1 dicing grid + 1 slicer) 8.0x8.0x8.0mm
083738	Dicing equipment (1 dicing grid + 1 slicer) 10.0x10.0x10.0mm



083739	French fries equipment 8.0x8.0mm
083740	French fries equipment 10.0x10.0mm

ROBOT COUPE MOD. R502

2 machines in 1: a cutter bowl and a vegetable preparation attachment on the same metal motor base, 2 speeds: 750/1500rpm, industrial induction motor, voltage, three phase, pulse function, delivered with s/s bowl 5.5ltr with handle and smooth blade, incl. vegetable slicer attachment with 1 large hopper and 1 cylindrical hopper, incl. 2 slicing discs (2.0mm, 5.0mm), 1 grating disc (2.0mm), 1 slicing disc julienne (3.0x3.0mm), 1 slicing disc and 1 dicing grid (for cubes 10.0x10.0mm), 1 french fries disc and 1 slicing disc (for french fries 10.0x10.0mm)



		Dim in cm
083659	Version 3x380V/50Hz, 1.0kW	38.0x35.0x66.5
083655	Version 3x380V/60Hz, 1.0kW	38.0x35.0x66.5
083656	Version 3x230V/60Hz, 1.0kW	38.0x35.0x66.5

Accessories to R502

083667	Coarse serrated blade
083668	Smooth blade

VEGETABLE PREPARATION MACHINE CL50

1 speed, 375rpm, motor base made in polycarbonate, automatic restart of the machine with the pusher, delivered with metal bowl and lid, 1 large hopper and 1 cylindrical hopper, no discs included

		Dim in cm
083670	Version 230V/50Hz, 0.55kW	35.0x32.0x59.0
083671	Version 230V/60Hz, 0.55kW	35.0x32.0x59.0



VEGETABLE PROCESSOR CL50 INCLUDING DISCS

1 speed, 375rpm, motor base made in polycarbonate, automatic restart of the machine with the pusher, delivered with metal bowl and lid, 1 large hopper and 1 cylindrical hopper, incl. 2 slicing discs (2.0mm, 5.0mm), 1 grating disc (2.0mm), 1 slicing disc julienne (3.0x3.0mm), 1 slicing disc and 1 dicing grid (for cubes 10.0x10.0mm), 1 french fries disc and 1 slicing disc (for french fries 10.0x10.0mm)

		Dim in cm
083672	Version 230V/50Hz, 0.55kW	35.0x32.0x59.0
083673	Version 230V/60Hz, 0.55kW	35.0x32.0x59.0
083679	Version 3x380V/50Hz, 0.55kW	35.0x32.0x59.0
083674	Version 3x380V/60Hz, 0.55kW	35.0x32.0x59.0
083678	Version 3x230V/60Hz, 0.55kW	35.0x32.0x59.0



VEGETABLE PROCESSOR CL60 WITHOUT DISCS

2 speeds, 375/750rpm, all s/s motor base, tilting and removable feed head, delivered with s/s automatic feed head with feeding tray

		Dim in cm
083675	Version 3x380V/50Hz, 1.5kW	60.0x72.0x122.5
083676	Version 3x230V/60Hz, 1.5kW	60.0x72.0x122.5



VEGETABLE PROCESSOR CL60 INCLUDING DISCS

2 speeds 375/750rpm, all s/s motor base, tilting and removable feed head, delivered with s/s automatic feed head with feeding tray, 2 slicing discs (2.0mm, 5.0mm), 2 grating discs (2.0mm, 3.0mm), 1 slicing disc and 1 dicing grid (for cubes 10.0x10.0mm), 1 slicing disc and 1 dicing grid (for cubes 20.0x20.0mm), wall disc holder

		Dim in cm
083681	Version 3x380V/50Hz, 1.5kW	60.0x72.0x122.5
083682	Version 3x230V/60Hz, 1.5kW	60.0x72.0x122.5
083683	Version 3x380V/60Hz, 1.5kW	60.0x72.0x122.5



Accessories to CL60

083685	Pusher feed head
083687	Straight and biais cut hole feed head, Ø 5.0-7.0cm
083686	Movable stand with rollers, s/s



Discs for R502, CL50, CL60

083741	Slicer almonds 0.6mm
083742	Slicer 0.8mm
083639	Slicer 1.0mm
083640	Slicer 2.0mm
083641	Slicer 3.0mm
083743	Slicer 4.0mm
083642	Slicer 5.0mm
083643	Slicer 8.0mm
083644	Slicer 10.0mm
083645	Slicer 14.0mm
083744	Slicer 4.0mm for cooked potatoes
083745	Slicer 6.0mm for cooked potatoes

083660	Ripple cut slicer 2.0mm
083661	Ripple cut slicer 3.0mm
083662	Ripple cut slicer 5.0mm

083632	Grater 1.5mm
083633	Grater 2.0mm
083634	Grater 3.0mm
083746	Grater 4.0mm
083635	Grater 5.0mm
083747	Grater 7.0mm
083636	Grater 9.0mm
083637	Grater Parmesan
083748	Grater Roesti potatoes
083749	Grater 1.0mm for horseradish paste

083750	Julienne 1.0x8.0mm
083751	Julienne 1.0x30.0mm onions/cabbage
083646	Julienne 2.0x2.0mm
083663	Julienne 2.0x4.0mm
083664	Julienne 2.0x6.0mm
083665	Julienne 2.0x8.0mm
083752	Julienne 2.0x10.0mm
083753	Julienne 3.0x3.0mm
083647	Julienne 4.0x4.0mm
083648	Julienne 6.0x6.0mm
083649	Julienne 8.0x8.0mm

083666	Dicing equipments (1 dicing grid + 1 slicer) 5.0x5.0x5.0mm
083651	Dicing equipments (1 dicing grid + 1 slicer) 8.0x8.0x8.0mm
083652	Dicing equipments (1 dicing grid + 1 slicer) 10.0x10.0x10.0mm
083653	Dicing equipments (1 dicing grid + 1 slicer) 14.0x14.0x14.0mm
083654	Dicing equipments (1 dicing grid + 1 slicer) 20.0x20.0x20.0mm
083754	Dicing equipments (1 dicing grid + 1 slicer) 25.0x25.0x25.0mm

083755	French fries equipment 8.0x8.0mm (not working with 083685)
083756	French fries equipment 10.0x10.0mm (not working with 083685)
083757	French fries equipment 10.0x16.0mm (not working with 083685)

Additional equipment for all machines

083658	Wall disc holder
--------	------------------



AUTOMATIC SIEVE-JUICER C80

1 speed 1500rpm, table top model, s/s sieve, delivered with perforated basket \varnothing 1.0mm
produces juice, fruit purees, vegetable mousses, sauce bases, bisques and fish soups

		Dim in cm
083701	Version 230V/50Hz, 0.65kW	61.0x36.0x54.0
018103	Version 230V/60Hz, 0.65kW	61.0x36.0x54.0
Accessories to juicer C80		\varnothing cm
083702	Perforated basket	0.05
083703	Perforated basket	0.30
083704	Perforated basket	0.10
083705	Rubber scraper (per unit)	



FLOOR STANDING SIEVING JUICER C120

1 speed 1500rpm, floor model delivered with s/s feet, delivered with perforated basket \varnothing 1.0mm

		Dim in cm
083706	Version 3x380V/50Hz, 0.9kW	103.0x40.0x86.0
083709	Version 230V/50Hz, 0.9kW	103.0x40.0x86.0
083708	Version 3x380V/60Hz, 0.9kW	103.0x40.0x86.0



BLIXERS

The blixer combines the features of two well-known appliances: the cutter and the blender/mixer. The blixer will easily realise your pureed, raw or cooked, semi-liquid, liquid or pasty meals

BLIXER 3

3000rpm, s/s motor shaft, pulse function, delivered with s/s bowl 3.7ltr with handle, fine serrated blade, sealed lid, lid scraper

		Dim in cm
083690	Version 230V/50Hz, 0.75kW	21.0x33.0x42.0
083691	Version 230V/60Hz, 0.75kW	21.0x33.0x42.0
Accessories to Blixer 3		
083758	Coarse serrated blade	
083692	Fine serrated blade	



BLIXER 5 PLUS

2 speeds, 1500/3000rpm, metal motor base, s/s motor shaft, pulse function, delivered with s/s bowl 5.5ltr with handle, fine serrated blade, sealed lid, lid scraper

		Dim in cm
083693	Version 3x380V/50Hz, 1.3kW	27.0x34.0x50.0
083694	Version 3x380V/60Hz, 1.3kW	27.0x34.0x50.0
083695	Version 3x230V/60Hz, 1.3kW	27.0x34.0x50.0
Accessories to Blixer 5 Plus		
083759	Coarse serrated blade	
083696	Fine serrated blade	



TABLE TOP CUTTER MIXER R8

2 speeds, 1500/3000rpm, pulse function, mechanical safety system and motor brake, transparent and sealed lid, delivered with s/s bowl with handle, s/s smooth blade

		Dim in cm
083699	Version 3x380V/50Hz, 2.2kW	31.5x54.5x58.5
083688	Version 3x230V/60Hz, 2.2kW	31.5x54.5x58.5
083689	Version 3x380V/60Hz, 2.2kW	31.5x54.5x58.5



THE 1st PROFESSIONAL COOKING CUTTER-BLENDER!
HOT or AMBIENT

- Mix - Chop - Blend
- Crush - Emulsify - Heat
- Cook



025307

COOKING CUTTER-BLENDER

variable speed function of 100 - 3500rpm, single phase, s/s bowl cutter 3.7ltr with a handle, liquid cap. 2.5ltr, heating capacity up to 140°C, precise temperature control +/- 1°C, micro-serrated s/s, 9 program functions, 230V/50-60Hz, 1.8kW

Dim in cm

22.6x33.8x52.2



025309 Bowl Set to Cooking Cutter-Blender,
incl. bowl, blade, lid and scraper



025310 Blade to Cooking Cutter-Blender

		Dim in cm
008708	Potato peeling machine, steel	50.0x60.0x58.5
Peeling cap. per peeling process 5.0kg, cap. 60.0kg per hour, 1 speed level, water connection: 3/4 inch, 230V/50Hz, 0.37kW		



		Dim in cm
025268	Potato peeling machine, steel	78.5x38.0x86.0
Peeling cap. per peeling process 10.0kg, cap. 120.0kg per hour, 1 speed level, water connection: 3/4 inch, 230V/50Hz, 0.75kW		



		Dim in cm
025269	Potato peeling machine, steel	81.0x38.0x92.0
Peeling cap. per peeling process 18.0kg, cap. 220.0kg per hour, 1 speed level, water connection: 3/4 inch, 230V/50Hz, 1.1kW		

		Dim in cm
025270	Potato peeling machine, steel	90.0x54.0x104.0
Peeling cap. per peeling process 25.0kg, cap. 450.0kg per hour, 1 speed level, water connection: 3/4 inch, 230V/50Hz, 1.1kW		

VEGETABLE PEELER

Housing of s/s, very thick abrasive plate, adjustable direction of discharge, loading cap. 25.0kg, 420.0kg/hour

		Dim in cm
031865	Version 230V/50Hz, 1.1kW	78.5x58.5x121.5
031866	Version 3x230/380V/50Hz, 0.9kW	78.5x58.5x121.5

031867	Base stand to vegetable peeler 031865/031866 incl. filter	
--------	---	--



ANLIKER-MACHINES

The vast selection of more than 30 discs provides ample scope for creative fruit and vegetable processing. The cutting discs can be changed in a flash. The ease of use starts with filling as there is a cutting surface/-feed nozzle inclined by -45°C , which enhances safety during operation.

031510



Dim in cm

031510	ANLIKER vegetable cutter GSM Five Star, cap. up to 400 servings, 230V/50Hz, 0.425kW	31.5x25.0x54.0
--------	---	----------------

Dim in cm

315211	ANLIKER vegetable cutter GSM Five Star, complete with standard accessories: 9 different discs for slicing, grating, cubes, french fries, pommes gaufrettes pommes alouettes, julienne and food pusher, 8 boxes for disc storing, 230V/50Hz, 0.26kW	31.5x25.0x54.0
--------	--	----------------

Discs for GSM Five Star

031511



031512



031511	Slicing disc, fine cut 1.0mm
--------	------------------------------

031512	Slicing disc, large cut 3.0mm
--------	-------------------------------

031513



031514



031513	Grating disc 0.9mm
--------	--------------------

031514	Julienne disc 2.0x2.0mm
--------	-------------------------

031515



031516



031515	Disc pommes alouettes 4.0x4.0mm
--------	---------------------------------

031516	Disc french fries disc 8.0x8.0mm
--------	----------------------------------

031517



031518



031517	Disc pomme gaufrettes 4.0mm
--------	-----------------------------

031518	Disc for cubes 8.0x8.0x8.0mm
--------	------------------------------

031522



031523



031522	Universal grating disc 2.5mm
--------	------------------------------

031523	Rotary food pusher
--------	--------------------

031519



031520



031519	Set of 6 plastic boxes for 6 discs
--------	------------------------------------

031520	Plastic box large for storage of 2 discs
--------	--

Dim in cm

036021	Spice grinder with drawer model no. 1P, brown, precision grinding system from very fine to coarse, easy to adjust, hopper capacity 1.0kg, output 14.0kg/h, s/s and aluminium body, 230V/50-60Hz, 0.6kW	25.0x32.0x55.0
--------	--	----------------



		Dim in cm
040229	Tomato slicer, slices 0.64cm, aluminium and plastic	39.0x21.5x20.0



		Dim in cm
031801	Vegetable cutting machine Mini-Green complete with 4 different discs, (grating disc 2.0mm, shredding disc 2.0mm, slicing disc 2.0 and 3.0mm), speed 1500rpm, 230V/50-60Hz, 0.25 kW	34.7x21.6x41.2



		Dim in cm
031802	Vegetable cutting machine Multi-Green complete with 4 different discs and cutter attachment, with twin blade rotor and cover, speed 1500rpm, 2.5ltr s/s bowl, 230V/50Hz, 0.25kW	34.7x21.6x41.2



		Dim in cm
030401	Gastro cutter motorbase and bowl s/s, cutter with s/s sandwich bottom, transparent lid, 2 working speeds, 1405/2820rpm, 3x380V/50Hz, cap. 6.0ltr	31.0x55.0



	Accessories to Gastro cutter	
030402	Additional knife set to Gastro cutter	

		Dim in cm
031853	Salad dryer electric with plastic basket, 330rpm, loading cap. 12.0kg basket cap 65.0ltr, 3x230/380V/50Hz, 0.75kW	57.8x63.9x100.5

		Dim in cm
031854	Salad dryer electric with s/s basket, 330rpm, loading cap. 12.0kg basket cap. 65.0ltr, 3x230/380V/50Hz, 0.75kW	57.8x63.9x100.5



031855	Additional s/s basket	
031856	Additional plastic basket	



POWER MIXER MINI MP

Special model for sauces and smaller preparations, variable speed from 2000-12500rpm, s/s blade, bell disc and tube, removable blade and emulsifying disc, delivered with 1 s/s wall support

		Tube length cm	Total length cm
083760	Mini MP 190 V.V., 230V/50Hz, 0.25kW	19.0	47.0
083761	Mini MP 240 V.V., 230V/50Hz, 0.27kW	24.0	52.0



POWER MIXER CMP

Compact, easy to handle, designed to meet catering needs, variable speed from 2300-9600rpm, speed self regulation system, s/s blade, bell disc and tube, removable foot and blade, delivered with 1 s/s wall support

		Tube length cm	Total length cm
083762	CMP 250 V.V., 230V/50Hz, 0.27kW, cap. 15.0ltr	25.0	61.0
083763	CMP 300 V.V., 230V/50Hz, 0.30kW, cap. 30.0ltr	30.0	66.0
083764	CMP 350 V.V., 230V/50Hz, 0.35kW, cap. 45.0ltr	35.0	71.8



POWER MIXER MP ULTRA

1 Speed, 9500rpm, s/s blade, bell disc and tube, removable foot and blade, foot equipped with a 3 level watertightness system, delivered with 1 s/s wall support

		Tube length cm	Total length cm
083765	MP 350 Ultra, 230V/50-60Hz, 0.44kW, cap. 50.0ltr	35.0	72.5
083766	MP 450 Ultra, 230V/50-60Hz, 0.50kW, cap. 100.0ltr	45.0	82.5
083767	MP 550 Ultra, 230V/50-60Hz, 0.75kW, cap. 200.0ltr	55.0	92.5
083768	MP 600 Ultra, 230V/50-60Hz, 0.85kW, cap. 300.0ltr	60.0	97.0



POWER MIXER CMP COMBI

Variable speed, speed self regulation system, s/s removable blade, bell, whisk and tube delivered with 1 s/s wall support

		Total length w/ tube cm	Total length w/ whisk cm
083769	CMP 250 Combi, mixer 2300-9600rpm, whisk 500-1800rpm, 230V/50Hz, 0.27kW, cap. 15.0ltr	64.0	73.0
083770	CMP 300 Combi, mixer 2300-9600rpm, whisk 500-1800rpm, 230V/50Hz, 0.30kW, cap. 30.0ltr	70.0	73.0
083771	MP 350 Combi Ultra, mixer 1500-9000rpm, whisk 250-1500rpm, 230V/50-60Hz, 0.44kW, cap. 50.0ltr	72.5	80.5
083772	MP 450 Combi Ultra, mixer 1500-9000rpm, whisk 250-1500rpm, 230V/50-60Hz, 0.50kW, cap. 100.0ltr	89.0	80.5



POWER MIXER MP 450 FW ULTRA

Variable speed from 250-1500rpm, speed self regulation system, removable whisk, metal gearbox, delivered with 1 s/s wall support

		Whisk length in cm	Total length w/ whisk cm
083773	MP 450 FW Ultra, 230V/50-60Hz, 0.5kW	28.0	80.5

083773



007307

		L in cm
007307	Mixer heavy-duty big stix, s/s variable speed motor, 18000rpm on high, user-replaceable couplings on power pack and shaft, completely sealed stainless steel shaft is easily removable and dishwasher safe, 230V/50Hz, 2.8A	40.5

		Tube length cm	Total length cm
021991	Mixer Micro Mix, s/s, variable speed from 1500 to 14000rpm/min, coiled power cord, easy cleaning, incl. Blade, Aeromix and tube, 230V/50Hz	16.5	43.0
010701	Handmixer BAMIX GASTRO 200 double insulated 2 speed motor, high speed up to 18'000rpm, cap. 1.0-20.0ltr, supplied with cutter, whisk, beating disc and wall holder, waterproof softgrip switch, specially suitable for sauces, 230V/50-60Hz, 0.2kW		
		Dim in cm	
042156	Mixer ROTOR Professional with s/s beaker 0.8ltr, available in silver-grey and blue infinitely, continuously variable speed range 8000-18000rpm, 230V/50-60Hz, 0.1kW	16.5x17.0x48.5	
		Ø cm	H in cm
083520	Blender ROTOR Gastronom GT900 with 4.0ltr transparent polycarbonate mixing beaker, professional machine with high power blade, continously variable speed range from 500-17000rpm, 230V/50-60Hz, 0.9kW	24.0	52.5
		Ø cm	H in cm
083521	Blender ROTOR Gastronom GT 900 with 2.0ltr s/s mixing beaker, continuously variable speed range from 1000 to 17000rpm, 230V/50-60Hz, 0.9kW	19.0	48.6
083522	Blender ROTOR Gastronom GT 600 socket, for all breaker, 230V/50Hz, 0.6kW		
083523	Blender ROTOR Gastronom GT 900 socket for all beakers, 230V/50Hz, 0.9kW		
		Ø cm	
083532	Blender ROTOR GK 900 with 4.0ltr transparent polycarbonate (Lexan) mixing beaker, professional machine with high power blade, for kitchen and bars (including ice crushing), continuously variable speed range from 500-17000rpm, 230V/50-60Hz, 0.9kW Remark: CE approved	28.8	
	Accessories to Gastronom blender		
083535	Beaker 2.0ltr polycarbonate (Lexan)		
083533	Beaker 2.0ltr s/s		
083534	Beaker 4.0ltr s/s		
083526	Beaker 4.0ltr polycarbonate (Lexan)		
		Dim in cm	
006162	Blender black, to crush ice, mix and puree, strong glass container, "clean-touch" display, with mini mix attachment, 4'000-10'000rpm, 230V/50-60Hz, 0.55kW	18.0x23.0x38.0	





		Cap.	Dim in cm
036002	ZUMEX orange juicer, fruit size up to 8.0cm, 230V/50-60Hz, available in 12 colours	13 fruits/min	72.0x36.5x36.0



		Cap.	Dim in cm
004508	ZUMEX Essential pro, automatic juice press with integrated filter and buckets for citrus fruits up to Ø 8.1cm, feeder cap. 5 oranges, 230V/50-60Hz, 0.3kW	18 fruits/min	74.0x47.0x50.0



		Cap.	Dim in cm
036602	ZUMEX Versatile pro, orange, automatic juice press with automatic feeder for citrus fruits up to Ø 8.1cm, feeder cap. 10.0kg, 230V/50-60Hz, 0.3kW	22 fruits/min	50.0x47.0x85.0



		Cap.	Dim in cm
025846	ZUMEX speed tank podium juice press with automatic feeder, with drain and clean system, for citrus fruits up to Ø 8.1cm, feeder cap. 15.0kg, s/s trolley with lockable casters, 230V/50-60Hz, 0.3kW	38 fruits/min	72.0x68.0x176.0



		Dim in cm
036511	SANTOS citrus juicer model 11, yellow/green painted base, output 30.0ltr/hour equipped with an unbreakable bowl, 3 removable squeezers, easy to use and clean, completely safe, 1500rpm, 230V/50-60Hz, 0.13kW	30.0x20.0x35.0



		Dim in cm
036512	SANTOS automatic citrus juicer model 10 with lever extracts the maximum of juice by centrifugal action, lever action start and stop, 1500rpm, 230V/50-60Hz, 0.23kW	20.0x30.0x38.0

		Dim in cm
025304	Juicer Soul, 12 fruits/min, fruit size up to 8.0cm, black push&juice concept, easy to remove and clean, 230V/50-60Hz, 0.09 kW, 2.5A	26.0x43.0x43.5
		Dim in cm
036018	SANTOS lever juicer model 70, adapted squeezer to all kinds of citrus fruits, accepts all kinds of glasses and jugs, easy to clean, removable bowl, cone and cup, lever action start and stop, output 50.0ltr/h, 230V/50-60Hz, 0.275kW	24.0x40.0x49.0
		Dim in cm
036510	SANTOS centrifugal juicer model 28, for continuous production of fruit and vegetable juices by centrifugal force, cap 100.0ltr/hour, 3000rpm, 230V/50-60Hz, 1.3kW	32.0x48.0x57.0
		Dim in cm
011284	SANTOS centrifugal juicer extractor model 68, automatic pulp ejection, 140.0ltr/hour, easy to clean, 230V/50-60Hz, 1.3kW	56.2x33.0x60.6
		Dim in cm
011285	SANTOS centrifugal juice extractor model 68J, automatic pulp ejection, incl. pulp tube, 140.0ltr/hour, easy to clean, 230V/50-60Hz, 1.3kW	56.2x33.0x60.6
		Dim in cm
036016	SANTOS centrifugal juice extractor model 50C, automatic pulp ejection, chrome, over 1.0ltr/min, 7.5ltr container, easy to clean, 230V/50-60Hz, 0.8kW	45.0x35.0x47.0
		Dim in cm
030263	NUTRISANTOS cold press juicer model 65, extra wide chute dia 7.95cm, fits whole fruits and vegetables, 60.0ltr/hour, ultra slow extraction to preserve nutrients, enzymes, vitamins and minerals, 230V/50-60Hz, 0.65kW	41.2x64.2x23.6
		Dim in cm
042153	Juice extractor, cap. 60.0kg/hour, complete in s/s, container cap. 3.25ltr, 230V/50-60Hz, 0.24kW	19.0x31.0x38.0
		Dim in cm
083697	Automatic centrifugal juicer J80 Ultra, 1 speed, 3000rpm, automatic feed system Ø 7.9cm, continuous pulp ejection, removable s/s basket, s/s bowl, 6.5ltr container, 230V/50Hz, 0.7kW	23.5x42.0x50.5
		Dim in cm
083698	Automatic centrifugal juicer J100 Ultra, automatic feed system Ø 7.9cm, continuous pulp ejection with 7.2ltr container for intensive use, removable s/s basket, s/s bowl, 230V/50Hz, 0.7kW	23.5x53.8x59.6



new



		Blade in cm	Dim in cm
042181	Prosciutto slicing machine manual, red painted, aluminium casing with steel parts, built-in blade sharpener, protection ring at blade, cutting length 26.0cm, cutting height 19.0cm, cutting thickness 0-20.0mm, without base	30.0	72.0x60.0x50.0
			Dim in cm
042182	Base 042181, red painted		56.0x38.0x80.0



		Blade in cm	Dim in cm
030520	Slicing machine, half oblique, carriage stroke 22.5cm, cutting height 18.0cm, cutting thickness adjustable from 0-1.6cm, 230V/50-60Hz	22.0	49.0x42.0x36.0



		Blade in cm	Dim in cm
080714	Slicing machine, cutting thickness 1.3cm, anodized cast aluminium alloy, ventilated motor, 230V/50Hz	25.0	57.0x56.0x37.0
080715	Slicing machine, cutting thickness 1.3cm, anodized cast aluminium alloy, ventilated motor, 230V/50Hz	30.0	64.0x61.0x42.0



		Blade in cm	Dim in cm
030542	Slicing machine vertical, cutting thickness adjustable from 0-1.5cm, carriage stroke 21.0cm, cutting height 17.0cm, 230V/50Hz	25.0	63.0x53.0x37.0



		Dim in cm
031835	Bread loaf slicing machine, output 200 slices/minute, suitable for french loaves, sticks and baguettes, 230V/50Hz, 0.37kW	41.8x47.2x85.7
031836	Shelf complete with polycarbonate container GN 1/1, depth 20.0cm	60.0x64.0x60.0

Bread loaf slicing machine, table model T-45 FL, width of slicing mechanism 4.2cm, white, 230V/50Hz, 0.4kW



		Dim in cm
063824	Bread loaf slicing machine, thickness of slices 0.9cm	60.0x64.0x60.0
063828	Bread loaf slicing machine, thickness of slices 1.0cm	60.0x64.0x60.0
063825	Bread loaf slicing machine, thickness of slices 1.1cm	60.0x64.0x60.0
063829	Bread loaf slicing machine, thickness of slices 1.2cm	60.0x64.0x60.0
031177	Bread loaf slicing machine, thickness of slices 1.5cm	60.0x64.0x60.0



Bread loaf slicing machine, standing model 45, width of slicing mechanism 4.5cm, 3x380V/50Hz, 0.6kW

		Dim in cm
063822	Bread loaf slicing machine, thickness of slices 0.9cm	68.0x64.0x105.0
063823	Bread loaf slicing machine, thickness of slices 1.1cm	68.0x64.0x105.0

PACOJET

Pacojet pacotizes (mincing, pureeing and preparing a mousse from frozen foodstuff) freshly frozen ingredients.

		Dim in cm
021324	PACOJET 2 food processor, 1 pacotizing blade, 1 spray guard, 2 pacotizing beakers with lids, 1 outer protective beaker, 1 chrome-steel spatula, 1 instruction manual, 1 international recipe book, 1 cleaning kit containing 1 blue washing insert, 1 blue sealing ring and 1 green rinsing insert, pacotizing blade 2000 rpm, motor 6000 rpm and 1.2 bar, 230V/50-60Hz, 0.95kW	49.8x18.2x36.0
		
	Remark: To work efficiently we recommend to order 2 additional sets of 4 pacotizing beakers with lids.	Video
Accessories to Pacojet 021324		
011304	Pacotizing Beakers with lids, set of 4, chrome steel, white, plastic, beaker capacity 1.0ltr, max. fill volume 0.8ltr.	
001926	Pacotizing Beakers with lids, set of 6, chrome steel, white, plastic, beaker capacity 1.0ltr, max. fill volume 0.8ltr.	
010725	Pacotizing Beakers with lids, set of 10, chrome steel, white, plastic, beaker capacity 1.0ltr, max. fill volume 0.8ltr.	
011305	Pacotizing blade, gold, hardened with titanium-nitride	
002106	Pacotizing blade, standard, metal finish, grey/silver	
011306	Spray guard, complete, black, rubber	
011307	Cleaning insert with rotating brushes, blue, plastic	
011308	Rinsing insert, green, rubber	
004526	Sealing Ring in connection with the cleaning insert, blue, rubber	
004527	Protective outer beaker, black, plastic	
012584	Beaker lid, white, plastic	
		P/U
023247	Beaker lid, yellow, plastic	10
023248	Beaker lid, blue, plastic	10
023249	Beaker lid, red, plastic	10
023258	Beaker lid, green, plastic	10
023259	Beaker lid, gold, plastic	10
004525	Spatula, chrome steel	
012586	Pacojet Coupe Set	
023260	Insulation box (for 4 pacotizing beakers), polystyrene	
		P/U
023261	Display protective foil Pacojet 2, anti-bacterial, anti-scratch, PET incl. microfiber cleaning cloth embossed with Pacojet logo and slogan	2





		Dim in cm
002824	Kitchen aid KSM 7580, mixer incl. dough hook, flat beater, whisk (all s/s) and a splash guard, cap. 6.9ltr, black, 230V/50-60Hz, 0.5kW	34.0x37.0x42.0



002826	Bowl s/s, cap. 6.9ltr	
--------	-----------------------	--

		Cap. ltr	Dim in cm
031825	Angled spiral mixer BPO25F1, with high and, low speed the angle spiral ensures kneading dough from 2.0 to 8.0kg, 230V/50-60Hz, 0.75kW	25.0	73.6x55.7x78.2



MAXIMAT SPIRAL MIXERS - s/s

Two motor machine with touch-panel kneading automatic and integrated thermometer for continuous measuring of the dough temperature controlled stop of machine. The bowl turning direction is choosable in the first speed for up to 90sec., 10 kneading programmes storable

		Cap. ltr	Dim in cm
070302	Maximat S80, 3x380V/50Hz, 2.4/4.4kW	123.0	106.5x67.5x119.3
070304	Maximat S120, 3x380V/50Hz, 3.5/8.6kW	184.0	135.4x87.7x132.0
070303	Maximat S160, 3x380V/50Hz, 3.5/8.6kW	270.0	125.0x78.2x132.0



		Dim in cm
070321	Bun divider/rounder, Piccolo 4 total amount of dough 1.2-4.0kg, 30 divisions, 0.04-0.135kg	61.0x65.0x138.0



		Dim in cm
031830	Hand dough sheeter LMP400, working width 40.0cm, teflon coated steel cylinders (Ø 6.0cm), adjustable from 0.1 to 34.0mm in thickness	100.0x68.0x40.0



		Dim in cm
011516	Manual butter portioning machine BT31 for 250.0gr butter, 1 round produces 2 pieces of butter of 8.0-10.0gr	35.0x17.0x23.0



		Dim in cm
031831	Dough sheeter LMP500BT, working width 50.0cm, cylinders can be regulated from 0.1-34.0mm, easy cleaning chromium plated steel, 3x380V/50Hz, 0.55kW	238.0x98.0x54.0



		Dim in cm
063101	Dough sheeter, bench model, changeable speeds, conveyor belts, 400V/50-60Hz, 0.55kW	205.0x95.5x55.5
063103	Dough sheeter, bench model, changeable speeds, conveyor belts, 400V/50-60Hz, 0.55kW	245.0x145.5x55.5



		Dim in cm
063105	Dough sheeter, floor model, changeable speeds, conveyor belts, 3x380/50-60Hz, 0.55kW	205.0x95.5x128.0
063107	Dough sheeter, floor model, changeable speeds, conveyor belts, 3x380/50-60Hz, 0.55kW	245.0x105.5x128.0





		Dim in cm
053610	Duplex AW CZ 20/82 Mincer/cutter complete with 1 knife plate, 2 double knives, 1 plate each 3.0mm and 8.0mm, 1 each narrow and wide insertion ring, bowl capacity 20.0ltr, 2 separate motors with two speeds, each for the cutter and mincer, 3x380V/50Hz, 16A	107.0x90.0x83.0



		Dim in cm
042610	FAMA TS-22 Unger Meat mincer, s/s mouth Ø 8.2cm, three plates, standard plate with 3 holes Ø 2.0cm, 10.0 and 4.5mm, two knives, ventilated and equipped with thermal protection, 3x380V/50Hz, 1.1kW	50.0x23.0x41.0



		Dim in cm
025266	Meat mincer 12S, steel easy cleaning, incl. 1 knife and 1 breaker plate 6.0mm, plate diameter (icon) 7.0cm, 160kg/h, 230V/50Hz, 0.75kW	29.0x46.0x50.0



		Dim in cm
028212	Computerized filler/linker KOMPAKTA 2-30 Fully electronic filling and portioning stuffer cap. 30.0ltr, portioning range 5-10000gr, portioning speed 250 portions/min, memory 99 programmes, 3x380V/50Hz, 3.3kW - suitable for all kinds of sausages for straight filling, portioning and linking of all kind of casings - cylinder made of solid s/s with special coating - including accessories and hydraulic coil	29.0x46.0x50.0



		Dim in cm
053615	Bowl cutter AW CU20, outside s/s, 3x380V/50Hz - bowl content capacity 20.0ltr - cutter hood, cutterbowl, knife shaft arm in s/s on casters with 4 swivel casters with brake - knife shaft and bowl with 2 speeds, separately controlled - motor rating knife shaft 2.6kW/3.2kW, 1600/3200rpm - motor rating bowl 0.12/0.18kW, 10.3/20.6rpm - contactor control with motor protection - knife head with 4 counter balance crescent knife discs	78.5x65.0x109.0



		Dim in cm
080719	Bowl cutter, cap. 5.3ltr, 1500-2800rpm, s/s construction, speed control, ventilated motor, 230V/50-60Hz, 0.35kW	32.0x38.0x32.0

		Dim in cm
080720	Bowl cutter, cap. 9.4ltr, 1500-2800rpm, s/s construction, speed control, ventilated motor, 230V/50-60Hz, 2x0.35kW	33.0x47.0x40.0



		Dim in cm
024986	Bone saw, blade 16.5cm, motor 1400rpm, working surface 43.0x47.5cm, cut height 25.0cm, cut width 20.0cm, 230V/50Hz	53.0x60.0x91.5

		Dim in cm
024989	Bone saw, blade 16.5cm, motor 1400rpm, working surface 43.0x47.5cm, cut height 25.0cm, cut width 20.0cm, 3x380V/50Hz	53.0x60.0x91.5

020628	Knife-sharpener , Prime Cut I
--------	-------------------------------



		Blade in cm
027453	Sharpening rod professional „QUINTUM“, 5-stage, s/s	25.0



		Dim in cm
020026	Sharpening machine, 1 grinding and 1 polishing station, diamond-coated grinding wheels, easy to use, fast cleaning, 230V/50Hz, 0.12kW, 1500rpm	20.2x55.9x19.7



		Dim in cm
020027	Sharpening machine, 2 grinding and 2 polishing stations, diamond-coated grinding wheels, easy to use, fast cleaning, 230V/50Hz, 0.18kW, 2500rpm	20.2x55.9x19.7



020640	Knife sharpening, honing and polishing machine model with water-cooled grinding wheels, 230V/50-60Hz
--------	---



		Dim in cm
020631	Regrinding machine, bench type with water-cooled grinding belt, 230V/50-60Hz	55.0x35.0x53.0

020632	Universal belt grinding attachment to 020631 for the regrinding of cutter blades and circular blades necessary for 020634, 020635 and 020636
--------	--



	Accessories to 020631
020634	Clamping plates for bowl cutter knives 40.0-100.0ltr
020635	Clamping plates for bowl cutter knives 120.0-200.0ltr
	For resharpener circular blade
020636	Set of 10 inserts
020637	Straight lever



		Dim in cm
033070	Gnocchi machine LA PARMIGIANA PG2-15 cap. 40.0kg per hour, 230V/50-60Hz, 0.65kW	48.0x47.0x94.0



		Dim in cm
080510	Noodle machine LA PARMIGIANA D-35, cap. 6.0-7.0kg/hour powered by heavy duty motor, 230V/50-60Hz, 0.56kW	67.0x34.0x68.0



		Dim in cm
033069	Noodle machine LA PARMIGIANA D45-C cap. 15.0kg/hour, mixing hopper cap. 4.0kg, can be combined with a vast selection of dies for making high quality pasta, powered by heavy duty motor, 3x380V/50Hz, 1.1kW	126.0x75.0x54.0



		Dim in cm
080511	Noodle machine LA PARMIGIANA D-35 in tandem with semi-automatic ravioli-making machine for ravioli 4.0x4.0cm, cap. 6.0-7.0kg per hour, 230V/50Hz, 0.56kW	34.0x67.0x68.0



		Dim in cm
025505	Ravioli machine LA PARMIGIANA PR90 cap. 30.0/60.0kg/hour depending on shape, double sheet with inlet from producing machine, 230V/50Hz, 0.75kW	60.0x65.0x145.0

D-35 ND45

080511	033069	Dies for noodle machine LA PARMIGIANA
080514	080614	Tagliatelle 1.8mm
080515	080615	Tagliatelle 2.0mm
080516	080616	Tagliatelle 2.5mm
080517	080617	Tagliatelle 3.0mm
080518	080618	Tagliatelle 3.5mm
080519	080619	Tagliatelle 4.5mm
080520	080620	Tagliatelle 5.0mm
080521	080621	Tagliatelle 6.0mm
080522	080622	Tagliatelle 7.0mm
080523	080623	Tagliatelle 8.0mm
080524	080624	Tagliatelle 10.0mm
080525	080625	Tagliatelle 12.0mm
080526	080626	Tagliatelle 14.0mm



080527	080627	Spaghetti 0.7mm
080528	080628	Spaghetti 0.8mm
080529	080629	Spaghetti 0.9mm
080530	080630	Spaghetti 1.1mm
080531	080631	Spaghetti 1.3mm
080532	080632	Spaghetti 1.4mm
080533	080633	Spaghetti 1.5mm
080534	080634	Spaghetti 1.7mm
080535	080635	Spaghetti 2.1mm
080548	080648	Spaghetti 3.0mm
080549	080649	Spaghetti 4.0mm



080555	080655	Linguine 2.0mm
080556	080656	Linguine 3.0mm
080557	080657	Linguine 4.0mm



080551	080651	Spaghetti quadri 1.8mm
080552	080652	Spaghetti quadri 2.5mm



080558	080658	Mafaldine-Riccie 12.0mm
080559	080659	Mafaldine-Riccie 16.0mm
080561	080661	Mafaldine-Riccie 20.0mm



080583	080683	Maccheroni lisci 2.5mm
080584	080684	Maccheroni lisci 4.0mm
080585	080685	Maccheroni lisci 6.0mm
080586	080686	Maccheroni lisci 8.0mm
080587	080687	Maccheroni lisci 10.0mm
080588	080688	Maccheroni lisci 12.0mm



D-35 ND45



080510	033069	Dies for noodle machine LA PARMIGIANA
--------	--------	---------------------------------------



080537	080637	Maccheroni rigati 4.5mm
080590	080690	Maccheroni rigati 8.0mm
080591	080691	Maccheroni rigati 10.0mm
080592	080692	Maccheroni rigati 12.0mm



080538	080638	Maccheroni 8.0mm
--------	--------	------------------



080540	080640	Gnocchi 30.0mm (conchiglie rigate)
--------	--------	------------------------------------



080562	080662	Curvi lisci 6.0mm
080563	080663	Curvi lisci 7.8mm
080564	080664	Curvi lisci 9.8mm
080565	080665	Curvi rigati 6.5mm
080566	080666	Curvi rigati 8.6mm
080567	080667	Curvi rigati 10.5mm



080542	080642	Conchiglie lisce 28.0mm
--------	--------	-------------------------



080568	080668	Trecce 8.8mm
--------	--------	--------------



080571	080671	Fusilli 7.0mm
080572	080672	Fusilli 8.4mm



080569	080669	Trottole 10.4mm
--------	--------	-----------------

080570	080670	Campanelle 11.4mm
--------	--------	-------------------

080546	080646	Casarecce 8.8mm
--------	--------	-----------------

080539	080639	Spirali 8.4mm
--------	--------	---------------

080541	080641	Radiatori rigati 30.0mm
--------	--------	-------------------------

080543	080643	Gnocchetti 12.0mm
--------	--------	-------------------

080544	080644	Gnocchetti 19.0mm
--------	--------	-------------------

080545	080645	Ruote 16.5mm
--------	--------	--------------

		Cap./h	Dim in cm
030550	Noodle machine multipurpose machine for the automatic production of fine-rolled pasta sheets, can knead and roll pasta simultaneously, 3x380V/50Hz	20.0kg	40.0x52.0x63.0

		Cap./h	
030551	Attachment for tagliatelle 2.0, 6.0, 12.0mm to 030550	18.0kg	

		Cap./h	Dim in cm
030553	Attachment for ravioli 2.0x2.0cm to 030550	25.0kg	28.0x56.0x30.0

		Cap./h	Dim in cm
030554	Attachment for gnocchi, 2 sizes, to 030550	40.0kg	21.0x33.0x52.5

			Dim in cm
018531	Noodle machine manual, prepares pasta stripes of 21.0cm width, adjustable to 10 different thicknesses, incl seasoned beech hopper protection accessory with a pasta feeding mechanism		22.0x32.5x27.5

		Cap./h	Dim in cm
018532	Noodle machine with electronic roller, prepares pasta stripes of 21.0cm width adjustable to 10 different thicknesses, incl seasoned beech hopper protection accessory with a pasta feeding mechanism, 220V/50Hz, 0.19kW	12.0	32.0x26.0x29.5

	Cutting attachment for noodle machine 018531 and 018532	Dim in cm
018533	Angel's hair, 1.5mm	30.0x20.0x24.0
018534	Tagliatelle, 2.0mm	30.0x20.0x24.0
018535	Trenette, 4.0mm	30.0x20.0x24.0
018536	Fettucine, 6.5mm	30.0x20.0x24.0
018537	Lasagnette, 12.0mm	30.0x20.0x24.0
018538	Spaghetti, 2.0mm	30.0x20.0x24.0

		Ø cm	H in cm
022204	Pasta drying rack, beechwood	30.0	34.0

		Cap. ltr	H in cm
021351	Rice cooker for 25-40 persons, s/s, inner pot: non stick coating, heat resistant with all-around keep warm function, Ø=32.0cm, including measuring cup, rice spoon and stirring spoon, 230V/50-60Hz, 1.95kW	8.0	35.0





		Dim in cm
010167	Cold counter GN 2/1, ventilated cooling, temperature 6°C to 10°C, show-case with intermediate shelf and lighting, the counter is equipped with sliding doors on operation side, 230V/50-60Hz, 0.29kW	75.0x77.5x60.0



		Dim in cm
010168	Cold counter GN 3/1, ventilated cooling, temperature 6°C to 10°C, show-case with intermediate shelf and lighting, the counter is equipped with sliding doors on operation side, 230V/50-60Hz, 0.34kW	108.0x77.0x60.0



		Cap. ltr	Ø cm	H in cm
007614	Cake display with LED lighting, double-glass, plastic, humidity up to 70%, 1 door, door hinged on the right, 4 support grids ø 31.5cm, spacing between the grids 16.0cm, bogie with support removable grids, temperature 2°C to 10°C, 230V/50Hz, 0.19kW	72.0	45.0	98.3



		Cap. Kg	Dim in cm
037821	Ice cube machine, air-cooled, storing container 6.5kg, cooling agent R404a, water connection 3/4", no filter system needed, 230V/50Hz, 0.31kW	25.0/24h	38.5x46.8x68.7

		Cap. Kg	Dim in cm
037820	Ice cube machine, water-cooled, storing container 6.5kg, cooling agent R404a, water connection 3/4", no filter system needed, 230V/50Hz, 0.31kW	25.0/24h	38.5x46.8x68.7



		Cap. Kg	Dim in cm
037822	Ice cube machine, air-cooled, storing container 22.0kg, cooling agent R404a, water connection 3/4", no filter system needed, 230V/50Hz, 0.42kW	60.0/24h	49.5x58.0x79.7

		Cap. Kg	Dim in cm
037823	Ice cube machine, water-cooled, storing container 22.0kg, cooling agent R404a, water connection 3/4", no filter system needed, 230V/50Hz, 0.42kW	60.0/24h	49.5x58.0x79.7

		Cap. Kg	Dim in cm
007024	Ice cube machine, cube size 2.8x2.8x3.2cm, air-cooled, 230V/50-60Hz, 1.3kW	210.0/day	56.0x70.0x88.0

		Cap. Kg	Dim in cm
007025	Ice cube machine, cube size 2.8x2.8x3.2cm, water-cooled, 230V/50-60Hz, 1.3kW	210.0/day	56.0x70.0x88.0

		Cap. Kg	Dim in cm
010372	Crushed ice machine, housing complete in s/s, storage capacity 1.0kg, plastic collector container, 230V/50-60Hz	3.0kg/min	32.0x18.0x33.0

		Cap. Kg	Dim in cm
007029	Nugget ice machine, air-cooled, 230V/50Hz, 1.46kW	430.0/day	56.0x70.0x75.0

		Cap. Kg	Dim in cm
023521	Ice crusher, s/s and plastic body, funnel and receptacle plastic, 230V/50Hz, 0.06-0.08kW	15.0/hour	17.2x24.0x46.3

		Cap. Kg	Dim in cm
036513	Ice shaver SANTOS No. 9 equipped with adjustable knife for shave and snow ice, safety switch when opening the drawer and hopper, 1500rpm, 230V/50-60Hz, 0.6kW	50.0/hour	42.0x25.0x35.0

		Cap. Kg	Dim in cm
091004	Ice cube machine freestanding, without water connection, 3 different cube sizes, storage cap. 1.5kg, water container 4.0ltr, air-cooled, incl. ice scoop, carry handles, 230V/50Hz, 0.2kW, 1.25A	15.0-20.0/day	43.1x38.0x43.5





		Dim in cm
021974	Cream machine Pony, 2.0ltr, with intensive cooling and cooling nozzle, s/s easy cleaning, double mixing roller s/s, fully electronic cooling control, continuous button with safety shutdown, quality compressor cooling, 230V/50-60Hz	23.0x39.0x44.0



		Dim in cm
021975	Cream machine Boy, 4.0ltr, with intensive cooling and cooling nozzle, s/s easy cleaning, double mixing roller s/s, fully electronic cooling control, continuous button with safety shutdown, quality compressor cooling, 230V/50-60Hz	27.0x47.0x44.0



001977	Cream whipper Gourmet Whip+ISI, 0.5ltr
001907	Cream whipper Gourmet Whip+ISI, 1.0ltr



003737	Bulbs box of 24 cartridges Remark: Dangerous goods (only small quantities can be shipped; max. 4 boxes per shipment)
--------	--



024189	Soda siphon, s/s, 1.0ltr
--------	--------------------------



		Dim in cm
420231	Ice Cream & Sorbet machine, compressor refrigeration, table top model, 1.4ltr per batch, production time 30-60min, incl. measuring cup and ice-cream scoop, 230V/50Hz, 0.15kW	29.5x39.5x31.5

		Dim in cm
029047	Soft ice freezer, air-cooled, non-self pasteurizing, counter top, one flavour, cap. 12.0ltr, production 245 cones/hour 75.0gr each, 230V/50Hz, 2.4kW	96.0x55.0x108.0

		Dim in cm
029048	Soft ice freezer, air-cooled, non-self pasteurizing, counter top, one flavour, cap. 12.0ltr, production 270 cones/hour 75.0gr each, 230V/50Hz, 2.4kW	96.0x55.0x108.0

		Dim in cm
029061	Soft ice freezer, air-cooled, cap. 13.0ltr, one flavour, production 465 cones/hour, 3x380V/50Hz, 2.5kW	45.0x78.2x160.5

		Dim in cm
029060	Soft ice freezer, air-cooled, cap. 13.0ltr, one flavour, production 510 cones/hour, 3x380V/50Hz, 2.5kW	45.0x78.2x160.5

		Dim in cm
015274	Soft ice freezer, air-cooled, cap. 2x13.0ltr, 2+1 flavours, production 670 cones/hour, 3x380V/50Hz, 5.0kW	50.0x78.2x160.5

		Dim in cm
080607	Batch freezer, 2.0-3.0kg per cycle, air-cooled, programmable ice cream consistency, automatic ice cream extraction, support shelf for s/s tub, chilled compartment to store 4 tubs, 230V/50Hz, 2.1kW	54.0x57.0x115.0

		Dim in cm
080608	Gelato and pastry machine, water-cooled, heating, cooking, cooling and freezing, 6 options to produce ice cream, 2 options for Sicilian granites and Cremolata, 6 options to produce sauces and toppings, 3x380V/50Hz	105.0x60.0x166.0



PIZZA OVENS

Upper and lower heat are thermostatically controlled and separately regulated.
They are insulated with rock-wool-files offering a maximum heat insulation.



		Dim in cm
010141	Pizza oven, 1 floor baking area 92.0x62.0x14.0, capacity for 6 pizzas ø 30.0cm, 3x380V, 50-60Hz, 6.0kW, 400°C	121.0x83.0x43.5



		Dim in cm
010144	Pizza oven, 2 floors baking areas 2x 92.0x62.0x14.0, capacity for 2x 6 pizzas ø 30.0cm, 3x380V, 50-60Hz, 12.0kW, 400°C	121.0x83.0x77.0



		Dim in cm
010142	Base unit for 010141 and 010144	115.5x66.5x90.0

Sous-vide is cooking “under vacuum”, fresh food such as fish, meat or vegetables are vacuum-packed and then cooked in precise temperature-controlled water.

Cooking Sous-vide yields healthy and nutritious dishes with high-quality taste, preserving aroma, flavour and vitamins. Freshness, colour and appearance remain unaltered until consumption, with a minimal shrinkage of the product.

Advantages:

- Consistent results
- Minimal shrinkage
- Extended shelf life without loss of quality
- Concentration of flavour
- Reproducible and precise
- Low energy cost
- Stress-free and efficient cooking
- Overcooking virtually impossible

PEARL



- guarantees a temperature stability of $\pm 0.03^{\circ}\text{C}$
- including a safety protection grid and strong circulating pump
- integrated timer for easy monitoring of the remaining cooking time
- vapour barrier protection (warning system for low water level)
- splash water protection

DIAMOND



Diamond has all features of Pearl, but additional innovative functions:

- pre-programmed memory keys for meat, fish, and vegetables
- straightforward HACCP data logging and calibration functions
- can be used with the core temperature sensor, with alarm when core temperature has been reached
- timers can be started separately from each other, with visual and acoustic signal



PEARL

		Dim in cm
073655	Heating immersion circulator for vessels up to 58.0ltr, incl. attachment clamp and timer, operating temperature 20°C to 95°C , temperature can be displayed in $^{\circ}\text{C}$ or $^{\circ}\text{F}$, pump capacity 0.3 bar, 15.0ltr/min, immersion depth 14.0cm, warning system for low water level, including protection grid for heater, timer, pump and float 230V/50-60Hz, 2.0kW, 9A	13.3x21.2x33.0



		Dim in cm
073657	Bridge mounted circulator, incl. extendable s/s bridge, for vessels up to 58.0ltr, operating temperature 20°C to 95°C , temperature can be displayed in $^{\circ}\text{C}$ or $^{\circ}\text{F}$, pump capacity 0.3 bar, 15.0ltr/min, immersion depth 14.0cm, warning system for low water level, including protection grid for heater, pump and float 230V/50-60Hz, 2.0kW, 9A	68.0x19.0x33.0



HEATING IMMERSION CIRCULATOR

With an insulated bath tank, temperature stability of +/- 0.03°C, operating temperature 20°C to 95°C, splash-proof operating keypad, bright LED temperature display, low-water alarm, timer, high-capacity pump 14.0ltr/min, s/s protection grid included, drain tap, robust handles, 230V/50-60Hz, 2.0kW



		Dim in cm
003291	Heating immersion circulator Pearl XS, with an insulated bath tank 13.0ltr	33.2x39.8x37.4



		Dim in cm
073660	Heating immersion circulator Pearl S, with an insulated bath tank 19.0ltr	33.2x57.7x37.4



		Dim in cm
073661	Heating immersion circulator Pearl M, with an insulated bath tank 27.0ltr	33.2x57.7x42.4



		Dim in cm
073663	Heating immersion circulator Pearl XL, with an insulated bath tank 58.0ltr	53.8x69.7x42.4

DIAMOND



		Dim in cm
073656	Heating immersion circulator for vessels up to 58.0ltr, incl. attachment clamp, operating temperature 20°C to 95°C, 3 integrated timers, pump capacity 0.3 bar, 14.0ltr/min, display for current temperature, core temperature and timer, memory keys for 3 different types of food, warning system for low water level, set temperature profiles on the integrated programmer or pc, including protection grid for heater, pump and float, 230V/50-60Hz, 2.0kW, 9A	13.3x21.2x33.0



		Dim in cm
073668	Bridge mounted circulator, incl. extendable s/s bridge, operating temperature 20°C to 95°C, 3 integrated timers, pump capacity 0.3 bar, 14.0ltr/min, display for current temperature, core temperature and timer, memory keys for 3 different types of food, warning system for low water level, set temperature profiles on the integrated programmer or pc, including protection grid for heater, pump and float, 230V/50-60Hz, 2.0kW, 9A	68.0x19.0x33.0

HEATING IMMERSION CIRCULATOR

With an insulated bath tank 13.0ltr, temperature stability of +/- 0.01°C, operating temperature 20°C to 95°C, splash-proof operating keypad, bright VFD temperature display, low-water alarm, three timers, preprogrammed temperature memory keys, core temperature alarm, guided-user auto calibration, simultaneous display of target and actual temperatures, core temperature and timer, PC control and recording, high-capacity pump 14l/min, s/s protection grid incl, drain tap, robust handles, 230V/50-60Hz, 2.0kW

		Dim in cm
003292	Heating immersion circulator Diamond XS, with an insulated bath tank 13.0Ltr	33.2x39.8x37.4

		Dim in cm
073664	Heating immersion circulator Diamond S, with an insulated bath tank 19.0ltr	33.2x57.7x37.4

		Dim in cm
073665	Heating immersion circulator Diamond M, with an insulated bath tank 27.0ltr	33.2x57.7x42.4

		Dim in cm
073666	Heating immersion circulator Diamond L, with an insulated bath tank 44.0ltr	53.7x69.7x37.4

		Dim in cm
073667	Heating immersion circulator Diamond XL, with an insulated bath tank 58.0ltr	53.8x69.7x42.4

ACCESSORIES

073669	Separation grid S, to divide the bath into sections, for Art. 073660, 073664
--------	--

073677	Separation grid M, to divide the bath into sections, for Art. 073661, 073665
--------	--

073678	Separation grid L, to divide the bath into sections, for Art. 073666
--------	--

073679	Separation grid XL, to divide the bath into sections, for Art. 073663, 073667
--------	---

073680	Retaining grids (2pcs) to keep the vacuum bags fully immersed, for S&M version
--------	--

073681	Retaining grids (2pcs) to keep the vacuum bags fully immersed, for L&XL version
--------	---





		Cap. ltr
001977	Cream whipper Gourmet Whip+ ISI	0.5

073682	Gourmet clamp to secure whip bottles and keep them stable in the water bath, for 0.5ltr bottles	
--------	---	--



073658	Core temperature sensor to all Diamond heating immersion circulators with s/s pointed end, cable length 1.5m	
--------	--	--



		L in cm
073684	Adhesive sealing tape, to seal the insertion points on vacuum bags	400.0



073685	Bath attachment clamp, extra-wide, to install Pearl and Diamond on large cooking pots (up to wall thickness 6.0cm)	
--------	--	--



073686	Software Easy Fusionchef, helps to control, visualize and log the cooking processes with HACCP compliance for Diamond	
--------	---	--



073005	USB interface adapter cable to connect the Diamond to PC when using the Easy Fusionchef software	
--------	--	--



		Ø cm
073004	Steam trapping balls to reduce heat and water loss, when using cooking vessels without a lid, 1000pcs	2.0



		Dim in cm
073006	Travel case for Pearl or Diamond	52.0x43.5x23.0



		Dim in cm
080710	Softcooker, high precision warmer with temperature control, protection rated s/s structure, can be applied to the pot by means of a clamp max depth 16.5cm, working temperature from 20°C to 100°C, best performances up to 50.0ltr, 230V/50Hz, 2.0kW	14.3x17.0x33.4



010478	Digital thermometer for internal core temperature, measuring range -199.9°C to +250°C, accuracy +/-0.1%	
--------	---	--



		Dim in cm
037834	Sous vide cooker Professional EU, 230V/50-60Hz, 1.3kW	42.0x11.0x9.0

010479	Vacuum bags for sous-vide, 1000pcs, 15.0x23.0cm
010480	Vacuum bags for sous-vide, 1000pcs, 20.0x30.0cm
010481	Vacuum bags for sous-vide, 1000pcs, 25.0x40.0cm
010482	Vacuum bags for sous-vide, 1000pcs, 35.0x50.0cm
Remark: Suitable for temperature over +85°C	
010415	Vacuum shrinking bags 10.0x25.0cm, 4500 pcs
010416	Vacuum shrinking bags 11.5x30.0cm, 3000 pcs
031057	Vacuum shrinking bags 13.0x20.0cm, 2000 pcs
010418	Vacuum shrinking bags 13.0x25.0cm, 4500 pcs
010419	Vacuum shrinking bags 13.0x30.0cm, 3000 pcs
010420	Vacuum shrinking bags 15.0x25.0cm, 3000 pcs
010421	Vacuum shrinking bags 15.0x30.0cm, 2500 pcs
010422	Vacuum shrinking bags 20.0x33.0cm, 2000 pcs
010423	Vacuum shrinking bags 20.0x40.0cm, 1500 pcs
031058	Vacuum shrinking bags 25.0x40.0cm, 1200 pcs



SOUS-VIDE BATHS

With s/s lid, convective water circulation, s/s water outlet, LED display, temperature range 25°C to 99.9°C

	Cap. ltr	Dim in cm
010401 Sous-vide bath complete, inside dimension 29.7x23.7x15.0cm, 230V/50-60Hz, 0.5kW	9.0	33.9x27.5x29.1
010407 Sous-vide bath complete with core-temperature sensor, 230V/50-60Hz, 0.5kW	9.0	33.9x27.5x29.1
010402 Sous-vide duobath complete, inside dimension 2x 29.7x23.7x15.0cm, 230V/50-60Hz, 2x 0.5kW	2x9.0	53.5x33.9x29.1
010408 Sous-vide duobath bath complete with core-temperature sensor, 230V/50-60Hz, 2x 0.6kW	2x9.0	53.5x33.9x29.1
010403 Sous-vide bath complete, inside dimension 50.3x30.0x15.0cm, 230V/50-60Hz, 1.0kW	20.0	53.5x33.5x29.1
010409 Sous-vide bath complete with core-temperature sensor, 230V/50-60Hz, 1.2kW	20.0	53.5x33.5x29.1
010404 Sous-vide duobath complete, inside dimension 2x 50.3x30.0x15.0cm, 230V/50-60Hz, 2x 1.0kW	2x20.0	66.5x53.5x29.1
010410 Sous-vide duobath complete with core-temperature sensor, 230V/50-60Hz, 2x 1.2kW	2x20.0	66.5x53.5x29.1
010406 Sous-vide bath complete, inside dimension 62.3x50.3x15.0cm, 230V/50-60Hz, 2.0kW	43.0	66.5x53.5x29.1
010411 Sous-vide bath complete with core-temperature sensor, 230V/50-60Hz, 2.4kW	43.0	66.5x53.5x29.1
010405 Sous-vide bath complete, inside dimension 62.3x50.3x20.0cm, 230V/50-60Hz, 2.0kW	58.0	66.5x53.5x29.1
010412 Sous-vide bath complete with core-temperature sensor, 230V/50-60Hz, 2.4kW	58.0	66.5x53.5x29.1

010401 / 010407



010402 / 010408



010403/ 010409



010404 / 010410



010405, 010406 / 010411, 010412



BAIN MARIES



		Dim in cm
056897	Table top bain marie 20.0ltr with drainage tap insulated walls, indicator light, adjustable thermostat up to 90°C, 230V/50Hz, 1.2kW	38.0x61.0x24.0

		Dim in cm
056898	Double table top bain marie with drains 2x13.5ltr, insulated walls, drainage tap, pilot light, separate regulation possible, without GN containers 230V/50Hz, 2x1.2kW	66.0x54.0x27.0

		Dim in cm
056899	Bain marie table-top, 3xGN 1/1 each 20.0cm deep, cap. 78.0ltr, welded-in heated basins, on/off switch for each basin, adjustable thermostat 30°C to 110°C, 1 drainage cook per basin, splash-proof, s/s, 230V/50Hz, 2.23kW	112.2x61.4x29.0

VACUUM PACKING MACHINES



		Chamber in cm	Dim in cm
010460	Vacuum packing machine Mini VAC welding bar 20.0cm, vacuum pump 4m ³ /h, 230V/50-60Hz, 0.2kW	28.0x22.0x5.5	40.0x26.0x22.0



		Chamber in cm	Dim in cm
	Vacuum packing machine S210 table model welding bar 31.0cm, vacuum pump 10m ³ /h, 230V/50-60Hz, 0.6kW	34.0x32.5x11.0	44.0x40.0x35.0
010464	Basic version DBV	010444	Comfort version SX
010454	GX with gas flush	010474	Comfort SX plus GreenVac
010484	GX with GreenVac		



		Chamber in cm	Dim in cm
	Vacuum packing machine S223 table model welding bar 40.0cm, vacuum pump 23m ³ /h, 3x380V/50-60Hz, 0.75kW	43.0x41.0x20.0	49.0x53.0x45.0
104651	Basic version DBV	104451	Comfort version SX
104551	GX with gas flush	104751	Comfort SX plus GreenVac
104851	GX with GreenVac		





		Chamber in cm	Dim in cm
	Vacuum packing machine S225 table model welding bars 2 x 46.5cm, vacuum pump 23m ³ /h, 3x380V/50-60Hz, 0.75kW	51.0x48.0x21.0	58.0x60.0x46.0
104631	Basic version DBV	104431	Comfort version SX
104531	GX with gas flush	104731	Comfort SX plus GreenVac
104831	GX with GreenVac		



		Chamber in cm	Dim in cm
	Vacuum packing machine S225M model on casters welding bars 2 x 47.0cm, vacuum pump 23m ³ /h, 3x380V/50-60Hz, 1.50kW	51.0x48.0x21.0	56.0x66.0x98.0
104471	Comfort version SX	104571	GX with gas flush
104771	Comfort SX plus GreenVac	104871	GX with GreenVac



		Dim in cm
	037831 Vacuum sealer Professional EU, 230V/50-60Hz, 0.110kW	44.0x14.0x8.0

		Dim in cm
	037832 Vacuum- and sous vide film, 2 rolls	20.0x600.0
	037833 Vacuum- and sous vide film, 2 rolls	28.0x600.0

034436 Smoking gun Pro produces cold smoke, which allows it to be used for any kind of food or liquid. As a flexible hand-held device, it is easy to use for infusion or finishing with a variety of smoky flavours and aromas. Your selection of combustibles including various wood chips, teas, herbs, spices, hay, and even dried flowers is limited only by your imagination. The all-new Smoking Gun Pro features a large robust housing designed specifically to withstand commercial use, including 4 mesh filters, hex key, set screw, 4 AA batteries, instruction book, 2 wood chip samples, 17.0x8.2x14.0cm



034437 Set of 4 smoking chips for smoking gun 034436, 4 x 35 grammes (apple, cherry, mesquite, hickory)



036528 HotmixPRO CRIO with freezing surface, Anti Griddle, primarily designed for the making of spatulated gelato, freezing plate dimension 46.0x42.6cm, -25°C, 230V/50Hz, 0.25kW

Dim in cm new



034442 The Sonicprep™ Ultrasonic homogenizer offers a wide range of techniques, such as extraction, infusion, homogenization, emulsification, suspension, degassing and rapid barrel-aging, features include, Ultrasonic processor with 0.4kW power output control to match power to the application, continuous or timed (0-15 minutes) operation, pulsed mode to minimize heat generation, broad process range from 1 ml to over 500 ml per sample, supplied with a standard titanium probe and a sound box, Generator 43.0x36.0x61.0cm, Sound Box 60.0x43.0x36.0cm, 230V/50-60Hz



420001 Shock-Freezer, air-cooling, s/s, cap. 5x 1/1 GN or 5x 60.0x40.0cm, with rapid cooling cycle 70°C to 3°C, shock freezing performance +70°C to -18°C, 230V/50Hz, 1.2kW

Dim in cm



420041 Shock-Freezer, with core-probe, s/s, capacity 3x 2/3 GN, rapid cooling cycle 70°C to 3°C, shock freezing performance +70°C to -18°C, 230V/50Hz, 0.56kW

Dim in cm



014257 Sous-Vide bath DocDeli D 22, operating temperature 25°C to 100°C, timer to control cooking time, circulation pump for water circulation (homogeneous temperature distribution), temperature stability +/-0.05°C, depth of cooking container 21.5cm, cap. for 5.0ltr, 230V/50-60Hz, 1.5kW

Dim in cm



014400 Sous-Vide bath DocDeli D 33, operating temperature 25°C to 100°C, timer to control cooking time, circulation pump for water circulation (homogeneous temperature distribution), temperature stability +/-0.05°C, depth of cooking container 21.5cm, cap. for 8.0ltr, 230V/50-60Hz, 1.5kW

Dim in cm



014401 Sous-Vide bath DocDeli D 68, operating temperature 25°C to 100°C, timer to control cooking time, circulation pump for water circulation (homogeneous temperature distribution), temperature stability +/-0.05°C, depth of cooking container 21.5cm, capacity for 16.0ltr, 230V/50-60Hz, 1.5kW

Dim in cm





022079 Smoker oven, 2 shelves, s/s, incl thermometer and sawdust, self installation

Dim in cm

011251 Helia hot or cold smoker Model 24, 230V/50-60Hz or 45.0x45.0x30.0

115V, 1.0kW incl.

-1 dripping sheet 30.0x40.0cm

-1 flat grill 30.0x40.0cm

-1 trout grill 30.0x40.0cm

-1 smoking pan

-1 kg smoking sawdust

-cap. 24 trouts at 250gr/12 at 500gr, 4 chickens or 7.0kg roasted meat

Dim in cm

011252 Helia hot or cold smoker Model 48, 230V/50-60Hz or 85.0x45.0x30.0

115V, 2.0kW incl.

-1 dripping sheet 30.0x80.0cm

-2 flat grills 30.0x40.0cm

-2 trout grills 30.0x40.0cm

-1 smoking pan

-1 kg smoking sawdust

-cap. 48 trouts at 250gr/24 at 500gr, 8 chickens or 14.0kg roasted meat



011253 Smoking sawdust beech 1.0kg

Dim in cm

022113 Stainless steel 2-level smoker, horizontal table-top smoker 71.5x41.5x36.0

for cold smoking of fish, meat, charcuteries etc. removable

sawdust drawer with heated pin on a timer to light the sawdust,

lower grill 60.0x40.0cm, upper grill 54.5x34.0cm, 230V/50-60Hz, 0.25kW



Dim in cm

080711 Minicooker, thermal blender, induction heating, incl. 5.0kg 36.0x30.0x29.0

scale with tare, potentiometer for cooking to +120°C, 2.0ltr s/s

beaker, with spatula, butterfly mixer and perforated basket,

motor 0.6kW, power heating 1.0kW, 230V/50-60Hz



080500 Hotmix multifunction machine, chopping, pureeing, liquidizing,

blending and mixing, heating system 25°C to 130°C, body made

of s/s, pulse and turbo function, up to 300 recipes storable,

LCD display, bowl capacity 2.0ltr, 12 speeds, 120-12500rpm,

230V/50Hz, 1.5kW

025839 Hotmix cook and chill machine, cook and chill in 2 separated and independent

bowls, max. 4 working hours, 26 speeds, left bowl: chill and freeze up to -24°C,

8000rpm, right bowl: cook 24°C to 190°C, 12500rpm the degree-by-degree

temperature control and 350 pre-stored recipes on two SD cards guarantee

constant, standardized and optimal results, 230V/50Hz, 4.35kW



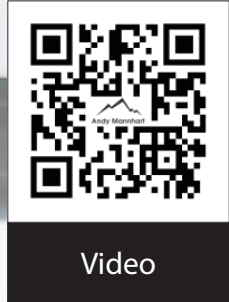

"SWISS ORIGINAL - THE NEW HOLD-O-MAT 411"

LIGHTEN YOUR WORK LOAD

- Store quick fried food and breaded dishes until serving in the Hold-o-mat. (Everything is always fresh and crispy because of the dehumidifier).
- Quick searing is sufficient, the Hold-o-mat gently simmers the food leaving your grill free to prepare more dishes.

ALSO SUITABLE FOR PARTIES AND OUTSIDE CATERING

- Food ready-prepared in the kitchen can be transported in the Hold-o-mat and served warm.
- The fold-out handles ensure optimum ease of carrying in quality.

MAKE MORE EFFICIENT USE OF YOUR COMBI-STEAMER

- The Hold-o-mat provides a <cook and hold> capability.
- Meat is kept warm in the Hold-o-mat and improves in quality.

CALM ORDERLINESS AT THE SERVING POINT

- From the Hold-o-mat directly to the guest.
- Continuously prepare set menus and...let's go!

		Dim in cm
025317	Hold-o-mat 411	67.5x41.5x42.3
Cap. 4x GN 1/1 (65.0mm), precise temperature control, with 4 handles, temperature range from 20°C to 120°C, modern OLED display, intelligent dehumidification system, the goods remain crispy, can be built into any stove and kitchen furniture, core temperature probe not included 230V/50-60Hz, 10A, 1.5kW		



025383	Core temperature probe for Hold-o-mat 411, with magnet-plug
--------	---





		Dim in cm
033109	Bread roll warmer, 1 level, s/s and plexiglass thermostatic temperature control, on/off switch, incl. water bowl for humidification, temperature 30°C to 60°C, 230V/ 50-60Hz	50.0x35.0x27.0



		Dim in cm
033127	Bread roll warmer, 2 levels, s/s and plexiglass thermostatic temperature control, on/off switch, incl. water bowl for humidification, temperature 30°C to 60°C, 230V/ 50-60Hz	50.0x35.0x41.0



		Dim in cm
015104	Hot-dog machine, 2 spits, 230V/50-60Hz, 0.45kW	32.0x30.5x38.0

015105	Hot-dog machine, 4 spits, 230V/50-60Hz, 0.60kW	32.0x30.5x38.0
--------	--	----------------



		Dim in cm
010908	Egg cooker for buffet, cap. 10 eggs enables each customer to cook his egg, supplied with 6 numbered baskets, thermostat with s/s bulb, pilot light, 230V/50-60Hz, 1.2kW	21.5x43.0x25.5



		Dim in cm
042250	Heating plate with adjustable thermostat, up to 75°C, 230V/50Hz, 0.6kW	60.0x40.0x17.0



new

		Dim in cm
031259	Warming tray GN 1/1 with glass, black, 230V/50-60Hz, 0.35kW	53.5x33.5x3.5

042185



		Ø in cm
042185	Heating lamp, copper finish, extensible from 90.0-170.0cm, thermal radiation onto the food approx. 115°C, 230V/50-60Hz	10.0

042186 Same as 042185, but chrome finish

042187 Same as 042185, but brass finish

042188

042188 Heating lamp, copper coated casing with infra-red bulb,
extensible from 90.0-170.0cm, on/off switch, 230V/50-60Hz

042189 Same as 042188, but white coated casing

042190 Same as 042188, but grey coated casing



		Dim in cm
042937	Heat & serve station Tibet II with hygienic protection, s/s frame, ceramic tiles 100.0x50.0cm, sealed with silicone, 2 on/off switch, 2x2.5kW heating lamp, 2 thermostat, 2 pilot lights, incl. set of screws, flat pack, 230V/50-60Hz	101.0x56.0x75.0



		Dim in cm
074049	Carving display, two single brass lamps on white solid surface base with etched glass sneeze guard and groove, 230V/50-60Hz	51.0x91.5x3.0

		Dim in cm
074050	Dual lamp warmer, dual brass lamp on black solid surface base with groove, 230V/50-60Hz	45.8x50.8x1.8
		Dim in cm
001462	Heating lamp Tibet, chrome, flexible arm with hygienic plastic hose, white bulb, on/off switch, 230V/50-60Hz, 0.25kW	22.0x22.0x40.0
		Dim in cm
031834	Carving station with cough protection and 2 adjustable heat lamps, continuously adjustable temperature control with thermostat, carving surface with retaining lip, incl. heat resistant carving board made of glass, 230V/50-60Hz, 1.25kW, temperature 30°C to 100°C	80.0x60.0x11.0/65.0
		Dim in cm
022199	Heating carving station, direct heating with infrared lamp on aluminium plate, 230V/50-60Hz, 1.1kW, 5A	59.0x41.5x47.0
020450	Carving station with bottom heat, stainless steel with stone plate, 1 heating lamp (275 watt), stoneplate additionally heated (100 watt), 230V/50-60Hz	
		Dim in cm
035124	Carving station lamp with s/s base, one lamp 230V/50-60Hz, 0.275kW, 2.8A	27.0x18.0x61.5
012859	Carving station with bottom heat, stainless steel with stone plate, 2 heating lamps (275 watt each), stoneplate additionally heated (100 watt), dim=63.5x46x62cm, 230V/50-60Hz	
		Dim in cm
035123	Carving station lamp with s/s base, two lamps 230V/50-60Hz, 0.550kW, 2.8A	27.0x18.0x61.5
		Dim in cm
007254	Compact combi steamer 4x 2/3 GN, s/s 4 functions: defrosting, circulated air, combination cooking, steaming, with water tank 1.3ltr, 1 grid incl., timer 0-120 minutes, temperature up to 200°C, 230V/50-60Hz, 2.5kW	55.0x54.5x38.0
		Dim in cm
028374	Halogen cooking pot, 12.0ltr glass container, 14 cooking modes, temperature range 50°C to 250°C, adjustable cooking time, 230V/50Hz, 1.3kW	30.6x33.0x47.6
		Dim in cm
010322	Party grill, grill platter of aluminium-die cast, temperature control, 8 pans and 8 spatulas incl., 230V/50Hz, 1.2kW	50.5x25.0x13.5



new

new



		Ø cm	H in cm
052101	Tatarus grill, grill hat made of steel with non-stick coating, incl. 4 pans for raclette with wooden handles incl. 230V/50Hz, 1.2kW	31.0	30.0



010121	Asia-Fondue, incl. 6 fondue baskets and 6 fondue forks, 230V/50Hz, 1.95kW		
--------	---	--	--



		Ø cm	H in cm
032966	Mongolian pot Luxe, cooper, incl. 6 sieves, capacity 3.5ltr, 230V/50-60Hz, 1.2kW	32.0	29.0



		Ø cm	H in cm
042565	Dualit hotpot soup kettle, 11.0ltr colour black, electric heating adjustable, insert pot s/s, 230V/50-60Hz, 0.85kW	34.0	38.0



042566	Dualit hotpot soup kettle, 11.0ltr colour copper, electric heating adjustable, insert pot s/s, 230V/50-60Hz, 0.85kW	34.0	38.0
--------	---	------	------



042567	Dualit hotpot soup kettle, 11.0ltr colour white, electric heating adjustable, insert pot s/s, 230V/50-60Hz, 0.85kW	34.0	38.0
--------	--	------	------



042568	Dualit hotpot soup kettle, 11.0ltr colour brown, electric heating adjustable, insert pot s/s, 230V/50-60Hz, 0.85kW	34.0	38.0
--------	--	------	------



			Dim in cm
010325	Warming plate, temperature adjustable, cooking zone 18.0cm, housing silver coated, 230V/50Hz		26.0x27.0x9.0



			Dim in cm
010347	Microwave model CM-1099A, easy to clean, flat cavity, glass ceramic bottom plate 33.5x33.5cm, 26.0ltr volume cavity with 2/3 GN cooking area, no turntable, 230V/50Hz		29.7x51.7x41.2



010120	Water boiler, 1.5ltr, 230V/50Hz, 2.3kW		
--------	--	--	--



		Ø cm	H in cm
new 036073	3D induction rethermalizer, natural, 6.6ltr, 50-60 minutes to rethermalize food, 230V/50-60Hz, 0.80kW	30.3	34.2



new 036076	3D induction rethermalizer, natural, 10.4ltr, 50-60 minutes to rethermalize food, 230V/50-60Hz, 0.80kW	35.3	34.2
-------------------	--	------	------



new 036075	3D induction rethermalizer, red, 6.6ltr, 50-60 minutes to rethermalize food, 230V/50-60Hz, 0.80kW	30.3	34.2
-------------------	---	------	------



new 036077	3D induction rethermalizer, red, 10.4ltr, 50-60 minutes to rethermalize food, 230V/50-60Hz, 0.80kW	35.3	34.2
-------------------	--	------	------



new 036078	Insert for 3D induction rethermalizer, 6.6ltr *for 036073 / 036075		
-------------------	--	--	--

new 036079	Insert for 3D induction rethermalizer, 10.4ltr *for 036076 / 036077		
-------------------	---	--	--

		Dim in cm
042044	Dualit pop up catering toaster with 2 + 2 slots, cap. 120 slices/hour, polished s/s, 230V/50-60Hz, 2.7kW	35.0x34.0x23.0



		Dim in cm
042980	Toaster, 3 slots with crumb catch tray, cap. 98 slices/hour, polished s/s, 230V/50-60Hz, 1.7kW	31.0x21.0x22.0



		Dim in cm
042981	Toaster, 4 slots with crumb catch tray, cap. 130 slices/hour, polished s/s, 230V/50-60Hz, 2.2kW	36.0x21.0x22.0



		Dim in cm
042982	Toaster, 6 slots with crumb catch tray, cap. 195 slices/hour, polished s/s, 230V/50-60Hz, 3.0kW	46.0x21.0x22.0



		Dim in cm
042983	Toaster, 6 slots with crumb catch tray, cap. 195 slices/hour, polished s/s, silver with black ends, black knobs, 230V/50-60Hz, 3.0kW	46.0x21.0x22.0



CONVEYORIZED ELECTRIC TOASTER

Combines fast heat-up, uniform toasting and dependable performance to handle peak serving periods in perfect toast fashion

		Dim in cm
010900	Conveyor toaster Model CT 540 B compact-size toaster with high cap. 540 slices/hour, top and bottom infrared quartz tubes can be regulated separately, speed control of belt, on/off-switch, 230V/50-60Hz, 0.6kW	63.0x41.0x56.5



		Dim in cm
004101	Dehydrator, incl. 3 drying trays, 12h timer, plastic body, 230V/50Hz, 0.6kW	33.5x28.0



		Dim in cm
033011	Vegetable and fruit dryer, 35°C to 74°C, 5 trays, rectangular, 230V/50-60Hz, 0.4kW	52.5x42.0x21.5





		Dim in cm
042183	Waffle Maker "Lolly" on a stick, coated plate, 4 pieces of 23.0x2.5x6.0cm, s/s casing, on/off switch, thermostat, digital timer, pilot light, 230V/50-60Hz, 2.2kW	31.0x34.0x25.0

		Dim in cm
042184	Dough dispenser to waffle machines, 6.0ltr, s/s	42.0x33.0x50.0

		Dim in cm
018646	Waffle machine, round model, s/s housing, cast iron plate, mica heating elements for homogenous and quicker cooking, removable drip tray for easy cleaning, equipped with a thermostat 0°C to 300°C, pilot light, adjustable feet, 230V/50-60Hz, 1.6kW	30.5x44.0x23.0

		Dim in cm
046813	Waffle machine, producing Brussels waffles 3.0x5.0cm large square, s/s housing, cast iron plate, mica heating elements for homogenous and quicker cooking, removable drip tray for easy cleaning, equipped with a thermostat 0°C to 300°C, pilot light, adjustable feet, 230V/50-60Hz, 1.6kW	30.5x44.0x23.0

		Dim in cm
429281	Waffle iron rotating, axial turnable, baking plates fix mounted, s/s casing, cast iron baking plates, 180°C turnable, two-sided central heating element, thermostat, digital timers, on/off switch, 230V/50Hz, 1.0kW	25.0x49.5x38.5

		Dim in cm
087820	Waffle machine 12 parts, non-stick coating thermostatically controlled with display lamp, waffle sizes 10.0x6.5x3.0cm, 230V/50-60Hz	70.0x23.0x19.0

		Dim in cm
087821	Waffle machine 6 parts, with non-stick coating, thermostatically controlled with display lamp, waffle sizes 10.0x6.5x3.0cm, 230V/50-60Hz	35.0x23.0x19.0

		Dim in cm
087822	Waffle machine 4 parts, with non-stick coating, thermostatically controlled with display lamp, waffle sizes produced 16.0x8.0x1.8cm, 230V/50-60Hz	41.0x32.0x19.0

		Dim in cm
046515	Freshcone machine, complete housing made of chromed steel, cast iron plate, mica heating elements for homogenous and quicker cooking, removable drip tray for easy cleaning, equipped with a thermostat 0°C to 300°C, pilot light, adjustable feet, 230V/50-60Hz, 1.5kW	30.4x48.0x28.0

		Dim in cm
046512	Crepe machine Model CSE 400, complete housing made of chrome steel with enamelled plate, Ø 40.0cm, spiral heating elements integrated in the cast iron plate with pilot light, drawer to keep plates or crepes warm, supplied with wooden scraper, equipped with a thermostat 0°C to 280°C, 230V/50-60Hz, 3.0kW	45.0x50.0x24.0

		Dim in cm
046513	Crepe machine with 2 enamelled cast iron plates, Ø 40.0cm, spiral heating elements intergrated in the cast iron plate with pilot light, drawer to keep warm plates or crepes, supplied with wooden scraper, equipped with a thermostat 0°C to 280°C, 3x380V, 50-60Hz	86.0x50.0x24.0

		Dim in cm	
042901	Waffle baking machine for exchangeable plates, without plates and dispenser, s/s casing, with digital timer, thermostat, on/off switch, pilot light, 230V/50-60Hz, 2.2kW	30.5x45.0x32.0	
EXCHANGEABLE PLATES FOR 042901			
		Dim in cm	
042045	Exchangeable plate for lolly on stick, cast iron	4x6.0x2.5x23.0	
	Ø cm	H in cm	
042046	Exchangeable plate for waffle bears on stick, aluminium coated plate	12.0	2.0
		Dim in cm	
042905	Exchangeable plate for Kant waffles, cast iron plate	2x8.0x16.0x1.5	
		Dim in cm	
042906	Exchangeable plate for cream waffles on stick, cast iron plate	6x6.0x8.0x2.5	
		Dim in cm	
042907	Exchangeable plate for Brussels waffles, cast iron plate	2x15.0x10.5x2.3	
	Ø cm		
042047	Exchangeable plate for Americano cake waffles, aluminium coated plate	19.0	
		Dim in cm	
042048	Exchangeable plate for Stroop waffles, cast iron plate	27.0x27.0	
	Ø cm		
042911	Exchangeable plate for waffles balls, aluminium coated plate, 25pcs	4.0	
	Ø cm		
042913	Exchangeable plate for small heart waffles cast iron plate, 5pcs	16.5	
	Ø cm		
042914	Exchangeable plate for big heart waffles cast iron plate, 5pcs	21.0	
		Dim in cm	
010913	Blinis machine, enamelled cast iron plate, 0.6x11.0cm, thermostat 0°C to 300°C, electric version, blinis machine for 6 pieces, 230V/50-60Hz	40.0x16.0	
		Dim in cm	
042920	Tartelette machine without plate s/s, on/off switch, thermostat, digital timer, pilot light, locking bow, 230V/50-60Hz, 3.2kW	43.0x42.0x32.0	
	Exchangeable plates, aluminium coated	Ø cm	
042921	5 tartelettes	12.5	
042922	9 tartelettes	9.0	
042923	13 tartelettes	7.0	
042927	30 tartelettes	4.2	
042924	15 boat moulds	10.2	
042925	12 waffles		





		Dim in cm
022201	Contact grill with cast iron plates, cooking surface 26.0x24.0cm, thermostat from 0°C to 300°C, juice tray, on/off switch, pilot light, with scraper for easy cleaning, 230V/50-60Hz, 2.0kW	33.0x38.5x22.0



		Dim in cm
010905	Panini/sandwich contact grill with cast iron plates, grooved lower and upper plate, spring-count-balance top, armoured heating elements for better spread of heating, scraper, thermostat setting up to 300°C, juice tray, drip-tray and thermostetting handles, on/off switch, pilot lights, quick temperature rising, cooking area 36.0x24.0cm, 230V/50-60Hz, 3.0kW	43.0x38.5x22.0



		Dim in cm
010910	Panini/sandwich contact grill Model XL 2 appliances in 1: A) contact grill, B) griddle plate cast iron plates, 1 large grill surface 36.0x36.0cm, 130 panini per hour, grooved lower plate, spring-count-balance top, armoured heating elements for better spread of heating, scraper, thermostat setting up to 300°C, juice tray, drip-tray and thermostetting handles, on/off switch, pilot lights, quick temperature rising, 230V/50-60Hz, 3.6kW	41.0x62.0x34.0



		Dim in cm
022203	Contact grill double model with cast iron plates, cooking area 53.5x24.0cm, thermostat from 0°C to 300°C, juice tray, on/off switch, pilot light, with scraper for easy cleaning, 3x380V/50-60Hz, 4.0kW	60.0x38.5x22.0



		Dim in cm
034429	High speed panini grill, hot and crunchy sandwiches, incl. baking paper set, cleaning brush, cleaning scraper, spatula, aerosol for cleanser, 3x380V/50Hz, 5.0kW	36.1x67.5x63.0

E1



	Cap.kg	Dim in cm
042535	15.0	50.0x74.0x79.0
Gyros grill mod. E1 spit l=57.0cm, maximum height of meat 34.0cm, electric grill, s/s (rust-proof), with 3 heating elements, shovel not included, 230V/50-60Hz, 3.9kW		

	Cap.kg	Dim in cm
042536	30.0	50.0x86.0x91.5
Gyros grill mod. E2, spit l=69.5cm, maximum height of meat 46.0cm, electric grill, s/s (rust-proof), with 4 heating elements, shovel not included, 3x380V/50-60Hz, 5.2kW		

E3



	Cap.kg	Dim in cm
042537	50.0	50.0x106.5x111.5
Gyros grill mod. E3 spit l=89.5cm, maximum height of meat 70.0cm, electric grill, s/s (rust-proof), with 6 heating elements, shovel not included, 3x380V/50-60Hz, 9.0kW		

	Cap.kg	Dim in cm
042538	30.0	50.0x86.5x91.5
Gyros gas grill mod. G2 spit l=69.5cm, maximum height of meat 47.0cm, LPG - natural gas, s/s (rust-proof), infrared burners with ceramic plates, shovel not included, 7.0kW		

G2



	Cap.kg	Dim in cm
042539	50.0	60.0x106.5x111.5
Gyros gas grill mod. G3 spit l=89.5cm, maximum height of meat 62.0cm, LPG - natural gas, s/s (rust-proof), infrared burners with ceramic plates, shovel not included, 8.75kW		

		Dim in cm
025305	Diamant charcoal grill, double-walled casing, adjustable smoke funnel, incl. lid thermometer, air supply control, heat-insulated lid handle, incl. fire grid and chrome steel grid, grill surface 64.0cm, massive steel core for heat retention, removable ash tray, incl. setting and wings	74.0x74.0x80.0



		Ø cm
025306	Outdoor rubber wheels for Diamant Setting, set of 4	10.0



		Dim in cm
117001	Gas lava rock grill, s/s, with "V-grid" for meat, height adjustable grid, grilling surface 76.0x42.0cm, 16.0kW	80.0x70.0x85.0



		Dim in cm
117011	Table-top gas lava rock grill, s/s, with grid for meat, grilling surface 2x 31.2x48.3cm, 8.0kW	66.0x57.0x28.2



		Dim in cm
022436	Salamander, 2 independent cooking areas with reinforced heating elements, cooking surface 49.5x37.5cm, 230V/50-60Hz, 3.0kW	60.0x59.0x59.0

		Dim in cm
022437	Salamander, 2 independent cooking areas with infrared quartz tubes (1050°C), no preheating, cooking surface 49.5x37.5cm, 230V/50-60Hz, 3.0kW	60.0x59.0x59.0



		Dim in cm
022441	Salamander, 3 independent cooking areas with infrared quartz tubes (1050°C), no preheating, cooking surface 74.0x37.5cm, 3x380V/50-60Hz, 4.5kW	80.0x59.0x59.0

Salamander Vitesse is available as table-top, wall or ceiling mounted version. Two heating-systems (heating coil or hi-light) in 4 configuration, accessible from all 4 sides, mechanical timer 0-15min, automatic turn off, 3x380V/50-60Hz

		Dim in cm
073509	Salamander Vitesse Standard, HiLight 4.6kW full power, 2.3kW left or right, 1.15kW half power 3x380V/50-60Hz	60.0x50.0x77.2



		Dim in cm
073584	Salamander Vitesse Classic 3.6kW full power, 1.8kW left or right, 0.9kW stand by, automatic plate detection, wall mounted version, 3x380V/50-60Hz, 16A	60.0x52.0x46.0



**CERAN COOKING UNIT**

Large glass ceramic surface with two heated cooking zones. No special pans required. Continuously variable regulation, starts cooking immediately and is highly efficient. Temperature can be separately regulated at front and back. Outside dimension 38.0x61.5x21.0cm

table	built-in	
073732	073733	Ceran cooking unit, 3x380V/50-60Hz, 16A 2x2.5kW

**INDUCTION WOK UNIT**

A large cuvette (bowl) for induction capable wok pans. The cooking zone can be regulated in a range from 0.15 to 3.5/5.0kW. Electronic sauce pan recognition with optical display for non-suitable pans, outside dimension 38.0x61.5x21.0cm



ECO table	built-in	
073540	073541	Induction wok unit 230V/50-60Hz, 16A, 3.5kW
073769		Induction wok s/s Ø 36.0cm

**INDUCTION COOKING UNIT**

One cooking zone for induction capable pans with a base diameter from 13.0 to 26.0cm. Regulation in a range from 0.15 to 3.5/5.0kW. Electronic sauce pan recognition, with optical display for non-suitable pans. Outside dimension 38.0x60.0x21.0cm



ECO table	built-in	
073542	073543	Induction cooking unit 230V/50-60Hz, 16A, 3.5kW

**INDUCTION COOKING UNIT**

Two cooking zones for induction capable pans with a base diameter from 13.0 to 26.0cm. Regulation in a range from 0.15 to 3.5/5.0kW. Electronic sauce pan recognition, with optical display for non-suitable pans. Outside dimension 38.0x60.0x21.0cm



ECO table	built-in	
073744	073745	Induction cooking unit 3x380V/50-60Hz, 16A, 2x3.5kW

**PASTA COOKER**

Directly heated deep-drawn inner container. Thermostatic temperature regulation. With drainage valve. Suitable for use with round or angular pasta baskets, as well as for perforated GN-containers. Up to 80 portions of ready-to-cook pasta/h. Outside dimension 38.0x60.0x21.0cm

table	built-in	
073514	073513	Pasta cooker, 3x380V/50-60Hz, 16A, 6.0kW
073750		Adapting lid for pasta cooker for 3 round baskets and 3 square basket
073751		Adapting lid for pasta cooker for 6 round baskets
073752		Adapting lid for pasta cooker for 6 square baskets
073753		Pasta basket round s/s
073754		Pasta basket square s/s
073755		Pasta basket large square s/s (to be used without adapting lid)

BAIN-MARIE

Directly heated deep-drawn inner container. Thermostatic temperature regulation. With drainage valve. Suitable for GN containers 1/1 with max. depth of 15.0cm. Outside dimension 38.0x60.0x21.0cm

table	built-in	
073516	073517	Bain-marie 230V/50-60Hz, 10A, 1.8kW
073860		Adapting GN dividing bar 32.5cm

DEEP FRYER

Temperature regulation between 100°C to 190°C. Frying quantities: up to 40 portions of french fries/h. Oil container deep-drawn in one piece with the work top. Heating element can be tilted out, incl. frying basket and lid. Outside dimension 38.0x61.5x21.0cm

table	built-in	
073518	073519	Deep fryer cap. 6.0ltr, 3x380V/50-60Hz, 10A, 5.8kW
029095		Additional deep frying basket

SILOFRIT

A system for keeping food hot, with top and bottom temperature regulation. 17.0cm deep-drawn container with perforated sheet metal insert tray makes cleaning as easy as could be wished for. Outside dimension 38.0x60.0x21.0cm

table	built-in	
073522	073523	Silofrit Chip scuttle 230V/50-60Hz, 10A, 1.0kW

GRIDDLE PLATE SINGLE

Smooth griddle surface, made of special steel, with seamless transition to the internal housing. Inbuilt collection basin in the cold zone area for fat runoff. Thermostatic temperature regulation up to 250°C. Outside dimension 38.0x60.0x21.0cm

table	built-in	
073720	073721	Griddle plate single 3x380V/50-60Hz, 10A, 4.0kW
073766		Removable splash guard s/s

GRIDDLE PLATE DOUBLE

Smooth griddle surface, made of special steel, with seamless transition to the internal housing. Inbuilt collection basin in the cold zone for fat runoff. Thermostatic temperature regulation (left and right) up to 250°C. Outside dimension 58.0x61.5x20.8/21.8cm

table	built-in	
073728	073729	Griddle plate double 3x380V/50-60Hz, 20A, 2x4.0kW
073767		Removable splash guard s/s

GRILL GRIDDLE PLATE, GRILLING SURFACE 33.0x50.0CM

Grooved grill surface and smooth griddle surface, made of special steel, with seamless transition to the internal housing. Inbuilt collection basin in the cold zone for fat runoff. Thermostatic temperature regulation (left and right) up to 250°C, outside dimension 58.0x61.5x20.8/21.8cm

table	built-in	
073724	073725	Grill griddle plate, 3x380V/50-60Hz, 20A, 2x4.0kW

COMBI GRIDDLE PLATE

Smooth griddle surface, made of special steel, with seamless transition to the internal housing. Runoff in the front griddle area with teflon closure and front drainage. Thermostatic temperature regulation up to 250°C. Outside dimension 38.0x61.5x20.8/21.8cm

built-in		
073749		Combi griddle plate 2x380V/50-60Hz, 16A, 4.0kW





eco INDUCTION COOKER FREESTANDING WITH 1 COOKING ZONE, KEEP WARM FUNCTION

		Dim in cm
035502	Version 230V/50-60Hz, 2.5kW, 10.9A	42.5x33.0x11.0
035503	Version 230V/50-60Hz, 3.5kW, 15.2A	52.0x38.5x17.5



eco INDUCTION COOKER FREESTANDING WITH 1 COOKING ZONE, KEEP WARM FUNCTION



		Dim in cm
037829	Version 230V/50-60Hz, 3.5kW	43.0x34.0x12.0



eco INDUCTION COOKER FREESTANDING, ROUND FOR WOKS WITH 1 COOKING ZONE

		Dim in cm
035504	Version 230V/50-60Hz, 3.5kW, 15.2A	52.0x38.5x22.0



eco INDUCTION COOKER BUILT-IN WITH 1 COOKING ZONE, TOUCH SCREEN

		Dim in cm
005033	Version 230V/50-60Hz, 1.0kW, 10.9A	36.0x36.0x8.5
035451	Version 230V/50-60Hz, 2.5kW, 10.9A	36.0x36.0x8.5



eco INDUCTION COOKER BUILT-IN WITH 1 COOKING ZONE, REMOTE CONTROL

		Dim in cm
035450	Version 230V/50-60Hz, 2.5kW, 10.9A	36.0x36.0x8.5

		Ø cm	Cap. ltr	H in cm
030918	Round-base wok, 7-ply, s/s	36.0	5.2	10.0
023059	Round-base wok, 7-ply, s/s	36.0	9.5	14.0

induction



		Ø cm	Cap. ltr	H in cm
023058	Flat-base wok, 7-ply, s/s	36.0	5.0	8.0

induction



		Ø cm	Cap. ltr	H in cm
017184	Wok round, 5-ply, s/s	36.0	6.0	10.0

induction



		Ø cm	Cap. ltr	H in cm
017187	Wok round non-stick, 5-ply	36.0	6.0	10.0

induction



		Ø cm	Cap. ltr	H in cm
017186	Wok flat 5-ply, s/s	36.0	5.5	9.0

induction



017309	Wok flat non-stick, 5-ply	36.0	5.5	9.0
--------	---------------------------	------	-----	-----

induction



		Ø cm	Cap. ltr	H in cm
014238	Sauteuse 7-ply, s/s	11.0	0.4	5.5

induction



		Ø cm	Cap. ltr	H in cm
014146	Sauteuse 7-ply, s/s	18.0	1.3	6.5
014147	Sauteuse 7-ply, s/s	20.0	1.8	7.5
014148	Sauteuse 7-ply, s/s	24.0	3.0	8.5
014149	Sauteuse 7-ply, s/s	26.0	3.7	9.0

induction



		Ø cm	H in cm
017179	Frying pan non-stick, 5-ply, excalibur coating	20.0	4.0
017180	Frying pan non-stick, 5-ply, excalibur coating	24.0	4.5
017181	Frying pan non-stick, 5-ply, excalibur coating	28.0	5.0
017182	Frying pan non-stick, 5-ply, excalibur coating	32.0	5.5

induction



		Ø cm
035392	Wok ring, s/s	32.0

induction



TABLE TOP INSTINCT INDUCTION GRIDDLE

- Short heat-up time from 20°C to 200°C in 3 1/2 minutes with 5kW/10kW and 4 1/2 minutes with 3.5kW
- Equipped with the latest RTCSmp technology. Rounded edges and a smooth surface made for effective, efficient cleaning. Temperature adjustment via stepless rotary control. 7-segment display of desired and current temperature.
- Patented realtime temperature control system for temperature controlled
- Frying with non-contact measurement and real time control specially developed induction griddle plate HPCR-inox treated surface
- Temperature measurement, control and monitoring over the entire griddle surface
- Instant response to changes in temperature setting
- Electronic monitoring of the energy supply
- Temperature adjustment range: 50°C to 230°C
- Replacable grease filter cartridge
- Reduction of the maximum power from 100% to 25%



Video



new

		Griddle area cm	Dim in cm
038319	RTCSmp tabletop INSTINCT induction griddle 3.5 1 griddle zone, 230V/50-60Hz, 3.5kW, 15A	49.3x35.2	53.1x49.3x19.8

new

		Griddle area cm	Dim in cm
038321	RTCSmp tabletop INSTINCT induction griddle 5 1 griddle zone, 3x380V/50-60Hz, 5.0kW, 8A	49.3x35.2	53.1x49.3x19.8



new

		Griddle area cm	Dim in cm
038322	RTCSmp tabletop INSTINCT induction griddle 10 2 griddle zones, with independent 3x380V/50-60Hz, 2x5kW, 10A	61.8x57.7	65.6x71.7x19.8



FRONT COOKING CONCEPT (VARITHEK)

Varithek air-cleaning-system ACS (push and pull - extraction) mobile stainless steel unit for frontcooking with integrated suction system for smell, steam and fat free food preparation, with inseration niche for holding 2 Varithek-elements "V-1/1". Closed cupboard with 2 revision doors, fan motor, odour filter and integrated fat filter, switch panel with on/off switch and 4 sockets with covers 2xSchuko and 2xCEE, 4 swivel casters with total brakes (Ø 8.0cm). Ready for connection with power cable 2m and CEE-plug, rated voltage 3N AC 3x380V, 50-60Hz, connected load 11.0kW

		Dim in cm
037427	V-ACS-1000-EC, digital, with splashguard	100.0x72.2x100.0

		Dim in cm
037500	V-ACS-1000-EC, digital, with splashguard and lighting bridge	100.0x72.2x122.5

Accessories for V-ACS-1000 EC

056932	Fold-up shelf s/s for guest side
056971	Fold-down shelf s/s for guest side

VARITHEK AIR-CLEANING-SYSTEM ACS WITH FLEXIBLE EDGE EXTRACTION

Like V-ACS-1000 EC (037427/037500) however with edge extraction, can be operated on the left or right or both sides, double extraction output thanks to second ventilator. One switch panel on the left and right, each equipped with on/off switch as well as with a 2xSchuko and 2xCEE socket

		Dim in cm
037494	V-ACS-1100-d3, digital, with splashguard	110.0x72.2x110.0

TABLE-TOP SYSTEM MODULE AST IN STAINLESS STEEL

Double-walled with base, without front panel, with grooves moulded inside for insertion of varithek-elements "V-1/1", GN containers and SWISS-PLY thermplates max. GN 1/1, for placement in recessed niche

		Dim in cm
056536	V-AST255-OF	40.0x71.6x26.0

		Dim in cm
056943	V-AST155-OF	40.0x71.6x16.0

SERVO ACS

Integrated circulation air extracion system, stainless steel panelling, 10.5kW, 3x380V/50-60Hz

		Dim in cm
056550	Servo ACS s/s 2/1 with 1 drawer with 2 built-in system module to Varithek system	107.0x78.5x115.2





		Dim in cm
056554	Servo ACS s/s 3/1 with 2 drawers with 3 built-in system module to Varithek system	143.3x78.5x115.2

		Dim in cm
021987	Deep-fryer / Pasta Boiler, 20°C to 190°C, s/s, short heating-up and response time, table-top or built-in, safety drainage cock, max. 6 pasta or deep-frying basket, 3x380V/50-60Hz, 4.5kW	62.0x40.0x22.0

VARITHEK INDUCTION WOK WITH CUVETTE V-400-IW-3500E-K 0.8-230V
For cooking with wok casing in stainless steel with ceran cuvette Ø 30.0cm and high-performance induction generator, splash-water protected IP4X, rated voltage; 1N AC 230V/50-60Hz, connected load: 3.5kW

		Dim in cm
056534	Varithek induction wok with cuvette Remark: For dedicated wok cooking Not suitable for Servo ACS 056554/056556	40.0x66.0x19.5

056953	Induction wok pan s/s, 6.0ltr, Ø 36.0cm
--------	---

		Dim in cm
031903	Varithek ceran hob GN 1/1, V-2.0 1/1-ck 2800Q 0.8, full surface heating zone, ceran heating plate, radiant element, casing made of s/s, control casing with on/off switch, mechanical, step less temperature control, splash-proof, for insertion in varithek GN-port, 230V/50-60Hz, 2.8kW Remark: For gentle cooking on ceran hob	32.5x62.0x7.8

		Dim in cm
002766	Varithek ceran hob 2.0 1/1-ch 800 0.8, in AST system or as a table unit, hob surface 29.5x50.6cm, s/s casing, 230V/50-60Hz, 0.8kW Remark: For keeping food warm on ceran hob	32.5x62.0x6.2

		Dim in cm
002765	Varithek induction hob V-2.0 1/1ik 3500e 0.8, for insertion in AST system or as table top unit, induction surface Ø 28.0cm, cooking on the whole surface, step less temperature control, s/s casing, 230V/50-60Hz, 3.5kW Remark: For flat cooking with induction pans and thermoplates	32.5x64.2x14.0

		Dim in cm
002764	Varithek induction hob V-2.0 1/1ik 3500Qe 0.8, for insertion in AST system or as table top unit, induction surface, cooking on the whole surface, step less temperature control, s/s casing, 230V/50-60Hz, 3.5kW Remark: For flat cooking with induction pans and thermoplates	32.5x64.2x14.0

056539	Wok pan with flat soil, s/s, 8.5ltr
--------	-------------------------------------

056951	Glass scraper, can be used for induction and ceran hobs
--------	---

DEEP FAT FRYER FREESTANDING, WITH DIGITAL DISPLAY, 50°C to 190°C, 3x380V/50-60Hz

		Dim in cm
073010	Deep fat fryer, incl. basket with 0.9ltr cap., oil cap. 7.5-9.0ltr, 8.0kW, 3x16A	20.0x65.0x75.0/90.0
		Dim in cm
073011	Deep fat fryer, incl. basket with 1.5ltr cap., oil cap. 12.5-14.5ltr, 11.0kW, 3x16A	30.0x65.0x75.0/90.0
		Dim in cm
073012	Deep fat fryer, incl. basket with 1.8ltr cap., oil cap. 17.0x20.5ltr, 16.0kW, 3x25A	40.0x65.0x75.0/90.0
		Dim in cm
073013	Deep fat fryer, incl. 2 baskets each 0.9ltr cap., oil cap. 2x7.5-9.0ltr, 2x8.0kW, 3x16A	40.0x65.0x75.0/90.0
		Dim in cm
073014	Basket to 073010 and 073013	14.0x32.0x15.5
073015	Basket to 073011	22.0x32.0x15.5
073016	Basket to 073012	30.0x32.0x15.5



		Dim in cm
025391	Deep fat fryer, table top model 1x 8.0ltr security thermostat, overheating protection, with oil drain, basket included, 230V/50-60Hz, 3.3kW	27.0x48.5x36.3



		Dim in cm
004184	Deep fat fryer, table top model 2x 8.0ltr security thermostat, overheating protection, with oil drain, basket included, 2x 230V/50-60Hz, 3.3kW	53.9x48.3x36.3





		D in cm
new	034613	64.5x72.5x134.5
	Charcoal oven HJX25M*BC with tray support, s/s, smoke outlet vent, cooking grill rack, charcoal grates, josper tongs, bristle brush, poker, ash hatch and handle, ash pan and also including firebreak s/s, 27.0cm and firebreak hat s/s, 20.0cm, rack for model HJX25 s/s, fire up time 30 minutes approximately, Josper charcoal daily consumption 10 to 12kg average, performance 9h, production per hour 60kg average, oven capacity in GN trays (per grill rack) 2xGN1/2 + 1xGN1/3, power equivalence 3.0kW, exhaust rate 2800m3/h, maximum smoke flow 7g/s, temperature 300°C to 350°C	



		D in cm
new	034577	165.0x70.0x75.0
	Dry Ager DX1000, s/s capacity 100kg meat, inclusive 1x s/s hanger, internal dimensions 138.0 x 54.0 x 56.0cm, insulated glass door UV protection, metallic tint, humicontrol 60% to 90%, DX AIRREG optimal airflow, activated carbon filter & UVC sterilization system, max. load 2-3 beef saddles up to 1.2m in length, 80kg, 5 shelves à 40kg, temperature 0°C to 25°C, 435.0ltr, 230V/50-60Hz, 0.19kW	



		D in cm
new	034594	90.0x60.0x61.0
	Dry Ager DX500, s/s capacity 20kg meat, inclusive 1x shelf, 1x bottom shelf, internal dimensions 71.0 x 50.0 x 43.0cm, external housing satin black, insulated glass door UV protection, metallic tint, humicontrol 60% to 90%, DX AIRREG optimal airflow, activated carbon filter & UVC sterilization system, max. load up to 20kg, 2 shelves à 40kg, temperature 0°C to 25°C, 132.0ltr, 230V/50-60Hz, 1.0kW	

		Dim in cm
027863	Cooling and heating plate built-in, anodized aluminium, 230V/50-60Hz, 0.144kW, 6A	57.0x36.0



		Dim in cm
028005	Cooling and heating plate freestanding, anodized aluminium, 230V/50-60Hz, 0.144kW, 6A	57.0x36.0





Andy Mannhart



		Blade in cm
001682	Tomato knife with prongs, black nylon handle	11.0



		Blade in cm
024443	Paring knife wavy edge with nylon handle	8.0



		Blade in cm
024441	Paring knife straight with nylon handle	8.0



	Kitchen set	Blade in cm
002720	1 Bread knife	18.0
	1 Kitchen knife	8.0
	1 Chef's knife	20.0
	1 Kitchen scissors	
	1 Sharpening steel	



		Blade in cm
027453	Sharpening rod professional „QUINTUM“, 5-stage, s/s	25.0



024570	Peeler REX with movable blade	
--------	-------------------------------	--



		Dim in cm
021122	Pizza wheel, s/s	6.7x19.0



		L in cm
025191	Cigar scissors, s/s	10.0







		Dim in cm
028329	Cutting board white, polyethylene	25.0x15.0x1.0
013643	Cutting board white, polyethylene	30.0x22.0x1.0



	018158	Ice cube spoon, s/s		L in cm
				24.0
	054189	Masher with handy end	Ø cm	L in cm
			2.5	21.0
	025801	Ice bucket, polished, 1.1ltr	Ø cm	H in cm
			11.5	12.0
	025802	Ice bucket 025801 with matching ice tong, s/s		L in cm
				18.0
	012871	Ice tong, serrated tips, s/s		L in cm
				17.5
	017124	Ice tong, serrated tips, s/s		L in cm
				18.5
	065020	Ice crusher/maker with 6 teeth, wooden handle		Dim in cm
				23.5x6.3
	065010	Ice pickel, wooden handle		L in cm
				17.5
	054002	Ice box aluminium, inner container plastic, 8.0ltr	Ø cm	H in cm
			27.0	20.0
	007316	Ice bucket with lid, tongs and drainer plate, acrylic, 1.8ltr	Ø cm	H in cm
			14.5	14.5

Stainless steel

	017728	Bill spike		Dim in cm
				9.0x22.0
	054000	"No-smoking" sign, set of 2		Dim in cm
				5.5x5.0x3.5
	054001	"Smoker" sign, set of 2		Dim in cm
				5.5x5.0x3.5
	017727	Sign "Reserved" written on both sides		Dim in cm
				10.0x5.0
	026000	Table number to be selected between 1 to 99, mirror polished, 1pc		Dim in cm
				7.5x5.5
	026001	Table number between 100 to 250 to be selected, mirror polished, 1pc		Dim in cm
				7.5x5.5

		Cap. ltr
001977	Cream whipper Gourmet Whip+ISI	0.5



		Dim in cm	Cap. ltr
042005	Spice compartment with transparent lid, 4 compartments	47.0x13.0x7.5	4x0.7



		Dim in cm	Cap. ltr
042007	Spice compartment with transparent lid, 6 compartments	50.0x15.5x9.0	6x0.7



Store and pour bottle complete, includes container, bottle neck, screw cap, nozzle

yellow	red	green	transparent	orange	brown	Cap. ltr
016565	016572	016577	016578	016579	016580	1.0
016597	016601	016603	016605	016607	016609	2.0



Polyethylene

		Cap. ltr
022050	Squeeze dispenser, clear	0.24
022051	Squeeze dispenser, yellow	0.24
022052	Squeeze dispenser, red	0.24
022053	Squeeze dispenser, clear	0.36
022054	Squeeze dispenser, yellow	0.36
022055	Squeeze dispenser, red	0.36
022056	Squeeze dispenser, clear	0.72
022057	Squeeze dispenser, yellow	0.72
022058	Squeeze dispenser, red	0.72



		Dim in cm
002681	Glass rimmer black, with sponge for lime juice, 2 cases for sugar and salt	20.0x7.5



		Dim in cm
003216	Bar caddy/holder allows quick access to cocktail napkins, stirrers & other accessories	24.0x15.0x10.0



		Dim in cm
002925	Bar non-slip mat, black	52.0x8.0x1.7





		Dim in cm
026003	Drip tray, s/s	44.0x27.5



		Dim in cm
004511	Bar/shelf liner roll, black, pvc	300.0x61.0



		Ø cm
012358	Round service tray, s/s	30.0
012359	Round service tray, s/s	35.0



		Dim in cm
007309	Non slip rectangular tray with rubber lining, black virtually unbreakable, dishwasher safe, resistant to food acids, alcohol and UV light	46.0x36.0x1.6

		Dim in cm
007310	Non slip rectangular tray with rubber lining, black virtually unbreakable, dishwasher safe, resistant to food acids, alcohol and UV light	61.0x43.0x1.6



		Dim in cm
007311	Non slip oval tray with rubber lining, black virtually unbreakable, dishwasher safe, resistant to food acids, alcohol and UV light	26.5x20.0x1.0



		Ø cm	H in cm
007312	Non slip round tray with rubber lining, black virtually unbreakable, dishwasher safe, resistant to food acids, alcohol and UV light	32.0	1.5

		Ø cm	H in cm
007313	Non slip round tray with rubber lining, black virtually unbreakable, dishwasher safe, resistant to food acids, alcohol and UV light	38.0	1.5

		Ø cm	H in cm
007314	Non slip round tray with rubber lining, black virtually unbreakable, dishwasher safe, resistant to food acids, alcohol and UV light	43.0	1.5



		Cap. ltr	Dim in cm
001446	Scoop, polypropylene	0.6	17.0x12.0
007248	Scoop, polypropylene	2.7	24.0x15.0

		H in cm	Cap. ltr
014231	Bitter bottle with pourer, heavy gauge glass	18.5	0.2
018520	Measure glass, 1.0, 2.0, 2.5, 4.0, 5.0cl		Cap. ltr 0.05
003066	Mixing glass with reinforced bottom	14.5	0.4
028615	Sugar dispenser, glass body, s/s lid	17.0	0.32
017237	Napkin holder, s/s	Dim in cm 9.8x10.0x13.0	



Polycarbonate

		P/U	Ø cm	H in cm	Cap. ltr
010154	Wine glass	6	7.9	18.8	0.3
010155	Flute glass	6	5.7	21.7	0.15
027536	Whisky glass	24	8.3	11.5	0.3
010157	Jug	12	22.0	26.1	2.0



Stainless steel

		H in cm	Cap. ltr
019310	Boston shaker, with mixing glass	30.0	0.80
038237	Boston cocktail shaker, with mixing glass	19.0	0.70
018165	Cocktail shaker		0.30
017121	Cocktail shaker		0.35
018164	Cocktail shaker		0.50
018163	Cocktail shaker		0.70
017122	Jigger double sided, 3.0/5.0cl, satin polished finish	6.5	
018169	Jigger double sided 2.0/4.0cl	7.3	



	017198	Jigger double sided 2.5/5.0cl	H in cm	8.5
	018168	Cocktail strainer/sieve with spring	Ø cm	11.0
			L in cm	15.5
	017123	Cocktail spoon	L in cm	28.0
	038243	Cocktail spoon set 4 pieces	L in cm	22.5
	018166	Squeezer for lemon slices, s/s	Dim in cm	8.0x7.0
	042150	Lemon juice press, two parts, s/s	Cap. ltr	0.4
			Dim in cm	11.5x10.0
	006025	Citrus press, s/s	L in cm	22.0
	042151	Juice press manual, chrome plated zinc, mirror polished finish, s/s strainer	H in cm	60.0
	034400	Can opener with black nylon handle	L in cm	20.8
	018196	Can opener with hanging loop, blade and handle, s/s	L in cm	18.0
	018177	Bottle opener with hanging loop, handle and opener, s/s	L in cm	18.5
	018194	Can opener table model, s/s	H in cm	60.0
	018195	Spare blade for can opener 018194		
	018197	Spare wheel for can opener 018194		
	001405	Corkscrew, zinc alloy chrome plated, wooden lever	L in cm	53.0

		L in cm
018179	Lever corkscrew with wings	17.5



		Ø cm
038220	Bottle opener, containing seal cutter, cork screw, dip ring and a wine sealer	17.0



		L in cm
007315	Waiter's friend with corkscrew, knife and bottle opener, s/s	11.0



		L in cm
018178	Lever corkscrew, with bottle opener and knife	13.0



		L in cm
018176	Bar tong with 10 functions, s/s	18.0



018170	Nut cracker	
--------	-------------	--





020536	Pourer with closing stopper
--------	-----------------------------

018172	Pourer with closing lid
--------	-------------------------



007091	Freeflow pourer
--------	-----------------

L in cm
9.0



018173	Portioning pourer 2.0cl, available in clear, red and blue
--------	---

018193	Portioning pourer 3.0cl, available in clear and blue
--------	--



007618	Automatic pourer 2.0cl
	Allots spirits in time intervals without having to raise and lower the bottle

L in cm
14.5



007619	Bottle holder for wall mounting for 3 bottles, aluminium, for 0.75 or 1.0ltr bottles
--------	--

Dim in cm
31.0-45.0x28.0

007625	Spirit portioner 2.0cl, plastic, for 0.75 and 1.0ltr bottles, not suitable for aniseed
--------	--

Ø cm	H in cm
5.5	15.0



007633	Spirit portioner 4.0cl, plastic, for 0.75 and 1.0ltr bottles, not suitable for aniseed
--------	--

Ø cm	H in cm
5.5	15.0

		Dim in cm
036017	Brushless blender model No. 62, low noise level, pre-programmed recipes, USB port and free software to create recipes, incl. 2.4ltr. container, 230V/50-60Hz, 1.0kW	24.7x20.0x44.0



		Dim in cm
091004	Ice cube machine, freestanding, without water connection, 15.0-20.0kg/day, 3 different cube sizes, storage capacity 1.5kg, water container 4.0ltr, air cooling, incl. ice scoop, carry handles, refrigerant fluid R134a, 230V/50Hz, 0.2kW, 1.25A	43.1x38.0x43.5



		Dim in cm
023521	Ice crusher, s/s and plastic body, funnel and 15.0/hour receptacle plastic, 230V/50Hz, 0.06-0.08kW	17.2x24.0x46.3



		Dim in cm
036000	Bar ice crusher No. 53, manual or automatic function, crushed ice in coarse or fine ice, max. output 160.0 to 300.0kg/h, 230V/50-60Hz, 0.13kW	23.6x35.3x47.4



		Dim in cm
083002	Drink mixer, black, s/s cup incl. 1 s/s agitator and 2 plastic agitators, suitable for all cups of any size between 11.0-17.5cm, aluminium body, 2 speeds, 230V/50-60Hz, 0.35kW, 15000-22000rpm	46.0x18.0x24.5



		Dim in cm
083005	Citrus squeezer black, s/s bucket, incl. 2 removable cones, aluminium body 230V/50-60Hz, 0.16kW, 1200rpm	33.0x30.0x21.8



		Dim in cm
036018	Lever juicer, adapted squeezer to all kind of citrus fruits, accepts all kind of glasses and jugs, easy to clean, removable bowl, cone and cup, lever action start and stop, output 50.0ltr/h, 230V/50-60Hz, 0.275kW	24.0x40.0x49.0



		H in cm
083103	Bar blender, 3 speeds, case made of s/s, pulse function, incl. 2.0ltr polycarbonate container, 230V/50Hz, 0.55-1.0kW, 3.2A	48.0



VINOJET: THE TECHNICAL SOLUTION TO SERVE BOTTLE WINES AND CHAMPAGNE

- System: unsold wine in part-empty bottles will be preserved in perfect condition by electronic controlled vacuum.
- Unlimited number of bottles: the VinoJet is capable of preserving an unlimited number of bottles of wine.
- Running costs: the system simply plugs into the mains and a regulated CO2 supply (dual system only) and therefore incurs minimal costs.
- Safety: the vacuum/compressor pump is dry running (not oil-filled). This eliminates any problems associated with oil mists, smells or restrictions on siting.
- Operation temperature: 0°C to 40°C



new

		Dim in cm
010811	VinoJet Single system incl. 20 wine stoppers mounting plate, cable and all necessary fixings, 110 or 220V/50Hz, 0.28kW	13.5x55.0



new

		Dim in cm
002147	Le Verre de Vin compact single, 24V DC, 0.06kW	13.5x17.7x25.5



new

		Dim in cm
002149	Le Verre de Vin compact dual, 24V DC, 0.06kW	13.5x17.7x25.5

new

		Dim in cm
010812	VinoJet Dual system incl. 20 wine stoppers and 3 champagne stoppers, mounting plate, cable, hose and all necessary fixings, 110 or 220V/50Hz, 0.28kW	13.5x55.0

010814	Additional wine stoppers, pack of 20 pcs	
--------	--	--

010815	Champagner stoppers PREMIUM in chrome with ball catcher, pack of 2pcs	
--------	---	--

		Dim in cm
038239	Champagne stopper	4.0x5.5

		Dim in cm
018161	Champagne bottle sealer, chromeplated	3.0x5.5

004845	Vacuum wine pump, incl. 2 stoppers	
--------	------------------------------------	--

004848	Wine pump stoppers 2 pieces	
--------	-----------------------------	--

		Ø cm
038240	Decanter funnel incl. stand	8.5



		Dim in cm
007564	Wine cabinet for 66 bottles WKb 1812 black, with glass door, 1 temperature zone, door hinge on the right side, including 2 grids, including active carbon filter, temperature 5°C to 20°C, 230V/50Hz	89.0x60.0x1.3

		Ø cm	H in cm	
025392	Wine cooler with base and rings, s/s	18.0	23.0	
025393	Wine cooler rings, s/s	18.0	20.0	
008206	Champagne bucket with rings, conical, s/s	20.0	19.5	
010236	Wine cooler stand, s/s, matches wine cooler 025393 and 025394		69.0	
004965	Wine cooler, mirror polished, s/s	20.5	20.0	Cap. ltr 4.0
004967	Wine cooler stand, mirror polished, s/s, matches wine cooler 004965		65.0	
000777	Champagne bowl, s/s	35.0	25.0	Cap. ltr 10.0
026010	Champagne bowl, polycarbonate, s/s	39.5	25.5	Cap. ltr 15.0
010147	Wine cooler insulated, double walled, s/s	9.5	19.0	
018800	Wine cooler double wall, acrylic	9.5	23.0	
010148	Wine cradle chrome plated, mirror polished finish	L in cm 25.0	H in cm 19.0	
026015	Wine thermometer glass, 0°C to 40°C	L in cm 15.0		
038222	Wine thermometer	L in cm 19.5		
038221	Wine pourer		Dim in cm 4.0x5.5	
038223	Drip rings satined, 2 pcs			



Stainless steel



019811
Tea pot with lid, s/s

Cap. ltr
0.6



019817
Coffee pot with lid, s/s

Cap. ltr
0.9



019818
Coffee pot with lid, s/s

Cap. ltr
1.5



019821
Creamer, s/s

Cap. ltr
0.35



026002 Tea egg, s/s

Ø cm
4.0



054004 Dispenser for condensed milk, sugar packs and stirrer, s/s

Dim in cm
11.0x17.5

Cast iron



017195
Japanese tea pot,
inside enamelled,
with s/s filter

Cap. ltr
0.8



017196
Nipon tea pot,
inside enamelled,
with s/s filter

Cap. ltr
0.6



VENTA®
BY BÜCHER DESIGN



livecookintable®

easy to build up | height adjustable | all tables on wheels

Item No.: 020969

High-Table: T_1 [LxWxH]: 1960 x 500 x 1080 mm

weight: 40 kg

Bar: T_2 [LxWxH]: 1800 x 800 x 920 mm

weight: 76 kg

exclusive version/high-table with glass-top
glass-top/colour range:



metal frame/colours:



compact panel:



Item No.: 020984

Stool: (LxWxH): 380 x 410 x 865 mm

weight: 4.5 kg

The mobile bar – a design experience, with an exclusive, modern design, flexibility and versatility.

The established STAGE buffet system from the VENTA Interior range can be converted into a Mobile Bar. In place of the glass panels already part of all versions, we have added an additional table-top option to our portfolio. The compact panel is a heavy-duty plastic surface.

We use this panel both as a table-top and as a covering, which enables a mobile bar to be created from a STAGE buffet table in an instant. A front panel is attached to the existing metal adapters on the long side. The two side coverings are also attached to the front panels using special connectors and without the need for tools.



modular system | trolleys for storage | variations of colour

For prefunctional area we recommend our cocktail tables and stools.



SET_70_LED

Cocktail Table
with additional LED frame
(including rechargeable battery)

Item No.: 020977
[LxWxH]: 700 x 700 x 1050 mm
weight: 20 kg

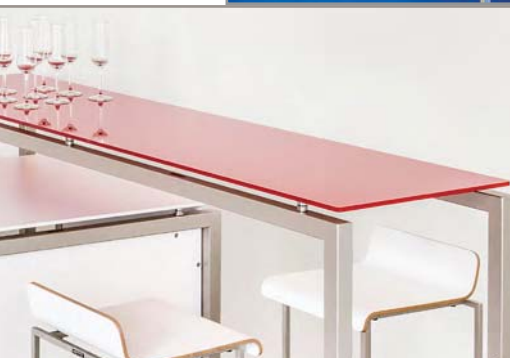

MULTI SHELF

BAR - BUFFET - LOUNGE - FURNITURE

new

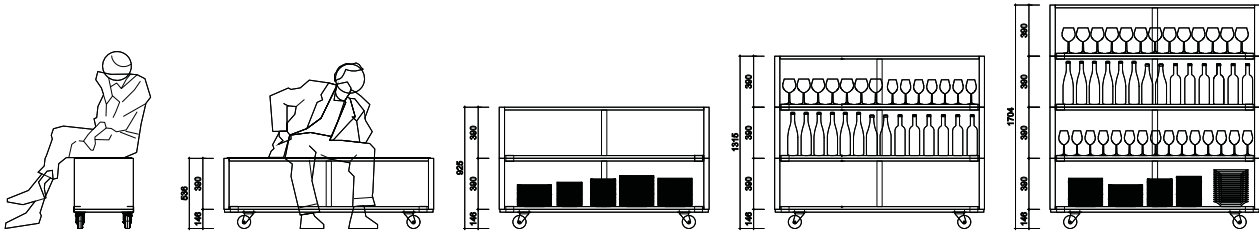

Application examples:

- 01 Seating bench
- 02 Sideboard on buffet height
- 03 Medium-high Shelf
- 04 Full-height Shelf

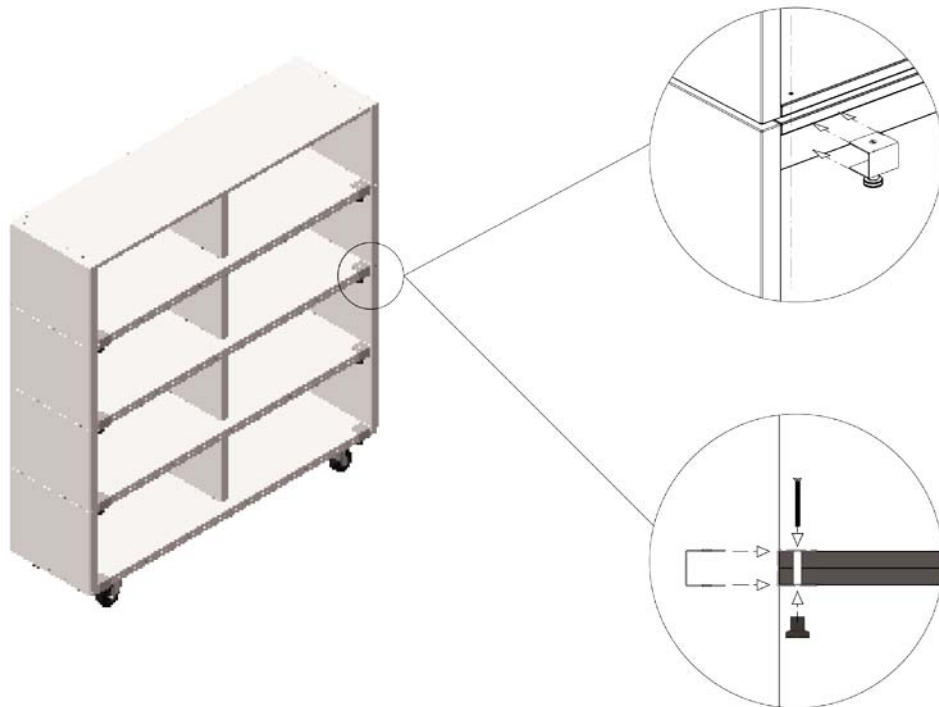
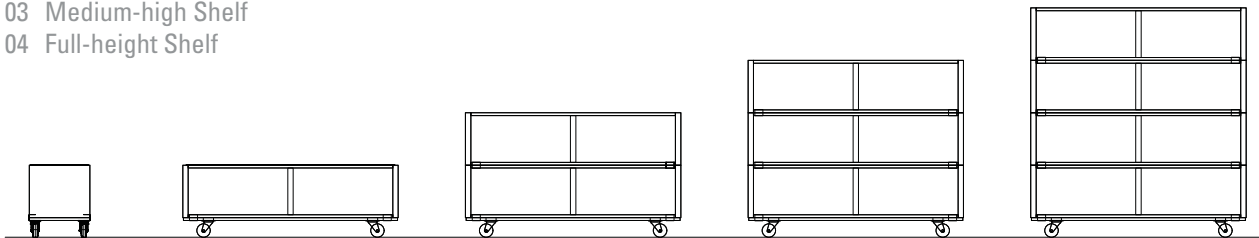

BAR ELEMENT

003444

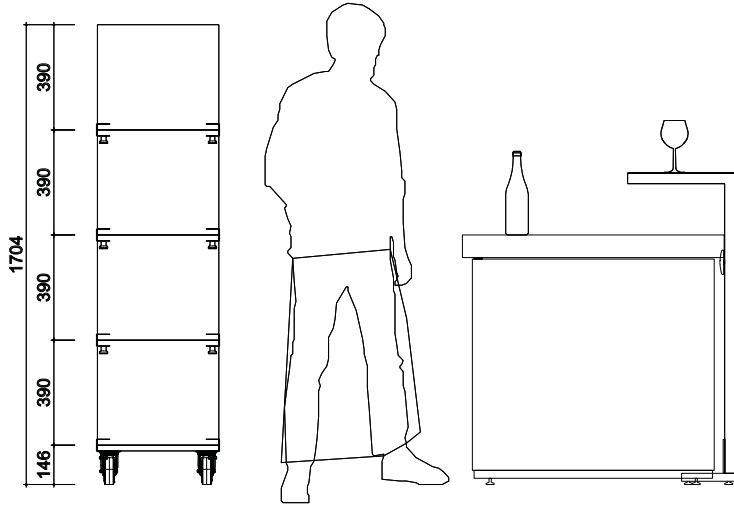

Multi Shelf

Modular furniture to use in various heights for various purposes

Bar Element

Light weight counter furniture in HPL to use with the livecookintable® Baukasten

LEM

019807

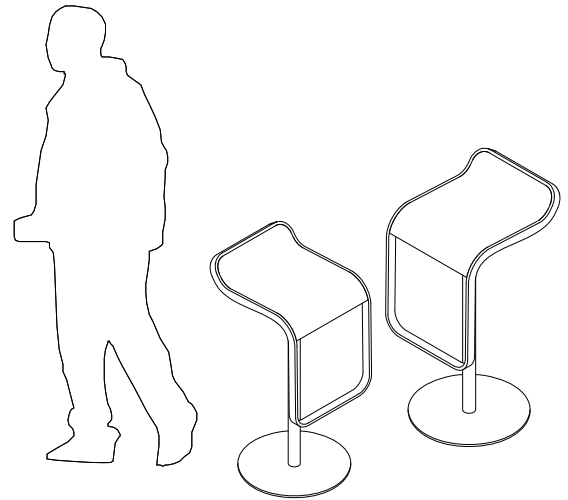

Lem Bar Stools

Bar stools with adjustable height black/ white leather, stainless



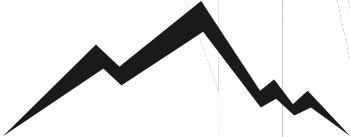
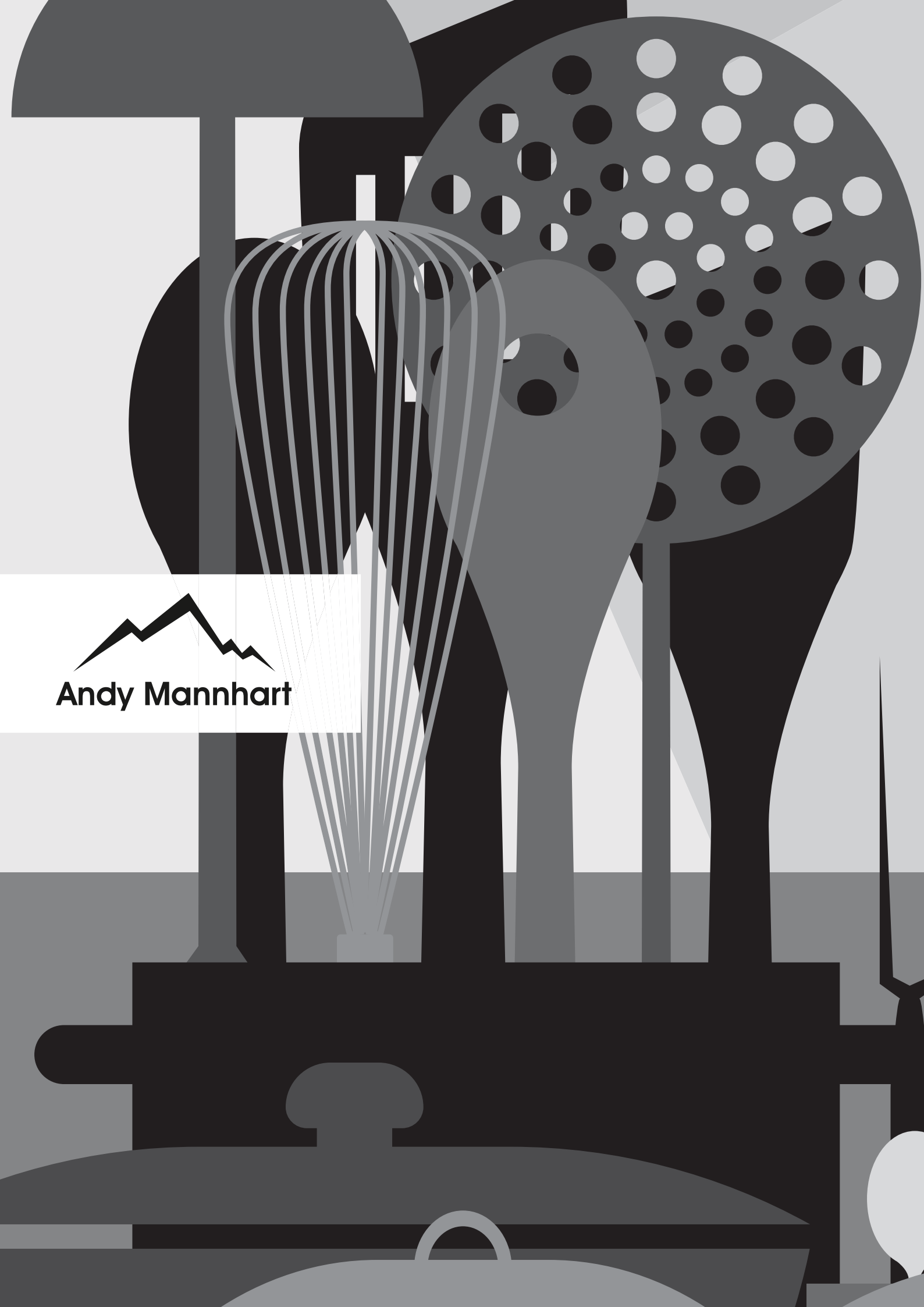

Andy Mannhart



REFERENCE LIST

List of hotel projects or complete kitchen renovations

Reference list

New hotel projects only or complete kitchen renovations



ADDRESS	Armani	Dubai	UAE
ADDRESS	Down Town	Dubai	UAE
ADDRESS	Mall	Dubai	UAE
ADDRESS	Marina Mall	Dubai	UAE
AMARI	Amari Trang Beach	Trang	Thailand
AMARI	Amari Watergate	Bangkok	Thailand
BEACHCOMBER	Coco Palm		Maldives
BEACHCOMBER	Le Paradis	Le Morne	Mauritius
BEACHCOMBER	Le Shandrani		Mauritius
BEACHCOMBER	Paradis		Mauritius
BEACHCOMBER	Victoria		Mauritius
BEAUFORT	Beaufort	Neuenburg	Switzerland
BEAUFORT	Beaufort Sentosa		Singapore
BERJAYA	Berjaya Beau Vallon Bay Beach Resort	Mahe	Seychelles
BERJAYA	Berjaya Hotel	Le Morne	Mauritius
BERJAYA	Berjaya Mahe Beach Resort	Mahe	Seychelles
BULGARI	Bulgari	Beijing	China
BULGARI	Bulgari	Shanghai	China
CATHAY PACIFIC	Inflight Kitchen	Cebu	Philippines
CENTURY	Century	Bangkok	Thailand
CENTURY	Century	Hong Kong	China
CENTURY	Century	Jakarta	Indonesia
CONRAD	Conrad Hotels & Resorts	Seoul	Korea
CROWNE PLAZA	Crowne Plaza	Abu Dhabi	UAE
CROWNE PLAZA	Crowne Plaza	Beijing	China
CROWNE PLAZA	Crowne Plaza	Changshu	China
CROWNE PLAZA	Crowne Plaza	Dubai	UAE
CROWNE PLAZA	Crowne Plaza	Gurgaon	India
CROWNE PLAZA	Crowne Plaza	Manila	Philippines
CROWNE PLAZA	Crowne Plaza	Sanya	China
CROWNE PLAZA	Crowne Plaza	Shijazhuang	China
CRUISE LINERS	Dream Cruises	Port Klang	Malaysia
CRUISE LINERS	Norwegian Bliss	Miami	USA
CRUISE LINERS	Norwegian Breakaway	Miami	USA
CRUISE LINERS	Norwegian Dawn		Germany
CRUISE LINERS	Norwegian Epic		USA
CRUISE LINERS	Norwegian Escape		USA
CRUISE LINERS	Norwegian Gem		USA
CRUISE LINERS	Norwegian Jewel		Malaysia
CRUISE LINERS	Norwegian Joy	Miami	USA
CRUISE LINERS	Norwegian Pearl		USA
CRUISE LINERS	Norwegian Star		USA
CRUISE LINERS	Norwegian Sun	Miami	USA
CRUISE LINERS	Pride of America		Malaysia
CRUISE LINERS	Pride of Hawaii		USA
CRUISE LINERS	Queen Elisabeth 2		USA
CRUISE LINERS	Seabourn Sojourn		USA
CRUISE LINERS	Silver whisper	Miami	USA
CRUISE LINERS	Sun Cruise		Singapore
CRUISE LINERS	Superstar Aries	Port Klang	Malaysia
CRUISE LINERS	Superstar Leo	Port Klang	Malaysia

CRUISE LINERS	Superstar Taurus	Port Klang	Malaysia
CRUISE LINERS	Superstar Virgo	Port Klang	Malaysia
CRUISE LINERS	Viking Century Sky		China
CRUISE LINERS	Viking Century Star		China
CRUISE LINERS	Viking Sun		China
DAEWOO HOTELS	Hanoi Daewoo Hotel	Hanoi	Vietnam
DUSIT HOTELS	Chaoren Thani Princess	Bangkok	Thailand
DUSIT HOTELS	Dusit Cha-Am	Cha-Am	Thailand
DUSIT HOTELS	Dusit Laguna	Phuket	Thailand
DUSIT HOTELS	Dusit Mangga Dua	Jakarta	Indonesia
DUSIT HOTELS	Dusit Resort	Pattaya	Thailand
DUSIT HOTELS	Dusit Thani Fulbari	Kathmandu	Nepal
EQUATORIAL HOTELS	Equatorial	Bangi	Malaysia
EQUATORIAL HOTELS	Equatorial	Ho Chi Minh City	Vietnam
EQUATORIAL HOTELS	Equatorial	Melaka	Malaysia
EQUATORIAL HOTELS	Equatorial	Penang	Malaysia
EQUATORIAL HOTELS	Equatorial	Shanghai	China
EVASON HIDEWAYS	Six Senses	Ziggy Bay	UAE
EVERGREEN HOTELS	Evergreen Hotel	Taipei	Taiwan
EVERGREEN HOTELS	Evergreen Laurel	Bangkok	Thailand
EVERGREEN HOTELS	Evergreen Laurel	Penang	Malaysia
EVERGREEN HOTELS	Evergreen Training Center	Taipei	Taiwan
FAIRMONT	Fairmont Jakarta Seneyan	Jakarta	Indonesia
FAIRMONT	Fairmont	Dubai	UAE
FAIRMONT	Fairmont	Jaipur	India
FAIRMONT	Fairmont Makkah Clock Royal Tower	Makkah	Saudi Arabia
FAIRMONT	Fairmont Quasar Istanbul	Istanbul	Turkey
FAIRMONT	Fairmont Riyadh	Riyadh	Saudi Arabia
FOUR SEASONS	Four Seasons	Beirut	Lebanon
FOUR SEASONS	Four Seasons	Damascus	Syria
FOUR SEASONS	Four Seasons	Hong Kong	China
FOUR SEASONS	Four Seasons	Riyadh	Saudi Arabia
GATE GOURMET	Gate Gourmet	Hong Kong	China
GATE GOURMET	Gate Gourmet	Shanghai	China
HARBOUR PLAZA	Harbour Plaza Hong Kong	Hong Kong	China
HARBOUR PLAZA	Oriental Harbour Plaza	Beijing	China
HILTON	DoubleTree by Hilton Hotel Gurgaon	New Delhi	India
HILTON	DoubleTree by Hillon Hotel Sukhumvit	Bangkok	Thailand
HILTON	Hilton	Addis Ababa	Ethiopia
HILTON	Hilton	Bali	Indonesia
HILTON	Hilton	Colombo	Sri Lanka
HILTON	Hilton	Dalian	China
HILTON	Hilton	Kuching	Malaysia
HILTON	Hilton	Kyonggiu	Korea
HILTON	Hilton	Makkah	Saudi Arabia
HILTON	Hilton	N'Djamena	Chad
HILTON	Hilton	Otaru	Japan
HILTON	Hilton	Rabat	Morocco
HILTON	Hilton Sal Cape Verde	Sal	Cape Verde
HILTON	Hilton	Sanya	China

Reference list

New hotel projects only or complete kitchen renovations



HILTON	Hilton	Seremban	Malaysia
HILTON	Hilton	Shanghai	China
HILTON	Hilton	Surabaya	Indonesia
HILTON	Hilton	Sydney	Australia
HILTON	Hilton Extention	Jakarta	Indonesia
HOLIDAY INN	Al Haza Holiday Inn	Riyadh	Saudi Arabia
HOLIDAY INN	Central Plaza Holiday Inn	Beijing	China
HOLIDAY INN	Holiday Inn	Amman	Jordan
HOLIDAY INN	Holiday Inn	Bangkok	Thailand
HOLIDAY INN	Holiday Inn	Beijing	China
HOLIDAY INN	Holiday Inn	Changfen	China
HOLIDAY INN	Holiday Inn	Makalla	Yemen
HOLIDAY INN	Holiday Inn	Qingdao	China
HOLIDAY INN	Hoilday Inn Pudong	Shanghai	China
HOLIDAY INN	Holiday Inn Sharjah	Sharjah	UAE
HOLIDAY INN	Holiday Inn Amrong	Chengdu	China
HOLIDAY INN	Holiday Inn Clark Field	Manila	Philippines
HOLIDAY INN	Holiday Inn Doha	Doha	Qatar
HOLIDAY INN	Holiday Inn Down Town	Dubai	UAE
HOLIDAY INN	Holiday Inn Marco Polo	Seoul	Korea
HYATT	Grand Hyatt	Abu Dhabi	UAE
HYATT	Grand Hyatt	Amman	Jordan
HYATT	Grand Hyatt	Bali	Indonesia
HYATT	Grand Hyatt	Berlin	Germany
HYATT	Grand Hyatt	Dubai	UAE
HYATT	Grand Hyatt	Fukuoka	Japan
HYATT	Grand Hyatt	Goa	India
HYATT	Grand Hyatt	Jakarta	Indonesia
HYATT	Grand Hyatt	Kochi	India
HYATT	Grand Hyatt	Macau	China
HYATT	Grand Hyatt	Mumbai	India
HYATT	Grand Hyatt	Sao Paulo	Brazil
HYATT	Grand Hyatt Erawan	Bangkok	Thailand
HYATT	Hyatt	Baku	Azerbaijan
HYATT	Hyatt	Manila	Philippines
HYATT	Hyatt Place	Jermuk	Armenia
HYATT	Hyatt Place	Riyadh	Saudi Arabia
HYATT	Hyatt Place	Yerewan	Armenia
HYATT	Hyatt Regency	Amsterdam	Netherlands
HYATT	Hyatt Regency	Almaty	Kazakhstan
HYATT	Hyatt Regency	Aqaba	Jordan
HYATT	Hyatt Regency	Baku	Azerbaijan
HYATT	Hyatt Regency	Bandung	Indonesia
HYATT	Hyatt Regency	Beograd	Serbia
HYATT	Hyatt Regency	Beijing	China
HYATT	Hyatt Regency	Bishkek	Kyrgyzstan
HYATT	Hyatt Regency	Fuzhou	China
HYATT	Hyatt Regency	Guam	USA
HYATT	Hyatt Regency	Hong Kong	China
HYATT	Hyatt Regency	Kathmandu	Nepal
HYATT	Hyatt Regency	Kiev	Ukraine
HYATT	Hyatt Regency	Kolkatta	India
HYATT	Hyatt Regency	Marinasmir	Morocco
HYATT	Hyatt Regency	Moscow	Russia
HYATT	Hyatt Regency	Mumbai	India
HYATT	Hyatt Regency	Oubaai	South Africa
HYATT	Hyatt Regency	Osaka	Japan
HYATT	Hyatt Regency	Sharm El Sheikh	Egypt
HYATT	Hyatt Regency	Surabaya	Indonesia

HYATT	Hyatt Regency	Tashkent.	Uzbekistan
HYATT	Hyatt Regency	Warsaw	Poland
HYATT	Hyatt Regency	Yogjakarta.	Indonesia
HYATT	Hyatt Regency Incheon.	Seoul	Korea
HYATT	Hyatt Regency Roissy.	Paris.	France
HYATT	Hyatt Regency, The Kilimanjaro	Dar es Salaam	Tanzania
HYATT	Hyatt Saujana.	Kuala Lumpur	Malaysia
HYATT	Park Hyatt.	Baku.	Azerbaijan
HYATT	Park Hyatt.	Busan	Korea
HYATT	Park Hyatt.	Chennai	India
HYATT	Park Hyatt.	Mallorca	Spain
HYATT	Park Hyatt.	Moscow.	Russia
HYATT	Park Hyatt.	Tokyo	Japan
HYATT	Park Hyatt.	Vienna.	Austria
HYATT	Park Hyatt.	Zanzibar.	Tanzania
HYATT	Park Hyatt.	Zurich	Switzerland
HYATT	Park Hyatt Saigon.	Ho Chi Minh City	Vietnam
HYATT	Park Hyatt Vendome	Paris.	France
INTERCONTINENTAL	Coex Convention Center	Seoul	Korea
INTERCONTINENTAL	Forum InterContinental	Shenzhen	China
INTERCONTINENTAL	Festival City	Dubai	UAE
INTERCONTINENTAL	InterContinental.	Doha.	Qatar
INTERCONTINENTAL	InterContinental.	Fujairah	UAE
INTERCONTINENTAL	InterContinental.	Phnom Penh.	Cambodia
INTERCONTINENTAL	InterContinental.	Tashkent.	Kazakhstan
INTERCONTINENTAL	InterContinental Borobudur	Jakarta	Indonesia
INTERCONTINENTAL	InterContintenal Financial Street.	Beijing.	China
INTERCONTINENTAL	Jacir InterContinental	Bethlehem.	Israel
INTERCONTINENTAL	Phoenicia InterContinental.	Beirut	Lebanon
INTERCONTINENTAL	InterContinental Resort.	Hua Hin	Thailand
INTERCONTINENTAL	InterContinental.	Saigon.	Vietnam
ITC	ITC Grand Maratha	Mumbai	India
ITC	ITC Katatiya	Hyderabad	India
JUMEIRAH	INTERNATIONAL Burj Al Arab (Pastry only)	Dubai	UAE
JUMEIRAH	INTERNATIONAL Emirates Towers	Dubai	UAE
JUMEIRAH	INTERNATIONAL Etihad Towers	Abu Dhabi.	UAE
JUMEIRAH	INTERNATIONAL Jumeirah Beach	Dubai	UAE
JUMEIRAH	INTERNATIONAL Wild Wadi Water Park.	Dubai	UAE
JUMEIRAH	Saadiyat Island	Abu Dhabi.	UAE
KEMPINSKI	Kempinski Al Othman	Al Khobar	Saudi Arabia
KEMPINSKI	Kempinski Siam	Bangkok.	Thailand
KEMPINSKI	Kempinski Lufthansa Center	Beijing.	China
KEMPINSKI	Kempinski Summerland.	Beirut	Lebanon
KEMPINSKI	Kempinski	Brugge	Belgium
KEMPINSKI	Kilimanjaro Kempinski Hotel.	Dar Es Salaam	Tanzania
KEMPINSKI	Kempinski	Djibouti	Africa
KEMPINSKI	Kempinski	Doha.	Qatar
KEMPINSKI	Kempinski	Jakarta	Indonesia
KEMPINSKI	Kempinski	Nairobi	Kenya
KEMPINSKI	Kempinski	Moscow.	Russia
KEMPINSKI	Kempinski Airport.	Munich	Germany
KEMPINSKI	Kempinski Ambience Hotel	New Delhi.	India
KEMPINSKI	Kempinski	Riga	Latvia
KEMPINSKI	Kempinski	Shenyang	China
KEMPINSKI	Kempinski	Shenzhen	China
KEMPINSKI	Kempinski Hotel.	Suzhou	China
KEMPINSKI	Kempinski	Yunchuan	China

Reference list

New hotel projects only or complete kitchen renovations



KEMPINSKI	Kempinski	Zanzibar	Tanzania
LOTTE	Lotte	Hanoi	Vietnam
LOTTE	Lotte	Yangoon	Myanmar
MANDARIN	Mandarin Oriental	Kuala Lumpur	Malaysia
MARCO POLO HOTELS	The Marco Polo	Davao	Philippines
MARCO POLO HOTELS	The Marco Polo	Singapore	Singapore
MARRIOTT	Courtyard by Marriott	Shenzen	China
MARRIOTT	Chalet Hotels (Marriott Mumbai)	Mumbai	India
MARRIOTT	Courtyard by Marriott	Abu Dhabi	UAE
MARRIOTT	Jordan Valley Marriott Resort	Dead Sea	Jordan
MARRIOTT	JW Marriott	Dubai	UAE
MARRIOTT	JW Marriott	Hanoi	Vietnam
MARRIOTT	JW Marriott	Shenzen	China
MARRIOTT	Marriott	Abu Dhabi	UAE
MARRIOTT	Marriott	Al Forsan	UAE
MARRIOTT	Marriott	Kigali	Rwanda
MARRIOTT	Marriott	Mumbai	India
MARRIOTT	Marriott	Manila	Philippines
MARRIOTT	Marriott	Siem Reap	Cambodia
MARRIOTT	Courtyard by Marriott	Gurgaon	India
MARRIOTT	Courtyard by Marriott	Phuket	Thailand
MARRIOTT	Fairfield	Jodhpur	India
MELIA HOTELS	Gran Melia	Jakarta	Indonesia
MERCURE HOTELS	Mercure	Davao	Philippines
MERCURE HOTELS	Mercure	Kathmandu	Nepal
MERIDIEN HOTELS	Le Meridien		Mauritius
MERIDIEN HOTELS	Le Meridien	Madinah	Saudi Arabia
MERIDIEN HOTELS	Le Meridien	Nagpur	India
MERIDIEN HOTELS	Le Meridien Jumeirah	Dubai	UAE
MERIDIEN HOTELS	Le Meridien Mina Seyahi	Dubai	UAE
MERIDIEN HOTELS	Le Royal Meridien	Bali	Indonesia
MERIDIEN HOTELS	Le Royal Meridien	Manama	Bahrain
MERIDIEN HOTELS	Le Royal Meridien President	Bangkok	Thailand
MERITUS HOTELS	Istana	Kuala Lumpur	Malaysia
MERITUS HOTELS	JC Mandarin	Shanghai	China
MERITUS HOTELS	Meritus Negara		Singapore
MERITUS HOTELS	Mutiara Beach	Penang	Malaysia
MERITUS HOTELS	Riviera Bay	Melaka	Malaysia
MERLIN	Merlin Beach	Khao Lak	Thailand
MILLENNIUM HOTELS	M Hotel	Makkah	Saudi Arabia
MILLENNIUM HOTELS	Grand Millenium	Muscat	Oman
MÖVENPICK HOTELS	MÖVENPICK Colombo	Colombo	Sri Lanka
MÖVENPICK HOTELS	MÖVENPICK Hotel Ankara	Ankara	Turkey
MÖVENPICK HOTELS	MÖVENPICK Hotel	Doha	Qatar
MÖVENPICK HOTELS	MÖVENPICK	Aqaba	Jordan
MÖVENPICK HOTELS	MÖVENPICK	Dead Sea	Jordan
MÖVENPICK HOTELS	MÖVENPICK	El Gouna	Egypt
MÖVENPICK HOTELS	MÖVENPICK	Petra	Jordan
MÖVENPICK HOTELS	MÖVENPICK Jolie Ville	Serena Beach	Egypt
MÖVENPICK HOTELS	MÖVENPICK Tunis	Tunis	Tunisia
MÖVENPICK HOTELS	MÖVENPICK Marché	Jakarta	Indonesia

MÖVENPICK HOTELS	MÖVENPICK Marché	Singapore	Singapore
MÖVENPICK HOTELS	MÖVENPICK Marché 2	Singapore	Singapore
MÖVENPICK HOTELS	MÖVENPICK Nabatean Castle	Petra	Jordan
NIKKO HOTELS	Nikko	Bangkok	Thailand
NIKKO HOTELS	Nikko	Hanoi	Vietnam
NIKKO HOTELS	Nikko	Kuala Lumpur	Malaysia
NIKKO HOTELS	Nikko	Tokyo	Japan
NIKKO HOTELS	Nikko	Yangoon	Myanmar
NOVOTEL	Novotel Balikpapan	Balikpapan	Indonesia
NOVOTEL	Novotel Bangalore Techpark	Bengaluru	India
NOVOTEL	Novotel	Bangkok	Thailand
NOVOTEL	Novotel King Power.	Bangkok	Thailand
NOVOTEL	Novotel	Mandalay	Myanmar
NOVOTEL	Novotel Ambassador	Seoul	Korea
NOVOTEL	Novotel Bangna	Bangkok	Thailand
NOVOTEL	Novotel Convection Centre	Hyderabad	India
NOVOTEL	Novotel	Juhu	India
NOVOTEL	Novotel Hefei	Hefei	China
NOVOTEL	Novotel Lotus	Bangkok	Thailand
NOVOTEL	Novotel Patong Beach	Phuket	Thailand
NOVOTEL	Novotel Phuket	Phuket	Thailand
NOVOTEL	Novotel Sungai Petani	Sungai Petani	Malaysia
OBEROI	Mashorba Resort	Srinagar	India
OBEROI	Oberoi	Mumbai	India
OBEROI	Oberoi		Mauritius
ONE & ONLY	One & Only Seef	Manama	Bahrain
PAN PACIFIC	Pan Pacific	Auckland	New Zealand
PAN PACIFIC	Pan Pacific	Melaka	Malaysia
PAN PACIFIC	Pan Pacific Airport	Kuala Lumpur	Malaysia
PAN PACIFIC	Pan Pacific Sutra Harbour	Kota Kinabalu	Malaysia
PENINSULA GROUP	Butterfield's Club	Hong Kong	China
PENINSULA GROUP	China Club	Beijing	China
PENINSULA GROUP	G's Club	Shanghai	China
PENINSULA GROUP	Menara Peninsula	Jakarta	Indonesia
PENINSULA GROUP	The Palace	Beijing	China
PENINSULA GROUP	The Peninsula	Chicago	USA
RADISSON	Radisson	Bali	Indonesia
RADISSON	Radisson	Bangkok	Thailand
RADISSON	Radisson Blu	Hua Hin	Thailand
RADISSON	Radisson Blu	Quoc	Vietnam
RADISSON	Radisson	Taba	Egypt
RADISSON	Radisson	Dubai	UAE
RADISSON	Radisson	Leeds	Great Britain
RAFFLES INTERNATIONAL	Merchant Court	Sydney	Australia
RAFFLES INTERNATIONAL	Raffles	Beijing	China
RAFFLES INTERNATIONAL	Raffles	Jakarta	Indonesia
RAFFLES INTERNATIONAL	Raffles	Singapore	Singapore
RAMADA RENAISSANCE	Ramada Renaissance	Doha	Qatar
RAMADA RENAISSANCE	Ramada Renaissance	Hong Kong	China
RAMADA RENAISSANCE	Ramada Renaissance	Seoul	Korea
RAMADA RENAISSANCE	Ramada Renaissance	Sakhalinsk	Russia

Reference list

New hotel projects only or complete kitchen renovations



REGAL HOTELS	Regal Airport	Hong Kong	China
REGENT HOTELS	Four Seasons	Bali	Indonesia
REGENT HOTELS	Grand Formosa Regent	Taipei	Taiwan
REGENT HOTELS	Regent.	Chiang Mai	Thailand
REGENT HOTELS	Regent.	Jakarta	Indonesia
RENAISSANCE	Renaissance Bangalore	Bangalore	India
RENAISSANCE	Renaissance Dubai	Dubai	UAE
RENAISSANCE	Renaissance Hotel Lucknow	Lucknow.	India
RENAISSANCE	Renaissance Hotel Tianjin	Tianjin.	China
RENAISSANCE	Renaissance Rajaprasong Hotel	Bangkok.	Thailand
RENAISSANCE	Renaissance Uluwatu.	Uluwatu	Indonesia
RITZ CARLTON	Ritz Carlton	Bali	Indonesia
RITZ CARLTON	Ritz Carlton	Beijing.	China
RITZ CARLTON	Ritz Carlton	Half Moon Bay	USA
RITZ CARLTON	Ritz Carlton	Istanbul	Turkey
RITZ CARLTON	Ritz Carlton	Muscat	Oman
RITZ CARLTON	Ritz Carlton	Osaka	Japan
RITZ CARLTON	Ritz Carlton	Philadelphia.	USA
RITZ CARLTON	Ritz Carlton	Seoul	Korea
RITZ CARLTON	Ritz Carlton	Shanghai	China
ROTANA	Al Bustan	Dubai	UAE
ROTANA	Rotana.	Makkah	Saudi Arabia
ROTANA	Rotana Beach	Abu Dhabi.	UAE
ROTANA	Sea Rock Rotana	Beirut	Lebanon
ROTANA	Pearl Rotana Capital Centre	Abu Dhabi.	UAE
ROTANA	Sundus Rotana	Muscat	Oman
RIXOS	Rixos Bab Al Bahr.	Ras Al Khaimah.	UAE
SEDONA	Sedona	Bintan	Indonesia
SEDONA	Sedona	Makasar.	Indonesia
SEDONA	Sedona	Manado	Indonesia
SEDONA	Sedona	Yangoon	Myanmar
SEDONA	Sedona Executive Club	Ho Chi Minh City	Vietnam
SHANGRI-LA	China World Hotel	Beijing.	China
SHANGRI-LA	Edsa Shangri-La	Manila.	Philippines
SHANGRI-LA	Shangri-La at the Fort	Manila.	Philippines
SHANGRI-LA	Island Shangri-La	Hong Kong	China
SHANGRI-LA	Shangri-La	Bangkok.	Thailand
SHANGRI-LA	Shangri-La	Beijing.	China
SHANGRI-LA	Shangri-La	Dalian	China
SHANGRI-LA	Shangri-La Hambantota	Ambalantotal	Sri Lanka
SHANGRI-LA	Shangri-La	Jakarta	Indonesia
SHANGRI-LA	Shangri-La	New Delhi.	India
SHANGRI-LA	Shangri-La	Penang	Malaysia
SHANGRI-LA	Shangri-La	Qingdao	China
SHANGRI-LA	Shangri-La	Surabaya	Indonesia
SHANGRI-LA	Shangri-La	Zhongshan	China
SHANGRI-LA	Shangri-La Academy	Beijing.	China
SHANGRI-LA	Shangri-La Mactan	Cebu.	Philippines
SHANGRI-LA	Shangri-La Rasa Ria	Kota Kinabalu	Malaysia
SHANGRI-LA	Shangri-La Rasa Sayang	Penang	Malaysia
SHANGRI-LA	The Kerry Centre	Beijing.	China
SHANGRI-LA	Traders	Beijing.	China
SHANGRI-LA	Traders	Shenyang	China
SHANGRI-LA	Shangri-La	Guilin	China

SHANGRI-LA	Shangri-La	Surabaya	Indonesia
SHERATON	Grand Hotel	Dubai	UAE
SHERATON	Sheraton Grande	Bangalore	India
SHERATON	Sheraton Grande	Bangkok	Thailand
SHERATON	Sheraton	Amman	Jordan
SHERATON	Sheraton	Ankara	Turkey
SHERATON	Sheraton	Bamako	Mali
SHERATON	Sheraton	Chennai	India
SHERATON	Sheraton	Dammam	Saudi Arabia
SHERATON	Sheraton Burj Al Salam	Dubai	UAE
SHERATON	Sheraton	Hanoi	Vietnam
SHERATON	Sheraton Hua Hin	Hua Hin	Thailand
SHERATON	Sheraton	Incheon	South Korea
SHERATON	Sheraton Rajputana	Jaipur	India
SHERATON	Sheraton Media	Jakarta	Indonesia
SHERATON	Sheraton	Mauritius	Mauritius
SHERATON	Sheraton	Makkah	Saudi Arabia
SHERATON	Sheraton Mughal	Mughal	India
SHERATON	Sheraton	Muscat	Oman
SHERATON	Sheraton	Nha Trang	Vietnam
SHERATON	Sheraton Laguna	Phuket	Thailand
SHERATON	Sheraton Towers	Singapore	Singapore
SHERATON	Sheraton Metechi Palace	Tbilisi	Georgia
SHERATON	Sheraton	Tokyo Bay	Japan
SHERATON	Sheraton	Wuxi	China
SHERATON	Sheraton	Zurich	Switzerland
SHERWOOD	Sherwood	Guam	USA
SHERWOOD	Sherwood	Taipei	Taiwan
SINGAPORE AIRLINES	Inflight Kitchen	Beijing	China
SOFITEL	City Center	Dubai	UAE
SOFITEL	Sofitel	Abu Dhabi	UAE
SOFITEL	Sofitel	Jinan	China
SOFITEL	Sofitel	Guiyang	China
SOFITEL	Sofitel	Johor Bahru	Malaysia
SOFITEL	Sofitel	Khon Kaen	Thailand
SOFITEL	Sofitel Royal Angkor	Angkor	Cambodia
ST REGIS	St Regis	Abu Dhabi	UAE
ST REGIS	St Regis	Amman	Jordan
ST REGIS	St Regis	Astana	Kazakhstan
ST REGIS	St Regis	Macau	China
ST REGIS	St Regis	Singapore	Singapore
SUN INTERNATIONAL	Carnival City Resort		South Africa
SUN INTERNATIONAL	Royal Mirage	Dubai	UAE
SUN INTERNATIONAL	Table Bay Victoria Alfred Hotel	Cape Town	South Africa
SUNWAY HOTELS	Sunway	Phnom Penh	Cambodia
SUNWAY HOTELS	Sunway Lagoon	Kuala Lumpur	Malaysia
SUNWAY HOTELS	Sunway Pyramid & Convention	Kuala Lumpur	Malaysia
SWISSOTEL	Swissotel	Beijing	China
SWISSOTEL	Swissotel	Dalian	China
SWISSOTEL	Swissotel	Seoul	Korea
SWISSOTEL	Swissotel Bosphorus	Istanbul	Turkey

Reference list

New hotel projects only or complete kitchen renovations



WESTIN	Westin	Abu Dhabi	UAE
WESTIN	Westin	Jeddah	Saudi Arabia
WESTIN	Westin	Kolkata	India
WESTIN	Westin	Kuala Lumpur	Malaysia
WESTIN	Westin	Kunming	China
WESTIN	Westin	Macau	China
WESTIN	Westin	Surabaya	Indonesia
WESTIN	Westin	Sydney	Australia
WESTIN	Westin	Tokyo	Japan
WESTIN	Westin Tai Pin Yang	Shanghai	China
WESTIN	Westin	Mumbai	India
WESTIN	Westin	Gurgaon	India

W HOTELS	W Hotel	Amman	Jordan
W HOTELS	W Hotel	Doha	Qatar
W HOTELS	W Hotel	Maldives	Maldives
W HOTELS	W Hotel	Seoul	Korea
W HOTELS	W Hotel	Shanghai	China
W HOTELS	W Hotel	Verbier	Switzerland

INDIVIDUAL HOTELS	Abu Dhabi Golf Club	Abu Dhabi	UAE
INDIVIDUAL HOTELS	Adare Manor	Limerick	Ireland
INDIVIDUAL HOTELS	Al Diyafa	Abu Dhabi	UAE
INDIVIDUAL HOTELS	Al Faisaliah	Riyadh	Saudi Arabia
INDIVIDUAL HOTELS	Al Murooj	Dubai	UAE
INDIVIDUAL HOTELS	Amadeus Restaurant	Dubai	UAE
INDIVIDUAL HOTELS	Astoria	St Petersburg	Russia
INDIVIDUAL HOTELS	Atteleia Holiday Village	Antalya	Turkey
INDIVIDUAL HOTELS	Al Diar	Yas Island, Dubai	UAE
INDIVIDUAL HOTELS	Alila	Goa	INDIA
INDIVIDUAL HOTELS	Armani	Dubai	UAE
INDIVIDUAL HOTELS	Alya Hotel Al Ain	Abu Dhabi	UAE

INDIVIDUAL HOTELS	Banyan Tree	Bali	Indonesia
INDIVIDUAL HOTELS	Banyan Tree	Phuket	Thailand
INDIVIDUAL HOTELS	Bitec Exhibition Center	Bangkok	Thailand
INDIVIDUAL HOTELS	Bodu Hula Resort		Maldives
INDIVIDUAL HOTELS	Borj al-Fateh	Karthoum	Sudan
INDIVIDUAL HOTELS	Borneo Convention Centre	Sarawak	Malaysia
INDIVIDUAL HOTELS	Brighton Beach Hotel	Sydney	Australia
INDIVIDUAL HOTELS	Bürgenstock	Obbürgen	Switzerland

INDIVIDUAL HOTELS	Capital Club	Dubai	UAE
INDIVIDUAL HOTELS	Cape Town International Convention Centre	Cape Town	South Africa
INDIVIDUAL HOTELS	Centara	Maldives	Maldives
INDIVIDUAL HOTELS	City of Dreams	Macau	Macau
INDIVIDUAL HOTELS	City of Dreams	Manila	Philippines
INDIVIDUAL HOTELS	Citra Land	Jakarta	Indonesia
INDIVIDUAL HOTELS	City Club	Manila	Philippines
INDIVIDUAL HOTELS	Cleveland Clinic	Abu Dhabi	UAE
INDIVIDUAL HOTELS	Conservatorium Hotel	Amsterdam	Netherlands
INDIVIDUAL HOTELS	Creek Golf & Yacht Club	Dubai	UAE

INDIVIDUAL HOTELS	Dana Plaza	Amman	Jordan
INDIVIDUAL HOTELS	Delta Grand Pacific	Bangkok	Thailand
INDIVIDUAL HOTELS	Dharamsey Nensey		Oman
INDIVIDUAL HOTELS	Dhow Palace Hotel	Dubai	UAE

INDIVIDUAL HOTELS	Diamond	Manila	Philippines
INDIVIDUAL HOTELS	Dubai Mall Hotel	Dubai	UAE
INDIVIDUAL HOTELS	Dubai Marina Mall Hotel	Dubai	UAE
INDIVIDUAL HOTELS	Dubai World Trade Center	Dubai	UAE
INDIVIDUAL HOTELS	Eden	Colombo	Sri Lanka
INDIVIDUAL HOTELS	Einstein	Aarau	Switzerland
INDIVIDUAL HOTELS	Elaf Galleria	Jeddah	Saudi Arabia
INDIVIDUAL HOTELS	Emerald	Bangkok	Thailand
INDIVIDUAL HOTELS	Emirates Marina Hotel		Kuwait
INDIVIDUAL HOTELS	Emirates Palace	Dubai	UAE
INDIVIDUAL HOTELS	Evasion	Dubai	UAE
INDIVIDUAL HOTELS	Facebook	Singapore	Singapore
INDIVIDUAL HOTELS	Fashion Cafe	Dubai	UAE
INDIVIDUAL HOTELS	Flight Kitchen	Phuket	Thailand
INDIVIDUAL HOTELS	Floating Hotel	Yangon	Myanmar
INDIVIDUAL HOTELS	Fortune Blue Wave Hotel	Bangkok	Thailand
INDIVIDUAL HOTELS	Four Points	Shanghai	China
INDIVIDUAL HOTELS	Galle Face Hotel	Colombo	Sri Lanka
INDIVIDUAL HOTELS	Galleria Suites	Manila	Philippines
INDIVIDUAL HOTELS	Ghazala	Cairo	Egypt
INDIVIDUAL HOTELS	Gold Coast	Hong Kong	China
INDIVIDUAL HOTELS	Grand Hotel	Djibloho	Guinea
INDIVIDUAL HOTELS	Grande Real Hotel	Albufeira	Portugal
INDIVIDUAL HOTELS	Gulf		Bahrain
INDIVIDUAL HOTELS	Hanoi Horison	Hanoi	Vietnam
INDIVIDUAL HOTELS	Heritage	Manila	Philippines
INDIVIDUAL HOTELS	Hillcrest	Taipei	Taiwan
INDIVIDUAL HOTELS	Hong Kong Disneyland	Hong Kong	China
INDIVIDUAL HOTELS	Horison Bekasi	Jakarta	Indonesia
INDIVIDUAL HOTELS	Hotel de la Paix		Cambodia
INDIVIDUAL HOTELS	Huvafen Fushi Resort		Maldives
INDIVIDUAL HOTELS	Hotel Excelsior	Delhi	India
INDIVIDUAL HOTELS	Howard Johnson Garden Plaza	Yixing	China
INDIVIDUAL HOTELS	Imperial Queens Park	Bangkok	Thailand
INDIVIDUAL HOTELS	Indigo	Mumbai	India
INDIVIDUAL HOTELS	Jeju Shinhwa World	Jeju	South Korea
INDIVIDUAL HOTELS	Jinji Lake Grand Hotel	Suzhou	China
INDIVIDUAL HOTELS	Jumeirah Golf Estates	Dubai	UAE
INDIVIDUAL HOTELS	Jumeirah Island	Dubai	UAE
INDIVIDUAL HOTELS	Kairaba Beach Hotel	Banjul	Gambia
INDIVIDUAL HOTELS	Kandooma		Maldives
INDIVIDUAL HOTELS	Kings Academy		Jordan
INDIVIDUAL HOTELS	KLCC	Kuala Lumpur	Malaysia
INDIVIDUAL HOTELS	Kowloon Panda	Hong Kong	China
INDIVIDUAL HOTELS	Kuredu Island Resort	Kuredu	Maldives
INDIVIDUAL HOTELS	Lac Side Casino Zürihorn	Zurich	Switzerland
INDIVIDUAL HOTELS	Landmark	Bangkok	Thailand
INDIVIDUAL HOTELS	Landmark	Beijing	China
INDIVIDUAL HOTELS	Le Royal Amman	Amman	Jordan
INDIVIDUAL HOTELS	Leeds Park Plaza	Leeds	Great Britain
INDIVIDUAL HOTELS	Layia Dubai	Dubai	UAE
INDIVIDUAL HOTELS	Long Beach	Antalya	Turkey
INDIVIDUAL HOTELS	Lujo	Bodrum	Turkey

Reference list

New hotel projects only or complete kitchen renovations



INDIVIDUAL HOTELS	Maia Resort	Seychelles
INDIVIDUAL HOTELS	Marina Hotel	Dubai UAE
INDIVIDUAL HOTELS	Marina Hotel	Yas Island, Dubai UAE
INDIVIDUAL HOTELS	Maxims Hotel	Manila. Philippines
INDIVIDUAL HOTELS	Medina Oberoi	Cairo Egypt
INDIVIDUAL HOTELS	Mediterranean Beach HotelCyprus
INDIVIDUAL HOTELS	Meeru Island ResortMaldives
INDIVIDUAL HOTELS	Military Camp	Riyadh. Saudi Arabia
INDIVIDUAL HOTELS	Ministry of Defence	
INDIVIDUAL HOTELS	Monarch Hotel	Dubai UAE
INDIVIDUAL HOTELS	Mosimann	London Great Britain
INDIVIDUAL HOTELS	Mulia Senayan	Jakarta Indonesia
INDIVIDUAL HOTELS	Nespresso Coffee Bar	Munich Germany
INDIVIDUAL HOTELS	Nestlé Professional.	Dubai UAE
INDIVIDUAL HOTELS	Nexus	Kota Kinabalu. Malaysia
INDIVIDUAL HOTELS	Nottingham Park Plaza	Nottingham Great Britain
INDIVIDUAL HOTELS	Oberwaid Kurhaus & Medical Center	St Gallen Switzerland
INDIVIDUAL HOTELS	Ocean Park Resort	Funchal/Madeira Portugal
INDIVIDUAL HOTELS	Orbit Gurgaon	Gurgaon India
INDIVIDUAL HOTELS	Panorama	Bahrain Bahrain
INDIVIDUAL HOTELS	Park	Zug Switzerland
INDIVIDUAL HOTELS	Park Plaza.	Bangalore. India
INDIVIDUAL HOTELS	Parkroyal	Penang Malaysia
INDIVIDUAL HOTELS	Plantetion Bay	Manila. Philippines
INDIVIDUAL HOTELS	Plaza	South Sinai Egypt
INDIVIDUAL HOTELS	Princess.	Surabaya Indonesia
INDIVIDUAL HOTELS	Putra World Trade Center	Kuala Lumpur Malaysia
INDIVIDUAL HOTELS	Queen Sirikit Convention	Bangkok. Thailand
INDIVIDUAL HOTELS	Rawi Warin Resort & Spa.	Krabi Thailand
INDIVIDUAL HOTELS	Rembrandt	Bangkok. Thailand
INDIVIDUAL HOTELS	Resort World	Sentosa Singapore
INDIVIDUAL HOTELS	Rex Hotel	Ho Chi Minh City Vietnam
INDIVIDUAL HOTELS	Riverside	Jakarta Indonesia
INDIVIDUAL HOTELS	Saba	Sandakan Malaysia
INDIVIDUAL HOTELS	SAF ClubOman
INDIVIDUAL HOTELS	Sana Hotel	Lisbon Portugal
INDIVIDUAL HOTELS	Santika	Manado Indonesia
INDIVIDUAL HOTELS	Sedartis	Thalwil Switzerland
INDIVIDUAL HOTELS	Semarak International	Medan. Indonesia
INDIVIDUAL HOTELS	Serenety Terraces	Phuket. Thailand
INDIVIDUAL HOTELS	Shagdag.Azerbaijan
INDIVIDUAL HOTELS	Shanti Ananda	Port Louis Mauritius
INDIVIDUAL HOTELS	Siam City	Bangkok. Thailand
INDIVIDUAL HOTELS	Solaire Resort & Casino	Manila. Philippines
INDIVIDUAL HOTELS	Southern BM	Bangkok. Thailand
INDIVIDUAL HOTELS	Studio City	Macau. China
INDIVIDUAL HOTELS	Subic Bay Yacht Club	Subic Philippines
INDIVIDUAL HOTELS	SunlandMaldives
INDIVIDUAL HOTELS	Sukhothai	Bangkok. Thailand
INDIVIDUAL HOTELS	Sutera Harbour Resort	Kota Kinabalu Malaysia
INDIVIDUAL HOTELS	Swiss Diamond	Moscow Russia
INDIVIDUAL HOTELS	Swiss Holiday Park	Morschach Switzerland
INDIVIDUAL HOTELS	Swiss-Re	Zurich Switzerland

INDIVIDUAL HOTELS	Taj Exotica	Mauritius
INDIVIDUAL HOTELS	The Citrus (Leela)	Mumbai India
INDIVIDUAL HOTELS	The Conference Palace Hotel	Abu Dhabi UAE
INDIVIDUAL HOTELS	The Diplomatic Club	Doha Qatar
INDIVIDUAL HOTELS	The Dorchester	London Great Britain
INDIVIDUAL HOTELS	The Empire Hotel & Country Club	Bandar Seri Begawan Brunei
INDIVIDUAL HOTELS	The Fullerton	Singapore Singapore
INDIVIDUAL HOTELS	The Madison Carmelo	Montevideo Uruguay
INDIVIDUAL HOTELS	The Metropolitan Palace	Dubai UAE
INDIVIDUAL HOTELS	The Park	Kolkata India
INDIVIDUAL HOTELS	The Residence	Tunis Tunisia
INDIVIDUAL HOTELS	The Residence	Mauritius
INDIVIDUAL HOTELS	The Riverbank Park Plaza	London Great Britain
INDIVIDUAL HOTELS	The Royal Abjar	Dubai UAE
INDIVIDUAL HOTELS	The South Beach	Singapore Singapore
INDIVIDUAL HOTELS	Three Dolphins Resort	Phuket Thailand
INDIVIDUAL HOTELS	Tiger Casino Resort	Manila Philippines
INDIVIDUAL HOTELS	Trident Hotel	Hyderabad India
INDIVIDUAL HOTELS	Tynian Dynasty	Saipan Saipan
INDIVIDUAL HOTELS	Uldudag	Ankara Turkey
INDIVIDUAL HOTELS	Venetian	Macau Macau
INDIVIDUAL HOTELS	Victoria Angkor	Siem Reap Cambodia
INDIVIDUAL HOTELS	Vietnam Airlines Caterers Ltd	Ho Chi Minh Vietnam
INDIVIDUAL HOTELS	Villa Nova	Barbados
INDIVIDUAL HOTELS	Vinpearl	Nha Trang Vietnam
INDIVIDUAL HOTELS	Westland	Kenya Kenya
INDIVIDUAL HOTELS	Wynn Resort	Macau Macau
INDIVIDUAL HOTELS	Xili Golf	Shenzhen China
INDIVIDUAL HOTELS	Yanbian Daewoo	Jilin China
INDIVIDUAL HOTELS	Yo Ho Beach	Taiwan
INDIVIDUAL HOTELS	Yuda Palace	Zhengzhou China
INDIVIDUAL HOTELS	Zara Nile Cruiser	Egypt
INDIVIDUAL HOTELS	Zimbali Forest Lodge	Natal South Africa
INDIVIDUAL HOTELS	Zürichsee Schifffahrt	Zurich Switzerland