

bright solutions

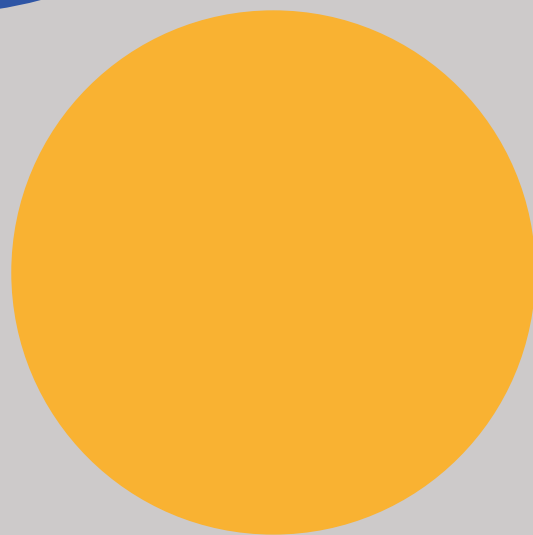

iNTEC<sup>®</sup>  
LIGHT



bright solutions

**INTEC**<sup>®</sup>  
LIGHT

**Quando la ricerca trova risposte  
alle esigenze, vecchie e nuove.  
Quando la tecnologia risolve problemi.  
Quando tecnica ed estetica  
si fondono armoniosamente.  
Lì, nascono le soluzioni più brillanti.**

When research finds solutions  
to needs, both old and new.  
When technology solves problems.  
When technology and aesthetic  
appeal harmoniously merge.  
That's when the bright solutions are born.



Milano



Napoli

# BRIGHT SOLUTIONS

IERI E OGGI, PRESENTI /  
YESTERDAY AND TODAY, PRESENT



## Un'evoluzione lunga oltre 100 anni

La nostra storia comincia a Napoli agli inizi del '900. È una storia di impegno, di evoluzione, di coraggio. Una storia che corre lungo il filo del tempo intrecciandosi costantemente con quella del vetro.

Generazione dopo generazione, **FAN Europe Lighting** evolve, cambia forma, sviluppa la sua idea di prodotto e di servizio, con l'obiettivo di diventare un punto di riferimento per tutto il settore dell'illuminazione.

## La nostra azienda, oggi

Oggi **FAN Europe Lighting** è una grande squadra di persone e di risorse. Alla ricerca dell'eccellenza nella qualità dei prodotti, abbiniamo un ecosistema di servizi e garanzie che abbiamo sviluppato e strutturato a misura di esigenza e di cliente.

La nostra tradizione non ci fa dimenticare l'importanza dell'originalità e della cura nel prodotto.

La nostra voglia di crescere ci spinge ad essere sempre al passo con la luce di oggi e di domani, una luce sempre più smart, sempre più green, sempre in evoluzione.

Our history began in Naples in the early 1900s. It's a history of commitment, evolution and courage. A history that follows the thread of time, constantly intertwining with that of glass.

Generation after generation, **FAN Europe Lighting** has evolved, changing shape, developing its concept of products and services to become a benchmark for the entire lighting industry.

Today, **FAN Europe Lighting** is a vast team of people and resources. In addition to pursuing excellence in product quality, we combine an ecosystem of services and guarantees, which we have developed and tailored to our customers' needs.

Our Italian heritage does not allow us to forget the importance of originality and product care. Our desire to grow motivates us to always keep up with the lighting of today and tomorrow, lighting that is always smarter, more eco-friendly and evolving.

**An evolution  
spanning more  
than 100 years**

**Our  
company,  
today**



# CUSTOM-MADE LIGHTING

UNA SINERGIA DI  
RISORSE E GARANZIE /  
A SYNERGY OF RESOURCES  
AND GUARANTEES

## La qualità, al primo posto

Componenti di qualità, controlli multipli, collaudi in fase di realizzazione: per la qualità non scendiamo mai a compromessi. Grazie a un team di esperti riusciamo a garantire la tecnologia più avanzata, finiture ogni anno più curate e nuovi design a prova di tempo!

## La gamma più completa di prodotti

Siamo una delle poche aziende al mondo a coprire così tanti settori di destinazione: dall'illuminazione industriale al prodotto decorativo. Siamo "appassionati ricercatori" e ogni anno arricchiamo la gamma con collezioni di tendenza e le innovazioni più efficienti in materia di tecnologia e sostenibilità.

L'evoluzione stilistica e tecnologica dell'illuminazione ha indirizzato la ricerca illuminotecnica verso progetti di illuminazione su misura, in cui i corpi illuminanti sono strumenti al servizio del progetto architettonico.

Questa fase evolutiva ci ha spinto ad ampliare la nostra divisione Project ed Illuminotecnica dedicata ai progetti su misura. La divisione esegue già servizi di progettazione, realizzazione prototipi, test e controllo di produzione per ogni prodotto presente sul nostro catalogo.

Quando i prodotti non incontrano le esigenze del cliente, realizziamo prodotti "customizzati" su misura per le esigenze del progetto e per valorizzare al massimo gli ambienti del disegno illuminotecnico. Grazie a strumenti informatici e software di calcolo fotometrico possiamo fornire per ogni nuovo prodotto i calcoli fotometrici per un adeguato sviluppo progettuale illuminotecnico.



Quality components, multiple checks, testing during the manufacturing process: we never compromise on quality. With our team of experts, we can guarantee cutting-edge technology, new improved finishes every year and new designs that will stand the test of time!

**Quality  
comes first**

We are one of the few companies in the world to cover so many target sectors: from industrial lighting to decor products. As "passionate researchers" every year we enrich our range with trend-setting collections and the most efficient innovations in terms of technology and sustainability.

**The most  
comprehensive  
range of  
products**

The stylistic and technological evolution of lighting has steered lighting research towards custom-made lighting projects, in which luminaires are used to support architectural design.

This evolutionary phase encouraged us to expand our Project and Lighting department focusing on custom-made projects. The department already provides design, prototyping, testing and production monitoring services for all the products in our catalogue. When products don't meet the customer's needs, we make bespoke products to meet project requirements and fully enhance lighting design contexts. Using computer tools and photometric calculation software, we can provide photometric calculations for each new product thereby appropriately developing the lighting design project.





# CUSTOMER EXPERIENCE

UN'ASSISTENZA SEMPRE ATTIVA / ASSISTANCE ALWAYS AVAILABLE

## Massima disponibilità di prodotti

Noi ci siamo, sempre! Con disponibilità, professionalità e un obiettivo chiaro: semplificare la vita dei nostri clienti. È una promessa che facciamo a chi non ci conosce. È una garanzia consolidata per chi lavora con noi da anni! Abbiamo a disposizione una delle più vaste gamme di articoli sul mercato ma riusciamo ad assicurare in ogni momento il 98% di disponibilità. Garantiamo che il restante 2% torni disponibile in 30 giorni!

## Spedizioni Veloci e sicure

Abbiamo sviluppato negli anni un sistema logistico efficiente in grado di garantire consegne in 24h per l'Italia e 48 per l'Europa, assicurando la massima cura nel trasporto. Un team multilingua è inoltre al servizio dei clienti per offrire supporto e assistenza.



We are always here for you! With our helpfulness, professionalism and a clear goal: to make life easier for our customers. It's a promise we make to those who don't know us. It's an established guarantee for those who have worked with us for years! We have one of the widest ranges of items on the market, but we can guarantee 98% availability at all times. We guarantee that the remaining 2% will be available in 30 days!

## Maximum product availability

Over the years, we have developed an efficient logistics system that guarantees deliveries within 24h in Italy and 48h in Europe, ensuring maximum care during transport. Our multilingual team also provides customers with support and assistance.

## Quick and safe shipments



# REASON WHY

## SOSTENIAMO IL GREEN / WE ARE ECO-FRIENDLY

Abbiamo eliminato la plastica dai nostri packaging. Selezioniamo e prediligiamo materiali provenienti da risorse sostenibili. Ricerchiamo le tecnologie con miglior efficienza energetica abbinati a sistemi smart in grado di ridurre ulteriormente i consumi. Questi e molti altri sono i nostri impegni a sostegno della sostenibilità!

We no longer use plastic in our packaging. We select and prefer materials from sustainable resources. We research the most energy-efficient technologies combined with smart systems that further reduce consumption. All this, and much more, shows our commitment to sustainability!



## GUIDA ALLA LETTURA DELLE TABELLE / GUIDE TO READING THE TABLES

**Ogni collezione è accompagnata da uno o più simboli per precisare la destinazione d'uso del prodotto**  
Every collection will be distinguished by a symbol for intended use

**Nome e caratteristiche collezione**  
Collection name and characteristics





**Certificazione e normative**  
Certification and regulations



Technical information - JET ALTO LUMEN

**Caratteristiche prodotto**  
Product characteristics



LED-JET-W-20HL 803141492411V	indoor 20W	outdoor 20W
LED-JET-B-20HL 803141492409D	indoor 20W	outdoor 20W
lumens	150 lm	150 lm
beam angle	38°	38°
PF	0,90	0,90

**Codice prodotto e codice ean**  
Product code and EAN code



LED-JET-W-30HL 803141492412Z	indoor 30W	outdoor 30W
LED-JET-B-30HL 803141492409Z	indoor 30W	outdoor 30W
lumens	3235 lm	3235 lm
beam angle	38°	38°
PF	0,90	0,90

**Variante colore**  
Colour variance  
ove esistente / where existing



LED-JET-W-40HL 803141492413A	indoor 40W	outdoor 40W
LED-JET-B-40HL 803141492410Z	indoor 40W	outdoor 40W
lumens	4300 lm	4300 lm
beam angle	38°	38°
PF	0,90	0,90

**Potenza** Power  
Per i prodotti senza LED integrato,  
dati attacco lampadina con  
potenza massima certificata /  
For the products without built-in  
LED max lamp holder power as  
required by CE certificate

**Temperatura colore LED  
espressa in Kelvin + lumen**  
Colour temperature in Kelvin + lumen  
ove esistente / where existing

Accessories not included / Not included accessories

LED-JET-MESH80 803141492407Z	for 20W
LED-JET-MESH70 803141492406D	for 30W
LED-JET-MESH60 803141492405D	for 40W

LED-JET-DIFF60 803141492404Z	for 20W
LED-JET-DIFF70 803141492403D	for 30W
LED-JET-DIFF80 803141492402B	for 40W

**Accessori**  
Accessories  
ove esistente / where existing

Fotometria del prodotto / Photometric curve



**Fotometria del prodotto**  
Photometric curve  
ove esistente / where existing



indoor use  
uso domestico / domestic use



outdoor use  
esterno / outdoor use



accommodation areas use  
strutture ricettive / accommodation areas use



office use  
uffici / office use



commercial areas use  
aree commerciali / commercial areas



urban areas use  
aree urbane / urban use



industrial areas use  
aree industriali / industrial use



bathroom use  
ambiente bagno / bathroom use

Sistemi di controllo per i nostri prodotti SMART / Control system easy installation



Smart Intec WIFI



RF 2.4G control system



Alexa e Google Home voice control

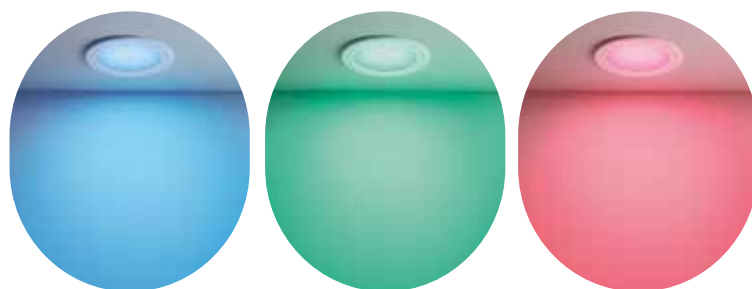

**EASY DOMOTICA** Con questo segmento tecnico intendiamo soddisfare al meglio la crescente esigenza di migliorare la qualità di vita domestica, e lavorativa attraverso l'utilizzo di dispositivi di illuminazione sempre più interconnessi fra loro tramite collegamenti sempre più semplificati dalle tecnologie wireless. I dispositivi di illuminazione diventano uno strumento estremamente personalizzato e modulabile che si fondono, anche in diversi momenti della giornata, con le evolute esigenze di illuminazione non più fine a se stessa ma adattata ai diversi umori sia di una utenza professionale che di una utenza domestica o ludica. Questa sezione raggruppa prodotti a bassa tensione che è possibile collegare con alimentatori a tensione costante in parallelo e si caratterizzano per la estrema flessibilità e modularità essendo essi compatibili con centraline di controllo in Radio Frequenza 2.4G, Infrarossi, Wifi o Bluetooth. Le centraline a loro volta prevedono interfacce wifi, bluetooth oppure possono essere controllate tramite wall pad o radiocomandi.

**EASY DOMOTICA** With this technical segment, we intend meet in the best way the growing need to improve the quality of home and working life through the use of lighting devices that are increasingly interconnected with each other through connections that are increasingly simplified by wireless technologies. The lighting devices become an extremely personalized and modular tool that merge, even at different times of the day, with the evolved lighting needs no longer as light source itself but light adapted to the different moods of both professional users, domestic users, playful users. This section groups low voltage products that can be connected with constant voltage power supply in parallel connection system and are characterized by extreme flexibility and modularity as they are compatible with 2.4G Radio Frequency, Infrared, Wifi or Bluetooth control units. The control units can be controlled by wifi, bluetooth devices or can be controlled via a wall pad or remote control.



È possibile controllare da remoto tutti gli apparecchi luminosi, con le APP INTEC e SMART LIFE /  
All luminaires can be remotely controlled with INTEC and SMART LIFE APPs.

Scarica l'app Smart Intec su /  
Download App Smart Intec on:

























**APP INTEC WI-FI** Ogni momento della vita quotidiana richiede la giusta luce. Grazie all'illuminazione Smart, creare l'atmosfera ideale per tutti i momenti sarà possibile con i nostri prodotti Wi-fi e Bluetooth. Tramite la **nostra app Smart INTEC** è possibile comandare da remoto tutti gli apparecchi luminosi per accendere o spegnere, cambiare temperatura colore Kelvin della luce e anche impostare scene. Tra i nostri articoli troverai una selezione di prodotti a LED integrato pronti all'installazione ma anche tutti gli accessori necessari per rendere smart qualunque apparecchio domestico e non. Una volta collegata e scaricata l'app INTEC, la creazione delle varie stanze sarà semplice e intuitivo grazie alle istruzioni step by step. Per controllare i nostri prodotti smart è possibile anche utilizzare gli smart speaker e video Amazon e Google. Abilita la skill e controlla i dispositivi semplicemente parlando.

**APP INTEC WI-FI** Every moment of everyday life require the right light. Thank to the Smart lighting it will be possible to create the ideal atmosphere connecting them and controlling them thorough Wi-fi or Bluetooth connection. **With our APP Smart Intec** it is possible to control from remote all the lighting devices with on-off, kelvin colour temperature changing, light colour and scenes functions. To instore some smart lamps it is necessary just your standard home electric connection, and wifi connection. Once connected the lamp and downloaded the APP Smart Intec it will be very easy to create groups and rooms in very easy process thank to the instructions step by step on the App. The smart lamps can be controlled also with Wifi voice control devices.

**SMART INTEC Bluetooth Sig Mesh** La rete Bluetooth è stata ben accolta nell'illuminazione industriale, commerciale e domestica, in quanto uno dei sistemi di controllo dell'illuminazione intelligente più semplici e convenienti che svolge un ruolo chiave nel facilitare l'inter-dialogo tra i dispositivi di illuminazione. I nostri articoli Bluetooth Sig Mesh possono essere collegati con i dispositivi intelligenti tramite l'APP Smart Intec e ogni dispositivo di illuminazione può comunicare con un altro numero infinito di dispositivi attraverso la rete mesh entro una distanza di 15m per ogni dispositivo. La rete Mesh Bluetooth può essere controllata da remoto tramite Wifi grazie alla connessione del gateway Bluetooth il quale a sua volta può connettersi ai dispositivi voice control Alexa e Google. Per tutti gli utenti, i prodotti mesh Bluetooth sono anche comodi da usare. Abilitata da una rete di dispositivi su larga scala e in grado di sfruttare il basso consumo energetico, una rete mesh Bluetooth può supportare migliaia di dispositivi che lavorano contemporaneamente. Quindi, non importa se sei a casa o in ufficio, puoi sempre eseguire un gran numero di dispositivi intelligenti connessi allo stesso tempo. Di conseguenza, i prodotti Bluetooth mesh smart forniscono una gamma completa di comodità per vivere e lavorare senza preoccuparsi degli alti costi energetici. Nella casa intelligente, il Bluetooth abbassa la soglia di utilizzo dei dispositivi domestici intelligenti con il suo basso consumo energetico, l'elevata compatibilità e le caratteristiche di alta sicurezza, fornendo un'esperienza domestica più economica, più user-friendly e più intelligente. Senza l'autorizzazione dell'utente, il segnale Bluetooth non sarà in grado di connettersi e tracciare il dispositivo, proteggendo la privacy dell'utente.

**SMART INTEC Bluetooth Sig Mesh** Bluetooth mesh has been well received across the industrial, commercial and domestic lighting, as one of the easiest and much convenient smart lighting control systems playing a key role in facilitating the inter-dialogue between lighting devices. Our Bluetooth mesh items can be connected with the smart devices through the APP Smart Intec and each lighting device can communicate with other infinite number of devices through the mesh network with all other devices within a distance of 15m. The Bluetooth mesh network can be controlled from remote area through Wifi thank to the connection of Bluetooth gateway that can connect in turn to Alexa and Google voice controls. For individual users, Bluetooth mesh products are also convenient to use. Enabled by a large-scale device network and able to take advantage of low power consumption, a Bluetooth mesh network can support thousands of devices working simultaneously. So, no matter if you are at home or in the office, you can always run a large number of connected smart devices at the same time. As a result, Bluetooth mesh smart products provide a full range of conveniences for living and working without worrying about high energy costs. In the smart home, Bluetooth lowers the threshold of using smart home devices with its low power consumption, high compatibility, and high-security characteristics, providing a lower cost, more user-friendly, and smarter home experience. Without the user's permission, the Bluetooth signal will not be able to connect and track any device, protecting the user's privacy.

# CARATTERISTICHE PRODOTTO / PRODUCT FEATURES

 <p>LED integrato SMD / Built-in SMD LED</p>	 <p>LED integrato COB / Built-in COB LED</p>	 <p>Prodotto ad alta efficienza luminosa / High luminous efficiency product</p>	   <p>Prodotto RGB / RGB product</p> <p>Prodotto RGB+UV / RGB+UV product</p> <p>Prodotto RGB+bianco+UV / RGB+white+UV product</p>	 <p>Prodotto RAINBOW / RAINBOW product</p>
 <p>Prodotto CCT (bianco dinamico) / Adjustable white</p>	 <p><b>Selectable color temperature (2700K 3000K 4000K)</b> Interruttore interno per la personalizzazione dei Kelvin / Internal switch for customization of Kelvin</p>	 <p><b>Selectable color temperature (3000K 4000K 6000K)</b> Interruttore interno per la personalizzazione dei Kelvin / Internal switch for customization of Kelvin</p>	 <p><b>Selectable color temperature (3000K 4000K)</b> Interruttore interno per la personalizzazione dei Kelvin / Internal switch for customization of Kelvin</p>	 <p><b>3 step CCT</b> Regolazione luce calda, naturale, fredda. Memory function tramite interruttore a parete / Warm, natural and cold light control. Memory function by means of a wall switch</p>
 <p><b>TOUCH DIMMER</b></p> <p><b>Touch dimmer</b> Intensità di luce regolabile / Dimmable light intensity</p>	  <p><b>Dimming</b> Intensità di luce regolabile a taglio di fase / Adjustable light intensity by phase cut-out dimmer</p>	   <p><b>3 step DIM</b> I prodotti 3 step dimmer permettono di regolare l'intensità luminosa utilizzando l'interruttore di casa / 3 step dimming function: modulation of light intensity by wall switch</p> <p>x1-100% x2-50% x3-10%</p>	 <p><b>Touch step dimming</b> Interruttore touch 3 luminosità / Step - 3 step brightness touch switch</p>	
  <p><b>SWITCH TOUCH</b> <b>TOUCH CONTROL</b></p> <p>Interruttore touch integrato / Built-in touch switch</p>	  <p><b>Indice resa cromatica / Colour rendering index</b></p>			

   
Prodotto UGR /  
Unified glare rating

UGR è un indice unificato in campo internazionale, sviluppato dalla CIE (commission international de l'Enclaireage), per la valutazione dell'abbagliamento diretto derivante dall'impianto di illuminazione. La norma europea per l'illuminazione dei posti di lavoro in interni **UNI-EN 12464-1** richiede un valore UGR specifico per ogni applicazione, compreso tra **10 e 30: più basso è il valore, minore è l'abbagliamento.**

UGR is an international unified data, developed by CIE (commission international de l'Enclaireage) for the evaluation of the glancing degree of the light sources. The European norme for the lighting of te specialical working place **UNI-EN 12464-1** requires a value UGR for every application, included between **10 and 30: lower is the value, lower is the anti glare ratee.**





Attacco sorgente /  
Light source

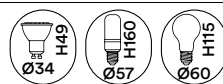

Misura lampadina consigliata /  
Recommended bulb size



Luce emergenza /  
Emergency light



Prodotto ad energia solare /  
Solar energy product



Calpestabile /  
Walkable

max 2000kg



Prodotto indoor e outdoor /  
Indoor e outdoor product



Connessione bluetooth /  
Bluetooth connection



Gesso verniciabile /  
Gypsum paintable



Cemento /  
Concrete



Prodotto galleggiante /  
Floating product



Prodotto anticorrosione /  
Corrosion-free



Incassi: direzione fascio di luce asimmetrica /  
Recessed lamps: description of asymmetrical light emission type



Plafoniere: direzione fascio di luce /  
Ceiling lamps: description of light emission type

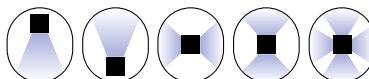

Applique: direzione fascio di luce /  
Wall lamps: description of light emission type

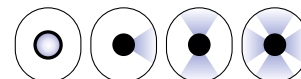

Incassi e segnapassi: direzione fascio di luce /  
Inground and walk lights: description of light emission type

# GRADI DI PROTEZIONE / IP PROTECTION RATE



## Classe IP / IP Class

**Tutti i prodotti presenti nel catalogo senza specifica grado IP si intendono IP20.**

All items in the catalogue without IP rating specific are IP20.



### Protezione da corpi solidi Protection against solid bodies

- 0**  
Nessuna protezione /  
No protection
- 1**  
Protetto contro corpi solidi di dimensioni superiori a 50 mm /  
Protected against solid bodies larger than 50 mm
- 2**  
Protetto contro corpi solidi di dimensioni superiori a 12 mm /  
Protected against solid bodies larger than 12 mm
- 3**  
Protetto contro corpi solidi di dimensioni superiori a 2,5 mm /  
Protected against solid bodies larger than 2,5 mm
- 4**  
Protetto contro corpi solidi di dimensioni superiori a 1 mm /  
Protected against solid bodies larger than 1 mm
- 5**  
Protetto dalla polvere senza deposito dannoso /  
Protected against dust no harmful deposit
- 6**  
Completamente protetto dalla polvere /  
Completely protected against dust

### Protezione da liquidi Protection against liquids

- 0**  
Nessuna protezione /  
No protection
- 1**  
Protetto contro le gocce d'acqua a caduta verticale /  
Protected against vertically-falling drops of water
- 2**  
Protetto contro le gocce d'acqua che cadono fino a 15° dalla verticale /  
Protected against drops of water falling at up to 15° from the vertical
- 3**  
Protetto contro le gocce d'acqua che cadono fino a 60° dalla verticale /  
Protected against drops of water falling at up to 60° from the vertical
- 4**  
Protetto contro le gocce d'acqua da tutte le direzioni /  
Protected against projections of water from all directions
- 5**  
Protetto da getti d'acqua da tutte le direzioni /  
Protected against jets of water from all directions
- 6**  
Protetto da getti d'acqua con una forte forza d'impatto /  
Protected against jets of water of similar force heavy seas
- 7**  
Protetto dagli effetti dell' immersione /  
Protected against the effects of immersion
- 8**  
Protetto contro gli effetti prolungati dell'immersione sotto pressione /  
Protected against pro-longed the effects of immersion under pressure



## Classe IK / IK Class

**Gradi di protezione degli involucri per apparecchiature elettriche contro impatti meccanici esterni.**

Degrees of protection for enclosures for electrical equipment against external mechanical impacts.

IK	Energia d'impatto (in Joules) / Impact energy (in Joules)
00	0
01	0,15
02	0,2
03	0,35
04	0,5
05	0,7
06	1
07	2
08	5
09	10
10	20

Classe isolamento elettrico /  
Appliance class

**Le classi di isolamento elettrico sono il raggruppamento omogeneo definito dall'IEC (International Electrotechnical Commission) delle caratteristiche tecniche applicabili ad un dispositivo elettrico per limitare i rischi di folgorazione conseguenti ad un guasto dello stesso.**

The electrical insulation classes are the homogeneous grouping defined by the IEC (International Electrotechnical Commission) of the technical characteristics applicable to an electrical device to limit the risk of electrocution resulting from its failure.

**I**  Questi apparecchi devono avere il telaio collegato alla terra elettrica da un conduttore di terra separato / These appliance must have their chassis connected to electrical earth by a separate earth conductor

**II**  Questi apparecchi sono progettati in modo da non richiedere la connessione delle messe a terra / These appliance are designed in such a way that it does not require a safety connection to electrical earth

**III**  Questi apparecchi sono progettati per essere alimentati da una fonte di alimentazione a bassissima tensione separata di sicurezza / These appliance are designed to be supplied from a separated/safety extra-low voltage power source

Certificazione e normative /  
Certification and regulations



Tutti i nostri prodotti sono certificati e conformi alle normative vigenti nella comunità Europea / All our products comply with CE norms and current European standards



EMC - Direttiva Europea sulla compatibilità elettromagnetica / EMC - European electromagnetic compatibility directive



Prodotto dimmerabile / Product dimmable



Prodotto non dimmerabile / Product not dimmable



DALI - Digital Addressable Lighting Interface Sistema di controllo domotico della luce / DALI - Digital Addressable Lighting Interface Domotic lighting control system



Dimensione foro quadrato per incasso a soffitto / Square cut-out size for ceiling recessed lamps



Dimensione foro rotondo per incasso a soffitto / Round cut-out size for ceiling recessed lamps



Dimensione foro quadrato per incasso a parete / Square cut-out size for wall recessed lamps



Dimensione foro rotondo per incasso a parete / Round cut-out size for wall recessed lamps

INDICE PER CATEGORIE /  
INDEX BY CATEGORY

---

**Indoor:**

- 034** SISTEMA BINARI /  
TRACK LIGHTS
- 126** INCASSI /  
RECESSED LAMPS
- 224** SISTEMI D'ILLUMINAZIONE  
MULTIFUNZIONE /  
MULTI-FUNCTION  
LIGHTING SYSTEM
- 260** APPLIQUE E PLAFONIERE /  
WALL LAMP AND CEILING LAMPS
- 286** VENTILATORI /  
FANS
- 314** SOTTOPENSILI E BARRE LED /  
CABINETS AND LEDBARS
- 336** PROFILI E STRIP LED /  
PROFILES AND STRIP LED

---

**Emergency:**

- 436** LAMPADE D'EMERGENZA /  
EMERGENCY LAMPS

---

**Outdoor:**

- 446** APPLIQUE /  
WALL LAMPS
- 528** PLAFONIERE /  
CEILING LAMPS
- 566** APPLIQUE, SOSPENSIONI  
E PALETTI CORRELATI /  
WALL, SUSPENSION AND  
FLOOR LAMPS COMBINED
- 662** LAMPADE DA TAVOLO  
RICARICABILI /  
RECHARGEABLE  
TABLE LAMPS
- 684** INCASSI E SEGNAPASSI /  
INGROUND AND WALK LIGHTS
- 720** SOLARI /  
SOLAR LAMPS
- 740** PROIETTORI /  
FLOOD LIGHTS
- 770** STRADALI /  
STREET LIGHTS

---

**Industrial:**

- 786** HIGH BAY & TRI-PROOF

---

**Decorative:**

- 798** EASY DOMOTIC 24V /
- 812** LUCI DECORATIVE  
TECNICHE DMX /  
DMX TECHNICAL  
DECORATION LIGHTING

---

**Accessories:**

- 840** COMPONENTISTICA /  
LIGHTING COMPONENTS

# INDICE FOTOGRAFICO / PHOTOGRAPHIC INDEX

## Indoor: SISTEMA BINARI / TRACK LIGHTS

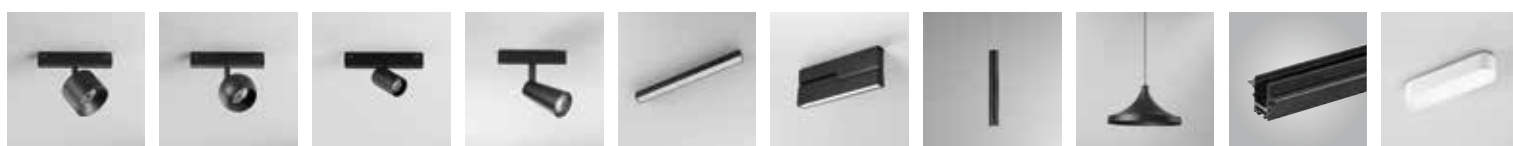

SHOT  
48

GOAL  
49

FANS  
50

TEMA  
52

LINE  
54

SLIDE  
56

TUBO  
57

CYMBAL  
59

DA VINCI  
accessories  
60-65

BERNINI LINE  
70-72



BERNINI FANS  
74

BERNINI TUBO  
75

BERNINI  
accessories  
76-79

EXPLORER  
84

PLANE  
86

JET ALTO  
LUMEN  
88

**DALI**  
JET  
90

JET FOOD  
92

OBOE  
93

ROCKET  
94



ROCKET  
applique  
95

SQUIB  
96

EXPRESS  
96

CLOCK  
97

MAXWELL  
98

HELP TRACK  
100

RAIL  
accessories  
102-107

**DALI**  
RAIL accessories  
108-113

TRACK  
accessories  
114-115

BUSBAR  
120-123



BUSBAR  
accessories  
124-125

**Indoor:**  
INCASSI /  
RECESSED LAMPS



APOLLO  
128-130



OUTSIDER  
132-134



DALI  
DELTA INC  
136



LYBRA  
138



DAMA  
139



FIBRA OTTICA  
140



STARLIGHT  
142



STARLIGHT30  
142



ASSO KIT 3  
144



EASY  
DOMOTICA  
ASSO  
146



DALI  
DOT  
148



HYDE  
150



SINKRO  
152



ELITE  
154



DALI  
QUARK  
156



XANTO  
158-160



MACK  
162



TRON  
164



SLIM CCT  
166



FLAP CCT  
168



TOTAL  
170



PLUS  
172



SNIPER  
174



GLOW  
175



POLARIS  
176



ORIONE  
177



FUSION  
178



BLITZ  
180



NEMO  
181



EASY  
DOMOTICA  
RAINBOW  
182



ZENIT  
183



DALI  
QUANTUM  
184



HORUS  
186



MATRIX  
188-190



TUBEX  
192



STARRY  
194



GHOST  
195



VULKAN  
196



ENTITY  
197



GOBLET  
198



SHADOW  
199



PHANTOM  
200



SPETTRO  
201



MINI  
202



HIVE  
203



SPIRIT  
204



SNOW  
205



MORGANA  
206



SENSO  
207



BRICK  
208



EVA  
209



SKILIFT  
210



ARIEL  
212



ANIMA  
214



STENOS  
216



VIPER  
218



AYRIS  
220



REFLEX  
222

**Indoor:**

SISTEMI D'ILLUMINAZIONE MULTIFUNZIONE /  
MULTI-FUNCTION LIGHTING SYSTEM



SHANE  
226



SHANE  
accessories  
231



NEXT  
232-236



NEXT  
accessories  
237



SEGMENTO  
238-241



METRO  
242

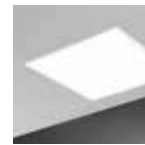

PANEL PRO  
244



PANEL BK CCT  
246



PANEL BK  
248

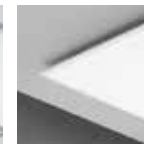

PANEL RGB  
250



PANEL IP65  
250

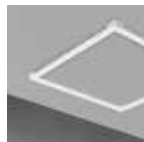

PANEL FR  
252

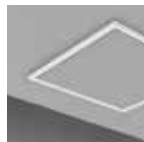

PANEL EDG  
252



PANEL SM  
253



PANEL BIS  
254



PANEL  
accessories  
256



PANEL DJ  
258

**Indoor:**

APPLIQUE E PLAFONIERE /  
WALL LAMPS AND CEILING LAMPS



KLIO CCT  
262



MIG  
264



GENESIS  
266



TOWN  
268



DOMO  
270



BLASTER  
272



CRUISE  
273



YACHT  
274



NOIR  
275



LANCER  
276



SACS  
278



RIVA  
279



AQA  
280



WALLY  
281



DIVA  
282



F1  
284



ROBY  
284



Q1  
285



**Indoor:**  
VENTILATORI /  
FANS



**Indoor:**  
SOTTOPENSILI E BARRE LED /  
CABINETS AND LEDBARS

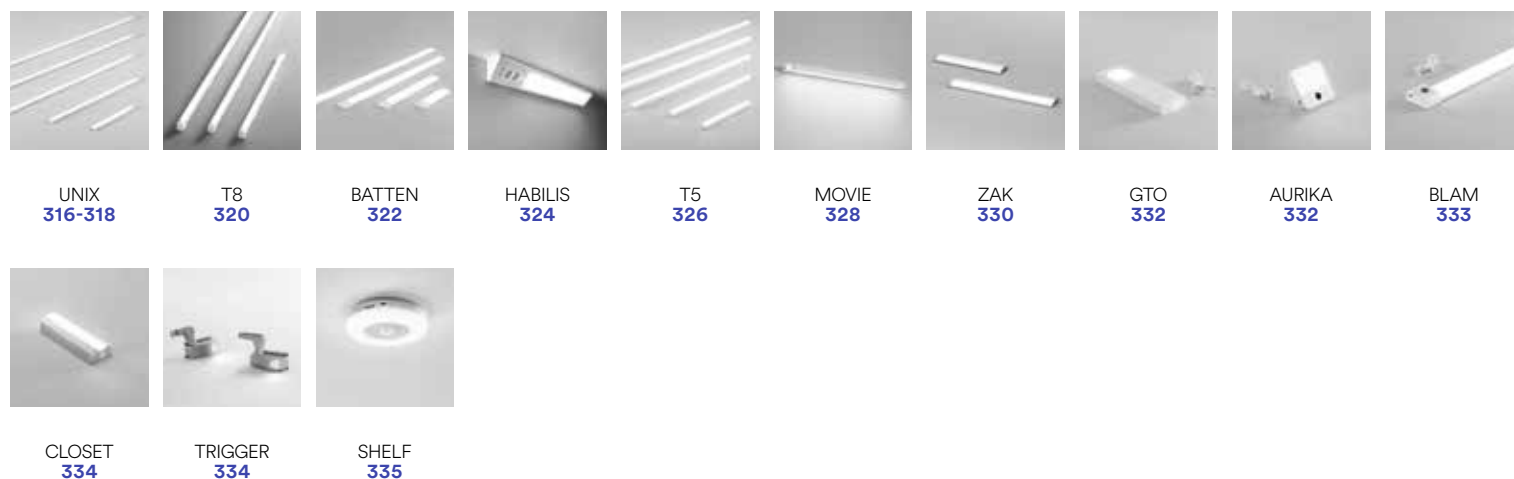

**Indoor:**

**PROFILI E STRIP LED /  
PROFILES AND STRIP LED**

GORIZIA PROFILE 340	BEND PROFILE 342	EDGE PROFILE 344	RIDGE PROFILE 346	ANGLE PROFILE 347	BERLINO PROFILE 348	ROMA PROFILE 350	MICRO PROFILE 352	INCR0 PROFILE 353	LOOP PROFILE 356
LINEA PROFILE 358	MILANO PROFILE 360	ULTRA PROFILE 362	CAMELOT PROFILE 364	TUBE PROFILE 366	NEWYORK PROFILE 368	DORIK PROFILE 370	IONIK PROFILE 371	STEPWAY PROFILE 372	DRIVEWAY PROFILE 374
GASH PROFILE 378	TRIM PROFILE 380	MOP PROFILE 381	VEIL PROFILE 382	WING PROFILE 383	DUAL PROFILE 384	INVISILINE PROFILE 388	PROFY BIS PROFILE 390	PROFY MONO PROFILE 390	PROFY GIMEL PROFILE 392
PROFY VELA PROFILE 392	PIANO PROFILE 395	PROFILE accessories 396	EASY DOMOTICA STRIP24V COB DIGITAL 398	EASY DOMOTICA STRIP24V COB RGB DIGITAL 399	EASY DOMOTICA STRIP24V 2835 IP67 120 400	EASY DOMOTICA STRIP24V 2835 5W 401	EASY DOMOTICA STRIP24V R20 2835 120 402	EASY DOMOTICA STRIP24V R20 COB 480 403	EASY DOMOTICA STRIP24V 2835 HL 128 404
EASY DOMOTICA STRIP24V FOOD 405	EASY DOMOTICA STRIP24V COB 406	EASY DOMOTICA STRIP24V COB IP67 407	EASY DOMOTICA STRIP24V 2835 3D 408	EASY DOMOTICA STRIP24V SLIM 120 409	EASY DOMOTICA STRIP24V 2835 60 410	EASY DOMOTICA STRIP24V 2835 60 IP67 411	EASY DOMOTICA STRIP24V 2835 120 412	EASY DOMOTICA STRIP24V 2835 120 IP68 413	EASY DOMOTICA STRIP24V 2835 CCT 414
EASY DOMOTICA STRIP24V 2835 240 415	EASY DOMOTICA STRIP24V 5050 60 416	EASY DOMOTICA STRIP24V 5050 60 IP67 417	EASY DOMOTICA STRIP24V 5050 RGB 418	EASY DOMOTICA STRIP24V 5050 RGB IP67 419	EASY DOMOTICA STRIP24V 5050 RGBW 420	EASY DOMOTICA STRIP24V 5050 RGBW IP68 421	STRIP230V SMD 422	STRIP230V COB 423	STRIP24V 5050 3D RGBW 424
EASY DOMOTICA STRIP 24V 5050 RGB CCT 425	EASY DOMOTICA STRIP24V 3838 168 RGB 426	WI-FI STRIP24V 5050 RGBW INT 428	WI-FI STRIP24V 2835 INT 429	EASY DOMOTICA INSIGN 430	STRIP SURROUND 431	EASY DOMOTICA FLEX24V 10X10 432	EASY DOMOTICA FLEX24V 6X6 433	EASY DOMOTICA FLEX24V 6X13 434	

**Indoor:**  
LAMPADRE D'EMERGENZA /  
EMERGENCY LAMPS



HUBLOT HELP 438    HELP INC 440    HELP TRACK 441    HELP EXIT 442    HELP 511 443    HELP 503 444    BOLT HELP 445

**Outdoor:**  
APPLIQUE /  
WALL LAMPS



COMPACT 448    DETROIT 449    ZODIAC 450    STEALTH 452    MIURA 454    GAMMA 455    VEYRON 456    BIOME 458    GOLF 460    POLO 462



RAY 464    TWIN 466-468    DESERT 470    DUKROT 472    WEISS 474    BORDER 476    LUXON 478    GRIS 480    AGERA 482    BOXTER 484



KLEIN 486    BEETLE 488    RIBBON 490    LASER 492    ALFA 494-496    DELTA 498    PARKER 500-502    PORTLAND 504    OAKLAND 505    JUMP 506



ONE 508    QUBO 510    TUCSON 512    HURACAN 514    SEATTLE 515    AUSTIN 516    BOSTON 518    ATLANTA 519    DENVER 519    MONDRIAN 520



GAETA 521    GRUBB 522    AKRON 523    PEG 524    TOGO 526

**Outdoor:**  
PLAFONIERE /  
CEILING LAMPS

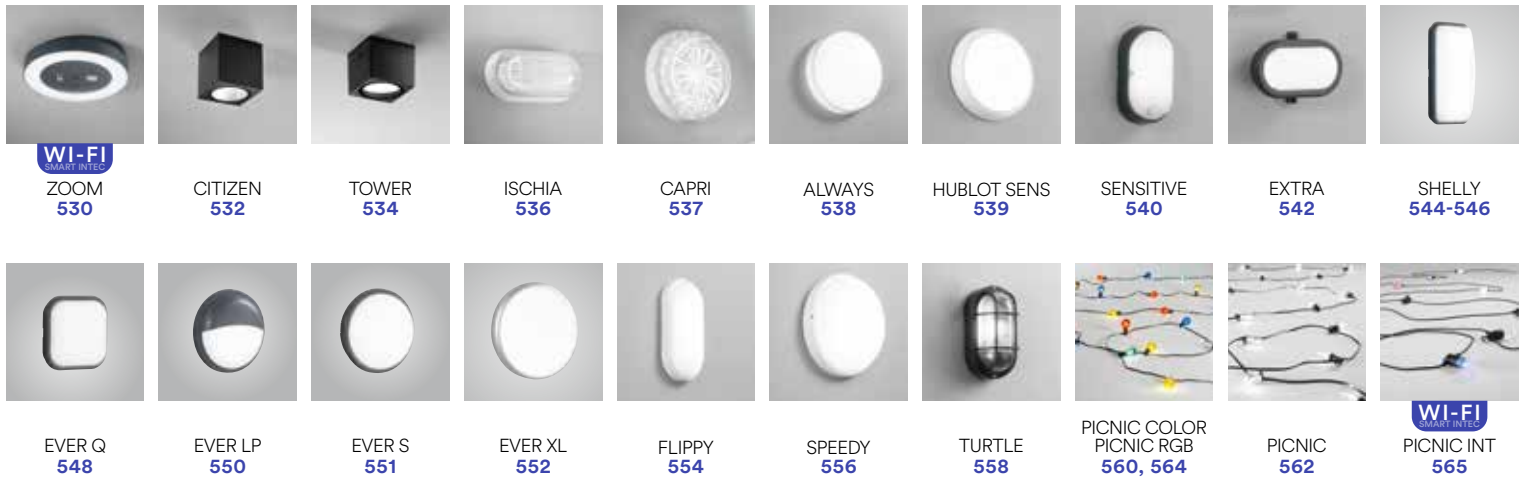

**Outdoor:**  
APPLIQUE SOSPENSIONI E PALETTI CORRELATI /  
WALL SUSPENSION AND FLOOR LAMPS COMBINED

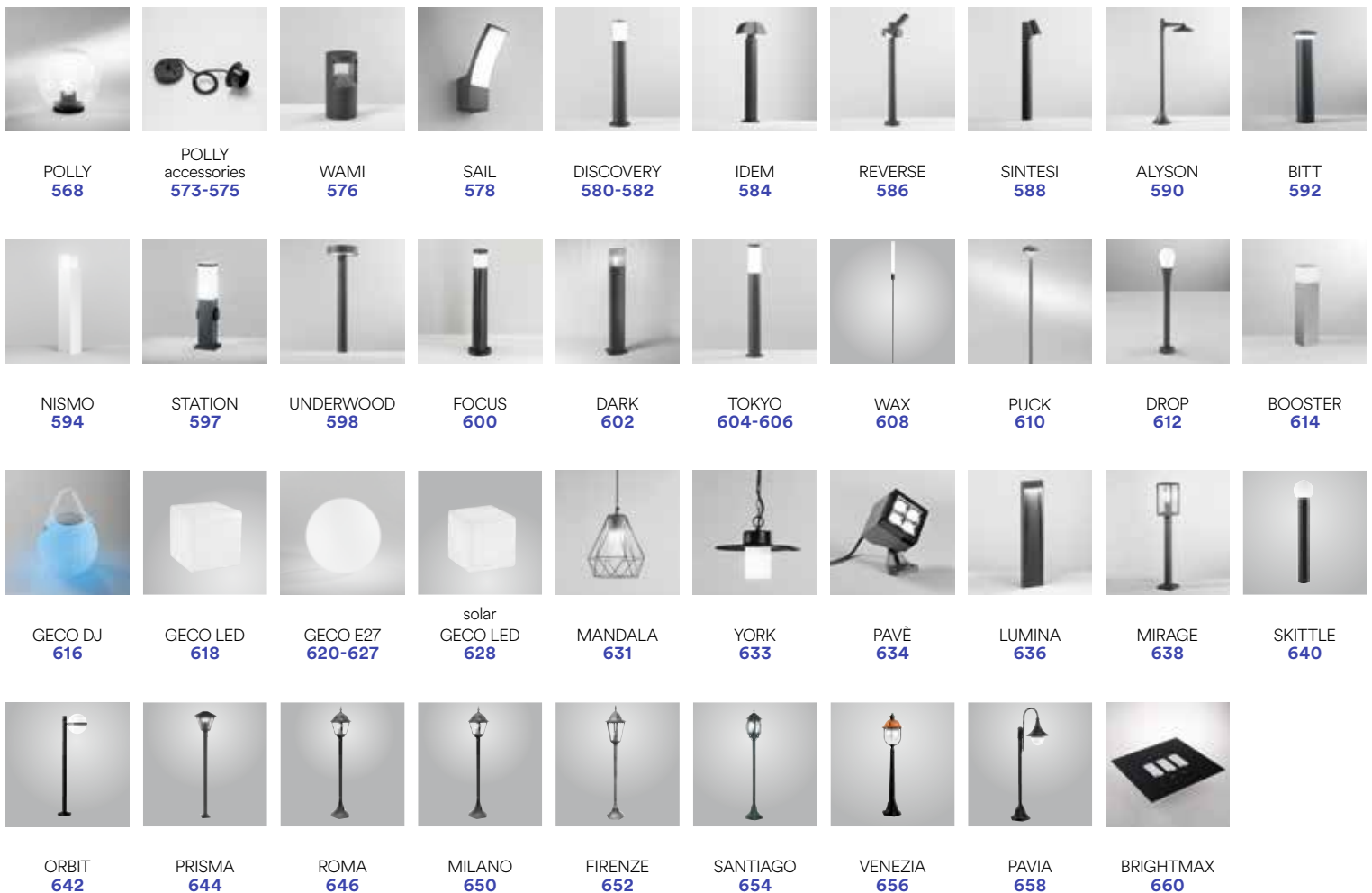

**Outdoor:**LAMPADRE DA TAVOLO RICARICABILI /  
RECHARGEABLE TABLE LAMPPARTY  
664LIBERTY  
667SMALL DRINK  
668DRINK  
670JAMMIN  
672BRIO  
674MYKES  
676COCKTAIL  
678CLIMAX  
680OBERON  
683**Outdoor:**INCASSI E SEGNAPASSI /  
INGROUND AND WALK LIGHTSBARRET  
686SUBWAY  
687RIDER  
688-690EASY  
DOMOTICA  
IMPACT  
691EASY  
DOMOTICA  
STEP  
692WALK  
694-696HUMMER  
698DRIVE  
700ELMO  
702GROUND  
704ONYX  
706STRATOS  
708SLAB  
710BREEN  
712SMILE  
714BOLT  
716STEPLIGHT  
718SHELBY  
719**Outdoor:**SOLARI /  
SOLAR LAMPSKYOTO  
722ENYA  
723TED  
724ALBERT  
725COSMO  
726ELIOS  
728EOS  
729SKYP  
730OPEN  
731ARGO  
733SHIVA  
734ULYSSE  
735GLASER  
736LUXOR  
739

---

**Outdoor:**  
PROIETTORI /  
FLOOD LIGHTS



**WI-FI**  
SMART-INTC  
VYSOR  
742



BANNER  
744



SAT  
746



AXEL  
748-750



AXEL SENSOR  
752



AXEL PORTABLE  
753

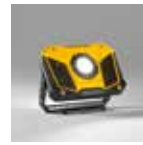

BULL  
754



KNOX  
756



ATHOS  
758



TAURUS  
760



FLOOD LIGHTS  
accessories  
762



GIOVE  
764



MASTER  
766



ENERGY  
768

---

**Outdoor:**  
STRADALI /  
STREET LIGHTS



AUREUS  
772



RADIUS  
774



FEBO  
776



IPERION  
778



STREETWAY  
780



HIGHWAY  
782



POLIS  
784

---

**Outdoor:**  
HIGH BAY & TRI-PROOF



AVATAR  
788



ATLANTIC  
790



NAUTILUS  
792



ARTIC  
794



OCEAN  
796

**Decorative:**  
EASY DOMOTIC 24V

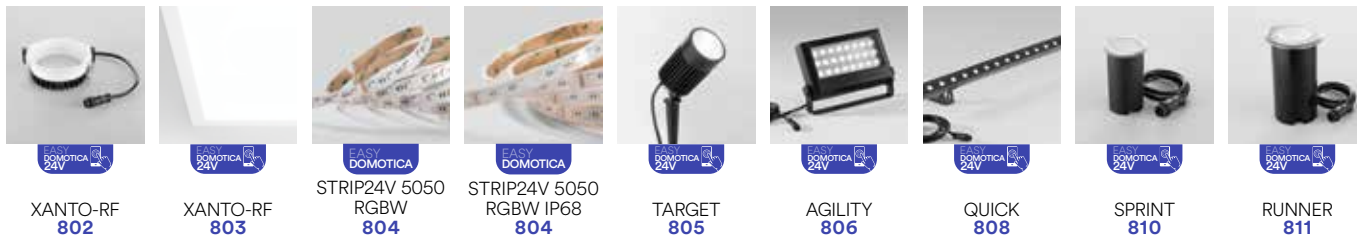

**Decorative:**  
LUCI DECORATIVE TECNICHE DMX /  
DMX TECHNICAL DECORATION LIGHTING

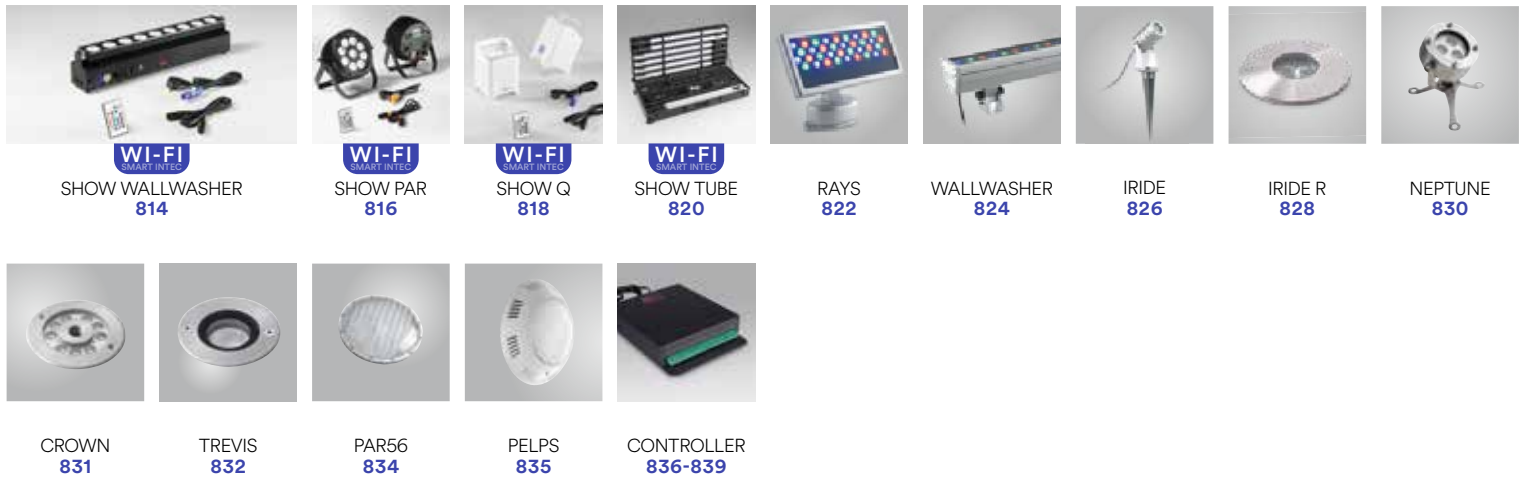

**Outdoor:**  
COMPONENTISTICA /  
LIGHTING COMPONENTS

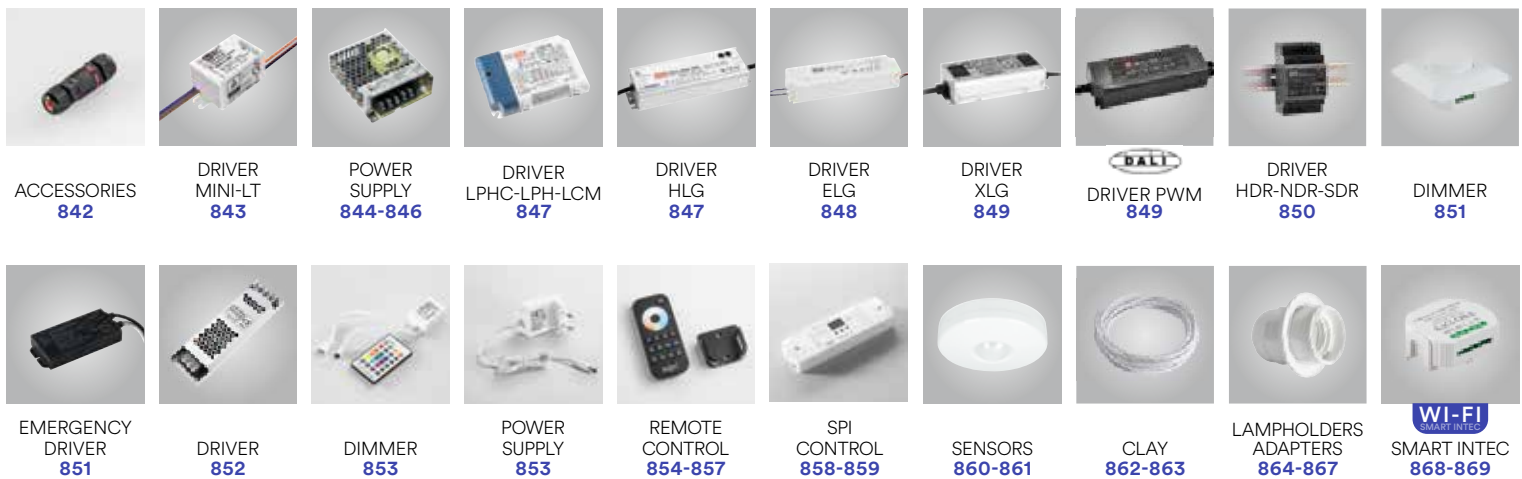

# INDICE ALFABETICO / ALPHABETICAL INDEX

articolo / article

pagina / page

AGERA	<b>482</b>
AGILITY Easy Domotica 24V	<b>806</b>
AKRON	<b>523</b>
ALBATROS	<b>292</b>
ALBERT	<b>725</b>
ALFA	<b>494-497</b>
ALISEO	<b>305</b>
ALWAYS	<b>538</b>
ALYSON	<b>590</b>
ANGLE PROFILE	<b>347</b>
ANIMA	<b>214</b>
APOLLO	<b>128-131</b>
AQA	<b>280</b>
ARGO	<b>733</b>
ARIEL	<b>212</b>
ARTIC	<b>794</b>
ASSO	<b>146</b>
ASSO KIT 3	<b>144</b>
ATHOS	<b>758</b>
ATLANTA	<b>519</b>
ATLANTIC	<b>790</b>
AUREUS	<b>772</b>
AURIKA	<b>332</b>
AUSTER	<b>298</b>
AUSTIN	<b>516</b>
AVATAR	<b>788</b>
AXEL	<b>748-751</b>
AXEL PORTABLE	<b>753</b>
AXEL SENSOR	<b>752</b>
AYRIS	<b>220</b>
BANNER	<b>744</b>
BARRET	<b>686</b>
BATTEN	<b>322</b>
BEEBLE	<b>488</b>
BEND PROFILE	<b>342</b>
BERLINO PROFILE	<b>348</b>
BERNINI FANS	<b>74</b>

articolo / article

pagina / page

BERNINI LINE	<b>70-73</b>
BERNINI PROJECT 48V	<b>66-69</b>
BERNINI PROJECT 48V Accessories	<b>76-79</b>
BERNINI TUBO	<b>75</b>
BIOME	<b>458</b>
BITT	<b>592</b>
BLAM	<b>333</b>
BLASTER	<b>272</b>
BLITZ	<b>180</b>
BLYTH	<b>290</b>
BOLT	<b>716</b>
BOLT HELP	<b>445</b>
BOOSTER	<b>614</b>
BORDER	<b>476</b>
BOREA	<b>303</b>
BOSTON	<b>518</b>
BOXTER	<b>484</b>
BREEN	<b>712</b>
BRICK	<b>208</b>
BRIGHTMAX	<b>660</b>
BRIO	<b>674</b>
BULL	<b>754</b>
BUSBAR	<b>120-123</b>
BUSBAR Accessories	<b>124</b>
BUSBAR Trunking System	<b>116-119</b>
CAMELOT PROFILE	<b>364</b>
CAPRI	<b>537</b>
CITIZEN	<b>532</b>
CLAY	<b>862</b>
CLIMAX	<b>680</b>
CLOCK	<b>97</b>
CLOSET	<b>334</b>
COCKTAIL	<b>678</b>
COMPACT	<b>448</b>
CONTROLLER	<b>836-839</b>

articolo / article

pagina / page

COSMO	<b>726</b>
CROWN	<b>831</b>
CRUISE	<b>273</b>
CYMBAL	<b>59</b>
DA VINCI PROJECT 48V	<b>36-47</b>
DA VINCI PROJECT 48V Accessories	<b>60-65</b>
DAMA	<b>139</b>
DARK	<b>602</b>
DELTA	<b>498</b>
DELTA INC	<b>136</b>
DENVER	<b>519</b>
DESERT	<b>470</b>
DETROIT	<b>449</b>
DIMMER	<b>851, 853</b>
DISCOVERY	<b>580-583</b>
DIVA	<b>282</b>
DOMO	<b>270</b>
DORIK PROFILE	<b>370</b>
DOT	<b>148</b>
DRINK	<b>670</b>
DRIVE	<b>700</b>
DRIVER	<b>843 847-852</b>
DRIVEWAY PROFILE	<b>374</b>
DROP	<b>612</b>
DUAL PROFILE	<b>384</b>
DUKROT	<b>472</b>
EDGE PROFILE	<b>344</b>
ELIOS	<b>728</b>
ELITE	<b>154</b>
ELMO	<b>702</b>
ENERGY	<b>768</b>
ENTITY	<b>197</b>
ENYA	<b>723</b>
EOS	<b>729</b>
ESPERO	<b>313</b>
ETESIA	<b>310</b>



articolo / article

pagina / page

EVA	209
EVER	548-553
EXPLORER	84
EXPRESS	96
EXTRA	542
F1	284
FANS	50
FEBO	776
FIBRA OTTICA	140
FIRENZE	652
FLAP CCT	168
FLEX24V 10X10	432
FLEX24V 6X13	434
FLEX24V 6X6	433
FLIPPY	554
FLOOD LIGHTS Accessories	762
FOCUS	600
FOEHN	305
FUSION	178
GAETA	521
GAMMA	455
GASH PROFILE	378
GECO DJ	616
GECO E27	620-627
GECO LED	618
GECO LED SOLAR	629
GENESIS	266
GHOST	195
GIOVE	764
GLASER	736
GLOW	175
GOAL	49
GOBLET	198
GOLF	460
GORIZIA PROFILE	340
GRECALE	306
GRIS	480

articolo / article

pagina / page

GROUND	704
GRUBB	522
GTO	332
HABILIS	324
HADLEY	296
HELP 503	444
HELP 511	443
HELP EXIT	442
HELP INC	440
HELP TRACK	100
HELP TRACK	441
HERON	288
HIGHWAY	782
HIVE	203
HORUS	186
HUBLOT HELP	438
HUBLOT SENS	539
HUMMER	698
HURACAN	514
HYDE	150
IDEM	584
IMPACT	691
INCRO PROFILE	353
INSIGN	430
INVISILINE PROFILE	388
IONIK PROFILE	371
IPERION	778
IRIDE	826-829
ISCHIA	536
JAMMIN	672
JET	90
JET ALTO LUMEN	88
JET FOOD	92
JUMP	506
KLEIN	486
KLIO CCT	262
KNOX	756
KYOTO	722

articolo / article

pagina / page

LAMP HOLDERS	864-867
LANCER	276
LASER	492
LEVANTE	309
LIBERTY	667
LINE	54
LINEA PROFILE	358
LOOP PROFILE	356
LUMINA	636
LUXON	478
LUXOR	739
LYBRA	138
MACK	162
MAGNUS	294
MANDALA	631
MASTER	766
MATRIX	188-191
MAXWELL	98
METRO	242
MICRO PROFILE	352
MIG	264
MILANO	650
MILANO PROFILE	360
MINI	202
MIRAGE	638
MIURA	454
MONDRIAN	520
MOP PROFILE	381
MORGANA	206
MOVIE	328
MYKES	676
NASHI	313
NAUTILUS	792
NEMO	181
NEPTUNE	830
NEWYORK PROFILE	368
NEXT	232-237
NISMO	594

articolo / article

pagina / page

NOIR	275
OAKLAND	505
OBERON	683
OBOE	93
OCEAN	796
ONE	508
ONYX	706
OPEN	731
ORBIT	642
ORIONE	177
OUTSIDER	132-135
PANEL Accessories	256
PANEL Easy Domotica 24V	803
PANEL BIS	254
PANEL BK	248
PANEL BK CCT	246
PANEL FR / EDG	252
PANEL IP65	250
PANEL PRO	244
PANEL RGB	250
PANEL SM	253
PANEL-DJ	258
PAR56	834
PARKER	500-503
PARTY	664
PAVÈ	634
PAVIA	658
PEG	524
PELPS	835
PHANTOM	200
PIANO PROFILE	395
PICNIC	562
PICNIC COLOR	560
PICNIC INT	565
PICNIC RGB	564
PLANE	86

articolo / article

pagina / page

PLUS	172
POLARIS	176
POLIS	784
POLLY	568-575
POLO	462
PONENTE	311
PORTLAND	504
POWER SUPPLY	844-846 853
PRISMA	644
PROFILE Accessories	396-397
PROFY BIS PROFILE	390
PROFY GIMEL PROFILE	392
PROFY MONO PROFILE	390
PROFY VELA PROFILE	392
PUCK	610
Q1	285
QUANTUM	184
QUARK	156
QUBO	510
QUICK Easy Domotica 24V	808
RADIUS	774
RAIL Accessories	102-107
RAIL DALI Accessories	108-113
RAINBOW	182
RAY	464
RAYS	822
REFLEX	222
REMOTE CONTROL	854-857
REVERSE	586
RIBBON	490
RIDER	688-690
RIDGE PROFILE	346
RIVA	279

articolo / article

pagina / page

ROBY	284
ROCKET	94-95
ROMA	646
ROMA PROFILE	350
RUNNER Easy Domotica 24V	811
SACS	278
SAIL	578
SANTIAGO	654
SAT	746
SCIROCCO	309
SEATTLE	515
SEGMENTO	238-241
SENSITIVE	540
SENSO	207
SENSOR	860-861
SHADOW	199
SHAPE	226-231
SHELBY	719
SHELF	335
SHELLY	544-547
SHIVA	734
SHOT	48
SHOW PAR	816
SHOW Q	818
SHOW TUBE	820
SHOW WALLWASHER	814
SINKRO	152
SINTESI	588
SKILIFT	210
SKITTLE	640
SKYP	730
SKYRON	303
SLAB	710
SLIDE	56
SLIM CCT	166
SMALL DRINK	669
SMART INTEC	868

articolo / article

pagina / page

SMILE	<b>714</b>
SNIPER	<b>174</b>
SNOW	<b>205</b>
SPEEDY	<b>556</b>
SPETTRO	<b>201</b>
SPI CONTROLLER	<b>858-859</b>
SPIRIT	<b>204</b>
SPRINT Easy Domotica 24V	<b>810</b>
SQUIB	<b>96</b>
STARLIGHT	<b>142</b>
STARLIGHT30	<b>142</b>
STARRY	<b>194</b>
STATION	<b>597</b>
STEALTH	<b>452</b>
STENOS	<b>216</b>
STEP	<b>692</b>
STEPLIGHT	<b>718</b>
STEPWAY PROFILE	<b>372</b>
STORM	<b>300</b>
STRATOS	<b>708</b>
STREETWAY	<b>780</b>
STRIP Easy Domotica 24V	<b>804</b>
STRIP SURROUND	<b>431</b>
STRIP230V COB	<b>423</b>
STRIP230V SMD	<b>422</b>
STRIP24V 2835 120	<b>412</b>
STRIP24V 2835 120 IP68	<b>413</b>
STRIP24V 2835 240	<b>415</b>
STRIP24V 2835 3D	<b>408</b>
STRIP24V 2835 5W	<b>401</b>
STRIP24V 2835 60	<b>410</b>
STRIP24V 2835 60 IP67	<b>411</b>
STRIP24V 2835 CCT	<b>414</b>
STRIP24V 2835 HL 128	<b>404</b>
STRIP24V 2835 INT	<b>429</b>
STRIP24V 2835 IP67 120	<b>400</b>

articolo / article

pagina / page

STRIP24V 3838 168 RGB	<b>426</b>
STRIP24V 5050 3D RGBW	<b>424</b>
STRIP24V 5050 60	<b>416</b>
STRIP24V 5050 60 IP67	<b>417</b>
STRIP24V 5050 RGB	<b>418</b>
STRIP24V 5050 RGB CCT	<b>425</b>
STRIP24V 5050 RGB IP67	<b>419</b>
STRIP24V 5050 RGBW	<b>420</b>
STRIP24V 5050 RGBW INT	<b>428</b>
STRIP24V 5050 RGBW IP68	<b>421</b>
STRIP24V COB	<b>406</b>
STRIP24V COB DIGITAL	<b>398</b>
STRIP24V COB IP67	<b>407</b>
STRIP24V COB RGB DIGITAL	<b>399</b>
STRIP24V FOOD	<b>405</b>
STRIP24V R20 2835 120	<b>402</b>
STRIP24V R20 COB 480	<b>403</b>
STRIP24V SLIM 120	<b>409</b>
SUBWAY	<b>687</b>
T5	<b>326</b>
T8	<b>320</b>
TARGET Easy Domotica 24V	<b>805</b>
TAURUS	<b>760</b>
TED	<b>724</b>
TEMA	<b>52</b>
TOGO	<b>526</b>
TOKYO	<b>604-607</b>
TOTAL	<b>170</b>
TOWER	<b>534</b>
TOWN	<b>268</b>
TRACK Accessories	<b>114</b>
TRACK RAIL Three-phase	<b>80-83</b>
TREVIS	<b>832</b>
TRIGGER	<b>334</b>
TRIM PROFILE	<b>380</b>

articolo / article

pagina / page

TRON	<b>164</b>
TUBE PROFILE	<b>366</b>
TUBEX	<b>192</b>
TUBO	<b>57</b>
TUCSON	<b>512</b>
TURTLE	<b>558</b>
TWIN	<b>466-469</b>
ULTRA PROFILE	<b>362</b>
ULYSSE	<b>735</b>
UNDERWOOD	<b>598</b>
UNIX	<b>316-319</b>
VEIL PROFILE	<b>382</b>
VENEZIA	<b>656</b>
VEYRON	<b>456</b>
VIPER	<b>218</b>
VULKAN	<b>196</b>
VYSOR	<b>742</b>
WALK	<b>694-697</b>
WALLWASHER	<b>824</b>
WALLY	<b>281</b>
WAMI	<b>576</b>
WAX	<b>608</b>
WEISS	<b>474</b>
WING PROFILE	<b>383</b>
XANTO	<b>158-161</b>
XANTO-RF Easy Domotica 24V	<b>802</b>
YACHT	<b>274</b>
YORK	<b>633</b>
ZAK	<b>330</b>
ZENIT	<b>183</b>
ZODIAC	<b>450</b>
ZOOM	<b>530</b>



# INDOOR

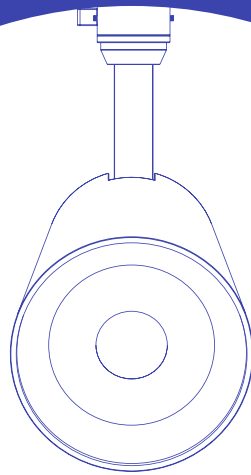

SISTEMA BINARI  
TRACK LIGHTS

# DA VINCI PROJECT **48V**





# DA VINCI PROJECT 48V

INTEC fa un salto nel futuro con il sistema Da Vinci, sistema progettato per integrarsi totalmente con l'architettura degli ambienti. Esso può essere fissato al soffitto o alle pareti, inserito nella muratura ad incasso a filo oppure nella versione a sospensione con luce bi-emissione.

Frutto della ricerca tecnologica più avanzata, il sistema consente di creare luce che scaturisce direttamente dalle pareti o dal soffitto, e gioca con gli spazi abitativi tracciando segni luminosi che variano a seconda della posizione del corpo illuminante, posizione che può essere modificata con la massima versatilità in ogni momento grazie al semplice inserimento dei corpi illuminanti all'interno del binario tramite il fluido sistema di innesti a sfere volventi.

INTEC leap forward into the future with the Da Vinci system, system designed to fully integrate with the architecture environments. It can be fixed to the ceiling or to the walls, inserted in the flush-mounted masonry or mounted in suspension version with single or bi-emission light.

Fruit of most advanced technological research, the system allows you to create light that springs directly from the walls or ceiling, and plays with living spaces by drawing luminous signs that vary according to the position of the luminaire, position which can be modified with maximum versatility at any time thanks to the simple insertion of the led luminous bodies inside the track by means of the fluid ball bearings.

A

## RECESSED TRACK TRIMLESS

Sistema di montaggio a incasso a filo / Recess mount system trimless

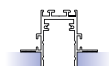

B

## RECESSED TRACK

Sistema di montaggio a incasso con cornice / Recess mount system with external trim

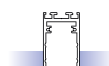

C

## SURFACE MOUNTED

Sistema di montaggio a plafoniera o a sospensione a vista / Ceiling or suspension mounting system

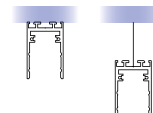

D

## PENDANT

Sistema di montaggio a sospensione bi-emissione / Bi-emission suspension mounting system

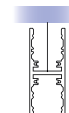





# DA VINCI PROJECT 48V



In base allo spazio da illuminare, è possibile aggiungere, rimuovere o orientare gli apparecchi, quando e dove necessario grazie ad un semplice click. Il sistema Da Vinci a sfere volventi è basato sul sistema plug & play, non ha quindi bisogno di complessi interventi tecnici. Ogni corpo illuminante Da Vinci ha solo bisogno di essere posizionato, inserito ed acceso.

Depending on the space to be illuminated, it is possible to add, remove or orient the appliances when and where necessary thanks to a simple click. The Da Vinci rolling ball system is based on the system plug & play, therefore it does not need complex interventions of technicians. Every Da Vinci luminaire just needs to be positioned, inserted and switched on.

All'interno del binario Da Vinci si può operare con inserimento di una vasta gamma di moduli di illuminazione decorativa sia con fari a spot orientabili, lampade sospese, che con lampade a led lineari fisse o movibili.

Inside the track Da Vinci can be inserted a wide range of decorative lighting modules with headlights, adjustable spots, suspended lamps, and with led linear lamps fixed or movable.

**A**  
**LINE**

Lampada lineare orientabile a led /  
Led adjustable linear lamp

**B**  
**SLIDE**

Lampada lineare orientabile a led /  
Led adjustable linear lamp

**C**  
**GOAL**

Faro luce spot orientabile /  
Spot orientable track light

**D**  
**SHOT**

Faro luce spot orientabile /  
Spot orientable track light

**E**  
**FANS**

Faro luce spot orientabile /  
Spot orientable track light

**F**  
**TEMA**

Faro luce spot orientabile /  
Spot orientable track light

**G**  
**CYMBAL**

Lampada sospensione led /  
Suspension led light

**H**  
**TUBO**

Lampada sospensione led /  
Suspension led light



# DA VINCI PROJECT 48V

Il binario Da Vinci è un binario completamente elettrificato a bassa tensione e si completa con elementi luminosi a led inseribili semplicemente con un click, grazie all'incastro a sfere volventi, lungo tutto il percorso.

La diversificata gamma di corpi illuminanti Da Vinci, e la ampia scelta di forme, angoli e connessioni permettono la realizzazione di disegni illuminotecnici che esprimono la massima dinamicità e poliedricità delle personalizzazioni.

Da Vinci track is a fully electrified low voltage track system and it is completed with led light elements which can be inserted simply with a click, thanks to the joint a rolling spheres, all along the path.

The diversified range of lighting fixtures Da Vinci, and the wide choice of shapes, angles and connections allow the creation of lighting designs which express the maximum dynamism and versatility of the customizations.

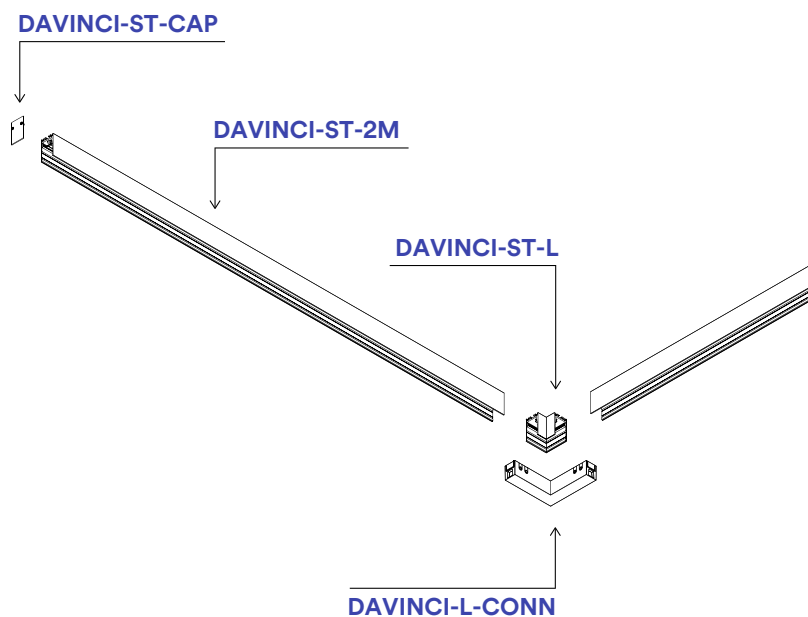
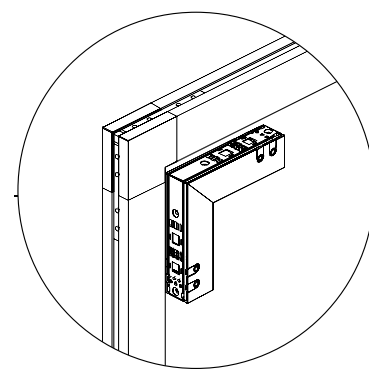

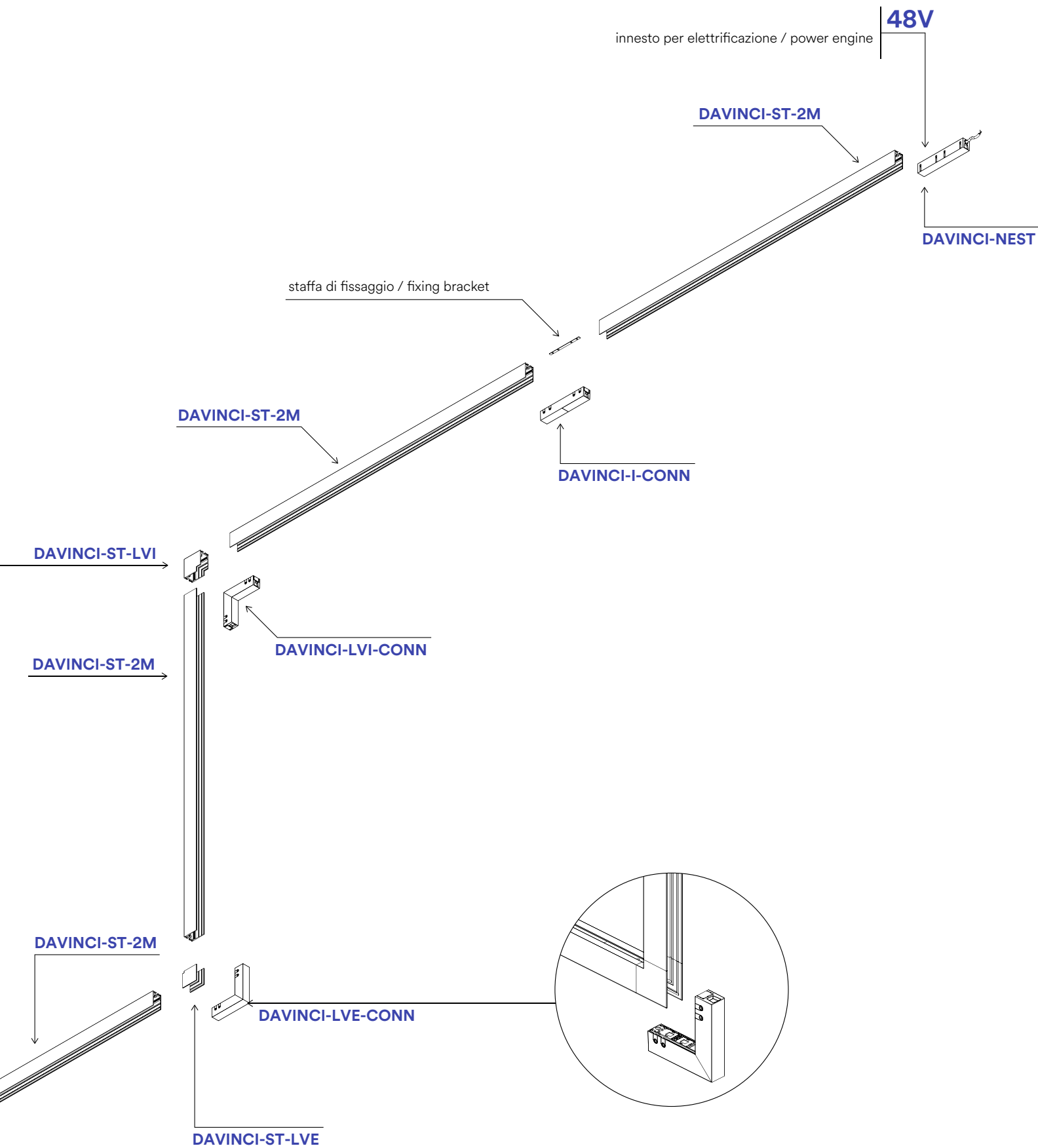

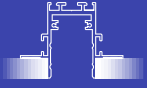

on photo:  
**TUBO / FANS**  
Recess mount system trimless

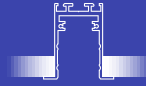

on photo:  
**CYMBAL / TEMA**  
Recess mount system with external trim

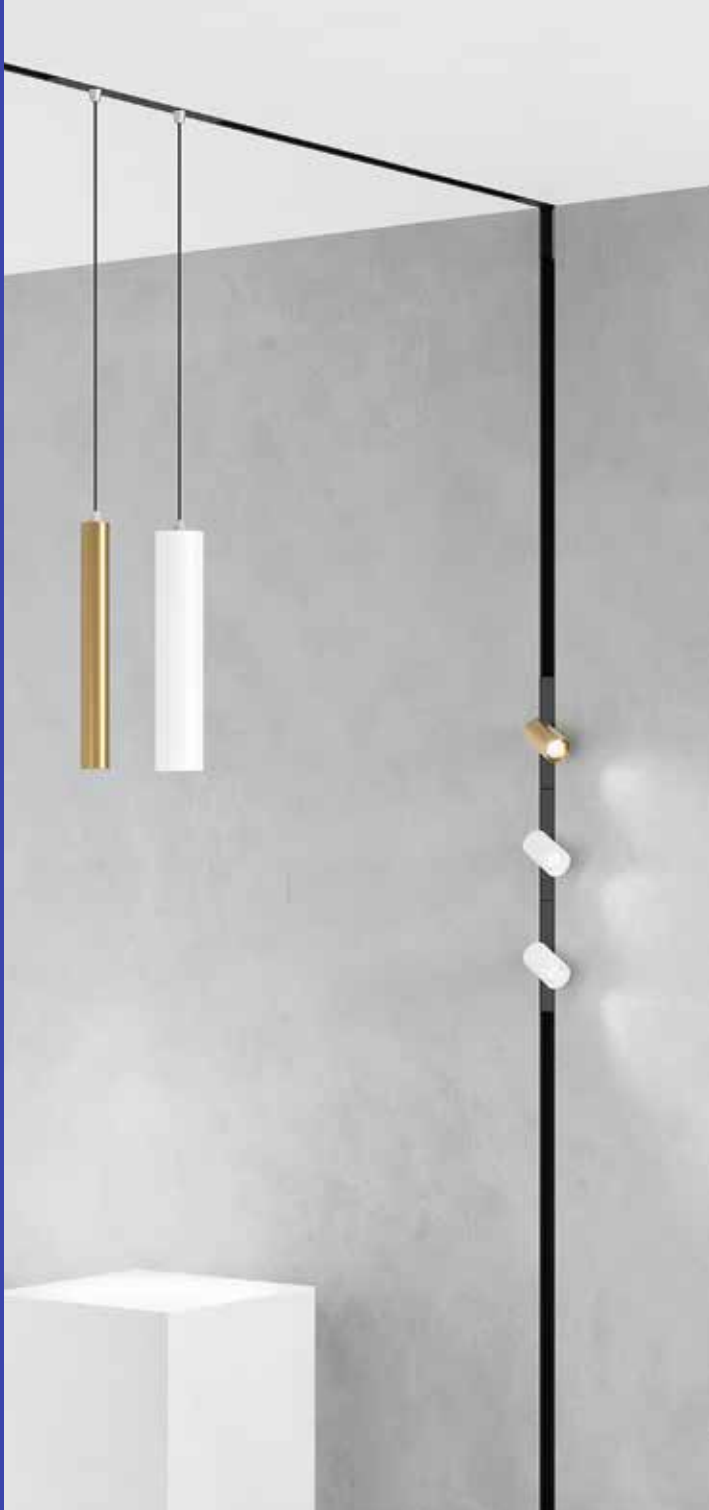

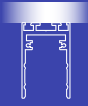

on photo:  
**CYMBAL / GOAL**  
Ceiling or suspension mounting system





on photo:  
**LINE UGR / LINE / TEMA**  
Ceiling or suspension mounting system





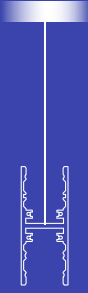

on photo:  
**SHOT / LINE URG / LINE / SLIDE**  
Biemission suspension mounting system

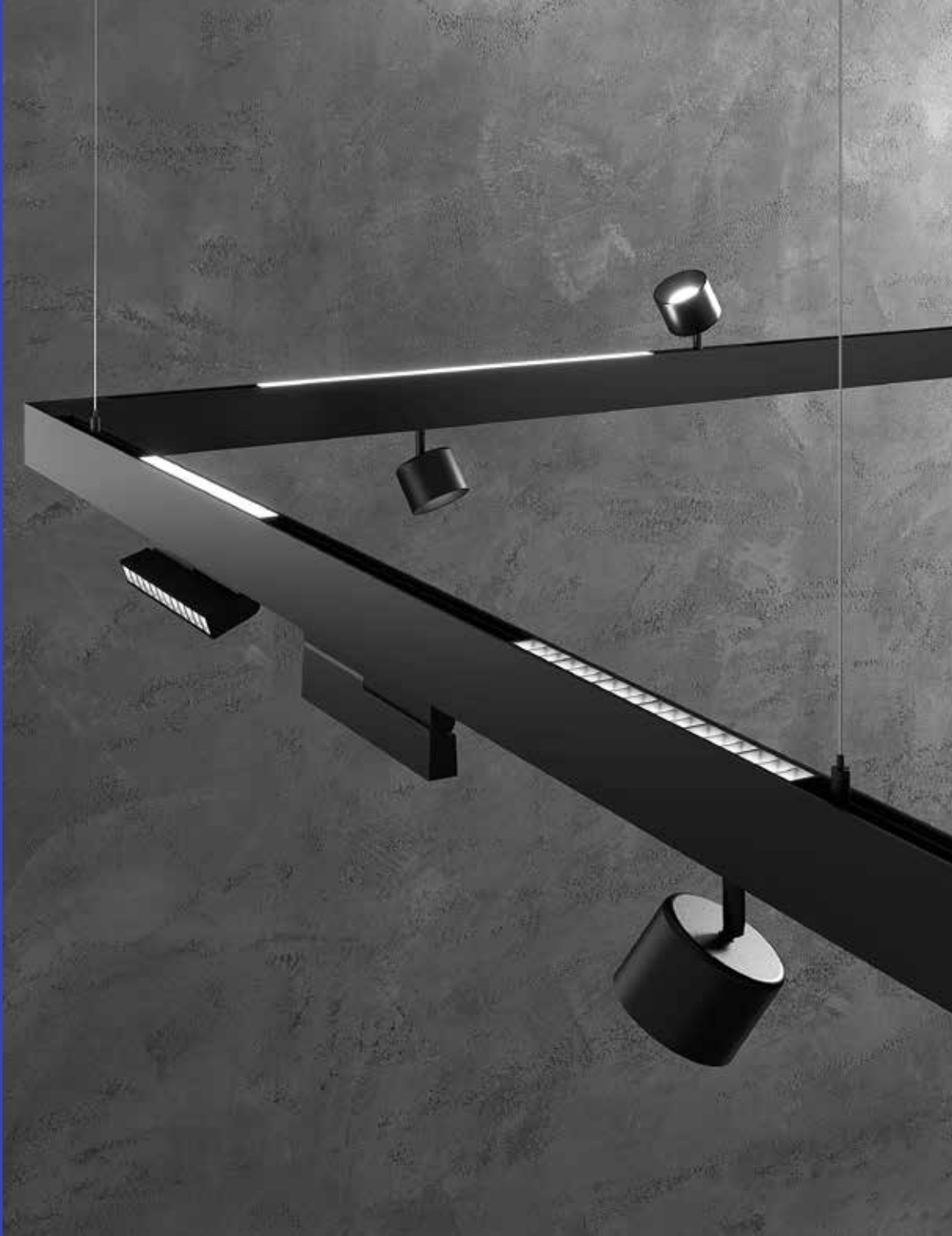

In.tec light    **SISTEMA BINARI / TRACK LIGHTS**

Da Vinci Project 48V  
Sfere volenti / Rolling spheres

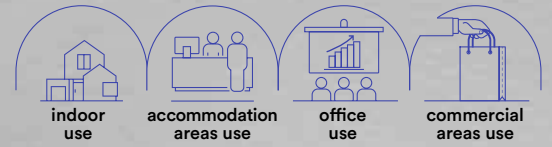

# SHOT

Proiettore a binario con luce spot orientabile per sistema Davinci con struttura in alluminio pressofuso.

Track headlamp with adjustable spot light for Davinci system with die-cast aluminum structure.



**Materiale**  
alluminio

**Colore**  
nero goffrato



**Temperatura colore**  
3000K / 4000K



**Driver**  
DC 48V  
non incluso

**Material**  
aluminum

**Colour**  
embossed black



**Colour temperature**  
3000K / 4000K



**Driver**  
DC 48V  
not included

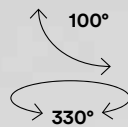

**DAVINCI-SHOT-B-10C**

8031414893911

lumen

colour temp.



980 lm

**DAVINCI-SHOT-B-10M**

8031414893928

lumen



980 lm

watt

10W

beam angle

24°

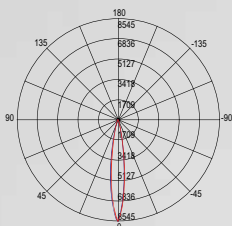

DAVINCI-SHOT-B

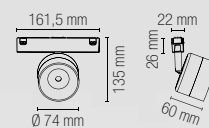

Da Vinci Project 48V  
Sfere volventi / Rolling spheres

# GOAL

Proiettore a binario con luce spot orientabile per sistema Davinci con struttura in alluminio pressofuso.

Track headlamp with adjustable spot light for Davinci system with die-cast aluminum structure.

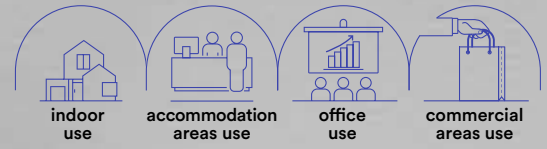

**Materiale**  
alluminio

**Colore**  
nero gofrato



**Temperatura colore**  
3000K / 4000K



**Driver**  
DC 48V  
non incluso

**Material**  
aluminum

**Colour**  
embossed black



**Colour temperature**  
3000K / 4000K



**Driver**  
DC 48V  
not included

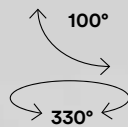

**DAVINCI-GOAL-B-10C**  
8031414893935

lumen

colour temp. | colour

980 lm | ●

**DAVINCI-GOAL-B-10M**

8031414893942

lumen

980 lm | ●

watt

10W

beam angle

24°

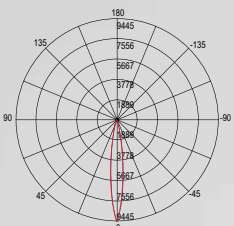
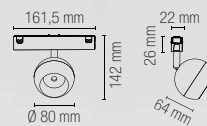

DAVINCI-GOAL-B



SISTEMI BINARI / TRACK LIGHTS  
In.tec light

# FANS

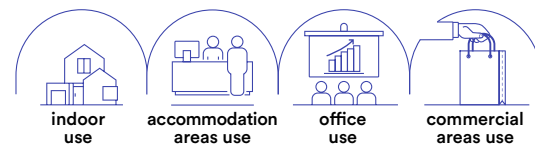

**Materiale**  
alluminio

**Colore**  
bianco opaco  
nero opaco  
oro



**Temperatura colore**  
3000K / 4000K



**Driver**  
DC48V  
non incluso

**Material**  
aluminum

**Colour**  
matt white  
matt black  
gold



**Colour temperature**  
3000K / 4000K



**Driver**  
DC48V  
not included

**Proiettore a binario con luce spot orientabile per sistema Davinci con struttura in alluminio pressofuso.**  
Track headlamp with adjustable spot light for Davinci system with die-cast aluminum structure.

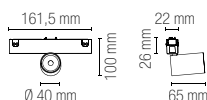

**DAVINCI-FANS-W-5C**

8031414893874

**DAVINCI-FANS-W-5M**

8031414893881

lumen

colour temp. | colour



490 lm

**DAVINCI-FANS-B-5C**

8031414893850

**DAVINCI-FANS-B-5M**

8031414893867

lumen



490 lm

**DAVINCI-FANS-G-5C**

8031414893898

**DAVINCI-FANS-G-5M**

8031414893904

lumen



490 lm

watt

5W

beam angle

24°

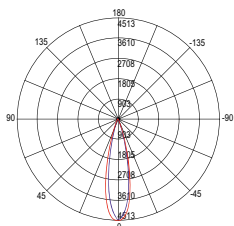

DAVINCI-FANS





SISTEMA BINARI / TRACK LIGHTS

In.tec light

# TEMA

**Proiettore a binario con luce spot orientabile per sistema Davinci con struttura in alluminio pressofuso. Diffusore in vetro trasparente.**

Track projectors with adjustable spot light for Davinci system with die-cast aluminium structure. Diffuser in clear glass.

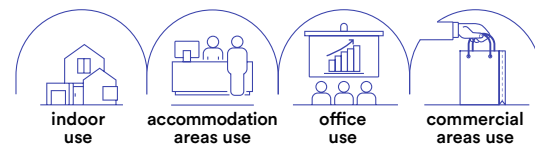

- Material**  
corpo in alluminio pressofuso
- Colore**  
bianco opaco  
nero opaco
- 
- Temperatura colore**  
3000K / 4000K
- 
- Driver**  
DC48V non incluso
- Material**  
aluminum die cast body
- Colour**  
matt white  
matt black
- 
- Colour temperature**  
3000K / 4000K
- 
- Driver**  
DC48V not included



	colour temp.	colour
<b>DAVINCI-TEMA-5C</b> 8031414876976 lumen		
<b>DAVINCI-TEMA-5M</b> 8031414876983 lumen		
	490 lm	490 lm
watt	5W	
beam angle	38°	

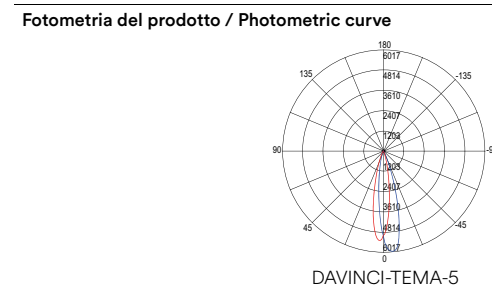
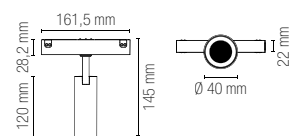



	colour temp.	colour
<b>DAVINCI-TEMA-W-10C</b> 8031414894031 lumen	1200 lm	
<b>DAVINCI-TEMA-W-10M</b> 8031414894048 lumen	1200 lm	
<b>DAVINCI-TEMA-10C</b> 8031414876990 lumen	1200 lm	
<b>DAVINCI-TEMA-10M</b> 8031414878215 lumen	1200 lm	
watt	10W	
beam angle	38°	

	colour temp.	colour
<b>DAVINCI-TEMA-W-20C</b> 8031414894055 lumen	1930 lm	
<b>DAVINCI-TEMA-W-20M</b> 8031414894062 lumen	1930 lm	
<b>DAVINCI-TEMA-20C</b> 8031414878222 lumen	1930 lm	
<b>DAVINCI-TEMA-20M</b> 8031414878239 lumen	1930 lm	
watt	20W	
beam angle	38°	

	colour temp.	colour
<b>DAVINCI-TEMA-W-30C</b> 8031414894079 lumen	3210 lm	
<b>DAVINCI-TEMA-W-30M</b> 8031414894086 lumen	3210 lm	
<b>DAVINCI-TEMA-30C</b> 8031414878246 lumen	3210 lm	
<b>DAVINCI-TEMA-30M</b> 8031414878253 lumen	3210 lm	
watt	30W	
beam angle	38°	

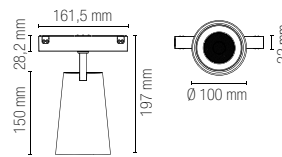
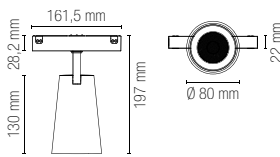
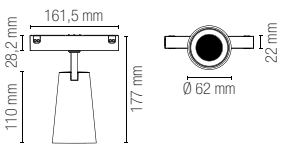

**Accessori inclusi / Included accessories**



Kit 2pz fermi per corpi illuminanti sistema con sfere volventi /  
Kit 2pcs of side brake for Davinci light source modules with rolling spheres joint system

**Accessori inclusi / Included accessories**



Kit 2pz fermi per corpi illuminanti sistema con sfere volventi /  
Kit 2pcs of side brake for Davinci light source modules with rolling spheres joint system

**Accessori inclusi / Included accessories**



Kit 2pz fermi per corpi illuminanti sistema con sfere volventi /  
Kit 2pcs of side brake for Davinci light source modules with rolling spheres joint system

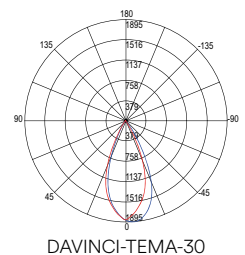
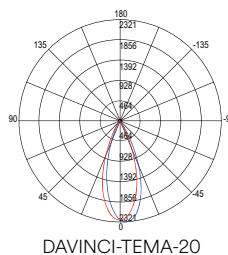
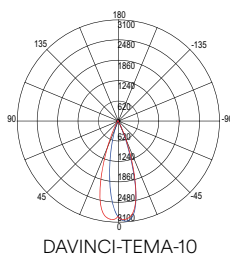

**Da Vinci Project 48V**  
Sfere volventi / Rolling spheres

# LINE

**Lampada lineare a LED per sistema Davinci con struttura in alluminio pressofuso e finitura in nero gofrato. Disponibile in varie misure.**

LED linear lamp for Davinci system with die-cast aluminum structure and embossed black finish.

Available in various sizes.

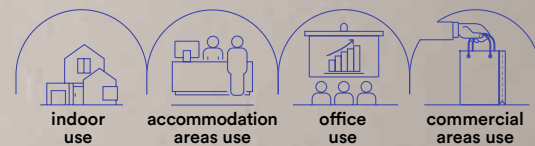

**Materiale**

corpo in alluminio pressofuso

**Colore**

nero



**Temperatura colore**

3000K / 4000K



**Driver**

DC48V non incluso

**Material**

aluminum die cast body

**Colour**

black



**Colour temperature**

3000K / 4000K



**Driver**

DC48V not included



**Fotometria del prodotto / Photometric curve**

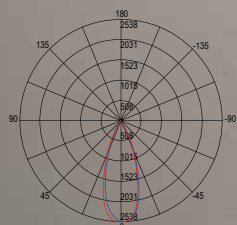

DAVINCI-LINE30 UGR

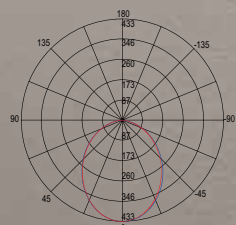

DAVINCI-LINE30

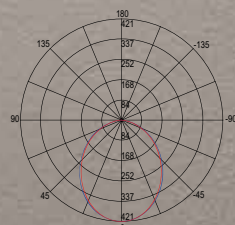

DAVINCI-LINE60

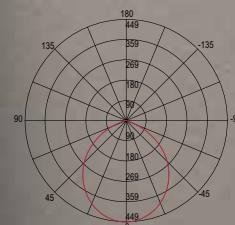

DAVINCI-LINE90

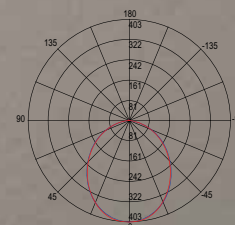

DAVINCI-LINE120



UGR <19

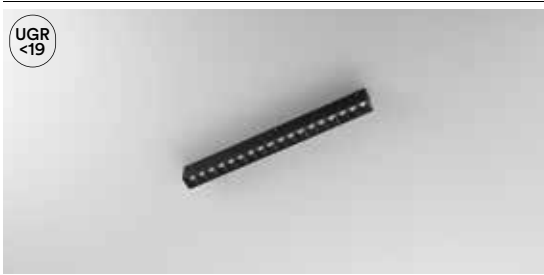

**DAVINCI-LINE30C-UGR**

8031414878321

lumen

colour temp.



1200 lm

colour

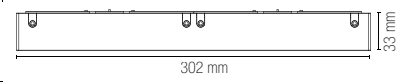

**DAVINCI-LINE30M-UGR**

8031414878338

lumen



1200 lm

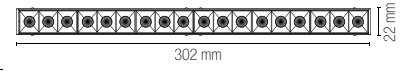

watt	10W
beam angle	30°



**DAVINCI-LINE30C**

8031414878260

lumen

colour temp.



1150 lm

colour

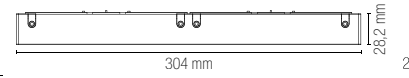

**DAVINCI-LINE30M**

8031414878277

lumen



1150 lm



watt	10W
beam angle	110°



**DAVINCI-LINE60C**

8031414878284

lumen

colour temp.



2300 lm

colour

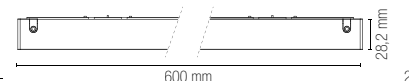

**DAVINCI-LINE60M**

8031414878291

lumen



2300 lm



watt	20W
beam angle	110°



**DAVINCI-LINE90C**

8031414878666

lumen

colour temp.



3450 lm

colour

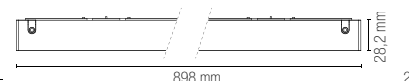

**DAVINCI-LINE90M**

8031414878635

lumen



3450 lm



watt	30W
beam angle	110°



**DAVINCI-LINE120C**

8031414878642

lumen

colour temp.



4600 lm

colour

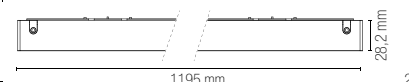

**DAVINCI-LINE120M**

8031414878611

lumen



4600 lm



watt	40W
beam angle	110°

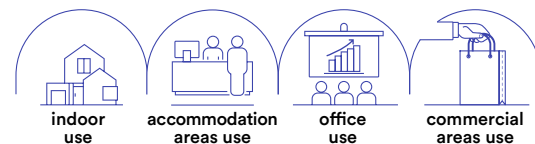

# SLIDE

Lampada lineare orientabile a LED per sistema Davinci con struttura in alluminio pressofuso.

LED adjustable linear lamp for Davinci system with die-cast aluminum structure.

### Materiale

corpo in alluminio pressofuso

### Colore

nero opaco



### Temperatura colore

3000K / 4000K



### Driver

DC48V non incluso

### Material

aluminum die cast body

### Colour

matt black



### Colour temperature

3000K / 4000K



### Driver

DC48V not included



	colour temp.	colour
<b>DAVINCI-SLIDE20C-UGR</b> 8031414878369		
lumen	1020 lm	
<b>DAVINCI-SLIDE20M-UGR</b> 8031414878376		
lumen	1020 lm	
watt	10W	
beam angle	30°	

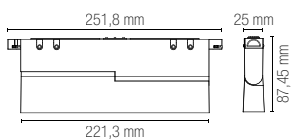

	colour temp.	colour
<b>DAVINCI-SLIDE20C</b> 8031414878345		
lumen	980 lm	
<b>DAVINCI-SLIDE20M</b> 8031414878352		
lumen	980 lm	
watt	10W	
beam angle	110°	

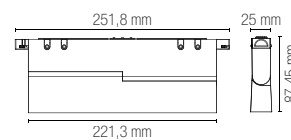

### Fotometria del prodotto / Photometric curve

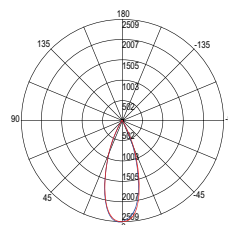

DAVINCI-SLIDE20 UGR

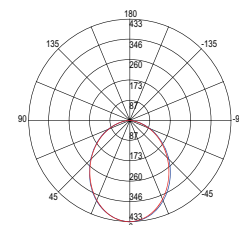

DAVINCI-SLIDE20



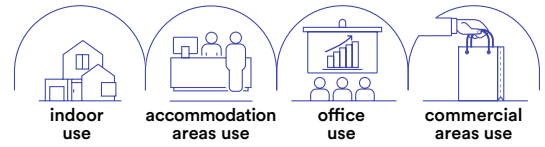

# TUBO

**Sospensioni tubolari a LED per sistema Davinci con struttura in alluminio pressofuso.**

LED tubular suspensions for Davinci system with die-cast aluminum structure.

**Materiale**

corpo in alluminio pressofuso

**Colore**

bianco opaco  
nero opaco  
oro



**Temperatura colore**

3000K / 4000K



**Driver**

DC48V non incluso

**Material**

aluminum  
die cast body

**Colour**

matt white  
matt black  
gold



**Colour temperature**

3000K / 4000K



**Driver**

DC48V not included



	colour temp.	colour
<b>DAVINCI-W-S35C</b> 8031414894093 lumen		
<b>DAVINCI-W-S35M</b> 8031414894109 lumen		
<b>DAVINCI-S35C</b> 8031414878390 lumen		
<b>DAVINCI-S35M</b> 8031414878406 lumen		
<b>DAVINCI-G-S35C</b> 8031414894116 lumen		
<b>DAVINCI-G-S35M</b> 8031414894123 lumen		
watt	3W	
beam angle	24°	

	colour temp.	colour
<b>DAVINCI-S60C</b> 8031414878680 lumen		
<b>DAVINCI-S60M</b> 8031414878659 lumen		
watt	5W	
beam angle	24°	

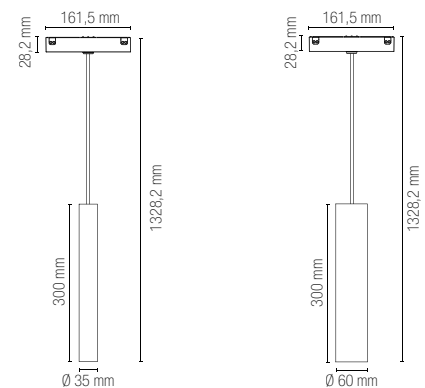

**Fotometria del prodotto / Photometric curve**

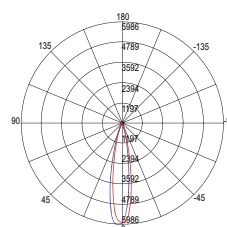

DAVINCI-S35

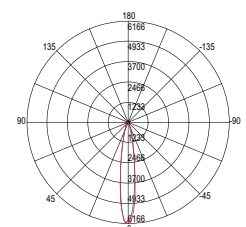

DAVINCI-S60





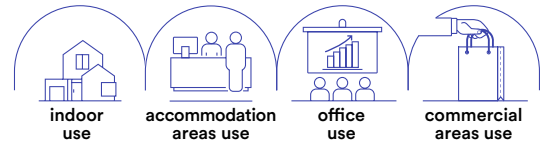

# CYMBAL

Lampada a sospensione  
LED in alluminio  
per sistema a binario.  
Aluminum LED suspension  
lamp for track system.

**Materiale**

alluminio

**Colore**

bianco opaco  
nero opaco



**Temperatura colore**  
3000K / 4000K



**Driver**

DC 48V  
non incluso

**Material**

aluminum

**Colour**

matt white  
matt black



**Colour temperature**  
3000K / 4000K



**Driver**

DC 48V  
not included



	colour temp.	colour
<b>DAVINCI-W-S40C</b> 8031414894017		
lumen	1855 lm	
<b>DAVINCI-W-S40M</b> 8031414894024		
lumen	1855 lm	
<b>DAVINCI-S40C</b> 8031414893997		
lumen	1855 lm	
<b>DAVINCI-S40M</b> 8031414894000		
lumen	1855 lm	

	colour temp.	colour
<b>DAVINCI-W-S15C</b> 8031414893973		
lumen	780 lm	
<b>DAVINCI-W-S15M</b> 8031414893980		
lumen	780 lm	
<b>DAVINCI-S15C</b> 8031414893959		
lumen	780 lm	
<b>DAVINCI-S15M</b> 8031414893966		
lumen	780 lm	

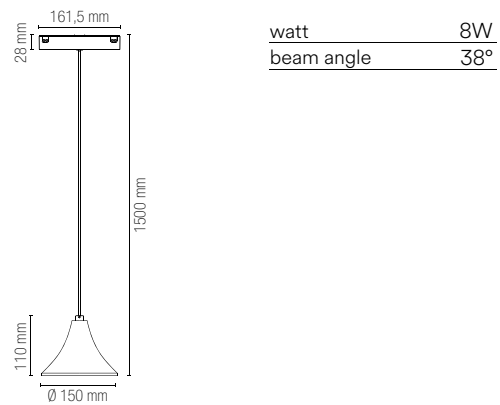
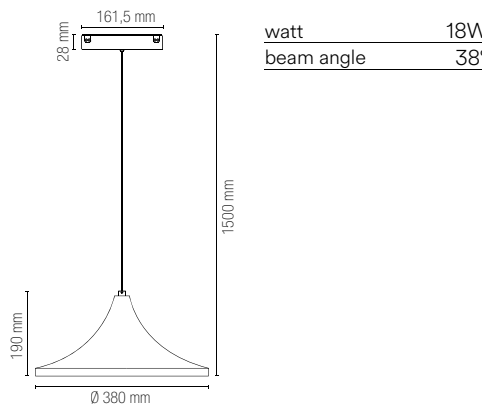

Fotometria del prodotto / Photometric curve

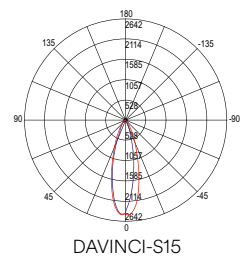
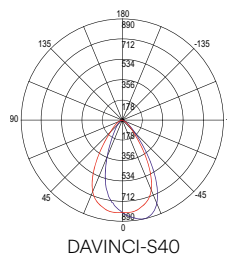

**DA VINCI**  
**PROJECT**  
**48V**



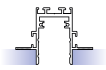

## Da Vinci Project 48V / RECESSED TRACK TRIMLESS

### Sistema di montaggio a incasso a filo / Recess mount system trimless

Binari ed accessori / Track rail and components

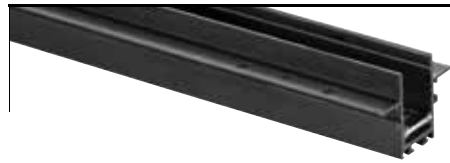

#### DAVINCI-TL-2M

8031414878055

Binario sistema Davinci montaggio ad incasso a filo 2 m nero 48V. Tappi e staffa di fissaggio inclusi.

Davinci system track rail invisible recessed trimless mount black colour 2 m 48V. Cups and fixing bracket included.

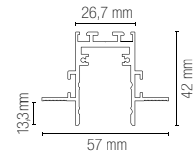

#### DAVINCI-TL-L

8031414878109

Connettore angolare in alluminio per binario elettrificato incasso a filo (trimless) sistema sfere volventi.

Angular connection in aluminum for Davinci trimless recessed rail in rolling spheres joint system.

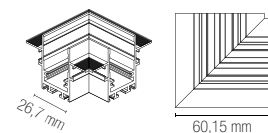

#### DAVINCI-TL-LVI

8031414878673

Connettore angolare verticale con connessione interna per binario elettrificato incasso a filo (trimless) con sistema sfere volventi.

Vertical angular connector internal connection for track electrified recessed rail (trimless) system built in rolling spheres joint system.

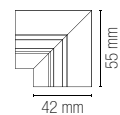

#### DAVINCI-TL-LVE

8031414878147

Connettore angolare verticale con connessione esterna in alluminio per binario elettrificato incasso a filo (trimless) con sistema sfere volventi.

Angular external emission connection in aluminum for electrified track trimless recessed rail in rolling spheres joint system.

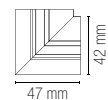

#### DAVINCI-TL-CAP

8031414878093

Tappo laterale per binario da incasso a filo (trimless) sistema sfere volventi.

End cap for Davinci trimless recessed rail in rolling spheres joint system.

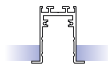

## Da Vinci Project 48V / RECESSED TRACK

### Sistema di montaggio a incasso con cornice / Recess mount system with external trim

Binari ed accessori / Track rail and components

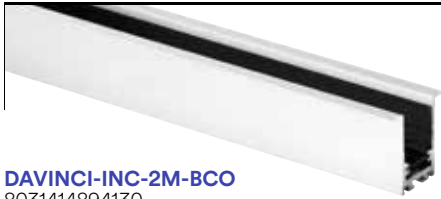

**DAVINCI-INC-2M-BCO**  
8031414894130

Binario sistema Davinci montaggio ad incasso 2 m bianco 48V. Tappi e staffa di fissaggio inclusi.

Davinci system track rail recessed mount white colour 2 m 48V. Cups and fixing bracket included.



**DAVINCI-INC-2M**  
8031414878024

Binario sistema Davinci montaggio ad incasso 2 m nero 48V. Tappi e staffa di fissaggio inclusi.

Davinci system track rail recessed mount black colour 2 m 48V. Cups and fixing bracket included.

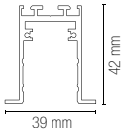

**DAVINCI-INC-L-BCO**  
8031414894147

Connettore angolare per binario elettrificato incasso sistema sfere volventi.

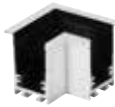

Angular connector for electrified track built in rolling spheres joint system.

**DAVINCI-INC-L**  
8031414878116

Connettore angolare per binario elettrificato incasso sistema sfere volventi.

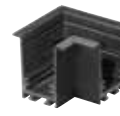

Angular connector for electrified track built in rolling spheres joint system.

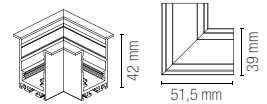

**DAVINCI-INC-LVI-BCO**  
8031414894154

Connettore angolare verticale connessione interna per binario elettrificato incasso sistema sfere volventi.



Vertical angular connector internal connection for track electrified system built in rolling spheres joint system.

**DAVINCI-INC-LVI**  
8031414878123

Connettore angolare verticale connessione interna per binario elettrificato incasso sistema sfere volventi.



Vertical angular connector internal connection for track electrified system built in rolling spheres joint system.

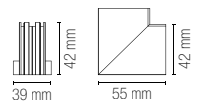

**DAVINCI-INC-LVE-BCO**  
8031414894161

Connettore angolare verticale connessione esterna per binario elettrificato incasso sistema sfere volventi.



Vertical angular connector external connection for track electrified system built in rolling spheres joint system.

**DAVINCI-INC-LVE**  
8031414878130

Connettore angolare verticale connessione esterna per binario elettrificato incasso sistema sfere volventi.



Vertical angular connector external connection for track electrified system built in rolling spheres joint system.

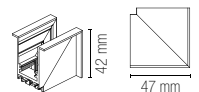

**DAVINCI-INC-CAP-BCO**  
8031414894178

Tappo laterale per binario ad incasso sistema sfere volventi.



End cap for recessed Davinci with rolling spheres joint system.

**DAVINCI-INC-CAP**  
8031414878413

Tappo laterale per binario ad incasso sistema sfere volventi.



End cap for recessed Davinci with rolling spheres joint system.



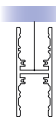

## Da Vinci Project 48V / PENDANT

### Sistema di montaggio a sospensione biemissione/ Biemission suspension mounting system

Binari ed accessori / Track rail and components

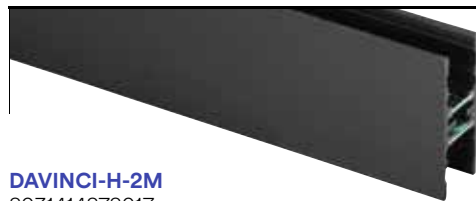

#### DAVINCI-H-2M

8031414878017

Binario sistema Davinci per montaggio a sospensione con doppia emissione; nero da 2 m 48V. Tappi e staffa di fissaggio inclusi.

Davinci system rail for suspension mounting with double emission; black 2 m 48V. Cups and fixing bracket included.

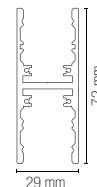

#### DAVINCI-H-L

8031414878048

Connettore angolare in alluminio per binario elettrificato biemissione con sistema sfere volventi.

Aluminum angular connection for double emission electrified track with rolling ball system.

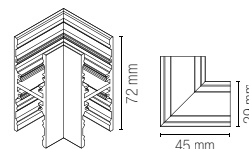

#### DAVINCI-H-CAP

8031414878451

Tappo laterale per binario biemissione con sistema sfere volventi.

End cap for double emitting Davinci rail in rolling spheres joint system.



#### DAVINCI-BOX

8031414878598

Scatola per alloggiamento driver e collegamento elettrico binari Davinci a sospensione.

Canopy for driver and connection box for suspension Davinci rail.

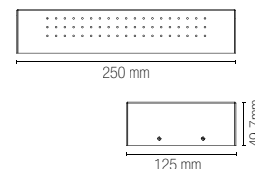

#### DAVINCI-S-3

8031414879762

Sistema sospensione 2 cavi di acciaio da 3m per binari Davinci.

Suspension kit 2 x 3m steel wire.

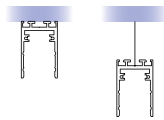

## Da Vinci Project 48V / SURFACE MOUNTED

### Sistema di montaggio a plafoniera o a sospensione a vista/ Ceiling or suspension mounting system

Binari ed accessori / Track rail and components



#### DAVINCI-ST-2M-BCO

8031414894185

Binario sistema Davinci con montaggio a soffitto o sospensione da 2 m bianco 48V. Tappi e staffa di fissaggio inclusi.



#### DAVINCI-ST-2M

8031414878031

Binario sistema Davinci con montaggio a soffitto o sospensione da 2 m nero 48V. Tappi e staffa di fissaggio inclusi.

Davinci system rail with ceiling mounting or suspension 2 m black 48V. Cups and fixing bracket included.

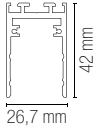

#### DAVINCI-ST-L-BCO

8031414894192

Connettore angolare per binario elettrificato montaggio a soffitto o sospensione sistema sfere volventi.



Angular connection for ceiling mounting electrified track or suspension in rolling spheres joint system.

#### DAVINCI-ST-L

8031414878062

Connettore angolare per binario elettrificato montaggio a soffitto o sospensione sistema sfere volventi.



Angular connection for ceiling mounting electrified track or suspension in rolling spheres joint system.

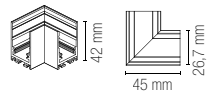

#### DAVINCI-ST-LVI-BCO

8031414894208

Connettore angolare per binario elettrificato connessione interna con sistema sfere volventi.



Angular connector for track electrified internal connection with spheres rolling joint system.

#### DAVINCI-ST-LVI

8031414878079

Connettore angolare per binario elettrificato connessione interna con sistema sfere volventi.



Angular connector for track electrified internal connection with spheres rolling joint system.

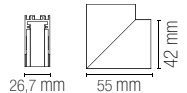

#### DAVINCI-ST-LVE-BCO

8031414894215

Connettore angolare per binario elettrificato connessione esterna e sistema a sfere volventi.



Angular connector for external connection electrified track in rolling spheres joint system.

#### DAVINCI-ST-LVE

8031414878086

Connettore angolare per binario elettrificato connessione esterna e sistema a sfere volventi.



Angular connector for external connection electrified track in rolling spheres joint system.

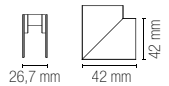

#### DAVINCI-ST-CAP-BCO

8031414894222

Tappo laterale per binario biemissione con sistema sfere volventi.



End cap for double emitting Davinci rail in rolling spheres joint system.

#### DAVINCI-ST-CAP

8031414878468

Tappo laterale per binario biemissione con sistema sfere volventi.



End cap for double emitting Davinci rail in rolling spheres joint system.

#### DAVINCI-BOX-BCO

8031414894246

Scatola per alloggiamento driver e collegamento elettrico binari Davinci a sospensione.



Canopy for driver and connection box for suspension Davinci rail.

#### DAVINCI-BOX

8031414878598

Scatola per alloggiamento driver e collegamento elettrico binari Davinci a sospensione.



Canopy for driver and connection box for suspension Davinci rail.

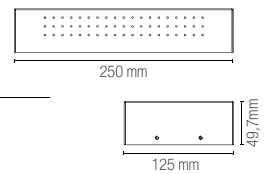

#### DAVINCI-S-3-BCO

8031414894239

Sistema sospensione 2 cavi di acciaio da 3m per binari Davinci.



Suspension kit 2 x 3m steel wire.

#### DAVINCI-S-3

8031414879762

Sistema sospensione 2 cavi di acciaio da 3m per binari Davinci.



Suspension kit 2 x 3m steel wire.

**DAVINCI-NEST**

8031414878161

Innesto per elettrificazione 48V compatibile con tutti i modelli di binario del sistema Davinci.

48V power engine for all Davinci rail system models.

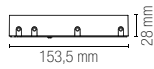

**DAVINCI-FLEX**

8031414894253

Innesto per elettrificazione 48V flessibile compatibile con tutti i modelli di binario Davinci.

Flexible 48V electrification mount compatible with all Davinci rail models.

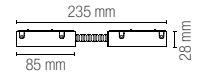

**DAVINCI-I-CONN**

8031414878178

Connettore 48V compatibile con i modelli di binario sistema Davinci.

Connector 48V compatible with all the Davinci rail system models.



**DAVINCI-COVER-2M**

8031414878154

Cover nera compatibile con tutti i modelli di binari Davinci 200 cm.

Cover in black colour compatible with all the Davinci track rail models 200 cm.



**DAVINCI-L-CONN**

8031414878185

Connettore angolare 48V compatibile con tutti i modelli di binario del sistema Davinci.

Angular connector 48V compatible with all the Davinci rail system models.

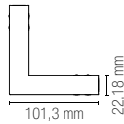

**DAVINCI-BRAKE**

8031414878383

Kit 2pz fermi per corpi illuminanti sistema con sfere volventi.

Kit 2pcs of side brake for Davinci light source modules with rolling spheres joint system.



**DAVINCI-LVI-CONN**

8031414878192

Connettore angolare interno 48V compatibile con tutti i modelli di binario del sistema Davinci.

Internal angular connector 48V compatible with all the Davinci rail system models.

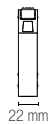
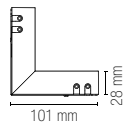

**DAVINCI-DR100**

8031414924813

Driver 100W 48V per binario Davinci.

100W 48V driver for Davinci system.

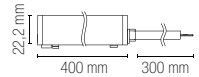

**DAVINCI-LVE-CONN**

8031414878208

Connettore angolare esterno 48V compatibile con tutti i modelli di binario del sistema Davinci.

External angular connector 48V compatible with all the Davinci rail system models.

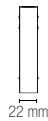
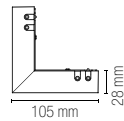

**DAVINCI-DR200**

8031414924820

Driver 200W 48V per binario Davinci.

200W 48V driver for Davinci system.

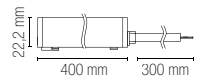

# BERNINI PROJECT 48V





In.tec light

**SISTEMA BINARI / TRACK LIGHTS**

**Schema di montaggio sistema binari.**  
Assembling technical sheet track rail system.

# BERNINI PROJECT 48V

INTEC proietta il suo sguardo nel futuro e si immerge nel mondo dell'arte illuminotecnica altamente personalizzata, garantendo contemporaneamente efficienza e flessibilità nel design.

Frutto di un attento studio delle tecnologie più avanzate, il binario Bernini è un sistema completamente elettrificato a bassa tensione. La vasta gamma di corpi illuminanti Bernini, insieme al caleidoscopio di forme, angoli e connessioni disponibili, consente di creare aree luminose dalle pareti o dal soffitto, modificandone i giochi di luce in qualsiasi momento tramite gli elementi luminosi a LED che si inseriscono facilmente con un click, grazie al sistema innovativo ad incastro lungo l'intero percorso.

INTEC casts its gaze into the future and plunges into the world of highly customized lighting art, simultaneously ensuring efficiency and flexibility in design.

The result of a careful study of the most advanced technologies, the Bernini track is a fully electrified low-voltage system. Bernini's wide range of luminaires, together with the kaleidoscope of available shapes, angles and connections, makes it possible to create luminous areas from the walls or ceiling, changing the play of light at any time through LED lighting elements that are easily inserted with a click, thanks to the innovative system of interlocking along the entire path.

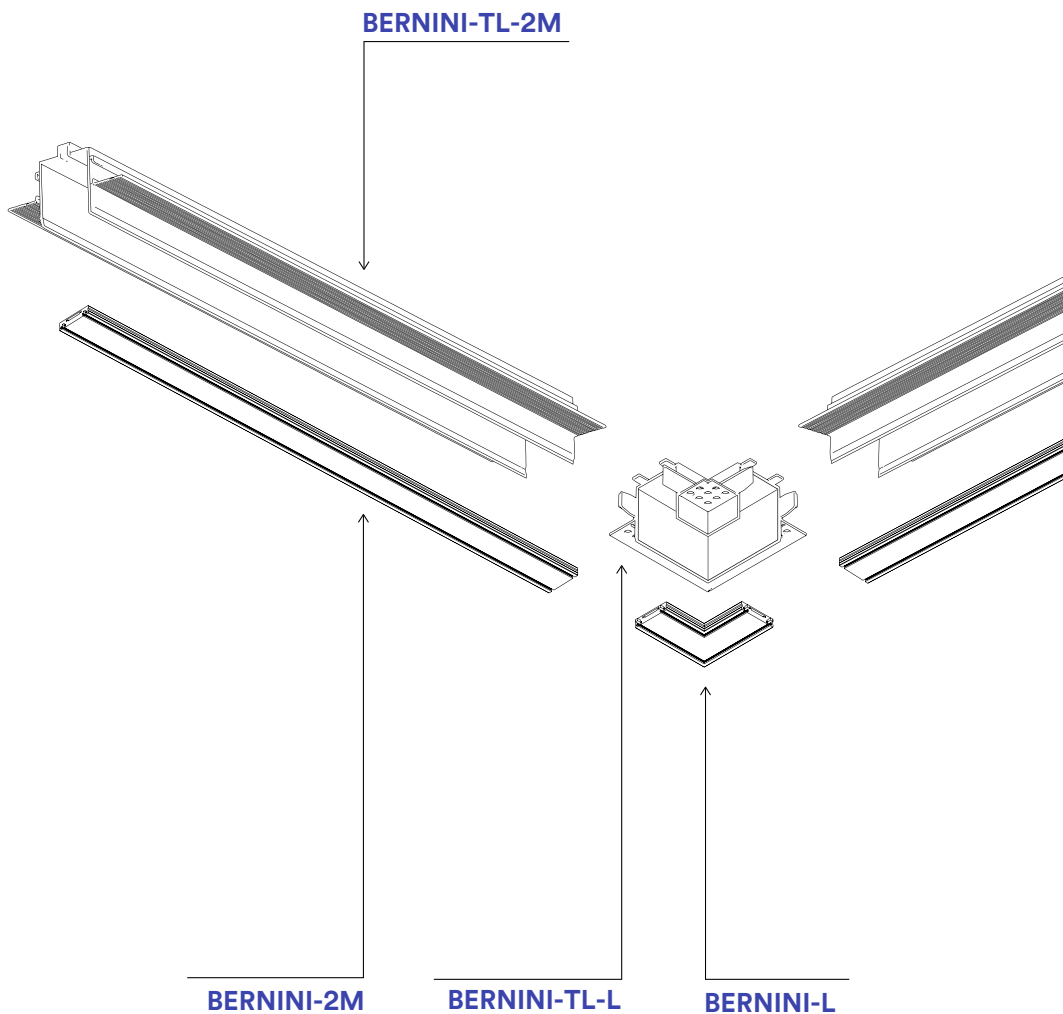

## DRIVER

Scelta tra due tipi di driver / Choice between two types of drivers

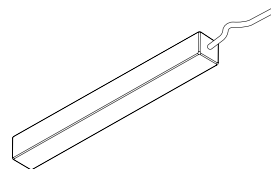

**BERNINI-DR100**  
**BERNINI-DR200**

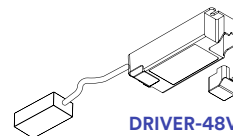

**BERNINI-NEST**

BERNINI-NEST + other type of DRIVERS-48V (not included)

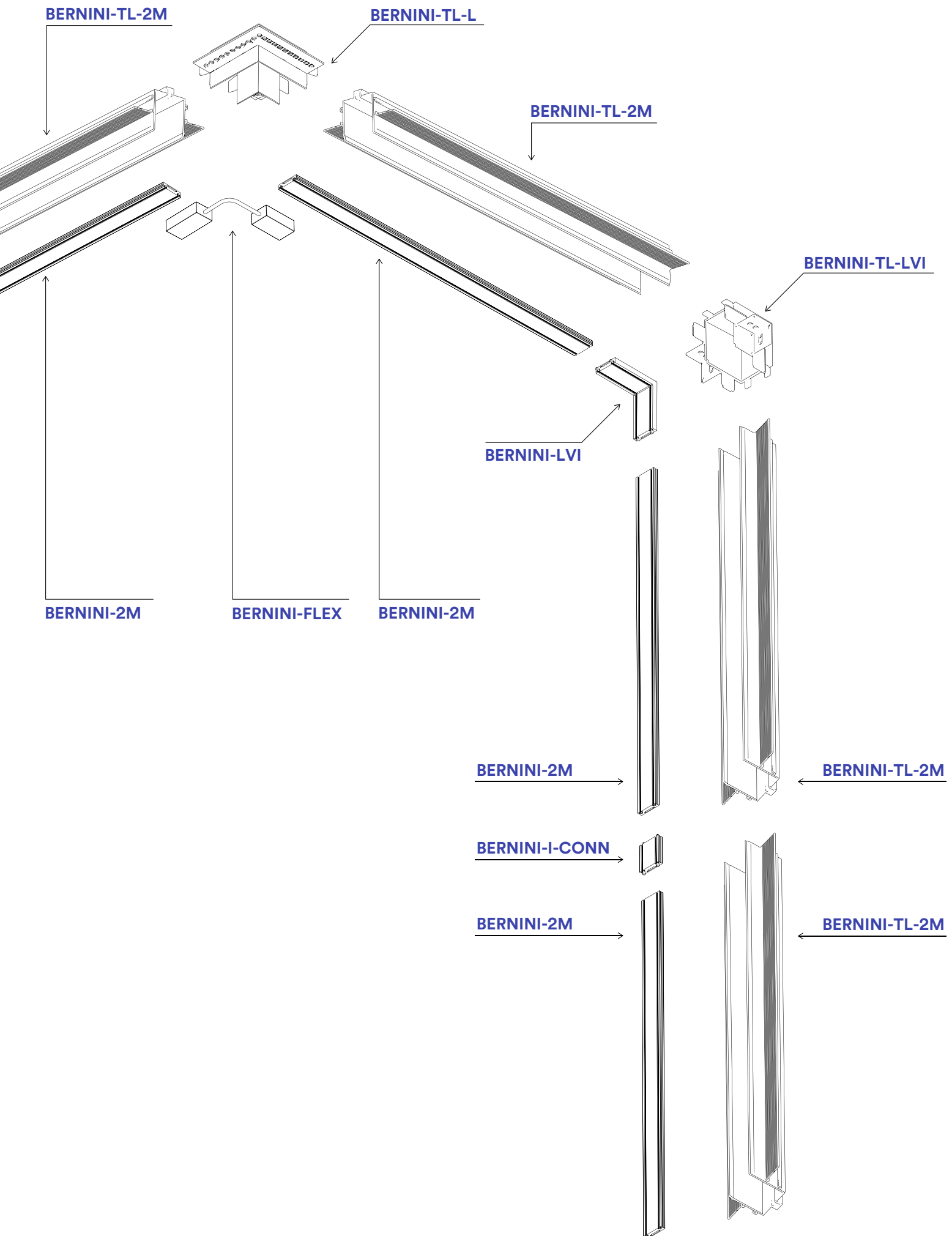

Bernini Project 48V

# BERNINI LINE

Lampada lineare orientabile a LED in termoplastica e alluminio con finitura in bianco o nero opaco.

Linear adjustable LED lamp in thermoplastic and aluminum with matt white or black finish.

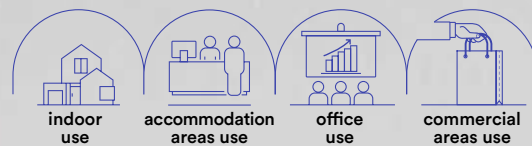

**Materiale**

alluminio e termoplastica

**Colore**

bianco opaco  
nero opaco



**Temperatura colore**

3000K / 4000K



**Driver**

DC48V non incluso

**Material**

aluminum and thermoplastic

**Colour**

matt white  
matt black



**Colour temperature**

3000K / 4000K



**Driver**

DC48V not included





# BERNINI LINE

**Lampada lineare orientabile a LED in termoplastica e alluminio con finitura in bianco o nero opaco.**  
 Linear adjustable LED lamp in thermoplastic and aluminum with matt white or black finish.

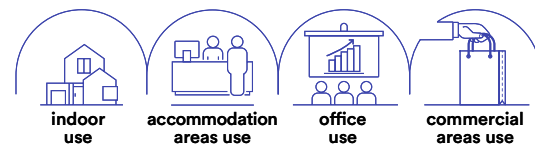

**Materiale**  
 alluminio e termoplastica

**Colore**  
 bianco opaco  
 nero opaco



**Temperatura colore**  
 3000K / 4000K



**Driver**  
 DC48V non incluso

**Material**  
 aluminum and thermoplastic

**Colour**  
 matt white  
 matt black



**Colour temperature**  
 3000K / 4000K



**Driver**  
 DC48V not included



	colour temp.	colour
<b>BERNINI-LINE12-BCO</b> 8031414920037		
lumen	720 lm	
<b>BERNINI-LINE12</b> 8031414907502		
lumen	720 lm	
watt	6W	
beam angle	30°	



	colour temp.	colour
<b>BERNINI-LINE12-UGR-BCO</b> 8031414920044		
lumen	720 lm	
<b>BERNINI-LINE12-UGR</b> 8031414907519		
lumen	720 lm	
watt	6W	
beam angle	30°	



**Accessorio non incluso / Not included accessory**  
 Adattatore per lampada lineare LED /  
 Adapter for linear LED lamp

<b>BERNINI-LINE-ADAT12-BCO</b> 8031414920075	
<b>BERNINI-LINE-ADAT12</b> 8031414898169	



**Fotometria del prodotto / Photometric curve**

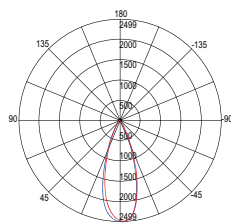

BERNINI-LINE12-UGR

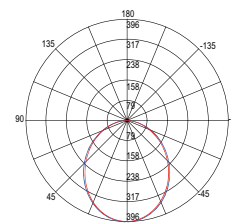

BERNINI-LINE12

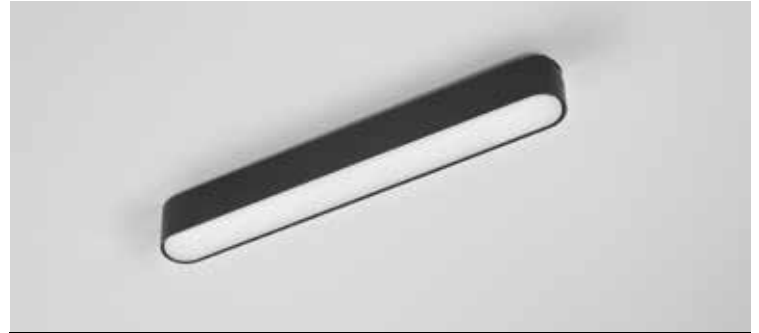
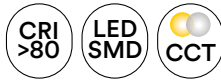

	colour temp.	colour
<b>BERNINI-LINE22-UGR-BCO</b> 8031414920068 lumen		
	1440 lm	
<b>BERNINI-LINE22-UGR</b> 8031414907533 lumen		
	1440 lm	
watt	12W	
beam angle	30°	

	colour temp.	colour
<b>BERNINI-LINE22-BCO</b> 8031414920051 lumen		
	1500 lm	
<b>BERNINI-LINE22</b> 8031414907526 lumen		
	1500 lm	
watt	12W	
beam angle	30°	

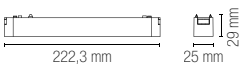

**Accessorio non incluso / Not included accessory**

Adattatore per lampada lineare LED /  
Adapter for linear LED lamp

- BERNINI-LINE-ADAT22-BCO**  
8031414920082
- BERNINI-LINE-ADAT22**  
8031414898176

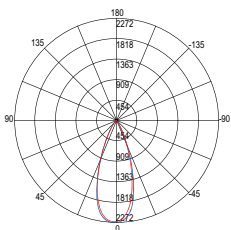
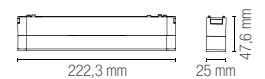

BERNINI-LINE22-UGR

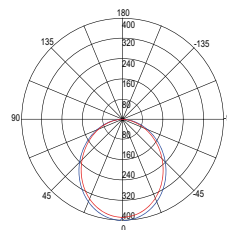

BERNINI-LINE22

# BERNINI FANS

**Faro luce spot orientabile per sistema a binario in termoplastica con finitura in bianco o nero opaco.**

Adjustable spot light in thermoplastic and aluminum track system with matt white or black finish.

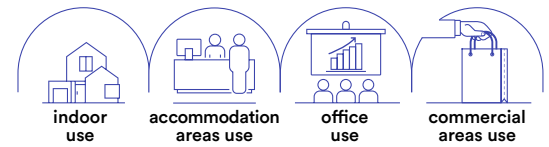

**Materiale**

alluminio e termoplastica

**Colore**

bianco opaco  
nero opaco



**Temperatura colore**

3000K / 4000K



**Driver**

DC48V non incluso

**Material**

aluminum and thermoplastic

**Colour**

matt white  
matt black



**Colour temperature**

3000K / 4000K



**Driver**

DC48V not included



**BERNINI-FANS-5-BCO**

8031414919994

lumen

**BERNINI-FANS-5**

8031414907496

lumen

colour temp. colour

550 lm

550 lm

watt

5W

beam angle

24°

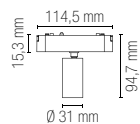

**BERNINI-FANS-15-BCO**

8031414919680

lumen

**BERNINI-FANS-15**

8031414907489

lumen

colour temp. colour

1750 lm

1750 lm

watt

15W

beam angle

30°

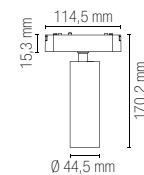

**Fotometria del prodotto / Photometric curve**

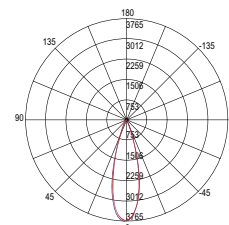

BERNINI-FANS-5

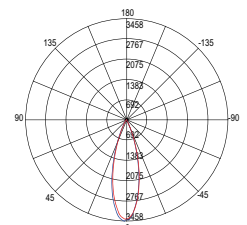

BERNINI-FANS-15

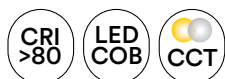

# BERNINI TUBO

Lampada sospensione LED per sistema binario in termoplastica e alluminio con finitura in nero opaco.

LED suspension lamp in aluminum and thermoplastic rail system with matt black finish.

**Materiale**

alluminio e termoplastica

**Colore**

bianco opaco  
nero opaco



**Temperatura colore**

3000K / 4000K



**Driver**

DC48V non incluso

**Material**

aluminum and thermoplastic

**Colour**

matt white  
matt black



**Colour temperature**

3000K / 4000K



**Driver**

DC48V not included



	colour temp.	colour
<b>BERNINI-S10-BCO</b> 8031414920112		
lumen	1100 lm	
<b>BERNINI-S10</b> 8031414907540		
lumen	1100 lm	
watt	9W	
beam angle	24°	

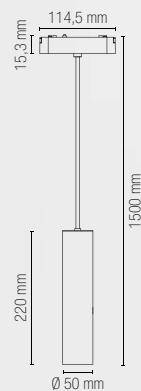



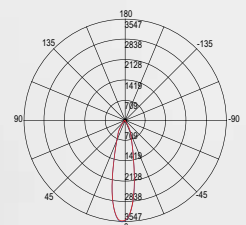



Fotometria del prodotto /  
Photometric curve

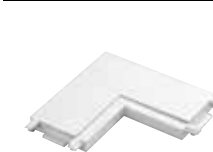

BERNINI-S10

**Binari ed accessori.**  
Track rail and components.

	<p><b>BERNINI-2M-BCO</b> 8031414919598</p>	<p>Binario Bernini 2 metri bianco 48V. 2 Tappi inclusi.</p>	<p>Bernini track rail white color 2 meters 48V. 2 Cups included.</p>
	<p><b>BERNINI-L-BCO</b> 8031414920020</p>	<p>Connettore angolare per binario elettrificato 48V.</p>	<p>Corner connector for 48V track.</p>
	<p><b>BERNINI-T-BCO</b> 8031414920129</p>	<p>Connettore a T per binario elettrificato 48V.</p>	<p>T connector for 48V electrified track.</p>
	<p><b>BERNINI-X-BCO</b> 8031414920167</p>	<p>Connettore a croce per binario elettrificato 48V.</p>	<p>Cross connector for 48V electrified track.</p>
	<p><b>BERNINI-LVI-BCO</b> 8031414920099</p>	<p>Connettore angolare per binario elettrificato 48V.</p>	<p>Angular connector for 48V electrified track.</p>
	<p><b>BERNINI-FLEX-BCO</b> 8031414920006</p>	<p>Innesto per elettrificazione 48V compatibile con tutti i modelli di binario Bernini.</p>	<p>48V electrification mount compatible with all Bernini rail models.</p>
	<p><b>BERNINI-NEST-BCO</b> 8031414920105</p>	<p>Innesto per elettrificazione 48V compatibile con tutti i modelli di binario Bernini.</p>	<p>48V electrification mount compatible with all Bernini rail models.</p>
	<p><b>BERNINI-I-CONN-BCO</b> 8031414920013</p>	<p>Connettore 48V compatibile con tutti i modelli di binario Bernini.</p>	<p>48V connector compatible with all Bernini rail models.</p>



**BERNINI-2M**

8031414897735

Binario Bernini  
2 metri nero 48V.  
2 Tappi inclusi.

Bernini track rail black  
color 2 meters 48V.  
2 Cups included.



**BERNINI-L**

8031414897773

Connettore angolare per  
binario elettrificato 48V.

Corner connector  
for 48V track.

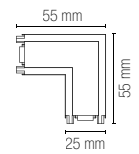

**BERNINI-T**

8031414897780

Connettore a T per  
binario elettrificato 48V.

T connector for 48V  
electrified track.

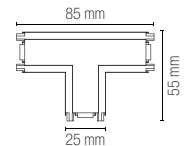

**BERNINI-X**

8031414898091

Connettore a croce per  
binario elettrificato 48V.

Cross connector for  
48V electrified track.

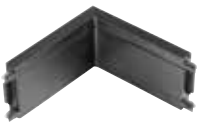
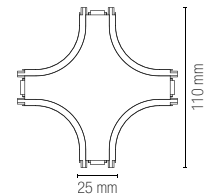

**BERNINI-LVI**

8031414898107

Connettore angolare per  
binario elettrificato 48V.

Angular connector for  
48V electrified track.

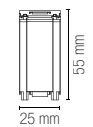

**BERNINI-FLEX**

8031414898152

Innesto per elettrificazione  
48V compatibile con tutti  
i modelli di binario Bernini.

48V electrification  
mount compatible with  
all Bernini rail models.

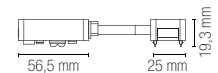

**BERNINI-NEST**

8031414898145

Innesto per elettrificazione  
48V compatibile con tutti  
i modelli di binario Bernini.

48V electrification  
mount compatible with  
all Bernini rail models.

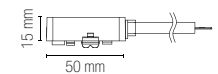

**BERNINI-I-CONN**

8031414898114

Connettore 48V  
compatibile con tutti i  
modelli di binario Bernini.

48V connector  
compatible with all  
Bernini rail models.



**Binari ed accessori.**  
Track rail and components.



**BERNINI-TL-2M-BCO**

8031414920136

Alloggio per sistema binario  
montaggio ad incasso  
a filo 2 metri.

Housing for recessed  
trimeless track rail  
system 2 meters.



**BERNINI-TL-L-BCO**

8031414920143

Connettore angolare verticale per  
alloggio con montaggio ad incasso  
a filo per binario Bernini.

Angular vertical connector for housing  
with recessed trimeless track rail system.



**BERNINI-TL-LVI-BCO**

8031414920150

Connettore angolare verticale  
per alloggio con montaggio ad  
incasso a filo per binario Bernini.

Angular vertical connector for housing  
with recessed trimeless track rail system.



**BERNINI-CAP-BCO**

8031414919642

kit 2 pezzi tappi laterali per  
binario elettrificato 48V.

2 pcs kit caps 48V  
electrified track.



**BERNINI-COVER-2M-BCO**

8031414919659

Cover nera compatibile con  
i modelli del binario Bernini.

Black cover compatible with  
Bernini track rail models.



**BERNINI-DR100-BCO**

8031414919666

Driver 48V 100W  
corrente costante.

Driver 48V 100W  
constant current.



**BERNINI-DR200-BCO**

8031414919673

Driver 48V 200W  
corrente costante.

Driver 48V 200W  
constant current.





**BERNINI-TL-2M**

8031414897759

Alloggio per sistema binario montaggio ad incasso a filo 2 metri.

Housing for recessed trimless track rail system 2 meters.

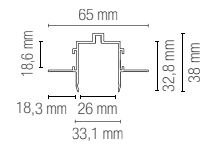

**BERNINI-TL-L**

8031414898138

Connettore angolare verticale per alloggio con montaggio ad incasso a filo per binario Bernini.

Angular vertical connector for housing with recessed trimless track rail system.

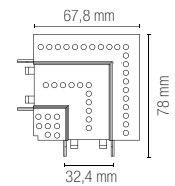

**BERNINI-TL-LVI**

8031414898121

Connettore angolare verticale per alloggio con montaggio ad incasso a filo per binario Bernini.

Angular vertical connector for housing with recessed trimless track rail system.

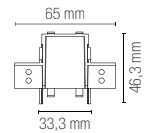

**BERNINI-CAP**

8031414897742

kit 2 pezzi tappi laterali per binario elettrificato 48V.

2 pcs kit caps 48V electrified track.



**BERNINI-COVER-2M**

8031414897766

Cover nera compatibile con i modelli del binario Bernini.

Black cover compatible with Bernini track rail models.



**BERNINI-DR100**

8031414898183

Driver 48V 100W corrente costante.

Driver 48V 100W constant current.

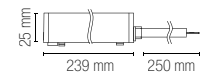

**BERNINI-DR200**

8031414897940

Driver 48V 200W corrente costante.

Driver 48V 200W constant current.

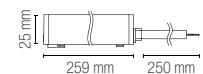

# TRACK RAIL THREE-PHASE





Schema di montaggio sistema binari.  
 Assembling technical sheet track rail system.

# TRACK RAIL THREE-PHASE

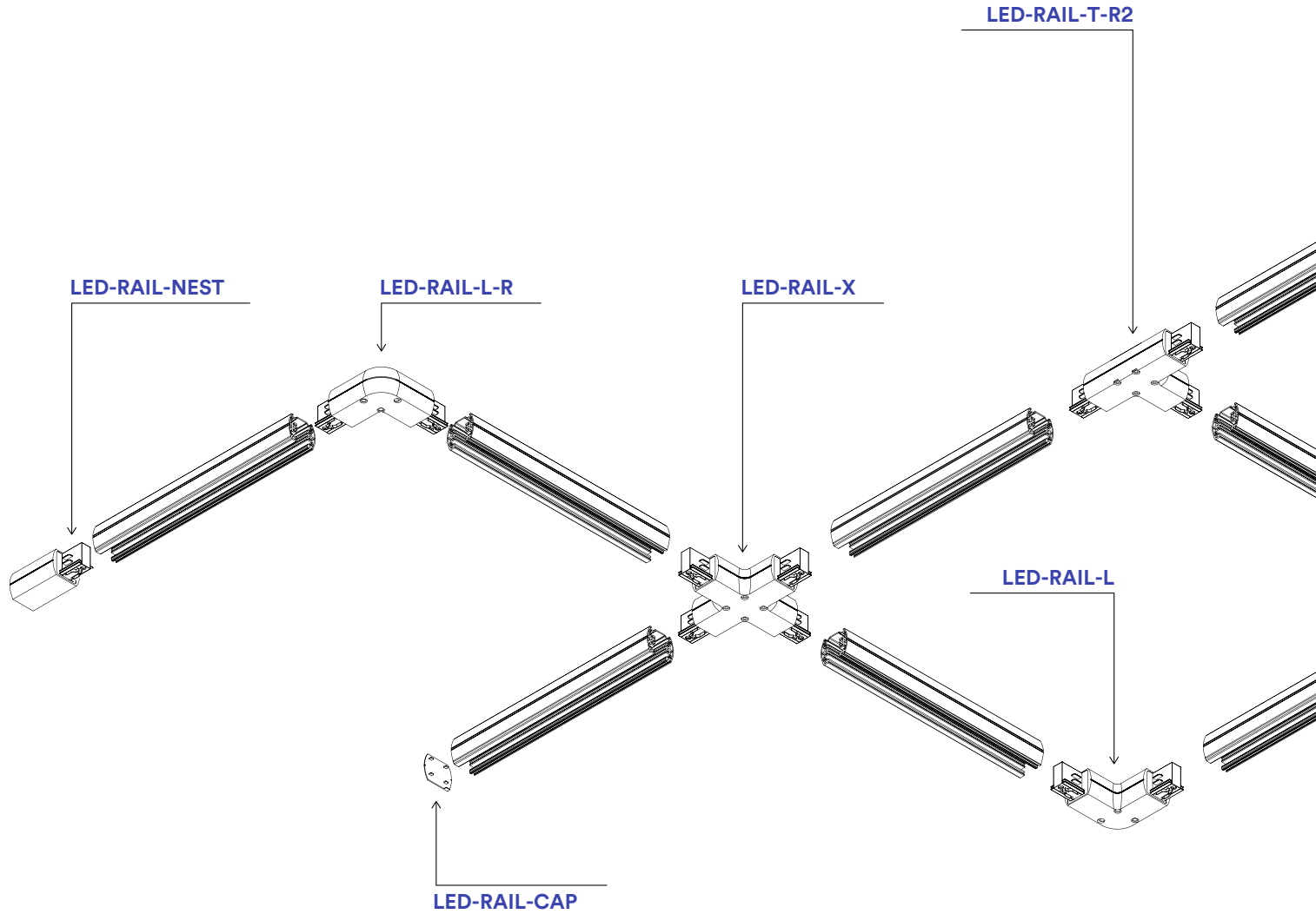

## RAIL NEST

Innesto per collegamento elettrico  
 /  
 Connector for electrical connection



## RAIL NEST L

Connettore a L con collegamento elettrico  
 /  
 L connector with electrical connection

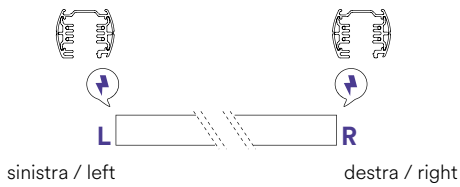
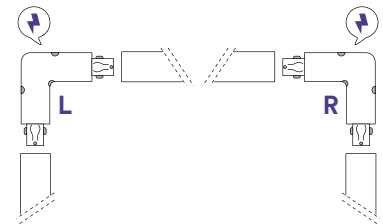

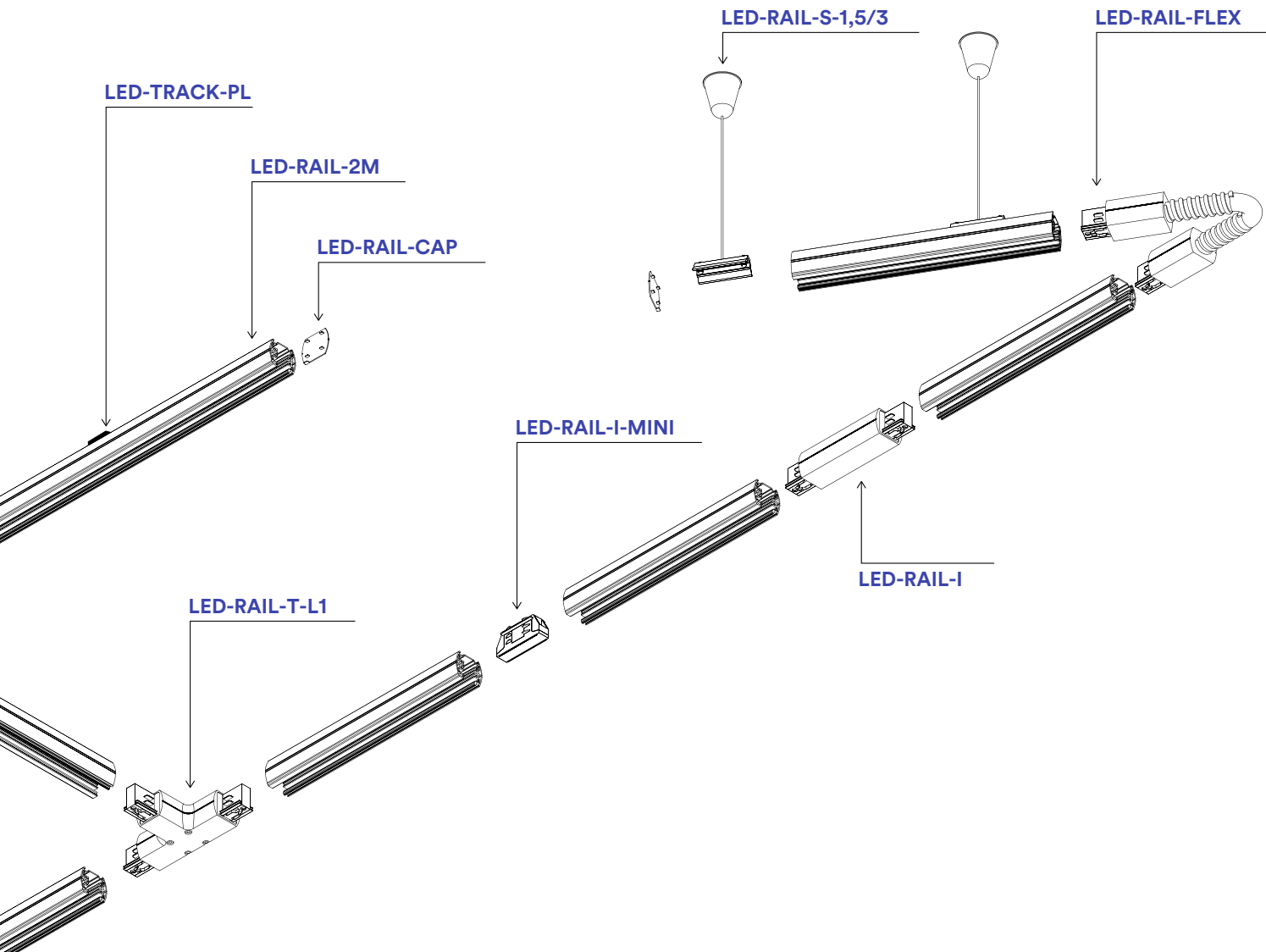

**RAIL NEST T**

Connettore a T con collegamento elettrico  
 /  
 T connector with electrical connection

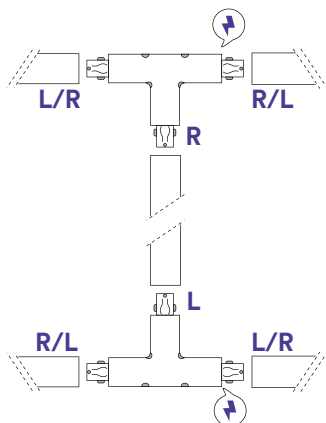

**RAIL NEST I**

Connettore lineare con collegamento elettrico  
 /  
 Linear connector with electrical connection

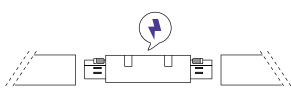

**RAIL MINI**

Connettore lineare  
 /  
 Linear connector

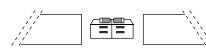

**RAIL S**

Kit sospensione per binario  
 /  
 Kit suspension for track rail

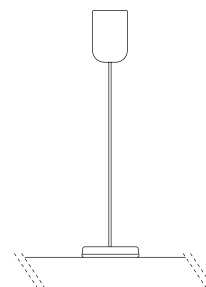

Trifase / Three-phase

# EXPLORER

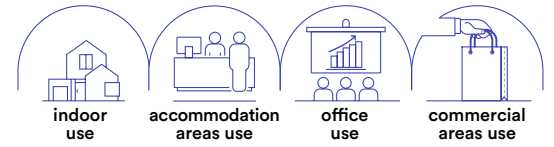

**Materiale**

alluminio

**Colore**

bianco opaco  
nero opaco



**Temperatura colore selezionabile**

3000K / 4000K



**Driver**

incluso

**Material**

aluminum

**Colour**

matt white  
matt black



**Selectable color temperature**

3000K / 4000K



**Driver**

included

**Faro a binario in alluminio con adattatore trifase e angolo di luce regolabile.**

Aluminum track light with three-phase adapter and adjustable light angle.

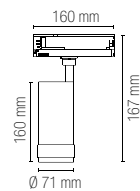

Angolo di luce regolabile /  
Adjustable beam angle



**LED-EXPLORER-BCO**

8031414923946

lumen

colour temp. | colour



4800 lm

**LED-EXPLORER-NER**

8031414923939

lumen



4800 lm

watt

30W

beam angle

15°- 55°

pf

0.90

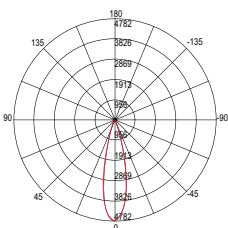

LED-EXPLORER





In.tec light

**SISTEMA BINARI / TRACK LIGHTS**

Trifase / Three-phase

# PLANE

Proiettore a binario in alluminio con adattatore trifase.

Aluminum track spotlight with three-phase adapter.

---

**Materiale**

corpo in alluminio  
pressofuso

---

**Colore**

bianco opaco  
nero opaco



---

**Temperatura colore**

3000K / 4000K



---

**Driver**

incluso

---

**Material**

aluminum  
die cast body

---

**Colour**

matt white  
matt black



---

**Colour temperature**

3000K / 4000K



---

**Driver**

included





	colour temp.	colour
<b>LED-PLANE-W-20C</b> 8031414924714 lumen	2400 lm	
<b>LED-PLANE-W-20M</b> 8031414924721 lumen	2400 lm	
<b>LED-PLANE-B-20C</b> 8031414924691 lumen	2400 lm	
<b>LED-PLANE-B-20M</b> 8031414924707 lumen	2400 lm	
watt	20W	
beam angle	38°	

	colour temp.	colour
<b>LED-PLANE-W-30C</b> 8031414924752 lumen	3600 lm	
<b>LED-PLANE-W-30M</b> 8031414924769 lumen	3600 lm	
<b>LED-PLANE-B-30C</b> 8031414924738 lumen	3600 lm	
<b>LED-PLANE-B-30M</b> 8031414924745 lumen	3600 lm	
watt	30W	
beam angle	38°	

	colour temp.	colour
<b>LED-PLANE-W-40C</b> 8031414924790 lumen	4800 lm	
<b>LED-PLANE-W-40M</b> 8031414924806 lumen	4800 lm	
<b>LED-PLANE-B-40C</b> 8031414924776 lumen	4800 lm	
<b>LED-PLANE-B-40M</b> 8031414924783 lumen	4800 lm	
watt	40W	
beam angle	38°	

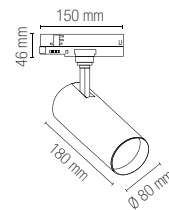
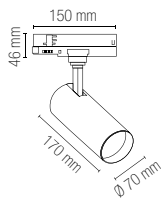
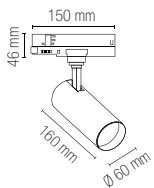

Fotometria del prodotto / Photometric curve

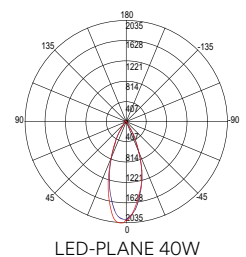
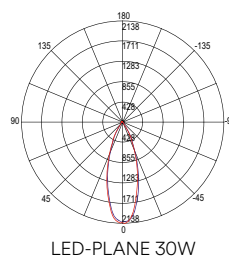
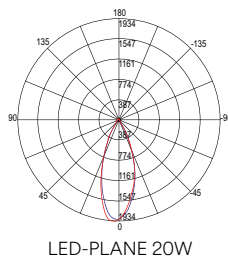

Trifase / Three-phase

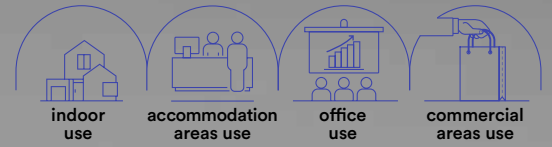

# JET ALTO LUMEN

Proiettore a binario in alluminio con adattatore trifase.  
Aluminum track spotlight with three-phase adapter.



**Materiale**

corpo in alluminio  
pressofuso

**Colore**

bianco opaco  
nero opaco



**Temperatura colore  
selezionabile**

3000K / 4000K



**Driver**

incluso

**Material**

aluminum  
die cast body

**Colour**

matt white  
matt black



**Selectable color  
temperature**

3000K / 4000K



**Driver**

included

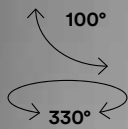

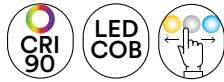

	colour temp.	colour
<b>LED-JET-W-20HL</b> 8031414924110		
lumen	4000 lm	
<b>LED-JET-B-20HL</b> 8031414924080		
lumen	4000 lm	
watt	20W	
beam angle	38°	
pf	0.90	

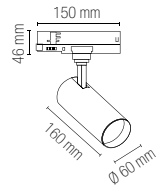

	colour temp.	colour
<b>LED-JET-W-30HL</b> 8031414924127		
lumen	6000 lm	
<b>LED-JET-B-30HL</b> 8031414924097		
lumen	6000 lm	
watt	30W	
beam angle	38°	
pf	0.90	

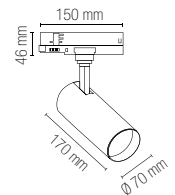

	colour temp.	colour
<b>LED-JET-W-40HL</b> 8031414924134		
lumen	8000 lm	
<b>LED-JET-B-40HL</b> 8031414924103		
lumen	8000 lm	
watt	40W	
beam angle	38°	
pf	0.90	

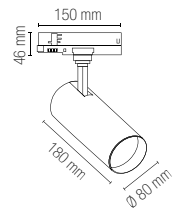

Accessori non inclusi / Not included accessories

Retina antiabbagliamento /  
Anti-glare retina



<b>LED-JET-MESH60</b> 8031414924073	for 20W
<b>LED-JET-MESH70</b> 8031414924066	for 30W
<b>LED-JET-MESH80</b> 8031414924059	for 40W

Deviatore flusso luminoso /  
Luminous flux diverter



<b>LED-JET-DIFF60</b> 8031414924042	for 20W
<b>LED-JET-DIFF70</b> 8031414924035	for 30W
<b>LED-JET-DIFF80</b> 8031414924028	for 40W

Fotometria del prodotto / Photometric curve

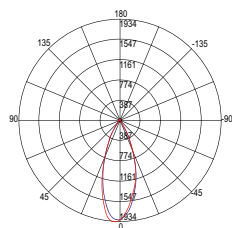

LED-JET ALTO LUMEN 20W

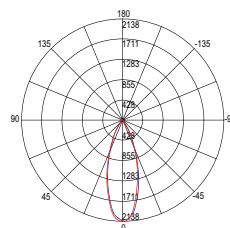

LED-JET ALTO LUMEN 30W

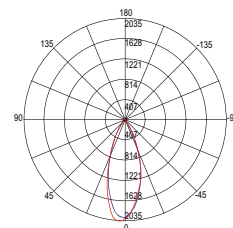

LED-JET ALTO LUMEN 40W

Trifase / Three-phase

# JET

Proiettore a binario in alluminio con adattatore trifase.  
Aluminum track spotlight with three-phase adapter.

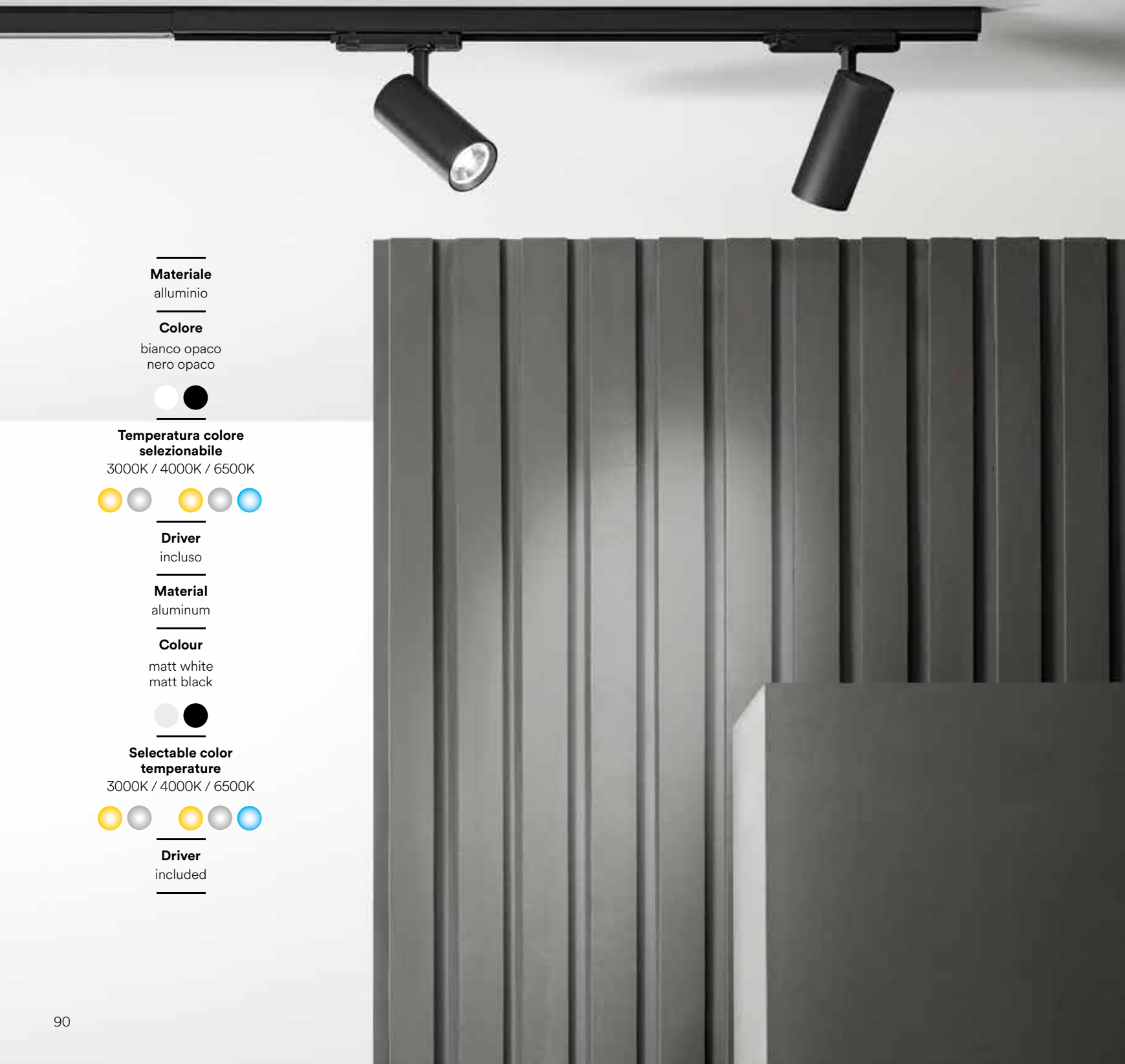
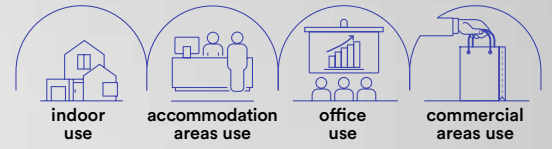

**Materiale**  
alluminio

**Colore**  
bianco opaco  
nero opaco



**Temperatura colore  
selezionabile**  
3000K / 4000K / 6500K



**Driver**  
incluso

**Material**  
aluminum

**Colour**  
matt white  
matt black



**Selectable color  
temperature**  
3000K / 4000K / 6500K



**Driver**  
included



DALI		colour temp.	colour
	<b>LED-JET-W-20DA</b> 8031414923755		
lumen		4000 lm	
	<b>LED-JET-B-20DA</b> 8031414923724		
lumen		4000 lm	
watt	20W		
beam angle	38°		
pf	0.90		

DALI		colour temp.	colour
	<b>LED-JET-W-30DA</b> 8031414923762		
lumen		6000 lm	
	<b>LED-JET-B-30DA</b> 8031414923731		
lumen		6000 lm	
watt	30W		
beam angle	38°		
pf	0.90		

DALI		colour temp.	colour
	<b>LED-JET-W-40DA</b> 8031414923779		
lumen		8000 lm	
	<b>LED-JET-B-40DA</b> 8031414923748		
lumen		8000 lm	
watt	40W		
beam angle	38°		
pf	0.90		

DALI		colour temp.	colour
	<b>LED-JET-W-20</b> 8031414893805		
lumen		2100 lm	
	<b>LED-JET-B-20</b> 8031414893775		
lumen		2100 lm	
watt	20W		
beam angle	38°		
pf	0.90		

DALI		colour temp.	colour
	<b>LED-JET-W-30</b> 8031414893812		
lumen		3235 lm	
	<b>LED-JET-B-30</b> 8031414893782		
lumen		3235 lm	
watt	30W		
beam angle	38°		
pf	0.90		

DALI		colour temp.	colour
	<b>LED-JET-W-40</b> 8031414893829		
lumen		4300 lm	
	<b>LED-JET-B-40</b> 8031414893799		
lumen		4300 lm	
watt	40W		
beam angle	38°		
pf	0.90		

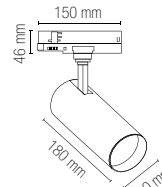
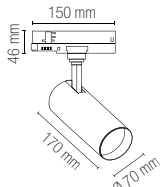
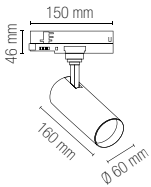

Fotometria del prodotto / Photometric curve

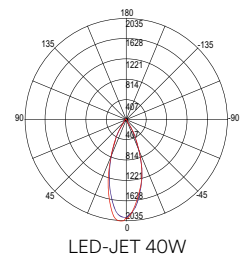
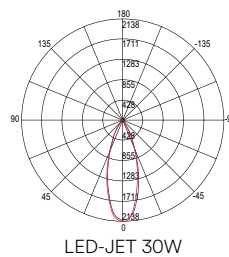
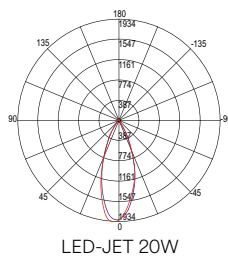

Trifase / Three-phase

# JET FOOD

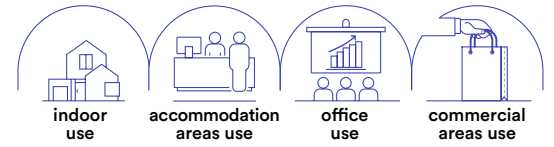

**Materiale**

corpo in alluminio pressofuso

**Colore**

bianco opaco  
nero opaco



**Temperatura colore**

2500K / 3000K / 3100K



**Driver**

integrato

**Material**

aluminum  
die cast body

**Colour**

matt white  
matt black



**Colour temperature**

2500K / 3000K / 3100K



**Driver**

built-in

**Proiettore a binario in alluminio pressofuso con adattatore trifase per l'illuminazione di generi alimentari.**

Die-cast aluminum track projector with three-phase adapter for food lighting.

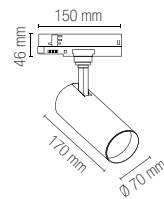

illuminazione per generi alimentari / Food lighting



	colour temp.	K	CRI	colour
<b>LED-JET-W-30BR</b> 8031414924189				
<b>LED-JET-B-30BR</b> 8031414924141				
lumen	4800 lm	2550 K	>90	
<b>LED-JET-W-30RM</b> 8031414924196				
<b>LED-JET-B-30RM</b> 8031414924158				
lumen	4800 lm	3100 K	>70	
<b>LED-JET-W-30FM</b> 8031414924202				
<b>LED-JET-B-30FM</b> 8031414924165				
lumen	4800 lm	3000 K	>63	
<b>LED-JET-W-30FR</b> 8031414924219				
<b>LED-JET-B-30FR</b> 8031414924172				
lumen	4800 lm	3000 K	>93	
watt				30W
beam angle				38°
pf				0.90



Trifase / Three-phase

# OBOE

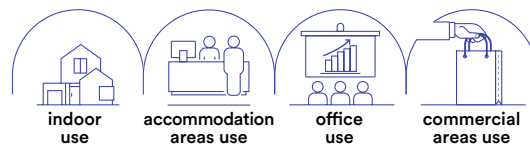

**Materiale**

corpo in alluminio pressofuso

**Colore**

bianco  
nero  
cromo  
oro  
bronzo



**Temperatura colore**

3000K / 4000K



**Driver**

integrato

**Material**

aluminum  
die cast body

**Colour**

white  
black  
chrome  
gold  
bronze



**Colour temperature**

3000K / 4000K



**Driver**

built-in

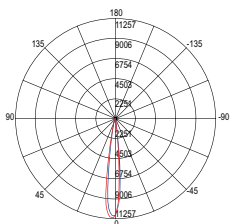

LED-OBOE-SC



**Sospensione in alluminio pressofuso con adattatore trifase.**

Die-cast aluminum suspension with three-phase adapter.

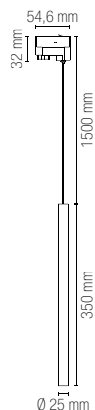

	colour temp.	colour
<b>LED-OBOE-SC BCO</b> 8031414865109		
<b>LED-OBOE-SM BCO</b> 8031414862047		
lumen	240 lm	
<b>LED-OBOE-SC NERO</b> 8031414865147		
<b>LED-OBOE-SM NERO</b> 8031414862030		
lumen	240 lm	
<b>LED-OBOE-SC CR</b> 8031414865130		
<b>LED-OBOE-SM CR</b> 8031414862061		
lumen	240 lm	
<b>LED-OBOE-SC ORO</b> 8031414865123		
<b>LED-OBOE-SM ORO</b> 8031414862054		
lumen	240 lm	
<b>LED-OBOE-SC BRO</b> 8031414865116		
<b>LED-OBOE-SM BRO</b> 8031414864287		
lumen	240 lm	
watt	3,5W	
beam angle	40°	

SISTEMA BINARI / TRACK LIGHTS

In.tec light

Trifase / Three-phase

# ROCKET

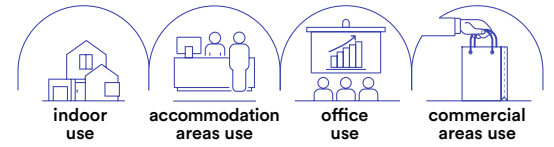

**Materiale**

corpo in alluminio pressofuso

**Colore**

bianco opaco  
nero opaco  
cromo  
oro  
bronzo

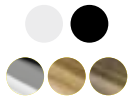

**Temperatura colore selezionabile**

3000K / 4000K



**Driver**

integrato

**Material**

aluminum  
die cast body

**Colour**

matt white  
matt black  
chrome  
gold  
bronze



**Selectable color temperature**

3000K / 4000K



**Driver**

built-in

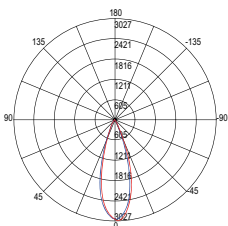

LED-ROCKET-7



**Proiettore a binario con luce spot in alluminio pressofuso con adattatore trifase.**

Track headlamp with spot light in die-cast aluminum with three-phase adapter.

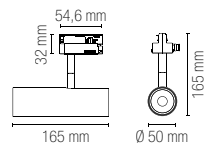

**LED-ROCKET-BCO**

8031414923953

lumen

colour temp.	colour
980 lm	

**LED-ROCKET-NER**

8031414923984

lumen

980 lm	

**LED-ROCKET-CR**

8031414923977

lumen

980 lm	

**LED-ROCKET-ORO**

8031414923991

lumen

980 lm		

**LED-ROCKET-BRO**

8031414923960

lumen

980 lm		

watt	7W
beam angle	38°



Trifase / Three-phase

# ROCKET

Spot applique.  
Wall spot light.

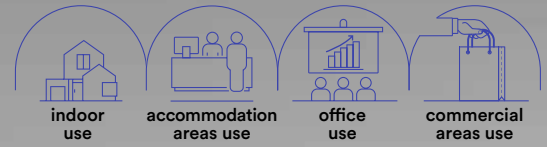

**Materiale**

corpo in alluminio  
pressofuso

**Colore**

bianco opaco  
nero opaco



**Temperatura colore  
selezionabile**

3000K / 4000K



**Driver**

integrato

**Material**

aluminum  
die cast body

**Colour**

matt white  
matt black



**Selectable color  
temperature**

3000K / 4000K



**Driver**

built-in



**LED-ROCKET-AP-BCO**

8031414924004

lumen

colour temp.	colour

980 lm

**LED-ROCKET-AP-NER**

8031414924011

lumen

980 lm

watt

7W

beam angle

38°

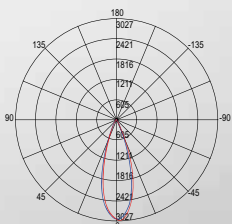

LED-ROCKET-APC

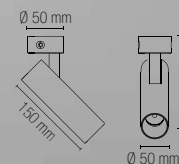

SISTEMA BINARI / TRACK LIGHTS

In.tec light

Trifase / Three-phase

# SQUIB

Proiettore a binario in alluminio con adattatore trifase.  
Aluminum track headlamp with three-phase adapter.



	colour	
<b>I-SQUIB-BCO</b> 8031414883226		
<b>I-SQUIB-NER</b> 8031414883233		
<b>I-SQUIB-ORO</b> 8031414895397		

1 x GU10 MAX 25W

Lampadina non inclusa / Light bulb not included

Trifase / Three-phase

# EXPRESS

Proiettore a binario in alluminio con adattatore trifase.  
Aluminum track headlamp with three-phase adapter.

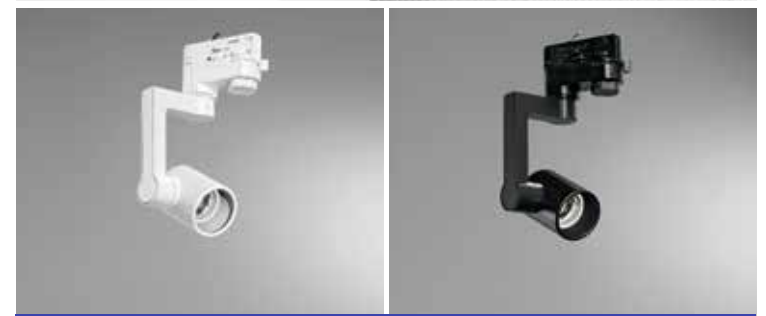
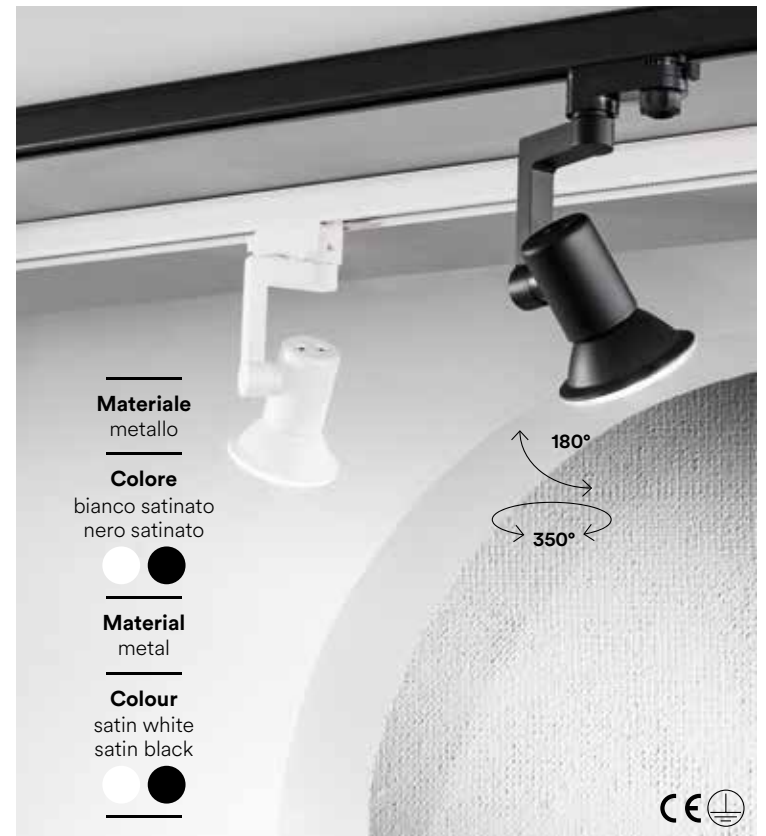

	colour	
<b>LED-EXPRESS</b> 8031440360470		
<b>LED-EXPRESS-B</b> 8031414864676		

1 x E27 MAX 42W

Lampadina non inclusa / Light bulb not included

Trifase / Three-phase

# CLOCK

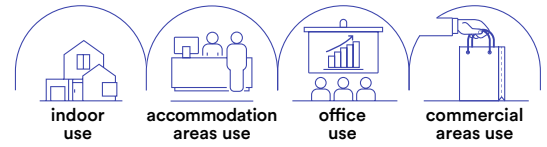

indoor use

accommodation areas use

office use

commercial areas use

## Materiale

alluminio con cavo in tessuto nero

## Colore

romo  
nero anodizzato



## Material

aluminum with black fabric cable

## Colour

chrome  
black anodized



## Sospensione in alluminio con adattatore trifase e cavo in tessuto nero.

Pendant lamp in aluminum with three-phase adaptor and black fabric cable.



## I-TRACK-CLOCK-CR

8031414864072

## I-TRACK-CLOCK-NERO

8031414864096

1 x E27 MAX 60W

colour



Lampadina non inclusa / Light bulb not included



Portalampada incluso / Lampholder included

SISTEMA BINARI / TRACK LIGHTS

In.tec light

Trifase / Three-phase

# MAXWELL

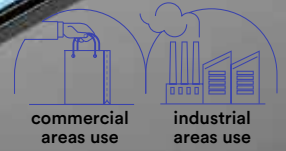

**Materiale**  
alluminio

**Colore**  
bianco  
nero



**Temperatura colore**  
3000K / 4000K



**Driver**  
integrato

**Durata e on/off**  
50.000h  
>25.000 on/off

**Material**  
aluminum

**Colour**  
white  
black



**Colour temperature**  
3000K / 4000K



**Driver**  
built-in

**Life time and on/off**  
50.000h  
>25.000 on/off

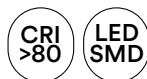

**Lampada lineare in alluminio con adattatore trifase.**

Linear aluminum lamp with three-phase adapter.



	colour temp.	colour
<b>MAXWELL-W-25C</b> 8031414884056	3000K	White
lumen	3300 lm	
<b>MAXWELL-W-25M</b> 8031414884049	3000K	White
lumen	3300 lm	
<b>MAXWELL-B-25C</b> 8031414884070	3000K	Black
lumen	3300 lm	
<b>MAXWELL-B-25M</b> 8031414884063	3000K	Black
lumen	3300 lm	

**Fotometria del prodotto / Photometric curve**

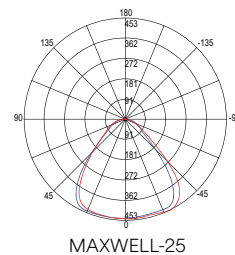

watt 25W  
beam angle 90°

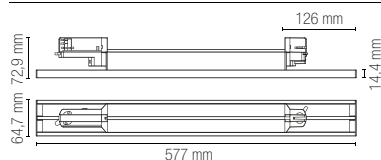

	colour temp.	colour
<b>MAXWELL-W-48C</b> 8031414884018	3000K	White
lumen	6500 lm	
<b>MAXWELL-W-48M</b> 8031414884001	3000K	White
lumen	6500 lm	
<b>MAXWELL-B-48C</b> 8031414884032	3000K	Black
lumen	6500 lm	
<b>MAXWELL-B-48M</b> 8031414884025	3000K	Black
lumen	6500 lm	

**Fotometria del prodotto / Photometric curve**

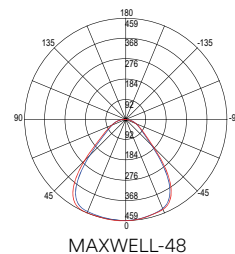

watt 48W  
beam angle 90°

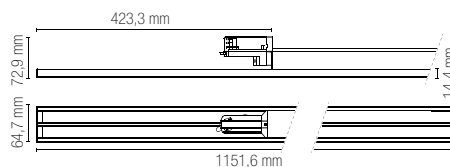

**Interruttore per regolazione potenza / Power switchable:**  
48W - 44W - 40W - 34W  
130 LM/W

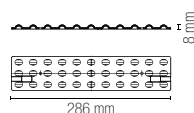

**Accessori non inclusi / Not included accessories**

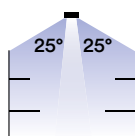

**BUSMAX-LENS-25**

8031414884117  
Lente per doppio fascio luminoso 25° / Double lens 25°  
Per i modelli **MAXWELL 25** occorrono 2 pezzi per l'intera lampada / 2 pieces need for the whole **MAXWELL 25** models  
Per i modelli **MAXWELL 48** occorrono 4 pezzi per l'intera lampada / 4 pieces need for the whole **MAXWELL 48** models

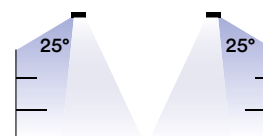

**BUSMAX-LENS-RL**

8031414884124  
Lente fascio di luce asimmetrica 25° sx-dx / Asymmetric lens 25° sx-dx  
Per i modelli **MAXWELL 25** occorrono 2 pezzi per l'intera lampada / 2 pieces need for the whole **MAXWELL 25** models  
Per i modelli **MAXWELL 48** occorrono 4 pezzi per l'intera lampada / 4 pieces need for the whole **MAXWELL 48** models

Trifase / Three-phase

# HELP TRACK

**Lampade di emergenza LED in policarbonato per sistema binario trifase.**

LED emergency lamps in polycarbonate for three-phase track system.

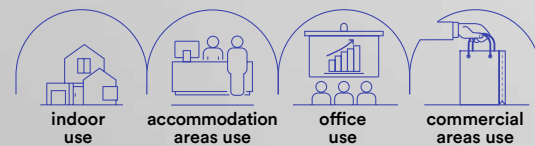



**Materiale**  
policarbonato

**Colore**  
bianco  
nero



**Temperatura colore**  
4000K



**Material**  
polycarbonate

**Colour**  
white  
black



**Colour temperature**  
4000K



**LED-HELP-W-TRACK**

8031414884179

lumen

colour temp. | colour



250 lm

**LED-HELP-B-TRACK**

8031414884162

lumen

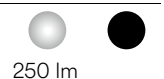

250 lm

watt

2W

beam angle

140°

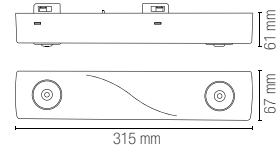

**LiFePO4 3.2V 3200mAh**

Batteria per emergenza inclusa /  
Included emergency battery



# RAIL

**Binari ed accessori.**  
Track rail and components.



**LED-RAIL-1M-BCO**  
8031414917211

Binari elettrificati trifase in alluminio bianco da un 1 m con tappi inclusi.

1 m track rail in white aluminum with three-phase adaptor and endcap included.

**LED-RAIL-2M-BCO**  
8031414917235

Binari elettrificati trifase in alluminio bianco da 2 m con tappi inclusi.

2 m track rail in white aluminum with three-phase adaptor and endcap included.

**LED-RAIL-3M-BCO**  
8031414917259

Binari elettrificati trifase in alluminio bianco da 3 m con tappi inclusi.

3 m track rail in white aluminum with three-phase adaptor and endcap included.



**LED-RAIL-PL-BCO**  
8031414925247

Kit 2 pz. Basette bianche per binario guida trifase.

Kit 2 pcs. white base for track rail three-phase.



**LED-TRACK-BASE**  
8031440361668

Base tonda bianca per faro adattatore trifase (adatto per EXPRESS, ROCKET, SQUIB, OBOE).

White round base for track lamp with three-phase adaptor (useful items EXPRESS, ROCKET, SQUIB, OBOE).



**LED-RAIL-CAP-BCO**  
8031414917273

Tappo per binario trifase bianco.

White cap for three-phase track rail.



**LED-TRACK-ADAT**  
8031414866410

Adattatore bianco per binario trifase.

White adapt for three-phase track rail.

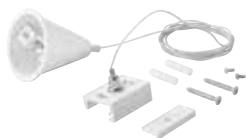

**LED-RAIL-S-1,5-BCO**  
8031414918034

Sistema sospensione 1,5 m per binari bianco.

White suspension 1,5 m for track rail.

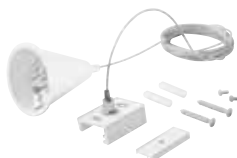

**LED-RAIL-S-3-BCO**  
8031414917457

Sistema sospensione 3 m per binari bianco.

White suspension 3 m for track rail.





**LED-RAIL-1M-NER**  
8031414917228

Binari elettrificati trifase in alluminio nero da un 1 m con tappi inclusi.

1 m track rail in black aluminum with three-phase adaptor and endcap included.

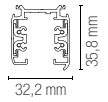

**LED-RAIL-2M-NER**  
8031414917242

Binari elettrificati trifase in alluminio nero da 2 m con tappi inclusi.

2 m track rail in black aluminum with three-phase adaptor and endcap included.

**LED-RAIL-3M-NER**  
8031414917266

Binari elettrificati trifase in alluminio nero da 3 m con tappi inclusi.

3 m track rail in black aluminum with three-phase adaptor and endcap included.



**LED-RAIL-PL-NER**  
8031414925254

Kit 2 pz. basette nere per binario guida trifase.

Kit 2 pcs. black base for track rail three-phase.

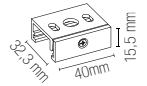

**LED-TRACK-BASE NERO**  
8031440361675

Base tonda nera per faro adattatore trifase (adatto per EXPRESS, ROCKET, SQUIB, OBOE).

Black round base for track lamp with three-phase adaptor (useful items EXPRESS, ROCKET, SQUIB, OBOE).

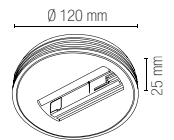

**LED-RAIL-CAP-NER**  
8031414917280

Tappo per binario trifase nero.

Black cap for three-phase track rail.

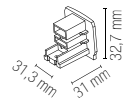

**LED-TRACK-ADAT NERO**  
8031414866397

Adattatore nero per binario trifase.

Black adapt for three-phase track rail.

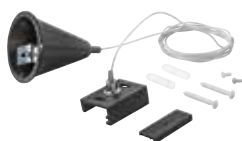
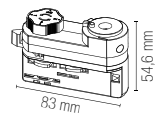

**LED-RAIL-S-1,5-NER**  
8031414917440

Sistema sospensione 1,5 m per binari nero.

Black suspension 1,5 m for track rail.

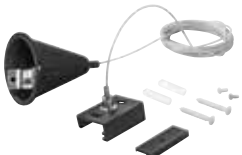
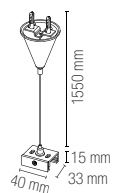

**LED-RAIL-S-3-NER**  
8031414917464

Sistema sospensione 3 m per binari nero.

Black suspension 3 m for track rail.

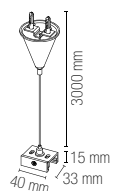









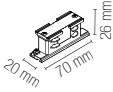

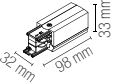
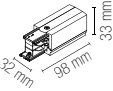
# RAIL

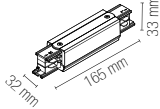
## Binari ed accessori.

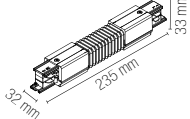
Track rail and components.

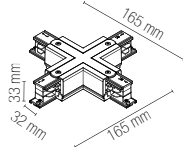
	<b>LED-RAIL-I-MINI-BCO</b> 8031414917938	Connettore lineare mini bianco a scomparsa per sistema binari trifase.	White mini invisible connector for three-phase track rail system.	
	<b>LED-RAIL-NEST-SX-BCO</b> 8031414917990	Innesto bianco sinistro per binari guida entrata L N + cavo di terra per circuito a trifase.	White recess power connector left side for three-phase track rail, L N input + ground cable for three-phase circuit.	
	<b>LED-RAIL-NEST-DX-BCO</b> 8031414918010	Innesto bianco destro per binari guida entrata L N + cavo di terra per circuito a trifase.	White recess power connector right side for three-phase track rail, L N input + ground cable for three-phase circuit.	
	<b>LED-RAIL-I-BCO</b> 8031414917914	Connettore bianco lineare per binari sistema trifase.	White straight connector for three-phase track rail system.	
	<b>LED-RAIL-FLEX-BCO</b> 8031414917891	Connettore bianco flessibile per sistema trifase.	White flexible power connector for three-phase track rail system.	
	<b>LED-RAIL-X-BCO</b> 8031414917556	Connettore a croce bianco per sistema trifase.	White cross connector for three-phase system.	
	<b>LED-RAIL-L-DX-BCO</b> 8031414917976	Connettore bianco track destro a L per binari guida trifase.	White L connector right side for three-phase track rail system.	
	<b>LED-RAIL-L-SX-BCO</b> 8031414917952	Connettore bianco track sinistro a L per binari guida trifase.	White L connector left side for three-phase track rail system.	

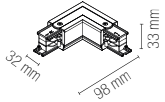
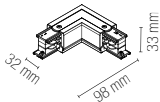
	<p><b>LED-RAIL-I-MINI-NER</b> 8031414917945</p>	<p>Black mini invisible connector for three phase track rail system.</p>	
	<p><b>LED-RAIL-NEST-SX-NER</b> 8031414918003</p>	<p>Black recess power connector left side for three-phase track rail, L N input + ground cable for three-phase circuit.</p>	
	<p><b>LED-RAIL-NEST-DX-NER</b> 8031414918027</p>	<p>Black recess power connector right side for three-phase track rail, L N input + ground cable for three-phase circuit.</p>	
	<p><b>LED-RAIL-I-NER</b> 8031414917921</p>	<p>Black straight connector for three-phase track rail system.</p>	
	<p><b>LED-RAIL-FLEX-NER</b> 8031414917907</p>	<p>Black flexible power connector for three-phase track rail system.</p>	
	<p><b>LED-RAIL-X-NER</b> 8031414917563</p>	<p>Black cross connector for three-phase system.</p>	
	<p><b>LED-RAIL-L-DX-NER</b> 8031414917983</p>	<p>Black L connector right side for three-phase track rail system.</p>	
	<p><b>LED-RAIL-L-SX-NER</b> 8031414917969</p>	<p>Black L connector left side for three-phase track rail system.</p>	

# RAIL

## Binari ed accessori.

Track rail and components.



---

### LED-RAIL-T-DX1-BCO

8031414917518



Connettore bianco destro a T  
per binari guida entrata  
L N + cavo di terra  
per circuito trifase.

Right white T connector  
for L N input guide  
rails + ground cable for  
three-phase system.

---

### LED-RAIL-T-SX1-BCO

8031414917495



Connettore bianco sinistro a T  
per binari guida entrata  
L N + cavo di terra  
per circuito trifase.

Left white T connector  
for L N input guide  
rails + ground cable for  
three-phase system.

---

### LED-RAIL-T-DX2-BCO

8031414917532



Connettore bianco destro a T  
per binari guida entrata  
L N + cavo di terra  
per circuito trifase.

Right white T connector  
for L N input guide  
rails + ground cable for  
three-phase system.

---

### LED-RAIL-T-SX2-BCO

8031414917471



Connettore bianco a T  
per binari guida entrata  
L N + cavo di terra  
per circuito trifase.

White T connector  
for L N input guide  
rails + ground cable for  
three-phase circuit.



**LED-RAIL-T-DX1-NER**  
8031414917525



Connettore nero destro a T  
per binari guida entrata  
L N + cavo di terra  
per circuito trifase.

Right black T connector  
for L N input guide  
rails + ground cable for  
three-phase system.

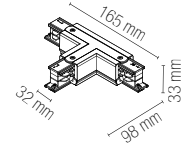

**LED-RAIL-T-SX1-NER**  
8031414917501



Connettore nero sinistro a T  
per binari guida entrata  
L N + cavo di terra  
per circuito trifase.

Left black T connector  
for L N input guide  
rails + ground cable for  
three-phase system.

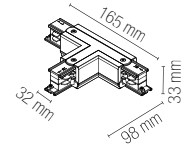

**LED-RAIL-T-DX2-NER**  
8031414917549



Connettore nero destro a T  
per binari guida entrata  
L N + cavo di terra  
per circuito trifase.

Right black T connector  
for L N input guide  
rails + ground cable for  
three-phase system.

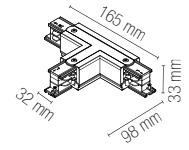

**LED-RAIL-T-SX2-NER**  
8031414917488



Connettore nero a T  
per binari guida entrata  
L N + cavo di terra  
per circuito trifase.

Black T connector  
for L N input guide  
rails + ground cable for  
three-phase circuit.

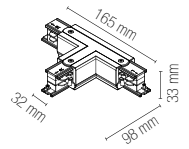

Trifase / Three-phase

# RAIL

## Binari ed accessori.

Track rail and components.



### LED-RAIL-1M-DA-BCO

8031414926169



Binari elettrificati trifase in alluminio bianco da un 1 m con tappi inclusi.

1 m track rail in white aluminum with three-phase adaptor and endcap included.

### LED-RAIL-2M-DA-BCO

8031414926183



Binari elettrificati trifase in alluminio bianco da 2 m con tappi inclusi.

2 m track rail in white aluminum with three-phase adaptor and endcap included.

### LED-RAIL-3M-DA-BCO

8031414926206



Binari elettrificati trifase in alluminio bianco da 3 m con tappi inclusi.

3 m track rail in white aluminum with three-phase adaptor and endcap included.



### LED-RAIL-PL-DA-BCO

8031414926428



Kit 2 pz. Basette bianche per binario guida trifase.

Kit 2 pcs. white base for track rail three-phase.



### LED-RAIL-CAP-DA-BCO

8031414926220



Tappo per binario trifase bianco.

White cap for three-phase track rail.

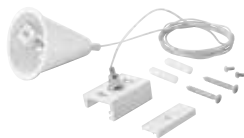

### LED-RAIL-S-1,5-DA-BCO

8031414926381



Sistema sospensione 1,5 m per binari bianco.

White suspension 1,5 m for track rail.

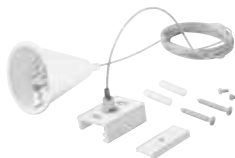

### LED-RAIL-S-3-DA-BCO

8031414926404



Sistema sospensione 3 m per binari bianco.

White suspension 3 m for track rail.

technical information



**LED-RAIL-1M-DA-NER**  
8031414926176



Binari elettrificati trifase in alluminio nero da un 1 m con tappi inclusi.

1 m track rail in black aluminum with three-phase adaptor and endcap included.

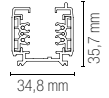

**LED-RAIL-2M-DA-NER**  
8031414926190



Binari elettrificati trifase in alluminio nero da 2 m con tappi inclusi.

2 m track rail in black aluminum with three-phase adaptor and endcap included.

**LED-RAIL-3M-DA-NER**  
8031414926213



Binari elettrificati trifase in alluminio nero da 3 m con tappi inclusi.

3 m track rail in black aluminum with three-phase adaptor and endcap included.



**LED-RAIL-PL-DA-NER**  
8031414926435



Kit 2 pz. basette nere per binario guida trifase.

Kit 2 pcs. black base for track rail three-phase.

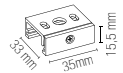

**LED-RAIL-CAP-DA-NER**  
8031414926237



Tappo per binario trifase nero.

Black cap for three-phase track rail.

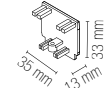

**LED-RAIL-S-1,5-DA-NER**  
8031414926398



Sistema sospensione 1,5 m per binari nero.

Black suspension 1,5 m for track rail.

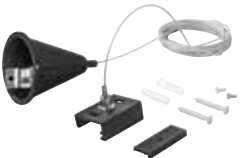
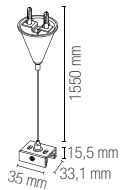

**LED-RAIL-S-3-DA-NER**  
8031414926411



Sistema sospensione 3 m per binari nero.

Black suspension 3 m for track rail.

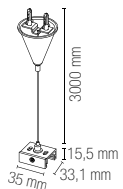







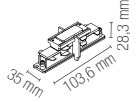

# RAIL

**Binari ed accessori.**  
Track rail and components.

	<p><b>LED-RAIL-I-MINI-DA-BCO</b> 8031414926282</p> <p>Connettore lineare mini bianco a scomparsa per sistema binari trifase.</p>	<p>White mini invisible connector for three-phase track rail system.</p> 
	<p><b>LED-RAIL-NEST-SX-DA-BCO</b> 8031414926343</p> <p>Innesto bianco sinistro per binari guida entrata L N + cavo di terra per circuito a trifase.</p>	<p>White recess power connector left side for three-phase track rail, L N input + ground cable for three-phase circuit.</p> 
	<p><b>LED-RAIL-NEST-DX-DA-BCO</b> 8031414926367</p> <p>Innesto bianco destro per binari guida entrata L N + cavo di terra per circuito a trifase.</p>	<p>White recess power connector right side for three-phase track rail, L N input + ground cable for three-phase circuit.</p> 
	<p><b>LED-RAIL-I-DA-BCO</b> 8031414926268</p> <p>Connettore bianco lineare per binari sistema trifase.</p>	<p>White straight connector for three-phase track rail system.</p> 
	<p><b>LED-RAIL-FLEX-DA-BCO</b> 8031414926244</p> <p>Connettore bianco flessibile per sistema trifase.</p>	<p>White flexible power connector for three-phase track rail system.</p> 
	<p><b>LED-RAIL-X-DA-BCO</b> 8031414926527</p> <p>Connettore a croce bianco per sistema trifase.</p>	<p>White cross connector for three-phase system.</p> 
	<p><b>LED-RAIL-L-DX-DA-BCO</b> 8031414926329</p> <p>Connettore bianco track destro a L per binari guida trifase.</p>	<p>White L connector right side for three-phase track rail system.</p> 
	<p><b>LED-RAIL-L-SX-DA-BCO</b> 8031414926305</p> <p>Connettore bianco track sinistro a L per binari guida trifase.</p>	<p>White L connector left side for three-phase track rail system.</p> 

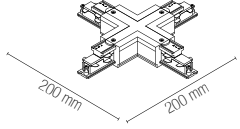

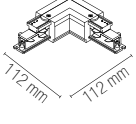
	<p><b>LED-RAIL-I-MINI-DA-NER</b> 8031414926299</p> <p>Connettore lineare mini nero a scomparsa per sistema binari trifase.</p>	<p>Black mini invisible connector for three phase track rail system.</p> <p></p>	
	<p><b>LED-RAIL-NEST-SX-DA-NER</b> 8031414926350</p> <p>Innesto nero sinistro per binari guida entrata L N + cavo di terra per circuito a trifase.</p>	<p>Black recess power connector left side for three-phase track rail, L N input + ground cable for three-phase circuit.</p> <p></p>	
	<p><b>LED-RAIL-NEST-DX-DA-NER</b> 8031414926374</p> <p>Innesto nero destro per binari guida entrata L N + cavo di terra per circuito a trifase.</p>	<p>Black recess power connector right side for three-phase track rail, L N input + ground cable for three-phase circuit.</p> <p></p>	
	<p><b>LED-RAIL-I-DA-NER</b> 8031414926275</p> <p>Connettore nero lineare per binari sistema trifase.</p>	<p>Black straight connector for three-phase track rail system.</p> <p></p>	
	<p><b>LED-RAIL-FLEX-DA-NER</b> 8031414926251</p> <p>Connettore nero flessibile per sistema trifase.</p>	<p>Black flexible power connector for three-phase track rail system.</p> <p></p>	
	<p><b>LED-RAIL-X-DA-NER</b> 8031414926534</p> <p>Connettore a croce nero per sistema trifase.</p>	<p>Black cross connector for three-phase system.</p> <p></p>	
	<p><b>LED-RAIL-L-DX-DA-NER</b> 8031414926336</p> <p>Connettore nero track destro a L per binari guida trifase.</p>	<p>Black L connector right side for three-phase track rail system.</p> <p></p>	
	<p><b>LED-RAIL-L-SX-DA-NER</b> 8031414926312</p> <p>Connettore nero track sinistro a L per binari guida trifase.</p>	<p>Black L connector left side for three-phase track rail system.</p> <p></p>	

Trifase / Three-phase

# RAIL

## Binari ed accessori.

Track rail and components.



---

### LED-RAIL-T-DX1-DA-BCO

8031414926480



Connettore bianco destro a T per binari guida entrata L N + cavo di terra per circuito trifase.

Right white T connector for L N input guide rails + ground cable for three-phase system.

---

### LED-RAIL-T-SX1-DA-BCO

8031414926466



Connettore bianco sinistro a T per binari guida entrata L N + cavo di terra per circuito trifase.

Left white T connector for L N input guide rails + ground cable for three-phase system.

---

### LED-RAIL-T-DX2-DA-BCO

8031414926503



Connettore bianco destro a T per binari guida entrata L N + cavo di terra per circuito trifase.

Right white T connector for L N input guide rails + ground cable for three-phase system.

---

### LED-RAIL-T-SX2-DA-BCO

8031414926442



Connettore bianco a T per binari guida entrata L N + cavo di terra per circuito trifase.

White T connector for L N input guide rails + ground cable for three-phase circuit.



**LED-RAIL-T-DX1-DA-NER**  
8031414926497



Connettore nero destro a T  
per binari guida entrata  
L N + cavo di terra  
per circuito trifase.

Right black T connector  
for L N input guide  
rails + ground cable for  
three-phase system.

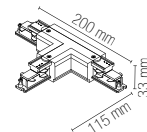

**LED-RAIL-T-SX1-DA-NER**  
8031414926473



Connettore nero sinistro a T  
per binari guida entrata  
L N + cavo di terra  
per circuito trifase.

Left black T connector  
for L N input guide  
rails + ground cable for  
three-phase system.

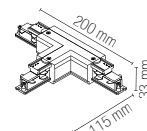

**LED-RAIL-T-DX2-DA-NER**  
8031414926510



Connettore nero destro a T  
per binari guida entrata  
L N + cavo di terra  
per circuito trifase.

Right black T connector  
for L N input guide  
rails + ground cable for  
three-phase system.

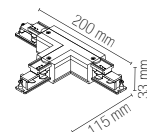

**LED-RAIL-T-SX2-DA-NER**  
8031414926459







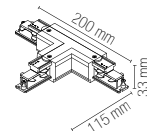



Connettore nero a T  
per binari guida entrata  
L N + cavo di terra  
per circuito trifase.

Black T connector  
for L N input guide  
rails + ground cable for  
three-phase circuit.

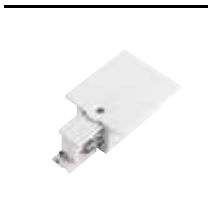

# TRACK

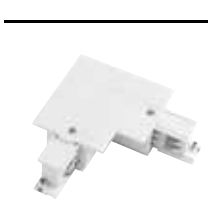
**Binari ed accessori.**  
Track rail and components.

	<b>LED-TRACK-1M-INC</b> 8031440361804	Binario trifase ad incasso in alluminio bianco 1 m.	Recessed track light in white aluminum 1 m.	
	<b>LED-TRACK-2M-INC</b> 8031440361811	Binario trifase ad incasso in alluminio bianco 2 m.	Recessed track light in white aluminum 2 m.	
	<b>INC-TRACK-STAFFE</b> 8031414879700	Kit 2pz staffe zincate per binario incasso	Kit 2pcs metal bracket for recessed track rail	
	<b>INC-TRACK-NEST</b> 8031414871193	Innesto sinistro per binario ad incasso trifase bianco.	White recess power connector left side for three-phase track rail.	
	<b>INC-TRACK-NEST-R</b> 8031414871179	Innesto destro per binario ad incasso trifase bianco.	White recess power connector right side for three-phase track rail in back version.	
	<b>INC-TRACK-I</b> 8031414871254	Connettore bianco lineare ad incasso per binari trifase.	White recess straight connection for three-phase track rail system.	
	<b>INC-TRACK-L-R</b> 8031414871216	Connettore bianco ad incasso destro a L per binari trifase.	White recess L connector right side for three-phase track rail system.	
	<b>INC-TRACK-L</b> 8031414871230	Connettore bianco ad incasso sinistro a L per binari trifase.	White recess L connector left side for three-phase track rail system.	

**LED-TRACK-1M-INC NERO**

8031414864836

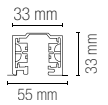
Binario trifase ad incasso  
in alluminio nero 1 m.Recessed track light in  
black aluminum 1 m.**LED-TRACK-2M-INC NERO**

8031414864058

Binario trifase ad incasso  
nero in alluminio 2 m.Recessed track light in  
black aluminum 2 m.**INC-TRACK-STAFFE**

8031414879700

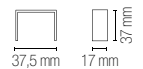
Kit 2pz staffe zincate  
per binario incassoKit 2pcs metal bracket  
for recessed track rail**INC-TRACK-NEST NERO**

8031414871209

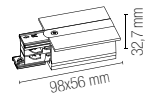
Innesto sinistro per binario  
ad incasso trifase nero.Black recess power  
connector left side for  
three-phase track rail.**INC-TRACK-NEST-R NERO**

8031414871186

Innesto destro per binario  
ad incasso trifase nero.Black recess power  
connector right side for  
three-phase track rail  
in back version.**INC-TRACK-I NERO**

8031414871261

Connettore nero lineare  
ad incasso per binari trifase.Black recess straight  
connection for three-phase  
track rail system.**INC-TRACK-L-R NERO**

8031414871223

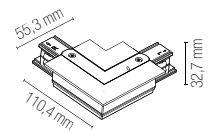
Connettore nero ad incasso  
destro a L per binari trifase.Black recess L connector  
right side for three-phase  
track rail system.**INC-TRACK-L NERO**

8031414871247

Connettore nero ad incasso  
sinistro a L per binari trifase.Black recess L connector  
left side for three-phase  
track rail system.

# BUSBAR TRUNKING SYSTEM



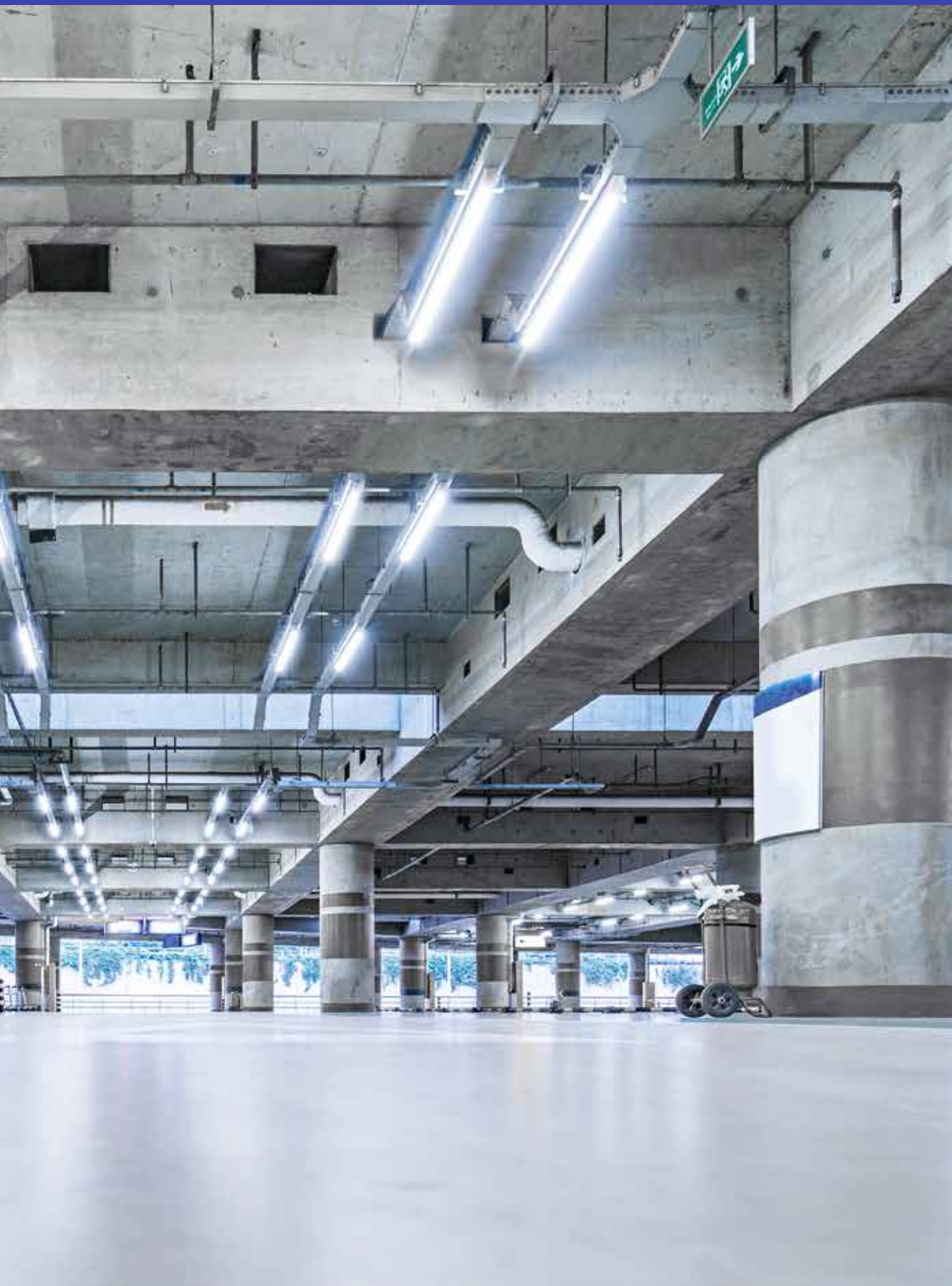

In.tec light    **SISTEMA BINARI / TRACK LIGHTS**

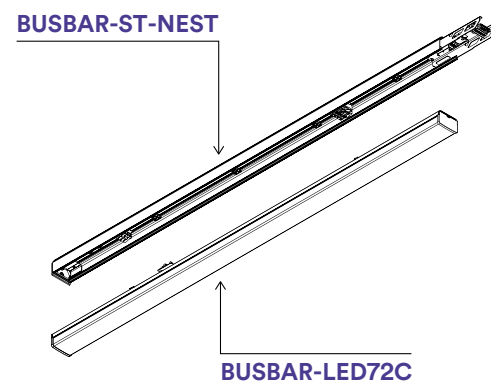
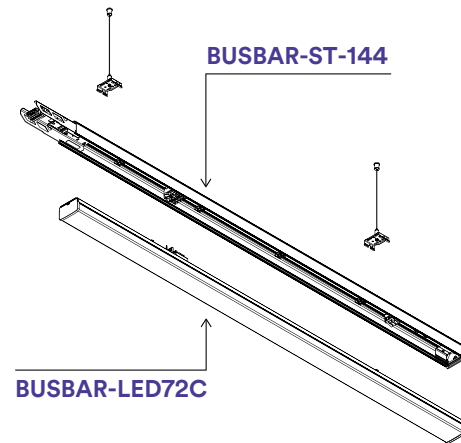
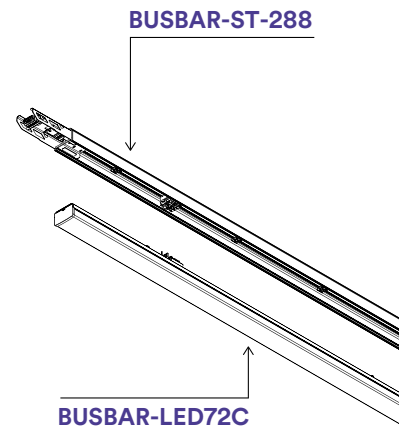
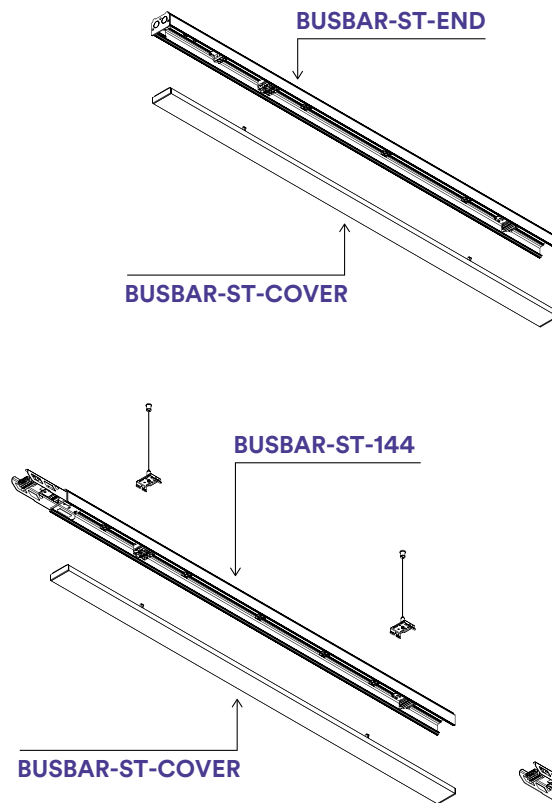
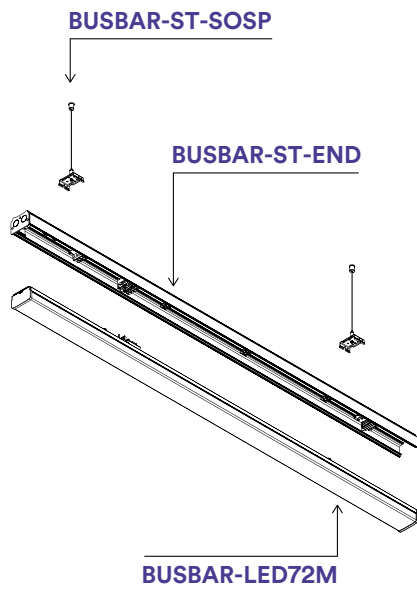

Schema di montaggio sistema binari.  
Assembling technical sheet track rail system.

# BUSBAR TRUNKING SYSTEM



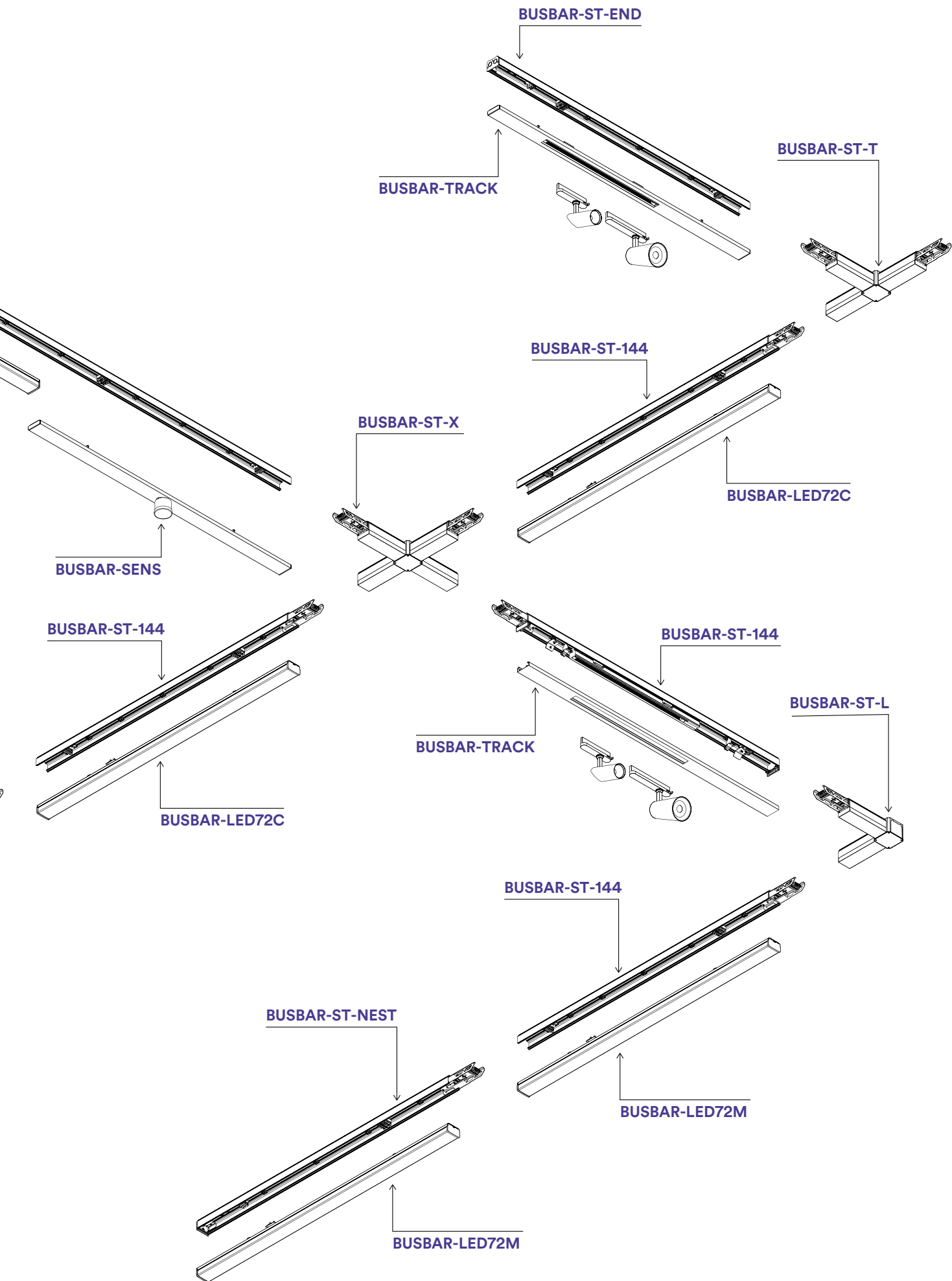

Trunking System

# BUSBAR

Sistema trunking lineare.  
Trunking linear system.

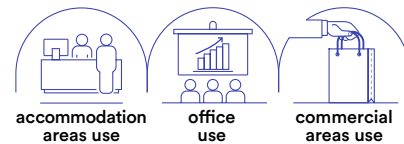

**Materiale**  
alluminio

**Colore**  
bianco



**Temperatura colore**  
3000K / 4000K



**Driver**  
integrato

**Durata e on/off**  
50.000h  
>25.000 on/off

**Material**  
aluminum

**Colour**  
white



**Colour temperature**  
3000K / 4000K



**Driver**  
built-in

**Life time and on/off**  
50.000h  
>25.000 on/off



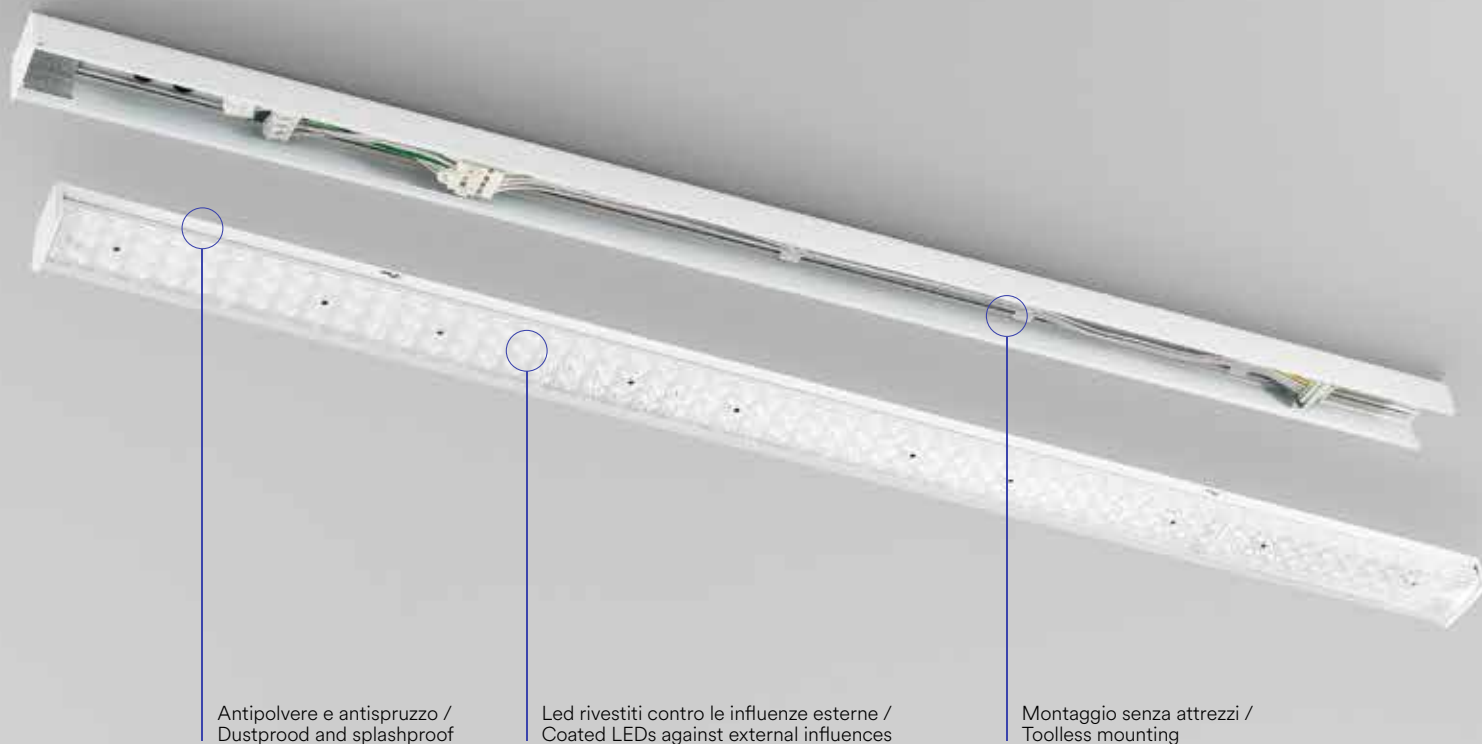

Antipolvere e antispruzzo /  
Dustproof and splashproof

Led rivestiti contro le influenze esterne /  
Coated LEDs against external influences

Montaggio senza attrezzi /  
Toolless mounting



Sistema di fissaggio a soffitto o a sospensione /  
Ceiling mount or pendant fixing system



Estensibile grazie ai moduli in 2 misure /  
Extendable thanks to the extruded aluminum modules



Sistema easy di aggancio binari /  
Track rail easy connection system



7 cavi L1 L2 L3 N E D+ D- trifase più dimmer /  
7 wire connection system L1 L2 L3 N E D+ D- three-phase + dimmer



Sistema easy di fissaggio della lampada /  
Lamp easy installation system

In.tec light **SISTEMA BINARI / TRACK LIGHTS**

**Lenti per diversi fasci di luce / Different beam angles optional lens**

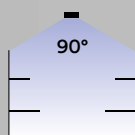

Lente inclusa /  
Included lens

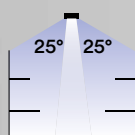

**Lente opzionale**  
doppio fascio luminoso 25° /  
**Optional lens** double lens 25°

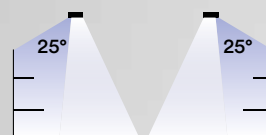

**Lente opzionale**  
fascio di luce asimmetrico 25° sx-dx /  
**Optional lens** asymmetric lens 25° sx-dx

Trunking System

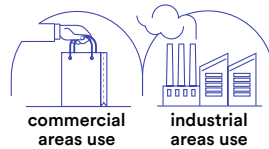

# BUSBAR

Lampada lineare per sistema trunking.  
Linear lamp for trunking system.

**Materiale**  
alluminio

**Colore**  
bianco



**Temperatura colore**  
3000K / 4000K



**Driver**  
integrato

**Durata e on/off**  
50.000h  
>25.000 on/off

**Material**  
aluminum

**Colour**  
white



**Colour temperature**  
3000K / 4000K



**Driver**  
built-in

**Life time and on/off**  
50.000h  
>25.000 on/off





**BUSBAR-LED72C**

8031414883936

lumen 9340 lm

**BUSBAR-LED72M**

8031414883929

lumen 9340 lm

watt 72W

beam angle 90°

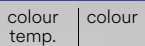

**BUSBAR-LED72M-HELP**

8031414898367

lumen 9340 lm

watt 72W

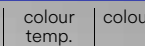

emergency light 3 h - 600 lm

watt 4W

beam angle 90°

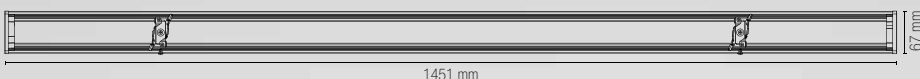

**Funzione MAINTAIN**  
sempre accesa /  
**MAINTAIN**  
function always on



**Funzione NON-MAINTAIN**  
emergenza /  
**NON-MAINTAIN** function  
only emergency

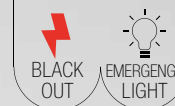

Compatibile con altri sistemi trunking in commercio / Compatible with other trunking systems



Fotometria del prodotto / Photometric curve

Accessori non inclusi / Not included accessories

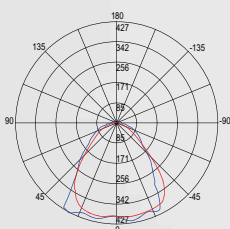

BUSBAR-LED72

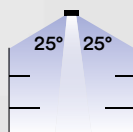
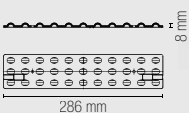

**BUSMAX-LENS-25**

8031414884117

Lente per doppio fascio luminoso 25° /  
Double lens 25°

Per tutta la lampada  
**BUSBAR** occorrono 5 pezzi /  
5 pieces need for the  
whole **BUSBAR** lamp

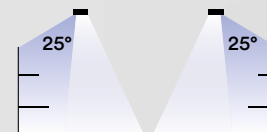

**BUSMAX-LENS-RL**

8031414884124

Lente fascio di luce asimmetrica 25° sx-dx /  
Asymmetric lens 25° sx-dx

Per tutta la lampada  
**BUSBAR** occorrono 5 pezzi /  
5 pieces need for the  
whole **BUSBAR** lamp

# BUSBAR

**Sistema blindosbarra lineare per installazione a sospensione e plafoniera.**  
Busways linear system bar for suspended installation and ceiling light.



**BUSBAR-ST-NEST**  
8031414883943

Binario innesto  
7 cavi per  
alimentazione. Feed trunking  
with 7 input wire.

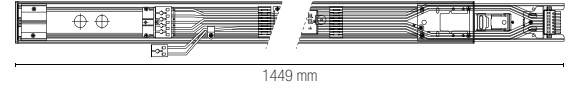

**BUSBAR-ST-END**  
8031414883950

Binario terminale  
7 cavi con sistema  
di connessione  
multipla. Terminal track  
rail 7 cables with  
multiple connection  
system.

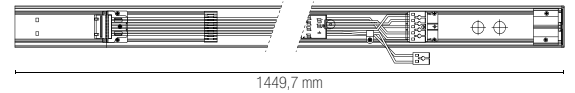

**BUSBAR-ST-144**  
8031414883967

Binario  
intermedio 7 cavi  
da 145 cm. Intermediate  
trunking with 7  
wire of 145 cm.

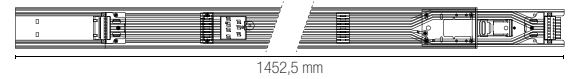

**BUSBAR-ST-288**  
8031414883974

Binario  
intermedio 7 cavi  
da 290 cm. Intermediate  
trunking with 7  
wire of 290 cm.

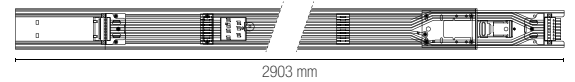

**BUSBAR-ST-L**  
8031414884087

Connettore a L  
7 cavi. L connector  
with 7 wires.

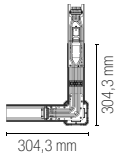

**BUSBAR-ST-T**  
8031414884100

Connettore a T  
7 cavi. T connector  
with 7 wires.

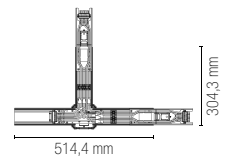

**BUSBAR-ST-X**  
8031414884094

Connettore a X  
7 cavi. X connector  
with 7 wires.

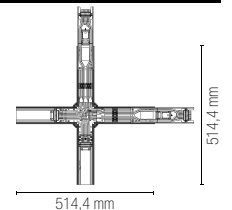

**BUSBAR-ST-COVER**  
8031414883981

Cover di  
alluminio bianco. White  
aluminum cover.

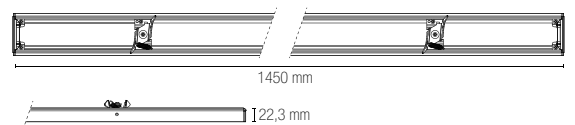

## BUSBAR-SENS

1 / function

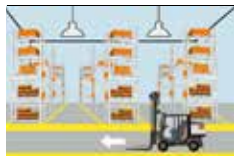

In un ambiente sufficientemente luminoso la lampada non si accende anche se viene rilevato movimento.

With sufficient ambient light, the light will not be switched on even if with motion signal.



In un ambiente poco luminoso il sensore accende la lampada non appena viene rilevato un movimento.

With insufficient ambient light, the sensor switches on the light when motion is detected.



Trascorso il tempo di attesa, il sensore spegne la lampada quando non viene rilevato movimento.

After elapse of hold time, the sensor switches off the light when no motion is detected.

## BUSBAR-SENS

2 / function



Se non viene rilevato movimento la lampada rimane ad un basso livello di luminosità.

If there is motion detected, the light will be remained at a low light level all the time.



Quando viene rilevato movimento, il sensore porta la lampada al 100% di luminosità.

When motion is detected, the sensor will switch on the light to 100% brightness.



Trascorso il tempo di attesa, il sensore attenua la luce all'attuale livello di luminosità se non è rilevato movimento.

After elapse of hold time, the sensor dims the light at present low light level if no motion is detected.

## BUSBAR-SENS

3 / function

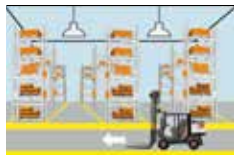

In un ambiente sufficientemente luminoso la lampada non si accende anche se viene rilevato movimento.

With sufficient ambient light, the light will not be switched on even if with motion signal.



In un ambiente poco luminoso il sensore accende la lampada non appena viene rilevato un movimento.

With insufficient ambient light, the sensor switches on the light when motion is detected.



Trascorso il tempo di attesa, il sensore attenua la luce all'attuale livello di luminosità se non è rilevato movimento.

After elapse of hold time, the sensor dims the light at present low light level if no motion is detected.

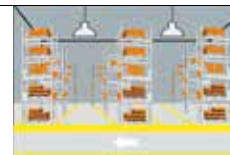

Trascorso il tempo di standby il sensore spegne la lampada se non è rilevato movimento.

After elapse of standby period, the sensor switches off the light if no motion is detected.



### BUSBAR-SENS

8031414884131

Cover elettrificata con sensore di movimento e crepuscolare da 3 funzioni incluso.

Electrified cover with motion and dusk sensor. 3 functions sensor.

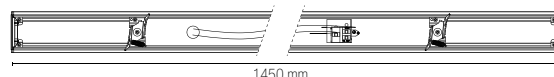

sensor LED-SENSOR-REMOTE p. 860



### BUSBAR-TRACK

8031414884148

Cover elettrificata con binario trifase.

Electrified cover with three phase track system.

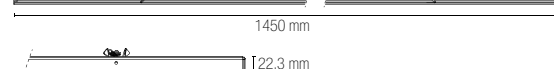
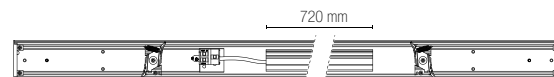

### BUSBAR-FIX

8031414884155

Kit 2 pz staffe per fissaggio a plafoniera.

Bracket kit 2 pcs for ceiling mounting.



### BUSBAR-ST-SOSP

8031414883998

Kit 2 pz cavi per binario a sospensione con cavo da 5 m.

Kit 2 pcs cables for suspension track with 5 m cable.





# INDOOR

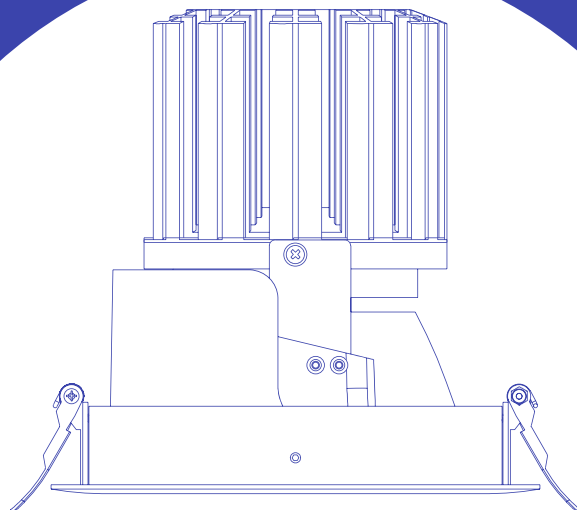

INCASSI  
RECESSED LAMPS

# APOLLO

Faretto ad incasso antiriflesso con struttura in alluminio e finitura con bordo bianco ed interno nero satinato. Luci spot con doppia orientabilità.

Anti-glare recessed spotlight with aluminum structure and finish with white border and satin black interior. Spot lights with double orientability.

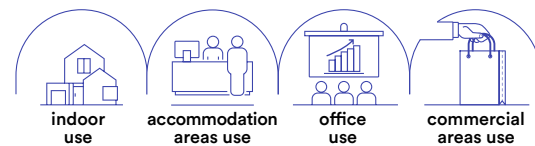

## Materiale

alluminio

## Colore

bordo bianco  
e interno  
nero satinato



## Temperatura colore

3000K / 4000K



## Driver

incluso

## Material

aluminum

## Colour

body with white  
edge and  
satin black internal



## Colour temperature

3000K / 4000K



## Driver

included





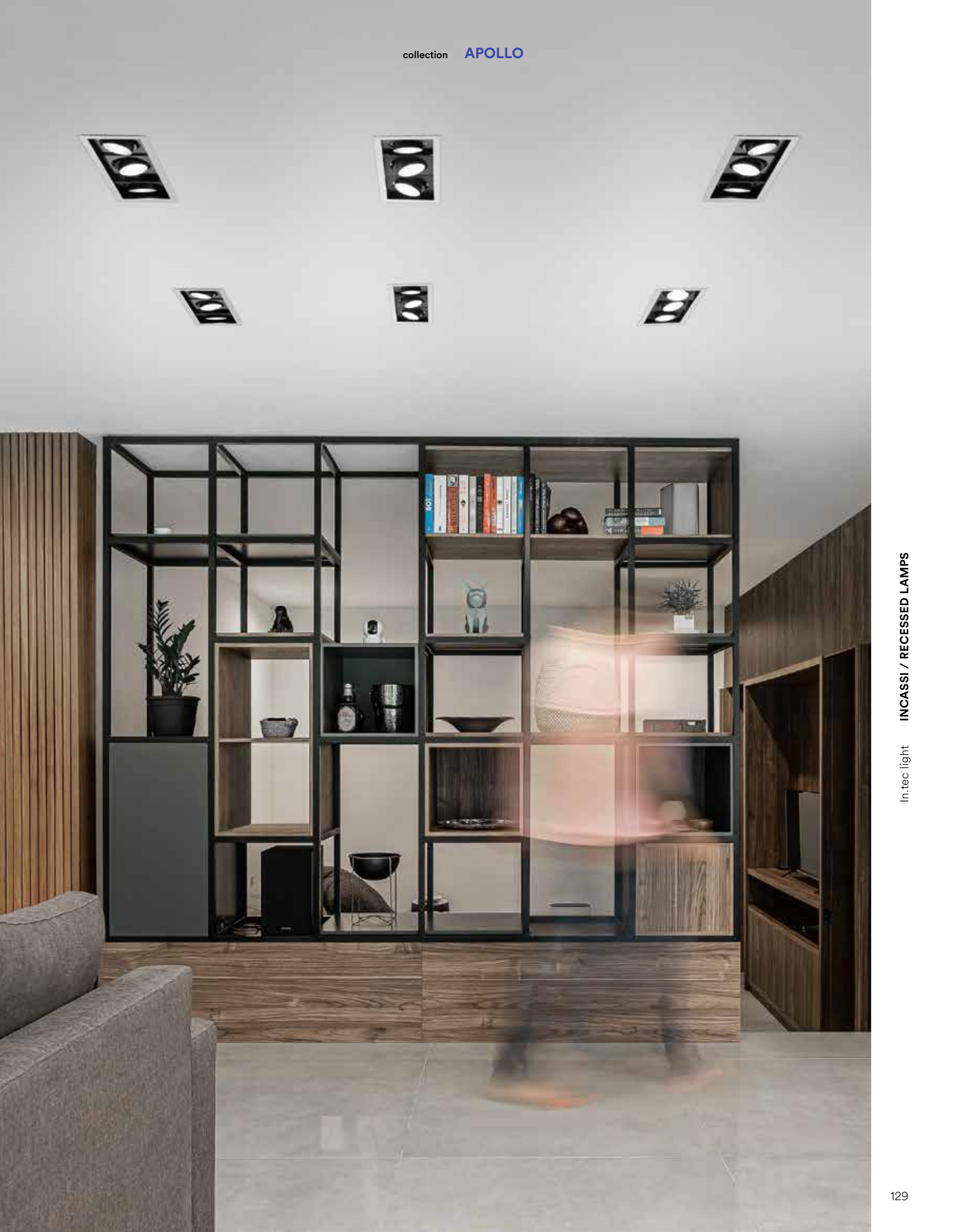

45°









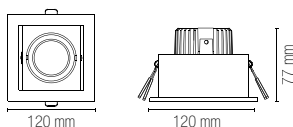

# APOLLO







<b>INC-APOLLO-1X10C</b> 8031440360623	colour temp. 	colour 
lumen	1000 lm	
<b>INC-APOLLO-1X10M</b> 8031440360630	colour temp. 	colour 
lumen	1000 lm	
watt	1 × 10W	
beam angle	40°	
pf	-	
	100 × 100 mm	

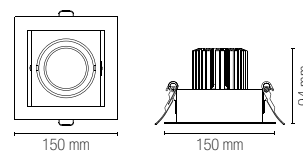





<b>INC-APOLLO-1X20C</b> 8031440360692	colour temp. 	colour 
lumen	2000 lm	
<b>INC-APOLLO-1X20M</b> 8031440360708	colour temp. 	colour 
lumen	2000 lm	
watt	1 × 20W	
beam angle	40°	
pf	-	
	125 × 125 mm	

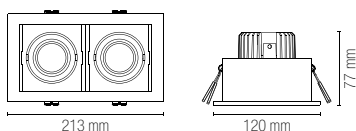





<b>INC-APOLLO-2X10C</b> 8031440360647	colour temp. 	colour 
lumen	2000 lm	
<b>INC-APOLLO-2X10M</b> 8031440360654	colour temp. 	colour 
lumen	2000 lm	
watt	2 × 10W	
beam angle	40°	
pf	-	
	190 × 100 mm	

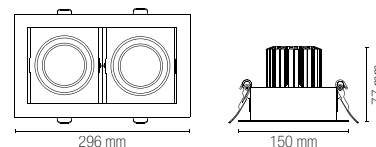





<b>INC-APOLLO-2X20C</b> 8031440360715	colour temp. 	colour 
lumen	4000 lm	
<b>INC-APOLLO-2X20M</b> 8031440360722	colour temp. 	colour 
lumen	4000 lm	
watt	2 × 20W	
beam angle	40°	
pf	-	
	245 × 125 mm	

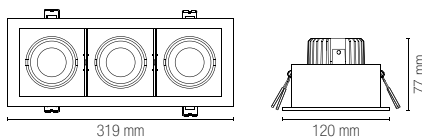

<b>INC-APOLLO-3X10C</b> 8031440360661	colour temp. 	colour 
lumen	3000 lm	
<b>INC-APOLLO-3X10M</b> 8031440360678	colour temp. 	colour 
lumen	3000 lm	
watt	3 × 10W	
beam angle	40°	
pf	-	
	290 × 100 mm	



<b>INC-APOLLO-3X20C</b> 8031440360746	colour temp. 	colour 
lumen	6000 lm	
<b>INC-APOLLO-3X20M</b> 8031440360739	colour temp. 	colour 
lumen	6000 lm	
watt	3 × 20W	
beam angle	40°	
pf	-	
	355 × 125 mm	

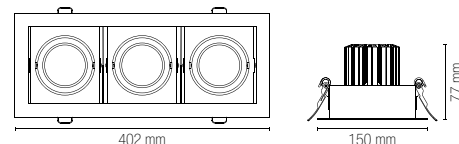



**INC-APOLLO-1X30C**

8031440360753

lumen

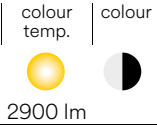

2900 lm

**INC-APOLLO-1X30M**

8031440360760

lumen



2900 lm

watt 1 × 30W

beam angle 40°

pf 0.90

175 × 175 mm

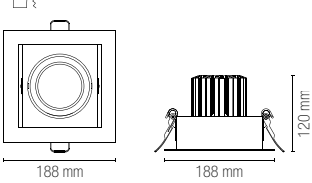

**INC-APOLLO-1X45C**

8031440360777

lumen

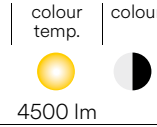

4500 lm

**INC-APOLLO-1X45M**

8031440360784

lumen

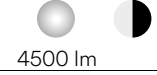

4500 lm

watt 1 × 45W

beam angle 40°

pf 0.90

175 × 175 mm

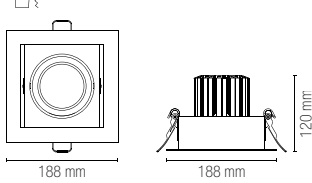

**Fotometria del prodotto / Photometric curve**

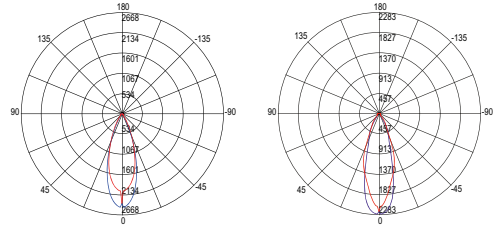

INC-APOLLO-1X10

INC-APOLLO-1X20

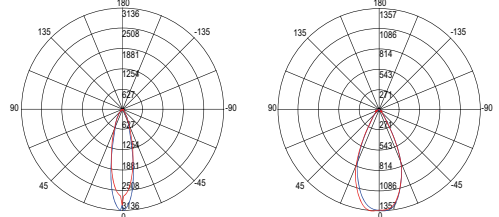

INC-APOLLO-1X30

INC-APOLLO-1X45

**INC-APOLLO-2X30C**

8031440360791

lumen



5800 lm

**INC-APOLLO-2X30M**

8031440360807

lumen



5800 lm

watt 2 × 30W

beam angle 40°

pf 0.90

320 × 175 mm

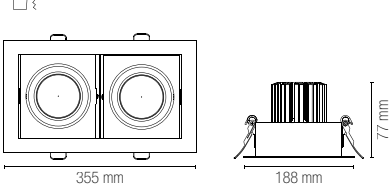

**INC-APOLLO-2X45C**

8031440360814

lumen

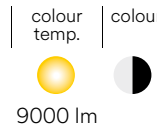

9000 lm

**INC-APOLLO-2X45M**

8031440360821

lumen



9000 lm

watt 2 × 45W

beam angle 40°

pf 0.90

320 × 175 mm

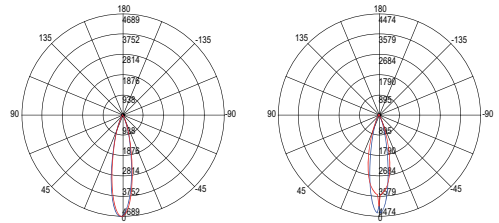
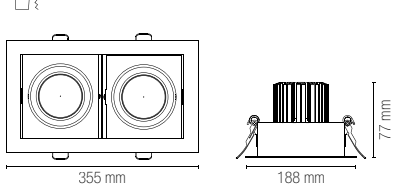

INC-APOLLO-2X10\*

INC-APOLLO-2X20\*

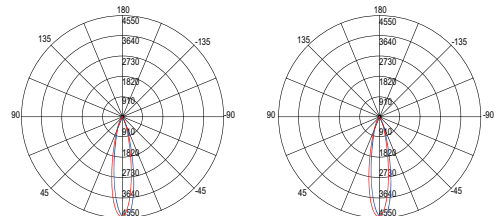

INC-APOLLO-2X30\*

INC-APOLLO-2X45\*

**INC-APOLLO-3X30C**

8031440360845

lumen

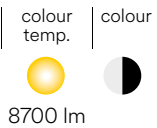

8700 lm

**INC-APOLLO-3X30M**

8031440360838

lumen



8700 lm

watt 3 × 30W

beam angle 40°

pf 0.90

475 × 175 mm

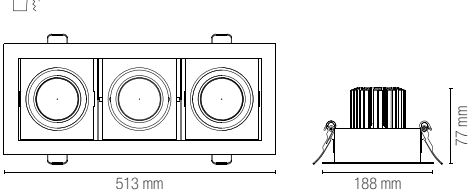

**INC-APOLLO-3X45C**

8031440360852

lumen

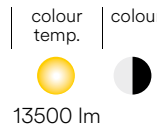

13500 lm

**INC-APOLLO-3X45M**

8031440360869

lumen



13500 lm

watt 3 × 45W

beam angle 40°

pf 0.90

475 × 175 mm

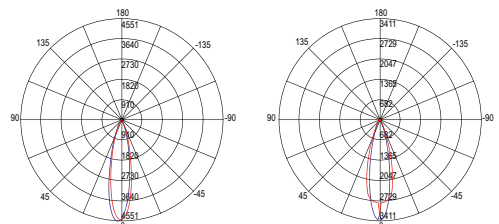
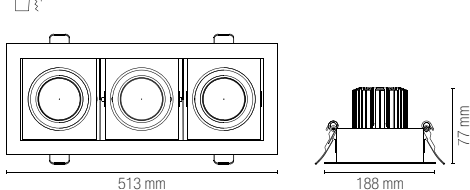

INC-APOLLO-3X10\*

INC-APOLLO-3X20\*

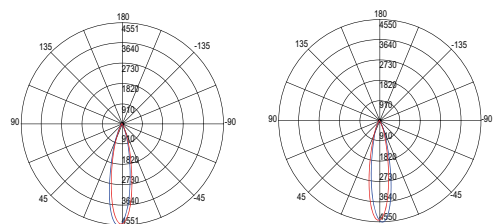

INC-APOLLO-3X30\*

INC-APOLLO-3X45\*

Le curve fotometriche rappresentano il singolo modulo LED per ogni elemento / Above photometric curve represent the single module of each element

# OUTSIDER

Faretto ad incasso antiriflesso con struttura in alluminio, finitura bianco opaco e bordatura interna nera. Luci spot con testa estraibile e orientabile a 350°.

Anti-glare recessed spotlight with aluminum structure, matt white finish and black inner border. Spot lights with pull-out head and adjustable to 350°.

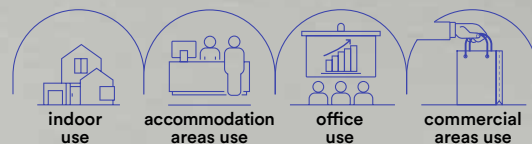

**Materiale**

alluminio

**Colore**

bianco opaco  
con bordatura  
interna nera



**Temperatura colore**  
3000K / 4000K



**Driver**  
incluso

**Material**

aluminum

**Colour**

matt white  
color and black  
internal ring



**Colour temperature**  
3000K / 4000K







**Driver**  
included







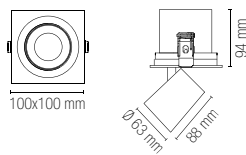

In.tec light **INCASSI / RECESSED LAMPS**

# OUTSIDER







<b>INC-OUTSIDER-1X15C</b> 8031414864225	colour temp. 	colour 
lumen	1375 lm	
<b>INC-OUTSIDER-1X15M</b> 8031414864119	colour temp. 	colour 
lumen	1375 lm	
watt	1 x 15W	
beam angle	24°	
pf	-	
	90 x 90 x pr. 96 mm	

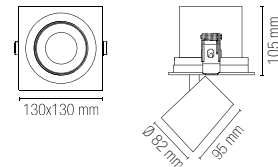





<b>INC-OUTSIDER-1X30C</b> 8031414864256	colour temp. 	colour 
lumen	3100 lm	
<b>INC-OUTSIDER-1X30M</b> 8031414864133	colour temp. 	colour 
lumen	3100 lm	
watt	1 x 30W	
beam angle	24°	
pf	0.90	
	116 x 116 x pr. 110 mm	

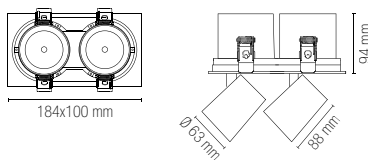





<b>INC-OUTSIDER-2X15C</b> 8031414864232	colour temp. 	colour 
lumen	2750 lm	
<b>INC-OUTSIDER-2X15M</b> 8031414864126	colour temp. 	colour 
lumen	2750 lm	
watt	2 x 15W	
beam angle	24°	
pf	-	
	174 x 90 x pr. 96 mm	

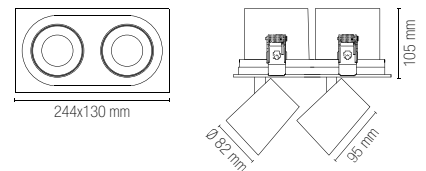





<b>INC-OUTSIDER-2X30C</b> 8031414864263	colour temp. 	colour 
lumen	6200 lm	
<b>INC-OUTSIDER-2X30M</b> 8031414864140	colour temp. 	colour 
lumen	6200 lm	
watt	2 x 30W	
beam angle	24°	
pf	0.90	
	230 x 116 x pr. 110 mm	

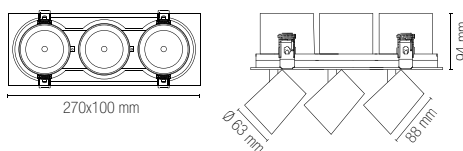

<b>INC-OUTSIDER-3X15C</b> 8031414864249	colour temp. 	colour 
lumen	4125 lm	
<b>INC-OUTSIDER-3X15M</b> 8031414864102	colour temp. 	colour 
lumen	4125 lm	
watt	3 x 15W	
beam angle	24°	
pf	-	
	260 x 90 x pr. 96 mm	



<b>INC-OUTSIDER-3X30C</b> 8031414864270	colour temp. 	colour 
lumen	9300 lm	
<b>INC-OUTSIDER-3X30M</b> 8031414864157	colour temp. 	colour 
lumen	9300 lm	
watt	3 x 30W	
beam angle	24°	
pf	0.90	
	335 x 116 x pr. 110 mm	

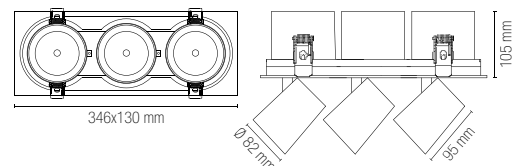



Fotometria del prodotto / Photometric curve

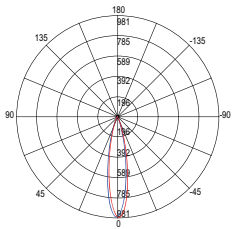

INC-OUTSIDER-1X15

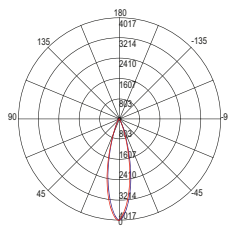

INC-OUTSIDER-1X30

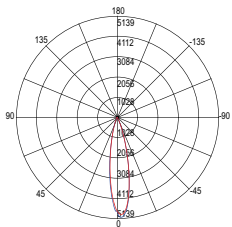

INC-OUTSIDER-2X15

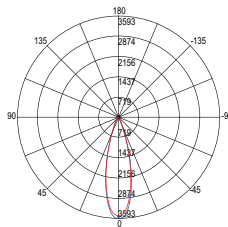

INC-OUTSIDER-2X30

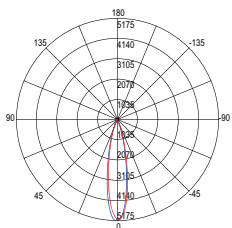

INC-OUTSIDER-3X15

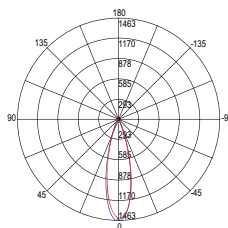

INC-OUTSIDER-3X30



In.tec light **INCASSI / RECESSED LAMPS**

Le curve fotometriche rappresentano il singolo modulo LED per ogni elemento / Above photometric curves represent the single module of each element

# DELTA INC

Faretto ad incasso antiriflesso con struttura in alluminio, finitura bianco satinato e riflettore silver. Luci spot con testa estraibile e orientabile. Disponibile anche nella colorazione per la linea food.

Anti-glare recessed spotlight with aluminum structure, satin white finish and silver reflector. Spot lights with removable and adjustable head. Also available for lighting food line.

---

**Materiale**

alluminio

---

**Colore**

bianco satinato  
e riflettore silver



---

**Temperatura colore  
selezionabile**

3000K / 4000K / 6500K



---

**Driver**

incluso

---

**Material**

aluminum

---

**Colour**

satin white and  
silver reflector



---

**Selectable color  
temperature**

3000K / 4000K / 6500K



---

**Driver**

included





**INC-DELTA-38DA**  
8031414923786  
lumen

colour temp.	colour

6080 lm

watt	38W
beam angle	60°
pf	0.90
	Ø 160 mm

Fotometria del prodotto / Photometric curve

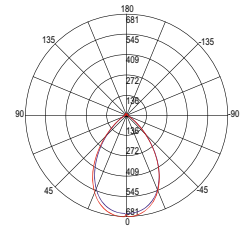

INC-DELTA-38



**INC-DELTA-38 INC**  
8031414893546  
lumen

colour temp.	colour

4300 lm

watt	38W
beam angle	60°
pf	0.90
	Ø 160 mm

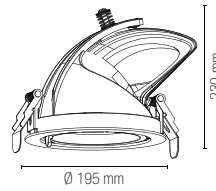

Illuminazione per generi alimentari / Food lighting



**INC-DELTA-38BR**  
8031414924226  
lumen  
K  
CRI

colour temp.	colour

6080 lm  
2500 K  
>90



**INC-DELTA-38RM**  
8031414924233  
lumen  
K  
CRI

colour temp.	colour

6080 lm  
3100 K  
>70



**INC-DELTA-38FM**  
8031414924240  
lumen  
K  
CRI

colour temp.	colour

6080 lm  
3000 K  
>63



**INC-DELTA-38FR**  
8031414924257  
lumen  
K  
CRI

colour temp.	colour

6080 lm  
3000 K  
>93

watt	30W
beam angle	24°
pf	0.90
	Ø 150 mm

# LYBRA

Faretto ad incasso rettangolare con struttura in alluminio e finitura in bianco satinato.

Diffusore con orientabilità verticale.

Rectangular recessed spotlight with aluminum structure and satin white finish.

Diffuser with vertical orientability.



**Materiale**

alluminio + PC

**Colore**

bianco satinato



**Temperatura colore selezionabile**

3000K / 4000K / 6500K



**Driver**

incluso

**Material**

aluminum + PC

**Colour**

satin white



**Selectable color temperature**

3000K / 4000K / 6500K



**Driver**

included



**Fotometria del prodotto / Photometric curve**

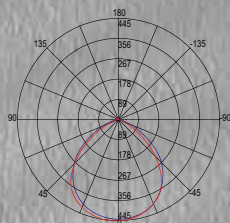

INC-LYBRA-38

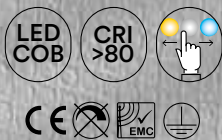

**INC-LYBRA-38**  
8031414893553

lumen

colour temp.



4400 lm

watt

38W

beam angle

120°

pf

0.90



220 x 140 mm

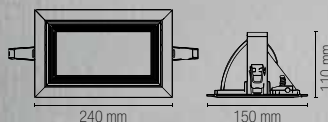

# DAMA

Faretto da incasso con struttura in policarbonato e doppia ghiera intercambiabile rotonda e quadrata. Disponibile in bianco o nero.

Recessed light with polycarbonate structure and double interchangeable ring round or square. Available in black or white colors.

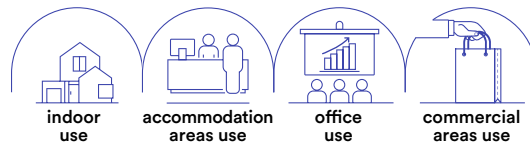

## Materiale

PC

## Colore

bianco  
nero



## Temperatura colore

4000K



## Driver

incluso

## Material

PC

## Colour

white  
black



## Colour temperature

4000K



## Driver

included



INCASSI / RECESSED LAMPS

In.tec light

## Fotometria del prodotto / Photometric curve

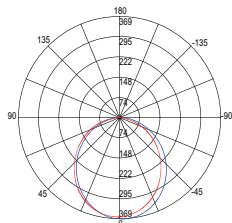

INC-DAMA-QR44



## INC-DAMA-QR44-BCO

8031414881581

lumen

colour temp.



300 lm

## INC-DAMA-QR44-NER

8031414881598

lumen



300 lm

watt

LED 3W

beam angle

100°



Ø 35 mm

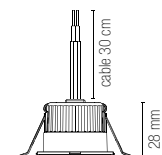
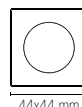

# FIBRA OTTICA



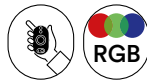

**Kit fibra ottica.**  
Fiber optic kit.



**Materiale**  
fibra ottica  
traslucente

**Temperatura colore**  
RGB + 4000K



**Material**  
translucent  
optical fiber

**Colour temperature**  
RGB + 4000K



**LED-OPTICAL-200**  
8031414925131

200 fiber of Ø 1mm  
Starry sky

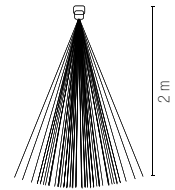

**LED-OPTICAL-500**  
8031414925148

500 fiber of Ø 0,75mm  
Side glow

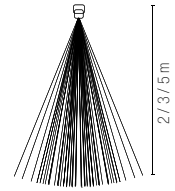

**LED-OPTICAL-ENG**  
8031414925155  
change color

DC12V + Adaptor 220V

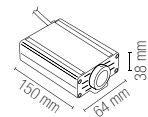
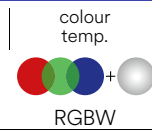

16W



**LED-OPTICAL-ENG-TW**  
8031414925162  
Change color twinkle effect

DC12V + Adaptor 220V

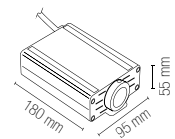
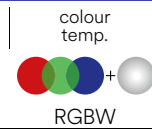

16W

# STARLIGHT STARLIGHT30



## STARLIGHT

**Materiale**  
alluminio

**Colore**  
bianco, argento



**Temperatura colore**  
4000K / BLU



**Driver**  
non incluso

**Material**  
aluminum

**Colour**  
white, silver



**Colour temperature**  
4000K / BLU



**Driver**  
not included

## STARLIGHT 30

**Materiale**  
alluminio

**Colore**  
bianco, argento



**Temperatura colore**  
4000K



**Driver**  
12V DC 100mA 6W

**Material**  
aluminum

**Colour**  
white, silver



**Colour temperature**  
4000K



**Driver**  
12V DC 100mA 6W

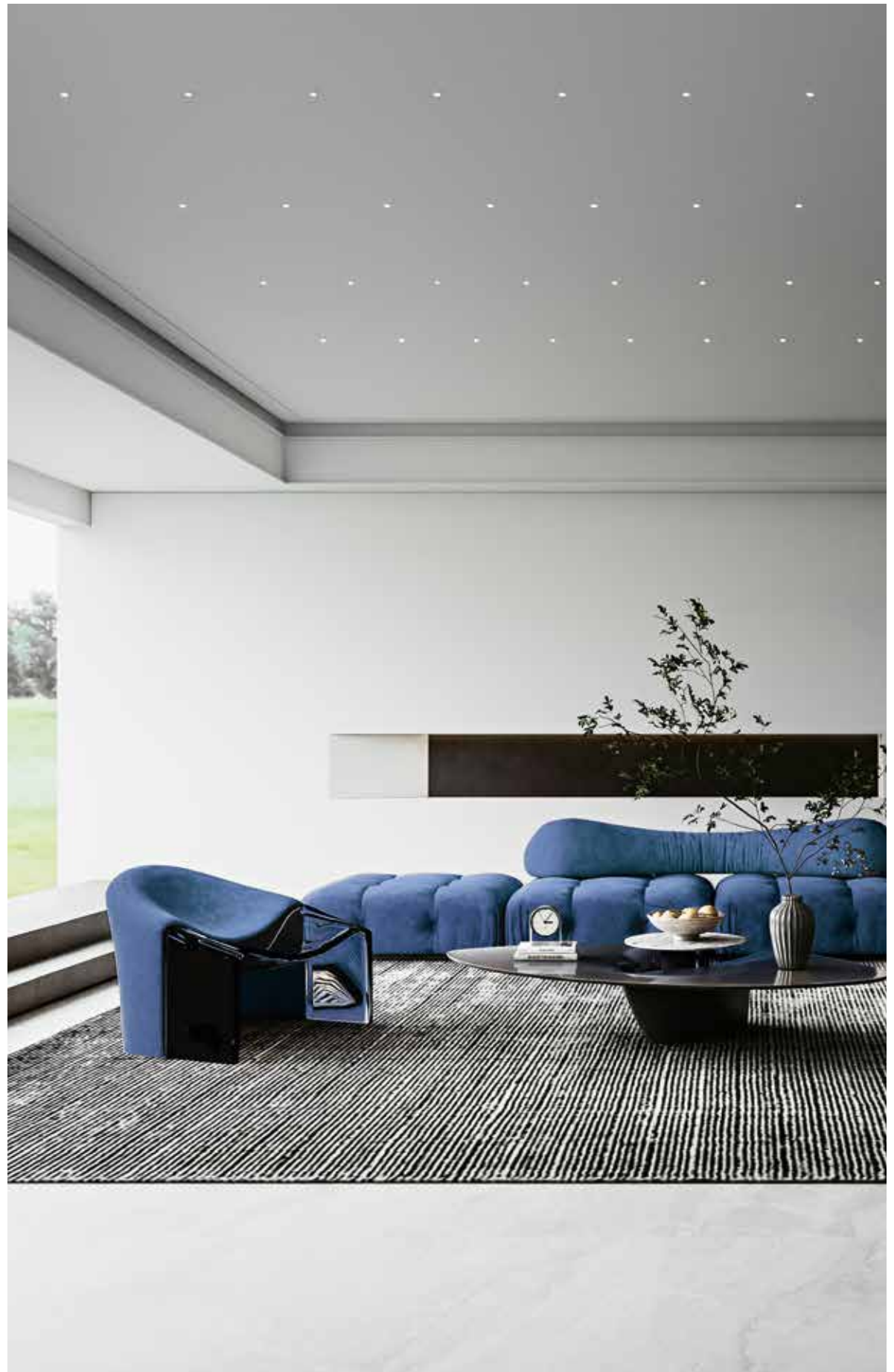





## STARLIGHT

Connessione in parallelo / Parallel connection



**Mini faretto a incasso cielo stellato con struttura in alluminio e doppia ghiera di colore bianco o silver intercambiabile.**

Downlight for decorative starlight with aluminum structure and double interchangeable ring color white or silver.

	colour temp.	colour
<b>LED-STARLIGHT-W</b> 8031440361682		
lumen	11 lm	
<b>LED-STARLIGHT-BLU</b> 8031440361699		
	blu	

with 1 m. cable  
watt

LED 0,2W

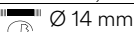

### Accessori inclusi / Included accessories



Ghiera bianca intercambiabile /  
White changeable ring



Ghiera silver intercambiabile /  
Silver changeable ring

### Accessori non inclusi / Not included accessories



**LED-STARLIGHT-NEX**  
8031440364430

Scatola connessione per 10 teste 12V DC 1A incl. Cavo 1m. /  
Box connection for 10 pcs 12V DC 1A with 1m. cable



**LED-STARLIGHT-CONN**  
8031440364843

Connettore con singola entrata  
3 uscite per kit cielo stellato  
12V DC 1A incl. Cavo 1m. /  
Connector one input three  
output for starlight 12V  
DC 1A with 1m. cable



**LED-STARLIGHT-DR**  
8031440364447

Driver 12V DC 100mA  
6W incl. Cavo 1m. /  
Driver 12V DC 100mA  
6W incl. 1m. cable

### Fotometria del prodotto / Photometric curve

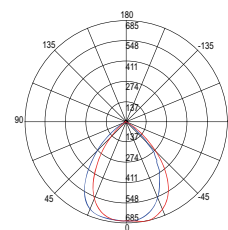

LED-STARLIGHT 0,2W

## STARLIGHT 30



**Kit 30 mini faretto a incasso cielo stellato con struttura in alluminio e doppia ghiera di colore bianco o silver intercambiabile.**

Kit 30 downlight for decorative starlight with aluminum structure and double interchangeable ring color white or silver.

	colour temp.	colour
<b>LED-STARLIGHT-30-W</b> 8031440357692		
lumen	11 lm x 30	
with 1 m. cable		
watt		

LED 30 x 0,2W

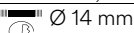

### Accessori inclusi / Included accessories



Ghiera bianca intercambiabile /  
White changeable ring



Ghiera silver intercambiabile /  
Silver changeable ring



3 Scatole connessione per 10 teste  
12V DC 1A incl. cavo 1m. /  
3 Boxes connection for 10 pcs  
12V DC 1A with 1m. cable



1 Connettore con singola entrata  
3 uscite per kit cielo stellato  
12V DC 1A incl. cavo 1m. /  
1 Connector one input three  
output for starlight  
12V DC 1A with 1m. cable



1 Driver 12V DC 100mA  
6W incl. Cavo 1m. /  
1 Driver 12V DC 100mA  
6W incl. 1m. cable

### Fotometria del prodotto / Photometric curve

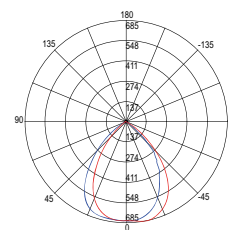

LED-STARLIGHT 0,2W

# ASSO KIT 3

Kit 3 faretto da incasso con struttura in alluminio disponibile nella versione silver quadrata o rotonda.

Kit 3 recessed spotlights with aluminum structure available in silver square or round.

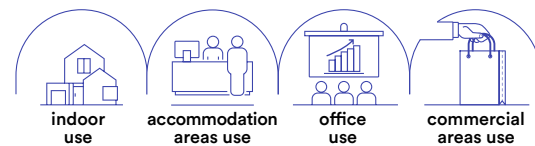

**Materiale**  
alluminio

**Colore**  
argento



**Temperatura colore**  
4000K



**Driver**  
230V incluso

**Material**  
aluminum

**Colour**  
silver



**Colour temperature**  
4000K



**Driver**  
230V included





**Kit 3 pz / Kit 3 pcs**



**INC-ASSO-Q3**  
8031414881628  
lumen

colour temp. | colour |  
3x100 lm



watt LED 1,2 W  
beam angle 30°  
Ø 25 mm



**Kit 3 pz / Kit 3 pcs**



**INC-ASSO-R3**  
8031414881611  
lumen

colour temp. | colour |  
3x100 lm

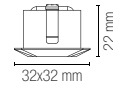

watt LED 1,2 W  
beam angle 30°  
Ø 25 mm



**Fotometria del prodotto / Photometric curve**

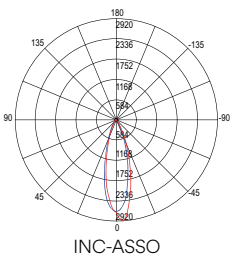

**Accessori inclusi / Included accessories**

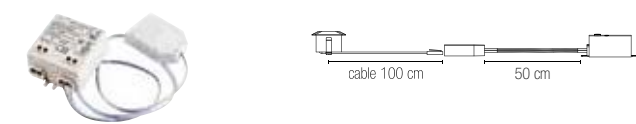
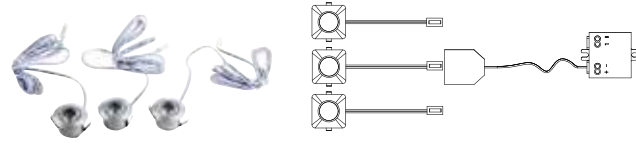

# ASSO

Faretto da incasso con struttura in alluminio disponibile in bianco nero nella forma quadrata o rotonda.

Recessed spotlight with aluminum structure available in black white in square or round shape.

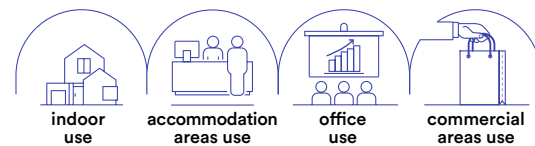

## Materiale

alluminio

## Colore

bianco  
nero



## Temperatura colore

3000K / 4000K / BLU



## Driver

DC 24V  
tensione costante  
non incluso

## Material

aluminum

## Colour

white  
black



## Colour temperature

3000K / 4000K



## Driver

DC 24V  
constant voltage  
not included





1 pz / 1 pcs



**INC-ASSO-Q30C**

8031414881642

lumen

colour temp. | colour



100 lm

**INC-ASSO-Q30M**

8031414881659

lumen



100 lm

watt

LED 1,2 W

beam angle

30°



Ø 25 mm

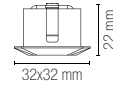

1 pz / 1 pcs



**INC-ASSO-Q30C-NER**

8031414881666

lumen

colour temp. | colour



100 lm

**INC-ASSO-Q30M-NER**

8031414881673

lumen



100 lm

watt

LED 1,2 W

beam angle

30°



Ø 25 mm

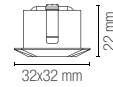

1 pz / 1 pcs



**INC-ASSO-R30C**

8031414877829

lumen

colour temp. | colour



100 lm

**INC-ASSO-R30M**

8031414877928

lumen



100 lm

**INC-ASSO-R30-BLU**

8031414877935



blu

watt

LED 1,2 W

beam angle

30°



Ø 25 mm

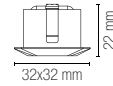

1 pz / 1 pcs



**INC-ASSO-R30C-NER**

8031414881635

lumen

colour temp. | colour



100 lm

**INC-ASSO-R30M-NER**

8031414881680

lumen



100 lm

watt

LED 1,2 W

beam angle

30°



Ø 25 mm



Fotometria del prodotto / Photometric curve

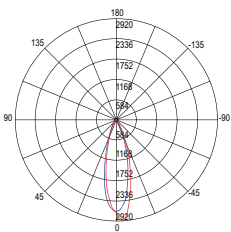

INC-ASSO

Accessori inclusi / Included accessories

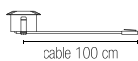

cable 100 cm

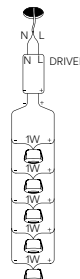

Connessione in parallelo / Parallel connection system

Driver p. 843-852

Controller pag. 854-857

# DOT

**Faretto da incasso con struttura  
in alluminio disponibile in bianco nero.**

Recessed spotlight with aluminum  
structure available in black or white.

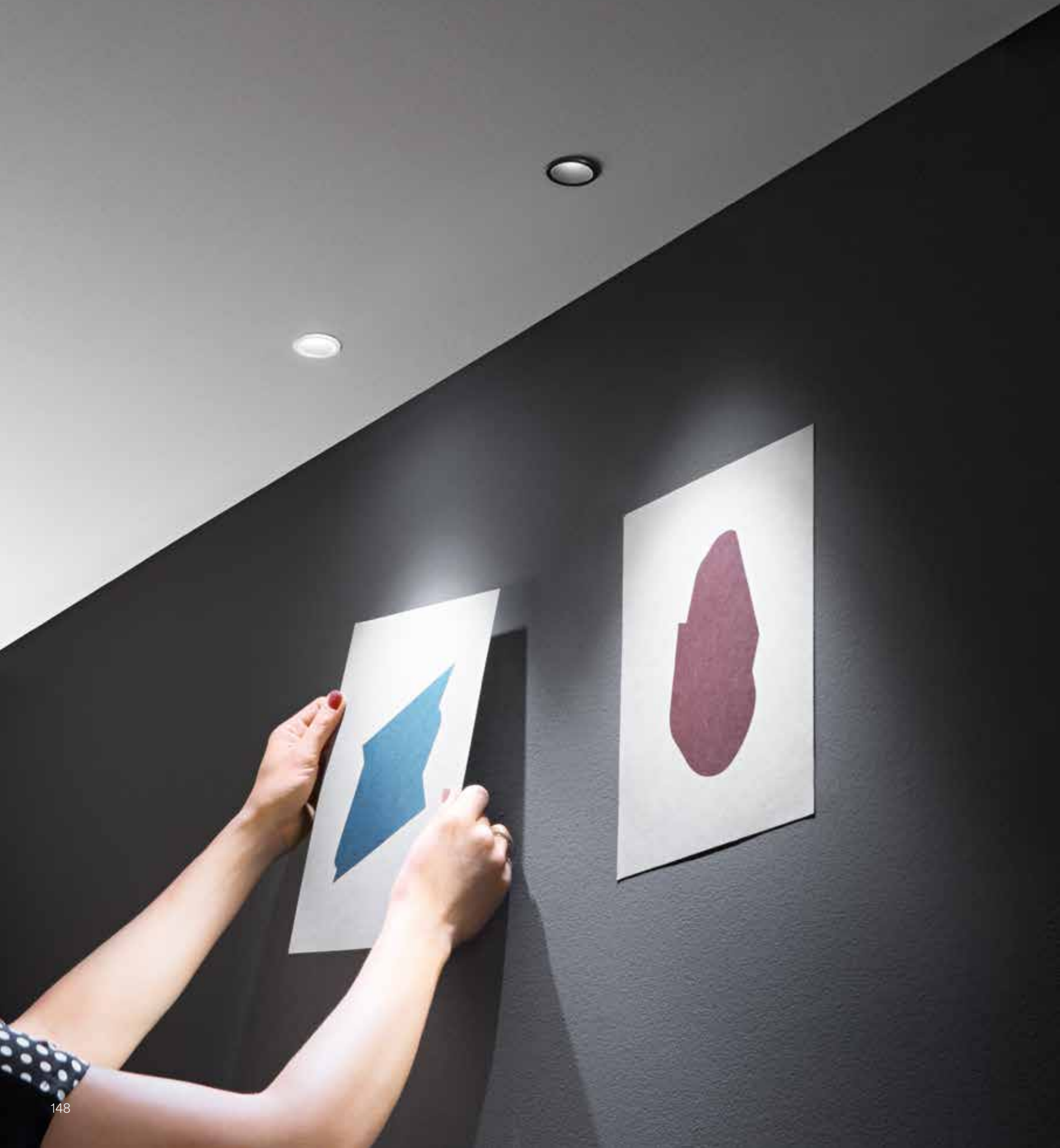

**Materiale**  
alluminio + PC

**Colore**  
bianco satinato  
nero satinato



**Temperatura colore selezionabile**  
3000K / 4000K / 6500K



**Driver**  
incluso

**Material**  
aluminum + PC

**Colour**  
satin white  
satin black



**Selectable color temperature**  
3000K / 4000K / 6500K



**Driver**  
included



Fotometria del prodotto / Photometric curve

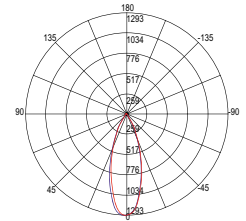

INC-DOT-R5



**INC-DOT-R5DA-BCO**

8031414923793

lumen

colour temp. | colour



600 lm

**INC-DOT-R5DA-NER**

8031414923809

lumen



600 lm

watt 5W

beam angle 24°

Ø 37 mm



**INC-DOT-R5-BCO**

8031414893584

lumen



480 lm

**INC-DOT-R5-NER**

8031414893614

lumen

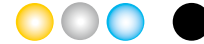

480 lm

watt 5W

beam angle 24°

Ø 37 mm

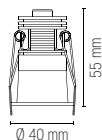

# HYDE

Faretto da incasso con struttura  
in alluminio disponibile in bianco nero.

Recessed spotlight with aluminum  
structure available in black or white.

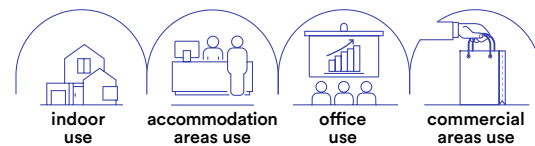

**Materiale**

alluminio + PC

**Colore**

bianco satinato  
nero satinato



**Temperatura colore  
selezionabile**

2700K / 3000K / 4000K / 6500K



**Driver**

incluso

**Material**

aluminum + PC

**Colour**

satin white  
satin black



**Selectable color  
temperature**

2700K / 3000K / 4000K / 6500K



**Driver**

included







<b>INC-HYDE-BCO</b> 8031414893560	colour temp.	colour
	750 lm	

watt	8W
beam angle	60°
	Ø 70 mm

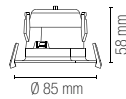

<b>INC-HYDE-NER</b> 8031414893577	colour temp.	colour
	750 lm	

watt	8W
beam angle	60°
	Ø 70 mm

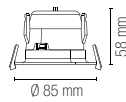

Fotometria del prodotto / Photometric curve

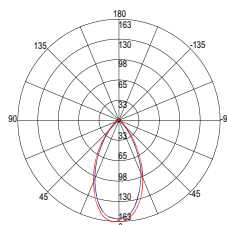

INC-HYDE

# SINKRO

Faretto da incasso lineare antiriflesso con struttura in alluminio pressofuso, finitura con bordo bianco e interno nero lucido.

Anti-glare linear recessed spotlight with die-cast aluminum structure, finish with white border and glossy black interior.

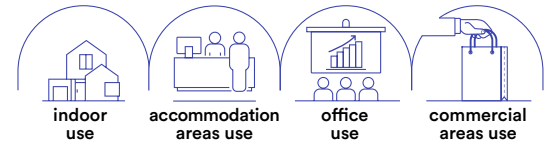

## Materiale

alluminio pressofuso

## Colore

bordo bianco e  
interno nero lucido



## Temperatura colore

4000K



## Driver

incluso

## Material

die cast aluminum

## Colour

white and glossy  
black inside



## Colour temperature

4000K



## Driver

included

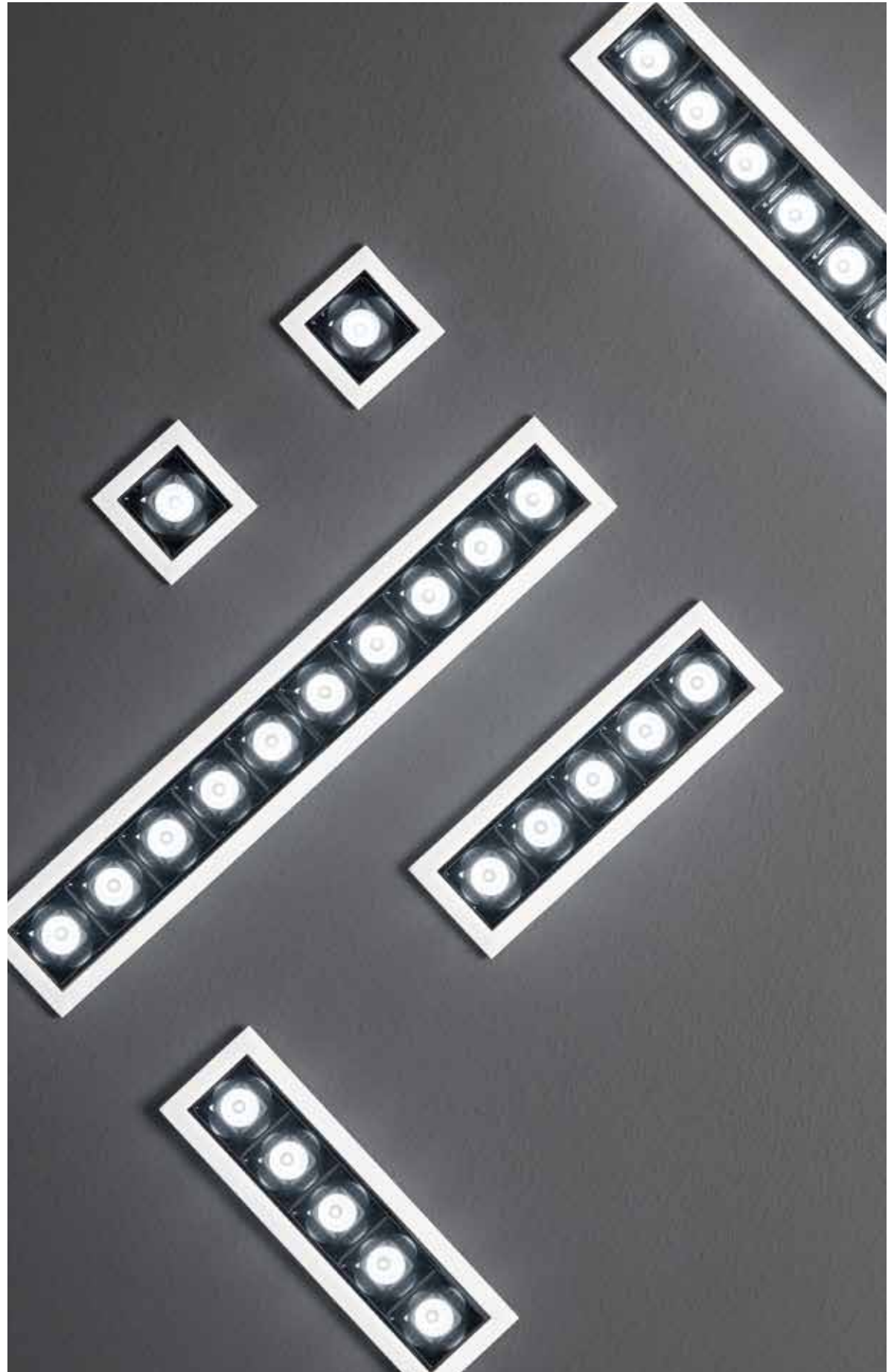



**INC-SINKRO-2M**

8031440360876

lumen

colour temp. | colour



230 lm

watt 2W

beam angle 45°

34 × 34 mm

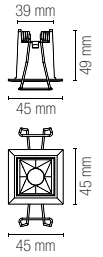

**INC-SINKRO-10M**

8031440360890

lumen

colour temp. | colour



1130 lm

watt 5 × 2W

beam angle 45°

136 × 34 mm

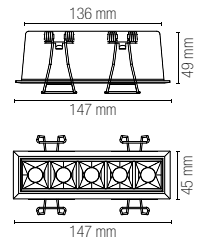

**INC-SINKRO-20M**

8031440360906

lumen

colour temp. | colour



2260 lm

watt 10 × 2W

beam angle 45°

269 × 34 mm

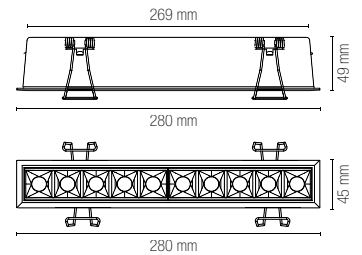

Fotometria del prodotto / Photometric curve

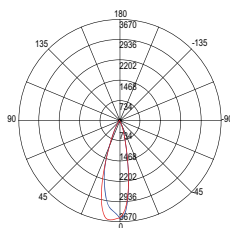

INC-SINKRO-2M

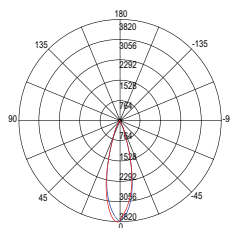

INC-SINKRO-10M

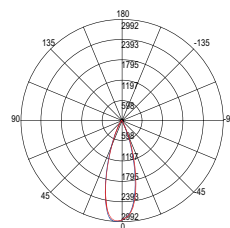

INC-SINKRO-20M

# ELITE

Faretto da incasso antiriflesso con struttura in alluminio e finitura in bianco goffrato. Luce spot orientabile.

Anti-glare recessed spotlight with aluminum frame and embossed white finish. Adjustable spot light.

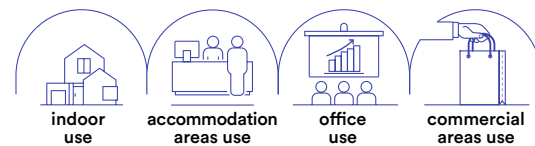

**Materiale**

alluminio

**Colore**

bianco goffrato



**Temperatura colore**

3000K / 4000K



**Driver**

incluso

**Material**

aluminum

**Colour**

Embossed white



**Colour temperature**

3000K / 4000K



**Driver**

included

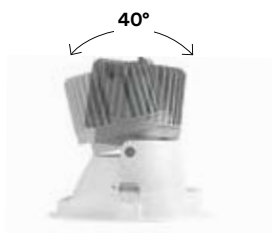



**INC-ELITE-1X10C**

8031440363396

lumen

colour temp. | colour

1000 lm

**INC-ELITE-1X10M**

8031440363365

lumen

1000 lm

watt 10W

beam angle 40°

pf -

Ø 95 mm

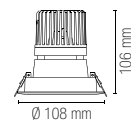

**INC-ELITE-1X20C**

8031440363372

lumen

colour temp. | colour

2000 lm

**INC-ELITE-1X20M**

8031440363341

lumen

2000 lm

watt 20W

beam angle 40°

pf -

Ø 107 mm

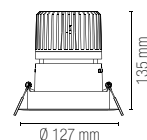

**INC-ELITE-1X30C**

8031440363358

lumen

colour temp. | colour

2900 lm

**INC-ELITE-1X30M**

8031440363327

lumen

2900 lm

watt 30W

beam angle 40°

pf 0.90

Ø 150 mm

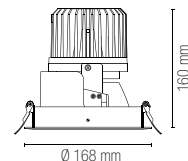

**INC-ELITE-1X45C**

8031440363334

lumen

colour temp. | colour

4500 lm

**INC-ELITE-1X45M**

8031440363303

lumen

4500 lm

watt 45W

beam angle 40°

pf 0.90

Ø 150 mm

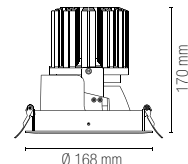

Fotometria del prodotto / Photometric curve

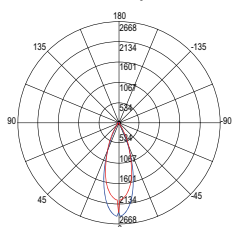

INC-ELITE-1X10

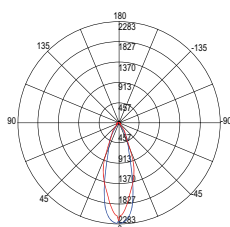

INC-ELITE-1X20

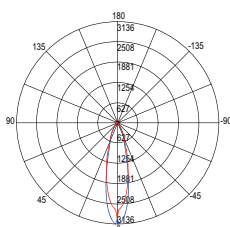

INC-ELITE-1X30

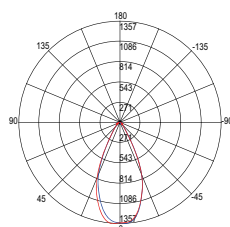

INC-ELITE-1X45

# QUARK

Faretto da incasso con struttura in alluminio antiriflesso e finitura in bianco o nero satinato.

Recessed spotlight with anti-reflective aluminum structure and satin black or white finish.

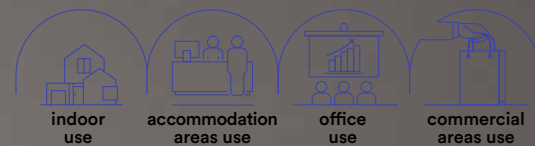

**Materiale**

alluminio + PC

**Colore**

bianco satinato  
nero satinato



**Temperatura colore selezionabile**

3000K / 4000K / 6500K



**Driver**

incluso

**Material**

aluminum + PC

**Colour**

satin white  
satin black



**Selectable color temperature**

3000K / 4000K / 6500K











**Driver**

included













DALI		colour temp.	colour
	<b>INC-QUARK-R8DA-BCO</b> 8031414923816	  	1040 lm
	<b>INC-QUARK-R8DA-NER</b> 8031414923847	  	1040 lm







watt	8W
beam angle	38°
	Ø 50 mm













DALI		colour temp.	colour
	<b>INC-QUARK-R12DA-BCO</b> 8031414923823	  	1480 lm
	<b>INC-QUARK-R12DA-NER</b> 8031414923854	  	1480 lm

watt	12W
beam angle	38°
	Ø 75 mm











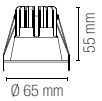

DALI		colour temp.	colour
	<b>INC-QUARK-R18DA-BCO</b> 8031414923830	  	2350 lm
	<b>INC-QUARK-R18DA-NER</b> 8031414923861	  	2350 lm

watt	18W
beam angle	38°
	Ø 80 mm

DALI		colour temp.	colour
	<b>INC-QUARK-R8-BCO</b> 8031414893621	   	830 lm
	<b>INC-QUARK-R8-NER</b> 8031414893652	   	830 lm







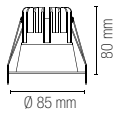

watt	8W
beam angle	38°
	Ø 50 mm



DALI		colour temp.	colour
	<b>INC-QUARK-R12-BCO</b> 8031414893638	   	1300 lm
	<b>INC-QUARK-R12-NER</b> 8031414893669	   	1300 lm

watt	12W
beam angle	38°
	Ø 75 mm



DALI		colour temp.	colour
	<b>INC-QUARK-R18-BCO</b> 8031414893645	   	2000 lm
	<b>INC-QUARK-R18-NER</b> 8031414893676	   	2000 lm

watt	18W
beam angle	38°
	Ø 80 mm

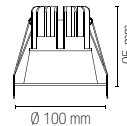

Fotometria del prodotto / Photometric curve

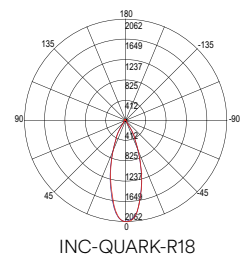
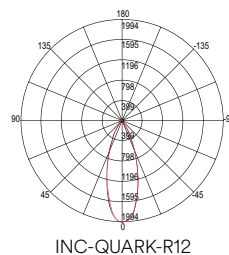
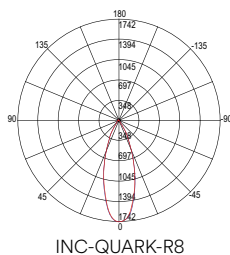

# XANTO

Faretto da incasso con struttura in alluminio pressofuso antiriflesso con finitura in bianco satinato. Disponibile dalla forma quadrata o rotonda in diverse misure.

Recessed spotlight with anti-glare die-cast aluminum structure with satin white finish. Available in square or round shape different sizes.

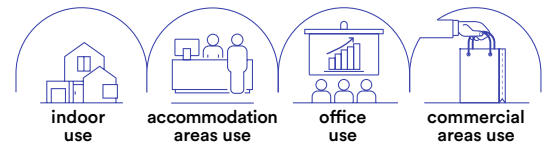

## Materiale

alluminio pressofuso

## Colore

bianco satinato



## Temperatura colore

3000K / 4000K / 5000K



## Driver

incluso

## Material

die cast aluminum

## Colour

satin white



## Colour temperature

3000K / 4000K / 5000K



## Driver

included







# XANTO



	colour temp.	colour
<b>INC-XANTO-C-R120</b> 8031414861101		
lumen	1120 lm	
<b>INC-XANTO-M-R120</b> 8031414861224		
lumen	1120 lm	
<b>INC-XANTO-F-R120</b> 8031414861163		
lumen	1120 lm	
watt	12W	
beam angle	98°	
pf	-	
	Ø 110 mm	

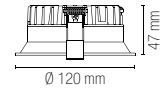

	colour temp.	colour
<b>INC-XANTO-C-R154</b> 8031414861118		
lumen	1700 lm	
<b>INC-XANTO-M-R154</b> 8031414861231		
lumen	1700 lm	
<b>INC-XANTO-F-R154</b> 8031414861170		
lumen	1700 lm	
watt	18W	
beam angle	98°	
pf	-	
	Ø 145 mm	

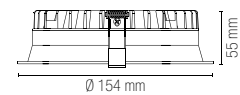

	colour temp.	colour
<b>INC-XANTO-C-R220</b> 8031414861125		
lumen	3000 lm	
<b>INC-XANTO-M-R220</b> 8031414861248		
lumen	3000 lm	
<b>INC-XANTO-F-R220</b> 8031414861187		
lumen	3000 lm	
watt	30W	
beam angle	98°	
pf	0.90	
	Ø 200 mm	

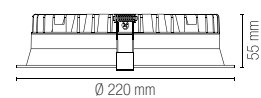

## Fotometria del prodotto / Photometric curve

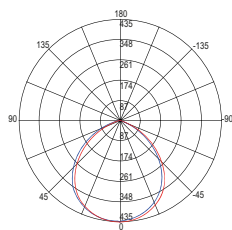

INC-XANTO-F-R120

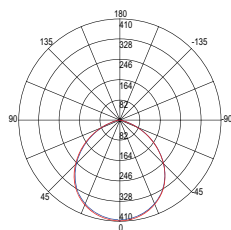

INC-XANTO-F-R154

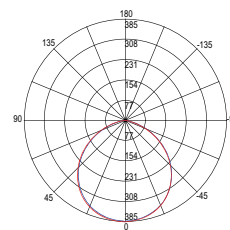

INC-XANTO-F-R220



	colour temp.	colour
<b>INC-XANTO-C-Q110</b> 8031414861071		
lumen	1120 lm	
<b>INC-XANTO-M-Q110</b> 8031414861194		
lumen	1120 lm	
<b>INC-XANTO-F-Q110</b> 8031414861132		
lumen	1120 lm	
watt	12W	
beam angle	98°	
pf	-	
	100 × 100 mm	

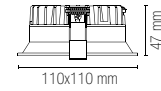

	colour temp.	colour
<b>INC-XANTO-C-Q145</b> 8031414861088		
lumen	1700 lm	
<b>INC-XANTO-M-Q145</b> 8031414861200		
lumen	1700 lm	
<b>INC-XANTO-F-Q145</b> 8031414861149		
lumen	1700 lm	
watt	18W	
beam angle	98°	
pf	-	
	136 × 136 mm	

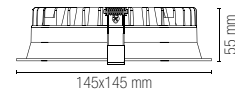

	colour temp.	colour
<b>INC-XANTO-C-Q220</b> 8031414861095		
lumen	3000 lm	
<b>INC-XANTO-M-Q220</b> 8031414861217		
lumen	3000 lm	
<b>INC-XANTO-F-Q220</b> 8031414861156		
lumen	3000 lm	
watt	30W	
beam angle	98°	
pf	0.90	
	200 × 200 mm	

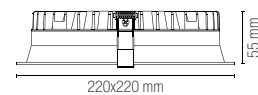

Fotometria del prodotto / Photometric curve

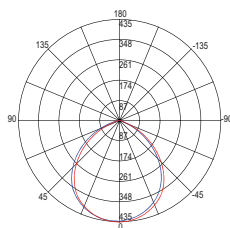

INC-XANTO-F-Q120

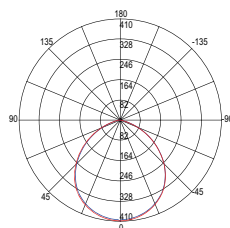

INC-XANTO-F-Q145

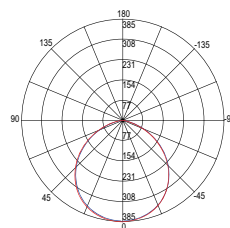

INC-XANTO-F-Q220

# MACK

Faretto da incasso in policarbonato anti  
abbagliamento con diffusore bianco e riflettore cromato.

Recessed spotlight in anti-glare polycarbonate  
with white diffuser and chromed reflector.

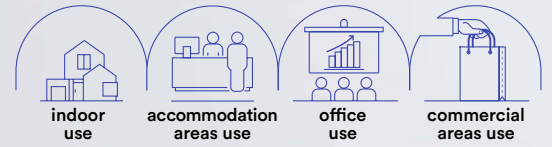

---

**Materiale**

PC

---

**Colore**

bianco con  
riflettore cromato



---

**Temperatura colore**

3000K / 4000K



---

**Driver**

integrato

---

**Material**

PC

---

**Colour**

white with  
chrome reflector



---

**Colour temperature**

3000K / 4000K



---

**Driver**

built-in

---



**INC-MACK-15C**

8031414873913

lumen

colour temp. colour



1650 lm

**INC-MACK-15**

8031414867974

lumen



1650 lm

watt 15W

beam angle 75°

Ø 125 mm

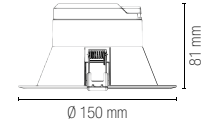

**INC-MACK-20C**

8031414873906

lumen

colour temp. colour



2500 lm

**INC-MACK-20**

8031414867981

lumen



2500 lm

watt 20W

beam angle 75°

Ø 160 mm

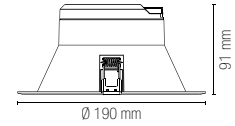

**INC-MACK-25C**

8031414873890

lumen

colour temp. colour



3050 lm

**INC-MACK-25**

8031414867998

lumen



3050 lm

watt 25W

beam angle 75°

Ø 200 mm

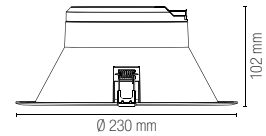

Fotometria del prodotto / Photometric curve

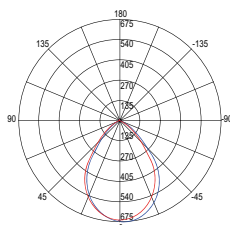

INC-MACK 15W

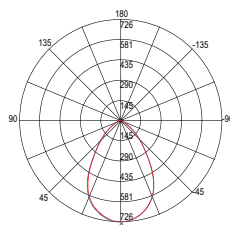

INC-MACK 20W

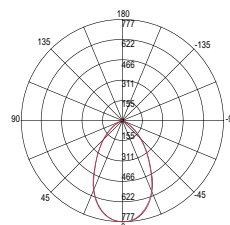

INC-MACK 25W

# TRON

Faretto da incasso con struttura in alluminio e diffusore in acrilico bianco opaco con interruttore per regolazione temperatura colore.

Recessed spotlight with aluminum structure and matt white acrylic diffuser with switch for color temperature regulation.

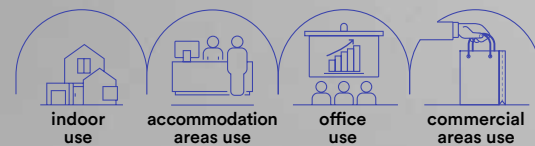

---

#### Materiale

struttura in alluminio,  
diffusore in acrilico

---

#### Colore

bianco opaco



---

#### Temperatura colore selezionabile

3000K / 4000K / 6000K



---

#### Driver

incluso

---

#### Material

aluminum structure,  
acrylic diffuser

---

#### Colour

matt white



---

#### Selectable color temperature

3000K / 4000K / 6000K



---

#### Driver

included



**INC-TRON-7**  
8031414876198  
lumen

colour temp.	colour

720 lm

watt	7W
beam angle	120°
pf	-
	Ø 75 mm

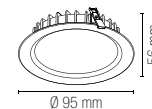

**INC-TRON-20**  
8031414876204  
lumen

colour temp.	colour

2480 lm

watt	20W
beam angle	120°
pf	0.90
	Ø 175 mm

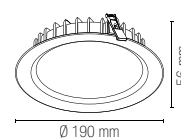

**INC-TRON-30**  
8031414876211  
lumen

colour temp.	colour

3300 lm

watt	30W
beam angle	120°
pf	0.90
	Ø 210 mm

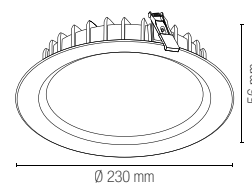

Fotometria del prodotto / Photometric curve

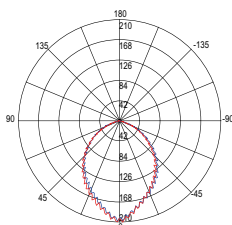

INC-TRON-7

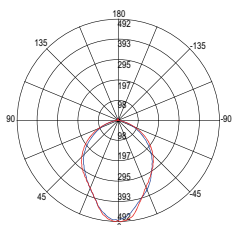

INC-TRON-20

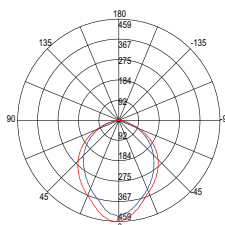

INC-TRON-30

# SLIM CCT

Faretto da incasso con struttura rotonda in alluminio pressofuso ultrasottile con interruttore per regolazione temperatura colore.

Recessed spotlight with round structure in ultra-thin die-cast aluminum with switch for color temperature regulation.

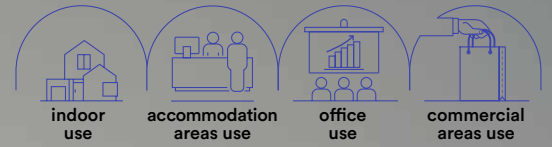

---

**Materiale**

alluminio pressofuso

---

**Colore**

bianco



---

**Temperatura colore selezionabile**

3000K / 4000K / 6500K



---

**Driver**

incluso

---

**Material**

die cast aluminum

---

**Colour**

white



---

**Selectable color temperature**

3000K / 4000K / 6500K



---

**Driver**

included



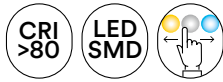

**INC-SLIM-8CCT**

8031414892310

lumen

colour temp.	colour

780 lm

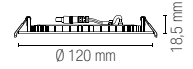

watt	8W
beam angle	120°
	Ø 110 mm



**INC-SLIM-12CCT**

8031414892280

lumen

colour temp.	colour

1260 lm

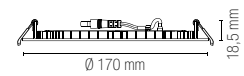

watt	12W
beam angle	120°
	Ø 160 mm



**INC-SLIM-18CCT**

8031414892297

lumen

colour temp.	colour

1980 lm

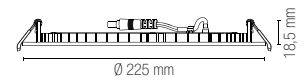

watt	18W
beam angle	120°
	Ø 205 mm



**INC-SLIM-24CCT**

8031414892303

lumen

colour temp.	colour

2700 lm

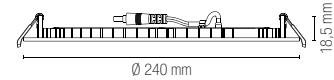

watt	24W
beam angle	120°
	Ø 220 mm

**Fotometria del prodotto / Photometric curve**

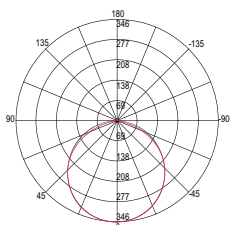

INC-SLIM-8CCT

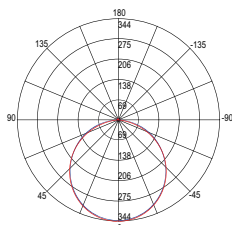

INC-SLIM-12CCT

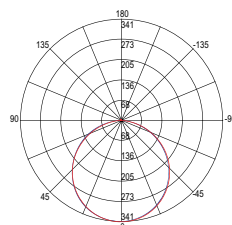

INC-SLIM-18CCT

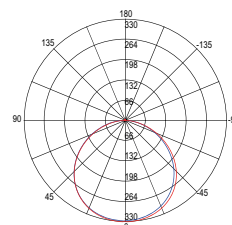

INC-SLIM-24CCT

# FLAP CCT

Faretto da incasso con struttura quadrata in alluminio pressofuso ultrasottile con interruttore per regolazione temperatura colore.

Recessed spotlight with square structure in ultra-thin die-cast aluminum with switch for color temperature regulation.



---

**Materiale**

alluminio pressofuso

---

**Colore**

bianco



---

**Temperatura colore selezionabile**

3000K / 4000K / 6500K



---

**Driver**

incluso

---

**Material**

die cast aluminum

---

**Colour**

white



---

**Selectable color temperature**

3000K / 4000K / 6500K



---

**Driver**

included

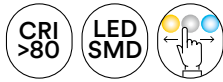

**INC-FLAP-8CCT**

8031414892273

lumen

colour temp.	colour

780 lm

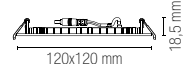

watt	8W
beam angle	120°
	110 × 110 mm



**INC-FLAP-12CCT**

8031414892242

lumen

colour temp.	colour

1260 lm

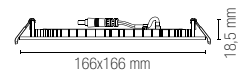

watt	12W
beam angle	120°
	160 × 160 mm



**INC-FLAP-18CCT**

8031414892259

lumen

colour temp.	colour

1980 lm

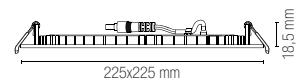

watt	18W
beam angle	120°
	205 × 205 mm



**INC-FLAP-24CCT**

8031414892266

lumen

colour temp.	colour

2700 lm

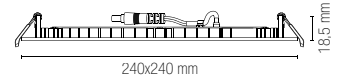

watt	24W
beam angle	120°
	220 × 220 mm

**Fotometria del prodotto / Photometric curve**

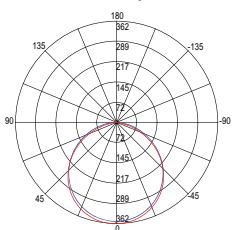

INC-FLAP-8CCT

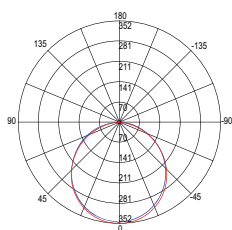

INC-FLAP-12CCT

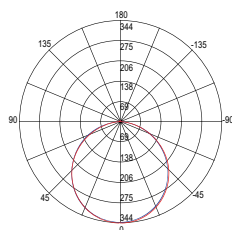

INC-FLAP-18CCT

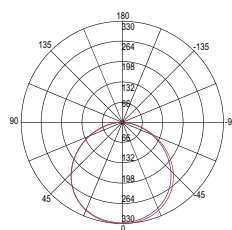

INC-FLAP-24CCT

# TOTAL

**Incasso in alluminio con diffusore  
in policarbonato effetto plafoniera  
con bordi illuminati.**

Built-in aluminum with polycarbonate  
diffuser with illuminated edges.

---

**Materiale**

alluminio + PC

---

**Colore**

bianco



---

**Temperatura colore  
selezionabile**

3000K / 4000K / 6500K



---

**Driver**

incluso

---

**Material**

aluminum + PC

---

**Colour**

white



---

**Selectable color  
temperature**

3000K / 4000K / 6500K



---

**Driver**

included

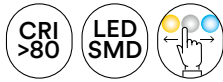

**INC-TOTAL-R15**  
8031414893744

lumen

colour temp.	colour

1600 lm

watt 15W  
beam angle 120°  
Ø 70 - 115 mm

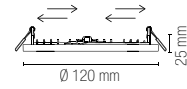

**INC-TOTAL-R24**  
8031414893751

lumen

colour temp.	colour

2680 lm

watt 24W  
beam angle 120°  
Ø 110 - 160 mm

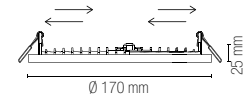

**INC-TOTAL-R30**  
8031414893768

lumen

colour temp.	colour

3300 lm

watt 30W  
beam angle 120°  
Ø 130 - 200 mm

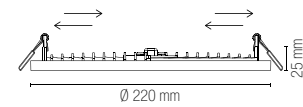

Fotometria del prodotto / Photometric curve

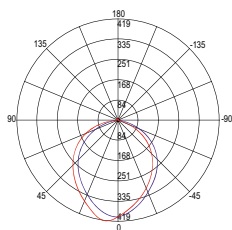

INC-TOTAL-R15

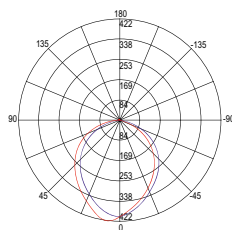

INC-TOTAL-R24

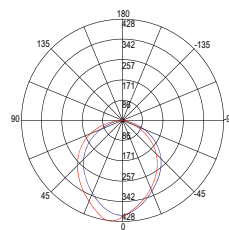

INC-TOTAL-R30

# PLUS

**Faretto da incasso con struttura in alluminio e diffusore in acrilico bianco opaco.**

Recessed spotlight with aluminum frame and matt white acrylic diffuser.

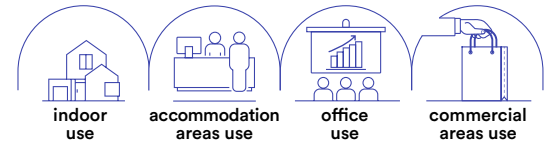

**Materiale**  
struttura in  
alluminio diffusore  
in acrilico

**Colore**  
bianco opaco



**Temperatura colore  
selezionabile**

3000K / 4000K / 6000K



**Driver**  
incluso

**Material**  
aluminum structure,  
acrylic diffuser

**Colour**  
satin white



**Selectable color  
temperature**

3000K / 4000K / 6000K



**Driver**  
included





**INC-PLUS-R8M**

8031414876105

lumen

colour temp.



780 lm

colour

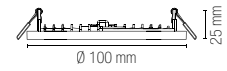

watt 8W

beam angle 120°

pf -

Ø 75 mm



**INC-PLUS-R20M**

8031414876136

lumen

colour temp.



colour



2200 lm

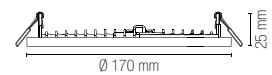

watt 20W

beam angle 120°

pf -

Ø 155 mm



**INC-PLUS-R30M**

8031414876167

lumen

colour temp.



colour



3500 lm

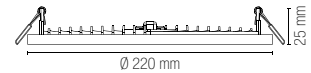

watt 30W

beam angle 120°

pf 0.90

Ø 205 mm

Fotometria del prodotto / Photometric curve

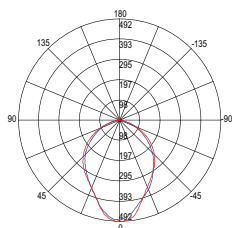

INC-PLUS-R8M

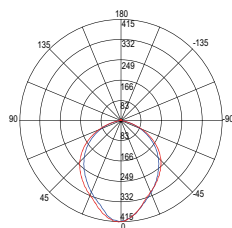

INC-PLUS-R20M

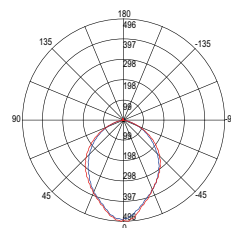

INC-PLUS-R30M

# SNIPER

Faretto da incasso con struttura in fibre di plastica e punto luce orientabile.

Recessed spotlight with plastic fibre structure and adjustable light point.

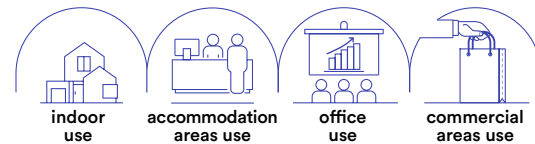

**Materiale**

PC

**Colore**

bianco



**Temperatura colore selezionabile**

3000K / 4000K / 6500K



**Driver**

integrato

**Material**

PC

**Colour**

white



**Selectable color temperature**

3000K / 4000K / 6500K



**Driver**

built-in

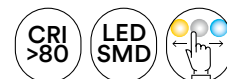

**INC-SNIPER-QR90**  
8031414888719

colour temp.

colour

lumen 660 lm

watt 7W

beam angle 38°

Ø 70 mm

95x95 mm 95x95 mm 53 mm

**Accessori inclusi / Included accessories**



due ghieri intercambiabili  
1 rotonda 1 quadrata /  
interchangeable ring

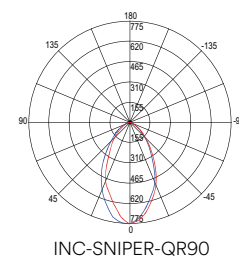

**INC-SNIPER-QR120**  
8031414888726

colour temp.

colour

lumen 1165 lm

watt 12W

beam angle 38°

Ø 90 mm

117x117 mm Ø 117 mm 53 mm

**Accessori inclusi / Included accessories**



due ghieri intercambiabili  
1 rotonda 1 quadrata /  
interchangeable ring

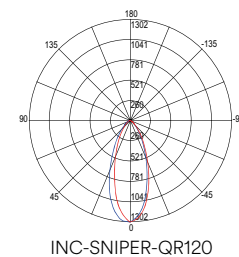



# GLOW

Faretto da incasso BBC in PC.  
BBC recessed spotlight in PC.

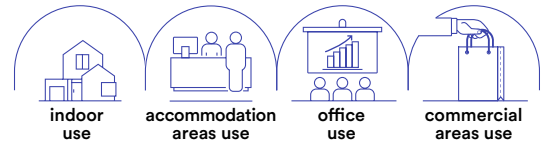

**Materiale**  
PC

**Colore**  
bianco

**Temperatura colore selezionabile**  
2700K / 3000K / 4000K



**Driver**  
integrato

**Material**  
PC

**Colour**  
white

**Selectable color temperature**  
2700K / 3000K / 4000K



**Driver**  
built-in

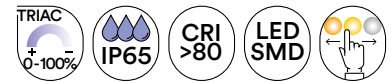

**INC-GLOW-R90**  
8031414925933  
lumen

colour temp. | colour |  
600 lm

watt 6W  
beam angle 68°  
Ø 68 mm

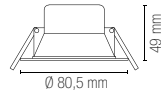
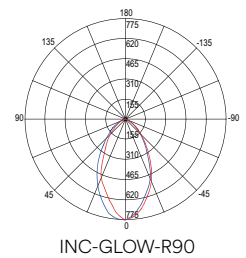

INCASSI / RECESSED LAMPS

In.tec light

# POLARIS

Faretto da incasso con struttura in alluminio e punto luce orientabile.  
Recessed spotlight with aluminum structure and adjustable light point.

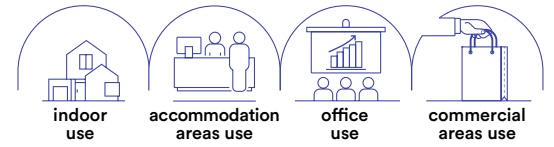

- Materiale**  
alluminio
- Colore**  
bianco gofrato  
silver gofrato
- Temperatura colore**  
4000K
- Driver**  
incluso
- Durata e on/off**  
25.000 h  
>10.000 on/off
- Material**  
aluminum
- Colour**  
embossed white  
embossed silver
- Colour temperature**  
4000K
- Driver**  
included
- Life time and on/off**  
25.000 h  
>10.000 on/off



**INC-POLARIS-R3 BCO**  
8031429681169

lumen 300 lm

**INC-POLARIS-R3**

8031432041196

lumen 300 lm

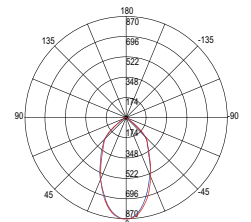
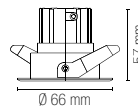

INC-POLARIS R3

watt 3W

beam angle 24°

Ø 55 mm

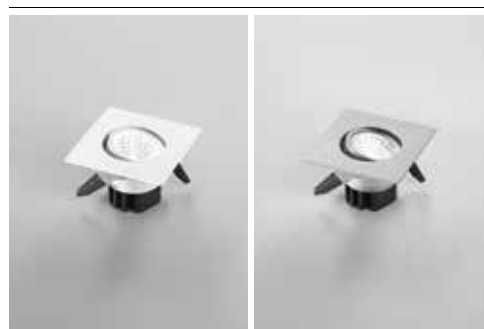

**INC-POLARIS-Q3 BCO**  
8031429761168

lumen 300 lm

**INC-POLARIS-Q3**

8031432051195

lumen 300 lm

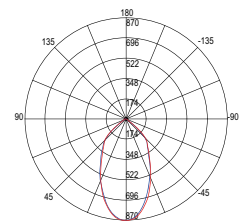
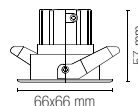

INC-POLARIS Q3

watt 3W

beam angle 24°

Ø 55 mm

# ORIONE

Faretto da incasso in alluminio nei colori bianco goffrato o silver goffrato.  
Recessed aluminum spotlight in white or embossed silver.

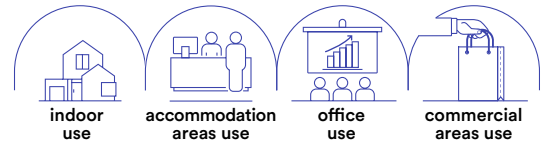

**Materiale**  
alluminio

**Colore**  
bianco goffrato  
silver goffrato



**Temperatura colore**  
4000K



**Driver**  
incluso

**Material**  
aluminum

**Colour**  
embossed white  
embossed silver



**Colour temperature**  
4000K



**Driver**  
included

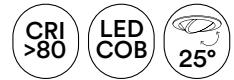

**INC-ORIONE-R6 BCO**  
8031429771167

lumen

colour temp.	colour

650 lm

**INC-ORIONE-R6**  
8031432021198

lumen

650 lm

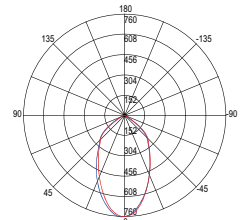
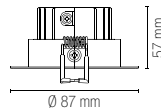

INC-ORIONE R6

watt 7W  
beam angle 87°  
Ø 75 mm



**INC-ORIONE-Q6 BCO**  
8031434361216

lumen

colour temp.	colour

650 lm

**INC-ORIONE-Q6**  
8031432031197

lumen

650 lm

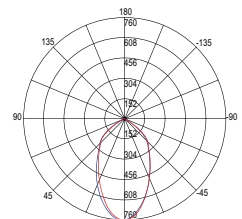
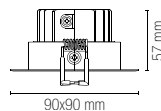

INC-ORIONE Q6

watt 7W  
beam angle 87°  
Ø 75 mm

INCASSI / RECESSED LAMPS

In.tec light

# FUSION

Faretto da incasso in alluminio con  
finitura in nikel, bianco satinato o oro.

Recessed aluminum spotlight with  
nikel, satin white or gold finish.

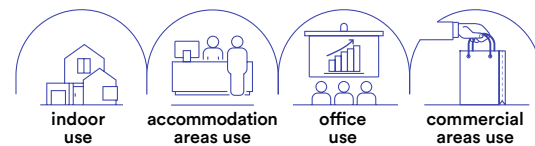

**Materiale**

alluminio

**Colore**

bianco satinato  
nikel  
oro



**Temperatura colore**

4000K



**Driver**

integrato

**Material**

aluminum

**Colour**

white  
nikel  
gold



**Colour temperature**

4000K



**Driver**

built-in





1 pz / 1 pcs



	colour temp.	colour
<b>INC-FUSION-5W BCO</b> 8031440361736 lumen	400 lm	
<b>INC-FUSION-5W NIK</b> 8031440361705 lumen	400 lm	
<b>INC-FUSION-5W ORO</b> 8031440361712 lumen	400 lm	

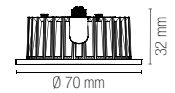

watt	5W
beam angle	120°
	Ø 60 mm

Kit 3 pz / Kit 3 pcs



	colour temp.	colour
<b>INC-FUSION-3X5W BCO</b> 8031440353335 lumen	3 × 400 lm	
<b>INC-FUSION-3X5W NIK</b> 8031440353342 lumen	3 × 400 lm	
<b>INC-FUSION-3X5W ORO</b> 8031440353359 lumen	3 × 400 lm	

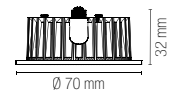

watt	3 × 5W
beam angle	120°
	Ø 60 mm

Fotometria del prodotto / Photometric curve

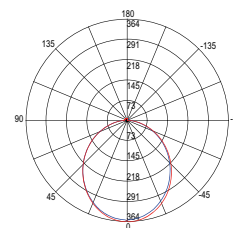

INC-FUSION 5W

Le curve fotometriche rappresentano il singolo modulo LED per ogni elemento / Above photometric curve represent the single module of each element

# BLITZ

Lampada sottopensile kit 3pz con struttura in alluminio in policarbonato bianco opaco.

Cabinet ceiling lamp kit 3pz with aluminum structure in opal white polycarbonate.

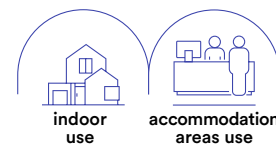

## Materiale

struttura in alluminio  
diffusore in pc

## Colore

bianco opaco



## Temperatura colore

4000K



## Driver

incluso

## Material

aluminum structure with PC diffuser

## Colour

satın white and silver reflector



## Colour temperature

4000K



## Driver

included

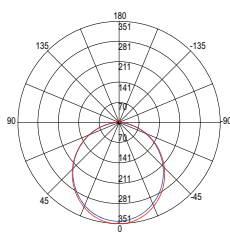

Le curve fotometriche rappresentano il singolo modulo LED per ogni elemento / Above photometric curve represent the single module of each element



## Accessori inclusi / Included accessories



**x3**  
Driver + morsettiera con cavo 1,5m / Driver + connector with 1,5m cable included

## Kit 3 pz / Kit 3 pcs



**LED-BLITZ-R3**  
8031440353274  
lumen

colour temp.



350 lm

watt 3 x 5W  
beam angle 105°

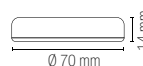

# NEMO

Lampada sottopensile da incasso con struttura in termoplastica con finitura in bianco o silver.

Recessed cabinet lamp with thermoplastic structure with white or silver finish.

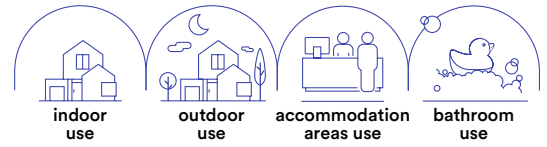

**Materiale**  
struttura in termoplastica

**Colore**  
bianco  
silver



**Temperatura colore**  
4000K



**Driver**  
integrato

**Material**  
thermoplastic structure

**Colour**  
white  
silver



**Colour temperature**  
4000K



**Driver**  
built-in

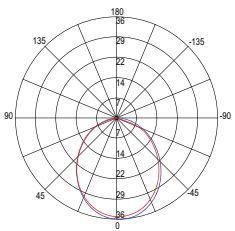

INC-NEMO 3,5W



**INC-NEMO-65 BCO**

8031414877065

lumen

colour temp.



277 lm

**INC-NEMO-65 SIL**

8031414877072

lumen



277 lm

watt

3,5W

beam angle

120°



Ø 55 mm



In.tec light INCASSI / RECESSED LAMPS

# RAINBOW

Faretto da incasso in alluminio in bianco o cromato.  
Recessed aluminum spotlight in white or chromed.

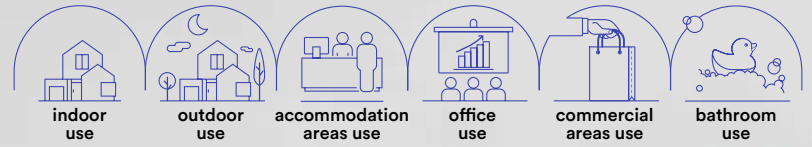

**Materiale**  
alluminio

**Colore**  
bianco  
cromo



**Temperatura colore**  
RGB + 4000K



**Driver**  
DC 12V  
tensione costante  
non incluso

**Material**  
aluminum

**Colour**  
white  
chrome



**Colour temperature**  
RGB + 4000K



**Driver**  
DC 12V  
constant voltage  
not included



EASY  
DOMOTICA



**INC-RAINBOW-M BCO**

8031414862627

lumen

**INC-RAINBOW-M**

8031414862603

lumen

colour  
temp.



110 lm

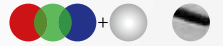

110 lm

watt

5W

beam angle

120°



Ø 90 mm

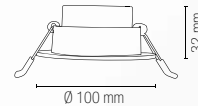

**Sistema di connessione /  
Connection system**

Driver pag. 843-852

Controller pag. 854-857

WHITE - BIANCO  
YELLOW - GIALLO  
GREEN - VERDE  
RED - ROSSO  
BLACK - NERO

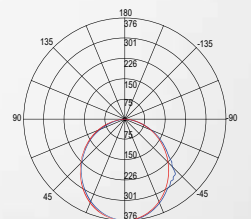

INC-RAINBOW 4000K



# ZENIT

Faretto da incasso orientabile con struttura in policarbonato e finitura in nickel, bianco satinato, cromo o oro.

Adjustable recessed spotlight with polycarbonate structure and nickel, satin white, chrome or gold finish.

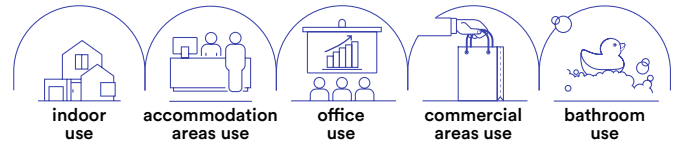

- Materiale**  
policarbonato
- Colore**  
bianco satinato  
nikel  
cromo  
oro
- Temperatura colore**  
3000K
- Driver**  
integrato
- Material**  
polycarbonate
- Colour**  
satin white  
nikel  
chrome  
gold finish
- Colour temperature**  
3000K
- Driver**  
built-in



	colour temp.	colour
<b>INC-ZENIT-5W BCO</b> 8031439881276		
lumen	390 lm	
<b>INC-ZENIT-5W NIK</b> 8031439901271		
lumen	390 lm	
<b>INC-ZENIT-5W CR</b> 8031439891275		
lumen	390 lm	
<b>INC-ZENIT-5W ORO</b> 8031439911270		
lumen	390 lm	

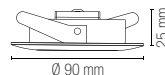
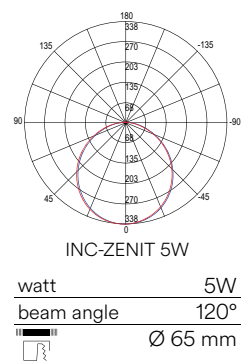

INCASSI / RECESSED LAMPS

In.tec light

# QUANTUM

Faretto da incasso con struttura in alluminio  
nelle versioni bianco e nero satinato.

Recessed spotlight with aluminum structure  
in white and satin black versions.

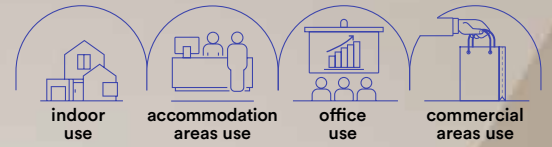

## Materiale

alluminio + PC

## Colore

bianco satinato  
nero satinato



## Temperatura colore selezionabile

3000K / 4000K / 6500K



## Driver

integrato

## Material

aluminum + PC

## Colour

satin white  
satin black



## Selectable color temperature

3000K / 4000K / 6500K



## Driver

built-in





**DALI**

	colour temp.	colour
<b>INC-QUANTUM-R18DA-BCO</b> 8031414923878		
lumen	2350 lm	
<b>INC-QUANTUM-R18-NER</b> 8031414923908		
lumen	2350 lm	
watt	18W	
beam angle	60°	
pf	-	
	Ø 120 mm	

**DALI**

	colour temp.	colour
<b>INC-QUANTUM-R30DA-BCO</b> 8031414923885		
lumen	4200 lm	
<b>INC-QUANTUM-R30DA-NER</b> 8031414923915		
lumen	4200 lm	
watt	30W	
beam angle	60°	
pf	0.90	
	Ø 140 mm	

**DALI**

	colour temp.	colour
<b>INC-QUANTUM-R40DA-BCO</b> 8031414923892		
lumen	5500 lm	
<b>INC-QUANTUM-R40DA-NER</b> 8031414923922		
lumen	5500 lm	
watt	40W	
beam angle	60°	
pf	0.90	
	Ø 165 mm	

<b>INC-QUANTUM-R18-BCO</b> 8031414893683		
lumen	2000 lm	
<b>INC-QUANTUM-R18-NER</b> 8031414893713		
lumen	2000 lm	
watt	18W	
beam angle	60°	
pf	-	
	Ø 120 mm	

<b>INC-QUANTUM-R30-BCO</b> 8031414893690		
lumen	3300 lm	
<b>INC-QUANTUM-R30-NER</b> 8031414893720		
lumen	3300 lm	
watt	30W	
beam angle	60°	
pf	0.90	
	Ø 140 mm	

<b>INC-QUANTUM-R40-BCO</b> 8031414893706		
lumen	4300 lm	
<b>INC-QUANTUM-R40-NER</b> 8031414893737		
lumen	4300 lm	
watt	40W	
beam angle	60°	
pf	0.90	
	Ø 165 mm	

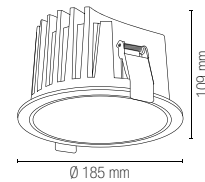
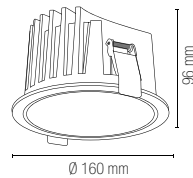
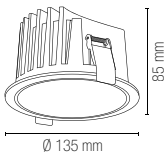

Fotometria del prodotto / Photometric curve

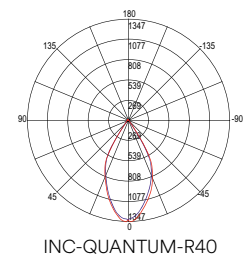
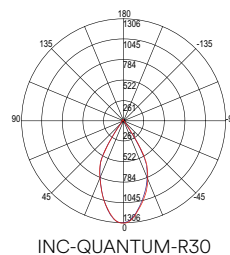
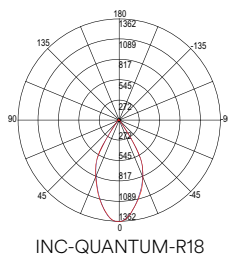

# HORUS

Faretto da incasso dimmerabile con struttura in policarbonato bianco opaco.  
Dimmable recessed spotlight with matt white polycarbonate structure.

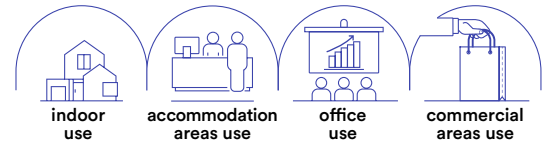

**Materiale**  
policarbonato

**Colore**  
bianco opaco



**Temperatura colore**  
4000K



**Dimmer**  
dimmer 1-10

**Driver**  
integrato

**Material**  
polycarbonate

**Colour**  
matt white



**Colour temperature**  
4000K



**Dimmer**  
dimmable 1-10

**Driver**  
built-in





**INC-HORUS-10W**

8031440363501

lumen

colour temp. | colour

1050 lm

watt 10W

beam angle 100°

pf -

Ø 90 mm

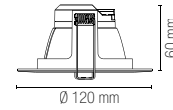

**INC-HORUS-15W**

8031440363518

lumen

colour temp. | colour

1900 lm

watt 15W

beam angle 100°

pf -

Ø 120 mm

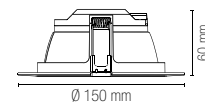

**INC-HORUS-20W**

8031440363464

lumen

colour temp. | colour

2600 lm

watt 20W

beam angle 100°

pf -

Ø 170 mm

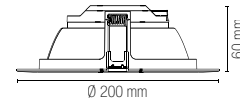

**INC-HORUS-25W**

8031440363495

lumen

colour temp. | colour

3250 lm

watt 25W

beam angle 100°

pf 0.90

Ø 200 mm

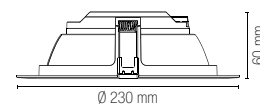

Fotometria del prodotto / Photometric curve

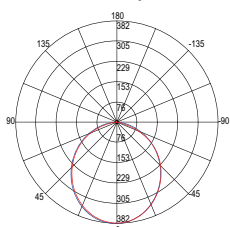

INC-HORUS-10W

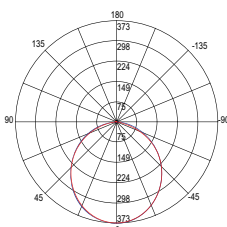

INC-HORUS-15W

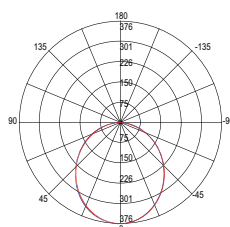

INC-HORUS-20W

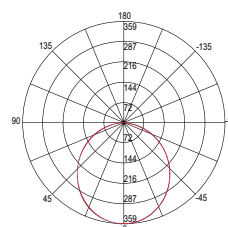

INC-HORUS-25W

# MATRIX

Faretto da incasso in metallo con lampadina GU10 inclusa disponibile nei colori bianco, nikel, oro e cromo.

Recessed metal spotlight with GU10 bulb included available in white, nikel, gold and chrome.



**Materiale**  
metallo

**Colore**  
bianco  
nikel  
cromo  
oro



**Temperatura colore**  
3000K



**Material**  
metal

**Colour**  
white  
nikel  
chrome  
gold



**Colour temperature**  
3000K





# MATRIX

Kit 3 pz / Kit 3 pcs

Ø 80 mm

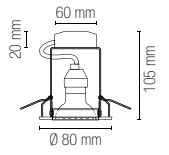

Kit 3 pz / Kit 3 pcs

Ø 100 mm  
orientabile / adjustable

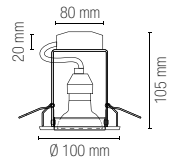

1 pz / 1 pcs

Ø 100 mm  
orientabile / adjustable

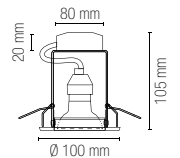





**INC-MATRIX-LEDF3 BCO**  
8031440359320



**INC-MATRIX-LEDF3 NIK**  
8031440359337



3 x GU10



5W LED  
Ø 60 mm

colour

Accessori inclusi / Included accessories



**3 lampadine LED SMD /  
3 LED SMD light bulbs**

watt	5W
beam angle	100°
cri	80
on/off	>10.000
3000K	
lumen	3 x 413 lm



**Staffa con connettore /  
Bracket with connector**

3 pz inclusi / 3 pcs included



**GU10 230V~50Hz  
Portalamпада /  
Lampholder**

3 pz inclusi / 3 pcs included

**INC-MATRIX-LEDM3 BCO**  
8031429651162



**INC-MATRIX-LEDM3 NIK**  
8031431571182



**INC-MATRIX-LEDM3 CR**  
8031440313032



**INC-MATRIX-LEDM3 ORO**  
8031440313025



3 x GU10



5W LED  
Ø 80 mm

colour

Accessori inclusi / Included accessories



**3 lampadine LED SMD /  
3 LED SMD light bulbs**

watt	5W
beam angle	100°
cri	80
on/off	>10.000
3000K	
lumen	3 x 413 lm



**Staffa con connettore /  
Bracket with connector**

3 pz inclusi / 3 pcs included



**Portalamпада /  
Lampholder  
GU10 230V~50Hz**

3 pz inclusi / 3 pcs included

**INC-MATRIX-LEDM1 BCO**  
8031440313063



**INC-MATRIX-LEDM1 NIK**  
8031440313049



**INC-MATRIX-LEDM1 CR**  
8031440313056



**INC-MATRIX-LEDM1 ORO**  
8031440313070



1 x GU10



5W LED  
Ø 80 mm

colour

Accessori inclusi / Included accessories



**Lampadina LED SMD /  
LED SMD light bulb**

watt	5W
beam angle	100°
cri	80
on/off	>10.000
3000K	
lumen	413 lm



**Staffa con connettore /  
Bracket with connector**

3 pz inclusi / 3 pcs included



**Portalamпада /  
Lampholder  
GU10 230V~50Hz**

3 pz inclusi / 3 pcs included

# TUBEX

Incasso in gesso componibile da integrare nel cartongesso per dare omogeneità tra parete e corpo illuminante. Punto luce regolabile e orientabile con finitura in bianco o nero gofrato.

Recessed paintable gypsum downlight to be integrated into the plasterboard to give homogeneity between the ceiling and the lighting body. Adjustable light point with embossed black or white finish.

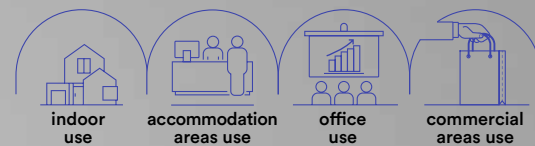

indoor use

accommodation areas use

office use

commercial areas use

---

**Materiale**

gesso e alluminio

---

**Colore**

bianco gofrato  
nero gofrato



---

**Temperatura colore**

3000K / 4000K



---

**Driver**

incluso

---

**Material**

gypsum and aluminum

---

**Colour**

embossed white  
embossed black



---

**Colour temperature**

3000K / 4000K



---

**Driver**

included



**INC-TUBEX-2C-BCO**

8031414883752

lumen

colour temp. | colour



190 lm



**INC-TUBEX-2M-BCO**

8031414883769

lumen



190 lm

**INC-TUBEX-2C-NER**

8031414883776

lumen



190 lm

**INC-TUBEX-2M-NER**

8031414883783

lumen



190 lm



**INC-TUBEX-BASE**

8031414883745

watt

2,5W

beam angle

30°



165 x 165 mm

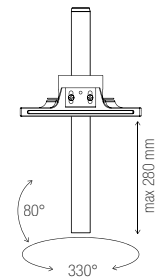
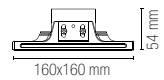

Modular system:  
INC-TUBEX-BASE  
+ INC-TUBEX-2

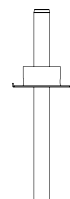
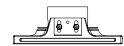

Staffa regolabile /  
Adjustable bracket

# STARRY

**Incasso in gesso componibile da integrare nel cartongesso per dare omogeneità tra parte e corpo illuminante.**

Recessed paintable gypsum downlight to be integrated into the plasterboard to give homogeneity between the ceiling and the lighting body.

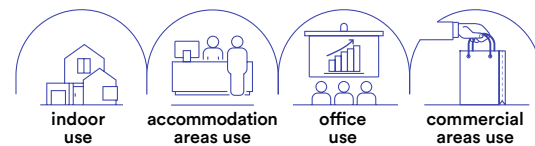

**Materiale**  
gesso  
alluminio

**Colore**  
bianco



**Temperatura colore**  
3000K / 4000K



**Driver**  
incluso

**Material**  
gypsum  
aluminum

**Colour**  
white



**Colour temperature**  
3000K / 4000K



**Driver**  
included



Modular system:  
LED-STARRY +  
INC-STARRY-R1

Modular system:  
LED-STARRY +  
INC-STARRY-Q1



**LED-STARRY-C**

8031414884476

lumen

colour  
temp.

160 lm

**LED-STARRY-M**

8031414884483

lumen

160 lm

watt

2,5W

beam angle

45°



**INC-STARRY-R1**

8031414884452



Ø 75 mm

**INC-STARRY-Q1**

8031414884469



75 x 75 mm

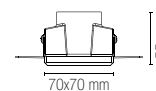
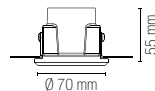

# GHOST

**Incasso in gesso verniciabile da integrare nel cartongesso per dare omogeneità tra parete e corpo illuminante.**

Recessed paintable gypsum downlight to be integrated into the plasterboard to give homogeneity between the ceiling and the lighting body.

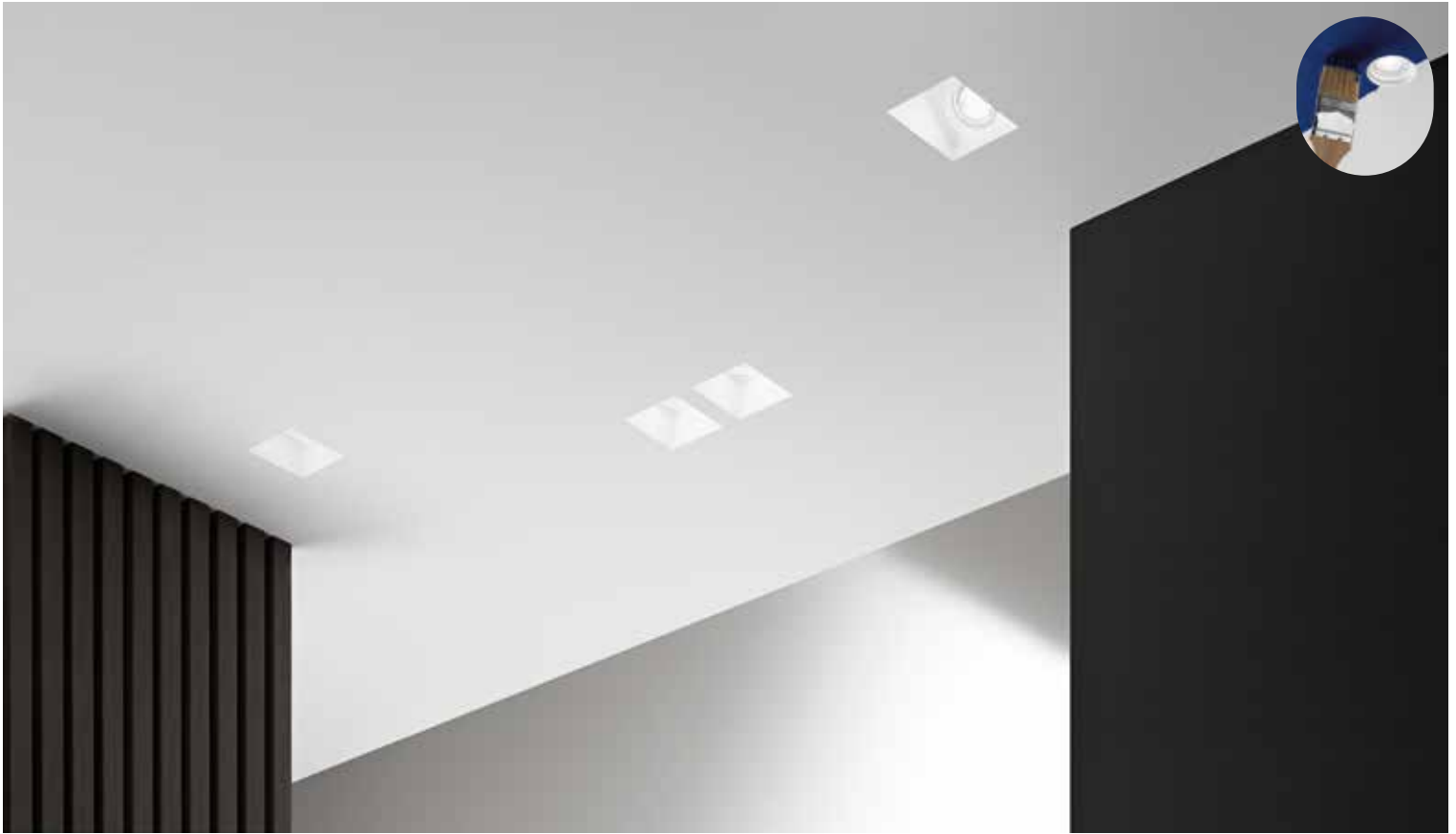
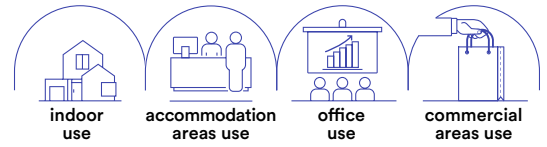

INCASSI / RECESSED LAMPS

In.tec light



**INC-GHOST-Q1D**  
8031434241211

1 x GU10 MAX 35W  
125 x 125 mm



**INC-GHOST-Q1**  
8031434261219

1 x GU10 MAX 35W  
125 x 125 mm



**INC-GHOST-Q2**  
8031434301212

2 x GU10 MAX 35W  
219 x 123 x 8-15 mm



Staffa regolabile /  
Adjustable bracket



Portalamпада incluso /  
Lampholder included



Lampadina non inclusa /  
Light bulb not included

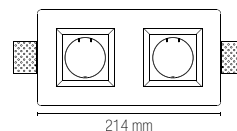
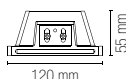
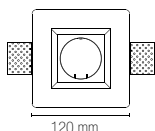
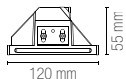
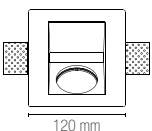

# VULKAN

**Incasso in gesso verniciabili con cilindri intercambiabili e finiture bianco, nero e oro satinato.**

Gypsum down light paintable with interchangeable cylinders and in white, black and satin gold finishes.

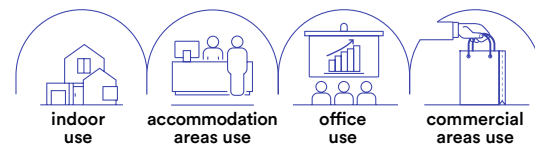

Modular system:  
INC-VULKAN-BASE  
+ INC-VULKAN

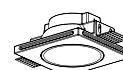

**INC-VULKAN-BASE**  
8031414883707

1 x GU10 MAX 35W



170 x 170 mm

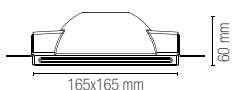

**INC-VULKAN-BCO**  
8031414883714

**INC-VULKAN-NER**  
8031414883721

**INC-VULKAN-ORO**  
8031414883738

1 x GU10 MAX 35W

1 x GU10 MAX 35W

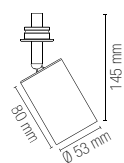

colour



Staffa regolabile /  
Adjustable bracket



Portalampana incluso /  
Lampholder included



Lampadina non inclusa /  
Light bulb not included

# ENTITY

**Incasso in gesso verniciabile con ghiera intercambiabili in finiture bianco, oro e cromo.**

Gypsum down light paintable with interchangeable cylinders white, black and satin gold finishes.

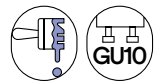
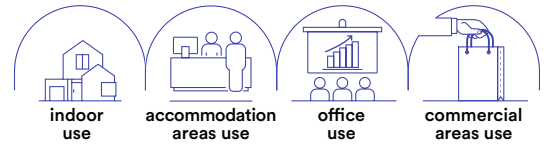

INCASSI / RECESSED LAMPS

In.tec light

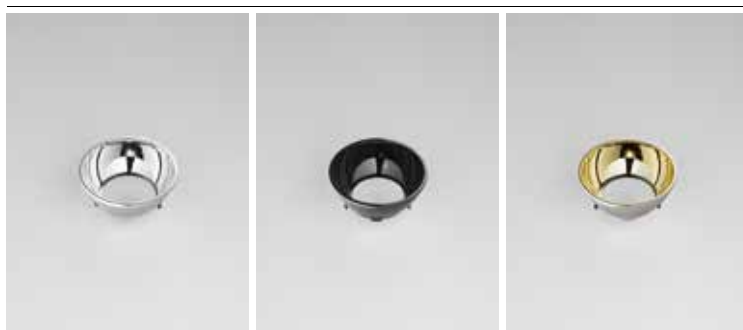

Modular system:  
INC-ENTITY-Q  
+ ENTITY-RING

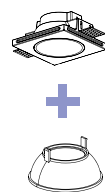

**INC-ENTITY-Q**  
8031414883790

1 x GU10 MAX 10W



125 x 125 mm

**ENTITY-RING-CR**  
8031414883813

**ENTITY-RING-NER**  
8031414883820

**ENTITY-RING-ORO**  
8031414883806

1 x GU10 MAX 35W

colour



Staffa regolabile /  
Adjustable bracket



Portalamпада incluso /  
Lampholder included



Lampadina non inclusa /  
Light bulb not included

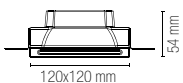

# GOBLET

**Incasso con struttura sporgente in gesso verniciabile e portalampane incluso.**  
Gypsum prominent down light paintable and lamp holder included.

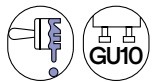
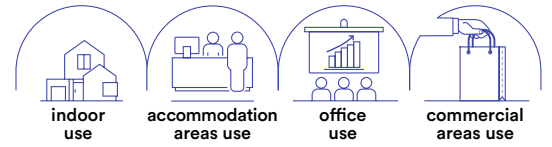

**INC-GOBLET-R**  
8031414882960

1 x GU10 MAX 35W  
Ø 75 mm



**INC-GOBLET-Q**  
8031414882977

1 x GU10 MAX 35W  
Ø 75 mm

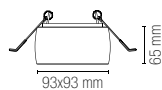
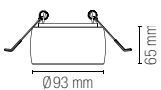

Portalampana incluso /  
Lampholder included



Lampadina non inclusa /  
Light bulb not included



# SHADOW

**Incasso con struttura in gesso verniciabile e portalampade incluso.**  
Gypsum downlight paintable and lamp holder included.

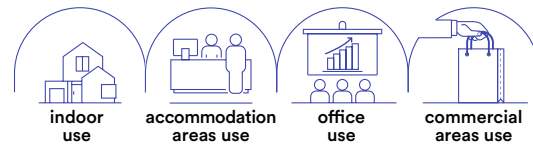

INCASSI / RECESSED LAMPS

In.tec light



**INC-SHADOW-R**  
8031414882984

1 x GU10 MAX 35W

Ø 90 mm

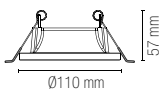

**INC-SHADOW-Q**  
8031414882991

1 x GU10 MAX 35W

Ø 100 mm

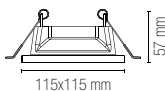

Portalamпада incluso /  
Lampholder included



Lampadina non inclusa /  
Light bulb not included

# PHANTOM

**Incasso con struttura in gesso verniciabile e portalampade incluso.**  
Gypsum downlight paintable and lamp holder included.

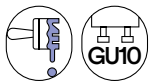
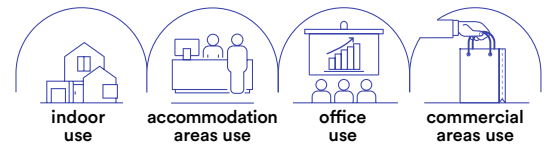

**INC-PHANTOM-R1**  
8031431551184

1 x GU10 MAX 35W  
Ø 83 mm



**INC-PHANTOM-Q1**  
8031431561183

1 x GU10 MAX 35W  
82 x 82 mm

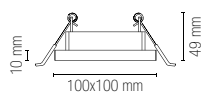
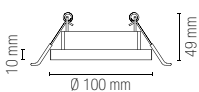

Portalampada incluso /  
Lampholder included



Lampadina non inclusa /  
Light bulb not included

# SPETTRO

**Incasso con struttura in gesso verniciabile e portalampade incluso.**  
Gypsum downlight paintable and lamp holder included.

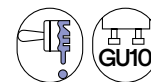
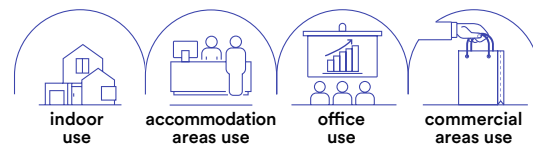

INCASSI / RECESSED LAMPS

In.tec light



**INC-SPETTRO-R1**  
8031431531186

1 x GU10 MAX 35W

Ø 85 mm

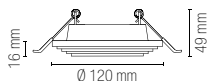

**INC-SPETTRO-Q1**  
8031431541185

1 x GU10 MAX 35W

Ø 95 x 95 mm

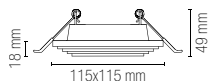

Portalamпада incluso /  
Lampholder included



Lampadina non inclusa /  
Light bulb not included

# MINI

**Incasso in gesso da integrare nel cartongesso per dare omogeneità tra parete e corpo illuminante.**

Recessed gypsum downlight to be integrated into the plasterboard to give homogeneity between the ceiling and the lighting body.

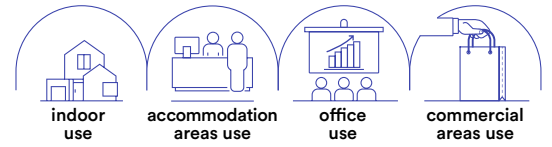

**INC-MINI-R1**  
8031414873623

1 x MINI GU10 MAX 35W  
bulb size  $\varnothing 34$  mm  
 $\varnothing 73$  mm

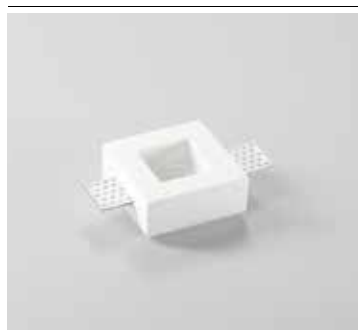
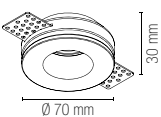

**INC-MINI-Q1**  
8031414873616

1 x MINI GU10 MAX 35W  
bulb size  $\varnothing 34$  mm  
73 x 73 mm

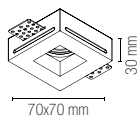

Portalamпада incluso /  
Lampholder included



Lampadina non inclusa /  
Light bulb not included

# HIVE

**Incasso in gesso verniciabile con 4 punti luce da integrare nel cartongesso per dare omogeneità tra soffitto e corpo illuminante.**

Recessed gypsum paintable downlight with 4 light to be integrated into the plasterboard to give homogeneity between ceiling and lighting body.

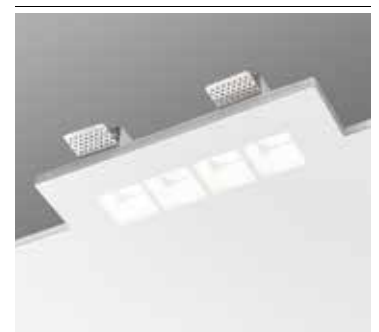
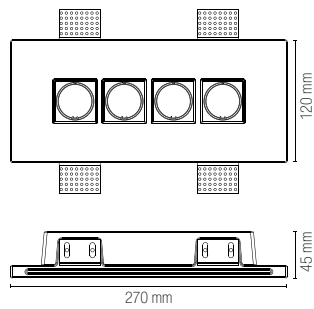
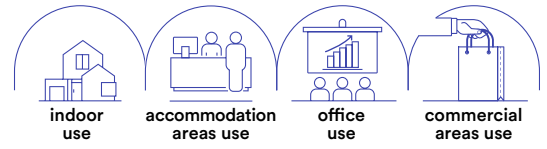

**INC-HIVE-RT4**  
8031414884278

4 x MINI GU10 MAX 35W  
bulb size Ø 34 mm  
275 x 125 mm



Staffa regolabile /  
Adjustable bracket



Portalamпада incluso /  
Lampholder included



Lampadina non inclusa /  
Light bulb not included

INCASSI / RECESSED LAMPS

In.tec light

# SPIRIT

**Incasso in gesso verniciabile da integrare nel cartongesso per dare omogeneità tra parete e corpo illuminante.**

Recessed gypsum downlight to be integrated into the plasterboard to give homogeneity between the ceiling and the lighting body.

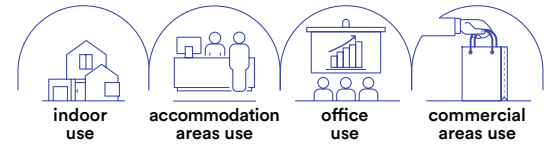

**INC-SPIRIT-R1**  
8031440362177

1 x GU10 MAX 35W  
Ø 103 mm

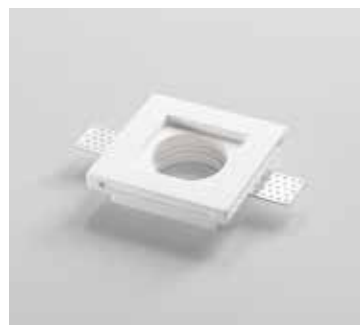

**INC-SPIRIT-Q1**  
8031440362160

1 x GU10 MAX 35W  
103 x 103 mm

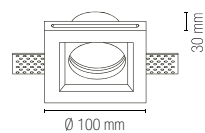
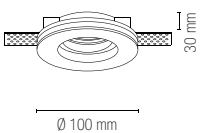

Portalamпада incluso /  
Lampholder included



Lampadina non inclusa /  
Light bulb not included

# SNOW

**Incasso in gesso verniciabile con diffusore in vetro satinato da integrare nel cartongesso per dare omogeneità tra soffitto e corpo illuminato.**

Recessed paintable gypsum downlight with satin glass diffuser to be integrated into the plasterboard to give homogeneity between the ceiling and the lighting body.

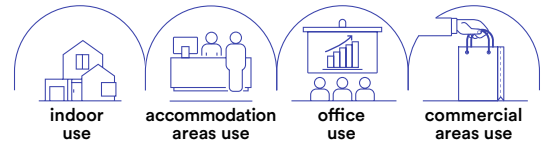

**INC-SNOW-R**  
8031440351607

1 x GU10 MAX 10W  
Ø 125 mm



**INC-SNOW-Q**  
8031440351577

1 x GU10 MAX 10W  
125 x 125 mm



 Staffa regolabile /  
Adjustable bracket

 Portalamada incluso /  
Lampholder included

 Lampadina non inclusa /  
Light bulb not included

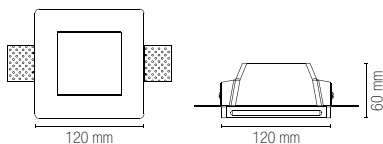
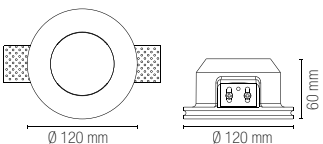

INCASSI / RECESSED LAMPS

In.tec light

# MORGANA

**Incasso orientabile in gesso verniciabile da integrare nel cartongesso per dare omogeneità tra soffitto e corpo illuminante.**

Adjustable and paintable recessed gypsum downlight to be integrated into the plasterboard to give homogeneity between ceiling and the lighting body.

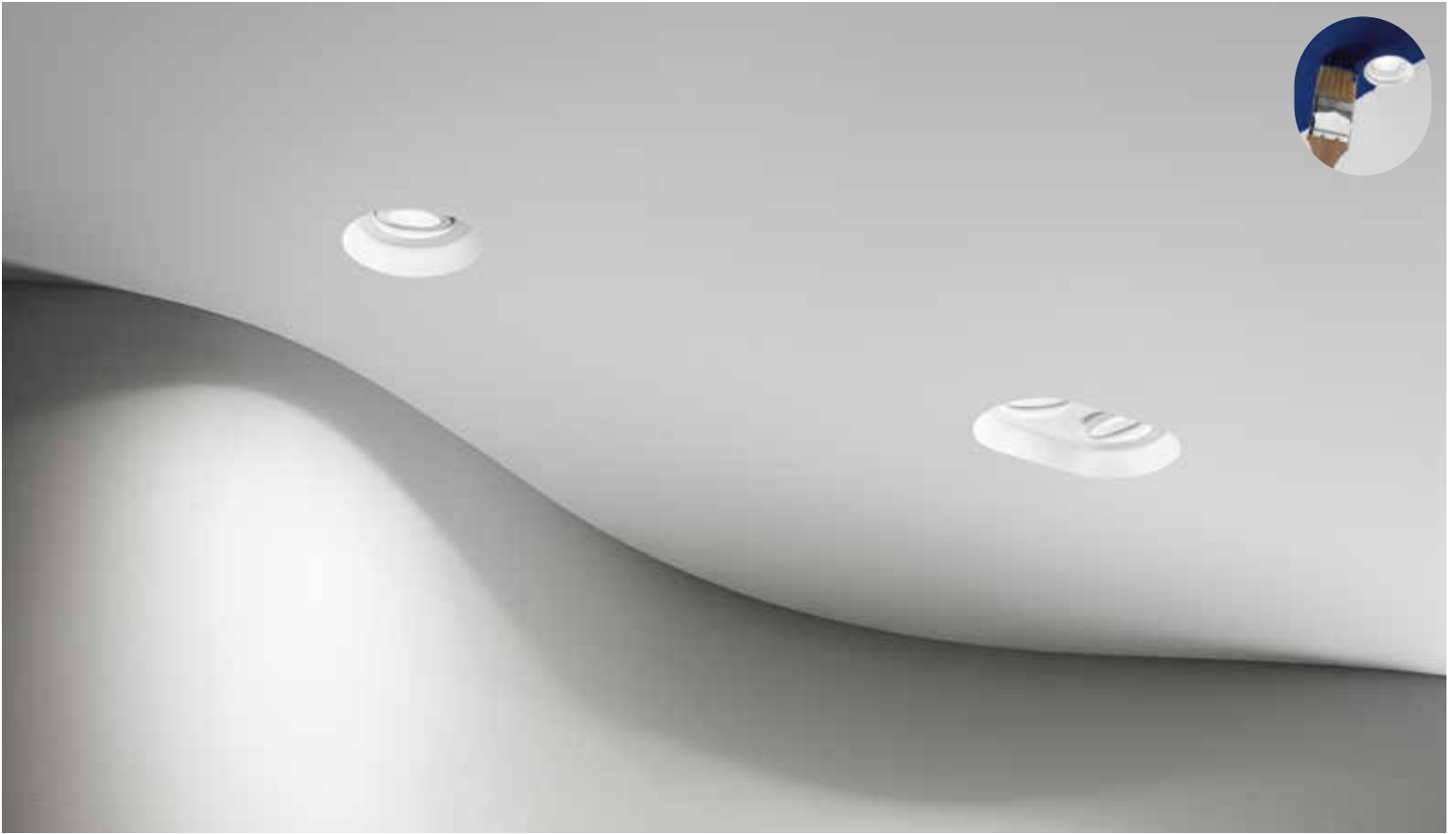
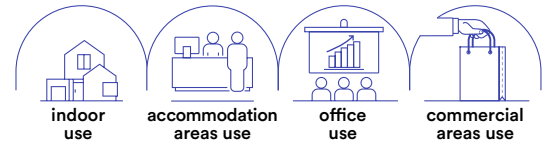

**INC-MORGANA-R1**  
8031434211214

1 x GU10 MAX 35W  
Ø 155 mm

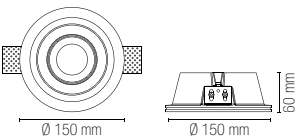

**INC-MORGANA-Q1**  
8031434231212

1 x GU10 MAX 35W  
160 x 160 mm

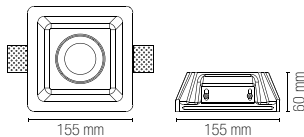

**INC-MORGANA-Q2**  
8031434201215

2 x GU10 MAX 35W  
260 x 160 mm

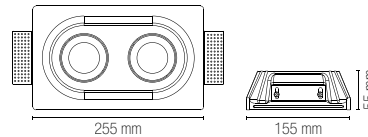

Staffa regolabile /  
Adjustable bracket



Portalampada incluso /  
Lampholder included



Lampadina non inclusa /  
Light bulb not included



# SENSO

**Incasso in gesso verniciabile da integrare nel cartongesso per dare omogeneità tra soffitto e corpo illuminante.**

Recessed gypsum paintable downlight to be integrated into the plasterboard to give homogeneity between ceiling and the lighting body.

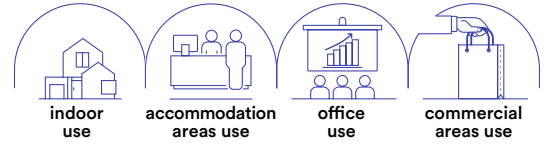

INCASSI / RECESSED LAMPS

In.tec light



**INC-SENSO-MINI**  
8031414892723

1 x MINI GU10 MAX 10W  
85 x 85 mm

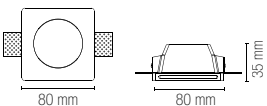

**INC-SENSO-1**  
8031434221213

1 x GU10 MAX 35W  
125 x 125 mm

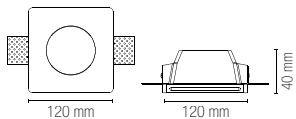

**INC-SENSO-2**  
8031414873593

2 x GU10 MAX 35W  
243 x 123 mm

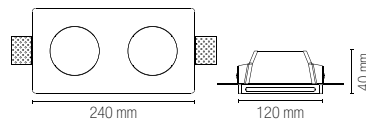

Staffa regolabile /  
Adjustable bracket



Portalamпада incluso /  
Lampholder included



Lampadina non inclusa /  
Light bulb not included

# BRICK

**Incasso in gesso verniciabile da integrare nel cartongesso per dare omogeneità tra soffitto e corpo illuminante con steli dalle forme modulari che sporgono dalla parete.**

Recessed gypsum paintable downlight to be integrated into the plasterboard to give homogeneity between ceiling and the lighting body with modular stems protruding from the wall.

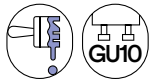
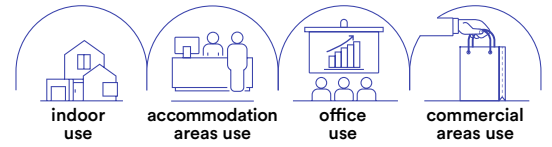

**INC-BRICK-Q1**  
8031414873586

1 x GU10 MAX 35W  
123 x 123 mm

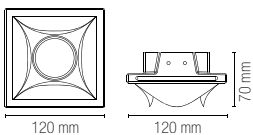

Staffa regolabile /  
Adjustable bracket



Portalampada incluso /  
Lampholder included



Lampadina non inclusa /  
Light bulb not included

# EVA

Struttura ad incasso a scomparsa in gesso verniciabile da integrare nel cartongesso per dare omogeneità tra soffitto e corpo illuminante.

Recessed structure in paintable gypsum to be integrated into the plasterboard to give homogeneity between the ceiling and lighting body.

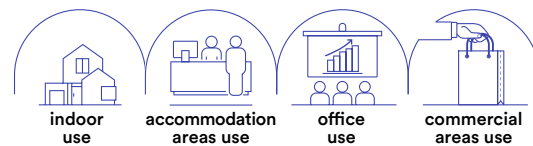

INCASSI / RECESSED LAMPS

In.tec light



**INC-EVA-R1**  
8031414873609

1 x E27 MAX 35W

Ø 185 mm

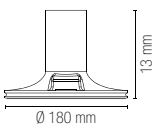

Portalamпада incluso /  
Lampholder included



Lampadina non inclusa /  
Light bulb not included

# SKILIFT

**Sistema componibile da incasso in gesso verniciabile da integrare nel cartongesso per dare omogeneità tra soffitto e corpo illuminante.**

Modular recessed system in paintable gypsum to be integrated into the plasterboard to give homogeneity between the ceiling and the lighting body.

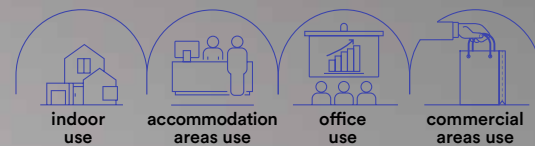

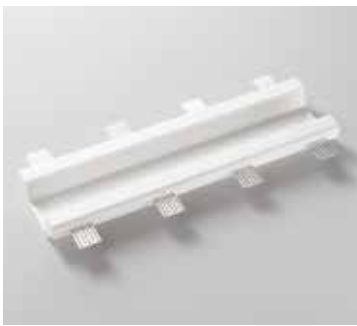

**INC-SKILIFT-40CM**  
8031414884346

 405 × 115 mm

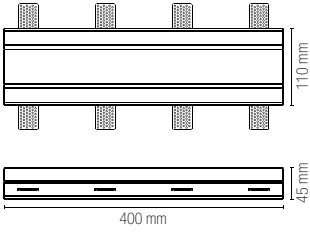

**INC-SKILIFT-20CM**  
8031414884322

 205 × 115 mm

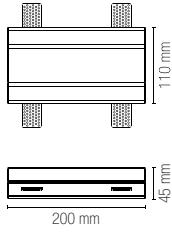

**INC-SKILIFT-L16CM**  
8031414884360

 165 × 165 mm

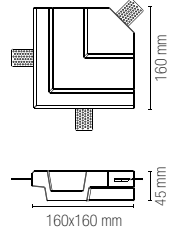

**INC-SKILIFT-CAP**  
8031414886869

 55 × 115 mm

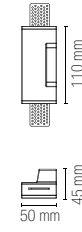

**INC-SKILIFT-6**  
8031414884339

6 x MINI GU10 MAX 35W  
bulb size  $\varnothing$  34 mm  
 405 × 115 mm

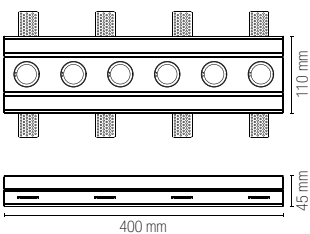

**INC-SKILIFT-3**  
8031414884315

3 x MINI GU10 MAX 35W  
bulb size  $\varnothing$  34 mm  
 205 × 115 mm

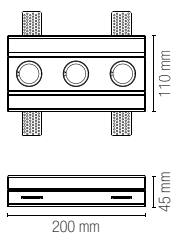

**INC-SKILIFT-L3**  
8031414884353

3 x MINI GU10 MAX 35W  
bulb size  $\varnothing$  34 mm  
 165 × 165 mm

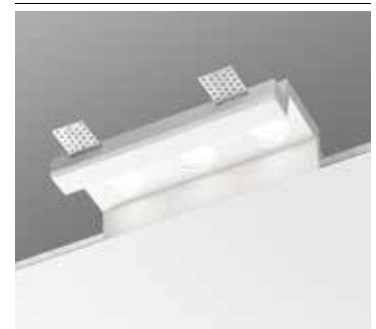
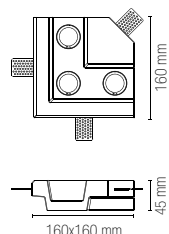

Portalamпада incluso /  
Lampholder included



Lampadina non inclusa /  
Light bulb not included

# ARIEL

**Segnapasso in gesso verniciabile da integrare nel cartongesso per dare omogeneità tra parete e corpo illuminante.**

Paintable gypsum wall-light to be integrated into the plasterboard to give homogeneity between the wall and lighting body.

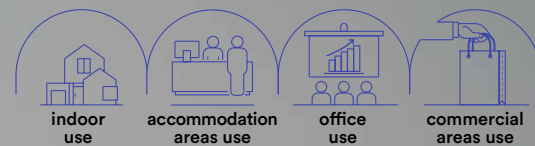



**I-ARIEL-QL1**  
8031434151213

1 x MINI GU10 MAX 35W  
bulb size  $\varnothing$  34 mm  
115 x 250 x 12 mm

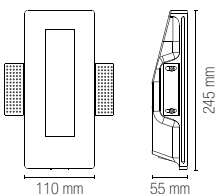

**I-ARIEL-RM1**  
8031434121216

1 x MINI GU10 MAX 35W  
bulb size  $\varnothing$  34 mm  
125 x 185 x 12 mm

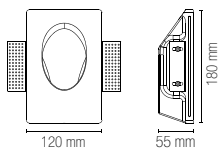

**I-ARIEL-RS1**  
8031434131215

1 x MINI GU10 MAX 35W  
bulb size  $\varnothing$  34 mm  
105 x 105 x 12 mm

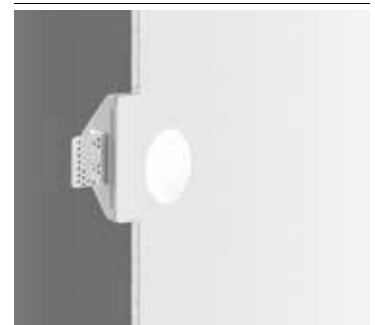
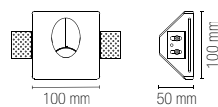

Staffa regolabile /  
Adjustable bracket



Portalampana incluso /  
Lampholder included



Lampadina non inclusa /  
Light bulb not included

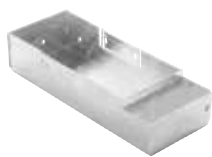

**I-ARIEL-QL1-BOX**  
8031414868360

Cassa di derivazione opzionale  
per fissaggio a parete in muratura  
materiale alluminio /  
Aluminum optional recess box  
for brickwork recess installation

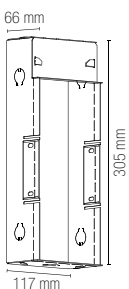

**I-ARIEL-RM1-BOX**  
8031414868384

Cassa di derivazione opzionale  
per fissaggio a parete in muratura  
materiale alluminio /  
Aluminum optional recess box  
for brickwork recess installation

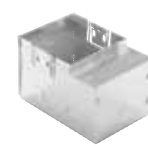
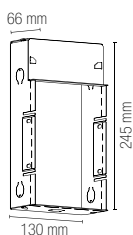

**I-ARIEL-RS1-BOX**  
8031414868377

Cassa di derivazione opzionale  
per fissaggio a parete in muratura  
materiale alluminio /  
Aluminum optional recess box  
for brickwork recess installation

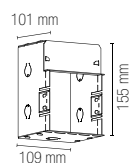

# ANIMA

**Applique in gesso verniciabile con leggera sporgenza da integrare nel cartongesso per dare omogeneità tra parte e corpo illuminante.**

Wall lamp in paintable gypsum with slight protrusion to be integrated into the plasterboard to give homogeneity between the part and the illuminating body.

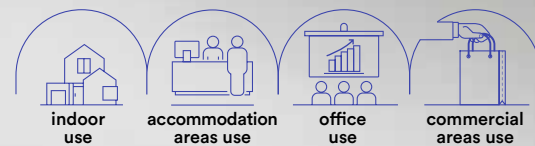



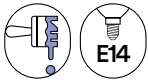

Staffa regolabile /  
Adjustable bracket



Portalamпада incluso /  
Lampholder included



Lampadina non inclusa /  
Light bulb not included

**I-ANIMA-AP2**  
8031414861323

2 x E14 MAX 14W  
320 x 260 x 90 mm



**I-ANIMA-AP2-BOX**  
8031414868391

Cassa di derivazione opzionale  
per fissaggio a parete in muratura  
materiale alluminio /  
Aluminum optional recess box  
for brickwork recess installation

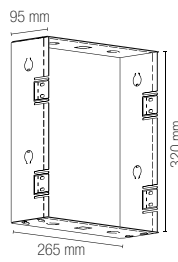
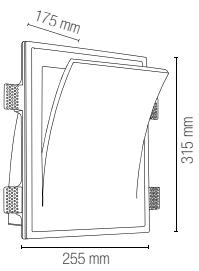

# STENOS

**Faretto da incasso con struttura in termoplastica orientabile ed antiriflesso.**

Recessed spotlight with adjustable and anti-reflective thermoplastic structure.

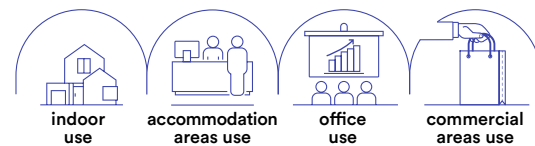



**INC-STENOS-R-OV**  
8031414875818



**INC-STENOS-Q-OV**  
8031414875856

**INC-STENOS-R-QU**  
8031414875832



**INC-STENOS-Q-QU**  
8031414875870

**INC-STENOS-R-RO**  
8031414875801



**INC-STENOS-Q-RO**  
8031414875849

**INC-STENOS-R-ML**  
8031414875825



**INC-STENOS-Q-ML**  
8031414875863

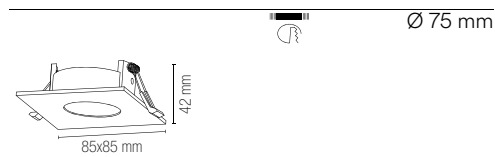
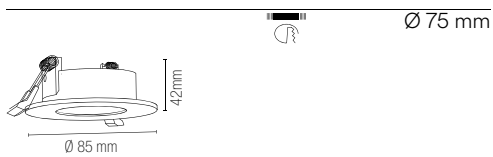

Lampadina  
non inclusa /  
Light bulb  
not included



Portalampada GU10  
o MR16 non inclusi/  
GU10 or MR16 lamp  
holder not included



Lampadina  
non inclusa /  
Light bulb  
not included

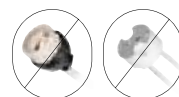

Portalampada GU10  
o MR16 non inclusi/  
GU10 or MR16 lamp  
holder not included

# VIPER



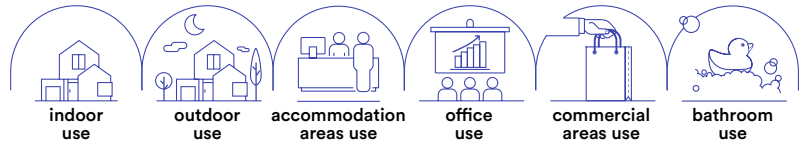

**Faretto con struttura in metallo e diffusore in vetro satinato.**  
Spotlight with metal structure and satin glass diffuser.

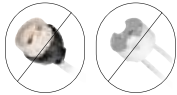

Portalampada GU10 o MR16 non inclusi / GU10 or MR16 lamp holder not included



Lampadina non inclusa / Light bulb not included



**INC-VIPER-R-BCO**  
8031414861590

**INC-VIPER-R-NIK**  
8031414861576

colour



Ø 74 mm

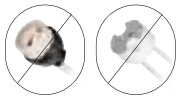
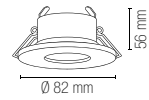

Portalampada GU10 o MR16 non inclusi / GU10 or MR16 lamp holder not included



Lampadina non inclusa / Light bulb not included



**INC-VIPER-Q-BCO**  
8031414861866

**INC-VIPER-Q-NIK**  
8031414861873

colour



Ø 74 mm

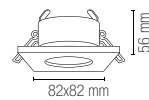

INCASSI / RECESSED LAMPS

In.tec light

# AYRIS

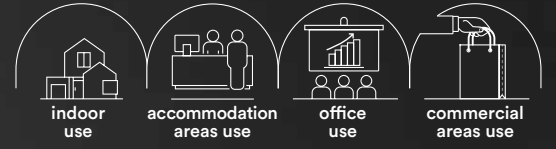



**Faretto ad incasso antiriflesso in alluminio nero o bianco goffrato.**  
Recessed spotlight with anti-reflective in black or white embossed aluminum.



Portalamпада incluso /  
Lampholder included



Lampadina non inclusa /  
Light bulb not included



	colour
<b>INC-AYRIS-R BCO</b> 8031414868216	
<b>INC-AYRIS-R NER</b> 8031414868193	
1 x GU10 MAX 35W	
	Ø 75 mm

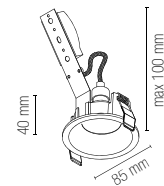

Portalamпада incluso /  
Lampholder included



Lampadina non inclusa /  
Light bulb not included



	colour
<b>INC-AYRIS-Q BCO</b> 8031414868223	
<b>INC-AYRIS-Q NER</b> 8031414868186	
1 x GU10 MAX 35W	
	72 x 72 mm

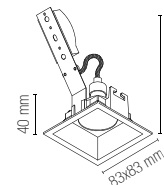



# REFLEX





**Incasso in metallo**  
Metal down light

**INC-REFLEX-SF1 BCO**  
8031439321260



**INC-REFLEX-SF1 NER**  
8031414861552



**INC-REFLEX-SF1 CR**  
8031439301262



**INC-REFLEX-SF1 ORO**  
8031439341268



**INC-REFLEX-SF1 NIK**  
8031439311261



**INC-REFLEX-SF1 BR**  
8031439331269



**INC-REFLEX-Q-SF1 BCO**  
8031414861538



**INC-REFLEX-Q-SF1 NER**  
8031414885053

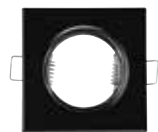

**INC-REFLEX-Q-SF1 NIK**  
8031414861545



**Incasso in metallo orientabile**  
Metal down light adjustable



**INC-REFLEX-SM1 BCO**  
8031439251260



**INC-REFLEX-SM1 NER**  
8031414861569



**INC-REFLEX-SM1 CR**  
8031439281267



**INC-REFLEX-SM1 ORO**  
8031439271268



**INC-REFLEX-SM1 NIK**  
8031439261269



**INC-REFLEX-SM1 BR**  
8031439291266



**INC-REFLEX-Q-SM1 BCO**  
8031440363310



**INC-REFLEX-Q-SM1 NER**  
8031414885060



**INC-REFLEX-Q-SM1 NIK**  
8031440363280



Lampadina  
non inclusa /  
Light bulb  
not included



Portalampada GU10  
o MR16 non inclusi/  
GU10 or MR16 lamp  
holder not included



Lampadina  
non inclusa /  
Light bulb  
not included



Portalampada GU10  
o MR16 non inclusi/  
GU10 or MR16 lamp  
holder not included



# INDOOR



SISTEMI D'ILLUMINAZIONE MULTIFUNZIONE  
MULTI-FUNCTION LIGHTING SYSTEM

# SHAPE

Barre in PC con connettori  
per composizioni personalizzate.

PC bars with connectors  
for customized compositions.

---

**Materiale**

PC

---

**Colore**

bianco



---

**Temperatura colore**

4000K / 6500K



---

**Driver**

integrato

---

**Material**

PC

---

**Colour**

white



---

**Colour temperature**

4000K / 6500K



---

**Driver**

built-in

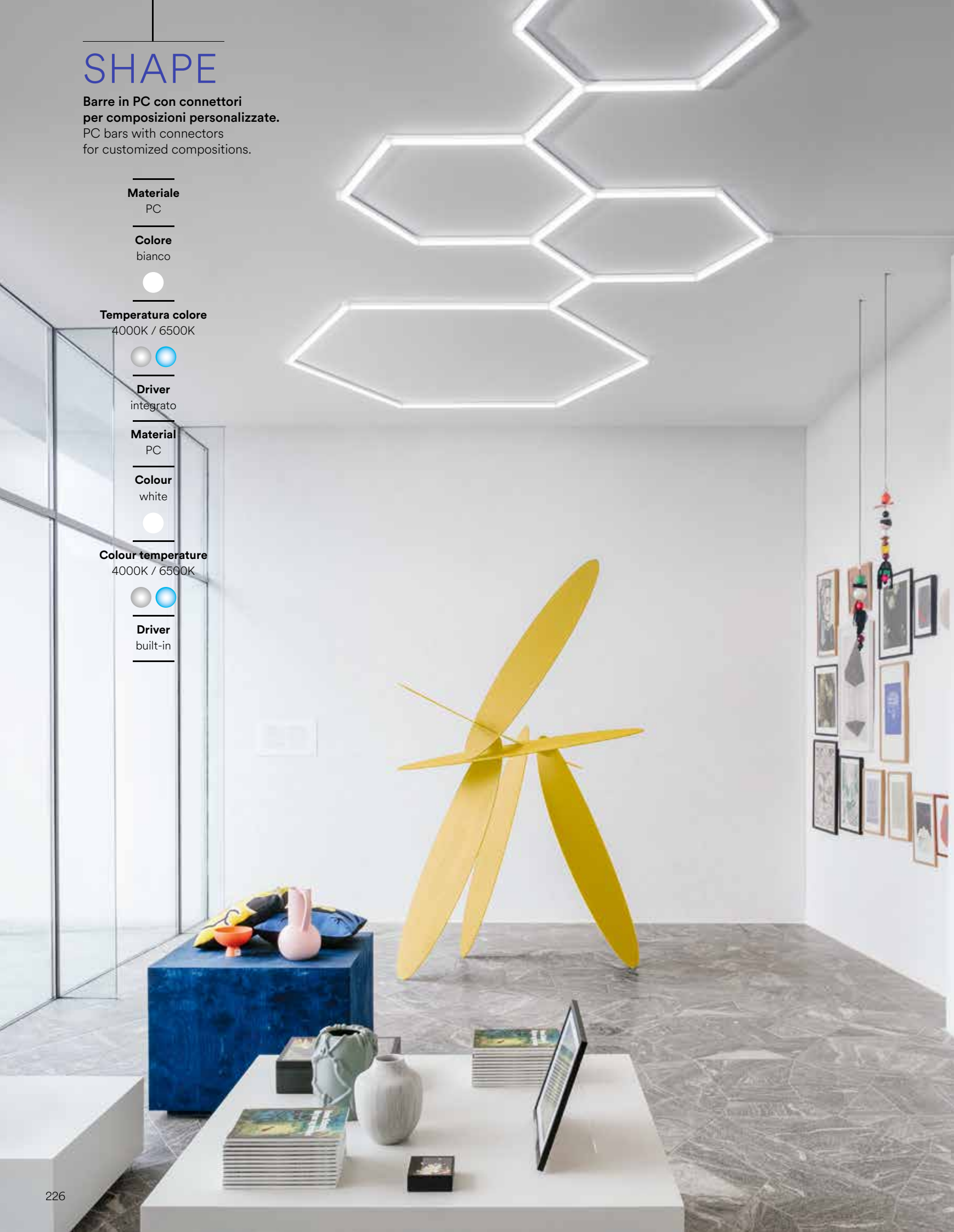



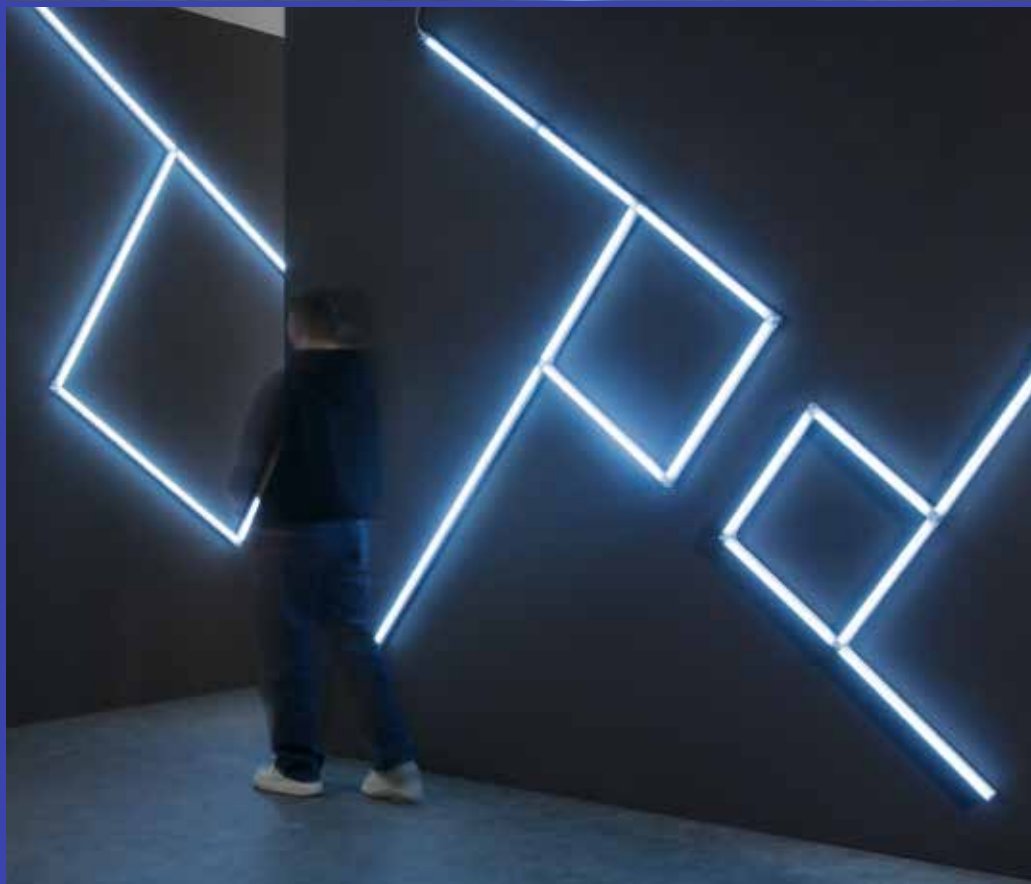



	colour temp.	colour
<b>LEDBAR-SHAPE-44M</b> 8031414925384		
lumen	700 lm	
<b>LEDBAR-SHAPE-44F</b> 8031414925391		
lumen	700 lm	

	colour temp.	colour
<b>LEDBAR-SHAPE-56M</b> 8031414925407		
lumen	900 lm	
<b>LEDBAR-SHAPE-56F</b> 8031414925414		
lumen	900 lm	

	colour temp.	colour
<b>LEDBAR-SHAPE-117M</b> 8031414925421		
lumen	1800 lm	
<b>LEDBAR-SHAPE-117F</b> 8031414925438		
lumen	1800 lm	

watt	7W
beam angle	120°

watt	9W
beam angle	120°

watt	18W
beam angle	120°

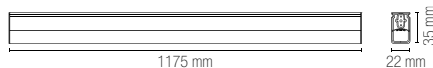
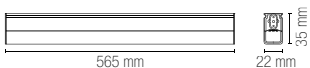
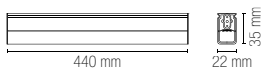

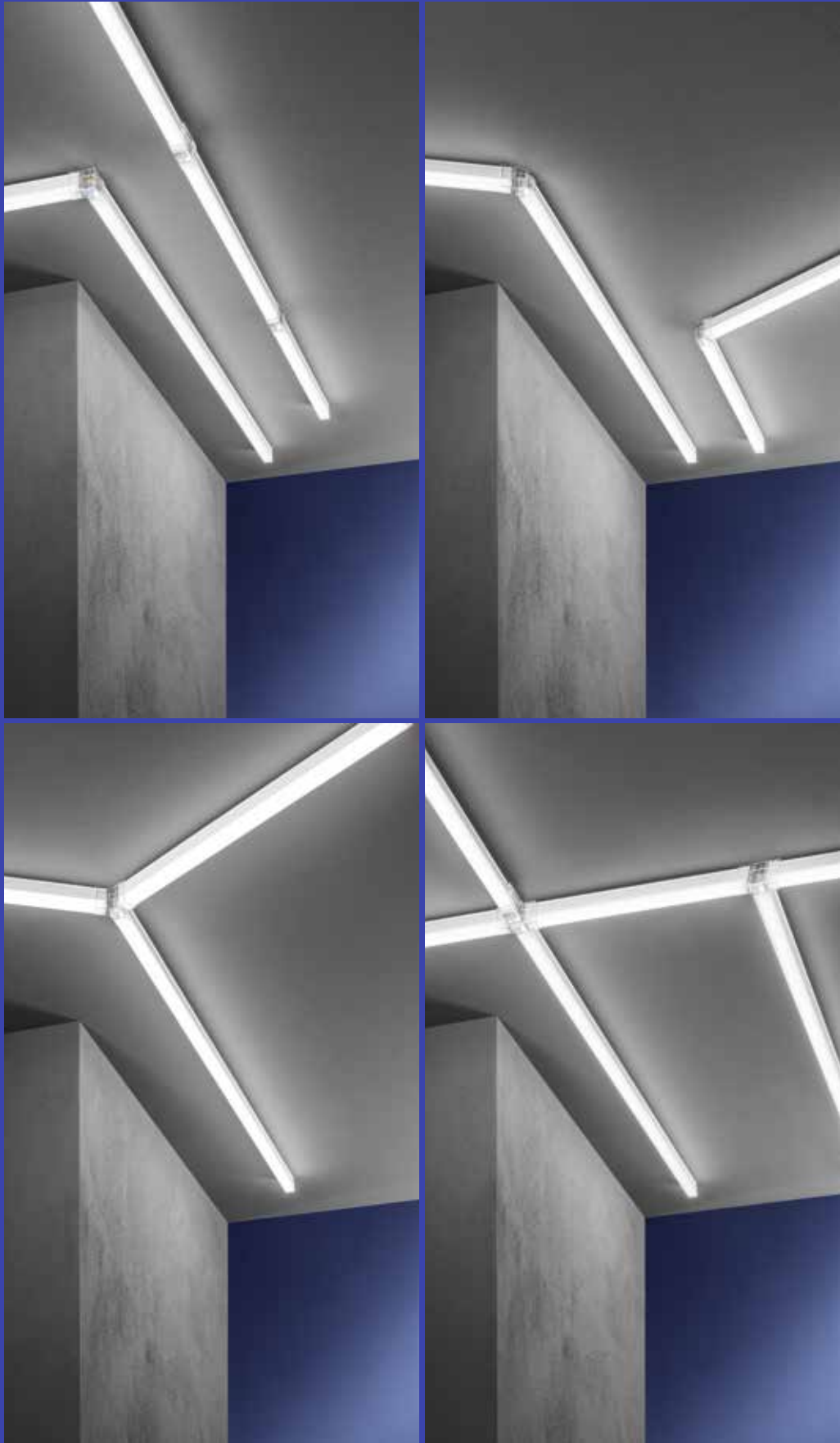



	<b>LEDBAR-SHAPE-I</b>	8031414925445	Connettore lineare	Linear connector
	<b>LEDBAR-SHAPE-L</b>	8031414925469	Connettore a L	L connector
	<b>LEDBAR-SHAPE-ANG</b>	8031414925452	Connettore angolo 120°	120° edge connector
	<b>LEDBAR-SHAPE-T</b>	8031414925483	Connettore a T	T connector
	<b>LEDBAR-SHAPE-T120</b>	8031414925476	Connettore a 3 angoli 120°	3 120° edge connector
	<b>LEDBAR-SHAPE-X</b>	8031414925490	Connettore a X	X connector
	<b>LEDBAR-SHAPE-NEST</b>	8031414925506	Innesto elettrico	Electrical nest

# NEXT

Barra a LED in metallo bianco o nero satinato  
con diffusore anti abbagliamento.

Metal LED bar satin white or black finish with antiglare diffuser.



indoor  
use



accommodation  
areas use



office  
use

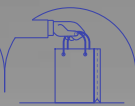

commercial  
areas use

---

**Materiale**

metallo

---

**Colore**

bianco satinato  
nero satinato



---

**Temperatura colore**

3000K / 4000K



---

**Driver**

incluso

---

**Material**

metal

---

**Colour**

satin white  
satin black



---

**Colour temperature**

3000K / 4000K



---

**Driver**

included



# NEXT

Barra a LED in metallo bianco o nero satinato con diffusore anti abbagliamento.

Metal LED bar satin white or black finish with antiglare diffuser.

**Materiale**

metallo

**Colore**

bianco satinato  
nero satinato



**Temperatura colore**

3000K / 4000K



**Driver**

incluso

**Material**

metal

**Colour**

satin white  
satin black



**Colour temperature**

3000K / 4000K



**Driver**

included

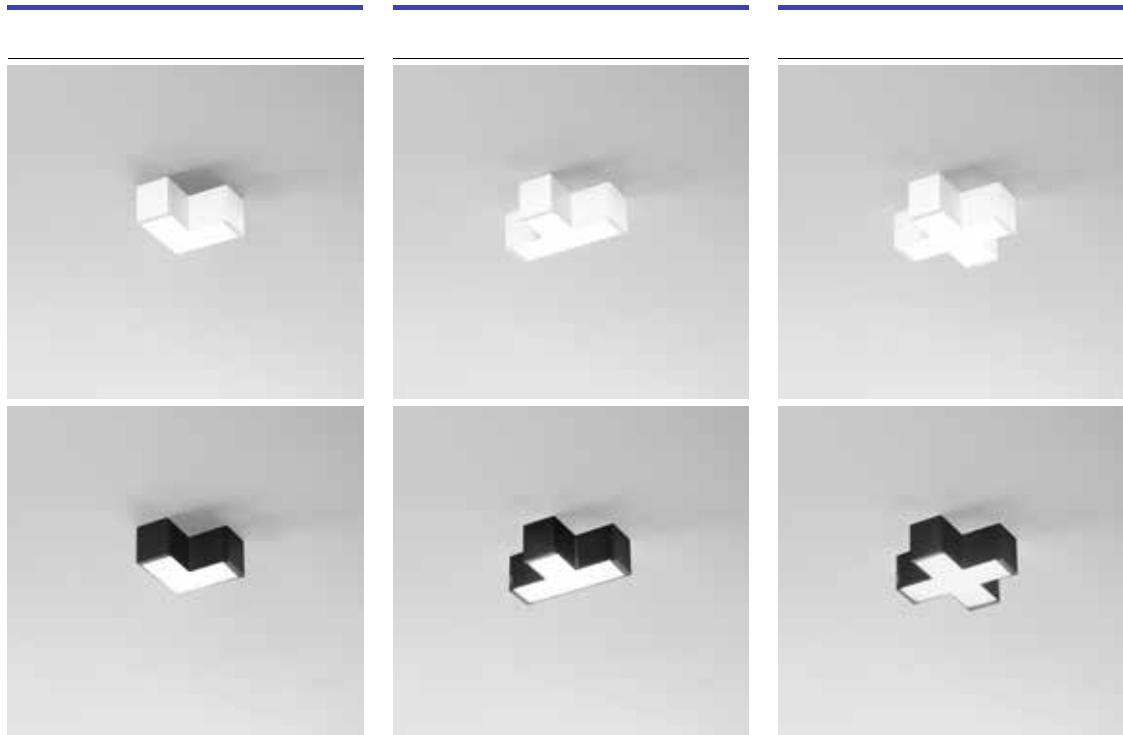

	colour temp.	colour
<b>LED-NEXT-W-L</b> 8031414921782		
lumen	640 lm	
<b>LED-NEXT-B-L</b> 8031414921775		
lumen	640 lm	

	colour temp.	colour
<b>LED-NEXT-W-T</b> 8031414921768		
lumen	800 lm	
<b>LED-NEXT-B-T</b> 8031414921751		
lumen	800 lm	

	colour temp.	colour
<b>LED-NEXT-W-X</b> 8031414921744		
lumen	960 lm	
<b>LED-NEXT-B-X</b> 8031414921737		
lumen	960 lm	

watt	8W
beam angle	100°
pf	-

watt	10W
beam angle	100°
pf	-

watt	12W
beam angle	100°
pf	-

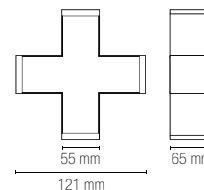
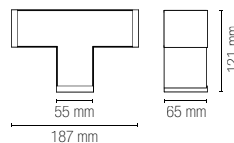
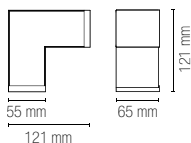



	colour temp.	colour
<b>LED-NEXT-W-60</b> 8031414921645 lumen		
	1920 lm	
<b>LED-NEXT-B-60</b> 8031414921638 lumen		
	1920 lm	

watt	24W
beam angle	100°
pf	0.90

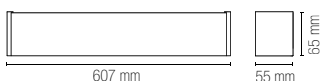

	colour temp.	colour
<b>LED-NEXT-W-90</b> 8031414921669 lumen		
	2880 lm	
<b>LED-NEXT-B-90</b> 8031414921652 lumen		
	2880 lm	

watt	36W
beam angle	100°
pf	0.90

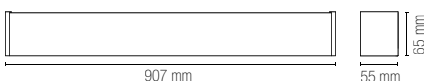

	colour temp.	colour
<b>LED-NEXT-W-200</b> 8031414921683 lumen		
	6400 lm	
<b>LED-NEXT-B-200</b> 8031414921676 lumen		
	6400 lm	

watt	80W
beam angle	100°
pf	0.90



**Accessori inclusi / Included accessories**



Connettore / Connector



Staffa per montaggio a plafoniera / Ceiling mounting brackets

**Accessori inclusi / Included accessories**



Connettore / Connector



Staffa per montaggio a plafoniera / Ceiling mounting brackets

**Accessori inclusi / Included accessories**



Connettore / Connector



Staffa per montaggio a plafoniera / Ceiling mounting brackets

# NEXT

Barra a LED in metallo bianco o nero satinato con diffusore anti abbagliamento.  
Metal LED bar satin white or black finish with antiglare diffuser.

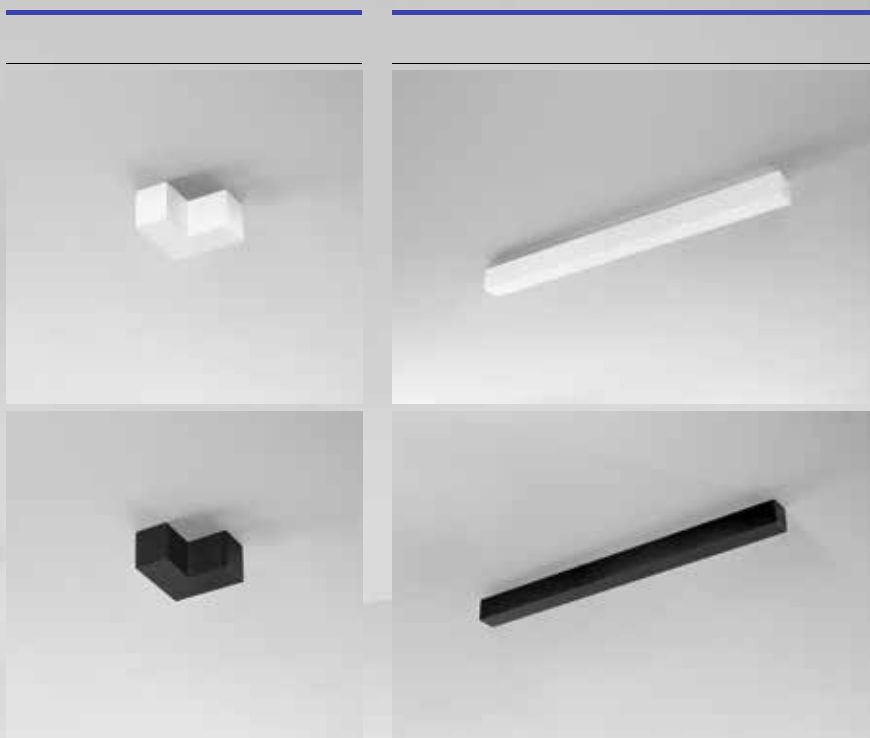

Barre NEXT senza sorgente luminosa per creare "tratti bui" /  
NEXT bar without light source to create "dark lines".

	colour		colour
<b>LED-NEXT-W-ST-L</b> 8031414921720	●	<b>LED-NEXT-W-ST60</b> 8031414921706	●
<b>LED-NEXT-B-ST-L</b> 8031414921713	●	<b>LED-NEXT-B-ST60</b> 8031414921690	●

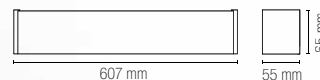
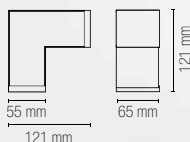

#### Accessori inclusi / Included accessories



Connettore /  
Connector



Staffa per montaggio a plafoniera /  
Ceiling mounting brackets



**LED-NEXT-W-FIX**

8031414921850

Staffa per fissaggio bianca White fixing bracket



**LED-NEXT-B-FIX**

8031414921799

Staffa per fissaggio nera Black fixing bracket



**LED-NEXT-W-S**

8031414921812

Kit sospensione bianco Suspension kit white color



**LED-NEXT-B-S**

8031414921805

Kit sospensione nera Suspension kit black color



**LED-NEXT-PL-FIX**

8031414921843

Kit per fissaggio a plafoniera Ceiling mounting kit



# SEGMENTO

**Supporto lineare modulare in acciaio rivestito in silicone nero.**

Modular linear support in steel and coated in black silicone.







indoor  
use



accommodation  
areas use



office  
use



commercial  
areas use





**Supporto lineare modulare in acciaio rivestito in silicone nero.**  
Modular linear support in steel and coated in black silicone.



**Strip LED non inclusa / Strip LED not included**

**Kit completo / Complete kit**



**I-SEGMENTO-6M**

8031414882458

Kit base 6 m con nastro tagliabile, arnesi, set di 2 basette ed accessori / 6 m basic kit with cuttable ribbon, tool kit, set of 2 bases and accessories

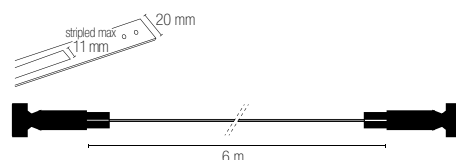

**Elementi singoli per comporre il kit / Single elements to compose the kit**

**Servizio customizzato taglio su misura / Customized cut service**



**I-SEGMENTO-1M**

8031414882441

TAGLIO 1 M NASTRO Indicare la misura desiderata nelle note del B2B (multipli di 1 metro) / 1 M TAPE CUT Indicate the desired size in the B2B notes (multiples of 1 meter)

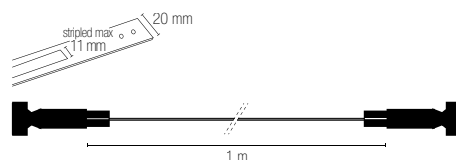

**I-SEGMENTO-BASE**

8031414894307

Base per piantana SEGMENTO / Base for SEGMENTO floor lamp



**I-SEGMENTO-FIX**

8031414882465

Set di 2 basette ed accessori / Set of 2 bases and accessories

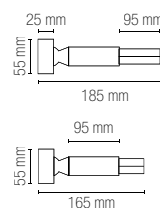

**I-SEGMENTO-TOOL**

8031414882472

Kit arnese / Tool kit

# METRO

Sistema cavi tesi con finitura cromo.  
Wire system chrome system.

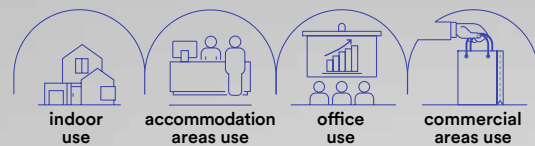

## LED-METRO-5

8031414862139

5 x MR16 MAX 9W  
Driver 50W included

5 m cable included

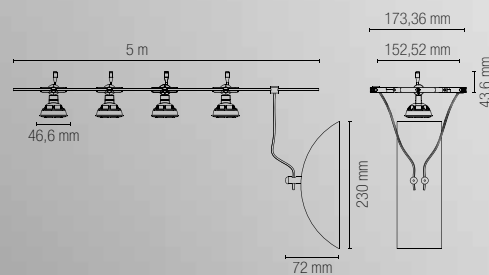

## I-WIRE-10M

8031414870387

Cavo 10 m / 10 m cable



Lampadina non inclusa /  
Light bulb not included



# PANEL PRO

**Pannello a LED con struttura in alluminio e diffusore in acrilico bianco.**

LED panel with aluminum structure and white acrylic diffuser.



indoor  
use



accommodation  
areas use



office  
use



commercial  
areas use





**Materiale**  
alluminio,  
diffusore in PMMA

**Colore**  
bianco

**Temperatura colore**  
3000K / 4000K / 6500K



**Driver**  
incluso

**Material**  
aluminum,  
PMMA diffuser

**Colour**  
white

**Colour temperature**  
3000K / 4000K / 6500K



**Driver**  
included



**LED-PANEL-60X60-PRO**

8031414904822

lumen

colour temp.

colour



4600 lm

watt 40W

beam angle 120°

pf 0.90

590 × 590 mm

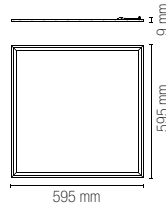

**Fotometria del prodotto / Photometric curve**

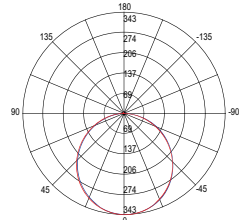

LED-PANEL-60X60-PRO



**LED-PANEL-30X120-PRO**

8031414904839

lumen

colour temp.

colour



4600 lm

watt 40W

beam angle 120°

pf 0.90

290 × 1190 mm

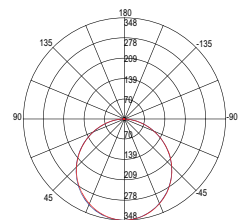
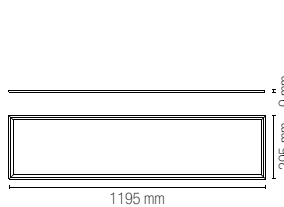

LED-PANEL-30X120-PRO

**Accessorio incluso / Included accessory**



Cavo di sicurezza per Panel Backlight 1,5 m / Safety cable for Panel Backlight 1,5 m

**LOOP-IN & LOOP-OUT linkable connection**

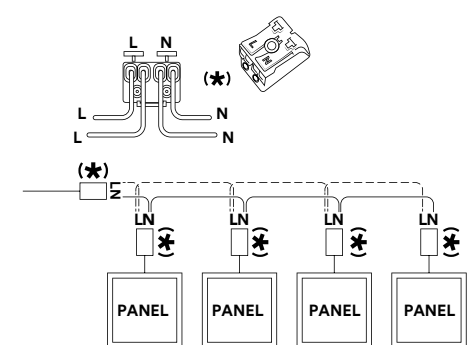

# PANEL BK CCT

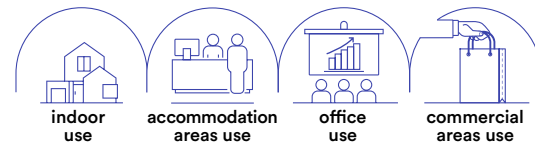

**Materiale**  
alluminio,  
diffusore in acrilico

**Colore**  
bianco



**Temperatura colore**  
3000K / 4000K / 6500K



**Driver**  
incluso

**Material**  
aluminum,  
acrylic diffuser

**Colour**  
white



**Colour temperature**  
3000K / 4000K / 6500K



**Driver**  
included

## Pannello a LED con struttura in alluminio e diffusore in acrilico bianco.

LED panel with aluminum structure and white acrylic diffuser.

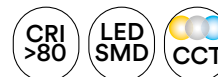

### LED-PANEL-60X120BK-CCT

8031414918201

lumen

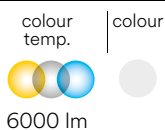

6000 lm

watt 60W

beam angle 120°

pf 0.90



590 × 1190 mm

### Fotometria del prodotto / Photometric curve

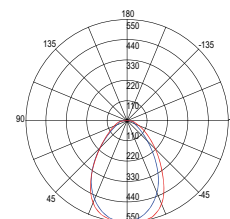

LED-PANEL-60X120BK

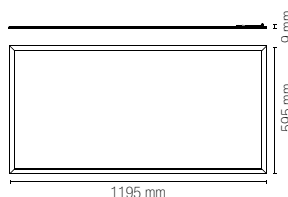





# PANEL BK

Pannello a LED con struttura in alluminio e diffusore in acrilico bianco.

LED panel with aluminum structure and white acrylic diffuser.

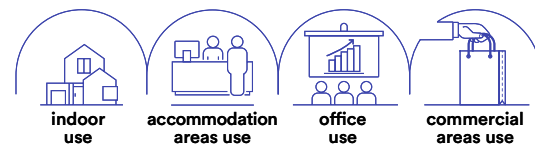

**Materiale**  
alluminio,  
diffusore in acrilico

**Colore**  
bianco



**Temperatura colore**  
3000K / 4000K / 6000K



**Driver**  
incluso

**Material**  
aluminum,  
acrylic diffuser

**Colour**  
white



**Colour temperature**  
3000K / 4000K / 6000K



**Driver**  
included





	colour temp.	colour
<b>LED-PANEL-C-60X60BK</b> 8031414885046 lumen		
<b>LED-PANEL-60X60BK</b> 8031414874323 lumen		
<b>LED-PANEL-F-60X60BK</b> 8031414874347 lumen		

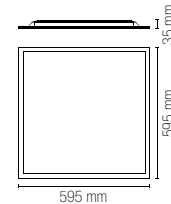

watt	40W
beam angle	120°
pf	0.90
	590 × 590 mm



	colour temp.	colour
<b>LED-PANEL-C-30X120BK</b> 8031414916177 lumen		
<b>LED-PANEL-30X120BK</b> 8031414874316 lumen		
<b>LED-PANEL-F-30X120BK</b> 8031414874330 lumen		

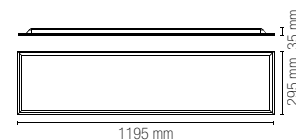

watt	40W
beam angle	120°
pf	0.90
	290 × 1190 mm

Fotometria del prodotto / Photometric curve

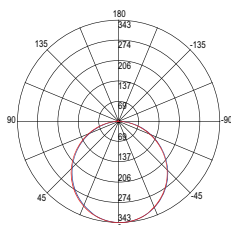

LED-PANEL-60X60 BK

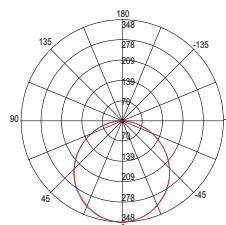

LED-PANEL-30X120 BK

PANEL RGB  
PANEL IP65

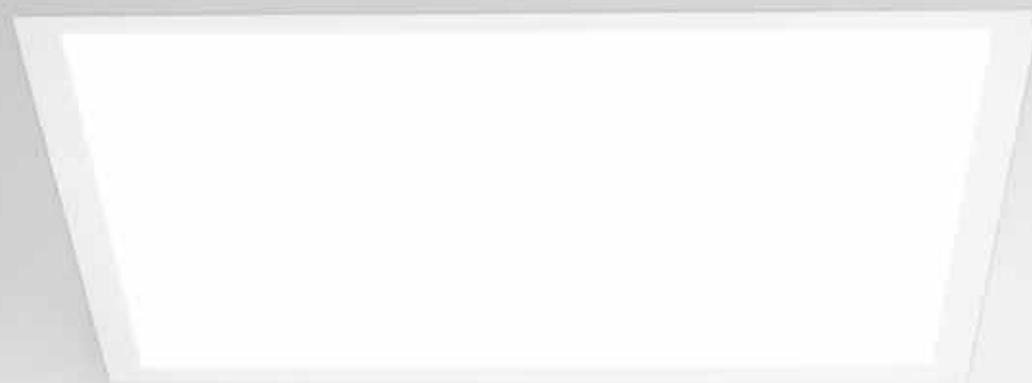
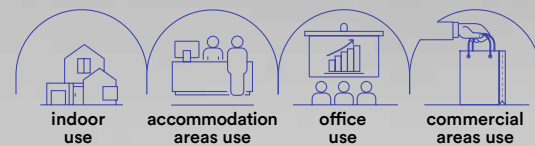

**Materiale**  
alluminio,  
diffusore in acrilico

**Colore**  
bianco



**Driver**  
incluso

**Dimmer**  
dimmerabile  
con radiocomando  
incluso

**Material**  
aluminum,  
acrylic diffuser

**Colour**  
white



**Driver**  
included

**Dimmer**  
dimmable with radio  
frequency remote control  
included

### PANEL RGB

**Pannello a LED con struttura in alluminio, diffusore in acrilico e finitura in bianco. Sistema di variazione colorazione luce RGB e luce bianca, con radiocomando incluso.**  
LED panel with aluminum structure, acrylic diffuser and white finish. RGB and natural white light adjustable with radio frequency remote control included.



**LED-PANEL-60x60-RGBW**  
8031414861064

colour temp. | colour  
RGB + 4000K  
4150 lm

watt	40W
beam angle	120°
pf	0.90
	590 x 590 mm

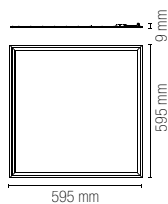

**Materiale**  
alluminio,  
diffusore in PMMA

**Colore**  
bianco



**Temperatura colore**  
4000K



**Driver**  
incluso

**Material**  
aluminum,  
PMMA diffuser

**Colour**  
white



**Colour temperature**  
4000K



**Driver**  
included

### PANEL IP65

**Pannello LED UGR<19 e IP65.**  
LED panel UGR<19 and IP65.



**LED-PANEL-60x60-IP65**  
8031414876303

colour temp. | colour  
3240 Lm

watt	36W
beam angle	120°
pf	0.90
	590 x 590 mm

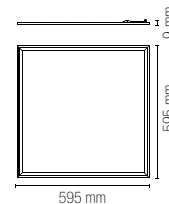

**Accessorio incluso /**  
**Included accessory**

Telecomando incluso /  
Remote control included

**Fotometria del prodotto /**  
**Photometric curve**

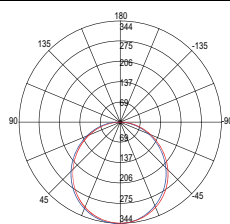

LED-PANEL-60x60-RGBW

**Fotometria del prodotto /**  
**Photometric curve**

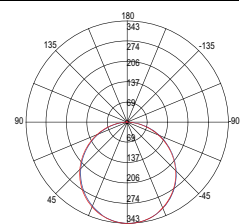

LED-PANEL-60x60 IP65 UGR

# PANEL FR / EDG

**Pannello LED a cornice luminosa.**  
LED panel with light frame.

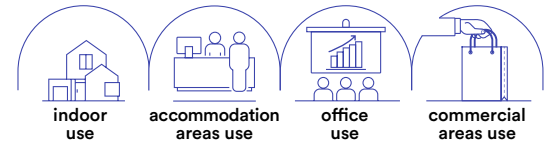

**Materiale**  
alluminio,  
diffusore in PMMA

**Colore**  
bianco

**Temperatura colore**  
CCT



**Driver**  
incluso

**Material**  
aluminum,  
PMMA diffuser

**Colour**  
white

**Colour temperature**  
CCT



**Driver**  
included

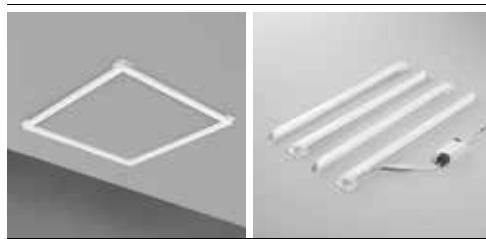

**LED-PANEL-60X60-FR**  
8031414897643

colour temp. CCT  
5000 lm

lumen

watt 40W  
beam angle 120°  
pf 0.90  
590 × 590 mm

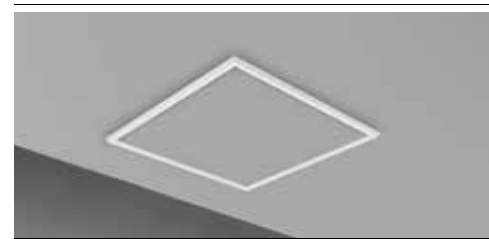
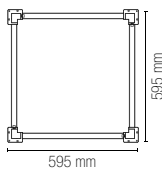

**LED-PANEL-60X60-EDG**  
8031414897650

colour temp. CCT  
4200 lm

lumen

watt 42W  
beam angle 120°  
pf 0.90  
590 × 590 mm

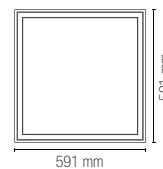

**Fotometria del prodotto /**  
**Photometric curve**

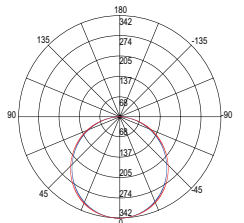

LED-PANEL-60X60-FR

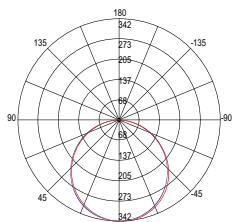

LED-PANEL-60X60-EDG

# PANEL SM

Pannello a LED, fissaggio easy a soffitto.  
LED panel, easy ceiling fixing.

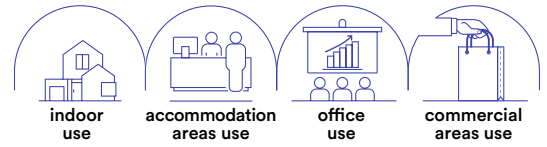

**Materiale**  
alluminio,  
diffusore in PMMA

**Colore**  
bianco

**Temperatura colore**  
4000K

**Driver**  
incluso

**Material**  
aluminum,  
PMMA diffuser

**Colour**  
white

**Colour temperature**  
4000K

**Driver**  
included

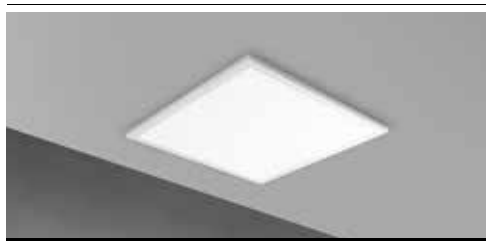

## LED-PANEL-60X60-SM

8031414897599

lumen

colour temp. 4000K  
colour 4000 lm

watt 24W  
beam angle 120°  
pf 0.90



590 × 590 mm

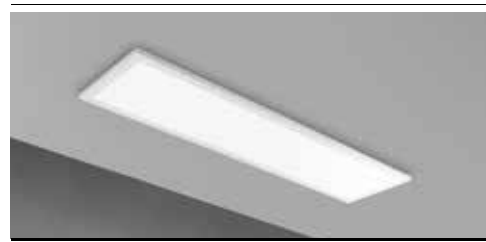
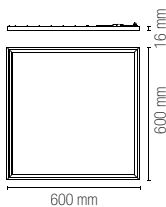

## LED-PANEL-30X120-SM

8031414897605

lumen

colour temp. 4000K  
colour 4000 lm

watt 24W  
beam angle 120°  
pf 0.90



290 × 1190 mm

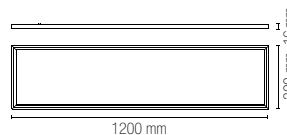

Fotometria del prodotto /  
Photometric curve

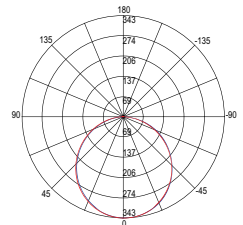

LED-PANEL-60X60-SM

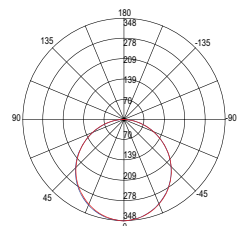

LED-PANEL-30X120-SM

# PANEL BIS

**Pannello a LED con struttura in alluminio e diffusore in acrilico bianco.**  
LED panel with aluminum structure, acrylic diffuser and white finish.

---

**Materiale**

alluminio,  
diffusore in acrilico

---

**Colore**

bianco



---

**Temperatura colore**

4000K



---

**Driver**

incluso

---

**Material**

aluminum,  
acrylic diffuser

---

**Colour**

white



---

**Colour temperature**

4000K



---

**Driver**

included

---







**LED-PANEL-60X60-BIS**

8031414865383

lumen

colour temp.	colour
5400 lm	
(↓ 2800 lm + 2800 lm ↑)	

watt

40W

beam angle

↓ 120° + 120° ↑

pf

0.90

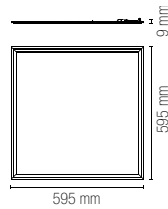

**LED-PANEL-30X120-BIS**

8031414865376

lumen

colour temp.	colour
5600 lm	
(↓ 2700 lm + 2700 lm ↑)	

watt

40W

beam angle

↓ 120° + 120° ↑

pf

0.90

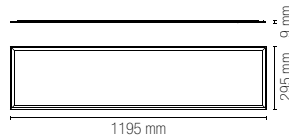

**Fotometria del prodotto / Photometric curve**

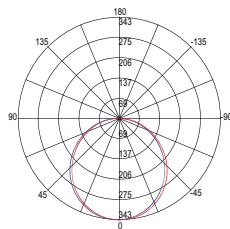

LED-PANEL-60X60-BIS

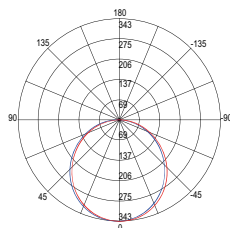







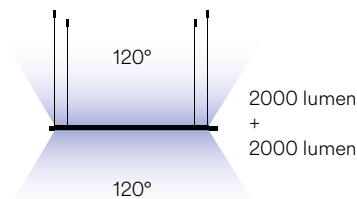

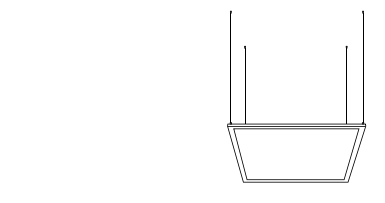

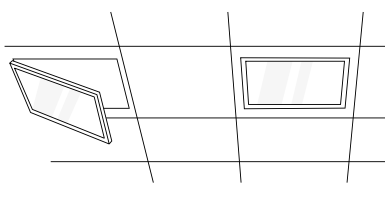

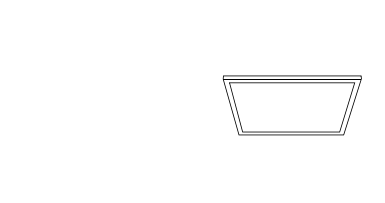
LED-PANEL-30X120-BIS

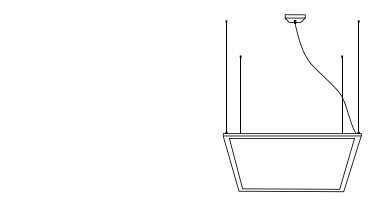
**Accessorio incluso / Included accessory**

Kit cavi acciaio ed elettrico 1,5 m / steel hanging cable and electric cable 1,5 m



	<p><b>LED-PANEL-KIT</b> 8031440352451</p> <p>Kit 6 cavi 150 cm in acciaio per sospensione.</p> <p>Steel cable kit 150 cm for suspension.</p>	
	<p><b>LED-PANEL-GANCI</b> 8031440361903</p> <p>Kit molle 4pz.</p> <p>Metal spring kit 4pcs.</p>	
	<p><b>LED-PANEL-STAFFE</b> 8031414866175</p> <p>Kit 6 staffe in acciaio per pannello LED.</p> <p>Steel fixing bars for LED panel.</p>	
	<p><b>LED-PANEL-BASE</b> 8031414866236</p> <p>Base a soffitto per driver pannello LED misura: 160 x 110 x 35 mm</p> <p>Metal canopy base for LED panel size: 160 x 110 x 35 mm</p>	
	<p><b>LED-PANEL-SOSP</b> 8031440361781</p> <p>Kit sospensione pannello cavo 1,5 m + scatola di connessione elettrica a soffitto misura: 120 x 120 x 60 mm</p> <p>Kit for suspension with 1,5 m cable + metal canopy with electric connection size: 120 x 120 x 60 mm</p>	
	<p><b>LED-PANEL-DR</b> 8031414889082</p> <p>PANEL-DR Output 45W 1000mA 45VDC Input 230VAC misura: 141 x 38 x 28 mm</p> <p>PANEL-DR Output 45W 1000mA 45VDC Input 230VAC size: 141 x 38 x 28 mm</p>	
	<p><b>LED-PANEL-DR-SLIM</b> 8031414888412</p> <p>PANEL-DR-SLIM Output 45W 1050mA 27-42V Input 220~240VAC misura: 265 x 23 x 20,5 mm</p> <p>PANEL-DR-SLIM Output 45W 1050mA 27-42V Input 220~240VAC size: 265 x 23 x 20,5 mm</p>	
	<p><b>LED-PANEL-DR-SLIM-DIM</b> 8031414888429</p> <p>PANEL-DR-SLIM-DIM Output 45W 1050mA 27-42V Input 220~240VAC 0-10V DIMM misura: 265 x 23 x 22,3 mm</p> <p>PANEL-DR-SLIM-DIM Output 45W 1050mA 27-42V Input 220~240VAC 0-10V DIMM size: 265 x 23 x 22,3 mm</p>	
	<p><b>LED-PANEL-SAFETY</b> 8031414904860</p> <p>Cavo di sicurezza per Panel Backlight 1,5 m /</p> <p>Safety cable for Panel Backlight 1,5 m</p>	

**Strutture in alluminio per montaggio a plafoniera per pannello LED.**

Aluminum structures for panel light surface mount.



	<p><b>LED-PANEL-60X60-MT</b> 8031414866212</p> <p>Struttura per pannello LED, finitura bianco gofrato</p>	<p>Aluminum frame for LED panel, embossed white</p>	<p>colour</p> <p>●</p>	<p>Misure dimensioni mm / Size mm</p>
	<p><b>LED-PANEL-60X60-MT GR</b> 8031414871452</p> <p>Struttura per pannello LED, finitura grigio gofrato</p>	<p>Aluminum frame for LED panel, embossed grey</p>	<p>colour</p> <p>●</p>	
	<p><b>LED-PANEL-60X60-MT NER</b> 8031414871469</p> <p>Struttura per pannello LED, finitura nero gofrato</p>	<p>Aluminum frame for LED panel, embossed black</p>	<p>colour</p> <p>●</p>	

	<p><b>LED-PANEL-60X120-MT</b> 8031414869176</p> <p>Struttura per pannello LED, finitura bianco gofrato</p>	<p>Aluminum frame for LED panel, embossed white</p>	<p>colour</p> <p>●</p>	<p>Misure dimensioni mm / Size mm</p>
	<p><b>LED-PANEL-60X120-MT GR</b> 8031414871506</p> <p>Struttura per pannello LED, finitura grigio gofrato</p>	<p>Aluminum frame for LED panel, embossed grey</p>	<p>colour</p> <p>●</p>	
	<p><b>LED-PANEL-60X120-MT NER</b> 8031414871476</p> <p>Struttura per pannello LED, finitura nero gofrato</p>	<p>Aluminum frame for LED panel, embossed black</p>	<p>colour</p> <p>●</p>	

	<p><b>LED-PANEL-30X120-MT</b> 8031414866199</p> <p>Struttura per pannello LED, finitura bianco gofrato</p>	<p>Aluminum frame for LED panel, embossed white</p>	<p>colour</p> <p>●</p>	<p>Misure dimensioni mm / Size mm</p>
	<p><b>LED-PANEL-30X120-MT GR</b> 8031414871506</p> <p>Struttura per pannello LED, finitura grigio gofrato</p>	<p>Aluminum frame for LED panel, embossed grey</p>	<p>colour</p> <p>●</p>	
	<p><b>LED-PANEL-30X120-MT NER</b> 8031414871476</p> <p>Struttura per pannello LED, finitura nero gofrato</p>	<p>Aluminum frame for LED panel, embossed black</p>	<p>colour</p> <p>●</p>	

# PANEL-DJ

Pannello a LED con struttura in alluminio e diffusore in acrilico. Sistema di variazione gradi Kelvin e di intensità regolabili con radiocomando incluso e speaker bluetooth.

LED panel with aluminum structure, acrylic diffuser and white finish. Adjustable Kelvin and luminous flux with radio frequency remote control included and speaker bluetooth.

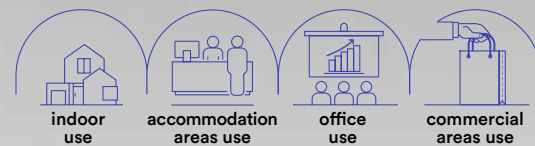

---

**Materiale**

alluminio,  
diffusore in acrilico

---

**Colore**

bianco



---

**Temperatura colore**

CCT



---

**Driver**

incluso

---

**Dimmer**

dimmerabile  
con radiocomando  
incluso

---

**Material**

aluminum,  
acrylic diffuser

---

**Colour**

white



---

**Colour temperature**

CCT



---

**Driver**

included

---

**Dimmer**

dimmable with radio  
frequency remote control  
included

---

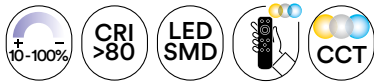

**LED-PANEL-60X60-DJ**

8031414876242

lumen

colour temp.



colour

CCT  
1840 lm

watt 42W  
beam angle 120°

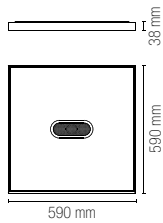

**SPEAKER**

2x5W connessione bluetooth 4.2 max 10 m /  
2x5W bluetooth 4.2 connection max 10 m



**LED-PANEL-30X60-DJ**

8031414876259

lumen

colour temp.



colour

CCT  
3360 lm

watt 23W  
beam angle 120°

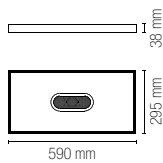

**SPEAKER**

2x5W connessione bluetooth 4.2 max 10 m /  
2x5W bluetooth 4.2 connection max 10 m

**Fotometria del prodotto / Photometric curve**

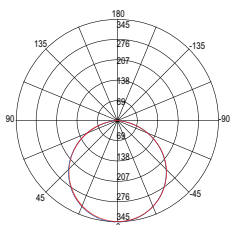

LED-PANEL-60X60-DJ

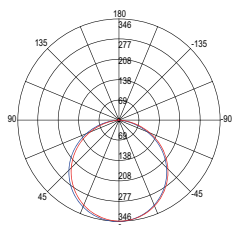

LED-PANEL-30X60-DJ

**Accessorio incluso / Included accessory**



**Radiocomando / Remote control**

Dimmerabile con radiocomando / Dimmable with radio frequency remote control



# INDOOR

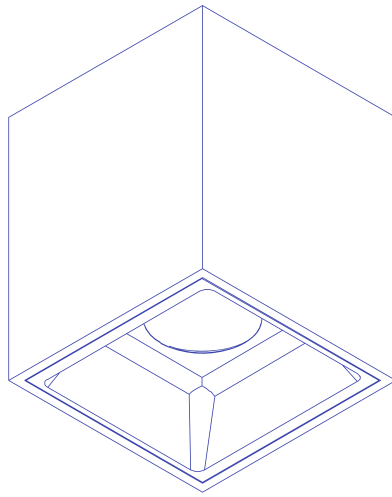

APPLIQUE E PLAFONIERE  
WALL LAMPS AND CEILING LAMPS

# KLIO CCT

Plafoniera a LED con struttura in alluminio pressofuso e diffusore in acrilico.  
LED ceiling lamp with die-cast aluminum structure and acrylic diffuser.

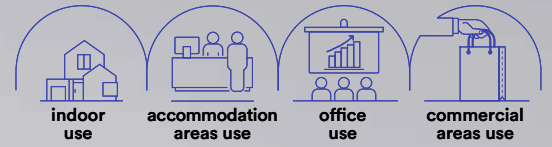

**Materiale**  
alluminio,  
diffusore in acrilico

**Material**  
aluminum,  
acrylic diffuser

**Colore**  
bianco goffrato

**Colour**  
embossed white



**Temperatura colore**  
3000K / 4000K

**Colour temperature**  
3000K / 4000K



**Driver**  
incluso

**Driver**  
included



## Fotometria del prodotto / Photometric curve

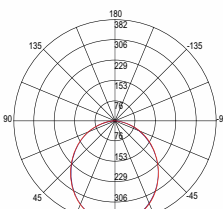

LED-KLIO-R11  
LED-KLIO-Q11

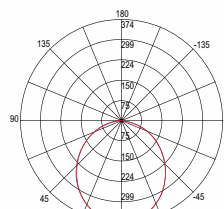

LED-KLIO-R17  
LED-KLIO-Q17

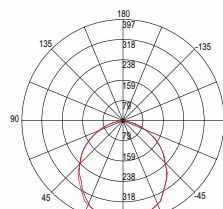

LED-KLIO-R21  
LED-KLIO-Q21

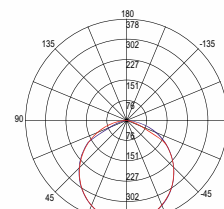

LED-KLIO-R40  
LED-KLIO-Q40



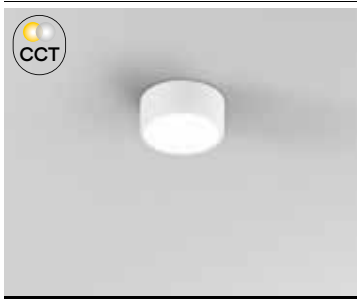

<b>LED-KLIO-R11</b> 8031440358675	colour temp.	colour
	2000 lm	
watt	16W	
beam angle	120°	
pf	-	

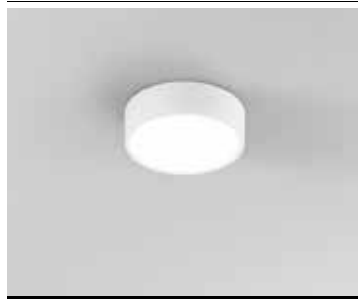
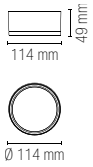

<b>LED-KLIO-R17</b> 8031440363587	colour temp.	colour
	3000 lm	
watt	22W	
beam angle	120°	
pf	-	

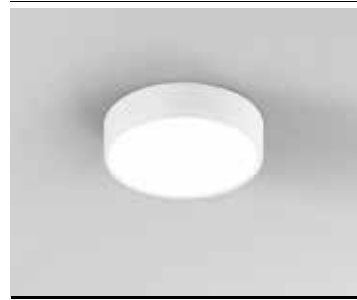
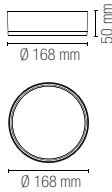

<b>LED-KLIO-R21</b> 8031440363594	colour temp.	colour
	4600 lm	
watt	36W	
beam angle	120°	
pf	0.90	

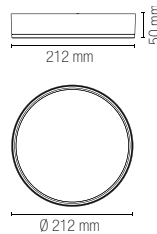

<b>LED-KLIO-R40C</b> 8031414875740	colour temp.	colour
	7800 lm	
<b>LED-KLIO-R40</b> 8031414868087	colour temp.	colour
	7800 lm	
watt	64,8W	
beam angle	120°	
pf	0.90	

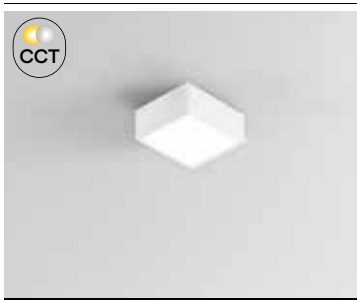
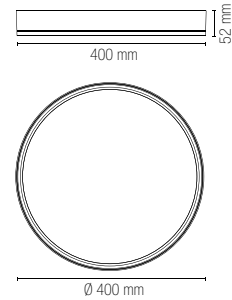

<b>LED-KLIO-Q11</b> 8031440363563	colour temp.	colour
	2000 lm	
watt	16W	
beam angle	120°	
pf	-	

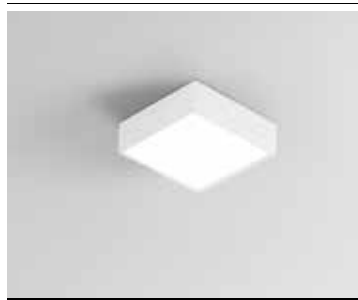
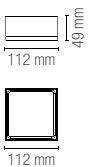

<b>LED-KLIO-Q17</b> 8031440363570	colour temp.	colour
	3000 lm	
watt	22W	
beam angle	120°	
pf	-	

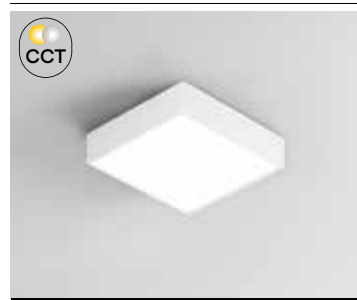
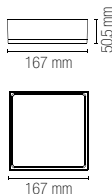

<b>LED-KLIO-Q21</b> 8031440363549	colour temp.	colour
	4600 lm	
watt	36W	
beam angle	120°	
pf	0.90	

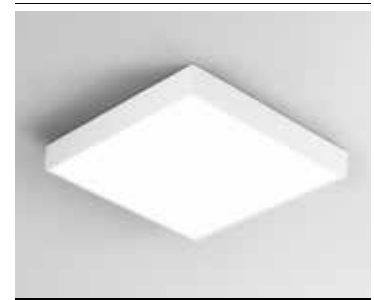
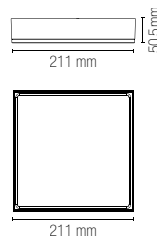

<b>LED-KLIO-Q40C</b> 8031414875702	colour temp.	colour
	7800 lm	
<b>LED-KLIO-Q40</b> 8031414868070	colour temp.	colour
	7800 lm	
watt	64,8W	
beam angle	120°	
pf	0.90	

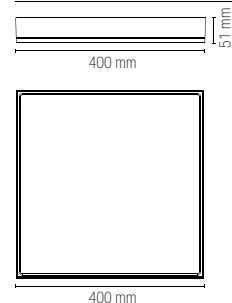

# MIG

## Plafoniera a LED anti-abbagliamento con struttura in alluminio.

Anti-glare LED ceiling lamp with aluminum structure.

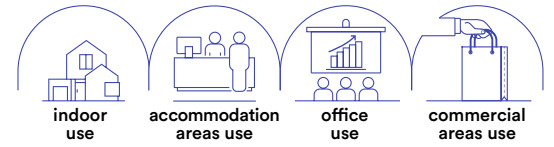

### Materiale

struttura in alluminio  
riflettore in acrilico

### Colore

bianco goffrato con  
riflettore bianco lucido,  
nero goffrato con  
riflettore nero lucido



### Temperatura colore selezionabile

3000K / 4000K



### Driver

incluso

### Durata e on/off

50.000 h >25.000 on/off

### Material

aluminum structure  
with acrylic reflector

### Colour

embossed white with  
glossy white reflector,  
embossed black with  
glossy black reflector



### Selectable color temperature

3000K / 4000K



### Driver

included

### Lifetime and on/off

50.000 h >25.000 on/off





	colour temp.	colour
<b>LED-MIG-R-BCO</b> 8031414924288 lumen		
<b>LED-MIG-R-NER</b> 8031414924295 lumen		
watt	20W	
beam angle	45°	
pf	0.90	

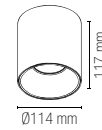

	colour temp.	colour
<b>LED-MIG-Q-BCO</b> 8031414924264 lumen		
<b>LED-MIG-Q-NER</b> 8031414924271 lumen		
watt	20W	
beam angle	45°	
pf	0.90	

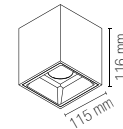

Fotometria del prodotto / Photometric curve

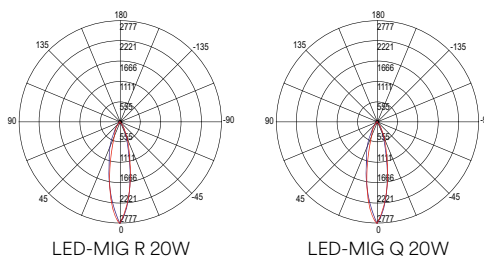

# GENESIS

**Plafoniera orientabile con struttura in alluminio bianco o nero opaco.**

Adjustable ceiling lamp with aluminum structure in matt white and black.

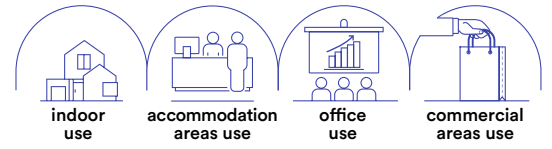



colour



**I-GENESIS-R6-BCO**  
8031414883202

1 x GU10 MAX 35W

colour



**I-GENESIS-R6-NER**  
8031414883219

1 x GU10 MAX 35W

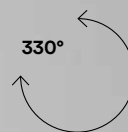
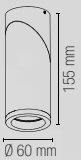

Lampadina non inclusa /  
Light bulb not included

# TOWN

Plafoniera con struttura in alluminio bianco o nero opaco.

Ceiling lamp with aluminum structure in matt white and black.

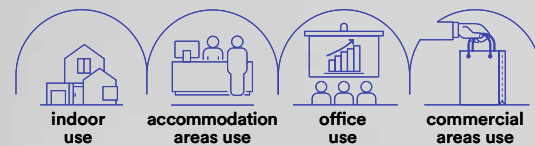



**I-TOWN-R BCO**

8031414868179

**I-TOWN-R NER**

8031414868162

colour



Lampadina non inclusa /  
Light bulb not included

1 x GU10 MAX 35W

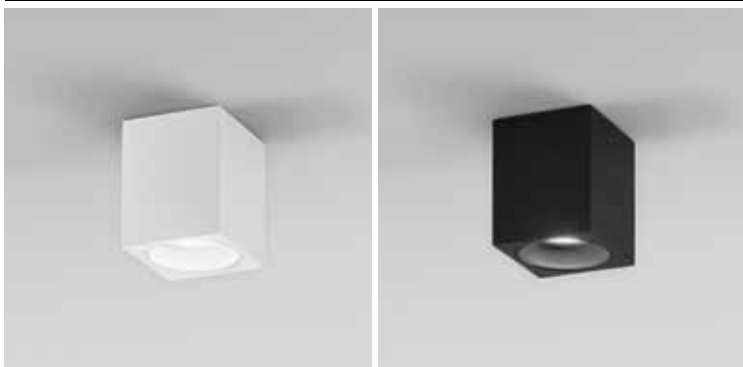
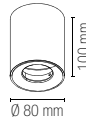

**I-TOWN-Q BCO**

8031414868155

**I-TOWN-Q NER**

8031414868148

colour



Lampadina non inclusa /  
Light bulb not included

1 x GU10 MAX 35W

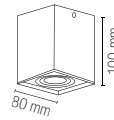

**I-TOWN-R2 BCO**

8031414883189

**I-TOWN-R2 NER**

8031414883196

colour



Lampadina non inclusa /  
Light bulb not included

2 x GU10 MAX 35W

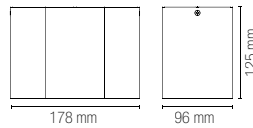

**I-TOWN-Q2 BCO**

8031414883165

**I-TOWN-Q2 NER**

8031414883172

colour



Lampadina non inclusa /  
Light bulb not included

2 x GU10 MAX 35W

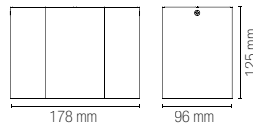

# DOMO

Plafoniera in alluminio con diffusore in acrilico.  
Aluminum ceiling lamp with acrylic diffuser.

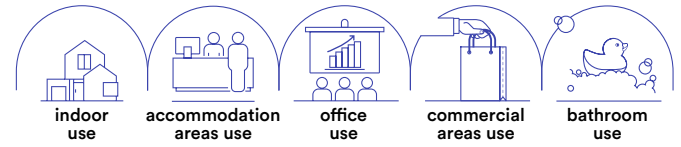

## Materiale

alluminio,  
diffusore in acrilico

## Colore

bianco  
nero  
cromo



## Temperatura colore

4000K



## Driver

incluso

## Material

aluminum,  
acrylic diffuser

## Colour

white  
black  
chrome



## Colour temperature

4000K



## Driver

included





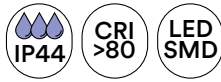

	colour temp.	colour
<b>LED-DOMO-R24-BCO</b> 8031414882779 lumen	2700 lm	
<b>LED-DOMO-R24-NER</b> 8031414893836 lumen	2700 lm	
<b>LED-DOMO-R24</b> 8031414876228 lumen	2700 lm	
watt		24W
beam angle		120°

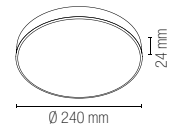

	colour temp.	colour
<b>LED-DOMO-Q24-BCO</b> 8031414882762 lumen	2700 lm	
<b>LED-DOMO-Q24 NER</b> 8031414893843 lumen	2700 lm	
<b>LED-DOMO-Q24</b> 8031414876235 lumen	2700 lm	
watt		24W
beam angle		120°

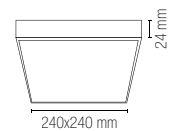

# BLASTER

Applique a LED con struttura cromata e diffusore in policarbonato.

LED wall lamp with chromed structure and polycarbonate diffuser.



**Materiale**  
alluminio,  
diffusore in PC

**Colore**  
struttura cromata  
diffusore bianco



**Temperatura colore**  
4000K



**Driver**  
integrato

**Material**  
aluminum,  
PC diffuser

**Colour**  
chrome structure  
white diffuser



**Colour temperature**  
4000K



**Driver**  
built-in driver

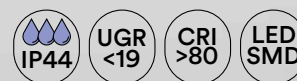

## LED-BLASTER-60

8031414866526

lumen

colour  
temp.



1720 lm

watt

15W

beam angle

133°

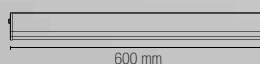

## LED-BLASTER-PLUG

8031414866519

lumen

colour  
temp.



1000 lm

watt

8W

beam angle

133°



plug max 2000W

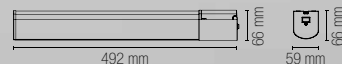

# CRUISE

Appliche a LED con struttura in termoplastica e diffusore in acrilico con fissaggio su cornice o su specchio.

LED wall lamp with thermoplastic structure and acrylic diffuser with frame and mirror fixing.



In.tec light APPLIQUE E PLAFONIERE / WALL LAMPS AND CEILING LAMPS

## Temperatura colore

4000K



**Driver**  
integrato

## Colour temperature

4000K



**Driver**  
built-in driver

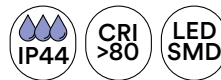

### SPOT-B-CRUISE-BCO

8031414897636

lumen

colour temp. colour

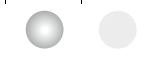

550 lm

### SPOT-B-CRUISE-NER

8031414897674

lumen



550 lm

### SPOT-B-CRUISE

8031440363426

lumen



550 lm

watt

5,2W

beam angle

120°

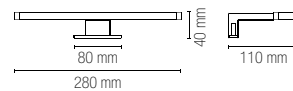

# YACHT

Applique a LED con struttura in termoplastica e diffusore in acrilico con fissaggio su cornice o su specchio.  
LED wall lamp with thermoplastic frame and acrylic diffuser with frame or mirror mounting.

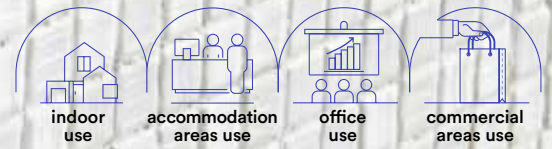

**Materiale**  
termoplastica

**Material**  
thermoplastic



**Colore**  
cromo  
diffusore in acrilico

**Colour**  
chrome  
acrylic diffuser



**Temperatura colore**  
3000K / 4000K

**Colour temperature**  
3000K / 4000K



**Driver**  
integrato

**Driver**  
built-in driver



	colour temp.	colour
<b>SPOT-B-YACHT-5C</b> 8031414915736	600 lm	
<b>SPOT-B-YACHT-5M</b> 8031414915743	600 lm	

watt 5W  
beam angle 120°

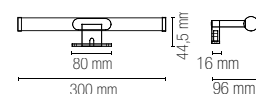

Fissaggio su cornice /  
Frame fixing



Fissaggio su specchio /  
Mirror fixing

# NOIR

Applique a LED nero con struttura in termoplastica e diffusore in acrilico con fissaggio su cornice o su specchio.  
Black LED wall lamp with thermoplastic frame and acrylic diffuser with frame or mirror mounting.

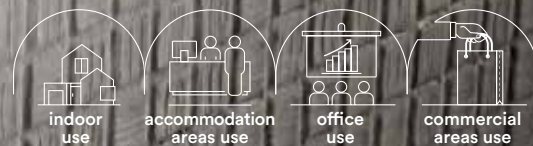

In.tec light - APPLIQUE E PLAFONIERE / WALL LAMPS AND CEILING LAMPS

**Materiale**  
termoplastica

**Material**  
thermoplastic

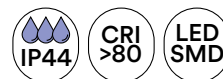

**Colore**  
nero opaco  
diffusore in acrilico

**Colour**  
satin black  
acrylic diffuser



**Temperatura colore**  
3000K / 4000K

**Colour temperature**  
3000K / 4000K



**Driver**  
integrato

**Driver**  
built-in driver

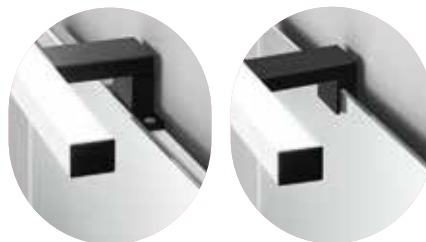

	colour temp.	colour
<b>SPOT-B-NOIR-5C</b> 8031414917570	600 lm	
<b>SPOT-B-NOIR-5M</b> 8031414917587	600 lm	
watt	5W	
beam angle	120°	

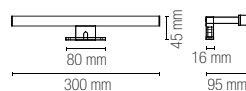

# LANCER

Applique a LED in alluminio bianco, nero, cromato ed oro spazzolato.  
LED wall light in white, black, chrome and brushed gold aluminum.



**Materiale**  
alluminio,  
diffusore in PC

**Colore**  
bianco goffrato  
nero goffrato  
cromo  
oro spazzolato

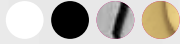

**Temperatura colore**  
3000K / 4000K



**Driver**  
integrato

**Material**  
aluminum,  
PC diffuser

**Colour**  
embossed white  
embossed black  
chrome  
brushed gold



**Colour temperature**  
3000K / 4000K



**Driver**  
built-in driver



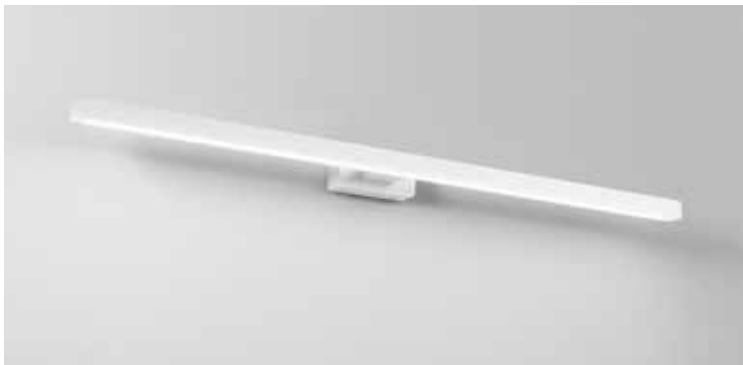
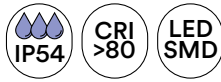

<b>LED-W-LANCER-C BCO</b> 8031414876679	colour temp.	colour
lumen	1000 lm	
<b>LED-W-LANCER BCO</b> 8031440361200		
lumen	1000 lm	
watt	13W	
beam angle	120°	

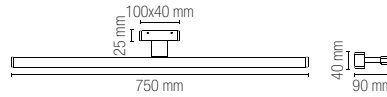

<b>LED-W-LANCER NERO</b> 8031440361217	colour temp.	colour
lumen	1000 lm	
watt	13W	
beam angle	120°	

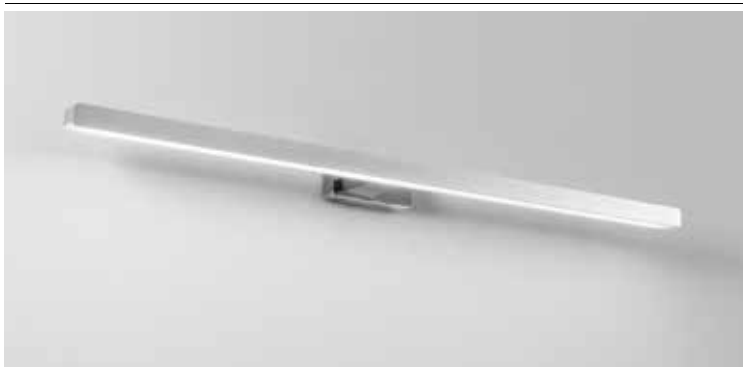
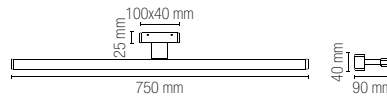

<b>LED-W-LANCER CR</b> 8031414882564	colour temp.	colour
lumen	1000 lm	
watt	13W	
beam angle	120°	

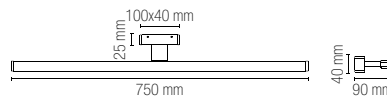

<b>LED-W-LANCER ORO</b> 8031414882571	colour temp.	colour
lumen	1000 lm	
watt	13W	
beam angle	120°	

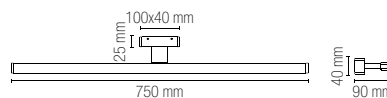

# SACS

Appliche a LED con struttura in termoplastica e diffusore in acrilico con fissaggio su cornice o su specchio.

LED wall lamp with thermoplastic structure and acrylic diffuser with frame and mirror fixing.



**Temperatura colore**

4000K



**Driver**

integrato

**Colour temperature**

4000K



**Driver**

built-in driver



**SPOT-B-SACS-XL**

8031414877010

lumen

colour temp.



colour



540 lm

watt

4W

beam angle

120°

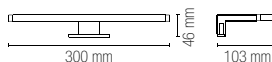



# RIVA

Applique a LED con struttura in termoplastica e diffusore in acrilico con fissaggio su cornice o su specchio.

LED wall lamp with thermoplastic structure and acrylic diffuser with frame and mirror fixing.



## Temperatura colore

4000K



## Driver

integrato

## Colour temperature

4000K



## Driver

built-in driver



APPLIQUE E PLAFONIERE / WALL LAMPS AND CEILING LAMPS

In.tec light



## SPOT-B-RIVA

8031440363457

lumen

colour temp.



575 lm

colour



watt

8W

beam angle

120°

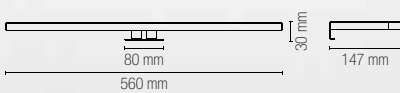

Fissaggio su cornice /  
Frame fixing



Fissaggio su specchio /  
Mirror fixing

# AQA

Applique a LED con struttura in alluminio e diffusore in acrilico con fissaggio su cornice o su specchio.

LED wall lamp with aluminum structure and acrylic diffuser with frame and mirror fixing.



**Materiale**  
alluminio,  
diffusore in PC

**Colore**

struttura cromata  
diffusore bianco



**Temperatura colore**  
4000K



**Driver**  
integrato

**Material**  
aluminum,  
PC diffuser

**Colour**

chrome structure  
white diffuser



**Colour temperature**  
4000K



**Driver**  
built-in driver

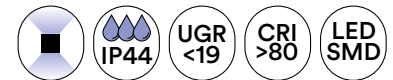

	colour temp.	colour
<b>SPOT-B-AQA</b> 8031414877027		
lumen	819 lm	
watt	8W	
beam angle	120°	

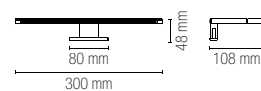

# WALLY

Applique a LED con struttura in alluminio e diffusore in acrilico con fissaggio su cornice o su specchio.  
LED wall lamp with aluminum structure and acrylic diffuser with frame and mirror fixing.



**Temperatura colore**

4000K



**Driver**

integrato

**Colour temperature**

4000K



**Driver**

built-in driver



**SPOT-B-WALLY**

8031440363471

lumen

colour temp.



colour



910 lm

watt

8W

beam angle

120°

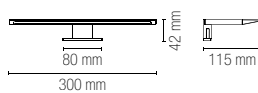

Fissaggio su cornice /  
Frame fixing



Fissaggio su specchio /  
Mirror fixing

# DIVA

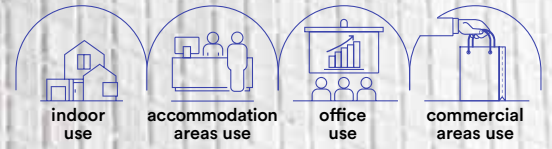

**Materiale**  
termoplastica

**Colore**  
struttura cromata  
diffusore bianco



**Temperatura colore**  
3000K / 4000K



**Driver**  
integrato

**Material**  
thermoplastic

**Colour**  
chrome structure  
white diffuser



**Colour temperature**  
3000K / 4000K



**Driver**  
built-in driver





**Applique a LED con struttura in termoplastica e diffusore in acrilico con fissaggio su cornice o su specchio. Disponibile in forma circolare con diametro di 75 mm o in forma quadrata di 45 mm.**

LED wall lamp with thermoplastic frame and acrylic diffuser with frame or mirror mounting. Available in circular form with a diameter of 75 mm or in square form with a diameter of 45 mm.



	colour temp.	colour
<b>SPOT-B-DIVA-R4C</b> 8031414915750		
lumen	460 lm	
<b>SPOT-B-DIVA-R4M</b> 8031414915767		
lumen	460 lm	

	colour temp.	colour
<b>SPOT-B-DIVA-Q4C</b> 8031414915774		
lumen	460 lm	
<b>SPOT-B-DIVA-Q4M</b> 8031414915781		
lumen	460 lm	

watt	4W
beam angle	100°

watt	4W
beam angle	100°

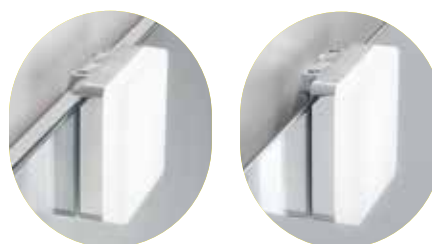
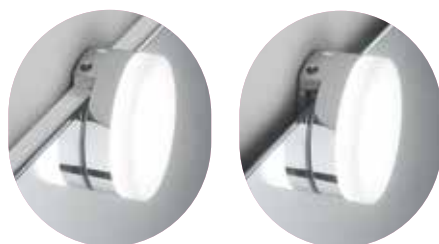
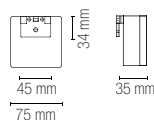
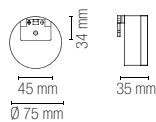

# F1

**Applique metallo flessibile cromo con diffusore in vetro bianco satinato.**  
Flexible chrome metal wall lamp with satin white glass diffuser.

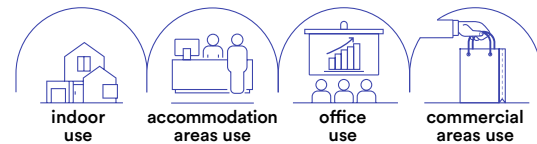

colour ●

**SPOT-F1**  
8031414076956

---

1 x G9 MAX 28W

IP21 G9

CE □

Lampadina non inclusa /  
Light bulb not included

# ROBY

**Applique da specchio in metallo cromato con diffusore in vetro bianco cromato.**  
Mirror wall lamp in chromed metal with white chromed glass diffuser.

colour ●

**SPOT-B-ROBY-CP**  
8031440312349

---

2 x E14 MAX 28W

**SPOT-B-ROBY**  
8031440312356

---

2 x E14 MAX 28W

IP23 E14

CE □

Fissaggio su cornice /  
Frame fixing

---

Lampadina non inclusa /  
Light bulb not included

Lampadina non inclusa /  
Light bulb not included

# Q1

**Applique metallo cromo con diffusore in vetro satinato.**  
Chrome metal wall lamp with satin glass diffuser.



In.tec light APPLIQUE E PLAFONIERE / WALL LAMPS AND CEILING LAMPS

colour

**SPOT-Q1**

8031414076932



2 x G9 MAX 28W

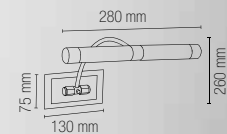

Lampadina non inclusa /  
Light bulb not included





# INDOOR

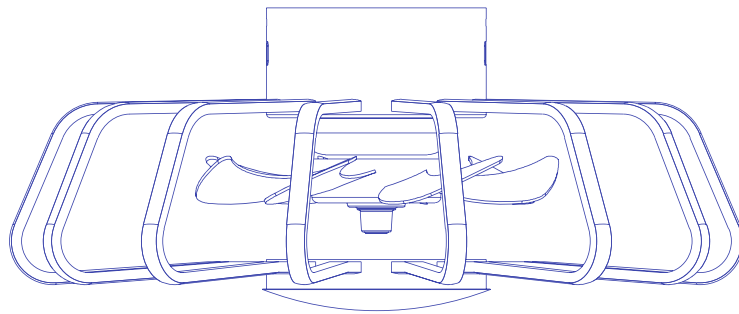

VENTILATORI  
FANS

# HERON

Plafoniera con ventilatore bladeless dalla forma circolare e con LED integrato.

Bladeless fan ceiling lamp with a circular shape and integrated LED.

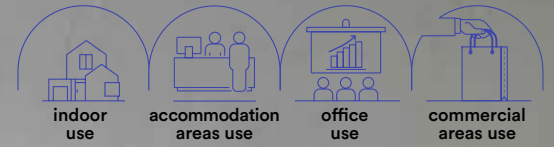

## Materiale

alluminio e acrilico

## Temperatura colore

CCT



## Materiale ventilatore

ventilatore interno ultrasilenzioso con sistema roteante per una maggiore diffusione dell'aria

## Driver

incluso

## Material

aluminum and acrylic

## Colour temperature

CCT



## Fan material

ultra silent bladeless fan with rotating system for greater air diffusion

## Driver

included





CONTROL SYSTEM included  
MEMORY FUNCTION



**LED-HERON-BCO**  
8031414919796

	colour temp.	colour
	CCT	
lumen	5280 lm	
led	48W 220-240V - 50/60Hz	
fan	20W 220-240V - 50/60Hz	
beam angle	120°	
potenza ventilatore / fan power	DC20W 6 velocità / speed	
volume aria / air volume	25 m <sup>3</sup> min.	
livello sonoro / sound level	48 dB	

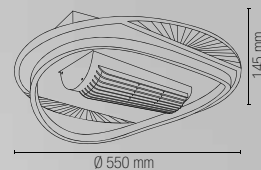

VENTILATORI / FANS

In.tec light

**Control system easy installation**

Regolazione velocità ventole / Fan speed adjustment

Impostazione timer / Timer setting

Regolazione intensità di luce (dimmer) / Light intensity (dimmer)

Regolazione gradi kelvin / Adjustable white

# BLYTH

Plafoniera con ventilatore bladeless dalla forma quadrata e con LED integrato.

Bladeless fan ceiling lamp with a square shape and integrated LED.

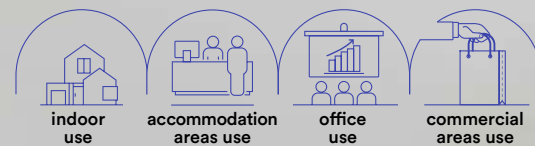

---

#### Materiale

alluminio e acrilico

---

#### Temperatura colore

CCT



---

#### Materiale ventilatore

ventilatore interno ultrasilenzioso con sistema roteante per una maggiore diffusione dell'aria

---

#### Driver

incluso

---

#### Material

aluminum and acrylic

---

#### Colour temperature

CCT



---

#### Fan material

ultra silent bladeless fan with rotating system for greater air diffusion

---

#### Driver

included





CONTROL SYSTEM included  
MEMORY FUNCTION



**LED-BLYTH-BCO**  
8031414919789

	colour temp.	colour
	CCT	
lumen	5280 lm	
led	48W 220-240V - 50/60Hz	
fan	20W 220-240V - 50/60Hz	
beam angle	120°	
potenza ventilatore / fan power	DC20W 6 velocità / speed	
volume aria / air volume	25 m <sup>3</sup> min.	
livello sonoro / sound level	48 dB	

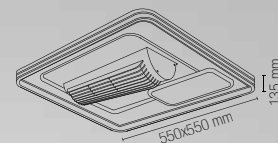

In.tec light **VENTILATORI / FANS**

**Control system easy installation**

Regolazione velocità ventole / Fan speed adjustment

Impostazione timer / Timer setting

Regolazione intensità di luce (dimmer) / Light intensity (dimmer)

Regolazione gradi kelvin / Adjustable white

# ALBATROS

Plafoniera con ventilatore.  
Ceiling lamp with fan.

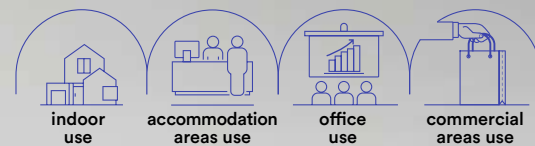

## Materiale

alluminio, acrilico

## Colore

bianco  
nero



## Temperatura colore

CCT



## Materiale ventilatore

3 lame in termoplastica  
retrattili

## Caratteristiche ventilatore

3 lame ultra silenziose  
con rotazione bilaterale

## Driver

incluso

## Material

aluminum, acrylic

## Colour

white  
black



## Colour temperature

CCT



## Fan material

3 thermoplastic  
retractable blades

## Fan characteristics

3 ultra-silent  
blades

## Driver

included





**LED-ALBATROS-BCO**  
8031414919765

colour temp.	colour
CCT	
4668 lm	

lumen	4668 lm
led	36W 220-240V - 50/60Hz
fan	30W 220-240V - 50/60Hz
beam angle	120°
potenza ventilatore / fan power	DC22W 6 velocità / speed
volume aria / air volume	25 m <sup>3</sup> min.
livello sonoro / sound level	48 dB

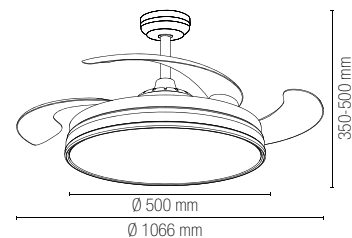

**LED-ALBATROS-NER**  
8031414919635

colour temp.	colour
CCT	
4668 lm	

lumen	4668 lm
led	36W 220-240V - 50/60Hz
fan	30W 220-240V - 50/60Hz
beam angle	120°
potenza ventilatore / fan power	DC22W 6 velocità / speed
volume aria / air volume	25 m <sup>3</sup> min.
livello sonoro / sound level	48 dB

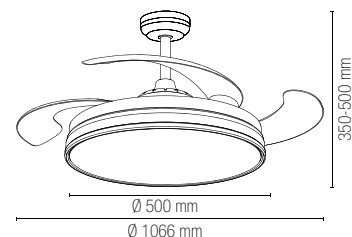

Reverse system - DC motor

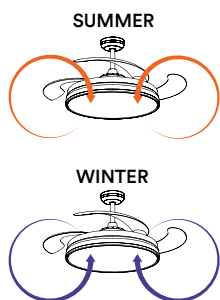

Control system easy installation

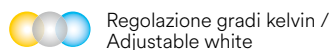
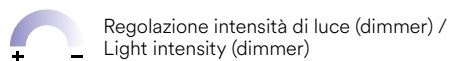
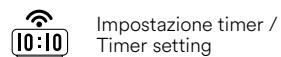
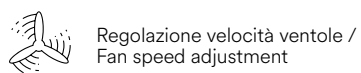

# MAGNUS

Plafoniera con ventilatore.  
Ceiling lamp with fan.

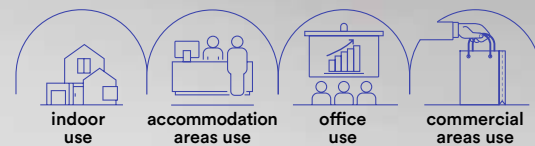

## Materiale

alluminio, acrilico

## Colore

bianco  
nero



## Temperatura colore

CCT



## Materiale ventilatore

3 lame  
in termoplastica

## Caratteristiche ventilatore

3 lame ultra silenziose  
con rotazione bilaterale

## Driver

incluso

## Material

aluminum, acrylic

## Colour

white  
black



## Colour temperature

CCT



## Fan material

3 thermoplastic  
blades

## Fan characteristics

3 ultra-silent  
blades

## Driver

included







**LED-MAGNUS-BCO**  
8031414919727

	colour temp.	colour
lumen	9400 lm	
led	80W 220-240V - 50/60Hz	
fan	32W 220-240V - 50/60Hz	
beam angle	120°	
potenza ventilatore / fan power	DC40W 6 velocità / speed	
volume aria / air volume	50 m <sup>3</sup> min.	
livello sonoro / sound level	48 dB	

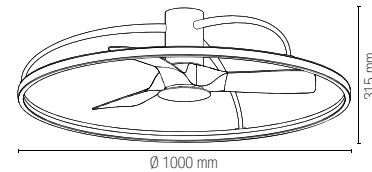

**LED-MAGNUS-NER**  
8031414919734

	colour temp.	colour
lumen	9400 lm	
led	80W 220-240V - 50/60Hz	
fan	32W 220-240V - 50/60Hz	
beam angle	120°	
potenza ventilatore / fan power	DC40W 6 velocità / speed	
volume aria / air volume	50 m <sup>3</sup> min.	
livello sonoro / sound level	48 dB	

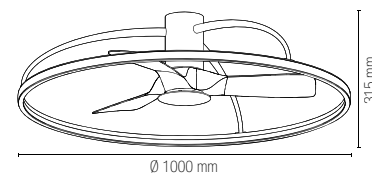

Reverse system - DC motor

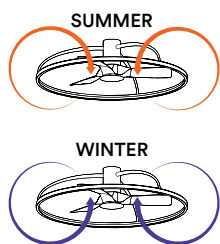

Control system easy installation

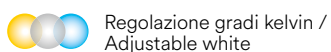
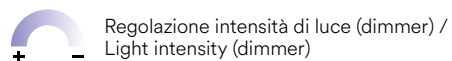
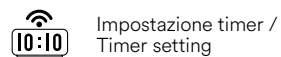
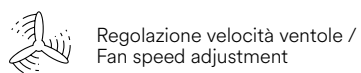

# HADLEY

Plafoniera con ventilatore.  
Ceiling lamp with fan.

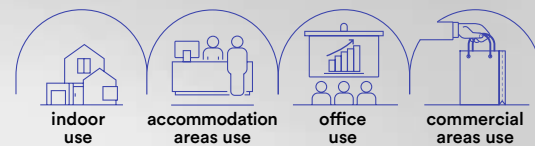

## Materiale

alluminio, acrilico

## Colore

bianco  
nero  
antracite



## Temperatura colore

CCT



## Materiale ventilatore

3 lame  
in termoplastica

## Caratteristiche ventilatore

3 lame ultra silenziose  
con rotazione bilaterale

## Driver

incluso

## Material

aluminum, acrylic

## Colour

white  
black  
anthracite



## Colour temperature

CCT



## Fan material

3 thermoplastic  
blades

## Fan characteristics

3 ultra-silent  
blades

## Driver

included





**LED-HADLEY-BCO**  
8031414919697

	colour temp.	colour
	CCT	
lumen	5250 lm	
led	40W 220-240V - 50/60Hz	
fan	11W 220-240V - 50/60Hz	
beam angle	120°	
potenza ventilatore / fan power	DC30W 6 velocità / speed	
volume aria / air volume	25 m <sup>3</sup> min.	
livello sonoro / sound level	48 dB	

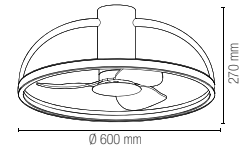

**LED-HADLEY-NER**  
8031414919710

	colour temp.	colour
	CCT	
lumen	5250 lm	
led	40W 220-240V - 50/60Hz	
fan	11W 220-240V - 50/60Hz	
beam angle	120°	
potenza ventilatore / fan power	DC30W 6 velocità / speed	
volume aria / air volume	25 m <sup>3</sup> min.	
livello sonoro / sound level	48 dB	

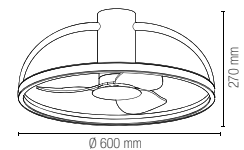

**LED-HADLEY-GR**  
8031414919703

	colour temp.	colour
	CCT	
lumen	5250 lm	
led	40W 220-240V - 50/60Hz	
fan	11W 220-240V - 50/60Hz	
beam angle	120°	
potenza ventilatore / fan power	DC30W 6 velocità / speed	
volume aria / air volume	25 m <sup>3</sup> min.	
livello sonoro / sound level	48 dB	

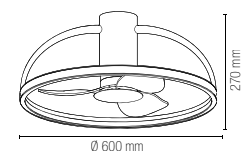

Reverse system - DC motor

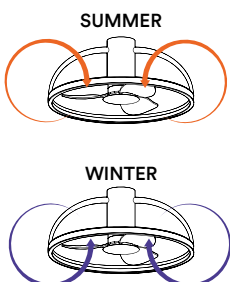

Control system easy installation

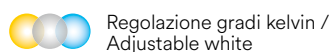
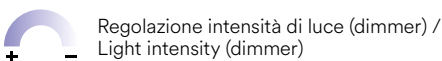
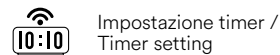
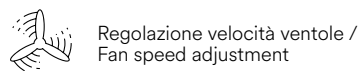

# AUSTER

Plafoniera con ventilatore.  
Ceiling lamp with fan.

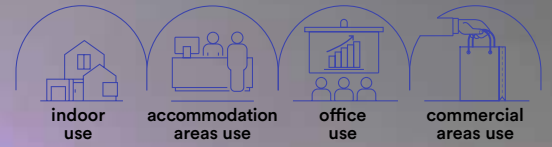

---

**Materiale**

alluminio, acrilico

---

**Colore**

bianco



---

**Temperatura colore**

RAINBOW + CCT



---

**Materiale ventilatore**

3 lame  
in termoplastica

---

**Caratteristiche ventilatore**

3 lame ultra silenziose  
con rotazione bilaterale

---

**Driver**

incluso

---

**Material**

aluminum, acrylic

---

**Colour**

white



---

**Colour temperature**

RAINBOW + CCT



---

**Fan material**

3 thermoplastic  
blades

---

**Fan characteristics**

3 ultra-silent  
blades

---

**Driver**

included

---



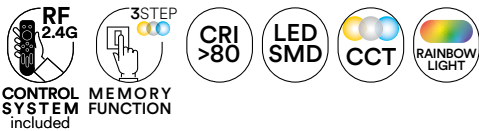

**LED-AUSTER-COLOR**

8031414919758

colour temp.	RAINBOW CCT	colour
--------------	-------------	--------

RAINBOW CCT

7650 lm

lumen	7650 lm
led	60W 220-240V - 50/60Hz
fan	28W 220-240V - 50/60Hz
beam angle	120°
potenza ventilatore / fan power	DC40W 6 velocità / speed
volume aria / air volume	50 m <sup>3</sup> min.
livello sonoro / sound level	48 dB

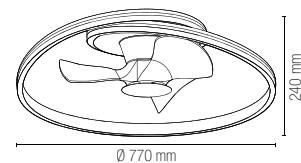

Reverse system - DC motor

**SUMMER**

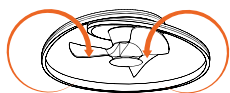

**WINTER**

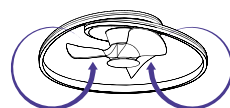

Control system easy installation

Regolazione velocità ventole / Fan speed adjustment

Impostazione timer / Timer setting

Regolazione intensità di luce (dimmer) / Light intensity (dimmer)

Regolazione gradi kelvin / Adjustable white

# STORM

Plafoniera con ventilatore.  
Ceiling lamp with fan.

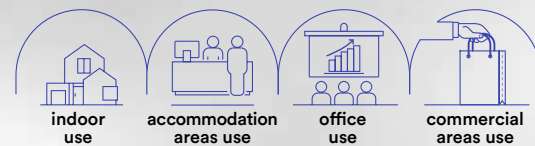

## Materiale

alluminio, acrilico

## Colore

bianco  
nero



## Temperatura colore

CCT



## Materiale ventilatore

3 lame  
in termoplastica

## Caratteristiche ventilatore

3 lame ultra silenziose  
con rotazione bilaterale

## Driver

incluso

## Material

aluminum, acrylic

## Colour

white  
black



## Colour temperature

CCT



## Fan material

3 thermoplastic  
blades

## Fan characteristics

3 ultra-silent  
blades

## Driver

included





**LED-STORM-BCO**

8031414919741

	colour temp.	colour
	CCT	
lumen	7450 lm	
led	60W 220-240V - 50/60Hz	
fan	28W 220-240V - 50/60Hz	
beam angle	120°	
potenza ventilatore / fan power	DC40W 6 velocità / speed	
volume aria / air volume	50 m <sup>3</sup> min.	
livello sonoro / sound level	48 dB	

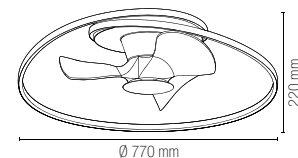

**LED-STORM-NER**

8031414919758

	colour temp.	colour
	CCT	
lumen	7450 lm	
led	60W 220-240V - 50/60Hz	
fan	28W 220-240V - 50/60Hz	
beam angle	120°	
potenza ventilatore / fan power	DC40W 6 velocità / speed	
volume aria / air volume	50 m <sup>3</sup> min.	
livello sonoro / sound level	48 dB	

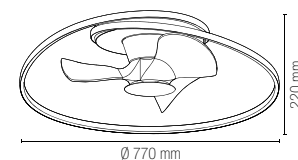

Reverse system - DC motor

Control system easy installation

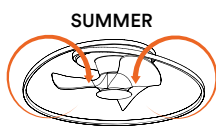

SUMMER



WINTER



Regolazione velocità ventole / Fan speed adjustment



Impostazione timer / Timer setting



Regolazione intensità di luce (dimmer) / Light intensity (dimmer)



Regolazione gradi kelvin / Adjustable white

**Plafoniere con ventilatore in bianco effetto cielo stellato.**  
Ceiling fan lamps with white starry sky effect.



**Materiale**

acrilico PMMA  
bianco effetto cielo stellato

**Temperatura colore**

CCT



**Materiale ventilatore**

7 lame bianche  
in termoplastica

**Caratteristiche ventilatore**

7 lame ultra silenziose  
con rotazione unilaterale.  
Ghiera esterna roteante per  
una maggiore diffusione dell'aria.

**Driver**

incluso

**Material**

PMMA acrylic white colour  
with starry sky effect

**Colour temperature**

CCT



**Fan material**

7 white  
thermoplastic blades

**Fan characteristics**

7 ultra-silent blades  
unidirectional rotation  
rotating outer ring for  
greater air diffusion

**Driver**

included





technical information

WI-FI  
SMART INTEC



## BOREA



### LED-BOREA-INT 8031414873692

	colour temp.	colour
	CCT 4450 lm	
lumen	4450 lm	
led	40W 220-240V - 50/60Hz	
fan	34W 220-240V - 50/60Hz	
beam angle	120°	
potenza ventilatore / fan power	AC 34W 900rpm 1050rpm 1200rpm	
volume aria / air volume	25 m <sup>3</sup> min.	
livello sonoro / sound level	48 dB	

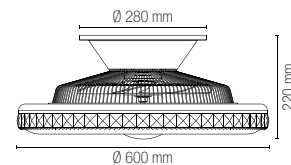

## SKYRON



### LED-SKYRON-INT 8031414873678

	colour temp.	colour
	CCT 4450 lm	
lumen	4450 lm	
led	40W 220-240V - 50/60Hz	
fan	34W 220-240V - 50/60Hz	
beam angle	120°	
potenza ventilatore / fan power	AC 34W 900rpm 1050rpm 1200rpm	
volume aria / air volume	25 m <sup>3</sup> min.	
livello sonoro / sound level	48 dB	

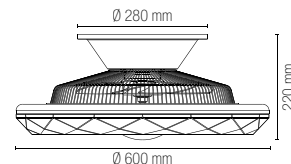

APPLIQUE E PLAFONIERE / WALL LAMPS AND CEILING LAMPS

In.tec light

#### Control system easy installation



On-off ghiera esterna /  
On-off outer ring



Regolazione velocità ventole /  
Fan speed adjustment



Impostazione timer /  
Timer setting



Regolazione intensità di luce (dimmer) /  
Light intensity (dimmer)



Regolazione gradi kelvin /  
Adjustable white



Smart  
Intec  
WIFI



RF 2.4G  
control  
system



ALEXA e  
GOOGLE  
HOME  
voice control



**Plafoniere con ventilatore in acrilico PMMA.**  
Ceiling fan lamps with PMMA acrylic fan.

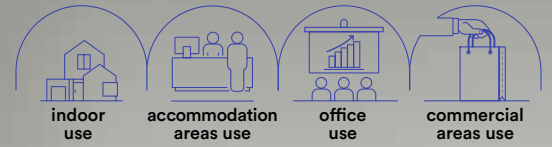

**Materiale**  
acrilico PMMA

**Temperatura colore**  
CCT



**Materiale ventilatore**  
7 lame trasparenti  
in termoplastica

**Caratteristiche ventilatore**  
7 lame ultra  
silenziose con  
rotazione unilaterale

**Driver**  
incluso

**Material**  
PMMA acrylic

**Colour temperature**  
CCT



**Fan material**  
7 trasparent  
thermoplastic blades

**Fan characteristics**  
7 ultra-silent  
blades unidirectional  
rotation

**Driver**  
included



technical information



## ALISEO



### LED-ALISEO-INT 8031414873661

	colour temp.	colour
	CCT	
lumen	4450 lm	
led	40W 220-240V - 50/60Hz	
fan	34W 220-240V - 50/60Hz	
beam angle	120°	
potenza ventilatore / fan power	AC 34W	
	900rpm 1050rpm 1200rpm	
volume aria / air volume	25 m <sup>3</sup> min.	
livello sonoro / sound level	48 dB	

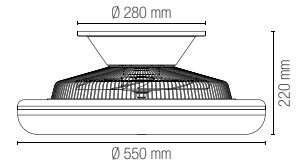

## FOEHN



### LED-FOEHN-INT 8031414873685

	colour temp.	colour
	CCT	
lumen	4450 lm	
led	40W 220-240V - 50/60Hz	
fan	34W 220-240V - 50/60Hz	
beam angle	120°	
potenza ventilatore / fan power	AC 34W	
	900rpm 1050rpm 1200rpm	
volume aria / air volume	25 m <sup>3</sup> min.	
livello sonoro / sound level	48 dB	

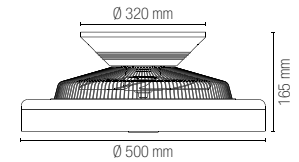

APPLIQUE E PLAFONIERE / WALL LAMPS AND CEILING LAMPS

In.tec light

### Control system easy installation



On-off ghiera esterna /  
On-off outer ring



Impostazione timer /  
Timer setting



Smart  
Intec  
WIFI



RF 2.4G  
control  
system



ALEXA e  
GOOGLE  
HOME  
voice control



Regolazione velocità ventole /  
Fan speed adjustment



Regolazione intensità di luce (dimmer) /  
Light intensity (dimmer)



Regolazione gradi kelvin /  
Adjustable white



# GRECALE

Plafoniera con ventilatore.  
Ceiling lamp with fan.

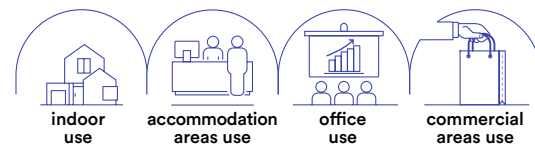

## Materiale

alluminio, acrilico

## Colore

bianco  
nero



## Temperatura colore

CCT



## Materiale ventilatore

7 lame  
in termoplastica

## Caratteristiche ventilatore

7 lame ultra silenziose  
con rotazione bilaterale

## Driver

incluso

## Material

aluminum, acrylic

## Colour

white  
black



## Colour temperature

CCT



## Fan material

7 thermoplastic  
blades

## Fan characteristics

7 ultra-silent  
blades

## Driver

included





**LED-GRECALE-W-INT**  
8031414885947

	colour temp.	colour
	CCT 8470 lm	
lumen	8470 lm	
led	80W 220-240V - 50/60Hz	
fan	22W 220-240V - 50/60Hz	
beam angle	120°	
potenza ventilatore / fan power	DC22W 6 velocità / speed	
volume aria / air volume	25 m <sup>3</sup> min.	
livello sonoro / sound level	48 dB	

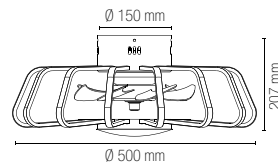

**LED-GRECALE-B-INT**  
8031414885954

	colour temp.	colour
	CCT 8470 lm	
lumen	8470 lm	
led	80W 220-240V - 50/60Hz	
fan	22W 220-240V - 50/60Hz	
beam angle	120°	
potenza ventilatore / fan power	DC22W 6 velocità / speed	
volume aria / air volume	25 m <sup>3</sup> min.	
livello sonoro / sound level	48 dB	

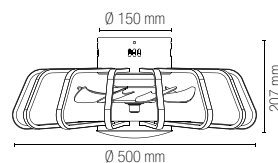

Reverse system - DC motor

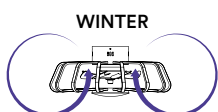

Control system easy installation

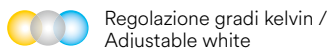
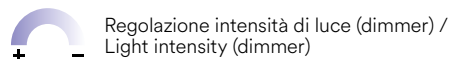
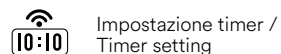
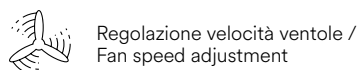

Smart  
Intec  
WIFI



RF 2.4G  
control  
system



ALEXA e  
GOOGLE  
HOME  
voice control



**Plafoniere con ventilatore in bianco effetto cielo stellato.**  
Ceiling fan lamps with white starry sky effect.



**Materiale**

acrilico PMMA  
bianco effetto cielo stellato

**Temperatura colore**

CCT



**Materiale ventilatore**

7 lame bianche  
in termoplastica

**Caratteristiche ventilatore**

7 lame ultra silenziose  
con rotazione bilaterale,  
ghiera esterna roteante per  
una maggiore diffusione dell'aria

**Driver**

incluso

**Material**

PMMA acrylic white colour  
with starry sky effect

**Colour temperature**

CCT



**Fan material**

7 white  
thermoplastic blades

**Fan characteristics**

7 ultra-silent blades  
bidirectional rotation  
rotating outer ring for  
greater air diffusion

**Driver**

included



technical information



## LEVANTE



### LED-LEVANTE-INT

8031414885930

	colour temp.	colour
	CCT 4450 lm	
lumen	4450 lm	
led	40W 220-240V - 50/60Hz	
fan	22W 220-240V - 50/60Hz	
beam angle	120°	
potenza ventilatore / fan power	DC22W 6 velocità / speed	
volume aria / air volume	25 m <sup>3</sup> min.	
livello sonoro / sound level	48 dB	

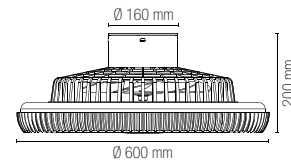

## SCIROCCO



### LED-SCIROCCO-INT

8031414885923

	colour temp.	colour
	CCT 4450 lm	
lumen	4450 lm	
led	40W 220-240V - 50/60Hz	
fan	22W 220-240V - 50/60Hz	
beam angle	120°	
potenza ventilatore / fan power	DC22W 6 velocità / speed	
volume aria / air volume	25 m <sup>3</sup> min.	
livello sonoro / sound level	48 dB	

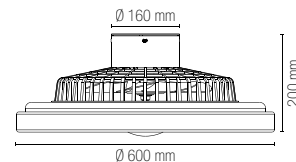

### Reverse system - DC motor

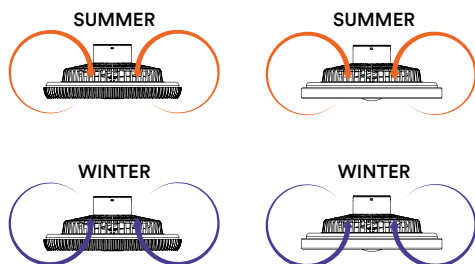

### Control system easy installation

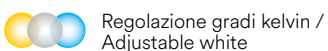
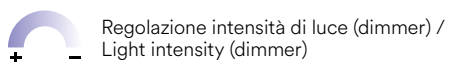
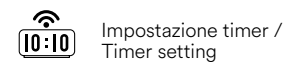
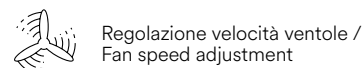
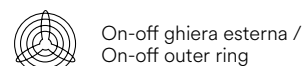

Smart Intec WIFI



RF 2.4G control system



ALEXA e GOOGLE HOME voice control



VENTILATORI / FANS

In.tec light

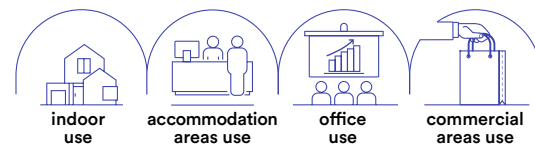

**Materiale**  
alluminio, acrilico

**Colore**  
bianco  
nero



**Temperatura colore**  
CCT



**Materiale ventilatore**  
7 lame  
in termoplastica

**Caratteristiche ventilatore**

7 lame ultra silenziose  
con rotazione bilaterale

**Driver**  
incluso

**Material**  
aluminum, acrylic

**Colour**  
white  
black



**Colour temperature**  
CCT



**Fan material**  
7 thermoplastic  
blades

**Fan characteristics**

7 ultra-silent  
blades

**Driver**  
included

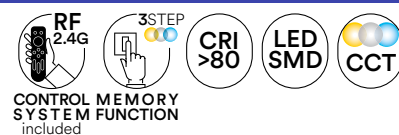

**Plafoniera con ventilatore.**  
Ceiling lamp with fan.

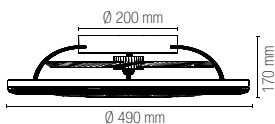

Reverse system - DC motor

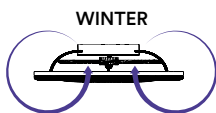

	colour temp.	colour
<b>LED-ETESIA-W-FAN</b> 8031414899005		
<b>LED-ETESIA-B-FAN</b> 8031414899012		
	CCT	
lumen	4800 lm	
led	30W 220-240V - 50/60Hz	
fan	22W 220-240V - 50/60Hz	
beam angle	120°	
potenza ventilatore / fan power	DC22W 6 velocità / speed	
volume aria / air volume	25 m <sup>3</sup> min.	
livello sonoro / sound level	48 dB	

**Control system easy installation**

Regolazione velocità ventole / Fan speed adjustment

Impostazione timer / Timer setting

Regolazione intensità di luce (dimmer) / Light intensity (dimmer)

Regolazione gradi kelvin / Adjustable white



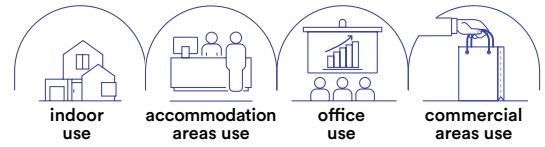

### Materiale

alluminio, acrilico

### Temperatura colore

CCT



### Materiale ventilatore

7 lame trasparenti  
in termoplastica

### Caratteristiche ventilatore

7 lame ultra  
silenziose  
rotazione bilaterale

### Driver

incluso

### Material

aluminum, acrylic

### Colour temperature

3000K / 4000K / 6500K



### Fan material

7 trasparent  
thermoplastic blades

### Fan characteristics

7 ultra-silent  
blades  
bidirectional rotation

### Driver

included



### Plafoniera con ventilatore. Ceiling lamp with fan.

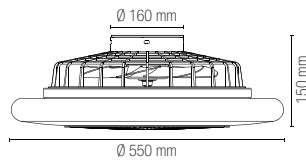

Reverse system - DC motor

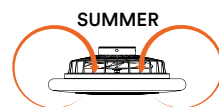

	colour temp.	colour
<b>LED-PONENTE-FAN</b> 8031414886586	 CCT	
lumen	4450 lm	
led	40W 220-240V - 50/60Hz	
fan	22W 220-240V - 50/60Hz	
beam angle		120°
potenza ventilatore / fan power	DC 22W 6 velocità / speed	
volume aria / air volume		25 m <sup>3</sup> min.
livello sonoro / sound level		48 dB

### Control system easy installation

Regolazione velocità ventole /  
Fan speed adjustment

Impostazione timer /  
Timer setting

Regolazione intensità di luce (dimmer) /  
Light intensity (dimmer)

Regolazione gradi kelvin /  
Adjustable white

**Plafoniera con ventilatore.**  
Ceiling lamp with fan.

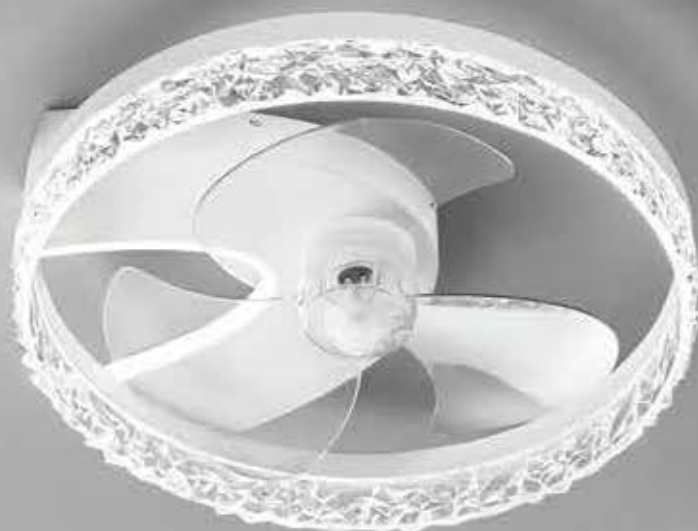

**Materiale**

alluminio, acrilico

**Temperatura colore**

CCT



**Materiale ventilatore**

3 lame trasparenti  
in termoplastica

**Caratteristiche ventilatore**

3 lame ultra  
silenziose  
rotazione bilaterale

**Driver**

incluso

**Material**

aluminum, acrylic

**Colour temperature**

3000K / 4000K / 6500K



**Fan material**

3 trasparent  
thermoplastic blades

**Fan characteristics**

3 ultra-silent  
blades  
bidirectional rotation

**Driver**

included



technical information



## ESPERO



### LED-ESPERO-FAN

8031414898992

	colour temp.	colour
	CCT	
lumen	4800 lm	
led	30W 220-240V - 50/60Hz	
fan	22W 220-240V - 50/60Hz	
beam angle	120°	
potenza ventilatore / fan power	DC22W 6 velocità / speed	
volume aria / air volume	20 m <sup>3</sup> min.	
livello sonoro / sound level	48 dB	

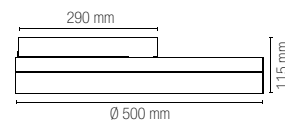

## NASHI



### LED-NASHI-FAN

8031414899029

	colour temp.	colour
	CCT	
lumen	4800 lm	
led	30W 220-240V - 50/60Hz	
fan	22W 220-240V - 50/60Hz	
beam angle	120°	
potenza ventilatore / fan power	DC22W 6 velocità / speed	
volume aria / air volume	20 m <sup>3</sup> min.	
livello sonoro / sound level	48 dB	

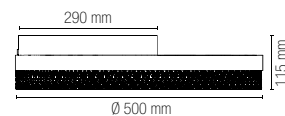

#### Reverse system - DC motor

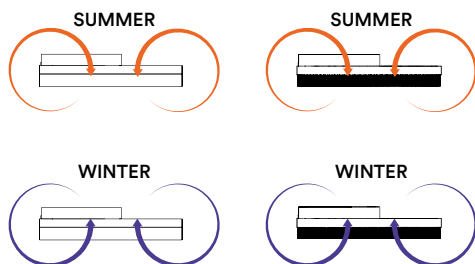

#### Control system easy installation



Regolazione velocità ventole /  
Fan speed adjustment



Impostazione timer /  
Timer setting



Regolazione intensità di luce (dimmer) /  
Light intensity (dimmer)



Regolazione gradi kelvin /  
Adjustable white



# INDOOR

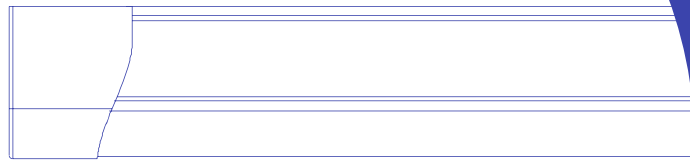

SOTTOPENSILI E BARRE LED  
CABINETS AND LEDBARS

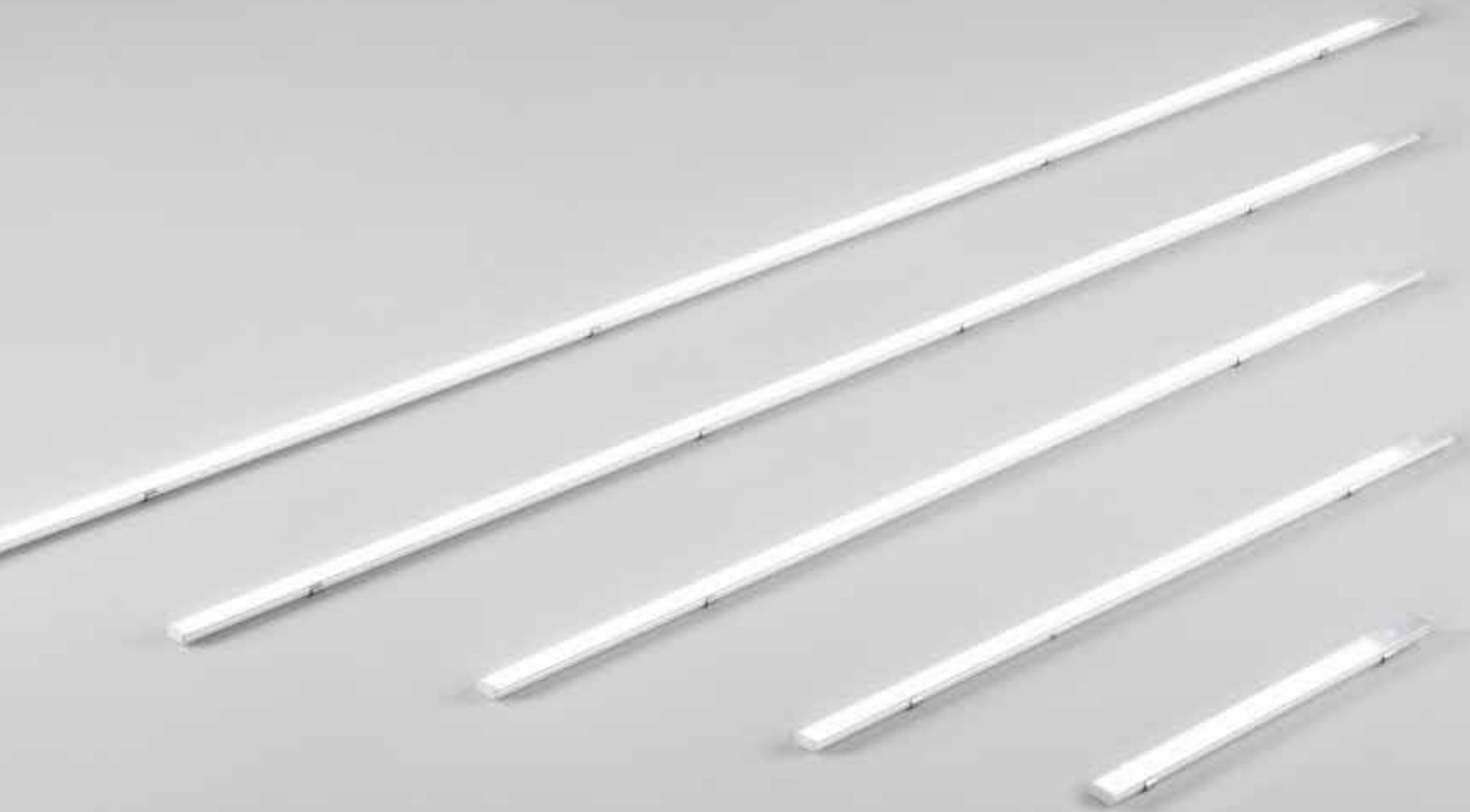

---

**Materiale**  
struttura in alluminio,  
diffusore in PC  
riflettente

---

**Colore**  
nikel



---

**Temperatura colore**  
4000K



---

**Driver**  
incluso

---

---

**Material**  
aluminum body  
with PC  
reflective diffuser

---

**Colour**  
nikel



---

**Colour temperature**  
4000K



---

**Driver**  
included

---



**Barra sottopensile  
in alluminio con  
diffusore in PC riflettente.**  
Cabinet bar with aluminum  
structure under wall unit  
with reflective PC diffuser.





Accessori inclusi / Included accessories



Staffe / Brackets

colour  
temp. | colour

### LEDBAR-UNIX-30

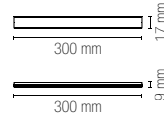

8031414866403	 
lumen	658 lm
watt	12W
beam angle	120°

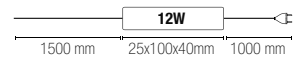

Accessori inclusi /  
Included accessories



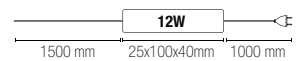
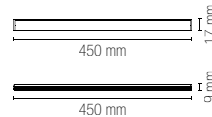

### LEDBAR-UNIX-45

8031414864614	 
lumen	978 lm
watt	12W
beam angle	120°



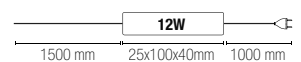
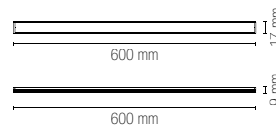

### LEDBAR-UNIX-60

8031414864621	 
lumen	1315 lm
watt	12W
beam angle	120°



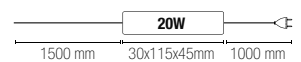
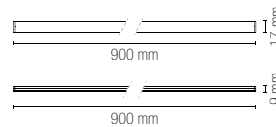

### LEDBAR-UNIX-90

8031414864492	 
lumen	1974 lm
watt	20W
beam angle	120°



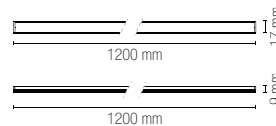

### LEDBAR-UNIX-120

8031414864508	 
lumen	2632 lm
watt	30W
beam angle	120°



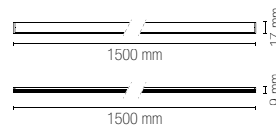

### LEDBAR-UNIX-150

8031414865185	 
lumen	3290 lm
watt	30W
beam angle	120°



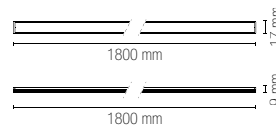

### LEDBAR-UNIX-180

8031414865154	 
lumen	3940 lm
watt	60W
beam angle	120°



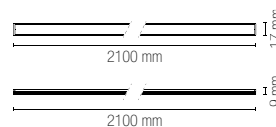

### LEDBAR-UNIX-210

8031414865161	 
lumen	4600 lm
watt	60W
beam angle	120°



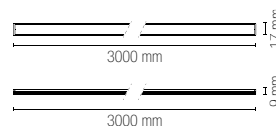

### LEDBAR-UNIX-270

8031414865178	 
lumen	5922 lm
watt	60W
beam angle	120°



### LEDBAR-UNIX-300

8031414870738	 
lumen	6580 lm
watt	60W
beam angle	120°

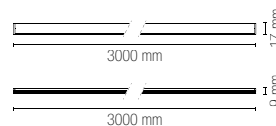





**Barra sottopensile  
angolare in alluminio con  
diffusore in PC riflettente.**  
Angular cabinet bar with  
aluminum structure under wall  
unit with reflective PC diffuser.



Accessori inclusi / Included accessories



Staffe / Brackets

	colour	colour			Accessori inclusi / Included accessories
	temp.				
<b>LEDBAR-UNIX-45 ANG</b> 8031414864607			978 lm	12W	
lumen					
watt					
beam angle			120°		
<b>LEDBAR-UNIX-60 ANG</b> 8031414864478			1315 lm	12W	
lumen					
watt					
beam angle			120°		
<b>LEDBAR-UNIX-90 ANG</b> 8031414864485			1974 lm	17,28W	
lumen					
watt					
beam angle			120°		
<b>LEDBAR-UNIX-120 ANG</b> 8031414864577			2632 lm	30W	
lumen					
watt					
beam angle			120°		
<b>LEDBAR-UNIX-150 ANG</b> 8031414866373			3290 lm	30W	
lumen					
watt					
beam angle			120°		
<b>LEDBAR-UNIX-180 ANG</b> 8031414866380			3940 lm	60W	
lumen					
watt					
beam angle			120°		
<b>LEDBAR-UNIX-210 ANG</b> 8031414866359			4600 lm	60W	
lumen					
watt					
beam angle			120°		
<b>LEDBAR-UNIX-240 ANG</b> 8031414866366			5264 lm	60W	
lumen					
watt					
beam angle			120°		
<b>LEDBAR-UNIX-300 ANG</b> 8031414866342			6580 lm	60W	
lumen					
watt					
beam angle			120°		

# T8

## Barra sottopensile con struttura in alluminio a LED integrato con diffusore in PC.

Cabinet bar with integrated LED aluminum structure for under cabinet with PC diffuser.



---

### Materiale

struttura in alluminio,  
diffusore in PC

---

### Colore

bianco



---

### Temperatura colore

4000K



---

### Driver

integrato

---

### Material

aluminum body  
with PC diffuser

---

### Colour

white



---

### Colour temperature

4000K



---

### Driver

built-in

---





colour temp. | colour

**LEDBAR-T8-60**

8031414875382

lumen

850 lm

watt

9W

beam angle

120°



**LEDBAR-T8-120**

8031414875399

lumen

1700 lm

watt

18W

beam angle

120°

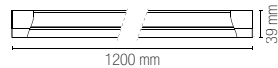

**LEDBAR-T8-150**

8031414875405

lumen

2300 lm

watt

24W

beam angle

120°



**Accessori inclusi /  
Included accessories**



# BATTEN

**Barra ultra sottile a LED integrato.**  
Ultra slim cabinet built-in LED bar.



---

### Materiale

struttura in PC bianco,  
diffusore in PC bianco

---

### Colore

bianco



---

### Temperatura colore

4000K



---

### Driver

integrato

---

### Material

PC white body with  
PC white diffuser

---

### Colour

white



---

### Colour temperature

4000K



---

### Driver

built-in

---





SOTTOPENSILI E BARRE LED / CABINETS AND LEDBARS

In.tec light

	colour temp.	colour	
<b>LED-BATTEN-30</b> 8031440357722			
lumen	1077 lm		
watt	9W		
beam angle	120°		
<b>LED-BATTEN-60</b> 8031440357739			
lumen	2166 lm		
watt	18W		
beam angle	120°		
<b>LED-BATTEN-120</b> 8031440357746			
lumen	4252 lm		
watt	36W		
beam angle	120°		
<b>LED-BATTEN-150</b> 8031440357753			
lumen	5677 lm		
watt	48W		
beam angle	120°		

**Accessori inclusi /  
Included accessories**



Staffe /  
Brackets

# HABILIS

**Barra sottopensile angolare in alluminio  
a LED integrato con diffusore in PC.**

Angular cabinet bar with integrated  
LED aluminum structure with PC diffuser.



---

**Materiale**

struttura in alluminio  
diffusore in PC

---

**Colore**

bianco



---

**Temperatura colore**

4000K



---

**Interruttore**

incluso

---

**Driver**

integrato

---

**Material**

aluminum body  
with PC diffuser

---

**Colour**

white



---

**Colour temperature**

4000K



---

**Switch**

included

---

**Driver**

built-in



colour temp. | colour

**LED-HABILIS-AP**

8031414881604

lumen

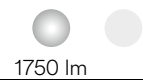

1750 lm

watt 15W

beam angle 105°

 2 plug max 16A

 2 USB 2.4A





# T5

## Barra sottopensile con struttura e diffusore in PC.

Cabinet bar with PC structure and diffuser.

### Materiale

struttura in PC  
diffusore in PC

### Colore

bianco



Temperatura colore  
4000K



### Interruttore

incluso

### Driver

integrato

### Material

PC white body with  
PC white diffuser

### Colour

white



Colour temperature  
4000K



### Swieth

included

### Driver

built-in

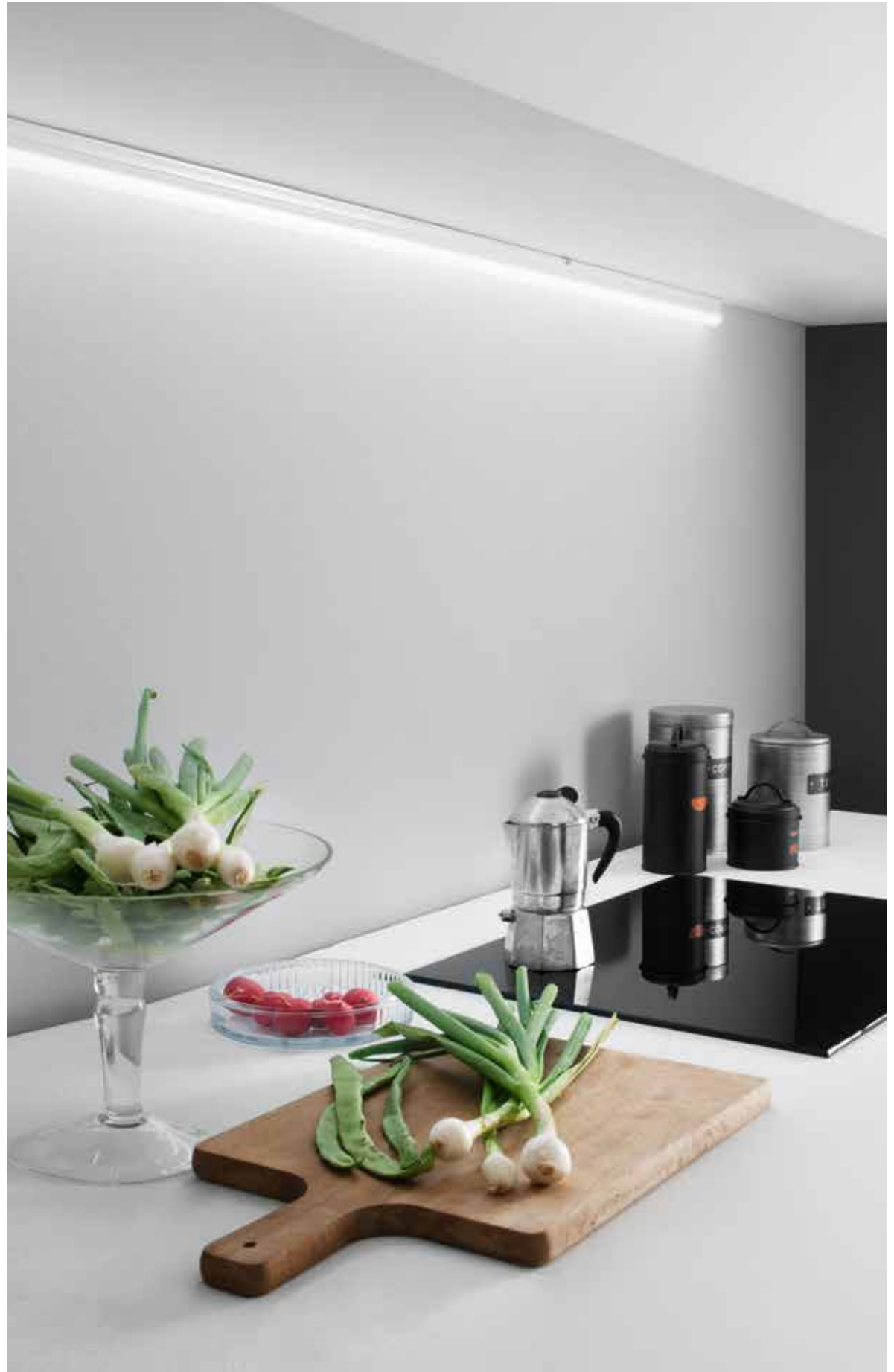





	colour temp.	colour		
<b>LEDBAR-T5-30</b> 8031440354691				
lumen	436 lm			
watt		5W		
beam angle		135°		
<b>LEDBAR-T5-60</b> 8031440354707				
lumen	784 lm			
watt		8W		
beam angle		135°		
<b>LEDBAR-T5-90</b> 8031440354677				
lumen	1249 lm			
watt		12W		
beam angle		135°		
<b>LEDBAR-T5-120</b> 8031440354684				
lumen	1565 lm			
watt		15W		
beam angle		135°		
<b>LEDBAR-T5-150</b> 8031414871742				
lumen	1926 lm			
watt		18W		
beam angle		135°		

**Accessori inclusi /  
Included accessories**



# MOVIE

## Barra sottopensile orientabile con struttura e diffusore in PC.

Adjustable cabinet bar with PC  
structure and diffuser.



### Materiale

struttura in PC  
diffusore in PC

### Colore

bianco

**Temperatura colore**  
4000K



**Temperatura colore  
selezionabile**  
2700K / 4000K / 6500K



**Interruttore**  
incluso

**Driver**  
integrato

### Material

PC body with  
PC diffuser

### Colour

white

**Colour temperature**  
4000K



**Selectable color  
temperature**  
2700K / 4000K / 6500K



**Switch**  
included

**Driver**  
built-in



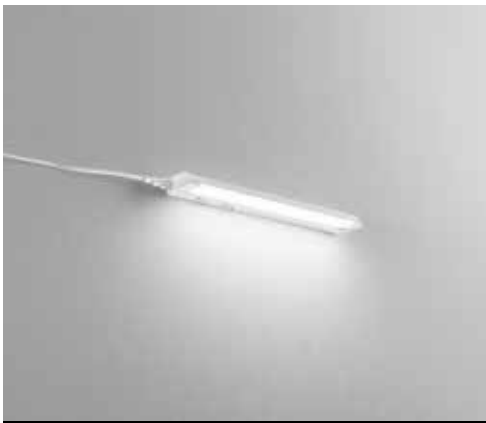
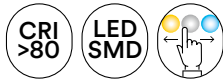

**LEDBAR-MOVIE-S**

8031414866427  
lumen

colour temp.	colour

500 lm

watt	6W
beam angle	120°

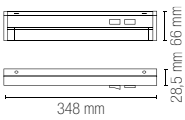

**LEDBAR-MOVIE**

8031440355100  
lumen

colour temp.	colour

800 lm

watt	8W
beam angle	120°

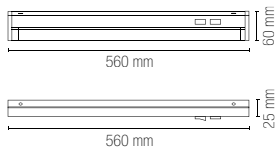

**LEDBAR-MOVIE-L**

8031414866441  
lumen

colour temp.	colour

1200 lm

watt	11W
beam angle	120°

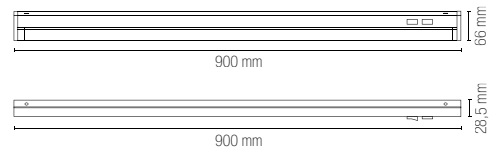

**Accessori inclusi /  
Included accessories**

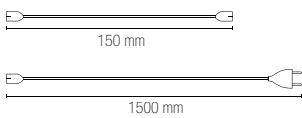

Connettore /  
Connector

AC220V~ 240V 50Hz  
MULTI-CONNECT

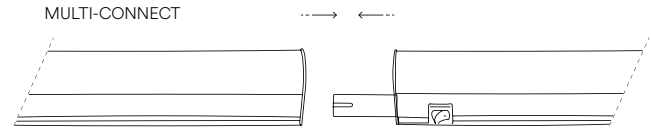

# ZAK

Lampada LED con sensore IR.  
IR sensor LED lamp.



**Materiale**  
struttura in alluminio,  
diffusore in PC  
riflettente

**Colore**  
silver



**Temperatura colore**  
3000K



**Driver**  
non incluso DC12V

**Material**  
aluminum body  
with PC reflective  
diffuser

**Colour**  
silver



**Colour temperature**  
3000K



**Driver**  
not included DC12V



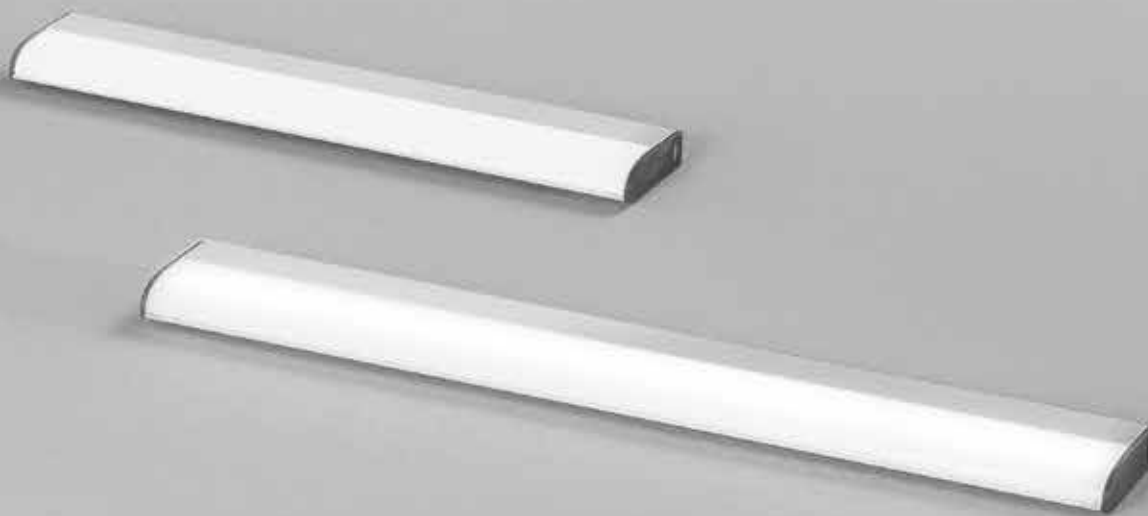

	colour temp.	colour	
<b>LEDBAT-ZAK-IR26</b> 8031414882281			
lumen	100 lm		
watt	1,20W		
beam angle	110°		
<b>LEDBAT-ZAK-IR35</b> 8031414882298			
lumen	150 lm		
watt	1,70W		
beam angle	110°		

**Accessori inclusi / Included accessories**

**IR**  
Sensore 2 funzioni /  
2 function sensor

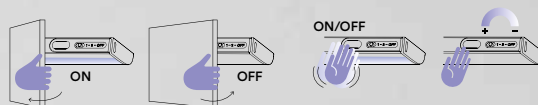

**3.7V 1600mAh**  
Batteria ricaricabile inclusa /  
Included rechargeable battery



**DC5V 0,4A Micro USB**  
Cavo / Cable

# GTO

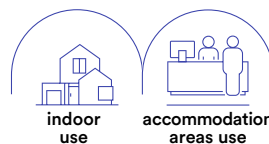

**Materiale**  
polycarbonato

**Colore**  
bianco



**Temperatura colore**  
3000K



**Material**  
polycarbonate

**Colour**  
white



**Colour temperature**  
3000K



**Lampada con sensore di movimento ricaricabile.**  
Rechargeable lamp with motion sensor.



**LEDBAT-GTO**  
8031414882274

lumen

colour temp. | colour



105 lm

watt

1W

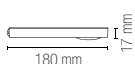
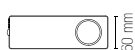

**Accessori inclusi /**  
**Included accessories**

Sensore di movimento /  
Motion sensor

2m in side  
4m in front  
120°

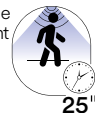

**DC 3.7V 1A**

Batteria ricaricabile /  
Rechargeable battery



**DC5V 0,4A Micro USB**  
Cavo / Cable

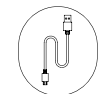

# AURIKA

**Materiale**  
polycarbonato

**Colore**  
bianco



**Temperatura colore**  
3000K



**Material**  
polycarbonate

**Colour**  
white



**Colour temperature**  
3000K



**Lampada LED con sensore IR.**  
IR sensor LED lamp.



**LEDBAT-AURIKA**  
8031414882250

lumen

colour temp. | colour



100 lm

watt

1,25W

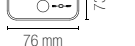

**Accessori inclusi /**  
**Included accessories**

**IR**  
Sensore / sensor

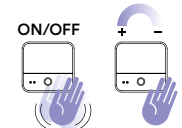

**DC 3.7V 2.2A**

Batteria ricaricabile /  
Rechargeable battery



**DC5V 0,4A Micro USB**  
Cavo / Cable

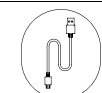

**Materiale**  
alluminio

**Colore**

struttura silver  
diffusore bianco

**Temperatura colore**  
3000K



**Material**  
aluminum

**Colour**









silver structure  
white diffuser

**Colour temperature**  
3000K



**Lampada LED con sensore IR.**  
IR sensor LED lamp.



	colour temp.	colour	<b>Accessori inclusi / Included accessories</b>		
<b>LEDBAT-BLAM-IR38</b> 8031414882267			<b>IR</b> Sensore / Sensor		
lumen	150 lm		<b>DC 3.7V 2.2A</b> Batteria ricaricabile / Rechargeable battery		2 hours
watt	1,7W		<b>DC5V 0,4A Micro USB</b> Cavo / Cable		

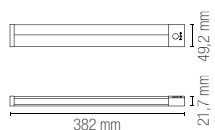

# CLOSET

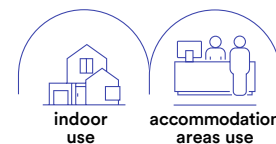

**Materiale**  
polycarbonato

**Colore**  
silver



**Temperatura colore**  
4000K



**Material**  
polycarbonate

**Colour**  
silver



**Colour temperature**  
4000K



**Lampada con sensore di movimento.**  
Lamp with motion sensor.

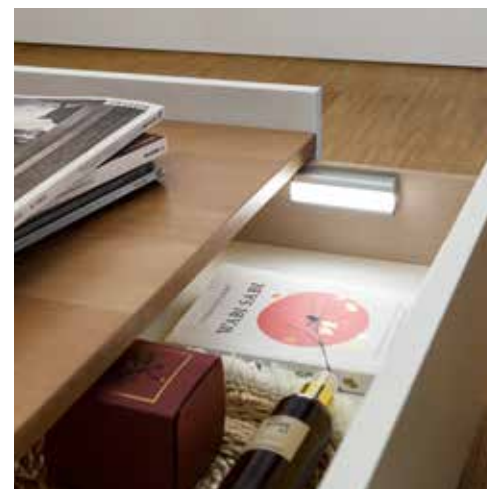

**LED-CLOSET-10**  
8031414873012

lumen

colour temp. | colour



105 lm

watt

1W

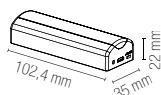

**Accessori inclusi /**  
**Included accessories**

Sensore di movimento /  
Motion sensor

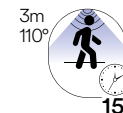

**DC 5V 1A**  
Batteria ricaricabile /  
Rechargeable battery



**Micro USB charging wires DC 5V**  
Cavo non incluso / Not included cable



# TRIGGER

**Materiale**  
polycarbonato

**Colore**  
silver



**Temperatura colore**  
4000K



**Material**  
polycarbonate

**Colour**  
silver



**Colour temperature**  
4000K



**Kit 2pz. copri cerniera.**  
Kit 2pz. hinge cover.



**LED-TRIGGER**  
8031414873005

watt

colour temp. | colour



0,2W DC12V



**Accessorio non incluso /**  
**Not included accessory**

**2x23A**  
Batteria / Battery

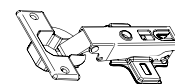

Compatibile per cerniera a scatto collo "0" /  
Compatible with "0" neck snap hinge



# SHELF



**Materiale**  
policarbonato

**Colore**  
struttura silver  
diffusore bianco

**Temperatura colore**  
4000K



**Material**  
polycarbonate

**Colour**  
silver structure  
white diffuser

**Colour temperature**  
4000K



**Lampada con sensore di movimento.**  
Lamp with motion sensor.



**LED-SHELF-R7**  
8031414873029

lumen

watt

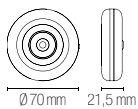

colour temp.      colour



110 lm

1W

**Accessori inclusi /**  
**Included accessories**

Sensore di movimento /  
Motion sensor

**DC 5V 1A**  
Batteria ricaricabile /  
Rechargeable battery

**Micro USB charging wires DC 5V**  
Cavo non incluso / Not included cable

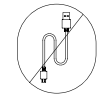
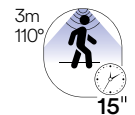



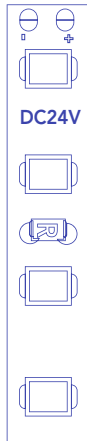

PROFILI E STRIP LED  
PROFILES AND STRIP LED

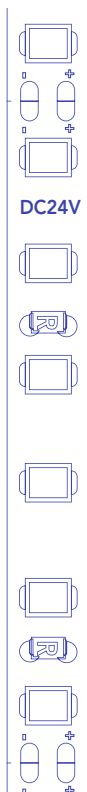

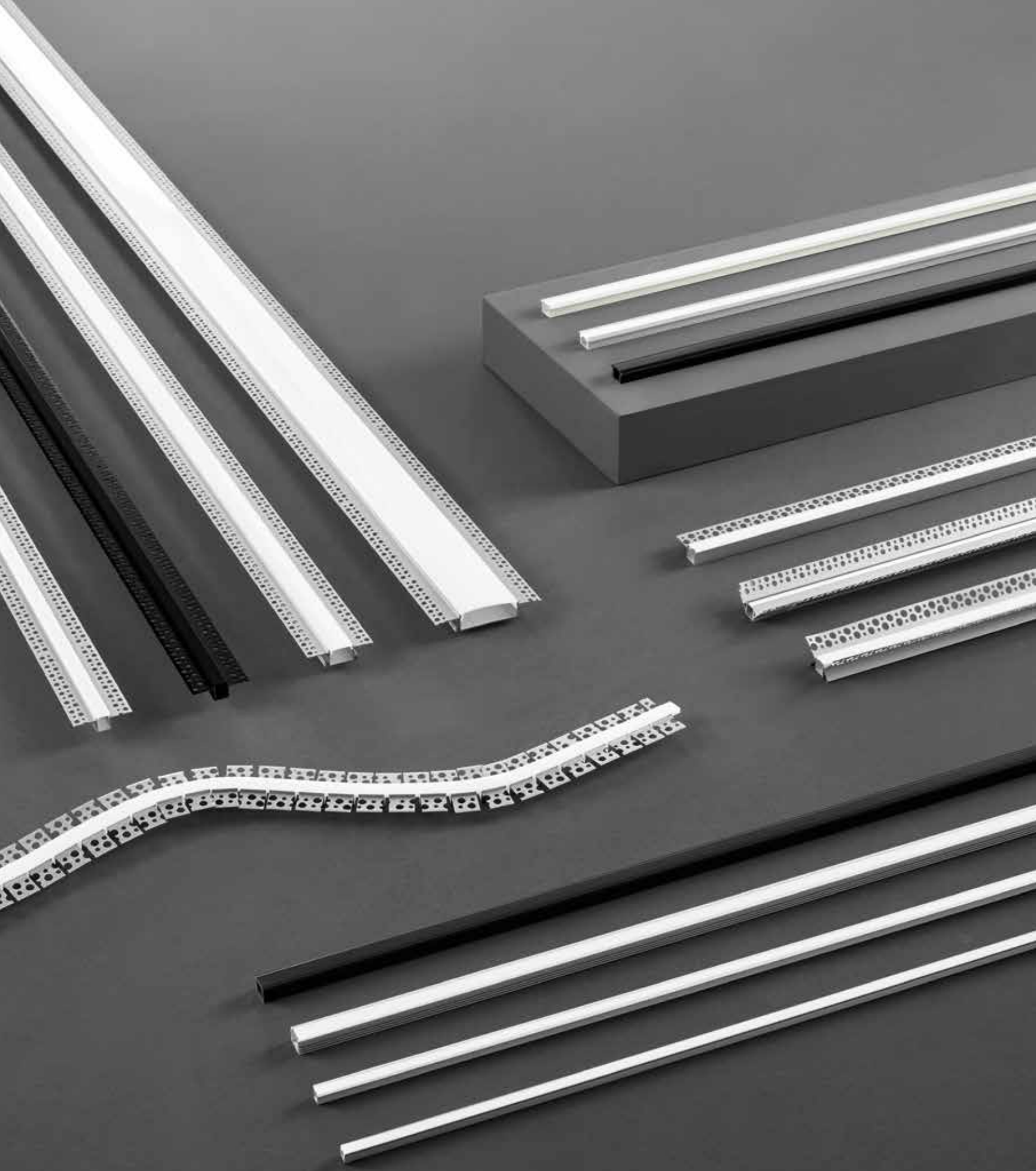

## Profiles for recessed and surface installation

**I profili per installazione a incasso o a parete sono realizzati con materiali di alta qualità e si distinguono per la loro facilità d'installazione. Garantiscono una distribuzione uniforme della luce e consentono configurazioni personalizzate. Proteggono le strisce LED durante il montaggio e si integrano perfettamente nell'ambiente circostante.**

Profiles for recessed or wall installation are made of high-quality materials and are distinguished by their ease of installation. They ensure even light distribution and allow custom configurations. They protect LED strips during installation and blend seamlessly into their surroundings.



Installazione ad incasso /  
Recessed installation

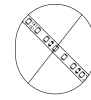

Strip LED non inclusa  
vedi p. 398 a p. 435 /  
LED strip not included  
see p. 398 to p. 435

# GORIZIA PROFILE

Profilo a rapido fissaggio  
nel cartongesso. Diffusore  
opale e tappi inclusi /  
Quick fixing profile in  
plasteboard with opal  
diffuser and caps included.

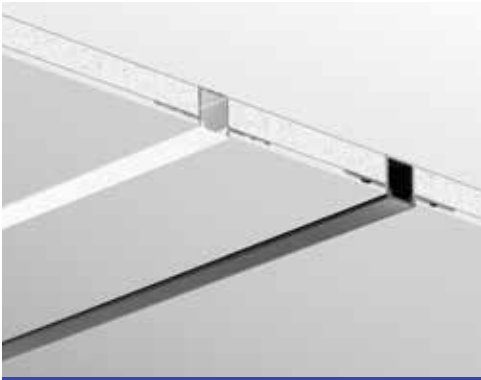
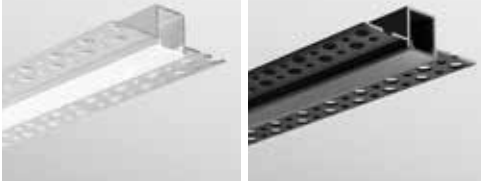

length | colour  
2 m | aluminum

**I-PROFILO-GORIZIA-S**  
8031414876587

**I-PROFILO-GORIZIA-S NER**  
8031414876624

2 m | black

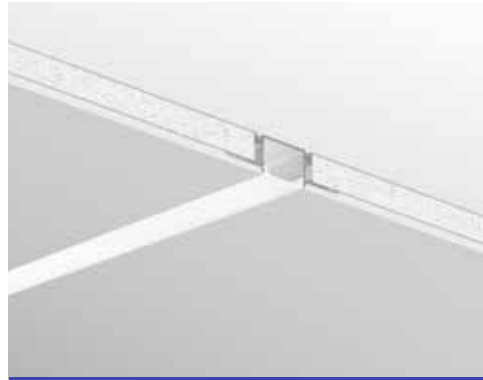
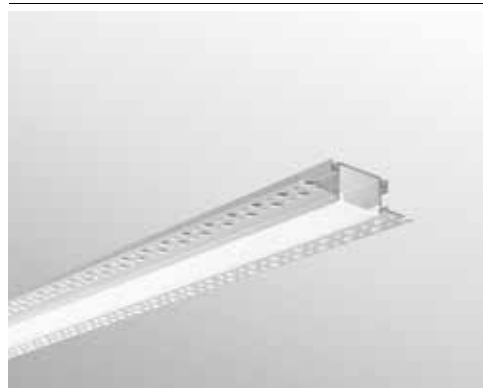

length | colour  
2 m | aluminum

**I-PROFILO-GORIZIA**  
8031414871124

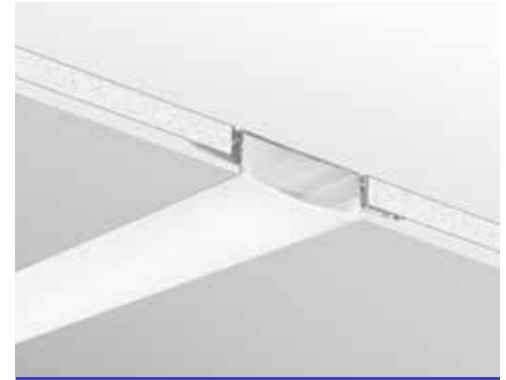
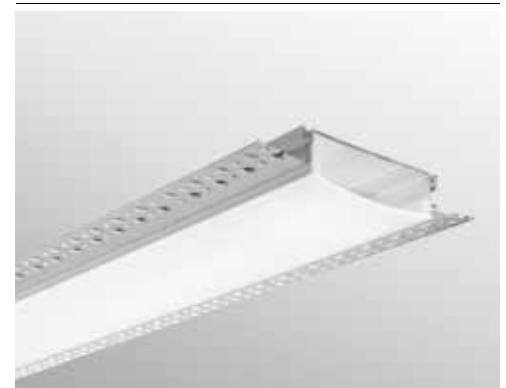

length | colour  
2 m | aluminum

**I-PROFILO-GORIZIA-XL**  
8031414871094

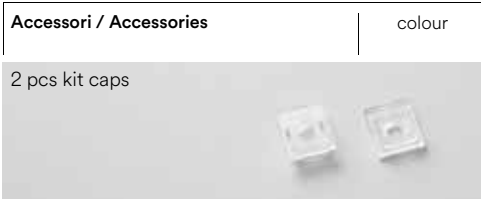
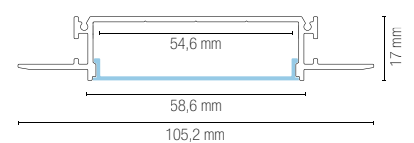
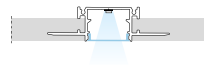
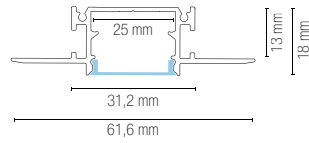
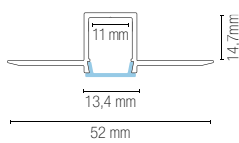

**I-PROFILO-GORIZIA-S-CAP**  
8031414890491

transparent

**I-PROFILO-GORIZIA-S-NER-CAP**  
8031414890507

black



**I-PROFILO-GORIZIA-CAP**  
8031414890484

silver



**I-PROFILO-GORIZIA-XL-CAP**  
8031414890514

silver



Installazione ad incasso /  
Recessed installation

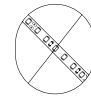

Strip LED non inclusa  
vedi p. 398 a p. 435 /  
LED strip not included  
see p. 398 to p. 435

# BEND PROFILE

Profilo snodabile a rapido fissaggio nel cartongesso.  
Diffusore opale e tappi inclusi /  
Articulated quick fixing profile in plasteboard  
with opal diffuser and caps included.

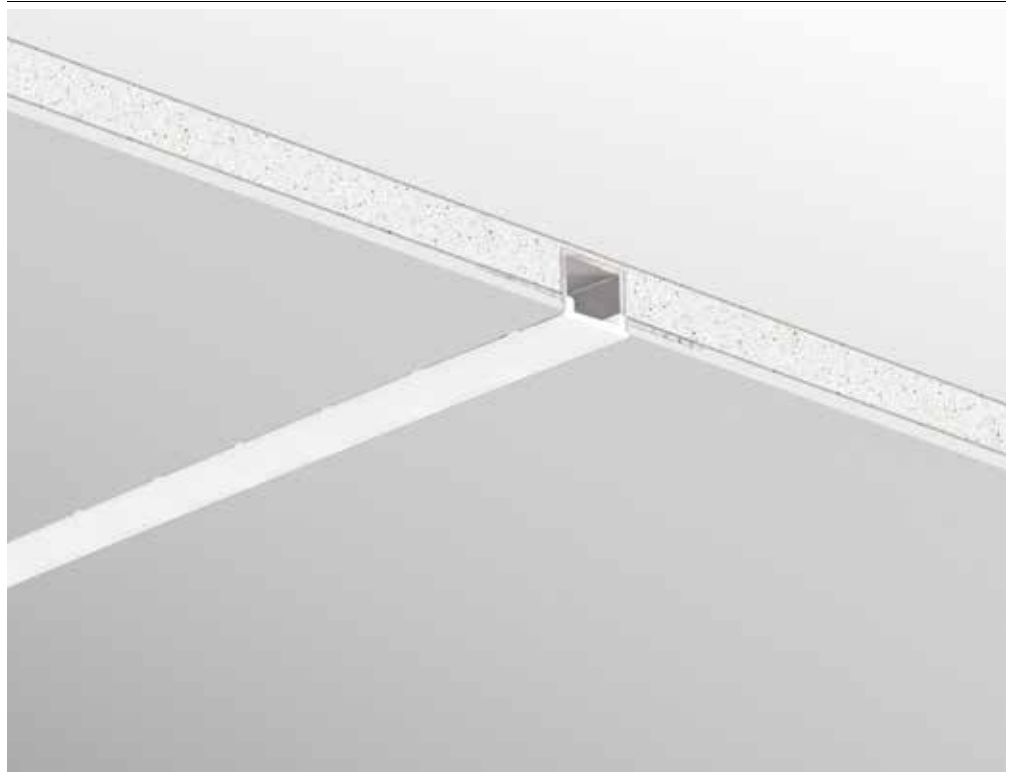
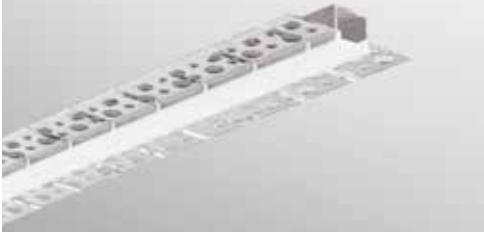

length | colour |  
[ ] [ ]

Accessori / Accessories

colour |

2 pcs kit caps

**I-PROFILO-BEND**  
8031414915811

2 m  aluminum

**I-PROFILO-BEND-CAP**  
8031414923557

silver

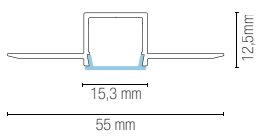



BEND



In.tec light    **PROFILI E STRIP LED / PROFILES AND STRIP LED**

Installazione ad incasso /  
Recessed installation



Strip LED non inclusa  
vedi p. 398 a p. 435 /  
LED strip not included  
see p. 398 to p. 435

# EDGE PROFILE

Profilo in alluminio a rapido  
fissaggio nel cartongesso,  
diffusore opale e tappi inclusi /  
Quick fixing profile in plasteboard  
with opal diffuser and caps included.

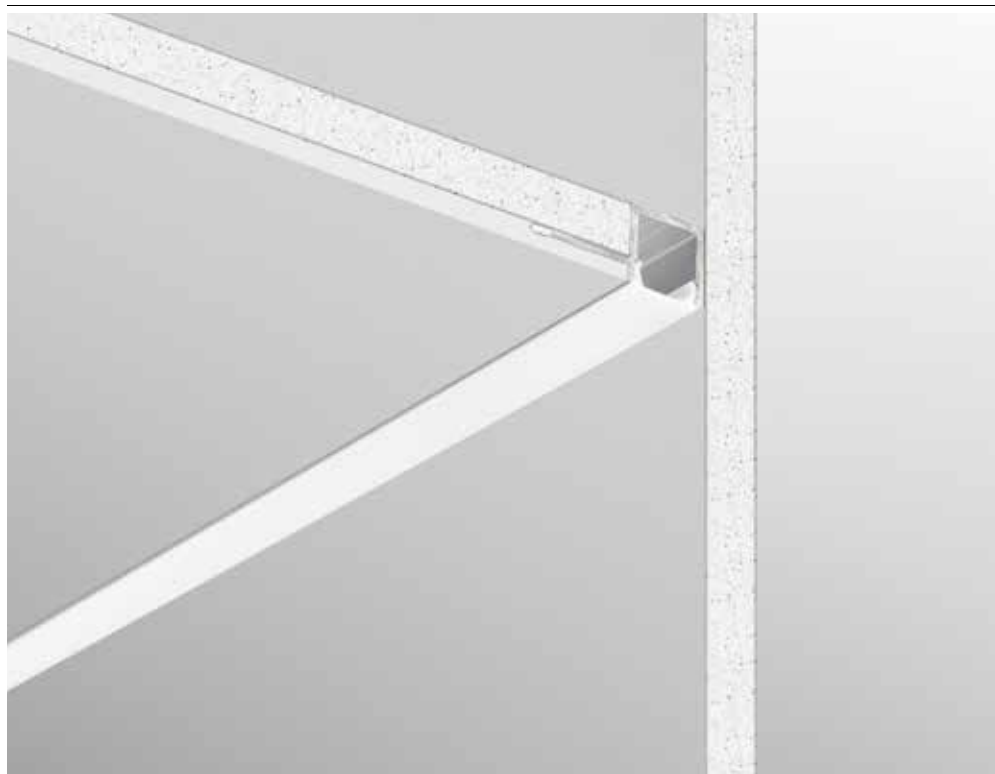
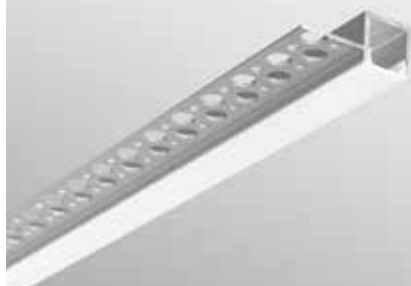

length | colour

**I-PROFILO-EDGE**  
8031414897575

2 m | aluminum

Accessori / Accessories

colour



2 pcs kit caps

**I-PROFILO-EDGE-CAP**  
8031414897582

silver

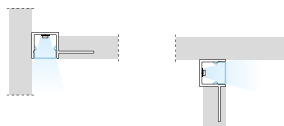
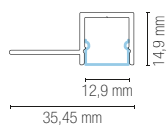

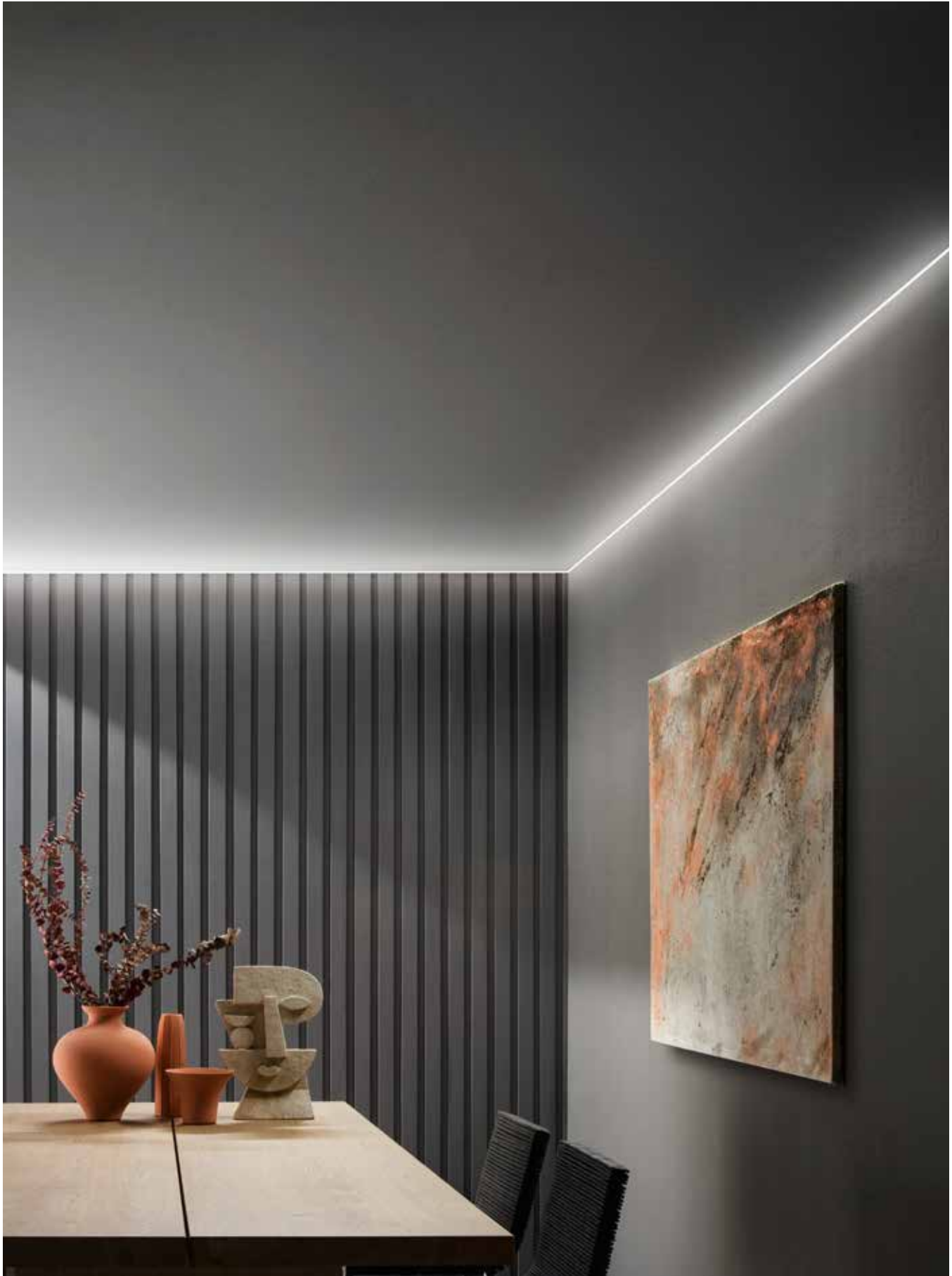

In.tec light PROFILI E STRIP LED / PROFILES AND STRIP LED

Installazione angolare ad incasso /  
Recessed angular installation



Strip LED non inclusa  
vedi p. 398 a p. 435 /  
LED strip not included  
see p. 398 to p. 435

# RIDGE PROFILE

Profilo angolare in alluminio a  
rapido fissaggio nel cartongesso,  
diffusore opale e tappi inclusi /  
Quick fixing angular profile in plasteboard  
with opal diffuser and caps included.

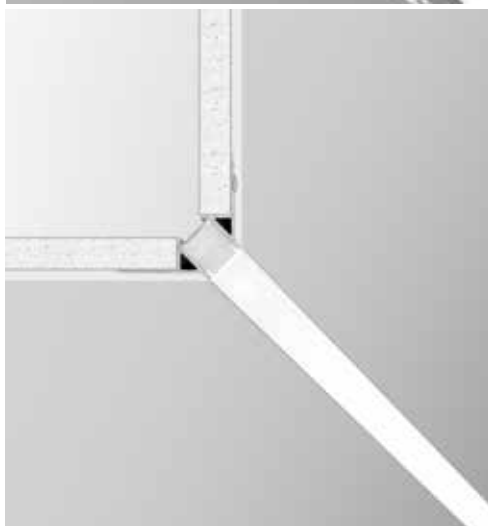
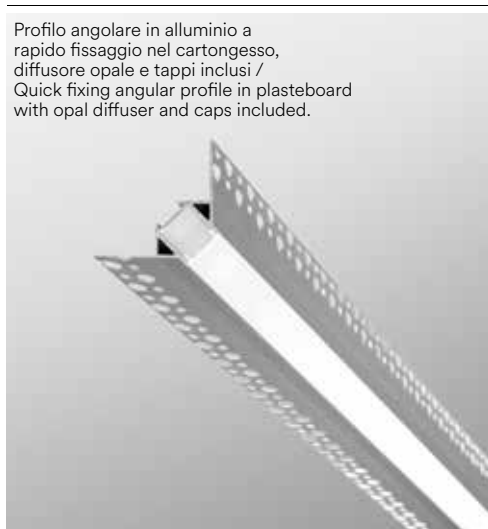

length | colour  
 | 

**I-PROFILO-RIDGE-2**  
8031414876570

2 m aluminum

Accessori / Accessories

colour



2 pcs kit caps

**I-PROFILO-RIDGE-CAP**  
8031414890552

aluminum

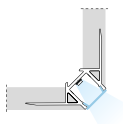
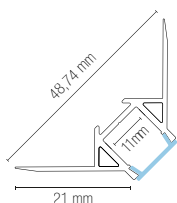

Installazione angolare ad incasso /  
Recessed angular installation

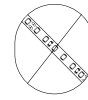

Strip LED non inclusa  
vedi p. 398 a p. 435 /  
LED strip not included  
see p. 398 to p. 435

# ANGLE PROFILE

Profilo angolare in alluminio a  
rapido fissaggio nel cartongesso,  
diffusore opale e tappi inclusi /  
Quick fixing angular profile in plasteboard  
with opal diffuser and caps included.

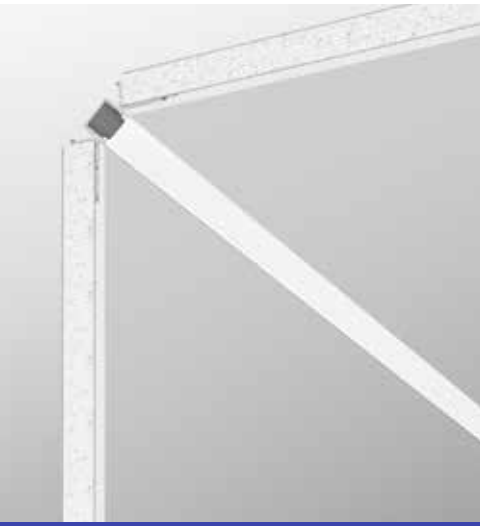
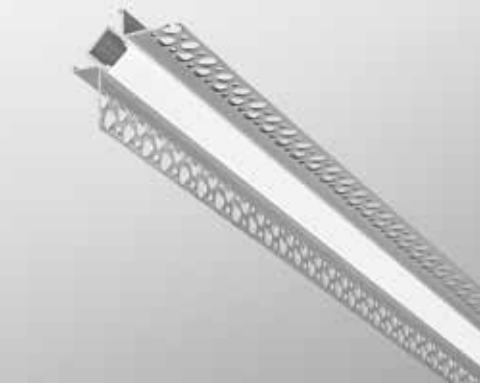

length | colour

**I-PROFILO-ANGLE**  
8031414915798

2 m | ● | aluminum



Accessori / Accessories

colour

2 pcs kit caps

**I-PROFILO-ANGLE-CAP**  
8031414923540

● | aluminum

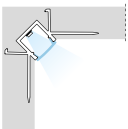
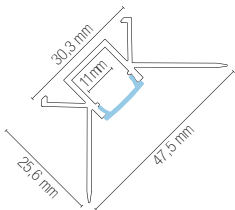

PROFILI E STRIP LED / PROFILES AND STRIP LED

In.tec light

Installazione ad incasso /  
Recessed installation



Strip LED non inclusa  
vedi p. 398 a p. 435 /  
LED strip not included  
see p. 398 to p. 435

# BERLINO PROFILE

Profilo a rapido fissaggio nel cartongesso o superfici esterne, diffusore disponibile in due varianti, tappi e staffe incluse / Quick-fixing profile in plasterboard or exterior surfaces, diffuser available in two variants, caps and brackets included.

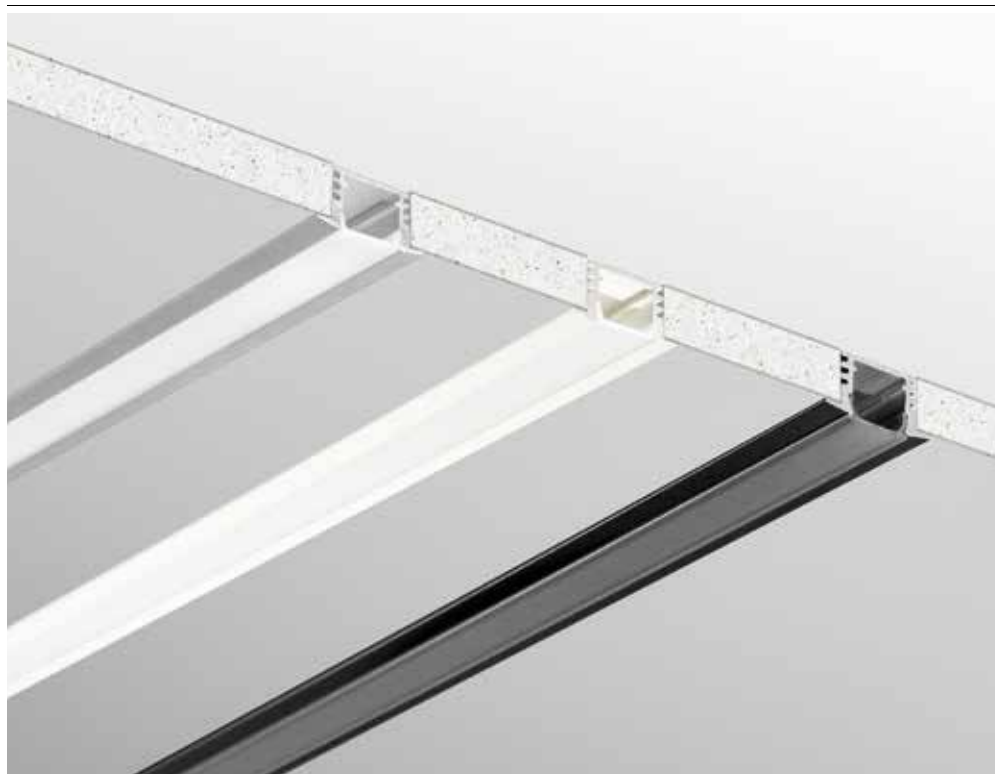

length  colour

<b>I-PROFILO-BERLINO</b> 8031434611212		1 m aluminum
<b>I-PROFILO-BERLINO-2</b> 8031440359405		2 m aluminum
<b>I-PROFILO-BERLINO-2 BCO</b> 8031414871070		2 m white
<b>I-PROFILO-BERLINO-2 NER</b> 8031414876617		2 m black

Accessori / Accessories

		colour
	2 m PC trasparent diffuser <b>I-PROF-BERLINO2-DIFF</b> 8031440357647	 transparent
	2 pcs kit caps <b>I-PROFILO-BERLINO-CAP</b> 8031414890446	 silver
	<b>I-PROFILO-BERLINO-BCO-CAP</b> 8031414890453	 white
	<b>I-PROFILO-BERLINO-NER-CAP</b> 8031414890460	 black

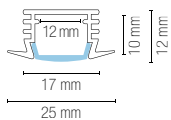



Installazione ad incasso o a superficie /  
Recessed or surface installation





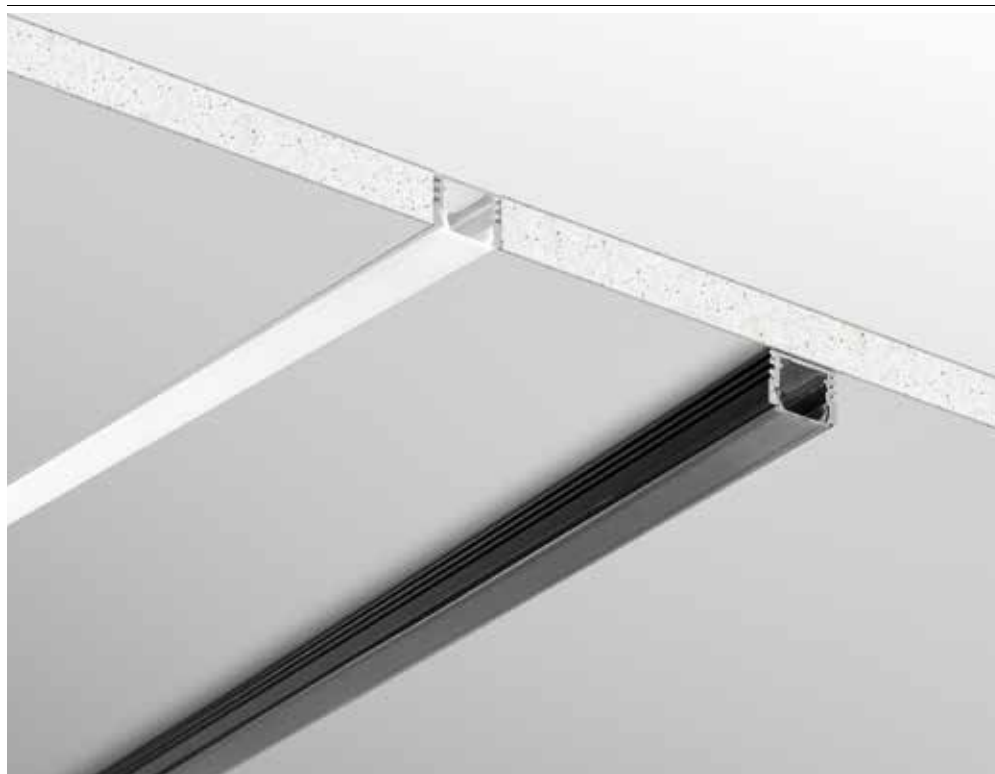

Strip LED non inclusa  
vedi p. 398 a p. 435 /  
LED strip not included  
see p. 398 to p. 435

# ROMA PROFILE

Profilo a rapido fissaggio nel cartongesso o superfici esterne, diffusore disponibile in due varianti, tappi e staffe incluse / Quick-fixing profile in plasterboard or exterior surfaces, diffuser available in two variants, caps and brackets included.



length  colour 

<b>I-PROFILO-ROMA</b> 8031434601213	1 m	 aluminum
<b>I-PROFILO-ROMA-2</b> 8031440359399	2 m	 aluminum
<b>I-PROFILO-ROMA-2 NER</b> 8031414876600	2 m	 black

Accessori / Accessories	colour
 2 m PC trasparent diffuser <b>I-PROF-ROMA2-DIFF</b> 8031440357630	 transparent
 2 pcs kit caps <b>I-PROFILO-ROMA-CAP</b> 8031414890569	 silver
 <b>I-PROFILO-ROMA-NER-CAP</b> 8031414890576	 black

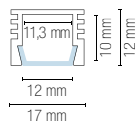





In.tec light PROFILI E STRIP LED / PROFILES AND STRIP LED

Installazione ad incasso o a superficie /  
Recessed or surface installation



Strip LED non inclusa  
vedi p. 398 a p. 435 /  
LED strip not included  
see p. 398 to p. 435

# MICRO PROFILE

Profilo a rapido fissaggio  
nel cartongesso o superfici  
esterne, diffusore opale,  
tappi e staffe inclusi /  
Quick-fixing profile in  
plasterboard or exterior  
surfaces, opal diffuser, caps  
and brackets included.



length | colour |  
 | 

Accessori / Accessories

colour |

**I-PROFILO-MICRO**  
8031414888740

  
2 m aluminum



2 pcs kit caps

**I-PROFILO-MICRO-CAP**  
8031414888757

  
silver

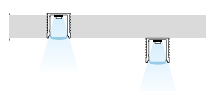

Installazione ad incasso /  
Recessed installation

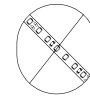

Strip LED non inclusa  
vedi p. 398 a p. 435 /  
LED strip not included  
see p. 398 to p. 435

# INCRO PROFILE

Profilo a rapido fissaggio  
nel cartongesso o superfici  
esterne, diffusore opale,  
tappi e staffe inclusi /  
Quick-fixing profile in  
plasterboard or exterior  
surfaces, opal diffuser, caps  
and brackets included.

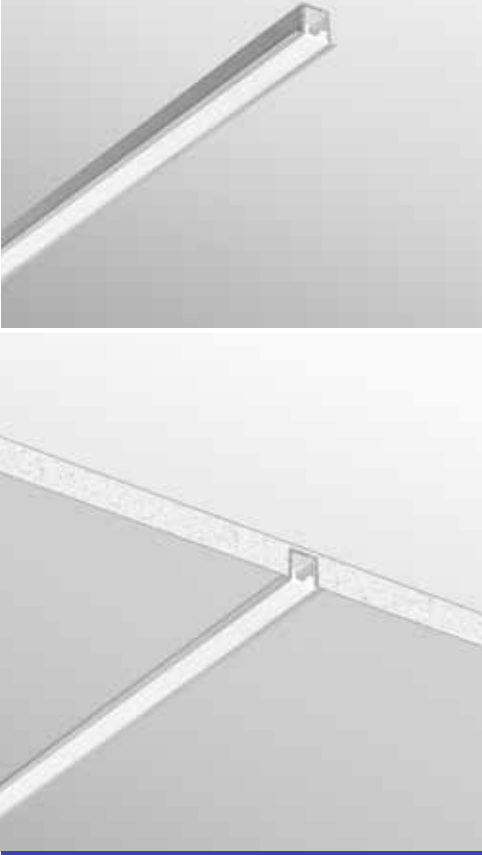

length | colour

**I-PROFILO-INCRO**  
8031414888764

2 m | ● | aluminum

Accessori / Accessories



2 pcs kit caps

**I-PROFILO-INCRO-CAP**  
8031414888771

colour

● | silver

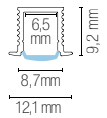

In.tec light | PROFILI E STRIP LED / PROFILES AND STRIP LED

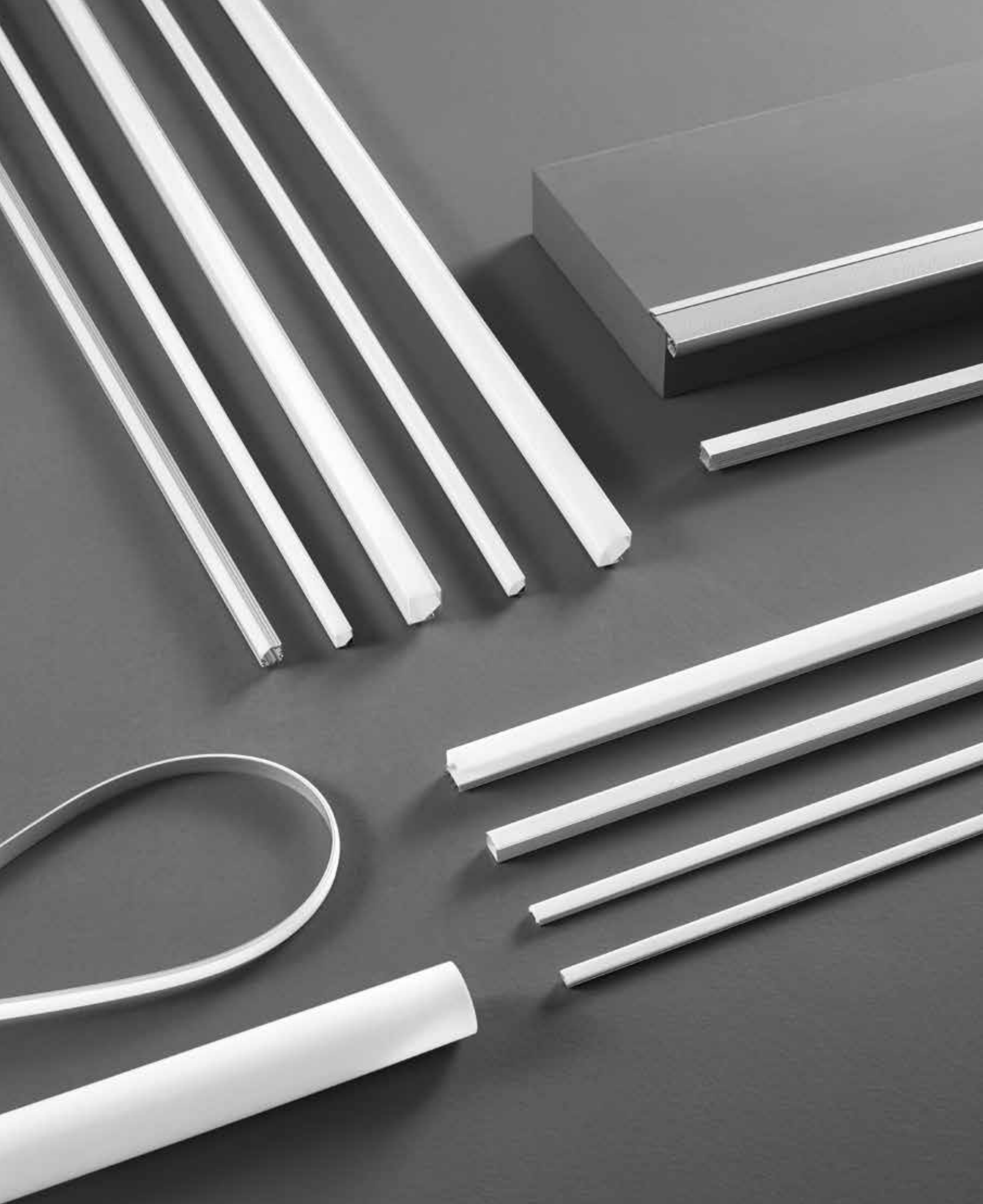

# Profiles for surface installation

**I profili per installazione a superficie (lineari, flessibili e angolari) sono progettati per cartongesso e muratura. Offrono un supporto resistente per l'illuminazione a LED, proteggendo le strisce durante l'installazione. Il design moderno consente configurazioni personalizzate per adattarsi a diverse esigenze architettoniche.**

Surface installation profiles (linear, flexible, and angular profiles) are designed for drywall and masonry. They offer durable support for LED lighting, protecting the strips during installation. The modern design allows custom configurations to suit different architectural needs.



Installazione a superficie /  
Surface installation

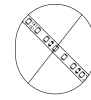

Strip LED non inclusa  
vedi p. 398 a p. 435 /  
LED strip not included  
see p. 398 to p. 435

# LOOP PROFILE

Profilo in alluminio per installazione a muro/soffitto o sospensione, diffusore a emissione a 180°, tappi e staffe inclusi / Aluminum profile for wall/ceiling installation or suspension, 180° emission diffuser, caps and brackets included.



length

colour

**I-PROFILO-LOOP-2**  
8031414881840

2 m aluminum

Accessori / Accessories

colour



2 pcs kit caps

**I-PROFILO-LOOP-CAP**  
8031414881857

silver

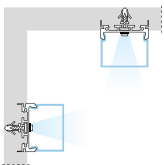
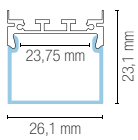



Installazione a superficie /  
Surface installation



Strip LED non inclusa  
vedi p. 398 a p. 435 /  
LED strip not included  
see p. 398 to p. 435

# LINEA PROFILE

Profilo in alluminio,  
tappi e staffe inclusi /  
Aluminum profile, caps  
and brackets included



length | colour

## I-PROFILO-LINEA-2-BCO

8031414881963

2 m

white

## I-PROFILO-LINEA-2-NER

8031414881987

2 m

black

### Accessori / Accessories

colour



2 pcs kit caps

#### I-PROFILO-LINEA-BCO-CAP

8031414881970

white



#### I-PROFILO-LINEA-NER-CAP

8031414882199

black

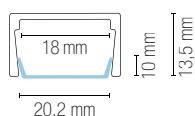





In.tec light PROFILI E STRIP LED / PROFILES AND STRIP LED

Installazione a superficie /  
Surface installation



Strip LED non inclusa  
vedi p. 398 a p. 435 /  
LED strip not included  
see p. 398 to p. 435

# MILANO

## PROFILE

Profilo con diffusore opale,  
tappi e staffette inclusi /  
Profile with opal diffuser  
caps and brackets included.



length  colour

<b>I-PROFILO-MILANO</b> 8031434611854	1 m	 aluminum
<b>I-PROFILO-MILANO-2</b> 8031440359412	2 m	 aluminum
<b>I-PROFILO-MILANO-2 BCO</b> 8031414871100	2 m	 white

Accessori / Accessories		colour
	2 m PC trasparent diffuser <b>I-PROF-MILANO2-DIFF</b> 8031440357654	 transparent
	2 pcs kit caps <b>I-PROFILO-MILANO-CAP</b> 8031414890538	 silver
	<b>I-PROFILO-MILANO-BCO-CAP</b> 8031414890521	 white

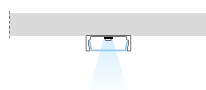
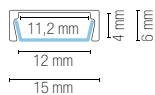



Installazione a superficie /  
Surface installation

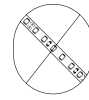

Strip LED non inclusa  
vedi p. 398 a p. 435 /  
LED strip not included  
see p. 398 to p. 435

# ULTRA PROFILE

Profilo con diffusore opale,  
tappi e staffette inclusi /  
Profile with opal diffuser,  
caps and brackets included.

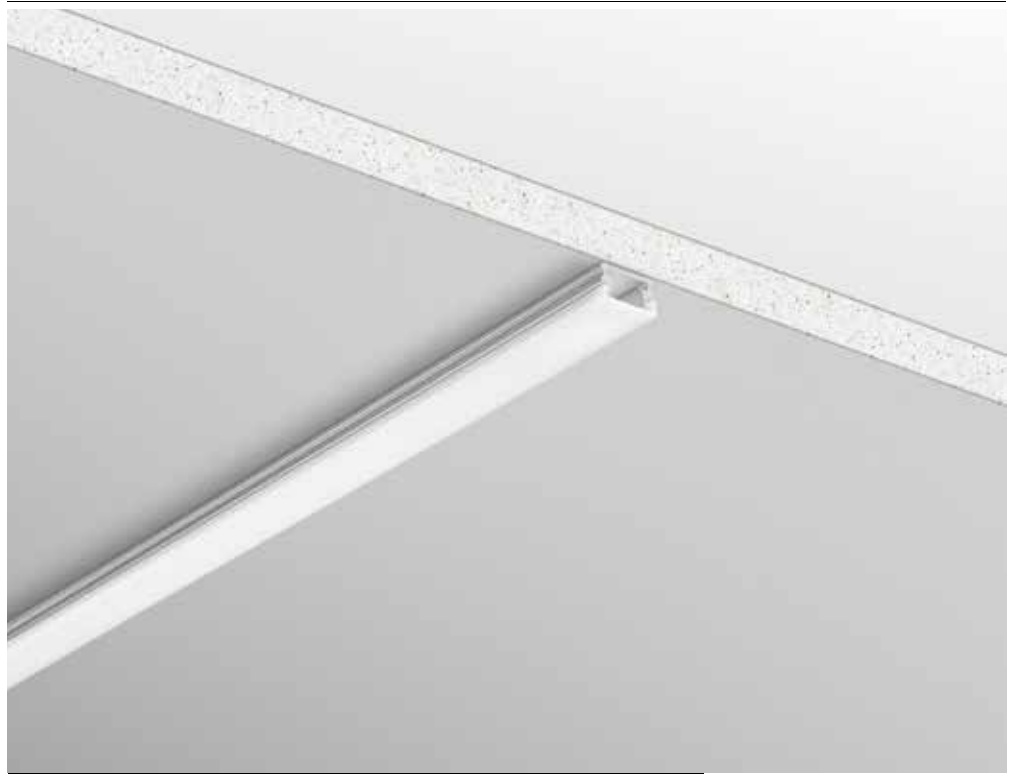

length  
 colour

**I-PROFILO-ULTRA**  
8031414888788

2 m  aluminum

**Accessori / Accessories**

colour



2 pcs kit caps

**I-PROFILO-ULTRA-CAP**  
8031414890255

 silver

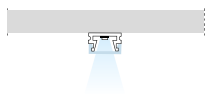
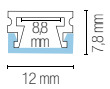

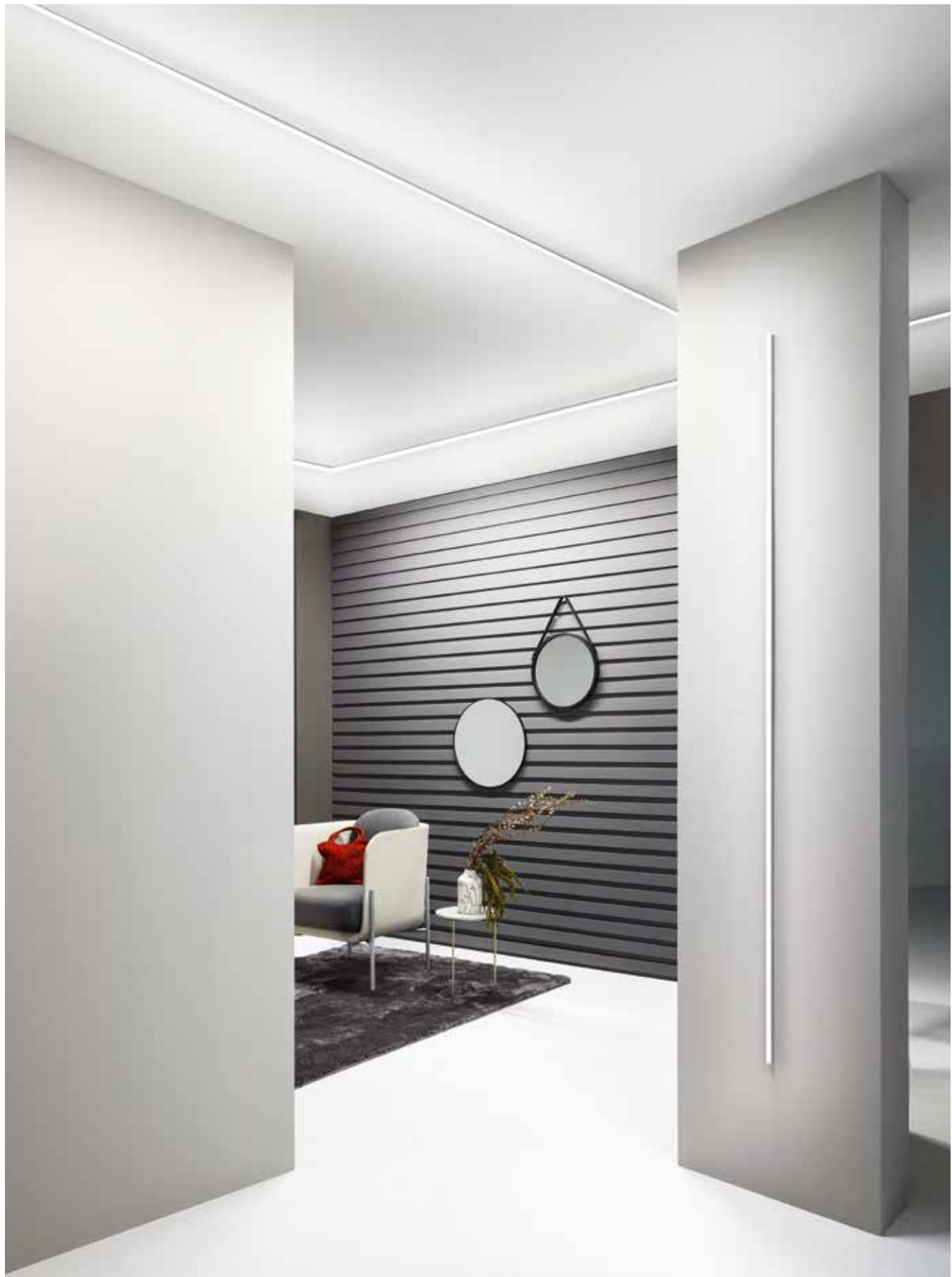

Installazione a superficie /  
Surface installation



Strip LED non inclusa  
vedi p. 398 a p. 435 /  
LED strip not included  
see p. 398 to p. 435

# CAMELOT PROFILE

Profilo flessibile con diffusore  
opale, tappi e staffette inclusi /  
Flexible profile with opal diffuser,  
caps and brackets included.



length | colour

**I-PROFILO-CAMELOT**  
8031414871087

2 m |  aluminum

**Accessori / Accessories**

colour



2 pcs kit caps

**I-PROFILO-CAMELOT-CAP**  
8031414890477

 silver

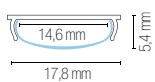



In.tec light PROFILI E STRIP LED / PROFILES AND STRIP LED

Installazione a superficie /  
Surface installation



Strip LED non inclusa  
vedi p. 398 a p. 435 /  
LED strip not included  
see p. 398 to p. 435

# TUBE PROFILE

Profilo in alluminio per installazione  
a muro/soffitto o sospensione, diffusore  
a emissione a 180°, tappi e staffe inclusi /  
Aluminum profile for installation wall/ceiling  
or suspension, 180° emission diffuser,  
caps and brackets included.



Installazione a plafoniera /  
Ceiling installation



Installazione a sospensione /  
Suspended installation

length  colour 

**I-PROFILO-TUBE-2**  
8031414881925

2 m  aluminum

Accessori / Accessories

colour



2 pcs kit caps

**I-PROFILO-TUBE-CAP**  
8031414881932

 white



Kit suspension mounting system 2,5 m

**I-PROFILO-TUBE-SOSP**  
8031414882243

 silver

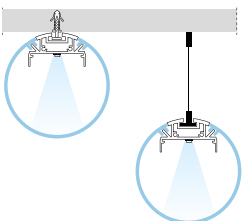
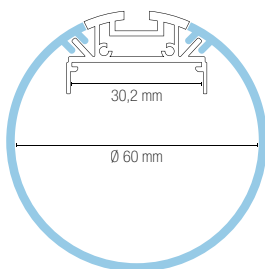





Installazione angolare a superficie /  
Angular surface installation



Strip LED non inclusa  
vedi p. 398 a p. 435 /  
LED strip not included  
see p. 398 to p. 435

# NEWYORK PROFILE

Profilo angolare a rapido fissaggio  
nel cartongesso, diffusore opale,  
tappi e staffe inclusi /  
Quick-fixing angle profile in plasterboard,  
opal diffuser, caps and brackets included.

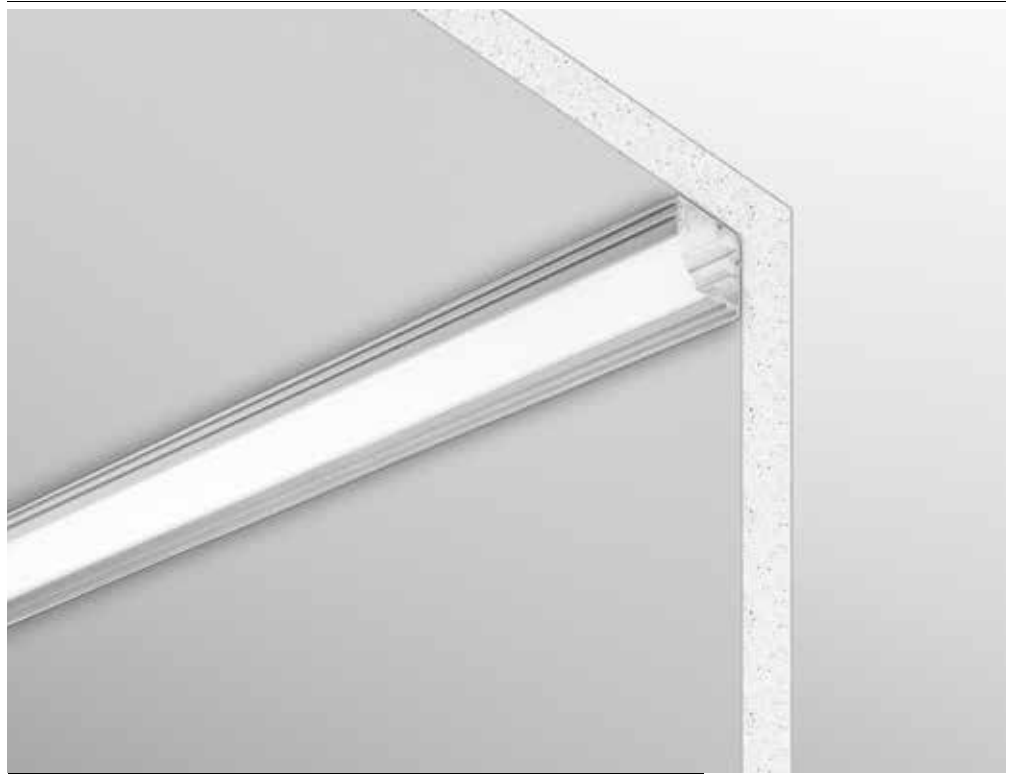

length  colour 

**I-PROFILO-NEWYORK**  
8031434581218

1 m  aluminum

**I-PROFILO-NEWYORK-2**  
8031440359382

2 m  aluminum

## Accessori / Accessories

colour 



2 m PC trasparente diffuser

**I-PROF-NEWYORK2-DIFF**  
8031440357623

 trasparente



2 pcs kit caps

**I-PROFILO-NEWYORK-CAP**  
8031414890545

 silver

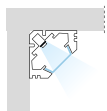
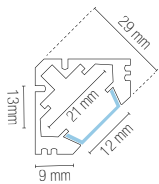



In.tec light PROFILI E STRIP LED / PROFILES AND STRIP LED

Installazione angolare a superficie /  
Angular surface installation

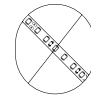

Strip LED non inclusa  
vedi p. 398 a p. 435 /  
LED strip not included  
see p. 398 to p. 435

# DORIK PROFILE

Profilo angolare in alluminio  
con fissaggio a parete, diffusore  
opale, tappi e staffe inclusi /  
Angular aluminium profile with  
wall mounting, opal diffuser,  
caps and brackets included.



length | colour

length | colour

Accessori / Accessories

colour

**I-PROFILO-DORIK-16-2**  
8031414882205



2 m aluminum

**I-PROFILO-DORIK-2**  
8031414876556



2 m aluminum



2 pcs kit caps for DORIK 16x16 mm

**I-PROFILO-DORIK-16-CAP**  
8031414882212

●  
silver



2 pcs kit caps for DORIK 29,7x29,7 mm

**I-PROFILO-DORIK-CAP**  
8031414877768

●  
silver

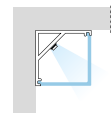
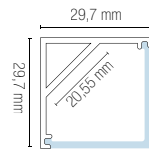
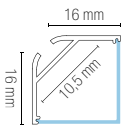

Installazione angolare a superficie /  
Angular surface installation

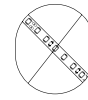





Strip LED non inclusa  
vedi p. 398 a p. 435 /  
LED strip not included  
see p. 398 to p. 435

# IONIK PROFILE

Profilo angolare in alluminio  
con fissaggio a parete, diffusore  
opale, tappi e staffe inclusi /  
Angular aluminium profile with  
wall mounting, opal diffuser,  
caps and brackets included.



length | colour  
 | 

length | colour  
 | 

**I-PROFILO-IONIK-16-2**  
8031414882229

2 m  aluminum

**I-PROFILO-IONIK-2**  
8031414876549

2 m  aluminum

## Accessori / Accessories



2 pcs kit caps for IONIK 16x16 mm

**I-PROFILO-IONIK-16-CAP**  
8031414882236

colour

 silver



2 pcs kit caps for IONIK 29,7x29,7 mm

**I-PROFILO-IONIK-CAP**  
8031414877775

 silver

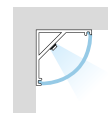
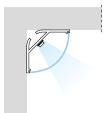
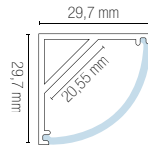
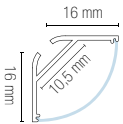

PROFILI E STRIP LED / PROFILES AND STRIP LED

In.tec light

Installazione calpestabile a superficie /  
Walkable surface installation

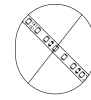

Strip LED non inclusa  
vedi p. 398 a p. 435 /  
LED strip not included  
see p. 398 to p. 435

# STEPWAY PROFILE

Profilo per gradini,  
diffusore opale e tappi inclusi /  
Step profile, opal diffuser  
and caps included.



length

colour

**I-PROFILO-STEPWAY**  
8031414876594

2 m aluminum

**Accessori / Accessories**

colour



2 pcs kit caps

**I-PROFILO-STEPWAY-CAP**  
8031414877782

silver

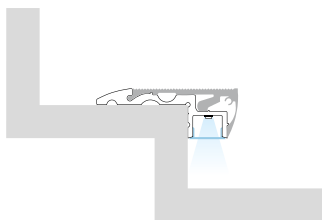
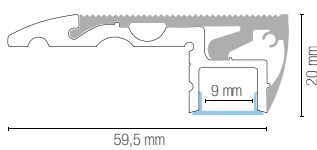



In.tec light PROFILI E STRIP LED / PROFILES AND STRIP LED

Installazione calpestabile ad incasso /  
Walkable recessed installation

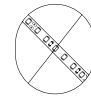

Strip LED non inclusa  
vedi p. 398 a p. 435 /  
LED strip not included  
see p. 398 to p. 435

# DRIVEWAY PROFILE

Profilo in alluminio a incasso carrabile,  
tappi e staffe inclusi /  
Driveway recessed aluminum profile,  
caps and brackets included.

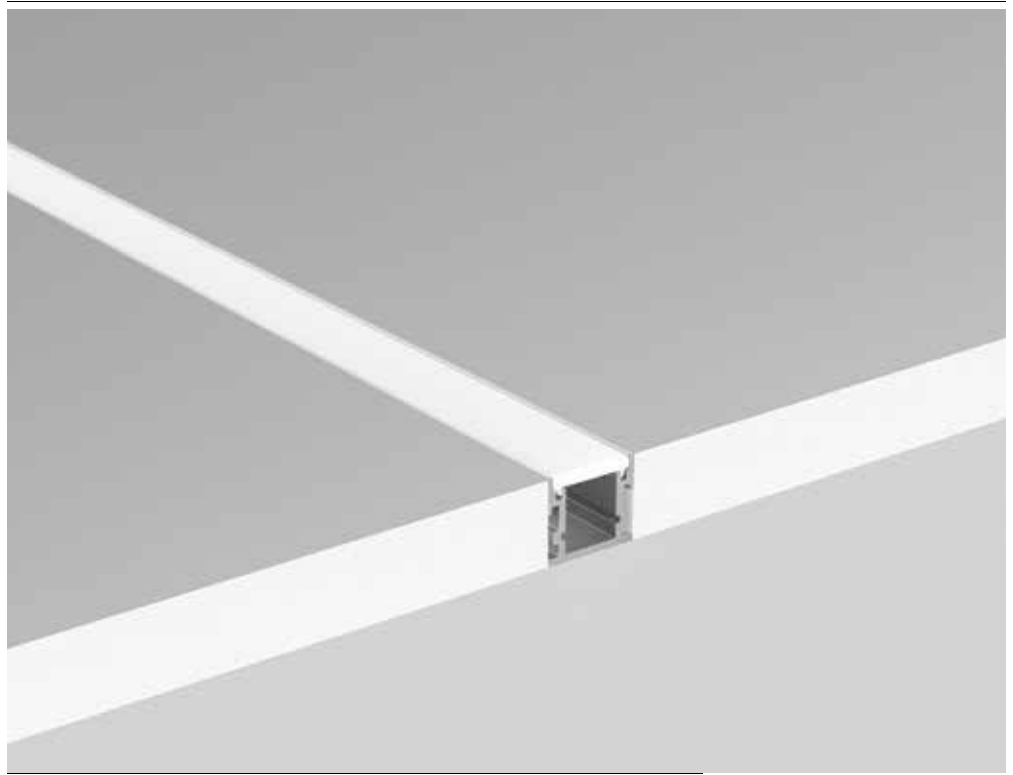

length

colour

**I-PROFILO-DRIVEWAY-2**  
8031414881949

2 m aluminum

pressure loads

max 2000 kg

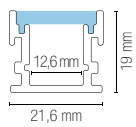

**Accessori / Accessories**

colour



2 pcs kit caps

**I-PROFILO-DRIVEWAY-CAP**  
8031414881956

silver









## Profiles for veil installation

**I profili per installazione a veletta sono progettati per consentire l'integrazione dell'illuminazione a LED nei soffitti e per distribuire uniformemente la luce nei vari ambienti, creando un'illuminazione diffusa. Questi profili permettono inoltre di nascondere le sorgenti luminose e i cablaggi, contribuendo a un aspetto estetico più pulito e moderno.**

Veil installation profiles are designed to allow LED lighting to be integrated into ceilings and to evenly distribute light in different rooms, creating diffuse lighting. These profiles also allow light sources and wiring to be hidden, contributing to a cleaner, more modern aesthetic appearance.



Installazione a veletta /  
Veil installation

# GASH PROFILE

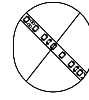

Strip LED non inclusa  
vedi p. 398 a p. 435 /  
LED strip not included  
see p. 398 to p. 435

Profilo a veletta bianco,  
diffusore opale e tappi inclusi /  
White veil profile, opal  
diffuser and caps included.





Applicazione con staffe I-PROFILO-GASH-STL /  
Installation by brackets I-PROFILO-GASH-STL



Applicazione con staffe I-PROFILO-GASH-STZ /  
Installation by brackets I-PROFILO-GASH-STZ



length  colour 

**I-PROFILO-GASH**  
8031414890262

2 m  aluminum

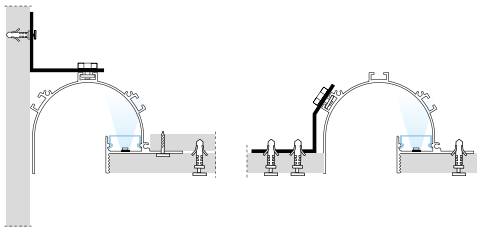
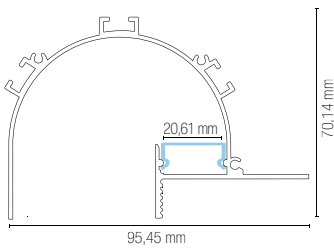

**Accessori / Accessories**



2 pcs kit caps

**I-PROFILO-GASH-CAP**  
8031414890279

colour 

white



2 pcs kit brackets with included screws

**I-PROFILO-GASH-STL**  
8031414889990



aluminum



**I-PROFILO-GASH-STZ**  
8031414890286



aluminum

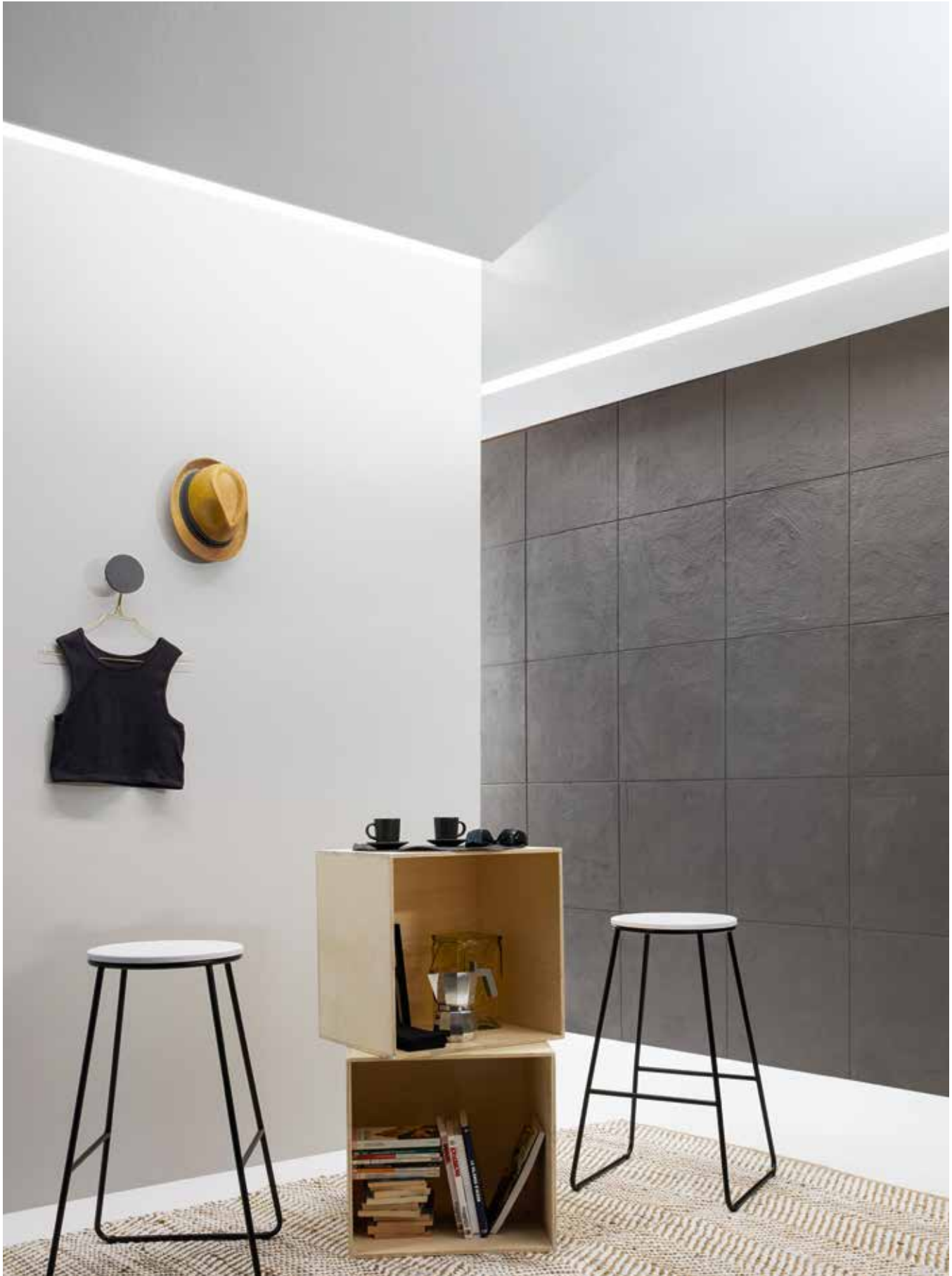

Installazione a veletta /  
Veil installation

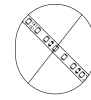

Strip LED non inclusa  
vedi p. 398 a p. 435 /  
LED strip not included  
see p. 398 to p. 435

# TRIM PROFILE

Profilo a veletta, diffusore  
opale e tappi inclusi /  
Veil profile, opal diffuser  
and caps included.

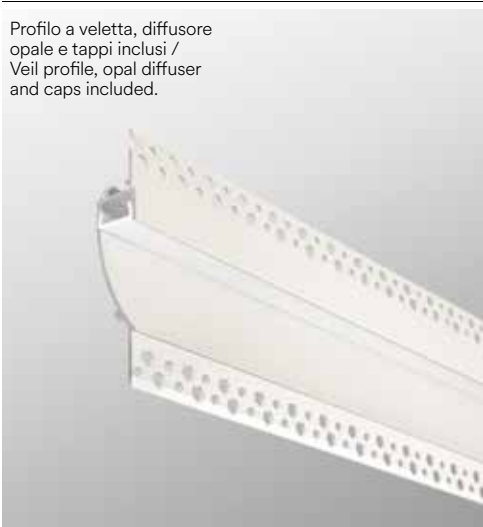

colour

**I-PROFILO-TRIM-2**  
8031414876563

2 m

white



Accessori / Accessories

colour



2 pcs kit caps

**I-PROFILO-TRIM-CAP**  
8031414890583

white

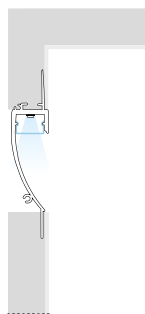
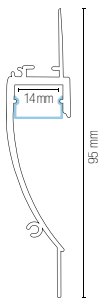

Installazione a veletta /  
Veil installation



Strip LED non inclusa  
vedi p. 398 a p. 435 /  
LED strip not included  
see p. 398 to p. 435

# MOP PROFILE

Profilo a veletta, diffusore  
opale e tappi inclusi /  
Veil profile, opal diffuser  
and caps included.



length | colour

**I-PROFILO-MOP**  
8031414890019

2 m | ● | white



Accessori / Accessories

colour

2 pcs kit caps

**I-PROFILO-MOP-CAP**  
8031414888733

● | white

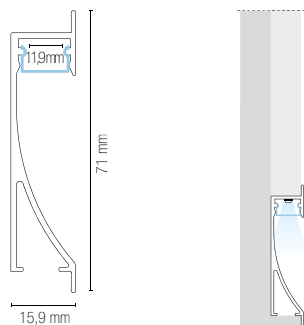

In.tec light PROFILI E STRIP LED / PROFILES AND STRIP LED

Installazione a veletta /  
Veil installation

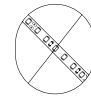

Strip LED non inclusa  
vedi p. 398 a p. 435 /  
LED strip not included  
see p. 398 to p. 435

# VEIL PROFILE



colour

Accessori / Accessories

colour

**I-PROFILO-VEIL-2**  
8031414881901

2 m

●  
white

2 pcs kit caps



**I-PROFILO-VEIL-CAP**  
8031414881918

●  
white

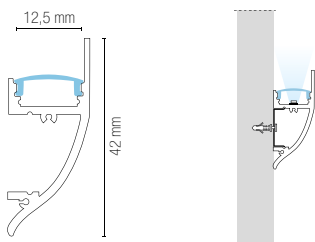



Installazione a veletta /  
Veil installation



Strip LED non inclusa  
vedi p. 398 a p. 435 /  
LED strip not included  
see p. 398 to p. 435

# WING PROFILE



length | colour

**I-PROFILO-WING**  
8031414915804

2 m | white

Accessori / Accessories

colour



2 pcs kit caps

**I-PROFILO-WING-CAP**  
8031414923564

white

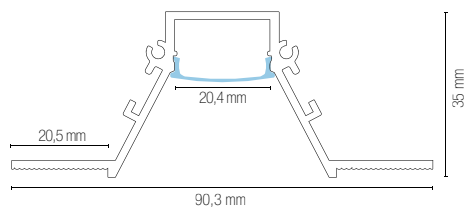

PROFILO STRIP LED / PROFILES AND STRIP LED

In.tec light

Installazione a veletta /  
Veil installation

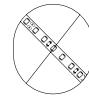

Strip LED non inclusa  
vedi p. 398 a p. 435 /  
LED strip not included  
see p. 398 to p. 435

# DUAL PROFILE

Profilo in alluminio a doppia emissione,  
tappi e staffe inclusi /  
Double-emitting aluminum profile,  
caps and brackets included.



length | colour

## I-PROFILO-DUAL-2-BCO

8031414881864

2 m

white

## I-PROFILO-DUAL-2-NER

8031414881888

2 m

black

### Accessori / Accessories

colour

2 pcs kit caps



#### I-PROFILO-DUAL-BCO-CAP

8031414881871

white



#### I-PROFILO-DUAL-NER-CAP

8031414881895

black

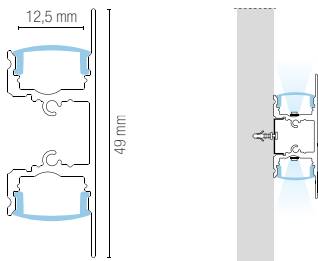



In.tec light PROFILI E STRIP LED / PROFILES AND STRIP LED



## Paintable gypsum profile, recessed and surface installation

**I profili in gesso verniciabile, progettati per un'installazione a incasso e/o superficie, sono disponibili in varianti lineari e decorative. Adatti all'utilizzo su cartongesso e muratura, offrono una solida versatilità e garantiscono un risultato tecnico ed estetico di alto livello per una vasta gamma di progetti illuminotecnici.**

Paintable gypsum profiles, designed for recessed and/or surface installation, are available in linear and decorative variants. Suitable for use on plasterboard and masonry, they offer solid versatility and ensure a high level of technical and aesthetic result for a wide range of lighting projects.



Installazione su cartongesso /  
Installation on plasterboard



Strip LED non inclusa  
vedi p. 398 a p. 435 /  
LED strip not included  
see p. 398 to p. 435

# INVISILINE PROFILE

Lastra in cartongesso con profilo in alluminio integrato /  
Plasterboard slab with integrated aluminum profile

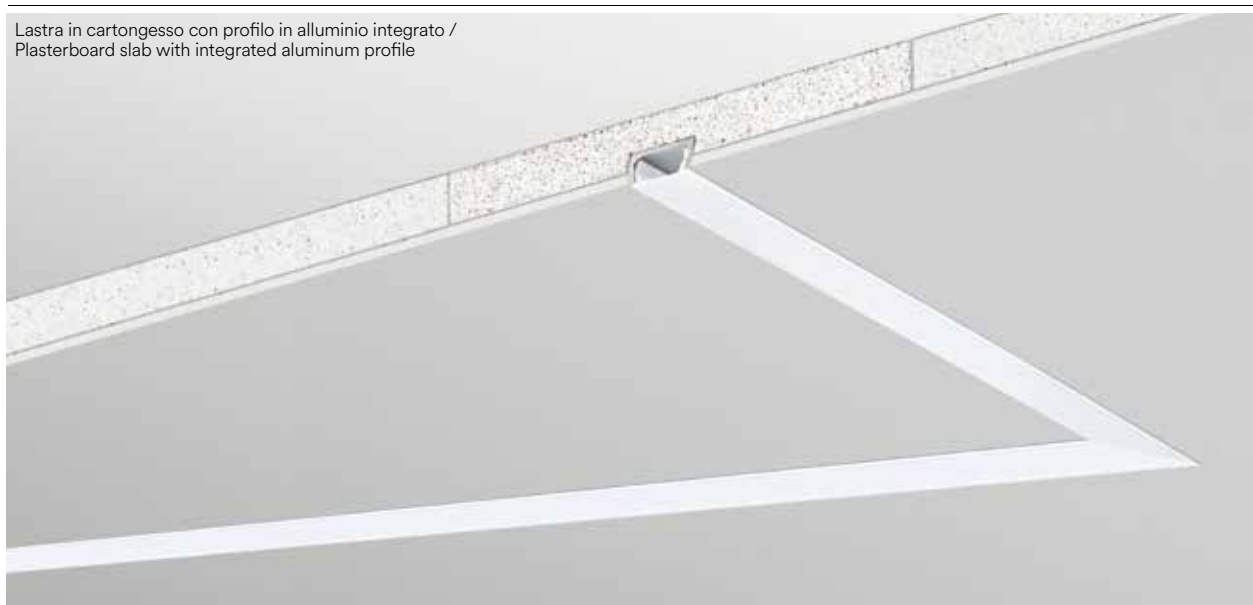

Kit 3 pz / Kit 3 pcs

length



length

**I-INVISILINE-2**  
8031414916221

2 m

**I-INVISILINE-L**  
8031414916238

2 m

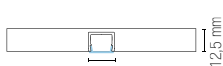
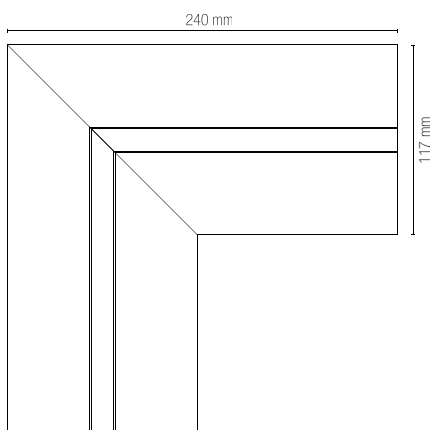
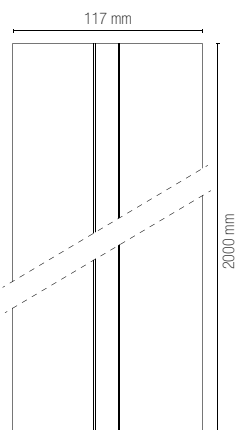



PROFILI E STRIP LED / PROFILES AND STRIP LED

Imtec light

Profili in gesso verniciabile /  
Paintable gypsum profiles

# PROFY BIS PROFILE

# PROFY MONO PROFILE

Profilo a veletta,  
diffusore opale e  
tappi inclusi /  
Veil profile, opal diffuser  
and caps included.



Profilo a veletta,  
diffusore opale e  
tappi inclusi /  
Veil profile, opal diffuser  
and caps included.



**I-PROFY-BIS**  
8031414882359

Profilo in gesso per led  
biemissione, incluso anima  
alluminio e diffusori in PC /  
Gypsum profile for led  
double emission including  
PC cover and aluminum

Diffusori in PC / PC-diffuser  
1000 × 61 × 41 mm

**I-PROFY-BIS-L**  
8031414882380

Angolo L per profilo in gesso per  
led biemissione incluso anima  
in alluminio e diffusori in PC /  
Gypsum corner profile including  
PC cover and aluminum

**I-PROFY-MONO**  
8031414882366

Profilo in gesso per led singola  
emissione, angolo 90° anima  
alluminio e diffusore in PC /  
Gypsum profile for LED single emission  
including PC cover and aluminum

Diffusori in PC / PC-diffuser  
1000 × 61 × 41 mm

**I-PROFY-MONO-L**  
8031414882397

Angolo L per profilo in gesso per  
led singola emissione, angolo 90°,  
anima alluminio e diffusore in PC /  
Gypsum corner profile including  
PC cover and aluminum

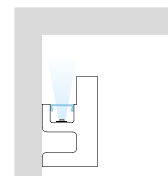
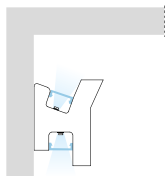
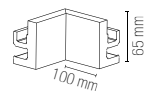
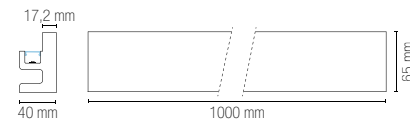
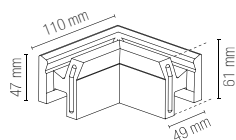
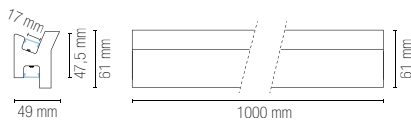



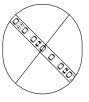

Strip LED non inclusa  
vedi p. 398 a p. 435 /  
LED strip not included  
see p. 398 to p. 435



PROFY BIS e PROFY MONO



In.tec light PROFY E STRIP LED / PROFILES AND STRIP LED

# PROFY GIMEL PROFILE

# PROFY VELA PROFILE

Profilo a veletta,  
diffusore opale e  
tappi inclusi /  
Veil profile, opal diffuser  
and caps included.



Profilo a veletta,  
diffusore opale e  
tappi inclusi /  
Veil profile, opal diffuser  
and caps included.



## I-PROFY-GIMEL 8031414882410

Profilo in gesso per led singola  
emissione, anima alluminio  
e diffusore in PC /  
Gypsum profile for led  
single emission including  
PC cover and aluminum

Diffusori in PC / PC-diffuser  
1000 × 61 × 41 mm

## I-PROFY-GIMEL-L 8031414882427

Angolo L per profilo in gesso  
per led, singola emissione,  
anima alluminio e diffusore in PC /  
Gypsum corner profile including  
PC cover and aluminum

## I-PROFY-VELA 8031414882373

Profilo in gesso per led singola  
emissione, anima alluminio  
e diffusore in PC /  
Gypsum profile for led  
single emission including  
PC cover and aluminum

Diffusori in PC / PC-diffuser  
1000 × 61 × 41 mm

## I-PROFY-VELA-L 8031414882403

Angolo L per profilo in gesso  
per led, singola emissione,  
anima alluminio e diffusore in PC /  
Gypsum corner profile including  
PC cover and aluminum

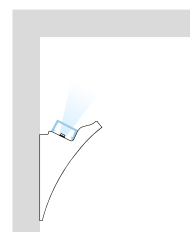
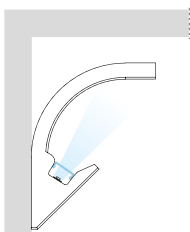
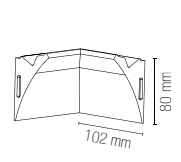
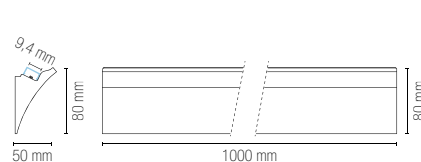
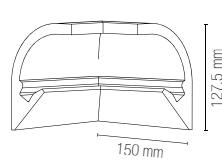
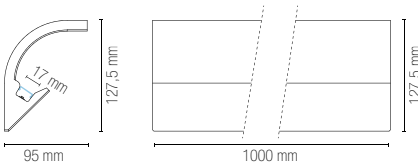



Strip LED non inclusa  
vedi p. 398 a p. 435 /  
LED strip not included  
see p. 398 to p. 435



PROFY GIMEL e PROFY VELA



In.tec light PROFY E STRIP LED / PROFILES AND STRIP LED



Installazione a superficie /  
Surface installation





Strip LED non inclusa  
vedi p. 398 a p. 435 /  
LED strip not included  
see p. 398 to p. 435

# PIANO PROFILE

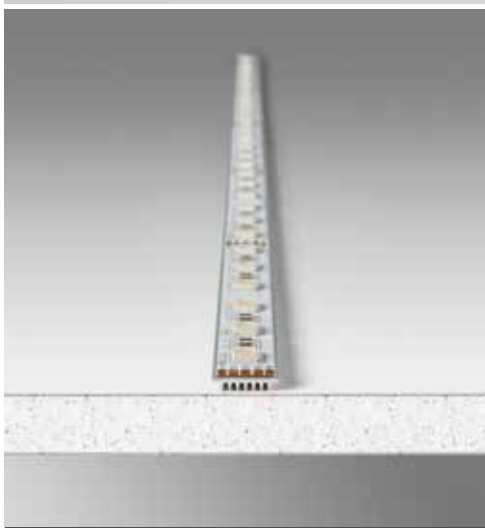
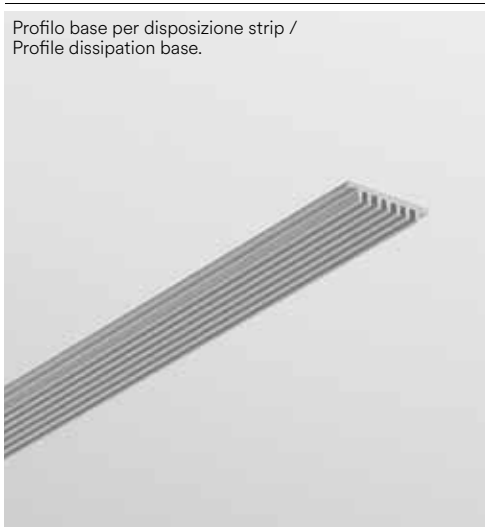
Profilo base per disposizione strip /  
Profile dissipation base.



length  colour 



## I-PROFILO-PIANO-2

8031414878802

2 m  aluminum

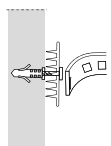
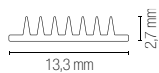

PROFILO STRIP LED / PROFILES AND STRIP LED

In.tec light

**Accessori per barre LED.**  
LED bar accessories.



**STRIP-HANDESENSOR-W**

8031414879335

Scheda rilevatore movimento mano per strip singolo colore input DC12V-24V output DC12V-24V 60/120W 5A max

Hand motion card for single color strip DC12V-24V output DC12V-24V 60/120W 5A max

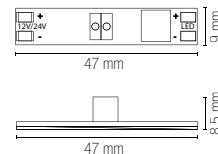

**Funzioni sensore interruttore**  
Raggio di rilevamento 5-15 cm

**Motion sensor switch**  
Detection range 5-15 cm

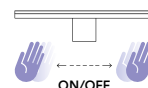

**STRIP-PIRESENSOR**

8031414879373

Scheda sensore movimento pir per strip Input DC12V-24V output DC12V-24V 60/120W 5A max

Pir motion sensor card for strip DC12V-24V output DC12V-24V 60/120W 5A max

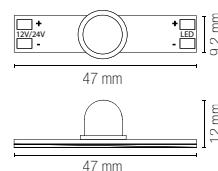

**Funzioni sensore movimento**

**Motion sensor function**

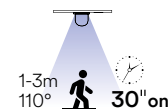

**STRIP-TOUCH-W**

8031414879359

Scheda pulsante touch per strip singolo colore input DC12V-24V output DC12V-24V 60/120W 5A max

Touch button card for single color strip DC12V-24V output DC12V-24V 60/120W 5A max

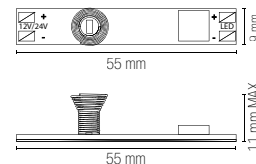

**Funzioni sensore touch**  
Passando sul sensore entro i 0,5 secondi si attiva la funzione ON/OFF

**Touch sensor function**  
When touching the sensor within 0,5 second the switch status changes ON/OFF

Restando sul sensore oltre i 0,5 secondi si attiva la funzione di regolazione di intensità luminosa (massima - minima - massima)

When touching the sensor for over 0,5 second the switch turn to adjustment status (high - low - high)











**I-PROFILO-INC-STAFFE**

8031414890002

Molla per incasso adatto per profili MILANO/ROMA/BERLINO, kit 2 pz

Metal spring for profile MILANO/ROMA/BERLINO, 2pcs kit

	<p><b>STRIP24V-8-CONN</b> 8031414925940 Easy connector lineare luce continua per strip LED da 8mm</p>	<p>Linear easy connector continuous light for strip LED strip 8mm</p>
	<p><b>STRIP24V-8-NEST</b> 8031414925964 Innesto elettrico easy connection luce continua per strip LED da 8mm</p>	<p>Easy connection electrical nest continuous light for LED strip 8mm</p>
	<p><b>STRIP24V-8-FLEX</b> 8031414925988 Easy connector flessibile luce continua per strip LED da 8mm</p>	<p>Flexible easy connector continuous light for strip LED strip 8mm</p>
	<p><b>STRIP24V-10-CONN</b> 8031414925957 Easy connector lineare luce continua per strip LED da 10mm</p>	<p>Linear easy connector continuous light for strip LED strip 10mm</p>
	<p><b>STRIP24V-10-NEST</b> 8031414925971 Innesto elettrico easy connection luce continua per strip LED da 10mm</p>	<p>Easy connection electrical nest continuous light for LED strip 10mm</p>
	<p><b>STRIP24V-10-FLEX</b> 8031414925995 Easy connector flessibile luce continua per strip LED da 10mm</p>	<p>Flexible easy connector continuous light for strip LED strip 10mm</p>
	<p><b>STRIP24V-8-L-CONN</b> 8031414926008 Easy connector angolare luce continua per strip LED da 8mm</p>	<p>Easy connector angular continuous light for LED strip 8mm</p>
	<p><b>STRIP24V-10-L-CONN</b> 8031414926015 Easy connector angolare luce continua per strip LED da 10mm</p>	<p>Easy connector angular continuous light for LED strip 10mm</p>

# STRIP24V COB DIGITAL

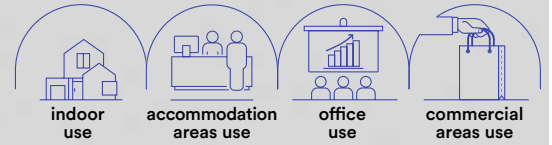

EASY  
DOMOTICA

**Rotolo 5 metri strip led digital.**  
**Protocollo WS2811.**

Roll 5 meters digital strip-led. Protocollo WS2811.



Driver p. 843-852  
Controller p. 858-859



**Materiale**

kapton  
senza silicone

**Temperatura colore**  
3000K / 4000K / 6500K



**Driver**  
DC24V

tensione costante  
non incluso

**Durata e on/off**

50.000h  
>25.000 on/off

**Material**

kapton  
without silicone

**Colour temperature**  
3000K / 4000K / 6500K



**Driver**  
DC24V

constant voltage  
not included

**Life time and on/off**

50.000h  
>25.000 on/off

**STRIP24V-COB-SPI-C**

8031414925513

lumen/m

total lumen

colour  
temp.



1020 lm

5100 lm

**STRIP24V-COB-SPI-M**

8031414925520

lumen/m

total lumen



1125 lm

5625 lm

**STRIP24V-COB-SPI-F**

8031414925537

lumen/m

total lumen



1095 lm

5475 lm

light source

COB

watt/m

15W

**Fotometria del prodotto / Photometric curve**

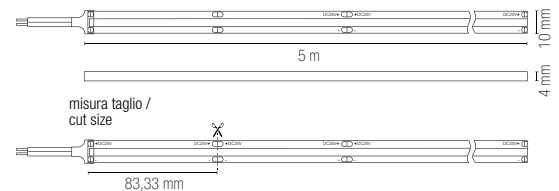
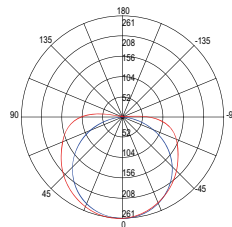

**Recommended Profiles p. 336 to p. 397**

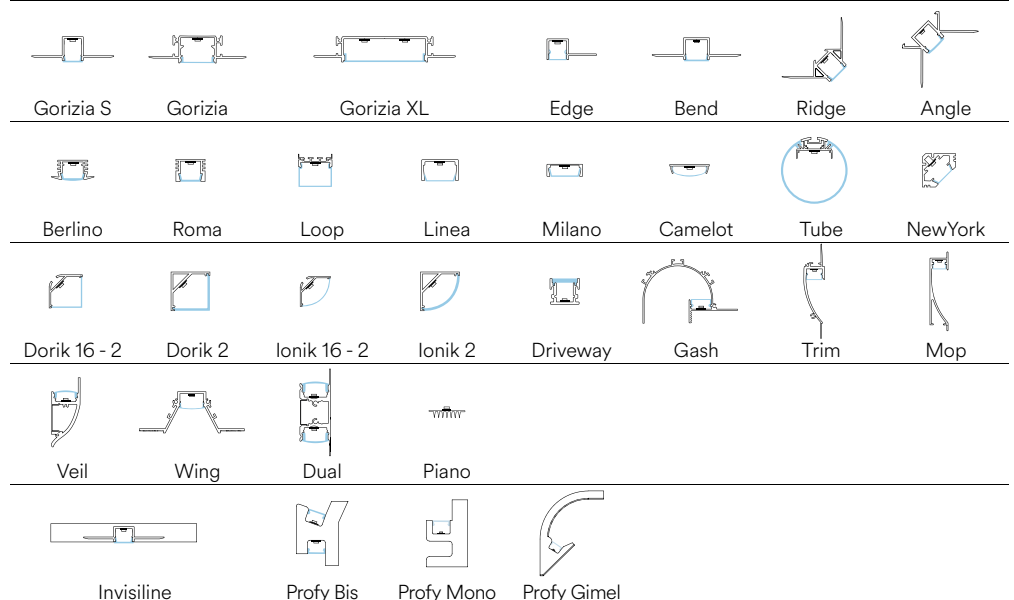



# STRIP24V COB RGB DIGITAL

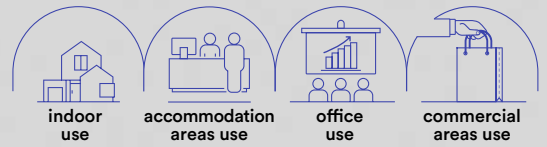

EASY DOMOTICA

**Rotolo 5 metri strip led digital.  
Protocollo WS2811.**

Roll 5 meters digital strip-led. Protocollo WS2811.



Driver p. 843-852  
Controller p. 858-859



colour temp.

**STRIP24V-COB-SPI-RGB**  
8031414925544



RGB

light source	COB 5050
watt/m	15W

**Materiale**

kapton  
senza silicone

**Temperatura colore**

RGB



**Driver**

DC24V  
tensione costante  
non incluso

**Durata e on/off**

50.000h  
>25.000 on/off

**Material**

kapton  
without silicone

**Colour temperature**

RGB



**Driver**

DC24V  
constant voltage  
not included

**Life time and on/off**

50.000h  
>25.000 on/off

**Fotometria del prodotto / Photometric curve**

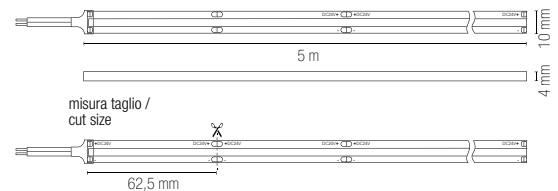
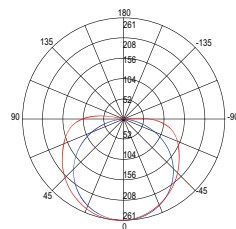

**Recommended Profiles p. 336 to p. 397**

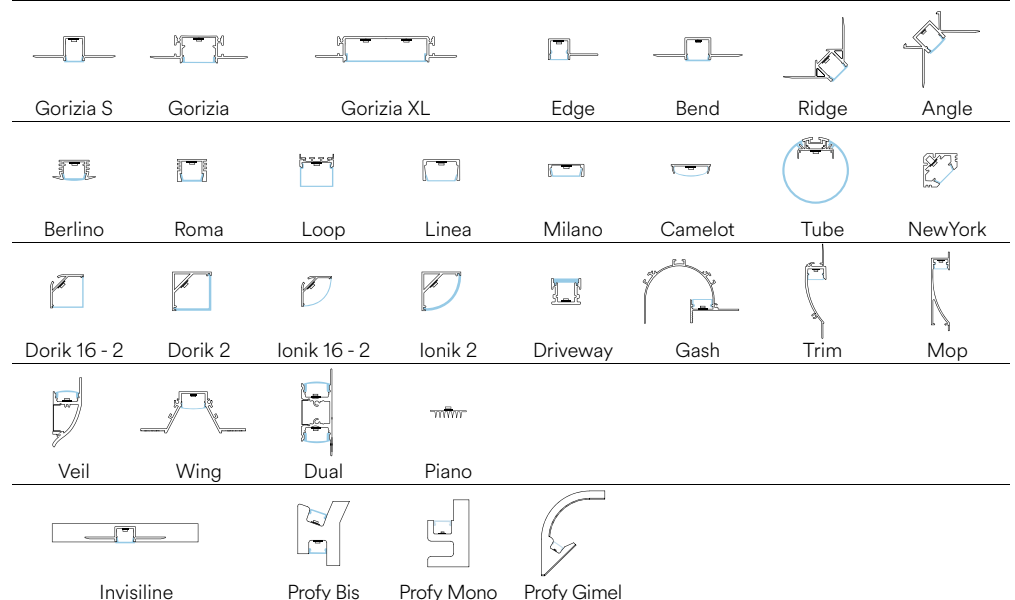

In.tec light PROFILI E STRIP LED / PROFILES AND STRIP LED

# STRIP24V 2835 IP67 120



EASY  
DOMOTICA

**Rotolo 5 metri strip led.**  
Roll 5 meters strip-led.



Driver p. 843-852  
Controller p. 854-857



**Materiale**

kapton con rivestimento in silicone

**Temperatura colore**

3000K / 4000K / 6500K



**Driver**

DC24V

tensione costante non incluso

**Durata e on/off**

50.000h

>25.000 on/off

**Material**

kapton with silicone cover

**Colour temperature**

3000K / 4000K / 6500K



**Driver**

DC24V

constant voltage not included

**Life time and on/off**

50.000h

>25.000 on/off

**STRIP24V-2835IP67-120C**

8031414925551

lumen/m

total lumen

colour temp.



1800 lm

9000 lm

**STRIP24V-2835IP67-120M**

8031414925568

lumen/m

total lumen



1980 lm

9900 lm

**STRIP24V-2835IP67-120F**

8031414925575

lumen/m

total lumen



1890 lm

9450 lm

light source

SMD 2835

watt/m

18W

led/m

120

**Fotometria del prodotto / Photometric curve**

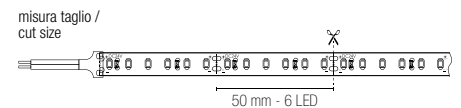
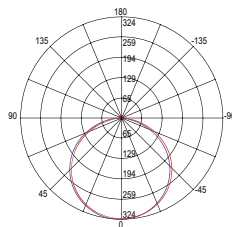

**Recommended Profiles p. 336 to p. 397**

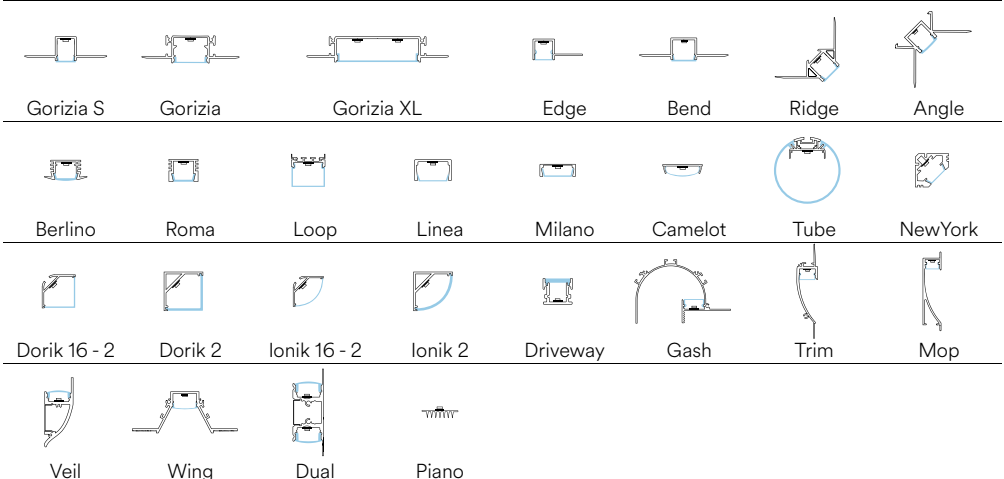

# STRIP24V 2835 5W

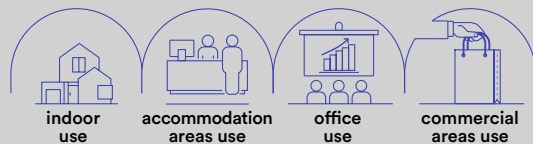

EASY DOMOTICA

**Rotolo 5 metri strip led.**  
Roll 5 meters strip-led.



Driver p. 843-852  
Controller p. 854-857



**Materiale**

kapton  
senza silicone

**Temperatura colore**

3000K / 4000K / 6500K



**Driver**

DC24V

tensione costante  
non incluso

**Durata e on/off**

50.000h  
>25.000 on/off

**Material**

kapton  
without silicone

**Colour temperature**

3000K / 4000K / 6500K



**Driver**

DC24V

constant voltage  
not included

**Life time and on/off**

50.000h  
>25.000 on/off

colour temp.

**STRIP24V-2835-5C**

8031414925582

lumen/m

total lumen



475 lm

2375 lm

**STRIP24V-2835-5M**

8031414925599

lumen/m

total lumen



500 lm

2500 lm

**STRIP24V-2835-5F**

8031414925605

lumen/m

total lumen



490 lm

2450 lm

light source

SMD 2835

watt/m

5W

led/m

60

**Fotometria del prodotto / Photometric curve**

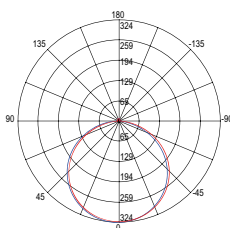

**Recommended Profiles p. 336 to p. 397**

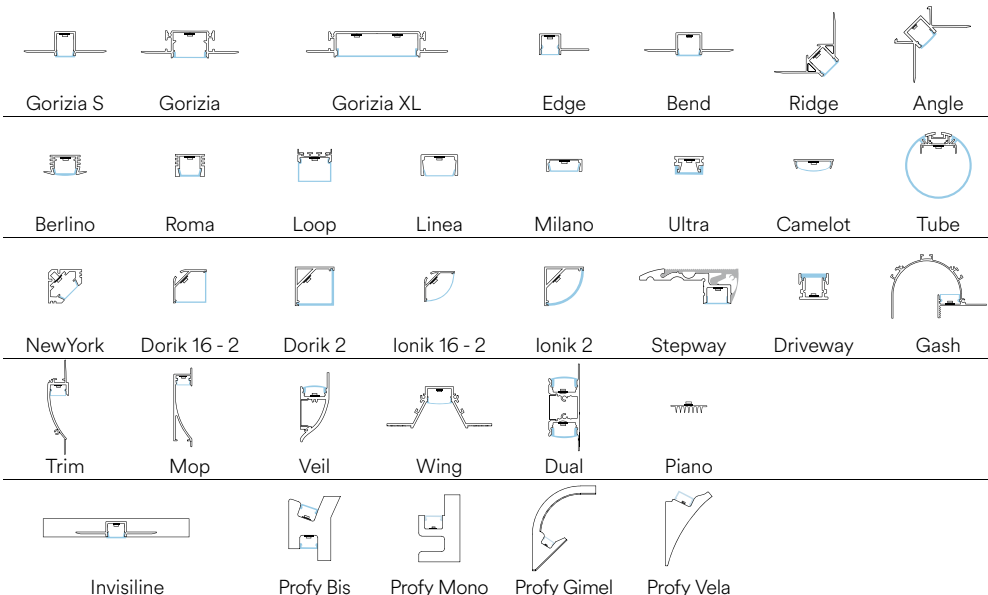

PROFILI E STRIP LED / PROFILES AND STRIP LED

In.tec light

# STRIP24V R20 2835 120

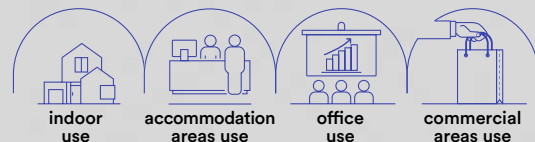

EASY  
DOMOTICA

**Rotolo 20 metri strip led.**  
Roll 20 meters strip-led.



Driver p. 843-852  
Controller p. 854-857



**Materiale**  
kapton  
senza silicone

**Temperatura colore**  
3000K / 4000K



**Driver**  
DC24V  
tensione costante  
non incluso

**Durata e on/off**  
50.000h  
>25.000 on/off

**Material**  
kapton  
without silicone

**Colour temperature**  
3000K / 4000K



**Driver**  
DC24V  
constant voltage  
not included

**Life time and on/off**  
50.000h  
>25.000 on/off

**STRIP24V-R20-2835-120C**

8031414925612  
lumen/m

colour  
temp.

1800 lm

**STRIP24V-R20-2835-120M**

8031414925629  
lumen/m

1980 lm

light source	SMD 2835
watt/m	18W
led/m	120

**Fotometria del prodotto / Photometric curve**

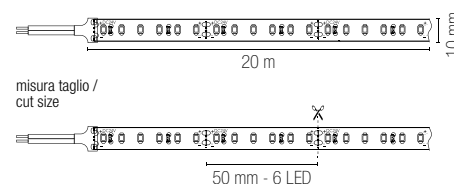
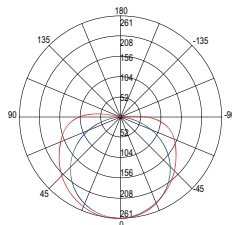

**Recommended Profiles p. 336 to p. 397**

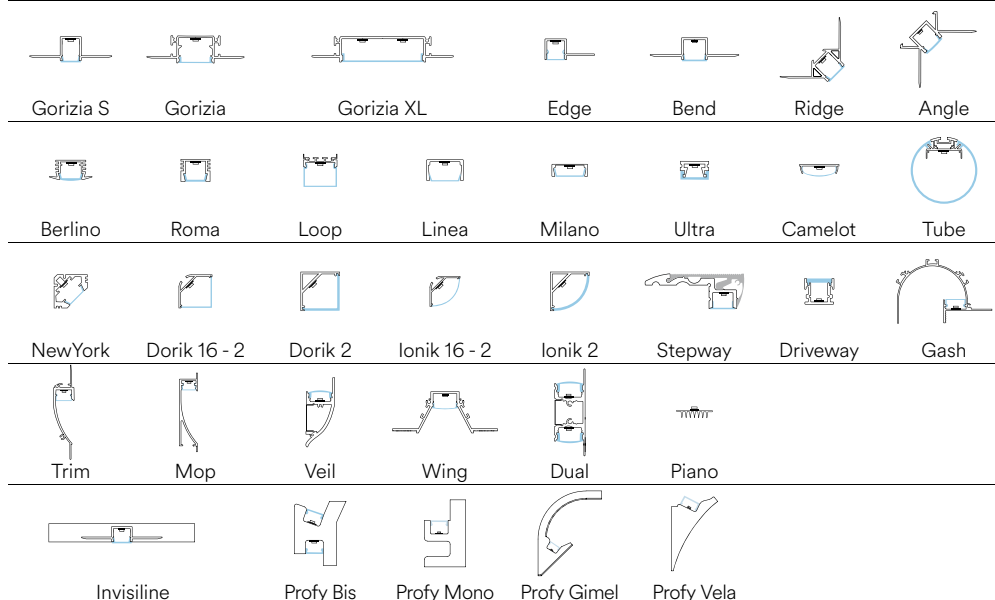

# STRIP24V R20 COB 480

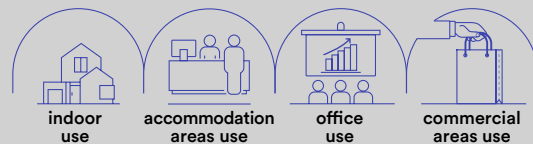

EASY DOMOTICA

**Rotolo 20 metri strip led.**  
Roll 20 meters strip-led.



Driver p. 843-852  
Controller p. 854-857



**Materiale**  
kapton  
senza silicone

**Temperatura colore**  
3000K / 4000K



**Driver**  
DC24V  
tensione costante  
non incluso

**Durata e on/off**  
50.000h  
>25.000 on/off

**Material**  
kapton  
without silicone

**Colour temperature**  
3000K / 4000K



**Driver**  
DC24V  
constant voltage  
not included

**Life time and on/off**  
50.000h  
>25.000 on/off

	colour temp.
<b>STRIP24V-R20-COB-480C</b> 8031414925636 lumen/m	 1650 lm
<b>STRIP24V-R20-COB-480M</b> 8031414925643 lumen/m	 1725 lm
light source	COB 480
watt/m	15W
led/m	480

## Fotometria del prodotto / Photometric curve

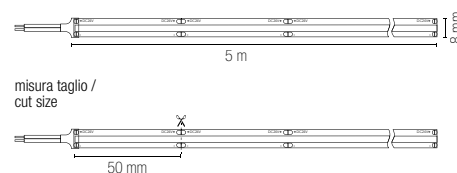
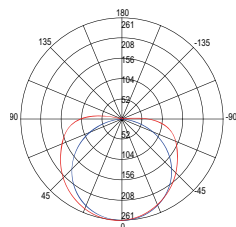

## Recommended Profiles p. 336 to p. 397

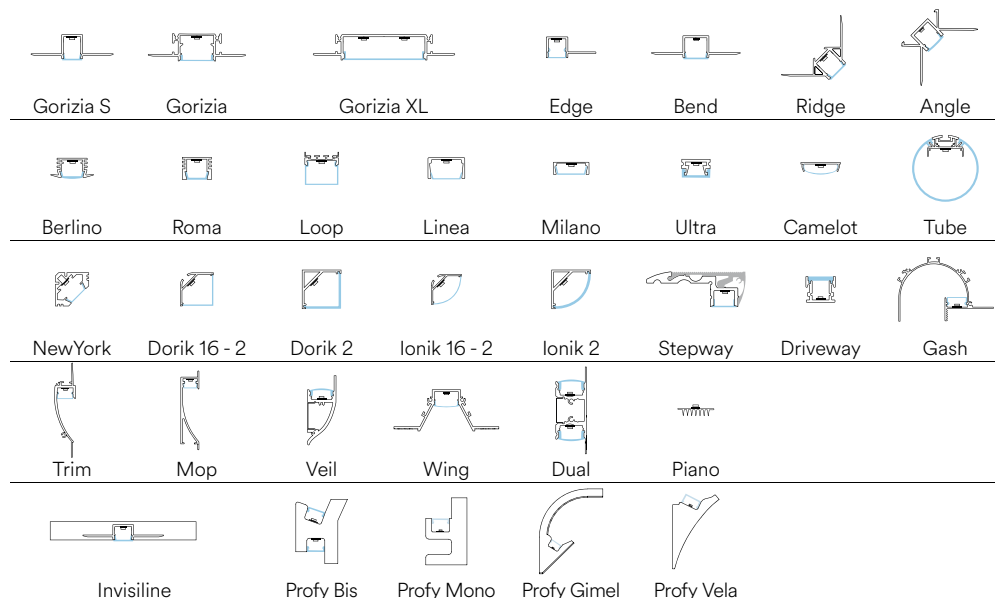

PROFILI E STRIP LED / PROFILES AND STRIP LED

In.tec light

# STRIP24V 2835 HL 128

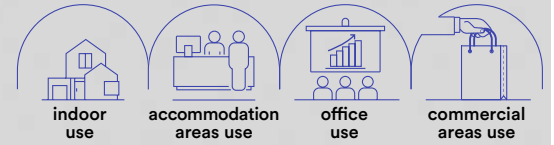

EASY  
DOMOTICA

**Rotolo 5 metri strip led.**  
Roll 5 meters strip-led.



Driver p. 843-852  
Controller p. 854-857



**Materiale**

kapton  
senza silicone

**Temperatura colore**  
3000K / 4000K / 6500K



**Driver**  
DC24V

tensione costante  
non incluso

**Durata e on/off**

50.000h  
>25.000 on/off

**Material**

kapton  
without silicone

**Colour temperature**  
3000K / 4000K / 6500K



**Driver**  
DC24V

constant voltage  
not included

**Life time and on/off**

50.000h  
>25.000 on/off

**STRIP24V-2835-HL-128C**

8031414925650

lumen/m

total lumen

colour  
temp.



2000 lm

10000 lm

**STRIP24V-2835-HL-128M**

8031414925667

lumen/m

total lumen



2100 lm

10500 lm

**STRIP24V-2835-HL-128F**

8031414925674

lumen/m

total lumen



2050 lm

10250 lm

light source

SMD 2835

watt/m

10W

led/m

128

**Fotometria del prodotto / Photometric curve**

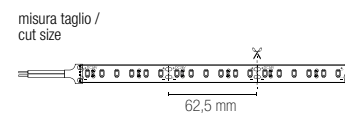
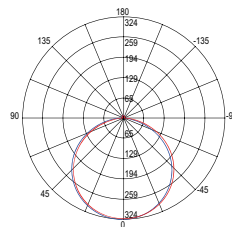

**Recommended Profiles p. 336 to p. 397**

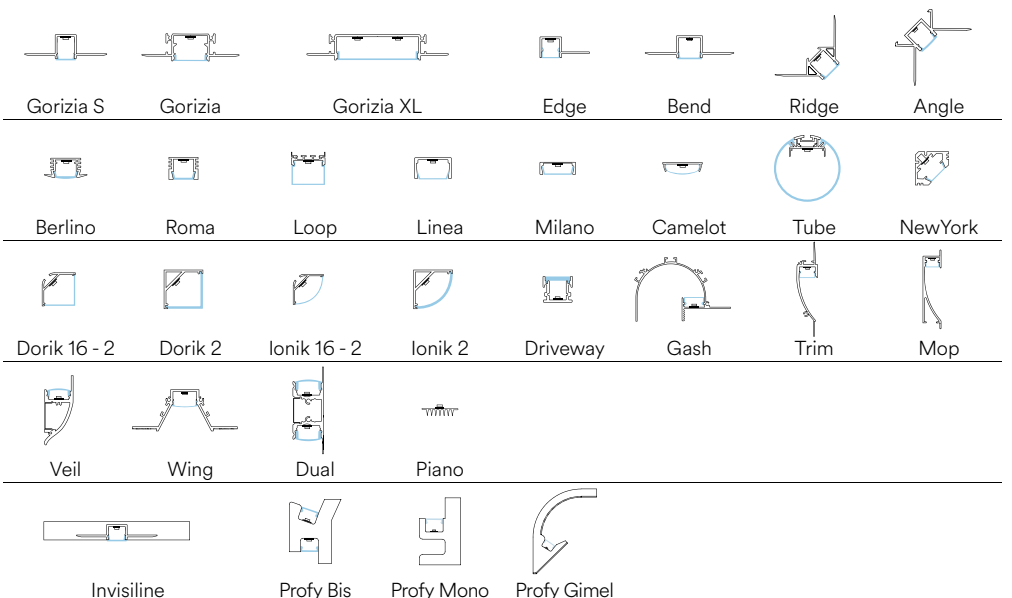

# STRIP24V FOOD



EASY  
DOMOTICA

**Rotolo 5 metri strip led.**  
Roll 5 meters strip-led.



Driver p. 843-852  
Controller p. 854-857



**Materiale**  
kapton con  
rivestimento  
in silicone

**Temperatura colore**  
2000K / 2600K / 5400K



**Driver**  
DC24V

tensione costante  
non incluso

**Durata e on/off**

50.000h  
>25.000 on/off

**Material**  
kapton  
with silicone  
cover

**Colour temperature**  
2000K / 2600K / 5400K



**Driver**  
DC24V

constant voltage  
not included

**Life time and on/off**

50.000h  
>25.000 on/off

Illuminazione per generi alimentari /  
Food lighting



**STRIP24V-2835-120MT**

8031414925681

lumen/m

total lumen

colour  
temp.



1800 lm

9000 lm

**STRIP24V-2835-120BR**

8031414925704

lumen/m

total lumen



1980 lm

9450 lm

**STRIP24V-2835-120FS**

8031414925698

lumen/m

total lumen



1980 lm

9900 lm

light source

SMD 2835

watt/m

18W

led/m

120

**Fotometria del prodotto / Photometric curve**

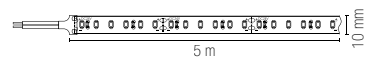
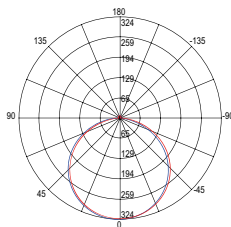

misura taglio /  
cut size



**Recommended Profiles p. 336 to p. 397**

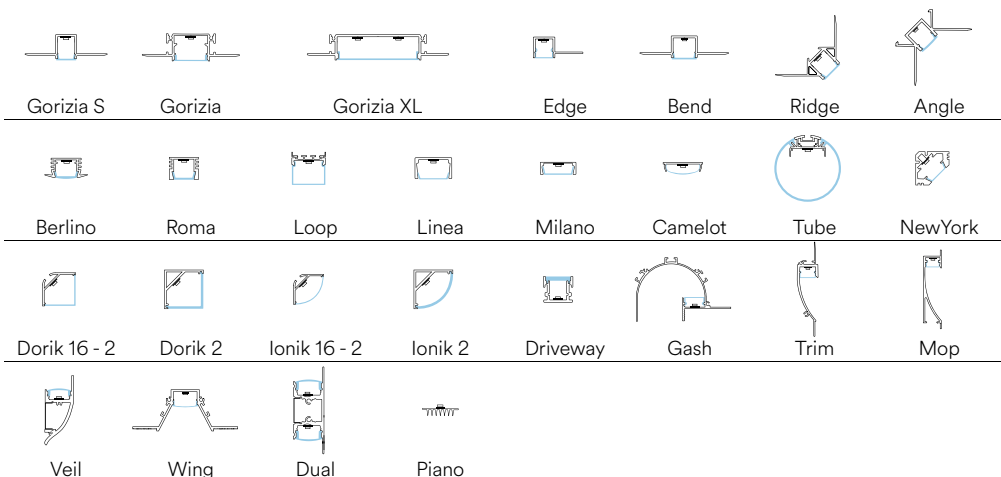

PROFILI E STRIP LED / PROFILES AND STRIP LED

In.tec light

# STRIP24V COB

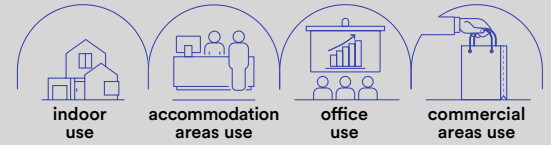

EASY DOMOTICA

**Rotolo 5 metri strip led.**  
Roll 5 meters strip-led.



Driver p. 843-852  
Controller p. 854-857



**Materiale**

kapton  
senza silicone

**Temperatura colore**  
3000K / 4000K / 6000K



**Driver**  
DC24V

tensione costante  
non incluso

**Durata e on/off**

50.000h  
>25.000 on/off

**Material**

kapton  
without silicone

**Colour temperature**  
3000K / 4000K / 6000K



**Driver**  
DC24V

constant voltage  
not included

**Life time and on/off**

50.000h  
>25.000 on/off

**STRIP24V-COB-480C**

8031414881697

lumen/m

total lumen

colour  
temp.



1538 lm

7690 lm

**STRIP24V-COB-480M**

8031414883516

lumen/m

total lumen



1700 lm

8500 lm

**STRIP24V-COB-480F**

8031414881703

lumen/m

total lumen



1698 lm

8490 lm

light source

LED COB 480

watt/m

16W

**Fotometria del prodotto / Photometric curve**

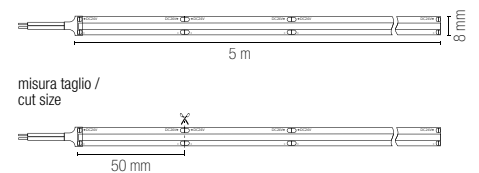
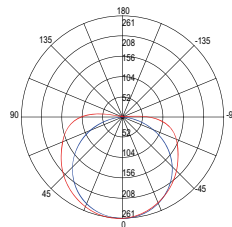

**Recommended Profiles p. 336 to p. 397**

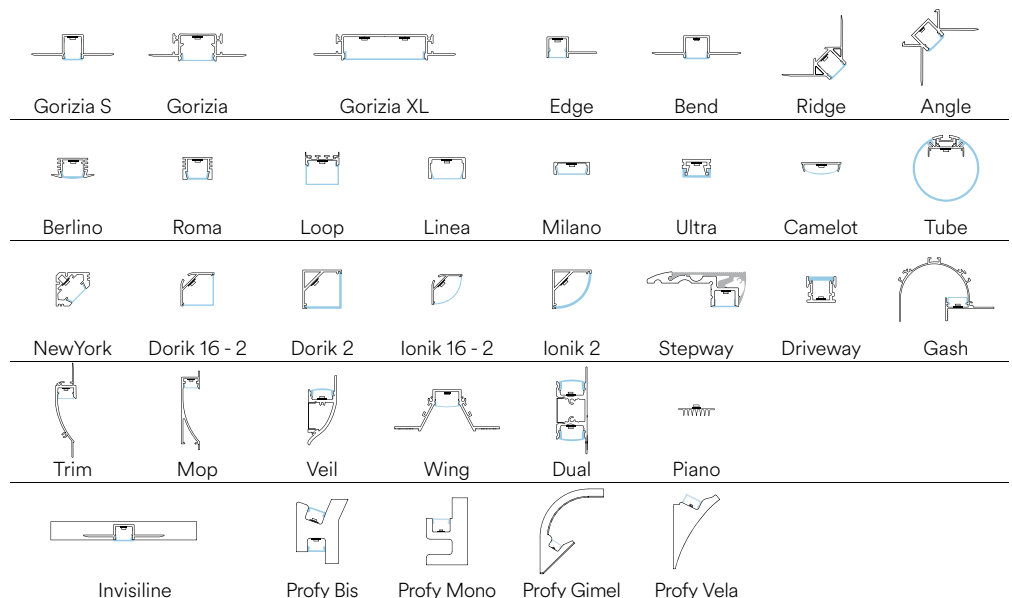



# STRIP24V COB IP67



EASY DOMOTICA

**Rotolo 5 metri strip led.**  
Roll 5 meters strip-led.



Driver p. 843-852  
Controller p. 854-857



colour temp.

**STRIP24V-COB-IP67-480C**

8031414881710

lumen/m

total lumen



1538 lm

7690 lm

**STRIP24V-COB-IP67-480M**

8031414881727

lumen/m

total lumen



1700 lm

8500 lm

**STRIP24V-COB-IP67-480F**

8031414881734

lumen/m

total lumen



1698 lm

8490 lm

light source

LED COB 480

watt/m

16W

**Materiale**

kapton  
con silicone

**Temperatura colore**

3000K / 4000K / 6000K



**Driver**

DC24V

tensione costante  
non incluso

**Durata e on/off**

50.000h

>25.000 on/off

**Material**

kapton  
with silicone

**Colour temperature**

3000K / 4000K / 6000K



**Driver**

DC24V

constant voltage  
not included

**Life time and on/off**

50.000h

>25.000 on/off

**Fotometria del prodotto / Photometric curve**

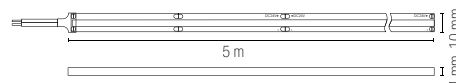
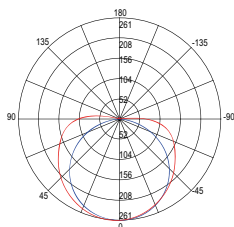

misura taglio /  
cut size



**Recommended Profiles p. 336 to p. 397**

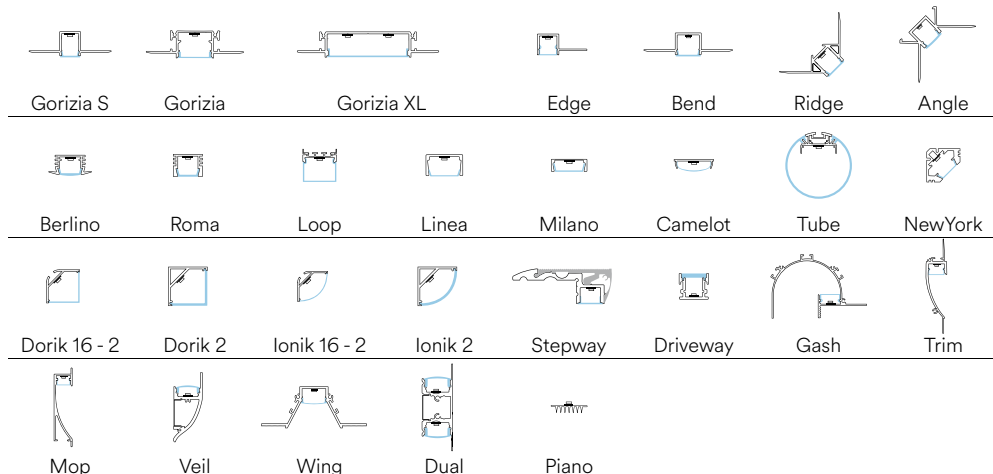

PROFILI E STRIP LED / PROFILES AND STRIP LED

In.tec light

# STRIP24V 2835 3D

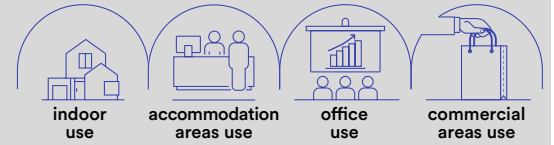

EASY  
DOMOTICA

**Rotolo 5 metri strip led.**  
Roll 5 meters strip-led.



Driver p. 843-852  
Controller p. 854-857



**Materiale**

kapton  
senza silicone

**Temperatura colore**  
3000K / 4000K / 6000K



**Driver**  
DC24V

tensione costante  
non incluso

**Durata e on/off**

50.000h  
>25.000 on/off

**Material**

kapton  
without silicone

**Colour temperature**  
3000K / 4000K / 6000K



**Driver**  
DC24V

constant voltage  
not included

**Life time and on/off**

50.000h  
>25.000 on/off

**STRIP24V-2835-3D-60C**

8031414878765

lumen/m

total lumen

colour  
temp.



1542 lm

7710 lm

**STRIP24V-2835-3D-60M**

8031414878727

lumen/m

total lumen



1480 lm

7400 lm

**STRIP24V-2835-3D-60F**

8031414878628

lumen/m

total lumen



1542 lm

7710 lm

light source

SMD 2835

watt/m

14W

led/m

60

**Fotometria del prodotto / Photometric curve**

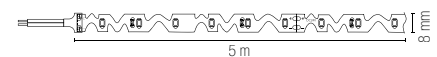
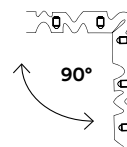
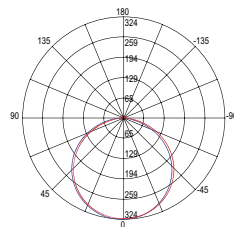

misura taglio /  
cut size

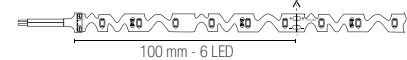

**Recommended Profiles p. 336 to p. 397**

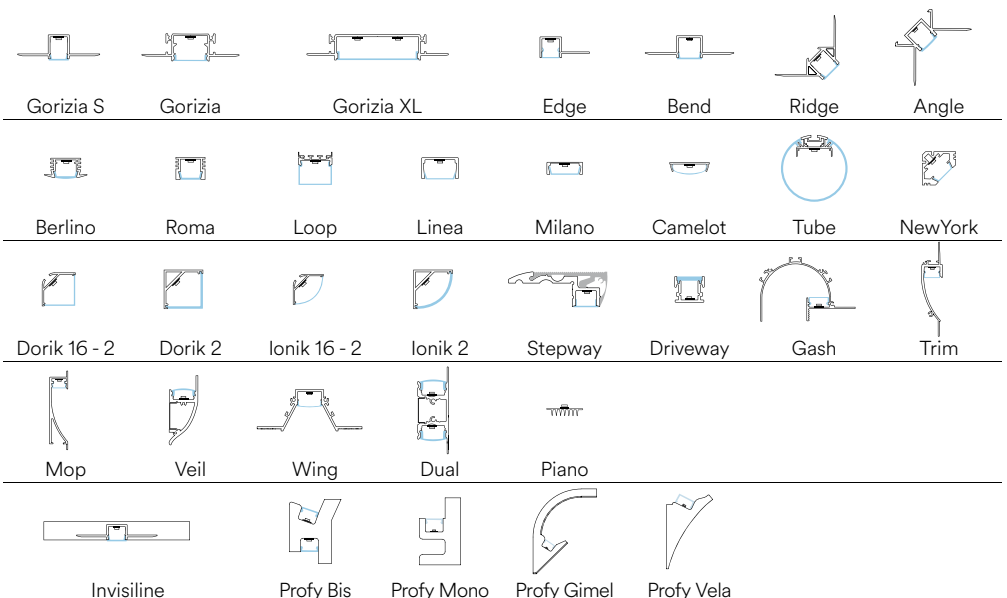

# STRIP24V SLIM 120

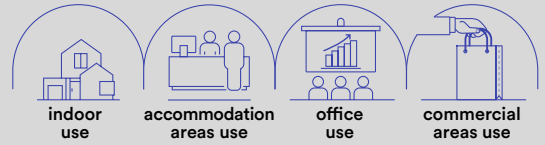

EASY  
DOMOTICA

**Rotolo 5 metri strip led ultrasottile.**  
Roll 5 meters ultra-thin strip-led.



Driver p. 843-852  
Controller p. 854-857



colour  
temp.

### STRIP24V-SLIM-120C

8031414881741

lumen/m

total lumen



1896 lm

9480 lm

### STRIP24V-SLIM-120M

8031414881758

lumen/m

total lumen



1838 lm

9190 lm

### STRIP24V-SLIM-120F

8031414881765

lumen/m

total lumen



1766 lm

8830 lm

light source

SMD 2835

watt/m

16W

led/m

120

#### Materiale

kapton  
senza silicone

#### Temperatura colore

3000K / 4000K / 6000K



#### Driver

DC24V

tensione costante  
non incluso

#### Durata e on/off

25.000h

>15.000 on/off

#### Material

kapton  
without silicone

#### Colour temperature

3000K / 4000K / 6000K



#### Driver

DC24V

constant voltage  
not included

#### Life time and on/off

25.000h

>15.000 on/off

#### Fotometria del prodotto / Photometric curve

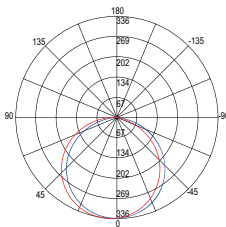

misura taglio /  
cut size



#### Recommended Profiles p. 336 to p. 397

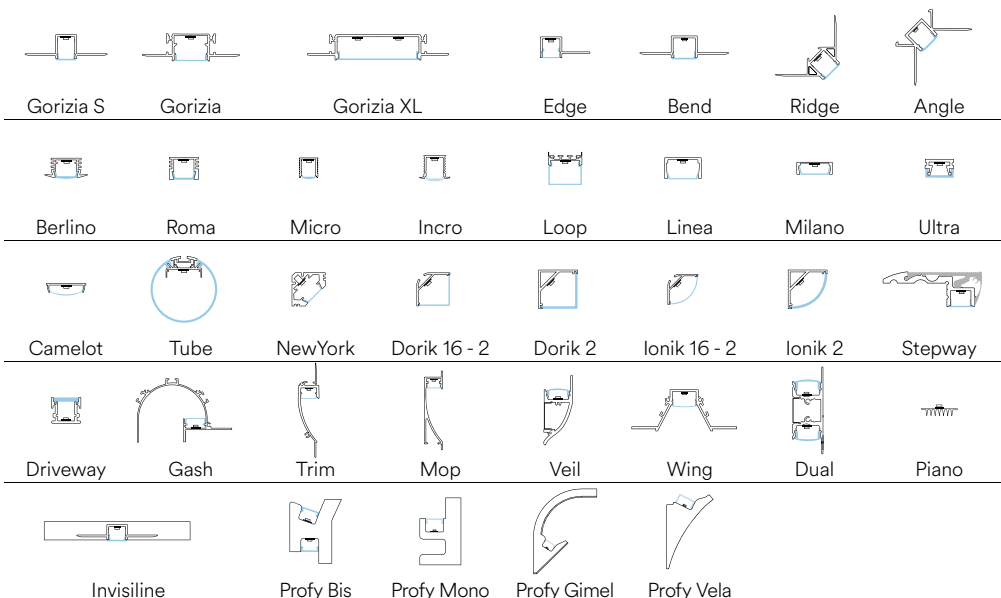

PROFILI E STRIP LED / PROFILES AND STRIP LED

In.tec light

# STRIP24V 2835 60

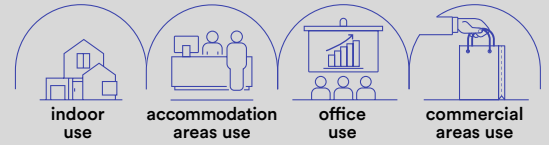

EASY  
DOMOTICA

**Rotolo 5 metri strip led.**  
Roll 5 meters strip-led.



Driver p. 843-852  
Controller p. 854-857



**Materiale**

kapton  
senza silicone

**Temperatura colore**  
3000K / 4000K / 6000K



**Driver**  
DC24V

tensione costante  
non incluso

**Durata e on/off**

50.000h  
>25.000 on/off

**Material**

kapton  
without silicone

**Colour temperature**  
3000K / 4000K / 6000K



**Driver**  
DC24V

constant voltage  
not included

**Life time and on/off**

50.000h  
>25.000 on/off

**STRIP24V-2835-60C**

8031414871278

lumen/m

total lumen

colour  
temp.



1542 lm

7710 lm

**STRIP24V-2835-60M**

8031414871285

lumen/m

total lumen



1480 lm

7400 lm

**STRIP24V-2835-60F**

8031414871292

lumen/m

total lumen



1542 lm

7710 lm

light source

SMD 2835

watt/m

14W

led/m

60

**Fotometria del prodotto / Photometric curve**

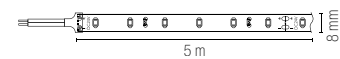
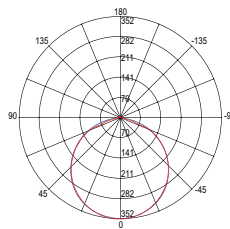

misura taglio /  
cut size

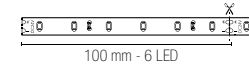

**Recommended Profiles p. 336 to p. 397**

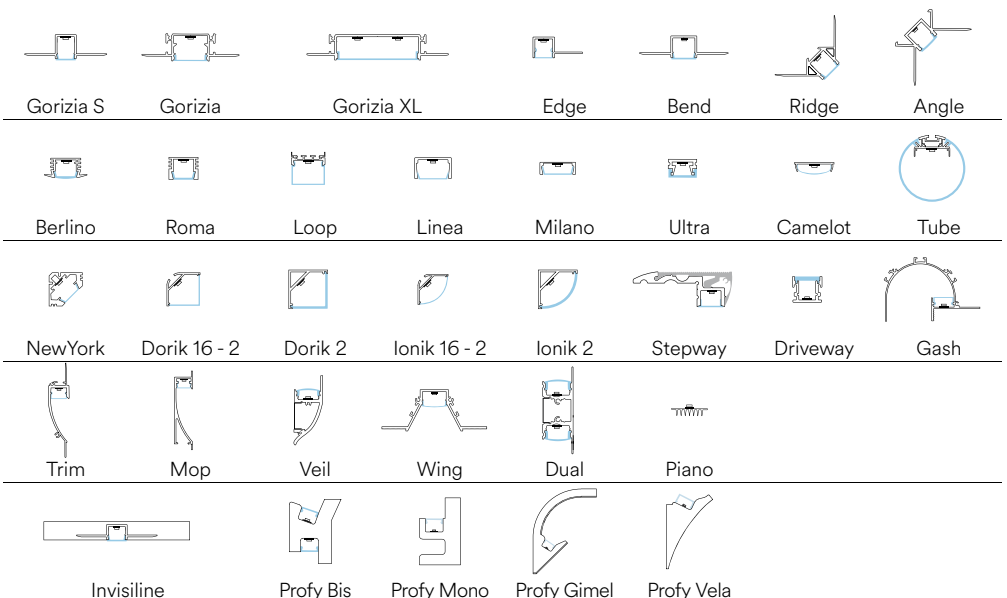

# STRIP24V 2835 60 IP67



EASY DOMOTICA

**Rotolo 5 metri strip led.**  
Roll 5 meters strip-led.



Driver p. 843-852  
Controller p. 854-857



**Materiale**

kapton con rivestimento in silicone

**Temperatura colore**

3000K / 4000K / 6000K



**Driver**

DC24V

tensione costante non incluso

**Durata e on/off**

50.000h

>25.000 on/off

**Material**

kapton with silicone cover

**Colour temperature**

3000K / 4000K / 6000K



**Driver**

DC24V

constant voltage not included

**Life time and on/off**

50.000h

>25.000 on/off

colour temp.

**STRIP24V-2835IP67-60C**

8031414871308

lumen/m

total lumen



1542 lm

7710 lm

**STRIP24V-2835IP67-60M**

8031414871315

lumen/m

total lumen



1480 lm

7400 lm

**STRIP24V-2835IP67-60F**

8031414871322

lumen/m

total lumen



1542 lm

7710 lm

light source

SMD 2835

watt/m

14W

led/m

60

**Fotometria del prodotto / Photometric curve**

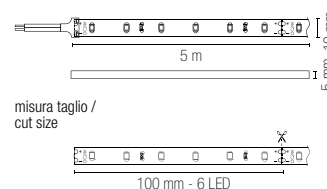
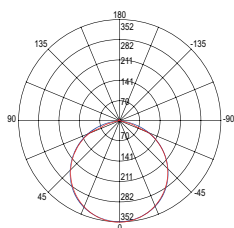

**Recommended Profiles p. 336 to p. 397**

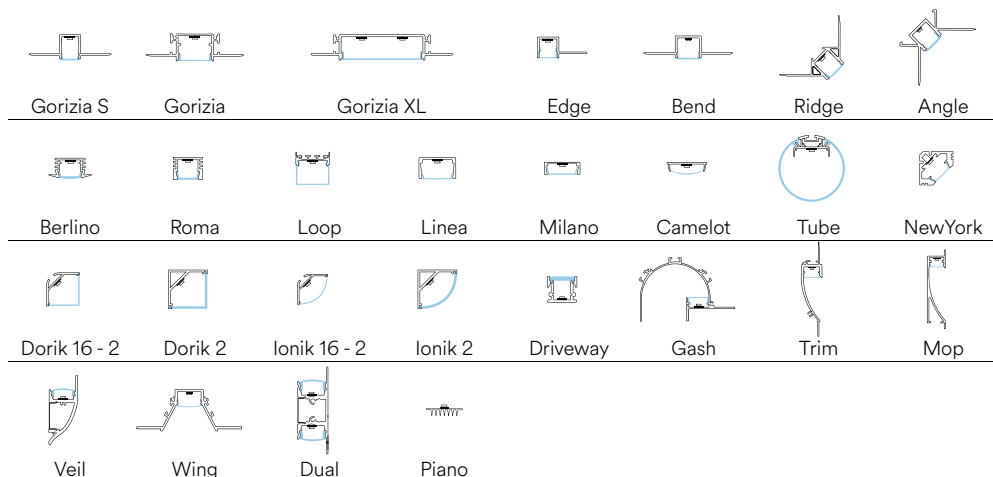

PROFILI E STRIP LED / PROFILES AND STRIP LED

In.tec light

# STRIP24V 2835 120

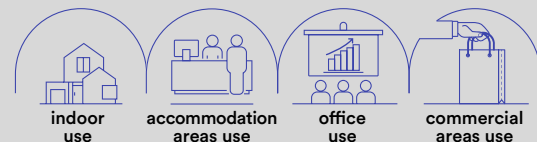

Per una corretta dissipazione applicare la strip su un supporto d'alluminio / For correct dissipation fix the strip on aluminium support

EASY DOMOTICA

**Rotolo 5 metri strip led.**  
Roll 5 meters strip-led.



Driver p. 843-852  
Controller p. 854-857



**Materiale**

kapton  
senza silicone

**Temperatura colore**

3000K/4000K/6000K/BLU



**Driver**

DC24V

tensione costante  
non incluso

**Durata e on/off**

50.000h  
>25.000 on/off

**Material**

kapton  
without silicone

**Colour temperature**

3000K/4000K/6000K/BLU



**Driver**

DC24V

constant voltage  
not included

**Life time and on/off**

50.000h  
>25.000 on/off

**STRIP24V-2835-120C**

8031414871056

lumen/m

total lumen

colour temp.



2342 lm

11710 lm

**STRIP24V-2835-120M**

8031414871063

lumen/m

total lumen



2280 lm

11400 lm

**STRIP24V-2835-120F**

8031414871032

lumen/m

total lumen



2258 lm

11290 lm

**STRIP24V-2835-120BLU**

8031414871049

lumen

light source

watt/m

led/m



BLU

SMD 2835

22W

120

**Fotometria del prodotto / Photometric curve**

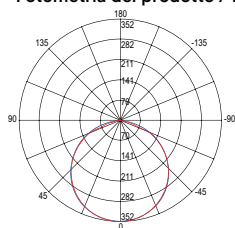

misura taglio /  
cut size

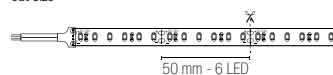

**Recommended Profiles p. 336 to p. 397**

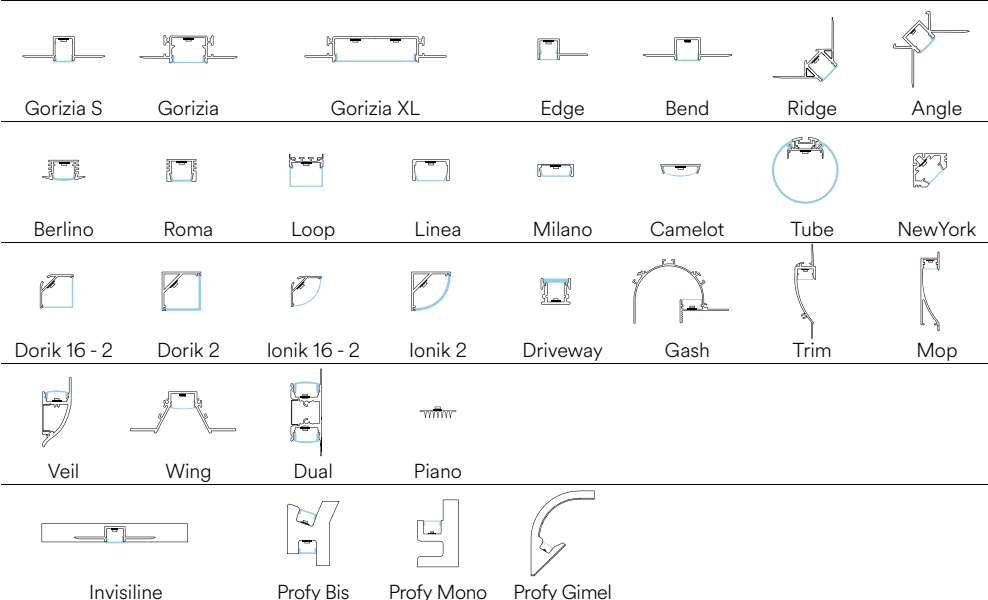

# STRIP24V 2835 120 IP68



EASY DOMOTICA

**Rotolo 5 metri strip led.**  
Roll 5 meters strip-led.



Driver p. 843-852  
Controller p. 854-857



colour temp.



**STRIP24V-2835IP68-120F**

8031414881772

lumen/m

total lumen

2258 lm

11290 lm

light source	LED COB 120
watt/m	18W
led/m	120

**Materiale**

kapton  
con silicone

**Temperatura colore**

6000K



**Driver**

DC24V

tensione costante  
non incluso

**Durata e on/off**

50.000h

>25.000 on/off

**Material**

kapton  
with silicone

**Colour temperature**

6000K



**Driver**

DC24V

constant voltage  
not included

**Life time and on/off**

50.000h

>25.000 on/off

**Fotometria del prodotto / Photometric curve**

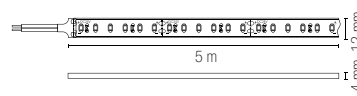
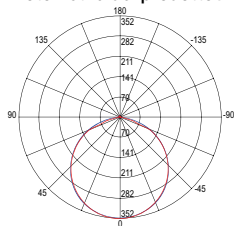

misura taglio /  
cut size



**Recommended Profiles p. 336 to p. 397**

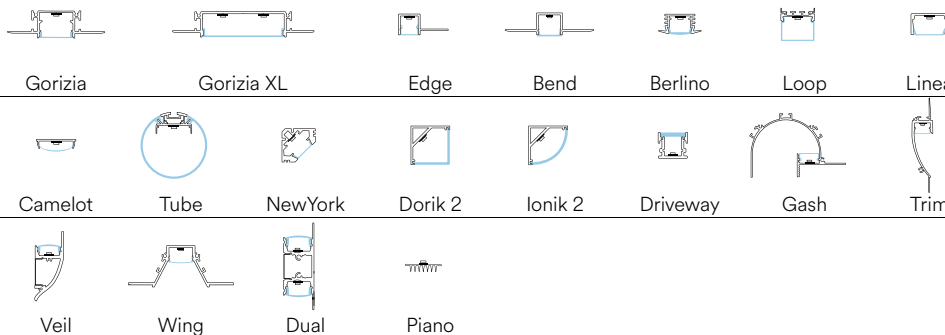

In.tec light PROFILI E STRIP LED / PROFILES AND STRIP LED

# STRIP24V 2835 CCT

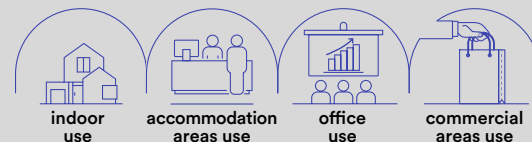

EASY  
DOMOTICA

**Rotolo 5 metri strip led.**  
Roll 5 meters strip-led.



Driver p. 843-852  
Controller p. 854-857



colour temp.

**STRIP24V-2835-CCT**

8031414875795

lumen/m

total lumen



2652 lm

13260 lm

**Materiale**

kapton  
senza silicone

**Temperatura colore**

CCT



**Driver**

DC24V

tensione costante  
non incluso

**Durata e on/off**

50.000h

>25.000 on/off

**Material**

kapton  
without silicone

**Colour temperature**

CCT



**Driver**

DC24V

constant voltage  
not included

**Life time and on/off**

50.000h

>25.000 on/off

**Fotometria del prodotto / Photometric curve**

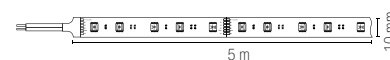
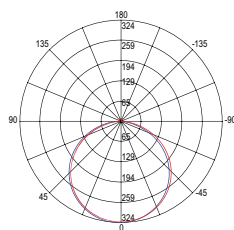

misura taglio /  
cut size



**Recommended Profiles p. 336 to p. 397**

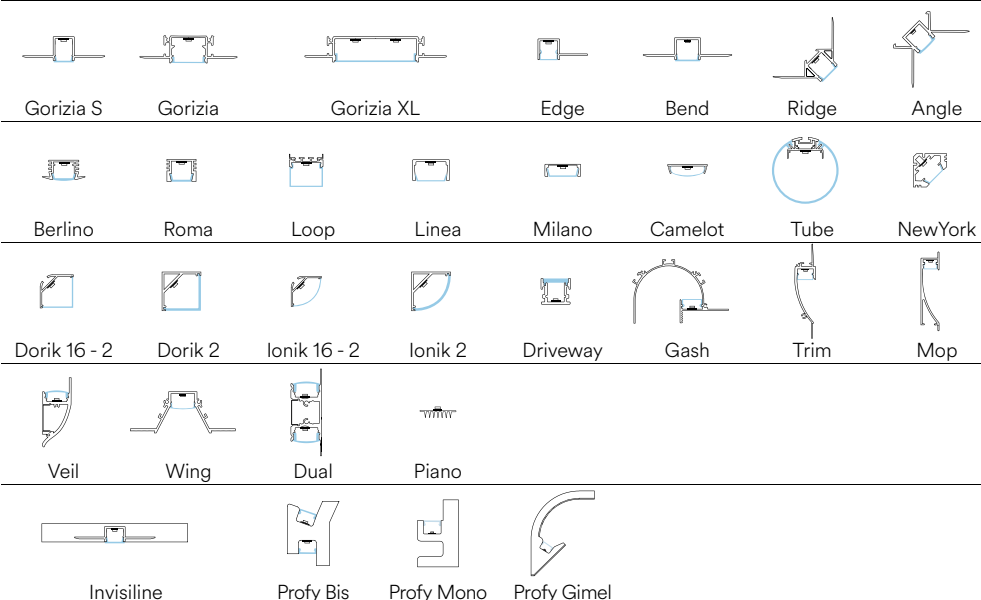



# STRIP24V 2835 240

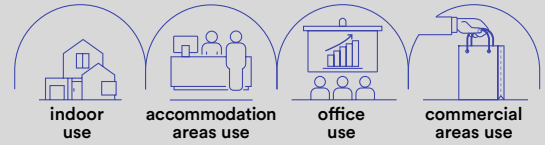

Per una corretta dissipazione applicare la strip su un supporto d'alluminio / For correct dissipation fix the strip on aluminium support

EASY DOMOTICA

**Rotolo 5 metri strip led.**  
Roll 5 meters strip-led.



Driver p. 843-852  
Controller p. 854-857



colour temp.

**STRIP24V-2835-240C**

8031414871018

lumen/m

total lumen



2706 lm

13530 lm

**STRIP24V-2835-240M**

8031414871025

lumen/m

total lumen



2640 lm

13200 lm

**STRIP24V-2835-240F**

8031414871001

lumen/m

total lumen



2526 lm

12630 lm

light source

SMD 2835

watt/m

26W

led/m

240

**Materiale**

kapton  
senza silicone

**Temperatura colore**

3000K / 4000K / 6000K



**Driver**

DC24V

tensione costante  
non incluso

**Durata e on/off**

50.000h  
>25.000 on/off

**Material**

kapton  
without silicone

**Colour temperature**

3000K / 4000K / 6000K



**Driver**

DC24V

constant voltage  
not included

**Life time and on/off**

50.000h  
>25.000 on/off

**Fotometria del prodotto / Photometric curve**

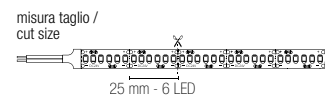
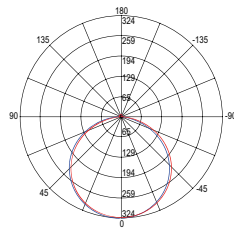

**Recommended Profiles p. 336 to p. 397**

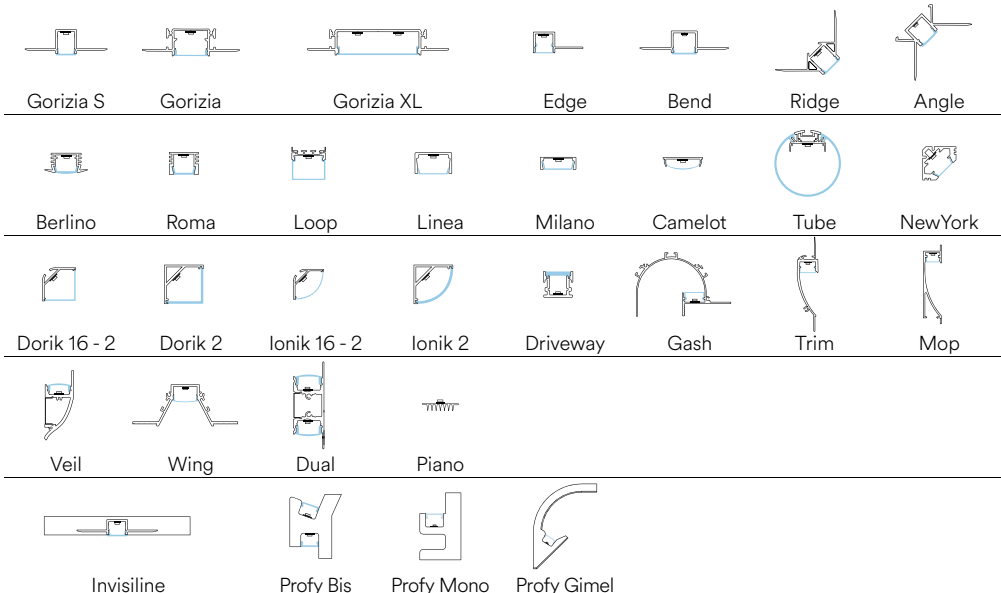

PROFILI E STRIP LED / PROFILES AND STRIP LED

In.tec light

# STRIP24V 5050 60

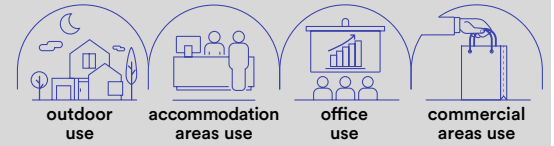

EASY  
DOMOTICA

**Rotolo 5 metri strip led.**  
Roll 5 meters strip-led.



Driver p. 843-852  
Controller p. 854-857



**Materiale**

kapton  
senza silicone

**Temperatura colore**

3000K / 4000K / 6000K



**Driver**

DC24V

tensione costante  
non incluso

**Durata e on/off**

50.000h  
>25.000 on/off

**Material**

kapton  
without silicone

**Colour temperature**

3000K / 4000K / 6000K



**Driver**

DC24V

constant voltage  
not included

**Life time and on/off**

50.000h  
>25.000 on/off

**STRIP24V-5050-60C**

8031414878420

lumen/m

total lumen

**STRIP24V-5050-60M**

8031414878741

lumen/m

total lumen

**STRIP24V-5050-60F**

8031414876129

lumen/m

total lumen

colour  
temp.



1390 lm

6950 lm



1430 lm

7150 lm



1314 lm

6570 lm

light source

SMD 5050

watt/m

14W

led/m

60

**Fotometria del prodotto / Photometric curve**

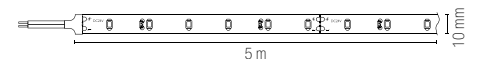
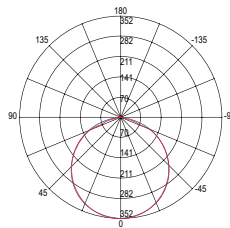

misura taglio /  
cut size

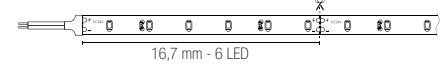

**Recommended Profiles p. 336 to p. 397**

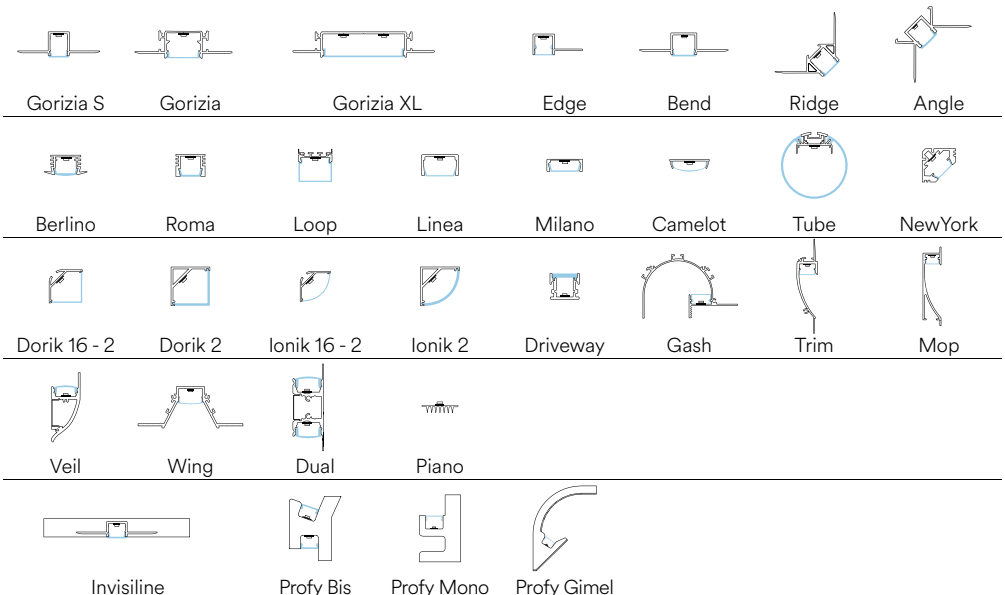

# STRIP24V 5050 60 IP67



EASY DOMOTICA

**Rotolo 5 metri strip led.**  
Roll 5 meters strip-led.



Driver p. 843-852  
Controller p. 854-857



**Materiale**  
kapton con rivestimento in silicone

**Temperatura colore**  
3000K / 4000K / 6000K



**Driver**  
DC24V  
tensione costante non incluso

**Durata e on/off**  
50.000h  
>25.000 on/off

**Material**  
kapton with silicone cover

**Colour temperature**  
3000K / 4000K / 6000K



**Driver**  
DC24V  
constant voltage not included

**Life time and on/off**  
50.000h  
>25.000 on/off

colour temp.

**STRIP24V-5050IP67-60C**

8031414876143

lumen/m

total lumen



1390 lm

6950 lm

**STRIP24V-5050IP67-60M**

8031414876150

lumen/m

total lumen



1430 lm

7150 lm

**STRIP24V-5050IP67-60F**

8031414876174

lumen/m

total lumen



1314 lm

6570 lm

light source

SMD 5050

watt/m

14W

led/m

60

**Fotometria del prodotto / Photometric curve**

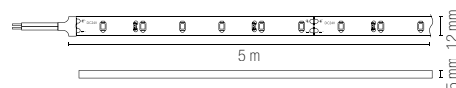
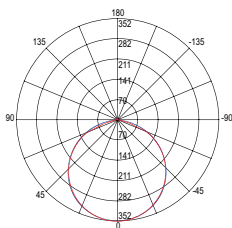

misura taglio / cut size

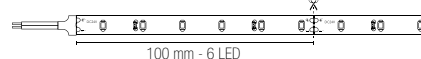

**Recommended Profiles p. 336 to p. 397**

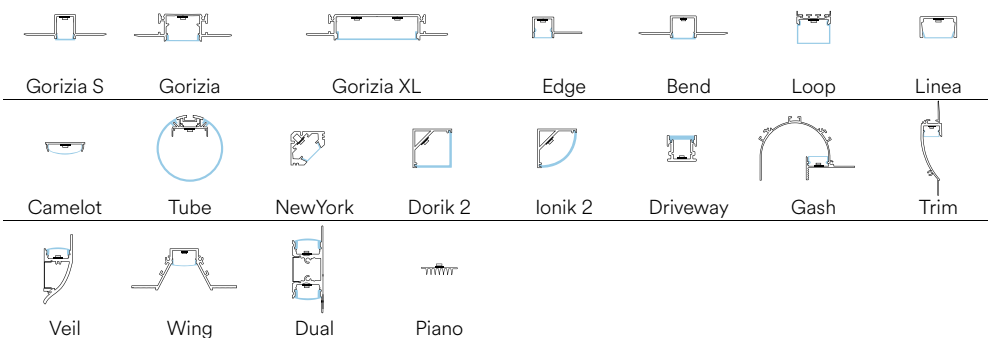

PROFILI E STRIP LED / PROFILES AND STRIP LED

In.tec light

# STRIP24V 5050 RGB

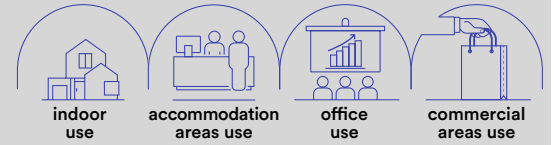

EASY  
DOMOTICA

**Rotolo 5 metri strip led.**  
Roll 5 meters strip-led.



Driver p. 843-852  
Controller p. 854-857



**Materiale**

kapton  
senza silicone

**Temperatura colore**

RGB



**Driver**  
DC24V

tensione costante  
non incluso

**Durata e on/off**

50.000h  
>25.000 on/off

**Material**

kapton  
without silicone

**Colour temperature**

RGB



**Driver**  
DC24V

constant voltage  
not included

**Life time and on/off**

50.000h  
>25.000 on/off

**STRIP24V-5050-RGB**  
8031414871360

colour  
temp.



RGB

light source	SMD 5050
watt/m	14,4W
led/m	60

**Fotometria del prodotto / Photometric curve**

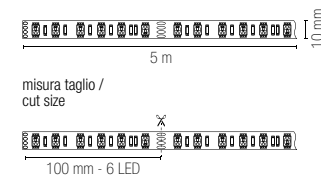
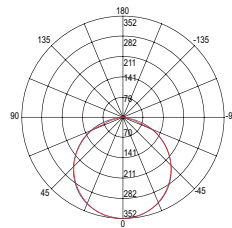

**Recommended Profiles p. 336 to p. 397**

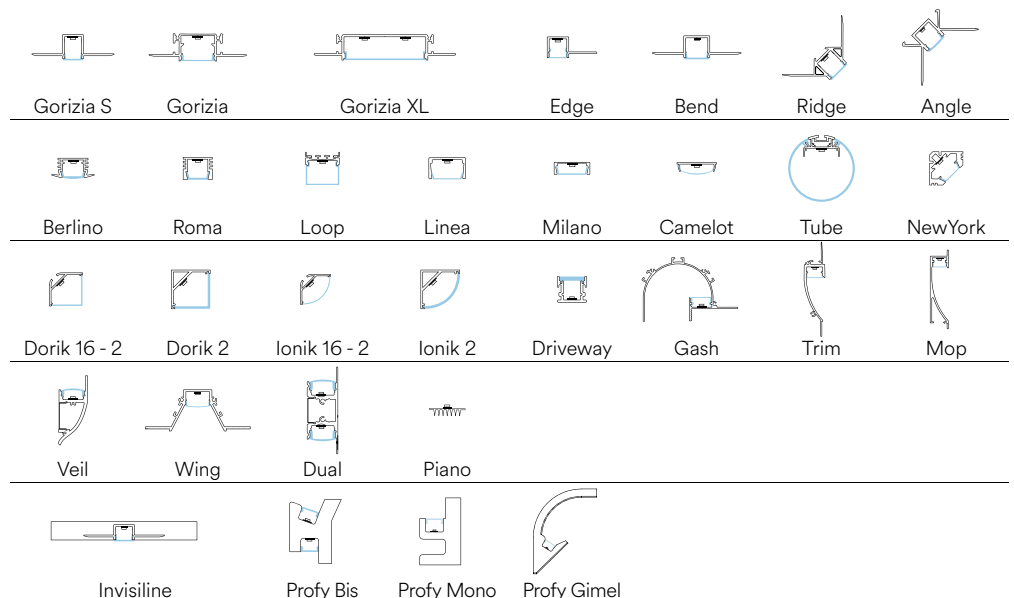

# STRIP24V 5050 RGB IP67



EASY DOMOTICA

**Rotolo 5 metri strip led.**  
Roll 5 meters strip-led.



Driver p. 843-852  
Controller p. 854-857



**Materiale**  
kapton con rivestimento in silicone

**Temperatura colore**

RGB



**Driver**

DC24V

tensione costante non incluso

**Durata e on/off**

50.000h  
>25.000 on/off

**Material**

kapton with silicone cover

**Colour temperature**

RGB



**Driver**

DC24V

constant voltage not included

**Life time and on/off**

50.000h  
>25.000 on/off

colour temp.



RGB

**STRIP24V-5050RGB-IP67**  
8031414871377

light source	SMD 5050
watt/m	14,4W
led/m	60

**Fotometria del prodotto / Photometric curve**

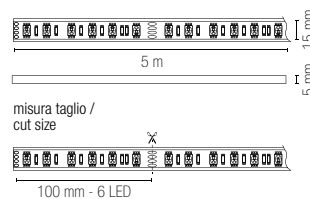
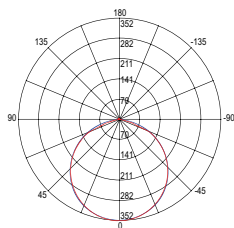

**Recommended Profiles p. 336 to p. 397**

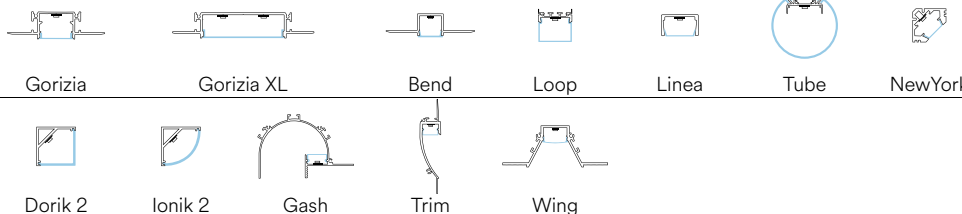

In.tec light PROFILI E STRIP LED / PROFILES AND STRIP LED

# STRIP24V 5050 RGBW

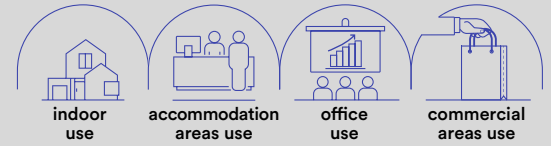

EASY  
DOMOTICA

**Rotolo 5 metri strip led.**  
Roll 5 meters strip-led.



Driver p. 843-852  
Controller p. 854-857



**Materiale**

kapton  
senza silicone

**Temperatura colore**

RGB + 4000K



**Driver**

DC24V

tensione costante  
non incluso

**Durata e on/off**

50.000h  
>25.000 on/off

**Material**

kapton  
without silicone

**Colour temperature**

RGB + 4000K



**Driver**

DC24V

constant voltage  
not included

**Life time and on/off**

50.000h  
>25.000 on/off

colour  
temp.

**STRIP24V-5050-RGBW**

8031414871384

lumen/m

total lumen



RGB + 1080 lm

5400 lm

light source

SMD 5050

watt/m

19,2W

led/m

60

**Fotometria del prodotto / Photometric curve**

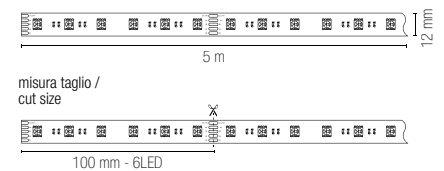
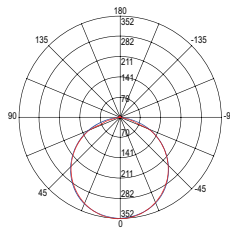

**Recommended Profiles p. 336 to p. 397**

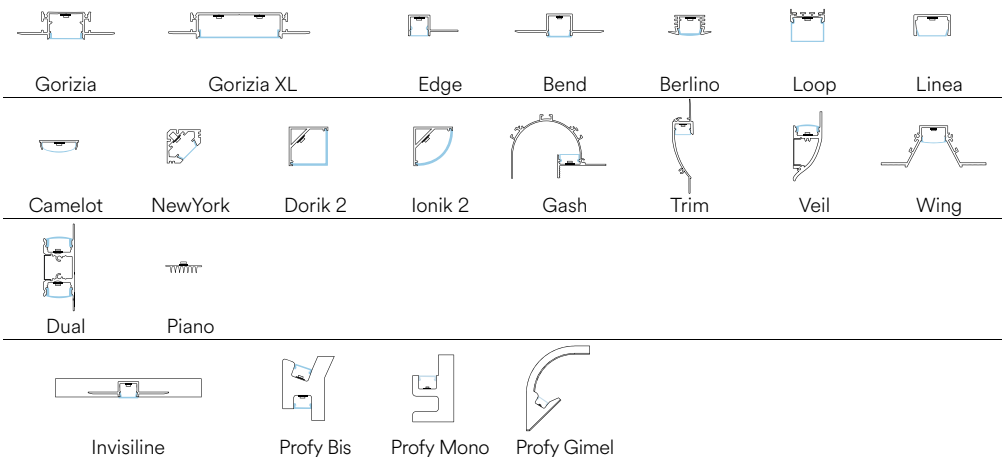

# STRIP24V 5050 RGBW IP68



EASY  
DOMOTICA

**Rotolo 5 metri strip led.**  
Roll 5 meters strip-led.



Driver p. 843-852  
Controller p. 854-857



**Materiale**  
kapton con  
rivestimento  
in silicone

**Temperatura colore**

RGB + 4000K



**Driver**

DC24V

tensione costante  
non incluso

**Durata e on/off**

50.000h  
>25.000 on/off

**Material**

kapton  
with silicone  
cover

**Colour temperature**

RGB + 4000K



**Driver**

DC24V

constant voltage  
not included

**Life time and on/off**

50.000h  
>25.000 on/off

colour  
temp.



RGB + 1080 lm  
5400 lm

**STRIP24V-5050RGBW-IP68**

8031414871407

lumen/m

total lumen

light source

SMD 5050

watt/m

19,2W

led/m

60

**Fotometria del prodotto / Photometric curve**

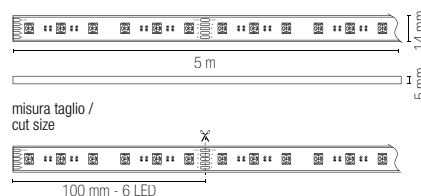
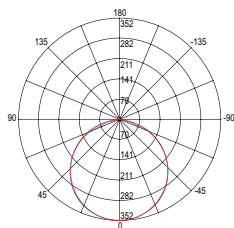

**Recommended Profiles p. 336 to p. 397**

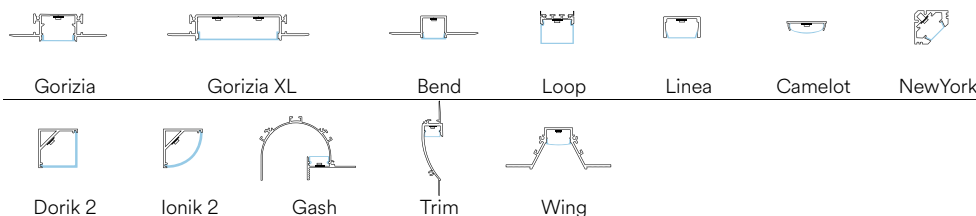

In.tec light PROFILI E STRIP LED / PROFILES AND STRIP LED

# STRIP230V SMD

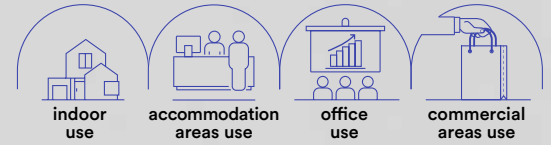

**Rotolo 20 metri strip led.**  
Roll 20 meters strip-led.



Driver p. 843-852  
Controller p. 854-857



**Materiale**  
kapton con rivestimento in silicone

**Temperatura colore**  
3000K / 4000K / 6500K



**Driver**  
220V DC incluso

**Durata e on/off**  
50.000h  
>25.000 on/off

**Material**  
kapton with silicone cover

**Colour temperature**  
3000K / 4000K / 6500K



**Driver**  
220V DC included

**Life time and on/off**  
50.000h  
>25.000 on/off

	colour temp.		colour temp.
<b>STRIP220V-2835-8C</b> 8031414926930 lumen/m	800 lm	<b>STRIP220V-2835-15C</b> 8031414927005 lumen/m	1700 lm
<b>STRIP220V-2835-8M</b> 8031414926947 lumen/m	800 lm	<b>STRIP220V-2835-15M</b> 8031414927005 lumen/m	1700 lm
<b>STRIP220V-2835-8F</b> 8031414926954 lumen/m	800 lm	<b>STRIP220V-2835-15F</b> 8031414927029 lumen/m	1700 lm
light source	LED SMD 2835	light source	LED SMD 2835
watt/m	8W	watt/m	15W
led/m	120	led/m	120

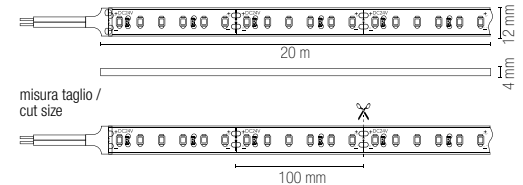

**Accessori non inclusi / Not included accessories**



**STRIP220V-8-L-CONN**  
8031414926992  
Connettore a L / L connector

**STRIP220V-10-L-CONN**  
8031414927067  
Connettore a L / L connector



**STRIP220V-8-FLEX**  
8031414926978  
Connettore flessibile, cavo 20 cm / Flexible connector, 20 cm cable

**STRIP220V-10-FLEX**  
8031414927043  
Connettore flessibile, cavo 20 cm / Flexible connector, 20 cm cable



**STRIP220V-8-NEST**  
8031414926961  
Innesto con cavo 20 cm / Nest with 20 cm cable

**STRIP220V-10-NEST**  
8031414927036  
Innesto con cavo 20 cm / Nest with 20 cm cable



**STRIP220V-8-CAPS**  
8031414927210  
Kit 3 pezzi tappi di chiusura / 3 pcs kit strip light end cap

**STRIP220V-10-CAPS**  
8031414927227  
Kit 3 pezzi tappi di chiusura / 3 pcs kit strip light end cap



**STRIP220V-8-CONN**  
8031414926985  
Connettori lineari / Linear connector

**STRIP220V-10-CONN**  
8031414927067  
Connettori lineari / Linear connector



# STRIP230V COB

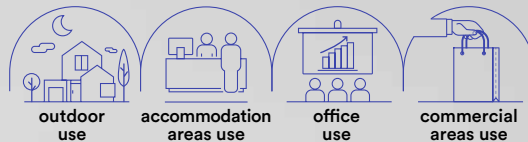

**Rotolo 20 metri strip led.**  
Roll 20 meters strip-led.



Driver p. 843-852  
Controller p. 854-857



- Materiale**  
kapton con rivestimento in silicone
- Temperatura colore**  
3000K / 4000K / 6500K
- Driver**  
220V DC incluso
- Durata e on/off**  
50.000h  
>25.000 on/off
- Material**  
kapton with silicone cover
- Colour temperature**  
3000K / 4000K / 6500K
- Driver**  
220V DC included
- Life time and on/off**  
50.000h  
>25.000 on/off

## STRIP220V-COB-12C

8031414927074

lumen/m

colour temp.



920 lm

## STRIP220V-COB-12M

8031414927081

lumen/m



920 lm

## STRIP220V-COB-12F

8031414927098

lumen/m



920 lm

light source

LED COB

watt/m

12W

led/m

260

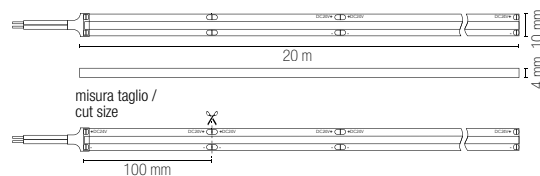

### Accessori non inclusi / Not included accessories



#### STRIP220V-12-L-CONN

8031414927111

Connettore a L /  
L connector



#### STRIP220V-12-CONN

8031414927104

Connettore a I /  
I connector



#### STRIP220V-12-NEST

8031414927135

Innesto con cavo 20 cm /  
Nest with 20 cm cable



#### STRIP220V-12-CAPS

8031414927234

Kit 3 pezzi tappi di chiusura /  
3 pcs kit strip light end cap



#### STRIP220V-12-ST

8031414927128

Kit 10 pcs staffette per fissaggio /  
Strip 220 10 pcs fixyng bracket

# STRIP24V 5050 3D RGBW

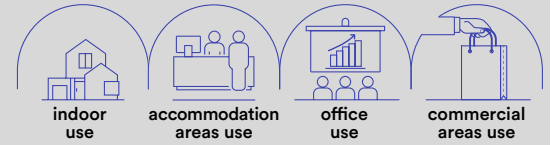

EASY  
DOMOTICA

**Rotolo 5 metri strip led.**  
Roll 5 meters strip-led.



Driver p. 843-852  
Controller p. 854-857



**Materiale**

kapton  
senza silicone

**Temperatura colore**

RGB



**Driver**

DC24V

tensione costante  
non incluso

**Durata e on/off**

50.000h  
>25.000 on/off

**Material**

kapton  
without silicone

**Colour temperature**

RGB



**Driver**

DC24V

constant voltage  
not included

**Life time and on/off**

50.000h  
>25.000 on/off

**STRIP24V-5050-3D-RGBW**

8031414878819

lumen/m

colour  
temp.



RGB + 264 lm

light source	SMD 5050
watt/m	10W
led/m	48

**Fotometria del prodotto / Photometric curve**

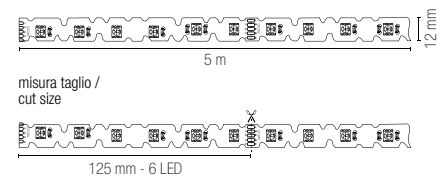
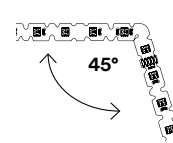
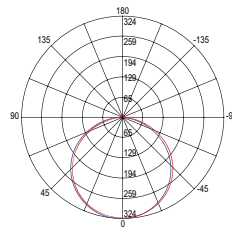

**Recommended Profiles p. 336 to p. 397**

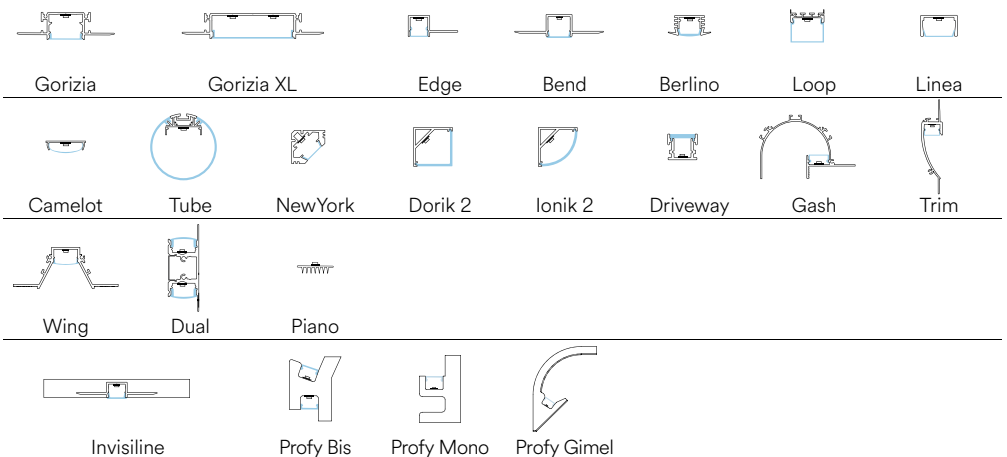

# STRIP24V 5050 RGB CCT

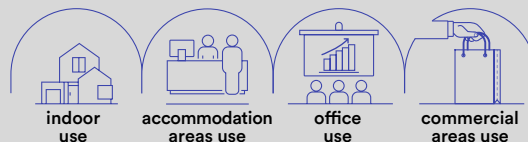

EASY  
DOMOTICA

**Rotolo 5 metri strip led.**  
Roll 5 meters strip-led.



Driver p. 843-852  
Controller p. 854-857



## Materiale

kapton  
con silicone

## Temperatura colore

RGB + CCT



## Driver

DC24V

tensione costante  
non incluso

## Durata e on/off

50.000h  
>25.000 on/off

## Material

kapton  
with silicone

## Colour temperature

RGB + CCT



## Driver

DC24V

constant voltage  
not included

## Life time and on/off

50.000h  
>25.000 on/off

colour  
temp.



**STRIP24V-5050-RGBCCT**  
8031414871391

lumen/m

712 lm

total lumen

3560 lm

light source

SMD 5050

watt/m

19,2W

led/m

60

## Fotometria del prodotto / Photometric curve

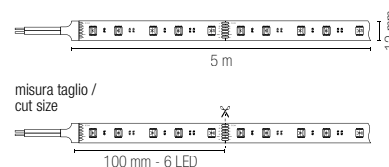
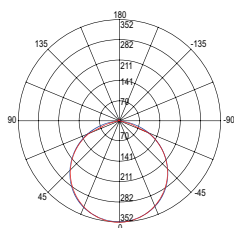

## Recommended Profiles p. 336 to p. 397

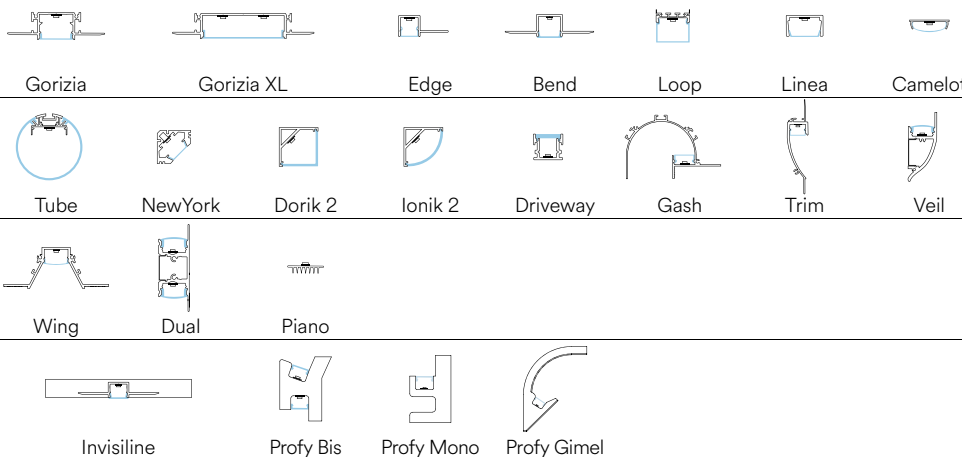

PROFILI E STRIP LED / PROFILES AND STRIP LED

In.tec light

# STRIP24V 3838 168 RGB

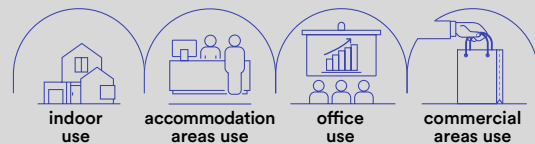

EASY  
DOMOTICA

**Rotolo 5 metri strip led.**  
Roll 5 meters strip-led.



Driver p. 843-852  
Controller p. 854-857



colour  
temp.

**STRIP24V-3838-168RGB**  
8031414877898



RGB

light source	SMD 3838
watt/m	24W
led/m	168

**Materiale**

kapton  
senza silicone

**Temperatura colore**

RGB



**Driver**

DC24V

tensione costante  
non incluso

**Durata e on/off**

50.000h  
>25.000 on/off

**Material**

kapton  
without silicone

**Colour temperature**

RGB



**Driver**

DC24V

constant voltage  
not included

**Life time and on/off**

50.000h  
>25.000 on/off

**Fotometria del prodotto / Photometric curve**

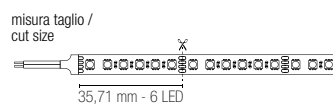
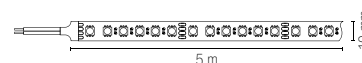
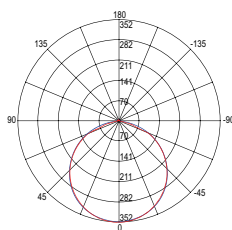

**Recommended Profiles p. 336 to p. 397**

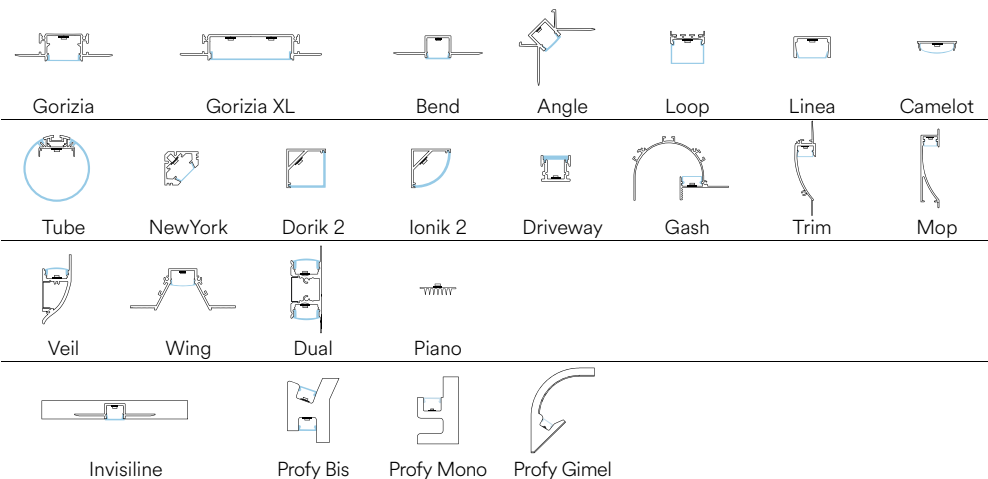



# STRIP24V 5050 RGBW INT

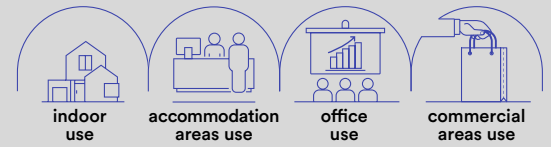

**WI-FI**  
SMART INTEC

**Kit strip LED Wi-Fi.**  
Kit strip LED Wi-Fi.



Driver p. 843-852  
Controller p. 854-857

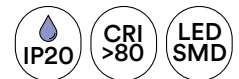

**Materiale**

kapton  
senza silicone

**Temperatura colore**

RGB + 4000K



**Driver**

12V DC  
incluso

**Durata e on/off**

25.000h  
>12.500 on/off

**Material**

kapton  
without silicone

**Colour temperature**

RGB + 4000K



**Driver**

12V DC  
included

**Life time and on/off**

25.000h  
>12.500 on/off

colour  
temp.

**STRIP24V-5050RGBW-INT**

8031414881796

lumen/m

total lumen



280 lm

540 lm

light source

SMD 5050

watt/m

12W

led/m

60

**Accessori inclusi / Included accessories**

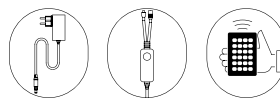

Driver + Telecomando + accessori Wi-Fi /  
Driver + Remote control + Wi-Fi accessories

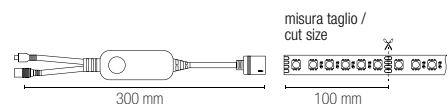

**Control system easy installation**



Smart  
Intec  
WIFI



ALEXA e  
GOOGLE HOME  
voice control

# STRIP24V 2835 INT

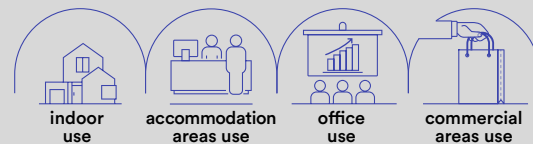

**WI-FI**  
SMART INTEC

**Kit strip LED Wi-Fi.**  
Kit strip LED Wi-Fi.



Driver p. 843-852  
Controller p. 854-857



**Materiale**

kapton  
senza silicone

**Temperatura colore**

3000K / 4000K



**Driver**

12V DC  
incluso

**Durata e on/off**

25.000h  
>12.500 on/off

**Material**

kapton  
without silicone

**Colour temperature**

3000K / 4000K



**Driver**

12V DC  
included

**Life time and on/off**

25.000h  
>12.500 on/off

	colour temp.
<b>STRIP24V-2835C-INT</b> 8031414882182	
lumen/m	380 lm
total lumen	760 lm
<b>STRIP24V-2835M-INT</b> 8031414881789	
lumen/m	380 lm
total lumen	760 lm
light source	SMD 2835
watt/m	8W
led/m	60

**Accessori inclusi / Included accessories**

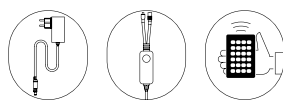

Driver + Telecomando + accessori Wi-Fi /  
Diver + Remote control + Wi-Fi accessories

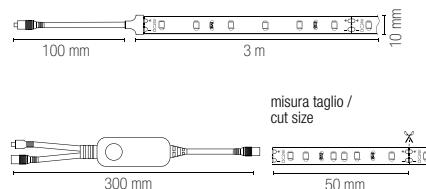

**Control system easy installation**



In.tec light PROFILI E STRIP LED / PROFILES AND STRIP LED

# INSIGN

**Kit 20 pz moduli LED.**  
Kit 20 pcs LED module.



kit 20pz con cavo 10cm / kit 20pcs with cable 10cm

EASY  
DOMOTICA



Driver p. 843-852  
Controller p. 854-857



Materiale PC	Material PC
<b>Temperatura colore</b> 6000K 	<b>Colour temperature</b> 6000K 
<b>Driver</b> DC12V tensione costante non incluso	<b>Driver</b> DC12V costant voltage not included
<b>Durata e on/off</b> 50.000h >25.000 on/off	<b>Life time and on/off</b> 50.000h >25.000 on/off

## LED-INSIGN-F-LENS

8031414871155

lumen

colour  
temp.



120 lm/m

sorgente luminosa / light source LED SMD 5050

watt/m 20 x 1,2W

beam angle 160°

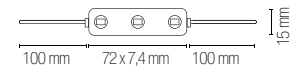

**Kit 20 pz moduli LED.**  
Kit 20 pcs LED module.

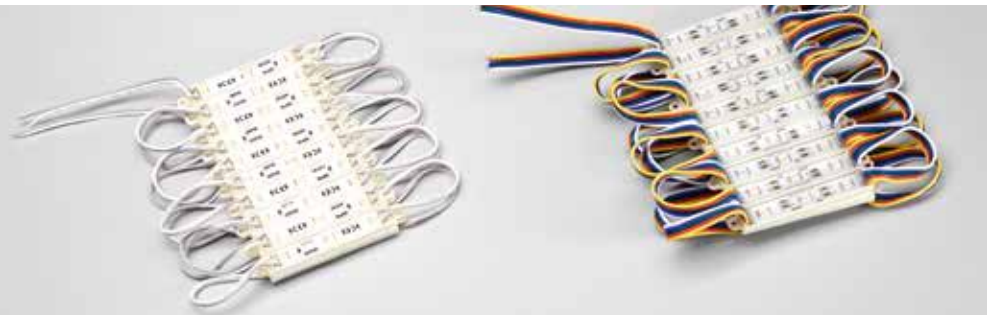

kit 20pz con cavo 10cm / kit 20pcs with cable 10cm

EASY  
DOMOTICA



Driver p. 843-852  
Controller p. 854-857



Materiale PC	Material PC
<b>Temperatura colore</b> RGB + 6000K 	<b>Colour temperature</b> RGB + 6000K 
<b>Driver</b> DC12V tensione costante non incluso	<b>Driver</b> DC12V costant voltage not included
<b>Durata e on/off</b> 50.000h >25.000 on/off	<b>Life time and on/off</b> 50.000h >25.000 on/off

## LED-INSIGN-F

8031414862979

lumen

colour  
temp.



72 lm/m

## LED-INSIGN-RGBW

8031414862955

lumen

colour  
temp.



RGB + 72 lm/m

light source SMD 5050

watt/m 20 x 0,72W

beam angle 120°

light source SMD 5050

watt/m 20 x 0,96W

beam angle 120°

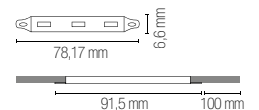
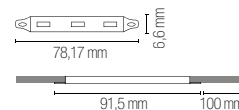



# STRIP SURROUND

## Strip LED comando touch con attacco USB.

LED strip light with switch touch control and USB connection.



CE

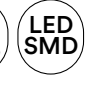

### Materiale

kapton con rivestimento in silicone

### Temperatura colore

RGB



### Material

kapton with silicone cover

### Colour temperature

RGB

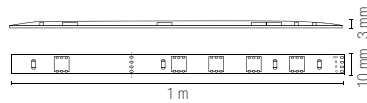

misura taglio / cut size

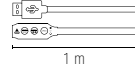

## STRIP-SURROUND 8031440354202

colour temp.



RGB

light source	SMD 5050
watt/m	1,5W
led/m	15

## Kit strip con telecomando e funzione RGB music color con attacco USB.

Kit strip with remote control and RGB music function with USB connection.



CE

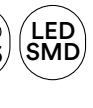

### Materiale

kapton con rivestimento in silicone

### Temperatura colore

RGB



### Material

kapton with silicone cover

### Colour temperature

RGB

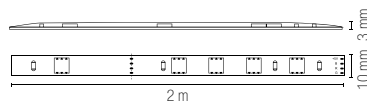

misura taglio / cut size

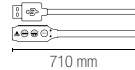
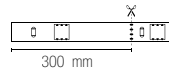

## STRIP-SURROUND-2M 8031414881802

colour temp.



RGB

light source	SMD 5050
watt/m	3W
led/m	60

# FLEX24V 10X10



EASY  
DOMOTICA

**Rotolo 5 metri striscia led ultraflessibile in silicone.**  
5 meters roll extra flexible led line in silicone.



Driver p. 843-852  
Controller p. 854-857



**Material**  
silicone

**Temperatura colore**  
3000K / 4000K

**Driver**  
DC24V  
tensione costante  
non incluso

**Durata e on/off**  
50.000h  
>25.000 on/off

**Material**  
silicone

**Colour temperature**  
3000K / 4000K

**Driver**  
DC24V  
constant voltage  
not included

**Life time and on/off**  
50.000h  
>25.000 on/off

	colour temp.
<b>FLEX24V-10X10-12C</b> 8031414925711	
lumen/m	1140 lm
total lumen	5700 lm
<b>FLEX24V-10X10-12M</b> 8031414925728	
lumen/m	1200 lm
total lumen	6000 lm
light source	SMD 2835
watt/m	12W
led/m	120

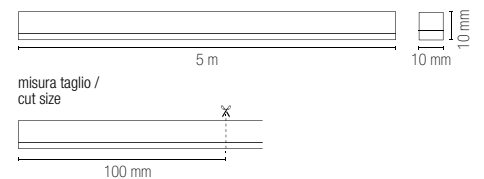

## Accessori non inclusi / Not included accessories



**FLEX24V-10X10-CAP**  
8031414925827

Kit 2 tappi in silicone /  
Kit 2 pcs silicon caps



**FLEX24V-10X10-ST**  
8031414925858

Kit 2 staffe /  
Kit 2 pcs brackets

# FLEX24V 6X6



EASY  
DOMOTICA

**Rotolo 5 metri striscia led ultraflessibile in silicone.**  
5 meters roll extra flexible led line in silicone.

CE EMC  
Driver p. 843-852  
Controller p. 854-857



**Materiale**  
silicone

**Temperatura colore**  
3000K / 4000K

**Driver**  
DC24V  
tensione costante  
non incluso

**Durata e on/off**  
50.000h  
>25.000 on/off

**Material**  
silicone

**Colour temperature**  
3000K / 4000K

**Driver**  
DC24V  
constant voltage  
not included

**Life time and on/off**  
50.000h  
>25.000 on/off

	colour temp.
<b>FLEX24V-6X6-5C</b> 8031414925735	
lumen/m	456 lm
total lumen	2280 lm
<b>FLEX24V-6X6-5M</b> 8031414925742	
lumen/m	480 lm
total lumen	2400 lm
light source	SMD 2835
watt/m	4,8W
led/m	120

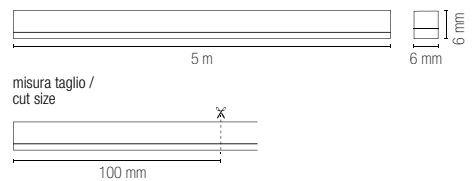

## Accessori non inclusi / Not included accessories



**FLEX24V-6X6-CAP**  
8031414925834

Kit 2 tappi in silicone /  
Kit 2 pcs silicon caps



**FLEX24V-6X6-ST**  
8031414925865

Kit 2 staffe /  
Kit 2 pcs brackets

PROFILI E STRIP LED / PROFILES AND STRIP LED

In.tec light

# FLEX24V 6X13



EASY  
DOMOTICA

**Rotolo 5 metri striscia led ultraflessibile in silicone.**  
5 meters roll extra flexible led line in silicone.



Driver p. 843-852  
Controller p. 854-857



**Materiale**  
silicone

**Temperatura colore**  
3000K / 4000K  
BLU/ROSSO/VERDE/ROSA/YELLOW

**Driver**  
DC24V (8,3A)  
tensione costante  
non incluso

**Durata e on/off**  
25.000h  
>15.000 on/off

**Material**  
silicone

**Colour temperature**  
3000K / 4000K  
BLUE/RED/GREEN/PINK/YELLOW

**Driver**  
DC24V (8,3A)  
costant voltage  
not included

**Durata e on/off**  
25.000h  
>15.000 on/off

	colour temp.
<b>FLEX24V-6X13-12C</b> 8031414925759	
lumen/m	1140
total lumen	5700
<b>FLEX24V-6X13-12M</b> 8031414925766	
lumen/m	1200
total lumen	6000
light source	SMD 2835
watt/m	12W
led/m	120

	colour temp.
<b>FLEX24V-6X13-12B</b> 8031414925773	
lumen	blue
<b>FLEX24V-6X13-12R</b> 8031414925780	
lumen	red
<b>FLEX24V-6X13-12G</b> 8031414925797	
lumen	green
<b>FLEX24V-6X13-12P</b> 8031414925803	
lumen	pink
<b>FLEX24V-6X13-12Y</b> 8031414925810	
lumen	yellow
light source	SMD 2835
watt/m	12W
led/m	120

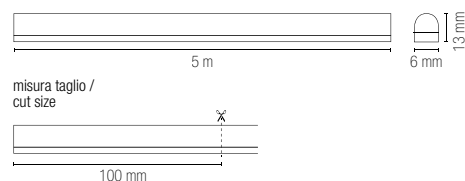

## Accessori non inclusi / Not included accessories



**FLEX24V-6X13-CAP**  
8031414925841

Kit 2 tappi in silicone /  
Kit 2 pcs silicon caps



**FLEX24V-6X13-ST**  
8031414925872

Kit 2 staffe /  
Kit 2 pcs brackets

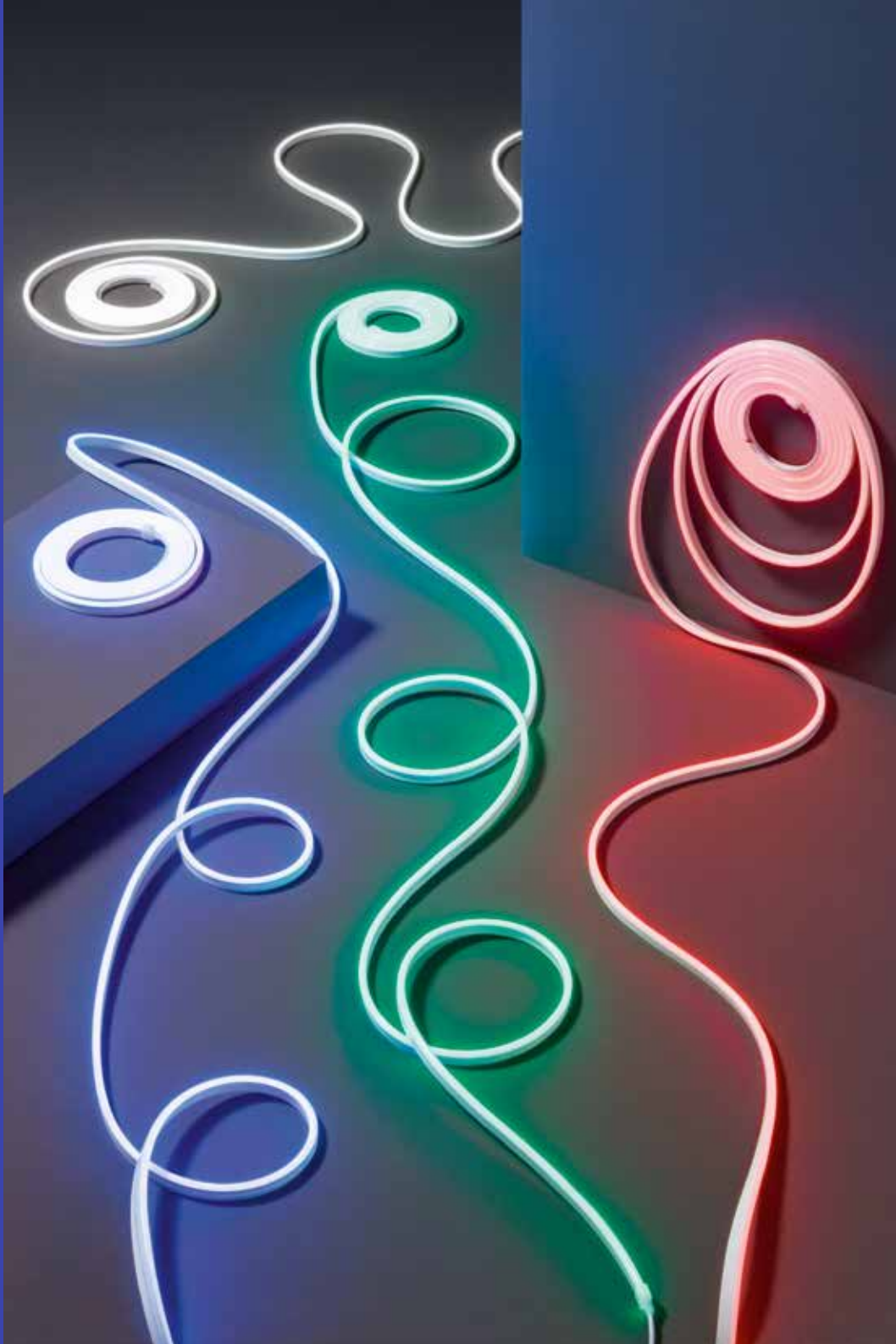



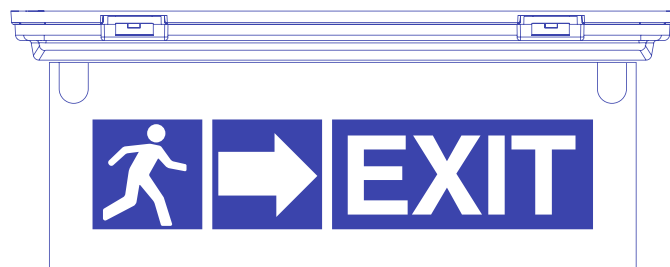

LAMPADE D'EMERGENZA  
EMERGENCY LAMPS

# HUBLLOT HELP

**Plafoniera LED in policarbonato bianca con batteria Ni-Cd con durata fino a 12H e funzione d'emergenza combinata e permanente.**

White polycarbonate LED ceiling light with Ni-Cd battery with 12H dino duration and emergency function mantain or non-mantain.



indoor  
use



accommodation  
areas use



office  
use



commercial  
areas use





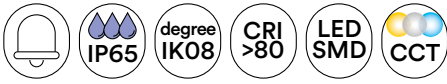

**Materiale**

PC + PC

**Colore**

bianco



**Temperatura colore**

3000K / 4000K / 6500K



**Driver**

integrato

**Material**

PC + PC

**Colour**

white



**Colour temperature**

3000K / 4000K / 6500K



**Driver**

built-in



**LED-HUBLOT-HELP**

8031414920488

lumen

colour temp. | colour



1800 lm

emergency light

2W - 200 lm

watt

18W

beam angle

120°

pf

0.90

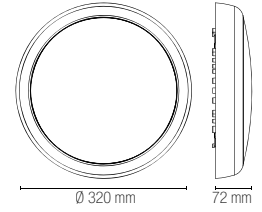

**Ni-Cd 6V 1800 mAh**

Batteria per emergenza inclusa /  
Included emergency battery



**Fotometria del prodotto / Photometric curve**

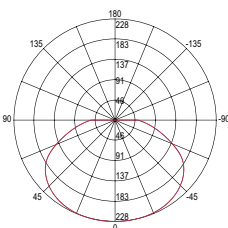

LED-HUBLOT-HELP

**Funzione MAINTAIN sempre accesa /  
MAINTAIN function always on**

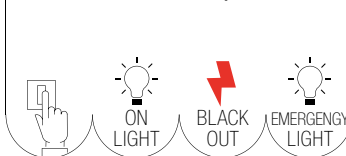

**Funzione NON-MAINTAIN emergenza /  
NON-MAINTAIN function only emergency**

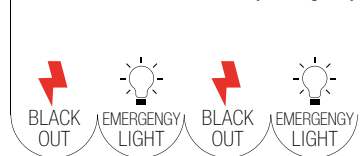

# HELP INC

**Incasso a LED emergenza in policarbonato bianco.**  
Emergency LED installation in white polycarbonate.

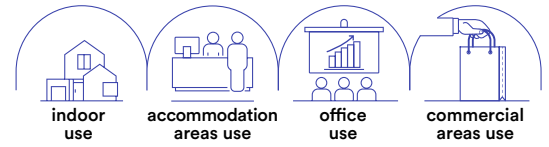

- Materiale**  
policarbonato

---

- Colore**  
bianco

---

- Temperatura colore**  
4000K

---

- Driver**  
incluso

---

- Material**  
polycarbonate

---

- Colour**  
white

---

- Colour temperature**  
4000K

---

- Driver**  
included



**Angolo di luce per open space /  
Open space beam angle**

	colour temp.	colour
<b>INC-HELP-R37</b> 8031414882786		
lumen	130 lm	
watt	1,2W	
beam angle	140°	
	Ø 32 mm	

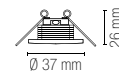

**LiFePO4 3.2V 1000mAh**  
Batteria per emergenza inclusa /  
Included emergency battery



**Fotometria del prodotto / Photometric curve**

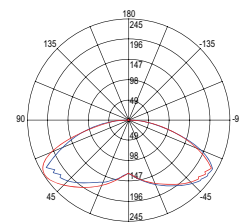

INC-HELP-R37

# HELP TRACK

Lampade di emergenza LED per sistema binario trifase nei colori bianco o nero.

LED emergency lamps for three-phase rail system in white or black.

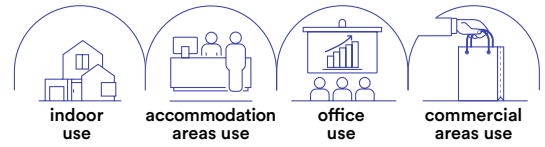

**Materiale**

polycarbonato

**Colore**

bianco  
nero



**Temperatura colore**

4000K



**Driver**

incluso

**Material**

polycarbonate

**Colour**

white  
black



**Colour temperature**

4000K



**Driver**

included



	colour temp.	colour
<b>LED-HELP-W-TRACK</b> 8031414884179		
lumen	250 lm	
<b>LED-HELP-B-TRACK</b> 8031414884162		
lumen	250 lm	

watt	2W
beam angle	140°

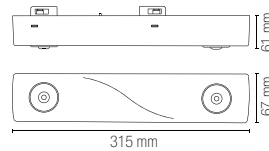

**LiFePO4 3.2V 3200mAh**  
Batteria per emergenza inclusa /  
Included emergency battery



LAMPADE D'EMERGENZA / EMERGENCY LAMPS

In.tec light

# HELP EXIT

Lampada a LED di emergenza multiuso:  
plafoniera, incasso ed incasso più bandiera.

Multipurpose emergency LED lamp:  
ceiling lamps, recessed light and recessed with flag.

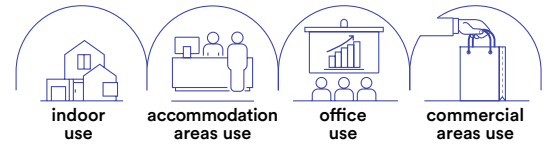

- Materiale**  
PC
- Colore**  
bianco
- Temperatura colore**  
4000K
- Driver**  
integrato
- Material**  
PC
- Colour**  
white
- Colour temperature**  
4000K
- Driver**  
built-in



	colour temp.	colour
<b>LED-HELP-EXIT</b> 8031414876310	4000K	white
lumen	400 lm	
emergency light	3 h - 400 lm	4W
watt		

**2 x 7.4V 1.8Ah Li-ion**  
Batteria per emergenza inclusa /  
Included emergency battery



Incluso adesivi /  
With stickers kit

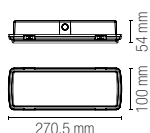

## Accessori / Accessories



**HELP-EXIT-KIT**  
8031414876327  
Kit incasso cornice e molle /  
Kit recessed with frame and spring

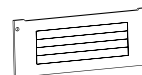

**HELP-EXIT-FLAG**  
8031414877331  
Kit bandiera incluso adesivi /  
Emergency flag with stickers kit



**Funzione MAINTAIN**  
sempre accesa /  
**MAINTAIN**  
function always on

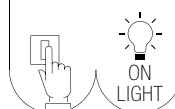

**Funzione NON-MAINTAIN**  
emergenza /  
**NON-MAINTAIN** function  
only emergency

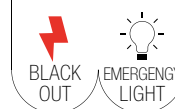

# HELP 511

Lampada di emergenza LED in policarbonato con batteria Li-on, incasso con cassetta di derivazione 511.

Emergency LED lamp in PC with Li-on battery; fit with recess box 511.

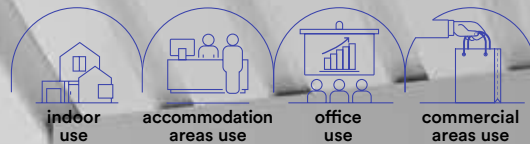

## Materiale

policarbonato

## Colore

bianco



## Temperatura colore

4000K



## Driver

integrato

## Material

polycarbonate

## Colour

white



## Colour temperature

4000K



## Driver

built-in



### LED-HELP-511

8031414862566

lumen

colour temp.



80 lm

colour



emergency light

3 h - 180 lm

watt

4W

beam angle

100°



275 x 95 x 35 mm

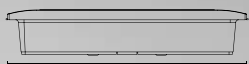

292 mm



83 mm

### Accessori inclusi / Included accessories

Scatola derivazione /  
Recess box hole



Adesivo /  
Stickers



### Li-ion 7.4V 1200mA

Batteria per emergenza inclusa /  
Included emergency battery



# HELP 503

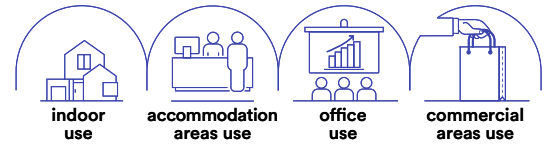

- Materiale**  
polycarbonato
- Colore**  
bianco
- Temperatura colore**  
4000K
- Driver**  
integrato
- Material**  
polycarbonate
- Colour**  
white
- Colour temperature**  
4000K
- Driver**  
built-in

**Lampada di emergenza LED in polycarbonato con batteria Li-on incasso con cassetta di derivazione 503.**

Emergency LED lamp in PC with Li-on battery; fit with recess box 503.



	colour temp.	colour
<b>LED-HELP-503</b> 8031414862573 lumen	●	●
	80 lm	
emergency light	3 h - 80 lm	
watt	1W	
beam angle	120°	
	90 × 55 × 31 mm	

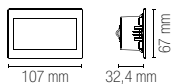

scatola derivazione 503  
503 junction box  
**non inclusa / not included**

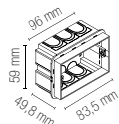

**Li-ion 3,7V 700 mAh**  
Batteria per emergenza inclusa /  
Included emergency battery





### Materiale

polycarbonato  
+ acciaio

### Colore

bianco  
nikel



### Temperatura colore

4000K



### Driver

integrato

### Material

polycarbonate  
+ stainless steel

### Colour

white  
nikel



### Colour temperature

4000K



### Driver

built-in

**Incasto segnapassi in polycarbonato con alloggiamento in cassetta di derivazione 503 con placchetta intercambiabile bianco o nikel in alluminio per funzione di emergenza combinata e permanente.**

Downlight in polycarbonate for recessed box 503 built-in-LED with replaceable in aluminum buckle white or nickel finish and double emergency function maintain or non-maintain.



	colour temp.	colour	Accessori inclusi / Included accessories
<b>INC-BOLT-503HP</b> 8031414866243 lumen			
emergency light	200 lm		
watt	3 h - 150 lm <sup>h</sup>		<b>2x</b> placchette / frames
	3W		<b>2x</b> staffette / brackets
	Ø 32 mm		

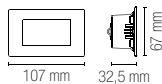

scatola derivazione 503  
503 junction box  
**non inclusa / not included**

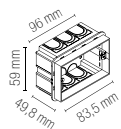

**Li-ion 3,7V 700 mAh**  
Batteria per emergenza inclusa /  
Included emergency battery



**Funzione MAINTAIN**  
sempre accesa /  
**MAINTAIN**  
function always on

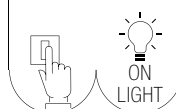

**Funzione NON-MAINTAIN**  
emergenza /  
**NON-MAINTAIN** function  
only emergency

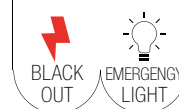





# OUTDOOR

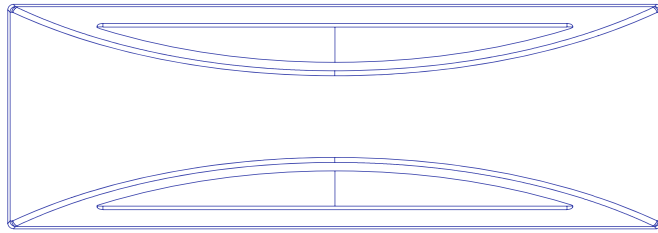

APPLIQUE  
WALL LAMPS

# COMPACT

Applique a LED in alluminio colore antracite con diffusore in policarbonato.  
Anthracite aluminum LED wall lamp and PC diffuser.

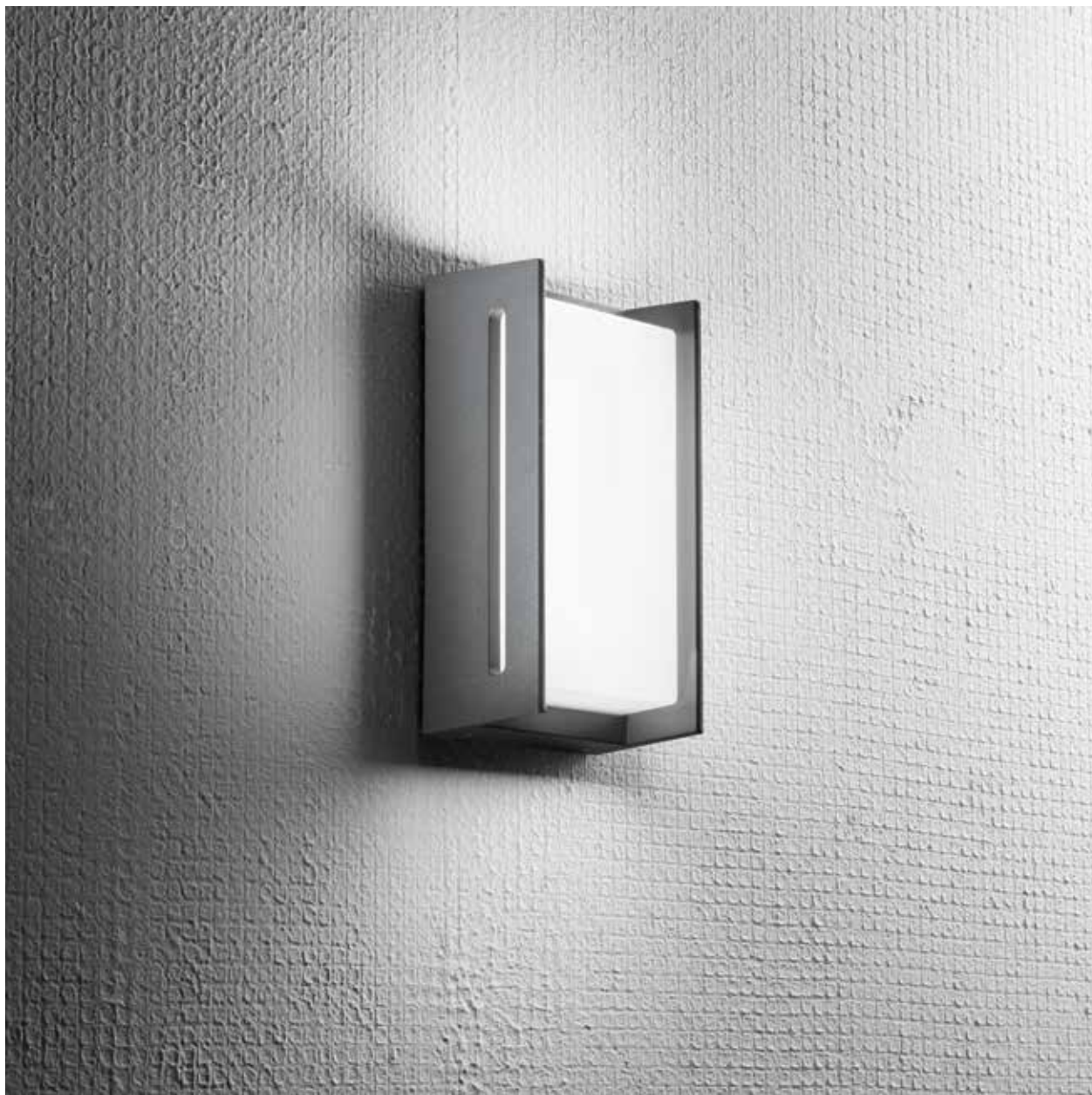
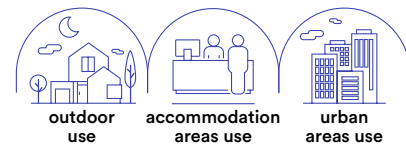

**Materiale**  
alluminio +  
policarbonato

**Colore**  
antracite



**Temperatura colore  
selezionabile**  
3000K / 4000K



**Driver**  
incluso

**Material**  
aluminum +  
polycarbonate

**Colour**  
anthracite



**Selectable color  
temperature**  
3000K / 4000K



**Driver**  
included



**LED-W-COMPACT**

8031414867110

lumen

colour  
temp.



2260 lm

colour



watt

18W

beam angle

120°

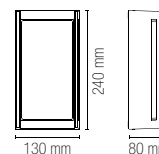

# DETROIT

Applique a LED in alluminio nero diffusore in policarbonato.  
Aluminum LED wall lamp black finish with PC shade.



In.tec light **OUTDOOR APPLIQUE / WALL LAMPS**

**Materiale**

alluminio +  
policarbonato

**Colore**

nero



**Temperatura colore  
selezionabile**  
3000K / 4000K



**Driver**  
incluso

**Material**

aluminum +  
polycarbonate

**Colour**

black



**Selectable color  
temperature**  
3000K / 4000K



**Driver**  
included



**LED-W-DETROIT-AP**

8031414862290

lumen

colour  
temp.



700 lm

colour



watt

10W

beam angle

120°

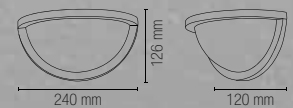

# ZODIAC

Appliche a LED in policarbonato nei colori bianco e nero.  
LED polycarbonate wall lamp in black and white.

**Materiale**

PC

**Colore**

bianco  
nero



**Temperatura colore selezionabile**

3000K / 4000K



**Driver**

integrato

**Material**

PC

**Colour**

white  
black



**Selectable color temperature**

3000K / 4000K



**Driver**

built-in



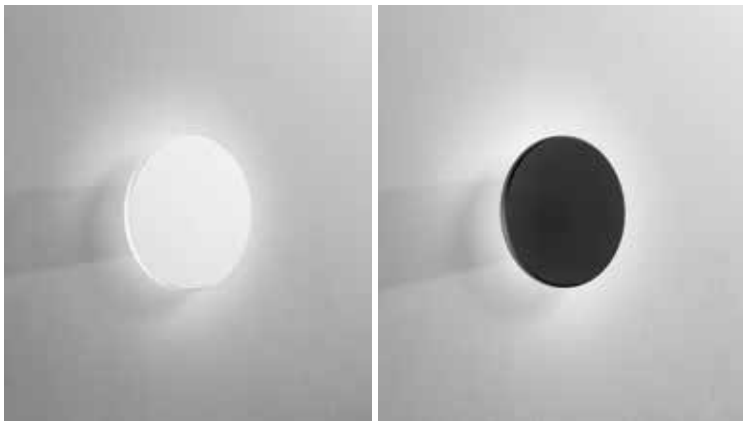

**LED-W-ZODIAC-M-BCO**

8031414889846

lumen

**LED-W-ZODIAC-M-NER**

8031414889853

lumen

colour temp.



1550 lm

colour



1550 lm

360°

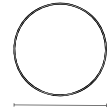

Ø 180 mm



47 mm

watt

12W

beam angle

360°

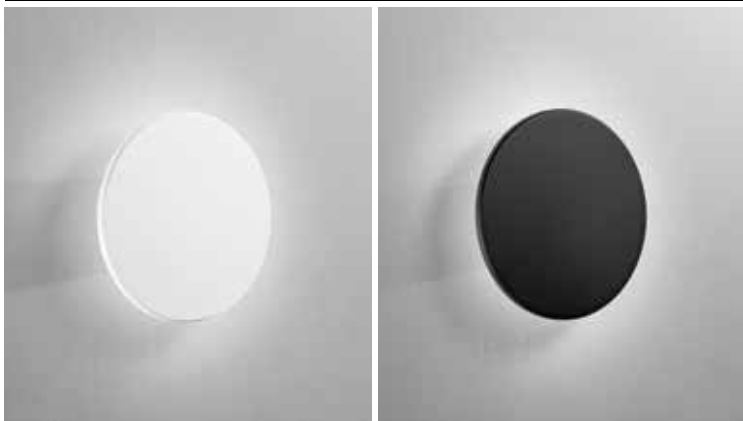

**LED-W-ZODIAC-L-BCO**

8031414889860

lumen

**LED-W-ZODIAC-L-NER**

8031414889877

lumen

colour temp.



2450 lm

colour



2450 lm

360°

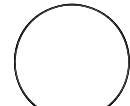

Ø 250 mm

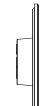

47 mm

watt

18W

beam angle

360°

# STEALTH

**Appliche a LED in alluminio gofrato bianco o nero.**  
Aluminum LED wall lamp embossed white or black.



**Materiale**  
alluminio

**Colore**  
gofrato bianco  
gofrato nero



**Temperatura colore selezionabile**  
3000K / 4000K



**Driver**  
incluso

**Material**  
aluminum

**Colour**  
embossed white  
embossed black



**Selectable color temperature**  
3000K / 4000K



**Driver**  
included

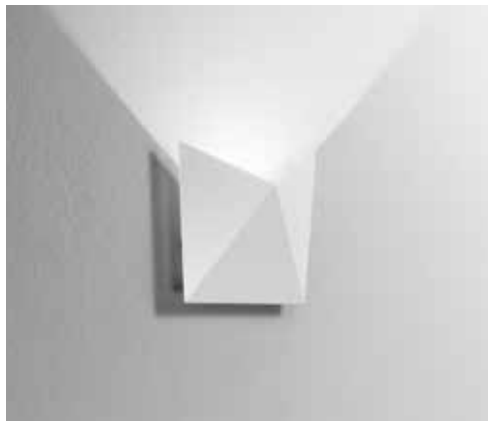

**LED-W-STEALTH BCO**

8031414866960

lumen

colour temp. | colour



580 lm

watt

6W

beam angle

120°

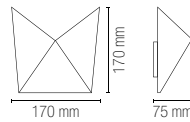

**LED-W-STEALTH NER**

8031414866953

lumen

colour temp. | colour



580 lm

watt

6W

beam angle

120°

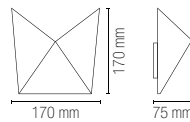

# MIURA

Applique a LED in alluminio  
bianco goffrato ultrasottile.

Ultra-thin embossed white  
aluminum LED wall light.



**Materiale**  
alluminio

**Colore**  
goffrato bianco



**Temperatura colore  
selezionabile**  
3000K / 4000K



**Driver**  
incluso

**Material**  
aluminium

**Colour**  
embossed white



**Selectable color  
temperature**  
3000K / 4000K



**Driver**  
included



**LED-W-MIURA/6W**

8031440351447

lumen

colour  
temp.



520 lm

colour



watt

2 x 3W

beam angle

↓ 110° + 110° ↑





# GAMMA

Applique a LED in alluminio gofrato bianco.  
Aluminum LED wall lamp embossed white finish.



In.tec light **OUTDOOR APPLIQUE / WALL LAMPS**

**Materiale**  
alluminio

**Material**  
aluminum

**Colore**  
gofrato bianco

**Colour**  
embossed white



**Temperatura colore selezionabile**  
3000K / 4000K

**Selectable color temperature**  
3000K / 4000K



**Driver**  
incluso

**Driver**  
included



**LED-W-GAMMA/10W**

8031434041217

lumen

colour temp. | colour



1100 lm

watt

2 x 5W

beam angle

↓ 120° + 120° ↑

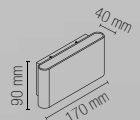

# VEYRON

Applique a LED in alluminio con doppia emissione bianco o nero goffrato.  
LED aluminum wall light with double emission in white or black.

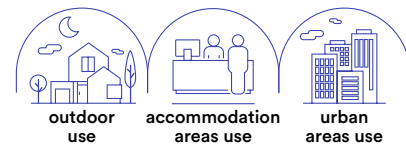

**Materiale**  
alluminio

**Colore**  
goffrato bianco  
goffrato nero



**Temperatura colore selezionabile**  
3000K / 4000K



**Driver**  
incluso

**Material**  
aluminum

**Colour**  
embossed white  
embossed black



**Selectable color temperature**  
3000K / 4000K



**Driver**  
included





**LED-W-VEYRON BCO**

8031440361163

lumen

colour temp. | colour



840 lm

watt

2 x 3,5W

beam angle

↓ 120° + 120° ↑

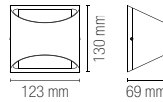

**LED-W-VEYRON NERO**

8031440361095

lumen

colour temp. | colour



840 lm

watt

2 x 3,5W

beam angle

↓ 120° + 120° ↑

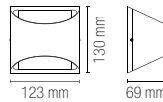

# BIOME

Applique a LED in alluminio bianco o nero gofrato.  
LED aluminum wall lamps in embossed white or black.

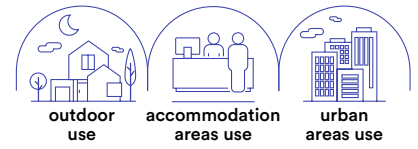

**Materiale**  
alluminio

**Colore**  
gofrato bianco  
gofrato nero



**Temperatura colore selezionabile**  
3000K / 4000K



**Driver**  
incluso

**Material**  
aluminum

**Colour**  
embossed white  
embossed black



**Selectable color temperature**  
3000K / 4000K



**Driver**  
included





**LED-W-BIOME BCO**

8031440361125

lumen

colour temp.



colour

840 lm

watt

2 x 3,5W

beam angle

↓ 120° + 120° ↑

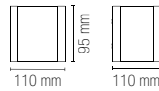

**LED-W-BIOME NERO**

8031440361132

lumen

colour temp.



colour

840 lm

watt

2 x 3,5W

beam angle

↓ 120° + 120° ↑

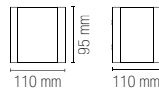

# GOLF

Appliche a LED in alluminio gofrato bianco o nero.  
Aluminum LED wall lamp embossed white or black finish.



**Materiale**  
alluminio

**Colore**  
gofrato bianco  
gofrato nero



**Temperatura colore selezionabile**  
3000K / 4000K



**Driver**  
incluso

**Material**  
aluminum

**Colour**  
embossed white  
embossed black



**Selectable color temperature**  
3000K / 4000K



**Driver**  
included



**LED-W-GOLF BCO**

8031440361101

lumen

colour temp. | colour



840 lm

watt

2 × 3,5W

beam angle

↓ 120° + 120° ↑

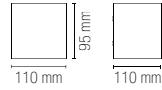

**LED-W-GOLF NERO**

8031440361118

lumen

colour temp. | colour



840 lm

watt

2 × 3,5W

beam angle

↓ 120° + 120° ↑

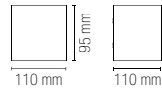

# POLO

Appliche a LED in policarbonato con singola o doppia emissione bianco o nero opaco.

Polycarbonate LED wall light with single or double emission in matt white or black.



**Materiale**

PC

**Colore**

bianco  
nero



**Temperatura colore selezionabile**

3000K / 4000K



**Driver**

incluso

**Material**

PC

**Colour**

white  
black



**Selectable color temperature**

3000K / 4000K



**Driver**

included





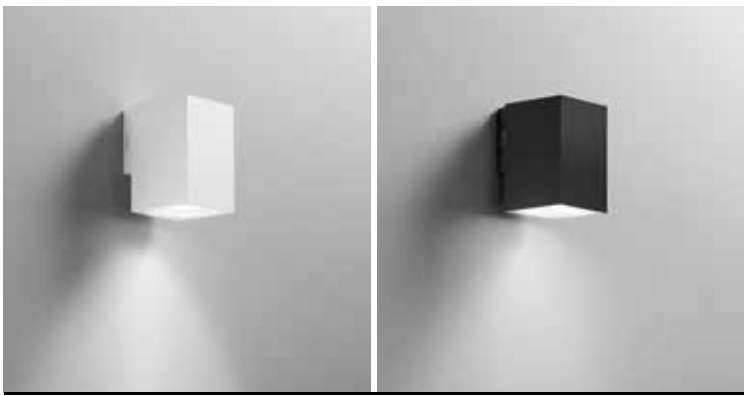

	colour temp.	colour
<b>LED-W-POLO-Q1-BCO</b> 8031414889655		
lumen	980 lm	
<b>LED-W-POLO-Q1-NER</b> 8031414889662		
lumen	980 lm	
watt	8W	
beam angle	60°	

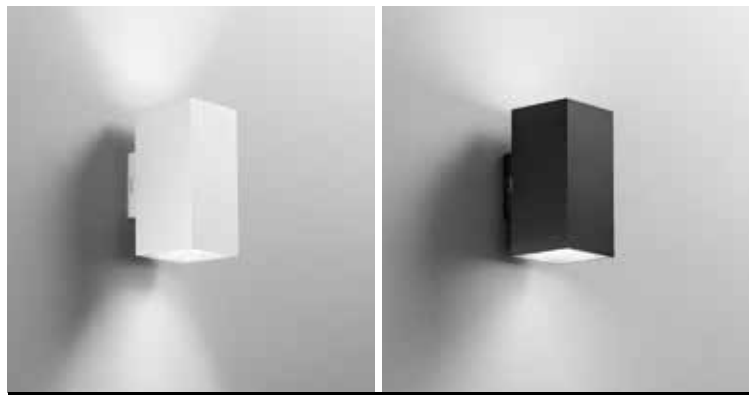
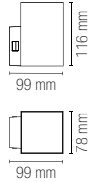

	colour temp.	colour
<b>LED-W-POLO-Q2-BCO</b> 8031414889679		
lumen	1960 lm	
<b>LED-W-POLO-Q2-NER</b> 8031414889686		
lumen	1960 lm	
watt	2 × 8W	
beam angle	↓ 60° + 60° ↑	

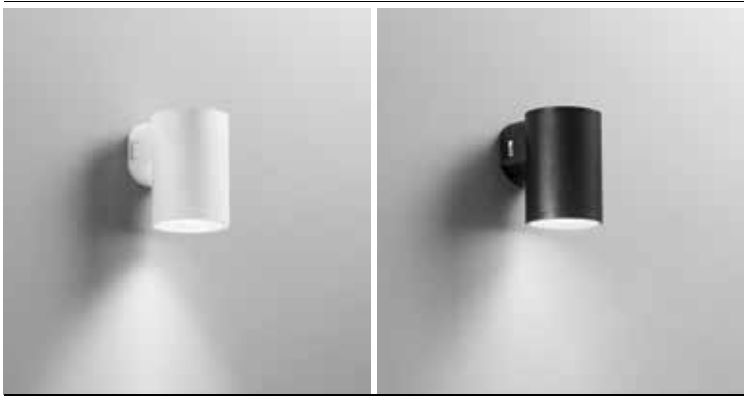
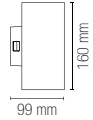

	colour temp.	colour
<b>LED-W-POLO-R1-BCO</b> 8031414889617		
lumen	980 lm	
<b>LED-W-POLO-R1-NER</b> 8031414889624		
lumen	980 lm	
watt	8W	
beam angle	60°	



	colour temp.	colour
<b>LED-W-POLO-R2-BCO</b> 8031414889631		
lumen	1960 lm	
<b>LED-W-POLO-R2-NER</b> 8031414889648		
lumen	1960 lm	
watt	2 × 8W	
beam angle	↓ 60° + 60° ↑	

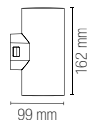

# RAY

Applique a LED in alluminio biemissione più  
emissione frontale in antracite o corten goffrato.

Aluminum LED wall lamp double emission light and  
front light stream embossed anthracite or corten finish.



**Materiale**  
alluminio

**Colore**  
goffrato antracite  
goffrato corten



**Temperatura colore  
selezionabile**  
3000K / 4000K



**Driver**  
incluso

**Material**  
aluminum

**Colour**  
embossed anthracite  
embossed corten



**Selectable color  
temperature**  
3000K / 4000K



**Driver**  
included





**LED-W-RAY ANT**

8031414867127

lumen

colour temp.	colour
--------------	--------



1100+390 lm

watt

14W

beam angle

↓ 50° + 50° ↑ + 120° →

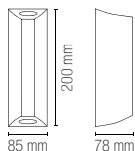

**LED-W-RAY BRO**

8031414870998

lumen

colour temp.	colour
--------------	--------



1100+390 lm

watt

14W

beam angle

↓ 50° + 50° ↑ + 120° →

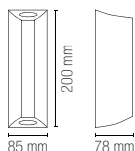

# TWIN

**Applique a LED in alluminio finitura bianco, antracite o nikel spazzolato.**

Aluminum LED wall lamp in white, anthracite finish or brush nickel.

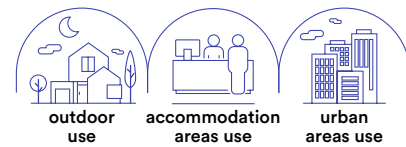

collection **TWIN**



In.tec light **OUTDOOR** APPLIQUE / WALL LAMPS

# TWIN

**Materiale**

alluminio

**Colore**

bianco  
antracite  
nikel spazzolato



**Temperatura colore**

4000K



**Temperatura colore selezionabile**

3000K / 4000K



**Driver**

incluso

**Material**

aluminum

**Colour**

white  
anthracite  
brush nikel



**Colour temperature**

4000K



**Selectable color temperature**

3000K / 4000K



**Driver**

included

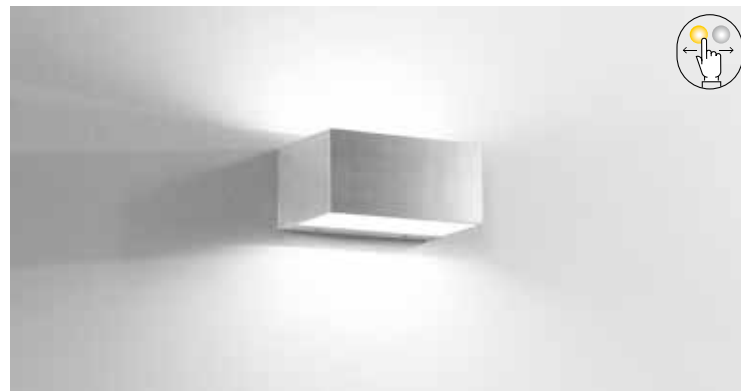

	colour temp.	colour
<b>LED-W-TWIN-S BCO</b> 8031414863976 lumen		
<b>LED-W-TWIN-S ANT</b> 8031414863709 lumen		
<b>LED-W-TWIN-S NIK</b> 8031414863983 lumen		

watt	12W
beam angle	↓ 90° + 90° ↑

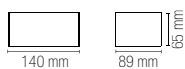

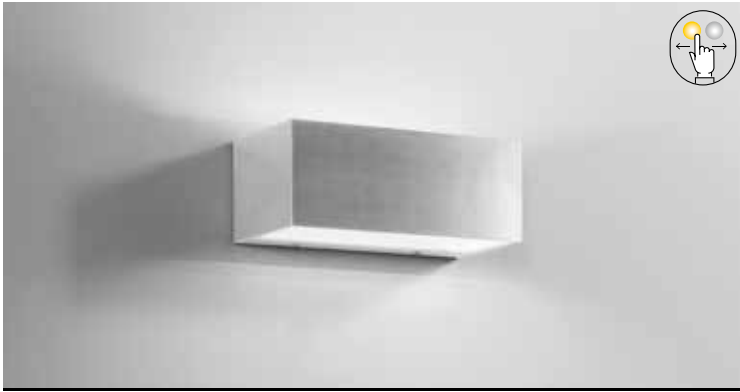

	colour temp.	colour
<b>LED-W-TWIN-M BCO</b> 8031414863969 lumen		
<b>LED-W-TWIN-M ANT</b> 8031414863693 lumen		
<b>LED-W-TWIN-M NIK</b> 8031414863990 lumen		

watt 18W  
beam angle ↓ 90° + 90° ↑

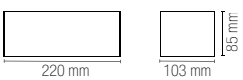

	colour temp.	colour
<b>LED-W-TWIN-XL BCO</b> 8031414863716 lumen		
<b>LED-W-TWIN-XL ANT</b> 8031414863686 lumen		
<b>LED-W-TWIN-XL NIK</b> 8031414864362 lumen		

watt 35W  
beam angle ↓ 90° + 90° ↑

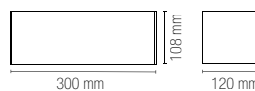

# DESERT

**Applique a LED in alluminio con biemissione, emissione frontale con finitura bianco, antracite e bronzo.**

LED aluminum wall lamp with double emission, frontal emission with white, anthracite and bronze finish.



outdoor  
use



accommodation  
areas use



urban  
areas use







**Materiale**  
alluminio

**Colore**  
gofrato bianco  
gofrato antracite  
gofrato corten



**Temperatura colore**  
3000K / 4000K



**Driver**  
incluso

**Material**  
aluminum

**Colour**  
embossed white  
embossed anthracite  
embossed corten



**Colour temperature**  
3000K / 4000K



**Driver**  
included

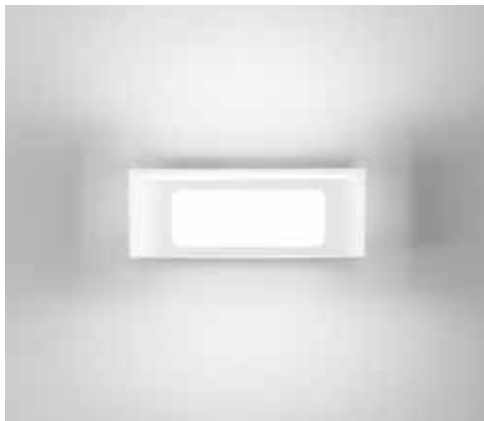

**LED-W-DESERT-BCO**  
8031414922895

	colour temp.	colour
lumen	580 lm	
watt		12W
beam angle		120°

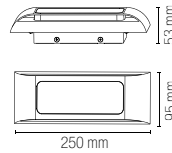

**LED-W-DESERT-ANT**  
8031414922918

	colour temp.	colour
lumen	580 lm	
watt		12W
beam angle		120°

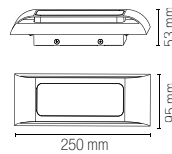

**LED-W-DESERT-BRO**  
8031414922901

	colour temp.	colour
lumen	580 lm	
watt		12W
beam angle		120°

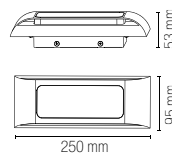

# DUKROT

Applique in alluminio con diffusore in policarbonato.  
Disponibile in bianco opaco, antracite e corten.  
Aluminum wall lamp with polycarbonate diffuser  
Available in matte white, anthracite and corten.



**Materiale**  
alluminio

**Colore**  
bianco opaco  
antracite  
corten



**Temperatura colore selezionabile**  
3000K / 4000K



**Driver**  
integrato

**Material**  
aluminum

**Colour**  
matt white  
anthracite  
corten



**Selectable color temperature**  
3000K / 4000K



**Driver**  
built-in



<b>LED-W-DUKROT-BCO</b> 8031414918591	colour temp.	colour
	lumen	1440 lm
watt	12W	
beam angle	180°	

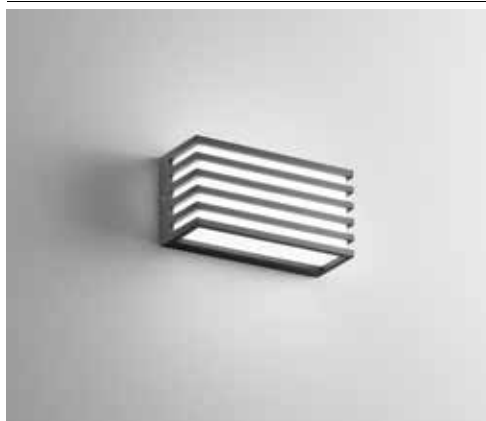
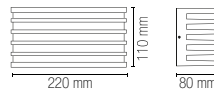

<b>LED-W-DUKROT-ANT</b> 8031414918584	colour temp.	colour
	lumen	1440 lm
watt	12W	
beam angle	180°	

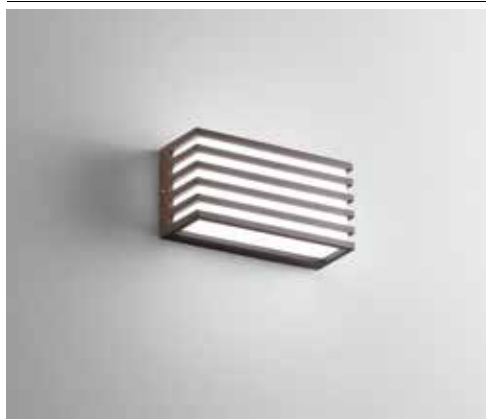
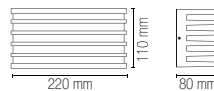

<b>LED-W-DUKROT-BRO</b> 8031414918607	colour temp.	colour
	lumen	1440 lm
watt	12W	
beam angle	180°	

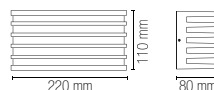

# WEISS

**Applique a LED in alluminio con finitura bianco, nero o corten.**  
Aluminum LED wall light in white, black and corten finish.



**Materiale**  
alluminio

**Colore**  
bianco  
nero  
corten



**Temperatura colore selezionabile**  
3000K / 4000K



**Driver**  
integrato

**Material**  
aluminum

**Colour**  
white  
black  
corten



**Selectable color temperature**  
3000K / 4000K



**Driver**  
built-in



**LED-W-WEISS-BCO**

8031414897193

lumen

colour temp. | colour



1800 lm

watt 16W

beam angle ↓ 120° + 120° ↑

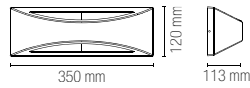

**LED-W-WEISS-NER**

8031414897216

lumen

colour temp. | colour



1800 lm

watt 16W

beam angle ↓ 120° + 120° ↑

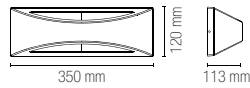

**LED-W-WEISS-BRO**

8031414897209

lumen

colour temp. | colour



1800 lm

watt 16W

beam angle ↓ 120° + 120° ↑

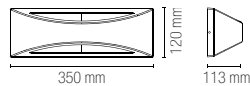

# BORDER

Applique angolare a LED con struttura e diffusore in policarbonato e finitura bianco o nero opaco.

Angular LED wall lamp with structure and diffuser in PC and matt white and black finish.

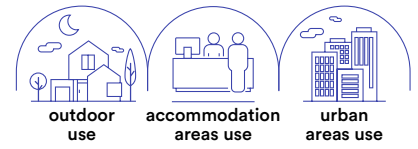

**Materiale**

PC

**Colore**

bianco opaco  
nero opaco



**Temperatura colore**

3000K / 4000K



**Driver**

incluso

**Material**

PC

**Colour**

matt white  
matt black



**Colour temperature**

3000K / 4000K



**Driver**

included





<b>LED-BORDER-30M-BCO</b> 8031414883578	colour temp.	colour
	lumen	3550 lm
watt	30W	
beam angle	120°	

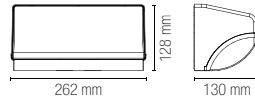

<b>LED-BORDER-30M-ANT</b> 8031414883561	colour temp.	colour
	lumen	3550 lm
watt	30W	
beam angle	120°	

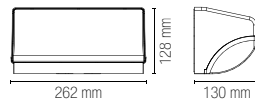

# LUXON

**Appliche angolare a LED con struttura e diffusore in alluminio e finitura bianco gofrato.**

Angular LED wall lamp with structure and diffuser in aluminum and embossed white and black finish.

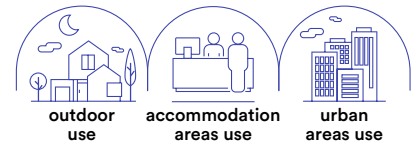

**Materiale**

alluminio

**Colore**

gofrato bianco  
gofrato nero



**Temperatura colore selezionabile**

3000K / 4000K



**Driver**

incluso

**Material**

aluminum

**Colour**

embossed white  
embossed black



**Selectable color temperature**

3000K / 4000K



**Driver**

included







**LED-W-LUXON BCO**

8031414870677

lumen

colour temp.	colour
--------------	--------



1550 lm

watt	12W
------	-----

beam angle	120°
------------	------

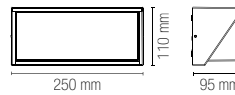

**LED-W-LUXON ANT**

8031414867097

lumen

colour temp.	colour
--------------	--------



1550 lm

watt	12W
------	-----

beam angle	120°
------------	------

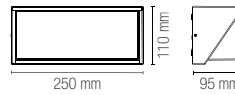

# GRIS

Applique a LED in alluminio con finitura bianco o nera.  
LED wall light in aluminum with white or black finish.





**Materiale**  
alluminio

**Colore**  
bianco  
nero



**Temperatura colore selezionabile**  
3000K / 4000K



**Driver**  
integrato

**Material**  
aluminum

**Colour**  
white  
black



**Selectable color temperature**  
3000K / 4000K



**Driver**  
built-in



**LED-W-GRIS-BCO**

8031414897223

lumen

colour temp. | colour



1390 lm

watt

12W

beam angle

180°

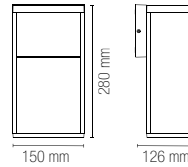

**LED-W-GRIS-NER**

8031414897230

lumen

colour temp. | colour



1390 lm

watt

12W

beam angle

180°

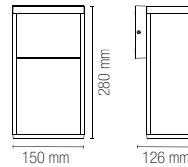

# AGERA

**Applique a LED in alluminio goffrato nero.**  
Aluminum LED wall lamp embossed black finish.

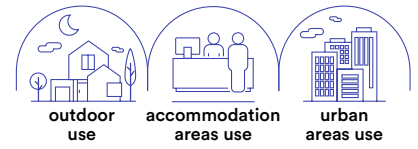

**Materiale**  
alluminio

**Colore**  
goffrato nero



**Temperatura colore selezionabile**  
3000K / 4000K



**Driver**  
incluso

**Material**  
aluminum

**Colour**  
embossed black



**Selectable color temperature**  
3000K / 4000K



**Driver**  
included





**LED-W-AGERA-90**

8031440360951

lumen

colour temp. | colour



680 lm

watt 2 × 3W

beam angle ↓ 120° + 120° ↑

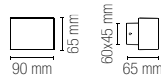

**LED-W-AGERA-180**

8031440360975

lumen

colour temp. | colour



1380 lm

watt 2 × 6W

beam angle ↓ 120° + 120° ↑

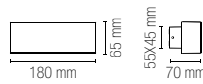

# BOXTER

Applique a LED in alluminio goffrato bianco, silver, nero o corten.  
Aluminum LED wall lamp embossed white, silver, black or corten finish.

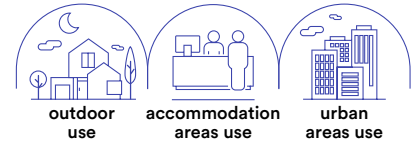

**Materiale**

alluminio

**Colore**

bianco  
silver  
nero  
corten



**Temperatura colore**

4000K



**Temperatura colore selezionabile**

3000K / 4000K



**Driver**

incluso

**Material**

aluminum

**Colour**

white  
silver  
black  
corten



**Colour temperature**

4000K



**Selectable color temperature**

3000K / 4000K



**Driver**

included

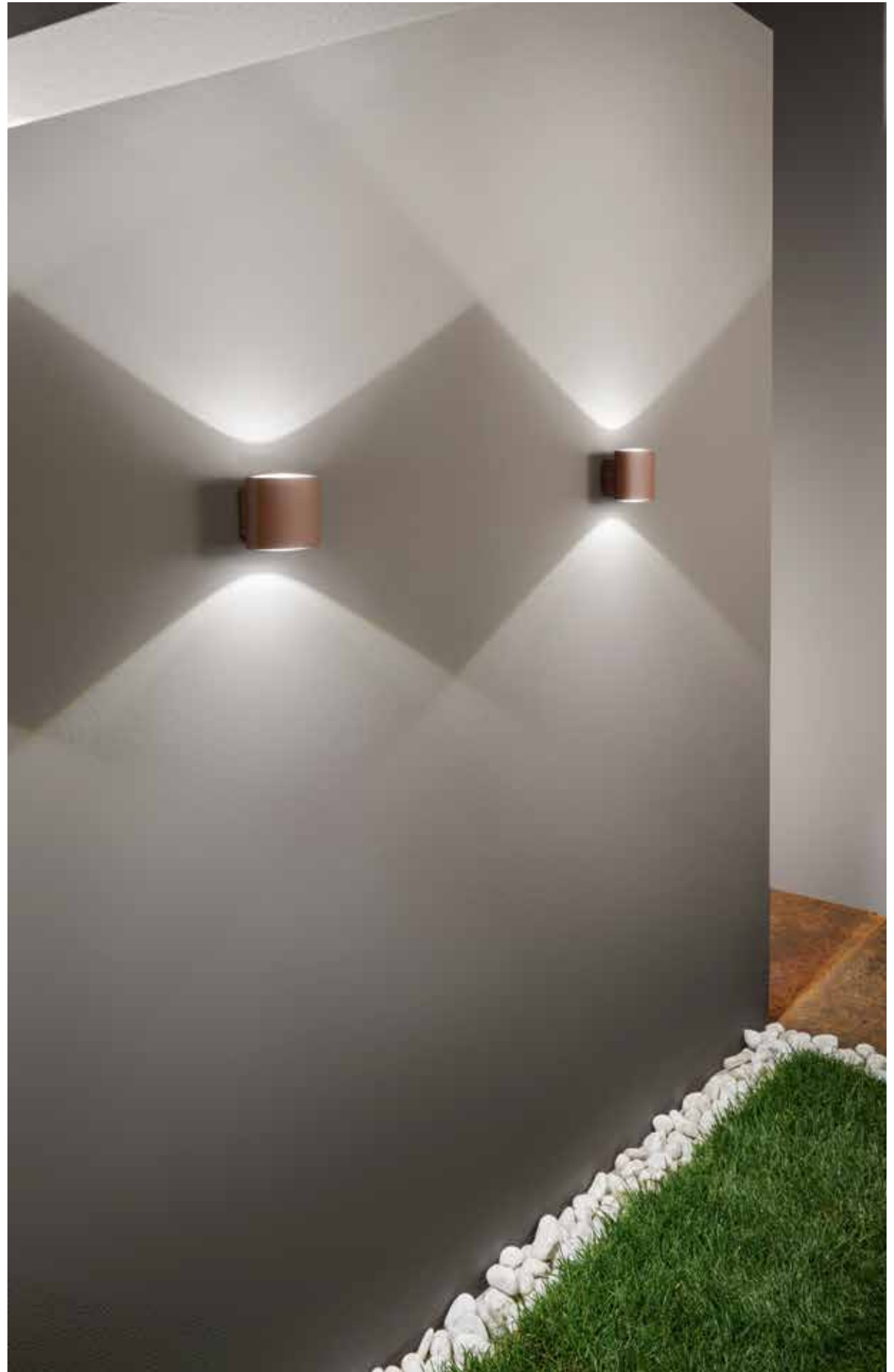



**LED-W-BOXTER BCO**

8031414873043

lumen

colour temp.



960 lm

watt  $2 \times 4W$

beam angle  $\downarrow 120^\circ + 120^\circ \uparrow$

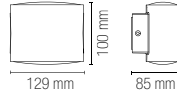

**LED-W-BOXTER SIL**

8031414862399

lumen

colour temp.



800 lm

watt  $2 \times 4W$

beam angle  $\downarrow 120^\circ + 120^\circ \uparrow$

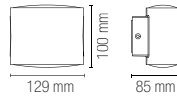

**LED-W-BOXTER NER**

8031414862382

lumen

colour temp.



960 lm

watt  $2 \times 4W$

beam angle  $\downarrow 120^\circ + 120^\circ \uparrow$

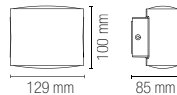

**LED-W-BOXTER BRO**

8031414862405

lumen

colour temp.



960 lm

watt  $2 \times 4W$

beam angle  $\downarrow 120^\circ + 120^\circ \uparrow$

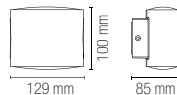

# KLEIN

Appliche a LED in policarbonato con  
biemissione nei colori bianco e nero.

Polycarbonate LED wall light with  
biemissione in matt white or black.



---

**Materiale**

PC

---

**Colore**

bianco opaco  
nero opaco



---

**Temperatura colore**

3000K / 4000K



---

**Driver**

integrato

---

**Material**

PC

---

**Colour**

matt white  
matt black



---

**Colour temperature**

3000K / 4000K



---

**Driver**

built-in



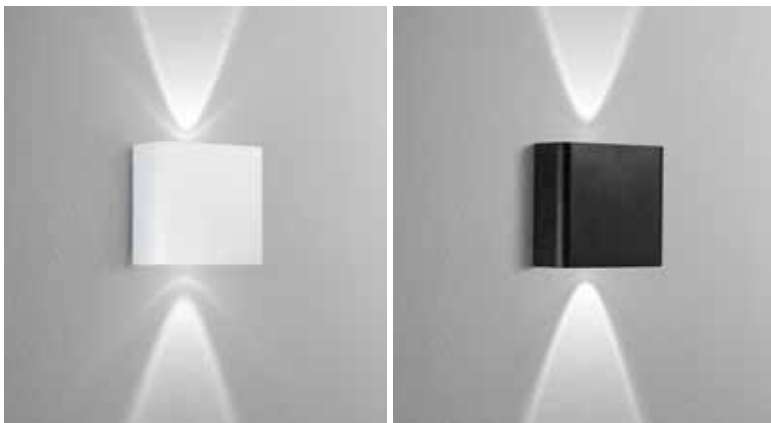

	colour temp.	colour
<b>LED-W-KLEIN-AP2-BCO</b> 8031414916337		
lumen	200 lm	
<b>LED-W-KLEIN-AP2-NER</b> 8031414916320		
lumen	200 lm	
watt	2W	
beam angle	60°	

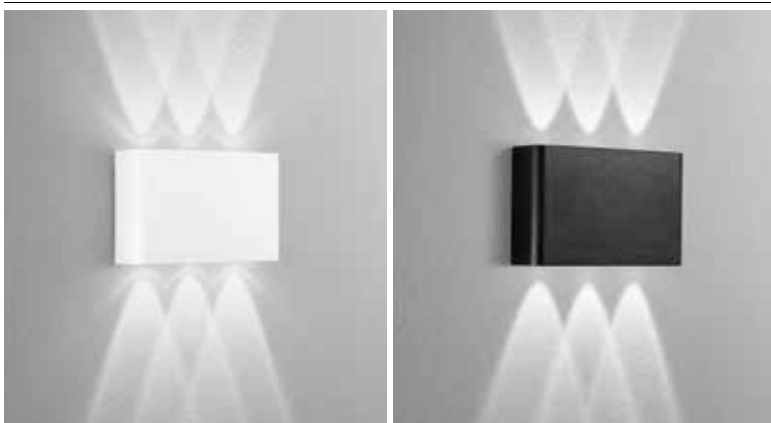
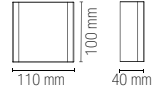

	colour temp.	colour
<b>LED-W-KLEIN-AP6-BCO</b> 8031414916351		
lumen	600 lm	
<b>LED-W-KLEIN-AP6-NER</b> 8031414916344		
lumen	600 lm	
watt	6W	
beam angle	60°	

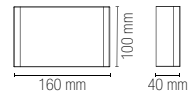

# BEETLE

Applique a LED in alluminio bianco o antracite goffrato.  
Aluminum LED wall lamp embossed white or anthracite finish.

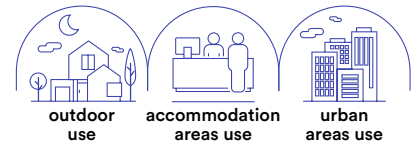

---

**Materiale**

alluminio

---

**Colore**

goffrato bianco  
goffrato antracite



---

**Temperatura colore selezionabile**

3000K / 4000K



---

**Driver**

incluso

---

**Material**

aluminum

---

**Colour**

embossed white  
embossed anthracite



---

**Selectable color temperature**

3000K / 4000K



---

**Driver**

included

---



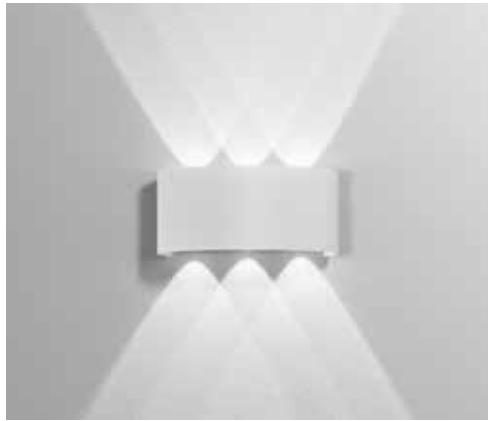
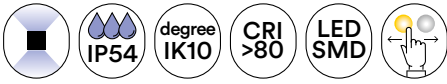

<b>LED-W-BEETLE BCO</b> 8031414876952	colour temp.	colour
	lumen	600 lm
watt	6W	
beam angle	100°	

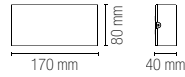

<b>LED-W-BEETLE GR</b> 8031414876969	colour temp.	colour
	lumen	600 lm
watt	6W	
beam angle	100°	

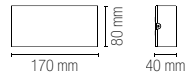

# RIBBON



- Materiale**  
alluminio

---

- Colore**  
gofrato antracite
- 

---

- Temperatura colore**  
4000K
- 

---

- Driver**  
incluso

---

- Material**  
aluminum

---

- Colour**  
embossed anthracite
- 

---

- Colour temperature**  
4000K
- 

---

- Driver**  
included

**Fascia a LED in alluminio in antracite gofrato.**  
Aluminum LED applique in embossed anthracite finish.



**LED-RIBBON-42**  
8031414882335  
lumen

colour temp.	colour
●	●
1600 lm	

watt	2 x 6W
beam angle	120°

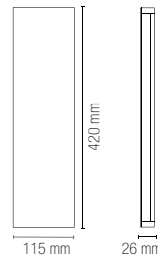

**LED-RIBBON-72**  
8031414882342  
lumen

colour temp.	colour
●	●
2600 lm	

watt	2 x 10W
beam angle	120°

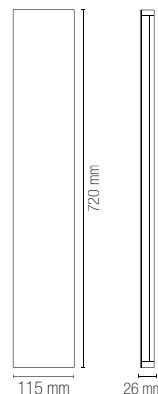

# LASER



outdoor  
use



accommodation  
areas use



urban  
areas use





**Materiale**  
termoplastica

**Colore**  
antracite



**Temperatura colore**  
4000K



**Driver**  
incluso

**Material**  
thermoplastic

**Colour**  
anthracite



**Colour temperature**  
4000K



**Driver**  
included

**Applicque a LED in termoplastica antracite.**  
LED wall lamp in thermoplastic anthracite.



**LED-LASER**  
8031414882328  
lumen

colour temp.	colour
170 lm	

watt	3W
beam angle	5°

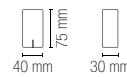

**LED-LASER-BIS**  
8031414882311  
lumen

colour temp.	colour
40 lm	

watt	5W
beam angle	2 × 4°

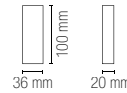

# ALFA

Appliche a LED in alluminio con  
paratie regolabili indipendenti.

Aluminum LED wall lamp with  
independent adjustable wings.



---

**Materiale**

alluminio

---

**Colore**

goffrato bianco  
goffrato silver  
goffrato antracite  
goffrato corten



---

**Temperatura colore**

3000K / 4000K



---

**Driver**

incluso

---

**Material**

aluminum

---

**Colour**

embossed white  
embossed silver  
embossed anthracite  
embossed corten



---

**Colour temperature**

3000K / 4000K



---

**Driver**

included

---





In.tec light **OUTDOOR** APPLIQUE / WALL LAMPS

# ALFA

**Materiale**  
alluminio

**Colore**  
goffrato bianco  
goffrato silver



**Temperatura colore**  
3000K / 4000K



**Driver**  
incluso

**Material**  
aluminum

**Colour**  
embossed white  
embossed silver



**Colour temperature**  
3000K / 4000K



**Driver**  
included



## LED-W-ALFA-10-BCO

8031414905843

lumen

colour temp. | colour



1200 lm

watt  $2 \times 5W$

beam angle  $\downarrow 10^\circ/120^\circ + 10^\circ/120^\circ \uparrow$

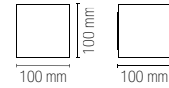

## LED-W-ALFA-10-GR

8031414905850

lumen

colour temp. | colour



1200 lm

watt  $2 \times 5W$

beam angle  $\downarrow 10^\circ/120^\circ + 10^\circ/120^\circ \uparrow$

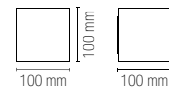

Luce biemissione con paratie regolabili indipendenti /  
Bi-emission light with independent adjustable wings

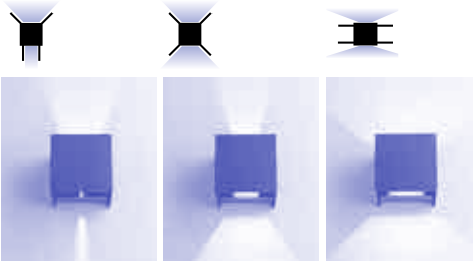



**Materiale**

alluminio

**Colore**

goffrato bianco  
goffrato antracite  
goffrato corten



**Temperatura colore**

3000K / 4000K



**Driver**

incluso

**Material**

aluminum

**Colour**

embossed white  
embossed anthracite  
embossed corten



**Colour temperature**

3000K / 4000K



**Driver**

included

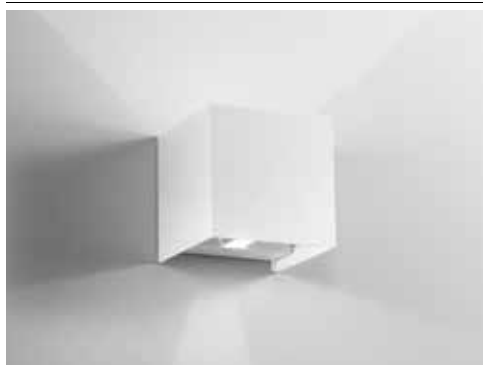

**LED-W-ALFA-20-BCO**

8031414905867

lumen

colour temp. | colour



1800 lm

watt 20W  
beam angle ↓ 10°/120° + 10°/120° ↑

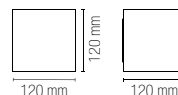

**LED-W-ALFA-20-ANT**

8031414905874

lumen

colour temp. | colour



1800 lm

watt 20W  
beam angle ↓ 10°/120° + 10°/120° ↑

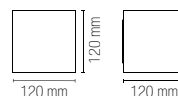

**LED-W-ALFA-20-BRO**

8031414905881

lumen

colour temp. | colour



1800 lm

watt 20W  
beam angle ↓ 10°/120° + 10°/120° ↑

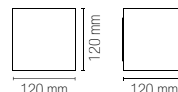

Luce biemissione con paratie regolabili indipendenti /  
Bi-emission light with independent adjustable wings

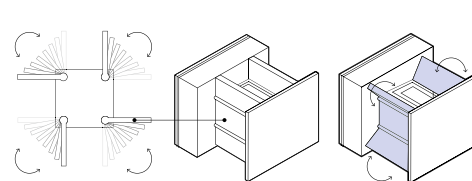

# DELTA

Applique a LED in alluminio bianco o silver goffrato con paratie regolabili indipendenti.

Aluminum LED wall lamp in embossed white or silver finish with independent adjustable wings.

---

**Materiale**

alluminio

---

**Colore**

goffrato bianco  
goffrato silver



---

**Temperatura colore**

3000K / 4000K



---

**Driver**

incluso

---

**Material**

aluminum

---

**Colour**

embossed white  
embossed silver



---

**Colour temperature**

3000K / 4000K



---

**Driver**

included





**LED-W-DELTA-10-BCO**

8031414905829

lumen

colour temp.	colour
700 lm	

watt 2 × 5W  
 beam angle ↓ 10°/120° + 10°/120° ↑

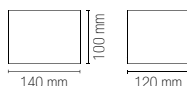

**LED-W-DELTA-10-GR**

8031414905836

lumen

colour temp.	colour
700 lm	

watt 2 × 5W  
 beam angle ↓ 10°/120° + 10°/120° ↑

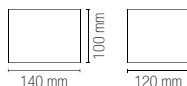

Luce biemissione con paratie regolabili indipendenti /  
 Bi-emission light with independent adjustable wings

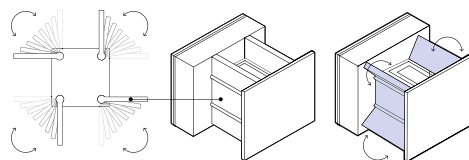
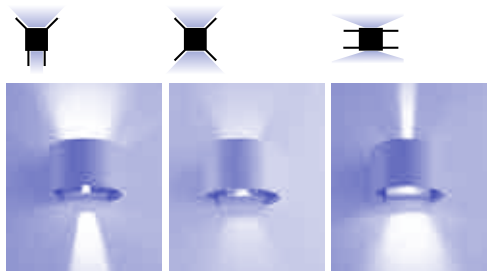

# PARKER

Applique a LED in cemento bianco o grigio naturale.  
LED wall lamp in natural white or grey concrete.

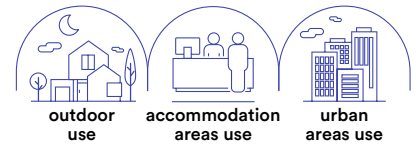

**Materiale**

cemento

**Colore**

bianco  
grigio



**Temperatura colore**

4000K



**Temperatura colore selezionabile**

3000K / 4000K



**Driver**

incluso

**Material**

concrete

**Colour**

white  
grey



**Colour temperature**

4000K



**Selectable color temperature**

3000K / 4000K



**Driver**

included

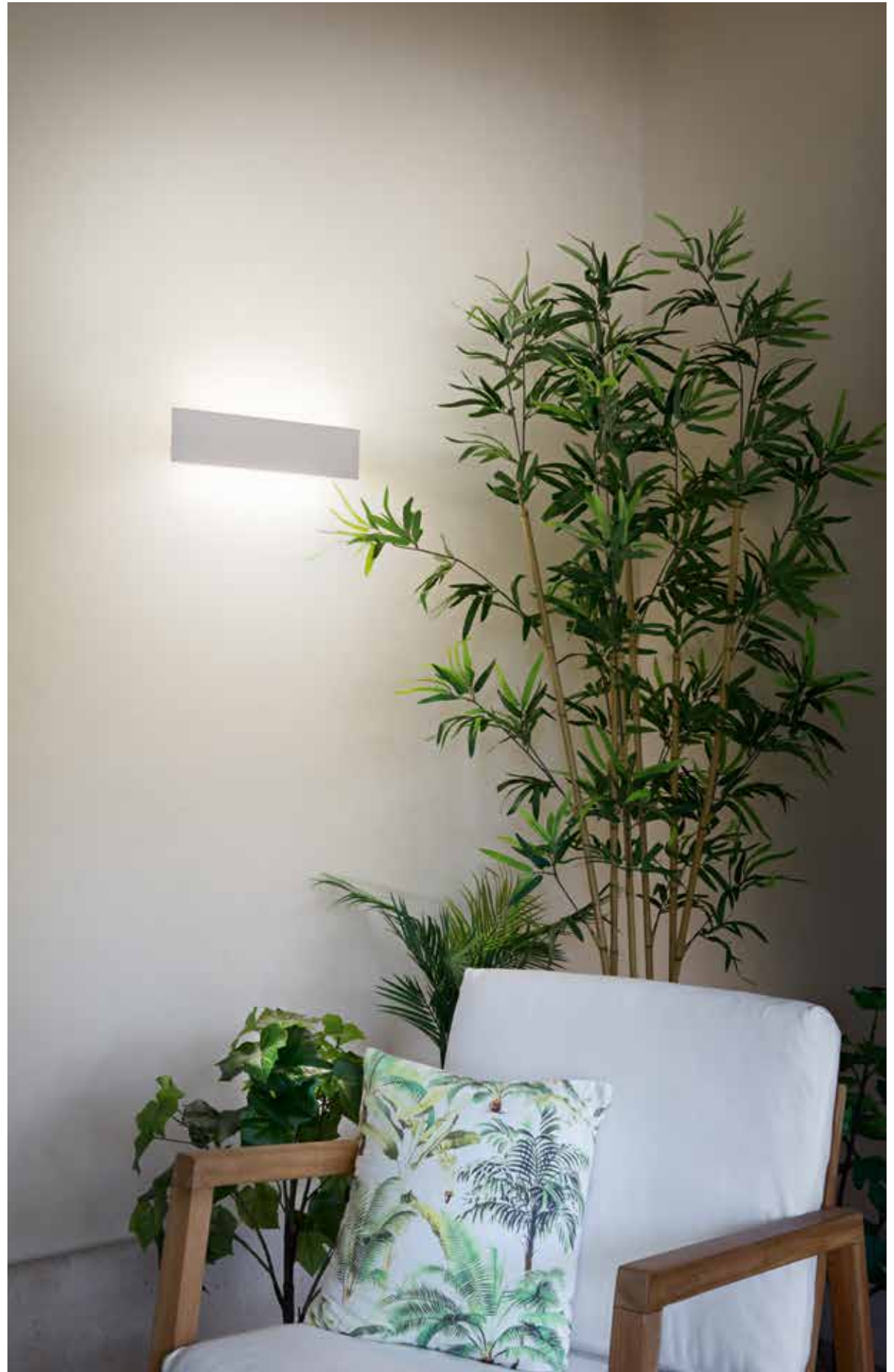





### LED-PARKER-AP30

8031414864195

lumen

colour temp.



colour



1080 lm

watt

9W

beam angle

↓ 120° + 120° ↑

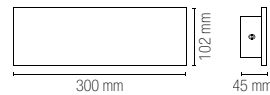

Connettore IP65 incluso / IP65 connector included



### LED-PARKER-AP40

8031414864201

lumen

colour temp.



colour



1400 lm

watt

12W

beam angle

↓ 120° + 120° ↑

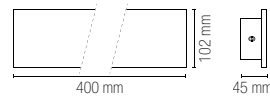

Connettore IP65 incluso / IP65 connector included



### LED-PARKER-AP60

8031414862504

lumen

colour temp.



colour



2640 lm

watt

20W

beam angle

↓ 120° + 120° ↑

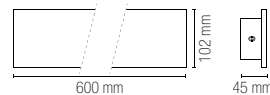

Connettore IP65 incluso / IP65 connector included



### LED-PARKER-AP120

8031414862511

lumen

colour temp.



colour



1500 lm

watt

30W

beam angle

↓ 120° + 120° ↑



Connettore IP65 incluso / IP65 connector included





**LED-PARKER-AP30 GR**

8031414866977

lumen

colour temp.	colour

1080 lm



Connettore IP65 incluso / IP65 connector included

watt	8,6W
beam angle	↓ 120° + 120° ↑

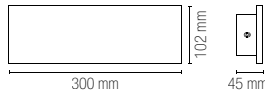

**LED-PARKER-AP50 GR**

8031414866984

lumen

colour temp.	colour

2100 lm



Connettore IP65 incluso / IP65 connector included

watt	16W
beam angle	↓ 120° + 120° ↑

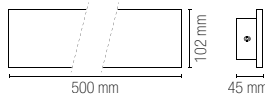

# PORTLAND

**Applique cilindrico in cemento bianco.**  
Cylindrical wall lamp in white concrete.



colour  
**I-PORTLAND-AP2 BCO**  
8031414863563  
2 x GU10 MAX 35W

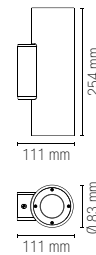

- Connettore IP65 incluso / IP65 connector included
- Lampadina non inclusa / Light bulb not included

# OAKLAND

Applique in cemento bianco.  
Wall lamp in white concrete.



**I-OAKLAND-AP2 BCO**  
8031414864218



2 x GU10 MAX 10W

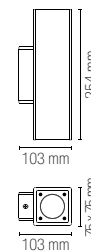

Connettore IP65 incluso /  
IP65 connector included



Lampadina non inclusa /  
Light bulb not included

# JUMP

Applique in alluminio bianco, silver o in acciaio inox.  
Wall lamp aluminum white, silver finish or stainless steel.



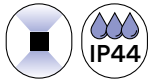

colour

**I-JUMP-AP2 BCO**

8031414862351



**I-JUMP-AP2 SIL**

8031414862344



**I-JUMP-AP2 INOX**

8031414862368



2 x GU10 MAX 35W

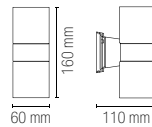

Lampadina non inclusa /  
Light bulb not included



colour

**I-JUMP-AP2-E27 SIL**

8031414865390



2XE27 MAX 60W

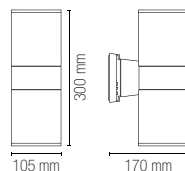

Lampadina non inclusa /  
Light bulb not included

# ONE

**Appliche a LED in alluminio con singola o doppia  
emissione bianco, antracite o corten goffrato.**

Aluminum LED wall light with single or double emission  
in embossed white, anthracite or corten.





colour

**I-ONE-AP1 BCO**

8031414878857



**I-ONE-AP1 ANT**

8031414073009



**I-ONE-AP1 BRO**

8031414048861



1 x GU10 MAX 35W



Lampadina non inclusa /  
Light bulb not included



colour

**I-ONE-AP2 BCO**

8031414878864



**I-ONE-AP2 ANT**

8031414082100



**I-ONE-AP2 BRO**

8031414079995



2 x GU10 MAX 35W

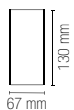

Lampadina non inclusa /  
Light bulb not included

# QUBO

Applique a LED in alluminio con singola o doppia emissione bianco, antracite o corten goffrato.

Aluminum LED wall light with single or double emission in embossed white, anthracite or corten.





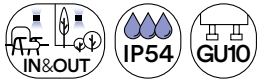

	colour
<b>I-QUBO-AP1 BCO</b> 8031414878833	
<b>I-QUBO-AP1 ANT</b> 8031414084203	
<b>I-QUBO-AP1 BRO</b> 8031414082117	
1 x GU10 MAX 35W	

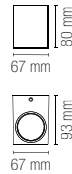

Lampadina non inclusa /  
Light bulb not included



	colour
<b>I-QUBO-AP2 BCO</b> 8031414878840	
<b>I-QUBO-AP2 ANT</b> 8031414084289	
<b>I-QUBO-AP2 BRO</b> 8031414083336	
2 x GU10 MAX 35W	

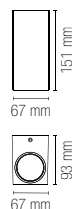

Lampadina non inclusa /  
Light bulb not included

# TUCSON

Applique in alluminio bianco, silver o bronzo gofrato con diffusore in policarbonato.  
Aluminum wall lamp in embossed white, silver or bronze PC diffuser.



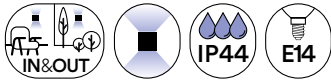

**I-TUCSON-AP BCO**  
8031414862160

colour



2 x E14 MAX 40W



Lampadina consigliata /  
Suggested light bulb



Lampadina non inclusa /  
Light bulb not included



**I-TUCSON-AP SIL**  
8031414862184

colour



2 x E14 MAX 40W

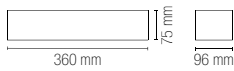

Lampadina consigliata /  
Suggested light bulb



Lampadina non inclusa /  
Light bulb not included



**I-TUCSON-AP BRO**  
8031414862191

colour



2 x E14 MAX 40W

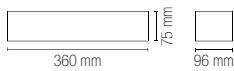

Lampadina consigliata /  
Suggested light bulb



Lampadina non inclusa /  
Light bulb not included

# HURACAN

Applique in alluminio pressofuso antracite goffato.  
Aluminum die-cast wall lamp embossed anthracite finish.



colour



**I-HURACAN-AP**  
8031440361026

1 x GU10 MAX 35W

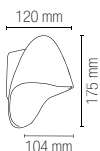

Lampadina non inclusa /  
Light bulb not included

# SEATTLE

Applique in alluminio, finitura antracite  
con diffusore opale in policarbonato.

Aluminum wall lamp with anthracite  
finish and PC opal diffuser.



colour



**I-SEATTLE-AP**  
8031440312233

1 x E27 MAX 42W

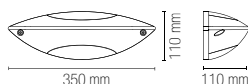

Lampadina non inclusa /  
Light bulb not included

# AUSTIN

Applique in alluminio bianco, silver,  
nero o bronzo con diffusore in policarbonato.

Aluminum wall lamp white, silver,  
black or bronze PC diffuser.

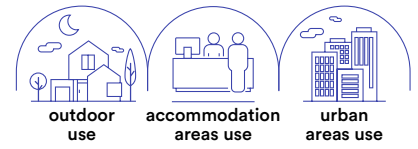



**I-AUSTIN-AP BCO**

8031440362122

1 x E27 MAX 42W

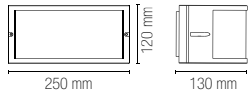

colour



Lampadina non inclusa /  
Light bulb not included



**I-AUSTIN-AP SIL**

8031414862429

1 x E27 MAX 42W

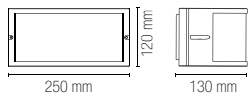

colour



Lampadina non inclusa /  
Light bulb not included



**I-AUSTIN-AP NER**

8031440362139

1 x E27 MAX 42W

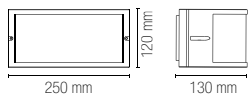

colour



Lampadina non inclusa /  
Light bulb not included



**I-AUSTIN-AP BRO**

8031440362108

1 x E27 MAX 42W

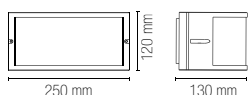

colour



Lampadina non inclusa /  
Light bulb not included

# BOSTON

Applique in alluminio finitura antracite  
con diffusore opale in policarbonato.

Aluminum wall lamp anthracite finish with PC opal diffuser.



colour



**I-BOSTON-AP**  
8031440312240

1 x E27 MAX 42W

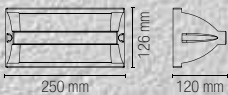

Lampadina  
non inclusa /  
Light bulb  
not included



# ATLANTA

Applique in alluminio finitura antracite  
con diffusore opale in policarbonato.

Aluminum wall lamp anthracite finish with PC opal diffuser.



colour 

**I-ATLANTA-AP**  
8031440312257

1 x E27 MAX 42W

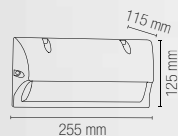

Lampadina non inclusa /  
Light bulb not included

# DENVER

Applique in alluminio finitura antracite  
con diffusore opale in policarbonato.

Aluminum wall lamp anthracite finish with PC opal diffuser.



colour 

**I-DENVER-AP**  
8031440312264

1 x E27 MAX 42W

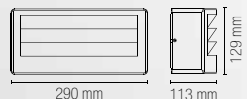

Lampadina non inclusa /  
Light bulb not included

OUTDOOR APPLIQUE / WALL LAMPS

In.tec light

# MONDRIAN

Applique in metallo bianco, nero, silver o bronzo con diffusore in vetro.  
Metal wall lamp white, black, silver or bronze glass diffuser.

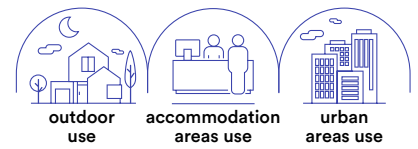

	colour
<b>I-MONDRIAN-AP BCO</b> 8031414896134	
<b>I-MONDRIAN-AP SIL</b> 8031414862306	
<b>I-MONDRIAN-AP NER</b> 8031414896127	
<b>I-MONDRIAN-AP BRO</b> 8031414862313	

1 x E27 MAX 25W

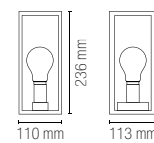

Lampadina  
non inclusa /  
Light bulb  
not included

# GAETA

Lantern in alluminio pressofuso finitura nero-oro con diffusore in vetro.  
Diecast aluminum black-gold finish lantern with glass diffuser.



In.tec light **OUTDOOR APPLIQUE / WALL LAMPS**



**LANT-GAETA-AP1**  
8031440313278

colour



1 x E27 MAX 60W

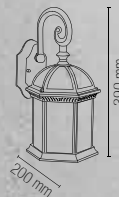

Lampadina  
non inclusa /  
Light bulb  
not included

# GRUBB

Proiettore in termoplastica picchetto incluso.  
 Termoplastic flood light with spike included.



colour



**LED-GRUBB-7M**  
 8031414883554

1 x E27

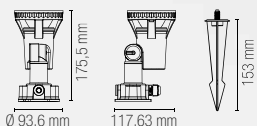

Accessori inclusi /  
 Included accessories



**Lampadina LED SMD /  
 LED SMD light bulb**

watt	7W
beam angle	100°
cri	80
on/off	>10.000
durata/life time	25000h

4000K	
lumen	510 lm
dimmer	



colour



**LED-GRUBB-15M**  
 8031414883547

1 x E27

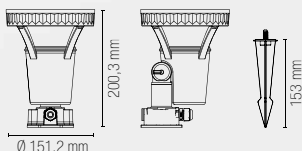

Accessori inclusi /  
 Included accessories



**Lampadina LED SMD /  
 LED SMD light bulb**

watt	15W
beam angle	100°
cri	80
on/off	>10.000
durata/life time	25000h

4000K	
lumen	1100 lm
dimmer	

# AKRON

Proiettore in alluminio con picchetto incluso.  
Aluminum flood light with spike included.



colour

**I-AKRON-BCO**

8031414882649



**I-AKRON-NER**

8031414882663



**I-AKRON-BRO**

8031414882656



1 x GU10 MAX 35W



OUTDOOR APPLIQUE / WALL LAMPS  
In.tec light



Lampadina non inclusa /  
Light bulb not included



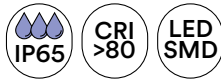

**Materiale**

PC

**Colore**

nero



**Temperatura colore**

3000K / 4000K



**Driver**

integrato

**Material**

PC

**Colour**

black



**Colour temperature**

3000K / 4000K



**Driver**

built-in

**Proiettore in termoplastica con picchetto incluso.**

Termoplastic flood light with spike included.



	colour temp.	colour
<b>LED-PEG-9C-NER</b> 8031414889600 lumen		
<b>LED-PEG-9M-NER</b> 8031414895403 lumen		
watt	9W	
beam angle	60°	

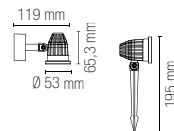

# TOGO

Plafoniera a LED in acrilico.  
LED acrylic ceiling lamp with diffuser.



**Materiale**

Acrilico PMMA

**Colore**

bianco



**Temperatura colore selezionabile**

3000K / 4000K / 6500K



**Driver**

integrato

**Material**

PMMA acrylic

**Colour**

white



**Selectable color temperature**

3000K / 4000K / 6500K



**Driver**

built-in driver







**LED-TOGO-Q10**

8031414883615

lumen

colour temp.		colour	
600 lm			

watt	5W
beam angle	120°

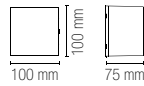

**LED-TOGO-Q25**

8031414883646

lumen

colour temp.		colour	
2400 lm			

watt	20W
beam angle	120°

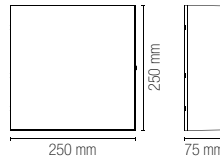

**LED-TOGO-RT20**

8031414883622

lumen

colour temp.		colour	
1000 lm			

watt	8W
beam angle	120°

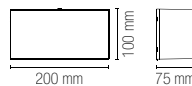

**LED-TOGO-RT30**

8031414883639

lumen

colour temp.		colour	
1500 lm			

watt	12W
beam angle	120°

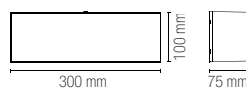



# OUTDOOR

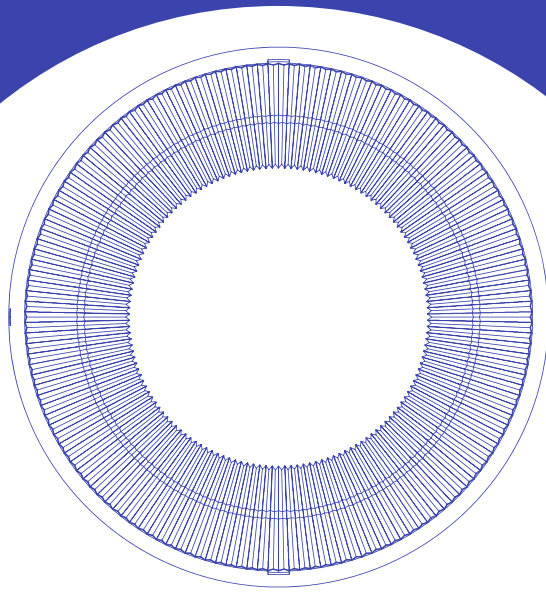

PLAFONIERE  
CEILING LAMPS

# ZOOM

Plafoniera a LED wifi con videocamera di sicurezza integrata.  
LED wifi ceiling lamp with built-in security camera.

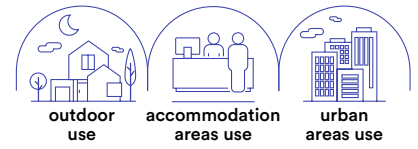

**Materiale**

alluminio + PC

**Colore**

goffrato antracite



**Temperatura colore**

4000K



**Driver**

integrato

**Material**

aluminium + PC

**Colour**

Embossed anthracite



**Colour temperature**

4000K



**Driver**

built-in





technical information **ZOOM**

**WI-FI**  
SMART INTEC



**LED-ZOOM-INT**

8031414877874

lumen

colour temp. | colour



3600 lm

watt 30W

beam angle 110°

pf 0.95

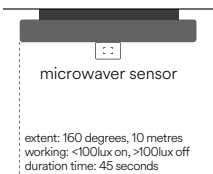
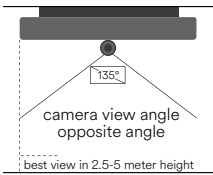
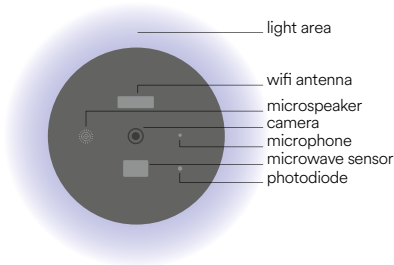
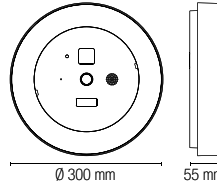

Tipo di sensore video  
Video sensor type

Pixel

Illuminazione minima  
Min illuminance

Angolo vista camera  
Camera view angle

Otturatore  
Shutter

Infrarossi  
IR

WDR

Video compression standard

Risoluzione video  
Max picture size

Frequenza fotogrammi  
Frame rate

Audio

Memoria

Impostazione immagine  
Image setting

Reset

Controllo della luce  
Lighting control

Interfaccia di protocollo  
Interface protocol

Comunicazione di protocollo  
Communication protocol

Funzioni generali  
General function

Wi-Fi

PIR

1/2,9" CMOS

2.0 Mega

Color 0.10lux @F2.0,  
black and white 0.01lux @F2.0

135°

1/25-1/100,000 per second

High power LED with ICR

Digital WDR

H.264  
32Kbps - 2Mbps

1920x1080

1-20 per second

Full duplex audio (doppio sistema di comunicazione)

Support SD card (MAX 128Gb) Cloud storage NVR

Support HD/SD; support mirror

Support

Support manual, sensor, plan switch light (gestione accensioni)

Private

TCP/IP, HTTP, DHCP, DNS, RTSP

Dual stream, password protection

IEEE802.11b/g/n

Support PIR and motion detection

Control system easy installation

Full duplex audio



Smart Intec WIFI



RF 2.4G control system



ALEXA e GOOGL HOME voice control



compatible with AMAZON ECHO SHOW GOOGLE CHROME CAST

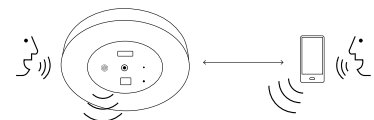

In.tec light **OUTDOOR** PLAFONIERE / CEILING LAMPS

# CITIZEN

Plafoniera in alluminio nelle versioni bianco, nero o corten.  
Ceiling wall lamp white, black or corten finish.





**I-CITIZEN-Q1-BCO**

8031414882922

**I-CITIZEN-Q1-NER**

8031414882939

**I-CITIZEN-Q1-BRO**

8031414882915

colour



1 x E27



Lampadina non inclusa /  
Light bulb not included

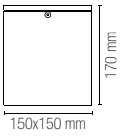

**I-CITIZEN-R1-BCO**

8031414882892

**I-CITIZEN-R1-NER**

8031414882908

**I-CITIZEN-R1-BRO**

8031414882885

colour



1 x E27



Lampadina non inclusa /  
Light bulb not included

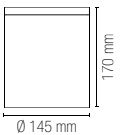

# TOWER

Plafoniera in alluminio nelle versioni bianco, nero o corten.  
Ceiling wall lamp white, black or corten finish.







colour

**I-TOWER-Q1-BCO**

8031414922093



**I-TOWER-Q1-NER**

8031414922116



**I-TOWER-Q1-BRO**

8031414922109



1 x GX53



Lampadina non inclusa /  
Light bulb not included



colour

**I-TOWER-R1-BCO**

8031414918522



**I-TOWER-R1-NER**

8031414918515



**I-TOWER-R1-BRO**

8031414918539



1 x GX53



Lampadina non inclusa /  
Light bulb not included



# ISCHIA

Plafoniera LED integrato, in termoplastica bianco con diffusore trasparente effetto diamantato.

Thermoplastic LED ceiling lamp with transparent diamond effect diffuser.

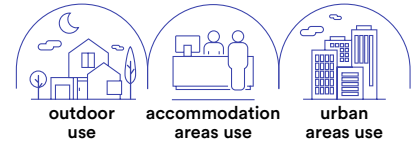

**Materiale**  
termoplastica



**Temperatura colore**  
3000K / 4000K



**Driver**  
integrato

**Material**  
thermoplastic

**Colour temperature**  
3000K / 4000K



**Driver**  
built-in



**LED-ISCHIA-L-BCO**

8031414883608

lumen

colour temp.



2300 lm

watt

20W

beam angle

100°

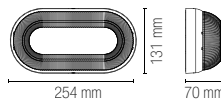

# CAPRI

Plafoniera LED integrato, in termoplastica bianco con diffusore trasparente effetto diamantato.

Thermoplastic LED ceiling lamp with transparent diamond effect diffuser.



In.tec light OUTDOOR PLAFONIERE / CEILING LAMPS

**Materiale**  
termoplastica

**Temperatura colore**  
3000K / 4000K



**Driver**  
integrato

**Material**  
thermoplastic

**Colour temperature**  
3000K / 4000K



**Driver**  
built-in



**LED-CAPRI-S-BCO**  
8031414883585  
lumen

colour temp.	colour
2350 lm	

watt	20W
beam angle	100°

**LED-CAPRI-L-BCO**  
8031414883592  
lumen

colour temp.	colour
3200 lm	

watt	30W
beam angle	100°

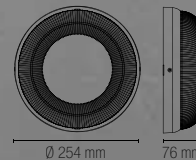
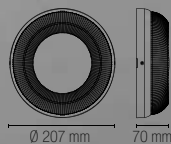



**Materiale**  
PC + PC

**Temperatura colore**

2700K / 3000K / 4000K / 5000K / 6500K



**Driver**  
integrato

**Material**  
PC + PC

**Colour temperature**

2700K / 3000K / 4000K / 5000K / 6500K



**Driver**  
built-in



**Plafoniera in termoplastica con selettore interno di watt e gradi Kelvin. Sensore radar 5.8GHz integrato con tasto di regolazione durata.**

Thermoplastic ceiling lamp with internal watt and Kelvin selector. integrated 5.8GHz radar sensor with duration adjustment button.

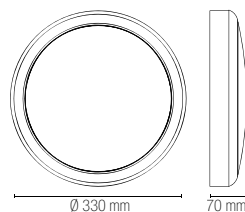

**LED-ALWAYS-RS**

8031414926923

lumen

colour temp.	colour
1500lm	1900lm / 2250lm

watt	15W / 20W / 25W
beam angle	120°
pf	0.90

**Accessori inclusi / Included accessories**

Sensore di movimento radar /  
Radar motion sensor

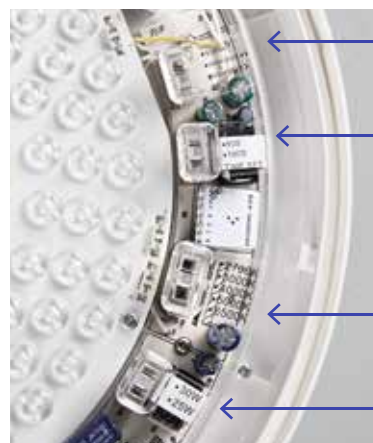

Modalità sensore:  
solo movimento - crepuscolare + movimento - solo crepuscolare /  
Sensor mode: motion only - dusk + motion - dusk only

Selezione durata accensione  
con sensore di movimento 60S - 180S /  
Motion sensor duration selection: 60S - 180S

Selezione gradi kelvin: 2700K 3000K 4000K 5000K 6500K /  
Kelvin degrees selection: 2700K 3000K 4000K 5000K 6500K

Selezione potenza: 15W 25W 30W /  
Power selection: 15W 25W 30W

# HUBLOT SENS

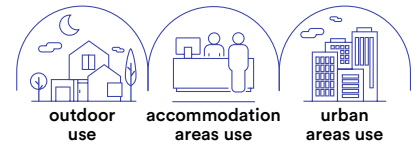

**Materiale**  
PC + PC

**Temperatura colore**  
3000K / 4000K / 6500K



**Driver**  
integrato

**Material**  
PC + PC

**Colour temperature**  
3000K / 4000K / 6500K



**Driver**  
built-in



**Plafoniera in termoplastica con selettore interno Kelvin, sensore microwave regolabile integrato regolabile.**

Thermoplastic ceiling lamp with internal Kelvin selector, integrated adjustable microwave sensor.

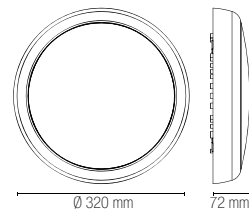

## LED-HUBLOT-SENS

8031414919604  
lumen

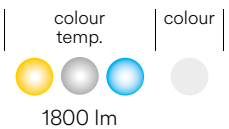

watt	18W
beam angle	120°
pf	0.90

### Accessori inclusi / Included accessories

Sensore di movimento 100% luce  
Dopo 30 secondi 20% luce /  
Motion sensor 100% light  
After 30 seconds 20% light

sensore regolabile con LED-SENSOR-REMOTE p. 860  
adjustable sensor with LED-SENSOR-REMOTE p. 860



OUTDOOR PLAFONIERE / CEILING LAMPS  
In.tec light

# SENSITIVE





**Materiale**

PP + PC

**Colore**

bianco  
antracite



**Temperatura colore**

3000K / 4000K



**Driver**

integrato

**Material**

PP + PC

**Colour**

white  
anthracite



**Colour temperature**

3000K / 4000K



**Driver**

built-in

**Plafoniera LED integrato con sensore di movimento; materiale base in PP bianco o antracite con diffusore bianco PC.**

LED ceiling lamp with motion sensor; PP white base or anthracite colour with white PC diffuser.



**Accessori inclusi / Included accessories**

Sensore di movimento regolabile / Adjustable motion sensor

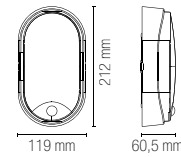
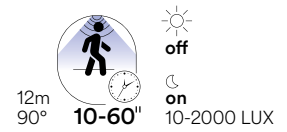

	colour temp.	colour
<b>LED-SENSITIVE-C BCO</b> 8031414876815 lumen	1000 lm	
<b>LED-SENSITIVE-BCO</b> 8031440361750 lumen	1600 lm	
<b>LED-SENSITIVE-ANT</b> 8031440361743 lumen	1600	
watt	14W	
beam angle	120°	

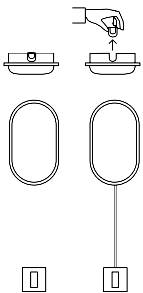

Doppio sistema di installazione / Double installation system

# EXTRA



outdoor  
use



accommodation  
areas use



urban  
areas use





**Materiale**

PP + PC

**Colore**

bianco  
antracite



**Temperatura colore**

4000K



**Driver**

integrato

**Material**

PP + PC

**Colour**

white  
anthracite



**Colour temperature**

4000K



**Driver**

built-in

**Plafoniera LED integrato materiale base PP bianco con diffusore bianco PC adatte ad installazione con impianto canaline esterne.**

Ceiling LED integrated white PP base material with white PC diffuser fit for surface mount cable ducts connections.

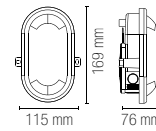

	colour temp.	colour
<b>LED-EXTRA-BCO</b> 8031440361071 lumen		
	1100 lm	
<b>LED-EXTRA-ANT</b> 8031440361064 lumen		
	1100 lm	
watt	10W	
beam angle	120°	

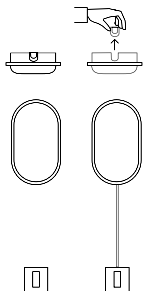

Doppio sistema di installazione /  
Double installation system

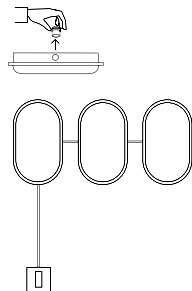

Adatte ad installazione con impianto canaline esterne /  
Surface mount cable ducts connections

# SHELLY





**Materiale**

PC + PC

**Colore**

bianco  
antracite



**Temperatura colore**

4000K



**Driver**

integrato

**Material**

PC + PC

**Colour**

white  
anthracite



**Colour temperature**

4000K



**Driver**

built-in

**Plafoniera LED integrato con sensore, base in policarbonato bianco o antracite diffusore in policarbonato bianco.**

Polycarbonate built-in LED ceiling lamp with sensor in white or anthracite colour with white PC diffuser.



**Accessori inclusi / Included accessories**

Sensore di movimento regolabile / Adjustable motion sensor

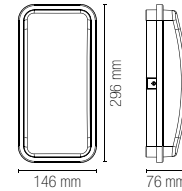
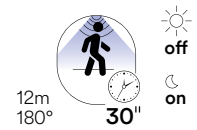

	colour temp.	colour
<b>LED-SHELLY-Q-MW BCO</b> 8031414862153		
lumen	2500 lm	
<b>LED-SHELLY-Q-MW ANT</b> 8031414862177		
lumen	2500 lm	
watt	20W	
beam angle	120°	

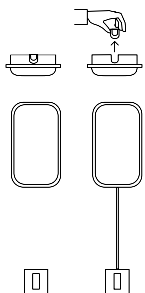

Doppio sistema di installazione / Double installation system

# SHELLY

**Materiale**

PC + PC

**Colore**

bianco  
antracite



**Temperatura colore**

3000K / 4000K



**Driver**

integrato

**Material**

PC + PC

**Colour**

white  
anthracite



**Colour temperature**

3000K / 4000K



**Driver**

built-in

**Plafoniera LED integrato, base in policarbonato bianco o antracite diffusore in policarbonato bianco.**

Polycarbonate built-in LED ceiling lamp in white or anthracite colour with white PC diffuser.



**LED-SHELLY-Q-S BCO**

8031414085507

lumen

colour temp.	colour
1900 lm	

**LED-SHELLY-Q-S ANT**

8031414862009

lumen

colour temp.	colour
1900 lm	

**LED-SHELLY-Q-L BCO**

8031414862016

lumen

colour temp.	colour
2500 lm	

**LED-SHELLY-Q-L ANT**

8031414862023

lumen

colour temp.	colour
2500 lm	

watt	15W
beam angle	120°

watt	20W
beam angle	120°

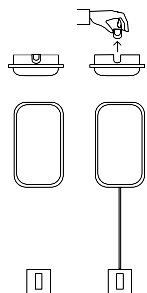
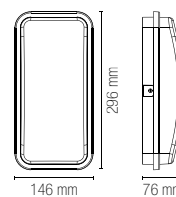
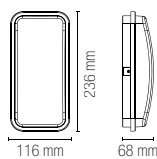

Doppio sistema di installazione /  
Double installation system

**Materiale**

PC + PC

**Colore**

bianco  
antracite



**Temperatura colore**

3000K / 4000K



**Driver**

integrato

**Material**

PC + PC

**Colour**

white  
anthracite



**Colour temperature**

3000K / 4000K



**Driver**

built-in

**Plafoniera LED integrato, base in policarbonato bianco o antracite diffusore in policarbonato bianco.**

Polycarbonate built-in LED ceiling lamp in white or anthracite colour with white PC diffuser.



	colour temp.	colour
<b>LED-SHELLY-S BCO</b> 8031440351720 lumen		
	1900 lm	
<b>LED-SHELLY-S ANT</b> 8031440351706 lumen		
	1900 lm	
watt	15W	
beam angle	120°	

	colour temp.	colour
<b>LED-SHELLY-L BCO</b> 8031440351713 lumen		
	2500 lm	
<b>LED-SHELLY-L ANT</b> 8031440351690 lumen		
	2500 lm	
watt	20W	
beam angle	120°	

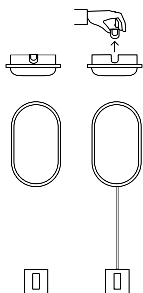
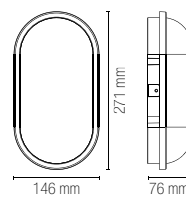
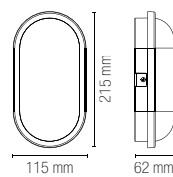

Doppio sistema di installazione / Double installation system

EVER

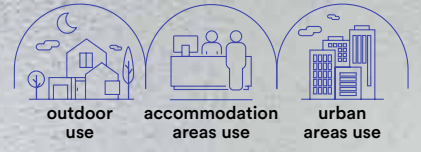

**Materiale**

PC + PC

**Colore**

bianco  
antracite



**Temperatura colore**

3000K / 4000K



**Driver**

integrato

**Material**

PC + PC

**Colour**

white  
anthracite



**Colour temperature**

3000K / 4000K



**Driver**

built-in

**Plafoniera LED integrato, base in policarbonato bianco o antracite, diffusore in policarbonato bianco.**

Polycarbonate built-in LED ceiling lamp in white or anthracite colour with white PC diffuser.



	colour temp.	colour
<b>LED-EVER-Q-S BCO</b> 8031414862238 lumen		
	1900 lm	
<b>LED-EVER-Q-S ANT</b> 8031414862269 lumen		
	1900 lm	

	colour temp.	colour
<b>LED-EVER-Q-L BCO</b> 8031414862276 lumen		
	3420	
<b>LED-EVER-Q-L ANT</b> 8031414862283 lumen		
	3420	

watt	15W
beam angle	120°
pf	-

watt	28W
beam angle	120°
pf	0.90

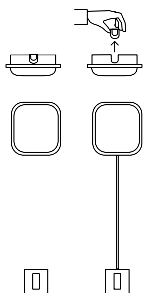
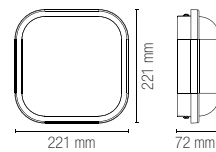
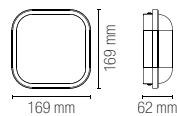

Doppio sistema di installazione / Double installation system

**Materiale**

PC + PC

**Colore**

bianco  
antracite



**Temperatura colore**

3000K / 4000K



**Driver**

integrato

**Material**

PC + PC

**Colour**

white  
anthracite



**Colour temperature**

3000K / 4000K



**Driver**

built-in

**Plafoniera LED integrato, base in policarbonato bianco o antracite, diffusore in policarbonato bianco.**

Polycarbonate built-in LED ceiling lamp in white or anthracite colour with white PC diffuser.



	colour temp.	colour
<b>LED-EVER-LP BCO</b> 8031440355650 lumen		
<b>LED-EVER-LP ANT</b> 8031440355643 lumen		

	colour temp.	colour
<b>LED-EVER-XLP BCO</b> 8031440355636 lumen		
<b>LED-EVER-XLP ANT</b> 8031440355629 lumen		

watt	20W
beam angle	120°
pf	-

watt	28W
beam angle	120°
pf	0.90

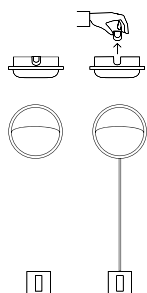
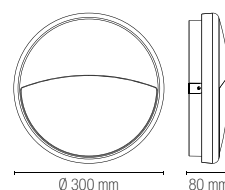
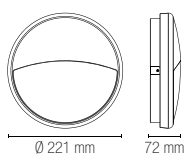

Doppio sistema di installazione /  
Double installation system





**Materiale**

PC + PC

**Colore**

bianco  
antracite



**Temperatura colore**

3000K / 4000K



**Driver**

integrato

**Material**

PC + PC

**Colour**

white  
anthracite



**Colour temperature**

3000K / 4000K



**Driver**

built-in

**Plafoniera LED integrato, base in policarbonato bianco o antracite, diffusore in policarbonato bianco.**

Polycarbonate built-in LED ceiling lamp in white or anthracite colour with white PC diffuser.

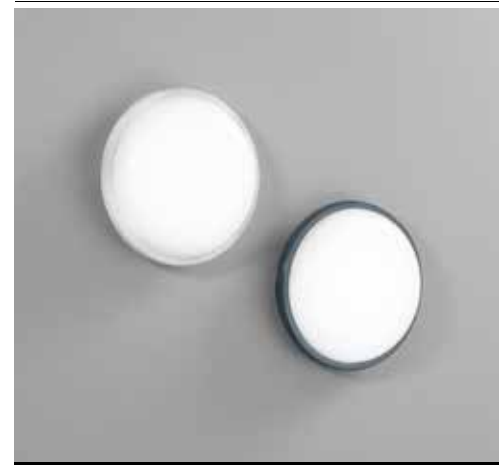
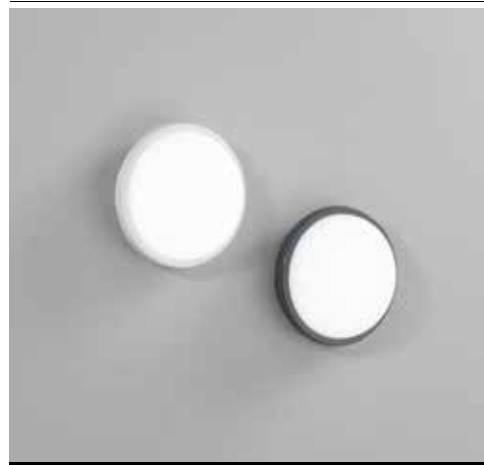

	colour temp.	colour
<b>LED-EVER-S BCO</b> 8031440351683 lumen		
	1900 lm	
<b>LED-EVER-S ANT</b> 8031440351638 lumen		
	1900 lm	

	colour temp.	colour
<b>LED-EVER-L BCO</b> 8031440351676 lumen		
	2500 lm	
<b>LED-EVER-L ANT</b> 8031440351645 lumen		
	2500 lm	

watt	15W
beam angle	120°
pf	-

watt	20W
beam angle	120°
pf	0.90

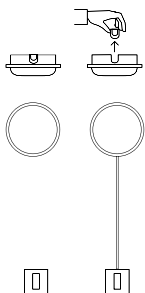
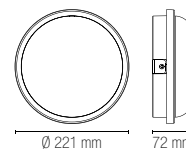
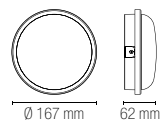

Doppio sistema di installazione /  
Double installation system

EVER



outdoor  
use



accommodation  
areas use



urban  
areas use



**Materiale**

PC + PC

**Colore**

bianco  
silver



**Temperatura colore**

3000K / 4000K



**Driver**

integrato

**Material**

PC + PC

**Colour**

white  
silver



**Colour temperature**

3000K / 4000K



**Driver**

built-in

**Plafoniera LED integrato, base policarbonato bianco o silver con diffusore in policarbonato bianco.**

Polycarbonate built-in LED ceiling lamp PC base white or silver with white PC diffuser.

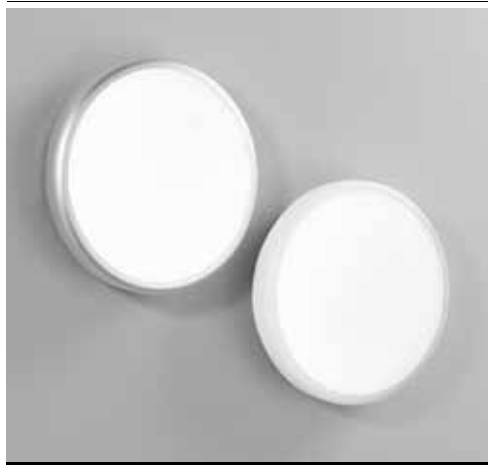

	colour temp.	colour
<b>LED-EVER-XL BCO</b> 8031440355612 lumen		
	3750 lm	
<b>LED-EVER-XL SIL</b> 8031440355605 lumen		
	3750 lm	

watt	28W
beam angle	120°
pf	0.90

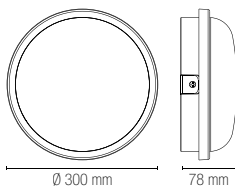

**Materiale**

PC + PC

**Colore**

bianco  
silver



**Temperatura colore**

4000K



**Driver**

integrato

**Material**

PC + PC

**Colour**

white  
silver



**Colour temperature**

4000K



**Driver**

built-in

**Plafoniera con sensore di movimento microwave, base in policarbonato, diffusore in policarbonato bianco.**

Ceiling lamp with microwave sensor in polycarbonate ceiling with white PC diffuser.

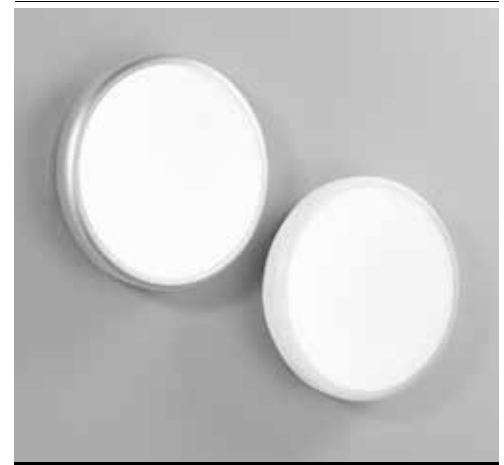

	colour temp.	colour
<b>LED-EVER-XL-MW BCO</b> 8031414862375 lumen		
	3750 lm	
<b>LED-EVER-XL-MW SIL</b> 8031414862610 lumen		
	3750 lm	

watt	28W
beam angle	120°
pf	0.90

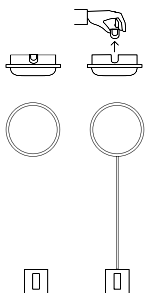
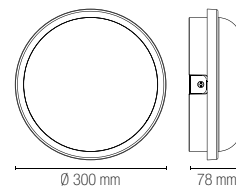

Doppio sistema di installazione / Double installation system

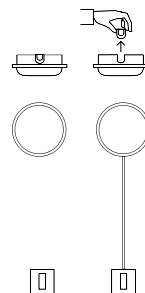

Doppio sistema di installazione / Double installation system

**Accessori inclusi / Included accessories**

Sensore di movimento regolabile / Adjustable motion sensor

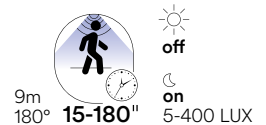

# FLIPPY





**Materiale**

PC

**Colore**

bianco



**Temperatura colore**

3000K / 4000K



**Driver**

integrato

**Material**

white PC

**Colour**

white



**Colour temperature**

3000K / 4000K



**Driver**

built-in

**Plafoniera con base in policarbonato, diffusore in policarbonato bianco.**

Ceiling lamp with polycarbonate ceiling with white PC diffuser.

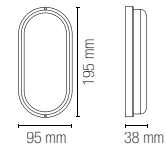

	colour temp.	colour
<b>LED-FLIPPY-12C</b>		
8031414922024		
lumen	1160 lm	
watt		12W
beam angle		120°

<b>LED-FLIPPY-12M</b>		
8031414922031		
lumen	1160 lm	
watt		12W
beam angle		120°

# SPEEDY





**Materiale**

PC

**Colore**

bianco



**Temperatura colore**

3000K / 4000K



**Driver**

integrato

**Material**

PC

**Colour**

white



**Colour temperature**

3000K / 4000K



**Driver**

built-in

**Plafoniera con base in policarbonato, diffusore in policarbonato bianco.**

Ceiling lamp with polycarbonate ceiling with white PC diffuser.

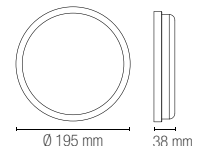

**LED-SPEEDY-18C**

8031414922000

lumen

colour temp.	colour
1800 lm	

watt	18W
beam angle	120°

**LED-SPEEDY-18M**

8031414922017

lumen

colour temp.	colour
1800 lm	

watt	18W
beam angle	120°

# TURTLE





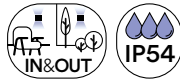

**Plafoniera bianca o nera con struttura in termoplastica e diffusore in vetro. Disponibile in forma circolare o ovale.**

White or black ceiling lamp with thermoplastic frame and glass diffuser. Available in circular or oval shape.



**I-TURTLE-AP-BCO**

8031414918577

**I-TURTLE-AP-NER**

8031414918560

colour



1 x E27

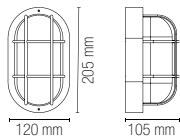

**I-TURTLE-PL-BCO**

8031414918553

**I-TURTLE-PL-NER**

8031414918546

colour



1 x E27

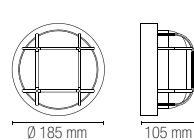

Lampadina non inclusa / Light bulb not included

# PICNIC COLOR



**Stringa elettrificata E12 per esterno con cavo in PVC inclusiva di spina schuko e connettore modulabile.**

Light string E12 PVC cable inclusive of schuko plug and modular connector.



colour

Accessori inclusi /  
Included accessories

**I-PICNIC-COLOR**  
8031414891863



25 x E12 MAX 20W



**Lampadina E12**  
**E12 light bulb**

7 rosse/red  
6 gialle/yellow  
6 verdi/green  
6 blu/blue

watt	0,3W
volt	230V

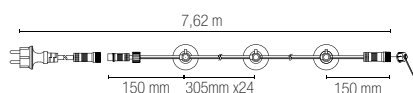

**END-TO-END**

easy connection / max 1000W

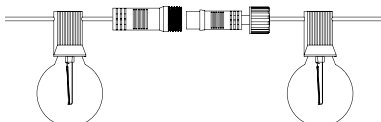

# PICNIC

**Stringa elettrificata E12 per esterno con cavo in PVC inclusiva di spina schuko e connettore modulare.**

Light string E12 PVC cable inclusive of schuko plug and modular connector.

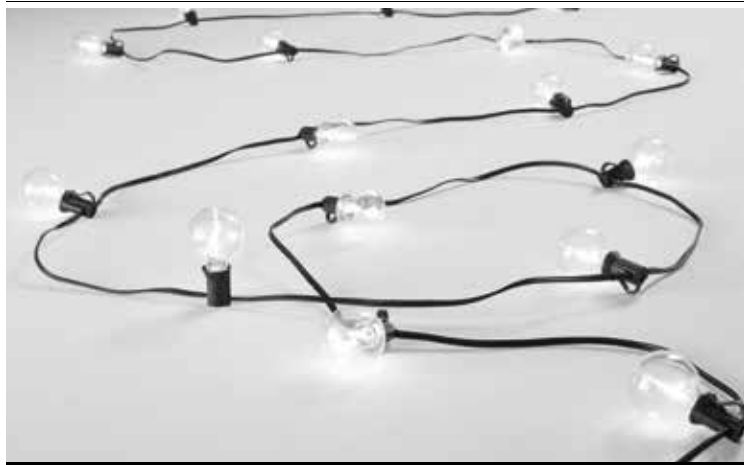
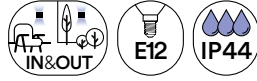

colour | Accessori inclusi / Included accessories

**I-PICNIC-LED**  
8031414884407



**Lampadina E12**  
**E12 light bulb**

watt	0,3W
volt	230V

3000K	
-------	--

25 x E12 MAX 20W

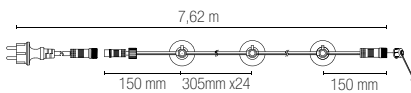

**Stringa elettrificata E12 per esterno con cavo in PVC inclusiva di pannello solare.**

Light string E12 PVC cable inclusive solar panel.



colour | Accessori inclusi / Included accessories

**I-PICNIC-SOLAR**  
8031414884414



**Lampadina E12**  
**E12 light bulb**

watt	0,3W
volt	3V

3000K	
-------	--

25 x E12 MAX 20W

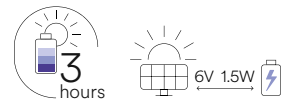

**3.7V 2200mAh**  
Batteria ricaricabile non sostituibile / Rechargeable battery non replaceable

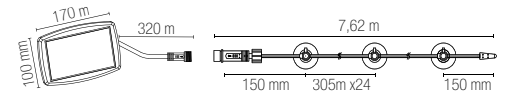

## END-TO-END

easy connection / max 1000W

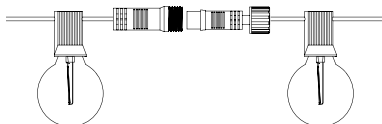

**Stringa elettrificata E14 o E27 per esterno con cavo in gomma inclusiva di spina schuko e connettore modulabile.**

Light string E14 or E27 for outdoor rubber cable inclusive of schuko plug and modular connector.



colour

**I-PICNIC-E27-BCO**  
8031414043064



**I-PICNIC-E27**  
8031414862719



10 x E27 MAX 25W



Lampadina non inclusa / Light bulb not included

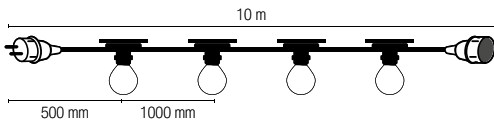

**END-TO-END**

easy connection / max 1000W

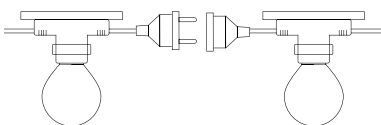

colour

**I-PICNIC-E14-BCO**  
8031414023745



**I-PICNIC-E14**  
8031414862726



10 x E14 MAX 25W



Lampadina non inclusa / Light bulb not included

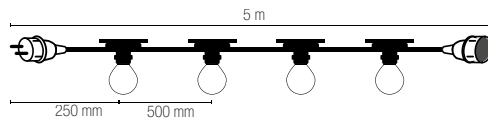

**END-TO-END**

easy connection / max 1000W

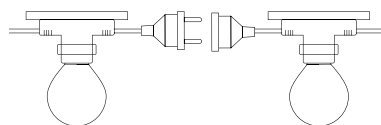

# PICNIC RGB

Stringa luminosa LED per esterno con cavo in PVC, inclusa spina schuko e connettore modulabile.

Telecomando per gestire il colore RGB.

Outdoor LED light string with PVC cable, including schuko plug and modular connector.

Remote control to manage RGB color.

**Materiale**

PC + PVC

**Colore**

nero



**Temperatura colore**

RGB



**Driver**

integrato

**Material**

PC + PVC

**Colour**

black



**Colour temperature**

RGB



**Driver**

built-in

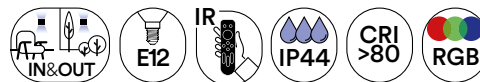

**I-PICNIC-LED-RGB**

8031414921911

colour temp.



RGB

colour



watt

10W

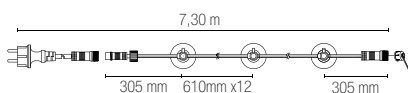

**END-TO-END**

easy connection / max 1000W



# PICNIC INT



Stringa elettrificata a LED per esterno con cavo in PVC inclusiva di spina schuko e connettore modulabile.

LED light string with PVC cable inclusive of schuko plug and modular connector.

**Materiale**

PC + PVC

**Colore**

nero



**Temperatura colore**

RGB + CCT

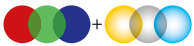

**Driver**

integrato

**Material**

PC + PVC

**Colour**

black



**Colour temperature**

RGB + CCT

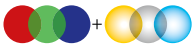

**Driver**

built-in



**I-PICNIC-INT**  
8031414884391  
lumen

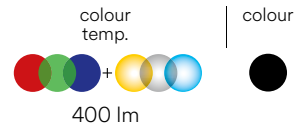

400 lm

watt	10 x 0,5W
beam angle	110°

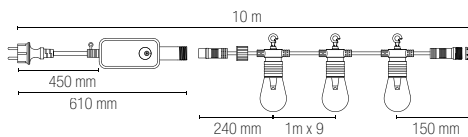

**END-TO-END**

easy connection / max 1000W

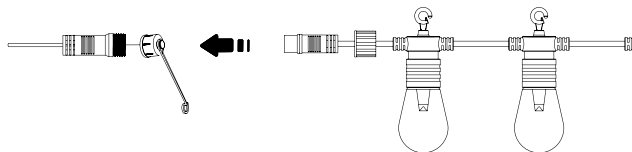

Control system easy installation



Smart Intec WIFI



RF 2.4G control system



ALEXA e GOOGLE HOME voice control





# OUTDOOR

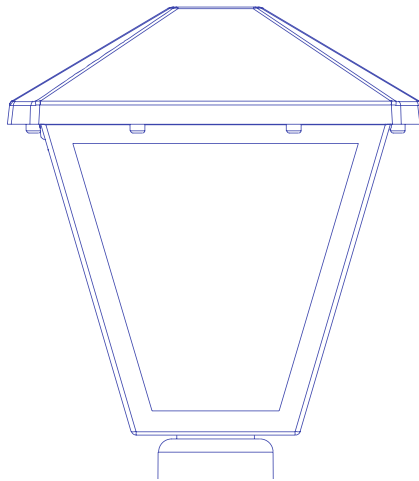

APPLIQUE SOSPENSIONI E PALETTI CORRELATI  
WALL SUSPENSION AND FLOOR LAMPS COMBINED

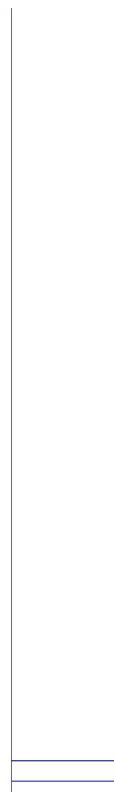

POLLY





In.tec light **OUTDOOR** APPLIQUE SOSPENSIONI E PALETTI CORRELATI / WALL SUSPENSION AND FLOOR LAMPS COMBINED

# POLLY

Collezione con base in fibre di plastica e sfere  
in PMMA nei colori trasparente, bianco o fumè.

Collection with base in plastic fibers and spheres  
in PMMA in transparent, white or smoked colors.



**I-POLLY-G20-TR180**  
8031414921973

colour



1 x E27 MAX 20W

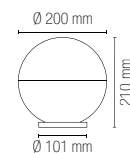

**I-POLLY-G25-TR180**  
8031414921980

colour



1 x E27 MAX 20W

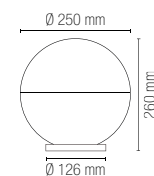

**I-POLLY-G30-TR180**  
8031414921997

colour



1 x E27 MAX 20W

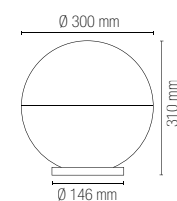

Lampadina  
non inclusa /  
Light bulb  
not included

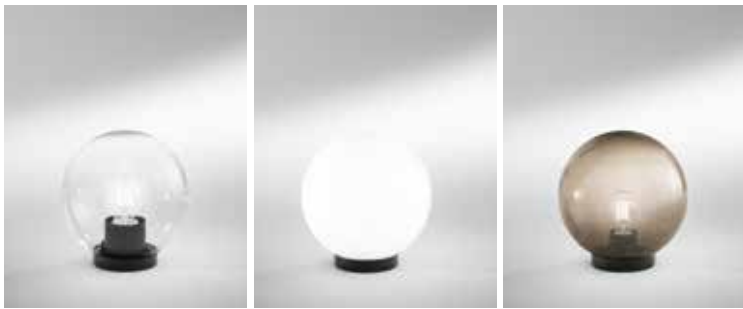

	colour
<b>I-POLLY-G20-TR</b> 8031414889136	
<b>I-POLLY-G20-BCO</b> 8031414889112	
<b>I-POLLY-G20-GR</b> 8031414889129	

1 x E27 MAX 20W

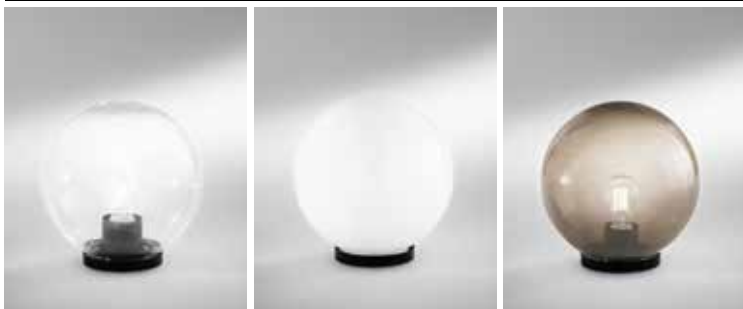
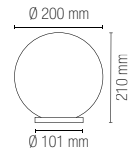

	colour
<b>I-POLLY-G25-TR</b> 8031414889167	
<b>I-POLLY-G25-BCO</b> 8031414889143	
<b>I-POLLY-G25-GR</b> 8031414889150	

1 x E27 MAX 20W

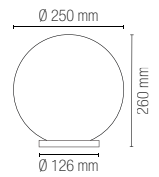

	colour
<b>I-POLLY-G30-TR</b> 8031414889198	
<b>I-POLLY-G30-BCO</b> 8031414889174	
<b>I-POLLY-G30-GR</b> 8031414889181	

1 x E27 MAX 20W

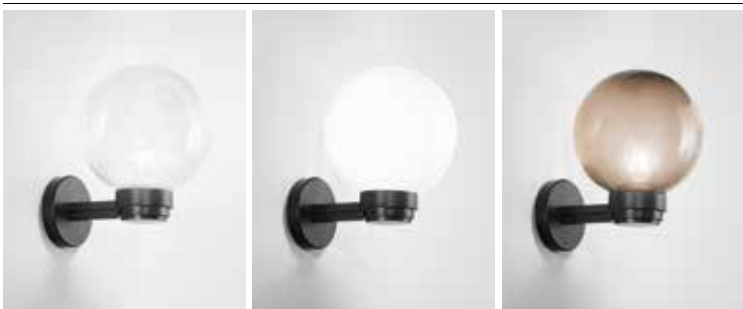
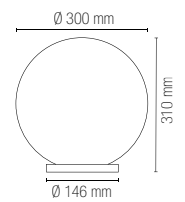

	colour
<b>I-POLLY-AP-TR</b> 8031414889105	
<b>I-POLLY-AP-BCO</b> 8031414889389	
<b>I-POLLY-AP-GR</b> 8031414889099	

1 x E27 MAX 20W

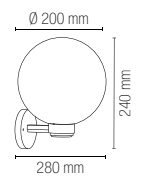

# POLLY





**I-POLLY-PD**  
8031414921942

Accessorio per sospensione con cavo in gomma e connettore / Suspension accessory with rubber cable

colour

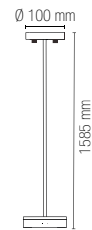

**I-POLLY-SPK**  
8031414921959

Accessorio per fissaggio a picchetto con connettore e fermacavo / Accessory for peg fixing with connector and cable holder

colour

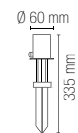

**I-POLLY-SPK-S**  
8031414921966

Accessorio per fissaggio a picchetto con cavo in gomma e presa schuko / Accessory for peg fixing with rubber cable and schuko socket

colour

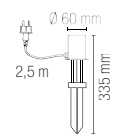

**Accessori inclusi / Included accessories**

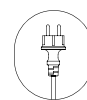

Cavo 2,5 m con spina schuko / 2,5 m of cable with schuko plug



# POLLY







	colour
<b>I-POLLY-TUBE100</b> 8031414890149	●
<b>I-POLLY-TUBE150</b> 8031414890156	●
<b>I-POLLY-TUBE200</b> 8031414890163	●

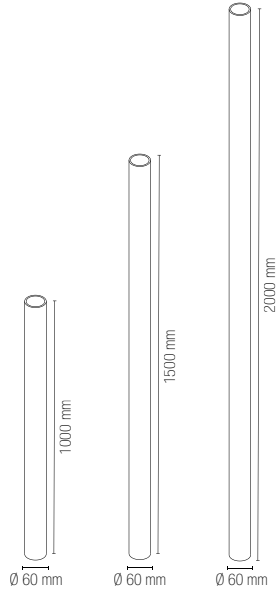

**I-POLLY-BASE**  
8031414889235

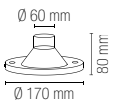

**I-POLLY-JOINT**  
8031414890170

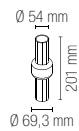

**I-POLLY-BASE-AP**  
8031414904587

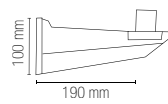

# WAMI

Collezione a LED integrato in alluminio pressofuso nei colori antracite o corten goffrato con temperatura colore selezionabile.

Integrated LED collection in die-cast aluminum in anthracite or corten embossed colors with selectable color temperature.



**Materiale**

alluminio

**Colore**

goffrato antracite  
goffrato corten



**Temperatura colore selezionabile**

3000K / 4000K



**Driver**

integrato

**Material**

aluminum

**Colour**

embossed anthracite  
embossed corten



**Selectable color temperature**

3000K / 4000K



**Driver**

built-in





technical information

WAMI

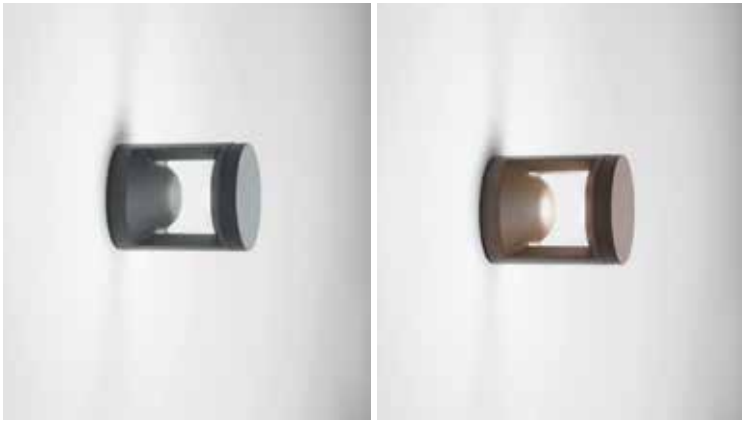

**LED-WAMI-AP-ANT**

8031414890026

lumen

colour temp.	colour
1530 lm	

**LED-WAMI-AP-BRO**

8031414890057

lumen

colour temp.	colour
1530 lm	

watt

12W

beam angle

120°

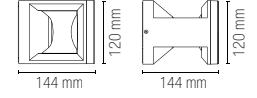

**LED-WAMI-P25-ANT**

8031414890033

lumen

colour temp.	colour
1530 lm	

**LED-WAMI-P25-BRO**

8031414890064

lumen

colour temp.	colour
1530 lm	

watt

12W

beam angle

120°

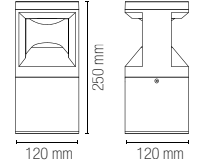

**LED-WAMI-P80-ANT**

8031414890040

lumen

colour temp.	colour
1530 lm	

**LED-WAMI-P80-BRO**

8031414890071

lumen

colour temp.	colour
1530 lm	

watt

12W

beam angle

120°

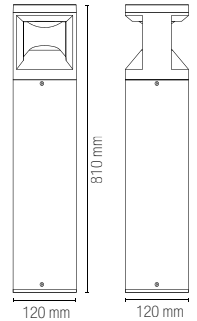

OUTDOOR APPLIQUE SOSPENSIONI E PALETTI CORRELATI / WALL SUSPENSION AND FLOOR LAMPS COMBINED

In.tec light

# SAIL

Collezione in alluminio a LED integrato con finitura bianco o antracite goffrato.  
Aluminum collection LED lamp white or anthracite embossed finish.

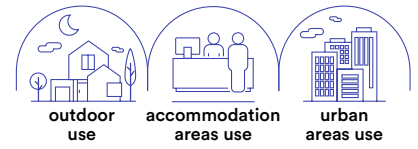

**Materiale**  
alluminio

**Colore**  
goffrato bianco  
goffrato antracite



**Temperatura colore**  
3000K / 4000K



**Driver**  
integrato

**Material**  
aluminum

**Colour**  
embossed white  
embossed anthracite



**Colour temperature**  
3000K / 4000K



**Driver**  
built-in





	colour temp.	colour
<b>LED-SAIL-AP-BCO</b> 8031414918614		
lumen	1440 lm	
<b>LED-SAIL-AP-ANT</b> 8031414920174		
lumen	1440 lm	
watt	12W	
beam angle	180°	

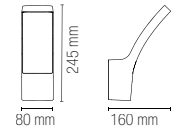

	colour temp.	colour
<b>LED-SAIL-APS-BCO</b> 8031414920181		
lumen	1440 lm	
<b>LED-SAIL-APS-ANT</b> 8031414918621		
lumen	1440 lm	
watt	12W	
beam angle	180°	

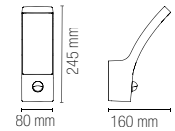

**Accessori inclusi / Included accessories**

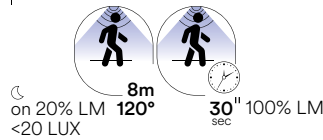

Sensore di movimento regolabile distanza max 6m 120° / Adjustable motion sensor max distance 6m 120°



	colour temp.	colour
<b>LED-SAIL-P90-BCO</b> 8031414918638		
lumen	1440 lm	
<b>LED-SAIL-P90-ANT</b> 8031414918645		
lumen	1440 lm	
watt	12W	
beam angle	180°	

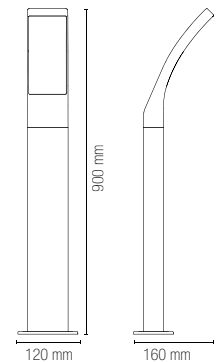

# DISCOVERY

Collezione a LED integrato in alluminio con finitura antracite goffrato.  
Aluminum collection LED lamp anthracite embossed finish.





# DISCOVERY





**Materiale**

alluminio

**Colore**

goffrato antracite



**Temperatura colore**

4000K



**Driver**

integrato

**Material**

aluminum

**Colour**

embossed anthracite



**Colour temperature**

4000K



**Driver**

built-in



**LED-DISCOVERY-AP**

8031414877836

lumen

colour temp.	colour

1440 lm

watt

13W

beam angle

360°

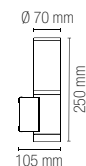

**LED-DISCOVERY-P65**

8031414877850

lumen

colour temp.	colour

1440 lm

watt

13W

beam angle

360°

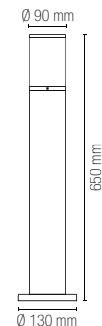

**LED-DISCOVERY-HUB**

8031414877867

lumen

colour temp.	colour

1440 lm

watt

13W

beam angle

360°



Plug 2X max 15A 250V 2500W

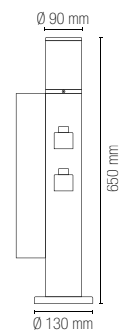

# IDEM

Lampada in alluminio a LED integrato finitura antracite goffrato.  
Aluminum collection anthracite colour built-in LED.



---

**Materiale**

alluminio

---

**Colore**

goffrato antracite



---

**Temperatura colore**

4000K



---

**Driver**

integrato

---

**Material**

aluminum

---

**Colour**

embossed anthracite



---

**Colour temperature**

4000K



---

**Driver**

built-in

---



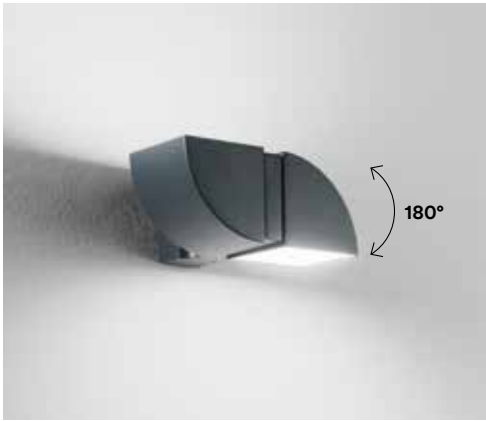

**LED-IDEM-AP**  
8031414883103  
lumen

colour temp.	colour
840 lm	

watt	8W
beam angle	120°

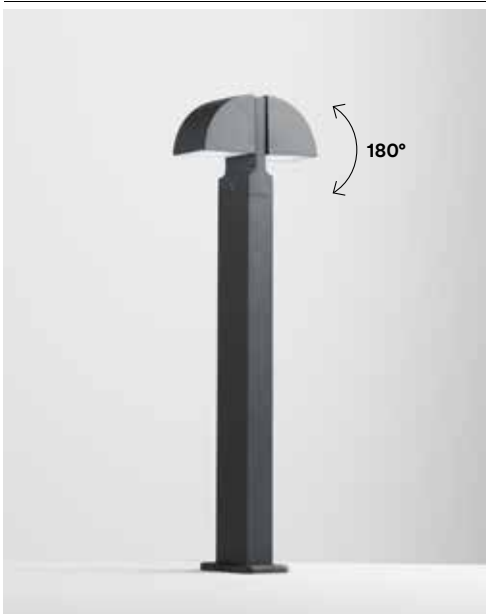
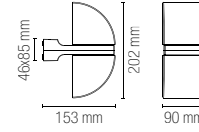

**LED-IDEM-P1**  
8031414883110  
lumen

colour temp.	colour
840 lm	

watt	8W
beam angle	120°

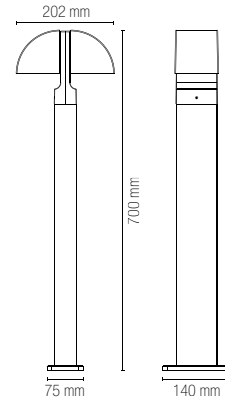

# REVERSE

Lampada in alluminio a LED integrato finitura antracite gofrato.  
Aluminum collection anthracite colour built-in LED.



**Materiale**  
alluminio

**Colore**  
gofrato antracite



**Temperatura colore**  
4000K



**Driver**  
integrato

**Material**  
aluminum

**Colour**  
embossed anthracite



**Colour temperature**  
4000K



**Driver**  
built-in

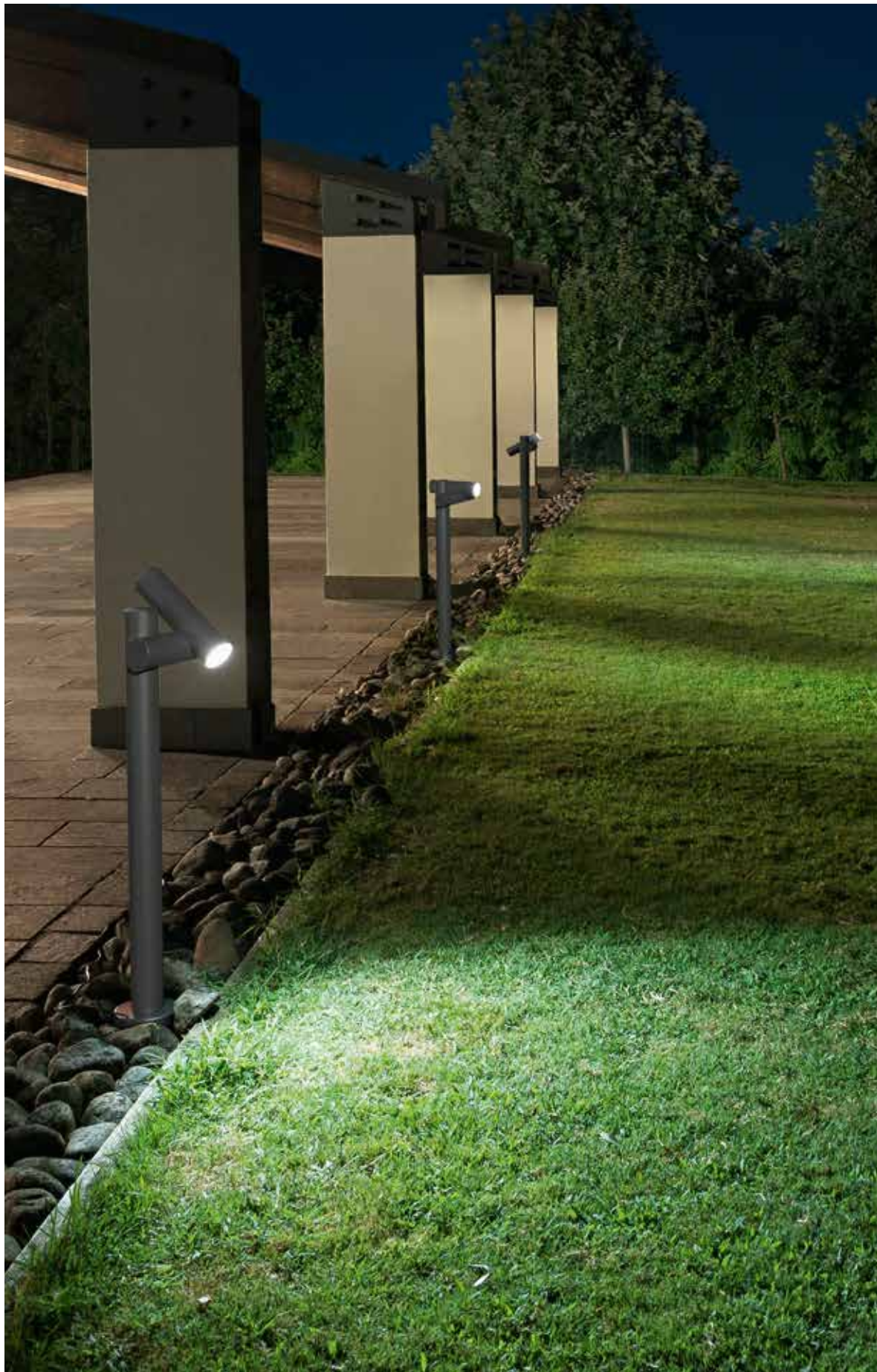

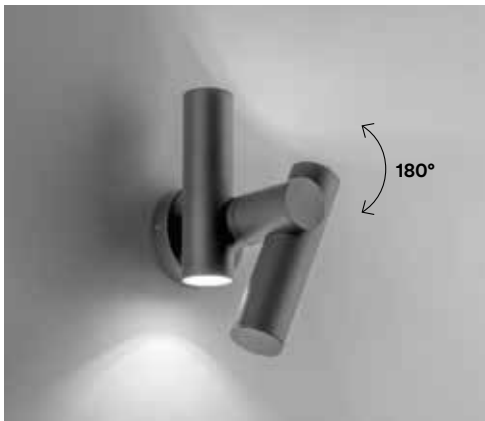

**LED-REVERSE-AP**

8031414883127

lumen

colour temp.	colour

620 lm

watt

7,5W

beam angle

120°

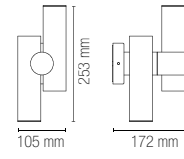

**LED-REVERSE-P1**

8031414883134

lumen

colour temp.	colour

460 lm

watt

5,3W

beam angle

120°

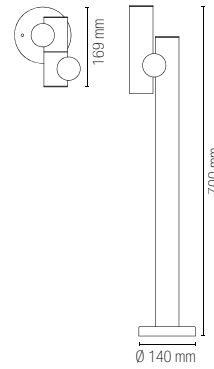

# SINTESI

Lampada in alluminio a LED integrato con finitura bianco o nero goffrato.  
Built in aluminum LED lamp white or black embossed finish.



**Materiale**  
alluminio

**Colore**  
goffrato bianco  
goffrato nero



**Temperatura colore**  
4000K



**Driver**  
integrato

**Material**  
aluminum

**Colour**  
embossed white  
embossed black



**Colour temperature**  
4000K



**Driver**  
built-in





	colour temp.	colour
<b>LED-SINTESI-AP BCO</b> 8031414862207 lumen	400 lm	
<b>LED-SINTESI-AP NERO</b> 8031414862221 lumen	400 lm	
watt	6W	
beam angle	100°	

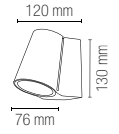

	colour temp.	colour
<b>LED-SINTESI-P BCO</b> 8031414862245 lumen	400 lm	
<b>LED-SINTESI-P NERO</b> 8031414862252 lumen	400 lm	
watt	6W	
beam angle	100°	

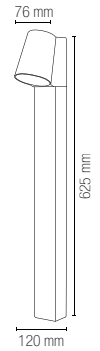

# ALYSON

Lampada in alluminio pressofuso a LED integrato nei colori nero o bianco gofrato con diffusore il policarbonato.

Built in aluminum LED lamp white or black embossed finish with PC diffuser.



**Materiale**  
alluminio

**Colore**  
gofrato bianco  
gofrato nero



**Temperatura colore**

4000K



**Driver**  
integrato

**Material**  
aluminum

**Colour**  
embossed white  
embossed black



**Colour temperature**

4000K



**Driver**  
built-in







	colour temp.	colour
<b>LANT-ALYSON/AP BCO</b> 8031440361514		
lumen	1300 lm	
<b>LANT-ALYSON/AP</b> 8031440361552		
lumen	1300 lm	
watt	12W	
beam angle	120°	

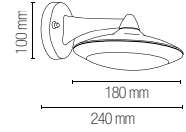

	colour temp.	colour
<b>LANT-ALYSON/P1 BCO</b> 8031440361538		
lumen	1300 lm	
<b>LANT-ALYSON/P1</b> 8031440361569		
lumen	1300 lm	
watt	12W	
beam angle	120°	

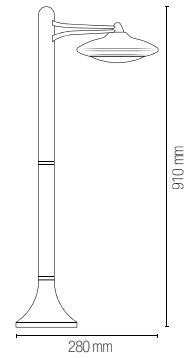

# BITT

Lampada in alluminio a LED integrato finitura antracite e corten goffrato.  
Aluminum collection anthracite and corten colour built-in LED.

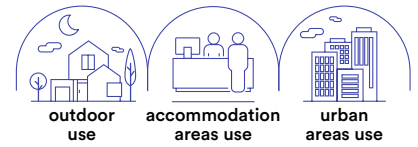

**Materiale**  
alluminio

**Colore**  
goffrato antracite  
goffrato corten



**Temperatura colore  
selezionabile**  
3000K / 4000K



**Driver**  
integrato

**Material**  
aluminum

**Colour**  
embossed anthracite  
embossed corten



**Selectable color  
temperature**  
3000K / 4000K



**Driver**  
built-in





	colour temp.	colour
<b>LED-BITT-P28-ANT</b> 8031414883011 lumen		
	1200 lm	
<b>LED-BITT-P28-BRO</b> 8031414883028 lumen		
	1284 lm	
watt	10W	
beam angle	120°	

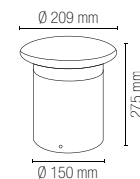

	colour temp.	colour
<b>LED-BITT-P76-ANT</b> 8031414883035 lumen		
	1200 lm	
<b>LED-BITT-P76-BRO</b> 8031414883042 lumen		
	1284 lm	
watt	10W	
beam angle	120°	

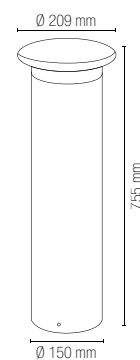

In.tec light **OUTDOOR** APPLIQUE SOSPENSIONI E PALETTI CORRELATI / WALL SUSPENSION AND FLOOR LAMPS COMBINED

# NISMO

Collezione in alluminio a LED integrato finitura bianco goffrato.  
Aluminum collection LED lamp white embossed finish.



**Materiale**

alluminio

**Colore**

goffrato bianco



**Temperatura colore selezionabile**

3000K / 4000K



**Driver**

integrato

**Material**

aluminum

**Colour**

embossed white



**Selectable color temperature**

3000K / 4000K



**Driver**

built-in



**LED-NISMO-AP**

8031440361224

lumen

colour temp. | colour



1430 lm

watt

12W

beam angle

120°

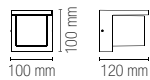

**LED-NISMO-P60**

8031440361231

lumen

colour temp. | colour



1430 lm

watt

12W

beam angle

120°

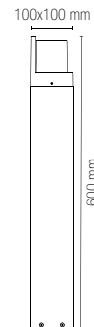



In.tec light **OUTDOOR** APPLIQUE SOSPENSIONI E PALETTI CORRELATI / WALL SUSPENSION AND FLOOR LAMPS COMBINED



# STATION

Collezione in acciaio finitura antracite.  
 Diffusore in policarbonato bianco.  
 Stainless steel collection anthracite finish.  
 White PC diffuser.

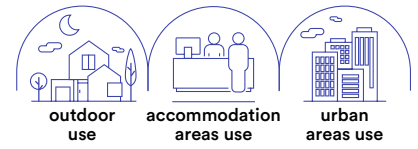

colour

**I-STATION-E27-SC2**  
 8031414879571



colour

**I-STATION-SC2**  
 8031414879564



Lampadina non inclusa /  
 Light bulb not included

1 x E27 MAX 60W



Plug 2X max 15A 250V 2500W



Plug 2X max 15A 250V 2500W

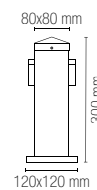
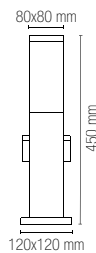

In.tec light **OUTDOOR** APPLIQUE SOSPENSIONI E PALETTI CORRELATI / WALL SUSPENSION AND FLOOR LAMPS COMBINED

# UNDERWOOD

Collezione in metallo finitura antracite o corten.  
Metal collection anthracite or corten finish.

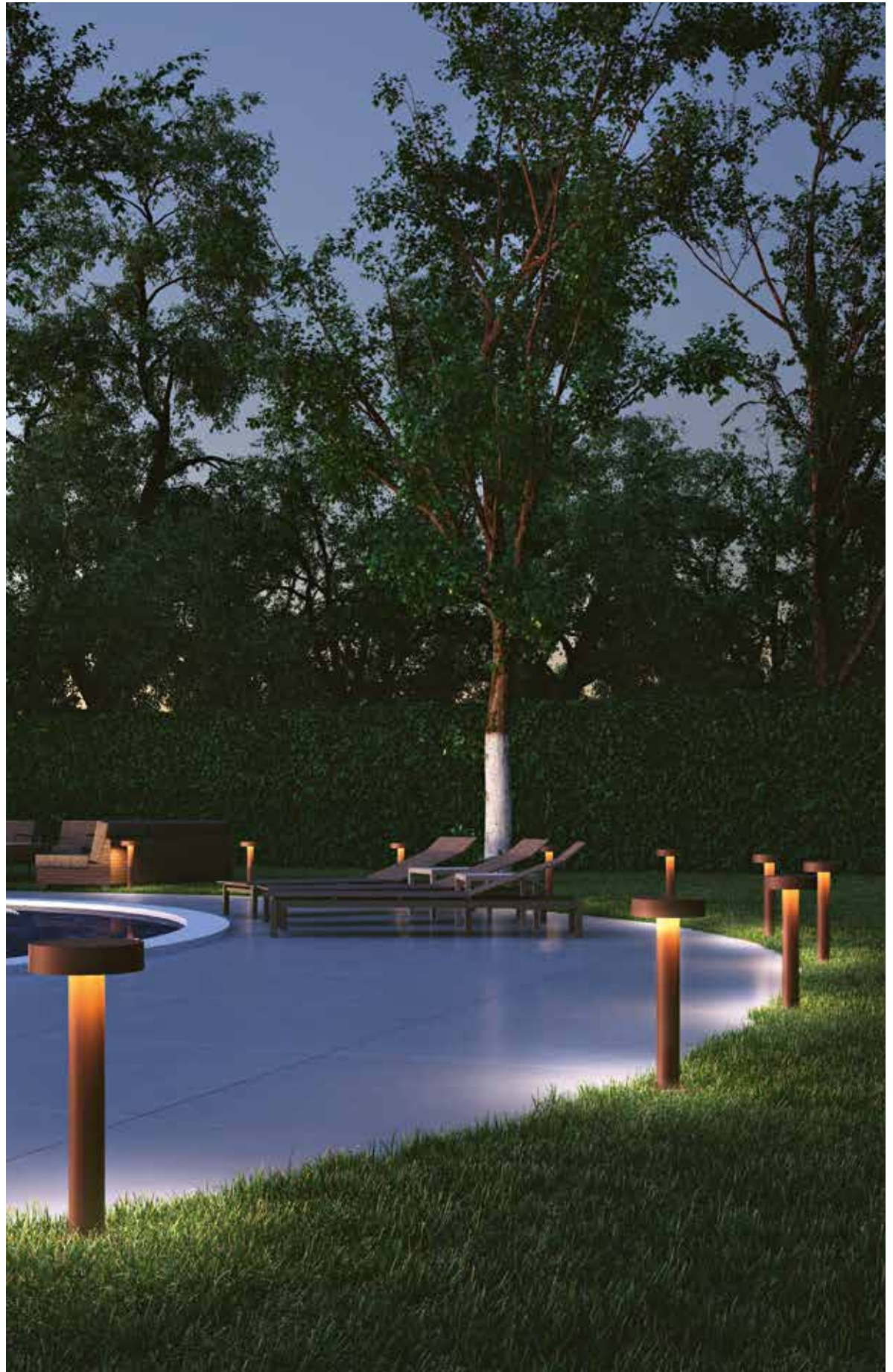
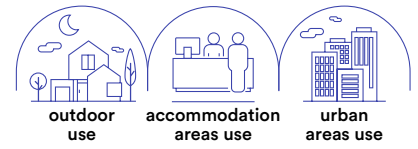





<b>I-UNDERWOOD-P70-ANT</b> 8031414883059	●
<b>I-UNDERWOOD-P70-BRO</b> 8031414883066	●

colour

4 x G9 LED

10W



Lampadina non inclusa /  
Light bulb not included

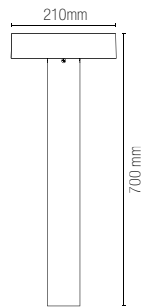

# FOCUS

Collezione a LED in policarbonato nei colori bianco e nero.  
LED polycarbonate collection in black and white colors.





**I-FOCUS-R-AP-BCO**

8031414916290

**I-FOCUS-R-AP-NER**

8031414916283

1 x GU10 MAX 35W

colour

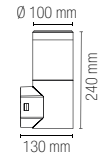

Connettore IP65 incluso /  
IP65 connector included



Lampadina non inclusa /  
Light bulb not included



**I-FOCUS-Q-AP-BCO**

8031414916313

**I-FOCUS-Q-AP-NER**

8031414916306

1 x GU10 MAX 35W

colour

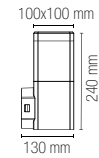

Connettore IP65 incluso /  
IP65 connector included



Lampadina non inclusa /  
Light bulb not included



**I-FOCUS-R-P-BCO**

8031414916252

**I-FOCUS-R-P-NER**

8031414916245

1 x GU10 MAX 35W

colour

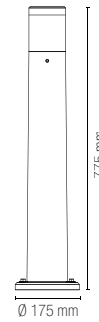

Connettore IP65 incluso /  
IP65 connector included



Picchetto per installazione  
nel terreno incluso /  
Picchetto per installazione  
nel terreno non incluso /



Lampadina non inclusa /  
Light bulb not included



**I-FOCUS-Q-P-BCO**

8031414916276

**I-FOCUS-Q-P-NER**

8031414916269

1 x GU10 MAX 35W

colour

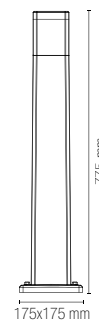

Connettore IP65 incluso /  
IP65 connector included



Picchetto per installazione  
nel terreno incluso /  
Picchetto per installazione  
nel terreno non incluso /



Lampadina non inclusa /  
Light bulb not included

# DARK

Collezione in acciaio inox con diffusore in policarbonato. Disponibile in antracite.  
Stainless steel collection with polycarbonate diffuser. Available in anthracite.



colour

**I-DARK-AP1**  
8031414918775



1 x E27 MAX 25W

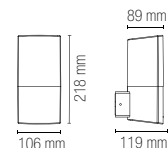

**I-DARK-AP1-S**  
8031414919093



1 x E27 MAX 25W

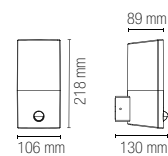

## Accessori inclusi / Included accessories

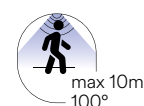

max 10m  
100°

Sensore di movimento regolabile  
distanza max 10m 100° /  
Adjustable motion sensor  
max distance 10m 100°



colour

**I-DARK-AP2**  
8031414919109

2 x E27 MAX 25W

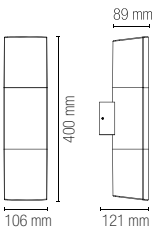

colour

**I-DARK-APV**  
8031414919116

1 x E27 MAX 25W

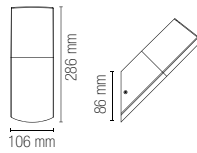

colour

**I-DARK-P1**  
8031414918782

1 x E27 MAX 25W

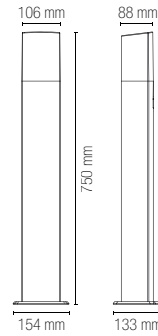

Lampadina non inclusa /  
Light bulb not included

# TOKYO

Collezione in acciaio inox con diffusore in policarbonato.  
Finiture bianco, bronzo, nikel spazzolato e grigio antracite.

Stainless steel collection with polycarbonate diffuser.  
White, bronze, brushed nickel and anthracite grey finishes.

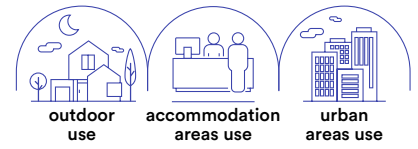



# TOKYO

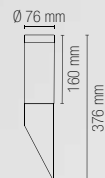

**I-TOKYO-AP BCO**

8031414864447

**I-TOKYO-AP ANT**

8031414888795

**I-ST021**

8031421451081

**I-TOKYO-AP BRO**

8031414864423

colour



Lampadina consigliata /  
Suggested light bulb



Lampadina non inclusa /  
Light bulb not included

1 x E27 MAX 40W





**I-TOKYO-P BCO**

8031414864416



**I-TOKYO-P ANT**

8031414888801



**I-ST022-1100**

8031421661084



**I-TOKYO-P BRO**

8031414864393



colour



Lampadina consigliata / Suggested light bulb



Lampadina non inclusa / Light bulb not included

1 x E27 MAX 40W



**I-TOKYO-P70 BCO**

8031414875320



**I-TOKYO-P70 ANT**

8031414888818



**I-ST022-700**

8031414877225



**I-TOKYO-P70 BRO**

8031414871780



colour



Lampadina consigliata / Suggested light bulb



Lampadina non inclusa / Light bulb not included

1 x E27 MAX 40W

# WAX

Collezione in alluminio a LED integrato con finitura antracite.  
Aluminum collection LED lamp with embossed anthracite finish.



**Materiale**  
alluminio

**Colore**  
goffrato antracite



**Temperatura colore**  
3000K



**Driver**  
DC24V  
tensione costante  
non incluso

**Material**  
aluminum

**Colour**  
goffrato antracite



**Colour temperature**  
3000K



**Driver**  
DC24V  
constant voltage  
not included



Driver p. 843-852  
Controller p. 854-857



	colour temp.	colour
<b>LED-WAX-P120</b> 8031414922956 lumen	363lm	
watt	3W	
beam angle	120°	
pf	0.90	

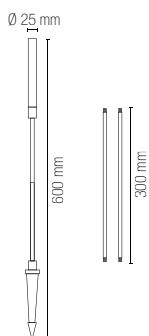

Picchetto per installazione  
nel terreno incluso /  
Picchetto per installazione  
nel terreno non incluso /



In.tec light **OUTDOOR** APPLIQUE SOSPENSIONI E PALETTI CORRELATI / WALL SUSPENSION AND FLOOR LAMPS COMBINED

# PUCK

Collezione in alluminio a LED integrato con finitura antracite o corten goffrato.  
Aluminum collection with integrated LED with anthracite or corten embossed finish.

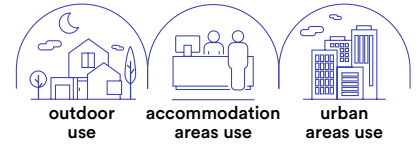

**Materiale**  
alluminio

**Colore**  
goffrato antracite  
goffrato corten



**Temperatura colore**  
3000K



**Driver**  
DC24V  
tensione costante  
non incluso

**Material**  
aluminum

**Colour**  
goffrato antracite  
goffrato corten



**Colour temperature**  
3000K



**Driver**  
DC24V  
constant voltage  
not included

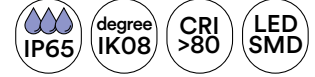

	colour temp.	colour
<b>LED-PUCK-P120-ANT</b> 8031414918652 lumen		
<b>LED-PUCK-P120-BRO</b> 8031414918669 lumen		
watt	3W	
beam angle	180°	

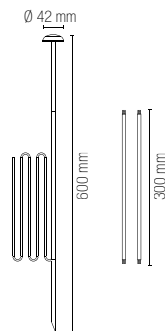



In.tec light **OUTDOOR** APPLIQUE SOSPENSIONI E PALETTI CORRELATI / WALL SUSPENSION AND FLOOR LAMPS COMBINED

# DROP

Collezione in alluminio finitura antracite con diffusore in policarbonato.  
Aluminum collection anthracite finish with PC diffuser.





**I-DROP-P33-ANT**  
8031414883073

colour



1 x G9 LED

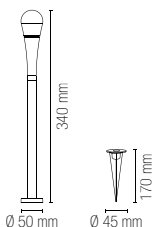

Lampadina consigliata /  
Suggested light bulb



Lampadina non inclusa /  
Light bulb not included



**I-DROP-P53-ANT**  
8031414883080

colour



1 x G9 LED

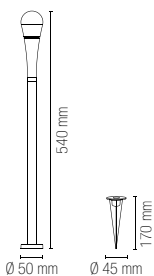

Lampadina consigliata /  
Suggested light bulb



Lampadina non inclusa /  
Light bulb not included



**I-DROP-P73-ANT**  
8031414882793

colour



1 x G9 LED

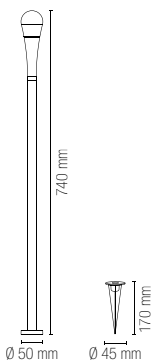

Lampadina consigliata /  
Suggested light bulb



Lampadina non inclusa /  
Light bulb not included

# BOOSTER

Collezione in metallo finitura silver.  
Metal collection silver finish.

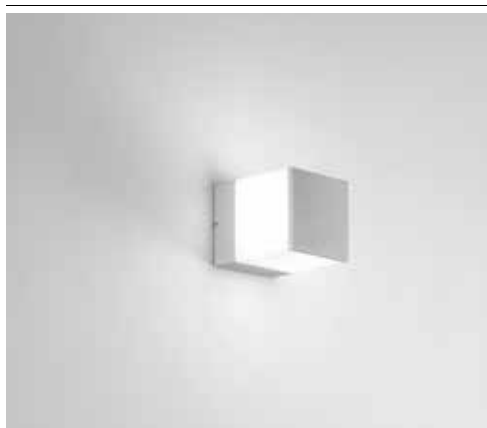
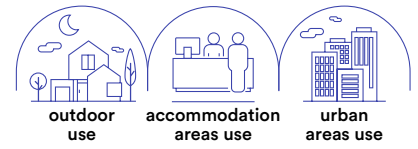

**I-BOOSTER-AP**  
8031414918492  
1 x E27 MAX 40W

colour

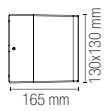

Lampadina non inclusa /  
Light bulb not included



**I-BOOSTER-P60**  
8031414918508  
1 x E27 MAX 40W

colour

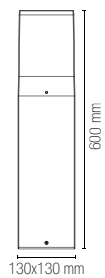

Lampadina non inclusa /  
Light bulb not included





technical information **BOOSTER**



In .tec light **OUTDOOR** APPLIQUE SOSPENSIONI E PALETTI CORRELATI / WALL SUSPENSION AND FLOOR LAMPS COMBINED

# GECO DJ

Lampada portatile LED RGBW in polietilene con speaker bluetooth incorporato.

LED portable RGBW lamp with speaker bluetooth included polyethylene material.



## Materiale

PE

## Temperatura colore

RGB + 4000K



## Driver

incluso

## Material

PE

## Colour temperature

RGB + 4000K



## Driver

included



	colour temp.
<b>I-GECO-DJ-L25</b> 8031414862542	+
lumen	RGB + 180 lm - 8h
watt	3W

## Accessori inclusi / Included accessories



Cavo per ricarica con adattatore DC5V 1A 1,2 m / Charging cable with adaptor DC5V 1A 1,2 m 230V 50Hz



Telecomando infrarossi / IR remote control



Speaker 10W Bluetooth 4.0, distanza connessione max 15 m, durata 2h / 10w speaker bluetooth 4.0 connection distance max 15 m, lasting time 2h



Batteria ricaricabile non sostituibile / Rechargeable battery non replaceable

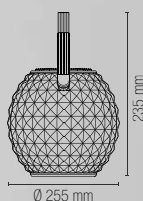



# GECO LED

Vaso e lampada LED RGBW in polietilene.  
Vase and RGBW LED lamp in polyethylene.

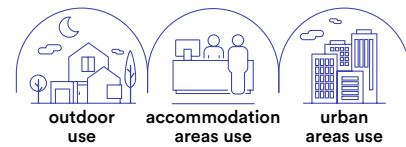

## Materiale

PE

## Temperatura colore

RGB + 4000K



## Driver

incluso

## Material

PE

## Colour temperature

RGB + 4000K



## Driver

included



## Accessori inclusi / Included accessories

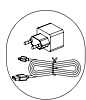

Cavo per ricarica con adattatore DC5V 1A 1,2 m / Charging cable with adaptor DC5V 1A 1,2 m  
IP20



Telecomando infrarossi / IR remote control



Batteria ricaricabile non sostituibile / Rechargeable battery non replaceable

### I-GECO-VASO-Q-L

8031414862535

lumen

### I-GECO-VASO-Q-XL

8031414864713

lumen

colour temp.



RGB 240 lm - 8h



RGB 240 lm - 8h

watt

4W

### I-GECO-VASO-R-L

8031414862528

lumen

### I-GECO-VASO-R-XL

8031414864720

lumen

colour temp.



RGB 240 lm - 8h



RGB 240 lm - 8h

watt

4W

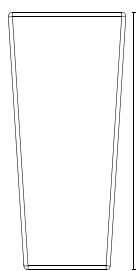

280x280 mm  
VASO-Q-L

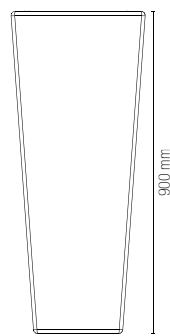

380x380 mm  
VASO-Q-XL

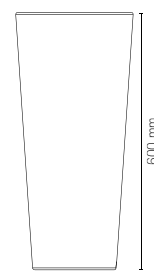

Ø 280 mm  
VASO-R-L

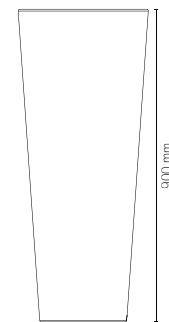

Ø 380 mm  
VASO-R-XL



**I-GECO-SFERA-L30**

8031414862436

lumen

	colour temp.	
	+	
RGB		240 lm - 8h

**I-GECO-SFERA-L40**

8031414862443

lumen

	+	
RGB		240 lm - 8h

**I-GECO-SFERA-L50**

8031414862450

lumen

	+	
RGB		240 lm - 8h

watt 4W

**I-GECO-CUBO-L30**

8031414862467

lumen

	colour temp.	
	+	
RGB		240 lm - 8h

**I-GECO-CUBO-L40**

8031414862474

lumen

	+	
RGB		240 lm - 8h

**I-GECO-CUBO-L50**

8031414862481

lumen

	+	
RGB		240 lm - 8h

watt 4W

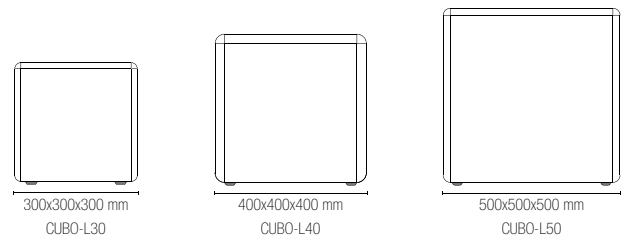
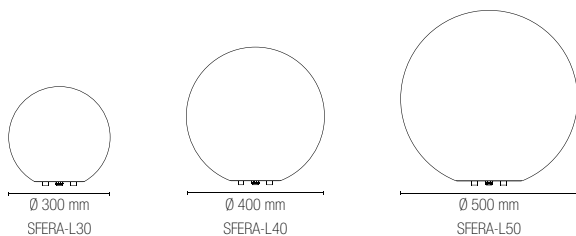

# GECO E27



Lampadine LED Intec consigliate per illuminazione multicolor o bianco dinamico presenti nel catalogo BULBS COLLECTION / Suggested LED Intec bulbs for multicolor or dynamic white lighting included in the catalogue BULBS COLLECTION

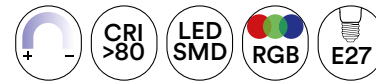

Lampada LED RGBW classe F / LED RGBW bulb class F

colour temp.

**KLASSIC-E27-RGBW**  
8031414905003



RGB 806 lm

watt	9W
beam angle	300°



IR Control system

# GECO E27

Collezione di lampade con attacco E27 in polietilene.  
PE lamp with E27 lampholder.



**I-GECO-SFERA-S30**  
8031414864461

1 x E27 MAX 42W

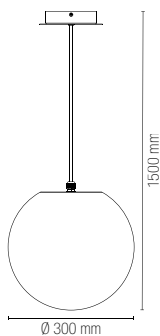

**I-GECO-SFERA-S40**  
8031414864454

1 x E27 MAX 42W

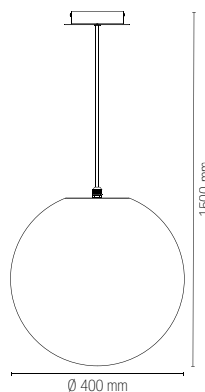

Lampadina non inclusa /  
Light bulb not included







**I-GECO-VASO-E-Q-L**  
8031414868506  
**I-GECO-VASO-E-Q-XL**  
8031414868131

1 x E27 MAX 42W



**I-GECO-VASO-E-R-L**  
8031414868513  
**I-GECO-VASO-E-R-XL**  
8031414868520

1 x E27 MAX 42W

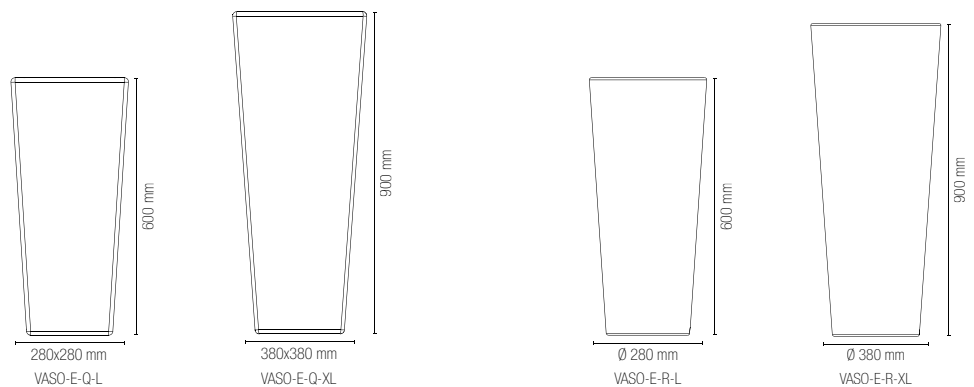

Lampadina non inclusa /  
Light bulb not included



**I-GECO-SFERA-E-L30**

8031414868476

**I-GECO-SFERA-E-L40**

8031414868483

**I-GECO-SFERA-E-L50**

8031414868490

1 x E27 MAX 42W

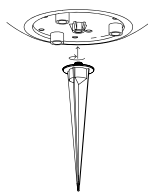

**I-GECO-SPK**

8031414878437

Picchetto alluminio per lampade GECO E27 / Aluminum spike for E27 GECO family

**I-GECO-CUBO-E-L30**

8031414867943

**I-GECO-CUBO-E-L40**

8031414868117

**I-GECO-CUBO-E-L50**

8031414868124

1 x E27 MAX 42W

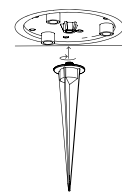

**I-GECO-SPK**

8031414878437

Picchetto alluminio per lampade GECO E27 / Aluminum spike for E27 GECO family

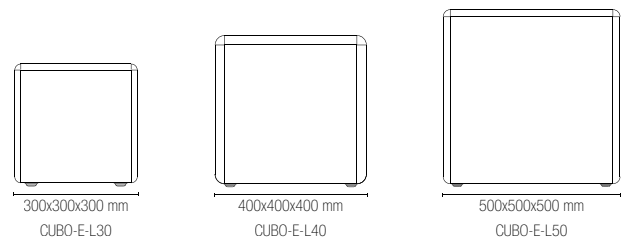

# GECO E27

Piantana in polietilene con struttura in metallo bianco opaco o antracite.

PE floor lamp with metal structure white or anthracite colour.



Ø 340 mm

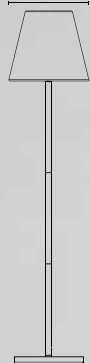

1530 mm

colour



Accessori inclusi / Included accessories

**I-GECO-BAR-PT**  
8031414868599

1 x E27 MAX 42W



Cavo 2,5 m  
con spina shuko /  
2,5 m of cable  
with schuko plug



IP44



Lampadina non inclusa /  
Light bulb not included



technical information

GECO E27



In .tec light **OUTDOOR** APPLIQUE SOSPENSIONI E PALETTI CORRELATI / WALL SUSPENSION AND FLOOR LAMPS COMBINED

Ø 300 mm



1500 mm

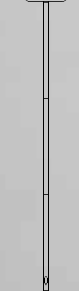

colour



Accessori inclusi / Included accessories

**I-GECO-SFERA-PT30**  
8031414864430

1 x E27 MAX 42W

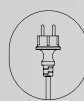

Cavo 2,5 m  
con spina shuko /  
2,5 m of cable  
with schuko plug



Lampadina non inclusa /  
Light bulb not included



# GECO LED SOLAR

Lampada portatile e galleggiante LED RGBW in polietilene con autoricarica solare.  
PE LED portable and floating RGBW lamp with solar self charge.



## Materiale

PE

## Temperatura colore

RGB + 4000K



## Driver

incluso

## Material

PE

## Colour temperature

RGB + 4000K



## Driver

included



## Accessori inclusi / Included accessories



Cavo per ricarica con adattatore DC5V 1A 1,2 m / Charging cable with adaptor DC5V 1A 1,2 m 230V 50Hz

IP20



Telecomando infrarossi / IR remote control



## Carica alimentatore / DC charge

Batteria ricaricabile non sostituibile / Rechargeable battery non replaceable



## Carica solare / Auto solar charge

Batteria ricaricabile non sostituibile / Rechargeable battery non replaceable

	colour temp.	
<b>I-GECO-SFERA-SOL30</b> 8031414870868	+	
lumen	RGB	90 lm - 12h
<b>I-GECO-SFERA-SOL40</b> 8031414870875	+	
lumen	RGB	90 lm - 12h
watt		1,5W

	colour temp.	
<b>I-GECO-CUBO-SOL30</b> 8031414870837	+	
lumen	RGB	90 lm - 12h
<b>I-GECO-CUBO-SOL40</b> 8031414870844	+	
lumen	RGB	90 lm - 12h
watt		1,5W

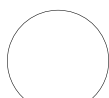

Ø 300 mm  
SFERA-SOL30

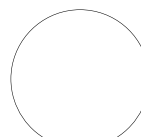

Ø 400 mm  
SFERA-SOL40

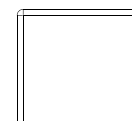

300x300x300 mm  
CUBO-SOL30

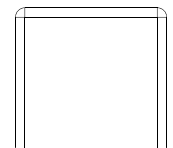

400x400x400 mm  
CUBO-SOL40





# MANDALA

Collezione in metallo antracite con diffusore in vetro trasparente.  
Metal collection anthracite finish with transparent glass diffuser.

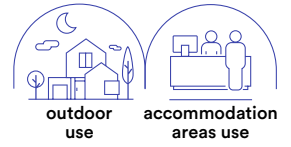

Lampadina consigliata /  
Suggested light bulb



Lampadina non inclusa /  
Light bulb not included

**LANT-MANDALA/S1**  
8031414870684

1 x E27 MAX 60W

colour



**LANT-MANDALA/AP**  
8031414862641

1 x E27 MAX 60W

colour

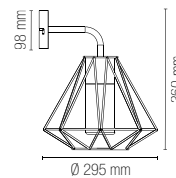
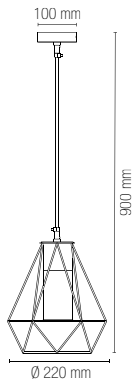

In.tec light **OUTDOOR** APPLIQUE SOSPENSIONI E PALETTI CORRELATI / WALL SUSPENSION AND FLOOR LAMPS COMBINED



# YORK

Collezione in alluminio nero con diffusore in policarbonato.  
Black aluminum collection with PC diffuser.

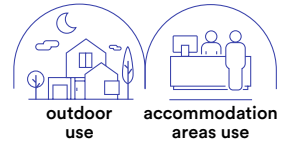

Lampadina consigliata /  
Suggested light bulb



Lampadina non inclusa /  
Light bulb not included

**LANT-YORK/S1**  
8031414862764

1 x E27 MAX 60W

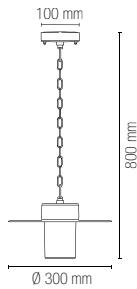

colour



**LANT-YORK/AP**  
8031414862757

1 x E27 MAX 60W

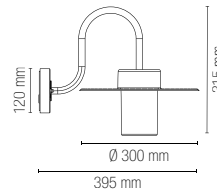

colour



In.tec light **OUTDOOR** APPLIQUE SOSPENSIONI E PALETTI CORRELATI / WALL SUSPENSION AND FLOOR LAMPS COMBINED

# PAVÈ

Proiettore in metallo color antracite con diffusore trasparente lucido nero in vetro.

Anthracite-colored metal projector with transparent glossy black glass diffuser.



## Materiale

metallo  
diffusore  
vetro trasparente

## Colore

antracite



## Temperatura colore

3000K / 4000K



## Driver

integrato

## Material

metal  
trasparent glass  
diffuser

## Colour

anthracite



## Colour temperature

3000K / 4000K



## Driver

built-in





<b>LED-PAVE-6</b> 8031414922925	colour temp.	colour
lumen	720 lm	
watt	6W	
beam angle	45°	
pf	-	

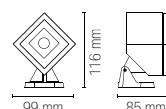

<b>LED-PAVE-18</b> 8031414922932	colour temp.	colour
lumen	2215 lm	
watt	18W	
beam angle	45°	
pf	-	

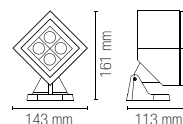

<b>LED-PAVE-30</b> 8031414922949	colour temp.	colour
lumen	3750 lm	
watt	30W	
beam angle	45°	
pf	0.90	

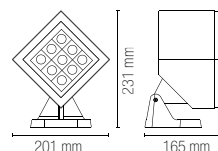

# LUMINA

Collezione in metallo color antracite con punto luce LED integrato.  
Lumina applique può essere utilizzato anche come segnapassi.  
Anthracite-colored metal collection with integrated LED light point.  
Limuna wall lamp can also be used as a step marker.



**Materiale**  
alluminio

**Colore**  
goffrato antracite



**Temperatura colore**  
3000K / 4000K



**Driver**  
integrato

**Material**  
aluminum

**Colour**  
embossed anthracite



**Colour temperature**  
3000K / 4000K





**Driver**  
built-in







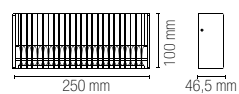

**LED-LUMINA-AP**  
8031414922864

colour temp.	colour
  	
1440 lm	

watt	12W
beam angle	120°
pf	-





**LED-LUMINA-P80**  
8031414922871

colour temp.	colour
  	
1440 lm	

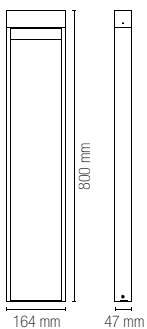
watt	12W
beam angle	120°
pf	-



**LED-LUMINA-P200**  
8031414922888

colour temp.	colour
  	
3690 lm	

watt	30W
beam angle	120°
pf	0.90

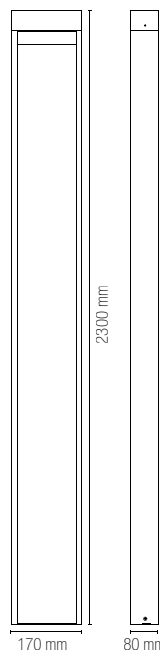

# MIRAGE

Lantern in metallo colore bianco o antracite diffusore in vetro trasparente.  
Metal lantern white or anthracite finish with clear glass diffuser.



colour

**LANT-MIRAGE-AP-BCO**  
8031414896394



**LANT-MIRAGE-AP**  
8031414867059



1 x E27 MAX 60W

130 x 130 mm

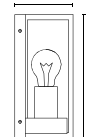

Lampadina non inclusa /  
Light bulb not included





**LANT-MIRAGE-S1-BCO**  
8031414896431

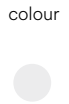

**LANT-MIRAGE-L1-BCO**  
8031414896400

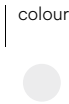

**LANT-MIRAGE-P90-BCO**  
8031414896424

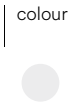

**LANT-MIRAGE-P200-BCO**  
8031414896417



**LANT-MIRAGE-S1**  
8031414867066



**LANT-MIRAGE-L1**  
8031414869190



**LANT-MIRAGE-P90**  
8031414869206



**LANT-MIRAGE-P200**  
8031414869213



1 x E27 MAX 60W

1 x E27 MAX 60W

1 x E27 MAX 60W

1 x E27 MAX 60W

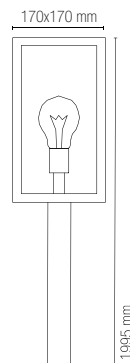
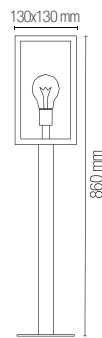
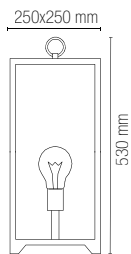
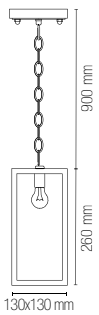

**Accessori inclusi / Included accessories**



Cavo 2,5 m  
con spina shuko /  
2,5 m of cable  
with schuko plug



# SKITTLE

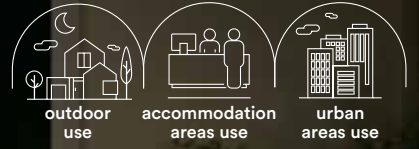



**Collezione in alluminio pressofuso  
colore antracite con diffusore in PC.**  
Collection in die-cast aluminum in  
anthracite colour with PC diffuser.



colour

**I-SKITTLE-AP**  
8031414881819



1 x E27 MAX 28W

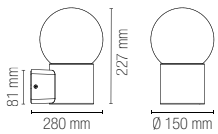

colour

**I-SKITTLE-PL**  
8031414881826



1 x E27 MAX 28W

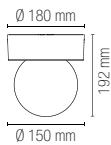

colour

**I-SKITTLE-P65**  
8031414881833



1 x E27 MAX 28W



colour

**I-SKITTLE-P100**  
8031414882434



1 x E27 MAX 28W



OUTDOOR APPLIQUE SOSPENSIONI E PALETTI CORRELATI / WALL SUSPENSION AND FLOOR LAMPS COMBINED

In.tec light



Lampadina consigliata /  
Suggested light bulb



Lampadina non inclusa /  
Light bulb not included

# ORBIT

Lantern in acrilico PMMA e base in alluminio pressofuso nero.  
Acrylic PMMA lantern with base in die cast aluminum black finish.



colour

**LANT-ORBIT/AP**  
8031414862658



1 x E27 MAX 60W

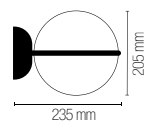

Lampadina non inclusa /  
Light bulb not included



colour

**LANT-ORBIT/S1**  
8031414862665



1 x E27 MAX 60W



colour

**LANT-ORBIT/L1**  
8031414866335



1 x E27 MAX 60W



colour

**LANT-ORBIT/P1**  
8031414862689



1 x E27 MAX 60W



colour

**LANT-ORBIT/P3**  
8031414862702



3 x E27 MAX 60W

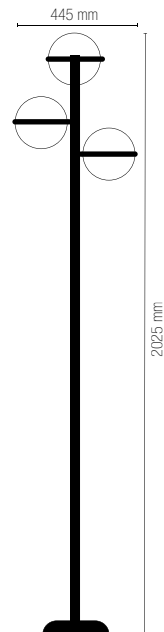
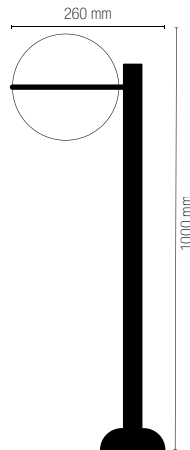
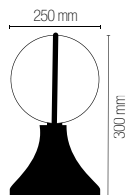
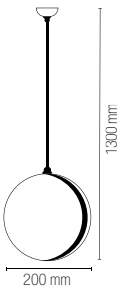

# PRISMA

Lantern in alluminio pressofuso colore antracite diffusore in vetro trasparente.

Die cast aluminum lantern anthracite finish with clear glass diffuser.

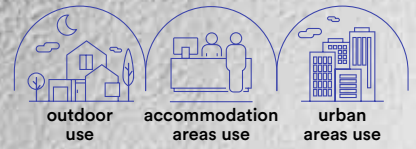



colour

**LANT-PRISMA/AP1A**  
8031414867103



1 x E27 MAX 60W

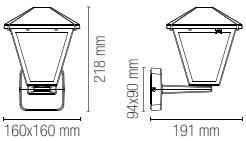

colour

**LANT-PRISMA/AP1B**  
8031414867073



1 x E27 MAX 60W

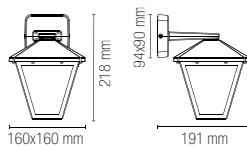

colour

**LANT-PRISMA/S1**  
8031414867080



1 x E27 MAX 60W

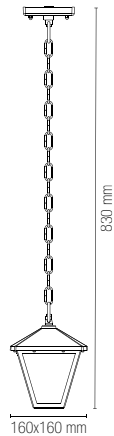

colour

**LANT-PRISMA/P1**  
8031414869183



1 x E27 MAX 60W

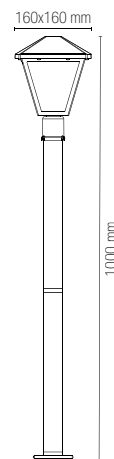

Lampadina consigliata / Suggested light bulb



Lampadina non inclusa / Light bulb not included

# ROMA

Lanterne in alluminio pressofuso con  
diffusore in vetro trasparente.

Die-cast aluminum lantern  
with clear glass diffuser.

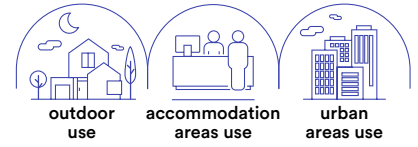

colour

**LANT-ROMA/AP1A BCO**  
8031434661217



**LANT-ROMA/AP1A**  
8031430751172



1 x E27 MAX 60W

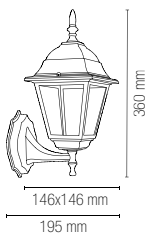

colour

**LANT-ROMA/AP1A-S**  
8031435921235



1 x E27 MAX 60W

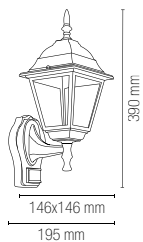

colour

**LANT-ROMA/AP1B BCO**  
8031434671216



**LANT-ROMA/AP1B**  
8031430761171



1 x E27 MAX 60W

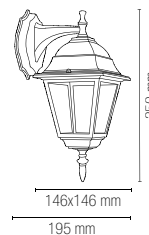

colour

**LANT-ROMA/S1 BCO**  
8031434681215



**LANT-ROMA/S1**  
8031430791178



1 x E27 MAX 60W

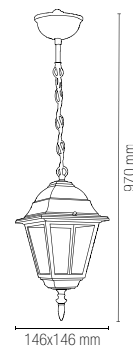

**Accessori integrati /  
Built in accessories**



**Sensore di  
movimento regolabile /  
Adjustable motion sensor**

ON	10lux
distanza / distance	1-8m
	90°
5 seconds - 5 minutes	



Lampadina non inclusa /  
Light bulb not included





colour

**LANT-ROMA/L1 BCO**  
8031436951248



colour

**LANT-ROMA/P1 BCO**  
8031436941249



colour

**LANT-ROMA/P3**  
8031430781179



colour

**LANT-ROMA-HEAD21**  
8031414878512



1 x E27 MAX 60W

1 x E27 MAX 60W

3 x E27 MAX 60W

1 x E27 MAX 60W

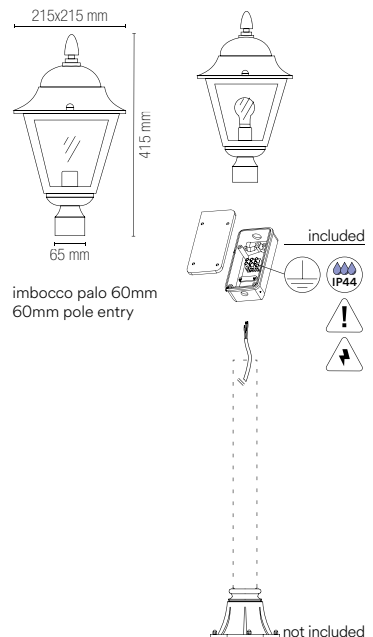
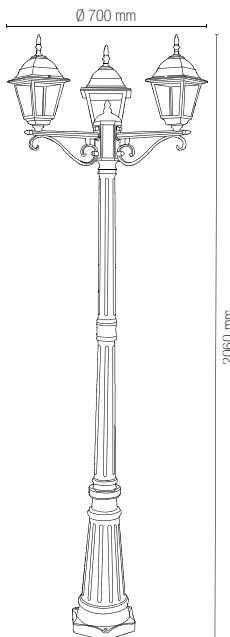
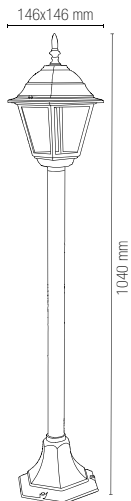
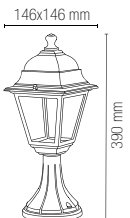





# MILANO

Lanterne in alluminio pressofuso con diffusore in vetro trasparente.

Die-cast aluminum lantern with clear glass diffuser.



colour

colour

**LANT-MILANO/AP1A BCO**  
8031436931240



**LANT-MILANO/AP1B BCO**  
8031436911242



**LANT-MILANO/AP1A**  
8031436921241



**LANT-MILANO/AP1B**  
8031436901243



1 x E27 MAX 60W

1 x E27 MAX 60W

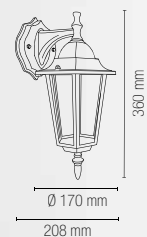
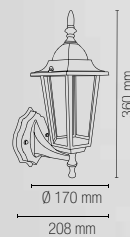

Lampadina non inclusa /  
Light bulb not included



colour

**LANT-MILANO/S1 BCO**  
8031436851234



**LANT-MILANO/S1**  
8031436841235



1 x E27 MAX 60W



colour

**LANT-MILANO/L1 BCO**  
8031436891247



**LANT-MILANO/L1**  
8031436881248



1 x E27 MAX 60W



colour

**LANT-MILANO/P1 BCO**  
8031436871232



**LANT-MILANO/P1**  
8031436971246



1 x E27 MAX 60W



colour

**LANT-MILANO-HEAD23**  
8031414878529



1 x E27 MAX 60W

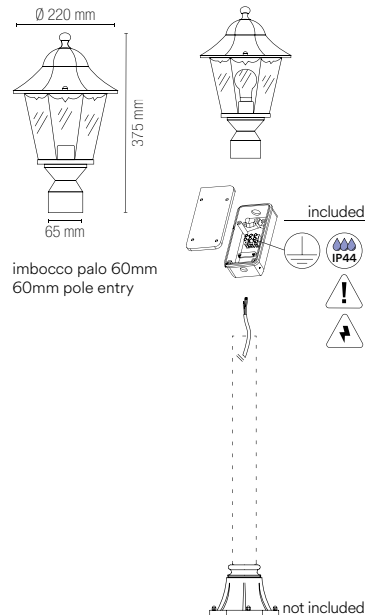
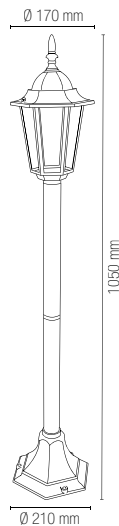
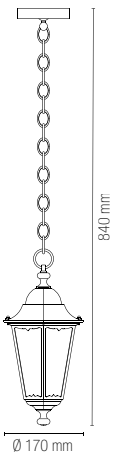

# FIRENZE

Lanterne in alluminio pressofuso nero pennellato  
argento con diffusore in vetro trasparente.

Diecast aluminum lantern black  
brush silver with clear glass diffuser.



outdoor  
use

accommodation  
areas use

urban  
areas use



colour

**LANT-FIRENZE/AP1A**  
8031430701177



1 x E27 MAX 60W

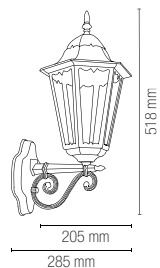

Lampadina non inclusa /  
Light bulb not included



colour

**LANT-FIRENZE/AP1B**  
8031430711176



1 x E27 MAX 60W



colour

**LANT-FIRENZE/S1**  
8031430741173



1 x E27 MAX 60W



colour

**LANT-FIRENZE/P1**  
8031430721175



1 x E27 MAX 60W



colour

**LANT-FIRENZE/P3**  
8031430731174



3 x E27 MAX 60W

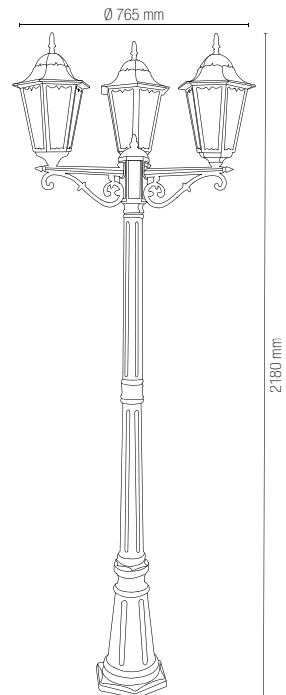
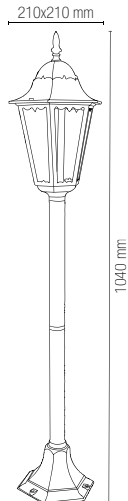
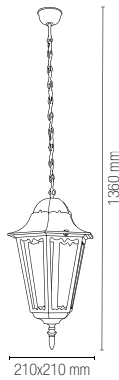
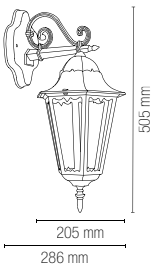

# SANTIAGO

Lanterne in alluminio pressofuso nero pennellato verde con diffusore in vetro trasparente.

Diecast aluminum lantern black brush green with clear glass diffuser.



colour

**LANT-SANTIAGO/APIA**  
8031430801174



1 x E27 MAX 60W

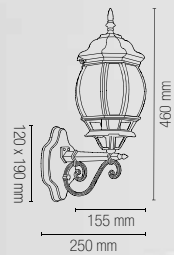

Lampadina non inclusa /  
Light bulb not included





colour

**LANT-SANTIAGO/AP1B**  
8031430811173



1 x E27 MAX 60W



colour

**LANT-SANTIAGO/S1**  
8031430841170



1 x E27 MAX 60W



colour

**LANT-SANTIAGO/P1**  
8031430821172



1 x E27 MAX 60W



colour

**LANT-SANTIAGO/P3**  
8031430831171



3 x E27 MAX 60W

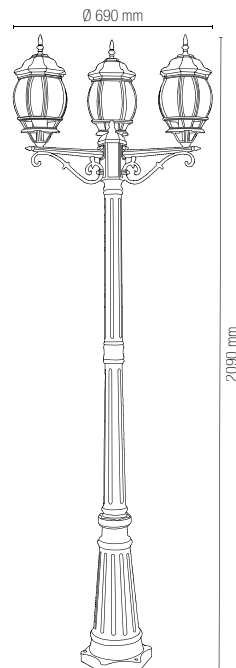
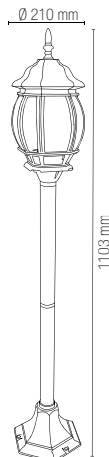
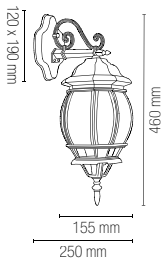

# VENEZIA

Lanterne in alluminio pressofuso con finiture in colore rame con diffusore in policarbonato trasparente.

Aluminum die-cast lantern with copper colour finish and clear polycarbonate diffuser.



colour

**LANT-VENEZIA-AP1A**  
8031440312004



1 x E27 MAX 60W

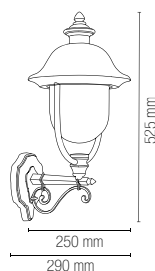

colour

**LANT-VENEZIA-AP1B**  
8031440311991



1 x E27 MAX 60W

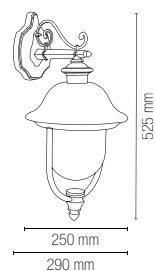

Lampadina non inclusa /  
Light bulb not included



colour

**LANT-VENEZIA-S1**  
8031440313285



1 x E27 MAX 60W



colour

**LANT-VENEZIA-L1**  
8031440311984



1 x E27 MAX 60W



colour

**LANT-VENEZIA-P1**  
8031440313308



1 x E27 MAX 60W



colour

**LANT-VENEZIA-P3**  
8031440313292



3 x E27 MAX 60W

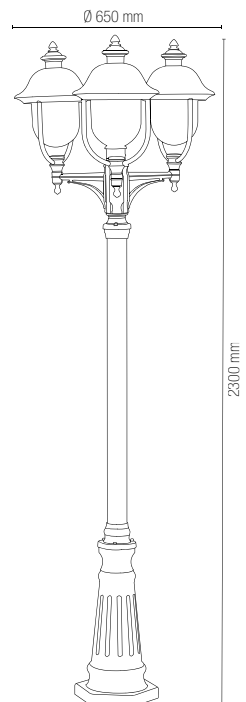
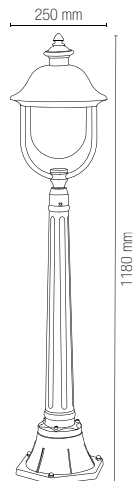
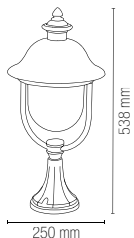
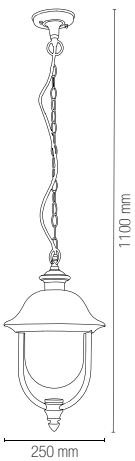

# PAVIA

Lanterne in alluminio pressofuso nero goffrato con diffusore in acrilico trasparente.

Die-cast aluminum lantern in embossed black colour with clear acrylic diffuser.





colour

**LANT-PAVIA-API**  
8031440312028



1 x E27 MAX 60W



colour

**LANT-PAVIA-S1**  
8031440312042



1 x E27 MAX 60W



colour

**LANT-PAVIA-P1**  
8031440312035



1 x E27 MAX 60W



colour

**LANT-PAVIA-P3**  
8031440312011



3 x E27 MAX 60W

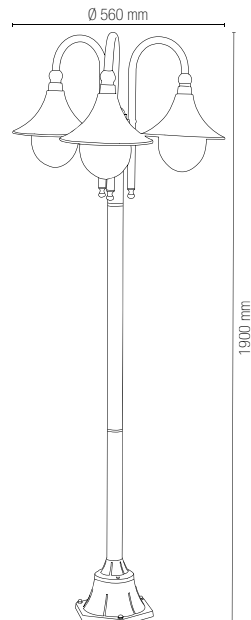
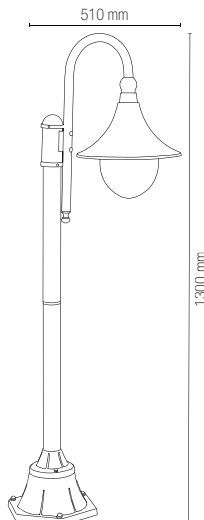
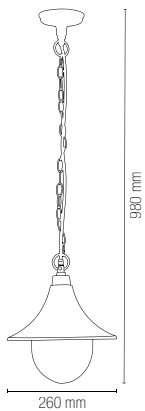
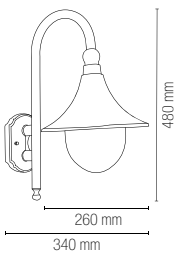

Lampadina non inclusa /  
Light bulb not included

# BRIGHTMAX

Modulo LED per lampioni con alimentatore  
OSRAM OT60 dali e mezzanotte virtuales

LED module for lampposts with OSRAM OT60  
dali power supply and virtual midnight.



**Materiale**

alluminio

**Colore**

nero



**Temperatura colore**

2700K / 4000K



**Driver**

incluso



**Durata e on/off**

50.000h  
>25.000 on/off

**Material**

aluminum

**Colour**

black



**Colour temperature**

2700K / 4000K



**Driver**

included



**Life time and on/off**

50.000h  
>25.000 on/off



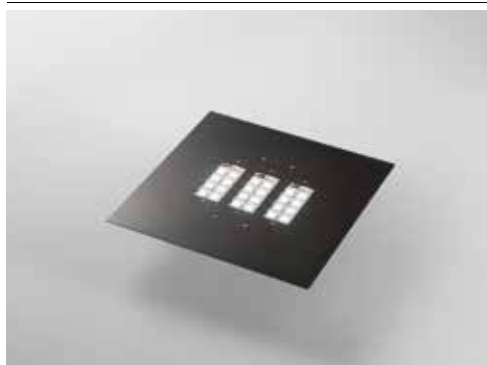
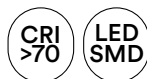

**BRIGHTMAX-60C**

8031414883899

lumen

colour temp. colour

9600 lm

**BRIGHTMAX-60M**

8031414883905

lumen

9600 lm

watt 60W

beam angle 360°

**Fotometria del prodotto / Photometric curve**

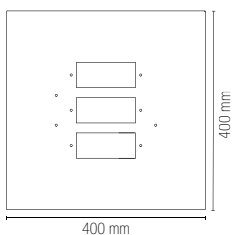
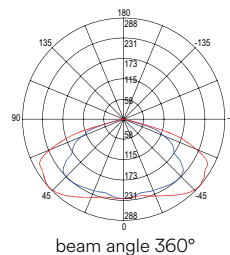

**BRIGHTMAX-LENS**

8031414883912

Lente bi-asimmetrico e tri-asimmetrico /  
Be-asymmetric and three-asymmetric lens

**Fotometria del prodotto / Photometric curve**

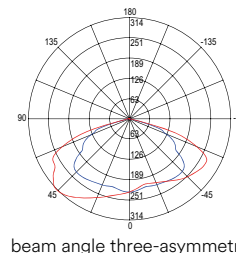
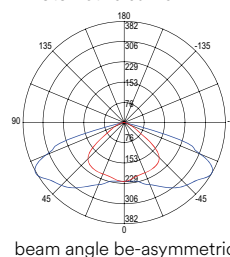

**Mezzanotte Virtuale / Virtual Midnight**

Sistema indipendente della riduzione della luce in 5 STEP. Il modulo LED è programmato con un determinato programma (personalizzabile su richiesta) per ottimizzare il risparmio energetico durante le ore notturne. L'apparecchio prevede un sistema di autoapprendimento che determina in maniera autonoma, in base alle accensioni e agli spegnimenti pregressi, il punto di Mezzanotte Virtuale. La Mezzanotte Virtuale è il punto che determina la riduzione di flusso in base al profilo impostato, lasciando invariato l'impianto. Per un corretto funzionamento del sistema Mezzanotte Virtuale è necessario un'accensione e uno spegnimento regolare quotidiano.

Independent system of light reduction in 5 steps. The LED module is set with a specific program (customizable) to optimize the energy saving time during night hours. The device is equipped with a out-feedback system which determine independently, the Virtual Midnight point based on the past switch on-switch-off time record. Virtual Midnight is the point which determines the light flux reduction based on the set profile, keeping the electrical system untouched. For a correct working of the system of Virtual Midnight it is necessary a daily regular cycle of switching on-off.

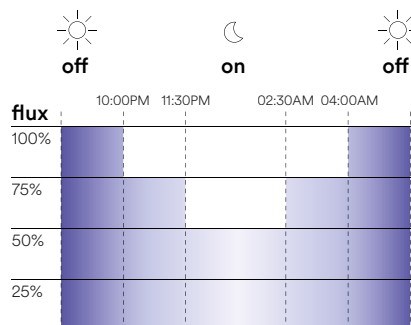

**Impostazioni di fabbrica / Default Settings**

hours	flux
ON ÷ 10:00	100%
10:00 ÷ 11:30	75%
11:30 ÷ 02:30	50%
02:30 ÷ 04:00	75%
04:00 ÷ OFF	100%





# OUTDOOR

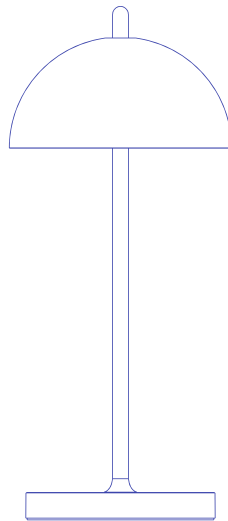

LAMPADE DA TAVOLO RICARICABILI  
RECHARGEABLE TABLE LAMP

# PARTY

Lampada da tavolo ricaricabile.  
Rechargeable table lamp.



## Materiale

metallo

## Colore

goffrato bianco  
goffrato nero  
goffrato verde  
goffrato oro  
goffrato crema  
goffrato corten



## Temperatura colore

3000K



## Material

metal

## Colour

embossed white  
embossed black  
embossed green  
embossed gold  
embossed cream  
embossed corten



## Colour temperature

3000K



	colour temp.	colour
<b>LED-PARTY-S-BCO</b> 8031414915965 lumen		
<b>LED-PARTY-S-NER</b> 8031414915958 lumen		
<b>LED-PARTY-S-VDE</b> 8031414915996 lumen		
<b>LED-PARTY-S-ORO</b> 8031414916009 lumen		
<b>LED-PARTY-S-CRM</b> 8031414915989 lumen		
<b>LED-PARTY-S-BRO</b> 8031414915972 lumen		

watt 1,5W

	colour temp.	colour
<b>LED-PARTY-L-BCO</b> 8031414916023 lumen		
<b>LED-PARTY-L-NER</b> 8031414916016 lumen		
<b>LED-PARTY-L-VDE</b> 8031414916054 lumen		
<b>LED-PARTY-L-ORO</b> 8031414916061 lumen		
<b>LED-PARTY-L-CRM</b> 8031414916047 lumen		
<b>LED-PARTY-L-BRO</b> 8031414916030 lumen		

watt 2,5W

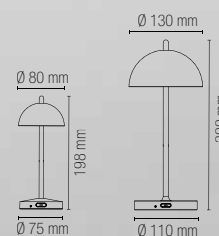

Accessorio non incluso /  
Not included accessory



Adattatore DC5V 1A /  
Adaptor DC5V 1A

Accessori inclusi /  
Included accessories



Cavo per ricarica  
magnetico /  
Magnetic  
charging cable



**DC3.7V 4000 mAh**  
Batteria ricaricabile  
non sostituibile /  
Rechargeable battery  
non replaceable





# LIBERTY

Lampada da tavolo ricaricabile.  
Rechargeable table lamp.



## Materiale

metallo

## Colore

goffrato bianco  
goffrato nero  
goffrato cromo lucido  
goffrato oro lucido



## Temperatura colore

3000K



## Material

metal

## Colour

embossed white  
embossed black  
embossed glossy chrome  
embossed glossy gold



## Colour temperature

3000K



OUTDOOR LAMPADE DA TAVOLO RICARICABILI / RECHARGEABLE TABLE LAMP

In.tec light



	colour temp.	colour
<b>LED-LIBERTY-BCO</b> 8031414916078		
lumen	300 lm - 8h	
<b>LED-LIBERTY-NER</b> 8031414916085		
lumen	300 lm - 8h	
<b>LED-LIBERTY-CR</b> 8031414916092		
lumen	300 lm - 8h	
<b>LED-LIBERTY-ORO</b> 8031414916108		
lumen	300 lm - 8h	
watt	2W	

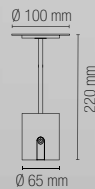

Accessorio non incluso /  
Not included accessory



Adattatore 12V 6A /  
Adaptor 12V 6A

Accessori inclusi /  
Included accessories



Cavo per ricarica  
magnetico /  
Magnetic  
charging cable



**DC3.7V 4000 mAh**  
Batteria ricaricabile  
non sostituibile /  
Rechargeable battery  
non replaceable

**LED-LIBERTY-STATION**  
8031414916115

input 12V 6A output V 1.5A

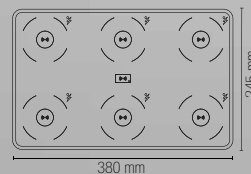



# SMALL DRINK

Lampada da tavolo ricaricabile.

Rechargeable table lamp.



## Materiale

metallo

## Colore

goffrato bianco  
goffrato nero  
goffrato oro  
goffrato corten



## Temperatura colore

3000K



## Material

metal

## Colour

embossed white  
embossed black  
embossed gold  
embossed corten



## Colour temperature

3000K



OUTDOOR LAMPADE DA TAVOLO RICARICABILI / RECHARGEABLE TABLE LAMP

In.tec light



	colour temp.	colour
<b>LED-DRINK-S-BCO</b> 8031414922963 lumen		
<b>LED-DRINK-S-NER</b> 8031414922987 lumen		
<b>LED-DRINK-S-ORO</b> 8031414922994 lumen		
<b>LED-DRINK-S-BRO</b> 8031414922970 lumen		
		1,5W

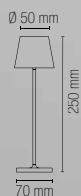

### Accessori inclusi / Included accessories



Base per ricarica con USB /  
Charging base with USB



**DC3.7V 2x2200 mAh**  
Batteria ricaricabile non sostituibile /  
Rechargeable battery non replaceable

**LED-DRINK-PS-S**  
8031414923014



input 220/240V 50/60hz output 5V 3A

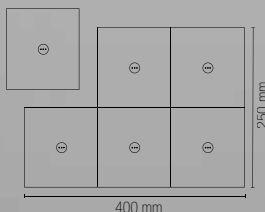

### Accessori inclusi / Included accessories



Cavo per ricarica 2,5m /  
Charging cable 2,5m

# DRINK

Lampada da tavolo ricaricabile.  
Rechargeable table lamp.



## Materiale

metallo

## Colore

goffrato bianco  
goffrato nero  
goffrato oro  
goffrato corten



## Temperatura colore

3000K



## Material

metal

## Colour

embossed white  
embossed black  
embossed gold  
embossed corten



## Colour temperature

3000K



	colour temp.	colour
<b>LED-DRINK-BCO</b> 8031414885299		
lumen	190 lm - 9h	
<b>LED-DRINK-NER</b> 8031414885312		
lumen	190 lm - 9h	
<b>LED-DRINK-ORO</b> 8031414885329		
lumen	190 lm - 9h	
<b>LED-DRINK-BRO</b> 8031414885305		
lumen	190 lm - 9h	
watt	2,2W	

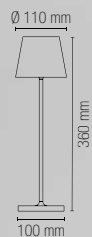

## Accessori inclusi / Included accessories



Base per ricarica con USB /  
Charging base with USB



5-7  
hours

**DC3.7V 2x2200 mAh**  
Batteria ricaricabile non sostituibile /  
Rechargeable battery non replaceable

## LED-DRINK-PS

8031414923007



input 220/240V 50hz output 5V 3A max 15W

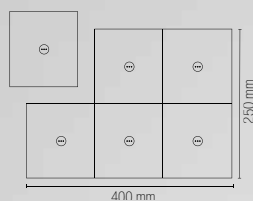





In.tec light **OUTDOOR** LAMPADE DA TAVOLO RICARICABILI / RECHARGEABLE TABLE LAMP

# JAMMIN

Lampada da tavolo ricaricabile.  
Rechargeable table lamp.



**Materiale**  
metallo e PE

**Colore**  
goffrato bianco  
goffrato nero



**Temperatura colore**  
3000K



**Material**  
metal and PE

**Colour**  
embossed white  
embossed black



**Colour temperature**  
3000K



	colour temp.	colour
<b>LED-JAMMIN-L-BCO</b> 8031414884377 lumen		
<b>LED-JAMMIN-L-NER</b> 8031414884384 lumen		
watt	2,2W	

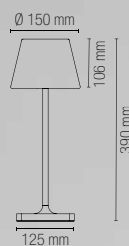

**Accessori inclusi /  
Included accessories**



**USB A 5V 2A  
USB C 5V 2A**  
Cavo per ricarica /  
Charging cable



**5-7  
hours**  
**DC3.7V 4000 mAh**  
Batteria ricaricabile  
non sostituibile /  
Rechargeable battery  
non replaceable



In.tec light **OUTDOOR** LAMPADE DA TAVOLO RICARICABILI / RECHARGEABLE TABLE LAMP

# BRIO

Lampada da tavolo ricaricabile.  
Rechargeable table lamp.



**Materiale**

PC

**Colore**

bianco  
nero



**Temperatura colore**

3000K



**Material**

PC

**Colour**

white  
black



**Colour temperature**

3000K



	colour temp.	colour
<b>LED-BRIO-BCO</b> 8031414889594 lumen		
<b>LED-BRIO-NER</b> 8031414889587 lumen		
watt	2,5W	

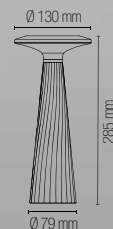

**Accessori inclusi /  
Included accessories**



**USB**  
Cavo per ricarica /  
Charging cable



**DC5V 2200 mAh**  
Batteria ricaricabile  
non sostituibile /  
Rechargeable battery  
non replaceable



In.tec light

**OUTDOOR** LAMPADE DA TAVOLO RICARICABILI / RECHARGEABLE TABLE LAMP

# MYKES

Lampada da tavolo ricaricabile.  
Rechargeable table lamp.



**Materiale**  
metallo e PE

**Colore**  
goffrato bianco  
goffrato nero



**Temperatura colore selezionabile**  
3000K / 4000K / 5000K



**Material**  
metal and PE

**Colour**  
embossed white  
embossed black



**Selectable color temperature**  
3000K / 4000K / 5000K

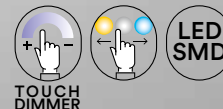

	colour temp.	colour
<b>LEDT-MYKES-WHITE</b> 8031414884445 lumen		
	300 lm	
<b>LEDT-MYKES-BLACK</b> 8031414884438 lumen		
	300 lm	
watt	4,5W	

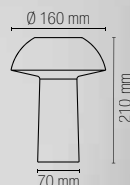

**Accessori inclusi /  
Included accessories**



Cavo per ricarica con adattatore DC5V 2A /  
Charging and speaker cable with adaptor DC5V 2A



# COCKTAIL

Lampada da tavolo ricaricabile.  
Rechargeable table lamp.



## Materiale

metallo

## Colore

goffrato bianco  
goffrato nero  
goffrato oro  
goffrato corten



## Temperatura colore

3000K



## Material

metal

## Colour

embossed white  
embossed black  
embossed gold  
embossed corten



## Colour temperature

3000K



	colour temp.	colour
<b>LED-COCKTAIL-BCO</b> 8031414882496 lumen	192 lm - 9h	white
<b>LED-COCKTAIL-NER</b> 8031414882502 lumen	192 lm - 9h	black
<b>LED-COCKTAIL-ORO</b> 8031414885282 lumen	192 lm - 9h	gold
<b>LED-COCKTAIL-BRO</b> 8031414882519 lumen	192 lm - 9h	brown
watt		2,2W



## Accessori inclusi / Included accessories



Cavo per ricarica /  
Charging cable



**DC3.7V 2x2200 mAh**  
Batteria ricaricabile non sostituibile /  
Rechargeable battery non replaceable





In.tec light **OUTDOOR** LAMPADE DA TAVOLO RICARICABILI / RECHARGEABLE TABLE LAMP

# CLIMAX

Lanterna ricaricabile.  
Rechargeable lamp.



- Materiale**  
metallo - acrilico
- Colore**  
nero opaco
- 
- Temperatura colore**  
3000K
- 
- Material**  
metal - acrylic
- Colour**  
matt black
- 
- Colour temperature**  
3000K
- 



	colour temp.	colour		colour temp.	colour
<b>LED-CLIMAX-L1</b> 8031414883141 lumen			<b>LED-CLIMAX-LG1</b> 8031414883158 lumen		
	140 lm - 8h			140 lm - 8h	
watt		2W	watt		2W

Accessori inclusi / Included accessories



**USB**  
Cavo per ricarica /  
Charging cable



**DC3.7V 2600 mAh**  
Batteria ricaricabile  
non sostituibile /  
Rechargeable battery  
non replaceable

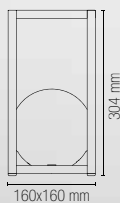



In.tec light **OUTDOOR** LAMPADE DA TAVOLO RICARICABILI / RECHARGEABLE TABLE LAMP



# OBERON

Lantern rechargeable.  
Rechargeable lamp.



## Materiale

metallo

## Colore

bianco



## Temperatura colore

3000K



## Material

metal

## Colour

white



## Colour temperature

3000K

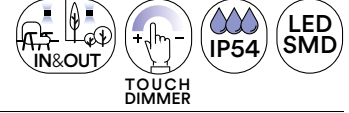

### LANT-OBERON

8031414882526

lumen

colour temp.



168 lm - 9h

colour



watt

2,2W

### LANT-OBERON-KIT-AP

8031414882533

Kit staffa applique per lume /  
Wall lamp bracket kit

### LANT-OBERON-KIT-S

8031414882540

Kit sospensione per lume cavo 2 m /  
Suspension kit 2 m cable

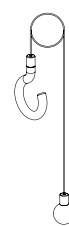
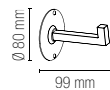
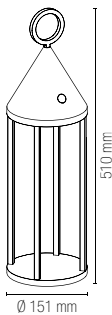

## Accessori inclusi / Included accessories



Cavo per ricarica con adattatore DC5V 1A 1,2 m /  
Charging cable with adaptor DC5V 1A 1,2 m



**DC3.7V 2x2200 mAh**  
Batteria ricaricabile non sostituibile /  
Rechargeable battery non replaceable



# OUTDOOR

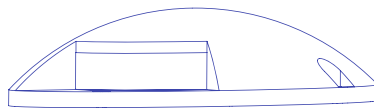

INCASSI E SEGNAPASSI  
INGROUND AND WALK LIGHTS

# BARRET

Segnapassi incasso.  
Recessed light.



**Materiale**  
alluminio

**Colore**  
nikel

**Temperatura colore**  
3000K / 4000K



**Driver**  
350mA 3,5V  
corrente costante  
non incluso

**Material**  
aluminum

**Colour**  
nikel



**Colour temperature**  
3000K / 4000K



**Driver**  
350mA 3,5V  
constant current  
not included



**LED-BARRET-R24C**  
8031440355070

lumen

colour temp. | colour | recessed box



85 lm

**LED-BARRET-R24**  
8031440364416

lumen



85 lm

Ø 20 mm

Ø 24 mm

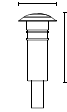
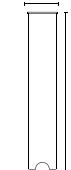

watt 1W  
driver 3,5V DC  
beam angle 40°  
pressure loads max 250 kg  
Ø 16 mm

Fotometria del prodotto /  
Photometric curve

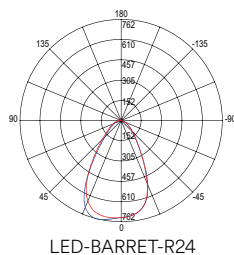

Connessione in serie /  
Serie connection system

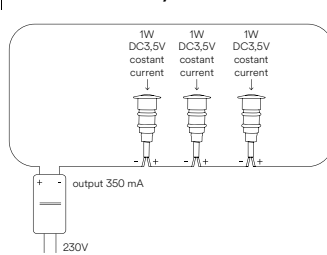

Driver p. 843-852

Accessori inclusi /  
Included accessories



x1  
Cavo 1 m /  
1 m cable





# SUBWAY

Segnapassi incasso.  
Recessed light.



**Materiale**  
alluminio

**Colore**  
nikel



**Temperatura colore**  
3000K / 4000K / BLU



**Driver**  
DC 12-24V  
tensione costante  
non incluso

**Material**  
aluminum

**Colour**  
nikel



**Colour temperature**  
3000K / 4000K



**Driver**  
DC 12-24V  
constant voltage  
not included



**LED-SUBWAY-R1C**

8031414879342

lumen

colour temp.



385 lm

**LED-SUBWAY-R1M**

8031414877263

lumen

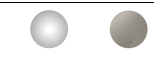

420 lm

**LED-SUBWAY-R1B**

8031414877270

lumen



53 lm

watt

3W

driver

12/24V

beam angle

15°

pressure loads

max 1000 kg



Ø 24 mm

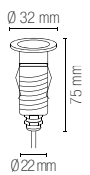

Fotometria del prodotto /  
Photometric curve

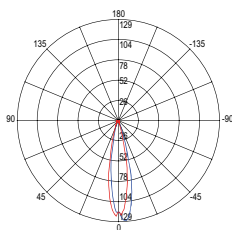

LED-SUBWAY-R1

Connessione in parallelo /  
Serie connection system

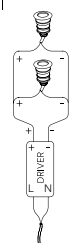

Driver p. 843-852  
Controller p. 854-857

Accessori inclusi /  
Included accessories

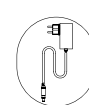

x1  
Cavo 1 m /  
1 m cable



OUTDOOR INCASSI E SEGNAPASSI / INGROUND AND WALK LIGHTS

In.tec light

# RIDER

Kit 6 pz segnapassi incasso.  
Kit 6pcs recessed light.



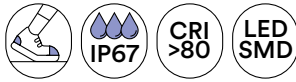

**Materiale**

acciaio

**Colore**

acciaio



**Temperatura colore**

RGB



**Driver**

12V 6W  
incluso

**Material**

steel

**Colour**

stainless steel



**Colour temperature**

RGB



**Driver**

12V 6W  
included



**LED-RIDER-R6**

8031436141236

lumen

colour temp.



360 lm

watt	6 × 0,6W
driver	12V 6W DC
beam angle	120°
pressure loads	max 100 kg
	Ø 23 mm



**LED-RIDER-R6-RGB**

8031439871260

lumen

colour temp.



RGB

watt	6 × 0,6W
driver	12V 6W DC
beam angle	120°
pressure loads	max 100 kg
	Ø 23 mm

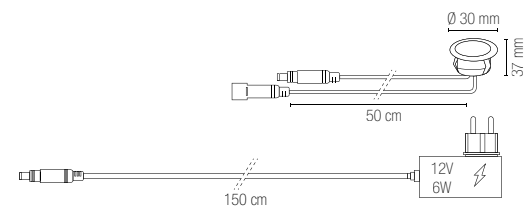
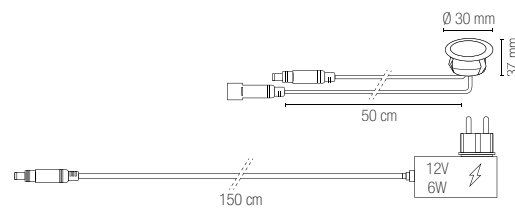

**Fotometria del prodotto / Photometric curve**

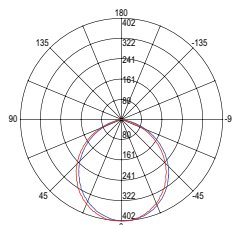

LED-RIDER-R6

**Accessori inclusi / Included accessories**



x6



x6

Cavo 1,5 m / 1,5 m cable



IP44

**Accessori inclusi / Included accessories**



x6



x1

Cavo 1,5 m / 1,5 m cable



IP44



IR Control system

# RIDER

Kit 6 pz segnapassi incasso.  
Kit 6pcs recessed light.

**Materiale**  
lega di zinco

**Colore**  
silver



**Temperatura colore**  
4000K



**Driver**  
12V 6W DC  
incluso

**Material**  
zinc alloy

**Colour**  
silver



**Colour temperature**  
4000K



**Driver**  
12V 6W DC  
included



outdoor  
use

accommodation  
areas use

urban  
areas use



colour temp. | colour

## LED-RIDER-R6-DIR

8031439921279

lumen 100 lm

watt 6 × 0,6W

driver 12V 6W DC

beam angle 105°

pressure loads max 100 kg

Ø 23 mm

Ø 33,3 mm

38 mm

50 cm

150 cm

12V 6W

12V 6W

### Fotometria del prodotto / Photometric curve

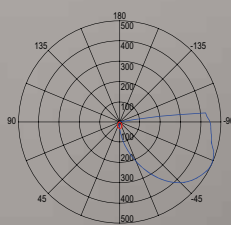

LED-RIDER-R6-DIR

### Accessori inclusi / Included accessories



x6



x1

Cavo 1,5 m /  
1,5 m cable



IP44

# IMPACT

Segnapassi incasso in alluminio.  
Aluminum recessed steplight.



**Materiale**  
alluminio

**Colore**  
nikel



**Temperatura colore**  
3000K / 4000K



**Driver**  
DC 24V  
tensione costante  
non incluso

**Material**  
aluminum

**Colour**  
nikel



**Colour temperature**  
3000K / 4000K



**Driver**  
DC 24V  
constant voltage  
not included



Connessione in parallelo /  
Serie connection system  
Driver p. 843-852  
Controller p. 854-857



EASY  
DOMOTICA



**LED-IMPACT24V-R1C**

8031414879298

lumen

colour temp.



170 lm



170 lm

recessed box

Ø 35 mm

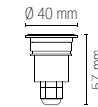
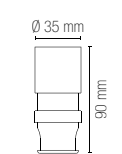

watt 2W  
driver DC 24V  
beam angle 105°  
pressure loads max 250 kg  
Ø 35 mm



Fotometria del prodotto /  
Photometric curve

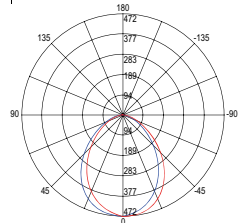

LED-IMPACT24V-R1C  
LED-IMPACT24V-Q1C

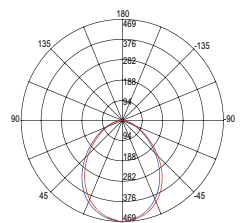

LED-IMPACT24V-R1M  
LED-IMPACT24V-Q1M



**LED-IMPACT24V-Q1C**

8031414879311

lumen

colour temp.



170 lm



170 lm

recessed box

Ø 35 mm

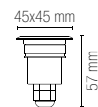
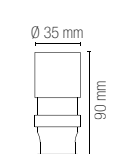

watt 2W  
driver DC 24V  
beam angle 105°  
pressure loads max 250 kg  
Ø 35 mm



Accessori inclusi /  
Included accessories

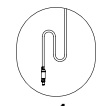

x1

Cavo 1 m / 1 m cable

OUTDOOR INCASSI E SEGNAPASSI / INGROUND AND WALK LIGHTS

In.tec light

# STEP

**Segnapassi incasso in alluminio.**  
Aluminum recessed steplight.



**Materiale**  
alluminio

**Colore**  
silver



**Temperatura colore**  
3000K / 4000K



**Driver**  
DC 24V  
tensione costante  
non incluso

**Material**  
aluminum

**Colour**  
silver



**Colour temperature**  
3000K / 4000K



**Driver**  
DC 24V  
constant voltage  
not included





**LED-STEP24V-R1C**

8031414879250

lumen

colour temp.	colour
170 lm	

**LED-STEP24V-R1M**

8031414879267

lumen

170 lm	

watt	2W
driver	DC 24V
beam angle	105°
pressure loads	max 250 kg
	Ø 35 mm

recessed box



Ø 35 mm

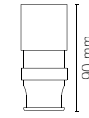

Ø 45 mm



**LED-STEP24V-R4C**

8031414879274

lumen

colour temp.	colour
170 lm	

**LED-STEP24V-R4M**

8031414879281

lumen

170 lm	

watt	2W
driver	DC 24V
beam angle	105°
pressure loads	max 250 kg
	Ø 35 mm

recessed box



Ø 35 mm

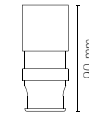

Ø 45 mm



Connessione in parallelo /  
Serie connection system  
Driver p. 843-852  
Controller p. 854-857

Fotometria del prodotto / Photometric curve

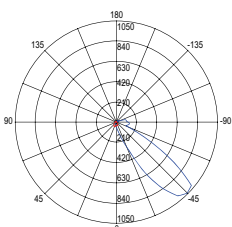

LED-STEP24V-R1C

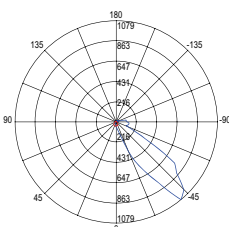

LED-STEP24V-R1M

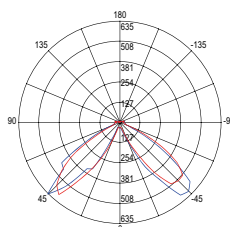

LED-STEP24V-R4C

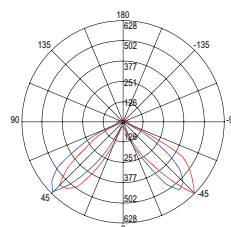

LED-STEP24V-R4M

Accessori inclusi /  
Included accessories



**x1**  
Cavo 1 m /  
1 m cable

# WALK

Faro calpestabile ad incasso in acciaio inox.  
Walkable recessed light in stainless steel.



- Materiale**  
acciaio inox

---

- Temperatura colore**  
4000K
- 

---

- Driver**  
integrato

---

- Material**  
stainless steel





---

- Colour temperature**  
4000K
- 

---

- Driver**  
built-in

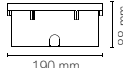

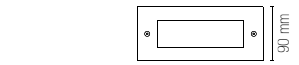
	colour temp.	colour	recessed box
<b>LED-WALK-RT</b> 8031414882816			
lumen	1500 lm		
watt	12W		
beam angle	30°		
pressure loads	max 2000 kg		





# WALK



### LED-WALK-Q7C

8031414885824

lumen

colour temp.



recessed box

345 lm

### LED-WALK-Q7

8031440355599

lumen

375 lm

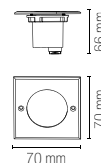

watt 3W

beam angle 30°

pressure loads max 2000 kg



### LED-WALK-Q11C

8031414885800

lumen

colour temp.



recessed box

930 lm

### LED-WALK-Q11

8031440355575

lumen

990 lm

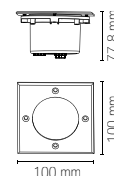
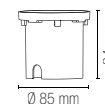

watt 8W

beam angle 30°

pressure loads max 2000 kg



### LED-WALK-Q14C

8031414885817

lumen

colour temp.



recessed box

1400 lm

### LED-WALK-Q14

8031440355551

lumen

1500 lm

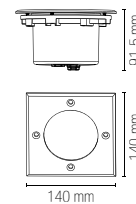
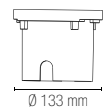

watt 12W

beam angle 30°

pressure loads max 2000 kg

## Fotometria del prodotto / Photometric curve

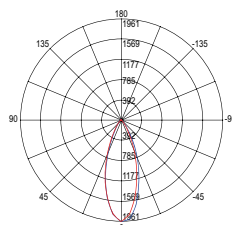

LED-WALK-Q7

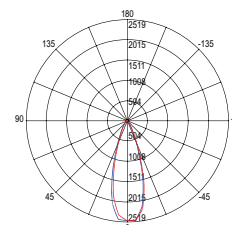

LED-WALK-Q11

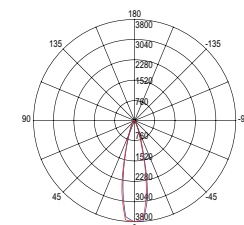

LED-WALK-Q14



**LED-WALK-R7C**

8031414885855

lumen

colour temp.	colour
345 lm	

**LED-WALK-R7**

8031440355582

lumen

375 lm	

watt	3W
beam angle	30°
pressure loads	max 2000 kg

recessed box

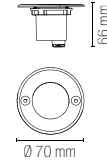

**LED-WALK-R11C**

8031414885831

lumen

colour temp.	colour
930 lm	

**LED-WALK-R11**

8031440355568

lumen

990 lm	

watt	8W
beam angle	30°
pressure loads	max 2000 kg

recessed box

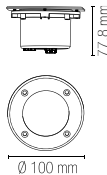
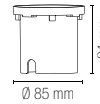

**LED-WALK-R14C**

8031414885848

lumen

colour temp.	colour
1400 lm	

**LED-WALK-R14**

8031440355544

lumen

1500 lm	

watt	12W
beam angle	30°
pressure loads	max 2000 kg

recessed box

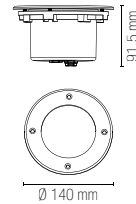
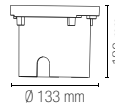

Fotometria del prodotto / Photometric curve

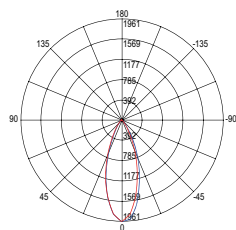

LED-WALK-R7

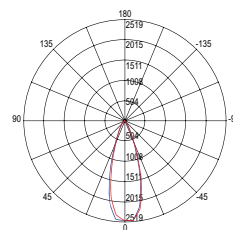

LED-WALK-R11

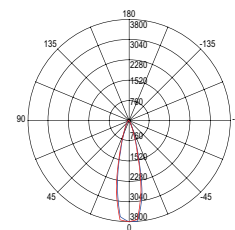

LED-WALK-R14

# HUMMER

Faro carrabile ad incasso in acciaio inox.  
Driveover recessed light in stainless steel.



outdoor  
use



accommodation  
areas use



urban  
areas use





colour	recessed box
<b>I-HUMMER-R1</b> 8031414893188	
<b>I-HUMMER-R1-ANT</b> 8031414895830	
<b>I-HUMMER-R1-BRO</b> 8031414893195	

1 x GU10 MAX 35W  
pressure loads max 500 kg

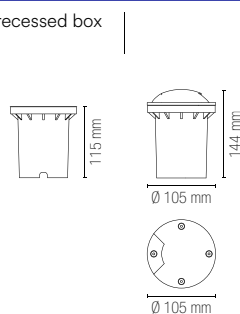

Lampadina non inclusa / Light bulb not included



colour	recessed box
<b>I-HUMMER-R2</b> 8031414893201	
<b>I-HUMMER-R2-ANT</b> 8031414895847	
<b>I-HUMMER-R2-BRO</b> 8031414893218	

1 x GU10 MAX 35W  
pressure loads max 500 kg

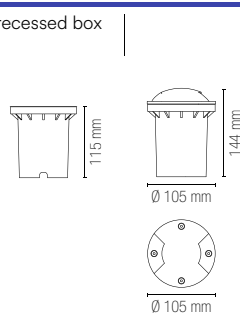

Lampadina non inclusa / Light bulb not included



colour	recessed box
<b>I-HUMMER-R4</b> 8031414877249	
<b>I-HUMMER-R4-ANT</b> 8031414895854	
<b>I-HUMMER-R4-BRO</b> 8031414893225	

1 x GU10 MAX 35W  
pressure loads max 500 kg

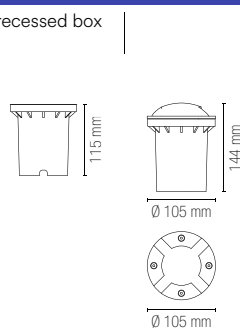

Lampadina non inclusa / Light bulb not included



colour	recessed box
<b>I-HUMMER-UP</b> 8031414893232	
<b>I-HUMMER-UP-ANT</b> 8031414895861	
<b>I-HUMMER-UP-BRO</b> 8031414893249	

1 x GU10 MAX 35W  
pressure loads max 500 kg

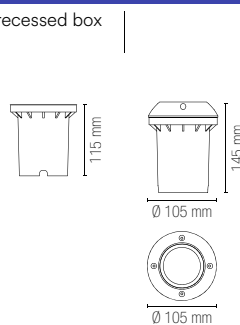

Lampadina non inclusa / Light bulb not included

# DRIVE

Faro calpestabile ad incasso in acciaio inox.  
Walkable recessed light in stainless steel.

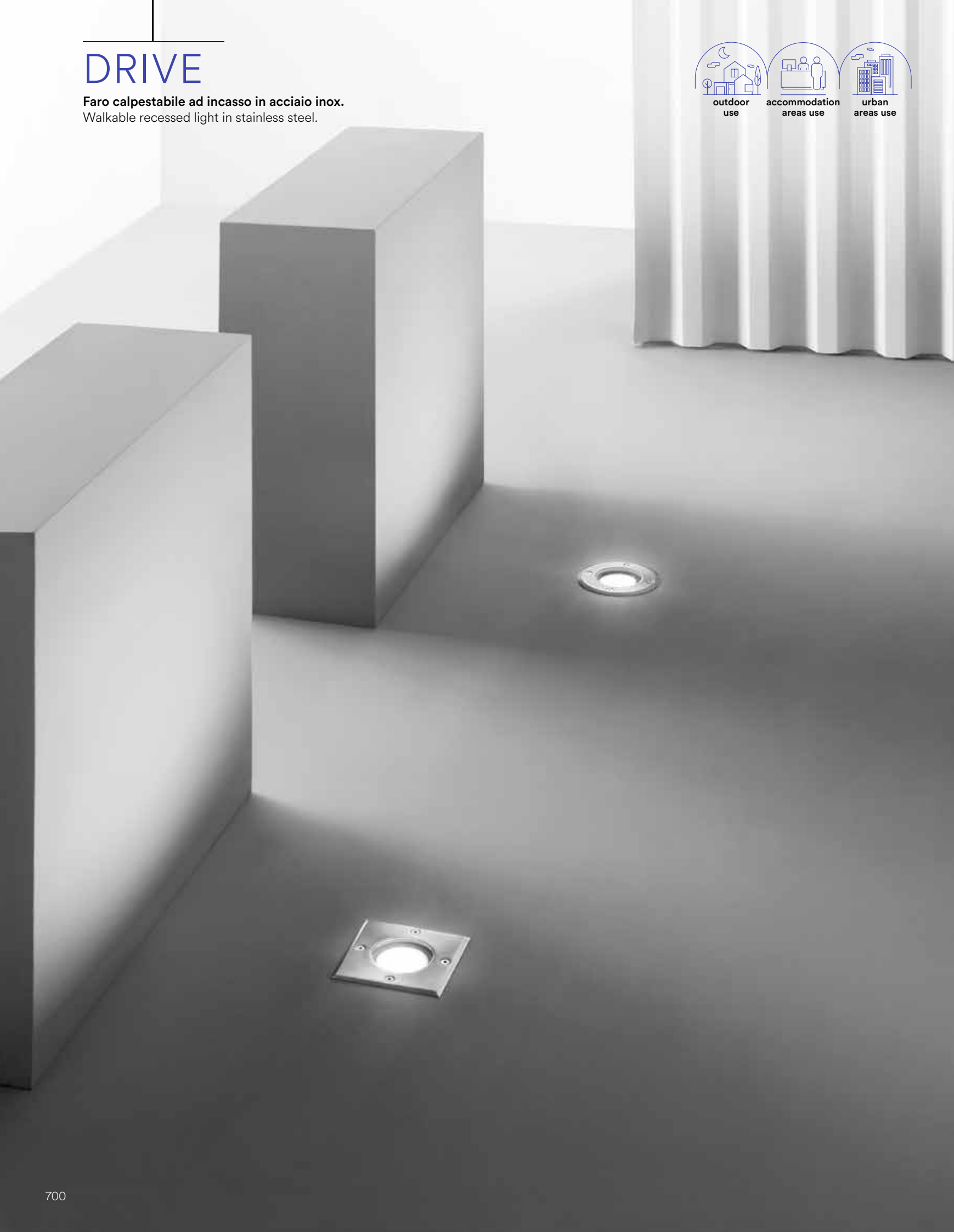



**I-DRIVE-R1**  
8031440313261

1 x GU10 MAX 42W  
pressure loads max 500 kg

colour



recessed box

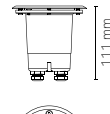
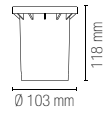

Lampadina non inclusa /  
Light bulb not included



**I-DRIVE-Q1**  
8031440313254

1 x GU10 MAX 42W  
pressure loads max 500 kg

colour



recessed box

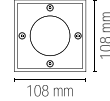
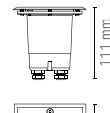
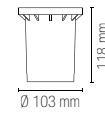

Lampadina non inclusa /  
Light bulb not included



**I-DRIVE-M-R1**  
8031440313247

1 x GU10 MAX 42W  
pressure loads max 500 kg

colour



recessed box

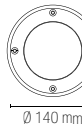
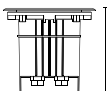
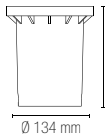

Lampadina non inclusa /  
Light bulb not included



**I-DRIVE-E27**  
8031440313230

1 x E27 MAX 60W  
pressure loads max 500 kg

colour



recessed box

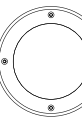
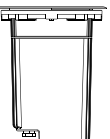

Lampadina non inclusa /  
Light bulb not included

# ELMO

Segnapassi in alluminio pressofuso.  
Die-cast aluminum steplight.

---

**Materiale**

alluminio

---

**Colore**

silver



---

**Temperatura colore**

3000K / 4000K



---

**Driver**

DC 24V  
tensione costante  
non incluso

---

**Material**

aluminum

---

**Colour**

silver



---

**Colour temperature**

3000K / 4000K



---

**Driver**

DC 24V  
constant voltage  
not included



outdoor  
use



accommodation  
areas use



urban  
areas use







**LED-ELMO-R1C**

8031414882823

lumen

colour temp.	colour

59 lm

**LED-ELMO-R1M**

8031414882830

lumen

colour temp.	colour

65 lm

watt 0,5W

beam angle 90°

pressure loads max 1000 kg

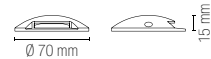

**LED-ELMO-R2C**

8031414882847

lumen

colour temp.	colour

116 lm

**LED-ELMO-R2M**

8031414882854

lumen

colour temp.	colour

121 lm

watt 1W

beam angle 90° x 2

pressure loads max 1000 kg

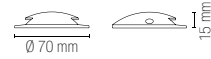

**LED-ELMO-R4C**

8031414882861

lumen

colour temp.	colour

226 lm

**LED-ELMO-R4M**

8031414882878

lumen

colour temp.	colour

236 lm

watt 2W

beam angle 90° x 4

pressure loads max 1000 kg



**LED-ELMO-UPC**

8031414897247

lumen

colour temp.	colour

360 lm

**LED-ELMO-UPM**

8031414897254

lumen

colour temp.	colour

380 lm

watt 3W

beam angle 180°

pressure loads max 200 kg



**I-ELMO-SPK**

8031414888092

**Accessori inclusi /  
Included accessories**



**x1**  
Cavo 30 cm /  
30 cm cable

# GROUND

Segnapassi in alluminio pressofuso colore antracite.  
Die-cast aluminum steplight in anthracite colour.



**Materiale**  
alluminio

**Colore**  
antracite



**Temperatura colore  
selezionabile**  
3000K / 4000K



**Driver**  
DC 24V  
tensione costante  
non incluso

**Material**  
aluminum

**Colour**  
anthracite



**Selectable color  
temperature**  
3000K / 4000K



**Driver**  
DC 24V  
constant voltage  
not included



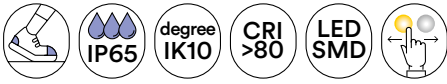



**LED-GROUND-R1**

8031414897261

lumen

colour temp.	colour
 	
730 lm	



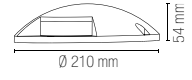

watt	6W
beam angle	120°
pressure loads	max 2000 kg



**LED-GROUND-R2**

8031414897278

lumen

colour temp.	colour
 	
1460 lm	



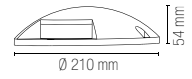

watt	12W
beam angle	120°
pressure loads	max 2000 kg



**LED-GROUND-R4**

8031414897285

lumen

colour temp.	colour
 	
1960 lm	



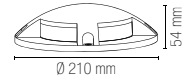

watt	16W
beam angle	120°
pressure loads	max 2000 kg



**LED-GROUND-UP**

8031414897292

lumen

colour temp.	colour
 	
1480 lm	



watt	12W
beam angle	120°
pressure loads	max 1000 kg

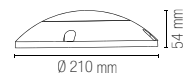

**LED-GROUND-SPK**

8031414897308

# ONYX

Segnapassi in alluminio pressofuso finitura nero o bianco goffrato.  
Die-cast aluminum steplight in embossed black or white finish.



outdoor  
use



accommodation  
areas use



urban  
areas use

## Materiale

alluminio

## Colore

bianco  
nero



## Temperatura colore

4000K



## Driver

integrato

## Material

aluminum

## Colour

white  
black



## Colour temperature

4000K



## Driver

built-in



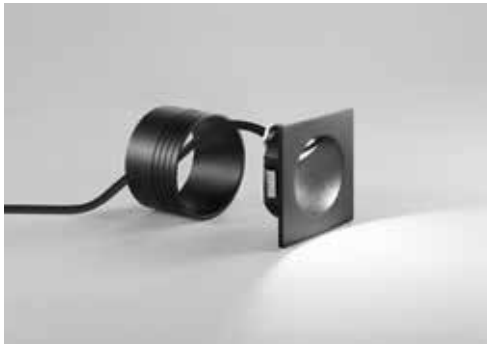

	colour temp.	colour
<b>INC-ONYX-Q1 BCO</b> 8031414864089		
lumen	420 lm	
<b>INC-ONYX-Q1 NERO</b> 8031440361262		
lumen	420 lm	
watt	2W	
beam angle	45°	
	Ø 68 mm	

recessed box

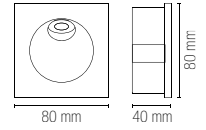
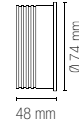

	colour temp.	colour
<b>INC-ONYX-R1 BCO</b> 8031440361248		
lumen	420 lm	
<b>INC-ONYX-R1 NERO</b> 8031440361255		
lumen	420 lm	
watt	2W	
beam angle	45°	
	Ø 68 mm	

recessed box

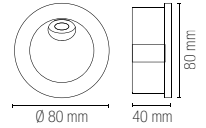
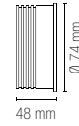

# STRATOS

**Incasso segnapassi alloggio in cassetta di derivazione 503 o 504 o 506, con mascherine in alluminio nei colori bianco, antracite, silver o corten.**

Downlight for recess box 503, 504 or 506, with aluminum masks in white, anthracite, silver or corten.



**Materiale**  
alluminio

**Colore**  
bianco  
silver  
nero  
corten



**Temperatura colore  
selezionabile**  
3000K / 4000K / 6000K



**Driver**  
integrato

**Material**  
aluminum

**Colour**  
white  
silver  
black  
corten

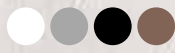

**Selectable color  
temperature**  
3000K / 4000K / 6000K



**Driver**  
built-in





**INC-STRATOS-503**  
8031414888184  
lumen

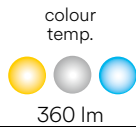

360 lm

watt 3W  
beam angle 120°



**INC-STRATOS-504**  
8031414888221  
lumen

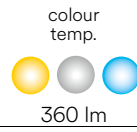

360 lm

watt 3W  
beam angle 120°



**INC-STRATOS-506**  
8031414888276  
lumen

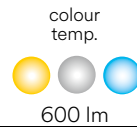

600 lm

watt 5W  
beam angle 120°

	colour
<b>INC-STRATOS-503W</b> 8031414886890	
<b>INC-STRATOS-503S</b> 8031414888214	
<b>INC-STRATOS-503B</b> 8031414888191	
<b>INC-STRATOS-503C</b> 8031414888207	

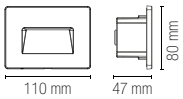

	colour
<b>INC-STRATOS-504W</b> 8031414888269	
<b>INC-STRATOS-504S</b> 8031414888252	
<b>INC-STRATOS-504B</b> 8031414888238	
<b>INC-STRATOS-504C</b> 8031414888245	

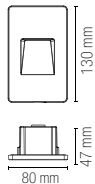

	colour
<b>INC-STRATOS-506W</b> 8031414888313	
<b>INC-STRATOS-506S</b> 8031414888306	
<b>INC-STRATOS-506B</b> 8031414888283	
<b>INC-STRATOS-506C</b> 8031414888290	

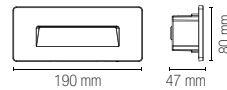

scatola derivazione 503  
503 junction box  
non inclusa / not included

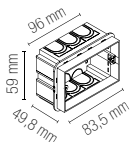

scatola derivazione 503  
503 junction box  
non inclusa / not included

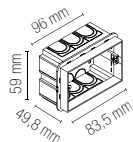

scatola derivazione 504  
504 junction box  
non inclusa / not included

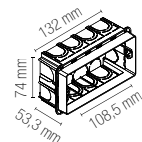

scatola derivazione 506L  
506L junction box  
non inclusa / not included

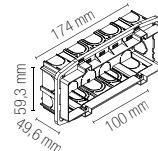

# SLAB

**Incasso segnapassi alloggio in cassetta di derivazione  
503 o 502 o 506, con diffusore in vetro temperato bianco.**

Down light for recess box 503 or 502 or 506  
with white tempered glass diffuser.



---

### Materiale

struttura in  
alluminio e diffusore  
in vetro temperato

---

### Temperatura colore selezionabile

3000K / 4000K / 5500K



---

### Driver

integrato

---

### Material

structure in  
aluminum and  
tempered glass diffuser

---

### Selectable color temperature

3000K / 4000K / 5500K



---

### Driver

built-in





**INC-SLAB-502**  
8031414888177  
lumen

colour temp.	colour
360 lm	

watt 3W  
beam angle 120°  
Ø 60 mm

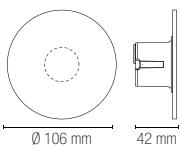

molle incluse / spring included



**INC-SLAB-503**  
8031414864683  
lumen

colour temp.	colour
440 lm	

watt 3W  
beam angle 120°  
92 × 55 × 31 mm

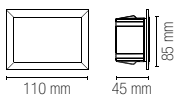

**INC-SLAB-506**  
8031414877232  
lumen

colour temp.	colour
730 lm	

watt 5W  
beam angle 120°  
163 × 60 × 50 mm

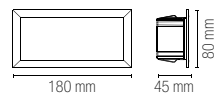

**Doppio sistema di fissaggio / Double fixing system**

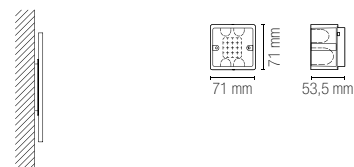

fissaggio incasso a muro o soffitto / Recessed wall or ceiling mounting

scatola derivazione 502E / 502E junction box **non inclusa / not included**

scatola derivazione 503 / 503 junction box **non inclusa / not included**

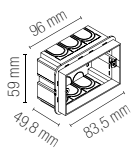

scatola derivazione 506L / 506L junction box **non inclusa / not included**

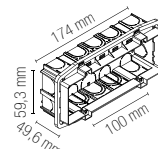

# BREEN

**Incasso segnapassi alloggio in cassetta di derivazione 503 o 506, nei colori bianco, antracite o corten goffrato.**

Downlight for recess box 503 or 506 in white, anthracite or corten embossed.



indoor use



outdoor use



accommodation areas use



office use



commercial areas use

---

**Materiale**

polycarbonato

---

**Colore**

bianco goffrato  
antracite goffrato  
corten goffrato



---

**Temperatura colore selezionabile**

3000K / 4000K



---

**Driver**

integrato

---

**Material**

polycarbonate

---

**Colour**

embossed white  
embossed antracyte  
embossed corten



---

**Selectable color temperature**

3000K / 4000K



---

**Driver**

built-in

---





	colour temp.	colour
<b>INC-BREEN-503 BCO</b> 8031414864690		
lumen	290 lm	
<b>INC-BREEN-503 ANT</b> 8031414866809		
lumen	300 lm	
<b>INC-BREEN-503 BRO</b> 8031414888139		
lumen	290 lm	

watt 3W

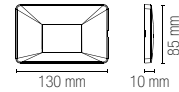

scatola derivazione 503  
503 junction box  
**non inclusa / not included**

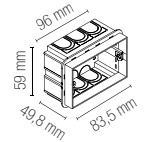

	colour temp.	colour
<b>INC-BREEN-506 BCO</b> 8031414888153		
lumen	380 lm	
<b>INC-BREEN-506 ANT</b> 8031414888146		
lumen	380 lm	
<b>INC-BREEN-506 BRO</b> 8031414888160		
lumen	380 lm	

watt 4W

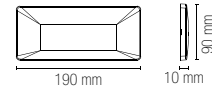

scatola derivazione 506L  
506L junction box  
**non inclusa / not included**

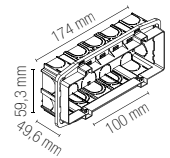

**Doppio sistema di fissaggio /  
Double fixing system**



fissaggio a muro /  
wall fixing

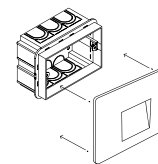

fissaggio su cassetta 503 /  
fixing on box 503  
**non inclusa / not included**

# SMILE

Appliche segnapassi a LED doppio fissaggio.  
Fissaggio a muro e su cassetta 502E.

Aluminum LED walk light double mounting system.  
Wall or 502E junction box mounting.



**Materiale**

alluminio

**Colore**

bianco  
nero



**Temperatura colore  
selezionabile**

3000K / 3500K / 4000K



**Driver**

integrato

**Material**

aluminum

**Colour**

white  
black



**Selectable color  
temperature**

3000K / 3500K / 4000K



**Driver**

built-in





**LED-SMILE-BCO**

8031414881574

lumen

colour temp.	colour
250 lm	

watt	3W
beam angle	100°

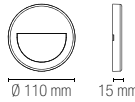

**Doppio sistema di fissaggio / Double fixing system**



fissaggio a muro /  
wall fixing

fissaggio su cassetta 502E /  
fixing on box 502E  
**non inclusa / not included**



**LED-SMILE-ANT**

8031414881567

lumen

colour temp.	colour
300 lm	

watt	3W
beam angle	100°

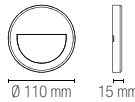

**Doppio sistema di fissaggio / Double fixing system**



fissaggio a muro /  
wall fixing

fissaggio su cassetta 502E /  
fixing on box 502E  
**non inclusa / not included**

# BOLT



**Materiale**  
alluminio e  
placchette in acciaio

**Colore**  
nikel  
bianco



**Temperatura colore**  
4000K



**Driver**  
integrato

**Material**  
aluminum and  
steel frames

**Colour**  
nikel  
white



**Colour temperature**  
4000K



**Driver**  
built-in

## Incasso segnapassi alloggio in cassetta di derivazione 503 funzione con sensore di movimento e crepuscolare con doppia placchetta in acciaio intercambiabile nei colori nikel o bianco.

Down light for recess box 503 and double sensor function  
motion and crepuscular with double interchangeable  
steel frame in nickel or white colours.



**INC-BOLT-503S**  
8031414866281  
lumen

colour temp.	colour
200 lm	

watt	3W
beam angle	120°

Installare più prodotti lateralmente  
ad una distanza minimo di 2 m /  
Install multiple bolt 503S within  
2 m of each other

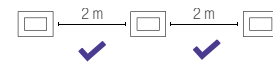

### Accessori inclusi / Included accessories



**2x**  
placchette /  
frames



**2x**  
staffette /  
brackets

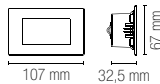

scatola derivazione 503  
503 junction box  
**non inclusa / not included**

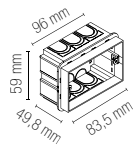

Non installare i prodotti uno di  
fronte all'altro per possibile conflitto /  
Do not install products one of facing  
each other for possible conflict



Il prodotto non va installato  
vicino ad una fonte di luce intensa  
e costante superiore di 20 LUX /  
Do not install the bolt 503S  
near a light source with  
intensity over 20 LUX

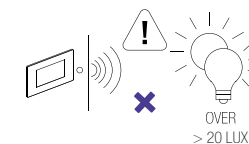

 5m 120° <b>60"</b> Sensore di movimento regolabile / Adjustable motion sensor	 <b>on 2 LUX</b> <b>off 1000 LUX</b> Sensore crepuscolare / Crepuscular sensor
--	--



**Materiale**

PC e  
placchette in acciaio

**Colore**

nikel  
bianco



**Temperatura colore selezionabile**

3000K / 4000K / 6500K



**Driver**

integrato

**Material**

PC and  
steel frames

**Colour**

nikel  
white



**Selectable color temperature**

3000K / 4000K / 6500K



**Driver**

built-in

**Incasso segnapassi alloggio in cassetta di derivazione 503 o 506L con doppia placchetta in acciaio intercambiabile nei colori nikel o bianco.**

Down light for recess box 503 or 506L with double interchangeable steel frame in nickel or white colours.



**INC-BOLT-503CCT**

8031414881543

lumen

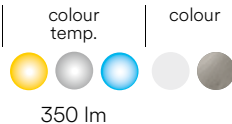

**INC-BOLT-506CCT**

8031414881550

lumen

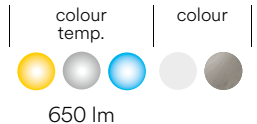

watt	3W
beam angle	120°

watt	5W
beam angle	120°

**Accessori inclusi / Included accessories**



**2x**  
placchette /  
frames



**2x**  
staffette /  
brackets

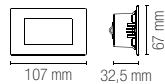

scatola derivazione 503  
503 junction box  
**non inclusa / not included**

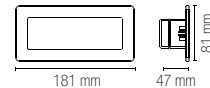
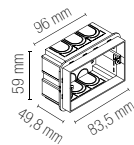



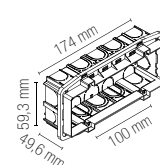

scatola derivazione 506L  
506L junction box  
**non inclusa / not included**



# STEPLIGHT





Applique segnapassi a LED in termoplastica antracite.  
Thermoplastic LED walk light anthracite finish.



- Materiale**  
termoplastica
- Colore**  
antracite goffrato
- 
- Temperatura colore**  
4000K
- 
- Driver**  
integrato
- Material**  
thermoplastic
- Colour**  
embossed anthracite
- 
- Colour temperature**  
4000K
- 
- Driver**  
built-in



**LED-STEPLIGHT**  
8031414882304  
lumen

colour temp.	colour		
			
95 lm		70 mm	50 mm 11,5 mm

watt	1W
beam angle	120°



# SHELBY

Applique segnapassi a LED in alluminio antracite.  
Aluminum LED walk light anthracite finish.



- Materiale**  
alluminio
- Colore**  
antracite goffrato
- Temperatura colore selezionabile**  
3000K / 4000K
- Driver**  
integrato
- Material**  
aluminum
- Colour**  
embossed antracyte
- Selectable color temperature**  
3000K / 4000K
- Driver**  
built-in



**LED-W-SHELBY-130**  
8031440361002  
lumen

colour temp.	colour
445 lm	

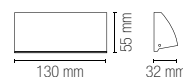

watt	4W
beam angle	120°



**LED-W-SHELBY-170**  
8031440361019  
lumen

colour temp.	colour
670 lm	

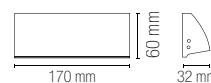

watt	6W
beam angle	120°

OUTDOOR INCASSI E SEGNAPASSI / INGROUND AND WALK LIGHTS  
In.tec light

# BREEN

**Incasso segnapassi alloggio in cassetta di derivazione 503 o 506, nei colori bianco, antracite o corten goffrato.**

Downlight for recess box 503 or 506 in white, anthracite or corten embossed.



---

**Materiale**

polycarbonato

---

**Colore**

bianco goffrato  
antracite goffrato  
corten goffrato



---

**Temperatura colore selezionabile**

3000K / 3500K / 4000K



---

**Driver**

integrato

---

**Material**

polycarbonate

---

**Colour**

embossed white  
embossed antracite  
embossed corten



---

**Selectable color temperature**

3000K / 3500K / 4000K



---

**Driver**

built-in

---





	colour temp.	colour
<b>INC-BREEN-503 BCO</b> 8031414864690		
lumen	290 lm	
<b>INC-BREEN-503 ANT</b> 8031414866809		
lumen	300 lm	
<b>INC-BREEN-503 BRO</b> 8031414888139		
lumen	290 lm	

watt 3W

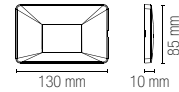

scatola derivazione 503  
503 junction box  
**non inclusa / not included**

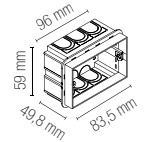

	colour temp.	colour
<b>INC-BREEN-506 BCO</b> 8031414888153		
lumen	380 lm	
<b>INC-BREEN-506 ANT</b> 8031414888146		
lumen	380 lm	
<b>INC-BREEN-506 BRO</b> 8031414888160		
lumen	380 lm	

watt 4W

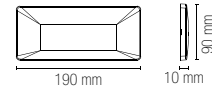

scatola derivazione 506L  
506L junction box  
**non inclusa / not included**

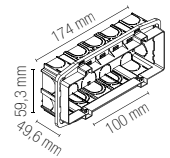

**Doppio sistema di fissaggio /  
Double fixing system**



fissaggio a muro /  
wall fixing

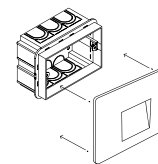

fissaggio su cassetta 503 /  
fixing on box 503  
**non inclusa / not included**



# OUTDOOR

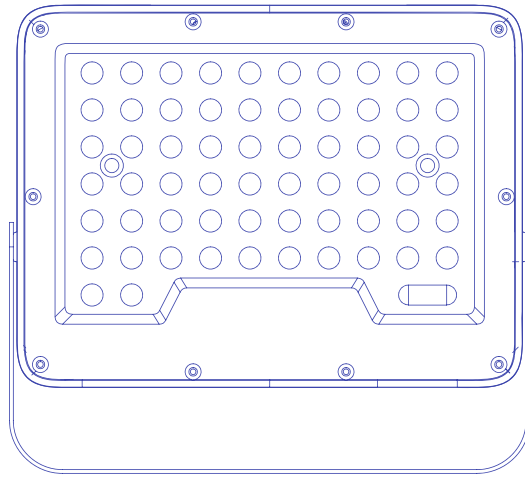

SOLARI  
SOLAR LAMPS

# KYOTO

Collezione in alluminio antracite con sensore e pannello solare.  
Anthracite aluminum collection with sensor and solar panel.



- Materiale**  
alluminio
- Colore**  
antracite goffrato
- 
- Temperatura colore**  
4000K
- 
- Driver**  
integrato
- Material**  
aluminum
- Colour**  
embossed anthracite
- 
- Colour temperature**  
4000K
- 
- Driver**  
built-in



**LED-KYOTO-AP**  
8031414883868  
lumen

colour temp.	colour
300 lm	

watt	2,5W
beam angle	120°

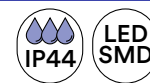
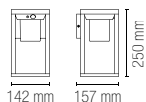

**LED-KYOTO-P80**  
8031414883875  
lumen

colour temp.	colour
300 lm	

watt	2,5W
beam angle	120°

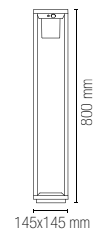

## Accessori inclusi / Included accessories



**Lithium 3,7V 2200mAh**  
Batteria non sostituibile /  
Battery non replaceable



max 4m  
90°

25"

**Sensore di movimento /**  
Adjustable motion sensor

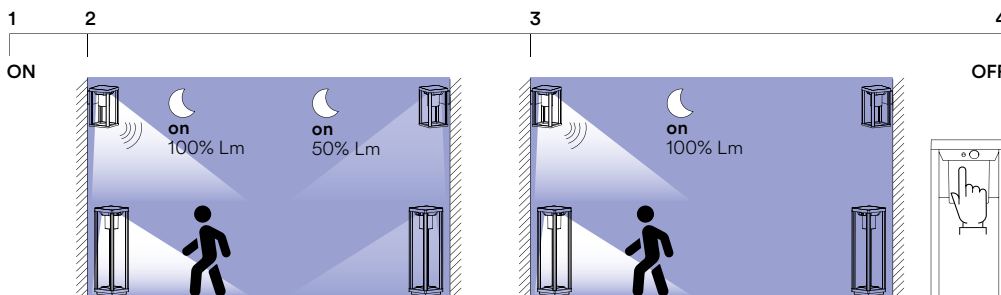

Sensore di movimento 100% luce  
Dopo 25 secondi 50% luce /  
Motion sensor 100% light  
After 25 seconds 50% light

Sensore di movimento 100% luce  
Dopo 25 secondi spegnimento luce /  
Motion sensor 100% light  
Light turns off after 25 seconds

# ENYA

Collezione in alluminio antracite con sensore e pannello solare.  
Anthracite aluminum collection with sensor and solar panel.



**Materiale**  
alluminio

**Colore**  
antracite gofrato



**Temperatura colore**  
4000K



**Driver**  
integrato

**Material**  
aluminum

**Colour**  
embossed anthracite



**Colour temperature**  
4000K



**Driver**  
built-in



**LED-ENYA-AP**  
8031414883844  
lumen

colour temp.	colour
600 lm	

watt	5W
beam angle	120°

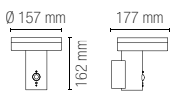

**LED-ENYA-P80**  
8031414883851  
lumen

colour temp.	colour
600 lm	

watt	5W
beam angle	120°

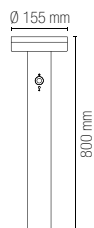

**Accessori inclusi / Included accessories**

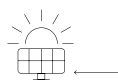

Pannello solare / Solar panel



**Lithium 3,7V 2200mAh**  
Batteria non sostituibile / Battery non replaceable



Sensore di movimento / Adjustable motion sensor

max 4m  
90°  
**25"**

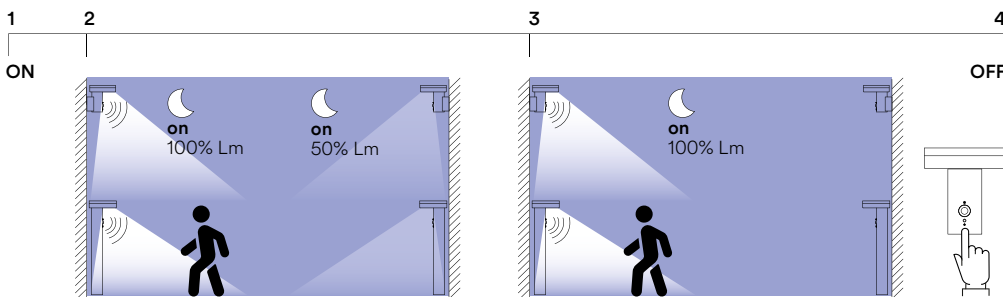

Sensore di movimento 100% luce  
Dopo 25 secondi 50% luce /  
Motion sensor 100% light  
After 25 seconds 50% light

Sensore di movimento 100% luce  
Dopo 25 secondi spegnimento luce /  
Motion sensor 100% light  
Light turns off after 25 seconds

In.tec light SOLARI / SOLAR LAMPS

# TED

Applique LED in alluminio antracite con sensore e pannello solare.  
Aluminum LED wall light anthracite finish with sensor and solar panel.



**Materiale**  
alluminio

**Colore**  
antracite



**Temperatura colore**  
4000K



**Driver**  
integrato

**Material**  
aluminum

**Colour**  
anthracite



**Colour temperature**  
4000K



**Driver**  
built-in



**LED-TED-AP**  
8031414883837  
lumen

colour temp.	colour
300 lm	

watt	3W
beam angle	120°

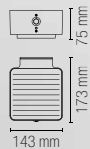

#### Accessori inclusi / Included accessories



Pannello solare / Solar panel



**Li-ion 3,7V 2200 mAh**  
Batteria non sostituibile /  
Battery non replaceable



max 4m  
90° 25"

Sensore di movimento /  
Adjustable motion sensor

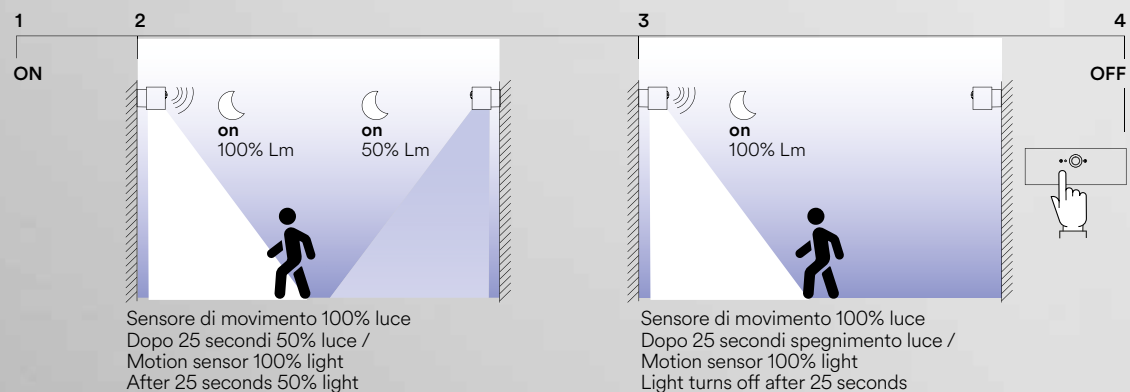



# ALBERT

Applique LED in alluminio antracite con sensore e pannello solare.  
Aluminum LED wall light anthracite finish with sensor and solar panel.

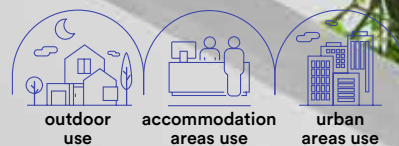

**Materiale**  
alluminio

**Colore**  
antracite



**Temperatura colore**  
4000K



**Driver**  
integrato

**Material**  
aluminum

**Colour**  
anthracite



**Colour temperature**  
4000K



**Driver**  
built-in



**LED-ALBERT-AP**  
8031414058716  
lumen

colour temp.	colour
300 lm	

watt	2,5W
beam angle	120°



### Accessori inclusi / Included accessories



Pannello solare / Solar panel



**Li-ion 3,7V 2000 mAh**  
Batteria non sostituibile /  
Battery non replaceable



max 4m  
90°  
25"

Sensore di movimento /  
Adjustable motion sensor

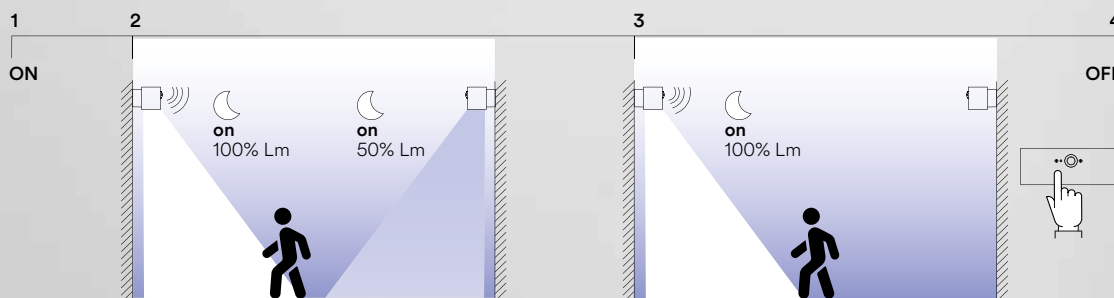

Sensore di movimento 100% luce  
Dopo 25 secondi 50% luce /  
Motion sensor 100% light  
After 25 seconds 50% light

Sensore di movimento 100% luce  
Dopo 25 secondi spegnimento luce /  
Motion sensor 100% light  
Light turns off after 25 seconds

In.tec light SOLARI / SOLAR LAMPS

# COSMO

**Proiettore a batteria in termoplastica nero con sensore di movimento regolabile.**  
Flood light with battery power in black thermoplastic with adjustable motion sensor.



**Materiale**  
termoplastica

**Temperatura colore**

6500K



**Driver**  
integrato

**Material**  
thermoplastic

**Colour temperature**

6500K



**Driver**  
built-in



**LED-COSMO/S**  
8031439841263

lumen

colour temp.



80 lm

colour



watt

1W

beam angle

120°



**Accessori inclusi / Included accessories**



off  
10 LUX

Sensore di movimento regolabile / Adjustable motion sensor



on  
2000 LUX

max 8m  
120°

10-60"

**Accessori non inclusi / Not included accessories**



**3 x 1,2V AAA**  
Batteria / Battery



**LED-COSMO/S-FV**  
8031439821265

lumen

colour temp.



80 lm

colour



watt

1W

beam angle

120°

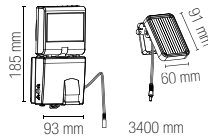

**Accessori inclusi / Included accessories**

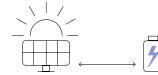

Pannello solare / Solar panel



**Li-ion 3,7V 1200 mAh**  
Batteria non sostituibile / Battery non replaceable /



off  
10 LUX

Sensore di movimento regolabile, accensione con 15 lux / Adjustable motion sensor, switch on 15 lux



on  
2000 LUX

max 8m  
120°

10-60"



Cavo 3,4 m / 3,4 m cable

# ELIOS

Proiettore in alluminio silver con pannello solare e sensore di movimento regolabile.  
Silver aluminium flood light with solar panel and adjustable motion sensor.



**Materiale**  
alluminio

**Colore**  
antracite



**Temperatura colore**  
5000K



**Driver**  
integrato

**Material**  
aluminium

**Colour**  
anthracite



**Colour temperature**  
5000K



**Driver**  
built-in



**LED-ELIOS-SOLAR**  
8031440355124  
lumen

colour temp.	colour
620 lm	

watt	9W
beam angle	120°

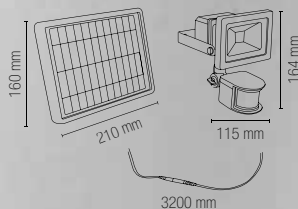

#### Accessori inclusi / Included accessories



Pannello solare /  
Solar panel



**Lithium 7,4V 1800 mAh**  
Batteria  
non sostituibile /  
Battery  
non replaceable /



12m  
120°

**off**  
2 LUX  
**on**  
2000 LUX

Sensore di movimento  
regolabile /  
Adjustable motion  
sensor



Cavo 3,2 m /  
3,2 m cable

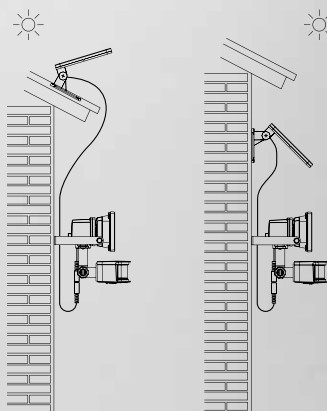

# EOS

Proiettore in termoplastica silver con pannello solare, sensore di movimento e crepuscolare.

Silver thermoplastic flood light with solar panel, motion and crepuscular sensor.



**Materiale**

termoplastica

**Colore**

silver



**Temperatura colore**

4000K



**Driver**

integrato

**Material**

thermoplastic

**Colour**

silver



**Colour temperature**

4000K



**Driver**

built-in



**LED-EOS-SOLAR**

8031414862740

lumen

colour temp.	colour
450 lm	

watt	4W
beam angle	100°

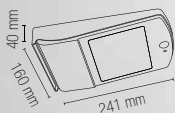

**Accessori inclusi / Included accessories**

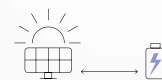

Pannello solare / Solar panel



**lithium 3,9V 4400mAh**  
Batteria non sostituibile /  
Battery non replaceable

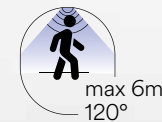

Sensore di movimento regolabile  
distanza max 6m 120° /  
Adjustable motion sensor  
max distance 6m 120°

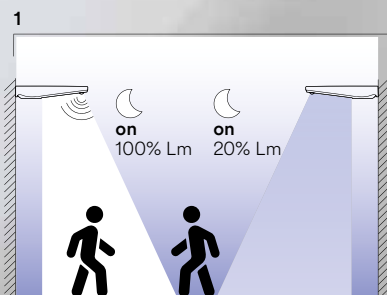

Sensore di movimento 100% luce  
Sensore crepuscolare 20% luce /  
Motion sensor 100% light.  
Crepuscular sensor 20% light

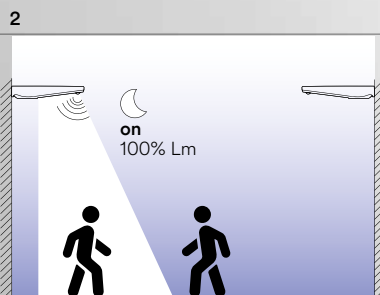

Sensore di movimento 100% luce  
No sensore crepuscolare /  
Motion sensor 100% light  
No crepuscular sensor

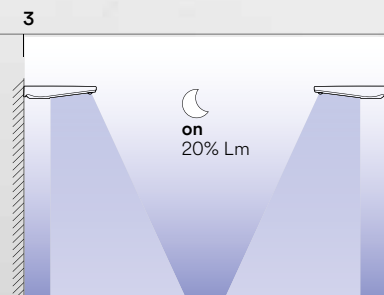

Sensore crepuscolare 20% luce  
No sensore movimento /  
Crepuscular sensor 20% light  
No motion sensor



SOLARI / SOLAR LAMPS

In.tec light

# SKYP

**Applique LED in termoplastica bianco con sensore e pannello solare.**  
Thermoplastic LED wall light white finish with sensor and solar panel.



**Materiale**

termoplastica

**Temperatura colore**

4000K



**Driver**

integrato

**Material**

thermoplastic

**Colour temperature**

4000K



**Driver**

built-in

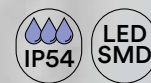

**LED-SKYP-AP**  
8031414870783  
lumen

colour temp.	colour
130 lm	

watt	3W
beam angle	120°

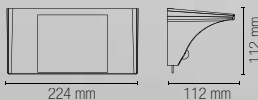

**Accessori inclusi / Included accessories**



Pannello solare /  
Solar panel



**Li-ion 3,7V 1200 mAh**  
Batteria non sostituibile /  
Battery non replaceable /



Sensore di movimento,  
accensione con 15 lux /  
Motion sensor,  
switch on 15 lux

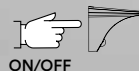

**Base easy-up** che permette il duplice utilizzo del faro come lampada da muro e lampada portatile /  
**Easy-up base** for double use of the lamp, as wall and portable lamp

# OPEN

Applique LED in termoplastica bianco con sensore e pannello solare.  
Thermoplastic LED wall light white finish with sensor and solar panel.



## Materiale

termoplastica

## Temperatura colore

4000K



## Driver

integrato

## Material

thermoplastic

## Colour temperature

4000K



## Driver

built-in



### LED-OPEN-AP

8031414870752

lumen

colour temp. colour

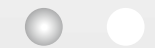

300 lm

watt

3W

beam angle

120°

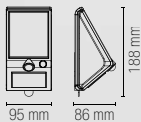

### Accessori inclusi / Included accessories



Pannello solare /  
Solar panel



**Li-ion 1200 mAh**  
Batteria  
non sostituibile /  
Battery  
non replaceable /



4-6m  
100°



off  
15 LUX



on  
<15 LUX

Sensore di  
movimento regolabile,  
accensione con 15 lux /  
Adjustable motion sensor,  
switch on 15 lux



**Base easy-up** che permette il duplice utilizzo del  
faro come lampada da muro e lampada portatile /  
**Easy-up base** for double use of the lamp,  
as wall and portable lamp





# ARGO

Proiettore in alluminio antracite con diffusore in acrilico con pannello solare, sensore di movimento e crepuscolare.

Anthracite aluminum flood light with acrylic diffuser, solar panel, motion and crepuscular sensor.



- Materiale**  
alluminio e acrilico
- Colore**  
antracite
- Temperatura colore**  
4000K
- Driver**  
integrato
- Material**  
aluminum and acrylic
- Colour**  
anthracite
- Colour temperature**  
4000K
- Driver**  
built-in



**LED-ARGO-SOLAR**  
8031414865345  
lumen

colour temp.	colour
130 lm	

watt	1,8W
beam angle	120°

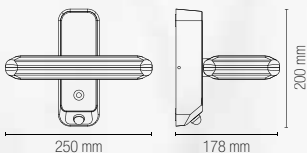

#### Accessori inclusi / Included accessories

Pannello solare / Solar panel

**Li-ion 3,7V 2200 mAh**  
Batteria non sostituibile / Battery non replaceable / 12 hours

Sensore di movimento / Motion sensor  
5m 100° **30"** on 130Lm 1,5 hours

Sensore crepuscolare / Crepuscular sensor  
off on 26 Lm 8 horas

# SHIVA

Proiettore in termoplastica antracite con pannello solare e sensore di movimento.  
Anthracite thermoplastic flood light with solar panel and motion sensor.



- Materiale**  
termoplastica
- Colore**  
antracite
- Temperatura colore**  
4000K
- Driver**  
integrato
- Material**  
aluminum and acrylic
- Colour**  
anthracite
- Colour temperature**  
4000K
- Driver**  
built-in



	colour temp.	colour
<b>LED-SHIVA-SOLAR</b> 8031414870769		
lumen	230 lm	

watt	2 x 1,5W
beam angle	120°



#### Accessori inclusi / Included accessories



Pannello solare /  
Solar panel



**Li-ion 3,7V 1200 mAh**  
Batteria non sostituibile /  
Battery non replaceable /



6m  
110°  
**30"**  
on  
230Lm  
1,5 hours

Sensore di movimento  
accensione <15 lux /  
Motion sensor  
switch on <15 lux



Cavo 1,9 m /  
1,9 m cable

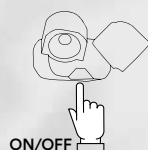

**Base easy-up** che permette il duplice utilizzo del faro come lampada da muro e lampada portatile /  
**Easy-up base** for double use of the lamp, as wall and portable lamp



**3 x 1,2V AAA**  
non inclusa /  
not included

**Doppia funzione:** auto-ricarica con pannello solare o alimentazione con pile AAA (non incluse) /  
**Double function:** auto recharge by solar panel or power by AAA battery (not included)

# ULYSSE

Proiettore in termoplastica antracite con pannello solare e sensore di movimento regolabile.

Anthracite thermoplastic flood light with solar panel and adjustable motion sensor.



**Materiale**

termoplastica

**Colore**

antracite



**Temperatura colore**

4000K



**Driver**

integrato

**Material**

thermoplastic

**Colour**

anthracite



**Colour temperature**

4000K



**Driver**

built-in



**LED-ULYSSE-SOLAR**

8031414882588

lumen

colour temp.	colour
1000 lm	

watt	10W
beam angle	120°

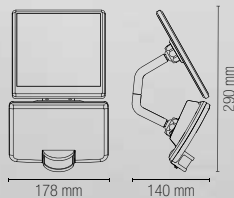

**Accessori inclusi / Included accessories**



Pannello solare / Solar panel



**lithium 3,7V 3000 mAh**  
Batteria non sostituibile / Battery non replaceable



8m  
110°  
**10-60"**  
on  
600Lm  
1 hours

Sensore di movimento e crepuscolare regolabili / Adjustable motion and crepuscular sensor



Cavo 2 m / 2 m cable

**Doppio sistema di montaggio / Double mounting system**

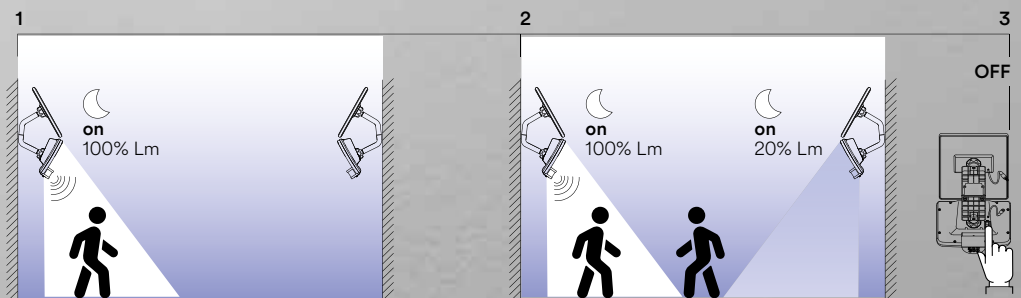
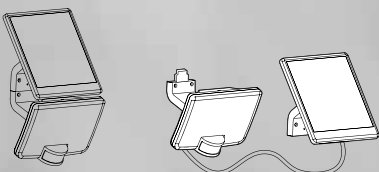

1  
Sensore di movimento 100% di luce  
No sensore crepuscolare /  
Motion sensor 100% light  
No crepuscular sensor

2  
Sensore di movimento 100% luce  
Sensore crepuscolare 20% luce /  
Motion sensor 100% light  
Crepuscular sensor 20% light

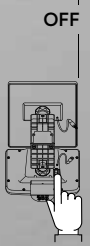

# GLASER

**Glaser è il proiettore a batteria con ricarica solare.**  
**Un dispositivo pratico ed efficiente per l'illuminazione sostenibile.**  
Glaser is the battery-powered floodlight with solar charging.  
A practical and efficient device for sustainable lighting.



**Materiale**  
alluminio

**Colore**  
silver

**Temperatura colore**  
3000K / 4000K



**Material**  
aluminum

**Colour**  
silver

**Colour temperature**  
3000K / 4000K





	colour temp.	colour
<b>LED-GLASER-SOL100C</b> 8031414917082		
lumen	1200 lm	
<b>LED-GLASER-SOL100M</b> 8031414917075		
lumen	1200 lm	
beam angle	120°	

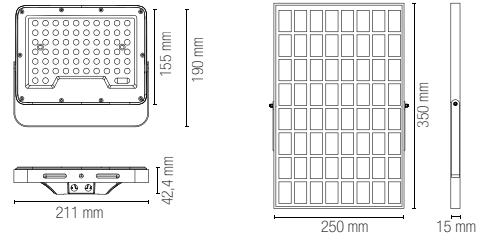

entrata cavo DC / DC connector

Accessori inclusi / Included accessories



**Li-ion 3.2V 10Ah**  
Batteria non sostituibile / Battery non replaceable



	colour temp.	colour
<b>LED-GLASER-SOL200C</b> 8031414917105		
lumen	1800 lm	
<b>LED-GLASER-SOL200M</b> 8031414917099		
lumen	1800 lm	
beam angle	120°	

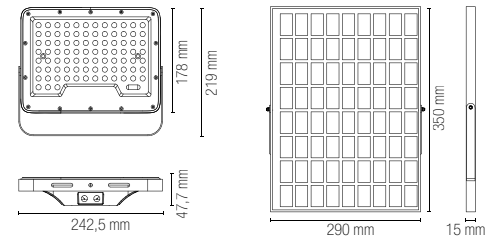

entrata cavo DC / DC connector

Accessori inclusi / Included accessories



**Li-ion 3.2V 15Ah**  
Batteria non sostituibile / Battery non replaceable



	colour temp.	colour
<b>LED-GLASER-SOL400C</b> 8031414917129		
lumen	3500 lm	
<b>LED-GLASER-SOL400M</b> 8031414917112		
lumen	3500 lm	
beam angle	120°	

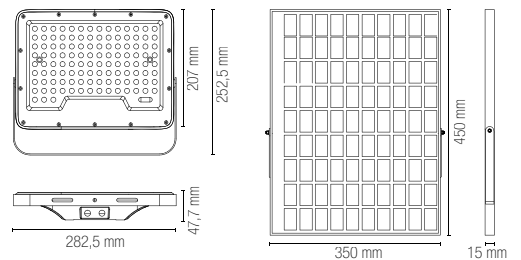

entrata cavo DC / DC connector

Accessori inclusi / Included accessories



**Li-ion 3.2V 24Ah**  
Batteria non sostituibile / Battery non replaceable

Accessori inclusi / Included accessories

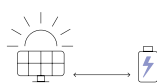

Pannello solare / Solar panel



Batteria non sostituibile / Battery non replaceable



Telecomando / Remote control

Accessorio non incluso / Not included accessory

**LED-GLASER-CABLE**  
8031414917136

Cavo 2 m per pannello solare con attacco maschio/femmina / 2 m extension cable for solar panel with male/female



# LUXOR

Lampione solare LUXOR, versatile con doppia opzione di installazione come applique o palo.

LUXOR solar streetlight, versatile with dual installation options as a sconce or a pole.

**Materiale**

PC

**Colore**

antracite



**Temperatura colore**

3000K / 4000K



**Material**

PC

**Colour**

anthracite



**Colour temperature**

3000K / 4000K



**LED-LUXOR-6C-SOLAR**

8031414921898

lumen

colour temp.



600 lm

**LED-LUXOR-6M-SOLAR**

8031414921904

lumen



600 lm

watt

6,5W

beam angle

90° x 110°

**Accessori inclusi / Included accessories**



Pannello solare / Solar panel



**Li-ion 3.7V 5.4AH**

Batteria non sostituibile / Battery non replaceable /

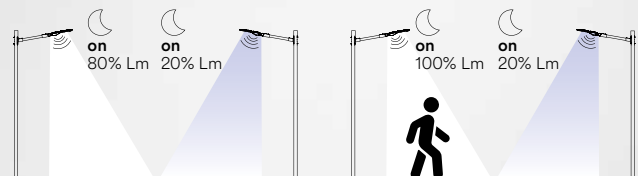
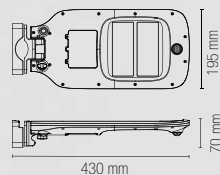

**Interruttore per due funzioni / Switch for two functions**

1. Sensore crepuscolare  
ON 100% luce per 10 min  
Dopo 2 ore graduale riduzione fino al 10% luce /  
Crepuscular sensor  
ON 100% light for 10 min  
After 2 hours gradual reduction to 10% light

2. Sensore di movimento  
ON 100% luce  
Dopo 20 secondi 20% luce /  
Motion sensor  
ON 100% light  
After 20 seconds 20% light





# OUTDOOR

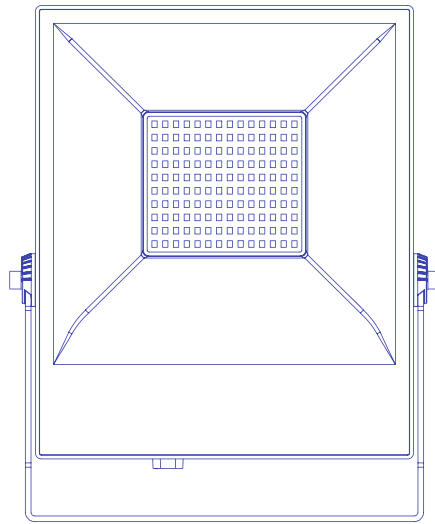

PROIETTORI  
FLOOD LIGHTS



**Proiettore con telecamera di sicurezza colore antracite con funzione smart Wi-Fi, compatibili con dispositivi iOS, android e VOICE CONTROL.**

Flood light with security camera, anthracite, smart Wi-Fi, compatible with iOS devices, android and VOICE CONTROL devices.



**Materiale**  
alluminio + PC

**Colore**  
antracite



**Temperatura colore**  
4000K



**Driver**  
integrato

**Material**  
aluminium + PC

**Colour**  
anthracite



**Colour temperature**  
4000K



**Driver**  
built-in

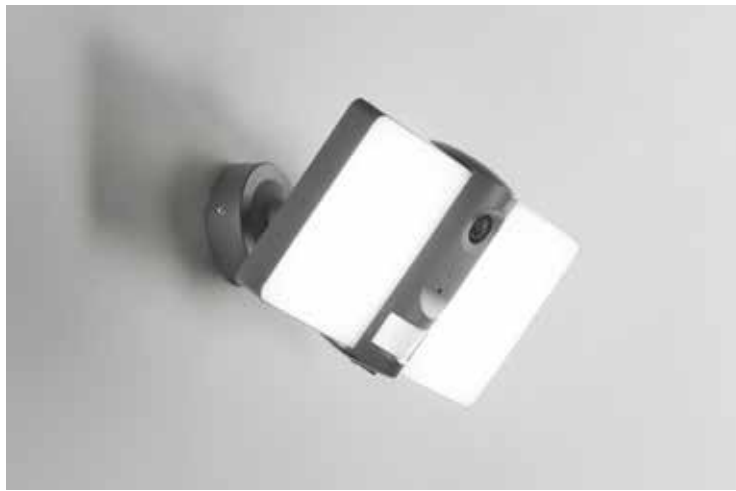

**LED-VYSOR-SECURITY**

8031414871810

lumen

colour temp. | colour

2640 lm

watt

20W

beam angle

120°

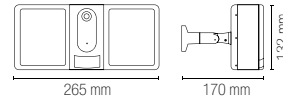

☾ on <100 LUX PIR  
☽ off >100 LUX PIR

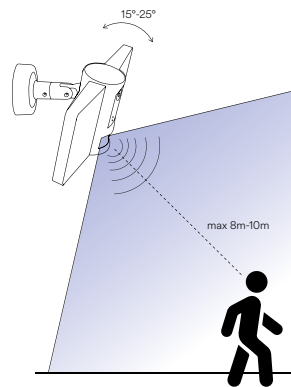
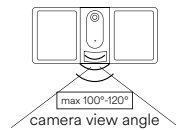

Tipo di sensore video  
Video sensor type

Pixel

Illuminazione minima  
Min illuminance

Angolo vista camera  
Camera view angle

Otturatore  
Shutter

Infrarossi  
IR

WDR

Video compression standard

Risoluzione video  
Max picture size

Frequenza fotogrammi  
Frame rate

Audio

Memoria (non inclusa)  
Storage (not included)

Impostazione immagine  
Image setting

Reset

Controllo della luce  
Lighting control

Interfaccia di protocollo  
Interface protocol

Comunicazione di protocollo  
Communication protocol

Funzioni generali  
General function

Wi-Fi

PIR

1/2,9" CMOS

2.0 Mega

Color 0.10lux @F2.0,  
black and white 0.01lux @F2.0

135°

1/25-1/100,000 per second

High power LED with ICR

Digital WDR

H.264  
32Kbps - 2Mbps

1920x1080

1-20 per second

Full duplex audio (doppio sistema di comunicazione)

Support SD card (MAX 128Gb) Cloud storage NVR

Support HD/SD; support mirror

Support

Support manual, sensor, plan switch light (gestione accensioni)

Private

TCP/IP, HTTP, DHCP, DNS, RTSP

Dual stream, password protection

IEEE802.11b/g/n

Support PIR and motion detection

Control system easy installation

Full duplex audio



Smart Intec  
WIFI



RF 2.4G  
control system



ALEXA e  
GOOGLE HOME  
voice control



compatible with  
AMAZON ECHO SHOW  
GOOGLE CHROME CAST

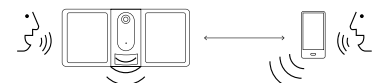

# BANNER

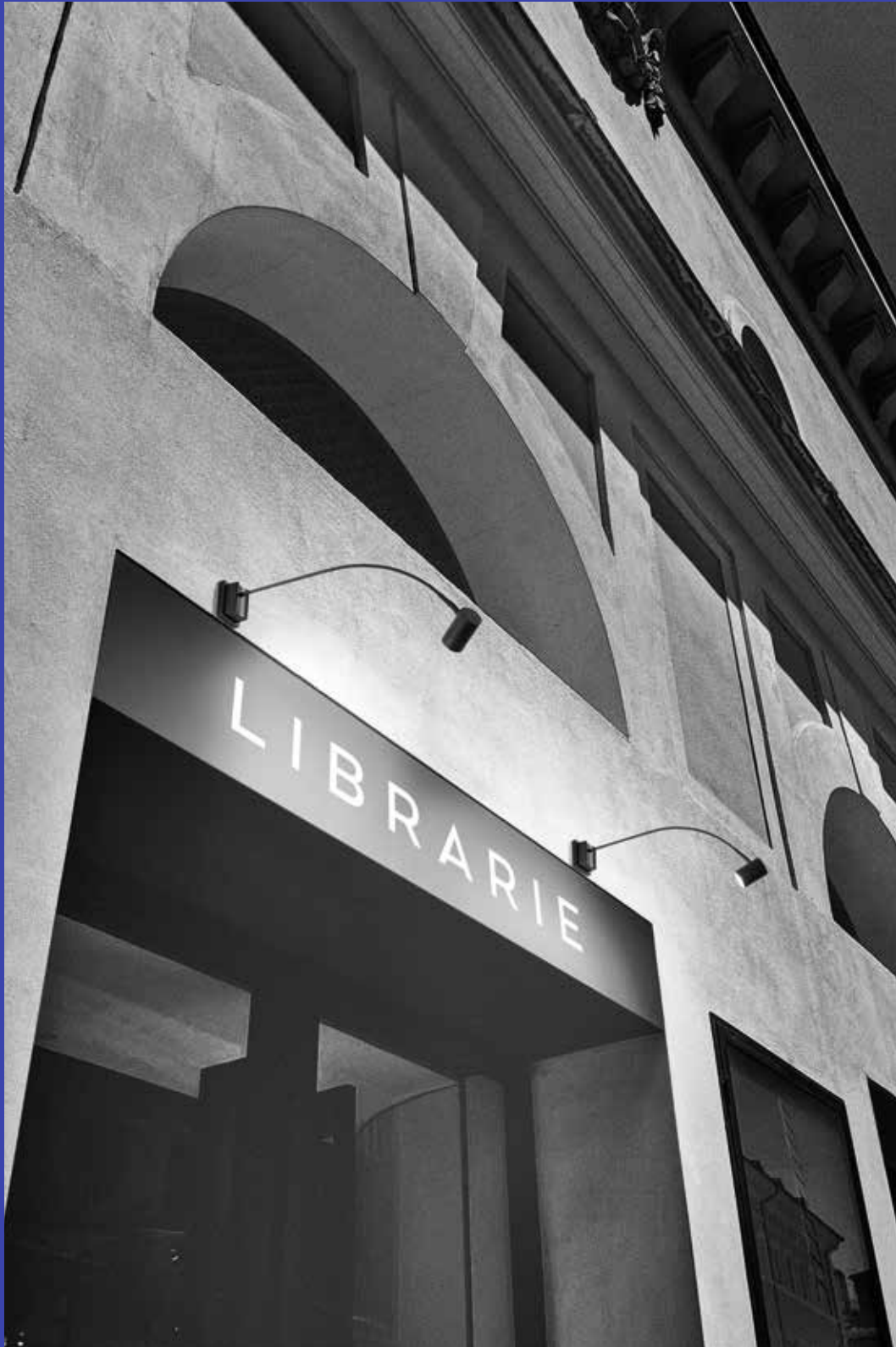



**Materiale**  
metallo

**Colore**  
nero satinato



**Material**  
metal

**Colour**  
satin black



**Proiettore in metallo nero satinato con struttura flessibile e punto luce orientabile.**  
Black satin metal projector with flexible structure and adjustable light point.

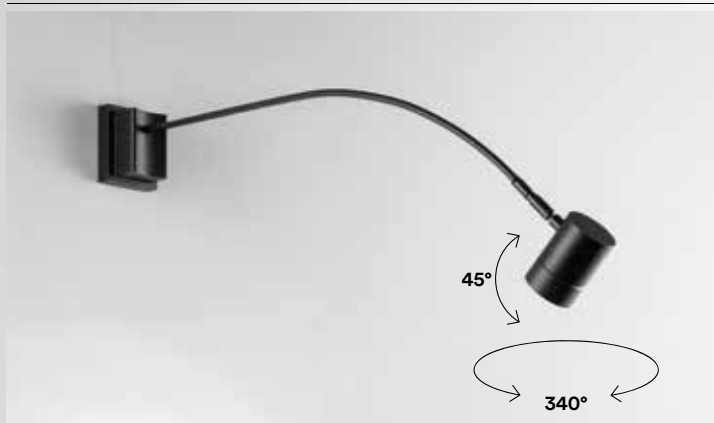

colour  
**I-BANNER-AP**  
8031414883004



Lampadina non inclusa /  
Light bulb not included

1 x GU10 MAX 35W

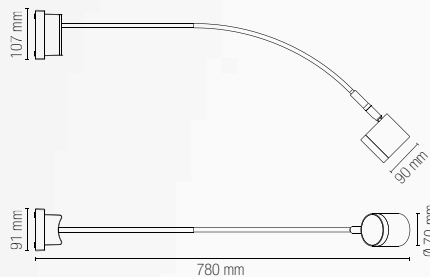

SAT



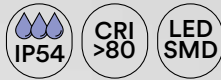

**Materiale**  
termoplastica

**Colore**  
antracite



**Temperatura colore**  
4000K



**Driver**  
integrato

**Material**  
thermoplastic

**Colour**  
anthracite



**Colour temperature**  
4000K



**Driver**  
included

**Proiettore in termoplastica LED integrato finitura antracite con diffusore in acrilico con sensore di movimento e crepuscolare regolabile.**

Built-in LED thermoplastic flood lamp anthracite finish with acrylic diffuser with adjustable night and motion sensor.



**LED-SAT-10**  
8031414868261  
lumen

colour temp.	colour
1200 lm	

watt 10W  
beam angle 120°

**LED-SAT-20**  
8031414868278  
lumen

colour temp.	colour
2400 lm	

watt 2 x 10W  
beam angle 120°

**Accessori inclusi / Included accessories**

Sensore di movimento regolabile / Adjustable motion sensor

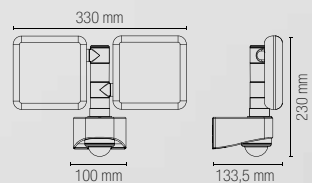
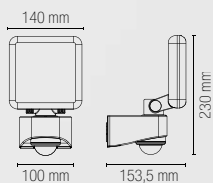

# AXEL

Proiettore in alluminio LED integrato finitura bianco o silver goffrato.  
Built-in LED aluminium flood lamp embossed white or silver finish.



**Materiale**

alluminio  
diffusore acrilico

**Colore**

bianco goffrato  
silver goffrato



**Temperatura colore**

3000K / 4000K



**Driver**

integrato

**Material**

aluminium  
acrylic diffuser

**Colour**

embossed white  
embossed silver



**Colour temperature**

3000K / 4000K



**Driver**

built-in







# AXEL

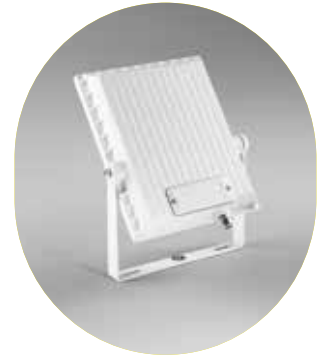

**LED-AXEL-10-BCO**  
8031414918744

lumen	1100 lm
watt	10W
beam angle	100°
pf	-

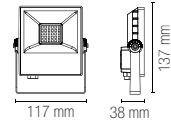
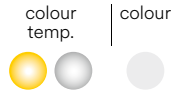

**LED-AXEL-20-BCO**  
8031414918751

lumen	2200 lm
watt	20W
beam angle	100°
pf	-

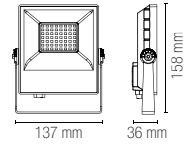
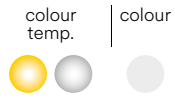

**LED-AXEL-50-BCO**  
8031414918768

lumen	5500 lm
watt	50W
beam angle	100°
pf	0.90

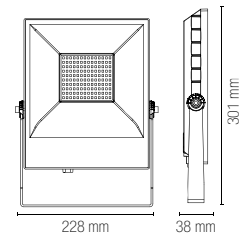
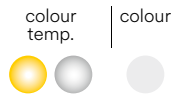

**Fotometria del prodotto / Photometric curve**

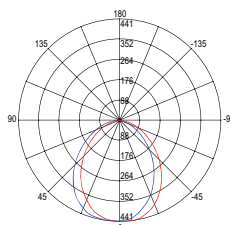

LED-AXEL/10W

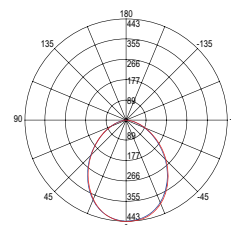

LED-AXEL/20W

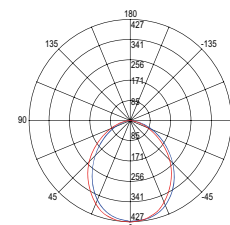

LED-AXEL/50W



**LED-AXEL-10-SIL**

8031414918676

lumen

colour temp. | colour



1100 lm

watt	10
beam angle	100°
pf	-

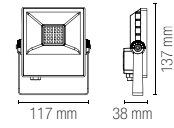

**LED-AXEL-20-SIL**

8031414918683

lumen

colour temp. | colour



2200 lm

watt	20W
beam angle	100°
pf	-

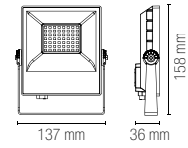

**LED-AXEL-30-SIL**

8031414918690

lumen

colour temp. | colour



3300 lm

watt	30W
beam angle	100°
pf	0.90

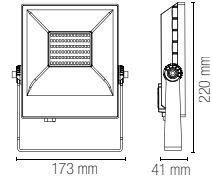

**LED-AXEL-50-SIL**

8031414918706

lumen

colour temp. | colour



5500 lm

watt	50W
beam angle	100°
pf	0.90

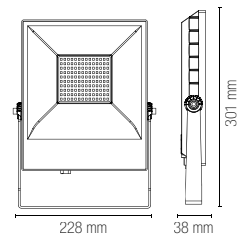

Fotometria del prodotto / Photometric curve

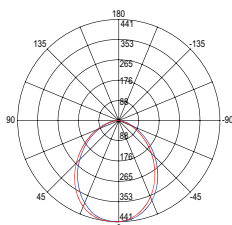

LED-AXEL/10W

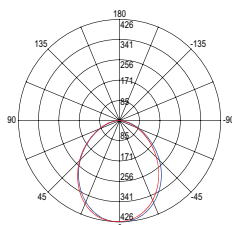

LED-AXEL/20W

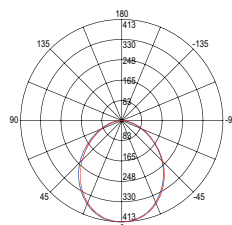

LED-AXEL/30W

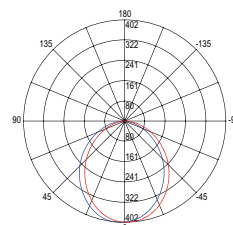

LED-AXEL/50W

# AXEL SENSOR

Proiettore in alluminio LED integrato finitura silver con sensore di movimento e crepuscolare regolabile.

Built-in LED aluminium flood lamp embossed silver finish with adjustable night and motion sensor.



**Materiale**

alluminio

**Colore**

silver gofrato

**Temperatura colore**

3000K / 4000K



**Driver**

integrato

**Material**

aluminium

**Colour**

embossed silver

**Colour temperature**

3000K / 4000K



**Driver**

built-in



**Accessori inclusi / Accessories included**

Sensore di movimento regolabile / Adjustable motion sensor



**LED-AXEL-S10-SIL**

8031414918713

lumen

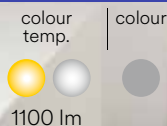

1100 lm

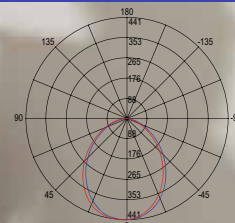

LED-AXEL-S/10W

watt 10W  
beam angle 110°

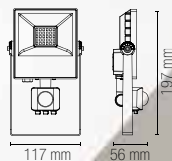

**Accessori inclusi / Accessories included**

Sensore di movimento regolabile / Adjustable motion sensor



**LED-AXEL-S30-SIL**

8031414918737

lumen

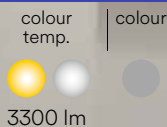

3300 lm

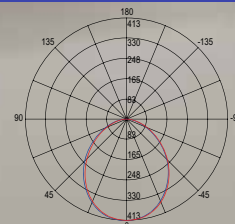

LED-AXEL-S/30W

watt 30W  
beam angle 110°

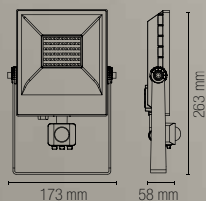

# AXEL PORTABLE

Proiettore LED portatile.  
LED portable flood light.



**Materiale**  
alluminio

**Colore**  
giallo/nero



**Temperatura colore**  
3000K / 4000K



**Driver**  
integrato

**Material**  
aluminium

**Colour**  
yellow/black



**Colour temperature**  
3000K / 4000K



**Driver**  
built-in



PROIETTORI / FLOOD LIGHTS  
In.tec light

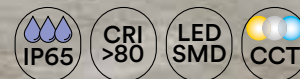

**Accessori inclusi /  
Included accessories**



Cavo 1,6 metri  
con spina /  
1,6 meter cable  
with plug



**LED-AXEL-P20-NER**  
8031414918720  
lumen

colour temp. colour  
2200 lm

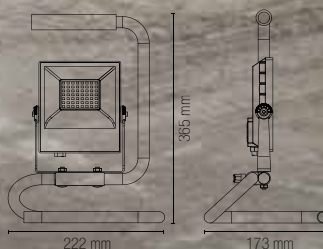
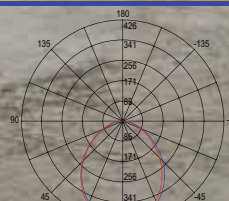

**LED-AXEL-P/20W**  
watt 20W  
beam angle 110°

# BULL

La collezione Bull presenta i proiettori portatili a batteria, disponibili in due versioni: con e senza bluetooth integrato.

The Bull collection presents battery-powered portable projectors, available in two versions: with and without built-in Bluetooth.



**Materiale**

plastica

**Colore**

giallo/nero



**Temperatura colore**

6500K



**Driver**

integrato

**Material**

plastic

**Colour**

yellow/black



**Colour temperature**

6500K



**Driver**

built-in



**LED-BULL-15DJ**

8031414917167

lumen

colour temp.



1200 lm

colour



watt

15W

beam angle

90°

switch DIMMER 25% 50% 70% 100% OFF

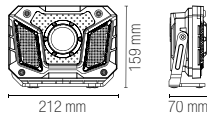

**LED-BULL-10**

8031414917150

lumen

colour temp.



1000 lm

colour



watt

10W

beam angle

90°

switch DIMMER 25% 50% 70% 100% OFF

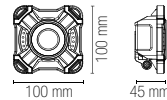

**SPEAKER**

2x5W connessione bluetooth 4.2 max 10 m /  
2x5W bluetooth 4.2 connection max 10 m

**Accessori inclusi / Included accessories**



**USB**

Cavo per ricarica 60 cm /  
60 cm charging cable



**3.7V/6600 mAh**

Batteria ricaricabile, non sostituibile /  
Rechargeable battery, non replaceable

**Accessori inclusi / Included accessories**



**USB**

Cavo per ricarica 60 cm /  
60 cm charging cable



**3.7V/6600 mAh**

Batteria ricaricabile, non sostituibile /  
Rechargeable battery, non replaceable



Adattatore non incluso /  
Adaptor not included



# KNOX

Realizzato in plastica e alluminio, Knox è un proiettore con temperatura selezionabile e con doppia presa schuko.

Made of plastic and aluminum, Knox is a fixture with selectable temperature and dual schuko plugs.



---

**Materiale**

plastica

---

**Colore**

giallo/nero



---

**Temperatura colore**

6500K

---

**Driver**

integrato

---

**Material**

plastic

---

**Colour**

yellow/black



---

**color**

temperature

6500K

---

**Driver**

built-in







<b>LED-KNOX-45</b> 8031414917174	colour temp. 2500 - 4959 lm	colour 
lumen		
watt	45W	
beam angle	120°	
	Plug 2X max 15A 250V 2500W	

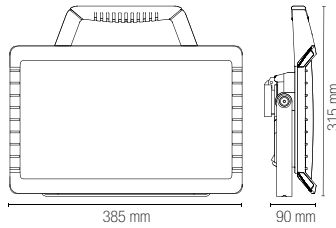

**Accessori inclusi / Included accessories**



Cavo 3 metri con spina /  
3 meter cable with plug



<b>LED-KNOX-80</b> 8031414917181	colour temp. 4600 - 9200 lm	colour 
lumen		
watt	80W	
beam angle	120°	
	Plug 2X max 15A 250V 2500W	

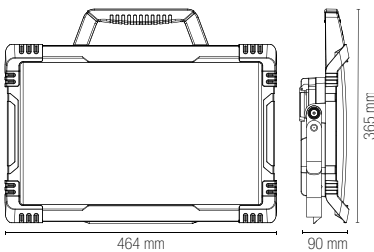

**Accessori inclusi / Included accessories**



Cavo 3 metri con spina /  
3 meter cable with plug



# ATHOS

Proiettore a led integrato in alluminio silver e diffusore satinato.  
Built-in LED aluminium flood lamp silver finish with satin diffuser.



**Materiale**  
alluminio

**Material**  
aluminium

**Colore**  
silver

**Colour**  
silver



**Temperatura colore**  
4000K / 6000K

**Colour temperature**  
4000K / 6000K



**Driver**  
integrato

**Driver**  
built-in





**LED-ATHOS-100**

8031414884186

lumen

colour temp. colour



10115 lm

**LED-ATHOS-100F**

8031414884193

lumen



9624 lm

watt 100W

beam angle 120°

pf 0.90

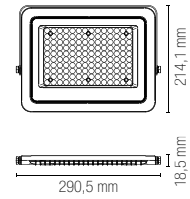

**LED-ATHOS-150**

8031414884209

lumen

colour temp. colour



14557 lm

**LED-ATHOS-150F**

8031414884216

lumen



14388 lm

watt 150W

beam angle 120°

pf 0.90

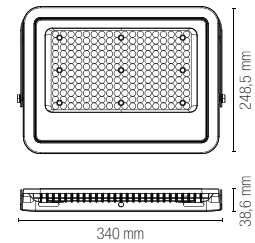

**LED-ATHOS-200**

8031414884223

lumen

colour temp. colour



20371 lm

**LED-ATHOS-200F**

8031414884230

lumen



20310 lm

watt 300W

beam angle 120°

pf 0.90

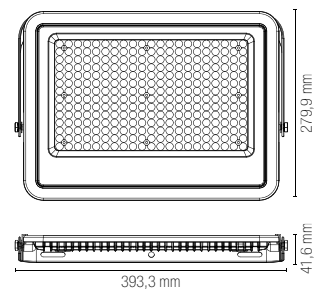

Fotometria del prodotto / Photometric curve

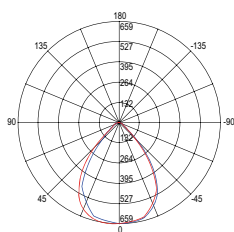

LED-ATHOS-100

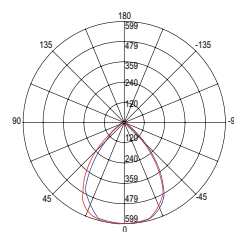

LED-ATHOS-150

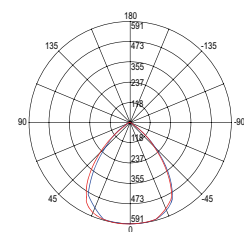

LED-ATHOS-200

# TAURUS

Proiettore a led integrato in alluminio nero diffusore in vetro temperato.  
Built-in LED aluminium flood lamp black aluminium body with tempered glass diffuser.



**Materiale**  
alluminio

**Colore**  
nero



**Temperatura colore**  
4000K / 6500K



**Driver**  
integrato

**Durata e on/off**  
50.000 h  
>25.000 on/off

**Material**  
aluminium

**Colour**  
black



**Colour temperature**  
4000K / 6500K



**Driver**  
built-in

**Life time and on/off**  
50.000 h  
>25.000 on/off



## Fotometria del prodotto / Photometric curve

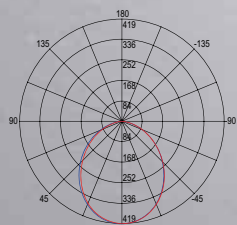

LED-TAURUS-70

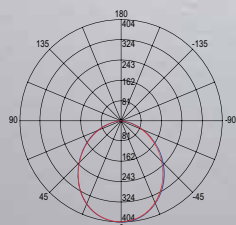

LED-TAURUS-100

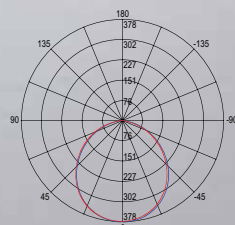

LED-TAURUS-150

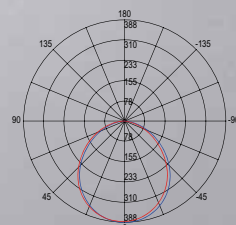

LED-TAURUS-200



	colour temp.	colour
<b>LED-TAURUS-70</b> 8031414875757 lumen		
	8400 lm	
<b>LED-TAURUS-70F</b> 8031414876662 lumen		
	8400 lm	
watt	70W	
beam angle	110°	
pf	0.90	

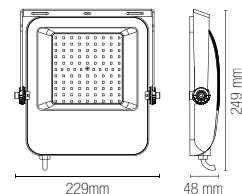

	colour temp.	colour
<b>LED-TAURUS-100</b> 8031414875764 lumen		
	12000 lm	
<b>LED-TAURUS-100F</b> 8031414876631 lumen		
	12000 lm	
watt	100W	
beam angle	110°	
pf	0.90	

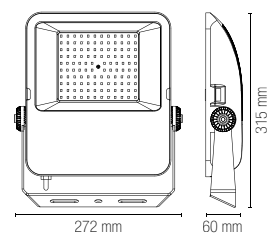

	colour temp.	colour
<b>LED-TAURUS-150</b> 8031414875771 lumen		
	18000 lm	
<b>LED-TAURUS-150F</b> 8031414876648 lumen		
	18000 lm	
watt	150W	
beam angle	110°	
pf	0.90	

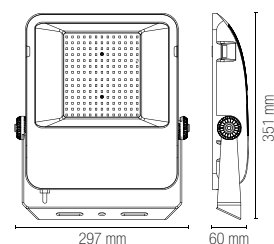

	colour temp.	colour
<b>LED-TAURUS-200</b> 8031414875788 lumen		
	26000 lm	
<b>LED-TAURUS-200F</b> 8031414876655 lumen		
	26000 lm	
watt	200W	
beam angle	110°	
pf	0.90	

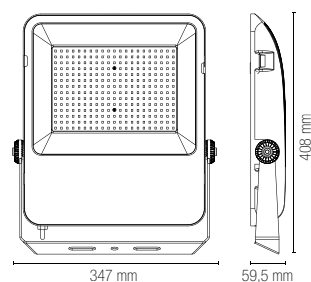



**I-FRAME-L-BCO**

8031440364577

Staffa fissaggio angolare  
colore bianco

Metal corner wall  
arms white color



**I-FRAME-L-GR**

8031440361880

Staffa fissaggio angolare  
colore grigio

Metal corner wall  
arms gray color



**I-FRAME-V-BCO**

8031440364553

Staffa V mobile 30°  
fissaggio parete  
colore bianco

Metal wall arms  
orientable 30°  
white color



**I-FRAME-V-GR**

8031440364584

Staffa V mobile 30°  
fissaggio parete  
colore grigio

Metal wall arms  
orientable 30°  
gray color



**I-TRIPOD**

8031440361729

Accessori per proiettori  
Sistema di fissaggio  
singolo e doppio

Flood light accessories  
Single and double  
connection system

**Accessori inclusi /  
Included accessories**



Cavo 2,8 metri  
con spina /  
2,8 meter cable  
with plug

**IP44**

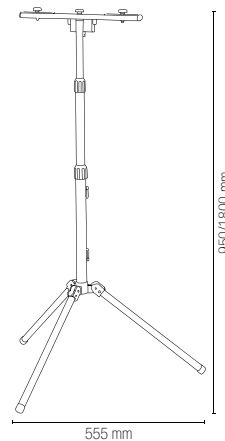

**I-SPIKE-ANT**

8031414877973

Picchetto alluminio  
antracite

Anthracite aluminum  
spike





In.tec light **PROIETTORI / FLOOD LIGHTS**

# GIOVE

Proiettore LED integrato struttura in alluminio pressofuso e diffusore in vetro temperato.

Built-in LED floor light die-cast aluminium body and tempered glass diffuser.



**Materiale**

alluminio

**Colore**

nero



**Temperatura colore**

6000K



**Driver**

incluso

**Durata e on/off**

50.000 h  
>25.000 on/off

**Material**

aluminium

**Colour**

black



**Colour temperature**

6000K



**Driver**

included

**Life time and on/off**

50.000 h  
>25.000 on/off



**Fotometria del prodotto**  
Photometric curve

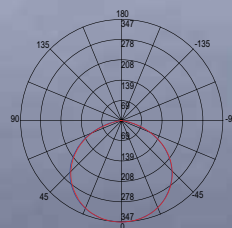

LED-GIOVE-100

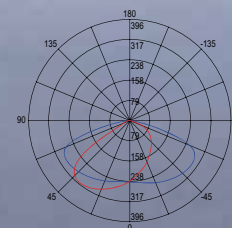

LED-GIOVE-200

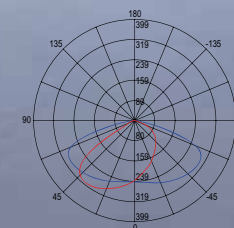

LED-GIOVE-300

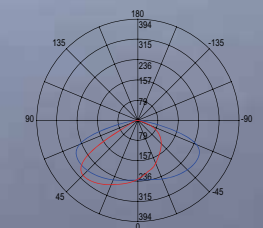

LED-GIOVE-400





	colour temp.	beam angle	colour
<b>LED-GIOVE-100</b> 8031414882557		150° x 80°	
lumen	15670 lm		
watt			100W
pf			0.90

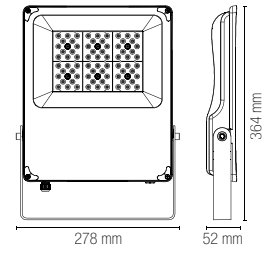

	colour temp.	beam angle	colour
<b>LED-GIOVE-200</b> 8031414876365		150° x 80°	
lumen	32666 lm		
<b>LED-GIOVE-200-30</b> 8031414885138		30°	
lumen	32666 lm		
<b>LED-GIOVE-200-60</b> 8031414885145		60°	
lumen	32666 lm		
<b>LED-GIOVE-200R-30</b> 8031414885152		30°	
lumen	RED		
<b>LED-GIOVE-200R-60</b> 8031414885169		60°	
lumen	RED		
<b>LED-GIOVE-200V-30</b> 8031414885176		30°	
lumen	GREEN		
<b>LED-GIOVE-200V-60</b> 8031414885183		60°	
lumen	GREEN		
watt			200W
pf			0.90

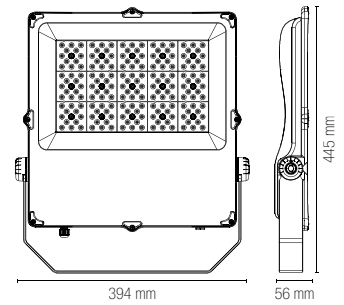

	colour temp.	beam angle	colour
<b>LED-GIOVE-300</b> 8031414876372		150° x 80°	
lumen	47150 lm		
watt			300W
pf			0.90

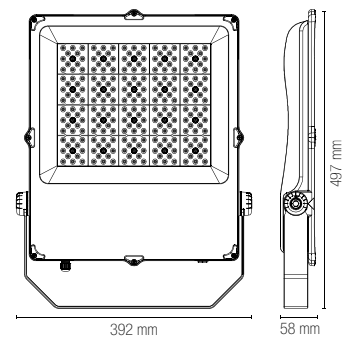

	colour temp.	beam angle	colour
<b>LED-GIOVE-400</b> 8031414876389		150° x 80°	
lumen	66031 lm		
watt			400W
pf			0.90

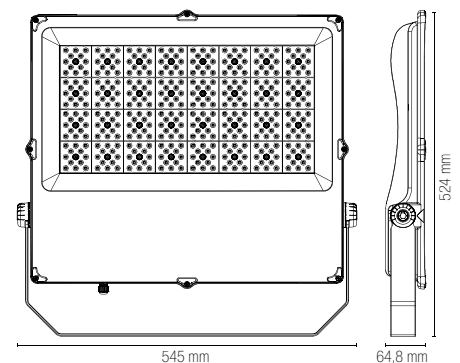

# MASTER



**Proiettore LED integrato struttura in alluminio pressofuso e diffusore con lenti in materiale autoestinguento, antiurto, anti-UV.**  
 Built-in LED floor light die-cast aluminium body and lens in anti-UV, self-extinguishing, shockproof material.



**Materiale**  
alluminio

**Colore**  
nero



**Temperatura colore**  
5700K



**Driver**  
incluso

**Durata e on/off**  
50.000 h  
>25.000 on/off

**Material**  
aluminium

**Colour**  
black



**Colour temperature**  
5700K



**Driver**  
included

**Life time and on/off**  
50.000 h  
>25.000 on/off



	colour temp.	colour
<b>LED-MASTER-960</b>		
8031414862122		
lumen	129600 lm	
watt	960W	
beam angle	60° x 100°	
pf	0.90	

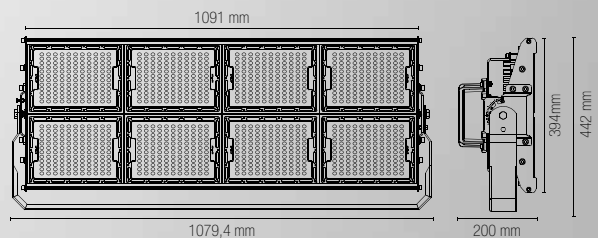
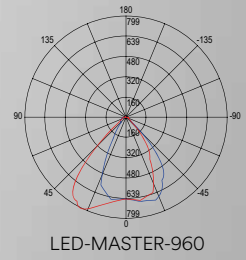

# ENERGY

Faro LED integrato per pensiline struttura in alluminio pressofuso e diffusore con lenti in materiale autoestinguente, antiurto, anti-UV.

Gas station built-in LED light in die-cast aluminium body and lens in anti-UV, self-extinguishing, shockproof material.



**Materiale**  
alluminio

**Colore**  
bianco



**Temperatura colore**  
4000K



**Driver**  
incluso

**Durata e on/off**  
50.000 h  
>25.000 on/off

**Material**  
aluminium

**Colour**  
white



**Colour temperature**  
4000K



**Driver**  
included

**Life time and on/off**  
50.000 h  
>25.000 on/off

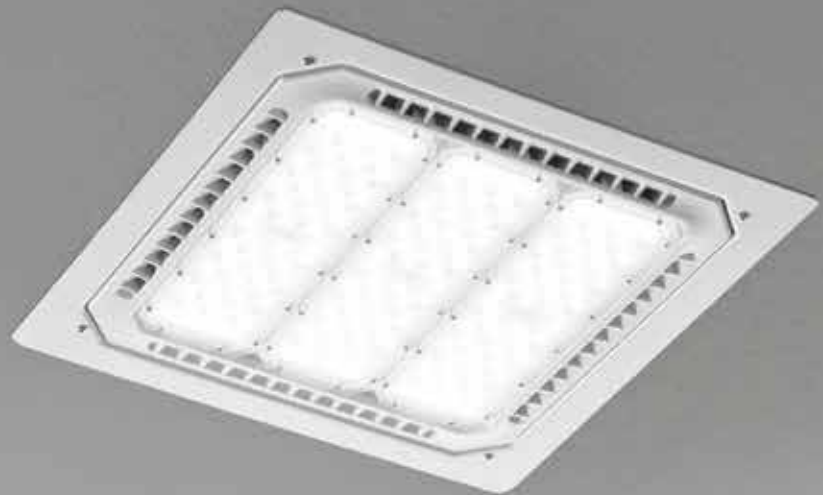



**LED-ENERGY-80-INC**

8031414862085

lumen

colour temp. | colour

● ●  
11100 lm

watt	80W
beam angle	80°
pf	0.90

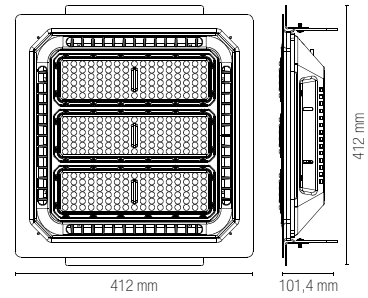

**LED-ENERGY-80-PL**

8031414862078

lumen

colour temp. | colour

● ●  
11100 lm

watt	80W
beam angle	80°
pf	0.90

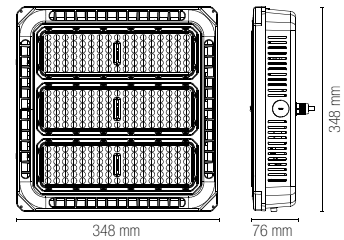

Fotometria del prodotto / Photometric curve

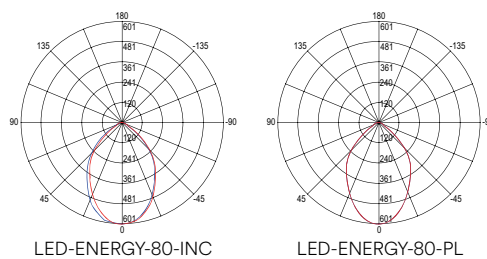



# OUTDOOR

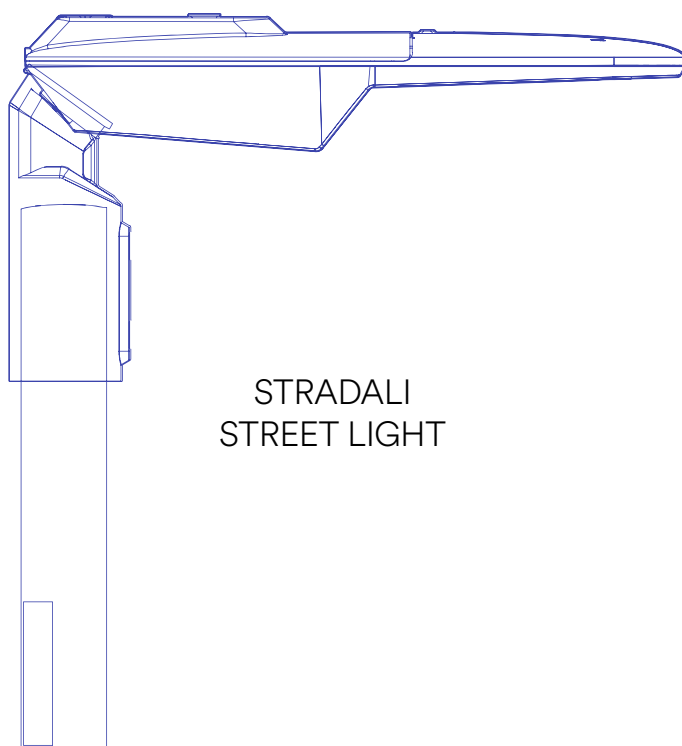

STRADALI  
STREET LIGHT

# AUREUS

Faro stradale LED in alluminio con pannello solare integrato.  
Aluminum LED street light with integrated solar panel.



**Materiale**  
alluminio

**Colore**  
antracite



**Temperatura colore**  
3000K / 4000K



**Driver**  
incluso

**Material**  
aluminum

**Colour**  
anthracite



**Colour temperature**  
3000K / 4000K



**Driver**  
included





**LED-AUREUS-20C-SOLAR**

8031414921874

lumen

colour temp.	colour

1600 lm

**LED-AUREUS-20M-SOLAR**

8031414921881

lumen

1600 lm

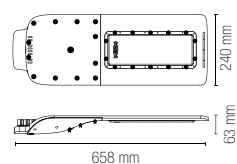

watt	20W
beam angle	80° x 80°

**Accessori inclusi / Included accessories**

Pannello solare /  
Solar panel

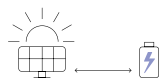

**3.2V 20Ah LiFePO4**

Batteria ricaricabile  
non sostituibile /  
Rechargeable battery  
non replaceable



Radiocomando /  
Remote control

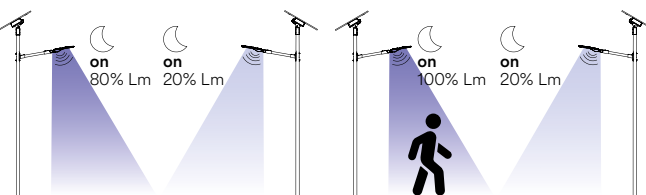

**Interruttore per due funzioni / Switch for two functions**

1. Sensore crepuscolare  
ON 100% luce per 10 min  
Dopo 2 ore graduale  
riduzione fino al 10% luce /  
Crepuscular sensor  
ON 100% light for 10 min  
After 2 hours gradual  
reduction to 10% light

2. Sensore di movimento  
ON 100% luce  
Dopo 20 secondi 20% luce /  
Motion sensor  
ON 100% light  
After 20 seconds 20% light

# RADIUS

Faro stradale LED in alluminio silver con pannello solare.  
Silver aluminum LED street light with solar panel.



**Materiale**  
alluminio

**Colore**  
silver



**Temperatura colore**  
3000K / 4000K



**Driver**  
incluso

**Material**  
aluminum

**Colour**  
silver



**Colour temperature**  
3000K / 4000K



**Driver**  
included



**LED-RADIUS-15C-SOLAR**

8031414917006

lumen

colour temp. | colour



2100 lm

**LED-RADIUS-15M-SOLAR**

8031414917013

lumen



2100 lm

watt 48W  
beam angle 80° x 140°  
pf 0.90

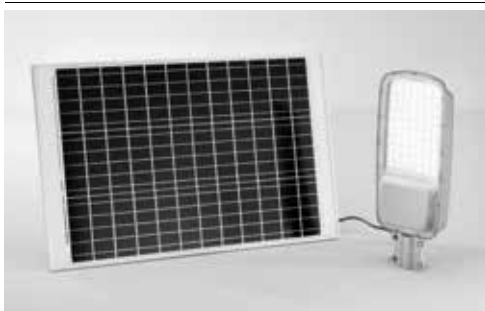
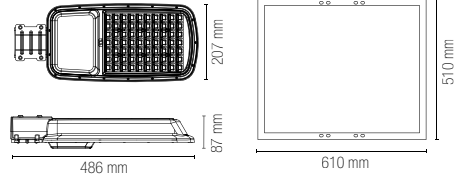

**LED-RADIUS-30C-SOLAR**

8031414917020

lumen

colour temp. | colour



4200 lm

**LED-RADIUS-30M-SOLAR**

8031414917037

lumen



4200 lm

watt 64W  
beam angle 80° x 140°  
pf 0.90

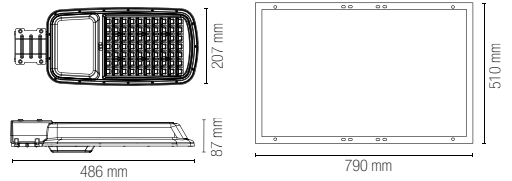

**Accessori inclusi / Included accessories**

Pannello solare / Solar panel

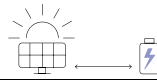

**50W - lithium 12,8V 54000 mAh**  
**75W - lithium 25,6V 36000 mAh**

Batteria ricaricabile non sostituibile / Rechargeable battery non replaceable



imbocco palo 60 mm / 60 mm pole entry

**Accessori non inclusi / Not included accessories**



**LED-RADIUS-REMOTE**  
8031414917048

Radiocomando / Remote control



**LED-RADIUS-ST**  
8031414917044

Staffa per montaggio su palo / Pole mounting bracket



**LED-RADIUS-ST-W**  
8031414917051

Staffa per montaggio su palo o a muro / Pole or wall mounting bracket

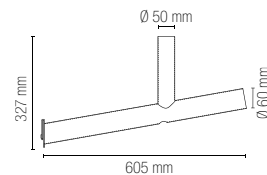
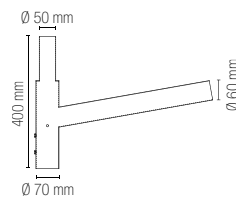

**Fotometria del prodotto / Photometric curve**

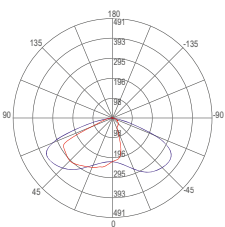

LED-RADIUS-15-SOLAR

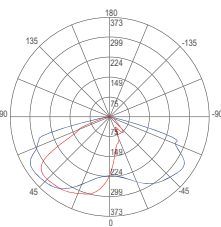

LED-RADIUS-30-SOLAR

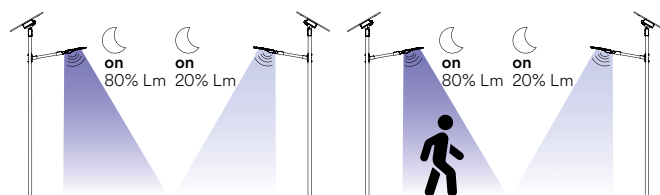

Sensore crepuscolare  
ON 80% luce  
Dopo 20 secondi 20% luce /  
Crepuscular sensor  
ON 80% light  
After 20 seconds 20% light

Sensore di movimento  
ON 80% luce  
Dopo 20 secondi 20% luce /  
Motion sensor  
ON 80% light  
After 20 seconds 20% light

# FEBO

Faro stradale LED in alluminio con pannello solare.  
Aluminum LED street light with solar panel.



**Materiale**  
alluminio

**Materiale pannello solare**  
celle in silicio  
monocristallino

**Colore**  
silver



**Temperatura colore**  
4000K



**Material**  
aluminum

**Solar panel material**  
monocrystalline  
silicon

**Colour**  
silver



**Colour temperature**  
4000K





Lenti in materiale autoestinguente, antiurto, anti-UV /  
Lens in anti-UV, self-extinguishing, shockproof material

**LED-FEBO-SOLAR**  
8031414879052  
lumen

colour temp.	colour
6800 lm	

watt **40W**  
beam angle **140° x 85°**

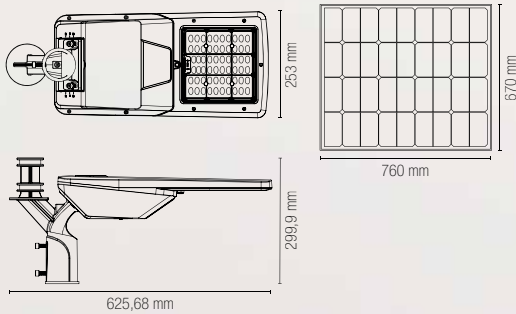

**Accessori inclusi / Included accessories**

Pannello solare / Solar panel



**Lithium 12,8V 30AH**

Batteria ricaricabile non sostituibile / Rechargeable battery non replaceable



imbocco palo 60 mm / 60 mm pole entry

**Fotometria del prodotto / Photometric curve**

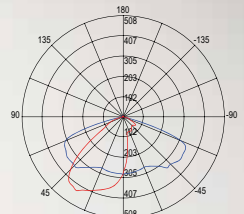

LED-FEBO-SOLAR

				Impostazioni di fabbrica / Default Settings	
☀ on <20lux		🌙 on		☀ off +12h	
flux	T1	T2	T3	hours	flux
100%				T1 <20lux ÷ +2h	100%
60%				T2 T1 ÷ +2h	60%
50%				T3 T2 ÷ +7h	10%
10%				T4 T3 ÷ +2h	50%
					+12h off

# IPERION

Faro stradale LED in alluminio silver con pannello solare.  
Silver aluminum LED street light with solar panel.



**Materiale**  
alluminio

**Materiale pannello solare**

celle in silicio  
monocristallino

**Colore**  
silver



**Temperatura colore**  
4000K



**Material**  
aluminum

**Solar panel material**

monocrystalline  
silicon

**Colour**  
silver



**Colour temperature**  
4000K



	colour temp.
<b>LED-IPERION-50-SOLAR</b> 8031414879069	9000 lm
<b>LED-IPERION-75-SOLAR</b> 8031414879076	13500 lm
watt	50W
beam angle	156° x 71°

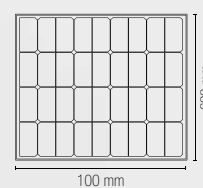
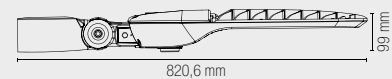
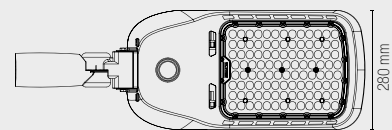

LED-IPERION-50-SOLAR

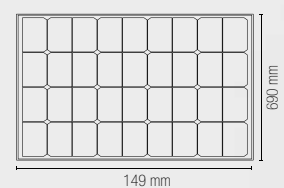

LED-IPERION-75-SOLAR



Lenti in materiale autoestinguente, antiurto, anti-UV / Lens in anti-UV, self-extinguishing, shockproof material

**Sensore microwave**  
max altezza 6m  
raggio 7m /  
**Microwave sensor**  
max height 6m  
radius 7m

Accessorio non incluso /  
Not included accessory

**LED-IPERION-REMOTE**  
8031414879083

Radiocomando multifunzione /  
Remote control multi-mode control

\*regolabile solo con radiocomando  
multifunzione LED-IPERION-REMOTE /  
\* adjustable only with LED-IPERION-REMOTE  
remote control



Accessori inclusi /  
Included accessories

Palo 60 cm /  
Pole 60 cm

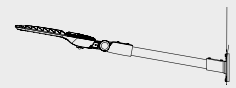

Pannello solare /  
Solar panel

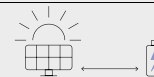

**50W - lithium 12,8V 54000 mAh**  
**75W - lithium 25,6V 36000 mAh**

Batteria ricaricabile  
non sostituibile /  
Rechargeable battery  
non replaceable



imbocco palo 60 mm /  
60 mm pole entry

Fotometria del prodotto /  
Photometric curve

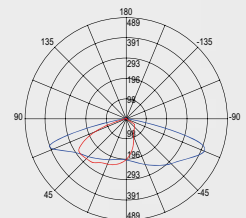

LED-IPERION-50-SOLAR

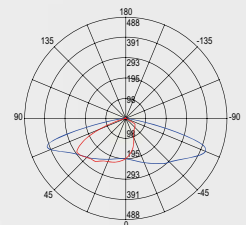

LED-IPERION-75-SOLAR

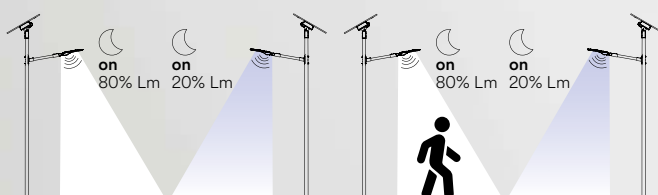

Sensore crepuscolare  
ON 80% luce  
Dopo 20 secondi 20% luce /  
Crepuscular sensor  
ON 80% light  
After 20 seconds 20% light

Sensore di movimento  
ON 80% luce  
Dopo 20 secondi 20% luce /  
Motion sensor  
ON 80% light  
After 20 seconds 20% light

# STREETWAY

Faro stradale LED integrato struttura in alluminio pressofuso e diffusore con lenti in materiale autoestinguente, antiurto, anti-UV.

Built-in LED street light die-cast aluminum body and lens in anti-UV, self-extinguishing shockproof material.



---

**Materiale**

alluminio

---

**Colore**

silver



---

**Temperatura colore**

4000K



---

**Driver**

incluso

---

**Durata e on/off**

50.000 h  
>25.000 on/off

---

**Material**

aluminum

---

**Colour**

silver



---

**Colour temperature**

4000K



---

**Driver**

included

---

**Life time and on/off**

50.000 h  
>25.000 on/off







**LED-STREETWAY-50**

8031414876334

lumen

colour temp. | colour

7800 lm

watt 50W  
beam angle 80° x 140°  
pf 0.90

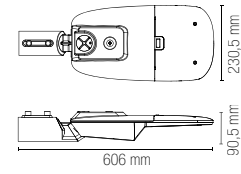

**LED-STREETWAY-100**

8031414876341

lumen

colour temp. | colour

15500 lm

**LED-STREETWAY-100FC**

8031414879113

lumen

15500 lm

crepuscular sensor on 6 lux off 50 lux

watt 100W  
beam angle 80° x 140°  
pf 0.90

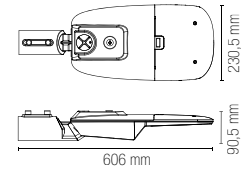

**LED-STREETWAY-150**

8031414876358

lumen

colour temp. | colour

22000 lm

watt 150W  
beam angle 80° x 140°  
pf 0.90

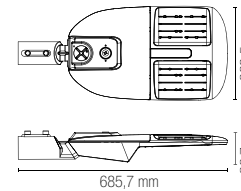

**LED-STREETWAY-200**

8031414879106

lumen

colour temp. | colour

29900 lm

watt 200W  
beam angle 80° x 140°  
pf 0.90

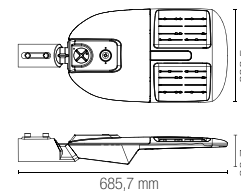

Fotometria del prodotto / Photometric curve

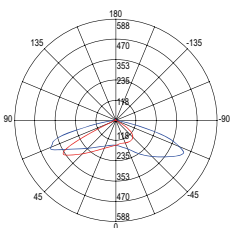

LED-STREETWAY-50W

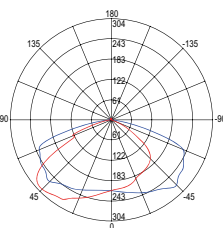

LED-STREETWAY-100W

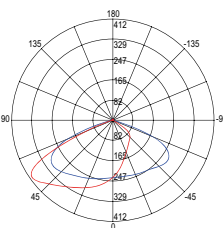

LED-STREETWAY-150W

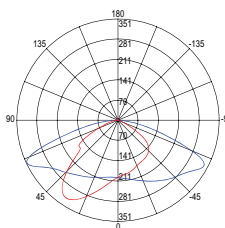

LED-STREETWAY-200W

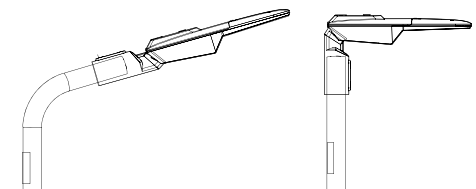

Doppio sistema di montaggio. Per palo Ø 60 mm / Double mounting system. Fit for Ø 60 mm pole

# HIGHWAY

Faro stradale LED integrato struttura in alluminio pressofuso e diffusore con lenti in materiale autoestinguente, antiurto, anti-UV.

Built-in LED street light die-cast aluminum body and lens in anti-UV, self-extinguishing shockproof material.



---

**Materiale**

alluminio

---

**Colore**

antracite



---

**Temperatura colore**

4000K



---

**Driver**

incluso

---

**Durata e on/off**

30.000 h  
>15.000 on/off

---

**Material**

aluminum

---

**Colour**

anthracite



---

**Colour temperature**

4000K



---

**Driver**

included

---

**Life time and on/off**

30.000 h  
>15.000 on/off





**LED-HIGHWAY-50**

8031414877034

lumen

colour temp. | colour



7500 lm

watt	50W
beam angle	135° x 80°
pf	0.90

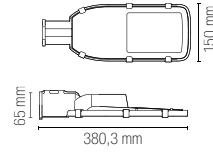

**LED-HIGHWAY-100**

8031414877041

lumen

colour temp. | colour



14000 lm

watt	100W
beam angle	135° x 80°
pf	0.90

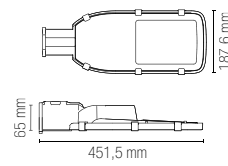

**LED-HIGHWAY-150**

8031414877058

lumen

colour temp. | colour



20000 lm

watt	150W
beam angle	135° x 80°
pf	0.90

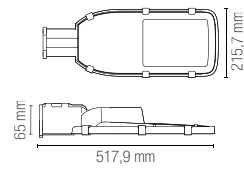

**LED-HIGHWAY-ADAT**

8031414877904

Adattatore 90° armature stradali highway imbocco palo 60 mm / 90° adapter 60 mm pole entry for street light

imbocco palo 60 mm / 60 mm pole entry

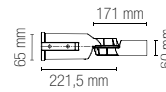

Fotometria del prodotto / Photometric curve

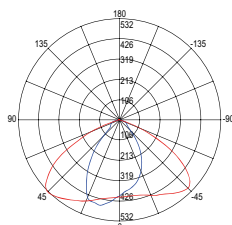

LED-HIGHWAY-50

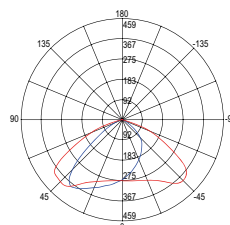

LED-HIGHWAY-100

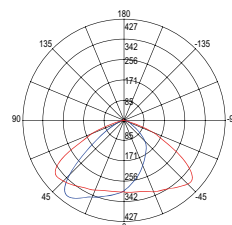

LED-HIGHWAY-150

# POLIS

Faro stradale LED con fissaggio su palo verticale orizzontale più versione a sospensione, in alluminio pressofuso con diffusore in vetro temperato.

Built-in LED street light die-cast aluminum body with tempered glass diffuser structure with mount bracket on vertical or horizontal pole and version with suspension mount bracket.



---

**Materiale**

alluminio pressofuso

---

**Colore**

silver



---

**Temperatura colore**

4000K



---

**Driver**

incluso

---

**Durata e on/off**

50.000 h  
>25.000 on/off

---

**Material**

die-cust aluminum

---

**Colour**

silver



---

**Colour temperature**

4000K



---

**Driver**

included

---

**Life time and on/off**

50.000 h  
>25.000 on/off

---



**LED-POLIS-50**

8031414879465

lumen

colour temp.	colour
7000 lm	

watt	50W
beam angle	155° x 75°
pf	0.90

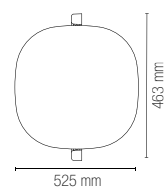
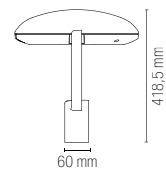
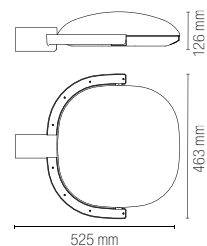

imbocco palo 60mm  
60mm pole entry



**LED-POLIS-S50**

8031414879472

lumen

colour temp.	colour
7000 lm	

watt	50W
beam angle	155° x 75°
pf	0.90

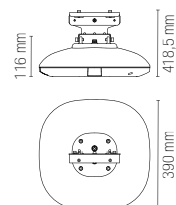

Fotometria del prodotto / Photometric curve

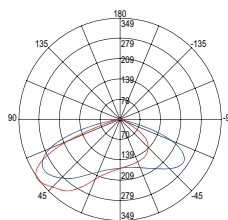

LED-POLIS-50

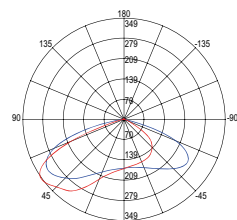

LED-POLIS-S50



# INDUSTRIAL

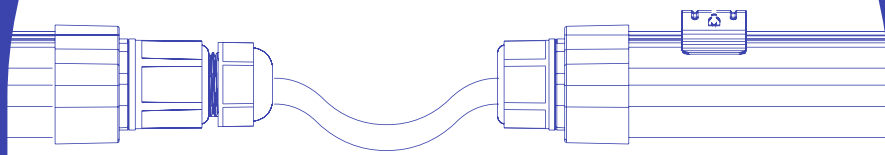

HIGH BAY & TRI-PROOF

# AVATAR

Lampada LED high bay in alluminio nero.  
Black aluminium high bay LED lamp.



**Materiale**  
alluminio

**Colore**  
nero



**Temperatura colore**  
4000K



**Driver**  
incluso

**Durata e on/off**  
50.000 h  
>25.000 on/off

**Material**  
aluminum

**Colour**  
black



**Colour temperature**  
4000K



**Driver**  
included

**Life time and on/off**  
50.000 h  
>25.000 on/off



## Fotometria del prodotto / Photometric curve

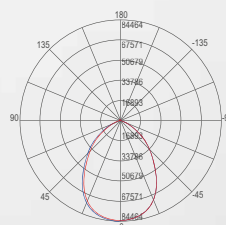

LED-AVATAR-100



LED-AVATAR-150

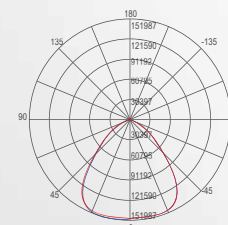

LED-AVATAR-200



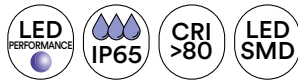

**LED-AVATAR-100**  
8031414903733

lumen	15000 lm
watt	100W
beam angle	90°
pf	0.90

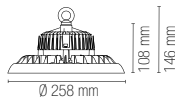

colour temp.



Accessorio non incluso /  
Not included accessory



Connettore IP67 incluso /  
IP67 connector included



**LED-AVATAR-150**  
8031414903740

lumen	22500 lm
watt	150W
beam angle	90°
pf	0.90

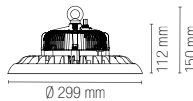

colour temp.



**LED-AVATAR-ST1015**  
8031414903771

Staffa per fissaggio a parete/soffitto  
AVATAR 100 e 150 /  
Bracket for wall/ceiling fixing  
AVATAR 100 and 150



Connettore IP67 incluso /  
IP67 connector included



**LED-AVATAR-200**  
8031414903757

lumen	30000 lm
watt	200W
beam angle	90°
pf	0.90

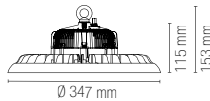

colour temp.



Accessorio non incluso /  
Not included accessory

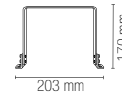

Connettore IP67 incluso /  
IP67 connector included

**LED-AVATAR-ST200**  
8031414903795

Staffa per fissaggio a parete/soffitto  
AVATAR 200 /  
Bracket for wall/ceiling fixing  
AVATAR 200



**LED-AVATAR-DR-HELP**  
8031414903764

emergency light	15W
-----------------	-----

Driver d'emergenza con staffa inclusa /  
Emergency driver with bracket included

**Li-FePO4 3000mAh-11.1V**  
Batteria per emergenza inclusa /  
Included emergency battery



Funzione **MAINTAIN** sempre accesa /  
MAINTAIN function always on

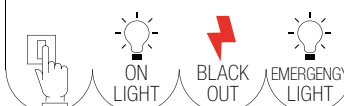

Funzione **NON-MAINTAIN** emergenza /  
NON-MAINTAIN function only emergency



# ATLANTIC

Plafoniera stagna per tubi a LED bilampada in PC+PC.  
Waterproof lamp for double LED tube in PC+PC.



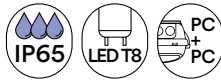

**LED-ATLANTIC-ST-60**

8031440355315

2 x T8 230V

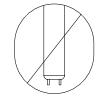

Lampadina non inclusa / Light bulb not included

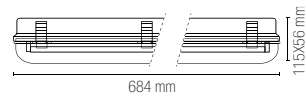

**LED-ATLANTIC-ST-120**

8031440355322

2 x T8 230V

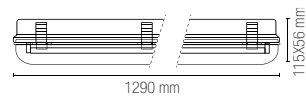

**LED-ATLANTIC-ST-150**

8031440355292

2 x T8 230V

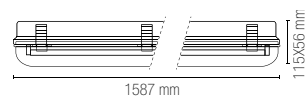

HIGH BAY & TRI-PROOF

In.tec light

# NAUTILUS

Plafoniere stagno in policarbonato.  
Waterproof ceiling lamps in polycarbonate.



**Materiale**  
policarbonato

**Colore**  
silver



**Temperatura colore**  
4000K



**Driver**  
integrato

**Durata e on/off**  
50.000 h  
>25.000 on/off

**Material**  
policarbonato

**Colour**  
silver



**Colour temperature**  
4000K



**Driver**  
built-in

**Life time and on/off**  
50.000 h  
>25.000 on/off



## Fotometria del prodotto / Photometric curve

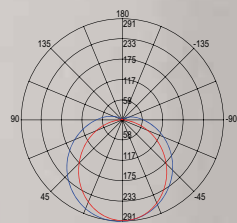

LED-NAUTILUS-60

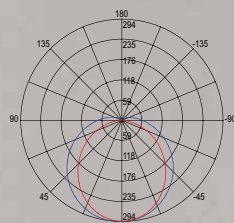

LED-NAUTILUS-120

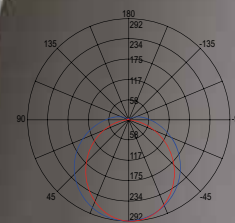

LED-NAUTILUS-150

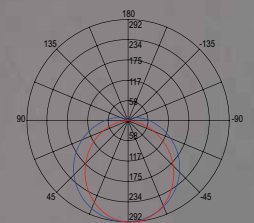

LED-NAUTILUS-PRO



	colour temp.	colour
<b>LED-NAUTILUS-60</b>		
8031414876501		
lumen	2900 lm	
watt	21W	
beam angle	120°	
pf	-	

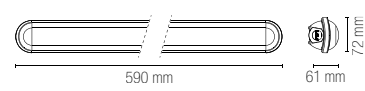

	colour temp.	colour
<b>LED-NAUTILUS-120</b>		
8031414876518		
lumen	5400 lm	
watt	40W	
beam angle	120°	
pf	0.90	

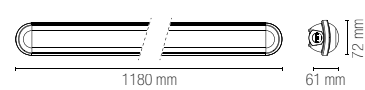

	colour temp.	colour
<b>LED-NAUTILUS-150</b>		
8031414876525		
lumen	7500 lm	
watt	55W	
beam angle	120°	
pf	0.90	

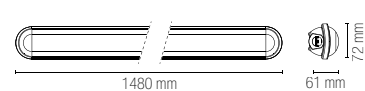

	colour temp.	colour
<b>LED-NAUTILUS-PRO</b>		
8031414876532		
lumen	10600 lm	
watt	80W	
beam angle	120°	
pf	0.90	

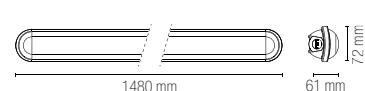

	colour temp.	colour
<b>LED-NAUTILUS-120HP</b>		
8031414919512		
lumen	5400 lm	
emergency light	3 h - 4W - 560 lm	
watt	40W	
beam angle	120°	
pf	0.90	

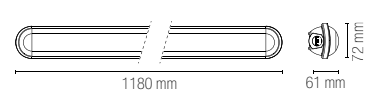

**16 hours** **LiFePo4 1500mAh, 3000mAh**  
 Batteria per emergenza inclusa / Included emergency battery

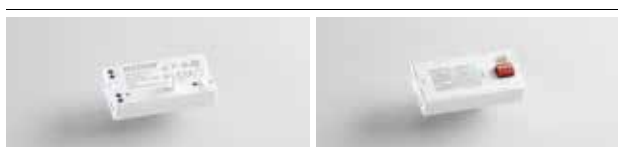

**NAUTILUS-SENS**  
8031414878758



In un ambiente sufficientemente luminoso la lampada non si accende anche se viene rilevato movimento.

With sufficient ambient light, the light will not be switched on even if with motion signal.



In un ambiente poco luminoso il sensore accende la lampada non appena viene rilevato un movimento.

With insufficient ambient light, the sensor switches on the light when motion is detected.

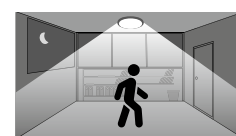

Trascorso il tempo di attesa, il sensore spegne la lampada quando non viene rilevato movimento.

After elapse of hold time, the sensor switches off the light when no motion is detected.

# ARTIC

Plafoniera stagna LED integrato in policarbonato.  
Built-in LED TRI PROOF ceiling lamps in PC.



---

**Materiale**

policarbonato

---

**Colore**

bianco



---

**Temperatura colore**

4000K



---

**Driver**

integrato

---

**Durata e on/off**

50.000 h  
>25.000 on/off

---

**Material**

polycarbonate

---

**Colour**

white



---

**Colour temperature**

4000K



---

**Driver**

built-in

---

**Life time and on/off**

50.000 h  
>25.000 on/off

---





**LED-ARTIC-30**

8031414882625

lumen 1200 lm

watt 9W  
beam angle 120°  
pf -

colour temp. colour

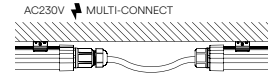
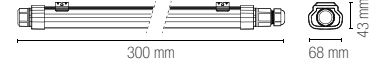

**LED-ARTIC-60**

8031414882632

lumen 1800 lm

watt 15W  
beam angle 120°  
pf -

colour temp. colour

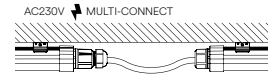
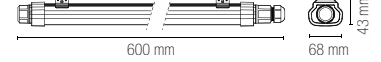

**LED-ARTIC-120**

8031414882601

lumen 4000 lm

watt 30W  
beam angle 120°  
pf 0.90

colour temp. colour

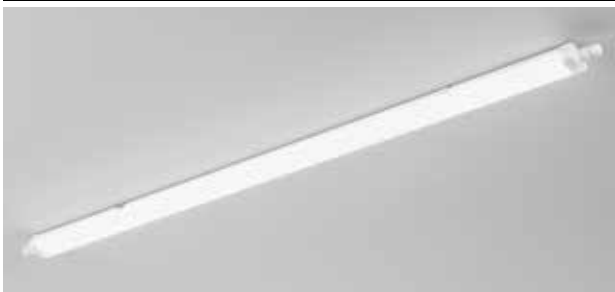
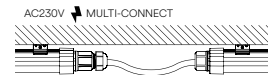
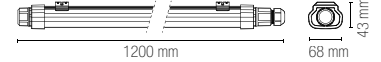

**LED-ARTIC-150**

8031414882618

lumen 5500 lm

watt 45W  
beam angle 120°  
pf 0.90

colour temp. colour

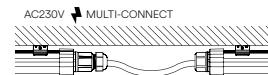

Fotometria del prodotto / Photometric curve

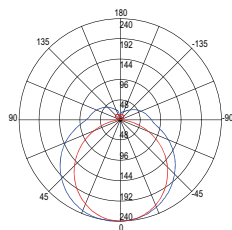

LED-ARTIC-30

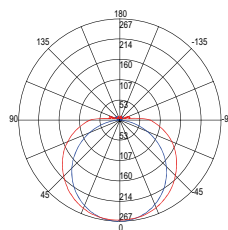

LED-ARTIC-60

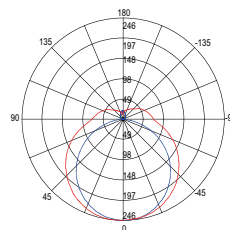

LED-ARTIC-120

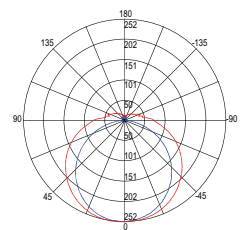

LED-ARTIC-150

# OCEAN

**Plafoniera stagna LED integrato in policarbonato.**  
Built-in LED TRI PROOF ceiling lamps in PC.



**Materiale**

policarbonato

**Colore**

bianco



**Temperatura colore**

4000K



**Driver**

integrato

**Durata e on/off**

30.000 h  
>15.000 on/off

**Material**

polycarbonate

**Colour**

white



**Colour temperature**

4000K



**Driver**

built-in

**Life time and on/off**

30.000 h  
>15.000 on/off



**LED-OCEAN-SENS**

8031414868858

lumen

colour temp.	colour
3240 lm	

watt	36W
beam angle	120°
pf	0.90

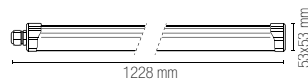

<b>Accessori inclusi / Included accessories</b>	crepuscolar sensor	motion sensor
Sensore microonde di movimento / Microwave motion sensor	<p>20% Lm</p>	<p>on 100% Lm    on 20% Lm</p>



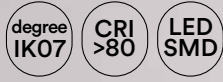

technical information **ARTIC**



**HIGH BAY & TRI-PROOF**

In.tec light



# DECORATIVE



EASY DOMOTIC 24V



# EASY DOMOTICA 24V

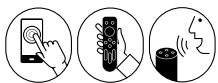

Con questo segmento tecnico intendiamo soddisfare al meglio la crescente esigenza di migliorare la qualità di vita domestica, e lavorativa attraverso l'utilizzo di dispositivi di illuminazione sempre più interconnessi fra loro tramite collegamenti sempre più semplificati dalle tecnologie wireless.

I dispositivi di illuminazione diventano uno strumento estremamente personalizzato e modulabile che si fondono, anche in diversi momenti della giornata, con le evolute esigenze di illuminazione non più fine a se stessa ma adattata ai diversi umori sia di una utenza professionale che di una utenza domestica o ludica. Questa sezione raggruppa diverse tipologie di prodotti 24V (ad esempio indoor e outdoor) che, grazie all'utilizzo di accessori easy connector, possono essere connessi tra di loro per il controllo simultaneo. Il controllo dei dispositivi diventa easy: la connessione ad alimentatori a tensione costante in parallelo è compatibile con centraline di controllo in Radio Frequenza 2.4G, Infrarossi, Wifi o Bluetooth e le centraline, a loro volta, prevedono interfacce wifi, bluetooth oppure possono essere controllate tramite wall pad o radiocomandi.

With this technical segment, we intend meet in the best way the growing need to improve the quality of home and working life through the use of lighting devices that are increasingly interconnected with each other through connections that are increasingly simplified by wireless technologies.

The lighting devices become an extremely personalized and modular tool that merge, even at different times of the day, with the evolved lighting needs no longer as light source itself but light adapted to the different moods of both professional users, domestic users, playful users. This section groups 24V products (for example indoor or outdoor) that, thanks to easy connector accessories, can be connected each other for simultaneous control. Devices control becomes easy: constant voltage power supply in parallel connection system are compatible with 2.4G Radio Frequency, Infrared, Wifi or Bluetooth control units and the control units can be controlled by wifi, bluetooth devices or via a wall pad or remote control.



**CAVO-4CH-CONN-MF**   
8031414878772

100 cm  
Cavo di connessione  
connettore M+F /  
100 cm  
Connection cable  
M+F connector



**CAVO-4CH-CONN-T**   
8031414878789

40+20 cm  
Cavo di connessione  
a T connettore M+F+F /  
40+20 cm  
T connection cable M+F+F  
connector



**CAVO-4CH-CONN-M**   
8031414878796

50 cm  
Cavo di connessione  
connettore M+cavi sciolti /  
50 cm  
Connection cable  
M+cables



# XANTO-RF

**Incasso in alluminio pressofuso antiriflesso con cavo easy connection integrato.**  
Diecast aluminum anti-glare down-light with built-in easy domotic cable.

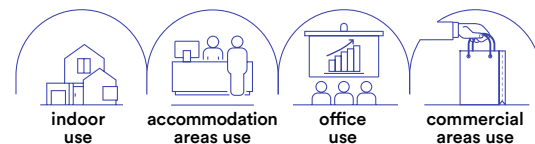

**Materiale**  
alluminio pressofuso

**Colore**  
bianco

**Temperatura colore**  
RGB + 4000K



**Driver**

DC 24V non incluso  
Tensione costante  
connessione  
in parallelo

**Durata e on/off**

25.000h  
>15.000 on/off

**Material**

die cast aluminum

**Colour**  
white

**Colour temperature**  
RGB + 4000K



**Driver**

DC 24V not included  
Constant voltage  
parallel connecting  
system

**Life time and on/off**

25.000 h  
>15.000 on/off

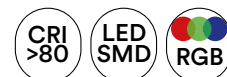

Driver p. 843-852  
Controller p. 854-857



**INC-XANTO-R120-24V**

8031414877942

lumen

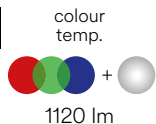

1120 lm

watt 12W  
beam angle 120°  
pf -

Ø 110 mm

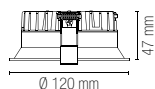

**INC-XANTO-R220-24V**

8031414878697

lumen

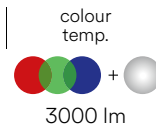

3000 lm

watt 30W  
beam angle 120°  
pf 0.90

Ø 200 mm

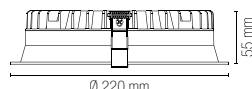

**Fotometria del prodotto /  
Photometric curve**

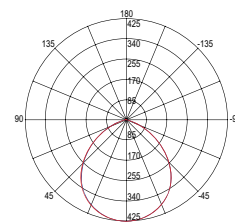

INC-XANTO-R120-24V

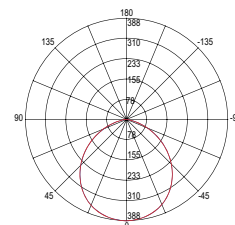

INC-XANTO-R220-24V

# PANEL

**Pannello LED con struttura in alluminio diffusore in acrilico con cavo easy connection integrato.**

LED panel with aluminum structure and acrylic diffuser with built-in easy domotic cable.

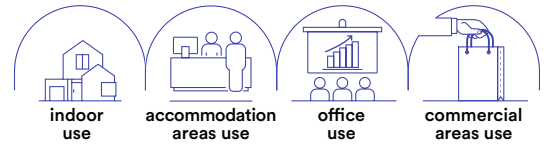

**Materiale**  
alluminio  
diffusore in acrilico

**Colore**  
bianco



**Temperatura colore**  
RGB + 4000K



**Driver**  
DC24V  
tensione costante  
non incluso

**Durata e on/off**  
20.000h  
>10.000 on/off

**Material**  
aluminum  
acrylic diffuser

**Colour**  
white



**Colour temperature**  
RGB + 4000K



**Driver**  
DC24V  
constant voltage  
not included

**Life time and on/off**  
20.000h  
>10.000 on/off

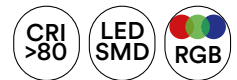

Driver p. 843-852  
Controller p. 854-857



Fotometria del prodotto /  
Photometric curve

**LED-PANEL-60X60-24V**

8031414875313

lumen

colour  
temp.  
3280 lm

watt 30W

beam angle 120°

pf 0.90

590 × 590 mm

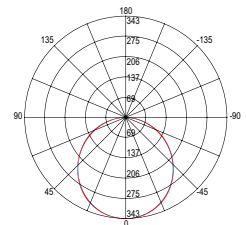

LED-PANEL-60×60-24V

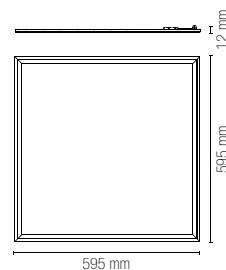

EASY DOMOTIC 24V

In.tec light

# STRIP

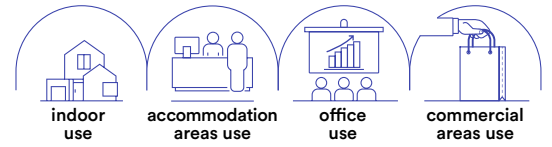

**Rotolo 5 metri strip led.**  
Roll 5 meters strip-led.



Driver p. 843-852  
Controller p. 854-857



**Materiale**  
kapton  
senza silicone

**Temperatura colore**  
RGB + 4000K

**Driver**  
DC24V  
tensione costante  
non incluso

**Durata e on/off**  
50.000h  
>25.000 on/off

**Material**  
kapton  
without silicone

**Colour temperature**  
RGB + 4000K

**Driver**  
DC24V  
constant voltage  
not included

**Life time and on/off**  
50.000h  
>25.000 on/off

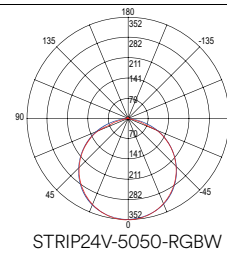

STRIP24V-5050-RGBW

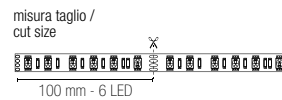

**STRIP24V-5050-RGBW**  
8031414871384  
lumen

colour temp.  
5400 lm/m

light source	SMD 5050
watt/m	19,2W
led/m	60

**Rotolo 5 metri strip led.**  
Roll 5 meters strip-led.



Driver p. 843-852  
Controller p. 854-857



**Materiale**  
kapton con  
rivestimento  
in silicone

**Temperatura colore**  
RGB + 4000K

**Driver**  
DC24V  
tensione costante  
non incluso

**Durata e on/off**  
50.000h  
>25.000 on/off

**Material**  
kapton  
with silicone  
cover

**Colour temperature**  
RGB + 4000K

**Driver**  
DC24V  
constant voltage  
not included

**Life time and on/off**  
50.000h  
>25.000 on/off

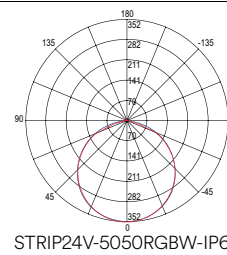

STRIP24V-5050RGBW-IP68

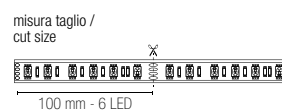

**STRIP24V-5050RGBW-IP68**  
8031414871407  
lumen

colour temp.  
5400 lm/m

light source	SMD 5050
watt/m	19,2W
led/m	60



# TARGET

Faro proiettore in alluminio con picchetto incluso, cavo easy connection integrato.

Aluminum flood light with spike included, built-in easy domotic cable.



**Materiale**  
alluminio

**Colore**  
nero



**Temperatura colore**  
RGB + 4000K



**Driver**

DC24V

tensione costante  
non incluso

**Durata e on/off**

30.000h  
>15.000 on/off

**Material**

aluminum

**Colour**

black



**Colour temperature**  
RGB + 4000K



**Driver**

DC24V

constant voltage  
not included

**Life time and on/off**

30.000h  
>15.000 on/off



Driver p. 843-852  
Controller p. 854-857

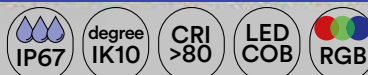

**LED-TARGET-8-24V**

8031414878604  
lumen

colour  
temp.



190 lm

watt 8W  
beam angle 30°

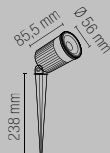

**LED-TARGET-30-24V**

8031414878550  
lumen

colour  
temp.



468 lm

watt 30W  
beam angle 30°

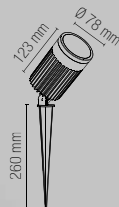

**Fotometria del prodotto /  
Photometric curve**

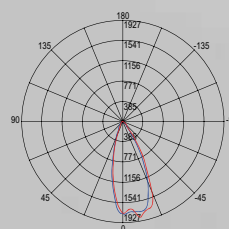

LED-TARGET-8-24V

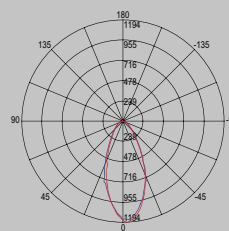

LED-TARGET-30-24V

EASY DOMOTIC 24V

In.tec light

# AGILITY





**Materiale**  
alluminio  
diffusore in vetro

**Colore**  
nero



**Temperatura colore**  
RGB + 4000K



**Driver**  
DC24V  
tensione costante  
non incluso

**Durata e on/off**  
20.000h  
>10.000 on/off

**Material**  
aluminum  
glass diffuser

**Colour**  
black



**Colour temperature**  
RGB + 4000K



**Driver**  
DC24V  
constant voltage  
not included

**Life time and on/off**  
20.000h  
>10.000 on/off

**Proiettore a led integrato in alluminio nero e diffusore trasparente.**  
Built-in LED aluminium flood lamp black finish with trasparent diffuser.



Driver p. 843-852  
Controller p. 854-857



**LED-AGILITY-36-24V**  
8031414915828  
lumen

colour temp.  
 735 lm

watt 36W  
beam angle 120°

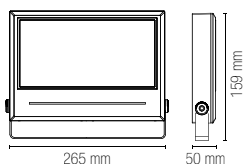

**LED-AGILITY-72-24V**  
8031414915835  
lumen

colour temp.  
 1540 lm

watt 72W  
beam angle 120°

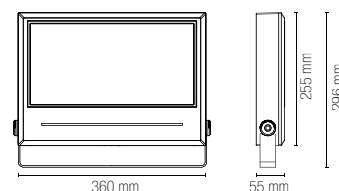

**Fotometria del prodotto / Photometric curve**

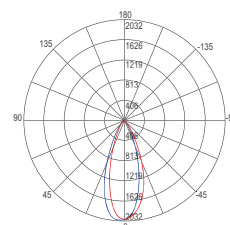

LED-AGILITY-36-24V

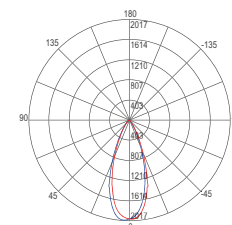

LED-AGILITY-72-24V

# QUICK





**Materiale**  
alluminio  
diffusore in vetro

**Colore**  
nero



**Temperatura colore**  
RGB



**Driver**  
DC24V

tensione costante  
non incluso

**Durata e on/off**

20.000h  
>10.000 on/off

**Material**

aluminum  
glass diffuser

**Colour**  
black



**Colour temperature**  
RGB



**Driver**  
DC24V

constant voltage  
not included

**Life time and on/off**

20.000h  
>10.000 on/off

**Proiettore a led integrato in alluminio silver e diffusore trasparente.**

Built-in LED aluminium flood lamp silver finish with transparent diffuser.



Driver p. 843-852  
Controller p. 854-857



**LED-QUICK-36-24V**

8031414915842  
lumen

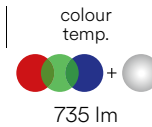

735 lm

watt	36W
beam angle	120°

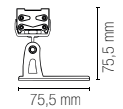
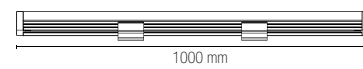

**LED-QUICK-72-24V**

8031414915859  
lumen



1800 lm

watt	72W
beam angle	120°

**Fotometria del prodotto / Photometric curve**

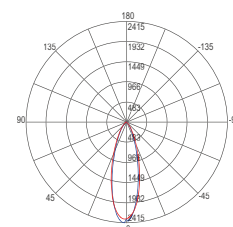

LED-QUICK-36-24V

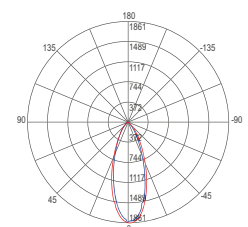

LED-QUICK-72-24V

# SPRINT

Segnapassi incasso a pavimento o parete  
con cavo easy connection integrato.

Inground and wall recessed light  
with built-in easy domotic cable.



**Materiale**  
alluminio

**Colore**  
acciaio



**Temperatura colore**  
RGB + 4000K



**Driver**

DC 24V  
tensione costante  
non incluso

**Durata e on/off**

25.000h  
>10.000 on/off

**Material**

aluminum

**Colour**

stainless steel



**Colour temperature**  
RGB + 4000K



**Driver**

DC 24V  
costant voltage  
not included

**Life time and on/off**

25.000h  
>10.000 on/off

EASY  
DOMOTICA  
24V



**LED-SPRINT-R5-24V**

8031414878543

lumen

colour  
temp.



60 lm

watt 1,5W

beam angle 108°

pressure loads max 100 kg

Ø 42 mm



Ø 50 mm



Driver p. 843-852  
Controller p. 854-857

Fotometria del prodotto /  
Photometric curve

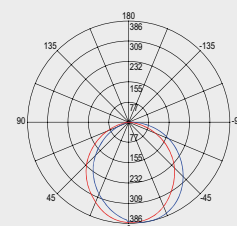

LED-SPRINT-R5-24V



# RUNNER

Segnapassi incasso a pavimento o parete  
con cavo easy connection integrato.

Inground and wall recessed light  
with built-in easy domotic cable.



**Materiale**  
alluminio

**Colore**  
nikel spazzolato



**Temperatura colore**  
RGB + 4000K



**Driver**

DC 24V  
tensione costante  
non incluso

**Durata e on/off**  
30.000h  
>15.000 on/off

**Material**  
aluminum

**Colour**  
brushed nickel



**Colour temperature**  
RGB + 4000K



**Driver**

DC 24V  
costant voltage  
not included

**Life time and on/off**  
30.000h  
>15.000 on/off



Driver p. 843-852  
Controller p. 854-857



**LED-RUNNER-Q8-24V**  
8031414878536  
lumen

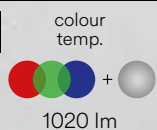

colour temp.  
1020 lm



**LED-RUNNER-R8-24V**  
8031414878567  
lumen

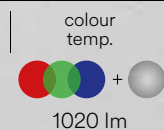

colour temp.  
1020 lm

Fotometria del prodotto /  
Photometric curve

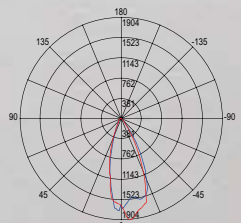

LED-RUNNER-Q8-24V  
LED-RUNNER-R8-24V

Accessori inclusi /  
Included accessories

x1  
Cassetta di  
derivazione /  
Recessed box

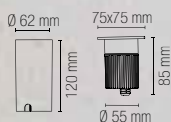

watt 10W  
beam angle 30°  
pressure loads max 100 kg  
Ø 63 mm



watt 10W  
beam angle 30°  
pressure loads max 100 kg  
Ø 63 mm

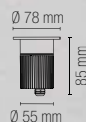

EASY DOMOTIC 24V

In.tec light





# DECORATIVE

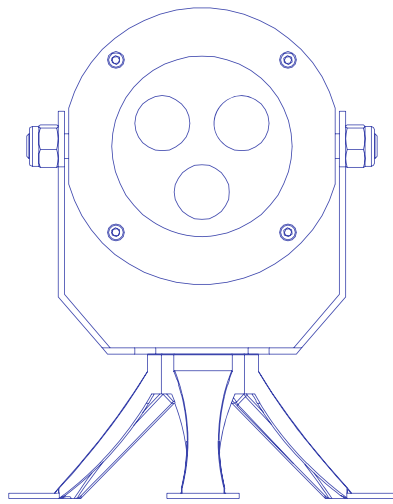

LUCI DECORATIVE TECNICHE DMX  
DMX TECHNICAL DECORATION LIGHTING

# SHOW WALLWASHER



outdoor  
use



accommodation  
areas use



office  
use



commercial  
areas use





technical information

SHOW WALLWASHER



**Materiale**  
alluminio

**Temperatura colore**  
RGBW + UV



**Driver**  
integrato

**Durata e on/off**  
50.000h  
>25.000 on/off

**Material**  
aluminum

**Colour temperature**  
RGBW + UV



**Driver**  
built-in

**Life time and on/off**  
50.000h  
>25.000 on/off

**Proiettore LED RGB full color in alluminio e wallwasher a batteria ricaricabile con 9 LED RGBW+UV e ricevitore DMX 512 integrato, per emettere una vasta gamma di colori mixando sei colori principali: rosso, verde, blu, bianco, ambra e ultravioletto.**

Full color RGB LED projector made of aluminum and rechargeable battery-powered wallwasher with 9 RGBW+UV LEDs and built-in DMX 512 receiver to emit a wide range of colors by mixing six main colors: red, green, blue, white, amber and ultraviolet.



<b>LED-SHOW-WW9</b> 8031414915446	colour temp. RGBW+UV	colour ●
lumen		
watt		9 x 18W
beam angle		45°

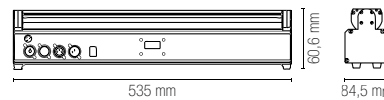

Tempo di ricarica /  
Charging time

Durata accensione /  
Ignition duration

Modalità auto /  
Auto mode

Modalità canali /  
Channel mode

Modalità automatiche  
tramite tasto /  
Automatic modes  
via push-button

Control mode

**Ricarica completa in 5 ore /  
Full recharge in 5 hours**

**RGBW+UV con la luminosità al massimo 3 ore /  
RGBW+UV with maximum brightness 3 hours**

**7 ore monocromatico più di 20 ore /  
7 hours monochrome more than 20 hours**

**6/11 DMX channel - 16.7 milioni di combinazioni colori /  
6/11 DMX channels - 16.7 million color combinations**

**Cambio colore colore stroboscopico, dimmerazione colore  
cambio colore graduale, cambio colori a step /  
Color change, strobe color, color dimming,  
gradual color change, step color change**

**DMX512, master/slave, auto, sound active/ Wireless DMX,  
WiFi mobile phone APP control**

**Accessori inclusi / Included accessories**



Accessori Wi-Fi /  
Wi-Fi accessories



5  
hours

**13200 mAh**  
Batteria ricaricabile, non sostituibile /  
Rechargeable battery, non replaceable

**Control system easy installation**



Smart  
WIFI



**ALEXA e  
GOOGLE HOME**  
voice control

# SHOW PAR





**Materiale**  
alluminio

**Temperatura colore**  
RGBW + UV



**Driver**  
integrato

**Durata e on/off**  
50.000h  
>25.000 on/off

**Material**  
aluminum

**Colour temperature**  
RGBW + UV



**Driver**  
built-in

**Life time and on/off**  
50.000h  
>25.000 on/off

**Faro LED a batteria ricaricabile con 9 LED RGBW+UV e ricevitore DMX 512 integrato, emette una vasta gamma di colori mixando i sei principali: rosso, verde, blu, bianco, ambr e ultravioletto, permettendo di creare ogni colore desiderato.**

Rechargeable battery-powered LED spotlight with 9 RGBW+UV LEDs and built-in DMX 512 receiver, emits a wide range of colors by mixing the six main ones: red, green, blue, white, amber and ultraviolet, allowing you to create any color you want.



	colour temp.	colour
<b>LED-SHOW-PAR9</b> 8031414915439		
lumen	RGBW+UV	
watt	9 x 18W	
beam angle	45°	

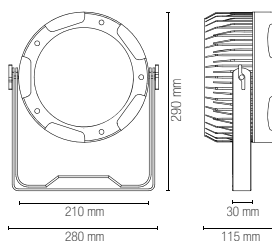

Tempo di ricarica /  
Charging time

Durata accensione /  
Ignition duration

Modalità auto /  
Auto mode

Modalità canali /  
Channel mode

Modalità automatiche  
tramite tasto /  
Automatic modes  
via push-button

Control mode

**Ricarica completa in 5 ore /  
Full recharge in 5 hours**

**RGBW+UV con la luminosità al massimo 3 ore /  
RGBW+UV with maximum brightness 3 hours**

**7 ore monocromatico più di 20 ore /  
7 hours monochrome more than 20 hours**

**6/11 DMX channel - 16.7 milioni di combinazioni colori /  
6/11 DMX channels - 16.7 million color combinations**

**Cambio colore colore stroboscopico, dimmerazione colore  
cambio colore graduale, cambio colori a step /  
Color change, strobe color, color dimming,  
gradual color change, step color change**

**DMX512, master/slave, auto, sound active/ Wireless DMX,  
WiFi mobile phone APP control**

**Accessori inclusi / Included accessories**



Accessori Wi-Fi /  
Wi-Fi accessories



**13200 mAh**  
Batteria ricaricabile, non sostituibile /  
Rechargeable battery, non replaceable

**Control system easy installation**



**Smart  
WIFI**



**ALEXA e  
GOOGLE HOME  
voice control**

# SHOW Q





**Materiale**  
alluminio

**Temperatura colore**  
RGBW + UV



**Driver**  
integrato

**Durata e on/off**  
50.000h  
>25.000 on/off

**Material**  
aluminum

**Colour temperature**  
RGBW + UV



**Driver**  
built-in

**Life time and on/off**  
50.000h  
>25.000 on/off

**Faro LED a batteria ricaricabile con 6 LED RGBW+UV e ricevitore DMX 512 integrato, emette una vasta gamma di colori mescolando i sei principali: rosso, verde, blu, bianco, ambr e ultravioletto, consentendo la creazione di ogni colore desiderato.**

Rechargeable battery-operated LED spotlight with 6 RGBW+UV LEDs and built-in DMX 512 receiver, emits a wide range of colors by mixing the six main ones: red, green, blue, white, amber and ultraviolet, allowing the creation of any desired color.



<b>LED-SHOW-Q6</b> 8031414915408	colour temp. RGBW+UV	colour
lumen		
watt		6 x 18W
beam angle		45°

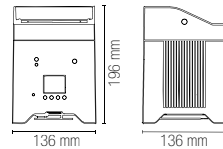

Tempo di ricarica /  
Charging time

Durata accensione /  
Ignition duration

Modalità auto /  
Auto mode

Modalità canali /  
Channel mode

Modalità automatiche  
tramite tasto /  
Automatic modes  
via push-button

Control mode

**Ricarica completa in 5 ore /  
Full recharge in 5 hours**

**RGBW+UV con la luminosità al massimo 3 ore /  
RGBW+UV with maximum brightness 3 hours**

**7 ore monocromatico più di 20 ore /  
7 hours monochrome more than 20 hours**

**6/11 DMX channel - 16.7 milioni di combinazioni colori /  
6/11 DMX channels - 16.7 million color combinations**

**Cambio colore colore stroboscopico, dimmerazione colore  
cambio colore graduale, cambio colori a step /  
Color change, strobe color, color dimming,  
gradual color change, step color change**

**DMX512, master/slave, auto, sound active/ Wireless DMX,  
WiFi mobile phone APP control**

**Accessorio non incluso / Not included accessory**



**LED-SHOW-CASE**  
8031414915415

Valigia per 10 pezzi /  
Case for 10 pcs

**Accessori inclusi / Included accessories**



Accessori Wi-Fi /  
Wi-Fi accessories



**9600 mAh**  
Batteria ricaricabile, non sostituibile /  
Rechargeable battery, non replaceable

**Control system easy installation**



**Smart  
WIFI**



**ALEXA e  
GOOGLE HOME  
voice control**

# SHOW TUBE

Faro LED a batteria ricaricabile con 9 LED RGBW+UV e ricevitore DMX 512 integrato, emette una vasta gamma di colori mescolando i sei principali: rosso, verde, blu, bianco, ambra e ultravioletto, permettendo la creazione di qualsiasi colore desiderato, dalle tonalità calde a quelle fredde.

Rechargeable battery-powered LED spotlight with 9 RGBW+UV LEDs and built-in DMX 512 receiver, emits a wide range of colors by mixing the six main ones: red, green, blue, white, amber and ultraviolet, allowing the creation of any desired color from warm to cool tones.

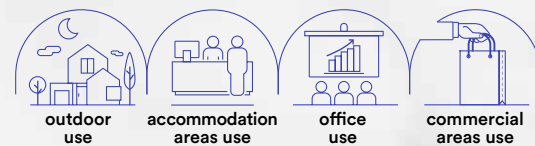





**Materiale**  
alluminio

**Temperatura colore**  
RGBW + UV



**Driver**  
integrato

**Durata e on/off**  
50.000h  
>25.000 on/off

**Material**  
aluminum

**Colour temperature**  
RGBW + UV



**Driver**  
built-in

**Life time and on/off**  
50.000h  
>25.000 on/off



**LED-SHOW-TUBE**  
8031414915422  
lumen

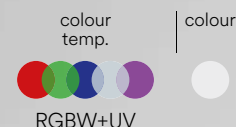

watt 8 x 28W  
beam angle 360°

Tempo di ricarica /  
Charging time

Durata accensione /  
Ignition duration

Modalità auto /  
Auto mode

Modalità canali /  
Channel mode

Modalità automatiche  
tramite tasto /  
Automatic modes  
via push-button

Control mode

**Ricarica completa in 5 ore /  
Full recharge in 5 hours**

**RGBW+UV con la luminosità al massimo 3 ore /  
RGBW+UV with maximum brightness 3 hours**

**7 ore monocromatico più di 20 ore /  
7 hours monochrome more than 20 hours**

**6/11 DMX channel - 16.7 milioni di combinazioni colori /  
6/11 DMX channels - 16.7 million color combinations**

**Cambio colore colore stroboscopico, dimmerazione colore  
cambio colore graduale, cambio colori a step /  
Color change, strobe color, color dimming,  
gradual color change, step color change**

**DMX512, master/slave, auto, sound active/ Wireless DMX,  
WiFi mobile phone APP control**



**Accessori inclusi / Included accessories**



Accessori Wi-Fi /  
Wi-Fi accessories



**10000 mAh**  
Batteria ricaricabile, non sostituibile /  
Rechargeable battery, non replaceable

**Control system easy installation**



**Smart  
WIFI**



**ALEXA e  
GOOGLE HOME  
voice control**

# RAYS





**Proiettore LED RGB FULL COLOR in alluminio.**  
LED RGB FULL COLOR lamp in aluminium.

**Materiale**  
alluminio

**Temperatura colore**  
RGB full color



**Driver**  
incluso

**Durata e on/off**  
50.000h  
>25.000 on/off

**Material**  
aluminum

**Colour temperature**  
RGB full color



**Driver**  
included

**Life time and on/off**  
50.000h  
>25.000 on/off

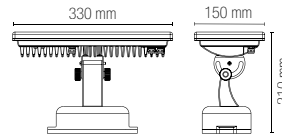

**LED-RAYS-36P**  
8031440355445

lumen

watt

beam angle

colour temp.

colour



RGB

30 × 1W

45°

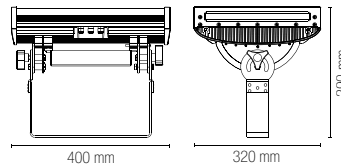
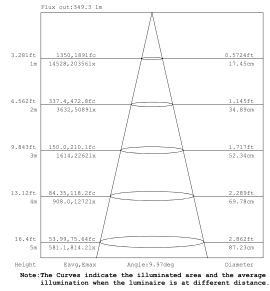
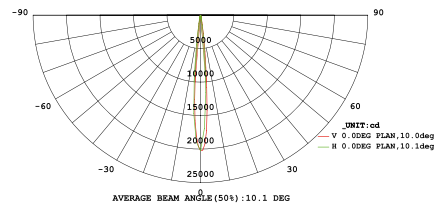

**LED-RAYS-72P**  
8031440358040

lumen

watt

beam angle

colour temp.

colour



RGB

72 × 2W

45°

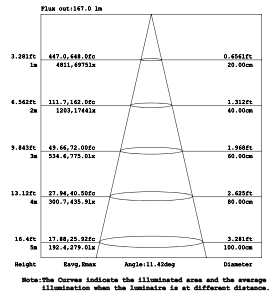
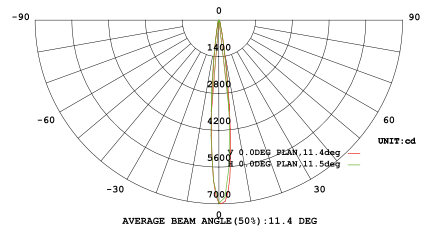

# WALLWASHER

Proiettore LED RGB FULL COLOR in alluminio.  
LED RGB FULL COLOR lamp in aluminium.

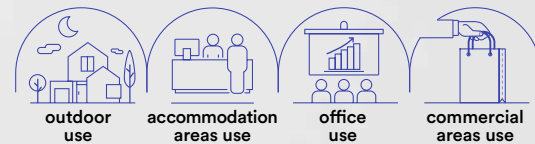

**Materiale**  
alluminio

**Temperatura colore**  
RGB full color



**Driver**  
integrato

**Durata e on/off**  
50.000h  
>25.000 on/off

**Material**  
aluminum

**Colour temperature**  
RGB full color



**Driver**  
built-in

**Life time and on/off**  
50.000h  
>25.000 on/off



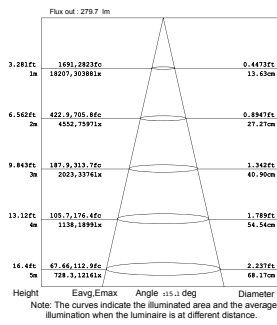
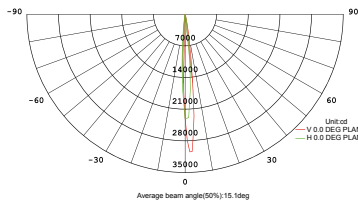

**LED-WALLWASHER-18**  
8031440359559  
lumen

colour temp. colour

watt  $18 \times 2W$   
beam angle  $45^\circ$

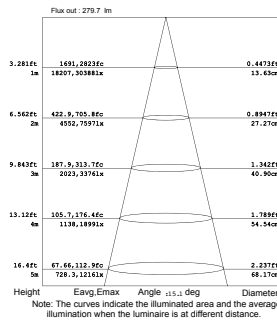
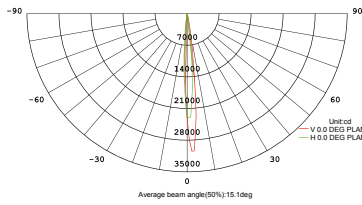
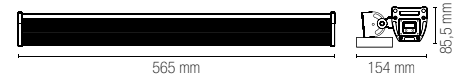

**LED-WALLWASHER-36**  
8031440359528  
lumen

colour temp. colour

watt  $36 \times 2W$   
beam angle  $45^\circ$



# IRIDE

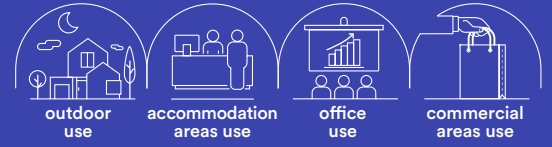



**Proiettore LED monocolor  
o RGB FULL COLOR in alluminio.**  
LED single colour or RGB FULL  
COLOR lamp in aluminium.

**Materiale**  
alluminio

**Temperatura colore**  
RGB full color + 6000K



**Driver**  
DC 12/24V  
non incluso

**Durata e on/off**  
50.000h  
>25.000 on/off

**Material**  
aluminum

**Colour temperature**  
RGB full color + 6000K



**Driver**  
DC 12/24V  
not included

**Life time and on/off**  
50.000h  
>25.000 on/off



**LED-IRIDE-3P**  
8031440358101  
lumen

colour temp. | colour  
RGB

watt | 3 x 1W  
driver | DC12/24V  
beam angle | 45°

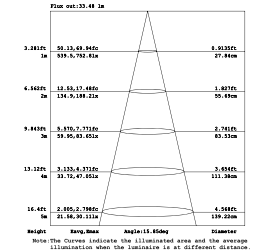
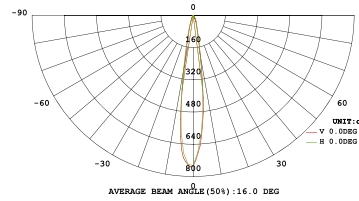
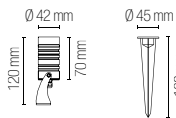

**LED-IRIDE-9P**  
8031440358118  
lumen

colour temp. | colour  
RGB

watt | 9 x 1W  
driver | DC12/24V  
beam angle | 40°

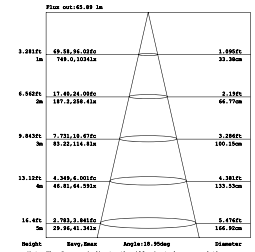
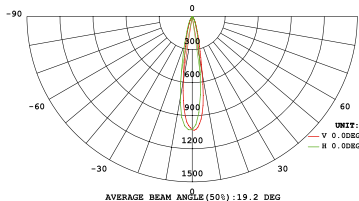
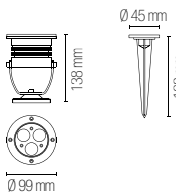

**LED-IRIDE-18P**  
8031440358088  
lumen

colour temp. | colour  
RGB

watt | 18 x 1W  
driver | DC24V  
beam angle | 40°

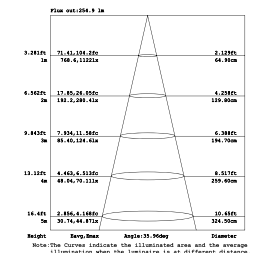
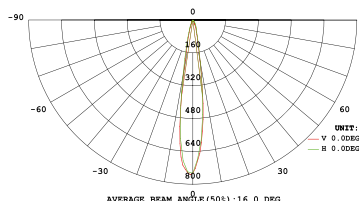
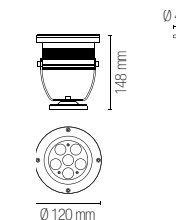

# IRIDE



outdoor  
use



accommodation  
areas use



office  
use



commercial  
areas use







technical information

**IRIDE**



**Incassi calpestabili LED RGB FULL COLOR**  
**corpo in lega di alluminio, ghiera in acciaio 316.**  
 Walkable built-in LED RGB FULL COLOR light 316  
 stainless steel cover and aluminium alloy housing.

**Materiale**  
 alluminio pressofuso

**Temperatura colore**  
 RGB full color



**Driver**  
 DC 12/24V  
 non incluso

**Durata e on/off**  
 50.000h  
 >25.000 on/off

**Material**  
 die cast aluminum

**Colour temperature**  
 RGB full color



**Driver**  
 DC 12/24V  
 not included

**Life time and on/off**  
 50.000h  
 >25.000 on/off



**LED-IRIDE-R6**  
 8031414868971  
 lumen

colour temp. | colour  
 RGB

recessed box

watt | driver | beam angle  
 3 x 1W | DC12/24V | 15°

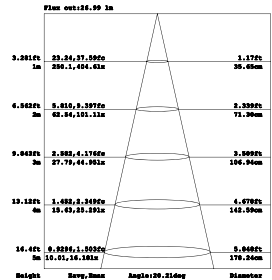
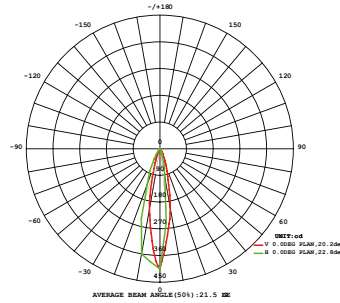
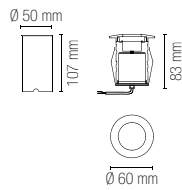
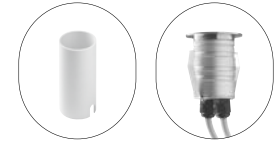

**LED-IRIDE-R12**  
 8031414868988  
 lumen

colour temp. | colour  
 RGB

recessed box

watt | driver | beam angle  
 9 x 1W | DC12/24V | 15°

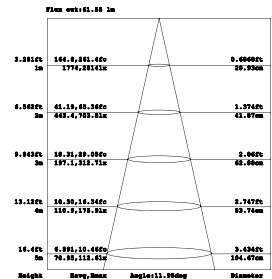
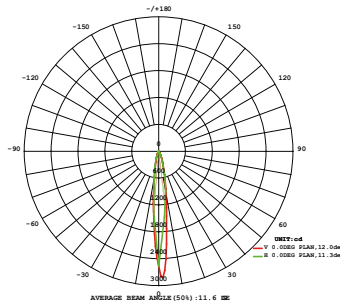
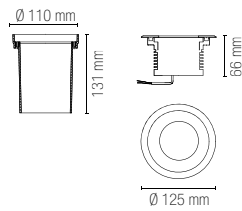

**LED-IRIDE-R14**  
 8031414868995  
 lumen

colour temp. | colour  
 RGB

recessed box

watt | driver | beam angle  
 18 x 1W | DC12/24V | 15°

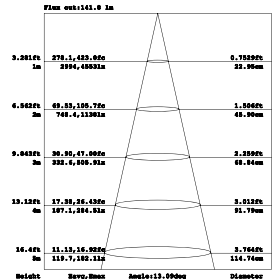
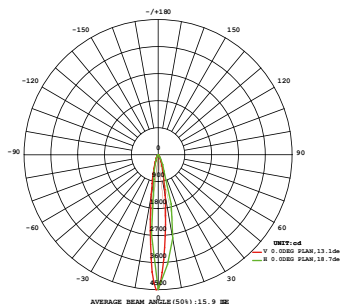
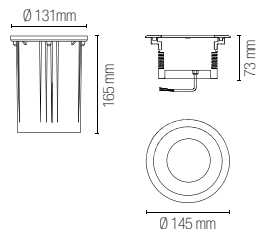

LUCI DECORATIVE TECNICHE DMX / DMX TECHNICAL DECORATION LIGHTING

In.tec light

# NEPTUNE

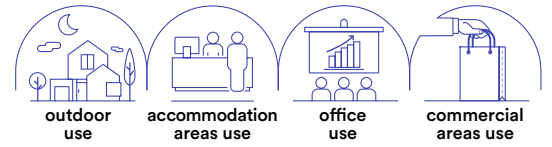

**Materiale**  
acciaio inox 316

**Colore**  
silver  
nero



**Temperatura colore**  
RGB full color



**Driver**  
DC24V  
non incluso

**Durata e on/off**  
50.000h  
>25.000 on/off

**Material**  
316 stainless steel

**Colour**  
black  
silver



**Colour temperature**  
RGB full color



**Driver**  
DC24V  
not included

**Life time and on/off**  
50.000h  
>25.000 on/off

**Proiettori per fontane LED RGB FULL COLOR.**  
LED RGB FULL COLOR fountain flood lamp.



**LED-NEPTUNE-3P**  
8031414869008  
lumen

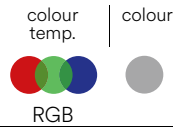

watt  $3 \times 3W$   
beam angle  $25^\circ$

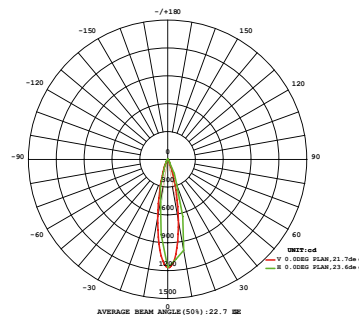
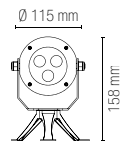

Height	Beam, Min	Beam, Max	Angle, 1/2	Beam, Max
0.381m	73.48	108.25	1.287rad	30.35cm
0.762m	14.87	21.65	2.834rad	76.64mm
1.143m	8.164	12.00	3.779rad	114.96mm
1.524m	4.886	7.040	5.039rad	152.81mm
1.905m	3.000	4.333	6.288rad	191.05mm

**LED-NEPTUNE-36P**  
8031440358057  
lumen

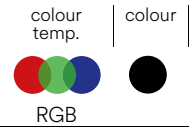

watt  $36 \times 1W$   
beam angle  $45^\circ$

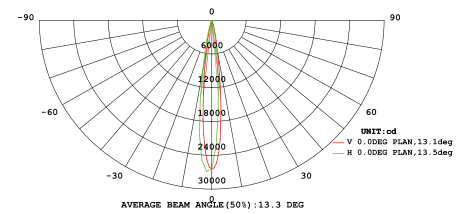
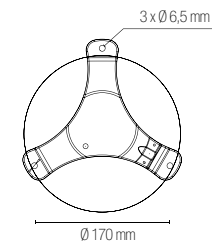
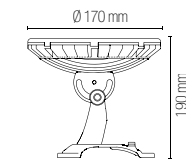

Height	Beam, Min	Beam, Max	Angle, 1/2	Beam, Max
0.381m	1600	2488	2.7433rad	83.28cm
0.762m	822	1252	1.5285rad	46.57cm
1.143m	487	736	2.2021rad	69.81cm
1.524m	300	452	3.0545rad	93.15cm
1.905m	187	276	3.828rad	116.50cm

# CROWN

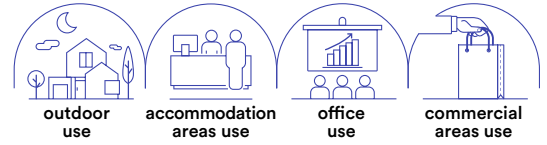

**Materiale**  
acciaio inox 316

**Temperatura colore**  
RGB full color



**Driver**  
DC24V  
non incluso

**Durata e on/off**  
50.000h  
>25.000 on/off

**Material**  
316 stainless steel

**Colour temperature**  
RGB full color



**Driver**  
DC24V  
not included

**Life time and on/off**  
50.000h  
>25.000 on/off

**Incasso per fontane LED RGB FULL COLOR.**  
LED RGB FULL COLOR fountain recess lamp.



**LED-CROWN-R14**  
8031414869015  
lumen

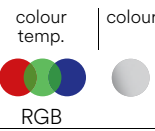

watt 9 x 2W  
beam angle 25°

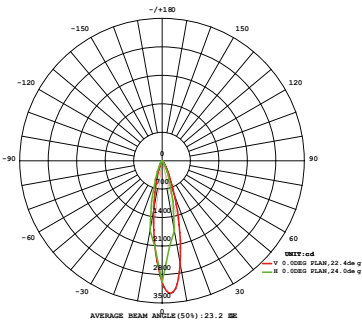
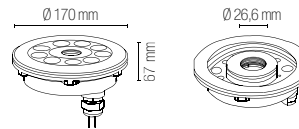

Flux out: 250.4 lm

Height	Beam Max	Beam at 25.00deg	Mounting
2.000m	1.89.3.299.16m	1.902m	30.79cm
4.000m	45.87.75.825m	2.882m	79.19cm
6.000m	33.89.33.385m	3.907m	119.05cm
8.000m	11.95.18.786m	5.915m	158.79cm
10.000m	7.258.12.895m	8.918m	198.49cm



# TREVIS





technical information

**TREVIS**



**Incasso immersione LED RGB FULL COLOR.**  
Immersion recessed light LED RGB FULL COLOR.

**Materiale**  
acciaio inox 316

**Temperatura colore**  
RGB full color



**Driver**  
DC 24V  
non incluso

**Durata e on/off**  
50.000h  
>25.000 on/off

**Material**  
316 stainless steel

**Colour temperature**  
RGB full color



**Driver**  
DC 24V  
not included

**Life time and on/off**  
50.000h  
>25.000 on/off



**LED-TREVIS-R7**  
8031414869022  
lumen

colour temp.	colour	recessed box
RGB	RGB	

watt 3W  
beam angle 25°

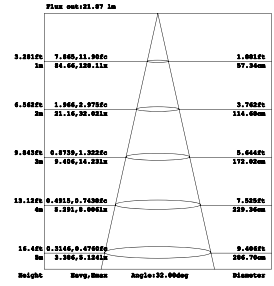
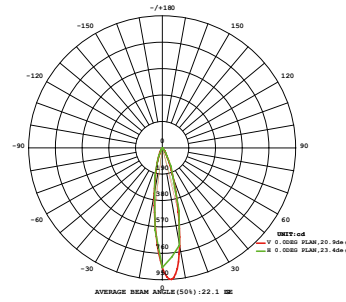
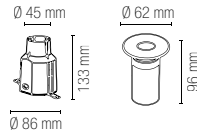
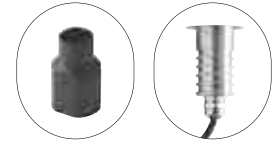

**LED-TREVIS-R11**  
8031414869039  
lumen

colour temp.	colour	recessed box
RGB	RGB	

watt 9W  
beam angle 25°

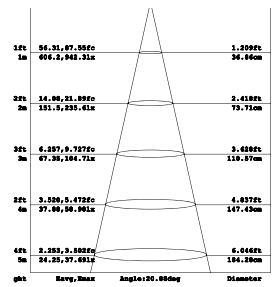
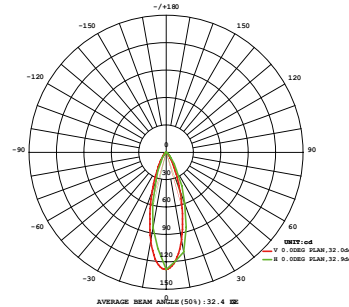
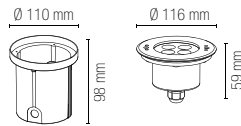

LUCI DECORATIVE TECNICHE DMX / DMX TECHNICAL DECORATION LIGHTING

In.tec light

# PAR56

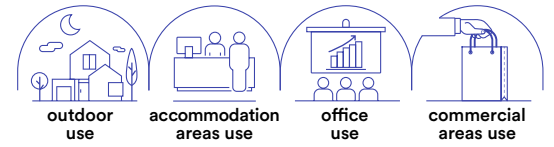

**Materiale**  
policarbonato

**Temperatura colore**  
RGB full color + 6500K



**Driver**  
AC 12V non incluso  
DC 24V non incluso

**Durata e on/off**  
50.000h  
>25.000 on/off

**Material**  
PC

**Colour temperature**  
RGB full color + 6500K



**Driver**  
AC 12V not included  
DC 24V not included

**Life time and on/off**  
50.000h  
>25.000 on/off

**Incasso LED a immersione per piscine.**  
Pool immersion LED down light.

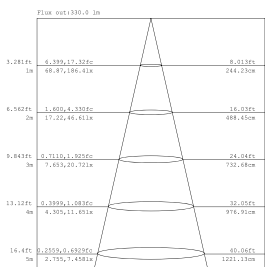
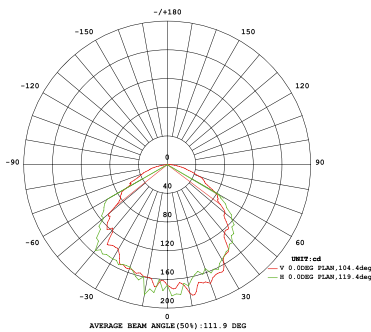

	colour temp.	colour
<b>LED-PAR56-24V-RGB</b> 8031414879755	RGB	
lumen		
watt		21W
driver		DC24V
beam angle		45°
1 m cable included		

	colour temp.	colour
<b>LED-PAR56-BCO</b> 8031440359504		
lumen	1050 lm	
watt		21W
driver		12V AC
beam angle		45°

<b>INC-POOL-PAR56</b> 8031440359511
Struttura incasso per PAR 56 per piscine in cemento / Recessed structure for PAR56 for concrete swimming pool
1 m cable included
Ø 260 mm

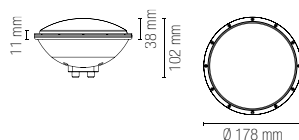
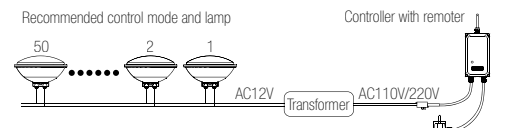

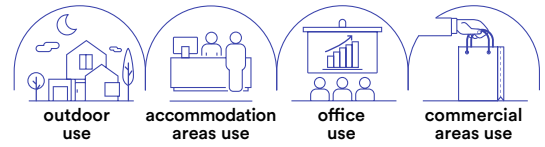

**Materiale**  
policarbonato

**Temperatura colore**  
RGB full color + 6500K



**Driver**

AC 12V non incluso  
DC 24V non incluso

**Durata e on/off**

50.000h  
>25.000 on/off

**Material**

PC

**Colour temperature**  
RGB full color + 6500K



**Driver**

AC 12V not included  
DC 24V not included

**Life time and on/off**

50.000h  
>25.000 on/off

**Lampada LED per piscine  
con fissaggio a parete.**  
Pool LED wall lamp.



	colour temp.	colour
<b>LED-PELPS24V-RGB</b>		
8031414868872	RGB	
lumen		
watt		18W
driver		DC24V
beam angle		45°
1 m cable included		

	colour temp.	colour
<b>LED-PELPS-BCO</b>		
8031414865420	1122 lm	
lumen		
watt		18W
driver		AC12V
beam angle		45°

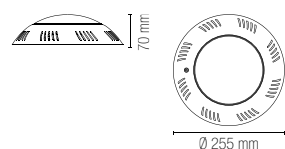

# CONTROLLER



## CONTROLLER-POOL

8031440359481

Controller 240V  
AC MAX 5A/1100W  
IP65 distanza max 30M

Controller 240V  
AC max 5A/1100W  
IP65 max distance 30M

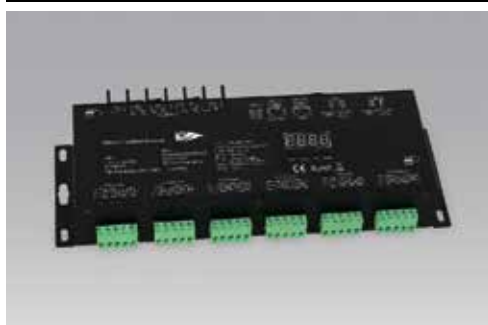
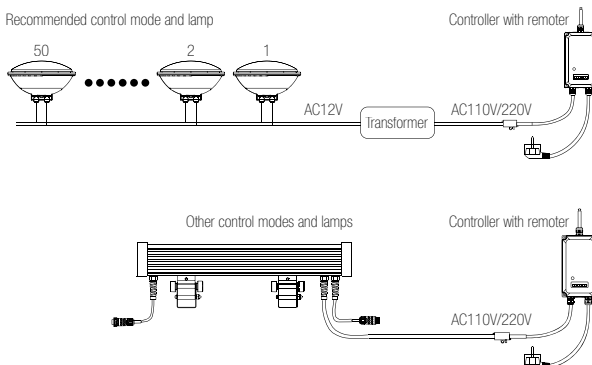
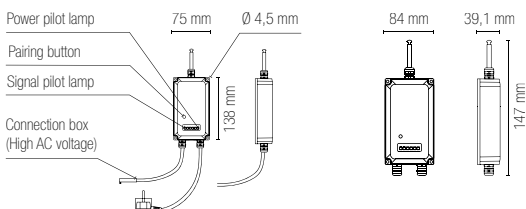

## CONTROLLER-DMX-24

8031414872718

Controller DMX 24 canali  
Tensione costante 4A  
Input VOLTAGE 12/24V DC  
Output POWER 24X(48-96)W  
Output CURRENT 24X4A

Controller DMX 24 channels  
Constant voltage 4A  
Input VOLTAGE 12/24V DC  
Output POWER 24X(48-96)W  
Output CURRENT 24X4A

264,5 × 83 × 42 mm



## SPLITTER-DMX-4

8031440359542

SPLITTER DMX  
6W XLR-3X4PCS XLR-5X4PCS

DMX SPLITTER  
6W XLR-3X4PCS XLR-5X4PCS





# CONTROLLER



## CONTROLLER-CTR-RGB

8031440358026

Centralina di comando  
C/PORTA DMX512 LED RGB  
Input 230V AC  
Output DC (12V 144W - 24V 300W)  
6 porte da 3 canali RGB

Control box with DMX512  
Port for LED RGB  
Input 230V AC  
Output DC (12V 144W - 24V 300W)  
6 ports 3 RGB channels

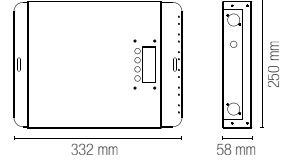

## CONTROLLER-CTR-RGB12

8031440355438

Centralina di comando  
C/PORTA DMX512 LED RGB  
Input 230V AC  
Output DC (12V 300W)  
6 porte da 3 canali RGB

Control box with DMX512  
Port for LED RGB  
Input 230V AC  
Output DC 12V 300W  
6 ports 3 RGB channels

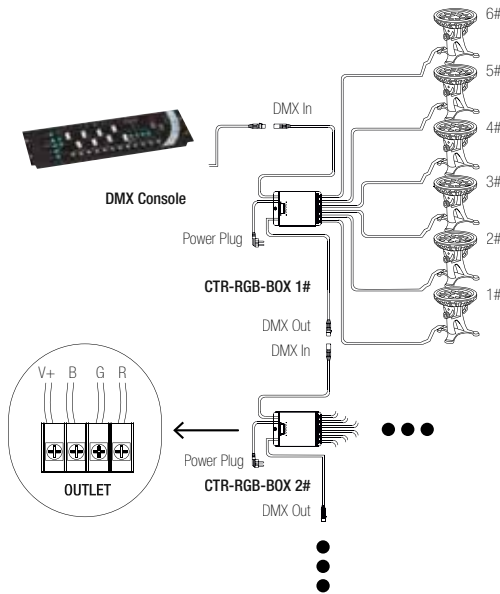

## CONTROLLER-PRO-3

8031440358033

Controller Master 3 canali  
per uso proiettori  
in modalità EASY  
IN 230V OUT DMX/XLR-3  
2 canali IP20

Controller Master 3 channels  
for flood in EASY MODE  
IN 230V OUT DMX/XLR-3  
2 channels IP20

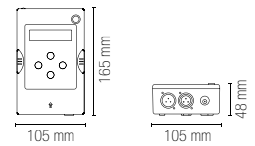

## CONTROLLER-PRO-2

8031440358002

Controller DMX LED  
3 canali RGB SEGNALE OUTPUT  
DMX/XLR-3 (due uscite)  
IP20 con cavo di ricarica

Controller DMX LED  
3 channels RGB OUTPUT SIGNAL  
DMX/XLR-3 (two port)  
IP20 with charge cable

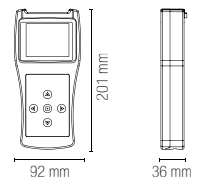
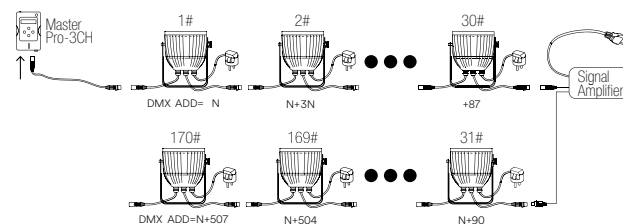

# CONTROLLER



**LED-SUNLITE-DE3**  
8031440359498  
SUNLITE 2X512 DMX ESA PRO/SUITE 2

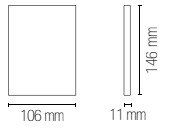

# CONTROLLER

## LED-SUNLITE-U9 8031440359467

SUNLITE Controller  
256 canali Input  
(218 steps max)

SUNLITE Controller  
256 channels Input  
(218 steps max)

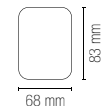

## LED-SUNLITE-GU2 8031422251093

SUNLITE DMX STICK-GU2  
128 canali Input 240V



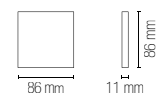













SUNLITE DMX STICK-GU2  
128 channels Input 240V

















COMPONENTISTICA  
LIGHTING COMPONENTS

## Accessori / Accessories

	<b>TRASFORMATORE-120</b> 8031440355094 Trasformatore di tensione 120W Input 240V AC Output 12V AC IP44 10A	 <b>IP44</b>	180 × 134 × 63 mm
	<b>LED-IRIDE-CAVO-2M-2P</b> 8031440355452 Cavo 2 poli per faretto IRIDE bianco alluminio	 <b>IP65</b>	2 metri / 2 meters
	<b>LED-IRIDE-CAVO-2M</b> 8031440358095 Cavo RGB 4 poli per faretto IRIDE RGB bianco alluminio	 <b>IP65</b>	2 metri / 2 meters
	<b>CONNETTORE-M</b> 8031440355469 Connettore maschio per DMX	 <b>IP68</b>	Male connector for DMX
	<b>CONNETTORE-F</b> 8031440355476 Connettore femmina per DMX	 <b>IP68</b>	Female connector for DMX
	<b>CONNECTBOX-IP68-3</b> 8031440358903 Scatola connessione a tre poli	 <b>IP68</b>	Connection box with three poles 35 × 115 × 71 mm
	<b>CONNECTBOX-IP68-2</b> 8031440358927 Scatola connessione a due poli	 <b>IP68</b>	Connection box with two poles 30 × 115 × 41 mm
	<b>GUAINA</b> 8031440355483 Guaina isolante	 <b>IP65</b>	Insulating sheath
	<b>CONNETTORE-IP20</b> 8031414897681 Connettore IP20 2L+2N		IP20 2L+2N Connector
	<b>CONNETTORE-IP65</b> 8031414897698 Connettore IP65	 <b>IP65</b>	IP65 Connector
	<b>CONNETTORE-IP68</b> 8031414897704 Connettore IP68	 <b>IP68</b>	IP68 Connector

# DRIVER

## Driver MINI and LT

	<b>I-DRIVER/4W</b> 8031414862801 MINI Driver corrente costante Output 2-12V 350mA 4W Input 100 ~ 240V	 MINI constant current driver Output 2-12V 350mA 4W Input 100 ~ 240V	38 × 27 × 21 mm
	<b>I-DRIVER/4W-24V</b> 8031414871797 MINI Driver corrente costante Output 24V DC 0.17A 4W Input 100 ~ 240V AC 50 ~ 60H	 MINI constant voltage driver Output 24V DC 0.17A 4W Input 100 ~ 240V AC 50 ~ 60H	38 × 27 × 21 mm
	<b>I-DRIVER-LT-75-24</b> 8031414876822 LT Driver tensione costante Output 24VDC 3.12A 75W Input 220 ~ 240V AC	LT constant voltage driver Output 24VDC 3.12A 75W Input 220 ~ 240V AC	305 × 30 × 17 mm
	<b>I-DRIVER-LT-150-24</b> 8031414876846 LT Driver tensione costante Output 24V DC 6.25A 150W Input 220 ~ 240V AC	LT constant voltage driver Output 24V DC 6.25A 150W Input 220 ~ 240V AC	336 × 30 × 17 mm
	<b>I-DRIVER-LT-30-24</b> 8031414896196 LT Driver tensione costante Output 24VDC 1.25A 30W Input 220 ~ 240V AC	LT constant voltage driver Output 24VDC 1.25A 30W Input 220 ~ 240V AC	251 × 30 × 16 mm
	<b>I-DRIVER-LT-60-24</b> 8031414896202 LT Driver tensione costante Output 24VDC 2.5A 60W Input 220 ~ 240V AC	LT constant voltage driver Output 24VDC 2.5A 60W Input 220 ~ 240V AC	305 × 30 × 18,2 mm
	<b>I-DRIVER-LT-100-24</b> 8031414896226 LT Driver tensione costante Output 24VDC 4.17A 100W Input 220 ~ 240V AC	LT constant voltage driver Output 24VDC 4.17A 100W Input 220 ~ 240V AC	312 × 30 × 18,2 mm
	<b>I-DRIVER-LT-200-24</b> 8031414896240 LT Driver tensione costante Output 24VDC 8.34A 200W Input 220 ~ 240V AC	LT constant voltage driver Output 24VDC 8.34A 200W Input 220 ~ 240V AC	335 × 30 × 21,6 mm
	<b>I-DRIVER-LT-60-48</b> 8031414896219 LT Driver tensione costante Output 48VDC 1.25A 60W Input 220 ~ 240V AC	LT constant voltage driver Output 48VDC 1.25A 60W Input 220 ~ 240V AC	305 × 30 × 18,2 mm
	<b>I-DRIVER-LT-150-48</b> 8031414896233 LT Driver tensione costante Output 48VDC 3.125A 150W Input 220 ~ 240V AC	LT constant voltage driver Output 48VDC 3.125A 150W Input 220 ~ 240V AC	335 × 30 × 21,6 mm

# ALIMENTATORI POWER SUPPLY

Alimentatori tensione costante LRS e RSP 12V /  
Costant voltage power supply LRS and RSP 12V



## STRIP-DRIVER12V-35W

8031440360265

Output 12V 3A 36W  
Input 85 ~ 264VAC 120 ~ 373VDC

99 × 82 × 30 mm



## STRIP-DRIVER12V-50W

8031414866779

Output 12V 4.2A 50W  
Input 85 ~ 264VAC 120 ~ 373VDC

99 × 82 × 30 mm



## STRIP-DRIVER12V-75W

8031439581268

Output 12V 6A 72W  
Input 85 ~ 264VAC 120 ~ 373VDC

99 × 97 × 30 mm



## STRIP-DRIVER12V-100W

8031440359368

Output 12V 8.5A 102W  
Input 85 ~ 264VAC 120 ~ 373VDC

129 × 97 × 30 mm



## STRIP-DRIVER12V-150W

8031439611262

Output 12V 12.5A 150W  
Input 85 ~ 132VAC / 170 ~ 264VAC  
by switch  
240 ~ 370VDC (switch on 230VAC)

159 × 97 × 30 mm



## STRIP-DRIVER12V-200W

8031440359375

Output 12V 16.7A 200W  
Input 85 ~ 264VAC 124 ~ 370VDC

215 × 115 × 30 mm



## STRIP-DRIVER12V-320W

8031440359344

Output 12V 26.7A 320W  
Input 88 ~ 264VAC 124 ~ 370VDC

215 × 115 × 30 mm



# ALIMENTATORI POWER SUPPLY

Alimentatori tensione costante LRS e RSP 24V /  
Costant voltage power supply LRS and RSP 24V



## STRIP-DRIVER24V-35W

8031414870943

Output 24V 1,5A 36W  
Input 85 ~ 264VAC 120 ~ 373VDC

99 × 82 × 30 mm



## STRIP-DRIVER24V-50W

8031440364744

Output 24V 2,2A 52W  
Input 85 ~ 264VAC 120 ~ 373VDC

99 × 82 × 30 mm



## STRIP-DRIVER24V-75W

8031414870950

Output 24V 3,2A 76W  
Input 85 ~ 264VAC 120 ~ 373VDC

99 × 97 × 30 mm



## STRIP-DRIVER24V-100W

8031440364751

Output 24V 4,5A 108W  
Input 85 ~ 264VAC 120 ~ 373VDC

129 × 97 × 30 mm



## STRIP-DRIVER24V-150W

8031414870967

Output 24V 6,5A 156W  
Input 85 ~ 132VAC / 170 ~ 264VAC  
by switch  
240 ~ 370VDC (switch on 230VAC)

159 × 97 × 30 mm



## STRIP-DRIVER24V-200W

8031440364737

Output 24V 8,4A 201W  
Input 85 ~ 264VAC 124 ~ 370VDC

215 × 115 × 30 mm



## STRIP-DRIVER24V-320W

8031414864959

Output 24V 13,4A 321W  
Input 88 ~ 264VAC 124 ~ 370VDC

215 × 115 × 30 mm

# ALIMENTATORI POWER SUPPLY



## I-DRIVER-UHP-200-24

8031414896387

Output 24V 8.4A 200W  
Input 90 ~ 264VAC 127 ~ 370VDC

194 × 55 × 26 mm

Alimentatori  
tensione costante  
UHP 24V /  
Costant voltage  
power supply  
UHP 24V



## I-DRIVER-UHP-350-24

8031414879618

Output 24V 14.6A 350W  
Input 90 ~ 264VAC 127 ~ 370VDC

220 × 62 × 31 mm

senza ventola / without fan



## I-DRIVER-UHP-500-24

8031414879625

Output 24V 20.9A 501W  
Input 90 ~ 264VAC 127 ~ 370VDC

220 × 62 × 31 mm

senza ventola / without fan

Alimentatori  
tensione costante  
RSP 36V /  
Costant voltage  
power supply  
RSP 36V



## STRIP-DRIVER36V-200W

8031414870974

Output 36V 5.56A 200W  
Input 88 ~ 264VAC 124 ~ 370VDC

215 × 115 × 30 mm



## STRIP-DRIVER36V-320W

8031414864829

Output 36V 8.9A 320W  
Input 88 ~ 264VAC 124 ~ 370VDC

215 × 115 × 30 mm

Alimentatori  
tensione costante  
RSP 48V /  
Costant voltage  
power supply  
RSP 48V



## STRIP-DRIVER48V-75W

8031414881536

Output 48V 1.6A 76,8W  
Input 88 ~ 264VAC 124 ~ 370VDC

99 × 97 × 30 mm



## STRIP-DRIVER48V-150W

8031414881529

Output 48V 3.3A 158,4W  
Input 85 ~ 132VAC 240 ~ 370VDC

159 × 97 × 30 mm



## STRIP-DRIVER48V-200W

8031414878307

Output 48V 4.2A 201W  
Input 88 ~ 264VAC 124 ~ 370VDC

215 × 115 × 30 mm



## STRIP-DRIVER48V-320W

8031414878314

Output 48V 4.2A 201W  
Input 88 ~ 264VAC 124 ~ 370VDC

215 × 115 × 30 mm

# DRIVER

Driver LPHC  
LPH and LCM



**I-DRIVER/18W-24V**  
8031414875351



LPH  
Output 24V 0.75A 18W  
Input 180 ~ 264VAC 254 ~ 370VDC

140 × 30 × 22 mm



**I-DRIVER/18W**  
8031439571269



LPHC  
Output 6~48V 350mA 16,8W  
Input 180 ~ 264VAC

140 × 30 × 22 mm



**I-DRIVER-DIMM-LCM25**  
8031414924653

LCM dimmable 42W  
Output DC 0~54V 350mA; 6~50V  
500mA; 6~42V 600mA; 6~36V  
700mA; 6~28V 900mA; 6~24V  
1050mA  
Input 180 ~ 277VAC 254~392VDC

105 × 68 × 23 mm



**I-DRIVER-DIMM-LCM40**  
8031439591267



LCM dimmable 42W  
Output DC 2~100V 350mA; 2~80V  
500mA; 2~67V 600mA; 2~57V  
700mA; 2~45V 900mA; 2~40V  
1050mA  
Input 180 ~ 295VAC 254~417VDC

123,5 × 81,5 × 23 mm



**I-DRIVER-DIMM-LCM60**  
8031439561260



LCM dimmable 60W  
Output DC 2~90V 500mA; 2~90V  
600mA; 2~86V 700mA; 2~67V  
900mA; 2~57V 1050mA; 2~42V  
1400mA  
Input 180 ~ 295VAC 254~417VDC

123,5 × 81,5 × 23 mm



**I-DRIVER-DIMM-LCM25DA**  
8031414924660



LCM dimmable 42W  
Output DC 0~54V 350mA; 6~50V  
500mA; 6~42V 600mA; 6~36V  
700mA; 6~28V 900mA; 6~24V  
1050mA  
Input 180 ~ 277VAC 254~380VDC(254~375VDC for DA2-Type)

105 × 68 × 23 mm



**I-DRIVER-DIMM-LCM40DA**  
8031414924677



LCM dimmable 42W  
Output DC 2~100V 350mA; 2~80V  
500mA; 2~67V 600mA; 2~57V  
700mA; 2~45V 900mA; 2~40V  
1050mA  
Input 180 ~ 295VAC 254 ~ 392VDC

123,5 × 81,5 × 23 mm



**I-DRIVER-DIMM-LCM60DA**  
8031414924684



LCM dimmable 60W  
Output DC 2~90V 500mA; 2~90V  
600mA; 2~86V 700mA; 2~67V  
900mA; 2~57V 1050mA; 2~42V  
1400mA  
Input 180 ~ 295VAC 254 ~ 392VDC

123,5 × 81,5 × 23 mm

Driver HLG  
IP67 12-24V



**I-DRIVER-HLG-320-12**  
8031440360258



Output 12V 22A 264W  
Input 90 ~ 305VAC 127 ~ 431VDC

252 × 90 × 43,8 mm

# DRIVER

## Driver ELG 24V IP67 dimmerabili e LPV 24V IP67 / Dimmable driver ELG 24V IP67 and LPV 24V IP67

	<b>I-DRIVER-ELG-100-24</b>	
	8031414876914 ELG Dimmable Output 24V 4A 100W Input 100 ~ 305VAC 142 ~ 431VDC continue 320VAC for 24Hrs; 360VAC for 1Hr	199 × 63 × 35,5 mm
	<b>I-DRIVER-ELG-100-24DA</b>	
	8031414876921 ELG Dimmable DALI Output 24V 4A 100W Input 100 ~ 305VAC 142 ~ 431VDC continue 320VAC for 24Hrs; 360VAC for 1Hr	
	<b>I-DRIVER-ELG-150-24</b>	
	8031414876891 ELG Dimmable Output 24V 6.25A 150W Input 100 ~ 305VAC 142 ~ 431VDC	219 × 63 × 35,5 mm
	<b>I-DRIVER-ELG-150-24DA</b>	
	8031414876907 ELG Dimmable DALI Output 24V 6.25A 150W Input 100 ~ 305VAC 142 ~ 431VDC	
	<b>I-DRIVER-ELG-240-24</b>	
	8031414876877 ELG Dimmable Output 24V 10A 240W Input 100 ~ 305VAC 142 ~ 431VDC	244 × 71 × 37,5 mm
	<b>I-DRIVER-ELG-240-24DA</b>	
	8031414876884 ELG Dimmable DALI Output 24V 10A 240W Input 100 ~ 305VAC 142 ~ 431VDC	
	<b>I-DRIVER-LPV-60-24</b>	
	8031414876839 LPV Output 24V 2.5A 60W Input 90 ~ 264VAC 127 ~ 370VDC	162,5 × 42,5 × 32 mm
	<b>I-DRIVER-LPV-100-24</b>	
	8031414876853 LPV Output 24V 4.2A 100W Input 90 ~ 264VAC 127 ~ 370VDC	190 × 52 × 37 mm
	<b>I-DRIVER-LPV-150-24</b>	
	8031414876860 LPV Output 24V 6.3A 150W Input 180 ~ 305VAC 254 ~ 431VDC	191 × 63 × 37,5 mm













## DRIVER

### Driver XLG 24V IP67

 	<b>I-DRIVER-XLG-75-24</b> 8031414873708 Output 24V 3.1A 75W Input 100 ~ 305VAC 142 ~ 431VDC	 IP67	140 × 63 × 32 mm
 	<b>I-DRIVER-XLG-100-24</b> 8031414879595 Output 24V 4A 100W Input 100 ~ 305VAC 142 ~ 431VDC	 IP67	140 × 63 × 32 mm
 	<b>I-DRIVER-XLG-150-24</b> 8031414879601 Output 24V 6.25A 150W Input 100 ~ 305VAC 142 ~ 431VDC	 IP67	180 × 63 × 35,5 mm
 	<b>I-DRIVER-XLG-200-24</b> 8031414879588 Output 24V 8.3A 200W Input 100 ~ 305VAC 142 ~ 431VDC	 IP67	199 × 63 × 35,5 mm

## DRIVER

### Driver PWM DALI2

 	<b>I-DRIVER-PWM-60-24DA</b> 8031414896356 Output 24V 2.5A 60W Input 90 ~ 305VAC 127 ~ 431VDC DALI2	  IP67	150 × 53 × 35 mm
 	<b>I-DRIVER-PWM-120-24DA</b> 8031414896363 Output 24V 5A 120W Input 90 ~ 305VAC 127 ~ 431VDC DALI2	  IP67	191 × 63 × 37,5 mm
 	<b>I-DRIVER-PWM-200-24DA</b> 8031414896370 Output 24V 8.3A 200W Input 100 ~ 305VAC 142 ~ 431VDC DALI2	  IP67	195 × 68 × 39,5 mm

## DRIVER

### Guida DIN a forma di gradino ultra sottile / Ultra Slim Step Shape DIN Rail



#### I-DRIVER-HDR-60-24

8031414896271

Output 24V 2.5A 60W  
Input 85 ~ 264VAC  
(277VAC operational) 120 ~ 370VDC  
(390VAC operational)

52,5 × 90 × 54,5 mm



#### I-DRIVER-HDR-100-24

8031414896288

Output 24V 3.83A 100W  
Input 85 ~ 264VAC  
(277VAC operational) 120 ~ 370VDC  
(390VAC operational)

70 × 90 × 54,5 mm



#### I-DRIVER-HDR-150-24

8031414896295

Output 24V 6.25A 150W  
Input 85 ~ 264VAC  
(277VAC operational) 120 ~ 370VDC  
(390VAC operational)

105 × 90 × 54,5 mm

## DRIVER

### Guida DIN industriale a uscita singola / Single Output Industrial DIN RAIL



#### I-DRIVER-NDR-240-24

8031414896301

Output 24V 10A 240W  
Input 90 ~ 264VAC 127 ~ 370VDC

63 × 125,2 × 113,5 mm



#### I-DRIVER-NDR-480-24

8031414896325

Output 24V 20A 480W  
Input 90 ~ 264VAC 127 ~ 370VDC

85,5 × 125,2 × 128,5 mm



#### I-DRIVER-NDR-240-48

8031414896318

Output 48V 5A 240W  
Input 90 ~ 264VAC 127 ~ 370VDC

63 × 125,2 × 113,5 mm



#### I-DRIVER-NDR-480-48

8031414896332

Output 48V 10A 480W  
Input 90 ~ 264VAC 127 ~ 370VDC

85,5 × 125,2 × 128,5 mm

## DRIVER

### Guida DIN industriale a uscita singola con funzione PFC / Single Output Industrial DIN RAIL with PFC Function





#### I-DRIVER-SDR-960-24

8031414896349

Output 24V 40A 960W  
Input 180 ~ 264VAC 254 ~ 370VDC

110 × 125,2 × 150 mm

## DIMMER

	<b>I-DIMMER-D1-10</b> 8031414877959 D1-10 dimmer Dimming range 1%-100% 1-10V 40mA	D1-10 dimmer Dimming range 1%-100% 1-10V 40mA	22,5 × 22,5 × 48,6 mm
	<b>I-DIMMER-D1-10S</b> 8031414896257 D1-10 dimmer Dimming range 1%-100% 1-10V 40mA	D1-10 dimmer Dimming range 1%-100% 1-10V 40mA	83,5 × 83,5 × 44 mm
	<b>I-DIMMER-D350S</b> 8031414896264 Dimmer a taglio di fase 220~240VAC 10~350W 1.5A	Trailing edge dimmer 220~240VAC 10~350W 1.5A	83,5 × 83,5 × 44 mm

## DRIVER

### Driver emergenza / Emergency driver

	<b>I-DRIVER-EMERGENCY</b> 8031414864751 Driver di emergenza 6-60V 400-40mA 4W 180Min Batteria 3,6V 3.0Ah Ni-Cd	Emergency driver 6-60V 400-40mA 4W 180Min Battery 3,6V 3.0Ah Ni-Cd	160 × 38 × 28 mm
	<b>I-DRIVER-HELP</b> 8031414862559 Driver di emergenza Output Voltage 10-120V Input Voltage 85-265V 3-40W. emergenza 120 min. 18650 Li-Ion Battery 3,7V 2.4Ah	Emergency driver Output Voltage 10-120V Input Voltage 85-265V 3-40W. emergency 120 min. 18650 Li-Ion Battery 3,7V 2.4Ah	131 × 55 × 21 mm
	<b>I-DRIVER-HELP-HV</b> 8031414882595 Emergency output voltage 230V AC, adatto per:  2,5W emergency power 3 hours emergency time  3,5W emergency power 2 hours emergency time  5W emergency power 1,5 hours emergency time  Battery 18650 LiFePO4 6.4V 1500mAh	Emergency output voltage 230V AC, suitable for:  2,5W emergency power 3 hours emergency time  3,5W emergency power 2 hours emergency time  5W emergency power 1,5 hours emergency time  Battery 18650 LiFePO4 6.4V 1500mAh	160 × 38 × 28 mm

# DRIVER

	<b>I-DRIVER-60-24</b> 8031414897797 Output 24V 2.5A 60W Input 176 ~ 264VAC 176~370VDC	178 × 53 × 23 mm
	<b>I-DRIVER-60-24-IP67</b> 8031414897841 Output 24V 2.5A 60W Input 176 ~ 264VAC	 160 × 50 × 31 mm
	<b>I-DRIVER-100-24</b> 8031414897803 Output 24V 4.1A 100W Input 176 ~ 264VAC 250 ~ 360VDC	188 × 53 × 23 mm
	<b>I-DRIVER-100-24-IP67</b> 8031414897858 Output 24V 4.2A 100W Input 176 ~ 264VAC	 220 × 50 × 31 mm
	<b>I-DRIVER-150-24</b> 8031414897810 Output 24V 6.3A 150W Input 175 ~ 264VAC 176 ~ 370VDC	220 × 53 × 23 mm
	<b>I-DRIVER-150-24-IP67</b> 8031414897865 Output 24V 6.25A 150W Input 176 ~ 264VAC	 230 × 65 × 21 mm
	<b>I-DRIVER-200-24</b> 8031414897827 Output 24V 8.3A 200W Input 175 ~ 264VAC 175 ~ 370VDC	274 × 53 × 23 mm
	<b>I-DRIVER-200-24-IP67</b> 8031414897872 Output 24V 8.3A 200W Input 175 ~ 264VAC	 230 × 65 × 31 mm
	<b>I-DRIVER-300-24</b> 8031414897834 Output 22-24V 11.5A 300W Input 175 ~ 264VAC 175 ~ 370VDC	230 × 65 × 31 mm
	<b>I-DRIVER-DELO42</b> 8031414897667 Output 6-38/40/42 VDC 0.45-1.10A 42W Input 220 ~ 240VAC DALI2 PUSH DIM	103 × 68,5 × 30,5 mm





## DIMMER







	<b>STRIP-SOUND</b> 8031434531213		
	Ricevitore musicale + telecomando RGB 12V per strip LED	Musical control receiver RGB 12V for strip LED + remote control	50 × 70 × 20 mm

## ADATTATORI POWER SUPPLY

Adattatore tensione costante /  
Costant voltage power supply

	<b>STRIP-ADAT-12W</b> 8031433141208		
	12V 12W - Spina CEE 7/16 IP20 Output 12V 1A Input 110-240V 0,5A IP20 - CLASSE 2		38 × 67 × 42 mm cavo/cable 1500 mm
	<b>STRIP-ADAT-24W</b> 8031433251204		
	12V 24W - Spina CEE 7/16 IP20 Output 12V 2A Input 110-240V 0,6A IP20 - CLASSE 2		38 × 80 × 50 mm cavo/cable 1500 mm
	<b>STRIP-ADAT-36W</b> 8031436601235		
	LED 12V 36W - Spina CEE 7/16 IP20 Output 12V 3A Input 110-240V 0,6A IP20 - CLASSE 2		35 × 100 × 50 mm cavo/cable 1500 mm







## REMOTE CONTROL

	<p><b>RF-WALLPAD-1CH</b> 8031414876426</p> <p>Wallpad RF 2.4G controllo dimmer-varialuce 4 zone 1 canale 2xAAA non include</p>	<p>RF 2.4G wallpad dimming light 4 zone 1 channel 2xAAA not included</p>	<p> 86 × 86 × 36,5 mm</p>
	<p><b>RF-WALLPAD-2CH</b> 8031414876433</p> <p>Wallpad RF 2.4G controllo CCT bianco dinamico 4 zone 2 canali 2xAAA non include</p>	<p>RF 2.4G wallpad CCT adjustable white 4 zone 2 channels 2xAAA not included</p>	<p> 86 × 86 × 36,5 mm</p>
	<p><b>RF-WALLPAD-5CH</b> 8031414876440</p> <p>Wallpad RF 2.4G controllo RGB/RGBW/RGB+CCT 4 zone 5 canali 2xAAA non include</p>	<p>RF 2.4G wallpad RGB/RGBW/RGB+CCT 4 zone 5 channels 2xAAA not included</p>	<p>  86 × 86 × 36,5 mm</p>
	<p><b>RF-DMXPAD-1CH</b> 8031414876457</p> <p>Wallpad RF 2.4G controllo dimmer-varialuce 4 zone 1 canale 230V collegabile con protocollo DMX 512</p>	<p>RF 2.4G wallpad dimming light 4 zone 1 channel 230V linkable with DMX512 protocol</p>	<p> 120 × 80 × 37 mm formato universale per cassetta 503 / universal size for 503 box</p>
	<p><b>RF-DMXPAD-2CH</b> 8031414876464</p> <p>Wallpad RF 2.4G controllo CCT bianco dinamico 4 zone 2 canali 230V collegabile con protocollo DMX 512</p>	<p>RF 2.4G wallpad CCT adjustable white 4 zone 2 channels 230V collegabile con protocollo DMX 512</p>	<p> 120 × 80 × 37 mm formato universale per cassetta 503 / universal size for 503 box</p>
	<p><b>RF-DMXPAD-5CH</b> 8031414876471</p> <p>Wallpad RF 2.4G controllo RGB/RGBW/RGB+CCT 4 zone 5 canali 230V collegabile con protocollo DMX 512</p>	<p>RF 2.4G wallpad RGB/RGBW/RGB+CCT 4 zone 5 channels 230V collegabile con protocollo DMX 512</p>	<p>  120 × 80 × 37 mm formato universale per cassetta 503 / universal size for 503 box</p>



# REMOTE CONTROL

	<p><b>RF-COM-1CH</b> 8031414876402</p> <p>Radiocomando RF 2.4G controllo dimmer-varialuce 4 zone 1 canale 2xAAA non include</p>	<p>RF 2.4G remote control dimming light 4 zone 1 channel 2xAAA not included</p> 
	<p><b>RF-COM-2CH</b> 8031414876396</p> <p>Radiocomando RF 2.4G controllo CCT bianco dinamico 4 zone 2 canali 2xAAA non include</p>	<p>RF 2.4G remote control CCT adjustable white 4 zone 2 channels 2xAAA not included</p> 
	<p><b>RF-COM-5CH</b> 8031414876419</p> <p>Radiocomando RF 2.4G controllo RGB/RGBW/RGB+CCT 4 zone 5 canali 2xAAA non include</p>	<p>RF 2.4G remote control CCT adjustable white 4 zone 2 channels 2xAAA not included</p>  
	<p><b>RF-COM-5CH-1ZN</b> 8031414897919</p> <p>Controllo RGB+CCT 1 zone Batteria CR2032</p>	<p>RGB+CCT Remote Control 1 zone Battery CR2032</p>
	<p><b>RF-COM-1CH-1ZN</b> 8031414897896</p> <p>Controllo luminosità 1 zone Batteria CR2032</p>	<p>Brightness Remote Control 1 zone Battery CR2032</p>
	<p><b>RF-COM-2CH-1ZN</b> 8031414897902</p> <p>Controllo CCT 1 zone Batteria CR2032</p>	<p>CCT Remote Control 1 zone Battery CR2032</p>
	<p><b>RF-COM-5CH-8ZN</b> 8031414897926</p> <p>Radiocomando RF 2.4G controllo RGB/RGBW/RGB+CCT 8 zone</p>	<p>8 scene 2xAAA non include RF Remote Controller 8 zones 8 scenes Battery: 2xAAA not included</p>

## REMOTE CONTROL

	<p><b>RF-RICEVITORE-1CH</b> 8031414897933</p> <p>Ricevitore RF 2.4G 1 canale per WALLPAD RADIOCOMANDO WALLPAD DMX utilizzabile per SINGOLO COLORE Input 8.5A 12-24V Output 1CH 8A - 40W/96W/192W/288W</p>	<p>RF 2.4G receiver box 2 channels for WALLPAD RADIOCOMANDO WALLPAD DMX usable for SINGLE COLOR Input 8.5A 12-24V Output 1CH 8A - 40W/96W/192W/288W</p>	<p>97 × 33 × 18 mm</p>
	<p><b>RF-RICEVITORE-2CH</b> 8031414876488</p> <p>Ricevitore RF 2.4G 2 canali per WALLPAD RADIOCOMANDO WALLPAD DMX utilizzabile per SINGOLO COLORE/CCT Input 10.5A 12-24V Output 2CH;5A/CH - 2x(60-120)W</p>	<p>RF 2.4G receiver box 2 channels for WALLPAD RADIOCOMANDO WALLPAD DMX usable for SINGLE COLOR/CCT Input 10.5A 12-24V Output 2CH;5A/CH - 2x(60-120)W</p>	<p>97 × 33 × 18 mm</p>
	<p><b>RF-RICEVITORE-5CH</b> 8031414876495</p> <p>Ricevitore RF 2.4G 5 canali per WALLPAD RADIOCOMANDO WALLPAD DMX utilizzabile per SINGOLO COLORE/RGB/RGBW/RGB+CCT Input 15.5A 12-24V Output 5CH;3A/CH - 5x(36-72)W</p>	<p>F 2.4G receiver box 5 channels for WALLPAD RADIOCOMANDO WALLPAD DMX usable for SINGLE COLOR/RGB/RGBW/RGB+CCT Input 15.5A 12-24V Output 5CH;3A/CH - 5x(36-72)W</p>	<p>114 × 38 × 20 mm</p>
	<p><b>RF-RICEVITORE-5CH-PRO</b> 8031414882724</p> <p>Ricevitore RF 2.4G 5 canali per WALLPAD RADIOCOMANDO WALLPAD DMX utilizzabile per SINGOLO COLORE/CCT/RGB/RGBW/RGB+CCT Input 30.5A 12-48V Output 5CH;6A/CH 12/24V 5 x (72-144)W 5CH;4A/CH 36/48V - 5x(144-192)W</p>	<p>RF 2.4G receiver box 5 channels for WALLPAD RADIOCOMANDO WALLPAD DMX usable for SINGLE COLOR/CCT/RGB/RGBW/RGB+CCT Input 30.5A 12-48V Output 5CH;6A/CH 12/24V 5x(72-144)W 5CH;4A/CH 36/48V - 5x(144-192)W</p>	<p>179 × 56 × 30 mm</p>
	<p><b>RF-RICEVITORE-4CH-IP67</b> 8031414882717</p> <p>Ricevitore RF 2.4G 4 canali per WALLPAD RADIOCOMANDO WALLPAD DMX utilizzabile per SINGOLO COLORE/RGB/RGBW Input 20.5A 12-36V Output 4CH;5A/CH - 4x(60-180)W</p>	<p>RF 2.4G receiver box 4 channels for WALLPAD RADIOCOMANDO WALLPAD DMX usable for SINGLE COLOR/RGB/RGBW Input 20.5A 12-36V Output 4CH;5A/CH - 4x(60-180)W</p>	<p> IP67 176 × 78 × 38 mm</p>

# REMOTE CONTROL

 <p><b>WI-FI</b> SMART INTEC</p>	<p><b>RF-WIFI-CONTROL-5CH</b> 8031414878710</p> <p>Ricevitore Wi-Fi + RF 2.4G 5 canali per WALLPAD RADIOCOMANDO WALLPAD DMX utilizzabile per SINGOLO COLORE/CCT/RGB/RGBW/RGB+CCT Input 15.5A 12-24V Output 5CH;3A/CH - 5x(36-72)W</p>	<p>Wi-Fi + RF 2.4G receiver box 5 channels for WALLPAD RADIOCOMANDO WALLPAD DMX usable for SINGLE COLOR /CCT/RGB/RGBW/RGB+CCT Input 15.5A 12-24V Output 5CH;3A/CH - 5x(36-72)W</p>	<p>114 × 38 × 20 mm</p> 
 <p><b>SMART INTEC</b> <b>BLUETOOTH</b> SIG MESH</p>	<p><b>RF-BT-CONTROL-5CH</b> 8031414878826</p> <p>Ricevitore Bluetooth + RF 2.4G 5 canali per WALLPAD RADIOCOMANDO WALLPAD DMX utilizzabile per SINGOLO COLORE/CCT/RGB/RGBW/RGB+CCT Input 15.5A 12-24V Output 5CH;3A/CH - 5x(36-72)W</p>	<p>Bluetooth + RF 2.4G receiver box 5 channels for WALLPAD RADIOCOMANDO WALLPAD DMX usable for SINGLE COLOR /CCT/RGB/RGBW/RGB+CCT Input 15.5A 12-24V Output 5CH;3A/CH - 5x(36-72)W</p>	<p>114 × 38 × 20 mm</p> 
	<p><b>RF-AMPLIFICATORE-5CH</b> 8031414882700</p> <p>Amplificatore 5 canali Input 25.5A 12-24VDC Output 5CH;5A/ CH 12/24V - 5x(60-120)W</p>	<p>5 Channel amplifier Input 25.5A 12-24VDC Output 5CH;5A/ CH 12/24V - 5x(60-120)W</p>	<p>107 × 75 × 24,5 mm</p>
	<p><b>RF-AMPLIFICATORE-2CH</b> 8031414882694</p> <p>Amplificatore 2 canali Input 16.5A 12-36VDC Output 2CH;8A/ CH 12/36V - 2x(96-288)W</p>	<p>2 Channel amplifier Input 16.5A 12-36VDC Output 2CH;8A/ CH 12/36V - 2x(96-288)W</p>	<p>175 × 45 × 27 mm</p>
	<p><b>RF-RIPETITORE</b> 8031414882731</p> <p>Ripetitore di segnale RF 2.4G AC100-240V DC12-24V</p>	<p>RF 2.4G signal Repeater AC100-240V DC12-24V</p>	<p>52 × 52 × 26 mm</p>

## SPI CONTROLLER



### LED-FORREST-SPI 8031414927319

Controller per strip led  
Pixel to Pixel effetto "RUN".

Avvio Show e spegnimento  
tramite pulsante N/O.

Compatibile con strip led Pixel to  
Pixel SPI WS2811 o altri protocolli.

Lunghezza strip, direzione e  
velocità programmabile  
tramite APP NewlabForrest.

Uscita di sincronia per  
effetti di rincorsa multipli.

Pixel to Pixel LED strip  
controller with "RUN" effect.

Show start and turn off via N/O button.







Compatible with Pixel to Pixel  
SPI WS2811 LED strips or other protocols.

Strip length, direction and  
speed programmable via  
NewlabForrest APP.

Synchronization output for  
multiple chasing effects.



# SPI CONTROLLER

	<p><b>RF-CONTROL-SPI</b> 8031414927340</p> <p>5-24VDC; 8A Input signal: RF2.4G; work with R9 remote; Output signal: SPI (TTL) Control dots: 1024 Dynamic mode: 32 kinds color light, 8 kinds white light Compatible with 49 kinds of Driving Ics</p>	<p>Compatible ICs: TM1803, TM1804, TM1809, TM1812, UCS1903, UCS1909, UCS1912, SK6813, UCS2903, UCS2909, UCS2912, WS2811, WS2812, WS2813, WS2815, TM1829, TLS3001, TLS3002, GW6205, MBI6120, TM1814B(RGBW), SK6812(RGBW), WS2813(RGBW), WS2814(RGBW), UCS8904B(RGBW), LPD6803, LPD1101, D705, UCS6909, UCS6912, LPD8803, LPD8806, WS2801, WS2803, P9813, SK9822, TM1914A, GS8206, GS8208, UCS2904, SM16804, SM16825, SM16714(RGBW), UCS2603, UCS5603, SM16714D, SM16703P, UCS7604(RGBW), UCS7804(RGBW).</p> <p>97 × 33 × 18 mm</p>
	<p><b>RF-WIFI-CONTROL-SPI</b> 8031414927333</p> <p>5-24VDC; 8A Input signal: Tuya APP + RF 2.4GHz; Output signal: SPI(TTL) x 2 Control dots: Max.1000 Rich dynamic effects, Multiple music rhythms, Wireless remote control Compatible with 49 kinds of RGB or RGBW LED strips</p>	<p>114 × 38 × 20 mm</p>
	<p><b>RF-DMX-DECODER-SPI</b> 8031414927357</p> <p>5-24VDC Input signal: DMX512/RDM+RF 2.4G; Output signal: pixel signal Control dots: 170 pixels (RGB 510 CH); Max 900pixels Compatible with 37 kinds of Driving ICs; Numeric display Reverse Polarity Protection</p>	<p>Compatible ICs: TM1803, TM1804, TM1809, TM1812, UCS1903, UCS1909, UCS1912, SK6813, UCS2903, UCS2909, UCS2912, WS2811, WS2812, WS2813, WS2815, TM1829, TLS3001, TLS3002, GW6205, MBI6120, TM1814B(RGBW), SK6812(RGBW), SM16714(RGBW), SM16703P, SM16714D, WS2813(RGBW), WS2814(RGBW), UCS8904B(RGBW), LPD6803, LPD1101, D705, UCS6909, UCS6912, LPD8803, LPD8806, WS2801, WS2803, P9813, SK9822, TM1914A, GS8206, GS8208, UCS2904, SM16804, SM16825, UCS5603, UCS2603.</p> <p>170 × 50 × 23 mm</p>
	<p><b>RF-PIR-CONTROL-SPI</b> 8031414927326</p> <p>Input voltage: 5-24VDC; Output type: 2*SPI(TTL), Input type: PIR sensor + Push button Pixel number: Max 960 Comes with 2 PIR Sensors(ER-C), 1 daylight sensor and 2 PIR sensor extension line(5m) Compatible with 28 kinds driving ICs</p>	<p>Compatible ICs: TM1804, TM1809, TM1812, UCS1903, UCS1909, UCS1912, UCS2903, UCS2909, UCS2912, WS2811, WS2812, TM1829, TM1914A, GW6205, GS8206, GS8208, LPD6803, LPD1101, D705, UCS6909, UCS6912, LPD8803, LPD8806, WS2801, WS2803, P9813, SK9822, SM16703P.</p> <p>186 × 86 × 25 mm</p>
	<p><b>RF-CONTROL-32CH-SPI</b> 8031414927364</p> <p>Input voltage: 5-24VDC; Output voltage: 32 x (5-24)VDC; 32CH, 1A/CH; 32 x (5-24)W Output type: Constant voltage + SPI(TTL) Reverse Polarity Protection Comes with 2 PIR Sensors(ER-C) and 1 daylight sensor, 2 PIR sensor extension line(5m)</p>	<p>Compatible ICs: TM1804, TM1809, TM1812, UCS1903, UCS1909, UCS1912, UCS2903, UCS2909, UCS2912, WS2811, WS2812, TM1829, TM1914A, GW6205, GS8206, GS8208, LPD6803, LPD1101, D705, UCS6909, UCS6912, LPD8803, LPD8806, WS2801, WS2803, P9813, SK9822, SM16703P.</p> <p>186 × 86 × 25 mm</p>
	<p><b>RF-COM-SPI</b> 8031414927371</p> <p>RGB/RGBW RF Remote Controller 1 zone Battery: CR2032</p>	<p>58,5 × 9 × 107 mm</p>

# SENSORI SENSORS

## Sensori industriali di movimento / Industrial motion sensors



### LED-SENSOR-HB 8031414879731

Load capacity  
400W  
220V - 240V

### Accessori inclusi / Included accessories



#### 1 / function

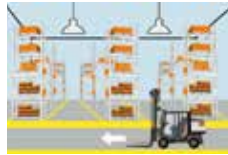

In un ambiente sufficientemente luminoso la lampada non si accende anche se viene rilevato movimento.

With sufficient ambient light, the light will not be switched on even if with motion signal.

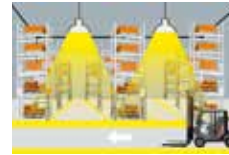

In un ambiente poco luminoso il sensore accende la lampada non appena viene rilevato un movimento.

With insufficient ambient light, the sensor switches on the light when motion is detected.

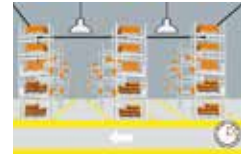

Trascorso il tempo di attesa, il sensore spegne la lampada quando non viene rilevato movimento.

After elapse of hold time, the sensor switches off the light when no motion is detected.



### LED-SENSOR-TP 8031414879724

Load capacity  
no limitation  
220V - 240V

IP65

#### 1 / function

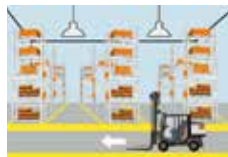

In un ambiente sufficientemente luminoso la lampada non si accende anche se viene rilevato movimento.

With sufficient ambient light, the light will not be switched on even if with motion signal.



In un ambiente poco luminoso il sensore accende la lampada non appena viene rilevato un movimento.

With insufficient ambient light, the sensor switches on the light when motion is detected.



Trascorso il tempo di attesa, il sensore spegne la lampada quando non viene rilevato movimento.

After elapse of hold time, the sensor switches off the light when no motion is detected.



### LED-SENSOR-REMOTE 8031414879717

Radiocomando per sensori industriali. Industrial sensor remote control.



# SENSORI SENSORS

Sensori adattabili a qualsiasi prodotto di Illuminotecnico /  
Sensors compatible for any lighting products



## I-SENSORE-360

8031435901237

Sensore PIR 230V  
max 1600W 360°  
distanza massima 5m.  
time 10 sec. - 4 min.  
lux 2 - 2000

PIR sensor 230V  
max 1600W 360°  
max 5m.  
time 10 sec. - 4 min.  
lux 2 - 2000



IP44

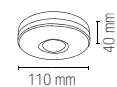

## I-SENSORE-130

8031434401219

Sensore PIR 230V  
max 1000W 130°  
distanza massima 12m.  
time 10 sec. - 4 min.  
lux 2 - 2000  
base accessoria angolare

PIR sensor 230V  
max 1000W 130°  
max 12m.  
time 10 sec. - 4 min.  
lux 2 - 2000  
corner accessory base



IP44

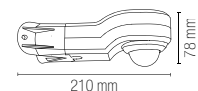







# CLAY

Prodotti in porcellana e cavi elettrici a treccia / Porcelain products and braid cables

	<b>I-CLAY-SCADER</b> 8031414865031	Scatola di derivazione elettrica CLAY in porcellana bianca	White porcelain external junction box CLAY	Ø 80 x H 45 mm
	<b>I-CLAY-INTERRUTTORE</b> 8031414865048	Interruttore rotativo CLAY in porcellana bianca 10A AC230V 50Hz	White porcelain rotating switch CLAY 10A AC230V 50Hz	Ø 65 x H 60 mm
	<b>I-CLAY-PRESA</b> 8031414865055	Presa elettrica CLAY polivalente in porcellana bianca 10/16A AC230V 50Hz	White porcelain universal socket CLAY 10/16A AC230V 50Hz	Ø 65 x H 37 mm
	<b>I-CLAY-PRESA-F</b> 8031414865062	Presa elettrica Schuko CLAY in porcellana bianca	White porcelaine Schuko socket CLAY	Ø 65 x H 50 mm
	<b>I-CLAY-E27</b> 8031414871117	Portalamпада CLAY in porcellana bianca E27 AC230V 50Hz	White porcelaine E27 lamp-holder AC230V 50Hz	Ø 45 x H 60 mm
	<b>I-CLAY-E14</b> 8031414870929	Portalamпада CLAY in porcellana bianca E14 AC230V 50Hz	White porcelaine E14 lamp-holder AC230V 50Hz	Ø 35 - H 60 mm
	<b>I-CLAY-BASE</b> 8031414870936	Rosone in porcellana bianca	White porcelain canopy	Ø 105 x H 30 mm
	<b>I-CLAY-ISOLATORI</b> 8031414865079	Kit 4 pz isolatori CLAY in porcellana bianca	White porcelain pulleys CLAY set 4 pcs	Ø 18 x H 20 mm

# CLAY

Prodotti in porcellana e cavi elettrici a treccia / Porcelain products and braid cables

	<b>I-CLAY-CAVO-BCO</b> 8031414865086	Cavo elettrico CLAY trecciato con rivestimento tessile bianco	Twisted white fabric wire CLAY	5 m 3 × 0,75 mm
	<b>I-CLAY-CAVO-2P-BCO</b> 8031414865277	Cavo elettrico CLAY trecciato con rivestimento tessile bianco	Twisted white fabric wire CLAY	5 m 2 × 0,75 mm
	<b>I-CLAY-CAVO-R25 BCO</b> 8031414871162	Cavo elettrico CLAY trecciato con rivestimento tessile bianco	Twisted white fabric wire CLAY	25 m 2 × 0,75 mm
	<b>I-CLAY-CAVO-ORO</b> 8031414865093	Cavo elettrico CLAY trecciato con rivestimento tessile in oro	Gold twisted fabric wire CLAY	5 m 3 × 0,75 mm
	<b>I-CLAY-CAVO-2P-ORO</b> 8031414865284	Cavo elettrico CLAY trecciato con rivestimento tessile oro	Gold twisted fabric wire CLAY	5 m 2 × 0,75 mm
	<b>I-CLAY-CAVO-R25 ORO</b> 8031414871131	Cavo elettrico CLAY trecciato con rivestimento tessile oro	Gold twisted fabric wire CLAY	25 m 2 × 0,75 mm
	<b>I-CLAY-CAVO-R25 MAR</b> 8031414871148	Cavo elettrico CLAY trecciato con rivestimento tessile marrone	Brown twisted fabric wire CLAY	25 m 3 × 0,75 mm
	<b>I-CLAY-CAVO3X1,5 BCO</b> 8031414877980	Cavo elettrico CLAY trecciato con rivestimento tessile bianco	White twisted fabric wire CLAY	25 m 3 × 1,5 mm
	<b>I-CLAY-CAVO3X1,5 MAR</b> 8031414878000	Cavo elettrico CLAY trecciato con rivestimento tessile in marrone	Brown twisted fabric wire CLAY	25 m 3 × 1,5 mm
	<b>I-CLAY-CAVO3X1,5 ORO</b> 8031414877997	Cavo elettrico CLAY trecciato con rivestimento tessile in oro	Gold twisted fabric wire CLAY	25 m 3 × 1,5 mm

## PORTALAMPADE LAMP HOLDERS

Accessori / Accessories

	<b>I-PORTALAMPADE-E14-L</b> 8031440354592 Portalampada E14 con copertura liscia in PET	E14 lamp holder with smooth PET cover
	<b>I-PORTALAMPADE-E14-S</b> 8031440354578 Portalampada E14 in PET con copertura filettata e ghiera	E14 PET lamp holder with cover threaded and ring
	<b>I-PORTALAMPADE-E14-T</b> 8031440354585 Portalampada E14 in PET con copertura mezza filettata con ghiera	E14 PET lamp holder with half threaded
	<b>I-PORTALAMPADE-E27-L</b> 8031440354554 Portalampada E27 con copertura liscia in PET	E27 lamp holder with smooth PET cover
	<b>I-PORTALAMPADE-E27-P</b> 8031440354561 Portalampada E27 in PBT	E27 lamp holder in PBT
	<b>I-PORTALAMPADE-E27-S</b> <b>8031440354530</b> Portalampada E27 in PET con copertura filettata e ghiera	E14 PET lamp holder with cover threaded and ring
	<b>I-PORTALAMPADE-E27-T</b> 8031440354547 Portalampada E27 in PET con copertura mezza filettata con ghiera	E14 PET lamp holder with half threaded
	<b>I-PORTALAMPADE-GU10</b> 8031435751221 Portalampada GU10 in PBT con cavo di 12 cm	GU10 lamp holder in PBT with 12 cm cable

# PORTALAMPADE LAMP HOLDERS

Accessori / Accessories

	<p><b>I-PORTALAMPADE-MR16</b> 8031439761264</p> <p>Portalampada MR16 in PBT con cavo di 10 cm</p>	<p>Lamp holder MR16 in PBT with 10 cm cable</p>
	<p><b>I-PORTALAMPADE-T8</b> 8031439851262</p> <p>Portalampada T8 in PBT fissaggio a clip</p>	<p>Lamp holder T8 in PBT clip fixing</p>
	<p><b>I-PORTALAMPADE-R7S</b> 8031414861491</p> <p>Portalampada R7S 118 mm in PBT incluso filo da 15 cm</p>	<p>Lamp holder R7S 118 mm in PBT including 15 cm wire</p>
	<p><b>I-PORTALAMPADE-G9</b> 8031414862962</p> <p>Portalampada G9 in PBT con cavo di 10 cm</p>	<p>Lamp holder G9 in PBT with 10 cm cable</p>
	<p><b>INC-MATRIX-KIT</b> 8031436651233</p> <p>Kit molle e anello per faretti incasso GU10</p>	<p>Kit springs and ring for recessed spotlights GU10</p>
	<p><b>CABLAGGIO</b> 8031414865499</p> <p>Cabl. trip. cavo tondo bianco H05VV-F spina Italia 10A, 250V</p>	<p>White round cable harness H05VV-F plug Italy 10A, 250V</p> <p style="text-align: right;">2,5 m 3 × 0,75 mm</p>

## ADATTATORI LAMPHOLDER ADAPTERS



### ADATTATORE-E14-E27

8031439351267

Adattatore da  
E14 a E27 in PET

Lamp holder adapter  
from E14 to E27 in PET



### ADATTATORE-E27-E14

8031439391263

Adattatore da  
E27 a E14 in PET

Lamp holder adapter  
from E27 to E14 in PET



### ADATTATORE-E27-2E27

80314439371265

Adattatore da  
E27 a 2 E27 in PET

Lamp holder adapter  
from E27 to E27 in PET



### ADATTATORE-E27-GU10

8031436171233

Adattatore da  
E27 a GU10 in PET

Lamp holder adapter  
from E27 to GU10 in PET



### ADATTATORE-E14-GU10

8031439361266

Adattatore da  
E14 a GU10 in PET

Lamp holder adapter  
from E14 to GU10 in PET



### ADATTATORE-GU10-E14

8031439431266

Adattatore da  
GU10 a E14 in PET

Lamp holder adapter  
from GU10 to E14 in PET



### ADATTATORE-GU10-E27

8031439421267

Adattatore da  
GU10 a E27 in PET

Lamp holder adapter  
from GU10 to E27 in PET



### ADATTATORE-G9-E27

8031439411268

Adattatore da  
G9 a E27 in PET

Lamp holder adapter  
from G9 to E27 in PET

## ADATTATORI LAMPHOLDER ADAPTERS



### ADATTATORE-G9-E14

8031439401269

Adattatore da  
G9 a E14 in PET

Lamp holder adapter  
from G9 to E14 in PET



### ADATTATORE-E27-E27

8031439451264

Adattatore da E27 a E27  
in PET con flessibile  
20 cm in metallo

Lamp holder adapter  
from E27 to E27 in PET with  
20 cm metal flexible tube



### ADATTATORE-EUC-UKG

8031414879809

Adattatore presa (EU) tipo C  
a presa (UK) tipo G

Adaptor (EU) C to (UK) G



### ADATTATORE-EUF-UKG

8031414879816

Adattatore (EU) F a (UK) G

Adaptor (EU) F to (UK) G



### ADATTATORE-EU2-E27

8031414922796

Adattatore per  
lampada d'emergenza

Emergency adapter



# SMART INTEC

## SMART HUB

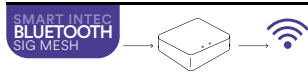

**SMART-GATEWAY-BT**  
8031414878970

Interfaccia di collegamento dispositivi bluetooth con rete WIFI

Device connection interface bluetooth with WIFI network



## SMART PLUG



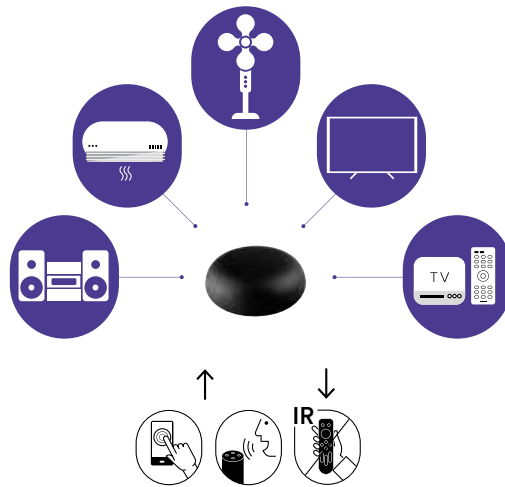

**SMART-IR**  
8031414878703











## SMART PLUG

		<b>SMART-POWER-SC4USB3</b> 8031414879014	Adattatore multipresa WIFI 4 Schuko 3 USB 1000-2400W 10A Input 100-240V WIFI 2.4GHZ	WIFI multi-socket adapter 4 Schuko 3 USB 1000-2400W 10A Input 100-240V 2.4GHZ WIFI
		<b>SMART-PRESA</b> 8031414878987	Adattatore presa WIFI 230V 50HZ 16A Frequenza 2.4GHz	WIFI socket adapter 230V 50HZ 16A 2.4GHz frequency

## SMART CONTROLLER

		<b>SMART-SWITCH-2</b> 8031414879045	Controller WIFI 2.4GHZ per accensione e timer Interruttori 2 vie 230V max 10A	2.4GHZ WIFI Controller for ignition and timer 2-way switches 230V max 10A
		<b>SMART-SWITCH-1</b> 8031414879038	Controller WIFI 2.4GHZ per accensione e timer Interruttori 1 via 230V max 10A	2.4GHZ WIFI Controller for ignition and timer 1-way switches 230V max 10A
		<b>SMART-START</b> 8031414879021	Controller WIFI 2.4GHZ per accensione e timer prodotti 230V max 2200W/10A	2.4GHZ WIFI Controller for ignition and timer products 230V max 2200W/10A

## SMART SENSOR

		<b>SMART-SENSOR</b> 8031414879007	Sensore infrarossi WIFI 2.4GHZ	Infrared sensor WIFI 2.4GHZ
			<b>SMART-PORTER</b> 8031414878994	Sensore porte e finestre WIFI 2.4GHZ alimentato a batterie AAA1,5V2





# INTEC<sup>®</sup>

LIGHT



divisione F.A.N. EUROPE LIGHTING s.r.l. a socio unico

Agglomerato A.S.I

## NAPOLI

Località Bosco Fangone  
80035 Nola (NA)

T +39 081 3151017

T +39 081 8210771

info@faneurope.it  
www.faneurope.it

## MILANO

Via Monzoro, 46  
20007 Cornaredo (MI)

T +39 02 84345083



Download Catalogue



SMART INTEC

Download App Smart Intec on:



concept  
**DITRE** IDEAS MAKERS

graphic artwork & photo editing  
**Ditre.com**

photo  
**Quasarfoto.com**  
**Ditre.com**  
**F.A.N. Europe photographic archive**

imagebank  
**shutterstock.com**  
**istockphoto.com**  
**unsplash.com**

styling  
**Cristina Romanello**  
**Laila Casellato**

credits  
**Infiniti Design**  
**Pointhouse**  
**Studio Menguante**  
**Paolo Loschi**  
**Gressoni**  
**Vbc ceramiche**

printed in Italy  
**Graficametalliana.com**  
April 2024

L'azienda si riserva il diritto di effettuare modifiche ai prodotti presenti in questo catalogo senza preavviso alcuno /

The company reserves the right to make changes to the products in this catalog without prior notice



**faneurope**<sup>®</sup>

