



WORKSHOP GEAR

 sales@bendtechgroup.com.au

 www.bendtechgroup.com.au

 2-10 Kewdale Road, Welshpool WA 6106

 **PERTH** (08) 9459 8600 **ADELAIDE** (08) 8231 1513 **DARWIN** (08) 8963 5621

HALGOOLIE (08) 9021 8300 **NEWMAN** (08) 9175 1164 **MT ISA** (07) 4743 6458



THE ENGINEERED APEX



GRIZZLY

The brand was born and named after the Grizzly Bear, a highly intelligent, fast, apex predator. The top of their food chain, the grizzly bear uses their immense strength and speed to succeed in their environment.



THE DNA

The GRIZZLY SAFETY PRODUCTS division of the Bend-tech Group is dedicated to supplying intelligent solutions that maximise safety and efficiency, fast. The GRIZZLY division is at the apex of the engineered manufacturing industry. Enabling you to evade danger through proactive, engineered tough solutions that create safe maintenance scenarios, GRIZZLY SAFETY PRODUCTS are safety, on your side.

GRIZZLY CHARACTERISTICS



HIGHLY
INTELLIGENT



THE APEX



CURIOUS



EXCELLENT MEMORY
& UNDERSTANDING



FAST



EVADES
DANGER

MISSION:
**TO BE THE APEX PROVIDER OF
INTELLIGENT, ENGINEERED SAFETY
SOLUTIONS.**





CONTENTS

WORKSHOP WHITEBOARD BENCH	4
E-HUB EFFICIENCY WORK MINI STATION	5

WORKBENCHES

WORKBENCH 1200MM	7
WORKBENCH 1800MM	8
WORKBENCH 2400MM	9
WORKBENCH 3000MM	10

TRESTLES

2 TONNE TRESTLE STAND 500MM	12
2 TONNE TRESTLE STAND 900MM	13
5 TONNE TRESTLE STAND 500MM	14
5 TONNE TRESTLE STAND 900MM	15
5 TONNE TRESTLE STAND 2400MM	16
10 TONNE TRESTLE STAND	17

STEEL RACKS

LADDER RACK	20
CHAIN RACK	22
CHAIN CADDY	24
SMALL GENERAL PURPOSE STEEL RACK	26
MEDIUM GENERAL PURPOSE STEEL RACK	27
LARGE GENERAL PURPOSE STEEL RACK	28
HORIZONTAL STEEL PLATE RACK	29
HORIZONTAL PLATE STORAGE RACK 8M	30
STEEL FREE STANDING STORAGE RACK	31

WORKSHOP WHITEBOARD BENCH

Our Workshop Whiteboard Bench incorporates work benches, a large whiteboard, and shelving for increased efficiency in mobile equipment workshops. Stands come pre-painted in safety yellow and can also have company identification stickers as an optional extra. In stock for immediate delivery.



Material:
Steel



Finish:
Grizzly Orange



Dimensions:
2000mm H / 1480mm L / 700mm W



**LARGE
WHITEBOARD**

**HEAVY-DUTY
MINE SPEC
CONSTRUCTION**

**STORAGE
SHELVES**

**HEAVY-DUTY
LOCKABLE
CASTORS**





 **CERTIFIED COMPLIANT** 
WITH AUSTRALIAN STANDARDS 

PART NO. 5500866

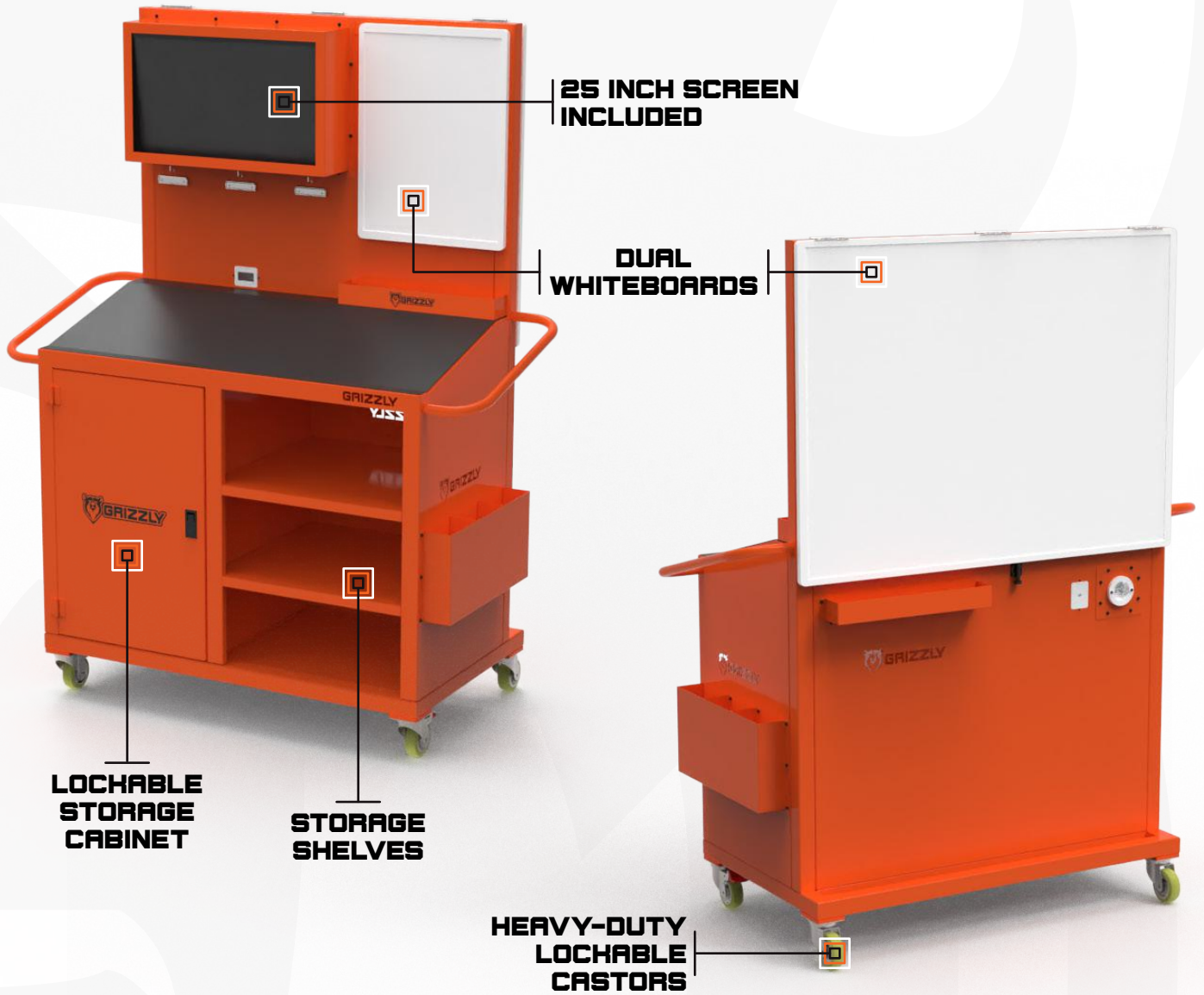

E-HUB EFFICIENCY WORK MINI STATION

The E-Hub Mini is a mobile workstation that allows an operation to harness efficiency and boost safety to the workshop floor. Saves on lost productivity, reduces risk of injury, and allows improved control of the workshop.



Material:
Steel



Finish:
Grizzly Orange



Dimensions:
1940mm H / 1200mm L / 580mm W

GRIZZLY WORKBENCHES

Introducing Grizzly's standard range of workbenches designed for all sites and workshops.

Available in a range of size options including 1200mm, 1800mm, 2400mm and 3000mm these work benches have a 2-tonne load limit and are certified and compliant with Australian standards.

Our standard workbenches provide an affordable solution that promotes both safety and productivity.

We understand the importance of customisation, and that's why we offer a range of fit-out options to tailor to the needs and requirements of your workplace. Lockable castors, forklift pockets, drain trays, and more can be incorporated, providing added convenience and functionality.

**THE
ENGINEERED
APEX**





WORKBENCH 1200MM

 Material:
Steel

 WLL:
2T

 Finish:
Grizzly Orange

 Dimensions:
900mm H / 1200mm L / 1200mm W

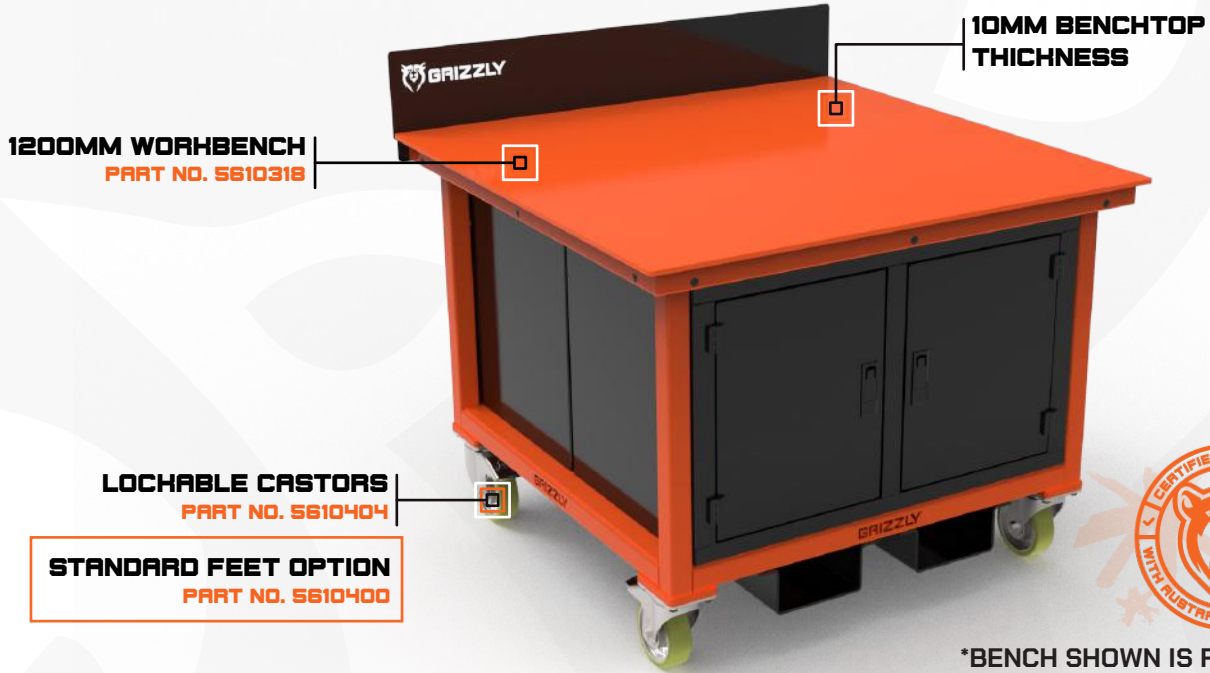

*BENCH SHOWN IS FULLY OPTIONED

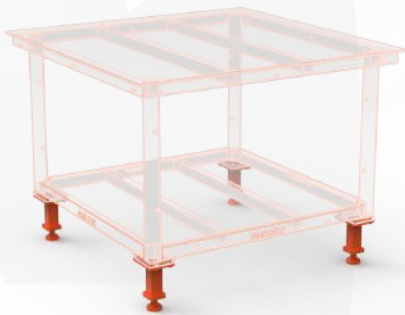

ADJUSTABLE FEET PART NO. 5610402

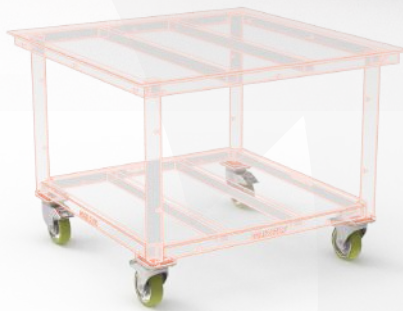

*High performance, industry leading German Blicke Castors
LOCKABLE CASTORS PART NO. 5610404

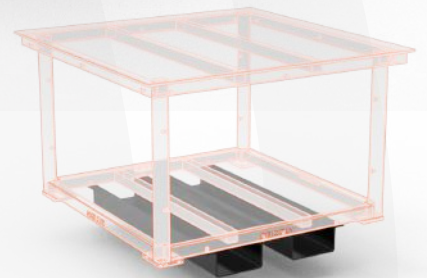

FORKLIFT SLOTS PART NO. 5610330



BACKBOARD PART NO. 5610331



OIL DRAIN TRAY PART NO. 5610472



CABINETS PART NO. 5610406

WORKBENCH 1800MM

 **Material:** Steel
  **WLL:** 2T
  **Finish:** Grizzly Orange
  **Dimensions:** 900mm H / 1800mm L / 1200mm W

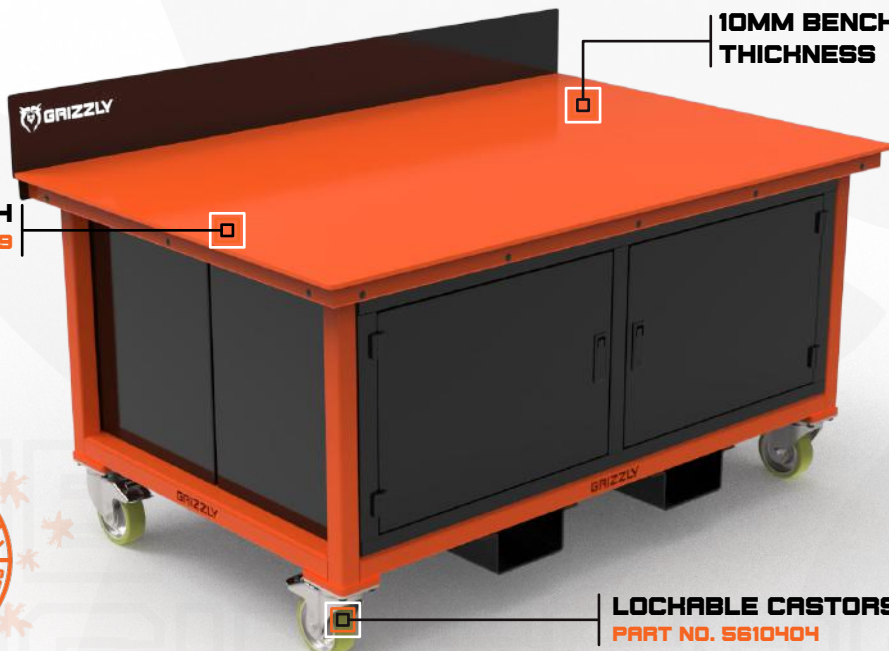

1800MM WORKBENCH
PART NO. 5610319

10MM BENCHTOP THICKNESS

LOCKABLE CASTORS
PART NO. 5610404

STANDARD FEET OPTION
PART NO. 5610400

*BENCH SHOWN IS FULLY OPTIONED



		
<p>ADJUSTABLE FEET PART NO. 5610402</p>	<p>LOCKABLE CASTORS PART NO. 5610404</p>	<p>FORHLIFT SLOTS PART NO. 5610330</p>

		
<p>BACHBOARD PART NO. 5610332</p>	<p>OIL DRAIN TRAY PART NO. 5610473</p>	<p>CABINETS PART NO. 5610407</p>





WORKBENCH 2400MM

 Material: **Steel**
  WLL: **2T**
  Finish: **Grizzly Orange**
  Dimensions: **900mm H / 2400mm L / 1200mm W**

2400MM WORKBENCH
PART NO. 5610320

10MM BENCHTOP THICKNESS

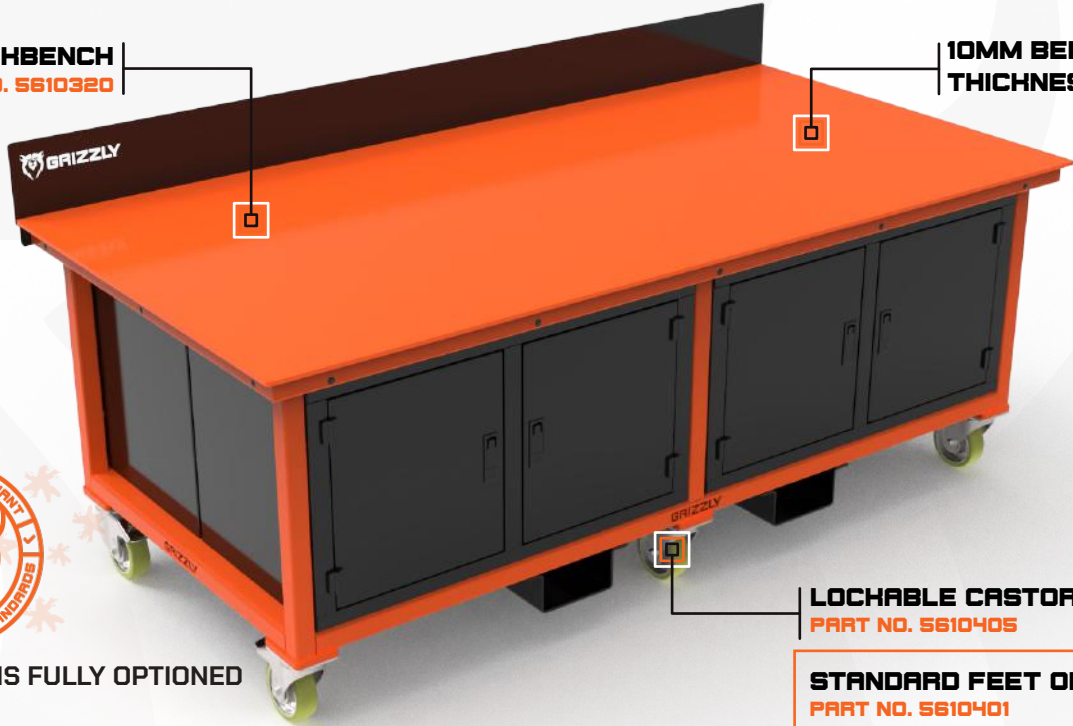

LOCKABLE CASTORS
PART NO. 5610405

STANDARD FEET OPTION
PART NO. 5610401



*BENCH SHOWN IS FULLY OPTIONED



ADJUSTABLE FEET PART NO. 5610403



*High performance, industry leading German Blicke Castors
LOCKABLE CASTORS PART NO. 5610405

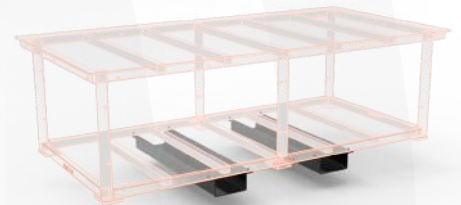

FORKLIFT SLOTS PART NO. 5610330



BACKBOARD PART NO. 5610333



OIL DRAIN TRAY PART NO. 5610474



CABINETS PART NO. 5610408

WORKBENCH 3000MM

+GST

 Material: **Steel**
  WLL: **2T**
  Finish: **Grizzly Orange**
  Dimensions: **900mm H / 3000mm L / 1200mm W**

3000MM WORKBENCH
PART NO. 5610321

10MM BENCHTOP THICKNESS

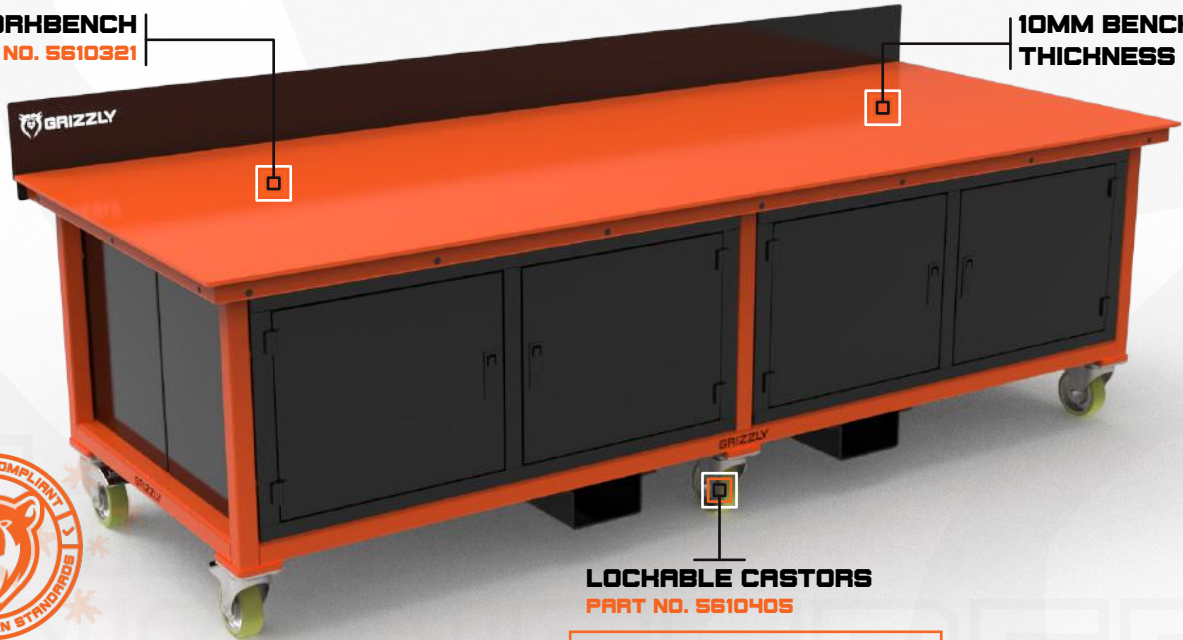

LOCKABLE CASTORS
PART NO. 5610405

STANDARD FEET OPTION
PART NO. 5610401

*BENCH SHOWN IS FULLY OPTIONED



ADJUSTABLE FEET PART NO. 5610403



*High performance, industry leading German Blicke Castors
LOCKABLE CASTORS PART NO. 5610405



FORKLIFT SLOTS PART NO. 5610330

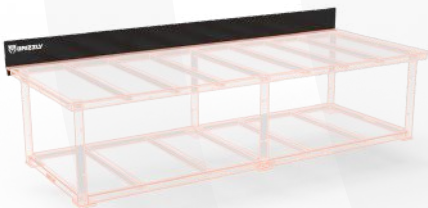

BACKBOARD PART NO. 5610334



OIL DRAIN TRAY PART NO. 5610475



CABINETS PART NO. 5610409

GRIZZLY TRESTLES

Suspended load safety is critical on-site and ensuring maintenance personnel are operating with equipment that ensures their safety should be top of mind.

Grizzly's range of workshop trestle stands are engineered and certified to AS4100 and AS1170. They are designed to be used for workshop duties such as plate cutting and supporting machinery or engineering components.

Grizzly trestles come in 2T,5T and 10T working load limits and are available in a range of sizes to ensure you have the gear you need to perform the maintenance required.

**THE
ENGINEERED
APEX**



2 TONNE TRESTLE STAND 500MM

Grizzly's engineered and certified workshop trestle stand can be used for general workshop duties such as plate cutting and supporting machine or engineering components up to the weight of 2 tonne (distributed evenly).



Material:
Steel



WLL:
2T



Finish:
Grizzly Orange



Dimensions:
500mm H / 1000mm L

*Patent Pending and Registered Design





 **CERTIFIED COMPLIANT** 
WITH AUSTRALIAN STANDARDS 

PART NO. 5508826

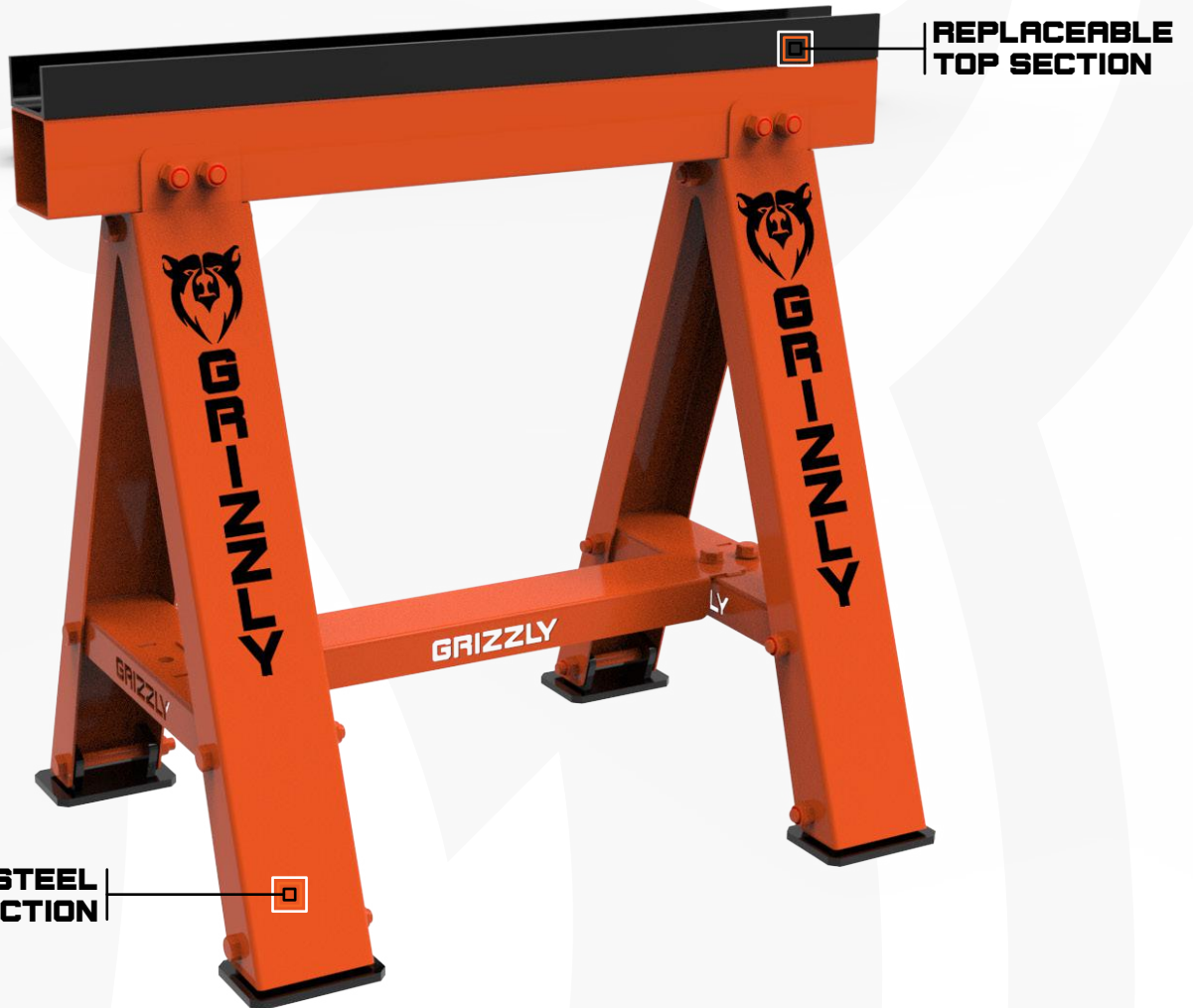

2 TONNE TRESTLE STAND 900MM

Grizzly's engineered and certified workshop trestle stand can be used for general workshop duties such as plate cutting and supporting machine or engineering components up to the weight of 2 tonne (distributed evenly).



Material:
Steel



WLL:
2T



Finish:
Grizzly Orange



Dimensions:
900mm H / 1000mm L

*Patent Pending and Registered Design

5 TONNE TRESTLE STAND 500MM

Grizzly's engineered and certified workshop trestle stand can be used for general workshop duties such as plate cutting and supporting machine or engineering components up to the weight of 2 tonne (distributed evenly).



Material:
Steel



WLL:
5T



Finish:
Grizzly Orange



Dimensions:
500mm H / 1000mm L

*Patent Pending and Registered Design



REPLACEABLE
TOP SECTION

HEAVY-DUTY STEEL
CONSTRUCTION

 **CERTIFIED COMPLIANT** 
WITH AUSTRALIAN STANDARDS 

PART NO. 5508839





 **CERTIFIED COMPLIANT** 
WITH AUSTRALIAN STANDARDS 

PART NO. 5508836



5 TONNE TRESTLE STAND 900MM

Grizzly's engineered and certified workshop trestle stand can be used for general workshop duties such as plate cutting and supporting machine or engineering components up to the weight of 5 tonne (distributed evenly).



Material:
Steel



WLL:
5T



Finish:
Grizzly Orange



Dimensions:
900mm H / 1000mm L

*Patent Pending and Registered Design

5 TONNE TRESTLE STAND 2400MM

Grizzly's engineered and certified workshop Trestle Stand can be used for general workshop duties such as plate cutting and supporting machine or engineering components up to the weight of 5 tonne (distributed evenly).



Material:
Steel



WLL:
5T



Finish:
Grizzly Orange



Dimensions:
900mm H / 2400mm L

*Patent Pending and Registered Design

**REPLACEABLE
TOP SECTION**

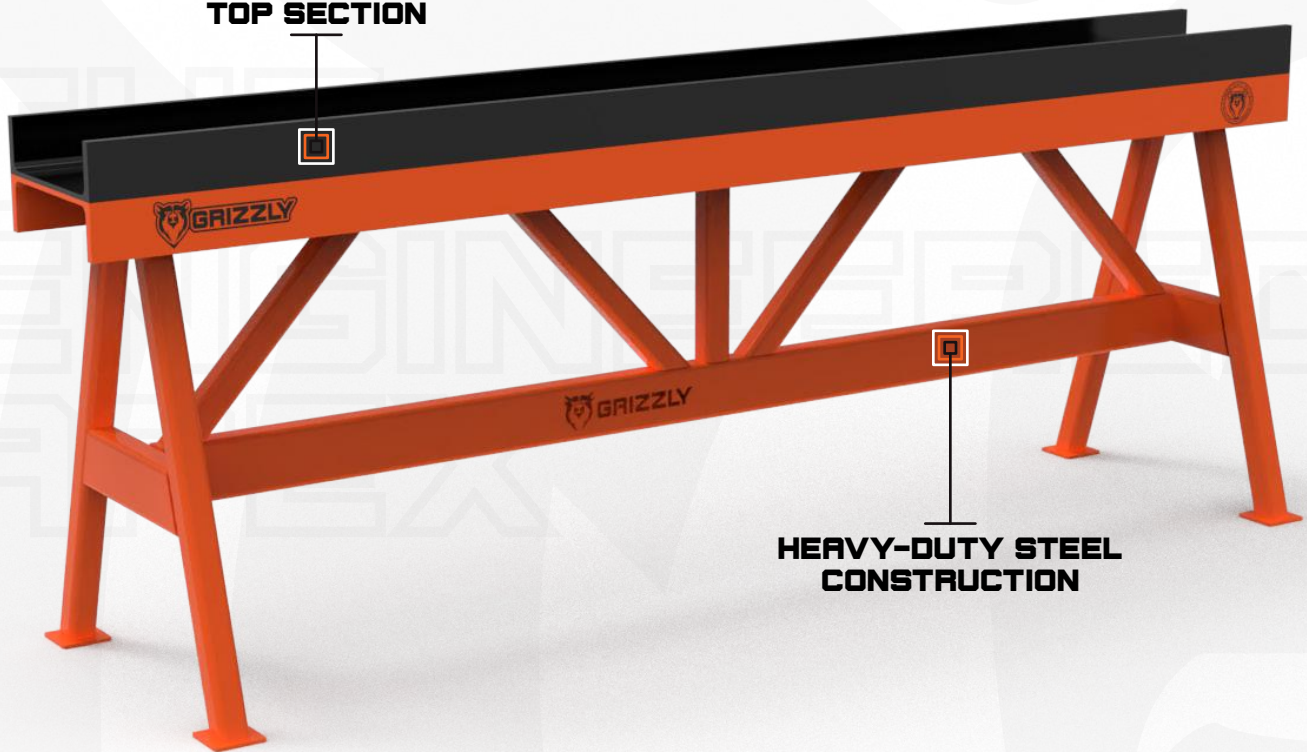

**HEAVY-DUTY STEEL
CONSTRUCTION**

 **CERTIFIED COMPLIANT** 
WITH AUSTRALIAN STANDARDS

PART NO. 5001760



CERTIFIED COMPLIANT ✓
WITH AUSTRALIAN STANDARDS

PART NO. 5001813



10 TONNE TRESTLE STAND

Grizzly's engineered and certified workshop trestle stand can be used for general workshop duties such as plate cutting and supporting machine or engineering components up to the weight of 10 tonne (distributed evenly).



Material:
Steel



WLL:
10T



Finish:
Grizzly Orange



Dimensions:
650mm H / 2400mm L

GRIZZLY STEEL RACKS

The safe and efficient storage of materials and equipment is critical to personnel safety on your operation. Suspended loads create a significant hazard if not handled correctly with certified equipment.

Grizzly's range of standard general-purpose equipment and material racks are certified to AS4100, AS1554 and AS1170 to ensure they outperform your requirements and eliminate the hazards associated with suspended load storage.

Our range of general-purpose equipment and material racks have a 3T per shelf working load limit and are available in 6m, 7.5m and 9m configurations.

THE ENGINEERED APEX



GRIZZLY SAFETY PRODUCTS



LADDER RACK

Our certified and compliant Ladder Storage Rack is a safe way of storing ladders on your site or operation. Available with a range of retrofittable additions our Ladder Storage Rack is an all round efficient solution.

 Material: **Steel**  WLL: **350KG**  Finish: **Powder Coated**  Dimensions: **2000mm H / 2050mm L / 990mm W**

*Patent Pending and Registered Design

PART NO. 5508809



*RACK SHOWN IS FULLY OPTIONED

WORKSHOP GEAR

LADDER RACK OPTIONS

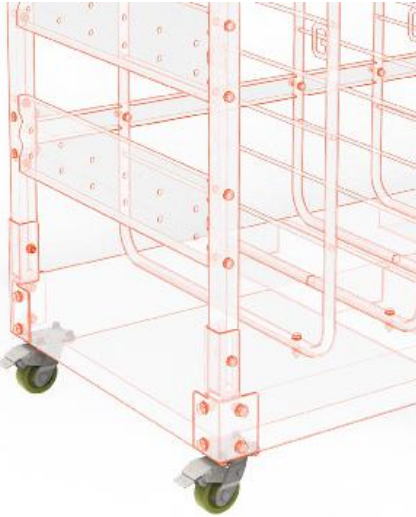

*High performance, industry leading German Blicke Castors

WHEELS

PART NO.
5508807

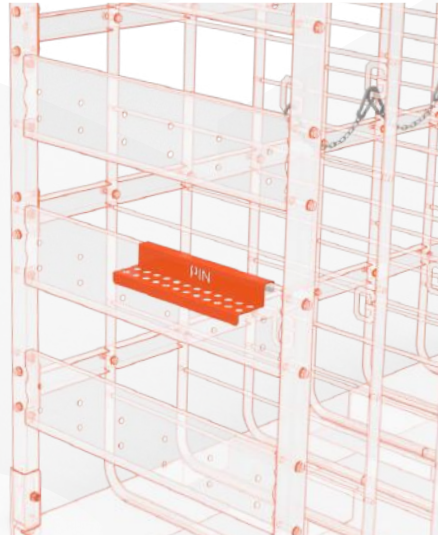

PIN STORAGE

PART NO.
5508821



PINS (BOX 12)

PART NO.
5508818



DOCUMENT HOLDER

PART NO.
5508817



TOOLBOX

PART NO.
5508816

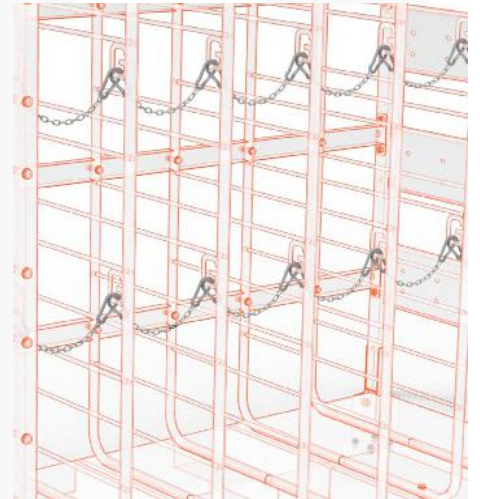

CHAINS

PART NO.
5508819

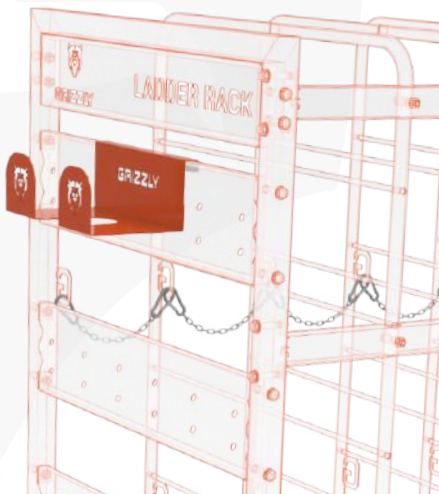







**BROOM/SHOVEL
HOLDER**

PART NO.
5508820

CHAIN RACK

Our certified and compliant Chain Rack is a safe way of storing chains and rigging equipment on your site or operation. Available with a range of retrofittable additions our Chain Rack is an all round efficient solution.

-  Material: **Steel**  WLL: **1200KG**  Finish: **Powder Coated**  Dimensions: **1380mm H / 2000mm L / 990mm W**
-  WLL: **40KG per pin**  WLL: **60kg per ring**

*Patent Pending and Registered Design

PART NO. 5508810



*RACK SHOWN IS FULLY OPTIONED

WORKSHOP GEAR CHAIN RACK OPTIONS

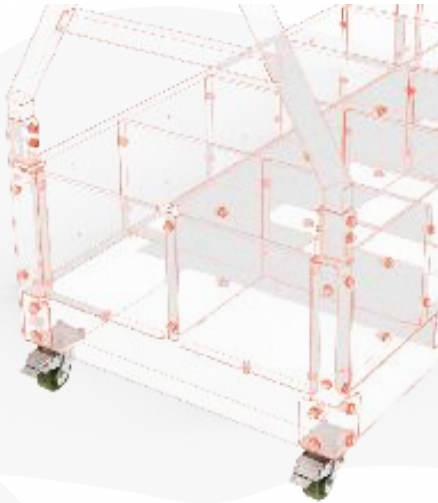

*High performance, industry leading German Blicke Castors

WHEELS

PART NO.
5508807

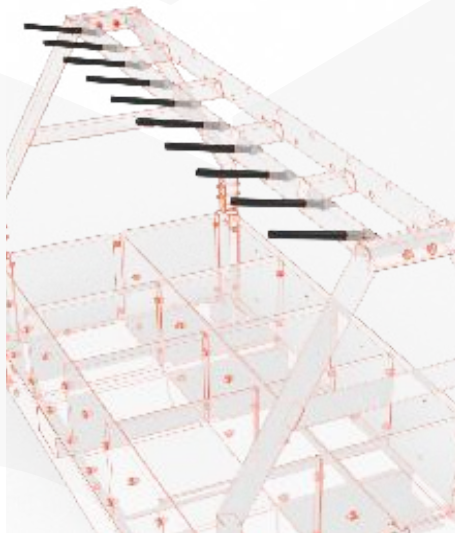

PIN ASSEMBLY [BOX 10]

PART NO.
5508812

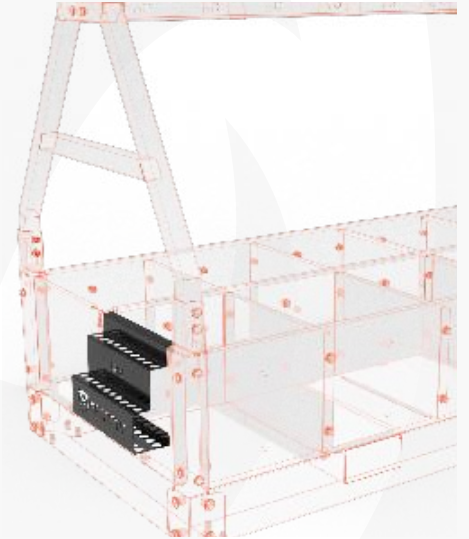

PIN RACK

PART NO.
5508815



DOCUMENT HOLDER

PART NO.
5508817

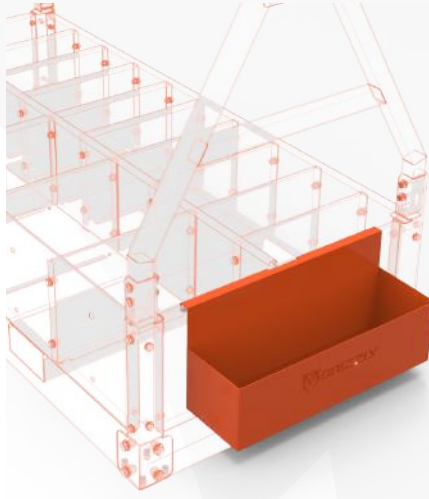

TOOLBOX

PART NO.
5508816



SHACKLES RACK

PART NO.
5508814

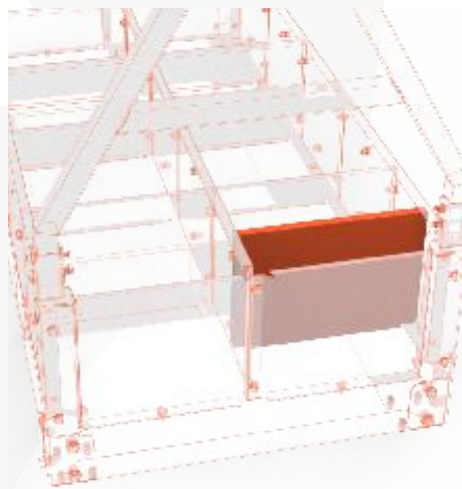

**VERTICAL DIVIDERS
[BOX 5]**

PART NO.
5508811

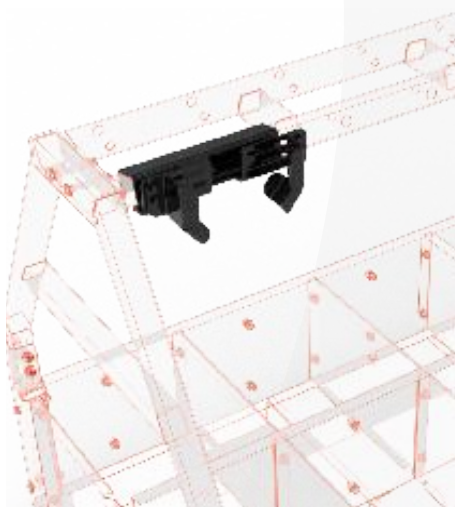

**LINK BRACKET
ASSEMBLY [BOX 5]**

PART NO.
5508813

CHAIN CADDY

Our certified and compliant Chain Caddy is a safe way of storing and transporting chains and rigging equipment around your site or operation. Available with a range of retrofittable additions our Chain Caddy is an all round efficient solution.

 Material: **Steel**  WLL: **100KG per ring**  Finish: **Powder Coated**  Dimensions: **920mm H / 1000mm L / 800mm W**

*Patent Pending and Registered Design

PART NO. 5508829
+ 5508807
+ 5508830
+ 5508834



*CADDY SHOWN IS FULLY OPTIONED

**HIGH PERFORMANCE,
INDUSTRY LEADING GERMAN
BLICHLER CASTORS**

WORKSHOP GEAR
CHAIN CADDY OPTIONS



*High performance, industry leading German Blicke Castors

WHEELS

PART NO.
5508807

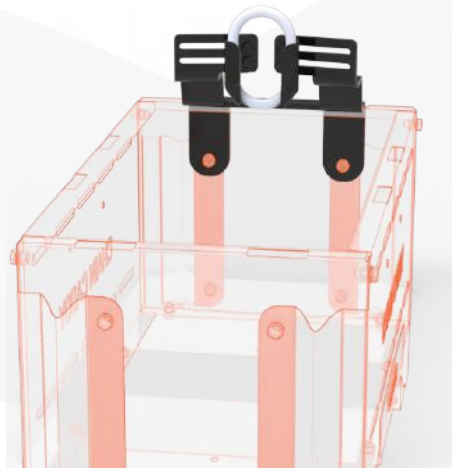

LINK BRACKET ASSEMBLY

PART NO.
5508830



SHACKLES RACK

PART NO.
5508831

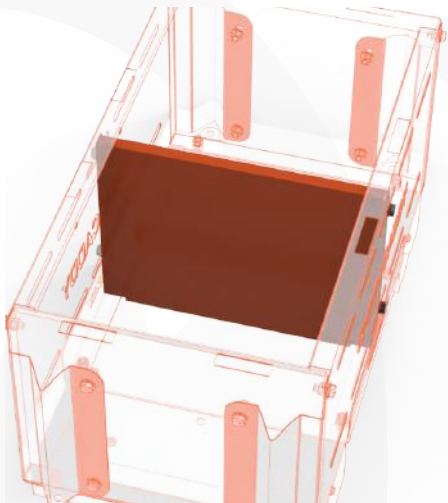

DIVIDER

PART NO.
5508832

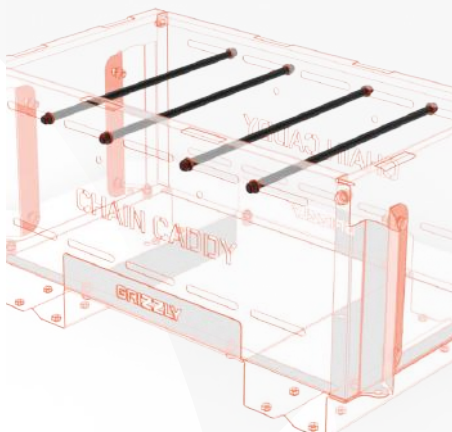

CHAIN BLOCK BAR [BOX OF 4]

PART NO.
5508833







REMOVABLE HANDLE

PART NO.
5508834

SMALL GENERAL PURPOSE STEEL RACK

Our Small General Purpose Steel Rack is used for storing steel and equipment. Being certified and compliant with Australian Standards ensures your site will satisfy any compliance audit.

 Material: **Steel**  WLL: **3T per shelf**  Finish: **Galvanised**  Dimensions: **2000mm H / 6000mm L / 2048mm W**

**CANTILEVERED TO
ENSURE OPTIMUM
SPACE UTILISATION**

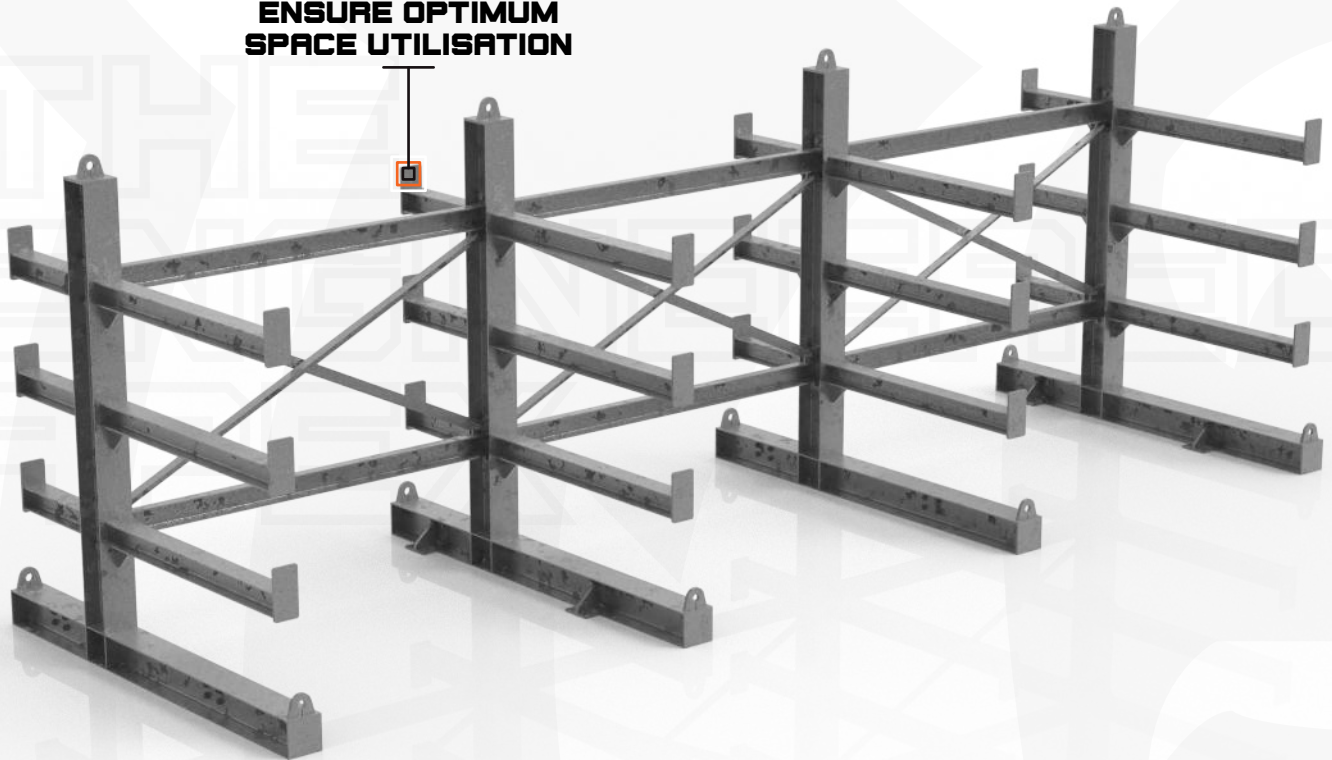



 **CERTIFIED COMPLIANT** 
WITH AUSTRALIAN STANDARDS 

PART NO. 5000221

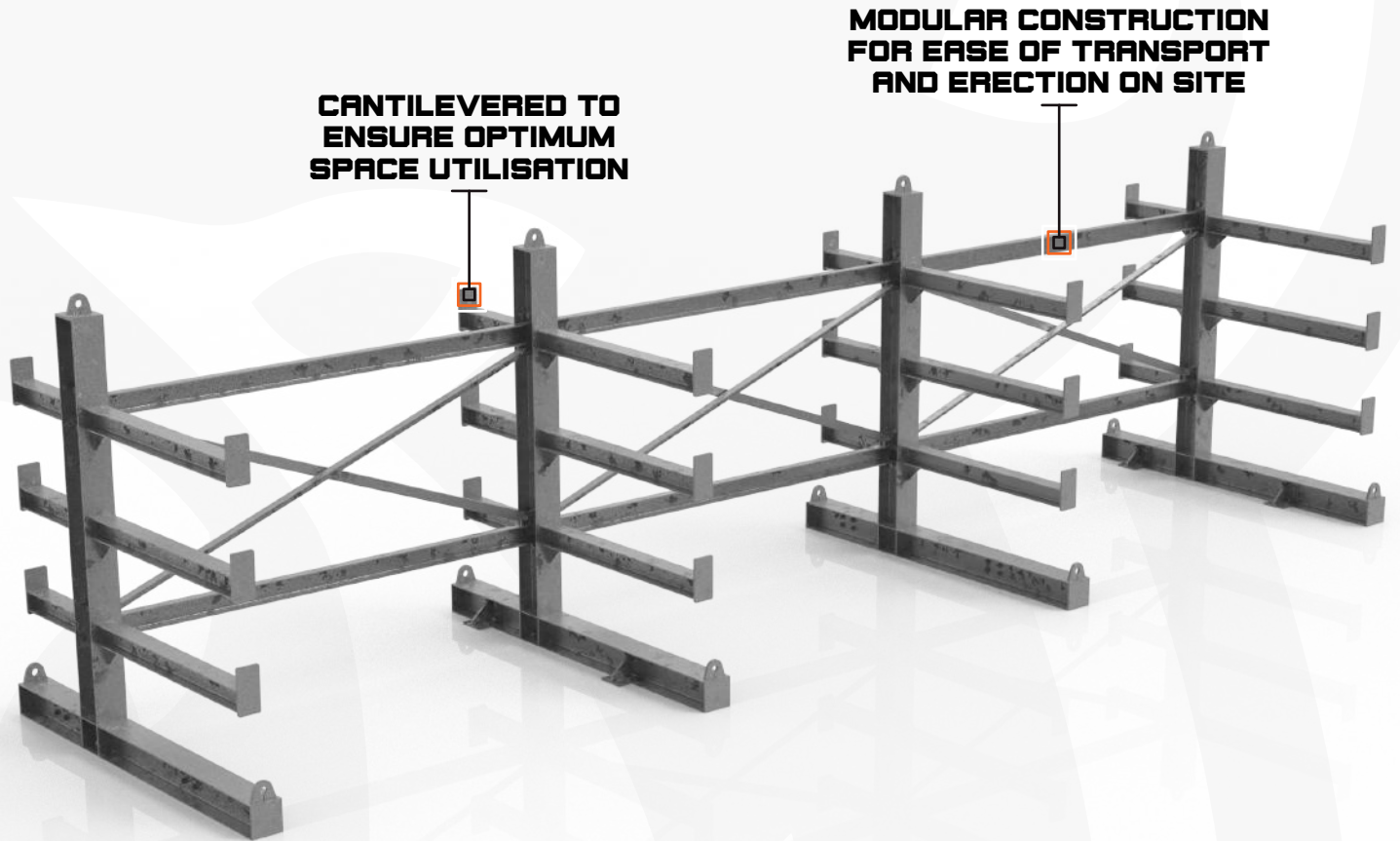

**CANTILEVERED TO
ENSURE OPTIMUM
SPACE UTILISATION**

**MODULAR CONSTRUCTION
FOR EASE OF TRANSPORT
AND ERECTION ON SITE**



MEDIUM GENERAL PURPOSE STEEL RACK

Our Medium General Purpose Steel Rack is used for storing steel and equipment. Being certified and compliant with Australian Standards ensures your site will satisfy any compliance audit.

 **Material:** Steel  **WLL:** 3T per shelf  **Finish:** Galvanised  **Dimensions:** 2000mm H / 7500mm L / 2048mm W

LARGE GENERAL PURPOSE STEEL RACK

Our Large General Purpose Steel Rack is used for storing steel and equipment. Being certified and compliant with Australian Standards ensures your site will satisfy any compliance audit.

 Material: Steel	 WLL: 3T per shelf	 Finish: Galvanised	 Dimensions: 2000mm H / 9000mm L / 2048mm W
--	---	--	--

**CANTILEVERED TO
ENSURE OPTIMUM
SPACE UTILISATION**

**MODULAR CONSTRUCTION
FOR EASE OF TRANSPORT
AND ERECTION ON SITE**

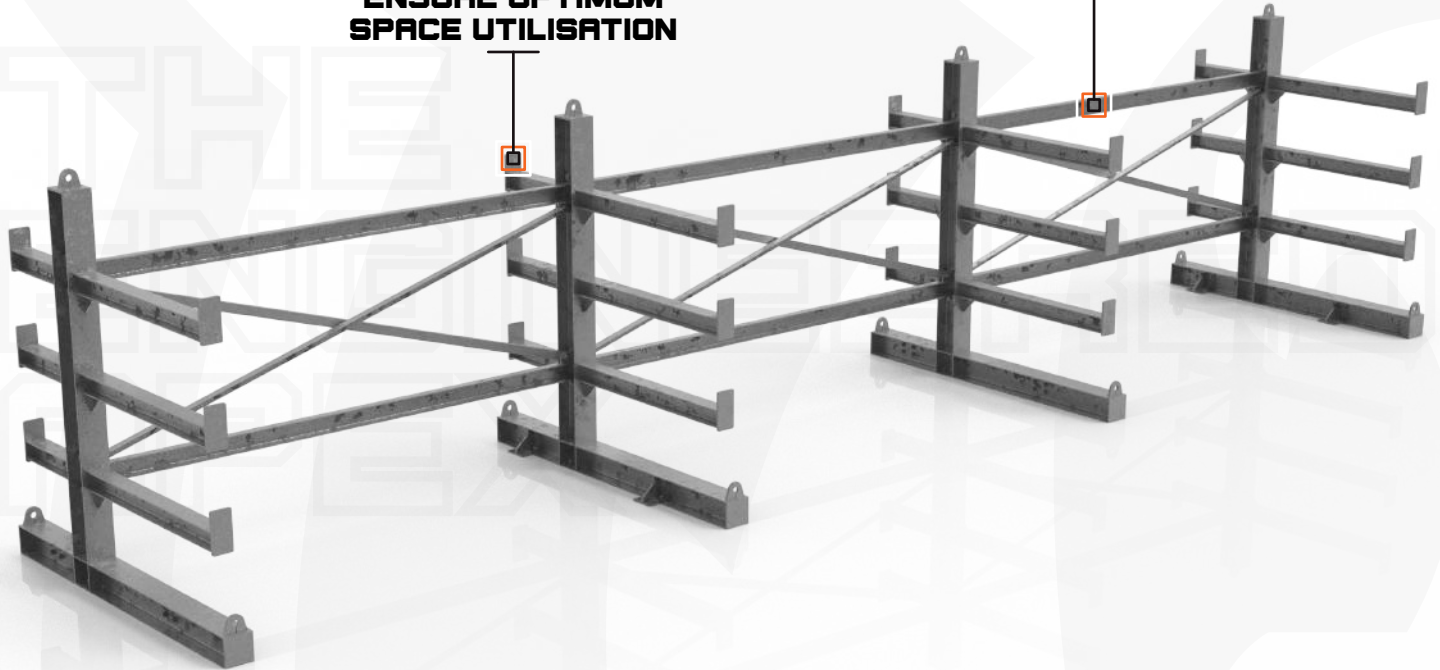



 **CERTIFIED COMPLIANT** 
WITH AUSTRALIAN STANDARDS 

PART NO. 5501660

**HEAVY-DUTY STEEL
CONSTRUCTION**

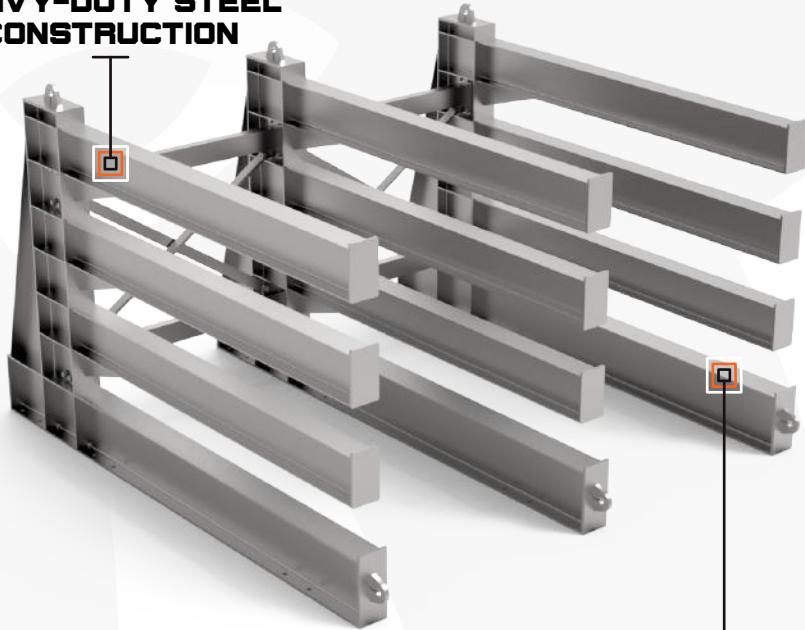

**HOT DIP
GALVANISED
FINISH**

HORIZONTAL STEEL PLATE RACK

A designed and engineered mobile steel plate rack for safe and efficient maintenance. Certified and compliant with Australian Standards.

 **Material:** Steel  **WLL:** 6.5T per shelf  **Finish:** Galvanised  **Dimensions:** 2004mm H / 3000mm L / 3328mm W

HORIZONTAL PLATE STORAGE RACK 8M

Our Horizontal Steel Plate Storage Rack is designed to store full size steel plates and sheeting. Engineered and certified ensures your site will comply with any safety audit.

 Material: Steel	 WLL: 6.5T per shelf	 Finish: Galvanised	 Dimensions: 2004mm H / 8000mm L / 3329mm W
--	---	--	--

**CANTILEVERED TO
ENSURE OPTIMUM
SPACE UTILISATION**

**MODULAR CONSTRUCTION
FOR EASE OF TRANSPORT
AND ERECTION ON SITE**

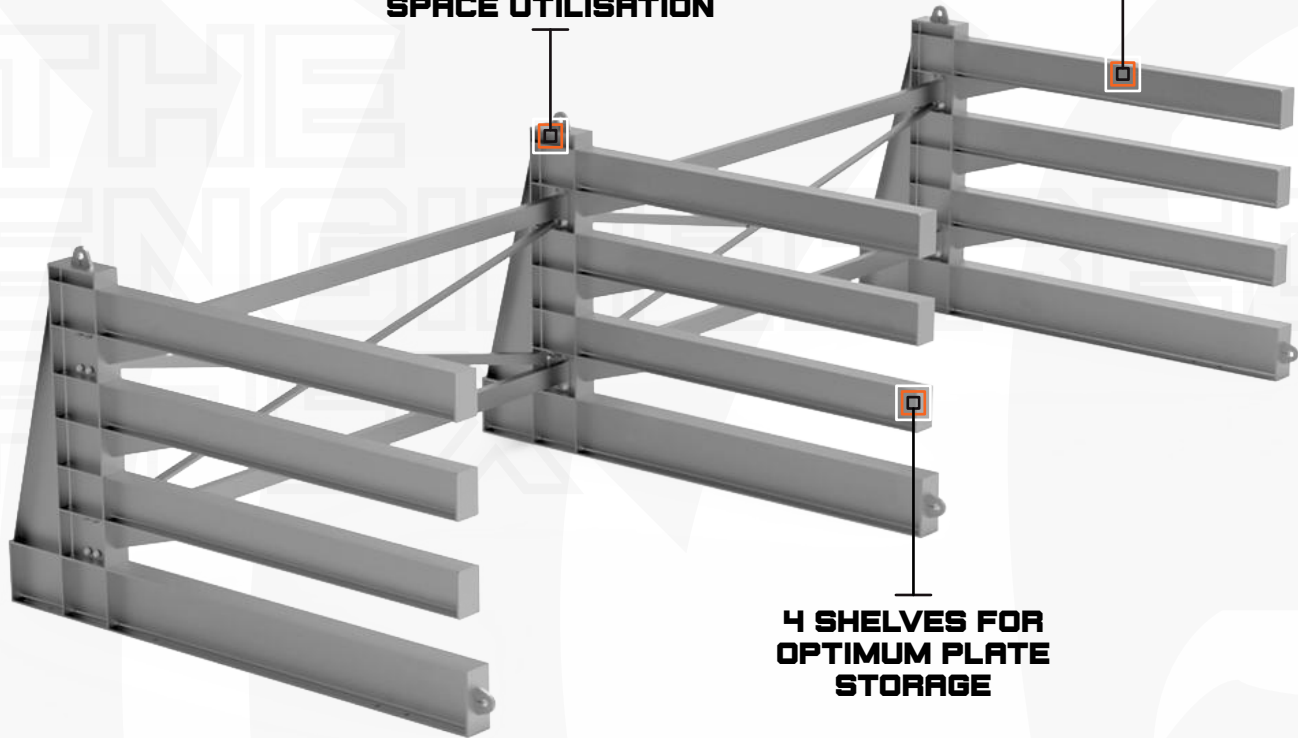

**4 SHELVES FOR
OPTIMUM PLATE
STORAGE**



 **CERTIFIED COMPLIANT** 
WITH AUSTRALIAN STANDARDS 

PART NO. 5003285

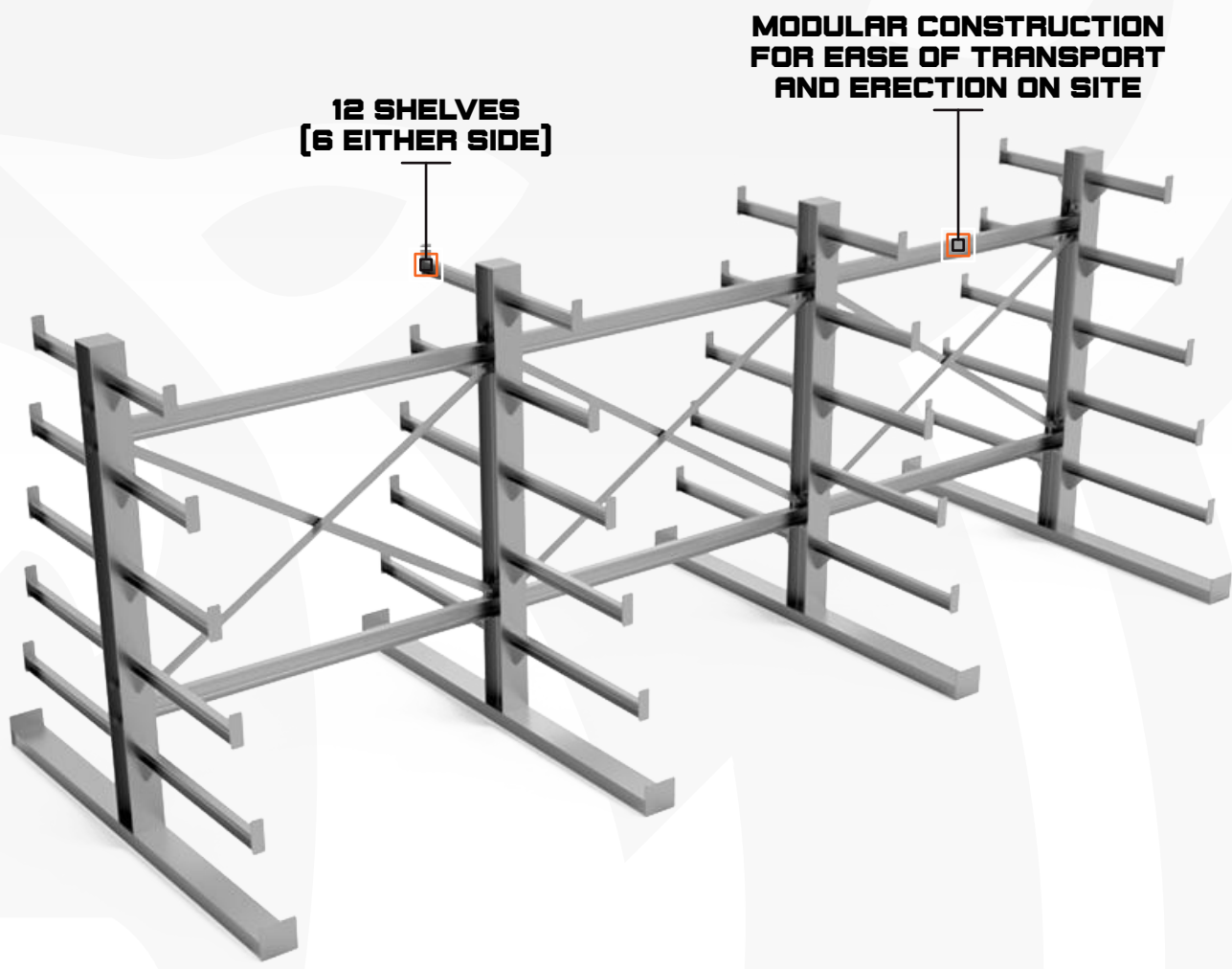

STEEL FREE STANDING STORAGE RACK

Our Steel Free Standing Steel Storage Rack is designed and engineering to be used for the storage of long length steel and tooling and will ensure your site complies in the event of any safety audit.

-
-  Material: **Steel**
 -  WLL: **4.8T per shelf**
 -  Finish: **Galvanised**
 -  Dimensions: **2250mm H / 6000mm L / 2400mm W**
-



BRAND STORY

We are excited to announce the redefined identity of our engineered safety products division. The transformation reimagined due to the sustained commitment to enabling and empowering maintenance professionals to succeed, safely.



ORIGINS

Our safety parts division offers an intelligent range of engineered safety solutions. The origins are steeped in a curious understanding of what heavy-industry professionals need to maximise safety during maintenance. With a deep-seated connection to the bespoke engineered solutions the Bend-tech provide through consulting, designing, engineering and manufacturing, GRIZZLY SAFETY PRODUCTS have been standardised to provide and answer to suspended loads, lifting and handling, working at heights, falls from height, equipment and material storage and falling objects.



EVOLUTION

The GRIZZLY SAFETY PRODUCTS range has grown into its own beast of an offering. With solutions that enable the evasion of danger and risks associated with all facets of maintenance, we knew the division required its own identity. We have been at the apex of the industry for many years, we are the go-to solution provider for heavy-industrial safety. The re-brand is an evolution of the offering our customers love.



VISION

Our new identity is an affirmation of our commitment to our mission – to be the apex provider of intelligent, engineered safety solutions. We imagine all of our current and future heavy-industrial customers operating in a proactive environment where safety and efficiency is maximised and maintenance associated danger is evaded.



PROMISE

GRIZZLY SAFETY PRODUCTS are designed, engineered and manufactured beyond the relevant safety standards. Our promise is to provide intelligently designed solutions that are manufactured in our state-of-the-art facility in Western Australia. These solutions eliminate risks associated with maintenance are extensive, the GRIZZLY range is all encompassing when it comes to enabling the evasion of danger and empowering personnel to perform safely.



THE ENGINEERED APEX



DARWIN
08 8963 5621

MOUNT ISA
07 4743 6458

NEWMAN
08 9175 1164

PERTH
08 9459 8600

HALGOORLIE
08 9021 8300

ADELAIDE
08 8231 1513

 sales@bendtechgroup.com.au

 www.bendtechgroup.com.au

