

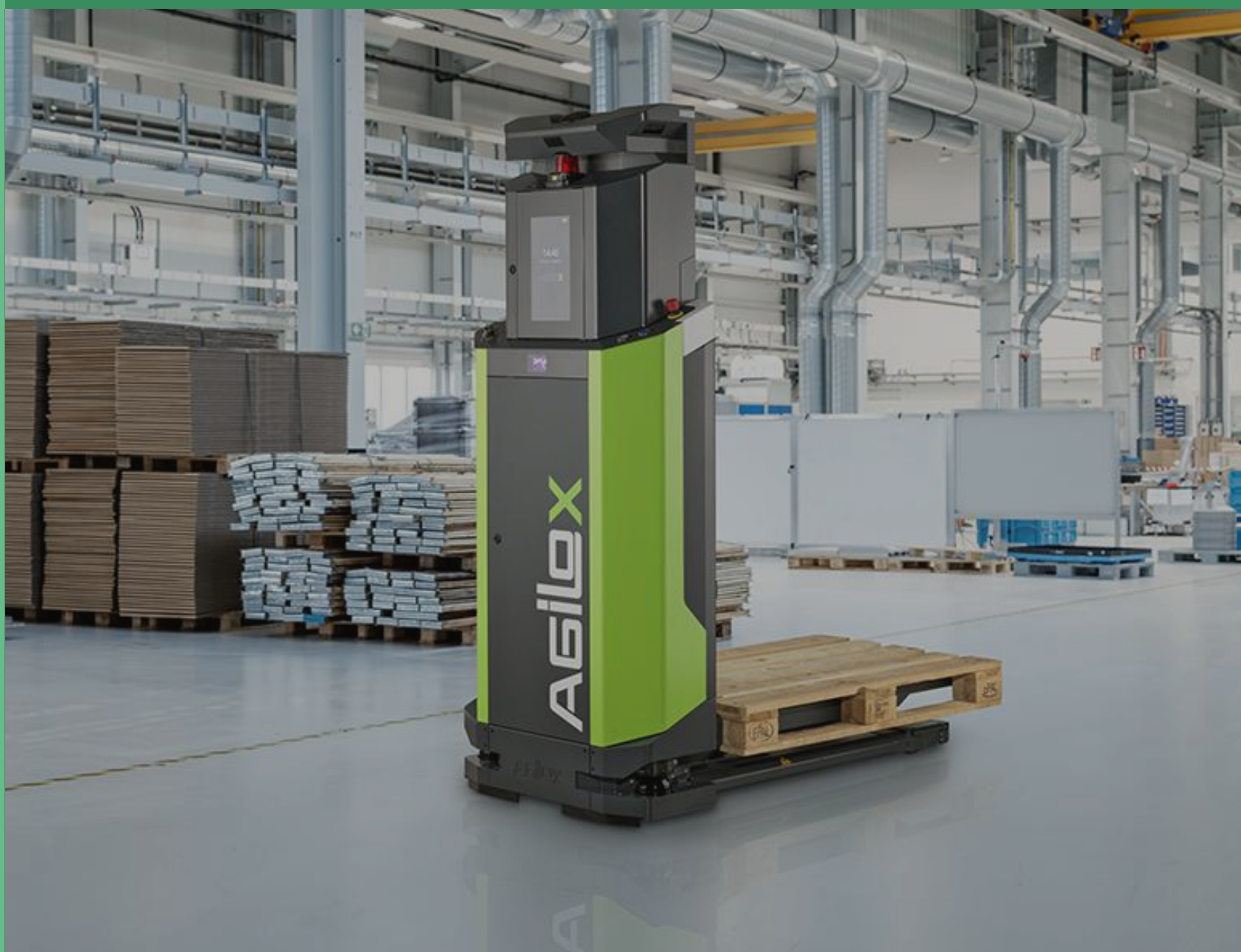

SCANLOX
SCANDINAVIAN LOGISTICS

AGILOX OFL

Data Sheet



AGILOX OFL

Free Lifter

Key Points

- Scissor-Free
- SWARM Intelligence
- Omnidirectional
- Energy Efficient
- Open Interfaces
- Analytics



Shaping the Future of Automation

The AGILOX OFL is a scissor-free AMR that redefines flexibility in material handling. Its innovative design enables seamless transportation, stacking, and storage of pallets and other load carriers up to a height of 1.200 mm without requiring infrastructure changes.

With omnidirectional movement and advanced safety technology, the OFL ensures precise, efficient, and fully autonomous operation in any environment.

VDA5050 Compatible

VDA5050 is an open standard for communication between autonomous robots and control systems. The standard ensures that robots from different manufacturers can be seamlessly integrated with central control systems.

All AGILOX AMRs are fully compatible with the VDA5050.

The AGILOX Family



Technical Specifications

Performance

Max. Lifting Height	1,200 mm
Max. Lifting Weight	800 kg
Max. Speed	1.4 m/s

Dimensions

1,655 x 800 x 1,988 mm (L x W x H)

Specifications

Drive System	4 Omnidirectional Drivers
Turning Circle	2,200 mm
Lift System	Dual Electric Spindles
Unit Weight	575 kg
Battery	LiFePO4, BMS 3 min. Charging = 1 h Operation

Load Carrier Types

Compatible load carriers and handling configurations.



Pallets
800 / 1,000 / 1,200
EUR Format



Closed Pallets
Plastic / Wood / Metal
CHEP



Pallet Boxes



Pallet Cages
Plastic / Wood / Metal



Roller Cages
Plastic / Wood / Metal

i Other types of carriers? Inquiry to supplier.

i NB: The vehicle is not limited by plastic wrap on the pallet's foot.

System Overview

REST API

A REST API is a way for different programs to communicate with each other. It acts as a common language, allowing systems to exchange information quickly and securely.

It works as a kind of intermediary that translates and passes messages between two systems.

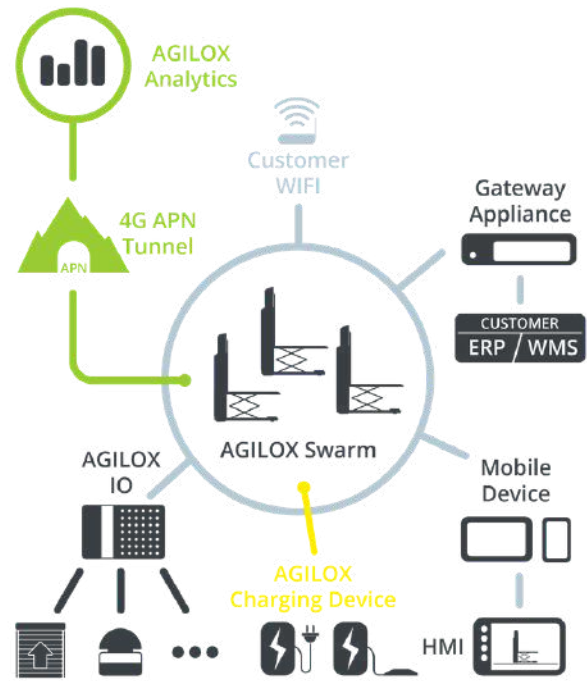

Efficient Charging

Operates 24/7 without battery replacement. 60 minutes of operation with just 3 minutes of charging.



Mobile Control

The AMRs are managed via smartphone, tablet, or any browser-enabled device.



Wi-Fi Connectivity

Requires customer-provided Wi-Fi for seamless communication between vehicles.



User-Friendly HMI

The interface is accessible through a web browser, ensuring easy interaction at any time.



System Integration

Easily connects to customer ERP, WMS, or MES via AGILOX JSON API.



Seamless Infrastructure Integration

The IO Box enables connection with existing systems, such as roller doors and fire alarms.



Swarm Intelligence

Decentralized navigation optimizes fleet coordination and efficiency.



Advanced Analytics

Real-time access to key performance data from anywhere.

HMI

Customer-Friendly Interface

The control system features a user-friendly and flexible HMI, providing full control, real-time monitoring, and the ability to adjust autonomous mobile robots and system settings on any device.

AGILOX seamlessly integrates with customer management systems. Orders from WMS, ERP, PMS, or MES are automatically converted into transport requests. The integration is provided as a gateway solution with an API (REST) for communication, utilizing JSON scripts combined with OPC I/O.



Key Features

Open Interface

Seamless integration with existing systems.

Zoom function

Improved screen visibility for detailed operation.

Realtime Vehicle Overview

Instant status updates on all AGILOX units.

Direct Workflow Adjustments

Modify layouts and parameters instantly.

Heatmaps

Visualize movement patterns and optimize efficiency.

Comprehensive Tools

All necessary tools included. Error by email or SMS.

Integrated Documentation

Always accessible and directly embedded.

Flexible Order Trigger Options

Easy Button

Operators can initiate transport orders via screen-configured buttons.

Scheduled Orders

Predefined transport tasks executed at specific times or intervals.

Sensor Activation

Automatic triggering based on PLC signals.

Software Integration

Seamless connectivity with customer management systems.

AGILOX Analytics

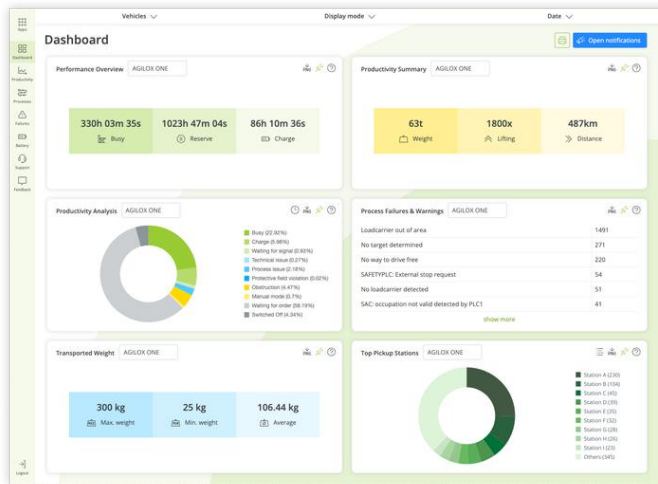

Performance Data



Easy Access

Analyze logistics data effortlessly via a browser.



Optimized Operations

Leverage real-time insights to improve fleet efficiency.



Maximum Security

Certified data center with highest security encryption.



Detailed Reports

3.5 billion + data points per vehicle for precise analysis.



Anywhere, Anytime

Access data from any device for continuous optimization.



Safety in the Overview by:

APN Connection

ISO 27001 Certified Data Centers

Encryption According to Highest Standards

Embracing the Power of Simplicity

All AGILOX AMRs communicate in real time, exchanging data on their position and status several times per second. They autonomously allocate tasks, manage the supply and removal of goods, efficiently navigate by identifying free routes, and effortlessly adapt to changes in their environment.

X-SWARM Technology

One for all. All for one. All for you.

All AGILOX AMRs communicate in real time, exchanging data on their position and status several times per second. They autonomously allocate tasks, manage the supply and removal of goods, efficiently navigate by identifying free routes, and effortlessly adapt to changes in their environment.

Plug & Perform

it's as easy as that

Plug & Perform technology allows for AMR deployment in under 12 hours, with workflows adaptable in minutes. Skip the long implementation times and high commissioning costs while easily integrating third-party modules, such as (high-)speed doors and IT systems. Built for open communication, the AMRs use Wi-Fi connectivity for smooth interaction and control.

Unique Simplicity

Because it's about ease of use

Engineered with a user-first approach, the technology is designed for intuitive and seamless operation. Hardware, controls, software, and cloud architecture are developed in-house and fully integrated to streamline every phase, from commissioning and operation to maintenance, control, and workflow adjustments.

Flexibility

Being flexible is a guarantee of success

The AMRs instantly adjust to changing requirements with a single click. Stations, map layouts, and entire workflows can be created, modified, or relocated effortlessly, without extra costs or external assistance.

Safety

It's also absolutely safe

The AMRs operate safely alongside employees, navigating shared travel and transport routes without incidents. Advanced safety sensors and a dynamic 360° protective field enable smooth and efficient performance in mixed traffic environments. They are certified to meet key industry safety standards, including CE, UL, and ISO 3691-4.

Supply Chain

Simply no more Standstill. 24/7

Maintain a seamless material flow with absolute flexibility, even in dynamic environments. In the event of a robot failure, the remaining AMRs in the swarm automatically take over to ensure uninterrupted operations. Prevent supply shortages and optimize transport throughput times with fully automated efficiency. Thanks to ultra-fast charging, AMRs are ready for use again within minutes, ensuring a perfectly synchronized material flow.

Features & Add-Ons



Obstacle Avoidance

3D sensor system improves safety in human-machine environments.



Rubber Guards

Front and fork-tip protection to deflect dirt.



Signal Lighting

Multi-color signals (blue, green, red) for increased visibility. Additional fork-tip lights (white, yellow).



Barcode Reader

Reads barcodes and QR codes for identification.



Charging Devices

Available as mobile or stationary units.



Touch Display

Interface Provides a clear overview of the AMR's status and enables simple user interactions.



ESD Protection

Prevents electrostatic charging in ESD-sensitive areas.



Safety & Scanners

The AMRs are equipped with advanced safety systems designed to protect employees, infrastructure, and the robots themselves.

Compliance with international standards such as ISO 3691-4 and EN1525.



Drive Path Design

Protective field	A	B	C	D	E	F	G	H	I	J
1200 x 800 mm	1400 mm	1600 mm	1900 mm	2900 mm	2000 mm	2200 mm	2600 mm	50 mm	200 mm	100 mm
Protective field	Ideal aisle width at 1.4 m/s		Min. aisle width at 1.2 m/s		Min. passage width at 0.3 m/s		Turning circle for pickup			
W=800mm/L=1200mm	> 2000 mm		> 1600 mm		> 1400 mm		> 2200 mm			

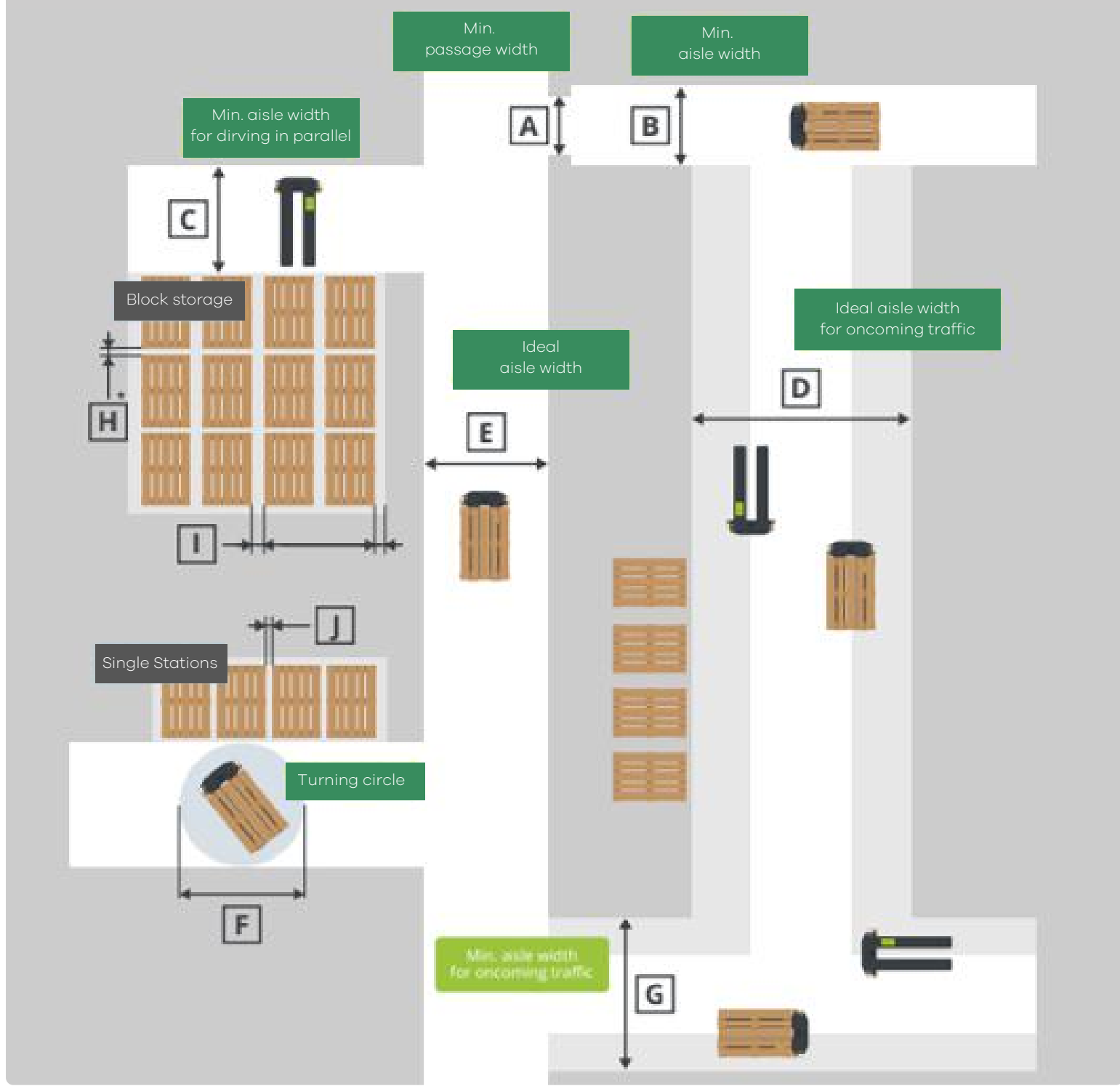

Dimensions

Scissor-Free Lifting System

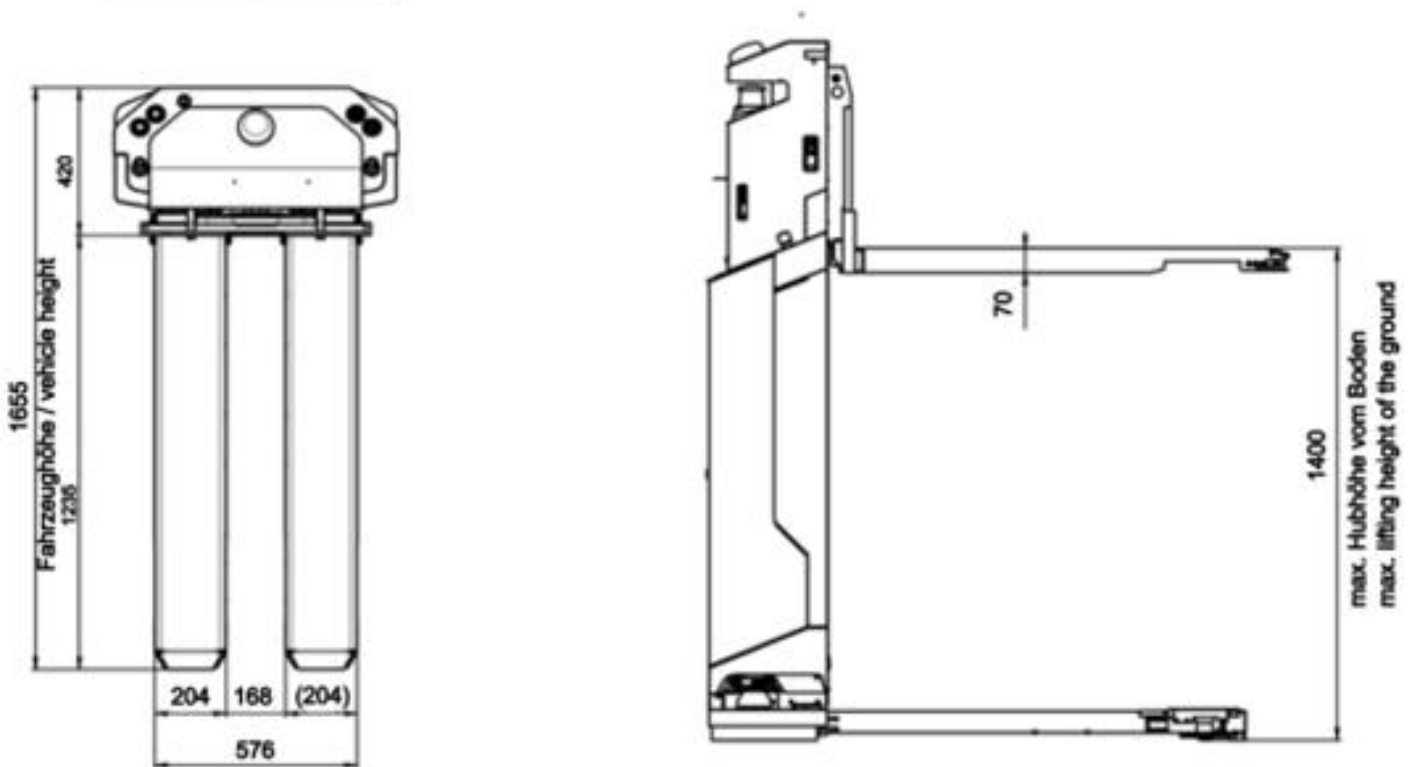
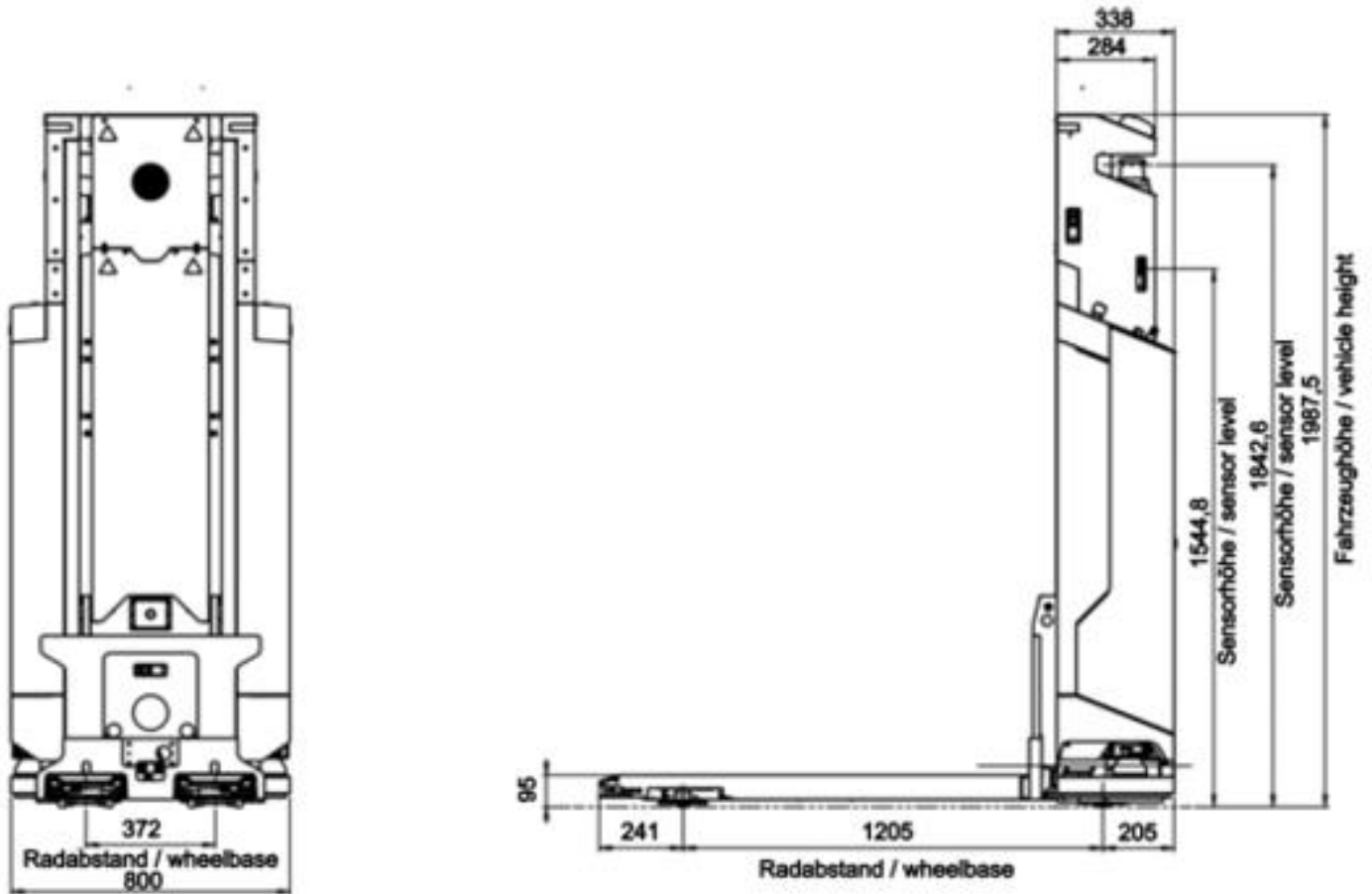

Compare AMR Models

Compare technical specifications and features side by side.

The table makes it easy to identify the solution that best fits your operational needs.



	OFL	ONE	NFK	OCF	ODM
Length	1,655 mm	1,511 mm	1,511 mm	2,784 mm	1,095 / 1,295 mm
Width	800 mm	810 mm	810 mm	1,200 mm	400 mm
Height	1,988 mm	1,862 mm	1,862 mm	2,566 mm	1,235 mm
Weight	575 kg	420 kg	420 kg	3,600 kg	160 / 175 kg
Lifting Capacity	800 / 1,200 kg	1,000 / 750 kg	1,000 kg	1,500 kg	300 kg
Lifting Height	1,390 mm	620 / 1.100 mm	620 mm	1,600 mm	250 mm
Station Height	1,200 mm	500 / 1,000 mm	-	1,450 mm	-
Speed	1,4 m/s	1,4 m/s	1,4 m/s	1,4 m/s	1,4 m/s
Load Carrier	Pallets & Custom	Pallets & Custom	Roller Cages & Custom	Pallets & Custom	Dollies & Custom
Workflow	Floor-to-Station	Floor-to-Floor	Floor-to-Floor	Floor-to-Station	Floor-to-Floor
Turning Radius	2,200 mm	2,100 mm	2,100 mm	3,500 mm	1,700 / 1,900 mm
Aisle Width	1,600 mm	1,600 mm	1,600 mm	2,100 mm	1,300 / 1,200 mm
Passage Width	1,400 mm	1,400 mm	1,400 mm	1,700 mm	1,000 mm
Charging Time	3 min. charging = 1 hour operation	3 min. charging = 1 hour operation	3 min. charging = 1 hour operation	3 min. charging = 1 hour operation	20-100 % in approx. 11 min.