



SROUND NG



S r o u n d

L u m i n a i r e S e r i e s



S R o u n d V . 3 A r e n a (6 0 °)	8
S R o u n d V . 3 L o w b a y (9 0 °)	9
S R o u n d V . 3 A S Y M M E T R I C	10
S R o u n d V . 2 I n d u s t r y A r e n a (6 0 °) - L o w b a y (9 0 °)	12
S R o u n d C r a n e	14
S R o u n d M i n i	15
S R o u n d R e d	16

SYSTEM OVERVIEW



IK 09 IMPACT STRENGTH*

Robust resistant housing structure. **IK Class 09**

*IK09 is valid for fragile parts of luminaire.



interior environment *outdoor environment*

IP65 - IP66 PROTECTION CLASS

SRound, having IP66 protection class, shows maximum resistance in many fields of industry.



In models reaching up to 70 °C

60.000 HOURS LIFE

@ Luminaire life exceeding 72.000 hours at ambient temperature of 70°C

Led Life - L70 : 72.000 @ Ta = 70 °C

Note: Driver life 50.000 hours.

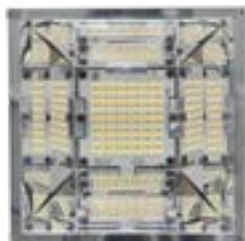
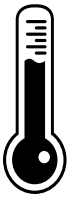

UNIQUE OPTICAL DESIGN

3 different optical luminescence options provide **SR**ound to be used in a wide range. It carries its specially designed optical efficiency to the top level via MIRO[®] 04 aluminum reflectors.

UGR: < 22



60°
Arena



90°
Lowbay



110°
Low Lowbay



Asymmetric

Up to 177 lm/W*
HIGH EFFICACY

Efficiency starting from 135 lm/W and up to 177 lm/W. (@4000K)

*Lumen values of the product.

**MULTIPLE
USAGE**

It provides dual-use due to special design T profile.



Double **SRound**



Single **SRound**

**TEMPERED GLASS
WITH SECURITY FILM**



Glass covered with security film preventing glass particles to fall in case of breakage on glass.

**WORKING AMBIENT
TEMPERATURE IN RANGE OF**

 **-35 °C and + 70 °C** 

Its has a wide working ambient temperature due to its superior housing design.



MODERN DESIGN

SRound high ceiling lighting fixture not only meets the requirements but also sets innovative standards. Sround brings lighting solutions with 4 different optical options together. it has efficient led technology and a specially developed optical system that combines the best light quality with visual comfort. Sround offers the perfect lighting experience at equal mounting heights.



OPTICAL OPTIONS



SRound provides the opportunity to be applied to different ceiling heights due to its rich optical variety.



60°
Arena



90°
Lowbay



110°
Low Lowbay



Asymmetric

Optic
Options

TERMAL PERFORMANCE

It shows maximum performance in industrial application fields with its specially designed compact housing which provides homogenous heat distribution.

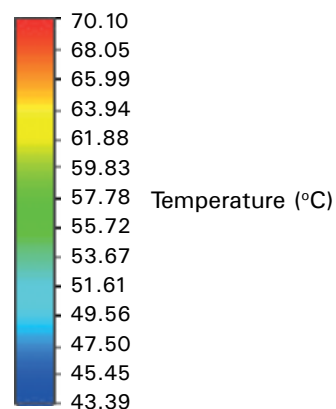
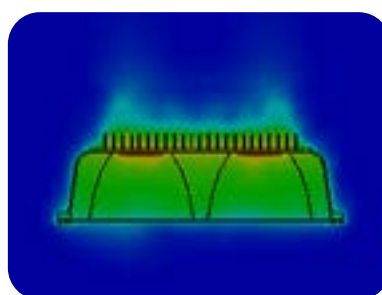

Note: During product design, thermal distribution analysis of SRound obtained results close to 99% by using FloEFD thermal analysis program.



Sround v.3

ARENA (60°)

HIGH-BAY LUMINAIRE



Sround V3, which shows maximum resistance to the challenging conditions of industrial facilities with its aluminum body; meets the lighting needs of different height production facilities with a wide lumen range of 9000 ~ 25400. With its armature efficiency reaching 177lm / W, arena optical angle options, it provides ideal lighting for industrial environment conditions where high performance is expected.



Technical Specifications

Housing	: Aluminium injection housing
Optical	: Miro silver reflector
Diffuser	: Tempered transparent glass / Tempered sanded glass
Light Source	: Mid Power LED
Power	: 52 W / 67 W / 90 W / 113 W / 163 W
Lumen	: 9168 lm / 11497 lm / 15206 lm / 18901 lm / 25448 lm
Input Voltage	: 220-240V AC 50/60Hz
Color Temp.	: 4000K / 5700K / 6500K
CRI	: > 80
IP	: IP65
Installation	: Surface mounted / Pendant
Colors	: SW 306G

Technical Drawing

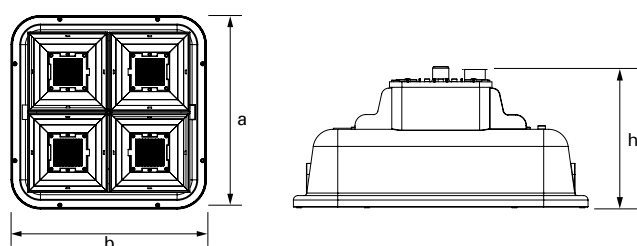

Photometric Curve

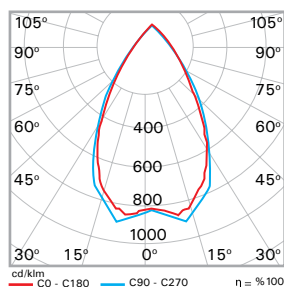

Dimensions (mm)

	a	b	h
Standart	400	400	190
Dual Model	842	400	320

Options

Emergency Kit	: Yes (1-3 hours)
Electronic Control	: DALI / Traceable DALI Kit

Purchase Order Table

Product Type	Product Code	Power (W)	Weight (kg)
56 W (4000K)	SRD 052U 40FS00 AR 9K16 V.3.504	51,8	8,2
67 W (4000K)	SRD 067U 40FS00 AR 11K4 V.3.504	66,7	8,2
90 W (4000K)	SRD 090U 40FS00 AR 15K2 V.3.504	89,6	8,2
113 W (4000K)	SRD 113U 40FS00 AR 18K9 V.3.504	113,3	8,2
163 W (4000K)	SRD 163U 40FS00 AR 25K4 V.3.504	162,7	8,2
163 W (4000K) 1Hour ACK	SRD 163U 40FS01 AR 25K4 V.3.504 HRC	221,8	9,5



SRound v.3

LOWBAY (90°)

HIGH-BAY LUMINAIRE



Aluminium injection housingdan üretilen Housingsi ile endüstriyel tesislerin zorlayıcı koşullarına maksimum dayanım gösteren Sround V.3 ; 9000 ~ 25400 geniş Lumen aralığı ile farklı yükseklikteki üretim tesislerinin aydınlatma ihtiyaçlarını karşılar. 177lm/ W'a ulaşan armatür verimliliği, lowbay Optical Angle Options ile yüksek performansın beklendiği endüstriyel ortam koşulları için ideal aydınlatma sağlar.



Technical Specifications

Housing	: Aluminium injection housing Housing
Optical	: Miro silver reflector
Diffuser	: Tempered transparent glass / Tempered sanded glass
Light Source	: Mid Power LED
Power	: 52 W / 67 W / 80 W / 90 W / 113 W / 134 W / 163 W
Lumen	: 9130 lm / 11399 lm / 13426 lm / 15129 lm 18738 lm / 21292 lm / 25253 lm
Input Voltage	: 220-240V AC
Color Temp.	: 4000K / 5700K / 6500K
CRI	: > 80
IP	: IP65 / IP66
Installation	: Surface mounted / Pendant
Colors	: SW 306G

Technical Drawing

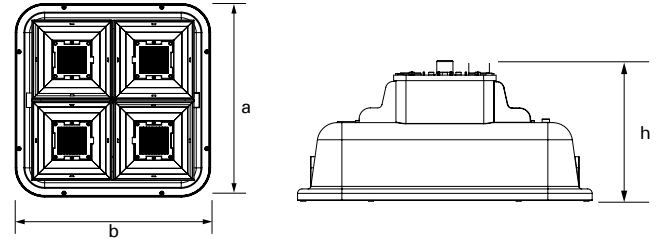

Photometric Curve

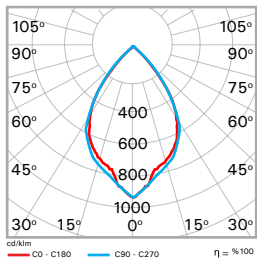

Dimensions (mm)

	a	b	h
Standart	400	400	190
Dual Model	842	400	320

Options

Emergency Kit	: Yes (1-3 hours)
Electronic Control	: DALI / Traceable DALI Kit
Angle Options	: 110°
Glass Options	: Sanded Glass

Purchase Order Table

Product Type	Product Code	Power (W)	Weight (kg)
52 W (4000K)	SRD 052U 40FS00 LB 9K13 V.3.504	51,8	8,2
67 W (4000K)	SRD 067U 40FS00 LB 11K3 V.3.504	66,6	8,2
80 W (4000K)	SRD 080U 40FS00 LB 13K4 V.3.504	79,3	8,2
90 W (4000K)	SRD 090U 40FS00 LB 15K1 V.3.504	89,5	8,2
113 W (4000K)	SRD 113U 40FS00 LB 18K7 V.3.504	113,3	8,2
134 W (4000K)	SRD 134U 40FS00 LB 21K2 V.3.504	134,4	8,2
163 W (4000K)	SRD 163U 40FS00 LB 25K2 V.3.504	162,8	8,2
163 W (4000K) 1Hour ACK	SRD 163U 40FS01 LB 25K2 V.3.504 HRC	162,8	8,2



SRound v.3

ASYMMETRIC

HIGH-BAY LUMINAIRE



The household produced from the Aluminum injection housings and the Sround V. 3, which shows maximum resistance to the challenging conditions of industrial facilities, meet the lighting needs of different high production facilities with a wide Lumen range of 9000 ~ 25400. Luminaire efficiency up to 177lm/W provides ideal lighting for industrial environments where high performance is expected with asymmetric Optical Angle Options.



Technical Specifications

Housing	: Aluminium injection housing Housing
Optical	: Miro silver reflector
Diffuser	: Tempered transparent glass / Tempered sanded glass
Light Source	: Mid Power LED
Power	: 113 W / 160 W
Lumen	: 18900 lm / 23557 lm
Input Voltage	: 220-240V AC 50/60Hz
Color Temp.	: 4000K / 5700K / 6500K
CRI	: > 80
IP	: IP65
Installation	: Surface mounted / Pendant
Colors	: SW 306G

Technical Drawing

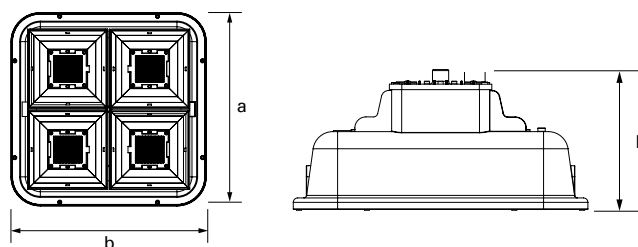

Photometric Curve

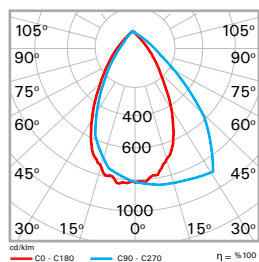

Dimensions (mm)

	a	b	h
Standart	400	400	190
Dual Model	842	400	320

Options

Emergency Kit	: Yes (1-3 hours)
Electronic Control	: DALI / Traceable DALI Kit

Purchase Order Table

Product Type	Product Code	Power (W)	Weight (kg)
113 W (4000K)	SRD 113U 40FS00 AS 18K9 65 V.3.504	113	8,2
160 W (4000K)	SRD 160U 40FS00 AS 23K5 65 V.3.504	160,8	8,2





SRound v.2 INDUSTRY

ARENA (60°) - LOWBAY (90°)

-35°C +70°C



HIGH-BAY LUMINAIRE

SRound V2 with its high IP-protected aluminum body, which offers maximum resistance to heavy industrial ambient conditions, guarantees excellent lighting performance in low-high temperature ambient conditions. With its 9000 ~ 18000 wide lumen range and arena / low bay optical options, it is the ideal lighting solution for demanding production conditions with an operating ambient temperature of -35°C ~ + 75°C. It is preferred in areas specializing in a wide range of implementations from iron and steel industry to shipyards.



Technical Specifications

Housing	: Aluminium injection housing Housing
Optical	: Miro silver reflector
Diffuser	: Tempered transparent glass
Light Source	: Mid Power LED
Power	
Arena	: 56 W / 70 W / 76 W / 80 W / 88 W / 106 W / 216 W
Lowbay	: 56 W / 70 W / 76 W / 80 W / 88 W / 106 W / 216 W
Input Voltage	: 220-240V AC 50/60Hz
Color Temp.	: 4000K
CRI	: Mid Power LED : > 80
IP	: IP65 / IP66
Installation	: Surface mounted / Pendant
Colors	: SW 306G

Technical Drawing

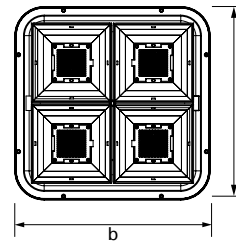

Mid Power LED Model / IP65

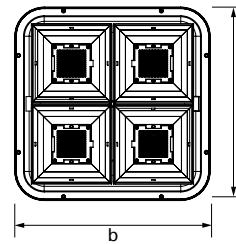
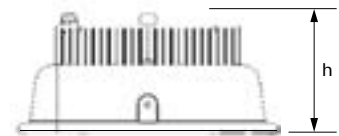

Mid Power LED External Case / IP66

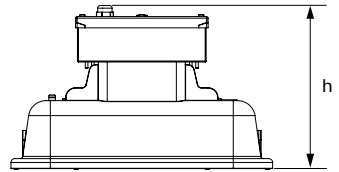

Photometric Curve

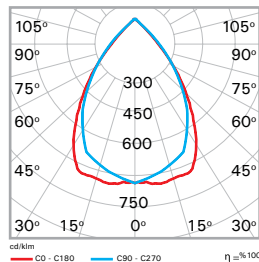
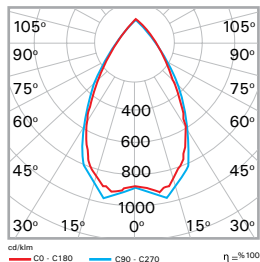

Dimensions (mm)

Mid Power LED Model

	a	b	h
Standart	400	400	190
Dual Model	842	400	320

Options

DALI Compatibility : Yes

Purchase Order Table

Arena

Product Type	Product Code	Max. Ortam Sıcaklığı
56 W (4000K)	SRD 056U 40FS06 AR 9K10 65 V.2.504	70°C
70 W (4000K)	SRD 069U 40FS06 AR 11K4 65 V.2.468	65°C
76 W (4000K)	SRD 076U 40FS06 AR 11K7 65 V.2.504	60°C
80 W 4000K	SRD 080U 40FS06 AR 13K3 65 V.2.468	60°C
88 W (4000K)	SRD 087U 40FS06 AR 13K3 65 V.2.504	60°C
106 W (4000K)	SRD 106U 40FS06 AR 18K0 65 V.2.468	55°C
216 W (4000K)	SRD 216U 40FS06 AR 31K4 65 V.2.560 INV	55°C

Lowbay

Product Type	Product Code	Max. Ortam Sıcaklığı
56 W (4000K)	SRD 056U 40FS06 AR 9K10 65 V.2.504	70°C
70 W (4000K)	SRD 069U 40FS06 LB 11K4 65 V.2.468	65°C
76 W (4000K)	SRD 076U 40FS06 LB 11K7 65 V.2.504	60°C
80 W 4000K	SRD 080U 40FS06 LB 13K3 65 V.2.468	60°C
88 W (4000K)	SRD 087U 40FS06 AR 13K3 65 V.2.504	60°C
106 W (4000K)	SRD 106U 40FS06 AR 18K0 65 V.2.468	55°C
216 W (4000K)	SRD 216U 40FS06 AR 31K4 65 V.2.560 INV	55°C





Sround Crane

-35°C +70°C



HIGH-BAY LUMINAIRE

SROUND CRANE, put into use more quickly by being mounted with special Crane suspension sets, meets all lighting requirements of cranes lighting. Sround Crane provides high protection against water and dust (IP66) with its perfect and simple designed housing.



Technical Specifications

Housing	: Aluminium injection housing Housing
Optical	: Miro silver reflector, Narrow angle (60°)
Diffuser	: Tempered transparent glass
Light Source	: Mid Power LED / Power LED
Power	: 71 W / 137 W / 160 W
Input Voltage	: 220-240V AC 50/60Hz
Color Temp.	: 4000K / 5700K / 6500K
CRI	: > 70 / > 80
IP	: IP65
Installation	: Surface mounted
Colors	: SW 306G

Technical Drawing

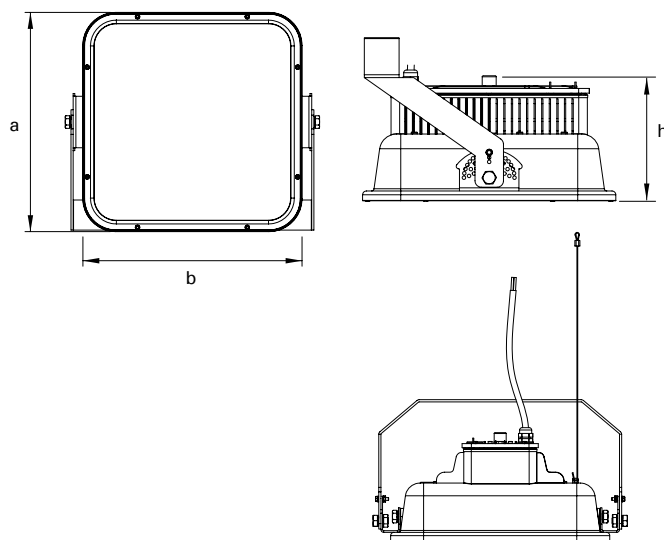

Photometric Curve

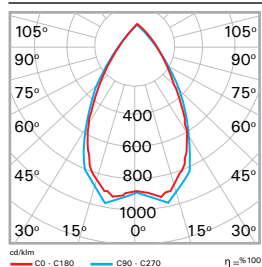

Dimensions (mm)

a	b	h
400	400	190

Options

ACK	: Var (1-3 Hour)
Electronic Control	: DALI / Traceable DALI Kit
Angle Options	: 90° / 110° / ASYMMETRIC

Purchase Order Table

Product Type	Product Code	Power (W)	Weight (kg)
71 W 4000K	SRD 071U 40FS06 AR 11K4 66 V.2.468	32,8	3,5
137 W 4000K	SRD 137U 40FS06 AR 21K4 66 V.2.468	78,5	3,5
160 W 4000K	SRD 160U 40FS06 AR 24K3 66 V.2.504 CRN	88,3	3,5



SRound mini v.2

HIGH-BAY LUMINAIRE



The updated high-IP shielded aluminum household can be used in workshop and low ceiling lighting applications with package range 4500 lm-11000lm, lowbay/lowlowbay optical angles and round Mini with six ceiling heights of 8M. It offers one-stop hanger, making it especially ideal for refit conversion projects.



Technical Specifications

Housing	: Aluminium injection housing
Optical	: Aluminum Reflector, 103°/ 75°
Diffuser	: Tempered acid matt glass
Light Source	: Mid Power LED
Power	: 33 W / 78 W / 88 W
Lumen	: 4500 lm / 9500 lm / 11000 lm
Input Voltage	: 220-590V 50-60 HZ
Color Temp.	: 4000K / 5700K / 6500K
CRI	: > 80
IP	: IP65
Installation	: Surface mounted / Pendant
Colors	: SW 306G

Technical Drawing

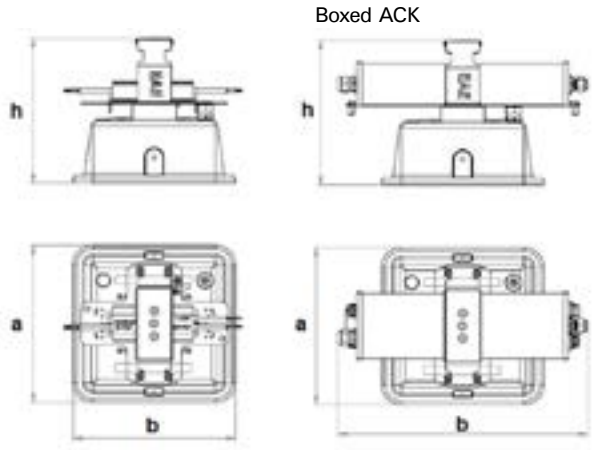

Photometric Curve

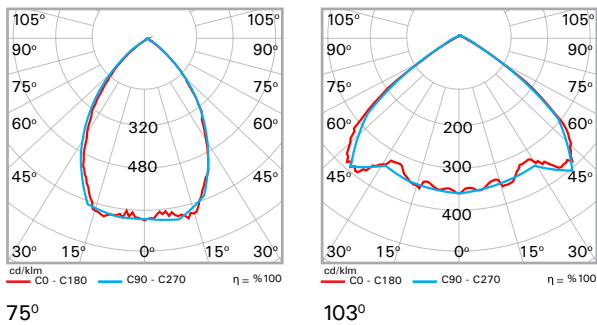

Dimensions (mm)

	a	b	h
Standart	265	265	244
Kutulu ve ACK	265	360	244

Options

DALI Compatibility : Yes

Purchase Order Table

	Product Type	Product Code	Power (W)	Weight (kg)
75°	33 W 4000K	SRD 033U 40AC00 075 4K60 65 MN V.2	32,8	3,5
	78 W 4000K	SRD 078U 40AC00 075 9K40 65 MN V.2	78,5	3,5
	88 W 4000K	SRD 088U 40AC00 075 11K4 65 MN V.2	88,3	3,5
103°	33 W 4000K	SRD 033U 40AC00 103 4K50 65 MN V.2	32,9	3,5
	78 W 4000K	SRD 078U 40AC00 103 9K20 65 MN V.2	78,5	3,5
	88 W 4000K	SRD 088U 40AC00 103 11K1 65 MN V.2	88,2	3,5

VERSION WITH SROUND MINI V. 2 BOX

	Product Type	Product Code	Power (W)	Weight (kg)
BOX 75°	33 W 4000K	SRD 033U 40AC00 075 4K60 65 MN BOX V.2	32,8	5,1
	78 W 4000K	SRD 078U 40AC00 075 9K40 65 MN BOX V.2	78,5	5,1
	88 W 4000K	SRD 088U 40AC00 075 11K4 65 MN BOX V.2	88,3	5,1
BOX 103°	33 W 4000K	SRD 033U 40AC00 103 4K50 65 MN BOX V.2	32,9	5,1
	78 W 4000K	SRD 078U 40AC00 103 9K20 65 MN BOX V.2	78,5	5,1
	88 W 4000K	SRD 088U 40AC00 103 11K1 65 MN BOX V.2	88,2	5,1

SROUND MINI V. 2 STANDART MODEL



SRound RED

-25°C +40°C



HIGH-BAY LUMINAIRE

Used as a warning light in heavy industrial environments with high roof with moving equipment such as a bridge crane that could pose a hazard to employees, round Red is used to show the direction of movement of the crane hook in environments where the noise of the equipment is high and therefore no audible warning is possible. It can also be used to show crane operators the area where they will load. Sanded glass is available.



Technical Specifications

Housing	: Aluminium injection housing Housing
Optical	: Micro silver reflector / Asymmetrical angle
Diffuser	: Tempered Sanded Glass / Tempered transparent glass
Light Source	: Power LED
Lumen	: 8666.8lm
Power	: 138.5 W
Input Voltage	: 220-240V AC 50/60Hz
Color Temp.	: RED
CRI	: > 70 / > 80
IP	: IP65
Installation	: Surface mounted / Pendant
Colors	: SW 306G

Technical Drawing

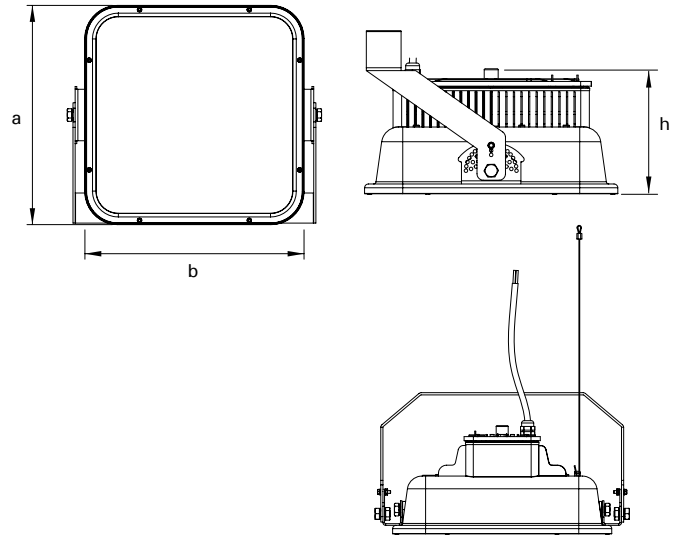

Photometric Curve

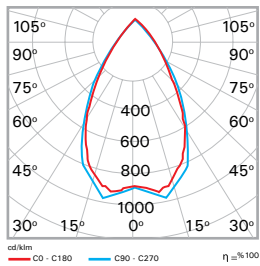

Dimensions (mm)

a	b	h
400	400	190

Purchase Order Table

Product Type	Product Code	Power (W)	Weight (kg)
140 W Kırmızı Led	SRD 140U RDFS00 AR 8K66 66	138,5	7,7



PRODUCT KEY CODES



S	R	D	0	5	6	U	4	0	F	S	0	0	L	B	9	K	1	6	5	V	2	504	PEND			
Product Code <i>SRD</i>			Power Consumption 56 62 69 71 76 79 80 87 92 100 103 110 132 137 163 165 210 220			Ceiling Type Surface Mounted <i>U</i>	Difusser Detail <i>Clear glass</i> <i>Single Filmed</i> <i>Sanded glass</i>			Kelvins 3000 4000 5000 5700 6500			Luminaire Type <i>AR: Arena</i> <i>LB: LowBay</i> <i>XW: Low LowBay</i> <i>AS: Asymmetric</i>			Lumen <i>Sample</i> <i>9K1: 9100</i>			IP <i>IP65</i>		Version		LED Pieces 504 468		Model <i>CRN: Crane</i>	
							Driver Code <i>00: Standard</i> <i>01: 1 Hour Emergency Kit</i> <i>02: 3 Hours Emergency Kit</i> <i>03: DALI</i> <i>04: DALI + 1 Hour Emergency Kit</i> <i>05: DALI + 3 Hours Emergency Kit</i> <i>06: Industrial</i> <i>24: Industrial + DALI</i> <i>49: DALI Driver + 3 Hours ACK + DALI Kit</i>																			



SUSPENSION SET SIZES AND TYPES



18.3 KG
Double luminaire

MULTIPLE USAGE

It provides dual-use due to special design T profile.



Single SRound



Double SRound



DOUBLE HANGER SET

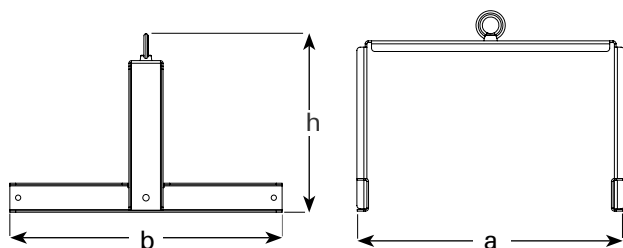

a	b	h	Weight
365 mm	470 mm	300 mm	2.7 kg

Order Code : 3093653
Product Code : SRD Double S. TK

SINGLE POINT SUSPENSION SET

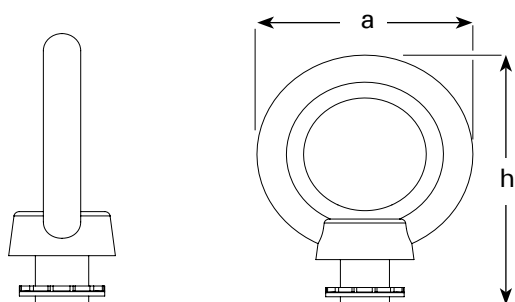

a	h	Weight
44 mm	55 mm	0,025 kg

Order Code : 3096325
 Product Code : SRD SINGLE
 POINT SUSPENSION SET

BUSBAR SUSPENSION SET

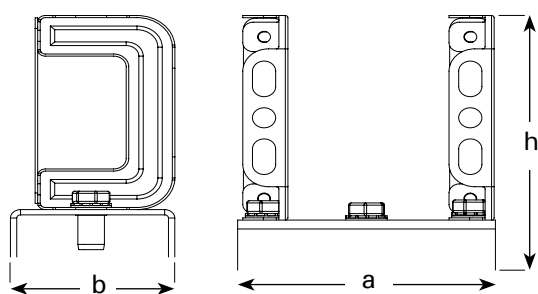

a	b	h	Weight
100 mm	65 mm	114,5 mm	0,3 kg

Order Code : 3096326
 Product Code : SRD BUSBAR
 SUSPENSION SET

CABLE TRAY SUSPENSION SET

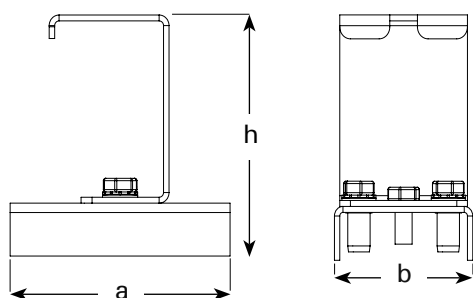

a	b	h	Weight
100 mm	65 mm	102,5 mm	0,4 kg

Order Code : 309634
 Product Code : SRD CABLE TRAY
 SUSPENSION SET

OPERATION COST ANALYSIS



400 W
Metal Halide



4x54 W
REVO Fluorescent



113 W
SRound

Light Level (Eort)	350 lux	350 lux	350 lux
Bulb Life (Hour)	8.000	23.000	60.000
Luminaire Number (Pieces)	25	30	20
Bulb Number (Pieces)	25	120	0
Bulb Power (W)	400	216	163
Balast / Driver Loss (W)	50	16	10
Luminaire Power (W)	450 W	232 W	113 W
Total Consumption Power (kW)	11.3 kW	7,0 kW	2,3 kW
<hr/>			
Annual Bulb Changing Cost (\$)	360,00	61,31	0,00
Daily Working Hours (Hour / Day)	16	16	16
Annual Working Day Number	330,0	330,0	330,0
Annual Working Hours (Hour / Year)	5,280	5.280	5.280
Energy Unit Price (\$/kwh)	0,10	0,10	0,10

Annual Energy Cost (\$) 5,940,00 3,674,88 1.193,28

Annual Operation Cost (\$/Year) 6.300,00 3.736,19 1.193,28

Annual Earning (\$/Year)

REFERENCE -1



5.106,72

ANNUAL EARNING

REFERENCE -2









2.542,91

ANNUAL EARNING

INVESTMENT RETURN ANALYSIS



NEW INVESTMENT	400 W Metal Halide		113 W SRound
	REFERENCE PRODUCT		6 MON. 
REFIT	4x54 Revo Fluorescent		113 W SRound
	REFERENCE PRODUCT		12 MON. 
	400 W Metal Halide		113 W SRound
	REFERENCE PRODUCT		12 MON. 
	4x54 Revo Fluorescent		113 W SRound
	REFERENCE PRODUCT		24 MON. 

ENERGY SAVING ANALYSIS

SAMPLE AREA

Height : 12m
Area : 30x30 m²

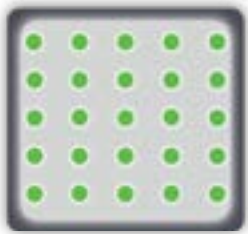

400 W Metal Halide
25 Pieces



4x54 W Revo Fluorescent
30 Pieces

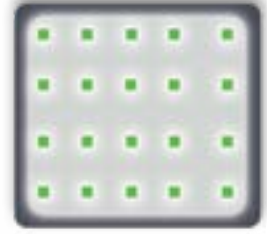

113 W SRound LED Luminaire
20 Pieces

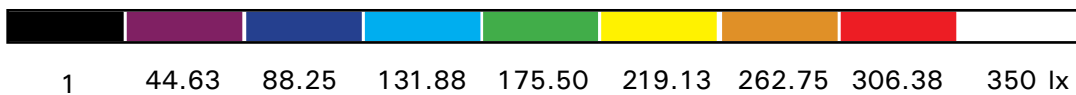
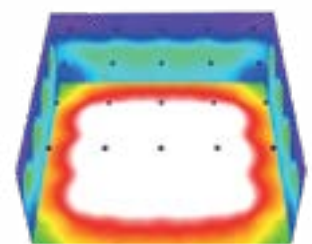
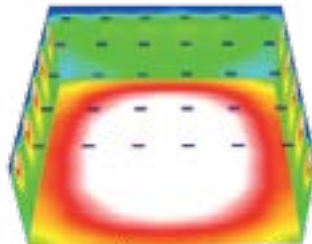
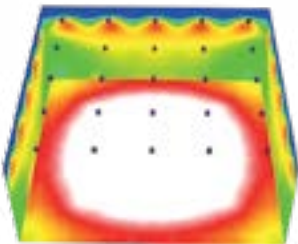

350 lux is the average light value of all luminaires.



Light Level	350 lux	350 lux	350 lux
Luminaire Number	25	30	20
Luminaire Power (W)	450 W	232 W	113 W
Total Consumption Power (kW)	11,3 kW	7,0 kW	2,3 kW

REFERENCE PRODUCT 1



%80 Energy Saving
 (Changing Metal Halide With SRound)

REFERENCE PRODUCT 2



%67 Energy Saving
 (Changing 4x54 Revo Fluorescent With SRound)

SRound

For those who want the best...

EAE LIGHTING-Brochure SRound - EN - Uptade Date: 30.06.2022
EAE. is provided with the right to perform changes deemed necessary without notifying in advance.
Please contact us for further information about products and details partaking in catalogue.



EAE LIGHTING Inc.

Ikitelli Organize Sanayi Bolgesi
Eski Turgut Ozal Caddesi No:20
Basaksehir / ISTANBUL - TURKEY
Tel : +90 212 413 21 00 (pbx)
Fax : +90 212 549 37 90
www.eaelighting.com



/eae group /eae group /eae group /eae corporate /eae group /eae group

engineering the light