

SUBMERGED III IMPLANT SYSTEM

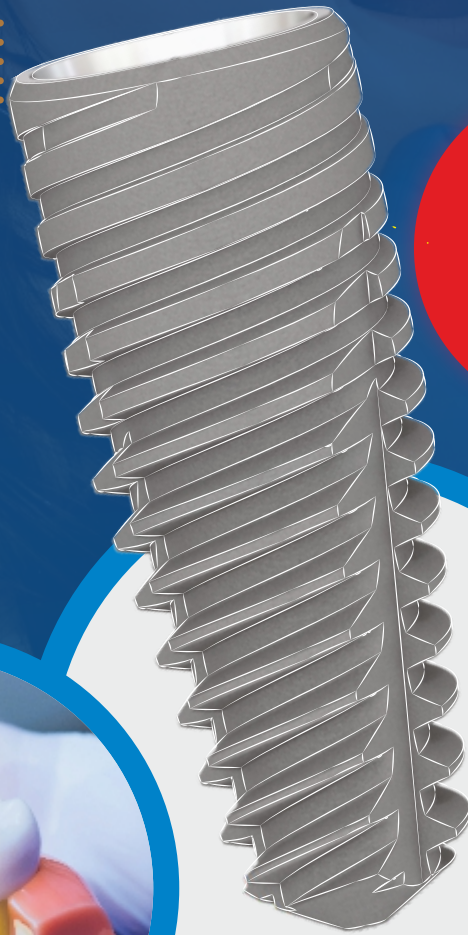

NEW
SLA
Surface



Fixture Design Concept

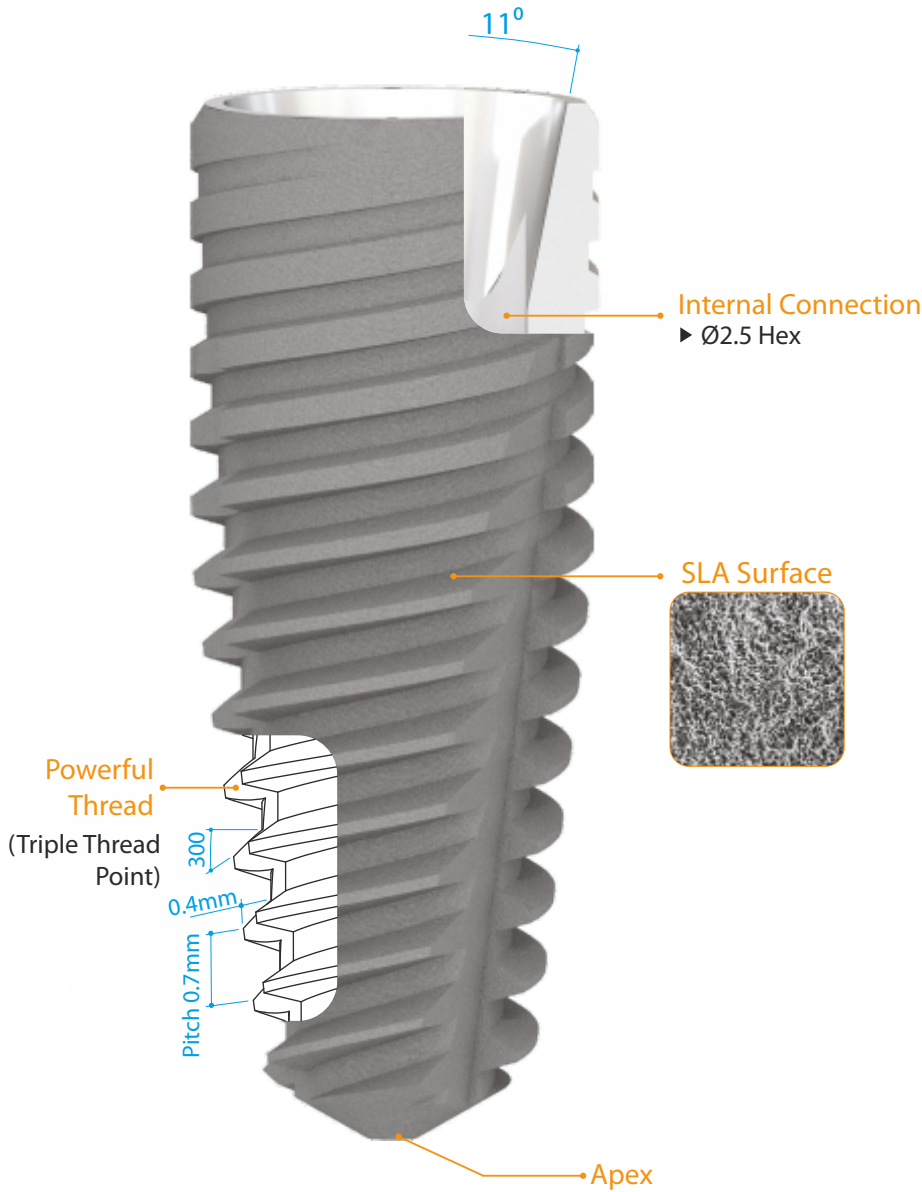

Cover Screw

Diameter	Code
Ø2.83	CCS283
Ø3.35	CCS335

- Grade V Titanium
- V-line Apex is designed for an excellent initial implantation
- High success rate in soft bone
- Possible for immediate loading
- ■ Color represents Ø3.6 fixture & compatible components

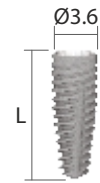

Ø3.6 Fixture		
Diameter	Length	Code
Ø3.6	8mm	C5F3608
	10mm	C5F3610
	12mm	C5F3612
	14mm	C5F3614



Ø4.0 Fixture		
Diameter	Length	Code
Ø4.0	8mm	C5F4008
	10mm	C5F4010
	12mm	C5F4012
	14mm	C5F4014



Ø4.4 Fixture		
Diameter	Length	Code
Ø4.4	8mm	C5F4408
	10mm	C5F4410
	12mm	C5F4412
	14mm	C5F4414

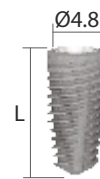

Ø4.8 Fixture		
Diameter	Length	Code
Ø4.8	8mm	C5F4808
	10mm	C5F4810
	12mm	C5F4812
	14mm	C5F4814



Ø5.2 Fixture		
Diameter	Length	Code
Ø5.2	8mm	C5F5208
	10mm	C5F5210
	12mm	C5F5212
	14mm	C5F5214

Prosthetic Components



Healing Abutment

Healing Abutment		
Diameter	Collar	Code
Ø4.0	1.5mm	CHA4015
	2.5mm	CHA4025
	3.5mm	CHA4035
	4.5mm	CHA4045

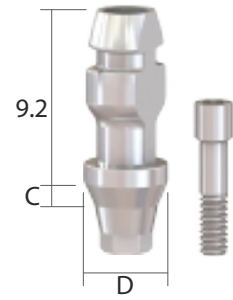

Impression Coping [Transfer] Close Tray Hex		
Diameter	Collar	Code
Ø4.5	1.5mm	ICT4515-21
	2.5mm	ICT4525-21
	3.5mm	ICT4535-21
	4.5mm	ICT4545-21

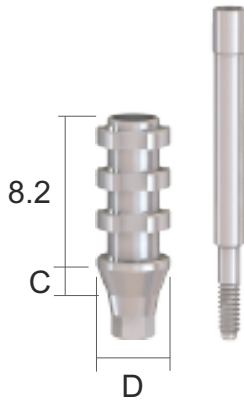

Impression Coping [Pick-up] Open Tray Hex		
Diameter	Collar	Code
Ø4.0	1.5mm	CIP4015
	2.5mm	CIP4025
	3.5mm	CIP4035
	4.5mm	CIP4045

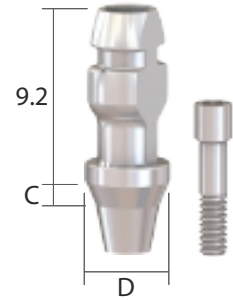

Impression Coping [Transfer] Close Tray Non-Hex		
Diameter	Collar	Code
Ø4.5	1.5mm	ICT4515N-21
	2.5mm	ICT4525N-21
	3.5mm	ICT4535N-21
	4.5mm	ICT4545N-21

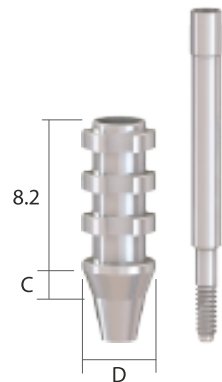

Impression Coping [Pick-up] Open Tray Non Hex		
Diameter	Collar	Code
Ø4.0	1.5mm	CIP4015N
	2.5mm	CIP4025N
	3.5mm	CIP4035N
	4.5mm	CIP4045N

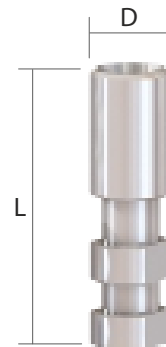

Fixture Analogue		
Diameter	Length	Code
Ø3.5	12mm	FA35-21



Abutment Screw	
Code	
AS16-21	

Abutments

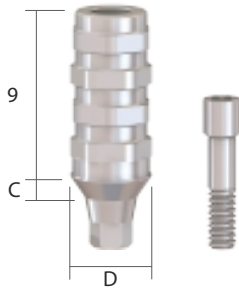

Temporary Abutment [Hex]		
Diameter	Collar	Code
Ø4.5	1.5mm	TA4515-21
	2.5mm	TA4525-21
	3.5mm	TA4535-21
	4.5mm	TA4545-21

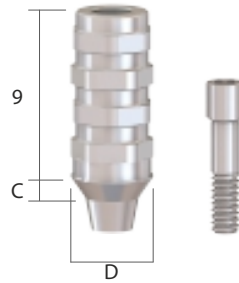

Temporary Abutment [Non-Hex]		
Diameter	Collar	Code
Ø4.5	1.5mm	TA4515N-21
	2.5mm	TA4525N-21
	3.5mm	TA4535N-21
	4.5mm	TA4545N-21

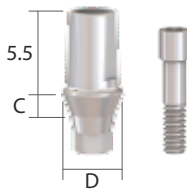

Cementation Abutment [Hex]		
Diameter	Collar	Code
Ø4.0	1.5mm	CCEA4015
	2.5mm	CCEA4025
	3.5mm	CCEA4035
	4.5mm	CCEA4045

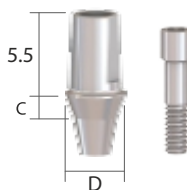

Cementation Abutment [Non-Hex]		
Diameter	Collar	Code
Ø4.0	1.5mm	CCEA4015N
	2.5mm	CCEA4025N
	3.5mm	CCEA4035N
	4.5mm	CCEA4045N

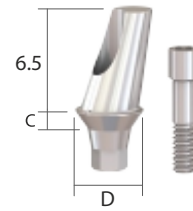

15° Angled Abutment [Hex]		
Diameter	Collar	Code
Ø4.5	1.5mm	AA451515-21
	2.5mm	AA452515-21
	3.5mm	AA453515-21
	4.5mm	AA454515-21
Ø5.5	1.5mm	AA551515-21
	2.5mm	AA552515-21
	3.5mm	AA553515-21
	4.5mm	AA554515-21

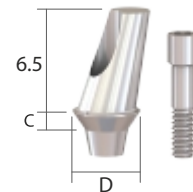

15° Angled Abutment [Non-Hex]		
Diameter	Collar	Code
Ø4.5	1.5mm	AA451515N-21
	2.5mm	AA452515N-21
	3.5mm	AA453515N-21
	4.5mm	AA454515N-21
Ø5.5	1.5mm	AA551515N-21
	2.5mm	AA552515N-21
	3.5mm	AA553515N-21
	4.5mm	AA554515N-21

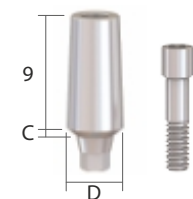

Milling Abutment [Hex]		
Diameter	Collar	Code
Ø4.5	1.0mm	MA4510-21
Ø5.5	1.5mm	MA5515-21
Ø6.5	3.5mm	MA6535-21

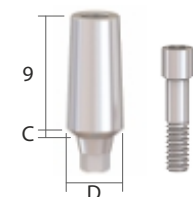

Milling Abutment [Non-Hex]		
Diameter	Collar	Code
Ø4.5	1.0mm	MA4510N-21
Ø5.5	1.5mm	MA5515N-21
Ø6.5	3.5mm	MA6535N-21

Abutments

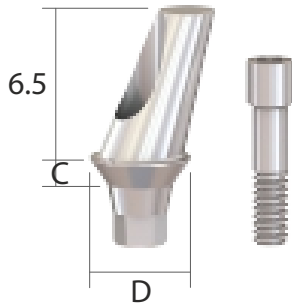

20° Angled Abutment [Hex]		
Diameter	Collar	Code
Ø4.5	1.5mm	AA451520-21
	2.5mm	AA452520-21
	3.5mm	AA453520-21
	4.5mm	AA454520-21
	1.5mm	AA551520-21
Ø5.5	2.5mm	AA552520-21
	3.5mm	AA553520-21
	4.5mm	AA554520-21

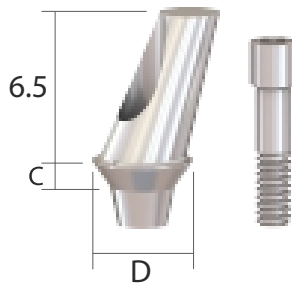

20° Angled Abutment [Non-Hex]		
Diameter	Collar	Code
Ø4.5	1.5mm	AA451520N-21
	2.5mm	AA452520N-21
	3.5mm	AA453520N-21
	4.5mm	AA454520N-21
Ø5.5	1.5mm	AA551520N-21
	2.5mm	AA552520N-21
	4.5mm	AA554520N-21



Ball Abutment / Cap		
Diameter	Collar	Code
Ø3.5	1.5mm	AA451520N-21
	2.5mm	AA452520N-21
	3.5mm	AA453520N-21
	4.5mm	AA454520N-21
Ø4.0	2.9mm	AA551520N-21

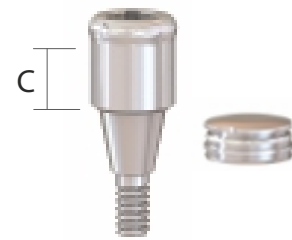

Retainer Abutment / Cap		
Diameter	Collar	Code
Ø4.5	1.0mm	RA3910-21
	2.0mm	RA3920-21
	3.0mm	RA3930-21
	4.0mm	RA3940-21
	5.0mm	RA3950-21
	6.0mm	RA3960-21
	7.0mm	RA3970-21
	8.0mm	RA3980-21
	9.0mm	RA3990-21
	10.0mm	RA39100-21
Ø5.5	2.4mm	CSRC

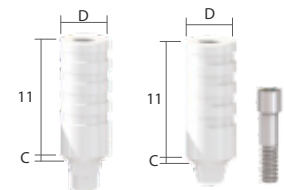

UCLA Abutment [Hex] / [Non-Hex]		
Diameter	Collar	Code
Ø4.5	1.0mm	UA4510-21
Ø4.5	1.0mm	UA4510N-21

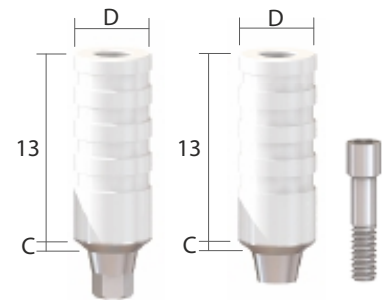

Cr-Co UCLA Abutment [Hex] / [Non-Hex]		
Diameter	Collar	Code
Ø4.5	1.0mm	Cr.UA4510-21
Ø4.5	1.0mm	Cr.UA4510N-21

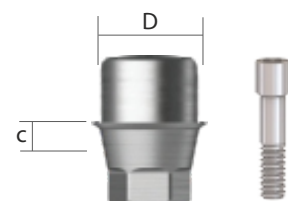

LINK Abutment [Hex]		
Diameter	Collar	Code
Ø4.5	1.0mm	LA4510-21

Prosthetic Components

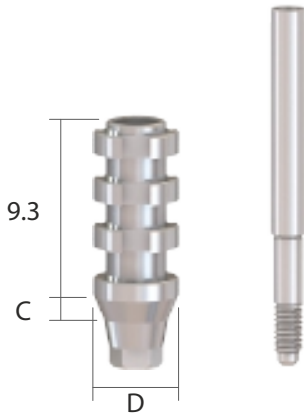

Impression Coping [Pick-up] Open Tray Hex

Diameter	Collar	Code
Ø4.5	1.5mm	CIP4515
	2.5mm	CIP4525
	3.5mm	CIP4535
	4.5mm	CIP4545
Ø5.5	1.5mm	CIP5515
	2.5mm	CIP5525
	3.5mm	CIP5535
	4.5mm	CIP5545
Ø6.5	1.5mm	CIP6515
	2.5mm	CIP6525
	3.5mm	CIP6535
	4.5mm	CIP6545

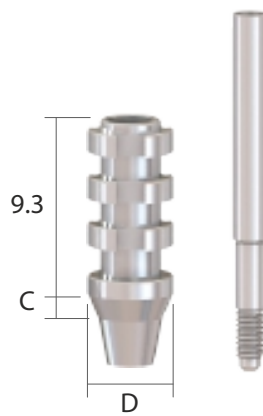

Impression Coping [Pick-up] Open Tray Non-Hex

Diameter	Collar	Code
Ø4.5	1.5mm	CIP4515N
	2.5mm	CIP4525N
	3.5mm	CIP4535N
	4.5mm	CIP4545N
Ø5.5	1.5mm	CIP5515N
	2.5mm	CIP5525N
	3.5mm	CIP5535N
	4.5mm	CIP5545N
Ø6.5	1.5mm	CIP6515N
	2.5mm	CIP6525N
	3.5mm	CIP6535N
	4.5mm	CIP6545N

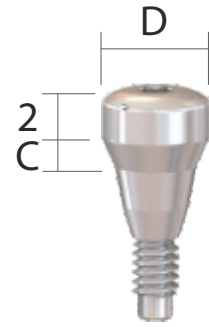

Healing Abutment

Diameter	Collar	Code
Ø4.5	1.5mm	CHA4515
	2.5mm	CHA4525
	3.5mm	CHA4535
	4.5mm	CHA4545
Ø5.5	1.5mm	CHA5515
	2.5mm	CHA5525
	3.5mm	CHA5535
	4.5mm	CHA5545
Ø6.5	1.5mm	CHA6515
	2.5mm	CHA6525
	3.5mm	CHA6535
	4.5mm	CHA6545

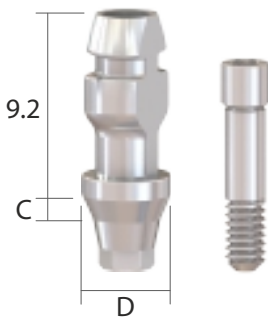

Impression Coping [Transfer] Close Tray Hex

Diameter	Collar	Code
Ø4.5	1.5mm	CIP4515
	2.5mm	CIP4525
	3.5mm	CIP4535
	4.5mm	CIP4545
Ø5.5	1.5mm	CIP5515
	2.5mm	CIP5525
	3.5mm	CIP5535
	4.5mm	CIP5545
Ø6.5	1.5mm	CIP6515
	2.5mm	CIP6525
	3.5mm	CIP6535
	4.5mm	CIP6545

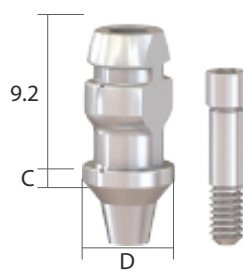

Impression Coping [Pick-up] Close Tray Non-Hex

Diameter	Collar	Code
Ø4.5	1.5mm	CIP4515
	2.5mm	CIP4525
	3.5mm	CIP4535
	4.5mm	CIP4545
Ø5.5	1.5mm	CIP5515
	2.5mm	CIP5525
	3.5mm	CIP5535
	4.5mm	CIP5545
Ø6.5	1.5mm	CIP6515
	2.5mm	CIP6525
	3.5mm	CIP6535
	4.5mm	CIP6545

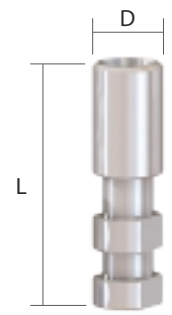

Fixture Analogue

Diameter	Length	Code
Ø3.8	12mm	CAN38

Prosthetic Components

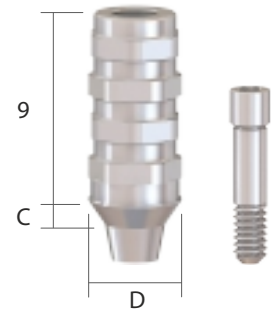
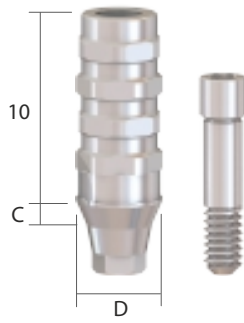

Temporary Abutment [Hex]

Diameter	Collar	Code
Ø4.5	1.5mm	CTA4515
	2.5mm	CTA4525
	3.5mm	CTA4535
	4.5mm	CTA4545
Ø5.5	1.5mm	CTA5515
	2.5mm	CTA5525
	3.5mm	CTA5535
	4.5mm	CTA5545

Temporary Abutment [Non-Hex]

Diameter	Collar	Code
Ø4.5	1.5mm	CTA4515N
	2.5mm	CTA4525N
	3.5mm	CTA4535N
	4.5mm	CTA4545N
Ø5.5	1.5mm	CTA5515N
	2.5mm	CTA5525N
	3.5mm	CTA5535N
	4.5mm	CTA5545N

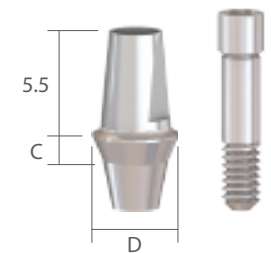
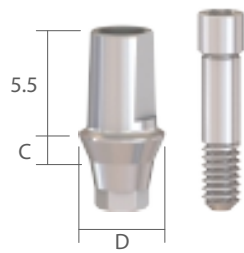

Cementation Abutment [Hex]

Diameter	Collar	Code
Ø4.5	1.5mm	CCEA4515
	2.5mm	CCEA4525
	3.5mm	CCEA4535
	4.5mm	CCEA4545
Ø5.5	1.5mm	CCEA5515
	2.5mm	CCEA5525
	3.5mm	CCEA5535
	4.5mm	CCEA5545
Ø6.5	1.5mm	CCEA6515
	2.5mm	CCEA6525
	3.5mm	CCEA6535
	4.5mm	CCEA6545

Cementation Abutment [Non-Hex]

Diameter	Collar	Code
Ø4.5	1.5mm	CCEA4515N
	2.5mm	CCEA4525N
	3.5mm	CCEA4535N
	4.5mm	CCEA4545N
Ø5.5	1.5mm	CCEA5515N
	2.5mm	CCEA5525N
	3.5mm	CCEA5535N
	4.5mm	CCEA5545N
Ø6.5	1.5mm	CCEA6515N
	2.5mm	CCEA6525N
	3.5mm	CCEA6535N
	4.5mm	CCEA6545N

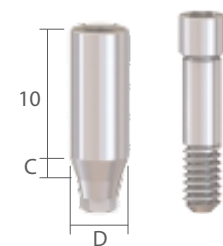
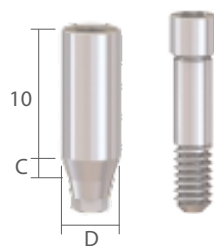

Milling Abutment [Hex]

Diameter	Collar	Code
Ø4.5	1.5mm	CMA45
Ø5.5	2.5mm	CMA55
Ø6.5	3.5mm	CMA65

Milling Abutment [Non-Hex]

Diameter	Collar	Code
Ø4.5	1.5mm	CMA45N
Ø5.5	2.5mm	CMA55N
Ø6.5	3.5mm	CMA65N

Abutments

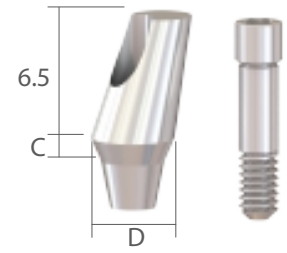
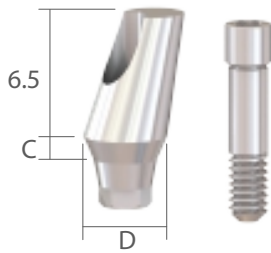

15° Angled Abutment [Hex]		
Diameter	Collar	Code
Ø4.5	1.5mm	CAA451515
	2.5mm	CAA452515
	3.5mm	CAA453515
	4.5mm	CAA454515
Ø5.5	1.5mm	CAA551515
	2.5mm	CAA552515
	3.5mm	CAA553515
	4.5mm	CAA554515

15° Angled Abutment [Non-Hex]		
Diameter	Collar	Code
Ø4.5	1.5mm	CAA451515N
	2.5mm	CAA452515N
	3.5mm	CAA453515N
	4.5mm	CAA454515N
Ø5.5	1.5mm	CAA551515N
	2.5mm	CAA552515N
	3.5mm	CAA553515N
	4.5mm	CAA554515N

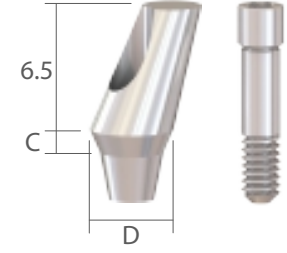
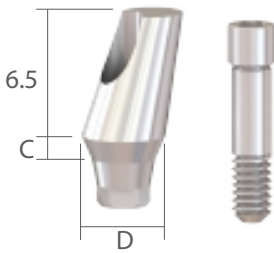

20° Angled Abutment [Hex]		
Diameter	Collar	Code
Ø4.5	1.5mm	CAA451520
	2.5mm	CAA452520
	3.5mm	CAA453520
	4.5mm	CAA454520
Ø5.5	1.5mm	CAA551520
	2.5mm	CAA552520
	3.5mm	CAA553520
	4.5mm	CAA554520

20° Angled Abutment [Non-Hex]		
Diameter	Collar	Code
Ø4.5	1.5mm	CAA451520N
	2.5mm	CAA452520N
	3.5mm	CAA453520N
	4.5mm	CAA454520N
Ø5.5	1.5mm	CAA551520N
	2.5mm	CAA552520N
	3.5mm	CAA553520N
	4.5mm	CAA554520N

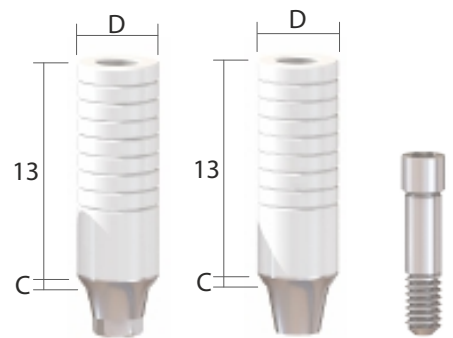
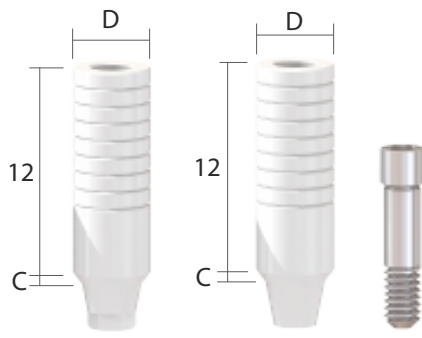

UCLA Abutment [Hex] / [Non-Hex]		
Diameter	Collar	Code
Ø4.5	1.0mm	CUAPH
	1.0mm	CUAPN

Cr-Co UCLA Abutment [Hex] / [Non-Hex]		
Diameter	Collar	Code
Ø4.5	1.0mm	Cr.CUAPH
	1.0mm	Cr.CUAPN

Abutments

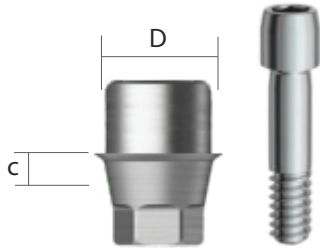

Ti-base LINK Abutment [Hex]		
Diameter	Collar	Code
Ø4.5	0.5mm	SLA4505
	1.0mm	SLA4510



Retainer Abutment / Cap		
Diameter	Collar	Code
Ø3.9	1.0mm	CSRA3910
	2.0mm	CSRA3920
	3.0mm	CSRA3930
	4.0mm	CSRA3940
	5.0mm	CSRA3950
	6.0mm	CSRA3960
	7.0mm	CSRA3970
	8.0mm	CSRA3980
	9.0mm	CSRA3990
	10.0mm	CSRA39100
Ø5.5	2.4mm	CSRC



Ball Abutment / Cap		
Diameter	Collar	Code
Ø4.5	0.5mm	CBA4505
	1.5mm	CBA4515
	2.5mm	CBA4525
	3.5mm	CBA4535
	4.5mm	CBA4545
Ø4.0	2.9mm	CBAC



Abutment Screw	
Code	
AS20-25	

Multi Unit Abutments

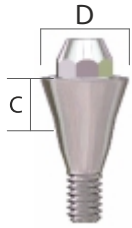

Multi Straight Abutment		
Diameter	Collar	Code
Ø4.8	1.5mm	SCOA4815-21
	2.5mm	SCOA4825-21
	3.5mm	SCOA4835-21
	4.5mm	SCOA4845-21



Multi Angled Abutment - 30° Hex		
Diameter	Collar	Code
Ø4.8	1.5mm	SCOA481530-21
	2.5mm	SCOA482530-21
	3.5mm	SCOA483530-21
	4.5mm	SCOA484530-21



Multi Angled Abutment - 30° Non- Hex		
Diameter	Collar	Code
Ø4.8	1.5mm	SCOA481530N-21
	2.5mm	SCOA482530N-21
	3.5mm	SCOA483530N-21
	4.5mm	SCOA484530N-21

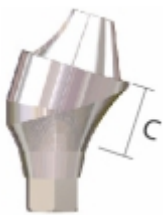

Multi Angled Abutment - 17° Hex		
Diameter	Collar	Code
Ø4.8	1.5mm	SCOA481517-21
	2.5mm	SCOA482517-21
	3.5mm	SCOA483517-21
	4.5mm	SCOA484517-21



Multi Angled Abutment - 17° Non- Hex		
Diameter	Collar	Code
Ø4.8	1.5mm	SCOA481517N-21
	2.5mm	SCOA482517N-21
	3.5mm	SCOA483517N-21
	4.5mm	SCOA484517N-21



Multi Abutment Healing Cap	
Code	
SCOP48	

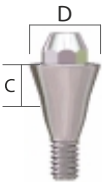

Multi Straight Abutment		
Diameter	Collar	Code
Ø4.8	1.5mm	SCOA4815
	2.5mm	SCOA4825
	3.5mm	SCOA4835
	4.5mm	SCOA4845



Multi Angled Abutment - 17° Hex		
Diameter	Collar	Code
Ø4.8	1.5mm	SCOA481517
	2.5mm	SCOA482517
	3.5mm	SCOA483517
	4.5mm	SCOA484517



Multi Angled Abutment - 17° Non- Hex		
Diameter	Collar	Code
Ø4.8	1.5mm	SCOA481517N
	2.5mm	SCOA482517N
	3.5mm	SCOA483517N
	4.5mm	SCOA484517N



Multi Angled Abutment - 30° Hex		
Diameter	Collar	Code
Ø4.8	1.5mm	SCOA481530
	2.5mm	SCOA482530
	3.5mm	SCOA483530
	4.5mm	SCOA484530



Multi Angled Abutment - 30° Non- Hex		
Diameter	Collar	Code
Ø4.8	1.5mm	SCOA481530N
	2.5mm	SCOA482530N
	3.5mm	SCOA483530N
	4.5mm	SCOA484530N



Multi Abutment Carrier	
Code	
MAC	

Multi Unit Abutments



Multi Abutment Healing Cap

Code
SCOP48



Impression Coping (Pick-Up)

Code
SCOAIP48



Impression Coping (Transfer)

Code
SCOAIT48



Analogue

Code
SCOAA48



Temporary Cylinder

Code
SCOAT48



Cr-Co Cylinder

Code
SCr.CO48



Plastic Cylinder

Code
SCOAP48



Multi Screw

Code
SCOHS14
Torque : 15~18Ncm

Digital Components

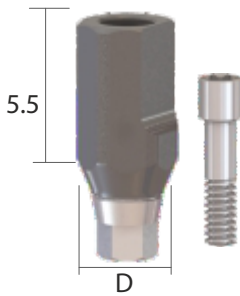

Scan Body

Diameter	Collar	Code
Ø4.0	1.5mm	SSB21M

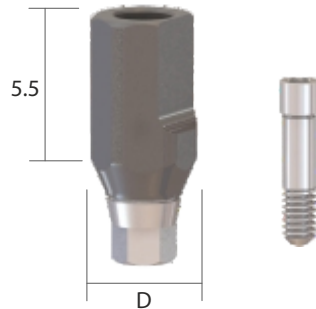

Scan Body

Diameter	Collar	Code
Ø4.5	1.5mm	SSB25M



Multi Scan Body

Code
SCOS48

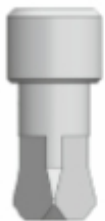

Digital Analogue

Code
SSDA4821



Digital Analogue

Code
SSDA4825



Multi Digital Analogue

Code
SCOSA48

Surgical Kit

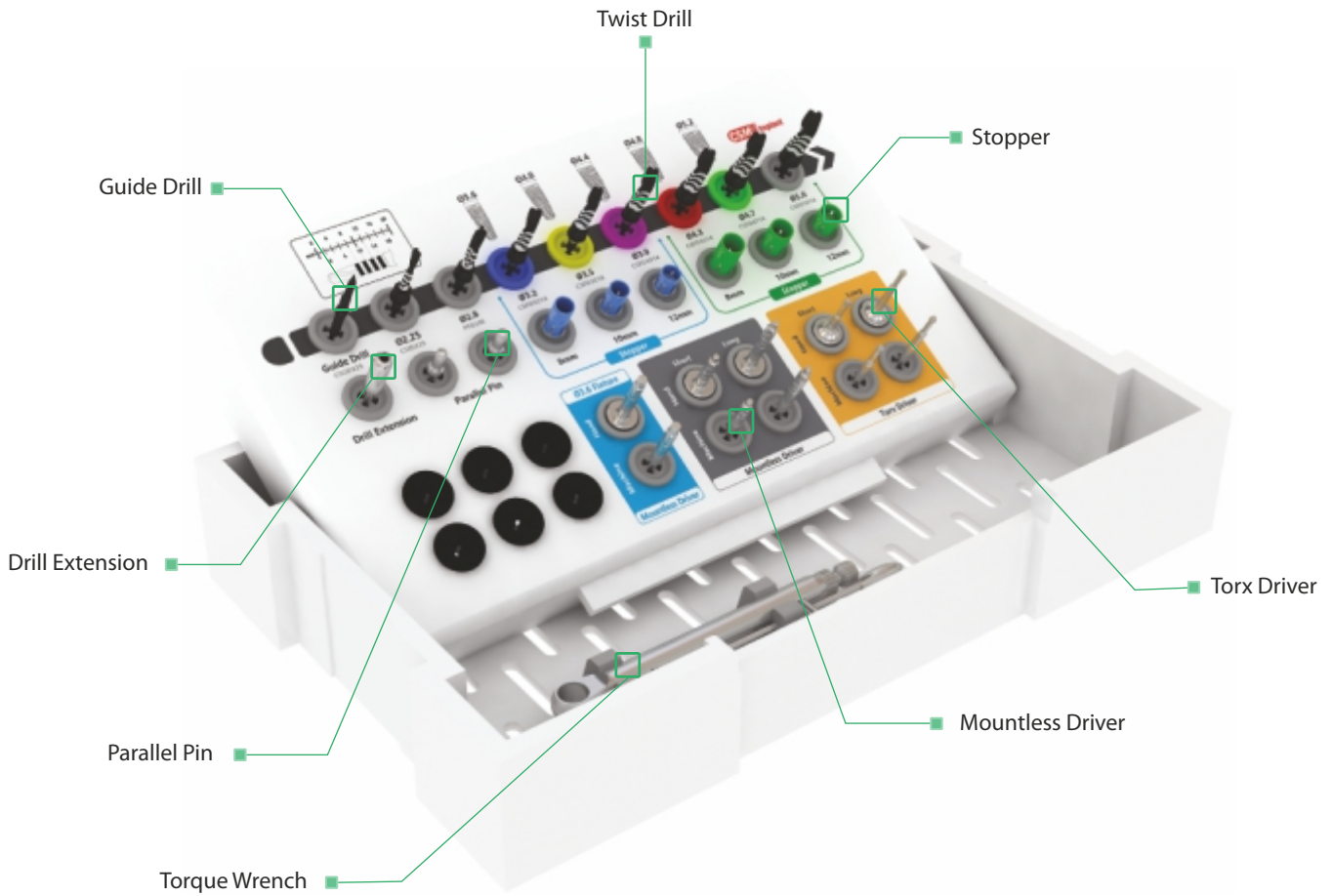

Features

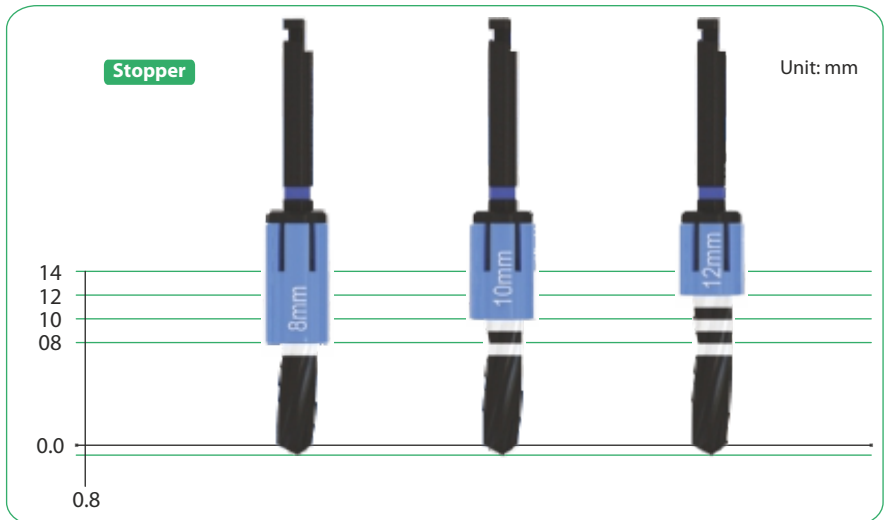
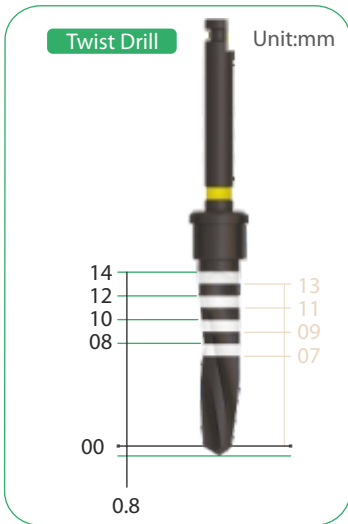



WHERE TRUST COMES FIRST



**Warranty Ke Saath Bhi
Warranty Ke Baad Bhi**

For any Sales & Support

 98211-84441, 84483-98852

 sales@unicorndenmart.com

Customer Care

Register Your Complaint with A Missed Call: **7065-558-558**

 011-45551250, 51, 55  97170-12081, 95994-48518

 care@unicorndenmart.com | care1@unicorndenmart.com

Connect With



Unicorn DenMart



Corporate Office: 3 Local Shopping Centre, MOR Land, Near J Block DDA Market,
New Rajender Nagar, New Delhi □ 110060

    /unicorndenmart.com

* Accessories shown may not be a part of standard equipment. Specifications are subject to change without notice.

Ver 6/2026