



### Attributes

Product Code  
Net weight  
Max. weight load  
Dimensions (w x l x h)  
Color options

For more color options, discuss with your sales representative.

2-1-029  
38 kg  
150 kg  
500x1462x445 mm



### Warranty

Structure  
Steel  
Paint  
Plastic  
Rubber  
Moving parts

Detailed information in the warranty document

25-15 years  
5-10 years  
2 years  
5-10 years  
1-3 years  
2 years

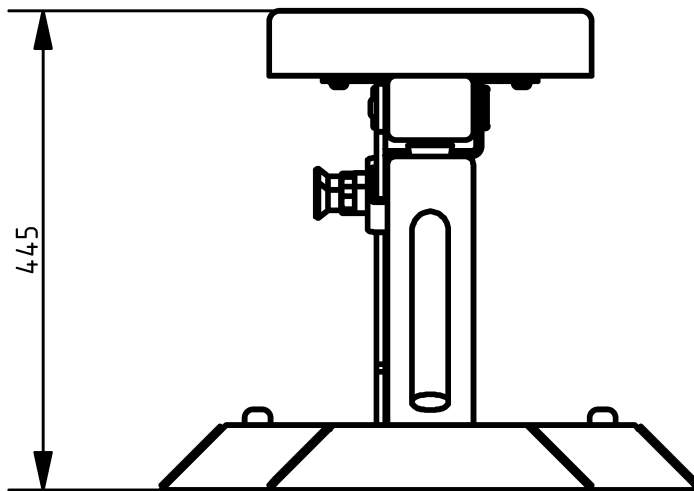
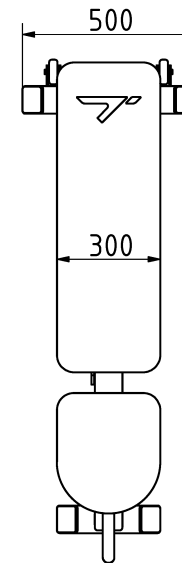
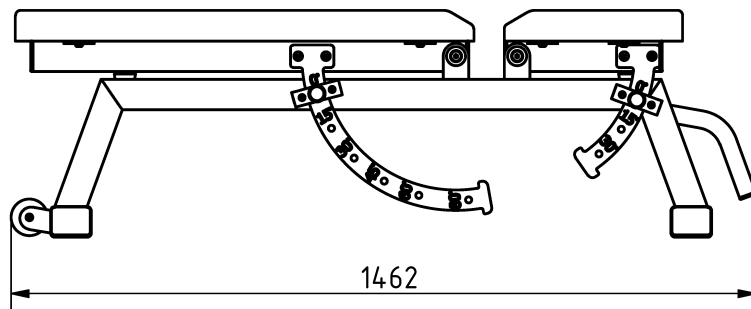

**BESTRONG**

 [bestrongworld](#)  [bestrongworld](#)  [global.bestrong.com](#)  [info@bestrong.com](mailto:info@bestrong.com)

