



Agricultural Fencing



Horse Fence
Sheep and Goat Fence
Field Fence
Welded Wire Fence
Barbed/Barbless Wire

Electric Field Fence
T-Posts and
Accessories
Wiring Options

Table of Contents

Category	Page
Table of Contents/Info	2
Fencing Guide	3-4
Horse Fence	5
Sheep and Goat Fence	6
Field Fence	7
Welded Wire	8
T-Posts / Electric Fence Posts	9
Barbed/Barbless Wire / Electric FenceWire Fence	10
Galvanized Steel Wire	11

Midwest Air Technologies Inc. is a leading producer of high-quality residential, farm, and recreational fencing products, outdoor living, plant support, and pet containment products. We manufacture and distribute these products under our YardGard®, FarmGard®, Gardener's Blue Ribbon®, Gilbert & Bennett®, and Pet Essentials® brands. Our diverse product offerings are available at national and regional retailers, providing our customers with the highest quality products at a great value. As we expand into new markets with innovative products, we continue to keep the consumer experience at the center of our development process.

Scan QR code for our online catalog or go to matproduct.com

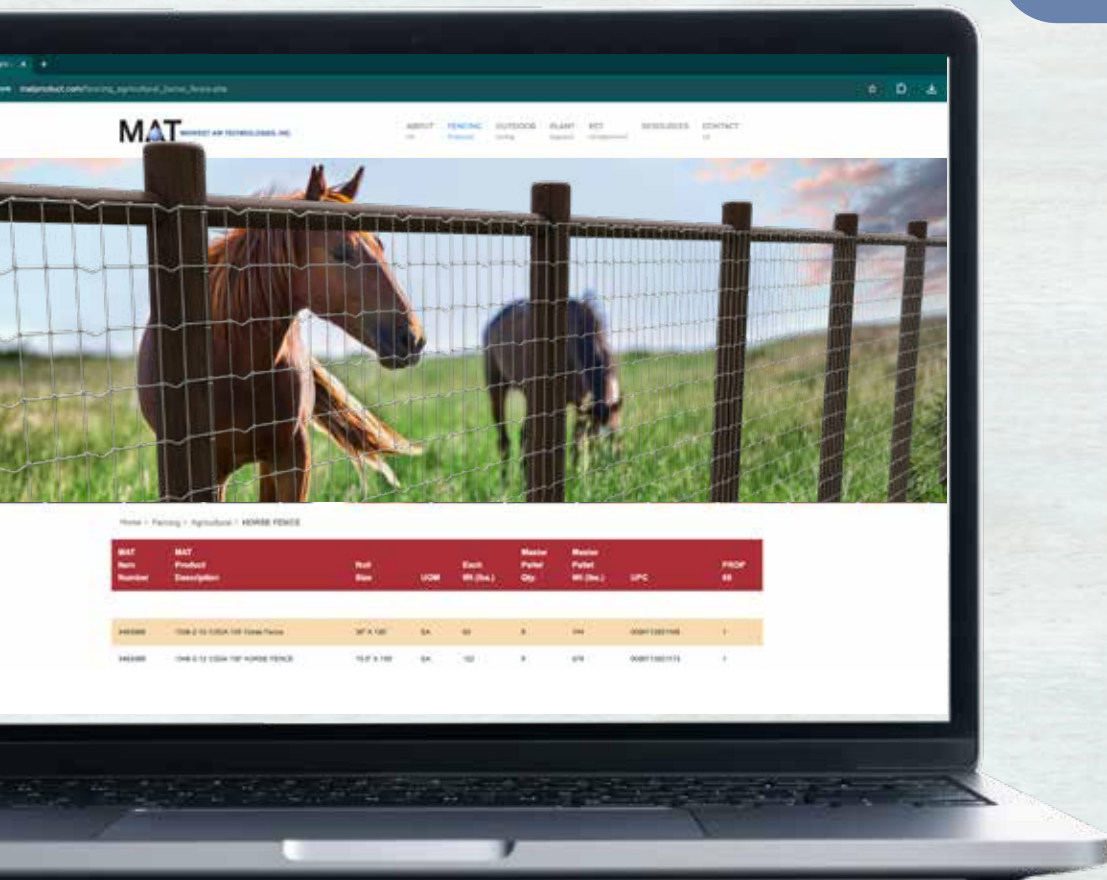

Fencing Guide

Gauge (Ga.)

A measure of wire thickness. The lower the number assigned to a wire the larger its diameter. MATI's full line of products come in a variety of gauges ranging from 9 gauge up to 27 gauge. Thicker wires are generally stronger, heavier, and more difficult to bend. The chart below shows you the size of each gauge wire used in producing MATI's agricultural and residential wire fencing.

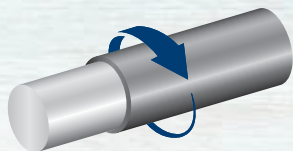

FarmGard® fencing materials are made of various gauges of wire. The lower the number assigned to a wire the larger its diameter. The chart and graphics accurately show the size of each gauge used in our fencing (shown to scale).

Gauge Size Chart			
Wire Gauge	SWG (Inch)	Top	Side
9	0.1483"	●	█
10	0.1350"	●	█
11	0.1250"	●	█
12	0.1055"	●	█
12.5	0.0985"	●	█
13	0.0915"	●	█
14	0.0800"	●	█
15	0.0720"	●	█
15.5	0.0673"	●	█
16	0.0625"	●	█
19	0.0410"	●	█
20	0.0348"	●	█
23	0.0258"	●	█
27	0.0173"	●	█

Minimum Coating Weight for Gauge Sizes



Class 1



Class 3

Gauge	Coating Weight
9	.35 oz/ft ²
10	.30 oz/ft ²
11	.30 oz/ft ²
12.5	.28 oz/ft ²
14	.25 oz/ft ²

Gauge	Coating Weight
9	.90 oz/ft ²
10	.85 oz/ft ²
11	.85 oz/ft ²
12.5	.80 oz/ft ²
14	.70 oz/ft ²

Zinc Coating and Galvanization

Zinc coating prevents corrosive substances reaching the underlying steel or iron wire.

Class 1 Galvanization

Wire coating that is typically found on basic barbed wire and field fence. Class 1 wire will typically last 2 to 11 years in most non-coastal climates.

Class 3 Galvanization

2.5 times thicker than Class 1 and may last approximately 13 to 30 years before rusting in non-coastal climates.

Electric Fencing

Electric fencing is a popular option for keeping animals contained, as well as keeping predators out. Most animals will quickly learn to stay away from the electric fence. The resulting psychological barrier will leave your animals enjoying life in the pasture and you with little concern of finding them wandering where they don't belong. It is also available in handy dispensing spools.



Fencing Guide

Hinge Joint

Vertical stay wire wraps around horizontal line wire to form hinged joint. This joint enables the fence to give under pressure and spring back into shape. The hinge joint, along with special expansion crimps, allow the product to expand and contract with weather changes and to stretch and conform to land contours. The hinge joint can be found on the top, bottom, and filler wire of MATI's FarmGard® field fence.



S-Knot

Design uses a separate piece of wire to secure the line wire to the vertical stay wire. This type of knot prevents the fence from buckling or sagging. The S-Knot increases the vertical strength of the fence, while still allowing flexibility. Its design profile is smooth and unlikely to injure an animal. S-Knots can be found in the filler wire of MATI's Horse Fence and Sheep and Goat Fence.



Barbed/Smooth Wire

12.5 gauge barbed wire features galvanized zinc coating, double strand, high-tensile wire, and a conventional twist where the strands twist in a single direction. Available with either 2 or 4 points. The sharp points are spaced 5" apart for 4-point barbed wire and 4" apart for 2-point barbed wire.

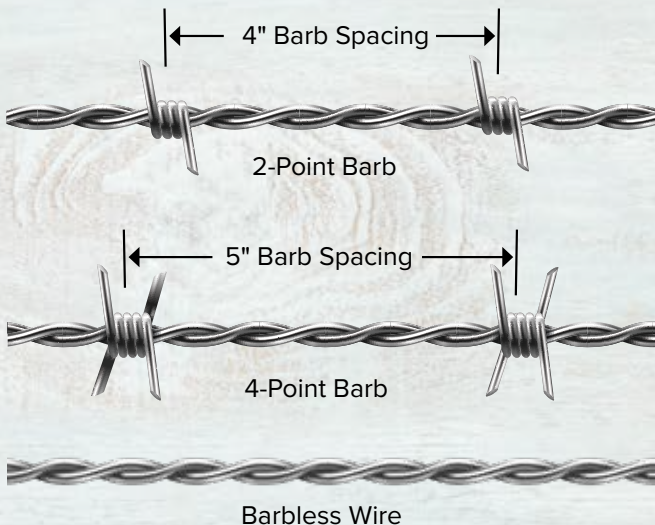

Proprietary Rust Resistance

FarmGard® utilizes stringent third party testing to rate our rust resistance as compared to the leading brand competitors to qualify our industry leading protection.

- ▶ Horse Fence
- ▶ Sheep and Goat Fence
- ▶ Field Fence
- ▶ Barbed Wire
- ▶ Barbless Wire



- ▶ Welded Wire



The FarmGard® Proprietary Production Process vs. Leading Brand's Galvanized Wire

Below is a visual representation of our wire coating in relation to the leading brand's wire with standard galvanization in 3rd party testing.



Horse Fence

2" x 4" Woven Mesh



The proprietary production process of FarmGard® horse fence features 10x corrosion protection*. Our non-climb horse fence is made of Class 1 galvanized zinc coated steel wire. Woven rather than welded, with expansion crimps to help the fence stretch and conform to the terrain. Top and bottom line wires are made from 10 gauge wire (hinge joint) with 12.5 gauge filler wire in between (S-Knot). This ideal fence for horse confinement features a 2" x 4" woven mesh design. Meets or exceeds ASTM A116-11.

- 10x unsurpassed corrosion resistance*
- Helps prevent injuries to horses



SKU	Classification	Roll Size	Fill Gauge	Top/Bottom Gauge	Weight
348308LC	1348-2-12.5-2x4-48x100	48" x 100'	12.5	10	122 lbs.
348310LC	1660-2-12.5-2x4-60x100	60" x 100'	12.5	10	151 lbs.
348312LC	1972-2-12.5-2x4-72x100	72" x 100'	12.5	10	180 lbs.
348328LC	1348-2-12.5-2x4-48x200	48" x 200'	12.5	10	244 lbs.

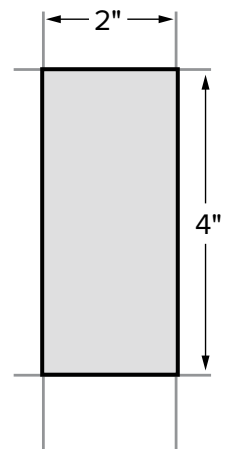

Sheep and Goat Fence

4" x 4" Woven Mesh

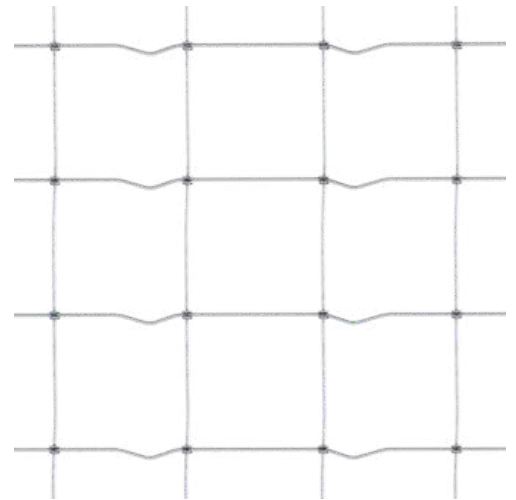
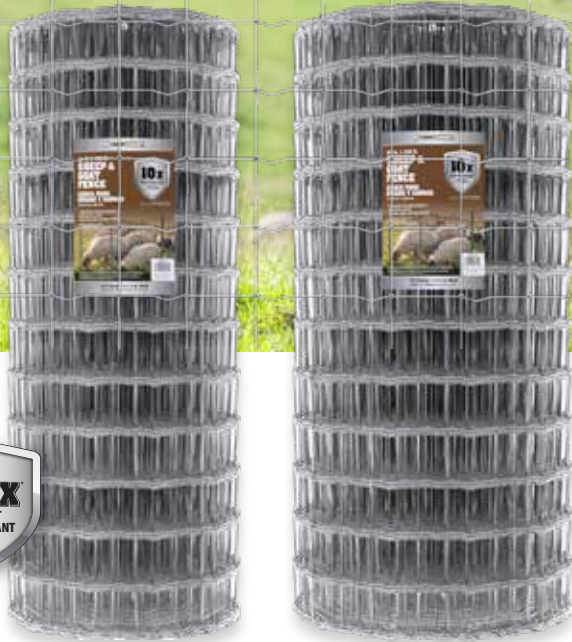

The proprietary production process of FarmGard® sheep and goat fence features 10x corrosion protection*. Our non-climb sheep and goat fence is made of Class 1 zinc coated steel wire. Top and bottom line wires are made from 10 gauge wire with 12.5 gauge filler wire in between. This fence is ideal for sheep, goats, and other livestock and features a 4" x 4" woven mesh design. These fences are built to last and resist buckling or sagging. Meets or exceeds ASTM A116-11.

- 10x unsurpassed corrosion resistance
- Helps prevent injuries to sheep and goats

SKU	Classification	Roll Size	Fill Gauge	Top/Bottom Gauge	Weight
348404LC	1348-4-12.5	48" x 100'	12.5	10	80 lbs.
348405LC	1348-4-12.5	48" x 330'	12.5	10	264 lbs.

* vs leading brand in 3rd party testing

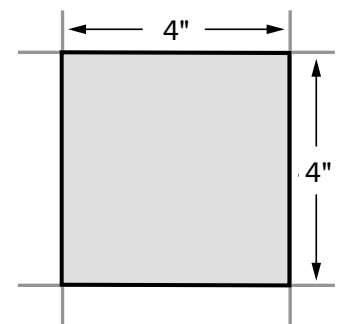

Field Fence

Woven Graduated Mesh

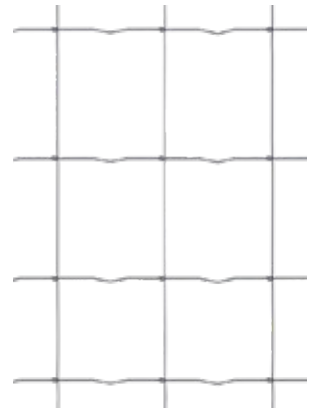

The proprietary production process of FarmGard® field fence features 10x corrosion protection*. Our field fence is ideal for containing livestock, keeping wild animals out, crop protection, and boundary definition. It is made from galvanized steel for extended life. The hinge joint knot style results in greater strength, better absorption of animal impact, and stretches to conform to land contours. Meets or exceeds ASTM A116-11.

- 10x unsurpassed corrosion protection*
- Woven gradual mesh – 8" tall at top and gradually decreases

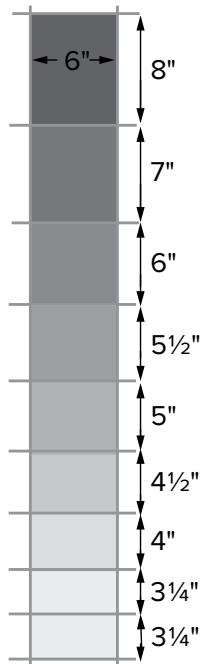

SKU	Classification	Roll Size	Top/Bottom Gauge	Fill Gauge	Weight
348124LC	939-6-11GA-Class1-330'	39" x 330'	9	11	241 lbs.
348126LC	1047-6-11GA-Class1-330'	47" x 330'	9	11	261 lbs.
348104LC	939-6-12.5GA-Class1-330'	39" x 330'	10	12.5	167.5 lbs.
348106LC	1047-6-12.5GA-Class1-330'	47" x 330'	10	12.5	191 lbs.
348105LC	939-6-12.5GA-Class1-132'	39" x 132'	10	12.5	69.7 lbs.
348108LC	1047-6-12.5GA-Class1-132'	47" x 132'	10	12.5	79.5 lbs.

* vs leading brand in 3rd party testing

Welded Wire Fence

2" x 4" Galvanized Steel Mesh

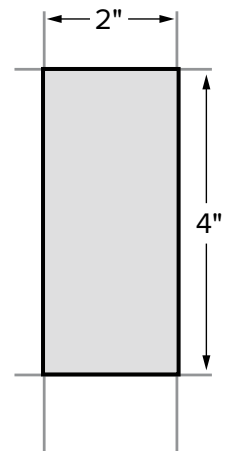
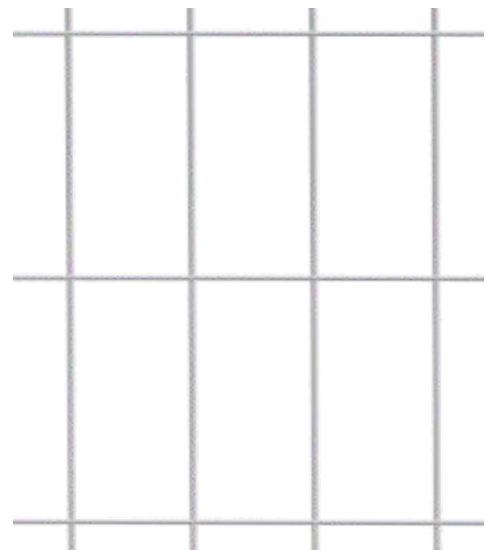

The proprietary production process of FarmGard® welded wire fence features 3x corrosion protection*. This all purpose fencing is ideal for property delineation, confinement of non-aggressive animals, backing for split fence rail wooden fences, and garden protection. It is flexible and easy to work with, but sturdy enough to withstand harsh conditions and last for years. Meets or exceeds ASTM F2453/F2453M-05.

- 3x unsurpassed corrosion protection*
- Utility fencing for farm and home

SKU	Classification	Roll Size	Gauge	Weight
308311FG	WeldWireGalv-2x4-14-3x100	36" x 100'	14	44.64 lbs.
308312FG	WeldWireGalv-2x4-14-4x100	48" x 100'	14	59.52 lbs.
308313FG	WeldWireGalv-2x4-14-5x100	60" x 100'	14	73.85 lbs.
308314FG	WeldWireGalv-2x4-14-6x100	72" x 100'	14	87.08 lbs.

* vs leading brand in 3rd party testing

Fence Posts

T-Posts and Electric Fence Posts



T-Posts with 2 coats of protective enamel rate among the highest quality sold in the U.S. and provide excellent performance and service for residential, farm, industrial, and commercial applications. The studded design adds strength, secures fence fabric, and prevents slippage of clips and insulators. Exceeds ASTM requirements.

- Available in medium weight (1.25 lbs./ft.) and heavy weight (1.33 lbs./ft)
- FarmGard® beige top provides enhanced night visibility
- Rugged, tightly welded anchor plate minimizes sideways and rotational movement

SKU	Length	Weight
901174AB	5'	6.25 lbs.
901175AB	5'6"	6.9 lbs.
901176AB	6'	7.5 lbs.
901178AB	6'6"	8.12 lbs.
901177AB	7'	8.75 lbs.
901181AB	7'6"	9.35 lbs.
901180AB	8'	10.1 lbs.
901172A	10'2"	14.1 lbs.

4' Plastic Step-In Posts

Features a polypropylene reinforced steel construction. The posts are constructed with 8 molded clips specifically for electric fences.

- Features a step-down footplate ledge for easy installation



SKU	Description	Weight
901120A	Step-In Post (White)	.81 lb.
901121A	Step-In Post (Black)	.81 lb.

4' Galvanized Steel Step-In Posts

This galvanized steel fence post features a post spade to provide stability and minimize rotation.

- Holds electric fence wire when used with a common wire insulator



SKU	Description	Weight
90183A	Electric Fence Post 3/8"	1.5 lb.

Barbed/Barbless Wire

Class 1 Galvanized - 1320'



FarmGard® offers both barbed and barbless wire on 1,320 ft. reels, featuring proprietary 10x corrosion protection* and a galvanized coating to resist weathering and rust. Each reel is mounted on a heavy-duty metal carrier for safe, convenient transport and meets or exceeds ASTM A121-92.

- 1,320 ft. reel length
- Galvanized coating for weather and rust resistance
- Heavy-duty metal carrier for easy handling

SKU	Classification	Barb Style	Barb Spacing	Gauge	Weight
317821LC	2pt-12.5G-BarbWire-1320'	2 pt.	4"	12.5	73.3 lbs.
317831LC	4pt-12.5G-BarbWire-1320'	4 pt.	5"	12.5	83.8 lbs.
317881LC	4pt-15.5G-BarbWire-1320'	4 pt.	5"	15.5	43.5 lbs.
317801LC	Barbless-12.5G-1320'	n/a	n/a	12.5	66.2 lbs.

* vs leading brand in 3rd party testing

Electric Fence Wire

Electric fence wire works by converting an electrical source into a high voltage pulse. This pulse is released on to an insulated fence about once per second. The pulse can vary in duration, but typically lasts about 150 microseconds. When an animal makes contact with this fence, it completes the electronic circuit and receives a shock. Made of galvanized steel for corrosion resistance.



- Less expensive and easier to install than conventional fences
- Permanent or temporary
- Ideal for rotational grazing

SKU	Size	Ft. Per Coil	Gauge	Weight
317627A	10 lb. coil	170'	9	225 lbs.
317624A	10 lb. coil	392'	12.5	45 lbs.
317677A	100 lb. coil	1,705'	9	10.2 lbs.
317676A	100 lb. coil	2,057'	10	20.5 lbs.
317675A	100 lb. coil	3,924'	11	225 lbs.
317673A	100 lb. coil	5,858'	14	45 lbs.
317672A	100 lb. coil	9,598'	16	10.2 lbs.

Galvanized Steel Wire

Rust and Corrosion Resistant



High Tensile Smooth Wire

Class 3 galvanized with a heavy zinc coating for long life and durability. The 12.5 gauge fence wire is an effective, dependable, low-cost solution for your perimeter. Exceeds ASTM A 854/A and 854 M-94 requirements.

- Superior strength grade vs. standard smooth wire
- Most often used in agricultural applications

SKU	Size	Ft. Per Coil	Weight
317579A	100 lb. coils	4000'	110.7 lbs.
317578A	50 lb. coils	2000'	50.2 lbs.



Smooth Merchant Wire (10 lb. Coils)

Galvanized multi-purpose single strand wire is available in a variety of gauge sizes.

- Ideal for tying, fastening, hanging, and bundling
- Used for shed, shop, home, and farm applications
- High resistance to corrosion and rust

SKU	Ft. Per Coil	Gauge
317527A	170'	9
317526A	205'	10
317525A	258'	11
317524A	392'	12.5
317523A	585'	14
317522A	960'	16
317577A	1,705'	9
317576A	2,057'	10
317575A	2,582'	11
317574A	3,924'	12.5
317573A	5,858'	14
317572A	9,598'	16



Black Annealed Wire (14 Ga.)

A superior strength grade 14 gauge wire. Annealing is a process used to return the wire to its ductility, which it had lost during drawing.

- Ideal for rotating grazing
- Permanent or temporary
- Galvanized for corrosion resistance

SKU	Length	Ft. Per Coil	Weight
317774A	1/4 mile	1,320'	225 lbs.
317772A	1/2 mile	2,640'	45 lbs.
317775A	1/4 mile	1,320'	10.2 lbs.
317752A	1/2 mile	2,540'	20.5 lbs.



FARM GARD®
39 in. x 330 ft.
FIELD FENCE
CERCA PARA CAMPOS
10x
RUST RESISTANT GALVANIZED MESH
11.0 Gauge • Cradled Mesh
Rolls 7.0' High

847.821.9646
www.matproduct.com

6700 Wildlife Way
Long Grove, IL 60047